

1213

626

TECHNICAL LIBRARY TECHNICAL LIBRARY
REFERENCE COPY REFERENCE COPY
3047979

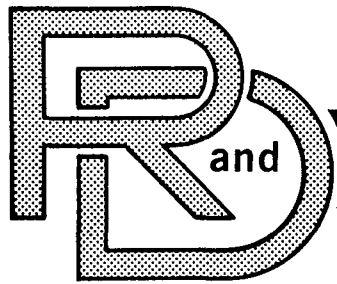

TARADCOM

LABORATORY

TECHNICAL REPORT

NO. 12503



NATO REFERENCE MOBILITY MODEL, EDITION I

USERS GUIDE
VOLUME I

CONTRACT NO. DAAK30-77-C-0027
OCT 1979

PETER W. HALEY
TARADCOM

by M. PETER JURKAT
PETER M. BRADY, JR.

STEVENS INSTITUTE OF TECHNOLOGY
DAVIDSON LABORATORY
HOBOKEN, NJ 07030

Approved for public release;
distribution unlimited.

*Not Classified
Spec. Ar-5108
12/13/82*



AR 43519

U.S. ARMY TANK-AUTOMOTIVE
RESEARCH AND DEVELOPMENT COMMAND
Warren, Michigan 48090

Approved for public release, distribution unlimited

20020725009

Technical Report 12503

NATO REFERENCE MOBILITY MODEL, EDITION I
USERS GUIDE

VOLUME I

OPERATIONAL MODULES

DA Project 1L162601AH91

Prepared by

Stevens Institute of Technology
Davidson Laboratory
Castle Point Station
Hoboken, NJ 07030

Contract DAAK30-77-C-0027

OCT 1979

for

US Army Tank-Automotive Research & Development Command
Warren, MI 48090

TABLE OF CONTENTS

LIST OF FIGURES	vi
LIST OF TABLES	vii
LIST OF APPENDICES	vii
I. INTRODUCTION AND OVERVIEW.	1
A. Background.	1
B. Modeling Off-Road Vehicle Mobility.	5
C. Overall Structure of the INRMM.	8
D. Model Inputs and Preprocessors.	12
1. Terrain.	12
2. Vehicle.	13
3. Driver	15
4. Scenario	15
E. Stand-Alone Simulation Modules.	17
1. Obstacle-crossing Module-OBS78B.	17
2. Ride Dynamics Module -- VEHDYN	18
3. Main Computational Modules -- NRMM	21
a. Areal Terrain Unit Module.	22
b. Road Module.	28
F. Acknowledgements.	30
II. ALGORITHMS AND EQUATIONS.	33
A. Control and I/O Module.	33
1. Subroutine SCN - Scenario & Control Input.	36
2. Subroutine VEH - Vehicle Input	36
3. Subroutine VPP - Vehicle Preprocessor Control.	36
4. Subroutine TERTL - Terrain Translator.	36
a. Terrain Input/Translation Subroutine MAP74	38
b. Terrain Input/Translation Subroutine MPRD74.	39
c. Terrain Input/Translation Subroutine MAP71	40
5. Subroutine AREAL - Areal Module Control.	41
6. Subroutine ROAD - Road Module.	41
7. Subroutine BUFFO - Basic Output.	42

B. Vehicle Preprocessor.	43
1. Subroutine 111 - Units Conversion Routine.	43
2. Subroutine 112 - Gross Combined Weight	44
3. Subroutine 113 - Maximum Tire Speed.	44
4. Subroutine 114 - Maximum Path Width.	46
5. Subroutine 115 - Tire Deflection Ratio	46
6. Subroutine 116 - Characteristic Length	46
7. Subroutine 117 - Ground Contact Area	47
8. Subroutine 118 - Controlling Lateral Distance.	47
9. Subroutine 119 - Maximum Rolling Radius.	48
10. Subroutine 1110 - Maximum Braking Force.	48
11. Subroutine 1111 - Horsepower/ton	48
12. Subroutine 1112 - Vehicle Cone Index in Fine Grained Soil.	49
13. Subroutine 1113 - Vehicle Cone Index in Coarse Grained Soil.	51
14. Subroutine 1114 - Vehicle Cone Index for Muskeg.	52
15. Subroutine 1115 - Combined Contact Pressure Factor	53
16. Subroutine 1116 - Power Train.	53
a. Subroutine TRAIN - Construction of Tractive Effort vs. Speed Curves.	54
(1) Subroutine AUTOM - Tractive Effort vs. Speed of Vehicle with Automatic Trans- mission and Torque Converter	56
(2) Subroutine STICK - Tractive Effort vs. Speed of Vehicle with Manual Trans- mission.	58
b. Subroutine FIT - Quadratic Curve Fit to Tractive Effort vs. Speed Relationship.	58
17. Subroutine 1117 - Rotating Mass Factor	62
C. Terrain Preprocessor.	63
D. Areal Module.	68
1. Subroutine IV1 - Obstacle Spacing and Area Denied.	68
2. Subroutine IV2 - Land/Marsh Operating Factors.	73

3.	Subroutine IV3 - Pull and Resistance Coefficients	74
	a. Fine Grained Soil	79
	b. Coarse Grained Soil	83
	c. Muskeg.	85
	d. Shallow Snow.	86
4.	Subroutine IV4 - Summed Pull and Resistance Coefficient . .	88
5.	Subroutine IV5 - Slip Modified Tractive Effort.	89
	a. Subroutine TFORCF - Soil Limited Tractive Effort. . .	95
	b. Subroutine VELFOR - Maximum Velocity Overcoming a Given Resistance.	96
	c. Subroutine SLIP - Powered Traction Element Slip for a Given Traction Coefficient.	99
	d. Subroutine QUADS - Quadratic Fit to 5 Points.	101
6.	Subroutine IV6 - Resistance Due to Vegetation	101
7.	Subroutine IV7 - Driver Dependent Vehicle Vegetation Override Check.	102
8.	Subroutine IV8 - Total Resistance Between Obstacles	102
9.	Subroutine IV9 - Speed Limited by Resistance Between Obstacles	103
10.	Subroutine IV10 - Speed Limited by Surface Roughness. . . .	104
11.	Subroutine IV11 - Total Braking Force -- Soil/Slope/ Vehicle	105
12.	Subroutine IV12 - Maximum Braking Force -- Soil/ Slope/Vehicle/Driver.	106
13.	Subroutine IV13 - Speed Limited by Visibility	107
14.	Subroutine IV14 - Selected Speed Between Obstacles.	108
15.	Subroutine IV15 - Maximum Speed Between and Around Obstacles	109
16.	Subroutine IV16 - Obstacle Override Interference and Resistance.	111
17.	Subroutine IV17 - Driver Dependent Vehicle Speed over Obstacles.	112
18.	Subroutine IV18 - Speed Onto and Off Obstacles.	113
19.	Subroutine IV19 - Average Terrain Unit Speed While Accelerating/Decelerating Between Obstacles	117

a.	Subroutine ACCEL - Time and Distance to Accelerate from one Velocity to Another.	123
b.	Subroutine TXGEAR - Time and Distance in a Gear	124
20.	Subroutine IV20 - Kinematic Vegetation Override Check.	129
21.	Subroutine IV21 - Maximum Average Speed	130
E.	Road Module	132
1.	Initialization.	133
2.	Velocity Dependent Resistance	133
a.	Surface Resistance	133
b.	Aerodynamic Resistance	135
c.	Wheeled Axle Turning Resistance.	135
d.	Tandem Wheel Aligning Resistance	136
3.	Non-Velocity Dependent Resistance	136
a.	Tracked Turning Resistance	136
b.	Rolling Resistance	137
c.	Grade Resistance	138
4.	Speed Limited by Resistance	138
5.	Speed Limited by Surface Roughness.	138
6.	Speed Limited by Sliding on Curves.	139
7.	Speed Limited by Tipping on Curves.	139
8.	Speed Limited by Visibility	139
9.	Curvature Speed Limit	141
F.	Linear Feature Module	144
III.	INPUTS AND OUTPUTS.	145
A.	Introduction.	145
B.	Vehicle Data.	147
C.	Terrain Input -- Operational Modules.	154
1.	Areal Terrain Input File - Class Interval Values.	154

2. Areal Terrain Input File - Real Values	157
3. Road Terrain Input File	160
D. Scenario and Control Input Data	162
E. Output.	170
IV. REFERENCES.	173

LIST OF FIGURES

I.A.1 -- Prospective Users of Vehicle Performance Prediction Methodology.	3
I.C.1 -- General Organization of the Initial Nato Reference Mobility Model	9
I.E.1 -- General Flow of INRMM Area1 Module	23
II.A.1 -- Structure of Control and I/O Module.	34
II.A.2 -- Structure of Subroutine TERTL.	37
II.B.1 -- Powertrain Calculation Logic of Subroutine 1116.	55
II.B.2 -- Plot of Tractive Effort vs. Speed Array.	59
II.B.3 -- Possible Anomaly in Quadratic Equation Fit to a Gear	61
II.C.1 -- Side View of an Obstacle	64
II.C.2 -- Vehicle Approach to Obstacle	65
II.D.1 -- Area Denied Due to an Obstacle	72
II.D.2 -- SUBROUTINE IV5 - Slip Modified Tractive Effort	90
II.D.3 -- Tractive Effort vs. Speed Modification for Soil and Slope.	91
II.D.4 -- Flow Chart of SUBROUTINE IV18.	114
II.D.5 -- Possible Speed Profiles Across an Obstacle and Between Obstacles.	119
II.D.6 -- Speed Profile when Obstacle Approach Speed Cannot be Attained.	121
II.D.7 -- Representation of Tractive Effort vs. Speed Relation	124

LIST OF TABLES

I.C.1 -- Terrain, Vehicle, Driver Attributes Characterized in INRMM Mobility Model Data Base.	11
II.D.1 -- Slipperiness Conditions and Parameters	81
II.E.1 -- Curvature Speed Limits	142
III.B.1 -- Vehicle Input Data -- NAMELIST VEHICL.	148
III.C.1 -- Terrain Input File Structure	155
III.C.2 -- Terrain Input File Structure -- Real Value	158
III.C.3 -- Terrain Input File Structure -- Roads.	161
III.D.1 -- Control Input Data - Operational Modules NAMELIST CONTRL.	165
III.D.2 -- Control and Scenario Variables - Operational Modules NAMELIST SCENAR.	168

LIST OF APPENDICES

A. Listing of Program NRMM	
B. Vehicle Input Files for Program NRMM	
M60 A1 (Tank).	B-2
M 151 (Jeep).	B-7
C. Terrain Input Files for Program NRMM	
Areal Terrain Input File -- Class Interval Format -- File CKK.	C-2
Road Terrain Input File -- Real Values Format -- File CKKRD.	C-3
D. Sample Output of Program NRMM	
Vehicle: M60 A1 Terrain: CKK.	D-2
Vehicle: M60 A1 Terrain: CKKRD.	D-10
Vehicle: M 151 Terrain: CKK.	D-18
Vehicle: M 151 Terrain: CKKRD.	D-26
E. Possible STOP's in Program NRMM	

I INTRODUCTION AND OVERVIEW*

The NATO Reference Mobility Model (NRMM) is a collection of equations and algorithms designed to simulate the cross-country movement of vehicles. It was developed from several predecessor models, principally AMC-74 (Jurkat, Nuttall and Haley (1975)). This report, in several volumes, provides some background and motivation for most aspects of the model, and presents documentation for the coded version now available through the U. S. Army Tank-Automotive Research and Development Command (TARADCOM).

A. Background

Rational design and selection of military ground vehicles requires objective evaluation of an ever-increasing number of vehicle system options. Technology, threat, operational requirements, and cost constraints change with time. Current postures must be reexamined, new options evaluated, and new trade-offs and decisions made. In the single area of combat vehicles, for example, changes in one or another influencing factor might require trade-offs that run the gamut from opting for an air or ground system, through choosing wheels, tracks or air cushions, to designating a new tire.

The former Mobility Systems Laboratory of the then U. S. Army Tank-Automotive Command (TACOM) and the U. S. Army Engineer Waterways Experiment Station (WES) are the Army agencies responsible for

* This chapter is adapted from Jurkat, Nuttall and Haley (1975).

conducting ground mobility research. In 1971, a unified U. S. ground mobility program, under the direction of the then Army Materiel Command (AMC), was implemented that specifically geared the capabilities of both laboratories to achieve common goals.

As a first step in the unified program, a detailed review was made of existing vehicle mobility technology and of the problems and requirements of the various engineering practitioners associated with the military vehicle life cycle. One basic requirement was identified as common to all practitioners surveyed: the need for an objective analytical procedure for quantitatively assessing the performance of a vehicle in a specified operational environment. This is the need that is addressed to a substantial extent by the INRMM and its predecessors.

In theory, a single methodology can serve some of the needs of all major practitioners, provided it relates vehicle performance to basic characteristics of the vehicle-driver-terrain system at appropriate levels of detail.

Three principal categories of potential users of the methodology were identified: the vehicle development community, the vehicle procurement community, and the vehicle user community (Figure I.A.1). The greatest level of detail is needed by the design and development engineer (vehicle design and development community) who is interested in subtle engineering details--for example, wheel geometry, sprung masses, spring rates, track widths, etc.--and their

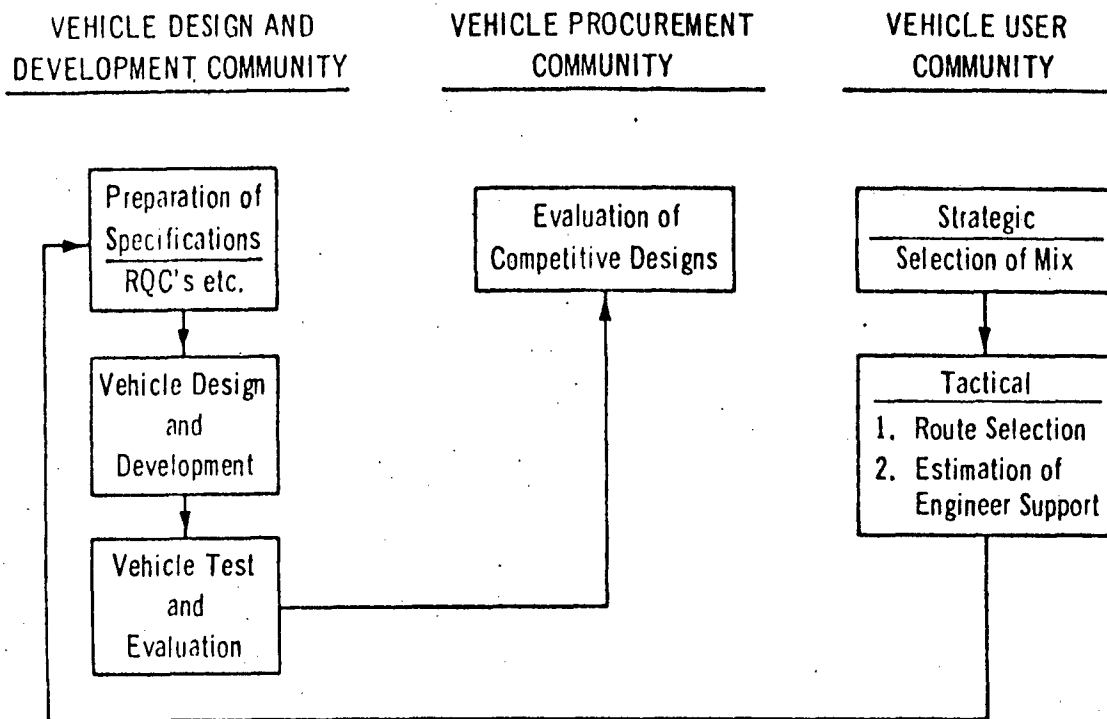

PROSPECTIVE USERS OF VEHICLE PERFORMANCE PREDICTION METHODOLOGY

FIGURE I-A-1

interactions with soil strength, tree stems of various sizes and spacings, approach angles in ditches and streams, etc. At the other end of the spectrum is the strategic planner (user community), who is interested in such highly aggregated characteristics as the average cross-country speed of a given vehicle throughout a specified region--the net result of many interactions of the engineering details with features of the total operational environment. Between these two extremes, is the person responsible for selection of the vehicles who must evaluate the effect of changes of major subsystems or choose from

concepts of early design stages. To be responsive to the needs of all three user communities, the methodology must be flexible enough to provide compatible results at many levels and in an appropriate variety of formats.

Interest in a single, unified methodology applicable to the needs of these three principal users led to the creation of a cross-country vehicle computer simulation combining the best available knowledge and models of the day. Much of this knowledge was collected in Rula and Nuttall (1971). The first realization of the simulation was a series of computer programs known as the AMC-71 Mobility Model, called AMC-71 for short (US ATAC(1973)). This model first became operational in 1971; it was published in 1973. It was conceived as the first generation of a family whose descendants, under the evolutionary pressures of subsequent research and validation testing results, application experiences, and growing user requirements, would be characterized by greater accuracy and applicability. A relatively current status report may be found in Nuttall, Rula and Dugoff (1974).

The first descendant, known as AMC-74, is the basis for the INRMM. It is documented in Jurkat, Nuttall and Haley (1975). The following is a description of this model.

B. Modeling Off-Road Vehicle Mobility

In undertaking mobility modeling, the first question to be answered was the seemingly easy one: What is mobility? The answer had been elusive for many years. Semantic reasons can be traced to the beginnings of mobility research, but there was also a pervasive reluctance to accept the simple fact that even intuitive notions about a vehicle's mobility depend greatly on the conditions under which it is operating. By the mid-1960s, however, a consensus had emerged that the maximum feasible speed-made-good* by a vehicle between two points in a given terrain was a suitable measure of its intrinsic mobility in that situation.

This definition not only identified the engineering measure of mobility, but also its dependence on both terrain and mission. When, at a suitably high resolution, the terrain involved presents the identical set of impediments to vehicle travel throughout its extent, mobility in that terrain (ignoring edge effects) is the vehicle's maximum straight-line speed as limited only by those impediments. But when, as is typically the case, the terrain is not so homogeneous, the problem immediately becomes more complex. Maximum speed-made-good then becomes an interactive function of terrain variations, end points specified, and the path selected. (Note that the last two constitute at least part of a detailed mission statement.) As a way to achieve a useful simulation in this complicated situation the INRMM deliberately

*Speed-made-good between two points is the straight-line distance between the points divided by total travel time, irrespective of path.

simplifies the real areal terrain into a mosaic of terrain units within each of which the terrain characteristics are considered sufficiently uniform to permit use of the simple, maximum straight-line speed of the vehicle to define its mobility in, along, or across that terrain unit. A terrain unit or segment specified for a road or trail is, similarly, considered to have uniform characteristics throughout its extent.

Maximum speed predictions are made for each terrain unit without concern for whether or not distances within the unit are adequate to permit the vehicle to reach the predicted maximum. This vehicle and terrain-specific speed prediction is the basic output of the model. The model, in addition, generates data that may be used to predict operational vibration levels, mission fuel consumption, etc., and can provide diagnostic information as to the factors limiting speed performance in the terrain unit.

The speed and other performance predictions for all terrain units in an area can be incorporated into maps that specify feasible levels of performance that a given vehicle might achieve at all points in the area. At this point, the output is reasonably general and is essentially independent of mission and operational scenario influences. The basic data constituting the maps must usually be further processed to meet the needs of specific users. These needs vary from relatively simple statistics or indices reflecting overall vehicle compatibility with the terrain, to extensive analyses involving detailed or generalized missions. None of these so called

post-processors is included as part of the INRMM.

C. Overall Structure of the INRMM

In formulating AMC-71, it was recognized that its ultimate usefulness to decision makers in the vehicle development, procurement, and user communities would depend upon its realism and credibility. (See Nuttall and Dugoff (1973).) These perceived requirements led to several more concrete objectives related to the overall structure of the model. It was determined that the model should be designed to:

1. Allow validation by parts and as a whole.
2. Make a clear distinction between engineering predictions and any whose outcome depends significantly upon human judgment, with the latter kept visible and accessible to the model user.
3. Be updated readily in response to new vehicle and vehicle-terrain technology.
4. Use measured subsystem performance data in place of analytical predictions when and as available and desired.

These objectives, plus the primary goal of supporting decision making relating to vehicle performance at the several levels, clearly dictated a highly modular structure that could both provide and accept data at the subsystem level, as well as make predictions for the vehicle as a whole. The resulting gross structure of the model is illustrated in Figure I.C.1.

At the heart of the model are three independent computational modules, each comprised of analytical relations derived from laboratory and field research, suitably coupled in the particular type of operation. These are:

FIGURE I.C.1 - GENERAL ORGANIZATION OF THE INITIAL
NATO REFERENCE MOBILITY MODEL

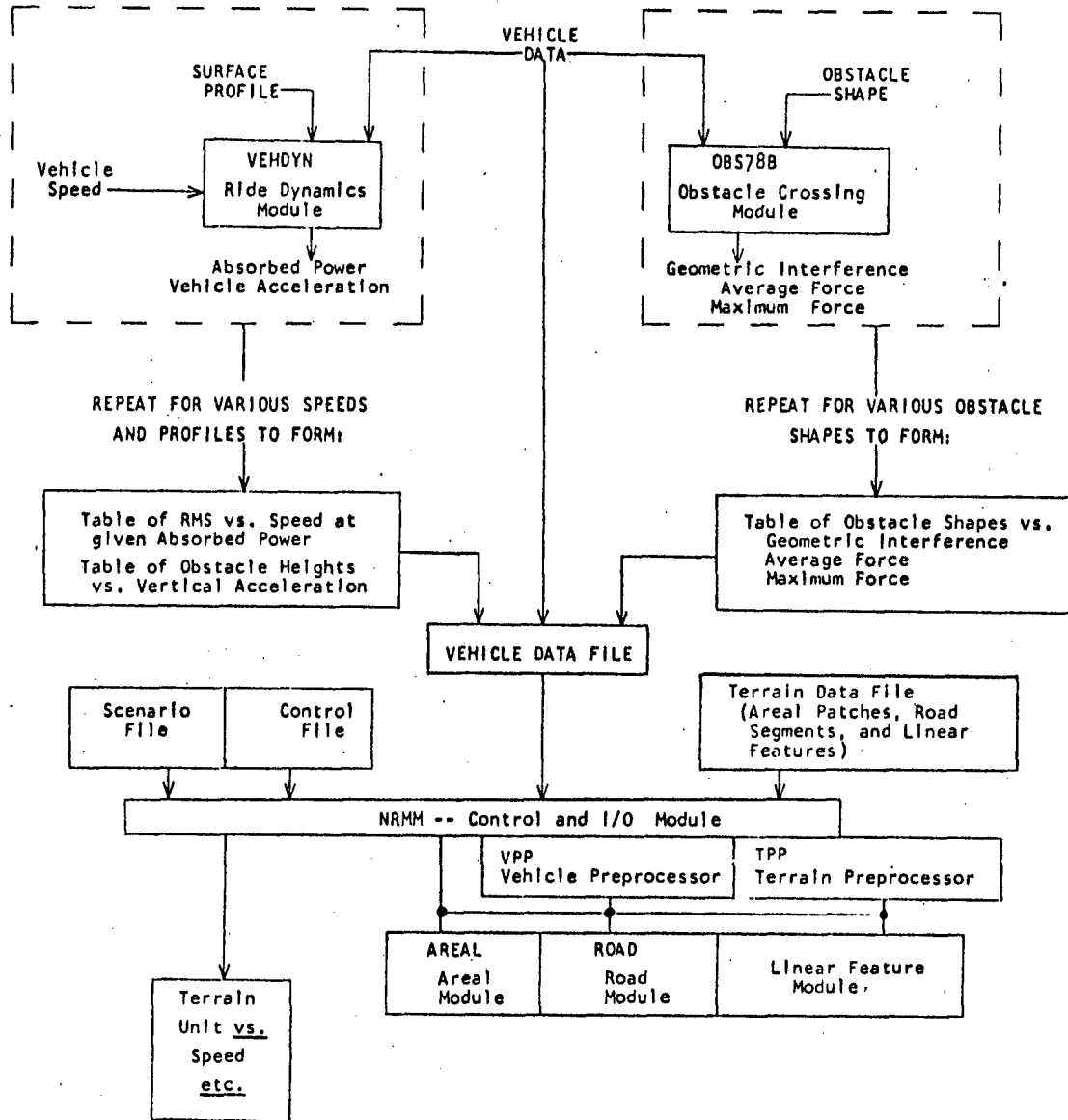

1. The Areal Module, which computes the maximum feasible speed for a single vehicle in a single areal terrain unit (patch).
2. The Linear Feature Module, which computes the minimum feasible time for a single vehicle, aided or unaided, to cross a uniform segment of a significant linear terrain

feature such as a stream, ditch, or embankment (not currently available).

3. The Road Module, which computes the maximum feasible speed of a single vehicle traveling along a uniform segment of a road or trail.

These Modules and the Terrain and Vehicle Preprocessors are collected in a computer program called NRMM and are described in this volume.

These three Modules may be used separately or together. Alternately, INRMM has the ability to simulate travel from terrain unit to terrain unit in the sequence given by the terrain input file. In this mode, known as the traverse mode, sufficient output data can be provided so that the user may calculate acceleration and deceleration times and distances between and across terrain unit boundaries, and thereby determine actual travel time and speed-made-good over a chosen route.

All three modules draw from a common data base that describes quantitatively the vehicle, the driver, and the terrain to be examined in the simulation. The general content of the data base is shown in Table I.C.1.

TABLE I.C.1

Terrain, Vehicle, Driver Attributes Characterized in INRMM
Data Base

Terrain	Vehicle	Driver
Surface Composition Type Strength	Geometric characteristics	Reaction Times Recognition distance
Surface Geometry Slope Altitude Discrete Obstacles Roughness Road Curvature Road Width Road Superelevation	Inertial characteristics Mechanical characteristics	Acceleration and impact tolerances Minimum acceptable speeds
Vegetation Stem Size Stem Spacing		
Linear Geometry Stream cross section Water velocity Water depth		

D. Model Inputs and Preprocessors

1. Terrain

For the purposes of the model, each terrain unit is described at any given time by values for a series of 22 mathematically independent terrain factors for an areal unit (including lake and marsh factors), 10 for the cross section of a linear feature to be negotiated, and 9 to quantify a road segment. General-purpose terrain data also include separate values for several terrain factor values that vary during the year. For example, at present such general data for areal terrain include four values for soil strength (dry, average, wet, and wet-wet seasons) and four seasonal values for recognition distances in vegetated areas. Similar variations in effective ground roughness, resulting from seasonal changes in soil moisture (including freezing) and in the cultivation of farm land, can be envisioned for the future. Further details on the terrain factors used are given in Rula and Nuttall (1975).

As discussed earlier, the basic approach to representing a complex terrain is to subdivide it into areal patches, linear feature segments, or road segments, each of which can be considered to be uniform within its bounds. Besides supplying actual values for the terrain factors, this concept may be implemented by dividing the range of each individual terrain factor value into a number of class intervals, based upon considerations of vehicle response sensitivity and practical measurement and mapping resolution problems. A patch or

a segment is then defined by the condition that the class interval designator for each factor involved is the same throughout. A new patch or segment is defined whenever one or more factors fall into a new class interval.

Before being used in the three computational Modules, the basic terrain data are passed through a Terrain Data Preprocessor, called TPP, in the Computer Program NRMM. This preprocessor does three things:

1. Converts as necessary all data from the units in which they are stored to inches, pounds, seconds and radians, which are used throughout the subsequent performance calculations.
2. Selects prestored soil strengths and visibility distances according to run specifications, which are supplied as part of the scenario data (see below).
3. Calculates from the terrain measurements in the basic terrain data a small number of mathematically dependent terrain variables used repeatedly in the computational modules.

2. Vehicle

The vehicle is specified in the vehicle data base in terms of its basic geometric, inertial, and mechanical characteristics. The complete vehicle characterization as used by the performance computation modules includes measures of dynamic response to ground roughness and obstacle impact, and the clearance and traction requirements of the vehicle while it is negotiating a parametric series of discrete obstacles.

The model structure permits use at these points of appropriate data derived either from experiments or from supporting stand-alone simulations used as preprocessors. Available as modules of the INRMM is a two-dimensional ride and obstacle crossing Dynamics Module for obtaining requisite dynamics responses (currently called VEHDYN and described in Volume III) and an Obstacle Module for computing obstacle crossing traction requirements and interferences (currently called OBS78B and described in Volume II). Both derive some required information from the basic vehicle data base, and both, when used, constitute stand-alone vehicle data preprocessors.

There is also a Vehicle Data Preprocessor called VPP (integral to NRMM) which, like the Terrain Data Preprocessor, has three functions:

1. Conversion of vehicle input data to uniform inches, pounds, seconds, and radians.
2. Calculation, from the input data, of controlling soil performance parameters and other simpler dependent vehicle variables subsequently used by the computational modules, but usually not readily measured on a vehicle or available in its engineering specifications.
3. Computation of the basic steady-state traction versus speed characteristics of the vehicle power train, from engine and power train characteristics.

As in the case of dynamic responses and obstacle capabilities, the last item, the steady-state tractive force-speed relation, may be input directly from proving ground data, when available and desired.

3. Driver

The driver attributes used in the model characterize the driver in terms of his limiting tolerance to shock and vibration and his ability to perceive and react to visual stimuli affecting his behaviour as a vehicle controller. While these attributes are identified in Figure I.C.1 and Table I.C.1 as part of the data base INRMM provides for their specific identification and user control so that the effects of various levels of driver motivation, associated with combat or tactical missions, for example, can be considered.

4. Scenario

Several optional features are available to the user of the INRMM (weather, presumed driver motivation, operational variations in tire inflation pressure) which allow the user to match the model predictions to features or assumptions of the full operational scenario for which predictions are required. Model instructions which select and control these options are referred to as scenario inputs.

The scenario options include the specification of:

1. Season, which, when seasonal differences in soil strength constitute a part of the terrain data, allows selection of the soil strength according to the variations in soil moisture with seasonal rainfall, and
2. Weather, which affects soil slipperiness and driving visibility, (including dry snow over frozen ground and associated conditions).
3. Several levels of operational influences on driver tolerances to ride vibrations and shock, and on driver strategy in

negotiating vegetation and using brakes.

4. Reasonable play of tire pressure variations to suit the mode of operation--on-road, cross-country, and in sand.

E. Stand-Alone Simulation Modules

As indicated above, the Model is implemented by a series of independent Modules. The Terrain and Vehicle Preprocessors, already described, form two of these. Two further major stand-alone simulation Modules will now be outlined.

1. Obstacle-crossing Module-OBS78B

This Module determines interferences and traction requirements when vehicles are crossing the kind of minor ditches and mounds characterized as part of the areal terrain; it is described fully in Volume II. It is used as a stand-alone Preprocessor Module to the Areal Module of INRMM.

The Obstacle-crossing Module simulates the inclination and position, interferences, and traction requirements of a two-dimensional (vertical center-line plane) vehicle crossing a single obstacle in a trapezoidal shape as a mound or a ditch. The module determines a series of static equilibrium positions of the vehicle as it progresses across the obstacle profile. Extent of interference is determined by comparison of the obstacle profile and the displaced vehicle bottom profile. Traction demand at each position is determined by the forces on driven running gear elements, tangential to the obstacle surface, required to maintain the vehicle's static position. Pitch compliance of suspension elements is not accounted for but frame articulation (as at pitch joints, trailer hitches, etc) is permitted.

The Obstacle-crossing Module produces a table of minimum clearances (or maximum interferences) and average and maximum force required to cross a representative sample of obstacles defined by combinations of obstacle dimensions varied over the ranges appropriate for features included in the areal terrain description. This simulation is done only once for each vehicle. Included in the INRMM Areal Module is a three-dimensional linear interpolation routine which, for any given set of obstacle parameters, approximates from the derived table the corresponding vehicle clearance (or interference) and associated traction requirements. Obviously, the more entries there are in the table, the more precise will be the determination.

2. Ride Dynamics Module- VEHDYN

The Areal Module examines as possible vehicle speed limits in a given terrain situation two limits which are functions of vehicle dynamic perceptions: speed as limited by the driver's tolerance to his vibrational environment when the vehicle is operating over continuously rough ground, and speed as limited by the driver's tolerance to impact received while the vehicle is crossing discrete obstacles. It is assumed that the driver will adjust his speed to ensure that his tolerance levels will not be exceeded.

The Ride Dynamics Module of INRMM, called VEHDYN and described in Volume III, computes accelerations and motions at the driver's station (and other locations, if desired) while the vehicle is operating at a given speed over a specific terrain profile. The

profile may be continuously, randomly rough, may consist solely of a single discrete obstacle, uniformly spaced obstacles of a specific height or may be anything in between. From the computed motions, associated with driver modeling and specified tolerance criteria, simple relations are developed for a given vehicle between relevant terrain measurements and maximum tolerable speed. The terrain measurement to which ride speed is related is the root mean square (rms) elevation of the ground profile (with terrain slopes and long-wavelength components removed). The terrain descriptors for obstacles are obstacle height and obstacle spacing.

The terrain parameters involved, rms elevation and obstacle height and spacing, are factors quantified in each patch description, and rms elevation is specified for each road segment. Preprocessing of the vehicle data in the ride dynamics module provides an expedient means of predicting dynamics-based speed in the patch and road segment modules via a simple, rapid table-lookup process.

The currently implemented Ride Dynamics Module is a digital simulation that treats vehicle motions in the vertical center-line plane only (two dimensions). It is a generalized model that will handle any rigid-frame vehicle on tracks and/or tires, with any suspension. Tires are modeled using a segmented wheel representation, (see Lessem (1968)) and a variation of this representation is used to introduce first-order coupling of the road wheels on a tracked vehicle by its tracks.

a) Driver model and tolerance criteria.

It has been shown empirically that, in the continuous roughness situation, driver tolerance is a function of the vibrational power being absorbed by the body. (See Pradko, Lee and Kaluza (1966).) The same work showed that the tolerance limit for representative young American males is approximately 6 watts of continuously absorbed power, and the research resulted in a relatively simple model for power absorption by the body. The body power absorption model, based upon shaping filters applied to the decomposed acceleration spectrum at the driver's station, is an integral part of the INRMM two-dimensional dynamics simulation.

In the past, only the 6 watt criterion was used to determine a given vehicle's speed as limited by rms roughness. More recent measurements in the field have shown that with sufficient motivation young military drivers will tolerate more than 6 watts for periods of many minutes. Accordingly, INRMM will accept as vehicle data a series of ride speed versus rms elevation relations, each corresponding to a different absorbed power level, and will use these to select ride-speed limits according to the operationally related level called for by the scenario. The Ride Dynamics Module will, of course, produce the required additional data, but some increased running time is involved.

The criterion limiting the speed of a vehicle crossing a single discrete obstacle, or a series of closely, regularly spaced obstacles,

is a peak acceleration at the driver's seat of 2.5-g passing a 30-Hz. filter. Data relating the 2.5-g speed limit to obstacle height and spacing can be developed in the ride dynamics module by inputting appropriate obstacle profiles.

INRMM requires two obstacle impact relations: the first, speed versus obstacle height for a single obstacle (spacing very great); and the second, speed versus regular obstacle spacing for that single obstacle height (from the single obstacle relation) which limits vehicle speed to a maximum of 15 mph. For obstacles spaced at greater than two vehicle lengths, the single-obstacle speed versus obstacle height relation is used. For closer spacings, the least speed allowable by either relation is selected.

3. Main Computational Modules - NRMM

The highly iterative computations required to predict vehicle performance in each of the many terrain units needed to describe even limited geographic areas are carried out in the three main computational modules. Each of these involve only direct arithmetic algorithms which are rapidly processed in modern computers. In INRMM, even the integrations required to compute acceleration and deceleration between obstacles within an areal patch are expressed in closed, algebraic form.

Terrain input data include a flag, which signifies to the model whether the data describes an areal patch, a linear feature segment,

or a road segment. This flag calls up the appropriate computational Module.

a) Areal Terrain Unit Module

This Module calculates the maximum average speed a vehicle could achieve and maintain while crossing an areal terrain unit. The speed is limited by one or a combination of the following factors:

1. Traction available to overcome the combined resistances of soil, slope, obstacles, and vegetation.
2. Driver discomfort in negotiating rough terrain (ride comfort) and his tolerance to vegetation and obstacle impacts.
3. Driver reluctance to proceed faster than the speed at which the vehicle could decelerate to a stop within the, possibly limited, visibility distance prevailing in the areal unit (braking-visibility limit).
4. Maneuvering to avoid trees and/or obstacles.
5. Acceleration and deceleration between obstacles if they are to be overridden.
6. Damage to tires.

Figure I.E.1 shows a general flow chart of how the calculations of the Areal Module are organized.

After determination of some vehicle and terrain - dependent factors used repetitively in the patch computation (1),* the Module is entered with the relation between vehicle steady-state speed and theoretical tractive force and with the minimum soil strength that the vehicle requires to maintain headway on level, weak soils. These data

* Numbers in parentheses correspond to numbers in Figure I.E.1.

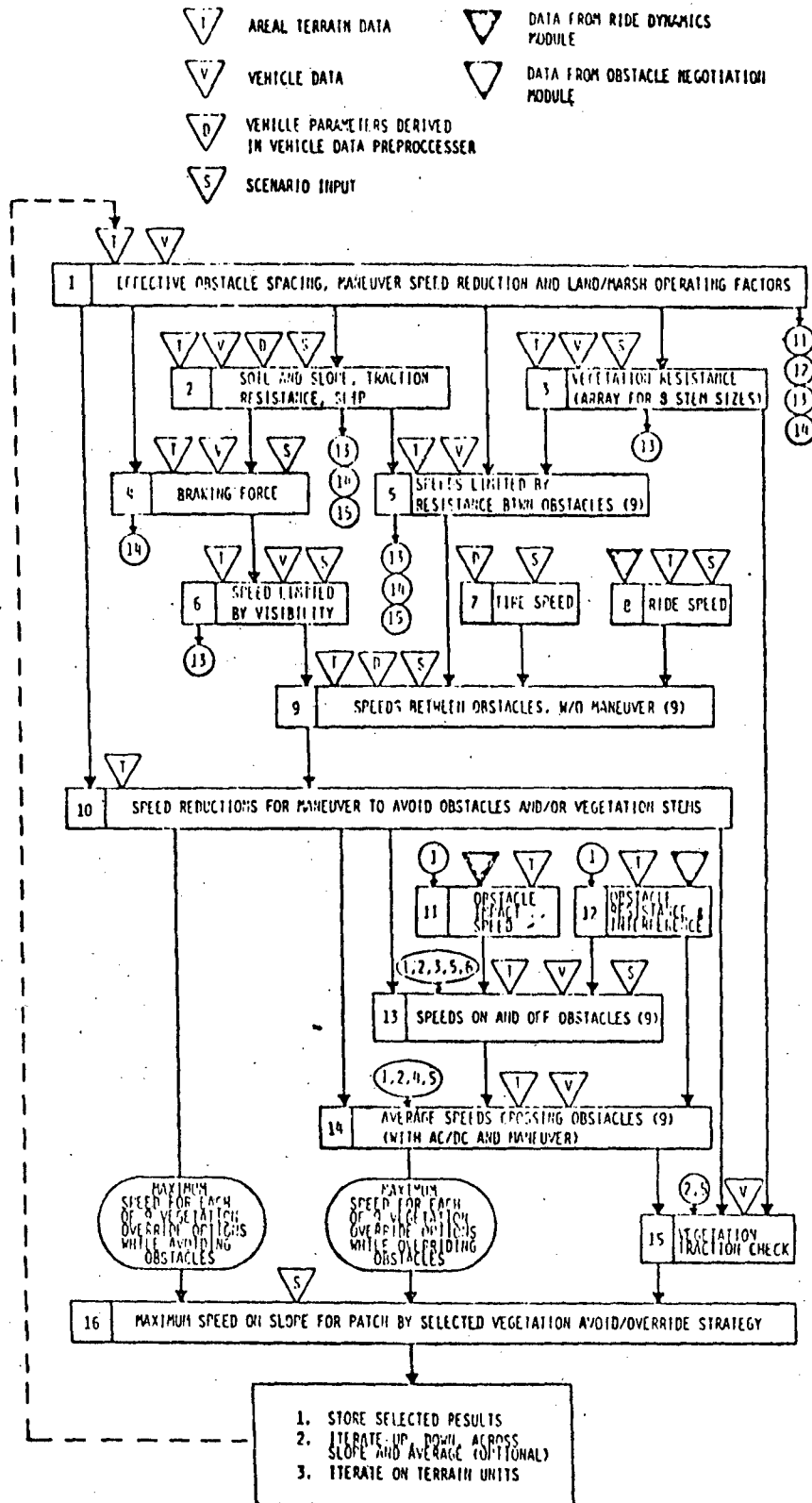

FIGURE I.E.1 -- GENERAL FLOW OF INRMM AREAL MODULE

are provided by the vehicle data preprocessor. Soil and slope resistances (2) and braking force limits (4) are computed, and the basic tractive force-speed relation is modified to account for soil-limited traction, soil and slope resistances, and resulting tire or track slip. Forces required to override prevailing tree stems are calculated for eight cases (3): first, overriding only the smallest stems, then overriding the next largest class of stems as well, etc., until in the eighth case all stems are being overridden.

Stem override resistances are combined with the modified tractive force-speed relation to predict nine speeds as limited by basic resistances (5). (The ninth speed corresponds to avoiding all tree stems.)

Maximum braking force and recognition distance are combined to compute a visibility-limited speed (6). Resistance and visibility-limited speeds are compared to the speed limited by tire loading and inflation (7), if applicable, and to the speed limit imposed by driver tolerance to vehicle motions resulting from ground roughness (8). The least of these speeds for each tree override-and-avoid option becomes the maximum speed possible between obstacles by that option, except for degradation due to maneuvering (9).

Obstacle avoidance and/or the tree avoidance implied by limited stem override requires the vehicle to maneuver (or may be impossible).

Using speed reduction factors (derived in 1) associated with avoiding all obstacles (if possible) and avoiding the appropriate classes of tree stems, a series of nine possible speeds (possibly including zero, or NOGO) is computed (10).

A similar set of nine speed predictions is made for the vehicle maneuvering to avoid tree stems only (10). These are further modified by several obstacle crossing considerations.

Possible NOGO interference between the vehicle and the obstacle is checked (12). If obstacle crossing proves to be NOGO, all associated vegetation override and avoid options are also NOGO. If there are no critical interferences, the increase in traction required to negotiate the obstacle is determined (12).

Next, obstacle approach speed and the speed at which the vehicle will depart the obstacle, as a result of the momentarily added resistance encountered, are computed (13). Obstacle approach speed is taken as the lesser of the speed between obstacles, reduced for maneuver required by each stem override and avoid option, and the speed limited by the driver to control his crossing impact (11). Speeds off the obstacle are computed on the basis solely of the soil-and slope-modified tractive force-speed relation (22), i.e. before the tractive force speed relation is modified to account for vegetation override forces, the traction increment required for obstacle negotiation, or any kinetic energy available as a result of the associated obstacle approach speed (13).

Final average speed in the patch for each of the nine tree stem override and avoid options, while the vehicle is overriding patch obstacles, is computed from the speed profile resulting, in general, from considering the vehicle to accelerate from the assigned speed off the obstacle to the allowable speed between obstacles (or to a lesser speed if obstacle spacing is insufficient), to brake to the allowable obstacle approach speed, and to cross the obstacle per se at the computed crossing speed.

Following a final check to ensure that traction and kinetic energy are sufficient for single-tree overrides required (and possible resetting of speeds for some options to NOGO) a single maximum in-patch speed (for the direction of travel being considered relative to the in-unit slope) is selected from among the nine available values associated with obstacle avoidance and the nine for the obstacle override cases. If all 18 options are NOGO, the patch is NOGO for the direction of travel. If several speeds are given, selection is made by one of two logics according to scenario input instructions.

In the past the driver was assumed to be both omniscient and somewhat mad. Accordingly, the maximum speed possible by any of the 18 strategies was selected as the final speed prediction for the terrain unit (and slope direction). Field tests have shown, however, that a driver does not often behave in this ideal manner when driving among trees. Rather, he will take heroic measures to reach some reasonable minimum speed, but will not continue such efforts when those measures involve knocking down trees that he judges it imprudent to attack,

even though by doing so he could go still faster. In INRMM, either assignment of maximum speed may be made: the absolute maximum which addresses the vehicle's ultimate potential, or a lesser value which in effect more precisely models actual driver behavior.

If the scenario data specify a traverse prediction, the in-unit speed and other predictions are complete at this point, and the model stores those results specified by the user and goes on to consider the next terrain unit (or next vehicle, condition, etc). When a full areal prediction is called for, the entire computation is repeated three times: once for the vehicle operating up the in-unit slope, once across the slope, and once down the slope. Desired data are stored from each such run prior to the next, and at the conclusion of the third run, the three speeds are averaged. Averaging is done on the assumption that one-third of the distance* will be travelled in each direction, resulting in an omnidirectional mean.

* the average speed, V_{av} , is the harmonic average of the three speeds, i.e.

$$V_{av} = 3 / [(1/V_{up}) + (1/V_{across}) + (1/V_{down})]$$

b) Road Module

The Road Module calculates the maximum average speed a vehicle can be expected to attain traveling along a nominally uniform stretch of road, termed a road unit. Travel on super highways, primary and secondary roads, and trails is distinguished by specifying a road type and a surface condition factor. From these characteristics, values of tractive and rolling resistance coefficients for wheeled and tracked vehicles on hard surfaced roads are determined by a table look-up. For trails, surface condition is specified in terms of cone index (CI) or rating cone index (RCI). Traction, motion resistance, and slip are computed using the soil submodel of the Areal Module, with scenario weather factors used in the same way as in making off-road predictions.

The relations used for computing vehicle performance on smooth, hard pavements are taken from the literature (Smith (1970) and Taborek (1957)).

The structure of the Road Module, while much simpler, parallels that of the Areal Module. Separate speeds are computed as limited by available traction and countervailing resistances (rolling, aerodynamic, grade, and curvature), by ride dynamics (absorbed power), by visibility and braking, by tire load, inflation and construction, and by road curvature per se (a feature not directly considered in the Areal Module). The least of these five speeds is assigned as the maximum for the road unit (for the assumed direction relative to the

specified grade).

The basic curvature speed limits are derived from American Association of State Highway Officials (AASHO) experience data for the four classes of roads (AASHO (1975)) under dry conditions and are not vehicle dependent. These are appropriately reduced for reduced traction conditions, and vehicle dependent checks are made for tipping or sliding while the vehicle is in the curve.

At the end of a computation, data required by the user are stored. If the model is run in the traverse mode, the model returns to compute values for the next unit; if in the areal mode, it automatically computes performance for both the up-grade and down-grade situations and at the conclusion computes the bidirectional (harmonic) average speed. Scenario options are similar to those for the Areal Module.

F. Acknowledgments

As with any comprehensive compendium covering knowledge in a particular subject area, the results are due to the combined effort of all workers in the discipline. The authors, in this case, are somewhat akin to the scribes of ancient days, recording and organizing the wisdom and folly of those around them.

There are those, however, whose contributions stand out as related to the creation of the Mobility Model itself. The authors wish to acknowledge these people explicitly.

Clifford J. Nuttall, Jr., currently with the Mobility Systems Division, Geotechnical Laboratory at the U. S. Army Engineer Waterway Experiment Station (WES) provided the inspiration for many of the submodels, guided the evolution of the content of the entire model, and provided the wisdom and judgement which hopefully kept the various portions in proportion with each other. Additional experience in use of this and predecessor models came from many studies conducted by Donald Randolph at WES. During the model development period, general direction and supervision at WES came from W. G. Schockley, A. A. Rula, E. S. Rush and J. L. Smith.

Peter Haley, from the Tank Automotive Concepts Laboratory, USA TARADCOM, and also the manager of the NATO Reference Mobility Model, in addition to providing overall guidance and judgment

did much of the seemingly endless detailed design and testing of the algorithms and code. He was aided in the coding by Thomas Washburn. Direct supervision of the model development at TARADCOM came from Zoltan J. Janosi, who also now serves as Chairman of the Technical Management Committee of the NATO Reference Mobility Model. General supervision during the project was provided by J. G. Parks, O. Renius, and Lt. Col. T. H. Huber. Dr. E. N. Petrick, Chief Scientist of USA TARADCOM, the moving force of the NATO RSI effort in the U. S. Army vehicle community, provided overall guidance and support for this activity. He has been aided in this by Edward Lowe, NATO Standardization and Metrication Officer at TARADCOM.

Newell Murphy of the Mobility Systems Division, WES, provided the driving force behind the current version of the Ride Dynamics Module, supervising its conception, creation, and testing as well as guiding the field work supporting it. Richard Ahlvin of WES and Jeff Wilson of Mississippi State University bore primary responsibility for the production of the sequence of computer programs which have implemented this Module.

The authors also wish to acknowledge the contributions of their colleagues at Stevens Institute of Technology. Jan Nazalewicz was responsible for much of the Obstacle Module. Supervision and guidance during the project came from I. Robert Ehrlich and Irmin O. Kamm.

The arduous task of entering and formatting the text of this report was performed by M. Raihan Ali and Gabriel Totino. Graphics and charts were prepared by Mary Ann McGuire and Christopher McLaughlin. The authors benefited from a careful review of the first draft by Peter Haley. Finally each of the authors notes than any errors are the fault of the other author.

II ALGORITHMS AND EQUATIONS

The INRMM has been implemented in a computer program called NRMM, written in FORTRAN Extended, version 4.6, for the CDC 6600 computer. The description of the Operational Modules which follows occasionally refers to particular aspects of this implementation.

A. Control and I/O Module

The Control and I/O Module (C&I/O) of NRMM consists of a main program and several subroutines which control the flow between vehicle and terrain input and the two operational modules for patches (Areal terrain units) and roads. It is also responsible for output. An overall illustration of the Control and I/O Module is given in Figure II.A.1.

After initialization and setting of variables to their default values, the program opens the files required. It then calls subroutine SCN to read the control variables, which determine how the program is to operate, and the scenario variables, which determine conditions of the simulation.

The program then calls subroutine VEH, which reads the vehicle data, and subroutine VPP, the Vehicle Preprocessor, which calculates vehicle descriptors derived from the vehicle input data, some of which depend on values of scenario variables. Details of these calculations are given in the next section, Section II.B.

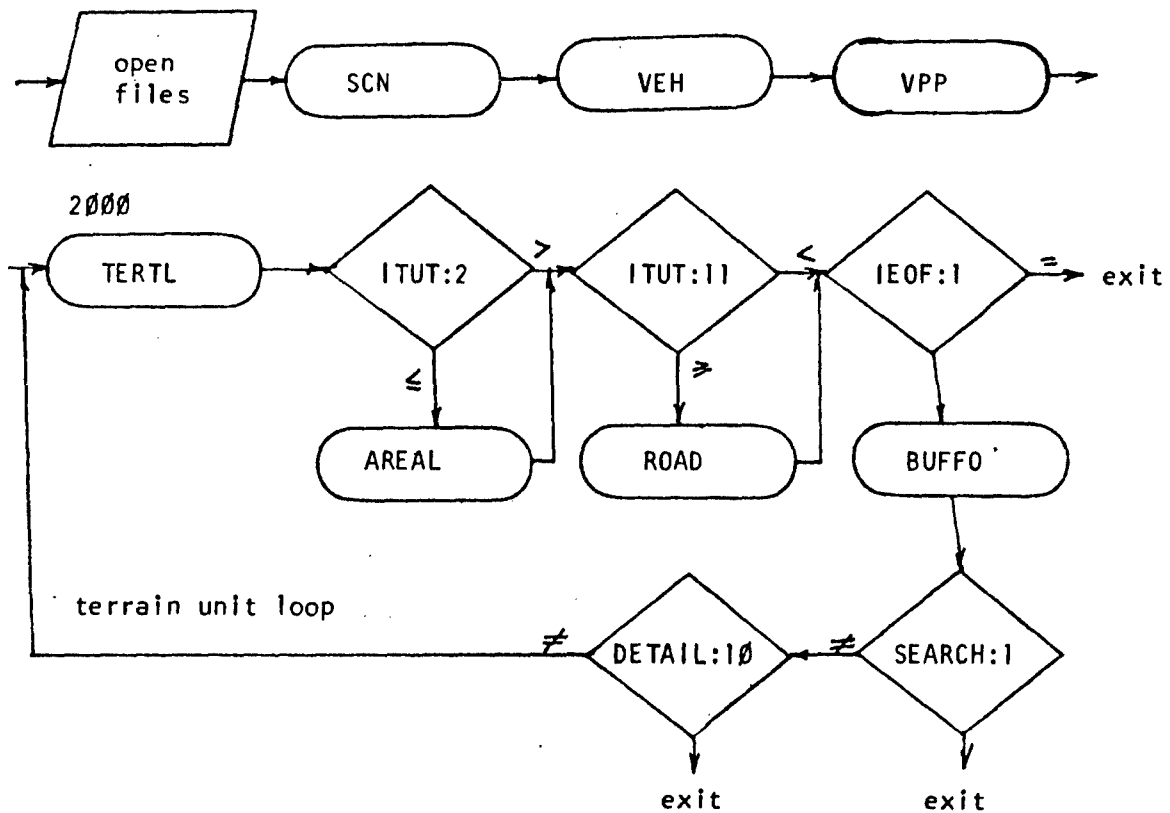

FIGURE 11.A.1 -- Structure of Control and I/O Module

The program then enters the terrain loop; that is, it reads the descriptors of the terrain unit under control of subroutine TERTL and its subroutines MAP71, MAP74, MPRD74, calculates several terrain descriptors derived from the primary terrain input data, some of which also depend on values of scenario variables. The program then selects the appropriate operational module, AREAL or ROAD, and calculates the speed the vehicle could be expected to go on that terrain unit. The program returns to TERTL and repeats these calculations if there is more terrain data. If not, the program exits.

There are two options that restrict the loop to a single terrain unit other than if only one terrain unit is present in the terrain input file. Setting control variable SEARCH to 1 indicates that a single terrain unit, whose terrain unit number is given by NTUX, is to be sought in the terrain input file and that the mobility model calculations are to be performed for that one unit only. Control variable DETAIL indicates to what level of detail the output is to be written. The following actions are taken for various values of DETAIL.

1. DETAIL = 1: only the output from BUFFO is written - this consists of terrain unit identification, grade, and maximum and selected speeds only.
2. DETAIL = 2,3 or 4: above output is written. Also control, scenario and vehicle input is echoed, and output from the vehicle Preprocessor is written.
3. DETAIL = 5 : results from almost all intermediate calculations are written. A printer-plot of the tractive effort vs. speed relationship is generated and program execution is terminated after the vehicle preprocessor.
4. DETAIL = 10: Results from almost all intermediate calculations are written.

Setting DETAIL to 10 results in a large volume of output. A check is made in the C&I/O Module and if DETAIL = 10 an exit is made after execution on one terrain unit.

The individual subroutines of the C&I/O Module will now be described briefly.

1. Subroutine SCN - Scenario and Control Input

This subroutine sets default values for the scenario variables (see Section III.D) and then reads the control variables. These consist of flags controlling writing of output for the entire program and individual routines, and the single terrain unit search described above. Then the scenario variables are read, echoed if the appropriate flag (KSCEN) was set to 1, and converted to standard units as necessary.

2. Subroutine VEH - Vehicle Input

This subroutine reads the vehicle parameters as described in Section III.B.1 below and echoes them if the flag KVEH is set to 1.

3. Subroutine VPP - Vehicle Preprocessor Control

This is the Vehicle Preprocessor control program. It consists solely of a series of calls to Subroutines II1, II2, ..., II17 and output statement executions as the flags KII1, KII2, ..., KII17 are set. If DETAIL = 5, a printer plot describing the vehicle power train is written using Subroutine PLTSET.

4. Subroutine TERTL - Terrain Translator

This subroutine controls the terrain data inputs. Since terrain files are often large and the results of long and expensive effort,

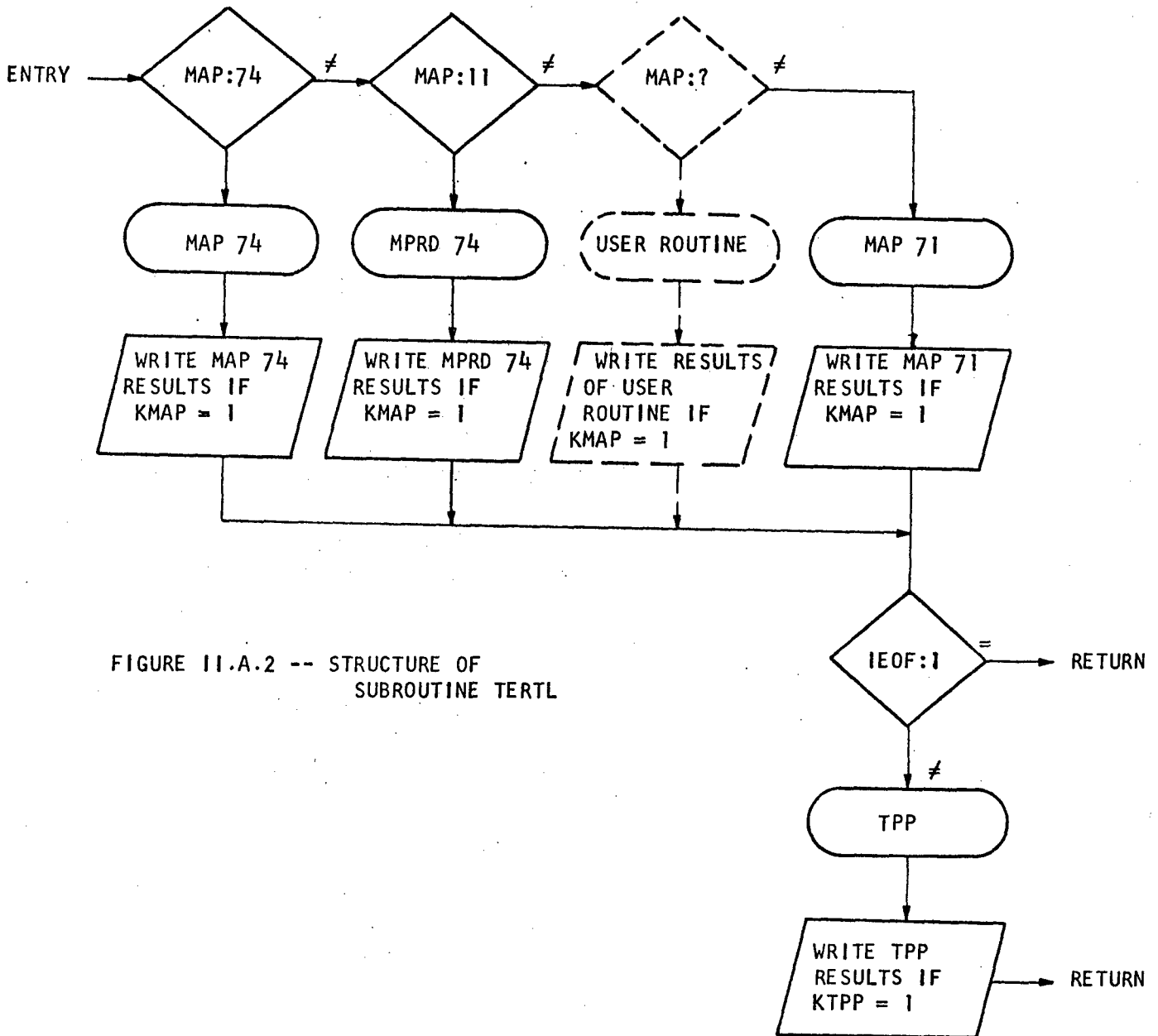

FIGURE 11.A.2 -- STRUCTURE OF SUBROUTINE TERTL

users will be reluctant to re-format their existing data to use the NRMM. Instead, the user may write a FORTRAN subroutine which reads the existing files and adjusts the data to satisfy the terrain data requirements of NRMM. Calls to these subroutines are controlled by a Control/Scenario variable called MAP. Three terrain data input routines are currently part of NRMM:

- i) Subroutine MAP71, called if MAP is not equal to one of the

values below,

- ii) Subroutine MAP74, called if MAP = 74,
- iii) Subroutine MPRD74, called if MAP = 11.

If the user writes a terrain input routine, called MXXXXX, for an existing data file, a unique, new value of MAP must be assigned and an appropriate IF, CALL and echo write (if desired) need to be added to Section 2., ALGORITHM, in Subroutine TERTL. Care must be taken that this new subroutine, MXXXXX, provides values for the complete list of terrain variables required by NRMM.

Each of the terrain data input subroutines must contain a check for end of terrain data. The existing routines use the CDC run-time FORTRAN function subprogram called EOF which returns a value of 1 if the READ tried to read a record but found an end-of-file instead. In this case the terrain input subroutines set the flag IEOF = 1 which is passed through TERTL to the C&I/O main program; whereupon the NRMM run will terminate.

If another terrain unit was read, TERTL will call Subroutine TPP, the Terrain Preprocessor, described in Section II.C. below, and will write the results if the flag KTPP is set. TERTL then returns.

a) Terrain Input/Translation Subroutine MAP74

This subroutine reads a record for each terrain unit consisting of actual terrain descriptors. These include various values for cone

index, grade, obstacle geometry and spacing, surface roughness, spacing of vegetation in eight stem diameter classes, and various values of recognition distance. The particular value of cone index and recognition distance chosen depend on the scenario variables ISEASN and MONTH, respectively. The format of the data to be read by this subroutine is described in Section III.C.2.

The input record also contains NTU, the terrain unit number. If SEARCH = 1 (that is, a particular terrain unit is sought), MAP74 will continue to read terrain unit records, discarding those for which NTU differs from NTUX. Only when a record is read for which NTU = NTUX will MAP74 return to TERTL.

b) Terrain Input/Translation Subroutine MPRD74

This subroutine was designed to read records describing roadway units, including trails compiled for a particular study. For this study the speed limits imposed by horizontal curvature were included as terrain data. Since the Road Module required road curvature as the descriptor, this routine translates the curvature speed limit back to curvature.

The routine first establishes a table relating curvature to maximum speed for four classes of roads: superhighways, primary roads, secondary roads, and trails. Then MPRD74 reads a record of actual values describing the roadway, including cone indexes, grade, recognition distances, surface roughness, curvature speed limit,

coefficient of friction, superelevation, and a surface condition factor. The curvature vs. speed table is then interpolated to set a curvature based on the curvature speed of the actual roadway unit. The format of the data to be read by this subroutine is described in Section III.C.3.

The input record also contains NTU, the terrain unit number. If SEARCH = 1 (that is, a particular roadway unit is sought), MPRD74 will continue to read roadway unit records, discarding those for which NTU differs from NTUX. Only when a record for which NTU = NTUX is read will MPRD74 process the data and then return to TERTL.

c) Terrain Input/Translation Subroutine MAP71

This subroutine was designed to read terrain data as class interval designators and to translate these designators into actual terrain descriptors. This is the format of the terrain data files read by an earlier mobility model, AMC71.

The entire range of possible values for each of the terrain descriptors is divided into a sequence of intervals from which a single number, the interval representative, is used for all terrain units whose actual value of that descriptor falls within that interval. This interval is given an integer as its designator. The terrain files read by MAP71 consist of records, one for each terrain unit, containing one or two digit integers designating those intervals into which the terrain descriptors fall.

The subroutine first establishes tables, one for each terrain descriptor, of representatives for each designator. This is done by DATA statements. Then records are read, tests are made for end of input file (and NTUX if SEARCH = 1) and the class interval representatives are loaded into the terrain descriptors by simple table lookup procedures. The format of the data to be read by this subroutine is described in Section III.C.1.

A test is made to check the compatibility of obstacle parameters and flags are set for those stem diameter classes not present in the terrain unit. The routine then returns to TERTL.

5. Subroutine AREAL - Areal Module Control

This subroutine is the control program for the Areal Module. It consists solely of a sequence of CALL's to subroutines named IV1, IV2, ..., IV21, each call followed by a test of the corresponding flag KIV1, KIV2, ..., KIV21 to determine if the results of that subroutine are to be written. The Areal Module is described in section II.D below. The subroutine then returns to the C&I/O main program.

6. Subroutine ROAD - Road Module

Since the Road Module is considerably smaller than the Areal Module no separate control program was written. This subroutine is the entire Road Module and described in Section II.E below.

7. Subroutine BUFF0 - Basic Output

This is the basic output subroutine of the C&I/O Module. The particular outputs are described in Section III.E.

B. Vehicle Preprocessor

The Vehicle Preprocessor Module consists of a sequence of subroutines named II1, II2, ..., II17, and some additional subroutines named TRAIN, AUTOM, STICK, LINEAR, FIT, APPROX, SOLVER, LINES, RESIDU, PLTSET, SCAL, LIMITS, FIXER and CURPT called by II16. These routines adjust dimensions and calculate derived vehicle descriptors, including the tractive effort vs. speed relationship.

The tractive effort vs. speed relationship, at this stage (i.e., without attenuation for soil limits or slip) also known as the rim pull curve of the vehicle, is fitted by a sequence of quadratic curves for various ranges of speeds. If the program encounters difficulties with the curve fit procedure it will print/plot the points and the curves for user analysis and intervention. Alternately the user may wish to have the points and curves plotted in any case by setting the switch DETAIL to 5.

The individual subroutines comprising the Vehicle Preprocessor will now be described.

1. Subroutine II1 - Units Conversion Routine

This routine changes those vehicle parameters that are not entered in the units of lbs, inches, radians and/or seconds into these units. One exception is the engine revolutions per minute which are converted to revolutions per second, not radians per second.

Those users describing their vehicles in SI units will be required to modify this routine extensively or perhaps write a separate program to change the vehicle data into the U.S. Customary units used in NRMM.

2. Subroutine II2 - Gross Combined Weight

The weight on each suspension assembly is given as part of the vehicle input. In addition, the flag $IP(i) = 1$ indicates that assembly i is powered and the flag $IB(i) = 1$ indicates that assembly i is braked. This subroutine sums the weights on all the assemblies into GCW and the weight on the powered and braked assemblies into GCWP and GCWB, respectively. The weight on the non-powered, GCWNP, and non-braked, GCWNB, assemblies is also calculated.

3. Subroutine II3 - Maximum Tire Speed

This subroutine calculates a maximum speed which a wheeled vehicle could travel without destroying the tire. This speed, VTIRE(j), calculated

for $j = 1$ fine grained soil
 $j = 2$ coarse grained soil
 $j = 3$ highway

depends primarily on tire size, construction, and inflation pressure.*
The formulas are, for each assembly i ,

$$s = (b_{ti} - .4b_{ri})/.75$$

* For further explanation on how inflation pressure is used in this Model see Section II.D.3.

$$h = (4.32/s^{2.38})[(W_i/n_i)(1/(d_{ri}+s))]^{1.71}$$

where b_{ti} = section width of tires
 b_{ri} = width of rims
 w_i = load on entire assembly
 n_i = number of tires
 d_{ri} = diameter of rims.

For radial tires (ICONST(i) \neq 1)

$$V_{tij} = 100.(p_{ij}/h)^2 \quad \text{in miles per hour}$$

and for bias ply tires (ICONST(i) = 1)

$$V_{tij} = 70.(p_{ij}/h)^{2.25} \quad \text{in miles per hour}$$

where p_{ij} = pressure used in tires on assembly i for
j = 1 fine grained soil
j = 2 coarse grained soil
j = 3 highway

V_{tij} = maximum safe speed for tires on assembly i at
pressure j.

V_{tij} is converted to inches per second in II3. The maximum safe
tire speed for the vehicle is then

$$VTIRE(j) = \min \{V_{tij} \text{ for all } i\}$$

for tire pressure j.

These relationships are patterned after Eklund (1945) with
modifications.

4. Subroutine II4 - Maximum Path Width

In this subroutine the maximum path width of the suspension assemblies is found by subtracting the clearance between the left and the right suspension assembly elements from the tread width and finding the largest such number.

5. Subroutine II5 - Tire Deflection Ratio

For each wheeled assembly i the variable δ_{ij} , or DFLCT(i,j), gives the deflection of the tire at the pressure used for $j = 1$ fine grained soil, $j = 2$ coarse grained soil, and $j = 3$ highway. This routine calculates the deflection ratio, DRAT(i,j), as the ratio of the deflection and the section height, h_i .

6. Subroutine II6 - Characteristic Length

In this routine the characteristic length, l_{ij} or CHARLN(i,j), of a suspension assembly i is set to the track length TRAKLN(i) of assembly i if tracked or

$$l_{ij} = 2(\delta_{ij} d_{ti} - \delta_{ij}^2)^{1/2} \quad \text{if wheeled}$$

where $\delta_{ij} = \text{DFLCT}(i,j)$

$d_{ti} = \text{diameter of tire on assembly } i$

7. Subroutine II7 - Ground Contact Area

In this routine the ground contact area, $GCA(i,j)$, for the elements on suspension i is set to

$2 * \text{characteristic length} * \text{track width}$ if tracked

or

$\text{characteristic length} * \text{section width}$ if wheeled

Since the characteristic length depends on tire pressure j , so does the ground contact area.

8. Subroutine II8 - Controlling Lateral Distance

In this routine, the minimum lateral distance, $WTMAX$, from the center of gravity to the supporting element of each suspension assembly is found. This represents the maximum lateral support base. Thus for wheeled vehicles

$$WTMAX = \min \{t_i/2 - y_{CG} + (b_i/2)*ID_i \quad \text{for all } i\}$$

where

t_i = tread width of suspension i

y_{CG} = lateral distance of center of gravity from vehicle center

b_i = section width of tires on suspension i

ID_i = 0 if singles

1 if duals

and for tracked vehicles

$$WTMAX = \min \{t_i/2 - y_{CG} \quad \text{for all } i\}$$

9. Subroutine II9 - Maximum Rolling Radius

The rolling radius of the tire is calculated from the revolutions per mile, $REVM_i$, which is an input parameter, as

$$RR = \max (12*5280)/(2 *REVM_i)$$

10. Subroutine II10 - Maximum Braking Force

This subroutine calculates the maximum braking force the vehicle can support by summing the product of the braking coefficient, $XBRCOF$, entered as part of the vehicle data, and the weight on each suspension element for those suspension elements which are allowed to be braked [$IB(i) = 1$].

This force is to represent the vehicle's ability to arrest its running gear regardless of the running gear ground surface traction coefficient.

11. Subroutine II11 - Horsepower/ton

Here the net horsepower, $HPNET$, entered as part of the vehicle data is divided by the weight of the vehicle supported on the powered traction elements, $CGWP$, converted to tons.

12. Subroutine II12 - Vehicle Cone Index in Fine Grained Soil

This routine calculates the single pass Vehicle Cone Index for fine grained soil (VCIFG) for each suspension assembly by applying the equations for all-wheeled and tracked vehicles to a single axle or a pair of tracked elements. For wheeled axles, a separate VCIFG is calculated for the three tire pressures, possibly different, recommended for fine grained soil, coarse grained soil, or roads. For wheeled axles, the following calculations are made:

Contact Pressure Factor: $CPFFG = W_i / (n_i b_i d_i / 2)$

where for each axle i

W_i = weight on axle

n_i = number of tires

b_i = section width

d_i = outside diameter of tire

Weight Factor: $WF = .553 W_i / 1000.$ if $W_i \leq 2,000$ lbs
 $= .033 W_i / 1000. + 1.$ if $2,000 < W_i \leq 13,500$
 $= .142 W_i / 1000. - .42$ if $13,500 < W_i \leq 20,000$
 $= .278 W_i / 1000. - 3.115$ if $20,000 < W_i$

Tire Factor: $TF = (10 + b_i) / 100.$

Grouser Factor: $GF = 1.00$ without chains ($ICHAIN_i = 0$)
 $= 1.05$ with chains ($ICHAIN_i = 1$)

Wheel Load Factor: $WLORF = (W_i / 1000) / (n_i / 2)$

Clearance Factor: $CLF = CLRMIN_i / 10$

Engine Factor: $EF = 1.00$ if less than 10 hp/ton
 $= 1.05$ if 10 hp/ton or more

Transmission Factor: $TFX = 1.00$ for automatic ($ITVAR = 0$)

= 1.05 for manual (ITVAR \neq 0)

Tire Deflection Factor: $TDF_{ij} = [((1 - \delta_{ij})/b_i)/.85]^{1.5}$

where δ_{ij} = deflection of the tire on axle i when inflated
with pressure recommended for

- j = 1 fine grained soil
- j = 2 coarse grained soil
- j = 3 roadway

Mobility Index: $XMI = [(CPFFG*WF)/(TF*GF) + WLORF - CLF]*EF*TFX$

Vehicle Cone Index (Wheeled, Fine Grained Soil)

$VCIFG_{ij} = [11.48 + .2 XMI - 39.2/(XMI + 3.74)]TDF_{ij}$

For a left- right pair of tracked suspension elements, the following
calculations are made:

Contact Pressure Factor: $CPFFG = W_i/(2l_i b_i)$

where for each left-right pair of tracked elements i

W_i = weight supported by pair

l_i = length of tracked element in contact with
ground

b_i = width of tracked element

Weight Factor: $WF = 1.0$ if $W_i < 50,000$
 $WF = 1.2$ if $50,000 \leq W_i < 70,000$
 $WF = 1.4$ if $70,000 \leq W_i < 100,000$
 $WF = 1.8$ if $100,000 \leq W_i$

Track Factor: $TF = b_i/100$

Grouser Factor: $GF = 1.0$ if grouser height less than 1.5 in.
 $GF = 1.1$ if grouser height is 1.5 in. or more

Bogie Factor: $WLORF = W_i/10/N_i/A_{Si}$

where N_i = total number of road wheels on tracks in
contact with ground

$$A_{Si} = \text{area of one track shoe (in}^2\text{)}$$

Clearance Factor: $CLF = CLRMIN_i/10$

Engine Factor: $EF = 1.00$ if 10 hp/ton or more on element i
 $= 1.05$ if less than 10 hp/ton on element i

Transmission Factor: $TFX = 1.0$ if automatic (ITVAR $\neq 0$)
 $TFX = 1.05$ if manual (ITVAR = 0)

Mobility Factor: $XMI = [(CPFFG*WF)/(TF*GF) + WLORF - CLF]*EF*TFX$

Vehicle Cone Index (Tracked, Fine Grained Soil)

$$VCIFG = 7 + .2 XMI - 39.2/(XMI + 5.6)$$

13. Subroutine II13 - Vehicle Cone Index in Coarse Grained Soil

This routine calculates the single pass Vehicle Cone Index for coarse grained soil (VCICG) for each suspension assembly by applying the equations for an all-wheeled and tracked vehicle to each single axle or each pair of left-right tracked elements. For wheeled axles, a separate VCICG is calculated for the three tire pressures, possibly different, recommended for fine grained soil, coarse grained soil, and roads.

For wheeled axles, the following calculations are made:

Wheel Diameter Factor: $WDF = 2.$ if $b_i/d_{ri} \geq 2.4$
 $WDF = 5.$ if $b_i/d_{ri} < 2.4$

where b_i = nominal tire width

d_{ri} = rim diameter

Contact Pressure Factor:

$$CPFCG = .607p_{ij} + 1.35[(117.*\text{ply rating})/(WDF*b_i + d_{ri})] - 4.93$$

where P_{ij} = pressure of tire on assembly i recommended
for $j = 1$ fine grained soil
 $j = 2$ coarse grained soil
 $j = 3$ roadways

Contact Area Factor: $CAF = \log_{10}(W_i/CPFCG)$

where W_i = weight on axle i

Strength Factor:

$$STF = .0526(n_i + .0211p_{ij}) - .35CAF + 1.587$$

where n_i = number of tires on axle i

Vehicle Cone Index is then 10 raised to the power STF:

$$VCICG_{ij} = 10^{STF}$$

For tracked assemblies, the VCICG is set equal to zero since it is not used in further calculations.

14. Subroutine II14 - Vehicle Cone Index for Muskeg

This routine calculates the single pass Vehicle Cone Index for muskeg (VCIMUK) as follows:

$$VCIMUK = 13 + .535 W_i / (b_i + d_i * n_i) \quad \text{for wheeled axles}$$

where W_i = weight on axle i

b_i = section width of tires on axle i

d_i = outside diameter of tires on axle i

n_i = number of tires on axle i

$$VCIMUK = 13 + .0625 W_i (b_i + l_i) \quad \text{for tracked}$$

assemblies

where b_i = track width

l_i = track length on ground

The use of these relationships to model vehicle performance on muskeg is included primarily for completeness. It is a simplistic model based on data of a single study, Schreiner(1967).

15. Subroutine II15 - Combined Contact Pressure Factor

This subroutine finds the maximum contact pressure factor across suspension assembly. For wheeled assemblies a separate maximum is sought for each pressure setting, $j = 1$ fine grained soil, $j = 2$ coarse grained soil, and $j = 3$ roadway.

16. Subroutine II16 - Power Train

This subroutine controls the calculations used to specify the power train of the simulated vehicle.

The driving, as opposed to braking, characteristics of the vehicle are modeled by a tractive effort vs. speed of vehicle relationship. This relationship is given by a series of quadratics

$$F(v) = c_n v^2 + b_n v + a_n$$

where different values for the constants c_n , b_n , a_n are used for different "gears", n . For computational purposes the gears are really speed ranges. Thus, if $v_0=0 \leq v_1 \leq v_2 \leq \dots \leq v_n$ is a non-decreasing sequence of speeds that represent the "gear" intervals, the tractive effort relationship given by the above formula applies for $v_{n-1} \leq v \leq v_n$.

The precise manner of selecting the sequence $\{v_n$:
 $n=0,1,\dots,NG\}$ and the number of gears, NG , consists of several
discrete steps. The logic of this calculation is shown in Figure
II.B.1.

The first step depends on whether the tractive effort vs. speed
was entered as part of the vehicle data. If so, Subroutine FIT is
entered immediately to calculate NG , the v_n 's, and the coefficients
 a_n , b_n , and c_n .

If the table of tractive effort vs. speed is to be constructed,
it is constructed from basic power train descriptors such as engine
torque at given RPM, the torque converter characteristics, the
transmission and differential and/or transfer case ratios, and the
radius of the drive sprocket or wheels. These calculations are
controlled and performed by Subroutine TRAIN and the Subroutines AUTOM
and STICK.

a) Subroutine TRAIN - Construction of Tractive Effort vs.

Speed Curves

This routine controls the calculations to construct a table of
tractive effort vs vehicle speed values. Since no slip or surface
characteristics are used, this may be called the "rim pull curve".
This routine first loads the speed array, $POWER(SPEED,N)$, with values
of forward speed from zero to 100 MPH in half mile-per-hour
increments. The variable $SPEED$ is declared integer and given a value 1

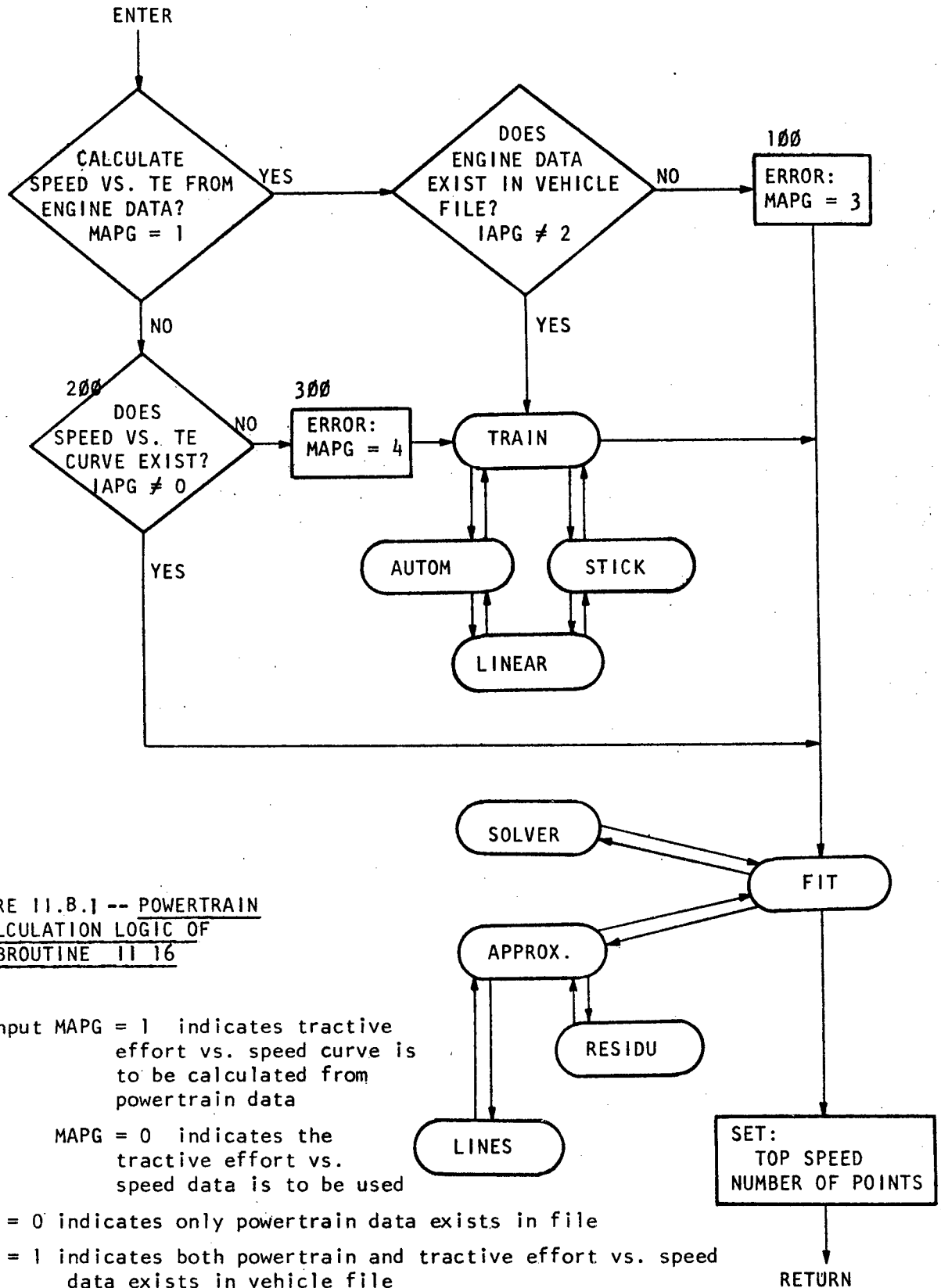

FIGURE 11.B.1 -- POWERTRAIN
CALCULATION LOGIC OF
SUBROUTINE 11 16

On input MAPG = 1 indicates tractive effort vs. speed curve is to be calculated from powertrain data

MAPG = 0 indicates the tractive effort vs. speed data is to be used

IAPG = 0 indicates only powertrain data exists in file

IAPG = 1 indicates both powertrain and tractive effort vs. speed data exists in vehicle file

IAPG = 2 indicates only tractive effort vs. speed data exists in vehicle file

and used for clarity. POWER(FORCE,N) is initialized at zero. Here the variable FORCE is also declared integer and given the value 2 and used for clarity.

The engine torque vs. engine speed relationship is stored in the array ENGINE where the speed values are located in ENGINE(RPM,N) and the torque in ENGINE(TORQUE,N). Here RPM =1 and TORQUE = 2, both declared integer. If the vehicle is fitted with an engine-to-transmission transfer gear box, this relationship is modified to represent the torque vs. speed at the output shaft of this gear box.

Subroutine TRAIN then calls AUTOM for simulation of an automatic transmission or STICK for simulation of a manual transmission. Upon return, diagnostic output is written if called for.

(1) Subroutine AUTOM - Tractive Effort vs. Speed of Vehicle with
Automatic Transmission and Torque Converter

The following calculations are performed for each transmission gear ratio and vehicle speed:

The routine first converts the vehicle speed to torque converter output speed by dividing by 2π times the wheel/sprocket radius and multiplying by the final drive and transmission gear ratios. A trial value of engine RPM is then chosen and the resulting

torque converter speed ratio is calculated. From the input data, a torque converter input speed is estimated (by linear interpolation of the torque converter input speed vs. speed ratio data). The square of the ratio of this torque converter input speed to the engine output speed [which physically must be one but may not be due to the trial value of engine speed not being physically realizable] is then multiplied by the input torque at which the torque converter relationships apply to yield a torque converter input torque. From the engine data, an engine output torque is estimated by linearly interpolating the engine speed vs. torque relationship (also input data). The mismatches between engine output torque and torque converter input torque and engine output speed and torque converter input speed (physically both of which must be the same) are used to adjust the estimated engine speed higher or lower. This adjustment is performed by following a binary iteration scheme.

Once an engine speed at which both the engine output torque matches the estimated torque converter input torque and the engine output speed matches the torque converter input speed has been determined, the torque converter torque ratio at the specified speed ratio is used to calculate a torque converter output torque which when multiplied by gear ratios and efficiencies of the transmission and final drive and divided by the moment arm of the driving wheel/sprocket yields a driving force (tractive effort).

For each gear, the above calculations are done for every speed in the vehicle speed array. For each speed, the maximum tractive

effort among those for various gears is chosen.

(2) Subroutine STICK - Tractive Effort vs. Speed of Vehicle with
Manual Transmission

For each speed and each gear, the vehicle speed is transformed into an engine speed by dividing by the circumference of the driving wheel/sprocket and multiplying by the final drive and transmission gear ratios. An engine torque is then estimated by linearly interpolating the engine speed vs. torque relationship. This torque is then transformed into a driving force (tractive effort) by multiplying by the transmission and final drive gear ratios and efficiencies and dividing by the moment arm of the driving wheel/sprocket.

For each speed, the maximum tractive effort among those for the various gears is chosen.

b) Subroutine FIT - Quadratic Curve Fit to Tractive Effort vs. Speed
Relationship

The Tractive Effort vs. Speed relationship above may be visualized as a sequence of points on a plot of those two variables. This routine determines the coefficients of a sequence of quadratics $F = a + bv + cv^2$ and the minimum and maximum speeds for which each of these quadratics fit the relationship plotted above. Each speed range for which a different set of coefficients (a,b,c) must be used

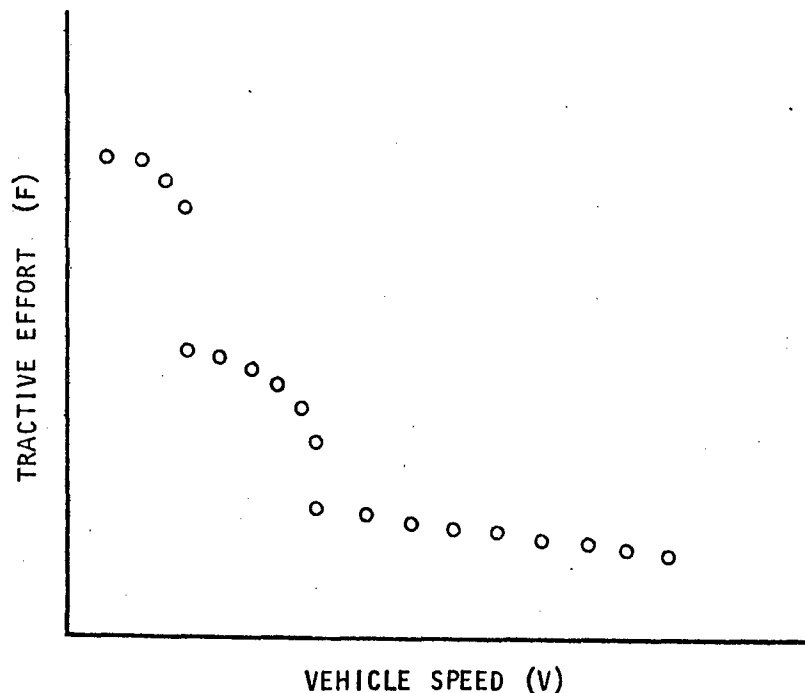

FIGURE 11.B.2 -- Plot of Tractive Effort vs. Speed Array

will be called a "gear" since for some vehicle transmissions the speed range may actually correspond to the speeds for which a particular transmission gear is used.

From the plot it is immediately apparent for what speed ranges each gear should be defined. This is due to the powerful pattern recognition capability of the human eye and brain. An efficient computer algorithm which has the same capability for a sequence of number pairs stored in computer memory is difficult to develop. Although the algorithm of this subroutine is capable of successfully distinguishing maximum and minimum speeds for each gear for large

class of engine/transmission combinations there are still occasional tractive effort vs. force relationships for which the quadratic fit procedure will not be satisfactory. In these cases the program will terminate and print-plot the relationship for human intervention.

The procedure used here is, starting with three points, to sequentially fit quadratics using a least squares criterion and to test if the next point falls within a range of 2% of the tractive effort predicted by extrapolation of the fitted curve. If it does, this (next) point is included in the current gear and the procedure is repeated for the following point. If it does not, a new gear is started.

When all the points "belonging" to gear n have been found the coefficients of the least squares fitted quadratic (ATF,BTF,CTF) are calculated by use of a matrix inversion routine called SOLVER and the minimum, VGV($n,1$), and maximum, VGV($n,5$), speeds of the gear are set. Three speed values are interpolated at regular spacing [VGV($n,2$), VGV($n,3$), and VGV($n,4$)] and the values of tractive effort for these five speeds are calculated [TRACTF($n,1$),...,TRACTF($n,5$)]. A new gear, $n+1$, is then started from the last speed value VGV($n,5$).

When these calculations are complete a subroutine called APPROX calculates the difference between the quadratic approximation to the points and the straight lines fitted between any two adjacent points within the speed range of the gear. Subroutine LINES and RESIDU are used here. RESIDU checks if the difference is large and sets an error

indicator if it is. This test is used to avoid anomalous fits such as illustrated in Figure II.B.3.

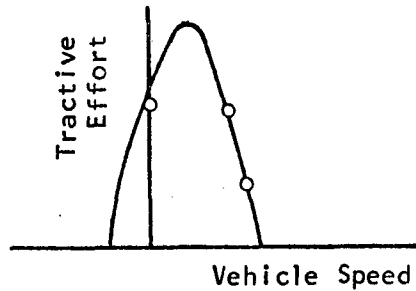

FIGURE II.B.3. -- Possible Anomaly in Quadratic Equation
Fit to a Gear

When this occurs, the program produces a print-plot of the tractive effort vs. speed relationship (both points and fitted curve) and writes a message indicating where the problem occurred and a suggestion that additional points be included in the tractive effort vs. speed array. The subroutines which are used to produce the print - plot are PLTSET, PNTRLT, SCAL, RESCAL, LIMITS and CURPLT.

If the basic tractive effort vs. speed relationship was originally entered as point pairs, all that is required is that additional point pairs be inserted as indicated. Otherwise, a possible solution is to enter the tractive effort vs. speed pairs as read from the printer-plot produced above as vehicle input data with the additional points inserted and to set MAPG to 0.

17. Subroutine II17 - Rotating Mass Factor

This routine calculates a factor which simulates the inertial mass of the rotating parts which have to be accelerated when the entire vehicle is accelerated. The factor varies depending on the gear in which the transmission is engaged. The formula is

$$\text{Rotating Mass Factor}_{NG} = 1 + m_{F1} + m_{F2} * (r_{NG})^2$$

where NG = gear number

$$m_{F1} = .14 \text{ if there is a tracked assembly on the vehicle} \\ = .03 \text{ otherwise}$$

$$m_{F2} = [.008(id)^{1.68}n_e] / n_c W$$

$$i = 2 \text{ if the engine is a two cycle diesel} \\ = 1 \text{ otherwise}$$

d = displacement in cubic inches

n_e = number of engines

n_c = number of cylinders

W = gross combined weight of vehicle

$$r_{NG} = (F_{NG}r_w) / (\eta Q_m)$$

F_{NG} = tractive effort at center speed of gear NG

r_w = rolling radius of driving wheel or sprocket
radius

$$\eta = .7 \text{ if there is a tracked assembly} \\ = .9 \text{ otherwise}$$

Q_m = maximum torque of engine regardless of gear.

C. Terrain Preprocessor

The Terrain Preprocessor is a short subroutine whose primary purpose is to adjust dimensions of the incoming terrain data, to select specific terrain values from optional ones based on scenario variables, calculate some derived terrain descriptors and adjust the terrain for a snow cover if so called for.

First the obstacle dimensions, recognition distance, radius of curvature, and stem spacing are converted to inches. Grade and obstacle approach angle are converted to radians. One of the RCI's given for dry, normal and wet season is selected based on the value of the scenario variable ISEASN.

An elevation correction factor for engine performance is calculated using the equation

$$ECF = 1 - .04e/1000.$$

where e = elevation of the terrain unit in feet, an input variable.

There are terrain situations where, even though the input data indicates obstacles are present in the patch, their effect on vehicle performance is negligible. In this case a flag, IOBS, is set to 1 indicating a patch bare of obstacles. This is done when

1. obstacle spacing is greater than 197 feet
2. obstacle approach angle is from 179 to 181 degrees.

Several parameters describing obstacle spacing are given by the equations below. A test is made to determine the consistency of the three input obstacle parameters in case of a mound since the class interval method of obstacle definition (e.g. as read by MAP71) could result in obstacles that cannot be physically realized. In this case the obstacle base width, OBW, is altered to be consistent with the other two parameters α_o and h_o . The resulting obstacle base width is designated here by w_o .

The ground level width of the obstacle:

$$w_{og} = w_o + 2h_o \text{ABS}(\cos\alpha_o / \sin\alpha_o) \quad \text{for trenches}$$

$$= w_o \quad \text{for mounds}$$

where w_o = base width of obstacle
 h_o = obstacle height
 α_o = obstacle approach angle

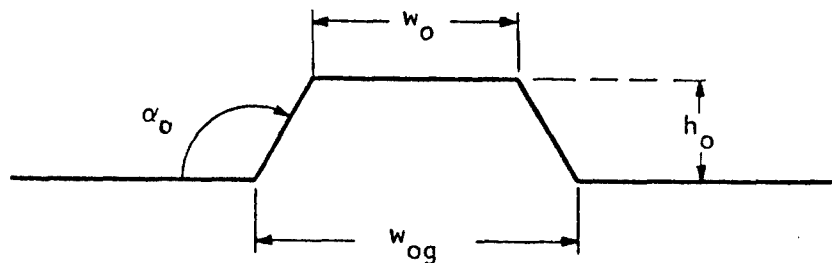

FIGURE II.C.1 -- Side View of an Obstacle

The top of a mound or bottom of a trench is the minimum obstacle width.

$$w_o = w_o \quad \text{for trench}$$

$$= w_o - 2h_o * \text{ABS}(\cos\alpha_o / \sin\alpha_o) \quad \text{for mound}$$

The maximum extent across an obstacle:

$$d_o = (w_{og}^2 + l_o^2)^{1/2}$$

where l_o = length of obstacle

It is assumed here that the ground level plan of the obstacles base is rectangular with width w_o and length l_o .

The mean obstacle approach width:

$$\bar{w}_{oa} = 2(l_o + w_{og})/\pi$$

It is assumed here that the rectangle represented by the base of the obstacle may be oriented at any angle to the approach path of the vehicle and that this approach angle is uniformly distributed between 0 and $\pi/2$. The mean approach width is derived by:

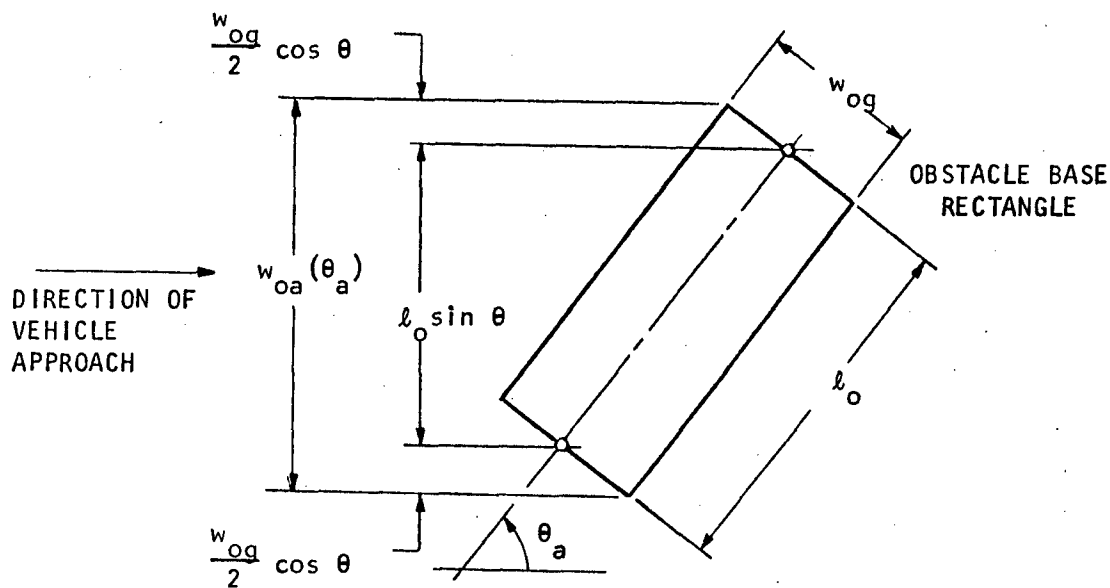

FIGURE 11.C.2 -- Vehicle Approach to Obstacle

where $w_{oa}(\theta_a)$ = obstacle approach width
 θ_a = vehicle approach angle

$$w_{oa} = (2/\pi) \int_0^{\pi/2} w_{oa}(\theta) d\theta$$

Note that for obstacle crossing, both in the Obstacle Module and in the Areal Module, it is assumed that $\theta_a = 90$ degrees. The calculations here are used in the calculations of speed reduction due to maneuvering around obstacles in Areal Module Subroutine IV1.

Average Terrain Unit Area per Obstacle:

$$A_o = \pi(S_o/2)^2$$

where $S_o =$ average obstacle spacing.

This average spacing is calculated by counting the number of obstacles in a large circular area of diameter D . Obstacle spacing is then

$$S_o = [(\pi/N)(D/2)^2]^{1/2}$$

where $N =$ number of obstacles in a circular area of diameter D . S_o is an input terrain variable. Since S_o can be interpreted as the circle diameter which on average contains one obstacle, the area per obstacle is given by the above formula.

For regularly spaced obstacles which cannot be avoided

$$w_{og} = d_o = \bar{w}_{oa} = A_o = 0.$$

If the scenario variable ISNOW calls for a snow cover of z_s inches, the "snow machine" is used. This is a portion of code which sets the surface/soil type to signal snow (IST = 4), reduces the height of obstacles $z_s \gamma / .8$ where $\gamma =$ snow specific gravity, and attenuates the surface roughness by a factor of $\gamma / .4$ for snow depth below twice the surface roughness, RMS, and by a factor of

$$1 - 1/2(1 - \gamma / .4) (z_s / \text{RMS})$$

for snow depths above twice RMS.

No snow is permitted on water covered terrain units and the above obstacle attenuation is not performed for roads and trails (which have no obstacles). The Terrain Preprocessor then returns to the Control and I/O Module.

D. Areal Module

The Areal Module, similar to the Vehicle Preprocessor, is a series of subroutines which are called sequentially by subprogram AREAL of the Control and I/O Module. This section will describe these subroutines in the order that they are called.

1. Subroutine IV1 - Obstacle Spacing and Area Denied

This subroutine calculates data for factors which are used in Subroutines IV2, IV15, IV16, IV17 and IV18 to model the average speed lost due to the increased time it would take a vehicle to maneuver around obstacles and vegetation. This speed loss is related to the size of the vehicle and the density (inverse spacing) of the obstacles and vegetation.

Vegetation, in NRMM, is categorized into NI categories and ranked from small to large stem diameter values. For the data files read by MAP71 and MAP74, NI = 8 and the spacing for a class is that for all the vegetation in that and higher classes. The data files yield a value for the average spacing of the vegetation in each stem diameter class. (The word "class" has been in common use for "category" in this field.) The vehicle/driver speed will be selected from those achieved under a variety of possible avoidance and override strategies. These strategies are all combinations of avoiding and overriding obstacles and avoiding or overriding vegetation in certain size classes as described below.

Within the program these various speed estimates are indexed by stem diameter classes $i = 1, 2, \dots, NI$. Thus, $SRFV(i)$ stands for the speed reduction factor due to overriding vegetation in stem diameter classes $1, 2, \dots, i-1$ and avoiding stem diameter classes $i, i+1, \dots, NI$. Furthermore, $SRFO(i)$ stands for the speed reduction factor due to avoiding obstacles while overriding vegetation in stem diameter classes $1, 2, \dots, i-1$ and avoiding those in classes $i, i+1, \dots, NI$. Eventually these $2NI$ factors will be applied (although not as explicitly calculated variables in the program) to $2NI$ speeds for each of 3 slope crossing conditions (uphill, level and downhill) if cross country simulation is called for ($NTRAV = 3$). This results in $6NI$ speed estimates. If $NTRAV = 1$, only one slope crossing condition is estimated and $2NI$ speeds are calculated.

This calculation of these speed reduction factors is based on the concept that each obstacle or tree to be avoided can be translated into an area of the terrain that is denied to the vehicle, or more precisely above which the CG of the vehicle cannot go. For instance, for a tree with a diameter of d and a vehicle with a width w the area denied by that one tree is a circle of radius $(d+w)/2$ centered at the tree. If many of the areas denied are scattered at random over the terrain unit, any one traverse will be forced to deviate from a straight line for maneuvers around the scattered obstructions. The length of the path is increased when the density of the obstructions and/or the size of the vehicle is increased. Both of these factors increase the area denied. For purposes of NRMM an empirical relation between speed reduction and overall area denied is used to account for

obstruction avoidance.

In this routine the area denied due to the obstacles, ADO, and the area denied due to avoiding vegetation in classes $i, i+1, \dots, NI$, PAV(i), are calculated. Several checks are made for various conditions.

Obstacle avoidance is considered first. If the terrain unit is bare of obstacles, NEVERO is set to 2 indicating that the obstacle override calculations are to be skipped and $ADO = 0$, indicating no area is denied due to obstacles. The routine then considers vegetation avoidance.

Alternately, if the obstacles are so arranged that they are unavoidable, such as in rice paddies, $ADO = 100$. and the effective obstacle spacing $OBSE = OBS$, the actual obstacle spacing.

If obstacles are potentially avoidable, consideration is given as to whether they are small enough to fit under the vehicle or must be bypassed. The variable WI represents the minimum width between running gear elements of the vehicle, i.e., an obstacle no wider than WI will fit under the vehicle if it is no higher than CL, the ground clearance of the vehicle. If the obstacle is wider than WI it will not fit between the running gear and the effective width of the obstacle, EWDTH, is the width of the vehicle, WPTH, plus the width of the obstacle, OAW. The effective obstacle spacing is then $OBSE = AREA/OAW$, the area assigned to each obstacle divided by the

effective obstacle width.

If the obstacle fits between the running gear elements, the effective width of the obstacle is the path width of a single running gear element, PWTE, plus the obstacle width, OAW. The effective obstacle spacing is then calculated as above. A check is made if the obstacle is higher than the ground clearance; if it is, NEVERO = 1 to indicate no obstacle override since the obstacle is too narrow to support the vehicle and too high to fit under it. Then the effective width and spacing is calculated from the full vehicle width, WDTN.

The area denied by the obstacles is then calculated by

$$ADO = 100 (\text{area denied by a single obstacle}) / (\text{terrain unit area per obstacle}).$$

The terrain unit area per obstacle is modeled as a circle whose diameter is the effective obstacle spacing. This area is $\pi(\text{OBSE}/2)^2$.

The area denied by a single obstacle is modeled by surrounding the rectangular obstacle base by a band the half-width of the vehicle and summing the areas of all the regions indicated in the figure II.D.1.

Thus the area denied by a single obstacle is

$$\text{OBL} * \text{WA} + 2(\text{OBL} * \text{WDTH}/2) + 2(\text{WA} * \text{WDTH}/2) + \pi(\text{WDTH}/2)^2.$$

The last term is the sum of the four quarter circles which form a full circle of radius $\text{WDTH}/2$.

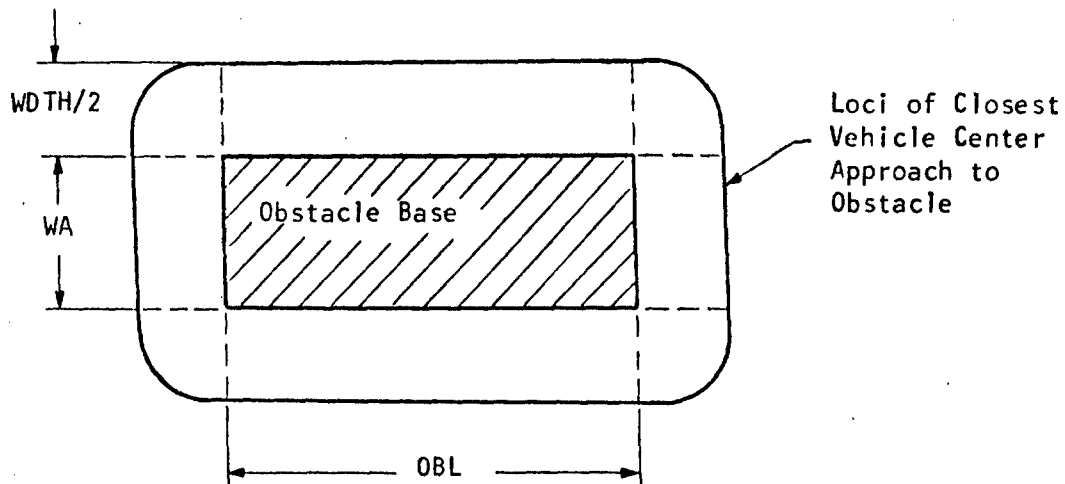

FIGURE 11.D.1 -- Area Denied Due to an Obstacle

To calculate the area denied by the vegetation to be avoided the density of stems in each stem diameter class is calculated first. Since the input data gives the average spacing of vegetation in a stem diameter class and greater, the spacing of individual classes has to be separated. This is given by:

$$d_i = (4/\pi)[1/s_i^2 - 1/s_{i+1}^2] \quad i = 1, \dots, NI-1$$

where d_i = density of stems in stem diameter class i

s_i = average spacing of stems in stem diameter classes
 $i, i+1, \dots, NI.$

NI = number of stem diameter classes

The percentage of the area denied by avoiding stems in stem diameter classes $i, i+1, \dots, NI$ is given by

$$PAV_i = 100/s_i^2 [\sum_{j=i}^{NI} d_{vj} d_j / \sum_{j=1}^{NI} d_j - WPTH]$$

where d_{vj} = diameter of stems in stem diameter class j
WDTH = width of the vehicle.

The total area denied due to avoiding obstacles and stems in stem diameter classes $i, i+1, \dots, NI$ is given by

$$ADT_i = ADO + PAV_i(100-ADO)/100$$

This formula takes some account of the possibility that the vegetation grows on obstacles. No additional area would be denied due to avoiding such vegetation.

2. Subroutine IV2 - Land/Marsh Operating Factors

This routine accounts for terrain units which may be water covered. The effect of the water may be to support part of the weight of the vehicle, reducing the effective normal forces on the running gear needed for traction. At the limit, the vehicle may be fully supported and will be swimming.

The routine first screens the terrain unit type. If it is dry, the float indicator is set to zero, r_{water} (WRATIO in the code) is set to one indicating the full load of the vehicle is on the running gear, and the under water drag area (DAREA) is set to zero. The routine then sets the tire pressure indicator, JPSI, and exits.

If the terrain unit is not dry, a test is made to determine if the water is sufficiently deep to prohibit fording. This can occur for a nonswimming vehicle and will result in a no go indicator, NOGOWD, to be set indicating the vehicle cannot proceed across this terrain unit. For a swimming vehicle this will result in a fully floating operation for which the selected terrain unit speed is set to the swimming speed, VSS, modified by vegetation avoidance. Water covered patches are assumed bare of obstacles.

If the vehicle can ford, that is, when the water is sufficiently deep to be noted but not deep enough to lift the vehicle clear off the ground or to stop its progress, the buoyancy is calculated by linear interpolation in a table of water depth (WDPTH) vs. weight reduction ratio (WRAT) yielding a value of r_{water} below 1.0 which, when applied to vehicle weight terms will reduce ground contact pressure. A final calculation results in the frontal area of the vehicle subjected to the water drag forces for later incorporation into the driving/braking force calculations. Before exit this routine sets JPSI, the tire pressure index. See description of the next routine for an explanation.

3. Subroutine IV3 - Pull and Resistance Coefficients

In this routine the draw-bar pull over weight (DOW) and resistance over weight (RTOW) coefficients for the given vehicle and the soil of the current terrain unit are calculated. Separate pull and resistance coefficients are calculated for each suspension

assembly, thus allowing the simulation of half tracks and tracked vehicles pulling wheeled trailers as well as combinations with large weight variations between axles. Also, different resistance coefficients are calculated for each assembly when it is braked and/or powered (DOWPB, RTOWPB) as opposed to towed in a free wheeling mode (RTOWT). The basic equations are included in Rula and Nuttall (1971) with revisions by Turnage (1972).

Four surface types are included: fine grained soils, coarse grained soils, muskeg and snow. For fine grained soils, provisions are made to simulate the effect on traction of slippery soil surface conditions due to recent rainfall, flooding and or standing water. Separate slipperiness effects are included for CH soils, which are largely impervious to water, and for other, more pervious fine grained soils. Coarse grained soils, muskeg and snow are assumed to never have slipperiness conditions caused by standing water, flooding or rainfall.

Where soil is very soft (soil strength exceeding vehicle cone index by at most 20) slipperiness is not a factor. If this excess (RCIX) is greater than 20 the pull coefficients are reduced by an exponential relationship detailed below. At a certain level, given by $RCIX > RCIS$, the reduction factor becomes constant indicating a "skating condition" on an extremely hard surface. The routine also accounts for the presence (NPAD = 1) or absence (NPAD = 0) of track road pads.

As described in the various routines of the Vehicle Preprocessor above [Sections II.B.3, II.B.5, II.B.6, II.B.7, II.B.12, and II.B.13], allowance is made for vehicles with central inflation pressure systems by allowing changes in tire pressure due to various soil conditions. The input data may contain up to three different tire pressures for use on fine grained soils, coarse grained soils, and highways. The scenario variable NOPP indicates how these should be used. If NOPP = 0, a vehicle which can change its inflation pressure is being simulated and the pressure appropriate for the terrain surface is used. On fine grained soil, muskeg, snow and water covered terrain units the fine grained soil pressure is used. If NOPP is not 0, the tire pressure is set to the inflation pressure to be used for all terrain units regardless of the type. The variable JPSI, set in routine IV2, indicates the pressure to be used: JPSI = 1 for fine grained soil pressure, JPSI = 2 for coarse grained soil pressure, and JPSI = 3 for highway pressure.

In the current subroutine, JPSI indexes the value of VCIFG, DRAT, CPFFG, CHARLN, and GCA to be used. These are, respectively, the vehicle cone indices for fine grained soil, the tire deflection ratio, the contact pressure factor for fine grained soil, the characteristic lengths of the traction elements, and the ground contact area. All of these values depend on tire deflection which depends on the inflation pressure.

This subroutine uses three other subroutines, FGSTR, FGSPC, and FGSPR. These will now be described.

Subroutine FGSTR calculates the fine grained soil towed motion resistance (RTOW) for a suspension assembly. The routine first checks if the assembly is both powered and braked. If so, the assumption is made that it will never be free rolling (towed) so RTOWT, the returned coefficient, is set to zero. If the assembly may be towed and is tracked an error list is written on unit LUN1 and the program is halted since towed, tracked assemblies are not simulated. For towed, wheeled assemblies

$$W' = W_i r_{\text{water}}/n_i$$

where W_i = weight on axle i

r_{water} = weight reduction ratio due to buoyancy
(=1. for dry terrain units)

n_i = number of wheels on axle i

Then

$$\beta = [RCI b_i d_i (\delta_{ij})^{1/2}] / [W' (1 - .5b_i/d_i)]$$

where RCI = rated cone index for assembly

b_i = section width of tire

d_i = outside diameter of tire

δ_{ij} = deflection ratio for pressure j

and

$$RTOW = 1 - .3412\beta \quad \text{for } \beta \leq 2$$

$$RTOW = .04 + .2/(\beta - 1.35) \quad \text{for } \beta > 2$$

This concludes Subroutine FGSTR.

Subroutine FGSPC calculates the fine grained soil pull coefficient (DOW). It depends on the contact pressure factor (CPF) and the excess rating cone index (RCIX) as follows:

$$RCIX = RCI - VCIFG_{ij}$$

For tracked assemblies and $CPF \leq 4$

$$DOW = .544 + .0463RCIX \\ - [(.544 + .0463RCIX)^2 - .0702RCIX]^{1/2}$$

$$\text{for } RCIX < 0, DOW = .076RCIX$$

For tracked assemblies and $CPF \geq 4$

$$DOW = .455 + .0392RCIX \\ - [(.455 + .0392RCIX)^2 - .0526RCIX]^{1/2}$$

$$\text{for } RCIX < 0, DOW = .056RCIX$$

For wheeled assemblies and $CPF < 4$

$$DOW = .3885 + .0265RCIX \\ - [(.3885 + .0265RCIX)^2 - .0358RCIX]^{1/2}$$

$$\text{for } RCIX < 0, DOW = .046RCIX$$

For wheeled assemblies and $CPF \geq 4$

$$DOW = .379 + .0219RCIX \\ - [(.379 + .0219RCIX)^2 - .0257RCIX]^{1/2}$$

$$\text{for } RCIX < 0, DOW = .033RCIX$$

This concludes Subroutine FGSPC.

Subroutine FGSPR calculates the motion resistance coefficient (RTOWPB) of a powered/braked assembly. Similarly to the previous routine, it depends on excess RCI and the contact pressure factor as follows:

For tracked assemblies:

$$RTOWPB = .045 + 2.3075/(RCIX + 6.5)$$

$$\text{for } RCIX < 0 \text{ and } CPF < 4 \quad RTOWPB = .4 - .072RCIX$$

$$\text{for } RCIX < 0 \text{ and } CPF \geq 4 \quad RTOWPB = .4 - .052RCIX$$

For wheeled assemblies and $CPF < 4$

$$RTOWPB = .035 + .861/(RCIX + 3.249)$$

$$\text{for } RCIX < 0 \quad RTOWPB = .3 - .043RCIX$$

For wheeled assemblies and $CPF \geq 4$

$$RTOWPB = .045 + 2.3075/(RCIX + 6.5)$$

$$\text{for } RCIX < 0 \quad RTOWPB = .4 - .029RCIX$$

This completes Subroutine FGSPR.

Returning to Subroutine IV3, initially a test is made to determine the soil type and a transfer is made to the appropriate portion of code which is described next.

a) Fine Grained Soil

For fine grained soils the excess RCI is calculated with respect to the $VCIFG_{ij}$ for assembly i and tire pressure j (if wheeled).

$$RCIX = RCI - VCIFG_{ij}$$

For an assembly never driven nor braked the powered resistance ($RTOWPB_i$) and pull coefficient ($DOWPB_i$) are set to zero and the towed resistance coefficient ($RTOWT_i$) is calculated by a call to Subroutine FGSTR. For powered or braked assemblies and a dry terrain

unit successive calls to FGSPC, FGSPR and FGSTR are used to calculate $DOWPB_i$, $RTOWPB_i$ and $RTOWT_i$, respectively.

If the terrain unit is wet, the value of NSLIP indicates the extent of surface water according to Table II.D.1. For wheeled assemblies, the factor

$$x = \delta_{ij}/.4 - .375$$

where δ_{ij} = deflection ratio of tires on assembly i at inflation j, is used to account for the beneficial effects of high inflation pressure, which helps to maintain the "circular" shape of the tire and thereby improves the tire's ability to break through the slippery layer.

Table II.D.1

Slipperiness Conditions and Parameters

NSLIP	Meaning
1	less than 1" rain with no free water
2	less than 6 hours rain with no free water
3	more than 6 hours rain with no free water
4	less than 1" rain with free surface water
5	less than 6 hours rain with free surface water
6	more than 6 hours rain with free surface water

CH Soils Impervious to Water

NSLIP	Tracked Assemblies		Wheeled Assemblies	
	DOWCS	RCIS	DOWCS	RCIS
1	.5	200	.35	300
2	.3	150	.25x	150
3	.3	200	.2x	200
4	.1	200	.15x	150
5	.1	300	.15x	150
6	.15	500	.15	100

All Other Fine Grained Soils

NSLIP	Tracked Assemblies		Wheeled Assemblies	
	DOWCS	RCIS	DOWCS	RCIS
1	.45	100	.3	80
2	.3	100	.1	80
3	.2	100	.1	80
4	.1	100	.1x	80
5	.1	100	.1	80
6	.15	100	.1	80

These relationships are not used for excess rating cone index, RCIX, less than or equal to 20. In that case the assumption is made that the soil is weak and plastic in relation to the load to be imposed on it by the vehicle and therefore surface water will not have a significant effect on traction and resistance. The coefficients $DOWPB_i$, $RTOWPB_i$ and $RTOWT_i$ are calculated by calls to

subroutines FGSPC, FGSPR, and FGSTR, respectively.

For a soil/vehicle combination where the excess rating cone index (RCIX) exceeds 20, values for comparison rating cone index (RCIO) and pull coefficient (DOWCO) are set as follows:

Tracked Assemblies: RCIO = 18. DOWCO = .4

Wheeled Assemblies: RCIO = 20. DOWCO = .55

and RCIS and DOWCS are set according to Table II.D.1.

If RCIX exceeds RCIS (from the table) and the assembly is wheeled, the pull coefficient is set to the table value of DOWCS and $RTOWPB_i$ and $RTOWT_i$ are calculated using subroutines FGSPR and FGSTR, respectively.

In case of a tracked assembly (and RCIX greater than or equal to RCIS), a further distinction is made for the presence of track road pads. If track pads are present (NPAD =1) the same calculations as for wheeled assemblies are made (under the observation that in both cases a rubber/soil interface exists). If there are no pads (NPAD = 0), in order to include the effect of grouser action when no pads are fitted the pull coefficient ($DOWPB_i$) is set to the average of DOWCS (from the table) and D (as calculated by subroutine FGSPC). The resistance coefficients are again calculated by subroutine FGSPR and FGSTR.

For excess rating cone index (RCIX) less than RCIS (from table) the pull coefficient (in this case DOWS) is calculated by the

log-linear relation

$$\frac{(\log DOWS - \log DOWCS)}{(\log DOWCO - \log DOWCS)} = \frac{(\log RCIX - \log RCIS)}{(\log RCIO - \log RCIS)}$$

For tracked assemblies with track pads, DOWS from this equation is averaged with the pull coefficient D from Subroutine FGSPC to form $DOWPB_i$. Otherwise DOWS becomes $DOWPB_i$. The resistance coefficients $RTOWPB_i$ and $RTOWT_i$ are calculated by subroutines FGSPR and FGSTR.

b) Coarse Grained Soil

This portion of Subroutine IV3 calculates the pull and resistance coefficients for each assembly when the terrain unit contains coarse grained soil. Dimensionless numerics developed by Turnage (1972) are used instead of the vehicle cone index (VCI). A basic cone index gradient term is calculated from

$$G = .8645CI/3.$$

For tracked vehicles, the towed resistance is set to zero since the NRMM does not model towed tracks. The pull coefficient is calculated from the pi term

$$\pi_t = [.6G(b_i l_i)^{1.5}]/W_i$$

where W_i = weight on assembly i

b_i = track width

l_i = track length on ground

by

$$DOWPB_i = .121 + .258 \log \pi_t \quad \text{for} \quad \pi_t \leq 25$$

$$\begin{aligned} \text{DOWPB}_i &= .339 + .109 \log \pi_t && \text{for } 25 < \pi_t \leq 100 \\ \text{DOWPB}_i &= .481 + .038 \log \pi_t && \text{for } 100 < \pi_t \leq 1000 \\ \text{DOWPB}_i &= .595 && \text{for } 1000 < \pi_t \end{aligned}$$

Then the powered/braked resistance coefficient is calculated from

$$\text{RTOWPB}_i = .6 - \text{DOWPB}_i.$$

For wheeled axles, if the axle is never towed, the towed resistance coefficient, RTOWT_i , is set to zero. If the axle can be towed, the π term is calculated by

$$\pi_t = G(b_i d_i)^{1.5} i^{1/3} / [(1 - \delta_{ij})^3 (1 + b_i/d_i) W_i / n_i]$$

where W_i = weight on axle

n_i = number of wheels on axle

b_i = section width of tires on axle

d_i = diameter of tires on axle

i = axle number (from front)

δ_{ij} = deflection ratio for tires at inflation j

The towed resistance coefficient is then calculated by

$$\begin{aligned} \text{RTOWT}_i &= .44 - .01 \pi_t \\ &+ [(.44 - .01 \pi_t)^2 + .0002 \pi_t + .08]^{1/2} \end{aligned}$$

If the wheeled axle can be powered or braked the width and weight are adjusted for the presence or absence of dual wheels. The π term is

$$\pi_d = G(B d_i)^{1.5} \delta_{ij} / W[i]^{1/2}$$

where the above notation is used with

$B = b_i$ for singles, $2b_i$ for duals

$W = W_i/n_i$ for singles, $2W_i/n_i$ for duals.

The pull coefficient is then given by

$$\text{DOWPB}_i = .53 - 4.5/(\pi_d + 3.7)$$

and the powered/braked resistance is

$$\text{RTOWPB}_i = .6 - \text{DOWPB}_i.$$

c) Muskeg

This portion of the subroutine IV3 calculates the pull and resistance coefficients for each suspension assembly when the surface of the terrain unit is designated as muskeg or peat. The equations used are basically those developed for fine grained soils when the contact pressure factor is greater than or equal to 4psi.

The excess rating index is calculated from

$$\text{RCIX} = \text{RCI} - \text{VCIMUK}_i$$

where RCI = rating cone index of terrain unit

VCIMUK_i = vehicle cone index calculated for assembly i

A candidate resistance coefficient is calculated by

$$\text{RT} = 1. \quad \text{if} \quad \text{RCIX} \leq -100$$

$$\text{RT} = 1. - .006(\text{RCIX} + 100.) \quad \text{if} \quad -100 < \text{RCIX} < 0$$

$$\text{RT} = .045 + 2.3075/(6.5 + \text{RCIX}) \quad \text{if} \quad 0 < \text{RCIX}$$

The towed resistance coefficient is set by

$$\begin{aligned} \text{RTOWT}_i &= \text{RT} && \text{if assembly may be towed} \\ &= 0 && \text{if assembly is always either powered} \\ &&& \text{or braked.} \end{aligned}$$

The powered resistance coefficient is set by

$$\begin{aligned} RTOWPB_i &= RT \quad \text{if assembly may be powered or braked} \\ &= 0 \quad \text{if assembly can only be towed.} \end{aligned}$$

For unpowered assemblies the pull coefficient is set to zero. For powered assemblies the following cases are distinguished:

$$\begin{aligned} DOWPB_i &= -1. && \text{if } RCIX \leq -100. \\ DOWPB_i &= -1. + .1(RCIX + 100.) && \text{if } -100. < RCIX \leq 0 \\ DOWPB_i &= .5464 + .1091RCIX \\ &\quad - [(.5464 + .1091RCIX)^2 - .192RCIX]^{1/2} \\ &&& \text{if } 0 < RCIX \text{ and} \end{aligned}$$

the vehicle is tracked with contact pressure factor less than 4 psi

$$\begin{aligned} DOWPB_i &= .3537 + .02258RCIX \\ &\quad - [(.3537 + .02258RCIX)^2 - .03071RCIX]^{1/2} \\ &&& \text{in all other cases.} \end{aligned}$$

d) Shallow Snow

This portion of subroutine IV3 calculates the pull and resistance coefficients for each suspension assembly when the scenario variables indicate that the terrain unit is covered with a shallow layer of snow. For this model shallow snow is defined as snow covering frozen ground at a depth less than the characteristic length of the tire or less than one third of the track length on ground.

Resistance is based on the force required for bulk movement of snow whereas traction is based on the Coulomb equation. Thus the towed resistance for wheeled vehicles is calculated from

$$RT = (10n_i b_i \gamma z_s) / (N d_i l_{ij})$$

where n_i = number of wheels on assembly i
 N = total number of wheel axles on vehicle
 b_i = section width of tire on assembly i
 d_i = diameter of tire on assembly i
 γ = specific weight of the snow
 z_s = snow depth
 l_{ij} = characteristic length of tire on assembly i
at inflation j (see Section II.B.6))

and for tracked vehicles from

$$RT = (\gamma z_s) / (2l_{ij})$$

where l_{ij} = the characteristic length of the track.
For suspension assemblies that are never towed, $RTOWT_i = 0$. For assemblies that may be powered or braked the above equations are used for $RTOWPB_i$.

The pull coefficients are calculated using

$$TOWMAX = \tan \phi + (cA_{ij}n_i) / W_i \quad \text{wheeled assembly}$$

$$TOWMAX = \tan \phi + (cA_i / W_i) \quad \text{tracked assembly}$$

where ϕ = internal angle of friction

c = cohesion

A_i, A_{ij} = ground contact area

n_i = number of wheels on assembly i

W_i = weight supported by assembly i .

The pull coefficient is then set to

$$DOWPB_i = TOWMAX - RT.$$

In all cases (fine grained soil, slippery fine grained soil, coarse grained soil, muskeg or snow) Subroutine IV3 passes on

$RTOWT_i$ = towed resistance coefficient

$RTOWPB_i$ = powered/braked resistance coefficient

$DOWPB_i$ = pull coefficient

for each suspension assembly i.

4. Subroutine IV4 - Summed Pull and Resistance Coefficients

In this routine the individual suspension assembly resistance and pull coefficients are summed to provide overall, average vehicle coefficients. The formulas concerning traction are:

$RTOWP$ = sum of $RTOWPB_i * W_i / GCWP$ for powered assemblies i

$DOWP$ = sum of $DOWPB_i * W_i / GCWP$ for powered assemblies i

$RTOWNP$ = sum of $RTOWT_i * W_i / (GCW - GCWP)$ for unpowered

assemblies i

where $RTOWP$ = average powered assembly resistance coefficient

$DOWP$ = average powered assembly pull coefficient

$RTOWNP$ = average un-powered assembly resistance coefficient

W_i = weight supported by assembly i

$GCWP$ = weight supported by all powered assemblies

GCW = gross combination weight

$RTOWPB_i$ = powered resistance coefficient of assembly i

$DOWPB_i$ = pull coefficient of assembly i

$RTOWT_i$ = towed resistance coefficient of assembly i.

The formulas concerning braking are similar to the above except that the summation is over the braked and non-braked assemblies.

5. Subroutine IV5 - Slip Modified Tractive Effort

This routine modifies the vehicle tractive effort vs. speed relationship, calculated in Subroutine II16 of the VPP, for slippage of the running gear in the soil. This relationship was stored as the coefficients of a quadratic relating speed to tractive effort in a "gear". Each gear was specified as an interval in the speed range of the vehicle.

This subroutine calls four other subroutines named TFORCF, VELFOR, SLIP, and QUAD5. These routines calculate

1. the soil limited maximum tractive effort (TFOR) available to the vehicle [by TFORCF]
2. the maximum velocity (VX) achievable when just overcoming a given resistance [by VELFOR]
3. the slip of the running gear (SLIP) when operating at a certain pull force coefficient [by SLIP]
4. the least square fitted quadratic to five points under the constraint that the fitted curve must pass through the extreme points of the independent variable, SPEED, [by QUAD5].

Subroutine IV5 first retrieves the appropriate ground contact pressure factor (either CPF CFG_j or CPF CCG_j) and, in the case of soil types other than snow, calls subroutine TFORCF to calculate the maximum tractive effort (TFOR) available from the soil. In case of snow cover this is calculated from the pull (DOWP) and powered resistance (RTOWP) coefficients times the effective weight on the powered wheels. The routine then performs the following calculations

FIGURE 11.D.2 -- SUBROUTINE IV5 -
Slip Modified Tractive Effort

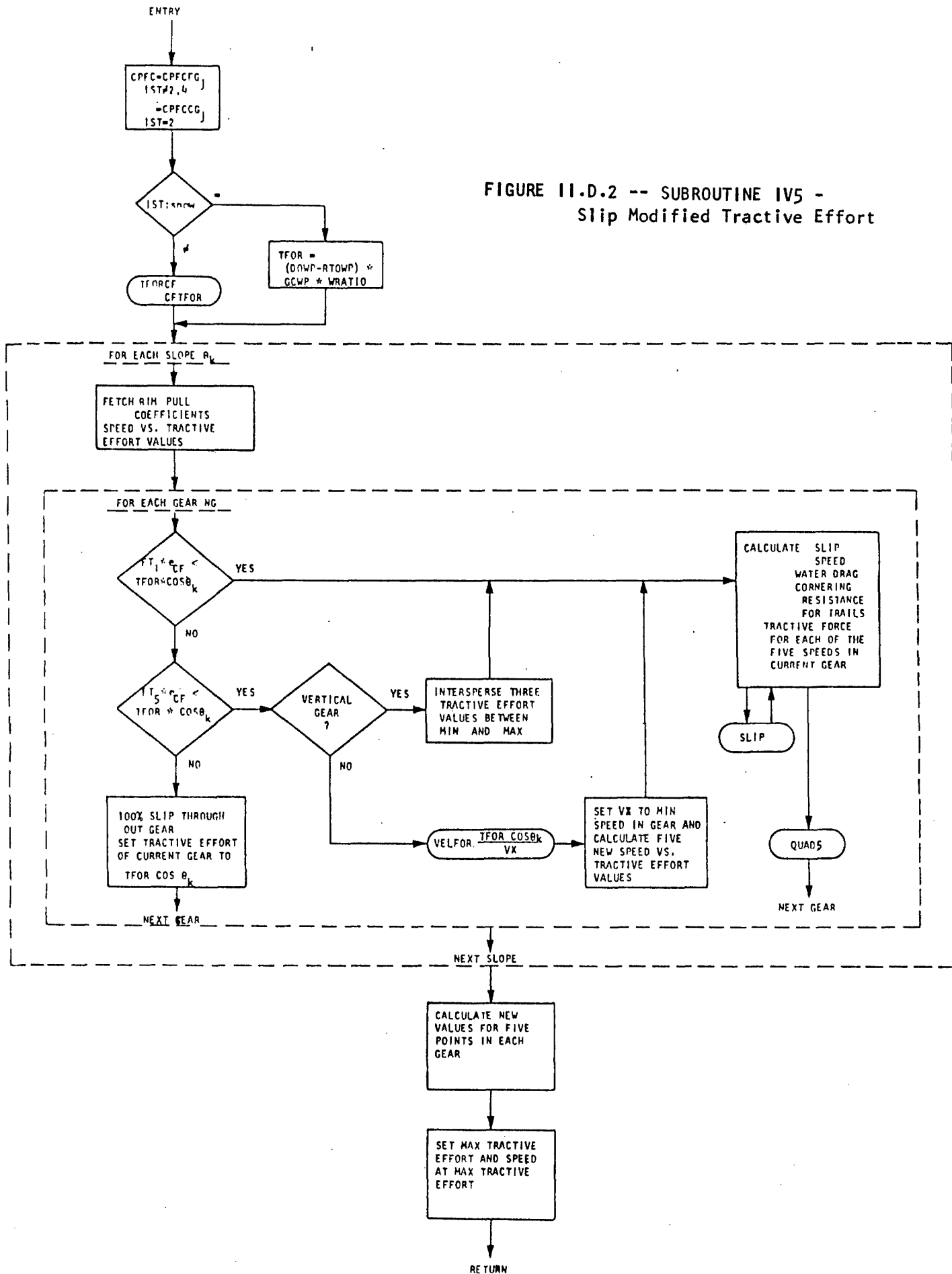

for each slope (θ_k) and gear (NG).

Gears do not necessarily correspond to real gears in the transmission; they are intervals in the total speed range for which the tractive effort vs. speed curve (rim pull curve) can be well approximated by a quadratic.

$$F = a_{NG} + b_{NG}v + c_{NG}v^2 \quad \text{for } v_{1,NG} \leq v \leq v_{5,NG}.$$

Five points $\{(v_{i,NG}, F_{i,NG}), i=1, \dots, 5: v_{i-1,NG} \leq v_{i,NG}, i=2, \dots, 5\}$ are given for the curve for each gear NG. A "vertical" gap, as shown in figure II.D.2, at speed \bar{v} is approximated as a gear with $v_{1,NG} = \dots = v_{5,NG}$ and five values of F as indicated by the figure. It is generally assumed that $F_{1,NG}$ is the maximum tractive effort in gear NG (i.e. $F_{1,NG} \geq F_{i,NG}$) and that $F_{5,NG}$ is

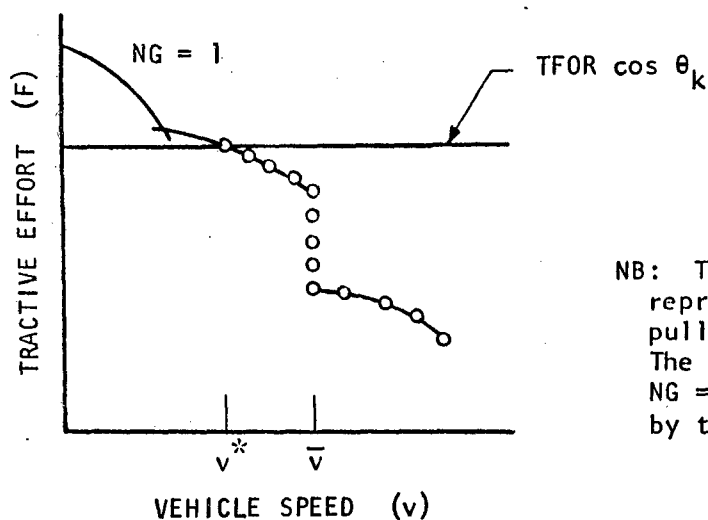

NB: The lines represent rim pull curve. The entire gear NG = 1 is represented by the point at $v = 0$.

FIGURE II.D.3 -- Tractive Effort vs. Speed Modification for Soil and Slope

the minimum tractive effort in gear NG (i.e. $F_{5,NG} \leq F_{i,NG}$).

The routine fetches the coefficients (a_{NG} , b_{NG} , c_{NG}) and the points ($v_{i,NG}$, $F_{i,NG}$) for each gear. These will be modified for slip. First the total tractive effort available from the vehicle in each gear NG, $F_{1,NG}e_{CF}$, corrected by a terrain unit elevation factor e_{CF} , is compared to the slope modified maximum surface traction $TFOR\cos\theta_k$. If not all the vehicle tractive force can be applied ($F_{1,NG}e_{CF} \geq TFOR\cos\theta_k$) the minimum surface tractive force $F_{5,NG}e_{CF}$ is compared to the maximum surface traction. If the vehicle tractive effort exceeds the maximum surface tractive force throughout the gear ($F_{5,NG}e_{CF} > TFOR\cos\theta_k$) the entire gear is approximated by 100% slip, the speeds $v_{i,NG}$ are all set to zero and the tractive effort is set to a constant $TFOR\cos\theta_k$. The quadratic then reduces to $a_{NG} = TFOR\cos\theta_k$ with $b_{NG}=c_{NG}=0$.

If the soil can support a tractive effort between the minimum and maximum of the gear NG ($F_{5,NG} < TFOR\cos\theta_k \leq F_{1,NG}$), the subroutine VELFOR is called to determine the speed v^* in the interval $[v_{1,NG}, v_{5,NG}]$ at which the vehicle produces the maximum surface tractive effort. The interval representing the gear NG is now adjusted to be $[v_{1,NG} = v^*, v_{5,NG}]$, the maximum tractive effort for this gear is reset to

$$F(v^*) = a_{NG} + b_{NG}v^* + c_{NG}(v^*)^2$$

and five new values of tractive effort are calculated at equally spaced speed values from v^* to $v_{5,NG}$. These become the new gear $\{(v_{i,NG}, F_{i,NG}), i=1, \dots, 5: v_{1,NG}=v^*\}$. If this gear was a

vertical gear, the five points would be equally spaced from $F_{1,NG}$ to $F_{5,NG}$ all at $v_{1,NG}$.

If the maximum available tractive effort in the soil, modified for slip, is greater than the rim pull tractive effort, corrected for elevation, everywhere in the gear ($TFOR\cos\theta_k > F_{i,NG}e_{CF}$) the computations proceed directly to adjustment of the speeds $V_{i,NG}$ for slip.

The above computations have the effect of limiting the tractive effort vs. speed curve of the vehicle, the rim pull curve, by the maximum tractive effort available from the terrain unit surface material. Each of the five points ($v_{i,NG}, F_{i,NG}$) for each gear NG are now individually adjusted for slip, altitude, and extra drag using the equations below. The force coefficient is calculated by

$$y = (F_{i,NG} e_{CF} r_w) / (GCWP \cos\theta_k) - CF$$

where r_w = proportion of vehicle weight on running gear (=1 except possibly for water covered terrain units)

CF = slip curve correction factor (calculated in Subroutine TFORCF)

$GCWP$ = gross combination weight on powered suspension elements.

This ratio is used by Subroutine SLIP to calculate the slip required of the traction elements (SLIPX) to produce force $F_{i,NG}$ for the given vehicle and terrain unit. The vehicle speed is then adjusted by

$$v_c = v_{i,NG} (1. - SLIPX)$$

and the new point $(v_c, F_{i,NG}^{eCF})$ replaces $(v_{i,NG}, F_{i,NG})$ in the tractive effort vs. speed curve for the current terrain unit.

For water covered terrain units a hyperbolic drag is calculated from

$$w_D = (.00111C_D A v_c^2)/2$$

where C_D = drag coefficient

A = submerged frontal area

and this drag is subtracted from $F_{i,NG}^{eCF}$.

For terrain units designated as trails, a cornering drag for wheeled assemblies is calculated by

$$F_c = F_e \left\{ \text{sum of } (W_e \cos \theta_k v_{i,NG, MPH} / 111.1 R')^2 \right. \\ \left. [.75/n_1 \alpha_1 (TFOR/GCWP)] \right\} \text{ for all wheeled assemblies 1}$$

where F_e = superelevation factor given by

$$F_e = 1 - 7.495R'e$$

e = superelevation angle

R' = radius of curvature in feet

$v_{i,NG, MPH}$ = speed $v_{i,NG}$ in MPH

W_1 = weight on axle 1

n_1 = number of wheels on axle 1

α_1 = cornering stiffness of tires on axle 1

This force is subtracted from $F_{i,NG}^{eCF}$.

The five new tractive effort vs. slip corrected speed points for each gear are now fitted with a quadratic which is constrained to

pass through the points for the minimum and maximum slip corrected speeds of the gear using Subroutine QUAD5. Before returning, subroutine IV5 sets the maximum available tractive effort value for each slope, FORMX(K), and the speed at which FORMX(K) occurs, VFMAX(K).

a) Subroutine TFORCF - Soil Limited Tractive Effort

The drawbar pull and traction vs excess rating cone index relationships used in NRMM are based on tests conducted at 20% slip (Turnage (1972)). Subroutine IV5 requires tractive effort at 100% slip.

This routine calculates the slip curve correction factor, CF, and the soil limited tractive effort, TFOR, according to the following formulas:

Fine Grained Soil

Tracked Vehicles

$$CF = DOWP - .758 + RTOWP \quad \text{for CPFC} < 4$$

$$TFOR = (CF + .82)GCWP$$

$$CF = DOWP - .671 + RTOWP \quad \text{for CPFC} \geq 4$$

$$TFOR = (CF + .71)GCWP$$

Wheeled Vehicles

$$CF = DOWP - .674 + RTOWP \quad \text{for CPFC} < 4$$

$$TFOR = (CF + .76)GCWP$$

$$CF = DOWP - .585 + RTOWP \quad \text{for CPFC} \geq 4$$

$$TFOR = (CF + .655)GCWP$$

Coarse Grained Soil

Tracked Vehicles

$$CF = .074$$

for rigid track

$$TFOR = (CF + .568)GCWP$$

$$CF = .1$$

for flexible track

$$TFOR = (CF + .695)GCWP$$

Wheeled Vehicles

$$CF = DOWP - .56 + RTOWP$$

$$TFOR = (CF + .575)GCWP$$

Muskeg

Wheeled Vehicles and $CPFC \geq 4$

$$CF = DOWP - .68 + RTOWP$$

$$TFOR = (CF + .745)GCWP$$

All other cases

$$CF = DOWP - .88 + RTOWP$$

$$TFOR = (CF + .91)GCWP$$

b) Subroutine VELFOR - Maximum Velocity Overcoming a Given
Resistance

This routine finds the maximum velocity, v^* , that a vehicle can travel while overcoming a given resistance from the tractive effort vs. speed curve after adjustment for soil limited traction and driving element slip.

The tractive effort vs. speed curve is given by

$$F = a_{NG} + b_{NG}v + c_{NG}v^2,$$

a sequence of quadratics in various speed ranges ($v_{1,NG} \leq v \leq v_{3,NG}$), where NG indexes the speed ranges from 1 to NGR, the number of speed ranges (or gears). Note that for this routine there are three speeds given for each gear. This routine in effect solves for maximum v given an F by solving the quadratic equation

$$c_{NG}v^2 + b_{NG}v + (a_{NG} - F) = 0.$$

Let the discriminant be denoted by

$$d^2 = b_{NG}^2 - 4(a_{NG} - F)c_{NG}.$$

For $d^2 < 0$ it must be true that $c_{NG} \neq 0$ and $a_{NG} - F \neq 0$. Then the quadratic has no real solution. If $c_{NG} > 0$, the tractive effort vs. speed curve for the gear NG lies entirely above the value F so the speed, v^* , that the vehicle can achieve is set to the maximum in the gear, namely $v^* = v_{3,NG}$. If $c_{NG} < 0$ the entire curve for the gear is below the value F so the vehicle cannot overcome the resistance in the gear NG and thus a lower gear is tested.

For $d^2 = 0$ two cases can occur. For $c_{NG} \neq 0$ there is a unique intersection between the quadratic and the line $F = \text{constant}$. Since a single point intersection (tangency) between the tractive effort vs. speed curve and the line $F = \text{constant}$ is, realistically, similar to no intersection at all, decisions like those for the case of $d^2 < 0$ are made when $c_{NG} < 0$ [seek a lower gear] and when $c_{NG} > 0$ [set $v^* = v_{3,NG}$]. When $c_{NG} = 0$, then $b_{NG} = 0$ (since $d^2 = 0$) and thus the tractive effort vs. speed curve for gear NG is a

horizontal line through a_{NG} . If $F < a_{NG}$ the vehicle can proceed at maximum speed in the gear [set $v^* = v_{3,NG}$] and if $F > a_{NG}$ the vehicle cannot overcome the resistance F in gear NG and thus a lower gear is sought.

For a positive discriminant, $d^2 > 0$, and $c_{NG} = 0$, the tractive effort vs. speed curve in gear NG is a straight line. If the intersection of this line with $F = \text{constant}$ is to the right of the maximum speed, $v_{3,NG}$, in gear NG then if $b_{NG} > 0$ the curve is below $F = \text{constant}$ in the speed range NG and the vehicle cannot overcome the resistance F in gear NG and thus a lower gear is sought. If $b_{NG} < 0$ then the curve is above $F = \text{constant}$ and $v^* = v_{3,NG}$. If the intersection is to the left of the minimum speed, $v_{1,NG}$, in gear NG then the reverse is true, namely that $v^* = v_{3,NG}$ if $b_{NG} > 0$ and a lower gear is sought if $b_{NG} < 0$. For the case when the intersection occurs at (v, F) and $v_{1,NG} < v < v_{3,NG}$ then $v^* = v$ for $b_{NG} < 0$ and a lower gear is sought for $b_{NG} > 0$.

For a positive discriminant and $c_{NG} \neq 0$ there are two real roots for the quadratic equation, the greater being designated by $v = RH$ while the lesser by $v = RL$. Three cases may be distinguished, the first for both roots negative. Then in the range of a gear the tractive effort vs. speed curve is either entirely above (indicated by $b_{NG} > 0$) or entirely below (indicated by $b_{NG} < 0$) the line $F = \text{constant}$. The $v^* = v_{3,NG}$ or lower gear is sought, respectively. In the second case only one root is positive, then results similar to the prior $d^2 > 0$, $c = 0$ case are used. The curves for positive v are

not straight lines in this case but they are strictly monotonic with less and less curvature for increasing v . In the third case when both RH and RL are positive a test is made as to their relationship to $v_{1,NG}$ and $v_{3,NG}$. The cases are distinguished by the determination of whether the tractive effort vs. speed curve is above or below $F = \text{constant}$. If it is above at $v_{1,NG}$ then the highest root in the interval $v_{1,NG} < v < v_{3,NG}$ is used as v^* . If the curve is above at both $v_{1,NG}$ and $v_{3,NG}$, then $v^* = v_{3,NG}$. If the curve is below at $v_{1,NG}$ a lower gear is sought.

If the subroutine cannot find a gear for which the tractive effort exceeds the resistance a final test against the maximum tractive effort, $FORMX$, is made. If $FORMX \geq F$, the velocity $v^* = v_{max}$, the velocity at which the vehicle exhibits its maximum tractive effort. If $FORMX < F$, then $v^* = 0$.

c) Subroutine SLIP - Powered Traction Element Slip for Given
Traction Coefficient

This routine uses empirical equations presented in Appendix A of Rula and Nuttall (1971) to determine the longitudinal slip of the powered traction elements in order to produce a given traction (pull) coefficient, y . These relationships are given by the following:

Fine Grained Soil

Tracked

$$S = .0257y - .0161 + .01519/ (.8353 - y) \quad \text{for } CPFC < 4$$

$$S = .0733y - .0063 + .00734/ (.7177 - y) \quad \text{for } CPFC \geq 4$$

Wheeled

$$S = .0621y - .021 + .01888/ (.7794 - y) \quad \text{for CPFC} < 4$$

$$S = .084y - .016 + .01414/ (.6697 - y) \quad \text{for CPFC} \geq 4$$

In case of wheeled vehicles with CPFC ≥ 4 on fine grained soil the slip is further reduced by dividing it by 1.1 if the vehicle is equipped with a locking differential.

Coarse Grained Soil

Tracked

$$S = -.0083 + .005312/ (.573 - y) \quad \text{for rigid tracks}$$

$$S = 1.074y - .72$$

$$+ [(1.074y - .72)^2 + .09y + .009]^{1/2}$$

for flexible tracks

Wheeled

$$S = .0074y - .0061 + .00374/ (.5785 - y)$$

This last value of S is further reduced by dividing by 1.1 if the vehicle is equipped with a locking differential.

Muskeg

$$S = .0585y - .0106 + .01336/ (.964 - y) \quad \text{for tracked vehicle with CPFC} < 4$$

$$S = .1024y - .00864 + .01062/ (.7564 - y) \quad \text{all others}$$

In the case of wheeled vehicles with a locking differential, S is further reduced by dividing by 1.1.

Shallow Snow

$$S = .3(1 - [1-y]^{1/2}) \quad \text{for } y < 1$$

$$S = 1 \quad \text{for } y \geq 1$$

In all cases if S lies outside the interval $0 \leq S \leq 1$ it is set to 1.

d) Subroutine QUAD5 - Quadratic Fit to 5 Points

This subroutine uses the least square criterion to fit a quadratic to five points under the constraints that the curve must pass through the points with the lowest and highest value of the independent variable.

6. Subroutine IV6 - Resistance Due to Vegetation

This subroutine calculates the resistance to vehicle motion caused by vegetation when the vehicle attempts to override it. Since vegetation is categorized into NI classes on the basis of stem diameter, separate resistance forces are calculated for each class. If the terrain unit is bare of vegetation all the resistances are set to zero. All resistances are also set to zero for the smallest stem diameter class. Otherwise, for each stem diameter class i beginning at class 2 the force needed to override the largest tree in class i is given by

$$F_{v,i+1} = (56/5.8) * d_{vmi}^3$$

and the force against the vehicle pushbar exerted by such an override attempt is given by

$$F_{vm,i+1} = (40 - b_{PB}/2) d_{vmi}^3.$$

The force required to override all the vegetation in classes i and stem diameters is given by

$$F_{v,i+1} = 12w100[\text{sum of } j d_{vj}^3 \text{ for } j=1 \text{ to } i]$$

where d_{vmi} = stem diameter of the largest stems in class i

d_{vj} = stem diameter of representative stem in class j

b_{PB} = push bar height of vehicle

w = width of vehicle

j = density of stems in class j .

These relationships may be found in Rula and Nuttall (1971) starting on page 157.

7. Subroutine IV7 - Driver Dependent Vehicle Vegetation Override Check

This routine determines the maximum stem diameter class which the driver will try to override. For each class not overridden an indicator is set as to whether it was driver tolerance or pushbar capacity that limited the override. The driver tolerance is based on longitudinal acceleration and is currently limited by 2 g's. Thus if for stem class i , $F_{vmi} > F_{mPB}$, the indicator will be set to no override [IMPACT(i)=1] due to pushbar weakness. If $F_{vmi}/GCW > 2.$, the indicator will be set to no override [IMPACT(i)=2] due to driver limit. If both limits are exceeded IMPACT(i)=3. The maximum stem diameter class to be overridden (indexed by MAXI) will be the largest stem class for which neither limit was exceeded.

8. Subroutine IV8 - Total Resistance Between Obstacles

In this routine the resistance to vehicle motion due to soil, slope and vegetation is summed to produce a resistance between obstacles. For each slope (up,level,down indexed by k) the resistance while overriding a single tree of stem diameter class i is given by

$$R_{T1ki} = GCW \sin \theta_k + (RTOWP * CGWP + RTOWNP * CGWNP) r_w \cos \theta_k + F_{v1i}$$

and the resistance while overriding all vegetation in stem diameter classes $i-1$ and smaller is

$$R_{Tki} = GCW \sin \theta_k + (RTOWP * GCWP + RTOWNP * GCWNP) r_w \cos \theta_k + F_{vi}$$

where GCW = gross combined weight

GCWP = gross combined weight on powered elements

GCWNP = gross combined weight on unpowered elements

θ_k = slope angle

RTOWP = powered elements resistance coefficient

RTOWNP = unpowered elements resistance coefficient

r_w = proportion of vehicle weight on running gear elements (=1 except possibly for water covered terrain units)

F_{v1i} = force required to override the largest tree in stem diameter class $i-1$

F_{vi} = force required to override vegetation in stem diameter classes $i-1$ and smaller.

9. Subroutine IV9 - Speed Limited by Resistance Between Obstacles

This routine uses Subroutine VELFOR (described as part of Subroutine IV5 above) to determine the maximum speed the vehicle could travel while overcoming the resistance R_{T1ki} and R_{Tki} calculated in Subroutine IV8.

If the resistance due to soil, slope and vegetation in a certain stem diameter class is larger than that which the vehicle is capable of overcoming at any speed, the velocity is set to zero and MAXI is lowered to reflect the fact that vegetation override will not be attempted for that class. In traverse mode (NTRAV=1) all velocities for slopes other than the designated slope are set to zero.

10. Subroutine IV10 - Speed Limited by Surface Roughness

Prior to runs of NRMM, a cross plot of speed vs. surface roughness was made from repeated runs of VEHDYN (See Chapter 1. Overview). Each of these cross-plots implies that, for the given surface roughness, the speed given is the maximum speed the vehicle can operate without subjecting the driver to vibrations exceeding a certain level of absorbed power. INRMM allows for several of these plots, giving results for several levels of absorbed power, to be entered as part of the vehicle data. The choice of which one to use is indicated by scenario variable LAC.

In this routine the speed vs. surface roughness array is searched and linearly interpolated for the maximum speed a vehicle could travel without subjecting the driver to vibrations resulting in an absorbed power greater than the limits implied by the choice of LAC.

11. Subroutine IV11 - Total Braking Force - Soil/Slope/Vehicle

This routine calculates the total braking force available to the vehicle. Two basic components are calculated. The first is the braking force due to the resistance of the running gear which is always present regardless of whether the brakes are on or not. This force is estimated as

$$X_1 = (RTOWB*GCWB + RTOWNB*GCWNB)r_w$$

where RTOWB = resistance coefficient of braked running gear elements

RTOWNB = resistance coefficient of unbraked running gear
elements

GCWB = gross combined weight on braked running gear elements

GCWNB = gross combined weight on unbraked running gear
elements

r_w = proportion of vehicle weight supported by running
gear elements (=1 except possibly for water covered
terrain units).

The other component calculated is due to the retardation force when the brakes are applied. The maximum retardation force available from the terrain unit surface material is calculated by

$$X_2 = (DOWB + RTOWB)GCWBr_w$$

where DOWB is the pull coefficient of the powered wheels. This force, adjusted for slope, is compared to the maximum force the vehicle can exert, X_{BR} , the lesser of the two being used. The total braking is the sum of these two components plus or minus the force due to gravity on slopes. Thus

$$T_{BFk} = GCWr_w \sin \theta_k + X_1 \cos \theta_k + \min[X_{BR}, X_2 \cos \theta_k]$$

where θ_k = slope angle.

If T_{BFk} is negative [due to $\sin\theta_k$ on downhill slopes] a no-go indicator is set , NOGOBF=1, under the supposition that the vehicle cannot be controlled without sufficient braking. Calculations are continued since the situation being simulated may not actually stop the vehicle, as for instance, on a long straight downhill slope for which the next terrain unit is flat and sufficiently bare of obstructions to allow run-out.

12. Subroutine IV12 - Maximum Braking Force -
Soil/Slope/Vehicle/Driver

In this routine the maximum braking force calculated in the previous routine may be attenuated due to simulation of driver actions. It has been observed that drivers do not always use the maximum braking force available either due to choice or lack of skill. In addition drivers may not even use all of that braking force, preferring to always keep some in reserve for "safety's sake". These actions are modeled by two vehicle inputs:

DCLMAX = the maximum braking force (in g's) a driver will use due to comfort or skill (the "lunch box" limit)

SFTYPC = the percentage of the theoretical maximum the driver will actually use "for safety" (e.g. to prevent lockup of wheels).

If the user wishes no restriction on the performance of the vehicle due to driver imposed limits, the scenario variables DCLMAX and SFTYPC

should be set to high values.

The braking used in further calculations is given by

$$B_{MXk} = \min[DCLMAX*GCW, T_{BFk}*SFTYPC/100]$$

where k = slope index (1 = up, 2 = level, 3 = down).

13. Subroutine IV13 - Speed Limited by Visibility

In this routine the maximum speed at which a driver may proceed to just stop within the visibility distance without exceeding the braking force (calculated in the previous routine) is calculated.

The recognition distance is calculated by:

$$D_r = D_v h_e / 60$$

where D_v = visibility distance

h_e = driver eye height.

The deceleration due to the braking force the driver will actually use is given by

$$a_{ck} = B_{MXk} g / GCW$$

where g = acceleration of gravity

k = slope index (1 = up, 2 = level, 3 = down)

B_{MXk} = maximum braking force actually used on slope k .

The maximum speed limited by visibility, V_{vk} , is calculated from the solution of the equation for recognition distance required to stop, which is

$$D_r = t_r V_{vk} + V_{vk}^2 / (2B_{MXk})$$

where t_r = reaction time between recognition and application of brakes.

If the braking force B_{MXk} is nonpositive, the speed limited by visibility is set to zero. In addition, if V_{vk} is positive but less than $VISMNV$, the minimum speed the driver will accept despite full obscuration of his vision, then V_{vk} is set to $VISMNV$.

14. Subroutine IV14 - Selected Speed Between Obstacles

This routine chooses the minimum among the following speeds for travel between obstacles. This selection is made for each slope - vegetation override class.

$VTIRE_j$ = maximum safe tire speed at inflation pressure j
99% of $V_{SOIL,k,i}$ = velocity limited by soil, slope
and vegetation resistance for slope
 k overriding vegetation in classes
 $i-1$ and smaller

V_{RID} = velocity limited by surface roughness

V_{vk} = velocity limited by visibility and braking force
on slope k

A separate speed limit, V_{ttki} , is chosen for each slope k (1 = up, 2 = level, 3 = down) and overriding vegetation in class $i-1$ and smaller. Less than 100% of $V_{SOIL,k,i}$ is used since the velocity - distance curve has an asymptote at $V_{SOIL,k,i}$, which means that a vehicle can never accelerate up to $V_{SOIL,k,i}$.

15. Subroutine IV15 - Maximum Speed Between and Around
Obstacles

This routine calculates, for each slope k and vegetation override index i , VBO_{ki} , the maximum speed the vehicle can achieve while traveling between obstacles, and $V_{AVOIDki}$, the speed which the vehicle can achieve in the terrain unit while avoiding all obstacles.

Between obstacles, VBO_{ki} represents the maximum speed a vehicle can travel while overriding vegetation in stem diameter classes $i-1$ and smaller while avoiding all vegetation in stem diameter classes i and larger by maneuvering. This maneuvering will lower the overall average speed due to path elongation and a variety of other factors. The extent to which this speed is lowered depends on PAV_i , the percentage of area denied due to maneuvering around vegetation in stem diameter classes i and greater. The relationships are:

Tracked Vehicles

for $PAV_i \leq 3\%$ no reduction ($VBO_{ki} = V_{ttki}$)

for $3\% < PAV_i \leq 7\%$

$$S_{MG} = [(392.93 - V_{ttki})PAV_i]/4 + (7V_{ttki} - 3*392.93)/4$$

$$VBO_{ki} = \min[S_{MG}, V_{ttki}]$$

for $7\% < PAV_i \leq 52.5\%$

$$S_{MG} = 453.2 - 8.603PAV_i$$

$$VBO_{ki} = \min[S_{MG}, V_{ttki}]$$

for $52.5\% < PAV_i$ set $VBO_{ki} = 0$

Wheeled Vehicles

for $PAV_i \leq 3\%$ no reduction ($VBO_{ki} = V_{ttki}$)

for $3\% < PAV_i \leq 7\%$

$$S_{MG} = [(450.33 - V_{ttki})PAV_i]/4 + (7V_{ttki} - 3*450.33)/4$$

$$VBO_{ki} = \min [S_{MG}, V_{ttki}]$$

for $7\% < PAV_i \leq 41.3\%$

$$S_{MG} = 542.11 - 13.112PAV_i$$

$$VBO_{ki} = \min [S_{MG}, V_{ttki}]$$

for $41.3\% < PAV_i$ set $VBO_{ki} = 0$

Around and between obstacles, $VAVOID_{ki}$ represents the overall maximum speed the vehicle can travel while overriding vegetation in stem diameter classes $i-1$ and smaller and avoiding both obstacles and vegetation in stem diameter classes i and greater. The equations used to calculate $VAVOID_{ki}$ are similar to those used above to calculate VBO_{ki} except that ADT_i , the percentage area denied by avoiding obstacles and vegetation in stem diameter classes i and greater, is used in place of PAV_i .

$$VAVOID_{k,i} \text{ for } k = 1,2,3 \text{ if } NTRAV = 3$$

$$\text{or } k = 1 \text{ if } NTRAV = 1$$

$$i = 1, \dots, NI$$

is the complete set of speeds calculated for driving strategy which avoids obstacles. The next comparable set of speeds is $VOVER_{ki}$, which simulates the driving strategy that overrides obstacles. From these two sets of speeds the overall terrain unit speed is selected with some modifications in the last two routines of the Areal Module, Subroutines IV20 and IV21.

16. Subroutine IV16 - Obstacle Override Interference and Resistance

This routine uses a simplistic three dimensional, linear interpolation routine, subroutine D3LINC, on the arrays developed from the Obstacle Module, OBS78B. prior to execution of the Operational Modules of the INRMM. Three tables were developed from the Obstacle Module

- i) FOO vs OBH, OBAA, and OBW
- ii) F_{OOMAX} vs OBH, OBAA, and OBW
- iii) CLEAR vs OBH, OBAA, and OBW

where OBH = obstacle height (denoted by h_o in TPP)

OBAA = obstacle approach angle (denoted by α_o in TPP)

OBW = obstacle base width (denoted by W_{og} in TPP)

FOO = overall tractive effort to override obstacle

F_{OOMAX} = maximum tractive effort required during override
of obstacle

CLEAR = minimum clearance/maximum interference during
override of obstacle

The outputs of this routine are FOM, FOMMAX, and CLR, which are the overall tractive effort, maximum tractive effort, and clearance/interference for overriding obstacles in the current terrain unit respectively.

If this routine determines that vehicle/obstacle interference occurs, the flag NEVERO is set to 3.

17. Subroutine IV17 - Driver Dependent Vehicle Speed Over Obstacles

The routine linearly interpolates two arrays developed from the Ride Dynamics Module, VEHDYN, prior to execution of the Operational Modules of the INRMM. These tables give

- i) VOOB vs OBH
- ii) VOOBS vs OBSE

where OBH = obstacle height (denoted by h_o in TPP)
OBSE = effective obstacle spacing (calculated in
subroutine IV1)

VOOB = maximum constant forward velocity during override
of an obstacle of height h_o which results in a
vertical acceleration on the driver (or some other
critical location) limited by a certain g level.
Currently 2.5g at the driver's station is used.

VOOBS = maximum constant forward speed during the override
of obstacles whose spacing is OBSE. This maximum speed
is limited by both the absorbed power criterion and
the vertical acceleration criterion on the driver (or
some other critical location on the vehicle).

The relationship between VOOBS and OBSE is used here without regard for obstacle height. Current practice is to generate this relationship using VEHDYN with a constant obstacle height for all spacings. The height used should be that which limits the vehicle speed to 15 mph. as determined from the single obstacle relation.

The logic of the routine is that if the average distance between obstacles (OBSE - WA) is less than the wheel base or track length on the ground, only the second array (VOOBS vs. OBSE) is interpolated and the resulting speed is used for VOLA, the maximum obstacle approach speed.

If the distance between obstacles is between the wheelbase or track length on the ground and twice the full wheelbase or track length both arrays are interpolated and the lesser of the two speeds is used for VOLA. If the distance between obstacles is greater than twice the wheelbase or track length on the ground then only the first array (VOOB vs. OBH) is interpolated and the resulting speed is used for VOLA.

18. Subroutine IV18 - Speed Onto and Off Obstacles

This routine determines the maximum approach speed, VA_{ki} , at the first contact with an obstacle and the exit speed, VXT_{ki} , when departing the obstacle after overriding. Possible adjustments to the speed between obstacles, VBO_{ki} , are also made. If the prior routines of the Areal Module have determined that there cannot be override or there can be no gain in speed due to override, an indicator NEVERO is set to 1,2 or 3. In this case the routine sets all the speeds $VA_{ki} = VXT_{ki} = VBO_{ki} = 0$.

If the obstacles are so closely spaced ($TL \geq OBSE - WA$) that the vehicle essentially is always in contact with one of them then an

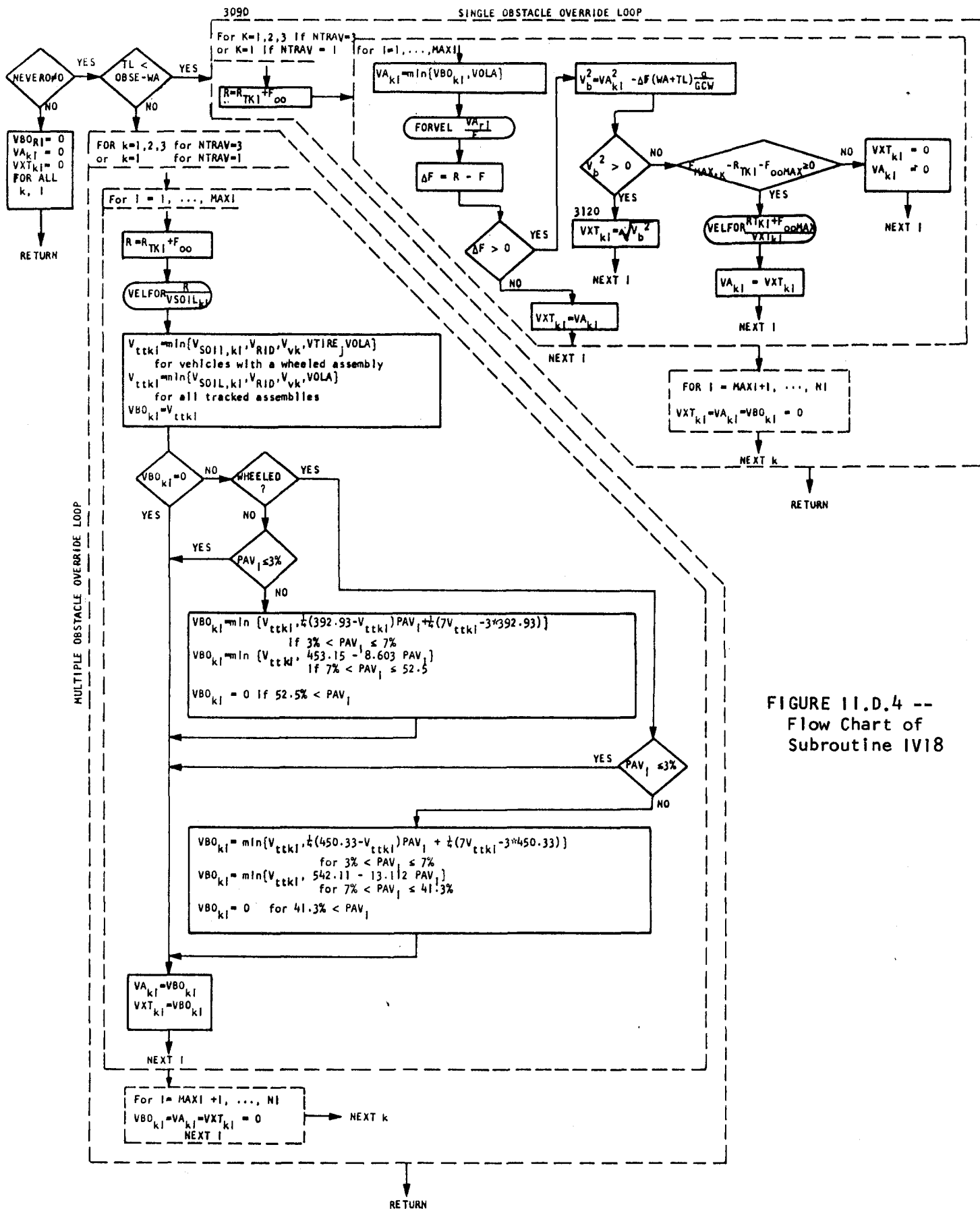

FIGURE 11.D.4 --
Flow Chart of
Subroutine IV18

assumption is made that the driver will choose to proceed at a steady speed over the terrain unit (i.e., no acceleration/deceleration between obstacles). This speed, V_{ttki} , is determined to be the maximum speed limited by the driver's comfort level overriding obstacles (VOLA), the general roughness level (V_{RID}), the visibility/braking force limit (V_{vk}), the tire limit ($VTIRE_j$) if there are wheeled suspension elements, and the soil/vegetation/slope/obstacle resistance limit ($VSOIL_{ki}$) calculated by VELFOR, a subroutine described above in Section II.D.5.b). The resistance used here is that of the soil/vegetation/slope for the terrain unit, plus that resistance due to overriding the obstacle, FOM. The speed "between obstacles", VBO_{ki} is then calculated from V_{ttki} by attenuating V_{ttki} due to possible maneuvering to avoid vegetation in stem diameter classes i and greater. This calculation is the same as that described in Subroutine IV15 above (Section II.D.15)). Then the approach and exit speeds are all set to the same value as the speed between obstacles ($VA_{ki} = VXT_{ki} = VBO_{ki}$). This will guarantee that no acceleration/deceleration can occur since no speed changes across and between obstacles will occur.

For the case where the vehicle can fit entirely between obstacles ($TL < OBSE - WA$) it is theoretically possible that the vehicle could accelerate to speed VBO_{ki} or some lesser speed after leaving the obstacle at speed VXT_{ki} before braking in order to reduce speed to VA_{ki} when approaching the next obstacle. In this case the three speeds, VA_{ki} , VXT_{ki} , and VBO_{ki} are calculated as

follows.

The resistance of soil and slope is given by R_{TK1} , the soil/slope/vegetation resistance avoiding vegetation in classes 1,2,...,NI. The use of this resistance makes the assumption that obstacles are bare of vegetation.

For each vegetation class i and slope class k the approach speed, VA_{ki} , is set equal to the lesser of the soil/slope/vegetation limited speed (V_{ttki}) and the human tolerance limited obstacle impact speed (VOLA). A subroutine, called FORVEL, is used to evaluate the tractive effort, F , available at speed VA_{ki} . This subroutine searches the various speed ranges or "gears" and then evaluates the appropriate quadratic. A force deficit is calculated by

$$\Delta F = R_{TK1} + F_{00} - F.$$

If $\Delta F \leq 0$ then there is enough tractive effort available to overcome both soil/slope and obstacle resistance hence no speed is lost in crossing the obstacle. In this case $VXT_{ki} = VA_{ki}$.

If $\Delta F > 0$, there is not enough tractive effort available. A check is made to see if the obstacle can be overcome by some of the kinetic energy of the vehicle. A terminal speed exiting the obstacle is calculated from

$$V_b^2 = VA_{ki}^2 - \Delta F(WA + TL)g/GCW$$

where WA = obstacle width

TL = wheel base or track length on ground

g = acceleration of gravity

GCW = gross combination weight.

If $V_b^2 \geq 0$, there is sufficient kinetic energy available to override the obstacle and the exiting speed is $V_{XT_{ki}} = V_b$.

If $V_b^2 < 0$, there is not sufficient energy available to override the obstacle when approaching it at $V_{A_{ki}}$. Since there usually is more tractive effort available at lower speeds, a test is made to see if the obstacle can be overridden at any speed by comparing $F_{MAX,k}$ to $R_{Tk1} + F_{OOMAX}$, where

$F_{MAX,k}$ = maximum tractive effort available

F_{OOMAX} = maximum tractive effort required
during obstacle override

If $F_{MAX,k} < R_{Tk1} + F_{OOMAX}$, override is not possible and
 $V_{A_{ki}} = V_{XT_{ki}} = 0$.

If $F_{MAX,k} > R_{Tk1} + F_{OOMAX}$, override is possible and the assumption is made that the vehicle will cross the entire obstacle at the speed, V_{FMAX} , which yields the maximum tractive effort. This is calculated by Subroutine VELFOR. Then $V_{A_{ki}} = V_{XT_{ki}} = V_{FMAX}$.

19. Subroutine IV19 - Average Terrain Unit Speed While

Accelerating/Decelerating Between Obstacles

This routine calculates the time it takes for the vehicle to traverse various portions of the terrain unit and the distance it

travels during this time. From this time and distance calculation an average speed, $VOVER_{ki}$, is calculated.

The various times and portions are specified by

T_a, X_a = time and distance during acceleration from velocity VXT_{ki} after leaving an obstacle

T_{BO}, X_{BO} = time and distance during constant velocity travel at speed VBO_{ki} between obstacles

T_b, X_b = time and distance during deceleration (braking) from VBO_{ki} (or some lesser speed if $T_{BO} = X_{BO} = 0$) to VA_{ki} , the maximum obstacle approach speed

T_{OO}, X_{OO} = time and distance crossing the obstacle.

If VBO_{ki} cannot be reached before braking must begin then $T_{BO} = X_{BO} = 0$. The various possibilities are indicated in Figure II.D.5.

The routine makes use of three other subroutines:

ACCEL - which calculates the time and distance to accelerate from one speed, V_a , to another $V_b > V_a$. If speed V_b cannot be reached by acceleration an error flag, NV2FLG, is set.

TXGEAR - which is called by ACCEL and calculates the time and distance required in one gear during acceleration

VELFOR - the maximum speed achievable while overcoming a given resistance (described as part of Subroutine IV5 above)

The above times and distances are calculated as follows:

$$X_{OO} = WA + TL$$

$$T_{OO} = 2X_{OO} / (VA_{ki} + VXT_{ki})$$

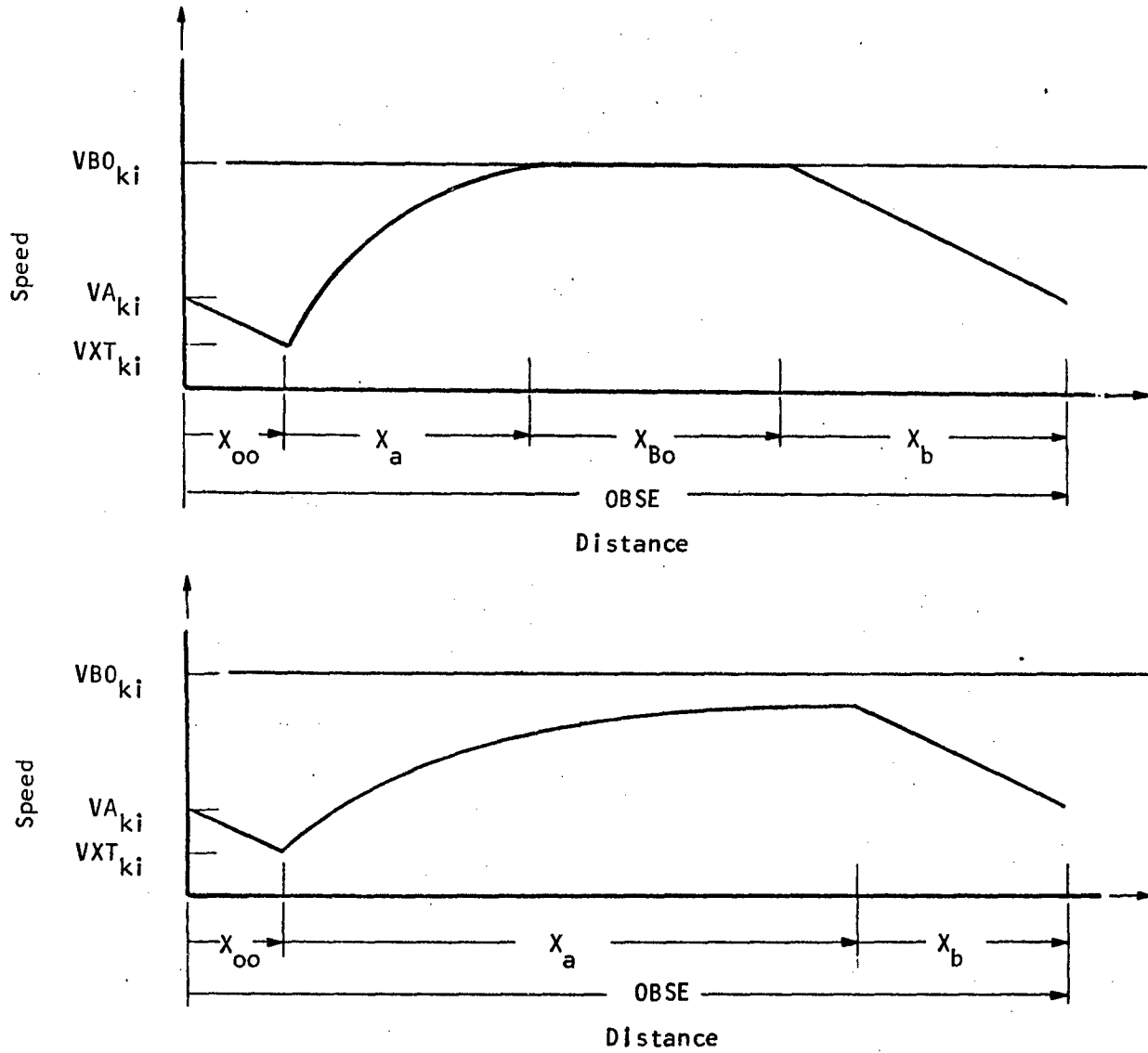

FIGURE II.D.5 -- Possible Speed Profiles Across an Obstacle and Between Obstacles

where WA = obstacle width

TL = wheelbase or track width on ground

$$X_{BO} = OBSE - X_{OO} - X_a - X_b$$

where $OBSE$ = effective obstacle spacing

$$T_{BO} = X_{BO}/V_{BO_{ki}} \quad \text{if } X_{BO} \geq 0$$

$$T_{BO} = 0 \quad \text{if } X_{BO} < 0$$

For any speed $V_M > VA_{ki}$,

$$T_b = [M_v(V_M - VA_{ki})]/B_{MXK}$$

where M_v = vehicle mass

B_{MXK} = maximum braking force

and

$$X_b = (V_M + VA_{ki})T_b/2$$

The overall average terrain unit speed while crossing obstacles is then given by

$$VOVER_{ki} = OBSE/(T_{OO} + T_a + T_b + T_{BO})$$

for slope $k = 1$ up, 2 level, 3 down if $NTRAV = 3$

$k = 1$ if $NTRAV = 1$

while overriding vegetation in stem diameter class $i-1$ and smaller and avoiding vegetation in stem diameter class i and larger. These relationships can all be calculated if X_a , T_a , and the final speed after acceleration, denoted above by V_M , are known.

Several initial checks are made. If $VXT_{ki} = VBO_{ki}$, then the speed between, onto and off the obstacle are all the same and the overall terrain unit speed crossing obstacles is $VOVER_{ki} = VBO_{ki}$. If $VA_{ki} = VXT_{ki} = 0$ then obstacles cannot be crossed and $VOVER_{ki} = 0$.

If $VXT_{ki} < VA_{ki}$, Subroutine ACCEL is called to determine if the vehicle can accelerate from $V_a = VXT_{ki}$ to $V_b = VA_{ki}$; that is, can the vehicle when leaving an obstacle at speed VXT_{ki} accelerate up to the maximum approach speed VA_{ki} in the distance

between obstacles? If the distance to do so, X_a , is greater than the space between obstacles, $OBSE - WA - TL$, or the flag $NV2FLG$ is set, it means the vehicle cannot accelerate to the approach speed VA_{ki} and $VELFOR$ is called to determine if there is any speed at which the vehicle can overcome the soil/slope/vegetation and obstacle resistance, given by $R_{TK1} + F_{OOMAX}$ (see Figure II.D.6 for the speed profile). If such an override speed exists, $VOVER_{ki}$ is set to this override speed; otherwise $VOVER_{ki} = 0$.

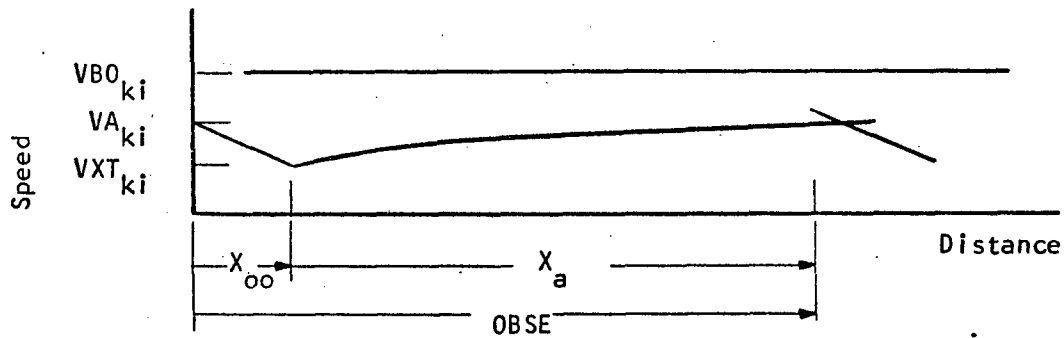

FIGURE II.D.6 -- Speed Profile when Obstacle Approach Speed cannot be Attained

Once it is known that there is enough distance between obstacles and/or the vehicle has enough excess traction to accelerate at least up to the approach speed of the next obstacle, Subroutine ACCEL is called to determine if the vehicle can accelerate to VBO_{ki} , the maximum speed between obstacles, and if so, the distance, X_a , and time, T_a , required. The time, T_b , and distance, X_b , to brake from VBO_{ki} to VA_{ki} are also calculated and if the sum of X_a and X_b is less than the space between obstacles, $OBSE - WA - TL$, then $VOVER_{ki}$ is calculated from formulas at the beginning of

this section. (See Figure II.D.5 for the speed profile of this case.)

If the distance, X_a , to reach VBO_{ki} plus the distance, X_b , to brake back down to VA_{ki} exceeds the distance between obstacles, then the speed VBO_{ki} can never be reached between obstacles before braking has to begin. The lower speed profile of Figure II.D.5 applies to this case. The distance-speed coordinates of the point B have to be determined. The speed coordinate, to be called V_M , must have a value in the interval from VA_{ki} and VBO_{ki} and the distance coordinate, $X_{00} + X_a$, must have a value between X_{00} and $OBSE - X_b$. Actually only one number among V_M , X_a , and X_b needs to be determined, since the others can be found from it and other known values.

V_M is the value sought. Successive approximations to V_M are postulated by a binary search within the speed interval from VA_{ki} to VBO_{ki} . For each such postulated value of V_M , the distance X_a to accelerate to V_M from VXT_{ki} and the distance X_b to decelerate from V_M to VA_{ki} are calculated. If $X_{00} + X_a + X_b > OBSE$ then V_M is adjusted to a lower value; if $X_{00} + X_a + X_b < OBSE$ then V_M is adjusted to a higher value. Ten such adjustment are made (corresponding to a speed precision of 2^{-10} of the difference between VBO_{ki} and VA_{ki}).

The distance coordinate is highly sensitive with respect to the final speed before braking, V_M , in the sense that a small difference in v_M can lead to a large difference in $X_{00} + X_a$. As a

consequence, it may result that even though the speed precision is as stated above, after 10 iterations the distance $X_{00} + X_a + X_b$ is still significantly different from OBSE.

If the final distance is larger than OBSE, VBO_{ki} is reduced by 1 MPH decrements and the entire search for V_M is repeated. If the distance is smaller, no corrective action is taken since the result is that there will be a distance between obstacle at which the vehicle will travel at the constant speed V_M . Any error caused by this are considered negligible.

A value of $VOVER_{ki}$ is calculated for every combination of slope k (up, level, down or traverse) and vegetation override/avoid strategy i ; for vegetation classes and/or obstacles which cannot be overridden $VOVER_{ki} = 0$.

a) Subroutine ACCEL - Time and Distance to Accelerate from
One Velocity to Another

This routine calculates the time, T , and the distance, X , required for the vehicle to accelerate from one speed, V_1 , to another $V_2 \geq V_1$. From the tractive effort vs speed curve, the "gear" or speed range, n_{g1} , of the initial speed V_1 is found ($V_{n_{g1},1} \leq V_1 \leq V_{n_{g1},3}$). Similarly, the gear, n_{g2} of the final speed, V_2 is found ($V_{n_{g2},1} \leq V_2 \leq V_{n_{g2},3}$).

If $n_{g1} < n_{g2}$, the Subroutine TXGEAR is called repeatedly to calculate the time and distance in each gear from n_{g1} to n_{g2} . If, within any gear, the vehicle cannot accelerate to the final speed of the gear, V_{n3} , or the final speed to be reached, V_2 , an error flag, NV2FLG, is set and the highest speed within that gear that the vehicle can achieve is calculated by a Binary search.

b) Subroutine TXGEAR - Time and Distance in a Gear

In this routine the quadratic functions representing tractive effort for vehicle speed are integrated to yield time and distance in each gear.

For illustrative purposes, a single gear, or speed range representing a fixed set of quadratic coefficients is shown on Figure II.D.7.

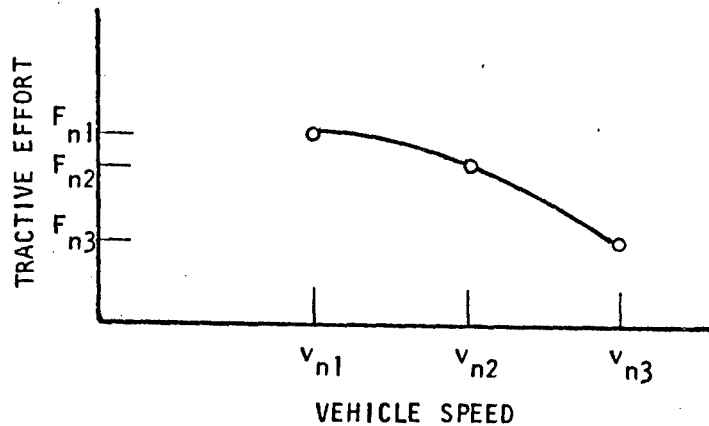

FIGURE II.D.7 -- Representation of Tractive Effort vs. Speed Relation

For this gear, the relationship is given by

$$F = a_n + b_n v + c_n v^2$$

for $v_{n1} \leq v \leq v_{n3}$. Similar sets of constants (a_n , b_n , c_n) were calculated in Subroutine IV5 for all gears $n=1,2,\dots$, NGR.

The differential equation to be solved is given by

$$M \dot{v} = F - R_{Tki}$$

where M = vehicle mass

R_{Tki} = soil/slope/vegetation resistance to be overcome.

The excess force $F - R_{Tki}$ is the tractive effort being used to accelerate from v_1 to v_2 within the gear n . Usually $v_1 = v_{n1}$ and $v_2 = v_{n3}$ but it is possible for $v_{n1} \leq v_1 \leq v_2 \leq v_{n3}$.

The above differential equation is separated and integrated thus

$$\begin{aligned} I &= \int_{v_1}^{v_2} (1/[c_n v^2 + b_n v + (a_n - R_{Tki})]) dv \\ &= \int_0^t (1/M) dt = t/M \end{aligned}$$

If the discriminant $d_n^2 = b_n^2 - 4c_n(a_n - R_{Tki})$, then the time to accelerate from v_1 to v_2 in gear r is given by

if $d_n^2 < 0$

$$t = 2M/(-d_n^2)^{1/2} \arctan[(2c_n v + b_n)/(-d_n^2)^{1/2}] \Big|_{v_1}^{v_2}$$

if $d_n^2 = 0$

$$t = -2M/(2c_n v + b_n) \Big|_{v_1}^{v_2}$$

if $d_n^2 > 0$ and $d_n = +[d_n^2]^{1/2}$

$$t = M/(d_n^2)^{1/2} \ln[(2c_n v + b_n - d_n)/(2c_n v + b_n + d_n)] \Big|_{v_1}^{v_2}$$

These relationships may be read from tables of integrals, e.g., Abramowitz and Stegun (1965).

In the cases $d_n^2 > 0$, the distance to accelerate from v_1 to v_2 can be calculated directly. For $d_n^2 > 0$, the equation for t can be solved for v_2 to yield

$$v_2(t) = 1/2c_n[2d_n/(1 - v_1 e^{td_n/M}) - b_n - d_n]$$

and this integrated to yield distance thus

$$\begin{aligned} X(t) &= \int_0^t v_2(t) dt \\ &= 1/c_n[(d_n - b_n)t/2 \\ &\quad + M \ln((1 - v_1 e^{td_n/M})/(1 - v_1))] \end{aligned}$$

Similarly for $d_n^2 = 0$

$$v_2(t) = 1/2c_n[2M/(2M/(2c_n v_1 + b_n) - t) - b_n]$$

and

$$\begin{aligned} X(t) &= \int_0^t v_2(t) dt \\ &= (M/c_n) \ln[2M/(2M - t(2c_n v_1 + b_n))] - b_n t/2c_n \end{aligned}$$

In the case $d_n^2 < 0$, the equation for t can be solved for $v_2(t)$ in terms of v_1 but this formula cannot be integrated in closed form to yield $X(t)$. In this case the gear is approximated by two straight lines fitted from (v_{n1}, F_{n1}) to (v_{n2}, F_{n2}) and from (v_{n2}, F_{n2}) to (v_{n3}, F_{n3}) . For each of these lines the integral equation

$$\int_{v_1}^{v_2} [1/(bv + (a - R_{TKi}))]dv = \int_0^t [1/M]dt$$

(where the coefficients a and b stand for either set) is solved to yield

$$t = (M/b)\ln[(bv_2 + (a - R_{TKi}))/(bv_1 + (a - R_{TKi}))]$$

$$v_2(t) = (v_1 + (a - R_{TKi})/b)e^{bt/M} - (a - R_{TKi})/b$$

$$\begin{aligned} X(t) &= \int_0^t v_2(t)dt \\ &= (1/b^2)[(bv_1 + a - R_{TKi})M(e^{bt/M} - 1) \\ &\quad - (a - R_{TKi})bt] \end{aligned}$$

These latter relationships are also used in the case where the quadratic formula for a gear really was a straight line, namely $c_n = 0$.

The only other case for which formulas are needed is the case where both $c_n = b_n = 0$. Here the integral equation is

$$\int_{v_1}^{v_2} [1/(a_n - R_{TKi})]dv = \int_0^t [1/M]dt$$

and

$$t = M[(v_2 - v_1)/(a_n - R_{TKi})]$$

$$X(t) = [(a_n - R_{TKi})t^2]/2M + v_1t$$

The various formulas above can, of course, yield negative values if applied without concern as to whether the vehicle can really accelerate from v_1 all the way to v_2 in gear r, and in fact whether the vehicle can accelerate beyond v_1 at all. NV2FLG = 1 will be used to represent the case where the vehicle cannot accelerate

beyond v_1 and $NV2FLG = 2$ will be used to denote the case where v_2 cannot be reached. These questions can be resolved by considering the locations of the two roots of

$$F = c_n v^2 + b_n v + (a_n - RTki) = 0.$$

As long as the quadratic on the left hand side represents positive values of tractive effort within the domain $v_1 \leq v \leq v_2$, there is excess tractive effort available for acceleration. To determine whether the quadratic is positive within $v_1 \leq v \leq v_2$ the coefficients can be tested; 27 combinations of c_n , b_n , and $(a_n - RTki)$ being positive, zero or negative can result. Let $R_2 = (-b_n + \sqrt{b_n^2 - 4c_n(a_n - RTki)})/2c_n$ be the larger root and $R_1 = (a_n - RTki)/c_n$ be the smaller. Then $NV2FLG = 1$ will result from

- $c_n > 0, b_n < 0, a_n - RTki \leq 0$ and $v_1 \leq R_2$
- $c_n > 0, b_n < 0, a_n - RTki > 0$
 - and $v_1 > R_1$ for $d_n^2 > 0$
 - or $v_1 = R_1$ for $d_n^2 = 0$
- $c_n > 0, b_n = 0, a_n - RTki < 0$ and $v_1 \leq R_2$
- $c_n > 0, b_n > 0, a_n - RTki \leq 0$ and $v_1 \leq R_2$
- $c_n \leq 0, b_n \leq 0, a_n - RTki \leq 0$ all cases
- $c_n \leq 0, b_n < 0, a_n - RTki > 0$ and $v_1 \geq R_1$
- $c_n = 0, b_n > 0, a_n - RTki < 0$ and $v_1 \leq R_1$
- $c_n = 0, b_n > 0, a_n - RTki = 0$ and $v_1 \leq 0$
- $c_n < 0, b_n \leq 0, a_n - RTki > 0$ and $v_1 \geq R_2$
- $c_n < 0, b_n > 0, a_n - RTki < 0$
 - and $v_1 \leq R_1$ or $v_1 \geq R_2$.

NV2FLG = 2 will result from

$$\begin{aligned} & c_n > 0, b_n < 0, a_n - R_{Tki} > 0 \\ & \quad \text{and } v_2 > R_1 \text{ or } v_1 < R_2 \\ & \quad \text{but not } v_1 > R_1 \text{ when } d_n^2 > 0 \\ & \quad \text{or } v_2 = R_1 \text{ when } d_n^2 = 0 \\ & c_n = 0, b_n < 0, a_n - R_{Tki} > 0 \quad \text{and } v_2 \geq R_1 \\ & c_n < 0, b_n \leq 0, a_n - R_{Tki} > 0 \quad \text{and } v_2 \geq R_2 \\ & c_n < 0, b_n > 0, a_n - R_{Tki} < 0 \quad \text{and } v_2 \geq R_2. \end{aligned}$$

Subroutine TXGEAR performs a decision tree on c_n , b_n , d_n^2 , R_1 and R_2 to determine if the flag NV2FLG needs to be 0, 1 or 2 and then uses the appropriate formulas for t and $X(t)$ to calculate the time and distance in gear n .

20. Subroutine IV20 - Kinematic Vegetation Override Check

Various prior subroutines have calculated speeds limited by various factors such as soil/slope/vegetation resistance, ride roughness, obstacle resistance, maneuvering to avoid obstacles and vegetation, etc. As each new factor was considered the possibility arose that the prior maximum speed for a given slope (up, level, down or traverse) and vegetation override/avoid strategy the speed first calculated on the basis of soil/slope/vegetation resistance had to be reduced. A question now arises if at the final speeds V_{VOID}_{ki} and V_{OVER}_{ki} there is enough excess traction and kinetic energy to still override vegetation in the stem diameter classes $i-1$ and smaller. This routine performs this test as follows:

Subroutine FORVEL is called to calculate the excess traction available at speed $VOVER_{ki}$ which is added to the kinetic energy $GCW (VOVER_{ki})^2/2g$, where GCW is the gross combination weight and g is the acceleration of gravity. If this sum is less than the force needed to override the largest stem diameter in class $i-1$, an indicator $NOGOVO_{ki}$ is reset. If the force is sufficient, $NOGOVO_{ki} = 1$. Similarly, $NOGOVA_{ki} = 1$ if the excess tractive effort plus the kinetic energy available at speed $VAVOID_{ki}$ is sufficient to override the largest stem in vegetation class $i-1$; otherwise $NOGOVA_{ki} = 0$.

21. Subroutine IV21 - Maximum Average Speed

In this routine a speed, from all the $VAVOID_{ki}$ and $VOVER_{ki}$, is selected according to several criteria which include:

1. for each k , select the maximum of all $VAVOID_{ki}$ and $VOVER_{ki}$
2. if the maximum speed is less than $VWALK$, the vehicle will proceed at that maximum speed.
3. if the maximum is greater than $VWALK$ and the resulting acceleration due to overriding vegetation is less than one g and the stem diameter class i is less than that designated by $IOVER$, then proceed at the maximum
4. if the maximum is greater than $VWALK$ but $i > IOVER$ or the acceleration is greater than g , continue to reduce the stem diameter class to be overridden until the criteria of 3) are met.

After the above are selected for each slope (up, level, down, or traverse) the final speeds calculated are the harmonic average of the individual speeds in each of the slopes. [If any of these individual speeds is zero, the harmonic average is set to zero.] Two speeds are

reported by this routine, the maximum speed (VMAX) regardless of vegetation override and the maximum speed (VSEL) which keeps the acceleration below one g and does not override stems in class IOVER or greater.

E. Road Module

The Road Module of the INRMM calculates the maximum speed a vehicle can travel if the terrain unit is a road or a trail. Roads in the INRMM are terrain units characterized by a non-yielding surface with a coefficient of friction and a surface condition factor as well as curvature, superelevation, roughness and slope. There are no obstacles or vegetation on roads. This Module is also used for trails, which are terrain units characterized by yielding soils but otherwise are similar to roads.

For both roads and trails it is assumed that each terrain unit contains sections for up and down or just level or up or down travel. In rolling terrain there are seldom stretches of road that would be classified as distinct terrain units that contain both up/down and level parts.

The major portions of this Module calculate aerodynamic, rolling, cornering and grade resistance, and from this find a speed limited by these resistances. This speed is compared to that limited by ride roughness, sliding and tipping on curves, and a braking/visibility limit. An overall curvature speed limit derived from tests conducted by the American Association of State Highway Officials (AASHO) is applied before a final maximum speed is selected.

These portions are comparable to various subroutines in the Areal Module. The Road Module, being shorter, was coded as a single

subroutine with calls to appropriate subroutines of the Areal Module for the yielding soil. These individual sections of the Road Module will now be described.

1. Initialization

Various constants are set, some of which are needed only for compatibility with the subroutines of the Areal Module used for trails.

2. Velocity Dependent Resistance

In this section the surface resistance, aerodynamic drag and turning resistance are calculated.

a) Surface Resistance

This calculation differs between roads and trails. For trails Subroutines IV3, IV4, and IV5 of the Areal Module are called to calculate

RTOWxx - the resistance coefficient for powered (RTOWP) non-powered (RTOWNP), braked (RTOWB), non-braked (RTOWNB), powered and braked (RTOWPB), and towed (RTOWT) running gear assemblies,

DOWxx - the pull coefficients of powered (DOWP), braked (DOWB), and powered and braked (DOWPB) running gear assemblies, and

Tractive effort vs. velocity relationship adjusted for the slip of the running gear. this relationship is given as a series of speed intervals (gears) for each of which a quadratic curve ($F = c_n v^2 + b_n v + a_n$) represents the relationship.

See the description of these routines in Section II.D above.

For hard surfaces, primary and secondary roads, resistances are calculated for each of the five velocity, force points of each gear and subtracted from the tractive effort. (See description of Subroutine IV5 in Section II.D.5). A new set of quadratics are then fitted, by Subroutine QUAD5, to yield a resistance modified tractive effort vs. speed relationship.

Initially the tractive effort, adjusted for altitude by the elevation correction factor ECF, is limited by the traction available from the surface given by

$$T_s = \mu_j \text{GCWP} \cos \theta_k$$

where μ_j = coefficient of friction for surface condition factor j

GCWP = gross combination weight on powered running gear assemblies

θ_k = slope angle.

If T_s is less than tractive effort (rim pull curve) the tractive effort vs. speed curve is modeled as a horizontal line at $F = T_s$ until such speed, v^* , that the rim pull curve is exactly equal to T_s . The gears are so adjusted that the first gear is a horizontal line at T_s for speed v such that $0 \leq v \leq v^*$ and the next gear

begins at $v_{n1} = v^*$. Five new (speed, tractive effort) points are interpolated from 0 to v^* and v^* to v_{n5} .

b) Aerodynamic Resistance

After adjustment for surface traction limit, the aerodynamic drag at each velocity, v_{ni} , in each gear is calculated from

$$F_{AD} = .0026 C_D A_F v_{ni}^2$$

adjusted so that the units match

where C_D = drag coefficient

A_F = frontal area. (ft.²)

c) Wheeled Axle Turning Resistance

First the superelevation factor is calculated from

$$e = 1 - 14.95 R_c e_a / 12 v_{ni}^2$$

where R_c = radius of curvature

e_a = superelevation angle.

The turning resistance for any wheeled assemblies is speed dependent and calculated by

$$F_{CC} = (e/n_i C_\alpha) [W_i \cos \theta_k v_{ni}^2 / 111 R_c]^2$$

where i = running gear (wheeled) index

R_c = radius of curvature

W_i = weight on axle i

n_i = number of wheels on axle i

C_α = average cornering coefficient (slope at slip angle = 0)

in lateral force vs. slip angle relationship, Lbs./Deg.). The units of C_{α} do not follow the INRMM standards in this formula. Furthermore, the constant 111, which comes from the formula in Smith (1970), implies that v_{ni} is in miles per hour. The code in NRMM makes a final adjustment to inches per second. Only terms for wheeled assemblies are included in the sum for F_{CC} . These two resistances are subtracted from the tractive effort vs. speed relationship and a new set of quadratics are fitted to the adjusted (speed, tractive effort-resistance) points by Subroutine QUAD5.

d) Tandem Wheel Aligning Resistance

This resistance is calculated by

$$F_{TC} = (e \mu_j / 2R_c) \sum_i (W_i + W_{i+1}) b_i$$

where i = index of front axle of a tandem pair

b_i = spacing between tandem axles.

3. Non-velocity Dependent Resistance

In this category are turning resistance on tracked assemblies and rolling and grade resistance.

a) Tracked Turning Resistance

The resistance of tracked assemblies to turns is given by the Merritt equation (Merritt (1946) or Ray (1970)) in terms of the width to length ratio

$$\alpha_i = t_i/l_i$$

where t_i = track of tracked assembly i

l_i = length of track on ground of assembly i

A "Merritt constant" is calculated as

$$M_{ki} = 1.0624 - .6999\alpha_i + .051848\alpha_i^2 + .05488\alpha_i^3$$

and a radius factor as

$$K_{1i} = M_{ki}(1.18 - .0090895 R_c/12. \\ + .00003779(R_c/12.)^2 + 6.70476*10^{-8}(R_c/12)^3)$$

The turning resistance is then calculated by

$$F_{CT} = \text{TFOR}/\text{GCW} \sum_i K_{1i}W_i + F_{CC} \quad \text{for trails} \\ = \mu_j \sum_i K_{1i}W_i + F_{CC} \quad \text{for roads}$$

where TFOR = maximum tractive effort available from surface

GCW = gross vehicle weight.

b) Rolling Resistance

The rolling resistance for trails (soft surface) is given by

$$F_R = S(\text{RTOWP}*\text{GCWP} + \text{RTOWNP}*\text{GCWNP})\cos\theta_k$$

where GCWNP = gross combination weight on non-powered wheels

S = surface condition factor.

For roads (hard surface) the rolling resistance is calculated separately for each running gear assembly i by

$$F_{Ri} = (.007 + .0939/\text{psi})W_iS \quad \text{for wheeled assemblies} \\ = .045W_iS \quad \text{for tracked assemblies}$$

where psi = pressure in the tires on axle i .

The total rolling resistance is $F_R = \sum F_{Ri}$.

c) Grade Resistance

The grade resistance is simply

$$F_{Gk} = GCW \sin \theta_k$$

for each slope angle θ_k .

4. Speed Limited by Resistance

The resistances calculated above are summed $F_T = F_{Gk} + F_R + F_{TC} + F_{CT}$ and Subroutine VELFOR (See description of Subroutine IV5 of the Areal Module) is used to calculate the maximum speed achievable, V_p , overcoming F_T .

5. Speed Limited by Surface Roughness

Each road or trail unit description includes an RMS elevation indicating microroughness of the surface. The VRIDE array, calculated from the results of repeated runs of the Ride Dynamics Module (Vol. III) is interpolated to yield the maximum speed, V_R , achievable over the current road or trail unit keeping the driver absorbed power below the level used in the cross-plots of the results of the Ride Dynamics Module. These crossplots are part of the vehicle data file. (See Section II.D.10.)

6. Speed Limited by Sliding on Curves

For trails and secondary roads it is possible for banking (or reversed camber) to be steep enough so that vehicles could slide on curves at achievable speeds. This section calculates the maximum speed achievable before sliding by

$$V_s = [385.9R_c(\tan e_a + \text{TFOR}/\text{GCW}) / (1 - \text{TFOR}\tan e_a/\text{GCWP})]^{1/2}$$

for trails,

$$V_s = [385.9R_c(\tan e_a + \mu_j) / (1 - \mu_j \tan e_a)]^{1/2}$$

for roads,

7. Speed Limited by Tipping on Curves

Similarly the maximum speed with which a vehicle could negotiate a curve before tipping over is calculated by

$$V_T = [385.9R_c(t_w + h_{CG}\tan e_a) / (h_{CG} - t_w \tan e_a)]^{1/2}$$

where t_w = maximum tread width

h_{CG} = height of CG.

8. Speed Limited by Visibility

The speed limited by a driver being able to see an obstruction in time to brake to a halt before striking it is calculated by a call to Subroutine IV13 of the Areal Module. That subroutine requires the maximum braking force available from the vehicle and surface, possibly

attenuated by the maximum deceleration to which the driver will choose to be subjected. The total braking force, F_{TB} , available is calculated by Subroutine IV11 of the Areal Module in case the terrain unit is a trail (soft surface). For roads (hard surfaces)

$$F_{TBk} = GCW \sin \theta_k + \min [X_{BR}, \mu_j GCW \cos \theta_k]$$

where X_{BR} = maximum braking effort of the vehicle.

The program may call a NOGO (not completing the processing for this terrain unit) if $F_{TBk} < 0$ due to insufficient braking ability.* When the total braking effort is available, the maximum braking effort the driver will actually use is calculated by

When the total braking effort is available, the maximum braking effort the driver will actually use is calculated by

$$F_{BMAX,k} = \min [D_{max} GCW, F_{TBk} S_p / 100.]$$

where D_{max} = maximum deceleration which the driver will use

S_p = percent of total braking effort driver will use
(simulating the effect that the driver will reserve some percentage of the braking effort "for safety")

These driver limits may be overridden by setting D_c and S_p to higher values. in the Scenario inputs. $F_{BMAX,k}$ is the force used by Subroutine IV13 to calculate speed limited by visibility, V_v .

* If post processors will concern themselves with acceleration/deceleration between terrain units in traverse mode, users may wish to change the code to allow all calculations in spite of the lack of braking ability (this requires the elimination of the two RETURN statements in Section 5B - Total Braking Hard Surface of the Computer Program).

9. Curvature Speed Limit

Since physical stability limits on vehicles are often far greater than the self imposed ones exhibited by a driver, a set of empirically derived curvature vs. speed limits are included in the Road Module Of the INRMM. They are based on a curve published by AASHO (1965) supplemented by observations made at the USAEWES. The relationships used are presented in Table I.E.1. This table is currently an integral part of the terrain input routine MPRD74. If user terrain input routines are to be added which will read road or trail data, this table (or others like it) will have to be included in these new routines.

Table II.E.1
Curvature Speed Limits

Radius of Curvature (feet)	Speed Limits (MPH)			
	Super-highways	Primary Roads	Secondary Roads	Trails
5730	100	100	70	55
1910	70	70	60	49
1146	60	60	58	44
819	54	54	50	42
637	48	48	43	39
458	41	41	36	34
327	34	34	31	29
229	29	29	26	23
164	25	25	23	19
115	19	19	19	14
82	13	13	13	10

The curvature speed limit, V_c , is calculated by a linear interpolation of this table. If the coefficient of friction, μ_j , or the surface limited pull ratio, TFOR/GCWP, is less than .7, the curvature speed limit, V_c , is further attenuated by the square root of the ratio of μ_j or TFOR/GCWP to .7.

10. Speed Selection

The Maximum roadway speed is now chosen for each slope angle θ_k to be the minimum of the following:

V_{TIRE_j} = speed limited by tire at inflation pressure j

V_p = speed limited by resistance

V_L = posted speed limits (scenario variable)

V_T = speed limited by tipping

V_s = speed limited by sliding on curve

V_{RID} = speed limited by ride roughness

V_V = speed limited by visibility/braking

V_C = speed limited by curvature.

In traverse mode, NTRAV = 1, only one speed for θ_k is reported. For bidirectional travel, NTRAV = 3, a speed for θ_k and $-\theta_k$ is calculated and a harmonic average is taken as the selected overall speed for the road or trail unit.

F. Linear Feature Module

No code or description of the Linear Feature Module of the INRMM is included at this stage of development.

III INPUTS AND OUTPUTS

A. Introduction

When the time came to produce a FORTRAN implementation of the Operational Modules of the INRMM, NRMM, following the AMC-74 Report (which is essentially a coding specification) the decision was made that the Vehicle and Terrain Preprocessors, Areal, Road and Linear Feature Modules would be coded following the ANSI FORTRAN -66 standard, to allow portability. However input and output would be part of the Control and I/O Module which need not conform to the Standard. The programmers have attempted, however, to use only those extensions to the FORTRAN language which are commonly available. In particular in NRMM, NAMELIST directed READ and WRITE are used for vehicle, scenario and control input and most output.

To use the model, the sequence of operations may be organized as follows:

1. Vehicle data are collected (or measured, estimated or assigned by analogy) and organized into computer input files in formats specified by Sections III.B, Vol. III, Vehicle Data for the Ride Dynamics Module, and III.a, Vol. II, Vehicle Data for the Obstacle Module, described below.
2. Terrain data are gathered (or measured, estimated, or assigned by analogy) and organized into computer input files in formats specified by Section III.C, Terrain Data for the Operational Modules, described below.
3. The range of obstacle and surface roughness data present in the terrain data files is used to specify the base values for input to the preprocessor modules. These base values are organized into input files in formats specified in Volumes II and III.

4. The Ride Dynamics Module, VEHDYN, is run using the vehicle data file and a terrain profile exhibiting a value of the surface roughness (RMS), obstacle height (OBH) of a single obstacle or obstacle spacing (OBS) for sequence of equally spaced, identical obstacles. Successive runs are made varying forward speed (V). Crossplots are made for RMS vs. V for fixed value of absorbed power, OBH vs. V for fixed value of maximum vertical acceleration, and OBS vs. V for fixed values of obstacle height and maximum vehicle acceleration. These three tables are made part of the vehicle input data for the Operational Modules.
5. The Obstacle Module, OBS78B, is run using the vehicle data file organized as in Section III.A, Vol. II and a table of obstacles described by height (OBH), approach angle (OBAA), and width (OBW). For each obstacle, OBS78B will calculate minimum clearance (CLRMIN), maximum force (FOOMAX), and average force (FOO) during a simulated override of the obstacle. These sets of six numbers are organized into a single table which is made part of the vehicle input data for the Operational Modules.
6. The vehicle data, along with the results of Steps 4 and 5 or equivalent data, above, is organized into a computer input file in format as specified by Section III.B below.
7. The scenario/control file is constructed for each operational module run as specified by Section III.D below.
8. The Operational Modules, organized into a source file called NRMM, is run using the vehicle file from Step 6, the terrain file from Step 2, and the scenario/control file from Step 7, above.

The result of these eight steps will be a computer file giving vehicle speed for each terrain unit which was included in the terrain file of the Operational Modules. Other results beside speed are also given. Usually, further computer programs which use this terrain unit vs. speed file as input will be required to further evaluate the vehicle performance. These other programs, called post-processor as a group, will be developed by the user for his or her own purpose.

Experienced programmers will notice that the coded version of the INRMM is highly modular and coded so that a person reading the code will have a good idea of what is being calculated. This approach has resulted in a rather inefficient program, both globally and locally. Experienced programmers will undoubtedly want to enhance program efficiency after the current code is understood.

B. Vehicle Data

The data used to describe the vehicle for NRMM consist of a large number of vehicle descriptors together with outputs of the ride dynamics and obstacle modules. All these data are organized into a single computer file and read from unit LUN3. The vehicle descriptors are read using a NAMELIST directed read statement (NAMELIST VEHICL). The descriptors which are included are listed and described in Table III.B.1.

The data from the Obstacle Module is read using a formatted READ statement which accepts the results as produced by the Obstacle Module program and described in Volume II. Sample input files are contained in Appendix B.

Table III.B.1

Vehicle Input Data - NAMELIST VEHICL

Variable Name	Description
ACD	Aerodynamic drag coefficient
ASHOE(I)	Area of one track shoe on track assembly I, (in ² .)
AVGC	Average cornering stiffness of tires (lb./deg.)
AXLSP(I)	Distance from running gear assembly I to next assembly (inter-axle distance) (in.)
CD	Hydrodynamic drag coefficient
CGH	Height of CG of loaded vehicle above ground (in.)
CGLAT	Lateral distance of CG measured from centerline of combination (in.)
CGR	Loaded horizontal distance from CG to centerline of rearmost suspension assembly of prime mover (in.)
CID	Displacement of each engine (in ³ .)
CL	Minimum ground clearance of combination (in.)
CLRMIN(I)	Minimum ground clearance of assembly I (in.)
CONV1(1,J)	Input speed component of the torque converter speed ratio versus torque converter input speed curve, (rpm)
CONV1(2,J)	Speed ratio component of the torque converter speed ratio versus torque converter input speed curve at constant input torque, TQIND
CONV2(1,J)	Torque ratio component of the torque converter speed ratio versus torque converter torque ratio curve
CONV2(2,J)	Speed ratio component of the torque converter speed ratio versus torque converter torque ratio curve
DFLCT(I,J)	Deflection of each tire on axle assembly I under load WGHT(I)/NWHL(I), in., at the pressure specified for J=1 fine grained, =2 coarse grained, =3 highway
DIAW(I)	Outside wheel diameter of unloaded tires on running gear assembly I (in.)
DRAFT	Combination draft when fully floating (in.) (0 if combination cannot float)

TABLE III.B.1 (Continued)

Variable Name	Description
ENGINE(1,J)	Engine speed component of engine speed versus engine torque curve, (rpm)
ENGINE(2,J)	Engine torque component of engine speed versus engine torque curve, (lb.-ft.)
EYEHGT	Height of driver's eyes above ground (in.)
FD(1)	Final drive gear ratio
FD(2)	Final drive efficiency
FORDD	Maximum water depth combination can ford (in.) (Note: FORDD= DRAFT if DRAFT ≠0.)
GROUSH(I)	Track grouser height of track assembly I (in.)
HPNET	Net engine power (HP.)
HVALS(N)	Nth obstacle height in driver limited speed vs obstacle height table for single obstacle crossing
IAPG	0 if power train data available only, 1 if both measured tractive effort and power train data given, 2 if measured tractive effort given only
IB(I)	1 if running gear assembly I is braked, 0 otherwise
ICONST(I)	0 if radial tires are on wheel assembly I, 1 if bias tires
ICONV1	Number of point pairs in the array CONV1(I,J)
ICONV2	Number of point pairs in the array CONV2(I,J)
ID(I)	0 if wheels on wheeled assembly I are singles, 1 if duals
IDIESL	2 if the engine is a two cycle diesel, 1 otherwise
IENGIN	Number of point pairs in the array ENGINE(I,J),
IP(I)	1 if running gear assembly I is powered, 0 otherwise
IPOWER	Number of point pairs in the array POWER(I,J)

TABLE III.B.1 (Continued)

Variable Name	Description
IT(I)	0 if assembly I is not part of a tandem axle, J if assembly I is the Jth of a tandem axle
ITCASE	1 if vehicle has engine to transmission transfer gear box 0 otherwise
ITRAN	0 if transmission is manual with clutch, 1 if automatic transmission with torque converter
ITVAR	1 if transmission is mechanical, 0 if transmission is hydraulic
LOCOIF	1 if all powered running gear assemblies have locking differentials, 0 otherwise
LOCKUP	0 if torque converter does not lockup, 1 if torque converter has lockup
MAXIPR	Number of surface roughness values per tolerance level
MAXL	Number of roughness tolerance levels specified
NAMBLY	Total number of running gear assemblies
NBOGIE(I)	Number of road wheels on track assembly I
NCHAIN(I)	1 if chains are present on tire on assembly I 0 otherwise
NCYL	Number of cylinders per engine
NENG	Number of engines
NFL(I)	0 if track on assembly I is rigid, 1 otherwise
NGR	Number of transmission gear ratios
NHVALS	Number of height values used in arrays VOOB and HVALS

TABLE III.B.1 (Continued)

Variable Name	Description
NPAD(I)	1 if track on assembly I has pads, 0 otherwise
NSVALS	Number of obstacle spacing values used in arrays VOOBS and SVALS
NVEH(I)	0 if running gear assembly I is tracked, 1 if wheeled
NWHL(I)	Number of tires on wheeled assembly I
NWR	Number of water depths between 0 and FORDD for which weight ratios are given
PBF	Maximum force pushbar can tolerate (lb.)
PBHT	Unit pushbar height (in.)
PFA	Vehicle projected frontal area (in ² .)
POWER(1,J)	Vehicle velocity component of the tractive effort versus speed curve (mi/hr. on input)
POWER(2,J)	Tractive force component of the tractive force versus speed curve (lb.)
QMAX	Maximum torque of each engine (ft.-lb.)
RDIAM(I)	Rim diameter of wheel for tires on axle assembly I (in.)
REVM(I)	Revolutions/mile of tire element on assembly I, (rev/mi)
RIMW(I)	Wheel rim width of assembly I, (in.)
RMS(N)	Nth surface roughness value (in.)
RW(I)	Track thickness + bogie rolling radius for tracked assembly I (in.)
SAE	Swamp angle (egress) (deg.)
SAI	Swamp angle (ingress) (deg.)

TABLE III.B.1 (Continued)

Variable Name	Description
SECTH(I)	Section height of tires on running gear assembly I (in.)
SECTW(I)	Section width of tires on running gear assembly I (in.)
SVALS(N)	Nth obstacle spacing in driver limited speed versus obstacle spacing table for successive obstacle crossing
TCASE(1)	Gear ratio for gear between engine and transmission (1. if no such gear)
TCASE(2)	Efficiency of gear between engine and transmission (1. if no such gear)
TL	Distance from front of first running gear assembly to rear of last (in.)
TPLY(I)	Tire ply rating of tires on axle I
TPSI(I,J)	Tire inflation pressure of tires on axle I (psi), specified for j=1 fine grained, =2 coarse grained, =3 highway
TQIND	Constant torque converter input torque at which torque converter performance curves are measured, (lb.-ft.)
TRAKLN(I)	Track length of track assembly I (in.)
TRAKWD(I)	Track width of track assembly I (in.)
TRANS(1,J)	Transmission gear ratio of gear NG
TRANS(2,J)	Transmission efficiency of gear NG
VAA	Vehicle approach angle (deg.)
VDA	Vehicle departure angle (deg.)
VFS	Vehicle fording speed
VOOB(I)	Maximum driver limited speed at which vehicle can impact an obstacle of height HVALS(I) if obstacles are spaced farther than two vehicle lengths apart (mph)

TABLE III.B.1 (Continued)

Variable Name	Description
VOOBS(I)	Maximum driver limited speed at which vehicle can impact successive obstacles spaced SVALS(I) apart (mph)
VRIDE(I,J)	Maximum speed over ground for surface roughness class I at roughness tolerance level J (mph)
VSS	Maximum combination still water speed without auxiliary propulsion (mph)
VSSAXP	Maximum combination still water speed with auxiliary propulsion (mph)
WC	Winch capacity (lb.)
WDAXP	Water depth at which auxiliary power can be used (in.)
WDPTH(N)	Nth water depth (in.)
WDTH	Maximum combination width (in.)
WGHT(I)	Weight on running gear assembly I (lb.)
WI	Minimum width between running gear elements (in.)
WRAT(N)	Ratio of vehicle weight on ground to total vehicle weight at Nth water depth, WDPTH(N)
WRFORD	Proportion of combination weight supported by ground when combination is operating at maximum fording depth
WT(I)	Tread width of running gear assembly I (in.) (Center to center plane if duals)
WTE(I)	Minimum width between left-right suspension elements (tires or tracks) on assembly I (in.)
XBRCOF	Maximum combination braking coefficient per assembly in lb./lb. of load carried

C. Terrain Input - Operational Modules

The user has several options in the organization of his terrain input data. First, the data required to describe each terrain unit varies depending on its nature, areal, road or linear feature. Secondly, over the years areal terrain data has been amassed in computer readable form in two different structures and the current computer program contains terrain data input/translation routines which accept data in each of these arrangements and perform the computations necessary to pass the expected data to the Terrain Preprocessor and the Areal Module. Only a single organization of road data is presently supported. Finally the user can, of course, prepare a customized subroutine to accept data in another format. The terrain data organization is signaled by the control variable MAP. The three organizations of data now implemented are described below.

It should be noted that the terrain input routines and the output subroutine, BUFF0, are now coded to deal with terrain data files which contain only areal units or road units, not a mixture of the two types.

1. Areal Terrain Input File - Class Interval Values

The first option for representation of areal terrain data is that used in the AMC-71 Mobility Model. For each of the 22 primary descriptors of the terrain unit, the data file contains the [integer] value of the factor class in which the descriptor lies.

Table III.C.1

Terrain Input File Structure

Variable Name	Input Format	Description
NPAT	I4	Terrain unit number (index)
IST	I2	Soil type - 1 fine grained 2 coarse grained 3 muskeg 6 fine grained soil CH relatively impervious to water
IRCI1	I2	Soil strength class - dry season
IRCI2	I2	Soil strength class - normal season
IRCI3	I2	Soil strength class - wet season
IGRADE	I1	Topographic slope class
IOA	I2	Obstacle approach angle class
IOH	I1	Obstacle height class
IOW	I1	Obstacle width class
IOL	I1	Obstacle length class
IOS	I1	Obstacle spacing class
IOST	I1	Obstacle spacing type 1 - potentially avoidable (random) 2 - nonavoidable (linear)
IRMS	I1	Surface roughness class
ISTEM1	I1	Spacing class of vegetation in stem diameter class 1 and greater
ISTEM2	I1	Spacing class of vegetation in stem diameter class 2 and greater
ISTEM3	I1	Spacing class of vegetation in stem diameter class 3 and greater

Table III.C.1 (Continued)

Variable Name	Input Format	Description
ISTEM4	I1	Spacing class of vegetation in stem diameter class 4 and greater
ISTEM5	I1	Spacing class of vegetation in stem diameter class 5 and greater
ISTEM6	I1	Spacing class of vegetation in stem diameter class 6 and greater
ISTEM7	I1	Spacing class of vegetation in stem diameter class 7 and greater
ISTEM8	I1	Spacing class of vegetation in stem diameter class 8 and greater
IRD	I1	Recognition distance class
AREA	F10.3	Area

Note: Area is not used in the Mobility Model. It is included in many of the existing terrain files and is included in the input and reported in the output for convenience in further processing of the output.

2. Areal Terrain Input File - Real Values

The second option supported by the current program for input of terrain data is a format used for a variety of studies performed in the United States during the middle of the 1970 decade. This format provides for input of actual values for various primary terrain descriptors. The organization of the data for each terrain unit is presented in Table III.C.2.

A few changes in the content of the terrain data should be noted. First, a fourth soil strength value is included to extend to an extremely wet seasonal condition, presently taken as the wet season condition during a year when daily rainfall is 150% of the long term average values for the area. Secondly, four recognition distances are included to provide for the variation in this quantity with season (primarily due to changes in vegetation). The value used is determined from the scenario variable MONTH.

The organization of the data should be carefully noted. The data for each terrain unit occupy two lines of the input file and some of the positions on each line are not used. Most of the data are read as four digit whole numbers with the decimal point omitted. To allow the expected range of the values to fit reasonably with the implied scaling a mixture of units is used, as noted in the table. In particular the surface roughness value is multiplied by 10.

Table III.C.2

Terrain Input File Structure - Real Values

Variable Name	Input Format	Description
NTU	I5	Terrain unit number
IST	I2	Soil type - 1 fine grained 2 course grained 3 muskeg 6 fine grained soil CH relatively impervious to water
	20X	Filler
RCIC(1)	I4	Soil strength - dry (RCI)
RCIC(2)	I4	Soil strength - average (RCI)
RCIC(3)	I4	Soil strength - wet (RCI)
RCIC(4)	I4	Soil strength - wet,wet (RCI)
GRADE	I4	Topographic slope (%)
AA	I4	Obstacle approach angle (deg.)
OBH	I4	Obstacle height (in.)
OBW	I4	Obstacle width (ft.)
OBL	I4	Obstacle length (ft.)
OBS	I4	Obstacle spacing (ft.)
IOST	I4	Obstacle spacing type 1 - potentially avoidable (random) 2 - nonavoidable (linear)
ACTRMS	I4	10*Surface roughness (RMS - 10*in.)

NOTE: The remaining data form the second line

	5X	Filler
S(1)	I4	Mean spacing (in ft.) of vegetation in stem diameter class 1 and greater
S(2)	I4	Mean spacing (in ft.) of vegetation in stem diameter class 2 and greater

Table III.C.2 (Continued)

Variable Name	Input Format	Description
S(3)	I4	Mean spacing (in ft.) of vegetation in stem diameter class 3 and greater
S(4)	I4	Mean spacing (in ft.) of vegetation in stem diameter class 4 and greater
S(5)	I4	Mean spacing (in ft.) of vegetation in stem diameter class 5 and greater
S(6)	I4	Mean spacing (in ft.) of vegetation in stem diameter class 6 and greater
S(7)	I4	Mean spacing (in ft.) of vegetation in stem diameter class 7 and greater
S(8)	I4	Mean spacing (in ft.) of vegetation in stem diameter class 8 and greater
RDA1	I4	Recognition distance - Winter
RDA2	I4	Recognition distance - Spring
RDA3	I4	Recognition distance - Summer
RDA4	I4	Recognition distance - Autumn
AREA	F8.4	Area of the terrain unit

NOTE: Area is not used in the mobility model. It is included in many of the existing terrain files and is included in the input and reported in the output for convenience in further processing of the output.

3. Road Terrain Input File

The terrain data input routine contained in the program is that required to accept the terrain data files which were prepared for studies conducted in the mid 1970's using programs other than the NRMM Road Module. These simple programs do not use the full collection of road descriptors required for the NRMM Road Module.

Missing values are provided by the input/translation routine, MPRD74. Furthermore, for the earlier studies, the road segment curvature was preprocessed into a speed limit so that the curvature must be computed from this speed limit (and the speed limit recomputed in TPP!). The organization of data is much like that described for areal terrain in the previous section. Soil strength is provided (for trails) for our seasonal conditions, visibility recognition distances for four seasons and most of the data is read as four digit whole numbers like that described in the previous section.

Table III.C.3

Variable Name	Terrain Input Format	File Structure Description	Roads
NTU	I5	Terrain unit number	
IROAD	I2	Road type index	
		1 - super highway	
		2 - primary road	
		3 - secondary road	
		4 - trail	
IST	I2	Soil type (used for trails)	
		1 - fine grained	
		2 - coarse grained	
		6 - fine grained, CH, relatively impervious to water	
IURB	I2	Urban code	
RCIC(1)	I4	Soil strength - dry season	(RCI)
RCIC(2)	I4	Soil strength - average season	(RCI)
RCIC(3)	I4	Soil strength - wet season	(RCI)
RCIC(4)	I4	Soil strength - wet, wet season	(RCI)
GRADE	I4	Topographic slope	(%)
RDA1	I4	Recognition distance - Winter	(ft.)
RDA2	I4	Recognition distance - Spring	(ft.)
RDA3	I4	Recognition distance - Summer	(ft.)
RDA4	I4	Recognition distance - Autumn	(ft.)
ACTRMS	I4	10*Surface roughness	(RMS - in.)
CURVV	I4	AASHO Curvature speed limit	(mph)
DIST	F8.4	Road segment length	(mi.)

NOTE: Road segment length is not used in the mobility model. It is included in many of the existing terrain files and is included in the input and reported in the output for convenience in further processing of the output.

D. Scenario and Control Input Data

To provide flexibility to the user in the use of the NRMM many options are provided through the scenario and control variables. The control variables SEARCH and NTUX allow restriction of the operational modules to a single terrain unit anywhere in the terrain file. The variable MAP indicates the format of the terrain input file. The remainder of the control variables allow the user to generate output at any of the 41 breakpoints in the flow of data through NRMM.

The scenario variables provide an option to model some of the operations which may be possible for a given vehicle on a fixed terrain. Presently available terrain files contain soil strength and visibility limits under different conditions which are specified by ISEASN and MONTH. Shallow snow can be introduced using the indicator ISNOW with the snow described by COHES, GAMMA, PHI and ZSNOW. For roadways, an overall speed limit can be set by VLIM and recognition distance variation due to weather (e.g. fog) can be introduced by RDFOG. Variables NSLIP and ISURF indicate surface moisture content for areal and road terrain units respectively.

The variable NTRAV allows the model to be run in "traverse" or "omnidirectional" modes. In the former mode the speed is calculated only for the topographic slope value (which may be negative) in the terrain data. In the latter mode, speeds are calculated with the input slope, its negative and [for areal units] zero slope and then the harmonic average of the speeds is computed and reported.

Several of the scenario variables describe the man-vehicle-terrain relations. These include the roughness acceptance level, LAC, speeds at which a driver will proceed regardless of lack of visibility (which may be different on and off road), VBRAKE and VISMN, and the driver's reaction time, REACT. Braking is controlled for comfort and safety through DCLMAX and SFTYPC while vegetation override is set through IOVER and VWALK.

The final scenario variables allow selection of the tire pressure (including the possibility of using the optimal tire pressure for each terrain unit as is possible on a vehicle equipped with a proper central tire inflation system) and selecting between an input (perhaps measured) tractive effort vs speed curve and one produced by the program from the power train characteristics.

The control and scenario variables are assembled into a single input data file and input to the program through two NAMELIST directed READ statements located in subroutine SCN. In SCN, default values are first set. Next most of the control variables are read using NAMELIST "CONTRL". The output print controls are then set as determined by the value of DETAIL. Finally, the remainder of the control variables and the scenario variables are read using NAMELIST "SCENAR". It is assumed that the computer self initializes variables to zero. The control and scenario variables are described in Tables III.D.1 and III.D.2. The variables are grouped in the tables as they are to be grouped in the input data file. Thus the second table contains both control and scenario variables. A sample data file is contained in

the Appendix.

TABLE III.D.1

Control Input Data - Operational Modules
NAMELIST CONTRL

Variable Name	Default Value	Description
DETAIL	1	<p>Level of detail of output</p> <ul style="list-style-type: none"> 1-Summary output together with any detailed outputs specified through the KXXXX variables described below. 2-Echoes of vehicle, control and scenario inputs together with output for each terrain unit of <ul style="list-style-type: none"> a) terrain unit number and type b) selected speed made good c) average speed made good d) speeds upgrade, on level and down grade contributing to the selected speed made good e) speeds upgrade, on level and down grade contributing to the average speed made good f) grade g) terrain unit area 3,4-Presently, the same as 2 5-All output possible from the vehicle preprocessor together with a printer plot of the tractive effort vs speed curve - terminates execution after the vehicle preprocessor 10-All outputs - in general, inputs and outputs are reported at each break-point in the flow of computation through the vehicle pre-processor and areal modules - can only be run on a single terrain unit (the effect is the same as setting all the KXXXX variables to 1)
NTUX		<p>The number of the terrain unit when output is to be produced for a single terrain unit from a terrain input data file with more than one terrain unit (see SEARCH)</p>
SEARCH		<p>Search option flag:</p> <ul style="list-style-type: none"> 0-Output desired for all terrain units in terrain input data file 1-Output desired only for a single terrain unit specified by NTUX

TABLE III.D.1 (Continued)

Variable Name	Default Value	Description
---------------	---------------	-------------

Note: The remaining variables are the output controls. For each the output described is produced if the variable = 1 and is not produced if the variable = 0. If DETAIL = 5 or 10, all values read are over written and set to 1.

KSCEN		Control and scenario variables are echoed
KVEH		Vehicle input data is echoed
KII1		Input and output of subroutine II1
KII2		Input and output of subroutine II2
KII3		Input and output of subroutine II3
KII4		Input and output of subroutine II4
KII5		Input and output of subroutine II5
KII6		Input and output of subroutine II6
KII7		Input and output of subroutine II7
KII8		Input and output of subroutine II8
KII9		Input and output of subroutine II9
KII10		Input and output of subroutine II10
KII11		Input and output of subroutine II11
KII12		Input and output of subroutine II12
KII13		Input and output of subroutine II13
KII14		Input and output of subroutine II14
KII15		Input and output of subroutine II15
KII16		Input and output of subroutine II16
KII17		Input and output of subroutine II17
KMAP		Terrain input data are echoed. The values reported are those passed to the computational modules after any translation required for the input file format
KTPP		Input and output of the terrain preprocessor
KIV1		Input and output of subroutine IV1
KIV2		Input and output of subroutine IV2
KIV3		Input and output of subroutine IV3
KIV4		Input and output of subroutine IV4
KIV5		Input and output of subroutine IV5
KIV6		Input and output of subroutine IV6
KIV7		Input and output of subroutine IV7
KIV8		Input and output of subroutine IV8
KIV9		Input and output of subroutine IV9
KIV10		Input and output of subroutine IV10
KIV11		Input and output of subroutine IV11
KIV12		Input and output of subroutine IV12

TABLE III.D.1 (Continued)

Variable Name	Default Value	Description
KIV13		Input and output of subroutine IV13
KIV14		Input and output of subroutine IV14
KIV15		Input and output of subroutine IV15
KIV16		Input and output of subroutine IV16
KIV17		Input and output of subroutine IV17
KIV18		Input and output of subroutine IV18
KIV19		Input and output of subroutine IV19
KIV20		Input and output of subroutine IV20
KIV21		Input and output of subroutine IV21

Note: This table is organized in a (hopefully) logical rather than alphabetical order - In particular, the KXXXX which provide output control are grouped after the other variables and are in order of use in the program.

TABLE III.D.2

Control and Scenario Variables - Operational Modules
NAMELIST SCENAR

Variable Name	Default Value	Description
COHES	.05	Cohesion of snow (lb./in ² .)
DCLMAX	.50	Maximum deceleration the driver will actually accept (g's)
GAMMA	.20	Specific gravity of snow
IOVER	9	The index of the maximum stem diameter class to be overridden if the speed to do so is greater than walking speed
ISEASN	1	Seasonal soil strength (moisture) indicator for areal terrain - 1 dry 2 normal 3 wet 4 wet,wet
ISURF	1	Seasonal surface traction condition indicator for roads - 1 dry 2 wet 3 ice covered
ISNOW		Shallow snow cover indicator 0 no snow 1 snow cover
LAC	1	Indicator of surface roughness absorbed power acceptance level
MAP	71	Terrain input file format indicator 71 - class interval values, areal terrain 74 - Real values, areal terrain 11 - Real values, road terrain
MAPG	1	Powertrain computation method 1-Tractive effort vs speed data calculated from engine & transmission characteristics 2-Input tractive effort vs speed data used
MONTH		Month of year (1=Jan.,2=Feb.,etc. required if MAP= 11 or 74)
NOPP	0	Operating tire pressure indicator 0-Tire pressure used for each terrain unit determined by surface type in that unit 1-Tire pressure for cross-country used for all terrain units 2-Tire pressure for sand used for all terrain units 3-Tire pressure for highways used for all terrain units
NSLIP	0	Surface moisture due to rain fall indicator (for areal terrain) 0-No moisture to make surface slippery 1-Less than 1 in. of rain with no free surface water 2-Less than 6 hours flooding with no free surface water

TABLE III.D.2 (Continued)

Variable Name	Default Value	Description
NSLIP		3-More than 6 hours flooding with no free surface water 4-Less than 1 in. of rain with free surface water 5-Less than 6 hours flooding with free surface water 6-More than 6 hours flooding with free surface water
NTRAV	3	Operational mode 1- Traverse 3-Omnidirectional
NTUX		Number of terrain unit to be examined if SEARCH = 1
PHI	21.0	Internal friction angle of snow (deg.)
RDFOG	1000.0	Recognition distance on road, influenced by weather (in.)
REACT	.5	Driver reaction time (time from recognition to initiation of deceleration) (sec.)
SFTYPC	90.0	Percent of maximum deceleration available that the driver will actually use (%)
VBRAKE	5.0	Speed at which vehicle will proceed on a road if visibility is entirely obscured (mph)
VISMNV	2.0	Speed at which vehicle will proceed in areal terrain if visibility is entirely obscured (mph)
VLIM	55.0	Speed limit on road (mph)
ZSNOW	3.0	Snow depth (in.)

E. Output

NRMM has been designed to provide to its users a quantity of output data which can vary from a single number, speed-made-good on one terrain unit, to hundreds of pages covered with numbers (to a printer and/or file). The selection of the data to be written during the program execution from that which is possible is determined by the input values of the control variables described in the preceding section. Four choices of outputs are implemented in the NRMM computer code at present through the control variable DETAIL.

If DETAIL = 1 only the basic output of the NRMM is written for each terrain unit in the terrain input file. This consists of the following for areal terrain units:

1. Terrain unit number, NTU
2. Terrain type, ITUT
 - 1 - normally dry patch
 - 2 - marsh or other water covered patch
 - 11 - superhighway
 - 12 - primary road
 - 13 - secondary road
 - 14 - trail
3. The omnidirectional speed-made-good attainable by the vehicle in the terrain unit, VMAX
4. The attainable speed-made-good going with the topographic slope (up grade)
5. The attainable speed-made-good on level
6. The attainable speed-made-good going against the topographic slope (down grade)
7. The selected omni-directional speed-made-good which considers both the vehicle capabilities and human factors, VSEL
8. The selected speed-made-good upgrade

9. The selected speed-made-good on level
10. The selected speed-made-good down grade
11. Grade (topographic slope)
12. Area of the terrain unit

All speeds are in miles per hour, grade (topographic slope) is in percent and area is repeated from the input file. On roads, since the selected speed-made-good is the same as the attainable speed-made-good, items 3.-6. are not included in the output, also, on a road one can only proceed with or against the given grade so item 9 is omitted.

If `DETAIL = 2`, the basic output table described above is preceded by listings of the values of the control and scenario variables and the vehicle input data. This additional data is written using `NAMelist`, so that the name of each variable precedes its value.

Setting `DETAIL = 5` provides complete information about the vehicle pre-processor. After each major subroutine of the vehicle pre-processor (II1 - II17) a `NAMelist` is written which contains the input and output of the subroutine. In addition, a line printer-plot of the tractive effort vs. speed curve is output. This printer-plot is also produced when errors are detected in the automatic curve-fitting section of the vehicle pre-processor. The program execution is terminated after the vehicle pre-processor (before any terrain data is read) at this output level.

If DETAIL = 10, all available data is written to the output file. In addition to all the data described above (except the printer plot), after each major subroutine of the Areal Module (IV1-IV21) the input and output of the subroutine is written. Again, this is done through a NAMELIST so that each variable is identified. Detail level 10 output is not presently implemented for the Road Module. Since this output is voluminous, the program terminates after a single terrain unit.

The user of the NRMM who requires a different selection of data from that written under one of the above options has two choices. The 42 control variables for writing of intermediate output KII1-KII17, KIV1-KIV21, KMAP, KSCEN, KTPP and KVEH provide great flexibility for production of desired output. Alternately, the output section of the Control & I/O Module, Subroutine BUFF0, can be modified to yield the desired results. Samples of output are included in the appendices.

IV REFERENCES

- Abramowitz, Milton and Stegan, Irene A., Handbook of Mathematical Functions, National Bureau of Standards, Applied Mathematics Series, December 1965.
- American Association of State Highway Officials (AASHO), A Policy on Geometric Design of Rural Highways, 1965, The American Association of State Highway Officials, Washington, D. C., pp 152 to 159.
- Eklund, K. F., "The Influence of Load and Inflation on the Selection of Pneumatic Tires for Military Vehicles", Report 922, April 1945, U. S. Army Engineers Research and Development Laboratories, Fort Belvoir, Va.
- Jurkat, M. P., Nuttall, C. J., and Haley, P. W., "The AMC '74 Mobility Model", Technical Report No. 11921 (LL-149), May 1975, U. S. Army Tank-Automotive Command, Warren, Mich.
- Lessem, A. S., "Dynamics of Wheeled Vehicles: A Mathematical Model for the Traversal of Rigid Obstacles by a Pneumatic Tire", Technical Report M-68-1, U. S. Army Waterways Experiment Station, CE, Vicksburg, Miss., May 1968.
- Merritt, H. E., "The Evolution of a Tank Transmission", The Institution of Mechanical Engineers, Vol. 154, p.412, April 1946.
- Nuttall, C. J., Jr., and Dugoff, H. J., "A Hierarchical Structure of Models for the Analysis of Land Mobility Systems", presented at Twelfth Annual U. S. Army Operations Research Symposium, Durham, N. C., Oct 1973.
- Nuttall, C. J., Jr., Rula, A. A., and Dugoff, H. J., "Computer Model for Comprehensive Evaluation of Cross-Country Vehicle Mobility", Earthmoving Industry Conference, SAE Paper No. 740426, presented at Society of Automotive Engineers, Apr 1974.
- Pradko, F., Lee, R. A., and Kaluza, V., "Theory of Human Vibration Response", Paper 66-WA-BHF-15, presented at ASME Meeting, Nov 1966.
- Ray, J. R., "Investigation of the Factors Involved in Steering Tracklaying Vehicles", Technical Report No. 10969 (AD 871157), May 1970, U. S. Army Tank-Automotive Command, Warren, Mich.
- Rula, A. A., and Nuttall, C. J., Jr., "An Analysis of Ground Mobility Models (ANAMOB)", Technical Report M-71-4, Jul 1971, U. S. Army Engineer Waterways Experiment Station, CE, Vicksburg, Miss.
- Rula, A. A. and Nuttall, C. J., Jr., "Terrain Modeling to Support Mobility Evaluation", Proceedings of Fifth International Conference, The International Society for Terrain-Vehicle Systems, Inc., Detroit, Mich., Vol 4, Jun 1975.

Schreiner, B. G., "A Technique for Estimating the Performance of Tracked Vehicles in Muskeg", Journal of Terramechanics, Vol. 4, 1967, No. 3, pp 23 to 29.

Smith, G., "Commercial Vehicles Performance and Fuel Economy", Society of Automotive Engineers, Special Publication 355, 1970.

Taborek, J. J., Mechanics of Vehicles, Penton Publications, Cleveland, Ohio, 1957.

Turnage, G. W., "Performance of Soils Under Tire Loads, Application of Test Results to Tire Selection for Off-Road Vehicles", Technical Report 3-666, Report 8, Sept 1972, U. S. Army Waterways Experiment Station, CE, Vicksburg, Miss.

U. S. ATAC, "The AMC-71 Mobility Model", Technical Report No. 11789 (LL 143), Vols. I and II, Jul 1973, U. S. Army Tank-Automotive Command, Warren, Mich.

```
PROGRAM NRMM (
+ INPUT = 81,
+ OUTPUT = 137,
+ TAPE1 = OUTPUT,
+ TAPE2 = 81,
+ TAPE3 = 81,
+ TAPE4 = 81,
+ TAPE5 = 81,
+ TAPE10 = 512 )
```

C
C
C
C
C
C
C
C
C
C

TITLE:
NATO REFERENCE MOBILITY MODEL
ORGANIZATION:
U.S. ARMY TANK AUTOMOTIVE RESEARCH AND DEVELOPMENT COMMAND

1. LABELED COMMON ASSIGNMENTS

COMMON /IO/	ISOF
COMMON /IO/	KBUFF
COMMON /IO/	LUN1
COMMON /IO/	LUN2
COMMON /IO/	LUN3
COMMON /IO/	LUN4
COMMON /IO/	LUN5
COMMON /IO/	LUN6
COMMON /IO/	LUN7
COMMON /IO/	LUN8
COMMON /IO/	LUN9
COMMON /IO/	LUN10
INTEGER	MB
COMMON /INDEX/	MD
INTEGER	DOWN
COMMON /INDEX/	DOWN
INTEGER	EEF
COMMON /INDEX/	EEF
INTEGER	FORCE
COMMON /INDEX/	FORCE
INTEGER	GR
COMMON /INDEX/	GR
COMMON /INDEX/	LEVEL
INTEGER	WB
COMMON /INDEX/	MN
INTEGER	FRM
COMMON /INDEX/	REM
INTEGER	SPEED
COMMON /INDEX/	SPEED
INTEGER	SR
COMMON /INDEX/	SR
INTEGER	TR
COMMON /INDEX/	TR
INTEGER	TORQUE

COMMON /INDEX/	TORQUE	
INTEGER	UG	
COMMON /INDEX/	UR	
INTEGER	MX	
COMMON /INDEX/	MX	
COMMON /VEHICL/	AGD	
COMMON /VEHICL/	ASHOE	(20)
COMMON /VEHICL/	AVGC	
COMMON /VEHICL/	AXLSP	(20)
COMMON /VEHICL/	CB	
COMMON /VEHICL/	CGH	
COMMON /VEHICL/	CBLAT	
COMMON /VEHICL/	CBR	
COMMON /VEHICL/	CED	
COMMON /VEHICL/	Cd	
COMMON /VEHICL/	CERMIN	(20)
COMMON /VEHICL/	CONV1	(2,25)
COMMON /VEHICL/	CONV2	(2,25)
COMMON /VEHICL/	CELCT	(20,3)
COMMON /VEHICL/	CSAM	(20)
COMMON /VEHICL/	DRAFT	
COMMON /VEHICL/	ENGINE	(2,50)
COMMON /VEHICL/	EYEHGT	
COMMON /VEHICL/	FB	(2)
COMMON /VEHICL/	FQRDD	
COMMON /VEHICL/	GROUSH	(20)
COMMON /VEHICL/	HVALS	(25)
COMMON /VEHICL/	IMPG	
COMMON /VEHICL/	IB	(20)
COMMON /VEHICL/	ID	(20)
REAL	IDIESL	
COMMON /VEHICL/	IDIESL	
COMMON /VEHICL/	IENGIN	
COMMON /VEHICL/	IR	(20)
COMMON /VEHICL/	ICONST	(20)
COMMON /VEHICL/	ICONV1	
COMMON /VEHICL/	IGONV2	
COMMON /VEHICL/	IPOWER	
COMMON /VEHICL/	IT	(20)
COMMON /VEHICL/	ITCASE	
COMMON /VEHICL/	ITRAN	
COMMON /VEHICL/	ITVAR	
COMMON /VEHICL/	LOCKUP	
COMMON /VEHICL/	MAXIPR	
COMMON /VEHICL/	MAXL	
COMMON /VEHICL/	NAMBLV	
COMMON /VEHICL/	NBOGIE	(20)
COMMON /VEHICL/	NCHAIN	(20)
REAL	NCYL	
COMMON /VEHICL/	NOYL	
REAL	NBNG	
COMMON /VEHICL/	NBNG	

COMMON /VEHICL/	HRNET	
COMMON /VEHICL/	NFL	(20)
COMMON /VEHICL/	NGR	
COMMON /VEHICL/	AHVALS	
COMMON /VEHICL/	NRAD	(20)
COMMON /VEHICL/	ASVALS	
COMMON /VEHICL/	NVEH	(20)
COMMON /VEHICL/	AMHL	(20)
COMMON /VEHICL/	NWR	
COMMON /VEHICL/	FBF	
COMMON /VEHICL/	PBHT	
COMMON /VEHICL/	PEA	
COMMON /VEHICL/	POWER	(2,20)
COMMON /VEHICL/	CNAX	
COMMON /VEHICL/	RBIAM	(20)
COMMON /VEHICL/	FEVM	(20)
COMMON /VEHICL/	RBMW	(20)
COMMON /VEHICL/	RMS	(20)
COMMON /VEHICL/	RM	(20)
COMMON /VEHICL/	SAE	
COMMON /VEHICL/	SBI	
COMMON /VEHICL/	SBCTH	(20)
COMMON /VEHICL/	SBCTW	(20)
COMMON /VEHICL/	SMALS	(25)
COMMON /VEHICL/	TCASE	(2)
COMMON /VEHICL/	TE	
COMMON /VEHICL/	TOLY	(20)
COMMON /VEHICL/	TOSI	(20,3)
COMMON /VEHICL/	TQIND	
COMMON /VEHICL/	TRAKEN	(20)
COMMON /VEHICL/	TRAKWO	(20)
COMMON /VEHICL/	TRANS	(2,20)
COMMON /VEHICL/	VAA	
COMMON /VEHICL/	VDA	
COMMON /VEHICL/	VES	
COMMON /VEHICL/	VBOB	(25)
COMMON /VEHICL/	VGOBS	(25)
COMMON /VEHICL/	VRIDE	(20,3)
COMMON /VEHICL/	VSS	
COMMON /VEHICL/	VSSAXP	
COMMON /VEHICL/	WC	
COMMON /VEHICL/	WDAXP	
COMMON /VEHICL/	WDPTH	(20)
COMMON /VEHICL/	WDTH	
COMMON /VEHICL/	WGHT	(20)
COMMON /VEHICL/	WRAT	(20)
COMMON /VEHICL/	WRFORD	
COMMON /VEHICL/	WT	(20)
COMMON /VEHICL/	WTE	(20)
COMMON /VEHICL/	WWXP	
COMMON /VEHICL/	XBRCCF	
COMMON /VEHICL/	WE	

COMMON /VEHICL/	LOCDF	
COMMON /VEHICL/	SHF	
COMMON /PREP/	A	(3,4)
COMMON /PREP/	ATF	(20)
COMMON /PREP/	EIF	(20)
COMMON /PREP/	CMARLN	(20,3)
COMMON /PREP/	COFCFG	(3)
COMMON /PREP/	COFCCG	(3)
COMMON /PREP/	COFCG	(20,3)
COMMON /PREP/	COFFG	(20,3)
COMMON /PREP/	CTF	(20)
COMMON /PREP/	CRAT	(20,3)
COMMON /PREP/	GCA	(20,3)
COMMON /PREP/	GCW	
COMMON /PREP/	GCWB	
COMMON /PREP/	GCWNB	
COMMON /PREP/	GCWNP	
COMMON /PREP/	GCWP	
COMMON /PREP/	FRT	
COMMON /PREP/	NDF	(38)
COMMON /PREP/	NVEHC	
COMMON /PREP/	PATE	
COMMON /PREP/	F	(3)
COMMON /PREP/	RMK	(20)
COMMON /PREP/	RR	
COMMON /PREP/	TRACTF	(20,5)
COMMON /PREP/	TRAPSI	(3)
COMMON /PREP/	VCICG	(20,3)
COMMON /PREP/	VCIFG	(20,3)
COMMON /PREP/	VCIMUK	(20)
COMMON /PREP/	VBV	(20,5)
COMMON /PREP/	VE	(20,3)
COMMON /PREP/	VDIRE	(3)
COMMON /PREP/	MEMAX	
COMMON /PREP/	X	(3)
COMMON /PREP/	XBR	
COMMON /OBS/	AVALS	(14)
COMMON /OBS/	CEAR	(7,14,5)
COMMON /OBS/	FBO	(7,14,5)
COMMON /OBS/	FBO MAX	(7,14,5)
COMMON /OBS/	FOVALS	(7)
COMMON /OBS/	LANG	
COMMON /OBS/	NGHGT	
COMMON /OBS/	NWDTH	
COMMON /OBS/	WVALS	(5)
COMMON /DERIVE/	AOT	(9)
COMMON /DERIVE/	NGGOBF	
COMMON /DERIVE/	CAREA	
COMMON /DERIVE/	CONB	
COMMON /DERIVE/	CONP	
COMMON /DERIVE/	CONPB	(20)
COMMON /DERIVE/	FA	(20,3)

COMMON /DERIVE/	FAT	(9)
COMMON /DERIVE/	FAT1	(9)
COMMON /DERIVE/	FB	(20,3)
COMMON /DERIVE/	FC	(20,3)
COMMON /DERIVE/	FNT	(9)
COMMON /DERIVE/	FQM	
COMMON /DERIVE/	FQMAX	
COMMON /DERIVE/	FQRMX	(3)
COMMON /DERIVE/	IFLOAT	
COMMON /DERIVE/	INAX	(3)
COMMON /DERIVE/	ISAFE	(3)
COMMON /DERIVE/	J	
COMMON /DERIVE/	MAXI	
COMMON /DERIVE/	BEMX	(3)
COMMON /DERIVE/	NEVERO	
COMMON /DERIVE/	CBSE	
COMMON /DERIVE/	PAV	(9)
COMMON /DERIVE/	RTOWB	
COMMON /DERIVE/	RTOWNB	
COMMON /DERIVE/	RTOWNP	
COMMON /DERIVE/	RQOWP	
COMMON /DERIVE/	RTOWPB	(20)
COMMON /DERIVE/	RQOWT	(20)
COMMON /DERIVE/	STRACT	(20,3,3)
COMMON /DERIVE/	SRFO	(9)
COMMON /DERIVE/	SRFV	(9)
COMMON /DERIVE/	STR	(3,9)
COMMON /DERIVE/	TBF	(3)
COMMON /DERIVE/	TBEN	(9)
COMMON /DERIVE/	TRES IS	(3,9)
COMMON /DERIVE/	VA	(3,9)
COMMON /DERIVE/	NGGOVA	(3,9)
COMMON /DERIVE/	VAVOID	(3,9)
COMMON /DERIVE/	VBO	(3,9)
COMMON /DERIVE/	IMPACT	(9)
COMMON /DERIVE/	VELV	(3)
COMMON /DERIVE/	VEMAX	(3)
COMMON /DERIVE/	VG	(20,3,3)
COMMON /DERIVE/	NGGOVO	(3,9)
COMMON /DERIVE/	VMAX	
COMMON /DERIVE/	VMAX1	(3)
COMMON /DERIVE/	VMAX2	(3,9)
COMMON /DERIVE/	VOLA	
COMMON /DERIVE/	VQVER	(3,9)
COMMON /DERIVE/	VRID	
COMMON /DERIVE/	VSEL	
COMMON /DERIVE/	VSEL1	(3)
COMMON /DERIVE/	VSEL2	(3,9)
COMMON /DERIVE/	VSCIL	(3,9)
COMMON /DERIVE/	VST	(3,9)
COMMON /DERIVE/	VXT	(3,9)
COMMON /DERIVE/	WGGONO	

COMMON /DERIVE/	WRATIO	
COMMON /TERRAN/	AA	
COMMON /TERRAN/	ACTRMS	
COMMON /TERRAN/	AREA	
COMMON /TERRAN/	AREAC	
COMMON /TERRAN/	CF	
COMMON /TERRAN/	DIST	
COMMON /TERRAN/	EANG	
COMMON /TERRAN/	EDF	
COMMON /TERRAN/	EDEV	
COMMON /TERRAN/	FNU	(3)
COMMON /TERRAN/	GRADE	
COMMON /TERRAN/	IGBS	
COMMON /TERRAN/	IOST	
COMMON /TERRAN/	IROAD	
COMMON /TERRAN/	IS	(9)
COMMON /TERRAN/	IST	
COMMON /TERRAN/	IJUR	
COMMON /TERRAN/	NE	
COMMON /TERRAN/	NTU	
COMMON /TERRAN/	CAW	
COMMON /TERRAN/	CBAA	
COMMON /TERRAN/	CBH	
COMMON /TERRAN/	CEL	
COMMON /TERRAN/	CBS	
COMMON /TERRAN/	CBW	
COMMON /TERRAN/	CBMINW	
COMMON /TERRAN/	CEIA	
COMMON /TERRAN/	NWASHO	
COMMON /TERRAN/	RADC	
COMMON /TERRAN/	RCI	
COMMON /TERRAN/	RCIC	(4)
COMMON /TERRAN/	RCURV	(11)
COMMON /TERRAN/	RD	
COMMON /TERRAN/	REA	(12)
COMMON /TERRAN/	S	(9)
COMMON /TERRAN/	SC	(9)
COMMON /TERRAN/	SDL	(9)
COMMON /TERRAN/	SURFF	
COMMON /TERRAN/	TANPHI	
COMMON /TERRAN/	THETA	(3)
COMMON /TERRAN/	VCURV	(4, 11)
COMMON /TERRAN/	WA	
COMMON /TERRAN/	WC	
COMMON /SCEN/	CEHES	
COMMON /SCEN/	VMALK	
COMMON /SCEN/	ECLMAX	
COMMON /SCEN/	GAMMA	
COMMON /SCEN/	TEVER	
COMMON /SCEN/	ISEASN	
COMMON /SCEN/	ISURF	
COMMON /SCEN/	ISNOW	

COMMON /SCEN/	KI11
COMMON /SCEN/	KI12
COMMON /SCEN/	KI13
COMMON /SCEN/	KI14
COMMON /SCEN/	KI15
COMMON /SCEN/	KI16
COMMON /SCEN/	KI17
COMMON /SCEN/	KI18
COMMON /SCEN/	KI19
COMMON /SCEN/	KI110
COMMON /SCEN/	KI111
COMMON /SCEN/	KI112
COMMON /SCEN/	KI113
COMMON /SCEN/	KI114
COMMON /SCEN/	KI115
COMMON /SCEN/	KI116
COMMON /SCEN/	KI117
COMMON /SCEN/	KMAP
COMMON /SCEN/	KSCEN
COMMON /SCEN/	KIPP
COMMON /SCEN/	KMEH
COMMON /SCEN/	KV1
COMMON /SCEN/	KV2
COMMON /SCEN/	KV3
COMMON /SCEN/	KV4
COMMON /SCEN/	KV5
COMMON /SCEN/	KV6
COMMON /SCEN/	KV7
COMMON /SCEN/	KV8
COMMON /SCEN/	KV9
COMMON /SCEN/	KV10
COMMON /SCEN/	KV11
COMMON /SCEN/	KV12
COMMON /SCEN/	KV13
COMMON /SCEN/	KV14
COMMON /SCEN/	KV15
COMMON /SCEN/	KV16
COMMON /SCEN/	KV17
COMMON /SCEN/	KV18
COMMON /SCEN/	KV19
COMMON /SCEN/	KV20
COMMON /SCEN/	KV21
COMMON /SCEN/	LAC
INTEGER	DETAIL
COMMON /SCEN/	DETAIL
COMMON /SCEN/	MAP
COMMON /SCEN/	MAPG
COMMON /SCEN/	MONTH
COMMON /SCEN/	NBPP
COMMON /SCEN/	NSLIP
COMMON /SCEN/	NRVAV
COMMON /SCEN/	NTUX

```
COMMON /SCEN/      PAI
COMMON /SCEN/      REACT
COMMON /SCEN/      RBFQG
INTEGER            SEARCH
COMMON /SCEN/      SEARCH
COMMON /SCEN/      SETYPC
COMMON /SCEN/      VBRAKE
COMMON /SCEN/      VISMNV
COMMON /SCEN/      VLIM
COMMON /SCEN/      ZONCW
C      2. INITILIZE PROGRAM VARIABLES
      KBUFF = 0
      LUN1 = 1
      LUN2 = 2
      LUN3 = 3
      LUN4 = 4
      LUN5 = 5
      LUN10 = 10
      MD = 2
      DOWN = 3
      EFF = 2
      FORCE = 2
      GR = 1
      LEVEL = 2
      MN = 1
      RPM = 1
      SPEED = 1
      SR = 2
      TORQUE = 2
      TR = 1
      UP = 1
      MX = 3
C      3. INITIALIZE I/O CHANNELS
      REWIND LUN2
      REWIND LUN3
      REWIND LUN4
      REWIND LUN5
      REWIND LUN10
C      4. READ SCENARIO PARAMETERS
      CALL SCN
C      5. READ VEHICLE PARAMETERS
      CALL VEH(KVEH)
C      6. EXECUTE VEHICLE PREPROCESSOR
      CALL VPP
C      7. EXECUTE TERRAIN TRANSLATOR
2000  CONTINUE
      CALL TERTL
C      8. EXECUTE AREAL OR ROAD MODULE
      IF(ITUT .LE. 2) CALL AREAL
      IF(ITUT .GE. 11) CALL ROAD
C      9. OUTPUT REQUESTED INFORMATION
      TF(IEOF .EQ. 1) GO TO 4000
```

CALL BUFF0
IF(SEARCH .EQ. 1) .OR. (DETAIL .EQ. 10) GO TO 4000
GO TO 2000

4000 CONTINUE
END

SUBROUTINE SCN

C -----
C SCENARIO INPUT ROUTINE
C -----
C

C 1. LABELED COMMON ASSIGNMENTS

COMMON /IO/ IEOF
COMMON /IO/ KBUFF
COMMON /IO/ LUN1
COMMON /IO/ LUN2
COMMON /IO/ LUN3
COMMON /IO/ LUN4
COMMON /IO/ LUN5
COMMON /IO/ LUN6
COMMON /IO/ LUN7
COMMON /IO/ LUN8
COMMON /IO/ LUN9
COMMON /IO/ LUN10
COMMON /SCEN/ CGHES
COMMON /SCEN/ VMALK
COMMON /SCEN/ DELMAX
COMMON /SCEN/ GAMMA
COMMON /SCEN/ IEVER
COMMON /SCEN/ ISEASN
COMMON /SCEN/ ISURF
COMMON /SCEN/ ISNOW
COMMON /SCEN/ KII1
COMMON /SCEN/ KII2
COMMON /SCEN/ KII3
COMMON /SCEN/ KII4
COMMON /SCEN/ KII5
COMMON /SCEN/ KII6
COMMON /SCEN/ KII7
COMMON /SCEN/ KII8
COMMON /SCEN/ KII9
COMMON /SCEN/ KII10
COMMON /SCEN/ KII11
COMMON /SCEN/ KII12
COMMON /SCEN/ KII13
COMMON /SCEN/ KII14
COMMON /SCEN/ KII15
COMMON /SCEN/ KII16
COMMON /SCEN/ KII17
COMMON /SCEN/ KMAP
COMMON /SCEN/ KSCEN
COMMON /SCEN/ KTPP
COMMON /SCEN/ KVEH

```

COMMON /SCEN/      K&V1
COMMON /SCEN/      K&V2
COMMON /SCEN/      K&V3
COMMON /SCEN/      K&V4
COMMON /SCEN/      K&V5
COMMON /SCEN/      K&V6
COMMON /SCEN/      K&V7
COMMON /SCEN/      K&V8
COMMON /SCEN/      K&V9
COMMON /SCEN/      K&V10
COMMON /SCEN/      K&V11
COMMON /SCEN/      K&V12
COMMON /SCEN/      K&V13
COMMON /SCEN/      K&V14
COMMON /SCEN/      K&V15
COMMON /SCEN/      K&V16
COMMON /SCEN/      K&V17
COMMON /SCEN/      K&V18
COMMON /SCEN/      K&V19
COMMON /SCEN/      K&V20
COMMON /SCEN/      K&V21
COMMON /SCEN/      LAC
INTEGER            DETA IL
COMMON /SCEN/      DETA IL
COMMON /SCEN/      MAP
COMMON /SCEN/      MAPG
COMMON /SCEN/      MONTH
COMMON /SCEN/      NOPP
COMMON /SCEN/      NSLIP
COMMON /SCEN/      NTRAV
COMMON /SCEN/      NTUX
COMMON /SCEN/      PHI
COMMON /SCEN/      REACT
COMMON /SCEN/      RDOFG
INTEGER            SEARCH
COMMON /SCEN/      SEARCH
COMMON /SCEN/      SFTYPC
COMMON /SCEN/      VBRAKE
COMMON /SCEN/      VISMV
COMMON /SCEN/      VLIM
COMMON /SCEN/      ZSNOW
  
```

C 2. SCENARIO INPUT PARAMETERS

```

NAMELIST /SCENAR/
+   COHES ,DCLMAX ,GAMMA ,IOVER ,ISEASN ,ISURF
+   ,ISNOW ,LAC ,MAP ,MAPG ,MONTH ,NOPP
+   ,NSLIP ,NTRAV ,NTUX ,PHI ,REACT ,RDOFG
+   ,SFTYPC ,VBRAKE ,VISMV ,VLIM ,ZSNOW
NAMELIST /CONTRL/
+   DETAIL ,KSCEN ,KVEH ,KII1 ,KII2
+   ,KII3 ,KII4 ,KII5 ,KII6 ,KII7
+   ,KII8 ,KII9 ,KII10 ,KII11 ,KII12
+   ,KII13 ,KII14 ,KII15 ,KII16 ,KII17
  
```

```

+      ,KMAP      ,KTPP      ,KIV1      ,KIV2      ,KIV3
+      ,KIV4      ,KIV5      ,KIV6      ,KIV7      ,KIV8
+      ,KIV9      ,KIV10     ,KIV11     ,KIV12     ,KIV13
+      ,KIV14     ,KIV15     ,KIV16     ,KIV17     ,KIV18
+      ,KIV19     ,KIV20     ,KIV21     ,NTUX      ,SEARCH
  
```

C 3. INITIALIZE SCENARIO VARIABLES

```

COHES = .05
VWALK = 4.00
DCLMAX = .50
GAMMA = .20
IOVER = 9
ISEASN = 1
ISNOW = 0
ISURF = 1
LAC = 1
DETAIL = 1
MAP = 71
MAPG = 1
NOPP = 0
NSLIP = 0
NTRAV = 3
PHI = 21.00
REACT = .50
RDFCG = 1000.00
SEARCH = 0
SFTYPC = 90.00
VBRAKE = 5.00
VISMNV = 2.00
VLIM = 55.00
ZSNOW = 3.00
  
```

C 4. READ CONTROL VARIABLES

```

READ(LUN4,CONTRL)
IF(DETAIL .EQ. 1) GO TO 330
IF(DETAIL .EQ. 2) GO TO 310
IF(DETAIL .EQ. 3) GO TO 310
IF(DETAIL .EQ. 4) GO TO 310
IF(DETAIL .EQ. 5) GO TO 320
IF(DETAIL .EQ. 10) GO TO 320
WRITE(LUN1,3000) DETAIL
STOP 1
  
```

GO TO 320

```

310   CONTINUE
      KSCEN = 1
      KVEH = 1
      GO TO 330
  
```

```

320   CONTINUE
      KSCEN = 1
      KVEH = 1
      KII1 = 1
      KII2 = 1
      KII3 = 1
      KII4 = 1
  
```

KI15 = 1
KI16 = 1
KI17 = 1
KI18 = 1
KI19 = 1
KIL10 = 1
KI111 = 1
KI112 = 1
KI113 = 1
KI114 = 1
KI115 = 1
KI116 = 1
KI117 = 1
KMAP = 1
KTPP = 1
KIV1 = 1
KIV2 = 1
KIV3 = 1
KIV4 = 1
KIV5 = 1
KIV6 = 1
KIV7 = 1
KIV8 = 1
KIV9 = 1
KIV10 = 1
KIV11 = 1
KIV12 = 1
KIV13 = 1
KIV14 = 1
KIV15 = 1
KIV16 = 1
KIV17 = 1
KIV18 = 1
KIV19 = 1
KIV20 = 1
KIV21 = 1

```
330 CONTINUE
      IF(KSCEN .EQ. 1) WRITE(LUN1,CONTROL)
C     5. READ SCENARIO VARIABLES
      READ(LUN4,SCENAR)
      IF(KSCEN .EQ. 1) WRITE(LUN1,SCENAR)
C     6. UNITS CONVERSION
      PHI = PHI*3.14159265/180.
      VBRAKE = VBRAKE*17.6
      VISMNV = VISMNV*17.6
      VLIM = VLIM*17.6
      VWALK = VWALK*17.6
3000 FORMAT(1X,31HINVALID ID SPECIFICATION OF DETAIL,12)
      RETRN
      END
SUBROUTINE VEH(KVEH)
-----
```

C VEHICLE PARAMETER INPUT ROUTINE
 C -----
 C
 C

1. LABELED COMMON ASSIGNMENTS

COMMON /IO/	IBOF	
COMMON /IO/	KBUFF	
COMMON /IO/	LUN1	
COMMON /IO/	LUN2	
COMMON /IO/	LUN3	
COMMON /IO/	LUN4	
COMMON /IO/	LUN5	
COMMON /IO/	LUN6	
COMMON /IO/	LUN7	
COMMON /IO/	LUN8	
COMMON /IO/	LUN9	
COMMON /IO/	LUN10	
COMMON /VEHICL/	ACD	
COMMON /VEHICL/	ASHOE	(20)
COMMON /VEHICL/	AMGC	
COMMON /VEHICL/	AXLSP	(20)
COMMON /VEHICL/	CD	
COMMON /VEHICL/	CGH	
COMMON /VEHICL/	CGLAT	
COMMON /VEHICL/	CGR	
COMMON /VEHICL/	CED	
COMMON /VEHICL/	CE	
COMMON /VEHICL/	CERMIN	(20)
COMMON /VEHICL/	CONV1	(2,25)
COMMON /VEHICL/	CONV2	(2,25)
COMMON /VEHICL/	DELCT	(20,3)
COMMON /VEHICL/	DRAW	(20)
COMMON /VEHICL/	DRAFT	
COMMON /VEHICL/	ENGINE	(2,50)
COMMON /VEHICL/	EMENGT	
COMMON /VEHICL/	FD	(2)
COMMON /VEHICL/	FERDD	
COMMON /VEHICL/	GROUSH	(20)
COMMON /VEHICL/	HVALS	(25)
COMMON /VEHICL/	IAPG	
COMMON /VEHICL/	IB	(20)
COMMON /VEHICL/	IG	(20)
REAL	IGIESL	
COMMON /VEHICL/	IBIESL	
COMMON /VEHICL/	IBENGIN	
COMMON /VEHICL/	IP	(20)
COMMON /VEHICL/	ICNST	(20)
COMMON /VEHICL/	ICONV1	
COMMON /VEHICL/	ICONV2	
COMMON /VEHICL/	IRQWER	
COMMON /VEHICL/	IT	(20)
COMMON /VEHICL/	ITCASE	
COMMON /VEHICL/	ITRAN	

COMMON /VEHICL/	JEVAR	
COMMON /VEHICL/	LOCKUP	
COMMON /VEHICL/	MAXIPR	
COMMON /VEHICL/	PAXL	
COMMON /VEHICL/	NMBLY	
COMMON /VEHICL/	ABEGIE	(20)
COMMON /VEHICL/	ACHAIN	(20)
REAL	ACYL	
COMMON /VEHICL/	NCYL	
REAL	ENG	
COMMON /VEHICL/	KENG	
COMMON /VEHICL/	FORNET	
COMMON /VEHICL/	NEL	(20)
COMMON /VEHICL/	NR	
COMMON /VEHICL/	NMVALS	
COMMON /VEHICL/	NBAD	(20)
COMMON /VEHICL/	NSVALS	
COMMON /VEHICL/	NMEH	(20)
COMMON /VEHICL/	NMHL	(20)
COMMON /VEHICL/	NMR	
COMMON /VEHICL/	FBF	
COMMON /VEHICL/	PBET	
COMMON /VEHICL/	FEA	
COMMON /VEHICL/	POWER	(2,201)
COMMON /VEHICL/	CNAX	
COMMON /VEHICL/	RDRAM	(20)
COMMON /VEHICL/	REVM	(20)
COMMON /VEHICL/	RDMW	(20)
COMMON /VEHICL/	FNS	(20)
COMMON /VEHICL/	RM	(20)
COMMON /VEHICL/	SAE	
COMMON /VEHICL/	SAE	
COMMON /VEHICL/	SECTH	(20)
COMMON /VEHICL/	SECTW	(20)
COMMON /VEHICL/	SVALS	(25)
COMMON /VEHICL/	TCASE	(2)
COMMON /VEHICL/	TE	
COMMON /VEHICL/	TOLY	(20)
COMMON /VEHICL/	TRSI	(20,3)
COMMON /VEHICL/	TGIND	
COMMON /VEHICL/	TRAKLN	(20)
COMMON /VEHICL/	TRAKWD	(20)
COMMON /VEHICL/	TRANS	(2,20)
COMMON /VEHICL/	VAA	
COMMON /VEHICL/	VDA	
COMMON /VEHICL/	VGS	
COMMON /VEHICL/	VQGB	(25)
COMMON /VEHICL/	VQGBS	(25)
COMMON /VEHICL/	VRIDE	(20,3)
COMMON /VEHICL/	VSS	
COMMON /VEHICL/	VSSXP	
COMMON /VEHICL/	WC	

```

COMMON /VEHICL/  NDAXP
COMMON /VEHICL/  WOPTH      (20)
COMMON /VEHICL/  WPTH
COMMON /VEHICL/  WGT      (20)
COMMON /VEHICL/  WRAT      (20)
COMMON /VEHICL/  WRFORD
COMMON /VEHICL/  WT      (20)
COMMON /VEHICL/  WTE      (20)
COMMON /VEHICL/  WWAXP
COMMON /VEHICL/  XBRCOF
COMMON /VEHICL/  W
COMMON /VEHICL/  LBCDIF
COMMON /VEHICL/  SHF
COMMON /OBS/     AVALS      (14)
COMMON /OBS/     CLEAR      (7,14,5)
COMMON /OBS/     FOC        (7,14,5)
COMMON /OBS/     FOCMAX     (7,14,5)
COMMON /OBS/     HVALS      (7)
COMMON /OBS/     NANG
COMMON /OBS/     NOHGT
COMMON /OBS/     NWIDTH
COMMON /OBS/     WVALS      (5)
  
```

C 2. VEHICLE INPUT PARAMETERS
 NAMELIST /VEHICLE/

```

+   ACD      ,ASHOE  ,AMGC   ,AXLSP  ,CD      ,CGH     ,CGLAT
+   ,CGR     ,CID    ,CL     ,CLRMIN ,CONV1   ,CONV2   ,DFLCT
+   ,CIAW    ,DRAFT  ,ENGINE ,EYEHGT ,FD      ,FORDD   ,GROUSH
+   ,HPNET   ,HVALS  ,IAPG   ,IB     ,ID      ,IDIESL  ,IENGIN
+   ,ICONST  ,ICONV1 ,CONV2  ,IP     ,IPOWER  ,IT      ,ITCASE
+   ,ITRAN   ,ITVAR  ,LBCDIF ,LOCKUP ,MAXIPR  ,MAXL    ,NAMBLY
+   ,NBOGIE  ,NCHAIN ,CYL    ,NENG   ,NFL     ,NGR     ,NHVALS
+   ,NPAD    ,NSVALS ,NVEH   ,NWHL   ,NWR     ,PBF     ,PBHT
+   ,PFA     ,POWER  ,OMAX   ,RDIAM  ,REVM    ,RIMW    ,RMS
+   ,RW      ,SAE    ,SAI    ,SECTH  ,SECTW   ,SVALS  ,TCASE
+   ,TL      ,TPLY  ,TPSI   ,TQIND  ,TRAKLN  ,TRAKWD  ,TRANS
+   ,VAA     ,VDA    ,WFS    ,VOOB   ,VOOBS   ,VRIDE   ,VSS
+   ,VSSAXP  ,WC     ,NDAXP  ,WOPTH  ,WDTH    ,WGHT    ,WI
+   ,WRAT    ,WRFORD ,WT     ,WTE    ,WWAXP   ,XBRCOF
  
```

C NAMELIST /BUMP/

```

+   AVALS      ,CLEAR      ,FOC      ,FOOMAX   ,HVALS
+   ,NANG      ,NOHGT     ,NWIDTH   ,WVALS
  
```

C 3. READ VEHICLE PARAMETERS

```

READ(LUN3,VEHICLE)
IF(KVEH.EQ.1) WRITE(LUN1,VEHICLE)
  
```

C -----
 C OBSTACLE INTERFERENCE HISTORY
 C -----

```

READ(LUN3,1000) DUMMY
READ(LUN3,2000) NOTET
READ(LUN3,1000) DUMMY
READ(LUN3,2000) NANG
READ(LUN3,1000) DUMMY
  
```

```

1000 READ(LUN3,2000) NWOTH
2000 READ(LUN3,1000) DUMMY
      READ(LUN3,1000) DUMMY
      FORMAT(A1)
      FORMAT(5X,I2)
      DO 3000 NW=1,NWOTH
        DO 3010 NA=1,NANG
          DO 3020 NH=1,NCHGT
            READ(LUN3,4000)
            +      CLEAR(NH,NA,NW),
            +      FOMAX(NH,NA,NW),
            +      FOO(NH,NA,NW),
            +      HOVALS(NH),
            +      AVALS(NA),
            +      WVALS(NW)
4000      FORMAT(F7.2,F10.1,F10.1,F10.2,F10.2,F10.2)
3020      CONTINUE
3010      CONTINUE
3000      CONTINUE
C      READ(LUN3,BUMP)
C      IF(KVEH .EQ. 1) WRITE(LUN1,BUMP)
      RETURN
      END
  
```

SUBROUTINE VPP

 VEHICLE PREPROCESSOR

1. LABELED COMMON ASSIGNMENTS

```

COMMON /IO/      IEGF
COMMON /IO/      KBUFF
COMMON /IO/      LUN1
COMMON /IO/      LUN2
COMMON /IO/      LUN3
COMMON /IO/      LUN4
COMMON /IO/      LUN5
COMMON /IO/      LUN6
COMMON /IO/      LUN7
COMMON /IO/      LUN8
COMMON /IO/      LUN9
COMMON /IO/      LUN10
INTEGER          NO
COMMON /INDEX/   ME
INTEGER          DOWN
COMMON /INDEX/   CGWN
INTEGER          EFF
COMMON /INDEX/   EFF
INTEGER          FORCE
COMMON /INDEX/   FORCE
INTEGER          GR
COMMON /INDEX/   GR
COMMON /INDEX/   LEVEL
  
```

INTEGER	MM	
COMMON /INDEX/	MM	
INTEGER	MM	
COMMON /INDEX/	MM	
INTEGER	SPEED	
COMMON /INDEX/	SPEED	
INTEGER	SR	
COMMON /INDEX/	SR	
INTEGER	TR	
COMMON /INDEX/	TR	
INTEGER	TORQUE	
COMMON /INDEX/	TORQUE	
INTEGER	UR	
COMMON /INDEX/	UR	
INTEGER	UX	
COMMON /INDEX/	UX	
COMMON /VEHICL/	ADD	
COMMON /VEHICL/	ASHOE	(20)
COMMON /VEHICL/	AVGC	
COMMON /VEHICL/	AXLSP	(20)
COMMON /VEHICL/	CB	
COMMON /VEHICL/	CGH	
COMMON /VEHICL/	CGLAT	
COMMON /VEHICL/	CGR	
COMMON /VEHICL/	CGD	
COMMON /VEHICL/	CB	
COMMON /VEHICL/	CERMIN	(20)
COMMON /VEHICL/	CONV1	(2,25)
COMMON /VEHICL/	CONV2	(2,25)
COMMON /VEHICL/	DELCT	(20,3)
COMMON /VEHICL/	DEAW	(20)
COMMON /VEHICL/	DRAFT	
COMMON /VEHICL/	ENGINE	(2,50)
COMMON /VEHICL/	EXBHGT	
COMMON /VEHICL/	FB	(2)
COMMON /VEHICL/	FORDD	
COMMON /VEHICL/	GROUSH	(20)
COMMON /VEHICL/	HVALS	(25)
COMMON /VEHICL/	IDPG	
COMMON /VEHICL/	IB	(20)
COMMON /VEHICL/	ID	(20)
REAL	IDIESL	
COMMON /VEHICL/	IDIESL	
COMMON /VEHICL/	IENGIN	
COMMON /VEHICL/	IR	(20)
COMMON /VEHICL/	ICONST	(20)
COMMON /VEHICL/	ICONV1	
COMMON /VEHICL/	ICONV2	
COMMON /VEHICL/	IPOWER	
COMMON /VEHICL/	IS	(20)
COMMON /VEHICL/	ICASE	
COMMON /VEHICL/	ITRAN	

COMMON /VEHICL/	ITVAR	
COMMON /VEHICL/	LECKUP	
COMMON /VEHICL/	IPAKIPR	
COMMON /VEHICL/	MAXL	
COMMON /VEHICL/	NAMBLY	
COMMON /VEHICL/	NBCGIE	(20)
COMMON /VEHICL/	NGHAIN	(20)
REAL	NOYL	
COMMON /VEHICL/	NOYL	
REAL	NENG	
COMMON /VEHICL/	NBNG	
COMMON /VEHICL/	FENET	
COMMON /VEHICL/	NEL	(20)
COMMON /VEHICL/	NGR	
COMMON /VEHICL/	NHVALS	
COMMON /VEHICL/	NRAD	(20)
COMMON /VEHICL/	NSVALS	
COMMON /VEHICL/	NMEH	(20)
COMMON /VEHICL/	NMHL	(20)
COMMON /VEHICL/	NMR	
COMMON /VEHICL/	FBF	
COMMON /VEHICL/	FBHT	
COMMON /VEHICL/	FEA	
COMMON /VEHICL/	POWER	(2,20)
COMMON /VEHICL/	GNAX	
COMMON /VEHICL/	RDJAM	(20)
COMMON /VEHICL/	REVM	(20)
COMMON /VEHICL/	RZMW	(20)
COMMON /VEHICL/	FNS	(20)
COMMON /VEHICL/	FM	(20)
COMMON /VEHICL/	SAE	
COMMON /VEHICL/	SAE	
COMMON /VEHICL/	SECTH	(20)
COMMON /VEHICL/	SECTW	(20)
COMMON /VEHICL/	SWALS	(25)
COMMON /VEHICL/	TEASE	(2)
COMMON /VEHICL/	TE	
COMMON /VEHICL/	TRLY	(20)
COMMON /VEHICL/	TRSI	(20,3)
COMMON /VEHICL/	TGIND	
COMMON /VEHICL/	TRAKLN	(20)
COMMON /VEHICL/	TRAKWD	(20)
COMMON /VEHICL/	TRANS	(2,20)
COMMON /VEHICL/	VAA	
COMMON /VEHICL/	VDA	
COMMON /VEHICL/	VES	
COMMON /VEHICL/	VGB	(25)
COMMON /VEHICL/	VOBS	(25)
COMMON /VEHICL/	VRIDE	(20,3)
COMMON /VEHICL/	VSS	
COMMON /VEHICL/	VSBXP	
COMMON /VEHICL/	WC	

COMMON /VEHICL/	NDAXP	
COMMON /VEHICL/	NDPTH	(20)
COMMON /VEHICL/	NDTH	
COMMON /VEHICL/	NDHT	(20)
COMMON /VEHICL/	NDPAT	(20)
COMMON /VEHICL/	NDRFORD	
COMMON /VEHICL/	NDT	(20)
COMMON /VEHICL/	NDTE	(20)
COMMON /VEHICL/	NDMAXP	
COMMON /VEHICL/	NDRCOF	
COMMON /VEHICL/	NDJ	
COMMON /VEHICL/	NDLCD IF	
COMMON /VEHICL/	NDHF	
COMMON /PREP/	ND	(3,4)
COMMON /PREP/	NDTF	(20)
COMMON /PREP/	NDTF	(20)
COMMON /PREP/	NDCHARLN	(20,3)
COMMON /PREP/	NDCRFCG	(3)
COMMON /PREP/	NDCRFCG	(3)
COMMON /PREP/	NDCRFCG	(20,3)
COMMON /PREP/	NDCRFFG	(20,3)
COMMON /PREP/	NDCTF	(20)
COMMON /PREP/	NDCRAT	(20,3)
COMMON /PREP/	NDCCA	(20,3)
COMMON /PREP/	NDGW	
COMMON /PREP/	NDGWB	
COMMON /PREP/	NDGWNB	
COMMON /PREP/	NDGWNP	
COMMON /PREP/	NDGWP	
COMMON /PREP/	NDERT	
COMMON /PREP/	NDNF	(38)
COMMON /PREP/	NDNEFC	
COMMON /PREP/	NDNTE	
COMMON /PREP/	NDR	(3)
COMMON /PREP/	NDRN	(20)
COMMON /PREP/	NDR	
COMMON /PREP/	NDTRACTF	(20,5)
COMMON /PREP/	NDTRAPSI	(3)
COMMON /PREP/	NDVEICG	(20,3)
COMMON /PREP/	NDVEIFG	(20,3)
COMMON /PREP/	NDVCMUK	(20)
COMMON /PREP/	NDVGV	(20,5)
COMMON /PREP/	NDVT	(20,3)
COMMON /PREP/	NDVTIRE	(3)
COMMON /PREP/	NDWEMAX	
COMMON /PREP/	NDX	(3)
COMMON /PREP/	NDWR	
COMMON /SCEN/	NDWHES	
COMMON /SCEN/	NDWALK	
COMMON /SCEN/	NDWCLMAX	
COMMON /SCEN/	NDWGAMMA	
COMMON /SCEN/	NDWIBVER	

COMMON /SCEN/	ISEASN
COMMON /SCEN/	ISURF
COMMON /SCEN/	ISNOW
COMMON /SCEN/	KI11
COMMON /SCEN/	KI12
COMMON /SCEN/	KI13
COMMON /SCEN/	KI14
COMMON /SCEN/	KI15
COMMON /SCEN/	KI16
COMMON /SCEN/	KI17
COMMON /SCEN/	KI18
COMMON /SCEN/	KI19
COMMON /SCEN/	KI110
COMMON /SCEN/	KI111
COMMON /SCEN/	KI112
COMMON /SCEN/	KI113
COMMON /SCEN/	KI114
COMMON /SCEN/	KI115
COMMON /SCEN/	KI116
COMMON /SCEN/	KI117
COMMON /SCEN/	KMAP
COMMON /SCEN/	KSCEN
COMMON /SCEN/	KTRP
COMMON /SCEN/	KWEH
COMMON /SCEN/	KV1
COMMON /SCEN/	KV2
COMMON /SCEN/	KV3
COMMON /SCEN/	KV4
COMMON /SCEN/	KV5
COMMON /SCEN/	KV6
COMMON /SCEN/	KV7
COMMON /SCEN/	KV8
COMMON /SCEN/	KV9
COMMON /SCEN/	KV10
COMMON /SCEN/	KV11
COMMON /SCEN/	KV12
COMMON /SCEN/	KV13
COMMON /SCEN/	KV14
COMMON /SCEN/	KV15
COMMON /SCEN/	KV16
COMMON /SCEN/	KV17
COMMON /SCEN/	KV18
COMMON /SCEN/	KV19
COMMON /SCEN/	KV20
COMMON /SCEN/	KV21
COMMON /SCEN/	LAC
INTEGER	DETAIL
COMMON /SCEN/	DETAIL
COMMON /SCEN/	MAP
COMMON /SCEN/	MAPG
COMMON /SCEN/	MGNTH
COMMON /SCEN/	NGPP

```

COMMON /SCEN/      NSLIP
COMMON /SCEN/      NTRAV
COMMON /SCEN/      NUX
COMMON /SCEN/      PHI
COMMON /SCEN/      REACT
COMMON /SCEN/      RFOG
INTEGER           SEARCH
COMMON /SCEN/      SEARCH
COMMON /SCEN/      SETYPC
COMMON /SCEN/      VBRAKE
COMMON /SCEN/      VISMV
COMMON /SCEN/      VEIM
COMMON /SCEN/      ZSNCW
  
```

C

2. ALGORITHM

```

CALL I11(
+ CONV1 ,ENGINE ,IAPG ,ICONV1 ,IENGIN ,IPOWER ,MAXIPR ,MAXL
+ ,NHVALS ,NSVALS ,PFA ,PGWER ,QMAX ,RPM ,SPEED ,TORQUE
+ ,TQINC ,VAA ,VDA ,VOCB ,VOOBS ,VRIDE ,VSS )
  NAMELIST /XII1/
+ CONV1 ,ENGINE ,IAPG ,ICONV1 ,IENGIN ,IPOWER ,MAXIPR ,MAXL
+ ,NHVALS ,NSVALS ,PFA ,PGWER ,QMAX ,RPM ,SPEED ,TORQUE
+ ,TQIND ,VAA ,VDA ,VOCB ,VOOBS ,VRIDE ,VSS
  IF(KII1 .EQ. 1) WRITE(LUN1,XII1)
  CALL I12(
+ GCW ,GCWB ,GCWAB ,GCWNP ,GCWP ,IB ,IP ,NAMBLY
+ ,WGHT )
  NAMELIST /XII2/
+ GCW ,GCWB ,GCWAB ,GCWNP ,GCWP ,IB ,IP ,NAMBLY
+ ,WGHT
  IF(KII2 .EQ. 1)
  + WRITE(LUN1,XII2)
  CALL I13(
+ ICONST ,NAMBLY ,NVEH ,NWHL ,RDIAM ,RIMW ,SECTW ,TPS )
+ ,VTIRE ,WGHT )
  NAMELIST /XII3/
+ ICONST ,NAMBLY ,NVEH ,NWHL ,RDIAM ,RIMW ,SECTW ,TPS )
+ ,VTIRE ,WGHT
  IF(KII3 .EQ. 1)
  + WRITE(LUN1,XII3)
  CALL I14(
+ NAMBLY ,PWTE ,WT ,WTE )
  NAMELIST /XII4/
+ NAMBLY ,PWTE ,WT ,WTE
  IF(KII4 .EQ. 1)
  + WRITE(LUN1,XII4)
  CALL I15(
+ DFLCT ,DRAT ,NAMBLY ,NVEH ,SECTH )
  NAMELIST /XII5/
+ DFLCT ,DRAT ,NAMBLY ,NVEH ,SECTH
  IF(KII5 .EQ. 1)
  + WRITE(LUN1,XII5)
  CALL I16(
  
```



```

+ CHARLN ,DFLCT ,DIAW ,NAMBL Y ,NVEH ,TRAKLN )
  NAMELIST /XII6/
+ CHARLN ,DFLCT ,DIAW ,NAMBL Y ,NVEH ,TRAKLN
  IF(KII6 .EQ. 1)
+ WRITE(LUNI,XII6)
  CALL II7(
+ CHARLN ,GCA ,NAMBL Y ,NVEH ,SECTW ,TRAKWD )
  NAMELIST /XII7/
+ CHARLN ,GCA ,NAMBL Y ,NVEH ,SECTW ,TRAKWD
  IF(KII7 .EQ. 1)
+ WRITE(LUNI,XII7)
  CALL II8(
+ CGLAT ,ID ,NAMBL Y ,NVEH ,SECTW ,WT ,WTMAX )
  NAMELIST /XII8/
+ CGLAT ,ID ,NAMBL Y ,NVEH ,SECTW ,WT ,WTMAX
  IF(KII8 .EQ. 1)
+ WRITE(LUNI,XII8)
  CALL II9(
+ IP ,NAMBL Y ,NVEH ,REVM ,RR )
  NAMELIST /XII9/
+ IP ,NAMBL Y ,NVEH ,REVM ,RR
  IF( KII9 .EQ. 1 ) WRITE(LUNI,XII9)
  CALL III0(
+ IB ,NAMBL Y ,WGHT ,XBRCOF ,XBR )
  NAMELIST /XIII0/
+ IB ,NAMBL Y ,WGHT ,XBRCOF ,XBR
  IF( KIII0 .EQ. 1 ) WRITE(LUNI,XIII0)
  CALL III1(
+ GCWP ,HPNET ,HPT )
  NAMELIST /XIII1/
+ GCWP ,HPNET ,HPT
  IF( KIII1 .EQ. 1 ) WRITE(LUNI,XIII1)
  CALL III2(
+ ASHOE ,CLRMIN ,CPFFG ,DFLCT ,DIAW ,GROUSH ,HPT ,IB
+ ,IP ,ITVAR ,NAMBL Y ,NBCGIE ,NCHAIN ,NVEH ,NWHL ,SECTH
+ ,SECTW ,TRAKLN ,TRAKWD ,VCIFG ,WGHT )
  NAMELIST /XIII2/
+ ASHOE ,CLRMIN ,CPFFG ,DFLCT ,DIAW ,GROUSH ,HPT ,IB
+ ,IP ,ITVAR ,NAMBL Y ,NBCGIE ,NCHAIN ,NVEH ,NWHL ,SECTH
+ ,SECTW ,TRAKLN ,TRAKWD ,VCIFG ,WGHT
  IF( KIII2 .EQ. 1 ) WRITE(LUNI,XIII2)
  CALL III3(
+ CPFCG ,IB ,IP ,NAMBL Y ,NVEH ,NWHL
+ ,RDIAM ,SECTW ,TPLY ,TPSI ,VCICG ,WGHT )
  NAMELIST /XIII3/
+ CPFCG ,IB ,IP ,NAMBL Y ,NVEH ,NWHL
+ ,RDIAM ,SECTW ,TPLY ,TPSI ,VCICG ,WGHT
  IF( KIII3 .EQ. 1 ) WRITE(LUNI,XIII3)
  CALL III4(
+ DIAW ,IB ,IP ,NAMBL Y ,NVEH
+ ,NWHL ,SECTW ,TRAKLN ,TRAKWD ,VCIMUK ,WGHT )
  NAMELIST /XIII4/

```

```

+ DIAW ,IB ,IP ,NAMBL ,NVEH
+ ,NWHL ,SECTW ,TRAKN ,TRAKWD ,VCIMUK ,WGHT
  IF( KII14 .EQ. 1 ) WRITE(LUN1,XII14)
    CALL III5(
+ CPFCG ,CPFCFG ,CPFC ,CPFFG ,IB
+ ,IP ,NAMBL ,NVEH ,NVEHC )
  NAMLIST /XII15/
+ CPFCG ,CPFCFG ,CPFC ,CPFFG ,IB
+ ,IP ,NAMBL ,NVEH ,NVEHC
  IF( KII15 .EQ. 1 ) WRITE(LUN1,XII15)
    CALL III6(
+ ATF ,BTF ,CONV1 ,CONV2 ,CTF ,EFF ,ENGINE ,FD
+ ,FORCE ,GR ,IAPG ,ICONV1 ,ICONV2 ,IENGIN ,IPOWER ,ITCASE
+ ,ITRAN ,KII16 ,LOCKWP ,LUN1 ,MAPG
+ ,NGR ,PE ,POWER ,RR ,RPM ,SPEED ,SR ,TCASE
+ ,TORQUE ,TQIND ,TR ,TRACTF ,TRANS ,VGV ,TOPSPD ,NPTS
+ ,IERRCR )
  NAMLIST /XII16/
+ ATF ,BTF ,CONV1 ,CONV2 ,CTF ,EFF ,ENGINE ,FD
+ ,FORCE ,GR ,IAPG ,ICONV1 ,ICONV2 ,IENGIN ,IERROR ,ITCASE
+ ,ITRAN ,KII16 ,LOCKWP ,LUN1 ,MAPG
+ ,NGR ,PE ,POWER ,RR ,RPM ,SPEED ,SR ,TCASE
+ ,TORQUE ,TQIND ,TR ,TRACTF ,TRANS ,VGV ,TOPSPD ,NPTS
+ ,IERROR
  IF( KII16 .EQ. 1 ) WRITE(LUN1,XII16)
    CALL III7(
+ CID ,IDIESL ,GCW ,NAMBL ,NCYL ,NENG
+ ,NGR ,NVEH ,QMAX ,RMX ,RR ,TRACTF )
  NAMLIST /XII17/
+ CID ,IDIESL ,NCYL ,NENG ,NVEH ,QMAX ,RMX
  IF(KII17 .EQ. 1) WRITE(LUN1,XII17)
  IF(( DETAIL .NE. 5 ) .AND. ( IERRCR .NE. 1 )) GOTO 100
  CALL PLTSET(
+ NPTS ,VGV ,NGR ,ATF ,BTF ,CTF
+ ,IPOWER ,POWER ,TOPSPD,LUN1)
  STOP 3
  CONTINUE
  RETURN
  END
  SUBROUTINE III(
+ CONV1 ,ENGINE ,IAPG ,ICCNV1 ,IENGIN ,IPOWER ,MAXIPR ,MAXL
+ ,NHVALS ,NSVALS ,PFA ,POWER ,QMAX ,RPM ,SPEED ,TORQUE
+ ,TQIND ,VAA ,VDA ,VOCB ,VOOBS ,VRIDE ,VSS )

```

100

C
 C
 C
 C
 C
 C

 UNITS CONVERSION ROUTINE

```

1. VARIABLE DECLARATION
REAL CONV1 (2,25)
REAL ENGINE (2,25)
INTEGER IAPG

```

```

INTEGER  ICONV1
INTEGER  IENGIN
INTEGER  IPOWER
INTEGER  L
INTEGER  MAXIPR
INTEGER  MAXL
INTEGER  RPM
INTEGER  SPEED
INTEGER  TORQUE
INTEGER  N
INTEGER  NH
INTEGER  NHVALS
INTEGER  NR
INTEGER  NS
INTEGER  NSVALS
REAL     POWER (2,201)
REAL     QMAX
REAL     TQIND
REAL     VAA
REAL     VDA
REAL     VQCB (50)
REAL     VQOBS (50)
REAL     VRIDE (50,10)
REAL     VSS
  
```

```

C      3. ALGCRITHM
      VSS=VSS*5280.*12./60./60.
      DO 110 NH=1,NHVALS
110    VQCB(NH)=VQCB(NH)*5280.*12./60./60.
      CONTINUE
      DO 120 NS=1,NSVALS
120    VQOBS(NS)=VQOBS(NS)*5280.*12./60./60.
      CONTINUE
      DO 135 L=1,MAXL
      DO 130 NR=1,MAXIPR
130    VRIDE(NR,L)=VRIDE(NR,L)*5280.*12./60./60.
      CONTINUE
135    CONTINUE
      PFA=PFA*144.
      VAA=VAA*3.14159265/280.
      VDA=VDA*3.14159265/280.
      IF( IAPG .EQ. 1 ) GO TO 145
      DO 140 N=1,IFCWER
140    POWER(SPEED,N)=POWER(SPEED,N)*(88./60.)*12.
      CONTINUE
145    CONTINUE
      IF( IAPG .EQ. 2 ) GO TO 199
      DO 150 N=1,IENGIN
150    ENGINE(RPM,N)=ENGINE(RPM,N)/60.0
      ENGINE(TORQUE,N)=ENGINE(TORQUE,N)*12.0
      CONTINUE
      DO 170 N=1,ICONV1
      CONV1(RPM,N)=CONV1(RPM,N)/60.0
  
```

```

170          CONTINUE
            CMAX =QMAX*12.0
            TQIND=TQIND*12.0
199          CONTINUE
            RETURN
            END
            SUBROUTINE II2(
+ GCW      ,GCWB      ,GCWNB ,GCWNP ,GCWP
+ ,IB      ,IP      ,NAMEBY ,WGHT )
C
            DIMENSION
+ IB(20) ,IP(20) ,WGHT(20)
C GROSS COMBINED WEIGHT ROUTINE
            GCW=0.0
            GCWP=0.0
            GCWB=0.0
            DO 210 I=1,NAMBLY
              GCW=GCW+WGHT(I)
              GCWB=GCWB+WGHT(I)*FLOAT( IB(I) )
              GCWP=GCWP+WGHT(I)*FLOAT( IP(I) )
210          CONTINUE
            GCWNP=GCW-GCWP
            GCWNB=GCW-GCWB
            RETURN
            END
            SUBROUTINE II3(
+ ICONST ,NAMBLY ,NVEH  ,NWHL  ,RDIAM
+ ,RIMW  ,SECTW  ,TPSI  ,VTIRE  ,WGHT )
C
            DIMENSION
+ ICONST(20) ,NVEH(20) ,NWHL(20)
+ ,RDIAM(20) ,RIMW(20) ,SECTW(20)
+ ,TPSI(20,3) ,VTIRE(20,3)
+ ,WGHT(20)
C MAXIMUM TIRE SPEED ROUTINE
            DO 325 J=1,3
              DO 320 I=1,NAMBLY
                VT(I,J)=0.
                IF( NVEH(I) .EQ. 0 ) GO TO 315
                S1=( SECTW(I)+0.4*RIMW(I) )/0.75
                HWY=( 4.32/(S1**2.38)
+ ((WGHT(I)/FLOAT(NWHL(I)))/(RDIAM(I)*S1))**1.71)
                IF( ICONST(I) .EQ. 1 ) GO TO 310
                VT(I,J)=( 100.*5280.*12./3600. )
+ ( (TPSI(I,J)/HWY)**2 )
                GO TO 320
310              CONTINUE
                VT(I,J)=( 70.*205280.*12./3600. )
+ ( (TPSI(I,J)/HWY)**2.25 )
315            CONTINUE
320          CONTINUE
325          CONTINUE

```

```

      DO 340 J=1,3
        VTIRE(J)=VT(1,J)
        DO 330 I=2,NAMBLY
          IF(VT(I,J) .LT. MTIRE(J))
            * VTIRE(J)=VT(I,J)
330    CONTINUE
340    CONTINUE
      RETURN
      END
      SUBROUTINE II4(
      * NAMBLY ,PWTE ,WT ,WTE )
C
      DIMENSION
      * WT(20) ,WTE(20)
C MAXIMUM PATH WIDTH OF COMBINATION'S TRACTION ELEMENTS
      PWTE=WT(1)-WTE(1)
      DO 410 I=2,NAMBLY
        IF((WT(I)-WTE(I)) .GT. PWTE)
          * PWTE=WT(I)-WTE(I)
410    CONTINUE
      RETURN
      END
      SUBROUTINE II5(
      * DFLCT ,DRAT ,NAME&Y ,NVEH ,SECTH )
C
      DIMENSION
      * DFLCT(20,3) ,DRAT(20,3) ,NVEH(20)
      * ,SECTH(20)
C TIRE DEFLECTION RATIOS
      DO 520 J=1,3
        DO 510 I=1,NAMBLY
          IF(NVEH(I) .EQ. 0) GO TO 500
          DRAT(I,J)=DFLCT(I,J)/SECTH(I)
500    CONTINUE
510    CONTINUE
520    CONTINUE
      RETURN
      END
      SUBROUTINE II6(
      * CHARLN ,DFLCT ,DIAW ,NAMBLY ,NVEH ,TRAKLN )
C
      DIMENSION
      * CHARLN(20,3) ,DFLCT(20,3) ,DIAW(20)
      * ,NVEH(20) ,TRAKLN(20)
C CHARACTERISTIC LENGTH OF ELEMENTS
      DO 630 J=1,3
        DO 620 I=1,NAMBLY
          IF( NVEH(I) .EQ. 1 ) GO TO 610
          TRACKED ELEMENT
          CHARLN(I,J)=TRAKLN(I)
          GO TO 620
610    CONTINUE

```

```

C          WHEELED ELEMENT
          CHARLN(I,J)=2.0
          +          *SQRT( (DFLCT(I,J)*DIAW(I))
          +          -(DFLCT(I,J)*BFLCT(I,J)) )
620      CONTINUE
630      CONTINUE
          RETURN
          END
          SUBROUTINE II7(
          + CHARLN ,GCA ,NAMBL ,NVEH ,SECTW ,TRAKWD )
          DIMENSION
          + CHARLN(20,3) ,GCA(20,3) ,NVEH(20)
          + ,SECTW(20) ,TRAKWD(20)
C GROUND CONTACT AREA OF ELEMENTS
          DO 730 J=1,3
            DO 720 I=1,NAMBL
              IF(NVEH(I) .EQ. 1) GO TO 710
C          TRACKED ELEMENT
              GCA(I,J)=CHARLN(I,J)*TRAKWD(I)*2.
710      CONTINUE
C          WHEELED ELEMENT
              GCA(I,J)=CHARLN(I,J)*SECTW(I)
720      CONTINUE
730      CONTINUE
          RETURN
          END
          SUBROUTINE II8(
          + CGLAT ,ID ,NAMBL ,NVEH ,SECTW ,WT ,WTMAX )
C
          DIMENSION
          + ID(20) ,NVEH(20) ,SECTW(20)
          + ,WT(20)
C CONTROLLING LATERAL DISTANCE TO C.G.
          WTMAX=500.
          DO 830 I=1,NAMBL
            IF(NVEH(I) .EQ. 0) GO TO 810
C          WHEELED ELEMENT
            TEMP=( WT(I)/2. *-CGLAT
            + ( SECTW(I)/2. )*FLCAT( ID(I) )
            GO TO 820
810      CONTINUE
C          TRACKED ELEMENT
            TEMP=( WT(I)/2. *-CGLAT
820      CONTINUE
            IF(TEMP .GE. WTMAX) GO TO 825
            WTMAX=TEMP
825      CONTINUE
830      CONTINUE
          RETURN
          END
          SUBROUTINE II9(
          + IP ,NAMBL ,NVEH ,REVM ,RR )

```

```
C
  DIMENSION
+   IP(20)                ,NVEH(20)                ,REVM(20)
C
C -----
C ROLLING RADIUS OF LARGEST POWERED TIRE ELEMENT
C -----
C
  RR=0.0
  DO 910 I=1,NAMBLY
    IF( IP(I) .EQ. 0 ) GO TO 910
    RX=( 5280.0*12.0 )/( 2.0*3.14159265*REVM(I) )
    IF( RR .LT. RX ) RR=RX
910  CONTINUE
  RETURN
  END
  SUBROUTINE II10(
+   IB      ,NAMBLY ,WGHT      ,XBRCOF ,XBR )
C
  DIMENSION
+   IB(20)                ,WGHT(20)
C
C -----
C MAXIMUM BRAKING FORCE DEVELOPED BY BRAKED ASSEMBLIES
C -----
C
  XBR=0.0
  DO 1010 I=1,NAMBLY
    XBR=XBR+XBRCOF*WGHT(I)*FLCAT( IB(I) )
1010 CONTINUE
  RETURN
  END
  SUBROUTINE III1 (
+   GCWP      ,HPNET      ,HPT )
C
C -----
C HORSEPOWER/TON
C -----
C
  HPT=HPNET/(GCWP/2000.)
  RETURN
  END
  SUBROUTINE III2(
+   ASHOF      ,CLRMIN      ,CPFFG      ,DFLCT      ,CIAW      ,GROUSH      ,HPT      ,IB
+   ,IP        ,ITVAR      ,NAMBLY      ,NBCGIE      ,NCHAIN      ,NVEH      ,NWHL      ,SECTH
+   ,SECTH      ,TRAKLN      ,TRAKWD      ,VCIFG      ,WGHT )
C
  DIMENSION
+   ASHOF(20)      ,CLRMIN(20)      ,CPFFG(20,3)
+   ,DFLCT(20,3)      ,CIAW(20)      ,GROUSH(20)
+   ,IB(20)      ,IP(20)      ,NBCGIE(20)
```

```

+ ,NCHAIN(20)      ,NVEH(20)      ,NWHL(20)
+ ,SECTH(20)      ,SECTW(20)     ,TDF(3)
+ ,TRAKLN(20)     ,TRAKWD(20)    ,VCIFG(20,3)
+ ,WGHT(20)
  
```

```

C
C -----+-----
C VEHICLE CCNE INDEX IN FINE GRAINED SOIL
C -----+-----
C
C      CO 1556 I=1,NAMBLV
C      IF( IP(I) .EQ. 0 .AND. IB(I) .EQ. 0 ) GO TO 1555
C      IF( NVEH(I) .EQ. 0 ) GO TO 1534
C
C      -----+-----
C      WHEELED ASSEMBLY ROUTINE
C      -----+-----
C      CONTACT PRESSURE FACTOR
C      CPFFG(1,1)=WGHT(I)
C      / ( SECTW(I)+FLOAT(NWHL(I))*DIAM(I)/2. )
C      CPFFG(1,2)=CPFFG(1,1)
C      CPFFG(1,3)=CPFFG(1,1)
C
C      WEIGHT FACTOR
C      IF( WGHT(I) .GE. 2000.0 ) GO TO 1510
C      WF=0.553*WGHT(I)/1000.
C      GO TO 1516
1510      CONTINUE
C      IF( WGHT(I) .GE. 13500. ) GO TO 1512
C      WF=0.033*WGHT(I)/1000.0+1.0
C      GO TO 1516
1512      CONTINUE
C      IF( WGHT(I) .GE. 20000.0 ) GO TO 1514
C      WF=0.142*WGHT(I)/1000.0-0.42
C      GO TO 1516
1514      CONTINUE
C      WF=0.278*WGHT(I)/1000.0-3.115
1516      CONTINUE
C      TIRE FACTOR
C      TF=(10.0+SECTW(I))/100.0
C
C      GROUSER FACTOR
C      IF( NCHAIN(I) .EQ. 0 ) GO TO 1518
C      GF=1.05
C      GO TO 1520
1518      CONTINUE
C      GF=1.0
1520      CONTINUE
C      WHEEL LOAD FACTOR
C      WLORF=WGHT(I)/1000.0/FLOAT(NWHL(I))/2.
C
C      CLEARANCE FACTOR
C      CLF=CLRMN(I)/10.0
C
C      ENGINE FACTOR
C      IF( HPT .LT. 10.0 ) GO TO 1522
C      EF=1.0
C      GO TO 1524
  
```



```

1522          CONTINUE
              EF=1.05
1524          CONTINUE
C            TRANSMISSION FACTOR
              IF( ITVAR .EQ. 0 ) GO TO 1526
              TFX=1.05
              GO TO 1528
1526          CONTINUE
              TFX=1.0
1528          CONTINUE
C            TIRE DEFLECTION FACTOR
              DO 1530 J=1,3
              TDF(J)=((1.0-DFLCT(I,J)/SECTH(I))/0.85)**1.5
1530          CONTINUE
C            MOBILITY INDEX
              XMI=(CPFFG(I,1)*WF/TF/GF+WLORF-CLF)*EF*TFX
C            VEHICLE CCNE INDEX
              DO 1532 J=1,3
              VCIFG(I,J)=(11.48+2.2*XMI-39.2/(XMI+3.74))
              *TDF(J)
1532          CONTINUE
              GO TO 1556
1534          CONTINUE
C            -----
C            TRACKED ASSEMBLY ROUTINE
C            -----
C            CONTACT PRESSURE FACTOR
              CPFFG(I,1)=WGHT(I)/(2.*TRAKLN(I)*TRAKWD(I))
              CPFFG(I,2)=CPFFG(I,1)
              CPFFG(I,3)=CPFFG(I,1)
C            WEIGHT FACTOR
              IF( WGHT(I) .GE. 50000.0 ) GO TO 1536
              WF=1.0
              GO TO 1542
1536          CONTINUE
              IF( WGHT(I) .GE. 70000.0 ) GO TO 1538
              WF=1.2
              GO TO 1542
1538          CONTINUE
              IF( WGHT(I) .GE. 100000.0 ) GO TO 1540
              WF=1.4
              GO TO 1542
1540          CONTINUE
              WF=1.8
1542          CONTINUE
C            TRACK FACTOR
              TF=TRAKWD(I)/100.0
C            GROUSER FACTOR
              IF( GROUSH(I) .LT. 1.5 ) GO TO 1544
              GF=1.1
              GO TO 1546
1544          CONTINUE
  
```

```

      GF=1.0
1546 CONTINUE
      C BOGIE LOAD RANGE FACTOR
        WLORF=WGHT(I)/10.0/FLOAT(NBOGIE(I))/ASHOE(I)
      C CLEARANCE FACTOR
        CLF=CLRMIN(I)/10.0
      C ENGINE FACTOR
        IF( HPT .LT. 10.0 ) GO TO 1548
          EF=1.0
          GO TO 1550
1548 CONTINUE
          EF=1.05
1550 CONTINUE
      C TRANSMISSION FACTOR
        IF( ITVAR .EQ. 0 ) GO TO 1552
          TFX=1.05
          GO TO 1554
1552 CONTINUE
          TFX=1.0
1554 CONTINUE
      C MOBILITY INDEX
        XMI=(CPFCG(I,1)*WF/TF/GF+WLORF-CLF)*EF*TFX
      C VEHICLE CONE INDEX
        VCIFG(I,1)=7.0+0.2*XMI-39.2/(XMI+5.0)
        VCIFG(I,2)=VCIFG(I,1)
        VCIFG(I,3)=VCIFG(I,1)
1555 CONTINUE
1556 CONTINUE
      RETURN
      END
      SUBROUTINE III3(
+ CPFCG ,IB ,IP ,NAMBL ,NVEH ,NWHL
+ ,KDIAM ,SECTW ,TPLY ,TPSI ,VCICG ,WGHT )
      DIMENSION
+ CPFCG(20,3) ,IB(20) ,IP(20)
+ ,NVEH(20) ,NWHL(20) ,KDIAM(20)
+ ,SECTW(20) ,TPLY(20) ,TPSI(20,3)
+ ,VCICG(20,3) ,WGHT(20)
      C
      C -----
      C VEHICLE CONE INDEX IN COARSE GRAINED SOIL
      C -----
      C
      DO 1670 I=1,NAMBL
        IF( IP(I) .EQ. 0 .AND. IB(I) .EQ. 0 ) GO TO 1660
        IF( NVEH(I) .EQ. 0 ) GO TO 1640
      C
      C -----
      C WHEELED ASSEMBLY ROUTINE
      C -----
      C WHEEL DIAMETER FACTOR
        IF( SECTW(I)/KDIAM(I) .LT. 2.4 ) GO TO 1610
        WDF=2.0
  
```

```

          GO TO 1620
1610      CONTINUE
          WDF=5.0
1620      CONTINUE
          DO 1630 J=1,3
C          CONTACT PRESSURE FACTOR
          CPFCC(I,J)=0.607*TPSI(I,J)+
+          1.35*(117.0*TPLY(I)/
+          (WDF*SECTW(I)+RDIAM(I)))-4.93
C          CONTACT AREA FACTOR
          CAF=ALEG10(WGHT(I)/CPFCC(I,J))
C          STRENGTH FACTOR
          STF=0.0526*FLCAT(NWHL(I))+0.0211*TPSI(I,J)
+          -0.35*CAF+1.587
C          VEHICLE CONE INDEX
          VCICG(I,J)=10.0**STF
1630      CONTINUE
          GO TO 1660
1640      CONTINUE
C          -----
C          TRACKED ASSEMBLY FACTOR
C          -----
          DO 1650 J=1,3
          VCICG(I,J)=0.0
1650      CONTINUE
1660      CONTINUE
1670      CONTINUE
          RETURN
          END
          SUBROUTINE LI14 (
+   DIAW ,IB ,IP ,NAMBL ,NVEH
+   ,NWHL ,SECTW ,TRAKLN ,TRAKWD ,VCIMUK ,WGHT )
          DIMENSION
+   DIAW(20) ,IB(20) ,IP(20)
+   ,NVEH(20) ,NWHL(20) ,SECTW(20)
+   ,TRAKLN(20) ,TRAKWD(20) ,WGHT(20)
+   ,VCIMUK(20)
C          -----
C          VEHICLE CONE INDEX IN MUSKEG
C          -----
          DO 1730 I=1,NAMBL
          IF( IP(I) .EQ. 0 .AND. IB(I) .EQ. 0 ) GO TO 1720
          IF( NVEH(I) .EQ. 0 ) GO TO 1710
          VCIMUK(I)=13.0+0.535*WGHT(I)
+          /((SECTW(I)+DIAW(I))*FLOAT(NWHL(I)))
          GO TO 1730
1710      CONTINUE
          VCIMUK(I)=13.0+0.0625*WGHT(I)
+          /((TRAKWD(I)+TRAKLN(I)))
1720      CONTINUE

```

```

1730 CONTINUE
      RETURN
      END
      SUBROUTINE II15 (
+   CPFCCG ,CPFCFG ,CPFCG ,CPFFG ,IB
+   ,IP      ,NAMBLV ,NVEH  ,NVEHC )
C
      DIMENSION
+   CPFCCG(3)           ,CPFCG(20,3)           ,CPFCFG(3)
+   ,CPFFG(20,3)       ,IB(20)               ,IP(20)
+   ,NVEH(20)
C
-----+-----
C COMBINED CONTACT PRESSURE FACTOR ROUTINE
C -----+-----
C
      N1=0
      N2=0
      DO 1800 I=1,NAMBLV
        IF( NVEH(I) .EQ. 0 ) N1=-1
        IF( NVEH(I) .EQ. 1 ) N2=1
1800 CONTINUE
      NVEHC=N1+N2
      IF( NVEHC .NE. 1 ) GO TO 1840
      DO 1830 J=1,3
        CPFCFG(J)=0.0
        CPFCCG(J)=0.0
      DO 1820 I=1,NAMBLV
        IF( IB(I) .EQ. 0 .AND. IP(I) .EQ. 0 ) GO TO 1820
        IF( CPFFG(I,J) .GT. CPFCFG(J) ) CPFCFG(J)=CPFFG(I,J)
        IF( CPFCCG(I,J) .GT. CPFCCG(J) ) CPFCCG(J)=CPFCCG(I,J)
1810 CONTINUE
1820 CONTINUE
1830 CONTINUE
      GO TO 1890
1840 CONTINUE
      DO 1880 J=1,3
        CPFCFG(J)=0.0
        CPFCCG(J)=0.0
      DO 1870 I=1,NAMBLV
        IF( NVEH(I) .NE. 0 ) GO TO 1860
        IF( IB(I) .EQ. 0 .AND. IP(I) .EQ. 0 ) GO TO 1850
        IF( CPFFG(I,J) .GT. CPFCFG(J) ) CPFCFG(J)=CPFFG(I,J)
        IF( CPFCCG(I,J) .GT. CPFCCG(J) ) CPFCCG(J)=CPFCCG(I,J)
1850 CONTINUE
1860 CONTINUE
1870 CONTINUE
1880 CONTINUE
1890 CONTINUE
      RETURN
      END
      SUBROUTINE II16 (

```

```

+ ATF ,BTF ,CONV1 ,CONV2 ,CTF ,EFF ,ENGINE ,FD
+ ,FORCE ,GR ,IAPG ,ICONV1 ,ICONV2 ,IENGIN ,IPOWER ,ITCASE
+ ,ITRAN ,KII16 ,LOCKUP ,LUN1 ,MAPG
+ ,NGR ,PE ,POWER ,RR ,RPM ,SPEED ,SR ,TCASE
+ ,TORQUE ,TQIND ,TR ,TRACTF ,TRANS ,VGV ,TOPSPD ,NPTS
+ ,IERRCR )
  
```

C
C
C
C
C
C

```

-----
POWER TRAIN SCENARIO LOGIC
-----
  
```

1. VARIABLE DECLARATION

```

REAL      ATF      (20)
REAL      BTF      (20)
REAL      CONV1    (2,25)
REAL      CONV2    (2,25)
REAL      CTF      (20)
REAL      ENGINE   (2,25)
REAL      FD       (2)
INTEGER   IAPG
INTEGER   ICONV1
INTEGER   ICONV2
INTEGER   IENGIN
INTEGER   IPOWER
INTEGER   ITCASE
INTEGER   ITRAN
INTEGER   KII16
INTEGER   LOCKUP
INTEGER   LUN1
INTEGER   MAPG
INTEGER   MD
INTEGER   EFF
INTEGER   FORCE
INTEGER   GR
INTEGER   RPM
INTEGER   SPEED
INTEGER   SR
INTEGER   TORQUE
INTEGER   TR
INTEGER   NGR
REAL      PE
REAL      POWER    (2,201)
REAL      RR
REAL      TCASE    (2)
REAL      TQIND
REAL      TRACTF   (20,5)
REAL      TRANS    (2,25)
REAL      VGV      (20,5)
  
```

PE=2.0

3. ALGORITHM

```

IF(MAPG .NE. 1) GO TO 200
IF(IAPG .EQ. 2) GO TO 100
  
```

C

```

      CALL TRAIN (
+       CONV1 , CONV2 , ENGINE , FD , ICONV1
+       , ICONV2 , IENGIN , ITCASE , ITRAN , LOCKUP
+       , EFF , FORCE , GR , RPM , SPEED
+       , SR , TORQUE , TR , NGR , PE
+       , RR , TCASE , TQIND , TRANS , IPOW
+       , POWER , LUN1 , KII16)
      CALL FIT (
+       IPOW , FORCE , SPEED
+       , POWER , ATF , BTF , CTF
+       , NGR , TRACTF , VGV , IERROR , LUN1 , KII16)
      GO TO 400
100    CONTINUE
      MAPG=3
      CALL FIT (
+       IPOW , FORCE , SPEED
+       , POWER , ATF , BTF , CTF
+       , NGR , TRACTF , VGV , IERROR , LUN1 , KII16)
      GO TO 400
200    CONTINUE
      IF( IAPG .EQ. 1) GO TO 300
      CALL FIT (
+       IPOW , FORCE , SPEED
+       , POWER , ATF , BTF , CTF
+       , NGR , TRACTF , VGV , IERROR , LUN1 , KII16)
      GO TO 400
300    CONTINUE
      MAPG=4
      CALL TRAIN (
+       CONV1 , CONV2 , ENGINE , FD , ICONV1
+       , ICONV2 , IENGIN , ITCASE , ITRAN , LOCKUP
+       , EFF , FORCE , GR , RPM , SPEED
+       , SR , TORQUE , TR , NGR , PE
+       , RR , TCASE , TQIND , TRANS , IPOW
+       , POWER , LUN1 , KII16)
      CALL FIT (
+       IPOW , FORCE , SPEED
+       , POWER , ATF , BTF , CTF
+       , NGR , TRACTF , VGV , IERROR , LUN1 , KII16)
400    TOPSPD = POWER(SPEED, IPOW)*(60./88.)/12.
      NPTS = INT((TOPSPD+.5)*4.)
      CONTINUE
      RETURN
      END
      SUBROUTINE AUTOM (
+       ENGINE , IENGIN , CONV1 , ICONV1 , CONV2
+       , ICONV2 , TQIND , TRANS , NGR , FD
+       , RR , PE , POWER , IPOW , RPM
+       , TORQUE , SR , TR , GR , EFF
+       , SPEED , FORCE , LUN1 , KII16)
  
```

C
 C

C AUTOMATIC TRANSMISSION WITH TORQUE CONVERTER
 C -----
 C
 C

1. VARIABLE DECLARATION

```

REAL CONV1 (2,25)
REAL CONV2 (2,25)
REAL ENGINE (2,25)
REAL ESMAX
REAL ESMIN
REAL FD (2)
INTEGER ICONV1
INTEGER ICONV2
INTEGER IENGINE
INTEGER IPOWER
INTEGER EFF
INTEGER FORCE
INTEGER GR
INTEGER RPM
INTEGER SPEED
INTEGER SR
INTEGER TORQUE
INTEGER TR
INTEGER N
INTEGER NG
INTEGER NGR
REAL PE
REAL POWER (2,201)
REAL P1
REAL RPMIN
REAL RPMOUT
REAL RR
REAL SPDINC
REAL SRATIC
REAL TF
REAL TORQEN
REAL TORQIN
REAL TQINC
REAL TRANS (2,25)
REAL TRATIC
  
```

C 2. ALGORITHM

```

DO 160 NG=1,NGR
  CO 150 N=1,201
    ESMIN=ENGINE(RPM,1)
    ESMAX=ENGINE(RPM,IENGINE)
    RPMOUT=(POWER(SPEED,N)/2.0/3.14159265/RR)
    *FD(GR)*TRANS(GR,NG)
  110 + CONTINUE
    RPMIN=(ESMIN+ESMAX)/2.0
    SRATIO=RPMOUT/RPMIN
    IF(SRATIO.LE.CONV1(SR,ICONV1)) GO TO 120
    SRATIO=CONV1(SR,ICONV1)
  120 CONTINUE
  
```

```

      CALL LINEAR (
+      CONV1 ,ICONV1 ,SR ,RPM ,SRATIO
+      ,SPDIND )
      TORQIN=TOIND*(RPMIN/SPDIND)**2.0
      CALL LINEAR (
+      ENGINE ,IENGIN ,RPM ,TORQUE ,RPMIN
+      ,TORQEN )
      IF( (ESMAX+ESMIN) .LE. 1.0/60.0 ) GO TO 130
C      EXIT LCGP
      IF(TORQEN .EQ. TORQIN) GO TO 130
C      EXIT LCGP
      IF(TORQEN .LT. TORQIN) ESMAX=RPMIN
      IF(TORQEN .GT. TORQIN) ESMIN=RPMIN
      GO TO 110
130    CONTINUE
      PI=PE*TORQIN/100.0
      IF( ABS(TORQIN-TORQEN) .GT. ABS(PI) ) GO TO 140
      CALL LINEAR (
+      CONV2 ,ICONV2 ,SR ,TR ,SRATIO
+      ,TRATIO )
      TF=TORQIN*TRATIO*TRANS(GR,NG)
+      *TRANS(EFF,NG)*FD(GR)*FD(EFF)/RR
      IF(POWER(FORCE,N) .LT. TF) POWER(FORCE,N)=TF
      IF(IPOWER .LT. N) IPOWER=N
140    CONTINUE
150    CONTINUE
160    CONTINUE
C      3.DIAGNOSTIC OUTPUT
      IF( KII16 .NE. 1 ) GOTO 300
      WRITE(LUN1,190)
190    FORMAT(1H1,6H$AUTOM,/)
      WRITE(LUN1,200)
200    FORMAT(1H0,8HCONV1 =)
      WRITE(LUN1,210) ((CONV1(I,J),I=RPM,SR),J=1,ICONV1)
210    FORMAT(10X,E14.8,2X,E14.8,2X,E14.8,2X,E14.8,2X,E14.8,2X,E14.8)
      WRITE(LUN1,220)
220    FORMAT(1H0,8HCONV2 =)
      WRITE(LUN1,220) ((CONV2(I,J),I=TR,SR),J=1,ICONV2)
      WRITE(LUN1,230) EFF
230    FORMAT(1H0,8HEFF =,I4)
      WRITE(LUN1,240)
240    FORMAT(1H0,8HENGINE =)
      WRITE(LUN1,210) ((ENGINE(I,J),I=RPM,TORQUE),J=1,IENGIN)
      WRITE(LUN1,245) FD(EFF),FD(GR)
245    FORMAT(1H0,8HFD =,E14.8,2X,E14.8)
      WRITE(LUN1,250) FORCE,GR,ICONV1,ICONV2,IENGIN,IPOWER,NGR
250    FORMAT(1H0,8HFORCE =,I4,/,
+      1H0,8HGR =,I4,/,1H0,8HICONV1 =,I4,/,
+      1H0,8HICONV2 =,I4,/,1H0,8HIENGIN =,I4,/,
+      1H0,8HIPOWER =,I4,/,1H0,8HNGR =,I4)
      WRITE(LUN1,260)
260    FORMAT(1H0,8HPOWER =)

```



```

WRITE(LUN1,210) ((POWER(I,J),I=SPEED,FORCE),J=1,IPOWER)
WRITE(LUN1,270) RR
270  FORMAT(1H0,8HRR      =,814.8)
WRITE(LUN1,280) RPM,SPEED,SR,TORQUE,TR
280  FORMAT(1H0,8HRPM    =,14,/,1H0,8HSPEED =,14,/,
+      1H0,8HSR        =,14,/,1H0,8HTORQUE =,14,/,
+      1H0,8HTR        =,14)
WRITE(LUN1,290)
290  FORMAT(1H0,8HTRANS  =)
WRITE(LUN1,210) ((TRANS(I,J),I=GR,EFF),J=1,NGR)
WRITE(LUN1,310) TQINC
310  FORMAT(1H0,8HTQINC  =,814.8)
300  CONTINUE
      RETURN
      END

```

```

SUBROUTINE FIT(
+  IPOWER ,FORCE ,SPEED
+  ,POWER ,ATF   ,BTF   ,CTF   ,NGR   ,TRACTF
+  ,VGV     ,IERROR ,LUN1 ,KII16)

```

C
 C
 C
 C
 C

```

-----
VARIABLE DECLARATIONS
-----

```

```

DIMENSION A      (3,4)
DIMENSION ATF    (20)
DIMENSION BTF    (20)
DIMENSION CTF    (20)
DIMENSION POWER  (2,20)
DIMENSION TRACTF(20,5)
DIMENSION VGV    (20,5)
DIMENSION X      (3)
INTEGER  BEGIN
INTEGER  FORCE
INTEGER  END
INTEGER  RIGHT
INTEGER  SPEED
LOGICAL  MEMBER
REAL     LOWER
REAL     MEDIAN

```

C
 C
 C
 C
 C
 C

```

-----
INITIALIZE PROGRAM INDICES
-----

```

```

PCT = 2.0
NGR=1
IERROR=0
FMAX=0.
VMAX=0.
DO 2000 I=1,IPOWER

```

```

      IF( POWER(FORCE,I) .GT. FMAX) FMAX=POWER(FORCE,I)
      IF( POWER(SPEED,I) .GT. VMAX) VMAX=POWER(SPEED,I)
2000  CONTINUE
C
C -----
C BEGIN BY FITTING A QUADRATIC TO THE FIRST THREE POINTS
C -----
C
      DO 2105 N=1,IPOWER
      IF( POWER(FORCE,N) .EQ. POWER(FORCE,N+1)) GO TO 2100
      LEFT=N
      RIGHT=LEFT+2
      NEXT=RIGHT+1
      BEGIN=LEFT
      END=RIGHT
      GO TO 2110
2100  ATF(NGR)=POWER(FORCE,N+1)
      BTF(NGR)=0.
      CTF(NGR)=0.
      LEFT=1
      RIGHT=N+1
      IF( POWER(FORCE,N+1) .NE. POWER(FORCE,N+2)) GO TO 2172
2105  CONTINUE
2110  CONTINUE
      DO 2121 IR=1,3
      DO 2120 IC=1,4
      A(IR,IC)=0.
2120  CONTINUE
2121  CONTINUE
2122  CONTINUE
C
C -----
C BUILD THE "A" MATRIX FOR THE LEAST SQUARES FIT PROCEDURE
C -----
C
      DO 2140 N=BEGIN,END
      IF(N-1 .LT. 1) GO TO 2130
C
C -----
C CHECK WHETHER TWO ADJACENT POINTS HAVE THE SAME VALUE OF
C SPEED AS MIGHT OCCUR AT A GEAR SHIFT POINT.
C -----
C
      IF(POWER(SPEED,N) .EQ. POWER(SPEED,N-1)
      + .AND. LEFT .LE. N-3) GO TO 2168
      IF(POWER(SPEED,N) .EQ. POWER(SPEED,N-1)
      + .AND. LEFT .EQ. N-2) GO TO 2165
      IF(POWER(SPEED,N) .EQ. POWER(SPEED,N-1)
      + .AND. LEFT .EQ. N-1) GO TO 2174
2130  A(3,4)=A(3,4)+POWER(FORCE,N)
      A(2,4)=A(2,4)+POWER(FORCE,N)*(POWER(SPEED,N)/17.6)
      A(1,4)=A(1,4)+POWER(FORCE,N)*(POWER(SPEED,N)/17.6)**2

```

```

A(3,3)=A(3,3)*1.
A(2,3)=A(2,3)*POWER(SPEED,N)/17.6)
A(1,3)=A(1,3)*POWER(SPEED,N)/17.6)**2
A(1,2)=A(1,2)*POWER(SPEED,N)/17.6)**3
A(1,1)=A(1,1)*POWER(SPEED,N)/17.6)**4
  
```

2140

```

CONTINUE
A(2,1)=A(1,2)
A(2,2)=A(1,3)
A(3,1)=A(1,3)
A(3,2)=A(2,3)
  
```

C
 C
 C
 C
 C
 C

```

-----
CALL SUBROUTINE TO INVERT "A" MATRIX AND SOLVE FOR
THE COEFFICIENTS TO THE FITTED QUADRATIC
-----
  
```

```

CALL SOLVER (A,X)
X(2)=X(2)/17.6
X(1)=X(1)/17.6/17.6
  
```

C
 C
 C
 C
 C

```

-----
CHECK NEXT POINT AGAINST THE MAXIMUM NUMBER IN ARRAY
-----
  
```

```

IF(RIGHT*1 .GT. IPOWER) GO TO 2170
MEDIAN=X(3)+X(2)*POWER(SPEED,NEXT)+X(1)*POWER(SPEED,NEXT)**2
DIFFER=PCT*MEDIAN/100.0
LOWER=MEDIAN-DIFFER
UPPER=MEDIAN+DIFFER
MEMBER=.TRUE.
IF(POWER(FORCE,NEXT) .LT. LOWER) MEMBER=.FALSE.
IF(POWER(FORCE,NEXT) .GT. UPPER) MEMBER=.FALSE.
IF(.NOT. MEMBER) GO TO 2170
RIGHT=RIGHT+1
NEXT=RIGHT+1
BEGIN=RIGHT
END=RIGHT
  
```

GO TO 2122

C
 C
 C
 C
 C

```

-----
STRAIGHT LINE GEAR
-----
  
```

2165

```

X(1)=0.
RIGHT=RIGHT-1
X(2)=(POWER(FORCE,RIGHT)-POWER(FORCE,LEFT))/
      (POWER(SPEED,RIGHT)-POWER(SPEED,LEFT))
X(3)=POWER(FORCE,LEFT)-X(2)*POWER(SPEED,LEFT)
GO TO 2170
  
```

2168

RIGHT=RIGHT-1

2170

```

CONTINUE
ATF (NGR)=X(3)
  
```

```

    BTF(NGR)=X(2)
    CTF(NGR)=X(1)
2172   VGV(NGR,1) =POWER(SPEED,LEFT)
    VGV(NGR,5) =POWER(SPEED,RIGHT)
    DO 2176 L=2,4
        VGV(NGR,L)=VGV(NGR,L-1) + (VGV(NGR,5) - VGV(NGR,1))/4.
2176   CONTINUE
    DO 2177 L=1,5
        TRACTF(NGR,L)=ATF(NGR) + BTF(NGR) * VGV(NGR,L) +
+      CTF(NGR) * VGV(NGR,L) * VGV(NGR,L)
2177   CONTINUE
    IF(CTF(NGR) .EQ. 0.) GO TO 2173
    CALL APPROX(
+   ,POWER ,FORCE ,SPEED ,NGR ,LEFT
+   ,RIGHT ,ATF ,BTF ,CTF ,IERROR
+   ,FMAX ,VMAX ,LUN1 )
    IF(CTF(NGR) .EQ. 0.) GO TO 2172
    GO TO 2173

```

```

C
C -----
C   BACKUP TWO POINTS FOR ARTIFICIAL GEAR AT GAP IN TRACTIVE FORCE.
C -----
C

```

```

2174   RIGHT=RIGHT-2
2173   IF(N-1 .LT. 1) GO TO 2175
    IF(LEFT .LE. N-2) GO TO 2175

```

```

C
C -----
C   IF A GAP IN THE TRACTIVE FORCE DATA OCCURS SUCH AS AT THE
C   SHIFT POINT OF A MANUAL TRANSMISSION, INSERT AN ARTIFICIAL
C   GEAR WHICH IS A VERTICAL LINE HAVING ZERO COEFFICIENTS AND
C   MN, MD, MX SPEED VALUES EQUAL TO THE VALUE AT THE GAP. SET
C   THE MN, MX TRACTIVE FORCE VALUES EQUAL TO THE END POINTS OF
C   THE DISCONTINUITY, AND THE MD TRACTIVE FORCE EQUAL TO THE
C   AVERAGE OF THE MN, MX VALUES. PROCEED TO THE NEXT REAL GEAR.
C -----
C

```

```

    IF(POWER(SPEED,N) .NE. POWER(SPEED,N-1)) GO TO 2175
    RIGHT=RIGHT+1
    ATF(NGR)=0.
    BTF(NGR)=0.
    CTF(NGR)=0.
    DO 2178 L=1,5
        VGV(NGR,L)=POWER(SPEED,RIGHT)
2178   CONTINUE
    TRACTF(NGR,1)=POWER(FORCE,RIGHT-1)
    TRACTF(NGR,5)=POWER(FORCE,RIGHT)
    DO 2179 L=2,4
        TRACTF(NGR,L)=TRACTF(NGR,L-1) -
+      (TRACTF(NGR,1) - TRACTF(NGR,5)) / 4.
2179   CONTINUE
2175   IF(RIGHT+2 .GT. IPCWER) GO TO 2180

```

```
      NGR=NGR+1
      LEFT=RIGHT
      RIGHT=LEFT+2
      NEXT=RIGHT+1
      BEGIN=LEFT
      END=RIGHT
GO TO 2110
2180 CONTINUE
C
C -----
C TEST FINAL POINT. FIT STRAIGHT LINE IF FINAL
C POINT LIES OUTSIDE OF PREVIOUS GEAR.
C -----
C
      IF(RIGHT .GE. IPOWER) GO TO 2190
      NGR=NGR+1
      LEFT=RIGHT
      RIGHT=LEFT+1
      BEGIN=LEFT
      END=RIGHT
      X(1)=0.
      X(2)=(POWER(FORCE, END)-POWER(FORCE, BEGIN))/
+      (POWER(SPEED, END)-POWER(SPEED, BEGIN))
      X(3)=POWER(FORCE, END)-X(2)*POWER(SPEED, END)
      GO TO 2170
2190 CONTINUE
C -----
C EXIT ROUTINE
C -----
      IF( KII16 .NE. 1 ) GOTO 2300
C -----
C DIAGNOSTIC OUTPUT
C -----
      WRITE(LUN1,2195)
2195 FORMAT(1H1,4H$FIT,/)
      WRITE(LUN1,2200)
2200 FORMAT(1H0,8HATF =)
      WRITE(LUN1,2210) (ATF(NG),NG=1,NGR)
2210 FORMAT(10X,E14.8,2X,E14.8,2X,E14.8,2X,E14.8,2X,E14.8,2X,E14.8)
      WRITE(LUN1,2220)
2220 FORMAT(1H0,8HBTf =)
      WRITE(LUN1,2210) (BTf(NG),NG=1,NGR)
      WRITE(LUN1,2240)
2240 FORMAT(1H0,8HCTF =)
      WRITE(LUN1,2210) (CTF(NG),NG=1,NGR)
      WRITE(LUN1,2260) FCRCE
      WRITE(LUN1,2250) IERRCR
2250 FORMAT(1H0,8HIERROR =,14)
2260 FORMAT(1H0,8HFORCE =,14)
      WRITE(LUN1,2270) IPOWER
2270 FORMAT(1H0,8HIPOWER =,14)
      WRITE(LUN1,2280) NGR
```

```

2280 FORMAT(1H0,8HNGR      =,34)
      WRITE(LUN1,2320)
2320 FORMAT(1H0,8HPOWER =)
      WRITE(LUN1,2210) ((POWER(L,N),L=1,2),N=1,IPOWER)
      WRITE(LUN1,2340) SPEED
2340 FORMAT(1H0,8HSPEED =,34)
      WRITE(LUN1,2350)
2350 FORMAT(1H0,8HTRACTF =)
      WRITE(LUN1,2210) ((TRACTF(NG,L),L=1,5),NG=1,NGR)
      WRITE(LUN1,2370)
2370 FORMAT(1H0,8HVGV      =)
      WRITE(LUN1,2210) ((VGV(NG,L),L=1,5),NG=1,NGR)
2300 CONTINUE
      RETURN
      END
      SUBROUTINE SOLVER (A,X)

```

C
 C
 C
 C
 C
 C
 C
 C
 C
 C

```

-----+-----+-----+-----+-----+
MATRIX INVERSION SUBROUTINE
-----+-----+-----+-----+

-----+-----+-----+-----+
VARIABLE DECLARATIONS
-----+-----+-----+

```

```

DIMENSION A(3,4)
DIMENSION B(3,4)
DIMENSION X(3)
INTEGER COLUMN
INTEGER ROW

```

C
 10
 20

```

DO 20 ROW=1,3
  DO 10 COLUMN=1,4
    B(ROW,COLUMN)=A(ROW,COLUMN)
  CONTINUE
CONTINUE
DO 50 KPIVOT=1,2

```

C
 C
 C
 C
 C

```

-----+-----+-----+-----+
NORMALIZE W.R.T. PIVOTAL ELEMENT
-----+-----+-----+

```

```

NPIVOT=5-KPIVOT
DO 30 KCUNT=1,NPIVOT
  COLUMN=5-KOUNT
  B(KPIVOT,COLUMN)=B(KPIVOT,COLUMN)
  /B(KPIVOT,KPIVOT)

```

30
 C
 C
 C

```

CONTINUE
KELIM=KPIVOT+1

```

```

-----+-----+-----+-----+
PERFORM ELIMINATION ON ROWS OF MATRIX A

```

```

C      -----
C
      DO 45 KOW=KELIM,3
      DO 40 COLUMN=KELIM,4
      B(ROW,COLUMN)=B(ROW,COLUMN)
+      -(B(ROW,KPIVOT)/B(KPIVOT,KPIVOT))
+      *B(KPIVOT,COLUMN)
40      CONTINUE
45      CONTINUE
50      CONTINUE
C
C      -----
C      PERFORM BACK SUBSTITUTION TO OBTAIN
C      COEFFICIENTS X(1), X(2), X(3)
C      -----
C
      X(3)=B(3,4)/B(3,3)
      DO 70 KBACK=2,3
      ICOEFF=4-KBACK
      KTERMS=ICOEFF+1
      Q=0.
      DO 60 COLUMN=KTERMS,3
      C=Q+B(ICOEFF,COLUMN)*X(COLUMN)
60      CONTINUE
      X(ICOEFF)=(B(ICOEFF,4)-Q)/B(ICOEFF,ICOEFF)
70      CONTINUE
      RETURN
      END
C
      SUBROUTINE APPROX
+ (POWER ,FORCE ,SPEED ,NGR ,NLEFT ,NRIGHT
+ ,ATF ,BTF ,CTF ,ERROR ,FMAX
+ ,VMAX ,LUN1)
C
C      -----
C      COMPARISON OF A SECOND ORDER POLYNOMIAL CURVE
C      FITTED TO THE POWERTRAIN DATA AND A STRAIGHT
C      LINE FITTED EXACTLY BETWEEN TWO ADJACENT POINTS.
C      -----
C
C      -----
C      1. VARIABLE DECLARATIONS
C      -----
      DIMENSION ATF (20)
      DIMENSION BTF (20)
      DIMENSION CTF (20)
      DIMENSION POWER (2,201)
      REAL LINE0 (120)
      REAL LINE1 (120)
      INTEGER FORCE
  
```

```

      INTEGER SPEED
      REAL QUAD0
      REAL QUAD1
      REAL QUAD2
      REAL XCOORD (201)
      REAL YCOORD (201)

C
C -----
C 2. ALGORITHM
C -----
C
      DO 200 N=NLEFT,NRIGHT
          XCOORD(N)=POWER(SPEED,N)
          YCOORD(N)=POWER(FORCE,N)
200  CONTINUE
          QUAD0=ATF(NGR)
          QUAD1=BTF(NGR)
          QUAD2=CTF(NGR)
          CALL LINES(
+ NLEFT ,NRIGHT ,XCOCRD ,YCCCRD ,LINE0 ,LINE1)
          CALL RESIDU(
+ NLEFT ,NRIGHT ,XCOCRD ,YCOORD ,LINE0 ,LINE1
+ ,QUAD0 ,QUAD1 ,QUAD2 ,IERROR ,FMAX
+ ,VMAX ,LUN1)
          ATF(NGR)=QUAD0
          BTF(NGR)=QUAD1
          CTF(NGR)=QUAD2
      CONTINUE
      RETURN
      END

C
      SUBROUTINE LINES
+ (NLEFT ,NRIGHT ,XCOCRD ,YCCGRD ,LINE0 ,LINE1)
C
C -----
C EXACT LINEAR FIT BETWEEN TWO ADJACENT POINTS
C -----
C
C -----
C 1. VARIABLE DECLARATIONS
C -----
C
      REAL LINE0 (120)
      REAL LINE1 (120)
      INTEGER SEG
      INTEGER SEG A
      INTEGER SEG B
      REAL XCOORD (201)
      REAL YCOORD (201)
  
```



```

C      2. ALGORITHM
C      -----
C
      SEGA=NLEFT+1
      SEGB=NRIGHT
      DO 200 SEG=SEGA,SEGB
        LINE1(SEG)=(YCOORD(SEG)-YCOORD(SEG-1))
+         /(XCOORD(SEG)-XCOORD(SEG-1))
      LINE0(SEG)=YCOORD(SEG)-LINE1(SEG)*XCOORD(SEG)
200    CONTINUE
      RETURN
      END
  
```

```

C
C      SUBROUTINE RESIDU
+ (NLEFT ,NRIGHT ,XCOORD ,YCOORD ,LINE0 ,LINE1
+ ,QUAD0 ,QUAD1 ,QUAD2 ,IERROR ,FMAX
+ ,VMAX ,LUN1)
  
```

```

C
C      -----
C      RESIDUAL BETWEEN FIRST AND SECOND ORDER POLYNOMIAL FIT
C      -----
  
```

```

C
C      -----
C      1. VARIABLE DECLARATIONS
C      -----
  
```

```

      REAL   ERRGR  (120)
      REAL   LENPPA
      REAL   LENPPB
      REAL   LINE0  (120)
      REAL   LINE1  (120)
      INTEGER SEG
      INTEGER Z
      INTEGER SEGA
      INTEGER SEGB
      INTEGER SEG1
      INTEGER SEG2
      REAL   QUAD0
      REAL   QUAD1
      REAL   QUAD2
      REAL   XCOORD (201)
      REAL   YCOORD (201)
  
```

```

C
C      -----
C      2. ALGORITHM
C      -----
  
```

```

C
C      -----
C      A. FUNCTIONS
C      -----
  
```

C 1. FIRST ORDER POLYNOMIAL
 $ALINE(Z,X)=LINE0(Z)+LINE1(Z)*X$
C 2. SECOND ORDER POLYNOMIAL
 $QUAD(X)=QUAD0+QUAD1*X+QUAD2*X**2$
C 3. RESIDUAL
 $RESID(Z,X)=ABS(QUAD(X)-ALINE(Z,X))$

C
C -----+-----
C B. DIFFERENCE CALCULATION BETWEEN QUADRATIC CURVE
C AND THE STRAIGHT LINE FITTED BETWEEN TWO ADJACENT POINTS.
C -----+-----
C

PCT1=0.05
PCT2=0.01
SEGA=NLEFT+1
SEGB=NRIGHT
DO 250 SEG=SEGA,SEGB

C
C -----+-----
C FIND THE VALUE OF X WHERE THE DIFFERENCE BETWEEN
C THE QUADRATIC CURVE AND THE STRAIGHT LINE VALUES
C OF Y ARE A MAXIMUM.
C -----+-----
C

XPOINT=(LINE1*SEGA-QUAD1)/(2.*QUAD2)
IF(XPOINT .LT. XCOORD(SEG-1)) .OR.
XPOINT .GT. XCOORD(SEG)) GO TO 230

C
C -----+-----
C CALCULATE THE SLOPE OF THE QUADRATIC AT XPOINT
C -----+-----
C

SLOPE=2.*QUAD2*XPOINT + QUAD1

C
C -----+-----
C CALCULATE THE MAXIMUM DISTANCE BETWEEN THE CURVE AND
C THE STRAIGHT LINE IF THE MAXIMUM OCCURS BETWEEN
C THE END POINTS OF THE LINE.
C -----+-----
C

ERROR(SEGA)=RESID(SEG,XPOINT)
GO TO 240

C
230 LENPPA=RESID(SEG,XCOORD(SEG-1))
 LENPPB=RESID(SEG,XCOORD(SEGA))

C
C -----+-----
C CALCULATE DIFFERENCE BETWEEN CURVE AND STRAIGHT LINE
C IF THE MAXIMUM OCCURS AT THE END POINTS OF THE LINE.
C -----+-----
C

ERROR(SEG)=AMAX1(LENPPA,LENPPB)

```

IF(ERROR(SEGA .EQ. LENPPA) XPOINT=XCOORD(SEG-1)
IF(ERROR(SEGB .EQ. LENPPB) XPOINT=XCOORD(SEG)
SLOPE=2.*QUAD2*XPOINT + QUAD1

C
C
C -----
C CALCULATE THE NORMALIZED SLOPE
C FOR THE ENTIRE POWERTRAIN CURVE
C -----
C
240 SLOPEN=ABS(SLOPE*VMAX/FMAX)
C
C -----
C CHECK WHETHER CURVE EXTENDS BEYOND MAXIMUM TRACTIVE FORCE
C IF SO, FIT STRAIGHT LINE BETWEEN POINTS AT WHICH THIS OCCURS.
C -----
C
C QMAX=AMAX1(QUAD(XPCINT),QUAD(XCOORD(SEG-1)),
+ QUAD(XCOORD(SEGB)))
C IF(QMAX .GT. FMAX) GO TO 260

C
C -----
C CALCULATE ALLOWABLE ERROR BETWEEN QUADRATIC
C CURVE AND STRAIGHT LINE WHICH INCLUDES VARIABLE
C ERROR BASED ON THE NORMALIZED SLOPE.
C -----
C
+ ALLOW=((QUAD(XCOORD(SEG-1)) + QUAD(XCOORD(SEG)))/2.)*
PCT1 + SLOPEN*PCT2*QUAD(XPCINT)
C IF(ALLOW .GT. ERROR(SEG)) GO TO 250
C SEG1=SEG - 1
C SEG2=SEG + 2
C WRITE(LUA1,2200) SEG1,SEG,SEG2,SEG1
C IERROR=1

250 CONTINUE
GO TO 270

260 QUAD2=0.
QUAD1=LINE1(SEG)
QUAD0=LINE04(SEG)
NRIGHT=SEG

2200 FORMAT(1X,32H-CURVE FIT ERROR EXCEEDED BETWEEN,1X,
+ 12HDATA POINTS:,2I3,/,
+ 8X,38HINSERT DATA POINT BETWEEN DATA POINTS:,2I3)

270 CONTINUE
RETURN
END
SUBROUTINE LINEAR ( ARRAY,IARRAY,INC,MDEP,X,Y )
C
C DIMENSION ARRAY(2,50)
C
C -----
C LINEAR INTERPOLATION SUBROUTINE
C -----

```

```

C      IF( ARRAY(IND,I) .LE. ARRAY(IND,IARRAY) ) GO TO 110
      THE VALUES IN ARRAY(I,J) ARE NOT ASCENDING
      STOP 4
110    CONTINUE
      IF( X .GE. ARRAY(IND,I) ) GO TO 120
      Y=0.0
      GO TO 150
120    CONTINUE
      IF( X .LE. ARRAY(IND,IARRAY) ) GO TO 130
      Y=0.0
      GO TO 150
130    CONTINUE
      NTEMP1=IARRAY-1
      DO 140 N=1,NTEMP1
      IF( .NOT. ( (X .GE. ARRAY(IND,N)) .AND.
+ (X .LE. ARRAY(IND,N+1)) ) ) GO TO 140
      Y=ARRAY(MDEP,N)+0.5*(ARRAY(MDEP,N+1)-ARRAY(MDEP,N))
+ (X-ARRAY(IND,N)) / (ARRAY(IND,N+1)-ARRAY(IND,N))
      GO TO 150
140    CONTINUE
C      ARRAY CANNOT BE INTERPLOATED
      STOP 5
150    CONTINUE
      RETURN
      END
      SUBROUTINE STICK (
+ ,ENGINE ,IENGIN ,TRANS ,NGR ,FD
+ ,RR ,POWER ,IPOWER ,RPM ,TORQUE
+ ,GR ,EFF ,SPEED ,FORCE ,LUN1
+ ,KII16)

```

```

C
C -----
C MANUAL TRANSMISSION ROUTINE
C -----
C

```

```

1. VARIABLE DECLARATION
REAL ENGINE (2,25)
REAL ESMAX
REAL ESMIN
REAL FD (2)
INTEGER IENGIN
INTEGER IPOWER
INTEGER EFF
INTEGER FORCE
INTEGER GR
INTEGER RPM
INTEGER SPEED
INTEGER TORQUE
INTEGER N
INTEGER NG
INTEGER NGR
REAL POWER (2,201)

```

```

REAL      RPMEN
REAL      RR
REAL      TF
REAL      TORQEN
REAL      TRANS (2,25)

C
C
2. ALGORITHM
ESMIN=ENGINE(RPM,1)
ESMAX=ENGINE(RPM,IENGIN)
DC 120 NGR=1,NGR
DO 110 N=1,201
  RPMEN=( PCWER(SPEED,N)/2.0/3.14159265/RR ) *
+      FD(GR)*TRANS(GR,NG)
  IF(RPMEN .LT. ESMIN) GO TO 110
  IF(RPMEN .GT. ESMAX) GO TO 120
  EXIT LE8P 110
  CALL L LINEAR(ENGINE,IENGIN,RPM,TORQUE,RPMEN,TORQEN)
  TF=TORQEN*TRANS(GR,NG)*TRANS(EFF,NG)
+      *FD(GR)*FD(EFF)/RR
  IF(POWER(FORCE,N) .LT. TF) POWER(FORCE,N)=TF
  IF(IPOWER .LT. N) IPOWER=N
110    CONTINUE
120    CONTINUE
DC 300 N=2,IPOWER
  NN=IPOWER - N + 1
  IF(POWER(FORCE,NN) .EQ. 0.)
+      POWER(FORCE,NN) = PCWER(FORCE,NN+1)
300    CONTINUE
C
3. DIAGNOSTIC OUTPUT
IF (KII16 .NE. 1) GOTC 210
WRITE(LUN1,100)
100  FORMAT(1H1,6H$STICK,/)
WRITE(LUN1,115) EFF
115  FORMAT(1H0,8HEFF      =,14)
WRITE(LUN1,125)
125  FORMAT(1H0,8HENGINE =)
WRITE(LUN1,130) ((ENGINE(I,J),I=RPM,TORQUE),J=1,IENGIN)
130  FORMAT(10X,6(E14.8,2X))
WRITE(LUN1,140) (FD(I),I=1,2)
140  FORMAT(1H0,8HFD      =,2(E14.8,2X))
WRITE(LUN1,150) FORCE,GR,IENGIN,IPOWER,NGR
150  FORMAT(1H0,8HFORCE  =,14,/,1H0,8HGR      =,14,/,
+      1H0,8HIENGIN   =,14,/,1H0,8HIPOWER =,14,/,
+      1H0,8HNGR      =,14)
WRITE(LUN1,160)
160  FORMAT(1H0,8HPOWER  =)
WRITE(LUN1,170) ((PCWER(I,J),I=SPEED,FORCE),J=1,IPOWER)
WRITE(LUN1,170) RPM
170  FORMAT(1H0,8HRPM   =,14)
WRITE(LUN1,180) RR
180  FORMAT(1H0,8HRR    =,E14.8)

```

```

190 WRITE(LUN1,190) SPEED
    FORMAT(1H0,8HSPEED =,34)
    WRITE(LUN1,200)
200 FORMAT(1H0,8HTRANS =)
    WRITE(LUN1,130) ((TRANS(I,J),I=GR,EFF),J=1,NGR)
210 CONTINUE
    RETURN
    END
  
```

```

SUBROUTINE TRAIN I
+ CONV1 ,CONV2 ,ENGINE ,FC ,ICONV1
+ ,ICONV2 ,IENGIN ,ITCASE ,ITRAN ,LOCKUP
+ ,EFF ,FORCE ,GR ,RPM ,SPEED
+ ,SR ,TORQUE ,TR ,NGR ,PE
+ ,RR ,TCASE ,TQIND ,TRANS ,IPOWER
+ ,POWER ,LUN1 ,KII16)
  
```

C
C
C
C
C
C
C
C

```

-----
CONSTRUCTION OF THE VEHICLE
TRACTIVE EFFORT .VERSUS. SPEED CURVE
FROM POWER TRAIN DATA
-----
  
```

1. VARIABLE DECLARATION

```

REAL CONV1 (2,25)
REAL CONV2 (2,25)
REAL ENGINE (2,25)
REAL FD (.2)
INTEGER ICONV1
INTEGER ICONV2
INTEGER IENGIN
INTEGER IPOWER
INTEGER ITCASE
INTEGER LOCKUP
INTEGER EFF
INTEGER FORCE
INTEGER GR
INTEGER RPM
INTEGER SPEED
INTEGER SR
INTEGER TORQUE
INTEGER TR
INTEGER N
INTEGER NGR
REAL PE
REAL POWER (2,201)
REAL RR
REAL TCASE (.2)
REAL TQIND
REAL TRANS (2,25)
  
```

C
C

2. ALGORITHM
 IPOWER=0

```

DC 2010 N=1,201
POWER(SPEED,N)=FECAT(N-1)*0.5*(88./60.)*12.0
POWER(FORCE,N)=0.0
2010 CONTINUE
C -----
C ADJUST TRANSMISSION INPUT FOR ENGINE
C TO TRANSMISSION TRANSFER CASE
C -----
IF( ITCASE .EQ. 0 ) GO TO 2021
CO 2020 N=1, IENGIN
ENGINE(RPM,N)=ENGINE(RPM,N)/TCASE( GR )
ENGINE(TORQUE,N)=ENGINE(TORQUE,N)*TCASE( GR )*TCASE( EFF )
2020 CONTINUE
2021 CONTINUE
C -----
C CHOOSE TRANSMISSION TYPE
C -----
IF( ITRAN .EQ. 0 ) GO TO 2040
CALL AUTOM (
+ ENGINE , IENGIN , CONV1 , ICONV1 , CONV2
+ , ICONV2 , TQIND , TRANS , NGR , FD
+ , RR , PE , POWER , IPOWER , RPM
+ , TORQUE , SR , TR , GR , EFF
+ , SPEED , FCFCF , LUN1 , KII16 )
IF( LOCKUP .EQ. 0 ) GO TO 2050
2040 CONTINUE
CALL STICK (
+ ENGINE , IENGIN , TRANS , NGR , FD
+ , RR , POWER , IPOWER , RPM , TORQUE
+ , GR , EFF , SPEED , FORCE , LUN1
+ , KII16 )
2050 CONTINUE
C
C 3. DIAGNOSTIC OUTPUT
IF( KII16 .NE. 1 ) GOTO 300
WRITE( LUN1,190 )
190 FORMAT(1H1,6H$TRAIN,/ )
WRITE( LUN1,200 )
200 FORMAT(1H0,8HCONV1 =)
WRITE( LUN1,210 ) (( CONV1( I,J ), I=RPM,SR ), J=1, ICONV1 )
210 FORMAT(10X,E14.8,2X,E14.8,2X,E14.8,2X,E14.8,2X,E14.8,2X,E14.8 )
WRITE( LUN1,220 )
220 FORMAT(1H0,8HCONV2 =)
WRITE( LUN1,210 ) (( CONV2( I,J ), I=TR,SR ), J=1, ICONV2 )
WRITE( LUN1,230 ) EFF
230 FORMAT(1H0,8HEFF =,f4 )
WRITE( LUN1,240 )
240 FORMAT(1H0,8HENGINE =)
WRITE( LUN1,210 ) (( ENGINE( I,J ), I=RPM,TORQUE ), J=1, IENGIN )
WRITE( LUN1,245 ) FD( EFF ), FD( GR )
245 FORMAT(1H0,8HFD =,E14.8,2X,E14.8 )
WRITE( LUN1,250 ) FORCE,GR,ICONV1, ICONV2, IENGIN, ITCASE, ITRAN,

```

```

+          IPOWER,LOCKUP,NGR
250  FORMAT(1H0,8HFORCE  =,14,/,
+       1H0,8HGR        =,14,/,1H0,8HICONV1 =,14,/,
+       1H0,8HICONV2   =,14,/,1H0,8HIENGIN  =,14,/,
+       1H0,8HITCASE   =,14,/,1H0,8HITRAN  =,14,/,
+       1H0,8HIPOWER   =,14,/,1H0,8HLOCKUP =,14,/,
+       1H0,8HNGR      =,14)
  WRITE(LUN1,260)
260  FORMAT(1H0,8HPOWER  =)
  WRITE(LUN1,210) ((POWER(I,J),I=SPEED,FORCE),J=1,IPOWER)
  WRITE(LUN1,270) RR
270  FORMAT(1H0,8HRR     =,E14.8)
  WRITE(LUN1,280) RPM,SPEED,SR,TORQUE,TR
280  FORMAT(1H0,8HRPM   =,14,/,1H0,8HSPEED  =,14,/,
+       1H0,8HSR       =,14,/,1H0,8HTORQUE =,14,/,
+       1H0,8HTR       =,14)
  WRITE(LUN1,285) (TCASE(I),I=GR,EFF)
285  FORMAT(1H0,8HTCASE =,2(E14.8,2X))
  WRITE(LUN1,290)
290  FORMAT(1H0,8HTRANS  =)
  WRITE(LUN1,210) ((TRANS(I,J),I=GR,EFF),J=1,NGR)
  WRITE(LUN1,310) TQIND
310  FORMAT(1H0,8HTQIND =,E14.8)
300  CONTINUE
      RETURN
      END
  SUBROUTINE I117(
+  CID ,IDIESL ,GCM ,NAMBL ,NCYL ,NENG
+  ,NGR ,NVEH ,QMAX ,RMX ,RR ,TRACTF )

```

C
 C
 C
 C
 C
 C

-----+-----
 ROTATING MASS FACTORS
 -----+-----

```

1. VARIABLE DECLARATION
  REAL    IDIESL
  REAL    MF1
  REAL    MF2
  REAL    NCYL
  REAL    NENG
  INTEGER NVEH (20)
  REAL    RMX (20)
  REAL    TRACTF (20,5)

```

C
 C

```

2. ALGORITHMS
  MF1 = 1.03
  ETA = 0.9
  DO 1710 I=1,NAMBL
    IF(NVEH(I) .NE. 0) GO TO 1710
    MF1 = 1.14
    ETA = 0.7
  GO TO 1720

```



```

1710 CONTINUE
1720 MF2 = (.008*((ICIESL*CID)**1.68)/(NCYL/GCW)*NENG
      DO 1730 NG=1,NGR
          GR = TRACTF(NG,3)*RR/ETA/QMAX
          RMX(NG) = MF1 + MF2*GR*GR
  
```

```

1730 CONTINUE
      RETURN
      END
SUBROUTINE TERTL
  
```

```

C -----
C TERRAIN TRANSLATORS
C -----
  
```

1. LABELED COMMON ASSIGNMENTS

```

COMMON /IO/      IEOF
COMMON /IO/      KBUFF
COMMON /IO/      LUN1
COMMON /IO/      LUN2
COMMON /IO/      LUN3
COMMON /IO/      LUN4
COMMON /IO/      LUN5
COMMON /IO/      LUN6
COMMON /IO/      LUN7
COMMON /IO/      LUN8
COMMON /IO/      LUN9
COMMON /IO/      LUN10
INTEGER         MD
COMMON /INDEX/  MD
INTEGER         COWN
COMMON /INDEX/  COWN
INTEGER         EFF
COMMON /INDEX/  EFF
INTEGER         FORCE
COMMON /INDEX/  FORCE
INTEGER         GR
COMMON /INDEX/  GR
COMMON /INDEX/  LBVEL
INTEGER         MA
COMMON /INDEX/  MA
INTEGER         RBM
COMMON /INDEX/  RBM
INTEGER         SREED
COMMON /INDEX/  SREED
INTEGER         SA
COMMON /INDEX/  SR
INTEGER         TR
COMMON /INDEX/  TR
INTEGER         TORQUE
COMMON /INDEX/  TORQUE
INTEGER         UP
COMMON /INDEX/  UP
  
```

INTEGER		
COMMON /INDEX/	MX	
COMMON /TERRAN/	AA	
COMMON /TERRAN/	ACTRMS	
COMMON /TERRAN/	AREA	
COMMON /TERRAN/	AREAC	
COMMON /TERRAN/	CA	
COMMON /TERRAN/	CBST	
COMMON /TERRAN/	EANG	
COMMON /TERRAN/	ECF	
COMMON /TERRAN/	ELEV	
COMMON /TERRAN/	FNU	(3)
COMMON /TERRAN/	GRADE	
COMMON /TERRAN/	ICBS	
COMMON /TERRAN/	IBST	
COMMON /TERRAN/	IROAD	
COMMON /TERRAN/	IS	(9)
COMMON /TERRAN/	IST	
COMMON /TERRAN/	IBUT	
COMMON /TERRAN/	NE	
COMMON /TERRAN/	NEU	
COMMON /TERRAN/	CAW	
COMMON /TERRAN/	CBAA	
COMMON /TERRAN/	CBH	
COMMON /TERRAN/	CBL	
COMMON /TERRAN/	CBS	
COMMON /TERRAN/	CBW	
COMMON /TERRAN/	CBMINW	
COMMON /TERRAN/	CDIA	
COMMON /TERRAN/	ANASFO	
COMMON /TERRAN/	RADC	
COMMON /TERRAN/	ROI	
COMMON /TERRAN/	ROIC	(4)
COMMON /TERRAN/	RCURV	(11)
COMMON /TERRAN/	RB	
COMMON /TERRAN/	FDIA	(12)
COMMON /TERRAN/	S	(9)
COMMON /TERRAN/	SE	(9)
COMMON /TERRAN/	SCL	(9)
COMMON /TERRAN/	SURFF	
COMMON /TERRAN/	TANPHI	
COMMON /TERRAN/	THETA	(3)
COMMON /TERRAN/	VCURV	(4,11)
COMMON /TERRAN/	WA	
COMMON /TERRAN/	WB	
COMMON /SCEN/	CGHES	
COMMON /SCEN/	VMALK	
COMMON /SCEN/	DOLMAX	
COMMON /SCEN/	GAMMA	
COMMON /SCEN/	IGVER	
COMMON /SCEN/	ISEASN	
COMMON /SCEN/	ISURF	

```
COMMON /SCEN/      JSNOW
COMMON /SCEN/      KII1
COMMON /SCEN/      KII2
COMMON /SCEN/      KII3
COMMON /SCEN/      KII4
COMMON /SCEN/      KII5
COMMON /SCEN/      KII6
COMMON /SCEN/      KII7
COMMON /SCEN/      KII8
COMMON /SCEN/      KII9
COMMON /SCEN/      KII10
COMMON /SCEN/      KII11
COMMON /SCEN/      KII12
COMMON /SCEN/      KII13
COMMON /SCEN/      KII14
COMMON /SCEN/      KII15
COMMON /SCEN/      KII16
COMMON /SCEN/      KII17
COMMON /SCEN/      KMAP
COMMON /SCEN/      KSCEN
COMMON /SCEN/      KIPP
COMMON /SCEN/      KVEH
COMMON /SCEN/      KIV1
COMMON /SCEN/      KIV2
COMMON /SCEN/      KIV3
COMMON /SCEN/      KIV4
COMMON /SCEN/      KIV5
COMMON /SCEN/      KIV6
COMMON /SCEN/      KIV7
COMMON /SCEN/      KIV8
COMMON /SCEN/      KIV9
COMMON /SCEN/      KIV10
COMMON /SCEN/      KIV11
COMMON /SCEN/      KIV12
COMMON /SCEN/      KIV13
COMMON /SCEN/      KIV14
COMMON /SCEN/      KIV15
COMMON /SCEN/      KIV16
COMMON /SCEN/      KIV17
COMMON /SCEN/      KIV18
COMMON /SCEN/      KIV19
COMMON /SCEN/      KIV20
COMMON /SCEN/      KIV21
COMMON /SCEN/      LAC
INTEGER           DETAIL
COMMON /SCEN/      DETAIL
COMMON /SCEN/      MAP
COMMON /SCEN/      MAPG
COMMON /SCEN/      MONTH
COMMON /SCEN/      NBP
COMMON /SCEN/      NSLIP
COMMON /SCEN/      NTRAV
```

```
COMMON /SCEN/      NTUX
COMMON /SCEN/      FBI
COMMON /SCEN/      REACT
COMMON /SCEN/      RFOG
INTEGER           SEARCH
COMMON /SCEN/      SEARCH
COMMON /SCEN/      SETYPC
COMMON /SCEN/      VBRAKE
COMMON /SCEN/      VISMV
COMMON /SCEN/      VIM
COMMON /SCEN/      ZSNOW
```

```
C 2. ALGORITHM
   IF(MAP.EQ.74) GO TO 2010
   IF(MAP.EQ.11) GO TO 2015
```

```
C
C CLASS INTERVAL TERRAIN TRANSLATOR
```

```
      CALL MAP71(
+ AA      ,ACTRMS ,AREA  ,ELEV  ,GRADE  ,IEOF   ,IOST   ,IS
+ ,IST    ,ITUT   ,LUN2  ,NI    ,NTU    ,NTUX   ,OBH   ,OBL
+ ,OBS    ,OBW    ,RCIC  ,RD    ,S      ,SD     ,SDL   ,SEARCH
+ ,WD )
```

```
C
C DIAGNOSTIC OUTPUT LIST
  NAMelist /XMAP71/
```

```
+ AA      ,ACTRMS ,AREA  ,ELEV  ,GRADE  ,IEOF   ,IOST   ,IS
+ ,IST    ,ITUT   ,LUN2  ,NI    ,NTU    ,NTUX   ,OBH   ,OBL
+ ,OBS    ,OBW    ,RCIC  ,RD    ,S      ,SD     ,SDL   ,SEARCH
+ ,WD
```

```
      IF((KMAP.EQ.1) .AND. (IEOF.EQ.0)) WRITE(LUN1,XMAP71)
      GO TO 2020
2010 CONTINUE
```

```
C
C NATURAL TERRAIN UNITS TRANSLATOR
```

```
      CALL MAP74(
+ AA      ,ACTRMS ,AREA  ,ELEV  ,GRADE  ,IEOF   ,IOST   ,IS
+ ,IST    ,ITUT   ,LUN2  ,MONTH  ,NI    ,NTU    ,NTUX   ,OBH
+ ,OBL    ,OBS    ,CBW   ,RCIC  ,RD    ,RDA   ,RDA1  ,RDA2
+ ,RDA3   ,RDA4   ,S     ,SD    ,SDL   ,SEARCH ,WD )
```

```
C
C DIAGNOSTIC OUTPUT LIST
  NAMelist /XMAP74/
```

```
+ AA      ,ACTRMS ,AREA  ,ELEV  ,GRADE  ,IEOF   ,IOST   ,IS
+ ,IST    ,ITUT   ,LUN2  ,MONTH  ,NI    ,NTU    ,NTUX   ,OBH
+ ,OBL    ,OBS    ,CBW   ,RCIC  ,RD    ,RDA   ,RDA1  ,RDA2
+ ,RDA3   ,RDA4   ,S     ,SD    ,SDL   ,SEARCH ,WD
```

```
C
C DIAGNOSTIC OUTPUT
  IF((KMAP.EQ.1) .AND. (IEOF.EQ.0)) WRITE(LUN1,XMAP74)
  GO TO 2020
```

```
C
C ROAD NET TRANSLATOR
```

```
C
2015 CALL MPRD74(
```

```

+ ACTRMS ,CURVV ,DIST ,EANG ,ELEV ,FMU ,GRADE
+ ,IECF ,IKOAG ,IST ,ITUT ,IURB ,LUN2 ,NTU ,NTUX
+ ,NVASHO ,MONTH ,RADC ,RCURV ,RC ,RDA ,RDFOG ,RCIC
+ ,SEARCH ,SURFF ,VCURM )
C      DIAGNOSTIC OUTPUT LIST
      NAMLIST /XROAD/
+ ACTRMS ,CURVV ,DIST ,EANG ,ELEV ,FMU ,GRADE
+ ,IECF ,IROAD ,IST ,ITUT ,IURB ,LUN2 ,NTU ,NTUX
+ ,NVASHO ,MONTH ,RADC ,RCURV ,RC ,RDA ,RDFOG ,RCIC
+ ,SEAKCH ,SURFF ,VCURY
      IF((KMAP .EQ. 1) .AND. (IECF .EQ. 0)) WRITE(LUN1,XROAD)
2020  CONTINUE
      IF(IECF .EQ. 1) GO TO 4000
C
C      TERRAIN PREPROCESSOR
C
      CALL TPP(
+ AA ,ACTRMS ,AREAB ,CI ,ECF ,ELEV ,GAMMA ,GRADE
+ ,IOBS ,ISEASN ,ISNCM ,IST ,ITUT ,NI ,OAW ,OBAA
+ ,OBH ,OBL ,CBMINW ,OBS ,OBW ,ODIA ,PHI ,RADC
+ ,RCI ,RCIC ,RD ,S ,TANPHI ,THETA ,WA ,ZSNOW )
C      DIAGNOSTIC OUTPUT LIST
      NAMLIST /XTPP/
+ AA ,ACTRMS ,AREAB ,CI ,ECF ,ELEV ,GAMMA ,GRADE
+ ,IOBS ,ISEASN ,ISNCM ,IST ,ITUT ,NI ,OAW ,OBAA
+ ,OBH ,OBL ,CBMINW ,OBS ,OBW ,ODIA ,PHI ,RADC
+ ,RCI ,RCIC ,RD ,S ,TANPHI ,THETA ,WA ,ZSNOW
C      DIAGNOSTIC OUTPUT
      IF(KTPP .EQ. 1) WRITE(LUN1,XTPP)
C      4. TERMINUS
4000  CONTINUE
      RETURN
      END
      SUBROUTINE AREAL
      -----
      -----
C
C
C
C
C      1. LABELED COMMON ASSIGNMENTS
      COMMON /IO/ IBOF
      COMMON /IO/ KBUFF
      COMMON /IO/ LUN1
      COMMON /IO/ LUN2
      COMMON /IO/ LUN3
      COMMON /IO/ LUN4
      COMMON /IO/ LUN5
      COMMON /IO/ LUN6
      COMMON /IO/ LUN7
      COMMON /IO/ LUN8
      COMMON /IO/ LUN9
      COMMON /IO/ LUN10
      INTEGER ID
  
```

COMMON /INDEX/	MD	
INTEGER	DGWN	
COMMON /INDEX/	DOWN	
INTEGER	EEF	
COMMON /INDEX/	EEF	
INTEGER	FORCE	
COMMON /INDEX/	FORCE	
INTEGER	GR	
COMMON /INDEX/	GR	
COMMON /INDEX/	LEVEL	
INTEGER	MM	
COMMON /INDEX/	MA	
INTEGER	REM	
COMMON /INDEX/	RRM	
INTEGER	SPEED	
COMMON /INDEX/	SPEED	
INTEGER	SR	
COMMON /INDEX/	SR	
INTEGER	TR	
COMMON /INDEX/	TR	
INTEGER	TORQUE	
COMMON /INDEX/	TORQUE	
INTEGER	U0	
COMMON /INDEX/	UB	
INTEGER	UX	
COMMON /INDEX/	MX	
COMMON /VEHICL/	AGD	
COMMON /VEHICL/	ASHOE	(20)
COMMON /VEHICL/	AVGC	
COMMON /VEHICL/	AXLSP	(20)
COMMON /VEHICL/	CB	
COMMON /VEHICL/	CGH	
COMMON /VEHICL/	CLAT	
COMMON /VEHICL/	CGR	
COMMON /VEHICL/	CID	
COMMON /VEHICL/	CA	
COMMON /VEHICL/	CURMIN	(20)
COMMON /VEHICL/	CENV1	(2,25)
COMMON /VEHICL/	CENV2	(2,25)
COMMON /VEHICL/	CFLCT	(20,3)
COMMON /VEHICL/	DEAW	(20)
COMMON /VEHICL/	DRAFT	
COMMON /VEHICL/	ENGINE	(2,50)
COMMON /VEHICL/	BYENGT	
COMMON /VEHICL/	FD	(2)
COMMON /VEHICL/	FORDD	
COMMON /VEHICL/	GROUSH	(20)
COMMON /VEHICL/	HYALS	(25)
COMMON /VEHICL/	IAPG	
COMMON /VEHICL/	IB	(20)
COMMON /VEHICL/	ID	(20)
REAL	IDIESL	

COMMON /VEHICL/	IDIESL	
COMMON /VEHICL/	IENGIN	
COMMON /VEHICL/	IR	(20)
COMMON /VEHICL/	ICONST	(20)
COMMON /VEHICL/	IQGNV1	
COMMON /VEHICL/	IQGNV2	
COMMON /VEHICL/	IPOWER	
COMMON /VEHICL/	IT	(20)
COMMON /VEHICL/	ITCASE	
COMMON /VEHICL/	ITRAN	
COMMON /VEHICL/	ITVAR	
COMMON /VEHICL/	LOCKUP	
COMMON /VEHICL/	MAXIPR	
COMMON /VEHICL/	MAXL	
COMMON /VEHICL/	NMBLY	
COMMON /VEHICL/	NBOGIE	(20)
COMMON /VEHICL/	NCHAIN	(20)
REAL	NGYL	
COMMON /VEHICL/	NGYL	
REAL	NBNG	
COMMON /VEHICL/	NBNG	
COMMON /VEHICL/	PNET	
COMMON /VEHICL/	AFL	(20)
COMMON /VEHICL/	NBR	
COMMON /VEHICL/	NHVALS	
COMMON /VEHICL/	NRAD	(20)
COMMON /VEHICL/	NSVALS	
COMMON /VEHICL/	NMEH	(20)
COMMON /VEHICL/	NMHL	(20)
COMMON /VEHICL/	NWR	
COMMON /VEHICL/	PBF	
COMMON /VEHICL/	PBHT	
COMMON /VEHICL/	PEA	
COMMON /VEHICL/	PPOWER	(2, 201)
COMMON /VEHICL/	CNAX	
COMMON /VEHICL/	FDIAM	(20)
COMMON /VEHICL/	FEVM	(20)
COMMON /VEHICL/	RBMW	(20)
COMMON /VEHICL/	RNS	(20)
COMMON /VEHICL/	FW	(20)
COMMON /VEHICL/	SAE	
COMMON /VEHICL/	SAI	
COMMON /VEHICL/	SECTH	(20)
COMMON /VEHICL/	SECTW	(20)
COMMON /VEHICL/	SVALS	(25)
COMMON /VEHICL/	TCASE	(2)
COMMON /VEHICL/	Te	
COMMON /VEHICL/	TRLY	(20)
COMMON /VEHICL/	TOSI	(20, 3)
COMMON /VEHICL/	TRIND	
COMMON /VEHICL/	TRAKLN	(20)
COMMON /VEHICL/	TRAKWD	(20)

COMMON /VEHICL/	TRANS	(2,20)
COMMON /VEHICL/	VAA	
COMMON /VEHICL/	VBA	
COMMON /VEHICL/	VES	
COMMON /VEHICL/	VQOB	(25)
COMMON /VEHICL/	VQOBS	(25)
COMMON /VEHICL/	VRADE	(20,3)
COMMON /VEHICL/	VSS	
COMMON /VEHICL/	VSSAXP	
COMMON /VEHICL/	WC	
COMMON /VEHICL/	WBAXP	
COMMON /VEHICL/	WBPTH	(20)
COMMON /VEHICL/	WGTH	
COMMON /VEHICL/	WGHT	(20)
COMMON /VEHICL/	WRAT	(20)
COMMON /VEHICL/	WRFORD	
COMMON /VEHICL/	WT	(20)
COMMON /VEHICL/	WTE	(20)
COMMON /VEHICL/	WWAXP	
COMMON /VEHICL/	XBRCCF	
COMMON /VEHICL/	WJ	
COMMON /VEHICL/	LGCDIF	
COMMON /VEHICL/	SHF	
COMMON /PREP/	A	(3,4)
COMMON /PREP/	ATF	(20)
COMMON /PREP/	BTF	(20)
COMMON /PREP/	CHARLN	(20,3)
COMMON /PREP/	CBFCFG	(3)
COMMON /PREP/	CBFCCG	(3)
COMMON /PREP/	CBFCG	(20,3)
COMMON /PREP/	CBFFG	(20,3)
COMMON /PREP/	CTF	(20)
COMMON /PREP/	CRAT	(20,3)
COMMON /PREP/	GCA	(20,3)
COMMON /PREP/	GCW	
COMMON /PREP/	GCWB	
COMMON /PREP/	GCWNB	
COMMON /PREP/	GCWNP	
COMMON /PREP/	GWNP	
COMMON /PREP/	HBT	
COMMON /PREP/	NBF	(38)
COMMON /PREP/	NVEHC	
COMMON /PREP/	FWTE	
COMMON /PREP/	F	(3)
COMMON /PREP/	RNX	(20)
COMMON /PREP/	RR	
COMMON /PREP/	TRACTF	(20,5)
COMMON /PREP/	TRAPSI	(3)
COMMON /PREP/	VEICG	(20,3)
COMMON /PREP/	VEIFG	(20,3)
COMMON /PREP/	VCIMUK	(20)
COMMON /PREP/	VGW	(20,5)

COMMON /PREP/	VT	(20,3)
COMMON /PREP/	VTIRE	(3)
COMMON /PREP/	WTMAX	
COMMON /PREP/	X	(3)
COMMON /PREP/	XBR	
COMMON /OBS/	AVALS	(14)
COMMON /OBS/	CLEAR	(7,14,5)
COMMON /OBS/	FGG	(7,14,5)
COMMON /OBS/	FOOMAK	(7,14,5)
COMMON /OBS/	FVALS	(7)
COMMON /OBS/	HANG	
COMMON /OBS/	HGHGT	
COMMON /OBS/	NACTH	
COMMON /OBS/	WVALS	(5)
COMMON /DERIVE/	ADT	(9)
COMMON /DERIVE/	NEGCBF	
COMMON /DERIVE/	CAREA	
COMMON /DERIVE/	CGWB	
COMMON /DERIVE/	CGWP	
COMMON /DERIVE/	CGWPB	(20)
COMMON /DERIVE/	FA	(20,3)
COMMON /DERIVE/	FAT	(9)
COMMON /DERIVE/	FAT1	(9)
COMMON /DERIVE/	FB	(20,3)
COMMON /DERIVE/	FC	(20,3)
COMMON /DERIVE/	FNT	(9)
COMMON /DERIVE/	FGM	
COMMON /DERIVE/	FGNMAX	
COMMON /DERIVE/	FORMX	(3)
COMMON /DERIVE/	IRLGAT	
COMMON /DERIVE/	IMAX	(3)
COMMON /DERIVE/	ISAFE	(3)
COMMON /DERIVE/	J	
COMMON /DERIVE/	MAXI	
COMMON /DERIVE/	BEMX	(3)
COMMON /DERIVE/	NEVERO	
COMMON /DERIVE/	CBSE	
COMMON /DERIVE/	FAV	(9)
COMMON /DERIVE/	REWB	
COMMON /DERIVE/	REWBNS	
COMMON /DERIVE/	REWBNP	
COMMON /DERIVE/	REWP	
COMMON /DERIVE/	REWPB	(20)
COMMON /DERIVE/	REWT	(20)
COMMON /DERIVE/	STRACT	(20,3,3)
COMMON /DERIVE/	SRFO	(9)
COMMON /DERIVE/	SRFV	(9)
COMMON /DERIVE/	SIR	(3,9)
COMMON /DERIVE/	TBF	(3)
COMMON /DERIVE/	TBEN	(9)
COMMON /DERIVE/	TRES IS	(3,9)
COMMON /DERIVE/	VA	(3,9)

COMMON /DERIVE/	AGGVA	(3,9)
COMMON /DERIVE/	AVOID	(3,9)
COMMON /DERIVE/	VBO	(3,9)
COMMON /DERIVE/	IMPACT	(9)
COMMON /DERIVE/	VELV	(3)
COMMON /DERIVE/	MBMAX	(3)
COMMON /DERIVE/	VB	(20,3,3)
COMMON /DERIVE/	NOGOVO	(3,9)
COMMON /DERIVE/	VMAX	
COMMON /DERIVE/	VMAX1	(3)
COMMON /DERIVE/	VMAX2	(3,9)
COMMON /DERIVE/	NBLA	
COMMON /DERIVE/	VOVER	(3,9)
COMMON /DERIVE/	VRID	
COMMON /DERIVE/	VSEL	
COMMON /DERIVE/	VSEL1	(3)
COMMON /DERIVE/	VSEL2	(3,9)
COMMON /DERIVE/	VSGIL	(3,9)
COMMON /DERIVE/	VIT	(3,9)
COMMON /DERIVE/	VXT	(3,9)
COMMON /DERIVE/	WDGONG	
COMMON /DERIVE/	WRATIO	
COMMON /TERRAN/	AD	
COMMON /TERRAN/	AGTRMS	
COMMON /TERRAN/	AREA	
COMMON /TERRAN/	AREAC	
COMMON /TERRAN/	CE	
COMMON /TERRAN/	CIST	
COMMON /TERRAN/	EANG	
COMMON /TERRAN/	ECF	
COMMON /TERRAN/	ELEV	
COMMON /TERRAN/	FNU	(3)
COMMON /TERRAN/	GRADE	
COMMON /TERRAN/	IGBS	
COMMON /TERRAN/	IGST	
COMMON /TERRAN/	INROAD	
COMMON /TERRAN/	IS	(9)
COMMON /TERRAN/	IST	
COMMON /TERRAN/	IBUT	
COMMON /TERRAN/	NI	
COMMON /TERRAN/	NEU	
COMMON /TERRAN/	CAW	
COMMON /TERRAN/	CBAA	
COMMON /TERRAN/	CBH	
COMMON /TERRAN/	CBL	
COMMON /TERRAN/	CBS	
COMMON /TERRAN/	CBW	
COMMON /TERRAN/	CBMINW	
COMMON /TERRAN/	CBIA	
COMMON /TERRAN/	CVASHO	
COMMON /TERRAN/	RADC	
COMMON /TERRAN/	FCI	

COMMON /TERRAN/	RCIC	(4)
COMMON /TERRAN/	FOURV	(11)
COMMON /TERRAN/	RD	
COMMON /TERRAN/	RCA	(12)
COMMON /TERRAN/	S	(9)
COMMON /TERRAN/	SB	(9)
COMMON /TERRAN/	SBL	(9)
COMMON /TERRAN/	SMRFF	
COMMON /TERRAN/	TANPH-I	
COMMON /TERRAN/	THETA	(3)
COMMON /TERRAN/	VCURV	(4, 11)
COMMON /TERRAN/	WA	
COMMON /TERRAN/	WB	
COMMON /SCEN/	CGHES	
COMMON /SCEN/	VMALK	
COMMON /SCEN/	CCLMAX	
COMMON /SCEN/	GAMMA	
COMMON /SCEN/	IGVER	
COMMON /SCEN/	ISEASN	
COMMON /SCEN/	ISURF	
COMMON /SCEN/	ISNOW	
COMMON /SCEN/	KI1	
COMMON /SCEN/	KI2	
COMMON /SCEN/	KI3	
COMMON /SCEN/	KI4	
COMMON /SCEN/	KI5	
COMMON /SCEN/	KI6	
COMMON /SCEN/	KI7	
COMMON /SCEN/	KI8	
COMMON /SCEN/	KI9	
COMMON /SCEN/	KI10	
COMMON /SCEN/	KI11	
COMMON /SCEN/	KI12	
COMMON /SCEN/	KI13	
COMMON /SCEN/	KI14	
COMMON /SCEN/	KI15	
COMMON /SCEN/	KI16	
COMMON /SCEN/	KI17	
COMMON /SCEN/	KMAP	
COMMON /SCEN/	KSCEN	
COMMON /SCEN/	KIPP	
COMMON /SCEN/	KVEN	
COMMON /SCEN/	KV1	
COMMON /SCEN/	KV2	
COMMON /SCEN/	KV3	
COMMON /SCEN/	KV4	
COMMON /SCEN/	KV5	
COMMON /SCEN/	KV6	
COMMON /SCEN/	KV7	
COMMON /SCEN/	KV8	
COMMON /SCEN/	KV9	
COMMON /SCEN/	KV10	

```

COMMON /SCEN/      KIV11
COMMON /SCEN/      KIV12
COMMON /SCEN/      KIV13
COMMON /SCEN/      KIV14
COMMON /SCEN/      KIV15
COMMON /SCEN/      KIV16
COMMON /SCEN/      KIV17
COMMON /SCEN/      KIV18
COMMON /SCEN/      KIV19
COMMON /SCEN/      KIV20
COMMON /SCEN/      KIV21
COMMON /SCEN/      LAC
INTEGER            DETAIL
COMMON /SCEN/      DETAIL
COMMON /SCEN/      MAP
COMMON /SCEN/      MAPG
COMMON /SCEN/      MONTH
COMMON /SCEN/      NCPP
COMMON /SCEN/      NSLIP
COMMON /SCEN/      NTRAV
COMMON /SCEN/      NJUX
COMMON /SCEN/      FBI
COMMON /SCEN/      REACT
COMMON /SCEN/      RDFOG
INTEGER            SEARCH
COMMON /SCEN/      SEARCH
COMMON /SCEN/      SETYPC
COMMON /SCEN/      VBRAKE
COMMON /SCEN/      VISMNV
COMMON /SCEN/      VMIN
COMMON /SCEN/      ZSNOW
  
```

C 2. ALGORITHM

```

CALL IV1(
+  ADG      ,ADT      ,AREAB ,CL      ,EWDTH ,IOBS  ,IOST  ,IS
+  ,NEVERO ,NI       ,CAW   ,OBAA   ,OBH   ,OBL   ,OBS   ,OBSE
+  ,ODIA    ,PAV     ,PWTE  ,S      ,SD    ,TDEN  ,WA    ,WDTH
+  ,WI )
  
```

C DIAGNOSTIC OUTPUT LIST
 NAMELIST /XIV1/

```

+  ADG      ,ADT      ,AREAB ,CL      ,EWDTH ,IOBS  ,IOST  ,IS
+  ,NEVERO ,NI       ,CAW   ,OBAA   ,OBH   ,OBL   ,OBS   ,OBSE
+  ,ODIA    ,PAV     ,PWTE  ,S      ,SD    ,TDEN  ,WA    ,WDTH
+  ,WI
  
```

C DIAGNOSTIC OUTPUT
 IF(KIV1 .EQ. 1) WRITE(LUN1,XIV1)
 CALL IV2(

```

+  CL      ,DAREA ,CRAFT ,FORDD ,GRADE ,IFLOAT ,IOBS  ,IST
+  ,ITUT   ,JPSI  ,NOGWD ,NOPP  ,NWR   ,PWTE   ,SRFV  ,VSEM
+  ,VSS    ,WD     ,WDPTM ,WDTH  ,WRAT  ,WRATIO ,WRFORD
  
```

C DIAGNOSTIC OUTPUT LIST
 NAMELIST /XIV2/

```

+  CL      ,DAREA ,CRAFT ,FORDD ,GRADE ,IFLOAT ,IOBS  ,IST
  
```

```

+ ,ITUT ,JPSI ,NGGMD ,NOPP ,NWR ,PWTE ,SRFV ,VSEE
+ ,VSS ,WD ,WDPH ,WDTH ,WRAT ,WRATIO ,WRFORD
C
DIAGNOSTIC OUTPUT
IF(KIV2 .EQ. 1) WRITE(LUN1,XIV2)
CALL IV3(
+ CHARLN ,CI ,CGHES ,CPFFG ,DIAW ,DOWPB ,DRAT ,GAMMA
+ ,GCA ,IB ,ID ,IP ,IST ,JPSI ,LUN1 ,NAMBL
+ ,NPAD ,NSLIP ,NVEH ,NWHL ,RCI ,RTOWPB ,RTOWT ,SECTW
+ ,TANPHI ,TRAKLN ,TRAKWD ,VCIFG ,VCIMUK ,WGHT ,WRATIO ,ZSNOW )
C
DIAGNOSTIC OUTPUT LIST
NAMELIST /XIV3/
+ CHARLN ,CI ,CGHES ,CPFFG ,DIAW ,DOWPB ,DRAT ,GAMMA
+ ,GCA ,IB ,ID ,IP ,IST ,JPSI ,LUN1 ,NAMBL
+ ,NPAD ,NSLIP ,NVEH ,NWHL ,RCI ,RTOWPB ,RTOWT ,SECTW
+ ,TANPHI ,TRAKLN ,TRAKWD ,VCIFG ,VCIMUK ,WGHT ,WRATIO ,ZSNOW
C
DIAGNOSTIC OUTPUT
IF(KIV3 .EQ. 1) WRITE(LUN1,XIV3)
CALL IV4(
+ DOWB ,DOWP ,DOWPB ,GCW ,GCWB ,GCWP ,IB ,IP
+ ,NAMBL ,RTOWB ,RTOWPB ,RTOWNP ,RTOWP ,RTOWPB ,RTOWT ,WGHT )
C
DIAGNOSTIC OUTPUT LIST
NAMELIST /XIV4/
+ DOWB ,DOWP ,DOWPB ,GCW ,GCWB ,GCWP ,IB ,IP
+ ,NAMBL ,RTOWB ,RTOWPB ,RTOWNP ,RTOWP ,RTOWPB ,RTOWT ,WGHT
C
DIAGNOSTIC OUTPUT
IF(KIV4 .EQ. 1) WRITE(LUN1,XIV4)
CALL IV5(
+ ATF ,AVGC ,BTF ,CD ,CPFCCG ,CPFCFG ,CTF ,DAREA
+ ,DOWP ,EANG ,ECF ,FA ,FB ,FC ,FORMX ,GCWR
+ ,IFLOAT ,IST ,ITUT ,JPSI ,LOCDF ,NAMBL ,NFL ,NGR
+ ,NTRAV ,NVEH ,NVEHC ,NWHL ,RADC ,RTOWP ,STRACT ,TFOR
+ ,THETA ,TRACTF ,VFMAX ,VG ,VGV ,WGHT ,WRATIO ,LUN1 )
C
DIAGNOSTIC OUTPUT LIST
NAMELIST /XIV5/
+ ATF ,AVGC ,BTF ,CD ,CPFCCG ,CPFCFG ,CTF ,DAREA
+ ,DOWP ,EANG ,ECF ,FA ,FB ,FC ,FORMX ,GCWR
+ ,IFLOAT ,IST ,ITUT ,JPSI ,LOCDF ,NAMBL ,NFL ,NGR
+ ,NTRAV ,NVEH ,NVEHC ,NWHL ,RACC ,RTOWP ,STRACT ,TFOR
+ ,THETA ,TRACTF ,VFMAX ,VG ,VGV ,WGHT ,WRATIO
C
DIAGNOSTIC OUTPUT
IF(KIV5 .EQ. 1) WRITE(LUN1,XIV5)
CALL IV6(
+ FAT ,FAT1 ,FMT ,NI ,PBHT ,SD
+ ,SDL ,TDEN ,WDT )
C
DIAGNOSTIC OUTPUT LIST
NAMELIST /XIV6/
+ FAT ,FAT1 ,FMT ,NI ,PBHT ,SC ,SDL ,TDEN
+ ,WDTH
C
DIAGNOSTIC OUTPUT
IF(KIV6 .EQ. 1) WRITE(LUN1,XIV6)
CALL IV7(
+ FMT ,GCW ,IMPACT ,MAXI ,NI ,PBF )

```

```

C      DIAGNOSTIC OUTPUT LIST
      NAMEDLIST /XIV7/
+     FMT      ,GCW      ,IMPACT ,MAXI      ,NI      ,PBF
C      DIAGNOSTIC OUTPUT
      IF(KIV7 .EQ. 1) WRITE(LUN1,XIV7)
      CALL IV8(
+     FAT      ,FAT1     ,GCW      ,GCWNP   ,GCWP    ,MAXI    ,NTRAV  ,RTOWNP
+     ,RTOWP   ,STR      ,THETA   ,TRESIS  ,WRATIO  )
C      DIAGNOSTIC OUTPUT LIST
      NAMEDLIST /XIV8/
+     FAT      ,FAT1     ,GCW      ,GCWNP   ,GCWP    ,MAXI    ,NTRAV  ,RTOWNP
+     ,RTOWP   ,STR      ,THETA   ,TRESIS  ,WRATIO
C      DIAGNOSTIC OUTPUT
      IF(KIV8 .EQ. 1) WRITE(LUN1,XIV8)
      CALL IV9(
+     FA       ,FB       ,FC       ,FORMX   ,MAXI    ,NGR
+     ,NI      ,NTRAV   ,TRESIS  ,VFMAX   ,VG      ,VSOIL )
C      DIAGNOSTIC OUTPUT LIST
      NAMEDLIST /XIV9/
+     FA       ,FB       ,FC       ,FORMX   ,MAXI    ,NGR      ,NI      ,NTRAV
+     ,TRESIS  ,VFMAX   ,VG      ,VSOIL
C      DIAGNOSTIC OUTPUT
      IF(KIV9 .EQ. 1) WRITE(LUN1,XIV9)
      CALL IV10(
+     ACTRMS   ,LAC      ,MAXIRR   ,RMS     ,VRID    ,VRIDE )
C      DIAGNOSTIC OUTPUT LIST
      NAMEDLIST /XIV10/
+     ACTRMS   ,LAC      ,MAXIRR   ,RMS     ,VRIDE   ,VRID
C      DIAGNOSTIC OUTPUT
      IF(KIV10 .EQ. 1) WRITE(LUN1,XIV10)
      CALL IV11(
+     DOWB    ,GCW      ,GCWB     ,GCWNB   ,NOGOBF  ,NTRAV
+     ,RTOWE   ,RTOWNB  ,TBF      ,THETA   ,WRATIO  ,XBR )
C      DIAGNOSTIC OUTPUT LIST
      NAMEDLIST /XIV11/
+     DOWB    ,GCW      ,GCWB     ,GCWNB   ,NOGOBF  ,NTRAV   ,RTOWB   ,RTOWNB
+     ,TBF     ,THETA   ,WRATIO  ,XBR
C      DIAGNOSTIC OUTPUT
      IF(KIV11 .EQ. 1) WRITE(LUN1,XIV11)
      CALL IV12(
+     BFMX    ,DCLMAX  ,GCW      ,NTRAV   ,SFTYPC  ,TBF )
C      DIAGNOSTIC OUTPUT LIST
      NAMEDLIST /XIV12/
+     BFMX    ,DCLMAX  ,GCW      ,NTRAV   ,SFTYPC  ,TBF
C      DIAGNOSTIC OUTPUT
      IF(KIV12 .EQ. 1) WRITE(LUN1,XIV12)
      CALL IV13(
+     BFMX    ,EYEHGT  ,GCW      ,NTRAV   ,RD      ,REACT   ,VELV    ,VISMNV )
C      DIAGNOSTIC OUTPUT LIST
      NAMEDLIST /XIV13/
+     BFMX    ,EYEHGT  ,GCW      ,NTRAV   ,RD      ,REACT   ,VELV    ,VISMNV
C      DIAGNOSTIC OUTPUT
  
```

```

    IF(KIV13 .EQ. 1) WRITE(LUN1,XIV13)
    CALL IV14(
+ JPSI ,NI ,NTRAV ,NVEHC ,VELV ,VRID
+ ,VSOIL ,VTIRE ,VTT
C DIAGNOSTIC OUTPUT LIST
  NAMEDLIST /XIV14/
+ JPSI ,NI ,NTRAV ,NVEHC ,VELV ,VRID ,VSOIL ,VTIRE
+ ,VTT
C DIAGNOSTIC OUTPUT
  IF(KIV14 .EQ. 1) WRITE(LUN1,XIV14)
  CALL IV15(
+ ADT ,NI ,NTRAV ,NVEHC ,PAV ,VAVOID ,VBO ,VTT
C DIAGNOSTIC OUTPUT LIST
  NAMEDLIST /XIV15/
+ ADT ,NI ,NTRAV ,NVEHC ,PAV ,VAVOID ,VBO ,VTT
C DIAGNOSTIC OUTPUT
  IF(KIV15 .EQ. 1) WRITE(LUN1,XIV15)
  CALL IV16(
+ AVALS ,CLEAR ,FOM ,FOMMAX ,FOO ,FOMMAX ,HOVALS ,NANG
+ ,NEVERO ,NOHGT ,NWDTH ,OBAA ,OBH ,OBMINW ,WVALS )
C DIAGNOSTIC OUTPUT LIST
  NAMEDLIST /XIV16/
+ AVALS ,CLEAR ,FOM ,FOMMAX ,FOO ,FOMMAX ,HOVALS ,NANG
+ ,NEVERO ,NOHGT ,NWDTH ,OBAA ,OBH ,OBMINW ,WVALS
C DIAGNOSTIC OUTPUT
  IF(KIV16 .EQ. 1) WRITE(LUN1,XIV16)
  CALL IV17(
+ HVALS ,NEVERO ,NHVALS ,NSVALS ,OBH ,OBSE
+ ,SVALS ,TL ,VCLA ,VGOB ,VGOBS ,WA )
C DIAGNOSTIC OUTPUT LIST
  NAMEDLIST /XIV17/
+ HVALS ,NEVERO ,NHVALS ,NSVALS ,OBH ,OBSE ,SVALS ,TL
+ ,VCLA ,VGOB ,VGOBS ,WA
C DIAGNOSTIC OUTPUT
  IF(KIV17 .EQ. 1) WRITE(LUN1,XIV17)
  CALL IV18(
+ FA ,FB ,FC ,FOM ,FOMMAX ,FORMX ,GCW ,JPSI
+ ,MAXI ,NEVERO ,NGR ,NI ,NTRAV ,NVEHC ,OBSE ,SRFM
+ ,TL ,TRESIS ,VA ,VBC ,VELV ,VFMAX ,VG ,VOLA
+ ,VRID ,VSOIL ,VTIRE ,VXT ,WA )
C DIAGNOSTIC OUTPUT LIST
  NAMEDLIST /XIV18/
+ FA ,FB ,FC ,FOM ,FOMMAX ,FORMX ,GCW ,JPSI
+ ,MAXI ,NEVERO ,NGR ,NI ,NTRAV ,NVEHC ,OBSE ,SRFM
+ ,TL ,TRESIS ,VA ,VBC ,VELV ,VFMAX ,VG ,VOLA
+ ,VRID ,VSOIL ,VTIRE ,VXT ,WA
C DIAGNOSTIC OUTPUT
  IF(KIV18 .EQ. 1) WRITE(LUN1,XIV18)
  CALL IV19(
+ BFMX ,FA ,FB ,FC ,FOMMAX ,FORMX ,GCW ,LUN1
+ ,NEVERO ,NGR ,NI ,NTRAV ,OBSE ,RMX ,STRACT ,TL
+ ,TRESIS ,VA ,VBO ,VFMAX ,VG ,VOVER ,VXT ,WA )

```

```

C      DIAGNOSTIC OUTPUT LIST
      NAMEDLIST /XIV19/
+     BFMX  ,FA      ,FB      ,FC      ,FOMMAX ,FORMX  ,GCW    ,LUN1
+     ,NEVERO ,NGR    ,NI      ,NTRAV  ,OBSE   ,RMX    ,STRACT ,TL
+     ,TRES IS ,VA      ,VBC     ,VFMAX  ,VG     ,VOVER  ,VXT    ,WA
C      DIAGNOSTIC OUTPUT
      IF(KIV19 .EQ. 1) WRITE(LUN1,XIV19)
      CALL IV201
+     FA      ,FB      ,FC      ,FORMX  ,GCW    ,MAXI   ,NGR    ,NOGOVA
+     ,NOGOVO ,NTRAV  ,STR    ,VAVCID ,VG     ,VOVER  )
C      DIAGNOSTIC OUTPUT LIST
      NAMEDLIST /XIV20/
+     FA      ,FB      ,FC      ,FORMX  ,GCW    ,MAXI   ,NGR    ,NOGOVA
+     ,NOGOVO ,NTRAV  ,STR    ,VAVCID ,VG     ,VOVER
C      DIAGNOSTIC OUTPUT
      IF(KIV20 .EQ. 1) WRITE(LUN1,XIV20)
      CALL IV211
+     DOWN   ,FMT     ,GCW    ,IMAX   ,IOVER  ,ISAFE  ,LEVEL  ,NI
+     ,NOGOVA ,NOGOVO ,NTRAV  ,UP     ,VAVOID ,VMAX   ,VMAX1  ,VMAX2
+     ,VOVER  ,VSEL   ,VSEL1  ,VSEL2  ,VWALK )
C      DIAGNOSTIC OUTPUT LIST
      NAMEDLIST /XIV21/
+     DOWN   ,FMT     ,GCW    ,IMAX   ,IOVER  ,ISAFE  ,LEVEL  ,NI
+     ,NOGOVA ,NOGOVO ,NTRAV  ,UP     ,VAVOID ,VMAX   ,VMAX1  ,VMAX2
+     ,VOVER  ,VSEL   ,VSEL1  ,VSEL2  ,VWALK
C      DIAGNOSTIC OUTPUT
      IF(KIV21 .EQ. 1) WRITE(LUN1,XIV21)
C      3. TERMINUS
      CONTINUE
      RETURN
      END
      SUBROUTINE MAP71
+     (AA     ,ACTRMS ,AREA   ,ELEV   ,GRADE  ,IEOF   ,IOST   ,IS
+     ,IST    ,ITUT   ,LUN2   ,NI     ,NTU    ,NTUX   ,OBH    ,OBL
+     ,OBS    ,OBW    ,RCIC   ,RD     ,S      ,SD     ,SDL    ,SEARCH
+     ,WD )
  
```

 MAP LEGEND INPUT ROUTINE (AMC71 FCRMAT)

```

1. VARIABLE DEFINITION
INTEGER  IS      (9)
REAL    RCIC    (4)
REAL    S       (9)
REAL    SD      (9)
REAL    SDL     (9)
INTEGER SEARCH
REAL    FNAA    (14)
REAL    FNGRAD (8)
REAL    FNOBH   (7)
REAL    FNCBL   (7)
  
```

REAL FNOBS (8)
 REAL FNGBW (5)
 REAL FNRCI (11)
 REAL FNRD (9)
 REAL FNRMS (9)
 REAL FNSPAC (8)

C 3. TERRAIN FEATURE CLASSES

C A. SURFACE STRENGTH CLASSES LB/SQIN

DATA FNRCI(1) /200.0/,
 + FNRCI(2) /250.0/,
 + FNRCI(3) /190.0/,
 + FNRCI(4) /130.0/,
 + FNRCI(5) / 80.0/,
 + FNRCI(6) / 50.0/,
 + FNRCI(7) / 36.0/,
 + FNRCI(8) / 29.0/,
 + FNRCI(9) / 20.0/,
 + FNRCI(10) / 14.0/,
 + FNRCI(11) / 5.0/

C B. GRADE CLASSES PERCENT

DATA FNGRAD(1) / 1.0/,
 + FNGRAD(2) / 3.5/,
 + FNGRAD(3) / 7.5/,
 + FNGRAD(4) /15.0/,
 + FNGRAD(5) /30.0/,
 + FNGRAD(6) /45.0/,
 + FNGRAD(7) /65.0/,
 + FNGRAD(8) /72.0/

C C. RECOGNITION DISTANCE CLASSES FT

DATA FNRD(1) /104.0/,
 + FNRD(2) /121.0/,
 + FNRD(3) / 50.0/,
 + FNRD(4) / 34.8/,
 + FNRD(5) / 26.6/,
 + FNRD(6) / 17.4/,
 + FNRD(7) / 12.5/,
 + FNRD(8) / 7.5/,
 + FNRD(9) / 2.6/

C D. OBSTACLE SPACING CLASSES FT

DATA FNOBS(1) /107.0/,
 + FNOBS(2) /131.0/,
 + FNOBS(3) / 51.2/,
 + FNOBS(4) / 31.5/,
 + FNOBS(5) / 22.3/,
 + FNOBS(6) / 15.7/,
 + FNOBS(7) / 10.8/,
 + FNOBS(8) / 3.9/

C E. OBSTACLE APPROACH ANGLE CLASSES DEG

DATA FNAA(1) /119.0/,
 + FNAA(2) /101.0/,
 + FNAA(3) /127.0/,
 + FNAA(4) /103.0/

```

+          FNAA(5)  /173.0/,
+          FNAA(6)  /187.0/,
+          FNAA(7)  /184.0/,
+          FNAA(8)  /196.0/,
+          FNAA(9)  /184.0/,
+          FNAA(10) /206.0/,
+          FNAA(11) /162.0/,
+          FNAA(12) /218.0/,
+          FNAA(13) /112.0/,
+          FNAA(14) /248.0/
C      F. OBSTACLE HEIGHT CLASSES      IN
      DATA FNOBH(1) / 3.15/,
+          FNOBH(2) / 7.87/,
+          FNOBH(3) /11.81/,
+          FNOBH(4) /15.75/,
+          FNOBH(5) /20.87/,
+          FNOBH(6) /28.35/,
+          FNOBH(7) /43.46/
C      G. OBSTACLE WIDTH CLASSES      FT
      DATA FNOBW(1) /11.80/,
+          FNOBW(2) / 3.48/,
+          FNOBW(3) / 2.49/,
+          FNOBW(4) / 1.51/,
+          FNOBW(5) / 0.49/
C      H. OBSTACLE LENGTH CLASSES      FT
      DATA FNOBL(1) / 0.66/,
+          FNOBL(2) / 2.36/,
+          FNOBL(3) / 5.25/,
+          FNOBL(4) / 8.53/,
+          FNOBL(5) / 15.09/,
+          FNOBL(6) /256.00/,
+          FNOBL(7) /492.0/
C      I. SURFACE ROUGHNESS CLASSES      IN
      DATA FNRMS(1) /3.25/,
+          FNRMS(2) /1.00/,
+          FNRMS(3) /2.00/,
+          FNRMS(4) /2.00/,
+          FNRMS(5) /4.00/,
+          FNRMS(6) /5.00/,
+          FNRMS(7) /8.00/,
+          FNRMS(8) /1.00/,
+          FNRMS(9) /8.00/
C      J. VEGATATION SPACING CLASSES      FT
      DATA FNSPAC(1) /300.0/,
+          FNSPAC(2) / 65.6/,
+          FNSPAC(3) / 51.2/,
+          FNSPAC(4) / 31.5/,
+          FNSPAC(5) / 22.3/,
+          FNSPAC(6) / 15.7/,
+          FNSPAC(7) / 10.8/,
+          FNSPAC(8) /  3.9/
C      4. REAC LEGEND
  
```

```

400  CONTINUE
      IEOF = 0
      READ(LUN2,4000)
+   NPAT  ,IST  ,IRC11  ,IRC12  ,IRC13
+   ,IGRADE ,IOA  ,IOH  ,ICW  ,IOL
+   ,IOS  ,IOST ,IRMS  ,ISTEM1 ,ISTEM2
+   ,ISTEM3 ,ISTEM4 ,ISTEM5 ,ISTEM6 ,ISTEM7
+   ,ISTEM8 ,IRD  ,AREA
4000  FORMAT(I4,4I2,I1,I2,15I1,F10.3)
      IF(EOF(LUN2).EQ.0) GO TO 420
      IEOF = 1
      GO TO 600
420  CONTINUE
      IF((SEARCH.EQ.1) .AND. (NTUX.NE.NPAT)) GO TO 400
C   5. CONVERT FROM CLASSE TO REAL UNITS
500  CONTINUE
C   A. TERRAIN UNIT NUMBER
      NTU=NPAT
C   B. TERRAIN UNIT TYPE
      ITUT=1
C   C. SOIL TYPE
C   IST
C   D. SURFACE STRENGTH LB/SQ-IN
      RCIC(1)=FNRCI(IRC11)
      RCIC(2)=FNRCI(IRC12)
      RCIC(3)=FNRCI(IRC13)
C   E. GRADE PERCENT
      GRADE=FNGRAD(IGRADE)
C   F. SURFACE ROUGHNESS IN
      ACTRMS=FN RMS(IRMS)
C   G. VISIBILITY FT
      RD=FN RD(IRD)
C   H. DEPTH OF STANDING WATER FT
      WD=0.0
C   I. ELEVATION FT
      ELEV=0.0
C   K. CBSTACLE SPACING FT
      OBS=FN OBS(IGS)
C   L. OBSTACLE AVOIDABILITY POTENTIAL
      IOST
C   M. CBSTACLE APPROACH ANGLE DEGREES
      AA=FNAA(IOA)
C   N. OBSTACLE HEIGHT IN
      CBH=FN OBH(IOH)
C   O. CBSTACLE WIDTH FT
      OBW=FN OBW(ICW)
C   P. OBSTACLE LENGTH FT
      CBL=FN OBL(IOL)
C   R. NUMBER OF STEM CLASSES
      NI=8
C   S. MEAN SPACING OF STEMS
      S(1)=FN SPAC(ISTEM1)

```

```

S(2)=FNSPAC(ISTEM2)
S(3)=FNSPAC(ISTEM3)
S(4)=FNSPAC(ISTEM4)
S(5)=FNSPAC(ISTEM5)
S(6)=FNSPAC(ISTEM6)
S(7)=FNSPAC(ISTEM7)
S(8)=FNSPAC(ISTEM8)
C      T. MAXIMUM STEM DIAMETER   IN
      SDL(1)=0.98
      SDL(2)=2.36
      SDL(3)=3.94
      SDL(4)=5.51
      SDL(5)=7.09
      SDL(6)=8.66
      SDL(7)=9.84
      SDL(8)=15.00
C      U. MEAN STEM DIAMETER   IN
      SD(1)=0.49
      SD(2)=1.67
      SD(3)=3.15
      SD(4)=4.73
      SD(5)=6.30
      SD(6)=7.88
      SD(7)=9.25
      SD(8)=12.42
C      V. BARREN VEGETATION FLAG
      NI1=NI-1
      DO 540 I=1,NI1
          IF( S(I) .EQ. S(I+1) ) GO TO 530
          IS(I)=0
          GO TO 540
530          CONTINUE
          IS(I)=1
540          CONTINUE
          IS(NI)=0
C      6. EXIT ROUTINE
600      CONTINUE
          RETURN
          END
          SUBROUTINE MAP74
          + (AA      ,ACTRMS ,AREA      ,ELEV      ,GRADE      ,IEOF      ,IOST      ,IS
          + ,IST      ,ITUT      ,LUN2      ,MONTH      ,NI          ,NTU       ,NTUX      ,OBH
          + ,OBL      ,OBS      ,CBW      ,RC IC     ,RD          ,RDA       ,RDA1     ,RDA2
          + ,RDA3      ,RDA4      ,S          ,SD         ,SDL        ,SEARCH    ,WD )
C
C      -----
C      MAP LEGEND INPUT ROUTINE (AMG74 FORMAT)
C      -----
C
C      1. GLOSSARY
C      AA      DEGREE      OBSTACLE - APPROACH ANGLE
C      ACTRMS  IN          RMS ROUGHNESS
  
```

C	AREA	SQ. MI.	AREA
C	ELEV	FT	ELEVATION
C	GRADE	PERCENT	SLOPE
C	IOBS	#	BARREN OBSTACLE FLAG
C	IOST	1-RANDCM	OBSTACLE - SPACING TYPE
C		2-LINEAR	
C	IS(I)	#	BARREN VEGETATION FLAG, CLASS I
C	ITUT	#	TERRAIN UNIT TYPE
C	IEOF	#	END OF INFORMATION FLAG
C	KMAP	#	CALL LIST DUMP FLAG
C	LUN2	#	BIOLOGICAL UNIT FLAG NUMBER 2, TERRAIN
C	MONTH	#	MONTH (1 THROUGH 12)
C	NI	#	NUMBER OF VEGETATION CLASSES
C	NTU	#	TERRAIN UNIT NUMBER
C	OBH	INCH	OBSTACLE - HEIGHT
C	OBL	FEET	OBSTACLE LENGTH
C	OBS	FEET	OBSTACLE - SPACING
C	OBW	INCH	OBSTACLE - WIDTH
C	RCIC(1)	RCI	SOIL STRENGTH - DRY
C	RCIC(2)	RCI	SOIL STRENGTH - AVERAGE
C	RCIC(3)	RCI	SOIL STRENGTH - WET
C	RCIC(4)	RCI	SOIL STRENGTH - WET,WET
C	RC	FEET	VISIBILITY
C	S(I)	FEET	STEM SPACING OF STEMS OF DIAMETER CLASS
C	SD(I)	IN	MEAN STEM DIAMETER, CLASS I
C	SDL(I)	IN	MAXIMUM STEM DIAMETER, CLASS I
C	WD	FEET	DEPTH OF STANDING WATER

2. VARIABLE DECLARATION

INTEGER	IS	(5)
REAL	RCIC	(4)
REAL	RDA	(12)
REAL	S	(9)
REAL	SD	(9)
REAL	SDL	(9)
INTEGER	SEARCH	
INTEGER	DATA	(25)

4. ALGORITHM

```

4000 CONTINUE
      IEOF = 0
      READ(LUN2,400)NTU,IST,DATA,AREA
400  FORMAT(I5,I2,20X,I2I4,/,5X,I2I4,F8.4)
      IF(EOF(LUN2) .EQ. 0) GO TO 4020
      IEOF = 1
      GO TO 5000
4020  RCIC(1) = DATA(1)
      RCIC(2) = DATA(2)
      RCIC(3) = DATA(3)
      RCIC(4) = DATA(4)
      GRADE = DATA(5)
      AA = DATA(6)
      OBH = DATA(7)
      OBW = DATA(8)
  
```

```

      OBW      = OBW / 12.
      OBL      = DATA(9)
      OBS      = DATA(10)
      IOST     = DATA(11)
      ACTRMS   = DATA(12)
      DO 4005 I=1,8
4005      S(I)   = DATA(I+12)
      CONTINUE
      RDA1     = DATA(21)
      RDA2     = DATA(22)
      RDA3     = DATA(23)
      RDA4     = DATA(24)
      CONTINUE
      IF((SEARCH .EQ. 1) .AND. (NTUX .NE. NTU)) GO TO 4000
      RDA(1)   = RDA1
      RDA(2)   = RDA1
      RDA(3)   = RDA1
      RDA(4)   = RDA2
      RDA(5)   = RDA2
      RDA(6)   = RDA2
      RDA(7)   = RDA3
      RDA(8)   = RDA3
      RDA(9)   = RDA3
      RDA(10)  = RDA4
      RDA(11)  = RDA4
      RDA(12)  = RDA4
      ACTRMS   = ACTRMS/10.0
      ELEV     = 0.0
      ITUT     = 1
      NI       = 8
      NI1      = NI-1
      DO 4040 I=1,NI1
      IF(S(I) .EQ. S(I+1)) GO TO 4030
      IS(I) = 0
      GO TO 4040
4030      CONTINUE
      IS(I) = 1
4040      CONTINUE
      IS(NI) = 0
      RD      = RDA(MCNT+1)
      SD(1)   = 0.49
      SD(2)   = 1.67
      SD(3)   = 3.15
      SD(4)   = 4.73
      SD(5)   = 6.30
      SD(6)   = 7.88
      SD(7)   = 9.25
      SD(8)   = 12.42
      SDL(1)  = 0.98
      SDL(2)  = 2.36
      SDL(3)  = 3.94
      SDL(4)  = 5.51
```

SDL(5) = 7.09
 SDL(6) = 8.66
 SDL(7) = 9.84
 SDL(8) = 15.00
 WD = 0.

5000

CONTINUE
 RETURN
 END

SUBROUTINE MPRD74

+ (ACTRMS ,CURVV ,DIST ,EANG ,ELEV ,FMU ,GRADE
 + ,IEUF ,IROAD ,IST ,ITUT ,IURB ,LUN2 ,NTU ,NTUX
 + ,NVASFO ,MONTH ,RADC ,RCURV ,RC ,RDA ,RDFOG ,RCIG
 + ,SEARCH ,SURFF ,VCURV)

 MAP LEGEND INPUT ROUTINE (ROAD MAP AMC74)

1. GLOSSARY

ACTRMS	INCH	RMS ROUGHNESS
CURVV	MPH	AASHC CURVATURE SPEED LIMIT
DIST	MILES	ROAD SEGMENT LENGTH
EANG	DEGREE	SUPERELEVATION ANGLE
ELEV	FEET	ELEVATION ABOVE SEALEVEL
FMU(1)	#	COEFFICIENT OF FRICTION - DRY
FMU(2)	#	COEFFICIENT OF FRICTION - WET
FMU(3)	#	COEFFICIENT OF FRICTION - ICE
GRADE	PERCENT	SLOPE
IROAD	#	ROAD TYPE
ITUT	#	TERRAIN UNIT TYPE
IST	#	SOIL TYPE
IURB	#	URBAN CODE
NTU	#	TERRAIN UNIT NUMBER
NTUX	#	SPECIFIC TERRAIN UNIT NUMBER
MONTH	#	MONTH (1 THROUGH 12)
RADC	FEET	RADIUS OF CURVATURE
RD	FEET	VISIBILITY DISTANCE
RDA(12)	FEET	VISIBILITY DISTANCE PER MONTH
RDFOG	FEET	WEATHER RECOGNITION DISTANCE
RCIC(1)	RCI	SOIL STRENGTH - DRY
RCIC(2)	RCI	SOIL STRENGTH - AVERAGE
RCIC(3)	RCI	SOIL STRENGTH - WET
RCIC(4)	RCI	SOIL STRENGTH - WET,WET
SURFF	#	ROAD SURFACE ROUGHNESS FLAG

2. VARIABLE DECLARATION

REAL	RCIC	(4)
REAL	RCURV	(1)
REAL	RDA	(12)
REAL	FMU	(3)
REAL	VCURV	(4,11)
INTEGER	RDATA	(1)

INTEGER SEARCH

C
C
C

3. ALGORITHM

A. AASHO TABLE RADIUS OF CURVATURE FT

RCURV(1) =5730.
RCURV(2) =1910.
RCURV(3) =1146.
RCURV(4) = 819.
RCURV(5) = 637.
RCURV(6) = 458.
RCURV(7) = 327.
RCURV(8) = 229.
RCURV(9) = 164.
RCURV(10) = 115.
RCURV(11) = 82.

C

B. AASHO TABLE SPEED LIMIT SUPERHIGHWAYS MPH

VCURV(1,1) =100.
VCURV(1,2) =70.
VCURV(1,3) =60.
VCURV(1,4) =54.
VCURV(1,5) =48.
VCURV(1,6) =41.
VCURV(1,7) =34.
VCURV(1,8) =29.
VCURV(1,9) =25.
VCURV(1,10) =19.
VCURV(1,11) =13.

C

C. AASHO TABLE SPEED LIMIT SECONDARY ROADS MPH

VCURV(3,1) =70.
VCURV(3,2) =60.
VCURV(3,3) =58.
VCURV(3,4) =50.
VCURV(3,5) =43.
VCURV(3,6) =36.
VCURV(3,7) =31.
VCURV(3,8) =26.
VCURV(3,9) =23.
VCURV(3,10) =19.
VCURV(3,11) =13.

C

D. AASHO TABLE SPEED LIMIT TRAILS MPH

VCURV(4,1) =55.
VCURV(4,2) =49.
VCURV(4,3) =44.
VCURV(4,4) =42.
VCURV(4,5) =39.
VCURV(4,6) =34.
VCURV(4,7) =29.
VCURV(4,8) =23.
VCURV(4,9) =19.
VCURV(4,10) =14.
VCURV(4,11) =10.

C

E. AASHO TABLE SPEED LIMIT PRIMARY ROADS MPH

```

    VCURV(2,1) = VCURV(1,1)
    VCURV(2,2) = VCURV(1,2)
    VCURV(2,3) = VCURV(1,3)
    VCURV(2,4) = VCURV(1,4)
    VCURV(2,5) = VCURV(1,5)
    VCURV(2,6) = VCURV(1,6)
    VCURV(2,7) = VCURV(1,7)
    VCURV(2,8) = VCURV(1,8)
    VCURV(2,9) = VCURV(1,9)
    VCURV(2,10) = VCURV(1,10)
    VCURV(2,11) = VCURV(1,11)
6000  CONTINUE
      IEOF = 0
      READ(LUN2,600) NTU,IROAD,IST,IURB,RDATA,DIST
600   FORMAT(15,3I2,1I4,F8.4)
      IF(IEOF(LUN2).EQ.0) GO TO 6020
      IEOF = 1
      GO TO 7000
6020  RCIC(1) = RDATA(1)
      RCIC(2) = RDATA(2)
      RCIC(3) = RDATA(3)
      RCIC(4) = RDATA(4)
      GRADE = RDATA(5)
      RDA1 = RDATA(6)
      RCA2 = RDATA(7)
      RDA3 = RDATA(8)
      RDA4 = RDATA(9)
      ACTRMS = RDATA(10)
      CURVV = RDATA(11)
      CONTINUE
      IF((SEARCH.EQ.1).AND.(NTUX.NE.NTU)) GO TO 6000
      RDA(1) = RDA1
      RDA(2) = RCA1
      RDA(3) = RCA1
      RDA(4) = RCA2
      RDA(5) = RCA2
      RDA(6) = RCA2
      RDA(7) = RCA3
      RDA(8) = RCA3
      RDA(9) = RCA3
      RDA(10) = RCA4
      RDA(11) = RCA4
      RDA(12) = RCA4
      ACTRMS = ACTRMS/10.
      ELEV = 0.
      EANG = 0.
      FMU(1) = 0.75
      FMU(2) = 0.35
      FMU(3) = 0.1
      ITUT = IRCAD + 10
      SURFF = 1.
      IF(ITUT.EQ.13) SURFF = 2.

```

```

NVASHO = 11
IF(ITUT .EQ. 11) RROAD = 1000.
  IF(ITUT .EQ. 12) RCRCAD = 500.
    IF(ITUT .EQ. 13) RROAD = 250.
      IF(ITUT .EQ. 14) RROAD = 150.
RD = AMIN1(RDA(MONTH),RDFOG,RROAD)
IF(CURVV .GT. VCURV(IRCAD,1)) GO TO 6060
IF(CURVV .LT. VCURV(IROAD,NVASHO)) GO TO 6070
DO 6030 NV=2,NVASHO
  IF(CURVV .LT. VCURV(IROAD,NV)) GO TO 6030
  RADC = RCURV(NV) + (CURVV - VCURV(IROAD,NV)) *
    (RCURV(NV) - RCURV(NV-1)) /
    (VCURV(IROAD,NV) - VCURV(IROAD,NV-1))
+
+
    GO TO 7000
6030      CONTINUE
        GO TO 7000
6060      RADC = RCURV(1) + (CURVV - VCURV(IROAD,1)) *
+
+
    (RCURV(1) - RCURV(2)) /
    (VCURV(IROAD,1) - VCURV(IROAD,2))
GO TO 7000
6070      RADC = RCURV(NVASHO) + (CURVV - VCURV(IROAD,NVASHO)) *
+
+
    (RCURV(NVASHO) - RCURV(NVASHO-1)) /
    (VCURV(IROAD,NVASHO) - VCURV(IROAD,NVASHO-1))
7000      CONTINUE
          RETURN
          END
  
```

SUBROUTINE TPP

+	(AA	,ACTRMS	,AREAD	,CI	,ECF	,ELEV	,GAMMA	,GRADE
+	,IOBS	,ISEASN	,ISNCH	,IST	,ITUT	,NI	,OAW	,OBA
+	,OBH	,OBL	,OBMINW	,OBS	,OBW	,ODIA	,PHI	,RADC
+	,RCI	,RCIC	,RD	,S	,TANPHI	,THETA	,WA	,ZSNGW

C
C
C
C
C
C

 TERRAIN PREPROCESSOR

1. VARIABLE DECLARATION

```

REAL    RCIC    (4)
REAL    S       (9)
REAL    THETA   (3)
  
```

C
C

3. ALGORITHM

A. UNITS CONVERSION

```

IF(ITUT .GE. 11) GO TO 3005
IOBS = 0
IF(OBS .GE. 197.0) ICBS = 1
IF(AA .GE. 179. AND. AA .LE. 181.) IOBS = 1
CBL = 12.*OBL
CBS = 12.*OBS
CBW = 12.*OBW
RD = 12.*RD
RADC = 12.*RADC
IF(ITUT .GE. 11) GO TO 3015
  
```

3005

```

      GO 3010 I=1,NI
      S(I) = 12.*S(I)
3010  CONTINUE
C      B. SLOPE ANGLE
3015  THETA(1) = ATAN(GRADE/100.)
      THETA(2) = 0.0
      THETA(3) = -THETA(1)
C      C. CONE INDEX
      CI = RCIC(ISEASN)
C      D. RATING CONE INDEX
      RCI = CI
C      E. ELEVATION CORRECTION FACTOR
      ECF = 1.-.04*ELEV/1000.
      IF(ITUT .GE. 11) GO TO 3030
C      F. OBSTACLE APPROACH ANGLE
      IF(IOBS .EQ. 1) GO TO 3020
      CBAA = AA*3.14159265/180.
C      G. OBSTACLE GEOMETRY VARIABLES
      IF(AA .GT. 180.) GO TO 3017
      IF((OBW/2.) .GT. (OBH*ABS(COS(OBAA)/SIN(OBAA))))
      GO TO 3016
      OBW = 2.*OBH*ABS(COS(OBAA)/SIN(OBAA))
3016  OBMINW = OBW - 2.*CBH*ABS(COS(OBAA)/SIN(OBAA))
      WA = CBH
      GO TO 3018
3017  CBMINW = CBW
      WA = OBW + 2.*OBH*ABS(COS(OBAA)/SIN(OBAA))
3018  AREA0 = 3.14159265*OBS*OBS/4.
      OAW = 2.*(CBL + WA)/3.14159265
      ODIA = (GBL*OBL + WA*WA)**0.5
      GO TO 3030
3020  CONTINUE
      WA = 0.0
      ODIA = 0.0
      OAW = 0.0
      AREA0 = 0.0
3030  CONTINUE
C      H. SNOW MACHINE
      IF(ITUT .EQ. 2) GO TO 3060
      IF(ISNOW .EQ. 0) GO TO 3060
      IST = 4
      TANPHI = SIN(RBI)/CCS(PHI)
C      OBSTACLE ATTENUATION
      IF(OBAA .GT. 3.14159265) .OR. (ITUT .GE. 11) GO TO 3040
      OBH = GBH-ZSNOW*GAMMA/0.8
3040  CONTINUE
C      SURFACE ROUGHNESS ATTENUATION
      IF(ZSNOW .LT. 2.0*ACTRMS) GO TO 3050
      ACTRMS = ACTRMS*(1.0-(1.0-GAMMA/0.4))
      GO TO 3060
3050  CONTINUE
      ACTRMS = ACTRMS*(1.-.5*(1.-GAMMA/.4)*(ZSNOW/ACTRMS))

```

3060

CONTINUE
 RETURN

END
 SUBROUTINE IV1
 + (ADD ,ADT ,AREAB ,CL ,EWDTH ,IOBS ,IOST ,IS
 + ,NEVERO ,NI ,CAW ,OBAA ,OBH ,OBL ,OBS ,OBSE
 + ,ODIA ,PAV ,PWTE ,S ,SD ,TDEN ,WA ,WDTH
 + ,WI)

C
 C
 C
 C
 C
 C
 C

 EFFECTIVE OBSTACLE SPACING AND SPEED REDUCTION FACTORS DUE
 TO VEGETATION AND/OR OBSTACLE AVOIDANCE

1. VARIABLE DECLARATION

REAL ADT (9)
 INTEGER STEM
 INTEGER IS (9)
 REAL PAV (9)
 REAL S (9)
 REAL SD (9)
 REAL TDEN (9)

C

3. ALGORITHM

NEVERO = 0

C

A. OBSTACLE SPACING AND STUMP/BOULDER INTERFERENCE CHECK

IF (IOBS .NE. 1) GO TO 3010

C

1. PATCH BARE OF OBSTACLES

NEVERO = 2
 ADD = 0.
 GO TO 3070

C

2. PATCH CONTAINS OBSTACLES

3010

CONTINUE
 IF (IOST .NE. 2) GO TO 3020

C

A. OBSTACLE ARE UNAVOIDABLE, UNABLE TO MANEUVER

OBSE = CBS
 ADD = 100.
 GO TO 3070

C

B. OBSTACLE ARE POTENTIALY AVOIDABLE

3020

IF (ODIA .LE. WI) GO TO 3030

C

1. OBSTACLE IS WIDER THAN MINIMUM WIDTH

C

+ BETWEEN RUNNING GEAR ELEMENTS.

EWDTH = WOTH*CAW
 OBSE = AREAQ/EWDTH
 GO TO 3060

C

2. OBSTACLE NARROWER THAN THE MINIMUM WIDTH

C

+ BETWEEN RUNNING GEAR ELEMENTS.

3030

CONTINUE
 EWDTH = PWTE*CAW
 OBSE = AREAQ/EWDTH

C

IF (OBAA .GE. 3.14159265) GO TO 3050

A. OBSTACLE IS CONVEX, (BOULDER/STUMP)

IF ((CL-OBH) .GT. 0.) GO TO 3040

```

C          1. BELLY HANGUP
          NEVERO = 1
          EMCTH = WDTH*OAW
          CBSE = AREA0/EMCTH
C          2. NO BELLY INTERFERENCE
          CONTINUE
C          B. OBSTACLE IS CONCAVE, (TRENCH/DEPRESSION)
          CONTINUE
C          B. AREA DENIED DUE TO AVOIDING OBSTACLES, (ADO)
          CONTINUE
          ADO = 100.*(CBL*WA*(OBL*WA)*WDTH*WDTH*WDTH*3.14159265/4 +
+ 7/(OBSE*OBSE*3.14159265/4. )
C          C. VEGETATION DENSITY
          CONTINUE
          NIA = NI-1
          NIB = NI+1
          DO 3090 I=1,NIA
            IF (IS(I) .NE. 1) GO TO 3080
            TDEN(I)=0.
            GO TO 3090
          TDEN(I) = (4.73.14159265)*(1./S(I)**2-1./S(I+1)**2)
          CONTINUE
          IF (IS(NI) .NE. 1) GO TO 3100
          TDEN(NI)=0.
          GO TO 3110
          TDEN(NI) = 4.73.14159265*S(NI)**2)
          TDEN(NIB) = 0.0
C          D. AREA DENIED BY VEGETATION, PAV(I)
          CONTINUE
          DO 3160 I=1,NI
            SUMA = 0.
            DO 3130 STEM=I,NI
              SUMA = SUMA+TDEN(STEM)
            CONTINUE
            IF (SUMA .NE. 0) GO TO 3140
            PAV(I) = 0.
            GO TO 3160
          CONTINUE
          SUMB = 0.
          DO 3150 STEM=1,NI
            SUMB = SUMB+SD(STEM)*TDEN(STEM)
          CONTINUE
          PAV(I)=100.*(SUMB/SUMA+WDTH)/S(I)**2
          CONTINUE
          PAV(NI+1) = 0.
C          E. TOTAL AREA DENIED DUE TO OBSTACLES AND VEGETATION
          CONTINUE
          DO 3240 I=1,NIB
            ADT(I)=ADO*PAV(I)*(100.-ADO)/100.
          CONTINUE
C          F. IS THERE ANY PENALTY FOR OBSTACLE AVOIDANCE
          DO 3250 I=1,NIB
  
```

```

                IF(ADT(I) .NE. PAV(I)) GO TO 3260
3250          CONTINUE
              NEVERO = 2
3260          CONTINUE
              RETURN
            END
          SUBROUTINE IV2
+ (CL      ,DAREA ,CRAFT ,FORDD ,GRADE ,IFLOAT ,IOBS ,IST
+ ,ITUT   ,JPSI  ,NOGCMD ,NOFP  ,NWR   ,PWTE  ,SRFV ,VSEL
+ ,VSS    ,WD    ,WDPH  ,WDTH  ,WRAT  ,WRATIO ,WRFORD )
C
C -----
C LAND/MARSH OPERATING FACTORS
C -----
C
C 1. VARIABLE DECLARATION
  REAL      SRFV (1)
  REAL      WDPH (2)
  REAL      WRAT (2)
C
C 3. ALGORITHM
C   A. SET OPERATION TYPE
      NOGOWD = 0
      IF(ITUT .EQ. 1) GO TO 3010
      IF(IST .EQ. 4) GO TO 3010
      GO TO 3020
C
C 1. DRY LAND OPERATION
3010      CONTINUE
          IFLOAT = 0
          WRATIO = 1.0
          DAREA = 0.0
          GO TO 2100
C
C 2. MARSH OPERATION
3020      CONTINUE
          IOBS = 1
          GRADE = 0.0
          IF(WD .LE. FORDD) GO TO 3040
C
C   A. WATER TOO DEEP TO FORD
          IF(CRAFT .NE. 0.0) GO TO 3030
C
C   1. WATER TOO DEEP FOR OPERATION
          NOGOWD = 1
          VSEL = 0.0
          RETURN
C
C   2. VEHICLE FULLY FLOATING
3030      CONTINUE
          IFLOAT = 0
          VSEL = VSS*SRFV(2)
          RETURN
C
C   B. VEHICLE IS FORDING
3040      CONTINUE
          IFLOAT = 1
          IF(WD .GT. WDPH(1)) GO TO 3050
          WRATIO = 1.0+WD*( WRAT(1)-1.0 )/WDPH(1)

```

```

      GO TO 3090
3050  CONTINUE
      DO 3080 N=2,NWR
          IF(WD .GT. WDPH(N)) GO TO 3070
          WRATIO = WRAT(N-1)+(WRAT(N)-WRAT(N-1))*
+ (WD-WDPH(N-1))/(WDPH(N)-WDPH(N-1))
          GO TO 3090
3070  CONTINUE
3080  CONTINUE
          WRATIO = WRAT(NWR)+(WRFORD-WRAT(NWR))*
+ (WD-WDPH(NWR))/(WFGRES-WDPH(NWR))
3090  CONTINUE
          DAREA = 2.0*PWTE*WD
          IF(WD .GT. CL) DAREA=WDTH*(WD-CL)+2.0*PWTE*CL
2100  CONTINUE
C      B. TIRE PRESSURE INDEX
          IF(NOPP .NE. 0) GO TO 2110
          JPSI = 2
          IF(IST .EQ. 1) JPSI = 1
          IF(IST .EQ. 3) JPSI = 1
          IF(IST .EQ. 4) JPSI = 1
          IF(IST .EQ. 6) JPSI = 1
          GO TO 3120
2110  CONTINUE
          JPSI = NOPP
3120  CONTINUE
          RETURN
      END
      SUBROUTINE IV3
+ (CHARLN ,CI ,COHES ,CPFFG ,DIAW ,DOWPB ,DRAT ,GAMMA
+ ,GCA ,IB ,ID ,IP ,IST ,JPSI ,LUN1 ,NAMBL
+ ,NPAD ,NSLIP ,NVEF ,NWHL ,RCI ,RTOWPB ,RTOWT ,SECTW
+ ,TANPHI ,TRAKLN ,TRAKWC ,VCIFG ,VCIMUK ,WGHT ,WRATIO ,ZSNOW )
C
C -----
C PULL AND RESISTANCE COEFFICIENTS
C -----
C
C 1. VARIABLE DECLARATION
      REAL B
      REAL CHARLN (20,3)
      REAL CI
      REAL COHES
      REAL CPFFG (20,3)
      REAL D
      REAL DIAW (20)
      REAL DOWCO
      REAL DOWCS
      REAL DOWPB (20)
      REAL DOWS
      REAL DRAT (20,3)
      REAL G
  
```

```

REAL      GAMMA
REAL      GCA      (20,3)
INTEGER   I
INTEGER   IB      (20)
INTEGER   ID      (20)
INTEGER   IP      (20)
INTEGER   IST
INTEGER   JPSI
INTEGER   KIV3
INTEGER   LUN1
INTEGER   NAMBL Y
INTEGER   NPAD    (20)
INTEGER   NSLIP
INTEGER   NVEH    (20)
INTEGER   NWHL    (20)
REAL      PID
REAL      PIT
REAL      RCI
REAL      RCIO
REAL      RCIS
REAL      RCIX
REAL      RT
REAL      RTOWPB  (20)
REAL      RTDWT   (20)
REAL      SECTW   (20)
REAL      TANPHI
REAL      TOWMAX
REAL      TRAKLN  (20)
REAL      TRAKWD  (20)
REAL      VCIFG   (20,3)
REAL      VCIMUK  (20)
REAL      W
REAL      WGHT    (20)
REAL      WRATIC
REAL      XK
REAL      XKDELT
REAL      XN
REAL      XNVEH
REAL      ZSNOW
  
```

```

C      3. DETERMINE SOIL TYPE
      IF(IST .EQ. 1) GO TO 3100
      IF(IST .EQ. 2) GO TO 3600
      IF(IST .EQ. 3) GO TO 3700
      IF(IST .EQ. 4) GO TO 3800
      IF(IST .EQ. 6) GO TO 3100
      STOP 6
  
```

```

C      4. FINE GRAINED SOIL FULL AND RESISTANCE COEFFICIENTS
3100  CONTINUE
      DO 3414 I=1,NAMBL Y,1
          RCIX=RCI-VCIFG(I,UPSI)
          IF((IP(I) .EQ. 1) .OR. (IB(I) .EQ. 1)) GO TO 3132
          RTOWPB(I) = R40
      
```



```
      DOWPB (I) = 0.0
      CALL FGSTR (
+       ,DIAW ( I )
+       ,DRAT ( I , JPSI )
+       ,IB ( I )
+       ,IP ( I )
+       ,NVEH ( I )
+       ,NWHL ( I )
+       ,RCI
+       ,RTOWT ( I )
+       ,SECTW ( I )
+       ,WGHT ( I )
+       ,WRATIO
+       ,LUN1 )
      GO TO 3414
3132 CONTINUE
      IF(NSLIP .NE. 0) GO TO 3134
      CALL FGSPC (
+       ,CPFFG ( I , JPSI )
+       ,D
+       ,NVEH ( I )
+       ,RCIX )
      DOWPB(I)=C
      CALL FGSPR (
+       ,CPFFG ( I , JPSI )
+       ,NVEH ( I )
+       ,RCIX
+       ,RTOWPE ( I ) )
      CALL FGSTR (
+       ,DIAW ( I )
+       ,DRAT ( I , JPSI )
+       ,IB ( I )
+       ,IP ( I )
+       ,NVEH ( I )
+       ,NWHL ( I )
+       ,RCI
+       ,RTOWT ( I )
+       ,SECTW ( I )
+       ,WGHT ( I )
+       ,WRATIO
+       ,LUN1 )
      GO TO 3414
3134 CONTINUE
      IF(NVEH(I) .EQ. 1) GO TO 3306
      A. TRACKED SLEEPY ROUTINE
      RCIO = 20.0
      DOWCO = 0.55
      IF( RCIX .GT. 20.0 ) GO TO 3168
      CALL FGSPC (
+       ,CPFFG ( I , JPSI )
+       ,D
+       ,NVEH ( I )
```

```

+          ,RCIX )
          DOWPB(IA=D
          CALL FGSPR (
+          CPFFG ( I , JPSI )
+          ,NVEH ( I )
+          ,RCIX
+          ,RTGWPE ( I ) )
          CALL FGSTR (
+          DIAW ( I )
+          ,DRAT ( I , JPSI )
+          ,IB ( I )
+          ,IP ( I )
+          ,NVEH ( I )
+          ,NWHL ( I )
+          ,RCI
+          ,RTOWT ( I )
+          ,SECTW ( I )
+          ,WGHT ( I )
+          ,WRATIC
+          ,LUN1
          GO TO 3214
3168      CONTINUE
          IF(IST .NE. 6) GO TO 3224
3174      IF(NSLIR .NE. 1) GO TO 3182
          DOWCS = 0.5
          RCIS = 200.0
          GO TO 3252
3182      IF(NSLIR .NE. 2) GO TO 3190
          DOWCS = 0.3
          RCIS = 150.0
          GO TO 3252
3190      IF(NSLIR .NE. 3) GO TO 3198
          DOWCS = 0.3
          RCIS = 200.0
          GO TO 3252
3198      IF(NSLIR .NE. 4) GO TO 3206
          DOWCS = 0.1
          RCIS = 200.0
          GO TO 3252
3206      IF(NSLIR .NE. 5) GO TO 3214
          DOWCS = 0.1
          RCIS = 300.0
          GO TO 3252
3214      IF(NSLIR .NE. 6) GO TO 3222
          DOWCS = 0.15
          RCIS = 500.0
          GO TO 3252
3222      STOP 7
3224      CONTINUE
          IF(IST .NE. 1) GO TO 3251
          RCIS = 100.0
          IF(NSLIR .NE. 1) GO TO 3230
  
```

```

      DOWCS = 0.45
      GO TO 3252
3230  IF(NSLIF .NE. 2) GO TO 3234
      DOWCS = 0.3
      GO TO 3252
3234  IF(NSLIF .NE. 3) GO TO 3238
      DOWCS = 0.2
      GO TO 3252
3238  IF(NSLIF .NE. 4) GO TO 3242
      DOWCS = 0.1
      GO TO 3252
3242  IF(NSLIF .NE. 5) GO TO 3246
      DOWCS = 0.1
      GO TO 3252
3246  IF(NSLIF .NE. 6) GO TO 3250
      DOWCS = 0.15
      GO TO 3252
3250  STOP
3251  CONTINUE
      STOP 10
3252  IF( RCIX .GE. RCIS ) GO TO 3282
      XN=ALOG20( DOWCO/DOWCS )/ALOG10( RCIS/RCIO )
      XK=DCWS*RCIS**XN
      DOWS=XK*(1./RCIX)**XN
      IF( NPAB(I) .EQ. 0 ) GO TO 3274
      DOWPB(I)=DCWS
      CALL FGSPR (
+       CPFGB ( I , JPSI )
+       ,NVEH ( I )
+       ,RCIX
+       ,RTCMPB ( I ) )
      CALL FGSTR (
+       DIAM ( I )
+       ,DRAT ( I , JPSI )
+       ,IB ( I )
+       ,IP ( I )
+       ,NVEH ( I )
+       ,NWEH ( I )
+       ,RCI
+       ,RTCNT ( I )
+       ,SECTW ( I )
+       ,WGHE ( I )
+       ,WRATIC
+       ,LUN1 )
      GO TO 3414
3274  CONTINUE
      CALL FGSPC (
+       CPFGB ( I , JPSI )
+       ,D
+       ,NVEH ( I )
+       ,RCIX )
      DOWPB(I)=0.5*( D+DCWS )

```

```
3282          GO TO 3414
             IF(NPAD(I).EQ.0) GO TO 3296
             DOWFBI(I)=DOWCS
             CALL FGSPR (
+             CPFFG ( I , JPSI )
+             ,NVEH ( I )
+             ,RCIX
+             ,RTCWPE ( I ) )
             CALL FGSTR (
+             DIAW ( I )
+             ,DRAT ( I , JPSI )
+             ,IB ( I )
+             ,IP ( I )
+             ,NVEH ( I )
+             ,NWHL ( I )
+             ,RCI
+             ,RTCWT ( I )
+             ,SECTW ( I )
+             ,WGHT ( I )
+             ,WRATIC
+             ,LUN1)
             GO TO 3414
```

```
3296          CONTINUE
             CALL FGSPC (
+             CPFFG ( I , JPSI )
+             ,D
+             ,NVEH ( I )
+             ,RCIX )
             DOWPB(I)=0.5*( D+DOWS )
             CALL FGSPF (
+             CPFFG ( I , JPSI )
+             ,NVEH ( I )
+             ,RCIX
+             ,RTOWPB ( I ) )
             CALL FGSTR (
+             DIAW ( I )
+             ,DRAT ( I , JPSI )
+             ,IB ( I )
+             ,IP ( I )
+             ,NVEH ( I )
+             ,NWHL ( I )
+             ,RCI
+             ,RTOWT ( I )
+             ,SECTW ( I )
+             ,WGHT ( I )
+             ,WRATIC
+             ,LUN1)
             GO TO 3414
```

```
3306          CONTINUE
C          B. WHEELED SLIPPERY ROUTINE
             XKDEL=( DRAT(I, JPSI)/0.4 )-0.375
             RCIO=18.0
```

```

DCWCO=0.4
IF( RCIX .GT. 20.0 ) GO TO 3324
  RCIX=RCIX-2.0
  CALL FGSPC (
    +   CPFFG ( I , JPSI )
    +   ,D
    +   ,NVEH ( I )
    +   ,RCIX )
  DOWPB(I)=C
  CALL FGSPF (
    +   CPFFG ( I , JPSI )
    +   ,NVEH ( I )
    +   ,RCIX
    +   ,RTCWPB ( I ) )
  CALL FGSTR (
    +   DIAW ( I )
    +   ,DRAT ( I , JPSI )
    +   ,IB ( I )
    +   ,IP ( I )
    +   ,NVEH ( I )
    +   ,NWFL ( I )
    +   ,RCI
    +   ,RTCWT ( I )
    +   ,SECTW ( I )
    +   ,WGHT ( I )
    +   ,WRATIC
    +   ,LUN1)
  GO TO 3414
3324 CONTINUE
IF(IST .NE. 6) GO TO 3378
  IF(NSLIP .NE. 1) GO TO 3338
    DOWCS = 0.35
    RCIS = 300.0
    GO TO 3394
  3338 IF(NSLIP .NE. 2) GO TO 3346
    DOWCS = 0.25+XKDELT
    RCIS = 150.0
    GO TO 3394
  3346 IF(NSLIP .NE. 3) GO TO 3354
    DOWCS = 0.2+XKDELT
    RCIS = 200.0
    GO TO 3394
  3354 IF(NSLIP .NE. 4) GO TO 3362
    DOWCS = 0.15+XKDELT
    RCIS = 150.0
    GO TO 3394
  3362 IF(NSLIP .NE. 5) GO TO 3370
    DOWCS = 0.15+XKDELT
    RCIS = 150.0
    GO TO 3394
  3370 IF(NSLIP .NE. 6) GO TO 3376
    DOWCS = 0.15

```

```

          RCIS = 100.0
          GO TO 3394
3376      STOP 11
3378      CONTINUE
          RCIS=80.0
          IF(NSLIP .NE. 1) GO TO 3386
          DOWCS=0.3
          GO TO 3394
3386      IF(NSLIP .NE. 4) GO TO 3392
          DOWCS=0.1+WKDELT
          GO TO 3394
3392      CONTINUE
          DOWCS = 0.1
3394      CONTINUE
          IF(RCIX .GE. RCIS) GO TO 3408
          XN=ALOG10(DWCO/DOWCS)/ALOG10(RCIS/RCIO)
          XK=DWCS*RCIS**XN
          DOWPB(I)=XK/(RCIX**XN)
          CALL FGSPR (
+           CPFFG ( I , JPSI )
+           ,NVEH ( I )
+           ,RCIX
+           ,RTOWPB ( I ) )
          CALL FGSTR (
+           DIAW ( I )
+           ,DRAT ( I , JPSI )
+           ,IB ( I )
+           ,IP ( I )
+           ,NVEH ( I )
+           ,NWHL ( I )
+           ,RCI
+           ,RTCWT ( I )
+           ,SECTW ( I )
+           ,WGHT ( I )
+           ,WRATIC
+           ,LUNI)
          GO TO 3414
3408      CONTINUE
          DOWPB(I) = DOWCS
          CALL FGSPR (
+           CPFFG ( I , JPSI )
+           ,NVEH ( I )
+           ,RCIX
+           ,RTOWPB ( I ) )
          CALL FGSTR (
+           DIAW ( I )
+           ,DRAT ( I , JPSI )
+           ,IB ( I )
+           ,IP ( I )
+           ,NVEH ( I )
+           ,NWHL ( I )
+           ,RCI

```

```

+           ,RTOWT ( I )
+           ,SECTW ( I )
+           ,WGHT  ( I )
+           ,WRATLC
+           ,LUN1:
3414      CONTINUE
          GO TO 3999
C      5. COARSE GRAINED SOIL PULL AND RESISTANCE COEFFICIENTS
3600      CONTINUE
          G = CI*.8645/3.
          DO 3630 I=1,NAMBL,1
            IF(NVEH(I) .EQ. 0) GO TO 3620
C          A. WHEELED ELEMENT ALGORITHM
            IF((VP(I) .EQ. 0) .OR. (IB(I) .EQ. 0)) GO TO 3610
              RTOWT(I) = 0.
              GO TO 3612
3610      CONTINUE
              W = WGHT(I)/FLOAT(NWHL(I))
              PIT = G*(1.5*SECTW(I)*DIAW(I)**1.5)/FLOAT(I)**(1./2.)
+ / ( W*((1.0-DRAT(I,JPS))**3.0)*(1.0*SECTW(I)/DIAW(I)) )
              RTOWT(I) = 0.44-0.01*PIT
+ *SQRT( ((0.44-0.01*PIT)**2)+0.0002*PIT+0.408 )
3612      CONTINUE
              IF((IP(I) .EQ. 0) .AND. (IB(I) .EQ. 0)) GO TO 3618
              IF(ID(I) .EQ. 1) GO TO 3614
              B = SECTW(I)
              W = WGHT(I)/FLOAT(NWHL(I))
              GO TO 3616
3614      CONTINUE
              B = 2.0*SECTW(I)
              W = 2.0*WGHT(I)/FLOAT(NWHL(I))
3616      CONTINUE
              PIC = G*((B*DIAW(I))**1.5)
              PIC = G*(1.5*SECTW(I)*DIAW(I)**1.5)
+ *(DRAT(I,JPS))/(W*(FLOAT(I)**0.5))
              DOWPB(I) = .53-4.5/(PIC+3.7)
              RTCWPB(I) = .6-DOWPB(I)
              GO TO 3630
3618      CONTINUE
              DOWPB(I) = 0.0
              RTCWPB(I) = 0.0
              GO TO 3630
C          B. TRACKED ELEMENT ALGORITHM
3620      CONTINUE
              RTOWT(I) = 0.0
              IF((IP(I) .EQ. 1) .AND. (IB(I) .EQ. 1)) GO TO 3621
              WRITE(LUN1,1000)
1000      FORMAT(
+ /,37H THERE IS NO SOIL PULL AND RESISTANCE,
+ /,37H ALGORITHM FOR TOWED TRACKED ELEMENTS)
              STOP
3621      CONTINUE

```

```

    PIT = 0.6*G*( (TRAKWD(I)*TRAKLN(I))**.5 )
    + /WGHT(I)/2.
    IF(PIT .GT. 25.) GO TO 3622
    DOWPB(I) = .121+.258*ALOG10(PIT)
    GO TO 3628
3622    IF(PIT .GT. 100.) GO TO 3624
    DOWPB(I) = .339+.109*ALOG10(PIT)
    GO TO 3628
3624    IF(PIT .GT. 1000.) GO TO 3626
    DOWPB(I) = .481+.038*ALOG10(PIT)
    GO TO 3628
3626    CONTINUE
    DOWPB(I) = .595
3628    CONTINUE
    RTOWPB(I) = .6 - DOWPB(I) + .045
3630    CONTINUE
    GO TO 3999
C      6. MUSKEG PULL AND RESISTANCE COEFFICIENTS
3700    CONTINUE
    DO 3728 I=1,NAMBL,I
    RCIX = RCI-VCIMUK(I)
    IF(RCIX .GT. -100.) GO TO 3710
    RT = 1.
    GO TO 3714
3710    IF(RCIX .GT. 0.) GO TO 3712
    RT = 1.-.006*RCIX+100.
    GO TO 3714
3712    CONTINUE
    RT = .045+2.3075/(6.5+RCIX)
3714    IF((IP(I) .EQ. 0) .OR. (IB(I) .EQ. 0)) GO TO 3716
    RTOWT(I) = 0.
    RTOWPB(I) = RT
    GO TO 3720
3716    IF((IP(I) .EQ. 1) .OR. (IB(I) .EQ. 1)) GO TO 3718
    RTOWT(I) = RT
    RTOWPB(I) = 0.4
    DOWPB(I) = 0.40
    GO TO 3720
3718    CONTINUE
    RTOWT(I) = RT
    RTOWPB(I) = RT
3720    IF(RCIX .GT. -100.) GO TO 3722
    DOWPB(I) = -1.0
    GO TO 3728
3722    IF(RCIX .GT. 0.0) GO TO 3724
    DOWPB(I) = -1.+.01*(RCIX+100.)
    GO TO 3728
3724    IF
    + ((NVEH(I) .EQ. 0) .AND. (CPFFG(I,JPSI) .LT. 4.0)) GO TO 3726
    DOWPB(I) = 0.3537+.02258*RCIX
    + -(((.3537+.02258*RCIX)**2.)-(.03071*RCIX)**.5)
    GO TO 3728

```



```

3726      DOWPB(I)=0.5464+.1091*RCIX
+ -((((0.5464+.1091*RCIX)**2)-(.192*RCIX)**.5)
3728      CONTINUE
          GO TO 3999
C        7. SHALLOW SNOW PULL AND RESISTANCE COEFFICIENTS
3800      CONTINUE
          XNVEH = 0.0
          DO 3805 I=1,NAMBLY
            XNVEH = FLOAT(NVEH(I)) + XNVEH
3805      CONTINUE
          DO 3820 I=1,NAMBLY,I
            IF(NVEH(I) .EQ. 0) GO TO 3814
            RT = 10.4*(FLCAT(NWHL(I))*SECTW(H)/DIAW(I))
+ *(GAMMA*ZSNOW/CHARLN(I,JPSI))/XNVEH
            IF((IP(I) .EQ. 0) .OR. (IB(I) .EQ. 0)) GO TO 3810
            RTOWT(I) = 0.
            RTOWPB(I) = RT
            GO TO 3813
3810      IF((IP(I) .EQ. 1) .OR. (IB(I) .EQ. 1)) GO TO 3812
            RTOWT(I) = RT
            RTOWPB(I) = 0.
            DOWPB(I) = 0.
            GO TO 3820
3812      CONTINUE
            RTOWT(I) = RT
            RTOWPB(I) = RT
3813      CONTINUE
            TOWMAX = TANPHI*COHES*GCA(I,JPSI)
+ *FLOAT(NWHL(I))/WGHT(I)
            DOWPB(I) = TOWMAX-RT
            GO TO 3820
3814      CONTINUE
            RT = 5.0*GAMMA*(ZSNOW/CHARLN(I,JPSI)-0.15)
            IF(RT .GE. 0.0) GO TO 3815
            RT = 0.0
3815      IF((IP(I) .EQ. 0) .OR. (IB(I) .EQ. 0)) GO TO 3816
            RTOWT(I) = 0.
            RTOWPB(I) = RT
            GO TO 3819
3816      IF((IP(I) .EQ. 1) .OR. (IB(I) .EQ. 1)) GO TO 3818
            RTOWT(I) = RT
            RTOWPB(I) = 0.
            DOWPB(I) = 0.
            GO TO 3820
3818      CONTINUE
            RTOWT(I) = RT
            RTOWPB(I) = RT
3819      CONTINUE
            TOWMAX = TANPHI*COHES*GCA(I,JPSI)/WGHT(I)
            DOWPB(I) = TOWMAX-RT
3820      CONTINUE
3999      CONTINUE
  
```

```

      RETURN
      END
      SUBROUTINE IV4
      + (DOWB ,DOWP ,DOWPB ,GCW ,GCWB ,GCWP ,IB ,IP ,
      + ,NAMBL Y ,RTOWB ,RTOWNB ,RTOWNP ,RTOWP ,RTOWPB ,RTOWT ,WGHT )
C
C -----
C SUMMED PULL AND RESISTANCE COEFFICIENTS
C -----
C
C 1. VARIABLE DECLARATION
      REAL DOWPB (20)
      INTEGER IB (20)
      INTEGER IP (20)
      REAL RTOWPB (20)
      REAL RTOWT (20)
      REAL WGHT (20)
C
C 3. ALGORITHM
      DOWB = 0.0
      DOWP = 0.0
      RTOWB = 0.0
      RTOWP = 0.0
      RTOWNB = 0.0
      RTOWNP = 0.0
      DO 3050 I=1,NAMBL Y
        IF(GCWP .EQ. 0.0) GO TC 3010
          RTOWP = RTOWNP+FLOAT(IP(I))*RTOWPB(I)*WGHT(I)/GCWP
          DOWP = DOWP+FLOAT(IP(I))*DOWPB(I)*WGHT(I)/GCWP
3010      IF((GCW-GCWP) .EQ. 0.0) GO TO 3020
          RTOWNP = RTOWNP+FLOAT(1-IP(I))
          + *RTOWT(I)*WGHT(I)/(GCW-GCWP)
3020      IF(GCWB .EQ. 0.0) GO TC 3030
          RTOWB = RTOWNB+FLOAT(IB(I))*RTOWPB(I)*WGHT(I)/GCWB
          DOWB = DOWB+FLOAT(IB(I))*DOWPB(I)*WGHT(I)/GCWB
3030      IF((GCW-GCWB) .EQ. 0.0) GO TO 3040
          RTOWNB = RTOWNB+FLOAT(1-IB(I))
          + *RTOWT(I)*WGHT(I)/(GCW-GCWB)
3040      CONTINUE
3050      CONTINUE
      RETURN
      END
      SUBROUTINE IV5
      + (ATF ,AVGC ,BTF ,CD ,CPFCCG ,CPFCFG ,CTF ,DAREA
      + ,DOWP ,EANG ,ECF ,FA ,FB ,FC ,FORMX ,GCWR
      + ,IFLOAT ,IST ,ITUT ,JPSI ,LOCDIF ,NAMBL Y ,NFL ,NGR
      + ,NTRAV ,NVEH ,NVEHC ,NWHL ,RADC ,RTOWP ,STRACT ,TFOR
      + ,THETA ,TRACTF ,VFMAX ,VG ,VGV ,WGHT ,WRATIO ,LUN1 )
C
C -----
C SLIP MODIFIED TRACTIVE EFFORT
C -----
C

```

```

C      1. VARIABLE DECLARATION
      REAL    ATF    (20)
      REAL    BTF    (20)
      REAL    CPFCCG (3)
      REAL    CPF CFG (3)
      REAL    CTF    (20)
      REAL    FA     (20,3)
      REAL    FATEMP (20,3)
      REAL    FB     (20,3)
      REAL    FBTEMP (20,3)
      REAL    FC     (20,3)
      REAL    FCTEMP (20,3)
      REAL    FORMX  (3)
      REAL    FQUADS (5)
      REAL    FTEMP  (20,5)
      REAL    FTEMPC (20,5)
      INTEGER NVEH   (20)
      INTEGER NWHL   (20)
      REAL    STRACT (20,3,3)
      REAL    THETA  (3)
      REAL    TRACTF (20,5)
      REAL    VFMAX  (3)
      REAL    VG     (20,3,3)
      REAL    VGTEMP (20,3,3)
      REAL    VGV    (20,5)
      REAL    VQUADS (5)
      REAL    VTEMP  (20,5)
      REAL    VTEMPC (20,5)
      REAL    WGHT   (20)
  
```

```

C      3. ALGORITHM
      FCC = 0.
      CPFC = CPF CFG(JPSI)
      IF (IST .EQ. 2) CPFC=CPFCCG(JPSI)
      IF (IST .EQ. 4) GO TO 3000
      CALL TFCRCF(CF, CPFC, DCWP, GCWP, IST, NFL, NVEHC, RTOWP, TFOR, LUN)
3000 DO 3060 K=1, NTRAV
      COSX = COS(THETA(K))
      IF (IST .EQ. 4) TFOR=(DCWP+RTOWP)*GCWP*WRATIO
      NG1 = 1
      DO 3060 NG=1, NSR
      FATEMP(NG,K) = ATF(NG)
      FBTEMP(NG,K) = BTF(NG)
      FCTEMP(NG,K) = CTF(NG)
      DO 3050 L=1,5
      VTEMP(NG,L) = VGV(NG,L)
      FTEMP(NG,L) = TRACTF(NG,L)
3050 CONTINUE
      L=1
      DO 3060 L1=1,5,2
      VGTEMP(NG,L1) = VGV(NG,L1)
      L=L+1
3060 CONTINUE
  
```

```

      DO 3500  NG=1,NGR
      IF(FTEMP(NG,1)*ECF .LT. TFOR*COSX) GO TO 3300
      IF(FTEMP(NG,5)*ECF .LT. TFOR*COSX) GO TO 3200
C
C      100% AT TOP SPEED IN GEAR
C
      NG1 = NG1+1
      FC(NG,K)=0.
      FB(NG,K) = 0.
      FA(NG,K)=TFOR*COSX
      DO 3100  L=1,3
      VG(NG,L,K) = 0.
      STRACT(NG,L,K)=FA(NG,K)
3100      CONTINUE
      GO TO 3500
C
C      100% SLIP AT OTHER THAN TOP SPEED
C
      IF (VTEMP(NG,5) .EQ. VTEMP(NG,1)) GO TO 3260
      FX = TFOR*COSX
      CALL VELFOR(FX,FATEMP,FBTEMP,FCTEMP,
      FX,K,NGR,VX,VFMAX,VGTEMP)
C
C      RESET LGW POINT TO LOWEST SPEED THAT IS NOT
C      100% SLIP
C
      VTEMP(NG,1) = VX
      FTEMP(NG,1) = FX/ECF
      XINT = (VTEMP(NG,5) - VTEMP(NG,1))/4.
      DO 3250  L=2,4
      VTEMP(NG,L) = VTEMP(NG,L-1) + XINT
      FTEMP(NG,L) = CTF(NG)*VTEMP(NG,L)*VTEMP(NG,L) +
      BTF(NG)*VTEMP(NG,L) + ATF(NG)
      +
3250      CONTINUE
      GO TO 3300
C
C      SPEEDS EQUAL - INCREMENT ON FORCE
C
      FTEMP(NG,1) = TFOR*COSX
      YINT = (FTEMP(NG,1) - FTEMP(NG,5))/4.
      DO 3380  L=2,4
      FTEMP(NG,L) = FTEMP(NG,L-1) - YINT
3380      CONTINUE
C
C      COMPUTE SLIP FOR ALL POINTS IN GEAR
C
3300      DO 3400  L=1,5
      VX = VTEMP(NG,L)
      FX = FTEMP(NG,L)*ECF
      FSL = FX/COSX*WRATIO
      YX = FSL/GCWP - CF
      IF (IST .EQ. 4) YX=FX/TFOR

```

```

CALL SLIP(CPFC,IST,LOCCIF,NFL,NVEHC,SLIPX,YX)
VTEMPO(NG,L) = VX*(1.-SLIPX)
WDRAG = .5*.00111*CD*DAREA*VTEMPO(NG,L)**2
IF(ITUT .NE. 14) GO TO 3390
  
```

DRAG CORNERING RESISTANCE FOR TRAILS (WHEELED)

```

FCC = 0.
FE = 1. - 7.495*(RACC/12.)*EANG
DO 3350 J=1,NAMBL
  IF(NVEH(J) .LT. 1) GO TO 3350
  F1 = ((WGHT(J)*COSX*VTEMPO(NG,L)**2)/
        (111.1*RACC))*(12./17.6/17.6)
  FCC = ((FE*F1*F1)/(FLOAT(NWHL(J))*AVGC))*
        .75/(TFOR/GCWP) + FCC
  
```

```

3350 CONTINUE
3390 FTEMPO(NG,L) = FX - FLOAT(IFLOAT)*WDRAG - FCC
3400 CONTINUE
  
```

COMPUTE NEW COEFFICIENTS

```

IF((NG .NE. 1) .OR.
  (FTEMP(NG,1) .NE. FTEMP(NG,5))) GO TO 3410
FA(NG,K) = ATF(NG)
FB(NG,K) = BTF(NG)
FC(NG,K) = CTF(NG)
GO TO 3430
  
```

```

3410 DO 3420 L=1,5
      FQUADS(L) = FTEMP(NG,L)
      VQUADS(L) = VTEMP(NG,L)
  
```

```

3420 CONTINUE
CALL QUADS(VQUADS,FQUADS,A,B,C)
FA(NG,K) = A
FB(NG,K) = B
FC(NG,K) = C
  
```

```

3430 L = 1
DO 3450 L1=1,5,2
  VG(NG,L,K) = VTEMP(NG,L1)
  STRACT(NG,A,K) = FC(NG,K)*VG(NG,L,K)*VG(NG,L,K) +
    FB(NG,K)*VG(NG,L,K) + FA(NG,K)
  
```

```

L = L+1
  
```

```

3450 CONTINUE
3500 CONTINUE
VFMAX(K) = VG(NG,1,K)
FORMX(K) = STRACT(NG,1,K)
  
```

```

3600 CONTINUE
RETURN
  
```

```

END
SUBROUTINE IV6
  
```

```

+ (FAT ,FAT1 ,FMT ,NI ,PBHT ,SD ,SDL ,TDEN
+ ,WDTH )
  
```

C
 C
 C
 C
 C
 C

 RESISTANCE DUE TO VEGETATION

1. VARIABLE DECLARATION

REAL FAT (9)
 REAL FAT1 (9)
 REAL FMT (9)
 REAL SD (9)
 REAL SDL (9)
 REAL TDEN (9)
 REAL TFAT (9)

C

3. ALGORITHM

FAT (1) = 0.0
 FAT1(1) = 0.0
 FMT (1) = 0.0
 TFAT(1) = 0.0
 DO 3030 I=1,NI
 IF(TDEN(I) .EQ. 0.0) GO TO 3020
 FAT1(I+1) = 456.75.81*SOL(I)**3
 FMT (I+1) = 440.-PBHT/2.)*SOL(I)**3.
 TFAT(I+1) = 0.40
 DO 3010 K=1,I
 TFAT(I+1) = TFAT(I+1)+TDEN(K)*100.0*SD(K)**3
 3010 CONTINUE
 FAT (I+1) = 12.*TFAT(I+1)*WOTH
 GO TO 3030

3010

3020

CONTINUE
 FAT1(I+1) = 0.0
 FMT (I+1) = 0.0
 FAT (I+1) = FAT(I)

3030

CONTINUE
 RETURN
 END

SUBROUTINE IV7
 + (FMT ,GCW ,IMPACT ,MAXI ,NI ,PBF)

C
 C
 C
 C
 C
 C

 DRIVER-DEPENDENT VEHICLE VEGETATION OVERRIDE CHECK

1. VARIABLE DECLARATION

REAL FMT (9)
 REAL IMPACT (9)

C

3. ALGORITHM

NI1 = NI+1
 DO 3040 I=1,NI1
 IMPACT(I) = 0
 IF(FMT(I) .LE. PBF) GO TO 3010
 IMPACT(I) = 1
 3010 IF((FMT(I)/GCW) .LE. 2.) GO TO 3020

3010

```

      IMPACT(I) = IMPACT(I)+2.
3020   IF(IMPACT(I) .NE. 0.) GO TO 3030
      MAXI = I
3030   CONTINUE
3040   CONTINUE
      RETURN
      END
      SUBROUTINE IV8
+ (FAT ,FAT1 ,GCW ,GCWNP ,GCWP ,MAXI ,NTRAV ,RTOMNP
+ ,RTOWP ,STR ,THETA ,TRESIS ,WRATIO )

```

C
 C
 C
 C
 C
 C

 TOTAL RESISTANCE BETWEEN OBSTACLES

1. VARIABLE DECLARATION

```

      REAL FAT (9)
      REAL FAT1 (9)
      REAL STR (3,9)
      REAL THETA (3)
      REAL TRESIS (3,9)

```

3. ALGORITHM

```

      DO 3020 K=1,NTRAV
      DUMMY = GCW*SIN(THETA(K))
+ (RTOWP*GCWP+RTOWNP*GCWNP)+COS(THETA(K))*WRATIO
      DO 3010 I=1,MAXI
      TRESIS(K,I) = DUMMY+FAT (I)
      STR (K,I) = DUMMY+FAT1(I)

```

3010
 3020

```

      CONTINUE
      CONTINUE
      RETURN
      END
      SUBROUTINE IV9
+ (FA ,FB ,FC ,FORMX ,MAXI ,NGR ,NI ,NTRAV
+ ,TRESIS ,VFMAX ,VG ,VSOIL )

```

C
 C
 C
 C
 C
 C

 SPEED LIMITED BY RESISTANCE BETWEEN OBSTACLES

1. VARIABLE DECLARATION

```

      REAL FA (20,3)
      REAL FB (20,3)
      REAL FC (20,3)
      REAL FORMX (3)
      REAL TRESIS (3,9)
      REAL VFMAX (3)
      REAL VG (20,3,3)
      REAL VSOIL (3,9)

```

3. ALGORITHM

```

      M2 = MAXI
      DO 3030 I=1,M2

```

```

      CALL VELFOR
      + (TRESIS(1,I),FA,FB,FC,FCRMX,1,NGR,VSOIL(1,I),VFMAX,VG)
      IF(VSOIL(1,I) .NE. 0.0) GO TO 3010
      MAXI = I
3010   IF(NTRAV .EQ. 1) GO TO 3020
      CALL VELFOR
      + (TRESIS(2,I),FA,FB,FC,FCRMX,2,NGR,VSOIL(2,I),VFMAX,VG)
      CALL VELFOR
      + (TRESIS(3,I),FA,FB,FC,FCRMX,3,NGR,VSOIL(3,I),VFMAX,VG)
3020   CONTINUE
3030   CONTINUE
      M1 = MAXI+1
      M2 = NI +1
      DO 3050 I=M1,M2
      VSOIL(1,I) = 0.0
      IF(NTRAV .EQ. 1) GO TO 3040
      VSOIL(2,I) = 0.0
      VSOIL(3,I) = 0.0
3040   CONTINUE
3050   CONTINUE
      RETURN
      END
      SUBROUTINE IV10
      + (ACTRMS ,LAC      ,MAXIPR ,RMS      ,VRID      ,VRIDE )
C
C
C -----
C SPEED LIMITED BY SURFACE ROUGHNESS
C -----
C
C 1. VARIABLE DECLARATION
      REAL      RMS      (20)
      REAL      VRIDE    (20,3)
C
C 3. ALGORITHM
      DO 3020 NR=2,MAXIPR
      IF(ACTRMS .GE. RMS(NR)) GO TO 3010
      VRID = VRIDE(NR-1,LAC)+(ACTRMS-RMS(NR-1))
      + *(VRIDE(NR,LAC)-VRIDE(NR-1,LAC))/(RMS(NR)-RMS(NR-1))
      GO TO 3030
3010   CONTINUE
3020   CONTINUE
      VRID = VRIDE(MAXIPR,LAC)
3030   CONTINUE
      RETURN
      END
      SUBROUTINE IV11
      + (DOWB ,GCW      ,GCWE      ,GCWNB ,NOGOBF ,NTRAV ,RTOWB ,RTOMNB
      + ,TBF      ,THETA ,WRATIO ,XBR )
C
C
C -----
C TOTAL BRAKING FORCE - SOIL/SLOPE/VEHICLE
C -----
C

```



```

C      1. VARIABLE DECLARATION
        REAL      THETA  (3)
        REAL      TBF    (3)
C      3. ALGORITHM
        X1 = (RTOWB*GCWB+RTGWNB*GCWNB)*WRATIO
        X2 = (DCWB+RTOWB)*CCWB*WRATIO
        TBF(1) = GCW*SIN(THETA(1))*WRATIO+X1*COS(THETA(1))
+ *AMINI(XBR,X2*CCS(THETA(1)))
        IF(NTRAV.NE.1) GC TO 3020
          IF(TBF(1).GE.0.0) GO TO 3010
            NOGOBF = 0
            GO TO 4000
3010    CONTINUE
        NOGOBF = 1
        GO TO 4000
3020    CONTINUE
        TBF(2) = X1+AMINI(XBR,X2)
        TBF(3) = GCW*SIN(THETA(3))*WRATIO+X1*COS(THETA(3))
+ *AMINI(XBR,X2*CCS(THETA(3)))
        IF(TBF(3).GE.0.0) GO TO 3030
          NOGOBF = 1
          GO TO 4000
3030    CONTINUE
        NOGOBF = 0
4000    CONTINUE
        RETURN
        END
  
```

SUBROUTINE IV12

+ (BFMX ,DCLMAX ,GCW ,NTRAV ,SFTYPC ,TBF)

```

C      -----
C      MAXIMUM BRAKING FORCE * SOIL/SLOPE/VEHICLE/DRIVER
C      -----
  
```

```

C      1. VARIABLE DECLARATION
        REAL      BFMX   (3)
        REAL      TBF    (3)
C      3. ALGORITHM
        BFMX(1) = AMINI(DCLMAX*GCW , TBF(1)*SFTYPC/100.)
        IF(NTRAV.EQ.1) GC TO 0010
          BFMX(2) = AMINI(DCLMAX*GCW , TBF(2)*SFTYPC/100.)
          BFMX(3) = AMINI(DCLMAX*GCW , TBF(3)*SFTYPC/100.)
3010    CONTINUE
        RETURN
        END
  
```

SUBROUTINE IV13

+ (BFMX ,EYEHGT ,GCW ,NTRAV ,RD ,REACT ,VELV ,VISMNV)

```

C      -----
C      SPEED LIMITED BY VISIBILITY
C      -----
  
```

```

C      1. VARIABLE DECLARATION
      REAL      BFMX  (3)
      REAL      VELV  (3)
C      3. ALGORITHM
      DO 3030 K=1,NTRAV
        IF(BFMX(K) .GT. 0.0) GO TO 3010
        VELV(K) = 0.0
        GO TO 3030
3010    CONTINUE
        RECD      = RD*EYENGT/60.
        ACC       = BFMX(K)*385.9/GCW
        D         = ((REACT*ACC)**2)+2.0*RECD*ACC
        C         = ACC*REACT
        VELV(K)   = -(C-SCR/D)
        IF(VELV(K) .GE. VISMNV) GO TO 3020
        VELV(K)   = VISMNV
3020    CONTINUE
3030    CONTINUE
      RETURN
      END
      SUBROUTINE IV14
+ (JPSI ,NI ,NTRAV ,NVEHC ,VELV ,VRID ,VSOIL ,VTIRE
+ ,VTT )

```

```

C
C -----
C      SELECTED SPEED BETWEEN OBSTACLES LIMITED BY, VISIBILITY,
C      RIDE, TIRES, AND SOIL/SLOPE/VEGETATION RESISTANCE.
C -----
C

```

```

C      1. VARIABLE DECLARATION
      REAL      VELV  (3)
      REAL      VSOIL (3,9)
      REAL      VTIRE (3)
      REAL      VTT   (3,9)
C      3. ALGORITHM
      NI1 = NI+1
      DO 3030 K=1,NTRAV
        DO 3020 I=1,NI1
          V1 = .99*VSOIL(K,I)
          IF(NVEHC .EQ. -1) GO TO 3010
          VTT(K,I) =
+ AMINI(VTIRE(JPSI), V1, VRID, VELV(K))
          GO TO 3020
3010    CONTINUE
          VTT(K,I) =
+ AMINI(V1, VRID, VELV(K))
3020    CONTINUE
3030    CONTINUE
      RETURN
      END
      SUBROUTINE IV15
+ (ADT ,NI ,NTRAV ,NVEHC ,PAV ,VAVOID ,VBO ,VTT )

```

```

C
C -----
C MAXIMUM SPEED BETWEEN AND AROUND OBSTACLES
C -----
C
C 1. VARIABLE DECLARATION
C   REAL    ADT    (9)
C   REAL    PAV    (9)
C   REAL    VAVCID (3,9)
C   REAL    VBO    (3,9)
C   REAL    VTT    (3,9)
C
C 3. ALGORITHM
C   NII = NI+1
C   DO 3200 K=1,NTRAV
C     CO 3190 I=1,NII
C       VBO(K,I)=VTT(K,I)
C       VAVCID(K,I)=VTT(K,I)
C       IF(VTT(K,I) .EQ. 0.) GO TO 3190
C       IF(NVEHC .EQ. 1) GO TO 3060
C
C     A. TRACKED VEHICLE ROUTINE FOR MANEUVERING AROUND
C       AND BETWEEN OBSTACLES
C
C       IF(PAV(I) .LE. 3.) GO TO 3030
C       IF(PAV(I) .GE. 7.) GO TO 3010
C       SMG=(392.93-VTT(K,I)/4.)*PAV(I)
C       + (7.*VTT(K,I)-3.*392.93)/4.
C       VBO(K,I)=AMIN1(SMG,VTT(K,I))
C       GO TO 3030
C 3010  IF(PAV(I) .GT. 52.5) GO TO 3020
C       SMG=453.15-8.603*PAV(I)
C       VBO(K,I)=AMIN1(SMG,VTT(K,I))
C       GO TO 3030
C 3020  VBO(K,I)=0.
C 3030  IF(ADT(I) .LE. 3.) GO TO 3190
C       IF(ADT(I) .GE. 7.) GO TO 3040
C       SMG=(392.93-VTT(K,I)/4.)*ADT(I)
C       + (7.*VTT(K,I)-3.*392.93)/4.
C       VAVCID(K,I)=AMIN1(SMG,VTT(K,I))
C       GO TO 3190
C 3040  IF(ADT(I) .GT. 52.5) GO TO 3050
C       SMG=453.15-8.603*ADT(I)
C       VAVCID(K,I)=AMIN1(SMG,VTT(K,I))
C       GO TO 3190
C 3050  VAVCID(K,I)=0.
C       GO TO 3190
C
C     B. WHEELED VEHICLE ROUTINE FOR MANEUVERING AROUND
C       AND BETWEEN OBSTACLES
C
C 3060  IF(PAV(I) .LE. 3.) GO TO 3090
C       IF(PAV(I) .GE. 7.) GO TO 3070
  
```

```

      SMG=((450.33-VTT(K,I)/4.)*PAV(I)
+      *(7.*VTT(K,I)-3.*450.33)/4.
      VBO(K,I)=AMIN1(SMG,VTT(K,I))
      GO TO 3090
3070      IF(PAV(I) .GT. 41.3) GO TO 3080
      SMG=542.11-13.112*PAV(I)
      VBO(K,I)=AMIN1(SMG,VTT(K,I))
      GO TO 3090
3080      VBO(K,I)=0.
3090      IF(ADT(I) .LE. 3.) GO TO 3190
      IF(ADT(I) .GE. 7.) GO TO 3100
      SMG=((450.33-VTT(K,I)/4.)*ADT(I)
+      *(7.*VTT(K,I)-3.*450.33)/4.
      VAVCID(K,I)=AMIN1(SMG,VTT(K,I))
      GO TO 3190
3100      IF(ADT(I) .GT. 41.3) GO TO 3110
      SMG=542.11-13.112*ADT(I)
      VAVCID(K,I)=AMIN1(SMG,VTT(K,I))
      GO TO 3190
3110      VAVCID(K,I)=0.
3190      CONTINUE
3200      CONTINUE
      RETURN
      END
      SUBROUTINE IV16
+ (AVALS ,CLEAR ,FCM ,FOMMAX ,FOO ,FOOMAX ,HOVALS ,NANG
+ ,NEVERO ,NOHGT ,NWDTH ,OBAA ,OBH ,OBMINW ,WVALS )

```

C
 C
 C
 C
 C

 OBSTACLE OVERRIDE INTERFERENCE AND RESISTANCE

1. VARIABLE DECLARATION
- REAL AVALS (14)
 - REAL CLEAR (7,14,5)
 - REAL CLR
 - REAL FOM
 - REAL FOMMAX
 - REAL FOO (7,14,5)
 - REAL FOOMAX (7,14,5)
 - REAL HOVALS (7)
 - INTEGER I
 - INTEGER II
 - INTEGER J
 - INTEGER JJ
 - INTEGER K
 - INTEGER KK
 - INTEGER N
 - INTEGER NANG
 - INTEGER NEVERC
 - INTEGER NOHGT
 - INTEGER NWDTH

```
REAL      OBAA
REAL      OBH
REAL      OBMINW
REAL      WVALS (5)
C  3. ALGRITHM
    IF(NEVERO .EQ. 0) GO TO 3010
        FOM      = 0.0
        FOMMAX   = 0.0
        GO TO 3150
3010 CONTINUE
    IF((NOHGT .NE. 1) .AND. (OBH .GT. HOVALS(1))) GO TO 3020
        I      = 1
        II     = 1
        GO TO 3050
3020 CONTINUE
    DO 3030 N=2,NOHGT
        IF(OBH .LE. HOVALS(N)) GO TO 3040
3030 CONTINUE
        I      = NOHGT
        II     = NOHGT
    GO TO 3050
3040 CONTINUE
        I      = N-1
        II     = N
3050 CONTINUE
    IF((NANG .NE. 1) .AND. (OBAA .GT. AVALS(1))) GO TO 3060
        J      = 1
        JJ     = 1
        GO TO 3090
3060 CONTINUE
    DO 3070 N=2,NANG
        IF(OBAA .LE. AVALS(N)) GO TO 3080
3070 CONTINUE
        J      = NANG
        JJ     = NANG
        GO TO 3090
3080 CONTINUE
        J      = N-1
        JJ     = N
3090 IF((NWDTH .NE. 1) .AND. (OBMINW .GT. WVALS(1))) GO TO 3100
        K      = 1
        KK     = 1
        GO TO 3130
3100 CONTINUE
    DO 3110 N=2,NWDTH
        IF(OBMINW .LE. WVALS(N)) GO TO 3120
3110 CONTINUE
        K      = NWDTH
        KK     = NWDTH
        GO TO 3130
3120 CONTINUE
        K      = N-1
```

```

      KK = N
3130  CONTINUE
      CALL D3LINC
      + (CLR ,CLEAR ,I ,II ,J
      + ,JJ ,K ,KK ,HOVALS ,AVALS
      + ,WVALS ,OBH ,CBAA ,OBMINW )
      IF(CLR .GE. 0.0) GC TO 3140
      NEVERO = 3
      GO TO 3150
3140  CONTINUE
      CALL D3LINC
      + (FOMMAX ,FOOMAX ,I ,II ,J
      + ,JJ ,K ,KK ,HOVALS ,AVALS
      + ,WVALS ,OBH ,CBAA ,OBMINW )
      CALL D3LINC
      + (FOM ,FOO ,I ,II ,J
      + ,JJ ,K ,KK ,HOVALS ,AVALS
      + ,WVALS ,OBH ,CBAA ,OBMINW )
3150  CONTINUE
      RETURN
      END
      SUBROUTINE IV17
      + (HVALS ,NEVERO ,NHVALS ,NSVALS ,OBH ,OBSE ,SVALS ,TL
      + ,VOLA ,VOOB ,VCCBS ,WA )
C
C -----
C DRIVER-DEPENDENT VEHICLE SPEED OVER OBSTACLES
C -----
C
C 1. VARIABLE DECLARATION
      REAL HVALS (25)
      REAL SVALS (25)
      REAL VOOB (25)
      REAL VOOBS (25)
C
C 3. ALGORITHM
      VOLA = 0.0
      IF( NEVERO .NE. 0 ) GOTO 3090
      IF((OBSE-WA) .LT. TL) GC TO 3030
      DO 3020 NH=2,NHVALS
      IF(OBH .GT. HVALS(NH)) GO TO 3010
      VOLAB = VCCB(NH-1)+(OBH-HVALS(NH-1))
      + *(VCOB(NH)-VCOB(NH-1))/(HVALS(NH)-HVALS(NH-1))
      GO TO 3030
3010  CONTINUE
3020  CONTINUE
      VOLAB = VCCB(NHVALS)
3030  CONTINUE
      IF((OBSE-WA) .LT. (2.*TL)) GO TO 3040
      VOLA = VOLAB
      GO TO 3090
3040  CONTINUE
      DO 3060 NS=2,NSVALS

```

```

      IF(OBSE .GT. SVALS(NS)) GO TO 3050
      VOLAS = VCGBS(NS-1)+(CBSE-SVALS(NS-1))
+ 4*(VOOBS(NS)-VOOBS(NS-1))/(SVALS(NS)-SVALS(NS-1))
      GO TO 3070
3050    CONTINUE
3060    CONTINUE
      VOLAS = VOOBS(NSVALS)
3070    CONTINUE
      IF((OBSE-WA) .LT. TL) GO TO 3080
      VOLA = AMIN1(WGLAB,VOLAS)
      GO TO 3090
3080    CONTINUE
      VOLA = VOLAS
3090    CONTINUE
      RETURN
      END
  
```

SUBROUTINE IV18

```

+ (FA      ,FB      ,FC      ,FOM      ,FOMMAX ,FORMX ,GCW      ,JPS I
+ ,MAXI    ,NEVERO ,NGR     ,NI      ,NTRAV  ,NVEHC ,OBSE     ,PAV
+ ,TL      ,TRESIS ,VA      ,VBO     ,VELV   ,VFMAX ,VG       ,VOLA
+ ,VRID    ,VSOIL  ,VTIFE  ,VXT     ,WA
  
```

C
 C -----
 C SPEED CNTO AND OFF OBSTACLES
 C -----
 C

1. VARIABLE DECLARATION

```

REAL    FA      (20,3)
REAL    FB      (20,3)
REAL    FC      (20,3)
REAL    FORMX   (3)
REAL    PAV     (9)
REAL    TRESIS  (3,9)
REAL    VA      (3,9)
REAL    VBO     (3,9)
REAL    VELV    (3)
REAL    VFMAX   (3)
REAL    VG      (20,3,3)
REAL    VSOIL   (3,9)
REAL    VTIRE   (3)
REAL    VTT     (3,9)
REAL    VXT     (3,9)
  
```

3. ALGORITHM

```

NLI=NI+1
MAXI1=MAXI+1
IF(NEVERO .EQ. 0) GO TO 3030
DO 3020 K=1,NTRAV
  DO 3010 I=1,NLI
    VBO(K,I) = 0.
    VA (K,I) = 0.
    VXT(K,I) = 0.
  
```

```

3010    CONTINUE
  
```

```

3020      CONTINUE
          GO TO 3150
3030      CONTINUE
          IF(TL .LT. (OBSE+NA)) GO TO 3090
C          A. MULTIPLE OBSTACLE ROUTINE
          DO 3080 K=1, NTRAV
            DO 3060 I=1, MAXI
              RESIST = TRESIS(K, I) + FOM
              CALL VEFOR
+ (RESIST, FA, FB, FC, FORM, K, NGR, VSOIL(K, I), VFMAX, VG)
              IF(NVE+C .EQ. -1) GO TO 3040
              VTT(K, I) =
+ AMIN1(VSOIL(K, I), VRID, VELV(K), VTIRE(JPSI), VOLA)
              GO TO 3050
3040      CONTINUE
          VTT(K, I) =
+ AMIN1(VSOIL(K, I), VRID, VELV(K), VOLA)
3050      CONTINUE
          VBO(K, I) = VTT(K, I)
          IF(VBO(K, I) .EQ. 0.) GO TO 3059
          IF(NVE+C .EQ. 1) GO TO 3056
C
C          TRACKED VEHICLE ROUTINE FOR MANEUVERING
C          BETWEEN OBSTACLES
C
          IF(PAV(I) .LE. 3.) GO TO 3059
          IF(PAV(I) .GE. 7.) GO TO 3051
          SMG = ((392.93 - VTT(K, I)) / 4.) * PAV(I)
+ (7. * VTT(K, I) - 3. * 392.93) / 4.
          VBO(K, I) = AMIN1(SMG, VTT(K, I))
          GO TO 3059
3051      IF(PAV(I) .GT. 52.5) GO TO 3052
          SMG = 453.15 - 8.603 * PAV(I)
          VBO(K, I) = AMIN1(SMG, VTT(K, I))
          GO TO 3059
3052      VBO(K, I) = 0.
          GO TO 3059
C
C          WHEELED VEHICLE ROUTINE FOR MANEUVERING
C          BETWEEN OBSTACLES
C
3056      IF(PAV(I) .LE. 3.) GO TO 3059
          IF(PAV(I) .GE. 7.) GO TO 3057
          SMG = ((450.33 - VTT(K, I)) / 4.) * PAV(I)
+ (7. * VTT(K, I) - 3. * 450.33) / 4.
          VBO(K, I) = AMIN1(SMG, VTT(K, I))
          GO TO 3059
3057      IF(PAV(I) .GT. 41.3) GO TO 3058
          SMG = 542.11 - 13.112 * PAV(I)
          VBO(K, I) = AMIN1(SMG, VTT(K, I))
          GO TO 3059
3058      VBO(K, I) = 0.
  
```



```

3059      VA (K, I) = VBO(K, I)
          VXT(K, I) = VBO(K, I)
3060      CONTINUE
          DO 3070 I = MAXI1, NI1
              VA (K, I) = 0.
              VXT(K, I) = 0.
              VBO(K, I) = 0.
3070      CONTINUE
3080      CONTINUE
          GO TO 3150
C      B. SINGLE OBSTACLE ROUTINE
3090      CONTINUE
          DO 3140 K = 1, NTRAV
              FORRQ = TRESIS(K, 1) + FOM
              DO 3130 I = 1, MAXI
                  VA(K, I) = AMINI(VBC(K, I), VOLA)
                  CALL FCRVEL
+ (F, FA, FB, FC, FORMX, K, NGR, VA(K, I), VFMAX, VG)
                  FORDEF = FORRQ - F
                  IF (FCRDEF .GT. 0.) GO TO 3100
                  VXT(K, I) = VA(K, I)
                  GO TO 3130
3100      CONTINUE
              VBSC = VA(K, I)**2 - FORDEF * (WA * TL) * 385.9 / GCW
              IF (VBSC .GT. 0.) GO TO 3120
              IF
+ ((FORMX(K) - TRESIS(K, 1) - FOMMAX) .GE. 0.) GO TO 3110
                  VXT(K, I) = 0.
                  VA (K, I) = 0.
                  GO TO 3130
3110      CONTINUE
              CALL VELFOR
+ ((TRESIS(K, 1) + FOMMAX), FA, FB, FC, FORMX, K, NGR, VXT(K, I), VFMAX, VG)
              VA(K, I) = VXT(K, I)
              GO TO 3130
3120      CONTINUE
              VXT(K, I) = SQRT(VBSC)
3130      CONTINUE
              DO 3140 I = MAXI1, NI1
                  VXT(K, I) = 0.
                  VA(K, I) = 0.
                  VBC(K, I) = 0.
3140      CONTINUE
3150      CONTINUE
          DO 3170 K = 1, NTRAV
              DO 3160 I = 1, MAXI
                  IF (VA(K, I) .GT. VBO(K, I)) VA(K, I) = VBO(K, I)
                  IF (VXT(K, I) .GT. VAK(K, I)) VXT(K, I) = VAK(K, I)
3160      CONTINUE
3170      CONTINUE
          RETURN
          END
  
```

```

SUBROUTINE IV19
+ (BFMX ,FA ,FB ,FC ,FOMMAX ,FORMX ,GCW ,LUN1
+ ,NEVERO ,NGR ,NI ,NTRAV ,QBSE ,RMX ,STRACT ,TL
+ ,TRESIS ,VA ,VBO ,VFMAX ,VG ,VOVER ,VXT ,WA )
  
```

C
C
C
C
C
C
C

```

-----
AVERAGE PATCH SPEED ACCELERATING/ DECELERATING BETWEEN
OBSTACLES AND CROSSING OBSTACLES
-----
  
```

1. VARIABLE DECLARATION

```

REAL BFMX (3)
REAL FA (20,3)
REAL FB (20,3)
REAL FC (20,3)
REAL FORMX (3)
REAL RMX (20)
REAL STRACT (20,3,3)
REAL TRESIS (3,9)
REAL VA (3,9)
REAL VBO (3,9)
REAL VFMAX (3)
REAL VG (20,3,3)
REAL VOVER (3,9)
REAL VXT (3,9)
  
```

C

3. ALGORITHM

```

      NI1 = NI+1
      DO 3020 K = 1,NTRAV
        DO 3010 I = 1,NI1
          VOVER(K,I) = 0.
          CONTINUE
3010    CONTINUE
3020    IF(NEVERO .NE. 0) GO TO 4000
          CONTINUE
          VM = GCW/385.9
          DO 3150 K = 1,NTRAV
            DO 3140 I = 1,NI1
              DETERMINE IF OBSTACLE EXIT SPEED, IS SPEED
              + BETWEEN OBSTACLES, IF SO IT IS "VOVER"
                IF(VA(K,I) .EQ. 0. .AND. VXT(K,I) .EQ. 0.)
              + GO TO 3140
                IF(VBO(K,I) .GT. VXT(K,I)) GO TO 3040
                  VOVER(K,I) = VXT(K,I)
                  GO TO 3140
3040    CONTINUE
              DETERMINE IF THERE IS ENOUGH DISTANCE
              + BETWEEN OBSTACLES TO ACCELERATE TO OBSTACLE APPROACH SPEED.
                IF(VXT(K,I) .GE. VA(K,I)) GO TO 3070
                  CALL ACCEL
              + (FA,FB,FC,GCW,I,K,NGR,NGR,NV2FLG,RMX,STRACT,
              + TA,TRESIS,VXT(K,I),VA(K,I),V2F,VG,XA,LUN1)
                IF
  
```

```

+ ((XA .LE. (OBSE-WA-TL)) .AND. (NV2FLG .EQ. 0)) GO TO 3060
      DUMMY = TRESIS(K,I)+FOMMAX
      IF(FORMX(K) .LT. DUMMY) GO TO 3050
      CALL VELFOR
+ (DUMMY,FA,FB,FC,FORMX,K,NGR,VOVER(K,I),VFMAX,VG)
      IF(VOVER(K,I) .GE. VXT(K,I)) GO TO 3140
      VOVER(K,I) = VXT(K,I)
      GO TO 3140
3050      CONTINUE
      VOVER(K,I) = 0.
      GO TO 3140
3060      CONTINUE
3070      CONTINUE
C      ACCELERATION/DECELERATION REQUIRED; DETERMINE
C      + IF "VBO" CAN BE REACHED IN TIME TO DECELERATE TO "VA"
      CALL ACCEL
+ (FA,FB,FC,GCW,I,K,NGF,NGR,NV2FLG,RMX,STRACT,
+ TA,TRESIS,VXT(K,I),VBO(K,I),V2F,VG,XA,LUN1)
      IF(NV2FLG .EQ. 2) GO TO 3090
C VBO      CAN BE REACHED
      TB = VM*(VBO(K,I)-VA(K,I))/BFMX(K)
      XB = .5*(VBO(K,I)+VA(K,I))+TB
      IF((XA+XB) .GT. (OBSE-WA-TL)) GO TO 3080
C      ENOUGH SPACE BETWEEN OBSTACLES
      TOO = 2.*(WA+TL)/(VA(K,I)+VXT(K,I))
      TBO = (OBSE-WA+TL-XA-XB)/VBO(K,I)
      VOVER(K,I) = OBSE/(TA+TBO+TB+TOO)
      GO TO 3140
3080      CONTINUE
3090      CONTINUE
C      ACCELERATION/DECELERATION REQUIRED;
C      + DETERMINE VELOCITY WHICH CAN BE REACHED BEFORE
C      + DECELERATION IS REQUIRED AND TIME BETWEEN AND
C      + OVER OBSTACLES.
      VLOW = VA(K,I)
      VHGH = VBO(K,I)
      DO 3130 J = 1,10
      VMID = (VLOW+VHGH)/2.
      CALL ACCEL
+ (FA,FB,FC,GCW,I,K,NGF,NGR,NV2FLG,RMX,STRACT,
+ TA,TRESIS,VXT(K,I),VMID,V2F,VG,XA,LUN1)
      IF(NV2FLG .NE. 2) GO TO 3100
      VHGH = VMID
      GO TO 3130
3100      IF(NV2FLG .NE. 1) GO TO 3110
      VHGH = VLOW
      VLOW = VA(K,I)
      GO TO 3130
3110      CONTINUE
      TB = VM*(VMID-VA(K,I))/BFMX(K)
      XB = .5*(VMID+VA(K,I))+TB
      IF((XA+XB) .LE. (OBSE-WA-TL)) GO TO 3120

```

```

          VHGT = VMID
          GO TO 3130
3120      CONTINUE
          VLOW = VMID
3130      CONTINUE
          IF((XA+XB) .LE. (OBSE-WA-TL)) GO TO 3145
          VBO(K,I) = VBC(K,I)-17.6
          GO TO 3070
3145      TBO = (OBSE-WA-TL-XA-XB)/VMID
          TOO = 2.*(WA+TL)/(VA(K,I)+VXT(K,I))
          VOVER(K,I) = OBSE/(TA+TBO+TB+TOO)
3140      CONTINUE
3150      CONTINUE
4000      CONTINUE
          RETURN
          END
  
```

SUBROUTINE IV20

+ (FA ,FB ,FC ,FORMX ,GCM ,MAXI ,NGR ,NOGCVA
 + ,NOGOVO ,NTRAV ,STR ,VAVOID ,VG ,VOVER)

C
 C
 C
 C
 C
 C

 KINEMATIC VEGETATION OVERRIDE CHECK

1. VARIABLE DECLARATION

```

REAL      FA      (20,3)
REAL      FB      (20,3)
REAL      FC      (20,3)
REAL      FORMX   (3)
INTEGER   NOGCVA  (3,9)
INTEGER   NOGOVO  (3,9)
REAL      STR      (3,9)
REAL      VAVOID  (3,9)
REAL      VG      (20,3,3)
REAL      VOVER   (3,9)
  
```

3. ALGORITHM

```

DO 3050 K = 1,NTRAV
  DO 3040 I = 1,MAXI
    CALL FORVEL (E,FA,FB,FC,FORMX,K,NGR,VOVER(K,I),VFMAX,VG)
    DUMMY = F+1.5*GCM*VOVER(K,I)**2./385.9
    IF(DUMMY .GT. STR(K,I)) GO TO 3010
    NOGOVO(K,I) = 0
    GO TO 3020
3010      CONTINUE
    NOGOVO(K,I) = 1
3020      CONTINUE
    CALL FORVEL (E,FA,FB,FC,FORMX,K,NGR,VAVOID(K,I),VFMAX,VG)
    DUMMY = F+1.5*GCM*VAVOID(K,I)**2./385.9
    IF(DUMMY .GT. STR(K,I)) GO TO 3030
    NOGCVA(K,I) = 0
    GO TO 3050
3030      CONTINUE
  
```

```

                                NOGOVA(K,I) = 1
3042      CONTINUE
3050      CONTINUE
          RETURN
          END
SUBROUTINE IV21
+ (DOWN ,FMT ,GCW ,IMAX ,IOVER ,ISAFE ,LEVEL ,NI
+ ,NOGOVA ,NOGOVC ,NTRAV ,UP ,VAVOID ,VMAX ,VMAX1 ,VMAX2
+ ,VOVER ,VSEL ,VSEL1 ,VSEL2 ,VWALK )

```

C
 C
 C
 C
 C
 C
 C

 MAXIMUM AVERAGE SPEED ALGORITHM

1. VARIABLE DECLARATION

```

REAL      A
REAL      B
INTEGER   DOWN
REAL      FMT      (9)
INTEGER   I
INTEGER   IOVER
INTEGER   IMAX     (3)
INTEGER   ISAFE    (3)
INTEGER   K
INTEGER   KIV21
INTEGER   LEVEL
INTEGER   LUN1
INTEGER   NI
INTEGER   NI1
INTEGER   NOGOVA   (3,9)
INTEGER   NOGOVC   (3,9)
INTEGER   NTRAV
INTEGER   UP
REAL      VAVOID   (3,9)
REAL      VMAX
REAL      VMAX1    (3)
REAL      VMAX2    (3,9)
REAL      VOVER    (3,9)
REAL      VSEL
REAL      VSEL1    (3)
REAL      VSEL2    (3,9)
REAL      VWALK

```

C
 C
 C

3. ALGORITHM

```

NI1=NI+1
DO 3020 K=1,NTRAV
  CO 3010 I=1,NI1
    A = VOVER (K,I)*FLOAT(NOGOVC(K,I))
    B = VAVOID(K,I)*FLOAT(NOGOVA(K,I))
    VMAX2(K,I) = AMAX1(A,B)

```

```

3010      CONTINUE
3020      CONTINUE
          DO 3070 K=1,NTRAV
            DO 3060 I=1,NI1
              IF(VMAX2(K,I) .GT. VWALK) GO TO 3030
              VSEL2(K,I) = VMAX2(K,I)
              GO TO 3050
3030      CCNTINUE
          IF((FMT(I)/GCN) .GT. 1..OR.I.GE.IOVER) GO TO 3040
          VSEL2(K,I) = VMAX2(K,I)
          GO TO 3050
3040      CCNTINUE
          VSEL2(K,I) = 0.0
3050      CONTINUE
3060      CONTINUE
3070      CONTINUE
          DO 3100 K=1,NTRAV
            VMAX1(K) = VMAX2(K,1)
            IMAX(K) = 1
            DO 3090 I=2,NI1
              IF(VMAX1(K) .GE. VMAX2(K,I)) GO TO 3080
              VMAX1(K) = VMAX2(K,I)
              IMAX(K) = I
3080      CONTINUE
3090      CONTINUE
3100      CONTINUE
          DO 3130 K=1,NTRAV
            VSEL1(K) = VSEL2(K,1)
            ISAFE(K) = 1
            DO 3120 I=2,NI1
              IF(VSEL1(K) .GE. VSEL2(K,I)) GO TO 3110
              VSEL1(K) = VSEL2(K,I)
              ISAFE(K) = I
3110      CONTINUE
3120      CONTINUE
3130      CONTINUE
          C
          IF(NTRAV .EQ. 1) GO TO 3150
          IF(VMAX1(UP) .EQ. 0.0) GO TO 3140
          IF(VMAX1(LEVEL) .EQ. 0.0) GO TO 3140
          IF(VMAX1(DOWN) .EQ. 0.0) GO TO 3140
          VMAX =
          + 3.0/((1./VMAX1(UP))+(1./VMAX1(LEVEL))+(1./VMAX1(DOWN)))
          GO TO 3160
3140      CONTINUE
          VMAX = 0.0
          GO TO 3160
3150      CONTINUE
          VMAX = VMAX1(UP)
3160      CONTINUE
          IF(NTRAV .EQ. 1) GO TO 3180
          IF(VSEL1(UP) .EQ. 0.0) GO TO 3170

```

```

      IF(VSEL1(LEVEL) .EQ. 0.0) GO TO 3170
      IF(VSEL1(DOWN) .EQ. 0.0) GO TO 3170
      VSEL =
+ 3.0/((1./VSEL1(UP))+(1./VSEL1(LEVEL))+(1./VSEL1(DOWN)))
      GO TO 3190
3170  CONTINUE
      VSEL = 0.0
      GO TO 3190
3180  CONTINUE
      VSEL = VSEL1(UP)
3190  CONTINUE
      RETURN
      END
  
```

```

C -----
C ROADWAY MODULE - AMC 74
C -----
C
  
```

SUBROUTINE ROAD

```

C
      INTEGER          MD
      COMMON /INDEX/   MD
      INTEGER          CNWN
      COMMON /INDEX/   CNWN
      INTEGER          CWN
      COMMON /INDEX/   CWN
      INTEGER          EFF
      COMMON /INDEX/   EFF
      INTEGER          FORCE
      COMMON /INDEX/   FORCE
      INTEGER          GR
      COMMON /INDEX/   GR
      COMMON /INDEX/   CR
      COMMON /INDEX/   LEVEL
      INTEGER          MN
      COMMON /INDEX/   MN
      INTEGER          RM
      COMMON /INDEX/   RM
      INTEGER          SPEED
      COMMON /INDEX/   SPEED
      INTEGER          SR
      COMMON /INDEX/   SR
      INTEGER          TR
      COMMON /INDEX/   TR
      INTEGER          TORQUE
      COMMON /INDEX/   TORQUE
      INTEGER          UR
      COMMON /INDEX/   UR
      INTEGER          LX
      COMMON /INDEX/   LX
      COMMON /VEHICL/  ACD
      COMMON /VEHICL/  ASHOE   (20)
      COMMON /VEHICL/  AVGC
      COMMON /VEHICL/  AXLSP   (20)
      COMMON /VEHICL/  CD
  
```

COMMON /VEHICL/	CGH	
COMMON /VEHICL/	CGLAT	
COMMON /VEHICL/	CGR	
COMMON /VEHICL/	CTD	
COMMON /VEHICL/	CK	
COMMON /VEHICL/	CARMIN	(20)
COMMON /VEHICL/	CGNV1	(2,25)
COMMON /VEHICL/	CGNV2	(2,25)
COMMON /VEHICL/	DELCT	(20,3)
COMMON /VEHICL/	DIAW	(20)
COMMON /VEHICL/	CRAFT	
COMMON /VEHICL/	ENGINE	(2,50)
COMMON /VEHICL/	EXENGT	
COMMON /VEHICL/	FD	(2)
COMMON /VEHICL/	FGRDD	
COMMON /VEHICL/	GROUSH	(20)
COMMON /VEHICL/	HVALS	(25)
COMMON /VEHICL/	IAPG	
COMMON /VEHICL/	IB	(20)
COMMON /VEHICL/	ID	(20)
REAL	IGIESL	
COMMON /VEHICL/	IGIESL	
COMMON /VEHICL/	IENGIN	
COMMON /VEHICL/	IR	(20)
COMMON /VEHICL/	ICGNST	(20)
COMMON /VEHICL/	ICGNV1	
COMMON /VEHICL/	ICGNV2	
COMMON /VEHICL/	ICOWER	
COMMON /VEHICL/	IT	(20)
COMMON /VEHICL/	ITCASE	
COMMON /VEHICL/	ITRAN	
COMMON /VEHICL/	ITVAR	
COMMON /VEHICL/	LECKUP	
COMMON /VEHICL/	MAXIPR	
COMMON /VEHICL/	MAXL	
COMMON /VEHICL/	NMBLY	
COMMON /VEHICL/	NBOGIE	(20)
COMMON /VEHICL/	ACHAIN	(20)
REAL	NOYL	
COMMON /VEHICL/	NOYL	
REAL	NONG	
COMMON /VEHICL/	NONG	
COMMON /VEHICL/	FNNET	
COMMON /VEHICL/	NFL	(20)
COMMON /VEHICL/	NBR	
COMMON /VEHICL/	NHVALS	
COMMON /VEHICL/	NEAD	(20)
COMMON /VEHICL/	NSVALS	
COMMON /VEHICL/	NVEH	(20)
COMMON /VEHICL/	NMHL	(20)
COMMON /VEHICL/	NWR	
COMMON /VEHICL/	PBF	

COMMON /VEHICL/	FBHT	
COMMON /VEHICL/	FFA	
COMMON /VEHICL/	FEWER	(2,201)
COMMON /VEHICL/	GNAX	
COMMON /VEHICL/	FDIAM	(20)
COMMON /VEHICL/	REVM	(20)
COMMON /VEHICL/	REMW	(20)
COMMON /VEHICL/	RMS	(20)
COMMON /VEHICL/	RW	(20)
COMMON /VEHICL/	SAE	
COMMON /VEHICL/	SAI	
COMMON /VEHICL/	SECTH	(20)
COMMON /VEHICL/	SECTW	(20)
COMMON /VEHICL/	SMALS	(25)
COMMON /VEHICL/	TGASE	(2)
COMMON /VEHICL/	TK	
COMMON /VEHICL/	TRLY	(20)
COMMON /VEHICL/	TOSI	(20,3)
COMMON /VEHICL/	TQINC	
COMMON /VEHICL/	TRAKLN	(20)
COMMON /VEHICL/	TRAKWD	(20)
COMMON /VEHICL/	TRANS	(2,20)
COMMON /VEHICL/	VAA	
COMMON /VEHICL/	VBA	
COMMON /VEHICL/	VBS	
COMMON /VEHICL/	VGBB	(25)
COMMON /VEHICL/	VBOBS	(25)
COMMON /VEHICL/	VRIDE	(20,3)
COMMON /VEHICL/	VSS	
COMMON /VEHICL/	WSSAXP	
COMMON /VEHICL/	WG	
COMMON /VEHICL/	WDAXP	
COMMON /VEHICL/	WBPTF	(20)
COMMON /VEHICL/	WBTH	
COMMON /VEHICL/	WGHT	(20)
COMMON /VEHICL/	WRAT	(20)
COMMON /VEHICL/	WRFRD	
COMMON /VEHICL/	WT	(20)
COMMON /VEHICL/	WTE	(20)
COMMON /VEHICL/	WMAXP	
COMMON /VEHICL/	XBRGOF	
COMMON /VEHICL/	WJ	
COMMON /VEHICL/	LOCDIF	
COMMON /VEHICL/	SHP	
COMMON /PREP/	A	(3,4)
COMMON /PREP/	ATF	(20)
COMMON /PREP/	BTF	(20)
COMMON /PREP/	CHARLN	(20,3)
COMMON /PREP/	CRFCFG	(3)
COMMON /PREP/	CRFCCG	(3)
COMMON /PREP/	CRFCG	(20,3)
COMMON /PREP/	CRFFG	(20,3)

COMMON /PREP/	CCF	(20)
COMMON /PREP/	CRAT	(20,3)
COMMON /PREP/	CCA	(20,3)
COMMON /PREP/	CCW	
COMMON /PREP/	CCWB	
COMMON /PREP/	CCWNB	
COMMON /PREP/	CCWNP	
COMMON /PREP/	CCWP	
COMMON /PREP/	FRT	
COMMON /PREP/	NBF	(38)
COMMON /PREP/	AVEHC	
COMMON /PREP/	FNTE	
COMMON /PREP/	F	(3)
COMMON /PREP/	FNX	(20)
COMMON /PREP/	FR	
COMMON /PREP/	TRACTF	(20,5)
COMMON /PREP/	TRIAPSI	(3)
COMMON /PREP/	VGICG	(20,3)
COMMON /PREP/	VGIFG	(20,3)
COMMON /PREP/	VGIMUK	(20)
COMMON /PREP/	VGW	(20,5)
COMMON /PREP/	VT	(20,3)
COMMON /PREP/	VTIRE	(3)
COMMON /PREP/	WEMAX	
COMMON /PREP/	X	(3)
COMMON /PREP/	XBR	
COMMON /DERIVE/	ABT	(9)
COMMON /DERIVE/	NEGOBF	
COMMON /DERIVE/	CAREA	
COMMON /DERIVE/	CCWB	
COMMON /DERIVE/	CCWP	
COMMON /DERIVE/	CCWPB	(20)
COMMON /DERIVE/	FA	(20,3)
COMMON /DERIVE/	FAT	(9)
COMMON /DERIVE/	FAT1	(9)
COMMON /DERIVE/	FB	(20,3)
COMMON /DERIVE/	FC	(20,3)
COMMON /DERIVE/	FNT	(9)
COMMON /DERIVE/	FQM	
COMMON /DERIVE/	FQMMAX	
COMMON /DERIVE/	FQRMX	(3)
COMMON /DERIVE/	ISLOCAT	
COMMON /DERIVE/	IMAX	(3)
COMMON /DERIVE/	ISAFE	(3)
COMMON /DERIVE/	J	
COMMON /DERIVE/	MAXI	
COMMON /DERIVE/	BEMX	(3)
COMMON /DERIVE/	NEVERG	
COMMON /DERIVE/	CASE	
COMMON /DERIVE/	FAV	(9)
COMMON /DERIVE/	RJGWB	
COMMON /DERIVE/	RTGWB	

COMMON /DERIVE/	RTOWNP	
COMMON /DERIVE/	RTOMP	
COMMON /DERIVE/	RTOMP8	(20)
COMMON /DERIVE/	RTOWT	(20)
COMMON /DERIVE/	STRACT	(20,3,3)
COMMON /DERIVE/	SAFO	(9)
COMMON /DERIVE/	SRFY	(9)
COMMON /DERIVE/	STR	(3,9)
COMMON /DERIVE/	TBF	(3)
COMMON /DERIVE/	TDEN	(9)
COMMON /DERIVE/	TRES IS	(3,9)
COMMON /DERIVE/	VA	(3,9)
COMMON /DERIVE/	NGBOVA	(3,9)
COMMON /DERIVE/	VAVGID	(3,9)
COMMON /DERIVE/	VBO	(3,9)
COMMON /DERIVE/	IMPACT	(9)
COMMON /DERIVE/	VBLV	(3)
COMMON /DERIVE/	VBNAX	(3)
COMMON /DERIVE/	VG	(20,3,3)
COMMON /DERIVE/	ANGGVD	(3,9)
COMMON /DERIVE/	VNAX	
COMMON /DERIVE/	VMAX1	(3)
COMMON /DERIVE/	VMAX2	(3,9)
COMMON /DERIVE/	VOLA	
COMMON /DERIVE/	VOVER	(3,9)
COMMON /DERIVE/	VRID	
COMMON /DERIVE/	VSEL	
COMMON /DERIVE/	VSEL1	(3)
COMMON /DERIVE/	VSEL2	(3,9)
COMMON /DERIVE/	VSGIL	(3,9)
COMMON /DERIVE/	VST	(3,9)
COMMON /DERIVE/	VXT	(3,9)
COMMON /DERIVE/	ANGGND	
COMMON /DERIVE/	WRATIO	
COMMON /TERRAN/	AA	
COMMON /TERRAN/	ACTRMS	
COMMON /TERRAN/	AREA	
COMMON /TERRAN/	AREA0	
COMMON /TERRAN/	CI	
COMMON /TERRAN/	CIST	
COMMON /TERRAN/	EANG	
COMMON /TERRAN/	ECF	
COMMON /TERRAN/	ELEV	
COMMON /TERRAN/	FNU	(3)
COMMON /TERRAN/	GRADE	
COMMON /TERRAN/	IQBS	
COMMON /TERRAN/	IQST	
COMMON /TERRAN/	IRGAD	
COMMON /TERRAN/	IS	(9)
COMMON /TERRAN/	IST	
COMMON /TERRAN/	ITUT	
COMMON /TERRAN/	NJ	

COMMON /TERRAN/	NJU	
COMMON /TERRAN/	CAN	
COMMON /TERRAN/	CBAA	
COMMON /TERRAN/	CBH	
COMMON /TERRAN/	CBL	
COMMON /TERRAN/	CBG	
COMMON /TERRAN/	CBW	
COMMON /TERRAN/	CBMINW	
COMMON /TERRAN/	CBIA	
COMMON /TERRAN/	NYASHO	
COMMON /TERRAN/	FADC	
COMMON /TERRAN/	ROI	
COMMON /TERRAN/	ROIIC	(4)
COMMON /TERRAN/	RCURV	(11)
COMMON /TERRAN/	RB	
COMMON /TERRAN/	RDA	(12)
COMMON /TERRAN/	S	(9)
COMMON /TERRAN/	SB	(9)
COMMON /TERRAN/	SDL	(9)
COMMON /TERRAN/	SURFF	
COMMON /TERRAN/	TANPHI	
COMMON /TERRAN/	THETA	(3)
COMMON /TERRAN/	VEURV	(4, 11)
COMMON /TERRAN/	WB	
COMMON /TERRAN/	WD	
COMMON /SCEN/	CBHES	
COMMON /SCEN/	VMALK	
COMMON /SCEN/	COLMAX	
COMMON /SCEN/	GAMMA	
COMMON /SCEN/	IGVER	
COMMON /SCEN/	ISEASN	
COMMON /SCEN/	ISURF	
COMMON /SCEN/	ISNOW	
COMMON /SCEN/	KI1	
COMMON /SCEN/	KI12	
COMMON /SCEN/	KI13	
COMMON /SCEN/	KI14	
COMMON /SCEN/	KI15	
COMMON /SCEN/	KI16	
COMMON /SCEN/	KI17	
COMMON /SCEN/	KI18	
COMMON /SCEN/	KI19	
COMMON /SCEN/	KI110	
COMMON /SCEN/	KI111	
COMMON /SCEN/	KI112	
COMMON /SCEN/	KI113	
COMMON /SCEN/	KI114	
COMMON /SCEN/	KI115	
COMMON /SCEN/	KI116	
COMMON /SCEN/	KI117	
COMMON /SCEN/	KNAP	
COMMON /SCEN/	KSCEN	

COMMON /SCEN/	KTPP
COMMON /SCEN/	KVEH
COMMON /SCEN/	KIV1
COMMON /SCEN/	KIV2
COMMON /SCEN/	KIV3
COMMON /SCEN/	KIV4
COMMON /SCEN/	KIV5
COMMON /SCEN/	KIV6
COMMON /SCEN/	KIV7
COMMON /SCEN/	KIV8
COMMON /SCEN/	KIV9
COMMON /SCEN/	KIV10
COMMON /SCEN/	KIV11
COMMON /SCEN/	KIV12
COMMON /SCEN/	KIV13
COMMON /SCEN/	KIV14
COMMON /SCEN/	KIV15
COMMON /SCEN/	KIV16
COMMON /SCEN/	KIV17
COMMON /SCEN/	KIV18
COMMON /SCEN/	KIV19
COMMON /SCEN/	KIV20
COMMON /SCEN/	KIV21
COMMON /SCEN/	LAC
INTEGER	CETAIL
COMMON /SCEN/	CETAIL
COMMON /SCEN/	MAP
COMMON /SCEN/	MAPG
COMMON /SCEN/	MONTH
COMMON /SCEN/	NEPP
COMMON /SCEN/	NSLIP
COMMON /SCEN/	NTRAV
COMMON /SCEN/	NBUX
COMMON /SCEN/	FHI
COMMON /SCEN/	REACT
COMMON /SCEN/	RFCCG
INTEGER	SEARCH
COMMON /SCEN/	SEARCH
COMMON /SCEN/	SETYPC
COMMON /SCEN/	VBRAKE
COMMON /SCEN/	WISMNV
COMMON /SCEN/	VWIN
COMMON /SCEN/	ZSNOW

C 1. VARIABLE DECLARATIONS

REAL	FATEMP (20,3)
REAL	FBTEMP (20,3)
REAL	FCTEMP (20,3)
REAL	FTEMP (20,5)
REAL	FTEMPC (20,5)
REAL	FGRADE (3)
REAL	FQUAD (5)
REAL	K1

```

REAL    MERITK
REAL    VGTEMP (20,3,3)
REAL    VPOWER (3)
REAL    VTEMP (20,5)
REAL    VTEMPO (20,5)
REAL    VROAD (3)
REAL    VQUAD (5)
  
```

C
C
C
C
C
C
C
C
C
C

2. ALGORITHMS

```

-----
ROUTINE 1 - SPEED LIMITED BY AERODYNAMIC, ROLLING, CORNERING
AND GRABB RESISTANCE
-----
  
```

SECTION 1A - INITIALIZATION

```

FCC      = 0.
FCTRAK   = 0.
FR       = 0.
FTC      = 0.
IGAP     = 0.
WTSPA    = 0.
WRATIO   = 1
  
```

C
C
C
C

1A.1 - SUPERELEVATION EFFECT FACTOR

```

FE = 1. - 7.495*(RADC/12.)*EANG
  
```

```

DO 6005 NG=1,NGR
  DO 6000 L=1,5
    VTEMP(NG,L) = VGV(NG,L)
    FTEMP(NG,L) = TRACTF(NG,L)
  
```

6000
6005

```

CONTINUE
CONTINUE
IF(NCPP .NE. 0) JPSI = NCPP
IF(NCPP .EQ. 0) JPSI = 3
  
```

C
C
C
C
C

SECTION 1B - VELOCITY DEPENDENT RESISTANCES

1B.1 - SOFT SURFACES (TRAILS)

```

IF(ITUT .NE. 14) GO TO 6102
CALL IV3(
+ CHARLN ,CI ,COMES ,CPFFG ,DIAM ,DOWPB ,DRAT ,GAMMA
+ ,GCA ,IB ,IC ,IP ,IST ,JPSI ,LUN1 ,NAMBL
+ ,NPAD ,NSLIP ,NVEH ,NWHL ,RCI ,RTOWPB ,RTOWT ,SECTW
+ ,TANPHI ,TRAKLN ,TRAKWD ,VCIFG ,VCIMUK ,WGHT ,WRATIO ,ZSNOW)
CALL IV4(
+ DOWB ,DOWP ,CCWPB ,GCW ,GCWB ,GCWP ,IB ,IR
+ ,NAMBL ,RTOWB ,RTGWB ,RTOWNP ,RTOWP ,RTOWPB ,RTOWT ,WGHT )
CALL IV5(
  
```

```

+   ATF   ,AVGC   ,BTE   ,CD     ,CPFCCG ,CPFCFG ,CTF   ,DAREA
+   ,DOWP  ,EANG   ,ECE   ,FA     ,FB     ,FC     ,FORMX ,GCWP
+   ,IFLOAT ,IST    ,ITUT  ,JPSI  ,LOCDIF ,NAMBL  ,NFL   ,NGR
+   ,NTRAV ,NVEH   ,NVEHC ,NWHL  ,RADC   ,RTOWP ,STRACT ,TEOR
+   ,THETA ,TRACTF ,VFMAX ,VG     ,VGV   ,WGHT  ,WRATIO ,LUNI )
    GO TO 6161
  
```

C
 C 18.2 HARD SURFACE (PRIMARY AND SECONDARY ROADS)
 C

```

6102 DO 6155 K=1,NTRAV,2
      NG1 = 1
      COSX = COS(THETA(K))
      DO 6154 NG=1,NGR
        FA(NG,K) = A.
        FB(NG,K) = B.
        FC(NG,K) = B.
        FATEMP(NG,K) = ATF(NG)
        FBTEMP(NG,K) = BTF(NG)
        FCTEMP(NG,K) = CTF(NG)
  
```

C
 C 18.2.1 - TRACTIVE EFFORT MODIFIED FOR SURFACE TRACTION
 C AND SPEED DEPENDENT RESISTANCES
 C

```

      IF(TRACTF(NG,1)*ECF .LT. FMU(ISURF)*GCWP*COSX)
+     GO TO 6130
      IF(TRACTF(NG,5)*ECF .LT. FMU(ISURF)*GCWP*COSX)
+     GO TO 6210
  
```

C
 C MINIMUM GEAR LIMITED BY SURFACE TRACTION
 C

```

      NG1 = NG1 + 1
      FC(NG,K) = 0.
      FB(NG,K) = 0.
      FA(NG,K) = FMU(ISURF)*GCWP*COSX
      DO 6105 L1=1,3
        VG(NG,L1,K) = 0.
        STRACT(NG,L1,K) = FA(NG,K)
6105 CONTINUE
      GO TO 6254
  
```

C
 C SURFACE TRACTION LIMIT SOMEWHERE WITHIN GEAR
 C

```

6110 IF(VTEMP(NG,1) .EQ. VTEMP(NG,5)) GO TO 6120
      FX = FMU(ISURF)*GCWP*COSX
      FORX(K) = FX
      L = 1
      DO 6111 L1=1,5,2
        VTEMP(NG,L,K) = VGV(NG,L1)
        L = L + 1
6111 CONTINUE
      CALL VELFOR(
+     FX , FATEMP , FBTEMP , FCTEMP , FORMX
  
```

```

      ,K      ,NGR      ,VX      ,VFMAX      ,VGTEMP )
C
C      RESET MINIMUM SPEED IN GEAR TO THE POINT THAT OCCURS
C      AT THE SURFACE TRACTION LIMIT
C
      VTEMP(NG,1) = VX
      FTEMP(NG,1) = FX/ECF
      XINT = (VTEMP(NG,5) - VTEMP(NG,1))/4.
      DO 6115 L=2,4
        VTEMP(NG,L) = VTEMP(NG,L-1) + XINT
        FTEMP(NG,L) = CTF(NG)*VTEMP(NG,L)**2 +
          BTR(NG)*VTEMP(NG,L) +
          ATF(NG)
      +
      +
6115      CONTINUE
          GO TO 6130
C
C      SPEEDS EQUAL, INCREMENT ON FORCE
C
6120      FTEMP(NG,1) = FMU(ISURF)*GCWP*CO SX
          YINT = (FTEMP(NG,1) - FTEMP(NG,5))/4.
          DO 6125 L=2,4
            FTEMP(NG,L) = FTEMP(NG,L-1) - YINT
          CONTINUE
6125
C
C      1B.2.2 - COMPUTE VELOCITY DEPENDENT RESISTANCES
C
6130      DO 6148 L=1,5
C
C      1B.2.2.1 - AERODYNAMIC DRAG
C
          FCC = 0.
          FAD = .0026*ACD*PFA*VTEMP(NG,L)*VTEMP(NG,L)/
            144./17.6/17.6
      +
C
          DO 6135 I=1,NAMBL
            IF(NVEH(I) .LT. 1) GO TO 6135
C
C      1B.2.2.2 - TURNING RESISTANCE (WHEELED)
C
          F1 = ((WGHT(I)*COSX*VTEMP(NG,L)**2)/
            (111.1*RADC))* (12./17.6/17.6)
          FCC = (FE*F1*F1)/(FLOAT(NWHL(I))*AVGC) +
            FCC
      +
      +
6135      CONTINUE
          FV = FAD + FCC
          FTEMP(NG,L) = FTEMP(NG,L) - FV
          VTEMP(NG,L) = VTEMP(NG,L)
6140      CONTINUE
          IF(VGV(NG,1) .NE. VGV(NG,5)) GO TO 6141
          IGAF = 1
          GO TO 6152
6141      IF((NG .NE. 1) .OR.

```



```

+          (FTEMP(NG,1) .NE. FTEMP(NG,5))) GO TO 6145
          FA(NG,K) = FTEMP(NG,1)
          FB(NG,K) = 0.
          FC(NG,K) = 0.
          GO TO 6152
6145      DO 6150 L=1,5
          FQUAD(L) = FTEMP(NG,L)
          VQUAD(L) = VTEMP(NG,L)
6150      CONTINUE
          CALL QUAD5(VQUAD,FQUAD,A0,B1,C2)
          FA(NG,K) = A0
          FB(NG,K) = B1
          FC(NG,K) = C2
6152      L = 1
          DO 6153 L1=1,5,2
          VG(NG,L,K) = VTEMP(NG,L1)
          STRACT(NG,L,K) = FC(NG,K)*VG(NG,L,K)**2 +
          FB(NG,K)*VG(NG,L,K) + FA(NG,K)
          L=L+1
6153      CONTINUE
6154      CONTINUE
          VFMAX(K) = VG(NG1,1,K)
          FORMX(K) = STRACT(NG1,1,K)
6155      CONTINUE
C
C      1C - NON-VELOCITY DEPENDENT RESISTANCES
C
C      1C.1 - DRAG FORCE FOR TANDEM ALIGNING (WHEELED)
C
          NSPACE = NAMBLV - 1
          DC 6160 I=1,NSPACE
          IF((NVEH(I) .LT. 1) GO TO 6160
          IF(IT(I) .NE. 1) GO TO 6160
          WTSPA = WTSPA + (WGHT(I) + WGHT(I+1))*AXLSP(I)
6160      CONTINUE
          FTC = FE*(0.5*FML*ISURF)*WTSPA/RADC)
C
C      1C.2 - TURNING RESISTANCE (TRACKED)
C
6161      DC 6165 I=1,NAMBLV
          IF((NVEH(I) .GT. 0) .OR. (RADC/12. .GT. 305.)) GO TO 6165
          ALPHA = WT(I)/TRAKLN(I)
          MERITK = 1.2624 - 0.6999*ALPHA +
          0.051848*ALPHA*ALPHA +
          0.054848*ALPHA*ALPHA*ALPHA
          XK1 = 1.18 - 0.0090895*RADC/12. +
          0.0003779*(RADC/12.1)**2 -
          (6.170476E-08)*(RADC/12.1)**3
          K1 = MERITK*XK1
          IF(ITUT .NE. 14) GO TO 6164
C
C      1C.2.1 - TURNING RESISTANCE SOFT SURFACE (TRACKED)

```

```

C
      FCTRAK = K1*(TFOR/GCW)*WGHT(I) + FCC
      GO TO 6185
C
C      1C.2.2 - TURNING RESISTANCE HARD SURFACE (TRACKED)
C
C      FCTRAK = K1*FMU(I,SURF)*WGHT(I) + FCC
6164      CONTINUE
6165
C
C      1C.3 - ROLLING RESISTANCE
C
C      IF(ITUT .NE. 14) GO TO 6170
C
C      1C.3.1 - SOFT SURFACE (TRAILS)
C
C      FR = (RTOWP*GCWP + RTOWNP*GCWNP)*COS(THETA)*SURFF
      GO TO 6185
C
C      1C.3.2.1 - HARD SURFACE (WHEELED)
C
C      DO 6178 I=1,NAMBLN
6170      IF(NVEH(I) .LT. 1) GO TO 6175
      F0 = .007 + .0939/TPSI(I),JPSI)
      FR = F0*WGHT(I)*SURFF + FR
      GO TO 6178
C
C      1C.3.2.2 - HARD SURFACE (TRACKED)
C
C      FR = .045*WGHT(I)*SURFF + FR
6175      CONTINUE
6178
C
C      1C.4 - GRADE RESISTANCE
C
C      DO 6190 K=1,NTRAV,2
6185      FGRADE(K) = GCW*SIN(THETA(K))
6190      CONTINUE
C
C      1C.5 - TOTAL NON-VELOCITY DEPENDENT RESISTANCES
C
C      DO 6199 K=1,NTRAV,2
      RESIST = FGRADE(K) + FR + FTC + FCTRAK
C
C      D - SPEED LIMITED BY TOTAL RESISTANCES
C
C      IF(IGAP .NE. 1) GO TO 6198
      DO 6197 NG=1,NGR
      IF(VGV(NG,1) .NE. VGV(NG,5)) GO TO 6197
      IF((FTEMPO(NG,1) .LT. RESIST) .OR.
      (FTEMPO(NG,5) .GT. RESIST)) GO TO 6197
      VPOWER(K) = VTEMPO(NG,1)
      GO TO 6199
6197      CONTINUE
  
```

```

6198      CALL VELFCR(
+         RESIST ,FA      ,FB      ,FC      ,FORMX
+         ,K      ,NGR    ,VEL     ,VFMAX  ,VG   )
          VPOWER(K) = VEL
6199      CONTINUE
C
C
C-----
C  ROUTINE 2 - SPEED LIMITED BY SURFACE ROUGHNESS
C-----
C
6200      CCNTINUE
          DC 6210 NR=2,MAXIWR
          IF(ACRMS .GE. RMS(NR)) GO TO 6210
          VRID = VRIDE(NR-1,LAC) + (ACRMS - RMS(NR-1)) *
+         (VRIDE(NR,LAC) - VRIDE(NR-1,LAC)) /
+         (RMS(NR) - RMS(NR-1))
          GO TO 6300
6210      CCNTINUE
          VRID = VRIDE(MAXIWR,LAC)
C
C-----
C  ROUTINE 3 - SPEED LIMITED BY SLIDING ON CURVES
C-----
C
6300      CONTINUE
          TANG = TAN(EANG)
          IF(ITUT .NE. 4) GO TO 6305
C
C  3A.1 - SLIDING ON CURVES SOFT SURFACES (TRAILS)
C
          VSLID = SQRT(385.9*RADC*(TANG + TFOR/GCWP) /
+         (1. - (TFOR/GCWP)*TANG))
          GO TO 6400
C
C  3A.2 - SLIDING ON CURVES HARD SURFACES
C         (PRIMARY AND SECONDARY ROADS)
C
6305      VSLID = SQRT(385.9*RADC*(TANG + FMU(ISURF)) /
+         (1. + FMU(ISURF)*TANG))
C
C-----
C  ROUTINE 4 - SPEED LIMITED BY TIPPING ON CURVES
C-----
C
6400      CONTINUE
          VTIP = SQRT(385.9*RADC*(WTMAX + CGH*TANG) /
+         (CGH + WTMAX*TANG))
C
C-----
C  ROUTINE 5 - TOTAL BRAKING FORCE
C-----
C

```

```

6500      CCNTINUE
          IF(ITUT .NE. 14) GO TO 6510
C
C      5A - TOTAL BRAKING SOFT SURFACES
C
          CALL IV11(
+         DCWB ,GCW ,GCWB ,GCWNB ,NOGOBF ,NTRAV ,
+         RTWB ,RTWNB ,TBF ,THETA ,WRATIO ,XBR )
          GC TO 6600
  
```

```

C
C      5B - TOTAL BRAKING HARD SURFACES
C
6510      TBF(1) = GCW*SIN(THETA(1)) +
+         AMIN1(XBR,FMU(ISURF)*GCWB*COS(THETA(1)))
          IF(NTRAV .NE. 1) GO TO 6530
          IF(TBF(1) .GE. 0.) GO TO 6520
          NOGOBF = 1
          VSEL = 0.
          RETURN
  
```

```

6520      NOGOBF = 0
          GO TO 6600
  
```

```

6530      TBF(3) = GCW*SIN(THETA(3)) +
+         AMIN1(XBR,FMU(ISURF)*GCWB*COS(THETA(3)))
          IF(TBF(3) .GE. 0.) GO TO 6540
          NOGOBF = 1
          VSEL = 0.
          RETURN
  
```

```

6540      NOGOBF = 0
  
```

```

C
C      -----
C      ROUTINE 6 - DRIVER DICTATED BRAKING LIMITS
C      -----
C
  
```

```

6600      CCNTINUE
          BFMX(1) = AMIN1(DCLMAX*GCW,TBF(1)*SFTYPC/100.)
          IF(NTRAV .EQ. 1) GO TO 6700
          BFMX(3) = AMIN1(DCLMAX*GCW,TBF(3)*SFTYPC/100.)
  
```

```

C
C      -----
C      ROUTINE 7 - SPEED LIMITED BY VISIBILITY
C      -----
C
  
```

```

6700      CONTINUE
          CALL IV13(
+         BFMX ,EYEHGT ,GCW ,NTRAV ,
+         RC ,REACT ,VELV ,VBRAKE )
  
```

```

C
C      -----
C      ROUTINE 8 - AASHO CURVATURE SPEED LIMIT
C      ADJUSTED FOR SLIPPERY SURFACES
C      -----
C
  
```

```

6800      CONTINUE
          IF(RADC/12. .LT. RCURV(NVASHO)) GO TO 6815
          IF(RADC/12. .GT. RCURV(1)) GO TO 6825
          DO 6810 NV=2,NVASHO
            IF(RADC/12. .LT. RCURV(NV)) GO TO 6810
            VAASHC = (VCURV(IROAD,NV) * (RADC/12. - RCURV(NV))) *
+              (VCURV(IROAD,NV-1) - VCURV(IROAD,NV)) /
+              (RCURV(NV-1) - RCURV(NV)) * 17.6
          GC TO 6830
  
```

```

6810      CONTINUE
          GO TO 6830
6815      VAASHO = (VCURV(IROAD,NVASHO) * (RADC/12. - RCURV(NVASHO))) *
+              (VCURV(IROAD,NVASHO) - VCURV(IROAD,NVASHO-1)) /
+              (RCURV(NVASHO) - RCURV(NVASHO-1)) * 17.6
  
```

```

          GC TO 6830
6825      VAASHO = (VCURV(IROAD,1) * (RADC/12. - RCURV(1))) *
+              (VCURV(IROAD,1) - VCURV(IROAD,2)) /
+              (RCURV(1) - RCURV(2)) * 17.6
  
```

```

6830      IF(((ITUT .NE. 14) .AND. (FMU(ISURF) .GE. .7)) .OR.
+          ((ITUT .EQ. 14) .AND. (TFOR/GCWP .GE. .7))) GO TO 6900
          IF((ITUT .NE. 14) .AND. (FMU(ISURF) .LT. .7)) GO TO 6840
  
```

C
 C 8A - SOFT SURFACES
 C

```

          VAASHC = VAASHO * SQRT((TFOR/GCWP) / 0.7)
          GO TO 6900
  
```

C
 C 8B - HARD SURFACES
 C

```

6840      VAASHC = VAASHO * SQRT(FMU(ISURF) / 0.7)
  
```

C
 C -----
 C ROUTINE 9 - MAXIMUM ROADWAY SPEED
 C -----

```

6900      CONTINUE
          VSEL = 0.
          DO 6950 K=1,NTRAV,2
            IF(NVEHC .LE. 0) VTIRE(JPSI) = 1760.
            VROAD(K) = AMIN1(VAASHO,VELV(K),VRID,VSLID,VTIP)
            VSEL1(K) = AMIN1(VLIM,VPOWER(K),VROAD(K),VTIRE(JPSI))
            IF(NTRAV .NE. 1) GO TO 6950
            VSEL = VSEL1(UP)
          RETURN
  
```

```

6950      CONTINUE
          IF((VSEL1(UP) .EQ. 0.) .OR. (VSEL1(DOWN) .EQ. 0.)) GO TO 7000
          VSEL = 2. / ((1. / VSEL1(UP)) + (1. / VSEL1(DOWN)))
  
```

```

7000      CONTINUE
          RETURN
          END
  
```

SUBROUTINE BUFF0

C
 C -----

C OUTPUT ALGORITHM
 C -----
 C
 C

1. LABELED COMMON ASSIGNMENTS

COMMON /IO/	IBOF	
COMMON /IO/	KBUFF	
COMMON /IO/	LUN1	
COMMON /IO/	LUN2	
COMMON /IO/	LUN3	
COMMON /IO/	LUN4	
COMMON /IO/	LUN5	
COMMON /IO/	LUN6	
COMMON /IO/	LUN7	
COMMON /IO/	LUN8	
COMMON /IO/	LUN9	
COMMON /IO/	LUN10	
INTEGER	MD	
COMMON /INDEX/	MD	
INTEGER	OWN	
COMMON /INDEX/	OWN	
INTEGER	EFF	
COMMON /INDEX/	EFF	
INTEGER	FORCE	
COMMON /INDEX/	FORCE	
INTEGER	GR	
COMMON /INDEX/	GR	
COMMON /INDEX/	LEVEL	
INTEGER	MN	
COMMON /INDEX/	MN	
INTEGER	RM	
COMMON /INDEX/	RM	
INTEGER	SPEED	
COMMON /INDEX/	SPEED	
INTEGER	SR	
COMMON /INDEX/	SR	
INTEGER	TR	
COMMON /INDEX/	TR	
INTEGER	TORQUE	
COMMON /INDEX/	TORQUE	
INTEGER	UR	
COMMON /INDEX/	UR	
INTEGER	UX	
COMMON /INDEX/	UX	
COMMON /DERIVE/	ADT	(9)
COMMON /DERIVE/	NGG0BF	
COMMON /DERIVE/	CAREA	
COMMON /DERIVE/	COMB	
COMMON /DERIVE/	COMP	
COMMON /DERIVE/	COMPB	(20)
COMMON /DERIVE/	FA	(20,3)
COMMON /DERIVE/	FAT	(9)
COMMON /DERIVE/	FAT1	(9)

COMMON /DERIVE/	FB	(20,3)
COMMON /DERIVE/	FC	(20,3)
COMMON /DERIVE/	FNT	(9)
COMMON /DERIVE/	FOM	
COMMON /DERIVE/	FOMMAX	
COMMON /DERIVE/	FZRMX	(3)
COMMON /DERIVE/	IGLOAT	
COMMON /DERIVE/	INAX	(3)
COMMON /DERIVE/	ISAFE	(3)
COMMON /DERIVE/	J	
COMMON /DERIVE/	MAXI	
COMMON /DERIVE/	BEMX	(3)
COMMON /DERIVE/	NEVERO	
COMMON /DERIVE/	CBSE	
COMMON /DERIVE/	PAV	(9)
COMMON /DERIVE/	RTWB	
COMMON /DERIVE/	RTOWNB	
COMMON /DERIVE/	RTOWNP	
COMMON /DERIVE/	RTOWP	
COMMON /DERIVE/	FRTOWPB	(20)
COMMON /DERIVE/	RTOWT	(20)
COMMON /DERIVE/	STRACT	(20,3,3)
COMMON /DERIVE/	SRFO	(9)
COMMON /DERIVE/	SRFV	(9)
COMMON /DERIVE/	STR	(3,9)
COMMON /DERIVE/	TBF	(3)
COMMON /DERIVE/	TDEN	(9)
COMMON /DERIVE/	TRES IS	(3,9)
COMMON /DERIVE/	VA	(3,9)
COMMON /DERIVE/	AGGOVA	(3,9)
COMMON /DERIVE/	VAVOID	(3,9)
COMMON /DERIVE/	VBG	(3,9)
COMMON /DERIVE/	IMPACT	(9)
COMMON /DERIVE/	VBLV	(3)
COMMON /DERIVE/	VEMAX	(3)
COMMON /DERIVE/	VE	(20,3,3)
COMMON /DERIVE/	AGGOVB	(3,9)
COMMON /DERIVE/	VMAX	
COMMON /DERIVE/	VMAX1	(3)
COMMON /DERIVE/	VMAX2	(3,9)
COMMON /DERIVE/	VOLA	
COMMON /DERIVE/	VOVER	(3,9)
COMMON /DERIVE/	VRID	
COMMON /DERIVE/	VSEL	
COMMON /DERIVE/	VSEL1	(3)
COMMON /DERIVE/	VSEL2	(3,9)
COMMON /DERIVE/	VSGIL	(3,9)
COMMON /DERIVE/	VWT	(3,9)
COMMON /DERIVE/	VXT	(3,9)
COMMON /DERIVE/	AGGONO	
COMMON /DERIVE/	WRATIO	
COMMON /TERRAN/	AA	

COMMON /TERRAN/	ACTRMS	
COMMON /TERRAN/	AREA	
COMMON /TERRAN/	AREAC	
COMMON /TERRAN/	CI	
COMMON /TERRAN/	DEST	
COMMON /TERRAN/	EANG	
COMMON /TERRAN/	EQF	
COMMON /TERRAN/	ELEV	
COMMON /TERRAN/	FNU	(3)
COMMON /TERRAN/	GRADE	
COMMON /TERRAN/	JOBS	
COMMON /TERRAN/	JOBT	
COMMON /TERRAN/	JROAD	
COMMON /TERRAN/	IS	(9)
COMMON /TERRAN/	IST	
COMMON /TERRAN/	ITUT	
COMMON /TERRAN/	MI	
COMMON /TERRAN/	MTU	
COMMON /TERRAN/	CAN	
COMMON /TERRAN/	CBAA	
COMMON /TERRAN/	CBH	
COMMON /TERRAN/	CBL	
COMMON /TERRAN/	CBS	
COMMON /TERRAN/	CBW	
COMMON /TERRAN/	CBMINW	
COMMON /TERRAN/	CDIA	
COMMON /TERRAN/	CMASPO	
COMMON /TERRAN/	FODC	
COMMON /TERRAN/	FGI	
COMMON /TERRAN/	FGIC	(4)
COMMON /TERRAN/	RQURV	(11)
COMMON /TERRAN/	RG	
COMMON /TERRAN/	RGA	(12)
COMMON /TERRAN/	S	(9)
COMMON /TERRAN/	SD	(9)
COMMON /TERRAN/	SDL	(9)
COMMON /TERRAN/	SURFF	
COMMON /TERRAN/	TANPHI	
COMMON /TERRAN/	THETA	(3)
COMMON /TERRAN/	VCURV	(4, 11)
COMMON /TERRAN/	WA	
COMMON /TERRAN/	WB	

C
C
C
C

 VARIABLE DECLARATIONS

REAL MPH
 ZMPH1=MPH(VMAX)
 ZMPH2=MPH(VMAX1(UP))
 ZMPH3=MPH(VMAX1(LEVEL))
 ZMPH4=MPH(VMAX1(DOWN))
 ZMPH5=MPH(VSEL)

```

ZMPH6=MPH(VSEL1(UP))
ZMPH7=MPH(VSEL1(LEVEL))
ZMPH8=MPH(VSEL1(DGWA))
IF(ITUT .GE. 1) GC TO 2030
IF(KBUFF .EQ. 1) GC TO 2020
KBUFF = 1
WRITE(LUN1,2000)
2000  FORMAT(70H1 NTU ITUT VMAX UP LEVEL DOWN VSEL UP LEVEL
+DOWN GRADE AREA,/)
C 3. DYNAMIC OUTPUT SECTION
2020  WRITE(LUN10) NTU, ITUT, ZMPH1, ZMPH2, ZMPH3, ZMPH4, ZMPH5, ZMPH6,
+ ZMPH7, ZMPH8, GRADE, AREA
+ WRITE(LUN1,3000) NTU, ITUT, ZMPH1, ZMPH2, ZMPH3, ZMPH4, ZMPH5, ZMPH6,
+ ZMPH7, ZMPH8, GRADE, AREA
GO TO 4000
2030  IF(KBUFF .EQ. 1) GC TO 2040
KBUFF = 1
WRITE(LUN1,2900)
2900  FORMAT(42H1 NTU ITUT VSEL UP DOWN GRADE DISTANCE,/)
2040  WRITE(LUN1,2950) NTU, ITUT, ZMPH5, ZMPH6, ZMPH8, GRADE, DIST
2950  FORMAT(1X, I4, 3X, I2, 5(1X, F5.2), 1X, F8.4)
3000  FORMAT(1X, I4, 4X, I1, 8(1X, F5.2), 1X, F5.2, 1X, F8.4)
C 3. TERMINUS
4000  CONTINUE
RETURN
END

```

SUBROUTINE ACCEL

```

+ ,FA ,FB ,FC ,GCW ,I
+ ,K ,NGF ,NGR ,NV2FLG ,RMX
+ ,STRACT ,T ,TRESIS ,V1 ,V2
+ ,V2F ,VG ,X ,LUN1

```

 TIME AND DISTANCE TO ACCELERATE FROM ONE VELOCITY TO ANOTHER

1. VARIABLE DECLARATION

```

REAL FA (20,3)
REAL FB (20,3)
REAL FC (20,3)
REAL RMX (20)
REAL STRACT (20,3,3)
REAL TRESIS (3,9)
REAL VG (20,3,3)

```

3. ALGORITHM

```

VM = GCW/385.9
```

A. DETERMINE GEARS (NG1, NG2) OF THE INITIAL
 AND FINAL VELOCITIES.

```

DO 3010 NG=1,NGF
IF(V1 .LE. VG(NG,3,K)) GC TO 3020

```

```

3010  CONTINUE
3020  CONTINUE
NG1 = NG

```

```

DO 3030 NG=NG1,NER
  IF(V2 .LE. VG(NG,3,K)) GO TO 3040
3030 CONTINUE
3040 CONTINUE
  NG2 = NG
  IF(NG1 .NE. NG2) GO TO 3080
C. B. SINGLE GEAR ROUTINE
  VL = V1
  VH = V2
  NG = NG1
  T = 0.
  X = 0.
  CALL TXGEAR
+ (FA,FB,FC,GCW,I,K,NG,NV2FLG,RMX,STRACT,TT,TRESIS,VL,VH,VG,XX)
  IF(NV2FLG .NE. 0) GO TO 3050
  T = TT
  X = XX
  GO TO 4000
3050 IF(NV2FLG .NE. 1) GO TO 3060
  GO TO 3260
3060 IF(NV2FLG .NE. 2) GO TO 3070
  GO TO 4000
3070 CONTINUE
  GO TO 4005
C. C. MULTIPLE GEAR ROUTINE
3080 CONTINUE
  T = 0.
  X = 0.
  VL = V1
  VH = VG(NG1,3,K)
  CALL TXGEAR
+ (FA,FB,FC,GCW,I,K,NG,NV2FLG,RMX,STRACT,TT,TRESIS,VL,VH,VG,XX)
  IF(NV2FLG .NE. 0) GO TO 3130
  T = TT
  VS = VG(NG1,3,K)
  X = XX
  IF(NG2 .LE. (NG1+1)) GO TO 3090
  GO TO 3160
3090 CONTINUE
  VL = VS
  VH = V2
  NG = NG2
  CALL TXGEAR
+ (FA,FB,FC,GCW,I,K,NG,NV2FLG,RMX,STRACT,TT,TRESIS,VL,VH,VG,XX)
  IF(NV2FLG .NE. 0) GO TO 3100
  T = T+TT
  X = X+XX
  GO TO 4000
3100 IF(NV2FLG .NE. 1) GO TO 3110
  VF2 = VG(NG1,3,K)
  NGF = NG1
  NV2FLG = 2
  
```

```
          GO TO 4000
3110      IF(NV2FLG .NE. 2) GO TO 3120
          GO TO 3260
3120      CONTINUE
          GO TO 4005
3130      IF(NV2FLG .NE. 1) GO TO 3140
          GO TO 4000
3140      IF(NV2FLG .NE. 2) GO TO 3150
          GO TO 3260
3150      CONTINUE
          GO TO 4005
C        D. ACCELERATE THROUGH INTERMEDIATE GEARS
3160      CONTINUE
          M1 = NG1+1
          M2 = NG2-1
          DO 3200 NG=M1,M2
          VL = VS
          VH = VG(NG,3,K)
          CALL TXGEAR
+ (FA,FB,FC,GCW,I,K,NG,NV2FLG,RMX,STRACT,TT,TRESIS,VL,VH,VG,XX)
          IF(NV2FLG .NE. 0) GO TO 3170
          T = T + TT
          VS = VG(NG,3,K)
          X = X + XX
          GO TO 3200
3170      IF(NV2FLG .NE. 1) GO TO 3180
          GO TO 3210
3180      IF(NV2FLG .NE. 2) GO TO 3190
          GO TO 3260
3190      CONTINUE
          GO TO 4005
3200      CONTINUE
          GO TO 3220
3210      CONTINUE
          NGF = NG-1
          V2F = VG(NGF,3,K)
          NV2FLG = 2
          GO TO 4000
3220      CONTINUE
          NG = NG2
          VL = VS
          VH = V2
          CALL TXGEAR
+ (FA,FB,FC,GCW,I,K,NG,NV2FLG,RMX,STRACT,TT,TRESIS,VL,VH,VG,XX)
          IF(NV2FLG .NE. 0) GO TO 3230
          T = T+TT
          X = X+XX
          GO TO 4000
3230      IF(NV2FLG .NE. 1) GO TO 3240
          NGF = NG-1
          V2F = VG(NGF,3,K)
          NV2FLG = 2
```

```

          GO TO 4000
3240      IF(NV2FLG .NE. 2) GO TO 3250
          GO TO 3260
3250      CONTINUE
          GO TO 4005
C          E. ERROR ROUTINE
3260      CONTINUE
          VAV=(VL+VH)/2.
          DO 3300 J=1,4
              CALL TXGEAR
+ (FA,FB,FC,GCW,I,K,NG,NV2FLG,RMX,STRACT,TT,TRESIS,VL,VAV,VG,XX)
          IF(NV2FLG .NE. 0) GO TO 3270
              VH = VAV
              VAV = (VL+VH)/2.
              GO TO 3300
3270      IF(NV2FLG .NE. 1) GO TO 3280
              VAV = (VAV+VH)/2.
              GO TO 3300
3280      IF(NV2FLG .NE. 2) GO TO 3290
              VH = VAV
              VAV = (VL+VH)/2.
              GO TO 3300
3290      CONTINUE
          GO TO 4005
3300      CONTINUE
          V2F = VAV
          NGF = NG
          NV2FLG = 2
          T = T+TT
          X = X+XX
C          4. TERMINUS
4000      CONTINUE
          RETURN
4005      WRITE(LUN1,4010)
          WRITE(LUN1,4020)
          WRITE(LUN1,4030) (FA(NG,K),NG=1,NGR)
          WRITE(LUN1,4040)
          WRITE(LUN1,4030) (FB(NG,K),NG=1,NGR)
          WRITE(LUN1,4050)
          WRITE(LUN1,4030) (FC(NG,K),NG=1,NGR)
          WRITE(LUN1,4060) GCW,K,NGR,NV2FLG
          WRITE(LUN1,4070)
          WRITE(LUN1,4030) ((STRACT(NG,M,K),M=1,3),NG=1,NGR)
          WRITE(LUN1,4080) T ,TRESIS(K,I),V1 ,V2 ,V2F
+ ,X
4010      FORMAT(1H1,6H$ACCEL,/)
4020      FORMAT(/,1X,8HFA =)
4030      FORMAT(9X,5(E15.8,5X),)
4040      FORMAT(/,1X,8HFB =)
4050      FORMAT(/,1X,8HFC =)
4060      FORMAT(/,1X,8HGCW =,E15.8,/,1X,8HK =,I4,/,1X,8HNGR =,
+ I4,/,1X,8HNV2FLG =,I4)

```

```

4070 FORMAT(/,1X,8HSTRACT =A
4080 FORMAT(/,1X,8HT      =,E15.8/,1X,8HTRESIS =,E15.8/,
+      1X,8HV1          =,E15.8/,1X,8HV2      =,E15.8/,
+      1X,8HV2F        =,E15.8/,1X,8HX        =,E15.8)
  
```

RETURN
 END

SUBROUTINE D3LINC

```

+ ID      ,A      ,I      ,II     ,J
+ ,JJ     ,K      ,KK     ,VALI   ,VALJ
+ ,VALK   ,VI     ,VJ     ,VK )
  
```

C -----
 C THREE-DIMENSIONAL LINEAR INTERPOLATION SUBROUTINE
 C EXTRAPOLATION AT CONSTANT LEVEL BEYOND LAST
 C ELEMENTS OF ARRAY.
 C -----
 C

1. VARIABLE DECLARATION

```

REAL      A      (7,14,5)
REAL      VALI   (7)
REAL      VALJ   (14)
REAL      VALK   (5)
  
```

2. ALGORITHM

```

IF(I .NE. II) GO TO 2010
  ALL = A(I, J, K)
  ALH = A(I, J, KK)
  AHL = A(I, JJ, K)
  AHH = A(I, JJ, KK)
  GO TO 2020
  
```

2010

```

CONTINUE
DUMMY = (VI-VALI(I))/ (VALI(II)-VALI(I))
ALL   = A(I, J, K)+DUMMY*(A(II, J, K)-A(I, J, K))
ALH   = A(I, J, KK)+DUMMY*(A(II, J, KK)-A(I, J, KK))
AHL   = A(I, JJ, K)+DUMMY*(A(II, JJ, K)-A(I, JJ, K))
AHH   = A(I, JJ, KK)+DUMMY*(A(II, JJ, KK)-A(I, JJ, KK))
  
```

2020

```

IF(J .NE. JJ) GO TO 2030
  AL = ALL
  AH = ALH
  GO TO 2040
  
```

2030

```

CONTINUE
DUMMY = (VJ-VALJ(J))/ (VALJ(JJ)-VALJ(J))
AL    = ALL+DUMMY*(AHL-ALL)
AH    = ALH+DUMMY*(AHH-ALH)
  
```

2040

```

IF(K .NE. KK) GO TO 2050
  C = AL
  GO TO 3000
  
```

2050

```

CONTINUE
D = AL+(AH-AL)*(VK-VALK(K))/ (VALK(KK)-VALK(K))
  
```

3000

3. TERMINUS

```

CONTINUE
RETURN
END
  
```

SUBROUTINE FGSPC

```
+ (CPF ,D ,NVEH ,RCIX)
C -----+-----
C FINE GRAINED SOIL FULL COEFFICIENT ALGORITHM
C -----+-----
C
C 1. ALGORITHM
C IF(NVEH .EQ. 1) GO TO 1040
C TRACKED ASSEMBLY
C IF(CPF .GE. 4.) GO TO 1020
C IF(RCIX .LT. 0.) GO TO 1010
C D =
C + .544+.0463*RCIX-((.544+.0463*RCIX)**2-.0702*RCIX)**.5
C GO TO 2000
1010 CONTINUE
C D = .056*RCIX
C D = .076*RCIX
C GO TO 2000
1020 IF(RCIX .LT. 0.) GO TO 1030
C D =
C + .4554+.0392*RCIX-((.4554+.0392*RCIX)**2-.0526*RCIX)**.5
C GO TO 2000
1030 CONTINUE
C D = .056*RCIX
C GO TO 2000
1040 CONTINUE
C WHEELED ASSEMBLY
C IF(CPF .GE. 4.) GO TO 1060
C IF(RCIX .LT. 0.) GO TO 1050
C D =
C + .3885-.0265*RCIX-((.3885-.0265*RCIX)**2-.0358*RCIX)**.5
C GO TO 2000
1050 CONTINUE
C D = .046*RCIX
C GO TO 2000
1060 IF(RCIX .LT. 0.) GO TO 1070
C D =
C + .379+.0219*RCIX-((.379+.0219*RCIX)**2-.0257*RCIX)**.5
C GO TO 2000
1070 CONTINUE
C D = .033*RCIX
C 2. TERMINUS
2000 CONTINUE
C RETURN
C END
SUBROUTINE FGSPR
+ (CPF ,NVEH ,RCIX ,RTGWPB)
C -----+-----
C FINE GRAINED SOIL POWERED ASSEMBLY MOTION RESISTANCE
C -----+-----
C
C 1. ALGORITHM
C IF(NVEH .EQ. 1) GO TO 1030
```

```

C          TRACKED ASSEMBLY
          IF(RCIX .LT. 0.) GO TO 1010
          RTOWPB = .045+2.3075/(RCIX+6.5)
          GO TO 2000
1010      IF(CPF .GE. 4.) GO TO 1020
          RTOWPB = .4-.072*RCIX
          GO TO 2000
1024      CONTINUE
          RTOWPB = .4-.052*RCIX
          GO TO 2000
C          WHEELED ASSEMBLY
1030      IF(RCIX .LT. 0.) GO TO 1050
          IF(CPF .GE. 4.) GO TO 1040
          RTOWPB = .035+.861/(RCIX+3.249)
          GO TO 2000
1040      CONTINUE
          RTOWPB = .045+2.3075/(RCIX+6.5)
          GO TO 2000
1050      IF(CPF .GE. 4.) GO TO 1060
          RTOWPB = .3-.043*RCIX
          GO TO 2000
1060      CONTINUE
          RTOWPB = .4-.029*RCIX
C          2. TERMINUS
2000      CONTINUE
          RETURN
          END
          SUBROUTINE FGSTR
          + (DIAW ,DRAT ,IB ,IP ,NVEH
          + ,NWHL ,RCI ,RTOWT ,SECTW ,WGHT
          + ,WRATIO ,LUN1 )
C          -----
C          FINE GRAINED SOIL TOWED MOTION RESISTANCE
C          -----
C          2. ALGORITHM
          IF((IP .EQ. 0) .AND. (IB .EQ. 0)) GO TO 2010
C          NEVER TOWED ASSEMBLY
          RTOWT = 0.
          GO TO 3000
2010      CONTINUE
C          TOWED ASSEMBLY
          IF(NVEH .NE. 0) GO TO 2020
C          TRACKED ASSEMBLY
          WRITE(LUN1,3010)
          WRITE(LUN1,3020) DIAW ,DRAT ,IB ,IP ,NVEH
          + ,NWHL ,RCI ,RTOWT ,SECTW ,WGHT
          + ,WRATIO
3010      FORMAT (1H1,6H$FGSTR,/)
3020      FORMAT (/ ,1X,8HDIAW =,E15.8,/,1X,8HDRAT =,E15.8,/,
          + 1X,8HIB =,I5,/,1X,8HIP =,I5,/,
          + 1X,8HNVEH =,I5,/,1X,8HNWHL =,I5,/,
          + 1X,8HRCI =,E15.8,/,1X,8HRTOWT =,E15.8,/,

```

```

+          1X,8HSECTW =,E15.8,/,1X,8HWGHT =,E15.8,/,
+          1X,8HWRATIO =,E15.8)
      STOP
2020    CONTINUE
C      WHEELED ASSEMBLY
      WPM = WGHT*WRATIO/FCAT(NWHL)
      BETA =
+ (RCI*SECTW*DIAM*DRAT*0.5)/(WPM*(1.+SECTW/2./DIAM))
      IF(BETA .GT. 2.) GO TO 2030
      RTOWT = 1.-.3412*BETA
      GO TO 3000
2030    CONTINUE
      RTOWT = .04+.2/(BETA-1.35)
      GO TO 3000
C      3. TERMINUS
3000    CONTINUE
      RETURN
      END

      SUBROUTINE FORVEL
+ (F      ,FA      ,FB      ,FC      ,FORMX
+ ,K      ,NGR     ,V      ,VFMAX  ,VG )
C      -----
C      FORCE AVAILIABLE AT A GIVEN VELOCITY
C      -----
C
C      1. VARIABLE DECLARATION
      REAL    FA      (20,3)
      REAL    FB      (20,3)
      REAL    FC      (20,3)
      REAL    FORMX   (3)
      REAL    VFMAX   (3)
      REAL    VG      (20,3,3)
C
C      2. ALGORITHM
      IF(V .GE. VFMAX(K)) GO TO 2010
      F = FORMX(K)
      GO TO 3000
2010    CONTINUE
      DO 2030 NG=1,NGR
      IF(V .GT. VG(NG,3,K)) GO TO 2020
      F = (FC(NG,K)*V+FB(NG,K))*V+FA(NG,K)
      GO TO 3000
2020    CONTINUE
2030    CONTINUE
      F = 0.
C      3. TERMINUS
3000    CONTINUE
      RETURN
      END

      SUBROUTINE QUAD
+ (A      ,B      ,C
+ ,X1     ,X2     ,X3
+ ,Y1     ,Y2     ,Y3

```



```

C      ,LUN1 )
C      -----
C      QUADRATIC FIT THROUGH THREE POINTS SUBROUTINE
C      -----
C
C      1. ALGORITHM
C      AA = (Y2-Y1)/(X2-X1)
C      BB = (Y3-Y1)/(X3-X1)
C      CC = (BB-AA)/(X3-X2)
C      A  = Y1-AA*X1+CC*X1*X2
C      B  = AA-CC*(X1+X2)
C      C  = CC
C
C      2. CHECK TO INSURE THAT THERE IS NO DIVISION BY ZERO (0)
C      IF((X3-X1) .EQ. 0. .OR. (X3-X2) .EQ. 0. .OR.
C      +   (X2-X1) .EQ. 0.) GO TO 3900
C      GO TO 4000
3900   WRITE(LUN1,3910)
3910   FORMAT(1H1,39H DIVISION BY ZERO (0) IN SUBROUTINE QUAD,/)
C      3. TERMINUS
4000   RETURN
C      END
C      SUBROUTINE QUAD5(X ,Y ,A ,B ,C)
C
C      -----
C      LEAST SQUARES FIT THROUGH FIVE POINTS PASSING
C      THROUGH THE FIRST AND LAST POINTS. EQUATION
C      OF THE FORM: Y= A + B*X + C*X**2
C      -----
C
C      1. VARIABLE DECLARATIONS
C      REAL X      (5)
C      REAL Y      (5)
C      REAL A
C      REAL B
C      REAL C
C
C      -----
C      TRANSFORM ARRAY INTO THE UNIT SQUARE
C      -----
C
C      CX=X(5) - X(1)
C      CY=Y(5) - Y(1)
C      XXSUM=0.
C      XYSUM=0.
C      DO 2000 I=1,5
C      XTI=(X(I) - X(1))/CX
C      YTI=Y(I) - Y(1)
C      XYSUM=XYSUM + YTI - XTI*CY
C      XXSUM=XXSUM + XTI*(XTI - 1.)
2000  CONTINUE
C
C      -----
  
```

```

C   UNIT SQUARE COEFFICIENTS
C   -----
C
C   C3=XYSLM/XXSUM
C   C2=CY - C3
C
C   -----
C   INTERMEDIATE TERM (NOT A COEFFICIENT)
C   -----
C
C   C4=1./ (CX*CX)
C
C   -----
C   FIVE POINT FIT COEFFICIENTS
C   -----
C
C   A=Y(1) + X(1)*C4*(X(1)*C3 - CX*C2)
C   B=C4*(CX*C2 - 2.*X(1)*C3)
C   C=C4*C3
C   RETURN
C   END
C   SUBROUTINE SLIP
C   + (CPFC ,IST ,LCCDIF ,NFL ,NVEHC
C   + ,S ,Y ,LUN: )
C   -----
C   SLIP ALGORITHM
C   -----
C   2. ALGORITHM
C   IF(IST .NE. 1) .AND. (IST .NE. 6) GO TO 2060
C   A. FINE GRAINED SOIL
C   IF(NVEHC .EQ. 1) GO TO 2020
C   TRACKED
C   IF(CPFC .GE. 4.) GO TO 2010
C   S = .0257*Y-.0161+.01519/(.8353-Y)
C   GO TO 2160
2010 CONTINUE
C   S = .0733*Y-.0063+.00734/(.7177-Y)
C   GO TO 2160
C   WHEELED
2020 IF(CPFC .GE. 4.) GO TO 2040
C   S = .0621*Y-.021+.01888/(.7794-Y)
C   IF(LCCDIF .NE. 1) GO TO 2030
C   S = S/1.1
2030 CONTINUE
C   GO TO 2160
2040 CONTINUE
C   S = .084*Y-.016+.01414/(.6697-Y)
C   IF(LCCDIF .NE. 1) GO TO 2050
C   S = S/1.1
2050 CONTINUE
C   GO TO 2160
2060 IF(IST .NE. 2) GO TO 2100

```

```

C      B. COARSE GRAINED SOIL
      IF(NVEHC .EQ. 1) GO TO 2080
C      TRACKED
      IF(NFL .EQ. 1) GO TO 2070
C      RIGID TRACK
      S = -.0083*.005312/(.573-Y)
      GO TO 2160
2070   CONTINUE
C      FLEXIBLE TRACK
      YY = 1.074*Y-.72
      S = YY+((YY*.42)+.09*Y+.009)**.5
      GO TO 2160
2080   CONTINUE
C      WHEELED
      S = .0074*Y-.0061+.00374/(.5785-Y)
      IF(LOCDIF .NE. 1) GO TO 2090
      S = S/1.1
2090   CONTINUE
      GO TO 2160
2100   IF(IST .NE. 3) GO TO 2130
C      C. MUSKEG
      IF((NVEHC .EQ. 1) .OR. (CPFC .GE. 4)) GO TO 2110
      S = .0585*Y-.0106+.01336/(.964-Y)
      GO TO 2160
2110   CONTINUE
      S = .1024*Y-.00864+.01062/(.7564-Y)
      IF((NVEHC .NE. 1) .OR. (LOCCIF .NE. 1)) GO TO 2120
      S = S/1.1
2120   CONTINUE
      GO TO 2160
2130   IF(IST .NE. 4) GO TO 2150
C      D. SHALLOW SNOW
      IF(Y .LT. 1) GO TO 2140
      S = 1.
      GO TO 2160
2140   CONTINUE
      S = .3*(1.-(1.-Y)**.5)
      GO TO 2160
C      E. ERROR
2150   WRITE(LUN1,2200)
      WRITE(LUN1,2210) CPFC ,IST ,LOCCIF ,NFL ,NVEHC
      + ,S ,Y
2200   FORMAT(1H1,6H$TICK,/)
2210   FORMAT(/,1X,8HCPFC =,E15.8,/,1X,8HIST =,I5 ,/,
      + ,1X,8HLOCDIF =,I5 ,/,1X,8HNFL =,I5 ,/,
      + ,1X,8HNVEHC =,I5 ,/,1X,8HS =,E15.8,/,
      + ,1X,8HY =,E15.8)
      STOP
C      F. FUNCTION LIMITS
2160   CONTINUE
      IF((S .GE. 0.) .AND. (S .LE. 1.)) GO TO 2170
      S = 1.
  
```

```
2170      CONTINUE
C        3. TERMINUS
          RETURN
        END
        SUBROUTINE TFORCF
+ (CF      ,CPFC  ,DCWP  ,GCWP  ,IST
+ ,NFL     ,NVEHC ,RTOW  ,TFOR  ,LUN1 )
C -----
C      SOIL LIMITED TRACTIVE EFFORT ALGORITHM
C -----
C      2. ALGORITHM
C      IF(IST .NE. 1) .AND. (IST .NE. 6) GO TO 2040
C      A. FINE GRAINED
C      IF(NVEHC .EQ. 1) GO TO 2020
C      TRACKED
C      IF(CPFC .GE. 4.) GO TO 2010
C      CF = (DCWP+.758)*RTOW
C      TFOR = (CF+.82)*GCWP
C      GO TO 3000
2010      CONTINUE
C      CF = (DCWP+.671)*RTOW
C      TFOR = (CF+.72)*GCWP
C      GO TO 3000
2020      CONTINUE
C      WHEELED
C      IF(CPFC .GE. 4.) GO TO 2030
C      CF = (DCWP+.674)*RTOW
C      TFOR = (CF+.76)*GCWP
C      GO TO 3000
2030      CONTINUE
C      CF = (DCWP+.585)*RTOW
C      TFOR = (CF+.655)*GCWP
C      GO TO 3000
2040      IF(IST .NE. 2) GO TO 2070
C      B. COARSE GRAINED
C      IF(NVEHC .EQ. 1) GO TO 2060
C      TRACKED
C      IF(NFL .EQ. 1) GO TO 2050
C      RIGID TRACK
C      CF = .076
C      TFOR = (CF+.568)*GCWP
C      GO TO 3000
2050      CONTINUE
C      FLEX TRACK
C      CF = .1
C      TFOR = (CF+.695)*GCWP
C      GO TO 3000
2060      CONTINUE
C      WHEELED
C      CF = RTOW+DOWD-.56
C      TFOR = (CF+.575)*GCWP
C      GO TO 3000
```

```

2070 IF(IST .NE. 3) GO TO 2090
C      C. MUSKEG
          IF((NVEHC .NE. 0) .OR. (CPFC .GE. 4.)) GO TO 2080
          CF = RTCWP+80WP-.88
          TFOR = (CF+.92)*GCWP
          GO TO 3000
2080 CONTINUE
          CF = RTOWP+DOWR-.68
          TFOR = (CF+.745)*GCWP
          GO TO 3000
2090 CONTINUE
C      D. ERROR
          WRITE(LUN1,2100)
          WRITE(LUN1,2110) CF      ,CPFC      ,DOWP      ,GCWP      ,IST
          +                ,NFL      ,NVEHC      ,RTOWP      ,TFOR
2100 FORMAT(1H1,7H$TFCRCF,/A
2110 FORMAT(/,1X,8HCF      =,E15.8,/,1X,8HCPFC      =,E15.8,/,
          +      1X,8HDOWP      =,E15.8,/,1X,8HGCWP      =,E15.8,/,
          +      1X,8HIST      =,I5      ,/,1X,8HNFL      =,I5      ,/,
          +      1X,8HNVEHC      =,I5      ,/,1X,8HRTOWP      =,E15.8,/,
          +      1X,8HTFOR      =,E15.8)
          STOP 12
C      3. TERMINUS
3000 CONTINUE
          RETURN
          END

```

SUBROUTINE TXGEAR

```

+ (FA      ,FB      ,FC      ,GCW      ,I
+ ,K      ,NG      ,NV2FLG ,RMX      ,STRACT ,T
+ ,TRESIS ,V1      ,V2      ,VG      ,X )

```

 TIME AND DISTANCE IN A GEAR

1. VARIABLE DECLARATION
- REAL FA (20,3)
 - REAL FB (20,3)
 - REAL FC (20,3)
 - REAL RMX (20)
 - REAL STRACT (20,3,3)
 - REAL TRESIS (3,9)
 - REAL VG (20,3,3)

2. ALGORITHM
- A. SET COMMON VALUES
- VM = (GCW/385.9)*RMX(NG)
 - A = FA(NG,K)
 - B = FB(NG,KA)
 - C = FC(NG,KA)
 - F = TRESIS(4,I)
 - CSQ = B*B-4.*A*F+C
 - NV2FLG = 0

B. SOLUTION TREE

```

IF(C) 26, 17, 1
C      1. POSITIVE CURVATURE
1      IF(B) 2, 11, 14
C      A. NEGATIVE SLOPE AT V=0.
2      CONTINUE
        IF(A-F) 3, 3, 4
C      1. NEGATIVE/ZERO EXCESS TRACTION
3      R2=(-B+SQRT(DSQ))/(2.*C)
        R1=(A-F)/(C*R2)
        IF(V1.GT.R2) GO TO 36
        NV2FLG=1
        RETURN
C      2. POSITIVE EXCESS TRACTION
4      IF(DSQ) 38, 8, 5
C      A. POSITIVE DISCRIMINANT
5      R2=(+B+SQRT(DSQ))/(2.*C)
        R1=(A-F)/(C*R2)
        IF(V2.LE.R1.OR.V1.GE.R2) GO TO 36
        IF(V2-R1) 7, 7, 6
6      NV2FLG=1
        RETURN
7      NV2FLG=2
        RETURN
C      B. ZERO DISCRIMINANT
8      R2=(-B+SQRT(DSQ))/(2.*C)
        R1=(A-F)/(C*R2)
        IF(V2.GT.R1.OR.V2.LT.R1) GO TO 37
        IF(V2-R1) 7, 6, 7
C      C. NEGATIVE DISCRIMINANT
C      B. ZERO SLOPE AT V=0.
11     IF(A-F) 13, 12, 08
C      1. ZERO EXCESS TRACTION
12     T=VM*(1./V1-1./V2)/C
        X=(VM/C)*ALOG(VM/(VM-V1*C*T))
        RETURN
C      2. POSITIVE EXCESS TRACTION
13     R2=SQRT(DSQ)/(2.*C)
        R1=(A-F)/(C*R2)
        IF(V1.GT.R2) GO TO 36
        NV2FLG=2
        RETURN
C      C. POSITIVE SLOPE AT V=0.
14     IF(A-F) 15, 15, 16
C      1. NEGATIVE/ZERO EXCESS TRACTION
15     R1=(-B-SQRT(DSQ))/(2.*C)
        R2=(A-F)/(C*R1)
        IF(V1.GT.R2) GO TO 36
        NV2FLG=2
        RETURN
C      2. POSITIVE EXCESS TRACTION
16     IF(DSQ) 38, 37, 36
C      2. ZERO CURVATURE

```

```

17      IF(B) 18,22,25
C      A. NEGATIVE SLOPE AT V=0.
18      IF(A-F) 19,19,20
C      1. NEGATIVE/ZERO EXCESS TRACTION
19      NV2FLG=1
      RETURN
C      2. POSITIVE EXCESS TRACTION
20      R1=-(A-E)/B
      IF(V1-R1) 21,19,19
21      IF(V2.LT.R1) GO TO 35
      NV2FLG=2
      RETURN
C      B. ZERO SLOPE AT V=0.
22      IF(A-F) 23,23,24
C      1. NEGATIVE/ZERO EXCESS TRACTION
23      NV2FLG=1
      RETURN
C      2. POSITIVE EXCESS TRACTION
24      T=VM*(V2-V1)/(A-F)
      X=((A-F)*T/(2.*VM)+V1)*T
      RETURN
C      C. POSITIVE SLOPE AT V=0.
25      IF(A-F.GE.0.) GO TO 35
      R1=-(A-E)/B
      IF(V1.GT.R1) GO TO 35
      NV2FLG=1
      RETURN
C      3. NEGATIVE CURVATURE
26      IF(B) 27,27,31
C      A. NEGATIVE/ZERO CURVATURE
27      IF(A-F) 28,28,29
C      1. NEGATIVE/ZERO EXCESS TRACTION
28      NV2FLG=1
      RETURN
C      2. POSITIVE EXCESS TRACTION
29      R1=(-B+SQRT(DSQ))/(2.*C)
      R2=(A-F)/(C*R1)
      IF(V1.LT.R2) GO TO 30
      NV2FLG=1
      RETURN
30      IF(V2.LE.R2) GO TO 36
      NV2FLG=2
      RETURN
C      B. POSITIVE CURVATURE
31      IF(A-F.GE.0..OR.DSQ.GT.0.) GO TO 32
      NV2FLG=1
      RETURN
32      R2=(-B-SQRT(DSQ))/(2.*C)
      R1=(A-F)/(C*R2)
      IF(V1.LE.R1) GO TO 33
      IF(V1.GT.R2) GO TO 33
      GO TO 34
  
```

```

33             NV2FLG=1
              RETURN
34             IF(V2.LE.R2) GO TO 36
              NV2FLG=2
              RETURN
C             C. ### ROUTINE
35             T=(VM/B)*ALOG((B*V2+A-F)/(B*V1+A-F))
              X=-((A-F)*T/B+(VM/(B*B))*((B*V1+A-F)*(EXP(T*B/VM)-1.))
              RETURN
C             D. LOG ROUTINE - POSITIVE DISCRIMINANT
36             D=SQRT(DSQ)
              V1BAR=(2.*C*V1+B+D)/(2.*C*V1+B+D)
              V2BAR=(2.*C*V2+B+D)/(2.*C*V2+B+D)
              T=(VM/D)*ALOG(V2BAR/V1BAR)
              X=(.5*(D-B)*T-V)*ALOG((1.-V1BAR*EXP(T*D/VM))/
+ (1.-V1BAR))/C
              RETURN
C             E. RECIPROCAL ROUTINE - ZERO DISCRIMINANT
37             T=2.*VM*(1./(2.*C*V1+B)-1./(2.*C*V2+B))
              X=(VM/C)*ALOG(2.*VM/(2.*VM-T*(2.*C*V1+B)))-.5*B*T/C
              RETURN
C             F. NEGATIVE ROUTINE - MAKE TWO GEARS FITTED BYW STRAIGHT
C             + LINES OUT OF ONE FITTED BY A QUADRATIC.
38             SH=(STRACT(NG,3,K)-STRACT(NG,2,K))/(VG(NG,3,K)-VG(NG,2,K))
              ZH=(STRACT(NG,2,K)*VG(NG,3,K)-STRACT(NG,3,K)*VG(NG,2,K))/
+ (VG(NG,3,K)-VG(NG,2,K))
              SL=(STRACT(NG,2,K)-STRACT(NG,1,K))/(VG(NG,2,K)-VG(NG,1,K))
              ZL=(STRACT(NG,1,K)*VG(NG,2,K)-STRACT(NG,2,K)*VG(NG,1,K))/
+ (VG(NG,2,K)-VG(NG,1,K))
              IF(V2.GE.VG(NG,2,K)) GO TO 39
              S=SL
              Z=ZL
              GO TO 42
39             IF(V1.LE.VG(NG,2,K)) GO TO 40
              S=SH
              Z=ZH
              GO TO 42
40             IF(V2.LE.AMAX1(-(ZH-F)/SH,-(ZL-F)/SL)) GO TO 41
              NV2FLG=2
              RETURN
41             TL=(VM/SL)*ALOG((SL*VG(NG,2,K)+ZL-F)/(SL*V1+ZL-F))
              TH=(VM/SH)*ALOG((SH*V2+ZH-F)/(SH*VG(NG,2,K)+ZH-F))
              X=(SL*V1+ZL-F)*VM*(EXP(SL*TL/VM)-1.)/(SL*SL)
+ *(SH*VG(NG,2,K)+ZH-F)*VM*(EXP(SH*TH/VM)-1.)/(SH*SH)
+ -(ZL-F)*TL/SL-(ZH-F)*TH/SH
              T=TL+TH
              RETURN
42             VZ=-(Z-F)/S
              IF(V2.LT.VZ) GO TO 43
              NV2FLG=0
              RETURN
43             T=(VM/S)*ALOG((S*V2+Z-F)/(S*V1+Z-F))
  
```

X=((S*V1+Z-F)*VM*(EXP(S*T/VM)-1))-((Z-F)*S*T)/(S*S)
 RETURN

C 3. TERMINUS
 END

SUBROUTINE VELFOR

+ ,F ,FA ,FB ,FC ,FORMX
 + ,K ,NGR ,VEL ,VFMAX ,VG

 C MAXIMUM VELOCITY OVERCOMING A GIVEN RESISTANCE
 C -----

C 1. VARIABLE DECLARATION

REAL FA (20,3)
 REAL FB (20,3)
 REAL FC (20,3)
 REAL FORMX (3)
 REAL VFMAX (3)
 REAL VG (20,3,3)

C 2. ALGORITHM

DO 10 INDEX=1,NGR
 NG=NGR+1-INDEX
 DSQ=FB(NG,K)**2-4.*FC(NG,K)*(FA(NG,K)-F)
 IF(DSQ) 1,2,4
 C DISCRIMINANT, NEGATIVE
 1 IF(FC(NG,K)) 10,10,20
 C DISCRIMINANT, ZERO
 2 IF(FC(NG,K)) 10,3,20
 C DISCRIMINANT, POSITIVE
 3 IF(FA(NG,K)-F) 10,20,20
 4 IF(FC(NG,K)) 11,5,11
 5 R=-((FA(NG,K)-F)/FB(NG,K))
 IF(VG(NG,1,K)-R) 7,6,6
 6 IF(FB(NG,K)) 10,20,20
 7 IF(VG(NG,3,K)-R) 9,9,8
 8 IF(FB(NG,K)) 30,10,20
 9 IF(FB(NG,K)) 20,10,20
 11 IF(FB(NG,K)) 12,12,13
 12 R2=(-FB(NG,K)+SQRT(DSQ))/(2.*FC(NG,K))
 R1=(FA(NG,K)-F)/(R2*FC(NG,K))
 GO TO 14
 13 R1=(-FB(NG,K)-SQRT(DSQ))/(2.*FC(NG,K))
 R2=(FA(NG,K)-F)/(R1*FC(NG,K))
 14 RL=AMIN1(R1,R2)
 RH=AMAX1(R1,R2)
 IF(FC(NG,K)) 18,18,15
 15 IF(VG(NG,1,K)-RL) 14,16,17
 16 IF(VG(NG,3,K)-RL) 20,20,40
 17 IF(VG(NG,1,K).GT.RL.AND.VG(NG,1,K).LT.RH) GO TO 10
 GO TO 20
 18 IF(VG(NG,1,K)-RL) 14,18,19
 19 IF(VG(NG,1,K)-RH) 22,21,10
 21 IF(VG(NG,3,K)-RH) 20,20,50
 10 CONTINUE

```

22      IF( FORMX(K)-F) 23,22,22
      VEL=VFMAX(K)
      GO TO 60
23      VEL=0.
      GO TO 60
20      VEL=VG(NG,3,K)
      GO TO 60
30      VEL=R
      GO TO 60
40      VEL=RL
      GO TO 60
50      VEL=RH
      GO TO 60
C      3. TERMINUS
60      CONTINUE
      END
      REAL FUNCTION MPH (ARG)
C      -----
C      UNITS CONVERSION
C      -----
C      1. VARIABLE DECLARATION
      REAL ARG
C      2. ALGORITHM
C      A. IN/SEC TO MPH
      MPH = ARG / 17.6
      RETURN
C      3. TERMINUS
      END
C
C
C      SUBROUTINE PLTSET(
+      NPTS, VGV, NGR, ATF, BTF, CTF, IPOWER,
+      POWER, TOPSPD,LUN1)
C
C      -----
C      PRINTER PLOT OF POWER TRAIN DATA AND
C      QUADRATIC CURVE FITTED TO THE DATA
C      -----
C
      REAL PCWER (2,201)
      REAL ATF (20)
      REAL BTF (20)
      REAL CTF (20)
      REAL VGV (20,5)
      REAL D1 (2,400)
      REAL D2 (2,400)
C
C      NPTS = NUMBER OF POINTS TO PLOT
C      VGV = GEAR MIN AND MAX SPEEDS
C      NGR = MAX NUMBER OF GEARS IN VEHICLE
C      ATF = A COEF. OF QUADRATIC EQUATION
C      BTF = B COEF. OF QUADRATIC EQUATION
```

```
C      CTF      = C COEF. OF QUADRATIC EQUATION
C      IPOWER  = NUMBER OF TRACTIVE FORCE POINTS
C      POWER   = TRACTIVE FORCE POINTS FOR MPH
C      TOPSPD  = TOP SPEED OF VEHICLE IN .25 MPH INCREMENTS
C      LUN1    = LOGICAL UNIT 1
C
C      ROUND OFF POWER ARRAY BY NEAREST .25 MPH
C
C      CALL RESCAL(IPOWER,POWER)
C      CALL FIXER(NPTS,IPWER,POWER,D1)
C
C      RECONSTRUCT QUADRATIC CURVE DATA USING COEF.
C
C      CALL CURPLT(NPTS,VGV,NGR,ATF,BTF,CTF,D2)
C
C      PLOT THE DATA ON PRINTER
C
C      CALL PNTPLT(D1,D2,NPTS,TOPSPD,LUN1)
C      RETURN
C      END
C
C      SUBROUTINE PNTPLT(
C      +  DATA1,  DATA2  ,NPTS,  TOPSPD,  LUN1)
C
C      -----
C      ROUTINE TO DO A PRINT PLOT
C      -----
C
C      DIMENSION DATA1(2,400),DATA2(2,400),IPDINT(120),AXH(13)
C      DIMENSION LABLY(400),LINE(12)
C
C      DATA1 = FIRST CURVE DATA POINTS
C      DATA2 = SECOND CURVE DATA POINTS
C      TOPSPD = MAXIMUM MILES PER HOUR IN PLOT
C      LUN1   = LOGICAL UNIT 1
C
C      DATA ICASH/10H+-----+---/
C      DATA IBLANK/10H /
C      DATA LABLY(52),LABLY(53),LABLY(54),LABLY(55),LABLY(56),
C      +  LABLY(57),LABLY(58),LABLY(59),LABLY(60),LABLY(61),
C      +  LABLY(62),LABLY(63),LABLY(64),LABLY(65),LABLY(66),
C      +  LABLY(67),LABLY(68)/
C      +  1FS,1H ,1HP,1F ,1HE,1H ,1HE,1H ,1HD,1H ,1H ,1H ,
C      +  1HM,1H ,1HP,1H ,1HH/
C
C      INITIALIZE PRINT LINE TO ALL SPACES
C
C      DO 5 K=1,120
C      IPDINT(K)=IBLANK
C      CONTINUE
C      DO 7 N=1,51
```

```
7   LABLY(N)=IBLANK
    DO 8 N=69,NPTS
8   LABLY(N)=IBLANK
C
C   SET UP Y AXIS LABEL
C
    DO 55 N=1,12
55  LINE(N)=IDASH
C
C   RESCALE PCINTS FOR .25 MFH INCREMENTS
C
    CALL RESCAL(NPTS,DATA1)
    CALL RESCAL(NPTS,DATA2)
C
C   COMPUTE MIN, MAX AND SCALE FACTORS FOR X AXIS
C
    CALL LIMITS(DATA1,CATA2,NPTS,BMIN,BMAX,SCALE)
C
C   PRINT X AXIS LABEL AND LABELED TIC MARKS
C
888  FORMAT(1H1,44X,20HTRACTIVE FORCE - LBS,/)
    WRITE(LUN1,888)
    STRT=BMIN
    DO 33 N=1,13
    AXH(N)=STRT
    STRT=STRT+((BMAX-BMIN)/12.)
33   CONTINUE
    WRITE(LUN1,777) (AXH(N),N=1,13)
777  FORMAT(1X,13(F8.0,2X).)
    WRITE(LUN1,50) (LINE(N),N=1,12)
50   FORMAT(6X,12A10,1H+)
C
C   INITIALIZE SPEED, FLAGS AND INDEX VARIABLES
C
    VSPEED=0.
    IFLG=100
    INDEX1=1
    INDEX2=1
C
C   NOW BEGIN PLOTTING LOOP
C
10   CONTINUE
C
C   BLANK PLOT STRING FOR NEW LINE
C
    DO 20 N=1,120
20   IPOINT(N)=IBLANK
C
C   GET ALL DATA1 POINTS AT THIS SPEED INTO PRINT STRING
C
30   IF (DATA1(1,INDEX1).NE.VSPEED) GOTG 40
    CALL SCAL(BMIN,SCALE,CATA1(2,INDEX1),1,IPOINT)
```

```

        INDEX1=INDEX1+1
        GOTO 30
C
C      NOW PUT DATA2 POINT FOR THIS SPEED INTO STRING
C
40  CONTINUE
    CALL SCAL(BMIN,SCALE,DATA2(2,INDEX2),2,IPOINT)
    INDEX2=INDEX2+1
C
C      PRINT STRING, CHECK IFLG TO SEE IF NUMBER IS
C      NEEDED ON AXIS
C
    IF (IFLG.LT.20) GOTO 60
    WRITE(LUN1,1000) LABLY(INDEX2-1),VSPEED,(IPOINT(J),J=1,120)
1000 FORMAT(1X,A1,F3.0,2H +,120A1)
    IFLG=1
    GOTO 70
60  CONTINUE
    WRITE(LUN1,1010) LABLY(INDEX2-1),(IPOINT(J),J=1,120)
1010 FORMAT(1X,A1,3X,2H I,120A1)
    IFLG=IFLG+1
C
C      BUMP VSPEED UP BY 0.25 MPH
C      IF NOT FINISHED, REPEAT FROM 10 WITH NEW VSPEED
C
70  CONTINUE
    VSPEED=VSPEED+0.25
    IF (INDEX2.LE.NPTS) GOTO 10
    WRITE(LUN1,65) TOPSPD,ILINE(N),N=1,120
65  FORMAT(1X,F4.1,1X,12A10,1H*)
    WRITE(LUN1,444)
444  FORMAT(/,21X,6HLEGEND,4,21X,6H-----,/,21X,17HX - DATA POINTS
+ ,/,21X,25H* - FITTED CURVE POINTS,
+ /,21X,40H0 - COINCIDENT VALUES OF CURVE AND DATA POINTS)
    RETURN
    END
C
C
SUBROUTINE SCAL(
+   BMIN,  SCALE,  DATA,  IFLG,  IPOINT)
C
C      -----1-----
C      HORIZONTAL SCALE SUBROUTINE
C      -----1-----
C
    DIMENSION IPOINT(120)
    DATA IEX,ISTAR,IZERC,I8LANK /1HX,1H*,1H0,1H /
C
C      BMIN = MINIMUM VALUE FOR X AXIS
C      SCALE= SCALE FACTOR FROM "LIMITS"
C      DATA = VALUE OF DATA POINT
C      IFLG = PRINT FLAG

```

```
C
C RETURNED :
C
C IPOINT = FORMATED LINE OF PLOT CHARS
C
C COMPUTE SCALE FACTOR
C
C IPT=INT(0.5+((DATA-BMIN)/SCALE))
C
C DETERMINE PRINT CHARACTER
C
C IF(IPT.LE.0.OR.IPT.GT.120) RETURN
C IF(IPOINT(IPT).EQ.IBLANK) GOTO 10
C IPOINT(IPT)=IZERO
C RETURN
10 IPOINT(IPT)=ISTAR
C IF(IFLG.EQ.1) IPOINT(IPT)=IEX
C RETURN
C END
C
C SUBROUTINE RESCAL(
C + NPTS, DATA)
C
C -----
C SUBROUTINE TO RESCALE ECR .25 MPH INCR.
C -----
C
C DIMENSION DATA(2,400)
C
C NPTS = NUMBER OF POINTS IN ARRAY
C DATA = ARRAY OF POINTS TO BE CHANGED
C
C AINCR = NUMBER OF DIVISIONS PER MILE / HOUR
C AINCR=4.
C DO 10 N=1,NPTS
C ITEMP=INT(.5+AINCR*DATA(1,N))
C DATA(1,N)=FLOAT(ITEMP)/AINCR
10 CONTINUE
C RETURN
C END
C
C SUBROUTINE LIMITS(
C + DATA1, DATA2, NPTS, BMIN, BMAX, SCALE)
C
C -----
C LOCATE MINIMUM MAXIMUM + SCALE FACTORS
C -----
C
C DIMENSION DATA1(2,400),DATA2(2,400)
C
```

```

C   DATA1   = ARRAY OF FIRST DATA
C   DATA2   = ARRAY OF SECOND DATA
C   BMIN     = DATA MINIMUM VALUE
C   BMAX     = DATA MAXIMUM VALUE
C   SCALE    = SCALE FACTOR
C
C   BMIN=9.9E99
C   BMAX=-9.9E99
C   DO 10 N=1,NPTS
C   BMIN=AMIN1(BMIN,DATA1(2,N),DATA2(2,N))
C   BMAX=AMAX1(BMAX,DATA1(2,N),DATA2(2,N))
10  CONTINUE
C   SCALE=ABS(BMAX-BMIN)/120.
C   RETURN
C   END
C
C
C   SUBROUTINE FIXER(
C   *   NPTS,   IPOWER,   POWER,   D1)
C
C   -----+-----+-----+
C   SUBROUTINE TO RESCALE POWER ARRAY
C   -----+-----+-----+
C
C   DIMENSION POWER(2,201),D1(2,400)
C
C   NPTS     = NUMBER OF POINTS IN PLOT
C   IPOWER    = NUMBER OF POINTS IN POWER ARRAY
C   POWER     = POWER DATA MPH AND TRACTIVE FORCE
C   D1        = NEW ARRAY OF POWER POINTS IN 25 MPH INCREMENTS
C
C   DO 5 N=1,NPTS
5     D1(1,N)=-1.
C     DO 10 N=1,IPOWER
C     NN=N
C
C   CONVERT FROM INCH / SEC TO MPH
C
C     D1(1,NN) = POWER(1,N) / 17.6
C     D1(2,NN) = POWER(2,N)
10  CONTINUE
C   RETURN
C   END
C
C
C   SUBROUTINE CURPLT(
C   *   NPTS,   VGV,   NGR,   ATF,   BTF,   CTF,   D2)
C
C   -----+-----+-----+
C   GENERATE CURVE FROM QUADRATIC EQUATION
C   -----+-----+-----+
  
```

REAL ATF (20)
REAL BTF (20)
REAL CTF (20)
REAL VGV (20,5)
REAL D2 (2,400)

C
C NPTS = NUMBER OF POINT IN CURVE
C VGV = GRAR SHIFT SPEEDS
C NGR = NUMBER OF GEARS IN VEHICLE
C ATF = A COEF. OF QUADRATIC EQUATION
C BTF = B COEF. OF QUADRATIC EQUATION
C CTF = C COEF. OF QUADRATIC EQUATION
C

C RETURNED;

C D2 = DATA ARRAY OF CURVE POINTS
C

VSPEED=-.25
NG=1
DO 10 N=1,NPTS
3 CONTINUE
VSPEED=VSPEED+.25
5 CONTINUE
IF(NG.GT.NGR) GOTO 10
Y=ATF(NG) + BTF(NG)*VSPEED*17.6 + CTF(NG)*(VSPEED*17.6)**2
IF((VSPEED * 17.6) .GT. VGV(NG,5)) GOTO 20
NG=NG+1
GOTO 5
20 CONTINUE
D2(1,N)=VSPEED
D2(2,N)=Y
10 CONTINUE
RETURN
END

APPENDIX B
VEHICLE INPUT FILES FOR PROGRAM NRMM

M60, TANK, COMBAT, FULL TRACKED, 105MM GUN
HEAVE NATURAL FREQUENCY 1.36 CY/SEC
\$VEHICLE
NAMBLV=1,
NVEH(1)=0,
WGHT(1)=109000.,
IP(1)=1,
IB(1)=1,
KEVM(1)=832.0,
TRAKWD(1)=28.,
GROUSH(1)=1.5,
NPAD(1)=1,
ASHOE(1)=194.,
TRAKLN(1)=167.,
NBOGIE(1)=12,
NFL(1)=1,
FW(1)=15.5,
WTE(1)=87.,
WT(1)=115.,
IAPG=1,
ACD=1.2,
CD=1.2,
PFA=92.,
HPNET=643.,
CID=1791.,
IDIESL=1.,
NCYL=12.,
NENG=1.,
QMAX=1682.,
IENGIN=13,
ENGINE(1,1)= 1200., 1610.,
 1300., 1645.,
 1400., 1670.,
 1500., 1682.,
 1600., 1680.,
 1700., 1675.,
 1800., 1655.,
 1900., 1630.,
 2000., 1600.,
 2100., 1560.,
 2200., 1515.,
 2300., 1470.,
 2400., 1420.,
ITCASE=1,
TCASE(1)= .862, .98,
ITRAN=1,
ITVAR=0,
TQIND=900.,
ICONV2=12,
CONV2(1,1)= 3.660, 0.0,
 3.125, 0.1,
 2.650, 0.2,

2.228, 0.3,
1.950, 0.4,
1.670, 0.5,
1.420, 0.6,
1.220, 0.7,
1.050, 0.8,
0.980, 0.85,
0.970, 0.90,
0.970, 1.00,

ICUNVI=12,
CONVI(1,1)= 1875., 0.0,
1850., 0.1,
1825., 0.2,
1815., 0.3,
1830., 0.4,
1895., 0.5,
1970., 0.6,
2030., 0.7,
2130., 0.8,
2210., 0.85,
2500., 0.9,
2800., 1.0,

LOCKUP=0,
NGR=2,
TRANS(1,1)= 3.497, 0.98,
1.250, 0.98,

FD(1)= 5.08, 0.98,

XBRCDF=0.8,

TL=167.,

CL=15.,

CGH=54.25,

CGR=119.5,

CGLAT=0.0,

PBHT=45.0,

EYEHGT=55.,

WIDTH=143.,

WI=87.,

WC=0.0,

PBF=218000.,

MAXL=1,

MAXIPR=9,

RMS(1)= 0.25,

1.0,

2.0,

3.0,

4.0,

5.0,

6.0,

7.0,

8.0,

VRIDE(1,1)= 35.25,
34.00,

21.13,
 14.10,
 11.00,
 10.75,
 10.50,
 10.25,
 10.00.

NHVALS=7,

VOOB(1)= 100.,
 100.,
 12.,
 6.,
 4.,
 4.,
 4.,

HVALS(1)= 4.0,
 9.0,
 10.0,
 12.0,
 15.0,
 20.0,
 40.0,

NSVALS=9,

SVALS(1)= 1.,
 5.,
 10.,
 25.,
 50.,
 100.,
 200.,
 400.,
 600.,

VOOBS(1)= .08,
 .39,
 .77,
 1.93,
 3.86,
 7.73,
 15.45,
 30.91,
 46.36,

\$END

NOHGT

3

NANG

8

NWDTH

3

CLRMIN	FCOMAX	FOO	HOVALS	AVALS	WVALS
INCHES	PCUNDS	POUNDS	INCHES	RADIANS	INCHES
37.03	8948.5	372.1	3.15	1.95	5.88
24.42	27276.2	1842.0	15.75	1.95	5.88

6.57	89773.8	5211.1	33.46	1.95	5.88
37.03	8948.5	394.3	3.15	2.48	5.88
24.38	24473.2	1604.8	15.75	2.48	5.88
6.72	50134.8	3800.0	33.46	2.48	5.88
37.03	8948.5	399.0	3.15	2.69	5.88
24.56	18969.2	1390.5	15.75	2.69	5.88
11.43	32415.7	3016.3	33.46	2.69	5.88
36.90	8456.0	386.8	3.15	2.86	5.88
24.30	17646.6	1259.3	15.75	2.86	5.88
20.43	30044.5	2787.9	33.46	2.86	5.88
38.22	8281.7	707.0	3.15	3.42	5.88
21.27	18699.8	2246.3	15.75	3.42	5.88
2.87	30044.5	2696.0	33.46	3.42	5.88
39.64	4124.4	224.7	3.15	3.60	5.88
31.01	13744.0	1544.0	15.75	3.60	5.88
-1.30	30816.3	2642.9	33.46	3.60	5.88
40.00	3757.7	174.5	3.15	3.80	5.88
36.03	13166.8	982.9	15.75	3.80	5.88
20.01	31678.1	2626.5	33.46	3.80	5.88
40.00	1612.7	30.6	3.15	4.33	5.88
39.54	4149.3	145.9	15.75	4.33	5.88
37.79	5566.1	-125.5	33.46	4.33	5.88
37.13	9272.2	484.4	3.15	1.95	29.88
24.26	12489.2	-316.4	15.75	1.95	29.88
6.57	79647.8	4974.4	33.46	1.95	29.88
37.13	9272.2	500.0	3.15	2.48	29.88
24.22	20072.6	862.5	15.75	2.48	29.88
6.62	51346.5	4342.5	33.46	2.48	29.88
37.13	9272.2	516.7	3.15	2.69	29.88
24.36	20378.0	1717.0	15.75	2.69	29.88
11.70	34087.7	3769.5	33.46	2.69	29.88
36.99	8456.0	527.7	3.15	2.86	29.88
24.57	15926.4	1465.5	15.75	2.86	29.88
20.55	30044.5	3131.9	33.46	2.86	29.88
37.17	8448.1	629.9	3.15	3.42	29.88
14.79	18895.7	1864.3	15.75	3.42	29.88
2.92	30044.5	3040.6	33.46	3.42	29.88
36.88	7208.2	-219.2	3.15	3.60	29.88
22.08	31861.0	2261.9	15.75	3.60	29.88
-11.56	34784.1	3152.8	33.46	3.60	29.88
36.71	9361.9	1001.2	3.15	3.80	29.88
27.21	20061.7	1637.8	15.75	3.80	29.88
3.49	48386.8	4522.6	33.46	3.80	29.88
38.68	5964.9	196.1	3.15	4.33	29.88
37.04	7279.0	-102.6	15.75	4.33	29.88
35.01	12253.2	759.8	33.46	4.33	29.88
37.17	9272.2	231.1	3.15	1.95	141.60
24.77	20814.9	1040.4	15.75	1.95	141.60
6.59	79704.9	4401.1	33.46	1.95	141.60
37.17	9272.2	236.3	3.15	2.48	141.60
24.44	35968.2	1861.0	15.75	2.48	141.60
6.62	52815.6	3648.1	33.46	2.48	141.60

37.17	9272.2	241.8	3.15	2.69	141.60
24.40	27603.5	1707.9	15.75	2.69	141.60
11.59	34088.9	3306.2	33.46	2.69	141.60
36.93	8456.0	429.9	3.15	2.86	141.60
24.46	18740.7	1827.2	15.75	2.86	141.60
20.55	30044.5	3062.1	33.46	2.86	141.60
34.03	8295.3	471.2	3.15	3.42	141.60
22.76	19012.2	2295.4	15.75	3.42	141.60
20.46	30044.5	3493.0	33.46	3.42	141.60
34.12	9326.8	741.4	3.15	3.60	141.60
16.75	32341.8	2497.8	15.75	3.60	141.60
9.38	34368.4	4266.5	33.46	3.60	141.60
33.89	9787.3	452.9	3.15	3.80	141.60
12.40	38383.1	2027.9	15.75	3.80	141.60
-1.83	48928.4	3741.5	33.46	3.80	141.60
33.91	8474.2	608.2	3.15	4.33	141.60
10.90	18269.4	955.9	15.75	4.33	141.60
-23.03	79892.1	5167.6	33.46	4.33	141.60

M151 JEEP
NATO MOBILITY MODEL
TEST VEHICLE

\$VEHICLE
WI=45.8,
LOCDIF=0,
NAMBLV=2,
NVEH(1)=1,
NVEH(2)=1,
WGHT(1)=1740.0,
WGHT(2)=1460.0,
IP(1)=1,
IP(2)=1,
IB(1)=1,
IB(2)=1,
RDIAM(1)=16.0,
RDIAM(2)=16.0,
RIMW(1)=4.5,
RIMW(2)=4.5,
ICONST(1)=1,
ICONST(2)=1,
TPLY(1)=6.0,
TPLY(2)=6.0,
REVM(1)=720.0,
REVM(2)=720.0,
DIAW(1)=30.8,
DIAW(2)=30.8,
SECTW(1)=7.15,
SECTW(2)=7.15,
SECTH(1)=7.40,
SECTH(2)=7.40,
TPSI(1,2)=15.0,
TPSI(2,2)=15.0,
TPSI(1,1)=15.0,
TPSI(2,1)=15.0,
TPSI(1,3)=25.0,
TPSI(2,3)=25.0,
DFLCT(1,1)=1.31,
DFLCT(1,2)=1.31,
DFLCT(2,1)=1.14,
DFLCT(2,2)=1.14,
DFLCT(1,3)=1.0,
DFLCT(2,3)=1.0,
NWHL(1)=2,
NWHL(2)=2,
ID(1)=0,
ID(2)=0,
CLRMIN(1)=11.4,
CLRMIN(2)=11.4,
WTE(1)=45.6,
WTE(2)=45.6,
WT(1)=53.0,

WT(2)=53.0,
NCHAIN(1)=0,
NCHAIN(2)=0,
HPNET=73.92,
ACD=1.2,
CD=1.2,
AXLSP(1)=85.,
AVGC=120.,
CID=141.5,
IDIESL=1.,
NCYL=4.,
NENG=1.,
QMAX=115.,
IT(1)=0,
IT(2)=0,
PFA=22.5,
IAPG=0,
IPOWER=17,
POWER(2,1)=2195.0,
POWER(2,2)=2185.0,
POWER(2,3)=2050.0,
POWER(2,4)=1815.0,
POWER(2,5)=1205.0,
POWER(2,6)=1180.0,
POWER(2,7)=1085.0,
POWER(2,8)=870.0,
POWER(2,9)=660.0,
POWER(2,10)=650.0,
POWER(2,11)=615.0,
POWER(2,12)=560.0,
POWER(2,13)=420.0,
POWER(2,14)=385.0,
POWER(2,15)=355.0,
POWER(2,16)=340.0,
POWER(2,17)=310.0,
POWER(1,1)=0.0,
POWER(1,2)=4.9,
POWER(1,3)=7.5,
POWER(1,4)=10.0,
POWER(1,5)=10.1,
POWER(1,6)=12.0,
POWER(1,7)=15.5,
POWER(1,8)=19.8,
POWER(1,9)=19.9,
POWER(1,10)=25.0,
POWER(1,11)=30.0,
POWER(1,12)=33.0,
POWER(1,13)=33.1,
POWER(1,14)=40.0,
POWER(1,15)=45.0,
POWER(1,16)=50.0,
POWER(1,17)=56.0,

I TRAN=0,
I ENGIN=10,
ENGINE(1,1)=800.0,
ENGINE(1,2)=1200.0,
ENGINE(1,3)=1600.0,
ENGINE(1,4)=2000.0,
ENGINE(1,5)=2400.0,
ENGINE(1,6)=2800.0,
ENGINE(1,7)=3200.0,
ENGINE(1,8)=3600.0,
ENGINE(1,9)=4000.0,
ENGINE(1,10)=4400.0,
ENGINE(2,1)=115.0,
ENGINE(2,2)=115.0,
ENGINE(2,3)=115.0,
ENGINE(2,4)=115.0,
ENGINE(2,5)=112.0,
ENGINE(2,6)=108.0,
ENGINE(2,7)=103.0,
ENGINE(2,8)=96.0,
ENGINE(2,9)=88.0,
ENGINE(2,10)=80.0,
ITCASE=0,
TCASE(1)=1.0,
TCASE(2)=1.0,
NGR=4,
TRANS(1,1)=5.712,
TRANS(1,2)=3.179,
TRANS(1,3)=1.674,
TRANS(1,4)=1.000,
TRANS(2,1)=0.9,
TRANS(2,2)=0.9,
TRANS(2,3)=0.9,
TRANS(2,4)=0.9,
FD(1)=4.86,
FD(2)=0.9,
LOCKUP=0,
XBRCOF=0.7,
CL=9.1,
VAA=66.0,
VDA=37.0,
TL=85.0,
WDTH=64.0,
CGH=10.3,
CGK=42.0,
CGLAT=0.0,
PBHT=20.0,
EYEHGT=52.5,
WC=0.0,
PBF=3200.0,
MAXL=1,
MAXIPR=9,

RMS(1)=0.25,
RMS(2)=1.0,
RMS(3)=2.0,
RMS(4)=3.0,
RMS(5)=4.0,
RMS(6)=5.0,
RMS(7)=6.0,
RMS(8)=7.0,
RMS(9)=8.0,
VRIDE(1,1)=76.5,
VRIDE(2,1)=21.0,
VRIDE(3,1)=9.5,
VRIDE(4,1)=5.1,
VRIDE(5,1)=2.0,
VRIDE(6,1)=2.0,
VRIDE(7,1)=2.0,
VRIDE(8,1)=2.0,
VRIDE(9,1)=2.0,
NHVALS=7,
VOOB(1)=100.0,
VOOB(2)=20.0,
VOOB(3)=6.0,
VOOB(4)=4.0,
VOOB(5)=2.0,
VOOB(6)=1.0,
VOOB(7)=1.0,
HVALS(1)=0.01,
HVALS(2)=4.0,
HVALS(3)=8.0,
HVALS(4)=12.0,
HVALS(5)=16.0,
HVALS(6)=20.0,
HVALS(7)=40.0,
NSVALS=16,
VOOBS(1)=15.0,
VOOBS(2)=15.0,
VOOBS(3)=15.0,
VOOBS(4)=15.0,
VOOBS(5)=15.0,
VOOBS(6)=15.0,
VOOBS(7)=15.0,
VOOBS(8)=15.0,
VOOBS(9)=15.0,
VOOBS(10)=15.0,
VOOBS(11)=15.0,
VOOBS(12)=15.0,
VOOBS(13)=15.0,
VOOBS(14)=15.0,
VOOBS(15)=15.0,
VOOBS(16)=15.0,
SVALS(1)=1.0,
SVALS(2)=2.0,

SVALS(3)=3.0,
 SVALS(4)=4.0,
 SVALS(5)=5.0,
 SVALS(6)=6.0,
 SVALS(7)=7.0,
 SVALS(8)=8.0,
 SVALS(9)=9.0,
 SVALS(10)=10.0,
 SVALS(11)=11.0,
 SVALS(12)=12.0,
 SVALS(13)=13.0,
 SVALS(14)=15.0,
 SVALS(15)=20.0,
 SVALS(16)=40.0,

\$

NOHGT
 3
 NANG
 8
 NWDTH
 3

CLRMIN INCHES	FOOMAX POUNDS	FUO POUNDS	HOV ALS INCHES	AVALS RADIANES	WVALS INCHES
6.85	941.6	31.2	3.15	1.95	5.88
-3.75	2179.6	127.1	15.75	1.95	5.88
-21.21	2208.5	237.5	33.46	1.95	5.88
6.85	1015.5	35.6	3.15	2.48	5.88
-3.54	1061.2	118.7	15.75	2.48	5.88
-13.36	960.9	160.6	33.46	2.48	5.88
6.85	696.1	25.5	3.15	2.69	5.88
-2.31	696.7	124.9	15.75	2.69	5.88
-3.95	646.3	98.2	33.46	2.69	5.88
7.45	411.2	34.3	3.15	2.86	5.88
2.93	404.0	69.7	15.75	2.86	5.88
2.61	799.3	98.3	33.46	2.86	5.88
7.19	417.7	40.9	3.15	3.42	5.88
5.50	444.5	88.7	15.75	3.42	5.88
3.10	799.3	103.9	33.46	3.42	5.88
7.42	704.7	35.5	3.15	3.60	5.88
1.20	757.6	135.1	15.75	3.60	5.88
-4.83	839.1	135.3	33.46	3.60	5.88
8.20	662.5	16.3	3.15	3.80	5.88
.08	1170.4	180.3	15.75	3.80	5.88
-9.54	1301.5	240.0	33.46	3.80	5.88
9.65	344.3	4.8	3.15	4.33	5.88
5.79	1150.8	43.5	15.75	4.33	5.88
-.23	2378.0	146.0	33.46	4.33	5.88
6.85	592.1	-2.8	3.15	1.95	29.88
-3.75	2163.4	99.1	15.75	1.95	29.88
-21.46	2029.6	150.9	33.46	1.95	29.88
6.85	1015.5	29.3	3.15	2.48	29.88
-3.75	1052.4	98.4	15.75	2.48	29.88

-4.92	1110.3	109.8	33.46	2.48	29.88
6.85	698.1	24.7	3.15	2.69	29.88
.59	658.0	69.2	15.75	2.69	29.88
.52	837.9	116.9	33.46	2.69	29.88
7.45	411.2	28.8	3.15	2.86	29.88
4.86	443.4	50.1	15.75	2.86	29.88
4.75	799.3	105.0	33.46	2.86	29.88
7.29	417.6	31.1	3.15	3.42	29.88
5.40	444.5	57.0	15.75	3.42	29.88
4.92	799.3	108.6	33.46	3.42	29.88
6.83	708.6	39.9	3.15	3.60	29.88
.78	761.3	119.2	15.75	3.60	29.88
-2.82	842.2	137.0	33.46	3.60	29.88
6.70	991.4	34.9	3.15	3.80	29.88
-2.46	1178.4	145.1	15.75	3.80	29.88
-10.26	1318.0	195.9	33.46	3.80	29.88
6.68	575.1	4.9	3.15	4.33	29.88
-3.01	2401.8	157.0	15.75	4.33	29.88
-23.83	2551.4	228.7	33.46	4.33	29.88
6.85	541.3	-6.0	3.15	1.95	141.60
-.50	2428.4	87.4	15.75	1.95	141.60
-11.40	2556.1	128.8	33.46	1.95	141.60
6.85	1093.9	18.1	3.15	2.48	141.60
2.04	1170.6	68.6	15.75	2.48	141.60
-.73	1304.9	145.9	33.46	2.48	141.60
6.85	707.5	16.9	3.15	2.69	141.60
4.40	758.7	75.1	15.75	2.69	141.60
3.83	837.9	132.5	33.46	2.69	141.60
7.45	416.8	17.0	3.15	2.86	141.60
6.75	443.4	65.4	15.75	2.86	141.60
6.88	799.3	103.0	33.46	2.86	141.60
7.67	417.2	19.1	3.15	3.42	141.60
7.28	388.0	65.9	15.75	3.42	141.60
6.85	799.3	106.8	33.46	3.42	141.60
6.84	707.1	20.1	3.15	3.60	141.60
4.25	760.1	78.2	15.75	3.60	141.60
3.88	839.7	135.9	33.46	3.60	141.60
7.08	1094.0	18.6	3.15	3.80	141.60
2.04	1168.7	83.3	15.75	3.80	141.60
-.60	1312.2	164.2	33.46	3.80	141.60
6.80	1131.4	30.3	3.15	4.33	141.60
-.03	2397.2	80.3	15.75	4.33	141.60
-15.46	2549.8	147.3	33.46	4.33	141.60

APPENDIX C
TERRAIN INPUT FILES FOR PROGRAM NRMM

AREAL TERRAIN INPUT FILE - CLASS INTERVAL FORMAT - FILE CKK

1 1 1 1 11 111111111111111111
2 1 5 5 51 111111111111111111
3 1 6 6 61 111111111111111111
4 1 8 8 81 111111111111111111
5 1010101 111111111111111111
6 1 1 1 12 111111111111111111
7 1 1 1 13 111111111111111111
8 1 1 1 14 111111111111111111
9 1 1 1 16 111111111111111111
10 1 1 1 17 111111111111111111
11 2 1 1 11 111111111111111111
12 2 5 5 51 111111111111111111
13 2 6 6 61 111111111111111111
14 2 8 8 81 111111111111111111
15 21010101 111111111111111111
16 2 1 1 12 111111111111111111
17 2 1 1 13 111111111111111111
18 2 1 1 14 111111111111111111
19 2 1 1 16 111111111111111111
20 2 1 1 17 111111111111111111
21 1 1 1 11 111111111111111111
22 1 1 1 11 111111311111111111
23 1 1 1 11 111111511111111111
24 1 1 1 11 111111711111111111
25 1 1 1 11 111111911111111111
26 1 1 1 11 111111666665551
27 1 1 1 11 111111887655551
28 1 1 1 11 111111666666661
29 1 1 1 11 111111888876551
30 1 1 1 11 111111888887651
31 1 1 1 1111433311666665551
32 1 5 5 5111433311887655551
33 1 5 5 5111433311666666661
34 1 1 1 1111433211887655551
35 1 5 5 5111433211666665551
36 1 1 1 11111352111111111111
37 1 1 1 11111352211111111111
38 1 1 1 11113352211111111111
39 1 1 1 11115352211111111111
40 1 1 1 11117352211111111111
41 1 1 1 111343722111111111111
42 1 1 1 111343732111111111111
43 1 1 1 111343782111111111111
44 1 1 1 11 111111111111111112
45 1 1 1 11 111111111111111113
46 1 1 1 11 111111111111111116
47 1 5 5 51 111111111111111112
48 1 5 5 51 111111111111111113
49 1 5 5 51 111111111111111116
50 1 7 7 71 111111111111111118

1	1	1	4	300	300	300	300	31000	1000	1000	1000	1	70	0.1000
2	2	1	4	300	300	300	300	7500	500	500	500	2	40	0.1100
3	2	1	4	300	300	300	300	7500	500	500	500	2	55	0.1200
4	2	1	1	300	300	300	300	3500	500	500	500	2	25	0.1300
5	3	1	4	300	300	300	300	3250	250	250	250	8	55	0.1400
6	3	1	4	300	300	300	300	15500	500	500	500	8	55	0.1500
7	3	1	4	300	300	300	300	3500	500	500	500	25	40	0.1600
8	3	1	4	250	190	80	80	3250	250	250	250	8	40	0.1700
9	4	1	4	250	190	36	36	3250	250	250	250	8	55	0.1800
10	4	1	4	200	200	200	200	15250	250	250	250	8	55	0.1900
11	4	1	4	200	200	80	80	15250	250	250	250	8	55	0.2000
12	4	1	4	250	200	200	200	3250	250	250	250	25	40	0.2100
13	4	1	4	250	200	200	200	379	79	79	79	10	30	0.2200
14	4	1	4	250	200	200	200	3250	250	250	250	10	9	0.2300

APPENDIX D

SAMPLE OUTPUT OF PROGRAM NRMM

This Appendix contains output generated by executing NRMM using the vehicle and terrain input files of Appendices B and C. In all cases, the control variable `DETAIL` was set to 2. This results in output of the control, scenario and vehicle data through `NAMelist` directed `WRITE`'s. This is followed by the speed-made-good as described in Section II.E. The control variable `SEARCH` was set to 0.

For the Areal terrain, the scenario variables `MAP` and `ISEASN` were set to 71 and 3 respectively. For the Road terrain, the scenario inputs were `MAP` = 11, `ISEASN` = 3 and `MONTH` = 1. The default values were used for all other control and scenario variables.

These outputs are presented as examples. The terrain files are artificial. They were made up to systematically exercise portions of the Model.

```
$CONTRL  
DETAIL = 2,  
KSCEN = 1,  
KVEH = 1,  
KII1 = 0,  
KII2 = 0,  
KII3 = 0,  
KII4 = 0,  
KII5 = 0,  
KII6 = 0,  
KII7 = 0,  
KII8 = 0,  
KII9 = 0,  
KII10 = 0,  
KII11 = 0,  
KII12 = 0,  
KII13 = 0,  
KII14 = 0,  
KII15 = 0,  
KII16 = 0,  
KII17 = 0,  
KMAP = 0,  
KTPP = 0,  
KIV1 = 0,  
KIV2 = 0,  
KIV3 = 0,  
KIV4 = 0,  
KIV5 = 0,  
KIV6 = 0,  
KIV7 = 0,  
KIV8 = 0,  
KIV9 = 0,  
KIV10 = 0,  
KIV11 = 0,  
KIV12 = 0,  
KIV13 = 0,  
KIV14 = 0,  
KIV15 = 0,  
KIV16 = 0,  
KIV17 = 0,  
KIV18 = 0,  
KIV19 = 0,  
KIV20 = 0,  
KIV21 = 0,  
NTUX = 1,  
SEARCH = 0,  
$END
```

SAMPLE OUTPUT OF PROGRAM NRPM - VEHICLE: M60A1, TERRAIN: CKK

```
$SCENAR  
COHES = .5E-01,  
DCLMAX = .5E+00,  
GAMMA = .2E+00,  
IOVER = 9,  
ISEASN = 3,  
ISURF = 1,  
ISNOW = 0,  
LAC = 1,  
MAP = 71,  
MAPG = 1,  
MONTH = 1,  
NOPP = 0,  
NSLIP = 0,  
NTRAV = 3,  
NTUX = 1,  
PHI = .21E+02,  
REACT = .5E+00,  
RDFOG = .1E+04,  
SFTYPC = .9E+02,  
VBRAKE = .5E+01,  
VISMNV = .2E+01,  
VLIM = .55E+02,  
ZSNOW = .3E+01,  
$END
```

SAMPLE OUTPUT OF PROGRAM NRMK - VEHICLE: M62A1, TERRAIN: CKK

\$VEHICLE

ACD = .12E+01,
ASHOE = .194E+03, 0.0, 0.0, 0.0, 0.0, 0.0, 0.0, 0.0, 0.0, 0.0, 0.0, 0.0,
2.0, 0.0, 0.0, 0.0, 0.0, 0.0, 0.0, 0.0,
AVGC = 0.0,
AXLSP = 0.0, 0.0, 0.0, 0.0, 0.0, 0.0, 0.0, 0.0, 0.0, 0.0, 0.0, 0.0,
0.0, 0.0, 0.0, 0.0, 0.0, 0.0, 0.0,
CD = .12E+01,
CGH = .5425E+02,
CGLAT = 0.0,
CGR = .1195E+03,
CID = .1791E+04,
CL = .15E+02,
CLRMIN = 0.0, 0.0, 0.0, 0.0, 0.0, 0.0, 0.0, 0.0, 0.0, 0.0, 0.0, 0.0,
0.0, 0.0, 0.0, 0.0, 0.0, 0.0, 0.0,
CONV1 = .1875E+04, 0.0, .185E+04, .1E+00, .1825E+04, .2E+00,
.1815E+04, .3E+00, .183E+04, .4E+00, .1895E+04,
.5E+00, .197E+04, .6E+00, .203E+04, .7E+00, .213E+04, .8E+00,
.221E+04, .85E+00, .25E+04, .9E+00,
.28E+04, .1E+01, 0.0, 0.0, 0.0, 0.0, 0.0, 0.0, 0.0, 0.0, 0.0,
0.0, 0.0, 0.0, 0.0, 0.0, 0.0, 0.0,
CONV2 = .366E+01, 0.0, .3125E+01, .1E+00, .265E+01, .2E+00, .2228E+01,
.3E+00, .195E+01, .4E+00, .167E+01,
.5E+00, .142E+01, .6E+00, .122E+01, .7E+00, .105E+01, .8E+00,
.98E+00, .85E+00, .97E+00, .9E+00,
.97E+00, .1E+01, 0.0, 0.0, 0.0, 0.0, 0.0, 0.0, 0.0, 0.0, 0.0,
0.0, 0.0, 0.0, 0.0, 0.0, 0.0, 0.0,
0.0, 0.0, 0.0, 0.0, 0.0, 0.0, 0.0, 0.0,
DFLCT = 0.0, 0.0, 0.0, 0.0, 0.0, 0.0, 0.0, 0.0, 0.0, 0.0, 0.0, 0.0,
0.0, 0.0, 0.0, 0.0, 0.0, 0.0, 0.0, 0.0,
0.0, 0.0, 0.0, 0.0, 0.0, 0.0, 0.0, 0.0, 0.0, 0.0, 0.0, 0.0,
0.0, 0.0, 0.0, 0.0, 0.0, 0.0, 0.0, 0.0,
0.0, 0.0, 0.0, 0.0, 0.0, 0.0,
DIAW = 0.0, 0.0, 0.0, 0.0, 0.0, 0.0, 0.0, 0.0, 0.0, 0.0, 0.0, 0.0,
0.0, 0.0, 0.0, 0.0, 0.0, 0.0, 0.0,
DRAFT = 0.0,
ENGINE = .12E+04, .161E+04, .13E+04, .1645E+04, .14E+04, .167E+04,
.15E+04, .1682E+04, .16E+04, .168E+04, .17E+04,
.1675E+04, .18E+04, .1655E+04, .19E+04, .163E+04, .2E+04,
.16E+04, .21E+04, .156E+04, .22E+04, .1515E+04,
.23E+04, .147E+04, .24E+04, .142E+04, 0.0, 0.0, 0.0, 0.0, 0.0,
0.0, 0.0, 0.0, 0.0, 0.0, 0.0, 0.0,
0.0, 0.0, 0.0, 0.0, 0.0, 0.0, 0.0, 0.0, 0.0, 0.0, 0.0, 0.0,
0.0, 0.0, 0.0, 0.0, 0.0, 0.0, 0.0, 0.0, 0.0, 0.0, 0.0, 0.0,
0.0, 0.0, 0.0, 0.0, 0.0, 0.0, 0.0,
0.0, 0.0, 0.0, 0.0, 0.0, 0.0, 0.0,
EYEHGT = .55E+02,
FD = .508E+01, .98E+00.

FORDD = 0.0,
GROUSH = .15E+01, 0.0, 0.0, 0.0, 0.0, 0.0, 0.0, 0.0, 0.0, 0.0, 0.0, 0.0,
0.0, 0.0, 0.0, 0.0, 0.0, 0.0, 0.0, 0.0,
HPNET = .643E+03,
HVALS = 0.0, .9E+01, .1E+02, .12E+02, .15E+02, .2E+02, .4E+02, 0.0,
0.0, 0.0, 0.0, 0.0, 0.0, 0.0, 0.0, 0.0,
0.0, 0.0, 0.0, 0.0, 0.0, 0.0, 0.0, 0.0,
IAPG = 1,
IB = 1, 0, 0, 0, 0, 0, 0, 0, 0, 0, 0, 0, 0, 0, 0, 0, 0, 0, 0,
ID = 0, 0, 0, 0, 0, 0, 0, 0, 0, 0, 0, 0, 0, 0, 0, 0, 0, 0, 0,
IDIESL = .1E+01,
IENGIN = 13,
ICONST = 0, 0, 0, 0, 0, 0, 0, 0, 0, 0, 0, 0, 0, 0, 0, 0, 0, 0, 0,
ICONV1 = 12,
ICONV2 = 12,
IP = 1, 0, 0, 0, 0, 0, 0, 0, 0, 0, 0, 0, 0, 0, 0, 0, 0, 0, 0,
IPOWER = 0,
IT = 0, 0, 0, 0, 0, 0, 0, 0, 0, 0, 0, 0, 0, 0, 0, 0, 0, 0, 0,
ITCASE = 1,
ITRAN = 1,
ITVAR = 0,
LOCDIF = 0,
LOCKUP = 0,
MAXIPR = 9,
MAXL = 1,
NAMBLV = 1,
NBOGIE = 12, 0, 0, 0, 0, 0, 0, 0, 0, 0, 0, 0, 0, 0, 0, 0, 0, 0, 0,
NCHAIN = 0, 0, 0, 0, 0, 0, 0, 0, 0, 0, 0, 0, 0, 0, 0, 0, 0, 0, 0,
NCYL = .12E+02,
NENG = .1E+01,
NFL = 1, 0, 0, 0, 0, 0, 0, 0, 0, 0, 0, 0, 0, 0, 0, 0, 0, 0, 0,
NGR = 2,
NHVALS = 7,
NPAD = 1, 0, 0, 0, 0, 0, 0, 0, 0, 0, 0, 0, 0, 0, 0, 0, 0, 0, 0,
NSVALS = 9,
NVEH = 0, 0, 0, 0, 0, 0, 0, 0, 0, 0, 0, 0, 0, 0, 0, 0, 0, 0, 0,
NWHL = 0, 0, 0, 0, 0, 0, 0, 0, 0, 0, 0, 0, 0, 0, 0, 0, 0, 0, 0,
NWR = 0,
PBF = .218E+06,
PBHT = .45E+02,
PFA = .92E+02,
POWER = 0.0, 0.0, 0.0, 0.0, 0.0, 0.0, 0.0, 0.0, 0.0, 0.0, 0.0, 0.0, 0.0, 0.0, 0.0, 0.0, 0.0, 0.0, 0.0,
0.0, 0.0, 0.0, 0.0, 0.0, 0.0, 0.0, 0.0, 0.0, 0.0, 0.0, 0.0, 0.0, 0.0, 0.0, 0.0, 0.0, 0.0, 0.0,
0.0, 0.0, 0.0, 0.0, 0.0, 0.0, 0.0, 0.0, 0.0, 0.0, 0.0, 0.0, 0.0, 0.0, 0.0, 0.0, 0.0, 0.0, 0.0,
0.0, 0.0, 0.0, 0.0, 0.0, 0.0, 0.0, 0.0, 0.0, 0.0, 0.0, 0.0, 0.0, 0.0, 0.0, 0.0, 0.0, 0.0, 0.0,
0.0, 0.0, 0.0, 0.0, 0.0, 0.0, 0.0, 0.0, 0.0, 0.0, 0.0, 0.0, 0.0, 0.0, 0.0, 0.0, 0.0, 0.0, 0.0,
0.0, 0.0, 0.0, 0.0, 0.0, 0.0, 0.0, 0.0, 0.0, 0.0, 0.0, 0.0, 0.0, 0.0, 0.0, 0.0, 0.0, 0.0, 0.0,
0.0, 0.0, 0.0, 0.0, 0.0, 0.0, 0.0, 0.0, 0.0, 0.0, 0.0, 0.0, 0.0, 0.0, 0.0, 0.0, 0.0, 0.0, 0.0,
0.0, 0.0, 0.0, 0.0, 0.0, 0.0, 0.0, 0.0, 0.0, 0.0, 0.0, 0.0, 0.0, 0.0, 0.0, 0.0, 0.0, 0.0, 0.0,
0.0, 0.0, 0.0, 0.0, 0.0, 0.0, 0.0, 0.0, 0.0, 0.0, 0.0, 0.0, 0.0, 0.0, 0.0, 0.0, 0.0, 0.0, 0.0,

SAMPLE OUTPUT OF PROGRAM NRMM - VEHICLE: M60A1, TERRAIN: CKK

```

0.0, 0.0, 0.0, 0.0, 0.0, 0.0, 0.0, 0.0,
TPSI = 0.0, 0.0, 0.0, 0.0, 0.0, 0.0, 0.0, 0.0, 0.0, 0.0, 0.0, 0.0, 0.0,
0.0, 0.0, 0.0, 0.0, 0.0, 0.0, 0.0, 0.0, 0.0,
0.0, 0.0, 0.0, 0.0, 0.0, 0.0, 0.0, 0.0, 0.0,
0.0, 0.0, 0.0, 0.0, 0.0, 0.0, 0.0, 0.0, 0.0, 0.0, 0.0, 0.0, 0.0,
0.0, 0.0, 0.0, 0.0, 0.0, 0.0,
TQIND = .9E+03,
TRAKLN = .167E+03, 0.0, 0.0, 0.0, 0.0, 0.0, 0.0, 0.0, 0.0, 0.0, 0.0, 0.0,
0.0, 0.0, 0.0, 0.0, 0.0, 0.0, 0.0, 0.0, 0.0,
TRAKWD = .28E+02, 0.0, 0.0, 0.0, 0.0, 0.0, 0.0, 0.0, 0.0, 0.0, 0.0, 0.0,
0.0, 0.0, 0.0, 0.0, 0.0, 0.0, 0.0, 0.0,
TRANS = .3497E+01, .98E+00, .1256E+01, .98E+00, 0.0, 0.0, 0.0, 0.0,
0.0, 0.0, 0.0, 0.0, 0.0, 0.0, 0.0, 0.0, 0.0,
0.0, 0.0, 0.0, 0.0, 0.0, 0.0, 0.0, 0.0, 0.0, 0.0, 0.0, 0.0,
0.0, 0.0, 0.0, 0.0, 0.0, 0.0, 0.0, 0.0,
VAA = 0.0,
VDA = 0.0,
VFS = 0.0,
VDOB = .1E+03, .1E+03, .12E+02, .6E+01, .4E+01, .4E+01, .4E+01, 0.0,
0.0, 0.0, 0.0, 0.0, 0.0, 0.0, 0.0,
0.0, 0.0, 0.0, 0.0, 0.0, 0.0, 0.0, 0.0,
VDOBS = .8E-01, .39E+00, .27E+00, .193E+01, .386E+01, .773E+01,
.1545E+02, .3091E+02, .4636E+02, 0.0, 0.0, 0.0,
0.0, 0.0, 0.0, 0.0, 0.0, 0.0, 0.0, 0.0, 0.0, 0.0, 0.0,
0.0,
VRIDE = .3525E+02, .34E+02, .2113E+02, .141E+02, .11E+02, .1075E+02,
.105E+02, .1025E+02, .1E+02, 0.0, 0.0,
0.0, 0.0, 0.0, 0.0, 0.0, 0.0, 0.0, 0.0, 0.0, 0.0, 0.0, 0.0,
0.0, 0.0, 0.0, 0.0, 0.0, 0.0, 0.0, 0.0, 0.0, 0.0, 0.0, 0.0,
0.0, 0.0, 0.0, 0.0, 0.0, 0.0, 0.0, 0.0,
VSS = 0.0,
VSSAXP = 0.0,
WC = 0.0,
WDAXP = 0.0,
WLPPTH = 0.0, 0.0, 0.0, 0.0, 0.0, 0.0, 0.0, 0.0, 0.0, 0.0, 0.0, 0.0, 0.0,
0.0, 0.0, 0.0, 0.0, 0.0, 0.0, 0.0,
WDTH = .143E+03,
WGHT = .129E+06, 0.0, 0.0, 0.0, 0.0, 0.0, 0.0, 0.0, 0.0, 0.0, 0.0, 0.0,
0.0, 0.0, 0.0, 0.0, 0.0, 0.0, 0.0,
WI = .87E+02,
WRAT = 0.0, 0.0, 0.0, 0.0, 0.0, 0.0, 0.0, 0.0, 0.0, 0.0, 0.0, 0.0, 0.0,
0.0, 0.0, 0.0, 0.0, 0.0, 0.0, 0.0,
WKFORD = 0.0,
WT = .115E+03, 0.0, 0.0, 0.0, 0.0, 0.0, 0.0, 0.0, 0.0, 0.0, 0.0, 0.0,
0.0, 0.0, 0.0, 0.0, 0.0, 0.0, 0.0,
WTE = .87E+02, 0.0, 0.0, 0.0, 0.0, 0.0, 0.0, 0.0, 0.0, 0.0, 0.0, 0.0,
0.0, 0.0, 0.0, 0.0, 0.0, 0.0, 0.0,
WWAXP = 0.0,

```

YBRCOF = .8E+00,
SEND

SAMPLE OUTPUT OF PROGRAM NRMM - VEHICLE: M60A1, TERRAIN: CKK

NTU	ITUT	VMAX	UP	LEVEL	DOWN	VSEL	UP	LEVEL	DOWN	GRADE	AREA
1	1	27.07	27.07	27.07	27.07	27.07	27.07	27.07	27.07	1.00	0.0000
2	1	21.20	18.81	21.15	24.35	21.20	18.81	21.15	24.35	1.00	0.0000
3	1	15.11	13.63	15.16	26.86	15.11	13.63	15.16	16.86	1.00	0.0000
4	1	8.09	7.68	8.08	8.55	8.09	7.68	8.08	8.55	1.00	0.0000
5	1	0.00	0.00	0.00	0.00	0.00	0.00	0.00	0.00	1.00	0.0000
6	1	23.86	19.29	27.07	27.07	23.86	19.29	27.07	27.07	3.50	0.0000
7	1	19.56	12.58	27.07	27.07	19.56	12.58	27.07	27.07	7.50	0.0000
8	1	15.54	8.39	27.07	27.07	15.54	8.39	27.07	27.07	15.00	0.0000
9	1	6.10	2.39	27.07	27.05	6.10	2.39	27.07	27.05	50.00	0.0000
10	1	2.17	.77	27.07	19.17	2.17	.77	27.07	19.17	65.00	0.0000
11	1	16.73	15.10	16.78	18.71	16.73	15.10	16.78	18.71	1.00	0.0000
12	1	9.20	8.63	9.22	9.82	9.20	8.63	9.22	9.82	1.00	0.0000
13	1	7.01	6.73	7.01	7.33	7.01	6.73	7.01	7.33	1.00	0.0000
14	1	5.48	5.28	5.49	5.71	5.48	5.28	5.49	5.71	1.00	0.0000
15	1	3.92	3.74	3.92	4.11	3.92	3.74	3.92	4.11	1.00	0.0000
16	1	16.31	11.53	16.78	26.54	16.31	11.53	16.78	26.54	3.50	0.0000
17	1	15.14	9.83	16.78	27.12	15.14	9.83	16.78	27.12	7.50	0.0000
18	1	12.27	6.76	16.78	27.12	12.27	6.76	16.78	27.12	15.00	0.0000
19	1	4.66	1.82	16.78	27.11	4.66	1.82	16.78	27.11	50.00	0.0000
20	1	2.47	.91	16.78	17.26	2.47	.91	16.78	17.26	65.00	0.0000
21	1	27.07	27.07	27.07	27.07	27.07	27.07	27.07	27.07	1.00	0.0000
22	1	21.13	21.13	21.13	21.13	21.13	21.13	21.13	21.13	1.00	0.0000
23	1	11.00	11.00	11.00	11.00	11.00	11.00	11.00	11.00	1.00	0.0000
24	1	10.50	10.50	10.50	10.50	10.50	10.50	10.50	10.50	1.00	0.0000
25	1	10.00	10.00	10.00	10.00	10.00	10.00	10.00	10.00	1.00	0.0000
26	1	14.54	13.12	14.60	16.23	9.26	9.26	9.26	9.26	1.00	0.0000
27	1	14.30	12.90	14.36	15.97	9.26	9.26	9.26	9.26	1.00	0.0000
28	1	9.98	9.84	9.97	10.14	0.00	0.00	0.00	0.00	1.00	0.0000
29	1	9.26	9.26	9.26	9.26	9.26	9.26	9.26	9.26	1.00	0.0000
30	1	5.37	5.17	5.37	5.59	5.37	5.17	5.37	5.59	1.00	0.0000
31	1	14.54	13.12	14.60	16.23	8.58	8.58	8.58	8.58	1.00	0.0000
32	1	10.74	10.11	10.36	11.92	8.58	8.58	8.58	8.58	1.00	0.0000
33	1	9.08	8.50	9.06	9.76	0.00	0.00	0.00	0.00	1.00	0.0000
34	1	14.30	12.90	14.36	15.97	9.24	9.24	9.24	9.24	1.00	0.0000
35	1	10.98	10.14	10.84	12.13	9.24	9.24	9.24	9.24	1.00	0.0000
36	1	27.07	27.07	27.07	27.07	27.07	27.07	27.07	27.07	1.00	0.0000
37	1	27.07	27.07	27.07	27.07	27.07	27.07	27.07	27.07	1.00	0.0000
38	1	10.45	10.28	10.44	10.63	10.45	10.28	10.44	10.63	1.00	0.0000
39	1	8.34	8.23	8.34	8.46	8.34	8.23	8.34	8.46	1.00	0.0000
40	1	8.09	7.99	8.09	8.20	8.09	7.99	8.09	8.20	1.00	0.0000
41	1	8.54	8.42	8.54	8.66	8.54	8.42	8.54	8.66	1.00	0.0000
42	1	5.76	5.72	5.75	5.81	5.76	5.72	5.75	5.81	1.00	0.0000
43	1	3.61	3.61	3.61	3.61	3.61	3.61	3.61	3.61	1.00	0.0000
44	1	27.07	27.07	27.07	27.07	27.07	27.07	27.07	27.07	1.00	0.0000
45	1	23.48	23.48	23.48	23.48	23.48	23.48	23.48	23.48	1.00	0.0000
46	1	10.90	10.90	10.90	10.90	10.90	10.90	10.90	10.90	1.00	0.0000
47	1	21.20	18.81	21.15	24.35	21.20	18.81	21.15	24.35	1.00	0.0000
48	1	20.97	18.81	21.15	23.48	20.97	18.81	21.15	23.48	1.00	0.0000
49	1	10.90	10.90	10.90	10.90	10.90	10.90	10.90	10.90	1.00	0.0000
50	1	6.04	6.04	6.04	6.04	6.04	6.04	6.04	6.04	1.00	0.0000

\$CONTRL
DETAIL = 2,
KSCEN = 1,
KVEH = 1,
KII1 = 0,
KII2 = 0,
KII3 = 0,
KII4 = 0,
KII5 = 0,
KII6 = 0,
KII7 = 0,
KII8 = 0,
KII9 = 0,
KII10 = 0,
KII11 = 0,
KII12 = 0,
KII13 = 0,
KII14 = 0,
KII15 = 0,
KII16 = 0,
KII17 = 0,
KMAP = 0,
KTPP = 0,
KIV1 = 0,
KIV2 = 0,
KIV3 = 0,
KIV4 = 0,
KIV5 = 0,
KIV6 = 0,
KIV7 = 0,
KIV8 = 0,
KIV9 = 0,
KIV10 = 0,
KIV11 = 0,
KIV12 = 0,
KIV13 = 0,
KIV14 = 0,
KIV15 = 0,
KIV16 = 0,
KIV17 = 0,
KIV18 = 0,
KIV19 = 0,
KIV20 = 0,
KIV21 = 0,
NTUX = 1,
SEARCH = 0,
\$END

```
$SCENAR  
COHES = .5E-01,  
DCLMAX = .5E+00,  
GAMMA = .2E+00,  
IOVER = 9,  
ISEASN = 3,  
ISURF = 1,  
ISNOW = 0,  
LAC = 1,  
MAP = 11,  
MAPG = 1,  
MONTH = 1,  
NOPP = 0,  
NSLIP = 0,  
NTRAV = 3,  
NTUX = 1,  
PHI = .21E+02,  
REACT = .5E+00,  
RDFOG = .1E+04,  
SFTYPC = .9E+02,  
VBRAKE = .5E+01,  
VISMNV = .2E+01,  
VLIM = .55E+02,  
ZSNOW = .3E+01,  
$END
```

SAMPLE OUTPUT OF PROGRAM NRPM - VEHICLE: M60A1, TERRAIN: CKKR

\$VEHICLE

ACD = .12E+01,
ASHOE = .194E+03, 0.0, 0.0, 0.0, 0.0, 0.0, 0.0, 0.0, 0.0, 0.0, 0.0, 0.0,
0.0, 0.0, 0.0, 0.0, 0.0, 0.0, 0.0, 0.0,
AVGC = 0.0,
AXLSP = 0.0, 0.0, 0.0, 0.0, 0.0, 0.0, 0.0, 0.0, 0.0, 0.0, 0.0, 0.0,
0.0, 0.0, 0.0, 0.0, 0.0, 0.0, 0.0, 0.0,
CD = .12E+01,
CGH = .5425E+02,
CGLAT = 0.0,
CGR = .1195E+03,
CID = .1791E+04,
CL = .15E+02,
CLRMIN = 0.0, 0.0, 0.0, 0.0, 0.0, 0.0, 0.0, 0.0, 0.0, 0.0, 0.0, 0.0,
0.0, 0.0, 0.0, 0.0, 0.0, 0.0, 0.0,
CONV1 = .1875E+04, 0.0, .185E+04, .1E+00, .1825E+04, .2E+00,
.1815E+04, .3E+00, .183E+04, .4E+00, .1895E+04,
.5E+00, .197E+04, .6E+00, .203E+04, .7E+00, .213E+04, .8E+00,
.221E+04, .85E+00, .25E+04, .9E+00,
.28E+04, .1E+01, 0.0, 0.0, 0.0, 0.0, 0.0, 0.0, 0.0, 0.0, 0.0, 0.0,
0.0, 0.0, 0.0, 0.0, 0.0, 0.0, 0.0, 0.0,
0.0, 0.0, 0.0, 0.0, 0.0, 0.0, 0.0, 0.0,
CONV2 = .366E+01, 0.0, .3125E+01, .1E+00, .265E+01, .2E+00, .228E+01,
.3E+00, .195E+01, .4E+00, .167E+01,
.5E+00, .142E+01, .6E+00, .122E+01, .7E+00, .105E+01, .8E+00,
.98E+00, .85E+00, .97E+00, .9E+00,
.97E+00, .1E+01, 0.0, 0.0, 0.0, 0.0, 0.0, 0.0, 0.0, 0.0, 0.0,
0.0, 0.0, 0.0, 0.0, 0.0, 0.0, 0.0, 0.0,
0.0, 0.0, 0.0, 0.0, 0.0, 0.0, 0.0, 0.0,
DPLCT = 0.0, 0.0, 0.0, 0.0, 0.0, 0.0, 0.0, 0.0, 0.0, 0.0, 0.0, 0.0,
0.0, 0.0, 0.0, 0.0, 0.0, 0.0, 0.0, 0.0,
0.0, 0.0, 0.0, 0.0, 0.0, 0.0, 0.0, 0.0, 0.0, 0.0, 0.0, 0.0,
0.0, 0.0, 0.0, 0.0, 0.0, 0.0, 0.0, 0.0,
0.0, 0.0, 0.0, 0.0, 0.0, 0.0,
DIAW = 0.0, 0.0, 0.0, 0.0, 0.0, 0.0, 0.0, 0.0, 0.0, 0.0, 0.0, 0.0,
0.0, 0.0, 0.0, 0.0, 0.0, 0.0, 0.0,
DRAFT = 0.0,
ENGINE = .12E+04, .161E+04, .13E+04, .1645E+04, .14E+04, .167E+04,
.15E+04, .1682E+04, .16E+04, .168E+04, .17E+04,
.1675E+04, .18E+04, .1655E+04, .19E+04, .163E+04, .2E+04,
.16E+04, .21E+04, .156E+04, .22E+04, .1515E+04,
.23E+04, .147E+04, .24E+04, .142E+04, 0.0, 0.0, 0.0, 0.0, 0.0,
0.0, 0.0, 0.0, 0.0, 0.0, 0.0, 0.0, 0.0, 0.0, 0.0, 0.0, 0.0,
0.0, 0.0, 0.0, 0.0, 0.0, 0.0, 0.0, 0.0, 0.0, 0.0, 0.0, 0.0,
0.0, 0.0, 0.0, 0.0, 0.0, 0.0, 0.0, 0.0, 0.0, 0.0, 0.0, 0.0,
0.0, 0.0, 0.0, 0.0, 0.0, 0.0, 0.0, 0.0, 0.0, 0.0, 0.0, 0.0,
0.0, 0.0, 0.0, 0.0, 0.0, 0.0, 0.0, 0.0,
EYEHGT = .55E+02,
FD = .508E+01, .98E+00,

SAMPLE OUTPUT OF PROGRAM NRMM - VEHICLE: M60A1, TERRAIN: CKKRD

0.0	0.0	0.0	0.0	0.0	0.0	0.0	0.0	0.0	0.0	0.0	0.0	0.0	0.0
0.0	0.0	0.0	0.0	0.0	0.0	0.0	0.0	0.0	0.0	0.0	0.0	0.0	0.0
0.0	0.0	0.0	0.0	0.0	0.0	0.0	0.0	0.0	0.0	0.0	0.0	0.0	0.0
0.0	0.0	0.0	0.0	0.0	0.0	0.0	0.0	0.0	0.0	0.0	0.0	0.0	0.0
0.0	0.0	0.0	0.0	0.0	0.0	0.0	0.0	0.0	0.0	0.0	0.0	0.0	0.0
0.0	0.0	0.0	0.0	0.0	0.0	0.0	0.0	0.0	0.0	0.0	0.0	0.0	0.0
0.0	0.0	0.0	0.0	0.0	0.0	0.0	0.0	0.0	0.0	0.0	0.0	0.0	0.0
0.0	0.0	0.0	0.0	0.0	0.0	0.0	0.0	0.0	0.0	0.0	0.0	0.0	0.0
0.0	0.0	0.0	0.0	0.0	0.0	0.0	0.0	0.0	0.0	0.0	0.0	0.0	0.0
0.0	0.0	0.0	0.0	0.0	0.0	0.0	0.0	0.0	0.0	0.0	0.0	0.0	0.0
0.0	0.0	0.0	0.0	0.0	0.0	0.0	0.0	0.0	0.0	0.0	0.0	0.0	0.0
0.0	0.0	0.0	0.0	0.0	0.0	0.0	0.0	0.0	0.0	0.0	0.0	0.0	0.0
0.0	0.0	0.0	0.0	0.0	0.0	0.0	0.0	0.0	0.0	0.0	0.0	0.0	0.0
0.0	0.0	0.0	0.0	0.0	0.0	0.0	0.0	0.0	0.0	0.0	0.0	0.0	0.0
0.0	0.0	0.0	0.0	0.0	0.0	0.0	0.0	0.0	0.0	0.0	0.0	0.0	0.0
0.0	0.0	0.0	0.0	0.0	0.0	0.0	0.0	0.0	0.0	0.0	0.0	0.0	0.0
0.0	0.0	0.0	0.0	0.0	0.0	0.0	0.0	0.0	0.0	0.0	0.0	0.0	0.0
0.0	0.0	0.0	0.0	0.0	0.0	0.0	0.0	0.0	0.0	0.0	0.0	0.0	0.0
0.0	0.0	0.0	0.0	0.0	0.0	0.0	0.0	0.0	0.0	0.0	0.0	0.0	0.0
0.0	0.0	0.0	0.0	0.0	0.0	0.0	0.0	0.0	0.0	0.0	0.0	0.0	0.0
0.0	0.0	0.0	0.0	0.0	0.0	0.0	0.0	0.0	0.0	0.0	0.0	0.0	0.0

QMAX = .1682E+04,
 RDIAM = 0.0, 0.0, 0.0, 0.0, 0.0, 0.0, 0.0, 0.0, 0.0, 0.0, 0.0, 0.0, 0.0, 0.0,
 0.0, 0.0, 0.0, 0.0, 0.0, 0.0, 0.0, 0.0, 0.0, 0.0, 0.0, 0.0, 0.0, 0.0,
 REVM = .832E+03, 2.0, 0.2, 0.0, 0.0, 0.0, 0.0, 0.0, 0.0, 0.0, 0.0, 0.0, 0.0,
 0.0, 0.0, 0.0, 0.0, 0.0, 0.0, 0.0, 0.0, 0.0, 0.0, 0.0, 0.0, 0.0,
 RTMW = 0.0, 0.0, 0.0, 0.0, 0.0, 0.0, 0.0, 0.0, 0.0, 0.0, 0.0, 0.0, 0.0,
 0.0, 0.0, 0.0, 0.0, 0.0, 0.0, 0.0, 0.0, 0.0, 0.0, 0.0, 0.0, 0.0,
 KMS = .25E+00, .1E+01, .2E+01, .3E+01, .4E+01, .5E+01, .6E+01,
 .7E+01, .8E+01, 0.0, 0.0, 0.0, 0.0, 0.0, 0.0, 0.0, 0.0,
 0.0, 0.0, 0.0, 0.0, 0.0, 0.0,
 RW = .155E+02, 3.0, 0.2, 0.0, 0.0, 0.0, 0.0, 0.0, 0.0, 0.0, 0.0, 0.0, 0.0,
 0.0, 0.0, 0.0, 0.0, 0.0, 0.0, 0.0, 0.0,
 SAE = 0.0,
 SAI = 0.0,
 SECTH = 0.0, 0.0, 0.0, 0.0, 0.0, 0.0, 0.0, 0.0, 0.0, 0.0, 0.0, 0.0, 0.0,
 0.0, 0.0, 0.0, 0.0, 0.0, 0.0, 0.0, 0.0,
 SECTW = 0.0, 0.0, 0.0, 0.0, 0.0, 0.0, 0.0, 0.0, 0.0, 0.0, 0.0, 0.0, 0.0,
 0.0, 0.0, 0.0, 0.0, 0.0, 0.0, 0.0, 0.0,
 SVALS = .1E+01, .5E+01, .1E+02, .25E+02, .5E+02, .1E+03, .2E+03,
 .4E+03, .6E+03, 0.0, 0.0, 0.0, 0.0, 0.0, 0.0, 0.0,
 0.0, 0.0, 0.0, 0.0, 0.0, 0.0, 0.0, 0.0, 0.0,
 TCASE = .862E+00, .98E+00,
 TL = .167E+03,
 TPLY = 0.0, 0.0, 0.0, 0.0, 0.0, 0.0, 0.0, 0.0, 0.0, 0.0, 0.0, 0.0, 0.0,

SAMPLE OUTPUT OF PROGRAM NRMM - VEHICLE: M40A1, TERRAIN: CKKR

```

0.0, 0.0, 0.0, 0.0, 0.0, 0.0, 0.0, 0.0,
TPSI = 0.0, 0.0, 0.0, 0.0, 0.0, 0.0, 0.0, 0.0, 0.0, 0.0, 0.0, 0.0, 0.0,
0.0, 0.0, 0.0, 0.0, 0.0, 0.0, 0.0, 0.0,
0.0, 0.0, 0.0, 0.0, 0.0, 0.0, 0.0, 0.0, 0.0, 0.0, 0.0, 0.0, 0.0,
0.0, 0.0, 0.0, 0.0, 0.0, 0.0, 0.0, 0.0, 0.0, 0.0, 0.0, 0.0, 0.0,
0.0, 0.0, 0.0, 0.0, 0.0, 0.0,
TQIND = .9E+03,
TRAKLN = .167E+03, 0.0, 0.0, 0.0, 0.0, 0.0, 0.0, 0.0, 0.0, 0.0, 0.0, 0.0,
0.0, 0.0, 0.0, 0.0, 0.0, 0.0, 0.0, 0.0,
TRAKWD = .28E+02, 0.0, 0.0, 0.0, 0.0, 0.0, 0.0, 0.0, 0.0, 0.0, 0.0, 0.0,
0.0, 0.0, 0.0, 0.0, 0.0, 0.0, 0.0, 0.0,
TRANS = .3497E+01, .98E+00, .1256E+01, .98E+00, 0.0, 0.0, 0.0, 0.0,
0.0, 0.0, 0.0, 0.0, 0.0, 0.0, 0.0, 0.0,
0.0, 0.0, 0.0, 0.0, 0.0, 0.0, 0.0, 0.0, 0.0, 0.0, 0.0, 0.0,
0.0, 0.0,
VAA = 0.0,
VDA = 0.0,
VFS = 0.0,
VOOB = .1E+03, .1E+03, .12E+02, .6E+01, .4E+01, .4E+01, .4E+01, 0.0,
0.0, 0.0, 0.0, 0.0, 0.0, 0.0, 0.0,
0.0, 0.0, 0.0, 0.0, 0.0, 0.0, 0.0, 0.0,
VOOBS = .8E-01, .39E+00, .37E+00, .193E+01, .386E+01, .773E+01,
.1545E+02, .3091E+02, .4636E+02, 0.0, 0.0, 0.0,
0.0, 0.0, 0.0, 0.0, 0.0, 0.0, 0.0, 0.0, 0.0, 0.0, 0.0,
0.0,
VRIDE = .3525E+02, .34E+02, .2113E+02, .141E+02, .11E+02, .1075E+02,
.105E+02, .1025E+02, .1E+02, 0.0, 0.0,
0.0, 0.0, 0.0, 0.0, 0.0, 0.0, 0.0, 0.0, 0.0, 0.0, 0.0, 0.0,
0.0, 0.0, 0.0, 0.0, 0.0, 0.0, 0.0, 0.0, 0.0, 0.0, 0.0, 0.0,
0.0, 0.0, 0.0, 0.0, 0.0, 0.0, 0.0, 0.0,
VSS = 0.0,
VSSAXP = 0.0,
WC = 0.0,
WDAXP = 0.0,
WDPATH = 0.0, 0.0, 0.0, 0.0, 0.0, 0.0, 0.0, 0.0, 0.0, 0.0, 0.0, 0.0,
0.0, 0.0, 0.0, 0.0, 0.0, 0.0, 0.0, 0.0,
WDTH = .143E+03,
WGHT = .109E+06, 0.0, 0.0, 0.0, 0.0, 0.0, 0.0, 0.0, 0.0, 0.0, 0.0, 0.0,
0.0, 0.0, 0.0, 0.0, 0.0, 0.0, 0.0, 0.0,
WT = .87E+02,
WRAT = 0.0, 0.0, 0.0, 0.0, 0.0, 0.0, 0.0, 0.0, 0.0, 0.0, 0.0, 0.0,
0.0, 0.0, 0.0, 0.0, 0.0, 0.0, 0.0,
WKFORD = 0.0,
WT = .115E+03, 0.0, 0.0, 0.0, 0.0, 0.0, 0.0, 0.0, 0.0, 0.0, 0.0, 0.0,
0.0, 0.0, 0.0, 0.0, 0.0, 0.0, 0.0,
WTE = .87E+02, 0.0, 0.0, 0.0, 0.0, 0.0, 0.0, 0.0, 0.0, 0.0, 0.0,
0.0, 0.0, 0.0, 0.0, 0.0, 0.0, 0.0,
WWAXP = 0.0,

```

SAMPLE OUTPUT OF PROGRAM NRNM - VEHICLE: M60A1, TERRAIN: CKKR

XBRCOF = .8E+00.

\$END

SAMPLE OUTPUT OF PROGRAM NRMM - VEHICLE: M60A1, TERRAIN: CKKRD

NTU	ITUT	VSEL	UP	DOWN	GRADE	DISTANCE
1	11	24.84	22.64	27.50	3.00	.1000
2	12	19.12	14.65	27.50	7.00	.1100
3	12	19.12	14.65	27.50	7.00	.1200
4	12	7.30	6.47	8.37	3.00	.1300
5	13	18.45	13.88	27.50	3.00	.1400
6	13	11.47	7.25	27.50	15.00	.1500
7	13	15.53	13.88	17.62	3.00	.1600
8	13	18.45	13.88	27.50	3.00	.1700
9	14	11.12	9.54	13.35	3.00	.1800
10	14	12.71	8.28	27.34	15.00	.1900
11	14	11.68	7.42	27.33	15.00	.2000
12	14	17.62	17.62	17.62	3.00	.2100
13	14	22.85	19.63	27.34	3.00	.2200
14	14	3.94	3.49	4.53	3.00	.2300

SAMPLE OUTPUT OF PROGRAM NRPN - VEHICLE: M151, TERRAIN: CKK

```
$CONTRL  
DETAIL = 2,  
KSCEN = 1,  
KVEH = 1,  
KII1 = 0,  
KII2 = 0,  
KII3 = 0,  
KII4 = 0,  
KII5 = 0,  
KII6 = 0,  
KII7 = 0,  
KII8 = 0,  
KII9 = 0,  
KII10 = 0,  
KII11 = 0,  
KII12 = 0,  
KII13 = 0,  
KII14 = 0,  
KII15 = 0,  
KII16 = 0,  
KII17 = 0,  
KMAP = 0,  
KTPP = 0,  
KIV1 = 0,  
KIV2 = 0,  
KIV3 = 0,  
KIV4 = 0,  
KIV5 = 0,  
KIV6 = 0,  
KIV7 = 0,  
KIV8 = 0,  
KIV9 = 0,  
KIV10 = 0,  
KIV11 = 0,  
KIV12 = 0,  
KIV13 = 0,  
KIV14 = 0,  
KIV15 = 0,  
KIV16 = 0,  
KIV17 = 0,  
KIV18 = 0,  
KIV19 = 0,  
KIV20 = 0,  
KIV21 = 0,  
NTUX = 1,  
SEARCH = 0,  
$END
```

SAMPLE OUTPUT OF PROGRAM NR*~~M~~ - VEHICLE: M151, TERRAIN: CKK

```
$SCENAR
COHES = .5E-01,
DCLMAX = .5E+00,
GAMMA = .2E+00,
IOVER = 9,
ISEASN = 3,
ISURF = 1,
ISNOW = 0,
LAC = 1,
MAP = 71,
MAPG = 1,
MONTH = 1,
NOPP = 0,
NSLIP = 0,
NTRAV = 3,
NTUX = 1,
PHI = .21E+02,
REACT = .5E+00,
RDFOG = .1E+04,
SFTYPC = .9E+02,
VBRAKE = .5E+01,
VISMNV = .2E+01,
VLIM = .55E+02,
ZSNOW = .3E+01,
$END
```

\$VEHICLE

ACD = .12E+01,
 ASHOE = 0.0, 0.0, 2.0, 0.0, 0.0, 0.0, 0.0, 0.0, 0.0, 0.0, 0.0, 0.4,
 J.0, 0.0, 0.2, 0.0, 0.0, 0.0, 0.0,
 AVGC = .12E+03,
 AXLSP = .85E+02, 0.0, 0.0, 0.0, 0.0, 2.0, 0.0, 0.0, 0.0, 0.0, 0.0,
 0.0, 0.0, 0.0, 0.0, 0.0, 0.0, 0.0,
 CD = .12E+01,
 CGH = .103E+02,
 CGLAT = 0.0,
 CGR = .42E+02,
 CID = .1415E+03,
 CL = .91E+01,
 CLRMIN = .114E+02, .114E+02, 0.0, 0.0, 2.0, 0.0, 0.0, 0.0, 0.0, 0.0,
 0.0, 0.0, 0.0, 0.0, 0.0, 0.0, 0.0, 0.0,
 0.0,
 CONV1 = 0.0, 0.0, 0.0, 0.0, 0.0, 0.0, 0.0, 0.0, 0.0, 0.0, 0.0, 0.0,
 0.0, 0.0, 0.0, 0.0, 0.0, 0.0, 0.0, 0.0, 0.0,
 0.0, 0.0, 0.0, 0.0, 0.0, 0.0, 0.0, 0.0, 0.0,
 0.0, 0.0, 0.0, 0.0, 0.0, 0.0, 0.0, 0.0,
 CONV2 = 0.0, 0.0, 0.0, 0.0, 0.0, 0.0, 0.0, 0.0, 0.0, 0.0, 0.0, 0.0,
 0.0, 0.0, 0.0, 0.0, 0.0, 0.0, 0.0, 0.0,
 0.0, 0.0, 0.0, 0.0, 0.0, 0.0, 0.0, 0.0,
 0.0, 0.0, 0.0, 0.0, 0.0, 0.0, 0.0, 0.0,
 DFLCT = .131E+01, .114E+01, 0.0, 0.0, 0.0, 0.0, 0.0, 0.0, 0.0, 0.0,
 0.0, 0.0, 0.0, 0.0, 0.0, 0.0, 0.0, 0.0,
 0.0, .131E+01, .114E+01, 0.0, 0.0, 0.0, 0.0, 0.0,
 0.0, 0.0, 0.0, 0.0, 0.0, 0.0, 0.0, 0.0,
 0.0, 0.0, .1E+01, .1E+01, 0.0, 0.0, 0.0, 0.0, 0.0, 0.0,
 0.0, 0.0, 0.0, 0.0, 0.0, 0.0, 0.0,
 0.0, 0.0, 0.0,
 DIAW = .308E+02, .308E+02, 0.0, 0.0, 0.0, 0.0, 0.0, 0.0, 0.0, 0.0,
 0.0, 0.0, 0.0, 0.0, 0.0, 0.0, 0.0, 0.0,
 0.0,
 DRAFT = 0.0,
 ENGINE = .8E+03, .115E+03, .12E+04, .115E+03, .16E+04, .115E+03,
 .2E+04, .115E+03, .24E+04, .112E+03, .28E+04,
 .108E+03, .32E+04, .103E+03, .36E+04, .96E+02, .4E+04,
 .88E+02, .44E+04, .8E+02, 0.0, 0.0, 0.0, 0.0,
 0.0, 0.0, 0.0, 0.0, 0.0, 0.0, 0.0, 0.0, 0.0, 0.0, 0.0, 0.0,
 0.0, 0.0, 0.0, 0.0, 0.0, 0.0, 0.0, 0.0, 0.0, 0.0, 0.0, 0.0,
 0.0, 0.0, 0.0, 0.0, 0.0, 0.0, 0.0, 0.0, 0.0, 0.0, 0.0, 0.0,
 0.0, 0.0, 0.0, 0.0, 0.0, 0.0, 0.0, 0.0, 0.0, 0.0, 0.0, 0.0,
 0.0, 0.0, 0.0, 0.0, 0.0, 0.0, 0.0, 0.0, 0.0, 0.0, 0.0, 0.0,
 0.0,
 EYEHGT = .525E+02,
 FL = .486E+01, .9E+00,
 FORDD = 0.0,

SAMPLE OUTPUT OF PROGRAM NRNM - VEHICLE: M151, TERRAIN: CKK

0.0	0.0	0.0	0.0	0.0	0.0	0.0	0.0	0.0	0.0	0.0	0.0	0.0	0.0
0.0	0.0	0.0	0.0	0.0	0.0	0.0	0.0	0.0	0.0	0.0	0.0	0.0	0.0
0.0	0.0	0.0	0.0	0.0	0.0	0.0	0.0	0.0	0.0	0.0	0.0	0.0	0.0
0.0	0.0	0.0	0.0	0.0	0.0	0.0	0.0	0.0	0.0	0.0	0.0	0.0	0.0
0.0	0.0	0.0	0.0	0.0	0.0	0.0	0.0	0.0	0.0	0.0	0.0	0.0	0.0
0.0	0.0	0.0	0.0	0.0	0.0	0.0	0.0	0.0	0.0	0.0	0.0	0.0	0.0
0.0	0.0	0.0	0.0	0.0	0.0	0.0	0.0	0.0	0.0	0.0	0.0	0.0	0.0
0.0	0.0	0.0	0.0	0.0	0.0	0.0	0.0	0.0	0.0	0.0	0.0	0.0	0.0
0.0	0.0	0.0	0.0	0.0	0.0	0.0	0.0	0.0	0.0	0.0	0.0	0.0	0.0
0.0	0.0	0.0	0.0	0.0	0.0	0.0	0.0	0.0	0.0	0.0	0.0	0.0	0.0
0.0	0.0	0.0	0.0	0.0	0.0	0.0	0.0	0.0	0.0	0.0	0.0	0.0	0.0
0.0	0.0	0.0	0.0	0.0	0.0	0.0	0.0	0.0	0.0	0.0	0.0	0.0	0.0
0.0	0.0	0.0	0.0	0.0	0.0	0.0	0.0	0.0	0.0	0.0	0.0	0.0	0.0
0.0	0.0	0.0	0.0	0.0	0.0	0.0	0.0	0.0	0.0	0.0	0.0	0.0	0.0
0.0	0.0	0.0	0.0	0.0	0.0	0.0	0.0	0.0	0.0	0.0	0.0	0.0	0.0
0.0	0.0	0.0	0.0	0.0	0.0	0.0	0.0	0.0	0.0	0.0	0.0	0.0	0.0
0.0	0.0	0.0	0.0	0.0	0.0	0.0	0.0	0.0	0.0	0.0	0.0	0.0	0.0
0.0	0.0	0.0	0.0	0.0	0.0	0.0	0.0	0.0	0.0	0.0	0.0	0.0	0.0
0.0	0.0	0.0	0.0	0.0	0.0	0.0	0.0	0.0	0.0	0.0	0.0	0.0	0.0
0.0	0.0	0.0	0.0	0.0	0.0	0.0	0.0	0.0	0.0	0.0	0.0	0.0	0.0
0.0	0.0	0.0	0.0	0.0	0.0	0.0	0.0	0.0	0.0	0.0	0.0	0.0	0.0
0.0	0.0	0.0	0.0	0.0	0.0	0.0	0.0	0.0	0.0	0.0	0.0	0.0	0.0
0.0	0.0	0.0	0.0	0.0	0.0	0.0	0.0	0.0	0.0	0.0	0.0	0.0	0.0
0.0	0.0	0.0	0.0	0.0	0.0	0.0	0.0	0.0	0.0	0.0	0.0	0.0	0.0
0.0	0.0	0.0	0.0	0.0	0.0	0.0	0.0	0.0	0.0	0.0	0.0	0.0	0.0

0.0

QMAX = .115E+03,

RODIAM = .16E+02, .16E+02, 0.0, 0.0, 0.0, 0.0, 0.0, 0.0, 0.0, 0.0, 0.0, 0.0, 0.0, 0.0,

0.0, 0.0, 0.0, 0.0, 0.0, 0.0, 0.0, 0.0,

0.0,

REVM = .72E+03, .72E+03, 0.0, 0.0, 0.0, 0.0, 0.0, 0.0, 0.0, 0.0, 0.0, 0.0, 0.0, 0.0,

0.0, 0.0, 0.0, 0.0, 0.0, 0.0, 0.0, 0.0,

0.0,

RIMW = .45E+01, .45E+01, 0.0, 0.0, 0.0, 0.0, 0.0, 0.0, 0.0, 0.0, 0.0, 0.0, 0.0, 0.0,

0.0, 0.0, 0.0, 0.0, 0.0, 0.0, 0.0, 0.0,

0.0,

RMS = .25E+00, .1E+01, .2E+01, .3E+01, .4E+01, .5E+01, .6E+01,

.7E+01, .8E+01, 0.0, 0.0, 0.0, 0.0, 0.0, 0.0, 0.0,

0.0, 0.0, 0.0, 0.0, 0.0, 0.0,

RW = 0.0, 0.0, 0.0, 0.0, 0.0, 0.0, 0.0, 0.0, 0.0, 0.0, 0.0, 0.0, 0.0, 0.0,

0.0, 0.0, 0.0, 0.0, 0.0, 0.0, 0.0, 0.0,

SAE = 0.0,

SAI = 0.0,

SECTH = .74E+01, .74E+01, 0.0, 0.0, 0.0, 0.0, 0.0, 0.0, 0.0, 0.0, 0.0, 0.0, 0.0,

0.0, 0.0, 0.0, 0.0, 0.0, 0.0, 0.0, 0.0,

0.0,

SECTW = .715E+01, .715E+01, 0.0, 0.0, 0.0, 0.0, 0.0, 0.0, 0.0, 0.0, 0.0, 0.0,

0.0, 0.0, 0.0, 0.0, 0.0, 0.0, 0.0, 0.0,

0.0,
SVALS = .1E+01, .2E+01, .3E+01, .4E+01, .5E+01, .6E+01, .7E+01,
.8E+01, .9E+01, .1E+02, .11E+02, .12E+02, .13E+02,
.15E+02, .2E+02, .4E+02, 0.0, 0.0, 0.0, 0.0, 0.0, 0.0, 0.0,
0.0, 0.0,
TCASE = .1E+01, .1E+01,
TL = .85E+02,
TPLY = .6E+01, .6E+01, 0.0, 0.0, 0.0, 0.0, 0.0, 0.0, 0.0, 0.0, 0.0, 0.0,
0.0, 0.0, 0.0, 0.0, 0.0, 0.0, 0.0,
0.0,
TPSI = .15E+02, .15E+02, 0.0, 0.0, 0.0, 0.0, 0.0, 0.0, 0.0, 0.0, 0.0, 0.0,
0.0, 0.0, 0.0, 0.0, 0.0, 0.0, 0.0, 0.0, 0.0, 0.0, 0.0, 0.0,
0.0, .15E+02, .15E+02, 0.0, 0.0, 0.0, 0.0, 0.0, 0.0, 0.0, 0.0,
0.0, 0.0, 0.0, 0.0, 0.0, 0.0, 0.0, 0.0,
0.0, 0.0, .25E+02, .25E+02, 0.0, 0.0, 0.0, 0.0, 0.0, 0.0, 0.0,
0.0, 0.0, 0.0, 0.0,
TQIND = 0.0,
TRAKLN = 0.0, 0.0, 0.0, 0.0, 0.0, 0.0, 0.0, 0.0, 0.0, 0.0, 0.0, 0.0,
0.0, 0.0, 0.0, 0.0, 0.0, 0.0, 0.0, 0.0,
TRAKWD = 0.0, 0.0, 0.0, 0.0, 0.0, 0.0, 0.0, 0.0, 0.0, 0.0, 0.0, 0.0,
0.0, 0.0, 0.0, 0.0, 0.0, 0.0, 0.0,
TRANS = .5712E+01, .9E+00, .3179E+01, .9E+00, .1674E+01, .9E+00,
.1E+01, .9E+00, 0.0, 0.0, 0.0, 0.0, 0.0, 0.0,
0.0, 0.0, 0.0, 0.0, 0.0, 0.0, 0.0, 0.0, 0.0, 0.0, 0.0,
0.0, 0.0, 0.0, 0.0, 0.0, 0.0, 0.0,
0.0, 0.0, 0.0, 0.0,
VAA = .66E+02,
VDA = .37E+02,
VFS = 0.0,
VOOB = .1E+03, .2E+02, .6E+01, .4E+01, .2E+01, .1E+01, .1E+01, 0.0,
0.0, 0.0, 0.0, 0.0, 0.0, 0.0, 0.0, 0.0,
0.0, 0.0, 0.0, 0.0, 0.0, 0.0, 0.0, 0.0, 0.0,
VOOBS = .15E+02, .15E+02, .15E+02, .15E+02, .15E+02, .15E+02, .15E+02,
.15E+02, .15E+02, .15E+02, .15E+02,
.15E+02, .15E+02, .15E+02, .15E+02, .15E+02, 0.0, 0.0, 0.0,
0.0, 0.0, 0.0, 0.0,
VRIDE = .765E+02, .21E+02, .95E+01, .51E+01, .2E+01, .2E+01, .2E+01,
.2E+01, .2E+01, 0.0, 0.0, 0.0, 0.0, 0.0, 0.0,
0.0, 0.0, 0.0, 0.0, 0.0, 0.0, 0.0, 0.0, 0.0, 0.0, 0.0, 0.0,
0.0, 0.0, 0.0, 0.0, 0.0, 0.0, 0.0, 0.0, 0.0, 0.0, 0.0, 0.0,
0.0, 0.0, 0.0, 0.0, 0.0, 0.0, 0.0, 0.0,
0.0, 0.0, 0.0,
VSS = 0.0,
VSSAXP = 0.0,
WC = 0.0,
WDAXP = 0.0,
WDPATH = 0.0, 0.0, 0.0, 0.0, 0.0, 0.0, 0.0, 0.0, 0.0, 0.0, 0.0, 0.0,
0.0, 0.0, 0.0, 0.0, 0.0, 0.0, 0.0,
WDTH = .64E+02,
WGHT = .174E+04, .146E+04, 0.0, 0.0, 0.0, 0.0, 0.0, 0.0, 0.0, 0.0, 0.0, 0.0,

SAMPLE OUTPUT OF PROGRAM NRMN - VEHICLE: M151, TERRAIN: CKK

0.0, 0.0, 0.0, 0.0, 0.0, 0.0, 0.0, 0.0, 0.0,
0.0,

WI = .458E+02,

WRAT = 0.0, 0.0, 0.0, 0.0, 0.0, 0.0, 0.0, 0.0, 0.0, 0.0, 0.0, 0.0,

0.0, 0.0, 0.0, 0.0, 0.0, 0.0, 0.0,

WRFORD = 0.0,

WT = .53E+02, .53E+02, 0.0, 0.0, 0.0, 0.0, 0.0, 0.0, 0.0, 0.0, 0.0,

0.0, 0.0, 0.0, 0.0, 0.0, 0.0, 0.0,

0.0,

WTE = .456E+02, .456E+02, 0.0, 0.0, 0.0, 0.0, 0.0, 0.0, 0.0, 0.0,

0.0, 0.0, 0.0, 0.0, 0.0, 0.0, 0.0, 0.0,

0.0,

WWXP = 0.0,

XBRCOF = .7E+00,

\$END

SAMPLE OUTPUT OF PROGRAM NR00 - VEHICLE: M151, TERRAIN: CKK

NTU	ITUT	VMAX	UP	LEVEL	DOWN	VSEL	UP	LEVEL	DOWN	GRADE	AR	EA
1	1	37.15	37.15	37.15	37.15	37.15	37.15	37.15	37.15	1.00	0.0000	
2	1	37.15	37.15	37.15	37.15	37.15	37.15	37.15	37.15	1.00	0.0000	
3	1	37.15	37.15	37.15	37.15	37.15	37.15	37.15	37.15	1.00	0.0000	
4	1	33.26	30.03	33.66	36.79	33.26	30.03	33.66	36.79	1.00	0.0000	
5	1	0.00	0.00	0.00	0.00	0.00	0.00	0.00	0.00	1.00	0.0000	
6	1	37.15	37.15	37.15	37.15	37.15	37.15	37.15	37.15	3.50	0.0000	
7	1	37.15	37.15	37.15	37.15	37.15	37.15	37.15	37.15	7.50	0.0000	
8	1	30.91	23.13	37.15	37.15	30.91	23.13	37.15	37.15	15.00	0.0000	
9	1	18.99	11.26	37.15	23.66	18.99	11.26	37.15	23.66	50.00	0.0000	
10	1	0.00	0.00	37.15	10.26	0.00	0.00	37.15	10.26	65.00	0.0000	
11	1	37.15	37.15	37.15	37.15	37.15	37.15	37.15	37.15	1.00	0.0000	
12	1	17.64	16.67	17.71	18.67	17.64	16.67	17.71	18.67	1.00	0.0000	
13	1	12.72	12.67	12.72	12.76	12.72	12.67	12.72	12.76	1.00	0.0000	
14	1	8.90	8.45	8.92	9.35	8.90	8.45	8.92	9.35	1.00	0.0000	
15	1	0.00	0.00	0.00	0.00	0.00	0.00	0.00	0.00	1.00	0.0000	
16	1	33.80	28.64	37.15	27.15	33.80	28.64	37.15	37.15	3.50	0.0000	
17	1	31.04	23.36	37.15	37.15	31.04	23.36	37.15	37.15	7.50	0.0000	
18	1	29.41	20.76	37.15	37.15	29.41	20.76	37.15	37.15	15.00	0.0000	
19	1	0.00	0.00	37.15	27.50	0.00	0.00	37.15	27.50	50.00	0.0000	
20	1	0.00	0.00	37.15	17.57	0.00	0.00	37.15	17.57	65.00	0.0000	
21	1	37.15	37.15	37.15	37.15	37.15	37.15	37.15	37.15	1.00	0.0000	
22	1	9.50	9.50	9.50	9.50	9.50	9.50	9.50	9.50	1.00	0.0000	
23	1	2.00	2.00	2.00	2.00	2.00	2.00	2.00	2.00	1.00	0.0000	
24	1	2.00	2.00	2.00	2.00	2.00	2.00	2.00	2.00	1.00	0.0000	
25	1	2.00	2.00	2.00	2.00	2.00	2.00	2.00	2.00	1.00	0.0000	
26	1	24.73	24.73	24.73	24.73	24.73	24.73	24.73	24.73	1.00	0.0000	
27	1	24.73	24.73	24.73	24.73	24.73	24.73	24.73	24.73	1.00	0.0000	
28	1	18.54	18.54	18.54	18.54	18.54	18.54	18.54	18.54	1.00	0.0000	
29	1	0.00	0.00	0.00	0.00	0.00	0.00	0.00	0.00	1.00	0.0000	
30	1	0.00	0.00	0.00	0.00	0.00	0.00	0.00	0.00	1.00	0.0000	
31	1	24.52	24.52	24.52	24.52	24.52	24.52	24.52	24.52	1.00	0.0000	
32	1	22.96	22.83	22.95	23.11	22.96	22.83	22.95	23.11	1.00	0.0000	
33	1	18.36	18.36	18.36	18.36	18.36	18.36	18.36	18.36	1.00	0.0000	
34	1	24.72	24.72	24.72	24.72	24.72	24.72	24.72	24.72	1.00	0.0000	
35	1	24.54	24.19	24.72	24.72	24.54	24.19	24.72	24.72	1.00	0.0000	
36	1	37.15	37.15	37.15	37.15	37.15	37.15	37.15	37.15	1.00	0.0000	
37	1	37.14	37.14	37.14	37.14	37.14	37.14	37.14	37.14	1.00	0.0000	
38	1	0.00	0.00	0.00	0.00	0.00	0.00	0.00	0.00	1.00	0.0000	
39	1	0.00	0.00	0.00	0.00	0.00	0.00	0.00	0.00	1.00	0.0000	
40	1	0.00	0.00	0.00	0.00	0.00	0.00	0.00	0.00	1.00	0.0000	
41	1	0.00	0.00	0.00	0.00	0.00	0.00	0.00	0.00	1.00	0.0000	
42	1	0.00	0.00	0.00	0.00	0.00	0.00	0.00	0.00	1.00	0.0000	
43	1	0.00	0.00	0.00	0.00	0.00	0.00	0.00	0.00	1.00	0.0000	
44	1	34.68	34.68	34.68	34.68	34.68	34.68	34.68	34.68	1.00	0.0000	
45	1	22.83	22.83	22.83	22.83	22.83	22.83	22.83	22.83	1.00	0.0000	
46	1	10.57	10.57	10.57	10.57	10.57	10.57	10.57	10.57	1.00	0.0000	
47	1	34.68	34.68	34.68	34.68	34.68	34.68	34.68	34.68	1.00	0.0000	
48	1	22.83	22.83	22.83	22.83	22.83	22.83	22.83	22.83	1.00	0.0000	
49	1	10.57	10.57	10.57	10.57	10.57	10.57	10.57	10.57	1.00	0.0000	
50	1	5.84	5.84	5.84	5.84	5.84	5.84	5.84	5.84	1.00	0.0000	

SAMPLE OUTPUT OF PROGRAM NRMM - VEHICLE: M151, TERRAIN: CKRD

\$CONTRL

DETAIL = 2,
KSCEN = 1,
KVEH = 1,
KII1 = 0,
KII2 = 0,
KII3 = 0,
KII4 = 0,
KII5 = 0,
KII6 = 0,
KII7 = 0,
KII8 = 0,
KII9 = 0,
KII10 = 0,
KII11 = 0,
KII12 = 0,
KII13 = 0,
KII14 = 0,
KII15 = 0,
KII16 = 0,
KII17 = 0,
KMAP = 0,
KTPP = 0,
KIV1 = 0,
KIV2 = 0,
KIV3 = 0,
KIV4 = 0,
KIV5 = 0,
KIV6 = 0,
KIV7 = 0,
KIV8 = 0,
KIV9 = 0,
KIV10 = 0,
KIV11 = 0,
KIV12 = 0,
KIV13 = 0,
KIV14 = 0,
KIV15 = 0,
KIV16 = 0,
KIV17 = 0,
KIV18 = 0,
KIV19 = 0,
KIV20 = 0,
KIV21 = 0,
NTUX = 1,
SEARCH = 0,

\$END

\$SCENAR

COHES = .5E-01,
DCLMAX = .5E+00,
GAMMA = .2E+00,
IOVER = 9,

SAMPLE OUTPUT OF PROGRAM NRMM - VEHICLE: M151, TERRAIN: CKKR

ISEASN = 3,
ISURF = 1,
ISNGW = 0,
LAC = 1,
MAP = 11,
MAPG = 1,
MONTH = 1,
NOPP = 0,
NSLIP = 0,
NTRAV = 3,
NTUX = 1,
PHI = .21E+02,
REACT = .5E+00,
RDFOG = .1E+04,
SFTYPC = .9E+02,
VBRAKE = .5E+01,
VISMNV = .2E+01,
VLIM = .55E+02,
ZSNCW = .3E+01,
\$END
\$VEHICLE
ACD = .12E+01,
ASHOE = 0.0, 0.0, 0.0, 0.2, 0.0, 0.0, 0.0, 0.0, 0.0, 0.0, 0.0, 0.0, 0.4,
0.0, 0.0, 0.2, 0.0, 0.0, 0.2, 0.0, 0.0,
AVGC = .12E+03,
AXLSP = .85E+02, 0.0, 0.0, 0.0, 2.0, 2.0, 0.0, 0.0, 0.0, 0.0, 0.0,
0.0, 0.0, 0.0, 0.0, 0.0, 0.0, 0.0, 0.0,
CD = .12E+01,
CGH = .103E+02,
CGLAT = 0.0,
CGR = .42E+02,
CID = .1415E+03,
CL = .91E+01,
CLRMIN = .114E+02, .114E+02, 0.0, 0.0, 0.0, 0.0, 0.0, 0.0, 0.0, 0.0,
0.0, 0.0, 0.0, 0.0, 0.0, 0.0, 0.0, 0.0,
0.0,
CONV1 = 0.0, 0.0, 0.0, 0.2, 0.0, 0.0, 0.0, 0.0, 0.0, 0.0, 0.0, 0.0, 0.0,
0.0, 0.0, 0.2, 0.0, 0.0, 0.0, 0.0, 0.0, 0.0, 0.0, 0.0,
0.0, 0.0, 0.0, 0.0, 0.0, 0.0, 0.0, 0.0, 0.0, 0.0, 0.0, 0.0,
0.0, 0.0, 0.0, 0.0, 0.0, 0.2, 0.0, 0.0, 0.0, 0.0,
CONV2 = 0.0, 0.0, 0.0, 0.0, 0.0, 0.0, 0.0, 0.0, 0.0, 0.0, 0.0, 0.0, 0.0,
0.0, 0.0, 0.2, 0.0, 0.0, 0.0, 0.0, 0.0, 0.0, 0.0, 0.0, 0.0, 0.0,
0.0, 0.0, 0.0, 0.0, 0.0, 0.0, 0.0, 0.0, 0.0, 0.0, 0.0, 0.0, 0.0,
0.0, 0.0, 0.0, 0.0, 0.0, 0.0, 0.0, 0.0, 0.0, 0.0, 0.0, 0.0,
DFLCT = .131E+01, .114E+01, 0.0, 0.0, 0.0, 0.0, 0.0, 0.0, 0.0, 0.0,
0.0, 0.0, 0.2, 0.0, 0.0, 0.0, 0.0, 0.0, 0.0, 0.0, 0.0, 0.0, 0.0,
0.0, 0.0, 0.0, 0.0, 0.0, 0.2, 0.0, 0.0, 0.0, 0.0, 0.0, 0.0, 0.0,
0.0, 0.0, .1E+01, .1E+01, 0.0, 0.0, 0.0, 0.0, 0.0, 0.0, 0.0, 0.0,
0.0, 0.0, 0.0, 0.0, 0.0, 0.0, 0.0, 0.0,

```

      2.2, 0.0, 0.0,
DIAW   = .308E+02, .308E+02, 0.0, 0.0, 0.0, 0.0, 0.0, 0.0, 0.0, 0.0, 0.0, 0.0,
0.0, 0.0, 0.0, 0.0, 0.0, 0.0, 0.0, 0.0, 0.0, 0.0,
0.0,
DRAFT  = 0.0,
ENGINE = .8E+03, .115E+03, .12E+04, .115E+03, .16E+04, .115E+03,
.2E+04, .115E+03, .24E+04, .112E+03, .28E+04,
.108E+03, .32E+04, .103E+03, .36E+04, .98E+02, .4E+04,
.88E+02, .44E+04, .8E+02, 0.0, 0.0, 0.0, 0.0,
0.0, 0.0, 0.0, 0.0, 0.0, 0.0, 0.0, 0.0, 0.0, 0.0, 0.0, 0.0, 0.0, 0.0,
0.0, 0.0, 0.0, 0.0, 0.0, 0.0, 0.0, 0.0, 0.0, 0.0, 0.0, 0.0, 0.0, 0.0,
0.0, 0.0, 0.0, 0.0, 0.0, 0.0, 0.0, 0.0, 0.0, 0.0, 0.0, 0.0, 0.0, 0.0,
0.0, 0.0, 0.0, 0.0, 0.0, 0.0, 0.0, 0.0, 0.0, 0.0, 0.0, 0.0, 0.0, 0.0,
0.0, 0.0, 0.0, 0.0, 0.0, 0.0, 0.0, 0.0, 0.0, 0.0, 0.0, 0.0, 0.0, 0.0,
0.0,
EYEHGT = .525E+02,
FD      = .486E+01, .9E+00,
FORDD   = 0.0,
GROUSH  = 0.0, 0.0, 0.0, 0.0, 0.0, 0.0, 0.0, 0.0, 0.0, 0.0, 0.0, 0.0, 0.0,
0.0, 0.0, 0.0, 0.0, 0.0, 0.0, 0.0,
HPNET   = .7392E+02,
HVALS   = .1E-01, .4E+01, .8E+01, .12E+02, .16E+02, .2E+02, .4E+02, 1.0,
0.0, 0.0, 0.0, 0.0, 0.0, 0.0, 0.0, 0.0, 0.0, 0.0,
0.0, 0.0, 0.0, 0.0, 0.0, 0.0, 0.0, 0.0, 0.0, 0.0,
IAPG    = 0,
IB      = 1, 1, 0, 0, 0, 0, 0, 0, 0, 0, 0, 0, 0, 0, 0, 0, 0, 0, 0, 0,
ID      = 0, 0, 0, 0, 0, 0, 0, 0, 0, 0, 0, 0, 0, 0, 0, 0, 0, 0, 0, 0,
IDIESL  = .1E+01,
IENGIN  = 10,
ICONST  = 1, 1, 0, 0, 0, 0, 0, 0, 0, 0, 0, 0, 0, 0, 0, 0, 0, 0, 0, 0,
ICONV1  = 0,
ICONV2  = 0,
IP      = 1, 1, 0, 0, 0, 0, 0, 0, 0, 0, 0, 0, 0, 0, 0, 0, 0, 0, 0, 0,
IPOWER  = 17,
IT      = 0, 0, 0, 0, 0, 0, 0, 0, 0, 0, 0, 0, 0, 0, 0, 0, 0, 0, 0, 0,
ITCASE  = 0,
ITRAN   = 0,
ITVAR   = 0,
LOCDIF  = 0,
LOCKUP  = 0,
MAXIPK  = 9,
MAXL    = 1,
NAMBL   = 2,
NBOGIE  = 0, 0, 0, 0, 0, 0, 0, 0, 0, 0, 0, 0, 0, 0, 0, 0, 0, 0, 0, 0,
NCHAIN  = 0, 0, 0, 0, 0, 0, 0, 0, 0, 0, 0, 0, 0, 0, 0, 0, 0, 0, 0, 0,
NCYL    = .4E+01,
NENG    = .1E+01,
NFL     = 0, 0, 0, 0, 0, 0, 0, 0, 0, 0, 0, 0, 0, 0, 0, 0, 0, 0, 0, 0,
NGR     = 4,
NHVALS  = 7,

```

SAMPLE OUTPUT OF PROGRAM NRNM - VEHICLE: M151, TERRAIN: CKKR

```

0.0, 0.0, 0.0, 0.0, 0.0, 0.0, 0.0, 0.0,
0.0,
REVM = .72E+03, .72E+03, 0.0, 0.0, 0.0, 0.0, 0.0, 0.0, 0.0, 0.0, 0.0, 0.0, 0.0,
0.0, 0.0, 0.0, 0.0, 0.0, 0.0, 0.0, 0.0,
0.0,
RIMW = .45E+01, .45E+01, 0.0, 0.0, 0.0, 0.0, 0.0, 0.0, 0.0, 0.0, 0.0, 0.0,
0.0, 0.0, 0.0, 0.0, 0.0, 0.0, 0.0, 0.0,
0.0,
RMS = .25E+00, .1E+01, .2E+01, .3E+01, .4E+01, .5E+01, .6E+01,
.7E+01, .8E+01, 0.0, 0.0, 0.0, 0.0, 0.0, 0.0,
0.0, 0.0, 0.0, 0.0, 0.0, 0.0,
RW = 0.0, 0.0, 0.0, 0.0, 0.0, 0.0, 0.0, 0.0, 0.0, 0.0, 0.0, 0.0,
0.0, 0.0, 0.0, 0.0, 0.0, 0.0, 0.0, 0.0,
SAE = 0.0,
SAI = 0.0,
SECTH = .74E+01, .74E+01, 0.0, 0.0, 0.0, 0.0, 0.0, 0.0, 0.0, 0.0, 0.0, 0.0,
0.0, 0.0, 0.0, 0.0, 0.0, 0.0, 0.0, 0.0,
0.0,
SECTW = .715E+01, .715E+01, 0.0, 0.0, 0.0, 0.0, 0.0, 0.0, 0.0, 0.0, 0.0,
0.0, 0.0, 0.0, 0.0, 0.0, 0.0, 0.0, 0.0,
0.0,
SVALS = .1E+01, .2E+01, .3E+01, .4E+01, .5E+01, .6E+01, .7E+01,
.8E+01, .9E+01, .1E+02, .11E+02, .12E+02, .13E+02,
.15E+02, .2E+02, .4E+02, 0.0, 0.0, 0.0, 0.0, 0.0, 0.0, 0.0,
0.0, 0.0,
TCASE = .1E+01, .1E+01,
TL = .85E+02,
TPLY = .6E+01, .6E+01, 0.0, 0.0, 0.0, 0.0, 0.0, 0.0, 0.0, 0.0, 0.0, 0.0,
0.0, 0.0, 0.0, 0.0, 0.0, 0.0, 0.0,
0.0,
TPSI = .15E+02, .15E+02, 0.0, 0.0, 0.0, 0.0, 0.0, 0.0, 0.0, 0.0, 0.0, 0.0,
0.0, 0.0, 0.0, 0.0, 0.0, 0.0, 0.0,
0.0, .15E+02, .15E+02, 0.0, 0.0, 0.0, 0.0, 0.0, 0.0, 0.0, 0.0,
0.0, 0.0, 0.0, 0.0, 0.0, 0.0, 0.0,
0.0, 0.0, .25E+02, .25E+02, 0.0, 0.0, 0.0, 0.0, 0.0, 0.0, 0.0,
0.0, 0.0, 0.0, 0.0, 0.0, 0.0, 0.0,
0.0, 0.0, 0.0,
TQIND = 0.0,
TRAKLN = 0.0, 0.0, 0.0, 0.0, 0.0, 0.0, 0.0, 0.0, 0.0, 0.0, 0.0, 0.0,
0.0, 0.0, 0.0, 0.0, 0.0, 0.0, 0.0,
TRAKWD = 0.0, 0.0, 0.0, 0.0, 0.0, 0.0, 0.0, 0.0, 0.0, 0.0, 0.0, 0.0,
0.0, 0.0, 0.0, 0.0, 0.0, 0.0, 0.0,
TRANS = .5712E+01, .9E+00, .3179E+01, .9E+00, .1674E+01, .9E+00,
.1E+01, .9E+00, 0.0, 0.0, 0.0, 0.0, 0.0, 0.0,
0.0, 0.0, 0.0, 0.0, 0.0, 0.0, 0.0, 0.0, 0.0, 0.0, 0.0,
0.0, 0.0, 0.0, 0.0, 0.0, 0.0, 0.0,
0.0, 0.0, 0.0, 0.0, 0.0, 0.0,
VAA = .66E+02,
VDA = .37E+02,
VFS = 0.0,
VOOB = .1E+03, .2E+02, .6E+01, .4E+01, .2E+01, .1E+01, .1E+01, 0.0,
0.0, 0.0, 0.0, 0.0, 0.0, 0.0, 0.0,

```

SAMPLE OUTPUT OF PROGRAM NRMM - VEHICLE: M151, TERRAIN: CKKR

```

      0.0, 0.0, 0.0, 0.0, 0.0, 0.0, 0.0, 0.0, 0.0,
VOOBS  = .15E+02, .15E+02, .15E+02, .15E+02, .15E+02, .15E+02, .15E+02, .15E+02,
      .15E+02, .15E+02, .15E+02, .15E+02,
      .15E+02, .15E+02, .15E+02, .15E+02, .15E+02, 0.0, 0.0, 0.0,
0.0, 0.0, 0.0, 0.0, 0.0, 0.0;
VRIDE  = .765E+02, .21E+02, .95E+01, .51E+01, .2E+01, .2E+01, .2E+01,
      .2E+01, .2E+01, 0.0, 0.0, 0.0, 0.0, 0.0, 0.0;
      0.0, 0.0, 0.0, 0.0, 0.0, 0.0, 0.0, 0.0, 0.0, 0.0, 0.0, 0.0, 0.0,
0.0, 0.0, 0.0, 0.0, 0.0, 0.0, 0.0, 0.0, 0.0,
      0.0, 0.0, 0.0, 0.0, 0.0, 0.0, 0.0, 0.0, 0.0, 0.0, 0.0, 0.0,
0.0, 0.0, 0.0, 0.0, 0.0, 0.0, 0.0, 0.0,
      0.0, 0.0, 0.0,
VSS    = 0.0,
VSSAXP = 0.0,
WC     = 0.0,
WDAXP  = 0.0,
WDPATH = 0.0, 0.0, 0.0, 0.0, 0.0, 0.0, 0.0, 0.0, 0.0, 0.0, 0.0, 0.0,
0.0, 0.0, 0.0, 0.0, 0.0, 0.0, 0.0, 0.0,
WDTH   = .64E+02,
WGHT   = .174E+04, .146E+04, 0.0, 0.0, 0.0, 0.0, 0.0, 0.0, 0.0, 0.0,
0.0, 0.0, 0.0, 0.0, 0.0, 0.0, 0.0, 0.0,
      0.0,
WI     = .458E+02,
WRAT   = 0.0, 0.0, 0.0, 0.0, 0.0, 0.0, 0.0, 0.0, 0.0, 0.0, 0.0, 0.0,
0.0, 0.0, 0.0, 0.0, 0.0, 0.0, 0.0, 0.0,
WRFCRD = 0.0,
WT     = .53E+02, .53E+02, 0.0, 0.0, 0.0, 0.0, 0.0, 0.0, 0.0, 0.0,
0.0, 0.0, 0.0, 0.0, 0.0, 0.0, 0.0,
      0.0,
WTE    = .456E+02, .456E+02, 0.0, 0.0, 0.0, 0.0, 0.0, 0.0, 0.0, 0.0,
0.0, 0.0, 0.0, 0.0, 0.0, 0.0, 0.0,
      0.0,
WWAXP  = 0.0,
XBRCOF = .7E+00,
$END

```

NTU	LTUT	VSEL	UP	DOWN	GRADE	DISTANCE
1	11	54.94	54.87	55.00	3.00	.1000
2	12	40.00	40.00	40.00	7.00	.1100
3	12	49.62	45.19	55.00	7.00	.1200
4	12	25.00	25.00	25.00	3.00	.1300
5	13	35.80	35.80	35.80	3.00	.1400
6	13	32.24	29.32	35.80	15.00	.1500
7	13	7.30	7.30	7.30	3.00	.1600
8	13	35.80	35.80	35.80	3.00	.1700
9	14	35.39	34.99	35.80	3.00	.1800
10	14	28.22	23.29	35.80	15.00	.1900
11	14	28.00	22.99	35.80	15.00	.2000
12	14	7.30	7.30	7.30	3.00	.2100
13	14	21.00	21.00	21.00	3.00	.2200
14	14	9.00	9.00	9.00	3.00	.2300

APPENDIX E
POSSIBLE STOPS IN PROGRAM NRMM

The program NRMM can terminate execution prior to normal completion for several reasons. In most such cases, an octal number is available to indicate at which of the STOPS the program halted.

<u>NUMBER</u>	<u>LOCATION</u>	<u>REASON FOR STOP</u>
1	SCN	User erroneously specified control variable DETAIL.
2	VEH	Towed track elements indicated in vehicle data are not permitted.
3	VPP	Printer plot of tractive effort vs. speed has been produced because either user specified DETAIL = 5 level of output or the tractive effort vs. speed curve fit error has been exceeded.
4	LINEAR	Interpolation routine LINEAR requires powertrain data to be inserted in ascending order of magnitude.
5	LINEAR	A calculated point is outside the bounds of the array to be interpolated. (Check powertrain data for errors.)
6	IV3	Terrain soil value, IST, does not conform to the soil types addressed in the Model. (Check terrain data.)
7	IV3	For tracked vehicles, slipperiness scenario variable NSLIP is outside the range used (0-6). (Check scenario data.)
10	IV3	Same as 7 except for non-CH soil type.
11	IV3	Same as 7 except for wheeled vehicles.
12	TFORCF	Soil type variable IST has erroneous value. Relationships for modifying the drawbar pull curve at 20% slip vs. soil type are available only for fine grained, coarse grained and muskeg soils. (Trace passage of variable IST and its value through the program.)

UNCLASSIFIED

SECURITY CLASSIFICATION OF THIS PAGE (When Data Entered)

REPORT DOCUMENTATION PAGE		READ INSTRUCTIONS BEFORE COMPLETING FORM
1. REPORT NUMBER 12503	2. GOVT ACCESSION NO.	3. RECIPIENT'S CATALOG NUMBER
4. TITLE (and Subtitle) NATO REFERENCE MOBILITY MODEL, EDITION I USERS GUIDE, VOLUME I		5. TYPE OF REPORT & PERIOD COVERED Final
		6. PERFORMING ORG. REPORT NUMBER SIT-DL-79-9-2058
7. AUTHOR(s) M. Peter Jurkat Peter M. Brady, Jr. Peter W. Haley		8. CONTRACT OR GRANT NUMBER(s) DAAK30-77-C-0027
9. PERFORMING ORGANIZATION NAME AND ADDRESS Stevens Institute of Technology, Davidson Lab Castle Point Station, Hoboken, NJ 07030		10. PROGRAM ELEMENT, PROJECT, TASK AREA & WORK UNIT NUMBERS
11. CONTROLLING OFFICE NAME AND ADDRESS US Army Tank-Automotive Rsch & Dev Command DRDTA-ZSA Warren, MI 48090		12. REPORT DATE OCT 1979
		13. NUMBER OF PAGES 390
14. MONITORING AGENCY NAME & ADDRESS (if different from Controlling Office)		15. SECURITY CLASS. (of this report) Unclassified
		15a. DECLASSIFICATION/DOWNGRADING SCHEDULE
16. DISTRIBUTION STATEMENT (of this Report) Approved for public release, distribution unlimited.		
17. DISTRIBUTION STATEMENT (of the abstract entered in Block 20, if different from Report)		
18. SUPPLEMENTARY NOTES Includes: Operational Modules; App A: Program Listing; App B: Vehicle Input Files; App C: Terrain Input Files; App D: Sample Output of Program; App E: Possible STOP's In Program.		
19. KEY WORDS (Continue on reverse side if necessary and identify by block number) Mobility Vehicle Performance Mobility Modeling Terrain Computerized Simulation		
20. ABSTRACT (Continue on reverse side if necessary and identify by block number) Instructions in the organization and use of the computer programs which implement the Initial NATO Reference Model (INRMM) are presented. A brief description of the mathematical equations and computing algorithms which pre- dict the speed of a vehicle over a variety of terrain, the input data required, and the outputs generated is included. Some aid to the interpretation of various output variables is given.		