



①

AD-A278 217



# Noise & Man '93

Nice, France

Bruit et Santé

Le bruit comme problème de santé publique

## Noise as a Public Health Problem

Proceedings of the 6th International Congress/ Actes du 6ème Congrès International

Nice 5-9 Juillet 1993

**DISTRIBUTION STATEMENT A**  
Approved for public release  
Distribution Unlimited

DTIC  
ELECTE  
APR 15 1994  
S B D

67108 94-11377



Volume II

Michel Vallet, editor

Actes INRETS N°34

DTIC QUALITY INSPECTED 3

INSTITUT NATIONAL DE RECHERCHE SUR LES TRANSPORTS ET LEUR SÉCURITÉ

94 4 14 037

# REPORT DOCUMENTATION PAGE

Form Approved  
OMB No. 0704-0188

Public reporting burden for this collection of information is estimated to average 1 hour per response, including the time for reviewing instructions, searching existing data sources, gathering and maintaining the data needed, and completing and reviewing the collection of information. Send comments regarding this burden estimate or any other aspect of this collection of information, including suggestions for reducing this burden, to Washington Headquarters Services, Directorate for Information Operations and Reports, 1215 Jefferson Davis Highway, Suite 1204, Arlington, VA 22202-4302, and to the Office of Management and Budget, Paperwork Reduction Project (0704-0188), Washington, DC 20503.

<b>1. AGENCY USE ONLY (Leave blank)</b>		<b>2. REPORT DATE</b> 5-9 Jul 93	<b>3. REPORT TYPE AND DATES COVERED</b> Second Report 5-9 Jul 93	
<b>4. TITLE AND SUBTITLE</b>  Sixth International Congress on Noise as a Public Health Problem			<b>5. FUNDING NUMBERS</b>  CSP-93-1009	
<b>6. AUTHOR(S)</b>  Dr Michel Vallet				
<b>7. PERFORMING ORGANIZATION NAME(S) AND ADDRESS(ES)</b> Institute National de Recherche sur les Transports et leur Security. 109 Ave Salvador Allende - Case 24 069675 Bron Cedex France			<b>8. PERFORMING ORGANIZATION REPORT NUMBER</b>	
<b>9. SPONSORING/MONITORING AGENCY NAME(S) AND ADDRESS(ES)</b> Sponsoring Agency: European Office of Aerospace Research & Development PSC 802 Box 14 FPO AE 09499-0200			<b>10. SPONSORING/MONITORING AGENCY REPORT NUMBER</b>	
<b>11. SUPPLEMENTARY NOTES</b>				
<b>12a. DISTRIBUTION/AVAILABILITY STATEMENT</b>  Approved for public release. Distribution unlimited.			<b>12b. DISTRIBUTION CODE</b>  A	
<b>13. ABSTRACT (Maximum 200 words)</b>  Volume 2 contains the 160 papers presented by participants during the Congress.				
<b>14. SUBJECT TERMS</b>			<b>15. NUMBER OF PAGES</b> 671	
			<b>16. PRICE CODE</b>	
<b>17. SECURITY CLASSIFICATION OF REPORT</b> UNCLASSIFIED	<b>18. SECURITY CLASSIFICATION OF THIS PAGE</b> UNCLASSIFIED	<b>19. SECURITY CLASSIFICATION OF ABSTRACT</b> UNCLASSIFIED	<b>20. LIMITATION OF ABSTRACT</b> UNCLASSIFIED	

ISBN 2-85782-372 X  
ISSN 0769-0266

Copyright © INRETS 1993  
Reproduction autorisée sous réserve d'en mentionner l'origine  
*All rights permitted provided that the origin is mentioned*

Accession For	
BTIS GRA&I	<input checked="" type="checkbox"/>
DTIC TAB	<input type="checkbox"/>
Unannounced	<input type="checkbox"/>
Justification	
By _____	
Distribution/ _____	
Availability Codes	
Dist	Avail and/or Special
A-1	

Les commandes doivent être adressées (*orders should be made to*)  
l'INRETS  
Service Publications  
2, Avenue du Général Malleret Joinville  
94114 Arcueil Cedex  
France

et être accompagnées d'un chèque bancaire ou postal de 500 FF (*with a cheque of 500 FF to*)  
à l'ordre de l'Agent Comptable de l'INRETS

# ORGANIZING COMMITTEE/COMITÉ D'ORGANISATION

## INRETS

Laboratoire Energie Nuisances  
Service Valorisation  
109, Avenue Salvador Allende  
69500 Bron  
France

Michel VALLET  
Dr. Research Director

Jacques LAMBERT  
Dr. Research Director

Michel MAURIN  
Dr. Researcher

Patricia CHAMPELOVIER  
Dr. Assistant Researcher

Isabelle VERNET  
Assistant Researcher

Yves CONUS  
Logo Designer

Nicole TELLAC  
Secretary of the congress

Alice DEBONNET  
(Chief of CIDB - Centre d'Information et de Documentation sur le Bruit)

## INTERNATIONAL COMMISSION

### ON THE BIOLOGICAL EFFECTS OF NOISE (ICBEN)

<b>Chairman/président</b>	Dr. Alain MUZET (France)
<b>Cochairman/vice-président</b>	Dr. Edgar SHAW (Canada)
<b>Secretary/secrétaire</b>	Pr. Birgitta BERGLUND (Sweden)
<b>Past Chairman/ex-président</b>	Dr. Henning von GIERKE (USA)

## **PATRONAGE AND SPONSORING/PATRONAGE ET MÉCÉNAT**

Ministère de l'Environnement (Direction Qualité de la Vie, DRAEI) - France

Ministère de la Recherche - France

Ministère de la Santé - France

Ministère de la Défense, DGA - France

Institut National de la Santé et de la Recherche Médicale (INSERM) - France

Institut National de Recherche et de Sécurité (INRS) - France

INRETS - Laboratoire Energie Nuisances, France

Commission des Communautés Européennes - DG XI

Acoustical Society of America

Société Française d'Acoustique - France

Acoustical Society of Japan

Institute of Acoustics - Great Britain

British Society of Audiology - Great Britain

US Air Force : CEVP, Environmental Planning Office

US Air Force : European Office of Aerospace Research and Development (EOARD)

US Air Force : Army Research and Development Standardization Group (USARDSG)

Department of Health and Welfare (Protection Branch) - Canada

World Health Organization (WHO)

Electricité de France (EDF)

*Acknowledgments are due to each Department or Institution*

## ADVISORY COMMITTEE

Dr. Lex Brown, University of Brisbane (Australia)

Dr. James M. Fields - Silver Spring (USA)

Pr. Barbara Griefahn, Institut für Arbeitsphysiologie - Dortmund (D)

Dr. Manfred Haider, Universität Wien (A)

Dr. Tammo Houtgast, T.N.O. - Soesterberg (NL)

Pr. Gerd Jansen, Universität Düsseldorf (D)

Dr. Dylan Jones, University of Wales College of Cardiff (GB)

Dr. Ronald G. de Jong, T.N.O. - Leiden (NL)

M. Ian Karlsson, National Swedish Environmental Board - Solna (S)

Major Robert Kull, Armstrong Laboratory, Wright-Patterson Base (USA)

Dr. Hans Lazarus, Bundesanstalt für Arbeitsschutz - Dortmund (D)

Dr. Olavi Manninen, National Board of Labour Protection - Jyvaskyla (SF)

Dr. Per O.L. Nilsson, Bispebjerg Hospital - Copenhagen (DK)

Dr. Evy Öhrström, University of Gothenburg (S)

Dr. Willy Passchier-Vermeer, T.N.O. - Leiden (NL)

Dr. Pierre Salamé, CNRS LPPE - Strasbourg (F)

Dr. Sieglinde Schwarze, Institut für Arbeitsmedizin - Düsseldorf (D)

Pr. Shirley J. Thompson, University of South Carolina - Columbia (USA)

Dr. Xavier Bonnefoy, World Health Organization - Copenhagen (DK)

Mr Pierre Schmeltz, Ministère de l'Environnement - Paris (F)

Dr. Herb Dean, US Air Force - Pentagon (USA)

Pr. Henri Arbey, Institut National Recherche Sécurité - Nancy (F)

Dr. David Stephens, NASA (USA)

**Noise induced hearing loss - Le bruit et les pertes auditives**  
**Free communications - Communications orales**

**Ahroon Wa - Hamernik RP - Davis RI - Patterson JH**  
*The relation among postexposure threshold shifts and NIPTS in the chinchilla* ..... 1

**Al Masri M - Martin A - Nedwell J**  
*Underwater hearing and occupational noise exposure limits*..... 5

**Andersen T - Courtois J**  
*Noise induced hearing loss treated with high-frequency hearing instruments* ..... 9

**Avan P - Loth D - Bonfils P - Menguy C - Teyssou M**  
*Otoacoustic emissions, physiopathology and early diagnosis of noise-induced hearing loss*..... 13

**Bennett J - Kersebaum M**  
*Deafness in military service*..... 17

**Bertrand RA - Zeidan J**  
*Retrospective field evaluation of HPD based on evolution of hearing*..... 21

**Borchgrevink HM**  
*Music-induced hearing loss >20 dB affects 30 % of norwegian 18 year old males before military service - the incidence doubled in the 80's, declining in the 90's*..... 25

**Carne C - Roure A**  
*A new solution for increasing noise protection*..... 29

**Cause JB**  
*Too loud music is a dangerous noise : let noise be seen*..... 33

**Chen M - Zhou SK - Chen J - Ye Q**  
*Age and sex difference on the air- conduction auditory threshold in china (hearing analysis of 1375 cases)* ..... 37

**Clark WW - Bohl CD**  
*Hearing levels of us industrial employees not exposed to occupational noise : the search for an appropriate database B*..... 38

**Courtois J - Andersen T - Larsen BV - Larsen H**  
*Noise induced treble hearing loss - Social handicap - Audiological rehabilitation* ..... 39

**Custard G**  
*A critical comparison of three methods for predicting noise induced deafness in workers*..... 43

**Eden D**  
*Australian mining industry experience in hearing conservation* ..... 47

**Fernandes JC**  
*Occupational disease in agricultural operations with tractors - Noise levels - tractor operator hearing loss* ..... 51

**Hallmo P - Borchgrevink HM - Mair IWS**  
*High-frequency thresholds : extensive loss above 2 kHz for impulse noise exceeding a critical level ?* ..... 53

**Hamernik RP - Ahroon WA - Davis RI - Lei SF**  
*Hearing threshold shifts from repeated six-hour daily exposure to impact noise* ..... 57

**Hellström PA**  
*The effect of sound transfer function to the tympanic membrane on noise induced hearing loss* ..... 61

**Henderson D - Subramaniam M**  
*Toughening : acoustic parameters* ..... 65

<b>Ishii EK - Talbott EO</b> <i>The use of industrial surveillance data in historical noise exposure reconstruction : a noise induced hearing loss researcher's nightmare</i> .....	69
<b>Köhler W - Fritze W</b> <i>Dips in the high-frequency range after steady-state noise exposure</i> .....	75
<b>Loth D - Avan P - Teyssou M - Menguy C</b> <i>Auditory hazard in relation to listening to portable digital compact-disc players</i> .....	79
<b>McKinley RL - Nixon CW</b> <i>Active noise reduction headsets</i> .....	83
<b>Meyer-Bisch C</b> <i>High-definition audiometry and high-frequency audiometry - Interest and limits in NIHL screening</i> .....	87
<b>Mills JH</b> <i>On the relation or correlation between temporary and permanent threshold shifts</i> .....	91
<b>Mondot JM - Leplay A - Guy M - Gamba R</b> <i>Assessment of noise exposure and risk of hearing damage from peak value and time history of noise</i> .....	95
<b>Nepomuceno JA - Belderrain ML</b> <i>HCP administration in petrochemical plant</i> .....	99
<b>Nixon CW - West DW - Allen NK</b> <i>Human auditory response to aircraft flyover noise</i> .....	101
<b>Patania F - Gagliano A - Luca A</b> <i>Noise-induced hearing losses : some experimental research's results</i> .....	105
<b>Precerutti G - Vaccari V</b> <i>Non industrial noise-induced hearing loss</i> .....	109
<b>Price GR</b> <i>An improved damage risk criterion for intense impulse noise</i> .....	113
<b>Ribeiro V - Ribeiro J - Cohen A</b> <i>Occupational hearing loss among workers of the steel industry ; a computerized survey</i> .....	115
<b>Rosenthal U - Axelsson A - Svedberg A</b> <i>Hearing in 18 year old men - Is high frequency hearing loss more common today than 17 years ago ?</i> .....	119
<b>Sousa-Uva A - Silva-Carvalho A - Ribeiro V - Pimenta A - Varao L - Sa-Leal A</b> <i>Implementation of a hearing conversation program at a airline company</i> .....	123
<b>Sliwinska-Kowalska M - Sulkowski WJ - Jedlinska U - Rydzynski K</b> <i>Relationships between functional and morphological changes in the cochlea of Guinea pigs after exposure to industrial noise</i> .....	127
<b>Svensson EB - Olofsson A</b> <i>Results of measurement of hearing protectors depending on realization of sound field</i> .....	131
<b>Sulkowski WJ - Sliwinska-Kowalska M - Kochanek K</b> <i>Frequency-specific brainstem evoked responses audiometry in assessment of noise-induced hearing loss</i> .....	135
<b>Touma JB</b> <i>Controversies in noise induced hearing loss (NIHL)</i> .....	139
<b>Van den Berg R - Passchier-Vermeer W</b> <i>Hearing protection devices : their attenuation in real working situations and simplified methods to measure their effectiveness</i> .....	141
<b>Weston RJ - Steele DG</b> <i>Noise dose levels from hearing protectors</i> .....	145



**Noise and communication - Bruit et communication**  
**Free communications - Communications orales**

<b>Carme C - Roure A</b> <i>How to increase a communication intelligibility in a very loud noise ?</i> .....	149
<b>Delgado C - Perera P - Santiago JS</b> <i>Influence of different acoustic parameters in the speech intelligibility in school rooms</i> .....	153
<b>Giua PE - Messino CD</b> <i>The lombard effect in various noise environments</i> .....	157
<b>Kersebaum M - Bennett JDC</b> <i>Noise induced hearing loss and communication : the military experience</i> .....	161
<b>Kunov HL - Dajani H - Seshagiri B</b> <i>Measurement of noise exposure from communication headsets</i> .....	165
<b>Laroche C - Héту R - Tran Quoc H - Larocque R</b> <i>"DetectsoundTM" : a user-friendly software for the analysis of warning sounds in noisy workplaces</i> .....	169
<b>Pachiani G - Le Breton B - Deleurence P - Pascal D - Gilloire A</b> <i>Noise annoyance when using a handsfree telephone in a car</i> .....	173
<b>Pekkarinen E - Vilkmann E - Sihvo M - Lauri ER</b> <i>Acoustic voice perturbation changes due to loading of voice during working-day</i> .....	177
<b>Seballos S - Costabal H - Matamala P</b> <i>An acoustic diagnosis of classrooms correlated with learning</i> .....	181
<b>Taillifet D</b> <i>Numerical prediction of noise and intelligibility levels in industrial halls</i> .....	185
<b>Viljanen V - Pekkarinen E</b> <i>Proper placement of sound absorption material into classroom</i> .....	189
<b>Woxen OJ - Borchgrevink HM</b> <i>Acoustic ear canal attenuation of hearing protectors and ANR-headsets at &gt;85 dB, inflight and in the laboratory</i> .....	193

**Community response to noise - La réponse de la communauté au bruit**  
**Free communications - Communications orales**

<b>Dankittikul W - Izumi K - Yano T - Kurosawa K - Yamashita T</b> <i>Cross-cultural comparison of community response to road traffic noise in Japan and Thailand</i> .....	197
<b>Lercher P - Widmann U</b> <i>Factors determining community response to road traffic noise</i> .....	201
<b>Lopez Barrio I - Carles JL</b> <i>Subjective response to traffic noise. The importance given to noise environment in choosing a place of residence</i> .....	205
<b>Öhrström E</b> <i>Long-term effects in terms of psycho-social wellbeing, annoyance and sleep disturbance in areas exposed to high levels of road traffic noise</i> .....	209
<b>Renew WD</b> <i>Attitudes to road traffic in Brisbane</i> .....	213
<b>Yano T - Izumi K - Yamashita T - Dankittikul W - Kurosawa K</b> <i>Cross regional comparison of community response to road traffic noise in Hokkaido and Kyushu, Japan</i> .....	217
<b>Albanese G - Barbaro S - Cosa M - Giaconia C - Grippaldi V</b> <i>Subjective response and sensitivity to road traffic noise : studies performed in Palermo (Italy)</i> .....	221

<b>Rylander R - Björkman M - Sörensen S</b> <i>Dose-response relationships for environmental noises</i> .....	225
<b>Finegold LS</b> <i>US air force research program on the effects of aircraft noise on humans : current status and future directions</i> .....	229
<b>Kalivoda MT</b> <i>Rating noise in the neighbourhood of a sawmill by psychoacoustics</i> .....	233
<b>Wolsink M - Springers M</b> <i>Windturbine noise ; a new environmental threat ?</i> .....	235

**Noise and animal life - Le bruit et la vie animale**  
**Free communications - Communications orales**

<b>Harrington FH</b> <i>The effects of low-level jet fighter overflights on caribou</i> .....	239
<b>Gladwin DN - McKechnie AM</b> <i>Case studies highlights potential compatibility of low-altitude aircraft operations with important wildlife resources</i> .....	243
<b>Anderson BA - Murphy SM - Kugler AB - Barber DS - Joyce MR</b> <i>The effects on waterbirds of increased noise from the expansion of a gas compressor plant at Prudhoe bay, Alaska</i>	247
<b>De Young DW - Krausman PR - Weiland LE - Etchberger RC</b> <i>Baseline ABRs in Mountain Sheep and Desert Mule Deer</i> .....	251
<b>Damon E - Jenssen A - Woxen OJ - Richmond DR - Borchgrevink HM</b> <i>Non-auditory effects on pigs exposed to complex weapon blast pressure waves in enclosures</i> .....	255
<b>Stephan E - Mönig T</b> <i>Acoustic inattentiveness as an indicator of fatigue in physically loaded Alsatian watchdogs</i> .....	259
<b>Bowles AE - Smultea M - Wursig B - Denaster DP - Palka D</b> <i>Observations on the relative abundance and behavior of marine mammals exposed to transmissions from the heard island feasibility test</i> .....	260
<b>Zhao Y - Liu S - Zhang S</b> <i>Effects of short term noise exposure on heart rate and EEG ST segment in male rats</i> .....	261
<b>Faustov A - Fraiman B - Bosova L</b> <i>The phase features of man and animal reaction to infrasound effect</i> .....	265
<b>Evans GW - Allen KM - Taffala R</b> <i>The cumulative effects of stress on psychophysiological and performance responses to noise</i> .....	269
<b>Maurin M - Vernet I</b> <i>Extensions of annoyance processings to combined exposures</i> .....	273
<b>Mehnert P - Griefahn B - Bröde P</b> <i>A new methodological approach for studies on the combined effects of noise and other occupational hazards</i> .....	277
<b>Notbohm G - Jansen G</b> <i>Interactive effects of noise and whole body vibration on performance in a five-choice-reaction task</i> .....	279
<b>Pjerotic L - Nikolic</b> <i>Impact of noise and air pollution on health</i> .....	283
<b>Poulsen T - Kim SW - Rindel JH - Carrick L - Clausen G - Fanger PO</b> <i>The combined effect of noise, air quality and temperature on human comfort</i> .....	287
<b>Prince M - Ivanatanoski G - Breysse P - Fechter L - Pena B</b> <i>The joint effect of noise and smoking on changes in hearing</i> .....	291

<b>Ishiyama T</b> <i>A social survey of community responses to road traffic noise</i> .....	375
<b>Koushki PA - Al-Felimban A - Al-Humud JM</b> <i>Exposure to traffic noise in Riyadh, Saudi Arabia : magnitude of noise and attitude of individuals</i> .....	379
<b>Krajcovic M</b> <i>Comparison of mathematical model of traffic noise level with the results of real measurements</i> .....	381
<b>Kuwano S - Namba S - Koyasu M</b> <i>The measurement of temporal stream of hearing by continuous judgements - in the case of the evaluation of helicopter noise</i> .....	385
<b>Lambert J - Champolovier P - Vernet I</b> <i>Annoyance from high speed train noise : an exploratory field study</i> .....	389
<b>Leobon A</b> <i>The cartography of a urban center soundscape</i> .....	393
<b>Mignerou JG - Lemieux P - Côté P</b> <i>Noise impact modelisation of new reserved bus corridors on residential facades</i> .....	397
<b>Nepomuceno JA - Belderrain ML</b> <i>Noise community problems in orange juice factory</i> .....	401
<b>Öhrström E - Skänberg AB</b> <i>The effect of exposure to noise and vibrations from trains - field surveys in areas exposed to different number of trains and different levels of vibrations</i> .....	403
<b>Persson K - Rylander R</b> <i>A pilot study assessing long-term effects among people exposed to low level, low frequency noise in their homes</i> ....	407
<b>Sato T</b> <i>A path analysis of the effect of vibration on road traffic noise annoyance</i> .....	411
<b>Shield B - Zhukov AN</b> <i>Community response to low frequency noise from an urban light rail system</i> .....	415
<b>Thibaud JP</b> <i>The sonic abilities of city dwellers</i> .....	419
<b>Turunen-Rise I - Flottorp G</b> <i>Evaluation of loudness of various noises in free and diffuse sound field</i> .....	423
<b>Vincent B - Champelovier P</b> <i>Changes in acoustical environment : need for an extensive evaluation of annoyance</i> .....	425
<b>Vos J - Veltman JA</b> <i>Startle response to impulse sounds produced by small and large firearms</i> .....	429
<b>Walker JG</b> <i>Prediction and assessment of structurally-radiated noise within buildings</i> .....	433

**Noise and communication - Bruit et communication**  
**Posters Session - Session de posters**

<b>Rajan R - Irvine DRF</b> <i>Reorganization of auditory cortical maps consequent on unilateral cochlear damage in adult mammals</i> .....	437
--	-----

<b>Schuemer-Kohrs A - Sinz A - Zeichart K</b> <i>Annoyance caused by railway-induced vibration and noise</i> .....	299
<b>Schust M</b> <i>Auditory and non-auditory effects of combined noise and heat exposure</i> .....	303
<b>Slama JG - Nunes Cossenza CA - Gueiros Teixeira S</b> <i>Noise control in tropical countries and cultural behaviours</i> .....	307
<b>Smith AP - Thomas M - Brockman P</b> <i>Noise, respiratory virus infections and performance</i> .....	311
<b>Suvorov GA</b> <i>Non-auditory and aural noise effects and their interaction</i> .....	315
<b>Zhao Y - Liu H - Du D - Zhao C</b> <i>Adverse effects of smoking for noise induced hearing loss among workers in Beijing</i> .....	317

**Community response to noise - La réponse de la communauté au bruit**  
**Posters Session - Session de posters**

<b>Aecherli W</b> <i>Psychological and social reasons for noise</i> .....	321
<b>Aguerri Sanchez MP - Celma Celma J</b> <i>Effects of noise on the citizen and its repercussions on municipal management</i> .....	323
<b>Albanese G - Barbaro S - Cosa M - Di matteo U - Giacomia C - Grippaldi V</b> <i>Acoustical impact on performance and behaviour in homogeneous zones of Palermo (Italy)</i> .....	327
<b>Arribas GE - Gallardo C - Molina M</b> <i>Noise contamination in the public hospital of Albacete</i> .....	331
<b>Aubree D</b> <i>Regulations, noise and discomfort</i> .....	335
<b>Bartels KH</b> <i>The problem of night time flight noise at the new international airport Munich II from a new preventive medical aspect</i> .....	339
<b>Preis A - Berglung B</b> <i>Perceived annoyance of intermittent environmental sounds</i> .....	343
<b>Bisio G - Schiapparelli P</b> <i>On the noise levels of the Hanbury botanical garden and of other gardens</i> .....	347
<b>Björkman M - Rylander R</b> <i>The relation between different noise descriptors for road traffic noise and the extent of annoyance</i> .....	351
<b>Chaussonnery R</b> <i>Reduction of aircraft noise around Nice (flight techniques and aircraft disturbance)</i> .....	355
<b>Droin L - Arras C</b> <i>Analysis of the various components related with the acoustical environment in urban areas, using neural network system</i> .....	359
<b>Finegold LS - Sneddon MD</b> <i>Development of prototype human response monitor (HRM) for use in noise effects research</i> .....	363
<b>Garcia A - Garcia AM</b> <i>Measurements of noise exposure in daily life</i> .....	367
<b>Hermant D - Moch A - Lecointre G</b> <i>Effects of noise on social and physical perceptions</i> .....	371

**Regulations and standards - Les réglementations sur le bruit**  
**Posters Session - Session de posters**

<b>Pimentel-Souza F - Alvares PA</b> <i>Noise pollution in Belo Horizonte city</i> .....	441
<b>Fogel AL - Fridman VE - Sobolev LY</b> <i>Screening of noisy junctions of a tractor</i> .....	445
<b>Eghtesadi K</b> <i>Active control of low frequency noise</i> .....	447
<b>Watson I</b> <i>Is hearing damage unaffected by discrete tones and Lp amplitude ?</i> .....	451
<b>Weston RJ - Steele DG</b> <i>Helicopter noise measurements for a database</i> .....	455

**Non-auditory physiological effects - Effets physiologiques non auditifs dus au bruit**  
**Free communications - Communications orales**

<b>Griefahn B - Bröde P</b> <i>Peripheral blood flow. A suitable indicator of noise-induced strain</i> .....	457
<b>Talbott EO - Findlay RC - Kuller LH - Day RD - Ishii EK</b> <i>Noise-induced hearing loss and high blood pressure</i> .....	461
<b>Lercher P - Kofler W</b> <i>Adaptive behavior to road traffic noise, blood pressure and cholesterol</i> .....	465
<b>Carter NL - Taylor R - Job RFS - Peplow P - Jenkins A - Morrell S</b> <i>Proposals for a studies of aircraft noise and health, Sydney airport</i> .....	469
<b>Hiramatsu K - Yamamoto T - Taira K - Ito A - Nakasone T</b> <i>Response to questionnaire on health around a military airport</i> .....	473
<b>Schmeck K - Poustka F</b> <i>Psychiatric and psychophysiological disorders in children living in a military jetfighter training area</i> .....	477
<b>Stansfeld SA - Shine P</b> <i>Noise sensitivity and psychophysiological responses to noise in the laboratory</i> .....	481
<b>Meyer-falcke A - Lanzendörfer A - Rack R - Jansen G</b> <i>Noise and pulmonary function : is there a correlation ?</i> .....	485
<b>Belojevic G - Kocijancic R - Stankovic T</b> <i>Injury rates in textile industry with regard to noise exposure</i> .....	489
<b>Zhao Y - Zhang S - Spear RC</b> <i>Investigation of dose-response relationship for noise induced neurasthenia syndromes</i> .....	493
<b>Schwarze S - Notbohm G - Jansen G</b> <i>The influence of binaural hearing on physiological responses</i> .....	497
<b>Fraiman BJ - Voronin AN - Fraiman EB</b> <i>The alternative mechanism of the infrasound influence on organism</i> .....	501
<b>Kabuto M - Kageyama T - Imai H - Nitta H - Minami M</b> <i>Heterogenous response of sympathetic nervous system to sound stimuli : finger plethysmographic responses of <math>\alpha</math>- and <math>\beta</math>- type</i> .....	505
<b>Bly SHP - Goddard M - McLean J</b> <i>A review of the effects of noise on the immune system</i> .....	509

<b>Schust M</b>	
<i>Noise and cardiac infarction - a review</i> .....	513

**Influence of noise on performance and behaviour -  
Influence du bruit sur les performances et le comportement**  
Free communications - Communications orales

<b>Tafalla RJ - Evans GW</b>	
<i>Noise, physiology and human performance : the potential role of effort</i> .....	515
<b>Salame P - Tassi P - Nicolas A - Ehrhart J - Dewasmes G - Libert JP - Muzet A</b>	
<i>Noise, after-effects of sleep, and cognitive performance</i> .....	519
<b>Khaldi S - Fakkar S - Olivier D - Vallet M</b>	
<i>Noise and vibration effects on drowsiness under real car driving conditions</i> .....	523
<b>Petit C - Tarriere C - Tamalet D</b>	
<i>Does noise improve or deteriorate the driving behavior ?</i> .....	527
<b>Hygge S</b>	
<i>Classroom experiments on the effects of aircraft, traffic, train, and verbal noise on long-term recall and recognition in children aged 12-14 years</i> .....	531
<b>Smith AP</b>	
<i>Noise and selective attention</i> .....	535
<b>Benton S - Robinson G</b>	
<i>The effects of noise on text problem solving for the word processor user (WPU)</i> .....	539
<b>Moch A - Maramotti I</b>	
<i>Multi-dimensional approach to noise effects and to noise after effects</i> .....	543
<b>Belojevic G - Öhrström E - Rylander R</b>	
<i>Effects of noise on mental performance with regard to subjective noise sensitivity</i> .....	547
<b>Santisteban C - Santalla Z</b>	
<i>The effects of everyday noises and their subjective level of pleasantness on recall of categorized lists</i> .....	549
<b>Santisteban C - Santalla Z</b>	
<i>The effects of everyday noise on comprehension and recall of reading texts</i> .....	553
<b>Kilcher H - Hellbrück J</b>	
<i>The "irrelevant speech"-effect : is binaural processing relevant or irrelevant ?</i> .....	557

**Noise disturbed sleep - La perturbation du sommeil par le bruit**  
Free communications - Communications orales

<b>Hofman W - Kumar A - Eberhart J</b>	
<i>Comparative evaluation of sleep disturbance due to noises from airplanes trains and trucks</i> .....	559
<b>Hume KI - Thomas C</b>	
<i>Sleep disturbance due to aircraft noise at rapidly expanding airport - Manchester, UK</i> .....	563
<b>Horne JA - Pankhurst FL - Reyner LA</b>	
<i>Aircraft noise on sleep - field study findings from morning sleep logs</i> .....	567
<b>Van F - Hume KI - Watson A</b>	
<i>EEG responses to aircraft noise in "noise sensitive" and "less noise sensitive" subjects</i> .....	569
<b>Diamond I - Egger P - Holmes D</b>	
<i>Random effects models for repeated observations in studies to ascertain the effect of aircraft noise on sleep disturbance</i> .....	573

Altena K - Beersma DGM <i>Sleep, noise and the immunosuppression.....</i>	575
Suzuki S - Kawada T - Sato T - Naganuma S - Ogawa M - Aoki S <i>Decrease of stage Rem, as a most sensitive indicator of all-night noise exposure.....</i>	579

**Community response to noise - La réponse de la communauté au bruit**  
Free communications - Communications orales

Griffiths ID <i>Changes in disturbance and annoyance as a function of changes in noise exposure.....</i>	583
Baughan CJ - Huddart L <i>Effects of traffic noise changes on residents' nuisance ratings .....</i>	585
Gjestland T - Granoien ILN - Liasjo KH - Bugge JJ <i>Community response to noise from a short term military aircraft exercise .....</i>	589
Bertoni D - Franchini A - Magnoni M - Tartoni P - Vallet M <i>Reactions of people to urban traffic noise in Modena, Italy.....</i>	593
Porter ND - Berry BF <i>Subjective effects and objective assessment of combined tonal and impulsive noise .....</i>	597
Meloni T - Krueger H <i>Loudness perception and annoyance of impulsive noise measured in the laboratory.....</i>	601
Rylander R - Ahrlin U - Lundquist B <i>Annoyance from artillery shooting range noise.....</i>	605
Staats HJ - De Jong HJ <i>A conceptual model for noise annoyance in outdoor recreational settings.....</i>	609
Kurra S <i>Evaluation of annoyance against transportation noises with respect to reading and listening activities.....</i>	613
Psichas K - Vallet M - Vogiatzis C <i>A social noise survey in the holiday - city of Rhodes.....</i>	615
Serefhanoglu M - Karabiber Z - Yügrük N - Erdem Aknesil A <i>Noise disturbance and patients reactions in hospitals.....</i>	619
Soyer M - Pichon JL <i>Acoustic annoyance in the hospital .....</i>	621

**Regulations and standards - Les réglementations sur le bruit**  
Free communications - Communications orales

Normand JC - Aboukhalil E - Luzy A - Pignat JC - Duclos JC <i>Audio-BRP : An audio-sonometric software package meeting the French regulations on occupational noise exposure .....</i>	625
Wallis AD - O'Rourke ST <i>Evaluation of different methods of statistical generation of noise load indices.....</i>	629
Prince MM - Stayner LT <i>A quantitative assessment of the risk of noise-induced hearing loss (NIHL) under the current OSHA standard .....</i>	633
Morelli L <i>Duties imposed by the noise at italian work regulations.....</i>	635

<b>Goncalves S - Nabuco M</b> <i>Noise regulations in Brazil</i> .....	639
<b>Schmidt DE - Szwarc A - Alvares JR</b> <i>Environmental impact of the Brazilian vehicle noise emission control program</i> .....	643
<b>Chan RH - Kwan A - Wai CP</b> <i>How adequately is the public protected from railway noise ?</i> .....	647
<b>Koppert AJ</b> <i>Airport noise standards in the Netherlands</i> .....	651
<b>Laroche C - Leroux T</b> <i>For a new canadian regulation on noisy toys</i> .....	655
<b>Looten A</b> <i>Comparative analysis of noise taxes applicable to noisy aircrafts in France-Germany-Switzerland</i> .....	650
<b>Rohrmann B</b> <i>The consideration of noise annoyance factors in immission regulations for industrial noise</i> .....	66
<b>Author index - Index des auteurs</b> .....	667



# THE RELATION AMONG POSTEXPOSURE THRESHOLD SHIFTS AND NIPTS IN THE CHINCHILLA

AHROON, William A., HAMERNIK, Roger P., and DAVIS, Robert I.

Auditory Research Laboratories  
State University of New York  
107 Beaumont Hall  
Plattsburgh, New York 12901 U.S.A.

PATTERSON, James, H. Jr.

U.S. Army Aeromedical Research Laboratory  
P.O. Box 620577  
Fort Rucker, Alabama 36362-0577 U.S.A.

A statistical analysis of postexposure threshold shift (TS) measures and noise-induced permanent threshold shift (PTS) showed that, across audiometric test frequency, there was a consistent relation between these variables of the form  $PTS \text{ (dB)} = a(e^{TS/b} - 1)$ , where for a given test frequency  $a$  (dB) and  $b$  (dB) are constants. Of the three postexposure measures of TS ( $TS_0$ ,  $TS_{max}$ , and  $TS_{24}$ ), correlations with PTS were highest for the  $TS_{max}$  and  $TS_{24}$  measures. PTS grew very slowly for  $TS_{max} < b$  (dB), and tended to grow linearly with  $TS_{24}$  as a result of the larger value of  $b$  (dB). (Research supported by NIOSH grant 2R010H02317 and USAARL contracts DAMD17-91-C-1113 and DAMD17-91-C-1120.)

**Introduction:** Temporary threshold shift (TTS) following exposure to noise has been a fundamental measure of the effects of a noise exposure on hearing in laboratory experiments using human and other mammalian species for more than 50 years. Since it seemed reasonable to assume that temporary losses of hearing somehow were related to permanent losses (Reger & Lierle, 1954), the former simply being a milder manifestation of the latter, TTS experiments became very popular. While a considerable amount has been learned about the behavior of TTS and its relation to exposure parameters, the results have arguably had a modest impact on our knowledge of how noise-induced permanent threshold shift (NIPTS) accumulates over a working lifetime. Auditory TSs following noise exposure represent a complex response whose biophysical substrates still are not completely understood. The magnitude of the shift, whether a TTS or a compound TS, its frequency specificity, and its postexposure time course, which is dependent upon the magnitude of the TS, vary in a complex manner with the exposure stimulus parameters, (Hirsh & Ward, 1952; Luz & Hodge, 1971; Hamernik et al., 1988). More recently, additional characteristics of TS in search of an explanation have been documented by Clark et al. (1987) and Canlon et al. (1988) who showed that TS was dependent upon previous exposure history as well as the scheduling of a daily interrupted exposure.

An underlying rationale that pervades many of the TS studies is the desire to estimate NIPTS based upon some measure of TS. This goal has remained elusive despite some attempts such as the use of a time-integrated TS as an index of NIPTS (Sitler, 1972). This paper presents a statistical analysis of the TS measured at various postexposure times and the resulting NIPTS using a data base obtained from over 900 chinchillas exposed to various noises.

**Methods:** The 936 chinchillas that were used in this analysis were classified into the following three data sets: (I)  $N = 192$ . Acute exposures to broad-band or narrow-band impacts having peak SPLs

in the range 129 through 147 dB. All exposures lasted for 5 minutes. Thresholds were measured at 0.125, 0.250, 0.5, 1.0, 1.4, 2.0, 4.0, 5.7 and 8.0 kHz using a behavioral avoidance conditioning paradigm. Experimental details can be found in Patterson et al. (1993). (II) N = 423. Acute exposures to broad-band impulses having peak SPLs in the range 150 through 160 dB. Exposures lasted from a fraction of a second to up to 16.5 hours. Thresholds were measured using evoked response audiometry recorded from the inferior colliculus. Postexposure measures were obtained only at 0.5, 2.0 and 8.0 kHz. Experimental details can be found in Hamernik et al. (1991). (III) N = 321. Five-day uninterrupted exposures to broad-band impacts, octave bands of noise, or combinations of these two classes of noise. Peak SPLs of the impacts ranged from 113 through 125 dB and RMS levels of the octave band noises varied between 86 and 95 dB. Postexposure TSs were obtained only at 0.5, 2.0 and 8.0 kHz. Experimental details can be found in Ahroon et al. (1993).

Threshold shift measurements were made immediately upon removal from the noise ( $TS_0$ ) and at regular postexposure intervals through the 24-hour postexposure time ( $TS_{24}$ ). From this set of TS recovery data, the maximum TS ( $TS_{max}$ ) was obtained as well as  $TS_{24}$ . Scatter plots of  $TS_0$ ,  $TS_{max}$  and  $TS_{24}$  versus the corresponding value of PTS for each animal at each audiometric test frequency were constructed. A least square regression fit of the relation  $PTS$  (dB) =  $a(e^{TS/b} - 1)$  to the TS, PTS data was performed.

**Results:** A sample of the raw data obtained at the 2 kHz test frequency for data set II is shown in the upper panels of Figure 1, along with the exponential curve that was fit using a least square regression of TS on PTS. The lower panel of this figure shows the same data set that was transformed into 5-dB bins by collecting all the TS data points in each 5 dB bin and computing the mean PTS

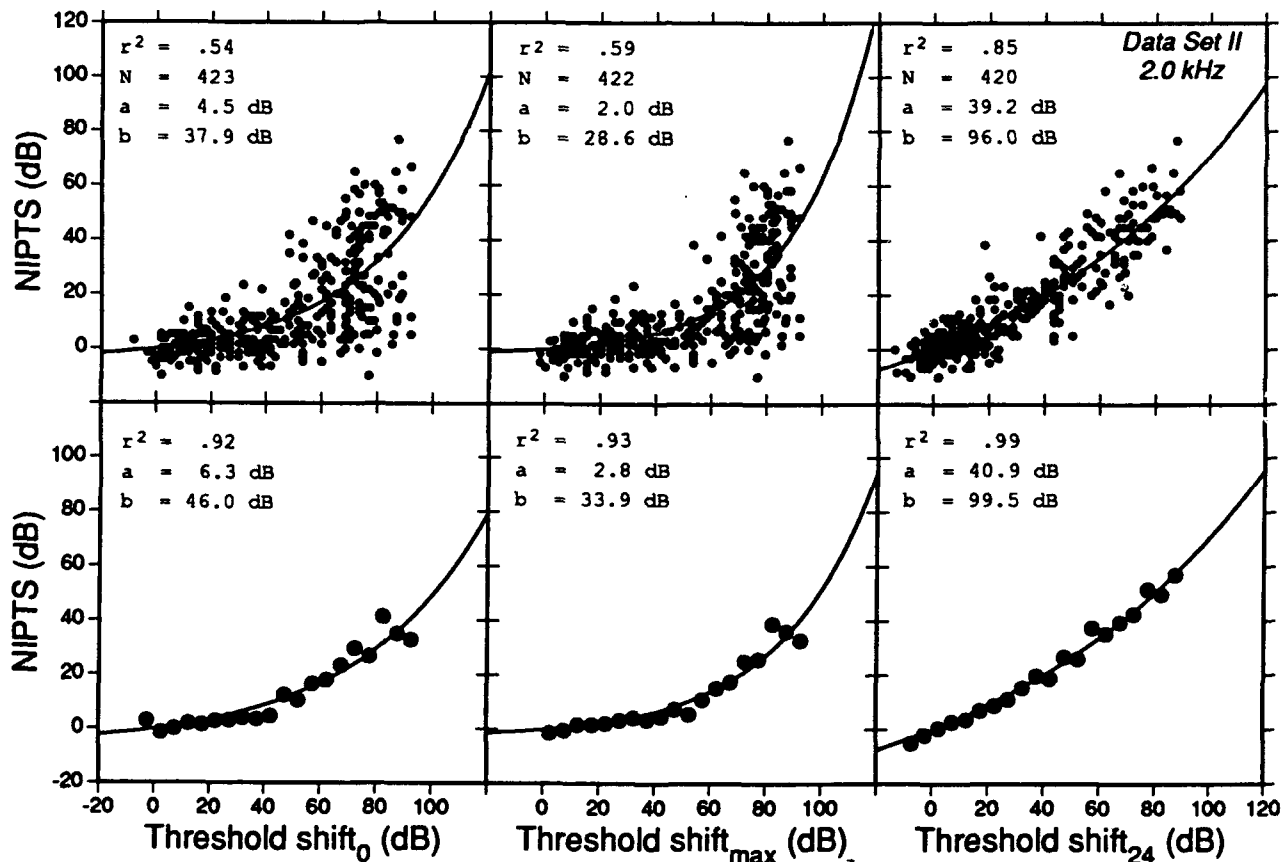

Figure 1. Scatter graphs for the 2.0 kHz test frequency for data set II. The top panels represent the raw data from over 420 animals while the lower panels represent the mean NIPTS in 5-dB wide TS bins. The left panels depict  $TS_0$ , the center panels  $TS_{max}$ , and the right panels  $TS_{24}$ . The least squares regression line to the exponential function  $NIPTS = a(e^{TS/b} - 1)$  is drawn in each panel.

corresponding to the TS data in that bin. The analysis was performed on the raw as well as the transformed data. This reduction of the data had the advantage of illustrating more clearly the relation between the various measures of TS and PTS. The regression analysis for both the raw data and the reduced data both yielded similar exponential relations between TS and PTS with similar values of the constants a and b. The only difference in these two analyses was that, as might be anticipated, the coefficient of determinance ( $r^2$ ) for the reduced set was typically much greater.

Several interesting features of the TS- PTS relationship emerged from these data.

(1) The  $r^2$  values for the  $TS_0$  and  $TS_{24}$  for each data set are shown in Figure 2. Typically, for all frequencies,  $r^2$  is greatest for the prediction of PTS from  $TS_{24}$  and least for  $TS_0$  measures. This is particularly evident in the  $TS_0$  data from data set III. The  $r^2$  values for the  $TS_{max}$  correlations tend to be as high as those obtained for  $TS_{24}$ ; however, considering the difficulty in obtaining this measure in many situations,  $TS_{24}$  is of more practical importance.

(2) Figure 3 shows the values of b and a/b for the  $TS_{max}$  and  $TS_{24}$  data. The value of b (dB) tends to be smallest for the  $TS_{max}$ -PTS relation indicating a typical exponential relationship between the two variables with a/b representing the slope of the relation at  $TS_{max} = 0$ . The slope for  $0 < TS_{max} < b$  tends to grow relatively slowly indicating a small accumulation of PTS for  $TS_{max} < b$ . The value of b for the  $TS_{24}$  measures can be several times that for the  $TS_{max}$  measures. Applying the power series expansion of  $e^x$ , the function  $a(e^{TS/b} - 1)$  becomes linear of the form  $PTS = (a/b)TS$ , for large values of b with a constant slope of a/b.

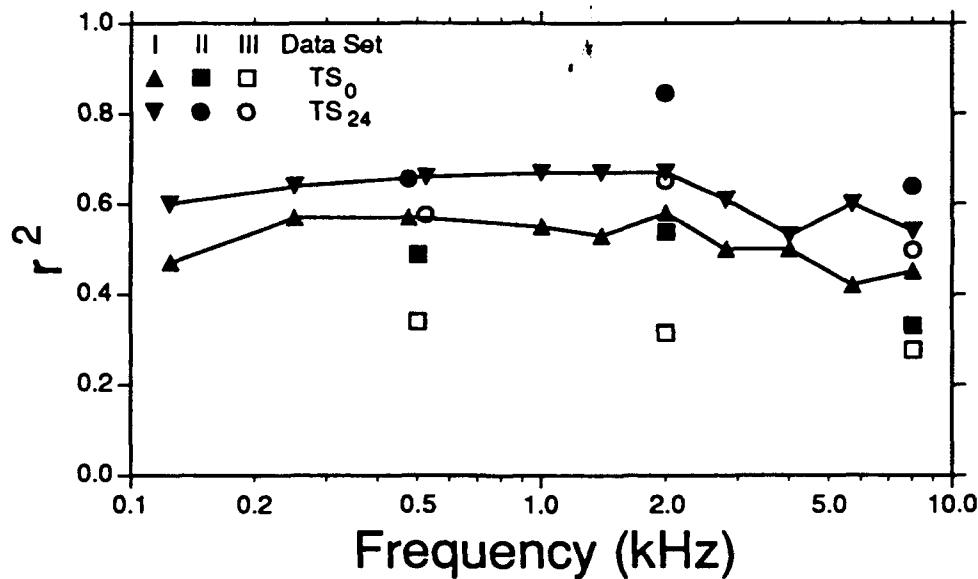

Figure 2. Coefficients of determinance ( $r^2$ ) for the exponential least-squares regression between NIPTS and  $TS_0$  or  $TS_{24}$  for all three data sets.

#### References:

- Ahroon, W.A., Hamernik, R.P. and Davis, R.I. (1993). Complex noise exposures: An energy analysis. *J. Acoust. Soc. Am.* 93:997-1006.
- Canlon, B., Borg, E. and Flock, A. (1988). Protection against noise trauma by pre-exposure to a low-level acoustic stimulus. *Hearing Res.* 34:197-200.
- Clark, W.W., Bohne, B.A. and Boettcher, F.A. (1987). Effects of periodic rest on hearing loss and cochlear damage following exposure to noise. *J. Acoust. Soc. Am.* 82:1253-1264.
- Hamernik, R.P., Ahroon, W.A. and Patterson, J.H. (1988). Threshold recovery functions following impulse noise trauma. *J. Acoust. Soc. Am.* 84:941-950.

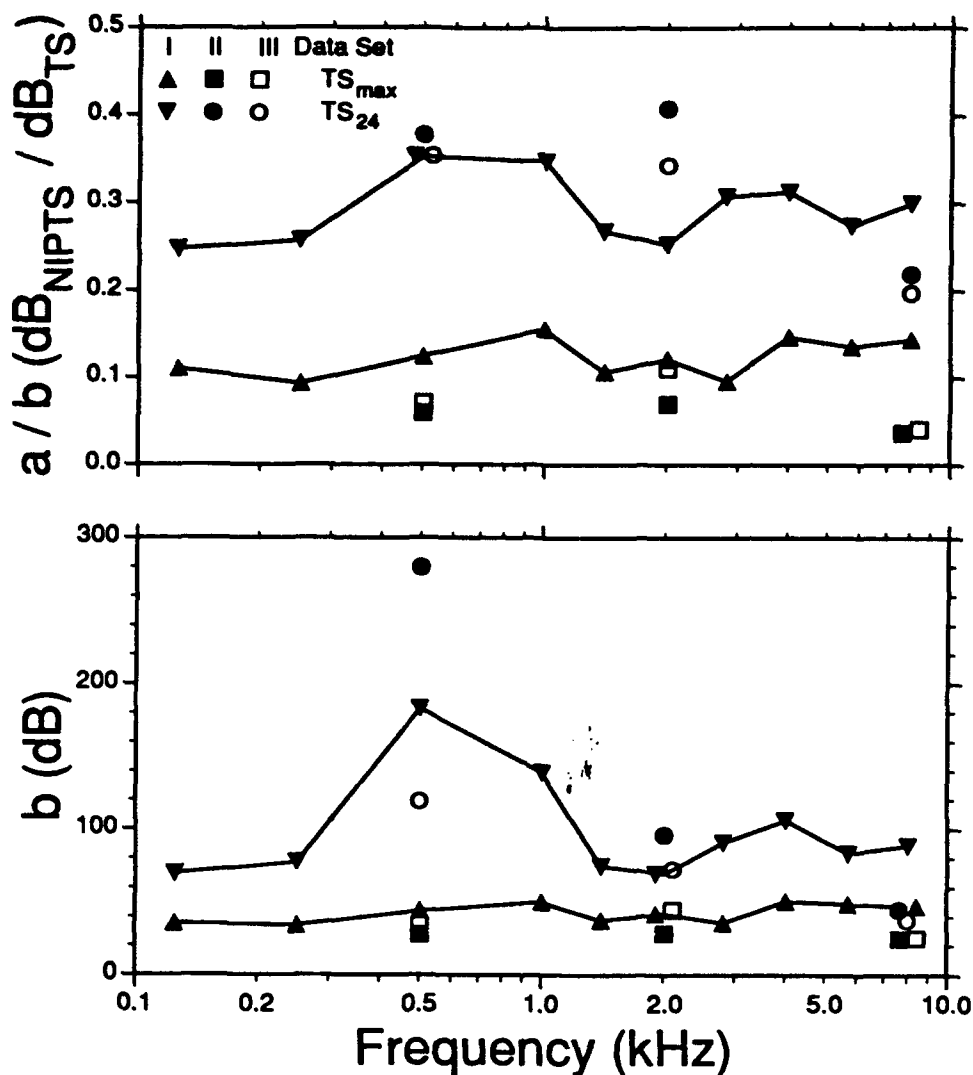

Figure 3. The values of the constants a and b derived from the exponential least-squares regression equations between  $TS_{max}$  or  $TS_{24}$  and NIPTS for all three data sets.

Hamernik, R.P., Ahroon, W.A. and Hsueh, K.D. (1991). The energy spectrum of an impulse: Its relation to hearing loss. *J. Acoust. Soc. Am.* 90:197-204.

Hirsh, I.R. and Ward, W.D. (1952). Recovery of the auditory threshold after strong acoustic stimulation. *J. Acoust. Soc. Am.* 24:131-141.

Luz, G.A. and Hodge, D.C. (1971). Recovery from impulse-noise induced TTS in monkeys and men: A descriptive model. *J. Acoust. Soc. Am.* 49:1770-1777.

Patterson, J.H., Jr., Hamernik, R.P., Hargett, C.E. and Ahroon, W.A. (1993). An isohazard function for impulse noise. *J. Acoust. Soc. Am.* 93:in press.

Reger, S.N. and Lierle, D. (1954). Changes in auditory acuity produced by low and medium intensity-level exposures. *J. Acoust. Soc. Am.* 58:433-438.

Sitler, R.W. (1972). The effect of impulse noise on the auditory evoked response threshold of chinchilla. Ph.D. dissertation, Syracuse University, Syracuse, NY, U.S.A.

# Underwater hearing and occupational noise exposure limits

Al-Masri M., Martin A., and Nedwell J.  
Institute of Sound and Vibration Research,  
University of Southampton,  
England, UK.

## SUMMARY

Divers are often exposed underwater to very intense noise, the levels of which can be as high as 200 dB SPL and hence greatly in excess of occupational noise limits recommended for exposure in air. The risks of noise damage to hearing underwater are potentially more serious than in air. There are currently no widely accepted noise exposure limits or hearing damage risk criteria for underwater use. Translation of the current noise exposure limits from air to water is not yet possible as the mechanisms of hearing underwater have not been well established. New work on underwater hearing thresholds emphasises the previous view that the submerged ear is somewhat less sensitive in water than in air. More importantly however, we have established that underwater hearing thresholds are on average 20-25 dB more sensitive than previously reported, and below 1 kHz this increases to 35 dB. This raises the possibility that previous proposals for underwater noise exposure limits may be too lax, and that noise induced hearing loss will occur at mid frequencies as opposed to higher audiometric frequencies as in air. Also, because the acoustic impedance of the human body is similar to that of water, it is probable that more sound energy is transmitted directly to the inner ear through the bones of the skull, and thus the hearing pathways underwater are probably different to those in air.

The current state of knowledge is reviewed, and new experimental results of underwater hearing mechanisms are presented. Some conclusions are drawn concerning the way in which the ear operates underwater and a new scale for underwater limits is proposed.

## 1 INTRODUCTION

The hazards to hearing from occupational noise in the industrial situation are well recognised and described in many National legislations. Such hazards must be reduced by engineering noise control and/or personal hearing conservation programmes to below acceptable limits. Unfortunately, there are currently no widely accepted noise exposure limits or hearing damage risk criteria applicable for underwater use. Professional divers are regularly exposed to intense noise which can reach sound pressure levels (SPL) above 200 dB (Smith, 1985). All SPL's quoted here are with reference to 20  $\mu$ Pa.

Underwater noise may originate from equipment operated by the divers themselves such as jet cleaning tools, rock drills and stud guns or from transmitted sounds such as sonar. As in air, the effects of exposure to occupational noise underwater may result in temporary or permanent sensorineural hearing loss (Molvaer, 1981). Additionally, high exposure levels may produce vertigo, nausea, and even vomiting. Vertigo underwater may cause the diver to become disoriented, and swim downwards instead of towards the surface or he may panic and surface missing important decompression stops. More seriously he may vomit into his mouth piece or mask, which can be fatal. However, direct transposition of well established limits from air to underwater use is not a simple task. This is because the hearing threshold and hearing mechanisms underwater are likely to be different from those in air.

## 2 PREVIOUS STUDIES OF UNDERWATER HEARING

Underwater hearing thresholds have been studied by Sivian (1943), Ide (1944), Wainwright (1958), Hamilton (1957), Montague and Strickland (1961), Brandt and Hollien (1967), Hollien and Brandt (1969), and Smith (1969) and others. These studies report widely scattered values for underwater hearing thresholds (Al-Masri et al, 1993).

A pilot study (Al-Masri et al, 1992) confirmed the main reason for the wide scatter of existing experimental results lies in the lack of appreciation of the significance of background noise and its masking effect on the threshold of hearing. Accordingly it is very difficult to propose a valid and reliable underwater hearing threshold curve based on such data. Further studies to establish and

standardize an underwater hearing threshold curve and to develop an underwater unit of hearing measurement equivalent to the dB(A) unit need to be carried out.

With regard to the mechanisms of hearing underwater, previous authors have proposed three somewhat interlinked theories to explain how sound is transmitted from water to the cochlea. These involve the "auricular" conduction pathway, the bone conduction pathway, and the dual conduction pathway. Up to this day, no one pathway has been shown to predominate, and all of them have been poorly evaluated.

### **3 MEASUREMENT OF UNDERWATER HEARING THRESHOLD**

#### **3.1 EXPERIMENTAL DESIGN**

An experiment was carried out to establish the underwater minimum audible field (MAF) and the relationship between MAF in air and underwater. This is essential for defining the relationship between these basic parameters and for setting up valid noise exposure limits and hearing damage risk criteria. Because air bubbles can naturally become trapped in the external ear canals when a person submerges underwater, the effect of their removal on the underwater MAF was included in the experimental design.

Preliminary experiments showed that measuring hearing thresholds underwater is a difficult task with many practical problems. To provide the subjects with hearing test experience, as well as to re-evaluate the in-air MAF, it was decided to test all hearing thresholds in air before underwater.

#### **3.2 EXPERIMENTAL METHODOLOGY**

The experiment was carried out using 24 subjects (18 male and 6 female) who were screened for normal hearing (air conduction hearing thresholds better than 10 dB HL) and for normal middle ear function using tympanometry and acoustic reflex measurements.

In air the subjects were divided into three groups, and the order balanced for testing hearing thresholds in an anechoic chamber under earphone using pure tone stimulus, MAF with pure tones and MAF with 1/3 octave bands noise. All of the hearing threshold measurements were carried out using The British Society of Audiology recommended procedures (1981).

Underwater hearing threshold measurements were carried out in the ISVR, Southampton University. Great care was taken to minimize the level of underwater background noise, which was found to be caused by both ground vibration and transmission of air borne noise. A steel water tank (2x1.5x1.5 m) was positioned on antivibration mounts, which attenuated the ground vibration noise transmission by at least 40 dB at all frequencies above 0.01 kHz. The ambient noise SPL in the laboratory was reduced to less than 10 dB at all frequencies above 0.125 kHz. The underwater ambient noise levels in the tank was estimated, using a transfer function approach, to be less than 16 dB SPL at all frequencies above 0.125 kHz. This level is about 20-25 dB below that which can be measured using available hydrophonic instrumentation. The temperature of the water was maintained at 35 °C.

The subjects underwater hearing thresholds were tested using 1/3 octave band noise because this was found to provide a superior sound field uniformity compared to pure tones and sinusoidal frequency modulation tones. The subjects were divided randomly into two groups. Their hearing thresholds were tested with and without removal of air bubbles from the ear canals, while using an open circuit SCUBA, wearing a T shirt, and sitting in a chair with a head rest at a distance of 1 m from the underwater loudspeaker. The loudspeaker and the head rest were both 0.35 m below the water surface. The subjects held their breath while hearing thresholds were established, and great care was taken to avoid breathing air bubble noise and other sources of extraneous noise.

#### **3.3 RESULTS**

The results are illustrated in Figure 1. In summary it was found that, (i) There was no significant difference between the subject's MAF for 1/3 octave band noise in air and that (ISO, 1987) for pure tone in air. (ii) The ear underwater is less sensitive than in air. (iii) Underwater hearing thresholds are frequency dependent and are on average 29 dB SPL at 0.5 kHz and 60 dB SPL at 8 kHz. (iv) The ear underwater is more sensitive at low frequencies, whereas in air it is more sensitive at the high

frequencies. (v) The removal of air bubbles from the ear canal elevates the underwater hearing thresholds by 5-15 dB at all frequencies.

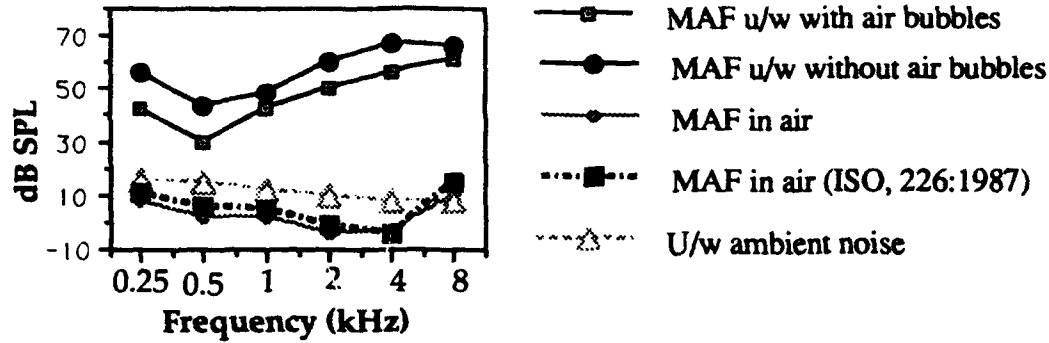

Figure 1: Underwater hearing thresholds for 1/3 octave band noise with and without air bubbles in the ear canals.

It can be seen from Figure 2, that underwater hearing thresholds with air bubbles in the ear canals are 20-35 dB more sensitive than the values reported by the reviewed studies. This means that the risk of damage to hearing from underwater noise exposure may be greater than previously expected. There are further important implications in the finding that the ear underwater is more sensitive at the low frequencies (around 0.5 kHz) whereas in air it is more sensitive at the high frequencies (around 3 kHz). Noise induced hearing loss in air occurs at the high frequencies around 4 kHz, about 1/2 octave above the ear canal resonance of approximately 2.5 kHz. Thus it can be expected that noise induced hearing loss underwater will occur at the mid frequencies around 1 kHz. Since this is the most important area for speech understanding, the potential affect of noise induced hearing loss is likely to have a greater adverse affect on the divers life than in air.

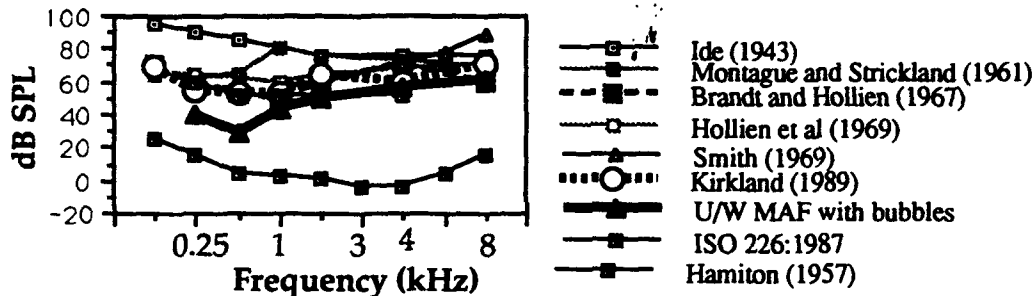

Figure 2: A comparison between underwater MAF and previous studies

A preliminary experiment was carried out on two divers with bilateral moderate conductive hearing loss due to stapes fixation. (AC-BC > 20 dB at all frequencies). The experiment was conducted to test the hypothesis that subjects hear sound underwater through the bone conduction pathway.

It was found that the conductive component was not apparent underwater as the subjects sensorineural thresholds were similar to these determined in the previous experiment. Furthermore the removal of air bubbles from the ear canals did not alter the subjects underwater MAF. These results support the hypothesis that the bone conduction pathway dominates underwater hearing mechanisms

#### 4. DISCUSSION

It can be concluded from these experiments that possible reasons for the reduction in sensitivity underwater compared to air are: (i) Diminished amplification function of head diffraction and the external ear resonance underwater. This is because the acoustic impedance of water and human body are approximately the same. (ii) Diminished effect of the middle ear transfer function (27 dB). (iii) The improvements in underwater hearing thresholds with air bubbles trapped in the ear canals are probably due to the "occlusion effect" and the reduction in load on the tympanic membrane by the water mass.

In air noise limits are usually expressed in terms of dB(A) and it is now possible to transpose the A-weighting scale from air to underwater in terms of the differences between hearing thresholds in air

and underwater. This will be called the W-weighting scale (dB(W)) and it's derivation is illustrated in Table 1.

Table 1: Proposed procedures for derivation of W-weighting scale for estimation underwater noise hazard.

Frequency (kHz)	0.25	0.5	1	2	4	8
MAF in air (ISO 226:1987) dB SPL	11	6	5	1	-4	15
A-weighting scale dB	-8	-3	0	1	1	-1
MAF underwater dB SPL	42	29	42	50	56	61
W-weighting dB	-38	26	37	50	59	47

It is proposed that current industrial noise limits can be applied to the underwater situation in terms of this new weighting scale. However, as noise induced hearing loss underwater may occur at the mid frequency range around 1 kHz, simple extrapolation of the current hearing damage risk criteria from air to underwater may not be valid. Ideally such hearing damage risk criteria should be based on epidemiological studies of the relationship between underwater noise exposure levels and the resulting disability. However, this data is not yet available, and considerable caution still needs to be exercised in applying noise limits underwater expressed in terms of this new unit.

## 5 CONCLUSION

The threshold of hearing underwater is reduced compared to that in air although underwater hearing thresholds are 20-35 dB more sensitive than previously reported. The presence of air bubbles in the ear canal improves underwater hearing thresholds by 5-15 dB. Noise induced hearing loss due to underwater noise exposure may occur at mid frequencies around 1 kHz. The bone conduction pathway dominates the underwater hearing mechanisms. At this stage, current noise exposure limits might be adopted for underwater use in terms of the W-weighting scale although it is not clear at this stage whether the underlying hearing damage risk criteria are fully applicable in this case.

## 6- ACKNOWLEDGEMENTS

The authors would like to thank Mr A.Giles for his technical assistance

## 7 REFERENCES

- Al-Masri M., Martin M., and Nedwell J. (1992). Underwater noise exposure and hearing. In European conference on underwater acoustic. edited by Weydert M., Elsevier Applied Science. London.
- Al-Masri M., Martin M., and Nedwell J. (1993) Underwater hearing: A review. ISVR Technical report No. 212. ISVR, University of Southampton.
- BRANDT J.F. AND HOLLIEN H. (1967). Underwater hearing thresholds in man. J.Acoustic. Soc. Am., 42(5), 966-971.
- HAMILTON P.M. (1957). Underwater hearing thresholds. J.Acoustic. Soc.Am., 29(7), 792-794.
- HOLLIEN H. AND BRANDT J.F. (1969). Effect of air bubbles in the external auditory meatus on underwater hearing thresholds. J.Acoustic. Soc. Am., 46(2), 384-387.
- IDE, J.(1944). Signalling and homing by underwater sound; for small craft and commando swimmers. Sound Report No.19, Naval Research Laboratory, Washington D.C.
- ISO/226: 1987. 'Normal equal-loudness level contours'.
- MOLVAER O.I. (1981) Hearing risk damage operating noisy tool under water. Scand J. Work Environ. Health., 7, 263 - 270.
- MONTAGUE.W.E AND STRICKLAND J.F. (1961). Sensitivity of the water-immersed ear to high- and low level tones. J.Acoustic. Soc .Am.,33,1376-1381.
- SMITH P.F. (1969). Underwater hearing in man: I. sensitivity. Rpt.No. 569. Submarine medical research Laboratory. US Naval Submarine Base Graton, Ct,1969. (NTIS No AD-691 402).
- SMITH P.F. (1985). Toward a standard for hearing conservation for underwater hyperbaric environments. The Journal of Auditory Research, 25, 221-238.
- Wainwright W.N.(1958). Comparison of hearing thresholds in air in water. J.Acoustic. Soc .Am 30(11),1025-1029.



NOISE INDUCED HEARING LOSS TREATED  
WITH HIGH FREQUENCY HEARING INSTRUMENTS.

ANDERSEN, Ture, M.D. ,Bsc.  
COURTOIS, Jean, M.D.

Dept. of Audiology,  
Odense University Hospital  
DK-5000 Odense C  
Denmark.

**ABSTRACT:**

A retrospective interview investigation including 103 patients with isolated hearing loss has been performed. All patients have been fitted with a special treble hearing instrument having a frequency response in the area 2 - 6 kHz.

The conclusion is, that when patients with isolated high-frequency hearing loss are selected according to their hearing demands, they will indeed benefit from this special hearing instrument fitting.

**INTRODUCTION:**

Concerning patients with isolated high-frequency hearing loss i.e. the typical noise induced hearing loss, the fitting of hearing instruments has been regarded as troublesome and often of only minor benefit for the patient. This is mainly due to two features in this particular kind of sensineural hearing loss : The normal hearing level in the low - and mid frequency area and the very abrupt slope in the high frequency area.

If the patient is fitted with a closed or semi-closed mould, the normal or almost normal hearing level in the frequency area 750 Hz to 1.5 or 2.0 kHz will produce an occlusion effect that compromises the use of a hearing instrument due to annoyance caused by internal noises, such as the patient's own voice, his respiration and sound from chewing.

The problem can be solved by the use of open mould fitting, but then of course the feed back problem will emerge. The other factor, the steep slope in the high-frequency area, will make it difficult to gain adequate amplification often at 3-4 kHz without feedback when using open mould fitting.

Then of course instruments with a sufficient high-frequency response will be needed and only over the past years, these have been available. Moreover it is often claimed that when having normal hearing level at 2 kHz the patient will only have minor effect from amplification in the area from 2.5 kHz and higher.

Because of the problems mentioned above it is our impression that patients with slight to moderate noise induced hearing loss are often not receiving any hearing instrument treatment.

The purpose of this retrospective semistructured interview investigation is to examine if patients with isolated high frequency hearing loss will benefit from hearing instrument fitting if proper selected according to their hearing demands.

**MATERIAL AND METHOD:**

At our clinic 3800 patients / year are treated and about 560 (15%)

are diagnosed as DNA Profesionalis. Since the introduction of a special high-frequency hearing instrument ( Oticon E43 ) this has been used for isolated high-frequency hearing losses in "active " patient i.e. patient having a major hearing demand in everyday or just in repeating special situations. Both patients having a larger hearing demand and their everyday job-situation i.e. teachers, as well as retired patients having only intermediate hearing demands when following lectures, going to concerts etc. have been fitted with this type of instrument.

111 patients with isolated high-frequency hearing losses, 1.0 kHz at 25 dB HL or better, who had been fitted with at least one type of E43 instrument for a period of at least 6 months were included in a retrospective semistructured interview investigation. Due to lack of response 8 patients were excluded. The rest, 103 patients, completed the investigation. The age ranged from 10 to 85 years with a mean of 55 years. The sex ratio was male/female 97/6.

All patients were fitted with open moulds. The vent in the mould was at least equivalent to a circular vent with a diameter of 3 mm. This was done to avoid the occlusion effect as well as to allow the patients to benefit from their normal hearing level in the low- and mid frequency areas by passing sounds of these frequencies almost undamped through the vent.

#### RESULTS:

At the time of the interview, where all patients had been treated for at least 6 months, the following pattern of use was found : 72 patients (70%) used their high - frequency instruments. 18 (17%) had ceased to use their hearing instrument and 13 (13%) had been fitted with a more conventional broad band instrument. Thus a total of 83% of the patients used hearing instrument of some kind.

Among the 72 patients who used the high-frequency instrument, 39 % used their instruments constantly, 37% used their instruments daily between 3 and 8 hours, 3% used their instruments daily but less than 3 hours, while 18 % used their instrument at special occasions only. Among the 72 patients 84.5 % reported that the instrument fulfilled their hearing demands to a high degree, while 12.8 % reported that their hearing demands were fulfilled to a moderate degree. 2.7% doubted if they had any benefit.

Regarding the subjective effect on speech discrimination in company with 5 to 8 persons, 72 % of the E43 users reported a marked improvement in comparison with the unaided situation. 11% reported a marked improvement in the same type of company even if background noise such as music was present. Only 2.7 % (2 patients) reported unpleasant sound quality and lowered discrimination in the similar situation but did not turn off their instruments.

In company with more than 8 persons 48 % reported marked subjective improvement of discrimination when using the E43 instrument. In the same company with background noise still 19 % (14 patients) reported a marked improvement. In this situation 21 % had annoyance due to the noise but still used their instruments, while 12 % turned off their instruments because of the noise.

16 patients had severe tinnitus and among these 10 reported a total masking effect when using the instrument, while the remaining 6 felt a pleasant but not total masking effect.

When using the instrument in outdoor environment 34 patients felt a marked positive effect when listening to natural sounds. 19 patients felt a positive effect, 17 patients has no opinion and 2 reported a

negative effect due to wind noise.

When listening to music the same numbers were 23, 27, 18 and 4 patients.

Regarding the 18 patients who ceased using hearing instrument 12 patients reported problems with the sound quality, ie. sharp, uncomfortable, noisy, or simply no subjective effect. 4 patients ceased because of lack of tinnitus masking effect, 1 because of reduced hearing demand and 1 because he found a hearing instrument unacceptable as such.

#### CONCLUSION:

When making a selection based on hearing demands in both job situation and in the type of situation, 83 % of patients with isolated high-frequency hearing loss chose to continue the use of hearing instrument after the test period of 6 months. 72 % did benefit from a special high-frequency hearing instrument and as a very remarkable result 19 % of the users reported a marked improvement in subjective discrimination when having conservation in background noise. These 14 patients all reported that now they had again the ability of conversating when attending a dinner party. Patients with noiseinduced hearing loss in the frequency area from 2.0 kHz can thus if proper selection is performed benefit from hearing instrument fitting.

12

# OTOACOUSTIC EMISSIONS, PHYSIOPATHOLOGY AND EARLY DIAGNOSIS OF NOISE-INDUCED HEARING LOSS

Paul AVAN, Drystan LOTH\*, Pierre BONFILS\*\*, Colette MENGUY\*, Monique TEYSSOU\*

Laboratoire de biophysique, Faculté de médecine, Université d'Auvergne, 63001 Clermont-Ferrand cedex, \*PAM Neurosensoriel, Hôpital Lariboisière, et \*\*Service ORL, Hôpital Boucicaut, Paris.

**SUMMARY:** Noise-induced hearing loss (NIHL) is mainly characterized by alterations of cochlear outer hair cells (OHC). These cells play a prominent role in the high frequency-selectivity and sensitivity of auditory receptors and these characteristics are altered by NIHL. Otoacoustic emissions are supposed to arise from normal OHC functioning and have been proposed as a sensitive objective tool for detecting early stages of NIHL. The present study is based on several experiments performed on 30 subjects exposed to high-level occupational noise and suffering from moderate high-frequency hearing losses (namely 15 to 50 dB hearing-threshold elevations between 2 and 8 kHz). Transient-evoked (TEOEs) and distortion-product emissions (DPOEs) were measured. When the diagnosis was based on TEOE frequency spectrum alone, 45% false negative (i.e. normal TEOE but pathological audiogram) were found. When considering TEOE amplitude and time pattern, this percentage decreased to 24%. When the diagnosis was based on 'DP-gram' (i.e. DPOE amplitude vs. frequency with eliciting primary tones of 60 dB SPL), the percentage of false negative was also very high i.e. 39%, but decreased to 15% when the slope of DPOE-amplitude vs. stimulus level, evaluated for primaries between 50 and 65 dB SPL, was also considered.

These results contrast with those obtained in cases of more severe deafness in that DPOEs are almost always undetectable above 40 dB of hearing loss. Models providing physiological interpretations of the behaviour of otoemissions are proposed. It appears that (i) TEOE properties depend on the whole basal cochlear state, (ii) DPOE properties give a more local reflect of the cochlear state and the slope of their growth function is sensitive to early alterations of this state. In conclusion, it seems necessary to account for more parameters of EOE than mere presence or absence in a frequency interval to improve the sensitivity of such tests.

*RESUME: Les pertes auditives liées au bruit sont provoquées notamment par des lésions des cellules ciliées externes de l'organe de Corti. Comme celles-ci sont supposées à l'origine des otoémissions acoustiques, celles-ci ont été proposées comme indicateur sensible et objectif de l'état cochléaire en vue d'un dépistage précoce. Pour tester le bien-fondé de cette hypothèse, 30 sujets exposés professionnellement au bruit et porteurs de pertes auditives modérées en hautes fréquences ont été testés en otoémissions provoquées par clics (TEOEs) et en produits de distorsion (DPOEs). De nombreux faux négatifs (surdités non détectables en otoémissions), soit 15 à 45% selon les paramètres considérés, ont été constatés. Au vu de ces résultats, de nouveaux paramètres à prendre en compte ont été proposés sur la base de modèles de genèse des otoémissions. La validation de ces modèles semble primordiale avant de proposer les otoémissions comme outil de dépistage précoce.*

## INTRODUCTION

A wealth of data support the idea that the outer hair cells of the organ of Corti are responsible for the high sensitivity and frequency-selectivity of a normal ear, as a result of their particular cytoskeleton and mechanical properties. Presumably, otoacoustic emissions, discovered by Kemp in 1978 and detectable in the outer ear canal, are a by-product of OHC operation. This operation gives rise to impedance discontinuities along the cochlea, hence generating click- or transient-evoked otoacoustic emissions (c-EOE), and nonlinearities that are involved in generating distortion-product otoacoustic emissions (DPOE) at frequency  $2f_1 - f_2$  when the cochlea is stimulated by two pure tones with different frequencies  $f_1$  and  $f_2$  ( $f_2 > f_1$ ).

Any cochlear impairment involving OHC results both in sensorineural hearing losses with decrease in frequency selectivity, and in EOE or DPOE alterations. Otoacoustic emissions tend to disappear whenever such impairments are associated with more than 40 dB-shift in auditory thresholds between 1-4 (resp. 1-8) kHz for c-EOE (resp. DPOE) (review in Probst et al, 1991). EOE detection has become a rapid non-invasive objective test and, owing to its high sensitivity to OHC impairment, it has been proposed as a screening test for early detection of cochlear hearing losses, in addition to its already extensive use for neonatal screening purposes.

However, recent experiments have shown that some parameters of EOE do not enable to gain information on the local cochlear state: it is clearly the case for the amplitude and detection threshold of c-EOE (e.g. Avan et al, 1991; Thornton, 1992) that are sensitive to the whole basal cochlear condition. Conversely, DPOE amplitudes appear to be much more local probes of OHC (Probst et al, 1991; Avan and Bonfils, 1993) although they do not seem to convey quantitative information on their state. The goal of this work was to establish what EOE characteristics can be clearly related to cochlear state, as evaluated from standard behavioral audiometry, and to address the following questions: are high-frequency hearing thresholds the most sensitive gauges to beginning cochlear impairment, or is it possible to detect some abnormal EOE property (when referred to a normative population) before any shift in hearing threshold? Is it possible to implement a diagnostic procedure with optimal sensitivity and specificity, namely as few as possible misses and false alarms?

## METHODS

### Patients and audiometry:

30 subjects took part to the study, in the framework of routine clinical examinations. They suffered from uni- or bilateral high-frequency hearing losses due to exposure to occupational noise. Otoscopy, tympanometry, ABR and acoustic reflex studies confirmed that hearing loss was purely of cochlear origin. A Békésy automatic sweep-frequency audiogram was done in addition to standard pure-tone audiometry (octave steps between .125 and 1 kHz then half-octave steps between 1 and 8 kHz). This enabled a more accurate measurement of the 'cutoff frequency'  $f_c$  of the audiogram and of  $N_d$ ,  $N_w$  and  $N_a$ , respectively the depth, width and area of the audiometric notch.

### Otoacoustic Emissions:

C-EOE were obtained using an ILO88 Otodynamics® analyser (Kemp et al, 1990) with its default setup, namely 85 dB SPL peak equivalent clicks and linear-artifact rejection mode. The maximum amplitude  $A_m$  and correlation coefficient  $cc$  of c-EOE were measured and converted to coherent output power COP as defined by LePage (1991) i.e.  $COP = A_m \times cc$  (in dB). The minimum and maximum frequencies  $f_{min}$  and  $f_{max}$  of detectable spectral EOE-components were also measured.

DPOE were elicited by equilevel primary tones of 50 to 65 dB SPL synthesized by an Ariel DSP16 board (Cubdis® system, Allen, 1989) with a frequency ratio  $f_2/f_1 = 1.22$ , and detected at  $2f_1 - f_2$  (more details in Bonfils and Avan, 1993).  $f_2$  was varied from 10 to 1 kHz by 1 kHz-steps. The amplitude of DPOE was considered as an indicator of cochlear function around the place coding for  $f_2$  (Allen and Fahey, 1992). DPOE amplitude was plotted against  $f_2$ , thereby defining the DP-gram.

### Analysis of data:

Firstly, a global analysis was performed by each of the 3 audiometric methods i.e. Békésy tracking, c-EOE and DPOE, in order to detect significantly abnormal ears. A limit between normal and abnormal ears had thus to be chosen according to what is known of normative populations (young adult subjects unexposed to occupational noise). This limit was: hearing threshold  $> 20$  dB HL for the Békésy audiogram,  $f_{max} < 3$  kHz for c-EOE and DPOE below noise floor at 60 dB SPL of primary levels. 42 ears for which all sets of data were available were kept for analysis. 33 had an abnormal audiogram. The percentage of false negative cases was calculated, considering the

audiogram as 'golden standard'. 9 ears had a normal audiogram, although the contralateral ear was impaired. In these cases, the study aimed at detecting early changes in EOE.

Secondly, a more detailed analysis of EOE properties was carried out in order to improve the sensitivity of diagnosis in all the cases with abnormal audiogram but normal c-EOE spectrum or DP-gram. For c-EOE, the COP was tentatively used as a more sensitive indicator of OHC impairment and its value was analyzed as a function of  $N_w$ ,  $N_d$  and  $N_a$ . As for DPOE, the slope of their growth function was computed for primary levels between 50 and 65 dB SPL (Bonfils and Avan, 1992).

## RESULTS

Abnormal audiograms: 15 ears (45%) had a normal c-EOE spectrum in spite of a hearing loss of 25-35 dB HL at one or several standard audiometric frequencies around 4 kHz. The COP was then introduced as another criterion. From normative data, it appeared conservative to consider as suspect any ear with COP < 3 dB SPL in spite of an apparently normal EOE frequency spectrum. Then, the percentage of false negative decreased to 24%.

13 ears of the same category (39%) presented a normal DP-gram, therefore identified as false negative cases of the DPOE technique. It is noteworthy that, as for c-EOE, none of them presented a hearing loss of more than 35 dB HL. When accounting for the slope of their DPOE growth function around 60 dB primary levels (that is,  $0.6 \pm 0.4$  dB/dB according to Bonfils and Avan, 1992), namely by considering that any slope > 1 dB was suspect, this number of false negative decreased to 5 i.e. 15%. Such abnormal slopes were found when  $f_2$  coincided with the audiometric notch.

Eventually, in order to assess how accurately the audiometric notch can be described by c-EOE and DPOE characteristics, the correlation between  $f_c$  and  $f_{max}$ , or  $f_c$  and notch in the DP-gram, was studied. The correspondence between  $f_c$  and  $f_2$  when there was either a notch in DP-gram or an abnormally steep slope was always very good i.e. less than 500 Hz between the two evaluations (no better result could be expected owing to the inaccuracy of Békésy sweep-frequency method). In contrast, there was a difference of 0.5 to 1 octave between  $f_c$  and  $f_{max}$  (with  $f_{max}$  always <  $f_c$ ) in most cases.

For the 9 ears with normal pure-tone audiograms, atypical EOE were found in 1 case and atypical DPOE characteristics in 5 cases. So far it is impossible to decide whether or not these anomalies represented an early reflect of cochlear impairment. It must be pointed out that the contralateral ears had clear hearing losses and that one subject complained of poor frequency discrimination in his 'normal' ear in noisy backgrounds.

## DISCUSSION

Obviously, the number of ears included in this study does not allow us to draw definitive conclusions as to whether EOE can be used in early screening of noise-induced hearing losses and which of their characteristics are more appropriate to this end. However, these results point out that at least when considering the most widely used characteristics (a comprehensive review of these is available in Probst et al, 1991), the number of false negative found with the two techniques is conspicuously high. Several reasons for these findings are easily found.

First for c-EOE, it is not possible to record their frequency components above 4-5 kHz in most cases, whereas beginning hearing losses are precisely to be found in this frequency range. It may account for a number of false negative. However, recent experiments (Avan et al, 1991, Thornton, 1992) have shown that c-EOE amplitudes (therefore indirectly presence) depend on the whole basal cochlear state thus can be sensitive to hearing losses at frequencies > 6 kHz. The improvement in test sensitivity when accounting for COP probably results from this property and tends to confirm the validity of the model proposed in the paper cited herein.

Secondly, DPOE amplitudes at a given level of primary tones do not seem to provide reliable information on the cochlear state when the hearing loss is  $\leq 30$  dB. This had already been pointed out in (Bonfils and Avan, 1992 and ref.in). This test is mainly used with a screening limit value of 30 dB. The possible sources of DPOEs are not yet very clearly identified and it must be noticed that when using 60 dB primary tones, the mechanical excitation that is likely to produce distortion tones is already widely distributed around the cochlear area coding for  $f_2$ . Therefore, many OHC contribute to the overall signal with unknown phases. It is not straightforward to predict the effects on DPOE amplitudes of an alteration of some of these OHCs. The only clear point is that DPOEs eventually disappear whenever a large % of OHCs are impaired. The finding that the slope of DPOE input/output functions tends to increase when there is some beginning OHC alterations has been described by Leonard et al (1988) as a sort of recruitment, i.e. as a spreading of the excitation pattern of mechanical nonlinearities in such a situation. This increase may be a confounding effect because it masks the fact that DPOE amplitudes would be abnormally low if elicited by lower level primaries (e.g. 50 dB SPL). Such primary levels are not always easy to use because they are too sensitive to background noise.

Further work is required to ensure that EOE's can be worthwhile measuring in order to detect early noise-induced hearing losses. In particular, it is evident that more parameters of the emissions have to be studied and more thoroughly understood. However, the effectiveness of EOE's in detecting more severe hearing losses i.e. well above 30 dB cannot be denied.

**ACKNOWLEDGEMENTS:** A part of this work has been funded by a grant of the French 'Ministère de l'Environnement' (89090) and another by a grant of 'Institut Electricité Santé' to P.Avan.

## REFERENCES

- Allen J.B. and Fahey P.F. (1992) Using acoustic distortion products to measure the cochlear amplifier gain on the basilar membrane. *J.Acoust.Soc.Am.*92, 178-188.
- Avan P., Bonfils P., Loth D., Narcy P. and Trotxoux J. (1991) Quantitative assessment of human cochlear function by evoked otoacoustic emissions. *Hear. Res.*, 52, 99-112.
- Avan P. and Bonfils P. (1993) Frequency-specificity of human distortion-product otoacoustic emissions. *Audiology*, 32, 12-26.
- Bonfils P. and Avan P. (1992) Distortion-product otoacoustic emissions: values for clinical use. *Arch. Otolaryngol. Head Neck Surg.* 118, 1069-1076.
- Kemp D.T. (1978) Stimulated acoustic emissions from within the human auditory system. *J.Acoust.Soc.Am.*, 64: 1386-1391.
- Kemp D.T., Ryan S. and Bray P. (1990) A guide to the effective use of otoacoustic emissions. *Ear Hear.*11, 93-105.
- Leonard G., Smurzynski J., Jung M.D., Kim D.O. (1990) Evaluation of distortion product otoacoustic emissions as a basis for the objective clinical assessment of cochlear function; in Grandori F, Cianfrone G, Kemp DT (eds): *Cochlear mechanisms and otoacoustic emissions*, *Adv.Audiol.* Karger, Basel, vol 7, pp 139-148.
- LePage E.L. and Murray N.M. (1991) Normative otoacoustic-emission data using the ILO88 system, *Inter Noise 91*, Sydney, pp. 217-220.
- Probst R., Lonsbury-Martin B.L. and Martin G.K. (1991) A review of otoacoustic emissions. *J.Acoust.Soc.Am.*, 89: 2027-2067.
- Thornton A.R.D. (1992) Click-evoked otoacoustic emissions: new techniques and applications. 3rd Int. Symp. on Cochlear mechanics and otoacoustic emissions, Rome.



## DEAFNESS IN MILITARY SERVICE

BENNETT John, KERSEBAUM Michael

University Department of Otolaryngology  
Manchester Royal Infirmary  
Manchester M13 9WL  
Great Britain

### Abstract

Military noise induced hearing loss (NIHL) is the single largest category of military medical disability. Despite the British Army Hearing Conservation Programme initiated in 1965, studies in 1980 showed a 28% prevalence of acoustic trauma among serving infantry personnel and current recruit training suffers a high wastage from this cause. Weapon systems continue to cause noise hazard and the military response has been a combination of monitoring and job placement (mainly British) and active treatment (mainly German).

### The Importance Of Good Hearing In A Military Environment

As the waging of modern warfare is based on not only on mechanisation but also on noisy weaponry, noisy environments will persist for many years to come. Financial considerations alone dictate that as NIHL is the single largest category of military medical disability it should be taken seriously. It is also very important from the point of view of efficient functioning at a military level since NIHL affects the high frequencies and hence consonants and speech discrimination. There is also difficulty in understanding speech when there are competing noise signals such as background noise. Military communication may contain much information of novel or unexpected content which requires a higher signal to noise ratio than expected for interpretation. A further complicating factor is multi-national operations. Research has shown that when exercises are conducted using soldiers with "poor"

hearing i.e. that level of hearing possessed by the deafest 25% of a platoon, then military function is compromised. This can have serious consequences when orders given over a radio can be misinterpreted, leading to so-called "friendly fire" incidents.

### The Risk Of Deafness From Weapon Noise

Impulse noise from firearms has been shown to be extremely hazardous to hearing, with in some instances an impairment being noted after a single shot. Continuous exposure to vehicle noise over prolonged periods is also a common problem in military service. The critical intensity above which risk of cochlear and hearing damage rapidly increases is 140dB. Damage risk criteria (DRC) specifying limits of permissible exposure to impulse noise have been detailed by a variety of authors but recent studies have shown that they may not be applicable to the noise from large weapons which have a different frequency spectrum. The European Community guidelines for a working environment to be no louder than 90db for an "average industrial working life" are hardly applicable. Neither is the equal energy concept as exposure to impulse noise may lead to more degeneration in the organ of Corti than expected. It is also the case that simultaneous exposure to uniform loud noise (such as vehicle engines etc) together with impulsed noise such as explosions and gunfire causes more profound changes in hearing than either separately. Complicating the matter further is the problem of the variation in human susceptibility, dramatically shown by experiments performed in the 1940's on "medical student volunteers" where controlled exposure to weapon noise under standardised conditions showed the large range of biological variation. An important factor in any exposure standard is the decision as to the acceptable level of risk.

### The Management of the Problem

Three main approaches are used in dealing with NIHL. Protective devices are used wherever possible to minimise the risk, those individuals unduly susceptible are

diagnosed early so that they can be removed from the risk, and any deafness which develops is treated.

### *Prevention*

Better design for military hardware is always considered but other factors such as weight, strength and cost are important. In the Bundeswehr the protective hood within the turret of the *Leopard 2* tank absorbs sound to reduce it to safe (less than 90db) levels, an improvement on that of its predecessor. Despite it being long known that it is possible to obtain 30-40dB insulation for incident sound of high frequency by means of a close-fitting plug this has not always been acted upon. However, during the firing of shoulder-fired antitank weapons, low frequency peak pressures of 170dB or more can hit the soldier's ear, despite ear-protectors. Although the use of hearing protectors is an accepted practice in noisy industries, protection rarely attains the levels predicted in the laboratory and it has also been shown that the efficiency of earmuffs decreases drastically in true field conditions. In addition, they might not be worn all the time through tactical considerations. This was seen in the Falkland Islands campaign where only about a fifth claimed to wear hearing protection "all or most of the time".

### *The Military Hearing Conservation Programme*

Within the Army it is essential that the overly susceptible individual be identified as early as possible in his career. This is done by audiometric testing before enlistment and regular monitoring. At the first sign of a significant deterioration in hearing the soldier can be provided with more effective protection, removed from the hazardous environment or rerolled to another trade. In any hearing conservation programme it is almost impossible to specify practical maximum noise levels and exposure times that will ensure safety for everyone due to biological variation in susceptibility. In any group exposed to the same noise burden a small percentage will develop relatively large amounts of permanent hearing loss, even though the group average itself is acceptably small. As yet there are no accurate and simple tests

available by which such persons can be identified in advance.

*The Treatment Of Noise Induced Hearing Loss*

The treatment of NIHL with or without tinnitus does not differ fundamentally from that of sudden hearing loss from unknown causes. The multiplicity of treatment regimes shows the present lack of a totally satisfactory method. Within the British Army treatment for temporary threshold shift is confined to rest and avoidance of further noise exposure until either the hearing has returned or another employment category has been given. In the Bundeswehr more aggressive therapies are advised, all with the aim of improving blood circulation within the inner ear.

## RETROSPECTIVE FIELD EVALUATION OF HPD BASED ON EVOLUTION OF HEARING

Robert A. BERTRAND and Jean ZEIDAN (\*)

### SUMMARY

There is general agreement that the laboratory attenuation of HPD's as measured by the NRR or HLM methods do not correspond to the "real field" attenuation. Several formulae, such as NIOSH method I, II or III, OSHA 50% rule or the HLM method have been proposed to extrapolate the laboratory attenuation results to the probable "real field" attenuation.

In our study, we compared the hearing levels (HL) of group of individuals or individuals for a specific period of time working at a known noise level exposure and using an HPD device of known laboratory attenuation.

Based on the HL, after a known period of time, we evaluated which  $Lex_{gh}$  would have produced this HL at the .5 fractile. This  $Lex_{gh}$  is assumed to be the actual "real noise exposure" reaching the ear.

The difference between the assumed  $Lex_{gh}$  at the .5 fractile and the  $Lex_{gh}$  measured by sonometry or dosimetry is considered the "real field attenuation" obtained with the HPD.

Based on our results, the NIOSH method No. 1 and HLM method seem the most appropriate theoretical approach.

Also, if the history of exposure to noise is available, this approach allows to evaluate "real field exposure" to noise based on HL evolution. It can be useful to detect subjects progressing abnormally either because they do not use HPD's or they do not use them properly.

(1) Dr. Robert A. Bertrand, m.d., f.r.c.s.(c)  
Clinical Professor, Dept. of Surgery, Université de Montréal.

(2) M.Sc. (Stat)

For reprints: Dr. Robert A. Bertrand, m.d.  
5445, Henri-Bourassa ouest suite 210  
Montréal (Québec) H4R 1B7  
Phone no: (514) 332-2050 Fax: (514) 339-1057

## INTRODUCTION

There is a general agreement that attenuation of HPD as measured by the NRR method in the laboratory does not correspond to the attenuation obtained in the field. Several reasons can explain this disparity, from improper use of HPD's, altered HPD's, eye glasses, etc. Several formulae have been proposed to try to give a theoretical field attenuation of HPD's. Among these, theories such as NIOSH I, II or III, HLM or the OSHA 50% formula are used. These theoretical approaches have severe drawbacks.

In our approach for field attenuation evaluation, we used an indirect approach based on ISO 1999. As a first step, we evaluated the HL of a group of workers or of an individual worker at a specific date. Knowing the noise exposure to which a group of workers or a worker is exposed to, it is possible to extrapolate the HL for a given period. Inversely, if for a given period, we evaluate the evolution of HL, we evaluate the noise level that, according to ISO 1999, would have produced this HL variation at the .5 fractile.

## METHODOLOGY

In our studies, we evaluated at a known noise level exposure for different time period workers in company who are drillers exposed to Lex 8, 118 dBA. According to Quebec Legislation, mandatory HPD's must be used over 115 dBA. In the groups studied, all workers used from 1980 to 1983 protector A whose attenuation is NRR 22 and from 1983 to 1983 protector B whose attenuation is NRR 24. It is to be noted that there are no scientific studies on humans to evaluate the effect of such high exposure for such a long period as , in all jurisdictions, it would be illegal to submit workers to such high levels on noise exposure without protection.

Our study was based on three groups of subjects in relation to their time exposure hearing levels:

- Group 1: exposure of five years
- Group 2: exposure of five to 10 years with an average of 8.6 years
- Group 3: exposure to greater than 10 years with an average of 12 years.

We evaluated the average exposure to noise that would have produce the average hearing level of employees in each group. The criteria to be included in the study were:

1. There was no known noise exposure before employment to this company.
2. The first baseline audiogram showed normal hearing as defined either by

an absolute threshold of 10 dB or less at each frequency or 10 dB plus the .5 fractile according to ISO 7029 for the presbycusis factor.

3. All subjects having otological pathology in one ear or unilateral high frequency HL were excluded.
4. There was the absence of systemic pathology or use of ototoxic drugs that could have influenced the auditory functions.

## RESULTS

In group A, whose exposure was 5 years at 118 dBA, we have 6 employees. The actual hearing levels after five years, showed a hearing level corresponding to an exposure of  $Leq$  98 dBA. In group B, whose average exposure was 8.6 years, the average HL is equivalent of an exposure of 98 dBA. For those exposed for a period longer than 10 years which average is 12.1 years, the actual hearing levels at the .5 fractile of ISO 1999 also correspond to an exposure of 98 dBA, Example of the audiometric results of Group B is presented in Table I.

TABLE I		GROUP B					
No. of subjects:10		Average age: 36.1			Years of exposure:8.6		
Average		500	1000	2000	3000	4000	6000
1986	R.E.	5	0	0	0	0	5
1991	R.E.	10	5	15	15	15	35
1986	L.E.	5	5	0	0	0	10
1991	L.E.	15	5	5	10	10	30

TABLE I: HL evolution in a known period of time for workers at 118 dBA wearing HPD with NRR of 24.

Miners exposed to  $Lex_{sh}$  118 dBA with use of ear muff HPD with NRR of 24. The evolution of hearing levels for this group of employees correspond to a  $Lex_{sh}$  of 98.0 dBA. The presumed attenuation of the HPD is 20 dBA.

Based on the results obtained, we can possibly conclude that the attenuation of HPD was of approximately 20 dBA. This figure is obtained by extrapolation.

For this group of workers exposed to high risk of noise-induced hearing loss, new measures must certainly be introduced since the field evaluation results do not seem to produce a safe hearing environment.

Another group of workers exposed to 97 dBA showed HL evolution compatible

**WORKER No.1**

LEX (W/O): 97 dBA @  
 LEX (W) : 82 dBA @  
 EXP. : 30 YEARS  
 SEX : M  
 AGE : 50 YEARS

**MUFF : NRR = 24 dB**

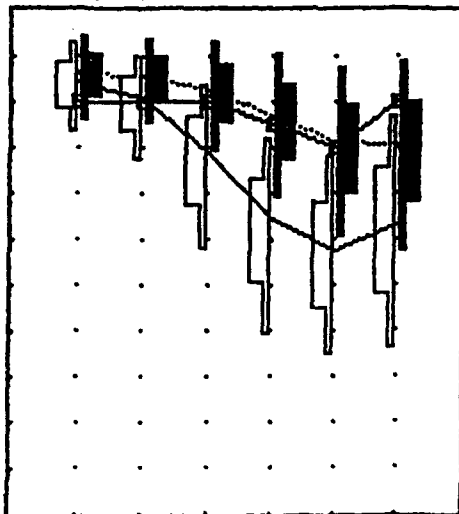
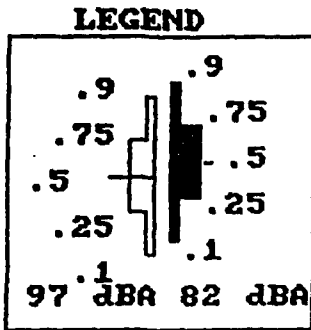

.5k 1k 2k 3k 4k 6k Hz

H.L. at age 50

R.E.	10	10	10	15	20	10
R.E.	10	10	10	15	20	10

W/O : Projection H.L. at age 50 Lex<sub>8h</sub> 97 dBA without HPD.

W : Projection H.L. at age 50 Lex<sub>8h</sub> 82 dBA with HPD.

FIG. 1 : The evolution of H.L. is equivalent to an exposure of Lex<sub>8h</sub> 82 dBA, based on a retrospective evaluation, using ISO 1999 at the .5 fractile.

This indirect approach of using HL evolution to evaluate HPD's attenuation according to the .5 fractile of ISO 1999, is a useful tool in HCP. From our studies, the theoretical recommendations of the HLM or NIOSH I method seem to better represent the field attenuation of HPD's.

**BIBLIOGRAPHIE**

- (1) ISO 7029 : 1984, Acoustique - Seuil normal d'audition par conduction aérienne en fonction de l'âge et du sexe pour les personnes otologiquement normales.
- (2) ISO 1999 : 1990, Acoustique - Détermination de l'exposition au bruit en milieu professionnel et estimation du dommage auditif induit par le bruit.
- (3) BURNS, W. et ROBINSON, D.W., Hearing and Noise in Industry, London, HMSO, 1970, Appendix 10.
- (4) ROBINSON, D.W. et SHIPTON, M.S., Tables for Estimation of Noise-Induced Hearing Loss, Report Ac 61, National Physical Laboratory, England, June 1977.
- (5) R. LUNDIN, "Three methods for calculating the attenuation - A presentation and comparison" Bilson AB, Sweden.
- (6) BARRY L. LEMPert Compendium of Hearing Protection Devices, National Institute for Occupational Safety and Health, Cincinnati, Ohio.



**MUSIC-INDUCED HEARING LOSS >20 dB AFFECTS 30% OF  
NORWEGIAN 18 YEAR OLD MALES BEFORE MILITARY SERVICE -  
THE INCIDENCE DOUBLED IN THE 80's, DECLINING IN THE 90's**

**BORCHGREVINK, HM  
HQ Defence Com Norway, FSAN/Environm Med, 0016 Oslo Norway**

**ABSTRACT**

The incidence of high frequency hearing loss >20dB in 18 year old Norwegian male conscripts BEFORE start of military service increased from around 15% in 1981/82 to around 35% in 1987/88/89, declining to around 31% in 1990/91 and 25% in 1992 (20dB screening audiometry, n=around 30.000 per year). The figures reflect leisure noise exposure, most likely MUSIC NOISE which may reach hazardous levels e.g. in discotheques, rock concerts and by "walkman" audio-headset listening devices. The hearing loss incidences were constant for other frequency ranges. The findings were confirmed when enrolment screening 1990 was validated against threshold audiometry at entry 1991 for the Army fraction of the same group. The incidence DECLINE recorded so far in the 1990's may be related to our rather extensive public information on music noise hazard through TV, radio, newspapers and teenager periodicals since 1988. However, for a "normal" teenager population the figures are still high, and restrictions on leisure noise exposure including music noise seem to be needed.

**INTRODUCTION**

Norway has 15 months' compulsory military service for all male citizens aged >18 years. Since 1981, audiometry of conscripts has been performed at enrolment, at the beginning of military service, during service (according to special criteria) and when ending military service (Borchgrevink 1988a+b). First we test for normal hearing, "screening audiometry 20 dB", whether one hears a tone of 20 dB or not on each ear for the standard test frequencies 250, 500, 1000, 2000, 3000, 4000, 6000, 8000 Hz. In case of hearing loss >20 dB for any frequency, pure tone threshold audiometry is performed for all the above test frequencies. Since 1981 the medical data have been categorized into digit codes and stored electronically to facilitate administration procedures. The "hearing digit" denotes whether the man has normal hearing, or low-, mid- or high frequency hearing loss >20 dB on one or both ears (Table 1). Noise exposure leads to selective high frequency hearing loss. Increasing incidence of high frequency hearing loss (hearing digits 5 and 4) recorded among Norwegian 18 year old men at consecutive annual examinations will thus reflect increased incidence of noise induced hearing loss.

**METHOD**

Pure-tone "screening audiometry 20 dB" (as described above) was performed on the entire Norwegian 18 year old male population (around 30.000 men) each year 1981-1992. The audiometers, method and periodicity of calibration, examination procedure and locations were the same each year. The operators shifted every year, but received exactly the same training and supervision. The audiometry results were reported for each man in a standard scheme registering whether the person could hear 20 dB, or not, on each ear for the standard test frequencies (given above). The "hearing digit" was calculated according to the code given in Table 1. The

audiometry results were stored in an electronic database in terms of hearing digits as part of the medical record for each man. The relative distribution of hearing digits - reflecting the incidence of low-, mid- and high frequency hearing losses >20 dB, and the incidence of normal hearing - were calculated for each enrolment group 1981-1992. For validation purposes the hearing loss incidence/distribution at enrolment screening 1990 was compared with threshold audiometry results for the Army fraction of the same group when entering military service 1991.

## RESULTS

The results showed that during the period 1981-87 the incidence of pure high frequency hearing loss (hearing digits 4 and 5) was doubled, increasing from around 15% in 1981/82 to around 35% in 1987 (Table 2). The high frequency hearing loss incidence stabilized around 35% in 1988 and 1989, and decreased slightly to around 31% in 1990/91, declining to around 25% in 1992 (Table 2). Low frequency hearing loss (digit 8), mid-frequency hearing loss (digits 6,7) and mixed hearing loss (digit 3) showed no corresponding variation. The hearing loss incidence/distribution at enrolment screening 1990 was confirmed by threshold audiometry results for the Army fraction of the same group when entering military service 1991 (Table 3, discussed below).

## DISCUSSION

Concerning the validity and reliability of the above results, the 30%-level high-frequency hearing loss incidence at enrolment 1990 (Table 2) was confirmed in the Army fraction of the same group at entry 1991 (Table 3). Hearing digit 2 is seldom calculated at enrolment. Thus the high-frequency loss incidence at entry 1991, digits 2+4+5 (=30.1%), corresponds to the enrolment 1990 incidence of digits 4+5 (=31.1%).

In military enrolment audiometry (partly ambulant) the background noise is most likely higher than in stationary units. Background noise will characteristically mask the lower frequencies, leading to (false) higher incidence of low-/mixed frequency hearing loss. This may partly be reflected in the higher figures for mixed losses at enrolment 1990 (Table 2) than at entry 1991 (Table 3), but did not influence high-frequency range results. Non-optimal, oblique placing of headsets may lead to a (false) somewhat higher incidence of high frequency hearing loss because the higher frequencies are more directional. However, the influence would be expected to be constant per year when examining large groups of subjects with the same equipment and procedures, supported by the corresponding high-frequency loss incidence found at enrolment 1990 and at entry 1991 (cf above). The locations, and the procedures for sample selection, audiometry, coding and storing of data were the same throughout the 1981-92 period. The incidence of low-, mid-, and mixed frequency hearing losses were largely constant 1981-92 (Table 2).

Thus, the incidence INCREASE 1981-87 and the incidence DECLINE 1990-92 recorded at enrolment only for high-frequency hearing loss should be reasonably valid.

Concerning incidence LEVEL, 50% of a 1980 random Oslo sample of students 15-17 years showed >10 dB high frequency hearing loss at a University clinic (Flottorp, in Turunen-Rise, Flottorp, Tvette 1991), supporting the 15-20% enrolment incidence of high frequency hearing loss >20 dB in the early 1980's.

Most of the noise induced hearing losses recorded at enrolment are probably small, less than 30 dB. Audiometry at entry registered in our central archives demonstrates that only some 15% of the conscripts show high frequency losses of 30 dB or more. Less than 5% show substantial losses that qualify for hearing digit 2 (Borchgrevink & Woxen IN PREP). In a population with small

hearing losses around 20 dB, categorical data sampling around a 20 dB cut-off will be sensitive to small, but valid, threshold fluctuations in the population.

In 18 year old men, the recorded high-frequency loss incidence levels and fluctuations can not be due to presbycusis, and consequently reflect NOISE INDUCED HEARING LOSS (NIHL). As schooling till age >18 years has increased (1982:50%, 1987:75%, 1992:85%, Min of Educ. estimates, pers.commun.) and occupational noise exposure has decreased due to the 1982 Regulations, the recorded NIHL reflects LEISURE NOISE, most likely MUSIC NOISE exposure. Hazardious music dB levels are produced, e.g. at rock concerts (>100 dBA<sub>Leq</sub>, 138 dBA max, Gøthe & al 1992), in discotheques (95-110 dBA<sub>Leq</sub>, 100-120 dBA max, Strømme/Telemark Labour Insp Norway, unpubl), brassband (80-103 dBA outdoors, Borchgrevink 1991c), by car audio-systems and by headsets (6 dB higher listening levels than from speakers, Hellstrøm & Axelsson 1988). In a symphony orchestra (76-102 dBA max, median 90 dBA) 45% had NIHL (Royster 1990). In Norway the "walkman" was introduced around 1979, 600.000 sets were sold by 1987, now >1 mill. - or one set per person aged 10-30 years (Radiolev. Landsforb, pers.commun.). A "Walkman" can produce 126 dBA<sub>Eq</sub> free-field, and one of 10 subjects showed 35 dB temporary threshold shift (TTS, mean 9 dB) after pop-music listening at "a level they enjoyed" (Hellstrøm & Axelsson 1988). TTS 5-25 dB were registered in 6 volunteers after one hour "walkman" music at 95 dBA<sub>Leq</sub> (Turunen-Rise, Flottorp, Tvete 1991; discussed by Borchgrevink 1991a+b). Listening levels vary, exceeded 90 dBA<sub>Leq</sub> in 25%, and 100 dBA<sub>Leq</sub> in 5% of subjects (Rice, Breslin, Roper 1987), and some 20% admitted tinnitus (Rice, Rossi, Olin 1987).

Susceptibility varies across individuals. TTS of 25dB and above is likely to produce permanent hearing loss upon repeated exposure (NATO RSG6 1987). Impulsive noise doubles the hazard (+3dB) (Buck 1982). Rock music contains impulse noise. Still, music seems to give less hearing loss than comparable noise exposure (Hellstrøm 1991). However, leisure noise tends to reduce the noise-free recovery periods and thus increases the hazard.

In spite of the slight NIHL incidence decline 1990-92 - possibly related to our rather extensive public information on music noise hazard through TV, radio, newspapers and teenager periodicals since 1988 - noise induced hearing loss registered in large fractions of the 18 year old school population calls for restrictions on leisure/music noise exposure.

#### REFERENCES

- Borchgrevink HM. One Third of 18 Year Old Male Conscripts show Noise Induced Hearing Loss >20 dB Before Start of Military Service. Reflecting increased leisure noise? In: Berglund B, Berglund U, Karlsson J, Lindvall T, eds. Noise as a public health problem, vol 2, Stockholm 1988a;2:27-32.
- Borchgrevink HM. The hearing prophylaxis programme of the Norwegian Armed Forces. In: Berglund B, Berglund U, Karlsson J, Lindvall T, eds. Noise as a public health problem, vol 2, Stockholm 1988b;2:33-38.
- Borchgrevink HM. Effects of noise - editor's introduction. In: Borchgrevink HM, ed. Effects of noise and blasts. Scand Audiol Suppl 34, 1991a;7-18.
- Borchgrevink HM. Effects of noise and blasts - summary and current status. In: Borchgrevink HM, ed. Effects of noise and blasts. Scand Audiol Suppl 34, 1991b;173-176.
- Borchgrevink HM, ed. Stoykilder i Forsvaret (Noise Sources in the Norwegian Armed Forces). HQ Defence Command Norway, Oslo 1991c.
- Buck, K. Influence of different presentation patterns of a given noise dose on hearing in guinea pig. In: Borchgrevink HM, ed. Hearing & Hearing Prophylaxis. Scand Audiol Suppl 16, 1982;83-87

Gøthe C-J, Cynkier I, Lind M-L, Blomberg R, Svensson EB, Ytterlind Å. Bullerexponering av elektroniskt förstarkt musikk - rockkonserter medfører risiko for hørselskade. Lakartidningen 1992; 82(43): 3579-3580.

Hellstrøm PA. The effects on hearing from portable cassette players: a follow-up study. J Sound Vibr 1991;151(3):461-469.

Hellstrøm PA, Axelsson A. Sound levels, hearing habits and hazards of using portable cassette players. J sound Vibr 1988;127(3): 521-528.

NATO RSG6 Report. Smoorenburg GF, Borchgrevink HM, Brinkmann H, Dancer A, Forrest MR, Forshaw SE, Papavasiliou A, Patterson JH, Pfander F, Phillips YY, Price GR. Effects of impulse noise. NATO AC/243(Panel 8/RSG.6)D/9, Bruxelles 1987.

Rice CG, Breslin M, Roper RG. Sound levels from personal cassette players. Brit J Audiol 1987;21:273-278.

Rice CG, Rossi G, Olina M. Damage risk from personal cassette players. Brit J Audiol 1987;21:279-288.

Royster JD. Music and hearing loss: playing deaf? Paper presented to the National Hearing Conservation Association annual meeting, Florida USA, March 2, 1990.

Turunen-Rise I, Flottorp G, Tvete O.A study of the possibility of acquiring noise induced hearing loss by the use of personal cassette players (walkman). In Borchgrevink HM (ed). Effects of noise and blasts. Scand Audiol Suppl 34, 1991;133-144.

TABLE 1. The hearing digit code

	HEARING DIGIT
Normal hearing, threshold <20 dB both ears, or	
Low-freq.loss >20 dB ≤500 Hz	one ear 9
" " " " both ears	8
Mid- " " " 1000, 2000 Hz	one ear 7
" " " " " both ears	6
High " " " ≥3000 Hz	one ear 5
" " " " " both ears	4
Mixed hearing loss >20 dB with combined	
low+mid, low+high, mid+high or low+mid+high loss	3
Sum dB loss for the 3 poorest neighbour freq.	NO-NOISE
in the left ear + in the right ear (=6 freq.)	SERVICE
≥150 dB when calculated ≤2000 Hz, mean ≥25 dB	FOR
≥200 dB " " ≥3000 Hz, mean ≥33 dB	2 CONSCRIPTS
	CONSCRIPTS
Impaired social hearing without hearing aid	1 DISMISSED

TABLE 3  
Entry incidence 1991  
of hearing digit  
distribution in %  
for Army conscripts

HEARING DIGIT	1991 LOSS
9 normal	65.7
8 low Hz	0.4
7 mid "	0.2
6 mid "	1.3
5 high "	16.6
4 high "	10.5
4+5 high	27.1
3 mixed"	2.6
2	3.0
1	-

n= 14 409

TABLE 2  
Enrolment incidence of normal hearing and low/mid/high/mixed frequency loss >20dB on one or both ears for the Norwegian male population aged 18 years given in % distribution for each year 1981-1992

HEARING DIGIT	1981	1982	1983	1984	1985	1986	1987	1988	1989	1990	1991	1992
LOSS												
9 normal	73.7	77.4	70.6	68.2	61.3	63.9	53.9	51.3	51.3	55.3	56.3	65.0
8 low Hz	1.5	2.7	1.3	1.3	1.5	0.8	0.8	0.8	1.5	1.5	1.2	2.1
7 mid "	0.8	0.7	0.3	0.4	0.4	0.3	0.3	0.3	0.3	0.2	0.4	0.3
6 mid "	0.3	0.2	0.1	0.2	0.1	0.1	0.1	0.1	0.1	0.1	0.1	0.1
5 high "	12.1	10.1	13.3	15.2	18.4	17.4	21.6	22.1	21.1	20.0	20.8	16.2
4 high "	5.9	4.2	6.4	7.3	10.9	9.0	14.1	14.5	13.9	11.1	10.0	8.4
4+5 high	18.0	14.3	19.7	22.5	29.3	26.4	35.7	36.6	35.0	31.1	30.8	24.6
3 mixed"	5.6	4.0	5.0	4.7	4.8	5.6	5.6	7.1	7.7	6.9	6.7	6.8
n=	34409	34856	35783	33419	27995	27612	33341	30792	29807	32722	34776	35200

# A new solution for increasing noise protection

Dr Christian CARME & Dr Alain ROURE(\*).

TechnoFirst SA  
Parc technologique et industriel de Nappollon  
399 rue des templiers  
13676 Aubagne Cedex - France

(\* Laboratoire de Mécanique et d'Acoustique (LMA) du C.N.R.S.  
31, chemin Joseph Aiguier - B.P. 71  
13420 Marseille Cedex 20 - France

**Abstract :** During the past ten years, the Laboratory of Mechanics and Acoustics (LMA) of the French National Center of Scientific Research (CNRS) has developed advanced technology for reducing unwanted noise and vibration.

This technology, known as active noise control (ANC) and active vibration control (AVC), utilizes very advanced analogue and digital signal processing methods to actively cancel unwanted noise and vibration. This is accomplished by computing in real-time the mirror image of the sound or vibration which needs to be reduced or controlled. When this mirror image signal is summed via a suitable transducer such as a loudspeaker with the unwanted sound or vibration, active noise and vibration control results.

ANC technology (named also ANR) can be used to improve dramatically the performance of standard hearing protection equipment. Existing hearing protection equipment does not work well to attenuate low frequency noise and vibration. This is because the acoustic wavelength of low frequency noise energy cannot be absorbed by passive noise absorption materials used in standard hearing protectors. By incorporating ANC technology in helmets, headsets, earplugs, and others types of hearing protection apparatus, a remarkable 25 to 35 of noise reduction can be achieved in low frequency spectrum.

In conclusion, ANC/AVC technology provides the means to create an ideal hearing protector. When combined with existing passive noise reduction techniques, this technology promises a new "active" solution for the prevention of human hearing loss.

## Introduction

We describe a system of Active Noise Control (ANC) for broadband noise, in real time, for any kind of individual protection (helmets, headsets, earplugs...). This comes from an electronic filter inserted into the loop's feedback control. This is an extension of the feedback technique, initially proposed by Lüg [1]. The filtering leads to a complex modification of the total transfer function which describes the open loop system.

Researchers in various laboratories have tried this method in order to reduce noise in ducts [2] and recently in helmets [3], [4]. But all of them use a classical analogical filter fitted empirically. We propose a numerical simulation of the phenomenon in order to compute the best ANC result for any kind of auditory cavity. These numerical techniques make possible a rigorous and general study of the problem and a systematic experiment.

## 1 - Principle

A classical noise protection device is put on the ear. The confined space between ear and device is modelised as a small acoustic cavity. In order to reduce the noise level in the cavity, we propose to implement an anti-noise system controlled by electro-acoustic feedback (cf. fig.1).

When the circuit is closed at point B, the linear superposition of the primary acoustic field (noise in the cavity) and the secondary acoustic field (pressure emitted by the loud-speaker) gives the following :

$$P_c(\omega) = P_m(\omega) \mu(\omega) + k.P_c(\omega) C(\omega) H_{lp}(\omega) C_a(\omega) \mu(\omega) \quad (1)$$

with :  $P_m(\omega)$  acoustic pressure measured in the cavity without feedback control;  
 $P_c(\omega)$  acoustic pressure measured in the cavity with feedback control;  
 $C_a(\omega)$  transfer function of the acoustic cavity;  
 $H_{lp}(\omega)$  transfer function of the loud speaker;  
 $\mu(\omega)$  transfert function of the microphone;  
 $C(\omega)$  control filter;  
 $k$  gain of the linear amplifier.

We show [5] that the electric observation of the phenomenon (considered from point B) is such that the relation (1) becomes :

$$P_c(\omega) = P_m(\omega) \mu(\omega) + k.P_c(\omega) C(\omega) H_{ex}(\omega) \quad (2)$$

with :  $H_{ex}(\omega)$  transfer function of the open loop system measured between the entrance A and the exit B.

We check that this  $H_{ex}(\omega)$  transfer function presents all the physical and mathematical characteristics of the electro-acoustic system under study.

The ANC in the cavity is given by the following relation :

$$P_c(\omega) / P_m(\omega) = 1 / [1 - k.C(\omega) H_{ex}(\omega)] \quad (3)$$

Noise reduction occurs when  $|P_c(\omega)|$  approaches zero. That is :

$$\text{If } |1 - k.C(\omega) H_{ex}(\omega)| \rightarrow \infty \text{ then } |P_c(\omega)| \rightarrow 0 \quad (4)$$

From a mathematical point of view, it is sufficient to increase the value of  $k$  to verify the relation (4). However the physical system, being linear and regular, becomes unstable in a closed loop as soon as the loop gain increases. This instability is nevertheless foreseeable if the Nyquist criterion is applied.

The example in fig.2 shows that the system is unstable for a value of  $k \gg 1$ . The only way of maintaining a large gain, in a given waveband, without exposing the system to instability, is to modify the Nyquist path for  $H_{ex}(\omega)$  which surrounds the critical point. This is achieved by the filter  $C(\omega)$  which has been put into the feedback loop.

**Nota Bene :** The critical point is given by the value (1,0) calculated by the characteristic equation of the relation (3).

## 2 - Choice and calculation of the filter $C(\omega)$

### 2.1. - Problem of the magnitude minimal phase shift compromise.

Not all the filters  $C(\omega)$  can be used successfully in our system. Indeed the Bayard-Bode law shows that according to the value of the magnitude's downward slope, the filter will present a minimal phase shift expressed by the relation :

$$\varphi(\omega_i) = 2\omega_i / \pi \int_{-\infty}^{+\infty} (\text{Ln } A(\omega) - \text{Ln } A(\omega_i)) / (\omega^2 - \omega_i^2) d\omega \quad (5)$$

with :  $\varphi(\omega_i)$  phase and  $A(\omega)$  magnitude of the filter.

If for example a 2nd order low pass filter is used to control the system, we show that the minimal phase shift calculated by the relation (5) is of  $180^\circ$  (cf Bode plots fig.3). In the pass band of the filter  $C(\omega)$  the closed loop system becomes unstable because the signal is out of phase.

So this local modification of the control filter  $C(\omega)$  illustrates the necessary compromise needed between the steep downward slope needed and the weak phase shift which will enable us to keep the closed loop system perfectly stable.

### 2.2. - Identification of the solution filter by numerical simulation.

In order to solve the problem of the magnitude/phase compromise we propose to compute the parameters of the electronic filter with optimization algorithms using the total transfer function  $H_{ex}(\omega)$  according to the shape sampled [6]. By this method the coefficients of  $C(\omega)$  calculated by the algorithm correspond to a physical solution which can be transposed directly to the experiment.

The filter  $C(\omega)$  used is defined by the expression :

$$C(\omega) = \sum_{i=1}^N A_i(j\omega)^{i-1} / \sum_{k=1}^K B_k(j\omega)^{k-1} \quad (6)$$

This very general definition of the filter  $C(\omega)$  has the advantage of not limiting the algorithm to a restricted category of solution filters. The algorithm used is of the gradient type with the steepest slope. The energy expression is given by the relation :

$$F_{\text{energy}} = \sum_{i=1}^N |1 - k.C(\omega_i) H_{ex}(\omega_i)|^2 \quad (7)$$

To ensure that the solution is stable we calculate a stability constraint ( $R_{\text{max}}$ ). This value is then introduced into a penalization functional :

$$F_{\text{stability}} = \exp [ \alpha ( R_{\text{max}} - \beta ) ] \quad (8)$$

Its role is to prevent the algorithm by penalizing it, from going on to optimize the parameters when it is heading towards an unstable solution.

### 2.3. - The result : a new generation of filters

This numerical minimization brought about the discovery of a new generation of analogical filters adapted to feedback control [7]. These new filters achieve to a good compromise between an important increase of gain and the total stability of the loop system, and they give a high quality of ANC.

We get a new 2nd order filter describe in fig.3. This filter may appear to resemble a 2nd order low pass filter as a similar magnitude.

However, its phase shift is less than  $180^\circ$  and its phase goes towards  $0^\circ$  when  $\omega$  goes towards the boundaries of the interval  $[0, +\infty)$ . This filter is also perfectly suitable for filtering by feedback. The phase shift does not interfere with the closed loop system except in the pass band of the filter since the phase goes towards  $0^\circ$

We have named this filter "the colver-leaf filter" on account of its particular Nyquist path shape (cf. fig. 6).

### 3 - The experiment

This technology is today fully patented and the CNRS is the owner of these patents. The CNRS decided four years ago to create and to give all rights on these patents to a compagny named TechnoFirst.

TechnoFirst manufactures and sells ANC units for : headsets, helmets, earplugs, air conditioning system, etc

Today TechnoFirst manufactures and sells this specific headset named : SAM PRO and SAM COM (ANC headset with communication system added).

The ANC obtained with the TechnoFirst's experimental active noise attenuator is given in fig.5. The divergence between the noise reduction given by the numerical model and the measurements taken during the experiment, is very slight. For the low frequencies, it is non-existent and for the other frequencies it does not exceed a few decibels.

TechnoFirst did also studies for others ANC's hearing protection apparatus for different compagnies like SILEC, ELNO, GIAT, TELEPHONICS, KOSS, ETC...

A schematic example is given fig.6 of an earplug with active noise control and its active noise reduction is given in fig.7. We can see a very interesting result according to the large frequency bandwidth of ANC.

### Conclusion

With TechnoFirst's loop feedback control system we can get an active noise reduction with an important gain out any looped system's instability.

This new generation of analogical filters, adapted to feedback control, achives to a good compromise between an important gain and the total stability of the looped system.

TechnoFirst's system shows the potential of a new generation of filters, of a type never used previously in problems of filtering by feedback.

That the reason why the SAM unit in a very loud noise and with large external motion is more stable and more powerful compared to competitor' units.

### 5 - References

- [1] Lueg, P., Process of silencing sound oscillations US patent N°2043416 filed: 1933 patented: 1937.
- [2] Trinder, M.C.J., and Nelson, P.A., Active noise control in finite length ducts. *Journal of Sound and Vibration* 89 [1983], 95.
- [3] Weeler, P.D., and Halliday, S.G., Aural communication in aviation. Paper reprinted from Conference Proceedings No.311, 1982.
- [4] Bose, A.G., Noise reduction in helmets. Report prepared by Steenecken, and Langhout for Bose corporation, 1985.
- [5] Carne, Ch., ANC for hearing protection. Proceeding of Euromech 213 colloquium communication n°ISSN 259 2320 CNRS/LMA [1986].
- [6] Carne, Ch., ANC in auditory cavities; methods and algorithms. *J. theoretical an applied mechanics. Special issue supplement to volume 6 : Active Noise and Vibration control*, [1987].
- [7] Carne, Ch., A new filtering method by feedback for ANC at ear. Proceeding of Inter Noise 88, volume 2, [1988], p. 1083.
- [8] Carne, Ch., Absorption acoustique active dans les cavités auditives. *Acustica* 66 [1984], p.233.

### 6 - Figures

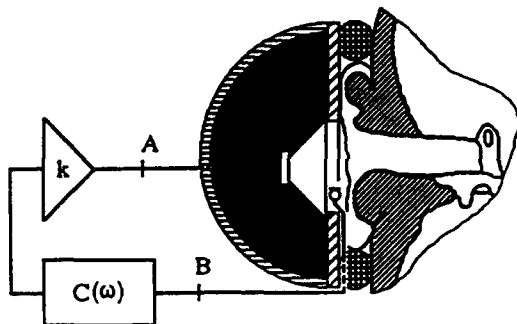

Fig.1 : Experimental block diagram of active attenuator by feedback filtering

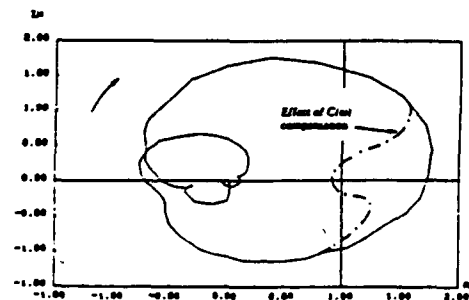

Fig.2 : Nyquist plot of  $k.C(\omega)Hex(\omega)$

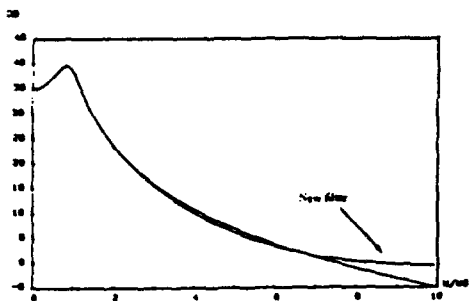

Fig.3a : Magnitude of 2nd order low-pass filter and the new 2nd order low-pass filter

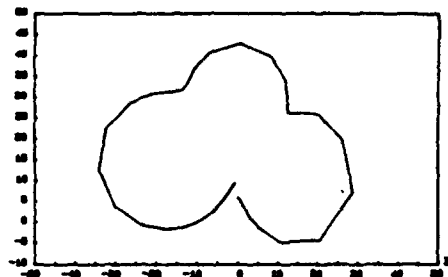

Fig.4 : Nyquist plot of the "clover-leaf filter"

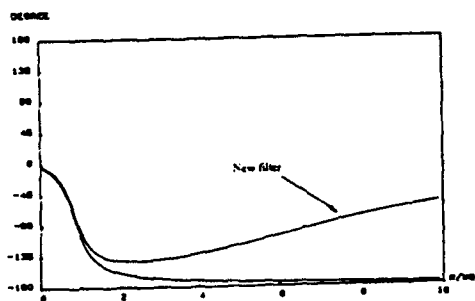

Fig.3b : Phase angle of 2nd order low-pass filter and the new 2nd order low-pass filter

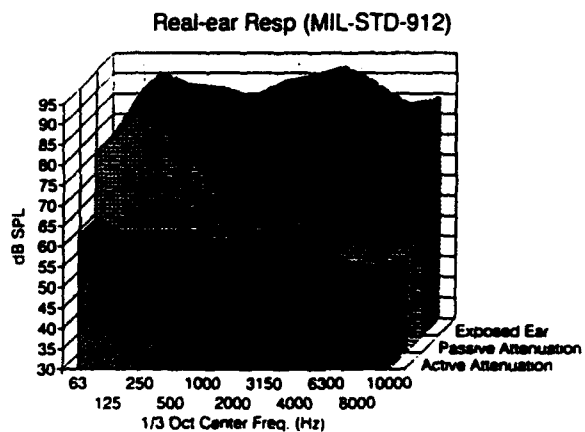

Fig.5 : Acoustic curves of noise reduction for a SAM unit

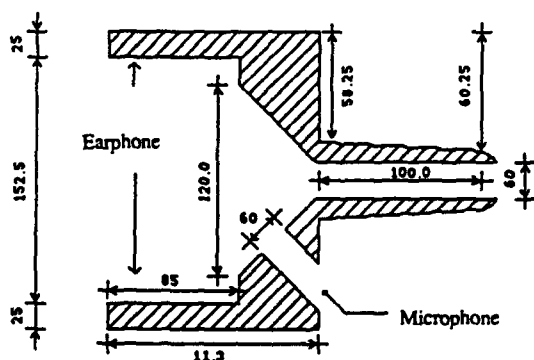

Fig.6 : Schematics of a TechnoFirst's ANC ear-plug

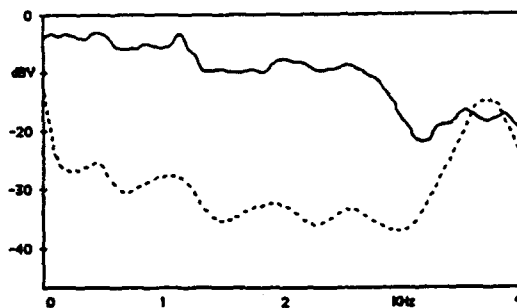

Fig.7 : Acoustic curves of noise reduction for TechnoFirst's ANC ear-plug



**"TOO LOUD MUSIC IS A DANGEROUS NOISE :  
LET NOISE BE SEEN"**

by CAUSSE Jean-Bernard, M.D.  
Causse clinic - Traverse de Béziers - 33440 COLOMBIERS (France)

**Keywords** : noise, music, BMJC (Audio Protect System)

**Summary**

Loud music is justified by its benefits to the mind and as it causes the body to secrete useful hormones. The loudness of music helps many of us feel greater pleasure.

However, over 105 decibels, high pitched tinnitus and poor speech discrimination due to specific high tones hearing loss are the risks of too loud music.

Music should not be louder than 105 decibels, measured at the entry of the external ear canal.

There is a difference of 15 decibels between the sensation of pain due to noise (120 decibels) and that of the danger due to noise (105 decibels). At the threshold of 105 decibels, danger to the ear is immediate and probable.

We have originated the concept that "noise can be seen", correlating noise to lights showing possible danger for the ear anatomic structures. We have originated a device demonstrating how dangerous the loudness of a noise can be, thru lights colored in green when there is no danger at all, orange when hearing fatigue may exist with time, and red when noise level measured at the entry of the external ear canal may create an immediate and probable danger.

**Résumé**

La musique forte peut se justifier par ses bénéfices sur le psychisme et par des sécrétions hormonales utiles à notre organisme. L'intensité de la musique est facteur d'euphorie supplémentaire.

Au-delà de 105 décibels toutefois existe un risque de sifflements aigus et de mauvaise intelligibilité de la parole par destruction des cils des cellules de Corti de notre oreille (correspondant à l'audition des fréquences aiguës). La musique ne devrait jamais être plus forte que 105 décibels mesurés à l'entrée du conduit auditif externe. Il existe une différence de 15 décibels entre le seuil de la douleur par le bruit (120 décibels) et celui du danger par le bruit (105 décibels). A 105 décibels, le danger est immédiat et probable.

Nous avons développé le concept : "le bruit se voit" en corrélant le niveau de danger par le bruit avec une lumière matérialisant le niveau de danger encouru par les structures anatomiques de l'oreille. Nous avons conçu un appareil convertissant le danger exprimé en paliers de décibels : en lumière verte lorsqu'il n'existe aucun danger ; orange lorsqu'existe un risque de fatigue auditive avec le temps; et rouge quand le bruit mesuré à l'entrée du conduit auditif externe correspond à un danger immédiat et probable.

**1) Significant and immediate danger due to too loud music starts at 105 decibels measured at the entry of the external ear canal**

Audition is due to variations of atmospheric pressure causing stimulation of the auditive anatomic structures.

Only an anecoïc chamber can give an idea of a zero decibel hearing level, where there is no stimulation of the tympanic membrane. Up to 80 decibels, music is only rythm and melody. There is no danger at all.

Between 80 and 105 decibels, the inner ear external Corti hair cells are exposed to too great stimulation, causing excessive muscle contractions. External Corti hair cells are made of actine and myosine, the same tissue as the muscles of the arm (for example).

At the level of sound loudness of 80 decibels, an exposure of a few hours is necessary to cause "fatigue" of those muscles. At 100 decibels, far less than one hour is necessary to cause it.

80 decibels represent a few people talking to each other in a room, in loud voices. 100 decibels is a "pneumatic drill" heard from 5 meters. The same at one meter has a sound level emission of 110 decibels.

Over 105 decibels, there is a danger of Corti hair cells damage. Danger is immediate and probable.

Anatomic structures lesions may be inflammation and oedema. If so, the individual will experience too loud and vibrating sounds, when hearing any sound or speech. Muffled hearing is usually described. When a tinnitus is experienced, it is nearly always located at 4 KHz on the audiogram. The tinnitus will disappear, as well as all the symptoms, spontaneously within a few hours. Some individuals have slightly stronger Corti hair cells. Hydrop and poor inner ear blood supply due to age (dysfunction of the stria vascularis) make the Corti hair cells more vulnerable to excessively loud noise.

At sound levels in excess of 105 decibels (but starting at 105 decibels on some individuals), the hair of the Corti hair cells may rupture. The hair may be detached from the tectorial membrane, or may be torn. (Fig.1)

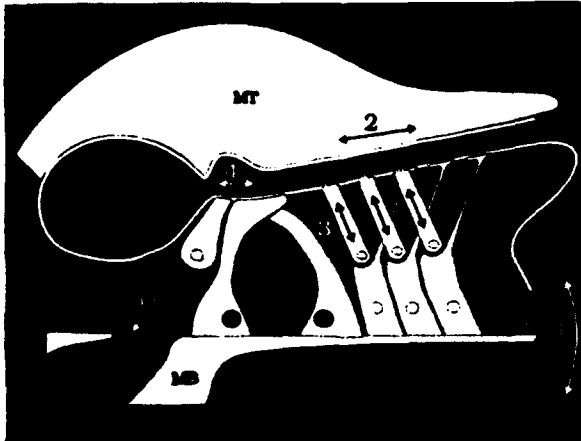

**Fig.1 :**

Legend : hair of the Corti hair cells are attached to the tectorial membrane.

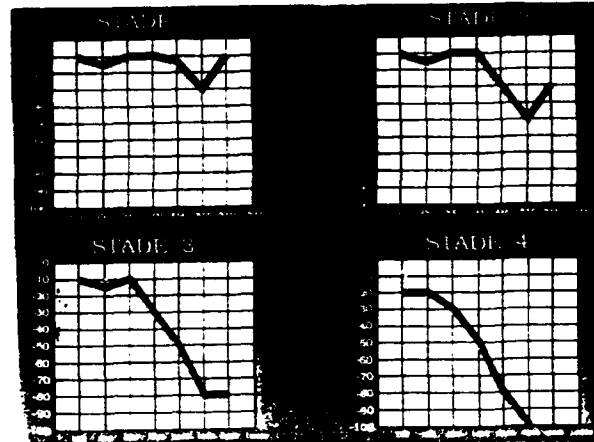

**Fig.2 :** Legend : 4 steps – Step I,II,III,IV represent increasing impairment of perception of the high pitched frequencies with the gradual alteration of the Corti hair cell function due to noise injury.

Deafness is the consequence. Deafness is due to the deterioration of the hair of the Corti hair cells specialized in the hearing of the high pitched frequencies.

Speech intelligibility becomes difficult, as high frequencies are not heard as well as mid and low frequencies. The high pitched frequencies sound "cy" of bicycle is no longer heard. The individual is likely to hear "bicle" instead of "bicycle" !

This phenomenon is even more likely to occur in a room where many people speak together. (Fig.2)

High tone tinnitus, vibrating sound and deafness last more than a few hours following acoustic trauma.

It is absolutely compulsory to commence specific treatment within a few hours, as soon as possible. Anti-inflammatory drugs, as well as Vit B, B6, Zinc Gluconate, and an agent to augment the blood supply to the inner ear cells are the most usual.

Hair cells will recover only if they have not been too severely torn by the acoustic trauma.

If a loud tinnitus becomes permanent, this is a real problem, as the individual may become obsessed by the tinnitus. Some patients are so severely disturbed that they become unable to sleep or rest because of impaired sleep, this dramatic situation may ultimately lead to suicide.

## **2) The pain threshold by excessively loud noise starts at 120 decibels only ! -**

At 5000 Watts, a loudspeaker within 20 meters means a sound intensity of 110 decibels, which is just in between a motorbike with no exhaust pipe within 1 meter (110 decibels) and a jet plane within 30 meters (120 decibels) ! Too loud music, in that circumstance, becomes evidently a very dangerous noise ! The danger is all the more great as the pain threshold by noise starts at only 120 decibels. Danger is not realised by the bulk of the

individuals sitting or standing within the 20 meters near the loudspeaker. The listeners being obliged to sit that near the loudspeakers are "hostages" !

Of 100 individuals in that dangerous situation described, 10 of them will suffer in the future from speech discrimination trouble, 7 will suffer from tinnitus for at least one month, and 3 will suffer from permanent tinnitus.

### 3) The ear is poorly protected from dangerous noise

The tympanic membrane is a kind of drum (ear drum) receiving the air vibrations. Only an explosion can tear the ear drum.

The ossicular chain is a sound vibration transmitting system, which leads the vibrations of the tympanic membrane to the inner ear fluids, and thus to the hair of the Corti hair cells. The hair of the Corti hair cells are like tiny algae vibrating in accordance with the ear drum.

The incus (second ossicle) has a long process moving in the manner of a record player arm.

The stapes, the tiniest and third ossicle, is kind of a needle of a record player.

The ossicular chain is stable and is usually not in danger by an acoustic trauma, unless again associated with an explosion.

The hair of the Corti hair cells convert their vibrations into electrical energy. The vibrations of the hair are of molecular size. The hair of the Corti hair cells are  $0.5 \mu$  diameter only ! Extremely tiny !

A tendon, named stapes tendon, is attached to the posterior crus of the stapes. When a sound is too loud, the stapes tendon contracts due to a muscle inserted in the stapes tendon pyramid.

This buffer effect on the vibrations of the stapes is efficient only for the low and mid tones. It is not at all efficient for the high tones. Therefore, the high frequency noises are the most dangerous. The hair that receive the high pitched frequencies have no protection at all !

When the eye is exposed to excessive light, the eyelid closes. Such a system does not exist for the ear.

### 4) "Noise can be seen"

We have originated a "red light noise signal" showing whether noise is at a dangerous level or not.

#### A - Concept of such a medical device protecting against loud noise danger

At crossroads, lights tell us if we can move or not :

- a green light is the indication that there is no danger ;
- an orange light warns that danger is possible, if we stay too long a time on the spot ;
- a red light tells us that danger is immediate and probable.

It is this analogy that the author of this paper has wished to realise. This concept was materialised with the aid of Michel Micossi, electronician engineer in our otologic research center, and Daniel Boutonnier.

A precise, miniaturized technological system conveys the amount of decibels to 3 diodes. The diode illuminates in green from 1 to 80 decibels indicating absence of danger from the surrounding noise perceived by the microphone.

Between 80 and 105 decibels, the light shows orange. This indicates there is no immediate actual danger but auditive fatigue is possible in time ; i.e. external Corti hair cells exposed too long a time to such a noise may experience fatigue.

At 105 decibels and over, the light is red : danger for the Corti hair cells (both inner and external Corti hair cells) is immediate and probable, even if the length of exposure to this noise is for a short time only.

#### B - Various utilisations of such a device

"Noise can be seen" ! This will prevent a situation in which "our ear is in danger" !

This concept, desired by an otologic surgeon, may be useful in many individual or professional circumstances. Let us describe just three situations, where this medical device may be helpful :

a) an individual wonders if he is sitting too near the loud speakers in a concert if the pocket BMJC Audio Protect sound danger signal, registered mark by BMJC, simplified as BMJC Audio Protect System (or BMJC A.P.S.) (Fig.1), lights up in orange. The auditor will know that there is no danger for the ear. He will benefit from loud music without being obliged to move away or protect his ear.



Fig.3 :  
Legend : Pocket BMJC Audio Protect sound danger signal (or BMJC A.P.S.)

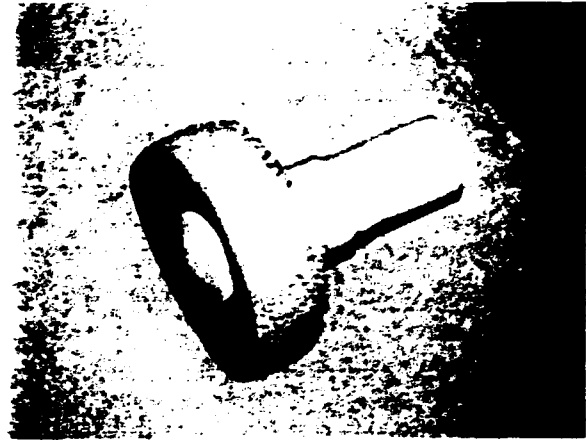

Fig.4 :  
Legend : the BMJC Audio Protect "special concert ear plug"

The auditor knows that there is no danger for the ear. He will benefit from loud music without being obliged to move away or protect his ear.

If it shows a red light and if, because the place is crowded, he cannot move away from the loud speakers and be seated elsewhere, he may use the BMJC Audio Protect "Special concert ear plugs", registered mark by BMJC. These have been conceived in order to enable the auditor to take maximum pleasure in hearing loud music, as the device only modulates the sound intensity an average of 10 decibels, in order to suppress only the few decibels which make the difference between loud music and a dangerous noise. This is what one may call a "veil effect". (Fig.4)

The handling piece (shaft) of the device is a rubber core which is not in contact with the ear canal skin. This handling piece makes the device very easy to insert or remove. The part of the device in contact with the skin of the ear canal is not a source of irritation, as it is as soft as sponge and represents a very small amount of material in contact with the skin.

b) A professional in radio communication, such as for instance a disc-jockey, wishes a loud feed back in order to experience a loud sound environment within the headset.

He will be able to set the sound volume in the headset, in order to see the orange light in its professional BMJC Audio Protect (registered mark by BMJC) device located in front of him. He may gauge his apparatus below the level of sound volume that endangers the ear. The microphone measuring the sound intensity is located in the headset.

c) Rock concert or night clubs employees may gauge the room volumes according to BMJC devices (registered mark by BMJC), strategically placed around the walls, in order to obtain an orange light in any place. 2 or more professional BMJC Audio Protect (registered mark by BMJC) devices may permit them to give the ideal loudness and protection whatever the type of music. The place should be prepared before the customers arrive.

### CONCLUSIONS

- Not to let the ear be endangered when too loud music becomes a dangerous noise. This is our concern. The concept and manufacturing of the prototype of a device showing danger applied to the ear in the same way as a crossroad light is the result.

- "Noise can be seen !"... and the "colour is in relationship with the amount of danger to the ear". This concept, if it receives the large distribution it looks to deserve, should help to protect individuals and professionals of music and communication against the danger of too loud music which becomes effectively dangerous noise. As a surgeon of deafness, one has no wish to see so many people suffering from debilitating tinnitus or speech comprehension problems due to badly used music !

# AGE AND SEX DIFFERENCE ON THE AIR-CONDUCTION AUDITORY THRESHOLD IN CHINA (HEARING ANALYSIS OF 1375 CASES)

CHEN MING, ZHOU SHI-KAI, CHEN JUAN, YE QING  
Department of Otolaryngology, Fujian Provincial Hospital  
N01 East Street, 350001 Fuzhou Fujian - China

The current interest in the relationship between noise exposure and auditory functions has led to a growing concern about the validity of the China reference level of otologically normal persons.

The factors of age correction is one of important researching subjects on audiology in evaluation of hearing function. In order to make sure of difference of age and sex on air-conduction of normal person in China, we adopted routine method of the epidemiologic investigation and statistics analysis and had surveyed 2889 normal persons in FUZHOU from May 1985 to August 1988. The oldest one is 86 years-old.

According to standard data, the unqualified subjects were ruled out, and 1244 otologically normal persons and 113 persons whose age is between 16 to 19 years-old (10 frequencies x 7 age groups x 2 sexes, 280 values). The frequency of auditory threshold of this group study were normal skewness distribution. The main manifestations of the hearing loss causing by age factors were increase of hearing threshold and decrease of hearing field.

This study has shown that with advancing age there is a steady decline in hearing acuity particularly at the higher frequencies. The study result showed that there were all significant different ( $p < 0.55$ ) in means, standard deviation, 95% percentiles, 50% median value and t-test of hearing loss of different frequencies varying with age. In the average hearing threshold curve of each age group, it is apparent that the hearing threshold curve of control group (15 to 19 years-old) is above zero degree level, the hearing threshold curve of the persons under 40 years-old approaches zero degree curve, the threshold of higher frequencies of persons after 40 years-old gradually increase with advancing age, the threshold of lower frequencies which is under 1000 HZ begins to change only after 50 years-old. So age corrections are only necessary for those over 40 years-old. In this study, there are not obvious difference between male and female age groups.

## HEARING LEVELS OF U.S. INDUSTRIAL EMPLOYEES NOT EXPOSED TO OCCUPATIONAL NOISE : THE SEARCH FOR AN APPROPRIATE DATABASE B

CLARK W.W. and BOHL C.D.  
Central Institute for the Deaf - Research Department  
818 South Euclid Avenue  
Saint-Louis, Missouri 63110 - USA

In order to assess the effects of occupational noise exposure on groups of industrial workers for whom audiometric data are available, it is necessary to compare the group hearing levels to those from a control population which is representative of the test group but without occupational noise exposure. Such a control group is included as Annex B to the international standard R 1999, "Acoustics - Determination of occupational noise exposure and estimation of noise-induced hearing loss" (ISO, Geneva, 1990). However, this control group has been criticized because it included some individuals with unreported exposures to occupational noise.

Because it was recommended in the standard that a separate control population be developed for each country under consideration, an attempt was made to evaluate hearing levels from a large number of industrial workers available in an audiometric database gathered from U.S. and Canadian industry and published by the National Institute for Occupational Safety and Health (ANSI S-12.13 databased).

Individuals who worked in noise levels below a time-weighted average level of 80 dB(A) were selected from the databases used for ANSI S-12.13 and frequency distributions of hearing levels by age and gender were calculated and reported. The data were then compared to the hearing levels reported in the control group of the ISO standard by calculating the percent with better hearing at 12 different hearing levels for each combination of test frequency, age and gender. Hearing levels of individuals in the ANSI S-12.13 group were significantly worse than those reported in the ISO appendix in 45 of 48 comparisons. In addition, a comparison of the data with individuals free from ear disease or exposure to environmental noise suggested the presence of "noise notches" in the hearing levels of males above age 40 and females above age 50.

If the source data are valid, these findings indicate that the hearing levels of U.S. industrial workers are worse than those reported as representative of a non-occupationally noise exposed population in the international standard. Further, the presence of an audiometric notch for some groups suggests significant noise exposure, either from previous noisy occupations, or from excessive non-occupational noise exposure.

(Work supported by grant OH 02128 from the National Institute for Occupational Safety and Health).

**NOISE INDUCED TREBLE HEARING LOSS  
- SOCIAL HANDICAP - AUDIOLOGICAL REHABILITATION (poster).**

**COURTOIS Jean, ANDERSEN Ture, LARSEN Bodil Vendelbo, LARSEN Helge.  
Audiological Department University Hospital, Odense Denmark.**

**Abstract:**

Many people suffering from noise induced hearing loss are endangered socially. The lack of balance between their good bass and their vanished treble hearing results in serious mistakes in many situations of everyday life. They are often considered "presenile fools" and often consider themselves likewise, losing their selfconfidence and isolating themselves. We can and must rehabilitate them audiologically with "tailor-made" hearing aid fittings.

**Resumé:**

Bon nombre de ceux qui souffrent de perte auditive due au bruit sont socialement très handicapés. Le déséquilibre entre leurs basses bien conservées et leurs aigües disparues est cause de sérieux malentendus dans bien des situations de la vie sociale. Ils finissent par être considérés comme des "idiots préséniles" et se figurent qu'ils le sont, perdant le respect d'eux-même et s'isolant de tous.

Nous pouvons et nous devons les réhabiliter à l'aide de prothèses auditives individualisées.

In our Audiological department at the University Hospital of Odense we examine and rehabilitate every year hundreds of patients with noise induced high tone hearing loss (658 in 1992). Most of them are workers in their fifties or sixties, who started working at a time when the individual protection against noise was unknown or insufficient or when many machos were afraid of losing their image if they used protectors.

Some patients are former military personnel, others are hunters as well in Denmark as in Greenland, which our department also covers audiologically. Many hunters cannot or do not want to use hearing protectors in order to avoid losing contact with the other hunters, the animals and all the noises of nature.

Most of these patients have a normal or almost normal hearing up to 1000 Hz inclusive. They have "only" a selective treble tone hearing loss, which many general practitioners and even some otologists still consider negligible and further more impossible to compensate audiologically. The reason for this mistake is that these patients converse almost normally when talking man to man (using lip reading) in quiet surroundings, for instance in a doctor's consulting room. "You have a treble hearing loss but your hearing is still so good, that you don't need hearing aids. On the contrary, it might further disturb your hearing ability".

However we must not confine ourselves to focusing on the audiological curves just trusting the discrimination percentages in quiet surroundings. To estimate the patient's hearing

problems we have to break the ice between ourselves and the patient at the same time winning his confidence. If we ask him to describe his practical difficulties in everyday life, if we listen to him and to his family, we discover the harsh realities: most of these people are in danger socially.

The lack of balance between their good bass and their vanished treble, distorts their perception of speech as if people were speaking to them "with warm potatoes in their mouths". That is what the patients tell us again and again. The potato can be very warm but when they concentrate their attention and use lip reading, they can manage a dialogue in quiet surroundings. However, they have great or extremely great difficulties as soon as they try to follow a conversation among 3-4 persons in moderate background noise. They misunderstand key words. Every language has its own acoustic traps.

Breath = Breast

Fashionable = Vegetable

Armagnac = Ammoniaque

Fortunato = Sfortunato

In Danish:

Kenya = Kina

Grønland = Holland

Lammesteg (roast lamb) = Andestæg (roast duck)

Boris Jeltsin = Doris Jensen (this mistake occurs every time)

Gift (married/poison) = gigt (rheumatism)

Fem (5) = seks (6)

Ni (9) = ti (10)

Tre (3) = tres (60).

We have a big collection of such misunderstandings which in a conversation can provoke stupid mistakes. The patients talk at cross purposes, which often results in their being considered fools. They become uncertain: they just answer "yes", "hmm", "well" etc. They imitate the other ones, laughing many times without knowing why they are laughing. Many of them have great social hearing demands as they have responsibilities at work, in political assemblies, in Trade Unions, in clubs, at evening classes, in choirs, in sport societies etc. When they have to cope with foreign languages or a type of intonation with which they are not acquainted, they experience it as "double Dutch". This is especially the case with young people's fast chatter in their modern "American" style. On the other hand it is very difficult for them in round table discussions to cope with low-voiced speech of distinguished gentlemen; and at parties they feel themselves "shut out".

At home TV and radio listening are a source of great irritation. The patient turns up, and the family turns down with the result that the patient is unable to understand a single word, especially if there is the least background noise, for instance when two persons are exchanging comments on the program. All this pesters the atmosphere of family life.

The patient apologizes explaining that he can't hear, but he runs amok when the youngsters turn up the loudspeaker to enjoy a terrible bass noise which they consider "music". "Stop this damned noise!" - "Listen, dad (granddad) - you just told us, that you are hard of hearing, and now you complain about noise disturbances. It's not a question of hearing, it's a question of brain - you are an old fool".



Many of them are at this age when panic sets in, when you are beginning to lose your hair as well as some other physical abilities. These hearing difficulties make them feel burnt out, and restrain their selfconfidence, their selfrespect. They can become reproachfull, and aggressive or can resign themselves to their fate, secluding themselves from society. This isolation can start or accelerate the vicious spiral of presenility.

In our modern society, really deaf people are respected and helped. But the problem is that these patients are not deaf. They understand when you speak to them as you do to a baby or to an old person, but they cannot follow a normal conversation. The result is dreadful. They are soon considered and they soon consider themselves "nuts", "presenile".

We always have a tendency towards estimating the patient's situation by his ability to perceive pure tones and to discriminate speech but we must not forget the tremendous emotional importance of all the other sounds of the world.

To these people, music sounds distorted. They hear perfectly well the piano, the double-bass but suddenly the melody of the violin disappears even though the artist is playing vivace.

Enjoying nature is a great hobby for many Danes. The light nights of Scandinavia are full of the concert of singing birds. Many of our patients, when treated with hearing aids tell us that they were shocked in the morning when they enjoyed again this symphony that they had not experienced for 10 to 20 years. "I had thought that many birds had disappeared because of pollution". Recovering the possibility of hearing a titmouse, a lark, is of great importance to a Dane. It can also be of importance to one's health to be able to hear the treble tones from mosquitoes, bees, and wasps.

The rustle of the wind in the trees, the quiet murmur of simmering soup, all this gives life another dimension. And the noise of the car engine and of clicking wipers.

Its our duty to help these people to break their isolation. Most of them, thanks to their recruitment, only need a moderate amplification of the treble frequencies to reestablish a better hearing balance. With the modern hearing aids it is easy to give a selective amplification that compensate their hearing loss especially in the area from 1000 to 4000 Hz. A gain of 20 to 30 dB is sufficient when you consider their narrowed dynamic range. Many otologists still consider recruitment a counter indication for hearing aid treatment. But a noise induced hearing loss has nothing in common with Meniere. In most noise injured patients the recruitment is to be considered "a good one" as the threshold of discomfort is not lower than in normal people.

Binaural treatment is of great importance to secure a stereophonic hearing in everyday situations where the patients complain of isolation.

New smart hearing aids meet the cosmetic demands and ease the acceptance of the treatment.

The great obstacle to hearing aid fitting in these patients is the occlusion effect. Everyone with normal hearing can experience the occlusion effect when speaking or crunching chips with a finger tip closing the opening of one or especially both ear canals. The sound vibration produced in mouth, nose, throat, muscles, even in back and feet is transmited to

the skull. This provokes a vibration of the air inside the canal, especially at low and medium frequencies. The Closing of the canal amplifies these bass and medium sounds. It explains many complaints of patients with noise induced hearing loss when they are fitted with too closed earmolds:

A sensation of disagreeable pressure in the ear, of claustrophobia, feeling one self as "being in jail", as "being inside a barrel".

Extremely disturbing noise when  
eating, chewing - "when I am eating it sounds like crunching gravel".  
speaking, singing - "I just hear myself speaking".  
breathing deeply  
walking - "stamping like a whole company of soldiers".

The solution is to fit the patients with sufficiently open molds, the problem being to open enough without provoking feedback. It's a crazy situation when a hearing aid suddenly starts beeping every time, the patient is going through a door or standing near other people in the bus. Once again the patient feels like a fool.

The whole audiological team must focus on these problems and design individually fitted ear-moulds or ITE-shells adapted to the patients hearing loss, to his social hearing demands, to his individual sensibility to the occlusion effect and to the anatomy of his ear canals. This tailoring of the ear moulds/shells is of tremendous importance for the success of the rehabilitation together with the pedagogical training of the fitted patient and his family, teaching them the hearing tactics.

The poster illustrates the technical aspect of the audiological rehabilitation. Besides, different kinds of open moulds will be exhibited in plastic models of external ears.

#### REFERENCES.

1. Courtois, J. 1990. Wax and other problems, s. 407-421.
2. Larsen, C.B. et al. 1990. The role of the earmould in hearing aid fitting, s. 277-295.
- 1 + 2. in Presbycusis and other age related aspects, Proceedings of the 14th Danavox Symposium. Ed. Janne Hartvig Jensen.
3. Courtois, J. et al. 1988. Open moulds, s. 175-200.
4. Courtois, J. et al. 1988. Hearing aid fitting in asymmetrical hearing loss, s. 243-256.
5. Courtois, J. 1988. The man behind the man behind the audiogram, s. 329-343.
- 3 + 4 + 5. in "Hearing aid fitting, theoretical and practical views". Proceedings of the 13th Danavox Symposium. Ed. Janne Hartvig Jensen.
6. Courtois, J. et al. 1992. Betydning af den individuelt fremstillede øreprop. (Poster). Proceedings of Nordisk Audiologisk Selskabs 11. kongres 1992. Ed. Bo Wæter.

# A CRITICAL COMPARISON OF THREE METHODS FOR PREDICTING NOISE INDUCED DEAFNESS IN WORKERS

CUSTARD Graham

Graham Custard Associates,  
10 Meriden Close, Ainsdale, Southport, PR8 2SN, England.

## Abstract

Noise hazard exposure of workers in the industrialised nations is leading to increasing numbers of deafness compensation claims in the courts, which in turn require reliable data or methods by which to judge their validity. Yet in the United Kingdom three such methods are available, each allegedly producing differing results:

- 1 BS 5330:1976 and its supporting data;
- 2 Government publications of 1986 and 1987;
- 3 ISO 1999:1990.

This paper summarises the results of a comparative study of these methods. It describes an improved model for their comparison which has revealed they predict similar hearing losses within experimental error. Recommendations are given for improving the practical application of the International Standard to occupational risk assessment.

## Résumé

L'exposition aux dangers du bruit qui menace les ouvriers des pays industrialisés amène dans les tribunaux une augmentation du nombre de réclamations pour dédommager de la surdité, et ces réclamations à leur tour nécessitent des données ou des méthodes sûres grâce auxquelles on peut décider de leur validité. Pourtant au Royaume Uni il existe trois méthodes de cette sorte, dont chacune produirait des résultats différents:

- 1 BS 5330:1976 et les données qui l'appuient;
- 2 Les publications du Gouvernement de 1986 et 1987;
- 3 ISO 1999:1990.

Cet exposé résume les résultats d'une étude comparative de ces méthodes. Il décrit un modèle plus efficace pour les comparer qui a montré qu'elles prédisent de semblables pertes d'ouïe dans les limites de l'erreur expérimentale. L'exposé présente des recommandations pour améliorer l'application pratique du Standard International à l'évaluation du risque du métier.

## Terms Used

H = total hearing loss,  $H_{60}$  = hearing loss at age 60 years.

N = noise induced deafness

A = deafness due to age

## Introduction

A great many of the industrialised nations are finding increasing numbers of claims by workers seeking compensation for noise-induced deafness. When such claims are pursued through the courts experts have to attempt to estimate the effect on the person's hearing at various stages in a frequently complex history of noise exposure: most histories are not simple. The method of estimation is not without controversy, particularly in the United Kingdom, which presently has three predictive methods available, each with its own vices and virtues.

## Vive la difference ?

The period between about 1960 and 1970 saw an intense period of study which yielded sufficient information to correlate the incidence and degree of deafness with noise exposure. 1973 saw publication of equations and tables by the British National Physical Laboratory, based on work by Burns, Robinson and Shipton, which was subsequently improved in about 1977<sup>1</sup>. This spawned the British Standard BS 5330<sup>2</sup>, in which the long-term energy principle of noise hazard became established. This says that deafness is related both to the average daily noise energy and to the noise energy accumulated over many years (noise immission). Robinson was a strong advocate of this.

Meanwhile, an International Standard was beginning to evolve based, it seems, on other data sources. It eventually became ISO 1999:1990<sup>3</sup>. However, the UK did not adopt it for various reasons, one of which being that it lacked the more convenient concept of noise immission.

The British Health & Safety Executive became alarmed by the presence of two diverse standards and asked Robinson to review all of the available data and report accordingly. He did so, at length in 1986<sup>4</sup>, and criticised not only the existing ISO but also censured his own enthusiasm for noise immission. After his tables of results were published in 1987, the U.K. was then left with three different methods of predicting noise induced hearing loss!

## Comparison

But which method is right? Certainly the British NPL method, with the concept of noise immission, is easiest to use in practice, even if it allegedly results in the wrong answers. If later methods are more accurate, they are of little practical use since they only allow for a continuous exposure to one type of noise - a very rare phenomenon in industry. In an attempt to overcome this problem, Robinson published a paper in 1991<sup>5</sup> suggesting how the equations relating age and deafness to total hearing loss ( $H = A + N - A.N/120$ ) might be applied to his own data for use in complex exposure histories.

This method is difficult both to visualise and apply in practice. An improvement is to reconstitute the original equations for formulating N in order to plot growth curves of this deafness with time. An example of such curves for N averaged over 1,2,3 kHz for an otologically normal population is shown in Figure 1, together with how they may be used. For example, a population is exposed to 90 dB(A) for the first 30 years and to 100 dB(A) for the final 10 years, what is  $H_{60}$ ? To solve this we enter the 90 dB(A) curve at 0 years and follow it for 30 years to find  $N = 11$  dB. We use this value of N as the starting point on the 100 dB(A) curve, which we follow for a further 10 years to read  $N = 19$  dB. The value of A is obtained from standard (agreed) tables and hence  $H_{60} = 12 + 19 - 2 = 29$  dB.

An important extension of this graphical model is that if it is applicable to Robinson's data then it can also transform ISO 1999 into a standard of greater practical value. The latter example applied to the equivalent ISO curves, computed from its equations as in Figure 2, yields  $N = 6$  dB after 30 years exposure and  $N = 15$  dB after 40 years. Hence  $H_{60} = 12 + 15 - 1 = 26$  dB.

Such curves have allowed a quantitative comparison of all three methods with identical noise histories of varying types and complexity. Some examples are shown in Table 1. The first type of history shown consists of a simple exposure to one level of noise (95 dB(A) for a period P years. The results of N and  $H_{60}$  are given. The second type shown is for a stepped exposure (95 then 100 dB(A)), each for 10 and 20 year periods. The third type is for a decreasing stepped exposure. The fourth type is for a stepped exposure to noise for 10 years each at levels from 85 to 100 dB(A), whilst the fifth type is for its mirror image. It will be seen from each of these examples (and many others) the predictions for N do not differ for each method by more than 7 dB(A) and the two do not differ from ISO results by more than about 5 dB(A). Slightly smaller differences for H are experienced. Furthermore, most results have smaller differences.

We must put these differences into the context of the two large errors in the underlying statistical data supporting the three methods. These errors are in the assessment of hearing loss by audiometry, and in the estimate of long term noise exposure of individuals. The former errors in practice are likely to have been at least  $\pm 5$  dB. Errors in assessing the daily noise exposure levels of subjects and then converting these to long-term estimates of exposure could have been of a similar magnitude. The combination of these two results is an error of approximately  $\pm 7$  dB. It should also be appreciated that the equations used by each method to predict values for N are merely attempts to best-fit the data, much of which is widely scattered.

ISO 1999:1990 and Robinson's later tables do not allow the use of the concept of noise immission. However, the tests undertaken so far reveal that the differences in predictions for N between the old British NPL method and ISO are fairly small in practice and are well within the estimated practical errors. Differences with the newer Robinson data are higher, yet still within this error. Consequently British courts need not reject the concept of noise immission for estimating noise induced hearing loss simply because later methods have abandoned the idea.

### Reconciliation ?

Whilst it is too late to expect ISO to return to the concept of noise immission, it can be demonstrated that the ISO standard may be transformed into a more useful working document if the data is presented in a graphical form and if the above method of applying such graphs to more complex (and realistic) noise exposures is accepted.

A revision of the ISO standard is already required and an independent technical committee should now critically appraise the formulae developed by Robinson and ISO and attempt to harmonise the results and conclusions, bearing in mind the experimental errors of the underlying data. ISO should agree appropriate sets of curves, of the type already described and standardise their practical application to more complex noise histories. Then we may be able to achieve an internationally acceptable standard which is useful in practice.

### References

- 1 Robinson DW, Shipton (1973 and 1977) *Tables for the Estimation of Noise Induced Hearing Loss*, NPL Acoustics Report Ac 61.
- 2 BS 5330:1976 - *Method of Test for Establishing the Risk of Hearing Handicap Due to Noise Exposure*.
- 3 ISO 1999:1990 - *Acoustics - Determination of Occupational Noise Exposure and Estimation of Noise Induced Hearing Impairment*.
- 4 Robinson DW (1986) - *Hearing Loss and Noise: A Review and Synthesis of Existing Experimental Data*, ISVR Contract Report No. 87/4. Later developed (1977) in *Tables for the Estimation of Hearing Impairment Due to Noise for Otologically Normal Persons and for a typical Unscreened Population*, ISVR Contract Report No. 87/4.
- 5 Robinson DW (1991) - *The Relation Between Hearing Threshold Level and its Component Parts*, British Journal of Audiology, 1991, 25, pp 93-103.

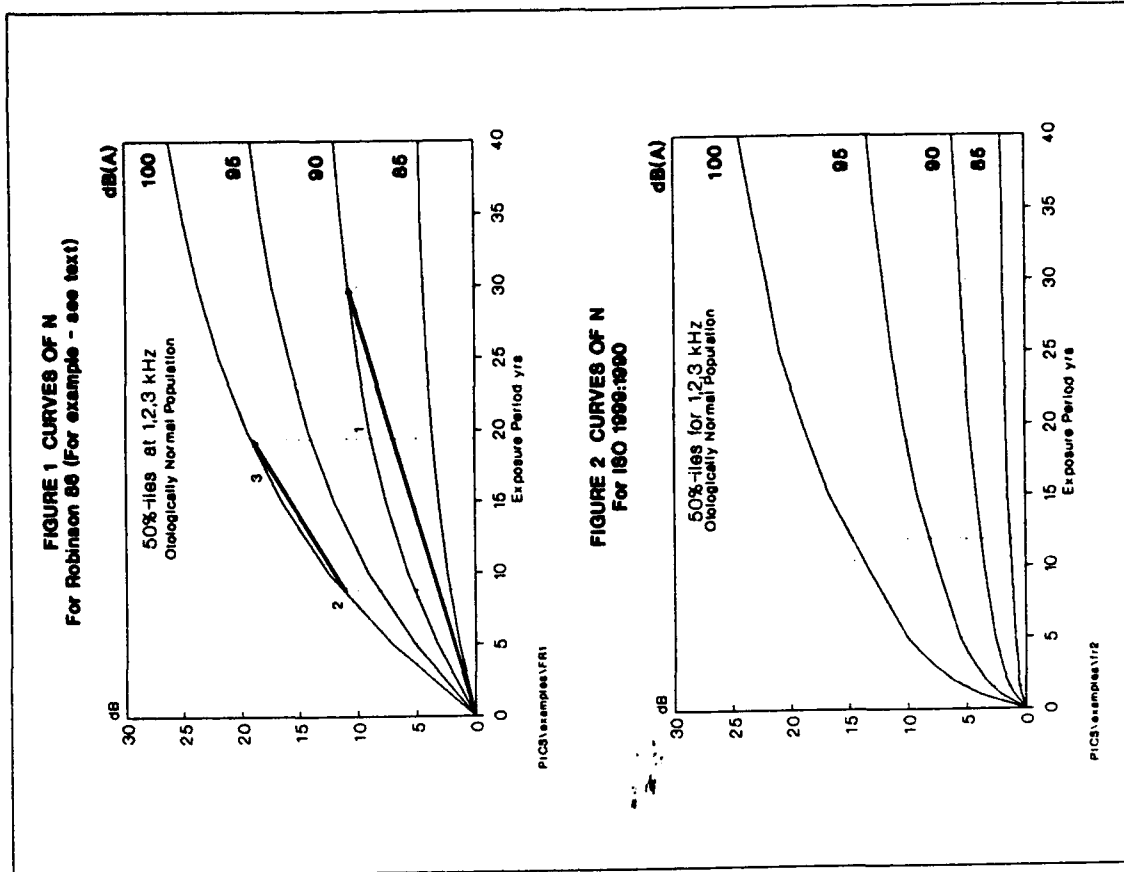

**Table 1 Examples Comparing the Three Methods for British NPL (B), Robinson 86 (R) and ISO 1999 (I) for exposure periods (P) as shown, and determined at age 60 yrs**

Type of Exposure history	P yrs =	10		20		30		40		
		N	H	N	H	N	H	N	H	
	B	7	17	10	20	12	22	13	23	
		R	9	20	14	25	17	27	19	29
		I	8	19	11	22	12	23	14	25
	B	13	23	18	28	<b>Notes</b>  N = noise effect H = total Hearing Loss				
		R	20	30	24					34
		I	15	26	22					32
	B	13	23	18	28					
		R	16	26	20					30
		I	16	26	20					30
	B	15	25	<b>These are 50%-ile values for an otologically normal population i.e. of Database A type according to ISO</b>						
		R	20							30
		I	16							26
	B	15	25							
		R	20							30
		I	16							26

Each histogram is width P years

# AUSTRALIAN MINING INDUSTRY EXPERIENCE IN HEARING CONSERVATION

EDEN, David  
Eden Dynamics Pty Ltd  
28 Oatley Avenue  
Oatley NSW 2223 Australia

## ABSTRACT

Australian mining companies are successfully reducing noise exposure to people working in the mining industry. Recent court cases show that whereas noise levels were commonly 100 dB(A) twenty years ago, noise excluding operator cabins and other acoustic treatments have, at least for earthmoving plant operators, reduced noise exposure to less than 90 dB(A), approaching 85 dB(A). Although the engineering may have been introduced for operator comfort, it has been effective in slowing the rate at which hearing loss continues.

Unfortunately some people in the mining industry may still think that it is sufficient to provide ear muffs or ear plugs without implementing all the steps recommended in the Australian Standard on Hearing Conservation. These steps are:

- \* motivation and education of all concerned
- \* measurement of the noise
- \* evaluation of any noise problem
- \* reduction of noise exposure
- \* provision of personal hearing protection and regular hearing testing if noise exposure remains excessive.

Juries typically award Australian \$80,000 to people who have lost some hearing due to noise exposure. Where there are still people working in a noisy environment, it now appears to be more economical to engineer noise reduction to protect all the people working there.

## INCIDENCE OF INDUSTRIAL DEAFNESS IN MINING

Noise induced hearing loss also known as industrial deafness or 'boilermaker's deafness' is the most frequently occurring occupational disease. Worksafe Australia (1990) estimates there are approximately 10,000 occupational deafness claims made annually in a working population of 7 million people. In just one State, NSW, there were 4654 claims in a fulltime workforce of 2.1 million (Workcover 1992). Of these claims, the vast majority, 4555 were by men, with an incidence of 3.9 injuries per 1000 workers (Workcover 1992).

### Distribution of type of occupational disease

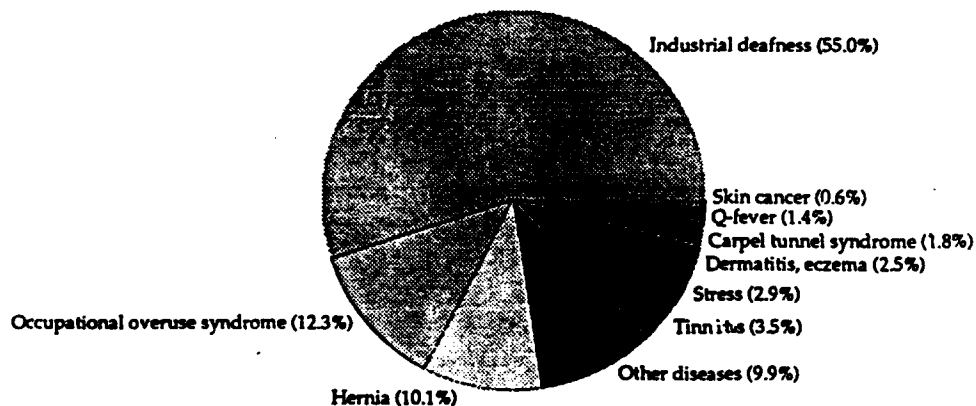

The pie chart reproduced from the Workcover (1992) statistics shows that of those injuries classified as diseases (by characteristics such as a slow and protracted cause or a repeated cause acting imperceptibly), deafness comprised 55% of the total in NSW. The statistics for coal mining available from the Joint Coal Board (1992) show that noise induced hearing loss comprised 59% to 80% of injuries classified as disease from 1988 to 1992.

Because of some unreliability of statistics relating to the mining industry, the NSW data excludes coal mining. The bar chart also from Workcover (1992) shows incidence of industrial deafness by industry in NSW, excluding data from the coal mining industry.

### Incidence of industrial deafness by industry

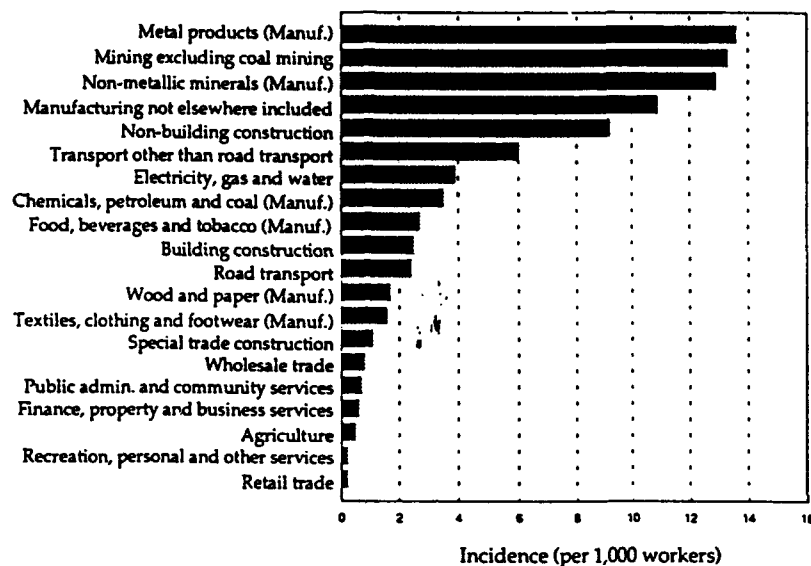

Once the 474 deafness claims in the NSW coal mining population of 16789 workers for 1990-1991 are added to the mining incidence data in the bar chart, the industry classification of mining in NSW has the greatest incidence of about 23 per 1000 workers. Mitchell and Else (1992) show that in 1988/89 there were somewhat fewer claims for occupational hearing loss in the other Australian States in our mining industry. They also show that the cost of noise induced hearing loss was significant in the Australian mining industry at \$3000 per claim. Manufacturing, especially metal products, employs more workers and is therefore likely to be the single industry classification with a greater total incidence of noise induced hearing loss and hence total cost to the community.

### **NOISE LEVELS ARE BEING REDUCED**

The high incidence of deafness in the mining industry is due to high noise levels over 80 dB(A) where people have to work. As well as measuring noise levels at different mines, our acoustical consulting practice has investigated more than a hundred individual cases of industrial deafness. One of the common threads is that noise levels are starting to be reduced at the workplace. In the mining industry in NSW, the earthmoving machinery used twenty years ago was less powerful but the operator was closer to the engine because the plant was smaller and less well treated acoustically than it is now. Cabins were not always supplied and exhaust mufflers were not always properly maintained. In the NSW coal industry about 1980, plant operators got cabins with airconditioning. Up until then, their noise exposure was to levels over 100 dB(A). Depending on the acoustic isolation of the cabins, noise levels were reduced towards 90 dB(A). In the case of electric shovels and very large draglines, the noise levels to which operators are exposed are less than 80 dB(A) in their cabins but still over 100 dB(A) in the machine engine rooms.



As a consequence of the reduced operator noise levels, younger miners who have more recently joined the industry have lost less hearing. Also, the rate of hearing loss is slower. Some dragline operators appear not to have lost any more than 5 dB of their hearing in the last 10 years whereas in the preceding 10 years driving bulldozers without cabins, plant operators have commonly lost 40 dB of hearing due to excessive noise exposure.

### **CLAIMS EXPERIENCE FOR INDUSTRIAL DEAFNESS**

Most claims for industrial deafness in Australia are through the various State Workers Compensation organisations. Claims under Common Law are also possible. In NSW there have been more than 300 claims for \$100,000 alleging negligence causing industrial deafness. In other States, such Common Law claims are fewer: one in Tasmania, one in Queensland and two in Western Australia are all those known to the author.

Because Workers Compensation courts take time to decide on the validity of claims, the different States in Australia have changed the law to speed up the processing of claims. This intention to streamline and reduce costs may have been successful for accidental injury claims but for injuries of slow onset including noise induced hearing loss, it has failed. As hearing is lost over time and people may not be aware of such an injury until years after it has begun, people working in noisy industries have been able to bypass the recently streamlined and simplified legislation by suing under Common Law for damages. Payments for such Common Law claims have been much greater than payments for Workers Compensation claims.

### **COST OF DEAFNESS COURT CASES**

The plaintiff in order to prove damages under Common Law, has to prove:

- a) noise levels were loud enough to cause loss of hearing, ie negligence,
- b) that loss of hearing was foreseeable and,
- c) an alternative safe means of work was available.

To encourage people to seek damages under the various simpler Workers Compensation legislation, all plaintiffs have to demonstrate is high noise levels at their place of work. But in the Workers Compensation courts, the damages awarded are rigidly set to a fixed low scale. For example in NSW (the most populous Australian State with 6 million people) the rate is \$839.80 for each 1% of lost hearing. Under Common Law, the damages awarded have reached the maximum of \$100,000 and typically are \$80,000 for 10% loss of hearing.

So although people who have lost some of their hearing may chose to sue for negligence and possibly be in court for typically one week, they may be awarded two years wages rather than two months wages if they were instead processed through a less risky and less expensive Workers Compensation court.

A consequence of the greater value of damages awarded is that the economics of noise control is slowly changing. Twelve years ago, Gibson and Norton (1981) thought payments for damages were about equal to the cost of reducing noise in the workplace, without allowing for the indirect costs of lost productivity.

It is apparent that the damages of \$80,000 typically awarded in each case under Common Law means it is about ten times more economical to reduce noise to safe levels. Once the cost of legal advice and expert reports from audiologists, doctors and engineers are added in, the total cost typically increases by another \$30,000 per court case. If there are appeals to higher courts, those legal costs rise for both sides. In the Gilmore versus Costain Australia Limited case appealed by the Joint Coal Board who was the insurer defending it, the total costs are estimated to have exceeded \$250,000. All those costs have to be paid by the side which lost, in this case the Joint Coal Board.

## REAL-WORLD PERFORMANCE OF HEARING PROTECTORS

Too often the defence of Common Law court cases relies on the effectiveness of hearing protectors (ear muffs or ear plugs). Eden and Piesse (1991) summarised the relevance of real-world or workplace tests conducted by others. We showed ear muffs typically give 6 dB less attenuation than their Australian laboratory Sound Level Conversion or SLC<sub>80</sub> performance and that the E.A.R. earplug gives 9 dB less performance.

However, when the steps recommended in Australian Standard 1269 "Hearing Conversation" are followed, it is the authors' opinion that hearing protector performance can be brought up to the Australian laboratory test results.

## CONCLUSION

Industrial deafness is a major cause of injury in the Australian mining industry. The cost of fighting just one Common Law court case for noise induced hearing loss is now much more expensive than reducing noise levels at the workplace. Engineered noise reduction produces benefits for all people who work in noisy workplaces. Reducing noise levels to below 85 dB(A) or 80 dB(A) is possible and reduces the difficulties of administering a hearing protection program.

If hearing protectors are used as a temporary expedient while noise levels are being reduced by engineering means, their real-world attenuation has to be used rather than laboratory test data to ensure workers are protected. Administrative difficulties and the higher cost of damages claims are now sufficient reason to choose engineering noise reduction in favour of hearing protectors.

## REFERENCES

- Eden, D and Piesse R 1991, *Real-World Attenuation of Hearing Protectors*, Western Pacific Regional Acoustics Conference IV, Brisbane.
- Gibson D C and Norton M P 1981, *The Economics of Industrial Noise Control in Australia*, Noise Control Engineering, Volume 16 Number 1 pp 126-135, New York.
- Joint Coal Board, 1992, *Lost Time Injuries, New South Wales Coal Mines, 1990-1991* (Joint Coal Board, Sydney).
- Joint Coal Board, 1992, *Lost Time Injuries, New South Wales Coal Mines, 1991-1992* (Joint Coal Board, Sydney).
- Mitchell, T and Else, D 1992, *Opening Occupational Health & Safety Opportunities for Underground Mining Companies by Closing the Knowledge Application Gap*, Fifth Underground Operators' Conference, Ballarat.
- Standards Australia, 1989 *Australia Standard 1269-1989 Acoustics - Hearing Conservation*. Standards Australia, Sydney.
- Workcover Authority of NSW, 1992. *Workers Compensation Statistics 1990/91* (Workcover Authority of NSW, Sydney).
- Worksafe Australia, 1990. *Noise Management at Work. Control Guide*. (Australian Government Publishing Service, Canberra).

# **OCCUPATIONAL DISEASE IN AGRICULTURAL OPERATIONS WITH TRACTORS - PART I : NOISE LEVELS**

**FERNANDES João Candido**  
**Pro. Dr. - Mechanical Engineering Department**  
**Universidade Estadual Paulista - UNESP**  
**Bauru City - São Paulo State - Brazil**

In the last years, the brazilian agricultural tractors were increased its power engine, increased the noise level and inducing a hearing loss in its operators.

In this work, the acoustical occupational problems of relations tractor-operator are analysed. We utilized a sample of 300 brasilian tractors, with same statistical distribution of the tractors in use in Brazil, measured according to International Standard ISO 5131, and Brazilian Standard NBR 9999.

This analysis is divided in four parts : tractor noise measurement in real conditions at agricultural work (198 tractors) ; tractor motionless (the engine noise only - 198 tractors) ; comparative analysis (four tractors and four implements) ; and noise spectral analysis (two tractors).

The results of measurements present noise levels very above the healthy levels : whereas knowledge of noise levels above 80 dB(A) already may induced a noise-induced hearing loss, and the Brazilian Working Law fix the limit in 85 dB(A) to 8 hours diary exposure, the brazilian tractors noise levels present levels between 90 dB(A) and 110 dB(A), with an average of 97,06 dB(A).

The results of noise spectral analysis present noise levels very above the NCB Curves (Balanced Noise Criterion Curves) developed by Beranek in 1989.

As conclusion, the brazilian tractors can be classified as the unhealthy equipment, inducing a loss hearing in its operators.



**HIGH-FREQUENCY THRESHOLDS: EXTENSIVE LOSS ABOVE 2kHz  
FOR IMPULSE NOISE EXCEEDING A CRITICAL LEVEL?**

HALLMO, P(1), BORCHGREVINK, HM(2), MAIR, IWS(1)

- (1) Ullevaal Univ Hosp, ENT Dpt, Lab Audiol, 0407 Oslo Norway
- (2) HQ Defence Com Norway, FSAN/Environm Med, 0016 Oslo Norway

**ABSTRACT**

169 males aged 18-59 years with known noise-induced hearing loss were interviewed on noise exposure history. Air + bone conduction thresholds were determined from 125-8000 Hz and 125-6000 Hz, respectively, according to standard procedures, supplemented by threshold determination in the high-frequency range 8-18 kHz in 1 kHz steps using Interacoustic ASHF10 tone generator, Koss HV/1A headset, KH70/B71 high-frequency bone vibrator, and 1/3 octave band contralateral masking. The material was classified according to Man & al. (1981). High-frequency (HF) thresholds were throughout higher than in age-matched subjects not exposed to noise. The degree of HF threshold elevation was age-related only in Grade I, slight acoustic trauma. HF thresholds were poor and overlapping for severe hearing loss Grades III+IV. Supported by case studies this indicated that single events of impulse noise exposure exceeding a critical level may cause extensive hearing loss from 2-3 kHz and up. Group data Grades I+II for the younger subjects, and individual audiograms showed a tendency towards HF hearing loss about one octave above the characteristic 3-6kHz "dip" .

**INTRODUCTION**

Noise-induced hearing loss (NIHL) may be produced by steady-state and impulsive noise. Audiometry in the conventional frequency (CF) range 125-8000 Hz characteristically shows threshold elevation in the 3-6 kHz region for NIHL. Increasing attention has been paid to high-frequency (HF) threshold effects above 8 kHz. The present study compares CF and HF hearing thresholds in noise-exposed subjects related to age, exposure time, and type of noise exposure - including impulse noise.

**METHOD**

The subjects were 169 males aged 18-59 years, with age distributions 18-24y(n=37), 30-39y(n=27), 40-49y(n=50), 50-59y(n=55). All had a known typical NIHL-like threshold shift of at least 20 dB at one or more of the frequencies 3,4 and 6 kHz. The majority (130) were recruited among military personnel, conscripts and professionals, who were exposed to steady-state and impulsive noise. All went through a semi-standardised interview on noise exposure history. Other causes of hearing loss such as heredity, previous ear disease, ototoxicity and head injury had been excluded. Pneumatic otomicroscopy was normal in all ears.

Air + bone conduction audiometry were performed in audiometric rooms satisfying ISO standards. In the CF range 125-8000 Hz thresholds were determined at octave intervals plus at 3 kHz and 6 kHz, using the OB70 headset, with contralateral masking according to standard procedures. In the HF range 8-18 kHz thresholds were determined in 1 kHz steps using Interacoustic ASHF10 tone generator, Koss HV/1A headset, and KH70/B71 high-frequency bone vibrator, with 1/3 octave band contralateral masking. Each age group studied was subdivided according to the degree of NIHL in

the CF range using the classification of Man & al (1981).

## RESULTS & DISCUSSION

Only selected aspects are summarised. The noise exposure history (type, level, regularity) varied considerably both within and across individuals. The mean noise exposure time increased with age, being 2.8y for ages 18-24y, 9.1y for ages 30-39y, 19.1y for ages 40-49y, and 25.6y for ages 50-59y. Practically all had experienced gunfire during Norway's one-year compulsory military service. Of the 169 subjects, 110 had been more frequently exposed to gun-fire, 24 were employed at airports and exposed to jet aircraft noise, and 52 had worked with noisy machinery, including air compression instruments. None had been exposed to steady-state noise alone. For the group, use of ear protectors had been occasional rather than routine, and hardly employed in the earliest years in subjects above 40 years.

NIHL >20 dB at 3, 4, or 6 kHz was diagnosed in 302 of the 338 ears, unilaterally in 32 subjects. Relating age to degree of hearing loss in the CF range (NIHL Grades I-IV, Man & al 1981) showed that the severity of NIHL tended to increase with age (Table 1).

-----  
 TABLE 1 Noise-induced hearing loss Grade I-IV, by age group  
 -----

AGE GROUP	NOISE-INDUCED HEARING LOSS (n= number of ears)				TOTAL n=
	NIHL GRADE				
	I	II	III	IV	
18-24y	41	15	5	0	61
30-39y	22	16	10	2	50
40-49y	28	31	23	5	87
50-59y	25	31	35	13	104
TOTAL n=	116	93	73	20	302 ears

-----

The most severe CF losses, NIHL Grade IV, were found in only 20 ears, 18 of them among subjects above 40 years, none was from the youngest age group 18-24y. This might reflect that NIHL increased with the reported age-related increase in noise exposure time (cf above), but might also be related to reduced occupational noise exposure and increased hearing protection instituted by the 1982 occupational noise regulations under the 1977 Work Environment Act.

Figures 1-4 show the mean hearing thresholds for each age group and NIHL Grades I-IV, both in the CF range 125-8000 Hz and in the HF range 8-18 kHz. Figure 3 also includes the normal age-matched HF thresholds. HF thresholds were throughout higher than in age-matched subjects not exposed to noise, and were elevated some 20 dB even for the youngest age group (18-24y) with slight Grade I hearing loss. All four age groups showed comparable overlapping CF range thresholds for all NIHL Grades I-IV. The degree of HF threshold elevation was age related only in Grade I, slight acoustic trauma. HF thresholds were poor and overlapping for severe hearing loss Grades III+IV in all age groups, and from NIHL Grade II for subjects above 30 years.

Most of the subjects had been exposed to gunfire impulse noise. Hearing protection, compulsory since 1982, had been less employed in the early career of the older age groups. Without hearing protection, most weapons produce hearing loss (NATO RSG6 1987). Case studies (e.g. Figure 5) indicated that single events of impulse noise exposure exceeding the individual's critical level

had caused extensive permanent unilateral or bilateral hearing loss from 2-3 kHz and up, cf Laukli & Mair 1985). Beyond a critical noise level extensive high-frequency cochlear damage has also been observed in animal experiments for pure tones (Johnstone & al 1982) and impulse noise (Hamernik, personal communication). Taken together, this indicates that single events of impulse noise exposure exceeding a critical level may cause extensive hearing loss from 2-3 kHz and up - not to be mistaken for an element of presbycusis.

Group data Grade I+II for the younger subjects, and individual audiograms showed a tendency towards HF hearing loss about one octave above the characteristic 3-6kHz "dip".

**REFERENCES**

Johnstone BM, Robertson D, Cody A. Basilar membrane motion and hearing loss. In HM Borchgrevink (ed) Hearing & Hearing Prophylaxis, Scand Audiol Suppl 16, 1982:89-93.  
 Laukli E, Mair IWS. High-frequency audiometry. Normative studies and preliminary experiences. Scand Audiol 1985;14:151-158.  
 Man A, Naggan L, Bergman M. Classification of the severity of acoustic trauma based on pure tone threshold audiometry. Acta Otolaryngol 1981;92:25-31.  
 NATO RSG6 Report. Smoorenburg GF, Borchgrevink HM, Brinkmann H, Dancer A, Forrest MR, Forshaw SE, Papavasiliou A, Patterson JH, Pfander F, Phillips YY, Price GR. Effects of impulse noise. NATO AC/243 (Panel 8/RSG.6)D/9, Bruxelles 1987.

Figure 1

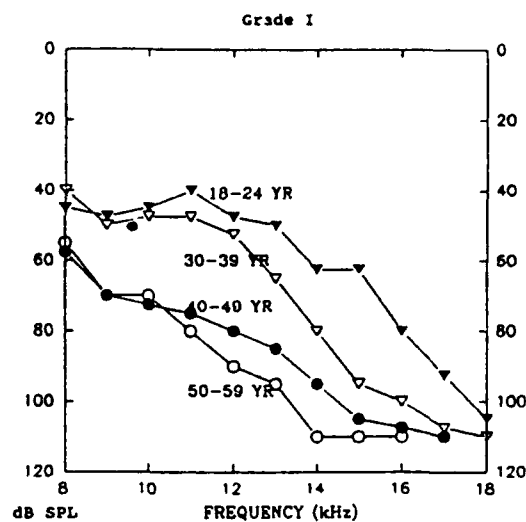
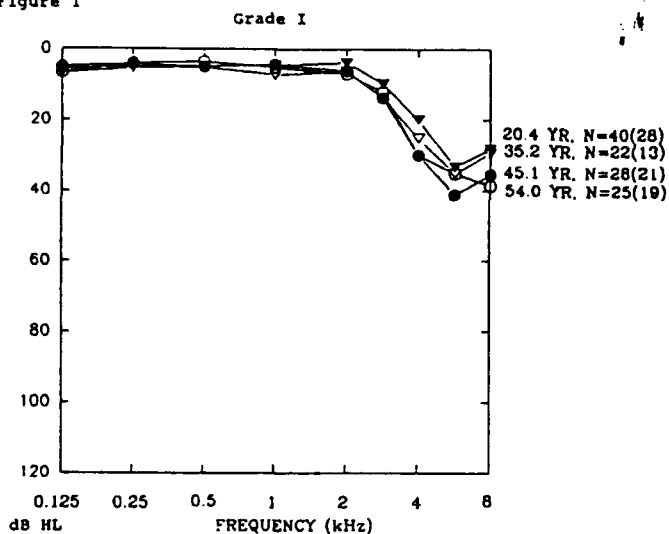
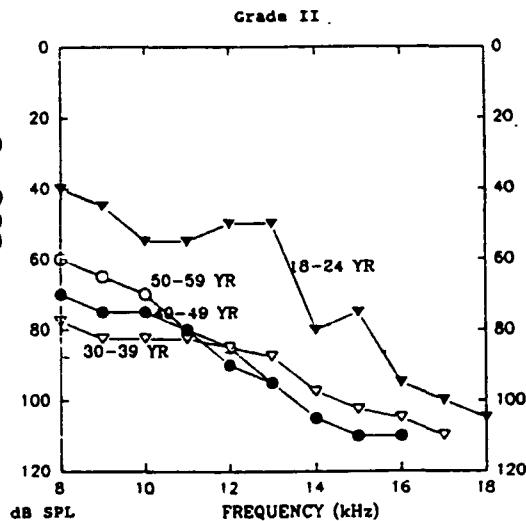
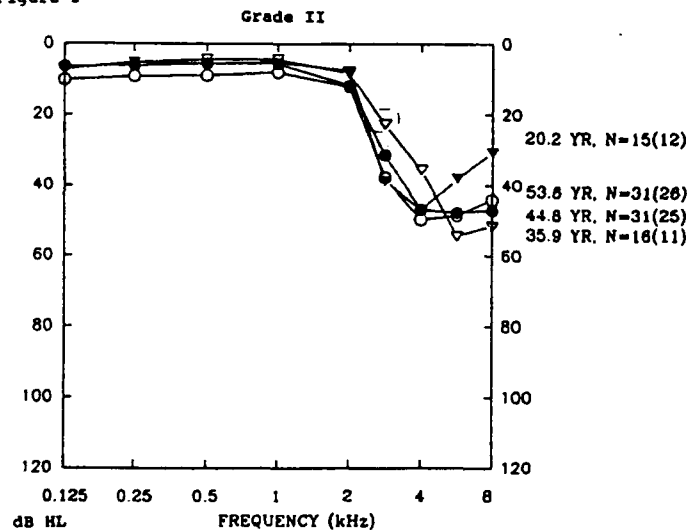

Figure 2



Figures 1-4: mean hearing thresholds for each age group and NIHL Grades I-IV 125-8000 Hz and 8-18 kHz. Figure 3 includes normal age-matched HF thresholds: A=18-24y B=30-39y C=40-49y D=50-59y.

Figure 3

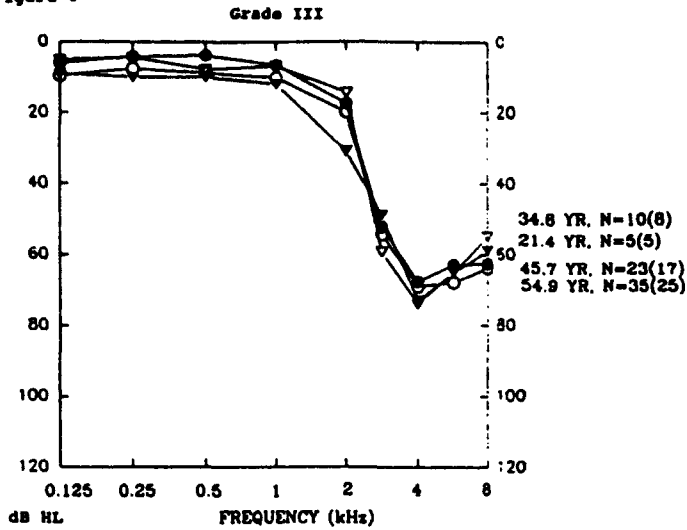

Figure 4

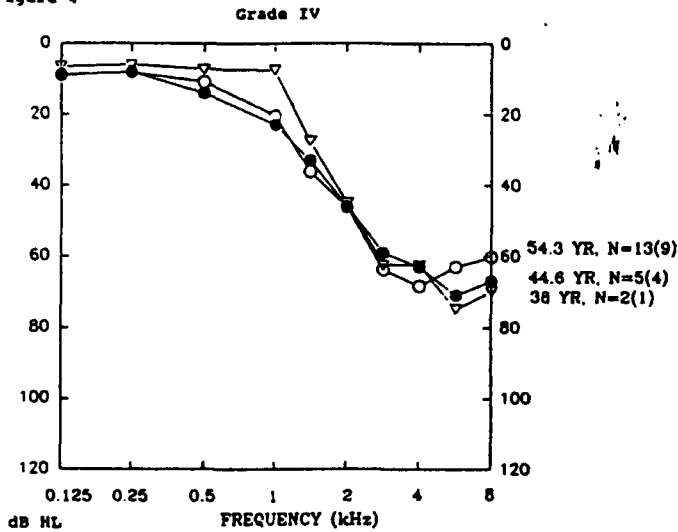

Figure 5

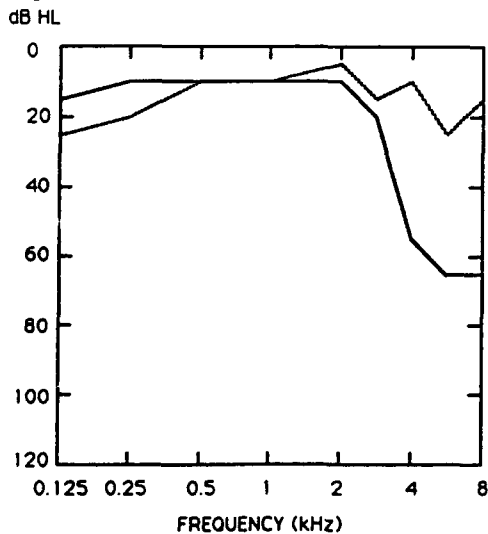

Figure 5: Unilateral high-frequency loss from 2-3 kHz and up in male medical doctor aged 57 years, no noise exposure apart from occasional gunfire some weeks during military service. Left ear: continuous curve. Right ear: dotted curve.



# HEARING THRESHOLD SHIFTS FROM REPEATED SIX-HOUR DAILY EXPOSURE TO IMPACT NOISE

HAMERNIK, Roger P., AHROON, William A., DAVIS, Robert I, and LEI, Sheau-Fang.

Auditory Research Laboratories  
State University of New York  
107 Beaumont Hall  
Plattsburgh, New York 12901 U.S.A.

The developing resistance to threshold shift (TS) from intermittent daily exposures to a broad band impact noise will be described. The chinchilla (N = 23) was used as an animal model, the evoked auditory response as a measure of threshold and surface preparation histology quantified sensory cell loss. The animals were exposed over a 20-day period to six-hour daily exposures of 107, 113, 119 or 125 dB peak SPL impacts presented 1/s. Thresholds measured at the beginning and end of each exposure period showed that up to 30 dB resistance to TS could be developed over the first five days of an interrupted exposure. The magnitude and the time course of the developing resistance to TS was frequency and intensity dependent. The higher level intermittent exposures tended to produce less permanent threshold shift (PTS) than uninterrupted equivalent energy exposures. (Research supported by NIOSH - 2R01OH02317.)

**Introduction:** Several studies (Clark et al., 1987, Canlon et al., 1988) using animal models have shown that the cochlea is capable of developing a resistance to noise-induced threshold shift that is dependent upon its previous exposure history and on the timing schedule of a repeated exposure. For example, the Clark et al. (1987) study using a 0.5 kHz octave band of noise at 95 dB SPL presented on an intermittent daily schedule for 36 days showed that following the first day of exposure the animals incurred a 35-45 dB threshold shift. However, on subsequent days TS declined and thresholds eventually came to within 10-15 dB of preexposure values. Noise-induced permanent threshold shift (NIPTS) for these groups was less than that for an equal energy uninterrupted group.

An interrupted impact noise exposure reported by Henderson et al. (1979) using 113 dB peak SPL impacts presented 1/s, 8 h/day for five days produced a consistent daily cycle of TS and postexposure recovery. The group mean TS following each day of exposure reached the asymptotic threshold shift level (ATS) produced by a control group exposed to the same impact for five days, 24 h/day. Their data did not show any evidence of a TS recovery such as that seen in the Clark et al. (1987) interrupted octave band noise exposures.

**Methods:** Twenty-three monaural chinchillas were used. The procedures for collecting the brainstem (inferior colliculus) evoked response pure tone thresholds, the generation of impulse stimuli and the surface preparation histology are described in detail in Ahroon et al. (1993). Four groups of animals were exposed to either 107, 113, 119 or 125 dB peak SPL impacts at the rate of 1/s. The exposures were presented on a regular six-hour daily schedule for 20 days. The pressure-time profile and spectrum for the 113 dB impact are shown in Figure 1. The other impacts had very similar spectra and time histories. Three pre- and postexposure audiograms were measured at octave intervals from 0.5 to 16 kHz and at the half-octave frequency of 11.2 kHz. The means of these threshold measures established the respective audiograms. Immediately prior to each daily six-hour exposure and immediately following each exposure, a single threshold measurement was obtained at 0.5, 2.0, and 8.0

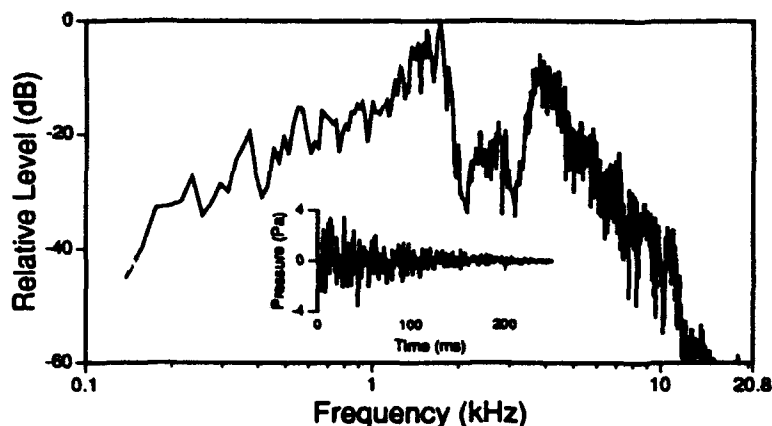

Figure 1. The relative energy spectrum of the 113 dB peak SPL impact along with the impact pressure-time history (inset).

kHz. Thirty days after the last six-hour exposure, postexposure audiograms were collected and the animals were euthanized under anesthesia and their cochleas removed and prepared for surface preparation histology. For comparison with the 113, 119 and 125 dB interrupted exposure groups, the data from Ahroon et al. (1993) on equivalent energy uninterrupted exposures is also presented.

**Results:** There were no statistically significant differences in the mean preexposure threshold across the four groups of subjects. Figure 2 illustrates the group mean TS at 8.0 kHz immediately prior to and following each daily exposure over the 20 day exposure period. Evident in these mean TS data is a recovery of TS as the intermittent exposure progresses. At the lowest intensity, the initial threshold shift,  $TS_i$ , at 8.0 kHz is the least, amounting to 45 dB. Over approximately the first 10 days of exposure TS recovers about 15 dB. That is, the maximum mean recovery,  $TS_r$ , defined as the difference between  $TS_i$  and the mean TS measured over the last five days of the exposure, was 15 dB. For the 113 dB peak SPL impact exposure which produced a  $TS_i$  of about 50 dB, TS recovered 30 dB over the first five days of exposure. As  $TS_i$  increased following the higher level exposures,  $TS_r$  was reduced and prolonged. These effects are summarized in Figure 3 where the ratio,  $TS_r/TS_i$ , is shown plotted as a function of

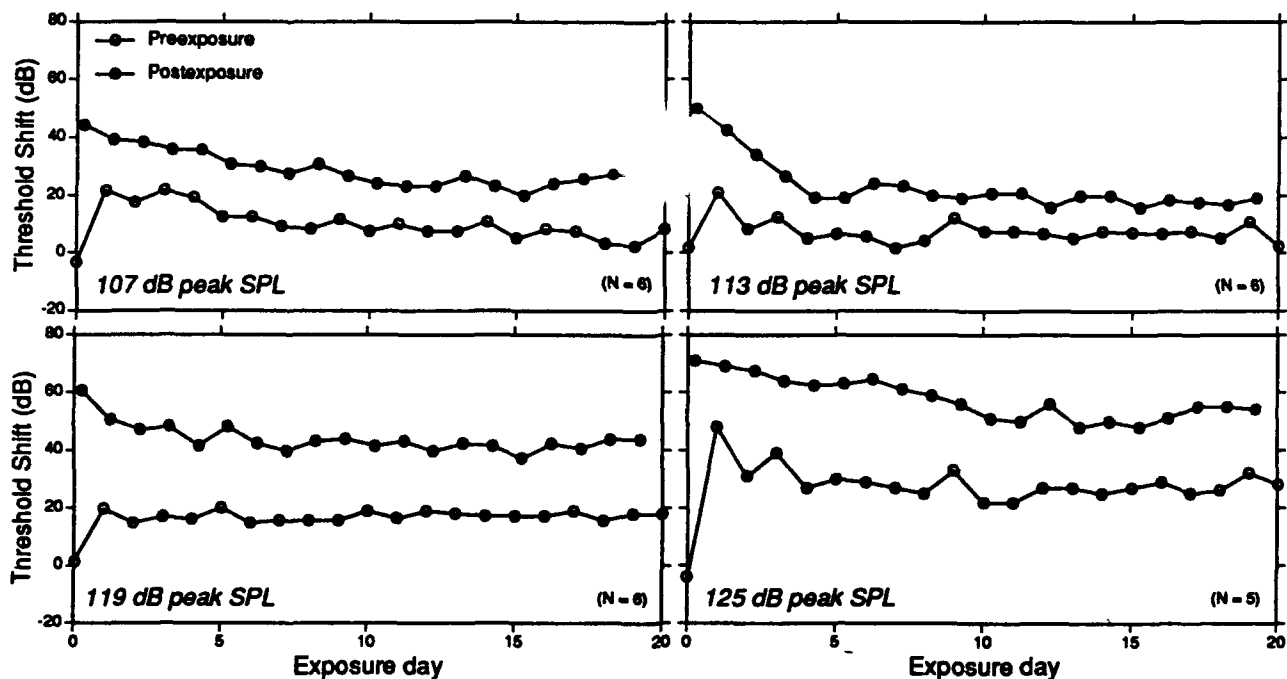

Figure 2. The daily mean preexposure (O) and postexposure (●) threshold shifts measured at 8.0 kHz for each of the four experimental groups over the 20-day exposure period.

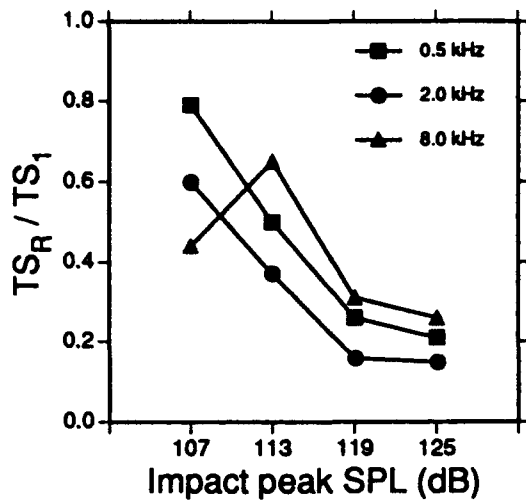

Figure 3. The ratio of threshold shift recovery to the threshold shift following the first day exposure for each test frequency and each exposure level.

Figure 4. A comparison of the mean permanent threshold shift audiograms for the interrupted and non-interrupted (equal energy) exposure paradigms at 113, 119 and 125 dB peak SPL. Error bars represent one standard error of the mean.

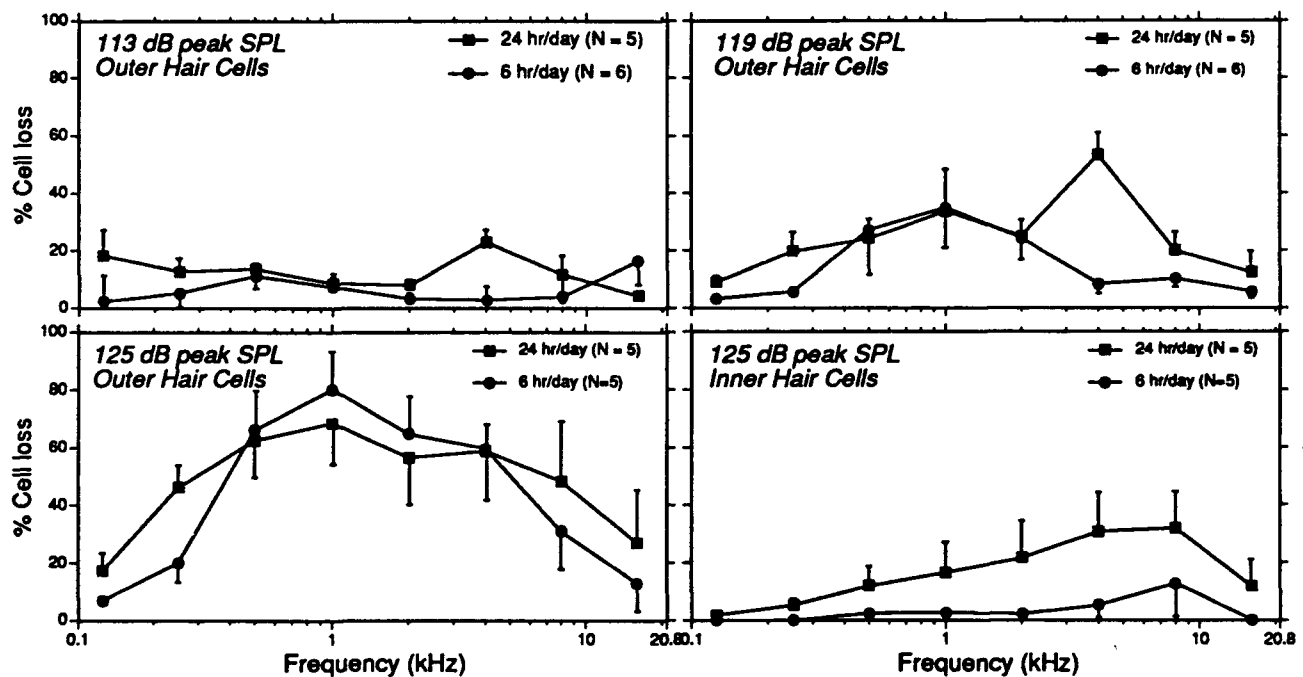
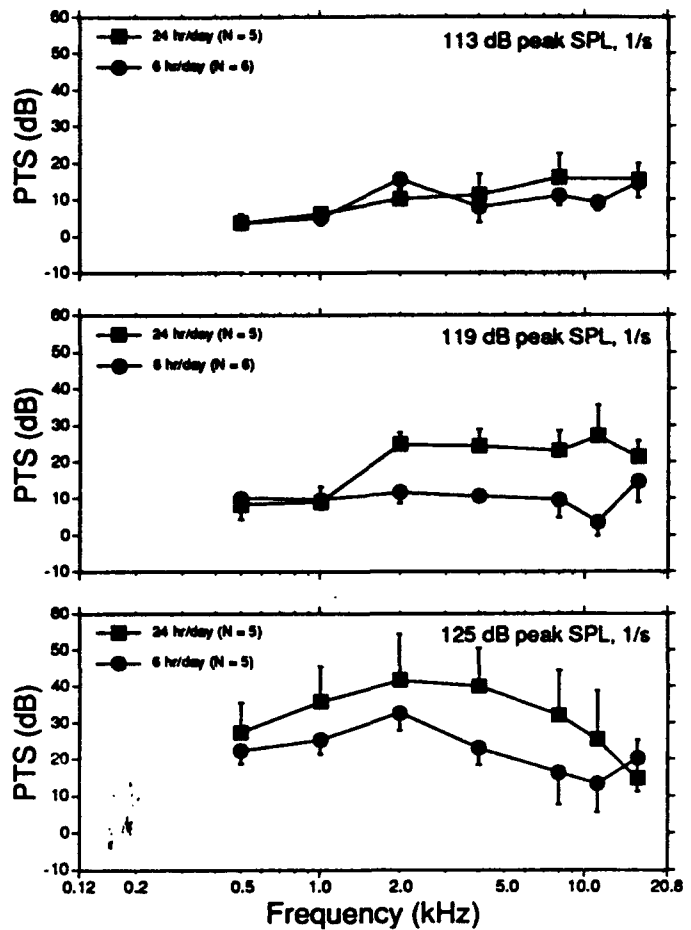

Figure 5. A comparison of selected group mean sensory cell loss across the length of the cochlea for the interrupted and non-interrupted (equal-energy) exposure paradigms at 113, 119 and 125 dB peak SPL. Error bars represent one standard error of the mean.

impact level for each of the three test frequencies. For the three frequencies that were tested daily, the amount of recovery systematically decreased as a proportion of the initial shift when the peak level or energy of the exposure increased. The PTS measured following a thirty-day recovery period is shown in Figure 4. In this figure, the PTS measured following the interrupted paradigm is compared to that measured from an equal energy exposure using the same impacts presented 24 hr/day for five days (Ahroon et al., 1993). The data for 107 dB are not shown since the exposure did not produce a significant PTS, and an equal energy comparison group is not available. While the largest  $TS_x$  was seen with the 113 dB exposures, there were no significant differences in PTS between the two groups. However, at the two higher level exposures, there were 15 to 20 dB differences in the mean PTS produced by the two equal-energy paradigms at most frequencies. Two way analyses of variance with repeated measures on one factor (frequency) were performed on the PTS data and on the outer and inner hair cell (OHC, IHC) loss data shown in Figure 5. For the pair of 113 dB exposures, there were statistically significant main effects of group and frequency and a significant group by frequency interaction for the IHC losses and a significant main effect of group and interaction with frequency for OHC losses. Losses in the non-interrupted group primarily at 4 kHz were responsible for these results. For the PTS measures, there were no statistically significant differences between the interrupted and non-interrupted paradigms. For the 119 dB exposures, there were statistically significant main effects of group and frequency and a statistically significant interaction for both the IHC and OHC cell losses, and a statistically significant main effect of group for the PTS data. The largest variability across animals was found in the 125 dB groups, and thus, despite the suggestive differences seen in the mean data in all indices of trauma (PTS, IHC loss and OHC loss) there were no statistically significant differences between the interrupted and non-interrupted paradigms.

Based upon these data there are peripheral cochlear mechanisms which effectively cause the auditory system to develop a resistance to threshold shift with repeated exposures to impact noise. The recovery of  $TS_x$  is reflected in a reduced PTS and sensory cell loss. The results of such an exposure paradigm are in conflict with the equal energy hypothesis.

#### References:

- Ahroon, W.A., Hamernik, R.P., and Davis, R.I. (1993). Complex noise exposures: An energy analysis. *J. Acoust. Soc. Am.* 93(2):997-1006.
- Canlon, B., Borg, E., and Flock, A. (1988). Protection against noise trauma by pre-exposure to a low-level acoustic stimulus. *Hearing Res.* 34:197-200.
- Clark, W.W., Bohne, B.A., and Boettcher, F.A. (1987). Effects of periodic rest on hearing loss and cochlear damage following exposure to noise. *J. Acoust. Soc. Am.* 82:1253-1264.
- Henderson, D., Hamernik, R.P., and Hyson, K. (1979). Hearing loss from simulated work-week exposure to impulse noise. *J. Acoust. Soc. Am.* 65:1231-1237.

# THE EFFECT OF SOUND TRANSFER FUNCTION TO THE TYMPANIC MEMBRANE ON NOISE INDUCED HEARING LOSS

P.A. Hellström  
Hearing research lab. Lindholmen Development  
Gothenburg, Sweden.

## Abstract

The influence of individual sound transfer functions (STFs) from free field to the ear drum on noise induced hearing loss (NIHL) was studied in two experiments. The STFs were measured with a miniature microphone provided with a probe-tube in an anechoic chamber. Three groups of subjects (12 subjects in each group) with significantly different STFs in the frequency range 2 - 4 kHz were exposed to narrow band noise with center frequency at 2 or 4 kHz. The subjects were exposed twice to each type of noise stimuli at different occasions. Hearing thresholds were registered with Békésy audiometry before and after the exposure and the temporary threshold shift (TTS) was calculated. The average TTS differed significantly between groups.

In a second study the STF was measured to the left and right ears in fifty 16-year-old male subjects adopting the method described above. The subjects' STF characteristics were compared to the high frequency hearing thresholds from left and right ears registered with Békésy audiometry. The statistical analysis showed significant differences in hearing thresholds between groups of subjects with different STFs in the frequency range from 3 to 4 kHz. Further, the hearing thresholds were significantly correlated (frequency range, 3.0 - 5.75 kHz) to the frequency of maximum STF. Subjects with maximum STF at 2 kHz showed more hearing loss than those with maximum STF at 4 kHz.

## Introduction

The acoustics of the outer ear influence the transmission of sound to the ear drum (1, 2, 3). From a diffuse field the SPL increases with about 15 dB to the ear drum, in the frequency range 2.5 - 3.15 kHz and from some directions in free field the SPL increases with more than 20 dB to the ear drum (1). These changes in sound transformations are due to the standing wave of the lowest mode in the outer ear canal (4). With an artificial shift of the frequency of the lowest mode the frequency of maximum TTS will change (5). Further, individual variations in the ear canal acoustics could influence the TTS (6). The ear canal volume could interact with both TTS and permanent hearing loss (7, 8).

## Material and methods

The middle ear function and acoustic reflex were measured with an impedance bridge (Grason Steadler GSI 33).

The audiometer was a computerized pulsed-tone Békésy (Entomed SA 260PA) with a linear-frequency sweep from 0.5 to 8 kHz and an attenuator response of 2.5 dB/sec.

The experiments were performed in an anechoic chamber (3.6 x 3.2 x 2.0 m).

**STF:** The experimental sound used for measurement of the STFs was white noise (Bruel & Kjaer 1405) amplified by (Adyton XP3). The subject was exposed with the experimental sound from a loudspeaker (Tannoy T165) positioned in front of the subject (00° azimuth) and at the same height as the ear canal entrance (00° elevation) at a distance of 1.2m.

The probe provided miniature microphone used in this experiment was an electret microphone (Knowles EA 1842). The microphone was connected to a real time 1/3-octave band analyzer (Norwegian Electronic 830). The microphone system was calibrated with a sound level calibrator (Bruel & Kjaer 4230, with probe tube adaptor DB0181). The microphone system, experimental chamber and the methods for using these in STF measurements are described by Hellstrom (1993) in detail.

**TTS:** From a large number of subjects with known STFs, 36 were selected to the experiment. The selection was based on their STF and if they had normal hearing (pure tone hearing threshold better than 20 dB HL in the frequency range 0.125 - 8kHz). Their STFs would either be low-, mid- or high-frequency dominated. The criteria for these three STF-groups were the relation between the STF-magnitudes at the 2 and 4 kHz 1/3-octave bands. If the STF-magnitude at 2 kHz exceeded the 4 kHz magnitude with more than 3dB the subject belonged to the low-frequency group (Low-f), if the opposite was true the subject belonged to the high-frequency group (High-f) and if the difference in magnitude between these 1/3-octave bands was less than 1,5 dB the subject belonged to the mid-frequency group (Mid-f). Twelve subjects were selected for each of these groups with a mean age of, 22, 19 and 22 years, respectively.

The exposure signals were 2 and 4 kHz narrow band noise.(3% width) (Bruel & Kjaer 1621).

Each subject was exposed at four different occasions for one of the exposure signals, twice to 2 and 4 kHz, respectively. The experimental order was randomized. The sound pressure level at a position corresponding to the center of the subject's head was 97 dB re 20 uPa for both exposure frequencies. The subject was seated on a chair in front of the speaker at a distance of 1.2 m, the left ear canal was occluded with an E-A-R<sup>(R)</sup> foam earplug, and the right ear was exposed for 10 min. Pre- and post-audiograms were registered with the Békésy audiometer and stored. The threshold was defined as the mean value between the end-points of excursions. The TTS was calculated from the average pre- and post-exposure audiograms.

**PTS:** From a school close to the research laboratory, all 16-year old students' hearing status were registered. Subjects were deleted from the study for the following reasons: an abnormal middle ear pressure, a known history of hearing loss caused by other factors than noise, tinnitus, or were treated by drugs that have known effects on hearing. From a total of 61 students, 50 were selected to the study. Their hearing thresholds from both ears were registered by Békésy audiometry. The subjects' STFs were measured from free sound field to the tympanic membrane in the anechoic chamber. Adopting the same method as described above (TTS) the subjects were divided in three groups; Low-freq, Mid-freq and High-freq.

## Results

**TTS:** The average STF within groups are displayed in Fig 1. The magnitude difference between 2 and 4 kHz was 4.8 dB in Low-f group, -0.3 dB in the Mid-f group and -5.3 dB in the High-f group.

The most dominant 1/3-octave was 2.5 kHz in the Low-f and Mid-f group and 4 kHz in the High-f group.

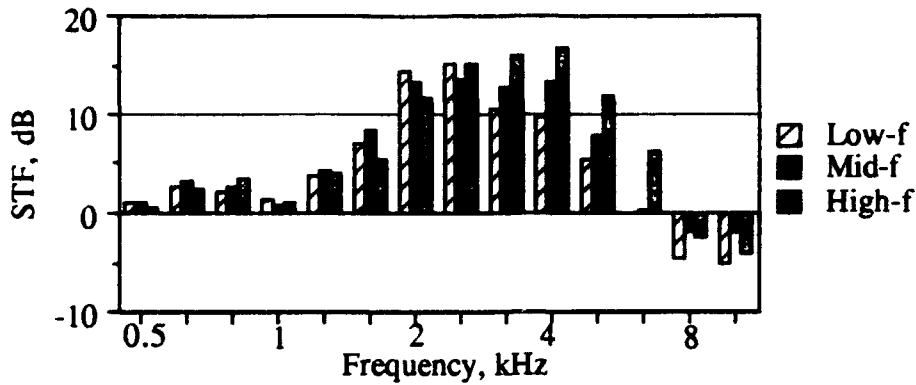

Figure 1. The average STFs within the three groups, Low-f, Mid-f and High-f.

The Low-f group acquired more TTS than the Mid-f and High-f groups after the 2 kHz exposure. After the 4 kHz exposure the High-f group showed more TTS than the other groups. The average differences in TTS between the 2 and 4 kHz exposures for each group are illustrated in Fig 2. A positive value indicates that the 2 kHz exposure resulted in more TTS than the 4 kHz exposure. As this figure indicates, the Low-f group evidenced more TTS after the 2 kHz exposure than after the 4 kHz exposure. The High-f group showed the opposite results and the Mid-f group was between the other groups. The frequency range of intersection in these lines is between 4.5 and 5 kHz. The differences in TTS between the Low-f and High-f groups were significant at 3.5, 5.5, 6.5 and 7.5 kHz ( $p < 0.05$ ). The corresponding differences between the Low-f and Mid-f groups were significant at 5.5, 6 and 6.5 kHz ( $p < 0.05$ ).

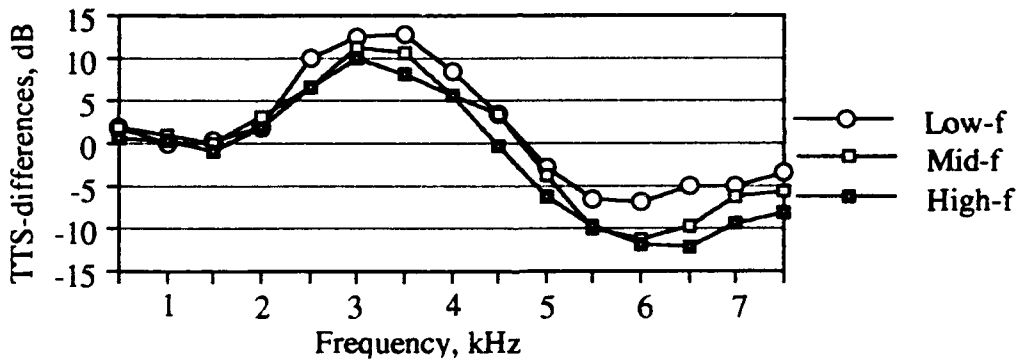

Figure 2. The average difference in TTS within groups after 2 and 4 kHz exposures. Each line illustrate the average difference from one of the three groups, respectively.

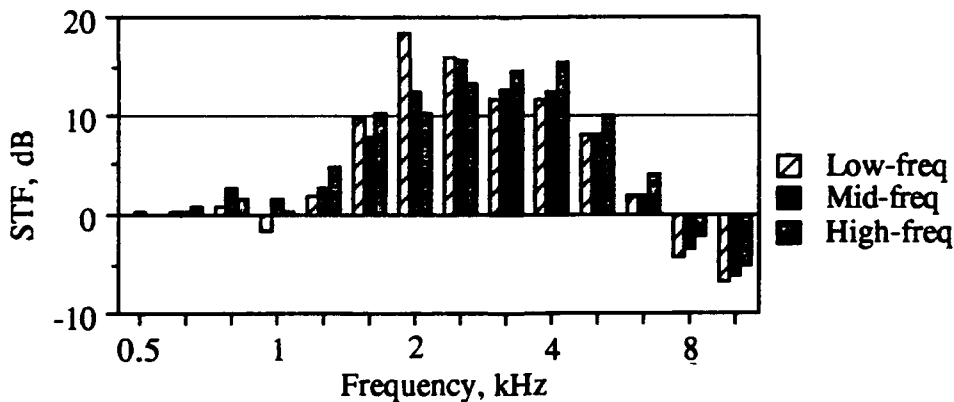

Fig 3. The bars illustrates the average STFs within the three groups in the PTS experiment.

**PTS:** In figure 3 the average STFs within groups are illustrated. The magnitude differ with 8 dB between the Low- and High-freq groups at the 2 kHz-band. The average hearing thresholds within the three groups are displayed in figure 4. The statistical analysis indicated significant differences between groups in the frequency range 3-4 kHz ( $p < 0.05$ ). Further, The Low-freq group showed significantly higher thresholds than the High-freq group in the frequency range 4.75 -7.5 kHz ( $p < 0.05$ ).

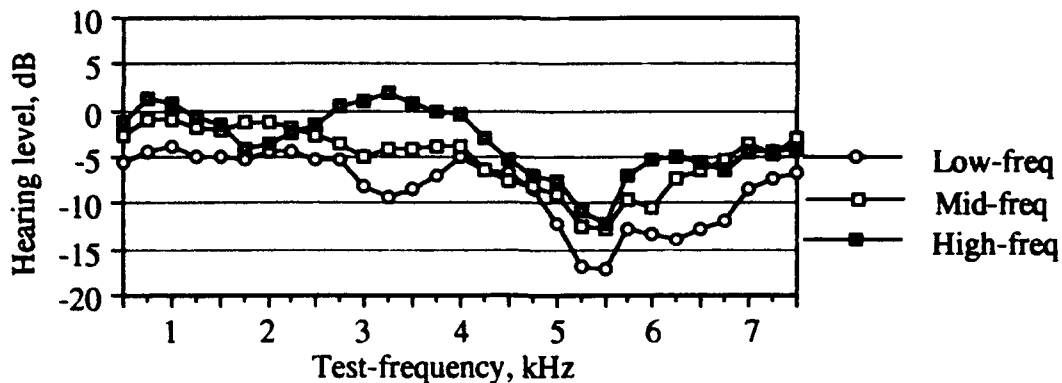

Fig 4. The three lines illustrates the average hearing thresholds within the three groups.

### Conclusion

In two experiments, we have shown that individual differences in STFs from free field to the ear drum could influence the sensitivity for NIHL. Subjects with significantly different STFs showed significantly different TTS after the same noise stimuli. Further, young male subjects with significantly different STFs had significantly different hearing thresholds in the frequency range between 4.5 and 8 kHz.

### References

- (1) Hellstrom, P.A., and Axelsson, A. Miniature microphone probe tube measurements in the external auditory canal. *J. Acoust. Soc. Am.*, 1993, 93, 2, 907-919.
- (2) Rabbitt, R.D., and Holmes, M.H. Three-dimensional acoustic waves in the ear canal and their interaction with the tympanic membrane. *J. Acoust. Soc. Am.*, 1988, 83, 1064-1080.
- (3) Stinson, M.R., and Lawton, B.W. Specification of the geometry of the human ear canal for the prediction of sound-pressure level distribution. *J. Acoust. Soc. Am.*, 1989, 85, 2492-2503.
- (4) Shaw, E.A.G. The external ear: New knowledge. *Scand. Audiol.*, 1975, Suppl. 5, 24-50.
- (5) Caiazzo, A.J., and Tonndorf, J. Ear canal resonance and TTS. *J. Acoust. Soc. Am.*, 1977, 61, 78-.
- (6) Rodriguez, G.P., and Gerhardt, K.J. Influence of outer ear resonant frequency on patterns of temporary threshold shift. *Ear and Hearing.*, 1991, 12, (2), 110-114.
- (7) Gerhardt, K.J., Rodriguez, G.P., Hepler, E.L., and Moul, M.L. Ear canal volume and variability in the patterns of temporary threshold shifts. *Ear and Hearing.*, 1987, 8, (6), 316-321.
- (8) Toremalm, N.G, Ivarsson, A. Bennerup, S., and Sheppard, H. The effect of ear canal volume in the development of noise-induced hearing loss. 1990, *Inter-Noise Proc.* 1223-1226.



## **TOUGHENING: ACOUSTIC PARAMETERS**

HENDERSON, Donald and SUBRAMANIAM, Malini  
Hearing Research Laboratory, State University of New York at Buffalo  
215 Parker Hall, Buffalo, New York USA

Several laboratories have reported that exposure to moderate levels of sound (Carlon et al., 1988 and Campo 1991) can protect subjects from more intense future exposures. In the Campo et al. experiment, chinchillas were exposed to an octave band noise (OBN) centered at 0.5 kHz at 95 dB SPL for 6 hours a day for 10 days. After the last exposure, the subjects were returned to quiet for five days and then they were re-exposed to the same noise, but at 106 dB SPL for 48 hours. Subjects with the prophylactic exposure developed 10 to 20 dB less permanent threshold shift than control subjects who were only exposed to the higher level noise. This paper reports on additional experiments that studied the generality of the "toughening" phenomenon. Specifically, the experiments address the question of whether a low frequency noise protects against future exposure to higher frequencies; if high frequency prophylactic exposures protect against future high frequency exposures; and, finally, how long does the prophylactic exposure have to be to be effective?

### **METHODS**

**Subjects:** Chinchillas (400-650 grams) were used as subjects. The left ear was surgically ablated and a permanent recording electrode was implanted in the region of the left inferior colliculus (Henderson et al., 1973).

**Audiological Testing:** Hearing levels were estimated using an evoked response and short duration signals ( 5 msec rise/fall, 10 msec on-time). Thresholds were measured at 5, 1, 2, 4, and 8 kHz before, during the 10 day "toughening" exposures, five days after the last of the 10 day "toughening" exposures and 30 days after the higher level traumatic exposures.

#### **Experimental Conditions:**

Experiment I: (a) .5 kHz OBN at 95 dB SPL, 6 hours/day for 10 days  
(b) 5 days quiet  
(c) 4 kHz OBN at 100 dB SPL for 48 hours

Experiment II: (a) 4 kHz OBN at 85 dB SPL, 6 hours/day for 10 days  
(b) 1 day or 5 days quiet period  
(c) 4 kHz OBN at 100 dB SPL for 48 hours

Experiment III: (a) .5 kHz OB at 95 dB SPL, 6 hours/day for 10 days  
20 days; or 1 and 10 days  
(b) 5 days quiet  
(c) .5 kHz OBN at 106 dB SPL for 48 hours

All experimental groups had appropriate controls. Furthermore, their pre-exposure thresholds were comparable to within the limits of the lab norm.

## RESULTS

**Experiment I:** The permanent threshold shift (PTS) for the experimental group exposed to the high frequency loss as shown in Figure 1 is approximately 20dB more than the control group exposed on to the high frequency noise. The "toughening" exposure did not protect against PTS, but may have actually made the subjects more vulnerable.

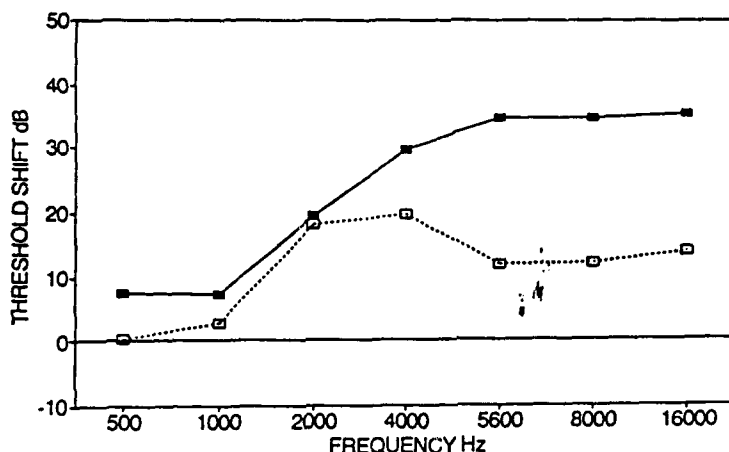

Figure 1. PTS following 4 kHz OBN exposure in the experimental (filled squares) and control group (empty squares).

**Experiment II:** Figure 2 shows the average daily threshold shifts for Experiment I and Experiment II. Both the 10 day toughening exposures produced progressively less temporary threshold shift over the 10 day period. The results for PTS are more complicated. Figure 3 shows that the group that was rested only 1 day developed significantly less PTS than the control group, however, the group that had a five day quiet period developed more PTS than both the control and other experimental groups. It should be noted that the group with only one day's rest has some residual threshold shift when they were exposed to the higher level noise, while the 5 day rest group had completely recovered.

**Experiment III:** The 10 day group had the majority of the threshold shift decrease over the first 3 or 6 days; the 20 day group paralleled the 10 day group and did not manifest any additional improvement over the last 10 to 14 days; the 1 and 10 day group showed some reduction on the second exposure (day 10) but much less reduction than the other two groups. The PTS for the three experimental and control groups is shown in Figure 4. All three experimental groups showed significantly less PTS than the control group. This result is surprising because the 1 and 10 day group had minimal reduction in TTS during the prior "toughening" exposures.

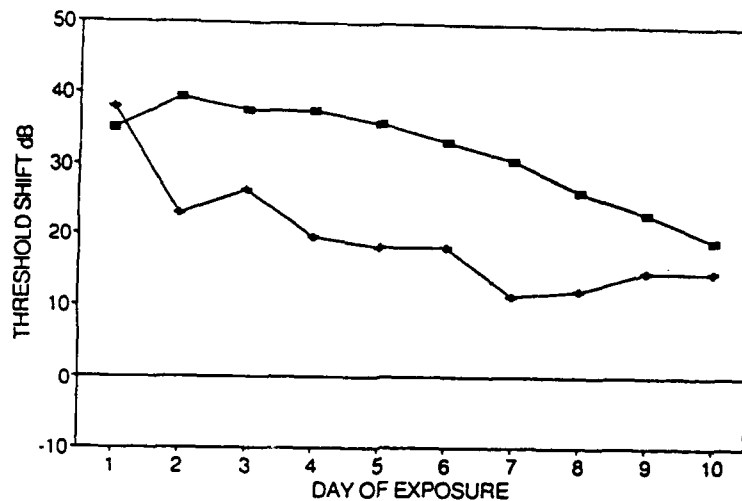

Figure 2. Average threshold shifts at the end of daily exposures at one octave above the exposure frequency for 0.5 kHz OBN (filled squares) and 4 kHz OBN (plus) "toughening" exposures.

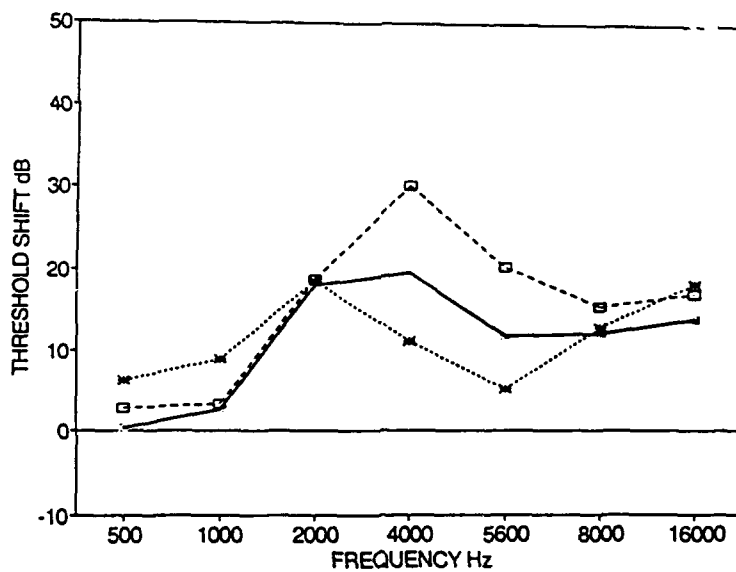

Figure 3. PTS following 4 kHz OBN exposure in control (filled squares), five day recovery group (empty squares) and one day recovery group (asterisk).

## DISCUSSION

All these experiments confirm the large reduction in TTS with repeated exposures. The high frequency exposures of Experiment II actually showed a larger change than the low frequency exposures. However, there appear to be differences in how the base and apex of the cochlea react to these prophylactic

exposures because the basal or high frequency end may be rendered more vulnerable with certain prior exposures.

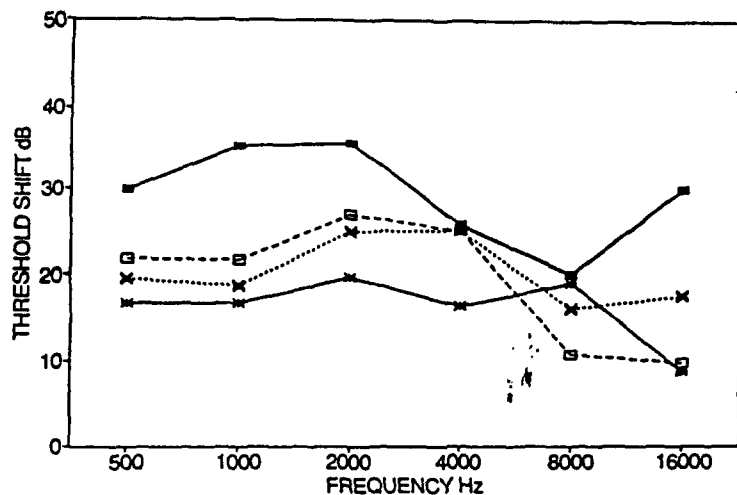

Figure 4. PTS in the control group (filled square), 10 day group (asterisk), and 1 and 10 days group (cross) and 20 day group (empty square).

The fact that the auditory system can be made more resistant with two relatively modest exposures (Experiment II and 10 day group) is quite remarkable. Future research on this problem is needed to learn the boundary conditions controlling "toughening" phenomenon as well as experiments to clarify the biological changes responsible for the phenomenon.

## REFERENCES

- Campo, P., Subramaniam, M. and Henderson, D. (1991) The effect of "conditioning" exposures on hearing loss from traumatic exposure. *Hear. Res.* 55, 195-200.
- Canlon, B., Borg, E. and Flock, A. (1988) Protection against noise trauma by pre-exposure to a low level acoustic stimulus. *Hear. Res.* 3, 197-200.
- Henderson, D., Hamernik, R.P., Woodford, C., Sittler, R.W. and Salvi, R. (1973) Evoked-response audibility of the chinchilla. *J. Acoust. Soc. Am.* 54, 1099-1101.

(Work supported by NIH 5R010H0115211)

**The Use of Industrial Surveillance Data for Noise Exposure: A Noise  
Induced Hearing Loss Researcher's Nightmare  
Chicago, Illinois  
(Preliminary)**

**ISHII, Erick K., M.P.H.  
TALBOTT, Evelyn Dr.P.H.**

**Department of Epidemiology  
Graduate School of Public Health  
University of Pittsburgh  
130 DeSoto Street  
Pittsburgh, PA 15261  
U.S.A.**

**ABSTRACT**

The use of surveillance data as a means of assessing historical noise exposure reconstruction in an occupational setting still raises heated debates. Currently, the types of data that are available for noise exposure are: personal noise measurements, job specific data, area wide noise levels (i.e., department data), ordinal ranked job or tasks, duration of employment, and ever/never employed in the industry (i.e., noisy vs. less noisy plant). Although the preference in exposure assessment is personal monitoring data, in many cases data do not exist, or are sparse and there is a question as to their validity when they are available. Most surveys use point source meters, not personal dosimeters, the industrial hygienist assumes that the noise levels are constant throughout the work day. This tends to underestimate the risk because most meters are read based on the midpoint of the dBA meter swing and dB scale has a logarithmic basis. The historical surveillance data was requested from the metal fabricating plants located in Chicago, Illinois. Upon interviewing the union leaders and plant management personnel, we determined that the noise levels decreased with the enforcement of the OSHA regulation and further decreased after the installation of the acoustical material (i.e., acoustical tile, and curtains) even without a major change in the metal fabricating process from the plant's opening. Thus, it was determined that the minimum amount of quantitative information to do a historical area wide exposure assessment was three time periods: pre-OSHA (before 1972, (T1)), post-OSHA to pre-acoustical modification (1972-1975, (T2)) and post-acoustical modification (after 1975, (T3)). When data on past exposure exist the principal concerns is the completeness of the data and the ability to combine data obtained from the various time periods that used differing methods of data acquisition. These concerns were encountered as there were only data on four departments in T1, eight in T2 and nine in T3. Furthermore, two of the four T1 areas increased in noise levels in T2 and five of the eight T2 areas increase in noise levels in T3 (especially since there should have been a decrease in noise levels). The reasons for discrepancies in the T1-T2 levels are because OSHA regulations are measuring for PELs and, therefore, its usage will generally be an over-estimation. The discrepancy in T2-T3 occurred because the measurement techniques changed from area wide surveillance to "personal monitoring" because of the OSHA regulation. Another problem

encountered is if one is constantly exposed to non-occupational noise; are the ISO guidelines more appropriate even though in the U.S. workplace OSHA is applied with full intensity of the law? Finally, leaving us with the question: Is the current surveillance data appropriate to use for this historical exposure reconstruction based on the fact that the process has not changed and that "personal monitoring" gives us a better estimate of exposure?

## Introduction

The U. S. Department of Health and Human Services has estimated that 8 million workers in the United States are exposed to potentially hazardous daily levels of occupational noise of greater than 80 dBA.<sup>1</sup> It is estimated, in the U.S. alone, that at least one million workers, in manufacturing have sustained work-related hearing impairment (>25 dB average hearing threshold at 1, 2, 3 kHz).

The association of noise induced hearing loss (NIHL) as a consequence of occupational noise exposure at relatively high exposure rates has been well documented. Since the 1800's, individuals working in industry began to show a trend between exposure and NIHL.<sup>1</sup> Cross-sectional/case-control studies of industrial cohorts indicate that noise exposure is the common factor in producing NIHL (the industrial workers were exposed to a broad spectrum of concomitant noise). The occupational guidelines in the United States were evaluated in the early 1970's and have since been lowered to the current action level above 85 dBA.<sup>2</sup>

Risk assessment is tied to exposure estimation and the sound equivalent level [SEL (5 dB trading value)] or noise immission level [NIL (3 dB trading value)] model.<sup>3,4</sup> Several factors are required to determine the environmental NIHL risk from occupational noise exposure:

- exposure-response relationship;
- exposure versus population;
- limitation, history and purpose of surveillance data;
- limitation of self report data; and
- relevant exposures of the population.

This paper will attempt to show some of the difficulties of using currently available surveillance data in assessing the true NIHL risk from occupational noise exposure and proposes a method analogous to the NIL method of assessing exposure that may have validity.

## Methods

The current retrospective prospective study was carried out using 285 of the 329 participants who worked in a noise exposed environment and could self report enough information [i.e., work department history (including time in location), hearing protection (HP) usage] to derive a noise exposure history. The initial calculated sample size for this plant was 400. The metal fabricating plant in the study had an extensive hearing conservation program (HCP) and required use of HP because their best administrative noise controls were not enough to meet Occupational Safety and Health Act (OSHA) regulations. Although, for various reasons, some of the workers did not wear the hearing protection.

The authors examined the exposure-response relationship between hearing loss (average dB loss at 1, 2, 3 and 4 kHz right ear), and A-weighted SEL, or NIL; trying to correct for HP attenuation. The clinical examination included measures of body mass index (BMI), high blood pressure (HBP), audiometric evaluation, detailed medical/personal habits, alcohol intake, smoking

history, noisy hobbies and occupational/military histories. Individuals found to have conductive hearing loss were excluded.

Since audiometric testing had to be conducted prior to any noise exposure (hobbies, occupational noise exposure), the men were queried about activities 24 hours prior to clinical visit. A standardized automatic audiometric testing procedure was administered by National Institute of Occupational Safety and Health (NIOSH) certified technicians under the supervision of a certified audiologist.

The procedure used for conducting the pure-tone audiogram was similar to that specified in the American Speech and Hearing Association Monograph Supplement No. 9 and include the basic feature of the Hughson-Westlake technique for determining pure-tone hearing threshold. The following frequencies were tested 0.5, 1, 2, 3, 4, 6 and 8 kHz. All audiometric testing was performed in a testing booth which conformed to the American National Standard Criteria for Background Noise in Audiometric Rooms. The booth and site were checked by a Bruel-Kjaer sound level meter with built in octave filter set. A Grayson-Stadler Clinical Audiometer equipped with TDH-39 headphones were used for the audiometric evaluation. The audiometers were initially calibrated and periodically checked thereafter. The sound pressure output of the audiometer was calibrated monthly.

#### Analysis

The SAS CORR procedure (Version 6.07) (SAS, 1989) was used to calculate the Pearson product-moment correlations and significant probabilities for all numeric variables, as well as select univariate statistics (the mean, standard deviation, sum, minimum and maximum).<sup>5</sup> The two variables correlated were a composite hearing loss value [the averaged 1, 2, 3 and 4 kHz right ear air conduction (ARAC)] vs. a noise exposure value (calculated SEL or NIL). The SEL (OSHA) and the NIL (ISO) were based on:<sup>3,4</sup>

$$E_a = L_{eq} + 10 \log_{10} \left( \frac{T}{T_0} \right)$$

Where  $E_a$  = SEL or NIL;

$L_{eq}$  = the continuous sound level in dBA (using the daily OSHA 5 dB trading; value or ISO 3 dB trading value based on the 1986 survey);

$T$  = the duration of the exposure expressed in calendar years;

$T_0$  = one calendar year.

The equal energy concept for hearing damage may be summarized in terms of following three hypotheses:

- In an individual equal amounts of A-weighted sound energy causes equal amount of damage to hearing;
- The extent of hearing damage that an individual accrues is proportional to a function of the acoustical energy received, although this relationship may not be a linear function; and

- A trading relationship exists between exposure time and noise level, the product of the two being a measure of the total acoustical energy received. (However, it is still heatedly debated as to whether this trading relationship is 3 dB or 5 dB.)

To estimate the correction for HPD'S the Environmental Protection Agency's noise reduction rating (NRR-7) was used as the maximum possible attenuation and it was further degraded by increments of 10 percent from 100 to 0 (i.e., 100, 90, 80, 70, ..., 0 percent). A further degradation procedure was use based on E·A·RLOG-20 (i.e., .70 for ear muffs, .50 for foam inset plugs, .20 for pre-molded insert plugs).<sup>6</sup> For those that reported wearing an HPD but did not recall the brand; we assigned them the most conservative NRR number and degradation factor.

### Results

Figure 1 is a display of three different surveys at four locations for this plant. These surveys were selected to represent the three periods in the plant (pre-OSHA (before 1972), OSHA to pre- acoustic curtains and tiles (1972-1975), and post-acoustic material 1975 to end of study). The distribution, except for the Skilled Trades Department, generally show that the noise levels measured decreased in the 1972-73 survey (Initial OSHA survey) and increased in the 1986 noise survey levels (all obtained surveys in the 1980's showed similar numbers).

Figures 2 and 3 show significant correlations, between ARAC and SEL (or NIL), for all percentages of A-weighted NRR values and the degradation percentage of the HPD'S based on the E·A·RLOG-20 (also significant).<sup>6</sup> There appears to be a break point, in both figures, between 50 and 60 percent where there is no a linear increase in the correlation. Even the correlation value for the E·A·RLOG-20 here is similar to those found at the 50 percent degradation.

### Discussion

The data described in this report suggest that using current surveillance is not the ideal method to ascertain exposure. However, because of historical changes in surveillance method (area wide to personal dosimeter) and assuming there is no change in the manufacturing process, current surveillance may provide a conservative estimate of noise exposure.

Also confounding this issue is the use of HPD's. It appears that HPD's are efficient at approximately 50 percent of the NRR value obtained using the Real Ear Attenuation (REAT) method specified by EPA in the real world setting. However, degrading the HPD based on type (ear muff, foam insert ear plug, pre-molded insert ear plug) may be more appropriate.<sup>6</sup> In addition, a major limitation of this study is that the information is self reported. Still, one could argue that this is more conservative than assuming that required protective devices are actually used.

Given the paucity of knowledge regarding the auditory and non-auditory effects of occupational noise, and the associated public health burden, prospective epidemiologic studies using careful standardized measurement techniques are needed to investigate this industrial health problem. The design of new methodologies for evaluation of exposure is also an important research priority.



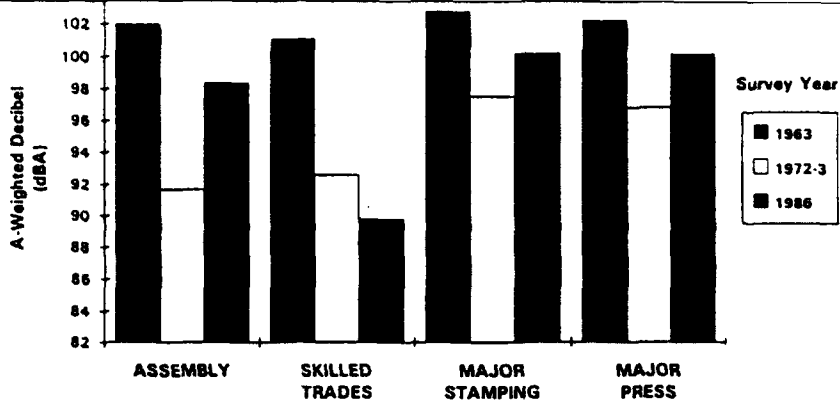

Figure 1 - Historical Noise Survey of Metal Fabricating Plant (1963, 1972-3 and 1986)

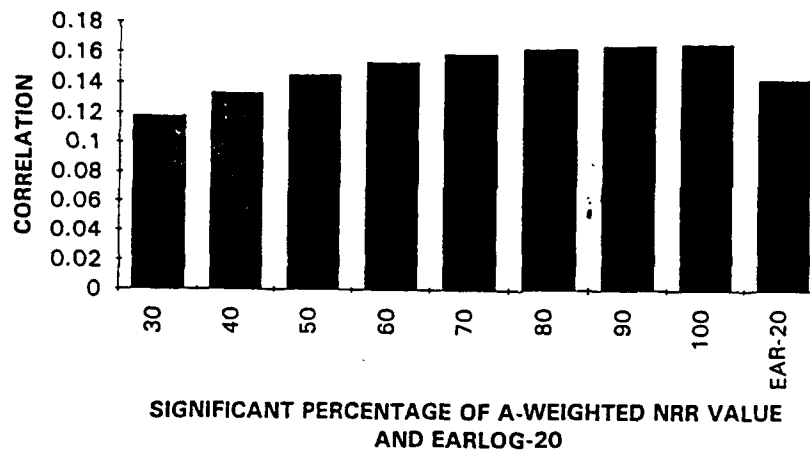

Figure 2 - Correlation between significant ( $P < 0.05$ ) Sound Exposure Level With Percent of A-Weighted NRR Value Correction, EARLOG-20 and Average Better Ear (1, 2, 3 and 4 kHz) In the Metal Fabricating Plant.

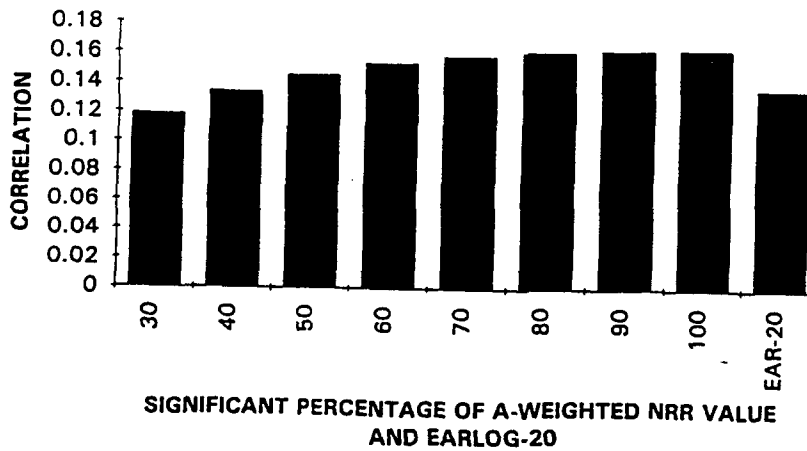

Figure 3 - Correlation between significant ( $P < 0.05$ ) Noise Immission With Percent of A-Weighted NRR Value Correction, EARLOG-20 and Average Better Ear (1, 2, 3 and 4 kHz) In the Metal Fabricating Plant.

## Reference

1. DHHS (NIOSH). *NIOSH Proposed National Strategies for Prevention of Leading Work Related Disease and Injuries -- Noise Induced Hearing loss*. U. S. Department of Health and Human Services, Public Health Service, Center for Disease Control, National Institute for Occupational Safety and Health, Division of Standards Development and Technology Transfer. NIOSH Publication No. 89-135; 1988.
2. U. S. Federal Register. *Occupational Noise Exposure; Hearing Conservation Amendment Final Rule*. Department of Labor, Occupational Safety and Health Administration; March 8, 1983.
3. Berger EH, Ward WD, Morrill JC, Royster LH. *Noise & Hearing Conservation Manual*. Akron, Ohio: American Industrial Hygiene Association; 1988.
4. Martin A. Energy Concept Applied to Impulse Noise. In: Henderson D, Hamernik RP, Dosanjh DS, Mills JH. *Effects of Noise on Hearing*. New York, NY: Raven Press; 1976:421-452.
5. SAS. *SAS Procedures Guide, Version 6, Third Edition*. Cary, NC: SAS Institute; 1989.
6. Berger EH. *E·A·RLOG-20: The Naked Truth About NRR*. Indianapolis, IN: Cabot Safety Corporation; 1993.

# DIPS IN THE HIGH-FREQUENCY RANGE AFTER STEADY-STATE NOISE EXPOSURE

KÖHLER Wilfried, Walter FRITZE and Alois HERBST

ENT Department  
Vienna University Medical School  
A-1090 Währingergürtel 18  
Austria

**Abstract:** In the literature anecdotal reports have been published on dips in high-frequency audiograms of noise-working men. These were either seen in single tracings or in averaged audiograms. To shed light on their occurrence high-frequency Békésy audiometry was done. This showed major dips to be present, which may well contribute to our understanding of cochlear mechanics, specifically of the mechanisms underlying the production of the 4-kHz dip.

Ever since audiometry helped to detect the typical sign of noise-induced cochlear damage in noise-working men, i.e. the PTS dip at 4 kHz, the causes underlying its occurrence have been a matter of controversy. In this controversy it was, however, usually forgotten that this was not the only dip seen. Dips in the high-frequency range were, in fact, shown in several papers. In most studies single tracings of noise-working men or averaged audiograms recorded at more or less identical noise exposure levels were presented [Fletscher, 1973; Fausti et al., 1981; Dieroff, 1982; Laukli and Mair, 1985]. But like the 4 kHz dip, dips in the high-frequency range show considerable interindividual frequency variations. As a result, they are largely extinguished in summation images and audiograms at best show shallow notching reflecting their main frequencies. In addition, audiograms are usually recorded at intervals of 1 kHz so that the dips, which are often quite narrow-based, are poorly defined.

The purpose of this study was to document the interindividual variability of these dips. Testing was done with a self-made computer-controlled sweep-frequency Békésy audiometer (pulse time 475 ms; pulse interval 225 ms; trapezoid 25 ms; pulse-to-pulse frequency interval 10 Hz; synthesizer HP 3325 A). For the frequency range of conventional audiometry TDH 39 earphones were used. The high-frequency range was tested with KOSS HV1A headsets. The frequency response was linear.

Using this set-up, 42 normal subjects and 74 noise-working men were tested. In noise-working men the problem with high-frequency audiometry is that the subjects should be young enough to hear sufficiently well in the high-frequency range, but that they should still have gone through a sufficient number of noise-working years to produce recognizable dips. This explains why not all of the high-frequency audiograms were evaluable.

The illustration shows the tracings of 20 subjects. The interruption between the 2 frequency ranges tested is attributable to the change of earphones. In some subjects high-frequency-range testing was done in 2 segments because of fatigue.

Dips can be seen to vary substantially in terms of their size. They mainly occur at the following frequencies:

- 3.5 - 5.2 kHz for the well-known PTS dip
- 8 - 10.8 kHz
- 12.6 - 15 kHz.

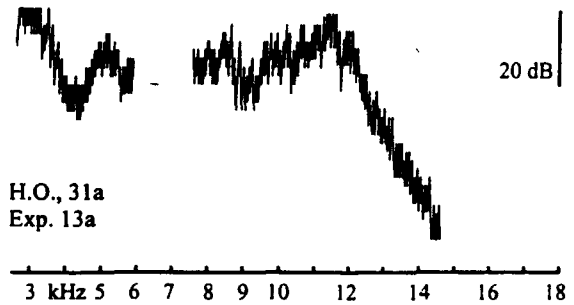
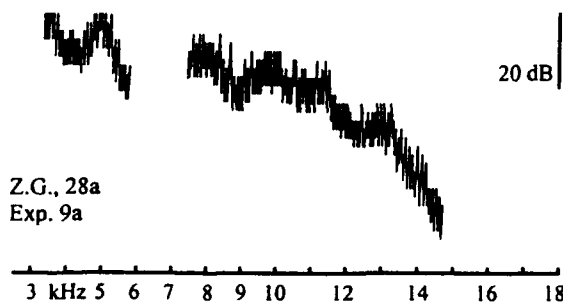
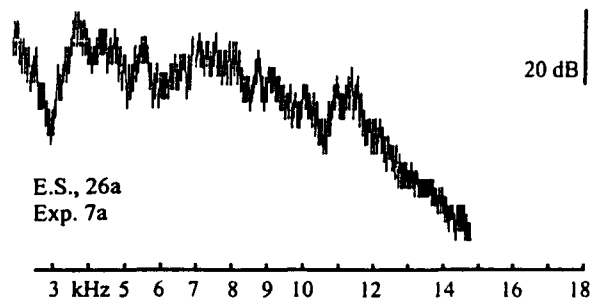
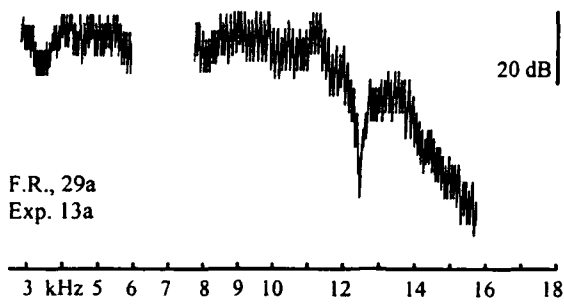
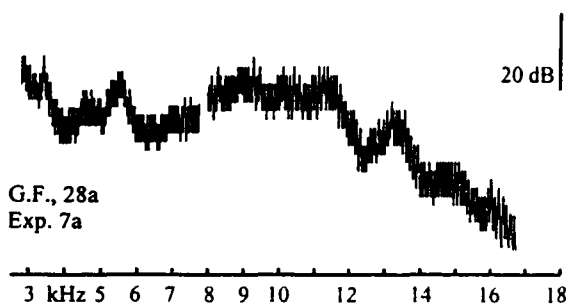
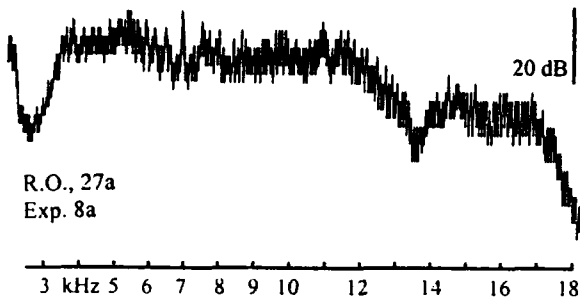
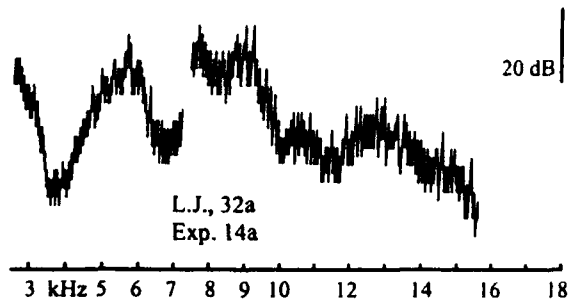
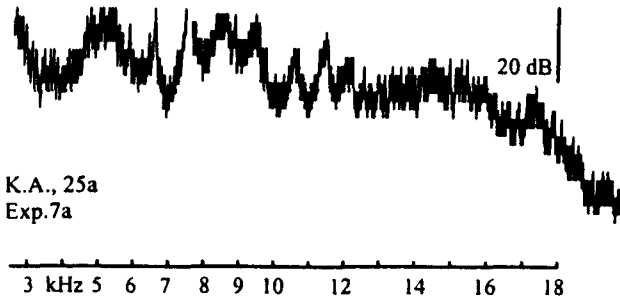

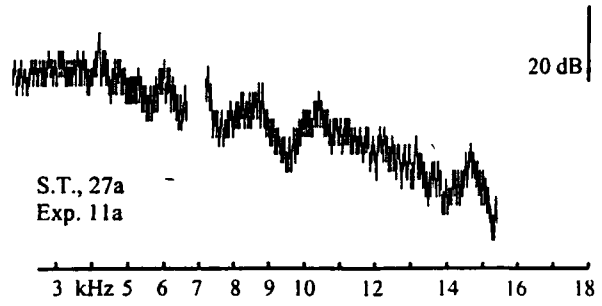
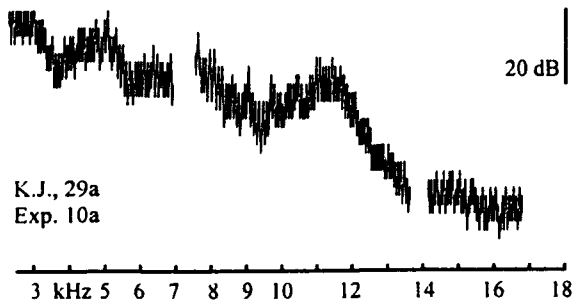
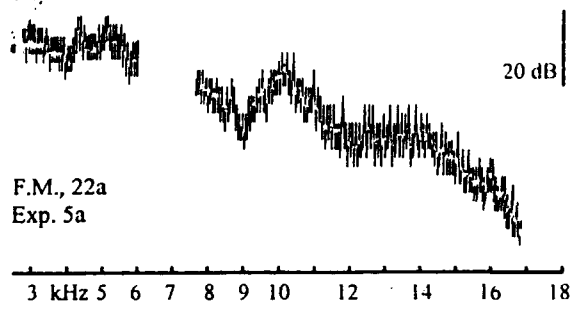
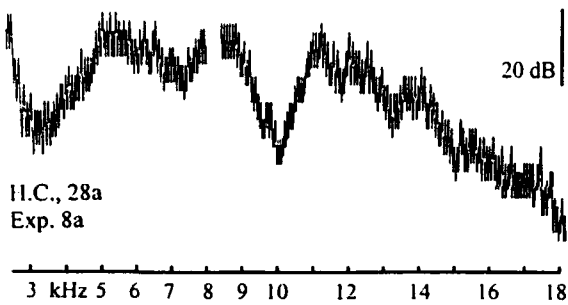
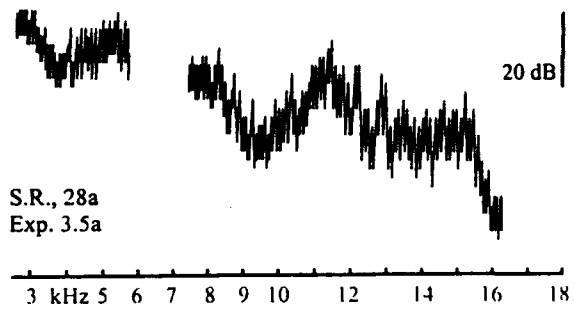
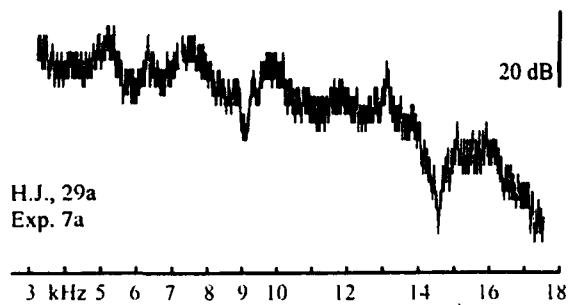
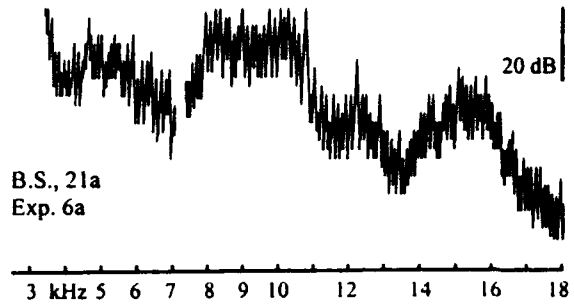
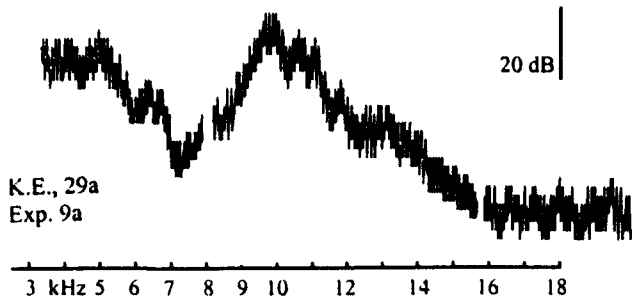

Vague evidence of these characteristics is also found in the studies quoted. In addition, there is good agreement with TTS experiments [Fritze and Köhler, 1986].

Interindividual variability is not only a feature of the dips in the high-frequency range; in the presence of these dips the well-known 4-kHz dip is often absent and in some subjects more than one dip is identifiable. (Some of these subjects underwent repeated testing with good reproducibility.) Like the occurrence, the frequency of the dips is quite variable. Attempts at detecting a consistent mathematical pattern proved to be abortive.

In normal subjects dips in the high-frequency range were rare or altogether absent. Together with their variable frequency this rules out a calibration error.

Apparently, the dips in the audiograms are attributable to vibrations which, while causing chemical damage, do not produce perceived auditory phenomena. That the damage is located at the level of the hair cells is supported by the work of Fridelius et al. [1987]. It may well be that these dips will help to improve our understanding of inner ear mechanics.

#### Literature:

- Dieroff HG (1982) Behavior of High-Frequency Hearing in Noise. *Audiology* 21:83-92
- Fausti SA, Erickson DA, Frey RH and Rappaport ZB (1981) The Effects of Impulsive Noise upon Human Hearing Sensitivity (8 to 20 kHz). *Scand Audiol* 10:21-29
- Fletscher JL (1973) High-Frequency Hearing and Noise Exposure. *Proceedings of the Int. Cong. on Noise as a Public Health Problem (Dubrovnik)* 271-280
- Fredelius L, Johannsson B, Bagger-Sjöbäck and Wersäll J (1987) Qualitative and quantitative changes in the guinea pig organ of Corti after pure tone acoustic overstimulation. *Hearing Research* 30:157-168
- Fritze W and Köhler W (1985) Temporary Threshold Shift Frequency Profiles After Low-Tone Exposure. *Arch Otorhinolaryngol* 242:49-51
- Laukli E and Mair IWS (1985) High-Frequency Audiometry. *Scand Audiol* 14:151-158

## **AUDITORY HAZARD IN RELATION TO LISTENING TO PORTABLE DIGITAL COMPACT-DISC PLAYERS.**

LOTH Drystan, AVAN Paul, TEYSSOU Monique,  
MENGUY Colette.

Service de Biophysique, P.A.M. Neurosensoriel,  
Hôpital Lariboisière, U.F.R. Paris VII,  
Pavillon P. Laurent, 2 r. A. Paré 75010 Paris.

### **SUMMARY**

The recent availability of portable high-performance digital disc-players in addition to cassette players, and with an increasing dynamic range, has enhanced the risk to hearing of their users. The present study aimed at attempting to evaluate this hazard. After selection of a digital player, 12 normally-hearing voluntary subjects were exposed to listening to two records (classical music and hard-rock) at an acoustic level complying with safety regulations. Their temporary threshold shift (TTS) were determined at 4 and 6 KHz just after exposure. The 0,5 KHz auditory thresholds were also measured as a control. At 4 and 6 KHz, the average value of TTS was 5 dB. There was no statistically significant difference neither between the TTS at 4 and 6 KHz, nor between TTS for the two records. The measurements have pointed out that very high acoustics levels could be reached (125 to 127 dBA) with a Leq (1 hour) of 110 dBA i.e much higher than tolerable levels. Thus there is a serious risk to hearing.

### **ÉTUDE DES RISQUES AUDITIFS SECONDAIRES A ÉCOUTE DES ENREGISTREMENTS NUMÉRIQUES SUR DISQUE À L'AIDE D'APPAREILS PORTABLES**

### **RESUME**

L'apparition récente, après celle des baladeurs, de lecteurs numériques portables aux performances exceptionnelles, en dynamique notamment, a augmenté les risques auditifs encourus par les utilisateurs. Le but de cette étude est de tenter d'évaluer ces risques. Après sélection d'un lecteur numérique, 12 sujets volontaires normaux ont été soumis à l'écoute de deux disques (musique classique et hard-rock) à des niveaux acoustiques inférieurs aux normes de sécurité. Leurs déficits auditifs temporaires (TTS) ont été mesurés immédiatement après exposition. La fréquence 0,5 kHz a été également évaluée à titre de témoin. A 4 et 6 kHz, on constate que la valeur moyenne des TTS est de 5 dB. Il n'a pas été trouvé de différence statistiquement significative entre TTS à 4 et 6 kHz et entre TTS pour un côté et une fréquence donnés selon le type de musique. Les mesures montrent que des niveaux acoustiques considérables peuvent être atteints. : 125 à 127 dB crête avec un niveau acoustique continu équivalent 1 heure de 110 dB (A), valeurs très supérieures aux normes. Le risque auditif existe donc.

## INTRODUCTION

There has been a considerable development of portable music players such as walkman® (analog) and discman® (digital) during these last years. Their users often express concern about the possible risk to hearing of these devices, and especially discmen, in view of the large acoustic dynamic range enabled by digital recordings.

After a study of the acoustical characteristics of 5 compact-disc (CD) players and their headphones (P1 to P5), 12 normally-hearing voluntary subjects have listened to 2 records played on one of the CD players (duration 1 hour, the 2 presentations being separated by several days). The exposure levels complied with safety regulations. A comparative test of hearing thresholds just before and a few minutes after exposure was carried out in order to evaluate the temporary threshold shifts (TTS) induced by listening to CD. Several characteristics of these 2 selected CDs were assessed on the different players with their output levels set to maximum, namely:

Leq (A) 1 hour

Max P (i.e. peak acoustical level)

$L_1$ ,  $L_{10}$ ,  $L_{50}$ ,  $L_{90}$  and  $L_{99}$  (repeated 4 times in an attempt to account more accurately for transients).

## OUTLINE OF THE MAIN RESULTS

1<sup>st</sup> record (CD1):

Leq (1 h) = 101 dBA

Max P = 121 - 123 dBA

$L_1$  = 109.5 dBA (i.e., during 1% of the time, the acoustic level was >  $L_1$ )

2<sup>nd</sup> record (CD2):

Leq (1 h) = 108 dBA

Max P = 126 - 127 dBA

$L_1$  = 114 dBA.

## CHOICE OF A PARTICULAR CD PLAYER AS A FUNCTION OF THESE RESULTS:

The device CD2 was kept for the experiment because it met the following criteria:

- a high output level, although not the highest of the 5 tested players,
- a marked peak in the frequency spectrum around 3-4 kHz, likely to induce TTSs in the most sensitive interval of the inner ear, 4-6 kHz.

## PARTICULAR SETUP FOR THE EXPERIMENT

The output level was adjusted on 2 particular subjects who were exposed to progressively increased levels, in order to produce some TTS (a few dB). Meanwhile, this level had to remain within the limits of comfort for the subjects and safety regulations (indeed, they were widely respected, namely  $L_{eq}(1h) = 93.7$  dBA for record #1 and 88.6 dBA for record #2 instead of 90 dB during 8 h, 5 days/week).

The histograms of levels of the 2 records were very different; the acoustic levels of CD1 were broadly distributed between 82.5 and 97.5 dBA whereas the level of CD2 was almost constant i.e. ranging from 87.5 to 92 dBA during 70% time.

Then the experiment aimed at evaluating the effect of listening to these two records on the pure-tone audiogram, i.e. on the TTS presented by the subjects after a period of exposure, with special attention to the classical TTS2 at 4 kHz measured 2 min after the end of the disk.



## AUDIOMETRY: OUTLINE OF THE METHOD

After a complete audiological checkup, an automatic audiogram (continuous tone, fixed frequency) was obtained at 0.5, 4 and 6 kHz just before starting the first record (duration 1 h). Another audiometric control was performed 30 s after the end of CD1, first for the left ear at 6, 4 and 0.5 kHz (duration of the measurement 1 min for each frequency, hence the auditory threshold at 4 kHz was obtained 2 min after the end of CD), then for the right ear. The same series of measurements was repeated several days later for CD2.

## RESULTS

As expected, the mean value of the TTS at 0.5 kHz did not significantly differ from 0 (this measurement permitted to check the consistency of test-retest auditory-threshold assessments, with the reasonable assumption that the exposures could not have any effect on low-frequency hearing). At 4 and 6 kHz, the following results were obtained.

- (1) The mean TTSs were of the order of 5 dB.
- (2) Comparisons between mean TTSs at 6 and 4 kHz for a given side and CD did not show any significant difference across frequency ( $p > 0.05$ , paired Student t-test).
- (3) Similarly, TTSs for a given side and frequency did not significantly depend on the type of music (CD1: classical, CD2: hard-rock).
- (4) In contrast, TTSs were slightly higher for the left ear (weakly significant,  $p = 0.05$ ).
- (5) When pooling all the TTS values obtained for CD1 and CD2, the difference between left and right became quite significant ( $p < 0.01$ ).

Several hypotheses may be proposed to account for this result:

- the audiometry is performed on the left ear 3 min earlier than the right one and some recovery may take place.
- moreover, at least for CD1, the acoustic levels played in the left ear were slightly higher owing to the disposition of the orchestra (however, there are also spectral differences between the two sides rendering very difficult to derive any practical consequence of such differences).

## CONCLUSION

- (1) The quality of small portable digital disc-players is so high that the maximum possible acoustic levels (namely around 127 dB with a Leq (1h) of around 108 dB) greatly exceed the recommended standards valid for occupational exposures, therefore creating an actual hazard for the listeners.
- (2) The TTSs recorded in more reasonable conditions corresponding to normal listening are of about 5 dB, in good agreement with what is expected owing to the delivered Leqs.
- (3) Therefore, it seems important to provide the users of portable CD players with accurate information on the chance they take in case of thoughtless use of such devices, for example in noisy backgrounds which may prompt them to raise the output level.

## ACKNOWLEDGEMENTS

This work has been supported by a grant of the French 'Ministère de l'Environnement', SRETIE, n° 90 366.



## ACTIVE NOISE REDUCTION HEADSETS

MCKINLEY, Richard L. and NIXON, Charles W.  
Armstrong Laboratory, Crew Systems Directorate, CFBA  
Wright-Patterson AFB, OH 45433-6573 USA

**ABSTRACT.** This paper reviews the accelerated growth of Active Noise Reduction (cancellation) headset technology over the past five years and describes the performance of current systems. The first active noise reduction (ANR) headset was not yet commercially available at the time of the last International Congress on the Biological Effects of Noise (ICBEN), "Noise 88," held in Stockholm in August, 1988. During the past five years a dramatic increase in the development and availability of ANR headset technology has occurred in both the European and American technical communities. Today numerous agencies, laboratories, and industrial establishments have efforts underway evaluating the potential applications of ANR technology while others work to produce circumaural ANR headsets, insert or semi-insert ANR headsets, and ANR earmuff systems without voice communications features. Most ANR headset systems in use today are used in aviation associated applications. This paper will describe the sound attenuation and speech communications performance of representative ANR headset technology. The limitations and advantages will be discussed as well as what can be expected from ANR headset systems.

**INTRODUCTION.** A revolution is underway in active noise-cancellation headset technology. The first commercially available active noise reduction (ANR) headset appeared on the market in the United States in the late summer of 1989 and today an estimated twelve or more different companies are involved in the development and marketing of ANR technology. Many of the early developments and evaluations were accomplished by the military because of their need to extend sound protection beyond the performance limits of traditional passive earmuff hearing protection devices. Information about the developments of ANR headsets and their performance has spread to the general public. Overall, active noise reduction headsets have been enthusiastically received and ongoing developments are being viewed with anticipation.

The growth of passive earmuff technology plateaued in the 1950's and 1960's. Over the years, good performing passive earmuffs have provided 20 dB to 40 dB of attenuation at frequencies of 1000 Hz and above with poor sound attenuation of 0 dB to about 25 dB at frequencies of 125 Hz to 250 Hz. Hearing damage risk is defined in terms of A-Weighted sound level in several noise exposure criteria for hearing. The overall A-weighted sound pressure level at the ear under an earmuff is often determined by the amount of acoustic energy present in the 125 Hz to 250 Hz region. A hearing conservation target is to increase low frequency sound attenuation to reduce the A-Weighted sound level at the ear. Active noise reduction headsets provide significantly improved attenuation of low frequency sounds up to about 1000 Hz. The combination active/passive attenuation found in ANR headsets, in addition to reducing noise exposure at the ear, can have additional benefits of reduced size, reduced headband force, and increased comfort.

**BACKGROUND.** The concept of active noise reduction is simple, however implementation is complex. Active noise reduction, as described by Paul Leug in 1936, (also called active noise cancellation or active attenuation) reduces the overall level of noise using the technique of wave addition or cancellation. A microphone placed in a noise field sends a copy of the noise to an electronic circuit. The electronics invert the signal and send it back to a

loudspeaker (180 degrees out of phase) which presents the inverted noise into the same space as the original noise. Components of the noise which are out of phase, effectively cancel each other reducing the overall level of the noise.

Active noise reduction technology was first integrated into a headset in the mid-1950's by Willard Meeker under a contract with the predecessor to our laboratory. This system demonstrated the feasibility of the active noise reduction headset. In the late 1970's P. D. Wheeler at the University of Southampton, under contract to Graham Rood, Royal Aircraft Establishment, United Kingdom, developed a flyable ANR headset system. The U.S. Air Force, under contract with the Bose Corporation, initiated development in 1980 of an active noise reduction system for use in Air Force headsets and helmets. The evaluations of these systems demonstrated that ANR systems were effective in decreasing crew member noise exposure at the ear, in improving speech intelligibility, and in increasing comfort.

**OBJECTIVE.** The objective of this effort is to describe the sound attenuation and speech intelligibility performance of a representative 1992 ANR headset and relate that performance to practical applications that will assist hearing conservationists in their analyses, evaluations, and decisions regarding the utility of these ANR systems. This information is intended to inform the reader of what is headset active noise reduction, how does it work, what does it do or not do, what are its limitations, and what can be expected in the future.

**APPROACH.** The approach was to measure the performance of the ANR systems in the laboratory, using a physical measurement procedure for attenuation performance and the Modified Rhyme Test for speech intelligibility. This performance data was then applied to real noise environments such as those found on multi-engine propeller aircraft.

**METHOD.** Laboratory measurements were made of the total and the passive sound attenuation of each of the headset units. The active cancellation was calculated as the difference between the total and passive attenuation at each of the one-third octave band test signals. The sound attenuation performance data was measured using ten live subjects with a Knowles 1834 miniature microphone positioned at the entrance to the ear canal. Speech intelligibility was measured on some of the headset units in four different levels of a broad band noise inside a reverberation chamber. Intelligibility was measured with the units in the passive mode and again in the active mode.

#### **WHAT ANR HEADSETS CAN AND CANNOT DO.**

*Sound attenuation* of the ANR system and a standard passive headset measured inside a flight helmet (HGU-55/P) with a miniature microphone system is shown in Figure 1. The maximum amount of active attenuation is the difference between the two curves and achieves a maximum of about 30 dB at 300 Hz. The high frequency attenuations of the two systems are very similar since active attenuation currently is not available above 1000 Hz. Therefore, the data above 1000 Hz is strictly passive attenuation with the small difference in attenuation being due to differences in ear cushion materials. The ANR system provides significant improvement in the low frequency attenuation when compared to the passive only headset. This data when applied to noise such as found in a multi-engine turbo-prop aircraft significantly reduces the A-weighted noise at the ear as shown in Figure 2. With a standard passive earcup the safe exposure limit is 85 minutes, while with the ANR headset the safe exposure limit is 24 hours.

*Speech intelligibility* of the ANR headset and passive headset were measured using the Modified Rhyme Test. The experienced subjects performed the test in the presence of pink

noise at sound pressure levels of 75 dB (ambient), 95 dB, 105 dB, and 115 dB. The ANR device exhibited significant improvements in intelligibility at all noise levels as shown in Figure 3. The ANR system was also tested in the passive only (ANR-OFF) and active modes (ANR-ON) with the ON mode providing the maximum intelligibility.

**FLIGHT TEST EXPERIENCE.** Prototype active noise reduction headsets were flight tested in a variety of military aircraft to identify features of the systems requiring improvement in subsequent models and to assess user acceptability. The two universal comments about the active attenuation were that there was clearly much less noise at the ears and that the signal-to-noise ratio was better resulting in improved quality and clarity of the speech.

**ROLE IN HEARING CONSERVATION.** Noise exposure criteria for hearing are based on the A-weighted sound pressure levels at the ears and the daily durations of exposures. In most industrial noise environments the overall noise levels are less than 100 dB and continuous voice communications are not a requirement. Conventional earplug and earmuff hearing protection devices are adequate to keep the levels of the noises at the ear below levels established to be hazardous to hearing. Many noise environments exceed these levels and require improved sound protection and/or voice communications. Active noise reduction headsets can provide capabilities that permit personnel to safely remain in certain noise environs for longer periods of time, to improve voice communications, and to increase overall acceptability of the headset.

ANR can reduce A-weighted noise level at the ear by 12-20 dB depending on the frequency spectrum of the noise. The more the noise is dominated by low frequency components the larger the benefit of using active noise reduction. The corresponding increase in safe allowable noise exposures can be an increase from 1 hour per day with passive hearing protection to 24 hours per day with active noise protection.

**DISCUSSION.** Active noise reduction headsets provide good passive sound attenuation and good low frequency active cancellation. These capabilities can be exploited in high level noise environs with flat spectra and those containing substantial low frequency energy. Little advantage can be gained in noise environments with the predominant energy above 1000 Hz. The improved signal-to-noise ratio at the ear of ANR units results in better quality and clarity than the passive units. Speech intelligibility and the monitoring of non-speech signals are improved with the reduction of the background auditory masking. Some current ANR systems are limited in reducing sound pressure levels that are above 110 dB, providing only small amounts of attenuation while other ANR systems effectively cancel sound pressure levels exceeding 130 dB.

**SUMMARY.** The design of first generation active noise reduction headsets has targeted some specific applications involving high intensity, low frequency noise and a requirement for voice communications. Initial investigations and experiences reveal that these devices are effective in these applications with very high user acceptability. The primary advantages are reduced noise exposure, improved speech intelligibility, improved perception of auditory signals, and increased comfort or acceptability. However, there are applications where ANR headsets do not provide any significant benefit. There are many industrial noise environments which can profit from the use of active noise reduction headset technology. The hearing conservationist may wish to consider the information provided herein to determine if the capabilities of ANR match the characteristics of noise and provide a sound attenuation or speech intelligibility advantage.

## Sound Attenuation in Helmet (HGU-55/P)

### ANR vs Passive

Mil 912 Method, 10 Subjects/3 Repeats Aug 1992

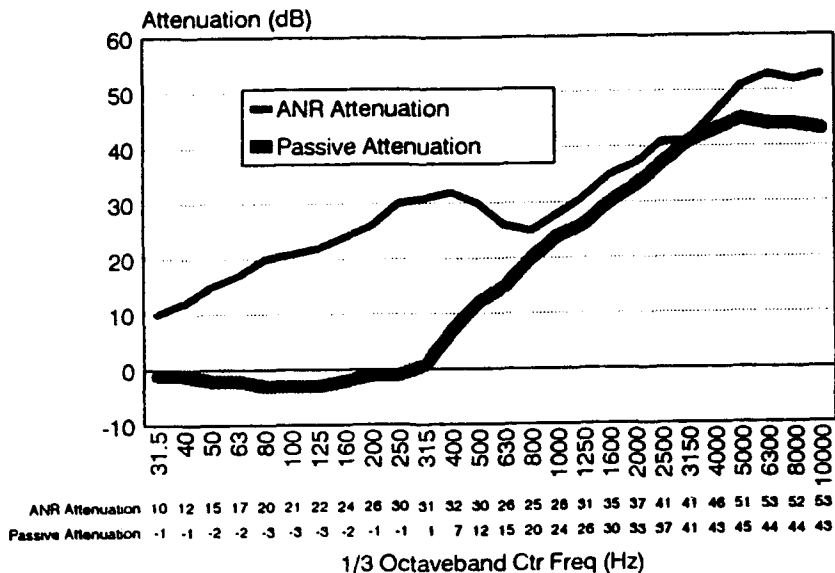

Figure 1

## Noise Levels at Ear ANR vs Standard Helmet Earcups

Multi-Engine Turbo Prop Aircraft

A-Weighted Noise Level at Ear (dB)

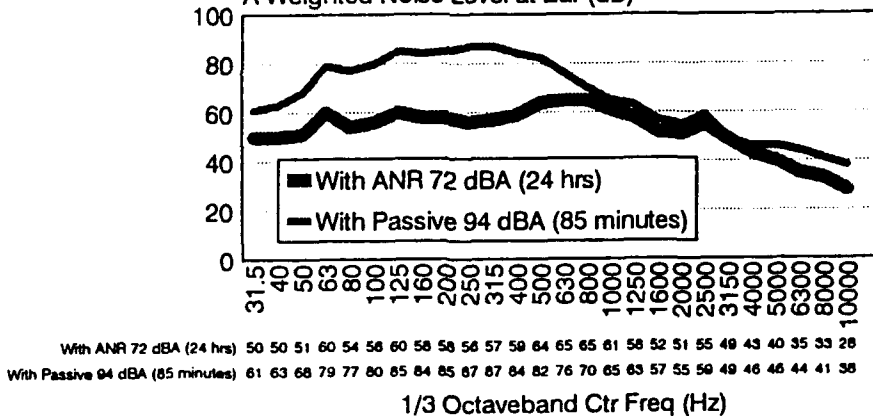
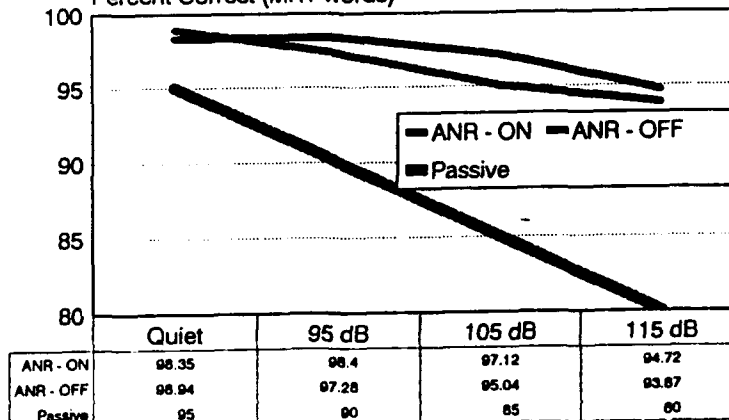

Figure 2

## Speech Intelligibility vs Aircraft Cockpit Noise Levels

vs Aircraft Cockpit Noise Levels

Percent Correct (MRT words)



Aug 1992

Figure 3

# HIGH-DEFINITION AUDIOMETRY AND HIGH-FREQUENCY AUDIOMETRY INTEREST AND LIMITS IN NIHL SCREENING

MEYER-BISCH Christian

Except International Consultants, 82 rue Stanislas - F 54000 NANCY

**Abstract.** High-Definition (HD) audiometry is characterised by the possibility to give threshold shifts within usual fixed frequencies (up to 400 frequencies in the range 125-8000Hz). It allows to draw very narrow notches. Two methods are used to perform a HD audiometry, both are automatic: Sliding frequency Békésy and Audioscan (controlled sliding frequency at constant level method). Extended High-Frequency (HF) audiometry concerns frequencies above 8kHz. Special HF audiometers have been developed since the eighties, and several questions about their interests and limits are still actual, with regard to the detection of NIHL. In order to illustrate the possibilities of HD and HF audiometry, the first results of three surveys are here related. One among a sample of 180 young militaries, another among a group of 200 HF-noise-exposed workers, and the third among a sample of 40 professional musicians. Everyone was submitted to an Audioscan (HD and HF) audiometry, a questionnaire and a clinical examination. The unit was connected directly to a computer so that the whole curves have been analysed, using the *illa* software. The possibility of HD audiometry to detect narrow notch and its reproducibility were very good. The duration of the examination was about 12 minutes for both ears (in *sub-normal* subjects). The problems of calibration, position of headphones and interpretation (reference values) are important to consider. In addition, HD and HF audiometry permits to define new criterions for hearing screening indicators with regard to prevention and public health topics.

**Résumé.** AUDIOMETRIE DE HAUTE DEFINITION ET AUDIOMETRIE DE HAUTES FREQUENCES. INTERET ET LIMITES POUR LE DEPISTAGE DES NIHL. L'audiométrie de haute définition (HD) est caractérisée par sa capacité à mesurer les seuils d'audition entre les fréquences fixes habituelles (plus de 400 fréquences entre 125 et 8000 Hz). Ceci permet de dessiner des encoches audiométriques très étroites. Il existe deux méthodes automatiques pour réaliser des audiogrammes HD: la technique de Békésy en fréquences glissantes, et la méthode Audioscan (balayage fréquentiel asservi à niveau constant). On parle d'audiométrie hautes fréquences (HF) pour les fréquences supérieures à 8kHz. Depuis les années 80, des audiomètres spéciaux ont été fabriqués mais les questions relatives à l'intérêt et aux limites de ces techniques restent posées, surtout si on les rapporte aux possibilités de détection des déficits auditifs engendrés par le bruit (NIHL). Pour illustrer les possibilités des audiométries HD et HF, les premiers résultats de trois enquêtes épidémiologiques sont rapportés ici. La première parmi un groupe de 180 conscrits, la seconde parmi un échantillon de 200 opérateurs exposés aux bruits de hautes fréquences, la troisième parmi un groupe de 40 musiciens. Outre un questionnaire et une otoscopie, chaque sujet a subi un audiogramme Audioscan (HD et HF). Les audiomètres étaient directement connectés à un PC et les courbes complètes ont été traitées par le logiciel *illa*. La possibilité de l'audiométrie HD de détection d'encoches et sa reproductibilité sont très satisfaisantes. La durée de l'examen est d'environ 12 minutes pour les deux oreilles chez des sujets *sub-normaux*. Il reste des problèmes liés à l'étalonnage, à la position des écouteurs et à l'interprétation des résultats. Par ailleurs, l'audiométrie HD et HF permet de proposer de nouveaux indicateurs de pertes auditives adaptés à la prévention et à la santé publique.

**Introduction.** Auditory impairments have to be detected as long as they are asymptomatic, if possible before irreversible damage occur. Actually, Public Health is also interested in audiometry, one of the earliest ways to screen infra-clinical hearing impairments (Occupational Medicine, Preventive Medicine...). Regarding to the collective aspect of the screening audiometry, the examination needs several features not completely reached by the conventional methods. To increase the precision and the sensitivity of the audiometric examination, we perform a basic pure tone threshold audiometry for the full frequency spectrum in high definition. High-Definition (HD) audiometry is characterised by the possibility to detect narrow notches within usual fixed frequencies. Such notches are seen by subjects without any known pathology or prior history of hearing damages.

Extended High-Frequency (HF) audiometry is also aimed at identifying the influence of otoaggressors at the earliest possible stage, particularly in industrial health care (noisy environment), and before 40 years old. Special HF audiometers have been developed since the eighties, using different transducers not always standardised in terms of calibration, and giving the results in dB SPL (sound pressure level), and rarely in HL (hearing level).

In order to evaluate the interest and the limits of these complementary audiometric methods, we have used the first results of three epidemiologic surveys performed among samples of young militaries, of workers and of musicians. The following studied criterions will be discussed: detection and reproducibility of fixed frequencies threshold shifts and notches, duration of examination, definition of new audiometric parameters and indicators, calibration and interpretation (predicted values).

**Material and methods.** There are two methods usable to perform a HD audiometry. Both are automatic: sliding frequency Békésy and Audioscan. This last method appears to be more sensitive and more precise to detect narrow notches [MEREDITH et al, 1992]. The principle was described in details formerly (MEYER-BISCH et al, 1990). The device used (AUDIOSCAN® ESSILOR) sweeps through 64 frequencies per octave at a constant level (in HL), beginning at 1kHz to 16kHz and then returns to 1kHz down to 125Hz. The following sweep begins from the central frequency of the non-response area, etc... Finally, step by step, the audiogram is completed and the notches are drawn on the screen and printed.

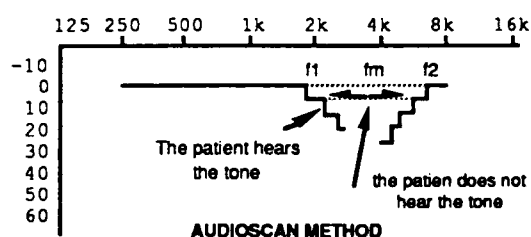
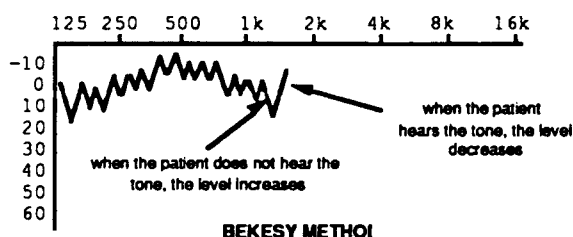

*Békésy and Audioscan methods are automatic. They can perform high-definition audiometry. The patient answers using a handswitch*

In addition, the audiometer was connected via a RS232 to a PC using the *illa* software. This allows to catch and analyse the whole curve on the computer. The following parameters were calculated: Hearing levels for standardised fixed frequencies, several hearing loss indicators..., special parameters to describe the localizations, the width and the depth of the notches, and several surface indicators.

Moreover, everyone was submitted to a questionnaire and an otoscopy.



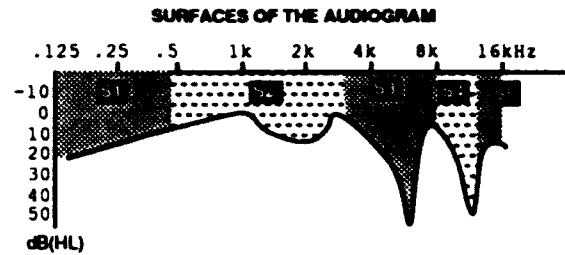
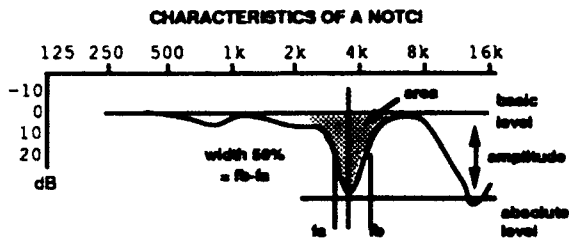

*Audiograms can be characterised by threshold shifts at fixed frequencies; they can also be summarised using hearing level indicators, notches characteristics or surfaces*

The subjects used in this work came from three epidemiologic surveys. The first was a sample of 180 young militaries examined during the first week they were incorporated in an air-base. Sixty of them were retested three months later in the same conditions. The second group came from a sample of technicians employed in telecommunication centres, exposed to high frequencies noises. And the third one was constituted with professional musicians, mostly often exposed to actual musics (amplified music).

The following criterions were used to appreciate the performances of the audiometric method: detection and reproducibility of fixed frequencies threshold shifts and notches, duration of examination, definition of new audiometric parameters and indicators, calibration and interpretation (predicted values).

**Results.** Narrow notches were observed in the three samples. The rates were depending on the ages and the prior histories. They were reproducible three months later in same conditions of examination. An example of such a reproducibility is given in the following audiograms.

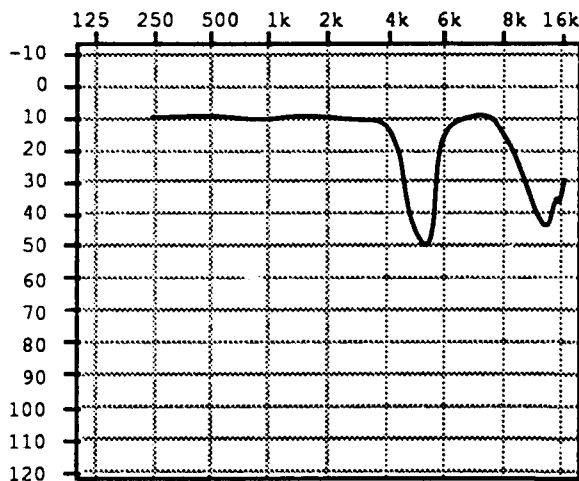

**FIRST EXAMINATION**

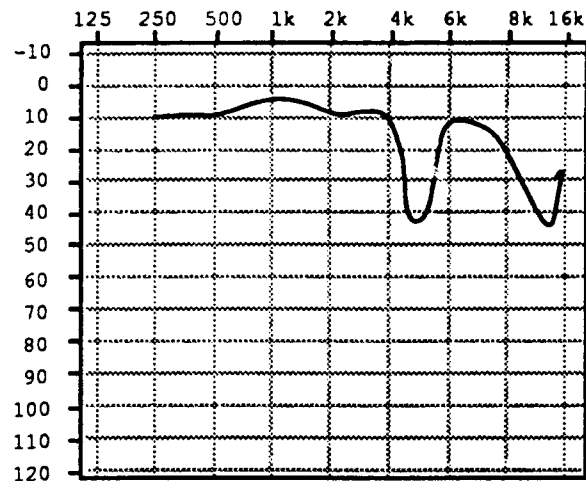

**SECOND EXAMINATION**

*Test and retest (3 months) of a 21 years old military without hearing history, not exposed to noise, and unilateral. The audiogram is smoothed. The conventional audiogram was normal.*

It may be interesting to smooth the curves in order to erase the non-significant variations. Then, precise threshold shifts may be determined on the curve for fixed frequencies. The reproducibility of the audiograms in terms of fixed frequencies values was excellent, as shown in the following median audiograms computed on 60 couples of examinations.

The high definition resolution (1/64 octave) has not constituted a limit of the method in our practice. Musicians, who had an experimented hearing, detected only a continuous sweep.

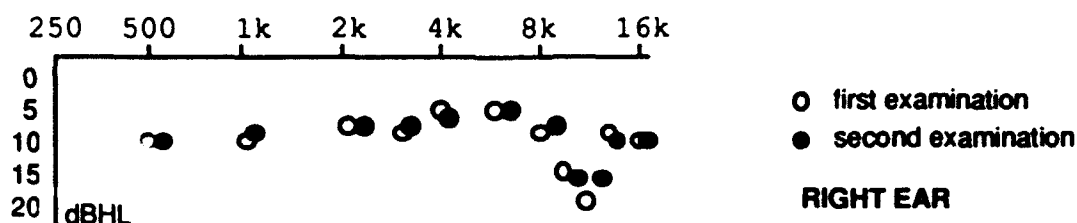

Surfaces calculated on different parts of the continuous audiogram (see above) are interesting to consider. S2 is the speech area (could be a medicolegal indicator), S3 is the classical NIHL area (corresponds to I346, an early indicator), S4 is earlier and S5 is related to the age. In our experience, S4 appears to be the most interesting indicator in terms of preventive screening by the youth (samples 1 and 3) and S3 after 40 years old (sample 2).

Duration of the test has been compared with other methods. For a Békésy test, the duration is constant, depending only on the speed of the sweep (4 minutes per ear). With the Audioscan method, it depends also of the severity of the hearing loss, the depth of the notch, etc... In our experience, it is possible to perform 4 HD and HF audiograms (both ears) per hour.

The problem of calibration of the audiometric system appears to be difficult to solve because it is related to the type of headphones, not always standardised in the HF audiometers, and also the definition of the zeros. In Audioscan, we have chosen the zeros proposed by Fausti. Another problem comes from the position of the headphones on the ear. In HF audiometry, it is necessary to be extremely attentive to be just in front of the ear canal. If not, 20dB errors may be observed.

The last problem consists in the interpretation of the curves. This interpretation requires the use of reference values (predicted) according to age and sex. In our experience, we have used those of Osterhammel.

**Conclusions.** According to these results, observed in various situations, positive aspects of HD and HF audiometry appear clearly: The detection of narrow notches, reproducibles and easy to characterize using new parameters is one of the most important advantages of HD audiometry. Moreover, it improves the accuracy and the precision of any audiometric examination for fixed frequencies and allows to extend the spectrum to HF, whatever the field of the medical practice. Furthermore, it is possible to define new criterions (surfaces) for screening indicators with regard to preventive medicine (also medico-legal indicators), based on HD and HF audiograms. The interpretation of such audiograms requires a good calibration of the audiometers, the use of standardised earphones (adjustable on an artificial ear) and predicted values according to the age and sex.

**Acknowledgment.** The author would like to thank Dr. C. Torres, Dr. N. Louradour, and Dr. Dartignan for helping the collect of data.  
No fund has been got for this paper.

#### References.

- MEREDITH R., STEPHENS D., SIRIMANNA T. et al: Audiometric detection of carriers of Usher's syndrome type II. *Journal of Audiological Medicine*, 1992, 1, 11-19.  
MEYER-BISCH C.: Audiométrie automatique de dépistage préventif: Le balayage fréquentiel asservi (Audioscan). *Cahiers de Notes Documentaires*, 1990, 139, 335-345.

## ON THE RELATION OR CORRELATION BETWEEN TEMPORARY AND PERMANENT THRESHOLD SHIFTS

John H. Mills, Ph.D.  
Dept. of Otolaryngology and Communicative Sciences  
Medical University of South Carolina  
171 Ashley Avenue  
Charleston, S.C. 29425

Over the past 25 years or so it has been shown in humans, chinchilla, gerbil, and several species of monkey that temporary threshold shifts produced by continuous exposures to noise are asymptotic after 8-24 hrs of exposure. This asymptotic threshold shift (ATS) is sustained for as long as the exposure is continued, at least in chinchilla for durations of several hundred days and in gerbil for at least 100 days or until ATS is confounded by the loss of hearing associated with increased chronological age. In 1969 (Mills *et al.*, *J. Acoust. Soc. of Amer.*) it was hypothesized that ATS produced by an exposure to a given noise was an upper bound on any PTS that could be produced by that noise regardless of the duration or scheduling of exposures. The hypothesis is necessarily correct providing TTS reaches a true asymptote rather than a temporary plateau, and providing TTS does not increase when a long duration exposure is terminated. Results of many experiments after 1969 have shown that TTS does indeed grow to a true asymptote and that TTS does not increase when a long duration exposure is terminated. There always appears to be some recovery when the exposure is terminated. Thus, knowing the ATS audiogram from a given exposure gives an upper bound estimate of the PTS audiogram from that exposure as well as a quantitative estimate of individual differences. Inasmuch as there seems to be a temporary component present in the ATS audiogram, there will not be a perfect match between the final PTS audiogram and the ATS audiogram. The PTS audiogram will show less hearing loss. ATS data from intermittent or non-continuous exposures to noise do not support a single-number correction factor (i.e. 3-dB, 5-dB, etc.) for the effects of intermittence. Indeed, for noise exposures with a wide-range of on-times and duty-cycles, correction factors can range from 0 dB to 8 dB or perhaps even more.

**Introduction.** There is a large data base on permanent threshold shifts produced by steady-state exposures to occupational noise. Many of these data have been reviewed, analyzed and synthesized (Johnson, 1973, 1991; Bauer *et al.*, 1991) and form part of the empirical basis for an international standard, Acoustic Determination of Occupational Noise Exposure and Estimation of Noise-Induced Hearing Impairment (ISO 1999). This standard presents a method to estimate noise-induced permanent threshold shift as a function of A-weighted sound exposure and years of exposure time. Inasmuch as this standard is based totally upon epidemiological studies of noise-induced permanent threshold shift, it is of some interest to compare predictions of the ISO standard with predictions from human and animal data generated from laboratory experiments. The prediction of interest is "safe levels", or

**"effective quiet", or "acoustic injury thresholds".**

**Results and Discussion.** What is the highest SPL of a noise that will not produce a measurable temporary threshold shift (TTS) nor interfere with the recovery of an existing threshold shift regardless of the duration of the exposure? What levels of noise will produce any asymptotic TTS of 5 dB or less? What are the highest levels of noise that will not produce an injury of the organ of Corti? These questions operationally define "effective quiet", "safe levels", and acoustic injury thresholds", respectively. These levels have been estimated from human TTS experiments for octave-band noise (Ward et al., 1976; Mills et al., 1970; 1979; 1983; Melnick, 1976); wide-band noise (Ward et al., 1976; Nixon et al., 1977; Mills et al., 1981), and from field studies (see Melnick, 1991). Estimates of safe levels are plotted on Figure 1 for octave bands of noise centered from 63 Hz to 4 kHz in octave steps. Data at higher and lower center frequencies are extrapolations. Also plotted on Figure 1 are two extremes of human audibility, the minimum audible field and the threshold of pain (see Yost and Nielsen, 1985). Of course, sounds below the threshold of audibility present no risk of noise-induced hearing loss. Sounds in excess of the threshold of pain could represent a risk of noise-induced hearing loss even for one short exposure; however, a precise estimate of the acoustic injury threshold from just one exposure to a non-impulsive sound can not be made at this time.

How do the "safe levels" or "acoustic injury thresholds" of Figure 1 compare with those specified by ISO 1999? At 4 kHz ISO 1999 specifies a level of 75 dB SPL. That is, exposure to noise centered at 4 kHz for nearly a lifetime (8 hrs/day) will produce no measurable hearing loss in any percentile of the population. Figure 1 suggests a SPL of 74 dB. At 2 kHz ISO predicts 80 dB whereas Figure 1 suggests 78 dB. Thus, for noise energy in the 2-4 kHz range the correspondence between ISO 1999 and predictions from laboratory experiments is outstanding. At lower frequencies there are significant disparities. For example, Figure 1 suggests safe levels of 82 dB at both 1 kHz and 0.5 kHz whereas ISO specifies levels of 89 dB at 1 kHz and 93 dB at 0.5 kHz. Differences in noise levels of 7 dB at 1 kHz and 11 dB at 0.5 kHz are significant and would translate into asymptotic threshold shifts of about 12 dB from the 1 kHz energy and nearly 20 dB from the 0.5 kHz energy. Reasons for the outstanding correspondence in the 2-4 kHz region and the significant disparities in the 0.5-1 kHz region are not clear.

On Figure 1 the region bounded by safe levels on the low side (open triangles) and the threshold of pain on the high side (filled triangles) is the area where the risk of hearing loss and acoustic injury of the ear is dependent upon parameters of the noise exposure (level, duration, number of exposures) as well as the susceptibility of the individual. Debate persists about many of the quantitative facts.

## **References**

**Bauer, P., Korpert, K., Neuberger, M., Raber, A., Schwetz, F. (1991) "Risk factors for hearing loss at different frequencies in a population of 47 388 noise-exposed workers" J.**

**Acoust. Soc. Am., 90:3086-3098.**

**International Organization for Standardization (1990) "Acoustic determination of occupational noise exposure and estimation of noise-induced hearing impairment (anon)" Draft International Standard Geneva: ISO/DIS1999.2.**

**Johnson, D.L. (1991) "Field studies: Industrial exposure" J. Acoust. Soc. Am. 90:170-181.**

**Johnson, D.L. (1973) "Prediction of NIPTS due to continuous noise exposure" EPA Rep. No. 5509-73-001-B or AMRL-TR-73-91 (AD 767205).**

**Melnick, W. (1991) "Human temporary threshold shift (TTS) and damage risk" J. Acoust. Soc. Am. 90:147-154.**

**Melnick, W. (1976) "Human Asymptotic Threshold Shift" IN: Effects of Noise on Hearing, Eds: D. Henderson, R.P. Hamernik, D.S. Dosanjh, and J.H. Mills (Raven, New York), pp. 277-289.**

**Melnick, W., and Maves, M. (1974) "Asymptotic Threshold Shift (ATS) in Man from 24-h Exposure to Continuous Noise" Ann. Oto. Rhinol. Laryngol. 83:820-829.**

**Mills, J.H., Adkins, W.Y., and Gilbert, R.M. (1981) "Temporary threshold shifts produced by wideband noise" J. Acoust. Soc. Am. 70:390-396.**

**Mills, J.H., Gilbert, R.M., and Adkins, W.Y. (1979) "Temporary threshold shifts in humans exposed to octave bands of noise for 16 to 24 hours" J. Acoust. Soc. Am. 65:1238-1248.**

**Mills, J.H., Gengel, R.W., Watson, C.S., and Miller, J.H. (1970) "Temporary changes of the auditory system due to exposure to noise for one or two days" J. Acoust. Soc. Am. 48:524-530.**

**Mills, J.H., Osguthorpe, J.D., Burdick, C.K., Patterson, J.H., and Mozo, B. (1983) "Temporary threshold shifts produced by exposure to low-frequency noise" J. Acoust. Soc. Am. 73:918-923.**

**Nixon, C.W., Johnson, D.L., and Stephenson, M.R. (1977) "Asymptotic behavior of temporary threshold shift and recovery from 23-and 48-hour noise exposures" Aviat. Space Environ. Med., 311-315.**

**Ward, W.D. (1991) "The role of intermittence in PTS" J. Acoust. Soc. Am. 90:264-269.**

**Ward, W.D., Cushing, E.M., and Burns, E.M. (1976) "Effective quiet and moderate TTS: Implications for noise exposure standards" J. Acoust. Soc. Am. 59:160-165.**

**Yost, W.A. and Nielsen, D.W. (1985) "IN: Fundamentals of Hearing, Holt, Rinehart and Winston, Inc. pp. 126.**

# RISK OF NOISE INDUCED HEARING LOSS

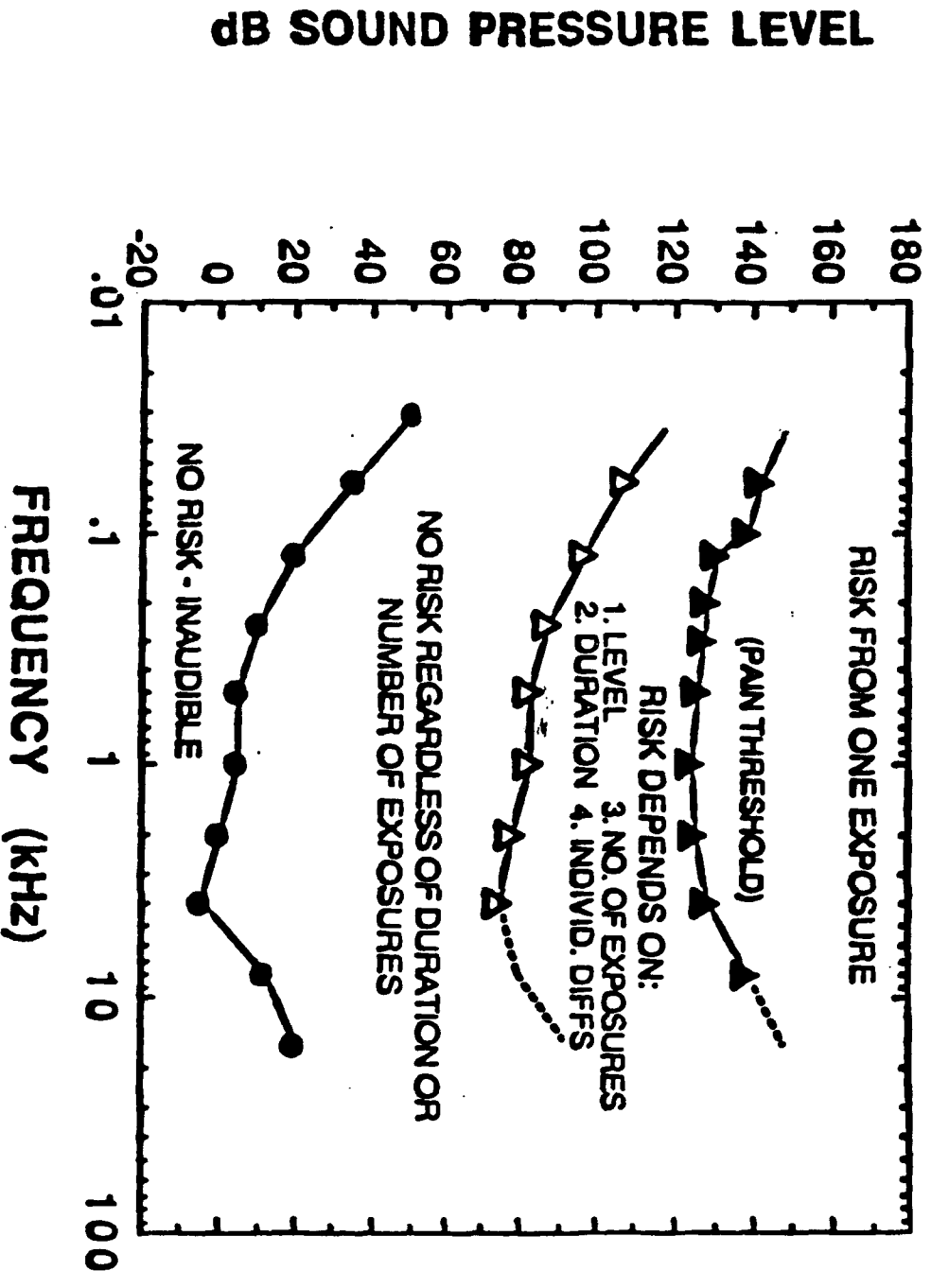

Figure 1  
 Categorization of the Range of Human Audibility  
 with Respect to Risk of Acoustic Injury of the  
 Ear.

# ASSESSMENT OF NOISE EXPOSURE AND RISK OF HEARING DAMAGE FROM PEAK VALUE AND TIME HISTORY OF NOISE

J.M. MONDOT, Acouphen, Villeurbanne (France)  
A. LEPLAY, M. GUY, Rhône-Poulenc Industrialisation  
R. GAMBA, Acoustique Gamba, Toulouse (France)

## SUMMARY

The present paper is presenting a methodological frame for the assessment of noise exposure and the identification of protective actions based on the division of the plant work force into HEG (Homogeneous Exposure Group) as developed and validated by Rhône Poulenc. Each HEG is representative of similar work functions and noise exposure patterns. The indicators are the daily noise exposure with their time history in terms of short  $Leq$  and the peak values within the time period. Time histories are used to check the measured data, to identify dominant noise exposure patterns, to identify highly contributing noise sources. The proposed approach offers an attractive link between the assessment of exposure and noise control planning. Critical aspects of the assessment of noise exposure are discussed.

## RESUME

Cette contribution présente les fondements d'une méthodologie d'évaluation systématique et d'identification des actions de réduction de l'exposition sonore des travailleurs telle que celle développée et validée par Rhône Poulenc. Efficace et économe en mesurage, celle-ci repose sur la décomposition des personnels exposés en Groupes Homogènes d'Exposition (HEG) représentatifs d'une même activité exercée dans les mêmes conditions d'exposition au bruit par les travailleurs appartenant au groupe. Les difficultés inhérentes à l'évaluation d'une exposition sur 8 heures et du niveau crête d'exposition sont discutées. L'approche proposée permet une continuité entre la démarche d'hygiène industrielle ayant pour objectif de quantifier l'exposition au bruit de l'ensemble des travailleurs d'un site et la démarche de réduction de bruit visant à mettre en oeuvre des solutions techniques permettant de réduire cette exposition.

## INTRODUCTION

The reduction of noise and noise exposure has received high priority within the EEC, as shown by the content of the machine and safety directive together with the directive concerning the protection of workers from the risks related to exposure to noise at work. National regulations e.g. (1), in application of the EEC directives require that employers establish effective occupational hearing conservation programs, including monitoring employee occupational noise exposure and implementing protective actions when the defined criteria expressed in terms of daily personal noise exposure and peak value, are exceeded. In France, the standard NFS 31084 (2) specifies how the above indicators are obtained.

Nowdays, the practise of the assessment of noise exposure at the work place is changing. In many areas of industry, due to an increase of automated tasks and to the reduction of the number of workers on production lines, many employees work at different locations throughout the day. Also, noise immission at a workstation is rarely stable on a 8 hour period. Finally, the progress of instrumentation, like e.g. short  $Leq$  storage capability, interface between meters and computers, provides an easy access to more detailed information and a better evaluation of the exposure.

## CRITICAL ASPECTS IN THE ASSESSMENT OF NOISE EXPOSURE AT WORK

Since exposure relates to the equivalent noise level received over a long period (shift duration, often 8 hours) the variations of noise emission with time, the spatial variation of the acoustical performance of halls and a detailed understanding of the main features of the worker activity are key parameters for an appropriate assessment of noise exposure. Figure 1 shows an exemple of a short  $Leq$  trace over a 8 hour period corresponding to a daily exposure of 100 dB(A) obtained on a worker in a chemical plant. Although the emission of the numerous machines present in the hall is relatively stable, there is a great variation of the worker exposure with time. This is due to the displacement of the worker in the hall and to the noise created by his own manipulations.

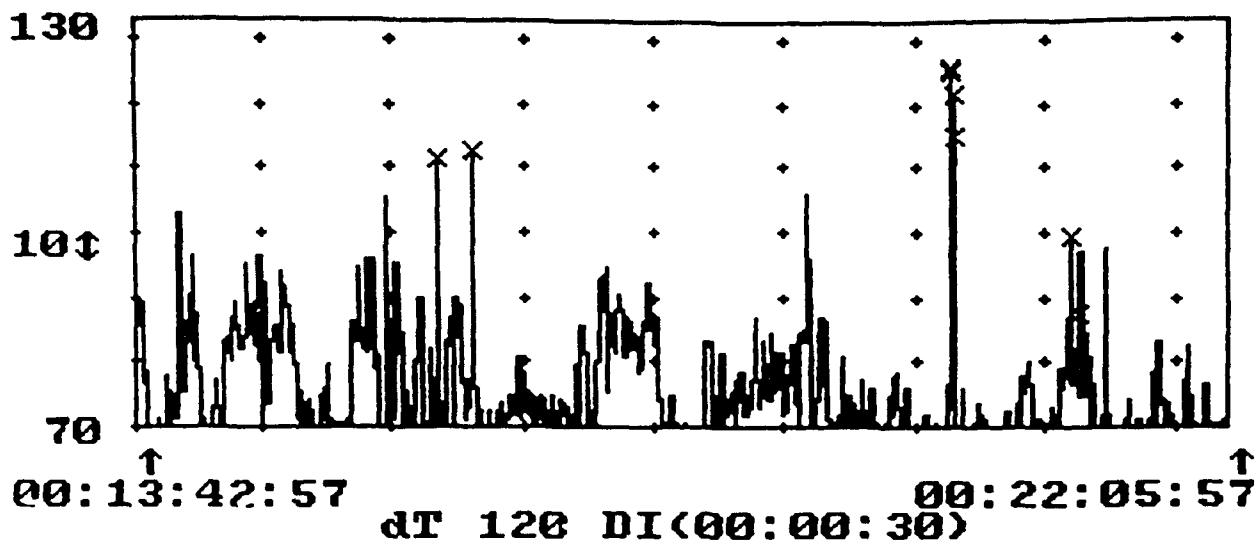

Figure 1 : Plot of short Leq (30 s samples) corresponding to a daily exposure of 100 dB(A)

Compared with the exposure measured on other workers in the same hall the same day, this particular worker had a 10 dB(A) higher daily exposure. This is due to the fact that he shovels up the product stuck into an inox loading funnel with an inox shovel many times during a short period to clean it. This example emphasized the importance of short noise events with high level on the exposure often caused by impacts due to manipulation (hammering, release of metal parts or cans,...), machine process (i.e. punch presses) or to air exhaust noise of all kind. Their contribution to the daily exposure increases with their number of occurrence and with their level difference with the background noise.

In large plants, due to the number of workers, the systematical evaluation of daily exposure for all workers from 8 hours measurement would be an almost impossible task (impossible in terms of cost and duration). In small industries, the assessment of noise exposure is often made by external organisations having in charge many plants and therefore little time to spend for the evaluation in each plant. Thus, a measurement strategy should be found in order to overcome the problem of cost and duration of the evaluation and still proceed with an acceptable accuracy.

Today the most commonly used sampling technique consists in measuring samples representative of exposure patterns identified from the analysis of the work situation (2). The accuracy of the evaluation is strongly linked with what is observed as being "representative" of a work situation. In particular, significant acoustical event of short duration to which the worker is exposed should not be missed. The daily noise exposure is obtained by summing the contribution of the identified exposure patterns. The measurements are made using integrating sound level meters or integrating dosimeters on representative time period. In both cases the storage of the corresponding short Leq are recommended. Measurements made with a sound level meter introduce an extra bias in the evaluation since it is difficult to maintain the microphone position close to the worker's ear.

Rather than selecting representative exposure patterns from which the daily exposure of all workers is reconstructed, an alternative approach consists in measuring the 8 hour exposure with a dosimeter with short Leq storage of workers taken as samples of a HEG (Homogeneous Exposure Group). This technique has been extensively used in the last decade, for exposure to toxic substances (3), (4). Applied in principle since several years i.e. (5) to noise in the U.S., this approach has been recently validated on a real plant scale by Rhône Poulenc (6). Recently, an attempt was made also to develop a technique based on random sampling of short Leq (one minute duration) (7). This approach is dedicated to situations with a permanently varying noise over a long term, with no representative patterns of exposure. Such a sampling technique, although providing estimates of the exposure on long period has the main drawback of increasing the risk of missing significant noise event of short duration. It relies upon statistical considerations rather than on observation.



## A METHODOLOGICAL FRAME FOR THE ASSESSMENT OF NOISE EXPOSURE AT WORK

The general frame of the methodology for the assessment of noise exposure at work developed and validated by Rhône Poulenc is illustrated in the flow chart Figure 2 from (8). After a deep analysis of the demand, the analysis of the work situations based on the study of the activity and a preliminary noise survey using sound level meters lead to a preliminary identification of the HEG and assessment of noise exposure. The number of HEG to represent the total plant work force will vary with plant size, plant organisation and local work practices.

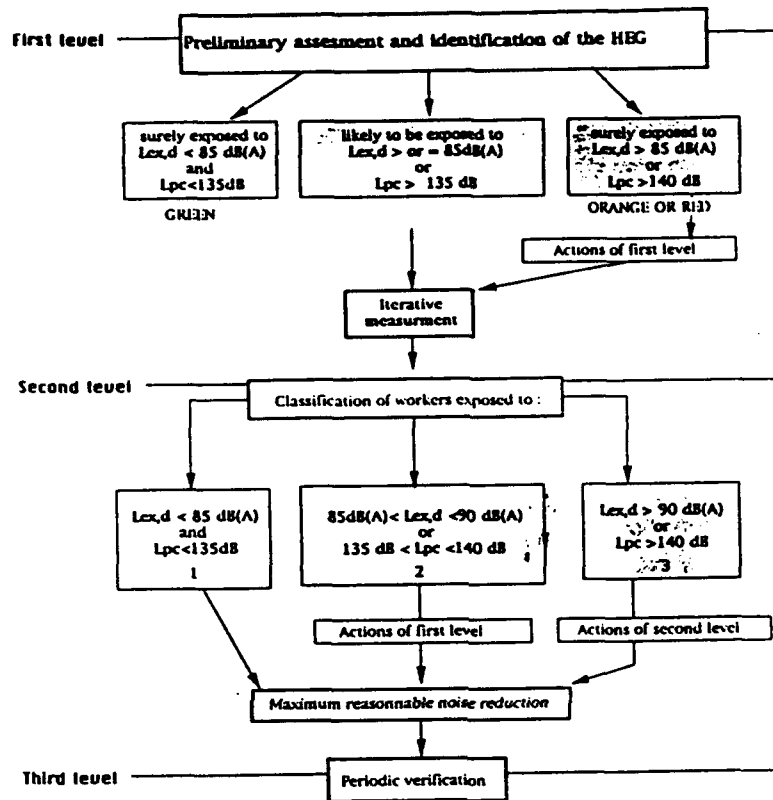

Figure 2

In most situations the daily noise exposure of a plant population spans a wide range. The goal of this first step of evaluation is to identify the workers which are surely exposed to less than 85 dB(A), 135 dB peak (the GREEN region) or exposed to more in order that the required measures should be implemented in an early stage of the classification. It is shown (6) that depending on the variability in the parameters contributing to the exposure a HEG falls into category 1 (in terms of a 5 % risk of the category limit to be exceeded) as long as its daily exposure is less than 77 dB(A). Similarly a HEG falls into category 3 if its daily exposure exceeds 93 dB(A). The work done by Rhône Poulenc on a real scale also shows how attractive is the approach since only 6 samples (workers) are sufficient to characterise a HEG. Iterative measurements using 8 hours samples and deeper understanding on the activity are required to refine classification.

This approach offers an attractive accuracy in the classification of workers into category 1, 2 or 3 with reduce cost and measurement.

### REDUCTION OF NOISE EXPOSURE AT WORK

The proposed framework is also a powerfull tool for the identification of protective actions. Studying short  $Leq$  trace representative of workers exposure for typical sequences of the activity (i.e. one second samples) leads to identifying the main noise events contributing on the worker exposure. In the following example of workers of a shift in a chemical plant, 4 HEG was identified one four each type of process conductor associated to different part of the production line. In one type of HEG a span of 13 dB(A) (86 to 99 dB(A)) was found in the daily exposure survey conducted by the medical staff (after identification of hearing losses for these workers) for the same process and product. Thus, the definition of this HEG was questioned. Typical work sequences were identified from an analysis of the activity and corresponding short  $Leq$  trace recorded.

Although the workers' complains focused on the background noise, it was found that the numerous actions of hammering on pipes when the product particals are stuck and on buckets to clean them (almost not mention by the workers when questioned about their activity) explained the variations in exposure and the risk of hearing damage. From the table and the figure below, by vaying the duration and number of occurence of the significant events on the noise exposure the situation was explained in simple terms understood by the different parties involved. Furthermore, the effect of noise reduction measures on the daily exposure can also be estimated.

OPERATION	Leq dB(A)	Duration of the noise event (mn)	Number of operations	Lex dB(A)
Normal round	90	35	3	83
Station in cabin	63	353	1	62
Long station close to an equipment for maintenance	97	60	0	0
Hammering actions :	Type 1	10	1	97
	•	5	0	0
	•	5	0	0
	Type 5	5	0	0
		5	0	0
Air exhaust	92	3	4	76
<b>TOTAL</b>				<b>97</b>

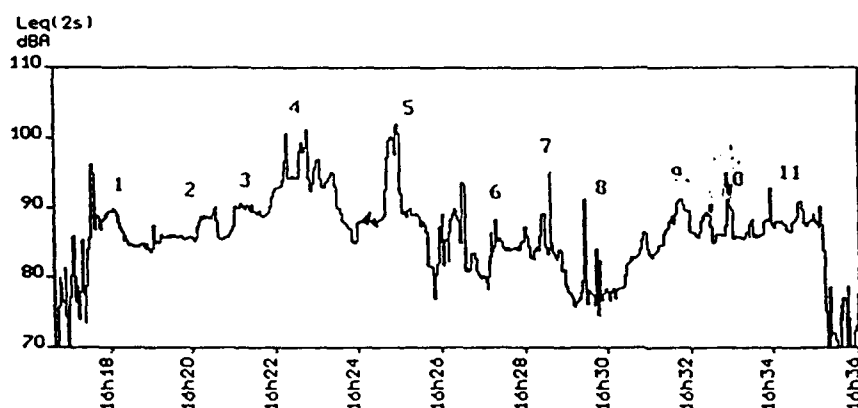

*Normal Round*

*Hammering sequence type 1*

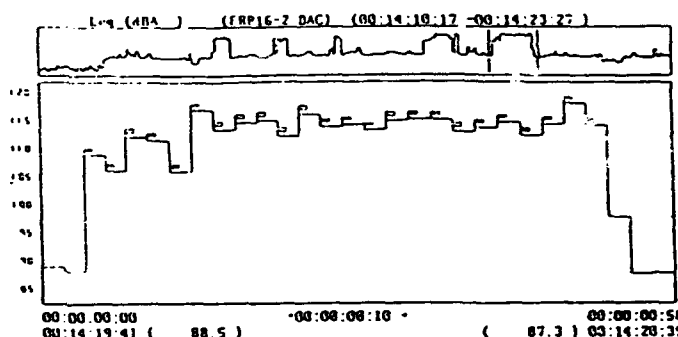

## REFERENCES

- (1) French legislation in application of the EEC directive 86/188
- (2) French standard NF S 31 084 "Méthodes de mesurage des niveaux sonores en milieu de travail en vue de l'évaluation de l'exposition sonore quotidienne des travailleurs".
- (3) A. Leplay, Rhône Poulenc, Application pratique d'une stratégie de prélèvements d'atmosphère au poste de travail, Journal de Toxicologie Unique et Expérimentale (1986).
- (4) B. Desprès, Rhône Poulenc, Contrôle de l'exposition atmosphérique : une stratégie originale de prélèvements dans une usine de chimie organique, Archives Maladie Professionnelle (1989).
- (5) A. M. Teplitzky, W.E. Bradley, "Power plant statistical audio dosimetry", Proceedings Inter Noise 1986 Boston
- (6) MM. Cornillon, Bassinot, Desprès, Guy, Leplay, Aubrun, Rhône Poulenc, Validation d'une stratégie des expositions individuelles au bruit, XXIV Congrès international de Médecine du Travail de Nice - ICOH - à paraître (1993).
- (7) L. Thiéry, M. Bénard "Présentation d'une nouvelle stratégie de mesurage de l'exposition des travailleurs soumis à des bruits fluctuants", Proceedings EuroNoise 92, London
- (8) R. Gamba, G. Abisou, " La protection des travailleurs contre le bruit, les points clefs ", Editions ANACT

## **HCP ADMINISTRATION IN PETROCHEMICAL PLANT**

**NEPOMUCENO J.A. and BELDERRAIN M.L.R.**

**ACUSTICA & SONICA**

**Ibirapuera - Rua Caravelas 527**

**São Paulo - CEP 04012-060 - Brazil**

**The Henrique Laje Refinery, of Petrobrás, in São José dos Campos, São Paulo - Brasil, is the first one plants in Brasil to implement an Hearing Conservation Program for its own initiate.**

**This program has been processing since September 1991 and introduces the common tasks of a HCP :**

- Noise Measurement and Monitoring.**
- Training and Lectures.**
- Estimate Application and Choice or Hearing Protection Devices.**
- Audiometry Examination Attendance.**
- Noise Control Design.**

**To benefit the employees directly, the HCP tasks had been changed in its sequence, to improve the industrial area noise condition.**

**We began the job establishing some rules in the document "Hearing Conservation Politic", it is, the compromise that the plant's management assumes with the employees to preserve their hearing.**

**In following, we had realized noise and vibration measurement and noise control design for the steam ejectors area. This area shows high level of noise, about 90 to 103 dB(A), and the project's implementation is initiating.**

**This "paper" will introduce the HCP 's development, the problems that had been found during its implementation and the accepted solution.**



NIXON, Charles W., WEST, Denise W., and ALLEN, Nancy K.  
Armstrong Laboratory, Crew Systems Directorate, CFBA  
Wright-Patterson AFB, OH 45433-6573 USA

**ABSTRACT.** A laboratory study measured changes in human hearing from noise exposures from low-flying aircraft representative of military training routes (MTR) and real world situations. In phase 1, subjects experienced four flyover noise exposures at levels of 115 dB(A) to 130 dB(A). In phase 2, a single flyover noise at a maximum level of 130 dB(A) was repeated for eight successive repetitions each separated by about 90 seconds, or until a temporary threshold shift was observed. Results are discussed in terms of the potential risk of hearing loss relative to exposures that are equivalent to those examined in this investigation.

**INTRODUCTION.** Noise from low flying aircraft may constitute a potential risk of noise-induced hearing loss. Human hearing threshold levels were measured following exposures to recorded noise from low-flying aircraft. Worst case scenarios were selected for study in which the maximum exposure was a series of eight individual noises at a level of 130 dB(A). Estimation of the relationships between the noise exposures and changes in hearing could assist Air Forces in the planning and management of air operations to minimize effects of the noise.

**STUDY.** All subjects participated in all conditions, serving as their own experimental controls. Hearing threshold levels were measured before and after each individual noise exposure. Exposures began at low sound pressure levels and were systematically increased until temporary threshold shift (TTS) was observed or the test condition was completed without TTS. Thirty volunteer female and male subjects participated in the experiment. All had normal hearing and normal middle ear function as determined by tympanometry. Subjects were paid for their participation.

*Criterion Measures.* Changes in hearing related to the noise exposures were measured by comparing pre-study with post-study pure tone audiograms, exposed ear vs protected ear audiograms, post-exposure flyover noise thresholds at 4000 and 6000 Hz, frequency distributions of the data, and final post-exposure vs one-hour post-exposure thresholds. A conservative Criterion TTS of only 10 decibels was used throughout the study. When a TTS of 11 dB or greater was observed, the subject was prohibited from additional exposures in that session.

*Stimuli.* The noise exposure stimulus was recorded on the ground under an F4 aircraft traveling at 579 knots at a ground clearance level of about 108 feet at a military training route in Europe. This single measurement was utilized for all noise exposures in the study being adjusted only in level to provide the four conditions of 115, 120, 125, and 130 dB(A). A microphone at the subjects position in the laboratory verified the levels of the stimuli experienced by the volunteers.

*Exposure and Hearing Measurement.* In phase 1, subjects were exposed to a series of four flyover noises at increasing levels of 115, 120, 125, and 130 dB(A) in a single session. In phase 2, subjects experienced a series of eight exposures at 125 dB(A) in session one and a series of eight exposures at 130 dB(A) in session two.

An audiogram for each subject was measured for pulsed pure tones at frequencies of 500, 1000, 2000, 3000, 4000, and 6000 Hz prior to and immediately following each testing session. During the experimental sessions, pre- and post exposure threshold levels were measured in one decibel steps only at 4000 and 6000 Hz. Only one ear of the subject was exposed to the noise, the other was fit with an effective earplug that was worn throughout the study sessions. The hearing threshold levels of the subjects were measured immediately before and after each individual flyover noise exposure in both phase 1 and phase 2. Initial exposures were presented at levels that did not produce TTS and were systematically increased until TTS was observed or the maximum exposure level for that condition was completed without any TTS. During a session, subjects donned headphones and

tracked hearing threshold levels for three minutes, alternating at 30 second intervals, between the 4000 and 6000 Hz tones. The subject removed the headphones, experienced the flyover noise and immediately donned the headset and repeated the threshold determinations at the two frequencies. *Phase 1.* The initial noise exposure (single aircraft flyover noise) was presented at a fixed sound pressure level of 115 dB(A) following determination of pre-exposure hearing threshold levels. Measurement of the post-exposure thresholds began immediately following cessation of the noise. After the post-exposure threshold determinations, the sound pressure level of the noise was increased a fixed amount of 5dB(A) (to 120 dB(A)) and presented to the subject who again, began threshold determinations immediately following the exposure. This "noise exposure, hearing test, noise exposure plus 5 dB" procedure continued until the subject completed the maximum level of 130 dB(A) or displayed a Criterion TTS. Subjects were given a five minute rest free from threshold tracking between the individual flyover noise exposures.

*Phase 2.* A single aircraft flyover noise was presented at a specified level (i.e., 125 dB(A)) with hearing threshold measured before and after each exposure using the same sequencing as in Phase 1. The single exposure was repeated at the specified level until the subject completed the maximum number of eight noise exposures or experienced a Criterion TTS. The two levels of flyover noise measure in Phase 2 were 125 dB(A) and 130 dB(A). Subjects did not rest from threshold tracking between stimulus presentations. As noted earlier, a very conservative Criterion TTS of only 10 decibels was utilized; when threshold level changes exceeded 10 decibels the subject was excused from further participation for that day.

**MEASUREMENT DATA.** All post-exposure audiograms for both ears were completed within 10 minutes following the final noise exposures at 130 dB(A). Hearing threshold levels measured at 4000 and 6000 Hz approximately two minutes following cessation of the exposures were subtracted from the average baseline values measured immediately prior to the exposure to indicate the changes in the threshold levels. In phase 2, hearing threshold levels were measured immediately before and after each of the individual eight exposures at 125 dB(A) and 130 dB(A). In all cases, for both the audiograms and the threshold levels tracked at 4000 and 6000 Hz, negative values indicated increases in sensitivity and positive values represented decreases in sensitivity.

**DISCUSSION.** The pre-study hearing threshold levels for each audiogram test frequency were compared to the post-study audiograms and were found to be essentially the same at the completion of both phase 1 and phase 2. Generally, about one-half of the subjects showed no change in hearing levels, one fourth showed a five decibel increase in sensitivity and about one fourth showed a five decibel decrease in sensitivity. There were no significant differences observed in the audiometric hearing threshold levels of the exposed ear when compared to those of the protected (unexposed) ear (Figure 1). These data revealed no substantive changes in hearing attributed to the noise exposures at the audiometric frequencies for the volunteer subjects.

In phase 1, the observed changes in hearing threshold levels at 4000 and 6000 Hz were relatively equally distributed between small increases and decreases in levels measured following the noise exposures. No patterns emerged to indicate a clear relationship between the noise exposures and the hearing of the subject population. Only three changes in excess of the Criterion TTS (10 dB) of three decibels or less were observed at approximately two minutes following cessation of an exposure with one showing an increase in sensitivity of 12 dB and two showing decreases of 11 and 13 decibels. The two decreases in sensitivity returned to pre-exposure levels within six minutes. Frequency distributions of the hearing threshold levels of 4000 and 6000 Hz measured about 2 minutes following exposures were reasonably uniform and normal with only a few outliers (Figure 2).

In phase 2, the frequency distributions of 4000 and 6000 Hz hearing threshold levels were also reasonably uniform, and normal in configuration. However, observed changes in these hearing levels were not equally distributed showing slightly higher values in the post-exposure thresholds, indicating small decreases in hearing sensitivity (Figure 3). It is clear that the distributions have shifted to the right of zero change, in the positive direction, revealing that the hearing sensitivity of the subjects, although small, had increased. In spite of these shifts in the distributions, all threshold levels remained within the Criterion TTS value of 10 dB.

There were four exceptions to these data, subjects whose hearing threshold levels following noise

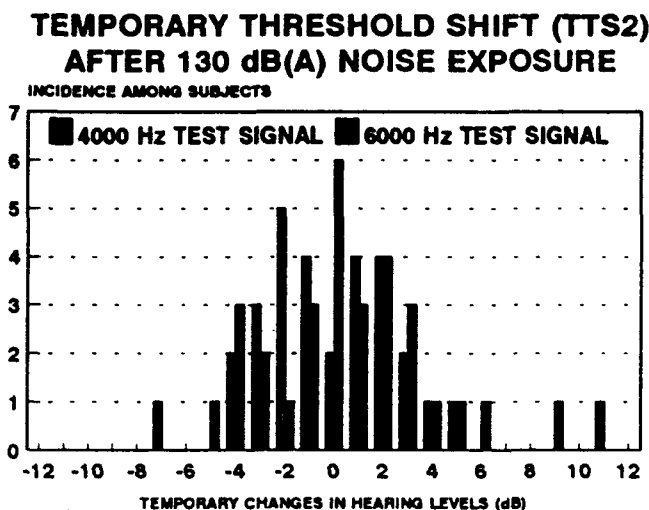
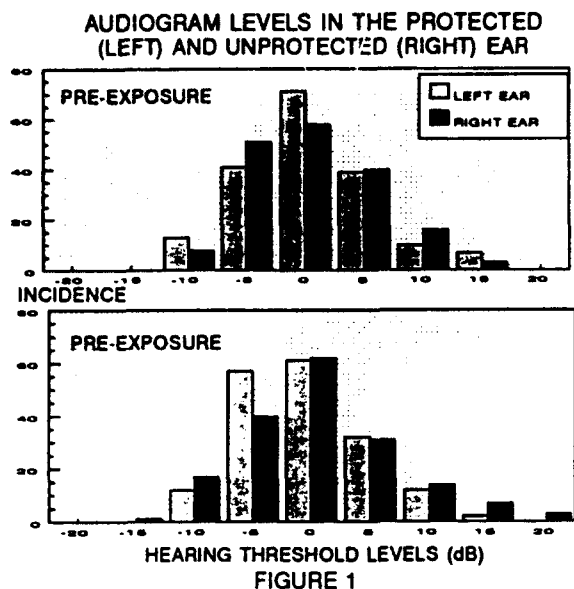

exposures exceeded the Criterion TTS at the 6000 Hz test signal. Two of these subjects successfully completed the experiment on a following day with no TTS and two failed a second time on a following day with TTS values of 11 dB and 17 dB and were excused from the study. The subjects dismissed from the study for exceeding the TTS standard at the 6000 Hz test frequency recorded normal audiograms at the conclusion of the test sessions from which they were dismissed. All subjects successfully completed phase 1. If a less conservative Criterion TTS of 17 dB had been utilized, all subjects would also have successfully completed phase 2 of the study.

*One-Hour Post-Exposure Thresholds.* Hearing threshold levels were also measured one hour following the post-exposure threshold after the eighth 130 dB(A) exposure in phase 2. No differences were observed between the two sets of data; the threshold level values measured at one-hour post-exposure were the same as the post-exposure values, no significant increases or decreases in hearing threshold levels were measured (Figure 4). The increases in TTS produced by aircraft flyover type noise measured at one to one and one-half hour post exposure over the post-exposure threshold values observed by other investigators were not present in these data.

**SUMMARY.** Measures of the pre-study and post-study audiograms for individual subjects exposed to recorded noise from low flying aircraft showed no significant changes at any test frequency or between the protected (left) and exposed (right) ears. Distributions of hearing threshold levels at 4000 and 6000 Hz shifted in the direction of decreased hearing sensitivity, with none exceeding 10 decibels for the worst case of eight successive exposures at 125 dB(A) and 130 dB(A). The TTS of two subjects exceeded the 10 dB Criterion TTS during the 130 dB(A) series of exposures and they were dismissed from the study. Hearing threshold levels at 4000 and 6000 Hz measured one-hour following the post-exposure measurements showed no significant increase or decrease in hearing.

## TEMPORARY THRESHOLD SHIFTS FOR EXPOSURES TO FLYOVER NOISES AT 125 dB(A) AND 130 dB(A)

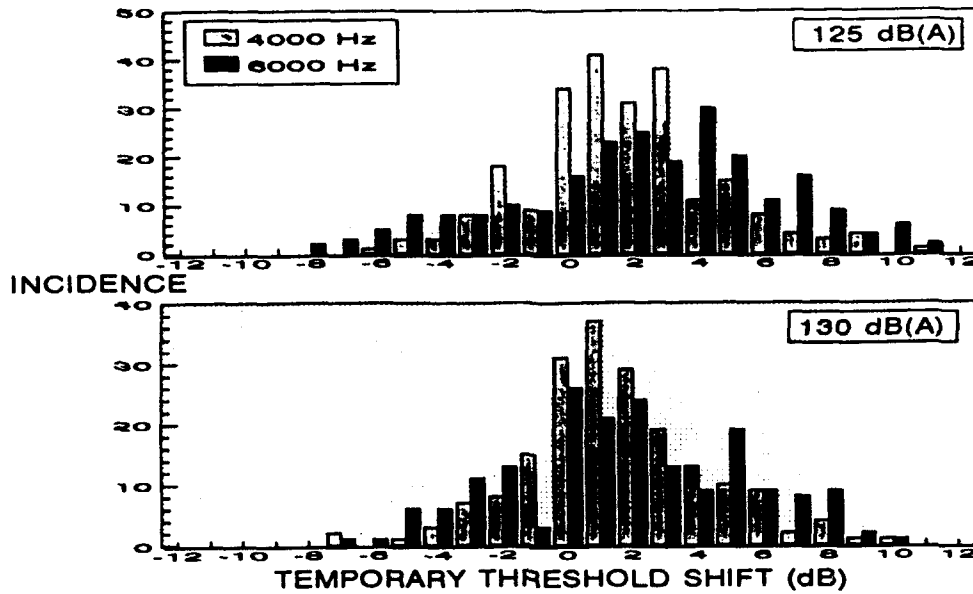

FIGURE 3

## POST EXPOSURE AND ONE HOUR POST EXPOSURE HEARING THRESHOLD LEVELS INCIDENCE AMONG SUBJECTS

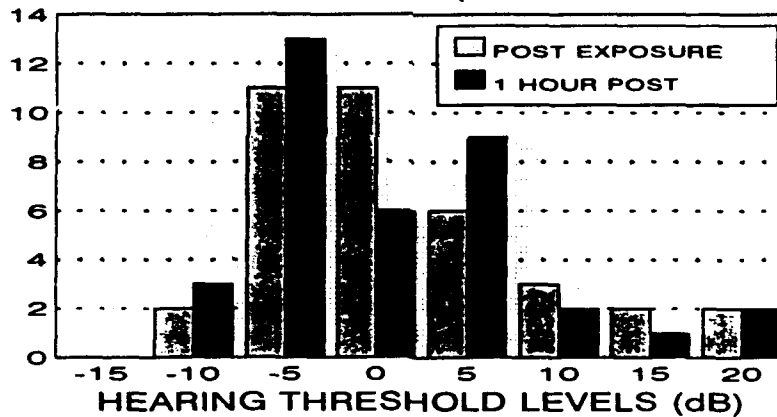

FIGURE 4

**CONCLUSIONS.** Worst case flavor noise exposures that exceed those that might be experienced in a real world situation under a low level military training route were utilized as stimuli in this study. Significant changes in hearing levels due to these exposures were not observed. An important discovery from these data was a slight shift of the frequency distribution of hearing threshold levels to poorer hearing for both the 4000 and 6000 Hz test frequencies following both the eight 125 dB(A) and the 130 dB(A) flavor noise exposure series. This suggests that multiple exposures of eight or less, within a time period of about 45 minutes and at the levels of 125 dB(A) and 130 dB(A), may indicate the threshold region at which behavioral measures of temporary hearing loss begin to appear at these frequencies for this stimulus. Overall, the data suggest that within the definitions of the laboratory worst case exposures relative to the real world exposures of a population under a MTR to a few flavor noises at the maximum levels of 130 dB(A), the probability of noise induced hearing loss must be very small.



## NOISE - INDUCED HEARING LOSSES: SOME EXPERIMENTAL RESEARCH'S RESULT

PATANIA Francesco \* - GAGLIANO Antonio \* - LUCA Anna

\* Engineering Faculty - Environmental Control's Technics  
University of Catania, Viale A. Doria, 6 - 95125 Catania (Italy)

### ABSTRACT

Human reaction to impact with noisy emissions is very subjective not only for psychological damages but also for somatic ones. For these reasons it is not quite reliable to try to find hearing losses only through physical or mathematical kind's theoretic formulations.

It is necessary for reliability of results to make investigation by experimental researches utilizing reasonable samples as such as to foresee noise's statistical hearing-effect on people in function both of work-noise exposure's times and loudness of noise.

Aim of this paper is to show, by obtained experimental diagrams and relative effected considerations, principal results coming from four experimental researches:

on the hearing damage of agricultural-machinery operators (year 1984);

on the hearing damage of construction-machinery operators (year 1987);

on the hearing damage of workshop-machinery operators (year 1988);

on the hearing damage of taxi-drivers (in progress).

All the tested categories run the typical risks caused by noise exposure.

The results try to find correlations between hearing losses and both work-noise exposure's times and loudness of noise and operator's biologic age.

### GENERALITY

All results shown in the present note coming from before carried out researches and from others still in progress (on taxi drivers and on continuous disco frequenters) all conducted in accordance with following operating procedures that are generally effective for any researches about matter.

- A) Cognitive researches on examined sample: registry-age, years of noise exposure, probable progress or past pathologies on the auditory apparatus, probable drugs or alcohol use, averaging daily frequency of noise exposure, averaging repose times of auditory apparatus.
- B) Survey in field: auditory threshold measure realized by B & K audiometer tipe 1800 before noise exposure, recording and estimation of sonor emission during an exposure fase realized by a sonar recorder tipe B & K Level Recorder 2307, measuring of threshold-level's model immediately after noise exposure. For in progress research on taxi drivers following data on cars have been pointed out: made year, horse power, car maintenance state, model car. Survey researches are reported on tables 1 and 2, and on diagrams and histograms (fig. 1 and 2).

## CONCLUSIONS

- 1- From the comparison among the obtained research results on agricultural, construction and workshop workers and i.e. on samples that presented: high est exposure levels, exposure times, repose times and working service time absolutely comparables it has been pointed out that the auditive losses caused by noise in different frequencies are comparables both as temporary and permanent losses and moreover they do not dipend either from the engine or from their horse power but only from sonor emission level (90 - 105 dB). Highest damaged frequencies are those swinging between 4000 and 5000 Hz.
- 2- From the comparison between previous sample results and continuous disco frequenters, that is a sample subjects to sonor emissions levels comparables (85 - 110 dB) it was noticed that the last present fewer damages as well if they are submitted to averaging exposure time slightly greater because it is continuative in the exposure period and that because of a a double reason: both because they have had exposure times for a number of years smaller than the machines operators and because (a very important reason) compared with noise psychologically they assume an attitude of "pleasure" opposite to working machines operators. In such sample it has been pointed out that all damages are "excited" when the subject makes use of alcohol and drugs in large quantity making "discontinuity" in excess. Also for these samples the most damaging frequencies swinging between 4000 and 5000 Hz, although damage is certainly fewer for all reasons previously shown.
- 3- From comparison among obtained results on taxi drivers and both samples shown in items 1 and 2 it has been pointed out that auditory damages suffered by this sample at the same exposure times, repose times and years of total exposure, but to different frequencies, are fewer than operators' ones. All this because this sample is subject to shorter exposure levels (70 - 85 dB). Moreover result shows that auditive damages suffered in different frequencies are bigger than disco sample ones in spite of the exposure during the time had bigger and repose times shorter. All this is possible thanks to a bigger influence on uditive damage due to exposure time. In this sample has been pointed out that mostly damaged frequencies are those swinging between 3000 and 4000 Hz, naturally smaller than those found in the others samples, as like as in reducing exposure sonor level automatically damaged frequencies worths reducing too. We have no certain reasons about this hypothesis because of some effectuated researches "narrowness" that is "statistically" a low number of samples employed to the effectuated researches. Further researches on samples more in great number than these examined tipologies could valid or not this last hypotesis.
- 4- Presence of "HUMMING" has been noticed in machines workers' group especial li with a non-elevated time of working activity and in disco frequenters' group that use alcohol and drugs.

TABLE 2

DISCO FREQUENTER								
N.	AGE	SEX	VISIT GENRE	TOXIC DRUGS	EXPOSURE TIMES (h)	WEEKLY FREQUENCY	EXPOSURE YEARS	PATHOLOGY
1	15	M	+	-	3	2	1	-
2	16	M	+	A1	4	1	1	-
3	16	M	+	A1	3	2	1	-
4	18	M	+	A1	5	1	2	-
5	18	M	+	A1	5	2	3	-
6	18	M	+	A1	4	2	2	-
7	19	M	+	-	4	1	3	-
8	20	M	+	D1	6	3	2	Sp1
9	20	M	+	A2	4	2	3	-
10	20	M	+	-	5	2	4	-
11	21	M	+	A1	5	2	5	-
12	22	M	+	D1	6	4	5	Sa1
13	23	M	+	A2	7	2	4	-
14	24	M	+	A1	6	2	8	-
15	24	M	+	A1	5	2	7	-
16	24	M	+	D1	7	3	8	Sa3
17	25	M	+	-	4	2	4	-
18	25	M	+	A2	6	2	9	-
19	25	M	+	D1 A1	7	3	7	-
20	26	M	+	A1	5	2	9	-
21	27	M	+	D1 A2	8	3	10	Sp1
22	27	M	+	A3	6	2	10	-
23	28	M	+	A3	7	3	12	-
24	31	M	+	A2	8	2	14	Sp1

MUSIC: + = NIGHT LEVEL DISCO; + = SOUTH AMERICAN; - = SLOW  
 ALCOHOL: A1 = LIGHT; A2 = MEDIUM; A3 = HEAVY  
 DRUG: D1 = LIGHT; D2 = MEDIUM; D3 = HEAVY  
 PATHOLOGIES: Sp = passed; Sa = attenuated  
 1 = LIGHT; 2 = MEDIUM; 3 = HEAVY

TAXI DRIVERS									
N.	AGE	WORK YEARS	ALCOHOL DRUGS	DAILY FREQUENCY	PATHOLOGY	MAINTEN STATE	HORSE POWER (CV/EV)	MODEL CAR	MODE YEAR
1	26	2	-	12	-	1	77/105	E.FO.B	1988
2	28	3	A1	12	-	1	77/105	E.FO.B	1987
3	30	5	A1	12	-	1	57/77	T.FI.B	1988
4	31	4	A1	12	Sp1	2	57/77	T.FI.B	1986
5	34	6	A1	12	-	1	85/116	C.FI.B	1986
6	35	8	A1	10	-	2	85/116	C.FI.B	1988
7	36	11	-	12	-	2	77/105	E.FO.B	1986
8	37	9	-	10	-	2	85/116	C.FI.B	1986
9	43	12	A2	10	Sp2	3	85/116	C.FI.B	1986
10	46	11	-	12	-	2	57/77	T.FI.B	1987
11	46	10	-	10	-	3	85/116	C.FI.B	1987
12	50	13	A1	10	-	2	57/77	T.FI.B	1986
13	50	15	-	12	Sp1	2	85/116	C.FI.B	1986
14	52	18	-	10	-	2	87/118	S.FO.B	1988
15	55	21	A1	8	Sp1	1	87/118	S.FO.B	1989
16	58	26	-	10	-	1	85/116	C.FI.B	1987
17	59	32	A1	8	-	1	87/118	S.FO.B	1988
18	60	28	-	8	Sp2	1	85/116	C.FI.B	1986

ALCOHOL: A1 = LIGHT; A2 = MEDIUM; A3 = HEAVY  
 DRUG: D1 = LIGHT; D2 = MEDIUM; D3 = HEAVY  
 PATHOLOGIES: Sp = passed; Sa = attenuated  
 1 = LIGHT; 2 = MEDIUM; 3 = HEAVY  
 MAINTENANCE STATE: 1 = GOOD; 2 = MEDIUM; 3 = POOR  
 MODEL CAR: C = CRONA; T = TIPO; F = FIAT; E = ESCORT;  
 S = SIERRA; FO = FORD; B = PETROL

Fig.1

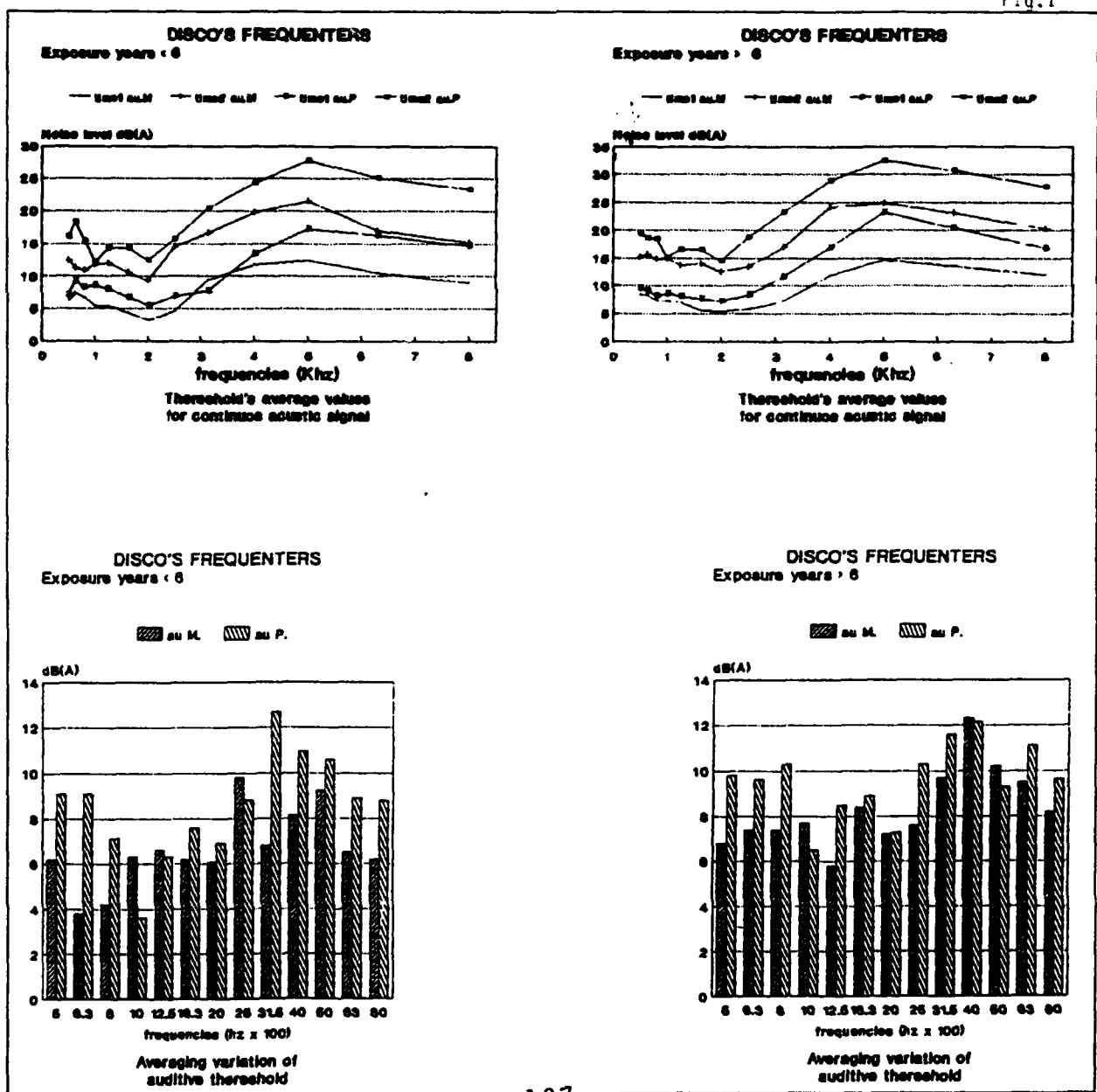

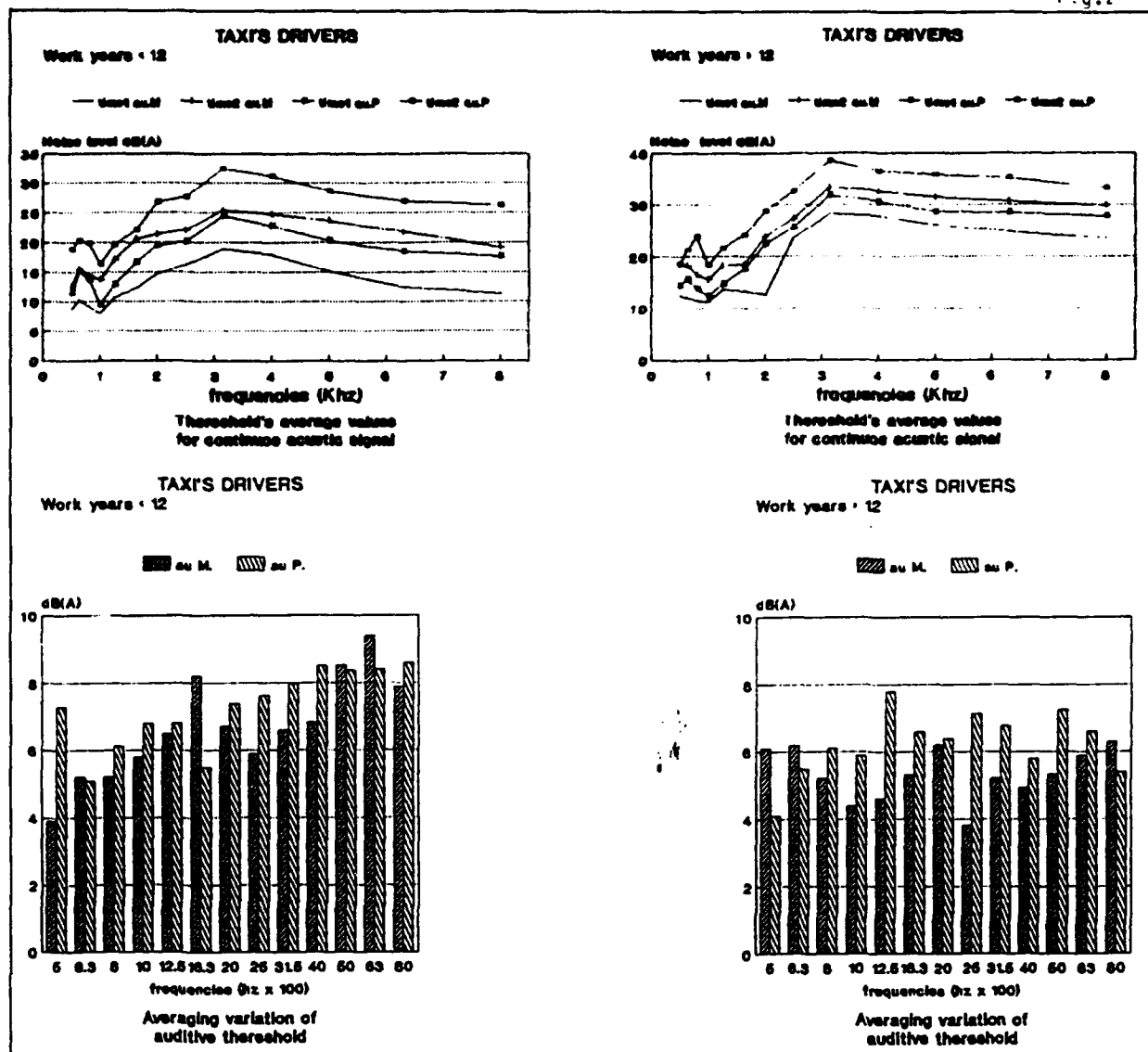

## BIBLIOGRAPHY

- 1) G. Cammarata, F. Patania, L. Marletta, F. Patanè - "La rumorosità ambientale nella zona aeroportuale di Catania" - Rivista Italiana di Acustica vol. IV, n.1 (ROMA 1982)
- 2) G. Cammarata, F. Patania, L. Marletta, F. Patanè - "Effetti della rumorosità delle macchine sugli operatori agricoli" - Atti del XII Convegno Nazionale AIA (PERUGIA 1984)
- 3) G. Cammarata, F. Patania - "Effetti della rumorosità delle macchine sugli operatori da cantiere" - Atti del XVI Convegno Nazionale AIA (MILANO 1988)
- 4) G. Cammarata, F. Patania - "On the hearing damage of machinery operators: experimental research work" - International Acoustical Meeting (Tampere, FINLAND June 1988)
- 5) G. Cammarata, F. Patania, L. Marletta, F. Patanè - "Indagine sull'inquinamento acustico nelle aree suburbane di Catania. Analisi degli indici di valutazione ed indagine sociologica" - Atti del IX Convegno Nazionale AIA (BARI 1981)
- 6) F. Patania, A. Gagliano - "Protezione dell'ambiente dalle attività antropiche" - Atti del XXI Convegno Nazionale AIA (PADOVA 1993).

Giovanni PRECERUTTI (\*), Vittorio VACCARI (\*\*)

- (\*) Università degli Studi di Pavia.  
Istituto di Clinica Otorinolaringoiatrica.  
Cattedra di Audiologia.  
Piazzale Golgi, 2 - I 27100 Pavia (PV) - Tel. 0039.382.526218
- (\*\*) Università degli Studi di Pavia.  
Dipartimento Ricerche Aziendali.  
Via S. Felice, 5 - I 27100 Pavia (PV) - Tel. 0039.382.386250

#### SUMMARY

We have observed a group of 987 audiograms of subjects without occupational noise exposure and with a hearing loss focused at 3-4 KHz.

A lot of causes considered from time to time source of this hearing loss, has been diligently looked in anamnesis, like head traumas, taking of otologic drugs, diabetes, viral infections, pregnancy or perinatal pathologies, etc.

41 patients passed this screening and their hearing loss didn't seem to be justified.

No sexes differences were encountered, age was equitably distributed from 10 to 70 years.

The dip was, nearly in all cases, bilateral (only in 4 cases was present monolaterally) with an average loss at 4 KHz of 32 +/- 12 dB.

We examined life side and qualities of this sample.

17 people were resident in front of internal highways or external expressways, with exposure levels, phonometrically measured of nearly 80 dB leq/day

7 people were usual haunters of discoteque at least once or twice weekly

3 people were usual walkmann users (3 or more hours/day)

in 14 people hypoacusia didn't seem be justified.

We think that in order to prevent auditory damage, social noise exposure, play exposure etc. was necessary reduced because in some subjects a particular cochlear weakness may justify an auditory damage with lower levels than recommended.

This occurs in 3% of our cases.

We have observed a group of audiograms gathered at the ORL Clinic of Pavia University.

The common characteristic was the presence of a dip, nearly in all cases bilateral, at 3-4 KHz.

Whenever such a hearing loss was found, the patient was asked if he had been exposed to occupational noise or if he had used guns.

In case of a negative answer (987 subjects in about 10 years) adequate anamnesis was gathered in order to detect other pathologies which might cause a similar audiometric loss, and a few medical tests were might cause a similar audiometric loss, and a few medical tests were prescribed (i.e. analysis of urine, glycaemia, lipoproteins).

The formulation of the questions and the tests were based on the researches of Profazio and Coll. (1), who report as the most frequent causes of hypoacusia: cardiocirculatory diseases (38%), head traumas (24%), taking of ototoxic drugs (22%), diabetes mellitus (13%), viral infections (12%), hyperlipoproteinemia (9%), cervical traumas (6%), kidney diseases (5%); etc.

Only in 41 subjects (4.15%) it was not possible to attribute the hearing loss to the causes above mentioned.

Table 1 shows the sample composition as to sex, age and average loss value.

Table 1 - Sample composition

SAMPLE COMPOSITION		
Total sample number 41 people	Men	Women
Sample number	23	18
Averaged age	32.82 s.d. 12.74	39.77 s.d. 14.13
3-4 Kc max dB loss average	32.22 s.d. 12.08	31.21 s.d. 10.97

It can be noted that the sample distribution is balanced enough as to sex and age, and that the hearing losses are similar.

At that point we examined a few life conditions which looked meaningful for the sample: the environmental noise of the subjects' residence and the possible play exposure, particularly discoteque haunting and use of walkmann.

Table 2 shows the results of the research.

Table 2 - Non industrial noise exposure

**SAMPLE ARRANGEMENT**

<b>Total sample number 41 people</b>	<b>Men</b>	<b>Women</b>
People resident in exposed area	N.7 av.age 46.8 4Kc dip 29.3+/-5.1	N.10 av.age 47.5 4Kc dip 34+/-12.6
People hunters of discoteque	N.5 av.age 26 4Kc dip 35+/-5.7	N.2 av.age 23 4Kc dip 28.7+/-2.5
People users of walkmann	N.2 av.age 18 4Kc dip 32.5+/-8.6	N.1 age 18 4Kc dip 20+/-7
People with not justified hypoacus.	N.9 av.age 29 4Kc dip 32.9+/-18.2	N.5 av.age 35 4Kc dip 27.8+/-6.3

In 14 cases (1.4% of the sample) we have found no evident cause which might justify the loss.

In a non industrial noise exposed population Profazio and Coll. (1 found a loss at 4,000 Hz of the subjects.

An anamnestic check, careful and completed with laboratory analyses, may justify many of the cases, but at least for 4% of them hypoacusia is not justified.

Though we have observed a much lower number of cases (about 1,000, corresponding to 5% of the audiologic tests executed in the ORL Clinic) the percentage of the not justified cases coincides with the one found by the researches above named.

It seems to be possible, however, that in 27 subjects (2.73%) the auditory damage may be caused by a non industrial noise exposure (social or play exposure) though of a lower intensity than the levels normally considered as harmful.

A particular cochlear weakness is to be assumed in these subjects for whom the auditory damage threshold is at lower levels than those usually considered as safe.

These people represent about 1.36% to the subjects we examined, but probably they are more, as some people with cochlear weakness may be found also among the subjects excluded from the research, being exposed to damaging noises or suffering from otopathies.

In order to prevent auditory damage, it is advisable, therefore, to reduce social and play noise exposure at lower levels than recommended.





# **AN IMPROVED DAMAGE RISK CRITERION FOR INTENSE IMPULSE NOISE**

**PRICE G.R.**

**US Army Human Engineering Laboratory  
Aberdeen Proving Ground, Maryland, USA 21005**

**A-weighted energy has gained general acceptance as an index of hazard for use with most industrial noises ; however, research indicates that it, along with the other methods currently used, does very poorly in rating the hazard from intense impulses.**

**In order to deal with the complexity of the ear's response to intense impulses, we have developed a mathematical model of the ear conformal with the structure of the ear that reproduces the response of the ear from free field pressures to basilar membrane displacements. The rating of hazard is based on a simple model of mechanical stress at the level of the basilar membrane. This model has been implemented in a PC-level computer, operates through menus and includes, in addition to spectral tuning, a non-linear stapes, a changing susceptibility along the cochlear partition, and can accommodate middle ear muscle contractions as well as the use of hearing protectors. This approach has the virtue of being complex enough to rank hazard far more accurately than other damage-risk criteria while still being simple enough to use.**



OCCUPATIONAL HEARING LOSS AMONG WORKERS  
OF THE STEEL INDUSTRY;  
A COMPUTERIZED SURVEY

RIBEIRO, Vasco; RIBEIRO, José; COHEN, A.  
Av. da República, 45 - 4<sup>o</sup>E, 1000 LISBOA, PORTUGAL.

ABSTRACT

A noise evaluation, clinical and audiologic survey of 1921 workers in the portuguese steel industry and some considerations about the "risk of deafness" in such industry.

RESUMÉ

Un étude du bruit, examen medical et audiologique de 1921 travailleurs de l'industrie de l'acier au Portugal et quelques considerations au sujet du "risque de surdit " dans cette industrie.

INTRODUCTION

As deafness caused by bilateral cochlear damage is found to be a prevailing situation in the professional pathology of the steel industry, the purpose of this paper is set on workers in the steel industry under a pathological environment exposure for human ear.

STUDY METHOD

A) Measurement of the sound levels in the working places, according to the 86/188/CE directive and corresponding noise spectral characterization.

B) Audiologic study of each worker under noise exposure covering: (1) Anamnesis; (2) Clinical observation by an ENT phisician; (3) Tonal audiometry according to ISO 6189, corrected according to the II Amnex of the 86/188/CE directive and including Bone conduction study; (4) Middle ear analysis; (5) Stapes reflexogram.

C) Computing the acquired data.

D) Interpretation of the acquired results thus allowing us to estimate the deafness risk in each area of the factory.

In fact, the 86/188/CE directive, on which the law of noise was based, does not cover the assessment of the individual susceptibility to noise in exposed workers, for it refers only to the characterization of the noise as the only source of risk.

Our approach to the problem of prevention evaluates the definition of the place of work, not only regarding the noise characterization, as well as the number of workers showing deafness by sound trauma, or those who, though not yet deaf, already reveal threshold decrease at 4KHz.

Sometimes, one surprisingly verifies that there is not always an interconnection between the intensity of the noise and the exposure period, and the sound-traumatic pathology.

This fact leads us to think that factors such as the individual susceptibility, the ergonomics and the working environment, may be the cause for these discrepancies. We are therefore of the opinion that it should be urgent to develop new methods of analysis in these areas, as well as to consider adding a new article on the assessment of the individual susceptibility to the legislation on professional deafness prevention.

**CONCLUSION:**

The present values show that there is still a lot of work to be done regarding the prevention at this particularly noisy sector of work, not only for the improvement of the environment and of the working conditions, as well as for the human aspect of the issue, by using noise reaction individual assessment, at admission, by individual sensibilization to the use of adequate protection, and by allowing the social possibility of rotative work of staff not able to stand noise exposure.

We truly hope that the values we here presented will be considered unreal 20 years from today.

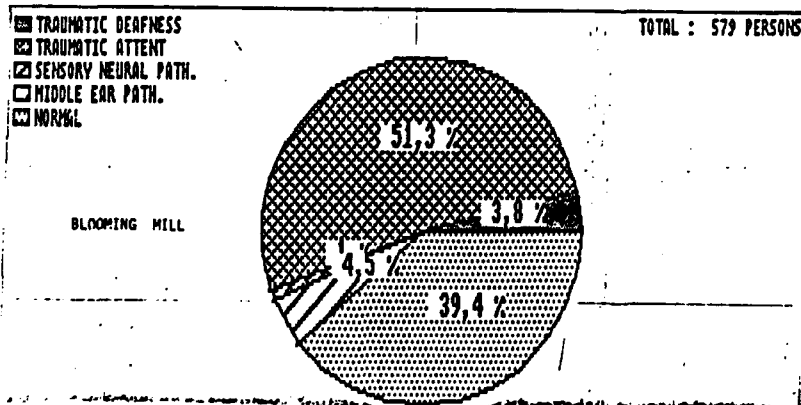
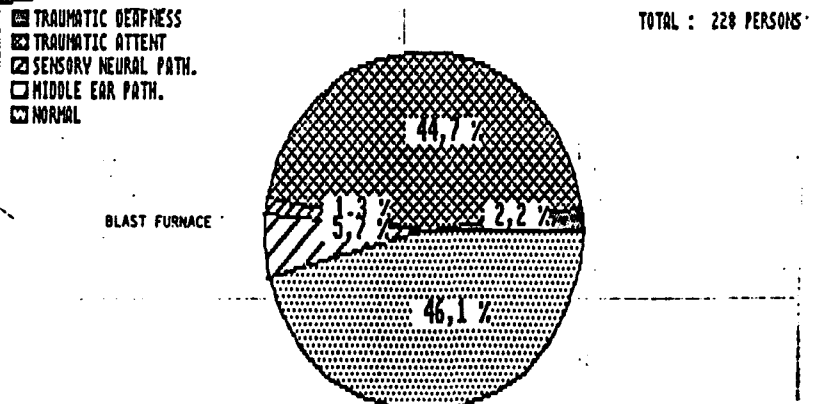
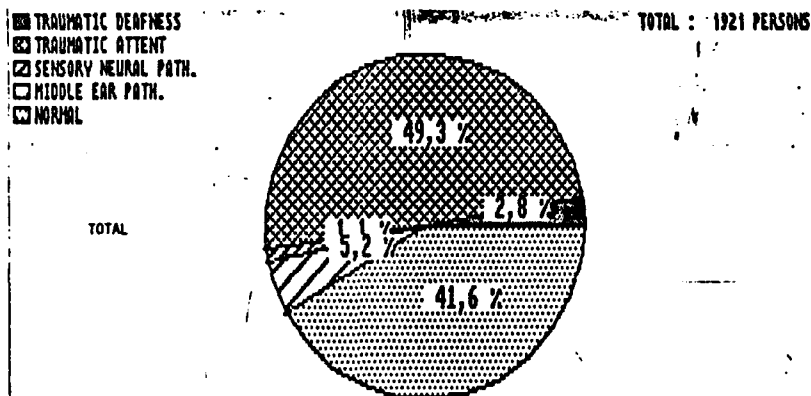

- TRAUMATIC DEAFNESS
- TRAUMATIC ATTENT
- SENSORY NEURAL PATH.
- MIDDLE EAR PATH.
- NORMAL

TOTAL : 338 PERSONS

SLABBING MILL

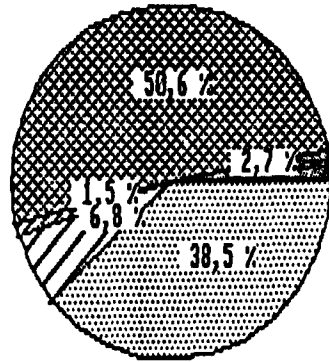

- TRAUMATIC DEAFNESS
- TRAUMATIC ATTENT
- SENSORY NEURAL PATH.
- MIDDLE EAR PATH.
- NORMAL

TOTAL : 88 PERSONS

POWER PLANT

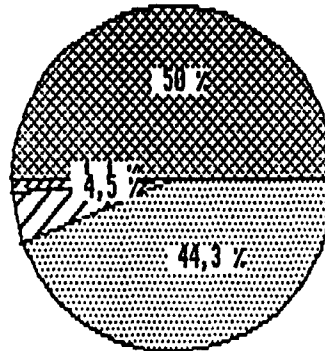

- TRAUMATIC DEAFNESS
- TRAUMATIC ATTENT
- SENSORY NEURAL PATH.
- MIDDLE EAR PATH.
- NORMAL

TOTAL : 249 PERSONS

MAINTENANCE

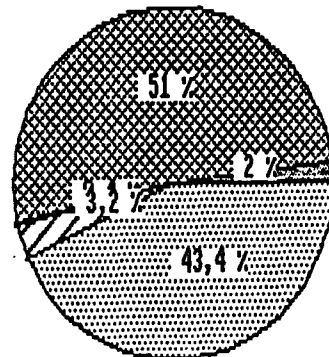

- TRAUMATIC DEAFNESS
- TRAUMATIC ATTENT
- SENSORY NEURAL PATH.
- MIDDLE EAR PATH.
- NORMAL

TOTAL : 98 PERSONS

TRANSPORTS

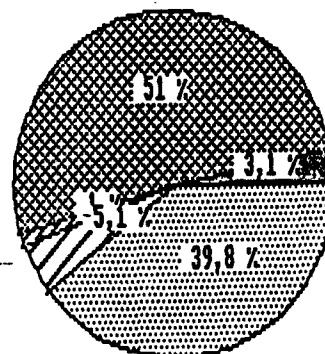

- ☒ TRAUMATIC DEAFNESS
- ☒ TRAUMATIC ATTENT
- ☒ SENSORY NEURAL PATH.
- ☐ MIDDLE EAR PATH.
- ☒ NORMAL

TOTAL : 223 PERSONS.

BASIC OXYGEN  
FURNACE

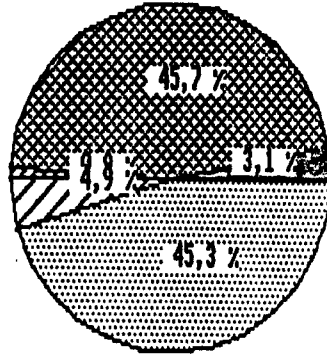

- ☒ TRAUMATIC DEAFNESS
- ☒ TRAUMATIC ATTENT
- ☒ SENSORY NEURAL PATH.
- ☐ MIDDLE EAR PATH.
- ☒ NORMAL

TOTAL : 89 PERSONS

QUALITY CONTROL

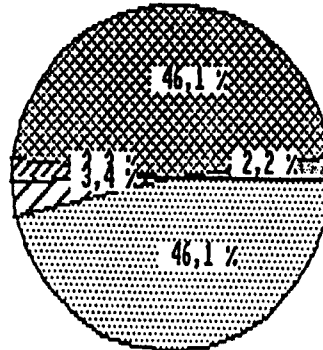

- ☒ TRAUMATIC DEAFNESS
- ☒ TRAUMATIC ATTENT
- ☒ SENSORY NEURAL PATH.
- ☐ MIDDLE EAR PATH.
- ☒ NORMAL

TOTAL : 29 PERSONS

OTHERS

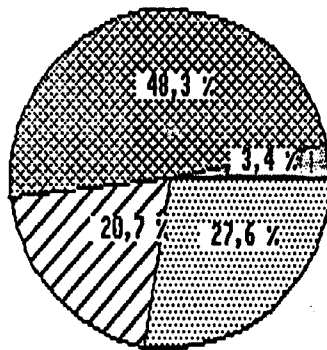

# HEARING IN 18-YEAR OLD MEN - IS HIGH FREQUENCY HEARING LOSS MORE COMMON TODAY THAN 17 YEARS AGO?

ROSENHALL Ulf (1), AXELSSON Alf (1) and SVEDBERG Alf (2)

Department of Audiology, Sahlgrenska hospital, University of Göteborg, Sweden (1) and  
Department of Audiology, University hospital, Uppsala, Sweden (2)

## ABSTRACT

A cohort comparison of the hearing of 18-year old men was performed in connection with conscription to military service. The first cohort, consisting of 37000 men, was studied with screening audiometry in 1970-77. The other cohort consisted of 500 men and was studied with pure tone threshold measurements in 1992. The prevalence of high frequency hearing loss was the same in both cohorts. In the seventies the prevalence of high frequency hearing loss was 7.8% - 6.2% for the left and right ears respectively. In 1992 the corresponding figures were 6.4% and 7.2%. There are no indications in the present material that hearing loss affecting noise-sensitive frequencies has become more common in recent years.

## INTRODUCTION

Concerns have been expressed about the notion that the environment has become more noisy in the last decades, in spite of the fact that considerable efforts have been made to reduce exposure to occupational noise. Leisure activities, particularly related to music listening, motor sports, shooting toys, games and fire crackers, have been regarded hazardous for young people's hearing (for a review, see Axelsson et al, 1981).

The incidence of hearing loss in young men has been reported to increase in recent years. Borchgrevink (1988) reported a prevalence of high frequency hearing loss of around 18% in 35000 18-year old Norwegian male conscripts in 1981. In 1987 the prevalence had increased to around 35%. According to Borchgrevink this increase in incidence probably reflects increased leisure noise exposure, most likely caused by excessive music listening. From Great Britain a similar, high prevalence of hearing loss (45%) in 20-year old males has been reported (Davis, 1993, personal communication).

## STUDY GROUPS AND METHODS

The present study is a cohort comparison of the hearing of two groups of 18-year old Swedish conscripts, one group tested in the seventies and the other in 1992.

### Cohort 1

The first group consists of 37017 men tested at the conscription for military service during

the years 1970-77 (most of them during the years 1973-76) at six conscription centers. In 1973 6804 conscripts were tested, in 1974 the number was 11110, in 1975 9824 and in 1976 6768. The conscripts were 18 years old and they came from all parts of Sweden.

Screening audiometry was performed at the frequencies 0.5, 1, 2, 3, 4 and 6 kHz using Tegnér PTA 6 screening audiometers. The screening level 20 dB HL was used; those with hearing thresholds  $\geq 25$  dB HL at one or more of the test frequencies were identified. All tests were carried out in sound-insulated test rooms by medical servicemen with no formal education in audiometry but with a considerable training to perform screening tests.

## **Cohort 2**

The other group consists of 500 18-year old conscripts tested in 1992. These conscripts came from the western region of Sweden and they constituted about 5% of all 18-year olds from that region, and we believe that they are representative for that age group. The average time-lag between cohort 1 and 2 was 17 years.

Pure tone audiometry was performed in a sound insulated test room using a Danplex DA 74 audiometer with TDH earphones. The air conduction thresholds at the frequencies 0.25, 0.5, 1, 2, 3, 4, 6 and 8 kHz were determined by a clinical audiologist. The results of this study are reported elsewhere (Axelsson et al, 1993).

## **RESULTS**

In cohort 1 (1970-77) the prevalence of hearing loss affecting the 3, 4 and 6 kHz region exceeding 20 dB HL at one or more of the frequencies was 7.8% for the left ear and 6.2% for the right ear. The total prevalence of hearing loss affecting one or both ears, was 14.2%.

The distribution of hearing losses is given in Fig. 1. Hearing loss was most common at the frequency 6 kHz with a prevalence of 5.2% of the right ear and 6.4% of the left ear. At 3 kHz the prevalence was 2.1% and 2.6% respectively. At 3 kHz the prevalence of hearing loss is 1-1.5%, and at 0.5-2 kHz less than 1%. Slight hearing loss (25-30 dB HL) was more common in the left ear than in the right, but moderate to severe hearing loss (35 -  $\geq 55$  dB HL) was equally common in both ears.

In cohort 2 (1992) the prevalence of high frequency hearing loss exceeding 20 dB HL at 3, 4 or 6 kHz was 7.2% for the left ear and 6.4% for the right ear. The total prevalence of hearing loss in one or both ears, was 14%.

The distribution of hearing loss is given in Fig. 2. At 6 kHz the prevalence of hearing loss was 6.4% of the left ear and 5.8% of the right. At 4 kHz the corresponding values was 4% and 2.2%. At 0.5 - 3 kHz 0.4% - 1.8% of the ears had defective hearing.

## **DISCUSSION**

Klockhoff et al (1986) studied the hearing status of a large number of Swedish conscripts on reporting to military service during the period 1976-79. A large percentage, 29%, had "defective" hearing ( $>20$  dB at one or more test frequency), in most cases high frequency losses. During military service the hearing deteriorated in 4.9% of the conscripts.

Our cohort 1 consists of the same conscripts as those studied by Klockhoff et al (1986). Our data emanate from the conscription and their data when the same young men started and finished



the military service. The prevalence of hearing loss at conscription was 14.2% and on reporting to military service 29%. The difference seems surprising since the period that elapsed from the conscription to the start of the military service was on average only 18 months, but can to a great extent be explained by methodological factors. The conscription tests were performed in six centers in Sweden, where sound insulated test rooms were used. The tests which were done in connection with the military service were performed at a large number of military units all over Sweden, where sound insulated test rooms were not available, and we think that this methodological difference could explain the discrepancy of the hearing loss prevalence. The comparison between hearing tests on reporting and at the end of military service is nevertheless justified since these tests were performed with the same methodology.

This clearly demonstrates the importance of the methodology used. Mass screening procedures might introduce systematic errors, which could have a pronounced influence on the prevalence of slight hearing loss. In the present report two different methods were used. In cohort 1 from 1970-77 a screening procedure was used at the conscription. It is unlikely that the prevalence of hearing loss was overestimated then since on reporting to military service soon afterwards the prevalence was doubled. On the contrary, there is a possibility that the prevalence of hearing loss could have been underestimated at the conscription.

In 1992 the participants of cohort 2 were tested by a clinical audiologist with approved methods and the prevalence of hearing loss is reliable in this material. The prevalence of hearing loss was the same in both cohorts. Consequently, there are no indications that noise induced hearing loss has become more common among 18-year old Swedes during the 15-22 years that elapsed between the two test sessions.

We cannot explain the difference between the Norwegian study performed by Borchgrevink in 1988 and the present one. It could be assumed that the prevalence of hearing loss should be similar in Norwegian and Swedish 18-year old men. Differences in methods used could be one explanation for the discrepancy. The prevalence of slight hearing loss very close to the screening level is obviously very sensitive to changes in the test procedure.

## REFERENCES

Axelsson A, Jerson T, Lindberg K, Lindgren F. Early noise induced hearing loss in teenage boys. *Scand Audiol* 10: 91-96, 1981

Axelsson A, Rosenhall U, Zachau G. Hearing in 18-year old Swedish males. *Scand Audiol*, submitted, 1993.

Borchgrevink HM. One third of 18 year old male conscripts show noise induced hearing loss >20 dB before start of military service - the incidence being doubles since 1981. Reflecting increasing leisure noise? Noise as a Public Health Problem. 2. Swedish Council for Building Research 27-32, 1988.

Klockhoff I, Lyttkens L, Svedberg A. Hearing damage in military service. *Scand Audiol* 15: 217-222, 1986.

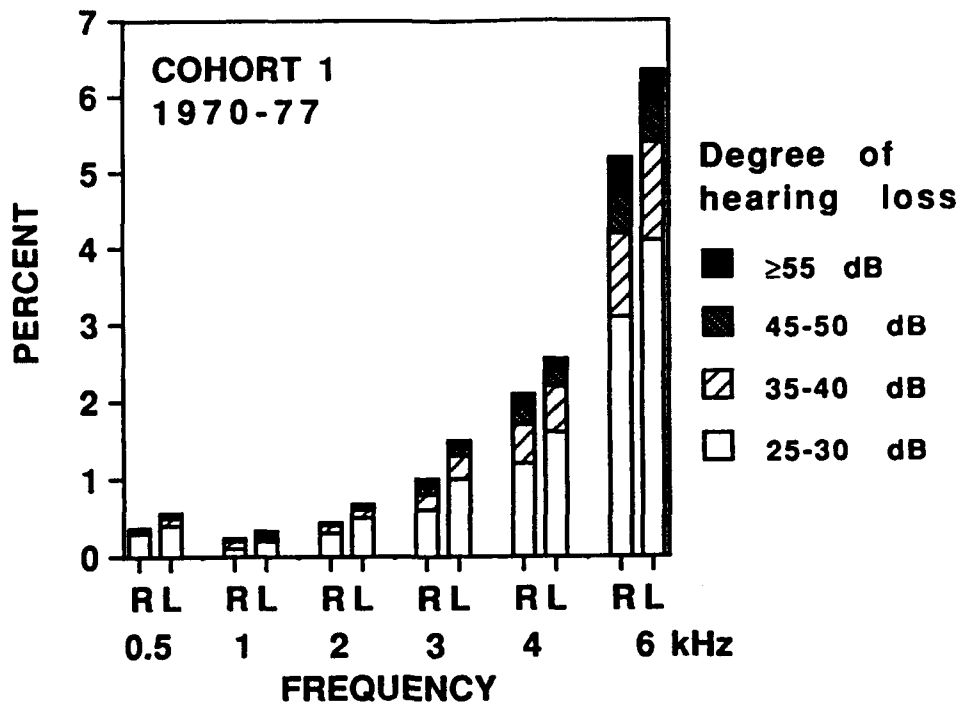

**FIGURE 1.** Prevalence of hearing loss ( $\geq 25$  dB HL) at the frequencies 0.5 - 6 kHz, cohort 1 (1970-77). Hearing loss is more common in the left ear (L) than in the right (R).

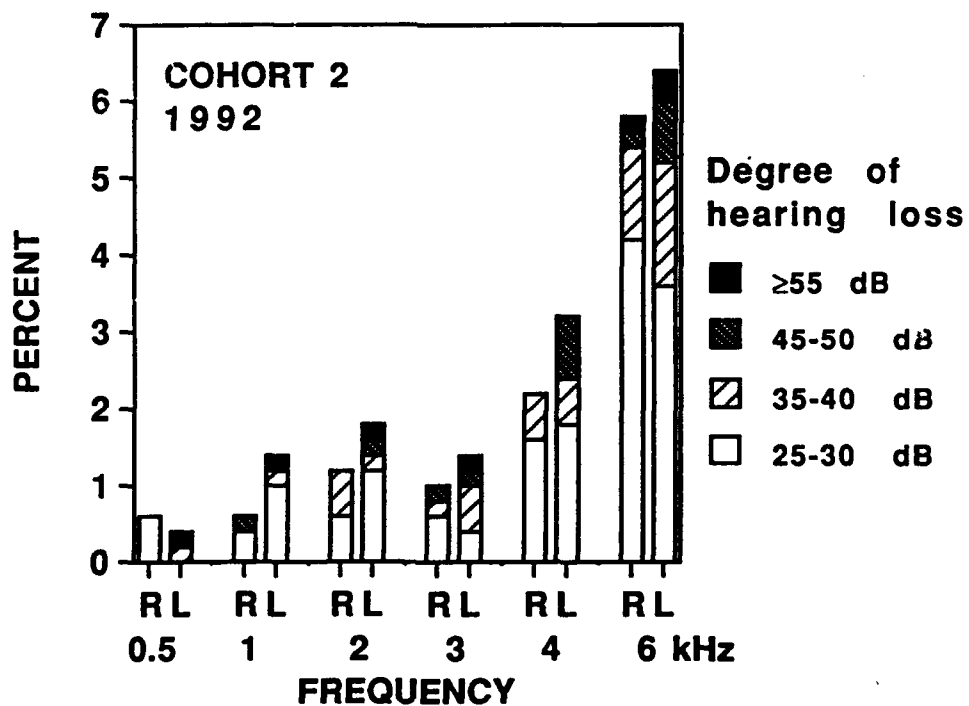

**FIGURE 2.** Prevalence of hearing loss ( $\geq 25$  dB HL) at the frequencies 0.5 - 6 kHz, cohort 2 (1992). Hearing loss is more common in the left ear (L) than in the right (R). The total prevalence of hearing loss is similar as in cohort 1.

## IMPLEMENTATION OF A HEARING CONSERVATION PROGRAM AT AN AIRLINE COMPANY

SOUSA-UVA, António; SILVA-CARVALHO, António; RIBEIRO, Vasco; PIMENTA, Armindo; VARÃO, Luísa and SÁ-LEAL, António  
Serviços de Saúde da TAP Air-Portugal, Edifício 8, Aeroporto de Lisboa, Apartado 5194, 1704 LISBOA CODEX, PORTUGAL.

### ABSTRACT

Noise-induced hearing loss is a major occupational health problem in many industries. This problem affects namely blue-colour employees working for commercial aviation companies.

It seems therefore justified to implement a HCP (hearing conservation program), ie a program for the prevention of on-the-job hearing loss, covering blue-colour personnel working for the Portuguese airline TAP Air-Portugal.

The Authors present preliminary data on both the sound survey of the areas concerned as well as the medical surveillance of the individual workers exposed to the risk, which includes:

- auditory history
- brief visual check of the ear canals
- audiometric evaluations and monitoring.

### RESUMÉ

La perte d'audition induite par le bruit se pose comme un grave problème de Santé au Travail dans de nombreuses industries. Ce problème touche notamment les "cols-bleus" employés par les compagnies d'aviation commerciale.

Il semble par conséquent pertinent d'implanter un Programme de Conservation de l'Audition, c'est-à-dire un programme pour la prévention de la perte permanente d'audition sur le lieu de travail à TAP Air-Portugal.

Les Auteurs présentent des données préliminaires concernant aussi bien le relevé sonore des zones en question, que la surveillance médicale des travailleurs exposés à ce risque, cette dernière comprenant:

- histoire audiolgique
- examen visuel bref des conduits auditifs
- évaluation audiométrique et enregistrement.

### INTRODUCTION

As a consequence of the chronic exposure to high levels of noise, noise-induced hearing loss is one of the most prevalent occupational diseases in the great majority of industries.

In many firms of the tertiary sector a large number of the workforce also carry out their tasks exposed to high levels of noise. This is the case in some commercial aviation companies, where the implementation of industrial hearing conservation programs (HCPs) is therefore necessary.

Noise-induced hearing damage is dose dependent, ie it varies according to the intensity and duration of the noise exposure; it also depends on the individual characteristics of the workers exposed to the risk, which include eventual cases of hypersusceptibility and some middle-ear pathologies.

The preliminary data presented here refer to just a part of the labourforce involved in the HCP we are currently carrying out, as they only include workers within the Maintenance & Engineering Division, where aircrafts are actually repaired and maintained.

## METHODS

### NOISE EXPOSURE EVALUATION

The authors carried out the sonometric characterization of TAP Air-Portugal working areas within Maintenance & Engineering Division. This included the evaluation of daily, weekly and peak exposure levels.

The quantification of exposure levels was made, in the case of continuous exposure, by means of sonometry with a noise statistical analyser from Brüel and Kjaer, type 4426, with A filter and precision sound level meter of Brüel and Kjaer type 2209 equiped with A filter and an octave filter (frequency analyser) type 1633. Measurements were carried out 1.5 meters above ground level and 1mt away from the walls (indoor measurements) and 3.5 mts away from reflector surfaces (outdoor measurements).

In cases with discontinuous exposure we used individual noise dosimeter from Quest Electronics type M-28 with an A filter for registration of the "Equivalent Continuous Sound Level" (Leq), "Maximum Sound Level" (Max L), "Peak Level" (L Peack), "Daily Exposure Level" (Lep, d) and "Sound Exposure Level" (SEL). The dosimeter was carried by the worker with the microphone close to the external ear during the work cycle.

The working areas were subsequently classified according to the following criterium:

- class 0 - Lep, d < 85 dB (A)
- class 1 - Lep, d between 85 and 89 dB (A)
- class 2 - Lep, d between 90 and 94 dB (A)
- class 3 - Lep, d > 95 dB (A)

### CLINICAL EVALUATION

The medical monitoring included a complete clinical examination which emphasised the following points:

- auditory history (details on the employee's occupational and non-occupational noise exposure; medical conditions affecting hearing; presence of tinnitus; other related information).
- brief visual check of ear canals.
- tonal audiometric evaluation, with both air and bone conductions and impedanciometry when required.

For this we used an audiometer Amplaid mod.455 with headphones TDH 49P, with bone oscillator B-71 and calibrated according to ISO 389. For impedanciometry a Grason-Stadler GSI 28-A was used. In order to quantify the hearing loss in a comparable way an "average hearing loss" (AHL) was calculated for each ear according to the following formula:

$$\text{AHL} = \frac{(2 \times 500) + (4 \times 1.000) + (3 \times 2.000) + (1 \times 4.000)}{10}$$

(Hz frequencies: 500; 1,000; 2,000 and 4,000)

This allowed us to classify the hearing damage in each ear into the following classes:

- Class 0 : normal hearing
- Class I : average hearing loss lower than 35dB or "dip" at 4,000, 6,000 or 8,000 Hz
- Class II : average hearing loss between 35 and 44.9 dB
- Class III : AHL between 45 and 59.9 dB(A)

Class IV : AHL equal to or greater than 60 dB

## RESULTS

The sound surveys carried out in the various working areas showed that labourforce is distributed as follows:

	Class 0	Class 1	Class 2 and 3	TOTALS
No. of workers exposed	295	176	994	1,465
No. of workers studied	72	170	323	565
No. of workers studied vs. workers exposed (%)	24	97	35	

class 0: this class also includes workers exposed to high levels of noise in the past

The study included 565 blue-colour workers with a mean age of 46 years. The mean duration of the noise exposure was 13 years. In 28 of these individuals a conductive hearing loss was detected.

The results of audiometric monitoring are shown in fig. 1. Fig. 2 shows the results obtained by audiometry in the various classes of exposure. Fig. 3 shows the types of audiometric profile versus exposure according to Leg. Fig. 4 shows a comparison of the audiometric results vs. duration of exposure.

## DISCUSSION AND CONCLUSIONS

The noise measurement data obtained through sound surveys reveals that a large percentage of the workers involved in this study are exposed to noise levels exceeding the "action level" and even the "maximum acceptable level", ie which are greater than 85 dB(A) and 90dB(A) respectively, according to EEC legislation.

There are inevitable limitations which are inherent to such a transversal epidemiological approach. If we consider, for example, the noise levels which were produced generally by industrial machinery in previous times, we can certainly assume that in the past these workers were exposed to noise levels even more dangerous than today's.

The audiometric results show that nearly 50% of the workers have a slight degree of hearing impairment which is probably due, among other things, to the poor acceptability of hearing protection devices (HPDs) by the individuals who were supposed to use them.

A system of warning signals and posters concerning noise exposure is currently being set up in the various industrial areas, including information on the main sources of noise and local levels of exposure.

Educational activities addressed to the workers involved have also been initiated, focused on the noise-induced hearing consequences as well as on the available protective measures.

Reliable information on the critical areas of noise exposure as well as on the main sources of such noise will soon be available.

This information will make possible to select and recommend the most suitable protective measures in environmental terms, so that the number of workers exposed to this serious occupational-risk may be substantially reduced.

HEARING LOSS/OVERALL NUMBERS  
n=540

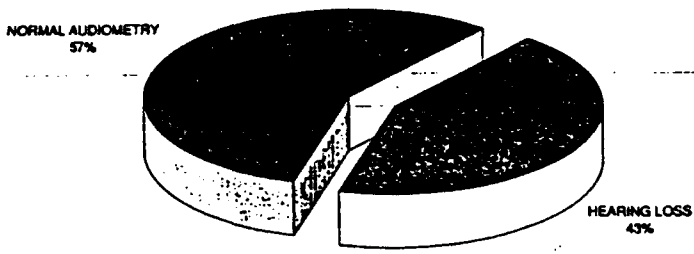

AUDIOMETRIC RESULTS VS. NOISE EXPOSURE  
n=565

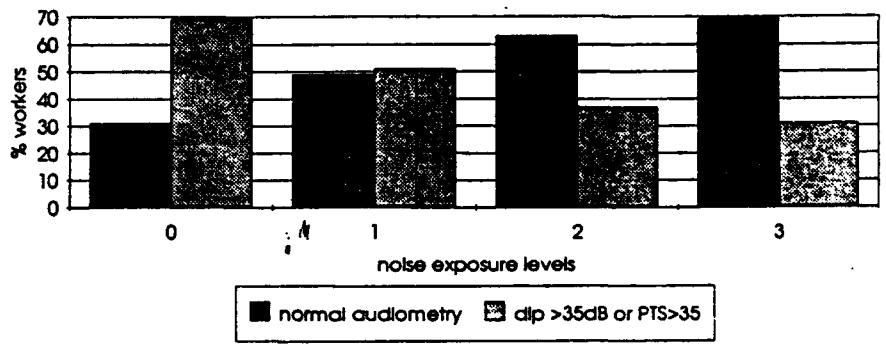

AUDIOMETRIC PROFILES VS. EXPOSURE  
(according to Leq)

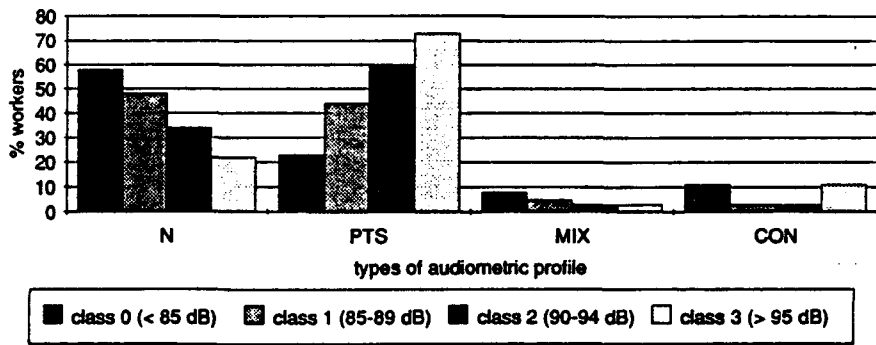

HEARING LOSS VS. EXPOSURE  
n=255

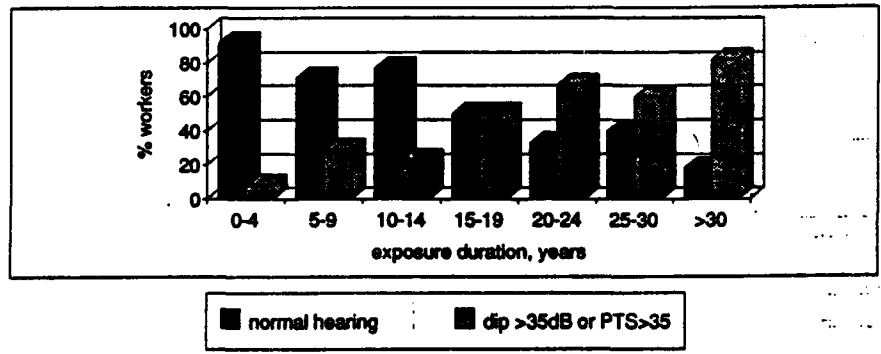

# RELATIONSHIPS BETWEEN FUNCTIONAL AND MORPHOLOGICAL CHANGES IN THE COCHLEA OF GUINEA PIGS AFTER EXPOSURE TO INDUSTRIAL NOISE

ŚLIWIŃSKA-KOWALSKA Mariola, SUŁKOWSKI Wiesław J., JEDLIŃSKA Urszula, RYDZYŃSKI Konrad

Audiology Division, The Nofer Institute of Occupational Medicine, 8, Teresa Str, 90-950 Lodz Poland

## Abstract

The aim of this study was to assess functional and morphological changes in the cochlea of guinea pigs after chronic exposure to industrial noise in a weaving-mill. Animals were exposed to continuous broad-band noise at the intensity 95-97 dB, 16 hours a day, 5 days a week, for 12 subsequent weeks. After each 4 weeks of exposure the hearing sensitivity was assessed by brainstem evoked responses audiometry and functional impairment was related to pathomorphological changes in the cochlea.

Chronic exposure to industrial noise caused a mean permanent hearing threshold shift (h.t.shift) of 23 dB already after the first 4 weeks. H.t.shift did not progress significantly after 8 and 12 weeks of exposure (asymptotic curve). The function of efferent fibres assessed by contralateral sound stimulation was also impaired. Morphological changes were observed in the second, the third and the fourth turns of the cochlea and included loss of cells or damage almost exclusively in outer hair cells. After 8 and 12 weeks of exposure, damage in the inner hair cells and pillar cells was also rarely observed. At the transmission electron microscopy floppy and fractured stereocilia and protrusions of cuticular plate were seen. Changes in stereocilia were observed in both types of sensory cells.

The results of our study suggest, that after chronic exposure to industrial noise both acoustic nerve and efferent fibres function are impaired. The first 20 - 30 dB of permanent h.t.shift is caused by the damage in outer hair cells.

## Introduction

The effects of noise on the cochlea depends on the type of noise used (4). Hypotheses concerning the mechanisms of hair cell injury presented over last years were based mainly on observations following exposure to very intense sounds (between 105 and 138 dB SPL) for a relatively short period of time (1 min. to 4 h) (3). Such exposures cause rather robust damage to the cochlea, and are not very characteristic for real human work stands. In our study, we were interested in damaging effects of chronic exposure to continuous industrial noise of moderate intensity, which is commonly present in the industry.

## Design of the study

A group of 32 Hartley guinea pigs were chronically exposed to a continuous, broad-band noise at the intensity 95-97 dB (A) in a weaving-mill. Spectral analysis revealed the highest intensity of noise in the frequency range from 0.25 to 1 kHz. During the experiment animals stayed in the factory and were exposed to noise 16 hours a day, 5 days a week for 12 subsequent weeks, until the asymptotic permanent hearing threshold shift (h.t.shift) was reached.

Before the experiment and after each 4 weeks of exposure hearing function was assessed by click-evoked auditory brainstem responses (ABR) audiometry. The method used in our laboratory was described in details elsewhere (5). After measurement of hearing threshold (h.t.) the effects of contralateral stimulation with white noise on ABR pattern was evaluated.

Morphological changes in the cochlea were assessed after each 4 weeks of experiment at the light

microscopy (surface preparations and cross sections), and transmission electron microscopy. A group of 18 control guinea pigs were kept during the experiment in the room with the background noise below 80 dB(A).

## Results

### Impairment of hearing sensitivity

After the first 4 weeks of exposure in all, but one, guinea pigs an impairment of hearing sensitivity was observed. In the majority of animals (78% of ears) h.t. shift ranged from 20 to 30 dB. Typical ABR recordings before and after 4 weeks of exposure in a guinea pig shows fig.1.

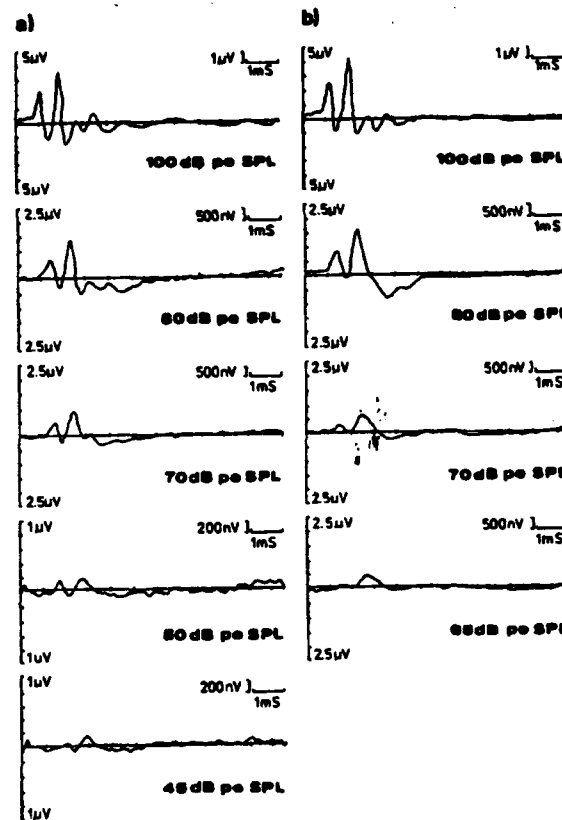

Fig.1 An example of auditory brainstem responses recordings in a guinea pig (a) before exposure, (b) after 4 weeks of exposure to a weaving-mill noise. The hearing threshold shift of 20 dB is seen.

Similar range of hearing loss was observed after 8 and 12 weeks of exposure, however, a decrease in the percent of ears with h.t. shift below 20 dB and an increase in the percent of ears with h.t. shift above 30 dB was noticed after subsequent weeks of exposure.

The asymptotic (or plateau) level of hearing loss in exposed to noise animals was reached after the first 4 weeks of exposure. Mean h.t. shift in noise-exposed animals was  $22.7 \pm 6.79$  dB after the first 4 weeks of exposure and did not progress significantly after 8 and 12 weeks of exposure, comparing with the control group of animals.

### Effect of contralateral stimulation on the ABR pattern

Before the experiment in the majority of guinea pigs the contralateral stimulation with white noise resulted in a decrease in the wave I and/or the wave II amplitude in the ABR pattern. This suppressive effect was seen already at the very low intensity, e.g. around h.t. to 10 dB above h.t., and may be considered as an effect of efferent fibres activation (2). However, in animals exposed to noise the suppressive effect was absent or was seen at least 25-30 dB above h.t.



### Morphological changes

Morphological changes after 4, 8 and 12 weeks of exposure were assessed in guinea pigs with 20 to 30 dB of hearing loss. The changes in sensory cells were observed in the second, the third and the fourth turns of the cochlea.

After the first 4 weeks of exposure a damage exclusively to outer hair cells (OHCs) was seen (fig.2).



Fig.2. Micrograph of the surface preparation of the guinea pig organ of Corti after 4 weeks of exposure. Damage to outer hair cells of the 1st and the 2nd rows is seen (arrow). Inner hair cells out of focus. 570x

Even when all OHCs were lost, and holes in the reticular lamina were present, inner hair cells (IHCs) appeared normal (fig.3).



Fig.3. Micrograph of the guinea pig organ of Corti after 4 weeks of exposure, cross section. Damage to outer hair cells is seen. The arrow points at the rupture of reticular lamina. Inner hair cell unchanged. 570x

The most sensitive to industrial noise were OHCs of the first and the third rows.

After 8 and 12 weeks of exposure apart of changes in OHCs, the damage to IHCs and pillar cells was also rarely seen. Stereocilia of both types of sensory cells revealed pathology (deflection, disarray).

At the transmission electron microscope the most consistent changes were found in the region of stereocilia and cuticular plate. Floppy or broken stereocilia were found in both types of sensory cells. Additionally in OHCs protrusion of cuticular plate was seen. After 12 weeks of exposure deflected stereocilia were seen also in the first turn of the cochlea (even if no damage to hair cells was found). In animals exposed for 8 and 12 weeks, the number of lysosomes and Hensen's body was increased.

### Discussion

Results of our study showed that prolonged exposure to genuine continuous industrial noise caused in majority of animals 20 to 30 dB of permanent hearing threshold shift, regardless of the duration of exposure. Such hearing loss was related to the damage mainly in OHCs and to changes in stereocilia of both types of sensory cells. Interestingly, already after 4 weeks of exposure the asymptotic level of hearing loss was achieved. Prolongation of noise exposure to 8 or 12 weeks resulted only in small further increase of hearing impairment, in both noise-exposed and control animals, and could be explain by presbycusis. It means that for prevention of hearing loss the most important is the first period of exposure to noise.

It has been shown, that if the efferent system of innervation is activated by contralateral noise stimulation, acoustic damage to the cochlea is reduced (1). The contralateral sound stimulation in healthy animals causes a decrease in response of auditory nerve, in our study seen as the decrease in amplitude of the wave I in the ABR pattern. Such suppressive effect may contribute to protection of ear against noise. On the other hand, in noise-exposed animals with pathological changes in OHCs (especially in OHCs of the first row), suppressive effect of contralateral stimulation was decreased or absent. This finding confirms an important role of OHCs in the efferent feedback.

### References

1. Cody A.R., Johnstone B.M.: Temporary threshold shift modified by binaural acoustic stimulation. *Hear.Res.*, 6: 199-205, 1982
2. Liberman M.Ch.: Rapid assessment of sound-evoked olivocochlear feedback: Suppression of compound action potentials by contralateral sound. *Hear.Res.*, 38: 47-56, 1989
3. Saunders J.C., Dear S.P., Schneider M.E.: The anatomical consequences of acoustic injury: A review and tutorial. *J.Acoust. Soc. Am.* 78(3): 833-860, 1985
4. Slepecky N.: Overview of mechanical damage to the inner ear: noise as a tool to probe cochlear function. *Hear.Res.* 22: 307-321, 1986
5. Śliwińska-Kowalska M., Sułkowski W., Chrześcijanek M., Kameduła T.: Auditory brainstem responses (ABR) in guinea pigs exposed to loud tones noise: A preliminary study. *Otolaryng. Pol.*, 4: 409-414, 1992.

### Acknowledgment:

This study was supported by the grant from the Polish State Committee for Scientific Research (grant N° 4 1102 91 01)

**RESULTS OF MEASUREMENT OF HEARING PROTECTORS DEPENDING ON  
REALIZATION OF SOUND FIELD**

SVENSSON Eva B., OLOFSSON Åke

Dept of Technical Audiology, Karolinska Institutet,  
P.O.Box 700 25,  
S-100 44 Stockholm, Sweden

**ABSTRACT**

For a certain hearing protector, tested at some laboratory in any country it is of greatest importance that the attenuation values obtained are comparable to those obtained from any other laboratory, testing according to the same standard. This statement ought to be an axiom. In reality it is not. Sometimes attenuation values obtained at two laboratories differ considerably. The way of producing the sound field might be a determining factor. Three different test procedures were carried out in order to find out in which way the field influences the results of the measurements. In two of the experiments a Brüel & Kjær head and torso simulator 4128 with and without hearing protectors was used. Measurements were done both in an anechoic room where two different loudspeaker configurations, both tetrahedrons, were simulated and in a sound-isolated booth (our ordinary test room where hearing protectors are type tested). The third experiment was performed according to ISO 4869-1:1990 with 16 test subjects in our ordinary test room. The results from the three experiments suggest that the realization of the sound field in ISO 4869-1:1990 should be specified.

**RESUME**

Lorsque l'on essaie un casque antibruit donné dans un laboratoire dans n'importe quel pays, il est d'une très grande importance que les valeurs d'atténuation obtenues sont comparables à celles obtenues chez un autre laboratoire en faisant les essais selon la même norme. Ceci devait être une évidence. Or en réalité ce n'est pas le cas. Parfois les valeurs d'atténuation obtenues dans deux laboratoires différents varient considérablement. La manière dont on produit un spectre sonore devait être un facteur décisif. Trois procédés d'essai différents ont été effectués dans le but de trouver comment le spectre peut influencer sur les résultats des mesures. Dans deux des expériences on a utilisé un simulateur pour la tête et pour le torse de la marque Brüel & Kjær 4128 avec et sans casque antibruit. On a fait des mesures dans des chambres sans écho où deux configurations différentes de haut-parleurs, les deux tétraèdres, ont été simulées et dans une cabine insonore (c'est-à-dire notre cabine d'essai ordinaire lorsque nous essayons des casques antibruit). La troisième expérience a été effectuée dans notre cabine ordinaire. Les résultats des trois expériences montrent qu'il faudrait spécifier la réalisation du spectre sonore dans ISO 4869-1:1990.

ISO Standard 4869-1:1990 and Swedish Standard SS 882151 describe a subjective method for measuring the sound attenuation of hearing protectors based on hearing thresholds. The measurements shall be carried out in a random-incidence sound field. The realization of the sound field is not specified in the standard. The standard just specifies certain requirements of the field in the absence of the test subject. This means that the field may be created in various ways at the laboratories: by different loudspeakers, and in test rooms with different dimensions and acoustics. The loudspeakers may be placed at the vertices of a regular tetrahedron or in other configurations. Anechoic chambers or sound-isolated booths may be used. Sometimes the attenuation values obtained at two laboratories differ considerably. The way of producing the sound field might be a determining factor.

In order to find out in which way the field influences the results of the measurements three different test procedures were carried out. Two different ear muffs Bilsom Viking 2421 and Bilsom Special 2453 were used for all the measurements below. Frequency responses with and without hearing protectors mounted on the manikin/test subjects were measured. During the first two test procedures a Brüel & Kjør head and torso simulator 4128 was used. For the third measurements test subjects were used.

In the first experiment two different loudspeaker configurations, both tetrahedrons, were simulated in an anechoic room. One of the configurations had one loudspeaker in front and two behind the Brüel & Kjør head and torso simulator 4128 (tetrahedron A). For the other configuration the positions were reversed 180 degrees (tetrahedron B). In both cases the position of the fourth loudspeaker was right above the torso. Only one loudspeaker was used at a time, placed successively at the different loudspeaker positions in the tetrahedrons. The complex transfer function from each position of the loudspeaker to the coupler in the head and torso simulator was measured. The transfer function was compensated for the frequency weighting of the loudspeaker. Within each one-third octave band, the level was then calculated for the case that the loudspeakers had been supplied by uncorrelated one-third octave bands of noise. The distance between the loudspeaker and the manikin was 1.25 m for each position. The calculated attenuation results differ as much as 7 - 8 dB at the worst frequency for the two loudspeaker configurations. This is the case for both of the hearing protectors measured. (Figure 1)

The second type of measurements were carried out in our ordinary test room, a sound-isolated booth, with our normal loudspeaker configuration, twelve loudspeakers (six around the floor and six around the ceiling), and two uncorrelated signals. The manikin was placed in the reference point of the room, i.e. where the test subjects are seated during an ordinary test session, and orientated in the normal way ( $0^\circ$ ). Measurements were also made with the manikin turned  $90^\circ$  and  $180^\circ$  counter-clockwise. The attenuation differences obtained when the manikin was turned, were of the same order as those in the anechoic chamber. (Figure 2)

When comparing the results from the two test rooms (tetrahedron A compared with  $0^\circ$  respectively tetrahedron B compared with  $90^\circ$ ) it is evident that there are differences here as well, up to 8 dB at the worst frequency (Figure 3).

The third experiment was performed according to ISO 10534-1 "Subjective method for the measurement of sound attenuation". Measurements were made in our ordinary test room in the same three directions as for the manikin for each test subject (0°, 90° and 180°).

The attenuation differences obtained when the subjects were turned were much smaller than those measured on the manikin, up to 2 - 3 dB - however most of them significant.

(Figure 4; \* = 5%, \*\* = 1%, \*\*\* = 0.1%)

When comparing the results from experiment number 2 and 3 you will find that the differences for many frequencies are considerably higher for the manikin than for the subjects.

The conclusions that could be drawn from these measurements are that the results suggest that the requirements of the sound field according to ISO 4869-1 are not rigorous enough. If type approval depends on the test laboratory chosen, there is a risk that the manufacturer chooses the laboratory giving the most favourable attenuation values - irrespective of whether these results are representative or not for the use of the hearing protector. There is also a risk that some hearing protectors do not get their type approval, although they should have it, only because of an unfavourable realization of the sound field. Both cases are, of course, undesirable.

#### REFERENCES

- ISO 4869-1981 "Acoustics - Measurement of sound attenuation of hearing protectors - Subjective method".  
ISO 4869-1:1990 "Acoustics - Hearing protectors - Part 1: Subjective method for the measurement of sound attenuation".  
SS 882151 "Hearing protectors - Test methods"; SIS Swedish Standardisation Commission, Sweden (1981).  
Mogensen J. (1992): "Retningsafhængighed af Insertion Loss målinger for høreværn"; The Acoustics Laboratory, Technical University of Denmark, Lyngby.  
Whittle L.S., Sutton G.J. & Robinson D.W. (1978): "The objective measurement of the attenuation of hearing protectors of the circumaural type"; NPL Acoustics Report AC 87.

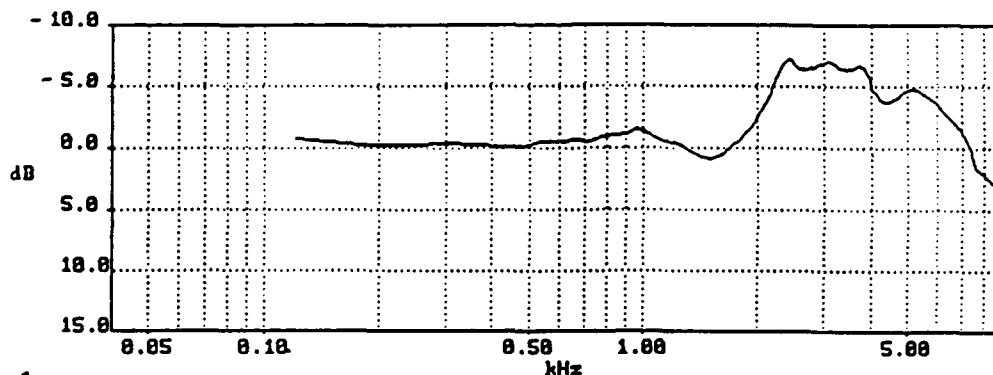

Figure 1

Difference in sound attenuation for Bilson Viking

(tetrahedron A/B)

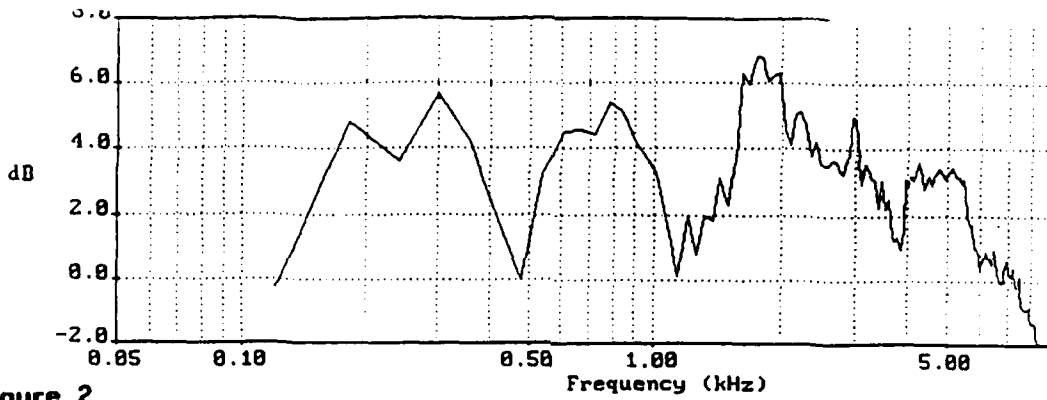

Figure 2

BILSON VIKING 0° - 180° TORSO

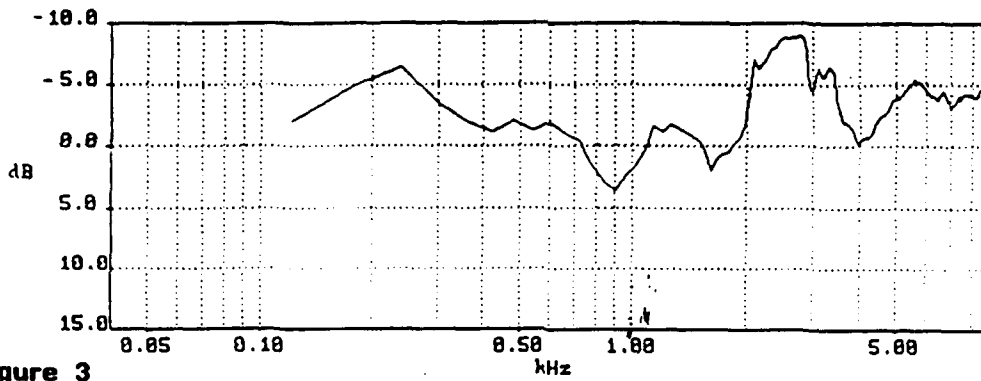

Figure 3

Difference in sound attenuation for Bilson Viking  
(tetrahedron A/dir 0°)

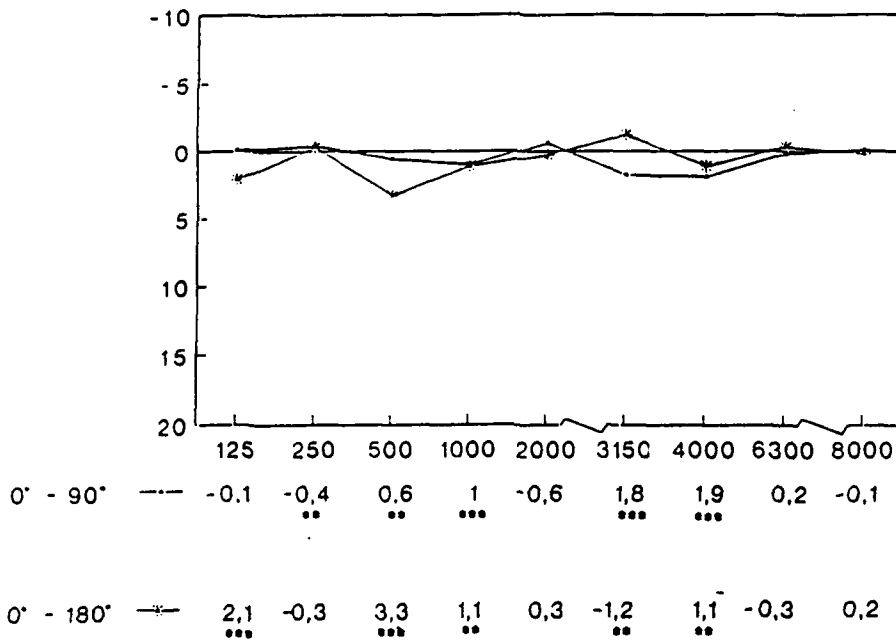

Figure 4

BILSON VIKING DIFFERENCE SUBJECTS

# FREQUENCY-SPECIFIC BRAINSTEM EVOKED RESPONSES AUDIOMETRY IN ASSESSMENT OF NOISE-INDUCED HEARING LOSS

<sup>1</sup>SULKOWSKI Wiesław J., <sup>1</sup>ŚLIWIŃSKA-KOWALSKA Mariola, <sup>2</sup>KOCHANEK Krzysztof

<sup>1</sup>Audiology Division, The Nofer Institute of Occupational Medicine, 8, Teresa Str., 90-950 Lodz, Poland;

<sup>2</sup>ENT Clinic, Medical Academy, 1a, Banach Str., 02-097 Warsaw, Poland

## Abstract

The conventional pure-tone audiometric tests considered as a main tool in the assessment of occupational noise-induced hearing loss (ONIHL) may unfortunately fail and do not reflect the true hearing thresholds. It is of frequent occurrence in the cases of industrial compensation claimants who motivated by gain attempt to exaggerate their hearing loss.

Searching for any objective measures quantifying a real hearing thresholds, the efficiency of frequency-specific brainstem evoked responses audiometry (Fspec.BERA) was assessed in a series of 35 medicolegal cases versus 10 normally hearing persons, as well as 10 well-cooperative patients with ONIHL.

The evoked potentials, generated by gaussian shaped tone pips of 1,2 and 4 kHz were collected by means of the Polish electrophysiological system EPTEST.

It was found and confirmed by the statistical analysis that the Fspec.BERA thresholds in well-cooperative subjects correspond closely with pure-tone audiometry thresholds within 5 dB; one may therefore conclude that the former, determined in 35 malingering claimants can be recognized as a reliable hearing thresholds.

## Introduction

With current epidemic of compensation claims for occupational noise-induced hearing loss (ONIHL), the number of cases, in which subjective pure-tone audiometry results are falsed by an examined persons and the amount of hypoacusis is exaggerated, still inexorably rise. It is estimated that about 25% of industrial workers employed at noisy posts and audiometrically tested attempt to feign a severe hearing impairment, motivated for financial gain (1,5). In the medicolegal practice therefore a need of use of an objective electrophysiological methods for a reliable hearing assessment becomes a necessity.

The main goal of this study is to describe our recent experience with application of the frequency-specific brainstem evoked responses audiometry (Fspec.BERA), which-in contrary to a standard click-evoked brainstem responses-is considered to be enable to reconstruct a behavioral pure-tone audiogram (3,4,5).

## Material and methods

Thirty five subjects claiming for compensation for ONIHL, demonstrating a great variability of responses in a pure-tone test-retest audiometric examination and other clinical signs of malingering, and ten normally hearing persons as well as ten well-cooperative patients with moderate degree of ONIHL were tested. The audiological procedure included pure-tone audiometry, speech audiometry, impedance testing, and next, the frequency-specific brainstem evoked responses were collected by means of the Polish electrophysiological system EPTEST. Three silver disc electrodes were attached in conventional way (active to midline of forehead, reference to ipsilateral mastoid, ground to contrlateral mastoid); using the recording filter

bandpass 200-2000 Hz the responses were sampled with a frequency of 100 kHz (12 bit resolution) and on-line averaged in a time window of 20 ms. The stimuli, presented monaurally at a rate of 37/s through TDH-39 earphones were digitally syntetised tone pips of alternating polarity of 1,2 and 4 kHz with gaussian rise-fall times of 1 ms and no plateau. The acquisition of responses for each stimulus, collected in the separate memory of EPTEST usually started at the stimulus level of 90 or 80 dB nHL, and depending on the result, the intensity of stimulus was decreased in 10 or 5 dB steps, until threshold level was approached; threshold was defined as the lowest stimulus intensity to elicit a reliably scorable auditory brainstem component. To establish it more precisely, two traces were collected at near-threshold intensity, and finally an independent observer identified threshold levels.

### Results and conclusions

Comparing the obtained results of the Fspec.BERA with results of the pure-tone audiometry in the group of normally hearing subjects a good agreement within 5 dB nHL was found between behavioral and electrophysiological thresholds, as it is illustrated by representative example in Fig.1.

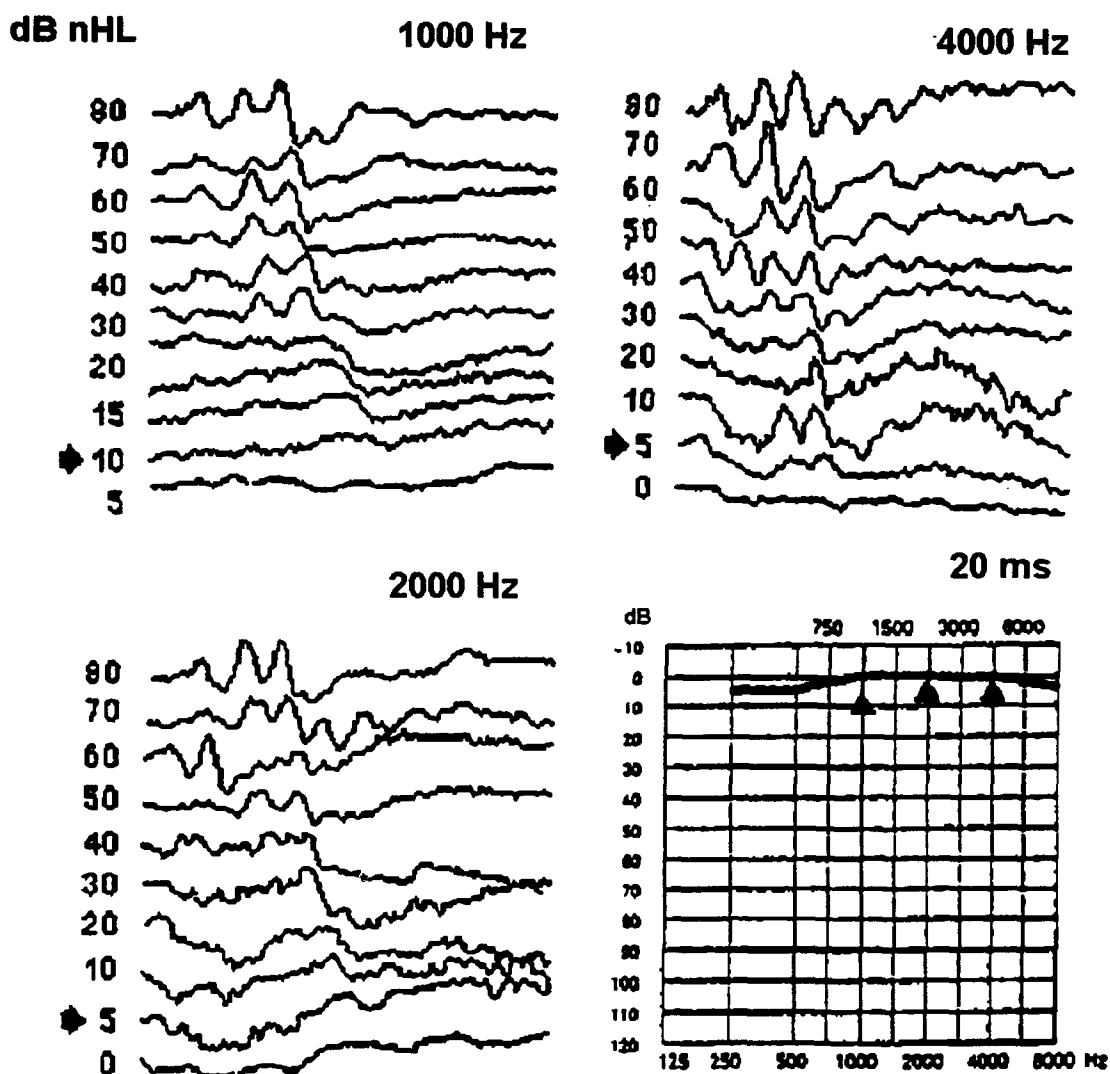

Fig.1. Fspec. BERA tracings with intensity series obtained for each of the 3 stimuli versus pure-tone audiogram in normally hearing subject



Also, in well-cooperative patients with moderate ONIHL, the highly significant correlation between both thresholds for all examined frequencies, proved by the linear regression function analysis, was stated and difference has not exceeded 5 dB nHL ( $p < 0.01$ ), as exemplified in Fig.2

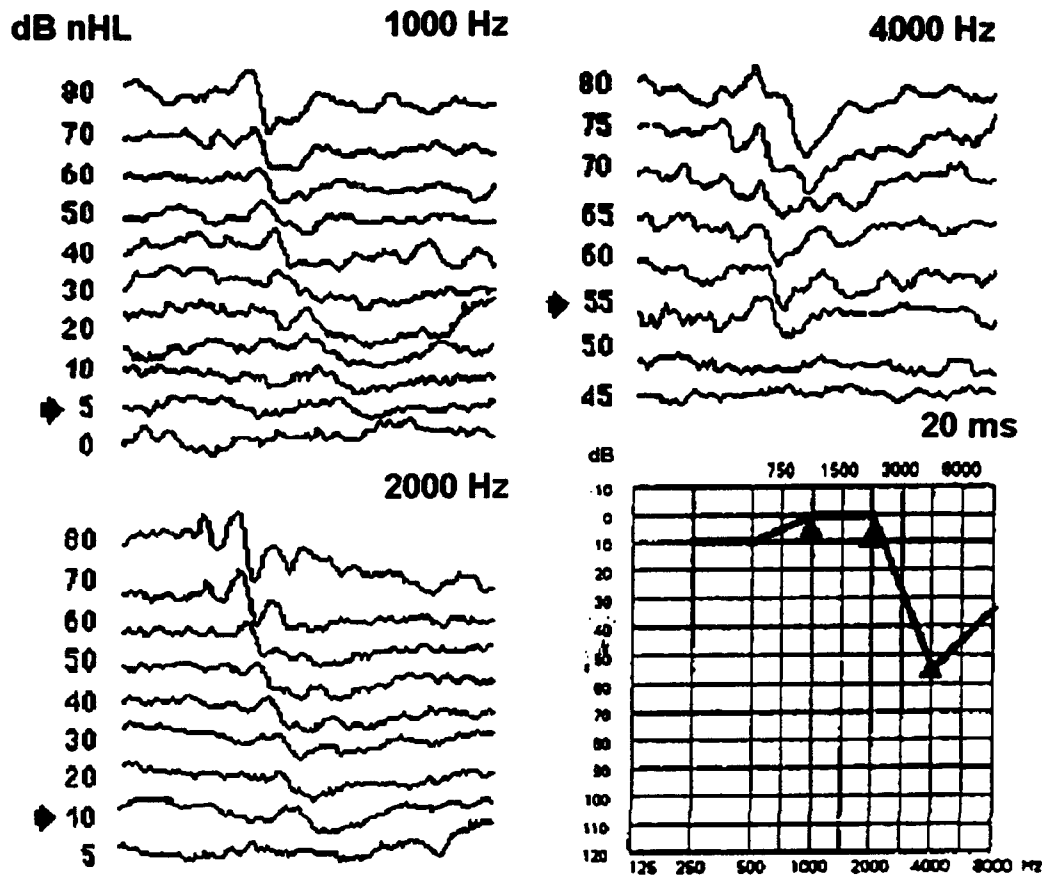

Fig.2. Fspec. BERA tracings with intensity series obtained for each of the 3 stimuli versus pure-tone audiogram in well-cooperative subject with moderate degree of noise-induced hearing loss

Taking into account the above data one may presume that the predicted hearing thresholds (by means of the Fspec.BERA) in the series of 35 uncooperative patients claiming for compensation for ONIHL have been defined as a true amount of hearing loss with a satisfactory precision. An example of the BERA tracings versus the pure tone audiogram in typical case of malingering is shown in Fig.3

Obviously, the accuracy of the brainstem evoked response measurements is strictly dependent from the quality of testing conditions and can be affected in not relaxed patients with strong muscle tension. Nevertheless, Drift et al (2) pointed out in their study that the auditory brainstem response threshold appeared to be as accurate measurement of hearing sensitivity as the pure-tone threshold and closed within 3.7 dB.

Summing up it may be concluded, the used by us electrophysiological method of brainstem evoked responses recording with employment of the frequency-specific stimuli of 1,2 and 4 kHz seems to be very efficient in detection and quantification of feigned hearing impairment in the industrial compensation claims and can be recommended in medicolegal work. The suggested protocol of examination is adequate for such purposes and more frequencies tested are not

needed if consider the Polish compensation formula which is based on the low fence of 30 dB-pure-tone average of 1, 2 and 4 kHz.

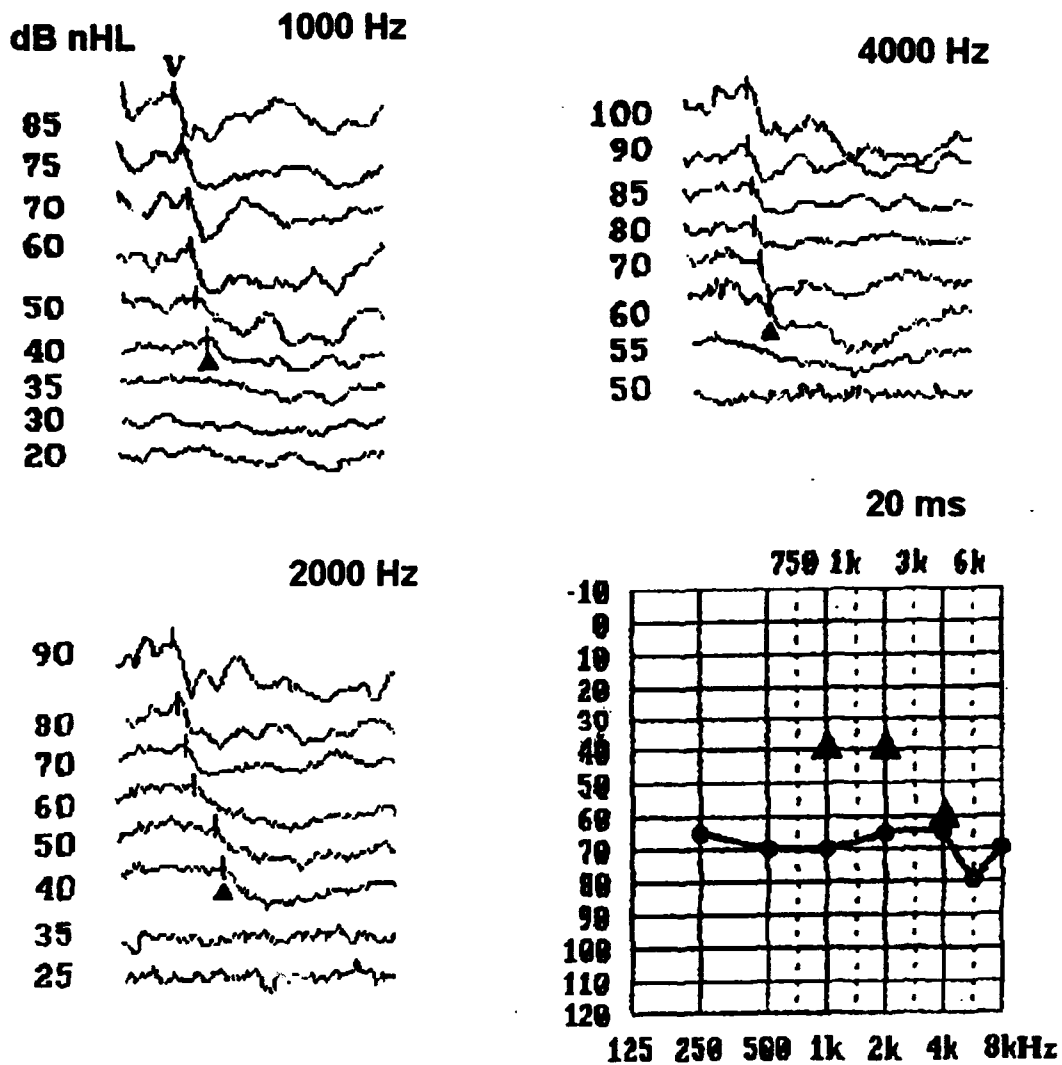

Fig.3. Fspec. BERA tracings with intensity series obtained for each of the 3 stimuli versus pure-tone audiogram in subject exaggerating his hearing loss.

### References

1. Alberti P.W.: Non-organic hearing loss in adults. In "Audiology and audiological medicine", ed. H.A. Beagley, Oxford University Press, Oxford, New York, Toronto, vol.2, pp.911-931, 1981.
2. Drift J.F.C.v.d., Brocaar M.P., Zanten G.A.v., Lamore P.J.J.: Inaccuracies in the measurements of auditory brainstem response data in normal hearing and cochlear hearing loss. *Audiology* 27, 109-118, 1988.
3. Kramer S.J.: Frequency-specific auditory brainstem responses to bone-conducted stimuli. *Audiology* 31, 61-71, 1992.
4. Munnerley G., Greville K., Purdy S., Keith W.: Frequency-specific auditory brainstem responses relationship to behavioural thresholds in cochlear-impaired adults. *Audiology* 30, 25-32, 1991.
5. Sułkowski W., Śliwińska-Kowalska M.: Noise-induced hearing loss and auditory evoked potentials measurements. *Proc. FASE-Congress 1992*, Swiss Acoustical Society, Zurich, pp.201-204, 1992.

## CONTROVERSIES IN NOISE INDUCED HEARING LOSS (NIHL)

TOUMA, Joseph B., M.D., F.A.C.S.

Huntington Ear Clinic, Inc.

1616 13th Avenue, Suite 100

Huntington, WV 25701

### ABSTRACT

Industrial noise induced hearing loss is a very common problem, especially in the industrialized countries. In the past decade, compensation claims soared, especially in the United States. This article addresses the increased susceptibility of the cochlea to noise due to circulatory problems, such as vascular diseases, hypertension, diabetes, and smoking. The effect of aging, non-industrial noise exposure, ototoxic drugs, exposure to industrial chemicals, and gun shooting on hearing will be discussed. The difficulty in assessing the degree of noise exposure, the importance of the 4000 Hz notch, and asymmetrical hearing loss will be stressed.

Correlation of Circulatory and Metabolic Factors With Noise Induced Hearing Loss: Several studies were conducted to determine the effect of vascular changes and metabolic diseases on hearing. In the late 60's and early 70's, articles by Rosen and Spencer suggested that there is direct effect of vascular diseases on the cochlea causing fluctuation of hearing. However, a series of articles such as Lowry, Isacson, Axelson, Lindgern, and others did not substantiate Rosen and Spencer's conclusions. Pillsbury in 1986 studied this issue. He used 64 rats, half were hypertensive and the other half normotensive. Half of each group was fed with a normal low fat diet and the other half with a high fat diet. This gave the researcher the opportunity to study several factors to determine which one will cause hearing loss and which factor will cause the cochlea to be more susceptible to noise. He concluded that in a quiet environment, none of these groups exhibited any statistically significant hearing loss. However, in the noise exposed group, those with hypertension and hyperlipoproteinemia experienced a significantly more hearing loss. With a significant number of the American population having hyperlipoproteinemia, hypertension, and obesity, this study becomes very significant, especially with the findings of C. Everett Koop, M.D., the past U. S. Surgeon General. He reported in July, 1988 that approximately 54 million Americans had hypertension, 36 million people had overweight problems, and 60 million Americans had high cholesterol levels.

In summary any vascular disease affecting the cochlea resulting from arteriosclerotic cardiovascular disease, hypertension, smoking, hyperlipoproteinemia, and diabetes can aggravate noise induced hearing loss.

Audiogram and NIHL: The 3000-4000 Hz notch is the earliest manifestation of NIHL. With additional exposure, the higher frequencies will follow suit. After many years of exposure to hazardous noise, the lower frequencies will be affected, but to a lesser degree, resulting in a ski slope audiogram. Annual audiograms can be very valuable in detecting permanent threshold shift which should trigger more stringent hearing protection measures due to inadequate protection.

Asymmetrical NIHL: In the majority of noise induced hearing loss, the audiogram is symmetrical. However, 5-6% of the audiograms can be asymmetrical due to more exposure to noise on one side. The effect of the head shadow varies from one study to the other, however, 6-10 decibels difference has been reported.

Asymmetry is usually found in truck drivers, shingle sawyers, some coal miners, and others. Part of the cause is the way power tools are handled, and frequently one ear will be turned toward the source of noise more than the other. Further research is badly needed to further study this phenomenon.

Effect of Hunting on NIHL: Gun fire produces Type A impulse noise which ranges from 130-140 decibels peak SPL. This can cause direct mechanical damage to the hair cells. The damage varies depending on the caliber of the fire arm, the type of ammunition, the number of shots used, shooting in open or close areas, and the use of ear protectors.

Since the 4000 Hz frequency is the earliest to be affected in gun shooting, and since the majority of compensation guidelines include only the 500, 1000 and 3000 Hz frequencies in calculating the wholeman impairment, the additional effect of hunting on compensation awards in early stages is insignificant.

Impact and Steady Noise Exposure: The exposure to the combination of impact and steady noise can be more damaging to the cochlea when one or both exceed 100 dB level than exposure to only one kind of noise alone. When exposure of both types is below 100 dB, the damage from the impact noise will lessen due to the protective effect of the stapedial reflex spurred by the continuous noise.

Interaction of Chemicals and Ototoxic Drugs with NIHL: Ototoxic drugs and chemicals which directly affect the hair cells aggravate noise induced hearing loss. This includes patients on Aminoglycosides, cisplatinum, and those who work around potentially ototoxic chemical agents, chemical intermediaries, waste products, and contaminants. Several studies concluded that there is a marked increase in hearing loss in those who are exposed to industrial noise and work around organic solvents such as Trichlorethylene, Xylene, Hexane, Carbon Disulfide, Toluene, Carbon Monoxide, Butyl Nitrate, and various heavy metals.

Tinnitus and NIHL: Tinnitus is very elusive. Not every individual suffering from NIHL will have tinnitus. Some individuals with severe high frequency sensory neural hearing loss may have no tinnitus, yet others with minimal hearing loss or normal hearing may have severe tinnitus. It is very difficult to quantify or prove tinnitus since it is subjective and it is impossible to objectively determine its severity or existence. However, high frequency sensory neural hearing loss is known to aggravate tinnitus.

Assessing the Degree of Industrial Noise Exposure: This is a very difficult task due to the continuous bombardment of the cochlea by many types of noise, both industrial and non-industrial. Noise exposure is very common in non-industrial settings, such as music from concerts, walkman radios, loud stereos, etc. Some sports such as motor sports, shooting, riding motorcycles, and snowmobiling can produce hazardous noise. Lawn mowing, jet engines, and other environmental noise can add to the hearing loss.

Animal studies are very valuable since it is impossible to obtain a highly screened non-noise exposed population. The effect of noise on laboratory animals can be applied to humans.

With adequate protection against both industrial and nonindustrial noise, any permanent threshold shift on the annual audiogram indicates unsatisfactory protection.

Age and Noise Exposure: Several studies concluded that older ears are more susceptible to noise than younger ones. However, the majority of hearing loss due to exposure to hazardous noise occurs in the first ten years to exposure.

Several charts containing the expected hearing level in each age group for males and females are available from OSHA, NIOSH, ISO-1999, and the Federal Register.

Acoustic Trauma and Dizziness: Some authors such as McCabe, Ylikoski, Man, and others found that loud noise can cause balance problems. Abnormal ENG, computerized platform testing, and rotary testing were found in those exposed to intense impulse noise. In laboratory animals hazardous noise was found to cause damage to the utricle, saccule and semicircular canal.

**HEARING PROTECTION DEVICES:  
THEIR ATTENUATION IN REAL WORKING-SITUATIONS AND  
SIMPLIFIED METHODS TO MEASURE THEIR EFFECTIVENESS**

VAN DEN BERG Ruurt, PASSCHIER-VERMEER Willy

TNO Institute of Preventive Health Care

P.O.Box 124, 2300 AC LEIDEN, The Netherlands.

**ABSTRACT**

A field research has been carried out to determine the frequency-dependent average attenuation of several hearing protection devices used in real working-situations. Also two measuring-methods were developed, which are suitable to test the attenuation of hearing protection devices as worn by individual employee in real working-situations in a simple, quick and reliable way.

It was shown that for hearing protectors worn in the ear canal use could be made of a special 'deep' ear muff and that for those worn over the ear canal a 'reference' ear muff could be used. An analysis of the reproducibility of attenuation-measurements and of the correlation between the overall-attenuation (in dB(A)) and the attenuation at specific test-frequencies showed 500 Hz to be the most suitable test frequency.

**Measuring methods**

In situations close to factories with noise exposed workers it is not possible to use the standardized method to establish the attenuation of hearing protectors (ISO 4869), because of the strict requirements for ambient noise and sound field. Therefore two adapted methods have been developed and checked, one method for devices worn *in* the ear canal, insert type hearing protectors (foam and cotton wool ear-plugs and individual pre-moulded hearing protection devices) and another method for devices worn *over* the ear canal (ear muffs, safety cap ear muffs, ear-plugs connected by a bow).

In the method to test insert type hearing protection devices a special constructed 'deep' ear muff is used to ensure that the devices do not touch the ear muff during testing. Small loudspeakers are mounted in the muffs for audiometry. The hearing threshold levels are measured twice: once with the hearing protection devices and once without them. The difference is the attenuation of the hearing protection device. Research in the laboratory showed that there were no statistically significant differences at any frequency in the attenuation, determined by this method compared with the standardised method (ISO 4869). The average difference and the standard deviation in the difference in attenuation measured with the standardised method and the above described method are given in Table 1 for each frequency. The test signals were pure tones. The tests were repeated with narrow-band noise. The results were about the same.

**Table 1 Average differences and standard deviations in the differences between the attenuation determined by means of the standardised method (ISO 4869) and determined with the 'deep' ear muff method for insert type hearing protectors using pure tones.**

<b>frequency (Hz)</b>	<b>125</b>	<b>250</b>	<b>500</b>	<b>1000</b>	<b>2000</b>	<b>3000</b>	<b>4000</b>	<b>6000</b>	<b>8000</b>
<b>average difference (dB)</b>	2.3	1.0	-0.6	2.3	-1.0	-0.4	-1.9	-1.3	-4.6
<b>standard deviation (dB)</b>	7.5	5.3	5.2	5.3	3.8	6.7	6.7	7.0	7.7

In the method to test hearing protectors which are worn over the ear canal, use was made of a 'reference' ear muff with known attenuation values. The hearing threshold levels are measured twice: once with the hearing protector and once with the 'reference' ear muff. To determine the attenuation of the hearing protector, comparisons are made between these two hearing threshold levels, taking the average attenuation of the 'reference' ear muff into account.

### **Attenuation of hearing protectors in real working-situations**

Measurements were carried out in a mobile audiometry-unit at 175 employees wearing hearing protection in real working-situations.

The data of 144 hearing protection devices were used to calculate the average attenuation and the standard deviation. The general conclusion for all types of hearing protectors is that the average and the so called effective attenuation (average attenuation minus one time the standard deviation) are less than those given by the manufacturer.

Largest differences of about 10 to 15 dB appear at ear-plugs connected by a bow and ear-plugs of cotton wool. Small differences of about 5 to 10 dB occur with ear muffs, safety cap ear muffs, foam ear plugs and individually pre-moulded hearing devices.

### **Simplified methods to measure the effectiveness of hearing protectors**

Comparison of an extensive set of 1/3 octave band noise spectra, determined at nearly 200 work situations, with the attenuation of 236 individual hearing protection devices showed that the most prominent frequency which determines the attenuation in dB(A) of hearing protection devices is 500 Hz, followed by 250 Hz and 1000 Hz. These 200 noise spectra were clustered in 13 'standard' noise spectra, divided into three categories: low-frequency, middle-frequency and high-frequency spectra. As criteria for the categories were taken the differences in C-weighted and A-weighted level ( $L_C - L_A$ ): for low-frequency spectra more than 9, for high-frequency spectra less than 1 and for the middle-frequency spectra between 1 and 9.

For each 'standard' spectrum there is a spread in the individual measuring results when  $D(A)$ , the A-weighted overall attenuation, is compared with the attenuation at one particular frequency ( $D(fr)$ ). An example of the overall A-weighted attenuation as a function of the attenuation at 500 Hz using a low-frequency standard spectrum measured with the method to test the insert type protectors ( $n=150$ ) is presented in Figure 1. The correlation-coefficient is used to characterise the spread. The average of the correlation-coefficients for each category of 'standard' noise spectra (low-, middle- and high-

frequency) is given per frequency and two combinations of frequencies (the average of 250+500 Hz and 500+1000 Hz) in Table 2. From this table it is clear that the highest correlation between D(A) and D(fr) exists at the lower frequencies, especially at the frequency of 500 Hz. Therefore, in first instance, a simplification of the measuring methods could be achieved by limiting the test-frequencies to the lower frequency-range and thus reducing the number of test-frequencies from 9 (as required by ISO) to 3: 250, 500 and 1000 Hz. With these three frequencies the attenuation measurements have been repeated.

Table 2 The average of the correlation-coefficients for each category of standard noise spectra (low, middle and high frequency) per frequency and two combinations of frequencies (the average of 250+500 Hz and 500+1000 Hz).

measuring method	noise spectrum	frequency (Hz)									combinations	
		125	250	500	1k	2k	3k	4k	6k	8k	250+500	500+1k
reference	low	.92	.97	.93	.78	.70	.77	.73	.69	.70	.99	.90
muff	middle	.66	.77	.95	.83	.82	.74	.75	.54	.61	.96	.93
	high	.54	.68	.86	.81	.89	.77	.84	.69	.76	.86	.87
insert type	low	.75	.82	.90	.78	.77	.70	.71	.50	.54	.95	.89
protectors	middle	.91	.95	.96	.79	.72	.79	.75	.71	.72	.99	.93
	high	.83	.87	.91	.80	.83	.85	.83	.79	.80	.92	.90

Figure 1 An example of the overall A-weighted attenuation as a function of the attenuation at 500 Hz using a low-frequency standard spectrum measured with the method to test the insert type protectors.

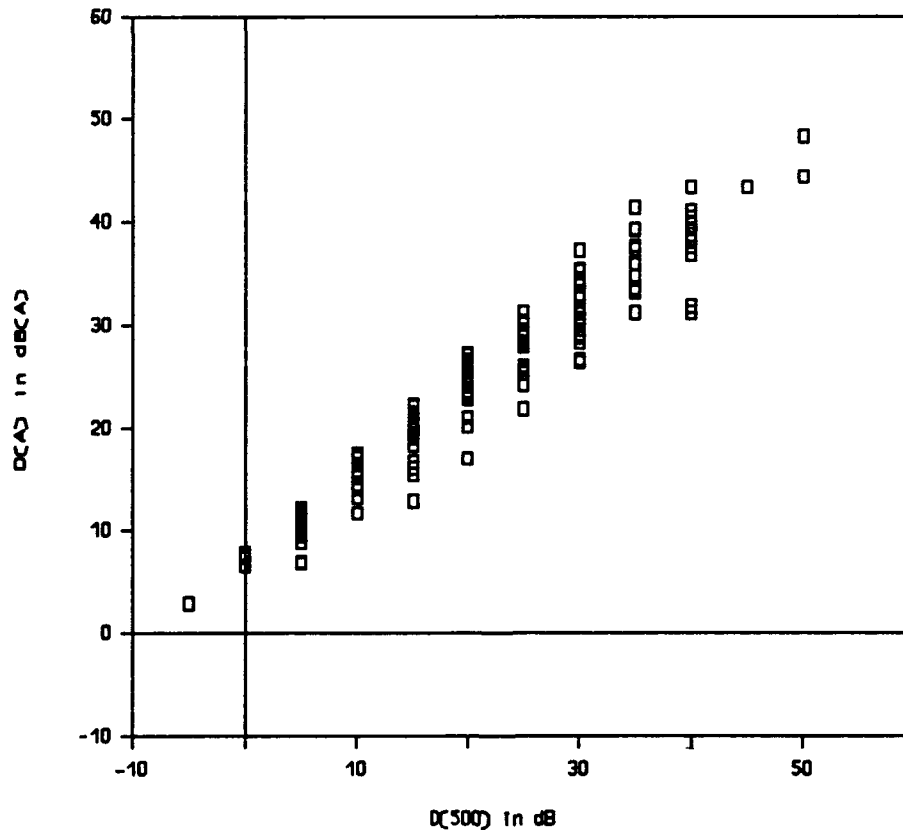

With in principal the same population as in the first extensive field measurements, the measurements of the attenuation of the insert type hearing protection devices were repeated a third time. The periods between the measurements were about half a year.

In the second field research 151 employees participated, 74 of them were measured with the 'reference' muff method. There were no statistical significant differences in attenuation at the three frequencies between first and second research. The standard deviations in the differences were 6.0, 5.8 and 7.3 dB respectively. These standard deviations correspond very well with those for hearing threshold level measurements for hearing conservation purposes. This implies for the individual employees that the attenuation of the types of hearing protectors which are measured with the 'reference' muff method (ear muffs, safety cap ear muffs, ear-plugs connected by a bow) do not differ to any extend from one measurement to another.

In the third field research 52 employees with insert hearing protectors participated. There appeared no statistical significant differences in the average attenuation determined in the second and third field research. The standard deviation in the attenuation values showed to be about 9 dB. An analysis showed that this increased standard deviation was due to variations in the attenuation of the hearing protectors.

On the basis of the repeated measurements it had to be concluded that for the individual employees the attenuation of the types of hearing protectors which are measured by means of the 'deep' muff method (foam and cotton wool ear-plugs and individual moulded hearing protection devices) is varying from one measurement to another, with a standard deviation in the attenuation of about 6 dB.

Since the reproducibility of both methods at the three frequencies 250, 500 and 1000 Hz is about the same and since the correlation-coefficient between D(A) and D(500) is higher than those for the other two frequencies, preference have to be given to 500 Hz as test frequency of the simplified methods.

## Literature

International Organisation for Standardization (ISO), Acoustics: Measurement of Sound Attenuation of Hearing Protectors: Subjective Method, Geneva: ISO, 1981, ISO 4869.

Berg, R. van den, Passchier-Vermeer, W., Crijns, H.

Persoonlijke gehoorbeschermingsmiddelen in concrete arbeidssituaties:

1. experimentele fase, publ.nr. 93.018; (in Dutch),
2. fase 1b, geluidspectra bij Hoogovens, publ.nr. 93.019; (in Dutch),
3. fase 2a, eerste veldonderzoek, publ.nr. 93.020; (in Dutch),
4. fase 3 en 4, herhalingsonderzoeken, publ.nr. 93.021; (in Dutch),

Leiden, Nederlands Instituut voor Praeventieve Gezondheidszorg - TNO, 1993.

Passchier-Vermeer, W., Berg, R. van den, Crijns, H.,

Persoonlijke gehoorbeschermingsmiddelen in concrete arbeidssituaties:

Ontwikkeling van een verkorte testmethode van de demping van persoonlijke gehoorbeschermingsmiddelen en bepaling van dempingswaarden in concrete arbeidssituaties, publ.nr. 93.022; (Final report, in Dutch),

Leiden, Nederlands Instituut voor Praeventieve Gezondheidszorg - TNO, 1993.



# NOISE DOSE LEVELS FROM COMMUNICATIONS HEARING PROTECTORS

Mr R J Weston, Mr D G Steele

Environmental Noise Department  
Royal Air Force Institute of Health and Medical Training  
Halton, Aylesbury, Bucks

## INTRODUCTION

Military ground crew involved with the turn round and maintenance of military aircraft are regularly exposed to very high levels of noise during their normal work. Personal protection is provided in the form of hearing protectors which have two way communications fitted. The problem of adequacy of the protection provided is not solely confined to the attenuation properties of the communications headset, but includes the sound level of the speech communications from the earphone inside the hearing protector and its contribution to the overall daily noise dose.

There are a number of ways of measuring the noise reduction capabilities of hearing protectors (HPDs), including both subjective and objective methods. These have been fully reviewed by Berger (1). The measurement technique used in this survey was based on the Noise Reduction (NR) paradigm. NR is the difference between the incident and the received sound pressure levels (SPLs), as exemplified by the SPL difference between the input and output of a HPD. It is similar to the technique used for measuring transmission loss (TL) between rooms. However, since the wavelength of the sounds beneath the HPD are larger or similar to the path lengths involved, no relationship between TL and NR can be clearly defined. In this application, the NR requires the simultaneous measurement of the sound both inside and outside the HPD. This has the advantage of permitting the measurement of NR for a time varying signal. The measurement technique used was based on measuring the Equivalent Continuous Sound Level (LEq) of the noise dose. This was carried out during engine running for a Hardened Aircraft Shelter (HAS) trial which took place at a Royal Air Force base in 1992.

## MEASUREMENT METHOD

The noise doses under the headsets worn by the ground crewman and the cockpit crewman were monitored using Cirrus type 701 "A" weighted dose meters, which were coupled to miniature microphones mounted at the ear and facing outwards into the cup of the maxiguard communications headsets.

The noise dose in the cockpit, but external to the headset, was monitored by another Cirrus type 701, modified to "C" weighting. The microphone was clipped onto the headset just above the ear cup with the diaphragm facing towards the front of the wearer. The noise dose in the HAS was determined from Sony RDAT recordings and replayed through a Cirrus meter.

## RESULTS

The noise dose levels contributed by the speech and residual external noise transmitted through the earcup were clearly identified. The estimate of the single number attenuation value for the headsets is given by the arithmetical difference between the "C" weighted dose external to the headset and the "A" weighted dose level underneath the headset, and ranged from 23 to 29dB. The contributions forming the different noise sources are illustrated graphically in Figures 1 to 4.

## DISCUSSION

Damage Risk Criteria. The basic Damage Risk Criteria (DRC) postulates, in terms of frequency and sound pressure level, the amount of noise which must not be exceeded if the risk to hearing impairment is to be avoided. It is usually depicted in graphical form. It relates the daily exposure for a 40 hour working week, 50 weeks per year, for a working life of 40 years. For the basic criterion (2) the summated daily exposure is given as 87dB(A) for 8 hours. The United Kingdom Royal Air Force hearing conservation programme provides for an 8 hour Damage Risk Criterion of 85dB(A) above which personnel must not be exposed.

### NOISE DOSE AT THE EAR

Cockpit Crewman. Overall, the cockpit crewman was subjected to an LAeq noise level of 94dB for 80 minutes and his DRC was exceeded. However, there is a significant contribution to the overall dose from the speech communications. Visual analysis of the level-time histories show that the speech level is over 30dB greater than the background noise from the aircraft engines. This level may have been exaggerated due to the positioning of the microphone close to the earphone but, even so, it illustrates clearly the need to reduce the gain to a level sufficient to overcome the masking effect of the background noise. Whilst the background sound level was dependant on the engine power level and ranged from approximately 68dB(A) on idle to 95dB(A) at one engine max dry power, the overall LAeq for the monitoring period was 90dB.

Ground Crewman. The ground crewman moved about the HAS but was exposed to a relatively constant noise level. He was exposed to an LAeq level of 100dB for 80 minutes and his DRC was exceeded. Again, there is a significant contribution from the speech communications, but not as much as in the cockpit crewman's situation. Visual analysis of the level-time histories show similar maximum speech levels to those of the cockpit crewman, but his external noise dose levels were 20dB higher. The background noise level at the ear clearly exceeds the DRC.

### ATTENUATION OF THE COMMUNICATION HEADSET

Historically, the accepted method of determining the effectiveness of an ear defender in a given situation is to measure the octave spectrum levels of the noise, subtract the assumed protection from each respective octave band level, and overlay the resulting spectrum with the DRC (2). This method has been used by many workers and laboratories over the years and was given formal recognition in the UK by the Department of Employment's Code of Practice for reducing the exposure of employed persons to noise (3).

This method is a cumbersome, if accurate, way of determining the level of protection and it is limited to known constant levels of noise. This limitation may be acceptable in many industrial situations, but workers such as those involved with the operation and maintenance of aircraft, especially military aircraft, are exposed to a continually varying noise level where it is virtually impossible to estimate the daily exposure rate accurately. In recent years engineers, hearing conservation officers, environmental health technicians, and medical officers trying to resolve hearing conservation problems, have often asked for a single figure attenuation factor which can be used to add or subtract from the "A" weighted DRC or noise measurement for a particular situation. The International Community has also recognised that for some practical purposes a simpler description for hearing protector

attenuation using a single number is to be preferred, and towards this end the ISO has published a Draft Proposal (4) to standardise a method for the overall evaluation and rating of hearing protectors. The Single Noise Rating (SNR) of hearing protectors is one method of calculating the NR using the following relationship:

$$SNR = LC - LA'$$

where LC is a nominal "C" weighted sound level of a pink noise, and LA' is the total "A" weighted sound pressure at the ear due to the attenuation by the hearing protector in question. The detailed calculation involves using octave attenuation data measured according to the subjective method described in ISO 4689 (BS 5108) (5).

The calculated SNR for the Maxiguard communication headset used was 22dB and this compared with the measured LC - LA' of between 23 and 29dB. The differences between the calculated attenuation and the field measurements emphasise the fact that the maximum attenuations achieved under laboratory conditions are not necessarily achieved in practical use.

#### CONCLUSIONS

As is expected with field measurements of this sort, comparing the resulting NR in the two subjects has thrown up differences in attenuation. Whether the higher levels to which the ground crewman is exposed is the cause of the better attenuation is not clear. No cognisance has been made for flanking bone-conduction paths since the method, like all objective procedures, lacks the ability to accurately determine the importance of flanking paths.

This investigation has highlighted the problem of providing hearing protection coupled with communications. Communications headsets are widely used, from telephone operators through to police motor cycle riders, and farm tractor drivers who just want to listen to music. The level of sound that passes through the protector must be summed with the level of sound produced by the communications system underneath. As yet there are no International or European standards to control the overall exposure level at the ear. However, this is currently being addressed by CEN TC 159, who are writing the hearing protector standards CEN 211, Acoustics, and ISO 43, SCI, WG17 who are researching test methods.

In this example it has been shown that the LAep,d can be exceeded in quite a short time. The attenuation of the headsets illustrates the need for the best protection possible, achieved both by the design of new products and in ensuring that they are worn and maintained properly.

#### REFERENCES

1. Berger, E "Methods of Measuring the Attenuation of Hearing Protection Devices. JASA Vol 79 No 6, June 1986.
2. Burns "Noise and Man". Clowes & Sons, 1973.
3. Dept of Employment "Code of Practice for Reducing the Exposure of Employed Persons". HMSO.
4. ISO "Acoustics Estimated Noise Reduction of Hearing Protectors". ISO DP/8353-2.
5. ISO "Method of Measurement of the Attenuation of Hearing Protection at Threshold". ISO 4869 Pt 2.

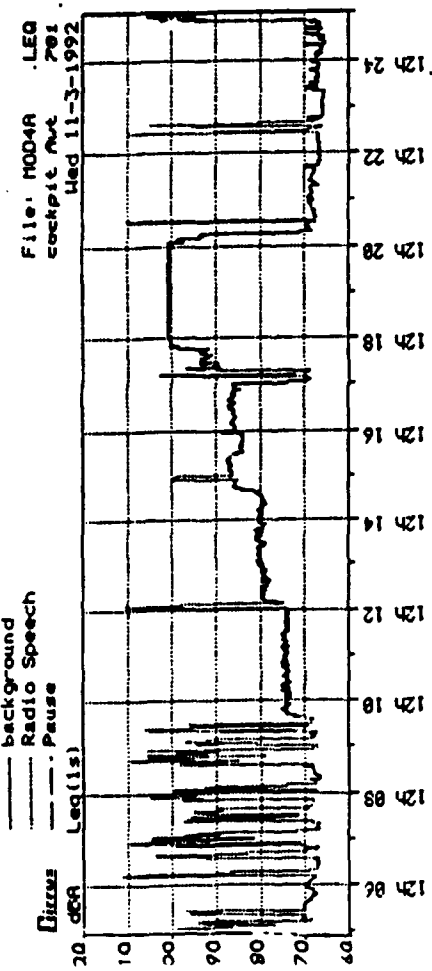

Figure 3. Time history of A-weighted noise level at the ear of cockpit crewman (12:05 > 12:25)

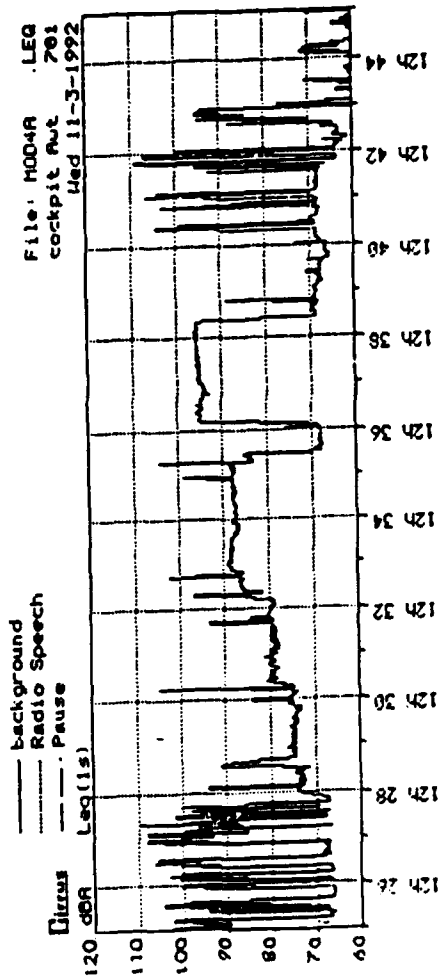

Figure 4. Time history of A-weighted noise level at the ear of cockpit crewman (12:25 > 12:45)

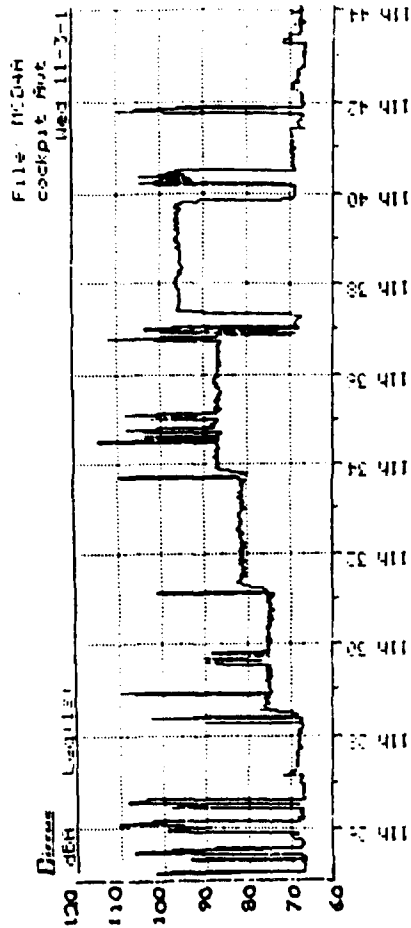

Figure 1. Time history of A-weighted noise level at the ear of cockpit crewman (11:25 > 11:45)

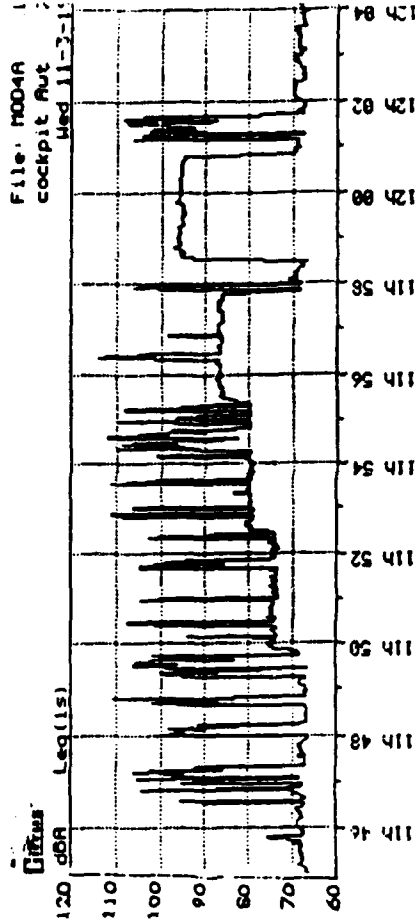

Figure 2. Time history of A-weighted noise level at the ear of cockpit crewman (11:45 > 12:05)

# How to increase a communication intelligibility in a very loud noise

Dr Christian CARME & Dr Alain ROURE(\*).

TechnoFirst SA  
Parc technologique et industriel de Nappollon  
399 rue des templiers  
13676 Aubagne Cedex- France

(\*) Laboratoire de Mécanique et d'Acoustique (LMA) du C.N.R.S.  
31, chemin Joseph Aiguier - B.P. 71  
13420 Marseille Cedex 20 - France

**Abstract :** In communications systems, it is well known that as the signal to noise ratio (S/N) of the communication channels improves, the intelligibility of the intended communication also improves.

Historically, communication headsets intended for use in high noise environments have used passive means to attenuate noise exterior to the headset to improve the intelligibility of communications. Unfortunately, passive noise attenuation materials used in communication headsets do not work well to prevent low frequency noise from entering the headset.

Research has also shown that the intelligibility of voice communications in high noise environments can be severely degraded by the presence of unwanted low frequency noise. Low frequency noise energy in voice communications has a tendency to mask the presence of articulated speech patterns and therefore affects considerably speech intelligibility.

Active noise control (ANC) or ANR (active noise reduction) can be used to significantly reduce the presence of low frequency exterior noise entering the headset and therefore has been shown to improve dramatically the overall intelligibility of headset communications in high noise environments.

ANC headset, helmet or earplug technology has been developed by the authors that combines active noise control and headset communications using a single transducer. Actual intelligibility test results, ANC performance curves and mathematic will be presented by the authors in this paper.

## 1) Introduction

This paper describes two kinds of problems encountered during our experimentation of Active Noise Control (A.N.C.) by feedback applied for different kind of individual protections: earmuffs, headsets, etc...

The first one appears with measurements of the active noise reduction. Due to the small dimensions of the cavities given by the human ear coupled with the earcups and the large acoustic waves treated by A.N.C. system [1], [2], we made the hypothesis that the acoustic field was uniform inside these cavities. However when we analyse the physical feeling of active noise reduction to the ear, during experimentation, we sometimes observe a difference with result given by measurement at the microphone. This shows that the acoustic field near the earphone is not uniform. So, a small range of the transfer function between the microphone and the tympanum gives a different result at ear. We will give in this paper a demonstration of this phenomenon and what are the parameters which modify this transfer function.

The second problem is: how to establish audio communication with other people when the A.N.C. system is on? To get this communication with an A.N.C. by feedback it is necessary to insert directly the corresponding electric signal inside the loop feedback. There are several possibilities to get different results, but only a few of them are applicable. We give in this paper the equations about these solutions in order to show the best way to reproduce an audio signal inside the earcup [3]. These results are given by the following curves computed by a numerical simulation and verified by experimentation. They show that it is possible also, according the insert point of audio signal, to obtain a better response of the earphone inside the earcup.

We present also an experimental result got by TechnoFirst for a prototype made for TELEPHONICS during the "US military VIS program" which presents an improvement of speech intelligibility in using a TechnoFirst's ANC for an headset.

## 2) The physical feeling of ANC at ear

When we use a headset or an earplug driven by an active noise control system, we would like to know if the sound level felt at ear corresponds to the control microphone measurement. According to the diagram given at fig.1 we can make the hypothesis that the acoustic pressure at microphone and at tympanum are exactly the same.

So we can write, when the feedback control system is on, that the acoustic pressure at microphone inside the earcup is given by:

$$P1(f) = P01(f) + P1(f) K.C(f) H1(f) \quad (1)$$

with:  $P1(f)$  acoustic pressure inside the earcup with A.N.C system on;  
 $P01(f)$  acoustic pressure inside the earcup with A.N.C system off;

- K stage gain of the amplifier;
- C(f) A.N.C. filter;
- H1(f) Transfer function between earphone and microphone.

Following this hypothesis the difference between the microphone and the tympanum gives at tympanum the acoustic pressure:

$$P2(f) = P02(f) + P1(f) K.C(f) H2(f) \quad (2)$$

- with:
- P2(f) acoustic pressure inside the earcup with A.N.C system on;
  - P02(f) acoustic pressure inside the earcup with A.N.C system off;
  - K stage gain of the amplifier;
  - C(f) A.N.C. filter;
  - H2(f) Transfer function between earphone and tympanum.

The equations (1) and (2) give:

$$P2(f) = P02(f) + \frac{P01(f) K.C(f) H2(f)}{1 - K.C(f) H1(f)} \quad (3)$$

The acoustic field which comes from the outside can be considered diffuse [4] inside the earcup. So we can make the hypothesis than for low frequencies P01 and P02 are similar. It's given by:

$$P01(f) = H'(f) P02(f) \quad \text{with } H'(f) = \text{cste} \quad (4)$$

So equations (3) and (4) give:

$$P2(f) = P02(f) \left[ 1 + \frac{H'(f) K.C(f) H2(f)}{1 - K.C(f) H1(f)} \right] \quad (5)$$

When modulus of  $[K.C(f)] \gg 1$ ; (5) gives :

$$P2(f) = P02(f) \left[ 1 - \frac{H'(f) H2(f)}{H1(f)} \right] \quad (6)$$

To get modulus  $[P2(f)] \ll 1$  it comes that :

$$\frac{H'(f) H2(f)}{H1(f)} = 1 \quad (7)$$

This result shows that for each frequency the product of  $H'(f)H2(f)$  divided by  $H1(f)$  gives the same modulus and a linear phase shift to get exactly the same active noise control result at microphone and at tympanum.

### 3) Conclusion

To adjust an objective measurement system of A.N.C. in headset we need to optimize the acoustic volume, created by the ear and the earcup, according to equations (5), (6) and (7). In this case the noise reduction given by ANC system at control's microphone will be representative to the ear feeling.

### 4) How to get a good intelligibility with an ANC headset.

We investigate the best way to introduce a communication signal into the cavity where the anti-noise device functioning [5], [6]. Several solutions are possible. We suggest a new one which gives a communication signal without any modification of the frequency broadband where ANC is taking place. In addition to the important ANC results achieved (20 dB on average and 40 dB on peak) this filter makes it possible to transmit, by summing the same secondary source and the audio communication signal. In order to do so, we simply introduce the signal, by using an electronic adder, between the filter C and the microphone (point A on fig.2). We demonstrated [7] that according to the equations of feedback control to get an audio communication we can write :

$$P(f) = \frac{P0(f) + K.C(f) H(f) S(f)}{1 - K.C(f) H(f)} \quad (8)$$

- With:
- P(f) acoustic pressure inside the earcup with A.N.C system on;
  - P0(f) acoustic pressure inside the earcup with A.N.C system off;
  - K stage gain of the amplifier;
  - C(f) A.N.C. filter;
  - H(f) Transfer function between earphone and microphone;
  - S(f) audio signal.

When the modulus of  $[1-K.C(f) H(f)] \gg 1$ ; (8) gives :

$$P(f) = \varepsilon + S(f) \quad (9)$$

#### 4-1) Second possibility

If S(f) is insert between the filter output and the amplifier input the equation of the acoustic pressure inside the earcup becomes:

$$P(f) = \frac{P0(f) + K.H(f) S(f)}{1 - K.C(f) H(f)} \quad (10)$$

When the modulus of  $[1 - K.C(f) H(f)] \gg 1$  ; (10) gives :

$$P(f) = \varepsilon + S(f)/C(f) \quad (11)$$

#### 4-2) Third possibility

If  $S(f)$  is insert between the amplifier output and the earphone input the equation of the acoustic pressure inside the earcup becomes:

$$P(f) = \frac{P_0(f) + H(f) S(f)}{1 - K.C(f) H(f)} \quad (12)$$

When the modulus of  $[1 - K.C(f) H(f)] \gg 1$  (12) gives:

$$P(f) = \varepsilon + S(f)/K.C(f) \quad (13)$$

We made an experimentation of these three possibilities for one kind of our active earmuff. The experiment conditions were to measure at microphone the acoustic pressure inside the earcup for an outside white noise excitation. To show clearly the frequencies reponse's audio signal modified by the choice of inserting the signal  $S(f)$  into the feedback loop, this signal is also a white noise. The stage gain for the audio signal  $S(f)$  is equal to 1.

The curves given at Fig.3. correspond at these measurements.

The curve labelled ANC. is the active reduction measured inside the earcup.

The curve labelled ANC.1 is the experimental result of equation (9).

The curve labelled ANC.2 is the result of equation (11).

The curve labelled ANC.3 corresponds to the equation (13).

We observe between curves ANC.1 and ANC.3 in the frequency zone where ANC is applied a large difference area. Curve ANC.1 has closed frequency response in low frequency than the direct signal  $S(f)$ . Curve ANC.3 shows in this configuration that the audio signal is traited by the ANC system like an external noise.

Results at Fig.3. show that the frequency response of the audio communication signal is better when we use the ANC. corresponding to equation (8).

#### 4-3) Experiment results

This technology is today fully patented [3] and the CNRS is the owner of these patents. The CNRS decided four years ago to create and to give all rights on these patents to a compagny named TechnoFirst.

TechnoFirst manufactures and sells ANC units system fbr : headsets, helmets, earplugs, air conditioning system, etc ... Today TechnoFirst manufactures and sells this specific headset named : SAM PRO and SAM COM (ANC headset with communication system added).

TechnoFirst did also for TELEPHONICS compagny an ANC helmet for the US VIS program. This VIS program corresponds to improve the quality of audio communication in very loud noise vehicules like tanks, etc...

Fig.4 shows the noise levels during the prototype'tests. The top curve corresponds at this noise level in a reverberent room. The middle curve is the passive attenuation given by the helmet. The bottom curve correspond at the passive noise reduction added to the active noise reduction given by the helmet prototype.

Fig.5 shows the audio signal with and without ANC according the block diagram given by equation (8). We can see that the frequency response is more linear when the ANC is on.

TELEPHONICS compagny did also some psychoacoustic tests by using the logatome test. We constated according these tests made at 124 dB SPL external noise that we were able to understand more than 91% of words with the TechnoFirst's ANC system on. Without the active noise control it was not possible to understand more than 75% of these logatomes.

#### 5) Conclusion

According to these results we can say that an ANC headset increases the intelligibility in a very loud noise in comparison to a passive headset.

We have three reasons for explaining this result :

The first one is because we reduce more noise with ANC than a traditionnal acoustic protection.

The second one is because of the feedback control we have a linear frequency response given by the earphone where ANC is applied.

The last reason is because ANC attenuates noise level in low frequencies which disturbs a lot ear's capability.

#### 6) References

[1] P.A. NELSON, S.J. ELLIOT, 'Active Minimisation of Acoustic Fields', Journal Theoretical and applied mechanics, vol 6 1987.

[2] P.A. NELSON & al., 'Quadaratic optimisation problems in the Active Control of free and enclosed sounds fields', IUTAM Symposium, Lyon 1987.

[3] C CARME, A. ROURE ' Patented FR 1986 03/394, extented to PCT, Europe, USA, ..., in 1987 & 1989.

[4] C CARME, A. ROURE ' Speech communication and experimantal ANC for individual acoustic protection', proceeding ACOUSTICS'90, Southampton 1990.

[5] C CARME 'A.N.C. for auditory cavities', Proceeding EUROMECH 213, Marseille 1986.

[6] C CARME 'A.A.A. dans les cavités' Thesis, Université Aix-MARSEILLE II 1987.

[7] C CARME 'A new filtering for A.N.C. at ear', proceeding Inter Noise, volume 2, p:1083, Avignon 1988.

7) Figures

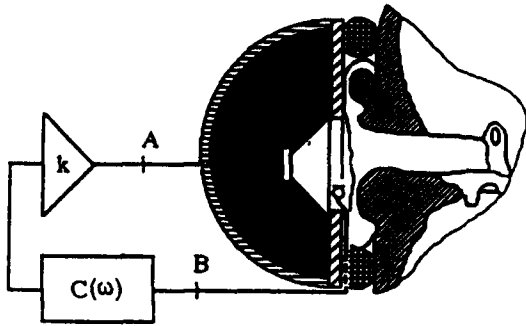

Fig. 1 : Experimental block diagram of active attenuator by feedback filtering

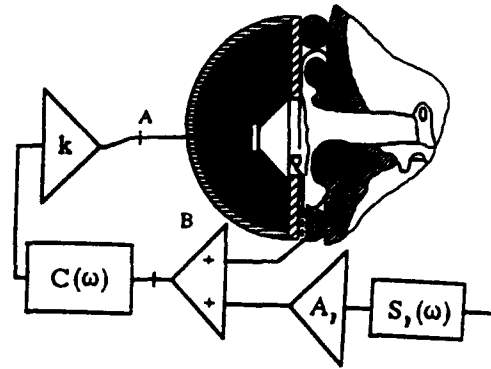

Fig. 2 : Experimental block diagram of active attenuator by feedback filtering with audio signal

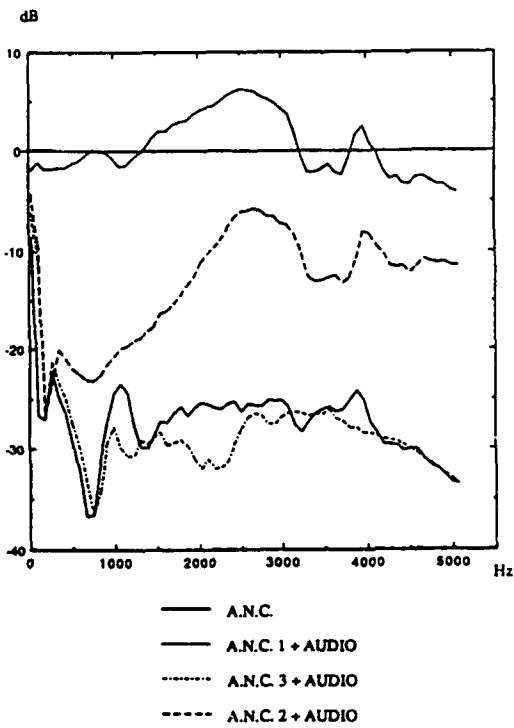

Fig.3 : Frequency response of different systems

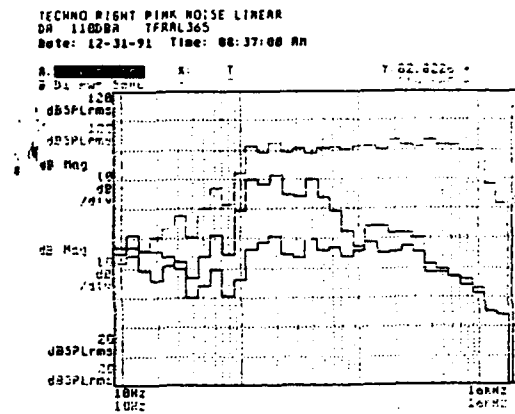

Fig. 4 : Measurement of acoustic curves of noise reduction for Telephonics's unit

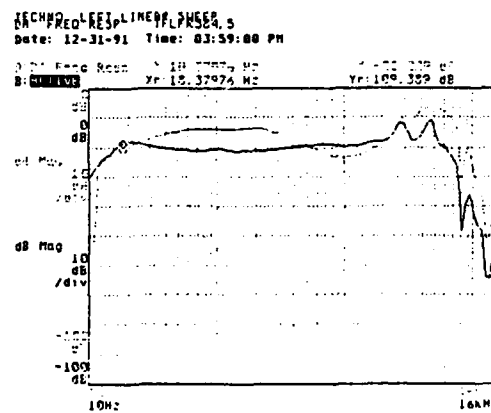

Fig.5 : Measurement of frequency response of Telephonics's unit



# INFLUENCE OF DIFFERENT ACOUSTIC PARAMETERS IN THE SPEECH INTELLIGIBILITY IN SCHOOL ROOMS

DELGADO, Carmen\*, PERERA, Plácido\*\*, SANTIAGO, J.Salvador\*

\* Instituto de Acústica del C.S.I.C., c/ Serrano 144, 28006 Madrid, Spain

\*\* Ayuntamiento de Madrid, c/ Barceló 6, 28004 Madrid, Spain

*Abstract.*— In this paper are presented the results of a joint study of the Instituto de Acústica and of the Municipality of Madrid of the speech intelligibility conditions in school rooms of public schools in Madrid, with different dates of construction.

Both objective and subjective parameters have been measured, such as reverberation time, acoustic insulation and background noise in the rooms, and speech intelligibility in children's sitting places by subjective and objective (RASTI) methods.

The conclusions derived from the study have been presented to the authorities, together with possible lines of action to improve the characteristics of the school rooms.

*Résumé.*— Dans cette communication, on présente les résultats d'une étude conjointe de l'Instituto de Acústica et la Municipalité de Madrid sur les conditions d'intelligibilité de la parole dans des salles de classe de quatre écoles à Madrid construites en différentes années.

On a mesuré des paramètres objectifs et subjectifs, tel que le temps de réverbération, l'isolement acoustique et le bruit de fond dans les salles, ainsi que l'intelligibilité de la parole à la place où sont assis les enfants, moyennant des méthodes subjective et objective (RASTI).

Les conclusions de l'étude ont été présentées aux autorités, ainsi que des recommandations pour l'amélioration des caractéristiques acoustiques des salles de classe.

## INTRODUCTION

With the aim of studying the influence of acoustic parameters of classrooms, such as acoustic isolation, reverberation time and background noise, on speech communication, four public schools of different period of construction were chosen. For the study, 294 school children of both sexes, of three levels, with ages ranging from eleven to fourteen years old were selected.

In the twelve classrooms, the acoustic insulation of walls, windows and doors, the reverberation time and RASTI measurements were determined in conditions of empty room. With the children at their sitting places, subjective measurements of speech intelligibility were performed. A previous ORL exploration and an audiometric study of the children were carried out to detect possible hearing anomalies that could have an influence on the results.

The parents answered a questionnaire, providing information about children diseases, family antecedents related to hearing, drugs consumption, etc. The teachers filled up a questionnaire on their personal appreciation about the classroom, vocal effort needed and related professional diseases.

## MEASUREMENTS

The objective measurements of insulation, reverberation time and RASTI values were performed using standard acoustic equipment: Brüel & Kjær Building Acoustics Analyzer, Tapping Machine and Speech Transmission Analyzer. For the RASTI measurements, the Transmitter was placed at the usual teacher's head position and the Receiver in different places in the room corresponding to pupils' representative positions (See Figure 1). During the measurements, the school buildings were unoccupied. For the background noise measurements, the classrooms were in activity, and the  $L_{90}$  was measured by means of a Noise Level Analyzer.

For the subjective measurement of speech intelligibility it has been used a phonetically balanced test constituted by spondaic words, previously recorded in the sound track of a video tape. The test consisted in one hundred words, distributed in groups of ten, and leaving a time interval between words long enough to allow the test subjects to write down the responses.

With the children seated at their usual places, the tape is reproduced through a loudspeaker situated at the theoretical position of the head of the teacher. The emission of each group of ten words is made at levels that decrease in steps of five dBA, starting from an initial sound level of 80 dBA, measured at one meter from the loudspeaker; this level has been considered as corresponding to "very loud voice". The sound level of the last group of words is emitted at a sound level of 45 dBA, corresponding to "whispered voice". During the test, the classroom had the doors and windows closed.

The children had to write down the words they hear, or believe to hear, in a template prepared for subsequent evaluation of the test.

## RESULTS

In the upper part of Figure 1 are presented the results of the intelligibility curves obtained by means of the subjective test, in schools A, B, C and D, in classrooms 1, 2 and 3. In the lower part, not to scale sketches of the classrooms, with the layout of the surroundings and the RASTI values measured in the points indicated, and the corresponding global speech intelligibility qualification of the room, according to the RASTI scale.

In Table I are included some characteristics of the classrooms, namely volume, measured and recommended reverberation time (for empty and occupied room), and background noise, as well as the values of intelligibility in the different classrooms corresponding to emitted sound levels of 60, 70 and 80 dBA, equivalent to "normal", "loud" and "very loud" voices. In Figure 2 are presented the values, measured and recommended, for acoustic isolation of the rooms.

The audiometric tests and ORL examination of the children, as expected, have not revealed significant anomalies.

## CONCLUSIONS

The intelligibility in the classrooms, measured both by the subjective and RASTI methods, is not appropriate for the purpose of teaching due to the excess of reverberation time. The best results obtained are for classroom D1, the smallest and less noisy one. An acoustic treatment of the rooms, to lower the reverberation times, could be an appropriate solution to the problem.

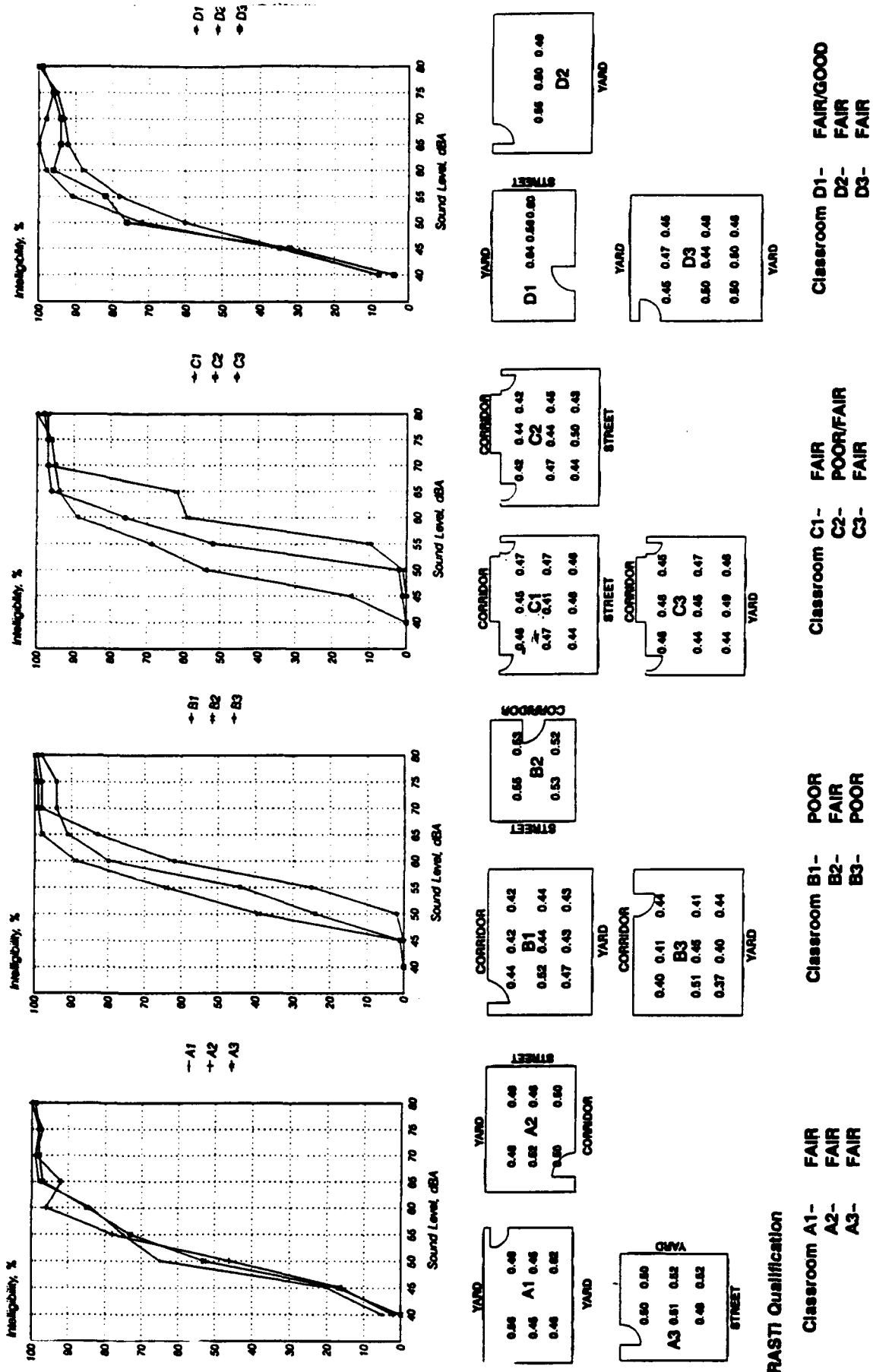

Figure 1.- Intelligibility (%), measured RASTI values in the different points studied and global RASTI qualification in the classrooms.

Table 1.- Volume, reverberation time, background noise and intelligibility in the classrooms

Room	Vol. (m <sup>3</sup> )	Reverberation Time (s)				L <sub>90</sub> (dBA)	Intelligibility (%)		
		T <sub>1</sub>	T <sub>2</sub>	T <sub>3</sub>	T <sub>4</sub>		I <sub>60</sub>	I <sub>70</sub>	I <sub>80</sub>
A1	153	1.54	0.69	< 1	0.37	45.5	84	99	100
A2	147	1.62	0.62	< 1	0.37	45.5	96	99	100
A3	147	1.52	0.67	< 1	0.37	51.5	85	98	99
B1	264	1.89	1	< 1	0.44	54.5	80	94	98
B2	141	1.88	0.75	< 1	0.36	52	89	99	100
B3	265	1.8	0.92	< 1	0.44	57.5	62	98	99
C1	162	2.39	0.68	< 1	0.38	45	89	95	100
C2	170	2.14	0.66	< 1	0.38	49	59	97	97
C3	172	2.25	0.72	< 1	0.38	45.5	76	97	98
D1	126	1.69	0.88	< 1	0.35	44.5	88	93	100
D2	163	1.69	0.99	< 1	0.38	44.5	98	98	99
D3	194	1.88	1.04	< 1	0.4	43.5	96	94	99

T<sub>1</sub>, RT measured, empty room; T<sub>2</sub>, RT calculated, occupied room; T<sub>3</sub>, RT recommended, empty room; T<sub>4</sub>, RT recommended, occupied room.

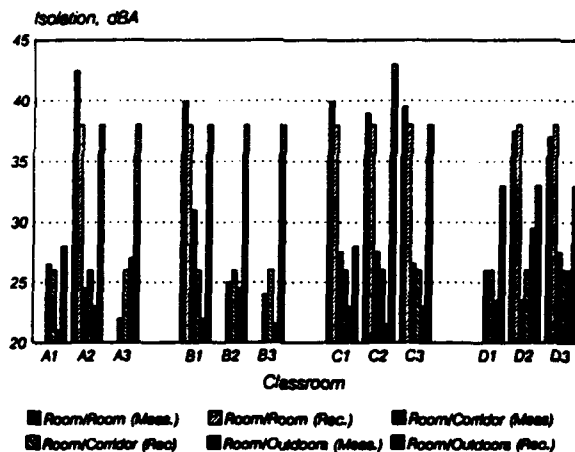

Figure 2.- Acoustic isolation, measured and recommended, of the classrooms.

Although the school B was built in the thirties, D in the fifties, A in the sixty-seventies and C in the eighties, there is not an improvement in the acoustic conditions of the classrooms. This is due, in the opinion of the authors, to the lack of acoustic standards about school buildings.

The poor acoustic conditions of the classrooms add further difficulties to the teachers' task. This fact has been revealed by the responses to the questionnaire, that show a high level of stress and impairment of the vocal chords along the school year, even with interruption of work and a need of rehabilitation.

school buildings.

A second part of this study will propose to the responsible authorities easy and non expensive constructive solutions for present and future

The present knowledge and the existing acoustic materials allow to suppose attainable solutions that can contribute to the improvement of school rooms and, consequently, the quality of education.

## THE LOMBARD EFFECT IN VARIOUS NOISE ENVIRONMENTS

P.E.Giua, Istituto di Acustica "O.M.Corbino" del CNR, Via Cassia  
1216 Roma 00189 Italy

C.D. Messinò Istituto di Tecnologie Biomediche del CNR, Via Morgagni  
30/E, Roma 00161 Italy

### ABSTRACT

A method is described that permits the accurate assessment of the Lombard effect without the use of headphones. Two identical dosimeters were used with their microphones located on the front and back of a helmet. The dosimeters simultaneously measured the  $L_{eq}$  and the n-percentile-exceeded levels. These data were then used to calculate both the voice and the noise level. The method was tested in various laboratory conditions and with different types of noise. Some data are given on the relationship of the Lombard effect with  $L_{eq}$  and other noise parameters.

### INTRODUCTION

The voice level of a speaker depends on the environmental noise. As a matter of fact a speaker rises his or her voice when noise level is high. This effect, named after the french scientist Lombard, has been usually measured by means of headphones that convey the noise to the speaker's ears and a microphone near to mouth to pick up the speaker voice. This setup is obviously not suitable for carrying out measurements in living environments, so that a precise assessment of this effect outside laboratory is quite difficult [1]. The aim of this work was 1) to set up a method in order to permit the measurement of the Lombard effect regardless of the environment and with any type of noise, 2) to measure the Lombard effect as a function of environment and noise parameters, in order to obtain a better understanding of speaker behaviour and noise annoyance.

### METHOD

We have carried out measurements with two dosimeters, worn at the same time. Fig 1, shows two convenient microphone positions. Dosimeters were Larson & Davis's Model 700. The voice of the wearer in absence of noise gives rise to two different readings: after pressure transformation, ( $V=10^{Leq/10}$ ), let us call these values  $V_1$  and  $V_2$ . Whatever the speech length may be, we have

$$V_2 = K * V_1$$

Where  $V_1$  is the value of dosimeter closer to mouth. This relationship holds for both equivalent level,  $L_{eq}$ , and each n-percentile exceeded level.  $K$  depends on microphone position, environment, vocal effort and wearer. The noise also gives rise to different readings,  $N_1$  and  $N_2$ . For the same noise source location and wearer position, the following relationship holds, if wearer is not speaking:

$$N2=H*N1$$

for however long the noise goes on.  $N1$  is the noise value measured by dosimeter closer to mouth. In general  $H$  depends on noise source location, microphone position, environment and wearer. When both noise and wearer speech are present, the dosimeter measures the pressure as a sum of both sources:

$$P1=N1+V1$$

$$P2=N2+V2$$

$P1$  is the transformed reading of dosimeter closer to mouth.

By combining previous relationships, we get,

$$N1'=(K*P1-P2)/(K-H)$$

$$V1'=(P2-P1)/(K-H)$$

$N1'$  and  $V1'$  are respectively the calculated noise and voice pressures that the dosimeter near to mouth would measure in absence of wearer speech or noise. The noise dose could be computed from

$$(N1'+H*N1')/2$$

This is the pressure that a microphone located a few centimeters above the ear would pick up. It is possible to get in some cases an accurate value of  $K$  by checking the cumulative distribution of the  $n$ -exceeded levels. For each  $n$ -exceeded level the transformed readings of both dosimeters are respectively

$$L1n=V1n+N1n$$

$$L2n=K*V1n+H*N1n$$

These are two equations with four unknowns. By taking more levels the difference between unknowns and equations is always two. (It is easy to see that this difference is zero if we are using a three dosimeter system, by taking four levels, or a four dosimeter system, by taking three levels). We can resolve the problem with a two dosimeter system by taking three levels, if the  $H$  value is known and the noise cumulative distribution is linear, ( $Nn=a*n+b$ ) and not parallel to the voice's one. If these conditions are not fulfilled, the results obtained are only approximate.

$H$  can be determined by measuring noise without wearer speech. It can also be evaluated by considering the shift between cumulative distribution curves at the highest  $n$  levels, presumably uninfluenced by speech. In common situations, where noise is diffuse or the speaker moves at random,  $H$  is 1 or very close to 1.

A two dosimeter system cannot accurately measure the noise field around the head, although some benefits regarding sound shadowing and building up can be obtained [2].

#### EXPERIMENTAL

Experiments were carried out with ten people (five men and five women), aged from 20 to 50, with normal hearing. Each person was seated in the middle of the room and heard the noise diffused by means of four loudspeakers or by headphones. Noise duration was 1 minute. The person listened to noise for 30 seconds, then he or she was told to read a short passage for the next 30 seconds at a level useful to be heard 1 meter ahead. The rooms were: 1) a living room of 25 square meters with acoustically treated walls and an averaged reverberation time of 0.2 seconds in the 100-10000 Hz band, 2) a reverberant room of 40 square meters and reverberation time of 3 second in the 100 Hz band. Noises used were white noise at constant level and amplitude modulated white noise. Modulation function was either triangular, with linear cumulative distribution and squared (with some smoothing) with different repetition rate and duration. Fig 2 shows some examples.

## RESULTS

Experiments were carried out to test the method performance. The constant coefficients K and H were determined both by measuring noise in absence of wearer voice and by using the n-exceeded levels. Results are very good in all experimental conditions, if K and H are determined with the first method. Results are also good, if K and H are taken from the n-exceeded levels, with noises having a linear cumulative distribution, at least among the used n-exceeded levels. In this case some errors were found, probably due to the low precision of the dosimeter's n-exceeded level measure. Instruments having a 0.1 instead of 0.5 dB precision would give more accurate results.

Fig 3 shows the Lombard effect due to white noise at constant level as a function of noise  $Leq$ . The slope of the averaged straight line is 0.69 with headphones (H), 0.71 with loudspeakers in the treated living room (L) and 0.73 in the reverberant room (R).

Fig 4 shows the effect due to an amplitude modulated noise (amplitude modulation frequency = 0,12 Hz) with noise dynamics = 25 dB. The curve slope is lower than the previous one and depends on environmental conditions.

Fig 5 shows the effect due to an amplitude modulated white noise with same frequency but with dynamics = 41 dB. The curve slope is still lower than the previous one and depends on environment in a similar way.

Fig 6 shows the Lombard effect due a sequence of short bursts of white noise, (burst duration = 1.5 second, repetition rate = 0.22 Hz). The curve slope is the lowest one (0.53) and depends on environmental conditions.

## CONCLUSION

These experiments show that the Lombard effect depends on the measurement method. The curve slopes vary as a function of method as well as of environmental conditions. This effect depends also on noise type. The proposed method, suitable for carrying out measurements in any environment, might be important for studying the Lombard effect in real life situations. The use of three or more dosimeters could be useful for improving the method performance. These measurements show also that the Lombard effect seems to depend not only on noise  $Leq$  but also on other noise features, besides the noise spectrum. Amplitude modulation frequency, dynamics, peak value, peak slope, repetition rate seem to be important in this respect. In general, it seems that less steep slopes are obtained as the signal-to noise ratio increases [3].

## REFERENCES

- [1] K.S.Pearsons, R.L.Bennett and S.Fidell: "Speech levels in various noise environments", EPA-600/1-77-025, U.S. Environ. Prot. Agency, May 1977
- [2] P.E.Giua, C.D.Messinò, D.L.Johnson: "Elimination of the influence of wearer's voice by a two dosimeter system". J. of Acoust. Soc. Am., 92, 2382, 1992.
- [3] H.Lane and B.Tranel: "The Lombard sign and the role of hearing in speech". J. Speech and Hearing Res., 14, 677, 1971.

FIG. 1



FIG. 2

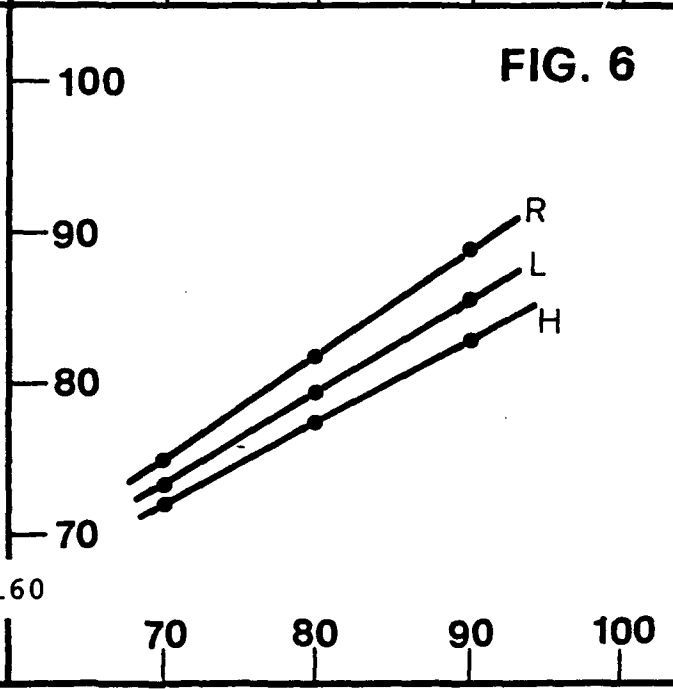
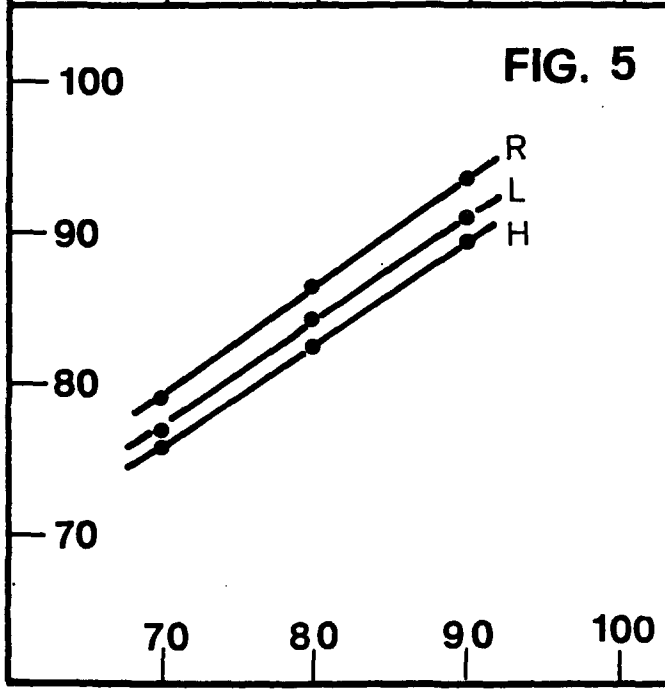
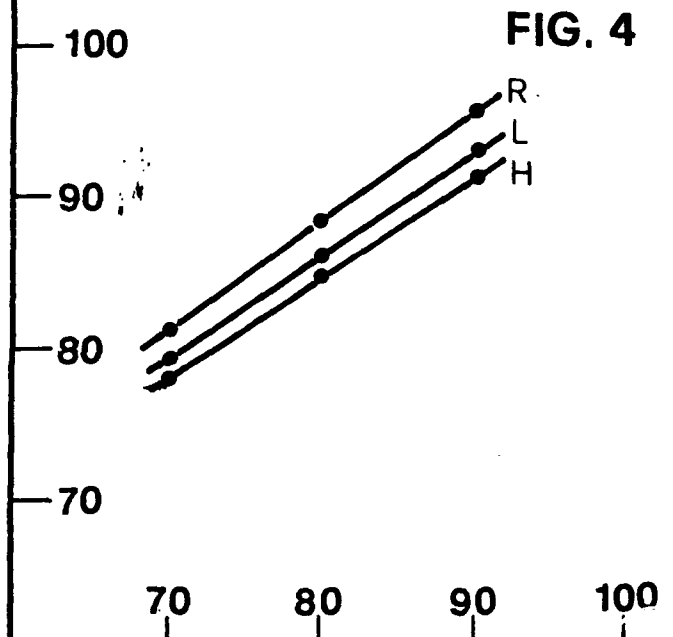
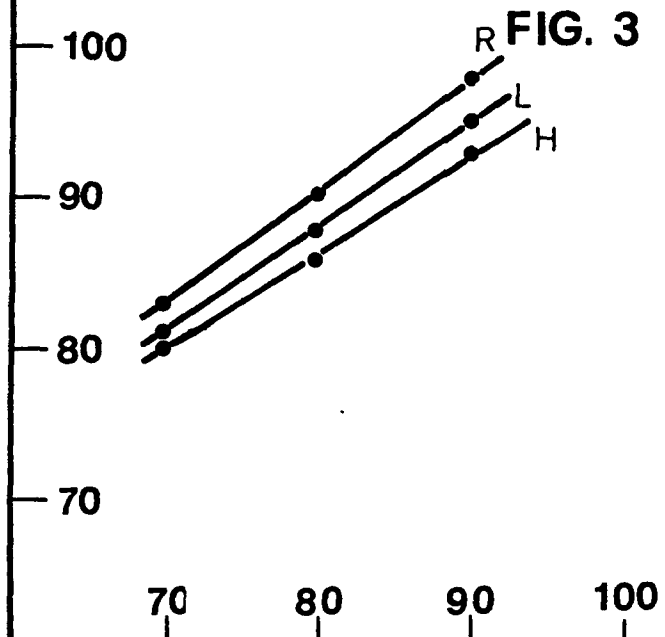
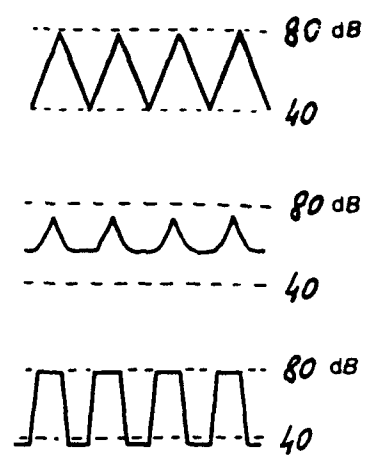

160



# NOISE INDUCED HEARING LOSS AND COMMUNICATION: THE MILITARY EXPERIENCE

KERSEBAUM Michael, BENNETT John

Bundeswehrkrankenhaus Giessen  
Department Ear, Nose & Throat Surgery  
(Chief, Dr. K. Heckrodt, Colonel)  
Schubertstr. 60  
W-6300 Giessen  
Germany

**Abstract.** Good hearing ability is an essential factor for military efficiency. Good communications are also essential, specially in multinational operations, for military command. Noise hazard and the resulting deafness compromise both. The methods by which they are tackled are reviewed. Some pointers to the future are discussed.

**Résumé.** Une bonne audition est la condition essentielle pour l'efficacité de l'armée. Une très bonne communication est pour la même raison absolument nécessaire en cas de commandos militaires, surtout pour des manoeuvres internationales. Un traumatisme dû au bruit, ainsi que la perte de l'audition qui en découle, empêche l'accomplissement de ces conditions. Les méthodes de traitements vont être ici présentées. Les évolutions possibles dans l'avenir vont également être discutées.

Noise induced deafness is the most common occupational disease in Germany and Britain. Up to the end of 1990, there were 217,000 cases noted in the former West Germany. Of these about 27,000 were serious enough to warrant a pension. In the German armed forces (Bundeswehr) the problem of noise induced hearing loss and its consequences are important military occupational topics. Here, the typical military exposure is to impulse noise. This is in contrast to industry where exposure is more usually to constant noise over a period of years, as well as fluctuating and intermittent noise. It is only relatively recently that the possibility of protecting the ears became obligatory. Previously, such deafness appeared to be synonymous with a military career. It was thought that by becoming familiar with the noise of shooting and explosions a soldier would become better prepared for his role in war. Despite education and better protection against noise, deafness is still found today as a result of noise.

## Noise Protection In The Bundeswehr

Protection against noise is provided equally for all members of the Armed Forces in every trade and all attached civilians and co-workers. Troublesome sound can also interfere with the efficiency and health of workers in the immediate vicinity. The workplace is therefore made as quiet as practically possible. Values for places where the following activities are taking place should not be exceeded:

- complicated intellectual work      55 dB(A)
- office work                              70 dB(A)
- specialised activities                85 dB(A)

It is possible for these to be exceeded by up to 5 dB(A) when it is not possible to reduce the noise. Hearing protection must be provided for all Bundeswehr personnel beyond 85 dB(A) and must be worn by all above 90 dB(A). This protection must limit the sound heard to a maximum of 90 dB(A).

Personnel protective devices within the Bundeswehr consist of earplugs, hearing protection headphones, hearing protective helmets, sound protecting devices and speaking equipment. Earplugs are worn within the ear canal and should not interfere with the military helmet or the receiving of orders. Research with Bekesy audiometry has shown that those earplugs with a perforation allow better communication than those without. Temporary threshold shift between the two was insignificant<sup>1</sup>. Such perforated devices offer the soldier who is forced to wear a device in the ear good protection yet do not compromise his ability to hear and communicate. On account of this, protective headphones are only on limited issue to units. Protective helmets with and without speaking facilities are provided for flight personnel. They cover the outer ear and surrounding head, thus protecting against bone conduction of sound. Above a sound level of 130 dB(A) this is changed to sound restricting equipment. This is to avoid inner ear disturbances of vomiting and unsteadiness. In armoured vehicles the sealing cushions of the communication equipment itself generates sufficient ear protection. Thus there must be a compromise between hearing protection and communication.

### Military communication in general

Each military act implicits communication: "You can not not communicate"<sup>2</sup>. In this, the human ear as organ of communication "par excellence", works often even better than the eyes. A shout can communicate about 100 m with a normal ear, 40 m with a poor ear and less than 5 m when there has been a temporary deafness following noise exposure. Which soldier of which army wants to rely on a deaf sentry? A "normal" ear can monitor 4-36 times as much area as ears with poorer sensitivity, or can provide 2-6 times as much warning time of the approach of enemy troops<sup>3</sup>.

Many elder soldiers have suffered a deafness because of training with loud weapons for a long period of time. Up to the sixties there wasn't put much effort in noise protection and hearing protection. First to be affected is the perception of high frequencies containing the consonants which give speech its meaning. Hence the ability to make fine discrimination between similar-sounding words is compromised. There is also difficulty in understanding speech when there are competing noise signals such as background noise<sup>4</sup>. To complicate matters, military communication may contain much information of novel or unexpected content and this requires a higher signal to noise ratio than expected for interpretation. Added to this is the further complicating factor of multi-national operations. The consequences of misinterpretation may be disastrous.

### Communication in air defence service:

Under aspects of military communication air defence service takes a very special place, but yet not with much consideration. Though it is obvious that the workplace of a radar-officer is not one of the most "noise-polluted", our own environmental noise measurements have shown, that there is a surprisingly high noise level. The busy air-traffic of Europe requires good communication abilities to avoid real dangers for flight security. Education and training of radar officers takes a long time and is extremely expensive. It takes three years of education to get the intercept control licence. In this time there have to be made 300-350 practical intercepts with to jets (e.g. F-4F Phantom, hunter and target). This means approximately 100 hours with costs of 25,000 DM each. This calculation does not include the costs of teachers, further personnel and the salary of the becoming radar officer. It may be counted for the pilots training only in little parts, because the ordered flight manoeuvres are not of full training effects to the pilots. This calculation was done to show what financial loss may

---

<sup>1</sup>Dancer A, Grateau P, Cabanis A, Barnabe G, Cagnin G, Vaillant T, Lafont D (1992) Effectiveness of earplugs in high-intensity impulse noise. *J. Acoust. Soc. Am.* 91 (3) 1677-1689

<sup>2</sup>Watzlawick P, Beavin JH, Jackson DD (1985) *Menschliche Kommunikation*. 7. Aufl. Huber, Bern-Stuttgart-Wien (Org. NY 1967)

<sup>3</sup>Zajchuk JT, Phillips YY. Effects of blast overpressure on the ear. *Annals Otology, Rhinology & Laryngology* 98: Supplement 140

<sup>4</sup>Bender DR, Mueller HG (1981) Military Noise Induced Hearing Loss: Incidence And Management. *Military Medicine* 146: 434-437

occur, when at the end of training time there would be no suitability, for instance because of a lack in speech recognition.

In the past the noise level in radio communication had to be high to get a clear signal. From that time we know officers with a unilateral hearing impairment. For critical intercept control conditions even today high noise levels are necessary. Because of the headset no avoidance is possible in the case of strong signals coming in. The reception quality depends on the kind of aircraft, weather and flight situation. Especially at controlling the F-4F Jet the noise level of the incoming signal varies often.

The workplace: the job takes place in an air-raid shelter with a central air-condition and no natural light. In different function areas are different, but constant temperatures. Many persons complain about tiring shifts. The electronic is cooled by air coming through holes in the floor, which may lead to common colds more often than usually. Some persons feel ear-ache and head-ache. Elder officers reported, that they had no problems in the first ten years of their job, then they had to start to turn on the sound intensity. At last full volume and highest concentration was necessary. In unison officers complaint that the headsets were uncomfortable and making pressure points, civil headphones would be better and cheaper ("What is the benefit of an uncomfortable headset, which is equally reliable at the north pole and in the tropics, when you wear it in an air-raid shell?").

Example of military communication: The track production officer (TPO) is responsible for position and identification of aircraft, co-ordination and data exchange with other detachments, recognising and announcement of electronically disturbances. For this he has headphones for normal action and another headset to communicate in a code with AWACS (Airborne Warning And Control System) and he has four different telephones (one of these for coded speech). Behind him is a box with the possibility to observe ten different frequencies for radio communication. Behind and above he has a loudspeaker (Public Address, PA) with high volume (85 dB(A)), because each announcement must be loud enough to hear through the headphones. In front of him he has got an other loudspeaker and microphone for air surveillance loops, i.e. corresponding with other radar officers in an area. Right in front there are two monitors for civil and military radar. On his right hand he finds a keyboard for data exchange with AWACS.

At the same time the TPO has to watch his monitors, keep in touch with radio communication under changing headsets, has to manage four different telephones and has to observe ten extra frequencies. To make it more difficult, for communication with AWACS speech will be digitised, cut, coded and again cut and digitised. Because of this speech sounds of tin, hollow and slowed down (Computer voice, Mickey Mouse voice). The speaker hears his echo in a time displace.

This pretentious and communication intensive action takes place in the operations hall. From our informal environmental noise measurements (section) result:

- noise level at workplace TPO	67-73 dB(A)
- noise level in headset TPO	60-66 dB(A)
- radio communication in headset TPO	72-78 dB(A)
- public address in headset TPO	85 dB(A)
- frequency box in headset TPO	82 dB(A)

(For reproducible and reliable measurement conditions we hope to get a KEMAR (Knowles Electronic Manikin for Acoustic Research) in the next few months).

Because some GFN-Display (Grow Up To Full Nadge (Nato air defence ground environment)) work at a frequency of 400 Hz, there is always a disturbing vibration at 800 Hz and 1,600 Hz.

For reasons of training the military command sometimes plays interference to the headsets (Comjam = Communication Jamming):

- wail
- changing of volume and frequencies
- disturbing noise in speech frequency
- disturbing speech e.g. broadcast in English, French, German

According to our opinion all this shows, that noise level is too high for such a communication intensive and responsible action as the TPO has to do. It is regulated for radar officers, that once a

year pure tone audiometry has to be made. This can not do justice to this complex and pretentious action. Even standard speech audiometry under silent conditions, like the "Freiburger Sprachtest" may be normal and nevertheless there might be a disorder of auditory selection, i.e. inability to discriminate a specific sound in the presence of competing sound sources<sup>5</sup>. At the moment we can't solve this problem in routine diagnostic, but hope that in the near future we will be able to manage this problem with binaural speech intelligibility tests under reproducible noise exposure. Last but not least we shouldn't forget the psychological effects on hearing and communication ability because of work under stress and air-raid shelter conditions<sup>6</sup>.

---

<sup>5</sup>Pröschel ULJ, Döring WH, (1992) Richtungsabhängiges Sprachverstehen unter Störschalleinfluß bei Störungen der auditiven Selektionsfähigkeit und bei seitengleicher Innenohrschwerhörigkeit. *Audiol. Akustik*: 192-203

<sup>6</sup>Babisch W, Elke JU, Goossens C, Gruber J, Ising H, Winter A (1985) Beeinflussung der zeitweiligen Hörschwellenverschiebung (TTS) durch psychologische Faktoren. *Z. Lärmbekämpfung* 32: 2-8

## MEASUREMENT OF NOISE EXPOSURE FROM COMMUNICATION HEADSETS

KUNOV Hans<sup>1</sup>, DAJANI Hilmi<sup>1</sup>, SESHAGIRI Baily<sup>2</sup>

<sup>1</sup>Institute of Biomedical Engineering, University of Toronto, Canada M5S 1A4

<sup>2</sup>Occupational Safety and Health Branch, Labour Canada, Ottawa, Canada K1A 0J2

### Abstract:

Measurement of noise exposure from communication headsets is difficult because of the inaccessibility of the ear canal. Moreover, acoustical measurements taken under the headset should be referenced to accepted standards for noise exposure.

We describe a method of measuring noise under communication headsets, and give some examples of measurements in the field. We found 8-hour noise exposures in the range of 64 - 95 dB(A). However, the highest level was due to a non-professionally modified headset, and disregarding this case, the upper level was 88 dB(A).

The measurements fell naturally into three groups: "office" settings, with environmental noise below 60 dB(A) ( $L_{eq}$ ); "street" settings with  $L_{eq}$  in the range 60 - 80 dB(A), and "noisy" settings with an  $L_{eq}$  larger than 80 dB(A). The median noise exposures in the three settings were 68.9 dB(A), 74.2 dB(A), and 81.6 dB(A), respectively.

The measurement of noise exposure from communication headsets presents a challenge. This is due to two facts: Firstly, it is difficult to obtain precision measurements of the sound field in a person's ear canal, especially under insert (intra-aural) headsets; Secondly, noise exposure standards refer to sound measured in a free field, using a standard sound level meter.

We have developed a method for estimating noise exposure, based on a manikin head with accurately simulated soft tissues in the ear canal as well as in the region surrounding the pinna (Kunov and Giguere, 1989; Kunov, 1989). This Acoustic Test Fixture (ATF) has the same external dimensions as KEMAR™, but the dynamic mass of the head is correct, and the acoustic isolation is better. We designed an analog filter to transform the sound pressure measured at the level of the ear drum in the ATF to the equivalent sound pressure of a diffuse free field (Kunov, Skobla and Munshi, 1991). The output from the filter is therefore a measure of the imaginary free field sound pressure that would have given rise to the same sound pressure at the ear drum as the one actually measured. The data for noise exposure from headsets can then be interpreted in terms of conventional standards and codes. The filter fits on to a Bruel & Kjaer Type 2231 integrating sound level meter for operational convenience.

Equipped with the ATF and the sound level meter with the attached filter, it is possible to perform accurate real-time field measurements of noise exposure from any source,

whether it is close to the ear (such as communication headsets), in the environment, or a combination of environmental and nearby sources. In practice, we often used an active signal splitter to create two identical signals for the communication headsets, one for the user, and one for the ATF, which is placed in a position that is acoustically similar to that of the user.

With this method, we performed detailed measurements of the noise exposure of workers who use headsets at eight different sites. The workers included air traffic controllers, telephone operators, telephone cable maintenance workers, and ground crew at two airports. They used different types of communication headsets (intra-, supra-, and circum-aural) of different makes. Figure 1 shows a measurement being taken of the noise exposure of ground workers at Toronto International Airport.

At each location, we measured the following parameters: The time-averaged equivalent sound level under the headset, expressed as  $L_{eq}$ , the maximum RMS level (fast response), the maximum peak pressure level, and the time-averaged environmental noise (expressed as  $L_{eq}$ ). Based on the measurements and information about the work schedules, we estimated the equivalent 8-hour noise exposure for the worker. All measurements were A-weighted and transformed to the diffuse field.

Figure 2 shows the estimated 8-hour noise exposure by type of environment. Workers in quiet office settings (telephone operators, air traffic controllers) with environmental noise < 60 dB(A) experienced noise exposure with a range of 64 - 81 dB(A) and a median of 68.9 dB(A). Both supra-aural and intra-aural headsets were used in this environment, with the latter producing the two highest readings. Workers in moderately noisy environments (environmental noise in the range 60 - 80 dB(A)) used supra-aural headsets and had exposure in the range of 70 - 84 dB(A) and a median of 74.2 dB(A). Workers in noisy workplaces (environmental noise in excess of 80 dB(A)) used circum-aural headsets which act as hearing protectors as well. Their noise exposure had a range of 76 - 95 dB(A) and a median of 81.6 dB(A). High environmental noise contributes to the exposure both directly and indirectly by causing the worker to raise the volume of the audio in the headset.

The range of noise exposures overall was 64 - 95 dB(A). The upper end of the range was found in connection with a hearing protector modified as a headset by non-experts. Disregarding this anomalous case, the highest noise exposure was 88 dB(A).

The maximum levels that were registered are shown in Figure 3. They were in the range of 85 - 98 dB(A) for "office" settings, 72 - 120 dB(A) for "street" settings, and 88 - 107 dB(A) for "airport" settings. The highest levels were associated with maintenance workers who, unlike other workers, did not use the headsets for communication but rather to detect faults in telephone cables (using a detection microphone).

An issue of current interest is the levels of impulsive noise in industrial settings. The measured maximum peak levels ranged between 87 and 129 dB(A) and proved to be closely correlated with the measured maximum RMS levels. The highest readings were

associated with the telephone cable maintenance workers. Although these readings are above 120 dB, they are lower than 140 dB, a critical level in some jurisdictions.

**References:**

Kunov, H. *Method for Measuring Noise Exposure from Communications Headsets*, Proceedings of the Annual Meeting of the Canadian Acoustical Association, Halifax, Oct. 16-19, 1989, p. 60-66 (abstract p.160).

Kunov, H. and Giguère, C. *An acoustic head simulator for hearing protector evaluation. I: Design and construction*, J. Acoust. Soc. Am. 85(3):1191-1196, 1989.

Kunov, H., Skobla, J., Munshi, M. *Real-time Method for the Measurement of Noise from Communication Headsets*, Report from the Institute of Biomedical Engineering, University of Toronto, July, 1991.

Rice, C.G., Breslin, M., Roper, R.G., *Sound levels from personal cassette players*, Brit. J. Audiol. 21:273-278, 1987

Skrainger, S.F., Royster, L.H., Berger, E.H., Pearson, R.G., *The contribution of personal radios to the noise exposure of employees at one industrial facility*, Am. Indust. Hyg. Assoc. J. 48(4):390-395, 1987



Figure 1: Measurement of noise exposure of ground worker at Toronto International Airport

**Estimated 8-hour noise exposure by environment**

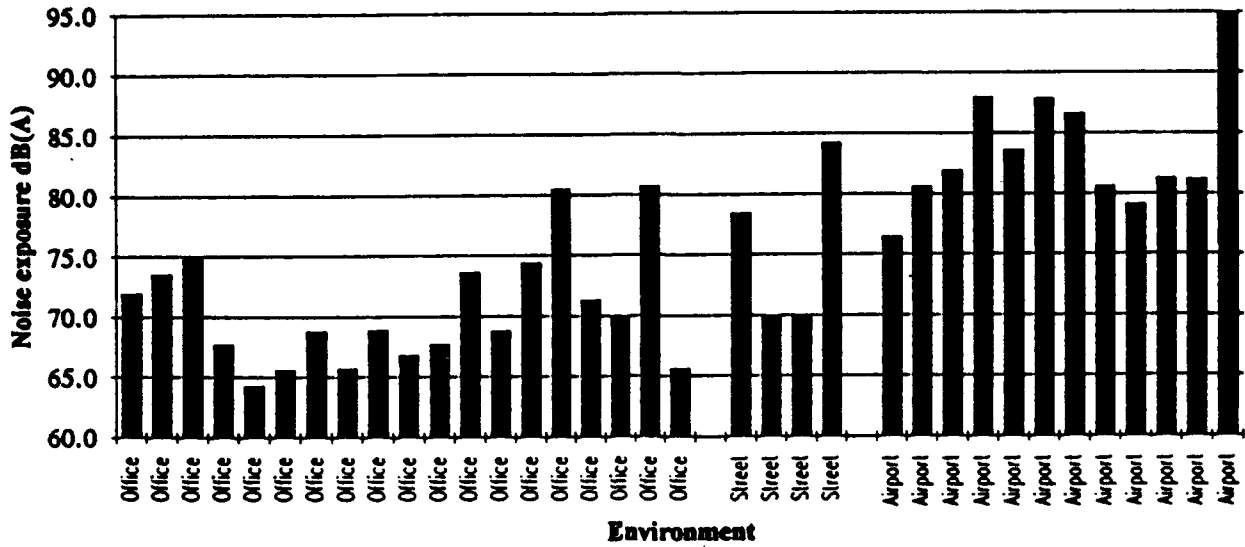

**Figure 2: Estimated 8-hour noise exposure by type of environment ("office", "street", "airport")**

**Maximum level by type of environment**

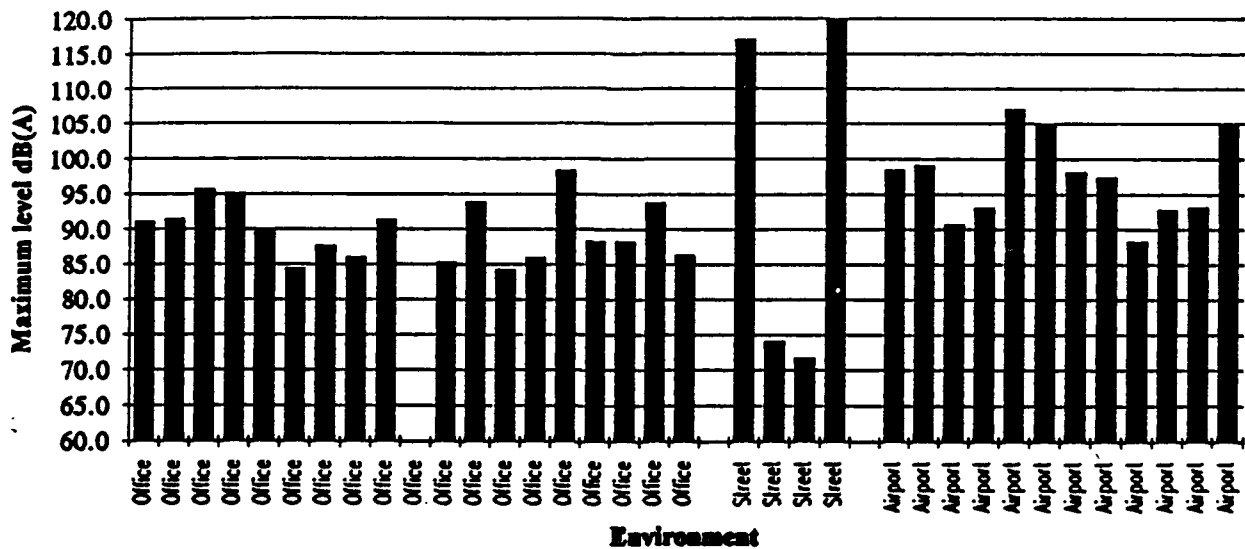

**Figure 3: Maximum level under the headset by type of environment ("office", "street", "airport")**



# "DETECTSOUND™": A USER-FRIENDLY SOFTWARE FOR THE ANALYSIS OF WARNING SOUNDS IN NOISY WORKPLACES

LAROCHE, Chantal<sup>1</sup>, HÉTU, Raymond<sup>2</sup>, TRAN QUOC, Hung<sup>2</sup>, LAROCQUE, Richard<sup>2</sup>

<sup>1</sup>Sonométrie Inc., 5757 Decelles, #514, Montréal, Qué., CANADA, H3S 2C3

<sup>2</sup>Groupe d'Acoustique de l'Université de Montréal, C.P. 6128,  
Succ.A, Montréal, Québec, Canada, H3C 3J7

## ABSTRACT

A computerized model (DETECTSOUND™) was developed to predict the detectability of warning sounds in noisy workplaces. This model takes into account the loss of auditory sensitivity and selectivity due to cochlear hearing loss and the use of hearing protectors. It is based essentially on loudness summation and excitation patterns. Before making the software available to health and safety personnel, a field study has been conducted in order to validate its prediction in terms of signal detection and recognition. The perception of three different warning sounds with well defined acoustic characteristics (a buzzer, a whistle and a horn) has been studied with different background noises from a steel and a bottling plant. At five different workstations, workers were asked to move their head only when they hear the buzzer emitted by a loudspeaker at different signal to noise ratios (-5 to +15 dB within a third octave band). The results shows that 1) the level of the signal that allows recognition has to be +12 dB over the background noise in at least one third octave band and 2) it is difficult to strictly apply the ISO 7731 standard used for the evaluation of warning sounds in the field. These facts confirm the usefulness of Detectsound software for health and safety personnel. (Work supported by Institut de Recherche en Santé et en Sécurité du Travail du Québec)

## SOMMAIRE

Un modèle informatisé (DÉTECTSONMC) a été développé afin de prédire la capacité de détection d'avertisseurs sonores en milieu de travail bruyant. Ce modèle prend en compte la perte de sensibilité auditive et de sélectivité fréquentielle attribuée à la perte auditive d'origine cochléaire ainsi que le port de protecteurs auditifs. Le modèle est essentiellement basé sur les principes de sommation de sonie et de patrons d'excitation. Avant de rendre cet outil accessible aux intervenants en santé et en sécurité du travail, une étude terrain a été menée afin de valider les prédictions du modèle en terme de détection et de reconnaissance de signaux sonores. La perception de trois avertisseurs sonores différents (ronfleur, sifflet, klaxon) a été analysée en présence de différents bruits de fond d'une aciérie et d'une usine d'embouteillage. À cinq postes de travail différents, on demandait aux travailleurs de faire un signe de la tête seulement lorsqu'ils percevaient le ronfleur émis par un haut-parleur à différents rapports signal/bruit (-5 à +15 dB dans au moins une bande de tiers d'octave). Les résultats ont démontré que 1) le niveau du signal doit être d'au moins +12 dB au-dessus du bruit ambiant dans au moins une bande de tiers d'octave pour permettre la reconnaissance des signaux et 2) il est difficile d'appliquer intégralement la norme ISO 7731 portant sur l'évaluation terrain des avertisseurs sonores. Ces observations soulignent la pertinence du logiciel DÉTECTSONMC pour aider les intervenants en santé et en sécurité du travail. (Projet subventionné par l'Institut de Recherche en Santé et en Sécurité du Travail du Québec)

## PROBLEM

Each year, deadly accidents occur in noisy workplaces because a warning signal is not heard (van Charente et al., 1990). Such accidents happen in many workplaces despite the fact that the use of auditory signals are governed by standards, like ISO 7731 (1986), and laws. These are based on many experimental studies of the detection of auditory signals in different background noises (Laroche et al., 1991). The studies were conducted by specialists in acoustics or ergonomics but very few practical tools are available to analyse existing warning signals in noisy workplaces and to make recommendations to improve these signals. The main goals of this study are to present the basis of the model DETECTSOUND™ and to present data on the validation of the program in a steel and a bottling plant.

## DESIGN OF THE PROGRAM DETECTSOUND™

Detection models have been suggested for subjects with normal hearing (Patterson, 1982; Zwicker and Scharf, 1965). These models take into account different factors such as the receiver, the sound signal and the background noise. Because there are very few practical tools which allow the prediction of detection ability for a whole population of workers and in order to improve safety in noisy workplaces the Groupe d'Acoustique de l'Université de Montréal (GAUM) has developed a computerized model (DETECTSOUND™) which takes into account the loss of auditory sensitivity and selectivity due to noise-induced hearing loss and the use of hearing protectors. The scientific foundations of the model have been presented in two previous papers (Laroche et al., 1991; Tran Quoc et al., 1992). Figure 1 outlines the flow chart of the program.

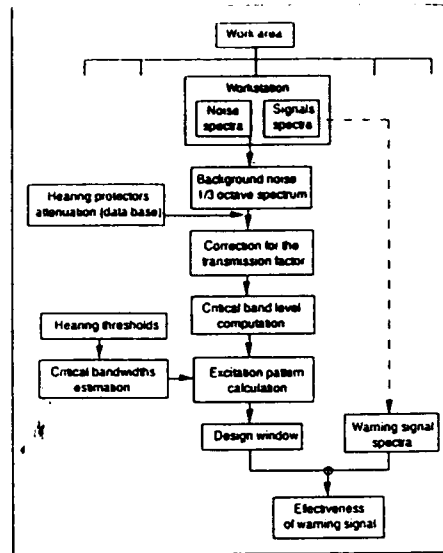

Figure 1. Flow chart of the program DETECTSOUND™

DETECTSOUND takes into account the following information:

- the background noise at each workstation (1/3 octave band levels from 25 to 12 500 Hz);
- the hearing protectors worn by a standard individual or by specific individuals (attenuation in dB from 63 to 8000 Hz);
- the audiogram of a standard individual or the actual individuals assigned to a workstation (hearing thresholds from 125 to 8000 Hz);
- all warning sounds that can be heard at the station (1/3 octave band levels from 25 to 12 500 Hz).

A standard individual refers to five different stages of hearing loss, stage 0 meaning normal hearing for a 55 years old man and stage 4 meaning an advanced level of noise-induced hearing loss. The loss of frequency selectivity is also taken into account in the software (Laroche et al., 1992). It is statistically related to the loss of sensitivity. In fact, the user do not have to enter this information. It is automatically computed based on the hearing thresholds. When these informations are entered in their specific table forms and computed together, the results are displayed in a graphic or a table form. Figure 2 presents an example of a graphical display called the "design window".

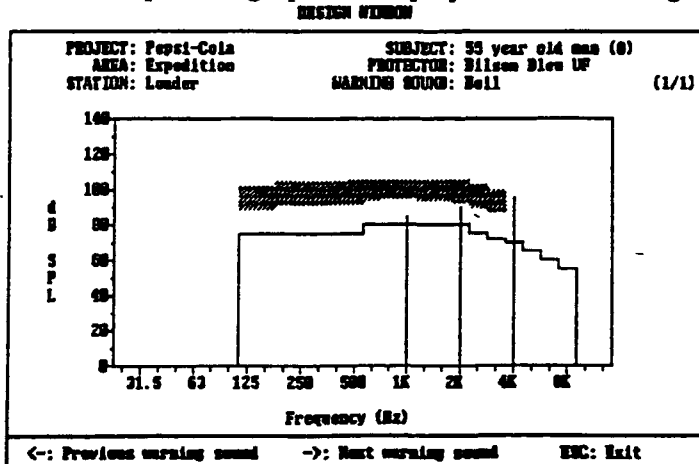

Fig.2 Graphical display of the design window for a particular workstation.

The frequency content is presented on the x axis and the level of each 1/3 octave band of the noise or the warning sound is on the y axis. The full horizontal line corresponds to the background noise level at the loading workstation of the expedition zone. The vertical lines correspond to the spectral content of the bell heard at this workstation. The dark zone represents the design window, i.e. the spectral and level region in which at least two spectral lines of a warning sound should be in order to attract attention and be recognized among different warning sounds. In this example, the bell will not be well recognized by 55 years old workers (stage 0 has been used in this example) wearing Bilsom Bleu UF because none of the three lines are inside or at the borders of the design window.

The design window is calculated by adding 12 to 25 dB to the masked threshold in each third octave band. The +25 dB limit has been imposed in order to provide protection against startle reactions as well as excessive annoyance. Another superior limit of 105 dB SPL was imposed in this example to avoid risk of acquiring temporary or permanent threshold shifts. The upper frequency limit has been set to 3000 Hz in order to take into account noise-induced hearing loss.

## FIELD STUDIES

### Method

In order to test the validity of Detectsound, we conducted field studies in a steel and a bottling plant. Based on a previous study done by Wilkins et al. (1981), we chose three warning sounds (one target which was a buzzer, and two incidental which were a whistle and a horn), recorded them on a DAT in a random order at five different levels (5 dB step). Each signal was presented 5 times at each level for a total of 75 signals separated by an average interval of 31 seconds (the range was 10 to 50 seconds).

The signals were presented to groups of workers at their workstation through a B & K 4224 sound source. The highest level of the buzzer was used to calibrate the presentation of all the signals. The S/N ratio in the 2.5 kHz third octave band (where the energy dominates for the buzzer) was set to +15 dB by adjusting the level of the buzzer. We insured that the sound levels did not vary from one zone to the other at a given workstation. When this was not the case, corrections were introduced into the raw results in order to standardize them.

The workers were asked to move their head when they heard the buzzer. Two observers wrote down the results.

The buzzer was chosen as the target signal because 1) it was judged as being the most common warning sound in noisy workplaces and 2) its acoustic characteristics were judged interesting in terms of spectrum. The two other warning sounds were used to test the recognition ability of workers. It is interesting to note that their spectral contents differ from that of the buzzer. The workers were asked not to respond to these two signals. A familiarization session was conducted before collecting the data.

### Results

Based on the data, the level of the signal that allowed recognition was estimated to be a signal-to-noise ratio of approximately +12 dB. The findings confirm an asymptotic performance when the signal was +12 dB above the masked threshold for normal listeners. This is illustrated in figure 3 for a group of 6 workers sharing the same work area in the steel plant. Even above 12 dB, the 100% recognition goal is not necessarily reached. This fact can be explained by two main reasons: 1) workers were too busy or too concentrated on their task to hear the signal or 2) it was so obvious that the signal was audible that they decide not to answer. These results show that subjective responses like recognition of warning sounds can be influenced by many factors which are difficult to control in a field study. Wilkins (1981) came to the same conclusion.

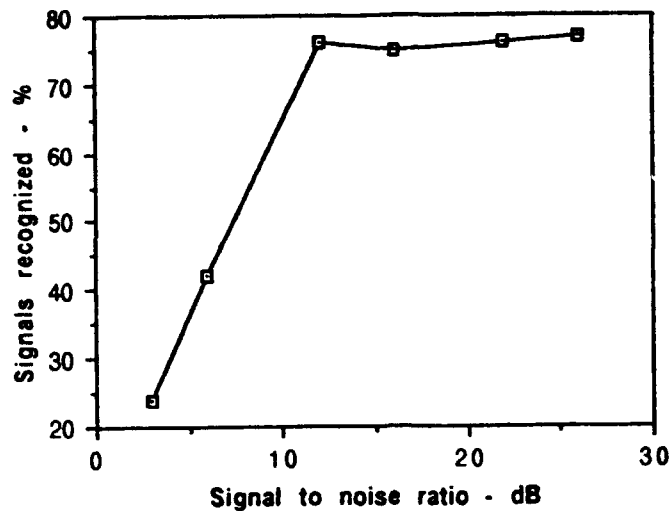

Figure 3. Percentage of signals recognized as a function of the signal-to-noise ratio in a work area of a steel plant

These findings served to validate the criteria adopted for the design window as described above. It also provided insights on the limited feasibility of listening tests as proposed in the ISO standard on auditory warning signals (ISO 7731, 1986). Such a test requires that the background noise be stable or quasi-stable, that the workstations be spatially well defined and shared by several workers simultaneously, and that the tasks performed are compatible with the addition of a secondary task of sound signal recognition. The restrictions imposed by such constraints clearly confirm the need for a practical instrument such as DETECTSOUND™ when the effectiveness of auditory signals is to be assessed.

### CONCLUSION

Despite methodological problems related to field studies, we have collected enough data to indicate that in order to be detected, to attract attention and to be recognized among other signals, warning sounds should reach at least 12 dB above the masked threshold imposed by background noise in at least one third octave band without reaching high signal to masked threshold ratios or high absolute levels (above 105 dB SPL).

These rules seem to be valid for people with noise-induced hearing loss. In this particular case, the frequency content should be well controlled (i.e. below 3 kHz) to take into account noise-induced hearing loss which appears above this frequency. Lab studies will confirm these hypothesis.

A "user friendly" version of the program is now available in order to provide a practical tool to health and safety personnel who are not familiar with the psychoacoustic concept of detection. Moreover, suppliers of warning signals will be able to use it to design safer warnings.

### RÉFÉRENCES

ISO 7731 (1986)

Laroche, C., Héту, R., Tran Quoc, H., Jossierand, B. and Glasberg, B. (1992). *Hearing Research*, 64, 61-72.

Laroche, C., Tran Quoc, H., Héту, R. and McDuff, S. (1991). *Applied Acoustics*, 32, 193-214.

Patterson, R.D. (1982). CAA Paper 82017, Civil Aviation Authority, London.

Tran Quoc, H., Héту, R. and Laroche, C. (1992). *Computer applications in Ergonomics*,

Occupational Safety and Health. Matilla and Karwowski Ed., Elsevier Science Publishers B.V.

van Charente, A.W.M., Mulder, P.G.H. (1990). *American Journal of Epidemiology*, 131, 652-663.

Wilkins, P. A. (1981). *British Journal of Audiology*, 15, 263-274.

Zwicker, E. and Scharf, B. (1965). *Psychological Review*, 72, 3-26.

# NOISE ANNOYANCE WHEN USING A HANDSFREE TELEPHONE IN A CAR

Georges PACHIAUDI, Blandine LE BRETON, Philippe DELEURENCE-

INRETS - LESCO Bron France

Dominique PASCAL, André GILLOIRE - CNET Lannion France

## ABSTRACT

*In a running car, noise gives rise to different problems of communication quality between drivers using a handsfree telephone and callers in the telephone network. The object of this study is to assess noise annoyance in these conditions. This experiment was carried out on a simulator that allows interactive audio-visual driving simulation. The research work was based on about 300 more or less noisy communications (according to the vehicle speed), held by 24 pairs of experimental subjects (caller inside the car - caller in the telephone network). A self estimation was made by a questionnaire. This research brings disturbances closely connected with noise into prominence, in terms of declared annoyance, effort to listen, effort to speak, quality and acceptability of communication, tiredness.*

## RESUME

*Dans un véhicule en mouvement, le bruit altère la qualité de la communication téléphonique entre le conducteur utilisant un radiotéléphone mains-libres et son correspondant dans le réseau. L'objet de cette recherche est d'évaluer les perturbations de la communication occasionnées par le bruit. Cette expérience a été réalisée sur simulateur de conduite. La recherche est basée sur 300 communications téléphoniques plus ou moins bruitées (selon la vitesse du véhicule), tenues par 24 paires de sujets (correspondants dans le véhicule-correspondants dans le réseau). Après chaque test, une autoévaluation est réalisée à partir d'un questionnaire. Les résultats mettent en évidence des perturbations liées au bruit en termes de gêne exprimée, d'effort d'écoute, d'effort d'élocution, de qualité et d'acceptabilité de la communication, de fatigue.*

## PROBLEMATICS

Noise affects conversations. Particularly inside an automobile passenger compartment, the noise generated by the engine, tyre/road interface and aerodynamic flow affects the communication between passengers, or telephone communications between the driver and some caller in the telephone network.

What about the use of the handsfree telephone in these conditions? It is clear that telephoning with a handsfree system while driving leaves the driver free to move; but the microphone will still pick up not only speech signals but also vehicular noise. Moreover, the coupling between microphone and loudspeaker in the vehicle may induce an acoustic echo for the subscriber in the network.

Then, the whole point is : in the course of conversation between the driver and the caller in the telephone network, what is the degree of noise annoyance for each one ? Does this annoyance lead to an effort to speak ? an effort to listen ? Does it lead to tiredness ? And finally, what is its contribution to the quality of communication judgment ? or even to acceptability judgment ?

The aim of this paper is to answer to these questions for the driver and for the subscriber in the telephone network.

*Note: This paper will not take into account the results concerning effects of echo. For the caller in the network, only the configurations without echo (0ms delay) have been selected.*

## **METHODOLOGY**

In order to reach our objective, a panel of subjects has been used ; the subjects - driver and caller in telephone network - had to evaluate the difficulties encountered during a test of conversation by filling up a questionnaire.

*Driving simulator.*- This research work was carried out on a driving simulator which places the drivers into road scenes similar to real life. Using a simulator allowed us to suppress, on one hand, the random aspect of traffic jam, and on the other hand any risk of driving in real road traffic conditions.

The driver was installed in a saloon car in front of a screen, on which a road lanscape was unfolding before his eyes. A work station "Silicon Graphics" provided a complete interactivity of the whole system in terms of trajectory, speed, acceleration and braking of the vehicle.

Moreover, the vehicular noise associated to different speeds was reproduced with four loudspeakers, from real recordings made in the same car, as accurately as possible. The handsfree telephone was composed of one microphone on the sun visor and a loudspeaker in the near area of the driver's ears.

*Independent variables.* - During this experimentation, 3 speeds were imposed to the driver :

- parking position, engine cut off : N0 (no noise)
- 90 kph : noise N1
- 130 kph : noise N2.

Concerning the vehicle, the noise was the only independent variable.

Concerning the telephone network, the subject was provided with a classical handset telephone; the use of a handsfree telephone in the vehicle may give rise to two difficulties for him: vehicular noise as mask of the driver's speech, and an acoustical echo of his own voice. So, the subscriber in the network was submitted to two independent variables : noise and echo ( described in terms of delay and attenuation ).

Then, the complete study was made up of 12 configurations :

3 noise values x 4 echo values (including 0ms delay).

Only "0ms delay" configurations are presented in this paper.

**Subjects.** - The tests have been carried out with 2 age groups : 18-35 years old (POP1) and over 45 (POP2). For each group, 12 pairs of subjects were selected according to the following criteria : both subjects of each pair had 1) to know each other, 2) to be familiar with the phone use, 3) to have no severe auditory deficiency, 4) to be of A school level and 5) in each group, one of the two subjects had to have his driving licence.

**Respective tasks.**- In each chosen configuration, each pair of subjects was asked to hold a conversation under a given pretext, as typical as follows : the subscriber in the telephone network (secretary, interviewer...) rang his partner in the vehicle (manager, interviewee....) and, with a given purpose (schedule, commercial transactions...), had to lead him to make a decision. So, the driver was submitted to a dual task : answering the phone whilst driving.

**Assessment** - After each test an assessment was requested by a questionnaire on the following points : noise annoyance, effort to listen, effort to speak, quality of communication, tiredness and acceptability (in comparison with normal telephone communication). The questions were answered on scales including 5 equidistant scores. So, for all items, the score 1 expressed an "important degradation" (e.g. very annoying noise, bad quality of communication...), and 5, "no degradation" (e.g. imperceptible noise, excellent quality of communication...).

## RESULTS

Mean values, such as MOS (Mean Opinion Score), were calculated for each judgment scale, for each noise condition, and for the 2 age groups. The results concerning the subjects in the telephone network are displayed in figure 1, and figure 2 shows those related to the subjects in the vehicle. MOS values are plotted as a function of noise, the age groups being taken as a parameter.

Generally, the higher the noise, the more degraded the judgment is, especially for noise

Fig.1 : EFFECT of NOISE on SUBSCRIBER in the TELEPHONE NETWORK

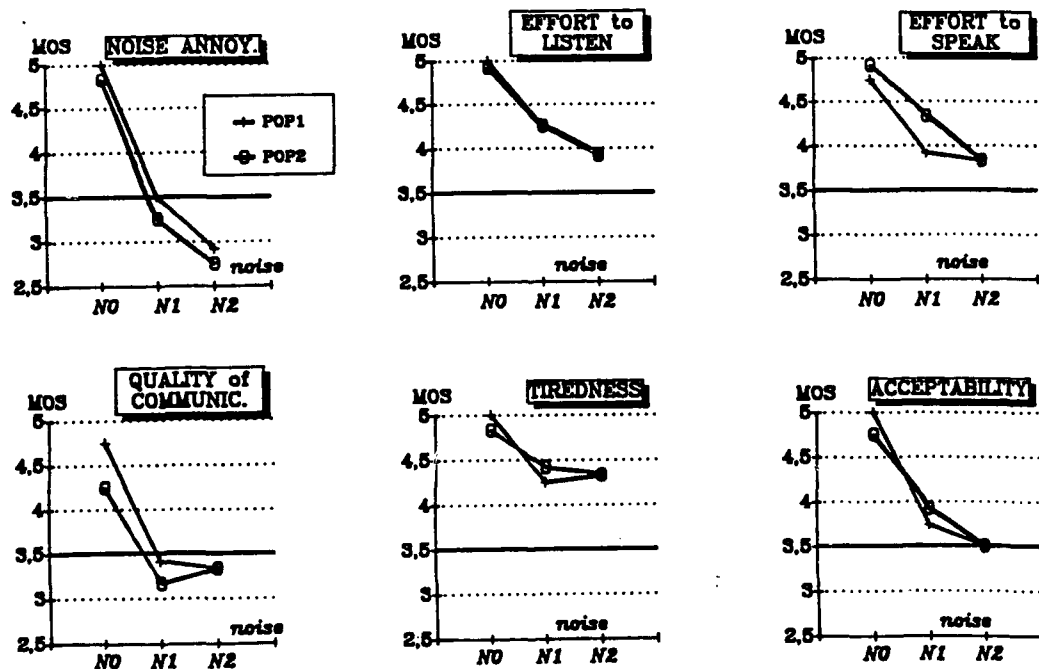

INRETS-LESCO

annoyance, effort to listen and acceptability. In terms of quality and tiredness judgment, the results concerning degradation with noise does not seem to be linear, but vary abruptly from no noise configuration (N0) to configurations with noise (N1 or N2).

Variance analysis tends to show a noise effect (at a significance level of 1%) and no significant effect according to age, pretexte and order. According to Pascal D. and Corvaisier D. (1), MOS values are compared with MOS value 3.5 which is likely to reflect a satisfactory level.

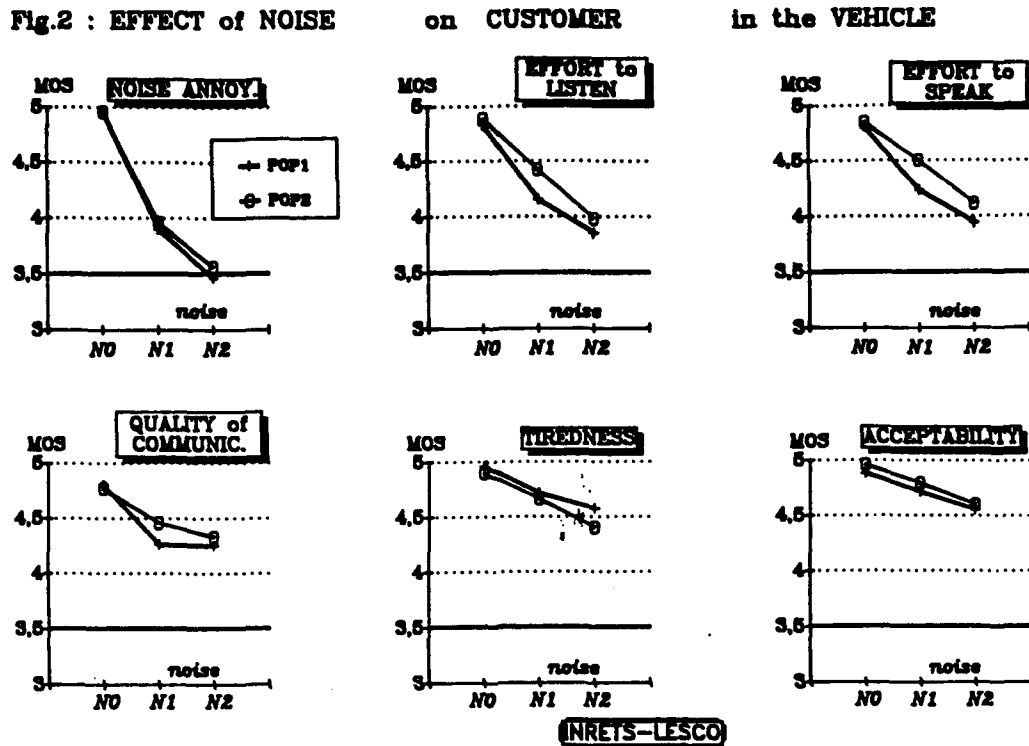

In the telephone network, the noise at 90 kph and at 130 kph leads to an unsatisfactory level ( $2.5 < MOS < 3.5$ ) in terms of noise annoyance and quality of communication, but does not induce any important tiredness or effort to speak ( $MOS > 3.5$ ).

In the car, where the received speech level was adjusted to a preferred listening level in the near area of the driver's ears, the noise does not induce any important degradation ( $MOS > 3.5$ ).

## CONCLUSIONS

When a handsfree telephone is used in a car, the vehicular noise disturbs the telephone conversation. The subscriber in the telephone network feels a noticeable noise annoyance, whatever the noise is. Furthermore, this degraded connection leads to an unsatisfactory level in terms of quality of communication judgment but no important effort to speak or to listen. The customer in the vehicle is relatively less disturbed by the noise: its effect is significant but not up to an unsatisfactory level.

For both users, the age effect is not significant.

(1) : Pascal D., Corvaisier D. :

*Echo acceptance conversation tests - 13th ICA, Belgrade -1989.*



# Acoustic voice perturbation changes due to loading of voice during working-day

PEKKARINEN Eeva<sup>1</sup>, VILKMAN Erkki<sup>2</sup>, SIHVO Marketta<sup>1</sup>, LAURI Eija-Riitta<sup>1</sup>

<sup>1</sup> Institute of Occupational Health, Topeliuksenkatu 41aA, SF-00250 Helsinki, Finland

<sup>2</sup> Department of Otolaryngology and Phoniatics, University of Oulu, SF-90220 Oulu, Finland

## Abstract

Under noisy conditions, speakers raise their voice levels to render their speech intelligible. In this process of adjustment, excess vocal effort is needed with the possible long-term consequences being laryngeal symptoms, functional or organic voice disorders. Besides background noise, the ergonomics and the relative air humidity may affect the loading of the voice. Vocal quality changes occur as a result of vocal fatigue. Cycle-to-cycle changes (jitter and shimmer) have been used to measure voice quality. The purpose of this study was to estimate the variation in the jitter and shimmer of healthy voices during a period that is considered to be a typical teacher's working day. To simulate a teacher's average working day, subjects read aloud for 5 x 45 minutes. Reading was performed at a normal or loud speaking level, in a standing or sitting position in an atmosphere of dry or humid air. Each 45 minute loading period was followed by a 15 minute rest period. After three reading periods, each subject had a 45 minute lunch break. The subjects' (40 females and 40 males) voice samples were recorded in a sound treated room five times during the loading task. Jitter and shimmer were measured from sustained /a/-vowel phonations. After reading aloud, both females and males had increases in fundamental frequencies. After the subjects' lunch break, the fundamental frequencies were lower but increased again during the afternoon loading period. The effect of loading on jitter was almost significant statistically, but jitter and shimmer were not significantly affected by reading level, posture or relative air humidity.

## Introduction

Speakers raise their voice level under noisy conditions to render their speech intelligible (vanHeusden 1979). In this process of adjustment, excess vocal effort is needed with the possible long term consequences being laryngeal symptoms, functional or organic voice disorders. In addition to background noise, ergonomics and the relative humidity of the air may affect the loading of the voice. As a result of vocal fatigue, voice quality changes. Cycle-to-cycle changes, jitter and shimmer, have been applied as voice quality measures. There is little information about the effects of speaking loudly or of ergonomics on vocal fatigue. Verdolini-Marston (1990) has shown that when subjects speak softly the subglottic threshold pressure is higher in dry air (30-35%) than in humid (85-100%) air. The purpose of this study was to estimate the changes in jitter and shimmer of healthy voices during a time period as long as a teacher's average working day.

## Materials and methods

A working day was simulated by reading aloud five x45 minute periods. Each 45 minute loading period was followed by 15 minutes of rest. Subjects had a 45 minute lunch break after three reading periods. Reading was performed at a normal (55-65 dB SPL at 2 m) or loud (65-75 dB SPL at 2 m) speaking level, in a standing or sitting position in dry (25±5%) or humid (65±5%) air. 40 female and 40 male subjects participated in the study. The subjects ranged in age from 18 to 45 years old, with a mean of 22 years old. Voice samples were recorded in a sound treated room five times during the simulated day. Fundamental frequency, jitter and shimmer were measured from sustained /a/-vowel phonations which were produced at a comfortable pitch and loudness. The length of the analysis window was 300 cycles and the measurements were made from the first and the last third parts of the phonations.

## Results

The fundamental frequency of sustained /a/-phonations are shown in Fig. 1. Reading aloud produced increases in fundamental frequencies for both female and male subjects. This rise was detected within the first 45 minutes of reading aloud. Fundamental frequencies decreased slightly after the lunch break, but increased again during the afternoon loading period. Statistically, the effect of loading was highly significant ( $p < 0.001$ , Repeated Measures of Analysis of Variance, Keselman HJ & al. 1984).

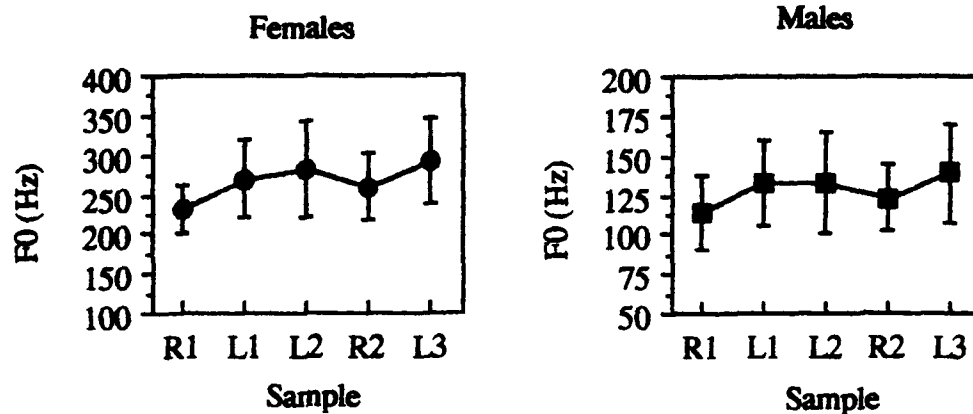

Fig. 1. Fundamental frequency of females ( $n=40$ ) and males ( $n=40$ ), means and standard deviations. R1=sample before reading, L1=sample after first loading period, L2= sample after third loading period, R2= sample after lunch break and L3= sample after fifth loading period.

Table 1. Jitter and shimmer values, mean  $\pm$ SD.  $n=40$   
R1=sample before reading, L1=sample after first loading period, L2= sample after third loading period, R2= sample after lunch break and L3= sample after fifth loading period.

Sample	Jitter		Shimmer	
	Females	Males	Females	Males
R1	2,2 $\pm$ 2,1	2,2 $\pm$ 1,9	0,9 $\pm$ 0,6	0,8 $\pm$ 0,4
L1	1,8 $\pm$ 1,3	2,8 $\pm$ 2,7	0,6 $\pm$ 0,4	0,8 $\pm$ 0,5
L2	2,1 $\pm$ 1,8	3,7 $\pm$ 3,8	0,6 $\pm$ 0,4	0,8 $\pm$ 0,4
R2	2,1 $\pm$ 2,0	2,5 $\pm$ 1,9	0,7 $\pm$ 0,3	0,9 $\pm$ 0,4
L3	2,2 $\pm$ 2,5	3,9 $\pm$ 3,4	0,6 $\pm$ 0,4	0,8 $\pm$ 0,5

The jitter and shimmer values for females and males are presented in Table 1. The Repeated Measures of Analysis of Variance produced no statistically significant effect on loading or reading conditions.

From the 80 subjects, 20 subjects were selected whose fundamental frequencies did not increase. Ten

**THIS  
PAGE  
IS  
MISSING  
IN  
ORIGINAL  
DOCUMENT**

was statistically almost significant ( $p < 0.05$  Repeated Measures of Analysis of Variance), but there was no significant difference in the changes of jitter between the groups (Analysis of Variance of Contrast Variables). Jitter values measured from the second segment of the sustained vowel were somewhat higher than values measured from the first segment, whereas the variability of the values was higher in the second segment than in the first segment. Mean values of shimmer increased during the loading of voice, but this change was not found to be statistically significant.

## Discussion

Jitter and shimmer have been found to correlate with the perceived quality of voice (Askenfelt 1986). High jitter levels have been linked to voices which have pathological masses in the vocal folds (Lieberman 1963). In this study, jitter increased as a result of vocal fatigue after reading aloud. However, no correlation was established between reading conditions and jitter values. This may support the findings of Orlikoff et al (1990, 1991) that jitter is dependent on voice level and on fundamental frequency. Since the loudness and the pitch of voice were not controlled in this study, the possible differences in jitter between groups may have been missed in the fundamental frequency increment.

Air humidity did not have an effect on the jitter or shimmer values for those subjects whose fundamental frequencies did not change. This may be due to high variability in fundamental frequency, jitter and shimmer. The standard deviations in this study included the intra- and inter subject variability in repeated task performances. Great variability makes the test insensitive in detecting the possible effects of relative humidity, reading loudness or posture on voice perturbation measures. Test sensitivity would be improved by controlling vocal intensity and pitch during voice tasks.

## Conclusions

- Loading of voice during a working day increases fundamental frequency and jitter values of sustained phonations among young and healthy subjects.
- Shimmer does not change significantly because of loading of voice during a working day.
- No effects of reading loudness, posture or relative humidity of air was found on fundamental frequency, jitter or shimmer.

## References

- Askenfelt AG, Hammarberg B. Speech waveform perturbation analysis: a perceptual-acoustical comparison of seven measures. *J Speech Hear Res* 1986; 29: 50-64.
- van Heusden E, Plomp R, Pols LCV. Effect of ambient noise on the vocal output and the preferred listening level of conversational speech. *Appl Acoust* 1979; 12: 31-43.
- Keselman HJ, Keselman JC. The analysis of repeated measures design in medical research. *Statistics in Medicine* 1984; 3: 185-195.
- Lieberman P. Some acoustic measures of the fundamental periodicity of normal and pathological larynges. *J Acoust Soc Am* 1963; 35(3): 344-353.
- Orlikoff RF, Baken RJ. Consideration of the relationship between fundamental frequency of phonation and vocal jitter. *Folia Phoniat* 1990; 42: 31-40. 1990
- Orlikoff RF, Kahne JC. Influence of mean sound pressure level on jitter and shimmer measures. *J Voice* 1991; 5(2): 113-119. 1991
- Verdolini-Marston K, Titze IR, Druker DG. Changes in phonation threshold pressure with induced conditions of hydration. *J Voice* 1990; 4: 142-151.

# AN ACOUSTIC DIAGNOSIS OF CLASSROOMS CORRELATED WITH LEARNING

SEBALLOS Sylvia\*, COSTABAL Hernán\*, MATAMALA Pedro\*\*

\*Universidad de Santiago de Chile, Facultad de Ciencia,  
Depto. de Física, Casilla 307, Santiago, Chile

\*\*Hospital Mutual de Seguridad, Medicina del Trabajo

## ABSTRACT

The aim of this investigation is to achieve a diagnosis of the acoustic environment inside classrooms and its correlations with audiological, learning and behavioral problems of schoolchildren between 7 and 18 year of age in Chile.

An analysis of principal components reduced all observed variables to a few dimensions, allowing to describe and predict the acoustic pollution problem. A Discriminator Analysis revealed an indicator of ambient noise which may prove useful in classifying environments acoustically polluted.

## RESUMEE

Dans ce travail on présente une méthode pour diagnostiquer des ambients acoustiques à l'intérieur des salles de classe et sa corrélation concernant des problèmes d'apprentissage, de réponse audiolgique et des comportement des étudiants chiliens d'age entre 7 et 18 ans.

Une analyse des composantes principales a permis réduire les variables observées à seulement quelques dimensions avec lesquelles on peut décrire et prédire les problèmes de pollution acoustique.

Une analyse discriminatrice a pu montrer l'existence d'un indicateur de bruit ambiant qui pourrait être utile dans la classification des ambients à faible et haut risques de devenir acoustiquement pollués.

## INTRODUCTION

This study describes the structure of the various factors that interfere in the Acoustic Pollution problem in educational schools. The investigation is centered on a diagnosis of the acoustic environment inside classrooms, and correlated with audiological, learning and behavioral problems of schoolchildren between 7 and 18 years of age in Chile. The present sample of data was obtained in three schools (a mixed one, one for man and one for woman).<sup>1</sup>

The acoustical factors include the following:

1. A classification of the classrooms as anechoic, reverberant or too reverberant, and indicating the possibilities of a treatment.<sup>2</sup>
2. A diagnosis of the acoustical environment, indicating the educational activities which can be performed in a normal way or which may be affected.<sup>3</sup>
3. An assessment of the (speech) signal received, determining the quality of the communication, and possible memory or concentration problems related to complex educational tasks.
4. A teacher's diagnosis on the noise quantity to which he/she is exposed, together with his/her anamnesis.

The information about the schoolchildren includes the auditory background, language background, psychological background, school results and results of a medical examination.

An analysis of principal components reduced all observed variables to a few dimensions, and is found adequate to describe and predict the problem. A Discriminator Analysis revealed an indicator of ambient noise which may prove useful in classifying environments of low or high risk of being acoustically polluted.<sup>4</sup> The criterion to decide if a given place is of high or low risk, will be based on the diagnosis by an expert in learning psychology, with the schoolchildren's history as a background. <sup>5</sup>, <sup>6</sup>

## PROCEDURE

The size of the sample was about 2000 schoolchildren and the following tests were proposed: a.- Test of comprehension of standardized reading; b.- Audiometric evaluation of pure tones (screening), which is a reliable procedure in order to obtain the auditive sensibility able to lead to the valid assumption of Logoaudiometric evaluation; c.- Application of a protocol to evaluate the articulation of oral language of fonemas and also to detect dislalias; d.- An acoustic evaluation of environment and closed places, including basic measurement of equivalent basic level, acoustics spectrum characteristics of room, reverberation time, signal-noise levels and doses of exposure.

## RESULT

The Analysis of principal components reduced 37 observed variables to a few dimensions and Discriminator Analysis revealed an indicator of ambient noise for classifying individuals into separate groups on the basis of their observed characteristics. More over, it permitted to solved problems like to lost information, unobtainable information, prediction and testing to destruction.

The correlation coefficient matrix shows:

- A tendency in schoolchildren with learning problems to show altered audibility patterns.
- The differences in the schoolchildren profile with learning problems, is shown in the audible rank and fundamentally in the frequencies spectra more sensitive to oral communication.
- Even though audibility levels considered as normals are HL 25 dB, we must highlight the existence of a threshold relatively high in low frequencies (250 and 500 Hz) for a very young population.
- For high frequencies, 6000 and 8000 Hz there are differences statistically significative in the threshold of pure or clean tone which belongs to the area of higher sensibility to be damaged by noise.

## BIBLIOGRAPHY

1. Liden, C.B. "Audiologic Aspects of Learning and Behavior". Pediatric Clinics of North America, Vol. 28, N°4, 1981.
2. Knudesen, V.O., Harris, C.M. Acoustical designing in architecture (Wiley, New York, 1965), pp. 194.
3. Bradley, J.S. "Speech intelligibility studies in classrooms". J. Acoust. Soc. Am. Vol. 80, N°3, 1986.
4. Cox, D.R. "Role of Models in Statitical Analysis". Statistical Science, Vol. 5, N°2, 169-174, 1990.
5. Communication disorders and emotional behavioral, disorders in children and adolescents". Journal of Speech and Hearing disorders, Vol. 55, 179-192, May 1990.
6. Brookhouser, P.E.; Worthington, D.W.; Kelly, W.J. "Unilateral hearing loss in children". Laryngoscope, N°101, 1991.





# NUMERICAL PREDICTION OF NOISE AND INTELLIGIBILITY LEVELS IN INDUSTRIAL HALLS

D.TAILLIFET

EDF, Département Acoustique et Mécanique Vibratoire  
1, avenue du Général De Gaulle, 92141 Clamart Cédex, FRANCE

## Summary :

EDF, the French electricity company, operates various types of plants.

To predict the noise levels and optimize noise control investments, numerical codes have been developed, based on finite difference methods for low frequencies, and ray methods for medium frequencies. Noise level maps can be predicted, and examples are given.

Ray methods can also be used to compute various intelligibility criteria such as WMTF or STI. It is thus possible to optimize the power and position of the loudspeakers used to emit vocal messages in the plant.

## Résumé :

EDF, Électricité de France, exploite divers types d'installations de production.

Pour prévoir les niveaux sonores, et optimiser les investissements d'insonorisation, des modèles numériques ont été développés. Ils utilisent des méthodes de différences finies pour les basses fréquences, et des méthodes de rayons pour les moyennes fréquences. Des cartes de bruit ont pu être calculées. Quelques exemples sont fournis.

Les méthodes de rayons permettent en outre de calculer divers critères d'intelligibilité tels le WMTF ou le STI. Il est ainsi possible d'optimiser en puissance et position les haut-parleurs utilisés pour transmettre des messages vocaux dans la centrale.

## EDF and its plants

The protection of the staff from noise in power plants of any type has been for years a continuous concern of Electricité de France.

Nevertheless, the progressive growing of the power of nuclear plants (900, 1300 and soon 1450 MW), and the building, for a given power, of a number of quasi identical plants has lead to the development of global approaches for noise control, using specific computer codes.

## Noise level prediction

The following methods all consider in a first step that relevant parameters of the sources (power and directivity or surface velocities) are known. A propagation computation thus leads to noise levels.

### a) simple laws

The first idea to predict noise level could be to use simple laws as Sabine's, or various simple methods based on spatial decay curve computation. Those methods are irrelevant to the problem, due to the size and shape of the halls, and to the high number of different type sources.

### b) Helmholtz equation

In certain cases, standing waves leading to spatial variation up to 10 dB, specially around 100 Hz, occur. These standing waves can be computed solving Helmholtz equation :

$$\Delta p + k^2 p = 0 ,$$

with boundary conditions such as wall impedance and velocity on the source surfaces. The equation, of course, deals with a pure tone propagation at the frequency  $f$  corresponding to the wave number  $k = \frac{2\pi f}{c}$ .

This equation can be solved by finite elements methods or finite difference methods. Both approaches have been implemented and validated in the case of simple geometries. Due to the important number of degrees of freedom, finite element methods cannot be used to compute great halls as the turbine hall.

A finite difference method has been used, for example at Dampierre, a 900 MW power plant. It has been shown that a 5dB mean noise level reduction could have been obtained if a 1000 m<sup>2</sup> surface had been covered with sound absorbant material. This computation appears as quite too heavy (several hours of a CRAY XMP computer) to be considered as a usual engineering tool.

### b) Medium frequency approach

In fact, the case of pure tones is relatively rare, and, usually, noise in power plants concerns a wide frequency band, corresponding to a great number of modal frequencies of the hall. In such a case, energetic approaches are usually considered as relevant.

The ray-tracing computation is thus based on geometrical acoustics approximations. It means that acoustical propagation is dealt with as if it was optical propagation, without diffraction. The geometry and acoustical parameters of the walls and various obstacles are given, as well as the power and directivity of the machine sources. The code "follows" a great numbers of rays emitted by the sources in their straightforward propagation. They carry a certain amount of acoustical energy which is decayed each time a wall or obstacle is encountered, according to the wall absorption coefficient. (fig 1). A certain number of cells are considered, so that when a ray goes through one of those cells, its energy is added to the energy already computed. The process ends when the energy of the ray is sufficiently decreased, usually after about twenty reflections, and a noise level map can be plotted, according to the energies stored in the cells.

The method gives quite good results when compared to measured noise levels. An inversion procedure even permits, using an optimization algorithm, to find the source powers giving the less square error comparing measured to computed noise level maps.

## Intelligibility level prediction

### a) the problem

In nuclear power plants, spoken messages are transmitted to various working places, specially in the turbine hall. Due to the high noise levels (around 90 dB(A)), and the high reverberation times (usually higher than 6 or 7 seconds at 1000Hz), the intelligibility of those messages is very poor, except when the worker is close to the loudspeaker. Increasing the message power is not always an efficient solution, and no usual engineering tools were available to optimize the situation.

### b) ray-tracing method: an opportunity

The idea of extending the existing ray-tracing method to intelligibility computation has thus emerged. In that case, the noise level map is considered as known. It may be computed as presented, or measured. A time dependant computation is made. Each loudspeaker is now a source, and a step in energy is considered as emitted. The ray-tracing procedure is implemented as for noise level computation, but time delay is stored as well as energy when one of the about 5000 rays taken into account reaches a cell. It is thus possible for each cell to plot a time history of the energy (fig3). The computation is made in five octave bands from 250 Hz to 4000Hz, wall coefficients and source emission being of different values.

It is then possible, using the time history, to compute various criteria as WMTF and STI.

#### d) results

Computations have been performed for various nuclear plant turbine halls. We noticed that in the situation usually dealt with in power plants, these two criteria give roughly comparable results, but the variation of the values with the background noise seems smoother for STI criterion than for WMTF criterion.

In the case of St Laurent B1, a complete study has been performed. In that hall which is roughly 90 meters long and 50 meters wide, 19 loudspeakers are present. The first computation gave the mean intelligibility level value : 52%, which is obviously insufficient, and leads of course to unintelligible messages. A predictive study was performed, testing numerically various numbers and dispositions of loudspeakers. A solution using 24 loudspeakers has proved quite good and their adjustable powers for each octave band have been numerically optimized using an optimization algorithm. The final result is an intelligibility level of 79%, which appears numerically as "the best" result. Considering the installation specificities, the solution that has been tested in the plant has a predicted intelligibility mean level of 64%.

The test was made in the plant, and RASTI measurements confirmed the results. Working people considered the improvement as quite significant.

### Conclusion

The method rapidly presented in this paper permits industrial predictive computation of a spoken message emission system. It can be used in many types of industrial situations, and gives a quantitative basis to guide the designers' know-how.

### References

- 1 KULOWSKI A. "Algorithmic representation of the ray tracing techniques" Applied acoustics 3-682X/85/, 1985
- 2 LUZZATO E, MOUEN MAKOUA D. "Application of the W.M.T.F Method for intelligibility prediction in industrial halls" INTERNOISE 86, Cambridge, USA

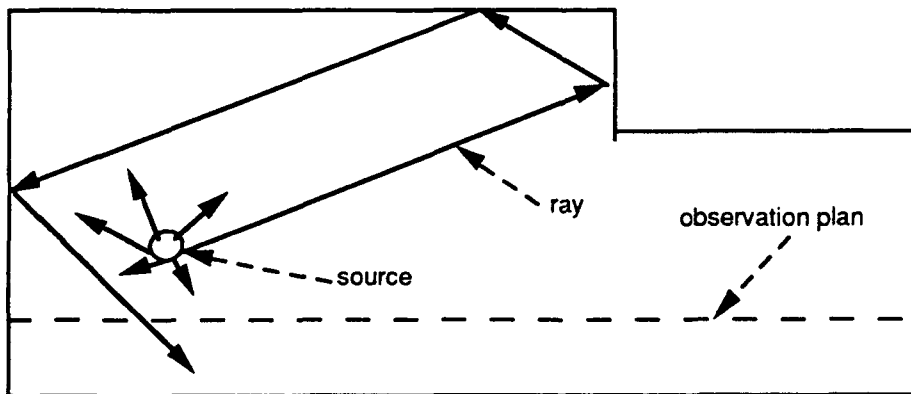

Fig 1. Illustration of Ray-tracing technique

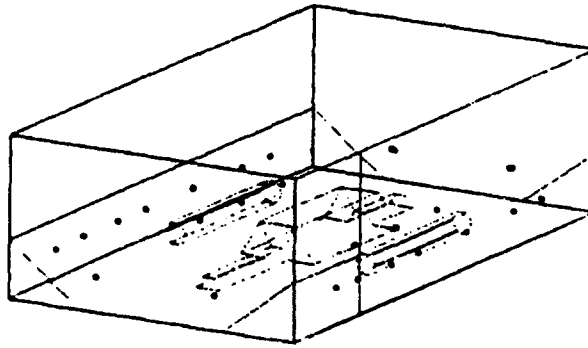

Fig 2 Modelisation of the turbine Hall

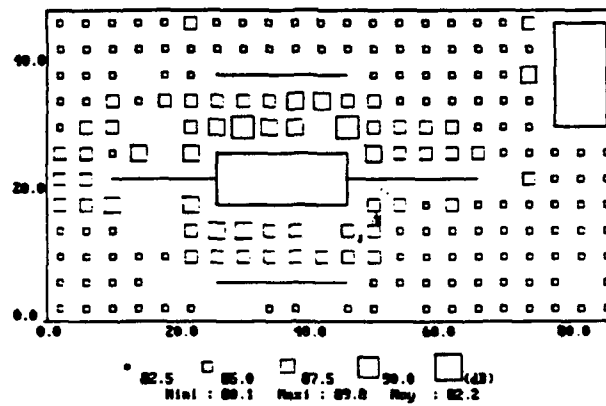

Fig 3 Noise level map dB(A)

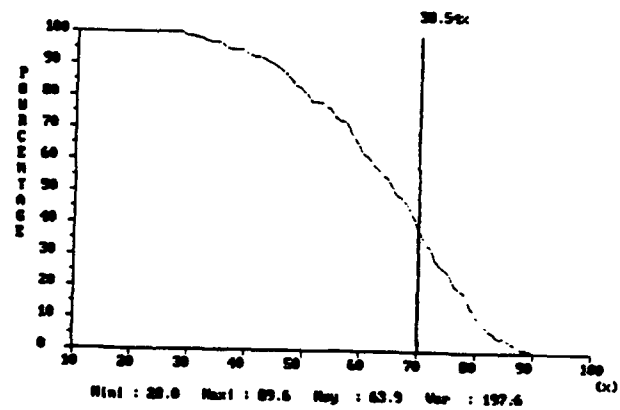
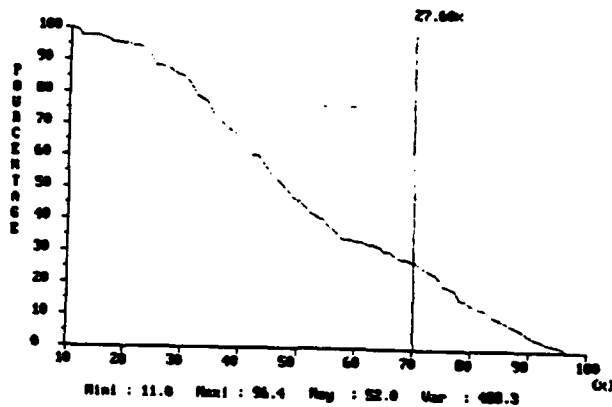

Fig 4a and 4b - Percentage of the hall surface (y-axis) for which the intelligibility level is higher than the value given on the x-axis

## PROPER PLACEMENT OF SOUND ABSORPTION MATERIAL INTO CLASSROOM

VILJANEN, Vesa\* and PEKKARINEN, Eeva\*\*

\* Turku Regional Institute of Occupational Health, DataCity, SF-20520, Finland

\*\* Institute Of Occupational Health, SF-00250 Helsinki, Finland

### ABSTRACT

Reverberation and noise in a room affect speech discrimination. Sound-absorbing materials are used to shorten reverberation times. Acoustic design of classrooms should be based on the objective of achieving the highest possible degree of speech intelligibility for all the pupils as well as for the teacher. Such acoustic conditions are attained by means of an optimal coverage with sound absorption material at the correct locations.

The aim with this study was to find good acoustic conditions for speech intelligibility, as measured with reverberation time and RASTI value.

The full-scale experiments involved were carried out in a space dimensioned for 30 pupils and built in a laboratory. Reduction of reverberation was implemented by means of 50 mm thick mineral wool panels, at five different arrangement alternatives. The target was obtaining a RASTI value of 0.75 or better. Obtaining that value requires mounting of mineral wool panels on two surfaces, i.e., on the ceiling and on the back wall. The total coverage required was about 30% of the total combined wall and ceiling surface area.

### INTRODUCTION

In most educational settings, classroom instruction is based on speech communication and, for this reason, good classroom acoustics is essential.

In a classroom, the distance between teacher and pupils is several meters. An acceptable speech transmission between them needs good reverberation conditions and low noise levels. The typical shape of a classroom is a rectangle, and the surfaces are usually hard. One possibility to affect reverberation conditions is to cover the ceiling and wall with sound-absorbing material, e.g., mineral wool. The coverage and arrangement of the material, however, affect the speech transmission properties of the room. Reverberation time measurement does not measure speech intelligibility, and the psychoacoustic method of speech recognition does not show minor changes in speech transmission between various locations in a room.

The Ministry of the Environment in Finland specifies limits for reverberation times in classrooms. Reverberation times should remain within a range of 0.6 to 0.9 s at frequencies from 250 to 2000 Hz.

The RASTI (Rapid Speech Transmission Index) method was used to estimate the speech transmission in the room (1). The relation of the subjective intelligibility scale to the RASTI values according to Houtgast & Steneken (2) is: excellent 1.00-0.75, good 0.75-0.60, fair 0.60-0.45, poor 0.45-0.30 and bad 0.30-0.

The aim of this study was to find good acoustic conditions for speech intelligibility, as measured using RASTI indexes and reverberation times. The results are to be used for the design of the classrooms acoustics of a school for 1000 pupils, which is to be completed in the autumn, 1994.

## METHODS

A test classroom was built in an acoustics laboratory. The room was dimensioned 8.8 by 7.1 m and 3.1 m high. Reduction of reverberation time in an empty classroom was implemented by means of 50 mm thick mineral wool panels. In the first phase of the experiment, the back wall was covered with the absorption material, step by step, while the side walls remained uncovered. In the second phase, mineral wool was applied on the ceiling alone, whereas all other surfaces were naked. Finally, absorption panels were fixed both on back wall and ceiling.

The reverberation time was measured according to ISO 3382 Standard (3), using building acoustics analyzer B&K 4418, sound source B&K 4224, and rotating microphone boom B&K 3923. The spatial averaging time was 16 s for each third-octave band. The radius of the microphone boom was 1 meter. In the RASTI method, the location of the transmitter was selected to represent the main speech area of the teacher, and that of the receiver, the listening areas of the pupils, respectively. The signal transmitter B&K 4225, was placed in front, and the receiver B&K 4419, at eight different locations in the room as shown in Fig.1. The measured time for each RASTI value was 16 s. The RASTI values shown are the means of three successive measurements. The various absorption material arrangements are shown in Table 1. Fig.1 shows the final arrangement of the mineral wool panels required for the acoustic design of the test classroom.

Table 1. Coverage and arrangement of mineral wool panels in the test classroom. Total floor area of classroom is 63 m<sup>2</sup>, and the combined area of walls and ceiling, 162 m<sup>2</sup>.

### Absorption material coverage (%)

Test No.	Ceiling (63 m <sup>2</sup> )	Of back wall (22 m <sup>2</sup> )	Of total area (162m <sup>2</sup> )	Area of absorption material (m <sup>2</sup> )
1.	No absorption material. Wall surfaces gypsum wallboard			
2.	-	37	5	8
3.	46	--	18	29
4.	100	--	39	63
5.	46	38	23	37
6.	46	38	28 See Fig1.	46

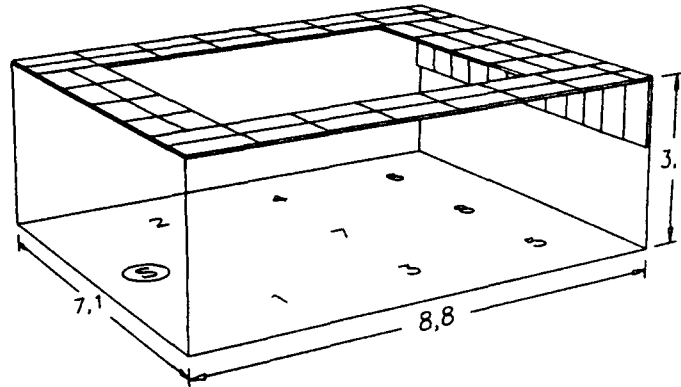

Fig. 1. Classroom setup for measurement. S denotes transmitter location, and 1 through 8, the locations of the receiver during the RASTI measurements.

### RESULTS

The reverberation times in the classroom are presented in Fig.2., for five octave bands. Fig. 3 shows the RASTI value dependence on the coverage and location of the mineral wool panels. The coverage of the absorption material is shown as a percentage of the total room surface area from which the floor area is subtracted.

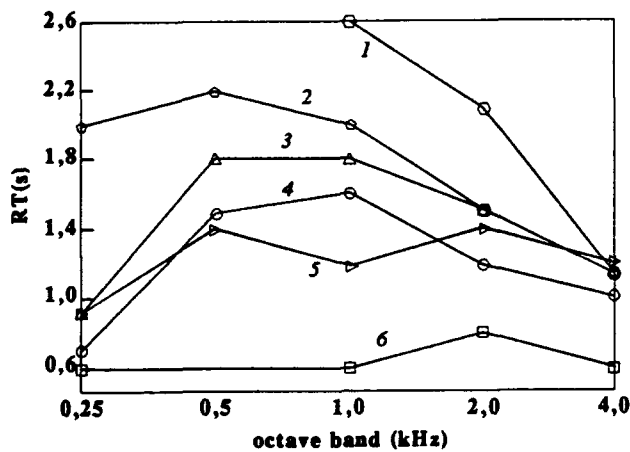

Fig .2. Dependence of reverberation time on coverage and location of absorption material

(Measured curves are numbered in Table 1)

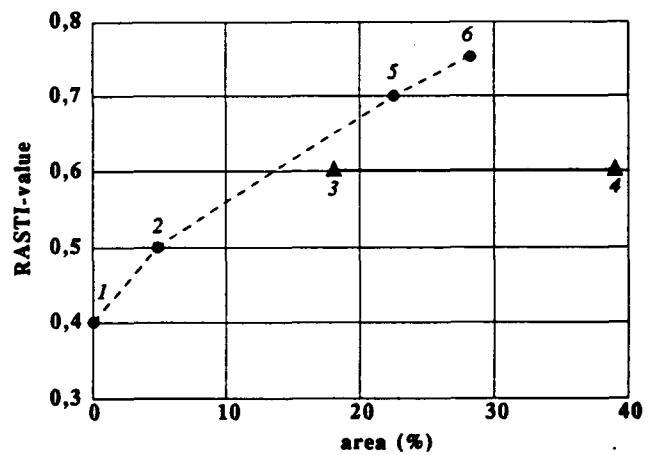

Fig .3. Dependence of RASTI value on coverage and location of absorption material.

## DISCUSSION

Measurements were conducted in an empty room because people have an absorptive effect that improves speech transmission whereas the presence of furniture makes the sound field more diffuse. On the other hand, during classroom instruction, pupils cause noise which decreases speech intelligibility. Also in practice, the measurements should be conducted in an unoccupied and unfurnished room because the amount of people and the type of furniture vary in different rooms. Thus, specifications are also given for unfurnished and for unoccupied rooms.

The RASTI method was considered to be a more valid method than reverberation time for estimating the speech transmission properties of a classroom. Our choice of acceptable acoustical treatment for classrooms was a treatment in which the RASTI value was 0.75 or better.

With an absorption material coverage of 30 % of the total area, a RASTI value of 0.75 or better was reached. Doubling the amount of absorption material did not give much higher values. The value 0.75 is as thus a compromise between the speech transmission quality and the amount of absorption material used.

Acoustic treatment is usually done by placing absorption material only in the ceiling. This is because the ceiling is free of furniture and shock-proof. However, placing material only in the ceiling does not produce satisfactory results. Minimum requirements according to the present study stipulate that material should be placed on two separate surfaces. The proper surfaces are the back wall and/or side wall and the ceiling. With the same amount of material, a significantly higher RASTI value is measured if the material is placed on two surfaces. Not only is the amount of absorption material a determining factor, as stated by the Sabine formula, but also the location of the material is very important.

## CONCLUSIONS

- The RASTI value depends on the placement and of coverage the absorption material.
- The use of mineral wool on one surface, in the ceiling or on the back wall, was not enough to yield an excellent acoustic environment, where the RASTI value is 0.75 or better. To achieve this, it was necessary to place mineral wool on two surfaces.
- The total area of absorption material needed to reach a RASTI value of 0.75 was approximately 30 % of the maximum absorption area, i.e., the area of the walls and the ceiling.

## References

1. IEC 268-16, Report on the RASTI method for the objective rating of speech intelligibility in auditoria. International Electrotechnical Commission, 1988.
2. Houtgast T, Steneken HJM. A multi-language evaluation of the RASTI method for estimating speech intelligibility in auditoria. *Acustica* 1984; 54: 185-99.
3. ISO 3382, Acoustics - Measurement of reverberation time in auditoria. International Organization for Standardization, Geneva, 1975.



ACOUSTIC EAR CANAL ATTENUATION OF HEARING PROTECTORS AND ANR-HEADSETS AT >85dB, INFLIGHT AND IN THE LABORATORY.

WOXEN, Ole J. and BORCHGREVINK, Hans M.  
HQ Defence Command Norway, FSAN Dpt. Environmental Medicine,  
Oslo.

ABSTRACT.

In the present study we examined the sound attenuation of the Alpha air-craft pilot helmet headset with and without active noise reduction (ANR) in 17 normal-hearing twenty-year-old male conscripts. We used the portable Rastronics PortaREM-20 "insertion gain" system. The stimulus was 8000-to-125 Hz falling free-field narrow-band sweep-noise. Registrations were performed in a non-attenuated room, first without Alpha-helmet, then with Alpha-helmet and ANR off, then with Alpha-helmet and ANR on (active). The mean attenuation values showed that the ANR-system provided additional attenuation up to 20 dB in the frequency range < 800 Hz, with standard deviations in the 4-5 dB range. The ANR thus offers extra attenuation for low frequency ( e.g. combustion engine) noise, where the "passive" muff/headset attenuation characteristically is poor and insufficient. With the same portable equipment corresponding results were obtained in an inflight helicopter case study with the Alpha helmet and the ANR system off versus on, using the actual helicopter noise as the "stimulus" noise source. For the frequencies 500 - 1000 Hz however, ANR produced a small amplification which increased when listening to radio communication. The same was found for Telex headset with ANR used for the High Frequency-radio in the P3B-Orion maritime surveillance aircraft. Noise accompanying the radio signal was not cancelled, but amplified by the ANR-system. Otherwise the "insertion loss" attenuation data matched or were somewhat poorer than the manufacturer's REAT data at threshold, but corresponded well with that of other authors (Hellström 1991). Thus the "insertion gain" procedure seems reliable and valid and thus may be applied to study hearing protector attenuation at noise hazard levels under operative and non-attenuated laboratory conditions.

INTRODUCTION.

Commercial computerized "insertion gain" equipment has recently been developed to improve the individual fitting of hearing aids. With this procedure a slender silicone probe-tube connected to an outside microphone is inserted in the ear canal, registering the sound pressure level < 5 mm in front of the tympanic membrane. In a previous study (Woxen & Borchgrevink 1991) we have shown that this equipment and the "insertion loss"-procedure proved satisfactory for objective attenuation measurements of hearing protectors at noise hazard levels (>85dB) for frequencies below 6000 Hz, and our attenuation data matched REAT and careful laboratory ear-canal-microphone studies at threshold.

In the present study we used a portable "insertion gain" system,

which allowed us to register headset noise attenuation both inflight and in the laboratory, with and without active noise reduction system(ANR) activated.

#### METHOD.

Study 1: In a non-attenuated laboratory, ear canal registrations were performed on 17 twenty-year-old male volunteers with normal otoscopy and normal hearing. We used the "PortaREM 20 insertion gain" system by Rastronics, Denmark. The stimulus used was a 8000-to-125 Hz falling 85 dB free-field narrow-band sweep-noise. For each subject registrations were performed without Alpha helmet, then with Alpha helmet and ANR off, then with Alpha helmet and ANR on (active).

Study 2: Case study in a Bell 412 helicopter with the subject seated behind the pilot wearing Alpha helmet with and without ANR active, and with and without radio communication - using the cabin noise as stimulus for the "insertion loss" registrations (level flight at travelling speed 94,7 dBA, at full speed 94 dBA, when hovering 91,6 dBA ; Bruel&Kjaer 2230/2232 noise level meter).

Study 3: A corresponding case study, in a P3-B Orion turbopropeller aircraft, with the subject wearing a Telex headset - with and without ANR active, and with and without the HF-radio in "plain-voice" position ( which the navigator finds tiring and disturbing).

#### RESULTS AND DISCUSSION.

Study 1: In the non-attenuated laboratory (fig. 1) the Alpha helmet with ANR off provided poor mean attenuation for the lower frequencies. With ANR active, the mean attenuation improved to reach 20 dB maximum below 800 Hz, with standard deviations in the 4-5 dB range. The manufacturer's data show somewhat better low frequency attenuation with ANR off, and match our data with ANR active below 800 Hz, but also shows some effect of ANR up to 2000 Hz. Our data correspond to ear canal registrations by Hellström (1991).

Study 2: In the Bell 412 helicopter (fig. 2), the Alpha helmet attenuation was comparable with laboratory data (study 1) below 500 Hz both with and without ANR when hovering. For frequencies 500 - 1000 Hz ANR active produced a small amplification which amounted to 12 dB maximum with radio communication (fig.3). This seems to be a general problem with ANR systems and compensatory modifications are sought by the manufacturer.

Study 3: In the P3-B turbopropeller aircraft, (fig.4) the Telex headset with ANR off showed little low-frequency attenuation, improving to 10-15 dB <600 Hz with ANR active. As in study 2 a small amplification was registered 700-2000 Hz, up to 8 dB. With radio communication ("plain voice"), ANR active gave better attenuation <400 Hz, but up to 15-17 dB amplification >400 Hz (fig. 5).

CONCLUSION.

Acoustic ear canal registrations with commercial "insertion gain" equipment provides reasonably reliable objective attenuation data for hearing protectors and active noise reduction (ANR) systems at noise hazard levels, both in the laboratory and under operative inflight conditions. Probe tube placement <5 mm in front of the ear drum is imperative. Inflight, ANR provides up to 20 dB extra attenuation below 800 Hz, where the headsets characteristically gives poor attenuation. Radio noise accompanying radio signals, is not cancelled, but is amplified in the mid-frequency range by the ANR system, and in the mid + high frequency range for HF radio signals.

REFERENCES.

Hellstrom.P.A. (1991) Objective methods for evaluation of conventional, non-linear and active hearing protector attenuation. In A. Dancer, D. Henderson, R. Salvi & R.P. Hamernik (eds.) Noise Induced Hearing Loss. B.C. Decker, Philadelphia/Toronto 1991.

Woxen & Borchgrevink (1991) Attenuation of hearing protectors at 85 dB SPL investigated by commercial "insertion gain" method. In H.M.Borchgrevink (ed.) Effects of Noise and Blasts. Scandinavian Audiology, suppl. 34, Oslo 1991.

fig. 1. Alpha helmet, active (ANR) and passive attenuation. "Insertion loss" data.

(..... SPL in ear canal)  
 — Passive  
 - - - - Active (+ANR)

(n=17)

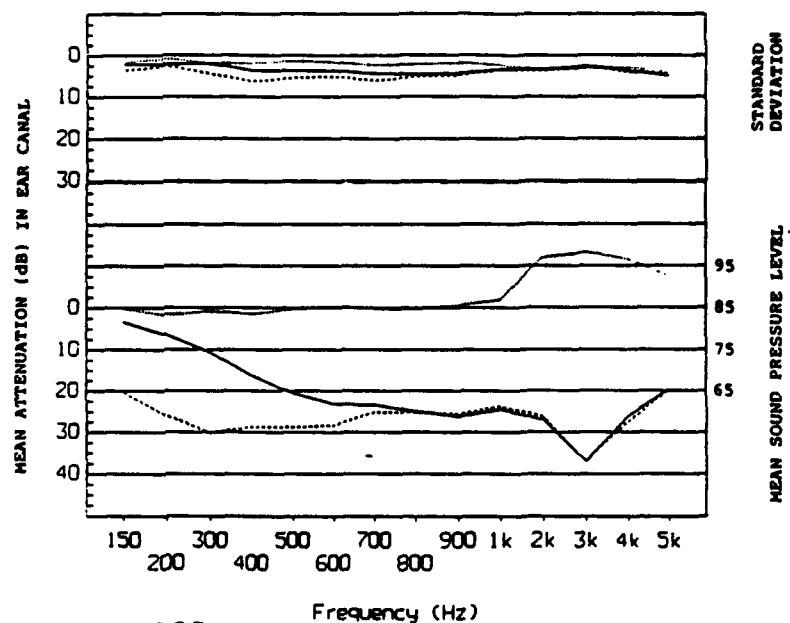

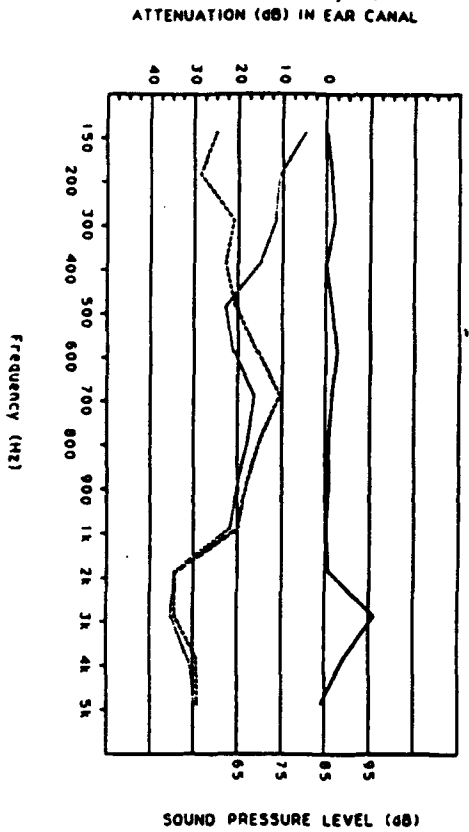

Fig 2 CASE STUDY, Bell 412 helicopter, hovering  
 sound pressure level in ear canal without hearing protection  
 attenuation of Alpha helmet (ANR passive)  
 attenuation of Alpha helmet (ANR active)

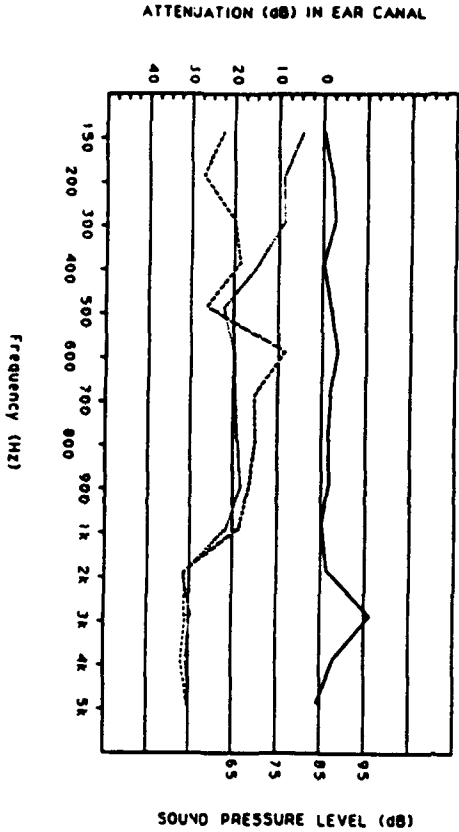

Fig 3 CASE STUDY, Bell 412 helicopter, hovering  
 sound pressure level without hearing protection  
 attenuation of Alpha helmet (ANR passive)  
 \* communication with flight control  
 attenuation of Alpha helmet (ANR active)  
 \* communication with flight control

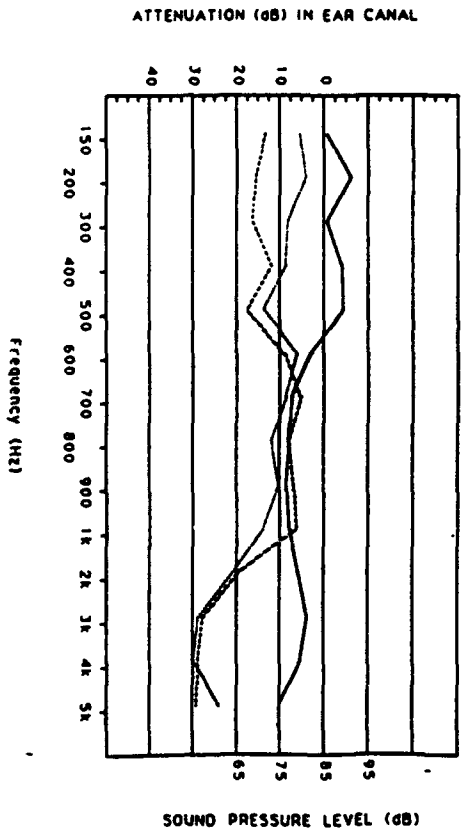

Fig 4 CASE STUDY, P3-B Orion  
 sound pressure level in ear canal without hearing protection  
 attenuation of Telex headset (ANR passive)  
 attenuation of Telex headset (ANR active)

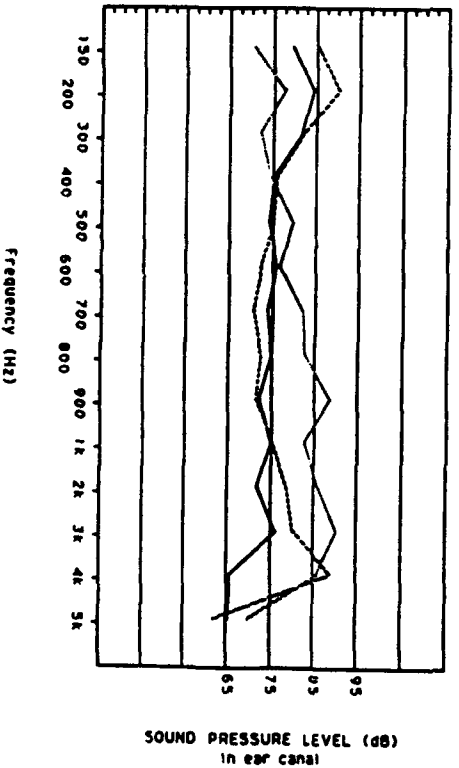

Fig 5 CASE STUDY, P3-B Orion.  
 sound pressure level in ear canal without hearing protection  
 sound pressure level in ear canal with Telex headset (ANR passive)  
 \* HF-radio ("plain-voice"-modus)  
 sound pressure level in ear canal with Telex headset (ANR active)  
 \* HF-radio ("plain-voice"-modus)

# CROSS-CULTURAL COMPARISON OF COMMUNITY RESPONSE TO ROAD TRAFFIC NOISE IN JAPAN AND THAILAND

DANKITTIKUL Wut \*, IZUMI Kiyoto \*, YANO Takashi \*\*,  
KUROSAWA Kazutaka \* and YAMASHITA Toshio \*\*\*

\* Muroran Institute of Technology, 27-1 Mizumoto, Muroran 050, JAPAN

\*\* Kumamoto University, Kurokami 2-39-1, Kumamoto 860, JAPAN

\*\*\* Ariake National College of Technology, Higashihagio 150, Omuta 836, JAPAN

In order to clarify the cross-cultural differences in the community response to road traffic noise, a series of social surveys were conducted in Japan and Thailand. Despite great difference in climate and culture, the fundamental characteristics of the annoyance response showed remarkable similarity. The traffic annoyance could not effectively be explained by the noise rating scales. Subjective response to traffic vibration, road safety, natural environment and environmental pollutions showed considerable contribution to the annoyance response.

## 1. INTRODUCTION

The evaluation of the community response to noise is widely being carried out on the energy basis and the Equivalent Sound Level ( $L_{eq}$ ) and its derivatives are recognized as the standard method for evaluating the environmental noise. By the experience from the recent studies, however, we have an assertion that it is difficult to make an effective noise evaluation without including non-acoustical factors. In order to clarify the contribution of non-noise factors and climatic factors to the community response to noise, a series of social surveys were conducted in three areas in Japan and Thailand by the same method. Site O was selected in Muroran, Japan, where the monthly average temperature ranged from  $-0.5^{\circ}\text{C}$  to  $21.5^{\circ}\text{C}$ . Site R and Site W were selected in Songkhla, Thailand, with the average temperature ranging from  $26.8^{\circ}\text{C}$  to  $28.7^{\circ}\text{C}$ . Site O is a downtown residential area with higher housing density and better urban facilities. Site R is a newly developed suburban area with lower housing density, whereas Site W is an old residential area in the heart of the city. The population of Muroran was 117,852 and that of Songkhla was 143,878 at the time of survey. This study is a part of Muroran-Gothenburg joint study.

## 2. MATERIALS AND METHOD

**Social Survey:** The questionnaire was first formulated in Japanese language basically following the standard questionnaire of the joint study. It comprised 23 questions relating environmental,

housing and personal factors plus 4 items filled in by the survey staff. Respondents in Site O were sampled out from the residents of detached houses by random sampling method referring to the residence registry. In Site R and Site W, respondents were directly selected on the site by the survey staff because of the lack of precise registry. The method of survey was the distribute-collect method. The questionnaire was first handed to the family of each selected respondent and was collected one to two days later. The percentages of effective questionnaire were 74.1, 92.6 and 89.5 % in Sites O, R and W, respectively. The details are shown in Table 1.

**Noise Measurement:** In Site O a major traffic road passed along the boundary and a secondary road passed through the site. One point for each road was selected along the road shoulder as the reference point. Referring to the past studies in the same area, seven observation periods were selected through 24 hours and  $L_{eq(1/3)}$  and  $L_{peak}$  were measured by the integrating sound level meter LA-500. The number and kind of vehicles were manually counted during the observation periods. National Highway Route 407 passed through the Site R. A 24-hour continuous measurement was carried out. Two roads with considerable traffic volume passed through the Site W. Two reference points were selected and the noise measurement was made during 11 observation periods decided by referring to the 24-hour measurement of Site R. Noise exposure of each sampling house was estimated by measuring the level difference in terms of  $L_{eq(1/6)}$  between the reference point and each housing block.  $L_{eq(24)}$ ,  $L_{DN}$ , and  $L_{MAX}$  of each sampling house were then calculated with the consideration for the background noise levels of the area.

**Table 1** Characteristics of the Surveyed Sites

Items	Muroran, JAPAN		Songkhla, THAILAND		
	Site O Point 1	Point 2	Site R	Site W Point 1	Point 2
Survey period	Sept. - Oct. 1991		July - August 1992		
Sample size	123		149	105	
No. of respondents	96		138	94	
Traffic volume / day	1,977	17,133	52,503	38,001	6,935
No. of heavy vehicles / day	93	1,998	2,214	945	15
No. of motorcycles / day	39	117	25,602	27,909	6,707
$L_{eq(24)}$ (dB)	38.8-67.8		47.9-75.4	59.2-68.5	

### 3. ANALYSIS AND RESULTS

**Single Regression Analysis:** The correlations of the annoyance responses due to road traffic noise (traffic annoyance) and noise exposures of each respondents' houses were analyzed by the linear regression method. The correlation coefficients in terms of  $L_{eq(24)}$  for Site O, Site R and Site W, were 0.490, 0.398 and 0.226, respectively.

$L_{eq(24)}$  explained the variation of traffic annoyance more effectively in the area with larger range of noise exposure. The determination coefficients, however, were only about 25% at most.  $L_{DN}$  and  $L_{MAX}$  did not effectively increase the correlation as shown in Table 2.

**Table 2** Determination Coefficient of Noise Rating Scales (%)

Site Area	Noise Rating Scales		
	$L_{eq(24)}$	$L_{DN}$	$L_{MAX}$
Site O	24.1	24.3	25.3
Site R	15.8	15.8	15.8
Site W	5.1	5.1	5.0

**Table 3** Categories of Non-Noise Variables

Category	Variable
<b>1. Potentials of Site Area</b>	Natural Environment <sup>O,R,W</sup> / Climate <sup>O,R,W</sup> / Streetscape <sup>R,W</sup> / Green of Parks <sup>O</sup> / Street Trees.
<b>2. Environmental Pollutions</b>	Traffic Vibration <sup>O,R,W</sup> / Vehicles Dust <sup>O,R,W</sup> / Vehicles Exhaust <sup>O,R,W</sup> / Odor from Garbage Stations <sup>O,R,W</sup> / Air Pollution from Factories <sup>O,R</sup> / Factory Noise <sup>O,R</sup> / Odor from Factories <sup>O,R</sup> / Neighborhood Noise <sup>O,W</sup> / Water Pollution from Houses <sup>R,W</sup> / Land Subsidence/ Odor from Market/ Odor from Fishing Port.
<b>3. Efficiency of Site Area</b>	Proximity to Cultural Facilities (Temples) <sup>O,R,W</sup> / Convenience of Working <sup>R,W</sup> / Convenience of Shopping <sup>R,W</sup> / Prox. to Market <sup>W</sup> / Prox. to Schools <sup>W</sup> / No. of Public Telephone <sup>W</sup> / Prox. to Sports Facilities <sup>R</sup> / Prox. to Fire Station <sup>O</sup> / Prox. to Community Parks <sup>O</sup> / Prox. to General Parks/ Prox. to Police Box/ Prox. to Post Office/ Prox. to Leisure Facilities/ Prox. to Shops & Stores/ Convenience of Health Services/ No. of Restaurants.
<b>4. Comfortability of Site Area</b>	Street Lightings <sup>O,W</sup> / Garbage Collecting & Disposal <sup>R</sup> / Sewage System.
<b>5. Safety of Site Area</b>	Road Safety <sup>O,R,W</sup> / Housing Security <sup>W</sup> .
<b>6. Housing Factors</b>	Width of Housing Lot <sup>W</sup> / Ventilation <sup>W</sup> / Adequacy of Parking Space <sup>W</sup> / Number of Rooms/ Esthetic Appeal/ Good Views from inside House/ Water Supply System/ Adequacy of Storage Space/ Temperature/ Natural Lighting/ Planning of House.
<b>7. Personal Factors</b>	Length of Residence in this Area <sup>W</sup> / Privacy Protection <sup>W</sup> / Sensitivity <sup>W</sup> / Former Residing Experience/ Length of Residence in Present Address/ Participation in Community Activities/ Quality of Site Location/ Neighborhood Companionship/ Willingness to Reside/ Sex/ Age/ Occupation/ Private Garden Occupancy/ Wife Working/ Attitude/ Member of Family; Infant, Schoolchildren, Aged Person, Patient./ Housing Type/ Family's Income/ Family's Income (observation).
<b>8. Noise Rating Scales</b>	$L_{eq(24)}$ <sup>O,R,W</sup> / $L_{DN}$ <sup>O,R,W</sup> / $L_{MAX}$ <sup>O,R,W</sup>

**Note:** Superscripts O, R and W indicate the statistically significant correlations above 5 % level in Site O,R and W, respectively.

**Multiple Regression Analysis:** In order to categorize the non-noise variables the cluster analysis was applied to all effective items in the questionnaire. The variables were categorized into eight groups as shown in Table 3. In order to clarify the contributions of each variable to the traffic annoyance, the multiple regression analysis was conducted. Variables were selected by examining the inter-correlation between the variables. Table 4 shows the summary of the analysis.  $L_{eq(24)}$  was proved as the dominant factor for Site O and Site R, where the range of noise exposure exceeded 25 dBA. Subjective response to traffic variation was the most effective factor throughout the three sites. Responses to the road safety, natural environment and self-reported sensitivity showed effective contribution to the traffic annoyance. The factors relating the environmental pollutions were also observed important. The sources of pollutions, however, varied from site to site. Severer the pollution, stronger the contribution to the traffic annoyance. As seen in Table 4, multiple regression models involving six to seven variables explained about half of the variation in the traffic annoyance.

**Table 4** Summary of Multiple Regression Analysis

SITE O		SITE R		SITE W	
Variable	Correlation Coefficient	Variable	Correlation Coefficient	Variable	Correlation Coefficient
Traffic Vibration	0.492	Traffic Vibration	0.486	Traffic Vibration	0.477
$L_{eq(24)}$	0.434	$L_{eq(24)}$	0.331	Water Pollution	0.327
Road Safety	0.181	Sensitivity	0.205	Natural Environment	0.228
Odor from Factories	0.127	Odor from Factories	0.189	Sewage System	0.191
Automobile Possession	-0.116	Natural Environment	0.101	Road Safety	0.070
Natural Environment	0.015	Road Safety	0.099	Sensitivity	0.063
				$L_{eq(24)}$	0.056
Determination Coefficient ( $R^2$ )	<b>0.536</b>	Determination Coefficient ( $R^2$ )	<b>0.477</b>	Determination Coefficient ( $R^2$ )	<b>0.593</b>

#### 4. CONCLUSION

Social surveys were conducted in three sites in Japan and Thailand. Single noise rating scales did not show the effectiveness to explain the annoyance response to road traffic noise. By multiple regression analysis, subjective response to traffic vibration, road safety, natural environment and environmental pollutions proved to have strong contribution to the traffic annoyance. Despite the great difference in climate and culture, the fundamental characteristics of the community response to road traffic noise showed remarkable similarity.

#### REFERENCES

- 1) Yano, T. et al., Inter-noise 91 proceedings, pp. 903-906, 1991.
- 2) Yano, T. et al., J.S.V. 151(3), pp. 487-495, 1991.
- 3) Izumi, K. et al., J.S.V. 151(3), pp. 505-512, 1991.



# FACTORS DETERMINING COMMUNITY RESPONSE TO ROAD TRAFFIC NOISE

LERCHER Peter, WIDMANN Ulrich

Dept. of Social Medicine, University of Innsbruck, Sonnenburgstr. 16, A-6020 Innsbruck

## Abstract

A socioepidemiologic study was carried out in five rural communities located along major transit-traffic routes through the Austrian part of the Alps. 1989 citizens (62 %), aged 25 to 64 responded to an interviewer administered questionnaire, covering sociodemographic, medical and detailed annoyance information. Noise measurements from over 70 locations allowed individual assignments of noise exposure based on 5 dB,A categories (range 40-75 dB,A,Leq). The relationship between noise levels (7 categories) and annoyance (4 grade scale) was analyzed by means of correlation and regression analysis. Observed individual correlation ( $r$ ) for this study was 0.27, correlation on group level 0.92. The overall dose-response curve indicated an upward deviation below levels of 50 dB,A, as compared to other surveys.

Rated impaired quality of life, perceived odorous pollution, noise sensitivity, homeownership and membership in a citizen initiative showed the most pronounced modification of the average noise-annoyance response. Smaller effects exhibited factors such as closing windows during night, installed sound proof windows, sleeping room facing road, rated avoidability of source related annoyance, low ratings on health status and noise related sleeping disturbance.

## Introduction

Over the past twenty years several authors have pointed out that only a comparatively small proportion of total variance of the annoyance reaction (typically less than 20 %) was found to be accounted for by physical measures of noise exposure (1, 2, 3, 4, 5, 6, 7, 8).

Further examinations have shown that measurement problems on the noise as well as the reaction side are not responsible for this huge lack of variance explanation (7).

Only a small group of investigators have examined non-acoustical factors and their quantitative contribution to the noise-annoyance curve in more detail (2, 3, 4, 7, 9).

From these investigations we know that environmental variables, life style, adaptive behavior and attitudes as well as personal characteristics play an important role as modifiers of the noise-annoyance relationship.

Among those, ratings of environmental quality, duration of residence, type of dwelling, homeownership, education, income, sex, age, judged noise sensitivity, personality traits and specific attitudes toward the noise source were the most commonly examined variables (6, 7).

Hitherto most surveys have been carried out in large urban and suburban agglomerations. Only a minority of studies have also included rural areas (3).

This survey was designed to get information about the noise-annoyance relationship in rural alpine communities, exposed to highway and main road traffic, that is to a large proportion through-traffic. It was hypothesized that non-acoustical factors may have a larger impact on annoyance ratings in these residential and recreational areas, although noise protection programs have already partly been carried out.

A second goal was to present the results in a way that policy makers could easily have access and compare the results with other surveys (9).

## Methods

**Study sites:** Five rural communities along two major transit-routes through the alpine part of Austria (Tyrol) were sampled systematically (10) to get a wide range of noise exposure (40 - 75 dB,A). Three communities were situated along a highway, two along a main road. The proportion of heavy traffic was nearly identical (20/50 % day/night). In two villages noise barriers with various degrees of effectiveness have already been established to protect areas of heavy exposure. Community size varied between 916 and 3772 inhabitants.

**Subjects:** Persons aged 25 to 64 with permanent residence were selected systematically from the census list. Those selected got an invitation to participate in the study. The overall response was 62 % (N=1989). No relationship was found between non-response and traffic noise. In the larger communities only a certain fraction of the inhabitants were approached to avoid a major bias through community characteristics.

**Noise exposure:** Day- and nighttime noise was recorded standardized in front of people's homes according to Austrian guidelines. An acoustician assigned to the homes of the participants an equivalent sound pressure level (seven 5 dB,A categories), based on long- and short-term data from over 70 measuring points. Day and night levels varied between 0 and 3 dB,A. 26 % of the sample were exposed to levels above 60 dB,A, 5.5 % above 65 dB,A.

**Interview information:** Participants were approached by trained interviewers with a standardized questionnaire already used in an earlier pilot study. The interview covered sociodemographic, occupational and life style information as well as medical and psychosomatic symptoms and a detailed annoyance questionnaire. The annoyance ratings used in this analysis were obtained on a widely used four grade scale (not at all, a little, moderately, very much).

**Statistical analysis:** Noise-annoyance curves were calculated separately for each modifying factor by means of regression analysis using mean annoyance response of one of the seven noise exposure categories. SAS-PC software was used.

## Results and discussion

Individual correlations ( $r$ ) between noise exposure level and reported annoyance ranged from -0.04 to 0.48 in the communities surveyed (Table 1). Correlations on the group level varied between 0 and 0.96 %. The zero correlation comes from a community with an extensive noise protection program already implemented.

The overall noise-annoyance relationship (Fig. 1) shows even at lower levels of exposure (below 45 dB,A) a certain amount of residual annoyance. This is somewhat different from other surveys. Our explanation is that the low background noise level in rural areas during night (20-30 dB,A) contrasts sharply with low frequency truck noise that is underestimated by the A-weighting scheme (10).

Among the determining factors of the noise-annoyance reaction, rated impaired quality of life (Fig. 2), perceived odorous pollution (Fig. 3), rated noise sensitivity, membership in a citizen initiative (Fig. 4) and homeownership (Fig. 5) showed the most pronounced departure from the mean annoyance response in this study. However, most non-acoustical factors show a simple parallelism of the annoyance reaction at a higher level. In contrast to this the indicator homeownership interacts distinctly with noise level.

A smaller but still relevant impact on the annoyance ratings had factors like windows closed during night, installed sound proof windows, low rating on health status, noise related sleep disturbance, sleeping room facing road, talking much about transit-traffic and rated avoidability of the noise source.

Sex, age, educational level, duration of residence, social support by friends or relatives did not show relevant modifications of the mean annoyance response.

## References

1. Griffiths ID, Langdon FJ. Subjective response to road traffic noise. *J Sound Vib* 1968; 8: 16-32.
2. Langdon FJ. Noise nuisance caused by road traffic in residential areas: Part III. *J Sound Vib* 1976; 49: 241-256.
3. Bradley JS, Jonah BA. The effects of site selected variables on human responses to traffic noise, Part I: Type of housing by traffic noise level. *J Sound Vib* 1979; 66: 589-604.
4. Finke HO, Guski R, Rohrmann B. Betroffenheit einer Stadt durch Lärm: Bericht über eine interdisziplinäre Untersuchung. Berlin: UBA, 1980.
5. Jones DM, Davies DR. Individual and group differences in the response to noise. In: Jones DM, Chapman AJ, Eds. *Noise and Society*. Chichester: Wiley, 1984: 125-153.
6. Fields JM, Hall FL. Community effects of noise. In: Nelson PM, Ed. *Community effects of noise*. London: Butterworth, 1986: Chapter 3.
7. Job RSF. Community response to noise: A review of factors influencing the relationship between noise exposure and reaction. *J Acoust Soc Am* 1988; 83: 991-1000.
8. de Jong RG. Review of research developments in community response to noise. In: Berglund B, Lindvall Th, Eds. *Noise as a Public Health Problem, Vol 5*. Stockholm: Swedish Council for Building Research, 1990: 99-113.
9. Fields JM. Policy-related goals for community response studies. In: Berglund B, Lindvall Th, Eds. *Noise as a Public Health Problem, Vol 5*. Stockholm: Swedish Council for Building Research, 1990: 115-134.
10. Lercher P. Auswirkungen des Straßenverkehrs auf Lebensqualität und Gesundheit. Transitstudie - Sozialmedizinischer Teilbericht. Innsbruck: Amt der Tiroler Landesregierung, 1992.

## Tables and Figures

**Table 1.** Noise - annoyance: Individual and group correlation by community

Study site	Individual correlation (r)	Group correlation (r)	Sample size (N)
Vomp*	-0.04	0.00	501
Ellmau*	0.43	0.92	384
Going*	0.48	0.96	221
Steinach*	0.24	0.93	642
Schönberg*	0.29	0.64	218
Total sample*	0.27	0.92	1966
International**	0.42	0.77	n.a.

\* Adjusted for age, sex, education by means of partial correlation analysis

\*\* Mean of 14 international studies on road noise: R.F.S. Job 1988 (7)

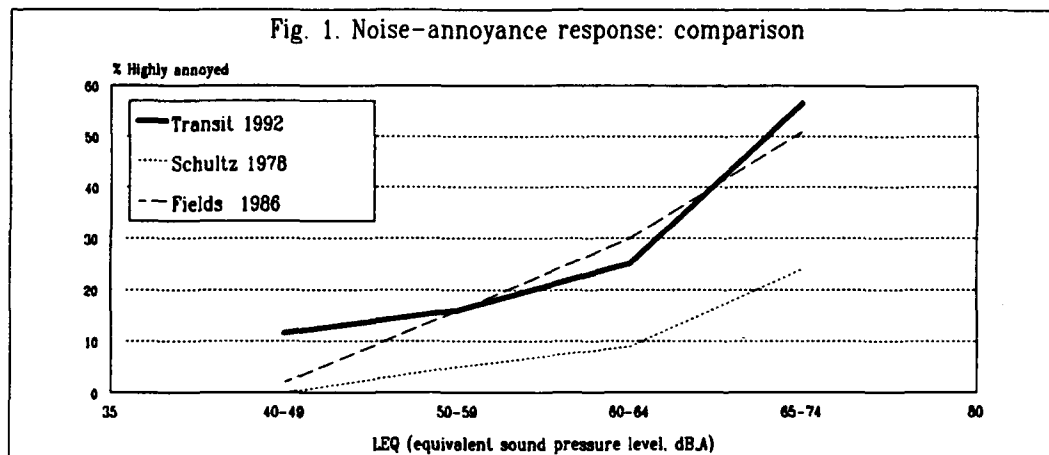

**Fig. 2. Noise – Annoyance – Response by Impairment of life quality**

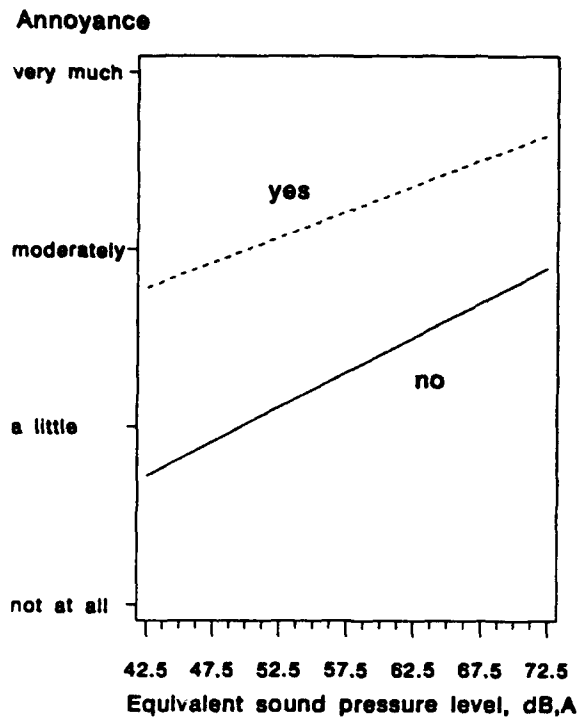

**Fig. 3. Noise – Annoyance – Response by perceived odorous pollution**

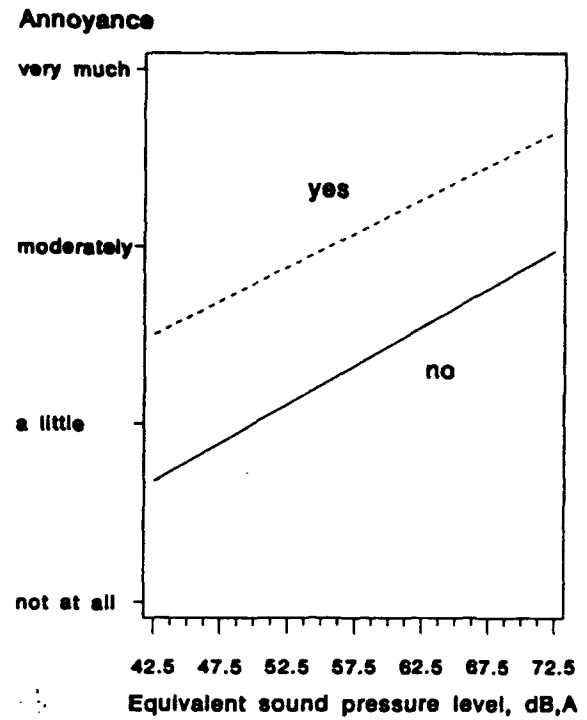

**Fig. 4. Noise – Annoyance – Response by initiative membership**

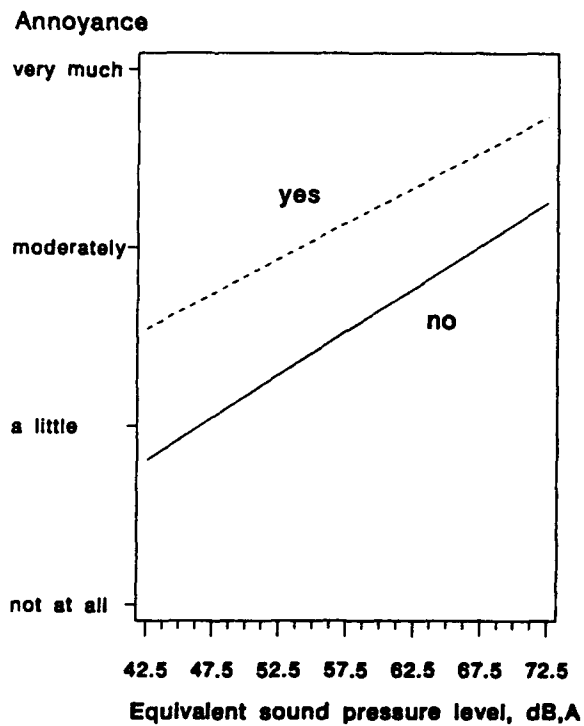

**Fig. 5. Noise – Annoyance – Response by homeownership**

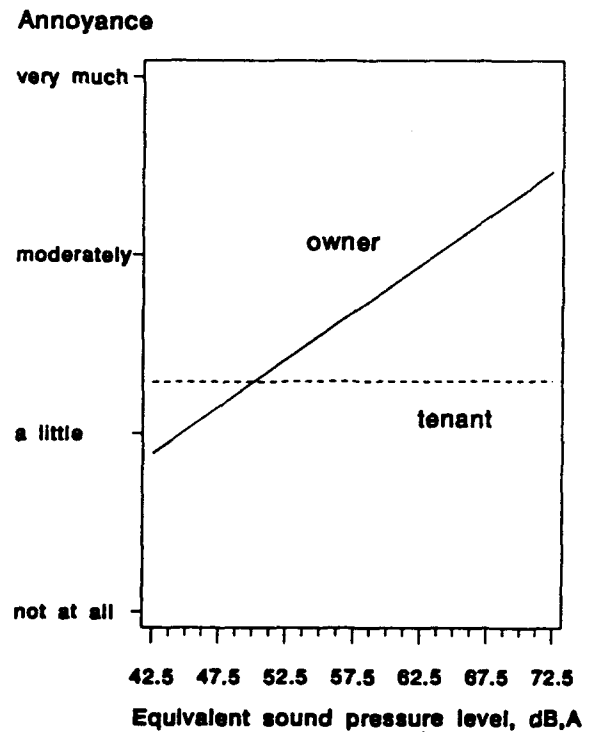

# SUBJECTIVE RESPONSE TO TRAFFIC NOISE. THE IMPORTANCE GIVEN TO NOISE ENVIRONMENT IN CHOOSING A PLACE OF RESIDENCE.<sup>1</sup>

LOPEZ BARRIO, Isabel; CARLES, José Luis  
Instituto de Acústica (CSIC)  
C/ Serrano, 144. 28006 MADRID

**Abstract.**— This paper present the results of a research project which principal aim was to determine subjective responses to traffic noise. The study was carried out with a sample of 800 subjects resident in Madrid and exposed to a wide range of noise levels (50–80 dBA). Results show a low correlation between individual annoyance and noise levels registered ( $r = 0.298$ ). Bearing in mind this outcome, other non-acoustic factors were considered (sensitivity and satisfaction with the neighbourhood). Of these factors, sensitivity proved to be an important response predictor. The study also analyzes how the population rated noise environment against other features of a neighbourhood when fixing their place of residence.

**Résumé.**— Ce travail présente une partie des résultats d'une recherche dont l'objectif principal a été la détermination des réponses subjectives quant au bruit de trafic. L'étude a été réalisée avec un échantillon de 800 sujets résidents á Madrid, exposés a une gamme ample de niveaux de bruits (entre 55–80 dBA). Les résultats de ce travail montrent une corrélation basse entre la gêne individuelle ressentie et les niveaux de bruit mesurés ( $r=0.298$ ). En tenant compte de ce résultat, a été aussi analysée l'importance d'autres facteurs non-acoustiques (sensibilité et satisfaction avec le quartier), étant la sensibilité une variable déterminante de telle réaction. De même, cette étude analyse l'importance attribuée à l'ambiance du bruit entrè les différents aspects du quartier quant au choix du lieu de résidence.

## Introduction

Noise is one of the main problems affecting our environment. This fact has given rise to a series of studies in the most developed countries aimed at determining subjective response to noise exposure. In Spain, with the exception of a few studies (García, 1987; Ayuntamiento de Zaragoza, 1990), most of the research carried out in this regard has been centred primarily on an evaluation of the noise levels affecting Spanish cities (acoustic maps), with only passing attention to the evaluation of subjective response to this form of pollution.

The present study aims to make a contribution to this field of acoustics and sets out some of the findings of a wider study designed to assess population response to traffic noise and determine possible non-acoustic variables of influence in this subjective response (age, sex, sensitivity, neighbourhood satisfaction, type of residence, etc.) Given the high degree of civic awareness on this matter in Spain, a second objective was to find out what importance people gave to noise environment in fixing their place of residence

## Methodology

The decision as to which areas to study was taken in line with the following criteria: a) exposure to a wide range of noise levels. b) the presence of different types of housing (tower blocks, detached dwellings, semi-detached dwellings). c) a certain uniformity of housing stock as regards period and

---

<sup>1</sup> This study forms part of a research programme financed by CICYT (No. SEUI PBO215).

type of construction, allowing us to presume similar insulation levels. d) a minimum of two windows looking onto the street.

Following these criteria, two zones of subsidized housing were selected in the Madrid metropolitan area. Both zones are exposed to a wide range of noise levels (50–80 dBA). The number of subjects participating in the study was 800, of whom 60% were women. The breakdown of the sample by noise levels is as follows: 30% –50–55 dBA; 29% – 56–65 dBA; 31% – 66–75 dBA and 10% – >75 dBA.

The questionnaire included items relating to satisfaction with neighbourhood, interference in daily life, personal characteristics associated with noise perception (sensitivity, adaptation, beliefs...), noise-associated conduct (closing windows) and questions concerning the subjects' individual characteristics.

Subjective response to noise environment was measured by means of the following question: "When at home, how annoyed do you get by the noise that reaches you from the street?". Answers were on a scale of four points: "very annoyed," "fairly annoyed", "slightly annoyed" or "not at all annoyed".

Noise levels were taken as those used in the study of the acoustic map of Madrid (Santiago, 1990, 1992). Measurements were taken during 8 hours a day in period of daylight and readings translated to the equivalent continuous sound level ( $L_{eq}$ ) in dBA.

## Results

In the zones studied, of all neighbourhood features analyzed<sup>1</sup>, traffic noise was one of the aspects with which respondents declared themselves least satisfied, second only to street insecurity. Among sources of traffic noise, motorcycles, car horns and sirens were the most noticed (80%) and the most annoying (32% "very annoyed").

As regards noise-related interferences, it was found that sleep and activities requiring concentration (reading, study) were stated as those suffering most interference from noise nuisance. The percentage of residents declaring themselves "very annoyed" by such disturbances was 52.5% and 49% respectively. The correlation between noise-exposure levels and interferences was  $r=0.300$ . Interference factors were likewise related to annoyance ( $r=0.521$ ) and the habit of closing windows ( $r=0.350$ ).

The percentage of subjects declaring themselves "very annoyed" varied with the noise level in question. A critical noise level was identified in the region of 65–75dBA  $L_{eq}$ , above which the degree of annoyance rapidly escalated. The correlation between noise level and individual responses was relatively low ( $r=0.296$ ), with noise level accounting for only 9% of variance on the annoyance scale.

When we used a multi-item scale (annoyance + loudness + interferences) to measure noise response, the noise-response correlation increased slightly ( $r=0.40$ ).

---

<sup>1</sup> Public transport, parks and gardens, refuse collection, neighbours, noise level, leisure facilities, air pollution, schools, health centres, street insecurity, shops and markets.

Given that noise level accounts for only a small percentage of variance in individual annoyance response, we next sought to determine other possible predictors of subjective response. To this end, we carried out a multiple regression analysis taking annoyance as a dependent variable and noise level and the various non-acoustic factors included in the study as independent variables.

Results (Table 1) show that the individual characteristics of most weight in predicting annoyance seem to be sensitivity to noise and perceptions of the quality of the area resided in (degree of satisfaction with different aspects of the neighbourhood). These two variables together with noise level account for 22% of the individual annoyance response variance. As the other non-acoustic variables analyzed (age, sex, beliefs, objective characteristics of housing, etc.) were not selected by the regression analysis, these do not seem to be determinants of noise response.

TABLE 1. Regression analysis on annoyance.

Variables	Std. reg. coeff.	R
Sensitivity	0.3421	0.1170
Noise level	0.4562	0.2081
Perceived quality of area	-0.4691	0.2200

We can observe from the results shown in Table 1 that, in this study, sensitivity, the first independent variable to enter the analysis and registering greater significance than noise level, is the main predictor of subjective annoyance response and, as such, the most important variable affecting said response.

Sensitivity to noise environment is measured on a scale of three categories, with subjects declaring themselves "sensitive", "not sensitive at all" (non-sensitive) or "neither" (neutral) (Langdon, 1976). According to the responses obtained, subjects were divided into three groups: sensitive, 43.3%; neutral, 42.8% and non-sensitive, 13.8%. Analyses carried out showed that sensitivity does not depend on noise level; the correlation between them is not statistically significant ( $r=0.03$ ). It was also found that sex throws up no significant differences as regards sensitivity to noise; 40% of men and 46% of women declared themselves "sensitive" to noise. In contrast, age did have a significant influence, with younger (18-30) subjects proving the least sensitive to noise (57.2% neutral). From this age onwards, a high percentage of subjects (51%) define themselves as "sensitive". On analyzing sensitivity jointly by age and sex, no significant differences were identified except in the 41-50 age group, in which 57% of women as against 35% of men declared themselves "sensitive" to noise.

Finally, it was found that although residents considered noise one of the least satisfactory of the neighbourhood characteristics mentioned, only 30% of those interviewed would consider a neighbourhood's noise environment as an important factor in the hypothetical case of being able to choose their place of residence (ideal neighbourhood). In this regard, those subjects exposed to levels of over 65 dBA in their present homes considered the noise aspect more important (49%) than those exposed to lower levels (14%). In this respect, prior experience of high noise levels would seem to be a determining factor.

## **Conclusions**

The correlation obtained between noise exposure level and annoyance was relatively low; a similar result to that found by other researchers.

Sensitivity to noise proved to be an important predictor of subjective response, accounting for a higher percentage of subjective response variability than exposure levels per se

The 65 dBA level was found to constitute a critical exposure point in terms both of subjective response and interferences.

## **Bibliography**

AYUNTAMIENTO DE ZARAGOZA (1990) El ruido como fenómeno psicosociológico urbano y su percepción ciudadana. Informe del Servicio de Medio Ambiente. Zaragoza.

GARCIA, A (1987) Noise nuisance caused by road traffic in urban areas. Proceedings of the 5th Congress of Noise as a Public Problem. 187-192. Stockholm.

SANTIAGO, S. (1990) La cartographie acoustique urbaine. Communications du colloque "Effets et traitement du bruit des transports". INRETS. Lyon.

LAMBERT, J.; SIMONNET, F. and VALLET, M. (1984). Patterns of behaviour in dwellings exposed to road traffic noise. *Journal of sound and vibration* 92 (2), 159-172.

LANGDON, F.J. (1976) Noise nuisance caused by road traffic in residential areas. *Journal of sound and vibration* 19 (2), 241-256.

RAW, G.J. and GRIFFITHS, I.D. (1988) Individual differences in response to road traffic noise. *Journal of sound and vibration* 121 (3), 463-471.



# LONG-TERM EFFECTS IN TERMS OF PSYCHO-SOCIAL WELLBEING, ANNOYANCE AND SLEEP DISTURBANCE IN AREAS EXPOSED TO HIGH LEVELS OF ROAD TRAFFIC NOISE.

ÖHRSTRÖM, Evy

*Department of Environmental Medicine University of Gothenburg, Medicinaregatan 16,  
413 90 Gothenburg, Sweden.*

The paper presents different studies on long term effects of exposure to high levels of road traffic noise. The results from the third study, which involves 6 noisy areas with different number of heavy vehicles and a quiet control area, are presented more in detail. The effects were evaluated by postal questionnaires with 22 questions on psycho-social wellbeing (PSW), as well as questions on sleep and general annoyance. The results showed that people having bedrooms facing the street had lower PSW and worse sleep quality as compared to those having bedrooms facing the courtyard.

## INTRODUCTION

Exposure to road traffic noise might in the long term lead not only to annoyance, sleep disturbance and interference with other activities, but also to decreased psycho-social wellbeing and increased medical symptoms. In some studies even more serious symptoms such as psychiatric symptoms have been connected with exposure to environmental noise. Concerning effects of noise exposure on psycho-social wellbeing and medical symptoms, a field survey in Gothenburg 1986 (1) involving 105 subjects at different distances from a heavy trafficked road (*study I*) showed that, except for noise annoyance and sleep disturbances, medical and psycho-social symptoms were significantly more frequent in the area close to the road. In 1989 (2) a second study (*study II*) was performed in a noisy area and a quiet control area involving 248 subjects. This study showed that psycho-social wellbeing (PSW) was significantly lower among people living in apartments facing the street in the noisy area as compared to the quiet control area. In the noisy area people had more difficulties to go to sleep and the use of sleeping pills and earplugs was higher than in the quiet control area. To further elucidate the possible long term health effects from road traffic noise a new study (*study III*) was performed in 1990 in 6 areas exposed to different numbers of heavy vehicles and a quiet control area.

## METHOD

**Questionnaire:** In study II a questionnaire was constructed to evaluate not only annoyance reactions and sleep disturbances but also psycho-social wellbeing (PSW). PSW was evaluated by 26 questions concerning depression, relaxation, activity, passivity, general well-being and social orientation. In study III a revised questionnaire on PSW containing 22 questions graded from 1 (worst) - 6 (best) was used. The postal questionnaire was sent to 841 subjects between 18 and 75 years of age who had lived in the area for at least one year. Of those who responded to the questionnaire (62 %) 434 fulfilled the requirement that their apartment should have at least one window facing the street. The sample in the quiet area was found to have different distribution in age and civil state and therefore an adjustment was made to get the same distribution as in the noisy areas. After this adjustment the sample in the quiet area was reduced from 160 to 95 subjects.

**Noise exposure:** To get a wide variation in noise exposure six city areas with different number of heavy vehicles were chosen ranging from 220 to 9 240 day and night. The Leq level ranged from 61.6 to 74.7 dBA, the total number of vehicles night and day varied between 5 590 and 77 000 and the number of noise events over 80 dBA maximum noise level ranged from 107 to 1417. In the quiet control area the maximum noise level did not exceed 50-55 dBA in front of the houses. A short description of some individual variables and the noise exposure is given in table 1.

*Table 1. Description of individual variables and noise exposure.*

	N1	N2	N3	N4	N5	N6	Control
Number of respondents	32	66	47	31	49	49	95
Time of residence:	8.4	7.3	13.4	6.2	8.8	7.1	10.7
Mean Age:	40.3	38.5	46.3	36.5	40.8	37.6	42.7
Total number of vehicles	5 590	11 900	12 900	23 100	25 500	77 000	-
Heavy vehicles	220	357	1 032	1 386	1 785	9 240	-
> 80 dBA max	107	274	1 417	1 099	761	831	0
Leq	61.6	64.5	70.7	69.1	70.6	74.7	-
L90	46.3	47.2	46.4	52.9	52.2	57.3	-

Other individual variables such as working outside home, sex, noise sensitivity and chronic illness did not differ significantly between the areas.

## RESULTS

Annoyance to noise and appreciation of the living environment is shown in table 2.

*Table 2. Annoyance and appreciation of the living environment.*

	N1	N2	N3	N4	N5	N6	Control
% very annoyed by noise	13	26	43	42	43	35	7
% very annoyed by exhausts	19	27	40	42	51	43	2
% not very satisfied with the living area	0	3	2	23	29	4	2
% wants to move	44	33	34	58	78	57	46
% due to environment	15	12	13	52	57	35	9

The main source of annoyance in the different areas was the road traffic. Between 13 and 43 % of the respondents were very annoyed by noise and 19-51 % by exhausts from the road traffic. In some areas (N4 and N5) more than 50 % wanted to move to a new apartment for environmental reasons.

The correlation between noise annoyance and different noise descriptors was 0.90 for number of events >80 dBA, 0.89 for L<sub>01</sub>, 0.79 for Leq and 0.28 for total number of vehicles. The relation between % very annoyed and number of noise events >80 dBA is shown in figure 1.

Figure 1. Relation between annoyance and number of high noise level events.

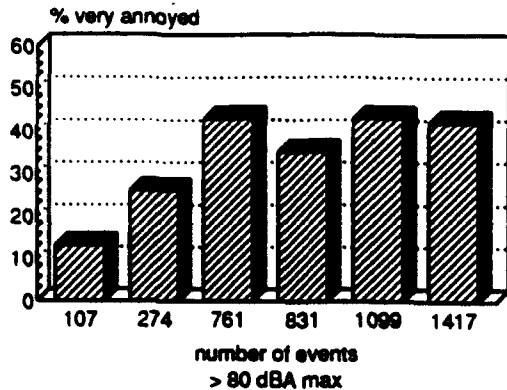

The figure shows that there is no difference in percentage of very annoyed respondents between the four areas with the highest number of noise events > 80 dBA maximum noise level.

Sleep disturbances in terms of a higher frequency of difficulties to fall asleep and more awakenings by noise were seen in some of the noisy areas, but on the whole the differences between the noisy areas and the control area were small.

Concerning *psycho-social wellbeing (PSW)* there were no significant differences between the noisy areas and the quiet control area.

Though neither sleep quality nor PSW could be significantly linked to the noise exposure, a close relationship was found between degree of noise annoyance, sleep quality and PSW. This is shown in figures 2 a and b. Those who were rather or very annoyed by the noise had significantly lower sleep quality - 3 versus 24 % ( $p=0.02$  Chi<sup>2</sup>-test) and lower PSW, 98.8 versus 104.5 ( $p=0.02$  Students t-test).

Figure 2 a. Relation between noise annoyance and sleep quality.

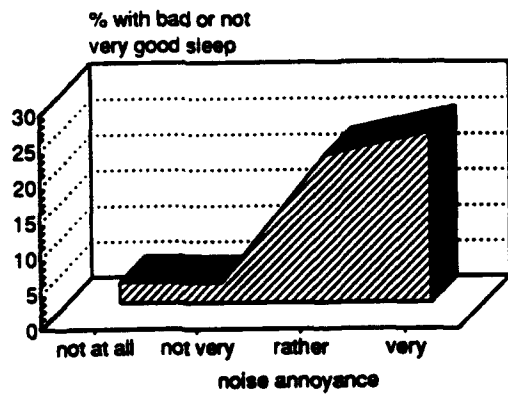
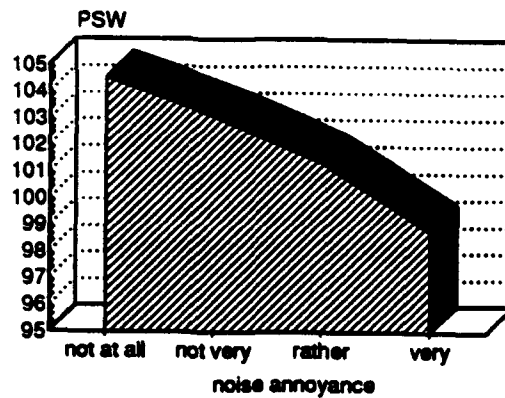

Figure 2 b. Relation between noise annoyance and psycho-social wellbeing (PSW).



Except for noise exposure many other factors might affect PSW well as sleep quality. The individual noise dose may vary within an area due to the disposition of different rooms in the apartment. A second analysis was done where the 6 noisy areas were divided into two samples; 1) respondents having bedrooms with windows facing the street and 2) respondents having bedroom windows facing the courtyard. The result of this analysis is shown in table 3.

Table 3. Annoyance, sleep and PSW among people having bedrooms facing the streets (n=89) and the courtyard (n=185).

	bedroom window facing street	bedroom window facing courtyard
% very annoyed by noise	47	27 p=0.0004 ♦
Never sleep with open window (%)	71	28 p<0.001 ♦
Difficulties to fall asleep % daily or weekly	29	15 p=0.009 ♦
Time to fall asleep % > 30 minutes	27	12 p=0.0004 ♦
Awakenings % >1 time/night	29	22 p=0.11 ■
Sleep quality % not very good or bad	22	9 p=0.001 ♦
PSW (mean)	99.2	102.6 p=0.045 ♦

t-test ♣, Chi<sup>2</sup>-test ♦, Fishers test ■

The table shows that 71 % seldom or never slept with open windows among those having bedroom windows facing the street. Concerning sleep quality, difficulties to fall asleep was the most pronounced difference between the groups. Finally PSW, especially in terms of the general wellbeing component, was significantly lower among those who had bedroom-windows facing the street.

### COMMENTS

The results from this study indicate that road traffic noise has a significant effect on psycho-social wellbeing as measured by the 22 questions on PSW. Noise-induced sleep disturbances seem to increase the risk for reduced psycho-social wellbeing. These results are in agreement with the findings in the earlier studies (1, 2). The study also elucidates some methodological problems that are present in these types of cross-sectional of field surveys. There are not only difficulties in estimating the "true" individual noise exposure dose. Considerable difficulties also exist when comparing different populations.

*Data on traffic volume was supplied by the Traffic Office and the noise measurements were performed by Martin Björkman, Dept. of Environm. Medicine, University of Gothenburg.*

### REFERENCES

Öhrström E (1989). Sleep disturbance, psycho-social and medical symptoms - a pilot survey among persons exposed to high levels of road traffic noise. *J Sound Vibr*, 133, 117-128.

Öhrström E (1991). Psycho-social effects of traffic noise exposure. *J Sound Vibr* 151, 513-517.

# ATTITUDES TO ROAD TRAFFIC IN BRISBANE

RENEW Warren Douglas

Department of Environment and Heritage  
160 Ann Street, Brisbane, Australia

## Abstract

A survey was carried out in Brisbane in 1991 to determine the attitudes of the population to road traffic. A total of 1038 interviews were conducted of people living along 36 roadways carrying a range of traffic loads. The responses to the comprehensive questionnaire were statistically analysed on the basis of attitudes to noise, air pollution and vibration. Comparisons of attitudes were made with a similar survey carried out in 1975 in Brisbane and two other Australian cities and some signs of an increased reaction to traffic noise were found.

## Résumé

Un sondage a été effectué en 1991 à Brisbane pour définir les attitudes de la population envers la circulation routière. Un total de 1038 personnes ont été interviewées, riverains de 36 rues fréquentées par une gamme de circulation routière. Les réponses au questionnaire détaillée ont été analysées statistiquement du point de vue des réactions au bruit, à la pollution de l'air et aux vibrations. Les attitudes ont été comparées avec celles d'une étude faite en 1975 à Brisbane et deux autres villes australiennes. Quelques indices d'une plus forte réaction au bruit de la circulation ont été trouvés.

## INTRODUCTION

The pre-eminence of noise as an environmental pollutant has been well established in numerous studies of environmental noise in cities. Reference may be made to an Australian study reported by Duhs [1]. Noise is widely known to be the most annoying environmental aspect of road traffic. For example, Maurin [2] showed that noise from road traffic in France was the predominant source of nuisance, followed by air pollution, vibration and safety.

## SURVEY DESIGN

The objective of the 1991 survey was to determine the effects that road traffic had on the residents of Brisbane. A further survey was designed to measure traffic noise levels so that dose response relationships could be obtained for traffic noise. The questions in the present survey were in part modelled on those used by Brown [3] so that valid comparisons could be made between attitudes in 1975 and in 1991.

A total of 54 questions were asked, on aspects of the environment, noise sensitivity,

demography and building design. In all, 1038 interviews were carried out in individual residences along 36 roadways. The selection of roadways was effected on a partly random basis; however, other criteria had to be satisfied, such as traffic flow rate and composition. Flow rates ranged from 2 000 to 31 000 vehicles per day, while the percentage of heavy vehicles ranged from 1% to 13%. The majority of the roadways permitted freely flowing traffic and  $L_{eq(24h)}$  values of noise level measured at one metre from building facades lay between 55 and 70 dB(A) .

## SURVEY RESULTS

**General.** When asked to name the noise sources most noticed in the area, 67.3% of respondents nominated traffic noise as their first choice. In all, almost 90% of respondents mentioned some aspect of traffic or vehicle noise in their first response to the question. The times when traffic noise was most noticeable were the morning (7 am to 9 am) and afternoon (4 pm to 6 pm) peak traffic hours. About 90% of respondents noticed traffic noise to some extent during these periods.

The following ranking of the most annoying aspects of traffic was obtained:

1. noise
2. individual vehicle noise
3. exhaust smell
4. visible exhaust fumes
5. health effects

**Complaints.** Only 8.5% of respondents admitted that they had made a complaint about traffic noise. Of these, 53.2% claimed that they were not satisfied with the result of the complaint. The major reasons given for not making a complaint were:

- . not bothered enough (45%)
- . no use complaining (40%)
- . no one to complain to (7%)

**Willingness to pay for noise reduction.** A total of 66% of respondents agreed that it was important to develop quieter vehicles, compared with a value of 80% obtained by Maurin in France. The additional percentages of price that respondents were prepared to pay for their next vehicle are shown in Fig.1. The results are similar to those reported by Maurin, except that there was a higher proportion of respondents willing to pay 10% more.

Only 28% of respondents were willing to pay a higher fuel price to pay for necessary noise reduction measures on very noisy roads. Of these, 59% were agreeable to paying up to 5% extra, while 30% were willing to pay between 5% and 10% extra.

### Noise effects

. Annoyance levels were determined by use of a seven point unipolar scale previously used by Brown [3]. A further assessment of the effect of noise was made by use of the seven point bipolar dissatisfaction scale employed by Langdon [4]. The relationships obtained are shown in

Fig. 2. The patterns are somewhat similar in shape, there being a tendency for the dissatisfaction score to be about one level higher than the annoyance level for a given percentage of respondents.

. A total of 63% of respondents considered that road traffic could affect their health and of these 24% claimed that it had affected their health. The major health problems put forward were irritability, stress and worry, followed by physical effects such as asthma and high blood pressure.

. On a four point scale (never, sometimes, a lot, nearly always) the following responses were received for noise interference at the "a lot" level:

activity	%
-----	
window shutting	17.1
listening to radio and TV	15.6
conversation	7.8
sleep	7.6

. For the majority of the noise effects considered, there was little difference between results obtained in 1975 and in 1991. However, there was a significant increase in the percentage of respondents who named noise as the major source of annoyance and who expressed annoyance at levels 3 and 4 on the annoyance scale. A much higher proportion of house owners in 1991 considered that traffic noise had affected property values.

## CONCLUSIONS

The study has shown that noise is the predominant source of annoyance resulting from road traffic. Traffic noise seriously affects residents by way of activity interference and health conditions.

## ACKNOWLEDEMENTS

The author expresses his gratitude to Ted Duhs of the Queensland University of Technology for assistance in conducting the survey and acknowledges the permission of the Executive Director (Environment) to publish this paper.

## REFERENCES

1. Duhs, E., Renew, W.D. and Eddington, N.J. 1989, Brisbane Noise Survey 1986 to 1988, Government Printer, Brisbane.
2. Maurin, M., Lambert, J. and Alauzet, A. 1988, Enquete nationale sur le bruit des transports en France, Rapport INRETS No. 71, Bron, France.
3. Brown, A.L. 1978, Traffic noise annoyance along urban roadways, Report No. AIR 206-6, Australian Road Research Board, Melbourne.
4. Langdon, F.J. 1976, Noise nuisance caused by road traffic in residential areas: Part 1, Journal of Sound and Vibration, vol.47, no.2, pp.243-263.

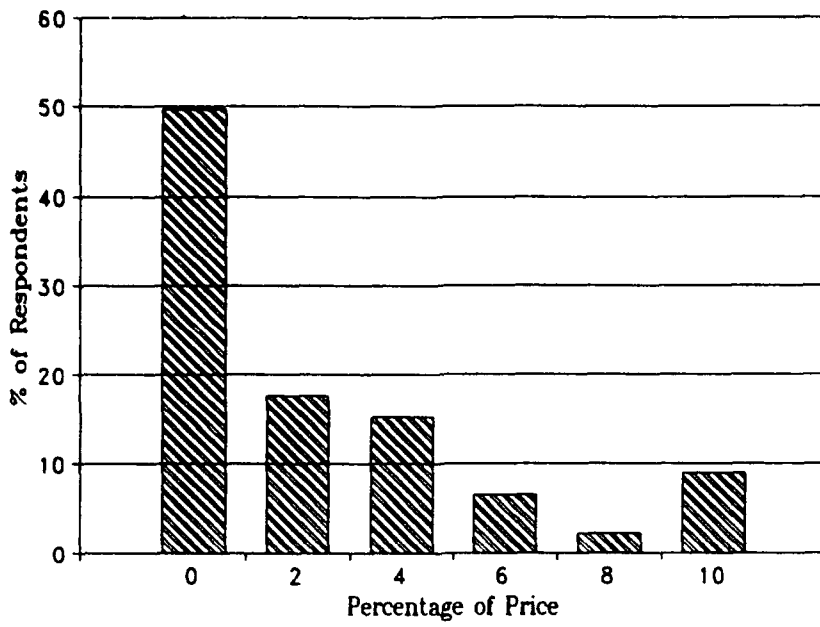

**Figure 1** Extra percentage of vehicle price

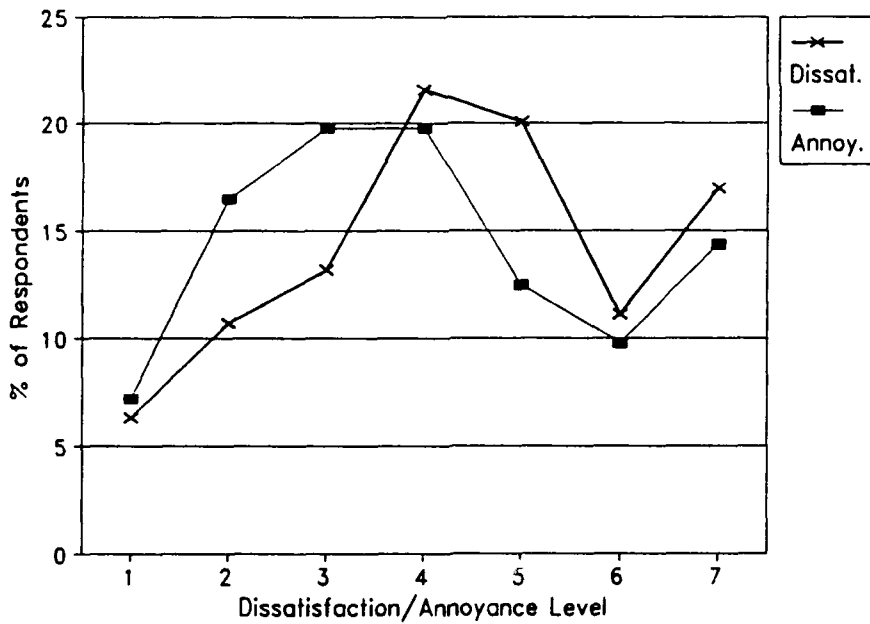

**Figure 2** Dissatisfaction and annoyance levels



# CROSS-REGIONAL COMPARISON OF COMMUNITY RESPONSE TO ROAD TRAFFIC NOISE IN HOKKAIDO AND KYUSHU, JAPAN

YANO Takashi\*, IZUMI Kiyoto\*\*, YAMASHITA Toshio\*\*\*,  
DANKITTIKUL Wut\*\* and KUROSAWA Kazutaka\*\*

\*Kumamoto University, Kurokami 2-39-1, Kumamoto 860, Japan

\*\* Muroran Institute of Technology, Mizumoto 27-1, Muroran 050, Japan

\*\*\* Ariake National College of Technology, Higashihagio 150, Omuta 836, Japan

The present study compares the community response to road traffic noise in Hokkaido, a colder area in Japan, and Kyushu, a warmer area. By using the same questionnaire and noise measurement methods in both areas, the results are directly and precisely compared. The correlations between various effects and outdoor noise exposure are consistently higher than those for indoor noise exposure. The dose-response relationships are almost the same in both areas. However, what factors strongly affect the annoyance are significantly different. The individual and indoor environmental factors strongly contribute to the annoyance in Hokkaido, while the outdoor environmental factors are more important in Kyushu. This difference may depend on the life style or the attitude to the environment.

## INTRODUCTION

Many social surveys on the effects of noise on people have so far been carried out throughout the world and some studies<sup>1,2)</sup> have presented general dose-response relationships. However, in order to directly compare the results from different surveys, it is required to use the same subjective and objective scales. With this background, the social surveys were carried out in Hokkaido, a colder area in Japan, and in Kyushu, a warmer area, by using the same questionnaire and measurement methods for noise exposure and sound insulation of windows as a part of Muroran-Gothenburg Joint Study. The objective of the present study is to discuss the cross-climatic comparison of dose-response relationships and the cross-regional comparison of the effect of non-physical factors on annoyance.

## METHOD

Social survey The face-to-face interview method was used for the survey. The questionnaire contains 31 questions and 5 observations by interviewers, which are divided into personal factors, environmental factors, housing factors and effects of road traffic noise. Each two sites as shown in Table 1 were selected in Hokkaido and Kyushu. Houses were all detached and were facing the road or separated from it by one house. The traffic volume ranged from 17,000 to 32,000 per day. Every kind of car was manually counted at the noise measurement. The respondents, 18 to 65 years of age, were randomly selected from the residence registers on a one person per family basis.

Noise measurement The noise measurements consist of day-long measurements at a reference point, a road shoulder in the center of the site, and simultaneous measurements for 10 minutes at the road shoulders closest to houses and in front of the houses to estimate the noise reduction from the road to the houses. The noise indices such as  $L_{eq}$ ,  $L_{dn}$  and percentile noise levels were calculated with the all day data sampled every one second. In site B, Hokkaido, however, the noise reduction was estimated by the noise propagation equation proposed by Kaku and Yamashita<sup>3)</sup>.

Table 1 Characteristics of the surveyed sites

Items	Area	Hokkaido		Kyushu	
		A	B	C	D
Survey period		Sep.-Oct.1988	Aug.-Sep.1989	Oct.-Nov.1990	Oct.-Nov.1990
Sample size		121	100	84	89
Number of respondents		75	50	53	74
Traffic Volume		32,208	21,786	16,971	19,128
Number of heavy vehicles		4,826	2,634	663	879
$L_{eq}$ (dB(A))		40.6-63.7	46.8-64.6	43.3-64.5	42.3-70.8

Sound insulation measurement of the windows Single window panes are generally found in Kyushu, while double or triple window panes are found in Hokkaido. Even if the outdoor noise exposure is the same in both areas, the indoor noise exposure is different, and this may affect the indoor activities. To estimate the indoor noise exposure, the sound insulation for the windows of typical detached houses in Hokkaido and Kyushu was measured with the method recommended by the Architectural Institute of Japan. When the mean sound insulation values are applied to the typical road traffic noise, the noise reductions are 32 dB(A) in Hokkaido and 24 dB(A) in Kyushu.

## RESULTS

Comparison of dose-response relationships Table 2 compares the correlation coefficients between some responses and noise exposure outdoor and indoor, based on 104 responses in Hokkaido and 97 responses in Kyushu. The indoor noise exposure was estimated by subtracting the sound insulation from the outdoor noise exposure, setting the minimum indoor noise level as 20 dB(A). All the correlation coefficients for the outdoor noise exposure are higher than those for the indoor noise exposure. This may be convenient for the noise measurement. However, the correlations are relatively low and at the maximum about 15 percent of the variance of the response can be explained only by the noise exposure. When comparing dose-response relationships for indoor annoyance in Hokkaido and Kyushu, no significant difference can be found.

Table 2 Correlation between responses and indoor/outdoor noise exposure (\*  $p < 0.05$ )

Response	Noise exposure	$L_{eq}$	$L_{dn}$	$L_1$	$L_5$	$L_{10}$	$L_{50}$
Indoor annoyance	Outdoor	0.295	0.296	0.296	0.298	0.296	0.282
	Indoor	0.252	0.260	0.274	0.270	0.265	0.193*
Indoor conversation	Outdoor	0.256	0.257	0.264	0.265	0.261	0.224
	Indoor	0.185*	0.191*	0.200*	0.200*	0.197*	0.127*
TV/radio disturbance	Outdoor	0.389	0.391	0.390	0.391	0.391	0.370
	Indoor	0.346	0.348	0.359	0.358	0.354	0.319
Awakening	Outdoor	0.273	0.276	0.274	0.275	0.274	0.259
	Indoor	0.254	0.253	0.258	0.257	0.257	0.217
Irritation	Outdoor	0.168	0.166	0.174	0.174	0.171	0.152
	Indoor	0.121	0.106*	0.119*	0.115*	0.112*	0.093

**Comparison of annoyance structure by path analysis**

Since the rate of variance in annoyance explained only by noise exposure is low in the present study, as well as the previous studies<sup>4,5</sup>, factors other than noise exposure should be considered in a multi-variate analysis to estimate the annoyance more precisely. Path analysis is suitable for the precise estimation of annoyance in the multiple stratum relationships between annoyance, endogenous variables and exogenous variables when calculating the direct and indirect effect of the variables on annoyance (see ref. 6). At first a priori path model was constituted, as shown in Figure 1, based on the findings from the previous studies and our experience. The variables from  $X_1$  to  $X_{11}$  are called exogenous variables independent

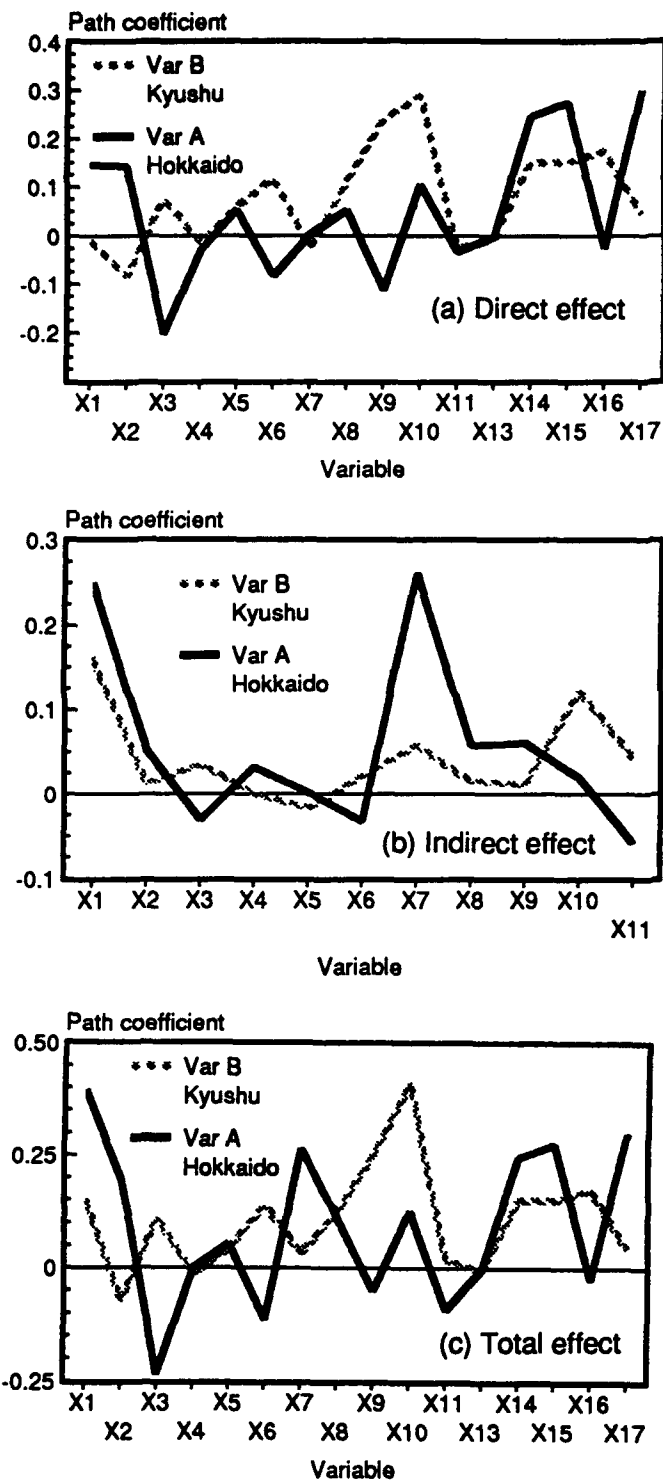

Fig.2 Path coefficient

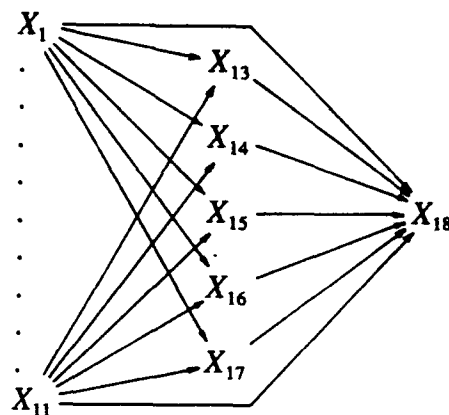

Fig.1 A priori path model

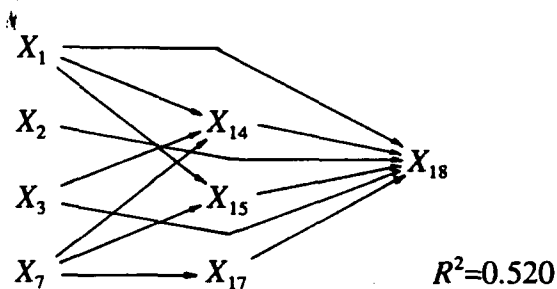

Fig.3 Revised path model (Hokkaido)

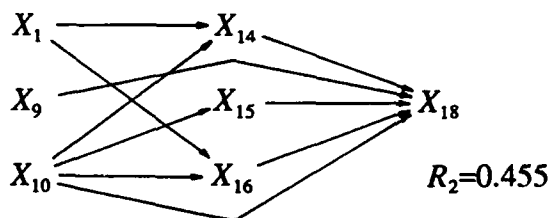

Fig.4 Revised path model (Kyushu)

$X_1$ : $L_{eq}$ ,  $X_2$ :length of residence,  $X_3$ :age,  $X_4$ :sex,  $X_5$ :possession of cars,  $X_6$ :opening windows or not,  $X_7$ :quality of sleep,  $X_8$ :sensitivity to noise,  $X_9$ :attitude to environmental pollution,  $X_{10}$ :view on natural environment,  $X_{11}$ :open facade direction,  $X_{13}$ :satisfaction with the community,  $X_{14}$ :TV/radio disturbance,  $X_{15}$ :awakening,  $X_{16}$ :vibration,  $X_{17}$ :irritation,  $X_{18}$ :annoyance

of other variables.  $X_{13}$  to  $X_{18}$  are endogenous variables dependent of other variables. The direct effect is obtained by calculating the path coefficient from the structure equation as the standardized partial linear regression coefficient. The indirect effect is the product of the path coefficients for the variables linking with the paths. The total effect is the sum of the direct and indirect effects. Figure 2 (a), (b) and (c) show the path coefficients for the direct, indirect and total effects, respectively. The coefficients of determination of the model are 0.55 for Hokkaido data and 0.49 for Kyushu data. In Hokkaido the direct effects of irritation, awakening and TV/radio disturbance are significantly larger and the indirect effects of  $L_{eq}$  and quality of sleep are larger. On the other hand, in Kyushu, the direct effects of view on natural environment and attitude to environmental pollution are significantly larger. The direct effect of  $L_{eq}$  is smaller while the indirect effect is larger. The total effect of  $L_{eq}$ , age, TV/radio disturbance, awakening and irritation are larger in Hokkaido, while those of view on natural environment and attitude to environmental pollution are larger in Kyushu. As a whole the effects of personal or indoor environmental factors are larger in Hokkaido, while those of outdoor environmental factors are larger in Kyushu. Figures 3 and 4 show the revised path models constituted by the statistically significant factors or important factors. These models show well the characteristics of the annoyance structure in both areas.

## DISCUSSION

At first it was assumed that the difference in type of window might affect various indoor activities and annoyance. On the contrary, however, the results showed that the correlations between the different type of responses and the outdoor noise exposure are higher than those for the indoor noise exposure. This is considered as follows: while the sound insulation measurements were carried out for the tightly closed windows, the indoor noise exposure obtained from the sound insulation data may be smaller than those in the real-life conditions as we sometimes open the windows. Secondly, the interference with the indoor activities are considered to be affected by the outdoor noise exposure in the garden or around the house, although people are asked about the indoor effects. This is consistent with the findings obtained by Griffiths et al<sup>7)</sup> and de Jong<sup>8)</sup>. Griffiths et al showed that there was no seasonal effect in the community response to road traffic noise, while the frequency of the opening of windows changed with season. De Jong reported that the correlation between indoor conversation interference and the highest outdoor noise exposure is higher than that for indoor noise exposure. They pointed out the consistency of perception or the regression of true object as the cause. The indoor noise exposure may not directly affect the response but the effect of the noise source is rather large. This elucidates the importance of the source measures. Although the simple dose-response relationships in both areas are not significantly different, the structures of annoyance described by the path model are different. This may depend on the life style or the attitude to the environment. That is, people in Hokkaido may evaluate the indoor environment more as they have to protect themselves from the cold environment, while people in Kyushu may evaluate to the outdoor environment owing to the moderate climate.

## REFERENCES

- 1) Schultz, T.J., J. Acoust. Soc. Am., 64(2), pp.377-405, 1978
- 2) Hall, F.L., J. Acoust. Soc. Am., 76(4), pp.1161-1168, 1984
- 3) Kaku, J. and Yamashita, M., J. Acoust. Soc. Jpn., 35(5), pp.257-261, 1979 (in Japanese)
- 4) Borsky, P.N., Proc. of 3rd Intr. Cong. on noise as a Public Health Problem, pp.453-474, 1980
- 5) Bradley, J.S. and Jonah, B.A., J. Sound Vib., 66(4), pp.589-604, 1979
- 6) Taylor, S.M., J. Sound Vib., 96(2), pp.243-260, 1984
- 7) Griffiths, I.D. et al, J. Sound Vib., 71(2), pp.227-240, 1980
- 8) de Jong, R.G., J. Sound Vib., 87(2), pp.297-309, 1983

# SUBJECTIVE RESPONSE AND SENSITIVITY TO ROAD TRAFFIC NOISE: STUDIES PERFORMED IN PALERMO (ITALY)

ALBANESE Giuseppe<sup>(\*)</sup>, BARBARO Salvatore<sup>(\*)</sup>, COSA Mario<sup>(\*\*)</sup>, GIACONIA Carlo<sup>(\*)</sup>, GRIPPALDI Vito<sup>(\*)</sup>

(\*) Dipartimento di Energetica ed Applicazioni di Fisica dell'Università di Palermo. Viale delle Scienze, Palermo, Italy.

(\*\*) Servizio Igiene Pubblica, U.S.L. Roma 1

**Abstract** - This paper will discuss the methodologies and contents of a series of research done by a DEAF's working group for the past five years. The purpose of this study was to co-relate the urban noise of Palermo with the degree of annoyance which influences both the mental and physical work activities of the people and their free time and period of rest. The fundamental instrument of investigation was a psycho-social survey availing of use and successive analysis of informative questionnaires. These were distributed to varied homogeneous groups of people: commercial and office workers in the city center, people who attend or work in the school, and residents. Some items were aimed at knowing the direct and indirect personal effects of traffic noise and individual sensitivity to it. These specific questions made it possible to set-up an index of exposition different from those commonly used and showed in literature. Furthermore, the answers allowed to formulate more accurate and reliable predictions of the degree of annoyance experienced by the people in their work environment and at home.

**Résumé** - Ce sont ici exposée soi les méthodologies soi les contraintes d'une série d'enquets conduites par un group de travail, pendant les derniers cinq années dans la ville de Palermo. Elles ont eteées faites au fin de lier le bruit ambiental (du mileu) au quel est exposée la population du centre hurbain de Palermo, au degré de reaction au dérangement produit soi aux activités intellectuelles et physiques, soi pendant les périodes de loisir et de repos. Le fondamental instrument d'étude est la récherche psycho-social, actuée parne la distribution et analyse de questionnaires informatives, proposés a specimens omogéneens d'individues. Le specimen même a été onstruit en relation aux differents chategories sociaux, correspondents a quelques de aires d'influence definies par les normes (operateurs du tertiaire dans le centre ancien, operateurs de l'école, residents). L'introduction supplementaire de questions specifique sur les effets directs et indirects du bruit de voie et sur l'autoévaluation de la sensibilité personnelle, consents de construire un indicateur d'exposition alternatif a ceux traditionnels et considerés objectifs. Tel indicateur peut permettre une prevision plus soignée du degré de mécontent ou "annoyance", lié á l'histoire psychophysique individuelle des subjects. Cet instrument d'analyse, outre que altératif est aussi specifique pour chaque aire de travail et vie.

In analysing the non specific environmental effects produced by road traffic noise on exposed urban community, an estimate of the annoyance is of primary importance.

Since a direct measure is not viable, a statistic social and social survey is more frequently matched to the physical one about the acoustical conditions.

It makes possible the evaluation of subjective (both individual and community) response to the existing noise climate, by interviewing a suitable population sample.

A DEAF working group, after having studied the main specialistic existing literature [1-7], set up a questionnaire as its own survey tool. About it, they cared in particular as regards:

- 1) its presentation;
- 2) its formal structure (sections, items numbering, ordering and formulation);
- 3) the acoustical survey hidding into a wider research field;
- 4) inserting of control polarized questions, put in key points, to verify sample's answering reliability;
- 5) avoiding conditioning paths or redundant questions;
- 6) introducing specific questions on acoustical impact, based on bother or dissatisfaction scales, both verbal or semantic;
- 7) asking to indicate noise effects both evaluated or personally experienced;
- 8) questioning about opinios on actions orientd to noise's level reducing or about environmental adjusting proposals.

The informative schedule joint to the questionnaire is composed by three different sections, concerning: firstly, interviewed subjects identifying data; secondly, the personal judgement on working conditions and environment; thirdly, the judgement and perceiving of impact of environmental noise. Social impact of road traffic noise is determined using, in self-rating the degree of bother, the scale by McKenel, by assigning a number to each level of response: 1 for "not at all" or "does not apply", 2 for "a little", 3 for "quite a lot" and 4 for "very much".

The basic structure has been validated by means of several testing and retesting, made in different territorial range urban realities. It has been possible to make ameliorative and retroactive actions, thanks to suggestions and remarks of psychologists and sociologists.

The social survey, developed 5 years long (1988-1992) [8-13] in the urban centre of Palermo, involved 3 different samples: a) commercial and office workers in the city center; b) people who attend or work in the school; c) people who are resident.

For each of them, question sets referred to the sample time by time analysed, were introduced. In the b) case, topic questions were, for example, about the judgement on ordinary teaching classroom, noise coming inside, direct and indirect effects of trouble deriving from road noise on educational process and about evaluation of loss of time in daily work. In the c) case, specific questions were about noise interfering on main activities and sleep.

As the coming back percentage of questionnaires was quite different for each of the three samples (60%, 10% and 35% for a), b) and c) respectively) the first has been chosen, because it was considered the most statistically reliable, to describe on a qualitative approach the process and the contents of the psychosocial survey.

The scores of subjective dissatisfaction are correlated to the common acoustical indexes ( $L_{eq}$ ,  $L_N$ , TNI, NPL) in order to find the best objective descriptor. The above analysis has put in evidence that, if noise exposure is expressed in terms of  $L_{10}$  and TNI, a high reliability level is reached in prevision, both for individual scores and middle computed scores. Clearly, the fitness of previsions decreases if the single questionnaire's scores are used, as the averaged responses smooth the random variability, and mask the spread of the various sensitivity's degrees.

With the aim of better reproducing the individual votes, we can make a preliminary subdivision of the sample in three groups corresponding to defined classes of declared sensitivity: poor or null, normal or mean, high.

A further more effective improvement of the prevision technique can be obtained by considering in explicit key the role of sensitivity in forming the individual votes (subjective judgements to the exposure) trying to calibrate the instrument (person) performing the measurement of bother. Then, functional relation is assumed of the type  $V_i = f(L, S)$  between the individual vote  $V_i$ , and the acoustic parameter  $L$  (commonly the  $L_{eq}$ ) and the degree of sensitivity  $S$ . As the vote does not traduce only a discomfort sense to the acoustical impact but, in general, a reaction to numerous negative environmental aspects, it is here assumed that the judgement signified about the acoustical climate is affected by an "apparent or fictitious" level of external noise, i.e. subjectively experienced by the exposed people as filtered through their personal sensitivity, which traduces the individual critical-acritical dimension on the whole.

If we refer, in particular, to  $L_{eq}$  scores, data commonly achieved in all environmental surveys and used as guide-line rate in normative or territorial programming instruments, and we consider available for  $f$  a linear formula, it's possible to write

$$V_i = a_1 + a_2 \cdot L_{eq,app}(S) \quad (1)$$

where  $L_{eq,app}(S)$  values can be deduced from the following expression

$$L_{eq,app}(S) = L_{eq} + a_3 \cdot S \quad (2)$$

and are the result of an amplification or reduction of real  $L_{eq}$  values, traducing an high or scarce sensitivity to annoyance. As in the normal sensitivity case, corresponding to a middle reactive people's behaviour, dissatisfaction or troublejudgement is objective, the appearing level will coincide with the real correspondent one. Actually, we attribute an  $S = 0$  value in the case of normal sensitivity,  $S = -1$  and  $S = +1$  if it is scarce or high.

The results reached during the social survey made in the center of Palermo showed that, to better and more adequately correlate acoustical conditions to annoyance effects on exposed people, it is necessary to introduce, in individual vote's statistical predetermination'equation, the parameter "apparent equivalent level". It has good chances to became a really alternative privilegiate noise descriptor, to substitute the objective variable.

It makes reliable the hypothesis that the dissatisfaction judgement to acoustical impact is conditioned both by the effectively existing noise level inside the environment and by an internal echo. This last "concept" is interpreting the psychophisic subjective conditions, like they are fitted in relation with the existential sphere.

## REFERENCES

### A) Background Reviews

- [1] Acoust.Soc.Am., New York (1975-1992)
- [2] Journal of Sound and Vibration, Academic Press Inc., London (1968-1992)
- [3] Applied Acoustics, Elsevier Science Publishers Ltd., England (1980-1992)
- [4] National Meetings of the Acoustical Italian Association (1985-1992)
- [5] J. Acoustique, Paris (1990-1992)
- [6] Rivista Italiana di Acustica, ESA Editrice, Roma (1989-1992)
- [7] Acustica, S. Hirzel Verlag, Stuttgart (1971-1992)

### B) Main Papers

- [8] BARBARO S., CANNISTRARO G., D'ORSO A., GIACONIA C., GRIPPALDI V.: Livelli di rumorosità da traffico e risposta della comunità nel Centro Storico di Palermo. 17th National Meeting of the Acoustical Italian Association, Parma 12-14th april 1989.
- [9] COSA M., BARBARO S., CANNISTRARO G., D'ORSO A., GIACONIA C., GRIPPALDI V., ORIOLI A., TRAPANI S.: Rumore da traffico e danno sulla popolazione esposta nel Centro Storico di Palermo. Workshop about ATMOSPHERIC POLLUTION, Milano 12-13th march 1990.
- [10] COSA M., BARBARO S., CANNISTRARO G., D'ORSO A., GIACONIA C., GRIPPALDI V., ORIOLI A., TRAPANI S.: Risposta soggettiva al rumore da traffico. Il ruolo della sensibilità nella formazione dei giudizi individuali. 18th National Meeting of the Acoustical Italian Association, L'Aquila 18-20th april 1990.
- [11] BARBARO S., GRIPPALDI V., RIZZO G., TRAPANI S.: Rumore in ambiente urbano. Valutazione di impatto ambientale. National Meeting "Rumore e vibrazioni in ambiente di vita e di lavoro". Roma, 1st october 1990.
- [12] COSA M., BARBARO S., CANNISTRARO G., D'ORSO A., GRIPPALDI V., TRAPANI S.: Controllo del clima acustico in aree urbane adibite ad attività scolastiche. National Meeting "RUMORE E VIBRAZIONI", Modena 22-24th november 1990.
- [13] COSA M., BARBARO S., CANNISTRARO G., D'ORSO A., GRIPPALDI V., TRAPANI S.: Traffic noise as a risk factor of annoyance in school areas. 11th Congress International Ergonomics Association, Paris, 15-20 Juillet 1991.





## **DOSE-RESPONSE RELATIONSHIPS FOR ENVIRONMENTAL NOISES**

**RYLANDER Ragnar, BJÖRKMAN Martin and SÖRENSEN Stefan**

**Department of Environmental Medicine University of Gothenburg**

**Medicinaregatan 16, S-413 90 Gothenburg, Sweden**

### **Abstract**

This report presents a principle for the establishment of guidelines for noise from aircraft, road traffic and trains. It is based on a dose-response relationship in which the number of noise events and the maximum noise levels from these are treated as independent variables, describing a non-linear function for the number of events and a linear function for the maximum noise levels. A suggestion is presented for guidelines for environmental noise annoyance (GENA) based on the new principles.

### **Background**

The effects of noise exposure are caused by the registration of the noise stimulation in the ear, the subsequent interpretations of the nature of the noise in the brain and the final reaction of the individual to the noise. The mode of function of the neuro-physiological reaction mechanisms implies that attention is particularly drawn to noise levels which differ from the background level. Noisy events are thus of primary importance for the reaction following exposures. Another characteristic of the neurophysiological reaction pattern is related to the number of events. It is initially possible to perceive an increase in the number of events, but only up to a certain number. Beyond this point, a further increase cannot be distinguished. These basic reaction principles are not acknowledged in the current principles designed to express environmental noise exposure as the average of all events and all noise levels (the equal energy principle).

In a few investigations in which the number of noise events and noise levels have been studied separately, a different dose-response pattern has been found. An increase in the number of events caused an increase in the extent of annoyance, but only up to a certain number. At this number (the breakpoint), a further increase in the number of events has not resulted in an increase in the extent of annoyance (1-6). The noise level from the noisiest event (maximum noise level, MNL), measured as dBA-max, determines the extent of annoyance regardless of the number of events. Using this dose-response relationship, Guidelines for Environmental Noise Annoyance (GENA) can be elaborated. The GENA presented below use a value of 10% very annoyed as the acceptable value in built-up areas (GENA<sub>10</sub>). The general principles on which they are based are applicable to all degrees of annoyance.

### **GENA<sub>10</sub> - aircraft noise**

The background for GENA<sub>10</sub> for aircraft noise is derived from studies in which the number of events and the MNL have been studied separately (1,3,5). A summary of the results is illustrated in Figure 1.

For areas where the number of overflights is above the breakpoint (about 50/24 hours) the  $GENA_{10}$  has been calculated to be 72 dBA MNL using the data in the figure and assuming that there is a linear dose-response relationship between MNL and annoyance. This means that 72 dBA from the noisiest aircraft type determines the extent of annoyance. For areas where the number of overflights is less than the breakpoint, MNL can increase successively with a decreasing number of events. While if the data in the figure suggest that the MNL value could be very high at a very low number of events, it is reasonable to have a maximum value even for single flights at 95 dBA MNL.

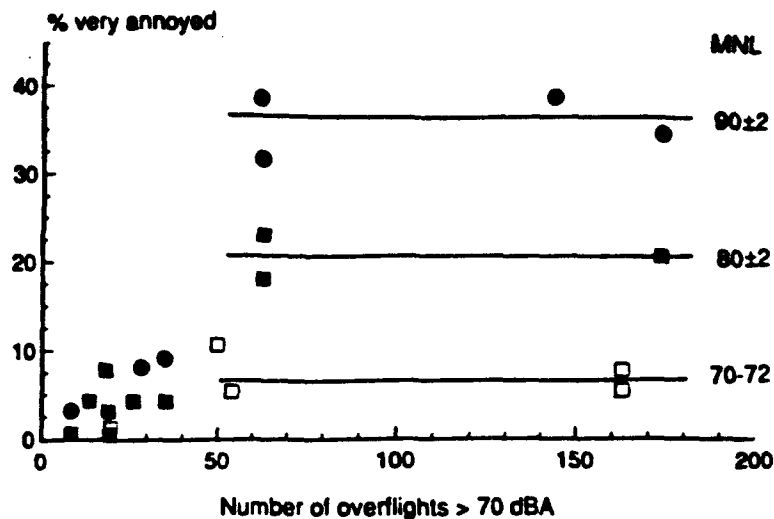

Figure 1: Dose-response relationship for aircraft noise

### $GENA_{10}$ - road traffic noise

The background for  $GENA$  for road traffic noise is from investigations in which the number of events and the noise values were studied separately (2,4). The results from one such study are summarized in Figure 2.

It is seen that the breakpoint for the number of heavy vehicles is about 1,500/24 hours. Data from unpublished studies suggest that if the number is defined as vehicles exceeding 85 dBA, the breakpoint is about 60 events/24 hours. Assuming a linear relationship between the MNL value and the extent of annoyance,  $GENA_{10}$  for traffic noise will be 75 dBA when the number of vehicles is above the breakpoint.

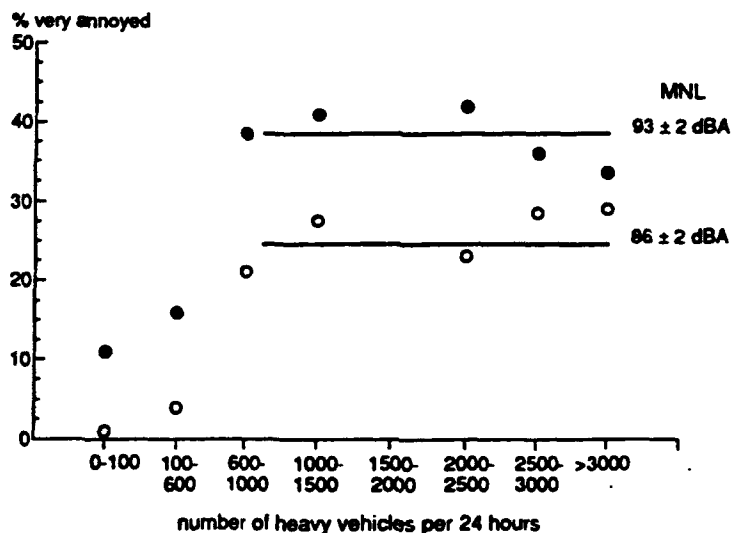

Figure 2: Dose-response relationship for road traffic noise

## GENA<sub>10</sub> - train noise

The background for GENA<sub>10</sub> train noise is the results of one study in which the number of trains and the MNL were studied separately (6) (Figure 3).

The material available for calculating GENA<sub>10</sub> for train noise is smaller than for aircraft and road traffic noise. An estimation from the figure suggests that the value is around 75 dBA MNL when the number of trains is above the breakpoint.

### Practical application

The new principle requires that the number of events and the exact way of measuring MBN are defined. Using the new principle, it is possible to set individual vehicle emission noise thresholds for the use of certain roads, flight paths or rail lines. It is also possible through measurements of individual vehicles to determine those which exceed the existing GENA.

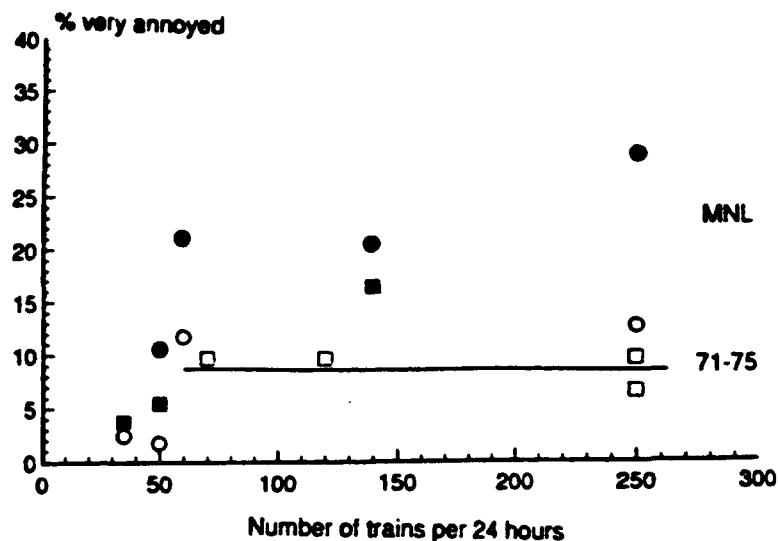

Figure 3: Dose-response relationship for train noise

**Acknowledgement.** This report and the research performed in the studies cited was supported by the Research Foundation at the Swedish National Environment Protection Board and the Swedish Transport Research Board.

### References

1. Rylander R, Björkman M, Åhrlin U, Sörensen S and Berglund K. Aircraft noise contours: Importance of overflight frequency and noise level. *J Sound Vib* 1980; 69:583-595.
2. Rylander R, Björkman M, Åhrlin U, Arntzen U and Solberg S. Dose-response relationships for traffic noise and annoyance. *Arch Env Health* 1986; 41:7-10.
3. Björkman M, Åhrlin U and Rylander R. Aircraft noise annoyance and average versus peak noise levels. *Arch Env Health* 1992; 47:326-329.
4. Björkman M. Community noise annoyance: Importance of noise levels and the number of noise events. *J Sound Vib* 1991; 151:497-503.
5. Rylander R, Sörensen S and Berglund K. Re-analysis of aircraft noise annoyance data against the dB(A) concept. *J Sound Vib* 1974; 36:399-406.
6. Sörensen S and Hammar N. Annoyance reactions due to railway noise. *J Sound Vib* 1983; 87:315-319.



# U.S. AIR FORCE RESEARCH PROGRAM ON THE EFFECTS OF AIRCRAFT NOISE ON HUMANS: CURRENT STATUS AND FUTURE DIRECTIONS

FINEGOLD, Lawrence S.  
USAF Armstrong Laboratory (AL/OEBN)  
Wright-Patterson Air Force Base, Ohio USA

## Abstract

This presentation summarizes the current status and future directions of the U.S. Air Force (USAF) research program to address the effects of environmental noise on humans. The separate research topics that are addressed include the following: community annoyance from USAF aircraft overflights along Military Training Routes (MTRs), a recent update of the 1978 Schultz community annoyance curve, sleep disturbance due to nighttime flight operations, possible non-auditory physiological effects of aircraft noise exposure, the effects of background noise on annoyance, and the development of a methodology to model the effects of combined noise sources. Both laboratory and field research projects are covered.

## Community Annoyance Research

The noise generated by aircraft flying along Military Training Routes (MTRs) is quite different from airbase noise exposure. MTR overflights occur sporadically and differ from the more regular and predictable noise associated with airbase operations. Low-altitude, high-speed MTR operations can generate noise events having rapid onset rates, high noise levels, short durations, and different spectral characteristics as compared to the noise from the same aircraft performing take-offs and landings. The high noise levels and rapid onset rates associated with observer locations directly under such flyovers can produce a startle-like response, which may further increase annoyance. The noise metric,  $L_{dnmr}$ , has been recommended to account for the higher human annoyance related to MTR operations (6, 9, 12).  $L_{dnmr}$  is an onset rate-adjusted, day-night average, A-weighted sound level and is based on the highest number of monthly operations in a year. Currently, a 5-dB penalty is applied to events with rapid onset rates, starting at 15 dB/s and reaching the maximum onset rate penalty at 30 dB/s.

Both laboratory and field research has been conducted to validate the application of the  $L_{dnmr}$  metric for aircraft noise exposure along MTRs. In-house laboratory research indicates that the maximum onset rate penalty should be about 12 dB. Recent USAF contract research has indicated that the maximum onset rate penalty should be about 10 dB, with the penalty starting at 30 dB/s and reaching the maximum penalty at 100 dB/s.

This research program was started in the laboratory environment and has progressed toward more realistic and natural settings. The current research project is being conducted in the subjects' own homes. Future research efforts are planned to investigate the effects of background noise and assess the effects of infrequent, sporadic overflight events, taking advantage of the capabilities of the Human Response Monitor (HRM), described later.

The original 1978 Schultz curve (11) for predicting community annoyance in response to general transportation noise has been updated, with the number of data points being nearly tripled (1, 2). The new community annoyance curve validated of the original work by Schultz, although various researchers have different preferences for the exact form of the new function. Another community annoyance research interest involves the evaluation of various noise metrics used for human effects prediction models. One approach being investigated involves using detectability metrics developed in research on human decision-making using the Theory of Signal Detection Theory (TSD) approach (3). Finally, in response to growing interest in the contribution of background noise levels to annoyance due to aircraft overflight noise, a research program is being developed to provide additional data on this topic. At the present time, an initial series of laboratory projects have been conducted and additional research is being planned.

#### Development of Human Response Monitor

As described elsewhere (5, 11), the Human Response Monitor (HRM) was developed to address human effects research issues that require the simultaneous collection of data on personal noise exposure and corresponding human responses to military aircraft overflight noise. Two research projects in which initial use of the HRM are being considered involve: (1) community annoyance due to overflights along MTRs and (2) sleep disturbance due to nighttime flight operations. The HRM is a miniaturized computer weighing less than 500 grams, with the capability of measuring noise exposure and administering an interview questionnaire. It can be carried by test subjects similar to a dosimeter. The user-system interface includes an LCD for display of interview questions and was designed to make the device easy to operate. The system design is based on high-speed, commercially available microprocessor technology and uses a Motorola 68332 microcontroller to handle the user-system interaction, data management, communication and other control tasks. A fully digital design was used, including a Motorola 96002 Digital Signal Processor (DSP) to perform the acoustic signal processing tasks. The HRM contains 1Mbyte of RAM and software to support complex signal processing and data storage. It will be able to collect noise exposure data using a variety of metrics for both single events and cumulative exposure, including A-Weighted and C-Weighted DNL, plus one-third octave band spectral data from 50Hz to 5KHz.

#### Sleep Disturbance Research

A field research project is currently being conducted to collect data to contribute to the development of a defensible dose-response relationship between nighttime aircraft noise exposure and sleep disturbance in overflown populations. This project builds upon the literature review by Pearsons et al. (9), the new sleep disturbance curve utilized in the 1992 report of the Federal Interagency Committee on Noise (FICON) (1) and the report of the major Civil Aviation Authority sleep disturbance study recently completed in

England (7). The USAF project involves collection of nighttime sleep disturbance data with a mix of military airbases and civilian airports, including information on both personal noise exposure and behavioral awakening, although the details of the research design have not yet been fully selected. At a minimum, a button-press response will be used to collect behavioral awakening data and indoor noise measurements will be made. This study is expected to be complete within one year.

### Health Effects Research

In the last few years, there has been continuing discussion concerning possible non-auditory health effects from military aircraft noise. In response to the need for defensible data on this topic, Phase I of a prospective epidemiologic field research project is nearing conclusion. Cardiovascular diseases, such as arrhythmias and hypertension, are the major dependent variables of interest. This project is being conducted as a tri-national cooperative effort and includes representatives from the United States, England and Canada. The Phase I effort will provide documentation of current military aircraft noise exposure in England, preliminary identification of sites in England for the main study and an initial evaluation of the feasibility of conducting the full prospective epidemiologic research study. This project builds upon an earlier literature review and methodological analysis of various research approaches available for addressing health effects by Thompson et al. (13). These authors concluded that: (1) no irrefutable evidence exists of aircraft noise exposure health effects and (2) the only scientifically defensible research approach is to conduct a long-term, prospective epidemiologic study.

### Development of Combined Noise Effects Model

As part of a long-term program to develop a computer-based environmental planning and decision support system for addressing noise issues in environmental impact analyses, including the effects of aircraft noise on humans, animals and structures, the Alpha Version of the Assessment System for Aircraft Noise (ASAN) was developed and tested in 1990 (4). Recently, the Beta Version of ASAN has been developed and is nearing completion of its field test (7). A future version will significantly expand the noise analysis capabilities of ASAN to include the combined noise effects from both subsonic and supersonic operations, and the combination of fixed- and rotary-wing aircraft with non-aircraft noise sources. The operations to be analyzed will also be expanded to include Air Force, Army and Navy flights. One of the potential applications is for modeling aircraft operations over land managed by the U.S. National Park Service and the U.S. Forest Service, such as in Alaska, where combined military operations play a more prominent role.

### References

1. Federal Interagency Committee on Noise (FICON) (1992). Federal Agency Review of Selected Airport Noise Analysis Issues. Fort Walton Beach, FL: Spectrum Sciences and Software, Inc.

2. S.A. Fidell, D.S. Barber and T.J. Schultz (1990). Updating a Dosage-Effect Relationship for the Prevalence of Annoyance Due to General Transportation Noise. *J. Acoust. Soc. Am.*, 89(1), 221-233.
3. S. Fidell, T. Schultz and D.M. Green (1988). A Theoretical Interpretation of the Prevalence Rate of Noise-Induced Annoyance in Residential Populations. *J. Acoust. Soc. Am.*, 84(6), 2109-2113.
4. L.S. Finegold, S.A. Fidell, N.H. Reddingius and B.A. Kugler (1990). NSBIT Program: Development of Assessment System for Aircraft Noise and Research on Human Impacts Due to Aircraft Noise. In *Proceedings of INTER-NOISE 90*, Gothenburg, Sweden, pp. 1115-1120.
5. L.S. Finegold and M.D. Sneddon (1993). Development of Prototype Human Response Monitor (HRM) for Use in Noise Effects Research. In *Proceedings of 6th International Congress on Noise as a Public Health Problem, NOISE & MAN 93*. Nice, France.
6. C.S. Harris (1990). Effects of Military Training Route Noise on Human Annoyance. In *Proceedings of NOISE-CON 90* (I.J. Busch-Vishniac, Ed.) New York: Noise Control Foundation, pp. 297-302.
7. B.A. Kugler, P.S. Sharp and L.S. Finegold (1993). Development and Test of Beta Version of Assessment System for Aircraft Noise (ASAN). In *Proceedings of NOISE-CON 93*, Williamsburg, VA (Accepted).
8. J.B. Ollerhead, C.J. Jones, J.A. Horne, et al. (1993). Report of a Field Study of Aircraft Noise and Sleep Disturbance. London: Department of Safety, Environment and Engineering, Civil Aviation Authority.
9. K.S. Pearsons, D.S. Barber and B.G. Tabachnick (1989). Analyses of the Predictability of Noise-Induced Sleep Disturbance (HSD-TR-89-029). Brooks Air Force Base, TX: USAF Armstrong Laboratory (AL/OEBN).
10. K.J. Plotkin, L.C. Sutherland and J.A. Molino (1987). Environmental Noise Assessment for Military Aircraft Training Routes. Vol. 2: Recommended Noise Metric (AAMRL-TR-87-001). Wright-Patterson Air Force Base, Ohio: USAF Armstrong Aerospace Medical Research Laboratory (AAMRL/BBE).
11. M.D. Sneddon and L.S. Finegold (1993). Environmental Noise Research Using the Human Response Monitor (HRM): Phase I - System Development. In *Proceedings of NOISE-CON 93*, Williamsburg, VA (Accepted).
12. E. Stusnick, K.J. Plotkin, K.A. Bradley and J.A. Molino (1993). The Effect of Onset Rate on Annoyance to Military Aircraft Noise. In *Proceedings of NOISE-CON 93*, Williamsburg, VA (Accepted).
13. S. Thompson, S. Fidell and B.G. Tabachnick (1989). Feasibility of Epidemiologic Research on Nonauditory Health Effects of Residential Aircraft Noise Exposure (HSD-TR-89-007). Brooks Air Force Base, Texas: USAF Armstrong Laboratory (AL/OEBN).



# RATING NOISE IN THE NEIGHBOURHOOD OF A SAWMILL BY PSYCHOACOUSTICS

KALIVODA Manfred T.

Federal Environmental Agency, Vienna, Austria

## Abstract

We know that in many cases the A-weighted sound pressure level  $SPL_A$  in general and the A-weighted equivalent level  $L_{A,eq}$  in particular are not convenient measures for rating industrial noise. Annoyance and sound quality are too complicated to be expressed by a simple parameter like the  $L_{A,eq}$  is. In a pilot study the Austrian Federal Environmental Agency has tried to find better - i.e. psychoacoustic - parameters to describe and rate noise annoyance in the neighbourhood of a sawmill.

Firstly noise was recorded on a digital audio tape by an artificial head for several hours trying to catch all noises, especially the most annoying activities. Afterwards these most annoying parts were edited and both the whole recordings and the most annoying parts were analysed. A digital measurement system based on signal processors is used for calculating psychoacoustical parameters such as Loudness and Sharpness and comparing them with  $SPL_A$  and  $L_{A,eq}$ .

The first results show that recording and editing noise helps to filter 'pure annoying periods' and that psychoacoustic methods can describe industrial noise better than A-weighted sound level.

## Situation

In the Twenties a small sawmill was founded near to the railways in a rural area. In time sawmill expanded and more and more residential properties were built in the neighbourhood. Now these dwellings are close to the works and people are annoyed by the noise.

As  $L_{A,eq}$  could not improve the situation and reduce complaints, the Austrian Federal Environmental Agency started a pilot study to find out better parameters to describe and estimate noise annoyance.

## Method

Noise from the sawmill was not analyzed at the location but recorded digitally using an artificial head. Binaural Signal-Processing (GENUIT [1]) was chosen for its great advantages in comparison with 'conventional' monaural recordings. Binaurally recorded noise is stored as realistically as possible and ~~can~~ the real sound situation can be reproduced and 're-heard' as required. Moreover, recorded noise can be electronically modified and this altered signal can be listened to.

The only disadvantage of this method is that SPL from binaurally recorded signals differs somewhat to SPL recorded with a level meter. This is due to the different transfer functions of the artificial head's outer ear and the level meter's microphone. Depending on the complexity of the

situation and the frequencies a difference of 1 to 2 dB is possible.

To be sure to catch all the most annoying activities around the sawmill, several hours recordings were made. In addition, background noise and traffic noise were also recorded.

In the laboratory samples of typical noise situations were chosen from the recordings and analysed in a manner corresponding to human hearing. That is, Loudness and Sharpness (ZWICKER [2]) were calculated on a 'Cortex Audio Workstation', a digital measurement system based on signal processors. Furthermore, third octave spectra, SPL<sub>A</sub> with time average 'fast' and 'impuls' and L<sub>A,eq</sub> were made to get the most comprehensive description of the (psycho)acoustical situation.

### Results

First of all Loudness and Sharpness analyses were made. The result was many charts containing greatly fluctuating values. The next step was to integrate these data and to calculate mean values of Loudness and Sharpness. But now the accuracy seemed to vanish. The spectral character of the samples could be seen clearly. On the other hand, mean Loudness reacted as slow as L<sub>A,eq</sub> did upon modifications of noise characteristic, while the impression of the improvement when hearing it was much better.

The ear is not an integrating but a differentiating organ and is able to detect time structures very well. Mean values do not take note of the reduction of few and short Loudness peaks while the ear does!

### Conclusions

It was not possible to find Loudness, Sharpness or any other psychoacoustic parameter as a 'miracle cure' for rating noise annoyance. The human ear is too selective to be acoustically modelled by one or several mean values. Especially time structure of noise cannot be expressed satisfactory by any time mean value. That is true of equivalent level as well as the psychoacoustic parameters.

Although we did not find a simple relationship between annoyance and (psycho)acoustic parameters for fluctuating noise, this does not mean that it was not worth while. In Austria physicians have to evaluate whether noise could be a health risk or annoying in many cases. The study showed that Loudness and Sharpness with their time functions value together with Binaural Signal-Processing yielded improved data for a medical noise valuation. Moreover, Binaural Signal-Processing appeared to be an excellent tool for ear-adequate noise reduction and sound engineering.

### References

- [1] GENUIT K.: Kunstkopf-Meßtechnik - Ein neues Verfahren zur Geräuschdiagnose und Analyse. Zeitschrift für Lärmbekämpfung 35, 1988, S.103-108.
- [2] ZWICKER E.: Psychoakustik. Springer Verlag, Berlin, Heidelberg, New York 1982.

# WINDTURBINE NOISE: A NEW ENVIRONMENTAL THREAT ?

WOLSINK, Maarten  
SPRENGERS, Maarten

Department of Environmental Science, University of Amsterdam  
Nieuwe Prinsengracht 130  
1018 VZ Amsterdam, The Netherlands

**Abstract:** The annoyance caused by wind turbine noise on locations in Denmark, the Netherlands and Germany was investigated. Residents around existing turbines were interviewed and emitted noise levels were computed based on site measurements. The number of people annoyed by wind turbine noise is small and the amount of annoyance is hardly related to the sound level. Nevertheless, residents around a windturbine site do not appreciate flexible use of noise standards.

## 1. Introduction.

One of the main factors in potential environmental impact of wind energy application is noise. Much technical research was carried out aimed at reduction of noise emissions from turbines. Still noise plays an important part in siting decisions, although nothing is known so far about the actual annoyance caused by wind turbine noise. Therefore the European Community financed a research project that was carried out on 16 locations in Denmark, the Netherlands and Germany, the leading wind power nations in Europe. The installed wind capacity in these countries has considerably increased in the last five years. Much of the new wind capacity comes from newly constructed wind farms. This has consequences as far as noise production is concerned. For a solitary turbine with a 95 dB(A) source level, the 40 dB(A) limit is approximately 160 metres away, while the limit increases to 520 metres if 16 of these same turbines are placed in a row.

The actual number of persons that can be annoyed by noise from operating turbines in Europe does still not exceed a few hundred. At the moment the major problem in noise annoyance research is the availability of operating turbines with people living close to them. Sixteen sites were selected with residents living within the 35 dB(A) region (table 1). Sound levels have been measured on sites, and sound level strata were calculated. The sound contour strata plots were combined with the actual distance between a subjects' house and the wind turbine location to obtain the objective sound level. Most of the subjects live in the region surrounded by the 35 dB(A) sound level, the criterion for site selection (table 2). Residents outside the 35 dB(A) region were included in the sample to create variance. Demographic variables as sex, age, etc. were evenly distributed.

## 2. Annoyance and noise as a cause.

For the appraisal of wind turbine noise three variables were constructed. In order to assess noise *annoyance* the respondents were first asked whether they had complaints about noise from various sources in the neighbourhood. Half of the complaints about noise annoyance were attributed to

Table 1: Sample by country

country	N of sites	N of respond.	% of total
Denmark	9	199	34.7
Netherlands	4	159	27.7
Germany	3	216	37.6
Total	16	574	100

Table 2: Sound levels at respondents home.

sound level	N of resp.	% of total
< 30 dB(A)	77	13.5
30-35 dB(A)	177	30.8
35-40 dB(A)	225	39.2
40-45 dB(A)	69	12.0
45-50 dB(A)	18	3.1
50-60 dB(A)	8	1.4
Total	574	100.0

noise from wind turbines. Nevertheless the total number of people indicating that they sometimes were annoyed, was only 6.4 % of the total sample.

A second instrument for measurement of appraisal was a semantic differential (3) referring to noise characteristics: loudness, duration, high-low, strong-weak, and intensity. With these five items an index of *perceived loudness* was constructed ( $\alpha = .84$ ). In general, the perceived loudness is very low with an average of 1.86 in a range of 1 to 5 ( $sd=1.00$ ). About one third of the subjects (35%) does not perceive any of the sound characteristics.

A third measurement of appraisal is *interference intensity*. It relates to various daily activities such as resting, leisuring, sleeping, talking, reading, thinking, listening to the radio, and watching television ( $\alpha = .93$ ). There were few people indicating interferences, as the average score on the resulting index is 1.40 ( $sd=2.47$ ) on a range of 1 to 5.

The noise that is complained about the most is the sound produced by the turbine blades (acoustical noise), followed by unspecified sounds during operation (probably the gearbox). Most of the annoyance is experienced between 16.00 pm and midnight and when people were outdoors.

The three indicators of annoyance show a reasonable correlation. Residents complaining about wind turbine noise also perceive more sound characteristics ( $\tau = .38$ ;  $p < .001$ ) and they reported more interferences of daily activities as well ( $\tau = .56$ ;  $p < .001$ ). From now on we will only refer to one construct indicating annoyance based on all three indexes.

There is only a very weak correlation between sound level and noise annoyance caused by wind turbines ( $\tau = .09$ ;  $p < .05$ ). Some situational factors were also examined, such as:

- \* the location of the residence relative to the turbines with regard to the dominant wind direction;
- \* other buildings between a subjects house and the wind turbine site;
- \* natural barriers, like trees etc., between a subjects house and the wind turbine site;

The result of this analysis is that the amount of noise annoyance is lower when buildings are standing between the respondents home and the wind turbine site. Furthermore none of these factors are related to annoyance. So we have to look at intervening variables.

### 3. Intervening variables.

We have tested the hypotheses which relate the level of annoyance with:

- \* the general attitude towards large scale use of wind power (index: 7);
- \* appraisal of the impact of turbines in the landscape (index: 7);
- \* perceived residential satisfaction, about housing and neighbourhood (index: 2);
- \* daily hassles from work, family etc. (index: 3);
- \* stress caused by wind turbine noise (index based on 4);
- \* the time the wind turbines were operational.

The appraisal of the scenic value of turbines in the landscape is included because it is the major factor determining wind power attitudes (5,7). Visual intrusion is the most important drawback of turbines as perceived by the public. Stress due to turbine noise was measured with an index based on states of mind, such as 'angry', 'nervous', 'irritated' and 'anxious' ( $\alpha = .93$ ). This is also a very skewed variable, because the extreme 'not at all irritated' etc. contained 88%-91% of the sample.

The analysis of annoyance causes major problems due to the very skewed distributions of the scores on the dependent and some of the independent variables. We carried out a multivariate analyses of the level of annoyance. It shows that stress due to noise of wind turbines is the major explanatory effect of the level of annoyance. Most of the subjects who tend to get stressed by the wind turbines have a high level of annoyance. In an equation with standardized effects (coefficients give an estimate of the relative weight; explained variance of 53%):

$$ANN = .69 SN + .11 DH + .10 LS - .06 TIME + -.58 + e$$

(ANN = annoyance; SN = stress due to noise; DH = daily hassles; LS = landscape; TIME = time of turbines are operational).

The visual impact of wind turbines on the landscape plays an intermediate role. Noise annoyance decreases the less intruding in the landscape wind turbines are judged. No additional effect of wind power attitudes exists. Daily hassles contributed significantly, but the effect is weak. Additional to the subjective characteristics there is still one effect. The longer turbines are operational, the lower the level of annoyance, even if we control for subjective characteristics.

The results presented here should be treated with caution. There are a number of methodological problems involved in a project in which subjects from different countries have been interviewed using translated questionnaires. The fact that only a very small number of residents around

operational wind turbines is annoyed by noise can be interpreted as a positive result. It means noise is not a major problem in the case of operational wind turbines. Nevertheless expectations about annoyance in the future caused by wind turbines that will be built, is a crucial factor in the planning phase of wind power projects (6).

#### 4. Siting wind turbines and flexible use of noise standards.

From attitude studies we know that the public does not think noise is a problem that is generally troubling the application wind power (5,7). Noise is considered to be a problem that can be prevented, but because of this fact wind power developers must be prudent. Noise will mostly be an issue when it comes to siting turbines and at that moment noise should be prevented. Research on noise annoyance indicates that the belief that the noise could be prevented increases the annoyance (1). The application of noise standards in a flexible way will probably not fit into an approach that convinces the public that noise prevention is taken seriously.

In attitudinal studies around three Dutch wind farms (6,7), respondents were asked to answer several questions regarding how noise standards should be applied. Although very few people are familiar with existing standards this does not mean that they do not have an opinion on noise standards. People are able to evaluate the authorities responsible for maintaining and checking standards, regardless of whether they can actually judge the risk themselves. Residents near wind farms have been asked whether noise standards should be relaxed for wind energy, whether "normal" standards should apply, or whether standards should in fact be stricter for wind turbines. In order to make a comparison, the same question was asked in relation to three other provisions: a highway through a residential area, a railway through a residential area, and a power station. The highway was included as a representative situation with which many respondents are familiar. The railway was used because standards above "normal" (60 dB(A) 24-hour value and 65 dB(A) near stations) already exist for railways. And the power station was added because it serves the same basic purpose: the production of electricity. In each instance, only a small minority turned out to be in favour of flexible use of standards, although the minority in the case of wind energy was the largest (table 1). This is caused by the positive attitude towards wind energy in general. Nevertheless, in spite of the fact that more than ninety per cent of the population has this positive attitude, only fifteen per cent of the interviewees wanted noise standards to be relaxed for wind turbines.

#### 5. The Herbaijum case.

One of the sites the noise annoyance research took place was the Herbaijum wind farm of ten 250 kW turbines, in the north of the Netherlands. At Herbaijum standards were indeed selectively applied. This happened before in that municipality for the benefit of the pilot project of the Dutch Electricity Generating Board (SEP). People involved in the Herbaijum project realized from the start that noise would be a problem. The shortest distance between the turbines and the village of Herbaijum was only 250 metres. In a letter to the municipality, the electricity company stated that a 50 dB(A) 24-hour noise level value was the best that could be achieved. This meant that the accepted standard would be exceeded by 10 dB(A). However, the municipality adopted the proposal. The community council decided in favour of construction of the wind farm even before the application for a Nuisance Act permit had been submitted. In this way, the council pronounced in advance that a 24-hour noise level value of 50 dB(A) was the proper standard and that the anticipation procedure could be used for the construction permit. The application for a Nuisance Act permit met with opposition at once and legal fight rose over the wind farm. The opponents appealed until the Council of State (highest Dutch appeal court).

Table 3. Judgments on flexible standards for noise (8).

standard may be	(N)	Herbaijum before siting (230)	Herbaijum after siting (146)	elsewhere after siting (348)
more flexible:				
near trunk road in town (%)		3	4	3
near railroad in town (%)		5	9	5
near wind farm (%)		15	18	14
near power plant (%)		4	8	5

In the Netherlands there are no specific standards for wind turbine noise. They must be derived from specifications for other installations (industrial noise). The crucial question in such cases is: what type of area is involved? Opponents of Herbaijum argue that the maximum 24-hour value should be determined on the basis of the fact that Herbaijum is situated in a rural area. For rural areas, the target value is 40 dB(A); for quiet residential areas with little traffic this value is 45 dB(A), and it is 50 dB(A) for residential neighbourhoods in the city. These values apply during the day-time, with a 5 dB(A) reduction in the evening and 10 dB(A) at night. The municipality was advised to regard Herbaijum, a village of less than 200 inhabitants, as a rural area (40 dB(A)). Instead they accepted the standard of 50 dB(A) only to open the way for the siting of the wind farm. In table 3 it becomes clear that the resident of Herbaijum do not appreciate this flexible use, although the attitudes towards wind power were also very positive there.

When noise standards are adjusted, this implicitly means that considerations leading to the choice of site carry more weight than noise pollution. These considerations are no longer considered during appeal proceedings, since sites are not then weighed against each other: a permit for only one site is under discussion. At Herbaijum, the chief selection criterion in the site study, the grid connection possibilities, outweighed noise. There were certainly better sites in the neighbourhood of Herbaijum at a greater distance from the village, but longer cables are more costly.

## 6. Conclusions.

Noise produced by wind turbines does not seem to be a major drawback of wind energy. If there is opposition for wind turbines, noise is used as an argument, but resistance stems rather from other considerations (6,7). Residents consider the noise problem to be easily soluble. This research on most of the wind farms in Europe that have residents at close distances, has shown that so far wind turbine noise should not be regarded as an environmental threat. The level of annoyance is low and hardly related to measured sound levels. The small amount of annoyance that exists is mainly due to other causes of negative feeling towards the wind turbines.

Although people living in the neighbourhood of wind turbines do not indicate that noise is a problem, this does not mean that the issue might be overlooked. People think noise from wind turbines can be reduced relatively easy, and they expect authorities to do so. Initiators need to approach the noise problem seriously, as they have to do with all objections to their plans. Almost everyone is convinced that the noise problem can be solved. The solution is to be found in careful selection of sites and adaptation of the layout of wind farms, not in adjusting noise standards. If the sites are carefully selected, taking the noise into account, there will probably not be much trouble afterwards because people are annoyed caused by noise.

## References:

1. Fields, J.M. (1992) *Effect of Personal and Situational Variables on Noise Annoyance: with special reference to implications for en route noise*. Nat. Technical Information Centre, Springfield VA.
2. de Jong, R.G. and S. Beurs (1978) *Luchtvaart en lawaai. Geluidhinder van de militaire vliegvelden*. TNO, Delft.
3. Kamp, I. van (1990) *Coping with noise and its health consequences*. Styx & PP Publications, Groningen, NL.
4. King, M.C., G.D. Burrows and A.V. Stanley (1983) Measurement of stress and arousal. Validation of the stress and arousal check-list. *Br. J. of Psych.* 74 (3) 285-279.
5. Wolsink, M. (1989) Attitudes and expectancies about turbines and wind farms. *Wind Eng.* 13 (4) pp.196-206.
6. Wolsink, M. (1990) The siting problem: wind power as a social dilemma. *ECWEC'90 Madrid*. pp.725-729. Stephens and Ass., Bedford, UK.
7. Wolsink, M. (1990) *Maatschappelijke acceptatie van windenergie. Houdingen en oordelen van de bevolking*. Thesis Publishers, Amsterdam.
8. Wolsink, M. (1991) The noise issue in siting decisions. in: *Wind Energy: Technology and Implementation. European Wind Energy Conference 1991 Vol.1*. Elsevier, Amsterdam p.747-751.

# THE EFFECTS OF LOW-LEVEL JET FIGHTER OVERFLIGHTS ON CARIBOU

HARRINGTON, Fred H.  
Mt. St. Vincent University  
Halifax, Nova Scotia B3M 2J6 Canada

**ABSTRACT** - The effects on caribou (*Rangifer tarandus*) of low-level jet fighter overflights from Canadian Forces Base-Goose Bay (Labrador) were investigated during the 1986-88 training seasons (April-October)(Harrington and Veitch, 1991, 1992). Visual observations of low-level (30 m agl) jet overpasses indicated an initial startle response but otherwise brief overt reaction by caribou on late-winter, alpine tundra habitat. In an experimental study, daily exposure to jet fighter overflights was manipulated for a sample of 10 caribou each year. The caribou were equipped with satellite-tracked radiocollars, which provided daily locations as well as indices of physical activity and movement. Half the animals were deliberately exposed to jet overflights; the other five caribou were avoided during training exercises and therefore served as controls. (In 1988, the control caribou were from a population that had never been overflown.) In 1986 and 1988, it was found that the level of an animal's exposure to low-level flying was not significantly related to its daily activity level or distance travelled. In 1987, when the highest exposure levels were achieved, caribou exposed more often to low-level overflights were significantly more active, suggesting a possible threshold effect. In a final phase of the study, the survival of calves of 15 satellite-collared females was monitored periodically during the low-level training season. It was found that the longevity of a female's calf was negatively correlated to the level of exposure she received during the early calving period. The results indicate that significant impacts of low-level jet fighter overflights can be minimized through a program of active and passive avoidance, based on a knowledge of the local population's calving chronology and movement patterns.

## INTRODUCTION

The continuation and expansion of military low-level flight training activities in northern Canada have increased concern regarding their impacts on caribou (*Rangifer tarandus*). Northwest of Goose Bay, Labrador, NATO forces stationed at Canadian Forces Base - Goose Bay initiated low-level jet fighter training in 1981. The number of flights by Alpha-jets, F-4, F-16 and Tornado aircraft has increased from approximately 1500 in 1981 to over 7000 by 1992. Within the training area, subsonic flights (typically 775-825km·h<sup>-1</sup>) within 30m agl (above ground level) are permitted.

The potential effects of this training can be conveniently divided into two classes: (1) short-term behavioural responses that indicate the energetic costs and the potential for injury resulting from individual overflights, and (2) long-term population responses that indicate the cumulative effects of overflights on population demographics and habitat use. The impacts of jet aircraft previously have only been assessed indirectly through the demographics and habitat use patterns of caribou frequently exposed to jet activity (Davis, *et al.*, 1985). The short-term effects of jet activity have not been systematically investigated.

The present study was designed to investigate both short-term and long-term effects of low-level jet-fighter training activity on caribou. Most of the data were obtained from the small (<750), sedentary Red Wine caribou population which inhabits the low-level training area year-round. Supplementary data were recorded from two other populations, the neighbouring Mealy Mountain population (<2,000), which is similar to the Red Wine population in most characteristics, and the much larger (>300,000), migratory George River caribou population.

Mealy Mountain caribou live outside the training area and are rarely if ever exposed to low-level jet activity, while George River caribou are exposed only during those periods when their migration brings them into the training area.

## Methods

**Short-term effects** were measured by watching the behavioural reactions of caribou to low-level overflights, and by determining the relationship between an animal's daily exposure to low-level flying activity and its daily movements and activity levels, as determined remotely by satellite telemetry. It was hypothesized that disturbance due to low-level flying would be reflected in increased activity levels and by greater daily distances travelled, as animals engaged in escape-related behaviours (running, walking) more frequently following overflights. We assessed **long-term effects** by determining the relationship between an animal's amount of exposure to low-level flying, measured daily, and its corresponding calf's survival, determined every 3-4 weeks. We hypothesized that frequent overflights during the calving and immediate post-calving periods would reduce calf survival.

**Short term effects** - Visual observations of caribou reactions to low-level jet overflights were conducted in late-winter (April/May) 1987 and 1988, when caribou inhabited open tundra habitat. We videotaped caribou responses to both jets, guided over the animals by radio from our location, and helicopters.

The relationships between level of exposure to overflights and activity or movements were studied through the use of satellite telemetry. In 1986 and 1987, prior to the initiation of the training season, 10 adult female Red Wine caribou were outfitted with satellite radiocollars, which permitted us to obtain daily location fixes as well as an index of total activity during the preceding 24-hrs. Half the tagged caribou were assigned to an **exposure group** and the rest to an **avoidance group** to serve as controls. Each morning prior to the day's training activity, the latest location fixes were obtained and relayed to the military coordinating centre as either target coordinates to be overflown as often as possible (exposure group) or avoided by at least 9.2 km (avoidance group). Following training missions, pilots reported the number and identity of each coordinate overflown, which became our measure of daily exposure to low-level flying. In 1988, the avoidance group was obtained from the Mealy Mountain population, to ensure that the effects of accidental or prior exposure to low-level overflights would not bias results for the control group. During 1988, we obtained flight tracks showing turning points for 83% of the missions flown, which we used to determine an animal's daily exposure to low-level training activity.

Multiple regression analysis was used to determine the relationships between the single independent variable (daily exposure to overflights) and the two dependent variables (total activity index and distance moved during the same 24-hr period). Other variables entered into the analysis included: three weather variables (isolated by factor analysis), season (pre-calving, calving, insect and fall), and presence/absence of calf.

**Long term effects** - Calf survival was periodically monitored during 1987 and 1988 in a sample of 15 females wearing satellite radiocollars. During 1987, each female's exposure to low-level overflights was experimentally manipulated on a daily basis. In 1988, daily exposure was determined by analyzing jet flight-tracks following the low-level flying season. Calf survival was monitored by survey flights every 3-4 weeks. A calf survival index was the number of survey periods (maximum = 4) that a cow was still accompanied by a calf. The low-level training season was divided into 7 biologically relevant periods, and Spearman correlations were computed between exposure to low-level overflights and the calf survival index for each period.



## RESULTS

**Short term effects: behavioural observations** - A total of 40 jet and 10 helicopter overflights of 9 groups of Red Wine caribou (size 4-33) were recorded during 1987 and 1988. High (300m agl) or wide (>75m) overflights resulted in detectable responses only 38% of the time (n=16), whereas direct overflights (30m agl and within 50m either side) resulted in overt responses significantly more often (88%; n=24; G-test,  $P<0.001$ ). Eleven of 21 direct overflights began with startle responses, in which caribou scrambled to their feet and/or bolted several body lengths away, coincident with the most intense sound of the jet's pass. Although caribou usually began to run after their initial response (22 of 27 overflights), they began slowing almost immediately. The median time from beginning to end of movement was 9s, with the last half of this period done at a slow walk. Caribou that were walking prior to the overflight reacted sooner and ran longer and farther than caribou that had been standing, feeding or lying. The one group overflown by both jets and helicopter responded sooner to the helicopter and ran significantly longer and farther.

Six series of a total of 13 F-16 jet overflights and one series of 5 helicopter overpasses of a group of several hundred George River caribou were observed in May 1988. Most caribou (70%; n=260; 13 overflights) reacted suddenly, scrambling to their feet and bolting forward as the jet passed. Although 90-95% then began to run, most began to slow shortly after the overpass, with 55% stopping within 5s. The median distance moved during a single overpass was 12-16m, ranging to a maximum of 50-68m for the second overpass in a series of two. Caribou within 50m of the jet's flight path moved twice as far as those more distant, and all caribou within 50m ran whereas 7% of caribou farther away from the flight track did not run. George River caribou ran sooner, faster and farther in response to helicopter overflights than to jet overflights.

**Short term effects: regression analysis** - Between 1986 and 1988, average daily exposure to jet overflights over the entire training season (April to October) for the female Red Wine caribou equipped with satellite radiocollars ranged from none to 4.5 overflights per day. Daily distance travelled by Red Wine caribou averaged over 3 km per day, and was significantly greater than the daily distances moved by the radiocollared Mealy Mountain females. However, daily distance travelled was not related to daily exposure to low-level training, but rather was weakly related to seasonal factors and the presence or absence of a calf. Daily activity level of the Red Wine caribou was significantly correlated to the distance the animal moved during the day and to factors related primarily to temperature (i.e., insect activity and consequent harassment). Together, these variables explained 20-32% of the variance in the daily activity index. In 1987, however, when we were able to expose the target caribou to the highest levels of low-level training activity, the daily activity index was significantly and positively correlated to daily exposure level. In addition, Mealy Mountain caribou in 1988 were significantly less active than Red Wine caribou the same year.

**Long term effects** - The survival of calves of 11 Red Wine and 4 Mealy Mountain female caribou was followed throughout the entire low-level training season. Calf survival was negatively correlated with exposure to low-level training activity for all 7 biological periods, and this relationship was significant ( $P<0.05$ ) during the calving and post-calving periods (23 May - 19 June) and during the two periods of insect harassment (4 July - 15 Sept.).

Five of the 15 females successfully brought their calves through the entire low-level training season. Two of these were Mealy Mountain caribou and thus were never exposed to low-level overflights. Of the three successful Red Wine females, one was never known to have been overflown, another experienced overflights only during the pre-calving period and again

briefly during the fall, and the last was exposed to overflights only during the calving period.

## DISCUSSION

Our observations indicate that caribou typically respond to low-level overflights of jet fighter aircraft by a short-lived but relatively intense startle reaction, apparently in response to the sudden and intense noise of the overpass. No cumulative effect of level of exposure to low-level flying activity could be demonstrated for movements, but there was an indication that exposure to frequent overflights might increase overall activity, and hence energy expenditure, to some degree.

Our most important finding was that the survival of a female's calf was negatively correlated to the level of her exposure to low-level training activity. The greatest negative impacts of low-level training activity would be expected during critical stages in the calves' development or during periods when other stressors are also acting. That this relationship was significant only during the calving and immediate post-calving periods, and again during the summer periods of insect harassment, when calves would be most sensitive to stress, indicates the biological validity of the relationship.

The most conservative conclusion from our study is that calf survival is affected by exposure to low-level training activity during the calving/post-calving period. Thus we recommend avoidance of calving areas during this month-long period, and further study of the potential link between calf survival and low-level flying.

## REFERENCES

- DAVIS, J.L., VALKENBURG, P. & BOERTJE, R.D. 1985. Disturbance and the Delta caribou herd. In: Martell, A.M. & Russell, D.E. (eds.) Proceedings First North American Caribou Workshop, Whitehorse, Yukon Territory, 1983. Canadian Wildlife Service Special Publication, Ottawa. Pp.2-6.
- HARRINGTON, F.H. & VEITCH, A.M. 1991. Short-term impacts of low-level jet fighter training on caribou in Labrador. *Arctic* 44(4), 318-327.
- HARRINGTON, F.H. & VEITCH, A.M. 1992. Calving success of woodland caribou exposed to low-level jet fighter overflights. *Arctic* 45(3), 213-218.

## ACKNOWLEDGEMENTS

This study was made possible largely through the dedicated assistance of Alasdair Veitch, who was in charge of the daily operation of the study, from capture of the collared animals through liaison with the various NATO commands operating out of Goose Bay, and Stu Luttich, who insured that all our logistical needs were met and provided our important link to the Labrador Wildlife Division. These individuals, our many field assistants, and the members of our steering committee, contributed to both the design of the study and its implementation.

A debt of gratitude is also due Major Dave Ghyselinks and his staff at the Military Coordinating Centre, CFB-Goose Bay, Tony Downs and the DND staff in Ottawa, and the officers, squadron leaders and operations personnel of the German Air Force, Royal Air Force and Royal Netherlands Air Force who insured our target animals were overflown and our controls were avoided. Staff at Telonics (Mesa, Arizona) and Service Argos (Toulouse, France; Landover, Maryland) kept our satellite collars working and insured the data arrived in timely fashion.

Funding was provided by the Newfoundland-Labrador Wildlife Division, the Department of National Defence, the Natural Sciences and Engineering Research Council (Canada) and Mount St. Vincent University.

**Case Study Highlights Potential Compatibility of Low-altitude Aircraft Operations  
with Important Wildlife Resources**

Douglas N. Gladwin and Alexie M. McKechnie  
Sterna Fuscata, Inc., Fort Collins, CO. U.S.A.

**Introduction: The Endangered Species Act**

The historic decline of many animal species in North America has been attributed to human disturbance and alteration of natural habitat (U.S. Fish and Wildlife Service, 1990). In 1973, recognition of this problem prompted The U. S. Congress to legislate The Endangered Species Act (The Act), which authorizes federal and state agencies to protect both plant and animal species from the threat of extinction. The U. S. Fish and Wildlife Service (USFWS) monitors plant and animal populations and may list any species as "threatened" or "endangered", depending on how high the risk of extinction of such species is. Under provisions of The Act, both categories protect species and require active measures for the reversal of population declines.

Section 7 of The Endangered Species Act requires federal agencies to insure that any action authorized, funded or carried out by them is not likely to jeopardize the continued existence of listed species or modify their critical habitat (USFWS, 1988). Since human-generated noise has the potential to disturb animals, federally-funded projects that necessarily or incidentally generate noise must address provisions of The Act if threatened or endangered species are found in the areas targeted for use.

Section 7 of The Act also requires agencies to prepare a biological assessment if the USFWS has advised that an endangered or threatened species is present in the area targeted for development. A biological assessment describes predicted impacts by the proposed activity to the species of concern. It results from a careful analysis of the proposed activity and how it might influence breeding, feeding, and other behavior of animals. It should describe impacts on animals at both individual and population levels. The assessment should consider physiological and behavioral effects of the proposed action and the consequences of those effects with respect to demographics of the species. Predictions of impacts can be made with variable degrees of certainty, depending on both the proposed action and the species in question.

The biological assessment is reviewed by the USFWS to determine whether the project could jeopardize the continued existence of any endangered or threatened species or result in the destruction or adverse modification of their habitat. The USFWS will draw one of several conclusions and issue a statement accordingly. It may be decided that the potential impacts are either nonexistent or so minimal that the species in the area will not be affected. Or the USFWS may determine that impacts will occur, but to so few individuals that population numbers will not be affected. If the USFWS decides that the viability of a species will be jeopardized, it will propose "reasonable and prudent" alternatives to the proposed action, designed to minimize predicted impacts. An authorization for continuation of the proposed project will be given, contingent upon the development agencies' efforts to honor the USFWS requests. The USFWS has the authority to revoke the permit for the project at any time if

it appears that the agency's activities are not in compliance with The Endangered Species Act.

#### Noise and The Endangered Species Act: A Case Study

In 1990 The Wisconsin Department of Transportation (WDOT), Bureau of Aeronautics, was required to comply with The Endangered Species Act before beginning construction of a general aviation airport in a rural area of Wisconsin. A pair of bald eagles historically nested in one of three trees 615 m from the end of one proposed runway. The nest trees are on private land adjacent to land designated for purchase and development by the WDOT. Bald eagles are listed as a threatened species in Wisconsin, though eagle populations have been increasing steadily in this state since passage of The Endangered Species Act (Gieck, 1989).

The USFWS requested that a biological assessment be prepared at the expense of the WDOT, which contracted Sterna Fuscata, Inc. for the project. Our company includes three wildlife biologists. We also sub-contracted an expert on bald eagles and disturbance, Dr. Mark Stalmaster, to advise us.

We had two objectives for the assessment: to predict as accurately as possible what impacts were likely to occur to the breeding eagle pair, and to recommend alternative actions to either decrease or mitigate disturbance. The primary concern of the USFWS was to assure that building an airport in the area would not compromise its value as breeding habitat for bald eagles. Disturbing the bald eagle pair during the breeding season could lower bald eagle productivity in the area by reducing the pair's breeding success or by causing them to abandon the nest site.

We addressed potential impacts of several components of airport activity, including noise generated by aircraft. Under the proposed runway plan, aircraft would pass directly over the eagle nest during takeoff and landing. Predicting aircraft overflight impacts posed several challenges. First, a survey of reported aircraft overflights of bald eagles suggests eagles are highly individual in their responses to aircraft stimuli. Second, it is unclear what components-visual, auditory or both- of any human-generated stimuli cause disturbance. Third, no studies of aircraft disturbance to bald eagles were directly comparable to the events proposed in Wisconsin.

Reactions to helicopters and small jets by bald eagles residing near an international airport were documented as minimal (Fleischner and Weisberg, 1986), ranging from a mere turning of the head to flying up momentarily from a perch. The majority of the planes serviced by the proposed airport, however, will be small single and twin-engine planes, which were not tested in that study. Also, while that study documented direct behavioral responses, indirect and physiological responses are still unknown. Various publications of biologists using small single- and twin- engine planes to census bald eagle nests described no eagle responses that should hinder nesting (Sprunt et al. 1973, Harper 1974, Swenson 1975, Fraser 1983). We were cautious in applying this information to this situation because it is not known how the frequency of overflights influence eagle reactions. Biologists generally flew over nests about once per week. The question is: how do eagles react to daily, even hourly, overflights?

Therefore, while our collective experience suggested that eagles would probably remain and breed successfully in the area, we could not refute the possibility that they would do otherwise. We recommended that the WDOT hire a raptor biologist to monitor the eagle pair for any behavioral or physiological responses to aircraft activities when the airport is completed. Monitoring the

pair prior to airport construction will provide baseline data on behavioral traits, which can be used for comparison with behavioral data once overflights have begun. Changes in rates of feeding, perching, or incubating could indicate disturbance. Flying up in alarm from the nest might knock eggs out, though to our knowledge this has not been reported for bald eagles. Remaining out of the nest, and thus leaving the eggs unattended could increase the risk of egg predation or of temperature changes (either hot or cold) that threaten the embryo. We advised that such responses to overflights could place eggs or young at risk. We cautioned that physiological responses, which are much more difficult to detect, might also influence breeding. We supported the USFWS guidelines that suggest that fixed-wing aircraft avoid flying less than 150 m above ground level (AGL) over eagle habitat during the breeding season, which lasts from mid-March through July. Avoidance was also recommended during winters when eagles resided in the area, if they appeared disturbed by aircraft. If the pair is disturbed by aircraft overflights, an alternative flight plan should be available. We designed a noise abatement procedure that can be used by pilots to avoid flying directly over the nest. Noise abatement procedures are commonly used and are easy to follow. We recommended a 45-degree turn to the right off of the runway nearest the nest, as soon as the departing aircraft attains an altitude of 120 m AGL. The original plan was for aircraft to depart directly over the nest tree. The procedure directs the plane as far away as possible from the eagle pair's nesting site without sacrificing aircraft safety. Using this pattern will prevent high-performance planes from approaching closer than 850 m to the eagle nest and low-performance aircraft, 300 m.

Landings on this runway will bring arriving aircraft within approximately 300 m of the eagle nest. Aircraft will usually be in a "power off" flight condition during this approach leg. However, we reasoned that noise disturbance will probably be minor. Landings on the crosswind runway (perpendicular to the runway leading near the nest) will bring aircraft within approximately 300 m from the nest at an elevation of 300 m AGL.

Protection and enhancement of the habitat for eagles was recommended as mitigation for development of the area. Identification of all components of the habitat used by the pair, including nest, perch and roosting trees, was recommended along with restriction of human activity within 100 m of these features. We suggested keeping existing trees in place to act as a buffer against visual and auditory stimuli generated by airport activities. We also encouraged protection of the eagle habitat by fee title purchase, conservation easements, or landowner agreement.

The USFWS issued a Biological Opinion, based on the assessment, that the airport project is not likely to jeopardize the continued existence of the bald eagle or result in the adverse modification of critical habitat. However, this statement was coupled with a concern that some of the airport activities in the project area may adversely affect the birds by disturbing their use of the area which could result in abandonment of their current territory. The Biological Opinion also noted that the potential exists for runway collisions between aircraft and eagles. Therefore, an "incidental take" statement was issued, meaning the WDOT is allowed to harm a small number (one eagle, in this case) of individual animals if it is incidental to an otherwise legal action. The WDOT was obligated to implement a conservation plan as mitigation. The conservation plan describes what steps the agency will take to minimize and mitigate impacts. The USFWS reviewed the plan to confirm that the "taking" will indeed be incidental and that the agency is sincere in its plans to minimize and mitigate

effects. The USFWS will authorize this kind of taking only when it will not reduce the likelihood of survival and recovery of the species. The WDOT was authorized to begin construction of the airport as long as the conservation plan is carried out.

We are hoping that careful monitoring of the eagles and their responses to various airport-related stimuli will help further our overall understanding of overflight impacts on raptors, especially on productivity. It is unknown which of the repertoire of behavioral responses to noise indicate disturbance. It is also unknown how disturbance levels are correlated with nesting failure. Monitoring the bald eagle pair both before and after airport activities begin will answer these questions; unfortunately there is a mere sample size of one. We encourage other consulting agencies and the scientific community to share their experiences with this subject so that future planners will enjoy a better predictive capability about the impacts of noise and other stimuli on wildlife.

#### References

- Fleischner, T.L., and S. Weisberg. 1986. Effects of jet aircraft activity on bald eagles in the vicinity of Bellingham International Airport. Unpubl. Report. DEVCO Aviation Consultants, Bellingham, WA. 12pp.
- Fraser, J. D., L. D. Frenzel, and J. E. Mathisen. 1985. The impact of human activities on breeding bald eagles in north-central Minnesota. *J. Wildlife Management* 49:585-592.
- Gieck, C.M. 1989. Wisconsin Bald Eagle Recovery Plan. *Passenger Pigeon* 51:335-340.
- Harper, J. F. 1974. Activities of fledging bald eagles in north-central Minnesota. M.S. thesis, Western Illinois Univ.
- Sprunt, A., IV, W. B. Robertson, S. Postupalsky, R. J. Hensel, C. E. Knoder, and F. J. Ligas. 1973. Comparative productivity of six bald eagle populations. *Trans. 28th North Amer. Wildlife and Natural Resources Conference*. 38:96-106.
- Swenson, J. W. 1975. Ecology of the bald eagle and osprey in Yellowstone National Park. M. S. thesis. Montana State Univ.
- U.S. Fish and Wildlife Service. 1988. Endangered Species Act of 1973 As Amended through the 100th Congress. U.S. Fish and Wildlife Service, Washington, D.C. 45 pp.
- U.S. Fish and Wildlife Service. 1990. Report to Congress: Endangered and Threatened Species Recovery Program. U.S. Fish and Wildlife Service, Washington, D.C. 406 pp.

# THE EFFECTS ON WATERBIRDS OF INCREASED NOISE FROM THE EXPANSION OF A GAS COMPRESSOR PLANT AT PRUDHOE BAY, ALASKA, USA

ANDERSON, Betty A.<sup>1</sup>, MURPHY, Stephen M.<sup>1\*</sup>, KUGLER, B. Andrew<sup>2</sup>,  
BARBER, David, S.<sup>2</sup>, and JOYCE, Michael R.<sup>3</sup>

\*Speaking Author

<sup>1</sup>Alaska Biological Research, Inc., P.O. Box 81934, Fairbanks, AK 99708 USA

<sup>2</sup>BBN Systems and Technologies, 21120 Vanowen St., Canoga Park, CA 91303 USA

<sup>3</sup>ARCO Alaska, Inc., P.O. Box 100360, Anchorage, AK 99510 USA

## ABSTRACT:

From 1989 to 1991, we studied the effects on waterbirds of an incremental increase in noise from the addition of two large gas-turbine compressors to an existing oilfield facility (the Central Compressor Plant) at Prudhoe Bay, Alaska, USA. Two species of loons, four species of geese, Tundra Swans (*Cygnus columbianus*), and ten species of ducks used the study area. The primary focus of the study was to evaluate the effects of noise on nesting Canada Geese (*Branta canadensis*) and brood-rearing Brant (*Branta bernicla*). We monitored waterbird populations and noise levels during pre-construction (1989), construction (1990), and operation (1991) in an 8.2 km<sup>2</sup> study area surrounding the site of the new compressors. We used acoustic data from all three years to develop an interactive computer model of the noise environment. Analysis of the one-third band octave frequencies indicated that the new compressors contributed most significantly at low frequencies (31.5 Hz and 63 Hz bands). Long-term average noise levels (measured in hourly Leq) collected at a monitoring site near the facility increased significantly from 52.2 dB (A scale) before construction to 54.9 dBA after addition of the new compressors. We used the computer model to predict the noise level at waterbird nests and flock locations and to produce noise contours around the facility. Noise contour analysis revealed that wind direction affected changes in noise levels in the immediate vicinity of the facility more than did the addition of the new compressors. Noise from the new compressors did not appear to affect the locations of waterbird nests or nesting success. Spring weather conditions had a greater effect on both the number and success of nesting birds than did increased noise. Shifts in the distribution of Canada Goose flocks during pre-nesting indicated avoidance of the immediate vicinity (within 500-750 m) of the facility in 1991, the first operational year of the GHX-1 compressors. Although estimated noise levels in brood-rearing habitats used by Brant were significantly higher in 1991 than in 1989-1990, we did not detect any significant changes in use of those areas. Only one other species, Spectacled Eider (*Somateria fischeri*), displayed a shift in distribution that could be attributed to avoidance of areas of increased noise. For other species, we found few changes in abundance and distribution that could be attributed to increased noise from the compressors.

## INTRODUCTION:

The Gas Handling Expansion (GHX) Project in the Prudhoe Bay Oilfield was designed to maintain efficient oil production by increasing gas processing and reinjection capability. The first phase (GHX-1) of the project resulted in the installation of two gas-turbine compressors adjacent to the existing 13 compressors at the Central Compressor Plant (CCP) located on the southwestern shore of Prudhoe Bay (Figure 1). The goal of this study was to evaluate the effects of this incremental increase in noise on waterbird populations in the vicinity, particularly nesting Canada Geese and brood-rearing Brant that annually use the area. The monitoring program was initiated in 1989 to acquire baseline information before construction of the new compressors. We also collected data during construction (1990) and during the first operational year (1991). The

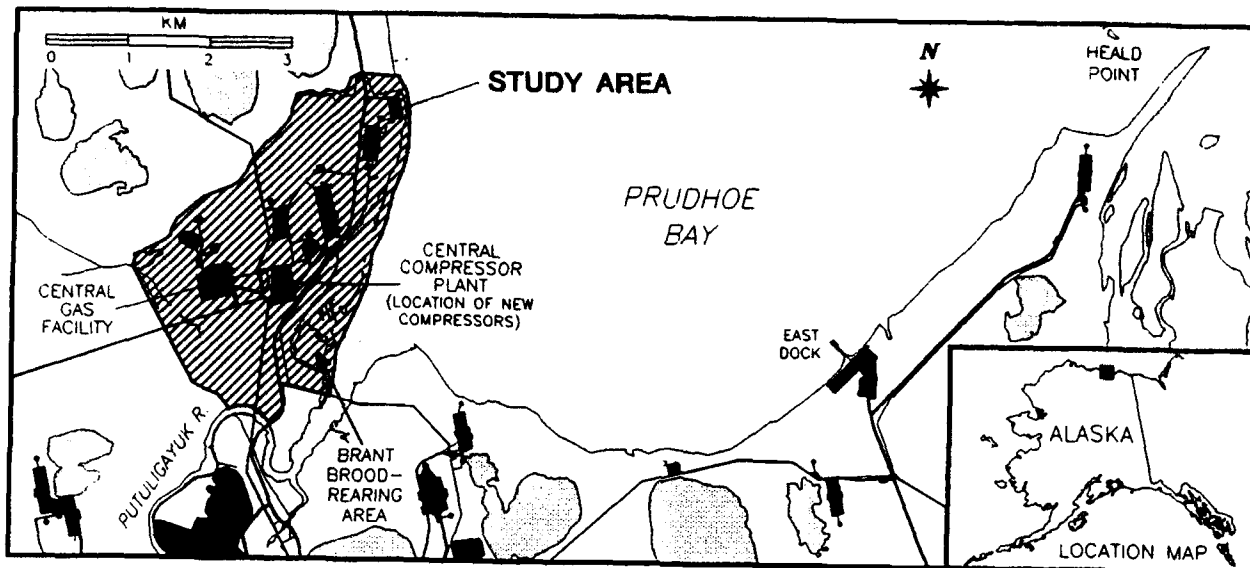

Figure 1. Location of the study area and important oilfield facilities at Prudhoe Bay, Alaska, USA.

specific objectives of the field program were to record the seasonal abundance, distribution, and habitat use of waterbirds during May-September; monitor the existing noise environment by measuring the sound pressure levels of steady-state sources of noise (e.g., facilities) and varying or intermittent sources (e.g., flaring); record weather information and measure noise propagation characteristics in the area to evaluate the local factors affecting noise attenuation; and evaluate the effects of noise on the seasonal abundance, distribution, habitat use, and nesting success of waterbirds.

The GHX-1 study area comprises 8.2 km<sup>2</sup> of land located along the southwestern shore of Prudhoe Bay (Figure 1). The study area is coastal tundra typical of the central Arctic Coastal Plain with a variety of lakes, ponds, and both salt-affected and freshwater wetlands (Bergman et al. 1977). Oilfield facilities in the study area include gravel roads, pipelines, and extensive gravel pads that support drill sites and large industrial plants.

#### METHODS:

Each year, we collected source and propagation acoustic data along transects radiating from the CCP and Central Gas Facility (CGF) by measuring both major continuous sources (plant equipment) and time-varying sources (e.g., gas-flare noise). We measured sound as Equivalent Sound Level ( $L_{eq}$ ; dB, A-scale) using a Larson-Davis Model 870 sound meter, and we also recorded sound with a Nagra SJ-IV tape recorder. We installed a stationary noise monitor on the mainland shore near the brood-rearing habitats used by Brant to directly assess changes in noise in that area. After analysis of field data, we developed an "acoustic prediction model" to predict the noise environment at any point near the CCP/GHX-1 and CGF facilities, and to construct noise contours around each facility.

We monitored the abundance, distribution, and habitat use of waterbirds in the study area primarily by road surveys during the pre-nesting, nesting, brood-rearing, and fall-staging seasons. We also conducted two foot surveys each year during the early nesting season to locate waterbird nests. During foot surveys, three observers walked the perimeters of all lakes, ponds, and wetland complexes, providing nearly complete coverage of nesting areas adjacent to aquatic habitats. All nests located were later revisited to determine nest fate. After each field season, we digitized locations of all flocks and nests and incorporated these data into a GIS system



compatible with the acoustic prediction model.

## RESULTS & DISCUSSION:

Analysis of acoustic data revealed that the GHX-1 compressors contributed mostly at the lower frequency ranges (31.5 Hz and 63 Hz) and, due to the specific location of the new compressors (at the northeast edge of CCP), noise generated by the facility was highly directional (over a range of 30° to 15° on each side of the northwest direction; Figure 2). Noise levels (hourly  $L_{eq}$ ) at the stationary noise monitor were significantly higher in 1991 than in 1989 (54.9 dBA and 52.2 dBA, respectively; Mann Whitney test,  $P < 0.05$ ). In addition to the noise from the CCP/GHX-1 facility, gravel-hauling traffic on the adjacent road, located approximately 250 m west of the microphone, contributed to the higher noise levels recorded in 1991.

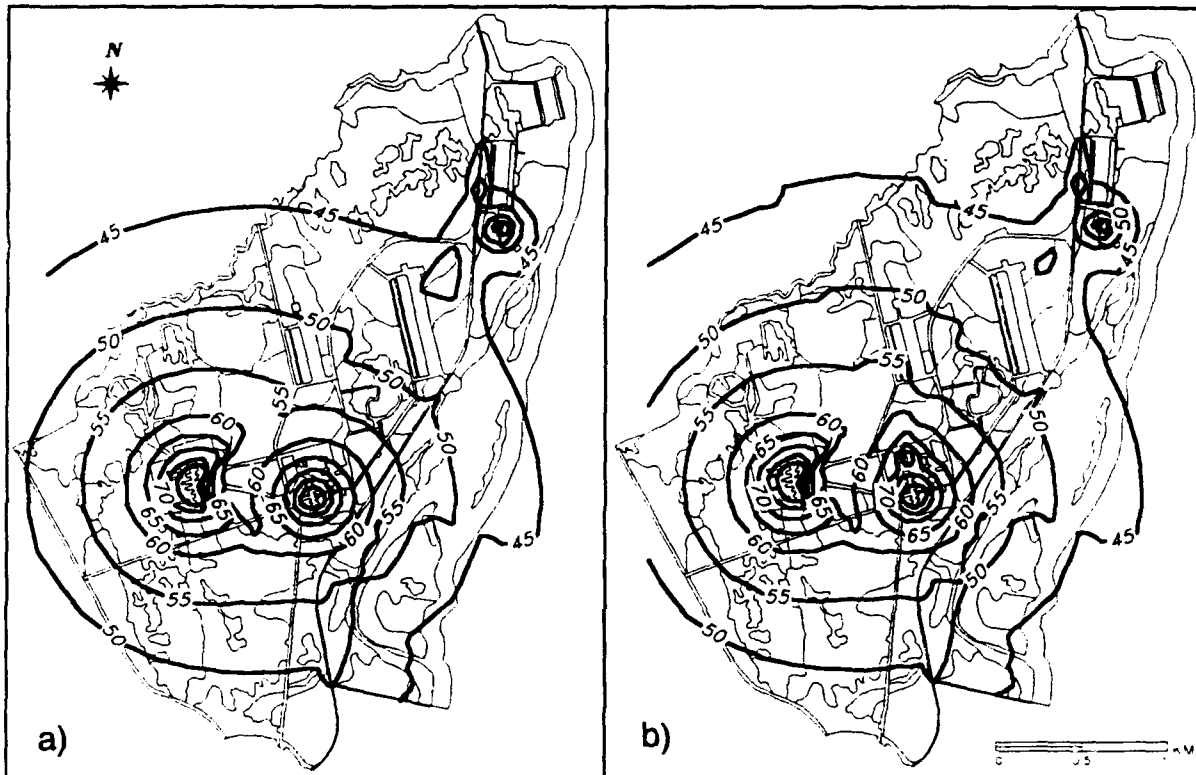

Figure 2. Estimated noise contours (5 dBA) around the Central Compressor Plant and Central Gas Facility, Prudhoe Bay, Alaska, USA, before construction (a) and during operation (b) of the GHX-1 compressors. Weather conditions modeled were no wind, air temperature of 4 °C (39 °F), and 80% relative humidity.

We recorded 17 species of waterbirds in the study area during the three years of this study: two species of loons (Pacific Loon [*Gavia pacifica*] and Red-throated Loon [*G. stellata*]); Tundra Swan; four species of geese (Snow Goose [*Chen caerulescens*], Brant, Canada Goose, Greater White-fronted Goose [*Anser albifrons*]); and ten species of ducks (Green-winged Teal [*Anas crecca*], Mallard [*A. platyrhynchos*], Northern Pintail [*A. acuta*], Northern Shoveler [*A. clypeata*], Eurasian Wigeon [*A. penelope*], American Wigeon [*A. americana*], King Eider [*Somateria spectabilis*], Spectacled Eider [*S. fischeri*], Oldsquaw [*Clangula hyemalis*], Red-breasted Merganser [*Mergus serrator*]). We saw six duck species (Red-breasted Merganser, Mallard, Green-winged Teal, American and Eurasian wigeons and Northern Shoveler) on <25% of all surveys for the three years. Because of the limited length of this paper, we will focus the discussion on the two main species of interest (Canada Geese and Brant) and only discuss other species if changes in distribution and abundance were significantly affected by increased noise from the new compressors. Complete results are provided in Anderson et al. (1992).

Canada Geese did not differ in abundance among years except during pre-nesting when we saw significantly fewer geese in 1990 than in either 1989 or 1991. During pre-nesting, geese are attracted to snow-free habitats created by dust from gravel roads and pads, but the warm spring conditions in 1990 increased the availability of snow-free habitats away from roads and facilities and thus allowed early dispersal of geese to nesting areas. Shifts in the distribution of Canada Geese attributable to avoidance of increased noise in 1991 were apparent only during pre-nesting, when flocks were located significantly farther from CCP (the site of GHX-1) in 1991 than in 1989 (1070 m [145 flocks] and 1622 m [98 flocks], respectively; Kruskal-Wallis pairwise comparison,  $P < 0.05$ ). The mean estimated noise level at the locations of these pre-nesting flocks also was significantly lower in 1991 than in 1989 (48 dBA and 52 dBA, respectively; Kruskal-Wallis pairwise comparison,  $P < 0.05$ ), indicating that the change in distribution could have resulted from avoidance of noisier areas near the facility.

Canada Geese had their highest nesting success in 1990 when 10 of 11 (91%) nests were successful. Nesting success was low (17%, 1 of 6 nests) in 1989 and intermediate (46%, 5 of 11 nests) in 1991. The distance of nest sites from CCP/GHX-1 did not differ significantly among years and the mean estimated noise levels at the nest sites also did not differ significantly among years, or between nest fates (Kruskal-Wallis tests,  $P < 0.05$ ). These results indicate that the location of Canada Goose nests and their ultimate fate (successful or failed) were not affected by noise generated by the oilfield facilities and that other factors, such as spring weather conditions or predation, influenced nesting success more strongly than did oilfield disturbance.

The other main species of concern, Brant, used the study area primarily during the brood-rearing and early fall-staging seasons; they did not nest in the area. Brant were the most common brood-rearing goose in the study area and several hundred adults and young occupied the coastal island at the mouth of the Putuligayuk River (Figure 1) from late June through August each year. Although we recorded significant annual changes in the abundance of Brant adults and young during brood-rearing, these changes were due to greater productivity in 1990 compared with 1989 and 1991, and not to any avoidance of the area because of noise from CCP/GHX-1 compressors. Although brood-rearing Brant using the coastal island southeast of CCP experienced significantly higher noise levels in 1991 than in previous years, they did not shift their use of the island to the southeastern end or increase their use of the mainland to the south, the quietest habitats available.

Only one other waterbird species, the Spectacled Eider, displayed a shift in distribution that might be attributable to avoidance of noise from CCP/GHX-1. During nesting, we saw Spectacled Eiders farther from CCP/GHX-1 in 1991 ( $\bar{x} = 1845$  m,  $n = 6$  flocks) than in 1989 ( $\bar{x} = 1246$ ,  $n = 7$ ). The mean estimated noise levels at the flock locations also differed significantly between 1989 ( $\bar{x} = 47$  dBA) and 1991 ( $\bar{x} = 42$  dBA). All observations of Spectacled Eiders during nesting were of non-breeding adults.

In conclusion, it appears that most waterbirds were habituated to the steady noise emanating from both the CCP and CGF facilities prior to the installation of the GHX compressors and that any adjustments that they may have made in reaction to noise from GHX was undetectable. Thus, noise from the GHX-1 compressors contributed little to the total noise environment and had little effect on use of the study area by most waterbirds.

#### LITERATURE CITED:

- Anderson, B.A., S.M. Murphy, M.T. Jorgenson, D.S. Barber, and B.A. Kugler. 1992. GHX-1 Waterbird and noise monitoring program. Final rep., prepared for ARCO Alaska, Inc., Anchorage, by Alaska Biological Research, Inc., Fairbanks. 132 pp.
- Bergman, R.D., R.L. Howard, K.F. Abraham, and M.W. Weller. 1977. Water birds and their wetland resources in relation to oil development at Storkersen Point, Alaska. U.S. Fish and Wildl. Serv., Resour. Publ. 129:1-38.

# BASELINE ABRs IN MOUNTAIN SHEEP AND DESERT MULE DEER

DeYOUNG,DW; Krausman,PR; Weiland,LE; Etchberger,RC

University of Arizona  
Tucson, Arizona 85724  
USA

## Abstract

The purpose of this study was to develop baseline data reflecting mid-to-high-frequency hearing sensitivity of young adult desert mule deer (*Odocoileus hemionus crooki*) and mountain sheep (*Ovis canadensis*). Baseline auditory brainstem responses (ABRs) were recorded from 4 desert mule deer and 5 mountain sheep. Click stimuli and tonebursts were used to elicit ABRs. Animals were sedated and transported from the Wildlife Research Center to the University Health Sciences Center, and lightly anesthetized with halothane during data collection. Thresholds for the various stimuli were determined. Thresholds were best for the click stimulus. The click-evoked wave IV-V complex was reliably present down to 45dB peak equivalent (pe) SPL in sheep and 55dB peSPL in deer. Mean latency-intensity functions and the 95% and 99% confidence intervals were calculated and plotted. The mean slopes of the latency-intensity functions were 20  $\mu$ s/dB and 32  $\mu$ s/dB for the sheep and deer, respectively. These are important in understanding the auditory sensitivity of these animals and may serve as a guideline for investigators examining the effects of noise on the mid-to high frequency hearing sensitivity of these animals.

## INTRODUCTION

Baseline click ABR hearing thresholds were determined for 4 desert mule deer and 5 mountain sheep. Estimated ABR thresholds and latency intensity functions have not been established for these animals. However these data are needed to better understand the sensitivity of these species.

## MATERIAL AND METHODS

This study was conducted following established animal research guidelines.<sup>1,2</sup> All deer and 3 sheep were used in a previous study.<sup>3</sup> Animals were restrained by injection with ketamine hydrochloride (HCL) and xylazine HCL. Animals were then blindfolded, hobbled, and transported to the Arizona Health Sciences Center and anesthetized to a light phase of anesthesia with halothane followed by endotracheal intubation. Body temperatures were monitored during the test session. ABRs were recorded using a Nicolet Spirit™ Portable EP System. Acoustic stimuli were rarefaction clicks (100  $\mu$ s in duration) presented monaurally through insert earphones (that introduce a latency delay of 0.9 ms) at the rate of 21.4/second. Clicks were initially presented at 105dB pe SPL and decreased in 10dB steps until threshold (lowest intensity level at which one of the ABR components was reliably observed) was reached. At least 5 points were obtained to determine latency-intensity functions for the IV-V complex of the ABR. Other stimuli included 4000 Hz, and 1000 Hz tonebursts with a two cycle rise/fall time and a one cycle plateau.

Otoscopic examinations were performed on all ears and ipsilateral ABRs were recorded using subdermal electrodes. A conventional electrode array was used<sup>4</sup> and electrodes placed rostral to the braincase and at each mastoid. The mean latency-intensity functions and their slopes ( $Y=mX$

+ b) were calculated for the click-evoked ABR. Following data collection, animals were blindfolded, hobbled, and transported to their pens where they were injected with yohimbine HCL and doxapram HCL for arousal.

## RESULTS AND DISCUSSION

Body temperature and anesthetics can influence the ABR.<sup>5</sup> However body temperatures were nearly constant and were in the normal range. Little is known about the effects of xylazine on the ABR, although, the other anesthetics and dosages used in this study are known to have minimal effects.<sup>6</sup>

### SHEEP

Peaks of interest were wave I, wave II and IV-V complex (Figure 2A). The IV-V complex was observable at the lowest stimulus intensities in all sheep and was therefore used to estimate hearing sensitivity. Mean thresholds were 47dB, 47dB, 69dB, and 89dB pe SPL for the click, 4000 Hz, 2000 Hz, and 1000 Hz tonebursts, respectively. There were no differences in ABRs between the 3 sheep used in the previous study and the 2 new sheep.

Hearing loss influences thresholds of the ABR components and can have an impact on latency-intensity functions. Human ABR studies have found that individuals with high frequency hearing loss tend to have steeper slopes than normal.<sup>7</sup> For the sheep, the mean slope of the click evoked latency-intensity function was 20  $\mu$ s/dB. Because of the high correlation between ears on the same animal only 1 ear of each animal was used to develop the means and 95% and 99% confidence intervals (Figure 1A). Latency-intensity functions for all 10 ears were evaluated relative to these values. Nine of the ears had latencies within the 99% confidence intervals while 1 ear exhibited increased IV-V complex (36 $\mu$ s/dB for the click stimulus) (Figure 1A). The 30dB poorer threshold for this ear along with an increased slope of the latency-intensity function (with latencies within the normative range at the higher intensity levels) suggest a 30dB sensorineural hearing loss for the high frequencies. It is interesting to note that this animal was also blind in the right eye.

### DEER

Peaks of interest were waves I, II, and V (Figure 2B). Wave V was observable at the lowest stimulus intensity in all deer and was therefore used to estimate hearing sensitivity. The click stimulus and the 4000 Hz toneburst resulted in the lowest thresholds. Mean thresholds were 58dB, 60dB, 76dB, and 90dB peSPL for the click, 4000 Hz, 2000 Hz, and 1000 Hz tonebursts, respectively. Mean wave V latency-intensity functions were slightly steeper for the deer (32  $\mu$ s/dB) than for the sheep (20  $\mu$ s/dB). The 95% and 99% confidence intervals for the deer are shown in Figure 1B.

The current data can be compared with human ABR results. In humans, a click-evoked ABR is first detectable at 10-20 dB above behavioral hearing threshold. The sheep and deer in the present investigation exhibited thresholds very similar to what we would expect for normally hearing humans (the human perceptual threshold for the click used in this study was approximately 25dB peSPL). This suggests that hearing sensitivity for sheep and deer, at least in the frequency region around 4000 Hz, is quite similar to humans. Although human studies have shown that the 4000 Hz region of the cochlea is most vulnerable to damage from noise exposure, it is not known whether or not this is also the frequency region which is vulnerable in the sheep and deer. Further studies are needed to determine the full frequency range of hearing in these species as well as the frequency range which is most vulnerable to noise damage.

## REFERENCES

1. Guide for the Care and Use of Laboratory Animals, U.S. Department of Health and Human Services, NIH Publication #86-23, 1986, pp 83.
2. Guide for the Care and Use of Agricultural Animals in Agricultural Research and Teaching, Consortium for Developing a Guide for the Care and Use of Agricultural Animals in Agricultural Research and Teaching, 1988, pp 74.
3. Krausman, PR, et al., The Influence of Noise and Desert Deer and Sheep, 6th Int. Congress on Noise as a Public Health Problem. July 5-9, 1993, Nice, France.
4. Hall, J (1992), Handbook of Auditory Evoked Responses, Chap. 5, pp 192-193, Needham Heights, MA; Allyn & Bacon.
5. IBID, Chap 3, pp 86-88.
6. Cohen, MS; Britt, RH., (1982), Effects of Sodium Pentobarbital, Ketamine, Halothane and Chloralose on Brainstem Auditory Evoked Responses, Anesth. and Analg. 61; 338-343.
7. Gorga, MP. et al., (1983), Some Comparisons Between Auditory Brain Stem Responses Thresholds, Latencies and the Pure-Tone Audiogram, Ear and Hearing, 6:105-112.

## ACKNOWLEDGEMENTS

We appreciate the assistance of Dr. T.J. Glatke, E.B. Patula, S.T. Cameron, and W.B. Ballard, University of Arizona, Tucson and E. Smith, Nicolet Instruments, Madison, Wisconsin.

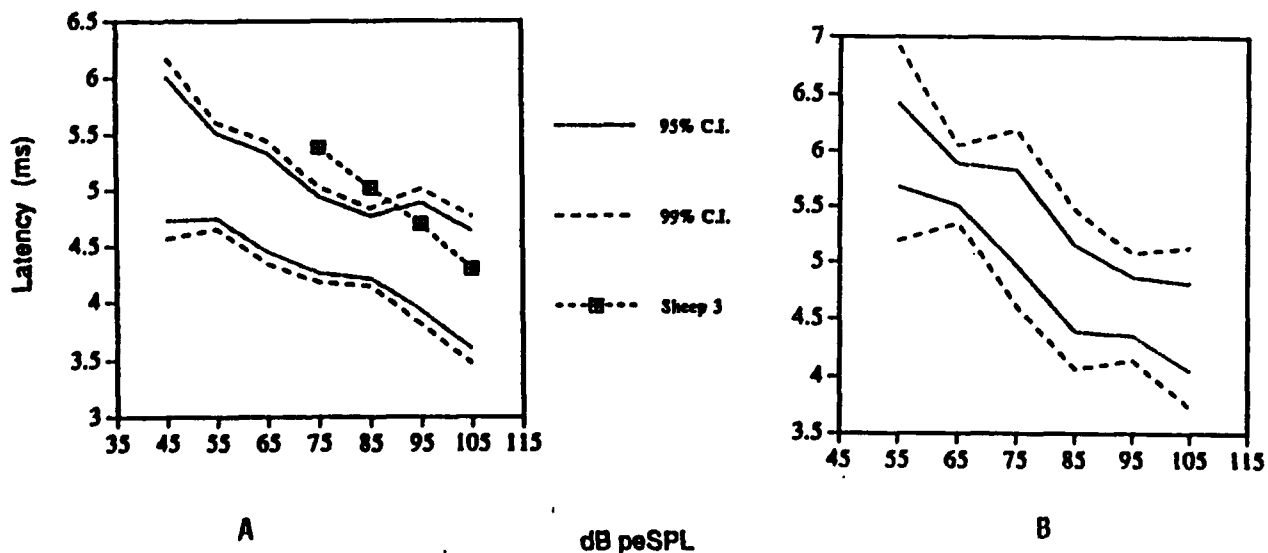
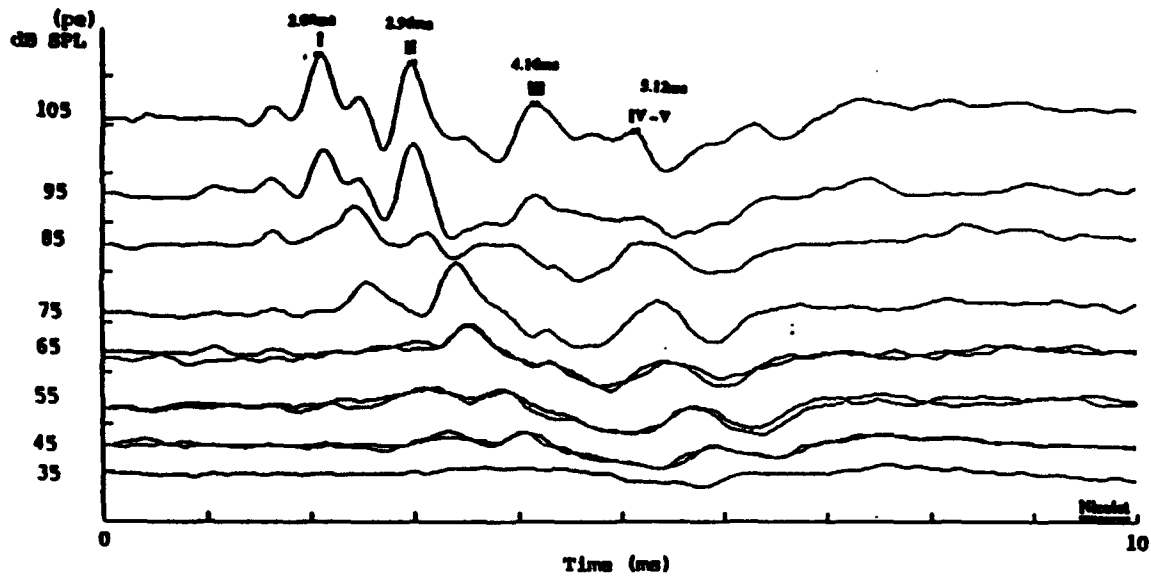
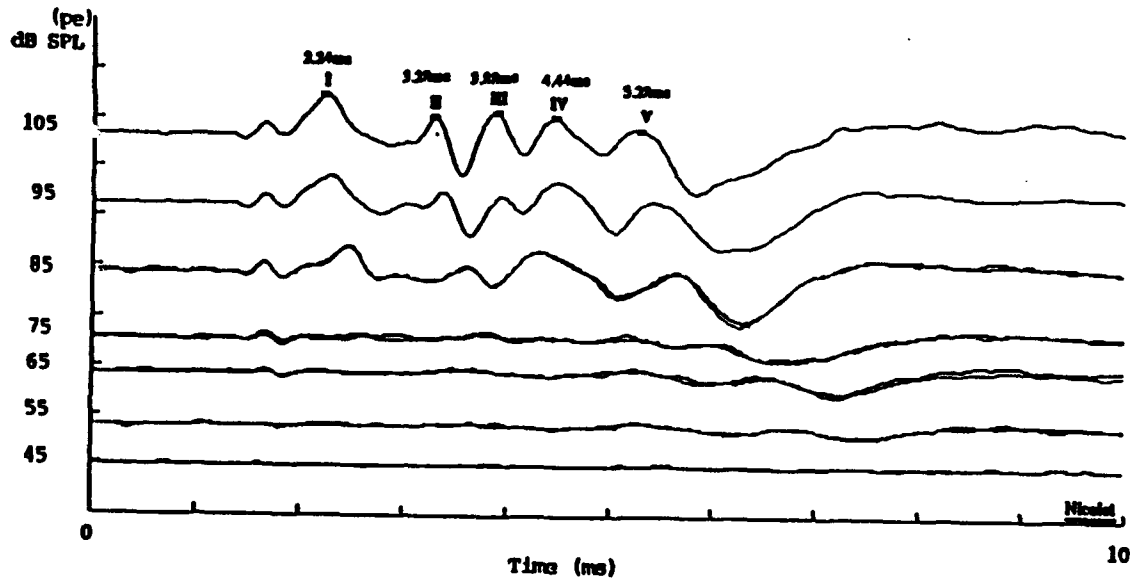

Figure 1. Latency-intensity functions with 95% and 99% confidence intervals for the mountain sheep, A; and for the desert mule deer, B. Note that one ear for sheep3 exhibited an increased threshold (75dB) and steeper slope when compared to the normative range.



A



B

Figure 2. Example auditory brainstem responses (ABRs) from a mountain sheep, A: and from a Desert mule deer, B.

NON-AUDITORY EFFECTS ON PIGS EXPOSED TO  
COMPLEX WEAPON BLAST PRESSURE WAVES IN ENCLOSURES

BORCHGREVINK HM(1), JENSSEN A(2), WOXEN OJ(1),  
RICHMOND DR(3), DAMON E (4)

- (1) HQ Defence Com Norway, FSAN/Environm Med, 0016 Oslo Norway
- (2) Norwegian Defence Construction Serv, FBT, 0015 Oslo Norway
- (3) 3006 Hyder SE, Albuquerque, New Mexico 87106, USA
- (4) 9715 Euclid NE, Albuquerque, New Mexico 87112, USA

**ABSTRACT**

We wanted to provide empirical data on animals physically comparable to man for estimation of the THRESHOLD for non-auditory hazard for personnel exposed to airblasts in enclosures. In a pilot study fall 1991 three antitank weapons of different power were fired from three different enclosure volumes, each time with a man-sized 60 kg Ketamin-anaesthetized pig placed vertically beside an instrument "manikin" inside the room, both with pressure transducers in and on the body. 11 pigs were exposed to one round each, another 5 pigs were non-exposed controls. Post-exposure necropsy showed traces, slight or severe inner organ injury in all exposure situations, indicating that the lowest exposure were at or close to blast injury threshold. The incidence of laryngeal and lung hemorrhage was lower than usually seen for more sharp-rising C4 charges. In small 8m<sup>3</sup> bunkers the Carl Gustav ATW peak pressure increased to above 206dB = >3atm compared to free-field 185dB = < 0.4atm). Impulse duration and positive overpressure were in the 70 msec range, with maximal impulse above 4000 kPa\*msec (fig. 1). The data contribute to the empirical data-base of a computer-model for assessment of complex blast-wave hazard being developed at WRAIR, USA.

**INTRODUCTION**

Impulse noise with peak pressure exceeding 1 bar (= 1atm, = 194dB) may produce airblast pressure waves that create diffuse bleeding by inner-organ tissue disruption, or air embolization (air bubbles in the blood) that block circulation in vital organs, leading to incapacitation or death within seconds or days without visible exterior trauma. In enclosures reflections lead to complex wave patterns with increased duration and peak levels - and increased hazard. The civilian population is at risk in case of indoor explosions in aircrafts, cars, trains, ships, chemical plants and oil industry installations - and when sheltering at war. Damage risk criteria as well as optimal diagnostic and therapeutic measures for complex blast-waves trauma in enclosures are largely unknown due to scarce scientific data (Richmond 1991, Richmond & Jensen 1992). The aim of this pilot study was to indicate empirically the impulse-to-enclosure-volume threshold for complex blast-wave effects on an animal comparable to man prior to a more comprehensive study on effects in scaled enclosure volumes.

**METHOD**

Three recoilless antitank weapon systems of different power were fired (single rounds) from three different enclosure volumes, each time with a man-sized 60 kg Ketamin-anaesthetized pig placed vertically beside an instrument "manikin" inside the room, both with pressure transducers in and on the body. Non-auditory effects were studied by necropsy 2h post-exposure. 11 pigs were exposed to one round each, another 5 pigs were non-exposed controls. The

blast-waves were created by 3 recoilless antitank weapons, the Carl Gustav 84mm, the M72-E4, M72-A2 and C4 charges, in 3 enclosures, the MG3 8m3 bunker, the Carl Gustav bunker, and a 33m3 room.

In the systematic paradigm one started with the assumed "worst case": the most powerful weapon (Carl Gustav 84mm) in the smallest enclosure (MG3 8m3 bunker), and if non-auditory effects were registered on necropsy, reduced the blast (to M72-E4 LAW, then to M72-A2 LAW) in the same enclosure until no effects were produced, or if still produced, increased enclosure volume with the same weapon until non-auditory effects were not produced - always single rounds - to find the injury threshold, supplying with appropriate C4 charges if the weapon blast repertoire had to be expanded. In case of slight pathology the exposure was repeated (new pig) before moving on.

The pressure-time history was registered flush on manikin's truncus (front+back+left+right), and flush in left+right ears; and on pig's truncus surface (front+back+left+right), in the pharynx+oesophagus+stomach, in front of the left+right ears, plus 3 gauges 0.3m from the animal in free air inside the enclosure.

Instrumentation included a mansized manikin (modified WRAIR metal body, head rectangular boxlike, trunk cylindrical); Kulite XT-190 gauges on truncus, in front of ears, and in "free air"; Endevco 8514 - 50psi (3.5bar) and 8514 - 20psi (1.4bar), and Endevco 8507C - 50psi (in pharynx/oesophagus/stomach, inside plastic gastric tubes); 80 kHz FM tape recorders, EMI SE 7000 A, 14 ch, and signal conditioners/amplifiers, 2311 from Measurement Group, VISHEY. Signals from all gauges were collected via signal conditioners and taperecorded, tape speed 60"/s, then played-back with 3 3/4"/s tape speed, digitized with 1 MHz sampling freq, analysed as required, and with the pressure-time history, impulse-time history and the frequency spectra presented as hard-paper copies + on 3.5" discettes. (Recordings will be used to verify load predictions by the ARA Prediction Model, and contribute to the data base of the WRAIR Injury Prediction Model).

Further details are given elsewhere (Richmond & Jenssen 1992, Borchgrevink & al 1992).

## RESULTS & DISCUSSION

In the 8m3 MG3-bunker, we performed three Carl Gustav rounds, two M72-E4 rounds and two M72-A2 rounds. In the 33 m3 room the Carl Gustav was fired once, then a 1.14kg C4 charge. In the Carl Gustav bunker, the Carl Gustav was fired in normal transverse position (as fired by soldiers, with back blast out the rear opening), and in oblique angle position (with back blast creating a rotating dynamic pressure inside the bunker).

The pressure-time patterns were somewhat different from those previously reported. The powerful weapons fired from small enclosures gave substantially increased peak pressure (kPa), overpressure duration (msec) and maximal impulse (kPa\*msec) levels compared to free-field registrations (e.g. by NATO RSG6 1987). Firing the Carl Gustav 84mm ATW in the small 8m3 bunker the peak pressure increased to above 206dB = >3atm compared to free-field 185dB = < 0.4atm. Impulse duration and positive overpressure were in the 70 msec range, with maximal impulse above 4000 kPa\*msec (figs. 1 and 2).

Post-exposure necropsy 2 hours post-exposure showed slight to severe inner organ injury in nearly all exposure situations, indicating that the lowest exposure were at or close to blast injury threshold. Traces of trauma were also recorded for Carl Gustav fired from Carl Gustav bunker according to ratified procedure for soldiers. The C4 charge was fatal. In the "oblique angle" Carl Gustav firing the back-blast and dynamic pressure caused burns and contused sternum. The incidence of laryngeal and



lung hemorrhage was lower than usually seen for more sharp-rising C4 charges (Phillips & al 1986). Strong pressure oscillations in the stomach e.g. in pig 3 (fig. 2) might have caused the stretch-like patterns of hemorrhage observed on the stomach. The substantial cranial one-atmosphere momentum caused by the difference between stomach (245.8 kPa) versus thorax pressure (158 kPa) (fig. 2) might explain the corresponding stretch-like contusions in the diaphragm, and possibly also the frequently observed liver hilus lacerations. Air administered into the stomach during endoscopy may have accentuated the stomach oscillations and influenced injury thresholds. Some pigs showed strong tendency to respiratory arrest when hanging anaesthetized in vertical body position. These issues including effects of vertical versus horizontal body position should be addressed in the forthcoming main study in scaled enclosure volumes ca 5.5m<sup>3</sup>, 16m<sup>3</sup> and 33m<sup>3</sup>.

#### REFERENCES

- Borchgrevink HM, Jenssen A, Woxen OJ, Richmond DR, Damon E. Effects of complex blast waves in enclosures. Report from Pilot study 21 Oct - 1 Nov 1991, Part 1. Oslo: HQ Defence Command Norway; FSAN Research Report 1992 No 1
- NATO RSG6 Report. Smoorenburg GF, Borchgrevink HM, Brinkmann H, Dancer A, Forrest MR, Forshaw SE, Papavasiliou A, Patterson JH, Pfander F, Phillips YY, Price GR. Effects of impulse noise. NATO AC/243(Panel 8/RSG.6)D/9, Bruxelles 1987.
- Phillips YY, Dancer A, Richmond DR. Nonauditory effects of repeated exposures to intense impulse noise. In RJ Salvi, D Henderson, RP Hamernik, V Colletti (eds). Basic and applied aspects of noise induced hearing loss. New York: Plenum 1986:489-499.
- Richmond DR. Blast criteria for open spaces and enclosures. In HM Borchgrevink (ed) Effects of noise and blasts. Scand Audiol Suppl 34, 1991:49-76.
- Richmond DR, Jenssen A. Compendium on the biological effects of complex blast waves. Oslo: Norwegian Construction Service, and HQ Defence Command Norway Joint Medical Service, 1992.

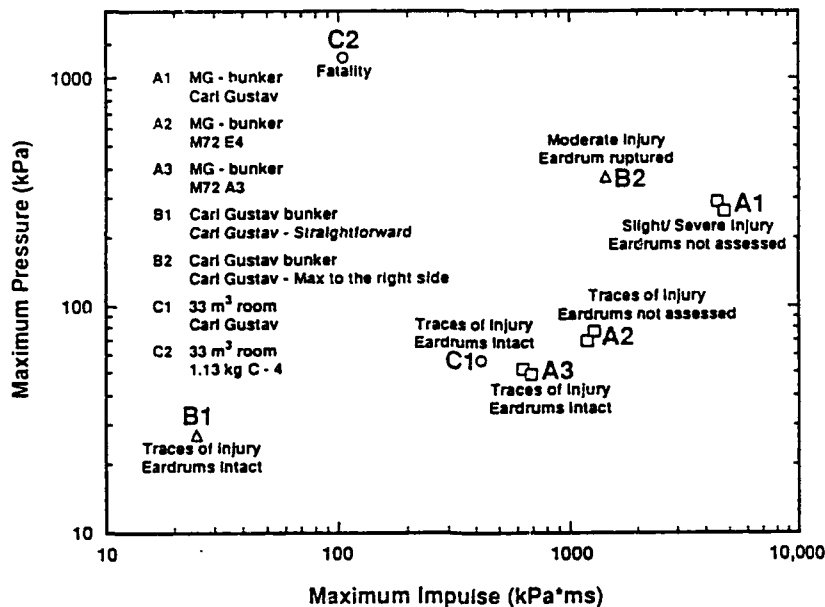

Figure 1. Pressure - Impulse diagram, complex blast wave effects on swine. Pressure and impulse values are a mean of the six measured on the animal.

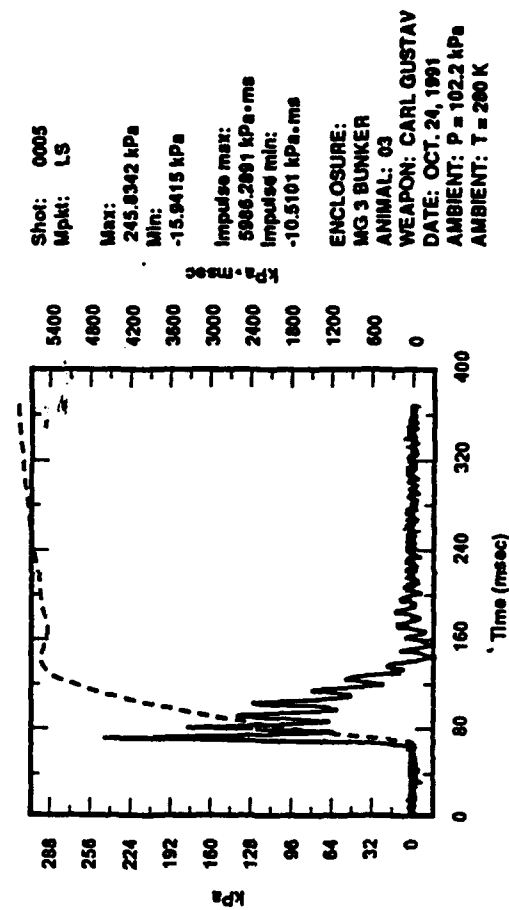
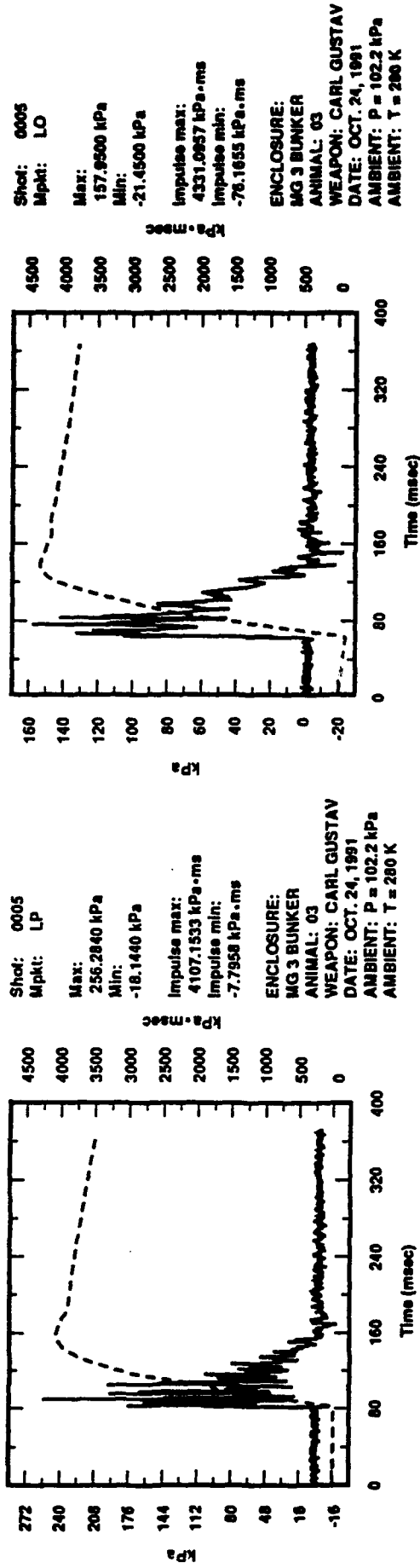

Figure 2.. Pressure-time measured inside animal: upper, in pharynx; upper right, in esophagus-thorax; lower, in stomach.

# ACOUSTIC INATTENTIVENESS AS AN INDICATOR OF FATIGUE IN PHYSICALLY LOADED ALSATIAN WATCHDOGS

STEPHAN, Eberhart and Thomas MÖNIG

Institut für Tierhygiene und Tierschutz

Tierärztliche Hochschule Hannover, D-3000 Hannover 71, Bünteweg 17 p, Germany

Usually, watchdogs are kept in order to defend an area or to support the attentiveness of the watchmen by some specially suited senses of the dogs. Under these senses the acoustic and olfactoric ones are of particular interest, whereas the optical sense mostly is of minor importance. Maintenance of a couple of well educated and specially trained dogs in order to safeguard is quite expensive. So, the guarding companies and military services sometimes intend to decrease the expenses by reduction of the number of their dogs. The (wrong) assumption is: The same work for less money, meaning that less dogs shall work more hours per day.

In that context the behaviour of six Alsatian watchdogs was investigated.

The particular interest was

- primarily, whether or not increased physical loadings exceed the physical and/or mental abilities of the animals and hereby violate the animal welfare legislation and
- secondly, whether or not these animals in the more loaded status develop the same attentiveness with respect to environmental stimuli as they do under less loading conditions. the attentiveness of the dogs

The physiologically important criteria heart frequency, respiration frequency and traction power were recorded, but they are not subject of that paper. The attentiveness of the dogs, interesting here in particular, was checked after their work in a treadmill (running rubber tape) by means of behavioural audiometry in a special type of kennel with regard to guarding-relevant noises of different qualities with higher and lower intensity.

The variable external testing conditions were:

- the duration of the working periods (0.5 - 2.0 hours),
- different speeds of the running rubber tape (2.5 - 5.0 km per hour),
- different breaks (1 - 2 hours),
- different climatic conditions (+20°C, 80% rel. humidity and -10°C, 60-75% rel. humidity).

These noise qualities and their used "loud" and "soft" sound pressure levels were (in dB, linear):

- 1. Wirecutting by a pair of pincers	"loud" 68,4	"soft" 48,4
- 2. Snapping of branches by treading	72,0	51,9
- 3. Smashing of a pane of glass by hammer	68,0	48,3
- 4. Chafing of a pine branch on jeans trousers	49,5	32,0
- 5. High frequency breathing of man	47,3	32,5

The results were:

- After lower physical loadings the animals reacted clearly on acoustic stimuli.
- After medium grade physical loadings the indication of low intensity acoustic stimuli was more rarely.
- After increased physical loadings the percentage of not indicated acoustic stimuli increased.
- During increased air temperature/humidity conditions the ability of the dogs to respond decreased.
- Anxious, watchful and sensitive watchdogs indicated the appearance of acoustic stimuli more frequently than others.

Even if the physical loadings of the dogs by more running work, e.g. more frequent and longer patrol duties, should not be relevant under the rules of the animal welfare legislation, the acoustic attentiveness of the animals decreases in dependance to the increasing physical loadings and also on warmer and more humid meteorological conditions.

Such unsuited only apparently economic measures may invalidate the success of guarding.

**OBSERVATIONS ON THE RELATIVE ABUNDANCE AND BEHAVIOR OF  
MARINE MAMMALS EXPOSED TO TRANSMISSIONS FROM  
THE HEARD ISLAND FEASIBILITY TEST.**

BOWLES Ann E.<sup>1</sup>, SMULTEA Mari<sup>2</sup>, WURSIG Bernd<sup>2</sup>, DEMASTER Douglas P.<sup>3</sup>,  
PALKA D.<sup>3</sup>

Hubbs-Sea World Research Institute, San Diego, CA<sup>1</sup>, Marine Mammal Research Program,  
Galveston, TX<sup>2</sup>, Southwest Fisheries Center, La Jolla, CA<sup>3</sup>

As part of a program to measure global warming, the Heard Island Feasibility test transmitted 209-220 dB re 1 $\mu$ Pa tones at 175 m depth, centred on 57 Hz with a maximum of 30 Hz bandwidth. The duty cycle averaged 19% during the 7 day experimental period, with a maximum duty cycle of 30%. The impact of this noise on marine mammals was estimated by measuring density and behavior in a 70x70 km square centered 60 km south-east of Heard Island (53° 25" S x 74° 30" E). Experienced marine mammal observers conducted line-transect surveys, and monitored marine mammal behavior both acoustically and visually.

Observers surveyed 1093 km (123 hrs) before and 1011 km (149 hrs) during the transmission experiment. Forty schools of cetaceans and 19 pinnipeds were sighted before and 40 schools and 25 pinnipeds were sighted after. Sightings of endangered cetaceans (blue whales, *Balaenoptera musculus*, fin whales, *B. physalus*, and sperm whales, *Physeter macrocephalus*) were rare, but did not differ before and during transmissions (3 schools in each period. Schools of hourglass dolphins (*Lagenorhynchus cruciger*) increased and schools of mid-sized whales, chiefly southern bottlenose whales (*Hyperoodon planifrons*) and minke whales (*B. acutorostrata*), decreased. The cause of these changes could not be ascertained. There were no consistent changes in direction of travel. Calls of sperm whales and pilot whales were detected 22% of hours monitored before the transmissions, but were not detected during the 7 day transmission period. Calls were detected again within 2 days after the end of transmissions.

Comparison of the behavior of endangered whales before and during transmissions showed changes in respiration and reorientation rates. However, these whales were able to navigate, interact and lunge-feed during transmissions.

# Effects of short-term noise exposure on heart rate and ECG ST segment in male rats

Zhao Yiming, Liu Shijie and Zhang Shuzhen

Department of Occupational Health, School of Public Health, Beijing Medical University, Beijing 100083, P.R.China

## ABSTRACT

It is known that chronic noise exposure can lead to changes of arrhythmia, Myocardial ischemia and coronary heart disease. But there were some differences in a few researches. These differences might be caused by many social-environmental factors. Animal research in laboratory can get rid of these disturbances. A new method was applied in the research to detect ECG in conscious unrestricted rats. By this method, effects of 100 dB(A) noise short-term (one hour) exposure on the changes of heart rate (HR) and ECG ST segment in male rats were studied. It was found HR and ST segment were stable before noise exposure. HR was decreased to minimum (by 60 beats/min) during 0-4 min of the noise exposure period and then increased slowly. ST segment was elevated at the beginning of the noise exposure. It was elevated into maximum (by 30  $\mu$ V) during 15-29 min of the noise exposure and then declined slowly. After the stop of noise exposure, HR and ST segment were recovered quickly into the level before noise exposure. A dose-response relationship was found from 40 min of noise exposure to beginning of noise stop, when rats exposed to different sound pressure level noise. These effects were characterized by 1) the stability and the reproductivity, same reactions of HR and ST segment in three days; 2) individual differences, reaction to the noise exposure could be divided into two types: type A, HR decreased and ST segment elevated, type B, HR and ST segment not changed, the basic ST segment of the rats with type A was 45 percent higher than that of the rats with type B; 3) parallel reaction between the changes of HR and ST segment, i.e. in the rats of which HR was decreased, the ST segment was elevated (type A), while in the rats of which HR was not changed, the ST segment was also not changed (type B). 4) dose-response relationship, it could be found in type A rats.

**KEY WORDS:** ECG, heart rate, noise, ST segment, type A reaction, type B reaction

It is well recognized that exposure to intense noise lead to not only hearing loss but also affects the cardiovascular system in man and animal<sup>[3]</sup>. Exposure to traffic noise (72 dB(A)) for one hour was reported to produce a decrease of heart rate HR in rabbits<sup>[5]</sup>. But some of other researches did not find the changes of HR on noise exposure<sup>[1,6]</sup>. The changes of HR was accelerated at the beginning of noise exposure, and then decelerated<sup>[2]</sup>. Some confounding factors could lead to different changes of HR. If one person exposed to noise, his HR would be decreased. But if having mental load at the same time, HR would be increased<sup>[8]</sup>. Short-term noise exposure could elevate HR in baboon, but chronic noise exposure declined it<sup>[3]</sup>. Three types of changes in HR during acute exposure to noise were observed in men. A few subjects maintain a higher HR as compared with the initial value, whereas some of them maintain a lower value; still others showed both a rise and fall throughout the noise exposure<sup>[9]</sup>. Studies on industrial workers exposed to intense noise revealed the tendency of increase occurrence of in coronary heart disease<sup>[10]</sup> and changes of ECG ST segment<sup>[11]</sup>. The purposes of this research were: (a) to avoid

stress caused in fixed experimental animals by using the method of detecting ECG of conscious unrestricted rats; (b) to determine what kind of changes of HR and ST segment will occur during short-term noise exposure in rats; (c) to investigate the characteristic of changes of HR and ST segment at different phases of noise exposure; (d) to observe dose-response relationship between noise exposure and changes of HR and ST segment; (e) to study the individual changes of HR and ST segment caused by noise in rats.

## METHODS

One hundred and eighty one male Wistar rats weighted  $211 \pm 34$  grams were used, which laid electrodes under skin by operation. Then the rats were fed in special cages in a semianechoic soundproof room. Sound pressure level (SPL) in the cages was less than 40 dB(A). The ECG signal was input into a digital system based on Apple II for analysis. HR and ST segment were measured every 5 min for each rat. The data of HR and ST segment were stored in diskettes. The experiments were divided into three periods, a) the first hour, self control, b) the second hour, exposed to 100 dB(A) wide spectrum steady state noise, c) the third and fourth hours, recovering. Curves of HR and ST segment of each rat were plotted for the individual analysis. Mean and SD of HR and ST segment were calculated, and self pairs t test were made in Apple II. Then the results were output by a plotter.

## RESULTS

Figure 1 illustrated the changes of HR on the noise exposure. In self control period, HR was stable. During noise exposure period, it was decreased to the minimum (by 60 beats/min) at the beginning of noise exposure, and then increased slowly. After stop of noise exposure, HR recovered quickly to the level of self control period. It was found that there were individual differences in the changes of HR on noise exposure. In 12 rats, HR of 7 rats were decreased (figure 2), while those of other 5 were not changed (figure 3) during noise exposure.

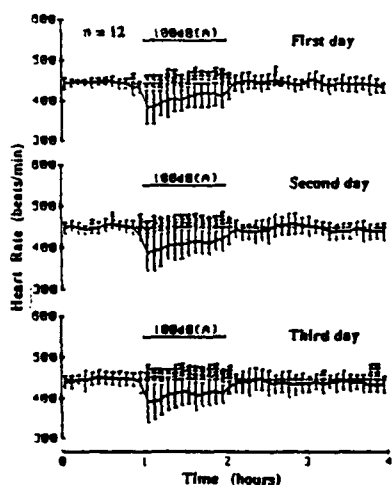

Fig 1. Effects of repeated noise exposure in three days on the noise stimulated changes of heart rate in male rats

\*  $p < 0.05$  \*\*  $p < 0.01$

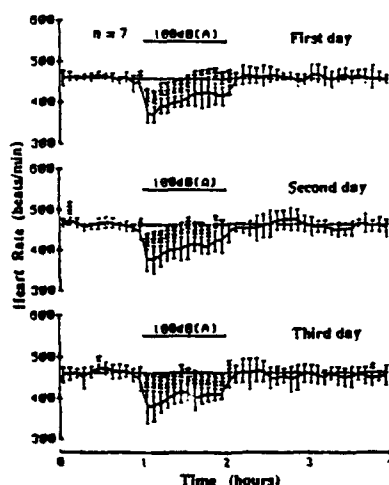

Fig 2. Effects of repeated noise exposure in three days on the noise stimulated changes of heart rate in type A male rats

\*  $p < 0.05$  \*\*  $p < 0.01$

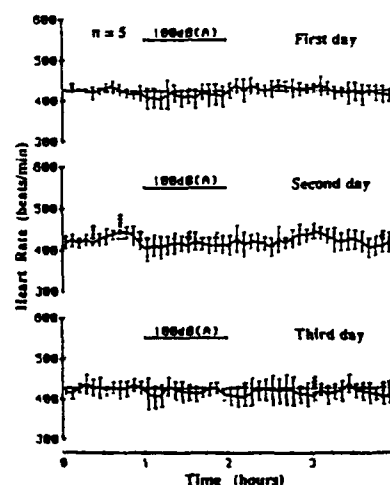

Fig 3. Effects of repeated noise exposure in three days on the noise stimulated changes of heart rate in type B male rats

\*  $p < 0.05$  \*\*  $p < 0.01$

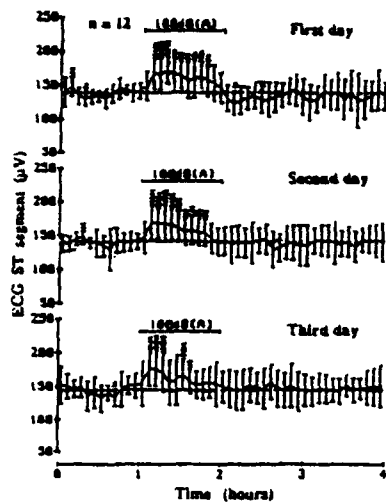

Fig 4. Effects of repeated noise exposure in three days on the noise stimulated changes of ECG ST segment in male rats  
\*  $p < 0.05$  \*\*  $p < 0.01$

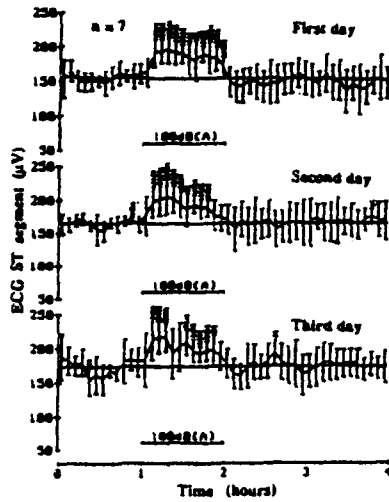

Fig 5. Effects of repeated noise exposure in three days on the noise stimulated changes of ECG ST segment in type A male rats  
\*  $p < 0.05$  \*\*  $p < 0.01$

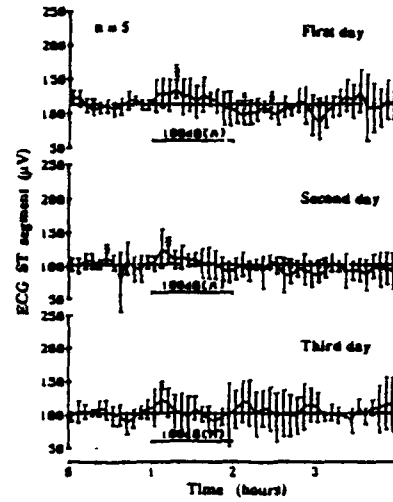

Fig 6. Effects of repeated noise exposure in three days on the noise stimulated changes of ECG ST segment in type B male rats  
\*  $p < 0.05$  \*\*  $p < 0.01$

Figure 4 illustrated the ST segment on the noise exposure. ST segment was stable in self control period. During noise exposure, it was elevated, and reached the maximum (by  $30 \mu V$ ) at the 15 - 29 min of noise exposure and then declined slowly. After stop of noise exposure, ST segment recovered quickly to the level of self control period. It was also found that there were individual differences in the ST segment during noise exposure. In 12 rats, the ST segments of the same 7 rats (the HR of which was decreased) were elevated (figure 5), and those of the other 5 were not changed (figure 6) during noise exposure.

Figure 7 and 8 showed changes of HR and ST segment during exposed to different SPL noise (80 - 100 dB(A)). From 40 min of noise exposure to beginning of noise stop, HR and ST segment were more recovered to the level of self control period in 80 dB(A) than in 100 dB(A). A dose-response relationship could be found.

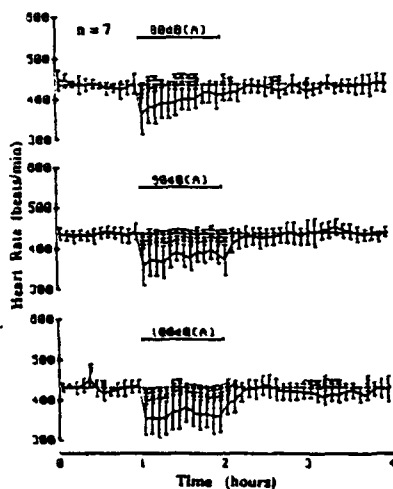

Fig 7. Effects of different sound pressure level noise exposure on the changes of heart rate in type A male rats  
\*  $p < 0.05$  \*\*  $p < 0.01$

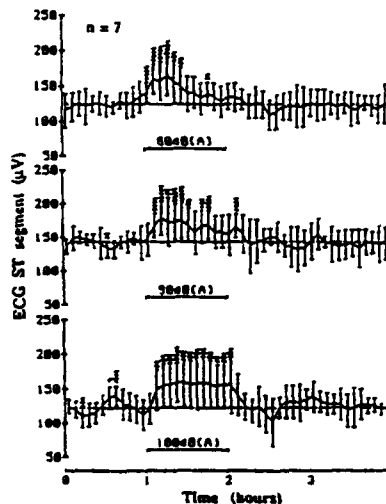

Fig 8. Effects of different sound pressure level noise exposure on the changes of ECG ST segment in type A male rats  
\*  $p < 0.05$  \*\*  $p < 0.01$

In total 181 rats, there were 99 of which the HR and ST segment were changed, 58 with HR and ST segment not changed, and 24 (12 versus 12) just one parameter (HR or ST segment) changed during noise exposure,  $p < 0.01$ . These results mean rats could be divided into two subgroups by means of their reactions of HR and ST segment on noise exposure. The rat with HR and ST segment changed during noise exposure belonged to subgroup A, the other with no changes belonged to subgroup B.

Basic level of ST segment within subgroup A ( $147 \pm 15 \mu V$ ) was higher than subgroup B ( $101 \pm 11 \mu V$ ),  $p < 0.05$ .

## DISCUSSION

In the preliminary of this research, we found if rats were restricted consciously, their HR might be changed in large range. The changes of HR might be stronger than those caused by noise. So, one of the most important research methods was to find a way of measuring ECG in conscious unrestricted rats. The method was established in the pre-experiment. By this method, it was found that noise could result in HR to be declined and ST segment elevated in myocardial ischemia condition (to inject pituitrin, isoprenaline or ligate coronary artery). It could be believed that ST segment changes were manifestation of myocardial ischemia, short-term noise exposure could cause a short-term reversible myocardial ischemia.

Based on individual differences of HR and ST segment in this research, it was found that rats could be divided into two types according to their reactions to noise exposure, HR and ST segment changed or unchanged. Different changes of HR during short-term noise exposure were also found in men<sup>[9,12]</sup>. Several epidemiological investigation demonstrated that only few persons had cardiovascular disorders (arrhythmia, coronary heart disease and hypertension), and most of them were healthy in cardiovascular system after chronic exposure to noise<sup>[7,11]</sup>. These results suggested that there are different reactions to noise exposure in cardiovascular system individually. If we know what kind reaction has latent danger in cardiovascular system when one is chronically exposed to noise, we can be in the early stage to estimate the probability of having cardiovascular diseases if one works in a noisy environment for long time and take a suitable treatment. This research can be used as an animal model to investigate the mechanism of noise on cardiovascular system.

## REFERENCE

1. Ising H. et al. Health effects of traffic noise. *Int Arch Occup Environ Health* 1980; 47:979
2. Manninen O. Boiresponses in man after repeated exposures to single and simultaneous sinusoidal or stochastic whole body vibrations of varying bandwidths and noise. *Int Arch Occup Environ Health* 1986; 57:267
3. Turkkan JS. et al. Novel long-term cardiovascular effects of industrial noise. *Physiol Behavior* 1984; 33:21
4. Neus H. et al. Zur reaction der Tümpulsamplitude auf Belarmung. *Int Arch Occup Environ Health* 1980; 47:9
5. Anzi Y. et al. Effects of noise for human and animal body (Chinese). *Health Investigation* 1980; 9:79
6. Andren L. et al. Noise as a contributory factor in the development of elevated arterial pressure. *Acta Med Scand* 1980; 207:493
7. Brown JE. et al. Certain non-auditory physiological responses to noise. *Am Ind Hyg Assoc J* 1975; 4:285
8. Mosskov JL. et al. III. Extra-auditory effects in short-term exposure to noise from a textile factory. *Int Arch Occup Environ Health* 1977; 40:174
9. Sing AP. et al. Effect of chronic and acute exposure to noise on physiological functions in man. *Int Arch Occup Environ Health* 1982; 50:169
10. Xiangshun W. Investigation of cardiovascular disease prevalence in 533 exposure noise workers (Chinese). *Chin Med J* 1980; 60:249
11. Min P. et al. Investigation of non-auditory effects of noise on human body (Chinese). *Occup Med* 1985; 12:58
12. Wenyuan G. Effects of warship noise on cardiovascular function in young person (Chinese). *Acta of 2nd Military Univ* 1985; 6:150



# THE PHASE FEATURES OF MAN AND ANIMAL REACTION TO INFRASOUND EFFECT.

FAUSTOV Anatoly , FRAIMAN Boris , BOSOVA Ludmila .

The Voronezh State Medical Institute, 394018, Voronezh, Plehanovskay ul. 12 , apt.  
17.

The time structure of the development reaction of organism on the infrasound is shown. The mistakes in the experiments depend on the ignorance of the phase structure of this reaction.

On a montu' la structure de developpment de la re'aktion de l'organisme dans le temps. Les fautes aux expe'riences peusent de'pendre de l'ignorance de la structure de phase de cette re'aktion.

## INTRODUCTION

For the investigation of the organism reaction on infrasound we made the development analysis of the interaction process between infrasound and human body within the time. Functioning parameters of the nervous and cardiovascular human and animal systems are studied on the base of the regular methods. The investigation covered hemodynamics, hemocoagulation, oxygen transportation, histology and histochemistry of myocardium, vessels, adipose cells changes, managerial function of the vegetative centers of the nervous system, and psychophysiological functions of the man-operator. Traditional Russian methods are used for this purpose not to investigate human and animals functions, but only to mark the direction of explored systems and organs reaction to infrasound effect.

All investigations have been carried out in that part of the room, where a person and animals were prompted to discomfort reactions. Infrasound physical nature in this part of the room was discussed by us in some other articles. The infrasound influence performed at the frequency of 12 - 14 Hz and at the sound pressure level of 90 - 100 dB.

## EXPERIMENTAL RESULTS

As it was proved by our investigations all reactions begin and go out in the specific time intervals called phase reactions to infrasound.

The human-being and animal reaction to the infrasound influence begins from the reaction of the nervous system. In the first minute the regulating activity of the vegetative nervous system sympathetic section is strengthened and the tension index of other structures of the central nervous system is increased.

Then by the twentieth minute of influence the activity of the subcortical structures of the brain becomes worse and the level of the person capacity for work is reduced. At that time

there appears the indication of more plastic and longer functioning humoral channel starting which controls the human-being functions.

On the first day at the end of the fourth - sixth hour of everyday six hour infrasound influence of 100 dB with the frequency of 10 Hz the obvious of reaction blood coagulation activity increase is developed. At that time the decrease of oxygen consumption from blood is registered, oxygen content is increased in venous blood without changing its percent level in arterial blood [fig.1].

On the third day the increased activity of some ferments of heart muscle respiratory cycle and active oppression of others are clearly registered.

By the sixth day of influence the coagulation activity of blood is reduced to the development of hypocoagulation. [fig.2].

By the twelfth day of influence the oxygen content in arterial and venous blood is normalized. The state of blood coagulation activity, the activity of respiratory ferments of the myocardial don't differ from the initial data. The histological changes of the muscular cells of the heart in the first day have a reversible character [fig.3].

By the twenty fourth day of influence the hypercoagulation of blood is appearing again, the activity of respiratory ferments of the myocardial is decreased approximately by 50 %. There appear destructive changes of myocardial [fig.4].

It should be stated in particular about the cells reaction containing - protector geparin. At first labrozit content was decreased, then their content per area unit, reaching the minimum by the twenty fourth day of influence.

#### DISCUSSION

So the primary reaction of the nervous system is going out, the nervous centers change for a new level of functionality starting the humoral reaction to the infrasound action. At first these reactions have an adapting character, the changes from the 12th to the 18th day of influence are small and reversible. And only after the 18th day of influence the reserve possibilities of human body are growing weak and visible changes in organs and systems can be seen. The second important moment, in our opinion, is that the infrasound can influence directly on the wall of the blood vessel model. The analogous changes are registered from the vascular basin of persons and animals. The reaction is developed instantly with the appearance of forced acoustic interaction and disappears with the turning off the acoustic generator. The direct influence of the infrasound on the vessels can explain the instant development of the nervous system reciprocal reaction as well as the development of all above stated functional and morphological changes in it.

The results clearly show the phase character of person and animals reaction, their interaction with the infrasound. The basic phases of this interaction are:

1. The functional phase
  - a) the nervous system primary reaction to the interaction between infrasound and vascular system,
  - b) a neurohumoral reaction,
  - c) a functional organs and tissue reaction to the infrasound effect.
2. The secretive phase or the functional systems tension phase followed by the organs and systems transfer to the new level of functioning in order to support a homoeothase.
3. Functional system exhaust phase.
4. Phase of the obvious morphofunctional modification development.

### CONCLUSION

The possibility of these phase development in a human-being and animals depends on the place of their location in the office or in the apartment. More exactly, it depends on their interaction with one or another component of the acoustic field energetic structure called zones according to our terminology.

This can lead us to the important conclusion: when a human-being and animals are out of the zone (with equal sound pressure level) it can not involve the infrasound reaction development, it can lead the investigators to misconception and be a reason for erroneous conclusions.

Besides the application of non-adequate and not enough sensitive methods with "short-term" experiments or when the time of the data intake got into the latent phase, all these can cause the erroneous conclusions even when the object is in the discomfort zone. And with all these the sound pressure level which influences the reaction development rate can be so low, that the delayed reaction development can be regarded as the absence of process development or adaptation to it. Actually the reaction is developing since the afferent vascular system receptors have a very low excitation threshold.

So, phase development of man and animals reaction to infrasound in a zone must be taken into account in the development of the hygienic standarts of infrasound.

We will present the above-described results in graphical forms. So, fig.1 a), b), c), d) show:

1. Nervous system reaction.
2. Humoral reaction.
3. Reaction of hemocoagulation.
4. Oxygen content in venous blood.
5. Level of person capacity for work.
6. Activity of respiratory cycle ferments.
7. Morphological changes of myocardial and cells-protectors.

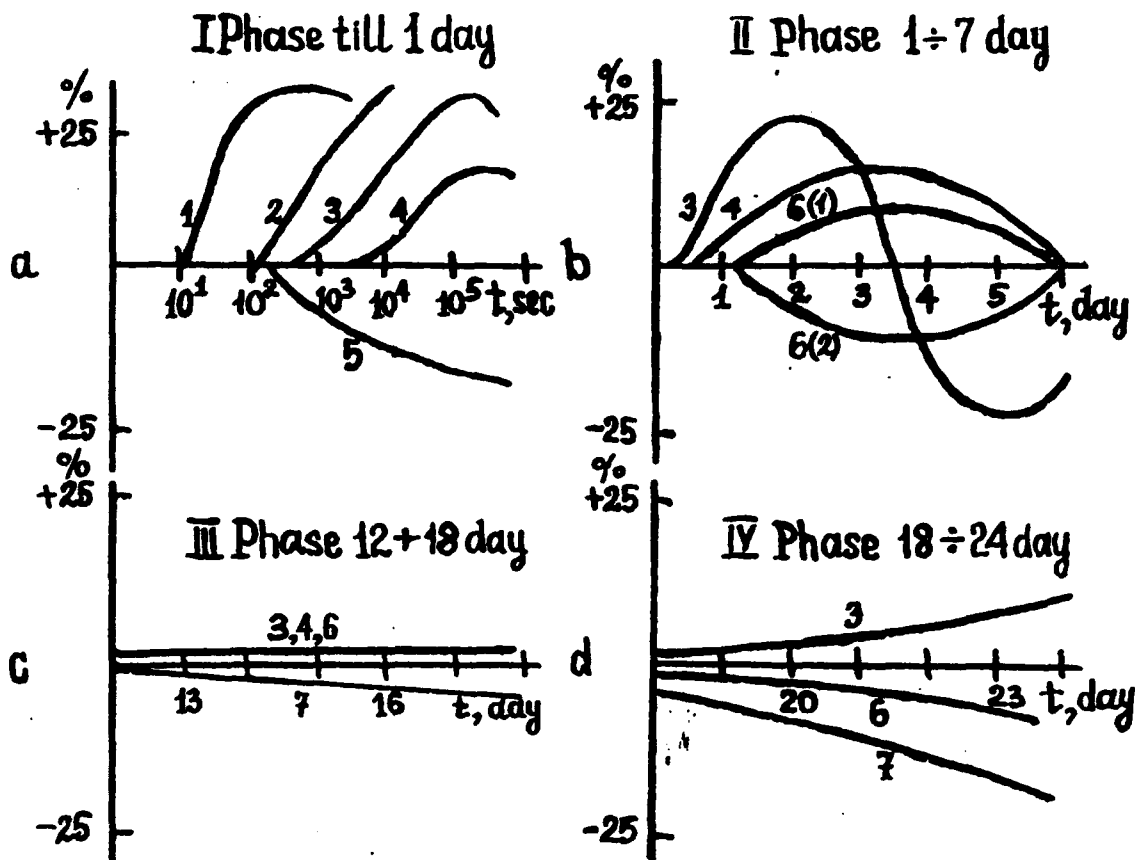

#### REFERENCES

1. Fraiman B.Ja., Ivannikov A.N., Zhukov A.N. On the Influence of Infrasonic Fields on Humans. 6-th International Meeting on Low Frequency Noise and Vibration. Leiden 1991, p. 49-56.
2. Zhukov A.N., Ivannikov A.N., Pavlov V.I., Fraiman B.Ja. Infrasonic in closed Volumes, Fortschritte der Akustik, DAGA-91 Bochum, Teil A, p. 385-388.
3. Fraiman B.Ja., Ivannikov A.N., Pavlov V.I. On possibility of the comfortable and the non-comfortable effect of the low-frequency acoustic noises. 6-th International FASE-Congress 1992. 29-31 July 1992. Zurich, Switzerland p.145-148

**THE CUMULATIVE EFFECTS OF STRESS ON PSYCHOPHYSIOLOGIC  
AND PERFORMANCE RESPONSES TO NOISE**

EVANS, Gary W., ALLEN, Karen M., and TAFALLA, Richard

Department of Design and Environmental Analysis, Cornell  
University, Ithaca, NY 14853-4401 USA; University of California,  
Irvine; University of Wisconsin, Stout

In a laboratory experiment, individuals were exposed either to a relaxing video tape or prepared and presented a speech before an audience. This was immediately followed by a task performance phase conducted either under quiet or noisy conditions. Following this task performance phase, an aftereffect phase was conducted under quiet conditions. Aftereffects were assessed by the Glass and Singer frustration tolerance paradigm.

A prediction of the adaptive cost hypothesis is that one of the costs of coping with a stressor is reduced capacity to cope with subsequent environmental demands. The initial stressor (speech) potentiated the negative effects of noise on cardiovascular functioning during the second phase (task performance) of the experiment. Subjects who had initially been in the speech condition also evidenced more negative aftereffects following exposure to noise during the second phase (task performance) of the experiment. The effects of noise on mental arithmetic performance during the second phase of the experiment were minimal and not adversely impacted by the initial stressor condition.

Au cours d'une expérience de laboratoire, des individus soit furent exposés à un film vidéo relaxant, soit préparèrent et présentèrent un discours en public. Juste après suivit une phase de réalisation de tâche conduite dans des conditions soit de calme soit de bruit. Après cette phase de réalisation de tâche, une phase d'évaluation des effets secondaires fut conduite dans des conditions de calme. Les effets secondaires furent évalués selon le paradigme de tolérance de la frustration de Glass et Singer.

L'hypothèse du coût adaptatif prévoit entre autres que l'un des coûts d'adaptation à un facteur de stress est une capacité réduite d'adaptation aux demandes suivantes de l'environnement. Le facteur initial de stress (discours) a rendu possible les effets négatifs du bruit sur le fonctionnement cardiovasculaire durant la deuxième phase de l'expérience (réalisation d'une tâche). Les sujets qui avaient initialement donné un discours présentèrent également des effets secondaires plus négatifs après l'exposition au bruit durant la seconde phase. Les effets du bruit sur la performance arithmétique mentale durant la seconde phase de l'expérience furent minimales et pas modifiées de façon négative par la condition initiale du facteur de stress.

Most research on stress and coping has focused on the salutary effects of coping. This research instead examines a potential adaptive cost of coping. Specifically, we hypothesize that one of the costs of coping with stressors is diminished capability to deal effectively with the demands placed upon the organism by other sources of stress (Cohen et al., 1986; Evans & Cohen, 1987; Schonpflug, 1986). If coping with environmental demands takes effort, one of the consequences of such effort may be fatigue and depletion of coping resources (Glass & Singer, 1972). Glass and Singer (1972) as well as others (Cohen, 1980) have shown that following exposure to stressors such as noise, crowding, or threat of electric shock, negative aftereffects occur. During the recovery period, following stressor exposure when the stressor is no longer present, evidence of residual negative effects are apparent such as diminished motivation to persist in problem solving.

Field investigations have also found diminished coping resources following stressor exposure. One or more stressful life events increased risk for negative psychological reactions to air pollution (Evans et al., 1987). The effects of daily hassles on psychological health were exacerbated by crowding (Lepore et al., 1991) and psychophysiological reactivity was potentiated by the chronic strains of coping with a technological disaster (Fleming et al., 1984).

In the present study we reasoned that individual vulnerability to adverse effects of noise might be affected by exposure to a prior stressor. We hypothesized that individuals who had to cope with the stress of delivering a public speech would show greater residual negative effects during noise than their counterparts who instead of delivering a speech watched a relaxing video tape. To put it differently, the adverse effects of noise on performance, psychophysiology, and motivation would be exacerbated by an immediately prior period of coping with a stressor.

### Method

Subjects. Eighty college students whose first language was English participated in this study in exchange for partial credit in introductory social science courses.

Dependent measures. Performance was measured as the percentage correct of Norinder mental arithmetic problems. In this task the subject is given two rows of digits. The subject is to mentally calculate the sum or difference as indicated for each row separately. Then if the top row is greater than the bottom, the subject mentally subtracts the two totals; if the bottom row is greater, then he/she mentally adds the two totals. Diastolic and systolic blood pressure were monitored every four minutes during the 20 minute performance phase of the experiment. Self reports of perceived stress were also monitored during this phase by six, seven point bi-polar adjectives (e.g., stressed - relaxed) (Cronbach alpha=.94). Adjectives were derived from a stress inventory developed by Mackay et al. (1978).

Aftereffects were measured during the period immediately following the task performance phase. The Glass and Singer

insoluble puzzles paradigm was employed (see Glass & Singer, 1972 for details). The number of insoluble puzzles attempted is the primary dependent measure.

Procedure. Subjects were randomly assigned to one of four conditions in a 2 (speech/video) by 2 (noise/quiet) factorial design. All subjects also participated in a 20 minute resting baseline physiological monitoring phase. In Phase 1 subjects either watched a relaxing nature video for 20 minutes or prepared and delivered a speech on euthanasia (a topic that most American college students are not well prepared to speak on). During the speech subjects believed they were being filmed and observed from behind a one way mirror.

In Phase 2 of the experiment subjects performed the Norinder Mental Arithmetic Task for 20 minutes under quiet (45 peak dBA) or noisy (90 peak dBA) conditions. The noise employed was the Glass and Singer noise tape and consists of a conglomerate of traffic noise, office machines, and foreign speech. Random intermittent bursts of noise occur throughout. All throughout Phase 2 blood pressure was automatically monitored every three minutes by a Critikon automated cuff. At the end of Phase 2 subjects indicated their perceived levels of stress.

For Phase 3, subjects performed the Glass and Singer insoluble aftereffects puzzle.

### Results and Discussion

The basic hypothesis of this study was that prior experience with a stressor (speech herein) would heighten one's vulnerability to the adverse effects of noise. Partial support was found for this hypothesis. Both blood pressure and aftereffects performance matched the hypothesis. As shown in Table 1, both diastolic ( $F(1,76)=3.89, p<.05$ ) and systolic ( $F(1,76)=6.68, p<.01$ ) blood pressure change scores from baseline were highest in the speech/noise cell.

Table 1. Psychophysiological Changes from Baseline (diastolic/systolic)

		Phase 1	
		Video	Speech
Noise	Low	4.32/-2.9	2.36/.69
	High	2.41/2.14	9.68/10.40

Subjects also made the least number of puzzle attempts (first and third insoluble puzzles combined) in the Speech/Noise aftereffect conditions ( $M=12.4$ ) compared to the other three aftereffect conditions (video/quiet  $M=21.2$ ; video/noise  $M=20.5$ ; speech/quiet  $M=20.0$ ),  $F(1,76)=5.35, p<.02$ .

Norinder mathematics performance was uniformly high and unaffected by noise or the prior stressor conditions. Self-reports of perceived stress were not significantly different but suggested a pattern opposite to the hypothesis. Subjects perceived the least stress during the two noise conditions ( $M=2.3$  and  $2.9$  for video and speech Phase 1 conditions); whereas more stress was perceived

during the low noise conditions following the video ( $M=3.4$ ) and the speech ( $M=4.7$ ). Perhaps following the initial speech, one's criterion for judging stress shifts upwards.

Both the blood pressure and aftereffects measures are in accord with the adaptive cost hypothesis. One of the costs of coping with a stressor like giving a speech may be less available coping resources to deal with the demands placed upon the organism by noise. Noise significantly increased blood pressure and significantly interfered with motivation to persist on insoluble puzzles especially following exposure to a psychosocial stressor. Immediately following a relaxing twenty minute period, these adverse effects of noise were absent.

The absence of performance decrements during noise following the stressful Phase 1 may be attributed to insensitive task parameters. We are currently replicating this study with a more demanding dual task and have found preliminary results more in accord with the adaptive cost hypothesis.

#### References

- Cohen, S. (1980). Aftereffects of stress on human performance and social behavior: A review of research and theory. Psychological Bulletin, 88, 82-108.
- Cohen, S., Evans, G. W., Stokols, D., & Krantz, D.S. (1986). Behavior, health, and environmental stress. NY:Plenum.
- Evans, G. W., & Cohen, S. (1987). Environmental stress. In D. Stokols & I. Altman (Eds.), Handbook of environmental psychology. NY:Wiley.
- Evans, G. W., Jacobs, S., Dooley, D., & Catalano, R. (1987). The interaction of stressful life events and chronic strains on community mental health. American Journal of Community Psychology, 15, 23-33.
- Fleming, R., Baum, A., & Singer, J. E. (1984). Toward an integrative theory of stress. Journal of Personality and Social Psychology, 46, 939-949.
- Glass, D. C., & Singer, J. E. (1972). Urban stress. NY:Academic.
- Lepore, S. J., Evans, G. W., & Palsane, M. N. (1991). Social hassles and psychological health in the context of chronic crowding. Journal of Health and Social Behavior, 32, 357-367.
- Mackay, K., Cox, T., Burrows, G., & Lazzerini, T. (1978). An inventory for the measurement of self-reported stress and arousal. British Journal of Social and Clinical Psychology, 17, 283-284.
- Schonpflug, W. (1986). Behavior economics as an approach to stress theory. In M. Appley & R. Trumbull (Eds.), Dynamics of stress. NY:Plenum.



# EXTENSIONS OF ANNOYANCE PROCESSINGS TO COMBINED EXPOSURES

MAURIN Michel, VERNET Isabelle

INRETS-LEN, case 24, 69675 Bron, cedex, FRANCE.

*Abstract* : In noise annoyance surveys, classic ordered categorical scales are employed in order to get a "supposed psychophysical relationship" between noise levels and resulting annoyance response. Related numerical data processing of categories are crude and then not very satisfactory. This may be improved when one gets the resources of the Measurement theory, for instance Adams and Messick results for ordered category scales. With combined exposures one uses specific features of "conjoint measurement".

*Résumé* : Les méthodes de traitement des notes de gêne sur l'échelle de 1 à 4 ou de 1 à 7 sont très répandues dans les enquêtes nuisances, mais toute statistique quantitative sur ces simples notes ordinales est sujette à caution. La théorie du Mesurage et ses précautions méthodologiques sont de nature à promouvoir un meilleur cadre numérique, en l'occurrence il peut s'agir des résultats d'Adams et Messick avec une seule nuisance. Dans les situations à expositions multiples nous utilisons les ressources du Mesurage conjoint.

## I - INTRODUCTION

In human sciences quantification is very attractive, associated numerical or statistical calculations also. In usual noise annoyance social surveys, noise levels are measured on a continuous decibel scale, and annoyance recorded on a four or seven (or else) categories scale between none and very important annoyance (or dissatisfaction, ...) [Langdon]. In a general way this is a matter of scaling, the suitability of which is poorly considered. When one gets linear regressions between noise levels and annoyance rates this becomes "a bit hair raising" as said Luce and Galanter because confusion between types of data and related statistical technics.

In a more general way this is a matter of Psychophysics with a "permanent" purpose, say to quantify sensations or human responses with respect to physical stimulations. Besides Weber-Fechner or Stevens laws, ordered category scales have been developed, all of them constituting a coherent relational framework [Maurin and al.]. More recently measurement theory renders possible clearer numerical assignments for sensations [Falmagne, Krantz and al., Roberts], for instance the Adams and Messick's method enables us to deal with a suitable order category processing [Maurin 85, 86, Maurin and al.].

Phenomena and experimental results are observed, and usually fit "a qualitative structure", (eg. preference for A is higher than for B, rods A and B put end to end have the same length than a third one ...). Measurement theory embeds observed qualitative structures into suitable mathematical structured spaces, and then we get the representation step into ad hoc spaces. Because empirical data can agree

with many representations, a following step, uniqueness, is related with the common part of them (in relation with group theory, here the groups of transforms between two representations). When mapping is made into real euclidian spaces (as usual), representation yields a numerical assignment for data, uniqueness defines the type of measurement scale employed, say absolute (no transform excepted identity), ordinal (monotonic transforms), interval (affine transforms), ratio (linear transforms), ... as forecasted by Stevens.

In practice observed data are number  $N_{ij}$  of respondents exposed to level stimulus  $S_i$   $i=1\dots I$  and rating category  $C_j$   $j=1\dots J$ , experimental conditional frequencies  $\omega_{ij} = N_{ij}/\sum_{q=1..J} N_{iq}$  and transformed frequencies  $z_{ij} = F^{-1}(\sum_{q=1..j} \omega_{iq})$ , with  $F$  a given cumulative distribution function. Adams and Messick's conditions are  $z_{pj} = a_{pq} z_{qj} + b_{pq}$ , say existence of real parameters  $a_{pq}$  and  $b_{pq}$ ,  $p, q = 1\dots I$ ,  $j = 1\dots J-1$ . When fulfilled there exist two embeddings  $\mu$  for stimuli and  $t$  for category boundaries on the same interval scale with  $t_0 = -\infty$  and  $t_j = +\infty$ . The numerical correspondence  $\mu_i$  versus the stimulus physical value  $S_i$  yields the psychophysical relationship.

## II - CONJOINT MEASUREMENT AND COMBINED EFFECTS

Applications for combined effects exposures are possible thanks to a new kind of measurement and some convenient circumstances.

### II.1 - Conjoint measurement's technic

The conjoint measurement appeared very few years after the beginning of measurement. It concerns designs of independent stimulations (economical, psychological, ...) and the possibility to get a measurement for each stimulus and for the resulting multi-dimensional situations (with representation and uniqueness steps). To do this we must have an observed dependent variable  $v$  (or response strength) for each situation such that

- 1) it yields a strict weak order structure on a situation's design,
- 2) it meets some specific conditions, also called "qualitative laws" ;

This is a measurement process which may help for discovery of quantitative relations (possibly unknown until now). Conjoint measurement has been first seen by economists (for instance questions with market-basket ...) and exposed in measurement terms by Luce and Tuckey. The most common results are related to additive measurements on interval scale. If  $A$  and  $B$  are two sets of respective elementary stimulations  $A_i, B_k$ , dependent variable is measured by  $\psi_{ik} = a_i + b_k$ , with  $a_i$  and  $b_k$  respective measurement values  $\mu_A(A_i), \mu_B(B_k)$  on the same interval scale. Luce and Tuckey developed additive for two sets case (with specific qualitative law), Krantz and Tversky additive for three (or more) sets case, say  $\psi_{ikl} = a_i + b_k + c_l (+\dots)$ , and some others like polynomial measurements ... [Krantz and al., Roberts].

Some qualitative laws are rather natural or trite and some others not so much ; among the simplest there are motononic conditions, say dependent variable  $v_{ikl\dots}$  has to be monotonic for each elementary sub-index  $i, k \dots$ . Among most elaborate conditions (figures) :

- for two stimuli, the "double cancellation" condition :

for all sets of indices  $i_1, i_2, i_3$  and  $k_1, k_2, k_3$  every time there is  $v_{i_2, k_1} \geq v_{i_1, k_2}$  and  $v_{i_3, k_2} \geq v_{i_2, k_3}$ ,  $v_{i_3, k_1} \geq v_{i_1, k_3}$  has to be met ;

- for three stimuli, a joint independent condition :

for all sets of indices  $\alpha_1, \beta_1, \gamma_1$  and  $\alpha_2, \beta_2, \gamma_2$ , ( $\alpha, \beta, \gamma$  any permutation of  $i, k, l$ ) every time there is  $v_{\alpha_1, \beta_1, \gamma_1} \geq v_{\alpha_2, \beta_2, \gamma_1}$ ,  $v_{\alpha_1, \beta_1, \gamma_2} \geq v_{\alpha_2, \beta_2, \gamma_2}$  has to be met.

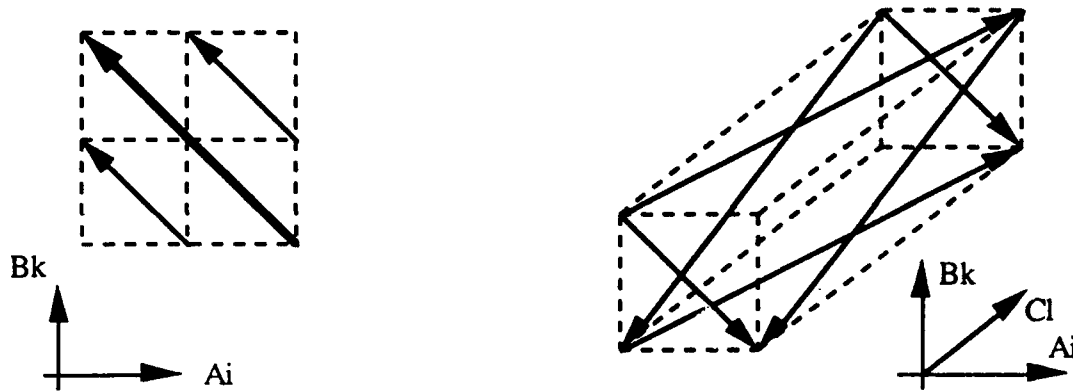

figures 1 : schematized qualitative law for additive conjoint measurement

two stimuli case - the double cancellation law

three stimuli case

## II.2 - The convenient "effect" of ordered category scales

Conjoint measurement has not been very used. We may think that it is due to some extent to the difficulty experienced in being able to make use of an ordinal dependent variable for each situation  $\{i, k, l, \dots\}$ .

II.2.1 - Let  $n$  the sub-index for a combined exposure, the couple  $\{i, k\}$  when two stimuli, or the triplet  $\{i, k, l\}$  when three stimuli, ..., and consider the dependent variable is the overall annoyance experienced by respondents. If we use an ordered category scale as in ordinary noise surveys (part I), for every  $n$  we easily get the conditional distribution  $D_n$  of percentages  $\omega_{nj}$  of  $C_j$   $j=1, \dots, J$  categories

and the median value  $M_n = j_n - 1 + \frac{1}{\omega_{nj_n}} (0,5 - \sum_{q=1}^{j_n-1} \omega_{nq})$ ,  $j_n$  such that  $\sum_{q=1}^{j_n-1} \omega_{nq} < 0,5 \leq \sum_{q=1}^{j_n} \omega_{nq}$ .

Thus  $M_n \in [j_n-1, j_n]$  and  $M_n \leq M_n'$  is a weak order relation. So ordered category scale for individual responses yields a rather simple ordinal dependent variable.

II.2.2 - Suppose related qualitative laws are fulfilled. Then it remains a numerical question, say how to find a numerical assignment for each stimulation  $a_i = \mu_A(A_i)$  for  $A_i$ ,  $b_k = \mu_B(B_k)$  for  $B_k$ , ... and the resulting additive response  $\psi_n = a_i + b_k (+ \dots)$ . This time again ordered category are useful provided  $\omega_{nj}$  data constitute a previous Adams and Messick measurement system, because we get an interval scale response  $\mu_n$ . This measured and quantified response enables us to consider the simple and final numerical processing, find the optimal values for the following minimization programs :

$$\text{two stimuli case : } \min_{a, b} Q(a, b) = \sum_{ik} (a_i + b_k - \mu_{ik})^2$$

three stimuli case :  $\min_{a,b,c} Q(a, b, c) = \sum_{ikl} (a_i + b_k + c_l - \mu_{ikl})^2$

with respective additional constraints as  $\sum_i a_i = 0$  or  $\sum_i a_i = \sum_k b_k = 0$  in order to neutralize translations on interval scale, (missing data for some  $n$  are available in these programs). There is a solution  $a_i^\circ(A_i), b_k^\circ(B_k), \dots$  and we get final values  $\psi_n = a_i^\circ + b_k^\circ$  (two st.) or  $\psi_n = a_i^\circ + b_k^\circ + c_l^\circ$  (three st.) ;  $\psi_n(A_i, B_k, \dots)$  is the conjoint measurement,  $a_i^\circ(A_i), b_k^\circ(B_k), \dots$  are partial or marginal psychophysical relationships.

### II.3 - Prerequisites for practical use

Observed and raw data are the table numbers  $N_{nj}$  of respondents exposed to combined situation  $n$  and rating category  $C_j$ , then conditional percentages  $\omega_{nj} = N_{nj}/N_n$ , cumulative percentages  $\sum_{q=1..j} \omega_{nq}$ , and related  $z_{nj} = F^{-1}(\sum_{q=1..j} \omega_{nq})$ . measurement requirements are first Adams and Messick conditions on  $z_{nj}$ , last some qualitative laws on medians  $M_n$ .

Remember  $n$  is a composite index in conjoint measurement  $\{i, k, l \dots\}$ . For two combined exposures (two sets  $A_i$  and  $B_k$  of respective elementary exposures) inputs are a three-way tables of integer data  $N_{\{ik\}j}$ ; for three ones inputs are a four-way table of  $N_{\{ikl\}j}$ . Above processings, minimizations and calculations are handled by computers and INRETS programs.

In conclusion ordered category scales and their improved technics render easy an acquisition of ordinal respondent variable (in order to meet qualitative laws for conjoint measurement), and also a final numerical processing for additive measurement. This is quite suitable to annoyance measuring, or any other individual psychological response, with a mere ordered scale as in classical noise surveys. To do this in combined effects context we only need sets of considered elementary exposures  $A_i, B_k, \dots$ , a definite ordered scale  $C_j$ , and the record of multi-way table  $N_{\{i,k,\dots\}j}$  for combined exposures.

### REFERENCES :

- Falmagne J.C., 1974, Foundations of fechnerian psychophysics, in Krantz, Atkinson, Luce, Suppes, Contemporary developments in mathematical psychology, vol II, San Francisco, Freeman, 127-159.
- Krantz D., Luce R.D., Suppes P., Tversky A., 1971, Foundations of Measurement, vol 1, Ac. Press.
- Langdon F.J., 1975, The problem of measuring the effects of traffic noise, in Alexandre, Barde, Lamure, Langdon, Road traffic noise, Applied Science, 27-69.
- Luce R.D., Galanter E., 1963, Discrimination, Psychological scaling, in Luce, Bush, Galanter, Handbook of math. psychology, vol 1, J. Wiley, 191-243, 245-307.
- Maurin M., 1985, The measurement of noise annoyance responses, Internoise, Munich, p. 993-996.
- Maurin M., 1986, L'association du Mesurage additif conjoint et des intervalles successifs, Mathématiques et Sciences Humaines, n° 96, 5-29.
- Maurin M., Versace R., Peris J.L., 1988, Noise annoyance measurement, category scales and context effect, the 5th International Congress on noise as a public health problem, Stockholm, vol 3, 235-240.
- Roberts F.J., 1979, Measurement theory, Reading Massachusetts, Add. Wesley P. Co.
- Stevens S.S., 1966, A metric for the social consensus, Science, 151, 530-541.
- Vallet M., Maurin M., Page M.A., Favre B., Pachiaudi G., 1978, Annoyance from and habituation to road traffic noise from urban expressways, Journal of sound and vibration, vol 60 n° 3, 423-440.

# A new methodological approach for studies on the combined effects of noise and other occupational hazards

Peter Mehnert, Barbara Griefahn, Peter Bröde

Institute for Work Physiology at the University of Dortmund  
Department for Environmental Physiology and Occupational Medicine  
Ardeystr. 67, D-4600 Dortmund 1, Federal Republic of Germany

**Fundamentals:** At many workplaces employees are exposed to multiple environmental hazards. Combinations of physical, chemical, psychological and other loads affect the well-being and the health of the workers exposed. The studies on the effects of combined environmental factors at the workplaces are important challenges for researchers in occupational and environmental health and safety. But it has to be pointed out, that investigations concerning combined effects are complex, time-consuming and also expensive. In order to improve this situation it is absolutely necessary to work out first a theoretical basis for the hypothetical interactions from which practical concepts for directed studies can be derived. The development of statistical models for the joint action of factors is an essential aid for the planning and execution of studies in this area. Application of adequate methods of data analysis increases the generalization of the results. The adaption of established methods in pharmacology and toxicology may be a first useful step.

**Methods:** In a comprehensive review models and methods from pharmacology concerning the joint action of mixtures of drugs were explored. Fundamental differences to the research on exposure to combined effects at the workplaces could be identified. For example in pharmacologic research the effect of the joint action is measured as a binary outcome (quantal response) in most cases, whereas the load of workers exposed to multiple agents is preferably acquired by means of quantitative variables. This aspect has important consequences regarding the application of statistical methods.

**Results:** Ashford (1981) presented a general framework for the joint action of drugs or other stimuli on biological organisms or other complex systems. This approach seems to be most suitable for adaption to investigations concerning the combined effects of noise and other occupational factors not only from a practical point of view, but also with respect to the development of a theoretical basis for the interactions of multiple factors. The mechanisms of interactions are put forward in terms of three main concepts: components of the applied stimulus, physiological subsystems and sites of action. The precise mode of action of a component at a site of action on a subsystem is set up on the basis of the drug-receptor theory.

**Application:** Exposure to hand-arm-vibration is often accompanied by exposure to other agents like noise or cold. In dependence on the intensity and duration of exposure workers can suffer from the vibration induced vasospastic disease (Raynaud syndrome). Concerning the pathophysiology of the disease a multifactorial etiology is assumed. The others factors i.e. noise and cold are suspected to influence the genesis of the disease. In order to evaluate the significance of these factors, a laboratory study has been planned with systematical combination and variation of the single factors. The approach of Ashford is used for the design and statistical analysis of this study.

To be presented in session 8 (Noise and combined agents)



# INTERACTIVE EFFECTS OF NOISE AND WHOLE BODY VIBRATION ON PERFORMANCE IN A FIVE-CHOICE-REACTION TASK

NOTBOHM, Gert and JANSEN, Gerd

Institute of Occupational Medicine, Heinrich-Heine-University, Moorenstr. 5, 4000 Düsseldorf/FRG

**Summary.** In two experiments, the combined effects of two environmental stressors (sinusoidal whole body vibration of 8 Hz and broadband noise of different sound levels) on performance were studied. In the first experiment, performance was best when Ss adjusted the intensity of sound to the perceived intensity of the vibration stimulus. In the second experiment, different types of motivational instruction influenced performance more distinctively as compared to the stress stimuli.

## 1 Introduction

Research on the combined effects of two stressors on performance has a long tradition. In the well-known "Cambridge studies" in the sixties and early seventies, different combinations of stressors were investigated systematically with respect to their effect on a variety of tasks such as tracking, vigilance, and a five-choice-reaction task (e.g. [4]). In short, the results did not allow for a conclusive theoretical explanation of the shifts in performance observed under different experimental conditions. Especially with the five-choice-reaction task, there was much evidence that the combined effects of two stressors differ significantly from the effect elicited by each single stressor, and in most cases the combined effect was compensatory, i.e. less than the effect of one single stressor.

With regard to the combined effects of *noise and vibration* on performance, most of the research was done by the Aerospace Medical Research Laboratory in Ohio. For more than ten years, the research group has been studying changes in tracking performance and in mental arithmetics, using as stimuli different levels of sound intensity and different frequencies and amplitudes of vibration. Some of their results give support to an intriguing suggestion: the effect of combined stressors seems to depend largely on the magnitude of the intensity levels applied, thus augmenting the effect of a single stressor in one case and neutralizing it in another case [2].

Further evidence that the magnitude of the intensity levels of the two stimuli are important in determining the combined effects on performance was gained from an experiment by Champion [1]. His results indicate that performance is not impaired substantially when the two combined stimuli are perceived by the subjects (Ss) as being of equal intensity. Thus, subjective processes, e.g. evaluating the distraction imposed by the combined stimuli and counterbalancing their effects through personal effort, seem to account for some of the inconsistencies observed in former research on performance with multiple stressors.

In 1988, we started investigating the combined effects of noise and whole body vibration in our own laboratory, using a five-choice-reaction task as a paradigm of performance [3]. In an experimental design with repeated measures, Ss were exposed to six different conditions of environmental stress in a random order: white noise of 75 dBA and of 100 dBA resp., single and then combined with sinusoidal whole body vibration of 4 and 8 Hz respectively. When vibration of 8 Hz was combined with noise of 100 dBA, performance was not impaired at all, but for the combination of the same vibration stimulus and noise of 75 dBA, performance was worse than with noise alone.

Proceeding from these puzzling results, we conducted two more experiments the results of which are presented in this paper. Both studies were aimed at confirming and further clarifying the interactive effects of whole body vibration of 8 Hz and noise of different intensity levels.

## 2 Methods

### 2.1 Subjects

24 male university students volunteered for participation in the two experiments, for which they were submitted to a medical examination on general health, spinal troubles and normal hearing.

## 2.2 Apparatus

Sinusoidal vibration of 8 Hz was presented by a hydraulic vibration exciter. Acceleration was  $3 \text{ m/s}^2$  in all experimental conditions. Subjects (Ss) were seated in a comfortable chair with back rest, which was mounted on top of the shake table, and were restrained by a lap belt.

The white noise stimuli were produced by a Brüel & Kjaer noise generator and was passed bilaterally to earphones worn by the subject. As the noise emission of the vibration exciter did not exceed 70 dBA, the sound level of 75 dBA which was supplied in both experiments as the lowest noise stimulus was sufficient to mask all ambient noise.

## 2.3 Task

On the shake table, a console was mounted bearing the reaction test device. It consisted of five coloured buttons on a horizontal panel and a glass plate on a vertical panel. Behind the glass plate, lights of the same five colours flashed in a random sequence controlled by a computer program. There were five lights for each colour irregularly distributed over the plate. The flashing rate depended on the subject's reaction, i.e. each pressing of a button elicited the next stimulus of light.

Ss were instructed to react as quickly and as accurately as possible. Each single reaction time and the scores on right and wrong answers ("hits" and "errors") were automatically computed. In both experiments, each experimental condition consisted of three trials lasting six minutes each. Each trial was followed by a rest of one minute. After each experimental condition, the subject's own evaluation of the strain endured and of his success in performance was registered by questionnaire.

## 3 Experiment 1: Effects on performance when the intensity of the noise and vibration stimuli are subjectively equal

### 3.1 Design

At the beginning of the experiment, Ss first had to become acquainted with the task. When explanations on the procedure of the experiment had been given, Ss were trained in the task during two training sequences consisting of three trials each. They were then exposed to the vibration stimulus for the first time and were asked to regulate a simultaneous noise stimulus to an intensity which they would judge as being equal to the intensity of the vibration stimulus. The regulation process was repeated several times, and the arithmetic mean of the trials was used later on as the individual level of self-regulated noise intensity. The individual noise levels obtained this way ranged from 90.2 to 98.7 dBA; the arithmetic mean for the group was 94.8 dBA.

After a resting period, each of the Ss was exposed to four different experimental conditions in a random order. The conditions were: white noise of 75 dBA, single and in combination with the vibration stimulus of 8 Hz, noise of 100 dBA combined with the vibration stimulus, and the vibration stimulus in combination with the individual level of self-regulated noise intensity. As noise of 75 dBA is not supposed to influence this type of performance, this condition could be considered as a control condition.

### 3.2 Results

Fig. 1 shows the number of correct reactions in the two training sequences and the experimental conditions. As there was no significant effect of trials on the results, the arithmetic mean of the three trials for each condition was used for as the basis for the analysis. There is a distinct effect of learning from the first to the second training sequence. During three of the four stress conditions, Ss keep this level of performance almost constant. Only the combination of vibration with self-regulated intensity of noise yields an improvement in performance. By Friedman analysis of variance, the difference between the four experimental conditions proved to be significant ( $p < 0.02$ ).

With respect to errors in response, there was no significant difference between the four experimental conditions. In general, with this task there is such a small number of errors in a trial of six minutes duration that the number of correct answers mainly reflects the reaction time, i.e. the speed of performance.

The results of this study give support to the hypothesis of Champion that performance is less impaired by combined stressors if the intensity level of each stimulus is perceived as being equal. Thus, a cognitive factor seems to be of major importance for maintaining performance, presumably the dis-



traction proceeding from the environmental agents and the effort needed to counterbalance this disturbance.

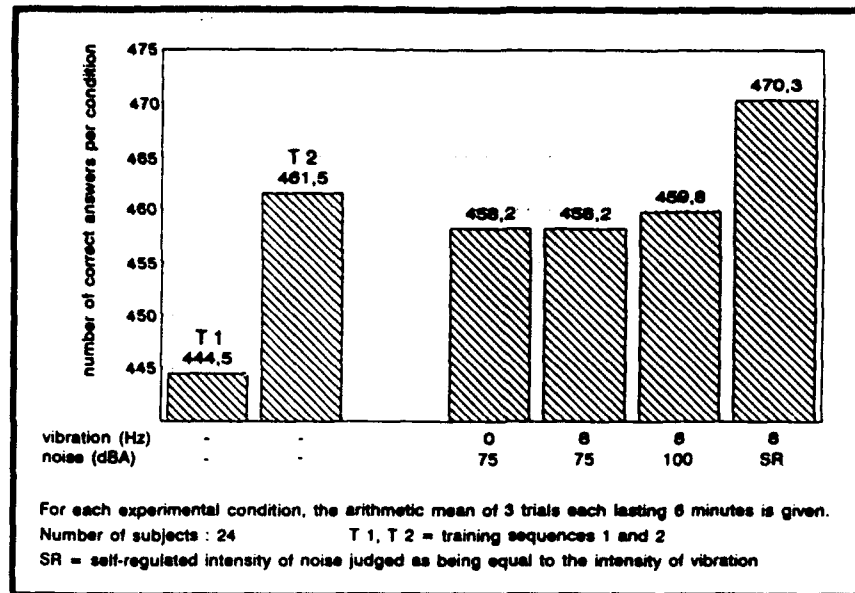

Fig. 1. Number of correct answers in the five-choice-reaction task

#### 4 Experiment 2: Effects of motivation on performance

##### 4.1 Design

Two weeks after the first experiment, the same Ss took part in the second experiment. They were divided into four groups of 6 persons each. The groups were matched by referring to the subjects' efficiency in the reaction task as shown in the former experiment.

Following a training sequence, all Ss had to submit themselves to the test while being exposed to noise of 75 dBA. This control condition was to assure the baseline values of performance for the following conditions, in which a different motivational instruction was attached to each of the four groups:

- no additional motivation (NO),
- knowledge of results (KR), i.e. a feedback on the numbers of right and wrong reactions was given after each trial,
- a financial incentive (FI), i.e. a bonus was promised for those ranking with the best results in performance at the end of the experiment,
- the combination of knowledge of results and financial incentive (KR/FI).

When each group had been given appropriate instructions, Ss repeated the reaction task with four different conditions of environmental stress: noise of 75 dBA and of 100 dBA resp., single and then each combined with vibration of 8 Hz. Within each group, the order of stress conditions was balanced.

##### 4.2 Results

To give a clearer impression of the results, we present only the shifts in the number of correct answers between the control condition and the experimental conditions. Fig. 2 shows the mean differences in response for each group of motivational incentive and for each stress condition in turn.

For the group without any additional motivation, there is a clear influence of the stress stimuli on the number of correct answers yielding a greater impairment of performance with the vibration conditions. When vibration was combined with noise of 100 dBA instead of 75 dBA, the impairment was less - similar to our results in a former experiment [3].

When knowledge of results was used by means of a feedback on performance after each trial of 6 minutes, there was no influence of the stress stimuli at all. The feedback, obviously, supplies sufficient information to adjust one's pace of reaction most favourably to the environmental condition.

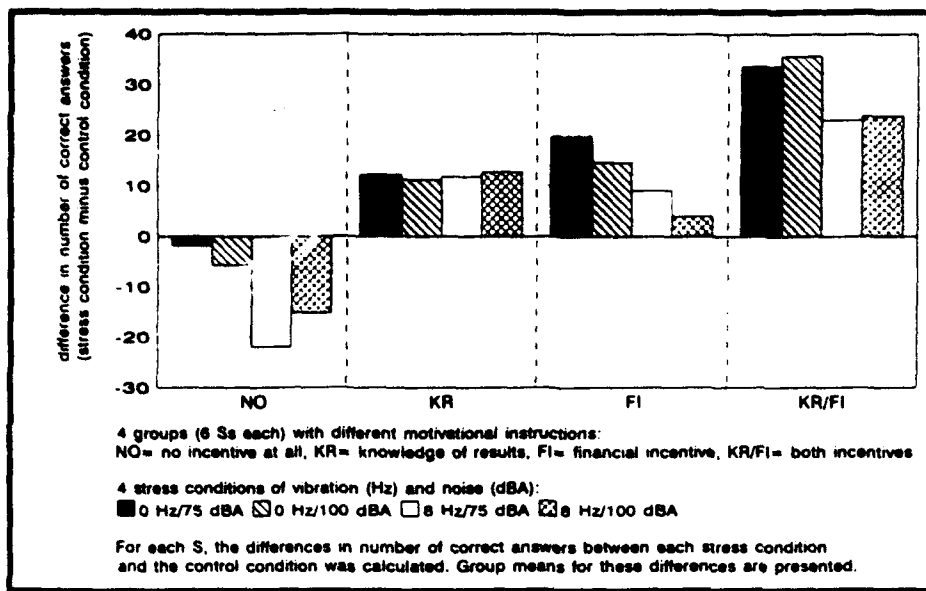

Fig. 2. Effects of motivation on performance in the five-choice-reaction task

When a financial incentive is given as an additional motivation, the results look quite different: With noise alone, there is a distinct increase in the number of correct answers, probably reflecting the enhanced effort of the Ss. During the conditions of combined stress, the effectiveness of the motivational incentive seems to be reduced as indicated by the lesser increase in correct answers.

The group which was motivated by knowledge of results as well as by financial incentive, displayed by far the greatest improvement in performance as compared to the control condition. Again, with noise alone, the increase in correct answers is more distinct than with the combined stressors.

Statistical analysis (MANOVA for repeated measures) proved the influence of the two motivational factors on performance to be significant.

## 5 Discussion

The small size of the groups in the last experiment allows only for tentative conclusions. The results suggest that an increase in effort by the Ss as induced by a financial incentive has a stronger influence on performance in this kind of task than the noise or vibration load applied. With regard to the different stress conditions, it holds true for the financial incentive as well as for no motivation at all that performance is worse with the combination of noise and vibration as compared with noise alone. Feedback on performance after each trial, however, largely neutralizes the influence of the different stress conditions thus indicating that also a senso-motorical mechanism of adjusting the optimum speed is involved.

Compensatory effects of combined stressors within a certain range of intensity as observed in the first experiment and in former studies, thus, might be explained mainly in terms of differences in Ss' motivation at any given time. Specific levels of intensity might be perceived as being less of a disturbance than others, thus influencing the intrinsic motivation of a person. This conclusion should be tested on a task which requires more adjustment to the environmental stress than the five-choice-reaction task.

## References

- 1) Champion, D.F. (1986): Some effects of combinations of noise and vibration on the performance of a cognitive task. Thesis, North Carolina State University at Raleigh
- 2) Harris, C.S.; Sommer, H.C. (1973): Interactive effects of intense noise and low-level vibration on tracking performance and response time. *Aerosp. Med.*, 44, 1013-1016
- 3) Notbohm, G.; Gros, E. (1988): Combined effects of whole-body vibration and noise on performance in a multiple reaction-time-task. In Aghazadeh, F. (ed.): *Trends in Ergonomics/Human Factors V*. Amsterdam, Elsevier, p. 505-512
- 4) Wilkinson, R.T. (1969): Some factors influencing the effect of environmental stressors upon performance. *Psychol. Bull.*, 72, 260-272

# IMPACT OF NOISE AND AIR POLLUTION ON HEALTH

PJEROTIC Ljiljana, NIKOLIC Mihailo  
Institute of Health-Belgrade, University of Belgrade, Yugoslavia

## ABSTRACT

Road traffic belongs to the most prominent sources of noise and air pollution in the contemporary environment. The city of Pancevo is an economic center and one of the leading industrial areas where we measured traffic noise in two areas : the center of the city and its industrial zone. The levels of noise were above 65 dB(A) with maximal value of 79 dB(A). We also observed high concentration of certain pollutants (CO, Pb). At the same time we also examined harmful effects of noise and air pollution on public health in the above zones. Other factors, living and occupational conditions, smoking, alcohol consuming and use of tranquilizers were also taken into account. Besides its effects on hearing, noise is also considered as a stress factor that influences nervous system, heart, blood vessels etc. Noise is a predominant cause of nervousness in the population covered by our study. In order 40 per cent of cases it disturbs sleep. People from industrial zone are more sensitive to noise than these living in the center. We also observed increased systolic blood pressure in former group. Factor analysis showed that smoking is the predominant factor which cause bronchitis chronica.

## 1 - INTRODUCTION

Traffic noise is not determined by time and has oscilations in intensity and frequency which is very important for people's rest and restitutio ad integrum. Traffic noise is always followed by air pollution. In recent years many studies have shown that the incidence of neurosis, chronic bronchitis, asthma, cancer, allergics conected with noise and air pollution are on the increase (1) (2) (3) (4).

## 2 - OBJECTIVES

The aim of this study was to investigate the levels of traffic noise and concentrations of air pollutants CO and Pb in the center of Pancevo ans its industrial zone and to find out harmful effects of noise and air pollution on the exposed population.

## 3 - MATERIALS AND METHODS

The population was defined as persons between 18 and 60 years of age, who have been inhabitants of Pancevo and exposed to noise and air pollution. Based on the zones 224 subjects have been living in were divided in 2 groups (165 subjects from the center and 59 subjects from industrial zone). We did not exclude the persons who had noisy jobs or workers in conditions of dust and gasses in order to provide a realistic estimate of health in a typical exposed population (5).

The noise levels were measured by noise analyser (Bruel & Kjaer) on 9 points in the center and on 2 points in industrial zone four times a day during rush hours (6). On the same places, at the same time CO was determined by reaction with Paladum Oxide, and Pb by pump (Casella type).

The subjects were asked to answer several questionnaires dealing with their living ans occupational conditions, attitutes toward environmental noise ans noise sensitivity, smoking, alcohol consuming, use of tranquilizers etc.

Hearing function, systolic and dyastollic pressure, pulse and pulmonal function were measured in the both groups (7) (8) (9) (10).

## 4 - RESULTS AND DISCUSSION

Average daytime noise levels in two investigated areas are reported in figure 1. It is observed that the noise levels exceed 65 dB(A) in both areas in all points.

Figure 1 : Average daytime noise levels in two areas in Pancevo

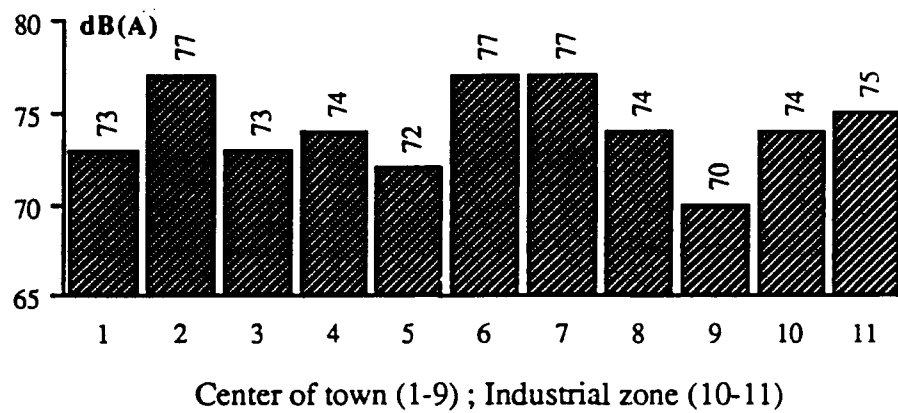

No difference in noise levels was found between two areas according to analysis of variance ( $F=3,139$ ,  $p > 0,05$ ), (11).

Average daytime concentration of CO and Pb on the same places are presented in figure 2 and figure 3. It is obvious that their levels were very high and over the permitted limits (12).

Figure 2 : Average daytime concentration of CO in two areas of Pancevo.

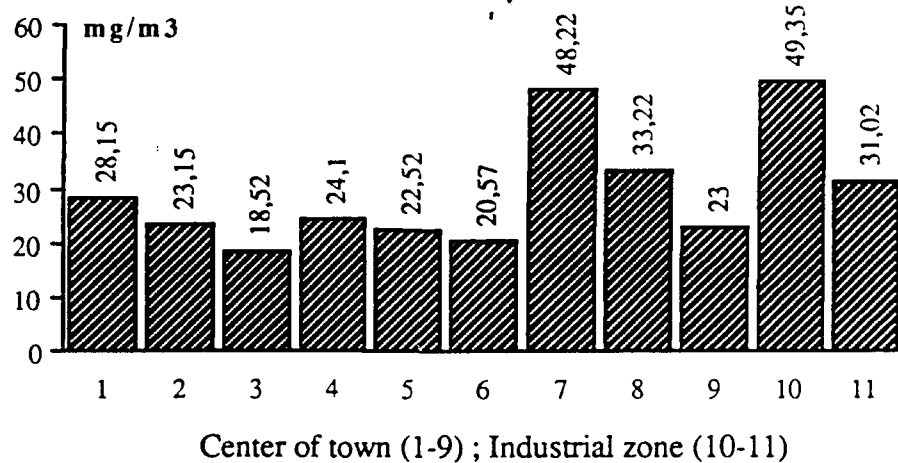
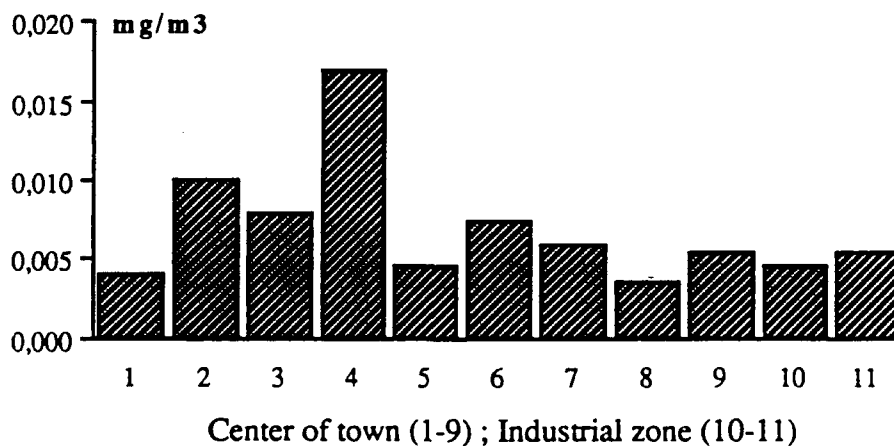

Figure 3 : Average daytime concentration of Pb in two areas of Pancevo.



Analysis of variance shows that there is no statistical difference between concentrations of CO in the two investigated areas ( $F=2,4446$  ;  $p >0,05$ ), but the concentrations of Pb are significantly higher in the center ( $F=5,053$  ;  $p >0,05$ ).

An important observation is to note that 57,9 % of subjects from the first group and 69 % subjects from the second one have noisy job. Noise is predominant cause of nervousness in both groups (20 % and 16,9 %). It disturbs sleep in 42,1 % of subjects in the first group, and in 40,7 % of those in the second. People from industrial zone are statistical significant more sensitive to noise than these from the center ( $\chi^2 = 13,813$  ;  $p >0,05$ ).

Audiometric results reveal high percentage of hearing loss in both groups, but most often it is mild (between 20-40 dB) with no differences between groups ( $\chi^2 = 2,3$  ;  $p >0,05$ ), Figure 4.

Figure 4 : Results of hearing loss degree

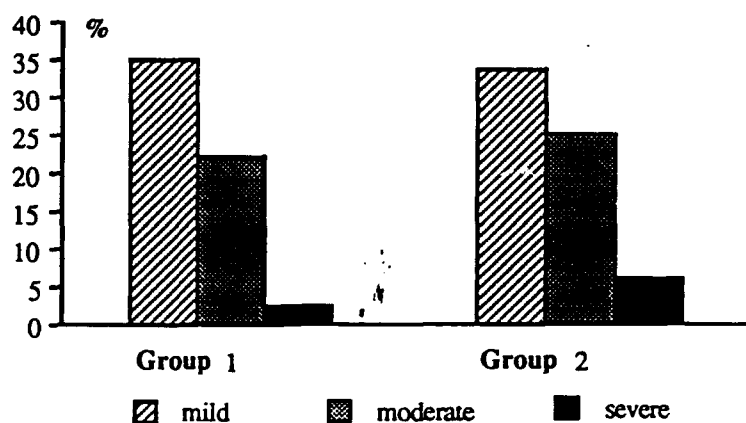

It was confirmed that hearing loss is highly connected with duration of work in noisy conditions ( $\chi^2 = 14,851$  ;  $p >0,05$ ), (13).

Investigations of blood pressure (figure 5) show that people from industrial zone have statistically significant higher systolic blood pressure ( $\chi^2 = 6,0312$  ;  $p >0,05$ ), but there are no differences in dynastolic pressure ( $\chi^2 = 0,996$  ;  $p >0,05$ ).

Figure 5 : Results of systolic blood pressure

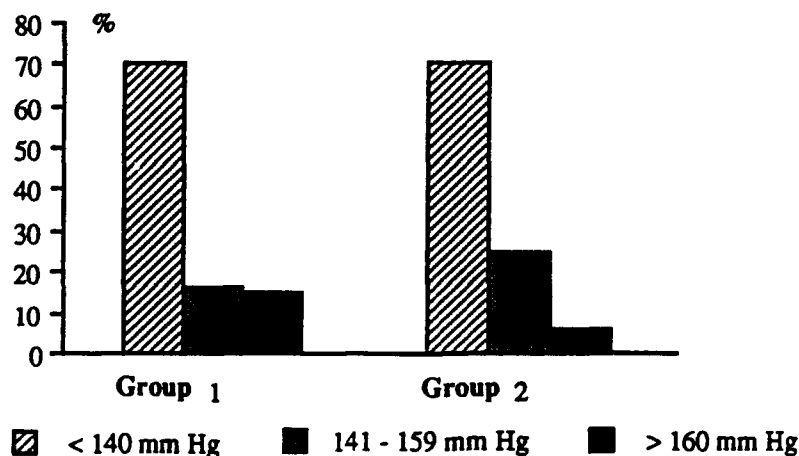

Factors analysis, which took into account all factors of the working and living environment which cause bronchitis chronica, showed that smoking is predominant factor in the whole investigated population ( $F=0,9$ ).

## 5 - CONCLUSIONS

Results of our study reveal that traffic noise and air pollution in Pancevo are very high in both zones and above permissible limits. Our study shows that great number of investigated subjects have low degree of hearing loss in both groups and high correlation between hearing loss and working in noise conditions. People from industrial zone are more sensitive to noise than those living in the center and also have increased systolic blood pressure. It is probably due to genetic hyperactivity of sympathetic center of hypothalamus. (14). Noise is a predominant cause of nervousness in this population and it also disturbs sleep. By this study we confirmed high correlation between smoking, number of cigarettes smoked, duration of smoking and bronchitis chronica.

It is therefore necessary to make the programme of preventive measures concerning air pollution, noise and public health.

## REFERENCES

- 1 - Nikolic M., Gec M (1991). Speciflenosti hormonskog reagovanja trudnica na dejstvo avionske buke. Glas CCCLXIV Srpske akademije nauke i umetnosti knj.41, Beograd 1991.
- 2 - Imai M, Joshida K, Katabatake M (1986). Mortality from asthma and chronic bronchitis associated with changes in air pollution. Arch. Environ. Health : 1986, 41 (1), p 29-35.
- 3 - Holberg CJ, O'Rourke MK, Labowitz M (1987). Multivariate analysis of ambient environmental factors and respiratory effects. Int J. Epidemiol. 1987, 16(3) p 399-410.
- 4 - Vilka V, Herahtela T (1988). The respiratory tract and air pollution. Duodecim, 1988, 104 (6), p 488-493.
- 5 - WHO (1980). Noise, Geneva, Environmental Health Criteria 12.
- 6 - ISO (1971). Acoustics assessment of noise with respect to community response. Geneva, ISO R 1996, 10 pp.
- 7 - Prazic M (1960). Govorna audiometrija, Izdavaéki zavod Jugoslovenske akademije, Zagreb 1960.
- 8 - Lamm G (1981). The cardiovascular disease programme of WHO in Europe. Copenhagen WHO, 115-125.
- 9 - WHO (1986). Community prevention and control of cardiovascular diseases. Geneva, Tech. rep ser 732.
- 10 - Quanjer PH (1983). Standard lung function testing. Bull. Psysiopath. Respir, 19 supp 5/7, 1983.
- 11 - Afifi A, Clark V (1984). Computer-aided multivariate analysis. Lifetime learning publications Belmont, California.
- 12 - WHO (1987). Air quality guidelines for Europe. WHO Regional publications, European series, n°43.
- 13 - Occupational exposure to noise. US Environmental protection agency, 2 nd ed. Washington, US DHEW, 6 : 17 (HSM73-11001), 1973.
- 14 - Smooker H et al. (1973). Hypertensive effects of prolonged auditory, visual and motion stimulation. Fed. Proc. 32 : 2105-2110.

# THE COMBINED EFFECT OF NOISE, AIR QUALITY AND TEMPERATURE ON HUMAN COMFORT

POULSEN Torben, KIM Sun Woo, RINDEL Jens Holger  
CARRICK Linda, CLAUSEN Geo, FANGER Per Ole

The Acoustics Laboratory and Laboratory of Heating and Air Conditioning  
Technical University of Denmark, DK-2800 Lyngby, Denmark

## ABSTRACT

An investigation was carried out on the perceived annoyance from the combined effect of three factors: air quality, temperature and noise level. The experiments were performed in two identical climate chambers. The condition (i.e. a combination of the three factors) in one chamber was kept constant whereas the noise level or temperature was changed in the other chamber. Sixteen subjects rated their annoyance in each condition. Furthermore the subjects indicated which of the two rooms they preferred to be in. The noise levels ranged from 40 to 75 dB  $L_{Aeq}$  in steps of 5 dB. Five temperatures from 21.3 °C to 30.8 °C were used. Four different estimated air qualities between 0.6 and 8.9 decipol were used. A change in temperature turned out to be a more important factor than a change in air quality. With neutral air quality and temperature, 50% of the subjects found the condition unacceptable when the noise level ( $L_{Aeq}$ ) exceeded 58 dB SPL.

## INTRODUCTION

The annoyance caused by noise has been studied in several investigations (e.g. [1,2]). The objective of such investigations have been to establish reasonable noise limits so that no persons (or just a few) will be annoyed by the noise. In real life, e.g. at a working place, the noise is never experienced independent of other factors such as temperature and air quality. In an office situation where the temperature has increased and the air quality has decreased, would it then be preferable to open a window in order to lower the temperature and increase the air quality, and possibly also increase the background noise due to a noisy street ?. The aim of the present investigation was to study the interaction between the three factors noise, air temperature and air quality.

## EXPERIMENTAL METHOD

The experiments were performed in two identical test chambers [3]. The condition in one chamber was kept constant whereas the noise level or temperature was changed in the other chamber. The experimental conditions are summarized in Table 1. Based on previous research [4,5] the air qualities and temperatures were chosen to achieve 10, 20, 40 and 60% dissatisfied persons. The noise levels were chosen to cover a range from the background noise level in the rooms to an expected unacceptable level. In Table 1 the neutral conditions are shown on a grey background. Only results from noise level variations will be given here.

Number	Chamber A			Chamber B		
	Temperature [°C]	Air Quality [decipol]	Noise Level [dB SPL]	Temperature [°C]	Air Quality [decipol]	Noise Level [dB SPL]
1	23.3	0.6	40	21.3	0.6	40-75
2	26.0	0.6	40	21.3	0.6	40-75
3	28.4	0.6	40	21.3	0.6	40-75
4	21.3	1.4	40	21.3	0.6	40-75
5	21.3	4.1	40	21.3	0.6	40-75
6	21.3	8.9	40	21.3	0.6	40-75
7	28.4	8.9	40	21.3	0.6	40-75
8	21.3	1.4	40	21.3-28.4	0.6	40
9	21.3	4.1	40	23.3-30.8	0.6	40
10	21.3	8.9	40	23.3-30.8	0.6	40

**Table 1.** The combinations of temperature, air quality and noise level used in the experiments.

Experiments 1 to 7 compared a set of conditions in chamber A with a number of noise levels in chamber B. The noise levels were presented in random order. In experiments 1 to 3 and in 4 to 6, two of the factors in chamber A and two of the factors in chamber B were kept at a neutral level. Experiment 7 combined a high temperature and a low air quality in chamber A. In experiment 8 to 10 a set of conditions in chamber A were compared with a range of temperatures in chamber B. The experiments were performed in a random order.

### Test subjects

Eight female and eight male subjects participated in the experiments. The subjects were paid for their participation. As the group was too large to be in the rooms at the same time the sixteen subjects were divided into two groups and the experiments performed twice. All subjects had normal pure tone thresholds (ISO 389), olfactory and chemical senses. Before the experiments the subjects were given instructions about test procedure and questionnaires.

### Stimuli

A road traffic noise signal previously used in annoyance measurements [6] was used. The noise was recorded 10 m from a busy main road with free-flowing traffic. A five-minute loop recording was continuously played in the rooms. The fluctuation in the noise level was generally within 5 dB. Two calibrated attenuators were used to control the noise level. The speakers (Telefunken O 86) were placed against the wall 1.5 m above the floor. In chamber A the noise level was kept at a constant A-weighted equivalent sound pressure level  $L_{Aeq}$  of 40 dB SPL. In chamber B the level was varied from 40 dB  $L_{Aeq}$  to 75 dB  $L_{Aeq}$  in 5 dB steps. The distribution of the level in the room was within 0.5 dB.

Different mixtures of carpet, rubber, fresh paint and cigarette butts were used to achieve the different air qualities in chamber A.



The loudspeakers and the air pollution sources were hidden behind a curtain.

### Test facilities

The experiments were performed in two adjacent environmental chambers. Four subjects were in the each of the rooms at the same time. After one minute exposure to the stimuli the subjects filled in a questionnaire. Then the subjects changed chamber and again, after one minute in the other chamber, they filled in the questionnaire.

Two questions were answered in both rooms:

Q1: *Imagine that during your daily work in an office you experienced the same air quality, noise and temperature as in this chamber. How annoying do you find these conditions ?*

Q2: *Do you think that the conditions in this chamber are acceptable for office work ?*

The response scales for these questions are shown in Figure 1 and 2. When the subjects have been in both rooms they answered the final question outside the rooms:

Q3: *Which of the two chambers would you rather be in ?*

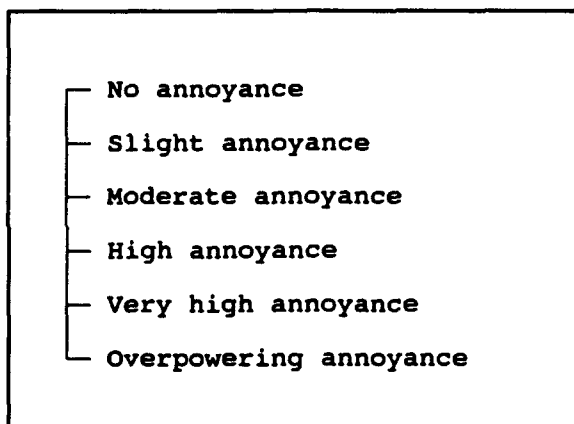

Figure 1 Response categories for question 1

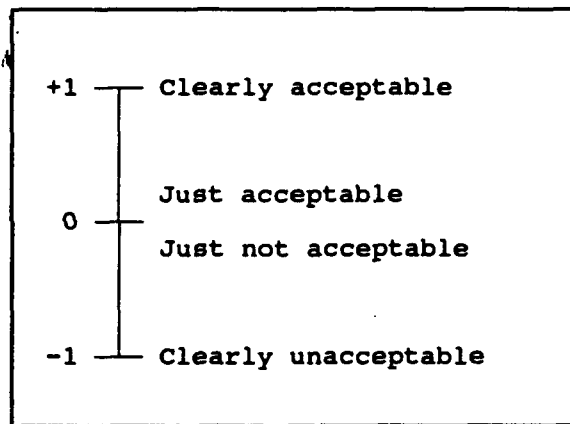

Figure 2 Response categories for question 2

### RESULTS

Figure 3 show the annoyance ratings (Q1) given in chamber B as a function of the noise level in the room. No annoyance = 0, overpowering annoyance = 5. From the figure it is seen that the annoyance ratings increase with noise level. The 'high annoyance' rating (=3) is reached at a  $L_{Aeq}$  level of 65 dB.

Figure 4 and 5 show the percentage of subjects preferring chamber A (Q3) as a function of the noise level in chamber B.

Figure 4 show the results with the temperature in chamber A as parameter (solid curves, experiment 1-3). In this figure also the preference for chamber A is shown in the situation where the temperature is high (28.4 °C) and the air quality is bad (8.9 decipol)(dashed curve, experiment 7). When the temperature in chamber A is 23.3 °C (stars) and the noise in both rooms is at the background level, 50% of the subjects prefer chamber A. When the temperature is 28.4 °C

(triangles) the 50% point is reached at a 60 dB noise level in chamber B.

Figure 5 show the results with the air quality in chamber A as parameter (experiment 4-6). From this figure it is seen that the change in air quality only has a minor influence on the subjects preference. The 50% point is reached at noise levels around 55 to 60 dB. From experiment 7 (fig. 4) it is seen that if the high temperature is combined with the bad air quality the 50% point is moved to 70 dB SPL. This is 10 dB higher than if the temperature and the air quality are tested individually. It may be noted that a 10 dB change correspond to a doubling of the loudness.

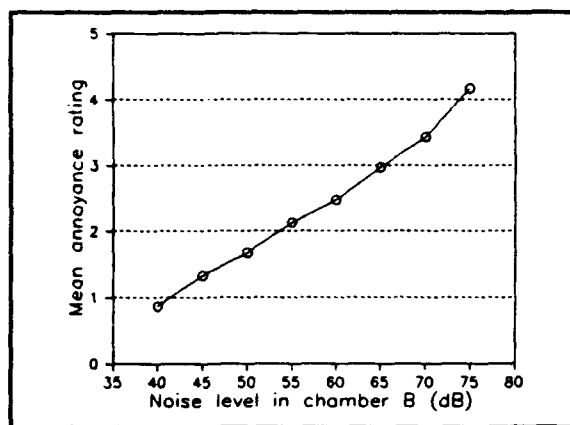

Figure 3 Annoyance rating in chamber B

From question Q2 it was possible to determine the relation between noise level and the percentage of subjects who found the condition unacceptable. The S-shaped curve increase from 20% to 80% when the  $L_{Aeq}$  level change between 50 dB and 65 dB SPL.

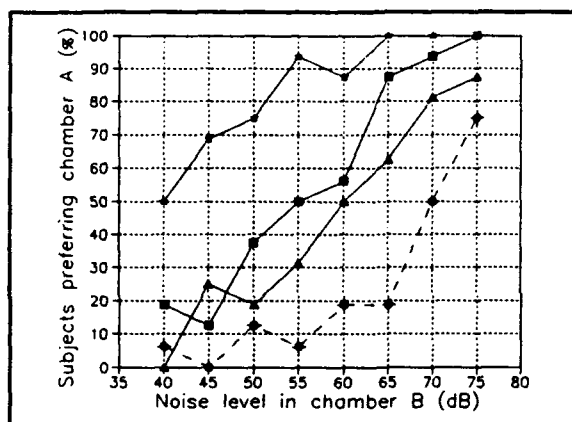

Figure 4 Preference for chamber A as a function of noise level in chamber B.

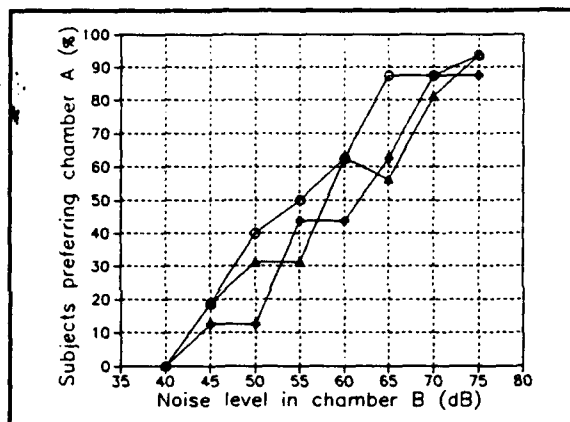

Figure 5 Preference for chamber A as a function of the noise level in chamber B.

## REFERENCES

- [1] Rice, CG. CEC joint research on annoyance due to impulse noise: laboratory studies. Proceedings 4th International Congress on Noise as a public Health Problem, 1983, 2, 1073-84.
- [2] Berglund B. Berglund M. Goldstein M. Lindvall T. Loudness (or annoyance) summation of combined community noises. J. Acoust. Soc. Am. 1981, 70, 1628-34.
- [3] Albrechtsen O. Twin climate chambers to study sick and healthy buildings. Proceedings of healthy Buildings '88, Stockholm, sept 1988, 3, 25-30.
- [4] ISO 7730. Moderate thermal environments - Determination of the PMV and PPD indices and specifications for thermal comfort. 1984
- [5] Fanger, PO. Introduction of the olf- and the decipol-unit to quantify air pollution perceived by humans indoor and outdoors. Energy and Buildings, 1988, 12, 1-6.
- [6] Poulsen T. Influence of session length on judged annoyance. J. Sound & Vib. 1991, 145, 217-24

# THE JOINT EFFECT OF OCCUPATIONAL NOISE AND SMOKING ON CHANGES IN HEARING ACUTTY

Mary M. Prince<sup>2</sup>, Genevieve M. Matanoski, Patrick N. Breysse, Laurence D. Fechter, and Beatriz Penà<sup>1</sup>

The Johns Hopkins University, School of Hygiene and Public Health, Baltimore, MD

- 1 Merck, Sharpe and Dohme International, Rahway, NJ.
- 2 Reprint requests to Dr. Mary M. Prince. Current address: National Institute of Occupational Safety and Health, 4647 Columbia Parkway, Cincinnati, OH 45226.

This research was conducted at Johns Hopkins University School of Hygiene and Public Health and was supported in part by grants (to LDF) from PHS, NIEHS, ES02852, ES03819.

## Abstract

A retrospective cohort study was conducted to determine whether cigarette smoking potentiates noise-induced changes in hearing acuity. The study population for analysis included 546 white male hourly employees in a large manufacturing plant. The population was classified into exposure groups based on cumulative noise during employment. Other risk factors such as medical conditions, hearing protection use, ototoxic chemical exposures, and hobbies affecting hearing were also examined in the analysis. The average annual rate of loss from baseline measures (in dB/year) was analyzed using least squares regression. A significant interaction between past cumulative noise exposure and smoking was found for the frequencies affecting noise induced hearing loss (ie., 3, 4, and 6 kHz). The joint effect of high cumulative noise and smoking increased the annual rate of loss by 1.4 dB/year (current smokers) to 1.9 dB/year (ex-smokers) above what was expected due to the independent effect of noise, smoking, and age. This study suggests that long-term heavy smoking has a relatively small effect on hearing loss, but in the presence of long-term moderate (85-95 dBA) noise there is some suggestion of a potentiating effect on noise induced hearing loss. However, this study should be viewed as preliminary until other studies with become available to verify these findings.

It has been well established that occupational noise exposure is a major cause of sensorineural hearing loss. A host of medical conditions (1,2) and ototoxic agents (2-27) have also been associated with sensorineural hearing loss. Such agents include certain drugs (2,3), and chemicals, such as heavy metals (3), asphyxiants (4-9) and organic solvents (3, 10-21). Smoking has also been examined as a possible personal risk factor for hearing loss in several epidemiologic studies (22-27). Despite the large body of literature on risk factors for hearing loss, there is still a relative dearth of epidemiologic data on how other factors may interact with noise to cause hearing loss. More recently, toxicologic data have demonstrated a synergistic effect of noise with carbon monoxide (28-30), toluene (31), and styrene (32). There is also epidemiologic evidence to support significant interactions between noise and carbon disulfide (33), and solvents such as toluene (34-35). The current epidemiologic study focused on the joint effect of cigarette smoking and noise exposure on hearing loss. The present paper presents the results of this study.

## METHODS

The eligible cohort for analysis was comprised of 546 hourly white males with at least two audiometric examinations. This cohort was selected from a larger population of employees having computerized audiometric data (N=5377) and who were employed as of 1978. Employees having

only one audiogram were excluded because (1) the cross-sectional selection of the cohort with differing ages and time since employment required that audiograms at the time of follow-up be controlled for in the analysis; and (2) the main interest was to examine how the rate of loss was affected by noise exposure and smoking. Women and non-whites were excluded because sample sizes were inadequate for meaningful statistical comparisons.

Hearing levels (re: 0 dB standard) at seven test frequencies (0.5, 1.0, 2.0, 3.0, 4.0, 6.0 and 8.0 KHz) were tested annually as part of the company's yearly medical examination. These computerized data files were available as of 1981. Calibration and audiometric examination procedures were conducted in accordance with OSHA regulations (36, 37). All hearing testers were certified by the Council on Hearing Accreditation.

### **Noise Exposure**

A parallel study of the noise environment at the plant site was conducted using historical industrial hygiene records collected over a period of 15 years (1973-1988). Personal dosimetry and area noise data were supplemented with interviews of plant industrial hygiene personnel to obtain professional evaluations of the noise environment. Historically, the noisiest areas of the plant included the power plant and manufacturing factories. A quantitative noise exposure assessment was developed to provide the data necessary to develop a time-dependent job-exposure matrix for noise, which included parameters related to the type of noise exposure, and hearing protection use. An exposure index representing cumulative past exposure to noise was examined in the present analysis because noise exposure was relatively low during the period (1981-88) when longitudinal measures on hearing levels were available. This indicator was defined as cumulative noise prior to the first audiogram, and was constructed for each individual in the study. The study cohort was classified into high, moderate, and low noise exposure groups on the basis of this variable.

### **Smoking and Other Risk Factors**

Smoking information was collected at the time of the preplacement examination, as well as during subsequent medical examinations. Although smoking information over time was available as of 1983, smoking data from the most recent medical history were used because smoking patterns did not significantly change over the 5-year time period of 1983-1988. Employees were asked whether they ever smoked, and if they smoked now. If they presently smoked, they were asked how many cigarettes were smoked per day. Data on amount smoked were not available for ex-smokers. Potentially ototoxic chemical exposures were analyzed as "ever/never" exposed since there were multiple exposures to several different agents, and the number of individuals with exposure to any one of the chemicals was small. Information was also available on medical conditions that might affect hearing, personal medication use, and hobbies that might affect hearing loss (i.e., music, hunting, snowmobile use and hobbies involving solvent exposure).

### **ANALYSIS**

Hearing thresholds at 3, 4, and 6 kHz were of major interest because these frequencies are most sensitive to the effects of noise (48). Since hearing levels at adjacent frequencies were highly correlated ( $r= 0.75-0.85$ ), the average over 3, 4, and 6 KHz was used in this analysis. The independent variable (Y) for analysis was defined as the annual rate of change in hearing levels (or rate of hearing loss). This was calculated as the difference in hearing levels (in dB) between the first and last audiometric exam, divided by the time period between the two exams in years. The coefficients in these models represented the mean annual rate of change in hearing levels (from baseline) associated with a given risk factor. Positive beta coefficients in the analysis represent an

increase in the rate of loss, implying that hearing is becoming poorer. Since the ability to detect an effect due to smoking and/or noise may differ by ear, each was analyzed separately.

Multiple least squares linear regression was used to assess the magnitude of the association between the risk factors of interest and noise-induced changes in hearing acuity. The SAS statistical package was used to fit all linear regression models (38). Hierarchical model-building was employed to determine the most parsimonious model describing the effects of several risk factors of interest on hearing acuity. Various nested models were tested for goodness of fit using the partial F-statistic (39). All final models were checked using standard diagnostic methods for least-squared regression (39). Due to missing missing smoking data and and exclusions of individuals with less than 1 year between audiograms, 473 individuals were available for the analysis.

## RESULTS

Table 1 presents the distribution of the most important risk factors for hearing loss among the entire eligible cohort (N=546). The most important variables included age at first audiogram, initial hearing level, smoking status, cumulative noise exposure, ever exposure to any ototoxic chemicals, hobbies involving loud noise or solvent exposure, diabetes (yes/no), middle ear conditions (yes/no), and years employed prior to 1978. Most of these factors and other risk factors for hearing loss were not found to be significantly related to hearing levels. Age and initial hearing level were the only factors positively related to changes in hearing acuity for both ears. However, when initial hearing levels were added to the models together with age, age was no longer significant. No statistically significant interactions between smoking and chemical exposure or between noise and chemicals were noted, although each ear responded differently when the joint effects of noise and smoking were examined.

The statistical modeling indicated a significant independent effect with smoking for the left ear (Table 2), while a statistically significant noise-smoking interaction was observed for the right ear (Table 3). Based on the left ear (eg. the worse ear) model, ex-smokers had mean annual rates of change that were 0.79 dB/year higher than non-smokers, whereas current smokers had rates that were 0.85 dB/year higher (Table 2). The joint effect of being an ex-smoker and having high cumulative noise exposure in the past added another 1.9 dB/year to the annual rate of loss expected from the independent effects of age, smoking, and noise (Table 3). For current smokers in the high cumulative noise group, an additional 1.4 dB/year was added to the independent effects of the other variables in the model.

## DISCUSSION

The results of this study should be viewed as preliminary given some of the inconsistencies observed in this analysis. No effect due to cumulative noise exposure was observed in the longitudinal analysis, although initial hearing levels of the population increased with increasing noise exposure. Also, the comparison group of non-smokers with low cumulative noise exposure had the highest initial hearing levels and the lowest rates of loss. Among the non-smokers, rates of loss declined with increasing cumulative noise dose. This unusual observation is probably not biologically motivated, but may reflect selection biases operating in this cohort. This is plausible given the cross-sectional nature of the subjects selected for study. At best, this analysis suggests that long term exposure to moderate occupational noise in combination with smoking may affect hearing acuity only in a subgroup of workers who have smoked for a long period of time and who had been exposed to the highest cumulative noise exposure in the past. This population was unique in that a large proportion (75%) of the cohort ever smoked cigarettes (Table 1). Furthermore, those who had such data, indicated that they smoked at least 1 pack per day. Since smoking information

over time was not available for the entire period of follow-up, it is possible that some misclassification by smoking status could have occurred. If the study results are true, the observation that the joint effect of smoking and noise was greatest among ex-smokers suggests that the study detected chronic long-term damage. This is consistent with the fact that the classification of subjects within noise categories was based on past cumulative exposure, and that smoking measures in this study also represented chronic low level exposure over the course of an individual's lifetime.

Inferences regarding an interaction between noise and smoking in the present occupational cohort cannot be generalized to the entire employee population nor to the general population. This cohort represented a small proportion of the total population with audiograms (~10%), which most likely represent a healthier population under routine medical surveillance. Due to the preliminary nature of this study, it is suggested that larger populations having more intense, continuous exposure to noise would also be informative in terms of validating the present study results. Subsequent studies of occupational hearing loss should be designed to allow an evaluation of how chemical exposure, noise and personal risk factors modify a population's susceptibility to auditory damage.

TABLE 1. Distribution of various risk factors for hearing loss among the study cohort (N=546)

RISK FACTOR	Number	Percent
<b>SMOKING</b>		
• Ever smokers:	362	75.0
• ex-smokers:	209	43.3
• current smokers:	153	31.3
<u>Number cigarettes/day<sup>1</sup> (N=135)</u>		
< 10	9	6.7
10-19	30	22.2
20-29	58	43.0
≥ 30	38	28.1
<u>Number of years smoked (N=273)</u>		
< 10	30	10.9
10-19	73	26.4
20-29	91	33.0
≥ 30	82	29.7
<u>Pack-years (N=100)</u>		
< 10	16	16.0
10-19	15	15.0
20-29	23	23.0
≥ 30	46	46.0
<b>CUMULATIVE PAST NOISE EXPOSURE</b>		
• Low	251	6.0
• Moderate	152	27.8
• High	143	26.2
<b>OTHER RISK FACTORS</b>		
• Diabetes	34	6.2
• Middle ear conditions	62	11.4
• Hobbies Involving <sup>2</sup> :		
- Loud Noise	54	11.2
- Solvents	17	3.6
• Any Ototoxic Chemicals	234	42.9

<sup>1</sup> Amount smoked (packs/day) was available for only current smokers.

<sup>2</sup> Due to missing medical history data, % are based on N=482.

**TABLE 2. Most parsimonious model for the independent effect of smoking: Annual rate of change, average over 3, 4, and 6 KHz<sup>1</sup>**

<b>VARIABLE IN MODEL</b>	<b>(β)</b> <b>(dB/year)</b>	<b>SE(β)<sup>2</sup></b>	<b>P<sup>3</sup></b>
<b>Age at first audiogram</b> (centered at mean)	0.007	0.011	0.56
<b>Initial Hearing Level</b> (left ear, average 3, 4 & 6 kHz.)	0.021	0.005	0.0001
<b>Cumulative Noise</b>			
• Moderate	-0.36	0.24	0.13
• High (ref: Low)	-0.007	0.25	0.97
<b>Smoking</b>			
• Ex-smoker	0.79	0.25	0.0015
• Current Smoker (ref: Never smoked)	0.85	0.26	0.0014

1 Based on analysis of Left ear hearing levels. Model  $F_{6,467} = 7.44$ ,  $p = 0.0001$ ;  $R^2 = 0.09$ . Intercept( $\beta_0$ ) = -0.39 (SE= 0.30)

2 SE= Standard error of beta coefficient (β)

3 P = Prob > |T|

**TABLE 3. Most parsimonious model for noise-smoking interaction: Annual rate of change, average over 3, 4, and 6 KHz<sup>1</sup>**

VARIABLE IN MODEL	( $\beta$ ) (dB/year)	SE( $\beta$ ) <sup>2</sup>	P <sup>3</sup>
Age at first audiogram (centered at mean)	0.019	0.011	0.09
Initial Hearing Level (Right ear, average 3, 4 & 6 kHz.)	0.013	0.005	0.009
Cumulative Noise			
• Moderate	-0.80	0.47	0.09
• High (ref: Low)	-1.30	0.50	0.01
Smoking			
• Ex-smoker	0.37	0.35	0.29
• Current Smoker (ref: Never smoked)	-0.05	0.38	0.89
Noise*Smoking Interaction			
• Ex-smoker*moderate noise	1.08	0.58	0.06
• Ex-smoker*High noise	1.91	0.62	0.002
• Current Smoker * Moderate Noise	0.22	0.64	0.73
• Current Smoker * High Noise	1.33	0.64	0.03

1 Based on analysis of Right ear hearing levels. Model  $F_{10,463} = 3.7$ ,  $p = 0.0001$ ;  $R^2 = 0.08$ . Intercept ( $\beta_0$ ) = 0.79 (SE= 0.33). Interaction was statistically significant at  $\alpha = 0.05$  level of significance (Partial  $F_{4,468} = 2.9$ ;  $p = 0.02$ ).

2 SE= Standard error of beta coefficient ( $\beta$ )

3 P = Prob > |T|

#### REFERENCES

1. DeWeese DD, Saunders WH, Schuller DE, et. al. Otolaryngology - Head and Neck Surgery, Seventh Edition. St. Louis, MO: The CV Mosby Co., 1988.
2. DeWeese DD, and Saunders WH. Hearing Losses. In: Textbook of Otolaryngology, Fifth Edition. St. Louis, MO: The CV Mosby Co., 1977.
3. Miller JJ. CRC Handbook of Ototoxicity. Boca Raton, FL: CRC Press Inc., 1985.
4. Fechter LD, Thorne PR, and Nuttal AL. Effects of CO on cochlear electrophysiology and blood flow. Hearing Res 27; 27:37-45.
5. Fechter LD, Richard CL, Mungekar M, et al. Disruption of auditory function by acute administration of a "room odorizer" containing butyl nitrite in rats. Fund Appl Toxicol 1989; 12:56-61.
6. Gato I, Miyoshi T, Yoshitano O. Deafness and peripheral neuropathy following CO intoxication. Fol Psychiat Neurol Jap 1972; 26:35-38.



7. Lumio JS. Hearing deficiencies caused by CO (generator gas). *Acta Oto-laryngologica* (Vapnargatan 6, Stockholm, Sweden) 1948; Suppl 71:3-112.
8. Morris TMO. Deafness following acute CO poisoning. *J Laryngol Otol* 1969; 83:1219-1225.
9. Baker SR and Lilly DJ. Hearing loss from acute carbon monoxide intoxication. *Ann Otol* 1977; 86:323-328.
10. Odkvist LM, Bergholtz LM, Ahlfeldt H, et al. Oto-neurological and audiological findings in workers exposed to industrial solvents. *Acta Otolaryngol* 1982; 386:249-251.
11. Odkvist LM, Larsby BR, Tham R, et al. On mechanisms of vestibular disturbances caused by industrial solvents. *Adv. Oto-Rhino-Laryngol* 1979; 25:167-172.
12. Odkvist LM, Larsby B, Fredrickson JMF et al. Vestibular and oculomotor disturbances caused by industrial solvents. *J Otolaryngol* 1980; 9(1):53-59.
13. Odkvist LR, Arlinger SD, Edling C, et al. Audiological and vestibulo-oculomotor findings in workers exposed to solvents in jet fuel. *Scand Audiol* 1987; 16:75-81.
14. Arlien-Soborg P, Zilstorff K, Grandjean B, et al. Vestibular dysfunction in occupational chronic solvent intoxication. *Clin Otolaryngol* 1981; 6:285-290.
15. Velazquez J, Escobar R, and Almaraz A. Audiologic impairment due to n-butyl alcohol exposition. *Neurotrophic Chemicals, XVI. International Congress on Occupational Health. Abstract Resume, S8-06, Tokyo, Japan, September 22-27, 1969, pp. 231-233.*
16. Putz VR, Johnson BL, and Setzer JA. A comparative study of CO and methylene chloride on human performance. *Environ Pathol Toxicol* 1979; 2:97.
17. Rebert CS, Houghton PW, Howd RA et al. Effect of hexane on the brainstem audiometry response and caudal nerve action potential. *Neurobehav Toxicol Teratol* 1982; 4:79-85.
18. Rebert CS and Sorenson SS. Concentration related effects of hexane on evoked responses from brain and peripheral nerve of the rat. *Neurobehav Toxicol Teratol* 1983; 5:69-76.
19. Pryor GT, Dickinson J, Howd RA et al. Transient cognitive deficits and high frequency hearing loss in weanling rats exposed to toluene. *Neurobehav Toxicol Teratol* 1983; 5(1):53-57.
20. Pryor GT, Dickinson J, and Feenex EM. Factors affecting toluene-induced ototoxicity in rats. *Neurobehav Toxicol Teratol* 1984; 6(3):223-238.
21. Pryor GT, and Howd RA. Toluene-induced ototoxicity by subcutaneous administration. *Neurobehav Toxicol Teratol* 1986; 8(1):103-104.
22. National Center For Health Statistics. Hearing Levels of Adults by Age and Sex. *Vital and Health Statistics* 1965. Series II, No 11, DHEW.
23. Zellman S. Correlation of smoking history with hearing loss. *JAMA* 1973. 223(8):920.
24. Ibrahim AS, Fatti-Hi AS. Cigarette smoking and hearing loss. *Hygie* 1983; 2(2)31-33.
25. Chung DY, Willson GN, Ganon RP et al. Individual susceptibility to noise. In: Hammernik RP, Henderson D, and Salvi R, eds. *New Perspectives on Noise-induced Hearing Loss*. New York, NY: Raven Press, 1982.
26. Barone JA, Peters JM, Garrabrant DH, et al. Smoking as a risk factor in Noise-induced hearing loss. *J Occup Med* 1987; 29(9):741-745.
27. Siegelaub AB, Friedman GD, Adour K, et al. Hearing loss in adults: Relation to age, sex, exposure to loud noise, cigarette smoking. *Arch Environ Health* 1974; 29:107-109.
28. Young JS, Upchurch MB, Kaufman MJ, et al. CO exposure potentiates high-frequency auditory thresholds induced by noise. *Hearing Res* 1986; 26:37-43.
29. Fechter LD, Young JS, and Carlisle L. Potentiation of noise-induced threshold shifts and hair cell loss by carbon monoxide. *Hearing Res* 1988; 34:39-48.
30. Fechter LD. A mechanistic basis for interactions between noise and chemical exposure. *Arch Complex Environ Studies* 1989; 1(1):23-28.
31. Johnson A-C, Juntunen L, Nysten P, et al. Effect of interaction between noise and toluene on auditory function in the rat. *Acta Otolaryngol (Stockh)* 1988; 105:56-63.
32. Fechter LD. Unpublished manuscript. Johns Hopkins University School of Hygiene and Public Health, 1991.
33. Morata TC. Study of the effects of simultaneous exposure to noise and carbon disulfide on workers' hearing. *Scand Audiol* 1989; 18:53-58.
34. Barregard J and Axelsson A. Is there an ototraumatic interaction between noise and solvents? *Scand Audiol* 1984 13:151-155.
35. Morata TC, Dunn DE, Kretschmer LW, et al. Study of the effect of simultaneous noise and toluene on workers' hearing and balance. *Proceedings of the Fourth International Conference on the Combined Effects of Environmental Factors*. Baltimore, Maryland: The Department of Environmental Health Sciences and The Environmental Health Sciences Center of the Johns Hopkins University School of Hygiene and Public Health, 1991, pp 81-86.

36. Occupational Safety and Health Administration (OSHA). Occupational Noise Exposure; Hearing Conservation Amendment. Federal Register 1981; 46(11):4078-4181
37. Occupational Safety and Health Administration (OSHA). Occupational Noise Exposure; Hearing Conservation Amendment. Federal Register 1983; 48(46):9738-9783
38. SAS User's Guide: Statistics, Version 5 Edition. Cary, NC: SAS Institute Inc, 1985.
39. Kleinbaum DG, and Kupper LL. Applied Regression Analysis and Other Multivariate Methods. Boston, MA: Duxbury Press, 1978.

## **Annoyance caused by railway-induced vibration and noise**

Schuemmer-Kohrs Anke, Sinz Albrecht, Zeichart Klaus  
OBERMEYER PLANEN + BERATEN, Institut für Umweltschutz und Bauphysik, Hansastr. 40,  
D-8000 München 21, Germany

&

Schuemmer Rudolf  
FernUniversität/ZIFF, Postfach 940, D-5800 Hagen, Germany

### **Abstract**

The study - a field investigation - deals with the effects of railway-induced building vibrations on people living near railroads. Furthermore, it should be investigated to what extent simultaneous noise influences the reactions to building-vibration.

Railway-induced building vibration leads to a serious amount of annoyance: 22% of the respondents feel "very annoyed", and even 14% assess their vibration load as "unacceptable"; only 21% of the respondents are "not at all annoyed". On the other hand, about 3/4 of the subjects asked rated the railway-induced noise as "more annoying" than the vibration.

The overall relationship between vibration intensity and annoyance is rather weak. The steepest increase of vibration reaction is found in the lower levels of vibration; thereafter there is little change in the reactions with increasing vibration load (non-linear relationship). Furthermore, the effect of vibration intensity is not the same for people suffering from simultaneous higher or lower noise levels (*vibration x noise* interaction).

### **Aims of the study**

The study deals with the effects of railway-induced vibrations on people living near long-distance railroads. The effects of three factors on vibration annoyance should be analysed: (1) vibration severity, (2) number of trains passing, and (3) the simultaneous noise level. (The project was funded by the German Federal Agency for Environmental Protection, "Umweltbundesamt", and the "Bundesbahnzentralamt - München".)

### **Method**

Residents living near railroads (*Ss*) were interviewed by means of a standardized questionnaire to record their annoyance by railway-induced vibrations and noise. Sound and vibration immissions were recorded in the living room and bedroom of each of 284 sample households. In about half of the residential units two *Ss* were interviewed. So there are 417 observations with both objective measurements and interview data.

*Response variables:* The questionnaire includes several items to measure the reactions to vibration - such as the general annoyance or disturbances of recreation and sleep by vibrations. The general annoyance (R1) was measured by an 11-point response scale (from (0) "not at all annoyed" up to (10) "extremely annoyed").

**Objective measurements of building vibration and noise:** The measurements were carried out in daytime. On the average 27 passing trains (passenger trains and freight trains) were recorded per residential unit. Several composite measures - based on the K-values of the German DIN 4150 (part 2) - were defined to evaluate the "typical" vibration level within each residential unit. Only two measures of the objective vibration and noise level are used here:

$$KB^* = \sqrt{\frac{1}{N} \sum_{i=1}^N KB_{Fmax,i}^2}$$

with  $KB_{Fmax,i}$  maximum of the K-weighted velocity of vibrations ("*Bewertete Schwingstärke*")  $KB_F(t)$  during the passing of the *i*-th train  
 N number of trains passing

$$L^* = 10 \times \log \frac{1}{N} \sum_{i=1}^N 10^{0.1 \times L_{AFmax,i}}$$

with  $L_{AFmax,i}$  maximum noise level (in dB(A)) for the passing of the *i*-th train  
 N number of trains passing

The distance between the nearest side of the buildings and the railroad range up to 60 meters. The measured values of  $KB^*$  (living room, at day) vary between 0.02 and 2.66 (Median=0.24; Mean=0.30; Std=0.27; N=284). The measured values of  $L^*$  (living room, closed windows, by day) vary between 39.6 and 72.9 (Median=56.7; Mean=57.0; Std=7.61; N=284). The maximum measured vibration values (i.e. the "worst" single train during the measuring time) range from  $KB_{Fmax}=0.03$  up to  $KB_{Fmax}=4.89$  (Median=0.49; Mean=0.63; Std=0.56; N=281).

## Results

**On the degree of railway-induced vibration annoyance:** 22% of the interviewed respondents feel "very annoyed" and even 14% assess their vibration load as "unacceptable"; only 21% of the respondents are "not at all annoyed".

**Comparison of the annoyance by railway noise and vibrations:** The Subjects (*Ss*) rated the railway noise as much more annoying than the railway-induced vibrations (e.g., the mean annoyance  $M=6.2$  for noise vs.  $M=4.2$  for vibrations on the 11-point annoyance scale). About 3/4 of all *Ss* asked to compare the railway-induced noise directly with the vibrations rated the noise as "more annoying" than the vibrations.

**On the effects of vibration severity and noise level on the vibration annoyance:** The relationship between the vibration level (e.g.  $KB^*$ ) and the individual vibration responses is rather weak: There is a great amount of interindividual variability in the annoyance reactions - even at the same level of vibration (i.e. the same  $KB^*$ -value). Accordingly, the correlations between  $KB^*$  (or other measurements of the vibration severity) and annoyance reactions are rather low. The coefficient of (linear) correlation between  $KB^*$  and the general annoyance (*R1*) is only  $r=0.17$  for the total sample ( $N=411$ ;  $p<.001$ ; an analogous coefficient results if Kendall's tau is used instead of Person's  $r$ :  $\tau=.22$ ;  $p<.001$ ).

Plotting the mean reactions against the  $KB^*$ -values for the total sample shows that the relationship is not linear. First (near the threshold) there is a rather steep increase of the reactions with increasing  $KB^*$ ; thereafter the stimulus-response curve is rather flat. The non-linearity of the relationship and the positive skewness of the distribution of the  $KB^*$ -values can be counterbalanced to some degree by a logarithmic transformation of the  $KB^*$ -values; the transformation improves the linear correlation: e.g.  $r=.31$  for the correlation between the transformed  $\log(KB^*)$  and the individual general annoyance for the total sample ( $N=411$ ;  $p<.001$ ) (vs.  $r=.17$  without the  $\log$ -transformation). Furthermore, the correlation between the vibration level ( $KB^*$ ) and the general annoyance by vibration (R1) is different for subsamples formed for different levels of noise (in terms of  $L^*$ ): In the subsample with higher noise level ("L+":  $L^* \geq 55$  dB(A)) there is a correlation of only  $r=0.05$ , whereas in the subsample with lower noise level ("L-":  $L^* < 55$  dB(A)) there is a correlation between  $KB^*$  and the general annoyance of  $r=.41$ . This means that the effect of the vibration severity is not the same for different levels of noise ("noise x vibration"-interaction). Some further evidence for this interaction was found by a multivariate analysis based on the general linear model with the two factors "vibration load" (5 levels:  $KB^* < .10 / 0.1 \leq KB^* < 0.2 / 0.2 \leq KB^* < 0.3 / 0.3 \leq KB^* < 0.4 / KB^* > 0.4$ ) and "noise load" (2 levels:  $L^* \geq 55$  dB(A) and  $L^* < 55$  dB(A)) as independent variables and 6 reaction variables as dependent variables. The analysis shows a significant main effect "vibration load" (Wilks lambda;  $p<.001$ ) and a tendency for the "vibration x noise"-interaction effect ( $p<.07$ ). The form of this interaction is demonstrated here by Figure 1 which shows the mean of only one of the reaction variables (general annoyance, R1) for each of the 5 vibration levels and of the 2 noise levels.

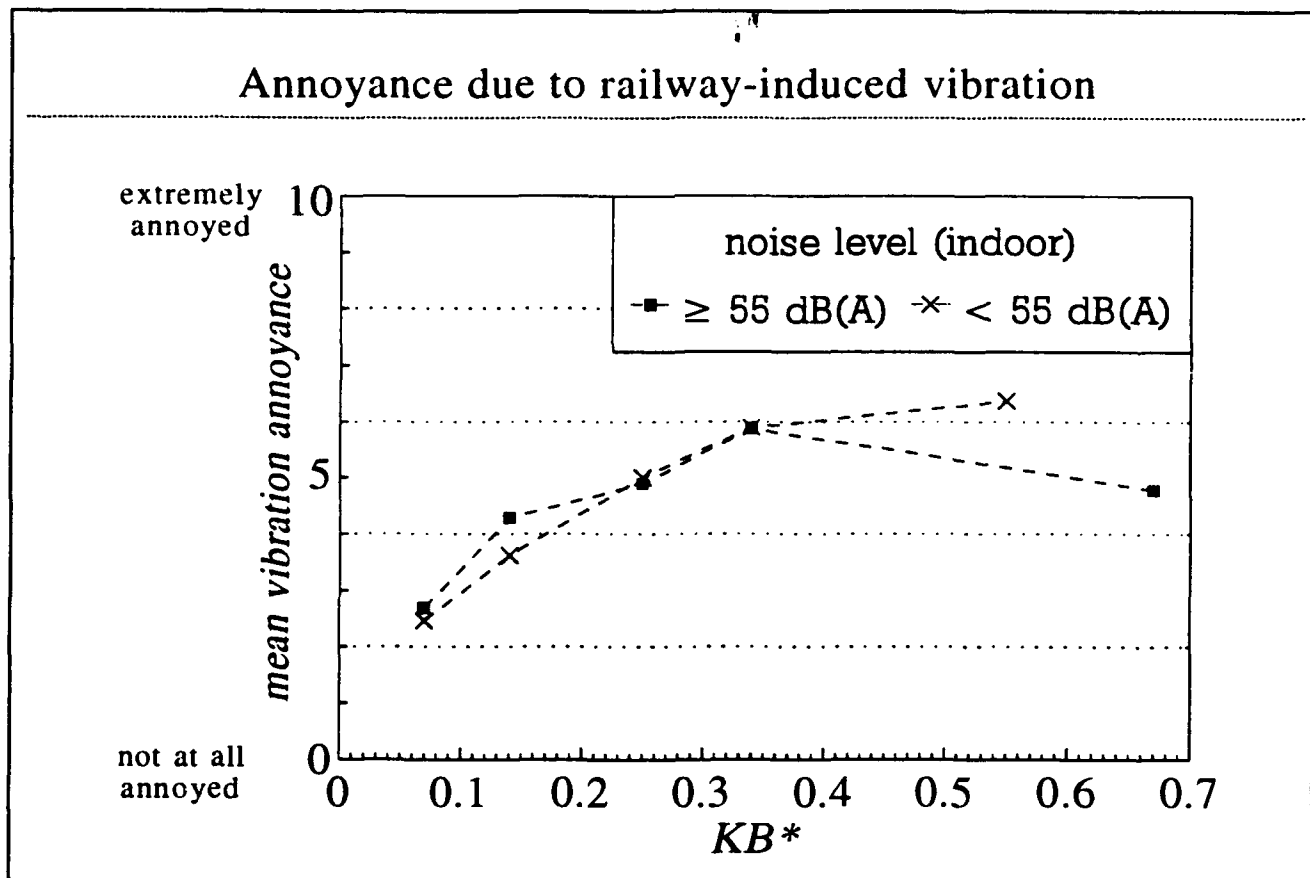

Fig. 1: Mean vibration-annoyance for five levels of vibration load and for two noise levels

Generalizing and simplifying, one can describe the results of this analysis as follows:

- In the group with low noise level ( $L^* < 55$  dB(A)) there is a monotonic increase in the mean responses up to a vibration level of  $0.3 < KB^* < 0.4$  for most of the reaction variables (the steepest increase is found in the lower levels of vibration); thereafter, there is little change of the mean reactions with increasing  $KB^*$ . For some variables there is even a decline in the mean response for the highest vibration level.
- In the group with higher noise level ( $L^* \geq 55$  dB(A)) there is a smaller increase of the mean responses with increasing vibration level than in the group with lower noise level ("L-"). For the higher vibration levels ( $KB^* > 0.3$ ) the mean responses of the "L+"-group are lower than those of the "L--" group. This confirms the hypothesis of a raised vibration threshold if there is a simultaneous high noise level (cf. the findings in the lab by Meloni & Krüger 1990). A possible interpretation is that, in the case of higher noise levels, the vibration is covered up to some degree by noise (cf. Meloni & Krüger 1990).

*On the effects of the number of trains on vibration annoyance:* Contrary to our expectations, there was no positive relationship between the annoyance reactions and the number of trains passing (e.g.  $r = -0.15$  for the general annoyance and the number of trains; the number of trains passing in both directions per 24h varied between 92 and 379; Median=206).

There is some evidence that it is rather the number of vibration events exceeding the threshold (here defined by  $KB_{F_{max}} = 0.1$ ) which influence vibration annoyance than the absolute number of trains passing by. But, unfortunately, in this study the number of *perceptible* events cannot be defined in the same way as done by Woodroof & Griffin, because the time for measuring was not constant (the measuring time was shorter in areas with high numbers of trains passing, and longer in areas with low numbers of trains).

Furthermore, there are also some hints that the number of perceptible vibration events has some impact on the annoyance responses *independent* of the intensity of the vibration. As a consequence this would mean that a mere reduction in the intensity of vibration would not suffice to reduce the annoyance if not, at the same time, the number of perceptible vibration events is reduced. But further studies are needed to clarify whether the vibration intensity trains usually produce is the more relevant factor or the vibration events which exceed the threshold.

## References

Meloni, T. & Krüger, H. (1990). *Wahrnehmung und Empfindung von kombinierten Belastungen durch Lärm und Vibration*. Zeitschrift für Lärmbekämpfung, 37, 170-175

Woodroof, H.J. & Griffin, M.J. (1987): *A survey of the effects of railway-induced building vibration on the community*. Southampton: University of Southampton, Institute of Sound and Vibration Research

# AUDITORY AND NON-AUDITORY EFFECTS OF COMBINED NOISE AND HEAT EXPOSURE

SCHUST, Marianne

Bundesanstalt für Arbeitsmedizin, Nöldnerstraße 40-42, O-1134 Berlin, Germany

## Abstract

In a laboratory experiment, the hypotheses were tested that noise increases the thermal strain and heat effects the sense of hearing. Two room temperatures (27°C and 37°C) were combined with sound levels of 65 dB(A) and 95 dB(A). 20 male healthy subjects participated in the experiment. We measured several physiological parameters (core and skin temperatures, heat flow density, heart rate, blood pressure, temporary threshold shift) and psychological states (personality tests, self assessment scales, Noise Sensitive Index (NSI), scales by Borg, scales by Fanger). The results partly confirm the hypothesis that vasoconstriction due to noise renders the required heat exchange more difficult. Testing all subjects we found no evidence for any temperature effect on the sense of hearing. Only within a homogeneous subgroup of subjects - concerning their hearing threshold throughout the preliminary phases of exposure - the faster recovery of the TTS under the influence of heat would rather support the oxygen-deficiency-hypothesis. Also the amount of aural symptoms of the NSI-data did not change due to high temperature conditions. Using the results of personality tests, the subjects were classified as "sensitive" and "non-sensitive" regarding strain. The group of subjects with a high subjective stress resistance showed a significant faster recovery of the temporary threshold shift than the other group. This result could be helpful for the development of individual tests to predict the noise-sensitivity and the noise induced hearing loss.

## Introduction

The combined influence of both heat and noise on the human organism has rarely been examined. There are many jobs within a hot and noisy work site, partially with high psycho-nervous stress. Therefore the effects of thermal and acoustic irritations are of interest for research, even if not very intense.

Provided that the ambient temperature exceeds 40°C it can be taken for granted that the vasomotoric reactions due to noise are superimposed by the thermal influence. In a lower range of temperature, a combined effect on the circulatory regulation can be expected (1, 2, 3, 4, 5). Different changes of combined noise and heat exposure on the sense of hearing have been reported (6, 7, 8). The results from Weinrich and Rentzsch (9, 10) indicate that heat causes an increase of auditory temporary threshold shift. In animal experiments, however, it could be proved that the noise-induced cochlea damage is smaller in the state of hyperthermy (11). In other studies including some other environmental factors besides noise and heat the variation of TTS under heat conditions could not be verified statistically (12, 13). The results of psychological experiments indicate a larger strain of several simultaneous factors than of an isolated one (14, 15).

In the present study the effect of heat on the sense of hearing and the influence of noise on the thermoregulation are checked. Moreover, it is examined, if there is any synergistic influence concerning the well-being and whether there exists any correlation between the personality and subjective states, on the one hand, and the physiological parameters, on the other hand.

## Methods

There was a total number of 20 male subjects in the age between 18 and 30 years. Before starting the tests, we carried through medical examinations, including audiometric tests. The preliminary personality diagnoses were especially related to the behaviour in stress situations. We used the

Jenkins Activity Survey, the State-Trait-Anxiety Inventory and the Freiburger-Personality-Inventory (16, 17). Two noise levels (white noise, 65 and 95 dB(A)) were combined with two ambient temperatures (27°C and 37°C). The experiment consisted of a preliminary phase of 45 minutes (27°C), an exposure of 60 minutes and a subsequent phase of 60 minutes. The air velocity was  $v_a < 0,15$  m/s and the absolute air humidity about 17hPa in all rooms.

The following physiological parameters were recorded:

- temporary threshold shifts (TTS) at 4kHz and 6 kHz
- heart rate (HR), systolic and diastolic blood pressures ( $BP_s$  and  $BP_d$ )
- core temperature (CT) sublingual
- skin temperature (ST) and heat flow density (HFD) at five measuring points (the average weighted sum of all points corresponded to AWST and AWHFD, respectively)

We used the following methods for measuring the psychological states:

- self assessment scales by Nitsch (18)
- Noise Sensitive Index (NSI) by Meister (14)
- general scale of perceptive intensities by Borg (19)
- psycho-physical scale by Fanger (20)

### Results

Under heat conditions the core temperature increased beginning from the 50th minute of exposure. This effect was independently of sound pressure level and continued in the subsequent phase. Within the thermally neutral range, a tendency of an elevated core temperature due to noise was observed. The skin temperature increased irrespectively of noise during heat exposures, but dropped under the influence of noise at lower temperature (Fig. 1). We could not prove any influence of sound pressure level on the heat flow density. Within the thermally neutral range, noise caused an increase of the heart rate (Fig. 2).

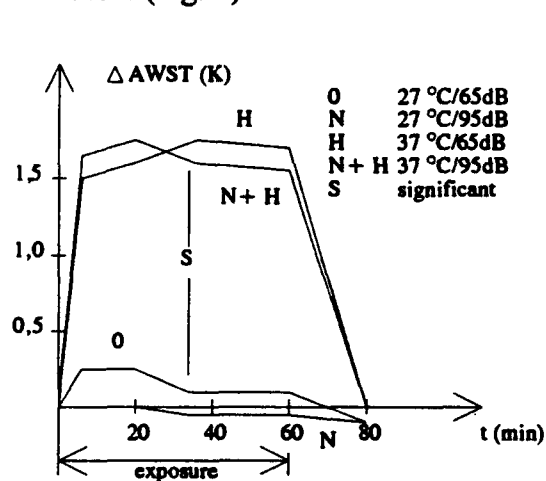

Fig. 1 variation of skin temperature vs. time

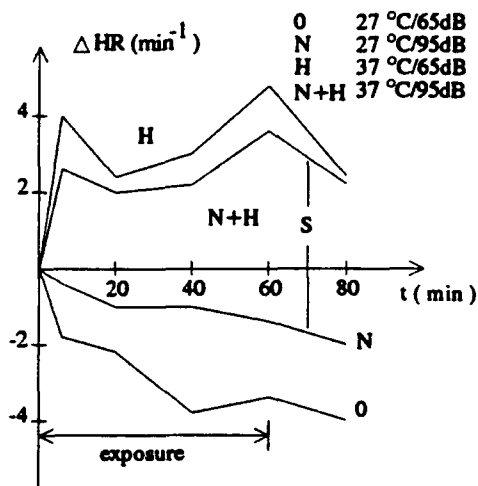

Fig. 2 variation of heart rate vs. time

The diastolic blood pressure decreased at a higher temperature and slightly increased during the noise exposure. Combined noise and heat did not verifiably influence these reactions. Contrary to the diastolic blood pressure, noise caused an obvious drop of the systolic blood pressure within the higher temperature range, particularly among a group of subjects with low  $RR_s$  (Fig. 3). As to the aural effects we could not prove any influence of the ambient temperature on the sense of hearing. Only the integral of the TTS for the period of the recovery after the exposure ( $ITTS_r$ ) was lower at higher temperature than within the thermally neutral range. This effect was significantly for a homogeneous group of subjects with a higher hearing threshold. The results from the Noise Sensitive Index (NSI) showed an increase of the total sum of complaints mainly caused by extraaural effects. The aural complaints did not reflect a higher aggravation at a high ambient temperature. The results of the self assessment scales indicated an increased strain and obviously fatigue-related impairments of subjective states due to combined noise and heat. Analysing the characteristics of the psycho-



physical scales, we could not find any influence of noise on the subjective evaluation of thermal situation. As the general scales of perceptive intensities suggested, the effort is the greatest under combined conditions. We used the data of personality tests to classify the subjects as "sensitive" and "non sensitive" regarding strain. The "sensitive" group showed a tendency to more significant deterioration of well-being than the other group (Fig. 4). Moreover, the  $ITTS_r$  was significantly higher in this group. We did not find any other correlation between the physiological and the psychological dates.

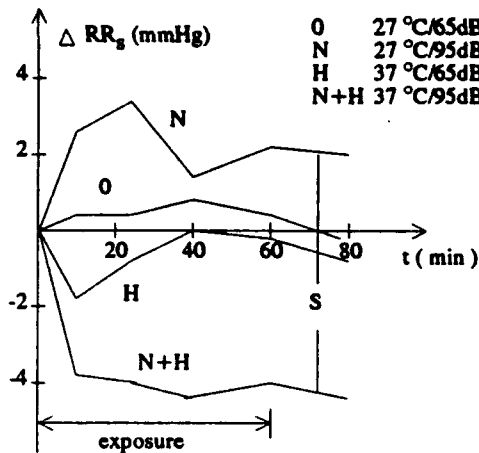

Fig. 3 variation of the systolic blood pressure vs. time

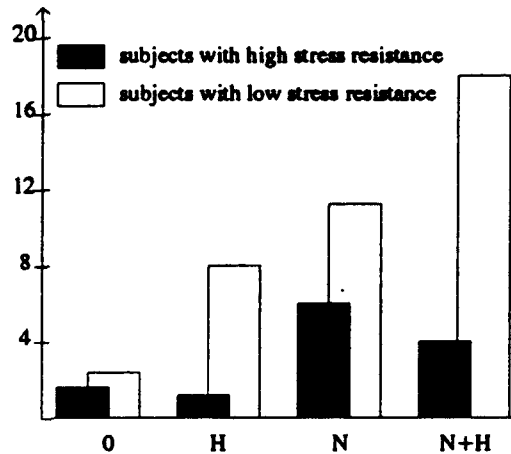

Fig. 4 variation of NSI - sum of complaints

## Discussion

The known vasoconstriction due to noise could be confirmed within the thermally neutral range. We established a rising core temperature and heart rate, as well as an increased systolic and diastolic blood pressure. The vasoconstriction was suggested to render the heat exchange more difficult so that additional thermoregulation work is necessary. But only the increase of skin temperature on the back of the hand and the drop of diastolic blood pressure due to heat showed weaker dimensions, when noise was added. Therefore, this hypothesis was, at least by interpreting the physiological recordings, partially confirmed only. On the other hand the results of the psychological tests regarding the impairment of well being pointed clearly to an additive effect of combined stress. It appears that there exist mechanisms compensating the additional thermoregulation work, but not measurable with the recorded physiological parameters. Besides, the decrease of systolic blood pressure caused by noise added to heat is still not explicable. About the aural effects, the results would rather support the oxygen-deficiency-hypothesis (21). Provided that the blood circulation in the inner ear exhibits a behaviour as the peripheral circulation, the oxygen-deficiency in the inner ear should have a weaker tendency under influence of heat. This hypothesis was confirmed, at least, for a homogeneous subgroup of subjects. There we stated a lower  $ITTS_r$  at higher ambient temperatures. On the other hand, the averaged data of all subjects do not provide evidence for any temperature effect on the sense of hearing. An interesting fact was observed as to the correlation between the results of personality tests and the development of the TTS. The group of subjects with a high subjective stress resistance showed a significantly faster recovery of TTS than the other group. This result could be helpful for the development of individual tests concerning the prognosis of noise-sensitivity and noise induced hearing loss. Further studies should rather examine the behaviour of defined groups of individuals with a greater deterioration of blood circulation and a greater impairment of subjective state during combined noise and heat stress. To make the additional thermoregulation work measurable it would be necessary to examine also biochemical parameters.

## Literature

1. Bhattacharya SK, Pradhan CK, Tripathi SR, Kashyap S: Human performance capability in psychomotor tasks at variable difficulty levels and physiological reactions under noise and heat conditions. *Ind-Health*. 29(4), 1991, 129-38
2. Shcherbak EA: Effect of a Combination of Heating Microclimate and Industrial Noise, and Their Combination with Lead Aerosols on the Prevalence of Cardio-vascular Diseases. *Noise and Vibration Bulletin*, 1989, 230-231
3. Bach V, Libert JP, Tassi P, Wittersheim G, Johnson LC, Ehrhart J: Cardiovascular responses and electroencephalogram disturbances to intermittent noises: effects of nocturnal heat and daytime exposure. *Eur-J-Appl-Physiol*. 63(5), 1991, 330-7
4. Suvorov GA, Babaian MA, Khvastunov RM: [Analysis of combined effects of noise and heating microclimate on various indicators of the status of the human body]. *Gig-Tr-Prof-Zabol*. (10), 1991, 8-12
5. Dupius H: Lärm und andere physikalische Faktoren. *Z. Arbwiss*. 33, 1979, 23-26
6. Manninen O: Simultaneous effects of sinusoidal whole body vibration and broadband noise on TTS<sub>2</sub>'s and R-wave amplitudes in men at two different bulb temperatures. *Int Arch Occup Environ Health* 51, 1983, 289-297
7. Dengerink HA, Trueblood GW, Dengerink JE: The Effects Of Smoking And Environmental Temperature On Temporary Threshold Shifts. *Audiology* 23(4), 1984, 401-410
8. Babaian MA, Denisov EI: [Combined effects of noise and heat and the evaluation of their biological equivalency], *Gig-Tr-Prof-Zabol*. (9), 1991, 24-7
9. Weinrich w: Auswirkungen gleichzeitiger Hitze- und Schallbelastung auf die zeitweilige Hörschwellenverschiebung (TTS<sub>2</sub>). *Z. ges. Hyg* 30, 1984, 646-647
10. Rentzsch M: Combined effects of sound, climate and air pollutants on noise induced hearing loss. *Arch Complex Environ Studies* 1, 1989, 41-44
11. Berndt H, Wagner H: Influence of body temperature and recovery of noise-induced cochlea damage. *Arch Oto-Rhino-Laryngol* 232, 1981, 199-202
12. Manninen O: Cardiovascular changes and hearing threshold shifts in man under complex exposure to noise, whole body vibrations, temperatures and competition-type psychic load. *Int Arch Occup Environ Health* 56, 1985, 251-274
13. Manninen O: Changes in Hearing, Cardiovascular Functions, Haemodynamics, Upright Body Sway, Urinary Catecholamines and Their Correlates after Prolonged Successive Exposures to Complex Environmental Conditions. *International Archives of Occupational and Environmental Health*, 60 (4), 1988, 249-272
14. Meister A: Der NSI - eine Methode zum Nachweis akuter körperlicher Beschwerden bei Schall- und Kombinationsbelastung. *Z. gesamte Hyg*. 35, 1989, 502-505
15. Richter J, Meister A, Bluethner R, Seidel H: Subjectiv evaluation of isolated and combined exposure to whole body vibration and noise by means of cross modality matching. *Arch Nerv Sup* 30, 1988, 47-50
16. Friedman R, Rosenman RH: *Der A-Typ und der B-Typ*. Reinbeck, Rowohlt, 1975
17. Spielberger CD, Gorsuch RL, Lushene RE: *Manal for the State-Trait Anxiety Inventory*. Palo Alto, Cons Psychol Press, 1970
18. Nitsch JR: Beanspruchung im Sport: Die EZ-Skala-ein Verfahren zur hirarchisch-mehrdimensionalen Befindlichkeitsskalierung. In: Nitsch JR, Udris I (eds) *Beanspruchung im Sport*. Limpert, Bad Homburg, 1976, 81-102
19. Borg G: On a general scale of perceptive intensities. In: *Reports from the Institute of Applied Psychology*. Vol 55, Stockholm, 1974, 6
20. Fanger PO: *Thermal comfort. Analysis and applications in environmental engineering*. McGraw Hill Book Company, USA, 1973, 110
21. Scheibe F, Haupt H, Ludwig C: Intensity-dependent changes in oxygenation of cochlear perilymph during acoustic exposure. *Hear-Res*. 63(1-2), 1992, 19-25

# NOISE CONTROL IN TROPICAL COUNTRIES AND CULTURAL BEHAVIOURS

SLAMA Jules Ghislain

NUNES COSSENZA Carlos Alberto, GUEIROS TEIXEIRA Suzana  
COPPE/UFRJ AND FAU/UFRJ, Caixa Postal 68501  
21945-970 Rio de Janeiro, RJ - Brasil

## Abstract

Over the years considerable knowledge has been accumulated in developed countries about acoustical treatments and man's response to noise.

For the acoustical technicians perform effectively in Tropical & Undeveloped countries, they must obtain certain information such as climate limitations and cultural behaviours. Therefor a solution that is applied successfully in colder climates, sometimes may appear as a distortion for the architectural parameters adopted in tropical areas.

The technological transfer of noise control methods and systems is the object of this article, for the acoustical goal that will depend on the particular environmental conditions we're dealing with.

The article will start by presenting three different cities in Brazil (Brasilia, Rio de Janeiro and Curitiba) in terms of urbanising & master-plan, with their climate and cultural particularities as a way to point out solutions for noise control in agreement to tropical demanding. Finally, there will be presented a series of reflections, sketches and illustrations about technological transfer of noise control solutions for tropical countries.

Cultural behaviours, climates and technological differences will be some of the topics of the following discussion to make understood why does not always an acoustical solution may suit with tropical demanding without any adaptation.

As we consider three brazilian cities we may also notice how aspects such as the urban design and its morphological aspects can deal with its sound quality. It's amazing how the structural dimension of a city can make it a better place or a worse still one [6].

If we take a whole country with its population, its government and aspects of urbanism, we may notice different types of territorial occupation among periods of time. As say Sergio Bernardes, a Brazilian urbanist, about Rio de Janeiro, the city itself is a witness of urban oppression; a city that's made of beauty when seeing from distance, yet kind of depressive as close as you get in. The urbanistic characters of Rio reveal an occupation mainly based on economical aspects. Besides, it also should be mentioned that politics and local governments, as well as the organizing and management entities of the city weren't

strong enough to provide a reliable basic structure according to the increased population.

As an answer to that uncontrolled occupation we deserve: high densities of population in determined areas, urban noise levels bothering multifunctional areas, also residential areas (Copacabana, Tijuca) that have been annoyed by high level of heavy traffic. The speculative values of its lands testifies the typical "Babellike" quarters. As a better solution to partially decrease the urban noise coming from the heavy traffic was the work on a subway. Nevertheless, as time passed both inflationary context plus the discontinuity of political managements interrupted the works on the subways wich had already started.

The opportunity of planning and building a new city is just amazing by all means. We are now talking about the capital of Brasil- Brasilia.[1] In process of time, when we take a look at it with the acoustical knowledge, we find out that some aspects such as the location of buildings to the main traffic views, the types of materials mainly applied to the facades of buildings could need an acoustical study. It could also be possible an acoustical barrier project [2] among the main traffic views wich cuts the city called "pilot plan".

Maybe we should call that point of view : "The acoustical texture of urbanistic plants". We could then add acoustical informations so that the urbanistic proposal gets noiseless. A brazilian city called Curitiba provides a morphological aspect that satisfies the urban quality control, besides, the cultural aspects of its local community that worked to decrease the problems like organisation and use of space.[3] It is not easy to describe the degree to which architectural differences such as the ones found in these three cities can affect noise levels; all we can notice is that the city design at best provides the lower density of population concentrated in small areas.

Those are the main differences on the concepts of these cities, which a noise source can either be amplified or avoided. The communities relationship of Curitiba is not as individual as in Rio, people are closer, also some of the acoustical solutions of noise control can be more easily adapted considering that their climate presents lower temperatures. The political leader of the city, Jaime Lerner, says that he has promoted something else besides a good administration; the spirit of rebirth, the friendship and closer contact within each quarter of the city.

However, we can't blame a whole city for its noisy pollution. In a community there should be this sense of self consciousness so that even from single products used everyday in our homes we could expect a noiseless performance. The applications of successfully noise control methods need to be adapted in our climates also considering that technology is not a product that can be sold; technology could start by an educational process that deals with the needs of determined culture. Being aware of climate limitations such as moistness and high temperatures for if not considered, imported solutions

may be unusefulness. The architectural goal in that case may not always be acoustics, but the priority of ventilation and refrigeration.

Taking into consideration the economical and social scenario interacting into the conjecture of cities; we could point out basic points such as:

1. The degeneracy of cities acoustical quality embraces cultural and political aspects more than technical ones.
2. The sustainance of an acoustical quality or improvement of a noiseless environment demands an educational process at first followed by technical integration and supervising with appropriate equipments.
3. The disastrous increase of urban improper concentrations and the impotence of representative government entities in providing noise control.
4. The technical failure of noise control turned out to be much more a matter of political and cultural behaviours.
5. The neighborhood noise disturbance if not claimed by consciousness community may not be punishable. Ex: Carnival, loudspeakers from commercial ales. By the way, in the legal aspect, one cannot be able to distinguish cultural behaviour from noise annoyance an acoustically degraded environment.
6. The effectiveness of noise control programs just can't happen while specialised supervising professionals with it's technical equipments are a few minority.

What has been summarised until now points out the possible failures of imported solutions and a lack of acoustical information among communities. To exemplify that, we can take elementary schools that were built to supply educational demanding. The projects themselves revealed a lack of any kind of acoustically adequate solution, not even the sense of translating to classrooms a design based on Acoustic Quality Criteria. Not surprisingly, both teacher and schoolmates did not find the conditions to concentrate or intelligibility and speech privacy [4]. The walls that separate the classrooms are shared and do not reach the roof. Maybe we could blame economical reasons plus need of natural ventilation systems; but it would still be an example of poor solution and omission of acoustical designing in the conception of projects.

It happens sometimes that political interests turn into priority decisions before discussing of what would be the environmental impact on the communities. A noisy traffic highway that had to be done in any case, for the ECO 92 couldn't be realised without it. Since it had to be done. It could not be missed in determined areas, at least on those with residential neighbourhood, an acoustical barrier or other treatment to reduce the noise impact on local communities.

At least it is recognised that after ruining the acoustical comfort, political organisation and its unfortunate experiences do contain a certain teaching for future projects!

The architectural concepts of buildings in tropical climates such as Rio, have to improve the best in natural ventilation. For those who have an economical support to acquire a flat with a porch, are also the ones who may become the victims of inadequate acoustical design and treatment against noise sources from streets. Natural ventilation? Oh no, it will now be adjusted for an air conditioning system, the noise from that source will not only be able to mask the street ones, but it can also prevent speech interference coming from his next neighbourhoods. By that way, we are not far from the point of having a particular noise source to avoid a neighbourhood one!

Cheap materials are in part guilty elements when talking about construction and neighbourhood noise sources. To the acquisition of a house or a flat in central areas the speculative price of a piece of land automatically forces the constructor to find a way of cheapening up the final costs by reducing the quality of materials. Some of the best acoustical windows, consisted of double glasses, may stuck on economic limitations of society, considering also basic materials like glass wool whose price can be five times higher than in Europe.

We must admit, that it is essential the need of elementary instructions for the projects design and, techniques to harmonise not only economical costs with natural ventilation, but to specify some design criteria according to each project considering the acoustical peculiarities of the surroundings.

To summarise, we wouldn't like to give a wrong impression that tropical countries, particularly this one, have more limitations than the aimed of changing. We shall mention a few good technical institutions that work for a better noise control, scientific entities and governmental programs "Projeto Silencio" that have been done to sensibilise both population and politics.

The efforts to improve the acoustical conditions are multidisciplinary being spread by the SOBRAC, The Brazilian Acoustical Society, has had a close collaboration among the brasilian society by it s seminars, international congress, being responsible for discussions, and techonological transfer.

[1] Maria Luiza Carrozza "Brasilia, a Utopia Frustrada"

M.Sc Thesis COPPE ,Federal University of Rio de Janeiro,

[2] Jules G.Slama, Suzana Gueiros Teixeira "Barreiras Acústicas e ruído de transito" IV International Seminar on Noise Control Rio de Janeiro 1992

[3] Suzana Gueiros Teixeira, "Controle de Ruído e países Subdesenvolvidos: Problemas Conjecturais" IV International Seminar on Noise Control Rio de Janeiro 1992

[4] Maria Julia de Oliveira Santos, "Ruído no Ambiente Escolar, causas e consequencias" M.Sc Thesis Faculty of Architecture, Federal University of Rio de Janeiro, 1993

[5] Hely Lopes Meirelles "Direito de Construir" Revista dos tribunais 1983.

[6] Del Rio, Vicente, "Desenho Urbano", Editora Pini 1987.

# NOISE, RESPIRATORY VIRUS INFECTIONS AND PERFORMANCE

SMITH Andrew, THOMAS Marie, BROCKMAN Pip

Health Psychology Research Unit  
School of Psychology  
University of Wales College of Cardiff  
P O Box 901, Cardiff CF1 3YG, Wales

## Abstract

There has been considerable research on the acute effects of noise exposure on performance. However, most of these studies have been carried out using healthy subjects and it is important to determine whether noise has a different effect on individuals suffering from a mild illness. Recent research has examined the effects of upper respiratory tract illnesses (colds and influenza) and shown that these may impair aspects of performance. The aim of the present study was to examine the combined effects of noise and upper respiratory viral illnesses on performance. One hundred and thirty four subjects took part in the study and all of the subjects completed a baseline session while healthy. This took place in the quiet and subjects completed tests measuring psychomotor performance, selective and sustained attention and episodic and working memory. Subjects then returned to the laboratory when they developed a cold and samples were taken to allow identification of the viruses. The subjects repeated the test battery, once in the quiet and then either in conglomerate noise played at a level of 70 dBA or in quiet again. Subjects returned to the laboratory one month later, when they were well, and repeated the procedure. Ninety one subjects developed colds and 65 of these were tested in noise and 26, in quiet. These subjects were compared with 43 healthy controls (22 tested in noise and 21 in quiet). Subjects with colds were slower than healthy controls on a simple reaction time task, and this effect was increased in noise. Noise also produced direct effects (e.g. on sustained attention) but these were not influenced by the viral illness.

## Introduction

The effects of noise on performance depend on contextual factors such as the nature of the noise, the type of task being carried out and characteristics of the person (see Smith & Broadbent, 1991; Smith & Jones, 1992). There is also a growing awareness that the effects of noise will be determined by its combination with other agents (see Manninen, 1988). Studies have been carried out examining noise and vibration, noise and other environmental stressors (e.g. heat) and noise and abnormal working hours (e.g. nightwork). Most studies of noise effects have used healthy subjects, yet, at any given time, a substantial number of the population will be suffering from minor illnesses, such as the common cold. Upper respiratory virus infections have been shown to produce selective impairments of human performance (see Smith, 1990; Smith, 1992). It is important, therefore, to determine whether the effects of noise will differ in ill and healthy subjects. Indeed, recommendations made on the basis of results from healthy subjects may not be applicable when the person is ill. Such research is both of practical importance and relevant to understanding the mechanisms through which noise produces its effects. The present paper reports preliminary results from our research programme on this topic.

## Experiment

One hundred and thirty four subjects (approximately equal numbers of males and females, age range 18-30 years) took part in the study. All subjects were familiarised with the procedures and then completed a baseline session when healthy. This took place in the

quiet and subjects completed tests measuring psychomotor performance, selective and sustained attention and episodic and working memory. Subjects returned to the laboratory when they developed a cold and subjective reports of symptoms and objective measures (e.g. weight of nasal secretion and sub-lingual temperature) were recorded. Nasal swabs were also taken to try to identify the virus producing the illness and blood samples were taken when the person was symptomatic and three weeks later so that changes in antibody levels could be examined. The subjects repeated the test battery twice - once in quiet to allow assessment of the effects of the illness, and then again in noise (conglomerate noise consisting of irrelevant speech and music played at a level of 70dBA) or quiet. Subjects returned to the laboratory one month later, when they were well, and repeated the procedure. Ninety one subjects developed colds and 65 of these were tested in noise and 26 in quiet. These subjects were compared with 43 healthy controls (22 tested in noise and 21 in quiet). Results are presented here for ratings of alertness and three of the performance tests. The cold subjects are treated as a single group rather than sub-dividing them on the basis of the infecting virus.

Alertness was rated using a visual analogue scale with Drowsy at the left end and Alert at the right. Scores could range from 1 (very drowsy) to 50 (very alert). The performance tests were carried out on an Amstrad PC, which controlled the timing of the stimuli and recorded responses (timing to an accuracy of 1 msec). The tasks discussed in this paper are the variable fore-period simple reaction time task, the five choice serial response task and the detection of repeated digits task. These are described in detail below.

*Variable fore-period simple reaction time task:* in the variable fore-period task a box was displayed on the screen and at varying intervals (from 1-8 secs) a square appeared in the box. The subject had to press a key as soon as the square was detected. This task lasted for 3 minutes.

*Five choice serial response task:* in the five choice serial response task five boxes were displayed on the screen and a square appeared in one of the boxes. The subject pressed the corresponding key and the square then appeared in another box and the subject had to press the next key. This task lasted for 3 minutes and the number of responses made, number of errors and number of gaps (occasional long responses) were recorded.

*Repeated digits detection task:* in this task subjects were shown three-digit numbers on the screen at the rate of 100 per minute. Each number was normally different to the preceding one but occasionally (8 times a minute) the same number was presented on successive trials. Subjects had to detect these repeats and respond as quickly as possible. The number of hits, reaction times for hits, and false alarms were recorded. The task lasted for 3 minutes.

## RESULTS

Analyses of covariance were performed on the data (with the baseline data as covariates to control for unwanted differences in alertness and performance prior to the illness/noise manipulation). The between subject factors were health status (colds v healthy) and noise conditions. The adjusted means from the analysis of covariance are shown in Table 1.



Table 1

	Healthy		Colds	
	Noise	Quiet	Noise	Quiet
1. Alertness	27.6	29.7	24.0	19.9
2. Simple reaction time (ms)	365	385	445	380
3. Detection of repeated numbers % hits	50.5	59.8	53.9	58.9
4. Five-choice serial response task % correct	88.6	86.6	86.6	84.6

The results show that subjects with colds reported that they felt less alert than the healthy subjects. This effects was highly significant ( $p < 0.0005$ ) and the interaction between noise and colds approached significance ( $p = 0.08$ ), which reflected the bigger effect of the cold in the quiet condition. A significant interaction between noise and colds was obtained in the analysis of the simple reaction time data ( $p < 0.05$ ). There was little difference between the reaction times of the healthy and colds subjects tested in quiet but subjects with a cold tested in noise were much slower than the healthy, noise group. The two other tasks did not demonstrate interactions between noise and colds. However, a main effect of noise was obtained in the detection of repeated numbers task ( $p < 0.05$ ), with subjects in noise detecting fewer targets. In contrast to this, a main effect of colds was significant ( $p < 0.05$ ) in the analysis of the accuracy of performing the five-choice serial response task ( $p < 0.05$ ), with subjects with a cold performing the task less accurately.

## DISCUSSION

The preliminary results from our research programme confirm that it is important to consider the health status of the person performing in noise. They also confirm that the nature of the task is another important factor in determining both the effects of noise and upper respiratory tract illness on performance. Subjects with a cold reported reduced alertness and had impaired performance on the task requiring hand-eye co-ordination. However, there was no difference between healthy subjects and those with colds on the detection of repeated numbers task. All of these results confirm findings reported earlier (e.g. Smith et al., 1987; Smith et al., 1992). The only task which showed a main effect of noise was the detection of repeated numbers task. Again, the impairment found here is in agreement with that reported in earlier studies (Jones, Smith & Broadbent, 1979; Smith, 1988). The one example of an interaction between noise and colds was obtained in the simple reaction time task. Further analysis will determine whether similar effects are found in the tasks not considered here or whether this is an isolated effect. Similarly, it is necessary to determine whether the effect is related to characteristics of the cold such as the infecting virus, severity of the symptoms, etc. The main aim of the present study was merely to document any interactions between noise and health status. A next step will be to consider the mechanisms underlying such effects. It will be difficult, however, to come up with precise answers here as both noise and upper respiratory tract illnesses probably influence performance through a variety of mechanisms, rather than producing their effects in a single, passive way.

## REFERENCES

- Jones, D.M., Smith, A.P. & Broadbent, D.E. 1979. Effects of moderate intensity noise on the Bakan vigilance task. *Journal of Applied Psychology*, 64, 627-634.
- Manninen, O. 1988. Recent advances in researches on the combined effects of environmental factors. Tampere : PK-Paino Oy.
- Smith, A.P. 1988. Acute effects of noise exposure: an experimental investigation of the effects of noise and task parameters on cognitive vigilance tasks. *International Archives of Occupational and Environmental Health*, 60, 307-310.
- Smith, A.P. 1990. Respiratory virus infections and performance. *Phil. Trans. R. Soc., London*, B 327, 519-528.
- Smith, A. P. Colds, influenza and performance. 1992. In: *Handbook of Human Performance, Vol 2: Health and performance*. (eds) A.P. Smith & D.M. Jones. London: Academic Press. pp. 197-218.
- Smith, A.P. & Broadbent, D.E. 1991. Non-auditory effects of noise at work: a review of the literature. *Health and Safety Executive Contract Research Report No. 30*.
- Smith, A.P. & Jones, D.M. 1992. Noise and performance. In: *Handbook of Human Performance, Vol.1: The physical environment*. (eds) A.P. Smith & D.M. Jones. London: Academic Press. pp. 1-28.
- Smith, A.P., Tyrrell, D.A.J., Al-Nakib, W., Coyle, K.B., Donovan, C.B., Higgins, P.G. & Willman, J.S. 1987. Effects of experimentally-induced virus infections and illnesses on psychomotor performance. *Neuropsychobiology*, 18, 144-148.
- Smith, A.P., Tyrrell, D.A.J., Barrow, G.I., Higgins, P.G., Willman, J.S., Bull, S., Coyle, K.B. & Trickett, S. 1992. Mood and experimentally-induced respiratory virus infections and illnesses. *Psychology and Health*, 6, 205-212.

SUVOROV G.

Institute of Occupational Health, Russian Academy of Medical sciences,  
31, Prospekt Budennogo, 105275, Moscow, Russia

Long-term researches /vast contingents of workers/ in noisy industrial conditions showed nervo-vascular changes at moderate noise levels up to 90 dB(A), increased noise up to 95 dB(A) caused aural and extra-aural changes. The rates of their occurrence are practically the same ; further, a 1 dB(A) rise increases three times as much hearing losses rates comparing with nervo-vascular disorders : they are 1.5 % and 0.5 %, respectively, for each decibel of noise exposure.

Comparative dynamic analysis of above-stated changes identifies functional disorders of nervous system if years in noisy occupation are no longer than five.

Cochlear neuritis progresses if years in noisy occupation are equal to a decade.

Further increase of years in noisy occupation show hearing function impairment much more expressed than vegetative-vascular changes. The latter impaires functional state and leads to the development of diseases among workers.



# Adverse effects of smoking for noise induced hearing loss among workers in Beijing

Zhao Yiming, Liu Heping\*, Du Dekuan\*, Zhao Chunyan\* and Lu Yujun\*

Medical Research Center, The Third Hospital, Beijing Medical University, Beijing 100083, P.R.China, \* Department of Occupational Health, Hygiene Station of Xuan Wu District, Beijing 100053, P.R.China

## ABSTRACT

1165 workers who were exposed long-term to industrial noise were studied to determine if there was a relationship between smoking and noise induced hearing loss (NIHL) in Xuan Wu district, Beijing. It was found that the prevalence of high frequency (3kHz - 6kHz) NIHL was 53.6% (292/454) in smoking workers and 40.0% (248/620) in non-smoking workers ( $p < 0.01$ ), but there was no difference for low frequency (500Hz - 2kHz) NIHL. For each frequency, prevalence of NIHL was higher in smoking workers from 4kHz to 8kHz, but not significantly different among other frequencies. Odds ratio (OR) of smoking also averaged over 1.4 from 4kHz to 8kHz (peak at 4kHz, OR = 1.77,  $p < 0.01$ ) with significant, and the others were lower than 1.1 either before and after adjusted by age, sound pressure level and working years with logistic model. These results strongly suggest that smoking is a risk factor for NIHL. Workers should be advised of the increased risk to hearing associated with smoking.

**KEY WORDS:** adverse effect, noise, prevalence, noise induced hearing loss, smoking

Noise is one of the most common occupational risk factors. It is known that long-term noise exposure can lead to hearing loss in workers. There is a high rate of smoking in occupational populations in China<sup>[1,2]</sup>. Smoking can induce many kinds of diseases. An epidemiological survey was conducted to explore the possibility that smoking might increase the risk to hearing of occupational noise exposure.

## SUBJECTS AND METHODS

The subjects were 1165 workers, who were exposed to noise for at least one year and who worked in 46 factories in Xua Wu district, Beijing. There are not significant confounding factors (using ear toxic chemicals, having infectious diseases with side effects of hearing loss, having head injury or hereditary trend for hearing impairment) in their personal histories. There were 685 male workers and 480 female workers in the investigation with means age of  $32.4 \pm 8.2$  years and noise working years  $9.2 \pm 7.8$  years of noise exposure.

An ND-2 sound level meter was used to measure sound pressure levels (SPLs) in workshops. Noise induced permanent threshold shift (NIPTS) were measured by an Danplex AS-72 audiometer in a sound barricaded room after the absence of noise exposure for more than 16 hours. High frequency NIHL was defined as from 3 kHz to 6 kHz in both ears, each NIPTS being higher than 25 dB. Low frequency NIHL was defined as the means of NIPTS from 500 Hz to 2 kHz with both ears higher than 25 dB. For each frequency, NIPTS higher than 25 dB also was defined as NIHL in this frequency.

Questionnaires were administrated by occupational medical doctors, including general information, occupational history of noise exposure, personal disease history, history of use of ototoxic drugs, smoking and drinking alcohol. Smoking was defined as smoking at least one cigarette per day.

The data were input into an IBM computer and analyzed by SPSS PC+ V3.0, EGRET V2.1 software to calculate means, standard deviation, prevalence of NIHL and odds ratio (OR) of smoking. Logistic regression was also carried out.

## RESULTS

The SPLs in workshops ranged from 76 dB(A) to 109 dB(A). Associated with increase of SPLs, prevalence of high frequency NIHL were elevated from 38.2% to 75.0%, and low frequency NIHL from 0 to 6.5%. There was a typical dose-response relationship between SPLs and prevalence of NIHL,  $p < 0.01$ .

Table 1. Relationship between smoking and prevalence of high and low frequency noise induced hearing loss (NIHL)

Group	High frequency of NIHL			Low frequency of NIHL		
	NIHL	Total	Prevalence(%)	NIHL	Total	Prevalence(%)
Smoking	292	545	53.6**	17	545	3.1
Non-smoking	248	620	40.0	24	620	3.9
Total	540	1165	46.4	41	1165	3.5

\*\* compared with non-smoking group,  $p < 0.01$

Table 1 shows that the prevalence of high frequency NIHL in smoking workers (53.6%) was significantly higher than in non-smoking workers (40.0%),  $p < 0.01$ . There was not a significant difference in the groups for low frequency NIHL. In comparing the crude prevalence of hearing loss between smokers and non-smokers at each frequency (figure 1), it was found that there were significant differences at 4 kHz to 8 kHz with the largest prevalence in both groups at 6 kHz. These results suggest that smoking is a risk factor for high frequency hearing loss among noise

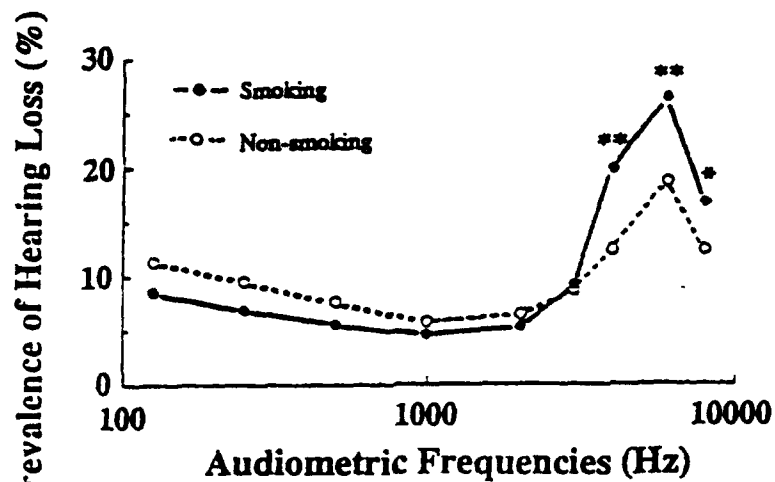

Fig 1. Comparison of adverse effect of smoking on different frequencies noise induced hearing loss in workers

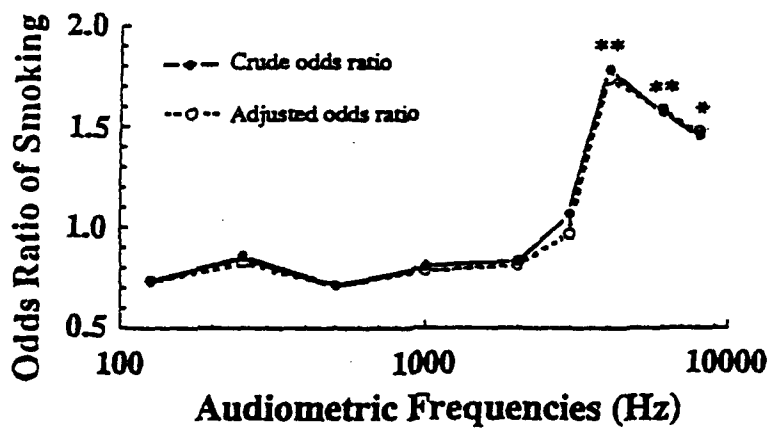

Fig 2. Odds ratio of Smoking for different frequencies noise induced hearing loss in workers

exposed workers. However, the noise exposure among smokers and non-smokers was slightly different, the average being 91 dB(A) and 9.6 years among smokers and 90 dB(A) and 8.7 years among non-smokers. In order to adjust for the possibility of confounding factors, a logistic model was employed. The outcome variable was the probability of hearing loss in excess of 25 dB at each audiometric frequency. The predictor variables were smoking, age, working years and dB(A) level. Figure 2 shows the crude and adjusted odds ratio (OR) for smoking as a function of frequency with the starred data points being those where significant differences were observed in the prevalence data. Clearly, adjusting for noise exposure and age made no difference in the OR for smoking which leads to the conclusion that the differences observed in figure 1 were due to smoking. The effect of smoking is maximum at 4 kHz (OR = 1.77) which suggests that this is the most susceptible frequency despite the fact that the prevalence of NIHL peaks at 6 kHz in these data.

## DISCUSSION

Barone<sup>[3]</sup> found the prevalence of high frequency NIHL in smoking workers to be higher than non-smoking workers, OR of smoking equal to 1.39,  $p = 0.002$ . This value corresponds closely to the 1.34 of finding in our survey. Molvaer<sup>[4]</sup> reported there was higher hearing loss in smoking divers. Our research also found adverse effects of smoking to the greatest above in 4 kHz for NIHL. These results strongly support smoking as a risk factor for NIHL.

Today, smoking is one of the biggest problems for population health in China. Sun Guifan<sup>[1]</sup> reported that about 52.9% of factory workers smoke. Zhang Guangyou<sup>[2]</sup> found that 39.5% of farmers smoke in rural areas. Our study also found 46.8% workers smoking. Overall there appears to be about fifty percent prevalence of smoking in Chinese occupational population. This is a serious problem! It is very important to advise workers that yet another reason to stop smoking to protect their hearing against noise exposure. Advising workers to reduce till stop smoking should be added into the occupational health education program.

## REFERENCE

1. Sun Guifan, et al. Investigation of smoking status for workers in factories (Chinese). *Chinese Public Health* 8(5):4, 1992
2. Zhang Guangyou, et al. Report of farmer smoking survey and farmer death related smoking in Zhangye (Chinese). *Journal of Chinese Prevention Medicine* 26(2):111-112, 1992
3. Barone JA., et al. Smoking as a risk factor in noise-induced hearing loss. *Journal of Occupational Medicine* 29(9):741-745, 1987
4. Molvaer OL, et al. Hearing acuity in professional divers. *Undersea Biomedical Research* 12(3): 333-349, 1985



AECHERLI Willy  
Association International contre le bruit  
Hirschenplatz 7, CH-6004 Lucern

Taking into consideration that each century, respectively each phase of human development, has its particularity, I wish to designate the second part of the 20th century, i.e. the time as of 1950 approx., as the age of noise where one started to worry seriously about the problem of noise and its control. In the beginning this happened on a strictly academic level and amongst specialists only. Due and thanks to constant public working of various private organizations, a greater part of the general public started to react. Today, at the end of the 20th century there is hardly anyone in the western and eastern industrial countries not being annoyed by noise emanating from either airplanes, road-traffic, industries or leisure. Noise, therefore, is a constant environmental factor in our today's society. It is the most recognised environmental burden, ranking before all other harmful environmental factors, due to the fact that human beings are immediately and directly concerned by noise. Noise is no word which would show a neutral or positive meaning in our cultural field. It does not make us think of a gift nor of something of great welcome, desire or consent. In the first place it refers to a frame where negative feelings such as anger, helplessness, rage and irritation predominate. Noise points to a problematic situation which is being experienced as most disturbing and which should come to an end as quickly as possible. If something is disturbing us we usually take it for granted that we after termination of such disturbing incident, are uninjured, intact and unhurt. However, noise has, over the last years, caused by experience and scientific knowledge, also being given the quality of lasting, destructive effects.

Noise in our days is being considered a factor causing various illnesses, which means that noise leads to ever-lasting health problems, thereby considerably reducing the quality of life. Noise, today, is a product of our social construction, which enters into our private and public consciousness. It stands for a metaphor being socially structured and creating a social reality by which the objective circumstances of the damages concerning health reach actual importance. Nevertheless and especially through the understanding that noise is a product of our common social behaviour, it is tolerated by a large part of the population and by the authorities and is also being accepted as a unchangeable fact. An explanation is being given by the definition "noise" as an annoying sound. In most of the producers of noise are not being affected by it and do not suffer by noise produced by themselves; on the contrary consider same in fact as being pleasant or even desirable. For ex. pop-music, reckless-drivers, motorcycle-drivers, riflemen, pilots.

I hereafter wish to point out two examples of collective misbehaviour which today have become the most important producers of noise, i.e. road-traffic-noise and noise emanating from aircraft. It is quite obvious that such sources for noise can only be diminished if and when the population shows enough acceptance and if in countries being governed democratically, regulations, constitution and law are being published for ex. prohibition for heavy vans to drive on Sundays and during night, no night-flights.

The noticeable boom in the automobile business, the construction of more efficient cars as well as mobility and comfort of large parts of the population will add to a constant increase of traffic-noise. The fact that the authorities have difficulties in limiting traffic, - thereby limiting traffic-noise - is somehow understandable considering the opposition from unions and lately also from certain parties who go for an uninhibited break-through of mobility.

Noise can have, next to purely acoustical, also social reasons, whereby it should be stated that it is also being given a largely subjective meaning. According to investigations made with 151 tenants of social apartments in Germany regarding their living-situations, conditions of living/lodging, and restrictions in living, it was evident that tenants more often feel frustrated by the noise made by their neighbours, if and when their life-situation is being considered unsatisfactory by them.

Complaints reg. noise made by neighbours also show a central discontentment of a person: for ex.: people feeling less at home in their apartment often judge their present living-situations as being restricted. This narrowness is due to the fact that they had given up - for ex. only lately - a larger and more comfortable apartment. During investigations they complain more often about having to suffer from arguments with neighbours: according to their opinion neighbours often listen to loud music or make too much noise. The treatment of complaints reg. noise is not only a technical problem: a better protection from noise or asking tenants to reduce noise, will not affect in the least people in unpleasant, negative, frustrated situations in life. What would have to be done in the first place is to deal with subjects of saving material existence in order to reduce the higher psychological and social vulnerability emanating from material and social insecurity.

Similar to the above is the problem of immissions regarding leisure: someone attending a loud party, a spectator of a spectacular football-game or of noisy motorsport-racing will no complain about the noise which she or he observes within call. However, all those being outsiders, wishing to take part, will express their (wanted or unwanted) being "out", by complaining about noise.

Attention is to be drawn to the fact that geographical differences in the population can lead to diversified understanding of noise. It is known that people living in the Mediterranean and southern part of the earth are much less irritated by noise than people living in the northern hemisphere. An investigation to compare cultures reg. noise-irritability made between German and Japanese tenants of apartment-buildings showed that noise from neighbours is of great inconvenience to Germans and is being considered a significant disturbance of their day-to-day life, whereas Japanese show strong reactions reg. their views and opinions which, however, hardly ever lead to any preventive measures. Noise is not something to be done away with but is also to be interpreted: let us think of noise being caused by children and young people. Apart from the fact that juveniles harm themselves, we have to ask us which functional importance it has, to be exposed to loud volumes of sound or to produce loud noise.

From this point of view, noise can be regarded as an instrument of strength/power. Children and juveniles very often find themselves in a social situation, the meaning of which is to be described with inferiority, disregarding of feelings, degradation of personal value.

Any equivalence is being refused by adults in the fields of home, school, at work and clubs. Physical superiority is being demonstrated either in a reckless or unaware manner. Under such circumstances children and juveniles are unable to develop an intact identity: they live in a cultural context which systematically aggravates the building up of self-confidence and sovereignty. They can intensify their own physical strength by technical means being at their disposal, such as hi-fi-installations etc. The development from child-juvenile-grown up also means to gain personal autonomy in additional domains. The music of the juveniles represents an instrument to create physically, in style and with regard to contents - own spheres.

A constantly new limiting of the own reach is being attempted and it is endeavoured to articulate in a charming way, different from the then younger and older colleagues. The articulation of lack of understanding and disturbance especially by older people is a proof that the differentiation and establishing of an own behaviour pattern is successful. This can be achieved by making music (actively) or by listening to in (receiving).

Noise - is it a necessity in a loud, noisy world? The loudness of our behaviour depends on the fact on which background we wish or have to withdraw. It is our aim not to go to ruin by background-noise, we will have to activate the intensity of our acting in order to be visible or audible as a "figure". In such a situation a person has to present itself somewhat "noisier", to be one of the party, to be modern, to be one of the crowd, and to be "in".

It seems to be "clever", to "produce" oneself "loud", loud in colors, in language, in behaviour. To be loud can be looked at as a typical requirement of our era/time and as an obvious, desired way of acting. To adapt oneself quietly to a situation is rather being judged as inadequate or deviating, something which does not conform to up-to-date and ideological standards, and which could be looked at as weakness or lack of influence.

## **EFFECTS OF NOISE ON THE CITIZEN AND ITS REPERCUSSIONS ON MUNICIPAL MANAGEMENT**

**AGUERRI SANCHEZ, Pilar  
CELMA CELMA, Javier**  
Town Council of Zaragoza - Environment Service  
Eduardo Ibarra street, s/n - 50.009 ZARAGOZA (Spain)

Based on the data provided by a psychosociological survey performed in the City, the effects which noise has on the population are analyzed from a subjective viewpoint; the different affects on different groups of the population are pointed out and their importance with respect to the town management of noise is commented on.

A partir des renseignements fournis par une enquête psychosociologique réalisée dans la Ville, les effets que provoque le bruit sur la population sont analysés, leur analyse étant faite d'un point de vue subjectif. Il y est constaté que les divers groupes de population sont affectés de façon différente, l'importance dont ils sont affectés étant commentée en vue de la gestion urbaine du bruit.

Based on the data provided by a psychosociological survey performed in the City, the effects which noise has on the population are analyzed from a subjective viewpoint; the different affects on different groups of the population are pointed out and their importance with respect to the town management of noise is commented on.

The Town Council, as the administration which is closest to the citizen, has an important responsibility with respect to the citizens' environmental well-being.

The management of the environmental problems cannot be focused from a merely technical viewpoint. To solve them, they must be considered as a whole, bearing in mind the psychosociological aspects which provoke and maintain the behaviours with environmental repercussions.

Aware of this, the Zaragoza Town Council, in collaboration with the University, has performed a psychosociological study whose aim is to find out how noise is perceived by the citizen. The research was carried out by means of a standardized questionnaire, complemented with a Lickert type attitude scale, and carried out by means of 700 door-to-door interviews according to age, sex and district levels.

Among the results, those referring to the effects which noise has on the citizens are highlighted and analyzed from a subjective viewpoint.

The main effect highlighted is how the quality of living is affected, especially in daily life. Thus, the noise of traffic is in 5th place with respect to the problems which affect the citizen personally, out of a list of 18 general social problems.

And, focusing more specifically on noise, 6 out of every 10 people consider the noise level in Zaragoza to be quite or very bothersome.

In addition to this problem, more than 70% of the citizens undergo more specific effects from noise:

- It prevents or makes it difficult for 27% to concentrate or carry out intellectual tasks.
- It produces psychic malaise in 33% (nervousness, irritation, stress...).
- It produces physical malaise in 13% (headaches,...) even increasing the problems in the sick.

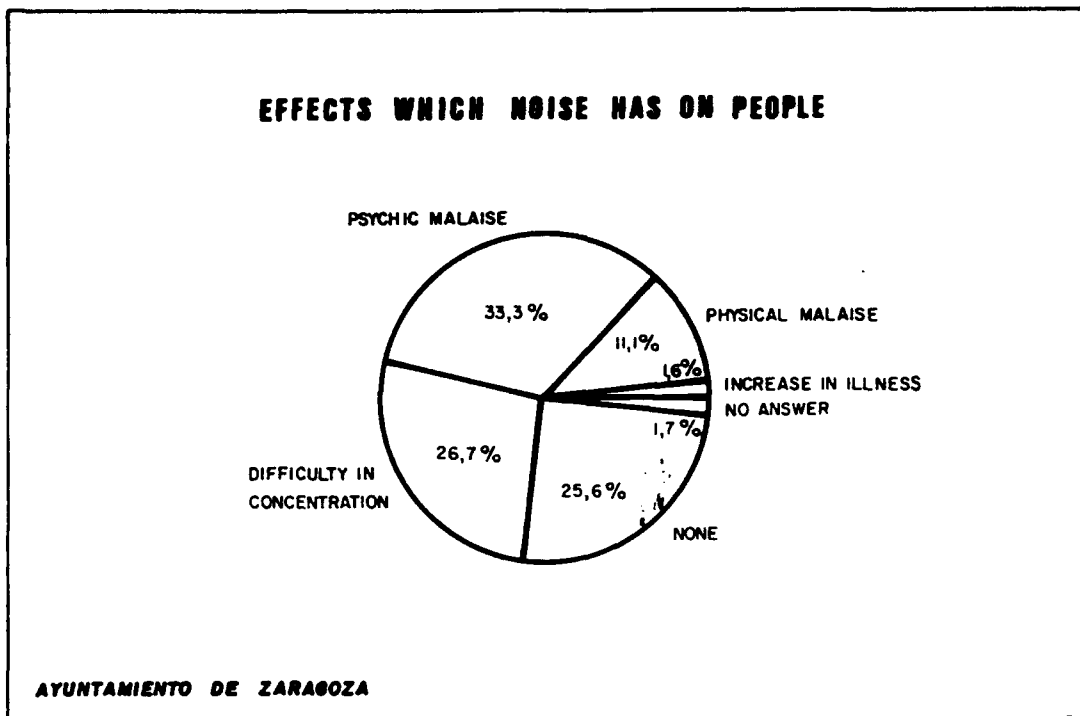

According to this chart, for 46% of the population the effects are important (psychic and physical malaise) and for 27% they are slight. The remaining 26% of those interviewed, are not affected by the noise at all.

There are no significant differences between sexes as regards the effects of noise. But there are differences with respect to age, study level, degree of malaise caused by noise at home and in the city and attitudes towards noise.

### AGE

The slight effects - difficulty in concentration or performing intellectual tasks - are suffered by the youngest; psychic malaise is more important in adults (33-59) and physical malaise is more important in the elderly people.

### STUDY LEVEL

The noise affects those with a lower level of studies to a lesser extent (33% affected of those not having finished Primary Education, opposed to 14% for those with higher studies).

Psychic malaise occurs almost the same at all levels. On the contrary, physical malaise occurs more in those with a lower education level (31% opposed to 1% for those with higher studies).

The difficulty in concentration produced by noise appears, on the contrary, in people with a higher education level (49%, opposed to 3% for those with a lower level).

## ATTITUDES TOWARDS NOISE

The group with negative attitudes towards noise includes a greater proportion of people suffering from the effects of noise (92%), opposed to those who are indifferent to noise (53%).

Differentiating the type of effect, physical malaise occurs to a greater extent among the least sensitive. On the contrary, psychic malaise occurs to a much greater extent among those who have negative attitudes towards noise (58%, opposed to 14% in those who are indifferent).

## DEGREE OF DISCOMFORT DUE TO THE NOISE LEVEL AT HOME AND IN THE CITY

In both aspects, the amount of people affected increases considerably as the level of discomfort increases.

Slight effects, such as difficulty in concentration, tend to increase, whilst psychic malaise increases very significantly. On the contrary, physical malaise tends to decrease.

## MOST AFFECTED ACTIVITIES

The people are bothered most by noise inside their homes when carrying out the following activities: firstly, sleeping and studying or performing an intellectual task, which affect half the people (54% and 49% respectively).

Secondly, affecting between one fourth and one fifth of the people: reading, watching TV and talking.

To a lesser extent, performing household chores or manual type jobs, listening to music or the radio.

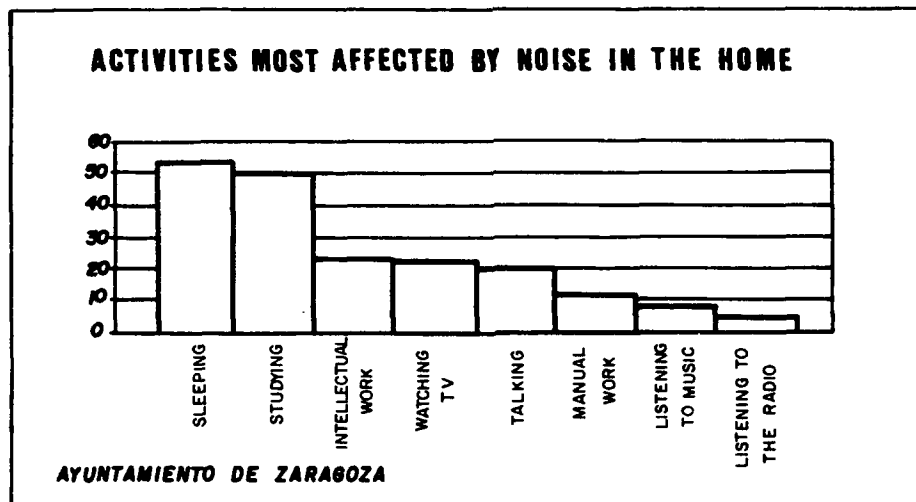

These results do not vary substantially when analyzed in view of the different independent variables.

## SUMMARY AND CONCLUSIONS

Noise, whose effects have been considered in many research studies, can be perceived subjectively by the citizens, highlighting its effects on performing intellectual and psychic tasks. In addition, it is seen how these effects occur to different extents depending on different circumstances. Young people with a high study level, negative attitudes towards noise and a high level of malaise perceived by the noise in their homes or city, are more aware of the effects of noise, having special difficulties in concentration and psychic effects. The physical effects follow a different affectation pattern (older age group, lower education level, less negative attitudes, less discomfort caused by noise in the home and city).

Discovering these effects and the typologies of those affected is an important piece of information to be taken into account in the town management of the noise, in order to be able to decrease the discomfort suffered by the population.

In this sense, - and bearing in mind that the population considers that the ideal measure to solve the noise problems is a personal change of attitudes and behaviours, with greater education and respect for others-, it would be interesting to carry out sensitization campaigns and behavioural changes, designed differentially for the two groups mentioned above, as well as the normal technical measures to reduce the noise level.

## ACOUSTICAL IMPACT ON PERFORMANCE AND BEHAVIOUR IN HOMOGENEOUS ZONES OF PALERMO (ITALY)

ALBANESE Giuseppe<sup>(\*)</sup>, BARBARO Salvatore<sup>(\*)</sup>, COSA Mario<sup>(\*\*)</sup>, DI MATTEO Umberto<sup>(\*)</sup>, GIACONIA Carlo<sup>(\*)</sup>, GRIPPALDI Vito<sup>(\*)</sup>

<sup>(\*)</sup> Dipartimento di Energetica ed Applicazioni di Fisica dell'Università di Palermo. Viale delle Scienze, Palermo, Italy.

<sup>(\*\*)</sup> Servizio Igiene pubblica, U.S.L. Roma 1

**Abstract** - By a suitable statistically significant sample, the experimental characterization of acoustically homogeneous zones in the urban territory of Palermo has been carried out through a picture of the road traffic environmental noise as values of  $L_{Aeq}$  for the day and night reference periods. From the comparison with the maximum normative limits of exposure or suggested by the W.H.O. and from the analysis of the statistic-cumulative distribution of emission levels, a set of risk maps has been drawn and the dimension of the problem noise has been evaluated particularly as influences on some ergonomic aspects. Giving a more specific significance to the concept of noise dose expressed by the composite index DNL, we propose a Zonal Risk Index linked to the single territorial class and defined as a suitable function of the degree of overcoming in regards to the standards ( $DNL_{exp} > DNL_{lim}$ ) and to the number of exposed people.

**Résumé** - En ayant un specimen statistiquement significatif, a été faite la caractérisation expérimentale d'aires acoustiquement homogènes dans le territoire urbain, en utilisant les valeurs moyennes de  $L_{Aeq}$ , pendant périodes de référence diurnes et nocturnes. Dans ce but, on a utilisé un cadre ambiant de trafic routier. Parmi de la comparaison avec le maximums limits normative d'exposition, ou bien sourgerés par l'O.M.S. et de l'analyse de la distribution statistique et cumulative de niveaux d'émission, a été produit un set de plans des risques. Les dimensions du problème du bruit ont été particulièrement évaluées en termes d'influence sur quelques aspects ergonomiques. En donnant un sens plus spécifique au concept de dose de bruit exprimé par l'index composé DNL (Day Night Level), on propose ici un index de risque en corrélation avec chaque classe territorial de destination du territoire. Il est nommé ZRI (Zone Risk Index) et il est défini comme une convenable fonction du degré de dépassement de standards ( $DNL_{exp} > DNL_{lim}$ ) et du nombre des sujets exposés.

Aim of the present paper is to evaluate the impact produced by the environmental noise on the intellectual and practical activities and on the rest and entertainment periods in the urban centre of Palermo in order to plan some effective efforts for reducing the risk in terms of public health and then in terms of unbalanced social cost.

The new Italian standards [1] provide an useful approach to the problem proposing the territorial analysis based on the various assigned utilizations and fixing restrictive limits of exposition, within the areas judged homogeneous in regards to the sources of annoyance, deduced from the social and sanitary requirements fit for allowing excellent environmental conditions.

Then, the urban territory of Palermo has been divided by the AA. in 6 "acoustically homogeneous" zones: protected (I), prevalently residential (II), mixed (III), busy (IV), prevalently (V) and totally industrial (VI) applying an operative methodology developed according to the standards by the choose of some apt territorial variables as for example the building density, the road traffic and the distribution of the productive activities [2].

Since the acquired reality by the town-planning did not avail of any criteria founded on the environmental quality, a given class or area along the urban territory may express different situations as partly non homogeneous if the acoustical climate is considered. Within these zones, after choosing a suitable sample which is statistically significant and sufficiently representative of the peculiar characteristics linked to the zonal typologies, the acoustical characterization has been carried out through a picture of environmental noise as  $L_{Aeq}$  corresponding to defined day and night time bands, also collecting information and data about the moving sources (road traffic) and the physical locations (sites) where the disturbance arises and evolves. Collected data have been elaborated in order to obtain for each measurement site

the corresponding time mean values  $L_d$  and  $L_n$  for the reference day (hours 6.00÷22.00) and night (hours 22.00÷6.00) periods. In Tab. 1 the results of the objective survey are synthetized reporting for each zone the mean values of sample and the dispersion degree of data (standard deviation  $\sigma$ ), and the comparison with the standard limits fixed for each zonal typology. So the typical acoustical conditions for each territorial class are found, and they are the starting points for planning the actions improving the air quality by procedures at a global level regarding the urban centre taken as a whole and/or local specific for each zone where the worst risk situations take place (black points).

From the analysis of the statistic-cumulative distribution of emission levels, a set of risk maps has been drawn expressing the probability that the normative limits and/or the maximum limits of exposure suggested by the W.H.O. can be exceeded (see Tab.2).

Starting from the aforesaid data and availing of the distribution of people along the territory, the dimension of the "problem noise" has been evaluated particularly as influences on some ergonomic aspects (behaviour, working and productive power).

In this connection we note that within the urban areas noises with  $L_{Aeq} = 35 \div 40$  dBA causes disturbances upon quality and duration of sleep particularly as interferences on the phase IV (sound sleep) and REM (dream) for the 10% of the exposed people at least. Effects of psychic type and annoyance take place over 40 dBA by day and 30 dBA by night, but in this case other physical, psychical and extrapositional factors have to be considered. Values exceeding 45÷55 dBA or increments of sound levels over 3÷5 dBA are responsible of neuroendocrine effects, alarm and neurovegetative syndromes. Psycosocial effects upon efficiency and performance appear at values of  $L_{Aeq}$  higher than 50 dBA, while at 50÷55 dBA the intellegibility of speech is affected, notably at 70÷75 dBA. Psychosomatic effects upon organs-target arise over 70 dBA, while the threshold of risk null can be locate at higher values (75÷80 dBA and over). Comparing these data with those showed in Tab. 2 puts in evidence as the problem is serious, even though the urban noise generally behaves as a risk factor rather the cause [3].

Afterwards, we have computed from the experimental data, for each sample element, the values of the composite index DNL (Day Night Level) which we have modified by us taking into account the time intervals fixed by the standards in force in Italy [1,3]:

$$DNL = 10 \cdot \log \left[ \frac{16}{24} \cdot 10^{L_d} + \frac{8}{24} \cdot 10^{(L_n+10)} \right] \quad (dBA) \quad (1)$$

and the mean results for each sample are reported in Tab. 3 performing the comparison with the fictitious threshold data ( $DNL_{lim}$ ) obtained by substituting to  $L_d$  and  $L_n$  in (1) the respective limit values.

We note that the utilization of DNL as an exposition index well traduces the noise dose experienced during the whole day and allows to evaluate the potential annoyance, through the graphical rating [4] of the per cent highly bothered people. The index DNL, which assumes significance as an absolute measure of the existing acoustical conditions, however seems inadequate when the correlation between the levels of exposition and the degree of interference within the various zones assumed as acoustically homogeneous is researched.

For this purpose a survey concerning the territorial classification in terms of potential risk, determined as a suitable function of the degree of overcoming compared to the maximum level of exposition referring to each homogeneous zone, may prove very profitable. Adopting the difference  $D = DNL_{exp} - DNL_{lim}$  as a global pilot parameter different levels of potential risk, expressed by a numerical code corresponding to a given sequence of ranges of existence for the parameter D.

As it is also important to assess the spread of the problem, which causes notable effects



of socio-sanitary and economical type, the basin of influence may be visualized by a second code corresponding to the number of exposed people at a zonal scale.

The acoustical impact produced by the external noise (mainly due to the road traffic) upon the activities commonly carried on within the confined homogeneous zones may be quantified computing the values of a Zonal Risk Index (ZRI). In this paper the proposed ZRI is obtained multiplying the codes referring to the level of potential risk and the basin of influence. The distribution of the values found for ZRI along the urban territory allows to proceed from the simple passive observation of the risk situations to the effective measures for the acoustical rehabilitation based on the priorities put in evidence.

The application of the procedure here proposed to different territorial realities is required in order to validate the base hypotheses. The suggested methodology is obviously susceptible of revision when a numerical and territorial wide data set will be available.

#### REFERENCES

- [1] Decreto Presidente Consiglio dei Ministri 1 marzo 1991: "Limiti massimi di esposizione al rumore negli ambienti abitativi e nell'ambiente esterno". (Gazzetta Ufficiale della Repubblica Italiana, n. 57, 8.3.1991).
- [2] COSA M., ALTERIO S., BARBARO S., DI MATTEO U., GIACONIA C., GRIPPALDI V., ORIOLI A., Criteri di valutazione della zonizzazione acustica in relazione alle sorgenti mobili, Giornata di Studio su INQUINAMENTO ACUSTICO, Milano 17 febbraio 1992, Gruppo Scientifico Italiano Studi e Ricerche.
- [3] COSA M., L'inquinamento da rumore, La Nuova Italia Scientifica, Roma (1992).
- [4] HARRIS C.M., Manuale di controllo del rumore, Ed. Tecniche Nuove, Milano (1989).

**TAB.1 - Mean values of  $L_d$  and  $L_n$  for each experimental sample and their comparison with the corresponding zonal limits.**

CLASS	DAY REFERENCE PERIOD			NIGHT REFERENCE PERIOD		
	$L_d$	$\sigma$	$L_{d,lim}$	$L_n$	$\sigma$	$L_{n,lim}$
I	72.0	5.00	50.0	66.0	5.62	40.0
II	72.5	5.67	55.0	66.5	9.80	45.0
III	73.0	5.01	60.0	62.5	8.42	50.0
IV	76.0	4.04	65.0	68.5	5.58	55.0
V	73.0	4.97	70.0	63.5	11.16	60.0
VI	71.5	1.87	70.0	68.0	7.72	70.0

**TAB.2 - RISK MAPS. Statistic-cumulative distribution of  $L_{A,eq}$  for each territorial class (%). The shadowed areas express the probability of overcoming the class limit as computed from the experimental samples. It is also shown the comparison with the limits suggested by W.H.O.**

CLASS	I	II	III	IV	V	VI
<b>DAY REFERENCE PERIOD</b>						
$\geq 50$ dBA	100	100	100	100	100	100
$\geq 55$ dBA	99	100	99	100	100	100
$\geq 60$ dBA	96	95	96	100	100	100
$\geq 65$ dBA	75	81	86	97	86	100
$\geq 70$ dBA	41	60	67	87	71	67
$\geq 75$ dBA	10	16	15	62	29	0
<b>NIGHT REFERENCE PERIOD</b>						
$\geq 40$ dBA	100	98	96	100	86	100
$\geq 45$ dBA	100	88	89	100	71	100
$\geq 50$ dBA	100	81	79	100	71	100
$\geq 55$ dBA	87	72	64	97	71	67
$\geq 60$ dBA	80	58	51	83	71	67
$\geq 65$ dBA	53	37	18	70	57	67
$\geq 70$ dBA	7	14	1	20	0	33
$\geq 75$ dBA	0	2	0	3	0	0

**TAB.3- Values of DNL for each zonal sample ( $DNL_{exp}$ ) and their comparison with the corresponding computed limits  $DNL_{lim}$ . Evaluation of the highly bothered people as per cent values (%HBP).**

CLASS	I	II	III	IV	V	VI
$DNL_{exp}$	74.0	74.5	73.0	77.0	73.0	75.0
% HBP	33.9	35.3	31.4	42.3	31.4	36.6
$DNL_{lim}$	50.0	55.0	60.0	65.0	70.0	76.0

## NOISE CONTAMINATION IN THE PUBLIC HOSPITAL OF ALBACETE

E. Arribas\*, C. Gallardo\* y M. Molina\*\*

\* Department of Applied Physics, Polytechnical Engineering College, University of Castilla-La Mancha, Avenida de España s/n, E-02071 Albacete, Spain.

\*\* Department of Nursing, Nursing College, University of Castilla-La Mancha, C/ Francisco Javier de Moya 1, E-02071 Albacete, Spain.

### ABSTRACT

The aim of this study is an investigation into the noise contamination of the Public Hospital of Albacete. While we were collecting the acoustic data, we handed out a questionnaire to the different groups of people living in the hospital, in order to find out if noise contamination has to be regarded a problem to be resolved.

In contrast to other types of contaminants, such as emissions of gases and liquids, noise is difficult to evaluate, since its evaluation does not only depend on the actual emission but also on the state of the receptor, i.e. it comprises a highly subjective component. So one and the same sound may cause pleasure or displeasure in two different persons or even in the same person according to the time of the day or the circumstances.

When entering any public building, specially buildings of the public health service, the first thing we notice is a continuous, non-ceasing background noise. Modern life requires a growing number of installations which all are sources of noise.

This study concentrates on a macrostructure that takes up and reflects all the defects of our philosophy of life and the construction techniques and electromechanical installations that are necessary for its functioning.

The Public Hospital of Albacete is a nine-storey building with a capacity of 500 beds. The different departments and activities on each floor are the following:

Sixth floor: Ophthalmology and Internal Medicine  
Paediatrics and Neonatology  
Fifth floor: Traumatology and Neurosurgery  
Urology, Otorhinolaryngology and Gynaecology  
Forth floor: Surgery  
Vascular Surgery  
Third floor: Internal Medicine  
Gastro-enterology and Infectious Diseases  
Neurology  
Engine Room for Intensive Care Unit

**Second floor:** Pneumology  
 Dialysis  
 Nephrology and Rheumatology  
 Intensive Care Unit  
**First floor:** Obstetrics and Gynaecology  
 Deliveries  
 Reanimation, Operating Theatre  
**Mezzanine:** Neonatology  
 Laboratory, Chapel  
 Engine Room for Air-Conditioning  
 Meeting Room, Management Offices  
**Ground floor:** Consulting Rooms for External Patients  
 Radiology  
 Emergency Admission  
 Foyen and Cafeteria  
**Semi-basement:** Workshops, Kitchen  
 Laboratories, Archives

We included the mezzanine, ground floor and semi-basement although there are no patients' rooms, in order to carry out a complete study of the building. Each floor is divided into two parts by the lift. each half is called "derecha" (right-hand side) or "izquierda" (left-hand side), depending on the side on which you leave the lift.

The Public Hospital of Albacete is situated very close to a bypass with rather heavy traffic which is supposed to have a great impact on the noise contamination of the building in question.

We carried out the measuring with the Brüel&Kjaer sound level meter 2235 with the integration module ZR 0035. For measuring the equivalent level (Leq) we used an integration time of 15 minutes after having checked that the Leq obtained within a time of 15 minutes and 1 minute are practically the same.

We carried out the measuring over the complete 24-hour day, on several days of each month, making sure that they were different days of the week. The sonometer was installed on a tripod and put up in different parts of each floor: patients. rooms, control zone (where the medical staff carry out a great part of their activities), chapel, engine rooms and laboratories.

The following table shows the maximum and minimum levels (en dBA) that we were obtained on each floor:

	Leq(min) (dBA)	Leq(max) (dBA)
Sixth floor	41.7	71.9
Fifth floor	43.3	72.1
Forth floor	39.6	71.3
Third floor	44.4	73.2
Second floor	41.4	85.2
First floor	42.5	72.8
Mezzanine	44.3	74.0

	Leq(min) (dBA)	Leq(max) (dBA)
Ground floor	46.3	88.3
Semi-basement	45.0	84.2

We attach the charts for two different days. One of them, that of the fifth floor, shows us the equivalent level, Leq, in the control zone on Tuesday, March 17th, 1992. The other one gives us the same information for the room 217 on Wednesday, June 24th, 1992.

The survey carried out among the different groups living in the hospital (patients, visitors, medical staff and other employees) showed that the noise is not regarded as a problem. What patients expect above all is being cured and treated with care. The noise, for them, is of minor importance.

### Acknowledgements

This work has been subventioned by "Consejería de Sanidad" of "Junta de Comunidades de Castilla-La Mancha".

### References

- Harris, C.M.: "Handbook of noise control". McGraw-Hill Book Company, 1979.
- Kryter, K.D.: "The effects of noise on man". Academic Press, New York, 1970.
- Rossing, T.D.: "The science of sound". Second Edition. Addison - Wesley Publishing Company, New York, 1990.
- Ward, D.: "Noise pollution". A Lara and R. W. Stephens, editors, London, 1984.

# 5th FLOOR

March, 17th, 1962

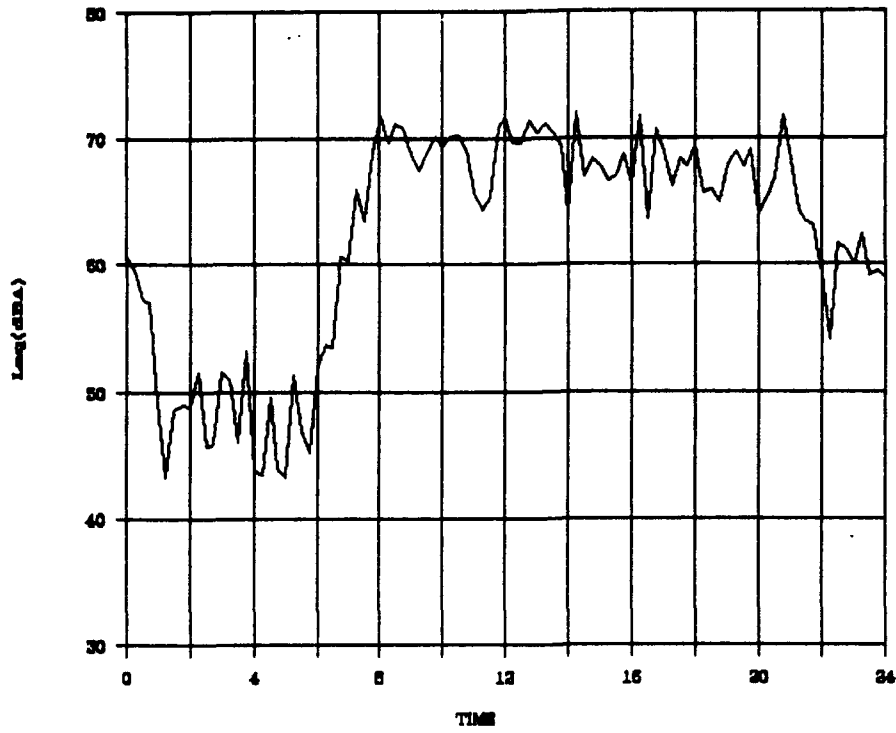

# ROOM 217

June, 24th, 1962

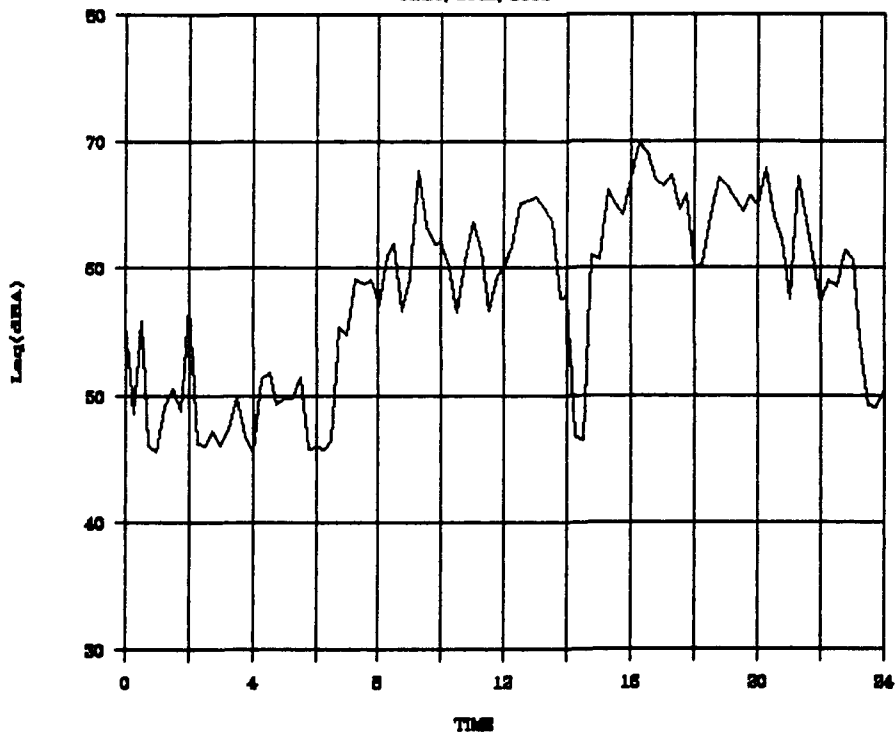

# REGULATIONS, NOISE AND DISCOMFORT

Dominique AUBREE

Centre Scientifique et Technique du Bâtiment, St.Martin d'Hères, France

## Summary

The 1969 French building regulations no longer seem adequate to ensure householders of real acoustic comfort. The results of a survey of 453 households in 38 operations show that the acoustic quality of housing has improved considerably over the last twenty years. Certain problems persist, however, particularly with regard to noise made by building installations. A large minority of people are still not satisfied, but their dissatisfaction is not functionally related, in a mathematical sense, to the acoustic quality of their homes.

## Résumé

Le règlement de la construction de 1969 ne paraît plus suffisant pour assurer aux occupants des logements un réel confort acoustique. Les résultats d'une étude réalisée auprès de 453 ménages dans 38 opérations font apparaître que la qualité acoustique des logements s'est très nettement améliorée au cours de ces vingt dernières années. Certains problèmes subsistent cependant, notamment en ce qui concerne les bruits d'équipements. On constate en outre qu'une forte minorité de personnes demeure insatisfaite, mais que cette insatisfaction n'est pas fonctionnellement liée à la qualité acoustique des opérations.

## Introduction

The 1969 French regulations stipulate that "the sound insulation of housing must be such that the level of noise which reaches the inside of each dwelling must not exceed the limits determined by a ministerial order ...<sup>1</sup>" It is now accepted that respecting these requirements is insufficient to provide real comfort to occupants. Although surveys have regularly shown that noise is the most important type of pollution which people have to put up with, no recent data was available which could be used to guide decisions to set up new regulations. In any case, there was no information from which a link could be established between the date of construction, the acoustic qualities of the building and occupant satisfaction.

This prompted the Construction Department at the Ministry of Public Facilities and Housing to have the C.S.T.B. and C.E.T.E.<sup>2</sup> carry out a study with a twofold purpose: (1) to assess the acoustic situation in dwellings built in compliance with the 1969 regulations, from both a technical and sociological point of view and (2) to explore the expectations of inhabitants concerning what can be done to improve the acoustic quality of their homes.

---

<sup>1</sup> Order of 14th June 1969 relating to sound insulation in housing, amended by the order of 22nd December 1975.

<sup>2</sup> Centre of Technical Studies for Public Facilities

## **1. The survey**

We will present here the initial results of a survey<sup>3</sup> of a population of 453 households in 38 operations, either tenants or new homeowners, chosen from the private and public housing sectors, including both flats and individual homes built between 1971 and 1992 in three French regions. The dwellings were also chosen according to their environmental situation, i.e. in a calm, noisy, or intermediate area.

The study consisted of jointly collecting technical data (acoustic quality) evaluated by the C.E.T.E. as part of a CRC<sup>4</sup> and the opinions of the people living in these dwellings.

## **II - The current housing situation**

### **2.1. Measurements**

Based on the data contained in the technical files, it is possible to divide the dwellings up according to various general criteria i.e. the quality of insulation from air-borne noise, from impact noise and from the noise made by building installations. But more specific information can also be used such as the insulating quality of concrete separating walls or floors against air-borne noise and impact noise or the quality of insulation from the noise made by certain installations such as controlled mechanical ventilation and lifts.

The acoustic quality is not evenly distributed among the different types of housing. In the case of air-borne noise or that made by installations, the results for individual homes are extremely different, either excellent or poor, while flats frequently have average results. The situation is not the same when impact noise is considered. The number of cases in which the results are either excellent or poor is significantly greater in the case of flats.

Private housing produces good or only adequate results more frequently in the case of air-borne noise, whereas public housing shows significantly more extreme results i.e. either excellent or poor. When it comes to impact noise or noise made by installations, opposite results are obtained for these two types of housing. The private sector is the most satisfactory when it comes to impact noise while the public sector comes out on top for installations.

Considering the progress which has been made with regard to the regulations in force, the acoustic quality of housing has improved considerably since 1971 for the different types of noises. It is obvious that the most important improvement has been made with impact noise insulation, followed very closely by noise from installations. On the other hand, although progress has also been made for air-borne noise, it is not nearly as marked.

### **2.2. The noises perceived**

The questionnaire proposed lists of noises which could have three origins. First of all, noises from the outside environment i.e. traffic, public areas or public buildings (shops, sports grounds) ; second, noises in close vicinity i.e. neighbouring houses or flats, common areas inside and outside blocks of flats, gardens and the immediate surroundings of individual homes ; and third, noises inside the home of the person being questioned.

The most frequent noises indicated as coming from the outside environment are motorbikes and cars which were mentioned by more than 90% of the people. Noises in close vicinity can be divided into three types - banging of doors, odd jobs and animals, mentioned by 70% and more of the people questioned. Inside noises include television, household appliances, banging of doors and running water, which account for more than 70% of the answers.

---

<sup>3</sup> The study was carried out jointly by the author and Mrs J. Rivoire, sociologist at the Lyon C.E.T.E.

<sup>4</sup> Building regulations inspection



If we consider how these noises relate to the acoustic quality of housing, several factors come to light. For noise from both outside and inside the home, no correlation was observed between the fact that the noise could be heard and the quality of the sound insulation. The frequency with which these noises are mentioned can vary, regardless of whether the acoustic quality is good or bad. The same is not true of noises in close vicinity to the home. Some of these, particularly noises from installations such as lifts, refuse chutes, mechanically controlled ventilation and running water, are mentioned more frequently when the quality of insulation from the noise made by these installations is poor or even simply acceptable. When it is good, or excellent, these noises are mentioned less frequently to a significant degree. It therefore appears that the acoustic quality of the home, even if it does not solve all the problems involved and even if it does not always seem to be perceived by the inhabitants, produces results which clearly show that it is effective. Does this produce greater satisfaction on the part of the inhabitants?

### 2.3. Satisfaction

The first observation we can make when we examine the graph below is that, generally speaking, most people are satisfied with the sound environment in which they live. Of course, this majority varies considerably when we go from outside noise, for which the figure is smaller (50%), to noise in the close vicinity, in which case two thirds of the population are satisfied, or to noise inside the home where the majority accounts for three quarters of the population.

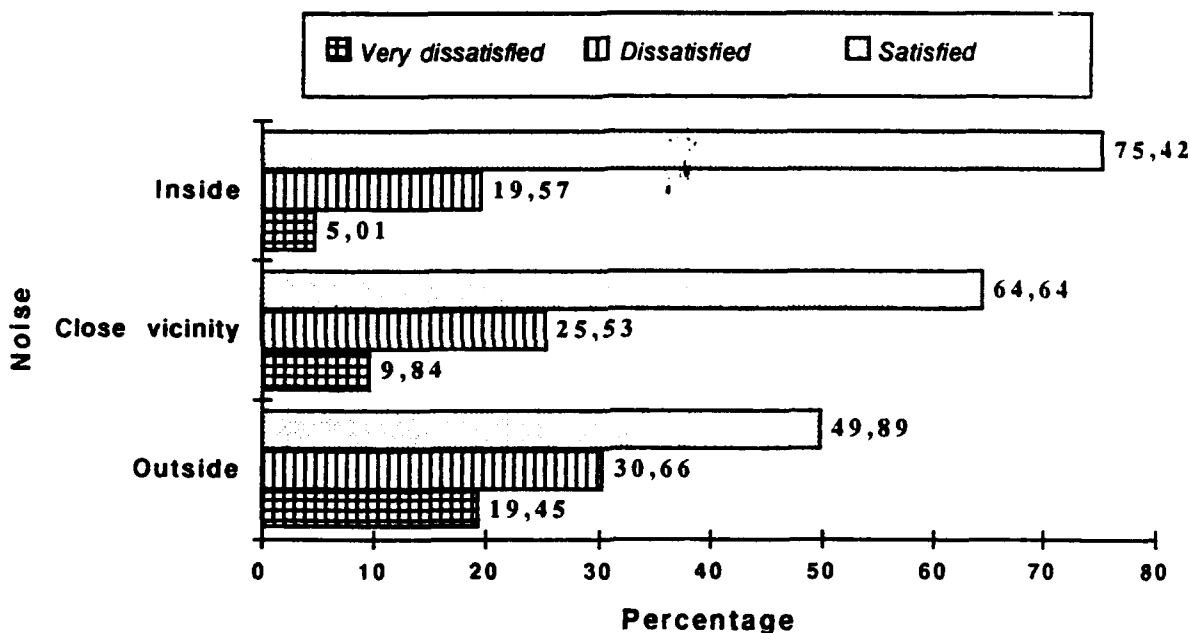

It can be noted, however, that, in any event, this leaves a large minority of people who are dissatisfied, and even very dissatisfied, accounting for half the population in the case of outside noise, more than one third for noise in close vicinity and more than one quarter for noise inside the home.

It can also be seen that dissatisfaction increases not only with the number of noises heard often or very often in the case of outside noise but also, though to a lesser degree, when it comes to noise in close vicinity to the home. However, we are forced to note once again that satisfaction is not functionally related to the acoustic quality of the home, even if noise made by installations is mentioned more frequently in housing in which the quality of insulation from this type of noise leaves something to be desired.

### III - The expectations of the inhabitants

It would be incorrect to say that the inhabitants do not expect anything of the regulations, since nearly one half (47%) think that "stricter regulations concerning the acoustic quality of materials, installations and vehicles" are necessary (regulate) and 45% consider that the respect of these regulations should be checked more often (control). However, this is not at the top of their list of expectations.

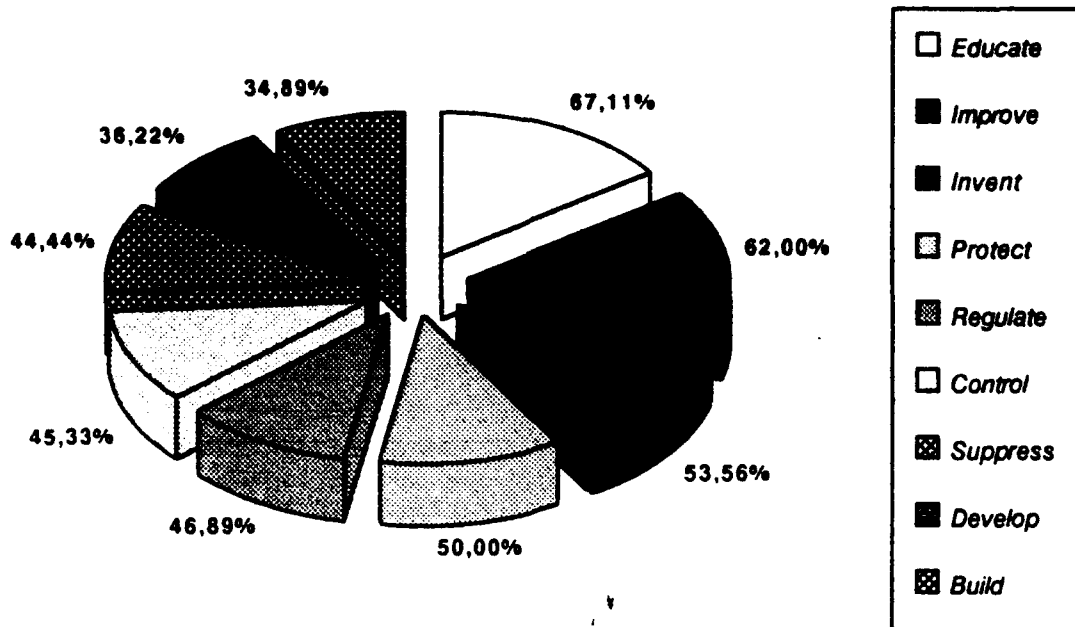

In particular, progress is expected not only from improving existing products (improve), but also from inventing new products (invent) in order to achieve more effective protection. Technology, rather than regulations, is called on to improve their living conditions by a large majority of the population surveyed. But most of the people questioned do not always opt for this type of solution. It is mostly from a change in the behaviour of their fellow creatures that they expect a real change in their living conditions. This is why, for two thirds of the population surveyed, the most necessary action and also perhaps the most effective lies in another type of intervention, which consists in "educating people so that they will have more respect for others" (educate). It is therefore from an upstream change in society that improvement is expected. And this type of change must be made by an authority outside the social group concerned since only a minority is interested in doing something about it and "collectively developing rules for living together" (develop). What is more, this solution only comes after suppression (suppress). If town planning solutions come at the bottom of the list (build), it is no doubt not because they seem ineffective, but rather because, for many people, the situation in which they find themselves suggests corrective (protect) rather than preventive action.

We are faced with a difficult and no doubt long-term task which involves the implementation of techniques which neither the sound engineers nor the legislators have yet mastered. Nevertheless their action would appear essential and an undeniable complement to any change in social behaviour.

**BARTELS, Karl-Hermann**  
Ärzte für vorbeugende Umweltmedizin e.V.  
Bahnhofstr. 48 a  
W-8056 Neufahrn  
Germany

## ABSTRACT

Since 1988 250 physicians of the two rural districts around the new airport Munich II (85 per cent of all practising medical doctors in this area) have initiated an exceptional new task and contributed in a purely preventive medical sense to the necessary amendment of the night flight noise law.

## HISTORY

It took 30 years to plan and build the Munich II airport which was finally opened in May 1992. - In spite of 25000 civilian objections, in spite of a 4 year lasting construction stop and furthermore in spite of a hearing before the highest court of justice in Berlin (1991) the airport was finally approved with the following restrictions:

1. Instead of 4 runways only 2 were granted.
2. Instead of 2050 hectares only 1387 hectares for ground purposes were approved.

During those 30 years the economic and technical framework only changed in that:

1. The number of the German civil aviation movements increased tremendously (from 200000 movements in the sixties up to 1,4 millions in the late eighties).
2. Technical improvements considerably reduced the fuel consumption and likewise the noise emission of the aircrafts. But since the number of aircraft movements had increased so much, the burden for the residents in the area of the airports remained almost the same.
3. According to official statements there are about 7 millions inhabitants in Germany living in the neighbourhood of the 12 big airports, which means that almost 7 million people are suffering more and more from the increased night flight noise.

Night flight restrictions are insufficient despite the demand of the German air-traffic-law, clause 29. - respect of night-time-rest.

With regard to future uniform European night flight regulations and additionally with regard to the present intention of the airport managers to spread the excessively increased civil air traffic movements into night time, it was and it is still more urgent to substantiate the necessity of the night flight restrictions using medical argumentation.

Medical aspects about night flight noise - yesterday und today

1. 1979:

At the final planning stage of the airport Munich II, the scientific criteria for health risks due to night flight noise were insufficient and only calculated as follows (1\*):

- a) First criterion was the so-called memorable-awakening-reaction.
- b) Second criterion was the 55 dB(A)-maximum-noise-level during the night inside the sleeping room.

2. 1989/91:

Both criteria were regarded as standard for the ruling even by the highest court of justice in Berlin.

3. 1988:

A publication of a German scientific dissertation in Berlin showed that as a result of road traffic noise human sleep had already deteriorated far below the so-called memorable-awakening reaction (2\*).

4. 1991:

Vallet calculated 48 dB(A) as maximum noise level inside the sleeping rooms of residents around airports; Vallet used for his calculations (3\*) the formula of Griefahn (4\*), medical expert at the Munich airport ruling.

5. 1988 - 1992:

The first German dissertation about night flight noise regarding especially the nightly excretion of catecholamines originated in Berlin:

It was determined that as from an equivalent permanent noise level of 36 dB(A) this excretion is markedly elevated (5\*).

6. 1993:

A multi-center-field-study at the international airport of Berlin-Tegel started with the research topic:

The influence of night flight noise on the catecholamine reaction of the airport residents  
24 hour measurements of the blood pressure is one important feature of these investigations.

#### Preventive medical activities

Since 1988 250 physicians of the two rural districts around the new airport Munich II have successfully participated in their spare time at the following activities:

1.

As medical consultants they were invited to different German courts of justice during the airport ruling.

2.

As medical doctors they built up constructive relations with various officials, e.g. politicians and especially the German legislator (ministry of environment), airport managers, flight-control managers, airplane constructors, pilots and mainly different researchers and their institutions; they took over the new role of skilled professional interpreters, stimulators and mediators.

3.

Especially because of the very good connections to different research institutions two scientific investigations were started and completed (5\*) (6\*).

4.

Using new medical argumentation these 250 physicians together with the German Medical Association for Balneology, publically claimed to protect the health of the residents with regard

5. The German legislator has already invited this group of medical doctors with their skilled professional knowledge to participate at the legislative procedure in the German Bundestag (parliament) with a view to forming a new flight noise law.

6. The interdisciplinary scientific experts circle, who regularly advises the German government about noise problems, has decided to come together in spring 1993 to discuss especially the new results of the night flight noise research.

### Conclusions

According to the Hippocratic oath all physicians are obliged to concern themselves with preventive medicine.

Over the last 5 years 250 physicians around the new German airport Munich II have pooled their ideas and medical expertise successfully contributing towards a scientific basis for the urgent new flight noise law. They have been the stimulators, interpreters and mediators.

This action might well encourage other physicians to participate in the solution of environmental medical problems.

### References:

- (1\*) Müller-Limmroth:  
Medizinisches Gutachten über die Auswirkungen des Fluglärms auf die Bevölkerung in der Umgebung d. geplanten Flughafens München am Standort Erding/Freising  
Institut für Arbeitsphysiologie, April 1979
- (2\*) Wagner, W.:  
Der Einfluß von Straßenverkehrsgeräuschen unterschiedlicher Pegel- und Zeitstrukturen auf den Nachtschlaf  
Dissertation, Berlin 1988
- (3\*) Vallet, M.; Vernet, I.:  
Nachtfluglärmindex und Ergebnisse der Schlafforschung  
Schr. Reihe Verein WaBoLu88, Gustav-Fischer-Verlag, Stuttgart 1992
- (4\*) Griefahn, B.:  
Präventivmedizinische Vorschläge für den nächtlichen Schallschutz  
Zeitschrift für Lärmbekämpfung, 37, 1990, 7 - 14
- (5\*) Maschke, Ch.:  
Der Einfluß von Nachtfluglärm auf den Schlafverlauf und die Katecholaminausscheidung  
Dissertation, Berlin 1992
- (6\*) Gruber, J., et. al.:  
Der Einfluß von Nachtflugbetrieb auf die Katecholaminreaktion von Flughafenwohnern  
Feldstudie Flughafen Berlin-Tegel, 1993



An intermittent environmental sound can be viewed as a two-component sound. From a perceptual point of view one component may distort the other one. A distortion ratio, defined as the duration sum of the distorted part of an intermittent sound to its total duration, is proposed as an index of perceived annoyance of intermittent sound. It follows that the more annoying the intermittent sound, the larger the value of the distortion ratio. The annoyance index for intermittent sounds helps identify the distorting and nondistorting components of intermittent sounds. The distortion ratio works as an annoyance index in all cases where the ambient component of intermittent sound is silence or background noise and the distorting part is any environmental sound such as aircraft overflights, passing heavy vehicles, distorted speech, or car noise. Empirical data suggest that not only acoustic but also informational content of intermittent sounds is important for annoyance perception.

### Intermittent Environmental Sound Composed of Two-Components

In the environment, any sounding or silencing event can be viewed as a distortion (part A of intermittent sound) of the ambient sound (part B of the intermittent sound). The distortion ratio was already applied as an annoyance index for distorting events such as aircraft overflights [5], passing heavy vehicles [3] and distorted speech [1]. Silence or background noise was viewed as ambient sounds, and a time window of 24 hours was used for aircraft overflights and heavy vehicles and of 4 s for distorted speech. It was shown that the larger the number of aircraft overflights or passing heavy vehicles, the larger the value of the distortion ratio and the more annoying the intermittent sound. Also speech distorted in one of two ways (either with silent gaps or with superimposed impulses of uniformly exciting noise [4]) was perceived as more annoying for larger values of the distortion ratio [2]. The aim of this paper is to verify if the distortion-ratio concept as an annoyance index may be applied to any intermittent sound including, for example, distorted pink noise (often used as a model noise in psychoacoustical experiments) and a typical environmental sound such as car noise.

### An Annoyance Index

The annoyance index,  $R$ , was developed and introduced by the present authors [1]. Let us assume that the duration of the time window of ambient sound is  $T_b$  and, due to distorting sounds, that  $\Delta T_b$  is the (remaining) duration sum of undisturbed ambient sound. The duration of  $\Delta T_b$  can be defined as

$$\Delta T_b = T_b - \Delta T_d \quad (1)$$

where  $\Delta T_d$  is the duration sum of the distorting sounds. The ratio,  $R$ , is proposed here as an index of annoyance applicable to various kinds of intermittent sounds. For each empirical case, the distortion ratio,  $R$ , is defined as

$$R = \Delta T_d / T_b \quad (2)$$

or alternatively,

$$R = 1 - \Delta T_b / T_b \quad (3)$$

For each intermittent sound two values of the distortion ratio can be calculated. Fig. 1 shows an example of the calculation of  $R_{AB}$  and  $R_{BA}$  for any intermittent sound. Let us assume that  $T_b$  is 3 s and that there are two parts, A and B, of intermittent sound. For example, let A be 250 ms and B be 50 ms. For A as a distorting component the ratio  $R_{AB}$  is 0.833, and for B as a distorting component the ratio of  $R_{BA}$  is 0.166.

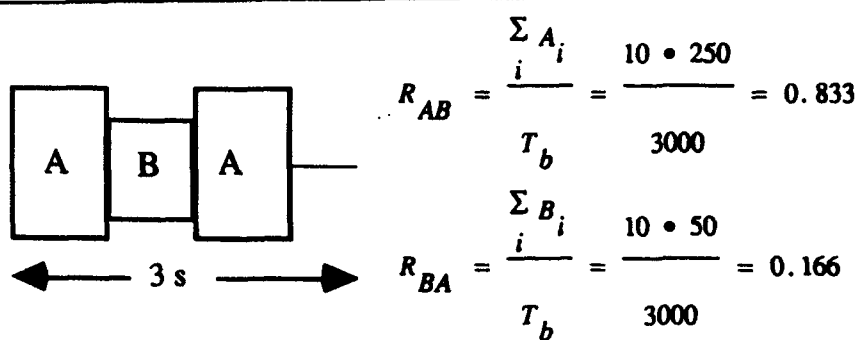

Fig. 1. Examples of the calculation of the annoyance index,  $R$ , for any intermittent sound: either A or B is perceived as the distorting component.

For intermittent sounds, the value of the distortion ratio is within the interval 0 to 1. When  $R$  is 0 no distortion exists, and the sound can be regarded as a continuous sound consisting only of ambient sound; the duration of it being equal to the time window,  $T_b$ . When  $R$  is 1 then only distortion exists, consisting of a continuous (distorting) sound filling the total time window.

### Annoyance of Intermittent Environmental Sounds

Two values of the distortion ratio were calculated for each of the three types of intermittent sounds (each experiment comprised two of them): (a) pink noise distorted by silent gaps (PN/G), (b) pink noise distorted by car noise (PN/C), (c) car noise distorted by silent gaps (C/G), and (d) car noise distorted by pink noise (C/PN) which is identical to case (b). The data for pink noise distorted by gaps or by car noises were collected in one experiment and data for car noise distorted by gaps and by pink noises in another independent experiment. The time parameters selected were the same for all intermittent sounds: The time window for each sound was 4 s. The ambient components in the intermittent sounds [pink noise in (a) and (b); car noise in (c) and (d)] and the distorting component [silent gaps in (a) and (c); car noise in (b) and pink noise in (d)] were each segmented into five different durations (see Table 1). Corresponding in duration, these five ambient component durations were then paired with the five distorting component durations, resulting in a total of 25 test signals for each of the three kinds of intermittent sound (PN/G, PN/C, C/G). It means that in total 200 annoyance ratios [see points (a)-(d) above] were calculated for the 75 unique intermittent sounds. The distortion ratios are given in Table 1 (cf. Eq. 2).

Scale values of perceived annoyance for intermittent sounds were obtained by calculating each subject's geometric mean of 12 magnitude estimates and then creating a group scale by taking the arithmetic means for the 19 or 20 participants in the experiments. In Fig. 2, the perceived annoyance of pink noise distorted by gaps (open circles) or by car noise (filled circles) is plotted against the distortion ratio (for PN/G and PN/C in the left-hand panel) and against the inverse distortion ratio (for G/PN and C/PN in the right-hand panel). In Fig. 3, the perceived annoyance of car noise distorted by

Table 1. Annoyance indexes,  $R_{AB}$ , for two-component intermittent sounds (time window:  $T_b = 4$  s).

Duration (ms) of Ambient Component A	Duration (ms) of Distorting Component B				
	25	50	100	250	500
25	0.500	0.663 (0.338)*	0.800(0.200)	0.906(0.094)	0.950(0.050)
50	0.332(0.667)	0.500	0.663(0.338)	0.825(0.175)	0.900(0.100)
100	0.200(0.800)	0.325(0.675)	0.500	0.700(0.300)	0.825(0.175)
250	0.088(0.912)	0.163(0.837)	0.437(0.562)	0.500	0.625(0.375)
500	0.044(0.956)	0.088(0.912)	0.250(0.750)	0.313(0.687)	0.500

\* Values within parenthesis are  $R_{BA}$ -ratios.



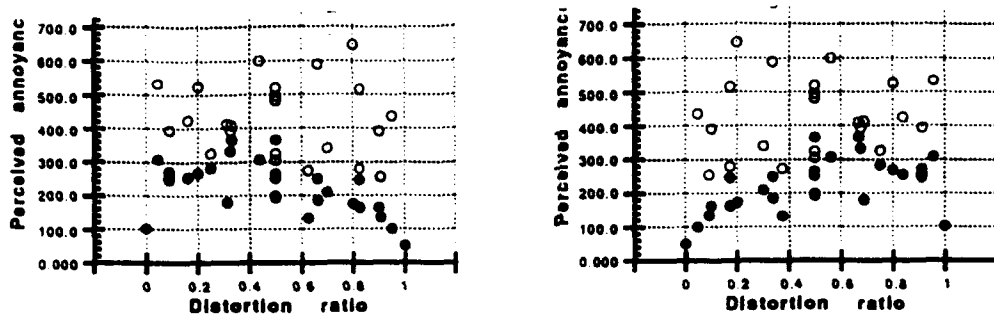

Fig. 2. Perceived annoyance of pink noise distorted by gaps (open circles) and by car noise (filled circles) plotted against the distortion ratio  $PN/G$  or  $PN/C$  (left-hand panel) and the inverse distortion ratio  $G/PN$  or  $C/PN$  with pink noise as the distorting sound (right-hand panel). [Data adopted from forthcoming article by Bech-Kristensen, Berglund & Preis.]

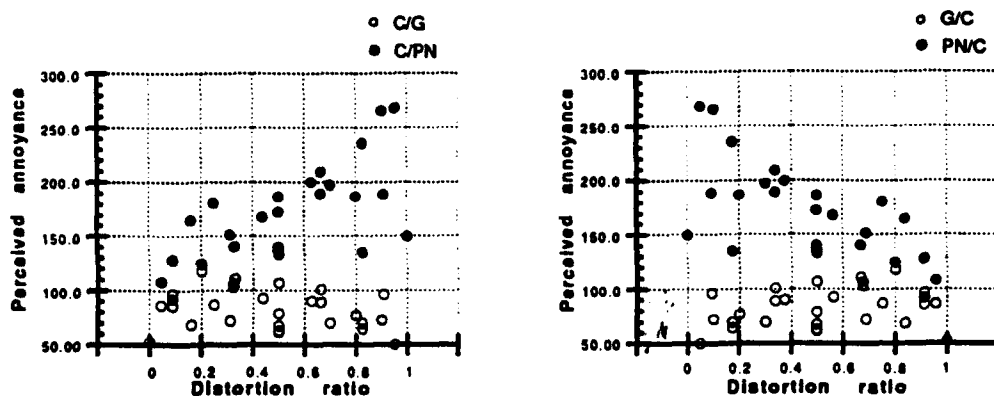

Fig. 3. Perceived annoyance of car noise distorted by gaps (open circles) and by pink noise (filled circles) plotted against the distortion ratio  $C/G$  or  $C/PN$  (left-hand panel) and the inverse distortion ratio  $G/C$  or  $PN/C$  with car noise as the distorting sound (right-hand panel). [Data adopted from forthcoming article by Berglund, Miecznik & Preis.]

gaps (open circles) or by car noise (filled circles) is plotted against the distortion ratio ( $C/G$  and  $C/PN$  in the left-hand panel) and against the inverse distortion ratio ( $G/C$  and  $PN/C$  in the right-hand panel). In all the panels the components of the intermittent sound are included as continuous sounds both for the case when the distortion ratio is 0 and 1. A comparison of the annoyance scales obtained in the two experiments (Fig. 2 vs. Fig. 3) shows that the subject groups are in great agreement (comparison of  $C/PN$  in Fig. 2 vs. Fig. 3; and  $PN/C$  in Fig. 2 vs. Fig. 3).

### Discussion and Conclusion

Pink noise with gaps was perceived as more annoying than when distorted by car noises. Conversely, car noise with gaps was perceived as much less annoying than when distorted by pink noise. On the other hand, it is seen that car noise is not dominating for annoyance compared to pink noise (right-hand panels of Figs. 2 & 3). In other words, for intermittent sound consisting of pink noise and car noise, pink noise is the distorting component. Analyzing the typical environmental sound, car noise, it is obvious that when car noise is distorted by gaps, the gaps cannot be identified as an annoying component of this sound (Fig. 3, left-hand panel); a plausible explanation may be that car noise naturally appears as distinct sound events but not pink noise. In agreement with such an explanation, the results presented in the right-hand panel of Fig. 3, show that in intermittent sounds of car noise and gaps, car noise is recognized as a distorting part of the ambient sound. The present findings indicate that not only the acoustic characteristics of sound are important for the annoyance per

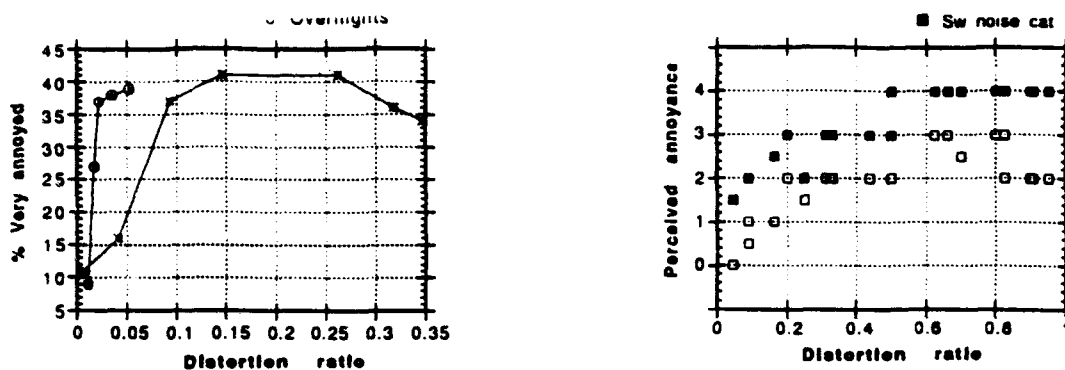

Fig. 4. "% very annoyed" as a function of the distortion ratio for overflights and for heavy vehicles (left-hand panel) and perceived annoyance as a function of the distortion ratio for speech distorted with silent gaps (open symbols) and noise impulses (filled symbols). [Adopted from [1]; left-hand panel based on data published in [3] and [5].]

ception but the listeners previous experience and expectations regarding the environmental sound. Thus, information is a vital factor in annoyance perception.

In conclusion, the distortion ratio can be used as an annoyance index in all cases where an ambient component of intermittent sound is silence (or background noise) and the distorting part is any environmental sound as, for example, aircraft overflights or passing heavy vehicles or distorted speech (see Fig. 4 reproduced from [1]) or car noise (see Fig. 2, right-hand panel).

When two components of intermittent sound are different in quality, as for example, speech and noise, the distortion ratio is still applicable. But, when two components of intermittent noise are similar, as for pink noise and car noise, the dominating sound for annoyance perception is easily identified. Therefore, the use of the distortion ratio as an annoyance index is promising for environmental sounds appearing as intermittent sounds in ambient background. However, for multiple sounds the character of the intermittent sounds should be identified before applying the distortion ratio as an annoyance index. The reason for this is that the annoyance index to some extent reflect the informational impact as well as the acoustic.

*Acknowledgements.* The present research was sponsored by the Swedish Environmental Protection Agency. Thanks go to Dr. Piotr Miecznik for preparing the experimental tapes and to Mr. Tommy Bech-Kristensen, B.A., for assisting in the data collection.

## References

- [1] Berglund, B., Harder, K., & Preis, A. Perceived annoyance of intermittent sounds. In G. Borg & G. Neely (Eds.), *Fechner Day '92*. Stockholm: International Society for Psychophysics, 1992, pp. 27-32
- [2] Berglund, B., Harder, K., & Preis, A. Annoyance perception of sound and information extraction. Stockholm University, Manuscript submitted to Journal, 1992.
- [3] Björkman, M., & Rylander, R. Community noise—the importance of noise levels and number of noise events. In A. Lawrence (Ed.), *Inter Noise 91. The Cost of Noise*. Poughkeepsie, N.Y.: Noise Control Foundation, 1991, pp. 271-274.
- [4] Preis, A., & Terhardt, E. Annoyance of distortions of speech: Experiments on the influence of interruptions and random-noise impulses. *Acustica*, 1989, 68, 263-267.
- [5] Rylander, R., Björkman, M., Åhrlin, U., Sörensen, S.A., & Berglund, K. Aircraft noise contours: Importance of overflight frequency and noise level. *Journal of Sound and Vibration*, 1980, 69, 583-595.

ON THE NOISE LEVELS OF THE HANBURY BOTANICAL GARDEN  
AND OF OTHER GARDENS

BISIO Giacomo°, SCHIAPPARELLI Piero\*\*

°Energy Engin. Dept., Univ. of Genoa, Via all'Opera Pia 15A, 16145 Genoa, ITALY  
\*\*Health Physics Dept., Galliera Hosp., Mura delle Cappuccine 14, Genoa, ITALY

ABSTRACT

This paper sets forth firstly some historical descriptive news of the Hanbury Botanical Garden, which is the most important in Liguria.

Subsequently, the results of noise level surveys on the whole area of the Hanbury Garden are dealt with and comparisons are made with the surveys of other gardens of Genoa. The A-weighted equivalent level is the basic measured parameter, and for many locations also the percentile levels, the linear level from 20 to 20000 Hz and the frequency analysis were recorded.

1. SOME HISTORICAL NEWS OF THE HANBURY GARDEN

The Hanbury Botanical Garden was founded in 1867 by Thomas Hanbury. With the aid of the brother Daniel and of skilful botanists, among whom the German Alwin Berger, T. Hanbury proposed to establish a center of acclimatization of plants coming from all the sides of the world. The Garden was a center of great scientific value. The Direction had relations with all the botanical gardens in the world and exchanged with them experiences, seeds, publications, among which Index Seminum and Hortus Mortolensis. In 1960 the Garden was bought by the Italian State, which bound itself to keep it according to the will of the founder, whose ashes are in a Mausoleum in the Garden. At the present time, the Hanbury Botanical Garden is committed to the Superintendence of the Environmental and Architectural Goods of Liguria as regards the monumental aspect, and to the University of Genoa as regards the scientific aspect.

2. NOISE LEVELS IN PUBLIC GARDENS

The danger of auditory and extraauditory damages following exposures to high noise levels can be reduced considerably by making a compensation by suitable time intervals of exposure to low or at least moderate noise levels, such as to allow the natural "recovery". In a modern town the areas of limited noise levels are more and more scarce, and thus the necessity arises to grant low noise conditions in suitable public gardens, obviously in addition to the inside of dwellings.

To this purpose in Genoa during 1983 a first specific noise survey relative to public gardens was made [1]. In this paper the noise levels of the Hanbury Garden are examined in detail and suitable comparisons are made with those of some public gardens of Genoa.

It is to be observed that trees and bushes have been often proposed as a natural way to reduce noise levels outdoors, but the actual outcome is still being debated in literature [2-9]. E.g., Embleton [2] found that vegetation reduced sound equally for all frequencies within 200 and 2000 Hz, while both Eyring [3] and Wiener and Keast [4] reported attenuation that increased monotonically with frequency. In ref. [5] Aylor comes to the conclusion that foliage reduces sound transmission substantially, especially at the higher frequencies where scattering is enhanced. However, Kragh [6] shows that a considerable depth of vegetation is needed for any worthwhile attenuation of sound in excess of that due to distance. Stevenson et al. [9] in particular evidence three effects that attenuate noise propagating through vegetation, namely the "ground

effect dip", scattering and absorption; all depend on the wavelength of sound. Some authors examined the sound level increases owing to rain and wind in the trees. In ref. [10] Miller reports various experimental data and nomograms for estimating sound levels from rainfall and the rustling of tree leaves by wind. Ng and Fricke [11] give an overview of some of the results of the laboratory and field measurements of sound produced by wind in the vegetation, and discuss the possible sound producing mechanisms.

Besides the auditory effects, psychological effects of vegetation are not to be neglected; the presence of vegetation may reduce noisiness, even if in a way depending upon the various persons.

### 3. MAIN EXPERIMENTAL RESULTS IN SEVERAL GARDENS AND VARIOUS REMARKS

#### 3.1. Leading criteria for acoustical records

In the acoustical surveys, whenever possible, the same criteria already used in the acoustic mapping of Genoa [12] and of La Spezia [13] Communes were employed. Sound levels were measured during both morning and afternoon hours of work days, excluding atypical conditions. The measurement points were chosen according to the various characteristics of the gardens.

The A-weighted equivalent level,  $L_{eq}$ , is the basic measured parameter. An integration interval of 5-15 minutes was chosen on the basis of the statistical distribution criteria, which are considered in ref. [12]. For many locations, also the following A-weighted parameters were recorded: maximum RMS level  $L_{mx}$ , the percentile levels  $L_1$ ,  $L_{10}$ ,  $L_{50}$ ,  $L_{90}$ ,  $L_{99}$  and minimum RMS level  $L_{mn}$ . In addition, for higher level locations the linear level from 20 to 20000 Hz (LIN) and the frequency analysis were recorded.

#### 3.2. Obtained results

In the Table 1, referring to the Hanbury Garden, the parameters  $L_{eq}$ ,  $L_{mx}$ ,  $L_1$ ,  $L_{10}$ ,  $L_{50}$ ,  $L_{90}$ ,  $L_{99}$ ,  $L_{mn}$  and LIN are shown. In the same Table for all the recorded locations the following values are reported: logarithmic mean ( $L_{gm}$ ), arithmetic mean ( $A_m$ ), standard deviation ( $\sigma$ ), skewness ( $s$ ) and kurtosis ( $k$ ).

One notes that in the position I there are the maximum values of  $L_{eq}$ ,  $L_{mx}$ ,  $L_1$ ,  $L_{10}$ , LIN, while in the position F there are the maximum values of  $L_{50}$ ,  $L_{90}$ ,  $L_{99}$ ,  $L_{mn}$ . In the position D there are the minimum values of  $L_{eq}$ ,  $L_{mx}$ ,  $L_1$ ,  $L_{10}$ ,  $L_{50}$ , while in the position A there are the minimum values of  $L_{90}$ ,  $L_{99}$ ,  $L_{mn}$ . In addition, one notes that there is a small difference between  $L_{mx}$  and  $L_{mn}$  in the position F, owing to the fact that the constant noise of water springs is prevailing. It is to be observed, however, that, with the exception of the positions in which a constant noise is prevailing or at least meaningful, equiva-

TABLE 1		dB(A) values recorded for some positions in the Hanbury Garden							
		Mean values for all the positions							
Positions	$L_{eq}$	$L_{mx}$	$L_1$	$L_{10}$	$L_{50}$	$L_{90}$	$L_{99}$	$L_{mn}$	LIN
A	42.2	46.7	46.5	45.0	41.5	37.5	35.5	35.1	
B	46.5	51.5	51.0	48.5	46.0	44.5	43.5	42.9	
C	43.5	56.0	51.5	45.0	42.5	40.5	39.5	39.1	53.4
D	40.7	45.9	44.5	41.5	40.5	40.0	39.5	39.4	58.8
E	49.7	66.5	61.5	51.0	43.5	39.0	37.0	35.4	
F	57.3	58.6	58.5	58.0	57.5	57.0	56.5	56.5	
G	53.5	61.1	58.5	54.0	53.5	52.5	52.0	51.7	65.1
H	47.7	59.5	59.0	49.5	44.0	42.0	41.0	40.2	58.1
I	58.6	71.1	69.0	61.5	55.0	48.0	46.0	45.5	70.2
J	54.4	68.1	66.5	55.5	48.0	44.5	42.0	41.1	
K	46.7	51.6	51.5	49.5	45.5	43.0	42.0	41.3	57.0
L	39.8	45.1	45.0	42.0	39.0	37.5	35.5	35.4	
M	49.3	52.6	52.5	51.0	49.0	48.0	47.5	47.3	66.4
N	45.1	50.8	49.5	47.0	44.5	43.0	42.0	41.9	
O	52.3	60.8	58.0	55.0	52.0	46.5	44.0	43.2	
$L_{gm}$	51.95	62.86	60.66	53.81	50.30	48.25	47.48	47.29	64.60
$A_m$	48.49	56.39	54.87	50.27	46.80	44.23	42.90	42.40	61.29
$\sigma$	5.636	7.899	7.208	5.576	5.375	5.310	5.619	5.768	5.568
$s$	0.207	0.282	0.343	0.235	0.517	0.832	0.862	0.905	0.232
$k$	2.000	1.995	2.178	2.288	2.158	3.109	3.284	3.346	1.717

lent levels which were recorded in the same position in different days differ among them to a maximum of 6 dB(A).

In Table 2, referring to the interior of the Hanbury Palace (situated inside the Garden) the values of Leq, Lmx, L1, L10, L50, L90, L99, Lmn are shown for two positions and the values of Leq and LIN for a third position: all the values are very low.

In Table 3, for some gardens of Genoa and for the Hanbury Garden, the area, the kind of vegetation and the extreme values of Leq and Lmx are shown. One notes that the values of the Hanbury Garden are lower than those of the other gardens chiefly owing to its topographical location. These values are also lower than those of a recent survey in the gardens of Palermo [14].

In addition, it is to be observed that in all the gardens where the influ-

TABLE 2	dB(A) values recorded inside the Hanbury Palace								
Position	Leq	Lmx	L1	L10	L50	L90	L99	Lmn	LIN
A	35.7	42.5	42.0	39.0	33.5	29.5	26.5	26.2	45.7
B	31.7	36.4	36.0	33.0	30.5	28.5	28.0	27.8	
C	32.9								

TABLE 3	Vegetation		Leq	Lmx
Gardens m <sup>2</sup>	Trees	Bushes	dB(A)	dB(A)
A 13800	Ilex, Plane, Magnolia, Pine	Box, Laurel, Pittosp.	55-62	67-78
B 22650	Plane, Ilex	Dwarf palm	56-59	61-67
C 17600	Ilex	Pittosporeae, Laurel	54-67	64-84
D 97000	Ilex, Pine, Oak, Palm, Magnolia, Camphor tree, Cedar, Araucaria	Pittosporeae, Laurel, Yew, Box, Camellia	50-69	63-77
E 36200	Pine, Ilex, Palm, Cypress, Camphor tree, Plate, Araucaria	Pittosporeae, Laurel, Dwarf palm	53-59	61-84
F 23400	Pine, Ilex, Palm, Cypress, Camphor tree, Plate, Araucaria	Pittosporeae, Laurel, Dwarf palm	52-69	64-88
G 28000	Ilex, Cypress	Rose, Pittosporeae	55-68	64-80
Hanbury Garden 180000	Citrus plantat., Acacia (70 sp.), Eucaliptus(23 sp.), Pine, Cypress, Euphorbia(90 sp.), Olive, Various exotic and Mediteranean species	Aloe (>100 sp.), Agave (114 sp.), European and Chinese Vines, Various exotic spec.	38.5 60.4	45.1 71.1

TABLE 4	Frequency analysis in octave bands of the Hanbury Garden									
Hz	20	40	80	160	315	630	1250	2500	5000	10000
G	59.6	54.6	49.7	42.5	56.3	53.7	50.7	50.4	50.2	42.0
H	52.2	46.6	43.2	42.3	41.3	40.8	38.2	48.2	36.2	32.2

TABLE 5	Frequency analysis in octave bands of some gardens of Genoa									
Hz	31.5	63	125	250	500	1000	2000	4000	8000	16000
A	67	69	65	57	51	51	50	48	44	35
B	67	71	66	58	55	54	48	43	36	
C	64	66	57	54	51	48	45	42	34	
D	58	61	62	57	50	48	44	40	34	
E	63	62	57	52	45	41	43	46	36	
F	63	62	57	52	45	41	43	46	36	
G	60	61	63	57	47	48	50	51	37	

ence of external irregular and high noise sources was valuable, one had that

$$L1 - L50 > L50 - L99 \quad \text{and} \quad L10 - L50 > L50 - L90$$

and, thus, a temporal statistical distribution similar to the Rayleigh distribution [15]. On the contrary, where continuous local noise sources were prevailing (see e.g. position F of Table 1), one had that

$$L1 - L50 = L50 - L99 \quad \text{and} \quad L10 - L50 = L50 - L90$$

and, thus, a temporal distribution very near to the gaussian distribution.

In Table 4 for two positions of the Hanbury Garden the frequency analysis is shown; in the position G there is the prevailing noise of water springs, while in the position H there are no prevailing noises.

In Table 5 the frequency analysis of some gardens of Genoa is shown; in this Table there is a notable prevalence of 31.5, 63, 125 Hz frequencies owing to road traffic (see ref. [12]).

#### 4. CONCLUSION

The location of the main considered garden, Hanbury, is good, even if not optimal, with reference to the roads and railway. The influence both of trees and of bushes is undoubtedly positive to attain a comfortable environment also from an acoustic point of view, probably supported by a psychological effect.

The survey of percentile levels, in addition to that of Leq, allows us to characterize the noisiness better with reference to other analyses limited to the use of Leq and Lmx. The temporal statistical distribution of noise is rarely near to a gaussian distribution, but is usually asymmetric and frequently similar to a Rayleigh distribution.

#### ACKNOWLEDGEMENTS

The authors wish to thank Prof. Paola Profumo, Prof. Paola Gastaldo of the Botanical Institute of the University of Genoa, and Mr. G.B. Bosio, Policeman Inspector of Genoa for their kind cooperation.

#### REFERENCES

1. Various authors: Programma 2 - Rilevamenti fonometrici in alcuni parchi pubblici della città di Genova. Atti Convegno Genova, 14 Gennaio. Pubblicazioni del Comune di Genova, Genova (1984).
2. Eyring C.F.: Jungle acoustics. J.Acoust.Soc.Am., 18, 257-270 (1946).
3. Wiener F.M., Keast D.N.: Experimental study of the propagation of sound over ground. J.Acoust.Soc.Am., 31, 724-733 (1959).
4. Embleton T.F.W.: Sound propagation in homogeneous deciduous and evergreen woods. J.Acoust.Soc.Am., 35, 1119-1125 (1963).
5. Aylor J.: Noise reduction by vegetation and ground. J.Acoust.Soc.Am., 51, 197-205 (1972).
6. Kragh J.: Road traffic attenuation by belts of trees. J.Sound Vib., 74, 235-241 (1981).
7. Rasmussen K.B.: Sound propagation over grass covered ground. J.Sound Vib., 78, 247-255 (1981).
8. Fricke F.: Sound attenuation in forests. J.Sound Vib., 92, 149-158 (1984).
9. Stevenson D.C. et al.: Attenuation of sound by vegetation. Proc.INTERNOISE 89, Newport Beach, CA, December 4-6, 1, 321-324 (1989).
10. Miller L.N.: Sound levels of rain and of wind in the trees. Noise Control Engineering, 11, 101-109 (1978).
11. Ng L.H., Fricke F.: Wind induced sound in vegetation. Proc.INTERNOISE 91, Sydney, 2-4 December, 1, 297-300 (1991).
12. Bartolini R., Bisio G., Magrini U.: The acoustic mapping of Genoa - The relative weight of the various noise sources and the spatial distribution of outdoor noise levels. Noise Control Eng.J., 34, 9-15 (1990).
13. Bisio G., Magrini A.: Acoustic survey of the noise levels in a middle size town - The influence of some traffic restrictions. Proc.INTERNOISE 92, Toronto, July 20-22, (1991).
14. Alterio S. et al.: Impatto acustico in aree a verde pubblico del Centro Storico di Palermo. Rilievi sperimentali e proposte di intervento. Atti del Convegno Nazionale Bologna - Modena, 20-24 Novembre, 653-656 (1990).
15. Sutherland L.C.: Indoor noise environment due to outdoor noise sources. Noise Control Eng., 11, 124-137 (1978).

# THE RELATION BETWEEN DIFFERENT NOISE DESCRIPTORS FOR ROAD TRAFFIC NOISE AND THE EXTENT OF ANNOYANCE

*BJÖRKMAN, Martin and RYLANDER, Ragnar*

*Department of Environmental Medicine, University of Gothenburg  
Medicinaregatan 16, S-413 90 Gothenburg, Sweden*

Traffic noise constitutes a complex acoustical phenomenon, and several methods have been developed to express the noise dose over a given time period. These measures are usually based on the equal energy principle such as the  $L_{Eq}$  measure.

Many studies on traffic noise annoyance demonstrate a fairly linear correlation between the equivalent noise level and the extent of annoyance. Later studies have shown that a better dose response relationship can be obtained, if the noise dose is based on the number of noise events and the maximum noise level expressed as two independent variables.

## INTRODUCTION

To further validate the validity of this dose-response relationship, a study was performed in the city of Gothenburg, Sweden during the time period 1989-91. The aim of the study was to develop methods for measuring and describing the maximum noise levels and the number of noise events under different traffic conditions, and to assess the importance of these factors for the extent of annoyance. To obtain a wide range of exposure conditions, streets representing different traffic situations were selected for a noise measurement program. In the first part, 11 areas were investigated in 1989 and during the second part, 9 additional areas with lower noise levels were studied in 1991.

## METHOD

The streets chosen had a medium to high traffic load and a proximity of residential areas in suitable size for a questionnaire study. The number of heavy vehicles ranged from 220 to 6,300 per 24 hours, and the areas were selected so that the adjacent houses had a uniform noise load from the road traffic. For the noise measurement programme, a mobile measuring caravan was positioned in each area and continuous noise measurements were performed during five weekdays Monday through Friday. Noise measurements were made at the front of a house situated approximately in the middle of each investigation area. All measurements were performed outdoors using a microphone positioned on a rod five meters above the ground. The values of  $L_{Eq}$ ,  $L_{01}$ ,  $L_{10}$ , maximum noise levels and number of noise events exceeding certain levels were registered at each site. The maximum noise level was defined as the highest instant peak A-weighted noise level from single noise events based on the average of several days of measurements. Data concerning the number of vehicles were obtained from official annual traffic statistics.

A questionnaire study was performed in all 20 areas using a random selection of persons from the municipal registers. Only persons aged 18 to 75 years who had resided for at least one year in their present apartment were selected.

A postal questionnaire with 17 questions and introductory letter were sent to each person. The

study was presented as a general investigation of environment in order to mask its true purpose. The extent of annoyance was defined as the proportion of respondents in each area who stated that they were "very annoyed" by road traffic noise.

A total of 1,350 persons were selected for the participation in the study. The sample size varied between 65 and 124 in the various areas and the total response rate was 68%.

## RESULTS

The noise measurements gave the following results for the different areas: the  $L_{Eq}$  varied between 60 and 75 dBA, the  $L_{01}$  between 73 and 82 dBA, the maximum noise levels varied between 89 and 97 dBA and the number of noise events above 85 dBA varied from 3 to 370 per 24 hours. The traffic countings showed that the number of heavy vehicles ranges from 105 to 9,240 per 24 hours and the total number of vehicles from 3,200 up to 77,000 per 24 hours.

A correlation matrix based on all noise and traffic data showed a high intercorrelation between  $L_{Eq}$ ,  $L_{01}$  and  $L_{10}$ . No significant correlation was seen between the  $L_{Eq}$  and the maximum noise level which indicates that the maximum noise level differs as an acoustical parameter from both  $L_{Eq}$  and  $L_{01}$ .

Figure 1 shows the dose-response relationship for all 20 areas, when the noise dose was expressed as the 24 hour  $L_{Eq}$  and the response as the percentage very annoyed.

The correlation coefficients between  $L_{Eq}$ ,  $L_{01}$  and % very annoyed was 0.77 and 0.69 respectively.

In earlier investigations where the number of noise events and the noise level have been studied separately, the results show that an increase in the number of noise events over a certain number (breakpoint) does not result in an increase in the extent of annoyance. The noise level from the noisiest event determines the extent of annoyance regardless of the number of events.

Figure 2 shows this principle applied to the results from the present study. In this figure the number of heavy vehicles per 24 hours is used as an indicator of the number of noise events. The figure shows that an increasing number of heavy vehicles leads to an increase in the annoyance reaction up to a breakpoint at around 1,500 heavy vehicles. A further increase in the number of vehicles above this breakpoint does not lead to an increase in the percentage of very annoyed persons.

There are several reasons why the number of heavy vehicles is closely related to the extent of annoyance. The noise levels from heavy vehicles are often clearly distinguishable from a background of lower levels from the passenger cars. The noise from heavy vehicles also has

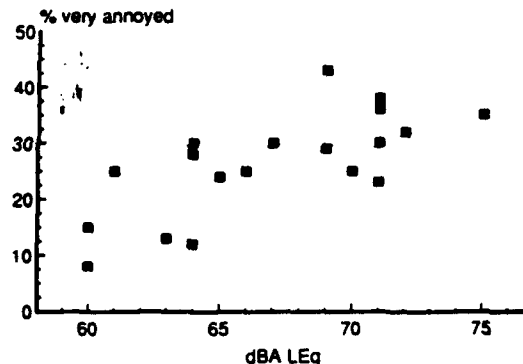

Figure 1: Relation between  $L_{Eq}$  and % very annoyed.



different acoustical character, dominating in the low frequency spectrum where the window attenuation in general is poor.

Figure 3 shows the dose-response relationship based on the same principle as described above but with the percentage very annoyed plotted against the number of noise events per 24 hours exceeding 85 dBA. As can be seen from the figure, the same type of relationship was present. The breakpoint in this case is around 60 noise events per 24 hours. The same type of dose-response relationship has also been found when analyzing data from the Scandinavian Aircraft Study. In this case the breakpoint lies around 50 overflights per 24 hours.

The figures shows that even though the noise exposure is the same the variations in the extent of annoyance is rather large. This can be explained by many different factors. One important factor is the planning of the apartment. Earlier Swedish studies have shown that persons living in apartments which only have windows facing the street traffic, are more annoyed than persons living in apartments with windows on both sides of the house.

Figure 4 shows the dose-response relationship, where each investigation area is divided in two sub parts. The filled circles show the annoyance reaction for persons living in apartments with windows only facing the noisy side of the building and the unfilled circles showing the reaction for persons living in the same area but in apartments with windows on both sides of the building. 10 of the investigation areas are not represented due to few persons (< 25 persons). As can be seen in the figure, two separate relationships can be defined and the extent of annoyance was higher among persons only having windows facing the street.

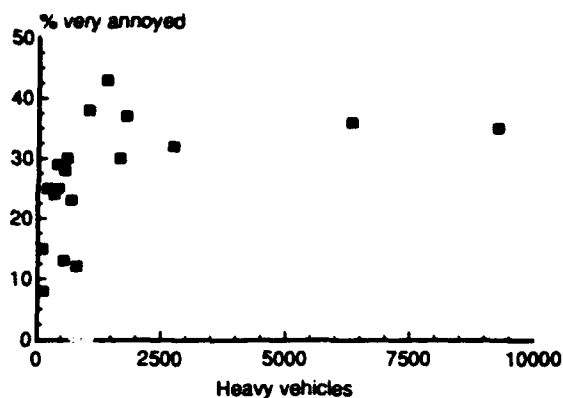

Figure 2: Relation the number of heavy vehicles per 24 hours and the extent of annoyance

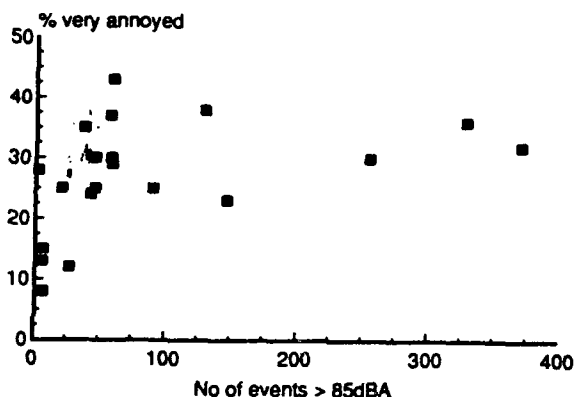

Figure 3: Relation between the number of noise events exceeding 85 dBA and the extent of annoyance

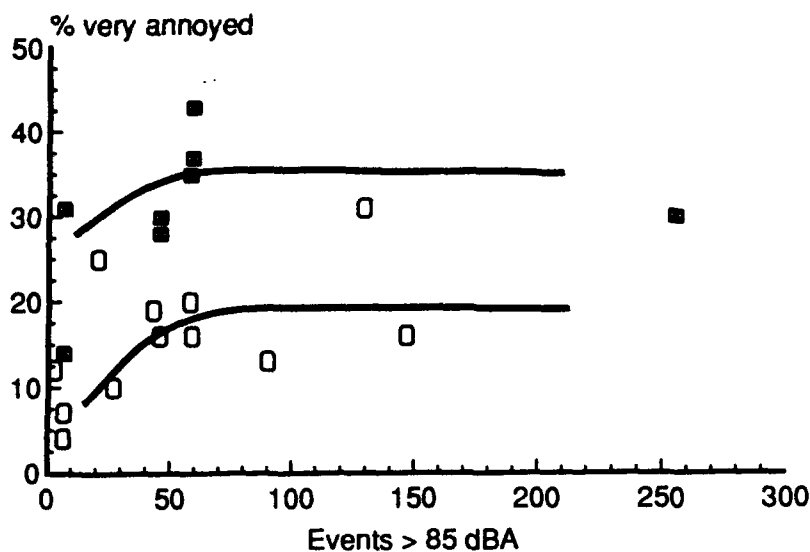

Figure 4. The relation between the number of noise events exceeding 85 dBA and the extent of annoyance. ■ persons living in apartments with windows only facing one side of the building. □ persons living in apartments with windows facing both sides of the building

#### CONCLUSIONS

The results from this study show that an increasing number of heavy vehicles leads to an increase in the extent of annoyance up to a breakpoint at 1,500 vehicles per 24 hours or 60 noise events exceeding 85 dBA per 24 hours. The planning of the apartment has an important effect on the annoyance reaction. The extent of annoyance among persons living in apartments with windows only facing the streets was higher compared to persons living in apartments having windows on both sides of the building.

The social survey study was performed by Ulla Åhrlin, Department of Environmental Medicine. The study was supported by the Swedish Transport Research Board Contract 39/89-63

#### REFERENCES

- Rylander R, Björkman M, Åhrlin U, Arntzen U and Solberg S. Dose-response relationships for traffic noise and annoyance. *Arch Env Health* 1986; 41:7-10.
- Björkman M, Åhrlin U and Rylander R. Aircraft noise annoyance and average versus peak noise levels. *Arch Env Health* 1992; 47:326-329.
- Björkman M. Maximum noise levels in road traffic noise. *Journal of Sound and Vibration* 1988; 127:583-587.
- Rylander R, Sörensen S and Berglund K. Re-analysis of aircraft noise annoyance data against the dB(A) concept. *Journal of Sound and Vibration* 1974; 36:399-406.
- Björkman M. Community noise annoyance: Importance of noise levels and the number of noise events. *Journal of Sound and Vibration* 1991; 151:497-503.

**REDUCTION OF AIRCRAFT NOISE AROUND NICE  
(FLIGHT TECHNIQUES AND AIRCRAFT DISTURBANCE)**

CHAUSSONNERY Robert

C.A.P.S.S.A. - Boite Postale N° 40 - 06601 ANTIBES CEDEX - FRANCE

---

Antibes-Juan les Pins is situated at 10 Km from the Nice Airport runways and directly under I.L.S. approach. Nice is receiving over 150 large aircraft on a typical summer day and that figure is expected to double over the next 15 years.

The disturbance level, already unacceptable, will only get worse. The community responded to that problem by first complaining to the City Council. Then, in 1987, a non-profit organization, CAPSSA\*, was created and submitted to the Directorate of Civil Aviation (D.G.A.C.) proposals centered on two main points :

- detouring most of the traffic over the sea,
- establishing a noise abatement procedure.

In waiting for the achievement of this action, CAPSSA decided to appeal to the good will of both airline companies and pilots, and widely distributed a memo encouraging pilots to reduce noise problems over Antibes-Juan les Pins.

Two observations campaigns were organized in 1991 and 1992, and the results show a positive évolution. This was appreciated by the inhabitants and it leads to think that when the arrangements undertaken will be applied, in next January, Antibes will recover a normal noise level.

---

L'agglomération d'Antibes-Juan les Pins est située dans l'axe et à 10 Km des pistes de l'aéroport de Nice qui reçoit quotidiennement, en été, environ 150 avions de ligne, trafic devant être doublé dans 15 ans.

Les nuisances subies sont inacceptables et ne peuvent que croître. La population a d'abord réagi en s'adressant aux autorités municipales. Puis, en 1987, une association "loi de 1901", le CAPSSA\*, fut créée en vue de résoudre ce problème. Ses propositions, adressées à la Direction de l'Aviation Civile, ont porté sur deux points principaux :

- détournement sur la mer d'une partie importante du trafic,
- établissement d'une procédure anti-bruit.

Dans l'attente de l'aboutissement de ces actions, le CAPSSA s'est attaché à sensibiliser les Compagnies aériennes et leurs pilotes en demandant à ceux-ci de réduire les nuisances sonores sur Antibes. Les enregistrements réalisés en 1991 et 1992 ont montré une évolution favorable de la situation, ce qui a été apprécié par la population et qui laisse penser que, lorsque les moyens prévus seront en place, en Janvier prochain, Antibes devrait retrouver un niveau de perturbation sonore acceptable.

---

(\*) : Comité d'Action Pour la Suppression des Survolés Aberrants - BP n° 40 . 06600 Antibes Cedex . France

## REDUCTION OF AIRCRAFT NOISE AROUND NICE

### (FLIGHT TECHNIQUES AND AIRCRAFT DISTURBANCE)

The town of Antibes-Juan les Pins, with a population of 75,000, is situated at 10 kilometers from the landing point of Nice Airport, and is directly under I.L.S. approach. Nice Airport is the third largest in France, receiving over 150 large aircraft on a typical summer day. That figure is expected to double over the next 15 years.

Aircraft approaching Nice fly over Antibes in descent on heights between 2,000 and 1,600 feet, most of them with landing gear and flaps lowered and, generally, at an excessive speed, often generating a noise level above 85 dBA. The urban area directly under the flight path has the greatest population density including, amongst others, a high school of 1,800 students, 10 primary schools and an hospital.

This level of disturbance over Antibes (noise, pollution and danger) is already unacceptable and is expected to get worse. The community's response to this problem first consisted of complaining towards the City Council who was supposed to intervene and obtain a solution from official authorities who were rather reluctant.

But, time going by without any result, and in order to help resolve this serious problem, the non-profit association CAPSSA was created in 1987. Since then, 7,000 people - figure close to 10% of the total population - have joined the Association for which more than 80% of them live at less than 1 Km from the theoretical axis of approach. The proposals that they have submitted to the French Directorate for Civil Aviation (D.G.A.C.) are centered on the following two points :

- redirecting most of the traffic over the sea so as to avoid the city of Antibes.
- application of a noise abatement procedure following the International Civil Aviation (I.C.A.O.) recommendations of June 1986.

The principle of the first proposal has, finally, been accepted on a technical aspect by French Civil Aviation Administration, providing that the total programme cost, of 8 Millions Francs, would be supported by the Community. A new VOR-DME\*\* guidance system will be installed and should be operational in January 1994. That procedure will affect 75% of aircraft landing at Nice Airport.

However, the second proposal, which will affect the remaining 25%, is still pending. This proposal was based upon the I.C.A.O. recommendations that were the results from the conclusions presented in June 1986 by a specific working group, in charge of "aircraft noise". They concluded that the level of aircraft noise is directly related to the engine power setting but, also, to the speed and to the plane configuration, and they proposed that a speed regulation be established in relation with the distance to the touch down point and that flaps and landing gear be lowered as late as possible. Many countries have implemented approach procedures complying with these requirements. Nothing similar has been done in France yet.

In order to convince the authorities that the I.C.A.O. noise abatement recommendations were efficient and should be applied in France like they are in most European countries, CAPSSA decided to conduct, every summer, an observations campaign during which : call signs, times, noise levels, average speeds and aircraft configurations were recorded. Furthermore, an observations group was in charge of evaluating the "psychological effect" of each flight. During 1991 and 1992 campaigns more than 3,600 arrivals had been recorded.

Besides the chronological recordings, some computerized analysis showed that :

- the same type of aircraft can generate a disturbance reading difference as large as 16 dBA,
- some aircraft known to be very noisy, such as DC 9, B 727-200 and B 737-200, can sometimes be far quieter than modern A 320,
- the clean configurations gave the lowest noise levels,
- the lowering of gear over the city, along with power setting adjustments, produced the worst results.

(\*\*) Visual Omni-Range - Distance Measuring Equipment.

At speeds above 400 Km/h (216 Kts), the landing gear and doors in transit usually generate a surge of 2 dBA over the commonly 85 dBA level imposed very often to the inhabitants. This additional disturbance leads to a visual stress due to the dramatic psychological effect of seeing the gear and flaps evolve under the fuselage.

These informations have been gathered through booklets which were mailed to the authorities concerned with aircraft noise reductions. Specific extracts, listing only their own planes, have been addressed to airline companies along with some precise comments. See page 4 for some exemples.

It is astounding to see the difference in disturbances caused by identical aircraft simply because of the different techniques of approach used. Landing procedures of all aircraft must comply to those making the least noise. This can only be obtained however, through the application of an official noise abatement procedure published by the French Civil Aviation Administration.

Meanwhile, as a result, the CAPSSA decided to appeal to the good will of the airline companies and their pilots. They widely distributed a memo asking them to follow a minimal noise approach with controlled deceleration over the descent trajectory and the lowering of gear at 1,500 feet after passing over the city.

Observations campaigns conducted in 1991 and 1992 made it possible to evaluate the level of acceptance of this appeal. The results were very encouraging, and confirmed that the I.C.A.O. recommendations of 1986 are perfectly applicable at Nice Airport. Comparing the 1991 and 1992 campaigns, it appeared that the noisiest approaches dropped from 38 to 31%.

A continuous descent with controlled deceleration and lowering of landing gear at 1,500 feet (9 kilometers from the runway) is a simple procedure for an airline pilot. This procedure also affords the best results for environmental protection.

These interesting results are, of course, appreciated by the residents who are regularly informed by the CAPSSA members that hold a weekly permanence downtown. Antibes inhabitants are eager to see the whole problem solved.

In January 1994, the new VOR-DME procedure should be applied, and then carefully monitored by CAPSSA observers. Meanwhile, action will be emphasized to obtain the official publication of the required noise abatement procedure.

Furthermore, departures are also under close watch. Although 3 possibilities are today offered, 90% of departing aircraft head for Antibes beacon and cross the shoreline between 6 and 9,000 feet. Request is made that this rate be decreased to 50%, and that old noisy aircraft (i. e. DC 9, B 727, B 737-200, BAC 111, according to I.C.A.O. classification) will have to reach 9,000 feet before flying over Antibes.

Finally, the Community of Antibes is attentive to a recent law, proposed by the Ministry of the Environment, dealing with aircraft noise, that is far from being satisfactory compared to other European regulations.

It is satisfying to note that the community has obtained some interesting results by working in conjunction with all key people involved : official authorities, airline companies, pilots and inhabitants. But, it is also stimulating to see that results can only be achieved through a permanent, firm, and positive action of the concerned community.

---

Statistical data available :

- speeds at 10 Km from the airport (570 meters above the city)
- lowering of the landing gear observed between 250 and 470 Km/h (135 and 254 Kts)
- psycho-sociological effects in 1991 and 1992.

### CHRONOLOGICAL ANALYSIS

19'92		AIRCRAFT				NOISE		APPROACH				
Date	Hour	Airline	FLT n°	From	Type	Ident.	DN dB	Effect	V GNM	LG/NC	Victor	Jugt
02.09	10.03	ITF	155	ORY	A91	SM	11	BB	183	-6		
02.09	10.12	CCM	304	CLY	A77	TS					DE	4*
02.09	10.20	DLH	4390	FRA	737						DE	4*
02.09	10.40	AFR	3113	BVA	737						DE	4*
02.09	10.44	ITF	839	LVS	320	AX	5	B	198	-1		3*
02.09	10.50	ITF	517	BLQ	320						DE	3*
02.09	10.53	ITF	253	ORY	320	ZB	16	BBB	204	-10		
02.09	10.16	TAT	486	MN	320	FE	17	BB	180	-4		
02.09	10.17	BMA	193	LHR	DC9		6	B	174	-6		2*
02.09	10.21	CCM	110	AJA	A77	WJ					DE	4*
02.09	10.28	AFR	326H	CDG	310		14	BB	181	-6		
02.09	10.30	FRL	50	ORY	M83						DE	5*
02.09	10.33	SWR	750	BVA	M81						DE	4*
02.09	20.08	ITF	335	ORY	A83	BY	7	B	170	-4		3*
02.09	20.38	CCM	210	BIA	A77	2C					DE	4*
03.09	10.28	ATIS	F 08001	RW05	120*		04m1	Cover			21/11	1021
03.09	10.35	CCM	302	CLY	A77	TS					DE	4*
03.09	10.45	DLH	360	MUC	733						DE	4*
03.09	11.02	ITF	180	CFE	ATR	VR	6	B	157	-66		
03.09	11.09	ITF	345	ORY	A83		8	B	176	APV		3*
03.09	11.19	BMA	193	LHR	DC9		12	BB	223	-12		
03.09	11.23	ITF	319	BOD	320	BJ	10	B	180	APV		
03.09	11.31	TAT	484	ETZ	720	M8	9	B	200	-55		
03.09	11.34	CCM	204	BIA	A77	2K	7	B	183	APV	DR	2*
03.09	11.36	AFR	306	CDG	320	N	15	BB	200	-24		
03.09	11.39	TAR	760	TUN	727		11	BB	151	-67		
03.09	11.40	ATIS	F 08001	RW05	120*		04m1	Cover			21/13	1020
03.09	11.42	AFR	673	AMS	735		7	B	171	-52		2*
03.09	11.46	AFR	103	BVA	737		8	B	160	-50		
03.09	11.52	BAL	682	LOW	732	A	6	B	10	-10		2*
03.09	11.55	ITF	367	LA	320	TA	9	B	164	-59		
03.09	12.04	ITF	445	ORY	320	SR	9	B	188	-57		
03.09	12.15	CCM	367	VIN	737		7	B	180	-50		2*
03.09	12.16	DLH	440	DUS	733						DE	4*
03.09	12.31	AFR	145	ZRH	737		10	B		-40	DC	
03.09	12.32	AFR	265	DUS	F28						DE	4*
03.09	12.37	BAW	342	LHR	737		9	B	167	-60		
03.09	15.00	ITF	57	SIB	320	AR					DE	4*
03.09	16.10	ITF	845	ORY	A83*	GN					DE	5*
03.09	16.13	AFR	3195	FCO	737						DE	4*
03.09	16.48	ATIS	N 14001	RW05	120*		04m1	Cover			22/12	1019
03.09	17.05	CCM	208	BIA	A77	2C					DE	4*
03.09	17.10	ITF	55	ORY	A83	RT	14	BB	193	-40		
03.09	17.34	ATIS	L 15007	RW05	140*		04m1	106m	17	3500	22/13	1018
03.09	17.39	FRL	40	ORY	M83		6	B	183	APV		3*
03.09	17.43	DLH	390	FRA	310						DE	4*

### OVERFLIGHT AND ACOUSTICAL PRINT

The approach of each aircraft recorded shows an acoustical print. This "acoustical signature" defines the aircraft disturbance versus the flight technique used.

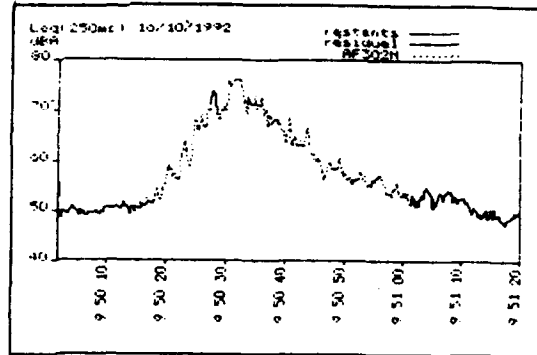

Paradoxically, an old BOEING 737 could be far less noisy than a modern 767 or MD87.

Two AIRBUS A320 could show an astounding difference of 16 dBA, within few minutes, if one conducts a non conventional approach and the other a low drag and low power approach.

V GNM : Speed, in Kts, at 8 nautical miles from touch down point.  
 LG/NC : Plane position, with respect to NC beacon, at the time of landing gear extension.  
 Victor : Approach over the sea (DE : requested & executed; DR : requested & rejected).  
 Jugt. : Appraising of approach execution (3\* : good, 4\* : very good, 5\* : extremely good).

### AIRBUS A320 - THE BEST APPROACHES

19'92		AIRCRAFT				NOISE		APPROACH				
Date	Hour	Airline	FLT n°	From	Type	Ident.	DN dB	Effect	V GNM	LG/NC	Victor	Jugt
31.07	15.18	ITF	6745	ORY	320	EZ	4	B				4*
31.07	17.15	ITF	4945	ORY	320		4	B				4*
08.08	13.50	AFR	314H	CDG	320		4	B				4*
08.08	14.23	ITF	6845	ORY	320	UP	4	B				4*
08.08	15.31	BAW	344	LHR	320		4	B				4*
01.08	15.08	ITF		ORY	320	FW	5	B				3*
08.08	15.07	AFR	316H	CDG	320		5	B				4*
03.08	11.33	ITF	6249	ORY	320	NV	5	B	192			4*
05.08	10.37	TAR	3824	TUN	320		5	B	154			3*
09.08	10.21	ITF	5219	BOD	320		5	B	165			4*
01.09	18.41	ITF	623	LVS	320	AX	5	B	167	-48		2*
08.09	19.10	ITF	253	ORY	320	ZB	5	B	167	-20		3*
07.09	11.30	AFR	306	CDG	320	N	5	B	180	APV		3*
06.08	16.49	ITF	629	LVS	320	AX	5	B	183	-50		2*
27.08	19.06	ITF	253	ORY	320	ZB	5	B	195	-1		3*
02.09	18.44	ITF	629	LVS	320	AX	5	B	198	-1		3*
01.08	15.05	ITF	316H	CDG	320		6	B				2*
01.08	17.45	DLH	4390	FRA	320		6	B				3*
03.08	11.57	ITF	319	BOD	320	BJ	6	B	142	-1		3*
02.08	17.21	ITF	5109	MTL	320	CD	6	B	168	NA		

### AIRBUS A320 - THE TRAUMATIC APPROACHES

19'92		AIRCRAFT				NOISE		APPROACH				
Date	Hour	Airline	FLT n°	From	Type	Ident.	DN dB	Effect	V GNM	LG/NC	Victor	Jugt
31.07	13.11	ITF	5009	NTE	320	LA	20	BBB				-21
31.07	11.27	AFR	306H	CDG	320		18	BB	200			-11
28.08	11.42	ITF	319	BOD	320	BJ	18	BBB				-15
15.08	11.32	ITF	3319	BOD	320	BJ	17	BBB	241			-7
02.08	14.20	ITF	5645	ORY	320	UP	16	BBB				NA
04.08	11.51	AFR	306H	CDG	320		16	BBB				NA
08.08	10.40	ITF	5619	LVS	320	BY	16	BBB	182			-8
08.08	15.02	ITF	6037	SIB	320	AR	16	BBB				-16
28.08	11.54	ITF	367	LA	320	TA	16	BBB	217			NA
31.08	12.05	ITF	367	LA	320	TA	16	BBB	245			-30
02.09	16.37	AFR	3559	LHR	320		16	BBB	200			NA
02.09	19.05	ITF	253	ORY	320	ZB	16	BBB	204			-10
03.08	12.14	ITF	5449	ORY	320	SR	15	BBB	188			-5
05.08	12.04	ITF	5445	ORY	320	SR	15	BB	251			8
31.08	12.09	ITF	445	ORY	320	SR	15	BB	245	APV		
03.09	11.36	AFR	306	CDG	320	N	15	BB	208	-24		
02.09	12.02	ITF	367	LA	320	TA	14	BB	174	NA		
03.09	19.01	ITF	253	ORY	320	ZB	14	BB	225	-30		
06.09	11.27	AFR	306	CDG	320	N	14	BB	183			-15
10.09	14.00	AFR	314	CDG	320	N	14	BB	218			-15

### SPEEDS AT 1800 FEET ABOVE ANTIBES

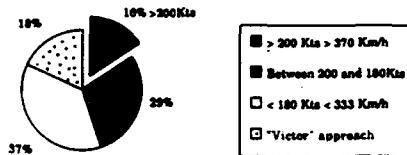

### LANDING GEAR EXTENSION



### PSYCHO - SOCIOLOGICAL EFFECTS

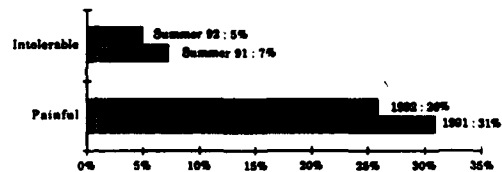

# ANALYSIS OF THE VARIOUS COMPONENTS RELATED WITH THE ACOUSTICAL ENVIRONMENT IN URBAN AREAS, USING NEURAL NETWORK SYSTEM

DROIN Laurent, ARRAS Christine

ACOUPHEN S.A.  
Ingénierie en acoustique et vibrations  
Centre d'Entreprise et d'Innovation  
BP 2132  
69603 Villeurbanne cedex (FRANCE)

## ABSTRACT

Measurements of noise levels lead to quantify the community noise potential, but are not sufficient to qualify the related community response. Such response depends on many parameters (social, cultural, urban, physical,...).

Hence, building up a methodology should allow to define, store, sort and analyse all such parameters and their interrelationships, both influencing the community noise response.

A multiple neural network learning system is used to the development of an adapted methodology and its applications. The potential of the proposed approach is emphasized through the case study of a part of Lyon city, representative of a typical urban situation. This work is aiming at developing a decision assisting tool in the acoustical design of urban areas.

## RESUME

Si la mesure des niveaux sonore permet de quantifier un potentiel de nuisances, elle ne suffit pas à déterminer la gêne associée à cette nuisance, qui dépend d'un ensemble de paramètres physiques, urbanistiques et socio-culturels.

Il est important de mettre en oeuvre une méthodologie qui permette de définir, stocker, trier et analyser l'ensemble des paramètres et leurs interrelations. La neuro-informatique a été utilisée pour développer une méthode adaptée à cette application et mise en oeuvre sur un site pilote représentatif d'un espace sonore urbain. A terme, un tel outil conduira à l'élaboration d'un système d'aide à la conception acoustique de sites urbains.

### 1 - Goal of the project

The managing and design of the urban acoustical environment, can not be limited to a physical acoustic question.

A qualitative approach must be treated in term of noise surroundings and by developping the knowledge of the structure of an urban acoustical environment. New kinds of representation and estimated model must be found.

It is important to build up a methodology allowing to define, store, sort and analyse the whole physical, urbanistic and socio-cultural parameters as well as their interrelationships, both influencing the community response. A Neural Network System can give reliable responses where classical data processing approaches prove to be ineffective.

This project does not claim to identify in an exhaustive way all urban acoustical environment characteristics, and all their interrelationships, but rather it studies the faisability of this open and evolutive approach .

## **2 - Neural network system as a aid and development.**

### **2.1 - General remarks**

The Neural Network System is a scientific subject set between biology and computers. It involves organised networks that simulate the functions of an human brain and depends on the target of the application.

There are three great phases to carry out an application : learning, supervised recognition, autonomous working and its setting up.

During the learning phase, a number of examples are judiciously chosen, with the cause and the effect (the corresponding entry of each exit). The network is managing by itself to transfert to the exit the expected reply according to the proposed entries and is making up a memory.

The recognition phase consists in testing the learning validity with several examples that are not learned yet and eliminating eventual ambiguities.

During the third phase new situations can always be added on this autonomous system.

### **2.2 - Interest of this approach**

This technic is the first attractive alternative to the computerised sequential calculation normally used in artificial intelligence.

It is directed to problems we know few things about on algorithms or reasonings to apply. It adapts itself to imprecise data and to the problems to solve.

The learning method can be summerized to "the knowledge by the example", saving time and development costs.

### **2.3 - The used software**

NESTOR is a neural software dedicated to classification. It allows up to separate different class of pictures which are highly linked, without worrying about complex relations that can exist between characteristics.

The nature of learning and the possibility of modifying the number of entry and exit parameters enables a permanent adjustment of the "a priori knowledge" of the studied case.

## **3 - The study principles and methods**

### **3.1 - Problem analysis**

The urban acoustical environment is characterized by many sources that produce sounds of various nature, intensity and periodicity propagating themselves in a physical environment in which geographical, urbanistic and architectural characteristics determine shaped, orientation and absorption factors, etc.

Some dominant and identifiable sources (principally in relation with transports and economical activities) can be listed and characterized by the fitting parameters, but most of the noise sources are not identifiable individually and depend on the "individual noisy behaviour".

They largely contribute to the "city rumbling" and participate to the acoustical identity of an urban area.

This rapid analysis allows to distinguish three kind of description parameters :

- urbanistic and architectural environment
- socio cultural environment
- identifiable noise sources characteristics (nature, intensity, periodicity).



### 3.2- Methodological approach

Everywhere in the urban space (map of an area), the value of several descriptor parameters having an effect on the acoustical environment, can be defined.

In the surveys made by "psychoacousticians" on specific situations (impact of urban highways for example), they suggest a quantitative classification of the noise pollution on a theoretical scale but a qualitative classification can be imagined at the same time, the community response can be result of a basic and wellknown factor, or be the result of an addition of infavourable situations.

The following diagram shows schematically the principle of the approach.

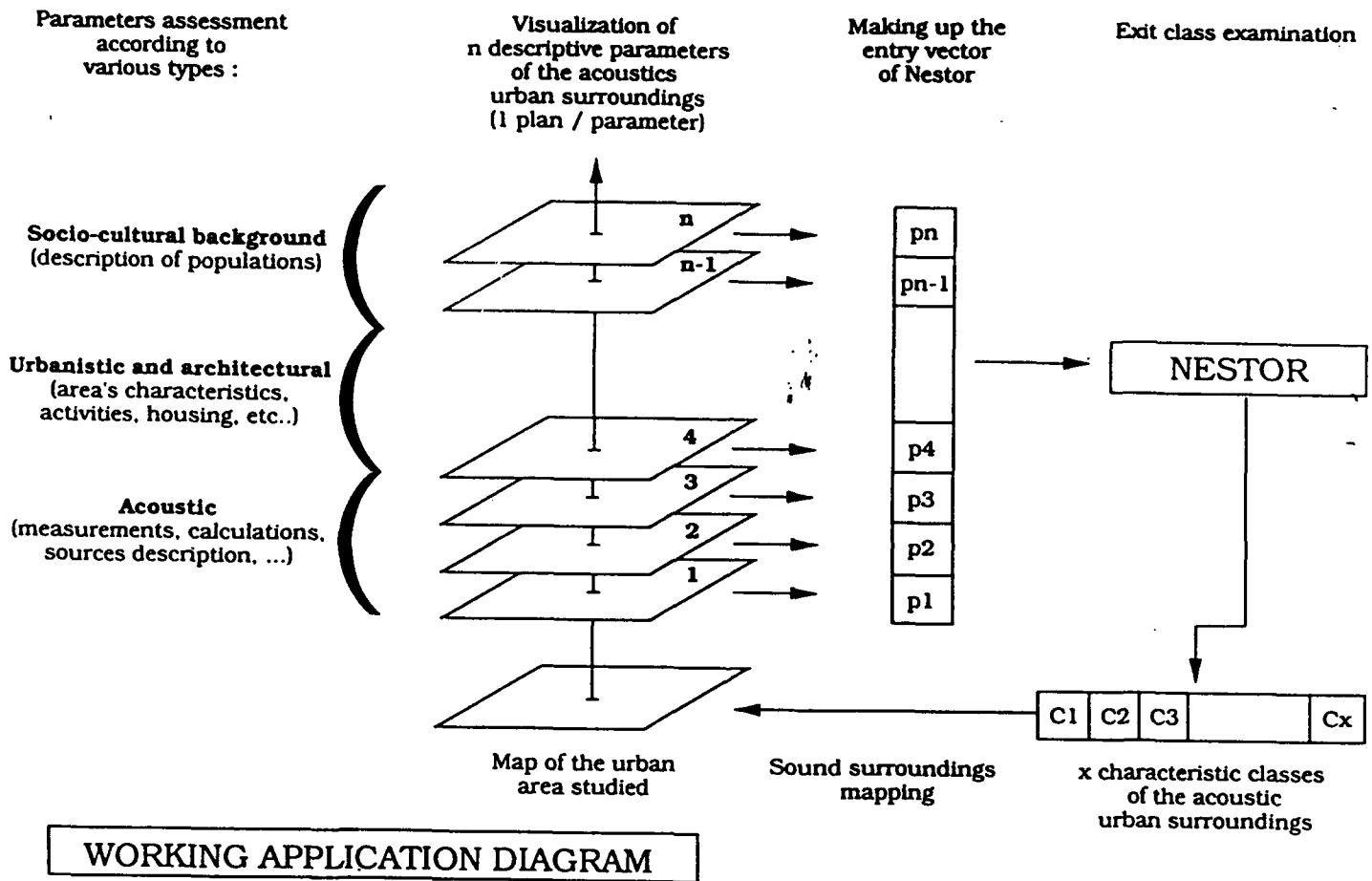

The system works by learning, thus a sufficient number of judicious examples can be given in order to allow it to make up its memory.

Successive learning stages and test are conducted on subsets of parameters in order to question some of them or introduce new parameters.

Maps are used to visualize the entry and exit parameters.

## 4- Application and development

### 4.1- Choice of an experimental environment

The seventh district of Lyon, chosen as an experimental area, offers various and representative components of a standard urban acoustical environment, as well as numerous projects of planning and restructuring.

In this environment, a work with all the data is carried out. "*Plan d'occupation des sols*", district study, data from INSEE, noise level measurements, list of the transport and economical activities, complaint files, etc.

Subsequently, other places will have to be invested in order to bring complementary elements to the learning, for the method validation.

### 4.2-Preliminary test

#### 4.2.1- Simulation from regulations

The notion of annoyance cannot be measured with a physical device. Many surveys have been carried out, to try to set up limits beyond which there is assumption of noise pollution.

Firstly, the regulation in force, that applies for the classified installations, transport infrastructures, neighbourhood noise, defines parameters related to the "*indicateur d'urgence*" and "*indicateur de bruit ambiant*".

The first testing led on acoustical characteristics showing that the system is able to recognize classes without knowing anything about the relations between parameters / classes.

#### 4.2.2- Application on the experimental area

The parameters of entry initially chosen characterise the urban area and the developing activity : "*coefficient d'occupation des sols*", homogeneity of the urban area, average height of buildings, activity of the area, presence of public facilities, etc.

The work consists in linking these parameters with those used before by referring to noise level measurements, the complaint file, calculation for traffic and rail noises, etc. and developing the map visualisation of each parameters (see the diagram).

The integration of the socio-cultural dimensions of the problem, the most delicate to consider, will have to be done by referring to results of surveys and ethnographic observations.

## 5 - Conclusion

There are several research directions and the problem is split up in small studies, integrated in the whole problem.

The suggested method adapts itself with the vagueness of data, allows a progressive approach of the problem and ensure the evolution in time and space.

From acquired and memorized knowledges, the system can carry on its learning on others environment and enrich its memory.

Eventually, such a tool will lead to the elaboration of a system aiding to acoustic conception of urban area by determining the noise surroundings.

(This project is partially financed by the French ministry of Environment).

## **DEVELOPMENT OF PROTOTYPE HUMAN RESPONSE MONITOR (HRM) FOR USE IN NOISE EFFECTS RESEARCH**

**FINEGOLD, Lawrence S.  
USAF Armstrong Laboratory  
Wright-Patterson Air Force Base, Ohio USA**

**SNEDDON, Matthew D.  
BBN Systems and Technologies, Inc.  
Canoga Park, California USA**

### Abstract

In order to collect real-time data concerning annoyance in response to aircraft overflight noise, a prototype Human Response Monitor (HRM) has been developed as part of a U.S. Air Force (USAF) research program on the effects of military aircraft noise on overflowed communities. The primary use of this device is to obtain human attitudinal and behavioral response data in response to sporadic, low-altitude, high speed training flights which occur along Military Training Routes (MTRs) and under Military Operations Areas (MOAs). Because it was designed to easily reconfigurable through software-driven setup options, the HRM is useful for a variety of other research application involving the effects of environmental noise on humans.

### Research Applications

The USAF is developing the HRM primarily to address research issues related to community exposure to noise from military training overflights in sparsely populated areas, such as rural communities along MTRs and under MOAs. The most important research topic is community annoyance, although other noise effects will also be addressed. The characteristics of the noise exposure from these operations requires an examination of the applicability of the well-known Schultz curve (1, 2, 4) for predicting community annoyance in these environments. Military flight operations in rural areas are typically infrequent, sporadic and unpredictable. The low number of daily and weekly events in most rural areas brings into question the applicability of the equal energy hypothesis, upon which the Schultz curve is based. USAF operations often involve low altitude, high speed overflights, which have much more variability in their geographic distribution on the ground than airport operations. Because the onset rates of these operations are much more rapid than approach and departure flights at civilian

airports, or of en route overflights of high altitude civilian fleet aircraft, there is also much more potential for startle effects.

For these reasons, a research program is being developed to address issues that must be resolved for the USAF to confidently predict community annoyance when changes in flight operations are contemplated for MTRs and MOAs. The HRM will allow the simultaneous recording of aircraft overflight noise data and information about people's reactions to these flights. One of the major topics of interest is the relationship between short- and long-term reactions to overflight noise. Traditional social survey techniques allow only assessment of long-term responses, whereas the HRM will allow researchers to investigate more precisely the factors that contribute to long-term annoyance. Comparisons can be made between reactions to individual overflights, as well as cumulative reactions to overflights during any given time interval (e.g., a day, a week, a month) to determine how much long-term reactions are influenced by individual exposures and by various patterns of cumulative exposure. The HRM will allow questionnaires to be administered to test subjects without the presence of an experimenter being required. Thus, for the first time, it will be possible to conduct field research in which personal, not place-oriented, noise exposure recordings and information on people's attitudinal and behavioral responses to aircraft overflights will be obtained.

In addition to addressing community annoyance issues, the HRM is also being considered for use in a nighttime sleep disturbance research program. In this research application, the HRM would be used to obtain recordings of nighttime noise exposure in people's sleeping quarters. For human response data collection, three options are currently being considered, including: (1) a button-press response to indicate actual awakenings, (2) use of an Actimeter to obtain nighttime wrist movement data as an indicator of awakening, and (3) administration of a questionnaire before retiring and upon awakening in the morning. To the extent possible, both outdoor and indoor noise recordings will be made, although the sound levels in the subjects' sleeping quarters are more important, since these are the sound levels to which people actually respond. Both military airbases and civilian airports are being considered as data collection sites. It is hoped that this research will allow development of a more defensible sleep disturbance curve (1, 3).

Another issue that will be addressed using the HRM is the relationship between the background (ambient) noise level and the sound levels of aircraft overflights. Since it is possible that the background noise level in an area may either enhance or mask the noise from aircraft intrusions, both of these phenomena will be addressed. For the former, a low background noise level may make the intrusive noise subjectively appear to be louder, for the latter, a high background noise level may make the intrusive noise much less audible and, hence, less annoying. To parallel the current U.S. National Park Service Congressionally-mandated study of the effects of aircraft overflights in the U.S. national park system, the HRM can be used in research to address the background noise level issue, as well as the other technical issues germane to this environment.

Another topic which the HRM is particularly well-suited to address is the relative annoyance from aircraft noise exposure versus that from other transportation noise sources, such as railroads and highway transportation. At the present time, no distinction is made between these noise sources in assessing their impacts on exposed populations, although some research suggests that, at equivalent sound levels, aircraft noise may be

more annoying than other types of transportation noises. Finally, because of its software-driven reconfigurability, the HRM can be used in a wide variety of environmental and occupational noise effects research. A variant of the HRM is even being produced without a microphone for use in a cardiovascular research program. The HRM is also ideal for occupational noise research, allowing the collection of accurate data on personal noise exposure and simultaneous, real-time data on the attitudinal and behavioral responses of workers.

## System Design

### HRM Capabilities

The prototype HRM is a small, light-weight powerful general purpose microcomputer that has been designed and optimized for noise effects research. It can be easily carried like conventional dosimeters and has a fully digital noise data collection component, an LCD and a 16-button keypad for administering response questionnaires, a large amount of memory, and is capable of communicating with a host computer via modem. The software for the HRM was developed to maximize the ease by which it can be reconfigured for use in different research projects. The configuration can even be modified remotely during an experiment via modem to allow the use of adaptive research designs. A more complete description of the HRM than is provided here can be found in the proceedings of a recent noise conference (5) and in technical reports (6, 7).

A variety of noise measurement capabilities are available with the HRM, including A-weighted, C-weighted or one-third octave band analyses over an audio frequency range from 50Hz to 5KHz. The researcher can specify many data collection parameters, such as integration times, can control what data are stored and how often, and can obtain a full range of derivative noise exposure information.

A new software algorithm has been developed for incorporation in the HRM to allow the identification of aircraft overflight events, to distinguish these from the myriad of other events that could be mistaken for overflights. This new capability will allow the identification of specific aircraft overflight events for matching with individual responses.

The HRM software and user-system interface allow hierarchical questionnaires to be administered to test participants, either by the subject indicating that an overflight has occurred or automatically through activation of the aircraft identification algorithm. The user-system interface was designed to be easy to learn and simple to use, while still allowing data collection using complex questionnaires and responses. The data can be uploaded easily to a host computer via modem for further analysis and the software configuration can be changed through the modem each day to allow the use of adaptive research designs.

### HRM Architecture

There are five major portions of the HRM architecture: an analog input module, a digital processing module, a 4x20 cell alphanumeric LCD with backlighting for nighttime use, a 16-button keypad, and an integral rechargeable battery pack. The analog

module contains the signal conditioning electronics, an A/D converter and the HRM's power regulators. The A/D converter is a 2-channel, 16-bit successive approximation converter that can be operated at conversion rates up to 50,000 samples per second per channel. The signal conditioning electronics provide software-controllable gain and buffering for two microphones (one internal and one external, or two external) plus input switching logic for internal device calibration. All signal processing is performed by the digital signal processor chip, which has the capability to perform a 1024 point Fast Fourier Transform (FFT) in 700  $\mu$ s. The HRM uses a fully digital design, with no weighting filter or analog integrators in the signal path. A variety of acoustic metrics can be calculated either by digital filtering or by FFT techniques.

Development of the next version of the HRM will primarily involve further miniaturization through the use of an application-specific integrated circuit (ASIC) design concept. This approach will decrease the size of the HRM from the current approximately 4x6 inch configuration to approximately 3x4 inches. The only practical limitation on the size will be the need to ensure that the LCD is readable to test subjects. The use of ASIC technology will also improve the system performance slightly over its current level.

#### References

1. Federal Interagency Committee on Noise (FICON) (1992). Federal Agency Review of Selected Airport Noise Analysis Issues. Fort Walton Beach, FL: Spectrum Sciences and Software, Inc.
2. S.A. Fidell, D.S. Barber and Schultz (1990). Updating a Dosage-Effect Relationship for the Prevalence of Annoyance Due to General Transportation Noise. *J. Acoust. Soc. Am.*, **89**(1), 221-233.
3. K.S. Pearsons, D.S. Barber and B.G. Tabachnick (1989). Analyses of the Predictability of Noise-Induced Sleep Disturbance (HSD-TR-89-029). Brooks Air Force Base, TX: USAF Human Systems Division, Noise and Sonic Boom Impact Technology (NSBIT) Advanced Development Program Office (HSD/YAH).
4. T.J. Schultz (1978). Synthesis of Social Surveys on Noise Annoyance. *J. Acoust. Soc. Am.*, **64**(2), PP.377-405.
5. M.D. Sneddon and L.S. Finegold (1993). Environmental Noise Research Using the Human Response Monitor (HRM): Phase I - System Development. In *Proceedings of NOISE-CON 93*, 2-5 May 1993, Williamsburg, VA.
6. M.D. Sneddon (1992). System/Segment Specification for the Human Response Monitor (BBN Report No. 7704). Canoga Park, CA: BBN Systems and Technologies, Inc.
7. J.E. Wagoner and S.A. Fidell (1990). Requirements and Conceptual Design for a Miniaturized, Computer-Based System for Real-Time Monitoring of Environmental Noise Exposure and Human Response (NSBIT Technical Operating Report No. 19). Wright-Patterson Air Force Base, OH: U.S. Air Force Armstrong Laboratory (AL/OEBN).

GARCIA Amando and GARCIA Ana María  
Laboratory of Acoustics, Department of Applied Physics  
Department of Medicine Preventive and Public Health  
University of Valencia, Valencia, Spain

## SUMMARY

Measurements of noise dose exposure have been carried out using noise dose meters and sound level meters for 22 different people. A total of 3288 hourly Leq values have been obtained in this noise exposure survey (along 137 complete days). The major activities carried out by all these people (at work, travel, leisure, etc.) have been simultaneously recorded. The Leq values exceeded 70 dBA for about 37% of the total time. The prevalence of the contribution of many usual "nonoccupational" noisy activities to the daily noise dose received actually by many people has been analysed.

## INTRODUCTION

The study of noise effects on people health and well being has always had a major difficulty: the accurate assessment of exposure. Indeed, this is a common problem in most of the research about environmental problems. But with noise it may be even more prominent as noise is one of the most ubiquitous contaminants in modern societies. Noise is present in the workplace, when moving in the street or in public or private transport, inside and outside the home, during sleeping and during leisure time.

Accurate exposure assessment is necessary in order to deduce dose response relationships, that support the presence of causal relationships and permit to establish different levels of risk. To have a most exact measurement it would be necessary to carry out personal dosimetries to everyone of the subjects in one study and during the 24 hours of the day. This is not feasible neither practical in most instances.

Another approach would be based in assigning a mean noise level to typical activities carried out along the day for most of the population: travelling, leisuring, staying at home, working, etc. Managing a great deal of data, it could be possible to establish typical ranges of noise exposure for typical activities and to lay down typical 24 hour noise exposure levels.

Research on this subject is very scarce. Some works have concentrated in measuring noise levels in definite situations, mainly in different jobs and work environments, but also in relation with traffic noise, noise around and inside the home, amplified music exposure, etc. But very few have tried to continuously measure daily personal exposures through some time and covering different activities (1,2,3). In this paper are presented the first results of a research with such an approach.

## MATERIAL AND METHODS

Measurements of noise exposure have been carried out using several Brüel & Kjaer noise dose meters (BK4428). The "low level mode" of this instrument has been selected in all the

measurements, as this instrument is mainly intended for measuring occupational noise, whose levels use to be much higher than levels in daily life.

Subjects included in the study are all volunteers and their main activities are distributed as follows: 4 University professors, 1 primary and 1 secondary teachers, 9 students, 4 clerks, 1 salesman, 1 solderer and 1 housewife. The information collected covers a total of 137 complete days, amounting 3288 hourly Leq values.

All subjects have carried continuously the noise dose meter for several consecutive days. Usually, the instrument was fastened in the breast pocket, lapel or belt. Maximum effort was made to keep measurement conditions as uniform as possible.

The persons wearing the noise dose meter were instructed to read and to record the data (instrument display) and their major activities, hour by hour, from waking up in the morning to going to bed in the night. The corresponding hourly equivalent sound levels (Leq) were later calculated by the authors. The activities were also coded by the authors, following uniform rules and generating five main categories of activities: sleep, home, work, leisure and travelling.

Noise levels in bedrooms are so low that their measurement with a BK4428 dose meter is not possible at all. In some few cases, these levels have been directly measured using a noise level statistical analyzer (BK4424) and an alphanumeric printer (BK2312). However, in most instances the night levels during sleep have been approximately inferred from a number of short measurements carried out in the bedrooms of the individuals with a sound level meter (BK2221).

The noise levels results obtained with the BK4428 dose meter in many different situations have been compared with those obtained with a BK2221 sound level meter situated close to the noise dose meter. This comparison has shown that the accuracy of Leq values obtained with the dose meter is about 2-3 dBA in the range of 60 dBA, and less than 1 dBA in the range of 70 dBA and higher.

## RESULTS

### 1. Variability of personal noise exposure (one subject).

In general, the recorded noise dose exposure for a given subject shows important hourly and day variations, according with the different activities carried out by this subject. The variability of individual noise dose has been studied in detail for one of the authors (AG). This author is an University professor that lives in the countryside, in an exceptionally quiet suburban area located about 20 km from Valencia.

The noise dose meter was worn by this author during 20 consecutive days. The mean value of all Leq hourly data collected (n=480) is 53.3 dBA, with a std.dev. of 20.0 dBA. The range is between 22 dBA and 87 dBA. These Leq values exceeded 70 dBA for 24% of the total time. Lowest Leq values correspond with levels measured during the night inside the dwelling (from 22 to 30 dBA). Occupational noise dose levels show a high variability, ranging between 58 to 70 dBA (working at the desk room), between 65 to 73 dBA (meeting with other people), between 72 to 81 dBA (at the University canteen) and between 73 to 82 dBA (lecturing in a classroom). The values of Leq(24 hr) range from 67 to 79 dBA, with a mean value of 71.6 dBA.

Clearly, individual variability of noise exposure along 24 hour of the day can be very high (all the information collected in this survey supports this conclusion). Considering that occupational noise



levels in this case are relatively low, the results obtained for  $Leq(24\text{ hr})$  are surprisingly high. The fact of living in a very quiet suburban area is not very significant for the global noise dose. Actually, there is an increase in noise dose related with a longer travel time to and from the city (in this case by car). It should be also noticed that an increase of 10-15 dBA in the lowest noise levels when at home (in the evening or night) would produce a negligible increase in the corresponding  $Leq(24\text{ hr})$  values, that are perhaps determined predominantly by not more than one or two very noisy specific activities carried out during the day.

## 2. Relation between $Leq$ values and activities (all sample).

Using all data collected in this survey (3288 hourly  $Leq$  values), the average daily pattern for all the participant subjects has been calculated. This dose pattern shows four main sections: very low levels during sleeping (from 0.00 to 7.00 hour), rising levels from getting up till starting activity (7.00 to 10.00), relatively high and flat levels related to the activities carried out during the day (10.00 to 21.00) and decreasing levels from arriving home to going to bed (21.00 to 0.00). This pattern applies generally to all people, though the interpersonal and intrapersonal noise dose variations are very important.

The  $Leq$  values for five main categories of activities show a normal distribution. However, the distribution for all 3288 sample is more irregular, as a consequence of the important differences between night and day periods. Mean hourly  $Leq$  values for each activity are as follows: sleeping, 37.9 dBA (sd=8.2); working, 73.3 dBA (sd=6.6); being at home, 66.5 dBA (sd=7.4); travelling, 76.1 dBA (sd=4.5); and leisure time, 75.2 dBA (sd=7.8). In about 37% of the total time of measurement the hourly  $Leq$  values exceeded 70 dBA.;<sup>#</sup>

The  $Leq(24\text{ hr})$  values range from 62 to 85 dBA, with a mean value of 73.9 dBA (sd=4.4). About 81% of these values exceed 70 dBA and 10% of them exceed 80 dBA. The hourly  $Leq(\text{max})$  values range from 68 to 97 dBA, with a mean value of 81.4 dBA (sd=5.4). About 55% of these values exceed 80 dBA. The relationship between  $Leq(24\text{ hr})$  and  $Leq(\text{max})$  is given by the equation:

$$Leq(24\text{ hr}) = 0.74 Leq(\text{max}) + 14.1 \quad (\text{dBA})$$

with a Pearson correlation coefficient  $r=0.896$  ( $p<0.001$ ).

Only about 27% of the hourly  $Leq(\text{max})$  values in our sample correspond to "work" activities. Most of these maximum hourly values are related with some other nonoccupational category: 10% with "home", 24% with "travel" and 39% with "leisure".

## DISCUSSION

Although the results presented in this paper are referred to a quite limited sample of subjects (but not so limited number of activities) to be representative of a clearly defined reference population, we must remember that about 81% of the corresponding  $Leq(24\text{ hr})$  values exceed 70 dBA and 10% of them exceed 80 dBA.

A known E.P.A. report suggest that  $Leq(24\text{ hr})$  should be kept under 70 dBA throughout 40 years to protect hearing (4). In this report, typical patterns of noise exposure for some groups of population are presented. The  $Leq$  values given for different activities are lower than those we have observed in the present survey.

In one of the broadest surveys on this subject, Kono et al. measured the daily noise exposure of 602 city residents in Japan (1), finding  $Leq(24 \text{ hr})$  mean values of 72.7 dBA for the 462 workers considered and of 69.9 dBA for the 140 housewives included in the study. About 66% of the former and 46% of the latter were exposed to noise level over the previously quoted E.P.A. recommendations.

One main question appear to be worth to be considered in relation to noise exposure in general population. As can be drawn for our results and those obtained in other similar studies, it is frequent to find that nonoccupational noise levels are quite important and can even be higher than recommended safe levels of exposure for workers. In any case, is not very adventurous to suspect that a substantially high proportion of the population (not only those occupationally at risk) is exposed, along their lives and during common daily activities, to noise levels with a potential danger over their health.

#### REFERENCES

- (1) S.Kono, T.Sone and T.Nimura. "Personal reaction to daily noise exposure exposure". Noise Contr. Engineer. 19 (1), 4-16 (1982).
- (2) Y.Mishina, Z.Darui, K.Kuno, A.Hayashi and K.Ikegaya. "Analysis and prediction of personal noise exposure in daily life". Proceedings of the 11th I.C.A. Paris. pp. 143-146 (1983).
- (3) D.L.Johnson. "Non-occupational noise exposure: Is it a problem?". Acoust. Soc. Amer. Meeting. Salt Lake City (1991).
- (4) U.S. E.P.A. "Information on levels of environmental noise requisite to protect Public Health and Welfare with an adequate margin of safety". Report No. 550/9 74-004 (1974).

# EFFECTS OF NOISE ON SOCIAL AND PHYSICAL PERCEPTIONS

**HERMAND Danièle**

Laboratoire de Psychologie Cognitive ( LABACOLIL ). Université Charles de Gaulle - Lille 3 -  
B. P. 149 - 59653 - Villeneuve d' Asq Cedex - France.

**MOCH Annie**

Université de Paris X - 200, Avenue de la République - 92001 - Nanterre - France.

**LECOINTRE Ghislaine**

Université Charles de Gaulle - Lille 3 - B.P. 149 - 59653 - Villeneuve D' Ascq - Cedex - France.

## **ABSTRACT**

This study concerns the effects of noise on social and physical perceptions in two situations : co-presence and co-operation. Forty female students were randomly assigned : 20 in experimental condition 92 dB (A) , 20 in control condition. The social and physical perceptions were assessed by three questionnaires concerning the task, the localisation of some objects present in the laboratory, and some characteristics of the partners. The results of Multivariate analysis of variance (Manova) show main effects of noise and situation. The interaction was also significant on the three scales of perception. In conclusion, noise but also the type of situation may have different effects on social or physical perceptions.

## **RESUME**

Cette recherche examine les effets du bruit sur la perception physique et sociale dans deux situations : coprésence ou coopération. Quarante étudiantes ont été affectées aléatoirement : 20 en condition expérimentale 92 dB(A), 20 en condition contrôle. Les perceptions physiques et sociales ont été évaluées par trois questionnaires relatifs à la tâche, à la localisation d'objets dans le laboratoire ou aux caractéristiques des compères. Les résultats de l'analyse multivariée de la variance (Manova) montrent des effets principaux du bruit, de la situation et de leur interaction sur les trois échelles de perception. En conclusion, le bruit mais aussi le type de situation peut avoir des effets différents sur la perception physique ou sociale.

## MAIN PURPOSE

According to Cohen & Lezak (1977), Cohen (1978), Broadbent (1971, 1979), Siegel & Steele (1980), Moch (1980, 1984, 1990), in noisy condition, the information process abilities would be exceeded, the subjects would be focused on the priority cues. So that, it can be expected that the subjects would process the task - relevant cues, to the detriment of other physical and social cues. The purpose of the present study is to test noise effects on social and physical perceptions in two situations of group: co-presence and co-operation.

## METHOD

### Subjects

At the University of Lille 3 (France), Forty female first year psychology students, were randomly assigned to the experimental conditions.

All subjects were between the ages of 18 and 22.

### Material and procedure

The subjects were supposed to solve puzzles in groups of four persons : one subject and three female partners : their presentation, the verbal and non verbal behavior have been standardized. One half of the subjects (20) were exposed during ten minutes to noise 92 dB(A), the other half (20) was in quiet condition.

The noise was a recorded combination of plant works. The task was a puzzle composed of 16 pieces which were different in size, color, shape and pattern. Two work situations, without verbal exchanges were proposed : either being simply together (co-presence) or performing the puzzle together (co-operation).

The social and physical perceptions were assessed by :

- An inquiry covering ten specific graphic cues concerning the task they were supposed to do.
- Ten questions concerning the designation and the localization of some objects present in the laboratory.
- Three scales of ten questions each concerning some characteristics of the partners.

A post-experimental questionnaire evaluated attractiveness of the partners and the subjective discomfort.

## RESULTS

Responses indicated by each subject on each scale of the experimental phase were converted into numerical values. Each numerical value (from 0 to 10) was the total score obtained at each questionnaire scale. Raw data are shown in table 1.

TABLE 1 . Mean scores for the physical and social perceptions.

Noise level	Situation	Physical & social perception		
		Task	Laboratory	Partners
CALM	Co-presence	5,4	4,9	5,86
	Co-operation	6,3	6,7	7,16
NOISE	Co-presence	7,2	2	3,33
	Co-operation	3,8	2,5	4,5

## STATISTICAL ANALYSIS

A mixed model Manova with Noise Level x Situation as the between subjects factors and cue perceptions (task, laboratory, and partners) as the repeated measure was performed on the corresponding data. Results of Manova are shown in table 2.

TABLE 2 - Manova results

Source of variation	DF	DF Error	F	Signification of F
Noise level	1	36	46.28	.000
Situation	1	36	< 1	
Perception	2	35	7.89	.001
Noise level x Situation	1	36	11	.002
Situation x Perception	2	35	14.60	.000
Noise level x Perception	2	35	14.17	.000
Noise level x Situation x Perception	2	35	10.49	.000

Three univariate analyses were also computed :

An Anova with a Subjects x Noise level x Situation, design : 10 x 2 x 2 was applied to the corresponding first column data : perception of the task (Table 1). Effects of the situation ( $F(1,36) = 9,425, p < .01$ ) and Noise level x situation interaction ( $F(1,36) = 27,87, p < .01$ )

were significant. So that, the noise influences the task perception in the two following situations : in co-presence, the subjects did better in the noisy group ( $F(1,36) = 9,76, p < .01$ ); but in co-operation, they did better in swiftness ( $F(1,36) = 18,84, p < .01$ ). According to the situation : in the noise condition, complex graphic cues recognition was higher in co-presence ( $F(1,36) = 34,85, p < .01$ ). Not in calm.

A second analysis of variance with a Subjects x Noise level x Situation design  $10 \times 2 \times 2$  was applied to the corresponding second column data (Table 1) : Physical perception of the laboratory. Effect of the noise level ( $F(1,36) = 27,45, p < .01$ ) was significant. The noisy group did not identify and localize certain objects so well . This finding was also true in the two work situations : Co-presence ( $F(1,36) = 8.90, p < .01$ ); co-operation ( $F(1,36) = 19,5, p < .01$ ).

A third analysis of variance with a Subjects x Noise level x Situation design  $10 \times 2 \times 2$  was applied to the corresponding third column data (Table 1): social perception of the partners. Effects of noise level ( $F(1,116) = 100,63, p < .01$ ), Situation ( $F(1,116) = 24,58, p < .01$ ) were significant. Therefore, noise, but also situation, cause change in social perception. The subjects in co - presence had a worse social perception than subjects in co - operation ( $F(1,58) = 5,34, p < .05$ ). When it was calm too ( $F(1,58) = 22,41, p < .01$ ). Therefore, noise influences social perception in the two following situations : Co - presence ( $F(1,58) = 45,15, p < .01$ ); Co - opération ( $F(1,58) = 55,53, p < .01$ ).

## DISCUSSION

In this research, according to the experimental conditions, the subjects show different perceptive abilities. The noisy group selects the most important information for the task. They neglect a lot of cues from the physical or social environment. The results illustrate the environmental overloaded model.

## REFERENCES BIBLIOGRAPHIQUES

- Broadbent , D. E. (1971) . *Decision and stress*, New york, Academic Press.
- Broadbent , D. E. (1979) . Human performance and noise. In C. M. Harris (Eds.). *Handbook of noise control*, New York, MacGraw Hill.
- Cohen, S. (1978) . Environmental load and the allocation of attention. In A. Baum, J. Singer, S. Valins (Eds.), *Advances in environmental psychology*, vol. 1, Hillsdale (New Jersey), Erlbaum.
- Cohen, S., Lezak, A. (1977) . Noise and inattentiveness to social cues, *Environment and Behavior*, 9, 559-572.
- Moch, A. (1980) . Les effets du bruit sur l ' homme, *Revue d' Acoustique*, 55, 251-256.
- Moch, A. (1984) . Aspects cognitifs des stress de l' environnement, *Le Travail humain*, 47, 155-165.
- Moch, A. (1990) . Evaluation et perception d' autrui dans le bruit, *Le Travail humain*, 53, 67-77.
- Siegel, J.M., Steele, C. M. (1980). Environmental distraction and interpersonal judgements, *British Journal of Social and Clinical Psychology*, 19, 23 -32.

ISHIYAMA Takeshi

Japan Automobile Research Institute, 2530 Karima, Tsukuba, Ibaraki 305, Japan

### ABSTRACT

This paper describes the effects of road traffic noise on the community. This study is based on 640 usable data samples collected via social surveys related to community responses to road traffic noise. The survey, which consists of a questionnaire and actual noise measurements around main roads, was carried out in three residential areas located mainly in Tokyo. As a result of the study, it was found that : (1) noise problem caused by road traffic was the most serious environmental problem in residential areas around main roads, (2) noise problem affected the general amenity of life in these areas, (3) residents wished that the automobile manufacturers and government would do more to somehow reduce noise pollution, (4) in cases where the noise exposures were the same, the residents' evaluations of annoyance were varied, (5) the characteristics of the survey area, the age and sensitivity to noise of residents, and the years of residency affected the level of annoyance, (6) sleep disturbance caused by noise was more serious than that of conversation or listening to television/radio, (7) the traffic noise problem affected people's attitudes towards roads.

### INTRODUCTION

In Japan, automobile noise emission levels are strictly controlled. Nevertheless, in major Japanese cities like Osaka and Tokyo, the residents living around main thoroughfares suffer from serious traffic-related noise pollution. To plan countermeasures to reduce the residents' annoyance caused by road traffic noise, the characteristics of community responses to traffic noise must be investigated. This paper describes the effects of road traffic noise on the community.

### SOCIAL SURVEY

Survey procedure. To accumulate basic data of community responses to traffic noise, a social survey was carried out near main roads in three residential areas in and around Tokyo. Area 1 is represented by typical suburban characteristics. The requirement for Area 2 consists of shops and residences in Tokyo. Lastly, Area 3 is the typical metropolitan residential area. In order to achieve a well-represented view of the community responses to road traffic noise, three different survey areas where noise pollution is serious were chosen. Each survey area was limited to 80 metres from the selected road. Our study consisted of (A) the community's responses to road traffic noise, (B) actual measurements of the noise level from the edge of the roads, (C) actual measurements of the noise level at individual residences.

Questionnaire for community responses. The questionnaire contained items relating to the extent and the aspect of annoyance caused by road traffic noise, disturbance of everyday activities, health effects, and attitudes towards roads and noise. The questionnaire sheets were distributed to all residences 80 metres from the selected roads. 640 usable survey data were collected; the percentage responded was 65%.

Noise measurement. The first measurement consisted of the noise exposure level;  $L_{eq}$  at individual residences. The data was taken from the front of the residences for ten minutes during the day. These measured noise levels are regarded as representative of the exposure noise levels of individual respondents. The second one required the measurement of the noise level;  $L_{eq}$  from the edge of the roads. The noise levels from the edge of the road, which is a representative point of the survey area, were measured for a period of 24 hours, ten minutes every hour. In addition, traffic volume and velocity were simultaneously measured from the same point. The noise exposure level in  $L_{eq}$  at individual

residences of the respondents was determined using these two kinds of measured noise levels. Table 1 indicates the characteristics of the three survey areas. The percentage of heavy vehicles in Area 3 is higher than those of Area 1 and Area 2.

Table 1. Characteristics of the three survey areas

Area	Noise Level* dB			Traffic volume*		Characteristics
	L <sub>eq</sub>	L <sub>max</sub>	L <sub>eq</sub> ; night	total/day	% of heavy vehicles	
Area 1	77.2	72.5	70.1	25890	5.2	Suburban city 60km from Tokyo
Area 2	78.3	71.9	71.9	54102	9.6	Shops and residences in Tokyo
Area 3	79.3	73.0	72.9	68568	19.9	Residential area in Tokyo

(\*...Noise level and traffic volume were measured from the edge of the road)

### SURVEY RESULTS

Environmental problem. Fig.1 shows the most serious concerns of the residents. It was found that noise problem was the most serious concern, while air pollution caused by road traffic was considered second. Fig.2 shows the effect of annoyance caused by noise on the general amenity of life in the area. Fig.2 indicates that the percentage of people who were "very annoyed" increased correspondingly with the rise of dissatisfaction.

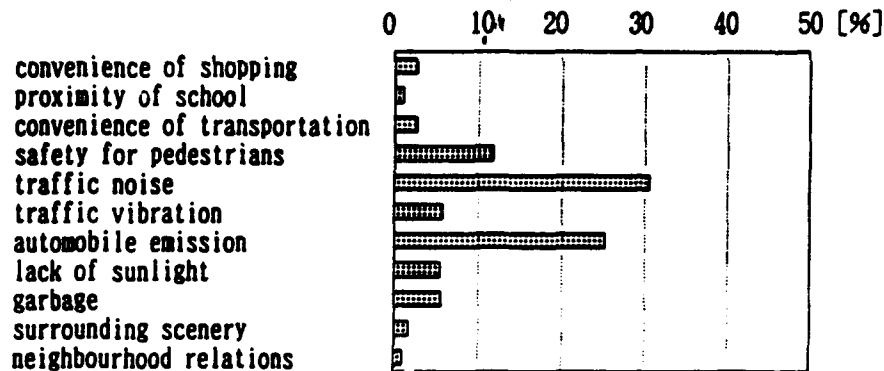

Fig.1. Most serious concerns of residents

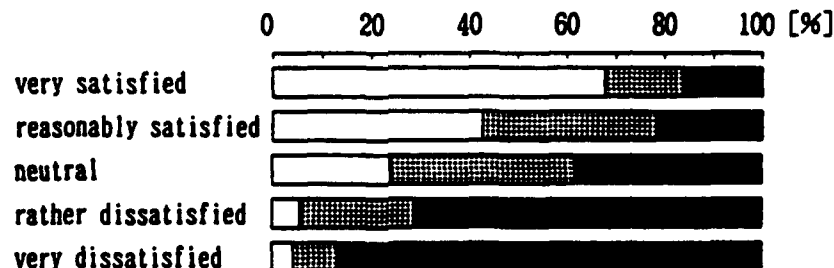

Fig.2. Effects of annoyance caused specifically by noise on the general satisfaction with the living environment (■: very annoyed, ■: rather annoyed, □: neutral/rather quiet/very quiet)

Relationship between noise exposure and distance from road. Fig.3 shows the relationship between noise exposure levels at individual residences and the distances from the road to the individual residences. For noise levels higher than 70 dB and distances less than 40 metres, it was found that there were many residents who responded "very annoyed".



Responsibility for solving noise problem. Fig.4 indicates the responses of "Who should be responsible for solving the traffic noise problem?". It was found in Fig.4 that the residents wished that the automobile manufacturers and government would do more to somehow reduce noise pollution.

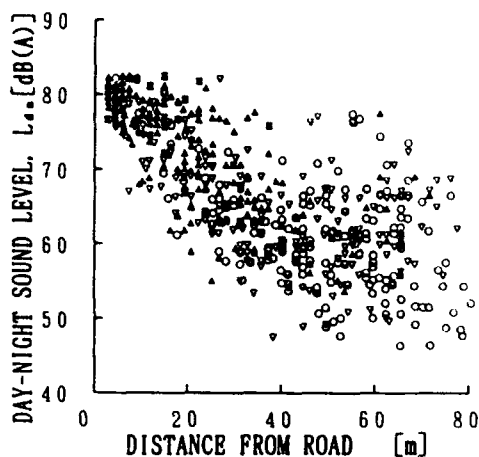

Fig.3. Relationship between noise exposure level and distance from road (▲:very annoyed, △:rather annoyed, ○:neutral/rather quiet/very quiet)

government  
municipality  
police  
automobile manufacturers  
automobile operators  
political parties  
community groups  
mass media  
no one's responsibility  
I don't know  
others

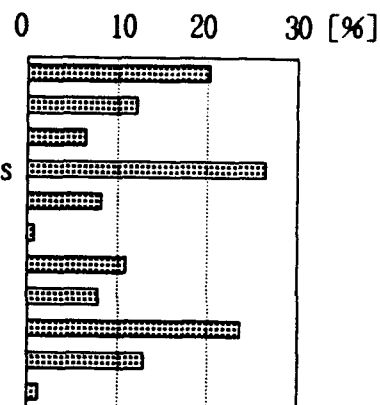

Fig.4. Who should be responsible for solving the noise problem?

### EFFECT OF NOISE ON THE COMMUNITY

Annoyance caused by noise. Fig.5 shows the relationship between noise exposure level in  $L_{dn}$  and annoyance interpreted as "the percent of highly annoyed people (1)". For our study, "highly annoyed people" were defined as those who responded in the top one out of five categories along the annoyance scale. It was found in Fig.5 that in cases where the noise exposures were the same, the residents' evaluations of annoyance were varied. As can be seen in Fig.5, the curve representing the residents' responses of Area 3 is significantly shifted higher than those of Area 1 and Area 2. One of the most likely reasons for the difference may be due to the higher number of heavy trucks which pass by Area 3 during the night.

Nonacoustical factors affecting annoyance. Several nonacoustical factors which may affect the variance of residents' annoyance were investigated. Fig.6-8 indicate the variance of "the percent of highly annoyed people" according to their "age", "sensitivity to noise" or "years of residency". It was found that these three factors influenced their annoyance level caused by road traffic noise. Effects of other factors like "sex", "occupation of respondent", "material of residence" and "whether the residence is privately owned or rented" were investigated but the variance was not enough to be conclusive.

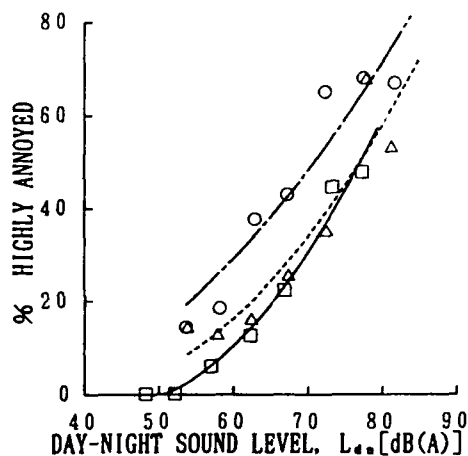

Fig.5. Influence of each different area on the percentage of highly annoyed people (□:suburban city, △:commercial/residential area in Tokyo, ○:residential area in Tokyo)

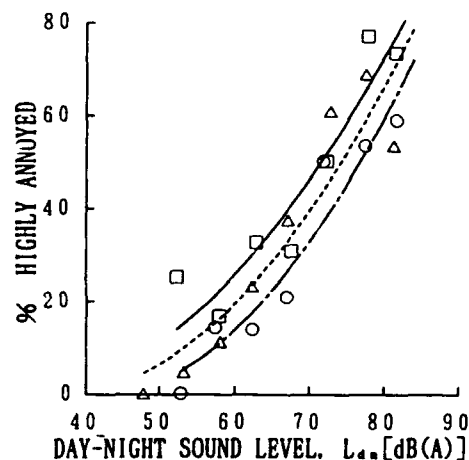

Fig.6. Influence of age on the percentage of highly annoyed people (□:older than 60, △:40-60, ○:younger than 40)

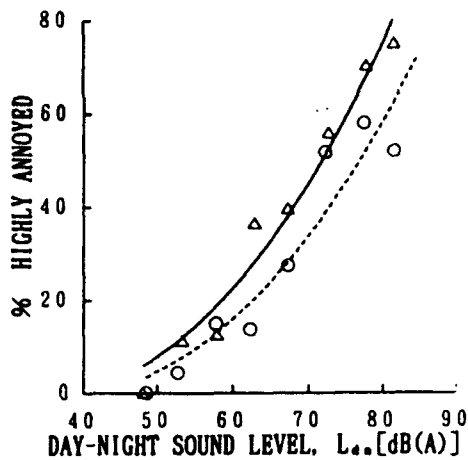

Fig. 7. Influence of sensitivity to noise on the percentage of highly annoyed people (—△—:sensitive, ...○...:moderate)

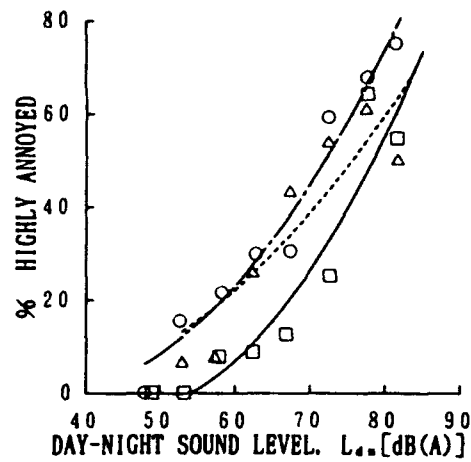

Fig. 8. Influence of the number of years of residency on the percentage of highly annoyed people (—□—:less than 5 years, ...△...:5-20 years, ...○...:more than 20 years)

Disturbance of conversation, listening, or sleep by noise. Fig. 9 shows the relationship between noise exposure and the percentage of people whose conversation, listening to the radio/television, or sleep is disturbed. For our study, we selected those who responded "often disturbed" to be representative of the percentage of people disturbed. Sleep disturbance caused by noise was found to be more serious than those of conversation or listening.

Attitudes towards roads. Fig. 10 shows the relationship between noise exposure and the percentage of people who think that roads are useful or roads do more harm than good for everyday life. It is clear that by observing Fig. 10, the percentage of people who regard roads as being harmful is directly related to the noise exposure level. In addition, it can be observed that as  $L_{dn}$  exceeds 79 dB the percentage of people who believe that roads do more harm than good exceeds those who believe that roads are useful.

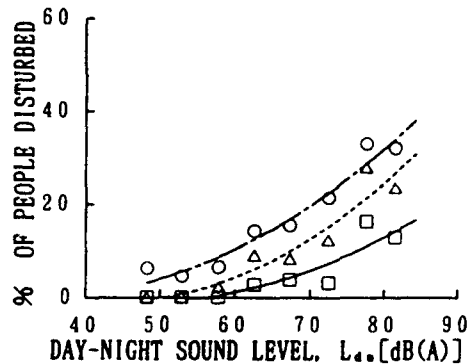

Fig. 9. Percentage of people whose conversation, listening, or sleep is disturbed (—□—:conversation, ...△...:listening, ...○...:sleep)

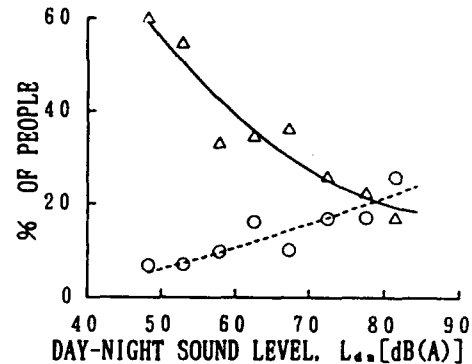

Fig. 10. Effect of noise on the residents' attitudes towards roads (—△—:roads are useful, ...○...:roads do more harm than good)

### CONCLUSIONS

In conclusion, as a result of the study it was found that : (1) noise problem caused by road traffic was the most serious concern in residential areas around main roads, (2) noise pollution affected the general amenity of life in these areas, (3) residents wished that the automobile manufacturers and government would do more to somehow reduce noise pollution, (4) in cases where the noise exposures were the same, the residents' evaluations of annoyance were varied, (5) the characteristics of the survey area, the age and sensitivity to noise of residents, and the years of residency affected the annoyance caused by road traffic noise, (6) sleep disturbance caused by noise was more serious than that of conversation or listening to television/radio, (7) noise pollution affected people's attitudes towards roads.

### REFERENCES

1. T. J. Schultz, "Synthesis of Social Surveys on Noise Annoyance," Journal of the Acoustical Society of America, 64(2), 377-405(1978).

**EXPOSURE TO TRAFFIC NOISE IN RIYADH, SAUDI ARABIA :  
MAGNITUDE OF NOISE AND ATTITUDE OF INDIVIDUALS**

**KOUSHKI P.A., AL-FELIMBAN A., AL-HUMUD J.M.**

**Kuwait University - Faculty of Eng. & Petroleum**

**P.O Box 5969 Safar - Code n0. 13060 Kuwait**

Due to rapid economic development and the growth of urbanization, traffic noise pollution has become a major concern for both the public and policy makers.

This paper reports the result of a 2-year research study undertaken to determine the magnitude of traffic noise and the attitudes of exposed individuals in the capital city of Riyadh.

Noise from traffic was monitored at 42 urban roadway locations during daily peak and off-peak hours in five time periods. Traffic flow characteristics of volume, speed and mix were also measured simultaneously with the monitoring of noise levels.

Results of the analyses indicated that roadways in Riyadh were noisy indeed, and a significant number of exposed individuals were annoyed with traffic noise. The paper concludes with recommendations for the mitigation of urban traffic noise.



# COMPARISON OF MATHEMATICAL MODEL OF TRAFFIC NOISE LEVEL WITH THE RESULTS OF REAL MEASUREMENTS

KRAJCOVIC Marian  
Fac. of Civ. Eng. TU Kosice  
Slovak Republic

## Abstract

Noise as a new phenomenon of civilisation's development is not a special form of environmental pollution only, but is harmful for all the people. Paper presents the comparison between the mathematical model of traffic noise and the results of real measurements in Slovak town conditions.

The source of negative influences on human organism in a surrounding of a society with a very high degree of technical development and civilisation there are not only the nerve and psychic loading of social nature. Omnipresent and unbreaking utterance of life in the great town's surroundings, by the factories, operations of various institutions and in many human flats is noise. Noise is one of the special form of social environment pollution. With his expansion, intensity and duration menaces not only the all psychophysiology of many people, but their psychic and body health.

Noise as a phenomenon for the prosecution - or better - as an accompanying product of technical development and civilisation belongs to harmful factors, to which higher attention must be given by society in the control of further development. The ability to adapt to other nerve and psychic loading is limited. The fight with noise is mainly in prevention its source, that's mean e.g. to dampen operation of various machines, apparatus and equipment in other noise, in noise screening of rooms, buildings and areas, where the noise arises, or in screenings of noise of these spaces, where it is penetrating. From the point of view of human dwelling protection against an excessive noise we are not always considering the possibility to built noisy operation / f.e. airports, railroad stations, roads, industry operations.../ in a sufficient distance from densely populated areas.

On the chair of geotechnique and transportation engineering of TU Kosice, there are made measurements of traffic noise in real areas from the point of view of height and distances from the source of noise, according to the official method of Research Institute of Buildings and Architecture / VUVA / in Prague, CR. Current results show, that a muffling of noise levels from traffic according to the real and mathematical calculated levels of volume of cars is different - especially according to the levels.

Calculation is made according to the relation :

$$L_{Aeqj} = L_{Aeqo} - \Delta L_{Ad} - \Delta L_{Aj} + \sum \Delta L_{Api} \quad [dB] \quad / 1/$$

- where  $L_{Aeqo}$  - an equivalent level of noise A in a distance of 7,5 m from the axis of pavement,  
 $L_{Aej}$  - equivalent level of traffic noise A in a controlled place,  
 $L_{Ad}$  - decrease of traffic noise level A by the distance over the terrain,  
 $L_{Aj}$  - decrease of traffic noise level A by the influence of final distance in controlled cross section of a road,  
 $L_{Api}$  - decrease /increase/ of a traffic noise A by the influence of a hinderness on road /terrain/ of noise spreading,

while the partial members of /1/ we calculated as:

$$\Delta L_{Aeqo} = 40 + 10 \log X \quad [dB]$$

$$\Delta L_{Ad} = 8,8 \log \frac{d_0^2 + (H+3)^2}{17(H+3)} \quad [dB]$$

$$\Delta L_{Aj} = 10 \log 180/\alpha_j \quad [dB]$$

$$\sum \Delta L_{Api} = \Delta L_{AZ} + \Delta L_{AK} + \Delta L_{AN} + \Delta L_{AB} + \Delta L_{AL} \quad [dB]$$

$$\Delta L_{AZ} = 2,7 \left( d_z/20 \right)^{-2,5} \quad [dB]$$

$$\Delta L_{AK} = 8 N/100 \quad [dB]$$

$$\Delta L_{AN} = -7 \log 1,1(d_N/10) \quad [dB]$$

$$\Delta L_{AB} = -9 \log (30\delta + 3) \quad [dB]$$

$$\Delta L_{AL} = -18 \log 1,1(b/10) \quad [dB]$$

where  $d$  - a distance of noise from communication on opposite front and repercussed to a controlled place  $g$  /m/,  
 $N$  - proportionate volume of haevy traffic in % /lorries

- and busses/,
- $dN$  - the shortest distance of noise between the controlled road and place /m/,
- $\delta$  - distance difference of noise spreading:  $\delta = a + b - c$  /m/,
- $a$  - distance from the hinderness /m/,
- $b$  - distance behind the hinderness /m/,
- $c$  - distance of fictitious length from noise source to the controlled place /m/,
- $X$  - corrected volume of traffic;  $X = n \cdot F_1 \cdot F_2 \cdot F_3$  /veh/h/
- $n$  - real volume of traffic /veh/h/,
- $F_1$  - coefficient of noise equivalence in dependence on volume of lorries and speed of heavy vehicles,
- $F_2$  - coefficient of noise equivalence in dependence on longitudinal slope of a road,
- $F_3$  - coefficient of noise equivalence in dependence on pavement quality and type of road,
- $d_0$  - distance of controlled place from the axis of road /m/,
- $H$  - height of controlled place from pavement level /m/,
- $\alpha$  - visual angle of road section seen from the controlled place /°/

By the calculating of traffic noise we used the method of dividing the road into sections according to various characteristics or to noise spreading conditions. The value of  $L_{eqj}$  was calculated for each section according to mathematical relations or VUVA's given methodics and corrections. By energetical sum of traffic noise on each sections, the final equivalent of noise level was calculated according the formula:

$$L_{eq} = 10 \log \sum 10^{L_{eqj}/10} \quad [dB] \quad /2/$$

Partial results of calculation and measurements can be seen in fig.1, where it is possible to see the noise level decrease in dependence on the height and distance of controlled place. In fig. 2 a cross section scheme of a road by controlled measuring is given.

We can conclude, that the methodics of VUVA corresponds with measurements results, but it is not possible to compare the calculation of traffic noise level based on mean traffic volumes and distribution of vehicles types in traffic flow. VUVA metho-

tics can be used for planning for designers, various authorities, as a base for noise protection planning. The traffic noise is becoming nowadays one of the most important enemies for town's inhabitants, because of its growth, its influence on work productivity /correct work/ and possibility for a healthy living. Therefore is a fight with the noise a world wide urgent problem because of limited psychic and nerve human ability to adapt to noise loading.

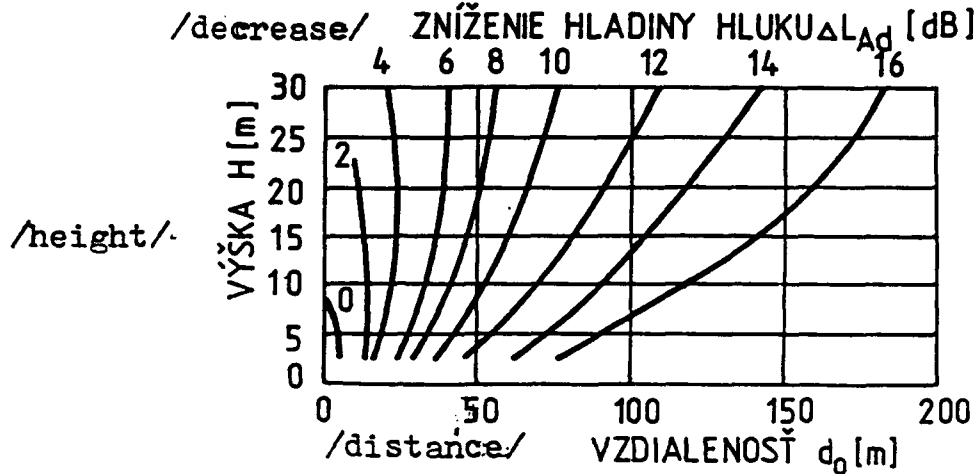

Fig.1 Noise level decrease in dependence on height and distance

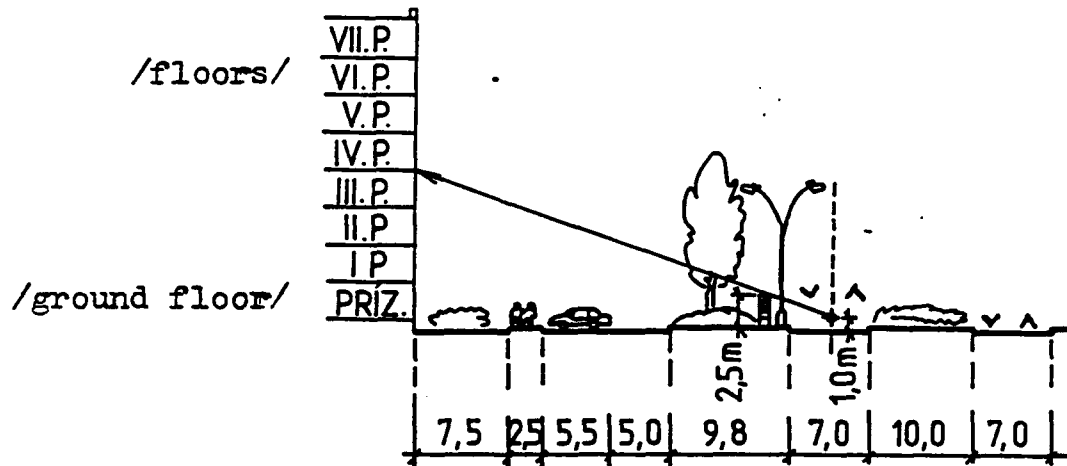

Fig.2 Cross section scheme of a road for measurement of traffic noise



# THE MEASUREMENT OF TEMPORAL STREAM OF HEARING BY CONTINUOUS JUDGMENTS

- IN THE CASE OF THE EVALUATION OF HELICOPTER NOISE -

Sonoko KUWANO\*, Seichiro NAMBA\* and Masaru KOYASU\*\*

\* College of General Education, Osaka University  
1-1 Machikaneyama, Toyonaka, Osaka, 560 Japan

\*\* Acoustical Engineering Laboratory  
2-13-11-806 Shinjuku, Shinjuku-ku, Tokyo, 160 Japan

## Abstract

In our daily lives we are surrounded with a variety of sounds which vary with time and spread in space. The configurations of sounds along the temporal stream have the meaning. The meaning will be destroyed if these sounds are divided into short segments as used in conventional psychophysical methods. The method of continuous judgment by category and the method of continuous judgment by selected description have been developed for examining the impression of temporally varying sounds along the stream. In this paper these methods are introduced with their procedures and applications to the evaluation of helicopter noise.

## 1. INTRODUCTION

Sounds give us information through the temporal variation. Along the temporal stream, they form a Gestalt including all the sounds already presented and coming in future, though each sound appears and disappears one after the other. The instantaneous impression of such sounds is based not only on each sound presented at that moment, but on the whole context. This holds good for music, speech or other sounds. It can be easily understood that the instantaneous impressions of music or speech sounds are greatly dependent on the context.

In order to evaluate continuously the impressions of sounds which vary with time, the authors have developed new methods called "the method of continuous judgment by category"<sup>1,2</sup> and "the method of continuous judgment by selected description"<sup>3,4</sup>. In the present study, these methods will be introduced and the measurement of temporal stream of hearing will be discussed by taking the evaluation of helicopter noise as an example.

## 2. EXPERIMENTS

### 2.1 Stimuli

Twenty-five kinds of recorded helicopter noise were used as stimuli. They were in three flying modes; taking-off, flyover and landing. The number of blades was two, three or five. The duration was about 1 min.

### 2.2 Procedure

#### (1) Experiment 1

The instantaneous impression of noisiness was judged using the method of continuous judgment by category. Subjects were asked to judge instantaneous noisiness using 7 categories from "intolerably noisy" to "not noisy at all" by pressing the corresponding key. A computer keyboard was used as a response box. Their responses were stored in a computer with the time when they responded.

#### (2) Experiment 2

The instantaneous multidimensional impression of timbre was judged using the method of continuous judgment by selected description. Subjects were asked to judge the instantaneous impression of timbre of sounds using adjectives in a prepared list and press the corresponding key. A list of adjectives was

prepared on the basis of the results of preliminary experiments, in which subjects were asked to express their impression to each sound using any adjectives they like. The adjectives used in Experiment 2 were; noisy, metallic, powerful, soft, dull and hard in Japanese.

### (3) Experiment 3

The overall impression of timbre of the helicopter noises were multidimensionally examined using semantic differential. Subjects were asked to judge their impression of timbre using these 7-point adjective scales after listening to each stimulus.

### 2.3 Subjects

Five females and seven males, aged between 20 and 41, with normal hearing ability participated in the experiments as subject.

## 3. RESULTS AND DISCUSSION

### 3.1 Instantaneous impression of noisiness

The continuous judgments of each subject to each stimulus were sampled every 100 msec and corresponded to the values of Leq of every 100 msec. The instantaneous judgments by twelve subjects were averaged taking the reaction time into account. High correlation was found between instantaneous judgments and the values of Leq of every 100 msec for all the 25 stimuli. This suggests that the instantaneous impression of noisiness is mainly determined by the A-weighted sound pressure level.

Examples of the relation between the instantaneous judgments and the values of Leq of every 100 msec for each stimulus are shown in Figs.1 and 2. The stimulus No.9 shown in Fig.1 is the noise from the helicopter in taking-off mode and with two blades. High correlation can be seen, but there is a systematic deviation from the regression line. This may be due to the effect of blade-slap noise, which includes a large impulsive component as is shown in Fig.3. The stimulus No.16 shown in Fig.2 is the noise from the helicopter in flyover mode and with five blades. In the case of this helicopter, the blade-slap noise is not prominent as is shown in Fig.4, and a good correlation can be seen between the instantaneous judgments and the values of Leq of every 100 msec.

The blade-slap noise may cause deterioration of timbre of helicopter noise. The effect of timbre was examined in Experiments 2 and 3.

### 3.2 Instantaneous impression of timbre

The percentages for the selection to each adjective for each five seconds by twelve subjects were calculated. An example of the result from the stimulus No.9 is shown in Fig.5. When the helicopter was approaching, subjects perceived the noise as being "noisy". Then impression "metallic" became dominant and when it left away the noise was perceived as being "soft". For the stimulus No.16, the impression of timbre did not change so much during the flight. The results of Experiment 2 show that the timbre of some types of helicopter noise varies according to the flight pattern and the flight mode.

### 3.3 Overall judgment

Examples of semantic profiles averaged for twelve subjects are shown in Fig.6. It was found that the overall impression of timbre of the noises were different from each other. Stimulus No.9 gives negative impression, such as metallic, annoying and unpleasant. On the other hand, stimulus No.16 was judged as being neutral.

### 3.4 Comparison between instantaneous and overall impressions of timbre.

The percentages with which each adjective was selected in continuous judgment in Experiment 2 were calculated for each stimulus and compared with the category scales in overall judgments in Experiment 3. Example are shown in

Figs.7 and 8. A fairly high correlation can be seen between the results of instantaneous judgments and overall judgments in the impression of "powerful". It was found that noises from the helicopters with two blades and/or in landing mode were judged as being more "powerful" than those with three or five blades, and/or in taking-off or flyover modes.

It was found that the impression of "metallic" was not strong in overall judgments and that the coefficient of correlation between overall judgments and instantaneous judgments was .586. The blade slap noise produced the impression of "metallic" which was reflected in the corresponding instantaneous judgments. However, it had little effect on the overall judgment. This fact suggests that overall impression can be evaluated with Leq.

These results suggest that the overall impression is not independent of the instantaneous impressions and that the relation between them is not so simple. The overall impression may be based on the interaction of weighted average of the instantaneous impressions. It is also suggested that the impressions of noisiness and timbre are temporally varying and it may be useful to examine the countermeasures of helicopter noises by relating the instantaneous impressions with the corresponding physical properties.

#### 4. FINAL REMARKS

The method of continuous judgment by category and the method of continuous judgment by selected description were introduced with their procedures and applications as follows.

1. The instantaneous impressions to the sounds which vary along the temporal stream can be measured reliably by these methods.
2. These methods can be applied to everyday sounds, and the relation between stimulus conditions and subjective responses, and the trade-off effect among stimulus conditions can be examined. This may be helpful to examine the countermeasures for preventing negative impressions of noises.
3. The overall impression of a sound is highly related to the instantaneous impressions. However, the overall impression is not a simple average of the instantaneous impressions. The overall impression may be based on the interaction of weighted average of the instantaneous impressions.
4. Instantaneous impression is affected by the preceding portions of the sounds as well as the corresponding instantaneous sound levels.
5. It was discussed that the context of the sounds has an important role in constructing instantaneous impressions.

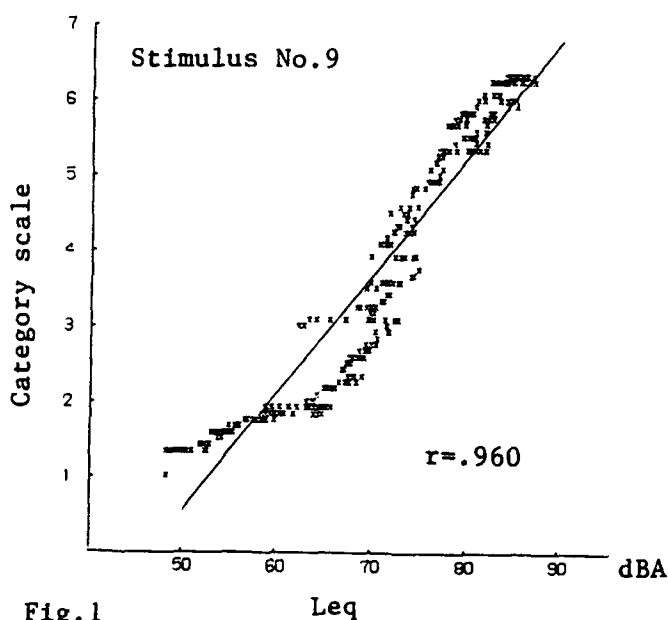

Fig.1

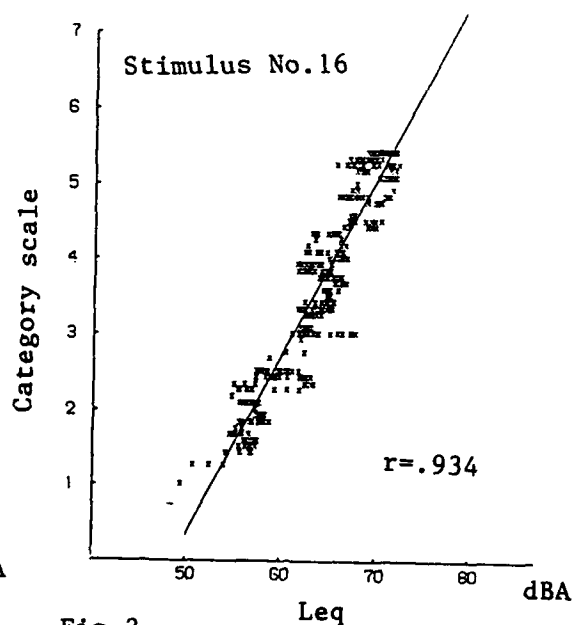

Fig.2

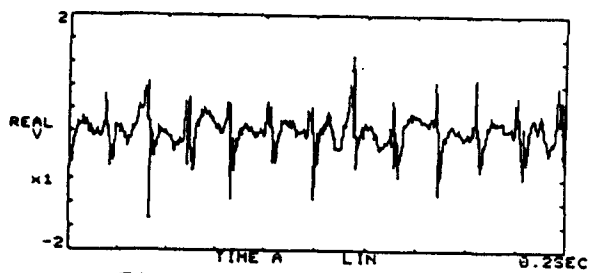

Fig. 3 Stimulus No. 9

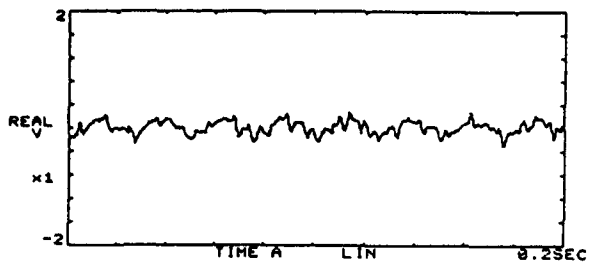

Fig. 4 Stimulus No. 16

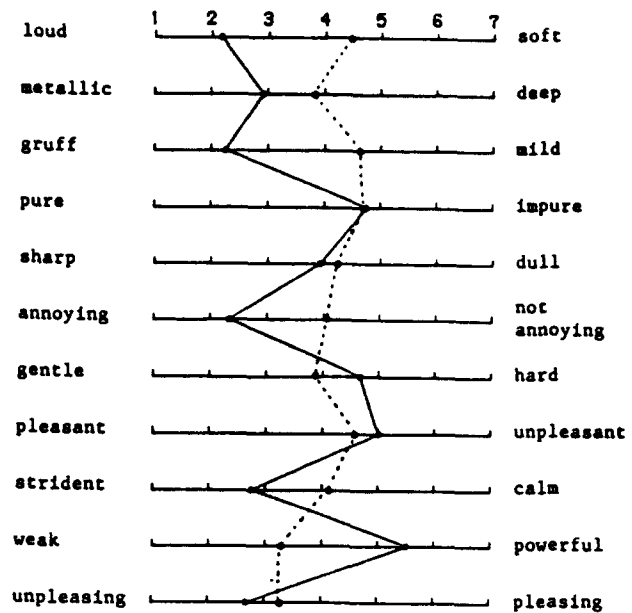

Fig. 6 — Stimulus No. 9 ..... Stimulus No. 16

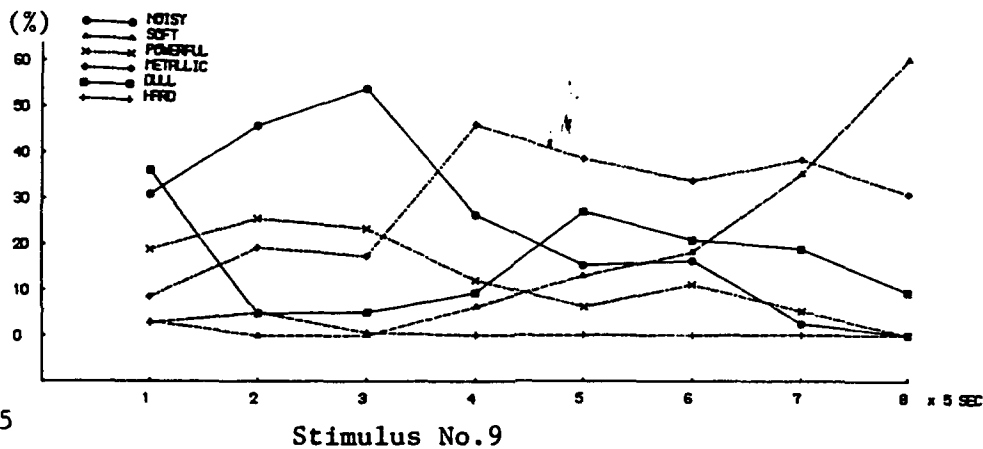

Fig. 5

Stimulus No. 9

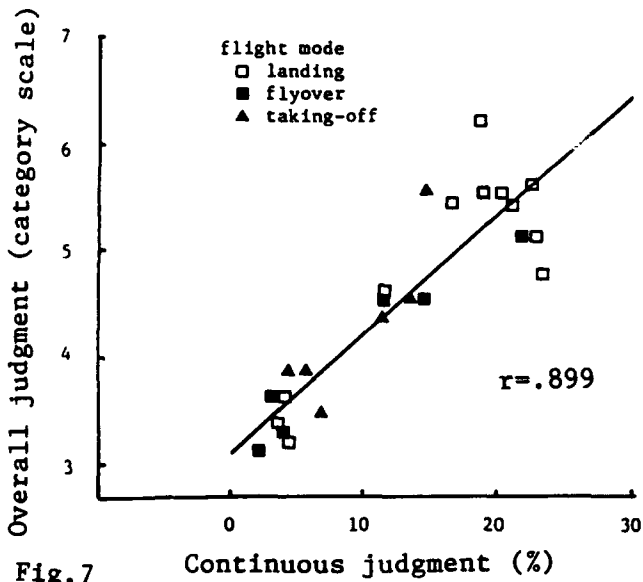

Fig. 7

Continuous judgment (%)

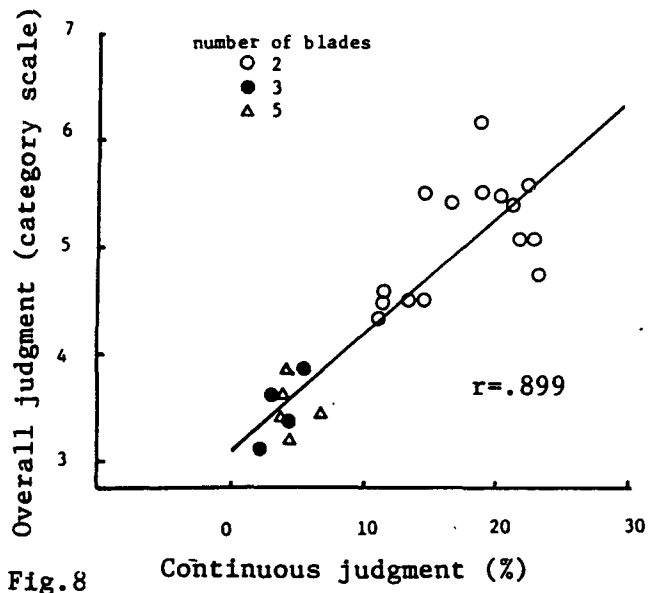

Fig. 8

Continuous judgment (%)

REFERENCES: 1) S.Namba & S.Kuwano, J.Acoust.Soc.Jpn.(E),1,99-106 (1980). 2) S. Kuwano & S.Namba, Psychol.Res.,47,27-37 (1985). 3) S.Namba & S.Kuwano, J.Acoust. Soc.Jpn.(E),11,43-51 (1990). 4) S.Namba et al., Music Percep., 8,251-276 (1991).

# ANNOYANCE FROM HIGH SPEED TRAIN NOISE AN EXPLORATORY FIELD STUDY

LAMBERT Jacques, CHAMPELOVIER Patricia, VERNET Isabelle  
INRETS - 109, avenue Salvador Allende, Case 24, 69675 BRON Cedex France

## Abstract

Forty respondents resident at 4 sites located along the track of the TGV Atlantique high speed train were interviewed to obtain information mainly centred on noise annoyance. The interview covered the quality of the environment in general, attitudes towards the new TGV line project, the perception of noise and its effects on home activities (indoors and outdoors), noise annoyance, the impact of noise protections (efficiency, appearance, visual intrusion), and fears for the future. Full 24 hour noise measurements were taken at each site in addition to one hour measurements. Daytime TGV Leq (from 8 a.m. to 8 p.m.) were in the 41 and 61 dB(A) range. In the light of these preliminary results, a larger scale social survey using a sample of 300 to 400 people will be carried out in 1993 to confirm that daytime Leq is an appropriate noise index for high speed train noise annoyance.

## Résumé

Une quarantaine de riverains de la voie nouvelle TGV Atlantique ont été interviewés principalement sur la question de la gêne due au bruit. Les principaux thèmes de l'entretien portaient sur la qualité de l'environnement à proximité immédiate du domicile, les attitudes des riverains vis-à-vis du projet de ligne nouvelle, la perception du bruit ainsi que ses effets sur les activités au domicile (tant à l'intérieur qu'à l'extérieur), la gêne due au bruit, l'impact des protections phoniques (efficacité, esthétique, intrusion visuelle) mises en place. Des mesures de bruit de longue (24 heures) et courte durée (1 heure) ont été effectuées dans chacun des quatre sites d'enquête. Les Leq de jour (8h - 20h) s'échelonnent entre 41 et 61 dB(A). A la lumière des premiers résultats obtenus dans cette enquête exploratoire, une enquête plus importante par questionnaire (300 à 400 personnes) sera réalisée en 1993 afin notamment de valider (ou non) le Leq (8h - 20h) en tant qu'indice représentatif de la gêne ressentie par les riverains lors de la création de ligne ferroviaire à grande vitesse.

## I - MAIN QUESTIONS

In France the law governing environmental impact studies for new transport infrastructures makes the protection of those homes most exposed to noise obligatory. In the field of rail transportation the first application of this law in 1989 - 1990 concerned the new TGV Atlantique line which runs from Paris to the West and South West of France. Along this line noise abatement measures (noise barriers and noise embankments) were implemented whenever forecast daytime Leq (8 a.m. to 8 p.m.) noise levels exceeded 65 dB(A).

Did this regulation attain the objective and did it limit noise to an acceptable or satisfactory level? If the answer is "no", it is vital to find out whether this is due to inadequate application of the regulation, inappropriate or insufficient regulation (noise level index and the time period or threshold levels retained) and whether there were any negative induced or secondary effects linked for example to the construction of the noise barriers. These two latter hypotheses lead to further questions:

1. Is there any specific impact of the noise generated by the TGV due to any of the specificities of its noise emissions such as the speed at which the noise appears and the slow disappearance of noise after the train has gone past, etc), line operating conditions (high traffic frequencies on some sections: 130 or 180 trains per day - a dozen per hour during peak hours and relatively high traffic levels during the evening), or the nature of the countryside through which the line runs (calm rural area), that existing regulation might not reflect?

## 2. Are noise barriers effective ? i.e. Are people who live nearby satisfied ?

Research programmes into annoyance caused by railway noise (ref.1) have already provided some answers to these questions but did not include high speed train lines to which noise control regulation now applies. INRETS surveyed people living close to the TGV Atlantique route at the request of the French Ministry of the Environment Noise Office to answer these specific questions. The results presented here only concern the exploratory phase of this work (ref.2).

## II - OBJECTIVES AND METHODS

### *Main objectives*

This exploratory survey was designed to :

1. Identify the main aspects of the impact of noise generated by the TGV (particularly noise annoyance and the satisfaction rating by people living adjacent to the noise protections ) ;
2. Identify the initial trends concerning annoyance expressed by people living adjacent and the non acoustical parameters that could have an impact on noise annoyance level.

### *General approach*

Forty interviews with people living close to the TGV Atlantique track were carried out in 4 zones. Depending on the zone, traffic varied between 55 to 130 trains per 24 hour period travelling at a maximum speed of 300 kph. The objective of these interviews was to describe attitudes to noise generated by the TGV and the impact of the noise protections. An estimate was made of noise exposure for every person interviewed by long and short period noise measurements and calculations.

### *Characteristics of the survey sample*

The sample interviewed was located in rural areas, either in isolated houses (farms) or in private homes in or close to villages and hamlets. 72 % of occupiers owned their homes when the new line opened and lived in their home all year round. For 8 % of occupiers their house was a holiday home. 43 % of the sample are farmers and wine makers, 23 % are non-agricultural workers and 33 % do not work at all ; all live from 50 to 1500 metres from the new tracks. Some benefit from noise abatement protection (screens, noise embankments, track running through a cutting) or the facade of their homes is soundproofed. Usually insulation was implemented by owners but not only for soundproofing purposes (table 1).

Table 1. Survey Sample (distance from the tracks - noise protections)

Noise protection Distance	Noise barrier or embankment	Track in cutting	Insulated dwelling	None	Total
0 - 100 m	4	1	1		6 (15 %)
100 - 200 m	6	3	4	3	16 (41 %)
200 - 400 m	1	1	3	8	13 (33 %)
400 - 800 m			1	2	3 (8 %)
> 800 m				1	1 (3 %)
Total	11 28 %	5 13 %	9 23 %	14 36 %	39

### *Topics evoked during the interviews*

Four major topics were discussed in the interviews with people living adjacent to the tracks :

- environment and lifestyle ;
- attitudes to the new railway line and fears concerning the opening of the line ;
- perception of the noise generated by the TGV, overall annoyance, effects on activities (sleep, conversation, ....), behaviours (closing windows, soundproofing facades, the need for medication, decisions to move, ...) and the acceptance of the noise 1 or 2 years after the opening of the new line ;
- noise protections : satisfaction levels, opinions about effectiveness, appearance and visual intrusion.

Final question concerned local inhabitants' fears about developments in the future.

### Noise measurements and exposure

In each survey zone a long term measurement (24 hours) and additional short term measurements (15 minutes or 1 hour) were implemented on the facades of buildings (see example in table 2).

Table 2. Results from measuring noise levels for a 24 hour period (55 TGV per day - distance from the tracks : 100 metres - no noise protection)

Period	Total Leq	TGV Leq	Leq from other sources	L90	L1	Number of TGV noise events		% of total time	
						> 70 dBA	> 80 dBA	> 70 dBA	> 80 dBA
6h-8h	61,6	61,2	46,0	42,8	68,2	8	1	0,7	0,2
8h-20h	62,3	61,8	50,3	41,6	69,2	42	30	0,7	0,3
20h-22h	61,2	61,0	52,0	41,6	64,8	4	4	0,5	0,2
22h-6h	48,7	46,0	46,1	42,9	54,5	1	1	ε	0
24h	60,5	59,9	50,7	41,9	65,0	55	36	0,5	0,2

Based on these long and short term measurements and extrapolations implemented by comparison and calculation it was possible to define the exposure of the total population interviewed to noise in terms of daytime Leq (8 a.m. - 8 p.m.) and background noise (L90) (table 3).

Table 3. Exposure of the sample population to noise from the TGV

Leq (8h-20h) - L90	0 - 5	5 - 10	10 - 15	15 - 20	≥ 20	Total
40 - 45		4	3	4		11
45 - 50	2		8	4		14
50 - 55		1	4	4	1	10
55 - 60			1	1		2
≥ 60					2	2
Total	2	5	16	13	3	39

Most of the people interviewed were exposed to noise levels below 55 dB(A) significantly below the legal threshold (65 dB(A)). Background noise level is usually between 26 dB(A) (isolated house in a zone with no trees nor vegetation) and 36 dB(A) (village house) if there are no major noise sources

close to the dwelling (i.e. roads) ; this figure is higher (+2 to 46 dBA) if the dwelling is close to a roadway. Most of the sample noted significant changes in noise levels ( $L_{eq} - L_{90}$  in excess of 10 dBA) (ref.3).

### III - MAIN RESULTS FROM THE EXPLORATORY SURVEY

Analysis of the interviews and noise level measurements reveals some hypotheses which should be validated in the 1993 questionnaire survey :

1. The noise abatement regulation seems to have been applied satisfactorily in the area surrounding the new line : in the absence of a prevailing wind, noise levels measured were all below the 65 dB(A) threshold. Wind probably significantly increase these levels. Are protective measures sufficient when the prevailing wind blows ?
2. Significant variations in excess of 10 dB(A) in noise exposure were recorded after the new line opened ; it would appear that taking into consideration of the initial noise situation in the evaluation of annoyance could be a major question.
3. Noise generated by the TGV is most often described as whistling or a thundering which can be heard at a distance and is often compared to a truck or an aircraft. The surprise effect due to the very high speed of the train is somewhat limited.
4. Noise is a daily annoyance particularly present mornings and evenings. Annoyance peaks at weekends and during the summer when people are in their gardens.
5. The major effects noted seem to concern sleep (particularly early in the morning), conversations held out of doors (44 %) and watching T.V. (36 %). Other statements concern annoyance from the construction works when the line was being built.
6. The relationship between annoyance and noise levels seems to depend on other parameters than noise itself. These include the opinion about the TGV as a new transport mode (which 2/3rds of the sample state to be positive) and the attitude of people to the new line itself (30 % are unfavourably disposed). The daytime  $L_{eq}$  currently used for regulatory purposes could be not sufficient to describe the annoyance felt during the pursuit of some activities (i.e noise has become a phenomenon in an environment which previously was extremely calm).
7. Now that the line has been operating for 1 or 2 years, a large part of the population (80 %) is becoming used to the noise ; however, this phenomenon is observed mostly in people exposed to noise levels that are considerably below the legal limit of 65 dB(A). Fears for the future should not be ignored, particularly those concerning increases in night time traffic (45 % of the sample).
8. 66% of the sample stated that noise protection measures were sufficiently effective (particularly those living where the tracks run through a cutting). Further attention should be paid to the use of these protective measures in rural environments (60 % of the sample think that noise barriers are ugly).

### References

- 1 - M. Vernet, D. Letisserand : "*Indicateurs de gêne due aux bruits ferroviaires - Etat de la question*". Rapport final INRETS-LESCO, novembre 1989.
- 2 - J. Lambert, P. Champelovier, I. Vernet : "*Impact du bruit sur les riverains du TGV Atlantique - Enquête exploratoire*". Rapport INRETS-LEN 9209, juin 1992.
- 3 - P.R. Williams, R.A. Hood, K.M. Collins : "*The assessment of noise from new railways*". Proceedings of Inter-Noise 91, Sydney 2-4 december 1991.



# THE CARTOGRAPHY OF A URBAN CENTER SOUNDSCAPE

LEOBON Alain

C.N.R.S. U.R.A 879 LABORATOIRE DE MECANIQUE.  
GROUPE "ACOUSTIQUE ARCHITECTURALE ET URBAINE"  
LE VAL JOYEUX CD.11 - 78450 VILLEPREUX.  
Tel: (33) (1).30.56.04.16

## Summary:

While using a town soundscape structural and phenomenological analysis, this paper proposes a description of urban sonic atmospheres. The proposed method permits the realisation of a *quality* noise map which seems to be a good evaluation tool of the reality of an urban center in term of sonic ambience's compositions. In fact, their sonic signatures tell us about the state of a town, its activities, its functions and the use of its streets, its animation.

## Résumé :

Tout en s'appuyant sur une analyse structurale et phénoménologique de l'environnement sonore urbain, ce texte présente une approche descriptive des ambiances sonores urbaines. La méthodologie proposée permet la réalisation d'une carte de bruit *qualitative* qui semble un bon outil d'évaluation de la réalité d'un centre urbain en terme de composition d'ambiances sonores . Les signatures sonores nous renseignent en effet sur un "Etat" de la Ville, sur son activité, sur les fonctions et l'usage de ses voies, sur son animation.

This paper presents a part of the results of a research contract between CNRS and Ville-de-Nantes conducted by SRETIE (Department of the Environment) on the topic "Sonic identity and life quality in a town center".

Having already initiated some measures touching the topic of noise (developing structures to analyse the answers given to complaints, controlling public houses with late closing hours and updating of cartographic data), the city of Nantes intended to take a more general view of the relationship between conditions of living and sonic environment in a highly-urbanised district.

While living in a town center presents undeniable advantages (proximity of services, commercial activity and leisure) the sonic nuisances cannot be neglected (traffic, hygiene services, commercial or activities and especially leisure). To come to an agreement between all parts, a better care of the urban sonic environment has become necessary. To give themselves the means to examine this topic in every respect, Nantes town hall wished to possess inventories and sensible representations presenting the "sonic life" in the districts, possible sonic malfunctionings, and above all allowing them to set up coordination structures between their different technical departments, whose decisions lead to direct consequences on the sonic environment. This study was partly financed by the Department of the Environment, with which Nantes town hall had concluded a pilot contract.

Therefore the aim was to establish an sonic inventory of a district of Nantes: Graslin hypercenter. To achieve this, we set up a methodology to analyse and describe this district's sonic atmospheres and their seasonal and temporal variations. The cartographic representations of this qualitative approach to noise will probably be extended in 1993 to the whole historic center of Nantes.

## 1- The constitutive elements of urban soundscapes

Let's recall the basic principles on which our works rest. The individual who crosses the town or lives in a district perceives "partly" his direct environment through a more or less inattentive listening of the surrounding sonic atmospheres. The perceptive integration of these various atmospheres, felt as a Whole by a district or town user, can be referred to as Soundscape.

These atmospheres are constituted by a certain number of elementary sonic information and sonic messages more or less relevant, which we call sonic items and micro-sonic-events (A.Moles, *Micropsychologie de la vie quotidienne*).

Relying on a structuralist hypothesis we will admit that every sonic atmosphere can thus be described as a combination of sonic items belonging to a limited type and, as such, indexable.

The sonic items are thus classified according to six sonic sources of reference:

— the source "Urban activity" (AU) relative to the "mechanical" sonic indications (traffic, works, etc.)

— the source "Human presence" (PH) relative to the pedestrian movements and presence (footsteps, voices, etc.)

— the source "Human activities" (AH) relative to the indications of animation of an area (whether it's commercial activity, leisure, animation, etc.)

— the source "Language and communication" (L) (music, sound signals, loud and challenging messages)

— the sources "Background noise" (BdF) (unidentifiable) and "Wildlife noise" (BdN) signalling indirectly the notion of relative calm of a soundscape. These two sources will be referred to as BR (*bruit résiduel* = residual noise).

(Figure 2: Classification of the main sonic items according to these sources)

## 2. The sonic walks or How to "phonograph" a sonic environment

The "sonic walk" is first an exploring attitude conciliating both the idea of a stroll inside a given topography and the idea of a halt (I make a stop at the street corner and listen to what's happening).

The registration of sonic data is led through a series of "sonic two-hours walks", marked out by about thirty fixed points involving each a three-minutes recording. These stopping points are referred to as PAS (*Points d'arrêt significatifs* = relevant stopping points).

The walks allow to register sonic sequences representative of the district's various sonic atmospheres. The recording apparel is a DAT numeric recorder equipped with "Artificial head" type microphones allowing a "holophonic" (3-dimensional sensation) restitution of the sound through headphone audition (Figure 1: Graslin district's sonic walk PAS).

Three walks led the same day (morning, afternoon and evening) allow to obtain a first sample of the district's sonic atmosphere. These "phonographs" are of course experienced again, the resulting samples compared and validated to obtain an sonic cartography really representative of the area. Up to this day, we have gathered data on the winter and summer 1992 periods.

## 3- Sequences content analysis : the Sound-balance profiles

After these "phonographs" of our soundscape, the first thing to do is to establish a precise list of the sonic items composing each recorded sequence. The sound taker for each sequence conducts this decoding through headphone audition.

As each sonic item belongs to a given source of reference, we can define a "Sound-balance profil" for each sequence: it is a chart presenting the relative importance of each sonic sources BdF, BdN, AU, AH, PH, L.

For each stopping point of the walk we have thus, for a typical day, three sequences, of some minutes each, accurately representative of the location's atmosphere. The compared Profiles for the morning, afternoon and evening will reflect the location's sonic atmosphere's temporal variations.

If the sonic identity of this area is strong, that is if its atmospheres are rather similar, the mean Profile will be used for the cartography (in the opposite case one or two typical situations will be taken out).

(Figure 3. An example of compared sound-balance profile).

## 4- Towards an sonic atmospheres typology: the sound-balance triangle

The PH, AH and AU sources are the three relevant sources, as the BR source only reflects the notion of relative calm or the absence of any emerging sonic item.

For example, for the traffic lines, an important percentage for the BR source means a decrease of traffic density, and thus a paradoxal increase of the potentially "human" component of the

soundscape. For this reason, the BR source's percentage (if less than 50 %) is redistributed on the Human presence source to the detriment of the Urban activity.

If the BR source is more than 50 %, we can claim that the sonic area lost all kind of sonic identity (night time desertification, for example) and the sonic sequence will be set aside from this type of analysis.

With this method, we have thus reduced our six sources to three relevant sources: Presence (P) = PH + BR, Animation (A) = AH + L and Urban activity (AU).

These three sources, P, A and AU, are always given in relative percentages and their sum is 100 %, since they reflect the whole of the sonic events present in the sequence.

If each source is represented by the summits of an equilateral triangle called "Sound balance triangle", a given sequence's atmosphere will be defined by a point inside the triangle. This point will be the centre of gravity of the three sources, whose weight measures their participation in the sonic sequence.

For each PAS in the walk, we have three sonic sequences: the morning sequence, afternoon and evening, and their representation in the balance Triangle will appear as a tripolar figure. This figure will occupy an area of the triangle more or less close to the summit of the predominating source. (Figure 4: the sound-balance triangle)

The sound balance triangle was experimentally divided in seven areas, each representing a relative balance of the sources sufficiently typical to allow claiming the absence of any relevant change in the sonic atmosphere.

To allow cartographic representation, a choice of seven colours indicates the seven areas. Thus the tripolar figure relative to each PAS in the sonic walk will be given a specific colour, and a cartographic representation of the district's atmospheres typology can be elaborated (Figure 5: Graslin district's sonic cartography).

Thus two maps of Graslin district's sonic atmospheres were set up, one for the winter season, the other for the summer season. The reading and interpretation of these maps are rather easy, since each colour corresponds to a very subtle combination of three extreme uses of public spaces: the pedestrian passage function (blue), the traffic line function (red), and place to stay and live function (yellow).

Our Laboratory has created a software processing the sonic sequences, making the sonic walk's analysis of content easier, allowing to work on several sonic data files, to compare their profiles, and to define the assigning of the sound colours by the sound balance triangle method. Named SACSSO (for *Système d'analyse de contenu de séquences sonores*, Sonic sequences' analysis of content system), this software is being optimised for the present time. It will soon allow the DAT monitoring, making easier the decoding of recorded sonic sequences, and more powerful statistic processing of the sonic data will be added.

## 5- The exploitation of the sonic atmospheres maps

A district's sonic atmospheres analysis allows in fact to establish a "phenomenology" of the actual use of the streets and public spaces, this use becoming subsequently comparable to what the visual landscape (pedestrian street, semi-pedestrian street, residential area, commercial function, public square, attractive area, ...) allows to imagine. On a general level, the sonic atmosphere's map seems to be a very good indicator of the use of urban spaces.

This kind of analysis allows as well to give an objective basis to some malfunctioning between sonic and visual identity. These malfunctionings often originate a feeling of uneasiness, insecurity and difficulty in the perceptive appropriation of some urban spaces by the passers-by or the residents:

- streets visually devoted to pedestrians but sonically "circulated" (Rue Scribe - Graslin district) (see figure 5),
- abrupt sonic ruptures between pedestrian areas and circulated lines (end of Plateau Contrescarpe),
- absence of specific sonic signatures related to the district's activities (sonic uniformity),
- soundscape deprived of excessive noise level but very dense and animated (with really challenging sonic signals), originating conflicts between residents and users (Ilot Gétry-Rameau-Suffren).

## 6- The live quality acoustic's indicateurs.

This type of study allows us as well to establish a series of sonic parameters, possibly revealing themselves as relevant figures, on a high level of generality, applying fully to urban soundscapes.

These could be Urban sonic life quality indicators. We mentioned just above in the text the idea of a coherence between sonic and visual perceptions, let's remark as well the following notions:

- the "sonic homeostasy" relative to the modifications of the sonic space's ambiance according to it's daly rythm,
- the "phonicity" measuring the intelligibility of a soundscape, that is our ability to identify all its components whitout efforts,
- the "sonic abundance" and the sonic animation related to the more or less great complexity of the sonic messages, but above all to the emergence of extraordinary micro-sonic events,
- last of all the notions of "sonic density" and noise level (Leq).

We will remark that a noise level's map would fail to provide an information as accurate about a district's sonic identity, but nothing prevents us, using the same recorded sonic sequences, from computing a mean noise level cartography (that can be superimposed to our atmosphere's data). The comparaison between the noise level map (realised with the software 01dB-dB Seuil) and atmosphere's maps of the same sonic walk shows without contest that the only functions of vehicle's traffic and the extreme situations of pedestrian areas are fully transcribed. These two cartographic methods appear to us as complementary as indissociable.

*This approach to a district's sonic life, or rather "to an sonic reading of a district's life" seems to bring an answer to a very concrete request from elected officials and from some municipal services:*

*— from the point of view of the local administration (urbain plans etc.) of mobility in a town center (modification of traffic, creation of pedestrian areas, cycle ways, etc.);*

*— from the point of view of the animation regulation in a town center, which appears at present as a task for social engineering: how to regulate the locations of leisure institutions, and cultural animation in public spaces so as to keep them perceived as a sign of high quality of life and of the emergence of an urban culture and not as a source of conflicts due to neighbourhood noises chasing away the residents.*

#### Liste des mots clefs relatifs aux items sonores classés par source

MOTS CLEFS DU REPERTOIRE	Fréquence d'apparition	MOTS CLEFS DU REPERTOIRE	Fréquence d'apparition
<b>Présence Humaine</b>		<b>Activité Humaine</b>	
Pas	12.93%	Impact	2.73%
Voix	10.81%	Cotinement	0.70%
De nombreux pas	4.16%	Porte	0.68%
Murmure	1.82%	Rumour	0.66%
Des Passants	1.79%	Tintement	0.63%
Rires	0.85%	Vaisselle	0.55%
Cris d'enfants	0.83%	Poussette	0.39%
Sifflements	0.55%	Regard	0.35%
Les enfants jouent	0.53%	Cliqueus	0.33%
Toisotements	0.48%	Extracteur d'air	0.33%
Cris	0.31%	Cabine téléphonique	0.22%
Bébé	0.09%	Casson	0.20%
<b>Circulation et Activité Urbaine</b>		Raclement	0.20%
Voitures	15.36%	Frousement	0.18%
Moteur	5.08%	Sonnerie	0.15%
Circulation	4.33%	Clefs	0.13%
Moto	3.22%	Manège	0.11%
Paroître	1.86%	Escalier mécanique	0.09%
Ferme	1.31%	Jouet	0.09%
Cannon	1.09%	Grincement	0.07%
Bus	0.79%	Balayer	0.04%
Klaxon	0.79%	Poissonnerie	0.04%
Démarrer	0.61%	Terrasse	0.04%
Tramway	0.50%	Volets	0.04%
Travaux	0.37%	Friture	0.02%
Crissements	0.35%	Horodateur	0.02%
Pneumatiques	0.33%	<b>Communication et Langage</b>	
Martens	0.28%	Voix intelligible	1.93%
Perçote	0.15%	Musique	0.81%
Avion	0.11%	Téléphone	0.07%
Amortisseurs	0.04%	Sifflet	0.04%
Eboueurs	0.04%	Cloches	0.02%
Embreyage	0.02%	Sirene	0.02%
Vélo	0.02%	<b>Bruit de la nature</b>	
<b>Bruit de Fond</b>		Ouverture	0.90%
Calmé	6.37%	Fontaine	0.70%
Période plus calme	2.71%	Abrements	0.48%
Bruit de Fond	2.12%	Vent	0.18%
BdF urbain	1.25%	Pigeons	0.07%
BdF Humain	0.96%	<b>FIGURE I.</b>	
Très calme	0.79%		

# NOISE IMPACT MODELISATION OF NEW RESERVED BUS CORRIDORS ON RESIDENTIAL FACADES

MIGNERON Jean-Gabriel, LEMIEUX Pierre et COTÉ Pierre

*Laboratoire d'acoustique, CRAD et École d'architecture, Université Laval, 1636 Pavillon Félix-Antoine Savard,  
Québec, Qué., Canada, G1K 7P4*

**SUMMARY:** *At the request of the Transport commission of the Quebec urban community (CTCUQ), a special modelisation has been developed in the Québec area, concerning the noise impact of the establishment of new reserved bus corridors. This modelisation took the precise acoustical power of the buses at different speeds and the influence of the bus stops (braking and acceleration) into account. Based on the IMPACT program, developed by the CRAD since 1985, the modelisation has specially been modified to consider three categories of vehicles, with different conditions of circulation and traffic lines. In addition to the possible fluctuation of the continuous equivalent level  $L_{eq}$ , as calculated on all the façades of the residential buildings (during the two peak hours of the morning and evening, with the change of the reserved corridors), the computation gave the the peak level produced by the passing of a bus, in the aim to evaluate the maximum instant annoyance.*

**SOMMAIRE:** *À la demande de la Commission des Transports de la Communauté Urbaine de Québec, une modélisation particulière a été mise en oeuvre pour faire apparaître l'impact du bruit résultant de l'implantation de nouveaux corridors réservés d'autobus dans l'agglomération de Québec. Cette modélisation tient compte de la puissance acoustique précise des autobus à différentes vitesses de circulation et de l'influence des arrêts (freinage, puis accélération). Basée sur le logiciel "IMPACT" développé au CRAD depuis 1985, elle a été modifiée pour tenir compte de trois catégories de véhicules, avec des conditions et des lignes de circulation différentes. En plus de déterminer les fluctuations possibles du niveau continu équivalent  $L_{eq}$  sur les façades de toutes les résidences en bordure des corridors (à l'heure de pointe du matin ou du soir, avec changement du corridor réservé), les calculs ont porté sur le niveau de pointe produit lors du passage d'un autobus, afin d'évaluer l'intensité de la perturbation momentanée.*

## INTRODUCTION

The aim of this study was to analyse the potential noise impact after the establishment of new reserved bus corridors, the "MÉTROBUS" network, operated by the Quebec urban community transport commission (CTCUQ); this network was composed of rapid transit lanes on reserved corridors, with limited stops, serving the main urban axes. It has been proposed that, after identification of the most sensitive residential areas, the possible impact resulting of the implementation of these new bus services would be estimated by computer modelisation based on the IMPACT program, developed by the CRAD, as a general noise impact model for urban and highway traffics and industrial locations. However, the proposed computation did not involve the production of traditional noise mapping, it rather involved two (or four) lines of impact points corresponding to the nearest windows of the first floors of the residential or commercial buildings and, occasionally, the windows of the upper residential floors. Thus, the impact resulted from the difference between two simulations, one based on the bus services as provided in the last few years, and the other on the new rapid network. The same computations have been repeated for each of the peak hours (morning and evening) and during the normal diurnal hours (slack period for buses), with the aim of reproducing the effect of the displacement of the main traffic flows and the new noise impact on the reserved lanes, reserved or not, used by buses.

In addition to general urban planning informations, such as the urban use, building vocation (commercial, institutional or residential, in relation with the impact sensitive modelisation requires complete topographic data, full description of the transversal design of urban corridors, distance of the façades, relative height of the windows (first and upper floors), position of traffic and parking lanes and all the circulation flows at different hours of the day (cars and buses). Moreover, the location of the principal traffic lights and all the bus stops have been taken into account.

COPY AVAILABLE TO DTIC DOES NOT PERMIT FULLY LEGIBLE REPRODUCTION

## MODELISATION PROCESS

Considering the growing complexity of projects and sites, the detailed computation on transversal noise propagation plans, previously used before 1985, has been replaced with new algorithms grouped in a new IMPACT program. This universal program, working on fast AT computers, has been used during the last years for many industrial and traffic noise studies. It allows the computation of many noise impact points for large road or highway patterns, whatever the geometric position and the shape of the roads investigated. On all basic segments, with an elementary chosen length along a traffic lane, the noise was considered as evenly distributed, with a power level per unit of length, established for both the light and the heavy vehicles. For the propagation, the program identified all screen effects, natural or caused by protective devices, between the line of sources and the calculated impact point. After that, the program compiled them, for each segment, with the corresponding reflections, diffractions and ground effects. The noise levels resulting from a reflected propagation were not only affected by distance effect, but also by an additional attenuation, according to the absorption coefficient of the reflective surface.

The model has been reprogrammed to take into account the specific needs of the project. Firstly, the reserved bus corridors have been added to the digitized input of the other traffic lanes; the acoustical powers of the buses at different speeds have also been added, to create a third category of vehicles. These average powers had previously been verified by sound surveys, made in the field on different models of buses, including the analysis of time signatures and spectral compositions, in different operating conditions, such as free flow at varying speeds and during stops. Numerical tables have been added to the program output, to compare the different impact levels for all façades of the buildings facing the analysed corridors. Finally, in addition to the continuous equivalent level (Leq), the maximal pressure level in dB(A), resulting on a façade during the passing of a bus, was introduced in the modelisation program. These two parameters have been calculated for three periods of the day: peak hours (morning and evening) and a normal diurnal hour, for all the façades of residential buildings facing the new "MÉTROBUS" corridors. Bus stops and major traffic lights were taken into account, the new bus ways have been digitized to reproduce the bus stop locations, with the corresponding speeds of a bus prior to a stop and its acceleration afterwards.

## RESULTS AND CONCLUSION

The resulting impact of the new bus network has been represented on maps similar to those on the following pages. The example of the figure n° 1 shows an analysed corridor, with traffic and bus lanes, main traffic lights, bus stops and the urban land use along the corridor. The example of the figure n° 2 shows the impact result for the two peak hours of morning and evening. The mapped values reproduced only the difference in term of noise impact, before and after the establishment of new reserved bus corridors, for all the first floor façades of the buildings facing the corridor (indicated on the outline of each building by the color code).

It is important to mention that this type of impact study would have been very difficult to realize, had it been solely dependent on an extensive sound measurement survey, conducted before and after introduction of the new bus network; because it would be necessary to identify, on countings, measurements and recordings, all types of noisiest vehicles, including trucks, motorcycles and buses (from different bus companies), in order to distinguish the contribution of only the CTCUQ buses using the new corridors. The modelisation gave, in this occasion, a mean response, reliable and indisputable, as well as the peak corresponding values.

## REFERENCES

- CENTRE D'ETUDE DES TRANSPORTS URBAINS: Guide du bruit des transports terrestres - Prévission des niveaux sonores, 317 p., Min. de l'Env. et Min. des Transp., CESTUR, 1980.
- MIGNERON, J.-G. et LECLERC, D.: "Le logiciel "IMPACT" et la modélisation de l'environnement sonore au voisinage des corridors routiers ou des infrastructures industrielles", pp.12.1-12.21, in Proc. Colloque Effets et Traitement du Bruit des Transports, INRETS, Lyon, décembre 1990.
- MIGNERON, J.-G., ASSELINEAU, M. et LOUVIGNÉ, B.: "Influence de la dynamique et de la composition spectrale sur la gêne résultant dans un logement, en présence d'échantillons de bruit de circulation reproduits à niveau équivalent constant", pp. 25-47, in Canadian Acoust., vol. 15, no 4, 1987.
- MIGNERON, J.-G., JACQUES, P., ESTEVE, A. et ASSELINEAU, M.: "Développement de modèles informatiques pour l'étude d'impact des autoroutes et le calcul des écrans acoustiques", in Congrès Intern. d'Acoust., Toronto, p. C4-8, vol. I, 1986.
- MIGNERON, J.-G. et coll.: Impact psychosociologique et économique du bruit des autoroutes urbaines pour le secteurs résidentiels les plus proches, Rapport final, SCHL, CRAD, 111 p., Contrat CR 6585/M12, décembre 1982.
- SOCIETE CENTRALE D'HYPOTHEQUES ET DE LOGEMENT: Le bruit du trafic routier et ferroviaire: ses effets sur l'habitation, SCHL, NH 15-29 et LNH 5183 82/02, Ottawa, 1977 et 1981.

TYPE D'UTILISATION

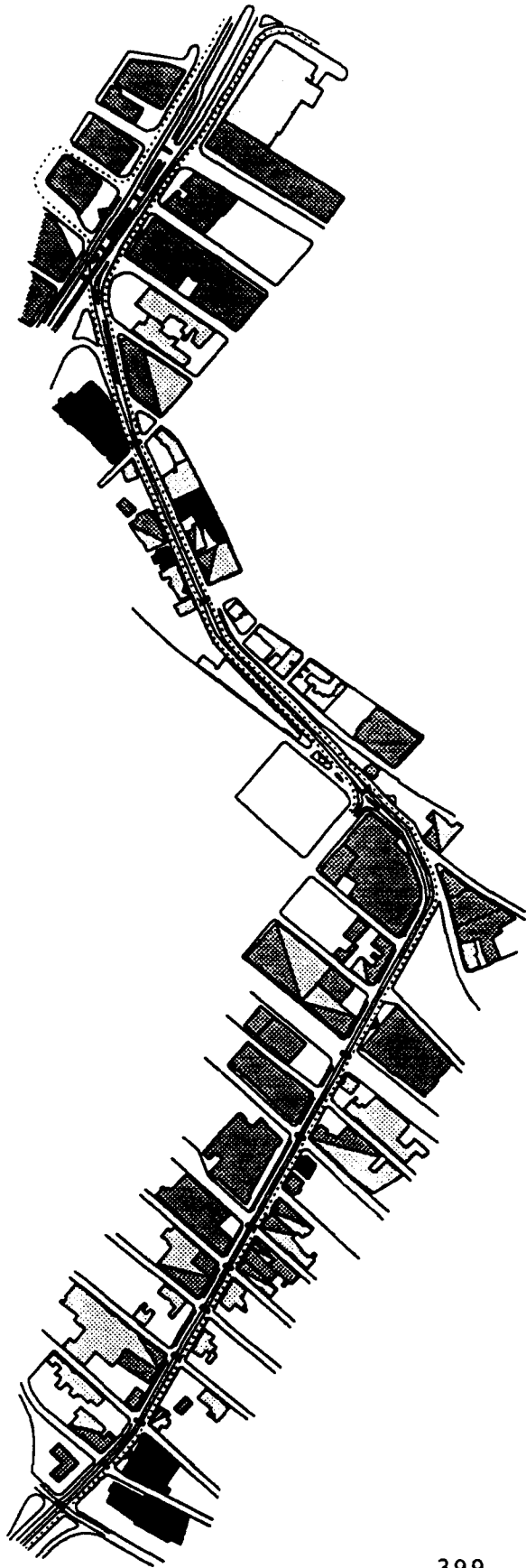

399

- FEU DE CIRCULATION
- ARRET D'AUTOBUS
- ARRET MÉTROBUS
- UTILISATION RÉSIDENTIELLE
- UTILISATION MIXTE (COM./ RÉS.)
- UTILISATION COMMERCIALE
- UTILISATION INSTITUTIONNELLE

### Côte d'Abraham-Dorchester

Figure N° 1: Corridor example, with traffic and bus lanes, main traffic lights, bus stops and urban land use.

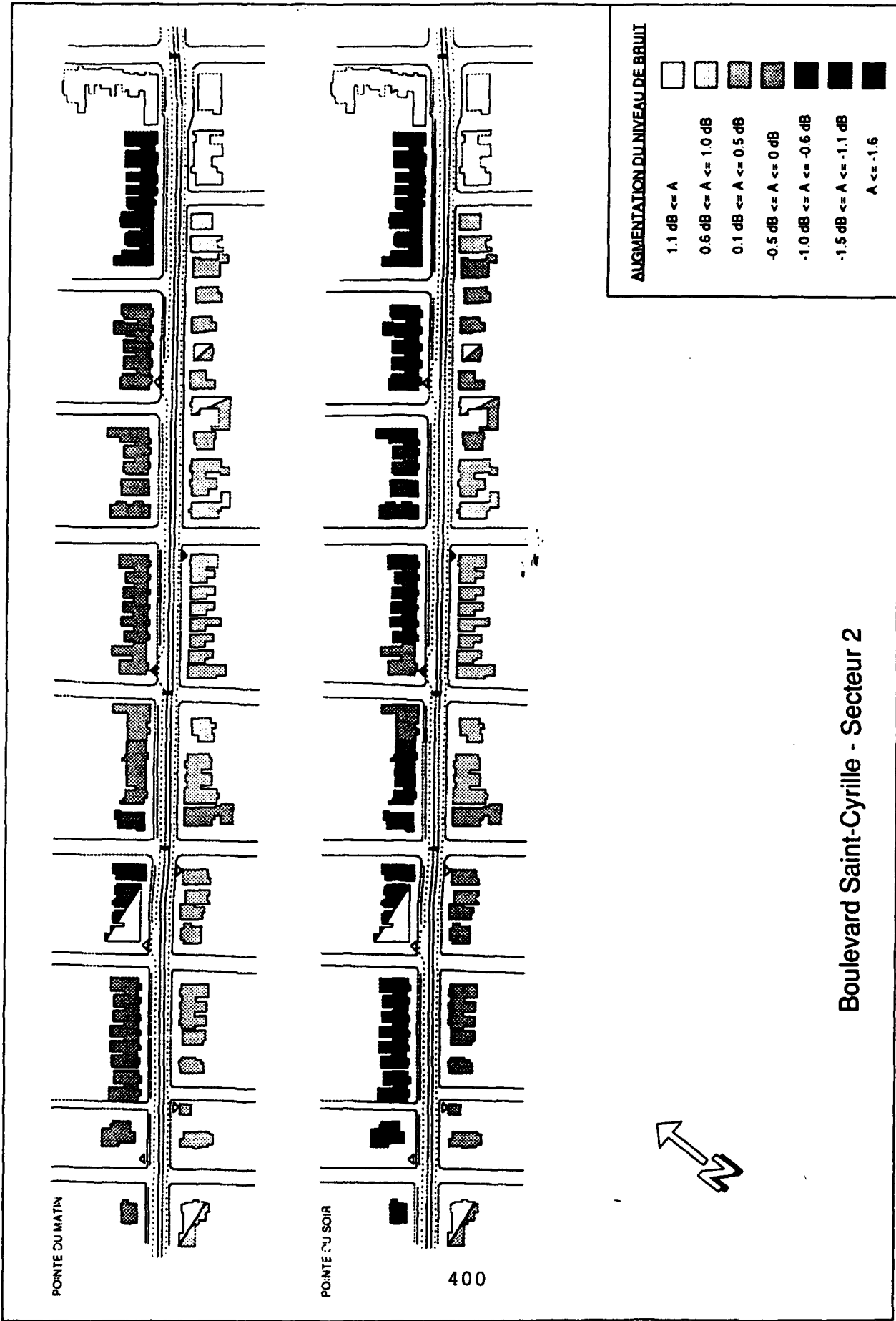

**Boulevard Saint-Cyrille - Secteur 2**

**Figure N° 2:** Corridor example showing the impact results for the two peak hours of morning and evening (the mapped values reproduce only the noise difference, before and after the establishment of new reserved bus corridors).



# NOISE COMMUNITY PROBLEMS IN ORANGE JUICE FACTORY

NEPOMUCENO J. A., BELDERRAIN M. L. R.

Acustica and Sonica

Ibirapuera, Rua Caravelas 527

Sao Paulo - CEP 04012 - 060 - Brazil

The orange juice evaporators operation in Citrosuco Paulista - Matao Plant - SP - Brazil, produces a sound field that reaches the neighbour community with values above those preconized by law.

The background noise level had been rated in 46 dB(A), therefore, the maximum noise level had been established in 56 dB(A).

The juice evaporators constitute the principal source of noise because of their dimensions - towers of 30m height, and consequent visual impact to the community.

The choice of an acoustic treatment with panels is so complicated due to little available space, and also to the ventilation and luminosity interferences with the operators area.

The problem has been penalized with the constant neighbours community reaction against the noise evaporator operation.

This paper will introduce the acoustic problem analysis including measurement, the accepted project solution and the results obtained until the present time.



# THE EFFECT OF EXPOSURE TO NOISE AND VIBRATIONS FROM TRAINS - FIELD SURVEYS IN AREAS EXPOSED TO DIFFERENT NUMBER OF TRAINS AND DIFFERENT LEVELS OF VIBRATIONS.

ÖHRSTRÖM Evy and SKÅNBERG Ann-Britt

*Department of Environmental Medicine, University of Gothenburg, Medicinaregatan 16,  
413 90 Gothenburg, Sweden.*

The paper presents preliminary results from field investigations of annoyance from noise and vibrations from railway traffic. Three main areas with low (20), medium (60) and high (160) number of trains night and day 24 hours have been investigated so far. All areas had high levels of vibrations in the ground  $>2$  mm/second. The results indicate that the reported annoyance reactions to noise probably were raised by high levels of vibration. Outdoor activity disturbances were the most frequently mentioned annoyance reactions. Regarding indoor activities interference with listening to radio and TV was the most pronounced reaction, especially in areas with a high number of trains per day. Further field surveys are planned in areas with no or very low vibrations.

## INTRODUCTION

A majority of the studies reported in the literature show that noise from trains causes less general annoyance than noise from road traffic (1). Guidelines and criteria for noise from train varies among the different countries, but in Sweden there are no guidelines for noise from train today. In 1990 we performed a first study of annoyance from trains at different distances from the railway in Kungälv city. It was found that not only noise was experienced as annoying. Vibrations, primarily from the goods trains, was reported as even more annoying than the noise.

In order to elucidate different effects of noise and vibrations from train as a basis for Swedish guidelines for noise and vibrations from trains, a larger study involving a number of investigations in different areas with and without vibrations was designed. The investigations will be finished in 1994. The main results from studies performed so far in areas with high levels of vibrations are presented in this paper.

## METHOD

An inventory of the Swedish railway lines was performed in 1991, using existing data of the extent of vibrations in the ground, total number of trains per day, number of goods trains and number of passenger trains. The following factors were included in the design of the study: vibration ( $<1$  mm/sec,  $>2$  mm/sec) and number of trains ( $<25$ /day to  $>150$ /day). Further the proportion of goods trains was considered. Information about the distribution of trains night and day was also considered as important. Areas up to 300 meters from the railway were chosen and the distance from each chosen house to the railway track is measured. I measurements and/or calculations of noise levels in dBA max and Leq is performed. The effects are evaluated by "traditional" postal questionnaires which earlier have been used in road traffic studies. The questionnaires are sent together with an introductory letter to each household between 18 and 75 years of age who have lived in the area

year. The main (masked) questionnaire contains questions about the living environment, sleep and wellbeing. Those who respond that they are rather or very annoyed by noise or vibrations from trains receive a second questionnaire with specific questions on activity disturbances.

## RESULTS

Table 1 shows the exposure and the number of respondents in each area. The mean response rate was about 75 % or 960 respondents in the main questionnaire and 95 % in the second questionnaire on activity disturbances. All the main areas had vibrations >2mm/second due to a ground of clay. Respondents living in minor areas with more stable ground like moraine or rocks (as stated by geological maps and comments in the questionnaire) and thus having less vibrations, (124 persons), were excluded from the main sample.

Table 1. Description of investigation areas and number of respondents.

<i>Investigation area: number of trains/day, Leq and vibration level</i>	<i>Noise interval in dBA max</i>	<i>Number of respondents</i>
<b>(Low) Säffle, Vålberg, Grums</b>	70 - 75	31
<i>total:</i> 20	76 - 80	73
<i>goods:</i> 7-11	81 - 85	72
<i>Leq:</i> 40 - 65	>85	31
<i>Vibr. mm/sec:</i> 2 - 8		
<b>(Medium) Kungsbacka</b>	70 - 75	16
<i>total:</i> 60	76 - 80	123
<i>goods:</i> 23	81 - 85	105
<i>Leq:</i> 45 - 65	86 - 90	44
<i>Vibr. mm/sec:</i> 2 - 15	>90	13
<b>(High) Partille</b>	70 - 75	144
<i>total:</i> 160	76 - 80	84
<i>goods:</i> 53	81 - 85	81
<i>Leq:</i> 45 - >70	86 - 90	44
<i>Vibr. mm/sec:</i> 2 - 3	<90	34

The table shows that the vibration level was higher in the areas with low and medium number of trains per day. The vibration level varies with type of house, distance from the railway track and with speed and weight of the trains (goods trains causing the strongest vibrations).

Figure 1 illustrates the relationship between max dBA level and annoyance to noise.

Figure 1. Relation between annoyance to noise and maximum dBA level.

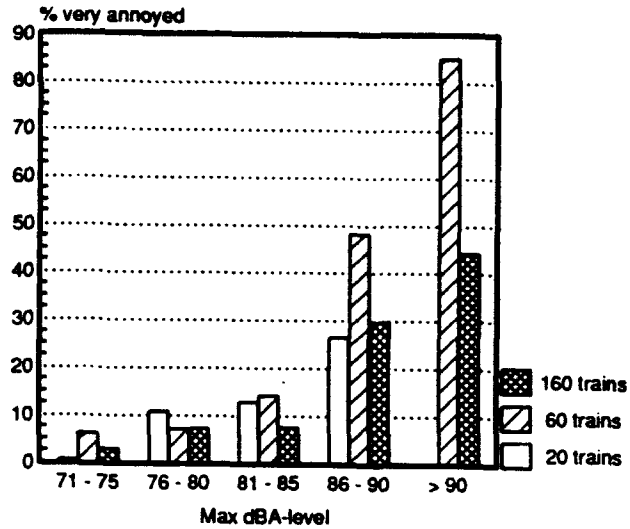

The figure shows a good relationship between the maximum dBA level and annoyance within each area but the percentage of annoyed respondents was much higher in the area exposed to 60 trains per day as compared to the area with 160 trains per day.

Figure 2 a and b illustrates the relation between distance to the railway truck and annoyance towards noise and vibrations from train.

Figure 2 a. Relation between annoyance to noise and distance to the railway.

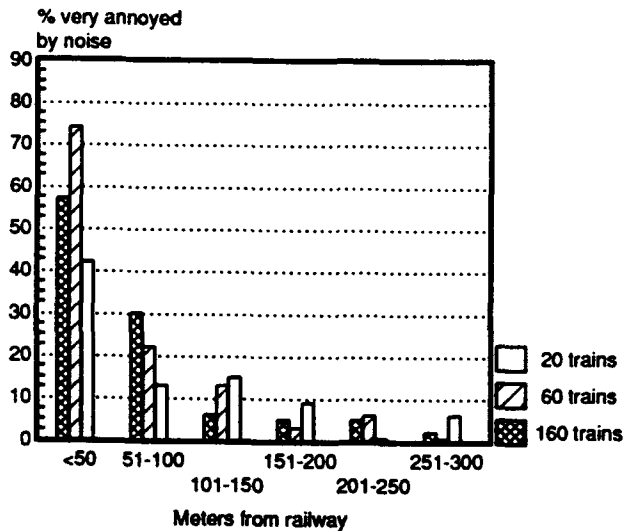

Figure 2 b. Relation between annoyance to vibrations and distance to the railway.

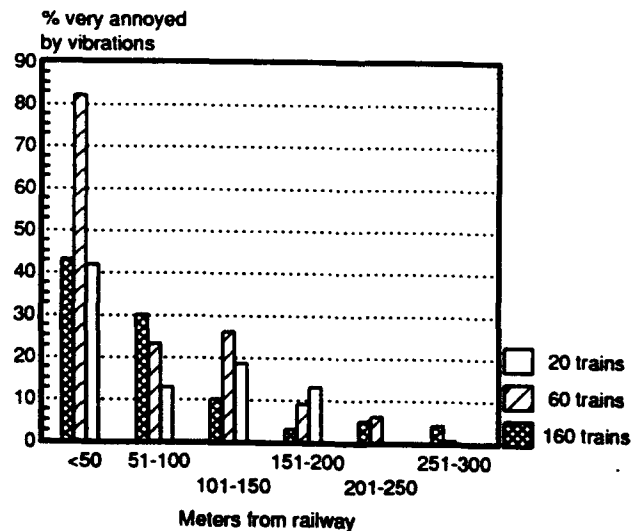
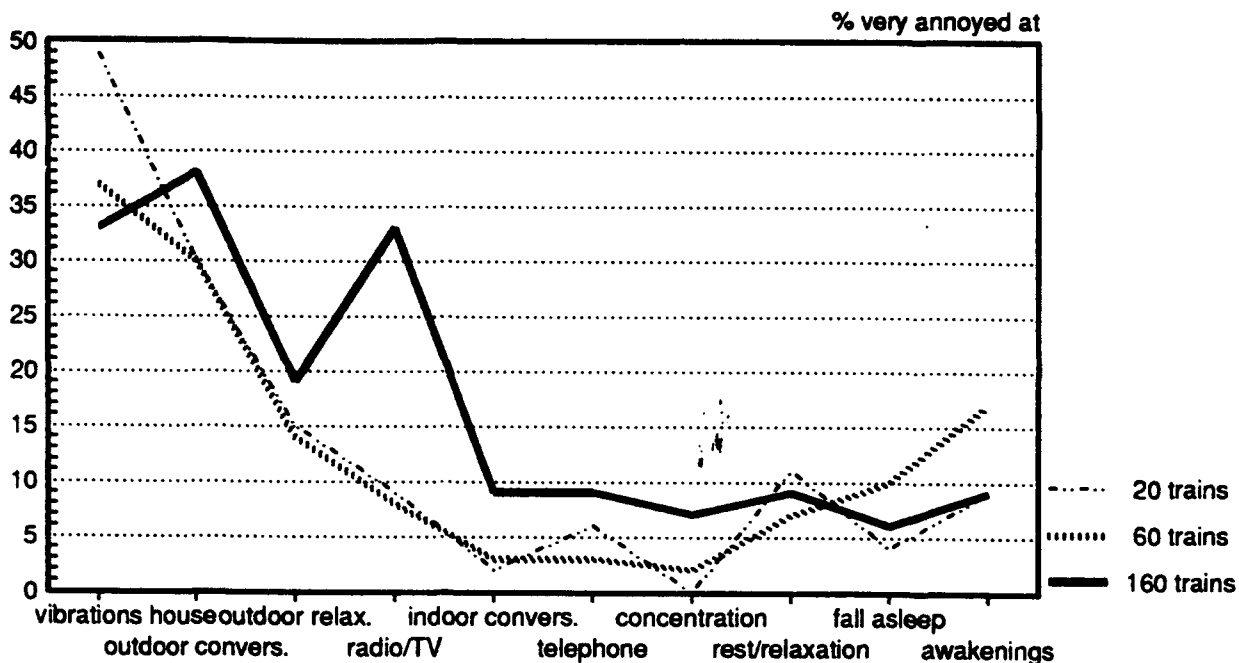

Figure 2 a shows that the the percentage of very annoyed respondents was low at distances more than 150 meters from the railway track. Annoyance reactions to vibrations (figure 2 b) were more frequent in the area with 60 trains at distances close to the railway track. In areas with 60 and 20 trains per day and more than 100 meters from the track, annoyance to vibrations were more frequent which is well in accordance with the higher level of vibrations.

The second questionnaire, which was sent to respondents who were rather or very annoyed by noise or vibrations from trains, showed that about 90 % mentioned the goods trains as most annoying. About 70 % were more annoyed during evenings and during nights. Figure 3 shows the pattern of activity disturbances outdoors and indoors due to noise and vibrations.

Figure 3. Percentage of respondents who reported that they were very annoyed by the trains during different types of activities.



The figure shows a similar pattern of activity disturbances in the three main areas, but in the area with 160 trains per day a higher proportion of the respondents are very annoyed when listening to radio/TV. Disturbance of rest and sleep seemed to be of less importance than effects during listening and conversation. It can also be noted that a higher percentage reported that they were very annoyed by vibrations in the house in the area with 20 trains per day.

### COMMENTS

The results from the studies show that vibrations seem to influence the annoyance response to noise. The studies in new areas with low or no vibrations will further elucidate this problem of combined effects of noise and vibrations from trains.

### REFERENCES

1. Moehler, U. Community response to railway noise: a review of social surveys. *Journal of Sound and Vibration* 1988, 120, 321-332.

# A PILOT STUDY ASSESSING LONG-TERM EFFECTS AMONG PEOPLE EXPOSED TO LOW LEVEL, LOW FREQUENCY NOISE IN THEIR HOMES.

PERSSON Kerstin and RYLANDER Ragnar

Department of Environmental Medicine, University of Gothenburg, Sweden.

This paper presents a pilot study assessing annoyance and effects on psycho-social wellbeing (PSW) and daily symptoms among people exposed to low frequency noise (LFN) in their homes. Comparisons were made with people living in the same areas, but not exposed to LFN. The effects were evaluated by postal questionnaires. The noise levels and frequency spectra were registered indoors in a representative sample of houses. The results showed that LFN may cause annoyance and disturb rest and concentration at levels normally occurring in the home. The degree of annoyance increased with noise level. No significant differences in daily symptoms or PSW were found between the exposed populations and controls. The people who were "rather" or "very" annoyed due to noise from the heat-pump had however more daily symptoms and a tendency to a lower PSW.

## INTRODUCTION

Case histories have shown that LFN, (<200 Hz) can cause annoyance at low dBA levels, an observation that has been confirmed in experimental studies. It has also been demonstrated that complaints on LFN constitute a major proportion of the total number of complaints on noise that was made to the Health and Environmental authorities in Sweden. (Persson and Rylander, 1988). There is however little reported information available as to the distribution of annoyance and occurrence of symptoms related to long-term exposure of low levels of LFN. A field study among people exposed to LFN in their homes was therefore undertaken. The aim was to study long term effects on annoyance reactions, health, and well-being in relation to noise exposure.

## METHODS

Two residential areas *A* and *M* comprising leased accommodation of comparable standard were selected. The LFN source was heat-pumps installed inside the houses for the exposed group, while for the control group, the heat-pumps were installed outside the houses.

*Questionnaire:* A questionnaire was developed where the questions were based on interviews with people very disturbed by LFN in their homes. The aim of the final questionnaire was masked by presenting the investigation as a general environmental study. As well as questions relating to domestic environment, the questionnaire contained specific questions relating to annoyance and activity disturbance due to noise from different installations in the building including heat-pumps. Psycho-social wellbeing was evaluated in eight questions and the categories fatigue, mental tiredness, well-being, social orientation and depression were formed. Included were also questions on symptoms occurring daily, like nausea/vertigo, headache, tiredness, tension, mental exhaustion and easily irritated, as well as question on discomfort related to LFN. Questions on sleep, general health, work and family conditions were also included. The questionnaire was mailed to a randomly selected person in each household, 18-75 years of age. The response rate was 76% and 67 % in the two areas respectively. Since analysis of the first questionnaire indicated that the respondents had not made a distinction between noise from ventilation and noise from heat-pumps, a second questionnaire was distributed where the noise sources were described more clearly. This questionnaire contained only questions on annoyance reactions from installations in the building. In total there were 41 exposed and 52 controls among the respondents. The average time of

residence was 1.6 years in area A and 4.3 years in area M, and there was an equal distribution of residence time between controls and exposed.

**Noise measurement:** When the questionnaire study was completed, noise levels were measured indoors in a random sample of houses using a Nortronic dual channel Real-time and intensity analyzer type 830. The noise signals were stored on a computer disk in the measurement instrument for further analysis. The average noise levels for the exposed and controls in both areas are shown in table 1

Table 1

Area	A			M	
Category	E <sub>L</sub>	E <sub>H</sub>	K	E <sub>L</sub>	K
Number of respondents	5	28	30	8	22
dBA	26,0 (2,8)	31,0 (5,1)	20 (0,85)	27,0 (2,1)	24,0 (3,5)
dB <sub>B</sub>	40,0 (3,0)	50,9 (5,5)	30,6 (0,07)	40,3 (2,9)	32,2 (0,3)
dB <sub>C</sub>	49,0 (3,0)	57,0 (7,8)	43,0 (1,3)	49,0 (5,4)	41,0 (3,2)

The exposed group was divided into a low exposed group (E<sub>L</sub>) comprising houses in area A and M and with an average level of 26.8 dBA, 39.6 dB<sub>B</sub> and a high exposed group (E<sub>H</sub>) (33.6 dBA, 51.5 dB<sub>B</sub>), comprising houses in area A. The noise levels for the controls (C) were < 24 dBA, and < 33 dB<sub>B</sub>.

## RESULTS

Figure 1 and 2 shows the average third octave band levels exceeding the normal hearing threshold (ISO 226 1987) of the frequency noise spectra < 200 Hz, for the different exposure groups in area A and M.

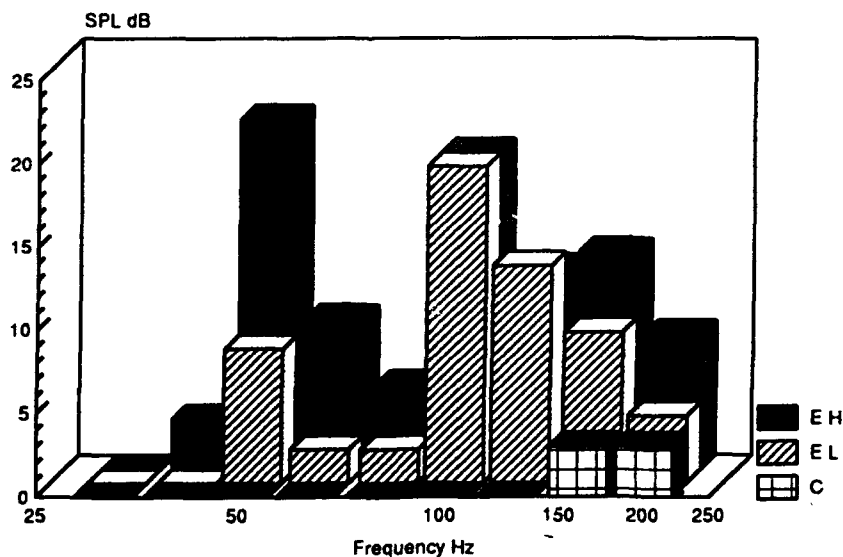

Figure 1. Third octave band levels exceeding the hearing threshold (ISO 226 1987) for exposed and controls in area A



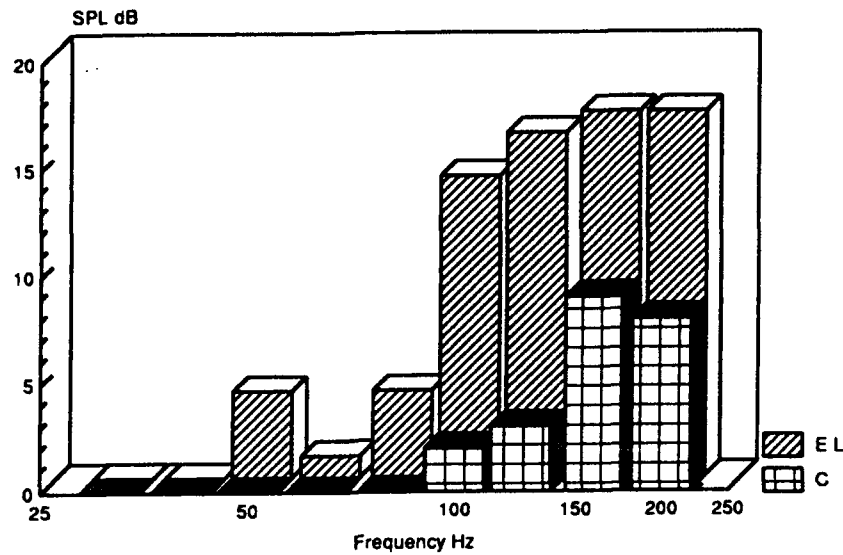

Figure 2. Third octave band levels exceeding the hearing threshold (ISO 226 1987) for exposed and controls in area M.

The exposure noises in both areas were dominated by low frequencies. In area A there were dominating frequencies around 50 and 100 Hz in E<sub>H</sub> and around 100 Hz in E<sub>L</sub>, while in area M the dominating sound pressure levels were in the range of 100 to 200 Hz. In both areas the sound pressure levels in the low frequency range clearly exceeded the normal hearing threshold.

The proportions of respondents reporting "rather" or "very": annoyed, disturbed rest/relaxation and disturbed concentration due to noise from the heat pump is shown in figure 3. Both areas are combined and divided into E<sub>H</sub>, E<sub>L</sub> and controls.

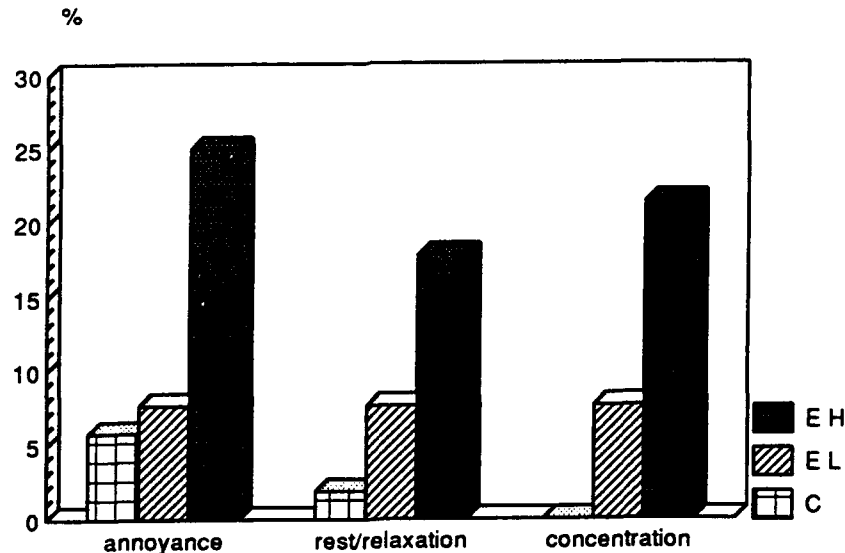

Figure 3. The proportion of respondents reporting "rather" or "very" on different annoyance reactions, due to heat pump noise.

The proportion of annoyance reactions increased with noise levels. In E<sub>H</sub> there were significantly

higher proportions reporting "rather" or "very" annoyed, disturbed rest/relaxation (  $p < 0.05$ ) and concentration ( $p < 0.01$ ) due to noise from heat-pumps as compared to the controls. In the (E<sub>L</sub>) there were few people reporting annoyance reactions.

No differences were found between exposed and controls regarding PSW or sleep disturbances.

Among the people who were "rather" or "very" annoyed due to noise from the heat pump, there was a tendency to a total higher value on psycho-social symptoms, particularly in relation to mental tiredness (  $p < 0.05$ ). They also reported more daily symptoms (unnatural tiredness ( $p < 0.05$ ) and a tendency to be easily irritated ( $p = 0.09$ )).

There was a significant dose response relationship between reported annoyance and noise levels. For the average degree of annoyance the correlation was 0.91 for dBB, respective 0.81 for dBA ( $p < 0.05$ ).

## CONCLUSION

The results show that long term exposure to LFN can cause annoyance, and disturb rest and concentration, at an average level of 33 dBA, 51.5 dBB in a domestic environment.

People who are "rather" or "very" annoyed due to noise from heat-pumps, had more daily symptoms, and a tendency to a higher degree of psycho-social symptoms in general.

There is a need to confirm these findings in a study on a larger population and with a wider variation of exposure.

## REFERENCES

*K. Persson and R. Rylander (1988)* Disturbance from low frequency noise in the environment - a survey among the local health and environmental health authorities in Sweden. *Journal of Sound and Vibration* 121, 339-345.

*International Standard Organization, ISO 226: (1987)* Normal equal-loudness contours for pure tones and normal threshold of hearing under free field listening conditions.

# ANALYSIS OF THE EFFECT OF VIBRATION ON ROAD TRAFFIC NOISE ANNOYANCE

SATO Tetsumi

Faculty of Engineering, Hokkaido Gakuin University  
Minami 10-chome, Sapporo, 064 Japan

The purpose of this study is to evaluate the contribution of the road traffic vibrations to the noise annoyance by using the surveyed data in Sapporo. Path analysis was used to estimate the direct and indirect effects of sixteen independent variables on noise annoyance. The principal findings are as follows: 1) The strong direct effects are found for disturbance of falling asleep, bothersomeness of vibration, noise level presented by  $Leq(24)$  and awakening. 2) Vibration level presented by VL10 has the strong indirect effect on noise annoyance. 3) The effect of 10dB of VL10 on noise annoyance is equal to that of about 3.5dBA of  $Leq(24)$ .

## 1. INTRODUCTION

The road traffic noise is one of the most harmful factor of the urban environment. Equivalent Sound Level ( $Leq$ ) is frequently used as the rating scale of road traffic noises, but there are many non-auditory factors which influence the noise annoyance. Among them, vibration is an important factor because most noise sources simultaneously cause vibration. In previous study (ref.1), the author showed the existence of the effect of vibration on road traffic and railway noise annoyance. The purpose of this study is to evaluate the contribution of the road traffic vibrations to the noise annoyance responses of residents in the community.

## 2. METHOD AND RESULT OF SURVEY

Three series of social surveys on road traffic noise and vibration were carried out in 1984, 1989 and 1990. Thirty-two residential areas in Sapporo City were selected as the target areas. In each area, two or three blocks containing about ten houses were selected where the distances from traffic roads were nearly equal. The number of blocks totaled 94. An example is shown in Fig. 1. The surveyed houses were all detached wooden structures and the total number of effective respondents was 584 (66.1% recovery).

The survey comprised attitude interviews and physical measurements. Key questions were about the annoyance of road traffic noise and how bothersome the road traffic vibrations are. These were answered on a five-point category scale (not at all, not so much, slightly, fairly, very).

After the interviews were completed, physical measurements were carried out both in terms of noise exposure levels and vibration levels (measured only vertical direction on the ground). These levels were measured at one outdoor position in each block as shown in Fig. 1.

Fig. 2 shows the relationship between the noise levels presented by  $Leq(24)$  and the vibration levels presented by VL10 for the 32 surveyed areas (94 blocks). The data are widely scattered around the axes of  $Leq(24)$  and VL10.

### 3. DISCUSSION

Taking notice of the fact that causal relations existed among the variables, a path analysis was performed on road traffic noise annoyance. Path analyses were successfully used in noise evaluation studies by Taylor(ref.2), Izumi(ref.3) and so on.

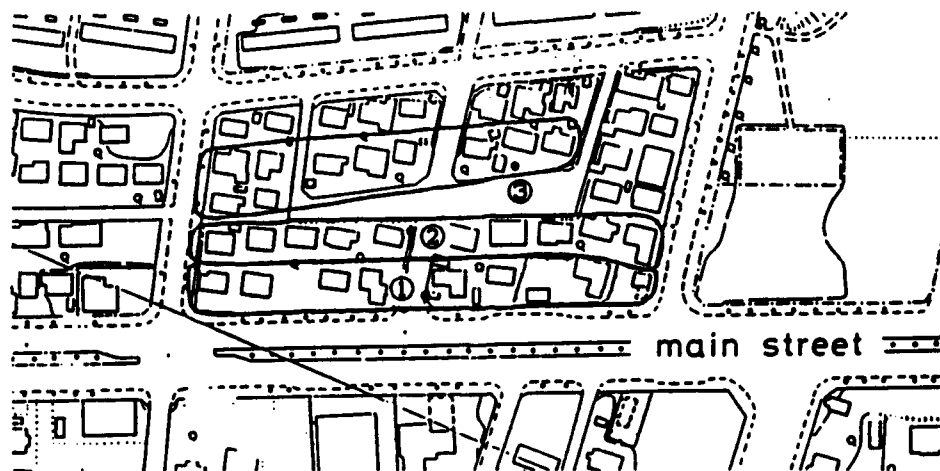

Fig. 1. An example of the surveyed area. This area was divided into three blocks and the physical measurements were carried out at positions 1, 2 and 3.

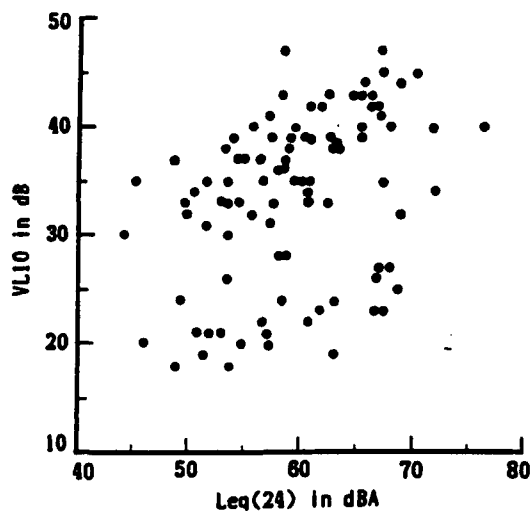

Fig. 2. Comparison of road traffic noise levels and vibration levels in each area (94 blocks).

Fig. 3 shows a primary model using seven personal or physical items as exogenous variables and nine questionnaire items on activity disturbance and related effects as endogenous variables. The most important point of this model is how to interpret the causal relation between vibration level and noise annoyance. Since the assumption that the vibration level causes directly noise annoyance is generally unreasonable, the author thought that the vibration level should be indirectly linked to noise annoyance through bothersomeness of vibration as endogenous variable. The first path links "vibration level" to "bothersomeness of vibration" and the second path links "bothersomeness of vibration" to "noise annoyance". The second path can be interpreted that the subjective attitude against the noise sources of respondent who is bothered by vibration causes annoyance response to noise. This model explained 54.3% of the variation in annoyance responses. Among the paths in this model, some were statistically proved to be not significant. A revised model as shown in Fig. 4 was made by excluding non-significant paths. The revised and simplified model explained 51.0% of the variation.

Table 1 shows the summary of effects on road traffic noise annoyance for the revised model. This table shows that the strong direct effects exist for disturbance of falling asleep, bothersomeness of vibration, noise level presented by  $Leq(24)$  and awakening; and vibration level presented by VL10 has the strong indirect effect on noise annoyance. It also shows that one standard deviation of  $Leq(24)$  has the direct effect of 0.230 measured by standard deviation, the indirect effect of 0.057 and the total effect of 0.287 on noise annoyance. In other words, in order to increase the noise annoyance by one standard deviation,  $Leq(24)$  should be increased by  $(1/0.287)=3.48$  measured by standard deviation. As the standard deviation of  $Leq(24)$  is 6.76dBA, the  $Leq(24)$  value is equal to  $(3.48 \times 6.76)=23.5$ dBA. As the same manner, in order to increase the noise annoyance by one standard deviation, VL10 should be increased by  $(1/0.116)=8.62$  measured by standard deviation. As the standard deviation of VL10 is 7.90dB, the VL10 value is equal to  $(8.62 \times 7.90)=68.1$ dB. Therefore the effect of 68.1dB of VL10 on noise annoyance is equal to that of 23.5dBA of  $Leq(24)$ . The ratio of these values (68.1:23.5) can be simplified as 10:3.5.

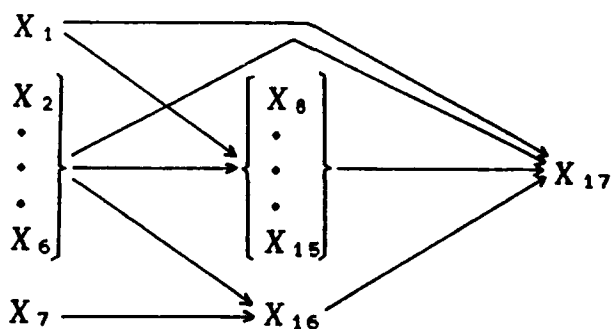

Fig. 3. Path model of road traffic noise annoyance. X1, Noise level presented by  $Leq(24)$ ; X2-X6, personal characteristics; X7, vibration level presented by VL10; X8-X15, activity disturbance and related effects; X16, bothersomeness due to road traffic vibration; X17, road traffic noise annoyance.

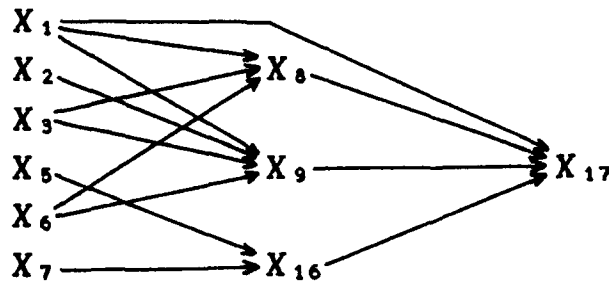

Fig. 4. Revised path model of road traffic noise annoyance.

Table 1. Summary of effects on road traffic noise annoyance for revised model.

Dependent variable	Independent variables	Direct effect	Indirect effect	Total effect
(X17) Road traffic noise annoyance	(X1) Leq(24)	.230	.057	.287
	(X2) Age	-	.025	.025
	(X3) Sex	-	-.059	-.059
	(X5) Length of residence	-	.044	.044
	(X6) Employment status	-	.051	.051
	(X7) VL10	-	.116	.116
	(X8) Disturbance of falling asleep	.310	-	.310
	(X9) Awakenings	.172	-	.172
	(X16) Botheredness due to road traffic vibration	.285	-	.285

#### 4. CONCLUSION

Surveys on the community response to road traffic noise and vibration were conducted. The principal findings are as follows: 1) The strong direct effects are found for disturbance of falling asleep, bothersomeness of vibration, noise level presented by Leq(24) and awakening. 2) Vibration level presented by VL10 has the strong indirect effect on noise annoyance. 3) The effect of 10dB of VL10 on noise annoyance is equal to that of about 3.5dBA of Leq(24).

#### REFERENCES

- 1) T. Sato, Proc. Inter-Noise 90, 1339 (1990).
- 2) S. M. Taylor, J. Sound Vib., 96(2), 243 (1984).
- 3) K. Izumi and T. Yano, Proc. Inter-Noise 90, 279 (1990).

# COMMUNITY RESPONSE TO LOW FREQUENCY NOISE FROM AN URBAN LIGHT RAIL SYSTEM

SHIELD Bridget and ZHUKOV Alexey

School of Engineering Systems and Design  
South Bank University  
London SE1 0AA

## ABSTRACT

The Docklands Light Railway (DLR) in London has given rise to many complaints of noise annoyance among local residents. A social survey has been carried out in order to examine the relationship between noise levels and community response along the DLR. A preliminary noise survey suggested that the most serious cause of complaints was the low frequency noise which occurred when the trains passed over lightweight viaducts. A further aim of the social survey was to attempt to establish whether low frequency noise was a particular cause of annoyance, and whether dB(A) was a suitable unit for the prediction of community response in this case.

## INTRODUCTION

The Docklands Light Railway (DLR) in London, which opened in 1987, was the first urban light transit system to be operated in the United Kingdom. Previous papers [1,2] have described the noise annoyance caused by the railway, in particular the serious disturbance caused by the high levels of low frequency noise which occur near to the lightweight steel and concrete viaducts. A social survey and noise survey have been carried out in residential areas along the route of the DLR in order to determine the extent of annoyance and to investigate more thoroughly the relationship between noise levels and community response.

The noise specifications for most transport systems are currently expressed in terms of  $L_{Aeq}$ . It has been argued previously [2] that the use of dB(A) and  $L_{Aeq}$  might not be appropriate for the prediction of community response to noise in cases where there are high levels of low frequency noise. It was hoped that the results of this survey would enable some conclusions relating to the use of dB(A) in such cases to be drawn.

## THE SURVEY

Sixteen residential sites along the railway were chosen for the questionnaire survey and noise survey. The questionnaire was designed to elicit information relating to the type and extent of annoyance and interference caused by the noise from the DLR. Valid questionnaire responses were obtained from 149 residents.

The noise survey consisted of recording the noise of several

trains passing each site. From the recordings the average third octave spectrum of the train passes at each site was determined, and the level corresponding to the average spectrum calculated. The third octave spectrum which gave rise to the highest level measured in linear dB was also noted. The 24 hour  $L_{eq}$  was calculated from the measured single event levels. All the sound levels of interest were expressed in linear dB, dB(A), dB(B) and dB(C).

## RESULTS OF THE SURVEY

**Annoyance and interference** Analysis of the questionnaire responses showed that 68% of respondents were annoyed to some extent by noise from DLR trains; 27% being 'very much annoyed', 21% 'moderately annoyed' and 20% 'a little annoyed'. Interference by the noise with everyday activities such as watching television or listening to music was also reported, 71% of respondents experiencing some interference. 26% of respondents also complained of sleep disturbance due to the train noise.

**Noise levels** The average train noise levels ranged from 60 to 71 dB(A), and from 71 to 82 dB(linear), the differences between the average levels at each site measured in dB(A) and linear dB ranging from 5 to 17 dB. The 24 hour  $L_{eq}$  levels ranged from 46 to 56 dB(A), and from 56 to 70 dB(linear).

At some sites, notably those near the lightweight viaducts, the noise spectra showed high peaks in the 50 Hz to 125 Hz third octave bands. At other sites such as those where the trains run on ground level ballasted track the spectra are relatively flat at frequencies up to approximately 1000 Hz [3].

## CORRELATIONS BETWEEN NOISE LEVELS AND RESPONSE

The questionnaire responses for each site were averaged to give one set of response data per site. The average annoyance scores, the number of people annoyed and the number of people affected in any way by the noise were correlated with the averaged noise level ( $L_{av}$ ), the 24 hour  $L_{eq}$  and the maximum noise level ( $L_{max}$ ) expressed in linear dB, dB(A), dB(B) and dB(C). The correlation coefficients obtained are shown in Tables 1, 2, and 3.

It can be seen that in all cases the highest correlations occur when the noise level is expressed in linear dB or dB(C), and the lowest when the A weighting network is used. This would indicate that it is the low frequency content of the sound that causes most annoyance. It also suggests that the use of dB(A) is not appropriate for the prediction of community response to such noise.

It can also be seen that the noise level which correlates most highly with all the disturbance indicators is the average level,  $L_{av}$ , expressed in linear dB.

## COMPARISON WITH OTHER SURVEYS

Figure 1 shows the regression lines of the  $L_{eq,24}$ /annoyance relationship for all the DLR sites (line 1), for those sites where the noise is predominantly low frequency (line 2) and for the sites where the noise is characterised by a relatively flat



spectrum (line 3). Also shown is the regression line of the Fields and Walker study of response to rail noise [4], line 4.

It can be seen that whereas there is a considerable difference between the Fields and Walker line and the line for all the DLR sites, the line for the 'flat spectra' DLR sites corresponds closely with that of the Fields and Walker survey. Furthermore the regression equation quoted by Fields and Walker for diesel trains, which have a greater low frequency content than other types of train, is very similar to that for all the DLR sites when the noise levels in both cases are expressed in linear dB.

It has also been shown previously [4] that the slope of the overall DLR regression line is very similar to that of a survey of response to noise from heavy road traffic, which also has a significant low frequency content.

#### CONCLUSIONS

It has been shown that a considerable amount of annoyance can be caused to a local community by the noise from an urban light transit system. It is therefore essential that the noise implications should be considered in the planning and design of future systems. It would also appear that, when high levels of low frequency noise occur, the A-weighted decibel may not be the most appropriate unit for use in specifying noise levels so as to minimise disturbance to the local community.

#### ACKNOWLEDGEMENTS

The authors would like to thank the Science and Engineering Research Council for funding this work.

#### REFERENCES

1. Shield B.M., Roberts J.P. and Vuillermoz M.L. Noise and the Docklands Light Railway. Applied Acoustics 26(4) (1989).
2. Shield B.M., Roberts J.P. and Vuillermoz M.L. Noise from the Docklands Light Railway - is  $L_{Aeq}$  a Suitable Measure? Proc. IOA 10(2) (1988).
3. Shield B.M. and Zhukov A.N. Correlation between annoyance and noise level on an urban light rail system. Euronoise '92, Proc. IOA 14(4) (1992).
4. Fields J.M. and Walker J.G. The response to railway noise in residential areas in Great Britain. Journal of Sound and Vibration, Vol 85 (2) (1982).

**Table 1**  
Correlation coefficients between annoyance score and noise levels

Level\Weighting	Linear	A	B	C
Lav	0.54	0.32	0.42	0.53
Leq (24h)	0.43	0.27	0.32	0.41
Lmax	0.39	0.09	0.30	0.39

**Table 2**  
Correlation coefficients between numbers annoyed and noise levels

Level\Weighting	Linear	A	B	C
Lav	0.58	0.37	0.44	0.55
Leq (24h)	0.46	0.31	0.34	0.44
Lmax	0.51	0.13	0.38	0.50

**Table 3**  
Correlation coefficients between numbers affected and noise levels

Level\Weighting	Linear	A	B	C
Lav	0.59	0.30	0.46	0.58
Leq (24h)	0.49	0.25	0.37	0.48
Lmax	0.41	0.19	0.38	0.42

**Figure 1** Noise/annoyance regression lines

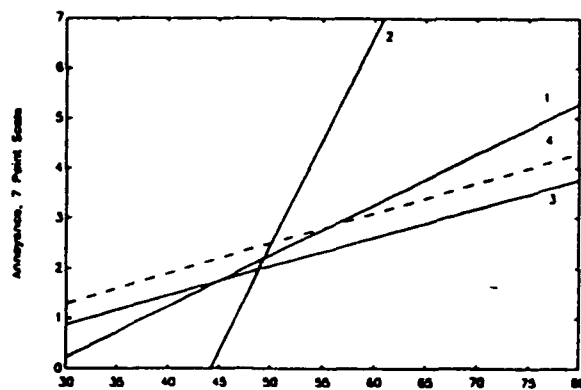

$L_{Aeq} - 24 \text{ Hour (dB)}$

# THE SONIC ABILITIES OF CITY DWELLERS

THIBAUD Jean-Paul

CRESSON (ura CNRS 1268)  
Ecole d'Architecture de Grenoble  
10, Galerie des Baladins  
381000 Grenoble

## Abstract

This article presents the interdisciplinary notion of "sound effect", and demonstrates how it relates to the sonic abilities of urban space users. The "gap effect" is used to illustrate the existence of sonic phenomena which can be understood within their event-related and situational dimensions.

## Résumé

Cet article vise à rendre compte d'une notion interdisciplinaire - celle d'*effet sonore* - et à montrer en quoi elle permet de rendre compte des savoir-faire sonores de l'utilisateur de l'espace urbain. L'"effet de créneau" est pris en exemple pour illustrer l'existence de phénomènes sonores qui ne prennent de sens qu'à partir du moment où il sont saisis dans leur dimension événementielle et située.

Between the two kinds of research devoted to sound within its environment - the predominantly technical ones that regard it as a nuisance against which protection is needed and the chiefly aesthetic one through the approaches of musicology and ethnomusicology - a third path has recently opened up, which aims to develop, in a more fundamental way, the anthropology of sound. The work carried out by the CRESSON Team (Research Center for Acoustic Space and Urban Environment) in France and the recent emergence of concepts such as 'soundscape' <sup>1</sup>, 'acoustic comfort' and 'sonic culture' <sup>2</sup> demonstrate this development.

This new approach questions how to identify the dweller's ordinary sonic culture, and which tool is used to analyze the complexity of the sonic urban environment. Referring to sonic culture implies that the dweller is not a simple receiver which reacts to stimuli, but that he develops an active listening and knows how to be heard. In other words, he possesses phonic abilities. This article presents the interdisciplinary notion of "sound effect", and demonstrates how it relates to the sonic know-how of urban space users. As we shall see, sound effect helps to understand daily sonic practice. It also articulates perceptions and

---

<sup>1</sup> MURRAY-SCHAFFER R. (1975), *The Tuning of the World*, New York, A. Knopf Inc.

<sup>2</sup> Actes du Colloque International *La Qualité sonore des Espaces Habités/Sonic Quality in the Living Environment* (1992), Grenoble, CRESSON

acoustical and spatial characteristics of the urban environment <sup>3</sup>. The "gap et. used to illustrate and define the notion of sound effect.

Let us explore an example stemming from research performed at the CRESSON labor. We have observed that in large residential buildings, mothers who call to their children from the window cry out in a high-pitched voice which benefit from the best directivity of these frequencies. Within this acoustical context, the sonic actor chooses his signal within a range of frequency even if the global sound level doesn't emerge from background noise, the predominant frequency is perceived and attracts attention (cf. diagram 1).

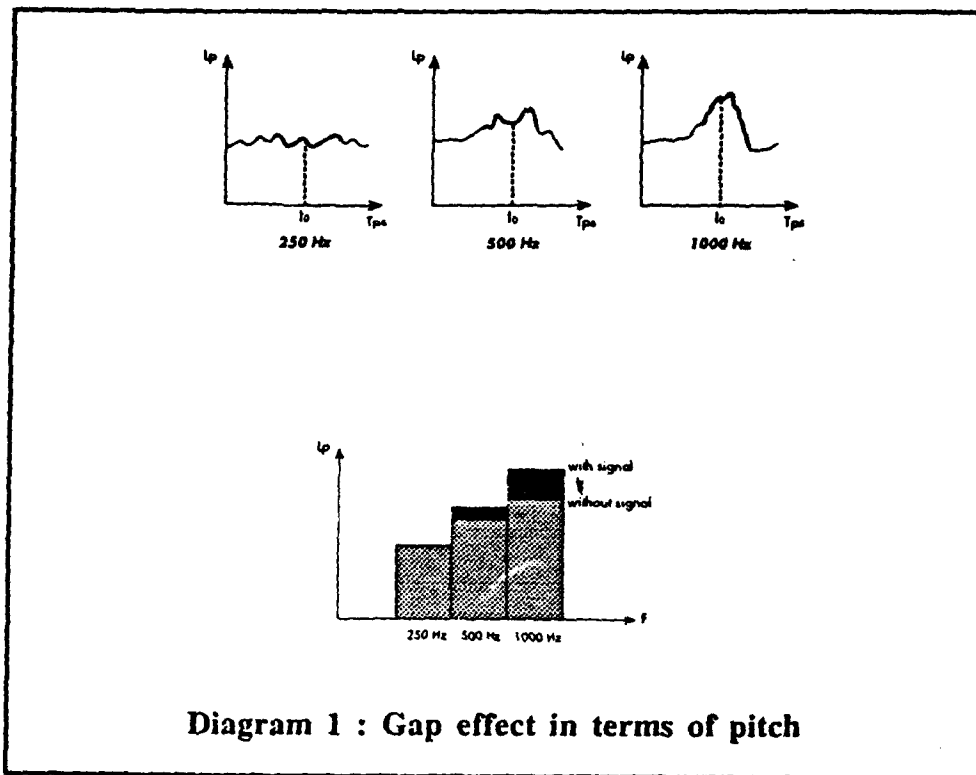

**Diagram 1 : Gap effect in terms of pitch**

In this case, the goal is to increase the efficiency of the signal within the range of frequency considered. This sonic phenomena named the "gap effect", is observed in numerous other urban situations. Other examples include the street singer who uses his voice in a range which provides an optimal output (optimal vocal fatigue for maximal listening). In a more general manner, the "gap effect" involves the different parameters of physical acoustics: pitch, but also intensity and duration. In terms of gap intensity, the sonic actor uses a situation in which a temporary lowering of the acoustic level allows him to send a signal to his listener. This is the case of a passer-by on the street who takes advantage of a relatively calm moment in terms of the traffic flow and calls out to someone on the sidewalk. The rhythmic gap is often found in professional environments. For example, the coppersmith profession is a typical example where socio-cultural practice is constrained to a small number of people. The blow of each hammer should be heard independently from other types of

<sup>3</sup> The notion of sound effect was developed by Jean-François Augoyard and elaborated by the team of CRESSON researchers. Please, refer to: Collectif CRESSON (sous la direction de Jean-François Augoyard) *Répertoire des effets sonores*, (to be published) for a more detailed description of this work.

hammering in order to check the quality of the blow, in which there is a rather pronounced almost planned rhythmic rotation. In the same manner, on a construction worksite, the simple listening of the hammering rhythm and their alternation (hammering on a panel, on wood...) enabled workers to notice while listening to a cassette recorded on the worksite: "that's a worksite that works well, we can tell that the guys are competent and working "in sync" with each other" or "this is a bad worksite, we hear everything backwards" <sup>4</sup>. The examples illustrated above convey the constant interaction between sound as physical reference which can be evaluated, but never abstract, and its interpretation or the particular modeling in which it becomes perceived. The sonic actors have the ability to appropriate the diverse physical components of sound in their environment.

Nevertheless, this presentation would be incomplete if we didn't show the significance of morphological and architectural factors in the phonic activity of city dwellers. In fact, the sonic actor also knows how to use acoustical dissemination by fully utilizing the space in which he is located. He sometimes uses a preferred acoustical area (wall, vault...) which reinforces, by the game of different reflections, the sound going to the listeners. For example, the location where adolescents "hang out" in the housing units of the 1950's correspond to a place of privileged dissemination, a genuine tool for communication from a distance. Adolescents use the acoustical characteristics of the space they appropriate to communicate with each other at far distances. This situation is linked to the reverberation in order to amplify, favor or simply allow the realization of the gap effect. The latter can also be linked to specific geometry of the location. The sonic actor places himself in a geometrically favorable sonic situation to maintain a maximal sonic level as long as possible. For example, we have observed that street musicians and singers always stand in areas where the surrounding architecture reinforces their music: in a large paved square and in front of a reflecting wall for a flute player in the square of the Palais des Papes in Avignon, or at the intersection of shops in the halls of the metro, in Paris. The choice of placement could highlight the best acoustical dissemination possible of sonic waves by focalizing or reinforcement. Thus, in a double half-circle shaped building (Galerie de l'Arlequin in Grenoble, France), which is quite high (8 to 12 stories), an association started a collection effort for a family who were victims of a fire. The "speaker" is situated with his loud speaker at successive points S and S' and orients this device in each direction (cf. diagram 2).

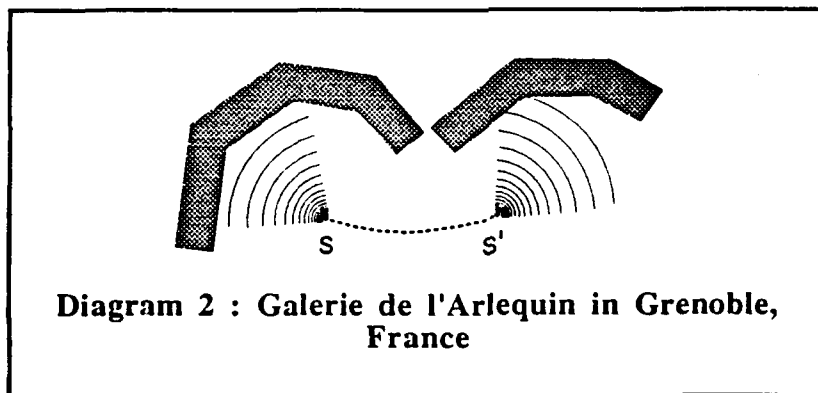

The gap effect is one example among other sound effects. It can be defined as an occurrence of sound emission when there is the most favorable context. When we refer to context, we mean the event-related context (opportunity linked to the moment) and the spatial context (opportunity linked to the area: layout, morphology). By using the example of the "gap

<sup>4</sup> THIBAUD, J.P. et al. (1990) *A l'écoute du chantier. des productions sonores aux modes de prévention*, Paris, CRESSON/Plan Construction et Architecture, Collection Recherches

effect", I wanted to show that sonic phenomena shapes and gives substance to human relationships and that these phenomena require the acknowledgement of the contextual dimensions of acoustical data.

If sound effect shouldn't be considered a concept taken in the strict meaning of the term, it seems particularly relevant as a tool to designate the physical elements of the sonic environment perceived within their event-related and locational dimensions. Over a long period of time, the field of acoustics has used the notion of "effect". The most well-known is part of the general culture (the Doppler effect, the Haas effect, the mask effect). Modern physics makes a place for this phenomena of modal and circumstantial nature. The Doppler effect like the cocktail effect or the Lombard effect results from an ensemble of conditions related to the existence of the object and its way of surfacing at a given moment. As a perceptible item, sound is immediately linked to a circumstantial cause. In other words, it is linked to the characteristics of the constructed environment and the conditions of hearing and listening (filtering, anamorphoses, the place of the listener, etc.). The sonic effect is not an object in itself but rather a manifestation of a phenomena which accompanies the existence of the object. For example, noise or sound doesn't change physically in the Doppler effect. It's the perceptible relationship between the observer and the emerging object which is modified, whether it be one or the other of the two which moves about at a great enough speed.

The sonic effect with a paradigm value. This is an idea half-way between universal and singular, both model and guide, it encourages a general discussion about sound, but it can't avoid examples. Instead of defining objects in a closed manner, it designates a class of phenomena by giving precise indications about their nature and by describing their dimension or their instrument. Without reducing it to an exclusively objective factor nor to an exclusively subjective one, the sonic effect ensures an encounter, an interaction between acoustic parameters, built environment and the soundscape of a cultural community.

Thus, within this definition, the sonic effect is a possible tool used to analyze urban acoustics and sonic practice. An analysis of sonic effects provides an access which respects the complexity of phenomena *in situ* and allows us to acknowledge phonic activities of dwellers in their daily experiences.

# EVALUATION OF LOUDNESS OF VARIOUS NOISES IN FREE AND DIFFUSE SOUND FIELD

TURUNEN-RISE I. and FLOTTORP G.

Det Audiologiske Institutt  
Rikshospitalet, Pilestredet 32, 0027 Oslo, Norway

In purpose to find a better measure between the subjective perceived noise and the objective measures used today, psychoacoustic experiments have been performed in free and diffuse sound field by using a method of magnitude estimation.

Various types of recorded noises from different work places, outdoors from transportation and synthetic noise, have been presented to test subjects in six separate test sequences, each lasting about 27 min. Two 27 min sequences with a pause of about 15 min were presented at three different days. The test sequences consisted of pairs of reference sound and test noise arranged in a specific manner with short pauses. The test noises lasted 1 s (industrial and other) or 10 s (transportation) with 50 ms rise and fall times and were presented at three different levels and in random order.

Totally about 60 (males and females, half of each) test subjects at three different age groups are used in the tests. The subjects have been instructed to give numerical values for their loudness impression of the noises by halving, doubling, tripling etc. on an infinite scale compared to the reference sound of filtered 1/3 octave bank pink noise with the constant sound pressure level (SPL) of 80 dBLIN, and given numerical value 100.

Some of the results of the subjective tests have been correlated with known objective measures. The results for constant synthesized noises with different frequency spectra have highly significant correlation between known measures like sone, phon, D-weighting and A-weighting and the median values of subjective evaluation of loudness. Correlation is best at high SPLs and for noises lasting 10 s. There seems to be little or no difference in the subjective evaluation of loudness in free and diffuse field.





**CHANGES IN THE ACOUSTIC ENVIRONMENT :  
NEED FOR AN EXTENSIVE EVALUATION OF ANNOYANCE  
A case of people living close to a noise barrier**

**VINCENT Bruno (\*) (\*\*) - CHAMPELOVIER Patricia (\*\*)**

(\*) Laboratoire d'Etude et d'Analyse de la Cognition et des Modèles  
Institut de Psychologie - Université Lyon 2  
Avenue Pierre Mendès-France, C.P. 11, 69676 BRON - FRANCE

(\*\*) Institut National de Recherche sur les Transports et leur Sécurité  
Avenue Salvador Allende. Case 24, 69675 BRON - FRANCE

## **SUMMARY**

The use of an annoyance index to determine annoyance from noise (for example, scaling) is pertinent in the context of legislation and in a stable acoustic environment. When change occurs a more qualitative approach becomes necessary to evaluate trends and variations. This paper is based on a survey of people living close to a motorway before and after noise abatement measures were taken. It was preceded by a laboratory study. The results show only a small reduction in annoyance level for a real reduction in noise level. However there is a clear change in lifestyles, modifications in behaviour patterns and statements relating to noise, leading to new perceptions and statements about the environment which up until then had been masked by the noise from the motorway. These modifications can be considered as indicators of annoyance evaluation. When a modification to the acoustic environment occurs, it is possible to confirm that the indices accounted for all the phenomena encountered.

## **RESUME**

L'utilisation d'un indice de gêne due au bruit (par exemple, les échelles) est pertinent dans le cadre d'une législation, ou dans le cadre d'un environnement acoustique stable. Face à une situation de changement, une approche plus qualitative devient nécessaire afin d'évaluer l'évolution et les variations de la gêne. Ce travail est issu d'une enquête menée avant et après protection, auprès de riverains d'une autoroute, précédée par une approche en laboratoire. Les résultats laissent apparaître une faible baisse de la gêne, compte tenu d'une réelle réduction du niveau de bruit. Par contre, apparaissent nettement une modification du vécu et une évolution des comportements et des représentations liés au bruit. Dès lors, émergent de nouvelles perceptions et représentations de l'environnement, jusqu'alors occultées par le bruit. Ces modifications peuvent être considérées comme des indicateurs d'évolution de la gêne. Face à une modification de l'environnement acoustique, une prise en compte de l'ensemble des indices de gêne se confirme bien.

## **INTRODUCTION**

Research carried out over the last 30 years into noise annoyance from land transportation has demonstrated great variations between individual annoyance levels as measured by scaling techniques. The 8 a.m. - 8 p.m. Leq only explains 40 % of this variation. Annoyance perceived does not seem to depend on the noise level alone but also on individual perceptions and most research undertaken up until now shows that the percentage of people affected by noise levels of 60 decibels (A) is growing strongly. These two points (extreme inter-individual variations in noise annoyance and the 60 dB (A) threshold) make it difficult to evaluate annoyance when noise is reduced by noise barriers, insulation of façades etc. Noise abatement measures do not eliminate all noise. At best they enable the 8.00am/8.00pm Leq to be maintained at around 60/65 dB (A) as required by French guidelines. At this noise level and for an average reduction of 5 to 10 dB (A), the annoyance expressed does not disappear for a significant percentage of people living close by. Our research examined noise annoyance to identify the existence of variations not revealed by the use of annoyance scales.

## METHODS AND RESULTS

Initially we examined different behavioural patterns related to noise to determine correlations. The analysis of these results enabled us to determine variations in annoyance more accurately. We used two methods : laboratory investigation and "in situ" research :

1) **Laboratory investigation** : Measurements were made in the laboratory of the effective noise in the room in which the subjects were placed. This is an optimised situation in which the noise that is measured is the noise effectively heard by the subjects. Subjects were asked to imagine the behaviour they would adopt when confronted with the noise.

Table 1 : Correlation between measured annoyance and behavioural indices

Behavioural indicators	close the windows	go into the garden	converse	sleep	read	jump
Correlation with annoyance	0.68	0.63	0.61	0.60	0.56	0.36

Annoyance correlates quite well with all the behavioural indicators. Annoyance indexes for speech and behaviour seem to evolve together - apart from "jump". This can be interpreted as an opposition between what can be considered as integrated forms of annoyance which are part of our daily lives - and which subjects can control to a certain extent (opening and closing windows, going into the garden or not) - and a more event-related type of annoyance such as "jump" which is not controlled and to which it is not easy to adapt.

Table 2 : Average annoyance depending on behavioural patterns which are "much" affected by noise

Behavioural indicators	Average annoyance score	Class <sup>1</sup> depending on the average annoyance score	Class <sup>2</sup> depending on the frequency of the behaviour
Jump	8	6	6
Converse	7.5	5	5
Windows	7	3	3
Garden	7.2	5	5
Read	7.4	5	5
Sleep	7	3	3

These data enable a classification to be made by ranking the order of the behavioural indices as a function of the "much" scores for verbal annoyance levels and the frequency at which they occur. "Jump" is the least common reaction to noise but is associated with high levels of annoyance and the highest noise. Closing the windows is an extremely common behavioural pattern when noise occurs and is associated with the lowest levels of annoyance and noise. Classification of the behavioural indicators<sup>3</sup> proposed enables distinction between voluntary patterns of behaviour in which subjects react in a dynamic way to a noisy environment (closing windows, not going into the garden, etc.). The common factor in these behavioural patterns is the possibility of controlling the situation to some extent by reducing exposure to noise. The opposite of these behavioural patterns is involuntary reflex behaviour (i.e "jumping"). In this case subjects have a passive relationship with their environment as they have no control over the noise. This type of reaction always gives rise to high perceived noise annoyance levels.

*This classification permits identification of all behavioural patterns that noise can induce in people living close to the source and show that what are conventionally considered to be annoyance indices do not reflect an intensity equivalent to the annoyance.*

<sup>1</sup> 1 is the lowest average annoyance, 6 is the highest average annoyance level

<sup>2</sup> 1 is the highest frequency, rank 6 is the lowest frequency

<sup>3</sup> Classification of behaviour which is "much" affected by noise : windows-sleeping-garden / reading-conversation-jumping.

2) **"in situ" annoyance** : an equivalent approach implemented by a questionnaire survey using a population of 300 people living close to a motorway enabled a virtually identical classification to be derived which distinguishes between adaptive behaviour patterns (closing windows) and induced behaviour patterns (jumping). There is a mean position in modified behaviour patterns but individuals retain some degree of control over these (going into the garden, increasing the volume of the T.V....). Conversely, the analysis in a real situation affects a different status to being woken up during the night to that identified in the laboratory in which the subjects were asked to imagine their reaction (i.e. opposing the real situation to the imaginary situation). Although it is infrequent to be awoken during the night the annoyance score for this occurrence is very high. In the context of an evaluation of variations in annoyance when protective measures are taken, these data, together with consideration of related indices, should improve the qualification of variations induced by reductions in noise levels.

### **APPLICATION IN A CONTEXT OF CHANGE**

Data based on two sites which were surveyed before and after protection (sample size : 75) enabled us to describe variations in annoyance and statements about change. Noise abatement measures included the erection of a glass and concrete noise barrier and the implementation of a low noise surface. The reduction in noise levels for each of the periods measured (morning, afternoon, meal-time, night...) over a 24 hours is stable (from 8 to 8.8 dB (A)). Analysis of the frequency spectrum shows extremely significant reductions in the 800 to 8000 Hz range. Reduction basically varies with distance from 10 to 3 dB (A) between 10 and 100 metres.

*Table 3 : Evolution of the noise level and the annoyance indexes before and after the implementation of the noise barrier.*

<b>INDICATORS</b>	<b>BEFORE</b>	<b>AFTER</b>
Leq 8h/20h (dB (A))	65.1	56.3
Annoyance level (Note/5)	3.25	2.97
Highly annoyed	22%	8%
Often or all the time annoyed	53%	39%
Acceptable noise level	64%	78%
Makes you jump	22%	9%
Makes you close the windows	75%	57%
Limits the use of the garden or the balcony	66%	35%
Makes you turn up the volume of your T.V.	33%	31%
Often disturbs sleep	13%	6%

The annoyance measurement scales show only a small reduction for a significant drop in noise levels. Fewer people (8% of the sample) find that annoyance is extreme. Furthermore, the frequency of behavioural patterns induced by noise is lower overall. It is interesting to note that behavioural patterns considered to represent high levels of annoyance (jumps, disturbed sleep) have decreased significantly. This drop also concerns adapting behavioural patterns (closing the windows, not using the garden).

*Table 4 : Changes in the perception of the environment*

<b>PERCEIVED ENVIRONMENT</b>	<b>BEFORE</b>	<b>AFTER</b>
The district is not very pleasant	8%	3%
Annoyances cited		
- odours	0%	6%
- dust	3%	9%
- other road noises	3%	12%
The motorway is considered to be		
- quiet	11%	9%
- clean	56%	77%
- safe	56%	62%
Miscellaneous noises	7%	10.8%
Neighbourhood noises	18%	40%

Table 4 shows trends in several environmental factors. Noise from the neighbourhood as well as other disturbances starts to emerge. The presence of a noise barrier leads to new perceptions : the population rediscovers an environment which was previously hidden by noise and sometimes this environment is not as peaceful as the inhabitants imagined.

Table 5 : *Expectations and actual experience of the noise barrier*

FACTORS	BEFORE	AFTER	COMMENTARIES
Effectiveness	73%	68%	Globally effectiveness meets expectations
Reduction in noise	80%	71%	Acoustic effectiveness drops by 9 points
Protection from dust	51%	20%	It protects less than expectations
Reduction in light	21%	10%	This worry was not confirmed
Stifling	15%	7%	It is less stifling than expected
Ugly	39%	22%	It is less ugly than expected
Functional	42%	53%	It simply becomes functional

This latter table enables us to understand the distance separating ideas before and after actual experience of the noise barrier. The noise barrier reduces noise levels and protects from dust less than expected. Its global effectiveness nevertheless meets expectations. Conversely, it is not as stifling nor as ugly as was expected. Nor does it cut out light (the noise barrier is made from concrete and glass). Statements concerning expectations revealed worries which were transformed by the reality into an "objective" perception : functionality is greater than was expected.

## CONCLUSIONS

Consideration of several indicators demonstrated changes in the qualitative perception of annoyances and the overall annoyance environment of people living the immediate area. It is probable that some of these new perceptions of the neighbourhood and of the appearance of the noise barrier had already been expressed by the annoyance scale which would explain the small variation occurring before and after the installation of the noise barrier. The annoyance scale alone would not enable evaluation of all the modifications to the environment and to perceptions resulting from reductions in road noise.

## REFERENCES

- LAMBERT (J), SIMMONET (F), *Patterns of behaviour in dwellings exposed to road traffic noise*. Journal of Sound and Vibration, 92 (2), pp 159-172, 1984.
- VINCENT (B) - CHAMPELOVIER (P) : *Attente et vécu des écrans acoustiques*
- EUROSYMPOSIUM - Maîtrise du bruit routier en milieu Urbain - 12-15 Mai 1992 - Nantes, FRANCE
- VINCENT (B) : "*Essai de modélisation de la gêne due au bruit*" Thèse de doctorat en Psychologie - Université Lyon 2 à paraître Septembre 1993.
- M. VALLET, M. MAURIN, J. LAMBERT et coll. *Effets du bruit de circulation automobile*. Note d'information n° 28, INRETS. 1983.

# **STARTLE RESPONSE TO IMPULSE SOUNDS PRODUCED BY SMALL AND LARGE FIREARMS**

VOS, Joos and VELTMAN, Johan A.

TNO Institute for Perception, Kampweg 5,  
3769 DE Soesterberg, The Netherlands

## **ABSTRACT**

In a simulated home environment, the human startle response was investigated for relatively high-level impulse sounds produced by two kinds of firearms. Subjective startle ratings and annoyance ratings were supplemented with eye-blink and heart-rate responses. The relations between the startle ratings and the autonomic responses turned out to be more complex than was expected.

## **INTRODUCTION**

Surveys of communities impacted by relatively high-level shooting sounds indicate that startle is one of the underlying causes of annoyance. In spite of a considerable number of experimental results reported in the literature, there is at present no model available to predict the startle response from the physical parameters of the sounds.

In the present laboratory study the human startle response is investigated for shooting sounds presented at indoor sound pressure levels of 80 and 90 dB(A,imp). Two categories of dependent variables were determined: a) subjective ratings (the degree of startle and annoyance experienced), and b) autonomic responses (muscular responses consisting of a number of typical involuntary contractions; heart-rate response). The nature and the degree of the startle reaction may depend on the kind of activity one is involved at. This issue was studied by including one group of subjects who performed a self-paced task which did not require continuous attention (reading in magazines), and a second group of subjects who performed an externally paced tracking task requiring continuous attention. Furthermore, we addressed questions such as habituation effects, the relationship between the subjective ratings and the autonomic responses, and the relation with annoyance ratings.

## **METHOD**

The sounds produced by the small firearms were based on a digital recording of the muzzle bang of a 7.62 mm gun; the rise time was 1 ms and most energy fell within a frequency band of 500 to 3000 Hz. The sounds produced by the large firearm were based on the recording of the muzzle bang of a 155 mm howitzer; the rise time was about 50 ms and the dominant spectral energy was found between 25 and 100 Hz. The sounds were presented via loudspeakers in a simulated home environment. Road-traffic sound and the sound of a personal computer served as continuously present background noise at an indoor level of 45 dB(A). Above 100 Hz, the level of the road-traffic sound decreased at a rate of about 9 dB/oct. The personal computer was used for instruction, the tracking task and/or data collection.

To determine eyeblinks, the electromyographic activity of the orbicularis oculi was recorded. From the R-waves in the electrocardiogram, the inter beat intervals (IBI) were determined. By means of interpolation, the IBI's were assigned to fixed moments in time in a period from 5 s before to 9.5 s after the onset of each bang.

There were four experimental blocks (bangs from the two types of firearms, presented at two different sound levels), each 20 min in duration, in which eight identical impulses were presented at pseudo-arbitrary points of time. One group of 16 subjects was asked to read in magazines, and a second group of 16 subjects performed a tracking task. The task of these subjects was to move a cursor (a small horizontal line with a gap in the middle) with a joystick in such a way that the track (upward moving saw-tooth patterns) passed right through the middle of the gap.

After each bang (reading task condition) or after the fourth and the eighth bang (tracking task condition) the subjects were asked to indicate the degree of annoyance and startle experienced by means of a 10-point rating scale labeled with "not at all" (0) and "extremely" (9). Twice per condition, all subjects also rated how annoyed they would be if they heard these sounds frequently at home in the living room.

## RESULTS

### *Subjective ratings*

Figs. 1a and 1c show that the startle ratings were highly affected by the level of the impulse sounds: averaged across the subjects, the 80 dB impulses yielded "a little" startle whereas a "moderate" startle rating was obtained for the 90 dB impulses. Neither the kind of task, nor the kind of firearm did significantly affect the startle rating. Figs. 1b and 1d show that also the annoyance ratings were highly affected by sound level. During the experiment the subjects in the reading task condition were much more annoyed than those in the tracking task condition. Independently of the task performed during the experimental sessions, all subjects expected to be highly annoyed by the sounds if heard at home. On the basis of the individual ratings of the 32 subjects for each of the four different stimulus conditions, correlation coefficients of about 0.70 were obtained between startle and annoyance ratings.

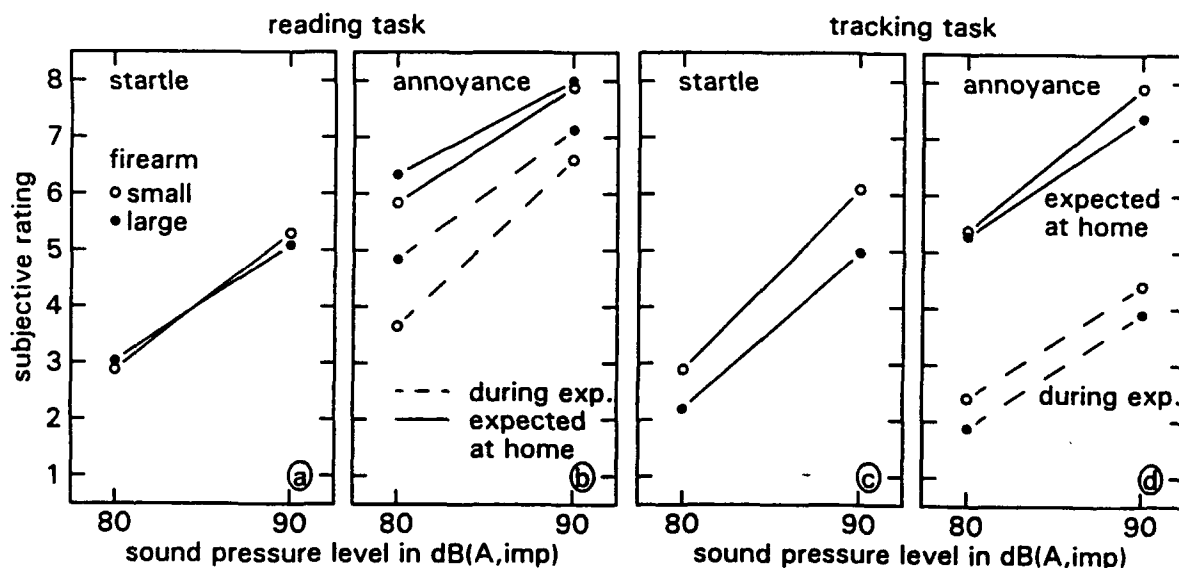

Fig. 1. Subjective startle and annoyance ratings for all conditions.

### Autonomic responses

From the electrocardiograms we determined the interpolated IBI for 30 successive 0.5 s intervals in a period from -5 to +9.5 s relative to the onset of each bang. Fig. 2 shows the results for the subjects in the reading task condition. Each mean value is based on 128 data (8 bangs presented to 16 subjects). The solid horizontal line in each panel of Fig. 2 represents the base line (the mean IBI for  $-5 \leq t \leq 0$  s). IBI's that were significantly different ( $p < 0.05$ ) from the base line (as determined with the help of analyses of variance) are indicated by filled circles.

The patterns in the results will be related to three types of responses frequently reported to be relevant to startle: the orienting, defense, and startle reactions [e.g., see Graham (1979)]. For the 80 dB impulses produced by the large firearm (Fig. 2b), a significant orienting reaction (an immediate increase of IBI) was obtained. For the small firearm (Fig. 2a), there was only a tendency for this effect to occur ( $p > 0.08$ ). In both conditions, the orienting reaction was followed by a defense reaction (a delayed decrease of IBI). The 90 dB sound produced by the small firearm (Fig. 2c) yielded a significant startle reaction (an immediate decrease of IBI). In the remaining condition (Fig. 2c) a defense reaction was obtained.

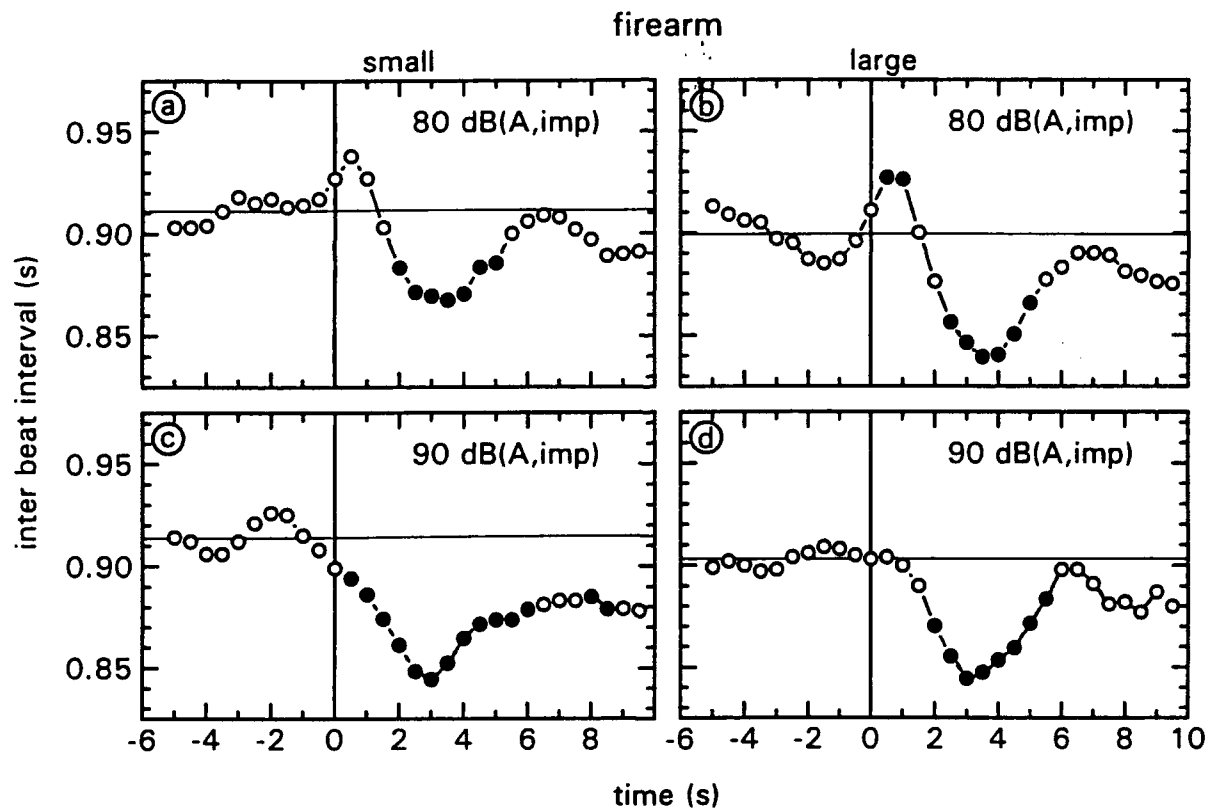

Fig. 2. Mean interpolated IBI's of the subjects who performed the reading task.

Except for a significant orienting reaction to the 80 dB impulses, the results in the tracking task condition (not shown) were quite different from those in the reading task condition: in no single condition were the mean IBI's after the impulses smaller than those in the base line, implying complete absence of defensive and startle reactions. In contrast, the 90 dB impulses yielded a delayed orienting reaction: 6-8 s after the bangs, a significant increase of IBI was found.

In general, the sounds produced by the small firearm resulted in more eye-blink reflexes (as determined within a 100 ms time window) than those produced by the large firearm. For the small firearm, the percentage of subjects who blinked in more than 50% of the cases was significantly affected by sound level. Moreover, these percentages were much higher in the tracking task condition (56% and 94%) than in the reading task condition (13% and 50%). For the sounds produced by the large firearm, the percentage of subjects blinking in more than 50% of the cases was very low (0% - 6%) and independent of task and sound level.

#### *Relationship between subjective startle rating and heart-rate response*

For the subjects who had performed the reading task two mean startle ratings (one based on the ratings given to the first four and the other based on those given to the second four bangs) for each of the four conditions were computed. Similarly, we determined the deviations of IBI for  $0.5 \leq t \leq 1.5$  s relative to their individual base lines. Recall that for this time period, a positive relative IBI represents the orienting response and a negative relative IBI represents the startle response. On the basis of their corresponding startle ratings, the relative IBI-values were assigned to one of three subjective startle classes: "not or a little startled" (0 - 2.3), "moderately startled" (2.3 - 5.6), and "considerably startled" (5.6 - 9). For the respective degrees of subjective startle, the mean relative IBI-values were 13, -0.5, and -19 ms. An analysis of variance indicated that the relative IBI-value significantly ( $p < 0.05$ ) decreased with the subjective startle rating.

### CONCLUSIONS

For relatively high-level shooting sounds, the rated degree of startle and the annoyance expected from these sounds if heard at home did neither depend on the kind of task nor on the kind of firearm by which the impulses were produced. These startle and annoyance ratings were highly correlated. The relations between the startle ratings and the autonomic responses turned out to be more complex than was anticipated. For example, a significant relationship between subjective startle and heart-rate response was found for the subjects in the reading task only. In addition, eye-blinks were frequently evoked by the impulses from the small firearm, whereas these responses occurred much less often for the other impulses. This finding was not consistent with the subjective ratings. To determine from which sound level startle reactions may first be expected, future experiments must be carried out for lower levels of the impulses.

### ACKNOWLEDGEMENTS

This research was supported by the Netherlands Ministry of Defence.

### REFERENCES

- Graham, F.K. (1979). Distinguishing among orienting, defense, and startle reflexes. In: H.D. Kimmel, E.G van Olst, and J.H. Orlebeke (Eds.), *The orienting reflex in humans* (Hilldale, NJ: Lawrence Erlbaum Associates) pp. 137-167.



# PREDICTION AND ASSESSMENT OF STRUCTURALLY-RADIATED NOISE WITHIN BUILDINGS

WALKER, John Gerard

Institute of Sound and Vibration Research  
University of Southampton  
Highfield, Southampton SO9 5NH

## Abstract

Information is available to relate subjective reactions to either noise or vibration for a variety of noise sources. Standards or guidelines have been defined which enable acceptable or allowable noise and vibration to be specified.

However, there is relatively little information about the specific problem of internal noise radiated by structural vibration within buildings. This is often referred to as ground-borne or structure-borne noise and commonly occurs in situations close to underground railway tunnels. Its spectral character is different from typical environmental noise as it is essentially low frequency sound, whereas airborne sound generally covers a much wider frequency spectrum.

A number of reports recommend methods for rating the impact of this type of noise, but there is as yet no international agreement on how best to describe and assess the noise.

The paper examines how structurally-radiated noise within buildings has been described; comparisons between the present methods of assessing the noise are made. A pilot laboratory study designed to identify potentially important characteristics of the noise is also described. It is anticipated that recommendations concerning the possible direction for the future will be made.

## Introduction

There is growing interest in environmental issues and in particular the impact of transportation developments on the quality of life of residents close to the roads, airports or railways. The noise and vibration created by transportation systems affects people and, whilst low levels of noise are unlikely to have any adverse effect, once the noise and vibration levels exceed a certain level they can annoy and disturb activities such as conversation, sleep and relaxation. Likewise vibration can be annoying and in extreme circumstances can cause concern that the structure of buildings may be damaged.

As a result, a great deal of information is available that allows the subjective reaction to be related to the level of noise for the different transportation modes. Standards or guidelines have been defined which enable maximum allowable levels of noise to be specified or which provide an indication of the potential reaction of people affected by the noise. These standards and guidelines refer specifically to sound propagated through the air from the source to the receiver. The most widely accepted and used measure of the noise is the equivalent continuous sound pressure level measured in dB(A) over specified periods of time. Some standards and guidelines may also specify the maximum level of noise.

In the same way, standards and guidelines exist for exposure of people and buildings to vibration generated by, for example, transportation systems or machines which is transmitted via the ground to the structures in which people or machinery are housed.

There is, however, little consistent information on the specific problem of noise radiated from vibrating building structures. This is often referred to as ground-borne noise or structure-borne noise. It is a phenomenon that is particularly likely to occur close to underground railway tunnels and it is assuming increasing importance with the growing number of metros and other railways systems which are being

developed and which will run in tunnels under urban areas. Structurally-radiated noise is different to normal airborne sound as it mainly comprises low frequency sound, normally in the range from about 25Hz to 200Hz, whereas airborne noise from a surface railway covers a much wider range from below 50Hz to above 5000Hz. There are no widely accepted standards for rating the impact of structurally-radiated sound, although a number of authors and organisations have recommended using either Noise Rating curves (ISO, 1971), Preferred Noise Criteria (Beranek, 1971), or the A-weighted sound level used by APTA (1981). NR and PNC curves were originally derived for rating continuous noises although corrections are available to the NR curves to allow for non-continuous noises, and the use of dB(A) to rate this type of noise has been questioned as the A-weighting network weights out or penalises noise at such low frequencies.

This paper considers how noise in buildings created by ground and structure-borne vibration from trains operating in tunnels might be assessed using the above-mentioned methods. A laboratory study designed to identify the particular characteristics of structurally-radiated noise that are most significant in determining annoyance, is currently being evaluated. Issues to be addressed in the analysis are identified in this paper.

### **Structurally-radiated noise levels within buildings**

Both the prediction of the structurally-radiated noise level and the assessment of any potential impact of the noise is imprecise. Not only is the vibration generated at the rail and the propagation of the vibration from a tunnel to a building difficult to predict but, in addition, the frequency characteristics of the structurally-radiated sound depends to a large extent on the type and construction of the building concerned. Vibration propagation from the railway track through the track structure, the tunnel and the ground to the foundations of a building depends upon the particular characteristics of each part of the propagation path, and particularly upon the characteristics of the ground and especially the amount of water it contains. Very low levels of vibration may well be imperceptible but there is still the possibility of audible low frequency sound being radiated by the building structure. Therefore, on occasions there may be no vibration problem but the potential for radiation of audible sound still remains.

In addition to the radiated sound, the vibration can cause small objects, window panes and structural fittings to vibrate. This phenomenon is often referred to as 'rattle' and it depends on the individual circumstances; it is impossible to define standards for this type of noise and it will not be considered further in this paper.

At the present time, the theoretical prediction of levels of vibration in a building is complex. Levels of ground vibration can be measured if the railway tunnel already exists. If not, it may be possible to use empirical data obtained for other similar situations or to combine empirical and the best theoretical methods to arrive at an estimate of the vibration level. In the same way, structurally-radiated sound can be predicted if precise details of the type of building structure are known; simpler, less precise methods, based on the relationship between vibration levels and noise, are available allowing the level of radiated sound to be predicted. Although this will not be exact for any particular situation, it could be used as an adequate guide.

### **Noise assessment**

An earlier paper (Walker and Ridler, 1991) examined the way in which each of the methods mentioned earlier (NR, PNC, dB(A)) assessed structurally-radiated noise from underground railway vibrations for a number of different environments (hotel bedroom, theatre, office, retail shops). A number of points emerged. Firstly, a range of levels is allowed under most of the guidelines, indicating that the specific situation is critical. Secondly, all guidelines suggest that, of the spaces considered, the theatre is the most sensitive building. Thirdly, the guidelines based upon the maximum A-weighted level are reasonably consistent. Fourthly, where comparison is possible, the predicted or measured NR and PNC

exceed the recommended levels by a greater margin than do the  $L_{Amax}$  recommendations, suggesting that the latter are the least strict. Finally, there may be definite advantages in presenting octave-band data as it indicates the "offending" frequencies if guidelines are exceeded.

Walker and Ridler concluded that, although the range of differences between the design aim for each method and the predicted noise level may not be too great, it was sufficient to affect significantly both the users of the buildings and those concerned with the construction of both new buildings and underground railways. More information was needed to improve our understanding of the effects of this type of noise on the users of enclosed spaces, in order to minimize these differences and to lead towards the derivation of the most appropriate assessment procedures.

It was as a result of this conclusion that a laboratory study was designed. Its specific purpose was to examine the influence of the low frequency characteristics as well as the overall noise level or responses. Subjects were asked to listen to noises that were simulated to reproduce the character of the noise created inside a room by structural vibration of the building when exposed to vibration from a railway tunnel. The noises were heard in a room specially designed to simulate a domestic living room. The temporal characteristic of the noise was constant, but three different spectra and three different noise levels were used.

Analysis of the data has recently begun; initial indications are that the level of the sound in the 30-50Hz range may be important in determining adverse response.

Further comment will be made on these findings at the Noise and Man Conference in July 1993.

However, with the growing developments in metro and railway systems which operate in tunnels below buildings, there is a need for more precise and widely-accepted methods of assessing the subjective reactions to this type of noise. It is hoped that the work mentioned above will assist in this task.

In order to achieve this, it is also essential that mathematical models for predicting the vibration generated and its propagation both through the ground and through building structures are improved, so that the precision of the predicted structurally-radiated noise levels can also be improved.

## References

International Organisation for Standardisation ISO/R 1996 (1971) Assessment of noise with respect to community noise.

L L Beranek, W E Blazier and J J Figwer (1971) J. Acoust. Soc. Am. 50, 1223-1228. Preferred Noise Criteria (PNC) curves and their application to rooms.

American Public Transit Association (1981) Guidelines for design of rapid transit facilities.

London Underground Ltd 1991 Promoter's memorandum on noise and vibration.

S A Ridler 1991 Proc IOA Spring Conference 1991. Structure-borne noise design aims in mixed developments.

J G Walker and S A Ridler (1991). Ground-borne noise from underground railways. Proc. IOA, Vol 13, Part 5, 1-5. Railway noise and vibration.



# REORGANIZATION OF AUDITORY CORTICAL MAPS CONSEQUENT ON UNILATERAL COCHLEAR DAMAGE IN ADULT MAMMALS

RAJAN, Ramesh and IRVINE, Dexter R. F.

Department of Psychology, Monash University, Clayton, VIC. 3168, Australia

In the auditory, somatosensory and visual systems, there is a topographic representation of the appropriate sensory epithelium in central nervous system (CNS) structures. These topographic representations ("maps") of the receptor surfaces in CNS sensory structures reflect the neuroanatomical connections. Hence, for many years these maps were believed to be modifiable in the developing animal in which neuroanatomical connectivity is malleable, but to be a relatively static feature of the mature nervous system. Over the last 10-15 years, however, a substantial body of evidence from the somatosensory system has demonstrated that elimination of input from a restricted region of the skin (and a variety of other alterations of sensory input) can result in substantial reorganization of the map of the body surface in the somatosensory cortex of adult animals. More recently, analogous reorganization has been described in adult visual and auditory cortex after restricted retinal and cochlear lesions, respectively.

In the auditory system, the topographic representation of the cochlea in CNS structures results in those structures being topographically organized with respect to frequency (i.e., tonotopically organized). A change in the representation of the cochlea in auditory cortex is therefore reflected in a change in tonotopic organization. The first demonstration of such reorganization in the adult auditory system was provided by Robertson and Irvine (*J.Comp.Neurol* 1989, Vol. 282), who examined the effects of restricted mechanical cochlear lesions in adult guinea pigs on the frequency organization of auditory cortex. The peripheral and central effects of the lesion were examined after recovery periods of 31-85 days. The loss in peripheral sensitivity produced by the lesion was assessed by measurements of cochlear neural sensitivity and by histological examination of the cochlea. Measurements of the threshold of the cochlear compound action potential (CAP) as a function of frequency (the CAP "audiogram") showed, in the majority of animals, a sharp notch of reduced sensitivity in the mid-frequency range from approximately 10 to 20 kHz. This loss of sensitivity was associated with a region of damaged or missing hair cells in the corresponding cochlear place. The frequency organization of auditory cortex in the hemisphere contralateral to the lesioned cochlea was examined using conventional microelectrode mapping techniques. At each recording site, the characteristic frequency (CF; frequency at which threshold is lowest) of a neuron cluster in the middle cortical layers was established using tone pulses presented to the lesioned ear via a sealed stimulating system. In these chronically lesioned animals, the region of cortex deprived of its normal input by the cochlear lesion was found to be wholly or partially occupied by expanded representations of lesion-edge frequencies (i.e., frequencies represented at the edge of the cochlear lesion). The thresholds at their new CFs of neuron clusters within these regions of expanded representation did not differ from normal thresholds at those frequencies. Expanded representations of this sort were not seen in acutely-lesioned guinea pigs in which the cortex was mapped within a few hours of the cochlear lesion, and hence reflect a reorganization of cortex during the recovery period rather than simply the residue of pre-lesion responses. This reorganization in auditory cortex is analogous to that seen in somatosensory cortex after digit amputation, and in visual cortex after restricted retinal lesions.

In this first study of adult auditory cortical reorganization after peripheral damage, the effects

of a unilateral cochlear lesion on the representation of the lesioned cochlea in the cortex contralateral to the lesion were determined. However, most auditory cortical neurons receive binaural input, i.e., both cochleas are topographically represented in each cerebral hemisphere. In normal animals, the contralateral and ipsilateral CFs of neurons excited by monaural stimulation of either ear are the same, so that the two frequency maps are in register. One question raised by Robertson and Irvine's data, therefore, concerns the fate of the representation of the normal ipsilateral cochlea in the cortex in which the representation of the contralateral lesioned cochlea has undergone reorganization. One possibility is that the representation of the ipsilateral cochlea is unchanged, such that the two frequency maps are out of register in the area in which the contralateral map is reorganized. An alternative possibility is that, despite normal ipsilateral input, the map of the ipsilateral cochlea might change to maintain the normal register between the two maps.

We have investigated this issue by determining the effects of unilateral restricted cochlear lesions in adult cats on the representations of the lesioned and normal cochleas in primary auditory cortex (area AI) contralateral to the lesioned cochlea. The basic experimental procedures used in these experiments were the same as those used in the chronically lesioned guinea pigs. One procedural difference arises from the fact that the cat's cochlea is embedded in temporal bone, and that mechanical lesions therefore had to be made by advancing a micropipette through the round window of the cochlea. Damage was consequently restricted to the basal end of the cochlea and, in all but one of the chronically lesioned cats, broad high-frequency lesions were produced, with edge frequencies in the range 18-24 kHz. Following the cochlear lesion, the cats were allowed to survive for periods from 2-11 months. They were then re-anaesthetised and cochlear sensitivity was measured in both ears before mapping AI contralateral to the lesioned cochlea.

In all cats with broad high-frequency losses in cochlear sensitivity, the effect on the frequency map of the lesioned ear in the contralateral cortex was similar to that observed in the guinea pig study. In each case, for frequencies with no losses in cochlear sensitivity, the AI CF map obtained with monaural stimulation of the lesioned contralateral ear showed the caudal-to-rostral, low-to-high-frequency gradient characteristic of normal animals. This normal tonotopic progression occurred for frequencies extending from the lowest CFs measured (<5 kHz), to frequencies at the edge of the cochlear lesion. However, in rostral regions of AI, in which the frequencies with losses in cochlear sensitivity would normally have been represented, there was now a large area within which all neural clusters had a CF at a frequency at the edge of the cochlear lesion, i.e., there was an expanded representation of the lesion-edge frequencies. This expanded representation of the lesion-edge frequency/frequencies occupied the rostral region of cortex in which the frequencies with elevated cochlear thresholds would normally have been represented.

In contrast, the map for stimulation of the ipsilateral ear in each of these animals was of the type seen in normal animals, with a normal rostral-to-caudal sequence of CFs from the lowest to the highest CFs measured. Most importantly, in the region of cortex occupied by an expanded representation of lesion-edge frequencies in the contralateral map, the ipsilateral maps showed a normal progressive increase of CF. The normality of ipsilateral CFs resulted in a lack of registration between the two maps only in the rostral region of cortex containing the expanded representation of contralateral lesion-edge frequencies.

In addition to determining the frequency organization of the map of the contralateral lesioned ear, quantitative data were also obtained on the thresholds and other characteristics of the responses to contralateral stimulation of neuron clusters in the region of the enlarged contralateral representation. These data were compared to data from control normal animals.

These data indicate unequivocally that the expansion of the representation of contralateral lesion-edge frequencies reflects a true reorganization during the post-lesion recovery period and that it cannot be explained in terms of the residue of pre-lesion responses (Rajan, Irvine, Wise, and Heil, submitted for publication).

Comparison of the other response properties of cortical neurons within the reorganized maps of the lesioned contralateral cochleas to normative data showed that the frequency "response areas" (tuning curves) were slightly less sharply-tuned than normal though the difference was generally not significant. Interestingly, response latencies in the reorganized regions of the contralateral map were significantly shorter than normal in three animals and significantly longer in one animal. The shorter latencies suggest that such reorganization may occur only in a sub-set of the pathways over which information is carried from the cochlear nuclei to higher auditory centres, (viz., the fast-conducting pathways).

The results of the guinea pig and cat studies indicate that reorganization of the cortical frequency map as a consequence of damage to a restricted region of the cochlea in adult animals is a general characteristic of the mammalian auditory system. The fact that such reorganization is seen at the cortex does not, however, mean that the primary locus at which reorganization occurs is at the cortex. In both the somatosensory and visual systems there is evidence for reorganization at subcortical levels, although there is uncertainty as to the extent to which cortical reorganization reflects changes at subcortical levels and the extent to which it involves intrinsic cortical processes. In the case of auditory cortical reorganization, the finding that changes in the representation of the lesioned contralateral cochlea occur without changes in the representation of the normal ipsilateral cochlea suggests that the changes seen in cortex must reflect reorganization in brainstem pathways. This conclusion arises from consideration of the fact that most binaural interaction occurs in brainstem pathways, and that the overwhelming majority of auditory thalamic and cortical neurons therefore receive binaural input. If cortical reorganization were to reflect changes in the efficacy of synapses made by either thalamo-cortical afferents or intra-cortical connections, the mechanisms postulated by most theories attributing cortical reorganization to intrinsic cortical processes, reorganization of the representation of the lesioned cochlea would be expected to be associated with changes in the representation of the unlesioned cochlea. These considerations, which have been developed in greater detail elsewhere (Rajan, Irvine, Wise and Heil, submitted for publication), suggest that the primary locus of the reorganization seen in our studies is a site at or before that at which binaural interaction occurs. This conclusion is supported by the fact that reorganization analogous to that we have described in auditory cortex is seen in some regions of the central nucleus of the inferior colliculus (ICC) of adult cats with cochlear lesions (Irvine, Rajan and Smith *Proc. Aust. Neurosci. Soc.* 1991). The fact that reorganization is seen in some but not all regions of ICC suggests that reorganization occurs in only a subset of the multiple brainstem pathways that provide input to ICC.

It is to be noted that the reorganization seen in cortical (and subcortical) maps after damage to restricted regions of the receptor epithelium should not, in most cases at least, be thought of as a central compensation for the peripheral loss. In the auditory system, for example, sensitivity to those frequencies that would normally produce activation in the damaged region of the cochlea is in no way restored by central reorganization. However, such reorganization demonstrates, under extreme conditions, the capacity of CNS structures in adult animals to undergo reorganization when confronted with altered patterns of input. The occurrence of reorganization under these conditions suggests that analogous changes might be produced by altered patterns of input associated with differential use of particular regions of receptor surfaces in the course of normal sensory/perceptual experience. This suggestion is supported by recent

evidence for changes in somatosensory cortical maps of monkeys trained in tasks involving either increased stimulation of a restricted region of the skin or perceptual discrimination of stimuli applied to a restricted region. Evidence of the plasticity of cortical maps in adult animals under a wide range of damage- and use-related alterations of sensory input has been interpreted as reflecting the operation of self-organizing mechanisms intrinsic to neocortex. The growing evidence for analogous plasticity in subcortical structures indicates that such mechanisms are not unique to cortex, although they might well prove to differ qualitatively at different levels of the central nervous system.

An interesting aspect of the present data is the implication of such damage-induced reorganization of CNS maps of the cochlea for humans. High-frequency losses of the type created in our experimental animals are a common phenomenon, and the occurrence of reorganization of frequency maps would be expected to have functional (perceptual) consequences. More detailed studies are required to determine if there is any applicability of the effects we have observed to effects noted in the human audiological literature.



## NOISE POLLUTION IN BELO HORIZONTE CITY

PIMENTEL-SOUZA, Fernando  
Full-Professor of Neurophysiology; Member of IBRO-UNESCO, PARIS

ALVARES, Pedro AlcAntra de Souza  
Lab of Acoustic-CETEC/MG, 1979-89; Brandt-Meio Ambiente

Dept. Physiology and Biophysics-Inst. Biological Sciences  
C.P. 2486, Federal University of Minas Gerais (UFMG)  
30.161, Belo Horizonte(BH), Brazil

**SUMMARY:** The noise in some Schools and in a Hospital of UFMG and in a Home in BH transgressed the City law and were away from Brazilian Technical Standards Association (ABNT) recommendations and auditive wellbeing, invading the dangerous band of stress. The external noise in the whole City gave an idea of impact in citizens. Complaints increase in Militar Police (MP) and Ambiental City Secretary (SMMA), whose action in 90s was felt. There is probably similar pollution in many towns in Brazil. People suffer and wait urgently from Authorities and Polititians Actions and Laws more effective to guard their remaining Healths.

**RESUME:** Le bruit dans des Ecoles et dans l'Hôpital de l'UFMG et dans une Résidence de BH n'ob'oit pas à la loi municipale, et il est fort éloigné des recommandations du Bureau Brésilien de Normes Techniques (ABNT) et du bien-être auditif, envahissant la bande dangereuse du stress. Le bruit extérieur dans toute la Ville a donné une idée des conséquences pour les citoyens. Les plaintes ont augmenté dans la Police Militaire et le Bureau Municipal de l'Environnement, dont l'action dans les années 90 a été perçue. Il y a peut être une pollution similaire dans plusieurs villes au Brésil. Les gens souffrent et attendent urgentement des Autorités et des Politiciens des Actions et des Lois plus effectives pour préserver ce qui reste de leur santé.

### 1) THE EXTERNAL SITUATIONS OF URBAN STREETS

A diagnosis from each zone in the City, during the day, was done in 1988 by Alvares et al (Alvares and Pimentel-Souza, 1992 [1]), considering almost only the traffic of vehicles, without industrial and of anyother accidental noise. The mean level of  $Leq=69.5$  dB(A). It's incomprehensible that: 1) the zone ZI (industrial) had an  $Leq=66.7$  dB(A) surprisingly almost 3 dB(A) less than the whole mean, maybe cause in implantation phase and not well used. It would be an ideal area to place the noisier activities, just as they do in the first world countries; 2) the mean of the 8 tradicional residential zone, in which incorporate a couple more of zones of the south district, considered "nobles", had an  $Leq=66.7$  dB(A), exactly the same as ZI, showing a big indefinition about the actual planning of the city; 3) the ZR5 include traditional noble residential districts of the mid-south and had an  $Leq=71.7$  dB(A), therefore 2 dB(A) above the mean. 4) the 6 comercial zones include districts of residential areas and showed  $Leq=73.8$  dB(A), so more than 4 dB(A) above the mean. However, even classified as commercials, a lot of these districts are typically residential and deserved better protection. 5) the 21 most serious points showed an  $Leq$  igual or superior to 79 dB(A); 6) The place H. Werneck, in the middle of a circle of 0.5 km that includes more than 50% of the Hospitals of the city, had a  $Leq=73.2$  dB(A), almost 4 dB(A) above

mean. The expectative is that the exclusively residential zones ZR1, including noble north districts, show an absolute better situation ( $Leq=61.0$  dB(A), so  $8.5$  dB(A) less than the mean).

The motor vehicles traffic is what contributes more to the noise pollution and grows numerically in Brazilian cities, aggravating the situation (CERNE, 1979[2]; AZEVEDO, 1984[3]). A flow of 1000 Brazilian noisy vehicles/hour gave about 78 dB(A) at 15 m at many critical areas without any protection. The noise level tends to get the same, when the traffic equals in Sao Paulo, Rio, BH or any other big Brazilian City. In these cities that are unprovided arteries, surrounded with a very thick and high architectural wall, trembling with motor vehicles surpassing and unknowingly people of the malefaction. The accidental topography of BH aggravates the traffic noise, but still Rio and Sao Paulo continue more agglomerated, arresting more the noise.

The Traffic Noise Index (TNI, Griffiths & Langdon, 1968[4]) is more adequate to subjective evaluation of annoyance. One of the lowest level residential areas, ZR1, have potentiality of being of the most annoyed, because the  $TNI=108$  dB(A), without considering noise of the Airport. However, the areas ZR3, ZR4, ZR4A, ZR4B, ZR5, and ZR6, that has a higher  $Leq$ , has a lower TNI, around 95 dB(A), owing to a permanently traffic more intense, having values of L90 and L10 closer. Assuming a bigger sensory "adaptation" to constant noise level, it is not enough to avoid its slow health damage (Pimentel-Souza, 1992[5]).

To reduce disturbance it's not enough to limit  $Leq$ , but to reduce also the oscillation between the L90 and L10. Paradoxally, in small towns of Brazil the noise with lower backgrounds may annoy more than in the bigger cities, due to the existence of the same sources, equipments, vehicles and people. To get better of pollution at a minimum of more than 5 dB(A) in mean it should punish the violators of used trucks, cars and motorbikes, conductors and vandals extremely noisy, bohemian, religious, sporting and semi-industrial activities in the residential zone and make all buses soundless (CERNE, 1979[2]). Our streets are turning into acoustic boxes and our buildings excellent sources and means of noise transmitters (IPT, 1988[6]; Gerges, 1991[7]). At mean time it should win 10 dB(A) adopting modern rules for the motor vehicles fabrication or lose them if we don't take any severe rules towards the urbanism and architecture. It is unbelievable how in Brazil it is not understandable that is more rational, cheap and healthy to decentralize, build and support the development of small cities than to destroy and bad repair the overloaded center of the big cities, sometimes with historic loss.

BH today can't be confused with the decanted one of the 40s and 50s, well deserved, called the "Garden City", with its restrained 400 thousand residents, that lived on the squares and streets with an auditable comfort of 20 to 30 decibels. At that time there was a maximum of 70 dB, against 107 in the districts next to detonation of mines today. There's an increase of more than 4000 times of peak noise pressure and something similar to the number of vehicles to an increase of 5 times of the population only (Nava, 1958[8]). The recovery policy of life quality will only be effective if it faces the mistakes of the new reality, once life is unimaginable easily degrading.

## 2) NOISE IN SOME SCHOOLS OF THE UFMG

The Ambiental City Law (ACL) establishes maximum levels of internal noise for 3 periods: Day (from 7AM to 7PM), evening (7PM

to 10PM) and night (10PM to 7AM), according to the ground use and occupation law. In 91 the noise in libraries of 7 central Schools of UFMG showed and  $Leq=53.4-68.2$  dB(A) and in auditoria  $Leq=51.1-66.5$  dB(A). A few times the noise level allowed audictible confort, levels below 50 dB(A), to its user and almost was well above the beginning of stress, already in a forwarded stage (Cantrell, 1974[9]; WHO, 1980[10]; Babisch, 1991[11]; Pimentel-Souza, 1992[5]). In the interior of libraries and auditoria didn't show as unsuitable places for reflection, for studies, for research, for intellectual criation and for the sensorial perception as it is prescribed.

### 3) INTERNAL NOISE IN THE MEDICAL PRACTICE HOSPITAL (MPH)

In 91 in the MPH of UFMG, during the hours of 9AM and 11AM, out of the traffic peak, the internal noise showed  $Leq=63.2-68.4$  dB(A). In the Intensive Treatment Center (ITCs) the noise, although less, only for some moments, did not follow the ACL, that in Hospitals is precribed equal to ZR1. At any moment the audictable confort would be proportioned to its future traumatic or life risk patients. The noise in MPH should still continue critic inclusive in the new part, because they were far away from the recommended values by ABTN (1987[12]) mentioning WHO (1980[10]), that is of 35 to 45 dB(A), in spite of some buses traffic detour from the neighbourhood, reducing it to about the half. On the contrary, it might come to grow after the opening to traffic of an extensive bridge in the area. Certainly the assesment of the ambiantal impact should not have considerate such aspect and International Agencies should not finance useless public works, as such bridge.

### 4) INTERNAL NOISE AT A RESIDENCY OF SOUTH AREA (NOBLE)

The internal noise in a residency, which is located about 20m of the traffic intersection, without frontal street movement of bus lines and having only local traffic at zone 4b (the second most protected by the ACL, with  $Leq=67.6$  dB(A), 2 dB(A) below mean and  $TNI=89$  dB(A)) was showed. In 91 since 5PM till 7PM the traffic noise reflected a lot in the interior, showing a strong oscilation between 55-81 dB(A) according with a flow of cars. From there on, in the evening and in the beginning of the night, the impulsive noise appear going up from the background noise (40 dB(A) at 11PM), but reaching the highest variation. It is not exceptional to have 95 dB(A) from a passage of a car with open exhaust. This relation sign/background noise is more than sufficient to wake up the majority of people even with deep sleep, which threshold in stages IV and paradoxal are from 35 and 31 dB(A) respectively (Lukas, 1971[13]).

### 5) CITIZENS COMPLAINTS

In 91 the noise perturbation constituted in the major complaints at SMMA (53% of the total) and PM, the citizen is basing on the ACL 4034/85, edict 5893/88 and article 42 of the National Penal Code. The complaints in BH increased so much that rapid call of the PM become almost useless (Alvares and Pimentel-Souza, 1992[1]). In 91 the MP received 17.3 calls per day mean, only attend to a few, when they sum up to plough an act of incident to posterior act of the SMMA or the Civilian Police. But, only SMMA is equipped with measurer of noise pression and after can assign a inspector to measure the perturbation, that doesn't exist no more to be catch. The major judiciary law suits don't even begin. The straigh complaints to SMMA were low because it concentrates at the

day time of work days and it was unknown its way of action. Till 91 damages to health and to work are not sued by the Procuracy and it's severity is underestimate by the Judges, because they are not well informed, just as the own Physicians. The unsatisfactory work accomplished until now putrify the institutions images and envolved professional categories. But, the MP is the only organ that maintain regular duty to restrain the noise pollution at times of trouble rest, at night and weekends, when most transgression happen. Between registered complaints in 91 at SMMA predominates perturbation of bars, restaurants and live music places (55% of complaints), that astonishingly continues to obtain at the Municipal Office approval to fix them in any district, and of semi-industrial activities, placed on residential areas. But, recent data seem to indicate a better information done by UFMG and midia, an increase of organization at SMMA, where complaints attained 2.9 per day mean in 92, whose fines triplicate in 92 relating to 91, and as the people know that SMMA became more effective than MP. Total usual complaints, SMMA and MP, decreased from 19,1 in 91 to 14 to 92, indicanting that some cases became solved, but still are underestimate in cause of bad people education and sensibility. By the TNI data during the day, the noise disturbance in BH due only to traffic should be provoking any annoyance in about 100% (Ollerhead, 1973[14]) and would reach a "high" disturbance in about 50% (Schultz et al, 1976[17]).

REFERENCES: 1. Alvares, PAS. and Pimentel-Souza, F. (1992). Rev Acústica e Vibrações, 10:23-42. 2. CERNE(Eds.) (1979). CERNE, BRON, 61p. 3. Azevedo, AV. (1984). CNI, RJ. 4. Griffiths, ID & Langdon, FJ (1968). J. Sound vib., 8(1), 16-32. 5. Pimentel-Souza, F. (1992). Rev Acústica e Vibrações. 10:12-22. 6. IPT (Ed.) (1988). PINI, SP. 415-460p. 7. Gerges, S. (1991). Sem. "Silêncio e Saúde". SMMA-ABES, BH, 25 junho. 8. Nava, J. (1958). Itatiaia, BH, 108p. 9. ABTN (1987). ABNT, RJ. 10. Cantrell, RW. (1974). The laryngoscope. LXXXIV, 10(2 supl), 1-55. 11. WHO (1980). WHO, Geneve, 103p. 12. Babisch, W (1991). Symp. "Noise and Disease", Berlin. 13. Lukas, JS. (1971). American Industrial Hygiene Conference, Toronto. 14. Ollerhead, JB. (1973). Appl. Ergon., 4(3), 130-138. 15. Schultz, TJ et al. (1976). Washington, DC, Dept. Housing and Urban Development.

FIGURE: COMPLAINTS ON SOUND POLLUTION IN BELO HORIZONTE

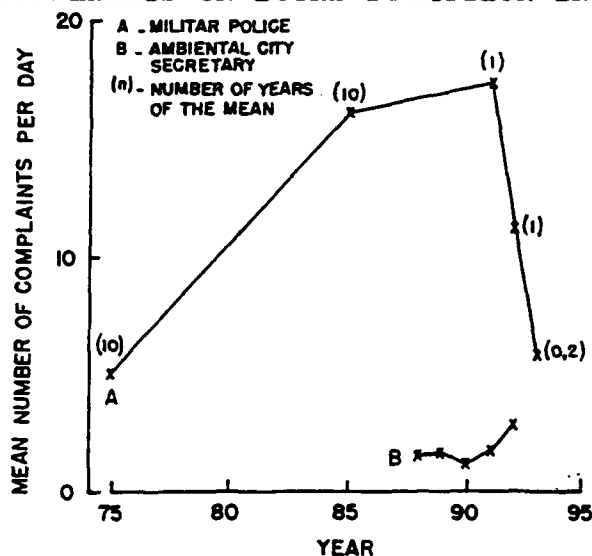

## SCREENING OF NOISY JUNCTIONS OF A TRACTOR

FRIDMAN V.E., FOGEL A.L., SOBOLEV L. Yu.  
Radiophysical Research Institute, N. Novgorod, USSR

One of the perspective directions of agriculture is the development of contactless methods of land cultivation. Such method is the powerful acoustic field actuating on the land surface. At present, mounting devices for the tractor have been already produced which are a set of tubes where a detonation wave is formed. At the output the detonation wave is transformed into a powerful acoustic wave which can effectively cultivate the surface layer of the soil. However, operation of such units is accompanied by a high level of noise.

The report presents the measurement results of the noise level and its spectral composition during the tractor operation with the acoustic ripper. The ripper is a unit with eight detonation tubes directed vertically downwards. All the unit is fixed to the tractor on a suspension. Measurement of the acoustic field is carried out in different schedules of the tractor operation without the protection screens, with one-layer screen and with special two-layer silencer screening the working unit of the tractor. A two-layer silencer is the distributed Helmholtz resonator with one solid and one punched screen. The silencer was intended for suppression of energy bearing components of the acoustic field spectrum. During measurements a system of microphones had been used with registration at four-channel tape-recorder for the definition of the integral level of the acoustic noise which is used for definition of the noise level corresponding to sanitary norms. The acoustic signal written is delivered to analog-digital storage and then the spectral analysis of noise was made.

During the experiments it was discovered that the basic noise energy is concentrated in the band of 400-600 Hz. Besides, there is a narrow line in the noise spectrum at the frequency of near 1.2 kHz. Ordinary one-layer screen introduces a slight modulation of the spectrum without change of the integral noise level. A two-layer silencer suppressed the energy bearing band of the spectrum and sharply decreased the noise level. So, at the distance of 60 m the integral noise level of the unit amounts of near 100 dB, and the noise level of the damped unit at the same distance was near 70 dB and satisfied the accepted sanitary norms.



# ACTIVE CONTROL OF LOW FREQUENCY NOISE

Kh. EGHTESEADI

Noise Cancellation Technologies, Inc.  
1015, West Nursery Rd  
Linthicum, MD 21090, USA

## ABSTRACT

Increasing power consumption in recent years has led to the use of larger and more powerful machines which are, in most cases, sources of noise. Correspondingly, there have been increases in low-frequency sources. The individual's response to low-frequency noise is difficult to assess because of the nature of the noise and wide differences in individual loudness sensation. The lack of directionality of low frequency noise renders the noise source unidentifiable, causing extra stress on the sufferers. Further, the noise is subjectively more annoying in the absence of the masking effect of higher frequencies, which are attenuated by the building itself or over long distances. The Noise Abatement Act, which is based upon dB(A) levels, gives insufficient protection against low frequency noise; there is a need for additional low frequency limits for the living environment. The conventional methods employed in controlling low-frequency noise are mainly passive, employing bulky insulating, as well as absorptive materials to stop the noise transmitting from source to listener. The hardware is expensive and relatively inefficient in reducing low frequency. This is an area where active noise attenuators are particularly useful due to their ability to cancel low frequency noise effectively. The purpose of this paper is to describe some of the advanced development of active control systems for low frequency noise.

## INTRODUCTION

The basic principal of active noise and vibration control is the creation of a wave form of equal amplitude and frequency that is 180 degrees out of phase with the offending noise or vibration. Active noise control (ANC) reduces noise by destructively interfering with the unwanted sound. There are four basic practical approaches to attenuating unwanted noise: "at source", zones, headsets and isolation. "At source" control, that is reducing the noise at its source, is the preferred approach to attenuating noise. Attenuating noise before it can spread, significantly reduces its complexity. An example of "at source" control is the electronic muffler on an automobile. Here noise is attenuated at the end of the exhaust pipe before it spreads into the surrounding environment. When noise cannot be controlled "at source", it can be reduced volumetrically, through zonal control. This technique can be used to quiet the cabins of vehicles such as cars, trucks, buses and aircraft. When the propagating area of the noise is too large or the environmental considerations are too complicated, noise can be attenuated at a person's ear. Industrial noise is most often reduced passively by using bulky headsets or uncomfortable ear plugs. Both of these passive approaches are less effective in handling low frequency noise. In addition, these techniques interfere with speech, warning signals and other desired sound which can be a safety hazard.

ANC can be applied to the previously unsolvable problem of low frequency noise and vibration, and in cost effective ways. In certain applications, such as electronic exhaust mufflers and active fan quieting, additional benefits of improved equipment efficiency and reduced energy consumption are possible. In this paper industrial applications of ANC for the following cases will be presented: exhaust noise, siren noise, and fan-generated airborne noise.

### ELECTRONIC MUFFLER

The electronic muffler eliminates the back pressure associated with conventional passive mufflers by employing a secondary source to reduce the low frequency noise. The exhaust passes through the passive element which serves to attenuate the high frequency noise. In automobiles a five percent (5%) improvement in city fuel economy has been reported and a two percent (2%) improvement with diesel buses. In an industrial blower a 24% improvement in fuel economy, a 20% improvement in throughput and a reduction in noise from 100 dBA have been measured. Electronic mufflers employ either the noise filtering or noise synthesis method to generate the cancellation signal. The cancellation signal is amplified and applied to loudspeakers in an arrangement such as that shown in Fig. 1. Fig. 2. shows the typical results from applying the NCT Electronic Muffler to a CSX MasterVac, a vacuum blower system used to unload bulk material from rail cars into trucks. The net result when combined with additional passive treatments from non-exhaust noise sources, was a decrease of over 25 dBA at the MasterVac operator position. It also increased worker productivity by allowing workers to increase their work shift at the MasterVac from 15 minute intervals to continuous 8 hour shifts. In addition, the drive motor realized a fuel savings of over 20% and the time required to unload a rail car decreased from 56 minutes to 45 minutes.

### ACTIVE CONTROL OF SIREN NOISE

A typical emergency vehicle siren can generate several different sound patterns. A typical noise pattern from an electronic siren is the "Fast Wail." In this siren the signal sent to the siren speaker is a high level square wave with a cyclically varying frequency. The frequency varies between 400 Hz and 800 Hz during each cycle. When this drive signal passes through the band limited speaker, the higher frequency harmonics are attenuated leaving behind a low frequency noise. The noise as heard in the vehicle cab is actually much more complex due to the acoustics of the cab. Resonance and multiple acoustical paths cause the noise to vary rapidly in amplitude as the frequency slews. This problem requires a system that can adapt at a rate faster than the rate of change of the noise. An active headset with digital controller was developed by NCT to address this problem. Fig. 3 shows the configuration of the active headset with its digital controller. Fig. 4 shows the resulting noise waveforms obtained by the active headset as measured in a vehicle cab. The upper half shows five seconds of the original noise at the ear with the active control turned off. The lower half shows the result when the ANC system is turned on. The system reliably reduces the siren noise by 10 to 15 dB with little impact on other external sounds.

### ACTIVE CONTROL OF FAN NOISE

Aerodynamic noise from fans is a major noise source for many industrial applications, this noise consists of tonal and broadband components. Passive attenuation is either not effective at low frequency or requires special thick absorbent material and large attenuators. In some cases the



fan and its housing were modified to produce the least amount of tonal noise, but the random noise either increased or remained unchanged. Passive attenuation also can have an impact on the aerodynamic efficiency of the fan. Since active attenuation can selectively cancel the noise and adapt to changes in the characteristics of the noise without significant impact on aerodynamic performance, it has special appeal to the industry. To demonstrate active control of broadband noise from a centrifugal fan, forward curved blades were used to minimize tonal noise at the blade passage frequency. This appliance fan operated at approximately 180 CFM and a metal mesh filter covered the inlet. Passive silencers consisting of a suitable length of ducting are normally used to control the noise with the optimum lining thickness being one-quarter of a wavelength. Since this technique is not practical for residential installation, this appliance fan was a prime candidate for ANC technology. A combination of passive and active attenuation techniques was employed to achieve an overall 12.8 dBA reduction in noise. The active noise attenuation components were composed of an "upstream" microphone as the input noise sensor, a loudspeaker as the secondary source for noise attenuation (housed in an assembly that also contains the electronic processing and control circuit); a power supply assembly; and a "downstream" microphone as the residual error microphone. The error microphone provided a signal input to the controller to adjust the filters. The electronic processing used an NCT controller with the Adaptive Feed Forward algorithm for digital filters to match the characteristics of the feed and error paths over changes in operating temperature and air flow as shown in Fig. 5. Fig. 6 shows the noise spectrum after the passive techniques were implemented but without the ANC and the spectrum with both passive and active attenuation. Certain frequencies in the 200-1200 Hz range are attenuated in excess of 10 dB and the resulting noise has been reduced by 7.9 dBA.

## CONCLUSIONS

Active noise control technique provides advantages such as improvement in system efficiency and size, energy savings, and adaptability to a variable low frequency noise source that is not available from the passive methods. In the future we will see extensive applications of this approach to numerous noise and vibration control problems.

Figure 1

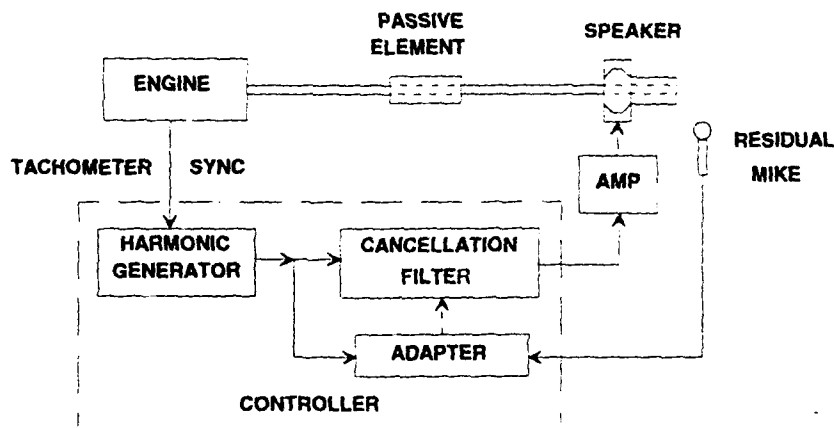

Figure 2

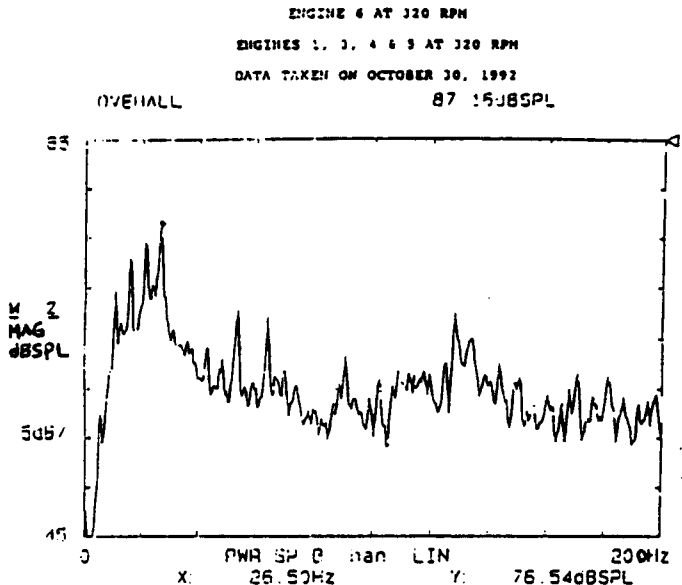
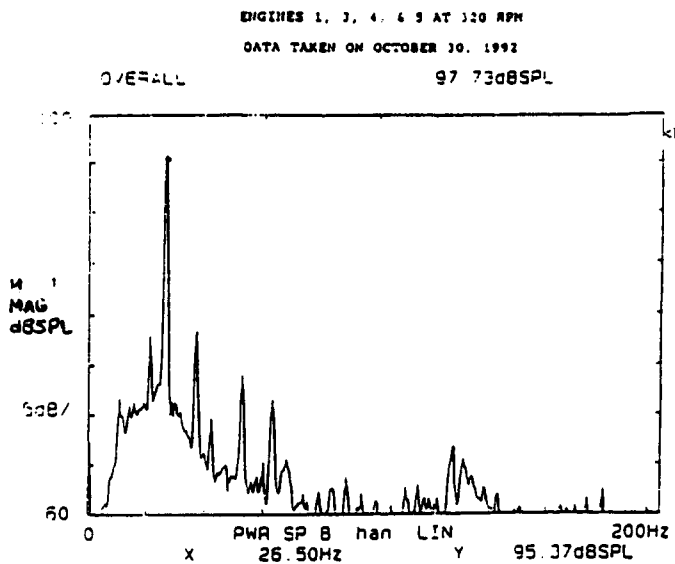

Figure 3

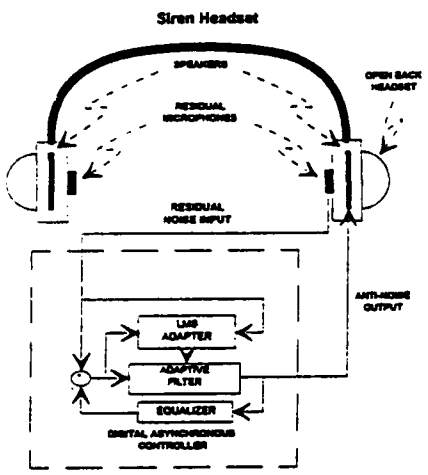

Figure 4

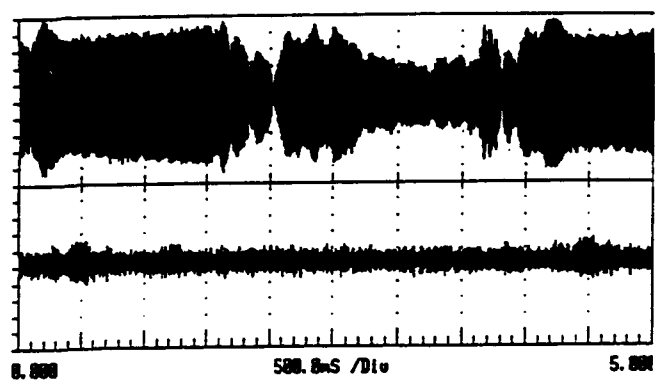

Figure 5

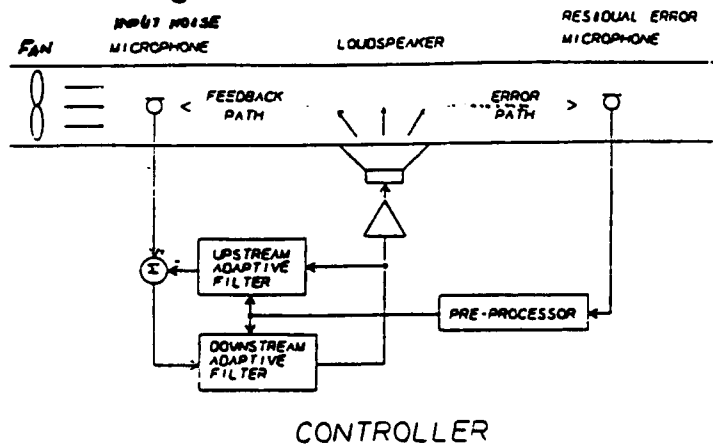
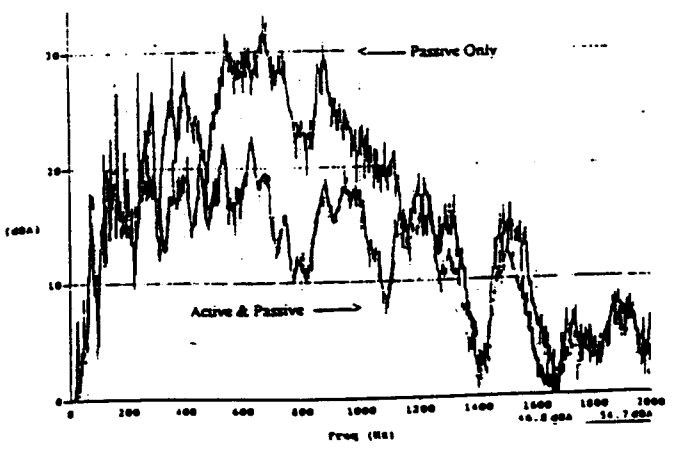

Figure 6



## IS HEARING DAMAGE UNAFFECTED BY DISCRETE TONES AND Lp AMPLITUDE?

WATSON Ian.  
SNV Consultants  
4 Kirkland Avenue  
Blanefield.  
By Glasgow. G63 9BZ.

### Abstract.

More than two thousand years ago Aristotle wrote "If at some time future facts should be established, more trust should be put in evidence of sense perception than in theories, save if these are shown to correspond to observation". Taking cognisance of these wise words there are serious doubts concerning the validity of some of the crucial assumptions which are the basis of the UK Noise at Work Regulations, the Health and Safety Executive Noise Guides and the units used to measure factory noise for personnel assessment.

Firstly, the Regulations do not take into account the bandwidth of the sound. Discrete tones are not considered to be more damaging to hearing than random, broad band sound. Secondly, the assumption that permanent hearing damage is related to sound energy per day rather than the accumulated effect of the amplitude and number of cycles of dynamic pressure is perhaps wishful thinking and contradicts proven experience for acoustically induced material fatigue failures. Thirdly, there is a crucial difference in the definition and conception of a "competent person" between the UK Regulations and the HSE Noise Guides.

### Introduction.

It is nigh impossible to establish reliable relationships for all the complex inter-related factors with the degree of irreversible hearing damage. The very gradual permanent deterioration in hearing sensitivity of Noise Induced Hearing Loss sufferers, the many inter-related parameters and the imprecision of audiometric measurements make irrefutable deductions extremely difficult.

Most of the existing information on the complex problem of NIHL is based on statistical evidence which can, at times, be misleading. However, it is beyond doubt that exposure to high sound levels causes both a rapid temporary, and a gradual permanent loss of hearing. The slow rate of damage makes it very difficult to quantify the risk to individuals of exposure to high sound pressure levels. It is almost certain that the second action level of a daily exposure to an Leq of 90 dB(A) is too high. Continuous exposure to this level of dynamic pressure for eight hours a day, five days a week, fifty weeks a year and for a working life of say forty years, would cause permanent hearing damage in many people.

### Are Discrete Tones More Damaging Than Random Noise?

NIHL is analogous to low and high cycle fatigue failure of materials. Hugh investments have been made to reduce the risk of acoustically induced fatigue failures in space, missile and AGR research. Crack initiation caused by dynamic sound pressure is critically influenced by the nature and bandwidth of the sound pressure. A discrete tone, which coincides with a structure resonance will, initiate fatigue cracks at much lower amplitudes than random, broad band sound.

It is logical to deduce that a similar phenomenon will occur with the way in which sound damages the hearing mechanism. A pure tone

is bound to induce greater damage than random sound of the same broad band amplitude. This hypothesis is supported by the fact that most people find pure tones more objectionable and painful than broad band noise. Five or ten decibel penalties are enforced for environmental noise control if discrete tones are present, for this reason.

It is therefor necessary to stipulate maximum sound pressure levels for pure tones in all the audible octave or third octave bands in the Regulations, for employers to be seen to be taking all reasonable and practical steps to avoid hearing damage to employees, visitors and the public at large.

**Hearing Damage - Sound Energy or Sound Pressure Amplitude Related?**

The use of sound energy as the basis for controlling the allowable first and second action sound pressure levels in the Regulations could be fundamentally wrong. A daily Leq of 90 dB(A) could be achieved by an exposure of slightly less than five minutes to 110 dB(A). Therefor, according to the Regulations, a person could be subjected to 110 dB(A) for four minutes every day for five days a week, fifty weeks in a year for forty years without permanent hearing damage! This gives an allowable total exposure to 110 dB(A) of the equivalent of more than eighty working days! The hypothesis that hearing will completely recover from daily exposures to very high dynamic sound pressures is in contradiction to the proven laws of metal fatigue, where failures occur due to the accumulation of cycles at high dynamic stresses.

ALLOWABLE DAILY EXPOSURE TIME FOR ONE dB LESS THAN THE UK SECOND ACTION LEVEL, AT SPECIFIED Lp.				TOTAL NUMBER OF ALLOWABLE CYCLES ASSUMING 1,000 HZ MILLIONS.		EQUIVALENT WORKING DAYS OF CONTINUOUS EXPOSURE IN A LIFETIME. DAYS.
Lp re 20µ Pa	DYNAMIC PRESSURE AT SAY 1,000 Hz Pa rms	No. OF CYCLES ASSUMING 1,000 HZ MILLIONS	TIME SEC-ONDS	IN ONE 5 DAY WEEK.	IN FORTY YEARS	
90	.6	21.6	21,600	108	194,000	6,750
100	2.0	1.84	1,840	9.2	16,600	575
110	6.3	.21	210	1.05	1,890	65.6
120	20.0	.025	25	.12	225	7.8
130	63.3	.002	2	.01	18	.63

The above table dramatically illustrates the effect of a lifetime's exposure to noise which is considered acceptable according to the current Regulations. The use of Leq and dose meters could therefor be misleading and give employees a false sense of safety.

Using sound pressure level [say 85 dB(A)], and not Leq values, as the criterion for hearing protection zones would simplify noise assessments, be a clear incentive for noise reduction and greatly reduce the number of people who suffer the torment of noise induced hearing loss.

### **The Responsibilities and Role of the "Competent Person".**

Everyone knows that there are many reasons why wearing ear muffs or plugs could be dangerous. Warnings of impending danger may not be heard. There could be health hazards due to lack of proper hygiene care or due to sweating and absence of adequate ventilation of the ear. Many find the continuous pressure of ear muffs very unpleasant and uncomfortable. However, for many the use of hearing protectors will be the lesser of two evils.

Item 7 of the UK Regulations correctly stipulates that every employer must take all reasonable and practical steps to reduce the exposure of employees to sound pressure levels exceeding the second or peak action levels, other than by the use of personal ear protectors. This means that employers will need advice on noise reduction at source and/or changes to the work procedures. To do this effectively and meaningfully requires the input of a qualified engineer who has basic acoustic knowledge and experience. The necessary judgements and proposals do not fall into the category of work which could be carried out by a technician who has been given a four day course on measuring sound, proper use of hearing protectors, etc.

Item 4 of the Regulations specifies that every employer must ensure that a competent person makes a noise assessment which is adequate for compliance with item 7. The Regulations therefor, in effect, specify the need for a qualified engineer with indepth acoustic knowledge and experience to control the noise assessment work. However, items 33 to 36 in the HSE Noise Guide No. 1 and Noise Guide No. 6 imply that a technician with a very limited training course can do this advanced work without guidance or supervision, and enable employers to comply with the Noise at Work Regulations (1989). Obviously a qualified engineer is required to control the entire noise assessment project.

To achieve the ultimate goal of reducing the noise and/or exposure time so that ear muffs or plugs are not required justifies the effort of a fully qualified engineer with indepth acoustic knowledge, training and many years experience. To reduce costs a specially trained technician could record sound measurements and help with the data collection, but he/she must be supervised by a competent person who is responsible for the noise assessment project. The relatively small increase in cost to employ a qualified person to control the investigation would be recovered in noise reduction benefits, prevention of expensive litigation and a reduced number of NIHL sufferers.

### **The Way Forward.**

If it can be shown that the Noise at Work Regulations do not give reasonable protection against NIHL for all employees, employers could lose expensive litigation battles even if they comply with the laws of the land. They are thus getting the worst of both worlds - high costs in administering ear protection zones and noise assessment investigations - as well as possible high legal costs and compensation payments to injured employees.

People have different resistances to the effects of exposure to high sound levels. Some may experience permanent hearing damage at sound pressure levels at five or possibly even ten decibels below others. Hence some form of audiometric screening is essential for those who are likely to be exposed to sound pressure levels at or above 85dB(A) or the new EC peak action level [130dB(C)] or the new pure tone levels. There could be co-operation between

industry and the National Health Service to provide selective audiometric screening for vulnerable employees.

Noise induced hearing loss is a very serious social problem. The fact that NIHL is the most common industrial injury is no credit to acousticians, engineers, medical personnel and civil servants who work in this field. The gradual way it permanently affects the unsuspecting victim is insidious to say the least. Environmental noise pollution would very soon worsen the quality of our lives if strict controls are not enforced. Noise reduction is, without doubt, one of the most important objectives for engineers in every discipline.

Inadequate enforcement of the Noise at Work Regulations by downgrading the role of the "competent person" could detrimentally affect product acoustic performance and compliance with the Regulations and new EC Directives on noise. The decision to give British industry a further two years to comply with the UK Machinery (Safety) Regulations 1992 could be counter productive and make our products acoustically inferior to our competitors in other EC countries. Better policing and enforcement of even more stringent regulations would not only reduce the risk of permanent hearing damage to employees, it would also improve the quality of the products we manufacture.

If hearing damage is in fact related to sound pressure amplitude and not to sound energy, measurements of  $L_p$  should replace  $L_{eq}$ . Identifying hearing protection zones will be much easier. Dose meters, if used at all, would record numbers of cycles at selected ranges of sound pressure levels. In general factory noise measurements and personnel noise assessments would be much less complicated, and Regulations would be very much easier to enforce.

All those responsible for the purchase of equipment, components and articles which generate a significant amount of noise, must treat acoustic performance as a major factor in the decision on which to buy. They could be making a very costly mistake if they do otherwise. It cannot be said too often that the least expensive and easiest way to control and reduce factory and environmental sound pressure levels is to induce manufacturers to produce quieter products by design, research and development. It is much more difficult and expensive (and sometimes virtually impossible) to reduce sound levels by minor modifications to operating equipment.

The market should respond to pressure from the public and from informed and concerned people. Directors who are in tune with these trends and forces will invest in improving the acoustic performance of their products, and thus make it easier for their clients to comply with the Regulations. They deserve to win a bigger share of the market.

## HELICOPTER NOISE MEASUREMENTS FOR A DATABASE

WESTON R. J., STEELE D. G.

Royal Air Force Institute of Health and Community Medicine,  
Halton, Aylesbury, Bucks, HP22 5PG - United Kingdom

Helicopter operations constitute a growing problem for both civil and military aviation due to an increasing number of day and night operations, lower flying altitudes, specific noise characteristics and a general tendency to operate nearer and nearer to communities. It has been said that helicopter noise has a number of unique characteristics, which has led to numerous studies into whether or not the indices should be weighted to reflect these features.

The RAF Institute of Health and Medical Training has been given the opportunity to investigate the features of helicopter noise characteristics, operations, metrics and interpretive criteria with respect to existing aircraft noise modelling systems and has embarked on a program for modelling helicopter noise around designated helicopter landing sites (HLS).

This paper discusses the noise source measurements used to create this database and some of the field studies used for validation.





# **PERIPHERAL BLOOD FLOW. A SUITABLE INDICATOR OF NOISE-INDUCED STRAIN**

GRIEFAHN, Barbara and BRÖDE, Peter

Institute for Occupational Physiology at the University of Dortmund  
Department of Environmental Physiology and Occupational Medicine  
Ardeystr. 67, D-4600 Dortmund 1, Federal Republic of Germany

## **Abstract**

Alterations of peripheral blood flow (vasoconstrictions) as measured at the finger-tips are valid indicators of the complex ergotropic strain evoked by noise. The quantification of the strain presupposes additionally a high reliability which was studied in the present paper.

The reliability proved to be sufficient if movements can be avoided during experimental sessions, if the finger-temperatures range between 24 °C and 33 °C and if the data are transformed into percentages related to the prestimulus values.

If, however, the interstimulus intervals become shorter than 30 seconds and if simultaneous recordings of sensumotor performance or the completion of questionnaires are required, alternative methods e.g. the recording of peripheral blood flow at the ear lobe are advisable.

## **1 Introduction and objectives**

Peripheral blood flow as measured at the finger-tips is regarded as a valid indicator of the complex ergotropic strain evoked by noise. The method is easy to handle, the subjects are scarcely bothered and the records are easy to evaluate. The dose-response relationship between noise-induced vasoconstrictions and the physical parameters of the sound as well as the influences of numerous exogenic and endogenic variables are intensively studied and sufficiently quantified.

The quantification of noise-induced strain requires a high reliability of the method applied. The latter must be questioned for peripheral blood flow as it depends highly on thermoregulation. To save body heat the width of the blood vessels decrease gradually with ambient temperatures and/or with the metabolic rates, thus reducing the heat-emitting surface of the body.

In contrast to external influences which are taken into account by adjusting the room temperature to a predefined level throughout an entire experimental series, internal influences are usually disregarded. The latter (the hormonal situation, the metabolic rate etc.) are apparently significant. Preceding this particular study the finger temperatures of 19 subjects were recorded 3 times a day at a constant air temperature of 22 °C. The measurements revealed a variation from 18.8 °C to 35.7 °C (16.9 K).

This rises the question whether noise-induced strain is reliably quantified by the alterations of peripheral blood flow. As the skin temperatures indicate the width of the blood vessels the extent of noise-induced vasoconstrictions may vary with the skin temperatures - according to the law of initial values.

If this assumption proves to be true, the finger temperatures have to be controlled in further studies or alternative methods must be applied. A reasonable alternative could be the blood flow at the ear lobe, which depends much less on the ambient climate. It is even likely that these responses are more reliable than those recorded at the finger-tips.

This alternative could have another advantage. The recordings at the finger-tips are highly susceptible to even slight motions. The latter cause artifacts and prevent simultaneous activities, e.g. the completion of questionnaires or the execution of sensumotor tests. These disadvantages may be reduced as the ear lobe is not actively moved.

## 2 Methods and evaluation

16 healthy and normal hearing subjects (8 male, 8 female, 21-61 yrs,  $\bar{x} = 37.3$  yrs) absol-ved 4 experimental 1-hour sessions. Their finger temperatures were randomly adjusted to 24, 27, 30, and 33 °C by inserting the right hand up to the midth of the forearm into an air-conditioned box. After the target temperature was reached short-term pink noises (1250 ms) were applied every 40 seconds. The sound pressure levels of 72, 78, 84, and 90 dBA occurred randomly but once within 4 consecutive stimuli. Heart rates and peripheral blood flow of the right ear lobe and of the right index finger were continuously recorded throughout the experiments.

The experiments were executed in a sound proof room at an air temperature of 21 °C. The subjects rested in a comfortable armchair, the noises were presented via loudspeakers.

**Evaluation:** Each individual trial was evaluated pulse by pulse and presented by 40 consecutive data covering the period from 10 seconds before until 30 seconds after noise onset. The width of the vessels was indicated by absolute data as converted into voltages and by relative numbers that is to say in percentages related to the prestimulus period.

According to a cluster analysis a period centered to the maximum response (minimum of blood flow) was determined as a significant parameter of the noise-induced vasoconstriction. This is in the present study for the finger-tip the period from the 5th to 10th and for the ear lobe from the 3rd to 6th second.

## 3 Results and discussion

**General response pattern:** Due to an increased sympathetic tone, noise-induced vasoconstrictions occurred at the finger-tip and at the ear lobe as well. The minimum after 5 or 6 seconds is followed by a gradual increase towards the baseline. The responses are considerably smaller at the ear lobe and the baseline is attained earlier (figure 2).

### 3.1 Vasoconstriction and skin temperature

Figure 1 presents in its upper part the width of the blood vessels at the finger-tips as converted into voltages, separately for the 4 finger temperatures. As expected, peripheral blood flow and noise-induced vasoconstrictions are significantly related to the skin temperatures. The higher the temperatures (the wider the vessels), the larger are the extents of the vasoconstrictions and the shorter are the time lags until their maxima (minima of blood flow) and the earlier are the baselines attained.

The fact that the extents of the vascular responses increase concomitantly with the width of the blood vessels or the skin temperatures respectively verifies again the law of initial values. The inverse relationship between the skin temperatures and the time lags until the minima is presumably related to the elasticity of the walls of the vessels. The vessels become rigid in the cold and need more time for any reaction.

Thus, the absolute vascular responses pretend that noise-induced strain decreases with

temperature. But, as there is no serious explanation for the assumption that the overall strain of the organism really decreases with lowered skin temperatures, it must be concluded that the absolute alterations are unsuitable for assessing the ergotropic noise effects.

If, however, the data are transformed into percentages (fig.1, lower part), the extents of the responses (minimum blood flow) are no longer related to the skin temperatures. As the minima of the individual trials are not as well defined as in the mean curves it is - for practical reasons - advisable to indicate the extent of a given response by the average over a time period centered to the minima. In the present study, the period from the 5th to the 10th second proved to be suitable as it includes the occurrence of the minima at any skin temperature.

The results are confirmed by the parameters of the appropriate regressions: the absolute alterations are significantly determined by the basic blood flow (width of blood vessels or skin temperatures), where the relative alterations are ever the same within the ranges studied here. The overall ergotropic strain induced by noise is still adequately assessed if the reactions are expressed in percentages.

The validity of this finding is restricted to a linear relation between the skin temperatures and the widths of blood vessels (and the extents of vasoconstrictions) which was true in this study. However, if the vessels are maximally constricted, their width and the skin temperature become independent of each other. Though the skin temperature may decrease furtheron, the vessels cannot constrict anymore. In this situation noise fails to cause additional constrictions. With reference to fig.1 the lower limit can be assumed near 24 °C as blood flow during the prestimulus period differs less between 24 °C and 27 °C than between 27 °C and 30 °C or 30 °C and 33 °C, respectively.

The upper limit of the valid range is probably near 35 °C. The emission of body heat presupposes a gradient of about 1 to 2.5 K between core and skin temperatures. As core temperatures must remain at 37 °C the skin temperature must not exceed 35 °C to 36 °C at the utmost. If the air temperature exceeds 35 °C the skin is cooled by evaporation of sweat. In this situation the dilatatory power of the heat stress becomes stronger than the constrictory power of noise.

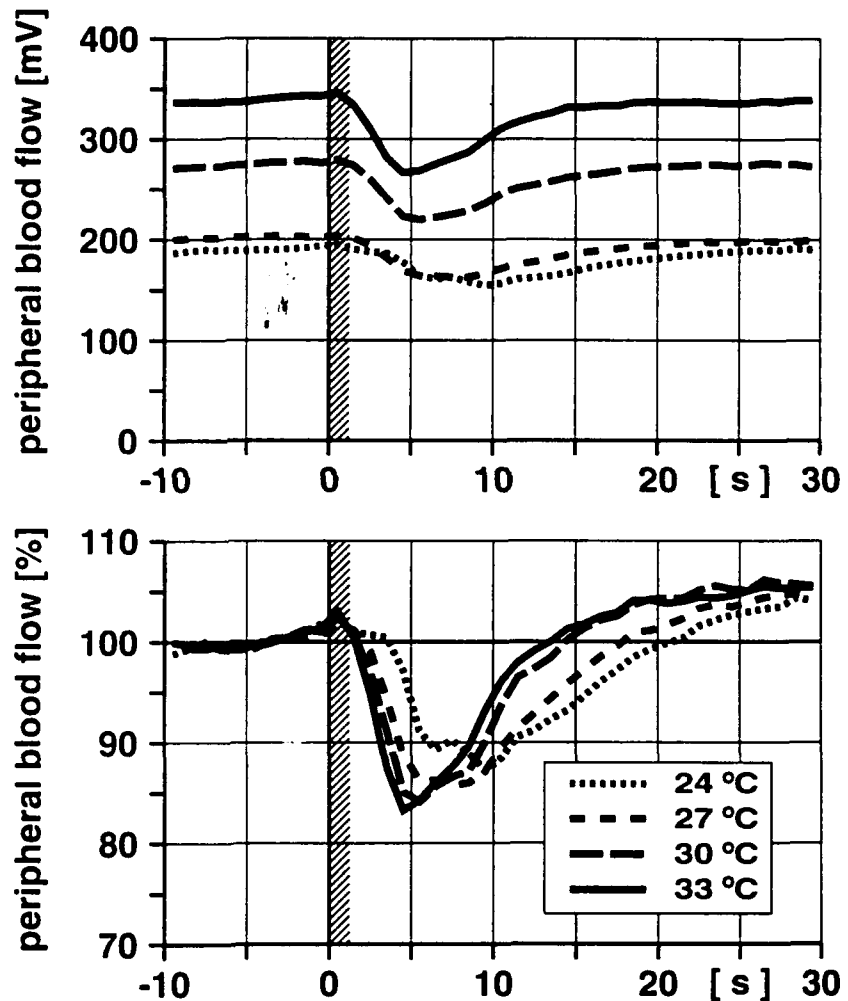

Figure 1: Peripheral blood flow at the finger-tip

Both, the upper and the lower limit have to be determined in future studies. This is essential because outside this range other measures must be applied to assess the strain evoked by noise.

### 3.2 Vasoconstrictions at the finger-tips and at the ear lobe

Alternative methods for the assessment of noise-induced stress are also desirable if the subjects cannot avoid movements, particularly in the case when simultaneous activities are required during the experimental sessions. Peripheral blood flow was therefore also recorded at the ear lobe because the latter is not actively moved and because its temperature varies much less with the ambient temperature as well as between subjects.

Peripheral blood flow as measured simultaneously at both locations, the ear lobe and the finger-tips are shown in figure 2. The data are transformed into percentages related to the prestimulus averages. In general, noise evokes vasoconstrictions at either location and the extents of the responses are significantly determined by the acoustic energy: the higher the sound pressure levels the larger the extents of vasoconstrictions (analysis of variance,  $p < 0.01\%$  for both locations). The extents of the vasoconstrictions at the ear lobe as well as their respective 'resolving power' are, however, considerably smaller, particularly for the lower sound pressure levels.

The smaller responses at the ear lobe are probably related to the local features of blood supply. This assumption refers to the results of several studies where cold air induced vasoconstrictions of all the skin vessels except at the head. Those vessels are probably also less susceptible to other stimuli as well.

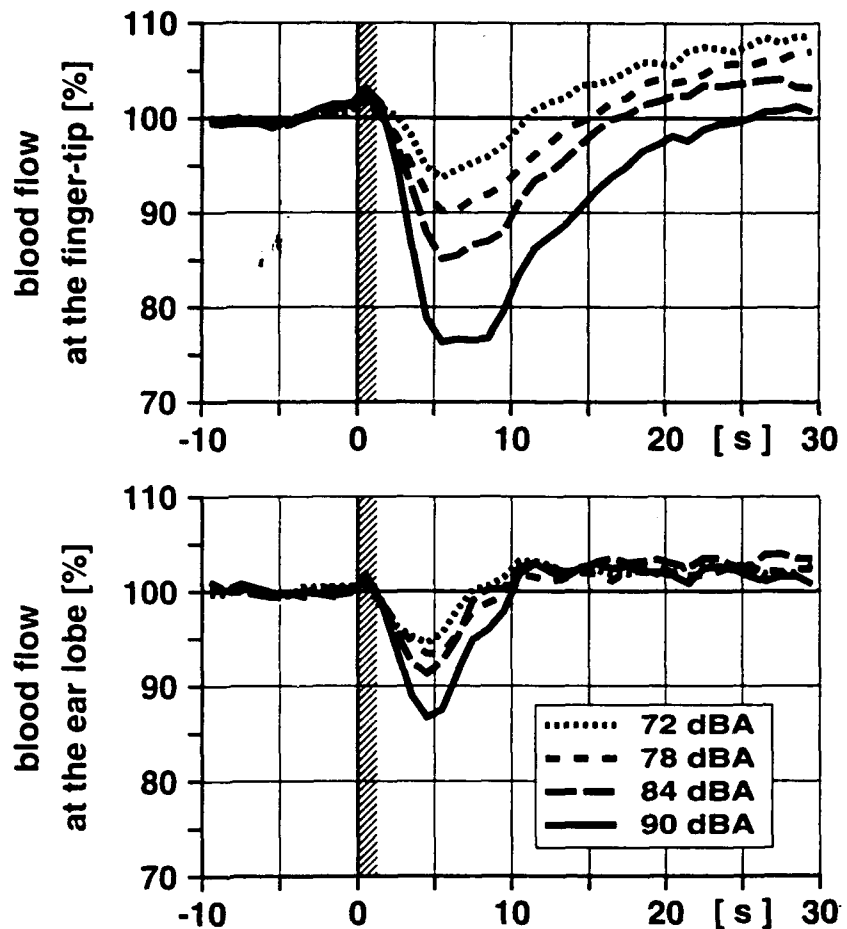

Figure 2

### 4 Conclusions

Comparing both, vasoconstrictions at the finger-tip and at the ear lobe the first is superior if movements can be avoided, if the finger-temperatures range between 24 °C and 34 °C and if the data are transformed into percentages related to the prestimulus values. Due to the faster re-attainment the recording at the ear lobe could be advantageous if the interstimulus intervals are shorter than 30 seconds (figure 2). Whether the recordings at the ear lobe are less susceptible to body movements has to be proved in future studies.

## NOISE-INDUCED HEARING LOSS AND HIGH BLOOD PRESSURE

TALBOTT, Evelyn, M.P.H., Dr.P.H.  
FINDLAY, Robert C., Ph.D.  
KULLER, Lewis H., M.D., Dr.P.H.  
DAY, Richard D., Ph.D.  
ISHII, Erick K., M.P.H.

Department of Epidemiology  
University of Pittsburgh  
130 DeSoto Street  
Pittsburgh, PA 15261  
U.S.A.

### ABSTRACT

An epidemiological study of occupational noise exposure, noise-induced hearing loss and high blood pressure was conducted in two large metal-assembly plants in Chicago, Illinois (1988-1989). The study's main objective was to determine if a group of workers exposed to noise greater than or equal to 89 dBA for 15 years or more had mean blood pressure levels which were significantly greater than a similar group of workers less exposed ( $\leq$  82 dBA) and moreover; if grouping the men within the two plants by a marker for noise exposure, (i.e. high frequency hearing loss as defined by 65 decibels or greater hearing threshold at 3, 4 or 6 kHz) would result in those men with severe noise-induced hearing loss (SNIHL) experiencing a greater prevalence of hypertension than the portion of men within each plant who did not have such hearing loss profiles ( $<$  65 decibels at any of these frequencies). These two major comparisons were to be made while controlling for the other major risk factors for hypertension (i.e., body mass index, alcohol intake, family history, etc.). The population consisted of a random sample of 500 hourly workers drawn from each of the two plants aged 40-62 (men 49.6 and 48.7) years with 15 or more years of employment at the present facility. The overall participation rate was 69% for plant 1 (exposed) and 68% for plant 2 (unexposed). The average length of time of employment was 25.0 and 22 years respectively in exposed and non-exposed groups. A pre-shift clinical examination was conducted on all study participants. This exam included measures of height, weight, pulse and blood pressure as well as an in-depth medical and personal habits history (alcohol consumption, smoking patterns, etc.) An in-depth occupational history, military and noise-related hobby questionnaire, and a lifestyle interference inventory was also completed. Audiometric testing was conducted to determine puretone hearing thresholds at .25 to 8 KHz frequencies. A lifetime history of hearing protection usage was obtained. Blood pressure was obtained using a random zero device taken three times after a ten minute period. An individual was considered hypertensive if the diastolic blood pressure was greater than or equal to 90 mmHg or he was currently on blood pressure medication. There was a significant difference (2-3 mmHg) between the mean diastolic blood pressures between the two plants [mean of 80 mmHg (S.D. 9.2) in Plant 1 compared to 77.8 mmHg (S.D. 11.0) in Plant 2,  $p < .014$ ], and a mean systolic blood pressure [123.3 mmHg (S.D. 14.2) versus 120.8 mmHg (S.D. 17.1),  $p = .059$ ], respectively. Moreover, there was also a greater proportion of men in Plant 1 (noise exposed) who were currently on blood pressure medication (17.9% compared to 13.1%) than

in the control plant. When data were combined for both plants and analysis of variance conducted with systolic and diastolic blood pressure used as the outcome variable with main effects tested for age, plant, noise-induced hearing loss, and race, there were significant differences seen in blood pressure for plant (i.e, Plant 1 compared to Plant 2), age, and noise-induced hearing loss. There was a greater prevalence of noise-induced hearing loss in Plant 1 compared to Plant 2 (30.1% compared to 20.7%) a tendency toward better hearing levels among non-whites versus whites was noted in this study. The mean blood pressures of these two plants, among those currently not on blood pressure medication, is equal or lower than national averages reported by NHANES, Framingham and others for this age group. However, the 2-3 mmHg difference noted in blood pressures between the two plants is a significant difference. National blood pressure drug lowering trials will often target a significant change of 2-3 mmHg in a population under study. Therefore, a shift in mean blood pressure over time in any population puts a group at increased risk of stroke, heart attack, and other cardiovascular events and should not be taken lightly. The aims of our present research are to further validate our previous noise and blood pressure study by its replication in a group of men (40-62) who have suffered chronic occupational noise exposure of 15 or more years duration (N=400) and a group of controls (N=400) also employed in hourly jobs who are less exposed.

#### METHODS OF STUDY:

In order to assure sufficient group size for stratified cells and noise-induced hearing loss comparisons, and to allow proper control for age and use of hearing protection, a total sample of 400 exposed and 400 less exposed should be sufficient.

Work noise levels as well as occupational history were used to delineate the population. Our criteria used in previous study were plants whose overall noise level are 89 dBA in the noise exposed plant 81 dBA for the less noise-exposed plant.

The clinical exam included measures of height, weight, pulse and blood pressure, as well as an in depth medical and personal habits history including alcohol consumption and smoking patterns. There was also an in depth occupational history, military and noisy hobby questionnaire and lifestyle interference inventory. This was administered at nearby union or plant facilities prior to work.

Because large variations in blood pressure have been shown to exist within a given subject, it is difficulty to detect differences between groups and may lead to misclassification of individuals. Therefore, multiple blood pressure measurements using standard procedures was implemented in this investigation. Blood pressure was determined three times within five minutes after a ten minute rest period and then repeated by a second staff member fifteen minutes later.

Audiometric testing must be conducted prior to any noise exposure (hobbies, etc.), therefore, the men were be queried about activities 24 hours prior to clinical visit. Standardized audiometric testing procedures were used and the technicians were supervised by a certified audiologist. The procedure used for conducting the pure-tone audiogram is similar to that

specified in the American Speech and Hearing Association Monograph Supplement No. 9 and includes the basic features of the Hughson Westlake techniques for determining pure-tone hearing thresholds. The following frequencies were tested: 500, 1000, 2000, 3000, 4000, 6000 and 8000 Hz. All audiometric testing will be performed in testing booths which conformed to the American National Standard Criteria for Background Noise in Audiometric Rooms. The booth and site will be checked by a Bruel-Kjaer sound level meter with built in octave filter set. A Grayson-Stadler Clinical Audiometer equipped with TDH-39 headphones will be used for the audiometric evaluation. The audiometers will be initially calibrated and periodically checked thereafter. The sound pressure output of the audiometer will be calibrated monthly. An in depth noise exposure questionnaire, which outlined information on previous employment, hobbies, military service, hearing disorders, ototoxic drugs, etc., will be administered to each worker.

Individuals found to have conductive (non-sensorineural) hearing losses were excluded. We used the definition of previous surveys for severe noise-induced hearing loss ( $\geq 65$  dB loss at 3, 4 or 6 K Hz). The previous study did not specify which ear (better ear or bilateral loss).

#### Methods of Analysis:

Participants on medications were removed for any analysis related to blood pressure as a continuous variable as their inclusion could introduce bias due to artificially lowering blood pressure. However, a multiple regression was conducted which included everyone from Plant 1 and Plant 2 and assigned a 0 or 1 to each person dependent on blood pressure status and plant number so that noise level between plants could be assessed.

The SAS Logistic procedure (Version 6.06) (SAS, 1990) was used to fit a multiple logistic regression model with hypertension as the binary dependent variable (0 = No, 1 = Yes). The independent variables tested for inclusion in the model were: 1) Alcohol (1 through 5); 2) Age (continuous); 3) Body Mass Index (continuous); 4) Family History of High Blood Pressure (0 = No, 1 = Yes); 5) Severe Noise-Induced Hearing Loss; and 6) Race (1 = Black/Other, 2 = White).

Backward stepwise logistic regression was carried out to obtain the final model. Initially, all six variables were entered into the model for the 309 individuals in Plant 1 and 278 individuals in Plant 2 that had a full complement of variables.

The major predictors of hypertension status were: body mass index; family history of high blood pressure; and age. For Plant 1, alcohol entered the model for the total (all ages) Plant 1, and for the older group, but not for younger. For Plant 2, in addition to the three major predictors, severe noise-induced hearing loss entered at the .0659 level. For the total combined Plants 1 & 2 group, in addition to BMI, age, race, family history of HBP, and alcohol, Plant number (Plant 1) showed a borderline effect at .08.

This study's main objective was to determine if a group of workers exposed to noise greater than or equal to 89 dBA for 15 years or more had mean blood pressure levels which were significantly greater than a similar group of workers less exposed ( $\leq 82$  dBA) and

moreover, if grouping the men within the two plants by a marker for noise exposure, (i.e., high frequency hearing loss as defined by 65 decibels or greater hearing threshold at 3, 4 or 6 kHz) would result in those men with severe noise-induced hearing loss (SNIHL) experiencing a greater prevalence of hypertension than the portion of men within each plant who did not have such hearing loss profiles (<65 decibels at any of these frequencies). These two major comparisons were to be made while controlling for the other major risk factors for hypertension (i.e., body mass index, alcohol intake, family history, etc.).

There was a significant difference (2-3 mmHg) between the mean diastolic blood pressures between the two plants [mean of 80 mmHg (S.D. 9.2) in Plant 1 compared to 77.8 mmHg (S.D. 11.0) in Plant 2,  $p < .014$ ], and a mean systolic blood pressure [123.3 mmHg (S.D. 14.2) versus 120.8 mmHg (S.D. 17.1),  $p = .059$ ], respectively. Moreover, there was also a greater proportion of men in Plant 1 (noise exposed) who were currently on blood pressure medication (17.9% compared to 13.1%) than in the control plant. When data were combined for both plants and analysis of variance conducted with systolic and diastolic blood pressure used as the outcome variable with main effects tested for age, plant, noise-induced hearing loss, and race, there were significant differences seen in blood pressure for plant (i.e., Plant 1 compared to Plant 2), age, and noise-induced hearing loss.

It is interesting to note that the group of workers with severe noise-induced hearing loss experienced an elevation in diastolic blood pressure most notably and consistently in the 40-49 age group (for Plant 1 the average blood pressure was 82.2 versus 79.8 for non-SNIHL, and in Plant 2 the average diastolic blood pressure was 81.1 for the noise loss group versus 76.8 for non-SNIHL). For non-white, it was 84.0 mmHg diastolic for SNIHL compared to 78.9 mmHg for non-SNIHL in Plant 1 and 81.1 for the noise loss group compared to 77.5 for the non-SNIHL group in Plant 2. The relationship for the older groups was somewhat less uniform. However, we do not know what effect selective attrition and health worker effect may have had, particularly on the older worker.

There was a greater prevalence of noise-induced hearing loss in Plant 1 compared to Plant 2 (30.1% compared to 20.7%). Prevalence is defined as the total number of existing cases at any one time, both new and old. There was a significantly greater risk of severe noise-induced hearing loss with employment of 15 years or greater in Plant 1 compared to Plant 2 in this study ( $p < .02$ ), but not significantly greater risk of currently being on anti-hypertension medication ( $p > .05$ ).

The mean blood pressures of these two plants, among those currently not on blood pressure medication, is equal or better than national averages reported by NHANES, Framingham and others for this age group. In previous studies of noise and blood pressure in other plants, the systolic and diastolic blood pressures have ranges from 82.2 mmHg to 83.9 mmHg diastolic for similar age groups and a mean of 128.9 mmHg systolic (Talbot, 1985). However, the 2-3 mmHg difference noted in blood pressures between the two plants is a significant difference. National blood pressure drug lowering trials will target a significant change of 2-3 mmHg in a population under study. Therefore, a shift in mean blood pressure over time in any population puts a group at increased risk of stroke, heart attack, and other cardiovascular events and should not be taken lightly.



# **ADAPTIVE BEHAVIOR TO ROAD TRAFFIC NOISE BLOOD PRESSURE AND CHOLESTEROL**

**LERCHER Peter, KOFLER Walter**

Dept. of Social Medicine, University of Innsbruck, Sonnenburgstr. 16, A-6020 Innsbruck

## **Abstract**

A socioepidemiologic study was carried out in five rural communities located along major transit-traffic routes through the Austrian part of the Alps.

1989 citizens (62 %), aged 25 to 64 responded to an interviewer administered questionnaire, covering sociodemographic, medical and detailed information on noise related behavior and annoyance. Noise measurements from over 70 locations allowed individual assignment of noise exposure based on 5 dB,A categories (range 40-75 dB,A,Leq).

Regression analysis (adjusted for age, sex, bmi, education) showed neither noise levels or annoyance ratings associated with blood pressure in the hypothesized direction. But coping variables did show more consistent associations (in addition adjusted for noise levels). Closing windows during night (- 4.3 mmHg), membership in a citizen initiative (- 3.9 mmHg) and the attitude "avoidability" (- 2.1 mmHg) were significantly associated with systolic blood pressure, membership in a citizen initiative also with diastolic blood pressure (- 1.7 mmHg).

A significant link with lower cholesterol levels could be established with people who closed windows during night(- 7.3 mg/dl). The other indicators (including noise and annoyance) did not show significant differences.

This study supports further work to include indicators of adaptive behavior or attitudes in the analysis of non-auditory health effects of environmental noise exposure.

## **Introduction**

From animal and human experimental studies it is well documented that blood pressure and to a smaller extent also cholesterol levels are affected by chronic exposure to noise (1, 2, 3).

Epidemiologic studies have revealed mixed and sometimes even contradictory results, as far as chronic effects are considered (4, 5, 6).

Aside from methodological shortcomings theoretical considerations have been put into the debate. Thus it has been hypothesized that the subjective appraisal of the experienced noise and the amount of control you gain to cope with it may be of crucial importance to detect non-auditory health effects in field studies (7, 8, 9, 10). The allowance for these factors has been largely neglected in the past.

In experimental settings stress researchers have already earlier proved that control over noise reduces catecholamin output (11). Furthermore, social psychologists have shown the importance of cognitive factors (12) involved in this complex process of human appraisal of experienced noise exposure.

In this cross-sectional study we evaluated the importance of subjective annoyance by road traffic noise and checked the possible effects on blood pressure and cholesterol of different adaptive strategies, exposed citizens have established to cope with the noise stress imposed on their daily lives. Thus not the measured outdoor noise exposure is in the center of this analysis but the behavior and the actions people have implemented to get some sort of control over the noise exposure and attitudes involved.

## Methods

**Study sites:** Five small rural communities along two major transit-routes through the alpine part of Austria (Tyrol) were sampled systematically (13) to get a wide range of noise exposure (40 - 75 dB,A). Three communities were located along a highway, two along a main road. The proportion of heavy traffic was nearly identical (20/50 % day/night). In two villages noise barriers have already been established to protect areas of heavy exposure.

**Subjects:** Persons aged 25 to 64 with permanent residence were selected from the census list. Those selected got an invitation to participate in the study. Overall response was 62 % (N=1989). No relationship were found between non-response and traffic noise. In the larger communities only a certain fraction of the inhabitants were approached to avoid a major bias through community characteristics.

**Noise exposure:** Day- and nighttime noise was recorded standardized in front of the facade according to Austrian guidelines. An acoustician assigned to the people's homes an equivalent sound pressure level (seven 5dB,A, categories), based on long term measurements from 15 sites (3 per community) and additional short-term data from over 50 measuring points.

26 % of the sample experienced exposure above 60 dB,A, 5.5 % above 65 dB,A.

**Interview information:** Participants were approached by trained interviewers with a standardized questionnaire already used in an earlier pilot study. The interview covered sociodemographic and life style information as well as a detailed questionnaire on annoyance and coping activities. The annoyance ratings used in this analysis were obtained on a widely used four grade scale (not at all, a little, moderately, very much). Most of the questions on coping strategies and attitudes were based on dichotomous responses ( yes/no or "... most of the time ...").

**Blood pressure (BP):** Measurements were made after a standardized protocol according to the recommendations of the WHO. Readings were based on the first and fifth Korotkoff phase.

The second measurements were used in the analysis.

**Cholesterol:** One sample of non-fasting serum cholesterol was obtained from each participant and immediately analyzed (Reflotron, BM). Measurements were conducted by trained people with a carefully watched internal and external quality control in close cooperation with the manufacturer.

**Statistical analysis:** Multiple linear regression analysis were used to check the effect of different coping factors, allowing for standard confounding factors (age, sex, education, body mass index). SAS-PC software was used.

## Results and discussion

Table 1 shows very clearly for both, noise level and annoyance ratings, that the dose-response relationship is not going in the hypothesized direction. On the contrary, the highest class even represents the lowest mean BP-levels, a finding already known from the Speedwell-study (5). Moreover, the relationship of BP with annoyance is completely going in the opposite direction. However, analysis of adaptive strategies and attitudes demonstrates more consistency (Table 2). Membership in a citizen initiative is significantly associated with lower SBP as well as lower DBP. The effect is going in the hypothesized direction. Differences of similar size exhibit the indicators "windows closed during night" and the attitude "avoidability" with SBP.

With cholesterol we see a neglectable difference, at least in the hypothesized direction, for noise and annoyance indicators (Table 3). Examining the relationship of cholesterol with the coping variables, only "closing windows during night" demonstrates a significant link (-7.3 mg/dl).

Overall, the observed differences are small, but may be of public health importance, when combined effects are considered in future analyses. At least for BP, more consistent results are seen, when implemented coping activities or preventive attitudes are considered in the analysis. Commonly used noise and annoyance indicators exhibit results being very difficult to interpret.

## References

1. Andrén L, Hansson L, Björkman M, et al. Noise as a contributory factor in the development of elevated arterial pressure. *Acta Med Scand* 1980; 207: 493-498.
2. Ising H. Streßreaktionen und Gesundheitsrisiko bei Verkehrslärmbelastung, WaBoLu-Berichte 2/1983. Berlin: Reimer, 1983.
3. Peterson EA, Augenstein JS, Hazelton CL, et al. Some cardiovascular effects of noise. *J Aud Res* 1984; 24: 35-62.
4. Kristensen TS. Cardiovascular diseases and the work environment: A critical review of the epidemiologic literature on nonchemical factors. *Scand J Work Environ Health* 1989; 15: 165-179.
5. Babisch W, Ising H. Epidemiologische Untersuchungen über gesundheitliche Auswirkungen des Lärms: Caerphilly und Speedwell - Verkehrslärmstudien II, Forschungsbericht 91-10501115-C. Berlin: Institut für Wasser-, Boden- und Lufthygiene des Bundesgesundheitsamtes, 1991.
6. Thompson SJ. Review: Extraaural health effects of chronic noise exposure in humans. In: Ising H, Kruppa B., Eds. *Noise and Disease*. Stuttgart/New York, 1993: 106-117.
7. Westman JC, Walters JR. Noise and stress: A comprehensive approach. *Environ Health Perspect* 1981; 41: 291-309.
8. Cohen S, Evans GW, Stokols D, et al. *Behavior, health and environmental stress*. New York, London: Plenum Press, 1986.
9. van Dijk FJH, Ettema JH, Zielhuis RL. Non-auditory effects of noise in industry VII. Evaluation, conclusions and recommendations. *Int Arch Occup Environ Health* 1987; 59: 147-152.
10. Pulles T, Biesot W, Stewart R. Adverse effects of environmental noise on health: an interdisciplinary approach. In: Berglund B, Lindvall Th, Eds. *Noise as a Public Health Problem*, Vol 5. Stockholm: Swedish Council for Building Research, 1990: 337-348.
11. Frankenhaeuser M, Lundberg U. The influence of cognitive set on performance and arousal under different noise loads. *Motiv Emotion* 1977; 1: 39-49.
12. Glass DC, Singer JE. *Urban stress: Experiments on noise and social stressors*. New York: Academic Press, 1972.
13. Lercher P. Auswirkungen des Straßenverkehrs auf Lebensqualität und Gesundheit. Transitstudie - Sozialmedizinischer Teilbericht. Innsbruck: Amt der Tiroler Landesregierung, 1992.

**Table 1.**

Adjusted\* means (95 % confidence interval) for systolic and diastolic blood pressure by noise annoyance and noise level

Exposure variable	Systolic blood pressure (95 % CI)	N	Diastolic blood pressure (95 % CI)	N
<b>Annoyance</b>				
not at all	134.6 (133.0, 136.1)	515	85.6 (84.6, 86.4)	515
a little	131.8 (130.3, 133.4)	543	84.4 (83.4, 85.3)	543
moderately	131.9 (130.3, 133.4)	525	84.8 (83.8, 85.7)	525
very much	129.3 (127.4, 131.2)	366	84.2 (83.0, 85.4)	366
<b>Noise level**</b>				
< 50 dB,A	131.4 (129.9, 132.9)	569	85.4 (84.4, 86.3)	569
50 - 59	133.3 (132.1, 134.5)	889	85.2 (84.4, 85.9)	889
60 - 64	131.0 (129.2, 132.8)	400	83.9 (82.7, 85.0)	400
≥ 65 dB,A	128.7 (125.3, 132.1)	108	82.2 (80.1, 84.3)	108

\* Adjusted for age, sex, body mass index and education

\*\* Leq<sub>6-22</sub> (equivalent sound pressure level, A-weighting)

**Table 2.**  
Adjusted\* mean difference (95 % confidence interval) for systolic (SBP) and diastolic blood pressure (DBP) by selected coping strategies

Coping variable	Mean difference SBP (95 % CI)	Mean difference DBP (95 % CI)
Windows closed during day	-0.62 (-2.27, 1.02)	0.07 (-0.96, 1.09)
Windows closed during night	-3.87 (-7.32,-0.43)	-0.16 (-2.32, 1.98)
Membership in citizen initiative	-4.30 (-6.51,-2.10)	-1.69 (-3.06,-0.31)
Avoidability of noise annoyance	-2.08 (-3.89,-0.28)	-0.69 (-1.81, 0.43)

\* Adjusted for age, sex, body mass index, education and noise level

**Table 3.**  
Adjusted\* means and mean difference (95 % confidence interval) for cholesterol (mg/dl) by noise annoyance and noise level

Noise indicator	Yes Mean	No Mean	Mean difference (95 % CI)
Annoyance moderately + very much	217.9	214.4	3.43 (-0.81, 7.67)
Noise level $\geq 60$ dB,A,Leq	216.7	215.5	1.20 (-3.59, 6.00)

\* Adjusted for age, sex, body mass index, education

**Table 4.**  
Adjusted\* means and mean difference (95 % confidence interval) for cholesterol (mg/dl) by selected coping strategies

Coping Variable	Yes Mean	No Mean	Mean difference (95 % CI)
Windows closed during day	216.4	215.4	1.02 (- 3.25, 5.28)
Windows closed during night	209.0	216.3	-7.26 (-16.28, 1.75)
Membership in citizen initiative	213.8	216.2	-2.41 (- 8.30, 3.47)
Avoidability of noise annoyance	216.9	214.7	2.18 (- 2.42, 6.79)

\* Adjusted for age, sex, body mass index, education and noise level

# PROPOSALS FOR STUDIES OF AIRCRAFT NOISE AND HEALTH, SYDNEY AIRPORT

CARTER\*,N.L., TAYLOR\*, R., JOB\*,R.F.S, PEPLOE\*, P.  
and JENKINS\*, A., MORRELL \*, S

\* National Acoustic Laboratories \* University of Sydney

## ABSTRACT

The Sydney Airport Health Study Committee (SAHS) was formed at the request of the Federal Airports Corporation (FAC) to plan a "definitive" study of the effects of aircraft noise at Sydney Airport on human health. The resulting proposals were regarded by the FAC as too expensive, and less costly studies were requested. The present paper outlines the original proposal and a second plan for a cheaper study of more limited scope.

Le Sydney Airport Health Study (SAHS) a été constitué au demande du Federal Airports Corporation (FAC) afin que organise une étude "definitive" sur la santé et le bruit des appariel aéien vers l'aéroport de Sydney en Australiè. Le FAC a decidé que le premier proposition a été trop chère et a demandé un autre proposition moins chère. Cet article concern la proposition originale et le deuxieme version moins chère.

## INTRODUCTION

In 1991 the Commonwealth Government of Australia agreed to a proposal by the Federal Airports Corporation (FAC) to construct a second North-South runway (the 'Third Runway') at Sydney's Kingsford Smith Airport. This approval was conditional on the FAC considering further Recommendation 1 of the Australian House of Representatives Select Committee on Aircraft Noise (HORSCAN) with a view to commissioning a "...definitive long-term study into the effects of aircraft noise on human health..". This condition was accepted by the FAC and the Third Runway is due to begin operations in July, 1995.

The FAC approached the National Acoustic Laboratories (NAL) for advice on the feasibility of a study of health effects at Sydney airport. NAL advised that a study of possible health effects of aircraft noise was feasible. Sydney's Kingsford Smith airport already possessed a sophisticated noise monitoring system operated by the Civil Aviation Authority (CAA). The time interval before the runway was opened made it possible to validate this system, and carry out measures of health in the surrounding community before and after the Third Runway was opened. The Sydney Airport Health Study (SAHS) Committee was formed with the task of developing, and if accepted to carry out, a research proposal for a 'definitive' study of the effects of aircraft noise on health.

The SAHS Committee reported that 'definitive' research would entail carrying out a suite of studies using somewhat different but complementary approaches. These study proposals are outlined in Section A below. This programme was regarded as too expensive by the FAC, and the SAHS committee was asked to propose studies with more restricted scope. These SAHS proposals are also outlined here, in Section B.

## A. 'DEFINITIVE' RESEARCH PROGRAMME

### 1. Research Questions Formulated by the SAHS Committee

- (i) Do current methods of monitoring aircraft noise used by the CAA permit valid predictions of aircraft noise exposure at individual dwellings in the vicinity of Sydney airport?
- (ii) Is habitual exposure to aircraft noise at home associated with deleterious effects on physical and/or mental health?
- (iii) Are any health effects related to 'Noise Reaction' in individuals?
- (iv) Do other forms of environmental noise (eg from traffic) increase or offset the effects of aircraft noise?
- (v) Do preexisting psychological factors in individuals, such as perceptions of the predictability or controllability of the noise, modify the effects of aircraft noise on physical or mental health?
- (vi) What is the direction of causality in the relationship between attitude to noise source and reaction to the noise?
- (vii) Are some individuals especially susceptible to health effects?
- (viii) Is sleep disturbance due to aircraft noise accompanied by physiological responses which could have implications for health?

### 2. The Research Plan

Commencement of operation of the Third Runway at Kingsford Smith Airport will increase noise exposure in some areas near the airport, decrease it in others, and leave still other areas. The research plan was to relate noise exposure to the health of people from each of the four types of noise exposure area.

### 3. Outline of Proposed Studies

#### 3.1. Noise Measurements

- (i) Australian Noise Exposure Forecast (ANEF), Australian Noise Exposure Index (ANEI),  $L_{dn}$ , N60, N70, N80, N90 (number of aircraft noise events with  $L_{Amax}$  greater than 60, 70, 80, and 90 dBA respectively) at each subject's dwelling;
- (ii) Background (mainly traffic) noise at all locations;
- (iii) Loudness, perceived noise level (PNL), measures of speech interference, indoor/ outdoor noise attenuation, Doppler effect/pitch changes and the rate of onset of noise level, loudness and noisiness.

#### 3.2. Cohort Studies

A number of cohort studies, each to last five years, was proposed to investigate the effects of aircraft noise on mental and physical (primarily cardiovascular) health and noise reaction.

Three cohorts were to be assembled: an adult cohort comprising persons aged 35 and over, an adult cohort aged 18-34, and a cohort of schoolchildren aged 7-8 years in 1993. In the schoolchildren and the 18-34 year old cohorts, the main cardiovascular measure was blood pressure. Indications of heart disease, including ambulatory studies of cardiac arrhythmia in males over age 55, were included in the over 35 years cohort.

It was also proposed to investigate effects of aircraft noise on birthweight and gestation length of babies born to women in the cohort during the five year study period.

Mental health outcomes to be measured included depression, anxiety, mood and psychiatric symptoms.

Noise reaction measures, taken on all members of the adult cohorts, were to have been correlated with the physical and mental health outcomes.

Possible confounding and modifying variables were to be measured in all cohorts.

The required sample size in each cohort was calculated to detect effects at  $p < .05$  for a power of 80%. The estimated sample sizes were:

- (i) Adult (over 35 years) cohort: 6,500 subjects.
- (ii) Adult cohort aged 18-34: 3,500 subjects.
- (iii) Birth weight study: 2900 women aged 18-49.
- (iv) Child blood pressure study: 1200 children aged 7-8 years.

### *3.3. Repeated Cross-Sectional Studies*

Repeated administration of tests of mental health in the cohort studies could bias the results of the later tests. It was proposed to administer these tests to independent samples drawn concurrently with the second, third and fourth surveys of the adult cohorts, and to compare results.

### *3.4. Perceived Predictability and Locus of Control*

It was proposed to examine a sub-sample of the adult cohort (first round of testing) for an association between perceived controllability and attributional style and reaction to aircraft noise. If a positive association were found, then these subjects would be retested concurrently with the later three rounds of the cohort surveys to determine the direction of causality.

### *3.5. Noise Reaction and Attitude Toward the Noise Source*

Attitude to the airport authority would be manipulated by a 'letter drop' to half of two 200-person samples from high and medium noise impacted areas. This would be followed by interviews measuring noise reaction.

### *3.6. Studies Accessing Health Records*

The scope of cohort studies is limited by the rarity of some health outcomes. To overcome this difficulty three studies were proposed. These were (i) a 'Small Area' or 'Database' study; (ii) a study of general practitioner consultations (attendances); (iii) a 'Time Series' study.

- (i) The *Small Area study* would obtain mortality, cancer incidence and mortality, hospital separation, and birth data from public records for a number of census collector districts (CCDs) in the inner city. Each CCD would be classified into four aircraft noise exposure groups as for the cohort studies. Incidence data would be obtained for each year before and several years after opening the Third Runway.
- (ii) In the *General Practitioner study* each of a number of general practitioners in the four noise exposure areas would be required to record each diagnosis and drug prescription over one time period before, and two periods after opening of the Runway.
- (iii) The *Time Series study* would correlate daily flight patterns with daily hospital admissions for mental disorders, coronary heart disease (CHD), myocardial infarction (MI), stroke and deaths, in CCDs classified into the four noise 'areas'.

### 3.7. Studies of Sleep and Health

- (i) A *laboratory experiment* was proposed to measure sleep, blood pressure and immune system responses to noise in shiftworkers during daytime sleep, and compare these responses with those of people sleeping at night.
- (ii) The *field sleep study* was aimed to obtain data on the effects of change in the aircraft noise environment on shiftworkers sleeping in their own homes during the day. Subjects were to be drawn from the adult cohort study to enable correlations with other health variables and measurement of possible confounding and modifying factors.

## B. SECOND PROPOSAL

### 1. Approach

Because financial resources did not permit all studies to be undertaken, the SAHS committee prepared a second research proposal of more limited scope. The decision was taken to retain a cohort study approach, since previous studies of the relationship between aircraft noise and health had been handicapped by the use of weaker epidemiological designs, and to dispense with those outcomes measures, the collection of which promised to be expensive and logistically difficult.

### 2. Study Plan

A decision was taken to study (i) blood pressure and (ii) cardiac arrhythmia. It was thought that not only were both these variables pertinent and able to be accurately measured, they were both "continuous" and so their study could be conducted on fewer subjects than other candidate health outcomes (eg, certain mental health outcomes).

In all cases the cohort studies proposed were restricted to one survey measurement before, and one after the commencement of the Third Runway.

### 3. Study Outlines

#### 3.1. Noise Measurements

Validation of the CAA noise measuring system, and surveys of background noise levels were retained. Measurement of several noise metrics proposed in A were deleted.

#### 3.2. Blood pressure: Adult Cohort.

The blood pressure study will entail home visits of a sample of 6000 adults drawn from the same four noise exposure areas described in section A. Demographic data and the main known confounders for blood pressure will be obtained from these individuals. A questionnaire to measure noise reaction and noise sensitivity will also be administered.

#### 3.3. Blood Pressure: Child Cohort

The blood pressure of 1200 children from homes and schools in the four noise areas will be measured.

#### 3.4. Cardiac Arrhythmia

A sample of 500 males (125 from each noise area), aged 55 or over at commencement of the study, will be given 24-hour Holter monitoring once before and once after commencement of operations from the Third Runway.



# **RESPONSE TO QUESTIONNAIRE ON HEALTH**

## **AROUND A MILITARY AIRPORT**

**HIRAMATSU, Kozo ( Mukogawa Women's University )**

**( Tozaki - cho 1-13, Nishinomiya, 663 JAPAN )**

**YAMAMOTO, Takeo ( Suzuka University of Medical Science and Technologies )**

**TAIRA, Kazuhiko ( The University of the Ryukyus )**

**ITO, Akiyoshi ( The Institute for Science of Labour )**

**NAKASONE, Tadashi ( Koza Health Office, Okinawa )**

### **ABSTRACT**

The results of a questionnaire survey relating to general health, the Todai Health Index, in a town, neighbouring a large U.S. airbase in the Ryukyus are reported. The level of aircraft noise exposure expressed by WECPNL ranges from 75 to 95 or more in the town. The sample size was 1,200 including 200 from the "control" group. Results of the analysis of the responses in terms of the noise exposure suggest that the residents in the town suffer from psychosomatic effects, especially perceived mental disease, due to the noise exposure of military aircraft and that such responses increase along with the levels of noise exposure.

### **1. Introduction**

A survey on community response to a questionnaire on general health using the Todai Health Index was carried out in a town neighbouring a military airport. This is a report of the analysis of the responses in relation to the level of aircraft noise exposure.

### **2. Materials and Methods**

#### **2.1 Method and Questionnaire**

The survey was undertaken by means of leave-and-pick-up questionnaire method in Chatan Town, Okinawa Prefecture, the Ryukyus, Japan: a town located in the immediate vicinity of Kadena Airport - the largest U.S. Airbase in the Far East. The questionnaire used in the present investigation is the Todai Health Index (THI) including 4 additional questions, besides the 130 original ones, asking about hearing loss, health perceptions, etc. THI was developed as a general health questionnaire by workers at the University of Tokyo ("Todai" in Japanese) in 1974 with the purpose of supplementing the Cornell Medical Index - Health Questionnaire. It consists of 130 questions regarding subjective symptoms, mental health, personality, health habits, and so forth. From the results twelve scale scores are calculated to reveal the pattern of complaints and personalities, and two discriminant scores indicate tendencies toward psychosomatic disease and neurosis. These are tabulated in Table 1.

## 2.2 Noise Exposure

Chatan Town suffers from high level of noise exposure due to flyovers of aircraft landing and taking-off from the airport. The noise exposure expressed by WECPNL ( Weighted Equivalent Continuous Perceived Noise Level ) in the town ranges from 75 to 95 or more (Fig.1), which exceeds the environmental standards for aircraft noise around commercial airports [70-75] set by the Japanese EPA. The Japanese EPA simplified the measurement and calculation of WECPNL as proposed by ICAO as the measure of the environmental standard as follows;

$$\text{WECPNL} = \overline{\text{dBA}} + 10 \log N - 27,$$

where  $\overline{\text{dBA}}$  stands for the energy mean of all peak levels of any one day, and N stands for the value emerging from the following equation:  $N = N_2 + 3N_3 + 10 ( N_1 + N_4 )$ , where  $N_1$  is the number of aircraft between 0:00a.m. and 7:00a.m.,  $N_2$  the number between 7:00a.m. and 7:00p.m.,  $N_3$  the number between 7:00p.m. and 10:00p.m., and  $N_4$  the number between 10:00p.m. and 12:00p.m. For the noise exposure around the military airport—where the number of events widely changes day after day—N is represented by the number of flyovers per day equaled or exceeded by the number of flyovers 10 per cent of the days in a year.

## 2.3 Subjects

Inhabitants in Chatan Town were stratified in 5 groups according to the level of noise exposure; WECPNL = 75-79, 80-84, 85-89, 90-94, 95-. One hundred male and a hundred female persons aged over 20 years inclusive were sampled from the pollbook of each group by stratified random sampling. As a non-noise-exposed "control" group, another 200 male and female subjects from Kitanakagusuku Village neighbouring Chatan Town (located in the opposite direction from the airport) were sampled. The total sample size was thus 1, 200.

## 3. Results and Discussion

One thousand fifty three persons (87.8%) answered the survey. Scale scores and discriminant scores were calculated from the responses. Results of the analyses can be summarized as follows.

1) Statistically significant differences are found between the noise exposure groups and the control group in the scale scores and discriminant scores concerning subjective complaints.

2) Dose-response relationships with respect to scale scores and noise exposure are not very clear in the range of WECPNL 75 to 94, when respondents are stratified by 5 units of WECPNL. For the stratification of the respondents into the groups of control, WECPNL=75-94 and WECPNL>95, tendencies of monotonous increase were found in the scale scores of mental instability, depressiveness, aggressiveness, nervousness, and tendencies toward somatic disease and neurosis.

3) Factor analysis (principal factor method with varimax rotation) indicates two factors which can be interpreted as the factors of perceived somatic disease (Factor 1) and perceived mental disease (Factor 2). The score of Factor 2 is the largest for the group of WECPNL>95 and the

smallest for the control group.

4) Among 89 females in the group of WECPNL95, 24 persons answered "Yes" "Are you hard of hearing?" The "Yes" response was significantly higher compared 87 females in the control group. Among 80 males in the group of WECPNL95, . . . answered "No" to the question "Do you think you are healthy?" "No" answers to the qu. . . the control group were 8 among 83. The scores described above are normalized by mean following equation and are illustrated as radar charts in Fig.2.

$$Z = (X - Y) / S,$$

where  $X$  is the mean of scale score, discriminant value or factor score of the noise exposed group  $Y$  that of the control group,  $S$  the standard deviation of the scores of the control group. The inner and outer circles indicate  $Z = -0.5$  and  $0.5$ , respectively.

#### 4. Conclusions

The present authors have described the results of a questionnaire survey relating to general health in a town neighbouring a large U.S. airbase in the Ryukyus, using the Todai Health Index. Results of the analysis of the responses in terms of the noise exposure suggest that the residents in the town suffer from psychosomatic effects, especially perceived mental disease, due to the noise exposure of military aircraft and that such responses increase along with the level of noise exposure.

#### ACKNOWLEDGEMENTS

The authors would like to acknowledge the kind assistance of Mr. UEMA, Tsuneaki for his help with the direction of the survey.

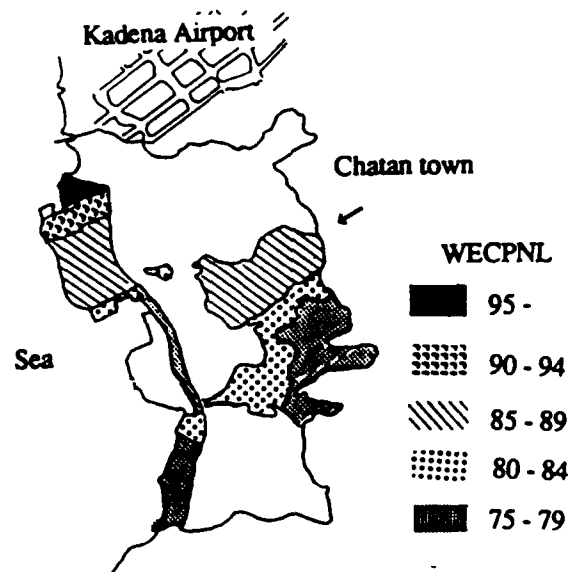
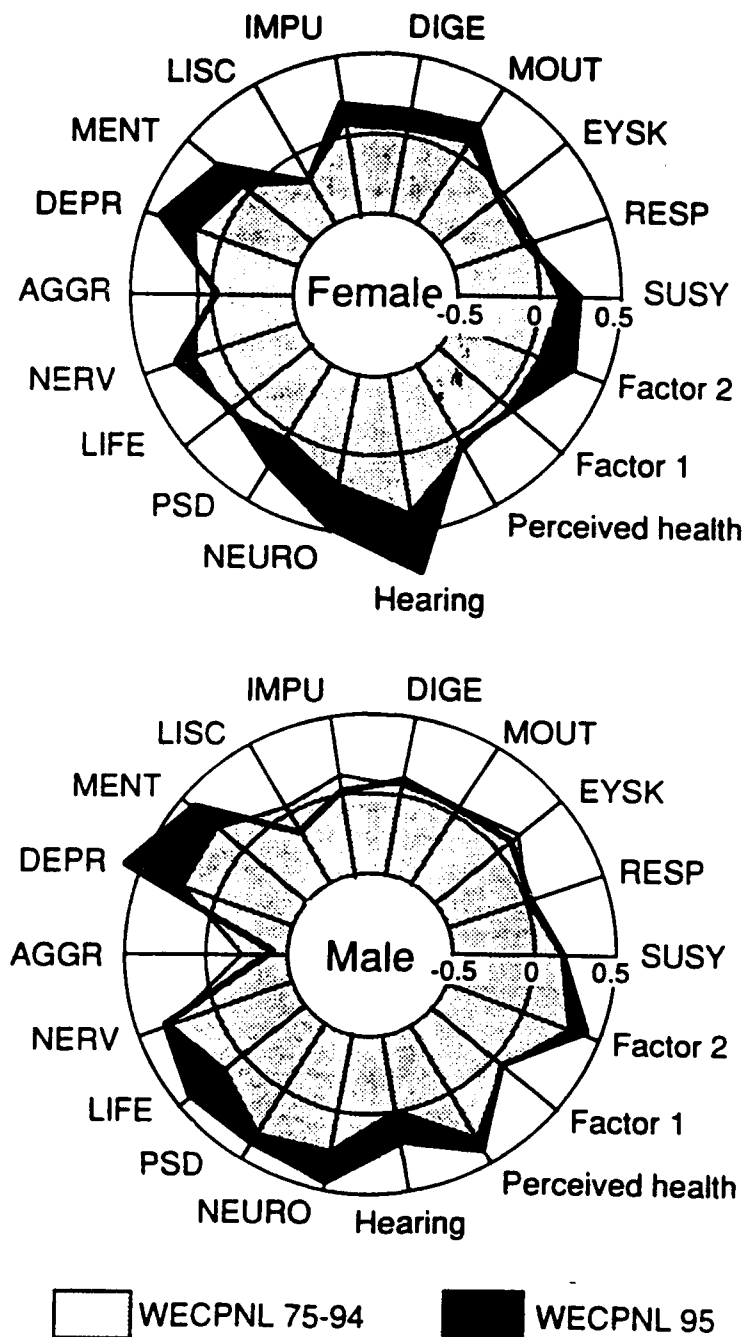

Fig.1. WECPNL in Chatan Town

**Table 1. Scales and discriminants to be calculated**

<b>SUSY</b> : Many subjective symptoms	<b>MENT</b> : Mental instability
<b>RESP</b> : Complaints reg. respiratory organs	<b>DEPR</b> : Depressiveness
<b>EYSK</b> : Complaints reg. eyes and skin	<b>AGGR</b> : Aggressiveness
<b>MOUT</b> : Complaints reg. mouth and evacuation	<b>NERV</b> : Nervousness
<b>DIGE</b> : Complaints reg. digestive organs	<b>LIFE</b> : Irregularity of daily life
<b>IMPU</b> : Impulsiveness	<b>PSD</b> : Psychosomatic disease
<b>LISC</b> : Lie scale	<b>NEURO</b> : Neurosis



**Fig. 2** Radar charts illustrating the results of the investigation.

# **PSYCHIATRIC AND PSYCHOPHYSIOLOGICAL DISORDERS IN CHILDREN LIVING IN A MILITARY JETFIGHTER TRAINING AREA**

**SCHMECK, Klaus & POUSTKA, Fritz**

Dep. of Child and Adolescent Psychiatry, Johann Wolfgang Goethe-University, Deutschordenstr. 50,  
D 6000 Frankfurt a.M., Germany

**Abstract:** 376 children and adolescents (4 to 17 years old) of two areas with different levels of low-altitude flight noise were investigated with a child psychiatric interview, several psychophysiological parameters and a questionnaire of important psychosocial stressors. Noise differed significantly between the two areas. Children in the high noise area showed higher levels of anxiety syndromes (separation anxiety, overanxiety, simple phobia, agoraphobia) and elevated levels of autonomous arousal (heart rate, habituation of blood pressure, skin conductance level, spontaneous fluctuations of SCL). No association could be found between noise and global psychiatric or psychosomatic disturbance, which were closely related to psychosocial stress. Intervening variables like noise annoyance, noise sensitivity or neurological impairment showed only little influence on children's health.

## **Introduction**

There is no doubt about the fact that human functioning is affected by high noise and that noise has to be regarded as an environmental stressor which produce stress reactions (Spreng 1984, de Jong 1993). Noise caused by military jetfighters seems to be particularly noxious because of its special characteristics (i.e. high maximum levels up to 125 dB(A), rapid rises in sound level up to 111 dB/s, high concentration of energy in low frequencies: Spreng 1993).

However up to now there are no convincing and corresponding results to the question, if noise exposure leads to long term damage or even diseases (Ising & Kruppa 1993, Griefahn 1982). According to Thompson (1993) there is a need in noise studies to consider intervening and modifying variables as well as confounders.

In our field study in a military jetfighter training area (Poustka & Schmeck 1990, Poustka, Eckermann & Schmeck 1992) we examined the effects of low-altitude flight noise on children and adolescents. In order to disentangle the complexity of influences on children's health the investigation included the measurement of objective noise burden, subjective impairment by noise, amount of psychosocial stressors in children's environment and children's traits like intelligence, neurological impairment or noise sensitivity.

## **Method**

376 children and adolescents aged 4 to 17 years living in two areas with different levels of military jetfighter noise were investigated with a child psychiatric interview (DISC, Costello et al. 1983) with both parents and children, a short neurological and psychological examination, peripheral psychophysiological measures as cardiac activity, blood pressure, electrodermal activity, muscle tension and motoric activity, a noise questionnaire and a questionnaire of important psychosocial stressors. Jetfighter noise was measured by the State Institute for Protection against Pollution (Landesanstalt für Immissionsschutz, Essen) independently from the

child psychiatric study in four communities of the high noise area and three communities of the low noise area (Strauch 1991).

## Results

1) **Noise Burden:** Mean number of low-level flights, rise of sound level, noise annoyance and a feeling of being threatened differed significantly between the two areas (see table 1). However there was no difference between maximum sound levels ( $LAF_{MAX}$ ), which reached 115 dB(A) in both areas.

Table 1: Noise measures

Area	mean no. of flights (n)	rise of sound level (90th perc.) (dB(A)/sec	noise annoyance (%)	being threatened (%)
<b>high noise area</b>				
Coesfeld	2.7	17.5	70.0	56.7
Raesfeld	4.4	18.8	75.3	57.8
Heiden	7.0	24.8	66.4	55.6
Velen	9.4	22.5	76.6	54.9
<b>low noise area</b>				
Drensteinfurt	1.2	11.0	46.7	39.1
Sendenhorst	2.4	11.0	49.4	32.8
Everswinkel	2.5	13.0	48.8	36.4

2) **Psychiatric Disturbance:** Global psychiatric disturbance of children and adolescents was not different between the two areas, and the number of DSM-III-diagnoses was similar. The most important variable to explain the variance of global psychiatric disturbance was 'psychosocial stress' (see Poustka 1991).

Significantly higher scores in the high noise area can be demonstrated if we regard anxiety syndromes in younger children aged 9 to 11 years (see figure 1).

Figure 1: Anxiety Syndromes, 9-11 year old children

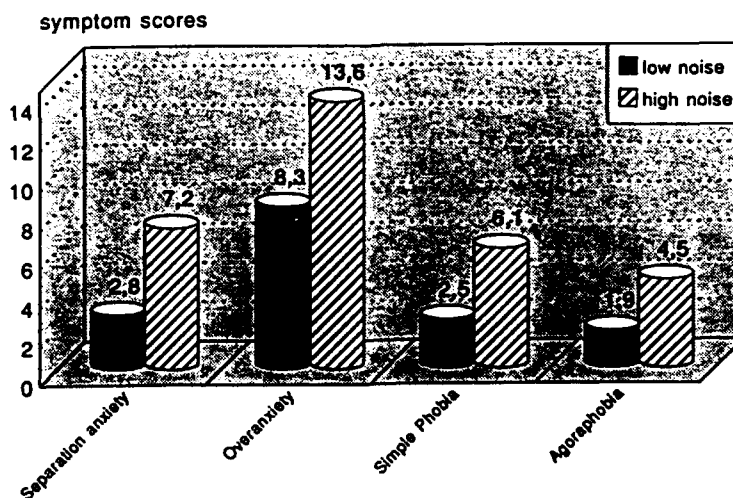

In a multi-level analysis we used analysis of covariance to evaluate the relative importance of noise in comparison to other influential parameters. Besides the covariate 'age' only 'noise' showed a high significant influence in the explanation of separation anxiety. We also found a significant influence of 'noise' in the explanation of agoraphobia. No interaction of two or more parameters could be found (table 2).

**Table 2: Analysis of covariance of anxiety syndromes (significance of F)**

	Separation Anxiety	Over-anxiety	Simple Phobia	Agora-phobia
Source of Variation covariate: Age	.000	.188	.325	.091
<u>Main Effects</u>				
Noise	.084	.257	.013	.055
Sex	.009	.419	.135	.039
Psychosocial Stress	.443	.340	.000	.024
Intelligence	.976	.929	.255	.525
Neurol. Disorders	.851	.451	.965	.857
Noise sensitivity	.191	.076	.473	.422
Feeling threatened	.412	.298	.709	.905
	.333	.402	.797	.589

3) **Psychophysiological activity:** Psychophysiological activity was significantly higher in the high noise area (see table 3). Children in this area showed an elevated level of heart rate, skin conductivity and spontaneous fluctuations and reduced ability of systolic blood pressure adaptation. The influence of all other independent variables besides the covariate 'age' was far away from any significance. Two significant interactions could be found: Children in the high noise area who felt annoyed about noise showed a decreased ability of systolic blood pressure adaptation. Children in the high noise area with high noise sensitivity had more spontaneous fluctuations of skin conductance level.

**Table 3: Analysis of covariance of psychophysiological parameters (significance of F)**

	heart rate	adaptation of systolic blood pressure	skin conductivity	spontaneous fluctuations
source of variation covariate: age	.000	.001	.000	.002
<u>main effects</u>				
noise	.128	.035	.038	.274
sex	.004	.043	.002	.007
noise annoyance	.336	.515	.391	.548
feeling of threat	.239	.847	.995	.809
noise sensitivity	.069	.770	.981	.810
psychosocial stress	.289	.496	.524	.404
psych. disturbance	.387	.611	.229	.702
intelligence	.876	.144	.931	.679
neurol. disorder	.316	.065	.770	.421
<u>interactions</u>				
noise X annoyance		.015		
noise X noise sensitivity				.016

4) **Psychosomatic disorders:** In spite of raised levels of autonomic activity we did not find any significant difference of somatic or psychosomatic complaints or diseases between the two areas with different noise burden. Parents in the high noise area did not report more symptoms like 'headaches', 'dizziness', 'pains', 'skin problems', 'allergies', 'asthma' or 'nervousnes' of their children (for further details see Schmeck 1992). However we could find a significant positive correlation between psychosocial stress and medical problems. 31.8% of children with high psychosocial stress had some kind of medical problem in comparison to 20.6% of low stressed children.

## Conclusions

1. Global psychiatric disturbance is more influenced by psychosocial stressors than by a physical stressor like aircraft noise. However we could demonstrate a higher level of anxiety in young children who live in an area with frequent low-altitude flight noise.
2. The noise of military jetfighters has a significant influence on the level of psychophysiological arousal of children. This higher autonomous activity is not associated with a greater amount of medical problems.
3. Psychosocial stress has no significant influence on psychophysiological activity, but there is an important association to psychosomatic complaints and other medical problems.
4. In our study intervening or possibly confounding variables like noise sensitivity, noise annoyance, a feeling of being threatened by military aircrafts, neurological disturbance or low intelligence don't seem to have an important impact on psychiatric or psychosomatic disturbance of children and adolescents.

## Literature:

- COSTELLO,A.J., EDELBROCK,C.S., KALAS,R., KESSLER,M.D. & KLARIC,S.H.: The NIMH Diagnostic Interview Schedule for Children (DISC). Unpublished Interview Schedule, Department of Psychiatry, University of Pittsburgh, 1982
- GRIEFAHN,B.: Grenzwerte vegetativer Belastbarkeit. Zum gegenwärtigen Stand der psychophysologischen Lärmforschung. *Zeitschrift für Lärmbekämpfung*, 29, p.131-136, 1982
- ISING, H. & KRUPPA, B. (eds.): *Noise and Disease*. Fischer Verlag, Stuttgart / New York 1993
- de JONG, R.G.: Review: Extraaural health effects of aircraft noise. in: ISING, H. & KRUPPA, B. (eds.): *Noise and Disease*. Fischer Verlag, Stuttgart / New York 1993
- POUSTKA,F.: Psychische Auffälligkeiten bei Kindern in Gebieten unterschiedlicher Tiefflugaktivitäten. in: POUSTKA,F. (Hrsg.): *Die physiologischen und psychischen Auswirkungen des militärischen Flugbetriebes*. Huber, Bern 1991
- POUSTKA,F., ECKERMANN,P. & SCHMECK,K.: Effect of aircraft noise and psychosocial stressors on mental disturbances of children and adolescents - an epidemiological survey in Westphalia. in: REMSCHMIDT,H. & SCHMIDT,M.H.(Hrsg.): *Developmental Psychopathology*. Hogrefe, Göttingen 1992
- POUSTKA,F. & SCHMECK,K.: Über die psychischen Auswirkungen von militärischer Tiefflugtätigkeit auf Kinder. Ergebnisse einer epidemiologischen Untersuchung in Westfalen. *Z.f.Kinder- und Jugendpsychiatrie* 18,2,1990, p.61-70
- SCHMECK,K.: *Beeinträchtigung von Kindern durch Fluglärm*. Klotz Verlag, Eschborn 1992
- SPRENG,M.: Risikofaktor Lärm - physiologische Aspekte. *Therapiewoche* 1984, 34, p.3765-3772
- SPRENG, M.: Specific features of military low-altitude flight noise: Criteria for risk of damage and physiological effects. in: ISING, H. & KRUPPA, B. (eds.): *Noise and Disease*. Fischer Verlag, Stuttgart / New York 1993
- STRAUCH,H.: Geräuschmissionen durch tieffliegende Militärflugzeuge. in: POUSTKA,F. (Hrsg.): *Die physiologischen und psychischen Auswirkungen des militärischen Flugbetriebes*. Huber, Bern 1991
- THOMPSON, S.J.: Review: Extraaural health effects of chronic noise exposure in Humans. in: ISING, H. & KRUPPA, B. (eds.): *Noise and Disease*. Fischer Verlag, Stuttgart / New York 1993



# NOISE SENSITIVITY AND PSYCHOPHYSIOLOGICAL RESPONSES TO NOISE IN THE LABORATORY

STANSFELD, Stephen., SHINE, Phil.

Academic Department of Psychiatry  
University College Medical School London  
Department of Psychopharmacology  
Institute of Psychiatry, London, UK

## **Abstract:**

Noise sensitivity is a predictor of noise annoyance and may be a risk factor for illhealth induced by noise. The evidence for this would be greatly strengthened if psychophysiological correlates of noise sensitivity were found in laboratory studies of noise exposure. Heart rate and skin conductance responses to pure tone and pneumatic drill noise were examined in 18 depressed and 18 sex- and age-matched non-depressed control subjects. High noise sensitive subjects had higher levels of physiological arousal with higher tonic skin conductance than low sensitive subjects. In highly noise sensitive subjects skin conductance response amplitude was greater and took longer to habituate and there were larger accelerative heart rate responses to noise in the window '3-5' seconds post-stimulus. In summary highly noise sensitive subjects demonstrate greater physiological arousal, more defence/startle responses and slower habituation to noise than low sensitive subjects consistent with noise sensitivity as a vulnerability factor to noise effects on health.

## **Introduction:**

Noise sensitivity as a risk factor for noise annoyance and for psychological illhealth is generally measured by self-report questionnaires. This raises the question of reporting bias in associations between noise sensitivity and health both measured by self-report instruments. The demonstration of psychophysiological correlates of noise sensitivity would support its role as a moderator of the effects of noise on health and might give clues to the psychophysiological mechanism underlying this effect.

Associations have been found between noise sensitivity and psychophysiological indices but they have not always been consistent. Atherley et al (1970) found that the ranking of the subjective importance of a series of sounds correlated with the length of decay time of the skin resistance response to these sounds. Similarly, Gang and Teft (1975) found an association between the meaning of dental engine noise and the magnitude of the physiological response.

Noise sensitivity has also been associated with raised heart rate to noise in several laboratory studies (Ising, 1980; Rövekamp, 1983; Di Nisi et al, 1987; Abel, 1990) but noise sensitivity was related to lower heart rates in a community study (Stansfeld et al, 1985). In addition, noise sensitivity has also been related to failure of habituation of the finger vasoconstriction response to noise (Cohen et al, 1973) although this was not found by Di Nisi et al (1987). The literature suggests association between psychophysiological responses to noise and the meaning of the noise stimulus with possibly slower habituation in noise sensitive subjects.

As part of a study of noise sensitivity and clinical depressive illness, we examined heart rate and skin conductance habituation to a series of pure tones (neutral) and pneumatic drill noise (aversive noise) in the laboratory.

## **Method:**

**Subjects:-** Men and women between 18 and 60 years with primary depressive disorder and age- and sex-matched control subjects of normal hearing were selected for the study.

**Experimental design:-** Each subject heard 18 I KHz pure tones and 18 pneumatic drill noises in a fixed random order through headphones in the laboratory after a rest period. The sounds were of three intensities (50 dBA, 75 dBA, 100 dBA). Each sound lasted 4 seconds and was enclosed in an envelope of 30m seconds risetime and declination.

**Attachment of electrodes:-** Heart-rate electrodes were attached to the dorsal surface of both forearms. The active skin conductance electrode was attached to the volar surface of the terminal phalanx of the (L) thumb positioned over the central whorl of the thumb print. Further details of the method are given in Stansfeld (1992).

**Measurement of Noise Sensitivity:-** There were two measures of noise sensitivity, the 21-item Weinstein Noise Sensitivity Scale (NS) (Weinstein, 1978) and the Broadbent Gregory Noise Annoyance (NA) scale from the General Noise Annoyance Questionnaire (Broadbent, 1972).

## **Results:**

**Skin conductance:** High NS subjects, in general, had higher levels of physiological arousal with more spontaneous fluctuations pre-experimentally ( $F = 4.47$ ,  $df 1,35$   $p < 0.05$ ) than low NS subjects. For tonic skin conductance levels there were highly significant three-way interactions between noise/tone, intensity of sound and Weinstein NS ( $F = 7.4$   $df 2,27$   $p < 0.003$ ). High NS groups had higher tonic skin conductance than low NS groups except for the low NS control group, which as it had only two subjects, may be untypical.

There was a small main effect of noise sensitivity, ( $F = 6.18$ ,  $df 1,28$   $p < 0.02$ ) on skin conductance response amplitude, calculated as the difference between pre- and post-stimulus log skin conductance levels. There were also interactions between NS and intensity ( $F = 8.0$   $df 2,27$   $p < 0.002$ ) and NS and repetitions by intensity ( $F = 3.9$ ,  $df 10,18$   $p < 0.006$ ). High NS subjects both begin with larger amplitudes at all three sound intensities than low NS subjects and also take longer to habituate, particularly for the high NS group exposed to 100 dBA.

**Heart Rate:** Pre-stimulus heart rate, measured as interbeat interval for five seconds prior to each stimulus was averaged for each of the thirty-six stimuli. In repeated measures analysis of variance there was a significant interaction between Weinstein NS and repetitions by Noise/Tone ( $F = 3.4$ ,  $df 5,24$   $p < 0.02$ ) and an interaction between NS and noise/tone ( $F = 5.6$ ,  $df 1,28$   $p < 0.03$ ). Both high NS and high NA subjects had faster heart rates than low NS and low NA subjects respectively for both noise and tone.

Heart rate responses were calculated from 10 seconds of measurement post-stimulus subtracted from the mean pre-stimulus score to give 10 difference scores for each stimulus. To reduce the data to manageable proportions three windows were defined, the initial deceleration (1-2 seconds post stimulus), the accelerative response (3-5 seconds post-stimulus) and the late decelerative response (6-9 seconds post stimulus) (Turpin & Siddle, 1978).

In the first window, using repeated measures analysis of variance there was a small significant interaction between NA and type of sound ( $f = 4.95$ ,  $df 1,28$   $p < 0.04$ ) but this was not found for the Weinstein scale.

In the second window, using the maximum accelerative value for each stimulus, in repeated measures analysis of variance, there was a significant main effect for type of sound in the NS

analysis ( $F = 12.06$ ,  $df 1,28$   $p < 0.002$ ) in which there were greater accelerative responses to noises than tones. When the maximum deflection was substituted for the maximum accelerative response there were significant main effects for NA ( $F = 8.14$ ,  $df 1,28$   $p < 0.009$ ) and a significant interaction between NA and Noise/Tone by repetition by intensity ( $F = 2.52$ ,  $df 10,19$   $p < 0.04$ ) but these were not found for the Weinstein scale. For NA high scorers there were larger accelerative responses for both noise and tone at all three intensities than in NA low scorers. Also high NA scorers tended to have more accelerative than decelerative responses across repetitions for 75 dBA and 100 dBA ( $F = 2.16$ ,  $df 10,19$   $p < 0.08$ ). In the third window there were no significant main effects.

### **Discussion:**

Physiological responses to noise in terms of heart rate and skin conductance, rapidly habituate in most people although there is a minority who habituate more slowly. Does this group include people who are more sensitive to noise? Certainly, delay in habituation, and having prolonged physiological arousal might provide a mechanism for ill effects on health caused by noise. Van Dijk (1986) has suggested that high levels of arousal may have an influential effect on how noise sensitive subjects cope with noise and arousal has been found to be an important moderating variable in studies of performance (Broadbent, 1983).

In this small study the greater number of spontaneous skin conductance fluctuations and the higher tonic skin conductance levels and higher tonic heart rates in noise sensitive subjects support the association of noise sensitivity with higher levels of physiological arousal. This is similar to studies of patients with chronic anxiety (Bond et al, 1974) which may parallel the consistent link of noise sensitivity with neuroticism (Stansfeld, 1992). Tonic heart rate across the experiment rose in exposure to noise but fell for exposure to tones for high NS subjects which is in keeping with a more discriminating response to sound in noise sensitive subjects.

High NS subjects, but not high NA subjects, had larger skin conductance responses to noise than low NS subjects which is not in keeping with findings in anxious patients. Such findings are similar, however, to normal subjects response to phobic stimuli (Öhman et al, 1974). This supports the self-report questionnaire findings that noise sensitivity is linked to perception of threat from environmental stimuli, especially noise sources (Stansfeld, 1992). The larger accelerative heart rate responses to noise and tone among high NA scorers in the second window post-stimulus does suggest slower habituation of defence/startle reactions to more intense noise. However, this was not significant for the Weinstein scale although a similar pattern exists in the mean scores. Many of the findings are not entirely consistent across the two noise sensitivity scales. This may be because psychophysiological measurements are difficult to administer and subject to many forms of error. Because of this these results need to be replicated in larger independent samples.

Altogether there does seem to be a pattern of higher physiological arousal to noise, phobic and defence/startle responses to noise and slower habituation to noise in noise sensitive subjects. These physiological findings may relate to both greater perception of threat from noise and greater reactivity to noise in sensitive subjects.

### **References:**

- Abel, S.M. (1990). The extra-auditory effects of noise and annoyance: an overview of research. *Journal of Otolaryngology* 19, 1-13.
- Atherley, C.R.C., Gibbons, S.L. & Powell, J.A. (1970). Moderate acoustic stimuli: the interrelation of subjective importance and certain physiological changes. *Ergonomics* 13, 536-545.

- Bond, A.J., James, C.D., Lader, M.H. (1974). Physiological and psychological measures in anxious patients. *Psychological Medicine*, 4, 364-373.
- Broadbent, D.E. (1972). Individual differences in annoyance by noise. *Sound* 6, 56-61.
- Broadbent, D.E. (1983). Recent advances in understanding performance in noise. *Proceedings of Fourth International Congress, Noise as a Public Health Problem. Volume 2* p.p. 719-738.
- Cohen, H.H., Conrad, D.W., O'Brien, J.F. & Pearson, R.G. (1973) Noise effects, arousal and human processing task difficulty and performance. *Human Factors*, march 1973, North Carolina State University at Raleigh.
- Di Nisi, J., Muzet, A., Weber, L.D. (1987). Cardiovascular responses to noise effects of self-estimated sensitivity to noise, sex, and time of day. *Journal of Sound and Vibration* 114, 271-279.
- Gang, M.J. & Teft, L. (1975). Individual differences in heart rate responses to affective sound. *Psychophysiology* 12, 423-426.
- Ising, H., Dienel, D., Günther, T., Market, B. (1980). Health effects of traffic noise. *International Archives of Occupational and Environmental Health* 47, 179-190.
- Öhman, A., Eriksson, A., Fredriksson, M., Hugdahl, K., Olofsson, C. (1974). Habituation of the electrodermal orienting reaction to potentially phobic and supposedly neutral stimuli in normal human subjects. *Biological Psychology* 2, 85-93.
- Rövekamp, A.J.M. (1983). Physiological effects of environmental noise on normal and more sound-sensitive human beings. *Proceedings of the IVth International Congress on Noise as a Public Health Problem* (Ed. Rossi, G.) Vol 1, 605-614. Centro Ricerche E Studi Amplifon: Milano.
- Stansfeld, S.A., Clark, C.R., Jenkins, L.M., Tarnopolsky, A. (1985). Sensitivity to noise in a community sample. I & II. The measurement of psychiatric disorder and personality. *Psychological Medicine* 15, 243-254 and 255-263.
- Stansfeld, S.A. (1992). Noise, noise sensitivity and psychiatric disorder: epidemiological and psychophysiological studies. *Psychological Medicine Monograph*, 22.
- Turpin, G., & Siddle, D.A.T. (1978). Cardiac and forearm plethysmographic responses to high intensity auditory stimuli. *Biological Psychology* 6, 267-282.
- Van Dijk, F.J.H. (1986). Non-auditory effects of noise in industry. II. A review of the literature. *International Archives of Occupational and Environmental Health* 58, 325-332.
- Weinstein, N.D. (1978). Individual differences in Reactions to Noise: A longitudinal study in a College Dormitory. *Journal of Applied Psychology*, 63, 458-466.

MEYER-FALCKE, Andreas; LANZENDÖRFER, Ariane; RACK, Reinhard

Institute of Occupational Medicine  
 Heinrich-Heine-University Düsseldorf  
 Gurlittstr. 55, D-W-4000 Düsseldorf 1, Germany

**Abstract**

Analogous to existing damage risk criteria (DRC) to avoid noise induced hearing loss (NIHL) the development of a new BLD (borderline diagramm) to avoid noise induced respiratory alteration is presented.

The investigation is divided into two partitions:

1. We analyzed and extracted 171 studies (1338 individuals) dealing with sound pressure effects on lung and airway system. From these datas we extracted a curve and extrapolated so that it encloses the whole relevant range of stress from 80 to more than 200 dB.
2. We examined 552 volunteers which were exposed to noise with different effecting times, sound pressure levels (SPL) and frequency spectrums in 7 various trials. Auditory and extraauditory physiological parameters were measured under the conditions of impulsive and continuous noise in a range from 94 to 175 dB. The more stress the more strain we could proof. Employees with NIHL showed significantly restricted reactions in acute experimental situations as well as regarding the effects of chronical noise exposition.

**1. Introduction**

Hearing can be protected sufficiently in almost every situation: administrative, technical and medical precaution is guaranteed. Even observing the existing limits to avoid noise induced hearing loss (NIHL) any extraauditory disturbances can not be excluded in general. Especially the respiratory system is endangered in comparison to other organs (WALBY and KERR, 1986). Following PHILLIPS et al. (1986) extraauditory damages can be suffered from noise by exceeding the curve of current DRC (damage risk criteria) only. However, occupational medicine cares for early alterations. Therefore a new BLD (borderline diagramm) regarding extraauditory noise effects has to be found below this harm limit. There is a need for regulation regarding impulsive noise with high energy and short effecting time as well as continuous noise with low sound pressure levels (SPL) lasting for years (KOKINAKIS and RUDOLPH, 1982).

**2. Material and Methods**

This investigation is divided into two partitions:

1. we give a survey about the literature dealing with sound pressure effects on lung and airway system;
2. we present own experimental investigations to verify noise effects on man with SPLs which are relevant for employees.

**2.1. Synopsis of existing datas**

With our intention to develop a new BLD that enables an assessment of risk for respiratory alterations, we analyzed 171 studies representing 1338 individuals and extracted SPLs and effecting times in view of influences on lung and airway system. The results of these examinations made on men and five species of animals were summarized to a borderline.

\* supported by a grant of German Ministry of Defence

## 2.2. Own experimental investigations

Auditory and extraauditory physiological parameters were measured under the conditions of impulsive and continuous noise in a range from 94 to 175 dB. We examined 552 volunteers which were exposed to noise with different effecting times, SPL and frequency spectrums in 7 various trials:

- rifle (10 shots,  $L_{max}$  158.8 dB,  $t_{eff}$  8.5 ms)
- bazooka (3 shots,  $L_{max}$  175 dB,  $t_{eff}$  3.75 ms)
- low-level airflight noise (5 flights,  $L_{max}$  105 dB,  $t_{eff}$  105 s)
- low-level airflight noise (5 flights,  $L_{max}$  94 dB,  $t_{eff}$  105 s)
- continuous white noise (105 dB,  $t_{eff}$  5 and 8 min)
- jet-engine noise ( $L_{max}$  135 dB,  $L_{eq}$  127.5 dB,  $t_{eff}$  9 min)
- reverberate chamber ( $L_{max}$  139 dB,  $L_{eq}$  133.4 dB,  $t_{eff}$  2 min).

To register the strain several pulmonary function parameters have been measured: PEF, MEF<sub>50</sub>, MEF<sub>25</sub>, ROS, RAW, FEV<sub>1</sub>, IGV and VC<sub>in</sub>.

## 3. Results

### 3.1. Definition of the new BLD

The borderline, below that no alterations have been seen by now, is a logarithmic straight line basing on the results extracted from literature. We extrapolated this curve so that it encloses the whole relevant range of stress from 80 dB (continuous noise) to more than 200 dB (impulsive noise) in contrast to existing curves about avoidance of lung damages (see figure 1).

### 3.2. Integration of own experimental investigations

In figure 2 the marks represent the technical informations of our experiments (MEYER-FALCKE, 1993). The borderline is confirmed by the results of our trials: The experimental group "reverberate chamber" is exposed to the greatest physical stress: according to that the most distinct reactions (significant increasing IGV,  $p < 0.05$ ) were shown. Connecting the points marking experimental series with similiar alterations of pulmonary function parameters, two parallels result below the BLD: well-marked and long-lasting, but reversible alterations of airway resistance (marks 2 and 6 in figure 2) as well as indeed clear but short-acting reflex-bronchoconstriction (1, 3a, 4, 5) only. Within the trial of "low-level airflight noise" the volunteers showed little reactions; we even could find indications for habituation (3b).

Hard of hearing persons showed significant bad pulmonary function parameters: the basic level of airway resistance was higher, reability of acute reactions reduced. Volunteers having bad pulmonary function showed significant stronger reactions than the others even more expressed when being smoker.

## 4. Discussion

The BLD was constructed because of the aim of occupational medicine to exclude any risk of health interferences for the noise exposed employees. Analogous to the existing curves to avoid NIHL (CHABA, 1968; PFANDER, 1975; SMOORENBURG, 1982) we presented a first conception of a new BLD to avoid strain of lung and airway system. Our BLD bases on the "isoenergy-concept" as well as the international used DRC to avoid NIHL. This conception is leaded by the hypothesis that impulsive noise with high energy and short effecting time has equivalent effects as continuous noise with low SPL lasting for long time. So our BLD is conceived as a linear relationship enclosing the range from high SPL to long effecting time.

In addition to the BLD two further boundary curves to avoid lung damages exist: the Z-curve (PHILLIPS et al., 1986) and the DASA-curve (DASA, 1968). The Z-curve can be used for risk assessment in free field exposition; this linear curve encircles the area of impulsive noise only, but renders the expected alterations at the point as well as the BLD. Extrapolating the exponential boundary curve of the DASA noise exposed persons seem to be in a non existing safety (PHILLIPS and JAEGER, zit. in NATO-RSG 6, 1987). In comparison transferring the datas of PFANDER's DRC (1975) with earplugs extraauditory danger would be overestimated.

There were no irreversible reactions induced by acute stimulation. However, long-lasting noise exposition in (work-)life seems to increase vulnerability to respiratory alterations. Parameters representing the airway resistance seem to change first. This is in accordance with other authors

(KUHN et al., 1981; VASSOUT et al., 1988; de KLEINE et al., 1990; PFANDER, 1991). Even by observance the BLD negative effects on lung and airway system can not be excluded in general. An increased risk has to be expected especially in existence of individual disposition.

## **5. Literature**

CHABA: Proposed damage-risk criterion for impulse noise; National Academy of Sciences, Report Working Group 57, chaired by W.D. Ward, 1968

DASA (Defense Atomic Support Agency) (ed.): Estimate of man's tolerance to the direct effects of air blast; Report 2113, Washington D.C. 1968

Kleine, M.J.K.de, C.M. Roos, W.J. Voorn, H.M. Jansen, J.G. Koppe: Lung function 8-18 years after intermittent positive pressure ventilation for hyaline membrane disease; Thorax 45 (1990) 941-946

Kokinakis W. and R.R. Rudolph: An assessment of the current state-of-the-art of incapacitation by air-blast; Acta Chir Scand Suppl 508 (1982) 135-151

Kuhn, H., R.R. Engel, U. King, G. Hörning: Psychophysiologische Untersuchungen beim Asthma bronchiale; 129-140 in: Zander. W.: Experimentelle Forschungsergebnisse in der Psychosomatischen Medizin; Verlag für Medizinische Psychologie im Verlag Vandenhoeck & Ruprecht Göttingen und Zürich 1981

Meyer-Falcke, A.: Festsetzung von Grenzwerten zur Vermeidung extraauraler Lärmschäden am Beispiel des respiratorischen Systems; Habilitationsschrift der Heinrich-Heine Universität Düsseldorf 1993

NATO-RSG 6 (research study group): Effects of impulse noise; Dokument AC/243 (Panel 8/RSG.6) D/9 Brüssel 1987

Pfander, F. (Hrsg.): Das Knalltrauma; Springer Verlag Berlin Heidelberg New York 1975

Pfander, F.: Untersuchungen mit dem Knallsimulator zur Entdeckung des akustisch empfindlichen Ohres mit zusammenfassender Betrachtung über die Reaktion des Hörorgans auf akustische Belastung; Forschungsbericht aus der Wehrmedizin Bonn 1991

Phillips, Y.Y., J.H. Patterson, B. Mozo, K.T. Dodd, T.G. Mundie: Determination of safe exposure limits for freefield heavy weapon noise; Paper presented at TTCP (Tripartite Technology Coordinating Program) Workshop on Launch Blast Overpressure, June 1986

Smootenburg, G.F.: Damage risk criteria for impulse noise; 471-490 in: Hamernik, R.P. (ed.) New perspectives on noise-induced hearing loss, Raven Press New York 1982

Vassout, P., R. Franke, G. Evrard, A. Dancer: Erkennung von Lungenverletzungen mit Hilfe der Oszilloresistometrie bei Belastung durch Luftstoßwellen; S-R 903/88, Institut Franco-Allemand de Recherchés de Saint-Louis 1988

Walby, A.P. and A.G. Kerr: Hearing in patients with blast lung; J Laryngology and Otology 100 (1986) 411-415

**6. Figures**

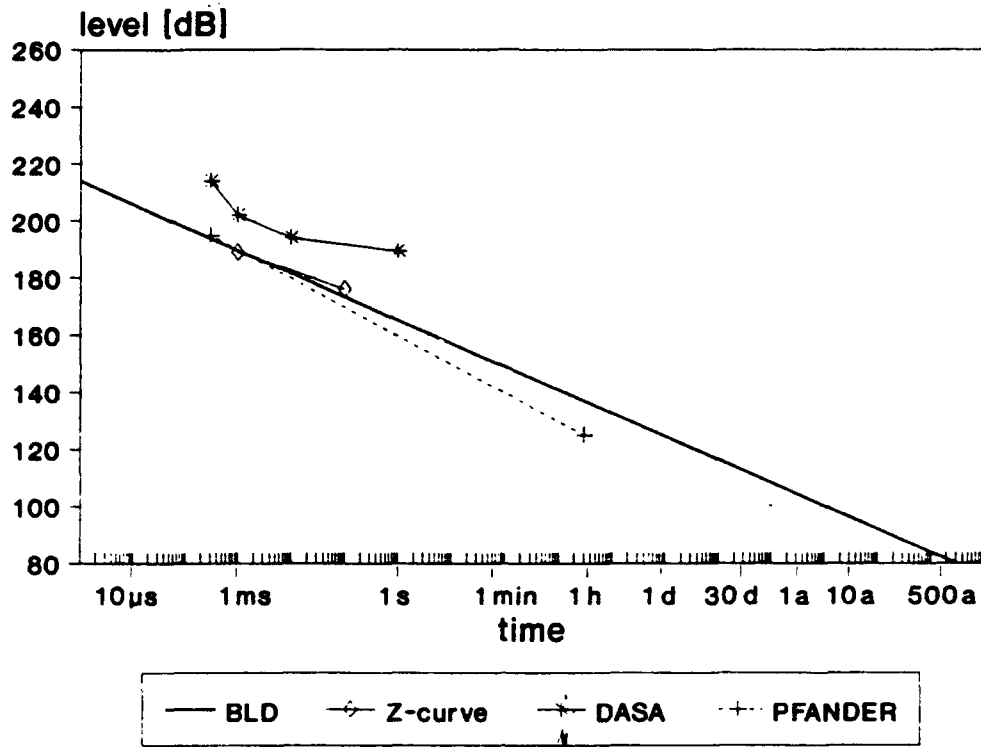

Figure 1:  
The new developed BLD to avoid respiratory disturbances in comparison with those of DASA (1968), PHILLIPS et al. (1986; Z-curve) and the DRC to avoid NIHL by PFANDER (1975)

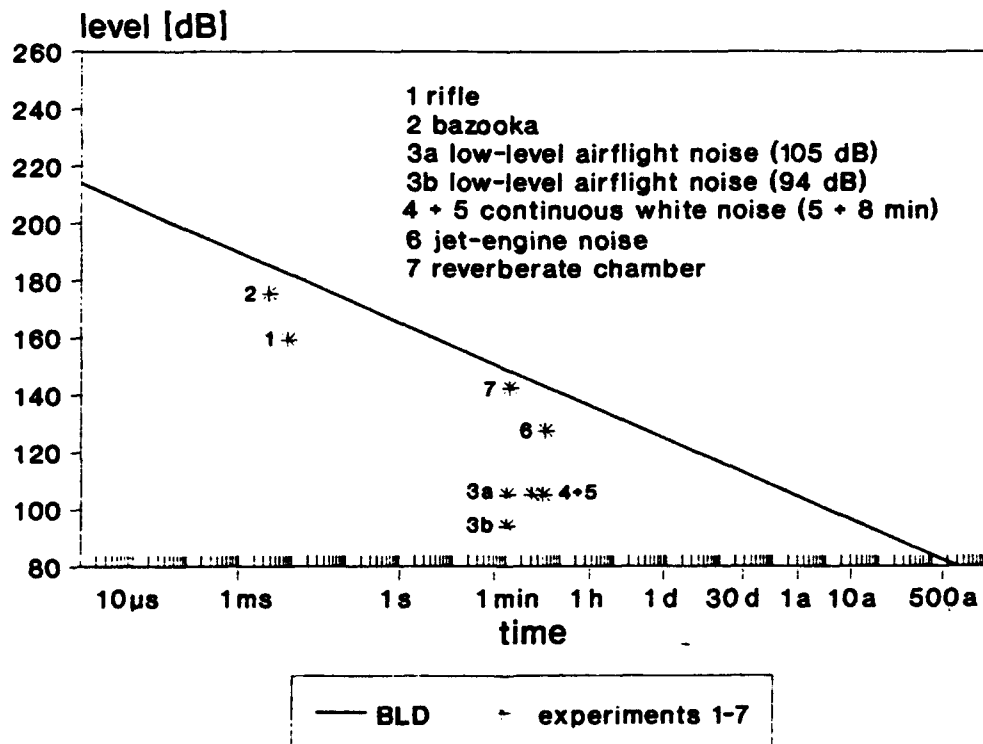

Figure 2:  
Integration of own experimental investigations into the BLD



# INJURY RATES IN TEXTILE INDUSTRY WITH REGARD TO NOISE EXPOSURE

BELOJEVIĆ Goran, KOCIJANČIĆ Radojka

Institute of Hygiene and Medical Ecology, Faculty of Medicine  
University of Belgrade, Yugoslavia

STANKOVIĆ Tatjana

"Dr Milutin Ivković" Health Centre, Belgrade, Yugoslavia

## Abstract

A three-year retrospective survey of injury rates was performed on a group of 95 female textile workers with similar work tasks. Four homogenous subgroups of workers were defined in relation to age (younger - 20-35 yrs, older - 36-50 yrs), and to occupational noise exposure level /Leq = 86 dB (A) and 104 dB (A)/. Among older workers, significantly lower injury frequency rates (IFR) / $P < 0.05$ /, and injury severity rates (ISR) / $P < 0.01$ / were found at 104 dB (A) noise level as compared to 86 dB (A). At a higher noise level, the accidents were more frequent and with longer absenteeism / $P < 0.01$ / among younger workers in comparison with the older ones.

## Introduction

The findings in several previous studies have indicated that work accidents might be related to noise stress (1, 2, 3, 4). The role of noise in accident causation has been explained by distraction effect, or by masking of important auditory signals (5). However, in most of these researches it was not possible to match the work tasks or workplace environments and actual accident risk for jobs at different occupational noise levels.

This survey was designed to compare the occupational accident data for two groups of blue-collar workers in the same plant, at equally risky workplaces, but with significantly different noise exposure levels.

## Material and Methods

A retrospective survey of accident data for the period of 3 years (1985-1987), was performed in "The Belgrade Wool Co.", on a group of 95 female blue-collar workers. Four subgroups of subjects were defined in relation to age (younger - 20-35 yrs and older - 36-50 yrs), and noise at worksites (spinners and weavers) /Table 1/.

Table 1. Composition of workers by age and experience, in relation to noise exposure level

Parameter	Spinners		Weavers	
	Younger (n=20)	Older (n=25)	Younger (n=17)	Older (n=33)
Age (yrs, $x \pm sd$ )	31 $\pm$ 3	43 $\pm$ 6	31 $\pm$ 3	46 $\pm$ 5
At present job (yrs)	11 $\pm$ 3	21 $\pm$ 7	9 $\pm$ 3	24 $\pm$ 7
Noise exposure / Leq dB (A) /	86		104	

Work tasks (permanent standing and walking, manual operations on machines, visual strain, shiftwork) and accident risk (close contact with the moving parts of machines) were similar at the subjects' workplaces.

Noise was measured with the Noise Level Analyzer Type 4426 (Bruel and Kjaer). The workers did not use any hearing protection except for cotton wool, and tonal liminar audiometry was performed with the "Peters AP6" audiometer. Hearing impairment was diagnosed for the subjects with 30 dB or more hearing loss at the frequencies 1, 2, and 4 kHz (6).

Accident and absenteeism data were obtained from the original medical records of workers. According to ILO recommendations (7), two indices were computed for each of the four subgroups of subjects: 1) injury frequency rate (IFR) - number of occupational accidents per million man - hours and 2) injury severity rate (ISR) - absenteeism (days) due to occupational accidents, per thousand man-hours.

Tested null hypothesis was that there were not any significant differences in IFR and ISR between the four subgroups. In statistical evaluation, the Student's t-test (proportions, two-tailed), and the Chi-square test were used, and P value < 0.05 was accepted as significant.

## Results

The audiometric findings showed that the number of workers with impaired hearing was significantly higher ( $P < 0.001$ , Chi square test) among older (70%), and younger weavers (29%), compared to older (12%), and younger spinners (5%).

For older workers, significantly lower IFR (Figure 1a) and ISR (Figure 1b) were found at a higher occupational noise level (weavers), as compared to less noisy workplaces (spinners). Among younger weavers, there was only a statistically insignificant trend towards increased number of accidents and absenteeism, as compared to younger spinners.

At a noise level of 104 dB (A), IFR (Figure 1a) and ISR (Figure 1b) were significantly higher among younger weavers in comparison with their older and more experienced fellow-workers.

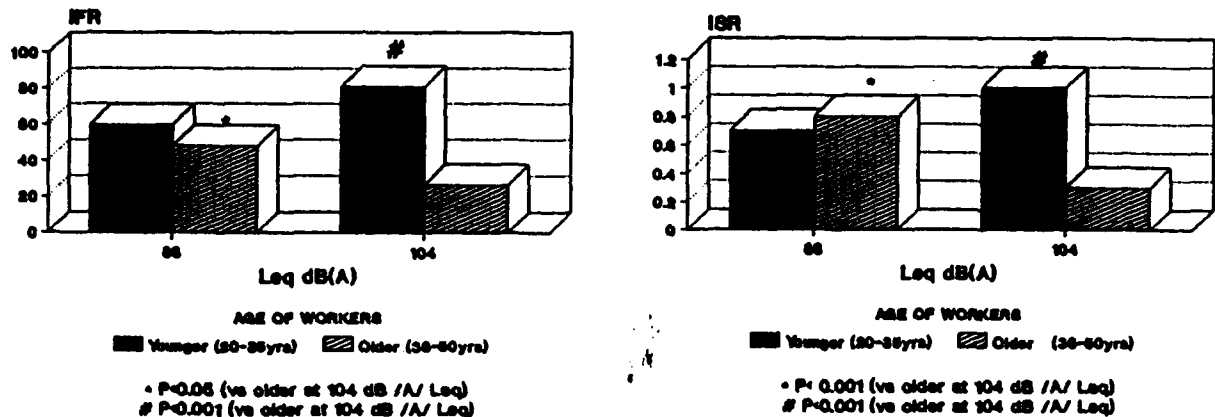

Figure 1. a) Injury frequency rates (IFR) and b) Injury severity rates (ISR) with regard to age of workers and noise exposure level (explanation of the rates in the text)

## Discussion

The obtained results point out the importance of a noise exposure level and workers' age for occupational accidents. Although earlier studies have showed that higher noise levels might be associated with increased accident occurrence (1, 3, 4), our study indicates that this may be partly true for less experienced workers, but this proportion can be inverse for older workers. Hearing impairment, which was significantly more frequently found in older workers at a higher noise level, might have lowered their arousal level at work. According to Broadbent's theory (8) this might have influenced their better attention and lower accident risk, compared to their mates at less noisy workplaces.

Our finding of a higher accident risk for younger, less experienced workers at a high noise exposure level, is congruent with the results of the previous studies, both in less (9, 10) and more noisy industries (1). This may be explained by a high arousal level and lack of attention of younger workers at noisy and risky workplaces. Furthermore, they often underestimate some risky operations or overrate self-abilities, while more experienced workers are usually better adapted and more willing to obey safety measures at workplace (11).

In conclusion, this survey has confirmed the earlier findings about the importance of occupational noise and age of workers for accident and absenteeism rates in industry. The highest accident risk at noisy workplaces was noticed for younger, less experienced workers. Therefore, when planning preventive measures against accidents in noisy industry, special attention should be paid to this category of workers.

#### References

1. Cohen A. Industrial noise and medical, absence and accident record data on exposed workers. Proceedings of the International Congress on Noise as a Public Health Problem, Dubrovnik 1973, EPA, Washington DC, 1974, pp 441-453
2. Cohen A. The influence of a company hearing conservation program on extra-auditory problems in workmen. J Pub Safety 1976 (8): 146-161
3. Noweir MH. Noise exposure as related to productivity, disciplinary actions, absenteeism, and accidents among textile workers. J Safety Res 1984 (15): 163-174
4. Melamed S, Luz J, Green MS. Noise exposure, noise annoyance and their relation to psychological distress, accident and sickness absence among blue-collar workers - the CORDIS study. Isr J Med Sci 1992 (28): 629-635
5. Wilkins PA, Acton WI. Noise and accidents - a review. Ann Occup Hyg, 1982 25(3): 249-260
6. WHO. Noise. Environmental Health Criteria 12. WHO, Geneva, 1980, p 33
7. ILO (International Labour Office). Encyclopaedia of Occupational Health and Safety, 3rd rev.ed, Geneva: ILO, 1983
8. Broadbent DE. Human performance and noise. In: Handbook of Noise Control (Edited by Harris CM). Mc Graw-Hill, New York, 1979
9. Baker CC. Ethnic differences in accident rates at work. Br J Ind Med, 1987 44 (3):206-211
10. Leigh JP. Individual and job characteristics as predictors of industrial accidents. Accid Anal Prev, 1986 18(3):209-216
11. Hale AR, Hale MA. A review of industrial accident literature. National Institute for Industrial Psychology, London, 1972

## Investigation of dose-response relationship for noise induced neurasthenia syndromes

Zhao Yiming\*, Zhang Shuzhen\*\* and Robert C. Spear\*\*\*

\* Medical Research Center, The Third Hospital, Beijing Medical University, \*\* Department of Occupational Health, School of Public Health, Beijing Medical University, Beijing 100083, P.R.China, \*\*\* Center for Occupational and Environmental Health, School of Public Health, University of California, Berkeley, CA, USA

### ABSTRACT

1101 female textile workers who did not have hearing protection were investigated for noise induced neurasthenia syndromes (NS). It was found there was a dose-response relationship between sound pressure level (SPL) of noise and prevalence of NS and its seven parameters, which include tinnitus, headache, giddy, sleeplessness, often dream, tired and bad memory. A logistic regression model was applied to explore if there were any confounding factors for noise induced NS. The results confirmed that SPL is an independent risk factor for noise induced NS.

**KEY WORDS:** female workers, logistic regression model, neurasthenia syndrome, noise

There were a few researches about noise induced neurasthenia syndromes (NS) having been published in chinese journals in recent years<sup>[1-13]</sup>. But all of them just appeared as a small part added with wide range researches with crude analysis. In this paper, NS was focused on with detail analysis.

### SUBJECTS AND METHODS

Subjects were 1101 female workers in a textile factory in Beijing. Each of them just exposed to one sound pressure level (SPL) noise for equal or more than five years. Brüel Kjær 2300 and 1625 sound level meters were used to measure SPL in the factory. It was found the SPL in everywhere of one workshop was less than  $\pm 2$  dB(A). Noise spectrum was typical of textile factory and broad band in nature. Using SPL, workers were divided into four groups, 75-80 dB(A), 86-90 dB(A), 96 dB(A) and 104

dB(A).

Ten trained medical students collected data from workers in the factory. The questionnaire included general information, occupational history of noise exposure, NS (defined as table 1), smoking and drinking behavior.

Table 1. Definition of neurasthenia syndromes

headache, giddy, dizziness	one or more=yes		
tinnitus, sleeplessness, dream	one or more=yes	three=yes	
tired, palpitation	one or two =yes		two=yes
limbs numb, bad memory	one or two =yes		

The data were input into IBM computer and analyzed with SPSS PC+ V3.0 and EGRET V2.1 software for calculating means, standard deviation, prevalence of NS and odds ratio (OR). Chi-square test and logistic regression model were applied at same times.

## RESULTS

Table 2 showed the dose-response relationship between SPL and each parameters of NS. Except dizziness, palpitation and limbs

Table 2. Prevalence of neurasthenia syndromes (NS) in female workers with different sound pressure level noise exposure

Parameter	Prevalence (%) (positive number/total)			
	104 dB(A)	96 dB(A)	86-90 dB(A)	75-80 dB(A)
NS	86.0(141/164)	68.7(202/294)	54.4(233/428)	52.6(113/215)
tinnitus	76.2(125/164)	35.7(105/294)	21.7( 93/428)	16.3( 35/215)
headache	47.6( 78/164)	44.6(131/294)	31.8(136/428)	31.6( 68/215)
giddy	53.0( 87/164)	50.0(147/294)	40.7(174/428)	38.6( 83/215)
dizziness	28.0( 46/164)	10.5( 31/294)	12.9( 55/428)	21.9( 47/215)
sleepless	32.9( 54/164)	29.9( 88/294)	24.8(106/428)	22.3( 48/215)
often dream	67.7(111/164)	61.9(182/294)	57.2(245/428)	50.7(109/215)
tired	82.9(136/164)	56.8(167/294)	62.4(267/428)	58.6(126/215)
bad memory	80.5(132/164)	65.3(192/294)	46.3(198/428)	43.7( 94/215)
palpitation	37.8( 62/164)	36.7(108/294)	29.4(126/428)	35.3( 76/215)
limbs numb	37.2( 61/164)	19.4( 57/294)	19.9( 85/428)	24.2( 52/215)

numb, each parameter's prevalence was significantly elevated with increase of SPL. By strata of working years, prevalence of NS

appeared same trend with SPLs and had not significant among different working year groups (figure 1). In order to explore the relationship among SPL, working years and age in detail, a logistic regression model was applied. Table 3 showed SPL had a positive relation with NS, OR=1.047,  $p < 0.001$ , working years and age

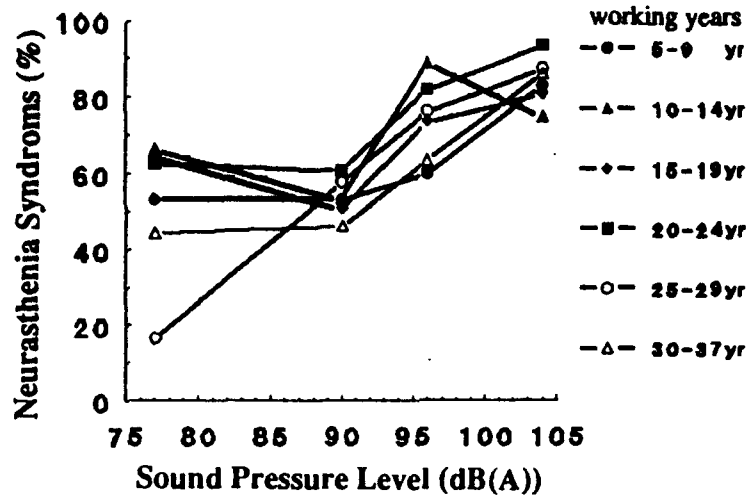

Fig 1. Prevalence of neurasthenia syndromes by sound pressure level and working years in textile female workers

had not significant with NS. It could be found in table 4 that

Table 3. A logistic model for neurasthenia syndromes with SPL, working years and age

Parameters	Coefficient	SE	p Value	OR
Constant	-3.680	0.888		
SPL	0.0461	0.0074	<0.001	1.047
Working years	0.0130	0.0255	0.612	1.013
Age	-0.0051	0.0292	0.861	0.995

Table 4. Estimated parameters for logistic model for risk of neurasthenia syndromes

SPL	Working years	Age
0.0476		
0.0460	0.0086	
0.0461	0.0130	-0.0051

the coefficient of SPL had not been significantly changed when working years and age added in the model. These results suggested SPL was an independent risk factor for NS and there was not cumulative effects for noise induced NS.

## DISCUSSION

Thirteen papers<sup>[1-13]</sup> were published in Chinese journal since 1978. All of them supported the working hypothesis of noise inducing more NS. Five of them<sup>[5,8,10-12]</sup> showed some trends of dose-response relationship between noise exposure and NS. The

results in this paper were same as them.

In theory, dose of noise exposure is combined with both SPL and duration of noise exposure (working years). In our research, the results showed there was not relationship between working years and prevalence of NS. It means there was not cumulative effect between noise exposure and NS. This result differs from five published papers<sup>[1-5]</sup>, which showed some trends between working years and prevalence of NS. It suggests that it needs more investigations on noise exposure and NS to know if it has cumulative effect.

#### REFERENCE

1. Deng Jinlun, et al. Effect of noise on non-auditory systems in weavers. (Chinese) Occupational Medicine 13(2):57, 1986
2. Industrial noise co-research program of Hunan province. Effects of textile noise on workers' health. Hunan Industrial Hygiene 2:22-28, 1981
3. School of Public Health, Shichuan Medical College, et al. Investigation of diagnostic standard on noise induced diseases. Journal of Shichuan Medical College 9(3):1-6, 1978
4. Zhang Yumei, et al. Effects of environmental noise on human health. Journal of Bethun Medical University 12(5):435-436, 1986
5. Liu Jiaju, et al. Investigation of industrial noise for human health. Chinese Preventive Medicine 18(2):98-100, 1984
6. Cheng Jiguang, et al. Effects of industrial noise on non-auditory systems in female weavers. Journal of Anhui Medical University 21(4):311, 1986
7. Pu Wenxiny, et al. Effects of textile factory noise on workers' health. Chinese Preventive Journal 18(2):94, 1984
8. Xu Xuanli, Investigation of noise for human health. Communication of Occupational Hygiene on Train 1:32-34, 1984
9. Liu Jichang, et al. Investigation of noise adverse effects on workers' health. Guanxi Medicine 7(1):23-26, 1985
10. Noise co-research program, Investigation of noise on workers' health in Tianjing textile factories. Occupational Health and Environmental Medicine 3(3):1-5, 1980
11. Fang Danqun, et al. General research of noise on workers' health. Occupational Health and Environmental Medicine 4(6):323-326, 1981
12. Li Enbo, Investigation of noise on workers' health. Safe, Environmental Protection and Occupational Health 1:17-20, 1983
13. Wu Weiping, et al. Effects of bulldozer noise on drivers' health. Occupational Medicine 14(5):60, 1987
14. Zhang Jiazhi, Noise and prevention of noise induced diseases. 1st edition, Beijing, People's Health Public House, 1979



# THE INFLUENCE OF BINAURAL HEARING ON PHYSIOLOGICAL RESPONSES

SCHWARZE, Sieglinde, NOTBOHM, Gert and JANSEN, Gerd

Institute of Occupational Medicine, Heinrich-Heine-University, Moorenstr. 5, 4 Düsseldorf/FRG

## ABSTRACT

Spatial hearing plays an important role in the auditory perception. While conventional techniques of sound measurement cannot account for the position of sound signals, nowadays, by using binaural techniques, it is possible to simulate the spatial distribution of sound sources. In a series of laboratory experiments it was tested, whether the perception of spatiality might have an influence on the physiological responses. There was evidence that industrial noise recorded and presented by artificial head caused stronger physiological responses than the same noise recorded and presented conventionally. Variations in the localization of noise sources containing either high or low information show that the influence of spatial distribution of noise sources on physiological responses tends to increase with a higher content of information of the noise. As this outcome might have important consequences for the evaluation of noise at the workplace or in the environment, further research is needed how to utilize the results obtained.

## 1 INTRODUCTION

As the correlations between noise load and noise effects are very weak, one possible explanation, among others, might be that the acoustical description of sound stimuli is still too inexact (3). Despite the variety of acoustical parameters the conventional methods of measuring and evaluating sound do not correspond to human hearing satisfactorily. Correction factors, e.g. for tonal or impulsive noises, improve this situation only moderately. Obviously, other phenomena have to be taken into account. One relevant factor could be the spatial distribution of sound sources. The perception of spatiality represents a basic property of human auditory system. Here, progress was made by applying binaural measurement. This new technology makes it possible to simulate the spatial sound field. The results presented in the fields of auditory perception and acoustical aesthetics are convincing, and there is a marked distinction when compared to the results of conventional methods of measurement (1, 2). Thus, the question arises whether the characteristics of binaural measurement are also relevant for the physiological effects of noise. By assessing sound immissions in greater accordance with human hearing, the effects of noise could be analyzed more precisely, and that way, the evaluation of sound immission in the natural and working environment could be improved.

Supported by grants of the German Federal Minister of Research and Technology, the basic aspects of this concept were investigated. Research was undertaken in two steps:

- 1) Based on physiological responses and subjective evaluations, the difference between the conventional method of measurement and the binaural measurement by artificial head was to be proved.
- 2) The most prominent acoustical parameter determining the difference between conventional and binaural measurement was to be identified.

## 2 METHODS

The study was conducted in a series of three experiments employing mainly the same subjects (48, 8, and 15 respectively). Ss were male and healthy; average age:  $24.7 \pm 2.4$  ys. They were exposed to different sounds via earphones during which their physiological responses were recorded with special respect to fingerpulse amplitude (FPA), skin conductance response (SCR), heart frequency (HF), and electro-myogram of m. frontalis (EMG). In addition to that, Ss' feelings of comfort and the subjective evaluation of the perceived sound stimuli were registered by questionnaire.

## 3 RESULTS OF EXPERIMENT 1

The first series was designed to provide evidence as to whether there is any difference in physiological responses or in subjective evaluation of noise, given that the Ss are exposed to the same sound and the same intensity ( $L_{Aeq} = 83$  dB), but at one time recorded and presented conventionally and at another time binaurally by means of an artificial head. Three different sound stimuli typical for working places of the timber and metal processing industries were used such as sounds coming

from engine construction, circular saw, and hacksaw. Pink noise was used as control. In order to avoid effects which are caused by the order of presentation, four different variations of sequence were chosen. Fig. 1 shows as an example the design of the variation type No. 2.

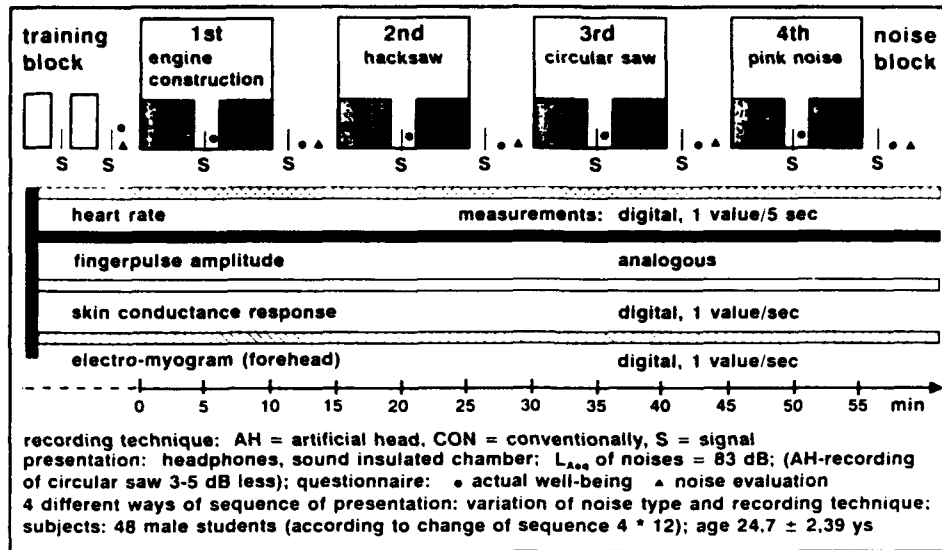

Fig. 1: Experimental design of the first series of experiments (VR1) shown by the example of noise recording variation No. 2

Concerning subjective evaluation, there is no substantial distinction with regard to the two different ways for recording and presentation. This might be due to the experimental design, because the judgements had to be given after the end of each noise block, so that the acoustical memory might have been overstrained. Concerning the physiological parameters, consistent differences between the two techniques arise, applying specifically to skin conductance response and fingerpulse amplitude. There is clearly a stronger response from sounds recorded by artificial head as compared to conventional recording. To give an example, fig. 2 depicts the pattern of SCR for the duration of the sound of the hacksaw.

From the entire results of this experiment we draw the conclusion that the difference between physiological responses might mainly be caused by auditory spatiality which is registered more realistically by means of binaural recording.

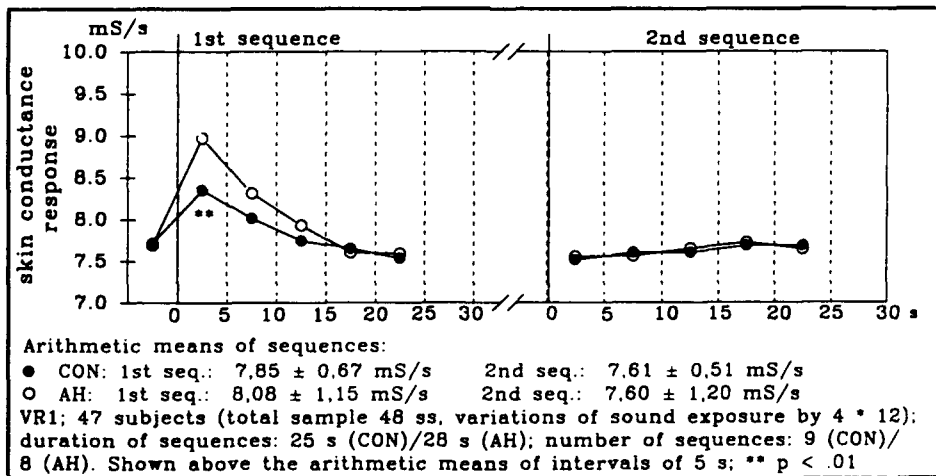

Fig. 2: Skin conductance response during presentation of hacksaw noises recorded with conventional sound measuring technique (CON) or with artificial head (AH)

## 4 RESULTS OF EXPERIMENT 2

For the listener, the differences between conventional and binaural techniques of recording essentially arise from the fact that in conventional recording the signals are reproduced without any information about the direction of sound incidence, whereas binaural recordings by artificial head allow for directional information, thus enabling the listener to localize the position of noise sources. Consequently, differences in physiological responses should be observed when the factor "spatial distribution" is varied by means of artificial head recording.

In the second experiment, noise sources of industrial machinery (hacksaws and coupling machine,  $L_{Aeq} = 84$  dB) were recorded by artificial head and were located at different places. In one recording, the noise sources were placed side by side which led to the perception as if they were issuing from the same direction (unidirectional); in the second, the noise sources were placed to the left and to the right of the listener which resulted in multidirectional sound incidence.

Regarding the physiological responses of FPA, SCR and EMG, all show stronger reactions during the multidirectional incidence. To give an example, fig. 3 displays the pattern of the FPA. There is a lesser difference in the responses with the initial reaction, i.e. during the first 30 s, but a greater one with the process of re-regulation. During exposure to multidirectional noise, the amplitude does not reach the baseline value at any time. Compared with the response to unidirectional noise, the mechanism of re-regulation, which normally leads the fingerpulse amplitude back to its baseline, is delayed by multidirectional noise. This result might imply that the listener perceives a multidirectional incidence of sound as being more of a strain.

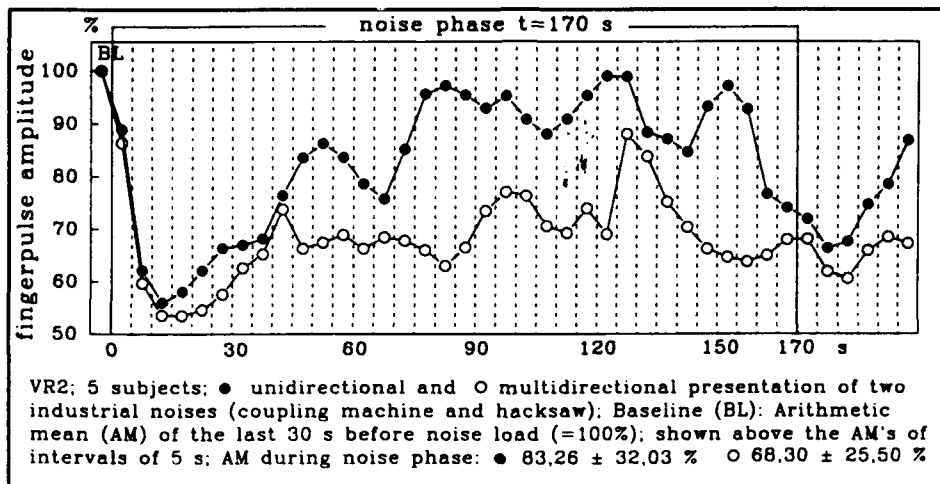

Fig. 3: Fingerpulse amplitude during unidirectional and multidirectional presentation of two industrial noises

## 5 RESULTS OF EXPERIMENT 3

So far, noises recorded at real working places were used, which enabled Ss to associate some kind of machinery and working processes and to relate the spatial distribution to their own position. In other words, the physiological responses with binaural presentation might have been amplified by the more realistic specimen of the noise source. Therefore, in the next experiment, sound stimuli containing less information were used in order to find out whether the physiological responses were still influenced by the spatial distribution.

Two independent stimuli of pink noise ( $L_{Aeq} = 83.2$  dB) were presented in three different ways: In the unidirectional recording, both noises were sent from the same direction (right side of the listener). In the bidirectional, one source was diverted to the left and the other one to the right. In the moving presentation, one noise source moved from the right to the left and the other one from the left to the right, crossing over in front of the head (duration: 10.2 s per moving cycle).

In this last experiment, the differences between the physiological responses relating to the location of the stimuli are smaller than in the other experiments. The pattern of the FPA response is similar to the results of experiment 2 (fig. 4). There is no difference in the initial reaction as regards the different presentations of pink noise. At the time of re-regulation, however, the baseline is reached only with the unidirectional noise. With the two other recordings, and most significantly with the moving signals, the process of re-regulation is delayed.

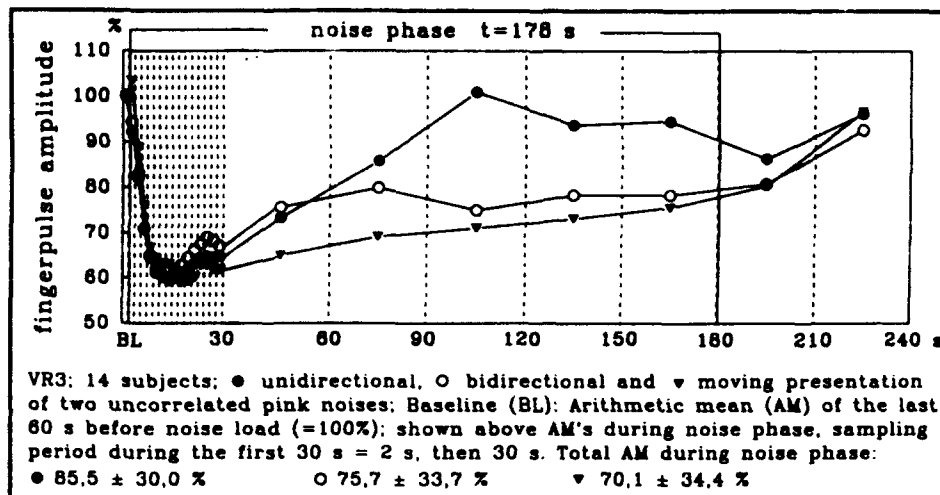

Fig. 4: Fingerpulse amplitude during different presentation of two pink noises (unidirectional, bidirectional moving)

## 6 DISCUSSION

The first experiment proves that industrial noise recorded and presented by artificial head induces more evident physiological responses when compared with conventional recordings. This distinction is essentially caused by the particular capacity of the artificial head, which lies in a more accurate reproduction of auditory spatiality. But this is only a rough outline of the special properties of the artificial head. Other factors of this technique might be of interest, such as direction of sound incidence, masking, movement of sound sources, the power of imagination of the Ss, better reproduction of the harshness or sharpness of sounds and so on.

In two subsequent experiments, some of these aspects were investigated. With a reduced number of Ss, the significance of spatial distribution was examined. With regard to industrial noise containing specific information Ss appear to be more strained by sound incidence issuing from different directions as compared with the same noise when coming from one direction.

As the third experiment indicates, the meaningfulness of the noise seems to have an impact on the responses to the stimulus. When sound sources with little information, as for example with pink noise coming from different directions, are used, there is a decrease in the differentiation of the various responses. Initial reactions of FPA and SCR do not really differ any more with regard to localization of the sound source. But it has to be emphasized that the re-regulation of FPA is delayed when a bidirectional sound stimulus is sent, and particularly with moving signals.

Concluding, there is clear evidence that spatial distribution, as far as industrial noise is concerned, has an influence on physiological responses. For noise protection at working places, considerable consequences may ensue along with new methods for the measurement and evaluation of noise to be developed and adjusted to practical needs. This way, the efficiency of preventive measures for the abatement of noise could improve, and subsequently, there could be more safety at work.

To this date, however, there is not enough information available in order to devise criteria for measuring noise, especially when they have to be included into technical standards. That is why current findings in this field have to be enlarged to guarantee reliable applications for binaural measurement of noise in practice. The distinguishing advantages of this technique have to be proved beyond doubt and quantified systematically in order to show that the higher expenses connected with its application really pay off in successfully abating noise in the human environment.

## 7 REFERENCES

- 1) Genuit K.: A special calibratable artificial-head-measurement system for subjective and objective classification of noise. INTERNOISE, 21.-23. July 1986 Cambridge, Massachusetts, pp 1313-1318
- 2) Genuit, K.: Gehörgerechte Lärmbewertung. In: Fortschritte der Akustik, Kongreßband der DAGA '91 -Teil A, S. 75 - 92; Bad Honnef, DPG-GmbH 1991
- 3) Zwicker, E; Fastl, H.: Sinnvolle Lärmessung und Lärmgrenzwerte. Z. Lärmbekämpfung 33 (1986) 61-67

# THE ALTERNATIVE MECHANISM OF THE INFRASOUND INFLUENCE ON ORGANISM.

FRAIMAN Boris , VORONIN Andrei , FRAIMAN Elizaveta .

The Voronezh State Medical Institute, 394018, Voronezh, Plehanovskay ul. 12  
, apt. 17.

The existence of the mechanism of the direct effect of the infra- sound on the blood vessels and blood is proved.

On a prouve' l'existence du me'canisme de l'action directe de l'infrason sur les vases sanguins et sur le sang.

## INTRODUCTION

The possibility of the infrasound influence on organism through aural organs has been discussed in details in press [1]. Nevertheless, the aural mechanism doesn't explain the harmfulness and harmlesseness of one and the same infrasound level, a fast development of heart and vessel reaction on the infrasound influence. These and other factors, met in our experiments, allowed us to suppose the possiility of the direct infrasound influence on the vascular system and blood.

## METHODS

The experiments have been caried out on the blood vessel model and with the volunteers' paticipation. The reogram of a person's shin was recorded "longitudially" in the computer memory at the infrasound level of 100 dB and frequency of 15 Hz in comfort and discomfort zones of the laboratory room. To control this the same record was made without the infrasound influence. The reographycal cycle was resolved into the harmonic components with the method of the fast Fourier transform. The diagram was made on the basis of amplitude values which composed the reogram spectrum. Each point of the diagram corresponds to 100 measurements.

The blood vessel model and the work with it have been described by us earlier [1]. The model was filled, in turn, with the physiological saline, polyglucin, teopolyglucin, plasma - like solution "Vamin - Glucosal" and stabilized blood. The infrasound influence was caried out in the discomfort zone at the frequency of 12.5 Hz and at the sound pressure of 100 dB. The results of the experiments are presented in figures and diagrams.

## REZULTS AND THEIR DISCUSSION

The clear amplitude peak is seen in the discomfort zone of the amplitude diagram for reogram spectrum. This amplitude peak is in the point which corresponds to harmonies equal in frequency with the infrasound active. The similar splash of amplitude is not presented on the curve where the reogramme harmonic amplitudes are indicated without the

infrasound generator on. In the comfort zone we have not also found the statistically reliable splash of amplitude with the infrasound influence. In earlier experiments we have shown that in the discomfort zone the acoustic oscillations can influence directly the wall of the blood vessel model [1]. The experiments carried out with a person's participation have shown that the infrasound influences directly the real vascular system too. And with all this one clearly observes that just the same sound pressure level in the comfort zone doesn't cause the changes in the reographical cycle. The fact of the zone reciprocal reaction coincides with the results of our investigations, described in other reports.

The instant reciprocal reaction of the model and the real blood vessel allow us to consider the direct infrasound influence on the blood vessel wall as the initial link of developing mechanism for a person's reciprocal reaction on infrasound.

Analysing this reaction it is necessary to bear in mind that the vessel is filled not simply with the solution of electrolytes but blood. Blood is the nonnewton fluid. The characteristics for the nonnewton fluids are: the elasticity, the relative independence of layers, compressibility. We have determined by experiment that if we take the oscillation amplitude in the model, filled with the physiological saline, as a 1 (unit) then the oscillations in the model filled with "Vamin - Glucosal" are 3.5 times more. The experiments carried out with pure blood stabilized with the sodium citrate have proved that in the blood vessel model there appeared the oscillations which amplitude is 4 times higher than in the model filled with the physiological saline. A small difference with the model filled with "Vamin - Glucosal" is obviously due to the fact that "Vamin - Glucosal" by its composition practically corresponds to the blood plasma. So it is experimentally proved that the vascular system of a person by its structure is able to assimilate the infrasound oscillation. This capability is realized in that part of the room which misses the "acoustic vortex" and the vector components of the energetic parameters for the acoustic wave are colinear [3].

The reaction of the vascular system can take place not only after the infrasound influence but with the acoustic oscillations of the low frequency acoustic range. The model experiments show that the similar reaction appears in the conditions when the size of the biological object doesn't prevent the distribution of the acoustic wave components in space, limited by the rigid walls [2].

The direct infrasound influence on the vascular system explains so fast development of the organism reciprocal reaction.

The zone development of this mechanism can explain some author's opinion about harmlessness and harmfulness of infrasound while examining the infrasound influence of the same level.

So we've revealed, that the direct infrasound influence alternative to the aural influence on the blood vessel wall can be the initial link of the mechanism for a person's and infrasound interaction.

Fourier spectrum reogrammae

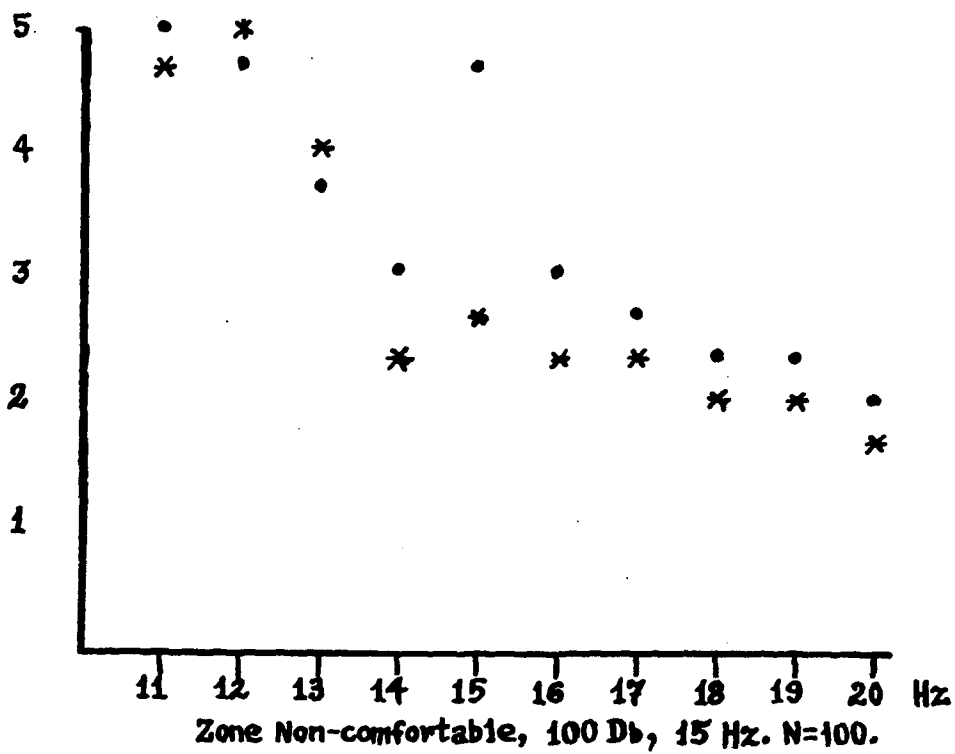
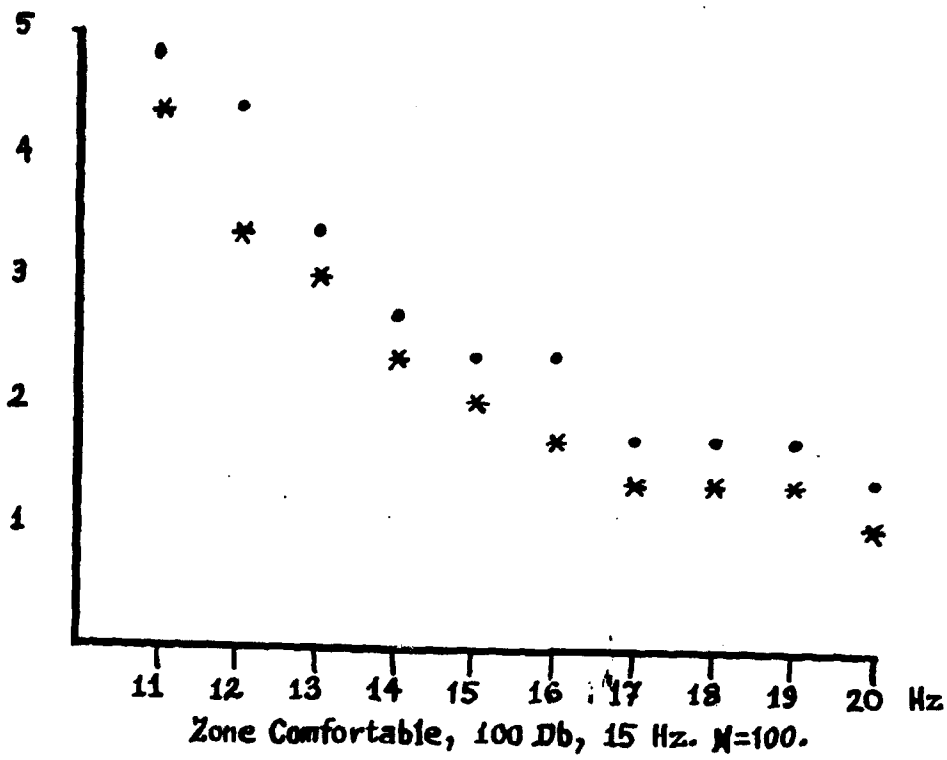

\* ---- Control.    • ---- Experiment.

## REFERENCES

1. Johnson Daniel L. Auditory and physiological effects of Infra-sound. "Inter-Noise-75" Proc. Int. Conf. Noise Contr. Eng. Sendai, 1975", Sendai, 1975, p.475-482.

2. Фрайман Б.Я. , Безруков В.Е. Условия при которых осуществляется прямое действие инфразвука на стенку модели кровеносного сосуда. Депонир. ВНИИТИ 1983 г., № 6748-83 .

3. Fraiman B.Ja., Ivannikov A.N., Pavlov V.I. On possibility of the comfortable and the non-comfortable effect of the low-frequency acoustic noises. 6-th International FASE-Congress 1992. 29-31 July 1992. Zurich, Switzerland p.145-148.



# HETEROGENOUS RESPONSE OF SYMPATHETIC NERVOUS SYSTEM TO SOUND STIMULI: FINGER PLETHYSMOGRAPHIC RESPONSES OF $\alpha$ - and $\beta$ -TYPE

KABUTO Michinori, KAGEYAMA Takayuki, IMAI Hideki, NITTA Hiroshi & MINAMI Masanobu. Urban Environment & Health Project, NIES, 16-2 Onogawa, Tsukuba, Ibaraki, JAPAN

## Abstract

Finger plethysmographic responses (FPR) of 35 young subjects exposed to white noise (WN) stimuli of 50, 70 and 90 dB were investigated to check level-response relationships, and to clarify a suggested heterogeneity of the FPR, 114 young and elderly were exposed to WN of 90 dB. Since accustomation was not observed for FPRs (% wave amplitude changes for each of ten 3-sec periods after WN onset) obtained from 5 exposures at irregular intervals, their mean FPR was used as the FPR value and the % change at the maximum response was expressed as  $FPR_{max}$ . Although a negative level-response relationship was demonstrated for the  $FPR_{max}$ , about 13 % of the subjects showed  $0 \% \leq FPR_{max}$  or  $\beta$ -receptor mediated cardiac response to epinephrine released from the adrenals, whereas the others showed  $FPR_{max} < 0 \%$  or  $\alpha$ -receptor mediated vasoconstrictions. Urinary excretion rates of catecholamine (CA) during nocturnal rest were significantly higher in the cases of  $\beta$ -response than those in the cases of  $\alpha$ -response when age, sex, ECG finding (normal vs ventricular hypertrophy) and hypertension (normal vs borderline) were adjusted. Thus, it is suggested that the heterogenous response may be related to chronic hypertonicity of the sympathetic nervous system, and may therefore be of some relevance in relation to the risk for noise-induced cardiovascular diseases.

## Introduction

Nonauditory physiological effects of noise on humans have commonly been characterized by large inter- and intraindividual variations,<sup>1)</sup> one possible cause of which is accustomation.<sup>1,2)</sup> According to pathophysiological studies on psychiatric patients, however, there may be a heterogeneity or difference of dominant response inter- as well as intraindividual even when exposed to the same stimulus,<sup>3)</sup> which may also cause variations in the results. Both of these biological phenomena, therefore, should be considered, especially for physiological effects in relation to the risk for cardiovascular diseases due to chronic exposures to noise.

On the other hand, finger plethysmographic response (FPR) to sound is known to reflect excitement of the sympathetic nervous system (SNS) in terms of blood flow decrease due to  $\alpha$ -receptor-mediated vasoconstriction or its increase due to  $\beta$ -receptor-mediated cardiac response to epinephrine released from the adrenals. Although accustomation was obvious in FPRs when sounds were presented regularly in our previous examinations,<sup>4)</sup> it could be avoided by presenting sounds at irregular intervals. Baseline fluctuations in the plethysmograph, which have been related to

mental activities,<sup>9)</sup> can also be attenuated using larger time constant of the amplifier than usual.

In the present study, using the previously developed system, individual variations in the responses to sound stimuli of the SNS were investigated in terms of the level-response relationship, as was suggested heterogeneity. The relationships between these responses and urinary excretion rates of catecholamine (CA) during nocturnal rest or sleeping period were also examined.

### Subjects and Methods

The study consisted of two parts to examine the level-response relationship between WN of 50, 70 and 90 dB in  $L_{Aeq}$  and  $FPR_{max}$  as defined below (Exp.1), and individual variations of  $FPR_{max}$  to WN of 90 dB, as well as the relationships between  $FPR_{max}$  and excretion rates of CA during sleep (Exp.2). Experiment 1 comprised 35 young subjects, and exp. 2 comprised 79 young (18-28 yrs old) and 35 elderly (60-83 yrs old) subjects. The subjects were exposed to WN binaurally through 2 speakers in an insulated room. A finger plethysmograph for 30 sec prior to and 30 sec after the onset of WN was recorded for 5 sessions separated by random intervals of 30 to 90 sec, from the left index finger through a photoelectrical plethysmogram meter (San-Ei-Sokki Co., Ltd.). The amplitudes were measured with a digitizer (Photoron Co., Ltd.).

The FPRs to WN were expressed as % change of the averaged wave amplitude for each of the 3-sec-periods after WN onset compared to that for 30 sec before WN. Five FPRs obtained in 5 sessions were averaged for each period and were defined as FPRs. Also, % change in FPR at the maximum response, whether constriction or dilation, was abbreviated as  $FPR_{max}$ . Urinary CA in the initial urinary excretion on the morning of the experimental day was determined using an EC-HPLC system (Shimadzu-Seisakusho Co., Ltd.) for each of free norepinephrine (NE), epinephrine (E) and dopamine (DA) concentrations and expressed by the excretion rate ( $\mu\text{g/hr}$ ) after the last urination of the prior night. Covariate analyses were done with the General Linear Model (GLM) in a SAS program.

### Results

A good level-response relationship between WN of 50, 70 and 90 dB and  $FPR_{max}$  was observed in Exp. 1 (Fig. 1), suggesting the existence of quantitative relationships between stimulus intensity and SNS excitement inasmuch as group means are concerned. Accustomation or attenuating trends of  $FPR_{max}$  were not observed under the given conditions. However, the distribution of  $FPR_{max}$  for 90 dB in Exp. 2 showed that it was greater than zero % in 12.5 % (14/112) of the subjects, whereas it was below zero % in the other 87.5 %. The increasing response was more frequent in elderly than in young people (21.2 vs 8.9 %).

On the other hand, the time prior to the maximum response was generally longer in cases of increasing FPR (4.6-22.2 sec) as compared to that in cases of decreasing FPR (3.0-9.0 sec). Therefore, the former is related to blood flow increase due to cardiac response to E released from

the adrenals and is called " $\beta$ -type response," whereas the latter is related to blood flow decrease or vasoconstriction and is called " $\alpha$ -type response." Their typical cases are shown in Fig. 2.

The excretion rates of NE, E and DA were significantly higher in the FPR of  $\beta$ -type as compared to those in the other categories, when their differences based on 4 categories of FPR<sub>max</sub> level (that is, (1)  $<0.75$ , (2)  $0.75 \leq & <0.9$ , (3)  $0.9 \leq & 1.0$ , and (4)  $1.0 \leq <$ ) were examined by covariate analyses using GLM procedures (Table 1). The results were consistent regardless of adjustment for age groups (20-29, 60-69, 70-79 and 80-89 yrs old), hypertension (normal vs borderline) and/or ECG findings (normal vs ventricular hypertrophy).

### Discussion

One of the major findings in the present results was the existence of  $\beta$ -type response to sound in about 13 % of the subjects, although detailed observations of each record revealed that only 3 out of 14 cases had weak simultaneous  $\alpha$ -type response around 8 sec after sound onset. Thus, it is likely that the SNS function of the SNS-adrenal axis but not that of the SNS-peripheral blood vessel axis, is predominantly sensitive to sound stimuli in the subjects with  $\beta$ -type. This hypersensitivity of the SNS-adrenal axis may also be related to their significantly enhanced CA excretion rates during nocturnal rest or hypertonicity of the SNS.

The present results that the  $\beta$ -type response was more frequent in elderly subjects than in young subjects and that there is no (or if any, weak) simultaneous  $\alpha$ -type response may reflect hypertention, indicated not only by blood pressure measurements but also by ECG finding related to ventricular hypertrophy, and/or reduced responsiveness of peripheral blood vessels as suggested by a mild/moderate degree of atherosclerotic changes indicated in eye camera examinations (data not shown). However, these could not be supported by the present data, which did not include patients with definitive hypertension and young patients who showed the existence of the  $\beta$ -response but not atherosclerotic changes. Nevertheless, further studies are needed to clarify, in particular, the relationship between  $\beta$ -type response and hypertension, if the report<sup>6)</sup> indicating that blood pressure response to sounds occur only in people with hypertension, whose excretion rates of CA are expected to be elevated, is taken into consideration.

On the other hand, Matoba et al.<sup>7)</sup> reported that reduction of the amplitude of the finger plethysmogram in response to 800 Hz-band noise of 90 dB correlated well with the Mecholyt test as well as 24 hour urinary CA levels. Although their findings are apparently unrelated with ours, the possibility that they were affected by the SNS hyperreactivities associated with the diseases cannot be denied, since the subjects were patients with vibration disease, cardiac diseases and hypertension. Also, it is possible that CA in 24-hour urine may not always correlate with excretion rates of CA during nocturnal rest, since CA excretion during the day is expected to vary largely depending on the activities of the patient.

Thus, the present study suggests that the heterogenous response may be related to chronic hypertonicity of the SNS as indicated by CA excretion rate during nocturnal rest. Therefore, further studies are hoped to clarify whether the indicated hypertonia of the SNS are due to stress or traits or whether the observed heterogeneity of the response is dependent on state or trait, especially for relating noise exposures to the risk for cardiovascular diseases.

**References**

1) Kryter, K.D.: In The effects of noise in man ed. by Kryter, K.D., Academic Press, NY, 1970, pp. 487-490. 2) Minami, M. and Kabuto, M.: Aircraft Nuisance Studies and Managements 9, 117-125, 1982. 3) Zahn, T.P.: Arch. Gen. Psychiatry 38, 251-258, 1981. 4) Asakura, K. et al.: Jap J Otoralyngol. 62, 593-597, 1990. 5) Kabuto, M., T. Takemoto and M. Minami: Jap J Hygiene 39, 651-660, 1984. 6) Arguelles, A.E. et al.: In Physiological effects of noise ed. by Welch, B.L. and Welch, A.S., Plenum Press, 1970, p43. 7) Matoba, T. et al.: J Exp Med 115, 385-392, 1975.

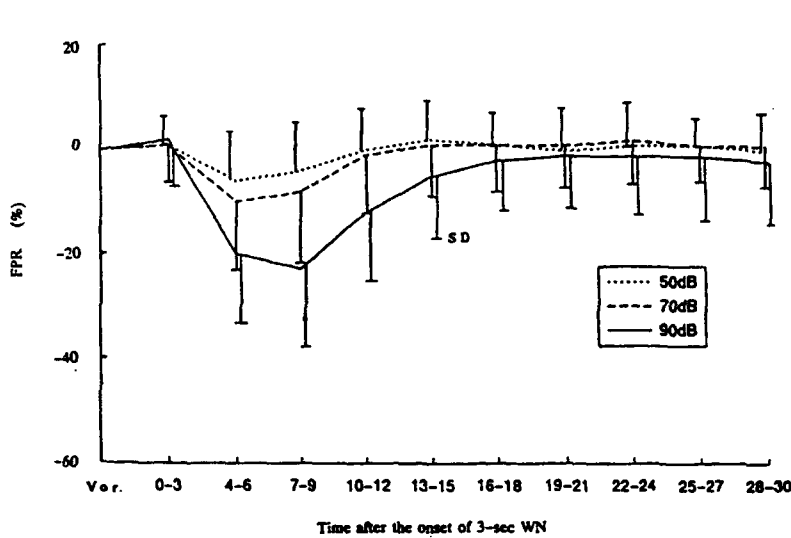

Fig.1: Mean FPR by WN of 50, 70 and 90 dB are illustrated.

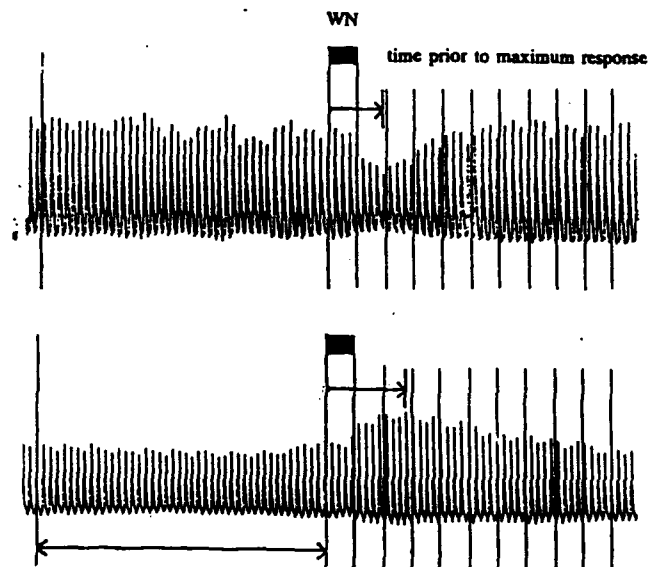

Fig.2: Typical plethysmographs for the periods of 30 sec before and ten 3-sec after the onset of 3-sec WN are shown, the upper and lower graphs of which indicate  $\alpha$ - and  $\beta$ -response, respectively.

Table 1: Adjusted# mean of urinary excretion rates of catecholamine during sleep according to FPR<sub>max</sub> categories. (n=108)##

categories of FPR <sub>max</sub>	catecholamine (pg/hr, mean $\pm$ S.E.)		
	NE	E	DA
1: 1.0= $\leq$ ###	1.84(0.27)	0.18(0.04)	8.10(1.26)
2: 0.9= $\leq$ & <1.0	1.26(0.21)	0.08(0.03)*	6.19(0.97)
3: 0.75= $\leq$ & <0.9	1.05(0.18)*	0.07(0.03)*	5.07(0.80)*
4: < 0.75	1.08(0.18)	0.08(0.03)*	6.14(0.79)

#-mean was obtained with adjusting for age, sex, blood pressure and ECG finding (ventricular hypertrophy only) by the GLM procedure in a SAS program. In the hypertension categories no subject with definitive hypertension was included.

##-eight subjects whose ECG findings were not available were excluded.

###-reference category

\*-shows that mean value is significantly lower with  $p < 0.05$  than that of the reference category or 1.0= $\leq$ FPR<sub>max</sub> by t-test.

## **A REVIEW OF THE EFFECTS OF NOISE ON THE IMMUNE SYSTEM**

**BLY, Stephen, GODDARD, Michael and MCLEAN, Jack**  
Bureau of Radiation and Medical Devices, 775 Brookfield Road,  
Ottawa, Ontario, Canada M5A 1C1

This paper provides a critical review and assessment of nine English language journal articles, published between 1988 and 1992, on noise induced effects on the immune system. A number of different endpoints were studied as indicators of immune system function. A wide variety of noise exposures were also created, with maximum sound pressure levels typically in the range of 90 to 110 dB. All were laboratory exposures, five with either rats or mice and four with humans. Six of the studies suggested that noise induced stress caused moderate suppression of the immune system. Three studies suggested immune system stimulation occurred with exposure to noise. Contradictory findings were obtained in two studies using volunteers which examined the dependence of immune system function upon the subject's control over the noise. Although the majority of these preliminary studies suggest that noise induced stress can suppress the immune system, more laboratory research is needed to provide the consistent findings required to serve as an indicator of the need and direction for epidemiological studies.

The main function of the immune system is to protect the host from harmful foreign substances and cells. The major structural components are the thymus, spleen, bone marrow and lymph nodes. The most important of the immune system's cells in the circulating blood and which are considered in this review are: (i) the granulocytes, the most common of which are the neutrophils, (ii) the thymus derived T-lymphocytes cells, (iii) bone marrow derived B lymphocytes, (iv) natural killer (NK) cells and (v) macrophages. The main function of neutrophils is to destroy harmful bacteria. Lymphocytes are involved in antigen recognition and in modulating the immune response. Natural killer cells have the unique capability to recognize, bind and lyse a variety of target cells without prior exposure to the target cell or antigen. Macrophages are responsible for digesting foreign cells and degrading complex antigens for recognition by lymphocytes.

The possibility that noise can affect human health by modulating the immune system is based on a body of experiments indicating that noise is a stressor [1] and a body of studies indicating that stress of various kinds can modulate immune function [2]. This review assesses 9 recent papers to determine if they provide support for the hypothesis that noise can affect health through modulation of the immune system.

The papers by Sieber et al., Irwin et al., Folch et al. and Kugler et al. were assessed as arriving at conclusions which were justified by both their statistical methods. The cytotoxic assay for splenic lymphocyte sub-populations in Irwin et al. is a standard method. Although their experimental groups were small, they performed 5 separate determinations of their results. Irwin et al. used se

control groups for different exposure times. This ensured that there were no correlations between results at different days, consistent with their statistical analysis. Seiber et al. had to take into account the large between-subject variance in NK cell activity and the need to identify differences between conditions. This was done in both their experimental design and in their statistical analysis which used a repeated-measures analysis of covariance, using the baseline NK activity as the covariate.

It is difficult to assess the significance of the results of these four papers with regard to the effect of noise stress on health, particularly if the papers are viewed as a body of evidence. Natural killer cell activity is thought to be important in host resistance to some viral challenges and to metastatic spread of tumours [2,3]. Irwin et al. showed a significant increase by about a factor of 2 in NK activity in male Sprague-Dawley rats, after 10 days of noise exposure. No statistically significant differences were found either at 1 or 4 days of exposure. Sieber et al. found that acute exposure of healthy male human volunteers to uncontrollable noise, but not to controllable noise, led to statistically significant reductions in NK cell activity by about a factor of 1.6. This was near to, but not beyond, the limit of normal values. Folch et al. found that thymulin, a hormone affecting thymus function, showed a reversible increase in concentration in the blood of mice after noise stress. The work of Kugler et al. showed a statistically significant reduction by about 25% in two lymphocyte sub-populations after acute, but not chronic, stress. Taken as a whole, it appears that no consistent conclusions can be drawn since two studies on animals show immune system stimulation, one on humans shows suppression, and one on animals shows suppression for acute exposure but no effect for chronic exposure.

In the papers by McCarthy et al., Bomberger and Haar and Weisse et al. [6 - 8] the statistical methods are adequate but the high variability or likelihood of artifacts in the biological assays casts some doubt on the significance of their findings. McCarthy et al. studied whether the biological functions of neutrophils, macrophages and lymphocytes from noise exposed rats were altered in in-vitro assays. Their assay for neutrophil function is subject to artifacts [9]. Also, a second, independent lymphocyte proliferation assay should have been used for verification of their results. Bomberger and Haar studied the in-vitro migration of prethymic stem cells in response to thymus supernatant. The use of a small sample size and the fact that many factors can affect lymphocyte migration casts doubt on the biological significance of the change in percent migration from 6.7% to 8.6% between exposed and controls, respectively. Weisse et al. found that subjects exposed to uncontrollable stress did not exhibit altered immunologic function. Subjects exposed to controllable stress exhibited a reduction in lymphocyte response to the mitogen concanavalin A at 90 minutes after the stressor was terminated. Lymphocyte response to mitogens is highly variable, particularly as the length of time-to-harvest increases. This could explain the surprising results in this paper.

The significance of the other two studies was difficult to assess due to lack of detail in the papers [10,11]. The study by Hinrichsen et al. suggested that, in a healthy population, the immune system was stimulated by noise stress. However, more details of the assay would have been desirable for assessment. Bukilica et al. found that noise stress affected the day of onset but, otherwise, had no effect on the incidence or severity of the autoimmune disease, experimental allergic encephalomyelitis, in a susceptible strain of rat. Their statistical analysis was not sufficiently detailed to ensure meaningful results. This was primarily due to the fact that they studied each group across time but did not appear to allow for correlated responses.

A wide variety of noise exposures were used in the different studies but no reasons were given for the use of particular exposure protocols. The total duration of noise exposure ranged from a minimum of 10 minutes per day [10] to a maximum of 22 hours per day [6], although most total exposure times were between 30 minutes and 2 hours per day. Only one of the exposures was stated as being environmental noise but no other details about the noise were given. Reproducible exposure conditions were in doubt for two studies in which a fire alarm bell and "rock music" from a radio station were used. In one case, noise and electric shock stresses were concurrent, confounding any interpretation concerning noise stress and its effect on the immune system.

In some cases, reproducible types of noise exposure were used but these differed significantly between papers. In the work of Irwin et al. the exposure consisted of continuous white noise. Bursts of white noise of fixed or random duration with random intervals between bursts were used in 2 cases [5,8] and intermittent pure tones were used in 3 cases [2,4,7], 2 of which contained bursts of fixed or random duration with random intervals between bursts [2,7]. The pure tones were at 3000, 2900 and 1000 Hz. The maximum sound pressure level fell in the range of 90 to 110 dB. Randomizing the duration of the noise bursts and/or the intervals between them should have ensured that the noise was meaningless to the subjects and reduced the likelihood of habituation during the acute exposure.

In general, little detail was presented of the techniques for noise exposure measurement and generation. In particular, the measurement methods for the quoted sound pressure levels were not indicated when headphones were used.

Four of the studies reviewed here add to the small body of existing literature indicating that noise stress can produce some modulation of certain immune functions. However, these results are not sufficient to provide support for the hypothesis that noise affects human health by modulation of the immune system. This conclusion arises from a number of factors. First, there were inconsistencies in the results between papers. Two studies on animals showed immune system stimulation whereas one study on animals showed suppression for acute exposure but no effect for chronic exposure. In the study on human volunteers, suppression of NK cell activity was found but this never exceeded the normal range of activity in humans. None of the other studies indicated whether the observed changes would affect the health of the subjects. Finally, the variety of noise exposures studied and the lack of detail in the description of the quantification of the noise exposure makes it impossible to assess the effect of the noise quantitatively. More research is needed to determine whether noise can affect human health by modulation of the immune system.

## REFERENCES

[1] Schwarze, S. and Jansen, G. (1990) Critical assessment of the methodological approaches for evaluating non-auditory physiological noise effects. Consequences for the continuation of noise research. In: *Noise as a Public Health Problem, Vol.4, New Advances in Noise Research - Part 1*. Berglund, B. and Lindvall, T. eds., Swedish Council for Building Research, Stockholm, Sweden, pp.373-379.

[2] Sieber, W.J., Rodin, J., Larson, L., Ortega, S. and Cummings, N. (1992) Modulation of human natural killer cell activity by exposure to uncontrollable stress. *Brain, Behavior, and Immunity, Vol.6*, pp.141-156.

- [3] Irwin, M.R., Segal, D.S., Hauger, R.L. and Smith, T.L. (1989) Individual behavioral and neuroendocrine differences in responsiveness to audiogenic stress. *Pharmacology, Biochemistry and Behavior*, Vol.32, pp.913-917.
- [4] Folch, H., Ojeda, F. and Esquivel, P. (1991) Rise in thymocyte number and thymulin serum level induced by noise. *Immunology Letters*, Vol.30, pp.301-306.
- [5] Kugler, J., Kalveram, K.T. and Lange, K.W. (1990) Acute, not chronic, exposure to unpredictable noise periods affects splenic lymphocytes and plasma corticosterone in the mouse. *International Journal of Neuroscience*, Vol.51, pp.233-234.
- [6] McCarthy, D.O., Ouimet, M.E. and Daun, J.M. (1992) The effects of noise stress on leukocyte function in rats. *Research in Nursing & Health*, Vol.15, pp.131-137.
- [7] Bomberger, C.E. and Haar, J.L. (1992) Restraint and sound stress reduce the in vitro migration of prethymic stem cells to thymus supernatant. *Thymus*, Vol.19, pp.111-115.
- [8] Weisse, C.S., Pato, C.N., McAllister, C.G., Littman, R., Breier, A., Paul, S.M. and Baum, A., (1990) Differential effects of controllable and uncontrollable acute stress on lymphocyte proliferation and leukocyte percentages in humans. *Brain, Behavior, and Immunity*, Vol.4, pp.339-351.
- [9] Wong, K. (1986) Quantitation of the respiratory burst induced in human neutrophils by phorbol myristate acetate. In: *CRC Handbook of methods for oxygen radical research*, ed. R. Greenwald, CRC Press, pp.369-372.
- [10] Hinrichsen, H., Barth, J., Ferstl, R. and Kirch, W. (1989) Changes of immunoregulatory cells induced by acoustic stress in patients with systemic lupus erythematosus, sarcoidosis, and in healthy controls. *European Journal of Clinical Investigation*, Vol.19, pp.372-377.
- [11] Bukilica, M., Djordjevi, S., Maric, I., Dimitrijevic, M., Markovic, B.M. and Jankovic, B.D. (1991) Stress-induced suppression of experimental allergic encephalomyelitis in the rat. *International Journal of Neuroscience*, Vol.59, pp.167-175.



# NOISE AND CARDIAC INFARCTION - A REVIEW

SCHUST Marianne

Bundesanstalt für Arbeitsmedizin

Nöldnerstrasse 40-42, 0-1134 Berlin , Germany

More than 200 references published in the English, French and Russian literature since 1975 were evaluated. There were included epidemiologic as well as human or animal experimental studies. Among these some comprehensive reviews contained again several hundred references. The aim of the present project was to integrate the findings on effects of chronic exposure to noise upon the prevalence of cardiac infarction. In addition the risk factors for cardiac infarction were considered. The results of animal experiments points clearly to a variation of biochemical parameters in consequence of chronic exposure to noise. Also the microcirculatory system is disordered. In human experiments the acute effects of noise are mainly investigated. The blood pressure and the heart rate are especially well examined. Studies including psychological analysis are rarely published. At least some results of the human experiments lead to the conclusion that chronic exposure to noise could be one of the risks for cardiac infarction.

The majority of epidemiologic studies shows a decisive methodological weakness. Therefore, a definite statement concerning the noise-induced risk for cardiac infarction is not possible. The authors often neglect to describe the sound event exactly or they do not take into the account the confounding variables. Cross sectional studies dominate in the literature. They are not suited to take into account the complex mechanisms the individual reaction to noise is based on. For the design of further epidemiologic studies one important conclusion from the results of human experiments has take into consideration, that : different sound events with similar sound pressure level and frequency characteristic produce completely different sensations and behavioural patterns in each individual. This fact is reflected by the measured physiological and biochemical parameters. That means that a certain kind of noise promote the risk for cardiac infarction for a certain individual under certain conditions. Therefore, the statistical procedures must be suited to analyse the obtained data corresponding to matching groups. Proposals for designing further studies are presented.



**NOISE, PHYSIOLOGY AND HUMAN PERFORMANCE:  
THE POTENTIAL ROLE OF EFFORT**

TAFALLA, Richard, J., and EVANS, Gary.

Department of Psychology, University of Wisconsin-Stout  
Menomonie, WI 54751 USA; Cornell University

Noise levels and effort were manipulated in a factorial design to test the hypothesis that effort can compensate for the negative effects of a stressor on human performance but at a psychophysiological cost. Generally, the results were consistent with the hypothesis. The effects of noise on task performance and both cardiovascular and neuroendocrine measures varied in the opposite direction as a function of effort.

Reviews of the literature on noise and performance reveal inconsistencies across studies (Cohen, Evans, Stokols & Krantz, 1986; Hockey, 1979; Smith, 1989). In subjects exposed to noise, cognitive task performance may deteriorate, improve, or remain unaffected (Koelga, 1986). There is some evidence that the harmful effects of noise on performance may be mediated by effort. These results suggest that greater effort investments to compensate for noise stress come at some psychophysiological cost (Frankenhaeuser, 1977; Kalsbeek, 1964; Welch, 1979).

In order to more rigorously determine if effort can compensate for the negative effects of a stressor on performance, but at some psychophysiological cost to the organism, the present study employed a 2 X 2 mixed factorial design, varying noise and effort independently. It was hypothesized that performance will decrease during noise exposure, under low effort, but remain constant under high effort. And, physiological indices of stress during noise will remain constant under low effort, but will increase under high effort.

Method

Subjects. Subjects included forty eight male college students participating for course credit.

Dependent Measures. Reaction time in milliseconds to the Norinder arithmetic task was used as a measure of performance. Heart rate, blood pressure, urine cortisol, and catecholamine were employed as indicators of sympathetic nervous system arousal.

Procedure. Subjects were randomly assigned to one of two conditions; Condition 1 - no noise, high and low effort, and Condition 2 - noise, high and low effort.

The time sequence was as follows:

- Day 1 - 30 minutes of instruction and practice.
- Day 2 - 90 minutes of experimental session.
- Day 3 - 90 minutes of experimental session.
- Day 4 - 90 minutes of baseline session.

Effort was manipulated by providing immediate feedback to the subject on the performance of the task. The original Glass and Singer noise tape was used as the noise source (Glass & Singer, 1972). At the end of each session, subjects rated their level of effort on a 10 point magnitude estimation scale anchored by "Nothing At All" and "Maximum".

### Results

Table 1 illustrates the means and standard deviations for all of the data including reaction time, blood pressure, heart rate, catecholamines and cortisol, and self reported effort.

Table 1 Means and standard deviations for the performance, physiological and self-report data.

		NOISE			
		NO NOISE		NOISE	
MEASURE		LOW EFFORT	HIGH EFFORT	LOW EFFORT	HIGH EFFORT
REACTION TIME	Mean	5138	4250	8110	5987
Milliseconds	S.D.	2789	1263	6801	4082
SYSTOLIC BP	MEAN	118.6	116.5	117.1	118.2
mm/mg	S.D.	6.6	7.2	5.9	6.1
DIASTOLIC BP	MEAN	70.2	68.1	66.8	68.9
mm/mg	S.D.	7.1	6.2	9.2	8.6
HEART RATE	MEAN	71.4	68.8	72.2	73.7
Beats/min.	S.D.	10.1	6.9	8.9	9.9
NORADRENALINE	MEAN	173.1	102.5	131.9	181.9
nM/min.	S.D.	137.9	79.9	78.2	124.4
ADRENALINE	MEAN	9.9	14.2	9.6	15.5
nM/min.	S.D.	5.5	16.0	7.7	15.2
CORTISOL	MEAN	218.7	129.1	235.3	259.7
nM/min.	S.D.	180.4	112.6	194.1	190.9
SELF-REPORT	MEAN	3.2	4.8	3.2	4.8
EFFORT	S.D.	1.5	2.2	1.5	2.3

Subjects report greater levels of effort in the high effort condition, but there are no differences between no noise and noise. No noise  $F(1,29) < 1.0, p > .05$ , or noise by effort interaction  $F(1,29) < 1.0, p > .05$  is seen, but a significant effort main effect is demonstrated  $F(1,29) = 18.20, p < .01$ . Subjects with knowledge of results feedback expend more effort on

the task. Reaction time (RT) decelerates with the noise condition, but accelerates with effort instruction. The slowest RT is in the noise, low effort condition (5140 ms) and changed by nearly 3 seconds from no noise to noise. RT decelerated from no noise to noise by only 1.6 seconds in the high effort condition. The a-priori t-value, between noise and no noise in low effort, was,  $df(1,27)=3.79$   $p<.001$ . Under high effort noise has little effect on RT, but under low effort, RT is significantly slowed by noise exposure.

Under the low effort condition, noise results in either a very small increase or even slight decreases in systolic blood pressure, heart rate (HR), noradrenaline (NA), adrenaline (A) and cortisol level. Within the high effort condition, however, increases are seen with noise in all psychophysiological measures. The a-priori t-value for heart rate, and systolic blood pressure was  $t(1,31)=2.45$ ,  $p<.01$ , and  $t(1,31)=1.05$ , ns, respectively. Diastolic blood pressure, however, failed to confirm the expected pattern.

The compensatory effects of effort under noise, high effort were significant for noradrenaline  $t(1,32)=2.44$ ,  $p<.01$ , but not significant for adrenaline  $t(1,32)=.31$ ,  $p>.05$ . Cortisol levels between the noise conditions in high effort were significantly higher  $t=(1,32)=2.31$ ,  $p<.05$ .

### Discussion

The significant evidence supporting the hypotheses include reaction time, heart rate, noradrenaline and cortisol. Systolic blood pressure, and adrenaline were not significant, but were in the correct direction. Diastolic blood pressure only partially fits the pattern. These variables suggest that the individual is struggling to maintain performance levels in reaction to noise in high effort.

The investment of mental effort, moderated the effects of noise on performance and physiology. Self-reported effort provided validation for the manipulation, and furthermore, demonstrated that the manipulation was independent of noise - no effect was seen as a function of noise condition.

This pattern of results fits in well with an emerging, alternative view of stress and health. In addition to examining the direct adverse effects of stressors on health and well being, researchers are increasingly focusing their attention on the costs and benefits of various coping strategies (Cohen, Evans, Stokols, & Krantz, 1986; Schonflug, 1986).

Summarizing, we have shown that noise interferes with task performance when motivation to perform well is not manipulated. With enhanced effort to perform, little or no effects of noise are seen on task performance. However, the mobilization of effort appears to heighten psychophysiological stress. The compensatory effects of effort during a stressor can have costs and benefits.

## References

- Cohen, S., Evans, G.W., Stokols, D., Krantz, D.S. (1986). *Behavior, Health & Environmental Stress*. New York: Plenum Press.
- Frankenhaeuser, M. Lundberg, U. (1977). The influence of cognitive set on performance and arousal under different noise loads. *Motivation and Emotion*, 1, 139-149.
- Frankenhaeuser, M. A (1986). Psychobiological framework for research on human stress and coping. In M H. Appley & R. Trumbull (Ed.) *Dynamics of stress physiological, psychological and social perspectives* (pp.101-106). New York: Plenum Press.
- Glass, D., & Singer, J. E. (1972). *Urban Stress*. New York: Academic Press.
- Hockey, G.R.J. Stress and cognitive components of skilled performance. In V. Hamilton & D. Warburton (Eds.), *Human stress and cognition*, New York: Wiley, 141-176, 1979.
- Kalsbeek, J.W.H. & Ettema, J.H. (1964). Physiological and psychological evaluation of distraction stress. *Proceedings of the 2nd International ergonomics association congress*, Dortmund.
- Koelga, H.S. (1986). Noise and vigilance: An evaluative review. *Human Factors*, 28, 465-481.
- Lundberg, U. (1982) Psychophysiological aspects of performance and adjustment to stress. In Wh. W. Krohne & L. Laux (Eds.), *Achievement, stress and anxiety* (pp. 75-91). Washington, D. C.: Hemisphere.
- Schonflug, W. (1986). Behavior economics as an approach to stress theory. In M.H. Appley & R. Trumbull (Eds.), *Dynamics of Stress* (pp. 81-98). New York: Plenum.
- Smith, A. (1989). A review of the effects of noise on human performance. *Scandinavian Journal of Psychology*, 30, 185-206.
- Welch, B.L. (1979). Extra-auditory health effects of industrial noise: Survey of foreign literature. *Aerospace Medical Research Laboratory, Aerospace Medical Division, Air Force Systems Command, Wright-Patterson*.

SALAMÉ Pierre, TASSI Patricia, NICOLAS, Alain, EHRHART Jean, DEWASMES Gérard, LIBERT Jean-Pierre, and MUZET, Alain.

CNRS / INRS. Laboratoire de Physiologie et de Psychologie Environnementales.  
21, Rue Becquerel, 67087 STRASBOURG. FRANCE

### ABSTRACT

Performance in a spatial memory task was measured either in quiet, or in noise, following one hour of sleep (nap) that took place at 00.00h. In quiet (45 dB(A)), comparisons with baseline (no-nap) showed consistent sleep inertia effects on speed that lasted 15 min. These slowings were removed when continuous pink noise was delivered at 75 dB(A) during the testing sessions. These results suggest that noise might interact with the after-effects of sleep, and might have indirect beneficial effects on some cognitive performance.

### RÉSUMÉ

Les performances dans une tâche de mémoire spatiale ont été évaluées en Silence ou en présence de Bruit, immédiatement après une heure de sommeil placée à 00.00h. En Silence (45dB(A)), des TR longs ont été observés pendant 15 min consécutivement au sommeil, en comparaison avec la condition de référence (sujets maintenus éveillés). Cette baisse était abolie en présence d'un bruit rose continu délivré à 75 dB(A) au cours du test. Ces résultats suggèrent que le bruit interagirait avec les effets consécutifs d'une heure de sommeil placée à 00.00h, et pourrait indirectement améliorer certaines performances cognitives.

### INTRODUCTION

Extensive research has been devoted to study the effects of noise on human performance. For both theoretical and ecological reasons, most of these studies clearly aimed at determining the extent to which noise might impair performance, rather than at hypothesizing that noise might have some beneficial effect and improve performance. One area of research in which such hypothesis could be tested relates to the after-effects of sleep. Abundant evidence suggests that performance is disrupted immediately after awakening, the disruptive effects being described as 'Sleep Inertia' (SI) (Naitoh, 1981). SI is a short-term after-effect of napping and "refers to the phenomenon of inferior task performance and/or disorientation occurring immediately after awakening from sleep relative to presleep status" (Naitoh and Angus 1989, p 226). SI effects are usually so profound that in most studies researchers delayed testing shortly following a nap or did not include these first data in their performance analyses. Haslam (1982) indicated that her subjects were totally unable to make a logical reasoning task within the first 5 min following a 4-hours nap that took place after 90 hours of sleep deprivation.

However, SI duration still remains unresolved. Seminara and Shavelson (1969) reported a decrement in performance for the period of 3 min following abrupt awakening. Wilkinson and Stretton (1971) found that SI effects on a reaction time task were still present 15 min after awakening. Dinges *et al.* (1981) asked their subjects to perform a 3 min subtraction task following a 1-hour afternoon nap and found also disruptive effects. Performance returned to baseline in a subsequent test that took place 35 min later. The authors speculated that SI effects would last 35 min.

The experiment described in this paper is only part of a larger research programme concerned with sleep fractionation, noise, and performance (Tassi *et al.* 1992), and had two main objectives. The first was to evaluate the duration of SI effects following 1- hour nocturnal nap taken from 00.00h to 01.00h on subsequent performance. The second objective was to test the hypothesis that noise might play some positive role on performance, and that a moderate broadband noise following awakening would act as arouser and would reduce the after-effects of sleep. SI effects were evaluated by testing the subjects just after awakening in two- 30 min sessions separated by a 10 min pause. In each session, the data which were continuously recorded were analyzed in 10 blocks of 3 min each. The performance of two independent groups of subjects were examined. The Quiet group was tested at 45 dB(A), and the Noise group had a continuous pink noise presented at 75 dB(A) during the testing sessions only.

---

1. This research was supported by grant No 101575 from Electricité de France.

## METHOD

### Subjects

Twenty-two male adults aged 19 - 27 years took part in the experiments. Twelve subjects served in the Quiet group, and 10 subjects participated in the Noise group. The subjects were selected according to medical, psychological (personality, morningness / eveningness), and performance criteria. All subjects were clearly informed about the experiments; each subject signed an informed consent, and was indemnified for his participation.

### Performance Task

The french version of the Spatial Memory Task extracted from the AGARD Stress Battery (NATO, 1989) was used. In this task, the subject had to rotate histograms mentally before making a same / different judgment. In each trial, two four-bar histograms were presented successively on the video screen. The subject had to decide whether the second histogram that was always rotated for 90° or 270° (horizontal bars) was identical with the first one (vertical bars), irrespective to the orientation difference. The response was 'same' when a complete match in bars length and location was detected, and 'different' if one bar differed in length from its corresponding one in the stimulus set. The task was displayed on a black-and-white video screen, and the subject was instructed to respond as quickly and as accurately as possible. Responses were given by pressing the appropriate response keys of the keyboard. Following either a response, or a deadline of 15 sec, a new trial was presented.

### Design and Procedure

The experimental design called for (1) one night of sleep in a sleep chamber to adapt to new sleep environments (adaptation night), (2) one night of staying awake all night to provide "baseline" performance (no-nap condition), and (3) one night when each subject was allowed to sleep 1- hour (nap condition). A cross-over design was adopted to control the amount of inter-subject variability. Hence, for each subject, the design comprised 3 nights with 8 to 10 days between successive nights. In all conditions, subjects arrived at the Laboratory at 16.30h and were tested in two- 30 min sessions between 17.00h and 18.10h (labelled session 1 and session 2) separated by a 10- min pause. In the no-nap condition, the subjects remained awake until 01.00h and then performed the task in two- 30 min sessions (labelled session 3 and session 4). In the nap condition, the subject was allowed one- hour of sleep from 00.00h to 01.00h during which physiological sleep variables (EEG, EOG, EMG) were recorded. At 01.00h, he was awakened, the electrodes were disconnected, and he was at the microcomputer work station within about 1.5- 2 min from the moment of awakening and performed the task in two- 30 min sessions. Since the laboratory facilities have 2 independent sleep chambers, the subjects were tested by pair in each night. The order of night/condition was counterbalanced.

### Noise

In the Quiet group, the background noise (ventilation and computer noises) was about 45 dB(A), and in the Noise group, a continuous pink noise was delivered through loudspeakers in each sleeping chamber, during the testing sessions only, at an intensity of 75 dB(A).

### Data analysis

For each group, factorial analyses of variance for repeated measures with two main factors of condition (no-nap / nap), and of block (the 10 3-min data points per session) were carried out. To estimate the probabilities associated with the block factor, and with its interaction with the condition factor, the dfs were adjusted according to the Geisser-Greenhouse's (1958) correction method. Each time the condition factor, or the condition x block interaction was significant, pairwise *t* tests were computed to make between-conditions comparisons of blocks. A probability level of 0.05 was accepted as statistically significant.

## RESULTS

Concerning sleep, 70% of the subjects of both groups were in slow-wave sleep (stage 3 and 4) at awakening. Also, 17% of the subjects of the Quiet group were in sleep stage 2 at awakening. Hence, these results indicate that the subjects did sleep, and most of them have been effectively awakened by the end of the nap.

Concerning the performances, analyses of accuracy revealed no significant change for any comparison at any testing session in any group (Quiet or Noise). Therefore, the following statistical analyses relate to mean Response Time (RT) for correct responses only.

### Quiet group

To assess the overall level of performance before any intervening disruption, the data of session 1 and of session 2 were first analysed. In neither session did the analysis of variance show any significant effect, suggesting that the performance in the baseline (no-nap) and in the nap conditions in these sessions was comparable. Performance in session 3 (01.00h), immediately after



awakening from the midnight 1- hour nap was different, and is represented in Figure 1, with that in session 4 (01.40h).

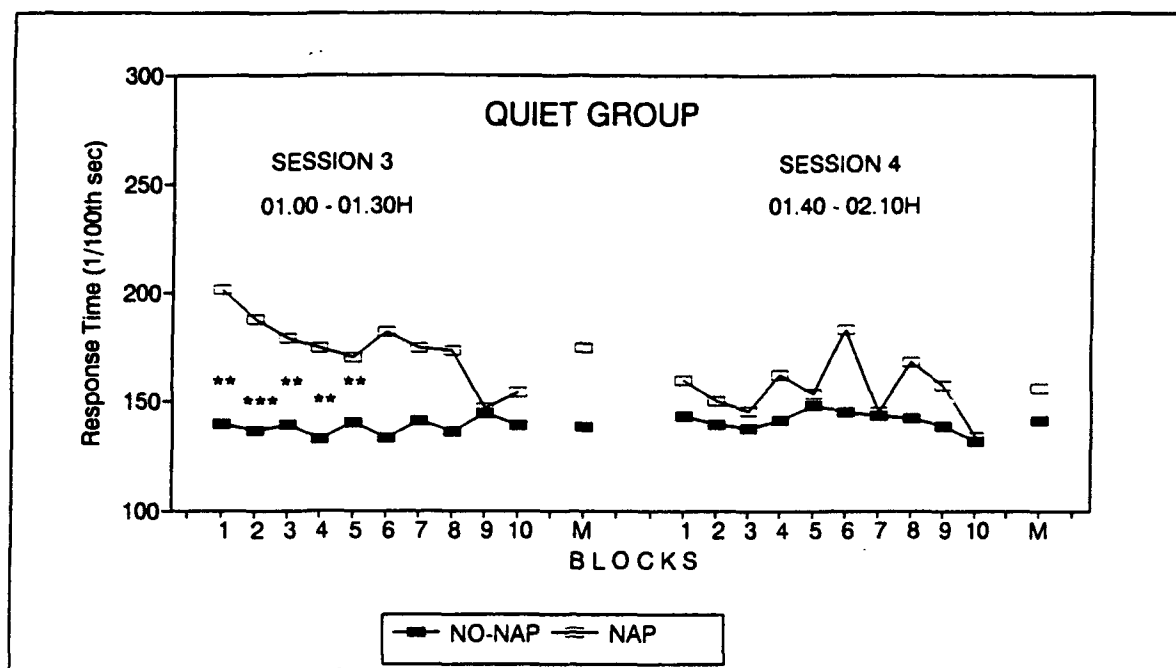

Figure 1. Quiet group. Mean RTs as a function of time in the no-nap condition, at the first 30 min session of the task, and at the second 30 min session. Blocks 1 to 10 refer to data points averaged every 3 min from the beginning of each session. M = the mean RT for each condition. \*  $p < 0.05$ ; \*\*  $p < 0.01$ ; \*\*\*  $p < 0.001$ .

In session 3, the analysis of mean RT showed a significant effect of condition ( $F_{1,11} = 16.65$ ;  $p < .01$ ), the effect of block was negligible ( $F_{9,90} = 1.65$ ;  $p > .05$ ), and the condition  $\times$  block interaction did not reach significance ( $F_{9,90} = 2.34$ ;  $p > .05$ ). Pairwise  $t$  tests were performed on each block of session 3.  $t$  Tests showed that post-nap RTs were significantly longer than those in the no-nap condition, in block 1 ( $t = 3.52$ ;  $p < .01$ ), block 2 ( $t = 4.58$ ;  $p < .001$ ), block 3 ( $t = 3.14$ ;  $p < .01$ ), block 4 ( $t = 3.57$ ;  $p < .01$ ), and block 5 ( $t = 3.31$ ;  $p < .01$ ). None of the remaining comparisons between blocks in session 3 was significant. In session 4, no significant effect emerged.

### Noise group

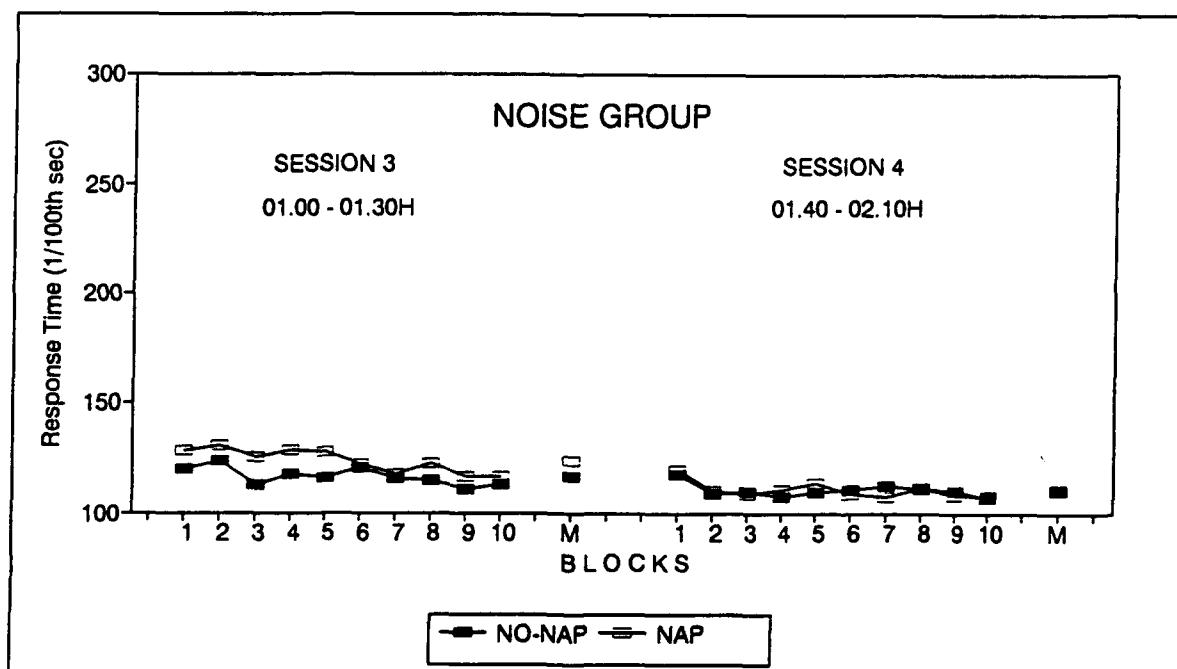

Figure 2. Noise group. Mean RTs as a function of time in sessions 3 and 4.

The analyses of variance made on data of session 1 and of session 2 showed no significant effect of any factor or interaction. Mean RTs as a function of blocks in session 3 and in session 4 are represented in Figure 2.

In session 3, the analysis of variance showed no effect of condition ( $F_{1,9} = 1.16$ ;  $p > .05$ ), there was a significant effect of block ( $F_{9,81} = 2.99$ ;  $p < .05$ ), and the condition x block interaction was not significant ( $F_{9,81} < 1$ ). In session 4, no significant effect emerged.

### Comparisons of the Quiet group with the Noise group

The last set of analyses attempted to compare the performance of the two groups more precisely, and included an additional main factor of group (Quiet vs Noise). In a preliminary analysis that compared the performances of the two groups in sessions 1 and 2, no difference between groups was obtained. In session 3, there was no effect of group ( $F_{1,20} = 2.71$ ;  $p > .05$ ), a significant effect of condition ( $F_{1,20} = 14.30$ ;  $p < .005$ ), of block ( $F_{9,180} = 2.71$ ;  $p < .01$ ), and the condition x group interaction was also significant ( $F_{1,20} = 6.44$ ;  $p < .05$ ). In session 4, no significant effect was obtained.

### DISCUSSION

From the results of the Quiet group 1 (Fig. 1), it appears first that in the no-nap condition, the performances across time were remarkably flat. In contrast, a one-hour nap resulted in an increase of post-nap RTs, indicating that immediately following awakening from the nap, the subjects needed more time to decide whether a complete match was present between the stimulus histogram held in short-term memory and the probe-histogram that followed. Second, this increase was transient since it was present in the first 15 min and then vanished in the remaining part of the testing sessions. The subjects were slow by an average of 450 ms during the first 15 min, and their performance level returned to baseline during the remaining 45 min of test. These results argue strongly in favour of direct SI effects on subsequent performance, and not of building up of fatigue and low motivation.

These results contrast heavily with those of the Noise group. In sessions 3 and 4 (01.00h and 01.40h respectively) of that group, the performance in the no-nap condition was very stable over the two testing sessions, but above all, no difference between the nap and no-nap conditions was observed. The comparisons of the two groups of subjects at sessions 1 and 2 (17.00h and 17.40h respectively) showed no difference between groups, suggesting that the basic performance of the two samples of subjects was comparable. Together with the significant group x condition interaction obtained in the comparison of the two groups, these results suggest that noise interacted with SI, and removed the slowing of RTs, without causing other impairment of performance. As such, continuous pink noise delivered at 75 dB(A) would have an indirect beneficial effect on RTs in a spatial memory task, in eliminating the detrimental after-effect of one-hour midnight sleep.

### REFERENCES

- DINGES, D.F., ORNE, E.C., EVANS, F.J. and ORNE, M.T. Performance after naps in sleep-conducive and alerting environments. In: L.C. Johnson, D.J. Tepas, W.P. Colquhoun, and M.J. Colligan (Eds) *Biological Rhythms, Sleep and Shiftwork*, Spectrum, New York, 1981: 539-552.
- GEISSER, S. and GREENHOUSE, S.W. An extension of Box's results on the use of the F distribution in multivariate analysis. *Ann. Math. Stat.*, 1958: 29, 885-891.
- HASLAM, D.R. Sleep loss, recovery sleep and military performance. *Ergonomics*, 1982: 25, 163-178.
- NAITOH, P. Circadian cycles and restorative power of naps. In: L.C. Johnson, D.J. Tepas, W.P. Colquhoun, and M.J. Colligan (Eds) *Biological Rhythms, Sleep and Shiftwork*, Spectrum, New York, 1981: 553-580.
- NAITOH, P., ANGUS, R.G. Napping and human functioning during prolonged work. In: D.F. Dinges and R.J. Broughton (Eds) *Sleep and Alertness: Chronobiological, Behavioral, and Medical Aspects of Napping*, Raven Press: New York, 1989: 221-246.
- NATO. Human Performance Assessment Methods. *AGARDograph No. 308. AMP Working Group 12 and AGARD Lecture Series 163*. Specialised Printing Services Ltd: Loughton, 1989.
- SEMINARA, J.L. and SHAVELSON, R.J. Effectiveness of space crew performance subsequent to sudden sleep arousal. *J. Aerosp. Med.*, 1969: 40, 723-727.
- TASSI, P., NICOLAS, A., DEWASMES, G., ESCHENLAUER, R., EHRHART, J., SALAMÉ, P., MUZET, A. and LIBERT, J.P. Effects of noise on sleep inertia as a function of circadian placement of a one-hour nap. *Percept. Mot. Skills*, 1992: 75, 291-302.
- WILKINSON, R.T. and STRETTON, M. Performance after awakening at different times of the night. *Psychon. Sc.*, 1971: 23, 283-285.

# NOISE AND VIBRATION EFFECTS ON DROWSINESS UNDER REAL CAR DRIVING CONDITIONS

KHARDI Salah, FAKHAR Sina, OLIVIER Daniel and VALLET Michel

INRETS-Laboratoire Energie-Nuisances  
109, avenue Salvador Allende. Case 24  
69675 Bron Cédex-France

## ABSTRACT

The real driving experiences with noise and vibration were used to investigate the influence of these settings on drivers vigilance. This study was a matter of examining the combined effects of noise and vibration on the vigilance of car drivers, this vigilance being employed as an indicator of the quality of the environment within the vehicles. In this paper, we show that vigilance levels are reduced by the noise effects. No significant effect of the vibration alone or combined with noise was obtained.

## RESUME

Dans le cadre de ce travail, nous avons examiné l'effet combiné du bruit et des vibrations sur la vigilance des conducteurs en situation réelle de conduite. Nous avons montré que le bruit fort entraîne en général une dégradation de la vigilance pendant la troisième heure de conduite. Quant aux vibrations seules ou additionnées à un bruit faible, elles n'engendrent pas un effet significatif sur l'évolution naturelle des niveaux de vigilance.

## INTRODUCTION

Over the last few years, the effect of stress and sustained attention on the drivers and safe driving have become a major focus of research [1]. Drowsiness is responsible for 26% of lethal crashes on French highways. Lafont [2] has revealed that for a yearly sample of about 300 killed, a loss of vigilance was the prime cause of fatal accidents compared with the others (burst tyres, a failure to make proper allowance for the weather conditions, a failure to keep a safe distance from the vehicle ahead, a loss of control of the vehicle and excessive speed). No statistics recording the drivers' levels of experience have been reported. One of the researches carried on by our laboratory concerning the driver's safety, is vigilance's detection, in order to prevent drivers from falling asleep behind the wheel. We have paid attention to this particular factor, manipulated by high noise and vibration. Noise and vibration are chosen because they not only represent an environmental source of inattention but are also appraised as a stressful task by the drivers.

Our experimental investigation permitted to examine the effects of noise and vibration on the state of the driver when driving a car under real conditions. The noise within a car travelling at a speed of 130 km/h constituted the first test situation. This noise was amplified so as to raise the level of by 4 dB(A), i.e. from 77 dB(A) to 81 dB(A), for the second, noisier test situation. The normal vibrations reached  $0.7 \text{ m/s}^2$  below 50 Hz. More severe vibration of  $1.52 \text{ m/s}^2$  was obtained on using a second car fitted with harder anti-vibration seat mountings. A different combination of noise and two levels of vibration, based on two levels of noise and two levels of vibration, applied on each of the four trips.

## METHODS

**SUBJECT DESIGN :** Thirteen subjects from 25 to 45 years old (six males and seven females), with no neurophysiological problems, realized a three hours' diurnal trip on highway (450 kms).

They can be considered typical of the driving population, having held driving licenses for a number of years and have been driving constantly until now. Subjects had to drive normally on respecting the legal speed limit. Each subject had driven four times.

**EXPERIMENTAL SET UP :** The experimental vehicle used was a Renault 21 model, a left-hand-drive car. Temperature inside the car is balanced by air conditioned system. The trip on the motorway running between Lyon and Dijon is approximately 450 kilometers long. During experimental runs, EEG, ECG and EOG signals, Steering Wheel movements and Vehicle's Speed were measured. Our apparatus have been installed aboard. The recorded data were analysed with the help of the digital computation facilities in INRETS-LEN Laboratory and by spectral analysis. The 180 minutes were analyzed in 15 sec periods.

The experimental arrangement is illustrated schematically in figure 1. A continuous EEG recorded from the human scalp (the most useful physiological indicator of central system activation) was obtained from electrodes glued on the head. The electrodes were adjusted so that there was a minimum movement artifact, which was immediately identifiable (non invasive's method). The signals were passed through a preamplifier. Our acquisition system is made of a set of connected up units. The signal delivered by the sensor is processed in conditioning block. The acquisition card's role is to transform an analogical signal delivered by the conditioning system into a numerical data.

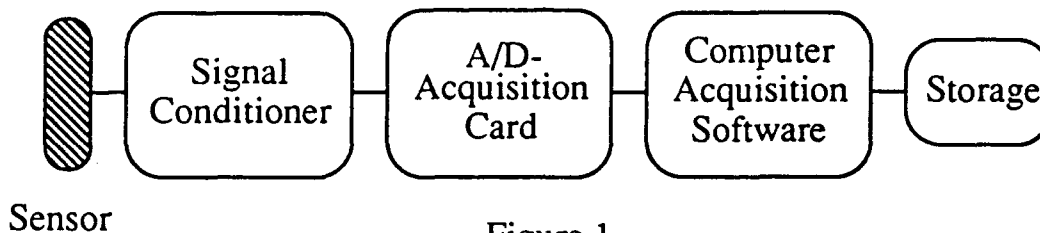

Figure 1

The EEG was analysed over 15 second periods as a function of the frequency concerned. We have then determined the ratio of alpha to the beta and the theta energies bands.

## RESULTS AND DISCUSSION

The litterature shows that there is a considerable discrepancy in the approach of vigilance's concept. So, we realized here a unification which represents a compromise between the EEG responses and the variations of the dynamical car' parameters.

The product of the alpha/beta ratio, the theta energy, the variations of the steering wheel movements ( $\Phi$ ) and of the vehicle's speed ( $V$ ), was employed as an indicator of the degree of vigilance.

This product is called the K-factor, and it is written empirically by :

$$K = I(\alpha/\beta) * I(\theta) * \Delta\Phi * \Delta V \quad (1)$$

Formula (1) can be interpreted as follows :

$I(\alpha/\beta)$  : the traditional ratio of alpha to the beta intensity

$I(\theta)$  : the theta intensity (in term of energy)

$\Delta\Phi = | \Phi_{max} - \Phi_{min} |$  : in degree

and

$\Delta V = | V_{max} - V_{min} |$  : in km/h

where  $\Delta\Phi$  and  $\Delta V$  are the absolute values of their fluctuation over each 15 sec epoch. Analysis suggested that periods of high vigilance were characterized by a minimum of the K-factor. Peculiarly, this situation has occured when all these parameters were on their lowest values.

For instance, we can see on figures 2a and 2b, the variation of the K-factor (arbitrary units)

during a trip on motorway for two specific periods and for two experimental conditions (v = low vibration; B = high noise).

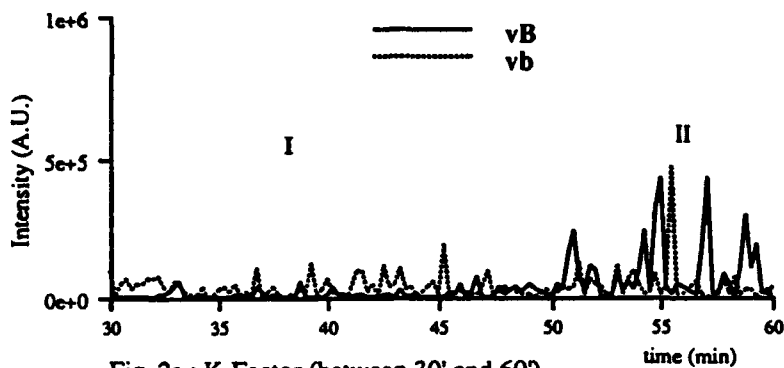

Fig. 2a : K-Factor (between 30' and 60')

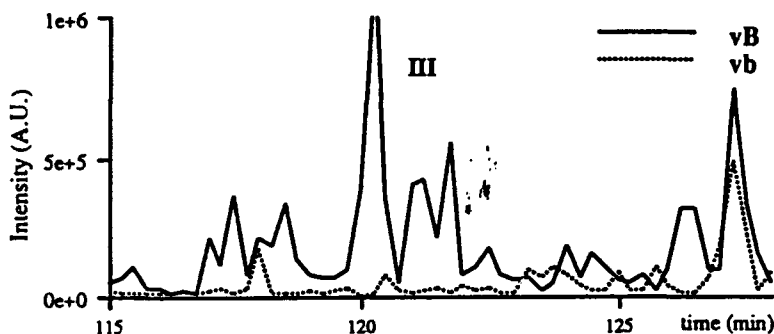

Fig. 2b : K-Factor (between 115' and 128')

Each point represents a 15 sec period. The main point is the vigilance level. Three degrees of vigilance are shown :

- I : High Vigilance
- II : Medium Vigilance
- III : Low Vigilance

The II and III phases last roughly few minutes each, and they are followed by a subject activation. These two phases can be interpreted as the moments of inattention.

We can see explicitly that the bad vigilance is marked by an increase of the K-factor, particularly for the high noise level (B situation). It arises approximately after two hours of driving. A close look at figure 2a, clearly demonstrates that around 55 minutes of driving, the K-Factor's pic for vB precedes the situation corresponding to that at vb ( $\Delta \approx 30''$ ). This is in sharp contrast to the phenomena depicted throughout the entire range of driving as shown in figure 2b where the K-Factor for vB is generally more important than the situation corresponding to vb. For this high noise condition, drivers showed behavioural signs of drowsiness. They would engage in gross, whole-body movements which appeared as if they were trying to "shake off" feeling of fatigue. For the high vibration, subjects didn't show a clear variation of the K-Factor between the vb (b = low noise) and the Vb (V = high vibration).

This result fits in with the one performed by Fakhar et al.[4] (see figure 3). The author's treatment was based on the optimum filtering procedure proposed by Kalman.

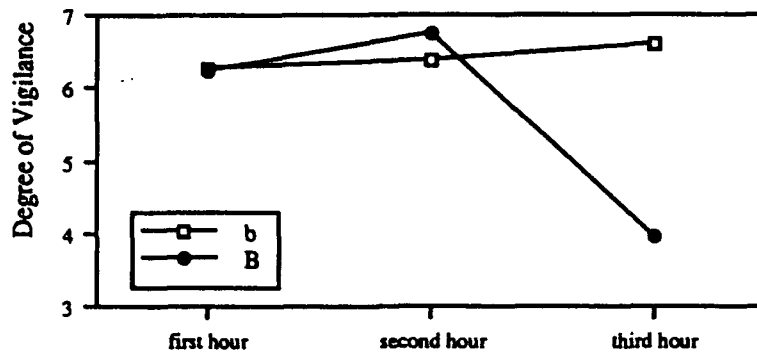

Fig. 3 : effects of time of noise on vigilance (arbitrary units) suggested by Fakhar (in Fakhar et al. [4])

The degree of vigilance decreased during the 3rd hour of driving when the noise level was greater than 80 dB(A). Vibration alone or in combination with this noise level, for this same period of time, had no effect. This later result could have been because the level of vibration was not in fact high enough.

The main findings so far as noise was concerned were as follows :

- \* a high level of noise leads to a decrease in the vigilance' levels. This decrease during exposure to noise only becomes apparent after a certain period of time. It has been noticed that the drivers were not aware of this decrease.
- \* the decrease in the vigilance' levels due to noise occurs essentially when the driving is very monotonous (driving along a straight road, speed virtually constant, ...). Vigilance grew progressively poorer with prolonged exposure to noise and with augmented driving time.

In this paper, we haven't studied the subject's discomfort due to vibration for a high frequency band at which the resonance of large organs of body is the most sensible. There is not sufficient evidence to confirm a vibration effect as in the case of noise. Because the extraordinary complexity of the various intervening factors on vibration inside the car, we know nothing about the exactly effect of variable vibration versus frequency on vigilance.

## CONCLUSION

An internal noise of 81 dB(A) has a significant effect on the decrease of vigilance of the driver after two hours of driving. Vibration does not appear to have any effect, neither on its own nor when combined with noise. These findings only apply to the observed range of noise and vibration. More severe conditions, i.e. either higher levels of noise or vibration or longer periods of driving could conceivably lead to different results. Also, it has been shown that K-factor is a useful measure, and a good description of the time of course of vigilance during the drive.

## REFERENCES

- [1] VALLET, M.  
Le Maintien de la Vigilance dans les Transports  
Actes des Journées d'Etude de l'INRETS. Bron, 18 et 19 octobre 1990  
Edited by Pradigme (1991)
- [2] VALLET, M.  
Vibration and low frequency noise in motor vehicles and their effects on vigilance and road safety  
A litteratur review  
J. Low Frequency Noise and Vibration, 1987, vol 6, N° 3, p.104-113
- [3] LAFONT, R. 1987, Rapport d'activité ASSECAR. PARIS
- [4] FAKHAR, S., VALLET, M., OLIVIER, D. and BAEZ, D.  
Effet du Bruit et des Vibrations sur la Vigilance des Conducteurs de Vehicules Legers en Situation de Conduite Monotone. RAPPORT INRETS N° 153, Avril 1992
- \* CEE Contract DG XII EV4V005800  
Cooperation with Département des Sciences de l'Environnement de RENAULT

# DOES NOISE IMPROVE OR DETERIORATE THE DRIVING BEHAVIOR ?

PETIT C., TARRIERE C., TAMALET D.  
RENAULT - Département des Sciences de l'Environnement  
132, rue des Suisses 92000 Nanterre - France

**ABSTRACT** : experiments on driving simulator were carried on to compare the driver's performance level in situations with noise and without noise. 36 subjects were tested under both conditions during two hours. They had to performed at the same time a driving task and a detection one. Behavioral responses were recorded continuously in order to estimate the driver's performance level.

## INTRODUCTION :

Decrease of vigilance, in spite of a general alertness degradation, is compatible with driving but makes it less safe. It is characterized by a decrease in signal responses, an increase of mistakes and braking time and a narrowing of the field of vision [1]. It is particularly susceptible to change constantly into drowsiness which is responsible of 26% of lethal crashes on french highways (prime cause of fatal accidents) [2]

In real driving conditions, several authors [3], [4] showed a decrease of vigilance with time (increase of alpha waves in the EEG and decrease of heart rate). The same results have been found in driving simulation [5]. Monotony is not the only cause of drowsiness ; environmental factors can also be responsible of vigilance decrease [6], [7]. A bibliographic analysis on the effects of noise [9] concluded that continuous white noise detracts from performance if cognitive demand were high, but has no significant effects if the task of alertness were undemanding. On the other hand, when noise varies in intensity or frequency, or when it is significant, an improvement in alertness can be observed [5], [9] or at least, no deterioration [10].

The aim of this study is to know if an engine noise heard by the driver improves, deteriorates or has no effect on his driving behavior.

## EXPERIMENT PROTOCOL :

36 subjects were placed in a driving simulator and realized two driving tests during two hours. 18 of them did one test without noise and vibrations and another one with noise and without vibration. The other 18 did one test with vibrations and without noise and another one with vibration and noise. Before the test, subjects drove for 15 minutes in order to get used to the simulator. The noise inside the car was amplified in order to raise a level of 80 dB(A). The simulated vibration corresponded to a highway vibratory spectrum and reached  $0,3\text{m/s}^2$  below 50 Hz. The temperature inside the car was maintained at 20°C. A film, representing a monotonous road without traffic, was projected on a screen in front of the driver. On this screen, the trace of a laser beam - symbolizing the vehicle - moved randomly and had to be corrected constantly by turning the steering wheel in order not to leave the road. Light bulbs - green and orange - attached around the windscreen, inside the passenger compartment, lit up randomly each in turn for a duration of four seconds, at a rate of 18 times per hour. The drivers were instructed to avoid leaving the road and to detect the lighting of the light bulbs, while driving. When the light was a green one the subject had to push on a switch on the steering wheel ; when it was an orange one, he had to brake. Response time to those signals, errors of detection (omission and inversion), and number of times the driver left the road were recorded and calculated.

## RESULTS

### Number of times drivers are leaving the road (fig 1) :

The noise seems to prevent the driver from leaving the road : the ratio decreases from 8 to 2 between tests in silence and with noise ; it decreases from 7 (vibrations alone) to 4 when noise is associated to vibration. Those differences are not statistically significant but the tendency is visible.

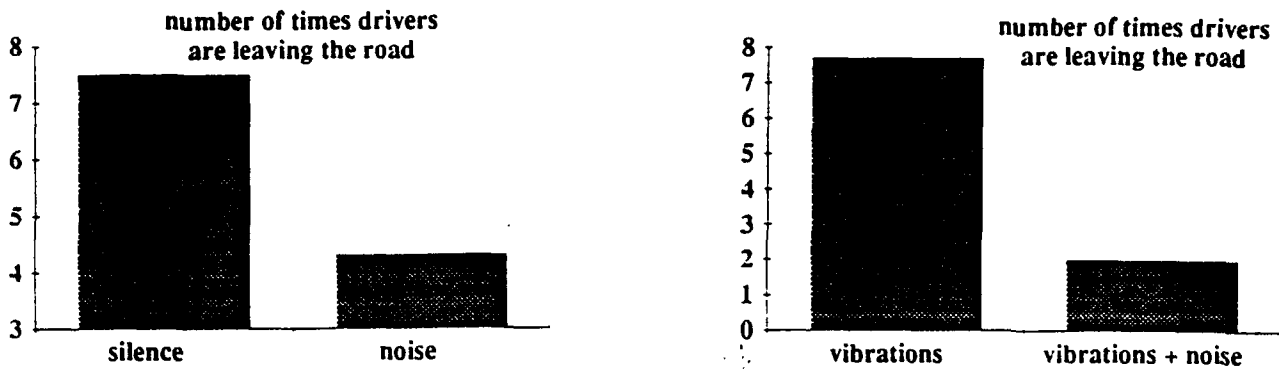

Figure 1

### Response time (fig 2) :

When the driver is submitted to an engine noise, this one improves his response time. The comparison of the results obtained with noise versus silence and with noise+vibration versus vibration alone, shows that the response time decreases of 0,1 seconde in both cases (N.S).

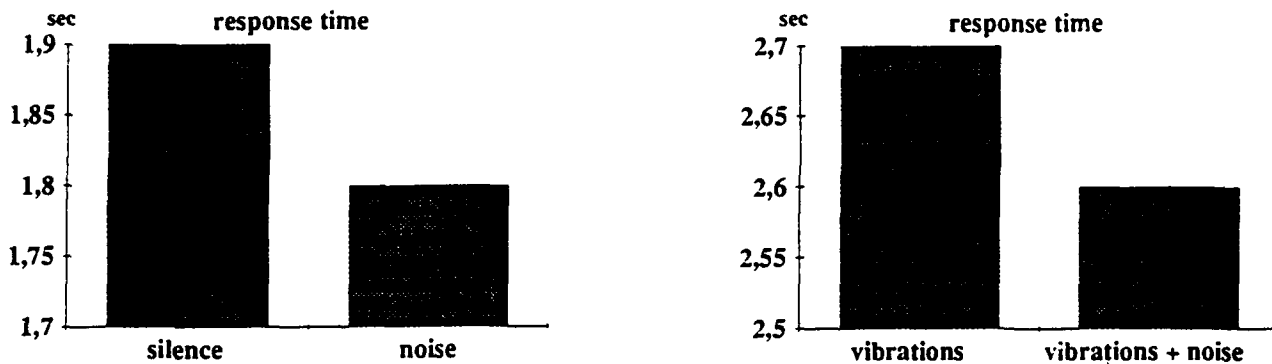

Figure 2



### Errors of detection (fig 3) :

The number of detection errors remains quite identical when subjects are submitted or not to noise. It decreases a little with noise but not significantly.

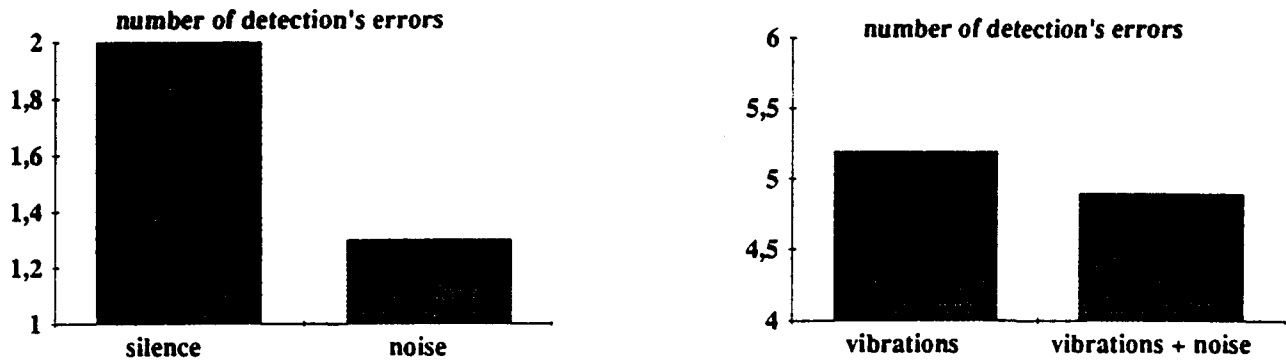

Figure 3

### DISCUSSION AND CONCLUSION

When they began the test, the drivers were told that they would have to realize two tasks : a driving task and a detection one. Noise allowed them to be concentrated on both tasks even though they had more difficulties to perform the driving task when they realized the test without noise.

The secondary task did not give very distinguishable differences between the two situations, but the tendency was the same : response time and number of detection errors were reduced when hearing noise.

As it has been already found in the litterature in other situations, the noise perceived by the driver inside the passenger compartment does not have any unfavourable effect on his performance. On the contrary, even if the differences were not significant, a tendency of performance improvement appears with noise.

Moreover, it has been shown in a previous communication [7] that physiologic parameters (EEG and ECG) didn't present significant deterioration between tests with and without noise.

The reduction of response time with noise can be explained by a stimulation of the reticular formation by the auditory canal ; reticular formation which has a well known activatory effect on flexor and extensor muscles (by facilitation of the synaptic transmission). The reduction of errors in the driving task can also be conferred on the arousal effect on the cortex by the reticular formation.

These results are comforting for the driver's comfort and safety, but should not arouse fear concerning the present trend to a reduction in car noise. The noise inside the car, indeed - less important than in this experiment, and still decreasing in the future - will remain loud enough to have the same effects on drivers than those obtained in this experiment.

## REFERENCES

- [1] DRORY, A. "Effects of rest and secondary task on simulated truck-driving task performance." *Human factors*, 1985, 27 : 201-207
- [2] LAFONT, R. Rapport d'activité ASSECAR. Paris, 1987.
- [3] O'HANLON, J.F. and KELLEY, G.R. "Comparison of performance and physiological changes between driver who performs well and poorly during prolonged vehicular operation". In : MACKIE R. (ed.) - *Vigilance*. New York, Plenum Press, 1977, 87-109.
- [4] RIEMERSMA, J.B.J., SANDERS, A.F., WILDERVANCK C., GAILLARD, A.W. "Performance decrement during prolonged night driving". In MACKIE, R. (ed.) - *Vigilance*. New York, Plenum Press, 1977, 41-51.
- [5] TARRIERE, C. and WISNER, A. "Effets des bruits significatifs et non significatifs au cours de l'épreuve de vigilance". *Le travail humain*, 1962, 25, 1-2 : 1-28.
- [6] KOELEGA, H.S. and BRINKMAN, J.A. "Noise and vigilance : An evaluative Review". *Human factors*, 1986, 28 (4), 465-481.
- [7] PETIT, C. and TARRIERE, C. "Effets synergiques du bruit, des vibrations et de la chaleur sur la vigilance et les performances des conducteurs." Rapport final - Contrat CEE-IRO, janvier 1991.
- [8] HANCOCK, P.A. "Environmental stressors". In : Warm J.S. (ed.) - *Sustained attention and human performance*. New York, J. Wiley, 1984, pp.103-142.
- [9] KIRK, R.E., HECHT, E. "Maintenance of vigilance by programmed noise." *Perceptual and motor skills*, 1963, 16 : pp.553-560.
- [10] ANDRE, A., CONTET, C., TARRIERE, C. " Effets du bruit sur le système cardio-vasculaire, les performances visuelles et la vigilance." *Compte rendu interne Renault*, 1985.

# CLASSROOM EXPERIMENTS ON THE EFFECTS OF AIRCRAFT, TRAFFIC, TRAIN, AND VERBAL NOISE ON LONG-TERM RECALL AND RECOGNITION IN CHILDREN AGED 12-14 YEARS

HYGGE, Staffan

The National Swedish Institute for Building Research, Gävle, Sweden

## Abstract

More than 550 students aged 12-14 years participated in three morning learning sessions on three different texts. The first session was a pre-test to determine their learning ability level. For half the classes, session two was performed in noise (66.1 dBA,  $L_{eq}$ ) and session three in relative silence (ambient noise). For the other half, the time order between noise and ambient noise was reversed. The students were exposed to one of four noise sources: aircraft, road, train and verbal noise (foreign languages). Recall and recognition tests one week later, showed no effect on the recognition items. For the recall items aircraft and road noise impaired learning, but train and verbal noise did not. The noise effect did not interact with the students' learning ability as measured by the pre-test. The average impairments from aircraft and road noise were 20 and 30 % respectively. The results are explained by the differences in predictability and fluctuation for the aircraft, road and train noise. For the verbal noise, it is speculated that there is a difference between *natural* and *machine-made* noise in attracting attention and impairing short or long term learning.

The school is the most prominent place for learning in modern society, and noise is one of the most common sources of complaint, but there are relatively few studies about the effects of noise on learning in schools (Evans, 1990).

Bronzaft & McCarthy (1975) showed worse reading ability, which increased with age, for children in the noisy side of a school-building facing a train-track than for children on the less noisy side. After a noise-abatement program, which equated the noise-levels, the differences in reading ability disappeared (Bronzaft, 1981). Green, Pasternack & Shore (1980) and Lukas, Dupree, & Swing (1981) also reported noise effects on reading ability that increased with higher grades. Cohen, Evans, Krantz, & Stokols (1980) found no effects of aircraft noise on reading ability and mathematical skills, but reported a marginal improvement after a noise reduction of 7 dBA (Cohen, Evans, Krantz, Stokols, & Kelly, 1980; Cohen, Evans, Krantz, & Stokols, 1986). A possible cause for the effects is impaired attention when exposed to noise (Cohen et al., 1980, 1981, 1986; Karsdorf & Klappach, 1968; Kyzar, 1977; Moch-Sibony, 1984). Taken together, these studies show detrimental effects of noise on school achievement. However, since they are correlational or cross-sectional, there is always the possibility that schools with high noise levels also have several uncontrollable characteristics that make them less suitable for learning.

In an experimental study Nurmi & von Wright (1980) found no noise effects on immediate or four-days delayed learning of a text read by high-school students. Hygge & Bergquist (1993), however, found that pop-music at 75 dBA, equivalent noise level ( $L_{eq}$ ) impaired scores on a one-week delayed recall test for students who were exposed before, but not after lunch. For easier recognition items there were no effects of pop-music.

The present series of four studies was designed to explore the effects of noise on one week long term-learning in children. Four noise sources with the same  $L_{eq}$  were employed: aircraft, road, train, and verbal noise. All students took part in three learning sessions, separated by a week, in their regular classroom. The first session was a pre-test for long-term learning. For half of the classes session two was the noisy condition, for the other half session three. This permitted both a

within subject analysis on the difference in learning scores between noise and ambient noise in sessions two and three, and a between subject analysis of the difference scores between session one, with ambient noise, and session two that was run in noise for half of the classes and in ambient noise for the other half.

### Method

**Subjects.** Thirty-two seventh grade classes were chosen for the study. By chance some of the pupils had read a text on the same subject as one of the texts in session 3 of the experiment, which left a total of 551 students for the between subject analysis, and 523 for the within subject analysis.

**Material.** Three texts about different ancient cultures, Arabian, Chinese, and Sumerian were taken from Carter (1982). The texts were approximately of the same length. After a formal pre-test with another 91 students of the same grade, five difficult open-ended questions and nine easier multiple choice questions were placed in a manual for scoring. The noise was played back through loudspeakers in front of the class-room. The equivalent sound level was set to 66.1 dBA  $L_{eq}$  4 m in front of the loudspeakers. For the aircraft road and train noise the peaks were at 76 dBA (*fast* setting), occurring at the same 12 points in time. The road noise had the same peak level but less defined events and a higher number of peaks. The verbal noise was a story read in German mixed with a story in Serbo-Croatian, with normal fluctuations for spoken languages. The background noise level in the ambient noise condition was 42 - 44 dBA,  $L_{eq}$ .

**Procedure.** In the first session all classes read the text about the Chinese. The two other texts appeared equally often in different conditions and presentation orders. The sessions were exactly one week apart, and always took place before lunch. The time for reading as well as testing was set to 15 min. The students also filled out questionnaires at the end of the sessions.

### Results

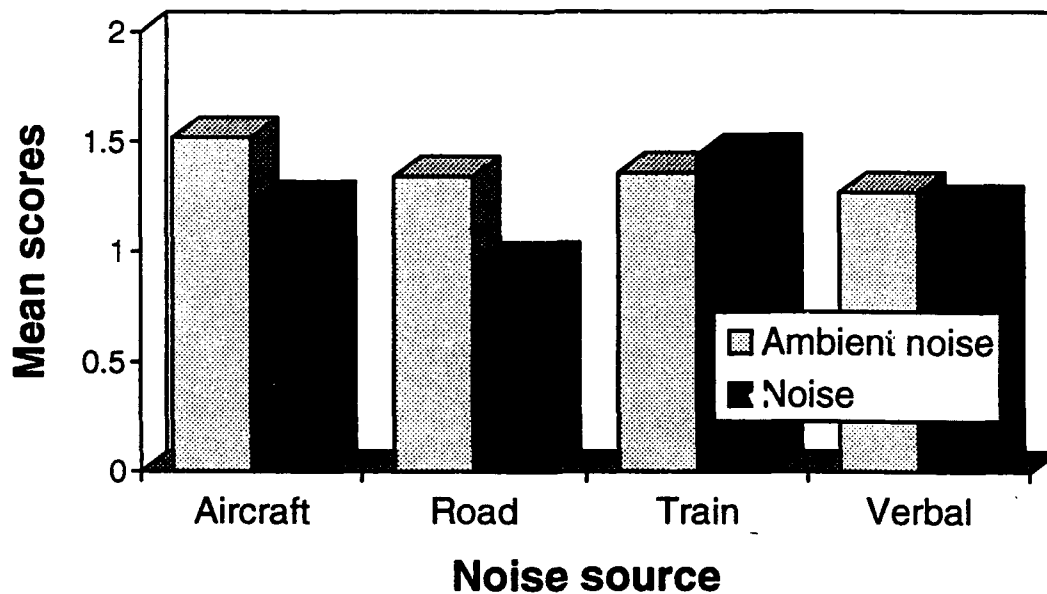

**Figure 1.** Mean scores on the difficult recall items in aircraft, traffic, train, and verbal noise. The scores are from the within subject analysis of sessions two and three.

**Within subject analyses.** The mean scores on the difficult recall items in sessions two and three are shown in Figure 1, and the corresponding analysis of variance yielded a significant effect

of Noise,  $F(1,515) = 6.99$ ,  $p < .010$ , and a borderline significance for the interaction Noise x Noise source,  $F(3,515) = 2.27$ ,  $p < .10$ . Separate  $t$ -tests of the difference between the noise and ambient noise conditions revealed a significant effect for aircraft noise,  $t(140) = 2.25$ ,  $p < .05$ , and for road noise,  $t(119) = 2.75$ ,  $p < .01$ , but not for train noise,  $t(127) = -.35$ ,  $p > .10$  and verbal noise,  $t(133) = .47$ ,  $p > .10$ . There was no interaction between the Noise factor and the Ability factor as assessed by the pre-test, or between the factors Noise x Ability x Noise source. This means that learning of the recall items was impeded by the aircraft and road noise but not by the train noise. This learning impairment from noise was not different between the able and less able learners. On the recognition items there were no effects of Noise.

**Between subject analyses.** The analysis of variance of the difference scores on the difficult recall items in sessions one and two, showed a significant effect of the Noise factor,  $F(1,535) = 3.54$ ,  $p < .01$ , and a significant interaction Noise x Noise source,  $F(3,535) = 2.92$ ,  $p < .05$ . Separate  $t$ -tests of the Noise factor showed a significant effect for aircraft noise,  $t(139) = 2.91$ ,  $p < .01$ , but not for road noise,  $t(146) = 1.28$ ,  $p > .10$ , train noise,  $t(126) = -.93$ ,  $p > .10$ , or verbal noise,  $t(132) = .98$ ,  $p > .10$ . The Ability factor did not interact with the other variables. For the recognition items there were no effects of Noise or its interaction with Ability or Noise source.

Thus, with the exception of the marginal effect from road noise, the pattern is similar to that of the within subject analysis.

**Other results.** The number of pages read were higher in silence than in train noise,  $t(99) = 3.03$ ,  $p < .01$ , but did not differ for the other noise sources. The pattern of significant noise effects on recall was not paralleled by self reports on perceived effort or difficulty of the texts. The ratings of the relative increase in difficulty while trying to learn and read in noise differed significantly between noise sources,  $F(1,500) = 9.48$ ,  $p < .001$  and  $F(1,500) = 11.07$ ,  $p < .001$  respectively. Separate  $t$ -tests showed that road noise and verbal noise, which did not differ, were rated as more impeding than aircraft and train noise, which did not differ.

## Discussion

In the within subject analysis, aircraft and road noise impaired long-term recall. Train noise had no effect on recall, and none of the noise sources affected recognition items. In the between subject analysis aircraft noise impaired recall and there was a non significant trend in the same direction for the road noise. The noise effects on recall did not interact with the students level of learning abilities as assessed by the learning test in session 1.

In neither analysis were there any effects of noise on the easier recognition items.

If distraction was a mediating mechanism for impaired learning, number of pages read would have differed between the noise and ambient noise conditions. This occurred for the train noise group, but that group showed no recall impairment. Thus, distraction is not a likely explanation. Nor are reported effort or perceived difficulty. Together with the finding that recognition items showed no noise effects, while recall items did, the results seem to be compatible with an information overload explanation (cf. Cohen et al., 1986).

A possible explanation of why train noise, in contrast to aircraft and road noise, did not show any effects on learning, is the predictable nature of the train noise, and its low degree of fluctuation. Since the aircraft and train noise had the same number of peaks at the same points in time, and the same peak value, the basic difference between the stimuli was degree of fluctuations in noise level, and hence predictability.

The lack of effect for the verbal noise was unexpected, and in contrast to well established results from verbal noise and short term (serial) recall (cf. Jones & Morris, 1992), and also in conflict to the self reports about difficulty in reading and learning in verbal noise. One reason for the lack of effect may be a dissociation between attention and long term learning for *natural* in

contrast to *machine-made* noise. Another possible reason is the meaningful nature of the material to be learnt, in contrast to serial recall of digits or letters.

### Acknowledgments

The research reported here was supported by outside grants from the Swedish Environmental Protection Agency. I am grateful to Eva Boman for data collection and scoring, to Gunnar Söderqvist for technical assistance, and to Martin Björkman for making the audio tapes.

### References

- Bronzaft, A. (1981). The effect of a noise abatement program on reading ability. *Environmental Psychology*, 3, 215-222.
- Bronzaft, A., & McCarthy, D. (1975). The effect of elevated train noise on reading ability. *Environment and Behavior*, 7, 517-527.
- Carter, R. (1982). *Äldre kulturer* [Older cultures]. Stockholm: Natur och Kultur.
- Cohen, S., Evans, G. W., Krantz, D.S., & Stokols, D. (1980). Physiological, motivational, and cognitive effects of aircraft noise on children: Moving from the laboratory to the field. *American Psychologist*, 35, 231-243.
- Cohen, S., Evans, G.W., Krantz, D.S., Stokols, D., & Kelly, S. (1981). Aircraft noise and children: Longitudinal and cross-sectional evidence on adaptation to noise and the effectiveness of noise abatement. *Journal of Personality and Social Psychology*, 40, 331-345.
- Cohen, S., Evans, G.W., Stokols, D., & Krantz, D.S. (1986). *Behavior, health, and environmental stress*. New York: Plenum Press.
- Evans, G. W. (1990). The nonauditory effects of noise on child development. In B. Berglund, U. Berglund, J. Karlsson, & T. Lindvall (Eds.), *Proceedings of the 5th International Conference on Noise as a Public Health Problem, Vol. 5* (pp. 425-453). Stockholm, Sweden: Swedish Council for Building Research.
- Green, K., Pasternack, B., & Shore, R. (1980). Effect of aircraft noise on children's reading and hearing levels. *Journal of the Acoustical Society of America*, 68, (Supplement 1), 90.
- Hygge, S., & Bergquist, S. (1993). *The effects of pop-music and time of day on long-term recognition and recall of a text in students aged 13-14 years*. Submitted for publication.
- Jones, D. M., & Morris, N. (1992). Irrelevant speech and cognition. In D.M. Jones and A.P. Smith (Eds.), *Factors affecting human performance: Vol. 1. The physical environment*. London: Academic Press. (pp. 29-53).
- Karsdorf, G., & Klappach, H. (1968). The influence of traffic noise on the health and performance of secondary school students in a large city. *Zeitschrift für die gesamte Hygiene*, 14, 52-54.
- Kyzar, B.L. (1977). Noise pollution and the schools: How much is much? *CEFP Journal*, 4, 10-11.
- Lukas, J.S., DuPree, R., & Swing, J. (1981, April). *Report on a study of the effects of freeway noise on academic achievement of elementary school children, and a recommendation for a criterion level for a school noise abatement program*. Sacramento, CA: Office of Noise Control, Epidemiological Studies Section, California Department of Health Services.
- Moch-Sibony, A. (1984). Study of the effects of noise on the personality and certain psychomotor and intellectual aspects of children, after a prolonged exposure (In French). *Travail Humaine*, 47, 155-165.
- Nurmi, J.E., & von Wright, J. (1983). Interactive effects of noise, neuroticism and state-anxiety in the learning and recall of a textbook passage. *Human Learning*, 2, 119-125.

# NOISE AND SELECTIVE ATTENTION

SMITH Andrew Paul

Health Psychology Research Unit  
School of Psychology  
University of Wales College of Cardiff  
P O Box 901, Cardiff CF1 3YG, Wales

## Abstract

The effects of noise on human performance depend on the type of noise, characteristics of the person exposed to the noise and the nature of the task. This view was examined in two experiments which used selective attention tasks where different aspects of attention could be measured within each task. The first experiment, using continuous white noise at a level of 78dBA, demonstrated several effects of noise on focused attention and categoric search. These effects were not modified by time of day or level of anxiety of the subject, although there was some evidence of interactions between noise and noise sensitivity, and noise and level of cognitive failure. The second experiment examined the effects of conglomerate noise (consisting of industrial noise and irrelevant speech) played at a level of 74dBA. The results confirmed some of the effects obtained in the first study but also demonstrated additional effects, suggesting that both general and noise-specific changes in selective attention are observed.

## Introduction

For over 40 years, psychologists have studied the effects of noise on performance (see Smith, 1992, for a review). The effects of noise depend on the nature of the noise, characteristics of the person exposed to the noise and features of the task (see Smith & Broadbent, 1992, for a general review of the importance of these). The aim of the present research was to examine the effects of different types of noise on aspects of selective attention. In addition, the possible modifying roles of personality, noise sensitivity and level of cognitive failure were considered. A major methodological feature of the research was that it measured different aspects of attention within the same task (see Broadbent, Broadbent and Jones, 1986, 1989). In addition, the experiments compared two major dimensions of selective attention, namely 'filtering' and 'categoric search' (see Kahneman & Treisman, 1984).

### *Experiment 1*

A between subjects design was used with half the subjects performing in noise and the others in quiet. Prior to the experiment subjects completed the cognitive failures questionnaire (Broadbent, Cooper, FitzGerald & Parkes (1982), the Spielberger Trait Anxiety Inventory and a noise sensitivity questionnaire (see Smith & Stansfeld, 1986). Subjects carried out the two tasks described below, and half the subjects carried out the tests in order focused/search and the others in the reverse order.

### *Subjects:*

Ninety-four students (age range 18-35 years) took part in the experiment.

### *Nature of the noise:*

Continuous freefield noise was used and the sound level was 78dBA with equal levels per octave ( $\pm 1$ dB) from 125 to 4000 Hz. The sound level in the quiet conditions was 50dBA.

### *Nature of the tasks:*

(a) *Focused attention task.* Subjects were seated at a distance 900 mm from a Sony monochrome monitor. The target letters were upper case As and Bs and they subtended 0.38 degrees in width and 0.51 degrees in height. On each trial three warning crosses were presented on the screen, the outside area being separated from the middle one by either 1.02 or 2.60 degrees. The subject was told to respond to the letter presented in the centre and ignore any distractors presented at the side. The crosses were on the screen for 500 ms and were then replaced by the target letter. This letter was either accompanied by (i) nothing; (ii) asterisks; (iii) letters which were the same as the target, or (iv) letters which differed. The two distractors were identical and the targets and accompanying letters were always A or B. The correct response to A was to press a key with the forefinger of the left hand, and to B to press a different key with the forefinger of the right hand.

Subjects were given 10 practice trials followed by five blocks of 64 trials. In each block there were equal numbers of near/far conditions, A or B responses, and equal numbers of the four distractor conditions. The nature of the previous trial was controlled.

(b) *Search task.* Each trial started with the appearance of two crosses in the positions occupied by the non-targets in the focused attention task (i.e. 2.04 or 5.20 degrees apart). The subject did not know in this task which of the crosses would be followed by the target. The letter A or B was presented alone on half the trials and was accompanied by a digit (1-7) on the other half. Again, the number of near/far stimuli, A v. B responses and digit/blank conditions were controlled. Half of the trials led to compatible responses (i.e. the letter A on the left of the screen, or letter B on the right) whereas the others were incompatible. The nature of the preceding trial was also controlled. In other respects (practice, number of trials, etc.) the task was identical to the focused attention task, and in both tasks the presentation of the stimuli and timing of responses were controlled by a Research Machines 380Z computer. The two tasks each took about 10 minutes to complete.

### *Results:*

Subjects in noise were slower at responding during the focused attention task, whereas there was little difference between quiet and noise conditions for the search task. This resulted in a highly significant effect of noise on the difference between the two tasks ( $F(1,90) = 9.11$ ,  $p < 0.05$ ; quiet mean = 32.1ms, noise mean = 14.8). In addition, noise reduced distraction from an irrelevant asterisk (\*) (\*-blank: noise mean = 3.2ms, quiet mean = 9.9ms) and also reduced the benefit from relevant items presented in the periphery (\*-agreeing letters, both in periphery: noise mean = 0.7ms, quiet mean = -7.7ms). The effects of noise were not modified by time of day or anxiety level of the subject.

An interaction between noise and noise sensitivity was obtained when the distraction produced by an irrelevant \* in the periphery was considered (\*-blank, both far: High noise sensitivity - noise mean = 4.0ms, quiet mean = -8.1ms; low noise sensitivity - noise mean = 5.7ms, quiet mean = 0.3ms). High noise sensitive subjects in noise were more distracted by the \* than high noise sensitives in quiet, whereas the reverse effect was observed for the low noise sensitive group.

Broadbent et al. (1982) suggested that high levels of cognitive failure may indicate vulnerability to stress. An interaction between noise and cognitive failure was found for the funnel vision effect (FUNNL). Subjects in quiet with high levels of cognitive failure showed greater funnel vision than low CFQ scorers (Funnl: quiet - High CFQ = 29.3ms, Low CFQ = 20.5ms) with the reverse being true in noise (Funnl: noise - High CFQ = 17.2ms, Low



CFQ = 27.7ms).

There was only one effect of noise in the categoric search task, with noise reducing the effects of a far, irrelevant stimulus (Digit-Blank, both far: Noise mean = 18.0ms, quiet mean = 28.7ms).

Overall, the present experiment demonstrated that noise has selective effects on the filtering and categoric search paradigms, and that it may alter aspects of distractibility. Interactions between noise and noise sensitivity, and noise and level of cognitive failure, also appear to be obtained only with certain dimensions of attention. The next experiment examined the effects of a different type of noise on the two tasks.

#### *Experiment 2:*

106 subjects took part in the study, with 50 being assigned to the noise condition and 56 to the quiet condition. A recording of industrial noise and irrelevant speech was played through headphones to the subjects at a peak level of 74dBA. In the quiet condition subjects just wore the headphones.

#### *Results*

A significant effect of noise was again found for the difference between categoric search and focussed attention, with noise reducing this (quiet mean = 42.7ms, noise mean = 28.3). This suggests that different types of noise produce similar effects on the two types of attention. However, differences from the first experiment were found with regard to the effects of noise on different types of distraction, and the noise used here also had effects on the overall speed and accuracy of performing the tasks, with noise increasing speed at the expense of accuracy.

#### CONCLUSIONS

Overall, the present studies have demonstrated that noise influences aspects of selective attention. Certain effects related to the difference between filtering and categoric search appear to be general and not modified by the type of noise or characteristics of the subjects. Other effects, relating to distractibility, are more specific and the precise effect of noise depends on the nature of noise and characteristics of the person performing in the noise.

#### REFERENCES

- Broadbent, D.E. (1982). Task combination and selective intake of information. *Acta Psychologica*, **50**, 253-290.
- Broadbent, D.E., Broadbent, M.H.P. & Jones, J.L. (1986). Performance correlates of self-reported cognitive failure and of obsessiveness. *British Journal of Clinical Psychology*, **25**, 285-299.
- Broadbent, D.E., Broadbent, M.H.P. & Jones J.L. (1989). Time of day as an instrument for the analysis of attention. *European Journal of Cognitive Psychology*, **1**, 69-94.
- Broadbent, D.E., Cooper, P.F., FitzGerald, P. & Parkes, K.R. (1982). The cognitive failures questionnaire (CFQ) and its correlates. *British Journal of Clinical Psychology*, **21**, 1-16.
- Kahneman, D. & Treisman, A. (1984). Changing views of attention and automaticity. In R. Parasuraman & D.R. Davies (Eds), *Varieties of Attention*. London: Academic Press.

Smith, A.P. (1992). Noise and aspects of attention. *British Journal of Psychology*, 82, 313-324.

Smith, A.P. & Broadbent, D.E. (1992). Non-auditory effects of noise at work: A review of the literature. *Health and Safety Executive*. London.

Smith, A.P. & Stansfeld, S. (1986). Aircraft noise exposure, noise sensitivity and everyday errors. *Environment and Behaviour*, 18, 214-226.

THE EFFECTS OF NOISE ON TEXT PROBLEM SOLVING FOR  
THE WORD PROCESSOR USER (WPU)

BENTON Stephen & ROBINSON Gregory

Human Factors Group  
Division of Psychology  
University of Westminster  
London. UK.

Abstract

A series of psychophysical investigations were conducted into the impact of different acoustic conditions upon WPU's performance and subjective state. The acoustic stimuli employed comprised of Speech, White and Narrow Band Low Frequency noise at both high and low intensities. Loudness matching procedures for all subjects ensured that within condition loudness was held stable between subjects. In an attempt to improve the sensitivity of measures of error, subject's text error correction scores were measured using an array of semantic/phonemic (concrete & abstract) stimuli which permitted detailed analysis of cognitive processing errors. The subjective impact of maintaining performance under noise, and no noise conditions, was recorded and combined with measures of personality. The results showed a significant condition dependent interaction between personality (Introvert/Extravert) error scores and annoyance, with the Low Frequency condition producing the worse working environment.

Experimental group

A group of 10 extraverts and 10 introverts was selected based upon scores on the Eysenck Personality Inventory (EPI) E.P.I.. Conventional testing using a Peter's pure tone conduction audiometer indicated that the group was audiometrically normal.

Experimental design and stimuli

The investigation was a two factor experiment with repeated measures. The factors were loud/quiet sound conditions and the three sound-text conditions. The acoustic stimuli were comprised of three stimuli. First, Narrow Band (NB) low frequency noise ( $f_c=140\text{Hz}$ , Bandwidth=1Hz and SPL=70db(c) for the quiet condition and 95db(c) for the loud condition.

Second, Speech and third White noise (20-20kHz) both of which were matched for loudness against the NB condition by each subject. The matched values were used as the reference level of SPL exposure. The subjects were randomly split into two groups designated for the two sound conditions of loud and quiet. The text errors were separated into two major categories comprised of Semantic errors, derived from the effect of homophores and were typically words that had the same acoustic properties but different meanings. As a sub-study the semantic error stimuli were divided into semantic concrete (noun variations) and semantic abstract (other). The second category of stimuli was acoustic concrete errors (A.C.E.) that were spelling mistakes that retained the overall configuration of the target word. All texts retained a common subject, structure, equality of length and word and topic familiarity. Error scores were recorded by the experimenter after one scan of the text. Subjects were also asked to rate the subjective experience on three 1-10 scales: Difficulty, Annoyance and Confidence. After a period of three days subjects were tested again under the remaining experimental condition.

#### Analysis

The level of difference in error types for experimental conditions (loud/quiet, (T-Test), for all noise types and interactions with text (Anova) and for annoyance and noise conditions (Anova).

#### Results

The greatest difference in performance between the quiet and loud conditions is produced by low frequency noise ( $p < 0.05$ ). This condition also induces the highest number of A.C.E. type errors compared across the other noise conditions ( $p < 0.05$ ). The same overall trend is maintained for the semantic type errors ( $p < 0.05$ ). Analysis of the annoyance scores indicated that there was a trend for subjects to rate the low frequency conditions (both loud and quiet) as the most annoying ( $p = 0.002$ ).

The analysis of extraversion and introversion showed that extraverts performed less well in the quiet conditions and produced the most errors under the speech and low frequency conditions. The extraverts also rated both the quiet and loud low frequency conditions as the most annoying.

## Conclusions

There is some evidence to suggest that individuals' performance was dependent upon the type of noise employed, with the low frequency noise likely to promote most errors. Also the impact of increased intensity upon performance was not equal across all conditions. The subjective evaluations made by subjects indicate that annoyance increased with increases in intensity with the low frequency condition producing the highest estimates for both loud and quiet exposures.



# **MULTI-DIMENSIONAL APPROACH TO NOISE EFFECTS AND TO NOISE AFTEREFFECTS**

**MOCH Annie & MARAMOTTI Isabelle**  
Paris X-Nanterre University  
Psychology Department  
220 avenue de la République  
92001 Nanterre Cedex, France

## **Abstract:**

The purpose of the study has been to examine noise effects and noise aftereffects on performances, subjective discomfort experienced and heart rhythm. Twenty subjects (Experimental Group) were exposed to 90 dB(A) and twenty subjects were used as Control Group. Individuals who were exposed to noise had inferior score marks, a stronger subjective discomfort and more important cardiac rhythm variations. A positive correlation between noise aftereffects and subjective discomfort was also shown.

## **Résumé**

Cette recherche examine les effets et les post-effets du bruit sur les performances, la gêne subjective et le rythme cardiaque. Vingt sujets ont été exposés à 90 dB(A) (Groupe Expérimental) et vingt sujets ont servi de Groupe Contrôle. Les individus soumis au bruit ont eu des scores inférieurs, une gêne subjective plus forte et des variations du rythme cardiaque plus importantes. Nous avons également mis en évidence une corrélation positive entre les post-effets et la gêne subjective.

## **Introduction**

The purpose of the study has been to examine existing links between noise effects and noise after-effects, through an experimental examination of several stress indicators. Through the numerous existing studies completed on noise (Moch, 1988, 1989, 1991, 1993; Maramotti 1991), we know that noise creates effects, but also aftereffects (Glass & Singer, 1972). Our approach, therefore, followed a double objective:

- As a first step, studying several noise effects and verifying the existence of possible correlation between them.
- As a second step, we tried to find out whether there was a relationship between noise effects and noise after-effects and what could be the nature of this relationship.

## **Material and method**

The main objective consisted in offering a multidimensional experimental approach based on the study and the comparison of a **control group** and of a **noise exposed group**. Effects have been defined by three indicators (performance, physiological and verbal indicators). The sample is made up of a total of 4 Paris VIII University students randomly assigned to experimental conditions.

The «noise exposed group» was exposed through earphones to an irregular noise, i.e. that of the

recording on a racetrack. The sound volume was set up through an Aclan SDF 80 sonometer to get a 90dB(A) Leq level. Each of the control group subjects wearing earphones helped maintain the same experimental conditions as for those in the noise exposed group. Wearing the hearphones was justified in the experiment protocol for both of the groups.

The experiment started by an attention test helping measure noise effects on performances. This is the **K-T Attention test**, (distributed by the ECPA) and developed by Dr Halter of the Zurich Work Psychology Institute. This test can be taken either on a collective or on an individual basis. As an essential feature it has an average duration of 5 to 8 mn, which we limited to only 5 mn, so as the noise exposure time be identical for all subjects. This attention test is essentially based on precision and swiftness. It is presented on a sheet of paper with two columns featuring letters, numbers, various signs. The right hand column is the base column; the left one represents the replication of the first one, yet containing errors. Subject's assignment consists in ticking in the left column the characters which are at variance with those on the right column. Every minute, the subject must also indicate with a square bracket his current location on the sheet. This allows recording the subject's speed, whereas the number of recognized errors measures the subject's attention. The K-T test therefore provides two types of results: *Time result and Precision result*. Both of these results help calculate a single performance indicator.

Through out the whole duration of the test, we have also measured the subject's *cardiac rhythm variations*, these making up the second indicator of noise effects. This cardiac rhythm measurement is performed via a pulsometer, based on index pulse measurements through an opto-electronic detection technique; this measurement makes up a physiological manifestation of stress. This measurement was taken on all subjects, on those making up the noise exposed group as well as those making up the control group (any without noise). Six measurements have been included through the 5 minute duration of the K-T Test, i.e. one measurement at the beginning, and then one every minute.

As our experimentation went on we studied the **noise aftereffects** through a test of puzzle solution. N.T. Feather's noise aftereffects studies which were later adapted by Glass & Singer led us, after a few alterations to select *frustration tolerance* as a means of measurement of noise aftereffects.

The task involved consists in, for the subject, after he has been exposed to noise, to be presented with three piles of cards, the front sides of which cannot be seen. Now these cards represent drawings which are different for each pile. Each of the pile has the same design which is shown on the reverse side so that the subject cannot see it. The experimentation however only takes the first two piles into account: the first pile contains a solvable test and the second pile an insolvable one. The third pile is made up of white pages only («dummy» test).

According to the test protocol the subject must follow with a pencil all of the lines of the drawing without ever lifting the pencil nor going over a line which has already been drawn upon. The subject is informed that he is allowed as many trials as he needs for a given test. As soon as he has completed the test, he must go over the next pile. In case of failure, and if he so wishes, he may also change piles as well.

The function of the first solvable test, which is generally solved by the subject, is only to let him believe that the second test is also solvable. Yet the second test, the insolvable one, helps measure the feeling of frustration. The mechanic is as follows: the subject can keep on attempting on the unsolvable graphic for a certain time. According to his threshold of tolerance, he goes over sooner or later at a variable speed to trying the third pile (dummy test).

Now the measurement of the threshold corresponds to the time interval between the beginning of the second, insolvable test and the moment when the subject decides to go over the third pile.

Finally, the experiment would end by the *appreciation of the subjective discomfort experienced*, which is performed through answering an inquiry sheet, corresponding to our *verbal indicator*. The inquiry is made up of two types of interrogations. On the one hand, how the *experiment was appreciated*, on the other hand, subject's *estimation of its duration*.

The elements for the appreciation of the experiment were measured on a 7 point scale, from «unpleasant» to «pleasant». The subject has to circle the number corresponding to the feeling she



experienced. The subject's estimation of the experiment duration was elicited through a question offering varying answer options of between 1 to 20 minutes.

The objective of this verbal indicator has been to ascertain not only the correlation with the other indicators but also the link between those subjects who have been bothered by the experiment, especially for the noise exposed group and their possible overestimation of this duration, reflecting this discomfort.

### Main results

Performance Indicator	Physiological Indicator	Variable Indicator (first question)	Variable Indicator (second question)
t = 2,42 p < .02	t = 10,03 p < .01	t = 3,51 p < .01	no significant

*Student test results table*

- *Performance Indicator*

The statistical analysis helped discover a significant difference among performances upon taking the K-T Attention test, depending on whether the subjects were exposed to noise stress or not. Noise exposed subjects had inferior scores than those from the control subjects. The average number of errors, indeed, for the noise exposed group was 23 as opposed to 13 for the control group. Thus it seems that noise effects bore importance on the number of errors, i.e. on subject's precision and attention.

- *Physiological indicator*

In general, almost all of the subjects experienced a cardiac rhythm acceleration whether or not they had been exposed to the sound stimulus. This pulsion increase is probably caused by the excitement involved in the experiment itself. However, we have ascertained that noise exposed subjects had more important rhythm variations than those of the control group (whether it be an acceleration or a reduction): an average of 16.5 for the noise exposed group and of 3.5 for the control group. The «Student T-test» has confirmed that this was a significant difference ( $p < .01$ ). It would appear therefore that the physical measurement has been a good indicator of stress reaction from the exposed subjects.

- *Variable indicator*

With regard to discomfort expressed vis-à-vis the noise stress, answers to the first question demonstrated that noise exposed subjects had judged the experiment in a less positive fashion than the control subjects, i.e. that they had found it less pleasant than the latter. The «Student t-test» has confirmed that this difference in appreciating subjective discomfort was a significant difference ( $p < .01$ ).

However, with regard to the second question concerning the experiment duration assesment we have not found any overestimation reflecting discomfort experienced by the exposed subjects. For the latter as those have both overestimated and underestimated this duration, as the control subjects did the same.

### ● *After-effects*

The calculation of the Bravais-Pearson correlation coefficient has revealed, for noise exposed subjects, a positive correlation between noise aftereffects and the two verbal indicators of subjective discomfort for those subjects who had been exposed to noise stress. There is a link between the discomfort as expressed and the frustration level. The more important is the discomfort, the more important the frustration. There is also a negative link between duration estimation and the level of tolerance vis-à-vis the frustration. The higher the duration estimation, the weaker the tolerance to frustration.

### **Conclusion**

We have ascertained the existence of differences between subjects exposed to noise stress and non exposed subjects for each of the three indicators, performance, physiological state and subjective discomfort. We have not been able to ascertain with regard to noise exposed subjects the existence of a compensation mechanism between noise effects and noise aftereffects.

### **References**

- GLASS, D.C., SINGER, J.E. : *Urban stress*. New York and London : Academic Press, 1972.
- MARAMOTTI, I. : *Approche expérimentale de la corrélation entre les effets et les post-effets du bruit en psychologie de l'environnement*. Cahier de Psychologie de l'Environnement. Paris, 1991.
- MOCH, A. : « Les effets psychologiques du bruit. » *La Recherche*, 203, pp.1198-1206, 1988.
- MOCH, A. : *Les stress de l'Environnement*. Saint-Denis : Presses universitaires de Vincennes, 1989.
- MOCH, A., BOSSE, F. : « Souffrance au bruit et relaxation psychosomatique » *Entretiens de psychomotricité*, pp.135-137, Editions de l'expansion scientifique française, 1991.
- MOCH, A., BOSSE, F. : *Le bruit dans la ville*, Paris : Lattes, 1993. (sous presse)

## EFFECTS OF NOISE ON MENTAL PERFORMANCE WITH REGARD TO SUBJECTIVE NOISE SENSITIVITY

BELOJEVIC Goran\*, ÖHRSTRÖM Evy\*\*, RYLANDER Ragnar\*\*

\* Institute of Hygiene and Medical Ecology, Faculty of Medicine,  
University of Belgrade, Yugoslavia

\*\* Department of Environmental Medicine, University of Gothenburg, Sweden

Objective and subjective effects of moderate levels of recorded traffic noise ( $L_{eq} = 55$  dBA and 75 dBA) on mental performance were studied in a laboratory setting. A total of 45 subjects (23 males and 22 females) was investigated with respect to subjective noise sensitivity (SNS). Four cognitive tasks were applied involving different psychological functions: Short Term memory (STM), Search and Memory 5 (SAM 5) / vigilance / , Hidden Figures (HF) / spatial reasoning / and Mental Arithmetic/ parallel processing. Three groups of 15 subjects were defined according to their scores on the Weinstein's Noise Sensitivity Scale: tolerant, moderately and highly sensitive to noise.

A similar balance of performance was observed in quiet conditions (30 dBA  $L_{eq}$ ), but significant differences in noise ( $P < 0.05$ ) were seen between the three groups on the STM (words) and MA (total results) tasks, and the lowest performance accuracy was demonstrated by the noise sensitive subjects. SNS was the primary factor responsible for these differences. There were no significant differences between the groups for the SAM 5 and HF tasks, either in quiet or noisy conditions. Annoyance, while performing tasks in noisy conditions, was regularly and significantly higher among subjects judged to be noise sensitive on the Weinstein's scale, as compared with those judged to have low and moderate SNS.



# THE EFFECTS OF EVERYDAY NOISES AND THEIR SUBJECTIVE LEVEL OF PLEASANTNESS ON RECALL OF CATEGORIZED LISTS

SANTISTEBAN Carmen and SANTALLA Zuleyma

*Departamento de Metodología de las Ciencias del Comportamiento. Facultad de Psicología.  
Universidad Complutense. E-28223 Madrid*

## SUMMARY

We assessed the influence of everyday sounds, viz. classical music (75 dBA), silence (60 dBA) and electric drill (85 dBA), and their subjective appraisal of pleasantness on performance in tasks involving memorization and subsequent recall of categorized word lists. Noise conditions were taken as the independent variable, and the number of errors made and clustering score as the dependent variables.

Noise pleasantness and the subjects' appraisal of their influence (pleasant or disturbing) on task yield were assessed by means of questionnaires that were completed before and after the experimental sessions under the different sound conditions assayed.

## RESUME

Dans ce travail on a réalisé des expérimentations pour évaluer l'influence, ainsi que les opinions des sujets sur l'agréabilité ou la gêne, des sons quotidiens sur la performance dans des travaux qu'impliquent rétention et récupération subséquente des listes de mots catégorisés. Les conditions sonores ont été considérées comme variable indépendante. Le nombre de mots rappelés, le nombre d'erreurs commises et le niveau de cloisement obtenu ont été pris comme variables dépendantes.

Les conditions sonores expérimentales ont été: musique classique (75 dBA), silence (60 dBA) et perceuse électrique (85 dBA).

L'agréabilité des sons et l'opinion des sujets sur son influence (sentiment d'agréabilité ou de gêne) sur la performance au travail a été évaluée par des questionnaires pre et post session de travail dans les conditions sonores indiquées.

## INTRODUCTION

The effect of noise on short-term recall of categorized word lists has been the subject of much study in the past 30 years. However, there is no universal agreement as to whether noise has positive, adverse or no effects in this respect, particularly if it is presented at a moderate intensity (McClellan, 1969; Berlyne *et al.*, 1965; Dormic, 1973; Dae and Wilding, 1977; Hockey and Hamilton, 1970; Hamilton *et al.*, 1972; Smith, 1985a; Smith Jones and Broadbent, 1981; Santisteban, 1990; etc.).

The essential differences between this work and other previously reported are as follows:

- (a) The subjects performed the assigned tasks under everyday sound conditions rather than in white noise;
- (b) the sounds were presented at a moderate intensity in a study hall and silence was represented by the absence of experimental noise; and
- (c) the study took into account the subjects' appraisal (on a preset scale) of the pleasing or disturbing effects of the sounds.

## MATERIALS AND METHOD

The experiment involved 75 subjects who were randomly chosen among the students at the Faculty of Psychology of the Complutense University (Madrid).

The subjects were randomly assigned to one of six experimental groups. Each group attended three experimental sections. In each session, a different word list was presented. The groups differed in the order of presentation of the sound conditions, which were counterbalanced with the experimental sessions.

The word lists were compiled in a preliminary study in order to use lists of similar difficulty. The list selection process involved 350 randomly chosen students from the studied population.

The words from which the lists were compiled belonged to five different verbal categories. The task assigned to the subjects involved recalling as many words as possible from the list which was presented under each sound condition. Each of the three lists used was composed of 20 words (5 words from each of four categories of the five employed).

Words were shown in succession in a *pseudo*-random order; each word was displayed in the middle of a screen for 0.5 seconds. After the last word was shown, the subjects were allowed 3 minutes to sort them and write them down in the same order as they recalled them.

The experimental sound conditions used included a sound that was classed as pleasant by the subjects (a piece of classical music played at 75 dBA), another that was categorized as unpleasant (the noise from an electric drill, 85 dBA) and silence.

The subjects' appraisal of (un)pleasantness of the sounds was determined by means of a pre-session questionnaire which included a pleasantness scale designed by Santisteban (1988). Also, the disturbing effect of the sounds in performing the assigned task and the subjects' appraisal of the adverse or beneficial effect of the sounds on performance in the task were assessed by means of a post-session questionnaire.

## RESULTS AND CONCLUSIONS

The dependent variable used was the subjects' performance, which was measured under each sound condition from (a) the overall number of correct words recalled, (b) the overall number of errors and (c) the overall clustering.

A variance analysis of the results revealed the absence of significant principal effects of the sound conditions or the order of presentation on performance. Nor were there any principal effects on clustering as measured by the Roenker, Thompson and Brown indices (1971).

An analysis of the replies to the pre-session questionnaire showed classical music to be the most pleasant of the three sound conditions for 56% of the subjects, followed by silence (44%). The average values obtained from the pleasantness scale for classical music, silence and electric drill noise were 8, 7 and -9, respectively.

The subjects' appraisal of the disturbing effects of the sounds through the post-session questionnaire was significantly different; thus, the average pleasantness scores were 3, 6 and -6 for classical music, silence and electric drill noise, respectively.

This trend was similar to that of performance appraisals: silence was judged to be the most favourable condition and performance was thought to be impaired by the other two sound conditions.

The analysis of the objective data and the subjects' appraisal of the effects of the three sounds are contradictory.

The lack of statistical significance of an adverse effect of the sound conditions on performance against the subjects' appraisal can be ascribed to psychological factors (Santisteban, 1991): the sound exposure times employed were very short and the subjects were used to working under adverse sound conditions, so they succeeded in maintaining their performance at the expense of further psychological and physiological investments.

## REFERENCES

BERLYNE, D.E.; BORSA, D.M.; CRAW, M.A.; GELMAN, R.S. and MANDELL, E.E. (1965). Effects of Stimulus Complexity and Induced Arousal on Paired-Associate Learning. *Journal of Verbal Learning and Verbal Behavior*. 4, 291-299.

DAEE, S.; WILDING, J.M. (1977). Effects of High Intensity White Noise on Short-Term Memory for Position in a List and Sequence. *British Journal of Psychology*. 68, 335-349.

DORNIC, S. (1973). Order Error in Attended and Non-Attended Tasks. In: Kornblum (Ed). *Attention and Performance*. Vol IV, 119-125. New York: Academic Press.

HAMILTON, P.; HOCKEY, G.R.J. and QUINN, J.G. (1972). Information Selection Arousal and Memory. *British Journal of Psychology*. 63, 181-189.

HOCKEY, G.R.J. and HAMILTON, P. (1970). Arousal and Information-Selection Patterns in Multi-Source Monitoring as a Function of Induced Arousal Shifts. *Journal of Experimental Psychology*. 101, 35-42.

Mc CLEAN, P.D. (1969). Induced Arousal and Time of Recall as Determinants of Paired-Associate Recall. *British Journal of Psychology*. 60, 57-62.

ROENKER, D.L.; THOMPSON, C.P.; BROWN, S.C. (1971). Comparison of Measures for the Estimations of Clustering in Free Recall. *Psychological Bulletin*. 76(1), 45-48.

SANTISTEBAN, C. (1988). Behavioral Decisions Analysis for Auditory Stimuli. In: *Proceedings of International Congress of Noise as a Public Health Problem*. Stockholm. Vol.3, 89-93.

SANTISTEBAN, C. and SANTALLA, Z. (1990). Efectos del Ruido sobre Memoria y Atención: Una Revisión. *Psicothema*. 2 (2), 49-91.

SANTISTEBAN, C. (1991). Ruido y Comportamiento Humano. En: El ruido en la ciudad. Gestión y Control. *Sociedad Española de Acústica*. I, 77-99.

SMITH, A. P. (1985a). The Effects of Noise on Recall of Lists of Associated Words. *Current Psychological Research and Reviews*. 4 (1), 17-21.

SMITH, A.P.; JONES, D.M.; BROADBENT, D.E. (1981). The Effects of Noise on Recall of Categorized List. *British Journal of Psychology*. 72, 299-316.



# THE EFFECTS OF EVERYDAY NOISE ON COMPREHENSION AND RECALL OF READING TEXTS

SANTISTEBAN Carmen and SANTALLA Zuleyma

*Departamento de Metodología de las Ciencias del Comportamiento. Facultad de Psicología.  
Universidad Complutense. E-28223 Madrid*

## SUMMARY

We studied the effects of five sound conditions on performance in recall and comprehension tasks. The sound conditions included four everyday sounds that were played at a similar, moderate intensity ( $L_{eq} = 65$  dBA), and silence, which was taken as the absence of experimental noise ( $L_{eq} = 45$  dBA).

This work complements our previous studies on the effects of everyday noise of moderate intensity on performance in tasks involving short-term memorization of word lists. While the results reveal the absence of statistically significant effects, they show a trend to poorer performance as task complexity is increased.

The task studied in this work was more complex than previous ones and the results obtained show the occurrence of a significant principal effect of the sound conditions on performance, which was significantly impaired by any of the four sounds relative to silence.

This work was also aimed at determining whether performance results are related to the subjects' appraisal [on a scale designed by Santisteban (1988)] of each sound pleasantness.

## RESUME

Dans ce travail on étudie les effets de cinq conditions sonores sur la performance en travaux de rappel et compréhension. Comme conditions sonores on a choisi quatre sons habituels qui ont été présentés à des niveaux similaires modérés d'intensité ( $L_{eq} = 65$  dBA). La cinquième condition est le silence, caractérisé par la non présence de son expérimental ( $L_{eq} = 45$  dBA).

Ce travail sert à compléter nos études antérieures sur les effets des sons quotidiens présentés à des niveaux modérés sur la performance dans des travaux de rappel à court terme de listes de mots, où on met en évidence qu'il ne se produisent pas d'effets statistiquement significatifs, mais les données montrent qu'il existe une tendance à une performance pire au fur et à mesure que le travail se complique.

Dans cette étude le travail exigé est plus complexe et les résultats montrent qu'il existe un effet principal significatif des conditions sonores sur la performance, celui-ci étant significativement inférieur en présence de n'importe lequel des quatre sons, en comparaison avec le silence.

Cette étude essaie aussi de chercher à savoir si les résultats en performance ont une relation avec l'appréciation subjective (évaluée sur l'échelle d'agrabilité, Santisteban 1988) des personnes sur l'agrabilité des sons.

## INTRODUCTION

The vast experimental information on the effects of noise on cognitive tasks does not allow one to conclusively assert that such effects are significant if sounds are presented at a moderate intensity. However, our experiments have shown that the effects of noise increase as the task assigned to the experimental subjects increases. Thus, our results show that, while there is no definite effect of noise on recall of lists of categorized words, it does affect recall and comprehension of a complex text read silently by the subjects under various sound conditions.

Our hypothesis rests on the idea expressed by Gossy (1988) that performance impairment does not significantly affect the superficial structure, but deeper levels, which accounts for the seemingly contradictory results reported by several authors. Thus, while Schwartz (1975) and Jones and Broadbent (1979) found noise to have significant effects on performance, Hygge (1988) and Rossi (1988) failed to find any effects in similar experiments—see the review by Santisteban (1990).

This work was aimed at determining not only whether the presence of everyday noise at a moderate intensity significantly affects performance in recalling and comprehending a written text, but also if the subjects' predisposition to each sound, classed as pleasant or unpleasant, influences their performance in the assigned task.

## MATERIALS AND METHOD

The experimental subject sample was representative of the students of Psychology at the final academic years of the Complutense University (Madrid). They were randomly chosen from among a group of students with similar curricula and academic performance.

The verbal material used consisted of five texts on scientific topics with which the subjects were fairly acquainted. The times allowed for the tasks and the difficulties of the texts were balanced in a preliminary study that involved the whole sample population.

In separate experimental sessions, the subjects were presented with the different texts and the order of presentation—randomly chosen—was counterbalanced with that of the sounds.

The sounds, quite common, were played at moderate intensity levels. They included classical music ( $L_{eq} = 55$  dBA), bird singing ( $L_{eq} = 75$  dBA), road traffic ( $L_{eq} = 65$  dBA) and electric drill noise ( $L_{eq} = 65$  dBA). The silence condition corresponded to  $L_{eq} = 45$  dBA. All sounds were played in free-field form and at the same pressure level as far as possible. Such a level was determined by the Stevens and Zwicker methods and was found to be *ca.* 80 phons, with maximal differences of less than 6 phons between the two types of measurement.

The subjects' appraisal of the sound pleasantness was determined by means of a questionnaire and their assessment was measured on a pleasantness scale designed by Santisteban (1988).

## RESULTS AND CONCLUSIONS

We recorded the number of correct answers and those of mistakes and gaps for each subject on each text under each sound condition. The table below lists the overall number of hits (T), errors (M) and gaps (G) obtained under each sound condition for each of the five texts (A-E).

Text	Music			Traffic			Birds			Drill			Silence		
	T	E	G	T	E	G	T	E	G	T	E	G	T	E	G
A	28	12	0	26	14	2	32	8	2	24	6	7	38	2	0
B	23	17	5	23	17	5	24	17	5	28	12	0	36	4	0
C	30	10	1	24	16	4	37	3	0	29	11	1	36	4	0
D	29	11	0	33	7	0	25	15	1	29	11	1	26	14	0
E	23	17	3	29	11	0	32	8	1	28	12	0	32	8	0
Total	133	67	9	135	65	11	150	51	9	138	62	9	168	32	0

A statistical analysis of the data by Friedman's and Wilcoxon's tests revealed a significant principal effect of the noise conditions on both hits, errors and gaps. However, there were no significant differences in performance on exposure of the subjects to the four experimental sounds: classical music, traffic noise, bird singing and electric drill noise. The analysis also revealed that the principal effects arose from the large differences between performance in silence and under the other four sound conditions.

A statistical analysis of the relationships between performance and the subjects' appraisal of the sound (un)pleasantness revealed that the effect of noise on comprehension and memorization while reading is seemingly independent of the (un)pleasantness score given by the subjects to the sounds.

## REFERENCES

- GOSY, M. (1988). Psychoacoustic Consequences of Noises for Communication. In: *Proceedings of International Congress of Noise as a Public Health Problem*. Stockholm.
- HYGGE, S. (1988). Interaction of Low-Density Noise and Moderate Heat on Cognitive Performance and Serial Reaction. In: *Proceedings of International Congress of Noise as a Public Health Problem*. Stockholm.
- JONES, D.; BROADBENT, D.E. (1979). Side-Effects of Interferences with Speech by Noise. *Ergonomics*. 22(9), 1073-1081.
- ROSSI, G. (1988). Noise and Task Performance. In: *Proceedings of International Congress of Noise as a Public Health Problem*. Stockholm.

SANTISTEBAN, C. (1988). Behavioral Decisions Analysis for Auditory Stimuli. In: *Proceedings of International Congress of Noise as a Public Health Problem*. Stockholm. Vol. 3,89-93.

SANTISTEBAN, C. and SANTALLA, Z. (1990 a). Efectos del Ruido sobre memoria y atención: Una revisión. *Psicothema*. 2 (2), 49-91.

SCHWARTZ, S. (1975). Individual Differences in Cognition: Some relationships between personality and memory. *Journal of Research in Personality*. 9, 217-225.

**THE "IRRELEVANT SPEECH"-EFFECT:  
IS BINAURAL PROCESSING RELEVANT OR IRRELEVANT?**

**KILCHER Horst & HELLBRÜCK Jürgen**  
Environmental and Health Psychology  
Catholic University of Eichstätt  
Ostenstr. 26  
D-8078\* Eichstätt

The term "irrelevant speech"-effect describes the fact that serial recall of visually presented items is disrupted by irrelevant background speech.

In our experiment we compare two different recording systems with which background speech can be recorded. The first is the conventional recording of a situation with one single microphone (we call it monaural condition). No spatial cues are captured in the record. The second is a quite new artificial head system where the sound is recorded together with spatial cues (binaural condition).

Our purpose was to test whether the different recording systems have different effects on performance in an irrelevant speech situation, due to the additional available spatial information. Two different situations, in which persons (two versus eight) were speaking at the same time, were recorded. Each situation was recorded simultaneously with both systems and presented in the experiment to each subject.

Compared with the quiet condition, any speech condition led to significantly worse performance. There was however no difference in performance due to the recording system. The disrupting effect of speech-sounds seems not to be affected by additional spatial cues, but to occur on more abstract levels.

Additionally to the presentation of the poster, an auditory demonstration of the different recording systems will be presented.

---

\*From July 1st 1993: D-85071 Eichstätt



# Comparative evaluation of sleep disturbance due to noises from airplanes, trains and trucks\*

Winni Hofman<sup>1,2</sup>, Anand Kumar<sup>2</sup> and Jacob Eberhardt<sup>3</sup>

<sup>1</sup>Department of Psychology, University of Amsterdam, Amsterdam, Netherlands

<sup>2</sup>Medcare Automation, Amsterdam, Netherlands

<sup>3</sup>Institute of Radio Physics, University of Lund, Lund, Sweden

## ABSTRACT

This paper presents results on the comparison of the effects of noise from three different sources (airplanes, trains and road traffic). For each source, 50 stimuli with a maximum level of 45 dB(A) and 15 stimuli with a maximum level 65 dB(A) were presented during sleep on separate nights. Moreover, on two additional nights 15 train and 15 airplane stimuli with a maximum level of 75 dB(B) were presented. This maximum level was obtained by equalizing it the maximum level in dB(B) of 65 dB(A) road traffic stimuli. Seven young adult males participated in the study.

Sleep during noise condition showed a significant decrease of total sleep time and an increase of REM sleep. Moreover there was a tendency of an increase of wake time after sleep onset and a decrease of slow wave sleep. These global measures of the pattern of sleep were not sensitive to different sources of noise. Reactions to individual stimuli, maximum level 65 dB(A), did show significantly more wake reactions to train stimuli than to truck stimuli or airplane stimuli. The adjustment of the loudness of the stimuli to the B-spectrum did not change the finding that the train stimuli elicited the most reactions.

## INTRODUCTION

The main sources of environmental noise during sleep are airplane noise, train noise and noise from road traffic. Most studies comparing different noise sources focused on annoyance measures. Vernet and Simmonet (1983) showed a difference in the arousal reactions in the EEG caused by different noise sources. This study was, however, based on subjects living in different sites. It is, therefore, not easy to conclude whether the differences in the effects are a result of differences in the methods and subjects or are due to the differences in the sound characteristics of the noises. The present study was designed to help in solving these problems.

In this study, each subject was exposed to noise stimuli from three sources (airplanes, trucks and trains). Moreover for each source the maximum level of the stimuli and the number of stimuli were also varied. Both the global parameters of the sleep EEG and arousals to individual stimuli were investigated. In this paper preliminary results on overall sleep parameters and responses to individual noise stimuli are described.

## METHODS

### PROCEDURES

Seven male subjects (20-30 years old) were exposed to noise stimuli from trucks, airplanes and trains during sleep. Each subject slept in the laboratory for 2 nights a week during 9 weeks. The first week was a baseline week. In the subsequent weeks, noise stimuli were presented in the second night. The first night was the adaptation night.

---

\* The data of the study was recorded at the University of Lund and was financed by the Swedish Environmental Protection Board. The Dutch Ministry of Housing, Planning and Environment financed the analysis of data. The first author was partially supported by Medcare Automation. Opinions presented in this paper are the sole responsibility of the authors and do not imply any endorsement from the supporting authorities.

Noise stimuli from airplanes, trains and trucks were recorded on tape and played back in the laboratory. On separate nights 50 stimuli of 45 dB(A) maximum level and 15 stimuli of 65 dB(A) maximum level from each of the noise sources were presented. Additionally, 15 train noise stimuli and 15 airplane noise stimuli, with a maximum level of 75 dB(B), were presented in two nights. Seventy-five dB(B) was the maximum level of truck stimuli (65dB(A)). The EEG, EOG, EMG, ECG and the sound level signal in dB(A) or dB(B) were recorded every night.

#### ANALYSIS

An automatic system, The Sleep Analyzer, analyzed the EEG, EOG and EMG signals. This system emulates the standardised criteria of classification of sleep stages (Rechtschaffen & Kales, 1968) and automatically classifies sleep stages. It also calculates the presence of EEG activity in the various frequency bands. The Sleep Analyzer, was used previously in the noise research (Griefahn, 1986 and Jurriens, 1980), has been validated against human judges and other automatic systems (Kumar et. al, 1981 and Campbell et. al, 1980).

The Sleep Analyzer processes signals from each night consistently in the same way. Therefore the sleep classification is not biased by the knowledge of experimental condition. The results of the classification were checked by two judges independently. For each night the overall parameters of the sleep EEG were calculated.

One trained human judge evaluated each occurrence of a noise stimulus to classify arousals in the EEG. She was a trained sleep researcher, but not familiar with the hypotheses concerning noise disturbance. Another experienced judge checked the arousal classification. Both of these judges were not involved in the methods and the computer programmes. Four minutes, before and four minutes (including the stimulus epoch) after the stimulus, were used as pre-stimulus and post-stimulus period respectively. Four arousal classes were used: **Class 0**: no reaction, **Class 1**: short duration arousals (high-frequency, high-voltage activity) in EEG, **Class 2**: a change from deep sleep or REM sleep to light sleep, and **Class 3**: awakening.

A computer program calculated the duration of the activity in the different frequency bands. It then calculated a ratio of the average duration of alpha and beta in the pre-stimulus period to the average duration of alpha and beta in the post-stimulus period. This ratio, depicting the lightening of sleep, is not subject to any bias or error that is possible in a human classification of arousal classes.

## RESULTS

### OVERALL SLEEP PARAMETERS

Table 1. Mean values parameters of total sleep in different conditions.

	Airplane			Train			Truck		Quiet
	45dB(A)	65 dB(A)	75 dB(B)	45dB(A)	65 dB(A)	75 dB(B)	45 dB(A)	65 dB(A)	35 dB(A)
Total sleep time (min.)	438.6	441.2	442.5	389.6	444.9	455.42	429.1	426.5	443.6
Wake after sleep onset(min)	8.1	12.7	7.9	12.3	8.3	15.3	9.5	23.1	5.8
Latency to REM	33.2	44.7	52.4	34.2	39.2	34.5	32.7	42.6	53.3
Latency to Slow Wave Sleep	15.0	12.7	13.1	13.5	13.9	16.5	13.6	17.3	17.3
REM sleep	81.2	75.2	79.7	67.3	92.1	63.4	79.2	71.6	74.9
Slow Wave sleep	94.2	78.7	96.2	68.3	75.7	83.8	75.2	69.8	91.8
Number of subjects	7	6	7	7	6	7	7	7	7

These data show a tendency of decrease in total sleep time and of time spent in slow wave sleep, and an increase in wake time after sleep onset and an increase in time spent in REM sleep in all noise conditions compared to the matched quiet nights.



Analysis of variance was performed to test differences between the 45dB(A), 65dB(A) and quiet conditions. In noise conditions, the total sleep time was decreased ( $F=6.29$ ,  $p=0.016$ ) and the time in REM sleep increased ( $F=4.06$ ,  $p=0.05$ ).

#### AROUSAL REACTIONS

Percentages of reactions to the individual noise stimuli are listed in Table 1. The chi-square value of the overall distribution of various arousal classes was 19.77 ( $p=0.07$ ), indicating a difference in arousal reactions in all classes among the five noise conditions.

The reliability of wake reactions was tested by comparing the post-stimulus wake reaction to the wake reaction in pre-stimulus control period, according to a method described by Mietinnen (1968). Each stimulus acts as its own control. A chi-square test, with 1 degree of freedom, can be calculated on the probabilities of reaction in 'case' and 'control' condition. All wake reactions were significant at 0.001 p-level.

**Table 2. Distribution of arousal classes in 65 dB(A) conditions.**

Arousal class	Airplane 65 dB(A)	Airplane 75 dB(B)	Train 65 dB(A)	Train 75 dB(B)	Truck 65 dB(A)
Waking EEG	20.0%	34.5%	33.8%	46.3%	26.7%
Micro arousals	20.0%	20.2%	29.6%	19.5%	18.6%
Change to light sleep	6.0%	3.6%	4.2%	3.7%	8.1%
No arousal	54.0%	41.7%	32.4%	30.5%	46.5%
Number of stimuli	50	84	71	82	86

The wake reactions in different noise conditions were compared. The relative risks, of wake reactions in one condition compared to wake reactions in other condition, were calculated in pairwise fashion. See table 2.

The relative risk (RR) in a cell shows the risk of the occurrence of wake reactions in the condition shown at the top of the column in proportion to the condition shown at the left of the row. For example, the airplane stimuli caused less wake reaction when compared to stimuli from trucks ( $RR=0.67$ ), whereas the adjustment of the loudness of airplane stimuli, to the loudness of B-spectrum, resulted in more wake reactions than the stimuli from truck ( $RR=1.36$ ). The adjustment of the loudness of the airplane stimuli resulted in more awakening reactions ( $RR=0.49$ ) than the airplane stimuli without the adjustment. For the train stimuli, this difference was not significant.

**Table 3. Relative risk of wake reactions in different conditions.**

	Airplane 65 dB(A)	Airplane 75 dB(B)	Train 65 dB(A)	Train 75 dB(B)	Truck 65 dB(A)
Airplane 65 dB(A)					
Airplane 75 dB(B)	0.49( $p<0.001$ )				
Train 65 dB(A)	0.58	1.02( $p<0.005$ )			
Train 75 dB(B)	0.43( $p<0.001$ )	0.74	0.72		
Truck 65 dB(A)	0.67( $p<0.001$ )	1.29( $p<0.001$ )	1.16( $p<0.001$ )	1.73( $p=0.05$ )	

The wake reaction can be confounded by different factors like time of occurrence of the stimuli, sleep stage of pre-stimulus period, stimulus duration, and variation between subjects. A logistic regression between the probability of the occurrence of the wake reactions and the above factors was calculated. Three variables, subject, stimulus duration and the time of occurrence of a stimulus predicted the wake reactions with an accuracy of 36%. However, the regression coefficients were very small. There was a tendency towards more wake reactions in the earlier part of the night and to shorter stimulus duration.

## CHANGES IN EEG FREQUENCIES

The mean duration of alpha and beta EEG in the post-stimulus epochs was increased when compared to the values of the pre-stimulus epochs. Seventy per cent of the stimuli resulted in a significant increase ( $p < .001$ , binomial test). In 49 % of the stimuli the alpha and beta duration was doubled.

## DISCUSSION

The decrease of the total sleep time, in both noise conditions as compared to the quiet condition, is important if one considers that all subjects planned to sleep for a constant period and that the noise stimuli occurred after sleep onset. In some cases, stimuli in the early morning led subjects to abort their sleep. No difference in total sleep time was found between the two noise conditions 45 dB(A) and 65 dB(A).

The increase of time spent in REM-sleep seems to be associated with the shortening of REM-latency. This, in combination with the tendency of a decrease in slow wave sleep, means that the temporal structure of sleep is disturbed. This will be reported later as the analysis of the temporal structure of the data was still in progress at the time of submission of this paper.

The main interpretation of these results is: noise stimuli of 65 dB(A) have a disturbing effect on sleep, but there is no convincing difference between the effects of the source of the noise. The high value of maximum level of stimuli can mask the differences in sources.

Analysis of the individual noise stimuli, maximum level 65 dB, however, did show some difference between the noise sources: train noise led to more arousal reactions than airplane noise and truck noise. This was true for the stimuli of 65 dB(A) as well as for the stimuli with a maximum level adjusted to 65 dB(B) road traffic stimuli. The adjustment of the loudness of the airplane and train stimuli to the B-spectrum resulted in more reactions to airplane noise than to truck noise stimuli, while it was the other way around for the A-spectrum stimuli. In more than 50% of the cases a reaction on the stimulus could be detected, ranging from micro arousals to stage wake. It can be concluded that our subjects responded differently on individual stimuli from the three noise sources, but the global sleep pattern was not sensitive to these effects.

## REFERENCES

- Campbell K., Kumar A. & Hofman W. (1980) Human and automatic validation of a phase-locked loop spindle detection system. *Electroencephal. Clin. Neurophys.* 48: 602-605.
- Griefahn, B. (1986) A critical load for nocturnal high-density road traffic noise. *American Journal of Industrial Medicine*, 9: 261-269.
- Jurriëns, A. A., Kumar, A., Hofman, W.F. & Diest, R. van (1980) Sleeping at home with different sound insulation. In: *Proceedings Inter-Noise: Ned. Akoustisch Genootschap*, Delft: 783-786.
- Kumar, A., Campbell, K., Hofman, W., Vallet, M., Jurriëns, A.A. & Diest, R. van (1981) Evaluation and validation of an automatic method of sleep stage classification of human sleep recordings done in the homes. In: *Proceedings of the Int. Conf. on cybernetics and society*, Atlanta (USA): 516-519.
- Miettinen O.S. (1969) Individual matching with multiple controls in the case all-or-none responses. *Biometrics* 25:339-355.
- Rechtschaffen, A. & Kales, A. (1968) Manual of standardised terminology techniques and scoring system for sleep stages of human subjects. Brain Information Service / Brain Research Institute, UCLA, Los Angeles.
- Vernet, M. & Simmonet, F. (1983) Comparison of the impact of railway noise and road traffic noise on sleep. In: Rossi, G. (Ed.) *Proceedings Fourth Int Congr on Noise as a Public Health Problem*. Milan: Centro Ricerche e Studi Amplifon:1023-1026.

# SLEEP DISTURBANCE DUE TO AIRCRAFT NOISE AT A RAPIDLY EXPANDING AIRPORT (MANCHESTER AIRPORT)

HUME, K.I. and THOMAS, C.

Department of Biological Sciences, Manchester Metropolitan University, Chester St., Manchester M1 5GD, UK.

## ABSTRACT

Noise pollution is the most obvious environmental problem for communities surrounding major airports. Sleep disturbance associated with aircraft noise is frequently quoted as a major cause of complaint and concern.

The extent of aircraft noise disturbance around Manchester Airport was assessed from 100 households in each of 9 communities at varying distances from the Airport by means of a computer aided telephone interview technique. The survey yielded many significant findings when sites close to the Airport were compared with a control site 11 miles distant.

The results clearly indicated that aircraft noise was a major source of environmental pollution and perceived as the main disadvantage of the Airport's operations. There was a clear relationship between the extent of the problem and the distance of the community from the Airport and/or high noise contour and/or flight paths. 65% of the respondents in the 4 communities nearest to the Airport accepted that there was a noise problem while fewer (57%) reported being affected by aircraft noise. Aircraft noise seems to have a greater affect on individuals than road traffic noise and in areas of high aircraft noise disturbance, road traffic seems to be tolerated much more than in areas with little aircraft noise. For the individuals who were affected by aircraft noise, the most frequent complaint was interference with communication followed by general irritation/annoyance and then sleep disturbance (20%). When sleep disturbance was reported it was a common event with 79% of disturbed sleepers reporting such problems at least once a week. However, on balance 89% of the respondents considered that the advantages of the airport outweighed its disadvantages, such as noise pollution.

## INTRODUCTION

Noise disturbance as a result of aircraft operations near major airports has been recognised as a cause of environmental pollution for many years. This noise pollution is the most obvious environmental problem for communities living close to airports and has implications for the health and quality-of-life of the residents. It is becoming increasingly evident that one of the main constraints on the future growth of air transportation will be such environmental issues.

Two previous studies at Manchester Airport employed postal questionnaires and had response rates of 79% and 51%. This study employed a telephone questionnaire which has the advantages that; (1) there is less bias in response, in that postal respondents who "feel strongly" about the topic are more likely to reply and (2) the number of respondents in specific areas can be controlled more accurately. The study reported here does not attempt to relate the degree of disturbance to particular noise events on

specific nights. Rather, it is a general assessment of the level of perceived disturbance, ie. a "snap-shot," in a number of communities at varying distances from the Airport and its flight-paths.

Surveys from targeted communities surrounding airports, such as the present study, tend to be "case studies" because each airport has a different: history, operational growth rate, local geography including the pattern of housing developments, socioeconomic structure of these communities, current operational pattern and policy of the airport. However, Manchester Airport does have a relatively high number of night flights during the summer months and is situated close to a densely populated conurbation making it an ideal case to study.

#### METHOD

A telephone survey was conducted by trained staff using a structured questionnaire from a random sample of households with telephones. The aim of the interview, as indicated to the respondents, was simply stated as "...carrying out a survey amongst residents in a number of communities in the Manchester area...". Interviews were conducted with a male or female adult (18+) member of the household, with the condition that in any one area equal numbers of males and females were interviewed. The interviews were carried out between 6.00 and 9.30 in the evening and lasted about 15 minutes. One hundred successful/complete interviews were conducted in each area.

Eight areas with some noise complaint history were surveyed, plus a control area which receives the benefits of the Airport, eg ease of access to air travel, but has hardly any noise problem. The study was carried out in May which is the start of the busy summer period for Manchester Airport. During this month there were, on average, 154,155,117 & 62 air movements during the morning, afternoon, evening and night respectively. A night flight restriction policy was in operation which limited the number of movements between 23.00 and 06.00. There was a total of 15,097 movements during this month of May and during the period of the survey the weather was generally fine and warm so some bedroom windows may well have been open at night.

#### RESULTS AND DISCUSSION

One of the main aims of the survey was to assess the current extent of the noise problem around the Airport. The results which best fulfill this aim come from three different yet related questions from different parts of the questionnaire:

*\* Is this area affected by any particular kinds of noise disturbance or noise?*

*\* If just one of the things, you have said cause a noise disturbance in this area, could be stopped, which one would you choose?*

*\* What is the main disadvantage of Manchester Airport?*

These three questions gave a similar pattern of response and the degree of disturbance was clearly related to the noise contour level and/or the distance from the airport and/or the flight path. The four nearest areas have similar high levels of complaint about noise levels. On average, 65% of the respondents in these communities complained spontaneously about aircraft noise and this far outweighed any other environmental issue. The control area was hardly affected by aircraft noise.

The number of respondents affected by aircraft noise in the most affected areas was below the level of respondents who indicated an acceptance of a noise problem, 57% compared with 65%. In addition, a similar pattern of response was apparent for the location of the community in relation to its distance from the airport/noise footprint/flight paths.

The next source of noise pollution spontaneously mentioned after aircraft was road traffic. A clear pattern exists in which the road traffic noise problem increases as the aircraft noise problem decreases as distance from the airport/noise contour/flight-path increases. However the problem seems to be qualitatively different in respect of these two sources of noise with aircraft causing a far greater effect than road traffic. This can be seen clearly on comparison of the respondents affected at least "quite a lot" by aircraft noise with those affected to the same extent by road traffic noise. Road traffic noise affects about 15% of respondents on average and gives similar percentages even in communities where it was the noise residents would most like stopped. This compares with 57% of respondents in areas nearest the Airport who indicated aircraft noise as the noise they would most liked stopped. Therefore, road traffic noise is tolerated to a far greater extent than aircraft noise even when it is considered to be the main noise pollutant.

Why does aircraft noise affect people more than road traffic noise? This could be due to familiarity with road traffic noise, its high frequency of events and traffic being restricted to roads. While aircraft are moving in three dimensions, with less restriction on precise location, with different loads and engine characteristics and, even at peak periods, pass much less frequently than motor vehicles on busy roads. Therefore, aircraft present a more novel stimulus to the listener and because of their height can be heard for a longer period than motor traffic. Another consideration involves safety, in that whereas a road accident is confined to other vehicles, pavements or other road boundaries an aircraft accident has the potential to affect individuals at any location. This was tragically demonstrated at Lockerbie in 1988. Therefore, aircraft noise has a more threatening aspect than road traffic noise.

The next question to address, for those individuals who are affected by aircraft noise, is - in what way are they affected by aircraft noise? Disturbance to communication in the house is the most frequently reported nuisance followed by disturbance in the garden and general irritation at the noise level. Sleep disturbance is the next most frequently quoted item where it peaks at 26%. This community is close to the Airport, within the main noise footprint and below its predominant take-off flight-path. In addition, the predominant age of the respondents was in the over 65 years category, therefore, one may predict that the high noise levels and elderly population would be particularly at risk to suffer from sleep disturbance.

On average, for the five nearest communities to the Airport 18% cited sleep disturbance as the main affect of aircraft noise. In response to the more general question whether "sleep was disturbed at all by aircraft noise" about one in three replied in the affirmative with a peak of 41%. Where sleep disturbance does occur it is not a rare occurrence with 79% of disturbed sleepers reporting such problems at least once a week and the most common response was several times a week.

Besides the problems caused by the Airport there was very substantial support for the Airport in terms of: the future of the area (95%), important employer (95%), brings business opportunities (94%). On balance 89% considered that the advantages outweighed the disadvantages of the Airport.

It is becoming increasingly evident that environmental issues, eg. sleep disturbance due to aircraft noise, may well constrain the large potential growth projected for air transportation over the next decade. However, the greater number of quieter jet aircraft replacing the older noisier jets would help to maintain an acceptable level of noise.

#### CONCLUSIONS

Aircraft noise was, by far, the greatest cause of environmental pollution in the communities living near to the Airport, its associated noise footprint and flight-paths.

There is a clear relationship between the distance from the Airport and the affect that aircraft noise has on the individuals in the community.

Aircraft noise seems to have a greater affect on individuals than road traffic noise and in areas of high aircraft noise disturbance, road traffic noise seems to be tolerated much more than in areas of low or nil aircraft noise.

The main effect of aircraft noise was on communication in the house and garden followed by general irritation/annoyance and sleep disturbance.

In those individuals affected sleep disturbance was a common event, occurring a number of times a week.

**AIRCRAFT NOISE AND SLEEP -**  
**FIELD STUDY FINDINGS FROM MORNING SLEEP LOGS**

**Horne JA, Pankhurst FL & Reyner, LA**

**Loughborough University, UK**

In the field study reported in our accompanying abstract (Horne et al), morning sleep logs were obtained for 5716 nights (95.3% response). 2483 contained reports of at least one awakening the previous night, with there being 7362 reported awakenings in all (i.e. some people were awoken more than once). The most frequent response to the cause of such awakenings, was "don't know", with "toilet" and "children" being the next commonest responses (these latter two responses were most prevalent in older men and younger women, respectively). Aircraft noise events (ANEs) were a comparatively minor cause, but seemed more likely to affect older people. Out of the 400 subjects, 97 (24.2%) reported being awoken by an ANE on at least one occasion on at least one night out of the 15 nights monitored per subject. In total this came to 285 subject nights (all sites); which is less than 5% of all nights. There was a significant age effect.





**EEG RESPONSES TO AIRCRAFT NOISE IN  
"NOISE-SENSITIVE" AND "LESS NOISE-SENSITIVE" SUBJECTS**

VAN, F., HUME, K. I. and WATSON, A.

Department of Biological Sciences, Manchester Metropolitan University,  
Chester Street, Manchester M1 5GD UK

**Abstract**

In order to investigate the effect of aircraft noise on sleep, EEG, EOG and EMG were recorded from 46 subjects (20-70 yrs, 23 male) living near 4 airports in the UK. EEG, EOG and EMG were recorded for 4 successive nights in blocks of three subjects using Medilog recorders (Oxford Instruments Ltd). On awakening, subjects assessed the quality of their sleep by completing a sleep log.

A total of 178 recordings were analyzed by an automatic computerized sleep analysis system (Oxford Instruments Ltd) and were subsequently checked and edited manually. A more detailed analysis was carried out by visually searching for EEG-responses to individual aircraft noise events (ANE) above 60 dB and comparing the EEG at that time with a quiet period between 2 and 5 minutes prior to the ANE.

Responses were categorized as hypnogram-responses (shifts to wakefulness, movement time or stage 1) or minor-arousals (brief movement artefact indications and brief EEG arousal).

The relative sensitivity of each subject to aircraft noise was determined by calculating the proportion of ANE which elicited a hypnogram responses. A separate measure of sensitivity was determined based on the proportion of ANE which elicited any EEG response.

Subjects were recorded in groups of 3 on the same night and in the same neighbourhood. Subjects in the same group were, therefore, exposed to similar levels of aircraft noise. The most and least sensitive subject in each block was identified and two groups of 15 subjects were formed for both indices of sensitivity. The "noise-sensitive" group consisted of the most sensitive subject in each block of 3 subjects and the "less noise-sensitive" group consisted of the least sensitive subject in each block. This is a very simple method of determining the relative noise-sensitivity of each subject and is not based on the subject's perception of his/her sensitivity.

Analysis revealed that relative noise-sensitivity was not determined by age. The sleep of noise-sensitive subjects contained more stage-1 sleep and more movement time but there were no significant differences between the two groups in terms of the amount of time in other sleep stages. "Noise-sensitive" subjects responded to more than twice as many ANE than "less noise-sensitive" subjects.

The results suggest that there is a wide variation in the sensitivity of individuals to ANE and that age is not a factor which determines noise-sensitivity.

## Introduction

The data presented here, were collected as part of a larger study to investigate the effect of aircraft noise on the sleep of individuals living near 4 airports in the U.K. EEG-responses to aircraft noise events (ANE) were investigated in two groups of subjects: those defined as "noise-sensitive" and those defined as "less noise-sensitive". Differences in sleep disturbance due to ANE, sleep-stage variables and subjective sleep quality between the two groups were investigated.

## Method

EEG, EOG and EMG were recorded from 46 subjects (20-70 yrs, 23 male) living near 4 airports in the UK. EEG, EOG and EMG were recorded for 4 successive nights in blocks of three subjects using a Medilog recorder (Oxford Instruments Ltd). On awakening, subjects assessed the quality of their sleep by completing a sleep log. The sleep log included two 5-point scales on which the subject indicated a) how they felt 15 minutes after waking (1 = very refreshed, 5 = very tired), b) how they slept (1 = extremely well, 5 = extremely badly).

A total of 178 recordings were analyzed by an automatic computerized sleep analysis system (Oxford Instruments Ltd) and were subsequently checked and edited manually. A more detailed analysis was carried out by visually searching for EEG-responses to individual aircraft noise events of greater than 60 dB and comparing the EEG at that time with a quiet period between 2 and 5 minutes prior to the ANE.

Responses were categorized as hypnogram-responses or minor-arousals. Hypnogram-responses included shifts to wakefulness of 15 seconds or more, movements of 10 seconds or more and shifts to stage-1 sleep. Minor-arousals included movements of less than 10 seconds and abrupt increases in EMG associated with two or more K-complexes. A response was associated with an ANE if it occurred within a window of 64 seconds beginning 16 seconds before the start of the ANE (i.e. the point at which the noise exceeded 60 dB). A response to an ANE was termed a "matched response" if it was preceded by a "pseudo-response" during the quiet period between 2 to 5 minutes prior to the ANE, and an "unmatched response" if it was not preceded by such a "pseudo-response".

The relative sensitivity of each subject to aircraft noise was determined by calculating the proportion of ANE which elicited an unmatched hypnogram-response. A separate measure of sensitivity was determined based on the proportion of ANE which elicited any (hypnogram-responses and minor-arousals) unmatched EEG response. Matched responses were not included in the analysis to determine the relative sensitivity of subjects in order to eliminate the possibility of ongoing EEG activity being classified as a response to ANE.

Subjects were recorded in groups of 3 on the same night and in the same neighbourhood. Subjects in the same group were, therefore, exposed to similar levels of aircraft noise. The most and least sensitive subject in each group was identified and two subject-groups of 15 each were formed for both indices of sensitivity (a: hypnogram-responses, b: hypnogram-responses and minor-arousals). The "noise-sensitive" group consisted of the most sensitive subject in each group of 3 subjects and the "less noise-sensitive" group consisted of the least sensitive subject in each group. This is a very simple method of determining the relative noise-sensitivity of each subject and is not based on the subject's perception of his/her sensitivity.

The data were analyzed to investigate differences in sleep variables, disturbance due to aircraft noise and subjective sleep quality between "noise-sensitive" and "less noise-sensitive" subjects.

## Results

Table 1: Results of analysis of age, response rate and sleep variables between the "noise-sensitive" and "less noise-sensitive" subjects (defined using the proportion of unmatched hypnogram-responses)

	NOISE-SENSITIVE	LESS NOISE-SENSITIVE	
Total no. of subject nights	60	58	
No. of subjects	15	15	
No. of males	9	7	
No. aged 20-34 yrs	7	4	
No. aged 35-49 yrs	6	4	
No. aged 50-70 yrs	2	7	
Mean age	36.9	42.7	n.s.
Mean proportion of hypnogram-responses	0.081	0.0329	p<0.001
Minutes of movement time	8.8	5.5	p<0.001
Minutes of stage-1 sleep	39.0	32.8	p<0.05

Table 2: Results of analysis of age, response rate and sleep variables between the "noise-sensitive" and "less noise-sensitive" subjects (defined using the proportion of any unmatched response)

	NOISE-SENSITIVE	LESS NOISE-SENSITIVE	
Total no. of subject nights	60	58	
No. of subjects	15	15	
No. of males	8	8	
No. aged 20-34 yrs	6	5	
No. aged 35-49 yrs	6	2	
No. aged 50-70 yrs	3	8	
Mean age	37.3	42.5	n.s.
Mean proportion of responses	0.1623	0.0626	p<0.001
Minutes of movement time	8.3	5.5	p<0.001
Minutes of stage-1 sleep	39.4	34.5	p<0.01

As revealed in table 1, the "noise-sensitive" subject group (based on the proportion of hypnogram-responses) consisted of 9 males and 6 females and the "less noise-sensitive" subject group consisted of 7 males and 8 females. Although there was a tendency for the "noise-sensitive" group to be younger, there was no significant effect of age.

The proportion of ANE above 60 dB which elicited a hypnogram response in the "noise-sensitive" subjects (8.1 %) was more than twice the proportion in the "less noise-sensitive" subjects (3.3 %).

Analysis of sleep-stage variables revealed that "noise-sensitive" subjects had greater amounts of movement time and stage-1 sleep than "less noise-sensitive" subjects. There were no significant differences between the two groups in the amount of stages 2, 3, 4 nor REM.

Although the "noise-sensitive" subjects responded to a greater number of ANE, they tended to report in sleep logs that they slept better and felt more refreshed 15 minutes after sleep than the "less noise-sensitive" subjects. These differences, however, did not reach significance.

A similar pattern of results was found when the definition of the least and most sensitive subjects was based on the proportion of ANE which elicited any unmatched response, as revealed in table 2.

### Discussion

The method used to distinguish between "noise-sensitive" and relatively "less noise-sensitive" subjects in terms of their EEG responses to ANE enabled two groups with significantly different response rates to be identified. "Noise-sensitive" subjects responded to 16.2 % of ANE above 60 dB and when noise sensitivity was defined in terms of hypnogram-responses, 8.1 % of ANE elicited a hypnogram-response in "noise-sensitive" subjects. The corresponding proportions for "less noise-sensitive" subjects were 6.3 % and 3.3 % respectively.

Male and female subjects were equally likely to be classified as "noise-sensitive" or "less noise-sensitive" by this method of analysis. Likewise, age did not appear to determine the relative sensitivity of the subjects.

Sensitivity to noise had no effect on the amount of sleep in sleep stages 2, 3, 4 and REM but there was more stage-1 sleep and more movement time in "noise-sensitive" subjects which may be interpreted as "noise-sensitive" subjects having more disturbed sleep.

The objective method of determining noise-sensitivity employed in the present experiment was not based on the subjects' perception of their sensitivity. A surprising result was that despite "noise-sensitive" subjects responding to a greater proportion of ANE, they reported sleeping better and being more refreshed after sleep than "less noise-sensitive" subjects. Subjective noise-sensitivity, may therefore, differ from the more objective noise-sensitivity determined by the method employed here.

### Conclusions

There is a wide variation in the sensitivity of individuals to ANE and age is not a factor which determines noise-sensitivity.

# RANDOM EFFECTS MODELS FOR REPEATED OBSERVATIONS IN STUDIES TO ASCERTAIN THE EFFECT OF AIRCRAFT NOISE ON SLEEP DISTURBANCE

DIAMOND, Ian, EGGER, Peter and HOLMES, David

Department of Social Statistics University of Southampton Southampton SO9 5NH

The key question when studying the relationship between aircraft noise and sleep disturbance is: "does the noise induce a sleep disturbance"? If there is only one noise event per individual then the relationship could be modelled very simply using binary regression. For example:

$$\ln\left(\frac{p}{1-p}\right) = a + b.N + \underline{X}' \underline{c}$$

where  $p$  is the probability of being disturbed

$N$  is noise level

$\underline{X}$  is a vector of covariates

$a, b, \underline{c}$  are estimated regression coefficients

Unfortunately, such a simple approach is not appropriate for two reasons: first, each individual will be exposed to more than one aircraft event and second, the aircraft are not the only potential source of disturbance, and the extent to which an individual is experiencing a disturbed night's sleep will influence whether s/he is disturbed by the aircraft noise.

Conventional statistical analyses such as those described above rely on the fundamental assumption that each observation is independent and therefore they cannot be used for studies of sleep disturbance which have repeated observations on the same individual.

This problem was particularly acute with the UK Sleep Disturbance study as the unit of measurement for each individual was whether or not they were disturbed in a thirty second epoch of time. Therefore for any one night an individual sleeping for eight hours would be exposed to 960 epochs of exposure. A conventional statistical analysis would consider each of these 960 observations as independent. This would of course be inappropriate as different individual have different propensities to be disturbed over a night.

To overcome this problem statistical models using a random effect were developed. The model used was now

$$\ln\left(\frac{p}{1-p}\right) = a + b.N + \underline{X}' \underline{c} + \sigma \delta_i$$

where  $\delta_i$  is a systematic error for the  $i^{\text{th}}$  subject which does not vary with

time but does vary across subjects.  $\delta_i$  is assumed to take a  $N(0,1)$

distribution.  $\sigma$  is an estimated regression coefficient for  $\delta_i$ .

Using this approach it is possible (a) to estimate the effects of various covariates on the probability of disturbance after first controlling for individual variability and (b) the estimate of  $\sigma$  allows a quantitative assessment of the degree of individual arousability due to aircraft noise.

The paper describes the model fitting procedure and describes the major results which show first that disturbance is strongly related to sex - men are around 25% more likely to be disturbed than women; the time of night of the event - disturbance is about a third late in the night; noise level - planes above 90dBA, SEL increased the probability of disturbance significantly; and whether the individual was disturbed in the quiet period since the last noise event. Second, a most important factor was individual arousability - very sensitive people (those in the 97.5th percentile) were around three times more likely to be disturbed as not very sensitive people (those in the 2.5th percentile).



# SLEEP, NOISE, AND IMMUNOSUPPRESSION

ALTENA Klaas\* and BEERSMA Domien G.M.\*\*

\* Hoofdweg 197, 4874 CE Oldeholtpade, the Netherlands

\*\* Academic Hospital, Department of Biological Psychiatry  
PO 30.001 9700 RB Groningen the Netherlands

## Abstract

This paper reviews evidence concerning the immunosuppressive effects of exposure to nocturnal noise. The purpose is to contribute to the setting of norms. Data will be reviewed which show (1) that aspects of the immune system are tightly connected to sleep processes, (2) that sleep disturbances suppress these aspects and the respective functions of the immune system, (3) that sleep physiology can be disturbed by noise even when subjects are not awakened, and (4) that nocturnal noise can exert immunosuppressive effects. To prevent immunosuppression, nocturnal noise should not exceed 40 dB(A), ( $L_{Amax}$  and  $L_{Aeq}$ ).

**SLEEP** proceeds from wakefulness via stage 1,2,3, and stage 4 to REM sleep each night. This sequence is cyclically repeated about five times per night for normal adults. Sleep stages 1,2,3 and 4 are also called nonREM sleep; stages 1 and 2 are the lighter sleep stages, stages 3 and 4 the deeper sleep stages (called Slow Wave Sleep, SWS). SWS is characterized by a high proportion of EEG delta waves of low frequency (<4 Hz) and high amplitude (>75  $\mu$ V); REM sleep is characterized by Rapid Eye Movements, a high frequency low voltage EEG as in the waking state, and muscular atonia.

**THE IMMUNE SYSTEM** protects against infectious microbial agents, viruses, parasites, bacteria and fungi, that can cause pathological tissue damage. Innate immunity acts as the first line of defence against infectious agents and most potential pathogens are checked before they establish an overt infection. If these first defences are breached, the adaptive immune system is activated and produces a specific reaction to each infectious agent which normally eradicates that agent. The following aspects are related to sleep: Natural Killer cells (NK's) are cells of the innate immune system and have the intrinsic capability to recognize and destroy virally infected cells and tumour cells. They are part of the first line of defence but are also activated by the adaptive immune system, e.g., when T cells of this system react to tumour cells and produce interferon to recruit and activate NK's. Cytokines are molecules which mediate interactions between cells. Interleukine (Il), interferon (IFN), and tumour necrosis factor (TNF) are cytokines that function in the immune system and influence sleep. Interleukines are molecules involved in the communication between cells of the immune system. They activate cells of the immune system. Il-1 and Il-2 activate NK's to cytotoxic (cell destroying) activity. IFN increases the resistance of cells to viral infections.

**SLEEP DISTURBANCE IS IMMUNOSUPPRESSIVE.** Recent immunological research has found an intimate relationship between sleep and the immune system. Krueger and Karnovsky (1987) concluded that many substances that lead to immune responses also enhance sleep and actually have been found in the brain, suggesting that sleep may be intimately

involved in processes that encounter infections. Opp et al. (1992) reviewed evidence on the relationship between microbial infection, cytokines and sleep. They conclude that cytokines modulate sleep and sleep serves an adaptive function in combating infectious disease. Moldofsky et al. (1986) found a dramatic activity of the immune system, dependent on SWS and consisting of a proliferation and activation of components of the immune system. Before sleep onset, NK cell activity is increased. At the onset of SWS there is a peak in the plasma Il-1 activity, followed by a peak in Il-2 plasma activity and about 1 hr later a sharp decline in NK activity. Moldofsky et al. (1989) found that sleep deprivation led to enhanced nocturnal plasma Il-1 and Il-2 like activities. With resumed nocturnal sleep, there was a prolonged decline in NK activity (measured as spontaneous cytolytic activity for human tumour cells). In this experiment the finding was replicated that before sleep onset, the activity of NK increases and drops after onset of sleep; it was argued that this decrease might be related to redistribution of NK cells into tissues for immune surveillance and lysis of pathogenic cells. Palmblad et al. (1976, 1979) found immunosuppressive effects in sleep deprivation experiments. Irwin et al. (1992) found a positive relationship between sleep EEG parameters (total sleep time, sleep efficiency, and duration of nonREM sleep) and Natural Killer cytotoxicity in both depressed and control subjects (fig. 1). Sleep efficiency is defined as the ratio of total sleep time to time in bed (%). These findings provide an electrophysiological basis to other studies that found a relationship between insomnia in controls, depressives, persons undergoing stress, and cytotoxicity of NK's. Sleep deprivation also leads to a reduced amount of NK's (Irwin, WF RS-congress, Hawaii, 1993).

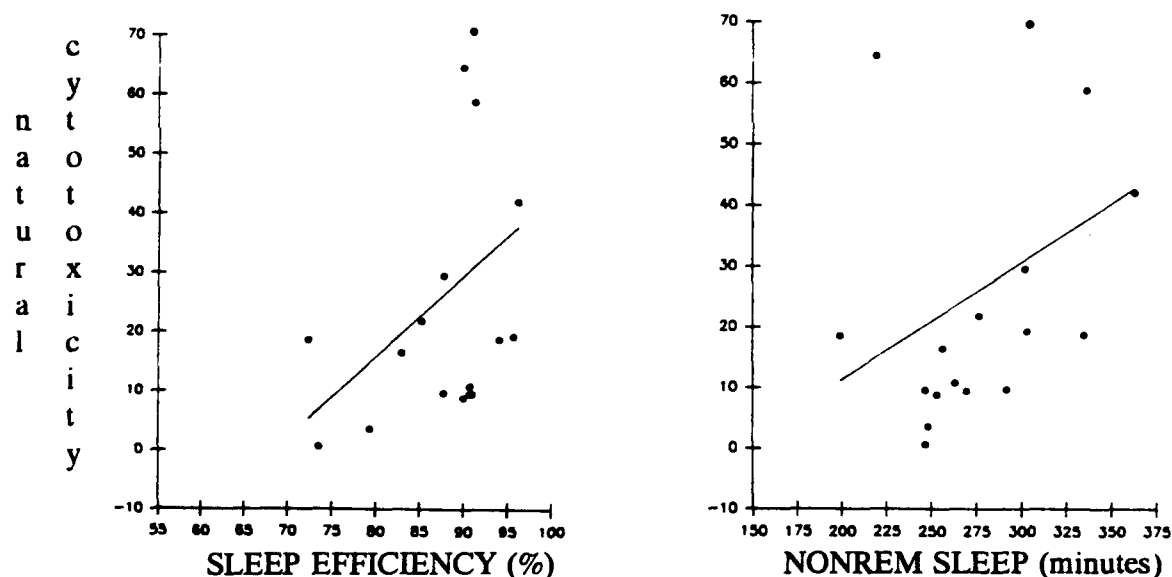

Fig. 1 Correlations (control subjects) between NK cytotoxicity and sleep efficiency (left) and between NK cytotoxicity and nonREM sleep (right); Irwin et al. (1992); figures reprinted with permission from the American Psychosomatic Society (copyright 1992).

**NOCTURNAL NOISE CAN CAUSE SLEEP DISTURBANCES.** A relationship between peak level, number of noise events and percentage awakenings has been described by Griefahn (1990). Sleep physiology however, can also be disturbed without awakenings. Short arousals (EEG, ECG, EOG, respiratory response) can be observed in response to nocturnal noise, as well as disturbances of sleep stage distribution. Disturbances of sleep stage distribution generally result in lighter sleep. Osada et al. (1968, 1969, 1972) report a shift to lighter sleep at levels of 40 dB(A) and higher (intermittent and continuous noise). Osada et al. (1974) report a shift to lighter stages of sleep with one or more stages and a decrease in



percentage of high amplitude low frequency EEG with 18 peaks of 50 dB(A) and background noise < 30 dB(A). Eberhardt et al. (1987a) reports a loss of SWS with 50 peak levels of  $L_{Amax} = 45$  dB(A) and background noise level of 27 dB(A); at a level of  $L_{Amax} = 55$  dB(A) an increased awake time and a decrease in amount of REM sleep was found. At a continuous level of 36 dB(A), except for a slight delay in the onset of stage 4, no influence on sleep stage distribution was found. These were results of a laboratory experiment. A study in the normal home environment with subjects exposed to heavy road traffic revealed that a 8 dB(A) *reduction* of noise level by mounting sound-insulating material, resulted in an earlier onset and prolonged duration of SWS (Eberhardt et al., 1987b).

At the level of sleep physiology, responses to disturbing noise can be observed even when the disturbances do not lead to awakenings. Such disturbances appeared to lead to an increased need for deep nonREM sleep (Dijk and Beersma, 1989). Furthermore, it must be noted that after an awakening and after falling asleep again, it takes time to reach the same level of deep sleep as occurred prior to the disturbance. Depending on the intensity of the disturbance, this may take more than half an hour. During this period recovery processes are less efficient than they could have been without disturbance (Achermann & Borbély, 1990).

**NOCTURNAL NOISE CAN HAVE IMMUNOSUPPRESSIVE EFFECTS.** Osada et al. (1968, 1969, 1972, 1974) found that proliferation of leucocytes during sleep, is inhibited by noise. Osada et al. (1968) found that increases of eosinophils and basophils (subclasses of leucocytes), observed in undisturbed controls, were remarkably inhibited by continuous traffic and factory noise of 40 dB(A). Two types of intermittent noise each half hour for the duration of 5 minutes, produced the same effect (Osada et al., 1969). Osada et al. (1972) found an immunosuppressive effect of train and aircraft noise of 50 or 60 dB(A) (with intervals of onset of 5, 10 or 20 minutes and a total exposure time of 20 min.) and continuous noise of 40 dB(A). (Subjects in this experiment were not exposed to intermittent noise of 40 dB(A)). Number of eosinophils and basophils, and total number of leucocytes decreased during exposition, but their percent changes were not influenced by the type or level of noise. Osada et al. (1974) studied the effects of 18 noise peaks (20 sec. duration each and total exposure time of 6 minutes) with background level < 30 dB(A). Increase of eosinophils and basophils was significantly inhibited by noise exposure even with peak levels of 40 dB(A).

**SLEEP STAGE DISTRIBUTION SHOULD BE PROTECTED.** Based on sleep stage changes and awakening reactions, most authors recommend a critical level for noise exposure of  $L_{Aeq} = 40$  dB(A) for continuous noise (Eberhardt et al., 1987a, pp. 69-70). Dormolen et al. (1988) conclude that the threshold for sleep arousals is 30 dB(A). Griefahn (1990) concluded that with increasing number of noise events the level at which 10% awakenings result, approaches 53 dB(A) ( $L_{Amax}$ , indoor level);  $L_{Amax}$  at which 10% sleep arousals result approaches 48 dB(A). Ollerhead et al. (1992) concluded that below outdoor event levels of about  $L_{Amax} = 80$  dB(A) (aircraft noise), the awakening rate is 1 in 75. This result is probably due to the recording technique used: wrist movements are supposed to indicate awakenings, while a person can obviously be awake without moving the wrist and a person also can make wrist movements while being asleep. Nocturnal noise which disturbs the distribution of sleep stages, including an increased sleep latency, decreased total sleep time, decreased sleep efficiency and decreased length and intensity of SWS, should be considered a health risk because of direct immunosuppressive effects. EEG-measurement of sleep disturbance below awakening threshold is necessary to relate sleep disturbance to suppression of the immune system; the measurements of number of awakenings is not sufficient to indicate immunosuppressive effects. Data, reviewed in this paper, suggest that the threshold for immunosuppressive effects may lie at about 40 dB(A) continuous and intermittent noise.

## REFERENCES

- Achermann, P. and Borbély, A.A. (1990). Simulation of human sleep: ultradian dynamics of electroencephalographic slow-wave activity. *J. Biol. Rhythms* 5, 141-157.
- Dijk, D.J. & Beersma, D.G.M. (1989). Effects of SWS deprivation on subsequent EEG power density and spontaneous sleep duration. *Electroencephalography and Clinical Neurophysiology*, 72:312-320.
- Dormolen, M. van, Kamp, I. van, Vries-Griever, A.H.G. de & Altena, K. (1988). Omgevingslawaai, slaap en gezondheid (Environmental noise, sleep, and health). (Report No. GA-HR-01-03). The Hague, the Netherlands: Department of Housing, Physical Planning and Environment (VROM).
- Eberhardt, J.L., Stråle, L.-O. & Berlin, M.H. (1987). The influence of continuous and intermittent traffic noise on sleep. *Journal of Sound and Vibration* 116(3), 445-464.
- Eberhardt, J.L. & Akselsson, K. R. (1987). The disturbance by road traffic noise of the sleep of young male adults as recorded in the home. *Journal of Sound and Vibration* 114(3), 417-434.
- Griefahn, B. (1990). Präventivmedizinische Vorschläge für den nächtlichen Schallschutz. *Zeitschrift für Lärmbekämpfung* 37, 7-14.
- Irwin, M.J., Smith, T.L. & Gillin, J.C. (1992). Electroencephalographic sleep and Natural Killer activity in depressed patients and control subjects. *Psychosomatic Medicine* 54:10-21.
- Krueger, J.M. & Karnovsky, M.L. (1987). Sleep and the immune response. In: B.D. Janković, B.M. Marković, and N.H. Spector (Eds.). *Neuroimmune Interactions. Proceedings of the Second International Workshop on Neuroimmunomodulation. Annals New York Academy of Sciences*, 496:510-516.
- Moldofsky, H, Lue, F.A., Eisen, J., Keystone, E., & Gorczynski, R.M. (1986). The relationship of Interleukin-1 and immunefunctions to sleep in humans. *Psychos. Med.*, 48 (5).
- Moldofsky, H., Lue, F.A., Davidson, J.R., and Gorczynski, R. M. (1989). Effects of sleep deprivation on human immune functions. *FASEB J.* 3: 1972-1977.
- Ollerhead, J.B., Jones, C.J., Cadoux, R.E., Woodley, B.J., Atkinson, B.J., Horne, J.A., Pankhurst, F., Reyner, L., Hume, K.I., Van, F., Watson, A., Diamond, D., Egger, P. Holmes, D. and McKean, J. (1992). Report of a field study of aircraft noise and sleep disturbance. London: Department of Transport.
- Opp, M.R., Kapás, L. & Toth, L.A. (1992). Cytokine involvement in the regulation of sleep. *Proc. Soc. Exp. Biol. Med.* 201, 16-27.
- Osada, Y., Tsunashima, S., Yoshida, K., Asano, M., Ogawa, S., Hirokawa, A., Nakamura, K. & Haruta, K. (1968). Experimental study on the influence of noise on sleep. *Bull. Inst. Publ. Health*, 17, 3.
- Osada, Y., Tsunashima, S., Yoshida, K., Asano, M., Ogawa, S., Hirokawa, A., Nakamura, K., & Haruta, K. (1969). Sleep impairment caused by short time exposure to continuous and intermittent noise. *Bull. Inst. Publ. Health*, 18, 1.
- Osada, Y., Tsunashima, S., Yoshida, K., Ogawa, S. & Ohkubo, C. (1972). Effects of train and jet aircraft noise on sleep. *Bull. Inst. Publ. Health*, 21, 3.
- Osada, Y., Ogawa, S., Ohkubo, C. & Miyazaki, K., (1974). Experimental study on the sleep interference by train noise. *Bull. Inst. Publ. Health*, 23 (3).
- Palmblad, J., Kantell, K., Strander, H., Froberg, J., Karlsson, C.-G., Levi, L., Grantstrom, M. & Unger, P. (1976). Stressor exposure and immunological response in man: interferon-producing capacity and fagocytosis. *J. of Psychosomatic Research*, 20, 193-199.
- Palmblad, J., Petrini, B., Wasserman, J., & Åkerstedt, T. (1979). Lymphocyte and granulocyte reactions during sleep deprivation. *Psychosomatic Medicine*, 41, 273-278.

**DECREASE IN STAGE REM,  
AS A MOST SENSITIVE INDICATOR OF ALL-NIGHT NOISE EXPOSURE**

Shosuke SUZUKI, Tomoyuki KAWADA, Taiichi SATO  
Seiichi NAGANUMA, Masayuki OGAWA, and Shigenobu AOKI  
Department of Public Health, Gunma University School of Medicine,  
Showa 3, Maebashi, Gunma, 371 JAPAN

(Abstract)

There has been no accepted view that stage REM is decreased most sensitively by all-night noise exposure. The authors conducted five noise exposure experiments and made sure that stage REM decreases first and most sensitively by noise among several other indicators of electroencepharogram: stage wake, S1, S2, S3+4, sleep latency, stage shifts, body movement, and others. Decrease in REM by noise may appear from the sound level of  $\geq 45$  dBA or more.

**INTRODUCTION** There are several papers that report REM time or %REM decreases due to noise exposure (Vallet et al. 1983; Jurrins et al. 1983; Griefahn 1986; Eberhardt et al. 1987), but a few papers report that it was not changed or even increased by noise exposure (Wilkinson & Campbell 1984; Griefahn & Gross 1986; Eberhardt & Axelsson 1987). The authors' five noise exposure experiments will be presented here having confirmed the decrease in stage REM by noise. They were published elsewhere mostly in Japanese: Kawada et al. 1988; Kawada et al. 1989a & b and Suzuki et al. 1991; and Sato et al. 1991; and Kawada et al. 1993.

**SUBJECTS AND METHODS** Subjects were requested not to take a nap in the daytime and not to drink alcoholic beverages. EEG electrodes were positioned according to the international 10-20 method. EEG, EMG and EOG were recorded via a telemetry system. Digital data with a sampling rate of 1/100 sec were recorded in floppy disks or in photo-magnetic disks. EEG waves and stages were judged with an computerized stage scoring system developed by us (Aoki et al. 1989) and partly by visual judgement both based on the atlas by Rechtschaffen and Kales (1968). The five experiments conducted differ a little in subjects, noise characteristics, and parameters adopted, which are shown in the table.

**RESULTS**

Experiment 1. Steady pink noise exposure of 60 dBA Three male and one female students were exposed all-night to steady pink noise of 60 dBA from a noise generator. Findings common to the four subjects compared with the respective control night EEG were decreased %REM and increased %S2. Other parameters were not common change or changed little. (Kawada et al. 1988; Suzuki et al. 1991)

Experiment 2. Steady pink noise exposure of 40, 50 and 60 dBA A 28-year-old male subject was exposed all-night to 40, 50 and 60 dBA of steady pink noise for 4 or 5 nights at each sound level and compared with the averaged stage composition of 10 control nights' EEGs. Significant changes observed were decreased %REM and increased %S2 at 60 dBA. Decrease in %REM were linear depending on the sound level. (Kawada et al. 1989; Suzuki et al. 1991)

Experiment 3. Intermittent pink noise exposure of 40, 50 and 60 dBA  
A 28-year-old subject was exposed all-night to 40, 50 and 60 dBA of intermittent

pink noise for 3 nights each with a duty cycle of 5-10 sec on and 2-12 sec off. Adverse effects of noise were pronounced at 60 dBA intermittent pink noise exposure. At this level, sleep latency and %SW increased. %REM at first increased at 40 and 50 dBA not significantly, and then decreased at 60 dBA significantly against 50 dBA. (Kawada et al. 1989b)

Experiment 4. Exposure to recorded truck-passing noise Five students were exposed one all-night to recorded truck-passing noise of peak levels: 55, 60 and 65 dBA, with intervals of 18, 13 and 31 min, respectively. Thus, a subject had 20 to 25 times of the truck-passing noise per night. Duration of the noise was 27 sec and major frequency of the noise was at 125 Hz to 2 KHz. Significant change was found only in %REM decrease in the noise exposed night compared with the quiet night by paired t-test. Other than sleep stage, total sleep time decreased in the noise exposed night. Other parameters were not changed significantly as shown in the table.

Experiment 5. Field survey of the effect of road traffic noise on sleep A paired comparison was made between sleep polygraphic parameters in a noisy apartment along a busy traffic road ( $L_{eq}$ : 46.6 dBA) and those recorded in a quiet suburban house ( $L_{eq}$ : 27.7 dBA). Five young men and three aged subjects slept in the houses and studied for total 76 nights.

The average values of 15 parameters were compared between the noisy and quiet place with the paired t-test: total sleep period or total recording time, total sleep time, sleep latency, REM latency, REM cycle, number of stage shifts, %SW, %S1, %S(3+4), %REM, %MT, %delta-epoch, and %delta-time, heart rate, and subjective sleep quality assessed with a questionnaire.

Among them, only the average %REM of young men of 23 nights decreased significantly in the noisy environment. (Sato et al. 1991)

## DISCUSSION

There are some other reports that %REM decreases by noise. Vallet et al. (1983) conducted an extensive field survey of 17 pairs of subjects in their own noisy bedroom along busy traffic roads ( $L_{eq}$ : 44.1 dB) and the noise reduced or insulated bed room ( $L_{eq}$ : 35.5 dB). There were no increase in the number of behavioral wakes, no decrease in S3 and S4, no increase in sleep latency, and no decrease in sleep time in the noisy bed-room. However, there were significant increases in %SW, decrease in %REM and REM latency, and decrease in quality of subjective sleep. REM was one of the most sensitive indicators of continuous road traffic noise exposure in  $L_{eq}$  44.1 dBA.

Griefahn and Gross (1986) carried out a home noise survey, and found increased %REM in a noisy condition of open window compared to that in quiet condition of closed window and with ear plug.

However, in another report, Griefahn (1986) recorded highway noise and exposed it to 36 students at four levels of bedroom noise of  $L_{eq}$  40, 47, 54 and 62 dBA, the amounting total to 360 nights. Among the EEG parameters, only the average REM time and %REM were reduced from 94 min in 40 dBA to ca. 80 min in  $L_{eq}$  47, 54 and 62 dBA. Other parameters did not change significantly. Subjective sleep was affected from 54 and 62 dBA by self-rating method and total awakening min per night increased also in 54 and 62 dBA by self-reporting method. Here, REM is the most sensitive parameter for all night sleep EEG which begins from  $L_{eq}$  47 dBA of highway noise among the other five EEG parameters. Subjective sleep rating was less sensitive than REM.

Home studies in the early 1980s in some EC laboratories shows are summarized. "Across subjects and conditions, wakefulness increased during soisy nights and there was a tendency to spend less time in Stage REM."(Jurrins et al. 1983 cited in Abel 1990)

In another report, Eberhardt et al.(1987) exposed continuous road traffic noise of  $L_{eq}$  36 dBA with minimum peak 34 to maximum peak 38 dB on the average and  $L_{eq}$  45 dBA with minimum peak 43 to maximum peak 47 dBA on the average. They found REM time decreased and instead SW+S1+MT increased at  $L_{eq}$  45 dBA. REM is also one of the most sensitive parameters of sleep EEG by continuous road traffic noise exposure of  $L_{eq}$  45 dBA.

TABLE Summary of the five noise exposure experiments, indicating decreased %REM in every experiment.

Experiment	Noise Exposed	Number of Subject	Significant Effects on:	No Significant Effects on:
1.	Pink, Steady 60dB	4 8 nights	%S2 ↑, %SREM ↓	%SW; %S3; %MT; Sleep lat.; REM lat.; Subjective sleep
2.	Pink, Steady 40dB 50dB 60dB	1 24 nights	%S2 ↑ & %SREM ↓ at 60dB %S3 ↑ at 40&50dB	%SW; %S1; %MT; Sleep lat.; Stage shifts
3.	Pink, Intermittent, Peak level: 40, 50 & 60dB	1 19 nights	%SW ↑ ↑, %S1 ↓, & %REM ↓ at 60dB Sleep lat. ↑ ↑ at 60dB Stage shift ↓ at 50&60dB	%S2, %S3, %MT
4.	Truck passing noise, Intermittent 3 passes per hr. Peak levels: 55, 60 & 65dB	5 10 nights	REM ↓ & %REM ↓ Total sleep time ↓	%S2; %S3; %S4; %MT; Stage shifts; Sleep lat.; Waking time; REM lat.; REM cycle; REM duration
5.	Truck passing noise, Noisy 46.6dB Quiet 27.1dB	8 5 youngs & 3 olds 78 nights	%REM ↓ of old group, only	Total sleep period; Total sleep time; REM; REM lat.; REM cycle; Stage shift; %SW; %S2; %S3+4; %MT; %delta epock; and %delta

lat.: latency in min; S1, S2, S3 and S4 are sleep stage 1, 2, 3 and 4, respectively; MT: movement time; dB: dB(A). Experiment 1, 2, 3, 4 and 5 are from Kawada et al.(1988) and Suzuki et al.(1991); Kawada et al.(1989a) and Suzuki et al.(1991); Kawada et al.(1989b); Kawada et al.(1993); and Sato et al.(1991), respectively.

## REFERENCES

- Aoki S, Kawada T, Takeuchi K, Ogawa M, Suzuki S (1988) Effects of noise on sleep. Part 1 Development of an automatic analysing system for all-night sleep polygraphy by microcomputer. Nippon Eisei Gaku Zasshi (Jpn J Hygiene) 43:1192-1101. (in Japanese)
- Eberhardt JL, Akseleson KR (1987) The disturbance by road traffic noise of the sleep of young male adults as recorded in the home. *J Sound Vib* 114:417-434.
- Eberhardt JL, Strá le L-O, Berlin MH (1987) The influence of continuous intermittent traffic noise on sleep. *J. Sound Vib* 116:445-464.
- Griefahn B (1986) A critical load for nocturnal high-density road traffic noise. *Am J Industr Med* 9:261-383.
- Griefahn B, Jansen G (1987) EEG-response caused by environmental noise during sleep. Their relationship to exogenic and endogenic influences. *Sci Total Environ* 10:187-199.
- Jurriens AA, Griefahn B, Kumar A, Vallet M, Wilkinson RT (1983) An essay in European research collaboration: common results from the project on traffic noise and sleep in the home. In: *Proc of 4th Int Congr on Noise as a Public Health Prob*, vol 2. Ed. Rossi G, Turin, Italy, pp929-937.
- Kawada T, Ogawa M, Aoki S, Takeuchi K, Suzuki S (1988) Sleep under noisy environment: analysis of sleep EEG under all night exposure of 60 dBA of pink noise exposure. Nippon Koshu Eisei Zasshi (Jpn J Public Health) 35:85-88. (in Japanese)
- Kawada T, Suzuki S, Aoki S, Ogawa M, Kimura K (1989a) Effect of noise on sleep. Part 2. A case report of the effects of three levels of stationary sound on sleep parameters. Nippon Eisei Gaku Zasshi (Jpn J Hygiene) 43:1102-8. (in Japanese)
- Kawada T, Suzuki S, Aoki S, Ogawa M, Kimura K (1989b) Effect of noise on sleep. Part 3. A case report of the effects of three levels of intermittent sound on sleep parameters. Nippon Eisei Gaku Zasshi (Jpn J Hygiene) 43:1109-15. (in Japanese)
- Kawada T, Naganuma S, Kiryu Y, Suzuki S (1993) The effect of noise on sleep. ---Changes in hypnograms of subjects exposed to repeated truck-passing sound. Nippon Eisei Gaku Zasshi (Jpn J Hygiene) 47:715-22. (in Japanese)
- Rechtchaffen A, Kales A (1968) A manual of standardized terminology, techniques and scoring system for sleep stages of human subjects. U.S. Government Printing Office, Washington D.C.
- Sato T, Ogawa M, Aoki S (1991) Effect of road traffic noise on sleep, a paired comparison between sleep polygraphic parameters recorded in a noisy apartment along a road traffic and those recorded in a quiet suburban house. Nippon Koshu Eisei Zasshi (Jpn J Public Health) 38:200-210. (in Japanese)
- Suzuki S, Kawada T, Ogawa M, Aoki S (1991) Sleep deepening effect of steady pink noise. *J Sound Vib* 151:407-413.
- Vallet M, Gagneux J-M, Balanchet V, Favre B, Labiale G (1983) Long term sleep disturbance due to traffic noise. *J Sound Vib* 90:173-191.
- Wilkinson RT, Campbell KB (1984) Effect of road traffic noise on quality of sleep: assessment by EEG, subjective report, or performance the next day. *J Acoust Soc Am* 75:468-475.

## CHANGES IN DISTURBANCE AND ANNOYANCE AS A FUNCTION OF CHANGES IN NOISE EXPOSURE

GRIFFITHS I.D.

University of Surrey

Department of Psychology

Guilford, Surrey, Great Britain

A large body of field research now shows that the psychological effects of changes in noise exposure are differentiable between activity disturbance and subjective annoyance. The relationship between noise level and activity disturbance is approximately the same before and after step-changes in exposure. However, changes in annoyance consequent upon exposure changes follow different rules from steady-state dose/response relations. This is true for both road traffic and aircraft noise.

The results indicate that, relative to steady-state, upward changes produce significantly greater changes in annoyance than would be expected (and reductions give significantly greater subjective improvement than predicted).

New data will be presented to elucidate whether changes in traffic composition (i.e. number of heavy vehicles) have similar effects.

There are implications for environmental planning.





# EFFECTS OF TRAFFIC NOISE CHANGES ON RESIDENTS' NUISANCE RATINGS

BAUGHAN Christopher and HUDDART Linda

Transport Research Laboratory, Crowthorne, Berkshire, England

## Abstract

Most information on the relation between traffic noise exposure and subjective nuisance comes from 'steady state' surveys at sites where there have not been sudden changes in noise exposure. Environmental appraisals often need to assess the effects of changes in exposure, and there is growing evidence that when noise exposure is changed, nuisance ratings change more than would be predicted from steady state relations. TRL has recently completed before and after surveys of residents at sites where traffic noise increased or decreased. The results support earlier findings of an excess change in nuisance ratings. The paper examines possible explanations of the results and their implications for environmental appraisal.

## 1 Introduction

Surveys before and after abrupt changes in traffic exposure have found that nuisance ratings change more than would be predicted from a relation between exposure and nuisance derived under "steady-state" conditions (Griffiths and Raw, 1986; Mackie and Davies, 1981; Brown et. al., 1985 and Brown, 1987). The excess change in nuisance ratings appears to be more than simply a short term effect (eg Griffiths and Raw, 1989). TRL was asked by the Department of Transport to conduct further surveys on the effects of traffic noise changes, with a view to deriving predictive equations. Results are reported in more detail by Huddart and Baughan (1993).

## 2 Method

Residents were interviewed at nine sites where traffic decreased and four where it increased. Two control sites, where no sudden change in traffic was expected, were also included. Interviews were conducted one to two months before the traffic change, and with the same people one to two months after the change. Between 33 and 50 repeat interviews were obtained per site. The ratings reported in this paper used a seven point scale with ends labelled "definitely satisfactory" and "definitely unsatisfactory". Site mean ratings are used throughout as the index of nuisance in regression analysis.

## 3 Results

Regression equations were derived, predicting change in noise dissatisfaction from change in noise exposure. Linear equations fitted the data reasonably well, but had intercepts on the dissatisfaction axis. Intercepts are likely to cause problems in environmental appraisal, since they make it necessary to specify under what particular circumstances there will be a change in noise nuisance if there is little or no change in traffic noise. One way of overcoming this problem is to use a power curve of the form  $y = ax^b$ . Curves with  $b = 0.33$  gave as good a fit as any other. The equation for the fourteen TRL sites and the seven sites studied by Griffiths and Raw is:

$$\text{Change in dissatisfaction} = 1.30(\text{change in } L_{A10,18hr} \text{ dB})^{0.33} \quad (r = 0.94)$$

Figure 1 shows this equation along with the relation derived from a TRL survey at 35 steady-state sites (Huddart, 1993). Also shown are power curves fitted separately to the increase and decrease data.

Noise dissatisfaction ratings at the control sites showed little change between the two interviews.

Figures 2 and 3 compare dissatisfaction before and after noise changes with the steady-state relation from the TRL 35 site survey. For decreases, both before and after levels differed significantly from steady state. For increases, only the after levels differed significantly from steady state.

#### 4 Discussion

Possible explanations of the findings are summarised below, along with implications for environmental appraisal.

##### 4.1 Differences between "before" and "steady-state" ratings

(i) *Awareness of a forthcoming road scheme might affect perceptions of traffic nuisance.* Any such effects ought to be excluded from environmental appraisals, but in the main study report we argue that they are probably small.

(ii) *Sites with unusually high nuisance levels might be the most likely to receive treatment.* This effect may well operate, but should anyway be included in environmental appraisals.

##### 4.2 Differences between "after" and "steady-state" ratings

(i) *Measurement bias theory:* At a given level of noise, people who have been chronically exposed and people who have experienced a change from another level may interpret the rating scales differently (Brown (1987)). This implies that both steady-state and before and after surveys underestimate the true effect of a change in noise.

(ii) *Adaptation theories:* One obvious explanation of the difference between "after" ratings and "steady-state" ratings is that "after" respondents are still at least partially adapted to their previous noise exposure. But an explanation is then needed of why the "after" ratings persist – ie why do respondents not seem to go on to adapt fully to their new conditions?

Raw and Griffiths (1990) attempted such an explanation by suggesting what are in effect two components of adaptation: behavioural coping and sensitivity. At the time of the after survey, there is already a partial movement of coping behaviour towards that found under steady-state exposure to the after conditions, together with a (mal-adaptive) change in sensitivity. Raw and Griffiths suggest that further net adaptation does not occur because coping and sensitivity either support each other at their "after" levels or undergo changes that cancel each other out.

Adaptation models imply that before and after surveys give the correct measure of change in nuisance at the time of the after survey. The Raw and Griffiths model suggests how this can also be the correct measure of longer term change.

(iii) *"After-change" sites may not be typical of steady-state sites at the same level of exposure.* This explanation again implies that before and after surveys measure a real change in nuisance.

(iv) *"After-change" people may not be typical of people living at steady-state sites with the same level of exposure.* Permanent or semi-permanent individual differences in sensitivity may result in the less sensitive people choosing to live at high exposure sites. This would imply that before and

after surveys gave the correct measure of nuisance change for those people actually experiencing the change. Although self-selection based on sensitivity seems plausible, there is little evidence that it actually happens (Job, 1991).

(v) Other theories include: *transient effects of the contrast between before and after conditions* (Langdon and Griffiths 1982), *bias in the "after" responses caused by beliefs about what is expected from the respondent* (Job, 1988), and *influence on nuisance of the respondent's attitude to the change* (Job, 1988; Scholes, 1977). In fact, the excess effect of change is now known not to be transient. An effect of attitude would generally be a true component of nuisance change. Response bias caused by the demand characteristics of the interviews are difficult to quantify, but there is some indication that they are likely to be small (Huddart and Baughan, 1993).

## 5 Conclusions

TRL surveys at sites where traffic noise has changed confirm that nuisance ratings change more than would be predicted from steady-state relations between exposure and nuisance.

It is not yet possible to say exactly what causes this excess change in nuisance ratings detected by before and after surveys. Probably a combination of the mechanisms outlined in Section 4 is at work. Candidate theories advanced so far generally imply that the effect is a real and persisting one.

The changes in traffic noise at the sites studied were caused by changes in traffic flow. The equations may not give good predictions of the effects of noise changes brought about in other ways - eg by noise screening or insulation, or the introduction of quieter vehicles or road surfaces.

## 6 Acknowledgements

The work described in this paper forms part of a Department of Transport funded research programme conducted by the Transport Research Laboratory, and the paper is published by permission of HPE Division, DOT and the Chief Executive of TRL.

## 7 References

BROWN, A L, A HALL and J KYLE-LITTLE (1985). Response to a reduction in traffic noise exposure. *Journal of Sound and Vibration*, **98**(2), 235-246.

BROWN, A L (1987). Response to an increase in road traffic noise. *Journal of Sound and Vibration*, **117**(1), 66-79.

GRIFFITHS, I D and G J RAW (1986). Community and individual responses to changes in traffic noise exposure. *Journal of Sound and Vibration*, **111**(2), 209-217.

GRIFFITHS, I D and G J RAW (1989). Adaptation to changes in traffic noise exposure. *Journal of Sound and Vibration*, **132**(2), 331-336.

HUDDART, L (1993). The extent of traffic nuisance at different times of the day and night. *Department of Transport, TRL Project Report (in publication)*. Transport Research Laboratory, Crowthorne.

HUDDART, L and C J BAUGHAN (1993). The effects of traffic changes on perceived nuisance. *Department of Transport, TRL Research Report (in publication)*. Transport Research Laboratory, Crowthorne.

JOB, R F S (1988). Over-reaction to changes in noise exposure: the possible effect of attitude. *Journal of Sound and Vibration*, 126(3), 550-552.

JOB, R F S (1991). Impact and potential use of attitude and other modifying variables in reducing community reaction to noise. *Transportation Research Record*, 1312, 109-115.

MACKIE, A M and C H DAVIES (1981). Environmental effects of traffic changes. *Department of the Environment, Department of Transport TRRL Report LR1015*. Transport Research Laboratory, Crowthorne.

RAW, G J and I D GRIFFITHS (1990). Subjective response to changes in road traffic noise: A model. *Journal of Sound and Vibration*, 141(1), 43-54.8

SCHOLES, W E (1977). The physical and subjective evaluation of roadside barriers. *Internoise*, A 144-153.

Crown Copyright 1993. The views expressed in this paper are not necessarily those of the Department of Transport.

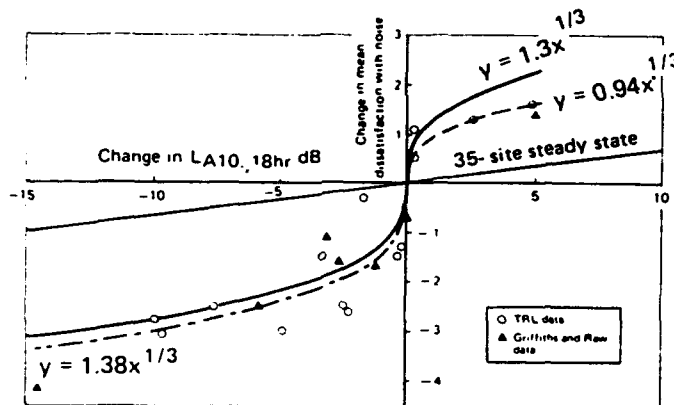

Fig. 1 Power fit to data from TRL and Griffiths and Raw Surveys

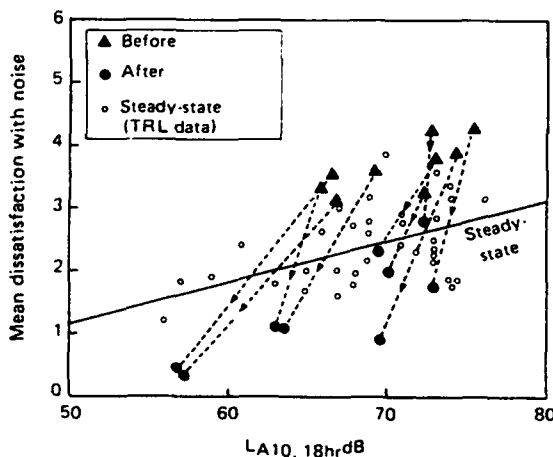

Fig. 2 'Before' and 'After' data for decrease sites

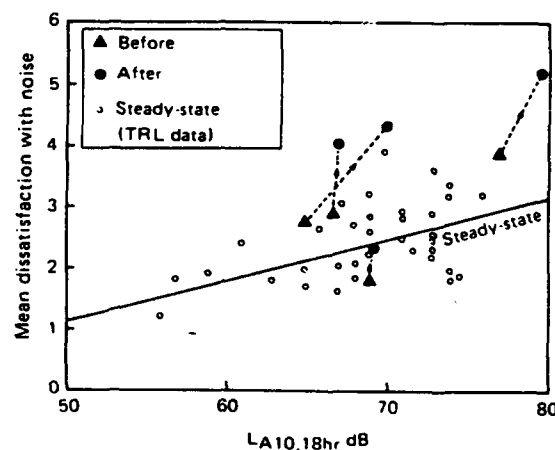

Fig. 3 'Before' and 'After' data for increase sites

**COMMUNITY RESPONSE TO NOISE  
FROM A SHORT TERM MILITARY AIRCRAFT EXERCISE**

GJESTLAND Truls  
GRANØIEN Idar L N  
LIASJØ Kåre H  
Acoustics Research Center, Trondheim, Norway

BUGGE Jens-Jørgen  
Norwegian Defense Construction Services

**ABSTRACT**

A study of community reactions to noise in the vicinity of a Norwegian airport has been conducted in connection with two large military exercises. This paper presents the results with an emphasis on the data from a panel of respondents. These results indicate that the general assessment of aircraft noise annoyance is not altered by short periods with increased noise exposure.

**SOMMAIRE**

Une étude sur les réactions de la population au bruit à proximité d'un aéroport a été menée en relation avec deux importants exercices militaires. Cet article présente les résultats de cette étude. Il souligne particulièrement les données d'une groupe de référence. Ces résultats montrent que des nuisance sonores causées par les avions n'est pas altéré par des périodes avec une exposition au bruit redoublée.

**BACKGROUND**

An extensive study of community reactions to aircraft noise has been conducted in the vicinity of a Norwegian airport that serves both civil and military traffic. This study has been initiated and financed by the Norwegian Defence Construction Services. Twice in the study period two large military exercises took place. During these exercises the total noise exposure increased on an average by 6 dB for a period of 2-3 weeks. The total group of more than 3,400 respondents also contained a panel. The reactions among these individuals were monitored throughout the study period. We have detailed information on an individual basis, and we can therefore analyze the data with respect to changes in the response for each single individual.

**STUDY DESIGN**

The exercises took place in March and September 1992. Telephone interviews were conducted before, during and after the first exercise and before and after the second exercise. Figure 1 shows a time diagram for the interviews and exercise periods. Noise measurements and radar tracking of the air traffic were also carried out in order to get a precise description of the total noise situation.

About 500 naive respondents participated in each series of interviews together with a panel of about 200. The questionnaire was presented as a general survey of neighborhood condition, and also contained a number of non-aircraft related issues.

**NOISE SITUATION**

The noise levels in the area have been recorded and compared with results from the INM aircraft noise calculation program, using the actual air traffic as input. For the remainder of this paper we have used calculated noise levels. The Norwegian aircraft noise index, EFN, is an integrated time

weighted noise index. For most practical purposes the EFN levels in this paper can be considered the same as DNL.

In this paper we have combined the results from respondents in within each 5 dB range, 36-40 EFN, 41-45 EFN, etc. The reference noise level is always based on the normal aircraft activity, disregarding the increased noise load during the two exercise periods.

## RESULTS

At an early stage in the interview the respondents were asked to list things they liked or disliked about their neighborhood. At that time there had been no reference to aircraft noise. We assume that people who voluntarily mention dissatisfaction about aircraft noise are genuinely annoyed by this phenomenon. The results are shown in Figure 2. In general the dissatisfaction is low, and the respondents do not seem to be influenced by the large increase in aircraft activity during the exercise (series 2).

The respondents were also asked directly: "Have you heard noise from aircraft while being at home the last month?". If the answer was positive, the following question was asked: "Would you consider this noise very annoying, quite annoying, a little annoying or not annoying?" The percentage that consider themselves "very annoyed" is shown in Figure 3. The scores are low, and there are no noticeable increase during the exercise.

The effect of the March exercise was studied in detail by observing the shift in response by the panel. These individuals were given identical questions throughout the study, and we can see how the response varies. Figure 4 shows the shift in response from February to March. The figure indicates the percentage of the panel members that considers the noise during the exercise less, equal to or more annoying than the noise situation before the exercise. The upper solid line shows the sum of respondents considering the new noise situation less or equally annoying. Only about 20 percent regard the noise situation during the exercise more annoying than before, even though the increase is as much as 6 dBA.

A similar effect can be observed before and after the exercise in September. Figure 5 shows the difference in response before and after the aircraft maneuver. There is no indication that the high noise levels during the September maneuver have caused a permanent shift in the assessment of noise annoyance.

An even more clear picture is derived by analyzing the total response to the question about aircraft noise annoyance the past month. Scale values 1 to 4 have been assigned to the response: very annoyed = 1, quite = 2, etc. Table 1 shows the average response for each series. At noise levels 46-50 EFN the average respondent is a little more than "not annoyed", and even at noise levels 66-70 EFN the average response is only slightly more than "a little" annoyed.

Table 2 shows the average shift in response between the different periods. The largest shift is from February to August. People seem on an average a little more annoyed by aircraft noise in August than in February. A reason for this can be that more time is spent outside during the summer. The shift, however, is not significant. The average shift from before to after the two maneuvers, -0.02 in the spring and +0.02 in the summer is not significant.

## CONCLUSIONS

The community response to aircraft noise around this Norwegian airport seems very stable. The response is not altered by a short term (2-4 weeks) increase in the noise load of the order of 6 dBA. Even during the peak of a military aircraft exercise the average assessment of noise annoyance is not significantly changed compared to the response during normal conditions. This reaction is observed among naive respondents and also among a panel of about 200 individuals that were monitored throughout the study period.

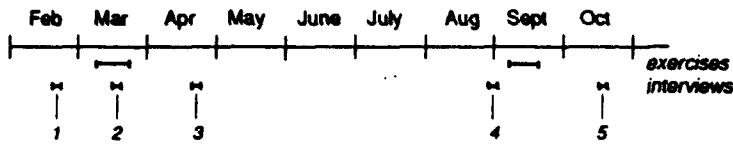

Figure 1. Interview periods and aircraft exercises

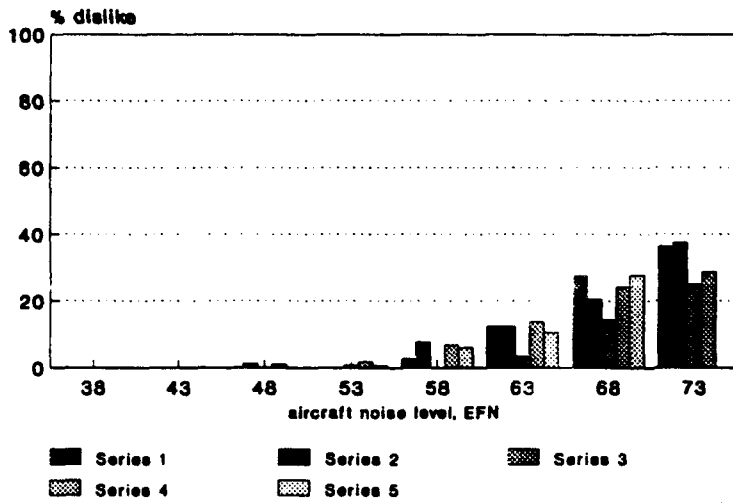

Figure 2. Percentage of all respondents that voluntarily mention they dislike aircraft noise in their community

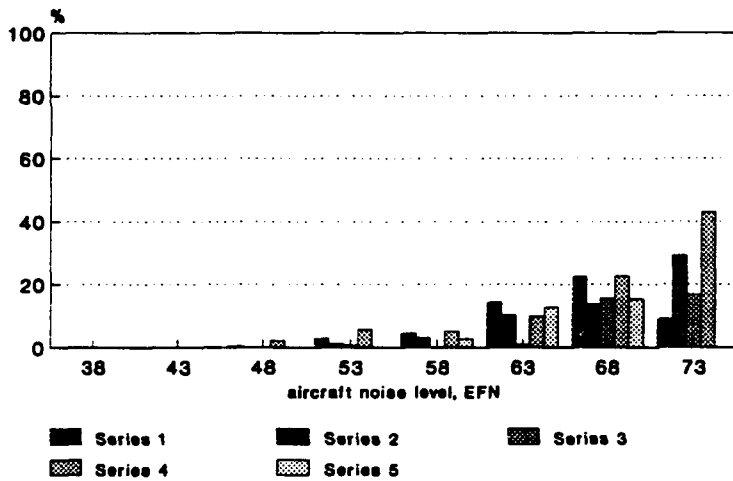

Figure 3. Percentage of all respondents that consider themselves "very annoyed" by aircraft noise

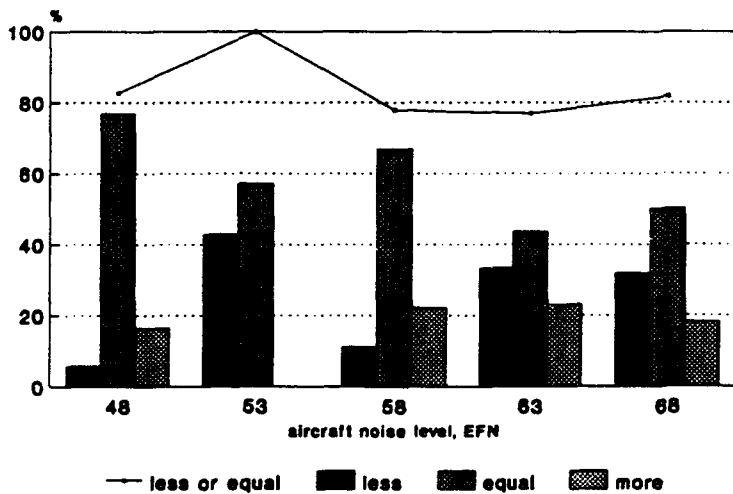

Figure 4. Percentage of panel that consider the noise during the March exercise being less, equally or more annoying than the situation before the exercise

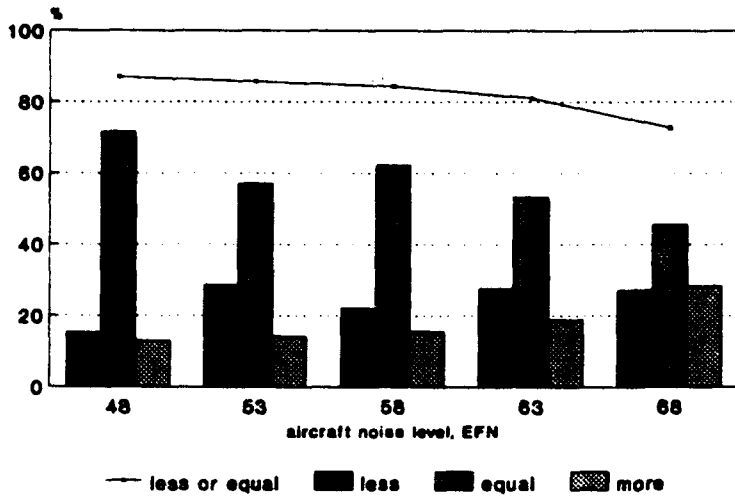

Figure 5. Percentage of panel that consider the noise after the September exercise being less, equally or more annoying than the situation before the exercise

Table 1. Mean annoyance score and standard deviation for all five studies  
1: very, 2: quite, 3: a little, 4 not annoyed

noise	February		March		April		August		October	
	A	$\sigma$	A	$\sigma$	A	$\sigma$	A	$\sigma$	A	$\sigma$
48	3.77	0.51	3.64	0.72	3.58	0.75	3.78	0.59	3.72	0.81
53	3.43	0.79	3.86	0.38	3.71	0.49	3.29	0.76	3.57	0.54
58	3.53	0.80	3.33	1.02	3.47	0.85	3.38	0.89	3.42	0.94
63	2.80	1.13	2.95	1.10	3.00	1.03	2.76	1.14	2.84	1.07
68	2.68	1.21	2.82	1.10	2.73	1.12	2.96	1.13	2.96	1.21

Table 2. Shift in panel response, mean and standard deviation

noise	Mar-Feb		Apr-Feb		Apr-Mar		Aug-Feb		Oct-Feb		Oct-Aug	
	A	$\sigma$	A	$\sigma$	A	$\sigma$	A	$\sigma$	A	$\sigma$	A	$\sigma$
48	-0.14	0.53	-0.19	0.77	-0.06	0.70	-0.07	0.57	-0.13	0.83	-0.07	0.85
53	+0.43	0.53	+0.29	0.76	-0.15	0.38	-0.14	0.38	+0.14	0.69	-0.29	0.76
58	-0.19	0.99	-0.06	0.74	+0.14	0.79	-0.22	0.82	-0.18	0.89	0.04	0.82
63	+0.15	0.93	+0.21	1.01	+0.05	0.79	-0.11	1.24	-0.03	1.28	+0.08	1.01
68	+0.14	1.13	+0.05	0.95	-0.09	1.02	+0.36	1.47	0.36	1.22	0.00	1.38
total	-0.03	0.87	-0.02	0.85	+0.01	0.78	-0.08	1.00	-0.06	1.04	+0.02	0.95



# REACTIONS OF PEOPLE TO URBAN TRAFFIC NOISE in MODENA, ITALY

\*BERTONI Daniele, \*FRANCHINI Andrea, \*MAGNONI Marco, \*\*TARTONI Pierluigi,  
\*\*\*VALLET Michel.

\*Unità Sanitaria Locale n° 16, Modena (I);

\*\*Chair of Biometric and Medical Statistics, University of Modena (I);

\*\*\*INRETS, Bron (F).

## ABSTRACT

A study is made of the relationship between traffic noise and the subjective and behavioural reactions of people living in Modena, drawing a distinction between the disturbance experienced with windows open and with windows shut. The reactions are also studied in the light of individuals' exposure to noise in the workplace, and a multifactorial analysis attempts to explain the higher percentage of variance reflected in the disturbance than in the noise itself.

## INTRODUCTION

This first large-scale socio-acoustic study to be conducted in Italy is based on a model, adopted in other countries during the '70s and '80s, of which both the methodologies of social enquiry and the noise measurement techniques have been gradually refined with the end in view of assigning realistic exposure parameters to the subjects interviewed. The aims are to identify thresholds above which significant reactions are triggered, and to assess the collective reactions to external noise and other non-acoustic factors.

## MATERIALS AND METHODS

The sample consisted in 908 subjects between 18 and 70 years of age, living in three acoustically dissimilar types of urban area (residential, mixed, and with heavy road traffic) and exposed variously to equivalent continuous noise levels ( $Leq_{7-19h}$ ) between 49 and 76 dB(A) [1]. The level of exposure assigned to each interviewee is based on measurements taken over 24 hours in reference buildings, in conjunction with transitory measurements serving to establish the differences in level according to the side and storey of the building occupied by the individual.

Social conditions were researched using an EEC questionnaire [2], adapted to the local situation and introducing as new items the evaluation of disturbance with windows open and windows closed, also questions on professional status which allow of assessing Personnel Exposure Levels (LEP) in the workplace.

## DISCUSSION OF RESULTS

### Behavioural effects

One set of questions was designed to confirm and quantify certain behavioural effects caused by traffic. The effects most reported (by over 20% of subjects) were the difficulty in listening to Hi-Fi or TV, the impossibility of keeping windows open or sitting out on balconies, and annoyance when reading. From a comparison of the mean values of  $L_{dn}$  and the conditions reflecting nil disturbance and maximum annoyance, two thresholds emerge: a first of between 60 and 62 dB(A) above which all the effects in question are manifested to a moderate degree, and a second of 68 and 70 dB(A) above which situations of constraint are experienced (fig 1).

### Subjective disturbance

Fig 2 shows the correlations between daytime traffic noise and the percentage of interviewees affected. The two curves, "windows open" and "windows shut", are constructed by calculating the percentage of subjects per nominal level of exposure who, being at home for at least 3 half-days per week, claimed to be greatly or significantly disturbed.

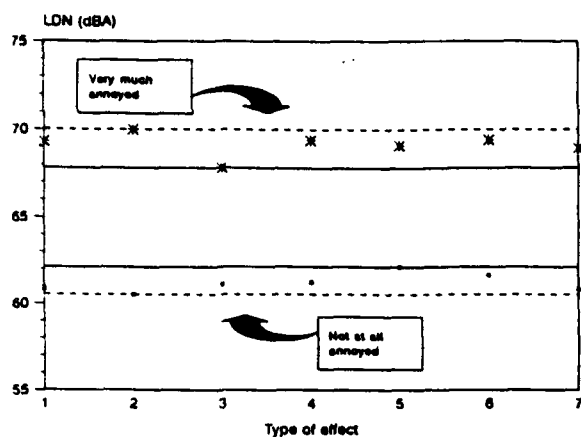

### TYPE OF EFFECT

- 1) Conversation disturbed
- 2) Windows cannot be kept open
- 3) Hi-Fi/TV difficult to hear
- 4) Reading disturbed
- 5) Difficulty in sleeping
- 6) Waking early
- 7) Relaxation spoiled

Fig 1 Mean value bands of Ldn reflecting the level of disturbance in 7 types of effect

Comparing the middle parts of the curves in fig 2 (60 - 70 dB(A)), at a given level of exposure, it will be seen that the numbers affected in the "windows open" condition are some 20-30% higher than in the "windows shut" condition. The difference is less in the bottom part of the curves, at modest levels of exposure, since the insulation afforded by the windows provides no benefit at low sound pressure levels, whereas the top part of the "windows open" curve indicates a tendency toward saturation that is absent with the windows shut.

—  $y=97.82/(1+\exp(18.20-0.29x))$ ;  $r^2=0.961$   
 - - -  $y=0.13x-12.87x+323.30$ ;  $r^2=0.928$

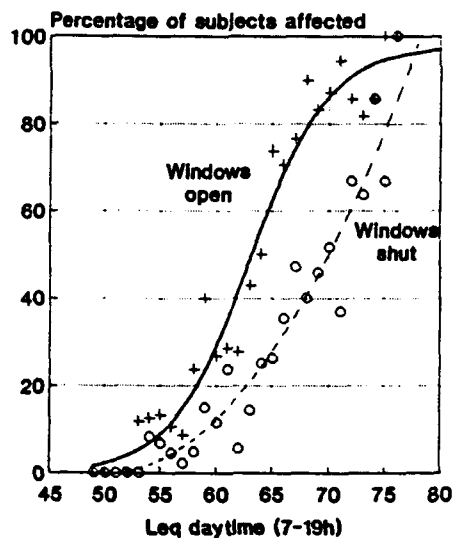

Fig 2 Correlation between percentage of subjects affected and noise level

—  $y=9.95/(1+\exp(14.08-0.23x))$ ;  $r^2=0.959$   
 - - -  $y=0.31x-15.97$ ;  $r^2=0.907$

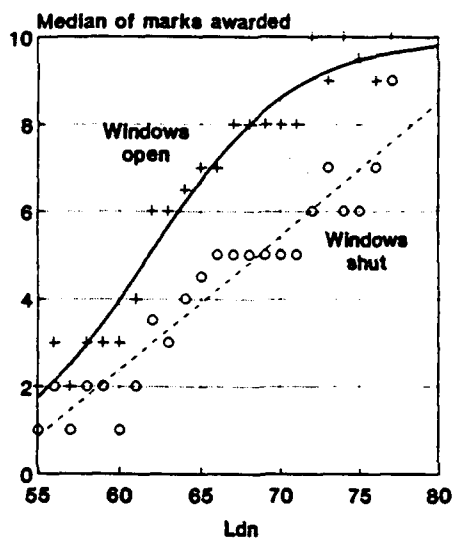

Fig 3 Correlation between median of marks awarded and noise level

### Relation of noise to disturbance

Each interviewee was asked to award a mark out of ten (0 - 10), reflecting the disturbance produced by traffic noise in his or her own home with windows open and with windows shut. Computation of the correlations between the individual marks and the external noise level Ldn, introduced to take account of overall noise (day + night), produced the following coefficients calculated according to Spearman:

windows open:  $r = 0.67$  ( $p < 0.01$ )  
 windows shut:  $r = 0.56$  ( $p < 0.01$ )

On the basis of  $r^2$ , it can be affirmed that the figures of 44.8% with windows open and 33.6% with windows shut are explained by noise. These coefficients are among the highest obtained in correlations of individual data [3], which suggests that the improvement is gained thanks to the device of discriminating between open and shut windows and to the high number of acoustic measurements effected in determining the nominal exposure levels. Having also calculated the median of the disturbance marks awarded by individuals exposed to the same nominal noise level, the body of gathered data allows the construction of a graph reflecting the relationship between noise and disturbance (fig 3).

As the comparison shows, the degree of disturbance from a given external level of noise above 60 dB(A) registers lower by 2 or 3 marks when the windows are shut, or in practice, the effect of closing the windows is to retain the same disturbance mark while the external noise level rises by 5 to 10 dB(A).

### Influence of exposure to noise in the workplace

From an analysis of his or her type of employment, and applying occupational noise levels furnished by a databank, each working interviewee was assigned a relative Personnel Exposure Level (LEP) [4]. The 513 subjects of the sample in this category were grouped into 3 LEP classes (LEP <70 dB(A): 233 subjects; LEP 70-80 dB(A): 220 subjects; LEP >80 dB(A): 60 subjects) and 3 classes of exposure to environmental noise ( $Leq_{19-22h}$  <58 dB(A);  $Leq_{19-22h}$  58...63 dB(A);  $Leq_{19-22h}$  >63 dB(A)), and a comparison was drawn with 389 subjects not exposed to occupational noise.

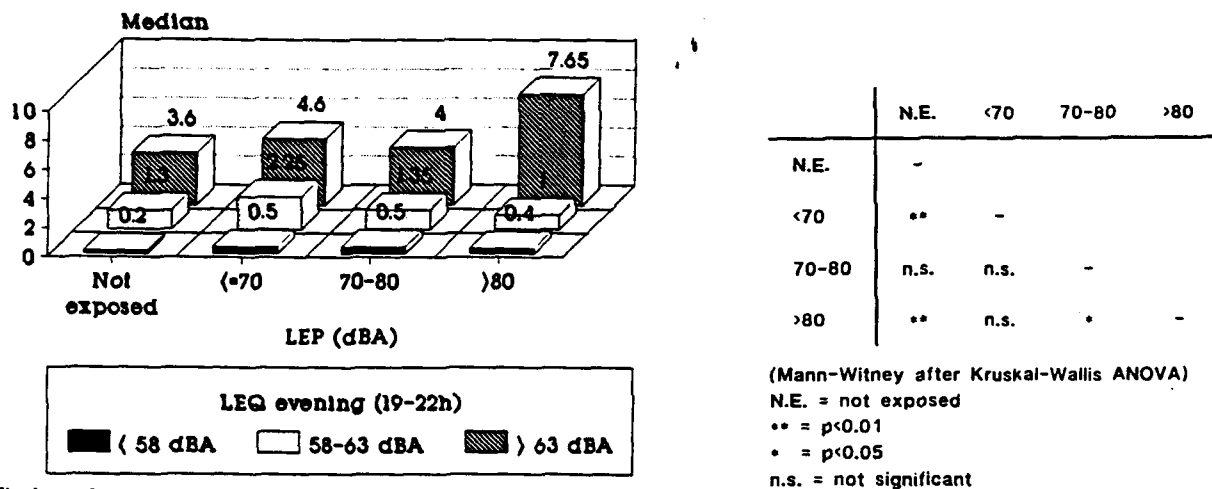

Fig 4 Influence of exposure to noise in the workplace on the disturbance at home due to traffic noise

Fig 4 shows clearly that subjects classified LEP >80 dB(A) and exposed to the highest levels of environmental noise invariably report the highest level of disturbance. This suggests the likelihood that the exposure to occupational noise and the exposure to traffic noise combine synergically in determining the degree of discomfort endured in the home.

### Influence of non-acoustic factors

Fig 5 summarizes the results of a canonical analysis of the two sets of variables considered. Analyzing the canonical redundancy [5], it becomes possible to quantify the degree of variance of the criterion set variables as explained by the predictor set variables, which emerges at 54% approximately, whereas the simple correlation between disturbance and noise accounts for no more than 44.8% of the variance.

The illustration allows a more detailed interpretation of the relationships between the variables: whilst certain factors have only a limited bearing on the overall picture, namely the frequency of visits to the doctor, size of household, size and type of dwelling, school age and income, others

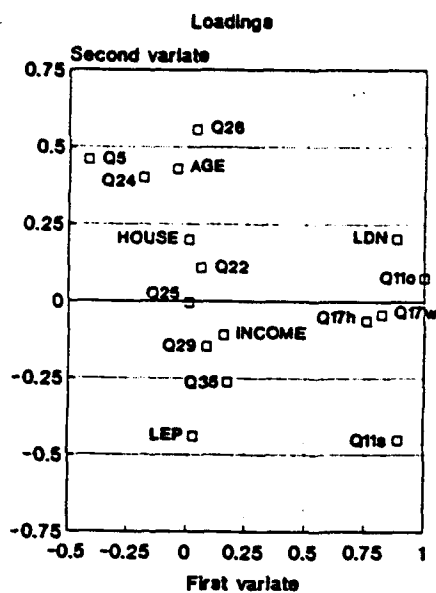

#### Predictor set variables

Q5 = satisfaction with neighbourhood  
 Q17w = windows cannot be left open  
 Q17h = Hi-Fi/TV listening disturbed  
 Q22 = number of medical visits p/a  
 Q24 = ownership of dwelling  
 Q25 = size of household  
 Q26 = sound insulation of windows  
 Q29 = type of dwelling  
 Q34 = school leaving age  
 HOUSE = size of dwelling  
 Ldn = day/night level  
 LEP = personnel exposure level

#### Criterion set variables

Q11o = disturbance with windows open  
 Q11s = disturbance with windows shut

Fig 5 Canonical structure

such as Ldn, the impossibility of keeping windows open, frustration when listening to Hi-Fi and TV and, inversely, the satisfaction with the neighbourhood, are significant in determining the perception of disturbance attributable to traffic noise with windows open (1st variate). Other factors appear to have a more specific influence on the perception of disturbance in the "windows shut" condition (2nd variate), namely LEP and, inversely, the sound insulation afforded by the windows, age, and size of household.

### CONCLUSIONS

The most significant results obtained consist in the satisfactory correlation between disturbance and individual external noise data, in the observation of a possible tendency of occupational noise to heighten the annoyance caused by environmental noise, and in the discovery that certain non-acoustic variables produce a higher percentage of variance attributable to disturbance than that attributable to sound level alone. In general terms there would appear to be a threshold in the region of 60 to 62 dB(A) Ldn above which a whole series of behavioural effects begin to be triggered by external noise. With the recent enactment of Italy's first laws limiting environmental noise, the importance of these results will be self-evident.

### NOTE

The procedure of assessing and assigning Personnel Exposure Levels (LEP) in the workplace was directed by Dr O. Nicolini, of the Servizio di Medicina del Lavoro (Occupational Medicine Dept), USL 16 Modena.

Mr. S. Simonini collaborated in the taking of noise level readings.

### BIBLIOGRAPHY

- 1) Bertoni D., Franchini A., Magnoni M.: Il rumore urbano e l'organizzazione del territorio (Urban noise and the organization of territory); Pitagora Editrice, Bologna - 1988.
- 2) Diamond I.D., Walker J.G.: An international study of the influence of residual noise on community disturbance due to aircraft noise; proceedings -Inter-Noise '86.
- 3) Job R.F.S.: Community response to noise: a review of factors influencing the relationship between noise exposure and reaction; JASA 83 (3) March 1988.
- 4) Bertoni D., Franchini A., Magnoni M., Nicolini O., Tartoni P.L., Vallet M.: L'influence du bruit au travail sur la gêne due au bruit dans l'habitat. (The influence of noise in the workplace on disturbance due to noise in the home). Act du colloque J. Cartier, Lion, 1990.
- 5) Wollenberg A. L.: Redundancy analysis: an alternative for canonical correlation analysis. Psychometrica, 41, 207-219, 1977.

# **SUBJECTIVE EFFECTS AND OBJECTIVE ASSESSMENT OF COMBINED TONAL AND IMPULSIVE NOISE.**

**PORTER Nicole D and BERRY Bernard F.**

**National Physical Laboratory, Teddington, Middlesex, TW11 0LW, U.K.**

## **ABSTRACT**

At the last International Congress on Noise as a Public Health Problem in 1988, results were presented of work carried out at NPL and elsewhere on the EC Joint project on Impulse Noise. That project formed part of the 4th Environment Programme (1). NPL's task was to investigate the relationship between the physical description of a large number of impulsive noises, and subjective data on annoyance and impulsivity, in order to derive an optimum rating procedure.

Recently, in a project sponsored by the UK Department of Environment, the previous research is being extended to the general problem of the assessment of industrial noise, to explore the effects of tonality and impulsiveness on subjective annoyance. Laboratory experiments are being conducted on the judged annoyance of specific types of industrial noise. The emphasis is on the use of actual recordings from existing sites, rather than simulations. Results of the initial experiments using tonal fan noise, compressor noise, and traffic noise were presented at Euronoise '92 (2).

In this paper we describe recent experiments using various combinations of tonal, impulsive and traffic noise. The results are aimed at providing a better understanding of the subjective response to noises with more than one feature.

## **RÉSUMÉ**

Cet article présente les dernières expérimentations menées au NPL concernant différentes combinaisons entre des bruits à caractère tonal, des bruits impulsifs et du bruit de trafic routes. Les résultats ont cherché à fournir une meilleure compréhension des effets subjectifs des bruits complexes comprenant les bruits précités.

## **1. INTRODUCTION**

Whilst the EC research work has led to the development of rating procedures for impulsive noise, and ISVR and NPL are continuing work on tonal penalties, the treatment of noise environments with combined tones and impulses also needs further clarification. For example, although the method contained in ISO 1996 (3) involves numerical addition of the adjustments for tonal and impulsive noise, the British Standard rating method (4) states that only a single 5 dB correction should be added if more than one of the characteristics is present. Alternatively, other approaches different to these "combined index" rating methods currently being explored in the UK (5) suggest that each feature should be examined separately and the measures of the separate features should not be combined. To assist with this clarification, we have conducted experiments which investigate the subjective rating of different combinations of tonal, impulsive and traffic noise.

## **2. AIMS OF EXPERIMENT**

- (1) To investigate the subjective rating of noise with more than one feature.
- (2) To improve our understanding of individual response to noises with various features.
- (3) To examine the requirements of an objective assessment procedure for rating combined features.

### 3. EXPERIMENTAL PROCEDURES

#### 3.1 Test Facilities

The experiments were carried out in the NPL listening room. The room is carpeted and furnished to give a reasonable simulation of domestic living room conditions. The presentation of the noises was automated using a LabWindows programme on a Toshiba T5200 PC controlling a Sony DAT player. All the test noises were digitally recorded at industrial sites and reproduced through a digital filter to account for the attenuation characteristics of a window/wall arrangement. The subjects were monitored by a closed circuit TV.

#### 3.2 Parametric tests

There were three component test noises, a tonal fan noise, traffic noise and an impulsive industrial type noise. Each component sound was presented at  $L_{eq(1min)}$  levels of 35, 45 and 55 dB(A) in various combinations. 24 noise combinations were presented to 24 subjects. The order of presentation of the combinations of noises was based on a balanced Latin square arrangement. At the end of the presentation of a noise the listeners were asked to make judgements using a numerical scale in answer to the question: "If you were in your own living room in the evening, do you think that you would be annoyed or upset by the sound you have just heard if it was present all of the time?"

#### 3.3 Non-parametric tests - interactive discussions

Following the presentation of the various combinations of noises, there was a short interactive discussion session during which the subjects were asked about the relative importance of each component when making an annoyance judgment. This commenced with all the component levels at 55 dB(A). After establishing whether this sound was annoying, the listeners were asked to describe any aspect of the sound that was particularly noticeable or annoying. They were then told that the experimenter could take action to control the sound and if one aspect of the sound could be changed, which aspect would the listener like to have changed. The listeners usually identified a feature of the noise attributable to the presence of one of the component noises e.g. banging, thumping, high pitch whine or whistle, and therefore the relative level of that component was reduced. However, on reducing a component level, an adjustment was made to keep the overall level constant so that the listeners were judging the relative combinations and not the overall levels of the sounds. This process was repeated as many times as possible.

### 4. RESULTS AND DISCUSSION

There will be a more complete analysis and discussion of the detailed results in the presentation of this paper at the time of the conference together with statistical analysis including the analysis of variance and an examination of interaction effects. However, due to limited space, we have only presented a few results in this paper.

#### 4.1 Parametric tests

Annoyance scores were shown to be relatively independent of traffic noise levels suggesting that the features contained within the traffic noise component are much less dominant in determining an adverse response than the features contained within the tonal and impulsive noise components.

Figure 1 is a three dimensional plot showing the mean annoyance scores with the various combinations of tonal and impulsive components. Since the effect of changing the level of traffic noise component was shown to be relatively insignificant in this experiment, this graph uses the mean annoyance scores where the traffic noise component was presented at 35 dB(A) at all times. The standard deviations of the mean annoyance scores ranged from 0.86 to 2.58,

the lowest standard deviations being for the cases where the impulsive component was at its maximum level, and the highest standard deviations in the cases where the impulsive noise was at its lowest level.

For this experiment, the added annoyance due to more than one feature in a noise cannot be easily represented by the simple addition of one or more "effective penalties". Should an "effective penalty" be examined, it would have to be level dependent and would depend on the subjective ranking and evaluation of any dominant features and on the main interaction effects with more than one feature present.

For this experiment, with the impulse component at its maximum level, the mean annoyance response is relatively independent of the level of the other components. This suggests that at an  $L_{eq(tmin)}$  level of the impulse component at 55 dB(A), the feature giving rise to the impulse component is dominant and has exceeded a threshold of annoyance. Combined rating procedures may conceal the information that the impulse component is the main cause for annoyance, and the best form of initial noise control would be to reduce the level of the impulse feature until it is no longer the dominant feature.

#### 4.2 Non-parametric tests

For the same  $L_{eq(tmin)}$  of 55 dB(A) of each component noise, 70 % expressed the opinion that the feature that they would prefer to be reduced in sensory magnitude was that giving rise to the impulsivity characteristic i.e. that at this level the impulse feature was the most dominant feature before tonality and absolute noise level. This supported the results of the first part of the experiment. For these subjects, as the relative level of the impulse component was reduced, the feature reported as the main cause of an adverse response gradually changed from the impulsive to the tonal nature of the noise.

Some of the differences in response between individuals can be attributed to the difference between the perception of relative importance of the components with respect to the subjective assessment of their thresholds of detectability and of annoyance. Some listeners reported that if a specific characteristic could be detected then the noise was unacceptable. This usually occurred with the detection of the impulse component. Other listeners expressed the opinion that although they could still hear the impulse or tone, these would not annoy them.

In general the listeners showed a good capability of identifying and describing characteristics of the noises which were responsible for giving rise to an adverse response.

### 5. CONCLUSIONS

We should note that the noises in this experiment form only a very small subset of possible noises exhibiting the characteristics of impulsivity and tonality. However, the results have confirmed that for the noise components used in this experiment, the rating of noise with more than one feature is not simple. Subjective response depends on the interaction effects between the judgment of features and where there is a dominant feature, the subjective evaluation of that feature. Any objective rating procedure requires good descriptors of the physical magnitudes of the various features that are meaningful in terms of the subjective characteristics that they are supposed to represent. Care should be taken when combining separate measures of features into overall indices since this may conceal information about the main cause for an adverse reaction e.g. in the case of a dominant feature. More detailed analysis will be discussed at the time of the conference. Further analysis of this work will be used to test a number of models such as those referred to by Vos (6), e.g. the dominance

model, energy summation models, independent effects model etc. The experiment has provided us with some subjective ratings of noises with more than one feature, has increased our understanding of individual response to these noises and has started to examine the requirements of an objective assessment procedure.

## 6. REFERENCES

1. Berry, B.F. and Bisping, R. EC Joint Project on Impulse Noise: Physical quantification methods, Proc. 5th International Congress on Noise as a Public Health Problem, 1988, Vol.3,p152-158.
2. Berry, B.F and Porter, N.D. The subjective and objective assessment of industrial noise. Proceedings of Euronoise '92, London. Proc. I.O.A Vol 14 Part 4 (1992) p383-395.
3. International Organization for Standardization. "Acoustics - Description and measurement of environmental noise" ISO 1996 Part 1: 1982, Parts 2 and 3: 1987.
4. British Standards Institution 1990. "Method for rating industrial noise affecting mixed residential and industrial areas", BS 4142:1990.
5. Porter, N.D, Flindell, I.H, Berry, B.F. An acoustic feature model for the assessment of environmental noise. Proceedings of Acoustics '93, Southampton, Proc. I.O.A. 1993.
6. Vos, J. Annoyance caused by simultaneous impulse, road-traffic and aircraft sounds: A quantitative model, J.A.S.A. 91(6), p3330, 1992.

## 7. ACKNOWLEDGEMENT

NPL would like to acknowledge the financial support of the UK Department of Environment.

Figure 1: The mean annoyance response to noise with various combinations of tone and impulse noise components with the traffic noise component at  $L_{eq(1min)}$  of 35 dB(A).

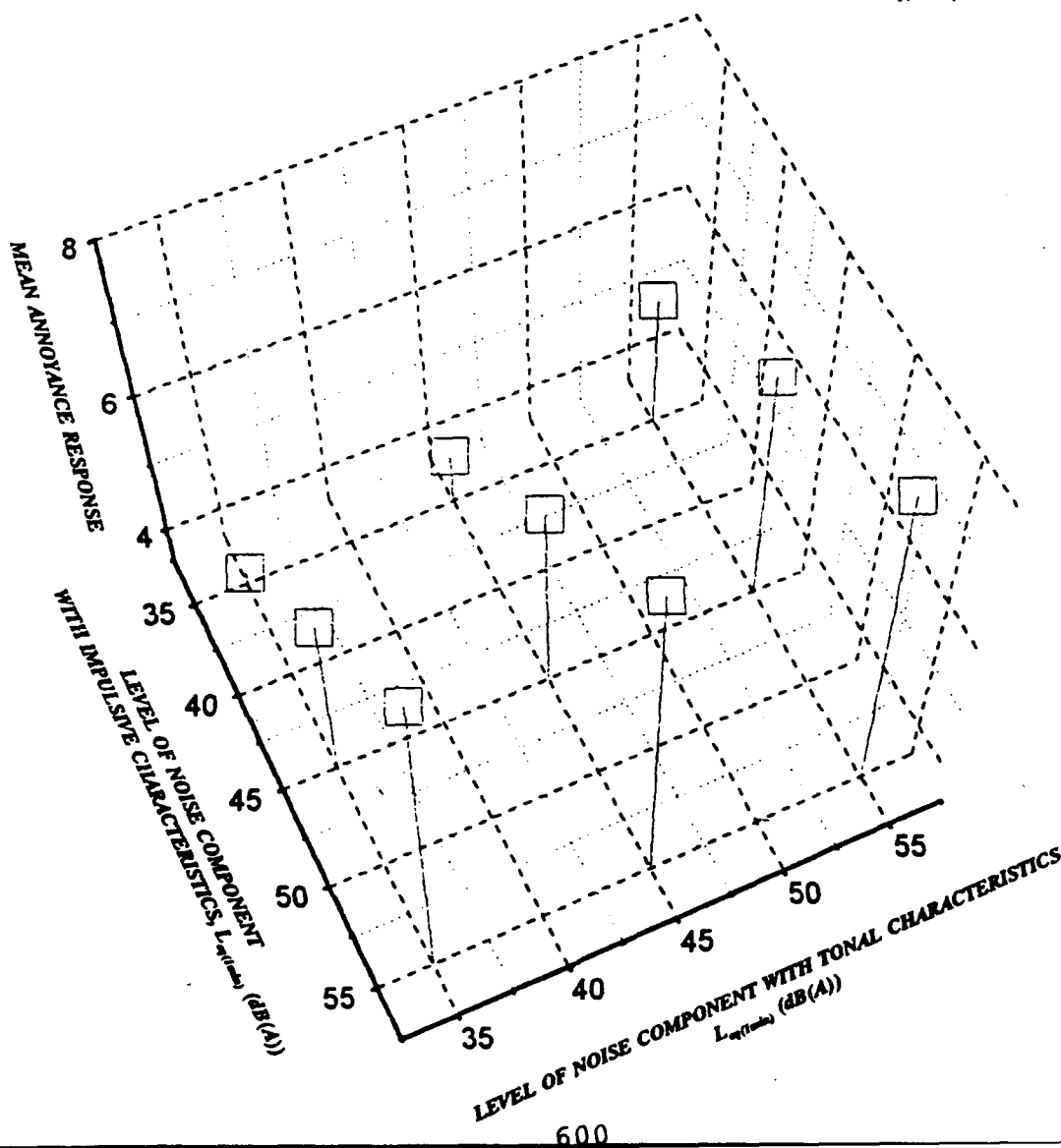



# LOUDNESS PERCEPTION AND ANNOYANCE OF IMPULSIVE NOISE MEASURED IN THE LABORATORY

MELONI Tommaso, KRUEGER Helmut

Department of Hygiene and Applied Physiology  
Swiss Federal Institute of Technology  
8092 Zurich, Switzerland

A system to simulate impulsive noise (shooting noise) in the laboratory was developed. The signals (stimuli) were presented in a test room resembling a typical living room. In order to be able to rate the loudness and the degree of annoyance, resp. disturbance, a method based on magnitude production was utilized. The subjects were asked to adjust a reference stimulus so as to achieve the same degree of disturbance as that of a test stimulus. They could regulate the sound level of this reference stimulus at will. To validate the method, two types of reference signal were employed: a real gunshot and an artificial noise resembling that of a passing car. In addition this "relative" method was compared with the results obtained with an absolute scaling method as has been widely employed in previous research. With the applied method ratings of various noise sources such as railway, road and aircraft noise can be based on the same auditory scale, i.e. the reference noise. Based upon the initial results it may be concluded that this method leads to reproducible and accurate findings.

Pour mesurer l'effet d'un bruit impulsif sur l'homme, on a construit un salon où on pouvait simuler exactement de telles immissions de bruits (des coups de feu). Pour évaluer la perception du volume, le degré des ennuis ou celui de la perturbation, une méthode psychométrique a été développée basée sur la production de magnitude (magnitude production). Les sujets d'expérience avaient perçu un stimulus fixe à examiner et ils étaient invités à régler un stimulus de référence du même degré de perturbation. La puissance du stimulus de référence pouvait être réglée continuellement par les cobayes. Pour évaluer cette méthode, on a changé la qualité du stimulus de référence: un vrai coup de fusil et un bruit artificiel tel qu'une voiture qui passe. Cette méthode relative a aussi été comparée à une méthode pour l'estimation absolue utilisée fréquemment dans des recherches antérieures. On a essayé ainsi de définir une échelle auditive. A l'aide de cette échelle auditive, des perceptions ultérieures de bruits différents comme un train, la circulation routière ou aérienne pourront être comparées par les sujets d'expérience. A partir des premiers résultats, nous avons montré que cette méthode menait à des conclusions reproductibles et sérieuses.

## INTRODUCTION

Compared with the situation in most other countries, the Swiss population is exposed to a greater degree of shooting noise. This includes on the one hand noise from small calibre weapons (rifles and pistols) and on the other hand noise from military training grounds, i.e. large weapons such as canons. In Switzerland there are more than 2,000 shooting ranges. Furthermore, as a result of the growing population the distances to residential areas are becoming smaller. This situation leads inevitably to conflicts - above all during leisure periods, where the people seek peace and quiet.

As an enhancement to field studies, laboratory experiments offer an attractive possibility for investigating specific questions under controlled conditions. Nevertheless laboratory experiments are beset

with **methodical problems**: How can one measure the impact of noise on man in a laboratory setting? With the goal of investigating the annoyance of shooting noise a variation of magnitude production was developed which allows a comparison of various noise sources using a reference noise as a standard unit. Actually, a wide range of reactions are conceivable: Aside from the harmful effects of very high levels or long durations, other effects may be investigated as described by the words comfort, discomfort, intensity (loudness), unpleasantness, annoyance or disturbance. With **psychophysical scaling methods** the relation between the subjective impression and a physical measure of the stimulus may be obtained (for ex. the method of magnitude estimation or the method of magnitude production). These scaling methods may basically be divided into "absolute" and "relative" methods. Absolute methods have been used for many years and are simple to employ. Especially in field studies they have proved appropriate for categorical classifications or simply for numerical rank-ordering. Despite the designation "absolute", the results must rather be considered as *relative* as it is usually not possible to compare the results from different studies using different scales. Relative methods may be employed only for one person at a time and are therefore suited to laboratory experiments. The method of paired comparisons and variations of this method have been used extensively. Aside from the method of constant stimuli the method of adjustment is possible. In this method the test person is asked to adjust a stimulus to achieve a certain relation (for example equality) to a second stimulus.

In the present study one question was the choice of an appropriate frequency weighting, above all the A- or C-weighting, to rate the impact of various weapons.

## METHODS

The acoustical stimuli were presented to the test subjects in a room which was furnished as a living room (Fig. 1). The **technical installation** permits a very realistic simulation of shooting noise with

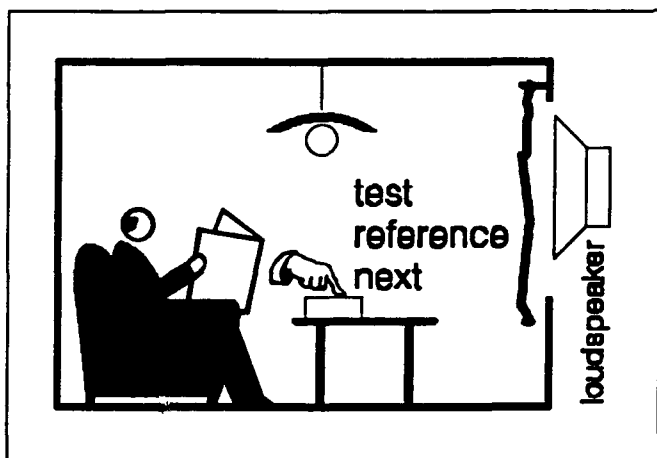

Fig.1: Test room.

respect to frequency response and sound level - up to 91 dB(A) [Rosenheck, et al. 93]. During the experiments a background noise with a level of 37 dB(A) was provided. The **acoustical stimuli** stemmed from actual field recordings. Four distances to the various weapons were simulated electronically. The noises from large, medium and small weapons were employed, having dominating frequencies ranging from 40 Hz up to 1 kHz. Furthermore, in order to relate the results to other types of noise an automobile drive-by was also included in the experiment.

The **subjects** were composed of 11 women and 40 men, i.e. 51 persons ranging from the ages of 20 and 61 (mean age = 40).

Appropriate to the living room setting the subjects could be asked to rate the **degree of disturbance**, instead of merely loudness. In order to create a situation in which an activity could be disturbed by the noise the subjects were asked to "try to relax, during the experiment thumb through the magazines on the table". Thus the current noise impact was measured, not the reaction with respect to a cognitive reality.

The scaling method was derived from elements taken from various standardized techniques. By adjusting the levels of the comparison (reference) noise, the subjects had to describe the degree of disturbance of a test noise. The reference derived from pink noise had a "haystack" temporal pattern and a total length of 3 seconds. The subjects had the task of adjusting the level of this reference noise until it sounded equally disturbing as the test noise (magnitude production). They were permitted to alternate between the test and reference noise at will. The level of each test noise was not varied, since each given level corresponded to a specific distance (and consequently frequency spectrum). The adjustment of the reference noise was accomplished with a potentiometer. In order to avoid a visual clue, the zero setting was altered randomly for each comparison.

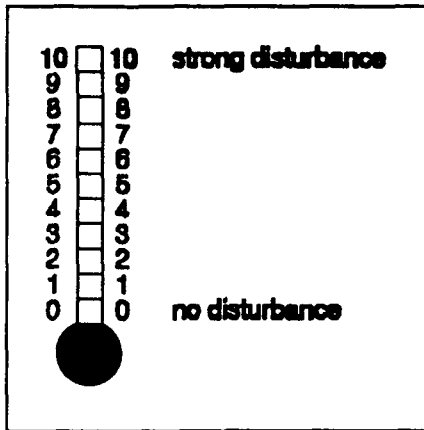

Fig. 2: Rating scale.

Before beginning the experiment, the hearing of each subject was screened with an audiometer. The experiment lasted 50 to 80 minutes. In addition to the above-described magnitude production method, an absolute scale was employed with a noise-, resp. disturbance-thermometer (Fig. 2). All stimuli were presented in random order. The pace of the experiment was determined by the test subjects themselves.

## RESULTS

From one group of experiments a comparison between the absolute (Fig. 3) and relative (Fig. 4) ratings is shown. The distribution of ratings for the 51 subjects is Gaussian. As an estimate for the scatter, the respective standard deviation between test subjects is plotted. Both methods yield qualitatively similar curves. Figure 5 shows the ratings as a function of the C-weighting.

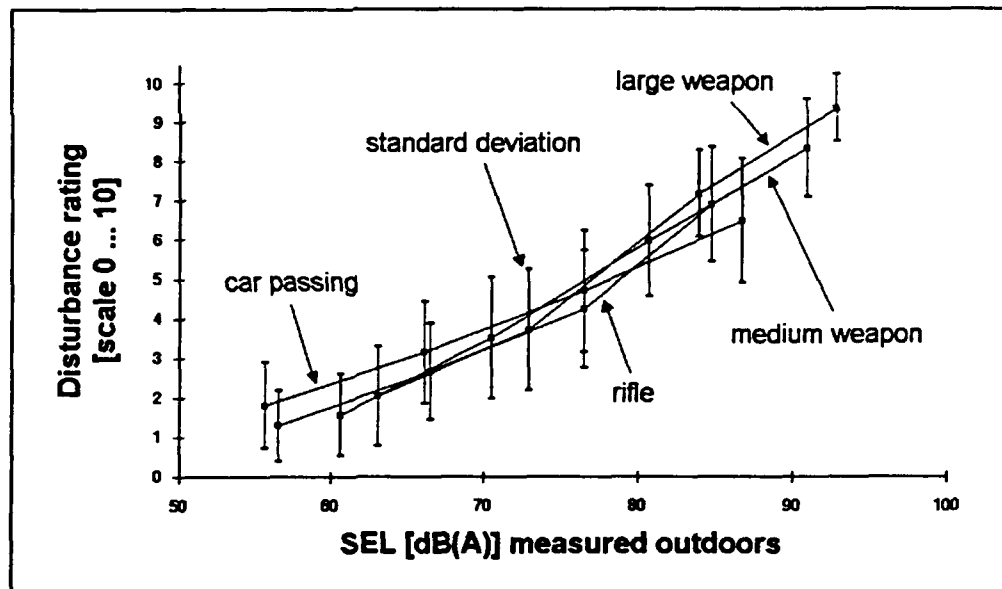

Fig. 3: Absolute rating.

## DISCUSSION

Analogue to Figure 4, relative judgements were also performed with a gunshot as the reference noise. Furthermore, aside from the question of disturbance, tests were undertaken in which loudness was evaluated. The results are similar to those presented here. The laboratory method described above was developed with a goal of being able to evaluate the impact of different noise types (for ex. railway, aircraft, road traffic and shooting noise) using a single reference signal. This would enable

the impact to be described by a unified auditory scale, independent of the particular noise type. This would be useful with regard to the derivation of noise criteria. However, it must be emphasized that an authentic disturbance situation cannot be fully reproduced in the laboratory. In particular, questions of noise acceptance must be resolved based on field studies.

One of the concrete questions in this study was: Which frequency weighting (A or C) is best suited in describing the subjective impact of weapon noise of different calibres? A comparison of Figures 4 and 5 shows that with the A weighting it is not necessary to distinguish between calibre,

i.e. a noise with a given A-level causes the same disturbance regardless of whether it stems from a small or large calibre weapon.

## REFERENCES

Rosenheck, A.; Baschnagel, K.; Bütikofer, R.: A laboratory installation for the subjective evaluation of noise from heavy weapons. INTER-NOISE 93, Leuven, Belgium.

## ACKNOWLEDGEMENTS

This project was supported by the Federal Office of Environment, Forest and Landscape as well as the Federal Department of Defence.

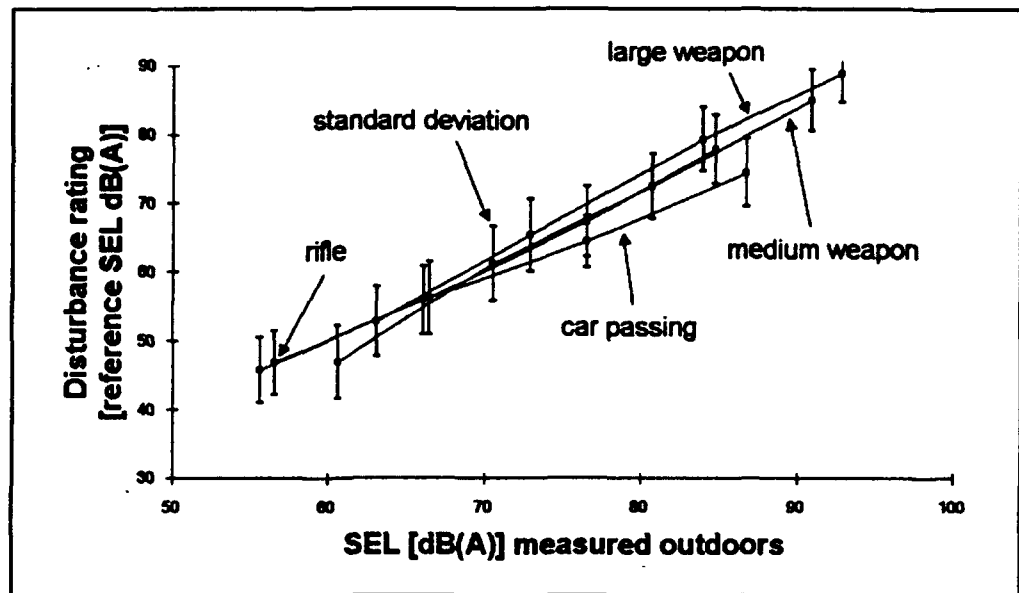

Fig.4: Relative rating.

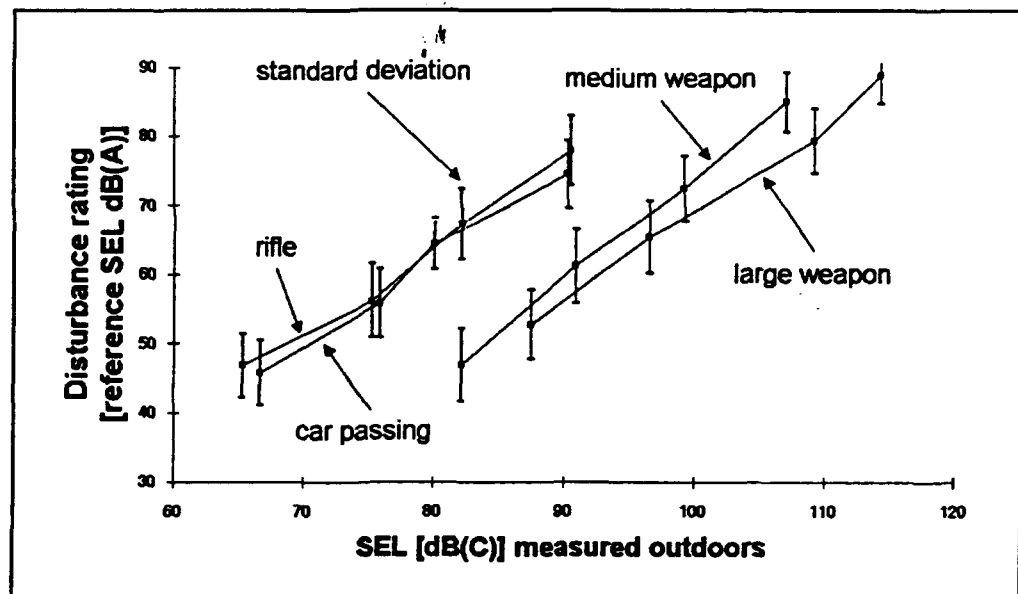

Fig.5: Relative rating.

## ANNOYANCE FROM ARTILLERY SHOOTING RANGE NOISE

RYLANDER Ragnar, ÅHRLIN Ulla, LUNDQUIST Björn

Department of Environmental Medicine, University of Gothenburg, Gothenburg, Sweden,  
Akustikkonsult, Box 30072, Gothenburg, Sweden

### Abstract

A social survey investigation was made in 20 areas around 8 artillery shooting ranges. The extent of annoyance and activity disturbances caused by the noise were determined. In all areas, the artillery shooting range noise was the most important source of annoyance in the environment. It caused widespread interference with rest, recreation and sleep. As regards dose-response relationships, LCdn showed a relatively poor relationship. When the exposure was expressed as the number of shots  $>110$  Lpeak, and the highest Lpeak values as independent variables, indications of a dose-response relationship equal to that previously found for other environmental noises were present.

### Introduction

Noise from artillery shooting ranges represents a special form of environmental noise with high peak levels, uneven distribution and frequent exposure during night-time. Previous investigations have demonstrated that artillery shooting noise has a great potential for causing annoyance and that the major activity disturbances are interference with conversation and rest and recreation (3,6,8). In view of their potent disturbance effects on the population, precise guidelines are needed to minimize the effects on the exposed population.

Previously performed studies on the effects of artillery shooting range noise (ASRN), report the noise exposure as a combined measure of number of events and noise levels, equal to the principles hitherto used for other types of environmental noises. The most common unit of measure is LCdn (3). Over the years, a number of studies has suggested that a dose response relationship based upon the number of events and the maximum noise level better corresponds to the principles for human perception of outside stimuli and that more precise dose-response relationships are obtained if this principle is used (1,2,4,5,7).

The present study was undertaken to evaluate the extent of general annoyance and activity disturbances around Swedish artillery shooting ranges. A total of 20 areas close to and further away from 8 different ranges were investigated to obtain an independent variation of the number of shots per time period and the noise levels. In each area, the exposure was estimated according to various derivatives of peak levels from the individual types of weapons as well as the number of events and the equal energy values. The extent of annoyance and activity disturbances were evaluated using standard questionnaires.

### Material and methods

#### *Exposure estimation*

The exposure to ASRN was expressed as Lpeak, LAI, LCI, LCx, LCdn and the number of shots, as well as the number of shots above different Lpeak levels. When calculating LCdn, a correction was inserted for the number of days that the particular shooting range was open.

### ***Population selection***

Around eight artillery shooting ranges in different parts of Sweden, 20 areas were later selected. Using population registers, one person aged 18-75 years who had lived there at least one year was randomly selected from each household. These persons received a postal questionnaire developed from in-depth interviews with persons living near an artillery shooting range not included in the study. In the introductory letter, the study was presented as a general study on the environment. The questionnaire contained questions on type of housing, annoyance due to different sources in the environment and on family conditions. The question on annoyance was graded as "not notice, notice but not annoyed, a little annoyed, rather annoyed and very annoyed".

Persons who had answered that they were "rather annoyed" or "very annoyed" by ASRN, received a further questionnaire with more detailed questions on how they experienced the consequences of the shooting noise in terms of activity interference, how often the annoyance was experienced and what time of day this was and whether the annoyance was related to any particular noises. Of the 2,014 persons selected, 1,483 (76%) responded to the first questionnaire after two reminder letters, and 400 (72%) of 552 to the second questionnaire.

### **Results**

#### ***Annoyance from artillery shooting range noise***

The results demonstrated that shooting range noise was the dominant source of annoyance in the areas investigated. In a few areas, road traffic noise and air pollution were also considered annoying. The proportion of the population in the different areas reporting that they were "very annoyed" by ASRN varied between 0 and 35%. Disturbances 1-2 times/week was the most common frequency of occurrence, and the majority of the respondents reported that evening and night-time activities at the range were the most annoying. Heavy weapons and vibrations caused by these were the characteristics of the ASRN which were experienced as most annoying. The most commonly disturbed activities were rest and recreation, as well as sleep in terms of difficulties in falling a sleep and awakenings.

#### ***Dose- response relationships***

There was a fair correlation between the extent of annoyance, expressed as per cent very annoyed in each area, and the equivalent energy value LCdn ( $r_{xy}=0.5235$ ). This is illustrated in Figure 1.

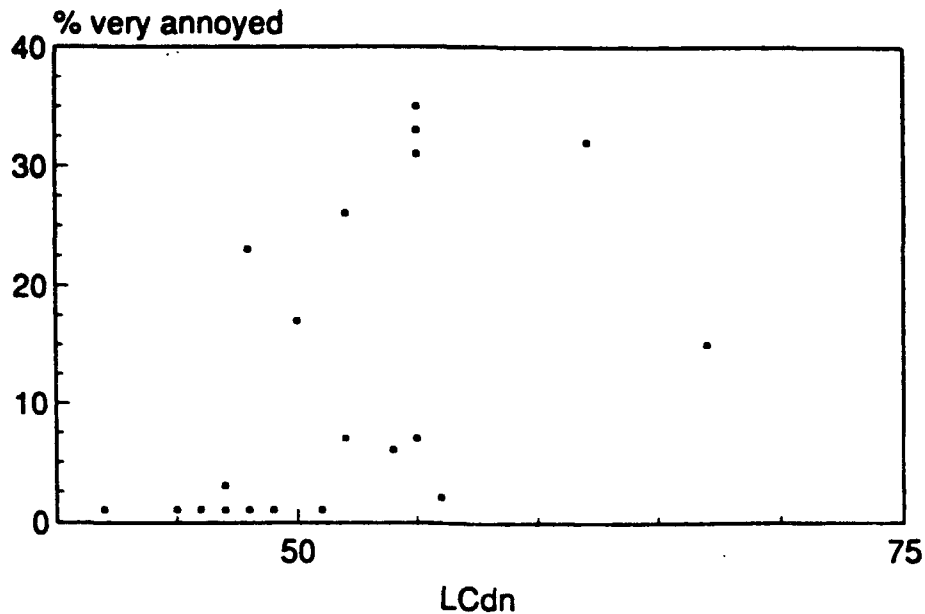

When the levels and number of events were evaluated independently, several threshold values for accepting an event were initially tested. The most meaningful relationships were found when the number of shots was defined as the number which had with a noise level equal to or above 110 Lpeak. The dose-response relationships between the extent of annoyance and the number of shots as well as different peak levels of the shots, are illustrated in Figure 2.

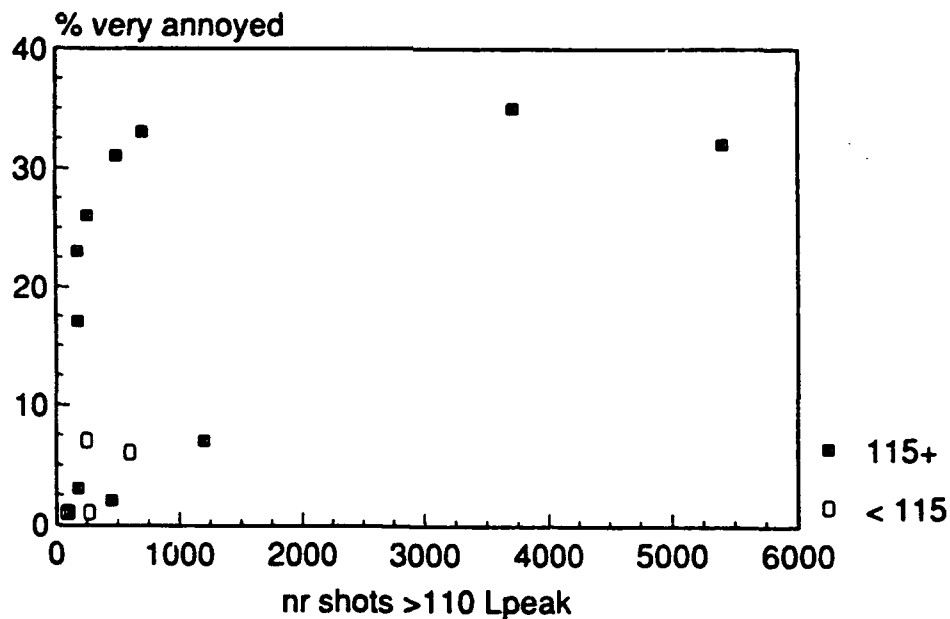

It is seen that when the maximum noise level was 115 Lpeak or more, the extent of annoyance increased very rapidly when the number of events increased. Two areas at around 3,700 and 5,400 shots showed about the same extent of annoyance. When the maximum noise level was less than 115 Lpeak, the extent of annoyance was less than 10% annoyed in all areas. The figure suggests that the breakpoint is at appropriately 600 shots/year. One area exposed to 1200 shots had a lower extent of annoyance.

## Comments

The commonly used LCdn unit gave a rather poor dose-response relationship. In previous studies, better dose-response relationships have been found for this unit. The reason for the discrepancy is probably that, when only one or a few shooting ranges are investigated, there is not enough variation in the units, noise level and number of shots to allow for an independent evaluation of these parameters.

Although the data points are relatively few, the results from this study seem to fit into the general type of dose-response relationship for environmental noises earlier described. One of the areas was exposed to a large number of shots, always during daytime hours and never on weekends, which may explain the unexpectedly low extent of annoyance. The reason for the unexpectedly low extent of annoyance in the area exposed to 1,200 shots with a high  $L_{peak}$  value is not known, and the exposure conditions are being further investigated. Nevertheless, in view of the methodological variations encountered, both in the noise exposure estimation and the determination of annoyance, it is not unexpected that occasional areas would deviate from a general dose-response pattern.

## Guidelines

If the present data were to be used for guideline purposes, the exposure in an area to be judged should be based upon an independent assessment of maximum noise levels and number of shots, both expressed in  $L_{peak}$ . In areas exposed to  $L_{peak}$  of 110 or less, the annoyance would be expected to be low. The number of shots does not need to be taken into account. If the maximum noise level is 115  $L_{peak}$  or above, even a very small number of shots will cause extensive annoyance. This could be decreased if the shooting activity were limited to daytime only.

## References

1. Björkman M, Åhrlin U and Rylander R. Aircraft noise annoyance and average versus peak noise levels. Arch Env Health 1992 (in press).
2. Björkman M. Community noise annoyance: Importance of noise levels and the number of noise events. J Sound Vib 1991; 151:497-503.
3. Bullen RB, Hede AJ, Job RFS. Community reaction to noise from an artillery range. Noise Control Eng J 1991; 37:115-128.
4. Rylander R, Björkman M, Åhrlin U, Sörensen S and Berglund K. Aircraft noise contours: Importance of overflight frequency and noise level. J Sound Vib 1990; 69:583-595.
5. Rylander R, Björkman M, Åhrlin U, Arntzen U and Solberg S. Dose-response relationships for traffic noise and annoyance. Arch Env Health 1986; 41:7-10.
6. Schomer PD. Assessment of community response to impulsive noise. J Acoust Soc Am 1985; 77:64-79.
7. Sörensen S, Hammar N. Annoyance reactions due to railway noise. J Sound Vib 1983; 87:315-319.
8. Vos J, Geurtsen FWM. Leq as a measure of annoyance caused by gunfire consisting of impulses with various proportions of higher and lower sound levels. J Acoust Soc Am 1987; 82:1201-1206.



# A CONCEPTUAL MODEL FOR NOISE ANNOYANCE IN OUTDOOR RECREATIONAL SETTINGS

STAATS, Henk, J. and DE JONG, Henk, J.  
Centre for Energy and Environmental Research,  
Dept. of Social and Organizational Psychology, Leiden University.  
P.O.Box 9555, 2300 RB Leiden, the Netherlands

## *Abstract*

Noise annoyance in outdoor recreational settings is a research field that is virtually unstudied and that may benefit from theoretical development. In this article a conceptual model on this subject is proposed. It stems from three scientific fields: existing research on noise annoyance, theories on psychological stress and theories on recreational behavior. Feelings of noise annoyance are supposed to emerge in a process called primary appraisal; during this process several factors influence the appraisal: noise sensitivity, relevant attitudes and the motivational salience of the setting in which annoyance is experienced. Next to the primary -evaluative- appraisal a secondary appraisal process estimates the means one has to control the (negative consequences of the) stressor. Again, several factors influence this judgment: the degree of annoyance experienced, characteristics of the source, locus of control, predictability of the noise and perceived decision freedom. Primary and secondary appraisal jointly lead to a coping or adaptation response, which can modify the intensity of the annoyance reaction.

## *1. Introduction: an approach from three fields of research*

Noise annoyance is influenced by a large number of factors. However, not much attention is paid to the psychological meaning of the environment in which noise is experienced. This is especially true for outdoor recreational environments as hardly any research is done in recreational settings. This implies that findings from earlier research cannot be simply extrapolated to recreational settings. The purpose of this paper is to advance understanding of noise annoyance in outdoor recreational settings and to point out some important concepts and relationships that should be investigated in empirical research.

Three fields of research have been taken as point of departure: (a) theories on psychological stress, (b) research on noise annoyance performed in home or work environments and in the laboratory and (c) theories on recreational behavior.

The structure of the model is derived directly from Lazarus' cognitive theory of stress (1966). Lazarus' theory states that stress is evoked in case of a disturbed balance between environmental demands and possibilities to react adequately to these demands.

Stress is the result of two processes: the primary and secondary appraisal of the stimulus. In the primary appraisal process the individual estimates if a stimulus is positive or negative to his well-being. The secondary appraisal is an evaluation of the possible means to cope with the stressor.

Important is the interdependence of the primary and secondary appraisal process: a negative appraisal of a situation and availability of control mechanisms are closely linked. The distinction is conceptual, not empirical as their interdependence constitutes the emotional reaction to a stressor (Lazarus and Folkman, 1984). Possibilities to cope comprise physical, psychological, social and material resources. Depending on the specific demands of the stressor, the value of different coping strategies is evaluated. A perfect coping response would eliminate the negative effect entirely, in reality the stressor can usually be modified only to some extent.

This two-stage process of cognitive appraisal is the basis for the model presented below. The noise in recreational settings is appraised in terms of negative consequences in relation to possibilities to cope, the outcome is a stressful emotion and some form of coping response follows.

Relevant findings of noise annoyance research will be described to the extent that they are incorporated in the model.

To conceptualize the specific qualities of recreational behavior, an elaboration of Iso-Ahola's model (1980) is used. In the model it is referred to as motivational salience. The two evaluative processes are affected by a number of other factors. The model is presented in figure 1.

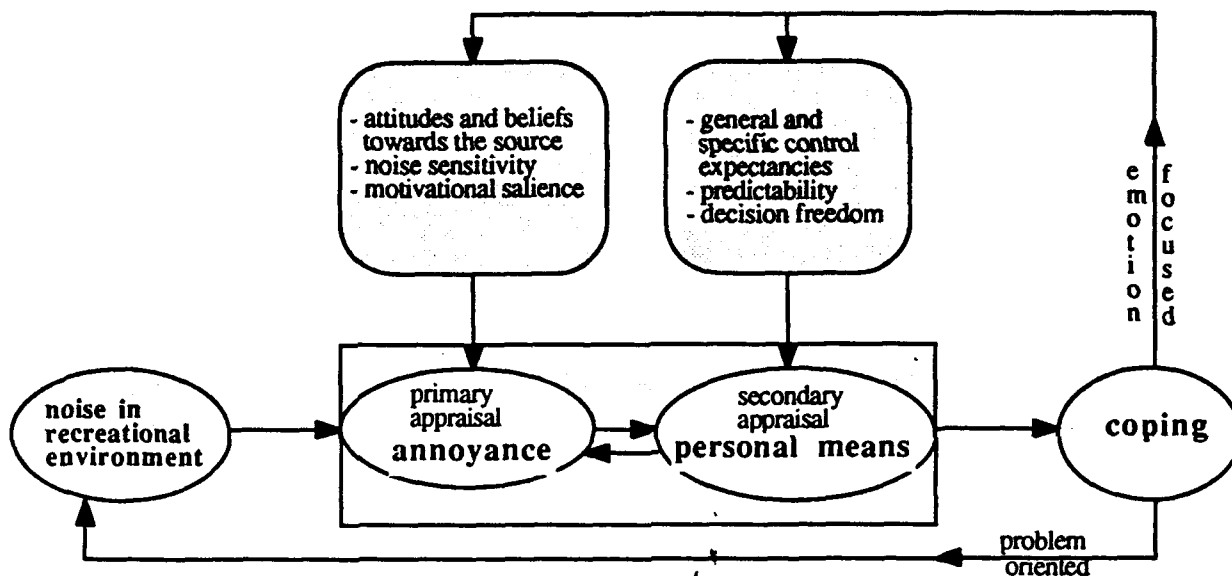

Figure 1. The process of noise appraisal and coping

### 2. Noise: physical characteristics and relevant indices

Noise sources in recreational settings will produce fluctuating sounds, a constantly changing volume, or intermittent sounds, the level of which is frequently reduced to background conditions. The sound spectrum will not be so diverse that tonal or impulsive sounds will dominate, which means that one of the generally accepted measures for describing sound levels is acceptable. We propose to use the equivalent sound pressure level  $L_{Aeq,T}$ , for sounds whose volume fluctuates within a rather narrow range, e.g., highway noise. For intermittent sounds, e.g., airplane noise, the peak sound level in dB(A), the A-weighted maximum sound pressure level,  $L_{Amax}$  may be a better predictor of annoyance (Rylander et al., 1980).

### 3. Primary appraisal: estimating significance for wellbeing

The primary appraisal estimates the (potential) influence to a subjects' wellbeing. A stress response may occur in case of a negative appraisal. Lazarus distinguishes three different cases: harm/loss, threat and challenge. Harm/loss implies that the negative event already has taken place. Threat implies a potential loss, challenge a risk, that might also have beneficial effects if the stressor is successfully countered.

Factors influencing appraisal are sensitivity to noise and specific attitudes and beliefs towards the noise source. These have proven their explanatory value in many studies (Fields, 1990). They seem to be equally useful in recreational settings (Staats and de Jong, 1992). Noise sensitivity, as a personality characteristic, is by definition not dependent of context. Relevant attitudes to and beliefs about the stressor that have proven to be influential in earlier studies are global evaluations of the noise source (positive-negative, useful, aesthetically pleasing) and beliefs about the care that is taken by people responsible to minimize the noise (Taylor, 1984; Job, 1988; Fields, 1990).

Especially in a recreational context the motivational salience of a situation (Stokols, 1979) will be important. Motivational salience or commitment (Folkman, 1984) refers to the extent to which the fulfilment of psychological needs is associated with a setting. Fundamental to the satisfaction of personal (recreational) needs is the construct of intrinsic

motivation. Intrinsically motivated behavior is defined as behavior for which no rewards exist other than the behavior itself. It can be described in different terms: by a striving for optimal levels of activation and incongruence (Iso-Ahola, 1980), as well as by a striving for competence and autonomy. Haggard and Williams (1992) mention self-consistency and positive regard as desirable outcomes of a recreational experience. Specific personal needs are derived from this construct. Fulfilment can more easily be accomplished during leisure time, when several limitations inherent to a work or household situation are absent. Disruption of the fulfilment of such personal needs probably will be judged as very annoying.

Motivational salience as mentioned in the model should be elaborated with concepts that measure expectations to fulfil recreational needs appropriate to the situation being studied, weighted with individual importance and the discrepancy of expectations and actual satisfaction of these needs.

#### *4. Secondary appraisal: evaluating the means to control the stressor*

In case of a negative first appraisal, the process of secondary appraisal estimates the means available to control the stressor. Preceding the discussion in the next section we make the distinction between problem oriented responses (directly aimed at the source of annoyance), emotion focused responses (aiming to change one's negative feelings towards the stressor) and adaptation. Adaptation is a very complex phenomenon: it may be the result of successful coping strategies, problem oriented, emotion focused or both. It does affect annoyance but it is not quite clear which mechanisms are involved, if aftereffects will occur and what circumstances activate what kind of adaptation. Stokols (1979) defines adaptation as an absence of response to a negatively valued stimulus which may occur when motivational salience is low. For the reasons mentioned adaptation is not included in the model.

We assume that several factors influence choices and outcomes of the appraisal process. The first of these is the degree of annoyance experienced. The interdependence of first and second appraisal is manifested by the two arrows between these concepts. The stronger the threat the more urgent an adequate coping response will be. On the other hand will the estimated availability of means of coping directly decrease the threat.

All other factors mentioned refer, in one way or another, to actual or perceived control.

The first of these pertains to the source of the noise. Some noise sources are not easily changed by direct individual action, e.g., airplane noise, highway noise.

Evaluating means of coping will also be influenced by personality: people with an internal locus of control will be more inclined to choose a problem oriented response than people who attribute the outcome of events to external causes (Folkman, 1984).

We suppose that perceived freedom influences the choice of coping strategies. This refers to personal freedom to decide on a recreational activity and the environment where this activity can be performed. Perceived freedom is high when an individual has many options to choose from, low when opportunities are strongly confined. We suppose a narrow range of options will lead to a stronger threat appraisal. We consider it an open question if degree of perceived freedom will influence the *kind* of coping response. On the one hand, high perceived freedom will lead to a sense of control because alternatives are available. This might lead to a change of activities and/or place (i.e., a problem focused coping response). On the other hand, when a situation is appraised as less threatful, an emotional coping response is usually more likely (Lazarus, 1966).

Another variable that will be directly relevant is predictability of appearance of the stressor. Being able to anticipate the onset of a stressor diminishes its impact. Studies on the effect of environmental stressors explain differences in annoyance due to highway and airplane noise to the predictability of the first compared to the second stressor, the first producing less intense feelings of annoyance.

Familiarity with the situation may also be a factor helpful in producing feelings of control: familiarity may make means of coping available, unknown to other individuals; it also may bring expectations of benefits in line with reality. Holidays, e.g., sometimes turn out to be stressful affairs, precisely because of a mismatch of high expectations and actual opportunities, due to a lack of familiarity with the chosen place.

### 5. Coping

The quality and intensity of emotions arising from the appraisal process influence the way in which they will be coped with. It is generally assumed that a problem oriented approach will be more beneficial than an emotion oriented approach. Annoyance will be more adequately reduced if one succeeds in changing the source of annoyance itself. In the case of environmental stressors in a recreational environment the situation is more complex. On the one hand are possibilities to act upon an environmental stressor often limited. On the other hand, outdoor recreational behavior is not as restricted to a certain location as other human behavior. A location is temporary and may be substituted for another, provided alternatives are available. Changing locations as a coping technique for noise annoyance in outdoor recreational settings thus depends on easily available alternatives, conceptually on the degree of perceived freedom. Assuming that changing places is psychologically equivalent to coping with a stressor directly, somewhat more opportunity exists for a problem oriented approach. However, this explanation is hypothetical.

Emotion focused coping may influence attitudes and beliefs about the source, about the consequences of the stressor, the expectations of the benefits derived from a recreational experience or about the perceived possibilities to control the stressor, e.g., by focusing on the regularity of appearance, thus improving its predictability. One option for emotion focused coping behavior may consist of the intention not to come back to this place, which may reconcile the individual with the noise source although it reduces its total number of available recreational options (cf. Campbell, 1983).

Coping may change the experience of annoyance. Reappraisal of the situation by problem oriented or emotion focused coping or both is indicated by the feedback loops to the noise source and the appraisal process.

### References

- Campbell, J.M. (1983) Ambient stressors. *Environment and Behavior*, 15, 355-380
- Fields, J.M (1990) A quantitative summary of non-acoustical variables' effect on reactions to environmental noise. *Proceedings of NOISE-CON 90: reducing the annoyance of noise*, p.303-308
- Folkman, S. (1984) Personal control and stress and coping processes: a theoretical analysis. *Journal of Personality and Social Psychology*, 46, 839-852
- Folkman, S. and Lazarus, R.S. (1988) Coping as a mediator of emotion. *Journal of Personality and Social Psychology*, 54, 466-475
- Haggard, L.M. and Williams, D.R. (1992) Identity affirmation through leisure activities: leisure symbols of the self. *Journal of Leisure Research*, 24, 1-18
- Iso-Ahola, S.E. (1980) *The social psychology of leisure and recreation*. Dubuque, Iowa: Wm. C. Brown Co.
- Job, R.F.S. (1988) Community response to noise: a review of factors influencing the relationship between noise exposure and reaction. *The Journal of the Acoustical Society of America*, 83, 991-1001
- Lazarus, R.S. (1966) *Psychological stress and the coping process*. New York: McGraw-Hill
- Lazarus, R.S. and Folkman, S. (1984) Coping and adaptation. In: Pervin, L. and Lewis, M. (Eds.) *The handbook of behavioral medicine*, 282-325. New York, Guilford
- Rylander, R., Björkman, M. and Arlin, U, Sörensen, S. and Berglund, K. (1980) Aircraft noise annoyance contours: importance of overflight frequency and noise level. *Journal of Sound and Vibration*, 69, 583-595
- Staats, H.J. and De Jong, H.J. (1992) Airplane noise annoyance in a recreational setting: the explanatory power of physical and psychological variables combined. *Manuscript in review*
- Stokols, D. (1979) A congruence analysis of human stress. In Sarason, I. en Spielberger, C. (eds.) *Stress and anxiety (vol.6)* New York: Hemisphere
- Taylor, S.M. (1984) A path model of aircraft noise annoyance. *Journal of Sound and Vibration*, 96, 243-260

# EVALUATION OF ANNOYANCE AGAINST TRANSPORTATION NOISES WITH RESPECT TO READING AND LISTENING ACTIVITIES

KURRA S.

Istanbul Technical University  
Department of Architecture - Div. of Physical Env.  
Takisla - Taksim 80191 - Istanbul, Turkey

Effects of noise on activity disturbance have been concerned widely in the field studies where the respondents were being asked about their annoyance while performing different activities at home. However, since it is difficult to determine the exact indoor noise conditions during these activities, these questions might have only an importance in supporting the general annoyance judgments about the noise (it has been investigated the annoyance degrees given by the subjects, raised after such questions during the interviews).

Simulated Environment Method gives some possibilities in analyzing the specifics aspects of annoyance problems, if a satisfactory simulation of the noise, the environment and the sample population, is achieved by considering also the non-auditory factors affecting the annoyance.

In this paper, the results of an experimental study which was carried out in a simulated environment laboratory in Japan are presented. The study aimed to determine the annoyance while performing : 1) a visual and 2) an aural activity, such as : reading an article and listening to a given speech from a radio, in a living room environment. The first task required a concentration and short-term memory upto an extent (since the subjects were asked to write a brief outline about the content what they read) and the second task was related to speech interference and masking. However, it was decided to determine the general annoyance in terms of interference with daily life activities, without focusing deliberately on masking or on short-term memory performance. Reading and listening activities were tested in a consecutive sessions within 30 minutes taking 15 minutes for each, under the continuous noise conditions during that time. 16 groups of subjects (64 in total) were used and noise conditions changed with pre-determined parameters. The purpose was to investigate how the activities were affected by the noise levels<sup>(\*)</sup>, by the transportation source type (like road traffic, railway and aircraft) and by the pass-by number (no. of vehicles/30 mn). Since the peak levels were found to be more efficient in activity disturbance, both  $L_{eq}$  (30 mn) and  $L_{av}$  peaks were used in the data evaluations. The annoyance descriptors were differentiated, like 1-7 point scale (SSV), HA %, disturbed % and medians.

The results indicated that the indoor noise level has been a dominant factor, as expected in the activity annoyance, but its increase has not a steady effect on annoyance degrees e.g. before 45 dB(A), a 10 dB(A) increase in level ( $L_{eq}$ ), causes 1,5 SSV increase for listening annoyance and 2 SSV for reading annoyance, whereas after 45 dB(A), more sharply increase in annoyance degrees is obtained for listening (3 SSV) more than for reading which tends to be very slightly affected. On the other hand, railway traffic appears to be more annoying source for both activities and this result is parallel to those obtained by previous investigations in Japan.

---

(\*) Noise levels changed from 30 to 55 dB(A) ( $L_{eq}$  indoor) at 5 dB(A) intervals.



# **A SOCIAL NOISE SURVEY IN THE HOLIDAY - CITY OF RHODES**

by : **Psichas** Kiriakos, M.Sc. (1)  
**Dr. Vallet** Michel (2)  
**Dr. Vogiatzis** Constantinos(1)

(1) Ministry of the Environment, 147 Patission Str., 11251 Athens, Greece

(2) INRETS, 109 av. Salvador Allende, 69675 Bron, France

This paper describes in summary the findings from a noise survey performed in the capital city of the island of Rhodes, which is a very well known tourist resort found in the southeastern part of the Aegean Sea .

The survey was carried out during the summer months of 1992 and was financed by the Ministry of the Environment, Physical Planning and Public Works in Greece , the European Fund for Regional Development and the city of Rhodes.

The first step towards the survey was the compilation of a noise map of the city. Then, on selected sites noise monitoring stations for 24 hr shifts were positioned. Acoustic measurements were carried out for the following indices : Lmax , Leq , L1, L50 , L90 and L95. Specific measurements were taken of the Leq 24hr, Leq - Day (08:00-18:00), Leq - Evening (18:00-21:00) and Leq -Night (21:00-18:00).

Those measurements covered the various land use differentiations namely :

- a. The commercial / tourist centre (Zone 1)
- b. The old city (intra muros) (Zone 2)
- c. The light industrial area and (Zone 3)
- d. The residential (Zone 4)

The purpose of the survey was firstly to monitor the various noise levels and secondly to gauge the people's opinion about the sound levels in order to proceed with possible measures against the principal noise sources.

It was decided to include the population of the tourists as well as the residents in the second step of the survey and to execute it via questionnaires carried out by professional interviewers.

The sample size of the questionnaire for the - permanent - Greek residents was 232 interviews (117 Male and 115 Female) meanwhile for the tourists / foreign visitors was 147 (75 Male and 72 Female )for a total of 379 persons.

Due to the completely different structure of the tourist population it was decided to create a separate questionnaire for the tourists that included -except the noise -some questions about other factors of the quality of tourist life like hotel service etc.

The reasons that diversify the structure of the two populations are mainly the following :

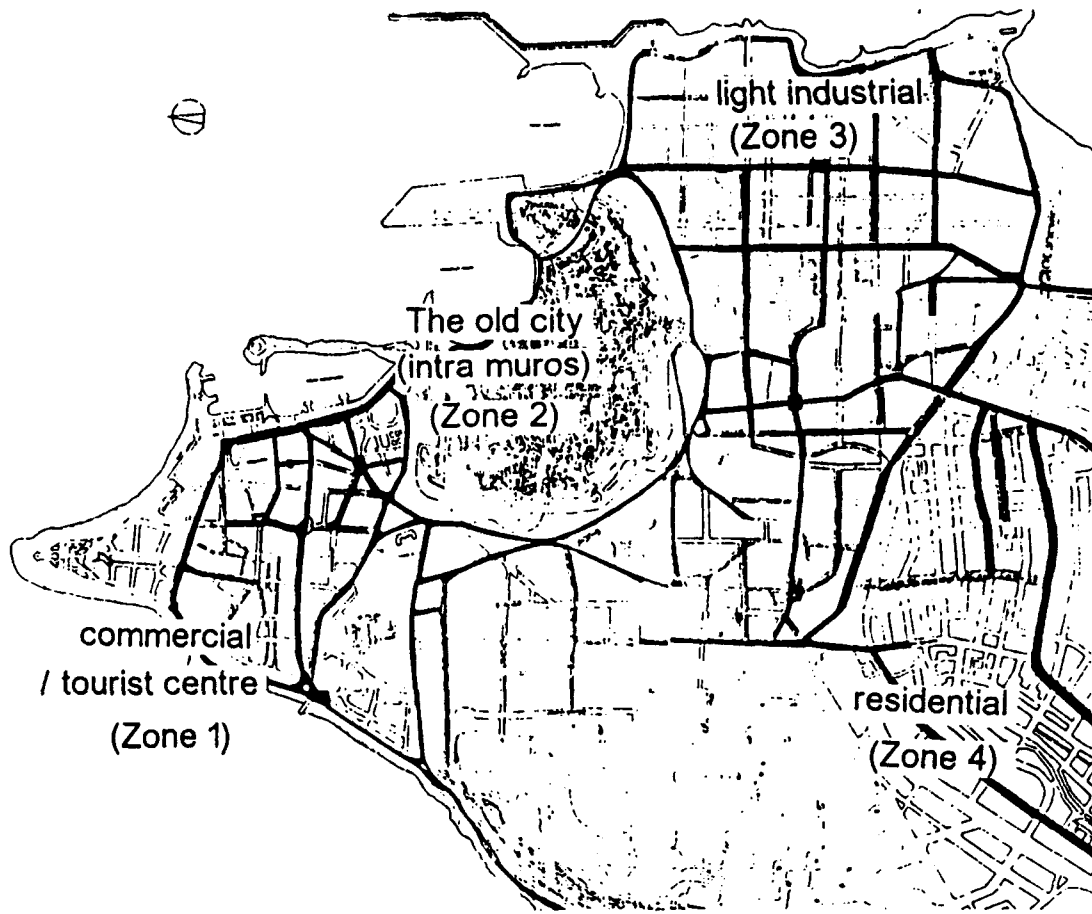

  
 ΔΗΜΟΣ ΡΟΔΟΥ  
 DE THE STRATEGIA IYI + PE SIA I  
 ΟΛΗ ΕΛΛΑΔΟΣ ΑΠΟ ΣΥΝΤΑΚΤΗ ΕΛΛΗΝΟΓΛΩΣΣΩΝ

MUNICIPALITY OF RHODES  
 IN COLLABORATION WITH THE  
 DEPARTMENT OF MUNICIPAL  
 PLANNING AND PUBLIC WORKS

ΜΑΡΤΙΟΣ 2000  
 ΑΝΤΙΣΤΡΑΤΗΓΙΚΟ ΣΧΕΔΙΟ  
 ΕΠΙΧΕΙΡΗΣΙΑΚΟΥ ΣΧΕΔΙΑΣΜΟΥ  
 21 Τεύχος Ροδών 02

ΧΑΡΤΗΣ  
 ΚΥΚΛΟΦΟΡΙΑΚΟΥ ΟΡΓΑΝΟΥ  
 ΡΟΔΟΥ 1991  
 Λεω.

TRAFFIC NOISE MAP OF RHODES  
 PLAN BY DEPT OF MUNICIPAL PLANNING  
 AND PUBLIC WORKS

ΕΠΙΧΕΙΡΗΣΙΑΚΟ ΣΧΕΔΙΑΣΜΟ  
 ΕΠΙΧΕΙΡΗΣΙΑΚΟ ΣΧΕΔΙΑΣΜΟ

ΤΥΠΟΜΗΜΕΡΑ  
 ΛΕΩΝ - ΛΕΩΝΩΝ

---	66	60 (A)
---	66-68	-
---	68-71	-
---	73-74	-
---	75-77	-
---	> 78	-

ΠΗΡΟΝΟΜΟ ΛΕΩΝΩΝ  
 ΣΥΝΤΑΚΤΗΣ: ΕΠΙΧΕΙΡΗΣΙΑΚΟ ΣΧΕΔΙΑΣΜΟ  
 ΣΥΝΤΑΚΤΗΣ: ΕΠΙΧΕΙΡΗΣΙΑΚΟ ΣΧΕΔΙΑΣΜΟ

ΕΚΔΑΤΗΡΙΑ  
 ΣΚΑΛΑ 1:5000  
 ΕΧΕΙΛΛΕ

city of Rhodes

The most important item of dislike for both the populations was the traffic noise. It is clear that the noise was disturbing them particularly during the night due to the fact that the use of air-conditioning is rather limited (9%). The noise from the bars and discos, although quite high, is restricted to a relatively limited area.

The vast majority of the tourists ( 95.3 % ) thought their stay was pleasant or very pleasant but 21% expressed the opinion that the city was very noisy.

The majority of the Greek residents (59%) seem to accept the noise levels which are -as well- the consequence of the cosmopolitan and touristic life that the city is projecting but they also believe that the State authorities should try much harder towards a better acoustical environment.



1. Cultural and behavioral differences especially due to the fact that the main body of the tourists comes from countries of the northern Europe ( United Kingdom , Scandinavian countries etc.
2. Socio-economic and psychological factors

In that context there was a chance for an insight into annoyance, both in residential and non-residential settings in the city.

Several questions were the same in both questionnaires so it is very interesting to compare the outcomes of the survey on the specific items they had in common.

The structure of human response was very similar in the two groups and an amazing similarity of the given answers was from a question about the subjective characterisation of the city's acoustic environment.

Exactly the same percentage of both the populations (39%) found the city noisy as it can be observed in the following graph.

**Noise Survey in the City of Rhodes 1992-93**  
*Characterisation of the Acoustic Environment*

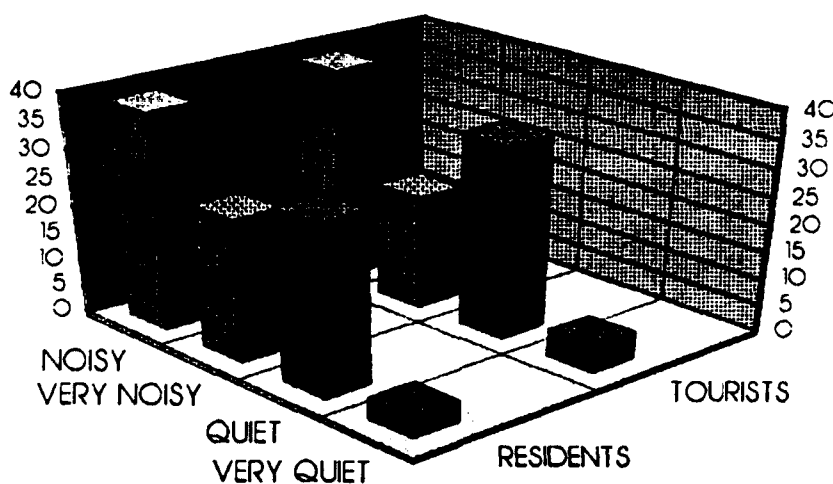

There was no influence of the age on the percentage of the highly annoyed people but young persons seem to tolerate noise better. Older people are less tolerant since nobody of this age finds Rhodes a quiet place.

The sex of the respondents had no effect on the answers. The 67.4% of the respondents had the opinion that their sleep was good, very good or excellent meanwhile a 21.8 % thought it was neither good or bad and they gave two main reasons: heat and noise, but out of those who expressed a negative opinion the "noise" reason increases to 75%, heat 20% and 5% for other reasons.

Noise is quoted as the main sleep disturbance reason by the 93% of the tourists who consider the city as noisy or very noisy. Only 50% of the people consider the city of Rhodes noisy among those giving the heat as the reason for sleep disturbance. So the sleep disturbance by noise, which is a behavioral response is very similar to the two populations : 32% for the tourists group and 30% for the residents.

There are again very similar perceptions of both the populations on the main source of noise which was identified as the traffic noise.

Given the temperature conditions, the 83% of the Greek residents replied that they sleep with the windows open during the night. For those reasons it was decided to insert certain questions and try to assess the differences of the disturbance for the Greek residents the mean weekdays (WD) and mean weekends (WE) with windows and/or balcony doors open (O) or closed (C) compared with the measured noise levels according to the zone (or sub-zone) they were.

As it can be seen in the following graph there is less annoyance in the light industrial and workshop urban area where there the rate = 5 for a noise level of 75 dB(A) meanwhile the much lower noise level of the residential subzone 4.1 which is 67.6 dB(A) creates much more annoyance rated 7.5.

Residents Noise Survey

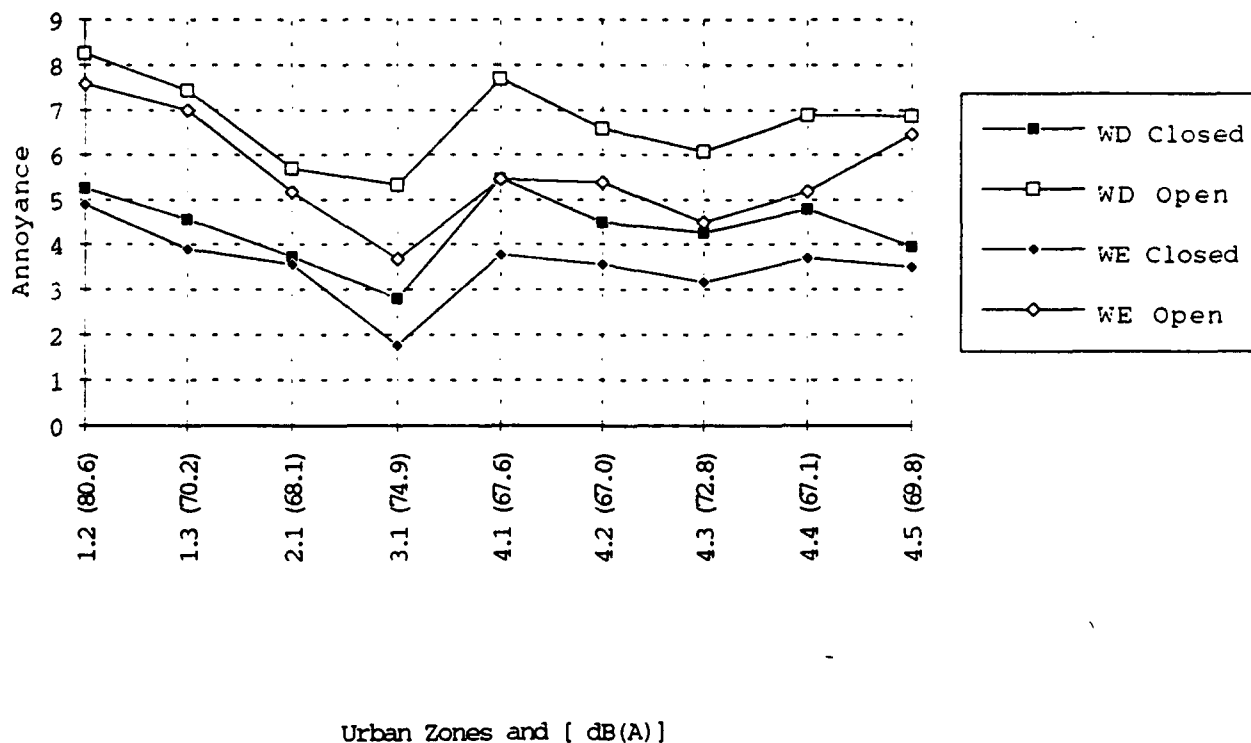

## **NOISE DISTURBANCE AND PATIENTS REACTIONS IN HOSPITALS**

**SEREFHANOGLU M., KARABIBER Z., YUGRUK N., ERDEM AKNESIL A.**

**Yildiz University  
Architectural Faculty  
Istanbul, Turkey**

Subjective influences of noise depends on people's health condition. Therefore hospitals, which are buildings for the people on unperfect health condition, have to be evaluated with special care by means of noise.

Due to the unplanned growth of the city, noise problem increases day by day and affects all the buildings as well as the hospitals in Istanbul.

The aim of this paper is to investigate and determine the noise problem at Istanbul's hospitals by sampling method. In this point of view, for the different functioned rooms of hospitals, outdoor and indoor noise measurements are made. Findings are compared with ISO and Noise Control Regulation of Turkey. On the other hand, patients reactions are determined by the questionnaire survey and noise problem at hospitals in Istanbul is evaluted.



## ACOUSTIC ANNOYANCE IN THE HOSPITAL

Monique SOYER et Jean-Louis PICHON  
Ecole Nationale de la Santé Publique, 35043 Rennes Cedex, France

### ABSTRACT

The noise in the hospital is often considered to be one of the principle sources of annoyance and discomfort. The objective of this study was to understand the problems caused by noise for the patients and for the staff, and the relation between the degree of annoyance and the acoustic quality of the buildings. This study has been carried out in three hospitals in the city of Rennes (France). The investigations consisted of two parts. First an inquiry among patients and personnel, to obtain an evaluation of their discomfort. The second part consisted of measurements of acoustic building quality.

Overall, the inquiry and the measurements demonstrated the effectiveness of acoustic treatments. The most important problem was the traffic passing through the hospital complex. But the study also showed that simple solutions can be envisaged to problems like doors slamming or telephones ringing. Nevertheless, we must recall that answers can not always be of a technical order. The results of this study suggest recommendations concerning the acoustic quality of the hospital buildings.

### RESUME

Le bruit dans l'hôpital est souvent considéré comme l'une des principales sources de nuisances et de désagrément. L'objectif de cette étude était de mieux cerner les problèmes causés par le bruit pour les malades et le personnel, et aussi la relation entre les nuisances sonores et la qualité acoustique des bâtiments. L'étude a compris deux parties. D'abord, on a estimé la gêne par une enquête auprès des malades et du personnel. Dans une deuxième partie, on a déterminé la qualité acoustique des locaux à l'aide de mesures.

Globalement, les résultats des enquêtes et des mesures ont montré l'efficacité des traitements acoustiques réalisés. Le passage des véhicules à travers le centre hospitalier reste un problème important. Des solutions simples et peu coûteuses peuvent être envisagées face à des problèmes comme les claquements des portes ou les sonneries de téléphone. Cependant, les remèdes ne sont pas toujours d'ordre technique, et des résultats appréciables dépendent des efforts collectifs. Les résultats de cette étude permettent de proposer des recommandations sur la qualité acoustique des bâtiments hospitaliers.

### INTRODUCTION

Noise at hospital is often mentioned by patients as being a frequent source of annoyance. Indeed for a hospitalised patient noise annoyance is often aggravated by worry, sleeplessness and fatigue (1) (2). Few studies have been published on this problem (3). The aim of this study was to determine the relationships between perceived noise annoyance by patients and staff, and the acoustic qualities of buildings of different dates of construction. This study carried out in collaboration with the Ministry of Public Health can contribute toward the drawing up of recommendations for noise prevention in hospitals (4).

### MATERIALS AND METHODS

A study of noise nuisance was carried out in three different departments in two city hospitals in Rennes. Department A (Pneumology) is located on the first floor of a building constructed in 1907 and renovated in 1985. Department B (General Surgery) is on the first floor of a large hospital block built in 1969 and renovated in 1982. Department C (Maternity and vascular Surgery) is located in a modern building constructed in 1981. Department A is exposed to high levels of bus traffic noise.

Two surveys, one involving patients and the other staff, were carried out in order to study the environmental premises characteristics, the relation between noise and patient health, sleep perturbation, how noise nuisance was perceived, and also to determine whether any relationship existed between the results. Questionnaires comprising 24 questions for patients and 15 questions for staff were based on previous studies (5) (6). They were pretested and correctly filled in with the help of nursing staff. 223 patient questionnaires and 199 staff questionnaires were completed. The results allowed us to determine which acoustic measurements to perform.

The acoustics of buildings were classified by the time of reverberation of rooms and corridors, sound proofing against interior and exterior noise, and measurements of perceived noise. All measurements were taken with accurate sound level meters in accordance with standards laid down by AFNOR standards.

## RESULTS

### I - Inquiry

Over 90 % of the patients participated in the survey. Fifty seven percent of the population studied consisted of those either in employment or seeking work. The mean age of patients for A and B was 59, and for C it was 40, in the latter case 40 % of the respondents were young women in maternity.

The fundamental result was that in the three departments an average of 30 % of patients were disturbed by noise and 26 % of patients considered that noise prevented them from sleeping.

The periods when noise was considered the most disturbing for patients was in the morning for 85 % throughout the 3 departments, and at night for 65 %. The most disturbing noise was that stemming from trolleys 74 % of patients.

Table 1 - The most disturbing noises according to patients

Departments	Degree of annoyance		
	A	B	C
Trolleys	86	68	73
Slamming doors	58	40	87
Footsteps	62	48	47
Traffic noise	61	33	54
Plumbing noises	53	32	54

In department A, 61 % of patients consider that they suffer annoyance from traffic noise due to buses passing frequently close to the building.

Combining different data shows that annoyance would seem to lessen with age and increase with time of stay (figures 1 et 2).

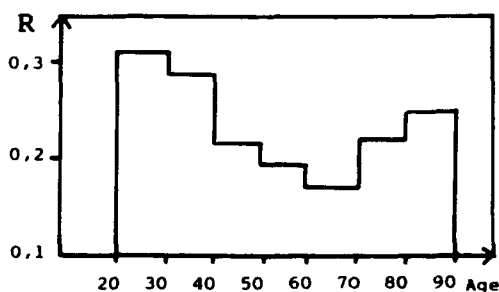

Fig.1 Annoyance in relation with age

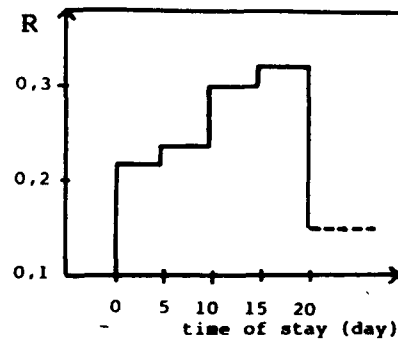

Fig.2 Annoyance in relation with time of stay

$$R = \frac{\text{number of people disturbed}}{\text{total number in sample}}$$

Ninety-one percent of staff considered that the hospital was noisy and 32 % were disturbed by noises. All members of staff surveyed had heard complaints from patients. The most disturbing noises were slamming noises, television, radio and outside traffic noise and visitors. The staff were less disturbed by trolleys but were disturbed by noise stemming from the patients.

## II - Acoustic study

Acoustic measurements enabled variations in acoustic quality to be determined objectively. Reverberation times in general were satisfactory and were in line with recommendations of the Who and the French Hospital governing body (La Direction des Hôpitaux) (figure 3) (4). Sound proofing against airborne noise inside the building was in general poorer than minimum recommended standards, 45 decibels (A) between patient's rooms (4). It is of a higher standard in the modern building. Sound proofing against impact noise was up to standard in general.

Measurements of noise levels  $Leq$  were carried out over a period of 24 hours in the three departments. In departments A and B the mean levels between 7.00 am and 8.00 pm are close to 40 dB(A) and slightly higher (figure 4). In department C the relatively high levels of 42 dB(A) between 10 pm and 6 am, partly due to the ventilation in the modern building, are higher than the recommended nighttime levels (4).

The measurement of emergence highlights the problem of certain noises especially ringing telephones, and hydraulic sound dampners on all the doors in department B have allowed noise levels to be reduced by a half on average.

As for as outside noise is concerned service A was exposed to mean outside noise levels of approximately 64 dB(A) between 7.00 am and 8 pm, and 57 dB(A) during the night between 10.00 pm and 6.00 am, what is more the existing sound proofing of 24 dB(A) is not adequate. The new building C thanks to double glazing has better acoustic qualities than the old buildings.

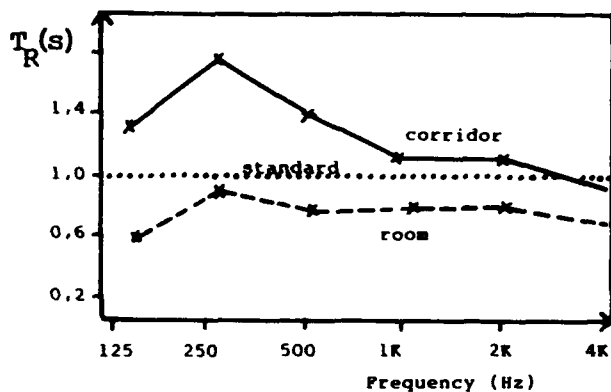

Fig.3 Time of reverberation of hospital premises

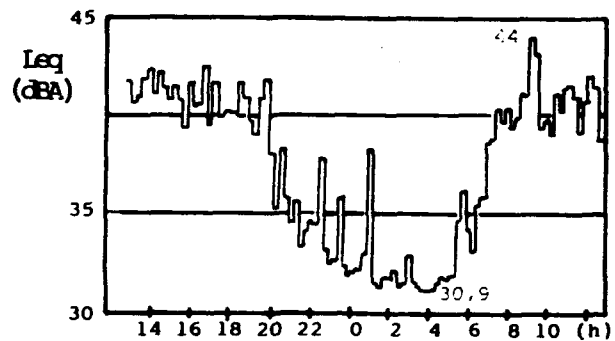

Fig.4 Noise experienced over 24 hours

## DISCUSSION

The comparison of the results of the noise level measurements and the surveys show that even if 30 % of patients and staff on average consider that they are disturbed by noise in the hospital, noise with the highest levels coming from outside traffic and the corridors produces the greatest degree of annoyance. A correlation also exists between night and morning periods of great disturbance and the noise levels during these times. These results are similar to those obtained in previous studies (6).

The reduction of noise annoyance when the acoustic quality of the premises is higher demonstrates the effectiveness of acoustic treatment as exemplified by the use of hydraulic anti-slamming devices on doors, and sound absorbing floor covering for footsteps.

The old buildings have lower acoustic quality than the new buildings which must meet recommended standards proposed by the hospital governing body of the Health Ministry (Direction des Hôpitaux du Ministère de la Santé) (4). Perceived noise annoyance also varies according to socio-cultural factors. People living in individual housing are on the average two times more sensitive to noise than those living in apartment blocks (6).

Outside noise often represents the greatest noise annoyance. More than 60 % of patients considered themselves to be disturbed by noises with outside levels (7.00 am - 8.00 pm) close to 64 dB(A) and in the case of old buildings where sound proofing was lower than 25 dB(A). French guidelines recommend a general upper limit  $L_{eq}$  (8.00 am - 8.00 pm) for road traffic noise of 65 dB(A), and the law of 31 December 1992 lay downs a standard of 60 dB(A) in the case of certain sensitive sites. Research carried out in view of European harmonization has shown that in certain countries such as Switzerland and the Netherlands minimum noise level standards are fixed for areas considered more sensitive (hospitals and schools)(7). These standards would seem to be appropriate and imply that hospital planners should favour quiet locations and attempt to avoid increases in traffic around the hospital.

In the wake of this study, training for hospital staff on noise prevention in order to improve patients comfort will be put in place by an interprofessional group comprising hospital managers, nurse managers and engineers (8).

#### CONCLUSION

The measurements carried out of noise levels are substantially in line with the results of the two surveys, particularly in relation to the effectiveness of noise reduction measures and the effect of noise on patients' sleep. When traffic exterior noise levels supersede 60 dB(A) by day the degree of annoyance experienced by patients is on the average 60 %. The recent French legislation of 31 December 1992 could help to prevent such noise annoyance.

What is more reducing noise annoyance is not simply a technical matter. Efforts to favour tranquility in the hospital must come from staff, patients and visitors alike. Training will be offered to hospital staff to improve the acoustic comfort of patients.

#### REFERENCES

- (1) VALLET M., MOURET J. - Les effets du bruit sur la santé. Ministère de la Santé et de l'Action Humanitaire. Centre d'Information et de Documentation sur le Bruit. Paris 1992.
- (2) MOCH A. - Les stress de l'environnement. De la perception au stress. Presses universitaires de Vincennes, Paris, 1989.
- (3) OCDE - Lutter contre le bruit dans les années 90, OCDE, Paris, 1991.
- (4) Ministère de la Santé et de l'Action Humanitaire. Guide "Le bruit à l'hôpital", 1989.
- (5) RABINOVITZ J., BAKONYI M. - Effects of noise in multi-storey buildings. Proceedings of the 5th International Congress on Noise as a public health problem, Stockholm, 1988, 247-252.
- (6) MICHON T. - Le bruit à l'hôpital. Mémoire Ingénieur du Génie sanitaire, ENSP Rennes, 1987.
- (7) LAMBERT J. - Réglementer l'exposition au bruit des transports terrestres vers une harmonisation européenne. Proceedings of the 6th International FASE Congress, Zurich 1992, 271-274.
- (8) BILLIER M., SOYER M. et al. - Nuisances sonores à l'hôpital. Présentation d'un module de formation du personnel pour la lutte contre les bruits de comportement et d'activité. Séminaire interprofessionnel ENSP Rennes, 1992.



**AUDIO-B.R.P. : AN AUDIO-SONOMETRIC SOFTWARE PACKAGE  
MEETING THE FRENCH REGULATIONS ON OCCUPATIONAL NOISE  
EXPOSURE**

**NORMAND Jean-Claude\*, ABOUKHALIL Elie\*\*, LUZY Annick\*\*, PIGNAT Jean-Christian\*\*\*, DUCLOS Jean-Claude\*,\*\*\***

**\* Institut Universitaire de Médecine du Travail de Lyon, Faculté Alexis Carrel,  
69372 LYON Cedex 08 (Pr G. PROST).**

**\*\* Association Bruit Recherche Prévention**

**\*\*\* Département d'O.R.L. (Pr J.C. PIGNAT)**

**Hôpital de la Croix Rousse, 69317 LYON Cedex 04, FRANCE**

Emergence of new European specifications on occupational noise exposure have lead France to change its own regulations with the issue of new orders (21 April 1988 and 3 September 1991). These orders refer to standards, occupational physicians find complex to use.

That is why, an audio-sonometric software package, AUDIO-B.R.P., is offered to occupational physicians to meet their needs in individual and group surveillance, according to French regulations.

L'apparition de nouvelles directives européennes en matière de bruit a conduit la France à modifier sa réglementation dans ce domaine, avec la publication des décrets du 21 avril 1988 et du 3 septembre 1991. Ces décrets font référence à des normes d'utilisation complexe pour les médecins du travail.

Pour ces raisons, un logiciel audio-sonométrique, AUDIO-B.R.P., est proposé aux médecins du travail pour assurer une surveillance individuelle et collective des salariés, conformément à la réglementation en vigueur.

Hearing impairment caused by chronic industrial noise develops over many years of exposure. Assessment of occupational deafness may be done by several approaches :

- preplacement examination with medical history and special attention to hearing acuity
- periodic examination of workers exposed to noise, by audiometric screening
- diagnosis of occupational deafness
- individual and collective control measures
- damage assessment
- compensation of the damage

Each of these approaches induces a various appreciation of occupational deafness

Emergence of new European specifications on occupational noise exposure have lead France to change its own regulations. French regulation is based on order n° 88-405 of the 21 April 1988 (protection of workers against noise) and order n° 91-877 of the 3 September 1991 (French occupational disease n° 42 : deafness induced by harmful noises). Theses orders refer to standards, occupational physicians find complex to use. Physicians must practice both medical survey, and also environmental assessment, individual and collective prevention or education.

That is why, an audio-sonometric software package, AUDIO-B.R.P., is offered to occupational physicians. AUDIO-B.R.P. has been regionally financed by the sickness state insurance (C.R.A.M.), the state work direction (D.R.T.) and several occupational health services (AGEMETRA, C.H.I., Renault V.I.).

AUDIO-B.R.P. operates on I.B.M. compatibles, single or multi-user. It consists of several modules, supported by standards and catalogues. Its refers to several French standards of the French Association of Normalisation (AFNOR NF S 31-013 and NF S 31-082) and uses various catalogues enabling to define :

- the activity of each factory (French Activity Nomenclature of the National Institute of Statistics and Economical Studies)
- the jobs (International Labour Office classification)
- the pathology (World Health Organization classification)
- the efficiency of hearing protectors (National Institute of Research and Safety tests).

The various modules meet the French regulations.

#### 1) The 21 April 1988 order (n° 88-405) : protection of workers against noise

The module *sonometry* integrates results of sonometry of workshops. Noise measurements are recorded both for continuous noise with different sound filters dB(A), dB(C) and for impulsive noises. It integrates the equivalent continuous sound pressure level for 8 hours,  $Leq,d$  (art. 1).

For specific works, it uses the weekly average of equivalent continuous sound pressure levels  $Leq,w$  (art. 6).

It helps physician to produce sonometry reports according to the AFNOR NF S 31-084 standard.

The module *headphones* helps physician to choice the best hearing protector available, headphones or ear-plugs (art. 3), according to AFNOR NF S 31-084 standard. It uses either the complex technique by spectral analysis or the simplified technique by estimated noise reduction ( $ENR_{80}$ ). Protective gear must be effective (noise level < 80 dB(A) for a daily exposure and impulsive component < 135 dB).

The module *audiometry* (art. 4 completed by the 31 January 1989 order : technical instructions for occupational physicians) allows :

- medical survey, with preplacement and periodic examinations
- medical records (which must be kept for 10 years) recording : job and workshop, type and attenuation of protective gear, dates and results of each noise measurements, medical examinations, tonal and vocal audiometries
- workers education by showing first, last but one, last tonal audiometry, comparison with non noise-exposed population, according to AFNOR NF S 31-082 standard, theoretical estimation of hearing loss at 60 years, according to AFNOR NF S 31-013 standard
- automatic classification of various degrees of occupational deafness and differential diagnosis for non occupational deafness
- various non nominative results, by workshop or plant, for the plant health and safety, working conditions committee (C.H.S.C.T.)
- computing several individual indices : mean hearing impairment (P.a.m.), mean hearing impairment standardized for 35 years old (P.a.m. 35), precece alert indicator (I.P.A.), annual hearing loss since the first and the last tonal audiometry
- Statistical studies by occupation, workshop or plant, by computing the mean hearing impairment (P.A.M.).

These modules meet all occupational physicians needs in information and education of workers (art. 5).

## 2) The 3 September 1991 order (n° 91-877) : French occupational disease n° 42, deafness induced by harmful noises

The module *results* uses records from various modules and catalogues : tonal audiometry, duration of exposure, occupations that carry a regulatory risk of hearing loss. It computes the legal indice (I.L.) of the 42nd French occupational disease by average of weighted hearing loss at defined frequencies (500, 1000, 2000 and 4000 Hz). It displays vocal audiometry threshold and, if not done, computes the theoretical auditive capacity (C.A.T.) from tonal audiometry.

## 3) Compensation

The module *results* assess a theoretical percentage of permanent partial incapacity (I.P.P.) from a guideline of the National Health Service (U.N.C.A.S.S. 1990). It computes theoretical compensation, which is complex (from parts of I.P.P. percentage and worker's wages) and the cost for the plant.

**AUDIO-B.R.P. is convivial and has particularly be designed for :**

**- an individual or collective follow-up of noise-induced hearing loss, by workshops or factories**

**- the making up of a database on occupational deafness**

**- epidemiological studies by crossing risk factors and duration to noise exposure or noise level**

**- a better respect of professional noise standards.**

# EVALUATION OF DIFFERENT METHODS OF STATISTICAL GENERATION OF NOISE LOAD INDICES.

Alan D. Wallis, Stephen T. O'Rourke

Cirrus Research plc Hunmanby, United Kingdom.

## 1. INTRODUCTION

To describe environmental noise levels, a single index such as  $L_{eq}$ , is usually inadequate. The essential requirements for a system to classify varying noise are that it should be clearly defined, logical, understandable and capable of being reproduced, with standards to describe the tolerances. Of the many systems proposed, the statistical levels, or  $L_n$  series, are the most widely used method of describing environmental noise.  $L_{10}$ ,  $L_{50}$  and  $L_{90}$  are the most common. How then do the  $L_n$  series match the essential requirements for a noise description system? This paper looks at some of the difficulties surrounding this area and concludes that an International standard is well overdue. Without such a standard, should we be using these  $L_n$  values as a measurement method?

## 2. MEETING THE REQUIREMENTS

The  $L_n$  series, which has many names, is usually defined as the level of noise, in dB(A) EXCEEDED for a stated percentage of time. Thus  $L_{10}$  is the level exceeded for 10% of the measuring time. From where does this definition come? Most other acoustic definitions are found in National or International standards. However, there is no standard which defines the  $L_n$  series, thus there is no yardstick by which the user can determine if the performance of a particular instrument is within expected and defined tolerances. Thus, the test for a standard is failed.

The test for logic is passed. There is little doubt that the use of the  $L_n$  series is logical. Even without the protection of a true standard, the use of the  $L_n$  levels has become the de-facto method of measuring environmental noise. Indeed, several countries have specified in their laws, that one or more  $L_n$  values should be used as the basis of determining if a particular noise climate is acceptable. The only illogical point would appear to be that several countries have put into law a measure which is not legally defined.

## EVALUATION OF DIFFERENT METHODS OF STATISTICAL GENERATION OF NOISE LOAD INDICES.

The test for understandability is also passed, although there are detractors, who can cogently and clearly state good cases for other statistical indices. However, even the most untrained person can understand the concept if clearly explained. However, it does not matter how many 'better' alternatives are proposed, the  $L_n$  series is already part of law so 'improvements' are now meaningless. The  $L_n$  series can be found from the histogram and thus in concept it can be defended as a mathematical computation.

The  $L_n$  series can be reproduced, but different methods will produce different numbers. This then is the main weakness of the statistical series. In the early years, the usual method of getting any  $L_n$  was by using a high speed level recorder, a statistical analyser and probability paper. Indeed a UK 'code' gave this as the method to adopt. Any serious worker knew full well that the value for  $L_{90}$  could be changed by changing the writing speed, paper speed, or damping of the level recorder. Yet, despite this, there was a conspiracy of silence to pretend that  $L_{90}$  was a single immutable value. There are instruments which purport to 'measure' the  $L_n$  series, when in fact they all use measured data to calculate the  $L_n$  series. References 1 and 2 give some early work on the differences that can occur between different methods.

### 3. METHOD OF CALCULATION

The usual way of producing the  $L_n$  series today is by 'binning' a series of data elements. These data elements can be either sound level,  $L_{eq}$  or even direct sampling of the ac waveform. The data is sampled at pre-set intervals and placed into one of a series of 'bins' or 'classes', each containing samples of the same range of levels. The smaller the bin width, the higher the resolution of the final answer. Naturally, the greater the number of data elements in the bins, the more nearly the distribution and thus the  $L_n$  value will approach the 'truth'. The number of elements in each bin is related to the bin width and the manufacturer is not constrained to any bin width by a standard. While 1 dB is common, some use 0,1 dB and unusual bin widths such as 3/8 dB have been used, to take advantage of particular digital resolutions.

If sound level samples are used, a time constant must be specified and "S" (Slow), "F" (Fast) and "I" (Impulse) have all been used. With any such exponential integration, the decay time of the rms rectifier greatly affects the value of the sample put into the bins. When the signal stops, the output from the rectifier will decay according to the time constant and thus for 'S' response, there will be significant output, and therefore incorrect data, for some seconds. After acquisition, the total number of samples in the bins is counted and the calculation is now done. For example, to get  $L_{20}$ , the total number of samples is divided by 5 and this number of samples is counted out of the bins, starting at the top. The bin in which the pointer rests after the count is the  $L_{20}$  bin. The value in decibels is the top edge of the class, not the centre but because there is no standard, many manufacturers use the bin center. To improve the accuracy of the calculation, some manufacturers start a secondary count which interpolates the data. This interpolation inside the bin can modify the final answer to a significant extent and great arguments take place in most companies as to how to do it. As there is no standard, these arguments cannot be resolved.

## EVALUATION OF DIFFERENT METHODS OF STATISTICAL GENERATION OF NOISE LOAD INDICES.

If instead of sound level, a true integral, such as short  $L_{eq}$ , is used as the input to the binning process, the original definition of 'the level exceeded---' become more appropriate as there will be no artifact of the instrumentation to artificially increase the higher number levels. With short  $L_{eq}$  the elementary period of the data acquisition becomes very important. For example, if very long periods are used with rapidly changing levels, the distribution will be very much lower than with a shorter elementary period. This is obvious as each short  $L_{eq}$  is an integral of the signal and thus a short term average of the energy. The result will be that as the time of each elementary period increases, the  $L_1$  level will drop while the  $L_{99}$  level will rise. In the limit, where only one element is left,  $L_1$  will equal  $L_{99}$ . While with one data element, it is ridiculous to talk of statistical distribution, the point of the varying levels becomes clear. When short  $L_{eq}$  is used as the basis of the calculation, the position of where the element boundary occurs is of no consequence as only true energy is used as the basis of distribution.

If no rectification is used at all and the ac output from the microphone is sampled directly at say 50kHz, these samples can be used to generate a statistical series. This is clearly the way sound level meters will be designed in the very near future to use as little hardware as possible, letting the computer do the weighting and response calculations. As no rectification has taken place, the maximum sample value will be at least 3dB higher than any rms level and if the signal is not perfectly sinusoidal, will be somewhat more than this. While this process is truly more in tune with the original definition of  $L_n$ , it clearly is a different statistical process to the calculation by binning the rms or mean square levels, so should have different names and symbols.

### 4. MEASURED DATA

While it is conventional in such a paper to give examples of the different values that can be obtained for  $L_{10}$  and  $L_{90}$ , this has been done many times and what has effectively been shown is that the difference depends on the form of the noise being measured. In any of the realisations of  $L_n$ , the variables of sample rate, response speed and class width are clearly going to have differing effects on the final answer. If this were simply an academic argument for or against the use of  $L_n$  values, the data could and would be chosen to make the evidence point the way required. However, the problem is more serious. Many countries have laws and some are given in the references. Ref 3 & 4. These laws, for example airport noise control, can cause airline operators to be heavily fined if they exceed a particular  $L_n$  value. It is clear the first time a major airline is so fined, their defence will be that  $L_n$  is not adequately specified- and they will probably win the argument. Apart from the legal situation, it would seem wrong for a mature sector, such as the acoustical control industry, to fail to have any recognised method of determining if a particular instrument meets the required level of accuracy.

## EVALUATION OF DIFFERENT METHODS OF STATISTICAL GENERATION OF NOISE LOAD INDICES.

The point of laws is to ensure that a set of rules is established that all parties to a dispute accept. With  $L_{10}$ ,  $L_{50}$  and  $L_{90}$ , we have the situation where NO standard whatsoever is in place to specify how we obtain these legally required numbers. Perhaps the most appropriate forum to generate such 'rules' is working group 4 of IEC Technical Committee 29, but in that group arguments are being put forward that as  $L_n$  is a calculation, it should not be in a measurement standard. While a academically correct point, the distinction in the mind of the user between sound level, which is a measurement and  $L_{10}$  which is a calculation, probably does not exist. It is a pity that academics should put these minute points of principle before the more important problem of having a realistic standard.

The alternative forum, the International Standard Organisation in Technical Committee 43 has not decided to work on a standard, presumably because it is an instrumentation standard which is required. The fact that it is a calculation instrument rather than a measuring instrument, is of little importance.

### 4. CONCLUSION

The  $L_n$  series are an integral part of the practice of noise measurement, particularly environmental noise measurement and it is a sad reflection on our science that no standard exists to produce the series.

Should the present situation continue and IEC fail to produce a standard which includes these series, the day will clearly come when a court will find that the laws which mandate the use of  $L_{10}$  are invalid as there is no written description of  $L_{10}$  that a court could accept as 'defined' in legal terms.

### 5. REFERENCES

1. Wallis A D. A comparison of Statistical Indices. ICA Zagreb Yugoslavia August 1989
2. Holding J M. A comparison of different methods of computing the statistical indices. Proc Internoise Newport Beach California Dec 1989
3. United Kingdom Land Compensation Act: Noise Insulation Regulations (1973 amended 1975).
4. Airport Noise Management and Land Use Planning. New Zealand Standard DZ 6805:1992



# **A QUANTITATIVE ASSESSMENT OF THE RISK OF NOISE-INDUCED HEARING LOSS (NIHL) UNDER THE CURRENT OSHA STANDARD**

**PRINCE M.M., STAYNER L.T.**

**Risk Assessment Program, Division of Standards Development and Technology Transfer  
National Institute for Occupational Safety and Health, Cincinnati, Ohio, USA**

In 1974, the Occupational Safety and Health Administration (OSHA) published a proposed noise regulation which set limits for noise exposure and defined the requirements for audio-metric testing. An amendment to the noise standard was published by the US Department of Labor in 1981 which established the elements and procedures of an acceptable hearing conservation program, including monitoring of noise exposure, audiometric testing, record keeping, and employee education. With a permissible exposure limit (PEL) of 90 dB(A) (8-hour TWA), the elimination of occupational NIHL under the present noise standard relies heavily on an effective hearing conservation program. However, the effectiveness of industry hearing conservation programs have not been systematically evaluated under the current noise standard.

The purpose of our analysis was to examine whether the current OSHA standard has reduced the risk of NIHL in general industry. Our analysis used audiometric test data from a variety of industries which were analyzed by the American National Standards Institute (ANSI) working group to examine hearing conservation program effectiveness. The ANSI data base uses information from companies that are currently required to comply with the OSHA noise standard and amendment. Data bases for comparison included both internal and external "control" groups with low noise exposure, as well as noise-exposed populations in which either the hearing conservation program was highly effective and/or the population was well protected via good hearing protection compliance. The risk estimates from this analysis will be compared to those from the NIOSH Occupational Noise and Hearing Survey of 1969-72, as a means of determining whether there is evidence that the risk of NIHL has been decreased due to the implementation of the OSHA noise standard and amendment.



**DUTIES IMPOSED BY THE NOISE AT ITALIAN WORK  
REGULATIONS**

MORELLI Luigi, M.D.  
"Studio Morelli"  
Via Sant' Agata 26 - 48100 Ravenna, (Italy)

The European Community (EC) is introducing Directives designed to harmonise its Member States legislation on health and safety at work. This paper carries out the duties by the noise at Italian work regulations - Departmental Order August 15th 1991 n. 277-.

Italian Government has assimilated E.C. Directives n. 86/188, n. 80/1107, n. 82/605, n. 83/477 with Departmental Order, August 15th '91 n. 277 about protection of employees against the risks originated by exposure to physical, chemical and biological risks in the work-site.

Particularly the Departmental Order, chapter IV, develops the individual daily exposure to noise in the work-site in TWA, die (8 hrs.) in dB(A). Especially during daily sthochastic work the evaluation could be expressed in TWA, week (40 hrs.) in dB(A).

The application of this Departmental Order, does not provide suggestions of the employees with TWA, die lower or equal to 80 dB(A).

For the employees working in exposure higher to 80 dB(A), we report on operative outline of duties in observation to Departmental Order n. 277, August 15th '91.

The main topics of the new Italian law are the detailed in the following points.

- 1 - Three limiting values are established for the  $L_{pp}$ : 80, 85 and 90 dB(A). Every time a higher limit is reached, more comprehensive actions against noise are required.
- 2 - The risk due to impulsive noise is taken into account stating that the sound pressure cannot have a value greater than 140 dB(Lin).
- 3 - The exposure of workers to noise must be evaluated in every plant (Art. 40).
- 4 - It is clearly stated that the owners and/or the managers of every plant must minimize the risk for the workers due to noise exposure. The action carried out on noise sources must be preferred (Art. 41).
- 5 - A principle of responsibility is clearly established: the owners and the managers of the plant are responsible for the noise measurements in the work place, the medical test on workers and the sound attenuation techniques.
- 6 - The workers can control that the safeguard procedures and devices be adequate.
- 7 - A technical annex to the law details the measurement procedures; I.E.C. class n. 1 instruments are required, and every measured value must be given with the associated random error.
- 8 - The program included a hearing conservation surveillance, which consisted of puretone audiometric screening and supplemental investigations of the exposed workers. The medical controls were matched with regard to the individual request.

\* \* \* \* \*

**Table 1: Summary of duties imposed by D.O. August 15th '91 n. 277**

D.O. n. 277/91	$L_{TFA}$ (I)				
	> 80 ≤ 85 dB(A) dB(A)		> 85 ≤ 90 dB(A) dB(A)		(II) > 90 dB(A)
<b>Art. 40</b> <u>Evaluation of noise-risk:</u> - Get the environment noise-level (TWA, $L_{TWA}$ / TWA, $L_{TWA}$ ) for individual exposure - New assessment is made for every change of lay-out	✓		✓		✓
<b>Art. 41</b> <u>Noise-risk in work-site:</u> - Danger signals exposure in risk-zone - Boundaries of the risk-zone					✓
<b>Art. 42</b> <u>Information for the employees:</u> - Risk of hearing-loss - Individual hearing protectors - Medical-audiological monitoring	✓		✓		✓
<b>Art. 43 comma 1,2,3</b> <u>Equipment for the employees:</u> - Obtain the individual hearing protectors			✓		
<b>Art. 43 comma 4</b> <u>Equipment for the employees:</u> - Obligation to use the individual hearing protectors					✓
<b>Art. 44 comma 4</b> <u>Health information:</u> - Medical-audiological monitoring by specific request of the employees	✓				

D.O. n. 277/91	L <sub>TPA</sub> (I)		
	> 80 ≤ 85 dB(A) dB(A)	> 85 ≤ 90 dB(A) dB(A)	(II) > 90 dB(A)
<p><b>Art. 44 comma 1,2</b> <b>Health information:</b></p> <ul style="list-style-type: none"> <li>- Medical-audiological monitoring</li> <li>- Frequency every two years</li> </ul> <p><b>Art. 44 comma 3</b> <b>Health information:</b></p> <ul style="list-style-type: none"> <li>- Medical-audiological monitoring</li> <li>- Frequency every year</li> </ul> <p><b>Art. 45</b> <b>Provide:</b></p> <ul style="list-style-type: none"> <li>- Technical-Administrative informations within 30 days, to Institutional and Public Entities charge of the control of the legislation</li> </ul>		✓	✓  ✓
<b>Notes:</b>			

(I) The L<sub>TPA</sub> action levels are values of daily personal exposure to noise.

(II) All the action shown at 90 dB(A) is also required where the peak sound pressure reaches 200 pascals (140 dB re 20 μ Pa).

## NOISE REGULATIONS IN BRAZIL

GONÇALVES, Sylvania

NABUCO, Marco

Brazilian Environmental Institute  
IBAMA - SAIN L4 Norte  
70818-900-Brasilia-DF-Brazil

National Institute of Metrology  
INMETRO-N.Sra Graças,50 - Xerem  
25250-040-D.Caxias-RJ-Brazil

### Abstract

Noise in Brazil has been considered a new matter since 1990 when an effective effort to reduce the noise levels in the country was started.

The laws were changed on 1990 when the "Silence Program" carried out under the Brazilian Environmental Institute - IBAMA coordination and supported by National Institute of Metrology - INMETRO begun.

Unfortunately the noise regulations on workplaces are not at the same step. Frequently, some contradiction can be found when evaluating noise induced hearing loss. At the same time the measurement procedures are not very well defined while a table with maximum dB(A) levels versus maximum exposure time is used as the criteria. The main objective of this paper is to present both regulations to be discussed and commented to support any changing in the law if necessary.

### The environmental noise regulation

Before 1990 it was used a very wide government regulation which indicated the procedures and criteria to evaluate the environmental noise levels. This regulation was replaced around march, 1990 by another one [1] now created by the Environmental National Council - CONAMA relating the law to two Brazilian Standards [2, 3] as suggested by a Technical Commission. These two standards are being discussed to be adapted as a result of the experience in using them.

A second regulation [4] created the National Program for Education and Control of Noise Pollution, called Silence Program to support and improve the noise regulations applications as the main task.

### The Silence Program

In general, the goals of the Silence Program are:

1. An educational program to be carried out at the secondary schools;
2. An informative program on the radio and television about the health problems related to the noise exposure;
3. An intensive course on noise measurements to be offered to the State Environmental Agencies;
4. The purchasing of sound level meters to be distributed among the agencies after the course;

5. An special effort to reduce the noise levels produced by machineries, toys, household electrical appliances and other sound sources that implicated in a Noise Labelling Program.

In practical terms the States and Districts Environmental Agencies are responsible to apply the noise regulations. They may have their own laws but never less restrictives than the national ones.

To start effectively the noise abatement program after changing the laws an intensive course on environmental noise measurements was offered to forty three technicians followed by a distribution of twenty eight new sound levels meters.

The Brazilian people is just starting to complain about its rights and there are not many official complaints against excessive noise levels yet. To increase the people comprehension about noise as a problem, an educational program on radio and TV was performed, and the subject environmental noise was included in the secondary schools curriculums in Brazil.

#### Vehicle noise abatement actions

The major noise sources in the Brazilian big cities are the vehicles. To reduce the traffic noise due to the vehicle flow is a hard task because it demands many connected actions involving different government departments. To start a noise abatement action on traffic noise it was decided to work at the source itself.

To do that many meetings were performed involving the IBAMA, the vehicles manufacturers association and the environmental agency of the state of São Paulo- CETESB, the state where the major manufacturers are installed. The first result was a changing on the maximum levels permitted as emission for the different types of vehicles.

#### The noise source labelling program

In Brazil it is not possible yet to buy any type of machinery with informations about the emitted noise. The Brazilian regulations do not state what is the maximum value permitted for emission with respect to machinery, but stabilishes what is the permitted emission levels as a function of different environments.

The first task of the noise labelling program was to promote a meeting between the government representatives, sound test laboratories and the manufacturers association. This meeting was held last March at the National Institute of Metrology Acoustics Laboratories.

Eight sound test laboratories participated of the meeting, with three government labs and five private including manufacturers laboratories.

As expected, the manufacturers association complained about the labelling program but they have decided to discuss it between its members. It was decided to start from household appliances because its large use among the people and an electrical energy labelling program working very well which includes refrigerators and air conditioning machines.



The noise labelling program intends to give to the consumer information about the machine as noise emitter, to permit the right choice and also to improve market competition which is one of the general goals of the Brazilian government.

To carry out the noise labelling program the following actions are planned:

- 1) A Brazilian acoustics laboratories network to perform the necessary sound power levels measurements;
- 2) A regulation establishing the manufacturers obligation to use a label on all machinery with the emitted sound power level in dB(A).

#### The workplace noise regulation

In Brazil the workplace noise control is performed by inspectors named by the Ministry of Work. The procedures to perform the control are stated by a government regulation [5] that establishes the measurement techniques and the maximum levels associated to maximum time exposures.

After the measurement a report is done and the employer must provide the solution that can be either a time exposure decreasing, or a reduction of the noise at the source or at the path or, simply distributing ear protectors among the workers, which is more common.

The ear protectors are not being tested yet in Brazil. There is a government program involving private and official laboratories to test all ear protectors as a part of a model approval routine.

At the same time audiometric tests should be performed to evaluate the hearing loss induced by noise. These tests are performed by specialists who send the worker to a Ministry of Work department once a loss is identified. After that the Ministry of Social Assistance is asked to pay an insurance. The problem is that each Ministry has a different criteria to evaluate the hearing loss, and many times it is possible to identify a situation where there is a loss using one criteria while this loss is not identified using the other one [6].

A special effort is being done to solve all these problems and the first task must be to correlate the regulations to international standards as it has been done with respect to vibration at workplaces.

#### Comments

All those programs are the result of the government effort to control and reduce the noise levels in Brazil.

It is always necessary to have the agreement from the consumers and manufacturers. The first agreement will be a consequence of the educational program about the health problems due to noise exposure at the secondary schools, the consumers associations and the television and radio programs.

To get an agreement from the manufacturers, always a hard task, the public opinion will be used to show them the importance of the program. After that a government regulation will be established to give legal support for the noise source labelling program.

With respect to the workplace noise, many things are still to be done, changing the laws, improving training programs for the government inspectors, increasing the purchase of new equipments and mainly working together with workers syndicates and associations who should promote an educational program among all workers involved with excessive noise levels.

Unfortunately this work is starting now and any solution will be achieved at least in one or two years.

#### References

- [1] RESOLUÇÃO/CONAMA/No. 001 de 08 de março de 1990 - D.O.U. de 02/04/90, Seção I, Pag. 6.408
- [2] Associação Brasileira de Normas Técnicas - ABNT - NBR 10151 - "Avaliação do Ruído em Áreas Habitadas Visando o Conforto da Comunidade - Procedimento" - 1987
- [3] Associação Brasileira de Normas Técnicas - ABNT - NBR 10152 - "Níveis de Ruído para Conforto Acústico - Procedimento" - 1987
- [4] RESOLUÇÃO/CONAMA/No. 002 de 08 de março de 1990 - D.O.U. de 02/04/90, Seção I, Pag. 6.408
- [5] Norma Regulamentadora NR 15 - "Atividades e Operações Insalubres - Anexo 1" - Ministério do Trabalho
- [6] Rita C. Marques, Silvia A. Sampaio, "A perda auditiva induzida por ruído e a atual legislação brasileira" - Proceedings of the IV International Seminar on Noise Control - Rio de Janeiro - Brazil - 1992

#### Acknowledgments

The authors wish to thank Francisco Parentes Corrêa for his reviewing of the manuscript.

## **ENVIRONMENTAL IMPACT OF THE BRAZILIAN VEHICLE NOISE EMISSION CONTROL PROGRAM**

SCHMIDT, Daniel Egon, SZWARC, Alfred and ALVARES JR, Olimpio de Melo

CETESB - Companhia de Tecnologia de Saneamento Ambiental, São Paulo, Brazil

### **ABSTRACT**

This study evaluates the vehicle noise emission reductions to be achieved due to the requirements of the new Brazilian Vehicle Noise Emission Legislation. Additionally, it estimates through mathematical modeling, the overall traffic noise pollution reduction expected to occur at selected traffic ways after the complete substitution of the present fleet.

### **INTRODUCTION**

In Brazil, automotive noise emissions have been subjected to control measures since 1971, under the provisions of Resolution CONTRAN N° 448/71<sup>1</sup>, set by the National Traffic Council. However, since then the regulation has not been updated and became obsolete. As a result a considerable number of vehicles produced in Brazil, particularly trucks, buses, motorcycles and mopeds have high noise emission levels. Consequently, the large number of noisy vehicles which are presently in use has contributed significantly to increase ambient noise to almost unbearable levels in many areas, particularly in the cities of Rio de Janeiro and São Paulo, which are among the noisiest cities in the world.

In order to counterbalance this serious problem, CETESB - the São Paulo State environment protection agency - proposed, in 1991, to the local motor vehicle industry and to IBAMA - the federal environment protection agency, a new set of regulations. Following deep technical discussions, the National Environment Council (CONAMA) approved Resolutions n° 1/93<sup>2</sup> and N° 2/93<sup>2</sup> that will become effective in July 1993 for imports and in January 1994 for locally produced vehicles.

### **NOISE REDUCTION**

In order to evaluate the degree of control of the new noise control regulations, three kinds of calculations were performed:

- a) the first calculation just considered the difference between the new and the former corresponding emission limits. As shown in Table 1, this difference ranges between 1 and 10 dB(A) and clearly expresses the progress brought by the new regulations. In practical terms, this means that the noisiest vehicle models shall have its noise levels reduced by 7 dB(A) and for most models this reduction will range from 2 to 4 dB(A);

b) a second way chosen to compare the new and the former regulations is to express the noise level differences in terms of percentage of sound energy reduction. This is a practical means of indicating the magnitude of noise abatement since, due to the logarithmic nature of the decibel scale, the algebraic difference does not clearly show the extent of control progress. In addition, the calculated values were helpful to predict ambient noise reductions, as discussed later. The percentage of sound energy reduction was calculated through the following equation, which was derived from the fundamental sound energy level equation.

$$R = \frac{\frac{L_1/10}{10} - \frac{L_2/10}{10}}{\frac{L_1/10}{10}} \cdot 100\% \quad \text{Where:}$$

R = reduction of sound energy in %;

L<sub>1</sub> = energy level generated by a vehicle in compliance with the former regulation - dB(A);

L<sub>2</sub> = energy level generated by a vehicle in compliance with the new regulations - dB(A).

Although the equation should have the variables L<sub>1</sub> and L<sub>2</sub> expressed in dB, to simplify calculations and considering its estimative purpose, both variables are expressed in dB(A);

c) the third way to evaluate the noise reduction, meant to be used for lay people information, was to express it in terms of source equivalence. According to this principle, the noise level resulting from a source with sound energy "n" times greater than a given source or from "n" identical sources is given by the equation  $L_n = 10 \log n + 10 \log E/E_0$ , where E is the energy and E<sub>0</sub> the reference energy. Therefore, the increase of the sound level due to the addition of identical sources is given by  $10 \log n$ . This means, for instance, that if a vehicle has a noise level 7 dB(A) higher than another one, the noisier vehicle is equivalent to five of the more silent vehicles, operating simultaneously. Table 1 shows that in terms of source equivalence (assuming that noise emission limits correspond to noise emission levels), it would be necessary 1,2 to 10 vehicles in compliance with the new regulations to generate the noise produced by a single vehicle produced in conformity with the former regulation.

### TRAFFIC NOISE REDUCTION

To predict the effect of the new noise control regulations on traffic noise reduction, an empiric model<sup>3</sup>, developed by IPT (the São Paulo Technological Research Institute) was used. This model, developed through a step-wise multiple linear regression, predicts the equivalent continuous sound level - Leq of a traffic way according to the following equation:

$$Leq = 53 + 7,9 \log Q + 0,22 p - 5,7 \log d \text{ (dB(A))}$$

Where:

Q = traffic flow (number of vehicles/hour);

p = percentage of heavy duty vehicles;

d = distance from observer to the center line of the traffic way.

The model is considered valid for the following variation ranges:

$$66 < Q < 10076 \text{ vehicles/hour}$$

$$0 < p < 39,8 \%$$

$$4 < d < 25,5 \text{ m}$$

$$6,0 < \text{traffic speed} < 58,5 \text{ km/h}$$

The application of the model was validated by CETESB\* on nine selected traffic ways, with a traffic flow from 2952 to 8300 vehicles/hour and a percentage of heavy duty vehicles that varied from 2,75% to 20,87%. The difference between the observed (Leq observed) and the predicted (Leq predicted) noise levels varied between - 2,23 to + 3,73 dB(A).

In order to include in the model the noise reduction of the new regulations, it was necessary to develop the concept of virtual traffic flow (Q'). This means a traffic flow equal to the one observed but with a reduced sound energy.

To calculate Q', it is assumed a complete replacement of the present fleet by vehicles in compliance with the new regulations and an average reduction of sound energy for heavy duty and light duty vehicles of, respectively, 80 % and 50%. Therefore,  $Q' = Q \text{ heavy duty} \times 0,2 + Q \text{ light duty} \times 0,5$ . Also, a new percentage of heavy duty vehicles (p') had to be calculated as:

$$p' = Q' \frac{\text{heavy duty}}{Q'} \times 100 \%$$

The L'eq levels were subtracted from the previously calculated Leq predicted levels and difference  $\Delta \text{Leq}$  represents the predicted decrease of ambient noise at the vicinity of the selected sites. To adjust the model to the observed values,  $\Delta \text{Leq}$  was subtracted from Leq observed and the final Leq level was calculated. The results are summarised in Table 2 which shows that the predicted decrease of ambient noise varies from 2,94 to 5,32 dB(A) at the nine sites.

#### **CONCLUSION**

The recent automotive noise control regulations have the potential to, in a few years, reduce considerably noise emissions from new vehicles. On the long term, the regulations will contribute to decrease traffic noise in already congested areas and help to prevent rapid degradation in areas with still little noise problems.

#### **BIBLIOGRAPHY**

- 1) Resolução Nº 448, de 14/10/1971 - Conselho Nacional de Trânsito, Brasília, DF.
- 2) Resoluções Nº 1 e Nº 2, de 11/02/1993 - Conselho Nacional do Meio Ambiente, Brasília, DF.
- 3) Instituto de Pesquisas Tecnológicas - Modelo Empírico para a Previsão de Tráfego para a Cidade de São Paulo, São Paulo, 1979.
- 4) Schmidt, D.E.; Szwarc, A. and Alvares Jr., O.M. - Impacto do Programa de Controle de Ruído Veicular, Seminário de Emissões Veiculares e os Combustíveis - AEA - Associação de Engenharia Automotiva, São Paulo, 1992.

**TABLE 1 - Comparison between the former and the new automotive noise control regulations**

VEHICLE TYPE	FORMER NOISE LIMIT dB(A)	NEW NOISE LIMIT dB(A)	REDUCTION dB(A)	SOUND ENERGY REDUCTION		
				SOURCE EQUIVALENCE	%	
A**	84	77	7	5,0	80,0	
B**	GVW ≤ 2 t	84	78	6	4,0	75,0
	2 > GVW ≤ 3,5 t	89	79	10	10,0	90,0
C**	power < 150 kW	89	80	9	8,0	87,0
	power ≥ 150 kW	91	83	8	6,3	84,0
D**	power < 75 kW	84	81	3	2,0	37,0
	75 kW < power < 150 kW	89	83	6	4,0	75,0
	power ≥ 150 kW	92	84	8	6,3	84,0
E**	<b>Engine size</b>					
	up to 80 cm <sup>3</sup>	84	77	7	5,0	80,0
	from 81 to 125 cm <sup>3</sup>	84	80	4	2,5	60,0
	from 126 to 175 cm <sup>3</sup>	84	81	3	2,0	50,0
	from 176 to 350 cm <sup>3</sup>	84	82	2	1,6	37,0
	above 350 cm <sup>3</sup>	84	83	1	1,2	20,5
	up to 80 cm <sup>3</sup>	84	75*	9	8,0	87,0
	from 81 to 175 cm <sup>3</sup>	84	77*	7	5,0	80,0
above 175 cm <sup>3</sup>	84	80*	4	2,5	60,0	

Notes:

- (\*) second phase of control - becomes effective in year 2001.
- (\*\*) vehicle-type classification: A) automobiles and light duty commercial vehicles; B) passenger vehicles with up to 9 seats and commercial vehicles; C) passenger vehicles with more than 9 seats and Gross Vehicle Weight (GVW) higher than 3,5 t; D) commercial vehicles with GVW higher than 3,5 t; E) motorcycles, mopeds, scooters and similar vehicles.
- (\*\*\*) test procedure and some other requirements are similar to those of the European Economic Community (EEC).

**TABLE 2 - Observed, calculated and future ambient noise levels**

SITE	Leq OBSERVED dB(A)	Leq CALCULATED dB(A)	Leq FINAL dB(A)	Δ Leq dB(A)
Av. dos Bandeirantes	81,4	79,75	76,65	4,75
Av. Cidade Jardim	77,3	77,24	74,36	2,94
Av. Jaguaré	78,8	77,70	74,80	4,00
Av. Vereador J. Diniz	78,6	77,24	74,44	3,56
Av. Francisco Morato	77,5	77,52	73,66	3,84
Av. Faria Lima	76,2	76,66	73,21	2,99
Av. Paulista	75,7	77,93	72,20	3,50
Av. Rebouças	78,0	78,15	74,80	3,20
Av. Eliseu de Almeida	82,2	78,47	76,88	5,32

## HOW ADEQUATELY IS THE PUBLIC PROTECTED FROM RAILWAY NOISE

Mr. CHAN Raymond  
Dr. KWAN Andrew  
Mr. WAI Chok Pong

Environmental Protection Department  
45/F & 46/F., Revenue Tower,  
5 Gloucester Road, Wan Chai,  
HONG KONG

### ABSTRACT

Recent revival of interests in mass transit all over the world once again led to greater attention being paid to the environmental impact of railways, noise being a significant one.

Meanwhile in the United Kingdom, a comprehensive review by the Mitchell Committee commissioned by Government to consider the "equitable" standard of railway noise with respect to eligibility for insulation against traffic noise showed that different standards and criteria were applicable. Of greater interest is that from the wide spread of noise standards, it could be inferred that apart from cultural and national differences, pragmatic considerations might have mitigated against the need to setting more stringent criteria for the purpose of protecting the majority of the public. A good example is the now generally agreed inadequacy of using a 24-hour descriptor to prevent night-time disturbance from train operation.

This paper describes the experience of dealing with train noise complaints in Hong Kong, a city of 6 million population heavily reliant on tracked mass transit. This paper will show that for better protection of the public, train noise standards should cater for different types of neighbourhood and at different times.

---

A very comprehensive work (Reference 1) was carried out by acousticians in the United Kingdom in an effort to derive an equitable noise levels for railway noise above which insulation should be provided to affected uses in the same manner as they are being provided to uses affected by excessive traffic noise under UK statutes. It provides some insight into the different international standards on railway noise. Essentially, a range of noise indices and levels have been adopted by different countries, as well as by different localities in the United Kingdom. There is a general consensus that railway noise impact is inadequately described if only a single descriptor over a long period, for example Leq 24 hours, is used. There are, therefore, attempts to stipulate a different level during the nighttime so as to more closely reflect the need for tranquility during these hours. A further observation of these various noise standards reveals that these differences tend to reflect the locational influence. A single value descriptor, therefore, is unable to reflect the expectation of a hosts of communities and therefore cannot represent a fair and adequate trigger level at which protection of the public from railway noise should be implemented.

2. Therefore it is argued that a single descriptor for an entire country does not adequately take into account the temporal and spatial differences that so much determine the acceptability of the intruding railway noise. This paper, therefore, sets out to describe how the foregoing issues can be considered if a drastically new approach is to be adopted to abate the impact of railway noise on its neighbouring uses, taking into account the prevailing background at different times. This paper will demonstrate that the system adopted in Hong Kong for assessing whether railway noise poses a statutory exceedance of the acceptable noise levels renders a more adequate protection to the community and in the meantime provides the flexibility which a single index system could not.

3. It is essential to firstly describe how railway noise is dealt with in Hong Kong. Under Hong Kong's Noise Control Ordinance (Reference 2), practically all noise from railway operations are controlled. If a complaint is lodged with the authority under the Ordinance, an investigation will be carried out to obtain noise levels at the complainant's premises to ascertain if that complaint is actionable. The procedures in obtaining the measured noise levels (MNL), making corrections such as tonality, impulsiveness and intermittency, and assessing if the corrected noise level (CNL), which represents the actual noise level perceived, constitutes a statutory exceedance are described in Reference 3. In essence, if the CNL exceeds the relevant acceptable noise levels (ANLs), which are the statutory levels under the Ordinance, shown in the table below, the railway noise complaint is actionable.

Table 1 Acceptable noise levels (ANLs) for different areas at different time of day under Hong Kong Noise Control Ordinance

Time Period	Area Sensitivity Rating (ASR)		
	A	B	C
Day (0700 to 2300 hours)	60	65	70
Night (2300 to 0700 hours)	50	55	60

4. The definition of the area sensitivity rating, ASR, is provided in Reference 3. Rural areas are normally classified as "A" whereas built-up urban areas will be considered as "C". In general, it is recognized that various locations in Hong Kong will already have different prevailing background noise which will constitute the acoustical characteristics of that particular locality and therefore, the noise level of any intruding event, including that of a railway operation, shall be judged by whether it falls in line with the local characteristics or otherwise. For example, a highrise apartment situated in a densely populated area fronting a major highway with traffic count of roughly 6,000 vehicles per hour will automatically receive an ANL of 60 and 70 dB(A) respectively during the nighttime and daytime, reflecting the fact that the ambient it is likely to have been exposed to even in the absence of an intruding event. Therefore, it is possible that a higher level of railway noise can be allowed in areas of C rating as compared to other quieter areas. The higher daytime ANLs even for given area sensitivity ratings, also provide the flexibility needed by railway operators to cope with the daytime demand for a more frequent service. The following paragraphs will utilize some actual data obtained in Hong Kong to show that the use of Table 1 essentially reflects more closely the expectations of the community and hence, the annoyance felt.



5. Table 2 below summarises the areas where noise from railway operations of two of Hong Kong's mass transit systems have provoked considerable complaints. These complaints relate only to the noise annoyance caused by running trains at night; complaints on other noisy activities such as track grinding, shunting near depots etc. are not presented. Where an "\*" appears, vigorous complaints have been lodged involving local pressure groups and politicians. Where "#" appears, the CNL exceeds ANL by 15 dB(A) or more but the complaint is not vigorous as these locations are at the influence of traffic noise.

Table 2 Nighttime noise levels at locations affected by railway operations

Location No.	Leq (30 min)., dB(A)			Leq (24hr)	No. of Complaints
	ANL	CNL	Background		
1	55	69	71#		2
2 (before)	55	69	55	60	*
(after)	55	67	55	60	
3	55	70	61		5
4	55	58	62		2
5	55	68	70#		0
6	55	60	68#		1
7	60	54	63		0
8 (before)	55	64	59	61	*
(after)	55	56	59	61	2
9	55	62	59		27
10	60	61	71		1
11	60	57	71		1
12	60	76	76#		2

6. In Table 2, the Leq (24 hour) values of two locations (#2 and 8) are also given. From the data of locations #2 and #8, where some remedial measures such as reducing train speed and installing trackside barriers have been done, the CNL dropped by 2 dB(A) and 8 dB(A) respectively during the worst half-hour at night. These drops resulted in a reduction in the number of complaints. However, the Leq (24 hr) values remained unchanged, demonstrating that this descriptor was insensitive to the reduction in noise level most needed by the community. The Leq (24 hr) values at these two locations also fall within most planning guidelines quoted in Reference 1, as well as these contained in the Hong Kong Planning Standards and Guidelines (Reference 4). However, since the CNLs exceeded the ANLs by such a wide margin at the night-time, community reactions showed that the reference to a 24-hr. Leq standard became irrelevant.

7. Furthermore, plotting the information contained in Table 2 provides some insights into how well the use of ANL correlates with the community's view of a statutory noise annoyance caused by running trains. It is noted that the true extent of community dissatisfaction cannot be wholly reflected in the number of complaints registered as there may well be many reasons why people do not lodge a complaint. Therefore, the fitting of a curve to these data points would be of little value. However, the indication is rather clear that the prevailing background does have an effect on whether community would be provoked by the noise of passing trains. A review of all the data points representing the difference between CNL and ANL immediately

reveals that all but one complaints lie in the positive region, demonstrating that the use of the CNL/ANL comparison aptly captures the annoyance felt by the residents. The sole exception complaint relates to a location where the residents are cumulatively affected by noise from road traffic, container port activities and railway operations. Further insight into the community's perception can be gained by viewing these complaints from the perspective of the difference between the CNL and the Background. Whilst one would have expected complaints to appear in the positive region (i.e.  $CNL > Background$ ), the six data points in the negative region, upon closer examinations, are complaints that relate to either squeal noise or noise from diesel locomotives. This observation probably points to the fact that the averaging nature (over 30 minutes) of the CNL does not fully stimulate the receiver's perception when noticeable squeals or high short-term maximum levels are present.

8. In conclusion, it is shown that a system similar to Hong Kong's which utilizes the difference between the train noise and a level representing the local characteristics, particularly during the night-time, provides a better basis for protecting the public. Further safeguard against short-term high levels and tonal components may also be necessary.

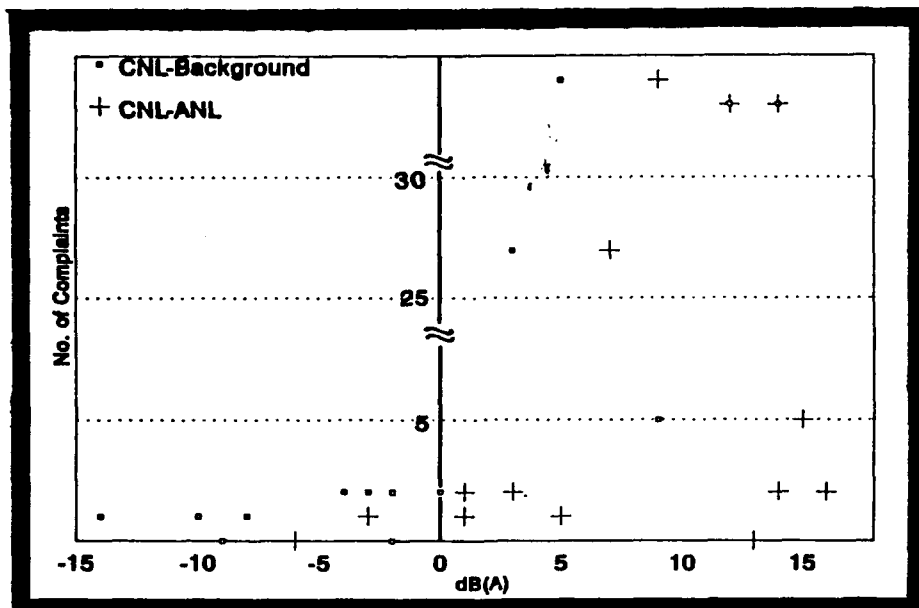

Figure 1 Correlation of complaints analysed with respect to the differences in magnitude between CNL, ANL and Background

Ref. 1 -- "Railway Noise and the Insulation of Dwellings" (1991),  
Mitchell Committee, UK Department of Transport

Ref. 2 -- "Noise Control Ordinance" (1988),  
Chapter 400 of the Laws of Hong Kong, Hong Kong Government

Ref. 3 -- "Technical Memorandum for the Assessment of Noise from  
Places other than Domestic Premises, Public Places or  
Construction Sites" (1989),  
Environmental Protection Department, Hong Kong Government

Ref. 4 -- "Environment Guidelines" 1986,  
Environmental Protection Department, Hong Kong Government

# **AIRPORT NOISE STANDARDS IN THE NETHERLANDS**

**KOPPERT, Abraham Jan**  
**Directorate General of Civil Aviation**  
**P.O.Box 90771**  
**2509 LT The Hague**  
**The Netherlands**

## **Abstract**

In the Netherlands noise zoning is obliged for all aerodromes, civil as well as military, according to the Aviation Act of 1978. The prescribed noise exposure index for calculating noise contours around commercial airports is the Kosten-unit. According to the law noise zoning has to be in agreement with the Structural Outline Plan for Airports. This policy paper was first published in 1979. During the public discussions about the Structural Outline Plan, new developments had arisen at most airports. The plans for a new runway at the regional Maastricht Airport in 1985 have triggered the public discussions on a special noise index for night flying operations. To continue the designation-procedure for Maastricht Airport the Griefahn-method is provisionally chosen for night operations and the largest/noisiest aircraft are excluded during the night period. Because of the consequences of such measures for Schiphol Airport and the other commercial airports a survey has been carried out on a national night index with good health protection.

## **Airport noise standards in the Netherlands**

### **Legislation**

In 1978 the Aviation Act was amended to incorporate a section on noise zoning around airports and the provision of public consultation procedures for establishing noise zones. The Act prescribes noise zoning around all civil and military aerodromes, used by engine-powered aeroplanes. In the Netherlands there are 4 major civil airports, including the national airport Schiphol, 3 civil annex military airports, 8 military airfields and 12 small aerodromes, which are entitled for noise zoning. To provide for a special night standard and better enforcement measures a new amendment of the Aviation Act is now under discussion in parliament coming into force at the end of 1993.

### **Local planning system and compensation.**

All noise zones have to be incorporated in local development plans after the designated noise zone becomes irrevocable. Municipals are obliged to incorporate these noise zones and to take the limit values into consideration in further development plans. Within the limit values planning and building restrictions become in force and compensation measures are carried out on behalf of the government. The government recovers the cost of these measurements from the airlines by adding a noise charge to the landing fees. The noise charge consists of two factors, one factor being related to the noise production of the aircraft, the other (monetary) factor being constant for all aircraft and established each year by ministerial decree to govern the total annual income to balance with the annual costs.

### **Commercial and military airports**

Noise zoning for commercial and military airports used by aircraft with a mass in excess of 6000kg is based on the Kosten-method. This method takes into account the number of aircraft during a one year-period, the maximum noise level of each aircraft-passage at a certain point on the ground and a weighting factor for the time of the day, evening or night. Noise contours are calculated from 35 up to 65 Kosten-units (= Ke), in steps of 5 Ke. The

value in Kosten-units corresponds with the average number of people who said to be annoyed by aircraft noise during public inquiries held around Schiphol Airport in 1963 and again in 1976.

The legal limit value is established by ministerial decree at 35 Ke. Above this value planning measures are taken to prevent new noise sensitive developments. Between 40 Ke up to 55 Ke all housing and other noise sensitive buildings are to be insulated against aircraft noise. From 55 Ke up to 65 Ke insulation is only to be applied when the costs are not exceeding the value of the property, otherwise the property will be purchased by the government and given a non-noise sensitive destiny or will be demolished. Above 65 Ke no noise sensitive buildings are allowed because of health considerations. Existing dwellings are purchased and demolished by the government.

The insulation values vary from 30 dB(A)-sound proofing at 40 Ke up to 40 dB(A)-sound proofing at 55 Ke and higher values. Around Schiphol Airport about 125 houses are demolished because of high noise exposure and more than 1500 houses and other buildings are already noise insulated at this moment.

Noise contours for noise zoning purposes are to be calculated for a future traffic forecast, so that they remain valid for a fairly long period. All noise zones must conform to the Structural Outline Plan for Airports. This basic planning decision was first published in 1979, but only approved in Parliament at 6 September 1988, after nearly 8 years of public discussion. During that period all commercial airports had developed plans for new runways or other enlargements of the airport. Noise zoning procedures that had already started had to be adjusted to the latest plans and to start all over again. The Structural Outline Plan is to be adjusted accordingly.

Consultations with regional and local authorities and the public inquiries according to the Aviation Act, together with the obliged environmental impact assessment for each airport development take several years.

For the larger commercial airports noise zoning procedures have not yet finished at this moment. Most noise zones for the commercial airports and all the military airfields are now expected to be established in 1994.

#### Small aerodromes

For aerodromes used by aircraft with a mass below 6000kg noise contours are calculated based on a Leq-method, called Bkl, based on the number of aircraft in the busiest half year with a weighting factor for evening and weekend operations. Noise contours are calculated for the values 50, 55 and 60 Bkl (= dB(A)). In the year 2000 these figures are to be reduced by 3 dB, forcing the aerodromes to take measures to reduce the noise by technical or operational means or to half the number of operations.

Within the noise zones no new noise sensitive buildings are to be developed. No insulation measures are required within these noise zones, because of the noise is only experienced outside the house.

#### Night operations

In the Kosten-method night operations between 23.00 and 06.00 hours local time are counted 10-times a daytime-operation (= 08.00 and 18.00 hours LT). The plans of a new runway at Maastricht Airport have triggered the discussions on a special noise index for night operations. Maastricht Airport was intended to function as a hub for a freight-integrator with a lot of night-time operations.

Many people proclaim that the Kosten-method is not adequate to predict the noise situation in case of a large number of night operations, because this method averages the noise over a whole year. In the planning-decision for the new runway at Maastricht Airport in 1985 it was conditioned that bedrooms in houses within the 80 dB(A)-peaklevel noise contour for the existing runway should be additionally insulated, so that the noise level inside a bedroom should be below 60 dB(A). Opponents of the airport extension took this condition to court and succeeded in 1986 in reducing the limit for bedroom-insulation to 55 dB(A)-peaklevel (indoors) by court-order based on the results of new research on sleep disturbance.

In the Environmental Impact Assessment for the development of Maastricht Airport this 55 dB(A)-peaklevel condition was taken into account. Also calculations were made based on a new method introduced by Dr. Griefahn of the University of Düsseldorf, which takes into account the number of noise events and the maximum noise levels.

After evaluating the results of the EIA the government decided to forbid operations with large aircraft, such as B747 and DC10, during the night at Maastricht Airport, because of the insulation-program that had to be carried out based on a 55 dB(A)-peaklevel contour or on the Griefahn-method when only a few of these large aircraft were operating, was too expensive.

To continue the procedures for the extension of Maastricht Airport a new scenario was drawn up and provisionally night contours based on the Griefahn-method with exception of the largest aircraft were taken into account. A study was launched for the consequences of this provisional decision for other airports and for the possibility of a national night index for aircraft noise.

The National Health Council had also reviewed the Griefahn-method and decided that the Griefahn-limit value took not into account all the health aspects. The Council advises the government on a method that takes into account all the health aspects of night operations.

A working group has studied the health effects, the economic effects, the enforcement and legal aspects of various dosis/effect-indices in relation to a possible national night index. The following indices are considered:

- a. the Griefahn-method starting from a limit value where the chance of awakening is not more than 10%. The Griefahn-limit value curve is valid from 1 up to 32 noise events each night period with noise levels from 61 down to 53 dB(A). The Griefahn-target value curve for 0% awakenings is drawn 6 dB(A) below the limit value curve.
- b. the Iso-reaction method based on several age-groups for people (age 71, 50 and 30 years) because of the different sensitiveness for noise.
- c. the LAeq-method for the average noise level during a night-period inside a bedroom taking into account the insulation-measures to be taken. This method is considered for a night period from 23.00-06.00hrs LT, as well as for a night period from 23.00-07.00hrs LT.
- d. the LAm<sub>ax</sub>-method in which only the noisiest aircraft is determinant.

Calculations are made for all the various methods to compare the different noise contours and the relating compensation measures with each other.

All calculations are based on a future traffic situation after the out-phasing of Annex 16/chapter 2-aircraft.

The flight tracks and dispersal of the tracks are optimized in relation to the built-up areas.

#### Remarks

The LAm<sub>ax</sub>-method in which only the noisiest aircraft is taken into account and the number of aircraft is not relevant, is not considered appropriate for a future national night index.

The Iso-reaction method gives various contours for the different age-groups. Insulation-measures differ for each age-group. This method is not considered as practical.

The Griefahn-method is hardly affected by a larger number of noise events and the limit value has been criticized by the National Health Council.

The LAeq-method gives a good relationship to the number of aircraft and corresponds with the noise index for small aerodromes and other noise sources.

A final choice for a national night index is still pending.

#### Conclusions

In the Netherlands a very complex system of airport noise exposure indices is being developed to take into account all the specific characteristics of airports and their use.

A review of the mathematical formulae of each index is given in the annex.

## Various Airport Noise Indices in the Netherlands

**Kosten-method**

The Kosten-method for commercial and military airports describes the average annoyance of people to aircraft noise.

Mathematical formula:  $B = 20 \cdot \log \sum_i (n_i \cdot 10^{L_i/15}) - 157$

**Bkl-method**

The Bkl-method for small airfields describes the average noise exposure around airfields used by aircraft below 6000kg in LAeq.

Mathematical formula:  $L_{ax} = 10 \log (1/T \cdot \sum_{t_1}^{t_2} 10^{L_A(t)/10} \cdot dt)$

**Griefahn-method**

The Griefahn-method describes the chance of awakenings from aircraft noise during a single night-period.

Mathematical formula:  $G_{LV} = \sum_{i=1}^N n_i \cdot (L_{Amax_i} - 53) - 12$

$$G_{TV} = \sum_{i=1}^N n_i \cdot (L_{Amax_i} - 47) - 12$$

**Iso-reaction method**

The Iso-reaction method describes the location, where - summoned over a year - no more than 36 awakenings per person occur depending on the age of the person.

Mathematical formula:  $K_{71} = \frac{(L_{53 \pm 61 \text{ dB(A)}} - 53) \times 0.10}{12}$

$$K_{50} = \frac{(L_{57 \pm 65 \text{ dB(A)}} - 57) \times 0.10}{12}$$

$$K_{30} = \frac{(L_{60 \pm 67 \text{ dB(A)}} - 60) \times 0.10}{12}$$

**Laeq-method**

The Laeq-method for night-operations summons all the aircraft noise events during a night-period.

Mathematical formula:  $L_{Aeq} = 10 \log \sum_{i=1}^N (10^{L_{AX_i}/10}) - 44$

## FOR A NEW CANADIAN REGULATION ON NOISY TOYS

LAROCHE, Chantal and LEROUX, Tony

Sonométrie Inc. Expertise-conseil en Bruit et Audition  
5757, ave. Decelles, bureau 406  
Montréal (Québec)  
Canada H3S 2C3

### ABSTRACT

The Canadian Federal Act prohibiting sale of hazardous products limits the sound level emitted by toys, equipment and other products for use by a child in learning or play to 100 dB. The literature shows that this legal criteria is not safe for children regarding the risk of acquiring hearing loss. Based on a safe limit of 75 dBA, more than 85 % of the toys available on the Canadian market are not safe and may induce hearing loss and other adverse effects on the long term. There is evidence that this situation is probably the same or even worse in many industrial countries. In fact, the current Act authorizes the sale of hazardous noisy toys that may contribute to some extent to deafness in children. Based on a review of literature and previous studies done by the Groupe d'Acoustique de l'Université de Montréal, a new regulation and a measurement method have been proposed to Consumers and Corporate Affairs Canada in order to correct the actual Act's deficiencies. The proposed limit for sound level has been set to 75 dBA for continuous sound and to 95 dB peak for toys producing impulsive noise. These limits seem to meet the safety criteria for children hearing health and also address the question of the quality of the acoustic environment to optimize children development. A method of measurement based on a Canadian Standard on noise emitted by small appliances [CSA Z107.71-M1981] has been proposed to assess noise levels emitted by toys. This paper will briefly present the results of a review of the literature on the topic including the examination of different industrial countries regulations.

### SOMMAIRE

La Loi fédérale canadienne interdisant la vente de produits dangereux limite le niveau sonore pouvant être produit par un jouet à 100 décibels. L'ensemble des études scientifiques démontrent que cette limite n'est pas satisfaisante pour assurer la protection de la santé auditive des enfants. Sur la base d'une limite sécuritaire de 75 dBA, il a été établi qu'une proportion importante (85%) des jouets sonores retrouvés sur le marché canadien comportent un risque d'atteinte à la santé des enfants. À la lumière des différentes législations répertoriées dans plusieurs pays industrialisés, il semble que cette situation ne soit pas exclusive au Canada. Cette vente autorisée de jouets potentiellement dangereux pourrait contribuer, dans une certaine mesure, à l'accroissement de la prévalence de la surdité chez les enfants. À partir d'une revue de littérature entreprise auparavant par le Groupe d'Acoustique de l'Université de Montréal, une nouvelle réglementation et un code d'essai précis ont été proposés à Consommation et Corporation Canada. Afin de corriger les lacunes de la réglementation actuelle, les limites de niveaux sonores pouvant être émis par les jouets ont été fixés à 75 dBA pour les bruits continus et à 95 dB crête pour les bruits de nature impulsionnelle. Ces limites respectent plus adéquatement les critères de protection de la santé auditive et rejoignent également les préoccupations en ce qui a trait à la qualité de l'environnement sonore dans lequel se développent les enfants. Un code d'essai pour les jouets sonores a été mis au point sur la base d'une norme canadienne portant sur les niveaux de bruit émis par les petits appareils électroménagers [CSA Z107.71-M1981]. Cet article présente les résultats de la revue de littérature incluant l'étude des différentes législations en vigueur dans différents pays industrialisés.

## 1. Introduction

The Canadian Federal Act prohibiting sale of hazardous products limits the sound level emitted by toys to 100 dB<sup>1</sup>. A review of the literature shows that this criteria is not safe for children regarding the risk of acquiring hearing loss<sup>2</sup>. Based on a world wide accepted safe limit of 75 dBA<sup>3</sup>, more than 85 % of the noisy toys available on the canadian market are not safe and may induce hearing loss and other adverse effects on the long term<sup>4</sup>. This needless risk for children health should be avoided using a more adequate federal regulation.

## 2. Inefficiency of the actual regulation

Two factors can explain the inefficiency of the current law.

The actual limit for sound level is too lax. The literature tends to demonstrate that children's inner ears are more sensitive to noise exposure and may develop hearing loss for noise dose that are safe for adults<sup>5,6,7</sup>. In the light of those findings the current limit of 100 decibels appears to be by far too high.

There is many different kind of toys that are emitting noise level that are over the actual legal criteria. Even toys like squeaking rattle can produce level as high as 100 dBA. Table 1 is showing the different kind of toys that have been tested for noise level by researchers around the world.

**Table 1 - Noise and Toys studies around the world**

Authors	Year	Country	Type of toys	Sound Level
Ward et al <sup>(8)</sup>	1961	USA	Toy "cricket"	140-145 dB SPL
Gjaevenes <sup>(9)</sup> peak	1966	Norway	Firecrackers Toy Firearms	All together 131-166 dB
			Maroons	
Hodge et al (10)	1966	USA	"Popguns"	160->170 dB SPL
Bess et al (11)	1972	USA	Model Airplanes	106-114 dBA
L.N.E. <sup>(12)</sup>	1973	France	Mecanical Toys Toy musical ins. Squeaking toys	91-107 dBA 102-112 dBA 99-101 dBA
Axelsson and Jerson (13)	1983	Sweden	Squeaking toys Moving toys Stationary toys Toys weapons Firecrackers	78-108 dBA 82-100 dBA 74-102 dBA 143-153 dB peak 125-156 dB peak
Plakke <sup>(14)</sup>	1983	USA	Arcade games	73-111 dBA
Gupta et al (15)	1989	India	Firecrackers	150 dB peak (3m)
Lacombe <sup>(4)</sup>	1989	Canada	200 toys	-----
Zhongping (16)	1990	China	Toy vehicules Elect. vehicules Electric game Electron. organ	74-97 dBA 68-94 dBA 64-96 dBA 70-90 dBA



Toys emitting noise from explosive source (firecrackers and cap gun for example), can be very harmful to hearing after one short exposure<sup>13</sup>. For example, Figure 1 show audiometric data obtained in one 5 year-old-boy exposed to the noise produced by one firecracker held close to his right ear by a small friend<sup>17</sup>.

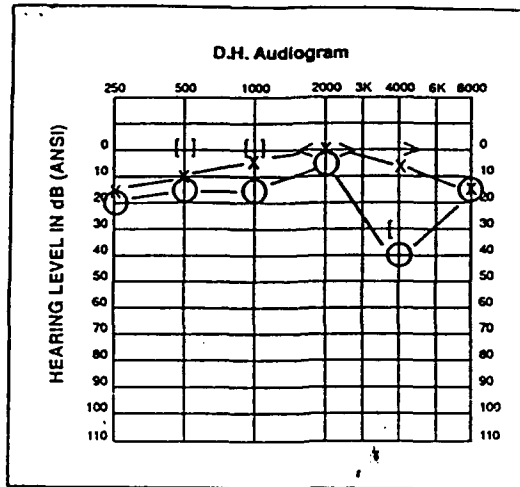

For this child, this impulsive noise exposure has induced hearing loss at 4 kHz at the right ear. It's the classical notched audiogram caused by intense noise exposure. The child also experienced pain and tinnitus for several days. The hearing loss was not detected at this time but was revealed by an audiometric school screening six months later. These "toys" are beyond the scope of the current Act and are covered by the federal Act on Explosives which regulates industrial explosives<sup>18</sup>.

On the other hand, the federal regulation does not include a precise and specific method for determining the sound level produce by a given toy. The actual legal text does not precise the weight to be used for dB nor any other technical specifications for determining the sound level, for instance:

- a) type of experimental room,
- b) type of noise produced by the toy and
- c) nature of the toy

Moreover, actually there is no systematic way to test each toy manufactured in Canada or entering into this country. In fact, the actual Act authorize the sale of hazardous noisy toys that may contribute to some extent in producing hearing loss in children. This situation does not seem to be different in countries where a specific regulation for noisy toys exist. Table 2 is showing the different regulation found in the world.

Country	Limit for sound level	Legal covering
Canada <sup>(1)</sup>	100 dB	Explosive toys excluded
Norway/Sweden <sup>(19)</sup>	90 dBA at 50 cm 135 dB peak	All toys
Netherlands <sup>(20)</sup>	Inspector's judgement	All toys
United States <sup>(21)</sup>	138 dB peak	Explosives cap only

### 3. Proposal of a new regulation

The actual proposal is to lower the limit to 75 dBA for continuous noise source at the distance which the toy is usually used and to limit the level at 95 dB peak for toys producing impulsive noise. Every toy should be controlled under the same experimental conditions in the manner edicted by CSA Z107.71- 1981 Standard on Consumers Small Appliances <sup>22</sup>.

This existing Standard, already approved by federal government and manufacturers, could be applied to sound emitted by toys. In addition, this method appears to be easy to implement, on technical and economical aspects, equally for toy manufacturers and federal responsible agency. This method of determining sound level produced by a given toy insure a uniform application and should be adopted as a part of the regulation.

Furthermore, toys emitting noise from explosive source should be banned considering the high level of risk for noise induce hearing loss even after one single exposure. This specific point must be included in the federal Act on hazardous products as also suggested by others reseachers in scandinavian countries <sup>19</sup>.

Every toy sold in Canada must be tested to insure a safe noise level in the same manner a test of toxicity is actually done by industry and government agency for paint coloring on every toy.

### 4. Conclusion

This proposal intends to reach a better achievement in protecting children's hearing integrity when it comes to noisy toys. The numerous failures identified in the actual Act should be corrected easily using a well documented safe noise level and a precise method of determining it as proposed above. These suggested legislative modifications will not lead to impose on federal government nor on toy manufacturers a large economical load.

### 5. References

[Work done for the Quebec Consumers Association and granted by Consumers and Corporate Affairs Canada].

- [1] Canada's Gazette II. 1968-69. c.42, annex I (1980).
- [2] Leroux, T. and Laroche, C. (1991) Proposed regulations on noisy toys.
- [3] ISO 1999 International Standard Organization (1985).
- [4] Lacombe, F. University of Montreal (1989).
- [5] Douek, E., Dodson, H.C., Bannister, L.H. et Ashcroft, P. The Lancet 20 (1976).
- [6] Stennert, E., Schulte, F.J. et Vollrath, M. Early Human Development (1977).
- [7] Bess, F. H., Peek, B.F. et Chapman, B. Pediatrics 63 (1979).
- [8] Ward, W.D. et Glorig, A. Laryngoscope 71 (1961).
- [9] Gjaevenes, K. J. Acoust. Soc. Am. 39 (1966).
- [10] Hodge, D.C. et McCommons, R.B. J. Acoust. Soc. Am. 40 (1966).
- [11] Bess, F.H., Powell, R.L. Clin. Pediatr.11 (1972).
- [12] Laboratoire National d'Essais (1973) Acoustic Tests on toys.
- [13] Axelsson, A. et Jerson, T. The National Swedish Board for Consumer Policies (1983).
- [14] Plakke, B.L. 4 (1983).
- [15] Gupta, D. et Vishwakarma, S.K. Laryngoscope 99 (1989).
- [16] Zhongping, W. Inter-Noise 90 (1990).
- [17] Cummings, R.J. The Hearing Journal 43 (7) (1990).
- [18] Canada's Gazette II. Explosives Act .
- [19] Axelsson, A. Personnal communication (1990)
- [20] Commodities Act, Netherland.
- [21] F 963-86. American Society for Testing and Materials (1986).
- [22] CSA Z107.71-M1981. Canadian Standard Association (1981).

# COMPARATIVE ANALYSIS OF NOISE TAXES APPLICABLE TO NOISY AIRCRAFT IN FRANCE - GERMANY - SWITZERLAND

LOOTEN André  
Consulting engineer - case postale 517  
1214 Vernier Switzerland

## Abstract

This paper will show the different noise tax systems in force in these countries. The cases of large airports such as Paris Orly, Paris CDG, Frankfurt, Munich, Zurich are exposed in detail. Medium-sized airports such as Nice, Marseilles, Toulouse, Lyons, Hamburg, Geneva are also treated. The taxes or special landing fees of 10 commercial aircraft are compared for these airports. Results of these incentives rules on the noise impact around French, German and Swiss airports are analysed. The trend of the non-certified or chapter 2 aircraft phase out is shown.

## Résumé

Nous comparons les différents systèmes de taxation du bruit des avions en vigueur en 1992 dans trois pays : France, Allemagne et Suisse. Nous exposons les cas de grands aéroports tels que Paris Orly, Paris CDG, Francfort, Munich, Zurich. La situation pour des aéroports de moyenne importance comme Nice, Marseille, Toulouse, Lyon, Hambourg, Genève est aussi traitée. Les taxes qui s'appliquent à 10 avions commerciaux ont été calculées et comparées pour ces différents aéroports. Les effets de ces taxes sur la charge de bruit autour des aéroports français, allemands et suisses sont analysés. L'évolution qualitative des flottes aériennes est aussi mise en évidence.

## The French System

At the end of December 1992, a law on general noise abatement was accepted by the French Parliament and is now in force (Law no 92 - 14440 J.O. 1-1-93). A chapter is dedicated to the method and the tariffs, allowing the calculation of the noise tax on commercial aircraft. Basically, the aircraft are classified into five groups (I - V). The tax rates are higher during the night period (22 h - 06 h). Only airports having more than 40'000 take-offs a year have to collect a noise tax and only aircraft exceeding 20 tons at take-off are taken into account. The two large airports of Paris, Orly and CDG, belong to a first class and show the higher rate. Nice, Marseilles, Toulouse belong to the second class with a medium rate. Lyons-Satolas is in the last class, with a very low rate. In addition, it is worth pointing out that the weight of the aircraft is not taken into account linearly. The various formulae and basic fees are shown below.

Noise group		Day Tax (6 h - 22 h)		Night Tax ( 22 h - 6 h)
I + non certified ICAO		$30 \times T \times \log M$		$40 \times T \times \log M$
II		$8 \times T \times \log M$		$12 \times T \times \log M$
III		$3 \times T \times \log M$		$4,5 \times T \times \log M$
IV		$2 \times T \times \log M$		$2,4 \times T \times \log M$
V		$T \times \log M$		$1,2 \times T \times \log M$
Paris-Orly et Paris-CDG		T = 34 Fr.	Nice, Marseilles, Toulouse	T = 12.50 Fr.
Lyons-Satolas		T = 0.50 Fr		

We choose three cases : a non-certified aircraft, B-707, taking-off from Lyons at night, a chapter -2-certified aircraft, B-747-200B, taking-off from Nice during the day and a chapter -2-certified aircraft, DC-9-50 taking off from Orly at night.

The first aircraft is ranked in group I, its MTOW is : 151 ton. The noise tax will amount to :  $40 \times 0.5 \times 2.179 = 43.60$  Fr.  $\approx$  12.85 DM. in Lyons.

The second aircraft is ranked in group III, its MTOW is : 352 ton. The noise tax will amount to :  $4.5 \times 12.5 \times 2.547 = 143.25$  Fr  $\approx$  42.25 DM in Nice.

The third aircraft is ranked in group IV, its MTOW is 55 ton. The noise tax will amount to :  $2.4 \times 34 \times 1.74 = 142$  Fr.  $\approx$  42 DM in Paris-Orly.

### The German system

There are no specific noise taxes on the aircraft in Germany. The airport authorities have chosen a different approach to curb noise and to penalise the old and polluting aircraft. The principle is quite simple and effective. All jet aircraft which do not comply with the noise certification granted by ICAO according to Annex-16, Chapter 3, have to pay higher landing fees. For propeller aircraft which are not certified by ICAO the landing fees are increased by 50%.

The classification based on the ICAO criteria avoids any dispute with the air carriers.

The aircraft maximum take-off weight is not truncated with a logarithmic calculation.

We show here the schedule of charges for two large airports : Frankfurt and Munich and one medium-sized airport : Hamburg. Owing to the nearness of the town, Hamburg airport is a worthy case.

The landing fees in force in 1992 for jet aircraft are shown below. It should be noted that there are no penalties when the aircraft comply with the chapter 3 specifications. This is the basic fee "T" showed in our tables. Besides night curfews, the landing fees applicable to non-certified or chapter -2 jet-powered aircraft are still higher during the night period (22 h - 06 h) and are truly dissuasive.

The figures used in our comparative analysis are related to the international traffic.

FRANKFURT / M ( T = 18.95 )		
Non-certified	Day + 36.95 DM per ton	Night + 36.95 DM per ton
Certif.-Ch 2	Day + 12.30 DM per ton	Night + 21.70 DM per ton
HAMBURG ( T = 19.60 )		
Non-certified	Day + 39.20 DM per ton	Night + 49.00 DM per ton
Certif.-Ch 2	Day + 19.60 DM per ton	Night + 29.40 DM per ton
MUNICH ( T = 15.70 )		
Non-certified	Day + 31.40 DM per ton	Night + 31.40 DM per ton
Certif.-Ch 2	Day + 11.78 DM per ton	Night + 15.70 DM per ton

For example, a non-certified aircraft landing in Munich during the day or at night time will bear an extra fee of 31.40 DM per ton, a chapter -2 - certified aircraft landing in Hamburg will bear an extra tax of 19.60 DM per ton during the day and 29.40 DM at night, whereas, a chapter -2- certified aircraft landing in Frankfurt will bear an extra fee of 12.30 DM per ton during the day and 29.40 DM at night. It is very interesting to choose the same aircraft as were taken as example for Lyons, Nice and Paris-Orly to compare the French noise taxes with the German extra landing fees perceived in Munich, Hamburg, and Frankfurt.

The B-707 extra landing fee in Munich at night is :  $151 \times 31.40 = 4741$  DM

The B-747-200 B extra landing fee in Hamburg during the day is :  $352 \times 19.60 = 6900$  DM

During the night the extra landing fee in Hamburg will amount to :  $352 \times 29.40 = 10349$  DM !!!

The DC-9-50 extra landing fee in Frankfurt at night will be :  $55 \times 21.70 = 1194$  DM

It is obvious that the discrepancies with the French taxes are very large and they are shown off in the next table.

Aircraft	Period	French airport noise tax [eq. DM]	German airport noise tax [DM]
B-707	Night	Lyons : 12.85	Munich : 4'741
B-747	Day	Nice : 42.25	Hamburg : 6'900
DC-9-50	Night	Orly : 42	Frankfurt : 1'194

Figure 1 shows a comparison between some noise taxes for 10 aircraft in Nice, Munich and Hamburg. Some taxes in Nice are so low that they do not appear on the graph.

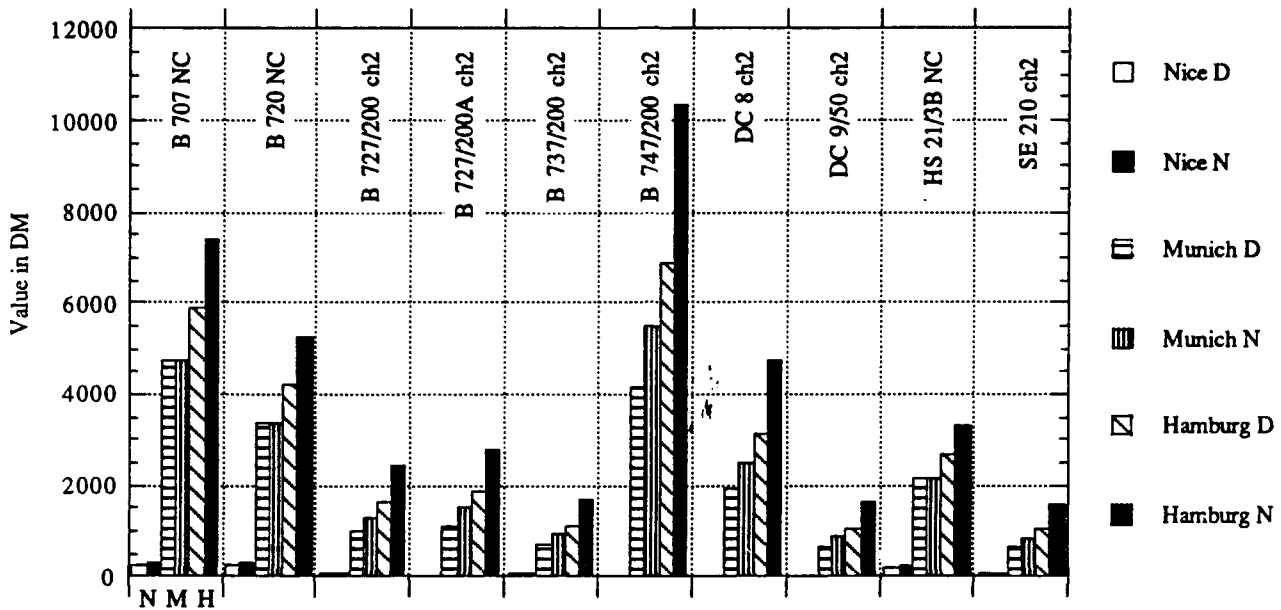

Fig.1 Day and night noise taxes on 10 aircraft in Nice, Munich, Hamburg

We have computed the noise taxes or extra landing fees for 51 commercial aircraft which are applicable for three German airports and the three classes of French airports during the day and during the night. Of course, it was unrealistic to display all the results in this publication. But 8 numeric tables and 14 graphs are available upon request.

### The Swiss system

In Switzerland, the commercial jet aircraft are put into 5 groups. Unfortunately, in numerous cases this classification does not agree at all with the three groups such as defined by the I.C.A.O. Quite surprisingly, some non-certified or very noisy aircraft are classified along with modern and low-noise rated aircraft and unduly escape any noise taxes. In Switzerland, there are no additional charges for the night period! Perhaps the federal office for civil aviation considers the overflights occurring after 22 h as non-disturbing for the communities around the airports. We give on the following table some examples valid since 1-5-1986.

Group	Type	Tax [CH.Fr]	[DM]
I	DC-8-20/ -30/ -40	400	440
II	B-707-100/-300/-300/-400 DC-8-50 BAC VC10 (1100) BAC VC10 Super (1150) HS 1231 Trident 1E-3E	265	291

III	B-707-100B/-300B/-300C B-720 B-727-200 Adv.   B-737-200 Adv. BAC 1-11 500/-539 DC-8-61/-63   DC-9-34/-40/-50 HS-121 Trident 1C-3B IL 76-M/-T-SC   IL- 86 Car.SE 210 3/6N/6R Tupolev TU 134 A /154 B2	200	220
IV	B 720 B B-727-100/-200 B-737- 100/-200 BAC 1-11   -200/-300 CV 990 A DC-8-62 DC-9-10/-20/-30   F-28 1-6000 IL- 62 SE 210 10B/-10R/-11R/-12	135	148
V	Airbus A-300 B2/B4/C4 Airbus A-310 B-737 200Ad.mix   B-747 100 B/C/F/SR B-747 200 B/C/F BAE 146/100/200   DC-10-10 GRU II/III IL-62 M/MK L1011 /100/200/500	0	0

It is worthwhile to pinpoint three cases. In Switzerland the noise tax on a DC-8-40 amounts to 400 S.Fr. ( ≈ 440 DM); when landing in Hamburg this aircraft has to bear an extra landing fee of 3'155 DM during the day and of 4'733 DM at night. For a B-727-100, the noise tax is 135 S.Fr in Zurich ( ≈ 148 DM ) but in Munich the extra landing fee will be 2'292 DM. A B-747-200 B bears no tax at all in Switzerland; in Germany this aircraft will be charged, during the day, with an extra landing fee of 6'899 DM in Hamburg, 4'329 DM in Frankfurt and 4'153 DM in Munich. During the night this noisy aircraft will bear a still more dissuasive extra landing fee : 10'348 DM in Hamburg, 7'638 DM in Frankfurt and 5'526 DM in Munich! Let it be remembered that the Munich new airport is in the open country, 40 Km away from the city.

### Results and conclusion

The next table shows the trend observed in Hamburg.

HAMBURG AIRPORT					
ICAO Certif.	1988	1989	1990	1991	% 88 / 91
Non-Certif.	192	188	175	101	- 47.3
Chap. 2	28'093	26'686	22'702	14'369	- 48.8
Chap. 3	8'687	13'950	19'226	25'530	+ 193.8

Since 1988, the records of Hamburg airport exhibit a regular decrease of the Leq measured by 11 out of 12 monitoring stations. Not surprisingly, noise results related to Zurich and Geneva airports are almost stable. The following table shows the change of the NNI indexes in Zürich.

Monit.Station	1988	1989	1990	1991
Rümlang	55	55	55	55
Oberhasli	49	48	48	47
Oberglatt	40	39	39	40
Höri	39	40	41	41
Glattbrugg	48	49	49	48
Kloten M.M	43	43	43	43

The recent French legislation enforcing noise taxes on commercial aircraft and the Swiss regulations show very large discrepancies with the German system and are incompatible with an efficient phasing out of the old and very polluting aircraft in Europe. A lack of coordination and of cohesion will lead to an increase of harmful effects around low-noise-taxed airports.

# THE CONSIDERATION OF NOISE ANNOYANCE FACTORS IN IMISSION REGULATIONS FOR INDUSTRIAL NOISE

ROHRMANN, Bernd

University of Melbourne, Department of Psychology  
Parkville, Victoria 3052, Australia

## A b s t r a c t

In a problem analysis, issues of characterizing and regulating industrial noise were investigated. The focus is on 'qualitative' features of noise situations and their treatment in immission standards such as the German regulation "TA Laerm". The study is based on a review of relevant social science and law literature and a series of expert interviews conducted in administrative institutions. The results show that noisiness factors such as impulse and tone characteristics, low frequency sound, information content, 'conspicuousness' of the sound, unfamiliarity and newness, perceived avoidability and immissions in times when quietness is particularly demanded are more relevant than the sound level per se; however, these factors are difficult to administrate. This leads to suggestions for modified noise regulations and their practical application when assessing immissions from industrial plants.

## P r o b l e m

Industrial noise (i.e., noise from factories, workshops, warehouses, service stations, pubs and so on) is a wide-spread and very heterogeneous type of environmental stressor. Research on the impacts on industrial noise (e.g., FINKE et al. 1980, GROENEVELD & GERRETSEN 1984, GUSKI 1989, GYR & GRANDJEAN 1984, KASTKA et al. 1983) showed that the actual sound levels are lower than with most other noise sources while annoyance is relatively higher, that the number of complaints is particularly large, and that noise indices such as  $L_{eq}$  are hardly predictive for subjective responses to this kind of noise.

Regarding noise protection standards/laws, industrial noise was actually regulated earlier than most other noise sources. In Germany, the "TA Laerm" was first released in 1968. It defines immission limits (based on a specific mean sound level which additionally considers tone and impulse characteristics plus time of day) for various types of residential areas. Because of the complex structure of industrial noise, the practical application

complex structure of industrial noise, the practical application of this regulation (as well as of similar norms) is often difficult and somewhat ambiguous. Over the last years it was increasingly discussed how to improve the assessment of industrial noise; also, in Germany a formal amendment of the TA Laerm is under way.

### T h e s t u d y

In a problem analysis issues of characterizing and regulating industrial noise were investigated. The focus was on 'qualitative' factors of noise situations and their treatment in regulations such as the TA Laerm. The main objectives were to evaluate the significance of such factors, to identify assessment problems and to recommend noisiness criteria suitable for administrative purposes.

The study is based on a review of relevant social science and law literature (including pertinent court decisions) and a series of interviews and discussions conducted with experts from local authorities (particularly health and safety control offices), state institutions and federal government.

### F i n d i n g s

The *literature review* revealed that industrial noise has been far less researched than other noise sources. However, the studies mentioned above (cf. also FIELDS 1991, JOB 1988, ROHRMANN 1984) clearly demonstrate that the correlation between acoustical exposure indices and responses such as annoyance is very low and that socio-psychological aspects of the perceived noise are crucial for the subjective evaluation of noise from industrial sources. Obviously industrial noise is less tolerated than other noises (the 'noisiness difference' might be 5 to 15 dB), and annoyance is often dominated by specific features of the noise, such as impulse and tone characteristics, low frequency sounds, information content (especially occurrence of human voice), 'conspicuousness' of the sound, unfamiliarity and newness, perceived avoidability and immissions in times when quietness is particularly demanded.

Experiences from administrative authorities confirm these findings. The *expert interviews* also elucidated related administrative difficulties, e.g., the proper consideration of information content or conspicuousness, the handling of irregular temporal noise patterns, and the valid overall-evaluation of heterogeneous industrial noise sources (such as a factory consisting of several different plants). Actually relevant parts of the assessment to be executed are not operationalized by acoustical measurements but require careful judgments and qualitative evaluations. In addition, the complex and time-consuming assessment process can lead to frictions with both the companies running the factory/enterprise to be regulated and the residents in the exposed neighborhood.



## C o n c l u s i o n s

Immission standards, including those for noise, have to meet substantial as well as practical criteria in order to be effective (cf. ROHRMANN 1993). The noise appraisal must reflect the socio-psychological process of perceiving and evaluating that noise, the assessment principles should be as explicit and unambiguous as possible, feasibility within the executing administration is to be considered, and the comprehensibility of the guidelines will strongly influence the acceptance of outcomes by the concerned parties.

Concluding from the present study, modifications or specifications of industrial noise regulations such as the "TA Laerm" seem to be necessary and advantageous. The main recommendations shall be briefly summarized.

*Occurrence of specific tones:* Addition of 3 or 6 dB, based on specific psycho-acoustic criteria.

*Impulses:* Similar routine. (Note: The use of specific national procedures, such as the tact-maximum method, should be terminated).

*Information content:* If human voices occur regularly, a 'malus' of 3 dB should be employed, based on a catalog of pertinent criteria (with examples).

*Low frequency components:* Application of modified sound measurement procedures which reflect this factor.

*Time of day:* Distinct standards for daytime, evening/holidays (monday to saturday, 18-22:00; whole sunday) and night; plus higher demands on noise prevention for sensitive time periods.

*Changes of noise emissions:* Informing exposed residents should be compulsory.

*Avoidability of noise:* Strict requirements regarding current technological standards of noise reductions are to be included in the assessment of a plant/workshop etc. (even if the present noise standards are fulfilled).

Further suggestions deal with the practical management of regulations for industrial noise by local authorities, e.g., training of the respective personnel, collaboration of experts, use of data banks and knowledge systems, and information of the public. Finally, in the long run the harmonization of standards for industrial noise within and across countries should be enhanced.

## R e f e r e n c e s

- FIELDS, J. 1991. A quantitative summary of non-acoustic variables' effects on reactions to environmental noise. Proceedings InterNoise '90, 303-308.
- FINKE, H.-O., GUSKI, R. & ROHRMANN, B. 1980. Betroffenheit einer Stadt durch Laerm - Bericht ueber eine interdisziplinare Untersuchung. Berlin: UBA-Texte.

- GROENEVELD, Y. & GERRETSEN, E. 1984. Characterization and evaluation of industrial noise - summary report. Delft, IMG-TNO report D64.
- GUSKI, R. 1989. Inhaltsanalytische Untersuchungen zu Freizeit- und Gewerbelärm. Zeitschrift fuer Laermbekaempfung, 36, 66-73.
- GYR, S. & GRANDJEAN, E. 1984. Industrial noise in residential areas: effects on residents. International Archive of Occupational and Environmental Health, 53, 219-231.
- JOB, R.F.S. 1988. Community response to noise. Journal of the Acoustical Society of America, 83, 991-1001.
- KASTKA, J., PAULSEN, R., RITTERSTAEDT, U., NELLESSEN, B. & SCHLIPKOETER, H.-W. 1983. Felduntersuchungen zur Stoerwirkung von Geräuschen unterschiedlicher Schwankungsbreite. Berlin: UBA-Forschungsbericht 83-105 01 312.
- ROHRMANN, B. 1984. Psychologische Kriterien fuer die "erhebliche" Belaestigung. In: Schick, A. & Walcher, K. P. (Eds.): Beiträege zu einer Bedeutungslehre des Schalls, Bern: Lang, 139- 150.
- ROHRMANN, B. 1984. Psychologische Forschung und umweltpolitische Entscheidungen: Das Beispiel Laerm. Opladen: Westdeutscher Verlag.
- ROHRMANN, B. in press (1993). Risk management by setting standards. In: Bayerische Rueck (Ed.): Society and Uncertainty. Karlsruhe: VVW.
- TA Laerm: Allgemeine Verwaltungsvorschrift ueber genehmigungsbeduerftige Anlagen nach § 16 der Gewerbeordnung - Technische Anleitung zum Schutz gegen Laerm 1968. Bonn, 26.7.1968.

NOTE:

This research was conducted on behalf of the Umweltbundesamt (Federal Environmental Agency) of Germany (Project No: UFOPLAN 10501944/13).

# AUTHORS INDEX - INDEX DES AUTEURS

Volumes 1 and 2 - Volumes 1 et 2

for the global index see volume 3 - pour l'index global voir volume 3

Session	Author - Auteur	Vol - Page	Session	Author - Auteur	Vol - Page
2	Abel SM	1 - 18	1	Bonfils P	2 - 13
9	Aboukhalil E	2 - 625	opening	Bonnefoy X	1 - 6
6	Aecherli W	2 - 321	2	Borchgrevink HM	2 - 193
6	Aguerri Sanchez MP	2 - 323	1	Borchgrevink HM	2 - 25
6	Ahrlin U	2 - 605	1	Borchgrevink HM	2 - 53
1	Ahroon WA	2 - 57	7	Borchgrevink HM	2 - 255
1	Ahroon WA	2 - 1	1	Borg E	1 - 62
1	Al Masri M	2 - 5	7	Bosova L	2 - 265
6	Al-Felimban A	2 - 379	7	Bowles AE	1 - 27
6	Al-Humud JM	2 - 379	7	Bowles AE	2 - 260
6	Albanese G	2 - 221	8	Breysse P	2 - 291
6	Albanese G	2 - 327	8	Brockman P	2 - 311
1	Alberti PW	1 - 41	8	Bröde P	2 - 277
8	Allen KM	2 - 269	3	Bröde P	2 - 457
1	Allen NK	2 - 101	6	Buchta E	1 - 59
5	Altena K	2 - 575	6	Bugge JJ	2 - 589
9	Alvares JR	2 - 643	4	Bullinger M	1 - 37
9	Alvares PA	2 - 441			
1	Andersen T	2 - 39	1	Canlon B	1 - 63
1	Andersen T	2 - 9	6	Carles JL	2 - 205
7	Anderson BA	2 - 247	2	Carne C	2 - 149
5	Aoki S	2 - 579	1	Carne C	2 - 29
6	Arras C	2 - 359	8	Carrick L	2 - 287
6	Arribas GE	2 - 331	5	Carter NL	1 - 51
1	Attanasio G	1 - 64	3	Carter NL	2 - 469
6	Aubree D	2 - 335	1	Causse JB	2 - 33
1	Avan P	2 - 13	9	Celma Celma J	1 - 70
1	Avan P	2 - 79	6	Celma Celma J	2 - 323
1	Axelsson A	2 - 119	6	Champelovier P	2 - 389
			6	Champelovier P	2 - 425
3	Babisch W	1 - 23	9	Chan RH	2 - 647
3	Babisch W	1 - 24	6	Chaussonnery R	2 - 355
6	Barbaro S	2 - 221	1	Chen J	2 - 37
6	Barbaro S	2 - 327	1	Chen M	2 - 37
7	Barber DS	2 - 247	1	Clark WW	2 - 38
6	Bartels KH	2 - 339	8	Clausen G	2 - 287
6	Baughan CJ	2 - 585	1	Cohen A	2 - 115
5	Beersma DGM	2 - 575	6	Cosa M	2 - 221
6	Belderrain ML	2 - 401	6	Cosa M	2 - 327
1	Belderrain ML	2 - 99	2	Costabal H	2 - 181
3	Belojevic G	2 - 489	6	Côté P	2 - 397
4	Belojevic G	2 - 547	1	Courtois J	2 - 39
1	Bennett J	2 - 17	1	Courtois J	2 - 9
2	Bennett JDC	2 - 161	5	Crawford G	1 - 51
4	Benton S	2 - 539	1	Custard G	2 - 43
6	Berglung B	2 - 343			
6	Berry BF	2 - 597	2	Dajani H	2 - 165
9	Berry BF	1 - 13	7	Damon E	2 - 255
6	Bertoni D	2 - 593	1	Dancer A	1 - 44
1	Bertrand RA	2 - 21	6	Dankittikul W	2 - 197
6	Bisio G	2 - 347	6	Dankittikul W	2 - 217
6	Björkman M	2 - 225	1	Davis RI	2 - 57
6	Björkman M	2 - 351	1	Davis AC	1 - 42
3	Bly SHP	2 - 509	1	Davis RI	2 - 1
1	Bohl CD	2 - 38	3	Day RD	2 - 461

6	De Jong HJ	2 - 609	7	Gladwin DN	2 - 243
6	De Jong RG	1 - 57	3	Goddard M	2 - 509
7	De Young DW	1 - 28	7	Golightly R	1 - 27
7	De Young DW	2 - 251	9	Goncalves S	2 - 639
2	Deleurence P	2 - 173	9	Gottlob D	1 - 67
2	Delgado C	2 - 153	6	Granoien ILN	2 - 589
7	Denaster DP	2 - 260	8	Griefahn B	2 - 277
4	Dewasmes G	2 - 519	5	Griefahn B	1 - 47
5	Dewasnes G	1 - 54	3	Griefahn B	2 - 457
6	Di matteo U	2 - 327	6	Griffiths ID	2 - 583
5	Diamond I	2 - 573	6	Grippaldi V	2 - 221
5	Diamond ID	1 - 48	6	Grippaldi V	2 - 327
9	Dickinson P	1 - 69	8	Groll-Knapp E	1 - 34
6	Drain L	2 - 359	5	Gruber J	1 - 53
8	Du D	2 - 317	8	Gueiros Teixeira S	2 - 307
9	Duclos JC	2 - 625	1	Guy M	2 - 95
5	Eberhart J	2 - 559	8	Haider M	1 - 34
1	Eden D	2 - 47	1	Hallmo P	2 - 53
2	Edworthy J	1 - 20	1	Hamernik RP	2 - 1
5	Egger P	2 - 573	1	Hamernik RP	2 - 57
9	Eghetesadi K	2 - 447	7	Harrington FH	2 - 239
5	Ehrhart J	1 - 54	7	Hayes CL	1 - 28
4	Ehrhart J	2 - 519	4	Hellbrück J	1 - 39
3	Elwood P	1 - 24	4	Hellbrück J	2 - 557
3	Elwood PC	1 - 23	1	Hellström PA	2 - 61
6	Erdem Aknesil A	2 - 619	1	Henderson D	1 - 64
7	Etchberger RC	2 - 251	1	Henderson D	2 - 65
4	Evans GW	1 - 37	6	Hermant D	2 - 371
8	Evans GW	2 - 269	2	Hétu R	2 - 169
4	Evans GW	2 - 515	3	Hiramatsu K	2 - 473
4	Fakkar S	2 - 523	5	Hofman W	2 - 559
8	Fanger PO	2 - 287	5	Holmes D	2 - 573
7	Faustov A	2 - 265	5	Horne JA	1 - 50
8	Fechter L	2 - 291	5	Horne JA	2 - 567
1	Fernandes JC	2 - 51	8	Hörtnagl H	1 - 34
6	Fields JM	1 - 58	2	Houtgast T	1 - 16
3	Findlay RC	2 - 461	6	Huddart L	2 - 585
6	Finegold LS	2 - 229	5	Hume KI	1 - 49
6	Finegold LS	2 - 363	5	Hume KI	2 - 563
6	Flottorp G	2 - 423	5	Hume KI	2 - 569
9	Fogel AL	2 - 445	5	Hunyor SN	1 - 51
7	Fraiman B	2 - 265	4	Hygge S	1 - 37
3	Fraiman BJ	2 - 501	4	Hygge S	2 - 531
3	Fraiman EB	2 - 501	3	Imai H	2 - 505
6	Franchini A	2 - 593	2	Irvine DRF	2 - 437
7	Francine JK	1 - 27	3	Ishii EK	2 - 461
9	Fridman VE	2 - 445	1	Ishii EK	2 - 69
1	Fritze W	2 - 75	6	Ishiyama T	2 - 375
1	Gagliano A	2 - 105	3	Ising H	1 - 23
3	Gallacher J	1 - 24	3	Ising H	1 - 26
6	Gallardo C	2 - 331	3	Ito A	2 - 473
1	Gamba R	2 - 95	6	Izumi K	2 - 197
6	Garcia A	2 - 367	6	Izumi K	2 - 217
6	Garcia AM	2 - 367	9	Jansen G	1 - 72
6	Giaconia C	2 - 221	8	Jansen G	2 - 279
6	Giaconia C	2 - 327	3	Jansen G	2 - 485
2	Gilloire A	2 - 173	3	Jansen G	2 - 497
2	Giua PE	2 - 157	1	Jedlinska U	2 - 127
6	Gjestland T	2 - 589	3	Jenkins A	2 - 469

7	Jenssen A	2 - 255
key note	Job RFS	1 - 73
3	Job RFS	2 - 469
1	Johnson DL	1 - 43
5	Jones C	1 - 55
4	Jones DM	1 - 38
7	Joyce MR	2 - 247
3	Kabuto M	2 - 505
3	Kageyama T	2 - 505
6	Kalivoda MT	2 - 233
6	Karabiber Z	2 - 619
5	Kawada T	2 - 579
5	Kelly D	1 - 51
2	Kersebaum M	2 - 161
1	Kersebaum M	2 - 17
4	Khardi S	2 - 523
4	Kilcher H	1 - 39
4	Kilcher H	2 - 557
8	Kim SW	2 - 287
1	Kochanek K	2 - 135
3	Kocijancic R	2 - 489
3	Kofler W	2 - 465
1	Köhler W	2 - 75
9	Koppert AJ	2 - 651
6	Koushki PA	2 - 379
6	Koyasu M	2 - 385
6	Krajcovic M	2 - 381
7	Krausman PR	1 - 28
7	Krausman PR	2 - 251
6	Krueger H	2 - 601
7	Kugler AB	2 - 247
7	Kugler BA	1 - 29
7	Kull R	1 - 27
7	Kull RCJ	1 - 31
3	Kuller LH	2 - 461
8	Kullman G	1 - 35
5	Kumar A	2 - 559
2	Kunov HL	2 - 165
6	Kurosawa K	2 - 197
6	Kurosawa K	2 - 217
6	Kurra S	2 - 613
6	Kuwano S	2 - 385
9	Kwan A	2 - 647
6	Lambert J	1 - 61
6	Lambert J	2 - 389
Key note	Lamure CA	1 - 75
3	Lanzendörfer A	2 - 485
2	Laroche C	2 - 169
9	Laroche C	2 - 655
2	Larocque R	2 - 169
1	Larsen BV	2 - 39
1	Larsen H	2 - 39
2	Lauri ER	2 - 177
2	Lazarus H	1 - 17
2	Le Breton B	2 - 173
6	Lecointre G	2 - 371
1	Lei SF	2 - 57
5	Leiss R	1 - 53
6	Lemieux P	2 - 397
6	Leobon A	2 - 393

1	Leplay A	2 - 95
6	Lercher P	2 - 201
3	Lercher P	2 - 465
9	Leroux T	2 - 655
6	Liasjo KH	2 - 589
4	Libert JP	2 - 519
8	Liu H	2 - 317
7	Liu S	2 - 261
9	Looten A	2 - 659
6	Lopez Barrio I	2 - 205
1	Loth D	2 - 13
1	Loth D	2 - 79
1	Luca A	2 - 105
6	Lundquist B	2 - 605
1	Lutman ME	1 - 42
9	Luzy A	2 - 625
4	Macken B	1 - 38
6	Magnoni M	2 - 593
1	Mair IWS	2 - 53
8	Manninen O	1 - 32
4	Maramotti I	2 - 543
1	Martin A	2 - 5
5	Maschke C	1 - 53
2	Matamala P	2 - 181
8	Matanoski G	2 - 291
8	Maurin M	2 - 273
7	McClenaghan L	1 - 27
7	McKechnie AM	2 - 243
1	McKinley RL	2 - 83
3	McLean J	2 - 509
8	Mehnert P	2 - 277
6	Meloni T	2 - 601
1	Menguy C	2 - 13
1	Menguy C	2 - 79
2	Messino CD	2 - 157
1	Meyer-Bisch C	2 - 87
3	Meyer-falcke A	2 - 485
6	Miedema HME	1 - 60
6	Mignerone JG	2 - 397
1	Mills JH	2 - 91
3	Minami M	2 - 505
6	Moch A	2 - 371
4	Moch A	2 - 543
6	Molina M	2 - 331
1	Mondot JM	2 - 95
7	Mönig T	2 - 259
9	Morelli L	2 - 635
3	Morrell S	2 - 469
1	Mozo BT	1 - 43
7	Murphy SM	1 - 29
7	Murphy SM	2 - 247
opening	Muzet A	1 - 3
5	Muzet A	1 - 54
4	Muzet A	2 - 519
9	Nabuco M	2 - 639
5	Naganuma S	2 - 579
3	Nakasone T	2 - 473
key note	Namba S	1 - 8
6	Namba S	2 - 385
1	Nedwell J	2 - 5

6	Nepomuceno JA	2 - 401	1	Pujol R	1 - 45
1	Nepomuceno JA	2 - 99			
5	Nicolas A	1 - 54	3	Rack R	2 - 485
4	Nicolas A	2 - 519	1	Rajan R	1 - 66
8	Nikolic	2 - 283	2	Rajan R	2 - 437
3	Nitta H	2 - 505	3	Rebentisch E	1 - 26
1	Nixon CW	2 - 101	6	Renew WD	2 - 213
1	Nixon CW	2 - 83	8	Rentzsch M	1 - 35
9	Normand JC	2 - 625	5	Reyner LA	1 - 50
8	Notbohm G	2 - 279	5	Reyner LA	2 - 567
3	Notbohm G	2 - 497	1	Ribeiro J	2 - 115
8	Nunes Cossenza CA	2 - 307	1	Ribeiro V	2 - 115
			1	Ribeiro V	2 - 123
9	O'Rourke ST	2 - 629	7	Richmond DR	2 - 255
5	Ogawa M	2 - 579	8	Rindel JH	2 - 287
5	Öhrström E	1 - 52	4	Robinson G	2 - 539
5	Öhrström E	1 - 56	9	Rohrmann B	2 - 663
6	Öhrström E	2 - 209	1	Rosenhall U	2 - 119
6	Öhrström E	2 - 403	2	Roure A	2 - 149
4	Öhrström E	2 - 547	1	Roure A	2 - 29
4	Olivier D	2 - 523	1	Rydzynski K	2 - 127
5	Ollerhead JB	1 - 48	6	Rylander R	2 - 225
5	Ollerhead JB	1 - 55	6	Rylander R	2 - 351
1	Olofsson A	2 - 131	6	Rylander R	2 - 407
			4	Rylander R	2 - 547
2	Pachiaudi G	2 - 173	6	Rylander R	2 - 605
7	Palka D	2 - 260			
5	Pankhurst FL	1 - 50	1	Sa-Leal A	2 - 123
5	Pankhurst FL	2 - 567	8	Saito K	1 - 33
2	Pascal D	2 - 173	4	Salame P	2 - 519
8	Pascher G	1 - 35	4	Santalla Z	2 - 549
1	Passchier-Vermeer W	1 - 40	4	Santalla Z	2 - 553
1	Passchier-Vermeer W	2 - 141	2	Santiago JS	2 - 153
1	Patania F	2 - 105	4	Santisteban C	2 - 549
1	Patterson JH	1 - 43	4	Santisteban C	2 - 553
1	Patterson JH	2 - 1	6	Sato T	2 - 411
2	Pekkarinen E	2 - 177	5	Sato T	2 - 579
2	Pekkarinen E	2 - 189	6	Schiapparelli P	2 - 347
8	Pena B	2 - 291	3	Schmeck K	2 - 477
3	Peploe P	2 - 469	9	Schmidt DE	2 - 643
opening	Perera P	1 - 4	8	Schuemmer-Kohrs A	2 - 299
2	Perera P	2 - 153	8	Schust M	2 - 303
6	Persson K	2 - 407	3	Schust M	2 - 513
4	Petit C	2 - 527	3	Schwarze S	1 - 22
6	Pichon JL	2 - 621	3	Schwarze S	2 - 497
9	Pietry Verdy MF	1 - 71	2	Seballos S	2 - 181
9	Pignat JC	2 - 625	3	Selvin S	1 - 25
1	Pimenta A	2 - 123	6	Serefhanoglu M	2 - 619
9	Pimentel-Souza F	2 - 441	2	Seshagiri B	2 - 165
8	Pjerotic L	2 - 283	6	Shield B	2 - 415
9	Porter ND	1 - 13	3	Shine P	2 - 481
6	Porter ND	2 - 597	2	Sihvo M	2 - 177
8	Poulsen T	2 - 287	1	Silva-Carvalho A	2 - 123
3	Poustka F	2 - 477	8	Sinz A	2 - 299
1	Prececutti G	2 - 109	6	Skänberg AB	2 - 403
6	Preis A	2 - 343	8	Slama JG	2 - 307
1	Price GR	2 - 113	1	Sliwinska-Kowalska M	2 - 127
8	Prince M	2 - 291	1	Sliwinska-Kowalska M	2 - 135
9	Prince MM	2 - 633	4	Smith AP	1 - 36
9	Psichas K	1 - 68	8	Smith AP	2 - 311
6	Psichas K	2 - 615	4	Smith AP	2 - 535
1	Puel JL	1 - 65	2	Smoorenburg GF	1 - 19

7	Smultea M	2 - 260	1	Varao L	2 - 123
6	Sneddon MD	2 - 363	6	Veltman JA	2 - 429
9	Sobolev LY	2 - 445	8	Vernet I	2 - 273
6	Sørensen S	2 - 225	6	Vernet I	2 - 389
1	Sousa-Uva A	2 - 123	2	Viljanen V	2 - 189
6	Soyer M	2 - 621	2	Vilkman E	2 - 177
3	Spear RC	1 - 25	6	Vincent B	2 - 425
3	Spear RC	2 - 493	9	Vogel A	1 - 15
1	Spencer HS	1 - 42	9	Vogiatzis C	1 - 68
6	Springers M	2 - 235	6	Vogiatzis C	2 - 615
6	Staats HJ	2 - 609	9	Von Gierke HE	1 - 12
3	Stankovic T	2 - 489	3	Voronin AN	2 - 501
3	Stansfeld SA	1 - 24	6	Vos J	2 - 429
3	Stansfeld SA	2 - 481			
9	Stayner LT	2 - 633	9	Wai CP	2 - 647
1	Steele DG	2 - 145	6	Walker JG	2 - 433
9	Steele DG	2 - 455	7	Wallace MC	1 - 28
7	Stephan E	1 - 30	9	Wallis AD	2 - 629
7	Stephan E	2 - 259	key note	Ward W	1 - 10
1	Subramaniam M	1 - 64	1	Ward WD	1 - 46
1	Subramaniam M	2 - 65	5	Watson A	1 - 49
1	Sulkowski WJ	2 - 127	5	Watson A	2 - 569
1	Sulkowski WJ	2 - 135	9	Watson I	2 - 451
8	Suvorov GA	2 - 315	7	Weiland LE	2 - 251
5	Suzuki S	2 - 579	7	Weisenberger ME	1 - 28
1	Svedberg A	2 - 119	1	West DW	2 - 101
1	Svensson EB	2 - 131	1	Weston RJ	2 - 145
9	Szwarc A	2 - 643	9	Weston RJ	2 - 455
			7	White RG	1 - 29
4	Tafalla RJ	2 - 515	6	Widmann U	2 - 201
8	Taffala R	2 - 269	7	Wisely S	1 - 27
2	Taillifet D	2 - 185	6	Wolsink M	2 - 235
3	Taira K	2 - 473	2	Woxen OJ	2 - 193
3	Talbott EO	2 - 461	7	Woxen OJ	2 - 255
1	Talbott EO	2 - 69	7	Wursig B	2 - 260
4	Tamalet D	2 - 527			
4	Tarriere C	2 - 527	3	Yamamoto T	2 - 473
6	Tartoni P	2 - 593	6	Yamashita T	2 - 197
5	Tassi P	1 - 54	6	Yamashita T	2 - 217
4	Tassi P	2 - 519	6	Yano T	2 - 197
3	Taylor R	2 - 469	6	Yano T	2 - 217
1	Teyssou M	2 - 13	1	Ye Q	2 - 37
1	Teyssou M	2 - 79	6	Yügrük N	2 - 619
6	Thibaud JP	2 - 419			
5	Thomas C	2 - 563	8	Zeichart K	2 - 299
8	Thomas M	2 - 311	1	Zeidan J	2 - 21
3	Thompson SJ	1 - 22	3	Zhang S	1 - 25
2	Tohyama M	1 - 21	7	Zhang S	2 - 261
1	Touma JB	2 - 139	3	Zhang S	2 - 493
2	Tran Quoc H	2 - 169	8	Zhao C	2 - 317
8	Trimmel M	1 - 34	3	Zhao Y	1 - 25
6	Turunen-Rise I	2 - 423	7	Zhao Y	2 - 261
			8	Zhao Y	2 - 317
1	Vaccari V	2 - 109	3	Zhao Y	2 - 493
opening	Vallet M	1 - 1	1	Zhou SK	2 - 37
4	Vallet M	2 - 523	6	Zhukov AN	2 - 415
6	Vallet M	2 - 593			
6	Vallet M	2 - 615			
5	Van F	2 - 569			
1	Van den Berg R	2 - 141			
9	Van Den Berg M	1 - 14			
5	Van F	1 - 49			