

2



AD-A277 963



**Defense Nuclear Agency
Alexandria, VA 22310-3398**

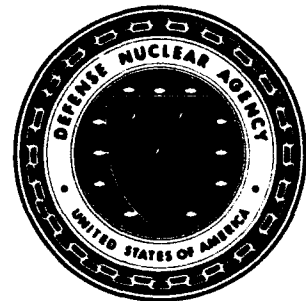

DNA-TR-93-69-V1

**Tagging RDT&E
Volume 1—Technology Assessments
and Development Reports**

**Benny J. Hill, et al.
BDM Federal, Inc.
P.O. Box 9274
Albuquerque International
Albuquerque, NM 87119**

March 1994

Technical Report

**DTIC
ELECTE
APR 08 1994
S G D**

CONTRACT No. DNA 001-89-C-0189

39808 **94-10714**

**Approved for public release;
distribution is unlimited.**

04 4 7 087

DTIC QUALITY INSPECTED 3

Destroy this report when it is no longer needed. Do not return to sender.

PLEASE NOTIFY THE DEFENSE NUCLEAR AGENCY,
ATTN: CSTI, 6801 TELEGRAPH ROAD, ALEXANDRIA, VA
22310-3398, IF YOUR ADDRESS IS INCORRECT, IF YOU
WISH IT DELETED FROM THE DISTRIBUTION LIST, OR
IF THE ADDRESSEE IS NO LONGER EMPLOYED BY YOUR
ORGANIZATION.



DISTRIBUTION LIST UPDATE

This mailer is provided to enable DNA to maintain current distribution lists for reports. (We would appreciate your providing the requested information.)

- Add the individual listed to your distribution list.
- Delete the cited organization/individual.
- Change of address.

NOTE:
Please return the mailing label from the document so that any additions, changes, corrections or deletions can be made easily.

NAME: _____

ORGANIZATION: _____

OLD ADDRESS

CURRENT ADDRESS

TELEPHONE NUMBER: () _____

DNA PUBLICATION NUMBER/TITLE

CHANGES/DELETIONS/ADDITIONS, etc.)
(Attach Sheet if more Space is Required)

DNA OR OTHER GOVERNMENT CONTRACT NUMBER: _____

CERTIFICATION OF NEED-TO-KNOW BY GOVERNMENT SPONSOR (if other than DNA):

SPONSORING ORGANIZATION: _____

CONTRACTING OFFICER OR REPRESENTATIVE: _____

SIGNATURE: _____

CUT HERE AND RETURN



**DEFENSE NUCLEAR AGENCY
ATTN: TITL
6801 TELEGRAPH ROAD
ALEXANDRIA, VA 22310-3398**

**DEFENSE NUCLEAR AGENCY
ATTN: TITL
6801 TELEGRAPH ROAD
ALEXANDRIA, VA 22310-3398**

REPORT DOCUMENTATION PAGE

Form Approved
OMB No. 0704-0188

Public reporting burden for this collection of information is estimated to average 1 hour per response including the time for reviewing instructions, searching existing data sources, gathering and maintaining the data needed, and completing and reviewing the collection of information. Send comments regarding this burden estimate or any other aspect of this collection of information, including suggestions for reducing this burden, to Washington Headquarters Services, Directorate for Information Operations and Reports, 1215 Jefferson Davis Highway, Suite 1204, Arlington, VA 22202-4302, and the Office of Management and Budget, Paperwork Reduction Project (0704-0188), Washington, DC 20503

1. AGENCY USE ONLY (Leave blank)	2. REPORT DATE 940301	3. REPORT TYPE AND DATES COVERED Technical 890915 - 930530	
4. TITLE AND SUBTITLE Tagging RDT&E Volume 1—Technology Assessments and Development Reports		5. FUNDING NUMBERS C - DNA 001-89-C-0189 PE - 62715H PR - TA TA - TA WU - DH093030	
6. AUTHOR(S) Benny J. Hill, Earl M. Dressel, Robert I. McCann, Randy E. Ca-been, Adam Wright, Warren T. Hedin, John J. Dickens, B. Jeanne Banks, Michael D. Rogers, John J. Corcoran, Gerald P.		8. PERFORMING ORGANIZATION REPORT NUMBER BDM/ABQ-93-0012-TR	
7. PERFORMING ORGANIZATION NAME(S) AND ADDRESS(ES) BDM Federal, Inc. P.O. Box 9274 Albuquerque International Albuquerque, NM 87119		10. SPONSORING/MONITORING AGENCY REPORT NUMBER DNA-TR-93-69-V1	
9. SPONSORING/MONITORING AGENCY NAME(S) AND ADDRESS(ES) Defense Nuclear Agency 6801 Telegraph Road Alexandria, VA 22310-3398 FCPRC/Nelson		11. SUPPLEMENTARY NOTES This work was sponsored by the Defense Nuclear Agency under RDT&E RMC Code B4613D TA TA EA018 OPAC 2600A 25904D.	
12a. DISTRIBUTION/AVAILABILITY STATEMENT Approved for public release; distribution is unlimited.		12b. DISTRIBUTION CODE	
13. ABSTRACT (Maximum 200 words) The purpose of the Tagging Research, Development, Test and Evaluation (RDT&E) contract was to assist in the development of tag and seal systems to support U.S. arms control treaty verification inspections. Numerous technical assessments of tag and seal technology concepts were performed. De-velopmental, functional, operational, and environmental testing of DOE prototypes and commercial tag and seal systems representing a wide range of technologies were conducted. In addition, the Secure Loop Inspectable Tag/Seal (SLITS), the Passive Tamper Indicating Loop Seal (PTILS), and the Universal videographic Reader (UR) systems were developed to the industrial (fieldable) prototype stage.			
14. SUBJECT TERMS Arms Control Treaty Verification Tags and Seals		15. NUMBER OF PAGES 354	
17. SECURITY CLASSIFICATION OF REPORT UNCLASSIFIED		16. PRICE CODE	
18. SECURITY CLASSIFICATION OF THIS PAGE UNCLASSIFIED		20. LIMITATION OF ABSTRACT SAR	
19. SECURITY CLASSIFICATION OF ABSTRACT UNCLASSIFIED		21. SECURITY CLASSIFICATION OF ABSTRACT UNCLASSIFIED	

CLASSIFIED BY:

N/A since Unclassified.

DECLASSIFY ON:

N/A since Unclassified.

6. AUTHOR(S) Continued

Allredge, Julie A. Trollinger, Dave E. Thomas, and M. Kim Johnson

Accession For	
NTIS CRA&I	<input checked="" type="checkbox"/>
DTIC TAB	<input type="checkbox"/>
Unannounced	<input type="checkbox"/>
Justification	
By	
Distribution /	
Availability Codes	
Dist	Avail and/or Special
A-1	

EXECUTIVE SUMMARY

CONTRACT HISTORY.

As the United States (U.S.) and the Union of Soviet Socialist Republics (USSR) negotiated the Strategic Arms Reduction Treaty (START), President Reagan expressed the prevailing mood of both nations, "Trust but Verify." Unlike the Intermediate Nuclear Forces (INF) Treaty where entire classes of weapons were eliminated, START proposed to reduce certain weapon systems to agreed levels and provide for on-site inspection of those weapons that were not destroyed. If each accountable weapon system component could have a unique, counterfeit and transfer resistant, and tamper indicating identifier (or tag), inspectors could determine unambiguously that the weapon or component inspected was allowed under the terms of the Treaty. The purpose of the Tagging Research, Development, Test and Evaluation (RDT&E) contract was to assist in the development of such tagging systems.

In 1988, the Defense Nuclear Agency (DNA) was designated as the Department of Defense executive agent for technology development in support of U.S. arms control treaty verification efforts. In 1989, START negotiations had progressed to the point where the U.S. Government was providing the USSR delegation with a demonstration of the Reflective Particle Tag (RPT) system developed by Sandia National Laboratories (SNL). Since neither the RPT system nor any of the several START tagging technologies developed by DOE were ready for production and operational employment, DNA solicited proposals for a Tagging RDT&E contract to assist in the development, test, and acquisition process. BDM was awarded the contract on September 15, 1989, for \$3,889,270 with an authorized level of effort (LOE) of 67,500 hours. The contract Statement of Work (SOW) included four tasks:

- (1) Tag Concept Assessment Support
- (2) Tag Prototype and Engineering Development
- (3) Soviet Perspectives Analysis
- (4) Tagging System Procurement.

The first technical instruction (TI FY90-01), tasked BDM to assist SNL in producing a fieldable industrial prototype of the RPT system. Other assessments of DOE-developed systems and other verification tasks resulted in added contract requirements. In March 1991, the contract scope increased to permit a contract ceiling of \$10,989,270, and an LOE of 152,100 hours (with option). Eventually, DNA increased the LOE authorized to 170,444 hours.

BDM performed numerous technical assessments of tag and seal concepts developed by the DOE National Laboratories and commercial companies. BDM also conducted developmental, functional, operational, and environmental testing of DOE prototype and commercial tag and seal systems representing a wide range of technologies. In addition, BDM originated several tag and seal concepts and performed proof-of-principle prototype demonstrations. Two BDM systems, the Secure Loop Inspectable Tag/Seal (SLITS) and the Passive Tamper Indicating Loop Seal (PTILS), and the associated Universal videographic Reader (UR), were selected by DNA for full development, and operational and environmental testing.

BDM originated several documents that have guided the development and assessment of tags and seals for treaty verification. BDM prepared a Laboratory Prototype Definition that described the maturity of concept development necessary for tag/seal assessments. BDM also developed a tag and seal Requirements Document, and an Environmental Specification that were used for development and testing of tag and seal systems for use with START treaty verification.

DOE TECHNOLOGIES.

The following sections briefly describe each of the DOE-developed tagging concepts examined under the Tagging RDT&E contract and the status of each concept at the completion of BDM involvement. Figure ES-1 provides a summary of the specific nature of BDM activities associated with each DOE concept.

Reflective Particle Tag (RPT) System. The RPT consists of micaceous hematite particles randomly distributed in an acrylic polymer that is applied directly to the surface of the item to be tagged. The tag signature is obtained by illuminating the tag from 20 different light angles and recording each resulting image. Subsequent readings can be compared to the original reading and a correlation

value computed to determine if the current reading is from the same tag as the reference reading. Due to the random nature of the distribution of reflective particles, and the random nature of the reflective surfaces on each particle, the tag is highly resistant to counterfeiting.

System	Developer	BDM Involvement
RPT	Sandia National Laboratories	Industrial Prototype Functional Checks Design Review Initial Operational Test and Evaluation Software Verification and Validation Signature Decision Statistic Analysis Environmental Testing
STAR Fiber Optic Seal	Lawrence Livermore National Laboratory	Concept Assessment Design Analysis Developmental Testing Seal Manufacturability Assessment
Ultrasonic Intrinsic Tag	Pacific Northwest Laboratories	Concept Assessment Functional Testing
Acoustic Resonance Spectroscopy	Los Alamos National Laboratory	Concept Assessment Analysis of Spectra Correlation Techniques Developmental Testing
Cornerstone Electronic Identification Device	Lawrence Livermore National Laboratory	Concept Assessment Application Studies
Microvideography System	Pacific Northwest Laboratories	Concept Assessment
Nonlinear Junction	Idaho National Engineering Laboratory	Concept Assessment Developmental Testing
Tamper Tape + RP	Pacific Northwest Laboratories	Developmental Testing
Python System	Sandia National Laboratories	Concept Assessment

Figure ES-1. DOE technologies and BDM involvement.

The RPT signature is read with a recorder/correlator system consisting of a computer, a reader head with LEDs to illuminate the tag, and a small video camera to transmit the tag's image to the computer for processing and storage. A reference image taken at the time the tag was installed is stored on a removable hard disk in the computer for comparison with subsequently acquired images.

The recorder/correlator unit also has a video microscope that can be used to examine the tag for indications of tampering and record images of any portions of the tag that the inspector believes needs further analysis.

Following the completion of extensive testing and analysis, two of the ten industrial prototype RPT systems were modified to incorporate features found desirable during testing. The remaining eight systems were not modified. The industrial prototype systems, including software and full documentation, were archived by DNA. These systems are fully functional, and with minor modifications to the eight unmodified systems, are suitable for field deployment and employment.

Sandia National Laboratories continued to improve the RPT design following the IOT&E in November 1990. The improved design has been named RPT-2 and is simpler to apply, requires a shorter curing time, has brighter specular reflections, and is less susceptible to tampering. The tag's randomly-oriented micaceous hematite (Fe_2O_3) particles are now suspended in an ultraviolet-cured polymer blend (rather than a Gafgard acrylic polymer) that is applied to the surface of a tagged item. The polymer blend is a 50/50% by weight composition of Gafgard 233 and Ebecryl 3700-20T. The Ebecryl, which is an epoxidized acrylic polymer, contains 5% by weight Ergacure 500. The tag is applied by daubing the polymer blend/hematite mixture onto a prepared and marked area on the surface of the item to be tagged, and then curing that mixture with a portable ultraviolet lamp. The RPT-2 was included in a second IOT&E in April 1992. The second IOT&E report concluded that RPT-2 is improved over the original version.

STAR Fiber Optic Seal. The STAR Fiber Optic Seal, developed by Lawrence Livermore National Laboratory (LLNL), consists of a fiber optic cable bundle with 18 single-mode glass fibers and a seal tie block that joins the ends of the cable bundle to form a secure loop. A unique signature is generated by coupling nine of the fibers to permit optical crosstalk. Light entering one fiber is scattered in the coupler to the other eight. Since this crosstalk is a function of the random alignment of fibers in each coupler, it provides a unique optical signature for each tag. The nine fibers not used to generate the unique signature were used for tamper detection purposes.

The laboratory prototype reader connected directly to the seal tie block and drove a scanning device that moved a single fiber across the ends of the nine signature fibers. This single fiber was used to introduce laser light into each signature fiber. The coupler causes crosstalk to the other eight fibers and the resultant light energy in each fiber is measured at the other end of the fiber by a detector in the reader. This process is repeated for all nine fibers at two different wavelengths and two polarities. These measurements of transmitted light energy constitute the seal's unique signature.

Due to difficulties with the prototype fiber optic connectors and scanning device, BDM was not able to complete sufficient readings to establish STAR signature uniqueness and repeatability. Coordination continued with LLNL regarding reader design, tag manufacturability, and methods of signature correlation. In June 1991, DOE notified DNA that the STAR system would require further development and was not ready for transition to DNA. BDM involvement ended at that time.

Ultrasonic Intrinsic Tag (UIT). The UIT concept was developed by Pacific Northwest Laboratories (PNL) for use on composite materials, such as those used in missile motor bottle construction (fiberglass-epoxy, Kevlar, etc.). The concept is based on the random distribution of acoustically dissimilar mediums within the composite material matrix. These acoustically dissimilar mediums represent sound discontinuities within the composite matrix that, when excited by the UIT ultrasonic source, produce a unique pattern of reflected sound signals.

The UT-3000 laboratory prototype UIT system consisted of three major components:

- (1) The CPU chassis used for image processing, correlation, and for control of the ultrasonic pulses
- (2) The monitor chassis containing a VGA monitor for displaying c-scan images and motor drivers for the scanner motors
- (3) A scanner which contained dual, motor driven, ultrasonic transducers.

Developmental testing of the laboratory prototype system conducted by BDM indicated that UIT signatures acquired from fiberglass-epoxy and graphite-epoxy composite samples were unique. Signature repeatability was very sensitive to accurate positioning of the scanner. These effects were most pronounced on the fiberglass-epoxy samples. While analysis of the signatures indicated a very low probability of signatures from different sources being attributed to the same source (false acceptance), there was a higher than desired probability that signatures drawn from the same location on the same source could be judged to be from different sources (false rejection). Stability of the UIT signature over extended periods of time and under varying environmental conditions is unknown. Following the completion of developmental testing, PNL recommended that DOE archive the system, thus DNA did not continue with industrialization of the UIT system.

Acoustic Resonance Spectroscopy (ARS). Acoustic Resonance Spectroscopy is a non-destructive evaluation technique developed by Los Alamos National Laboratory (LANL) that uses the various modes of natural vibrations of any solid object to determine the object's acoustic signature. In the ARS system, a simple broadband acoustic transducer (even an audio speaker) is used to sweep through a range of frequencies, from low to high, to excite the characteristic resonant frequencies of an object. A second transducer in contact with the object picks up these minute mechanical vibrations. This signal is amplified many orders of magnitude and is processed by a portable personal computer.

BDM assessed the potential of ARS as a verification tool in four stages that included:

- (1) Examination of the system's basic physics and engineering concepts
- (2) The application of finite element analysis methods to analyze the response signatures of a simple structural model
- (3) Laboratory readings of samples of missile motor bottle construction materials
- (4) Field readings of Minuteman II and III stages, and complete missiles.

BDM concluded that the ARS concept demonstrated potential for use in verification. However, additional development work and analysis was needed to improve signature repeatability and to determine the most appropriate signature correlation algorithm. This work is now underway at LANL.

Electronic Identification Device (EID). BDM's work in assessing the potential of EIDs (a miniature integrated circuit microprocessor that can be read directly or remotely) for treaty verification applications was conducted in two phases. The first phase involved a review of the Cornerstone EID development underway at LLNL. The second phase involved a survey of the EIDs available on the commercial market today and the development of concepts for EIDs designed specifically to support the requirements of arms control treaty verification.

The LLNL Cornerstone concept involves combining unique identification, data encryption, and tamper detection in a single EID chip design. Data would be encrypted using the Data Encryption Standard (DES) method. A capacitance type sensor with less than 10 micron movement sensitivity would be used for tamper detection. At the time of the BDM review of the Cornerstone concept, this chip had been designed but not yet placed into production.

In phase two of this assessment, BDM determined that EIDs offer great potential for arms control applications due to their flexibility, simplicity of deployment and employment, and low cost when produced in volume. There are a number of EID designs available and in use in the commercial market today but most, if not all of these, would require some modifications to be acceptable for use in treaty verification. These modifications center on data security and methods of securing the EID to the item of interest.

Microvideography (MV). The MV system developed by Pacific Northwest Laboratories (PNL) is intended to be a simple, low cost means of verifying the authenticity of printed labels or other identifying marks using the surface microstructure of the label or mark as a signature. The system hardware consists of a microscope/video camera system for recording magnified video images of the labels being examined, and a computer for examining and comparing those images. During an inspection, video images of either intrinsic or applied surface features are recorded. These are visually compared to a

reference image to determine the authenticity of the item or label. BDM's assessment of the MV technology was limited to analysis of bar code imagery supplied by PNL. The system operation was demonstrated to BDM but the equipment was not made available for use by BDM analysts.

Based on this limited examination of the system, BDM believes that MV might be appropriate for applications where an inventorying technique combined with tamper detection capability would be useful. However, additional testing and analysis would be required to determine the adequacy of the system's performance. In addition, the current system design relies on an inspector's subjective judgement to determine the authenticity of an image. BDM recommends that if further development of the MV concept is pursued, an objective technique be employed for image comparison since some of the differences in label images can be very subtle.

Nonlinear Junction (NLJ). The NLJ concept makes use of the exponential relationship between current and voltage in semiconductor diodes to produce a characteristic signature for each tag. A tag containing a number of Schottky diodes is exposed to a high frequency electromagnetic source. Each diode rectifies the signal and produces harmonics to the fundamental frequency. The diodes also interact with each other, creating a more complex response to the excitation source. The tag then re-radiates a portion of the fundamental frequency, along with harmonics of that frequency. This re-radiated complex harmonic signal, when captured and measured, forms the unique signature for each tag.

The tag reader system consists of a microwave transceiver and a computer. The transmitter produces an amplitude modulated signal that is swept from 2.7 to 4.0 GHz. This output is radiated through a standard gain horn to excite the tag. The horizontal and vertical components of the tag response signal are received by two separate standard gain horns, then filtered, and amplified. Signature correlation is a modified root-mean-square (RMS) calculation comparing the measured signature with a reference signature for the tag.

The BDM assessment of the NLJ system was conducted in two phases. In the first phase it was determined that the NLJ concept showed promise for the

unique identification of TLIs. However, testing identified three areas that required further investigation.

- (1) Alternatives to the tag's hard ceramic backing material are desirable to reduce the probability that the tag could be transferred from one TLI to another without detection.
- (2) The signature of a tag, created by affixing a Schottky diode network to a backing material, exhibited a great deal of sensitivity to temperature.
- (3) Correlation techniques are desired that could take into account slight shifts in tag signature frequency.

Following completion of the first phase, DNA authorized additional BDM effort to examine the three areas noted above. Instead of mounting the circuit components on ceramic backing material, these components were applied directly to the TLI and epoxied in place. These tags did not generate harmonic responses, as well as those mounted on ceramic. Signature variations due to temperature for directly applied tags were similar to those experienced during the first phase of testing. Additional correlation approaches were used, but none of them were able to handle the large signature changes resulting from temperature variations. With the completion of this second phase of testing, the NLJ laboratory prototype system was returned to INEL.

Tamper Tape + RPT. Commercial tamper tapes consist of an adhesive backing on one or more layers of vinyl composites or sheet plastic. After proper application, this type of seal is difficult to remove without an indication (tearing or delamination of the multiple layers) that tampering has occurred. A reflective particle (RP) disk was added by PNL to increase the difficulty of counterfeiting the tag and to make each tag unique. Micaceous hematite, the same material used in the RPT, was used to generate the RP signature. At the request of DNA, BDM conducted some limited testing of the prototype tapes with the RP signature.

The results of BDM testing indicated that tapes with high reflective particle densities had greater signature stability during temperature shock experiments than did those with lower particle densities. This was particularly noticeable during testing at low temperatures (14°F). Correlations using reference readings obtained before the tape was applied to a substrate tended to be lower than when

the reference reading was obtained after the tape was applied to the substrate. Again, cold temperature and low particle density accentuated this effect. Tamper tape + RPT development continues at PNL.

Python. The Python seal under development by SNL consisted, at the time of the BDM assessment, of a loop containing 64 plastic optical fibers in a clear sheath that terminated in a clear, marbled polycarbonate block. Two methods were used to generate a unique signature for each seal. The first is an RP signature area at the base of each block. A second signature, which also provided tamper detection capability, was obtained by inserting a cutting blade through a slot in the block. This blade would cut and damage some of the fibers in a random fashion and create a unique signature when light was passed through the cable.

Although a reading system had not been identified at the time of the BDM assessment, the RP signature could be read by a device similar to that used for reading the RPT but adapted specifically for the Python dimensions. Another approach would be to photograph the light pattern of the plastic fiber ends as was done with the Cobra Seal®.

DNA tasked BDM to assess the feasibility of the Python concept, to compare Python with the STAR seal being developed by LLNL, and to provide a development plan for Python. At the time this work began, Python was still in the design stage, and functional prototypes had not been fabricated. Accordingly, BDM's assessment was based on design data provided verbally by SNL. BDM found that the development of Python was feasible and would not require excessive development effort or unrealistic manufacturing techniques. In comparison to the STAR fiber optic seal, Python's design would outperform STAR in 8 of 10 categories where a difference could be established. Finally, BDM recommended that SNL put together a more complete development plan and provided a specific approach to the development of such a plan.

Following completion of the work described above, BDM had no further involvement with Python. Development work continues at SNL.

BDM-DEVELOPED TECHNOLOGIES.

Secure Loop Inspectable Tag/Seal (SLITS). DNA challenged BDM to design a simple, inexpensive, secure tag/seal as an alternative to those already being developed. As a result, BDM developed the Secure Loop Inspectable Tag/Seal (SLITS) System. SLITS was designed to be used when the entire tag/seal can be visually and tactilely examined or when it can be removed and replaced each time an inspection occurs. It incorporates a loop that can be wrapped securely around a tagged item or threaded through a hasp or closure to act as a seal. The ends of the loop are secured in an optically clear seal (or joint) block and are embedded in an epoxy/RP mixture within the block.

There are two types of SLITS loops. In one, the Kynar loop, a Kevlar core is encased in a Teflon tube, which is surrounded by a Kynar braid. In the other, a plastic fiber optic loop and a Kevlar strength member are enclosed in a transparent Teflon tube. The materials for both, which were chosen to make any tampering (splicing, etc.) readily apparent, are highly resistant to seamless chemical bonding and they facilitate both tactile and visual inspections. The Kynar loop emphasizes strength and redundancy of the tamper-revealing elements (braid and tube), whereas the fiber optic loop offers a valuable aid to inspectors in locating tampering (splice attempts) along with simplified external features (the smooth Teflon tube).

Under the direction of DNA, BDM conducted an IOT&E which included SLITS. Results showed that the SLITS system met all operational requirements, was easy to read, and relatively easy to construct and apply to tagged items. As a result of this testing it was determined that the design with the Kynar outer braid was the preferred design. SLITS has also been subjected to adversarial analysis by INEL. To date, INEL has been unable to achieve undetected opening of SLITS. At the completion of the Tagging RDT&E contract, all SLITS system equipment, materials, and documentation will be archived at DNA.

Passive Tamper Indicating Loop Seal (PTILS). BDM developed PTILS to address inspection scenarios where the entire loop seal could not be accessed or seen. This concept includes a loop with a reinforced plastic optical fiber sealed into a closed loop by a plastic joint block containing an RP signature. Some preliminary

work has also been done on the use of aluminized Mylar particles as the reflective element. Using Mylar instead of hematite appears to improve visual tamper detection capability in the deeper RP signature region of the PTILS joint block. With PTILS, on-site assessment of whether the loop has been cut and spliced does not rely on the subjective assessment of the inspector. Furthermore, all parts of the loop do not have to be accessible to the inspector for a definitive assessment of the loop integrity to be made. Only access to the joint block is required.

Processing and analysis of the fiber's signal trace generated by an Optical Time Domain Reflectometer (OTDR) provides a high confidence means of tamper detection and allows PTILS to be used in situations where visual and tactile inspection of a loop seal would be unacceptably laborious, intrusive, or hazardous. The OTDR used is commercial-off-the-shelf (COTS) equipment manufactured by Opto-Electronics, Inc.

The PTILS tamper detection method automatically records the fiber characteristics over the entire length of the tag/seal loop. The record of the tamper inspection containing the evidence of any covert splice attempt is stored as a small digitized file on a magnetic floppy disk alongside the RP signature data. Comparison of this data with reference data acquired at the time PTILS was installed, shows whether or not any tampering has occurred, and if so, exactly where it occurred. Also, the record can be analyzed on-site in software to provide a "red light/green light" tamper assessment, relieving the inspector of having to make a subjective seal integrity call.

PTILS has completed industrial prototype development, functional testing, and limited environmental testing. At the completion of the Tagging RDT&E contract, all PTILS system equipment, materials, and documentation will be archived at DNA.

Universal videographic Reader (UR). The UR industrial prototype system, developed by BDM from an earlier SNL-designed RPT reader, provides a single reading system for several types of tags, including RPT and SLITS. It records video images of RP signatures and computes how well these video images compare to previously-recorded images of the same tag to determine, with a high level of confidence, the authenticity of the inspected tag.

The process of comparing the original reference image and the current (verification) image is called correlation. Correlation values equal to or greater than a predetermined threshold value indicate that the current tag signature and the reference signature came from the same tag. A correlation value less than the threshold value indicates that these signatures came from different tags. Threshold values are established at levels which ensure the probability of determining that signatures from the same tag are from different tags (false rejection), or that signatures from different tags are from the same tag (false acceptance), is less than 10^{-6} .

The UR system consists of a field deployable equipment set and a separate calibration set used in a laboratory. The field equipment is made up of three subsystems:

- (1) **Computer.** An IBM-PC compatible 286 with a math coprocessor, 8 megabytes of RAM, 20 megabyte hard drive, and VGA monitor or better
- (2) **Fiber Optic Connecting Cable.** A 150-foot military tactical fiber optic interface cable, that provides video, audio, and data transmission between the computer and the reader-end during operations
- (3) **Reader End.** The reader-end includes a fiber optic interface, battery, belt box, tag reader head (with a CCD camera), microscope head (also with a CCD camera), video monitor, and audio headset.

BDM conducted an IOT&E of the UR system and determined that the system is capable of being used in the field. Several modifications were made to the system after IOT&E to improve user-friendliness and versatility. INEL conducted an adversarial analysis assessment of this system, and upon completion of the Tagging RDT&E contract, the documented UR system will be delivered to DNA.

COMMERCIAL TAG/SEAL TECHNOLOGIES.

At DNA direction, BDM also evaluated two commercially-developed tag and seal concepts. These were the VACOSS-S system, developed by

FORSCHUNGSZENTRUM JULICH GmbH (KFA) of Germany and licensed for production by Aquila Technologies Group, Inc., and the MIKOS concept, developed by MIKOS Ltd. and International Development and Resources Inc. (IDR).

VACOSS Loop Seal. The **VARIABLE CODING SEAL SYSTEM-SERIES (VACOSS-S)** active, reusable, battery powered electro-optic seal is presently in use by the International Atomic Energy Agency. The seal consists of a fiber optic cable attached at both ends to a seal case forming a loop. A light pulse is generated by the seal case and transmitted in one end of the fiber optic cable at either 125 millisecond or 250 millisecond intervals. When that pulse is not detected at the other end of the cable, a tamper event is recorded. In addition to the seal and fiber optic loop, system hardware consists of a palm-top reader (HP-95LX) and a serial interface unit linking the reader with the seal.

In accomplishing its assessment of the VACOSS-S, BDM conducted functional and environmental tests and also evaluated the systems capability to operate under field conditions. In general, the VACOSS-S meets the manufacturer's specifications and operates as expected. One of the seals that underwent rain and salt fog environmental testing experienced corrosion problems with the fiber optic loop connectors and subsequent difficulties with loop tamper event recording. In addition, one of the two models of lithium batteries used to power the seal failed prematurely. Both of these problems are being addressed by Aquila in a modified version of the seal.

MIKOS Concept. The MIKOS process is based on using the image of a random, complex mosaic, applied tag to create a reference image. The reference image is subsequently compared to the applied tag to establish the identity of the tagged object, assuming that the applied tag has not been transferred to another object. Overlaying the reference image on the tag or a positive image of the tag results in a visual phenomenon that MIKOS calls the Flash Correlation Artifact (FCA). The FCA is a type of Moire pattern that appears when the reference image transparency is brought into near registration with the tag or its positive image.

Unfortunately, MIKOS would not allow BDM to have access to proprietary data necessary for a full assessment of the MIKOS concept. The limited BDM

assessment concluded that the process might have potential as an inexpensive tagging concept, pending further analysis addressing the vulnerability of the process to counterfeiting or transfer and the determination of acceptable ranges of values for tag particle parameters (e.g., size, shape, specular reflection, etc.).

OTHER BDM STUDIES

Environmental Specification. On June 1, 1990, BDM delivered to DNA a proposed "Environmental Specification for the Strategic Arms Reduction Treaty (START) Verification System." This specification was based on the requirements specified for equipment associated with the Peacekeeper Rail Garrison System and MIL-STD-810, Environmental Test Methods and Engineering Guidelines. The initial objective of this effort was to develop a set of environmental specifications applicable to the RPT system. These specifications were later broadened to include all tagging systems designed for use in START verification.

In April 1991, after evaluating several tagging concepts for START, and taking into consideration the uncertainties associated with the eventual inspection protocols that would govern the use of tags and seals in any arms control agreement, BDM recommended to DNA that several of the more severe environmental specifications be modified. These modifications would allow the consideration of more COTS components. This would avoid disqualifying some concepts prior to determining the nature of the environment that the treaty provisions specify for using that concept. These modifications have been approved by DoD agencies and were published in January 1993.

START Verification Requirements. The document "Strategic Arms Reduction Treaty (START) Tagging System Requirements," dated October 1990, was developed by BDM for DNA to pull together, in a single authoritative reference, all of the requirements regarding tags and tagging systems that were emerging from such sources as START negotiations, tag system development efforts, and security requirements. This document provided high-level statements of such requirements as tag signature uniqueness and repeatability, and the ability of the tag to resist counterfeiting and undetected tampering or transfer.

This document also incorporated the environmental specifications which had been published earlier, and the reliability standards, which had been established as part of the logistics plan for the RPT system.

SMART Analysis of Tagging Concepts. The Simple Multi-Attribute Rating Technique (SMART) is a structured decision-making process for evaluating various options based on multiple evaluation criteria. This process defines a value structure for decision making based on input from people who are experts in the problem area. It also measures possible solutions against that value structure, and produces a measure of value for each possible solution. The solution with the highest value score is the best or "most favored" solution.

This process had been used for the comparison of alternative security systems for the Peacekeeper Rail Garrison program and in support of an Air Force Mishap Prevention Program analysis. It was used on two occasions in support of the Tagging RDT&E contract to rate tagging systems against weighted performance criteria. BDM has provided DNA with detailed explanations of the process.

Tagging Ballistic Missile Systems. The BDM report entitled "Evaluation of the Effectiveness and Suitability of Tags on Ballistic Missile Systems (U)," dated October 15, 1990, analyzed the structural and material properties of Soviet missiles and their canisters to determine the effectiveness and suitability of U.S. and Soviet concepts for tagging Soviet systems. Relevant missile intelligence was obtained through visits at military bases to collect data, and by contacting the Defense Intelligence Agency (DIA) and U.S. Air Force Foreign Technology Division (FTD) analysts. The best combination of a U.S. tag concept and missile system location was selected with the assistance of BDM personnel possessing expertise in missile design and operations, and on the basis of intelligence estimates.

Information on Soviet tagging concepts was obtained from DOE sources and evaluated for satisfaction of technical and safety issues. Requirements for additional, hard intelligence and recommendations for DT&E and OT&E were provided. This report was classified SECRET.

Canister Tagging. DNA, as part of their examination of a wide variety of possible tagging applications and scenarios, tasked BDM to assess identified tagging methodologies for application to U. S. and Soviet ICBM canisters. The BDM report, "Evaluation of the Effectiveness of Tags on Ballistic Missile Canisters (U)," dated July 3, 1991, includes a review of then current tagging systems and of available data on U.S. and Soviet canisters. It identifies which tagging methodologies might be most appropriate and where on the canister these tags might be applied. Finally, the report concludes with recommendations for additional studies and actions that would provide the detailed data on which to base a decision on the tagging of canisters. The report was classified SECRET.

Tagging of START Mobile TELS and CFE TLE. The purpose of this August 23, 1990 report was to examine tagging systems and concepts and determine their suitability for the tagging of mobile TELS used by weapon systems limited under the START treaty, and items of equipment limited under the CFE treaty. The report considered 17 tagging systems, weighed them subjectively against broad tag system requirements, and recommended candidates for each application. The report recommended that:

- (1) CFE tagging requirements be defined. This would provide clearer focus to R&D efforts.
- (2) Operational concepts be developed for commercially available tagging systems such as adhesive labels, bar codes, serial number tracking, and license plates/credit cards.
- (3) A field demonstration to include selected available tagging systems be held as soon as possible.
- (4) DoD investigate possible locations for tags on all types of CFE TLE including aircraft so that operational factors could be assessed, as well as the technical aspects of any tagging system.

Serial Number Tracking for CFE Destruction Verification. One approach to identifying and tracking military equipment is to use the manufacturer's serial number applied when the equipment is produced. In the report "Assessment of

Serial Number Tracking for CFE Destruction Verification," dated June 28, 1991, BDM assessed the application of this approach to monitoring the destruction of treaty-limited equipment (TLE) under the provisions of CFE.

This report addressed the applicable CFE treaty provisions which are U.S. objectives and the potential needs for verification of TLE destruction; issues related to the reciprocal application of serial number tracking; and how a serial number tracking system might be applied to U.S. and NATO forces.

The report concluded that serial number tracking for verification of TLE destruction could make a significant contribution to the verification process, and provided recommendations regarding specific implementation provisions.

Overview of the Pros and Cons of Tagging for CFE. The purpose of this report was to examine the overall utility of tagging as a means of verifying compliance with the provisions of CFE, in light of previous BDM studies of tagging applications for CFE. The report provided to DNA on August 16, 1991, concluded that:

- (1) It was unlikely that tagging approaches, including serial number tracking, could be successfully negotiated during CFE follow-on talks.
- (2) Tagging of a large subset of TLE in operational units is impractical and probably non-negotiable.
- (3) Serial number tracking should be employed to track TLE destruction, conversion, recategorization, and reclassification, except for attack helicopters and combat aircraft, which should be tagged.
- (4) Future negotiations should attempt to obtain agreement on routine data exchange of all destroyed and converted TLE serial numbers.
- (5) Follow-on negotiations should aim to extend CFE-1 to explicitly permit close inspection and serial number tracking of ground TLE in designated permanent storage, of TLE decommissioned and awaiting disposal, and the provision of working registers of serial numbers to visiting inspectors.

CFE Field Demonstration. This report examined how a field demonstration might be useful in determining the usefulness of tagging CFE TLE. The report proposed a limited field demonstration that would focus on the application and

reading of selected tagging systems to determine their ruggedness, reliability, and signature repeatability under field conditions.

Participating tagging systems would be selected by an interagency group from those tags available at that time and both government and commercially developed tagging systems could be included. The demonstration would involve the tagging of 20 to 40 TLE, and could be conducted in conjunction with an already scheduled unit field training exercise. The report was provided to DNA on September 18, 1991.

Sealing Casting Pits. During the course of the START negotiations, the U.S. Government believed that the treaty might require the inspection of rocket motor production facilities to determine if these facilities were in compliance with any treaty limitations on the production of certain missile motors. Accordingly, DNA tasked BDM to examine means by which casting vessels used in the production of solid rocket motors (SRM) might be sealed to either prevent their undetected use or to limit the size of the motor that could be cast using that vessel.

BDM evaluated several layered approaches for sealing casting pits including:

- (1) External vessel seals that would prevent removal of the casting pit lid
- (2) Vessel access seals that would prevent removal of an SRM from a casting enclosure
- (3) SRM size limiting seals that would limit the dimensions of cast SRMs
- (4) SRM size/weight detection systems
- (5) Seals that would disable hoists and or hydraulic systems used for removing SRMs from the casting pit
- (6) Seals on casting pit ingress/egress control systems.

The sealing approach considered best was a "monitored external vessel seals scheme." This sealing scheme involves sealing the casting pit lid to the casting vessel with two seals; a fiber optic seal with a visual signature, and a rigid seal with an ultrasonic signature. Both seals would be monitored by a secure video surveillance system that covers the seal installation area, thus increasing the difficulty of bypassing the seals without detection. The report on this

investigation was submitted to DNA on November 27, 1990. This report was classified SECRET.

Shipment of Hazardous Materials. BDM was tasked to look into the shipment of hazardous materials primarily to the Soviet Union. This involved locating the appropriate agencies, identifying regulations, and marking, packing, and labeling of all material shipped along with the appropriate documentation. The authorities regulating the shipment of hazardous materials to the Former Soviet Union (FSU) were:

- (1) The U.S. Department of Transportation (DOT)
- (2) The U.S. Department of Defense (DoD)
- (3) The U.S. Department of Labor, Occupational Health and Safety Administration (OSHA)
- (4) The United Nations, International Civil Aviation Organization (ICAO), and the International Air Transport Association (IATA)
- (5) The receiving country.

In an effort to unify the various requirements generated by these agencies, the U.S. Air Force recently notified all commands that CONUS and overseas military air shipments must comply with the ICAO performance oriented packaging requirements as published in the IATA Dangerous Goods Regulations (DGR).

Even though one set of hazardous material transportation regulations can now be used by all air carriers in the U.S. and overseas, it is desirable that hazardous material packages be shipped under the control of one authority for the entire journey to an FSU point-of-entry. Accordingly, a shipment to the FSU should be transported by military air from the U.S. to the FSU. Surface transportation within the U.S. would be contracted to civilian carriers.

All specifics regarding packaging and labeling of hazardous materials is documented in appendix F, of the "Reflective Particle Tag (RPT) Initial Operational Test and Evaluation (IOT&E) Final Test Report," dated February 15, 1991.

SUMMARY OF CONTRACT TECHNICAL INSTRUCTIONS.

DNA issued a total of 17 Technical instructions (TIs) to BDM under the provisions of the Tagging RDT&E contract. Figure ES-2 depicts the TI, the applicable SOW task, the LOE expended on each TI, and the total cost associated with that effort.

TI Number	Descriptive Task Title	SOW Task	Level of Effort	Dollars Spent
TI FY90-01	Reflective Particle Tag System Development	2	29,326	\$1,540,000
TI FY90-02	Feasibility Study - CFE Treaty Limited Equipment	1	2,080	170,078
TI FY90-03	Environmental Specifications	2	263	12,901
TI FY90-04	Statistical Analysis	2	3,528	150,884
TI FY90-05	Ultrasonic Intrinsic Tag Assessment	1	8,112	400,702
TI FY90-06	STAR Fiber Optic Assessment	1	7,080	400,244
TI FY90-07	Study Plan for CFE Tagging Demonstration	2	1,637	102,189
TI FY90-08	Python Seal Assessment	2	1,347	106,158
TI FY90-09	Casting Pit Seals Study	2	722	48,680
TI FY90-10	Innovative Tag Development	1	9,839	544,347
TI FY90-11	Soviet Concept Assessment	3	525	25,540
TI FY90-12	Serial Number Tracking Assessment	1	868	66,424
TI FY91-13	Tag Concept Assessment and Documentation Acoustic Resonance Spectroscopy Assessment Electronic Identification Device Assessment Nonlinear Junction Assessment Microvideography Assessment Tamper Tape + RP Assistance VACOSS-S Assessment Contract Closeout	1 & 3	28,760*	1,651,427*
TI FY91-14	DOE Tagging Technology Transition RPT Transition Universal Reader Development (Non-DOE System) Ultrasonic Intrinsic Tag Assessment Python Assessment	2 & 4	34,579*	1,735,869*
TI FY91-15	Universal Reader Innovative Tag Development	2	7,047	484,515
TI FY91-15	Innovative Tag Development MIKOS Assessment Development & Testing Passive Tamper Indicating Loop Seal Development	2	32,862*	2,037,347*
TI FY91-16	CFE Wrap Up Efforts	1	1,880	143,570

* Data as of 3-22-93, showing LOE and dollars estimated to completion.

Figure ES-2. TIs issued under Tagging RDT&E contract.

CONVERSION TABLE

Conversion factors for U.S. Customary to metric (SI) units of measurement.

MULTIPLY $\xrightarrow{\hspace{10em}}$ BY $\xrightarrow{\hspace{10em}}$ TO GET
 TO GET $\xleftarrow{\hspace{10em}}$ BY $\xleftarrow{\hspace{10em}}$ DIVIDE

angstrom	1.000 000 X E -10	meters (m)
atmosphere (normal)	1.013 25 X E +2	kilo pascal (kPa)
bar	1.000 000 X E +2	kilo pascal (kPa)
barrel	1.000 000 X E -28	meter ² (m ²)
British thermal unit (thermochemical)	1.054 350 X E +3	joule (J)
calorie (thermochemical)	4.184 000	joule (J)
cal (thermochemical/cm ²)	4.184 000 X E -2	mega joule/m ² (MJ/m ²)
curie	3.700 000 X E +1	*giga becquerel (GBq)
degree (angle)	1.745 329 X E -2	radian (rad)
degree Fahrenheit	$t_k = (t^{\circ}F + 459.67)/1.8$	degree kelvin (K)
electron volt	1.602 19 X E -19	joule (J)
erg	1.000 000 X E -7	joule (J)
erg/second	1.000 000 X E -7	watt (W)
foot	3.048 000 X E -1	meter (m)
foot-pound-force	1.355 818	joule (J)
gallon (U.S. liquid)	3.785 412 X E -3	meter ³ (m ³)
inch	2.540 000 X E -2	meter (m)
jerk	1.000 000 X E +9	joule (J)
joule/kilogram (J/kg) radiation dose absorbed	1.000 000	Gray (Gy)
kilotons	4.183	terajoules
kip (1000 lbf)	4.448 222 X E +3	newton (N)
kip/inch ² (ksi)	6.894 757 X E +3	kilo pascal (kPa)
ktop	1.000 000 X E +2	newton-second/m ² (N-s/m ²)
micron	1.000 000 X E -6	meter (m)
mil	2.540 000 X E -5	meter (m)
mile (international)	1.609 344 X E +3	meter (m)
ounce	2.834 952 X E -2	kilogram (kg)
pound-force (lbs avoirdupois)	4.448 222	newton (N)
pound-force inch	1.129 848 X E -1	newton-meter (N·m)
pound-force/inch	1.751 268 X E +2	newton/meter (N/m)
pound-force/foot ²	4.788 026 X E -2	kilo pascal (kPa)
pound-force/inch ² (psi)	6.894 757	kilo pascal (kPa)
pound-mass (lbm avoirdupois)	4.535 924 X E -1	kilogram (kg)
pound-mass-foot ² (moment of inertia)	4.214 011 X E -2	kilogram-meter ² (kg·m ²)
pound-mass/foot ³	1.601 846 X E +1	kilogram/meter ³ (kg/m ³)
rad (radiation dose absorbed)	1.000 000 X E -2	**Gray (Gy)
roentgen	2.579 760 X E -4	coulomb/kilogram (C/kg)
shake	1.000 000 X E -8	second (s)
slug	1.459 390 X E +1	kilogram (kg)
torr (mm Hg, 0° C)	1.333 22 X E -1	kilo pascal (kPa)

*The becquerel (Bq) is the SI unit of radioactivity; 1 Bq = 1 event/s.
 **The Gray (Gy) is the SI unit of absorbed radiation.

TABLE OF CONTENTS

Section	Page
EXECUTIVE SUMMARY.....	iii
CONVERSION TABLE.....	xxv
FIGURES	xxxi
TABLES	xxxv
1 INTRODUCTION	1
1.1 BACKGROUND.....	1
1.2 CONTRACT SCOPE.....	1
1.3 REPORT PRESENTATION	2
2 CONTRACT DELIVERABLES	5
3 DOE-DEVELOPED SYSTEMS.....	13
3.1 REFLECTIVE PARTICLE TAG (RPT) SYSTEM.....	13
3.1.1 Overview.....	13
3.1.2 Schedule	14
3.1.3 System Description	16
3.1.4 Activity Description.....	22
3.1.5 Results.....	34
3.2 STAR FIBER OPTIC TAG SYSTEM.....	34
3.2.1 Overview.....	34
3.2.2 Schedule	36
3.2.3 System Description	36
3.2.4 Activity Description.....	38
3.2.5 Results.....	39
3.3 ULTRASONIC INTRINSIC TAG SYSTEM.....	40
3.3.1 Overview.....	40
3.3.2 Schedule.....	42
3.3.3 System Description	42
3.3.4 Activity Description.....	45
3.4 PYTHON SYSTEM.....	53
3.4.1 Overview.....	53
3.4.2 Schedule.....	54
3.4.3 System Description	54
3.4.4 Activity Description.....	58
3.4.5 Results.....	58

TABLE OF CONTENTS (continued)

Section	Page
3.5 ACOUSTIC RESONANCE SPECTROSCOPY.....	63
3.5.1 Overview.....	63
3.5.2 Schedule.....	64
3.5.3 System Description	65
3.5.4 Activity Description.....	70
3.5.5 Results.....	71
3.6 ELECTRONIC IDENTIFICATION DEVICES (EIDs)	74
3.6.1 Overview.....	74
3.6.2 Schedule.....	77
3.6.3 System Description	78
3.6.4 Activity Description.....	84
3.6.5 Results.....	85
3.7 MICROVIDEOGRAPHY.....	89
3.7.1 Overview.....	89
3.7.2 Schedule.....	90
3.7.3 System Description	90
3.7.4 Activity Description.....	93
3.7.5 Results.....	94
3.8 NONLINEAR JUNCTION (NLJ) SYSTEM.....	98
3.8.1 Overview.....	98
3.8.2 Schedule.....	99
3.8.3 System Description	100
3.8.4 Activity Description	102
3.8.5 Results.....	104
3.9 TAMPER TAPE ASSESSMENT.....	106
3.9.1 Overview	106
3.9.2 Schedule	107
3.9.3 System Description	107
3.9.4 Activity Description.....	108
3.9.5 Results	109
4 BDM-DEVELOPED SYSTEMS.....	116
4.1 SECURE LOOP INSPECTABLE TAG/SEAL (SLITS).....	119
4.1.1 Overview.....	119
4.1.2 Schedule.....	121
4.1.3 System Description	122
4.1.4 Activity Description.....	130
4.1.5 Results.....	139

TABLE OF CONTENTS (continued)

Section	Page
4.2 SECURE LOOP OPTICAL TAG/SEAL (SLOTS) / PASSIVE TAMPER INDICATING LOOP SEAL (PTILS).....	145
4.2.1 Overview.....	145
4.2.2 Schedule	148
4.2.3 System Description	150
4.2.4 Activity Description.....	163
4.2.5 Results.....	174
4.3 THE INNOVATIVE TAGS CREATIVE TASK.....	181
4.3.1 Overview.....	181
4.3.2 Schedule	185
4.3.3 System Description	186
4.3.4 Activity Description.....	219
4.3.5 Results.....	220
4.3.6 References to section 4.3.....	225
4.4 UNIVERSAL VIDEOGRAPHIC READER (UR).....	227
4.4.1 Overview.....	227
4.4.2 Schedule	229
4.4.3 System Description	230
4.4.4 Activity Description.....	239
4.4.5 Results.....	243
5 COMMERCIALY-DEVELOPED SYSTEMS	250
5.1 VARIABLE CODING SEAL SYSTEM - SERIES ASSESSMENT	250
5.1.1 Overview.....	250
5.1.2 Schedule	251
5.1.3 System Description	252
5.1.4 Activity Description.....	253
5.1.5 Results.....	253
5.2 MIKOS PROCESS ASSESSMENT.....	259
5.2.1 Overview.....	259
5.2.2 Schedule.....	260
5.2.3 System Description	260
5.2.4 Activity Description.....	261
5.2.5 Results	262
6 SUPPORTING STUDIES / DEVELOPMENTS	266
6.1 STANDARDS AND SPECIFICATIONS DEVELOPMENT	266
6.1.1 Overview.....	266
6.1.2 Schedule.....	268
6.1.3 Objective and Scope	269
6.1.4 Activity Description.....	269
6.1.5 Conclusions and Recommendations.....	271

TABLE OF CONTENTS (continued)

Section	Page
6.2 CONVENTIONAL FORCES IN EUROPE (CFE)	273
6.2.1 Tagging of Start Mobile Missile Transporter, Erector, Launchers (TELS) CFE Treaty Limited Equipment (TLE)	273
6.2.2 Serial Number Tracking for CFE Destruction Verification	276
6.2.3 Overview of the Pros and Cons of Tagging for CFE.....	280
6.2.4 CFE Field Demonstration	282
6.2.5 CFE Wrap-Up.....	284
6.3 CASTING PITS	287
6.3.1 Overview.....	287
6.3.2 Schedule.....	288
6.3.3 System Description	288
6.3.4 Activity Description.....	289
6.3.5 Results	290
6.4 TAGGING BALLISTIC MISSILE SYSTEMS	294
6.4.1 Overview	294
6.4.2 Schedule	294
6.4.3 Objective and Scope.....	295
6.4.4 Activity Description.....	295
6.4.5 Conclusions and Recommendations.....	296
6.5 CANISTER APPLICATIONS.....	297
6.5.1 Overview.....	297
6.5.2 Schedule.....	298
6.5.3 Objectives and Scope.....	298
6.5.4 Activity Description.....	299
6.5.5 Conclusions and Recommendations.....	299
6.6 TECHNOLOGY TRANSFER	300
6.6.1 Overview.....	300
6.6.2 Objective and Scope	302
6.6.3 Activity Description	303
6.6.4 Conclusions and Recommendations.....	303
6.7 HAZARDOUS MATERIAL TRANSPORTATION.....	304
6.7.1 Overview.....	304
6.7.2 Schedule.	305
6.7.3 Objectives and Scope.....	305
6.7.4 Activity Description.....	305
6.7.5 Conclusions and Recommendations.....	306
6.8 SIMPLE MULTI-ATTRIBUTE RATING TECHNIQUE (SMART) ANALYSIS.....	307
6.8.1 Overview.....	307
6.8.2 Schedule.	308
6.8.3 Objectives and Scope.....	309
6.8.4 Activity Description.....	310
6.8.5 Conclusions and Recommendations.....	312

TABLE OF CONTENTS (Continued)

Section	Page
7 CONCLUSIONS AND RECOMMENDATIONS.....	314
7.1 CONCLUSIONS	314
7.2 RECOMMENDATIONS.....	315

FIGURES

Figure	Page
1-1 Chart showing contract changes that occurred.....	3
3-1 RPT documents produced for Tagging RDT&E.....	15
3-2 Schedule of RPT activities.....	16
3-3 The reflective particle tag	17
3-4 The RPT application kit.....	18
3-5 The RPT reading system	19
3-6 The region of overlap for two RPT images.....	21
3-7 Chart showing the list of documents produced during the STAR FOT task.....	35
3-8 Schedule of STAR FOT activities.....	37
3-9 Schematic diagram of the STAR FOT surrounding a TLI.....	38
3-10 UIT system assessment schedule.....	43
3-11 The UT-3000 system, showing the CPU chassis, the monitor chassis, and the scanner	44
3-12 A conceptual illustration of the UIT ultrasonic sound waves interrogating a composite material sample	44
3-13 Typical internal timegate extraction for a graphic-epoxy sample.....	34
3-14 Python Seal.....	55
3-15 Python seal fiber optic cable	56
3-16 Python seal RP and fiber optic signature areas.....	57
3-17 ARS schedule of activities.....	64
3-18 Wideband acoustic resonance spectroscopy system - generic concept.....	65
3-19 Heterodyne acoustical resonance setup.....	67
3-20 Homodyne acoustical resonance setup.....	67
3-21 Typical resonant frequency response	68
3-22 Overlay of the resonance signatures of four "identically" manufactured "small" items.....	69
3-23 Overlay of the resonance signatures of three "identically" manufactured "small" objects filled with different substances	69
3-24 Depiction of the types of electronic identification devices.....	75
3-25 EID concept assessment schedule	78
3-26 Block diagram of EID tag - the building block concept	79

FIGURES (continued)

Figure	Page
3-27 EID with separate microprocessor and tamper detection integrated circuits	80
3-28 An EID with Tamper Tape. The Tamper Tape provides the secure method of attachment and the EID provides the secure data protection	81
3-29 A contact EID with wiring in Tamper Tape. The wiring placed within the Tamper Tape gives added protection against intrusion or removal of the EID	82
3-30 EID loop tag/seal with a switch. The loop material could be a simple inspectable rope that is continuously monitored by; the EID/switch assembly	84
3-31 Microvideography schedule of activities	90
3-32 Illustration of a microvideographic image of a bar code	91
3-33 Video head and video monitor used to acquire the image of a bar code.....	92
3-34 Microvideography additional components	92
3-35 NLJ schedule of activities	100
3-36 NLJ tag.....	101
3-37 NLJ tag reader system.....	101
3-38 Tamper tape schedule of activities	107
3-39 Prototype version of a tamper tape tag	108
3-40 Task 5 correlation summary.....	115
4-1 Generic classes of tags.....	117
4-2 Schedule of Innovative Tags and SLIS development.....	122
4-3 SLITS design including the protective cover.....	123
4-4 The SLITS loop design.....	125
4-5 Alternative SLITS loop design incorporating a plastic optical fiber	127
4-6 Tamper detection in the SLITS joint block.....	129
4-7 Tamper detection in the SLITS loop	129
4-8 Modified SLITS with loop exit ports and a locking lid	142
4-9 One piece SLITS joint block design.....	144
4-10 Schedule of SLOTS/PTILS development.....	150
4-11 Industrial prototype PTILS design.....	151
4-12 Types of splices in optical fibers.....	151

FIGURES (continued)

Figure		Page
4-13	Cross-section view of loop construction in the industrial prototype P _T ILS...	152
4-14	Operational principles of an OTDR.....	157
4-15	Photograph of the OFM10 OTDR manufactured by Opto-Electronics Inc., identical in appearance to the OFM20.....	158
4-16	Steps in the on-site inspection of P _T ILS.....	159
4-17	Multiple wrap SLIS design.....	160
4-18	Photograph of the OTDR board manufactured by Antel Optronics	161
4-19	The multiple wrap SLOTS cable layout concept	162
4-20	Possible jacketing configuration of the multiple wrap SLOTS loop	163
4-21	An OFM20 OTDR trace of a -44 dB reflectivity, 0.7 dB throughput loss "splice" in 250 μm PMMA fiber	169
4-22	Comparison of OTDR performance at different wavelengths accounting for differences in the peak power output of the laser diode	171
4-23	Comparison of Antel board OTDR traces on an optical fiber before and after splicing multiple times with the Fujikura splicing machine.....	174
4-24	Type of tags and seals that can be developed.....	183
4-25	BDM Creative Task schedule	186
4-26	Typical hysteresis curves for normal ferromagnetic materials and amorphous magnetostrictive materials.....	188
4-27	Propagation of a domain wall in an amorphous wire.....	189
4-28	BDM laboratory measurement of the Barkhausen jump for normal and spliced amorphous magnetostrictive wires.....	190
4-29	One possible implementation of a tag/seal utilizing the large Barkhausen effect in amorphous wire	190
4-30	Conceptual design of a composite signature read-at-home tag/seal.....	193
4-31	SLITS modified as a read-at-home tag/seal.....	193
4-32	The SEAM proof-of-concept system.....	196
4-33	SEAM produces a scan of target material properties.....	198
4-34	The SEAM experimental configuration.....	199
4-35	High contrast sample - copper strips on glass	202
4-36	Scan across a 2 mm x 2 mm copper-on-glass sample (aperture = 1 mm, standoff = 1 mm).....	202

FIGURES (Continued)

Figure	Page
4-37 Scan across a 2 mm x 2 mm copper-on-glass sample (aperture = 1.5 mm, standoff = 1 mm).....	202
4-38 Sampling locations on Peacekeeper motor bottle material.....	203
4-39 Scan of Peacekeeper motor bottle material (aperture = 1 mm, standoff = 1 mm).....	203
4-40 Scan of Peacekeeper motor bottle material, with larger aperture (aperture = 1 mm, standoff = 1 mm).....	204
4-41 Suggested COTS components of prototype SEAM system	206
4-42 Fourier transforms with a lens	207
4-43 A simple illustration of how a Fourier transform happens.....	209
4-44 Conceptual Fourier optical imaging system design	209
4-45 Selected values of the nonlinear refractive index coefficient n_2	214
4-46 Illustration of devitrification of the PNL optical fiber at fusion splice	216
4-47 Checkerboard current array with 1 mm separation.....	218
4-48 Null-field array with a movable field detector (mouse).....	219
4-49 Documents produced during the UR system assessment.....	228
4-50 UR assessment schedule of activities	229
4-51 Miltope Tiger 2 computer.....	231
4-52 UR reader-end equipment	232
4-53 UR calibration subsystem.....	233
5-1 VACOSS-S schedule of activities.....	251
5-2 The VACOSS-S.....	252
5-3 MIKOS process assessment schedule	260
6-1 Combined flange seal/custom bracket installation mode	291
6-2 Video surveillance installation location and field-of-view at a Thiokol Peacekeeper casting pit.....	292

TABLES

Table	Page
2-1 Tagging RDT&E documentation status	6
2-2 Unclassified/classified documents sent to DNA and CVR for archiving	12
3-1 RPT system expenditures	14
3-2 Critical values for tag verification decision rule	30
3-3 STAR FOT system expenditures	36
3-4 UIT system expenditures	42
3-5 Test trial descriptions for the UIT FT&E program	49
3-6 Pythen system expenditures	53
3-7 Pythen/STAR FOT comparison summary	61
3-8 ARS system expenditures	64
3-9 EID tag assessment expenditures	77
3-10 MV assessment expenditures	90
3-11 NLJ system expenditures	99
3-12 Tamper tape assessment expenditures	107
4-1 Innovative Tags reports to DNA	120
4-2 SLITS expenditures	121
4-3 Environmental test results on SLITS	132
4-4 Briefings by BDM that discussed Innovative Tags developments	133
4-5 SLOTS/PTILS reports to DNA	148
4-6 SLOTS/PTILS expenditures	148
4-7 Creative Task expenditures	185
4-8 List of other concepts assessed	222
4-9 UR system expenditures	229
4-10 Specifications applicable to the UR system	235
5-1 VACOSS-S expenditures	251
5-2 MIKOS process assessment expenditures	259
6-1 Environmental specification expenditures	268
6-2 Environmental specification schedule milestones	268
6-3 Results of the environmental specification for START	272
6-4 START Mobile TELS and CFE TLE expenditures	274
6-5 Serial Number Tracking expenditures	277
6-6 CFE field demonstration expenditures	283

TABLES (Continued)

Table		Page
6-8	Casting Pits expenditures.....	288
6-9	Tagging ballistic missile systems expenditures.....	294
6-10	Canister application expenditures.....	298
6-11	SMART analysis schedule milestones.....	308

SECTION 1 INTRODUCTION

1.1 BACKGROUND.

The Defense Nuclear Agency (DNA) awarded the Tagging RDT&E contract to BDM International, Inc. on September 15, 1989. This program was a 30 month period of performance contract, with a contract value of \$3,889,270 and a 67,500 hour level of effort (LOE). The BDM subsidiary, the Strategic Systems & Technology (SS&T) Company was the prime subcontractor supporting this effort. The BDM subsidiary, the Engineering Services Company, replaced SS&T as the prime subcontractor in December 1990. Technical staff were transferred between the two BDM companies in early January 1991.

When the contract was awarded, the United States and the Soviet Union had been negotiating reductions in strategic arms for over a decade. DNA anticipated that the draft treaty would be signed in the near future. The Strategic Arms Reduction Treaty (START) reduced weapon systems, it did not eliminate them. This required that a method be developed to distinguish between authorized treaty-limited items (TLIs) and illegal TLIs. This was significantly different from the Intermediate Nuclear Forces (INF) Treaty which eliminated classes of weapons. The assumptions for the INF Treaty included the concept that discovery of any eliminated system would establish a violation. That assumption was not viable for the START treaty.

1.2 CONTRACT SCOPE.

Each technical instruction addressed one or more of the four basic contract tasks. The four contract tasks were:

- (1) Tag Concept Assessment Support
- (2) Tag Prototype and Engineering Development
- (3) Soviet Perspectives Analysis
- (4) Tagging System Procurement.

The scope of the contract grew during the first year. In December 1990, DNA requested that BDM propose a new LOE, increasing the effort of the basic contract by 27 man-years. An optional six month, 18 man-year effort following the end of the basic contract period was also added. In March 1991, the contract was modified to incorporate this revised LOE and the contract value increased to \$9,214,409 for the basic 30-month period, and \$10,989,270 with the option. Incremental funding increased to \$7,204,000 with a period of performance through November 30, 1991. This increased the hours associated with the LOE to 118,260 hours for the basic contract with an added 33,840 hours for the option. In September 1991, the contract funding increased to \$7,704,000.

In October 1991, DNA executed a no-cost modification to the contract and added 16,000 hours LOE to the basic LOE estimate, raising the LOE to 134,260 hours.

In January 1992, the contract value was increased to \$8,904,000 and in February 1992, the full value of the basic contract was exercised (\$9,214,409). During February 1992, DNA requested BDM to develop estimates for work to be accomplished during the option period. Since evaluation of these proposals would take time, BDM was asked to agree to a no-cost extension to the basic contract from March 15, 1992 to May 15, 1992. On April 30, 1992, DNA exercised the option and incrementally funded \$1,350,000 of the \$1,774,861 option authorization, increasing the LOE 55,944 hours, for a total of 170,444 hours. The period of performance was extended to October 24, 1992. Figure 1-1 contains a chart reflecting these contract changes.

On October 16, 1992, the contract modification (P0018) extended the period of performance to May 30, 1993.

1.3 REPORT PRESENTATION.

The sections which follow are organized to allow the reader to easily find systems or activities of particular interest. Since a contract of this magnitude and duration has such a large amount of information to report, a presentation based on the work performed by systems and studies is a better way of presenting the information than by Technical Instruction (TI) or basic contract task area.

POO #	DATE	CONTRACT VALUE	FUNDING	LOE (HRS)	CHANGE	PERIOD OF PERFORMANCE
	9/15/89	\$ 3,889,270	\$ 279,000	67,500	Start	30 months 3/15/92
001	10/4/89	NC	NC	NC	DD254	NC
002	2/8/90	NC	\$ 2,179,000	NC	\$ 1,900,000	NC
003	5/4/90	NC	NC	NC	DD254	NC
004	6/6/90	NC	NC	NC	DD 1423	NC
005	9/27/90	NC	\$ 2,678,400	NC	499,400	NC
006	12/8/90	NC	\$ 3,579,000	NC	\$ 900,600	NC
007	3/13/91	\$ 9,214,409	\$ 7,204,080	118,260	\$ 3,625,000	NC
008	9/30/91	NC	\$ 7,704,080	NC	\$ 500,000	NC
009	10/23/91	NC	NC	134,260	16,000 hrs	NC
010	1/14/92	NC	\$ 8,994,000	NC	\$ 1,200,000	NC
011	1/21/92	NC	NC	NC	CDRL 2	NC
012	1/23/92	NC	NC	NC	SB/DB plan	NC
013	2/3/92	NC	\$ 9,214,409	NC	CDRL	NC
014	2/28/92	NC	NC	NC	per. of perform	through 5/15/92
015	4/30/92	\$ 10,989,270	\$ 10,564,409	155,914	\$ 1,350,000 opt	through 10/24/92
016	7/7/92	NC	NC	NC	CDRL 2	NC
AM ltr	8/5/92	NC	NC	170,444	14,500 hrs	NC
017	9/30/92	NC	\$ 10,989,270	NC	\$ 424,861	NC
018	10/16/92	NC	NC	NC	per. of perform CDRL2 4/30/93	through 5/30/93

Figure 1-1. Chart showing contract changes that occurred.

Section 2 contains a summary listing of all hardware, software and documentation delivered to DNA on this contract. Some of these items were specified on the Contract Data Requirements List and others were not.

Section 3 contains information about the efforts performed on DOE-developed systems. These systems include:

- (1) Reflective Particle Tag (RPT) System
- (2) STAR Fiber Optic Tag System

- (3) Ultrasonic Intrinsic Tag (UIT) System**
- (4) Python System.**
- (5) Acoustic Resonance Spectroscopy (ARS) System**
- (6) Electronic Identification Devices (EID)**
- (7) Microvideography**
- (8) Nonlinear Junction (NLJ)**
- (9) Tamper Tape + RP.**

Section 4 describes the work performed on systems and concepts developed by BDM. These concepts include those pursued as part of the Innovative Tags Creative Task: Read-at-Home Tag/Seals, Scanning Electromagnetic/Acoustic Measurement (SEAM), Fourier Optics Imaging, Null-Field Tags, Magnetostrictive Wire/Ribbon Tag, Electrical Resistance Tag, Pressure Blow-out Tag, Nonlinear Optical Fibers, and Diffraction Ribbons, plus others. The systems described are SLITS, SLOTS, PTILS, and Universal videographic Reader (UR).

There were some commercially-developed systems assessed on the contract. Section 5 addresses the assessment of commercially-developed systems (VACOSS-S, commercial EIDs, and MIKOS).

Section 6 is devoted to the many supporting studies and developments as requested by DNA. The Standards and Specifications development work is discussed, as well as the SMART and Technology Transfer studies. Others included CFE, Related Studies, Serial Number Tracking, Casting Pits, Tagging Ballistic Missile Systems, Canister Applications, and Hazardous Material Transportation.

Section 7 contains the conclusions and recommendations followed by applicable references and the appendices.

SECTION 2

CONTRACT DELIVERABLES

The contract identified three Contract Data Requirements List (CDRL) items. CDRL items included; a Bimonthly Progress Report (CDRL 1); Draft Final Report (CDRL 2); and Quarterly Cost Performance Report (CDRL 3).

In addition to CDRL items, the technical instructions required that BDM provide reports and other documentation to support contract objectives (see table 2-1). Documentation included transition plans, environmental test plans, developmental and initial operational test & evaluation plans, functional test reports, integrated logistics support plans, manufacturing plans, program plans, test reports, assessment reports, software design documents, software source code, software validation & verification (V&V) reports, design reviews, specifications, level II drawings, operations manuals, maintenance plans, system descriptions, and briefings. In all, over 190 different documents were produced and delivered to DNA during the execution of the contract.

The wide variety of documentation developed during the execution of this contract supported different objectives as specified by the 17 Technical Instructions. These documents were submitted to the DNA Program Manager as they were produced.

On February 12, 1993, based on the Program Manager's request, three sets of documentation were sent to DNA and the Center for Verification Research (CVR) for archive purposes. On March 26, 1993, three sets of classified documents were also sent to DNA and CVR for the archive. Table 2-2 shows the list of documents sent out for archival purposes.

Table 2-1. Tagging RDT&E documentation status.

	DOCUMENT TITLE	AUTHOR(S)	REVIEW	DATE	CDRL #	TI #'s	COMMENTS
1	RPT REPORT/BRIEFING	MERKING, SULLIVAN	OU8D(A)	11/16/69	-	1	
2	RPT TRANS PLAN	MERKING, SULLIVAN, HEDIN, CABEEN	DNA, O8D	12/1/69	-	1	
3	CFE STUDY PLAN	STOCKTON, FISCHER	DNA	12/11/69	-	2	CLASSIFIED
4	PROGRESS REPORT 1	MERKING	DNA	1/6/69	7	ALL	
5	CFE ANNOTATED BRIEFING	STOCKTON, FISCHER	CFE WKG GROUP	2/9/69	-	2	EVANS
6	CONCEPT OF OPERATIONS	MCCANN	DNA, O8IA, SNI	2/13/69	-	1	
7	DATA MANAGEMENT PLAN	MCCANN, MERKING, HEDIN,	DNA	2/21/69	-	1	
8	CFE ANNOTATED BRIEFING	STOCKTON, FISCHER	DNA	2/23/69	-	2	
9	RPT CFE COMPLEX CC	FISCHER	DNA	2/25/69	-	1	CLASSIFIED
10	RPT ASSEMBLY PLAN	WRIGHT, FARRELL, BOLDEN, HEMBREE	DNA	3/1/69	-	1	
11	PROGRESS REPORT 3	ALL	DNA	3/6/69	7	ALL	
12	FIBER OPTIC ASSESSMENT REPORT	DRESSEL, CABEEN, HEMBREE, MERKING	DNA, LLNL	3/13/69	-	6	CLASSIFIED
13	SATCOM TX	NEALE	DNA	3/20/69	-	1	
14	DATA COMPRESS	BAUDER	DNA	3/20/69	-	1	
15	ULTRASONIC ASSESSMENT REPORT	CABEEN, DRESSEL, HEMBREE, MERKING	DNA, PNL	3/21/69	-	5	CLASSIFIED
16	QUALITY PROGRAM PLAN FOR RPT	JONES	DNA	4/20/69	-	1	
17	FIBER OPTIC UPDATE REPORT	DRESSEL, CABEEN, HEMBREE, MERKING	DNA, LLNL	4/24/69	-	6	
18	ULTRASONIC UPDATE REPORT	CABEEN, DRESSEL, HEMBREE, MERKING	DNA, PNL	4/24/69	-	5	
19	TAG MOBILE ICBM LAUNCH	MCCANN, CONLEY	DNA	4/25/69	-	1	CLASSIFIED
20	TAG LAUNCH CANNISTERS	MCCANN, CONLEY	DNA	4/27/69	-	1	CLASSIFIED
21	CFE STUDY PLAN	FISCHER, STOCKTON	DNA	5/1/69	-	2	
22	TAGGING STATUS BRIEFING	MERKING, et al.	FCDNA	5/3/69	-	1	UNDEM
23	PROGRESS REPORT 3	ALL	DNA	5/9/69	7	ALL	
24	LIT DATA REQUIREMENTS FOR STAT	HEMBREE	DNA	5/17/69	-	4	
25	PODEY MT RAIL CAR CO	MCCANN	DNA	5/18/69	-	1,5,6,10	
26	RPT DESIGN REVIEW	CABEEN, HEMBREE, HEDIN, DRESSEL	DNA, SNI	5/21/69	-	1	
27	RPT B&P	HEDIN, ROBERTS	DNA, O8IA, SNI	6/1/69	-	1	
28	ENVIRON SPEC	HEDIN, ROBERTS	DNA, LLNL, SNI, PNL	6/1/69	-	3	
29	STATISTICAL FORENSICS	DIXON	DNA	6/1/69	-	4	
30	RPT DECISION STATISTIC	HEMBREE	DNA, SNI	6/15/69	-	1	
31	RPT SOFTWARE DESIGN	HEMBREE	DNA, SNI	6/18/69	-	1	CLASSIFIED
32	PNL/SNI CORRELATION METHOD	HEMBREE, DIXON	DNA, SNI	6/18/69	-	1,4,5	
33	OPS DEV FIELD TEST	MCCANN	DNA	6/20/69	-	6	

Table 2-1. Tagging RDT&E documentation status (continued).

DOCUMENT TITLE	AUTHOR(S)	REVIEW	DATE	CRCL #	TR's	COMMENTS
34 DETAILED LIST OF RPT EQUIPMENT	CABEEN	FCDNA	8/21/80	-	1	
35 ENVIRONMENTAL TEST PLAN	LEE, CABEEN, HEDIN, SCANTLEN	SML	8/22/80	-	1	
36 RPT IDTAE OPERATIONAL TEST PLAN	MCCANN	DNA, SML, OSIA	7/1/80	-	1	
37 OPER TEST PLAN RPT IDTAE	MCCANN	DNA	7/1/80	-	1	
38 PROGRESS REPORT 4	ALL	DNA	7/6/80	1	ALL	
39 ALTERNATIVE TAG PAPER	DRESSEL	DNA	7/10/80	-	6	
40 BOW UTEP	HEDIN, CABEEN, WRIGHT	UTEP INT	7/12/80	-	1	
41 ULTRASONIC TRANSITION PLAN	WALLACE, CABEEN, KARASIEWICZ	DNA	7/19/80	-	5	CLASSIFIED
42 SW REQS SPEC FOR RPT	HEMBREE, UMSTEAD	DNA	8/2/80	-	1	
43 RPT/FOUNT/ PROG SLIDES	CABEEN	DNA	8/2/80	-	1,5,6	
44 TAGGING STATUS BRIEFING	MERKLING, et al.	DNA	8/10/80	-	ALL	BOREN
45 FIBER OPTIC TRANSITION PLAN	DRESSEL, HEDIN	DNA	8/13/80	-	6	
46 TI-12 STUDY PLAN BRIEF	STOCKTON	DNA	8/15/80	-	12	
47 FIBER OPTIC SECTION II	ROGERS	DOE/ALL	8/15/80	-	6	
48 STRUCTURE DIAGRAM FOR STAR FOT	ROGERS	DNA	8/17/80	-	6	
49 FIBER OPTIC COUPLER	HILL	DNA	8/21/80	-	6	
50 RECOMMEND CFE TLE	STOCKTON, ESTES	DNA	8/23/80	-	2	CLASSIFIED
51 COST PERFORMANCE REPORT	MERKLING, HEDIN	DNA	8/29/80	3	ALL	
52 GENTLER/SAMPLER TAGS	HILL	DNA	8/30/80	-	10	
53 TI-10 ASSESSMENT REPORT	HILL	DNA	8/30/80	-	10	
54 PROGRESS REPORT 5	ALL	DNA	8/2/80	1	ALL	
55 DECISION ANALY FOR VERIFICATION	HEMBREE	DNA	9/13/80	-	ALL	
56 CASTING PIT PROGRAM PLAN	MCCLOSKEY	DNA	9/14/80	-	6	
57 APPROACH TO DECISION ANALYSIS	HEMBREE	DNA	9/18/80	-	4	
58 STAR FO MANUFACT PLAN	ROGERS	DNA	9/21/80	-	6	
59 TI-12 FINAL REPORT	STOCKTON	DNA	9/30/80	-	12	
60 PHOTOGRAPHS & LABELS	ROGERS	DNA	10/12/80	-	1	
61 EFFECT TAGS BALLUS MISS (DRAFT)	CONLEY, DRESSEL	DNA	10/15/80	-	11	CLASSIFIED
62 TAGGING REQUIREMENTS	MCCANN	DNA, DOE	10/24/80	-	ALL	
63 LABORATORY PROTOTYPE DEFINITION	ROGERS	DNA	10/24/80	-	ALL	
64 SMART BRIEFING	FISCHER	DNA, OUSDA(P), JCS	10/24/80	-	ALL	
65 TAGGING STATUS BRIEFING	MERKLING, et al.	DNA	11/1/80	-	ALL	BOREN
66 RPT OPERATIONS MANUAL	HOLTEN	DNA	11/1/80	-	1	

Table 2-1. Tagging RDT&E documentation status (continued).

	DOCUMENT TITLE	AUTHOR(S)	REVIEW	DATE	CDRL #	TI #	COMMENTS
67	EFFECT TAGS BALLIS MISS (FINAL)	CONLEY, DRESSEL	DNA	11/2/90	-	11	CLASSIFIED
68	INNOVATIVE TAG INTERIM REPORT	HILL	DNA	11/5/90	-	10	
69	PROGRESS REPORT 6	ALL	DNA	11/9/90	1	ALL	
70	PYTHON FEASIBILITY REP	MCCLOSKEY, SALAZER, HAACK	DNA	11/19/90	-	8	
71	LABORATORY PROTOTYPE DEFINITION	ROGERS	DNA	11/20/90	-	ALL	
72	CASTING PIT ASSESSMENTS	MCCLOSKEY, SALAZER, HAACK	DNA	11/27/90	-	9	
73	COST PERFORMANCE REPORT	MERKLING, HEDIN	DNA	11/27/90	3	ALL	
74	LAB PROTOTYPE DEFINITION	ROGERS	DOE	11/27/90	-	ALL	
75	TAGGING REQUIREMENTS DOCUMENT	MCCANN	DNA/PNL/DOE/LLNL/SNL	11/27/90	-	ALL	
76	RPT SOFTWARE VAV FINAL REPORT	HEMBREE	DNA/SNL	12/4/90	-	1	
77	RPT IDT&E STATUS BRIEFING	MERKLING, et al.	DNA, JCS	12/15/90	-	1	BOREN
78	LAB PROTOTYPE DEFINITION	ROGERS	OSIA	12/19/90	-	ALL	
79	TAGGING REQUIREMENTS DOCUMENT	MCCANN	OSIA	12/19/90	-	ALL	
80	PROGRESS REPORT 7	ALL	DNA	1/8/91	1	ALL	
81	INNOVATIVE TAG BRIEFING	MERKLING, HILL, DRESSEL	DNA	1/16/91	-	10	DAVE
82	MINUTES - 1/16/91 MEETING	HEDIN	HODNA, FCDNA	1/16/91	-	1, 10	
83	COST PERFORMANCE REPORT	MERKLING, HEDIN	DNA	2/12/91	3	ALL	
84	RPT IDT&E FINAL TEST REPORT	SHOEBOTHAM, ESTILL, HERRERA	DNAFC, SNL	2/15/91	-	1	
85	ANALY & PROOF-OF-PRINCIPLE/INNOV	HILL, DRESSEL	HODNA, FCDNA	2/19/91	-	10	
86	LIT DT&E TEST PLAN (DRAFT)	HAACK	DNAHQ &FC, PNL, OSIA	2/19/91	-	5	
87	STAR FO DT&E TEST PLAN (DRAFT)	HIGBIE	DNAHQ &FC, LLNL, OSIA	3/5/91	-	6	
88	PROGRESS REPORT 8	ALL	DNA	3/8/91	1	ALL	
89	PROGRAM PLAN	MERKLING, MCCANN, HEDIN	DNA, SNL	3/11/91	-	ALL	
90	CONSID ABOUT LLNL CORREL ALGOR	DIXON	DNAFC, LLNL, SNL	3/20/91	-	6	
91	INNOVATIVE TAG BRIEFING	HILL, DRESSEL	DNA, DOE, OUSD(A)	4/2/91	-	15	CVR SHWNGLE
92	INNOVATIVE TAG BRIEFING	HILL, DRESSEL	DNA	4/16/91	-	15	EVENSONDAVE
93	ENVIRONMENTAL SPEC MODIFICATION	HIGBIE, MCCANN	DNA/OSIA	4/24/91	-	3	
94	COST PERFORMANCE REPORT	MERKLING, HEDIN	DNA	5/7/91	3	ALL	
95	PROGRESS REPORT 9	ALL	DNA	5/13/91	1	ALL	
96	INNOVATIVE TAG BRIEFING	HILL, DRESSEL	NSA, DNA	5/14/91	-	15	BOREN, FECH
97	INNOVATIVE TAG BRIEFING	HILL, DRESSEL	DNA, OUSD(A)	5/23/91	-	15	MNICHHELLO
98	INNOVATIVE TAG BRIEFING	HILL, DRESSEL	INEL, DNA	5/24/91	-	15	TRANG
99	LIT TEST PLAN BRIEFING	ROGERS	DNA	6/3/91	-	5	SHAPPLES
100	INNOVATIVE TAG BRIEFING	HILL, DRESSEL	CIA, DNA	6/10/91	-	15	SPALDING
101	IL-OTB BRIEFING	LAWSON	INEL, DNA	6/10/91	-	15	

Table 2-1. Tagging RDT&E documentation status (continued).

	DOCUMENT TITLE	AUTHOR(S)	REVIEW	DATE	CORL #	TI #s	COMMENTS
102	SMART ANALYSIS	HEDIN, FISCHER	DNA	6/21/91	-	ALL	
103	RPT OPERATIONS MANUAL	SHOEBOTHAM	DNA	6/22/91	-	1	
104	ENVIRONMENTAL TEST REPORT (RPT)	CABEEN, LEE, HERRERA	DNA	6/22/91	-	1	
105	RPT PROGRAMMER'S MANUAL	SMITH, MCCORMICK	DNA	6/22/91	-	1	
106	RPT DOCUMENTATION (12/89 to 6/91)	CABEEN, et al.	FCDNA	6/22/91	-	1	DISEMBARKOCCOPY
107	TAGGING BRIEFING	MERKING, HILL	DNA	6/26/91	-	13, 16	ANDREOZZI
108	PHOTOS, SLITS SAMPLES	CABEEN, ROGERS	DNA	6/27/91	-	14, 16	
109	SMT FOR CFE ASSESSMENT	STOCKTON	DNA	6/28/91	-	12	
110	PROGRESS REPORT 10	ALL	DNA	7/12/91	7	ALL	
111	CANISTER STUDY	CONLEY	DNA	7/16/91	-	13	CLASSIFIED
112	INNOV TAG/UNY READER BRIEFING	CABEEN, HILL, DRESSSEL	DNA, CUBDA	7/17/91	-	14, 16	JOHNSON
113	ENVIRON SPEC RESPONSE (SAC)	HEDIN, MCCANN	DNA	7/24/91	-	13	
114	PYTHON DEVELOPMENT STATUS	MCCLOSKEY	DNA	7/25/91	-	14	CLASSIFIED
115	ENVIRON SPEC DECISION PAPER	MCCANN	DNA	7/30/91	-	13	
116	FIBER OPTIC IOTAE TEST PLAN	SHOEBOTHAM	DNA	7/31/91	-	6	
117	UIT TEST RESULT BRIEFING	ROGERS, HERRERA	FCDNA	7/31/91	-	14	SHAPPLES
118	CREATIVE TASK BRIEFING	HILL	FCDNA	7/31/91	-	15	SHAPPLES
119	UIT TEST RESULT BRIEFING	ROGERS, HERRERA	PNL	8/7/91	-	14	UNDEM
120	CFE PROS-CONS	STOCKTON/STUART	DNA	8/17/91	-	16	
121	COST PERFORMANCE REPORT	MERKING, HEDIN	DNA	8/23/91	3	ALL	
122	DNA CONTRACTOR'S BRIEFING	HILL, CABEEN	DNA	8/29/91	-	14, 15	EVENSON
123	PROGRESS REPORT 11	ALL	FCDNA	9/11/91	7	ALL	
124	SLOTS DEVELOPMENT BRIEFING	HILL, DRESSSEL	FCDNA	9/11/91	-	15	SHAPPLES
125	CFE FIELD DEMO PLAN	STOCKTON	HODNA	9/18/91	-	16	
126	RPT CLOSEOUT DOCUMENTATION	CABEEN	FCDNA	9/19/91	-	14	
127	UIT LAB PHOTO PRELIM TECH EVAL	ROGERS	FCDNA	9/19/91	-	14	
128	TAGGING PHOTO ALBUM	ROGERS	FCDNA	9/26/91	-	ALL	
129	ARIS SYSTEM DESCRIPTION	JOHNSON, THOMAS	FCDNA	9/27/91	-	13	
130	ARIS SYSTEM DESCRIPTION	JOHNSON, THOMAS	FCDNA	10/7/91	-	13	
131	LAB PROTOTYPE DEFINITION (FINAL)	ALL	FCDNA	10/10/91	-	ALL	
132	INNOVATIVE TAGS FOR CFE	FISCHER, STOCKTON	DNA, ORNA	10/21/91	-	16	
133	COST PERFORMANCE REPORT	FISCHER, HEDIN	FCDNA	11/14/91	3	ALL	
134	PROGRESS REPORT 12	ALL	FCDNA	11/25/91	7	ALL	
135	SEAM CONCEPT BRIEFING	HUTCHINS	FCDNA	11/19/91	-	15	SHAPPLES
136	TAG/REAL CONCEPTS BRIEFING	FISCHER	HODNA	11/20/91	-	14, 16	CELEC
137	TAG/REAL CONCEPTS BRIEFING	FISCHER	HODNA	11/29/91	-	15	ANDREOZZI

Table 2-1. Tagging RDT&E documentation status (continued).

	DOCUMENT TITLE	AUTHOR(S)	REVIEW	DATE	CDRL #	TR's	COMMENTS
100	TAGSREAL CONCEPTS BRIEFING	FISCHER	OUSDA	11/25/91	-	14, 15	JOHNSON, HORN
101	TAGSREAL CONCEPTS BRIEFING	FISCHER	OUSDA	12/4/91	-	14, 15	RICHARDSON
102	TAGSREAL CONCEPTS BRIEFING	FISCHER	OUSDP	12/6/91	-	14, 15	MILLER
103	ARIS MODEL & CORRELATION (DRAFT)	JOHNSON, THOMAS	LANL	12/12/91	-	13	
104	SLITSLOT/SUNNY READER BRIEFING	HILL, CABEEN, DRESSSEL	DNA, OSA, FCDNA	12/10/91	-	15	RHODAS
105	DNA CAMERA READY REPORTS	TROLLINGER	HQ DNA TITL	12/10/91	-	ALL	
106	RPT COMPRESSION TEST	HERRERA	FCDNA	1/2/92	-	13	
107	PROGRESS REPORT 13	ALL	FCDNA	1/4/92	1	ALL	
108	TAGSREAL CONCEPTS BRIEFING	FISCHER	OUSDP	1/9/92	-	14, 15	CROUCH
109	UIT FUNCTIONAL TEST REPORT (DRAFT)	ROGERS, HERRERA	PNL	1/15/92	-	14	
110	MICROVIDEOGRAPHY ASSESSMENT	MCCLOSKEY, TRUSKE	PNL	1/21/92	-	13	
111	ARIS MODEL & CORRELATION (FINAL)	JOHNSON, THOMAS	FCDNA	2/3/92	-	15	SHARPLES
112	SEAM CONCEPT BRIEFING	MUTCHINS	FCDNA	2/11/92	-	15	
113	COST PERFORMANCE REPORT	FISCHER, HEDIN	FCDNA	2/19/92	3	ALL	
114	MIKOS PROCESS FINAL REPORT (DRAFT)	CONLEY, TRUSKE	MIKOS	2/21/92	-	15	EVENSON
115	RDT&E PROGRAM REVIEW	FISCHER	HQ DNA	2/27/92	-	ALL	
116	MIKOS PROCESS FINAL REPORT	CONLEY, TRUSKE	FCDNA	3/18/92	-	16	
117	PROGRESS REPORT 14	ALL	FCDNA	3/23/92	7	ALL	
118	MICROVIDEOGRAPHY ASSESSMENT	MCCLOSKEY, TRUSKE	FCDNA	3/24/92	-	13	
119	TAGGING OVERVIEW BRIEFING	FISCHER	OUSDA	3/31/92	-	ALL	SWINGLE/ROGZAK
120	VACOSS TEST PLAN	BANKS, DARROW	FCDNA	4/9/92	-	13	
121	UR IOTAE TEST PLAN (DRAFT)	SHOEBOTHAM	CVR, FCDNA	4/9/92	-	14	
122	UIT FUNCTIONAL TEST REPORT (FINAL)	ROGERS, HERRERA	FCDNA	4/16/92	-	14	
123	INTERIM REPORT ON INNOVATIVE TAGS	DRESSSEL	FCDNA	4/22/92	-	16	
124	SUPPLEMENTAL RPT FINAL REPORT	ESTILL, HERRERA	FCDNA	4/28/92	-	13	
125	COST PERFORMANCE REPORT	FISCHER, HEDIN	FCDNA	4/29/92	3	ALL	
126	NLJ TAG ASSESSMENT (DRAFT)	DICKENS, ANTINONE, WILLIAMS	FCDNA	5/8/92	-	13	
127	PROGRESS REPORT 15	ALL	FCDNA	2/13/93	7	ALL	
128	INTRO TO LLNL EID PROGRAM	KARASKEWICZ, FORRESTER	FCDNA, LLNL	5/15/92	-	13	
129	TAMPER TAPE PHASE 2	BANKS, DARROW	PNL	5/19/92	-	13	
130	WILLIAMSBURG CONFERENCE BRIEFING	FISCHER	HQDNA	5/1/92	-	ALL	ARMS CONTROL
131	PLAN FOR ARS MEASMTS AT HILL AFB	DICKENS, THOMAS, JOHNSON	LANL/HAFB	6/18/92	-	13	
132	TAMPER TAPE PHASE 2 FINAL	BANKS, DARROW	FCDNA, PNL	6/24/92	-	13	
133	TAMPER TAPE EXPERIMENT REPORT	BANKS, DARROW	FCDNA, PNL	6/24/92	-	13	
134	BRIEFING ON PTL 8	DRESSSEL	FCDNA	6/28/92	-	15	CAPT NELSON
135	TAGGING PROGRAM BRIEFING	FISCHER	HQDNA	7/1/92	-	ALL	C. MONTE
136	PLAN FOR ARS MEASMTS AT HILL AFB	DICKENS, THOMAS, JOHNSON	FCDNA, LANL, HAFB	7/2/92	-	13	
137	PROGRESS REPORT 16	ALL	FCDNA	7/16/92	7	ALL	

Table 2-1. Tagging RDT&E documentation status (concluded).

	DOCUMENT TITLE	AUTHOR(S)	REVIEW	DATE	CONTR. #	TI/F's	COMMENTS
176	INTERNAL TECHNICAL REPORT ON FTLS	DRESSEL, HILL	FCDNA	9/1/82	-	15	
177	COST PERFORMANCE REPORT	FISCHER, MEDOW	FCDNA	9/2/82	3	ALL	
178	MJ TAG ASSESSMENT FINAL REPORT	DICKENS, THOMAS	FCDNA	9/21/82	-	13	
179	PROGRESS REPORT 17	ALL	FCDNA	9/11/82	1	ALL	
180	FUNG TEST REPORT FOR VACORS (FINAL)	BANKS, DARRON	FCDNA	9/28/82	-	13	
181	PROGRESS REPORT 18	ALL	FCDNA	11/16/82	1	ALL	
182	COST PERFORMANCE REPORT	FISCHER, MEDOW	FCDNA	12/1/82	3	ALL	
183	LR IOT/REALITY and RPT-3 (FINAL)	MERRERA, ESTILL, CABEEN	FCDNA	1/9/83	-	14	
184	ENVIRON SPEC FOR START (FINAL)	MEDINA, MCCANN, ROBERTS	FCDNA	1/16/83	-	ALL	
185	PROGRESS REPORT 19	ALL	FCDNA	1/19/83	1	ALL	
186	EFFECT OF TAGS ON BALLISTIC MISS	COMLEY, TROLLINGER	MODNA TTTL	1/27/83	-	13	CLASSIFIED
187	COST PERFORMANCE REPORT	FISCHER, MEDOW	FCDNA	1/29/83	3	ALL	
188	ARS ASSESSMENT FINAL REPORT	DICKENS	FCDNA	1/31/83	-	13	
189	RESULTS OF RED TEAM INSPECTIONS	DRESSEL, HILL	FCDNA	2/3/83	-	15	
190	PROGRESS REPORT 20	ALL	FCDNA	3/12/83	1	ALL	
191	LR OPERATIONS MANUAL	WRIGHT	FCDNA	3/31/83	-	14	
192	LR FABRICATION SPECIFICATION	HAACK	FCDNA	3/31/83	-	14	
193	COST PERFORMANCE REPORT	FISCHER, MEDOW	FCDNA	4/29/83	3	ALL	
194	TAGGING RDT&E DRAFT FINAL REPORT	ALL	MODNA TTTL	4/29/83	2	ALL	
195	PROGRESS REPORT 21	ALL	FCDNA	TBD	1	ALL	
196	PROGRESS REPORT 22	ALL	FCDNA	TBD	1	ALL	Closeout Report
197	COST PERFORMANCE REPORT	FISCHER, MEDOW	FCDNA	TBD	3	ALL	Closeout Report

Table 2-2. Unclassified/classified documents sent to DNA and CVR for archiving.

Date	Report
October 31, 1989	RPT Transition Plan
March 19, 1990	Ultrasonics Concept Assessment Report (U)
March 30, 1990	Fiber Optic Concept Assessment Report (U)
May 21, 1990	RPT Design Review
May 24, 1990	Fiber Optic Transition Plan (U)
June 1, 1990	RPT ILSP
June 1, 1990	RPT Environmental Test Plan
July 1, 1990	RPT IOT&E Test Plan
July 3, 1990	UIT Transition Plan, Draft (U)
August 30, 1990	Initial Report on Innovative Tags
October 15, 1990	Python Seal Concept Feasibility Assessment (U)
October 31, 1990	Innovative Tags Interim Report
December 1, 1990	Tagging Requirements Document
November 13, 1990	Python Development Status
November 27, 1990	Solid Rocket Motor Casting Pit Sealing Schemes (U)
November 30, 1990	RPT Software V&V Final Report
January 31, 1991	TI FY90-10 Assessment Report
February 15, 1991	RPT IOT&E Final Test Report
March 11, 1991	Tagging Program Plan
July 3, 1991	Eval of the Effect of Tags on Ballistic Missile Can. (U)
October 7, 1991	ARS System Description
December 1, 1991	Environmental Specification for START (Final)
January 15, 1993	
February 5, 1992	ARS Modeling & Correlation
March 8, 1992	Nonlinear Junction Tag Assessment Report (Draft)
March 19, 1992	MIKOS Process Final Report
March 24, 1992	Microvideography Assessment Final Report
April 9, 1992	VACOSS-S Test Plan
April 16, 1992	UIT Functional Test Report Final
April 29, 1992	Supplemental RPT Final Report
May 15, 1992	Introduction to LLNL EID Program
June 24, 1992	Tamper Tape Experiment Report
June 24, 1992	Tamper Tape Phase II Final Report
July 2, 1992	ARS Measurement Plan at Hill AFB
August 1, 1992	Interim Technical Report on PTILS
August 31, 1992	Nonlinear Junction Tag Assessment Report (Final)
September 22, 1992	Functional Test Report for VACOSS-S (Final)
January 31, 1993	ARS Assessment Final Report

SECTION 3

DOE-DEVELOPED SYSTEMS

3.1 REFLECTIVE PARTICLE TAG (RPT) SYSTEM.

3.1.1 Overview.

The reflective particle tag (RPT) consists of micaceous hematite particles randomly distributed in an acrylic polymer that is applied directly to the surface of the item to be tagged. The tag signature is obtained by illuminating the tag from 20 different light angles and recording each resulting image. Subsequent readings can be compared to the original reading and a correlation value computed to determine if the current reading is from the same tag as the reference reading. Due to the random nature of the distribution of reflective particles, and the random nature of the reflective surfaces on each particle, the tag is highly resistant to counterfeiting.

The RPT signature is read with a recorder/correlator system consisting of a computer, a reader head with LEDs to illuminate the tag, and a small video camera to transmit the tag's image to the computer for processing and storage. A reference image taken at the time the tag was installed is stored on a removable hard disk in the computer for comparison with subsequently acquired images. The recorder/correlator unit also has a video microscope that can be used to examine the tag for indications of tampering and record images of any portions of the tag that the inspector believes need further analysis.

Following the completion of extensive testing and analysis, two of the ten industrial prototype RPT systems were modified to incorporate features found desirable during testing. The remaining eight systems were not modified. The industrial prototype systems, including software and full documentation, were archived by DNA. These systems are fully functional, and with minor modifications to the eight unmodified systems, are suitable for field deployment and employment.

Sandia National Laboratories continued to improve the RPT design following the Initial Operational Test and Evaluation (IOT&E) in November 1990.

The improved design has been named RPT-2 and is simpler to apply, requires a shorter curing time, has brighter specular reflections, and is less susceptible to tampering. The tag's randomly-oriented micaceous hematite (Fe₂O₃) particles are now suspended in an ultraviolet-cured polymer blend (rather than a Gafgard acrylic polymer) that is applied to the surface of a tagged item. The polymer blend is a 50/50% by weight composition of Gafgard 233 and Ebecryl 3700-20T. The Ebecryl, which is an epoxidized acrylic polymer, contains 5% by weight Ergacure 500. The tag is applied by daubing the polymer blend/hematite mixture onto a prepared and marked area on the surface of the item to be tagged, and then curing that mixture with a portable ultraviolet lamp.

3.1.1.1 Documentation Produced. Figure 3-1 lists each RPT document produced under the Tagging RDT&E contract, along with its date, and a brief description.

3.1.1.2 Expenditures. The RPT assessment effort began in September 1989 and was completed when the final report was delivered in April 1992. The following table (table 3-1) lists the labor hours, the associated loaded labor costs (without fee and tax) plus the ODC's expended during the conduct of the RPT assessment.

Table 3-1. RPT system expenditures.

TI	Hours	Loaded Labor Costs	ODC's	Total Costs
FY90-01	29,326	\$1,314,346	\$225,654	\$1,540,000
FY90-04	3,528	\$150,509	\$375	\$150,884
FY91-14	305	\$11,268	\$0	\$11,268
Total	33,159	\$1,216,123	\$226,029	\$1,702,152

3.1.2 Schedule.

Figure 3-2 depicts the schedule of activities that were performed during the RPT assessment effort under TI-01, and continued under TI-14.

Document	Date	Description
RPT Transition Plan	December 1, 1989	Describes requirements for transitioning lab prototype to industrial prototype. Also describes lab prototype.
Environmental Specification	December 31, 1989	Defines the environment the RPT system would be required to operate in (later environmental specs were not RPT specific)
RPT Design Review	May 21, 1990	Design review of industrial prototype. Covered changes since publication of the Transition Plan.
Integrated Logistics Support Plan (ILSP)	June 1, 1990	Describes planned logistic support requirements for RPT system. Includes operational and maintenance concepts.
Environmental Test Plan	June 22, 1990	Describes the environmental tests to be performed on the system.
IOT&E Test Plan	July 1, 1990	Defines and describes the test to be performed during the IOT&E.
Software Requirements Specification	August 3, 1990	Documents the software requirements for the RPT system.
Operations Manual for Application and Reading of RPTs	December 4, 1990	The manual prepared for IOT&E participants.
Software System Verification & Validation Final Report	November, 1990	Describes results of software V&V and suggests improvements that could be made.
IOT&E Final Test Report	February 15, 1991	Reports IOT&E results and analyses. Describes improvements needed for hardware and software.
Environmental Test Report	June 22, 1991	Describes environmental test results and specifies improvements needed to meet requirements.
Operations Manual for Tag Application and Reading	June 22, 1991	Updated manual reflecting user comments and hardware and software improvements following the IOT&E.
Supplemental RPT Test Final Report	April 29, 1992	Reports results and analysis of modified RPT system. Decision rule for tag verification using modified RPT system was developed.
UR IOT&E Combined with SLITS and RPT-2	January 8, 1993	New IOT&E which included test of the new SNL-designed RPT-2

Figure 3-1. RPT documents produced for Tagging RDT&E.

RPT SCHEDULE

- Initiation of task
- Design Review(s)
- Publication of Transition Plan
- Environmental Specification
- Integrated Logistics Support Plan (ILSP)
- Environmental Test
- Publication of Environmental Test Report
- Publication of IOT&E Test Plan (July 1, 1990)
- IOT&E (November 1-7, 1990)
- Extra Cold-weather tests
- Publication of IOT&E Report (February 15, 1991)
- Dates of V&V
- Publication of V&V Report
- Planning for Supplemental tests
- "Stop work" from OUSD(A)
- Aug/Sept 1991 test dates
- Analysis leading to decision statistic and date of report

Figure 3-2. Schedule of RPT activities.

3.1.3 System Description.

Reflective-particle tags (RPTs) were developed as a means to verify compliance with arms limitation/reduction treaties and to provide positive inventory control of weapon systems. The RPT features include:

- (1) Ease of construction
- (2) Durability
- (3) Stability
- (4) Unique signatures
- (5) Difficult to counterfeit
- (6) Difficult to remove without destroying the tag
- (7) Ability to be applied to a variety of surface materials.

The tags are made of materials that are readily obtainable and safe to use. They are relatively easy to read using either the reading equipment developed especially for the RPT or the UR. In either case, reader software is used to

compare (correlate) the tag's image with an image made at the time the tag was constructed (the reference image) and to provide a measure of whether the tag is authentic.

The RPT system consists of two major subsystems: the tag and the tag reading equipment. Both are described and illustrated below in the configuration that existed when OUSD(A) cancelled further development of the industrial prototype.

3.1.3.1 The Tag. The RPT is shown in figure 3-3. The tag, which is $2\frac{5}{8}$ " x $\frac{3}{4}$ ", consists of randomly-oriented micaceous hematite (Fe_2O_3) particles suspended in an acrylic polymer (Gafgard 233) that is applied to the surface of the tagged item. The tag is protected by a coating of Ebecryl 1259/Ergacure 500 (5% by weight). As shown in figure 3-3, the tag includes fiducial markings (approximately $\frac{1}{16}$ " wide) that are used during a reading for aligning the tag reader. These markings also contain the tag and fiducial identification numbers, as well as high contrast white squares that are used during the correlation process to align the tag's current image with its reference image.

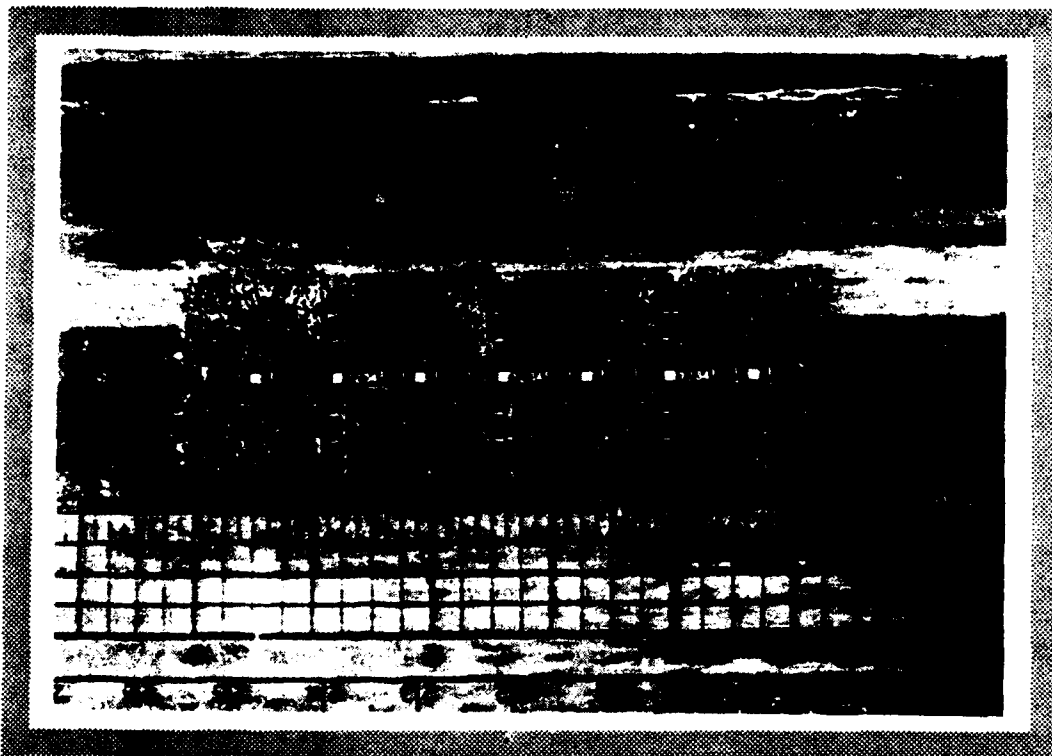

Figure 3-3. The reflective particle tag.

The tag is applied by daubing the Gafgard/hematite mixture onto a prepared and masked area on the surface of the item to be tagged and partially curing that mixture with a portable ultraviolet lamp (see figure 3-4). The Ebecryl overcoat is then applied and the entire tag is fully cured with the lamp. All required materials are assembled in the tag application kit. The entire kit is contained in a rugged 11¹/₄"H x 20"W x 16³/₄"D carrying case.

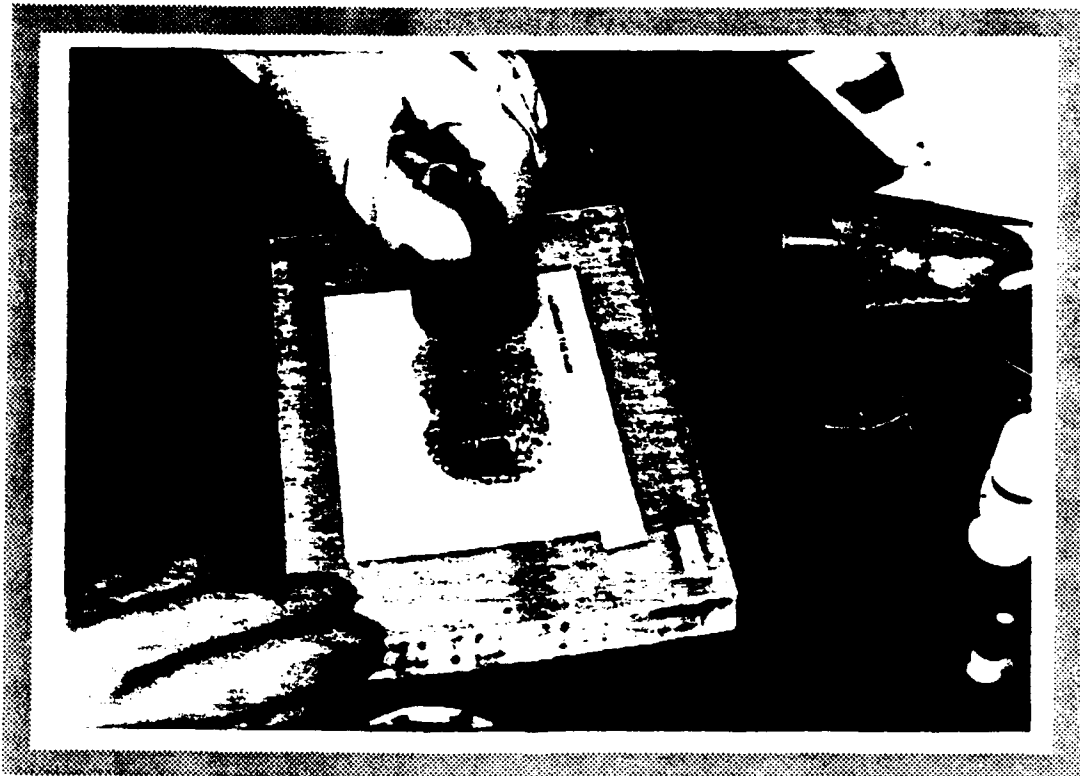

Figure 3-4. The RPT application kit.

3.1.3.2 The Reading Equipment. The RPT reading system is shown in figure 3-5. It consists of a recorder/correlator, an electronics control cabinet (ECC), and an accessory case that includes the reader head, the video microscope, a video monitor, and system cabling. The recorder/correlator includes a computer with a 286 micro-processor; circuit boards for digitizing tag images and for sequencing the reader head's LEDs, which illuminate the tag during a reading; a 3¹/₂" high-density, 1.44 megabyte (MB) disk drive for recording the tag images; and connections for the reader head, the video microscope, and the video monitor. All this is contained in a rugged 14"H x 22¹/₂"W x 12¹/₂"D carrying case.

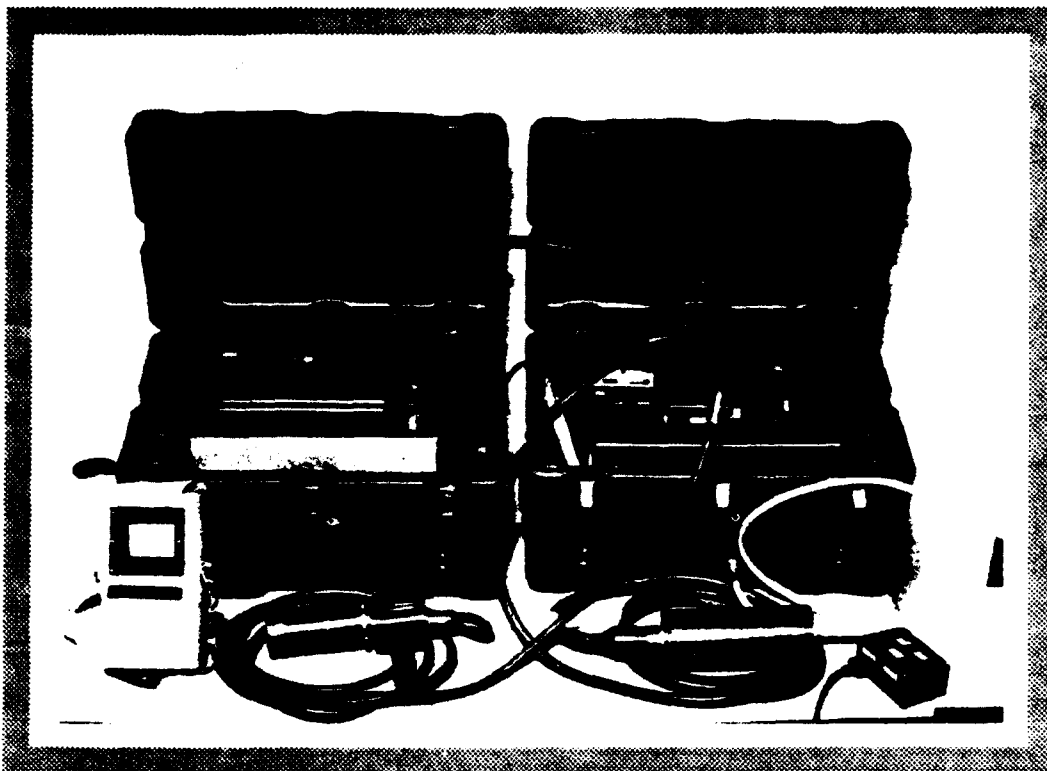

Figure 3-5. The RPT reading system.

The ECC, which is also contained within a rugged 14"H x 22¹/₂"W x 12¹/₂"D carrying case, contains the computer power supply, a 40 MB hard disk that stores the operating system, image correlation software and tag reference images, and the reader head and video microscope camera controls. During operations, the recorder/correlator and the ECC are connected by cable.

The accessory case contains the system's reader head, video microscope, video monitor, and cabling. The case is ruggedized and is 7¹/₄"H x 24"W x 18"D.

The system described above has been replaced by the Universal videographic Reader discussed later in this report (see section 4.4).

3.1.3.3 Tag Readings. During a tag reading, the equipment operator uses the image in the video monitor to align the reader head cross hairs with the tag fiducials. The operator then activates the reading sequence in which 20 images, each one illuminated from a different angle by one of 20 LEDs in the reader head, are recorded for a single fiducial position along with archival data such as the date, time, tag and fiducial number, etc. Each image consists of a 484 x 512 pixel

array with each pixel assigned an intensity value from a 256-level gray scale. From this 242 kilobyte image, the brightest 1% of the pixels are retained and used for image correlation. This process, which is termed "thresholding," excludes the image background and causes the image correlation process to be based totally on the light reflected from the hematite particles.

3.1.3.4 Correlating Readings. A tag's authenticity (or lack thereof) is determined by comparing a reading made in the field (a verification reading) with one made at the time the tag was applied to its TLI (the reference reading) and determining the degree to which the two readings are alike, or correlated. (It should be noted that a complete inspection of a tag will consist of readings at one, two, or all three fiducial marks on the tag, depending on the inspection protocol in use.) First, for each fiducial, each image from the verification reading is compared with its corresponding (same LED) image from the reference reading and their degree of similarity is quantified by computing a correlation number (as described in the following two paragraphs). Then, using the 20 individual correlation numbers, a single decision statistic, such as the median correlation number, is calculated and used to represent the overall signature correlation for the set of 20 correlation numbers.

The system's computer uses four basic steps to calculate a correlation number for each pair of corresponding images. First, there is a coarse alignment, in which the pixel array of each image is translated and rotated until the high-contrast white squares in its fiducial (see figure 3-1) are in the position expected by the system's computer. This achieves a registration between the two images to within about one pixel.

Next, the region of overlap between the coarsely-aligned images is determined (see figure 3-6). Only this overlap region will be used in the final correlation.

The verification image is thresholded as described above (the reference image is already thresholded). The final step is to make fine adjustments in the registration between the two thresholded images. In this procedure, the verification image is translated one pixel in each of eight directions about its

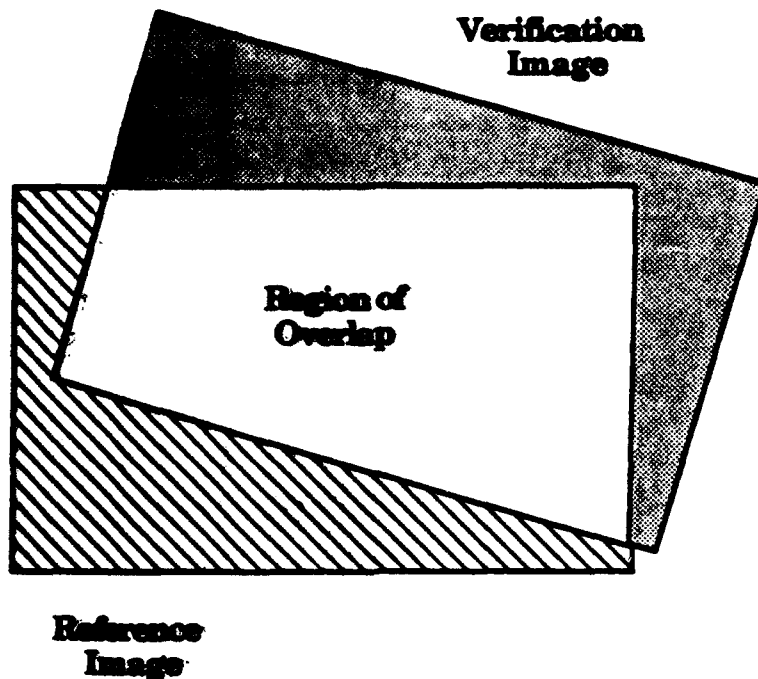

Figure 3-6. The region of overlap for two RPT images.

coarse-adjustment position, and is also rotated slightly clockwise and counterclockwise. The highest correlation number computed for any of these positions (including the original, coarse-adjustment position) then becomes the correlation number for the two images being compared.

To compute the correlation numbers, the N -pixel region of overlap between the two images is represented by two N -dimensional vectors (one for each image) in which the gray scale intensity of each pixel is the amplitude of the coordinate in the dimension representing that pixel. Thus, for each image, the gray scale intensities of all N pixels define a vector with a specific direction. In this view, the correlation between the two images is measured by how closely their vectors "point" in the same direction. The specific measure used is $\cos(\theta)$, where θ is the angle between the vectors. For vectors that point in exactly the same direction, θ is zero, $\cos(\theta) = 1$, and the images have a perfect correlation value of 1. For vectors that are orthogonal, θ is 90° , $\cos(\theta) = 0$, and the images are totally unlike with a correlation value of zero. (Although correlation numbers have values between zero and one, for convenience the system's computer multiplies the correlation numbers by 100 and displays them as two digit values. For example, a correlation

number of ".83682..." will be displayed as "84.") Mathematically, the correlation number is:

$$CN = \frac{\bar{I}_1 \cdot \bar{I}_2}{|\bar{I}_1| |\bar{I}_2|}$$

The system's computer uses the equivalent expression:

$$\text{correlation number} = 100 \cdot \left[1.0 - \frac{\sum_i (I_{1i} - I_{2i})^2}{\sum_i I_{1i}^2 + \sum_i I_{2i}^2} \right] = 200 \cdot \left[\frac{\sum_i I_{1i} I_{2i}}{\sum_i I_{1i}^2 + \sum_i I_{2i}^2} \right]$$

where I_{1i} = the gray-scale intensity of the i^{th} pixel in one image
 I_{2i} = the gray-scale intensity of the i^{th} pixel in the other image.

The summation covers the thresholded pixels in the region of overlap between the two images. Note that this definition of correlation number is self-normalizing, and therefore, is relatively insensitive to variations in light intensity from one reader to another.

3.1.4 Activity Description.

The Tagging RDT&E program began with the requirement to transition verification concepts into fieldable systems suitable for treaty negotiations and subsequent verification operations, particularly as applied to the START treaty. The first of these was the RPT system.

BDM's approach was to develop a Transition Plan that outlined the various upgrades necessary to transition the RPT system (some of which were already underway at SNL) and to specify the appropriate testing that would verify the upgraded system's suitability for field use. At DNA's direction, BDM developed an RPT environmental specification, a draft of which was published in December 1989, and which drove many subsequent upgrades to the system. In addition, BDM performed statistical analyses necessary to support the transition process.

The major test activities directed by the Transition Plan were software verification and validation (accomplished June to October 1990), environmental testing (November 1990), and the system's IOT&E, that was held from November 1-7, 1990.

These tests revealed the need for further hardware and software modifications to the system. A BDM/SNL team was incorporating these changes into two equipment sets when, on April 18, 1991, OUSD(A) directed that further RPT development be terminated. Modifications already in progress to two equipment sets were completed and these sets were used in the development of UR software, and acquiring supplementary RPT data using modified software. BDM analyzed this supplementary data to establish the decision statistic criteria. The results of these analyses were published in April 1992.

Each major RPT activity is described in more detail in the following paragraphs.

3.1.4.1 Transition Plan. The first technical instruction on the contract (TI FY90-01) called for developing a Transition Plan to upgrade the RPT system from a laboratory prototype to an industrial prototype certified for field use. By DNA's definition, the laboratory prototype had adequately demonstrated proof-of-principle, but had not been fully tested and evaluated under field conditions. The Transition Plan, therefore, was dominated by the need to put the system through an IOT&E that would provide the necessary verification that the system was ready for field certification.

The Plan, which was published December 1, 1989, in addition to pointing out the need for an IOT&E, provided a schedule and a work breakdown structure (WBS) for accomplishing the transition task, and described actions necessary to upgrade the system to an industrial prototype ready for testing. These actions covered virtually every component of the RPT. With each component, documentation (particularly O&M documentation) was upgraded and the functional tests performed.

3.1.4.2 Environmental Specification. When the tagging program began, both DNA and BDM recognized the need for establishing requirements and standards

for verification equipment. The RPT Transition Plan included a requirement to define the operational environment, which BDM proceeded to do under DNA's direction. The first draft of the resulting environmental specification, published in December 1990, was RPT specific. The requirements were based on the Rail Garrison *Weapon System Specification* and MIL-STD-810D, *Environmental Test Methods and Engineering Guidelines*. The Rail Garrison specification was used as a baseline document because it dealt with mobile missile systems, which were then the prime candidates for START tagging. MIL-STD-810D was used because it defines world-wide environmental parameters for electronic equipment, including the expected environments in the Soviet Union. BDM later suggested modifications to certain specifications so that otherwise qualified COTS components would not be eliminated from consideration before specific tagging conditions and environments were defined. These modifications were accepted by OUSD in January 1993.

3.1.4.3 Environmental Testing. Environmental testing was conducted in November 1990. The purpose was to determine whether RPT tags and reading equipment could endure the various environments they would be subject to in field operations without failing or experiencing unacceptable degradation. Included were tests for high altitude (low pressure), high and low temperatures, temperature shock, humidity, fungus, salt fog, vibration, shock, and electromagnetic interference (EMI). The tests were in accordance with MIL-STD-810D *Environmental Specifications* and the Rail Garrison *Weapon System Specification*. Only tests applicable to the RPT system were performed and modifications were made where necessary.

The reading equipment performed satisfactorily in the different physical environments tested, but certain problems were uncovered. During the salt fog test, the hinges on the equipment cases rusted and corroded. While this did not affect the equipment operation, over time, it could affect the ability of the cases to seal moisture. BDM recommended stainless steel hinges for production versions of the cases.

EMI/EMR testing identified the need to modify or redesign the system's cabling in order to meet the requirements of MIL-STD-461C, *Electromagnetic Emission and Susceptibility Requirements for the Control of Electromagnetic*

Interference, prior to producing units for field use. BDM has estimated that these changes, and the necessary retesting, would require a five man-month LOE that could be accomplished in parallel with other necessary modifications should the decision be made to complete the RPT work.

Tags applied to composite substrates, such as Kevlar, glass/epoxy, and graphite/epoxy showed no significant problems as a result of any of the tests. However, the correlation values of tags applied to aluminum and steel substrates dropped more than 15 points in the salt fog and fungus tests because of rust and corrosion around the tags. Since this corrosion is an inherent property of aluminum and steel when they are exposed to moisture, some type of protective covering will be required for tags on these substrates if they will be exposed to high humidity. SNL produced similar results with tags on aluminum and steel substrates, and worked toward a solution to that problem.

3.1.4.4 IOT&E. All activity associated with the RPT's transition from a laboratory prototype to an industrial prototype focused on preparing for the IOT&E, that was to provide the basis for a decision certifying the system for field use. The IOT&E was the subject of extensive planning and coordination among the various agencies involved. The test plan was published on July 1, 1990, and distributed to the appropriate agencies for comment. The RPT IOT&E was conducted at the BDM facilities in Albuquerque, New Mexico, from November 1-7, 1990.

The IOT&E was designed to determine:

- (1) The operational effectiveness and suitability of the system's application procedures and tag reading equipment
- (2) The uniqueness and consistency of RPT signatures when applied and read by operational personnel in the field.

The critical operational issues that were fully or partially addressed by the IOT&E were:

- (1) Tag application quality
- (2) The ability of the system to provide unique and consistent signature readings

- (3) **The reliability, availability, and maintainability of the reading equipment**
- (4) **The logistics support required by the reader system**
- (5) **Limitations on transporting the tag application materials or the reader system**
- (6) **Human factors**
- (7) **Training required to operate the RPT system**
- (8) **The compatibility of the system with TLIs and data transmission systems**
- (9) **The suitability of the system software for operational use.**

The test consisted of five trials. In the first trial, operational personnel built RPTs on samples of TLI substrate materials and then read the signatures of those tags under workbench (laboratory) conditions. In the four remaining trials, readings were carried out with the tags mounted on mockups of potential TLIs under simulated field conditions of sunlight, indoor lighting, darkness, and cold weather.

The IOT&E showed that the system was user-friendly and did not require extraordinary skill levels or extensive training in order to be used. The predicted false acceptance rate was only 2×10^{-8} (based on fitting appropriate probability distributions to the test data), which easily met operational requirements. However, the false rejection rate was high, especially in extreme cold weather.

It was found that different equipment sets produced statistically significant differences in correlations. In general, when a tag was read with the same equipment set used to make the tag's reference reading, the correlation was higher than when another equipment set was used. (This was confirmed after the IOT&E through a series of 20 controlled readings specifically designed to check this IOT&E finding.) Operationally, this effect could cause fluctuations in the false rejection rate. Different operators of the equipment sets also produced differences in correlations. However, since their differences were much less than those produced by the different equipment sets, the potential operational significance of this effect was small.

The availability of the reader equipment during the test was .98, slightly below the desired goal of .99. However, not enough operating time was accumulated to make a valid prediction of the mature system's availability rate.

The recorder/correlator, ECC, and reader head all have electric-resistance heaters that bring their internal temperature up to the system's minimum operating temperature when the environment is cold. However, during cold weather (-20°F) tests, the batteries used to power the system's portable power supply/inverter completely drained before the reading equipment warmed up. At the conclusion of the IOT&E, several simple modifications were made to improve the performance of the power supplies and a supplemental cold weather trial was conducted. Even with the improvements, the power supplies exhibited short operational times before draining. Because of this and the considerable weight of the power supplies, the decision was made to eliminate them and negotiate a provision that the inspected party must supply utility power for all RPT operations.

Separation tests were used to examine the effectiveness of tag applications. Testing evaluated the perpendicular force (in tension) that a tag could bear before tag material was detached from the surface of a TLI. The test method conformed to ASTM Standard D 4541-85. These tests showed that the forces required to detach tags are high enough that they are very unlikely to be produced unintentionally or by natural means. In fact, the tags have a desirable tendency to break apart well before separation occurs. This suggests that tags are likely to be ruined by this type of separation process, and therefore, be unusable on a different (presumably) illegal weapon system.

Generally, the RPT system performed well during the IOT&E. However, in addition to the problems mentioned already, the test revealed image degradation due to high ambient light levels (particularly in direct sunlight), inconsistent calibrations, and occasional reader head instability. These problems led to a series of equipment modifications, described in section 3.1.4.8.

3.1.4.5 Software Verification and Validation. In conjunction with the IOT&E, BDM performed a software verification and validation (V&V) that documented the design description for the RPT software, validated the operational aspects of the

implementation, and verified that the software satisfied the functional requirements of the RPT Requirements Specification. The V&V began in June 1990 and was completed in October 1990, shortly before the start of the IOT&E. The major concerns resulting from the V&V were:

- (1) Critical and noncritical errors relating to inconsistencies, full-disk conditions, duplicate disk errors, memory allocations, and error trapping
- (2) Algorithm problems
- (3) Maintainability of the software.

The software used during the system's IOT&E (see section 3.1.4.4 above) would have been adequate for field operations, although problems would have existed with maintaining it. The IOT&E participants were encouraged to comment on any improvements they would have liked in the software. Their major concerns were the need for:

- (1) More feedback to the user
- (2) The ability to cancel (abort) a tag reading when the user realizes it was not what they wanted.

The system's software performed satisfactorily during the IOT&E. Nevertheless, following the test, modifications were made to the software to improve its efficiency and maintainability and to take full advantage of the hardware modifications being made at the same time. The software modifications that were made to satisfy the concerns raised by the V&V and the IOT&E participants are described in section 3.1.4.8.

3.1.4.6 Supplemental Tests. Once the modifications resulting from the IOT&E had been made to two equipment sets, BDM planned to run these sets through a series of IOT&E supplemental tests. These tests were intended to provide data to answer three questions:

- (1) What improvements had been made in reading equipment performance as a result of the hardware and software modifications since the IOT&E?

- (2) How long does it take to make an RPT reading?
- (3) Will the modified reading equipment configuration provide acceptable field performance?

One particularly important objective under the third question was to establish a decision statistic criteria for deciding whether tags pass or fail their readings and to determine the predicted false acceptance/false rejection rates based on these criteria.

A test plan was produced, and the tests were scheduled to take place between April 22 and May 3, 1991. However, the supplemental tests were cancelled when, on April 18, 1991, OUSD(A) directed DNA to close out work on the RPT system.

However, in conjunction with developmental testing of the UR system, additional RPT readings were obtained between September 18 and October 1, 1991. Analysis of these additional readings showed the modifications identified during RPT system testing (and also incorporated into the UR and software design) improved on the performance of the IOT&E version of the RPT system in several areas. Thresholding of image data reduced data storage requirements by over 90% and allowed the data to be placed on a 3.5" diskette. Also, the median correlation number (MCN) increased and the variance decreased using the modified RPT system over the IOT&E version of the RPT system.

3.1.4.7 Optimum Decision Statistic/Threshold Tests. Although further development of the RPT system had been cancelled, it was still necessary to determine the optimum decision statistic criteria for the reflective particle tag. This was particularly important because changes in the correlation algorithm subsequent to the IOT&E may have affected the distribution of the MCN. The UR DT&E test setup was used for making readings of RPTs with the current version of the tag reading system. These readings were conducted September 18 and October 1, 1991.

The MCN was used as the measure to gauge against a critical value. The decision rule is such that if the MCN is greater than or equal to the critical value, the verification signature will be accepted as genuine; otherwise, it will be

rejected. Any decision rule for verifying a tag may commit either of two possible error types: a false rejection or a false acceptance. A false rejection occurs when a legitimate verification signature is rejected. A false acceptance occurs when an illegitimate verification signature is accepted. An illegitimate verification signature is one from a tag other than that to which the reference signature belongs - possibly from a counterfeit tag. The probability of a false rejection is called the false rejection rate (FRR), and the probability of a false acceptance is called the false acceptance rate (FAR).

The critical value developed for the MCN was selected to meet a requirement of $FRR = 10^{-6}$. As shown in the first row of table 3-2, the MCN critical value that yields an FRR of 10^{-6} is 20.6. Given that critical value, the FAR for unlike comparisons was calculated to be 3.48×10^{-22} . The second row of table 3-2 shows similar figures for $FRR = 10^{-3}$ and demonstrates the tradeoff inherent in shifting the critical value. In this case the critical value was increased resulting in a *reduced* probability of false acceptance at the cost of an *increased* probability of false rejection.

Table 3-2. Critical values for tag verification decision rule.

SPECIFIED FRR	CRITICAL VALUE FOR MCN	RESULTANT FAR
1.0E-06	20.6	3.48E-22
1.0E-03	41.2	4.56E-49

Given that the requirement is that both the FRR and FAR be $\leq 10^{-6}$, the **decision rule for tag verification** is as follows: if the verification reading MCN is at least 20.6, then that tag is the same one that the reference reading was obtained from; otherwise, it is a different tag.

3.1.4.8 System Modifications. At the beginning of the tagging program, SNL was developing its industrial prototype version of the RPT reader system. Design changes continued throughout the transition period and resumed after the IOT&E uncovered several problems with the reader system. However, no basic

change was needed to the RPT concept, nor were any major redesigns necessary for any of SNL's RPT components during the course of the tagging program.

Laboratory Prototype. The laboratory prototype differed in several ways from the current industrial version of the system, described in section 3.1.3, above. The greatest differences were in the system's computer, which was a desktop ruggedized Tiger PC/AT, manufactured by Miltope Corporation, and in the fact that there was no ECC unit. Among other differences, the laboratory prototype reader head contained 21 LEDs and its legs were positioned differently, the video microscope had three magnifications (3.5x, 5x, and 10x), and none of the units had heaters for use in cold ambient temperatures.

Industrial Prototype Development. Numerous changes were required to transition to the industrial prototype system. In the reader head, the number of LEDs was reduced from 21 to 20 in order to mount the LED circuit board. The reader's legs were repositioned to enhance stability and shortened to reduce image degradation from scattered light. A new light diffuser was incorporated to improve the uniformity of lighting from each LED, and hence, reduce the variation between readings. A small heater was installed in the reader assembly to extend the ambient temperature operating range. One change that was started, but later dropped, involved a second ("low profile") reader head with a 90° angle, that was to be used when tag access did not permit use of the original ("in-line") reader head.

A similar "low-profile" video microscope was also dropped. However, the video microscope was redesigned to provide additional user flexibility and simplified to provide only two magnification settings (the 5x was eliminated). A heater was also added.

The recorder/correlator was redesigned to conform to the environmental specifications. The desktop configuration was dropped, and the computer was repackaged in a ruggedized carrying case. The computer now had expansion slots to accommodate two boards; a 22-function, touch-pad input to replace the standard computer keyboard; a 2x40 character ASCII display; increased ROM; and heating elements to maintain necessary operating

temperatures. Software was modified to accommodate the new input/output devices.

The ECC was added to the system at this time to accommodate devices that had been in the laboratory prototype's Miltope computer, or elsewhere. Housed in a ruggedized case identical to that used for the recorder/correlator, the ECC contained a removable 40 MB hard disk, two camera control units, a switchable (110v/220v) power supply, and circuitry to prevent the system from being operated until it reached an acceptable temperature. The hard disk used an SCSI controller, and was given a ruggedized housing by SNL. Provisions were made for copying acquired data to another disk.

Reader Changes Subsequent to the IOT&E. When the changes described above were completed, the RPT reader system was an industrial prototype, essentially the same as the current version. However, during the developmental testing and the IOT&E, several further improvements were suggested. These suggestions arose from problems encountered with the system by test participants and from potential problems discovered by BDM and SNL technical personnel. The improvements were incorporated into two of the existing equipment sets, but RPT work was curtailed by direction of OUSD(A) before they could be incorporated into other sets. Many of these improvements were implemented by performing minor modifications to the hardware, while others required more extensive development work. Among these improvements were:

- (1) Replacing the system's single power cable with separate 110v AC and 220v AC power cables that are less susceptible to degradation at temperature extremes
- (2) Providing a functional check (calibration) tag in the reader head's lens-cap plate to eliminate calibration variations
- (3) Providing a shield to block ambient light to the video monitor
- (4) Modifying the reader head feet to improve the reader head's stability and decrease ambient light leakage
- (5) Installing heavy-duty connectors to prevent damage
- (6) Repotting the power input connectors to eliminate a safety hazard

- (7) Installing grounding lugs to provide static protection (this work was not completed)
- (8) Installing unmodified CPU boards to eliminate component failures on the boards
- (9) Applying conformal coating to exposed circuit boards to prevent condensation
- (10) Modifying the temperature control system to prevent potentially damaging transients in the system's electronics
- (11) Installing a power indicator light for the system's hard disk
- (12) Adding a 3 $\frac{1}{2}$ " floppy drive.

Software modifications were implemented to maximize the system's potential and to take full advantage of the hardware modifications described above. These modifications, which were completed in May 1991, included:

- (1) Resolving inconsistencies, unnecessary calculations, and maintainability concerns found during the software V&V
- (2) Using thresholded reader head images to greatly reduce storage requirements and permit images to be stored on the system's new floppy disk
- (3) Increasing the modularization of the code to make it more readable and easier to follow and maintain
- (4) Converting the code to a single compiler (rather than the two used during development) to improve maintainability and to simplify future software modifications
- (5) Adding C data structure to make it easy to add summary information and to simplify future software modifications
- (6) Changing the file structure to eliminate confusion between data files and to provide for increased header information
- (7) Modifying the correlation algorithm to fix black-level sensitivity and to limit correlation to the region of overlap between the two images
- (8) Not saving calibration images, since this is not required by the new functional (calibration) checks that replaced the old calibration routine.

General RPT System Modification Observations. Sandia National Laboratories' RPT system development efforts were successful and satisfied rigorous environmental requirements. The subsequent BDM development of the UR was significantly aided by the SNL effort and responded to OSIA requests for a more portable and less environmentally robust system.

3.1.5 Results.

There are 10 RPT systems in existence. Two have been modified as described in section 3.1.4.8.3 and can be considered as "latest generation." Should a go-ahead be given, BDM estimates it will take approximately six months to complete the industrial prototype transition activities. This would include modifying the remaining eight systems, bringing all 10 systems into compliance with EMI standards, conducting and documenting a supplemental IOT&E, having the software verified and validated, producing level-2 drawings, and completing a Type C product specification. Procurement activities could commence at the end of these activities.

3.2 STAR FIBER OPTIC TAG SYSTEM.

3.2.1 Overview.

BDM's assessment of Lawrence Livermore National Laboratory's (LLNL), STAR Fiber Optic Tag (FOT) system began in the Spring of 1990, under TY FY90-06. BDM recognized that the system examined in this first review required considerable development before DNA would be in a position to transition the technology for field use. There were many unanswered questions, plus technical and manufacturing challenges that had to be resolved; these were addressed in the first assessment report produced as a result of the TI.

The JCS favored the STAR concept as it had the potential to be less intrusive than the RPT concept, which required the identifier be affixed to the TLI. Briefings were held with the JCS in June 1990 to present the coordinated schedule for transitioning STAR to an industrial prototype. The JCS and HQDOE supported DNA's position, that once the system had satisfied laboratory prototype

requirements, the system would be transitioned to DNA for industrial prototype development.

BDM continued to monitor the STAR development process as the design continued to evolve. BDM planned a test program and began testing an engineering prototype STAR design in August 1990. This system failed and was returned to LLNL for repair. Further testing continued on the repaired system, but BDM was not able to complete sufficient readings to establish signature uniqueness and repeatability. In June 1991, DOE withdrew STAR from further transition consideration, and returned the concept to the research and development stage.

3.2.1.1 Documentation Produced. Figure 3-7 lists each STAR FOT document produced under the Tagging RDT&E contract, along with its date, and a brief description.

Document	Date	Description
STAR Fiber Optic Assessment Report	3/13/90	Describes early STAR design.
Fiber Optic Update Report	4/24/90	Addresses later LLNL design modifications.
STAR Fiber Optic Transition Plan	5/24/90	Classified
Program Structure Diagram Report for the STAR Fiber Optic Tag System	8/17/90	Describes the processing sequence conditions, looping structure, control points, flow of control, and data interactions within the STAR FOT system.
STAR Fiber Optic Tag Manufacturability Assessment Plan (Draft)	9/21/90	Describes the process BDM would execute in determining the manufacturability and associated risks of producing the STAR FOT
DOE Tagging System Concepts Demonstration	11/8/90	Describes tag evaluation proposed by the Center for Verification Research
Developmental Test and Evaluation Plan for the STAR Fiber Optic System Laboratory Prototype (Draft)	3/5/91	Describe the test and analysis plans for the laboratory prototype to primarily assess tag uniqueness and also determine ability for transition to industrial prototype.
Consideration about LLNL's Correlation Algorithm	3/20/91	Analysis of the signature correlation algorithm proposed by LLNL.
Fiber Optic DT&E Test Plan	7/31/91	Plan for BDM test of STAR system.

Figure 3-7. Chart showing the list of documents produced during the STAR FOT task.

3.2.1.2 Expenditures. The STAR FOT assessment effort began on February 13, 1990, when TI FY90-06 was turned on and was completed when the final report was delivered in July 1991. The following table (table 3-3) lists the labor hours, the associated loaded labor costs (without fee and tax) plus the ODC's expended during the conduct of the STAR FOT assessment.

Table 3-3. STAR FOT system expenditures.

TI	Hours	Loaded Labor Costs	ODC's	Total Costs
FY90-06	8,112	\$362,875	\$37,827	\$400,702
FY91-14	5,885	\$273,786	\$16,355	\$290,141
Total	13,997	\$636,661	\$54,182	\$690,843

3.2.2 Schedule.

Figure 3-8 depicts the schedule of activities that were performed during the STAR FOT system assessment efforts under TI FY90-06.

3.2.3 System Description.

The STAR Fiber Optic Tag/Seal is a fiber optic cable bundle with 18 single-mode glass fibers and a seal tie block which joins the ends of the cable bundle to form a secure loop (see figure 3-9). A signature is generated by coupling nine of the fibers to permit optical crosstalk. Light entering one fiber is scattered in the coupler to the other eight. Since this crosstalk is a function of the random alignment of fibers in each coupler, it provides a unique optical signature for each tag. The nine fibers not used to generate the unique signature were used for tamper detection purposes.

The laboratory prototype reader connected directly to the seal tie block and drove a scanning device that moved a single fiber across the ends of the nine signature fibers. This single fiber was used to introduce laser light into each signature fiber. The coupler causes crosstalk to the other eight fibers and the resultant light energy in each fiber is measured at the other end of the fiber by a detector in the reader. This process is repeated for all nine fibers at two different

wavelengths and two polarities. These measurements of transmitted light energy constitute the seal's signature.

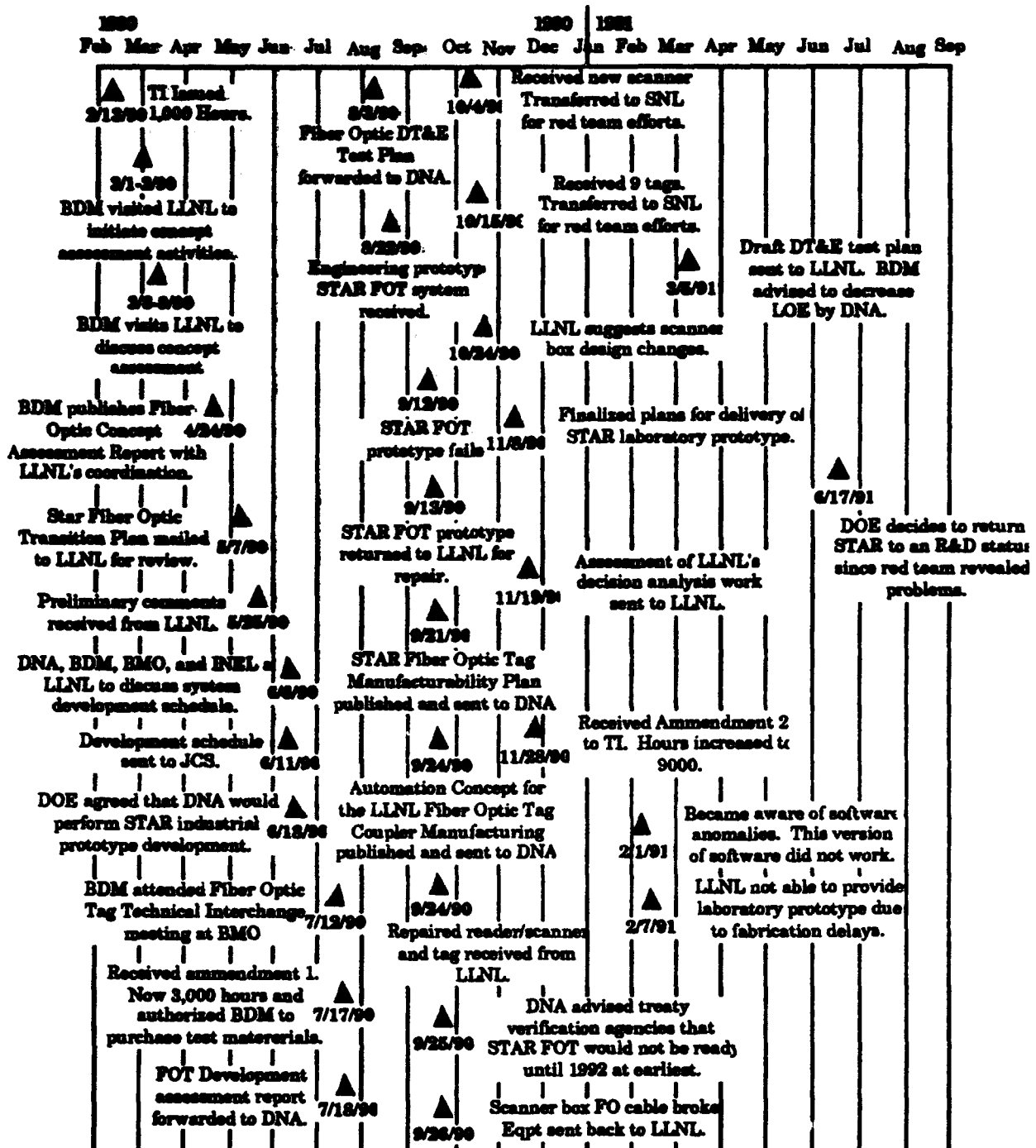

Figure 3-8. Schedule of STAR FOT activities.

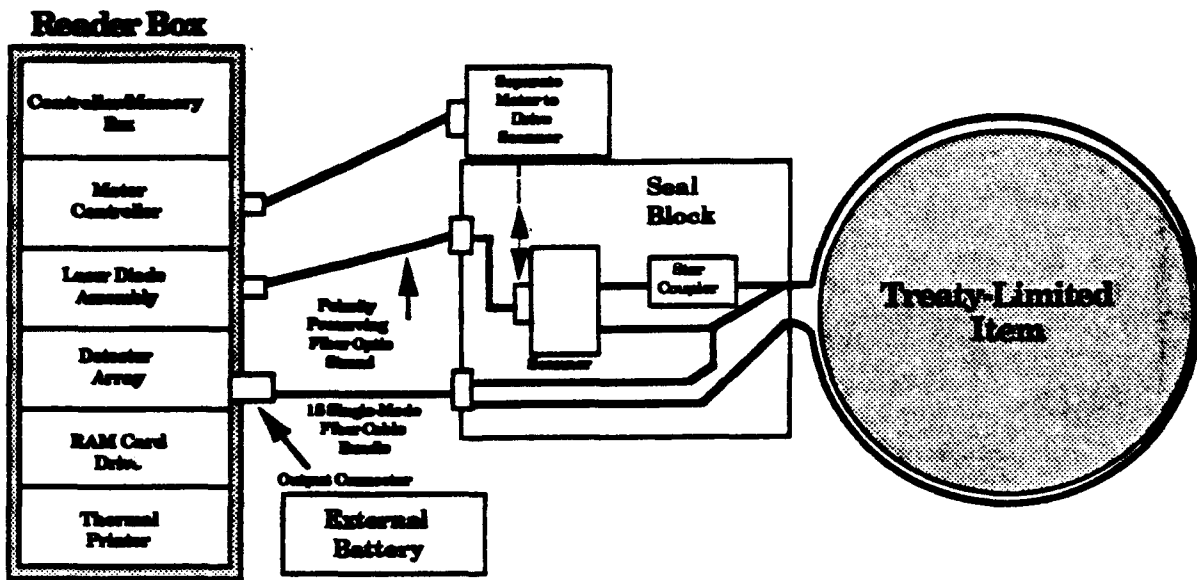

Figure 3-9. Schematic diagram of the STAR FOT surrounding a TLI.

3.2.4 Activity Description.

DNA tasked BDM to conduct a concept assessment of the STAR, incorporate the results into a concept of operations, and produce a transition plan for developing an industrial grade prototype from the DOE laboratory prototype, by issuing Technical Instruction TI FY90-06, on February 13, 1990.

BDM visited LLNL in early March 1990 and conducted a technical review of the STAR concept. BDM's initial report was forwarded to DNA in mid-March. Serious technical issues were raised and an extended development schedule postulated. A copy was forwarded to LLNL for comment and an updated/coordinated report was forwarded to DNA in late April. The transition plan was drafted and forwarded to LLNL for comment in May. Meetings were held at LLNL and Washington, D.C. (JCS) in May and June 1990, addressing STAR FOT schedule challenges. Many in Washington favored the STAR concept since it was perceived to be less intrusive than the RPT system. These meetings demonstrated clearly that the risks associated with an early availability were extremely high. LLNL's plan to continue the STAR development through industrial prototype stages was not favored by the JCS, and DOE agreed with the original plan to transition the concept to DNA when laboratory prototype

requirements were satisfied. The JCS preference for the STAR concept waned following these discussions; however, the assessment and functional evaluations continued.

In July 1990, the TI was amended to permit BDM to purchase components to test five STAR tag/seals and increased the LOE by 300% to 3,000 hours. In the Fall of 1990, BDM received the first STAR prototype and began testing.

Equipment failures and tag design problems complicated data collection and motivated FOT system changes. A second amendment was issued in November which increased the LOE to 9,000 hours.

Design changes and LLNL difficulties delivering tags/seals for developmental testing caused DNA in March 1991 to request that BDM cease scheduled activity, and with a low level of effort, monitor LLNL progress.

In June 1991, BDM learned that DOE had decided to withdraw the STAR concept from further DNA transition activity. The concept required more R&D effort before it would be ready for consideration as a treaty verification technology. Consequently, this assessment effort ended on June 17, 1991.

3.2.5 Results.

Due to difficulties with the prototype fiber optic connectors and scanning device, BDM was unable to complete sufficient readings to establish STAR signature uniqueness and repeatability parameters. LLNL system developers continued to modify the STAR design so that it was difficult to establish configuration data. The Idaho National Engineering Laboratory (INEL) STAR FOT adversarial analysis identified problems with the STAR design. The BDM assessments combined with the INEL reports combined to convince DOE that more development was required before transitioning activities continued.

As a result of testing the engineering prototype system, BDM concluded that:

- (1) The majority of the signature for a given input fiber typically is concentrated in 2 or 3 output fibers
- (2) Signatures exhibited slight drift over time that may not be operationally significant
- (3) Alignment of the beam entering the input fiber appears not to be critical (changes due to alignment are small)
- (4) Changes in wavelength alter signatures only slightly
- (5) Changes in polarity altered signature slightly (apparently somewhat more than changes in wavelength).

3.3 ULTRASONIC INTRINSIC TAG (UIT) SYSTEM.

3.3.1 Overview.

BDM's assessment of the Ultrasonic Intrinsic Tag (UIT) system developed by PNL was done in two phases. The first phase was a concept assessment performed under FY90-05, which delivered to DNA not only the assessment report but also a concept of operations and a transition plan for packaging the system into an industrial grade prototype. In addition, BDM explored sources for COTS ultrasonic imaging hardware for potential use in the industrial version of the UIT system.

During the second phase of the UIT assessment performed under FY90-14, BDM planned a Developmental Test and Evaluation (DT&E) for the UIT laboratory prototype system to assess the system's capability and operability attributes. BDM and PNL personnel had several coordination meetings in preparation for the testing. Since the UIT prototype system was not designed to withstand the environmental conditions required by a formal DT&E effort, the test plan was modified and BDM conducted a Functional Test and Evaluation (FT&E) which would not subject the UIT system to environmental extremes it was not designed to tolerate. The technical considerations and structure of this test, along with the results, are discussed in section 3.3.5.

PNL delivered to BDM a UIT laboratory prototype system and other system-related materials and supplies for the conduct of the FT&E. The FT&E exercised the UIT system on several types of composite material substrates. Following

some system familiarization efforts, the initial baseline readings were completed on June 24, 1991 and the final test trial was completed on September 12, 1991. During review of the test data and subsequent statistical analysis, an error was discovered in the data reduction algorithm. PNL provided BDM with a correction to the algorithm and DNA agreed that BDM should reprocess the data for five of the nine test trials using the corrected algorithm.

BDM reprocessed the data and completed the statistical analysis, producing a draft test report in January 1992. This draft was coordinated with PNL and published as the final UIT Laboratory Prototype Functional Test Report on April 16, 1992. DNA decided not to continue with the UIT industrialization design and development portion of the UIT Transition Plan based upon BDM's preliminary assessment, functional testing results, and a recommendation from Dr. Hal Udem of PNL in a letter to Dr. Jim Fuller at HQDOE.

3.3.1.1 Documentation Produced. The following list of documents represents those delivered to DNA during both phases of the UIT assessment. Certain documents were classified. The classification level is noted in parentheses.

- (1) Ultrasonic Assessment Report (S), March 21, 1990
- (2) Ultrasonic Update Report, April 24, 1990
- (3) Ultrasonic Transition Plan (S), July 19, 1990
- (4) UIT DT&E Test Plan (Draft), February 19, 1991
- (5) UIT Laboratory Prototype Preliminary Technical Evaluation, September 19, 1991
- (6) UIT Functional Test Report (Draft), January 15, 1992
- (7) UIT Functional Test Report (Final), April 16, 1992.

3.3.1.2 Expenditures. The UIT assessment effort began in February 1990 and was completed when the final report was delivered in April, 1992. The following table (table 3-4) lists the labor hours, the associated loaded labor costs (without fee and tax) plus the ODC's expended during the conduct of the UIT assessment.

Table 3-4. UIT system expenditures.

TI	Hours	Loaded Labor Costs	ODC's	Total Costs
FY90-05	8,112	\$362,875	\$37,827	\$400,702
FY91-14	5,885	\$273,786	\$16,355	\$290,141
Total	13,997	\$636,661	\$54,182	\$690,843

3.3.2 Schedule.

Figure 3-10 depicts the schedule of activities that were performed during the UIT assessment efforts under TI's 05 and 14.

3.3.3 System Description.

The UIT laboratory prototype system, or UT-3000, is a special purpose ultrasonic imaging system used to identify TLIs by acquiring a unique intrinsic signature. The UIT is used on TLIs composed of epoxy-based composite materials. A baseline signature is recorded, then in subsequent readings, the signature authenticity is verified through correlation with the baseline signature. Essentially, the intrinsic characteristics of the TLI itself, serve as the tag for the TLI. There is no need for an affixed or attached identifier. The UIT laboratory prototype system as shown in figure 3-11 consists of three major assemblies; the CPU chassis, the monitor chassis, and the scanner.

The UIT concept is based on the random distribution of dissimilar mediums within the composite material and the acoustic properties of these mediums. Since these acoustically dissimilar mediums represent sound discontinuities within the composite matrix, a unique pattern of reflected sound signals is produced when excited by the UIT ultrasonic source. Figure 3-12 illustrates this concept showing the ultrasonic sound waves entering the TLI material and being reflected by discontinuities within the material. This complex, reflected signal constitutes the tag signature of the TLI at that specific location, thus the "tag" is not applied or attached to the TLI, but is based on the TLI's unique intrinsic properties.

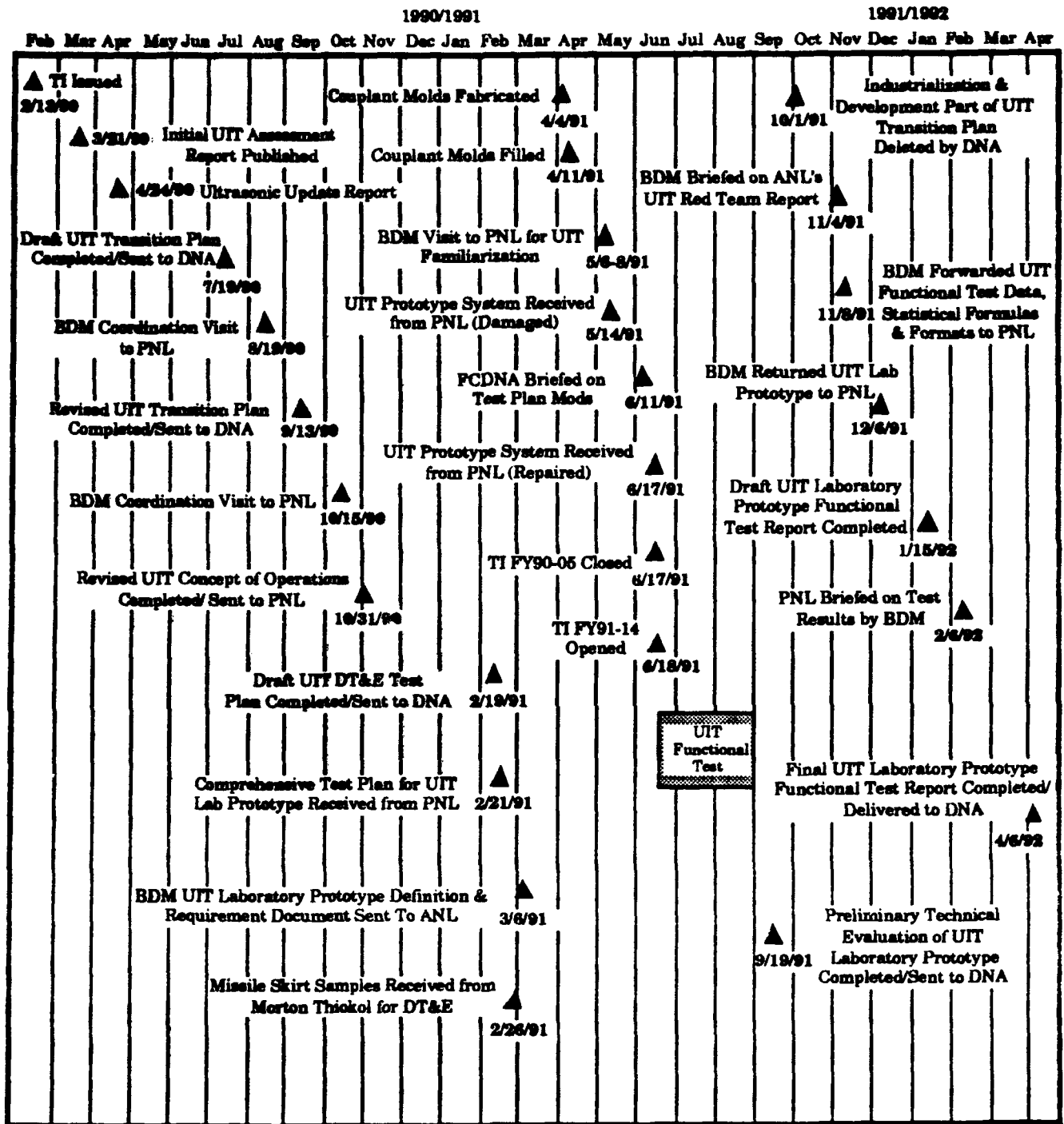

Figure 3-10. UIT system assessment schedule.

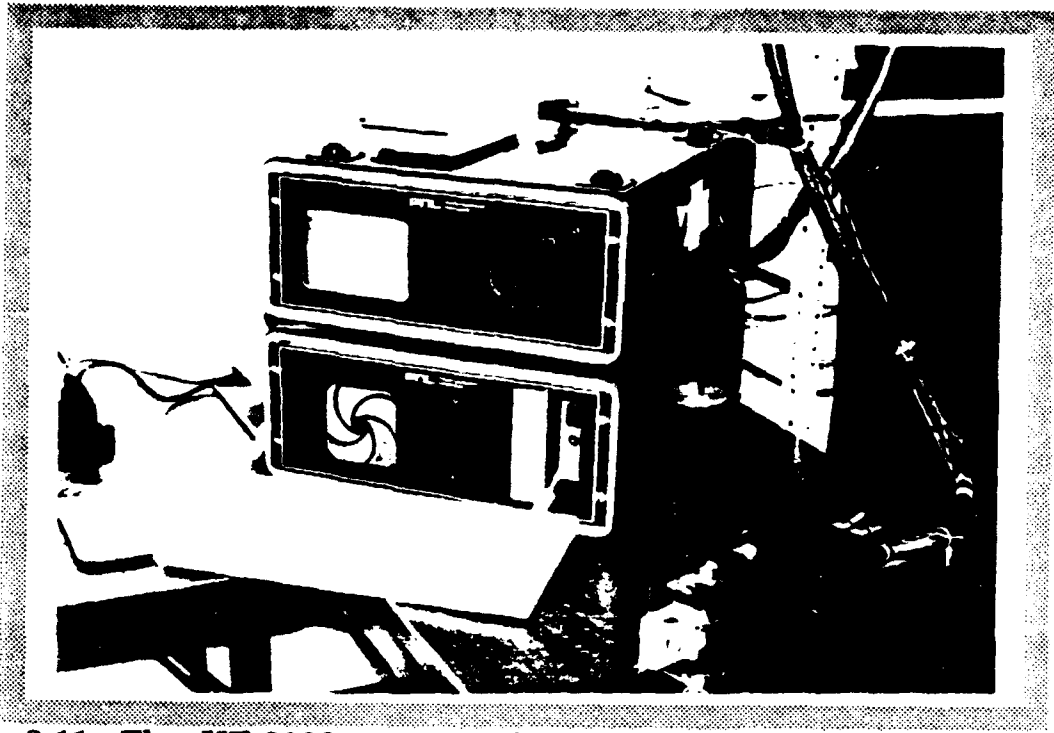

Figure 3-11. The UT-3000 system, showing the CPU chassis, the monitor chassis, and the scanner.

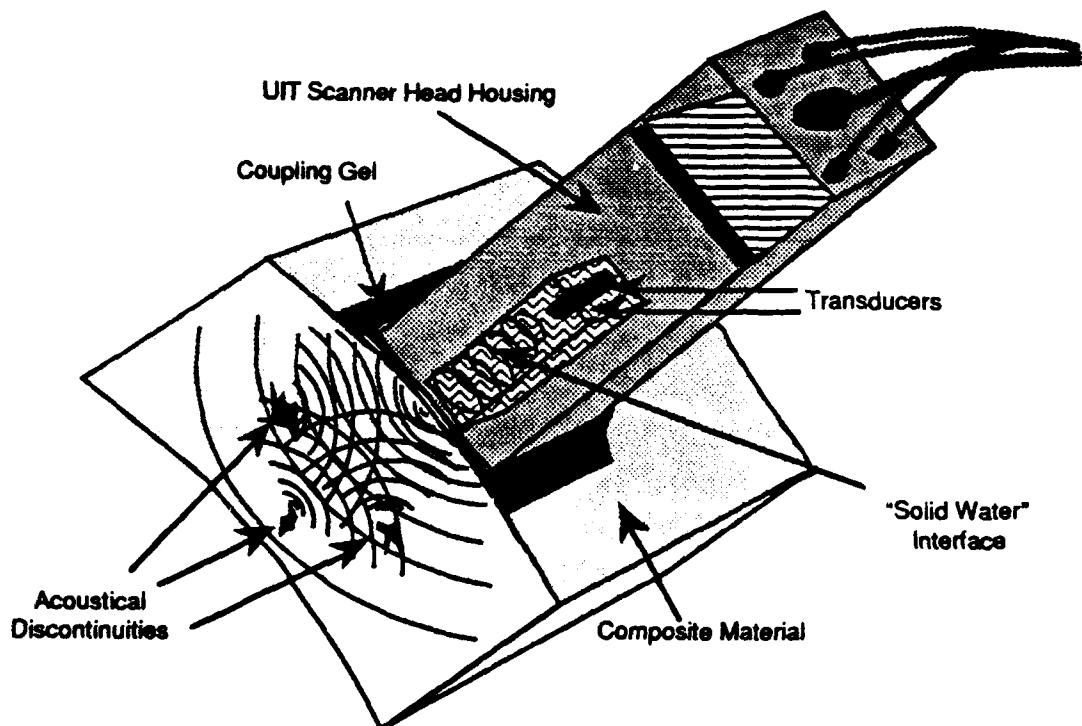

Figure 3-12. A conceptual illustration of the UT ultrasonic sound waves interrogating a composite material sample.

The reflected sound signal is composed of many damped sinusoidal waveforms that combine destructively and constructively. Each damped sinusoidal waveform has 256 data points representing the ultrasonic reflection at increasing depths. Each signature acquired by the system over a 2"x 2" scan area consists of 10,000 of these waveforms stored in three dimensions. To reduce this large amount of data for correlation, the data is extracted from the file in the form of timegates. Each timegate represents a UTT signature waveform deeper into the composite material. Figure 3-13 illustrates the timegate extraction obtained for a graphite-epoxy test sample used during the UTT Functional Test. These timegate extractions are then cross correlated with the baseline signature acquired during the initial reading of the composite material. The cross correlation determines if the two signature waveforms are similar enough to be declared the same. If they are the same, the TLI has been positively identified.

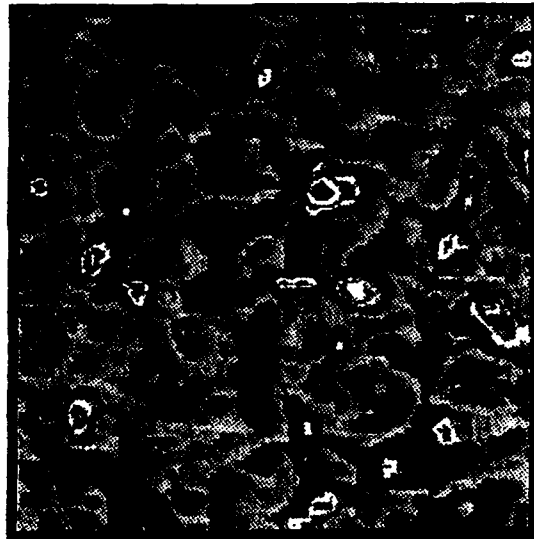

Figure 3-13. Typical internal timegate extraction for a graphite-epoxy sample.

3.3.4 Activity Description.

The activities described in the following paragraphs are essentially in chronological order and represent a concise, but complete summary of the work performed by BDM during the UTT system assessment. Contractual information is also provided when appropriate.

BDM was tasked by DNA on February 13, 1990 in TI FY90-05 to conduct a concept assessment of the UIT, incorporate the results into a concept of operations, and produce a transition plan for developing an industrial grade prototype from the DOE laboratory prototype developed by PNL.

BDM initially performed an assessment of the UIT system and forwarded a report to DNA and PNL for comment in March 1990. An updated report was sent to DNA in April 1990, after receiving and incorporating PNL's comments. BDM also coordinated an information exchange with Argonne National Laboratory (ANL), who was performing the UIT adversarial analysis effort. With DNA's approval, BDM shared information with them about the UIT assessment. In July 1990, BDM received a copy of a UIT adversarial analysis status report from ANL.

BDM began work on a transition plan for developing an industrial prototype grade UIT at the beginning of the TI effort. The plan was completed on July 13, 1990. A copy of the transition plan was forwarded to DNA on July 19, 1990. BDM visited PNL on August 19, 1990, and updated the UIT transition plan based upon information learned during the visit about design developments. An updated transition plan was completed on September 13, 1990, and mailed to DNA on September 20, 1990. BDM also used this same design information to update the concept of operations. It was delivered to PNL for comment on October 31, 1990.

During the period November 1990 through May 1991, BDM worked with PNL to finalize the UIT requirements document and develop a draft test plan for analyzing the UIT system. BDM contacted Morton Thiokol for cost and lead time estimates for missile skirt materials. This material would be required for UIT testing. BDM also worked with PNL to acquire a laboratory prototype UIT system for testing to determine the viability of the concept. During this period, BDM also explored sources of COTS ultrasonic imaging hardware for potential use in an industrial prototype grade UIT system. BDM contacted OUSD(P)/DTSA regarding UIT system exportability. BDM learned that these COTS system components and software were "acceptable for use in this project from a technology security and exportability viewpoint."

BDM continued preparation for DT&E by acquiring samples of various missile skirt materials from Morton Thiokol (BDM also sent some skirt material to ANL for adversarial analysis) and completed the automated experimental data acquisition system software and hardware. Tag alignment jigs were fabricated for use in the test trials and techniques for data transfer, processing, and analysis were developed and tested. BDM also contracted for the fabrication of five couplant cassette molds and had them filled with AQUAFLEX couplant.

On June 17, 1991, TI FY90-05 was closed and the UIT assessment work was continued under TI FY91-14.

The UIT laboratory prototype system sent by PNL to BDM in early May 1991 was damaged in shipment. It was shipped back to PNL for repair and returned to BDM in mid-June 1991. Since this caused a delay in the start of testing, BDM modified the UIT test plan to account for the shorter test period, and briefed DNA about the changes. Baseline readings on the system were completed by June 24, 1991.

The UIT laboratory prototype Functional Test was then conducted with the final trial being completed on September 12, 1991. During BDM's review of the test data, and subsequent statistical analysis, an error was discovered in the algorithm that establishes the initial portion of the reflected ultrasonic waveform. PNL provided BDM with a correction to the software. DNA authorized BDM to reprocess five of the nine test trials using the corrected algorithm. A preliminary technical evaluation of the UIT laboratory prototype system was delivered to FCDNA on September 19, 1991.

Dr. Hal Udem, PNL, wrote a letter to Dr. Jim Fuller, HQDOE, on October 1, 1991, recommending "...the temporary hold, or even archival, of a hardware (UIT industrialization) development program." Based upon this recommendation and BDM's preliminary assessment of the UIT laboratory prototype system, DNA decided not to continue with the UIT industrialization design and development as specified in the UIT Transition Plan.

On November 4, 1991, BDM was briefed by Dr. Alex Devolpi, ANL on their UIT adversarial analysis report. On November 18, 1991, BDM sent PNL three

optical disks containing all UIT a-scan signatures, and c-scan extractions acquired during the functional test, along with Macintosh computer files containing the formulas, calculations and formats used in the statistical analysis. BDM returned the UIT laboratory prototype system to PNL on December 6, 1991. Statistical analysis of the reprocessed data was completed and preliminary results were sent to PNL on January 7, 1992.

The draft UIT Laboratory Prototype Functional Test Report was completed on January 15, 1992. BDM personnel traveled to PNL on February 6, 1992, to brief them on test results and receive their comments on the report. PNL's formal comments on the report were received in early April 1992, and the final report was published and delivered to DNA on April 16, 1992.

3.3.5 Results.

This section provides the technical information associated with the activities discussed in the previous section. The functional testing, the analysis, the results, and the subsequent decisions made after the test are described in the following sections.

3.3.5.1 Functional Test and Evaluation Structure. The UIT laboratory prototype FT&E was structured to achieve the test objectives. The objectives are shown in table 3-5 and are mapped to specific test trials. The trials were developed to assess the specific performance and sensitivities of the UIT system. They were designed to determine the extent to which each of several variables influenced the UIT signature. Each trial was designed to achieve specific objectives by controlling test conditions as much as possible, and adjusting only those test variables necessary to complete the trial.

Due to the focus on the START treaty, graphite-epoxy and fiberglass-epoxy samples from U.S. strategic assets were obtained for use during the trials. These test samples were cut into 1' x 1' sections by the manufacturer (Morton Thiokol). Each section was classified as a unique tag. As shown in the above table, these tag samples were subjected to rigorous environmental testing, even though the UIT system was not. The system was not designed to withstand the temperature and humidity variations specified in the Tagging Systems Requirements

Document. Engineering judgement was used to assess the feasibility of upgrading the UIT laboratory prototype system to meet the required environmental specifications.

Table 3-5. Test trial descriptions for the UIT FT&E program.

TRIAL DESCRIPTION	OBJECTIVES	VARIABLES
1. Baseline Acquisition	<ol style="list-style-type: none"> 1. Test UT3000 system 2. Test AEDAS and data processing systems 3. Train operators 4. Prepare samples 5. Develop fiducial techniques 6. Check samples for "reasonableness" 7. Establish minimum warm-up time 8. Acquire "baseline signatures" for future correlations 	Repeated baseline signatures
2. System Noise and Calibration	<ol style="list-style-type: none"> 1. Quantify variations of Mean Square Difference (MSD) values without reader head movement 2. Quantify variations of MSD values of system calibration between tag readings 	Multiple calibrate/signature readings over many test samples
3. Operator Variability	Determine variability in MSD values as a function of operator	Multiple Operators
4. Equipment Variability	Determine variability of MSD values between UIT systems	Multiple UIT systems
5. Scanner Placement	<ol style="list-style-type: none"> 1. Determine the effect of placement inaccuracy – both x-y and angular displacements from nominal "zero" position 2. Provide input to evaluate position correction algorithms 	x, y, and θ displacements of the scanner head
6. Tag Temperature	Determine stability of MSD as a function of temperature	Vary temperature of the sample
7. Tag Humidity	Determine stability of MSD as a function of humidity to which the sample is exposed	Vary relative humidity of the sample
8. Compressive Loads	Signature stability as tag loading conditions are varied	Vary tag loading conditions
9. Baseline Reacquisition	Determine change in baseline for all samples	Change in Baseline signatures vs time

In addition to the functional test trials, the UIT system software underwent a V&V that involved static and dynamic analysis. The software V&V effort focused specifically on the system performance, both operationally and computationally.

To support the acquisition of the test environmental conditions and allow off-line analysis of the UIT signature data, BDM developed an Automated Experiment Data Acquisition System (AEDAS). AEDAS recorded information such as operator identification, time, date, trial identification, etc., along with the environmental conditions for each trial. This information was, in turn, used during the statistical analysis to differentiate between the various test conditions that could have an effect on the signature stability.

3.3.5.2 Functional Test and Evaluation Summary. The UIT laboratory prototype system proved effective as a proof-of-concept system. The system operated extremely well from a reliability standpoint and the issues relating to the reader alignment sensitivity and system fieldability can be addressed with additional engineering. The problems associated with the "solid water" couplant cartridge might also be resolved with additional engineering and chemistry; however, these are more significant than alignment and ruggedization. The most difficult problems are those associated with the unknown long-term signature stability and material sensitivity. A potentially lengthy test effort would have to be undertaken to address the issue of signature stability under long-term environmental exposure. These tests will have to be conducted on each composite material to be tagged, and "customizing" of each UIT system may be necessary to tag a broad spectrum of material types. Given the limited number of weapon systems with exposed composite materials, undertaking such a development and test program, with the potential for limited success, may not be appropriate at this time.

3.3.5.3 Functional Test and Evaluation Conclusions. The signatures acquired on the fiberglass-epoxy and graphite-epoxy samples during the functional testing appeared to have unique characteristics. This conclusion is supported by the signature data acquired during the Baseline Acquisition Trial, where the environmental conditions and other variables that could affect the signature repeatability were minimized. The separation between the like and unlike

distributions for this trial suggest a relatively low probability of misclassifying an *unlike* tag as a *like* tag.

In assessing the repeatability of the UIT signatures throughout all the functional test trials, a statistical sampling of UIT images suggested the probability of falsely classifying unlike tags as like tags, was low. The opposite scenario, however, was not always true. During some of the trials, the like tag comparison values did approach, and in some cases even overlap, into the distribution of the unlike tag comparisons. This means that the rejection of a valid UIT signature is possible with the present UIT laboratory prototype design, and therefore, was determined to be unacceptable as a tagging concept in its present form. The UIT concept was withdrawn by DOE for further consideration as a Tagging System.

Analyses of the simulated operational scenario test trials indicated the repeatability of the signature was affected by two dominant factors. These are the varying capability of different operators and the accuracy with which they can position the reader head on the tag area. These affects were most pronounced on the fiberglass-epoxy samples. The signatures acquired on the graphite-epoxy samples were more repeatable throughout the test trials than those acquired on the fiberglass-epoxy samples. This suggests a material sensitivity and that all material types to be tagged will require separate signature evaluation.

Overall, the UIT laboratory prototype system was well engineered and operated without any major failures throughout the UIT FT&E. Ruggedizing the system to meet the environmental specifications will require the addition of environmental control systems and shock isolation equipment. Without a major redesign, ruggedizing the present setup will significantly increase an already bulky system. Additional engineering will need to be focused on the "solid water" couplant cartridges. The present design is limited to operating temperatures above freezing and requires a clean working environment to install the cartridge into the reader head. The reader head is the most fragile subassembly of the UIT system and will require ruggedizing to assure accurate and repeatable scanning operation in a field environment.

The software used to perform hardware control and establish the operator interface was well written and functioned very reliably. It allowed for easy quality control checking of the UIT signature during and immediately following the acquisition of a "tag" signature, and provided adequate feedback to the system operator as to the status of all critical systems throughout the signature acquisition procedure. In addition, the UIT software was reasonably documented and not difficult for an experienced C-programmer to interpret.

Acquisition and processing of a UIT signature was reasonably efficient given the size of the signature files being read. The actual scanning operation took approximately 30 seconds with the entire signature acquisition and correlation procedure requiring approximately 10 minutes to perform.

The most significant potential disadvantage in the UIT composites concept is the stability of the ultrasonic signature is unknown over an extended period of time and under varying environmental conditions. Also, the specific ultrasonic characteristics of composite materials vary from one material type to another, further complicating attempts to globally address the signature stability issue.

The UIT system cannot penetrate energy absorbing materials such as cork or Environmental Protection Material (EPM), which serve as a protective covering over most of the composite materials used on U.S. missiles. This limits the locations where UIT signatures can be acquired without removing the EPM, especially when the TLIs are read in canisters.

3.3.5.4 Final Status/Availability. Based upon the recommendation of PNL's Dr. Hal Udem and BDM's preliminary assessment of the UIT laboratory prototype system, DNA decided not to continue with the UIT industrialization design and development portion of the UIT Transition Plan. The UIT laboratory prototype system has been archived at PNL, and DNA has requested that no changes be made to it without their approval. However, findings documented in ANL's adversarial analysis report, and BDM's Functional Test Report, along with additional insight gained at PNL while adversarial analysis and functional testing were being conducted, should provide a firm basis for continuing the industrialization process when and if DNA should decide there is a requirement for the system.

3.4 PYTHON SYSTEM.

3.4.1 Overview.

DNA authorized two phases of effort for the Python system being developed by SNL. In July 1990 BDM was tasked, through TI FY90-08, to provide a feasibility assessment for the Python Seal. DNA asked for a loop seal design comparison analysis. The SNL development plan was also to be assessed for possible improvement suggestions. This was accomplished and completed in October 1990, and a final report for the effort was written. The next phase of activity was requested under TI FY91-14 in May 1991. At that time, BDM was to continue monitoring the SNL Python development effort and make periodic progress reports to DNA.

3.4.1.1 Documentation Produced. During the first phase of Python assessment, the final classified report, "Python Seal Concept Feasibility Assessment (U)," was prepared and delivered to DNA in November 1990. The second phase effort did not produce a document but was reported in the Bimonthly Progress Report (CDRL 1) for July, September, and November 1991 and January and March 1992.

3.4.1.2 Expenditures. The Python system assessment effort under FY90-08 began in July 1990 and was completed when the final report was delivered in October, 1990. The corresponding starting and ending dates for the second phase under FY91-14, are May 1991 and March 1992. The following table (table 3-6) lists the labor hours, the associated loaded labor costs (without fee and tax) plus the ODC's expended during the conduct of the Python assessment.

Table 3-6. Python system expenditures

TI	Hours	Loaded Labor Costs	ODC's	Total Costs
FY90-08	1,347	\$103,222	\$3,292	\$106,514
FY91-14	214	\$19,068	\$115	\$19,183
Total	1,561	\$122,290	\$3,407	\$125,697

3.4.2 Schedule.

BDM's original schedule for the first phase of Python work was three months in duration, July 1990 through October 1990. This time frame was not ideal since SNL was still designing Python and LANL was conducting the adversarial analysis. During the early months of 1991, SNL planned to develop the Python Seal to the laboratory prototype stage by October 1991. This is what prompted the May 1991 through March 1992 time window for phase two of BDM's effort. The status and results on the Python task were to be reported in the Bimonthly Progress Report delivered to DNA.

3.4.3 System Description.

The following design information for the Python Seal documents the existing Python Seal information when BDM was performing the feasibility assessment. It is based on SNL's preliminary Python Seal design and their published Python Development Plan. SNL provided information primarily through conversations. At the time of these discussions, the Python development effort was in its initial stages and many of the ideas for the seal did not have the benefit of development testing or analysis. Development testing and design analysis will cause the design of the Python to take new directions, so this information represents the Python status at the time the study was conducted. For example, the seal described in this report has a rectangular seal body, subsequent to BDM's assessments, the body was changed. It now has a cylindrical configuration.

The fiber optic Python Seal uses existing fiber optic seal technology as the foundation for its development. It is illustrated in figure 3-14. It consists of a fiber optic cable, a seal body with multiple signature features, and a reader/verifier to read and record those signatures. As with other fiber optic seals, light is used to test the continuity of the cable. The Python Seal design has 64 plastic fibers in a single cable. When the seal is installed, a knife blade is inserted into the seal body and cuts several of the fibers. Randomness is achieved by the way the 64 fibers lay in the cable bundle (a manufacturing parameter). To read the seal signature, light is injected into one end of the cable, illuminating all fibers simultaneously. The relative positions of the fibers and the intensity of the light at the other end of

the cable are viewed and recorded. The recorded pattern is compared with a baseline pattern recorded during installation of the seal. Relative light intensity, position, and aberrations at the ends of the fibers constitute the fiber optic signature of the seal. In addition to this signature, an RP signature is attached to the end of the seal body.

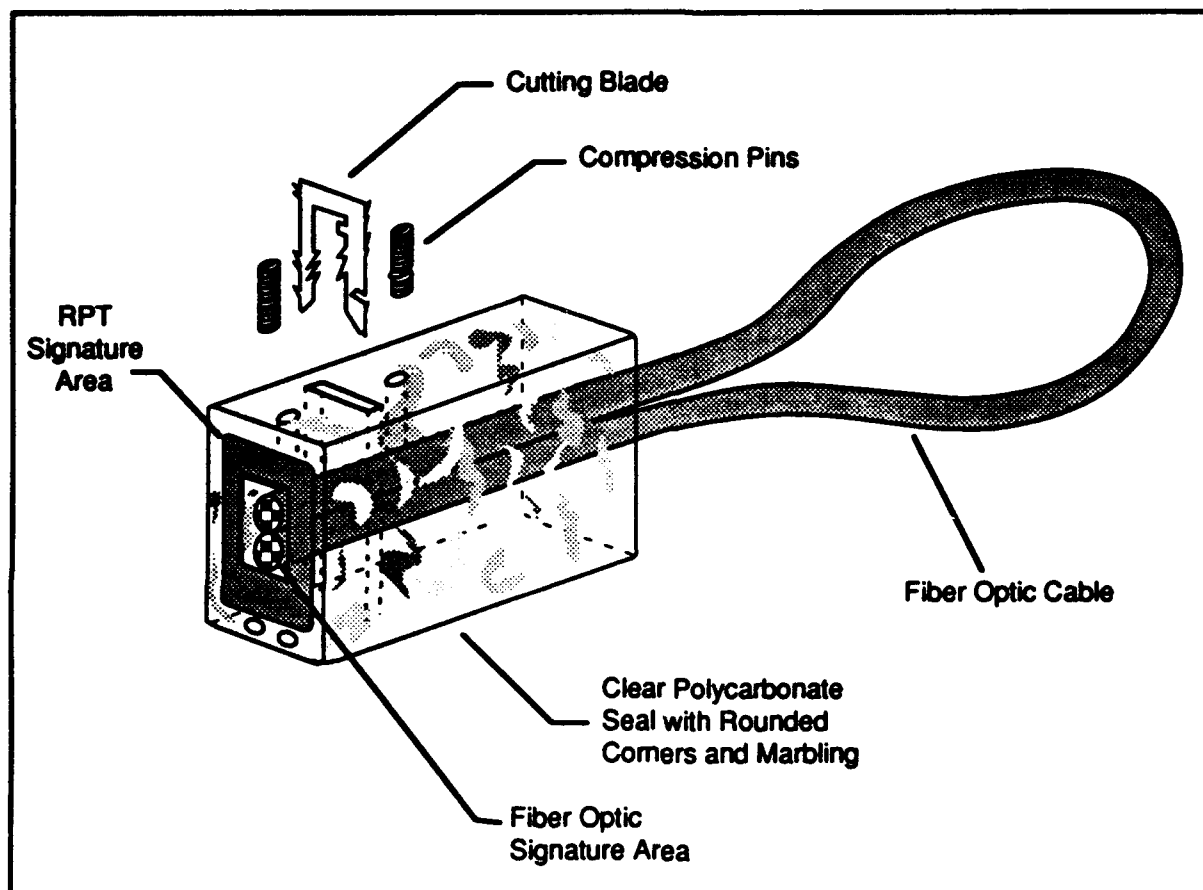

Figure 3-14. Python Seal.

3.4.3.1 Python Fiber Optic Cable. Unlike existing fiber optic seals, the cable for the Python Seal will be manufactured "privately." That is, the cable will be manufactured with a special process and be available only to the U.S. Government for the purposes of assembling Python Seals. Should this seal be used in a treaty context, issues of reciprocity must be addressed. Current fiber optic seals use commercially-manufactured cable that is available to the general public. The Python cable's special process will assure that the fibers in the cable do not stay in the same relative positions along the length of the cable. This will

complicate the task of the adversary who wishes to cut and splice the cable to defeat it. The cable will have a transparent sheath, which will allow the inspector to visually inspect the length of the fiber cable. Transparent sheathing will make splices easier to detect. Figure 3-15 illustrates the Python Seal's fiber optic cable design.

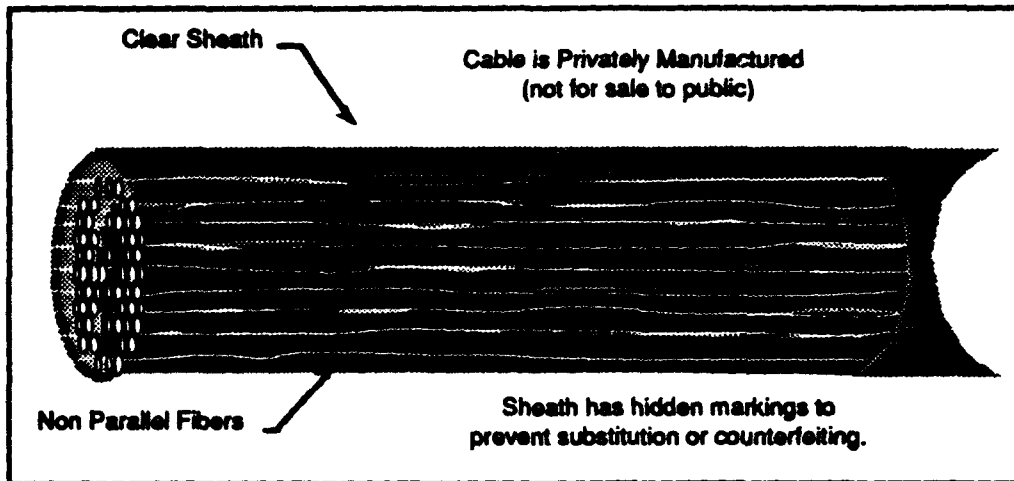

Figure 3-15. Python seal fiber optic cable.

SNL assumes that the seal will be accessible at inspections, allowing inspection of the entire cable. If the Python Seal is used in an application where it will not be fully visible, the seal will be removed and a new seal installed. The removed seal is then inspected on-site and returned to the laboratory for analysis.

Other features that were being considered for the Python Seal cable design included:

- (1) Marking the cable sheath with a concealed unique code that would be read by a simple reader, making it difficult to replace the sheath with a counterfeit
- (2) Reducing the diameter of the fibers to 100 μm and increasing the number of fibers, complicating the cutting and splicing task of the adversary.

These features would improve Python's tamper detection and tamper resistance qualities.

3.4.3.2 Python Seal Body. The seal is formed by terminating the two ends of the fiber optic cable in the seal body, which prevents the seal from being easily removed, provides a fixture for holding the cable, and provides a location for reading the seal signature. The ends of the cable are sheared flush with the end of the seal body after the compression pins are installed and the cutting blade is driven into the cable. The reader head mates to the end of the seal body and reads the signature after installation.

In addition to the signature provided by the cut fiber optic fibers, an RP will be attached to the end of the seal body to provide a seal body unique signature. The RPT is a tagging concept currently under development by SNL for DOE. The RPT system consists of reflective particles, randomly distributed in a clear plastic material that will be attached to the end of the seal body and capable of being read by the reader/verifier system. The RPT tag material is a mixture of a clear plastic matrix material and micaceous hematite particles that are randomly shaped and multifaceted. When these materials are applied to a surface and illuminated with a light source, a unique random pattern is created. As the material is illuminated from different angles, different patterns are created. Figure 3-16 illustrates the end of the Python Seal body with the two signature areas. The RPT tag reader consists of a fixed number of light sources and video cameras for alignment and reading the signature of the tag.

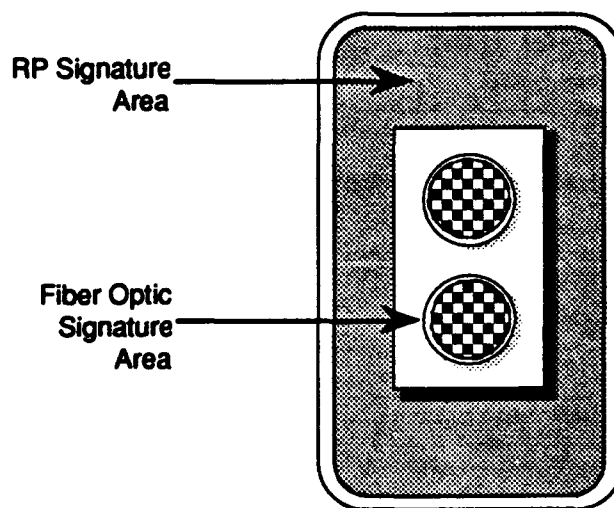

Figure 3-16. Python seal RP and fiber optic signature areas.

3.4.3.3 Python Reader/Verifier. The design of the Python Seal's reader/verifier was still evolving as the report for the assessment was being written. A computer-based reader/verifier was to be used to compare and analyze the signature using image processing techniques and off-the-shelf hardware. A belt pack size unit with an umbilical head to connect to the seal was planned. Both the signature of the partially cut fiber optic cable and the RP signature were to be read simultaneously using a windowing scheme to separate the two images.

In addition to the computer-based reader/verifier, a simple Polaroid camera scheme was also to be developed as part of the Python development plan to allow easy reading of the Python Seal in less stressing applications than the treaty verification environment.

3.4.4 Activity Description.

The primary activities performed by BDM were contacts with SNL personnel, either in person or by telephone to get information about the latest developments in the Python Seal design. In support of the comparison requested by DNA, STAR FOT documentation was reviewed. Since neither the Python or STAR seals were developed, the comparison was made using engineering judgement and the available design documentation as it existed in late 1990. The conclusions were discussed and reviewed with DNA personnel and informally reviewed by SNL.

3.4.5 Results.

The results of BDM's Python feasibility assessment and subsequent monitoring of development status are best described in the BDM report, "Python Seal Concept Feasibility Assessment (U)." The following paragraphs summarize the contents of that document.

Sandia National Laboratories was tasked by DOE to develop a new fiber optic seal. Previous fiber optic seal development work at SNL concentrated on applications where the adversary was unsophisticated and the assets being sealed were not as important as intercontinental ballistic missiles. The need to effectively apply tags and seals to these valuable items imposes special

requirements on the seal design. The fact that national assets of countries could be brought to bear for long periods of time to defeat the seals, compounds an already difficult problem. SNL wrote a plan for the development of a new seal, called the Python Seal. BDM was tasked by DNA to review and assess the feasibility of this plan and to compare the performance of the Python Seal with the STAR FOT. In addition, BDM was tasked to evaluate SNL's development plan and to discuss areas of BDM participation in this development.

3.4.5.1 Feasibility. BDM adopted practicality, suitability, and soundness of approach as a way to address the feasibility of the Python concept. The practicality of the Python design concerns the effort required to develop it. If the concept requires advances in the state-of-the-art and the investment of enormous resources it would not be a practical design. BDM's assessment indicates there is nothing in the suggested design that was beyond the current state-of-the-art for fiber optic cables nor does the design call for excessive development effort or unrealistic manufacturing techniques.

A question can be raised, however, about the need for the RP signature feature. Currently, no quantitative analyses or test results exist to qualify or disqualify the fiber optic signature alone as a sufficient signature. BDM recommends that the fiber optic seal signature be investigated for uniqueness and counterfeitability prior to the finalization of the design of the Python system.

The Python Seal's suitability for its intended application was the second feature of feasibility. This feature addressed the usefulness of the design for its intended application.

The last aspect of feasibility was the soundness of the approach adopted by SNL. BDM recommends that a more structured engineering approach be taken to the development of the Python. This would include addressing the DNA developed requirements document and a structured design review process. To define the signature requirements, early testing would be useful.

3.4.5.2 Comparison of Python to STAR. The second part of BDM's task was to evaluate the relative merits of the Python design relative to the STAR FOT design. With the limited design information available, the comparisons performed

showed the Python Seal design to be superior to the STAR FOT design. For this comparison, BDM developed required attributes for fiber optic seals and used these attributes to evaluate the two seal designs under consideration. These attributes are performance parameters which can be rated and were developed from general seal and tag requirements. Since neither of the seals were available as a working prototype, the actual performance could not be measured and evaluated. Based on the design information available, engineering judgement was used to project an anticipated performance in each category for each seal. The attributes and the ratings of the two seals are shown in table 3-7. The Python Seal is expected to outperform the STAR FOT in 8 of 10 categories where a difference could be estimated.

The ratings were defined as follows: a plus (+) is assigned if a seal's expected performance in the category was judged to be fully acceptable. A zero (0) is assigned if the performance was judged to be adequate. A minus (-) is assigned if the expected performance of the seal in that category was judged to be inadequate. In areas where testing is needed or insufficient information exists to support a judgment, no rating (NR) was assigned.

3.4.5.3 Development Plan. There are several features of an engineering development effort that should be included in the SNL Python Seal Development Plan to establish an efficient and focused program. Specifically:

- (1) Use the DNA requirements document to guide the system designers.
- (2) Develop appropriate fiber optic signature reading approaches and test the fiber optic seal signature to establish its uniqueness and counterfeit resistance, and determine the need for an RP signature feature. It may be that the fiber optics alone can provide a unique signature. These tests should be conducted without delay and prior to further development of the RP feature.
- (3) Coordinate the design of the reader/verifier to maximize use of the data from the signature tests.
- (4) Use a structured design review process to assure that the Python design meets requirements.

Table 3-7. Python/STAR FOT comparison summary.

	Python	STAR
Security-Related Attributes		
Uniqueness of Signature *	+	NR
Signature Repeatability	+	-
Tamper Resistance/Detection	+	-
Counterfeit Resistance	+	0
Operational/Environmental-Related Attributes		
Durability	+	-
Compatibility with TLI	+	NR
Ease of Operation	0	0
Environmental/Interface Requirements	NR	NR
Field Assembly	+	-
Field Validation	+	+
System Readiness/Reliability/Maintainability	NR	NR
Portability	+	0
Other Attributes		
Technology Transfer	+	-
Producibility	+	-
Cost	NR	NR

* Statistical analysis on uniqueness not performed

Additional comments that can be made on the development of the Python are:

- (1) The scope of BDM's effort under this task was to assess the feasibility of the Python Seal. However, in addition to the Python, the Government is developing the STAR FOT for treaty verification applications. These development efforts are currently independent. Although an independent development process was effective for certain purposes, efficient use of resources demand that the efforts be coordinated to a certain extent and that eventually one design be selected and produced.

At present, no such plan exists. BDM strongly recommends that an appropriate plan be written to coordinate the two efforts, and that at an appropriate time a decision be made to develop and produce one seal.

- (2) Depending upon the application, and if appropriate treaty language exists, the Python Seal lends itself to early deployment. If an inspector has the option of taking the replacing the seal and taking the removed seal to the laboratory for inspection to detect signature and tampering, then the existing Python design should provide adequate security and could be deployed now. Improvements to Python could be included in a planned product improvement program.
- (3) Pursuant to #2 above, the Python development could easily be broken into two phases. The first phase could be accomplished in a few months and could incorporate the tamper detection features planned for the seal body and cable. The second phase would include the RP feature and its reader/verifier, and would take longer.
- (4) The Python development was currently not a high priority at SNL. The one-year plus development planned for the Python could be met with the application of increased resources.
- (5) BDM could assist in all phases of the development of the Python. Preliminary discussions with SNL indicated that SNL would like BDM's support in the latter stages of development of the seal, in areas such as manufacturability assessments, transition planning, and producibility and manufacturability design. However, due to BDM's expertise, facilities, and proximity to SNL, BDM could assist in all phases of development.

3.5 ACOUSTIC RESONANCE SPECTROSCOPY.

3.5.1 Overview.

Acoustic Resonance Spectroscopy (ARS) is a non-destructive evaluation technique developed by Los Alamos National Laboratory (LANL) that uses the various modes of natural vibrations of any solid object to determine the object's acoustic signature. In the ARS system, a simple broadband acoustic transducer (even an audio speaker) is used to sweep through a range of frequencies, from low to high, to excite the characteristic resonant frequencies of an object. A second transducer in contact with the object picks up these minute mechanical vibrations. This signal is amplified many orders of magnitude and is processed by a portable personal computer.

BDM assessed the potential of ARS as a verification tool in four stages that included:

- (1) Examination of the system's basic physics and engineering concepts
- (2) The application of finite element analysis methods to analyze the response signatures of a simple structural model
- (3) Laboratory readings of samples of missile motor bottle construction materials
- (4) Field readings of Minuteman II and III stages, and complete missiles.

BDM concluded that the ARS concept demonstrated potential for use in verification. However, additional development work and analysis was needed to improve signature repeatability and to determine the most appropriate signature correlation algorithm. This work is now underway at LANL.

3.5.1.1 Documentation Produced. The following documents were delivered to DNA in conjunction with the ARS assessment. All documents were unclassified.

- (1) "System Description for the Los Alamos National Laboratory (LANL) Acoustic Resonance Spectroscopy (ARS) System," October 7, 1991

- (2) "Acoustic Resonance System (ARS) Assessment Modeling and Simulation Results - Interim Report," February 5, 1992
- (3) "Plan for Acoustic Resonance System (ARS) Measurements at Hill Air Force Base, Utah," July 2, 1992
- (4) "Acoustic Resonance Spectroscopy (ARS) Assessment Report (Final)," January 31, 1993.

3.5.1.2 **Expenditures.** The ARS assessment effort began on July 29, 1991 and was completed in January 1993 with the publication of the final assessment report. Table 3-8 lists the labor hours, the associated loaded labor costs (without fee and tax) plus the ODC's expended during the conduct of the ARS assessment.

Table 3-8. ARS system expenditures.

TI	Hours	Loaded Labor Costs	ODC's	Total Costs
FY91-13	5,457	\$449,587	\$6,312	\$455,899

3.5.2 Schedule.

Figure 3-17 depicts the schedule of activities that were performed during the ARS assessments efforts under TI FY91-13.

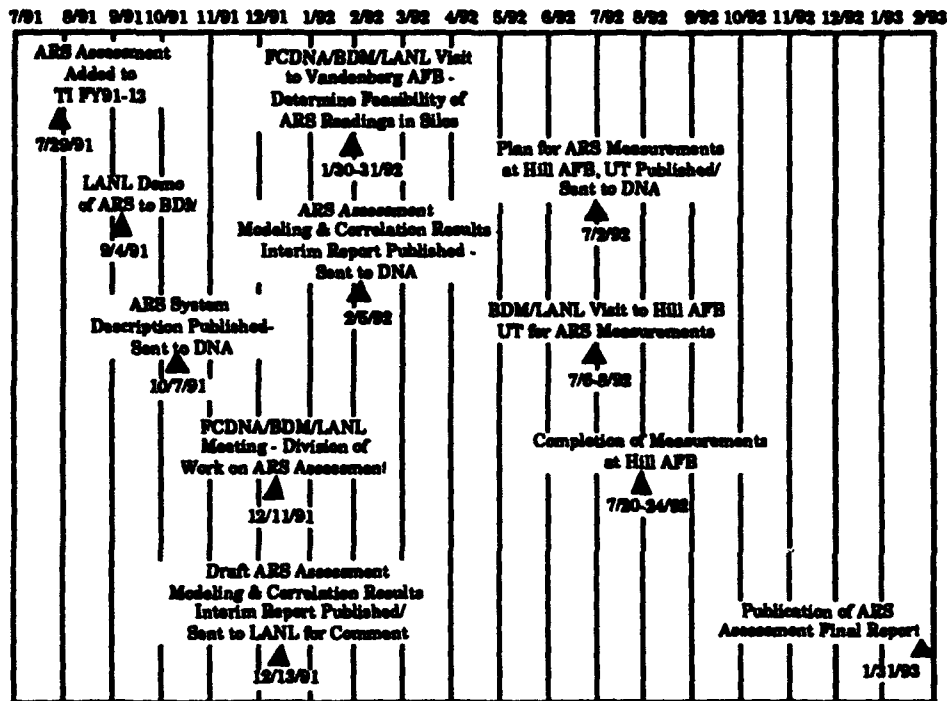

Figure 3-17. ARS schedule of activities.

3.5.3 System Description.

The basic system is simple in concept. That is, an object is excited acoustically with a swept, continuous wave signal varying from 2 to 100 kHz (typically, most of the useful information has been present at 30 kHz or less), and a monitoring transducer measures the object's resonances as a function of frequency. The output of the monitoring transducer is processed with a PC, resulting in a frequency domain display. The ARS equipment is in the laboratory prototype stage of development. Modifications and improvements have been made to various components of the system and the procedures for its use; however, the system concept remains the same.

The actual engineering of this concept involves some degree of complexity and has evolved through various stages. The first unit built is illustrated in Figure 3-18. This is a "broadband" unit in that the buffer plus signal amplifier is not band-limited within the total frequency range of interest. This means that the unit is sensitive to noise, and consequently, does not have a large dynamic range. The transducers used are piezoelectric crystals supplied by Valpey-Fisher (PZT-5A). They are packaged at LANL in either 1" or 1/2" diameter containers that can magnetically attach to the device under test (DUT). One of the transducers is fed by a driver and vibrates on the surface of the DUT while the other acts as a pick-up that outputs an electrical signal proportional to the amplitude of the vibration.

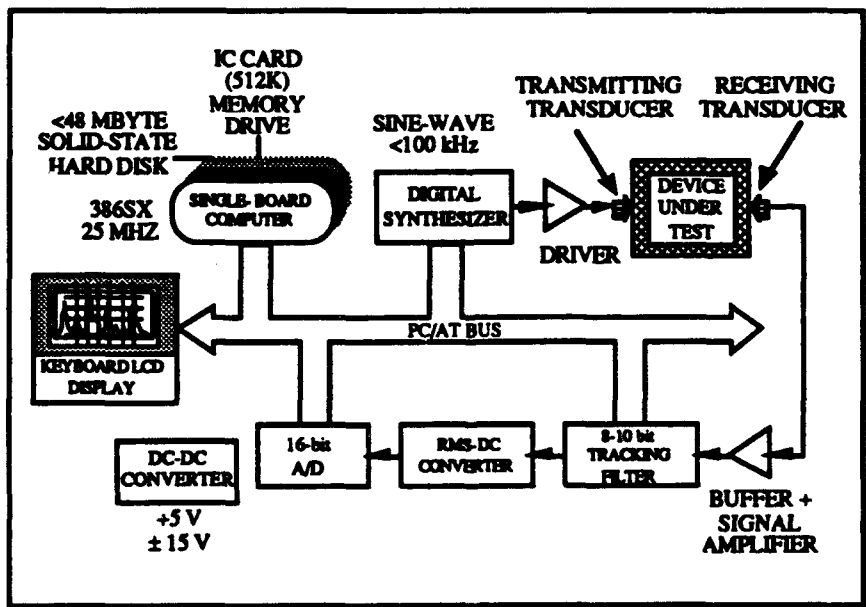

Figure 3-18. Wideband acoustic resonance spectroscopy system - generic concept.

Figures 3-19 and 3-20 show modifications to the basic system. Figure 3-19 shows a heterodyned system that allows the actual processing of the DUT resonance information to be performed at 1 kHz. This serves to reduce the noise floor of the system by narrowing the bandwidth of the signal while retaining the vibrational amplitude information. That is, if spurious noise occurs, it would have to be in the 1 kHz bandwidth at the particular frequency being monitored at the time. Thus, the chances of a resonance being monitored at a particular frequency, while a spurious noise source at the same frequency is present, is significantly reduced.

Figure 3-20 represents a further refinement of the noise reduction technique in that the effective bandwidth of the processed data is further reduced to 10 Hz. This is accomplished by chirping the oscillator output at the 10 Hz frequency, mixing the output from the receiving transducer with the original signal, and low pass filtering the mixed signal to retrieve the resonant amplitude data at 10 Hz as opposed to the driving frequency. This is called a homodyne technique. This allows an effective signal-to-noise ratio of 80 to 90 dB to be achieved. Note also that the original input signal is phase shifted by 90° to provide a cosine that is mixed with the output signal. This allows the phase to be calculated by comparing the output amplitude signal (normalized) to the phase shifted signal. The amplitude of the resultant signal is proportional to the phase shift and can be calculated with the PC. This allows time domain representations of the output to be formulated, if so desired.

LANL has combined each of these techniques into one package. Each technique has its advantage, ranging from broadband capability to enhanced dynamic range. Additionally, the total system can interface to any compatible PC, including a laptop PC, via an RS-232 bus. This makes an extremely compact system that is easily portable. Additionally, the power requirements are on the order of 5 watts, discounting the display screen.

Additional work has been accomplished in creating a receiver transducer using fiber optics. This receiver allows the DUT response to be monitored without actually touching the object. It can be placed from 1 mm to 2.5 cm off the object's surface and resolve surface movements down to 10 Angstroms in amplitude. This, coupled with the fact that the transmitting transducer can be a broadband

speaker (as was demonstrated in the Tooele chemical weapon and Minuteman testing), allows a DUT to be scanned without actually contacting the surface.

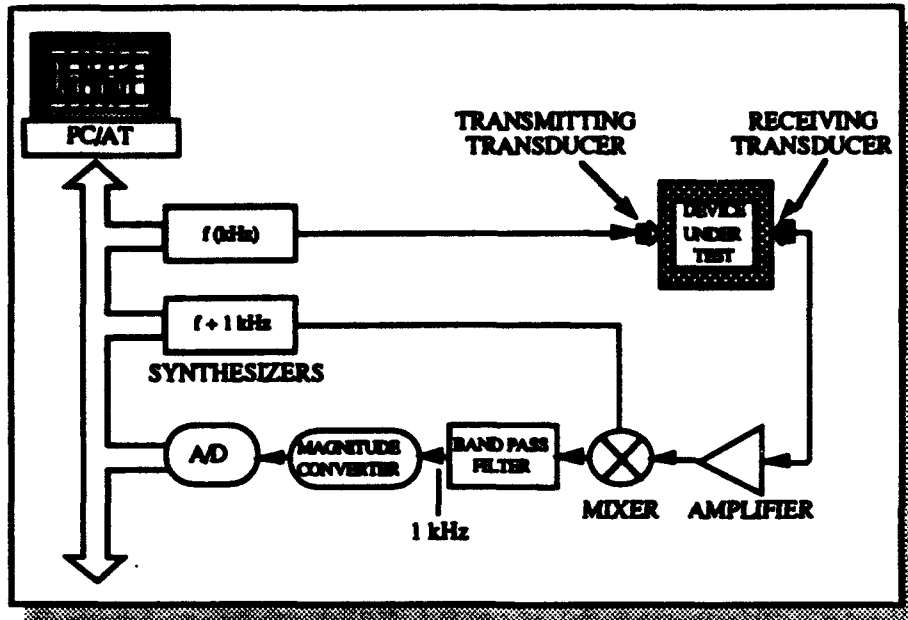

Figure 3-19. Heterodyne acoustical resonance setup.

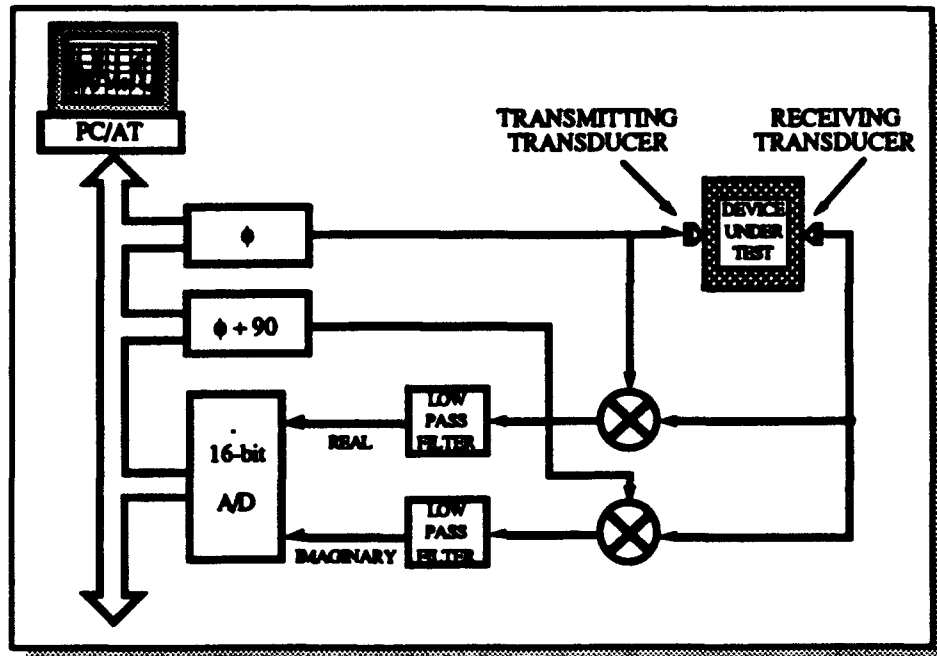

Figure 3-20. Homodyne acoustical resonance setup.

One other key point in the system operation is the scan time. Currently it is 10 seconds or less. This includes the calculation time required to provide the frequency domain display.

It must be noted that when making repeatability measurements, the absolute amplitude of the frequency spectra can vary. However, the relative amplitude of the resonant peaks remains the same. It is, therefore, necessary to normalize the individual outputs to the maximum peak level. When this is done, spectra essentially overlay. A typical output display from the system is represented in figure 3-21.

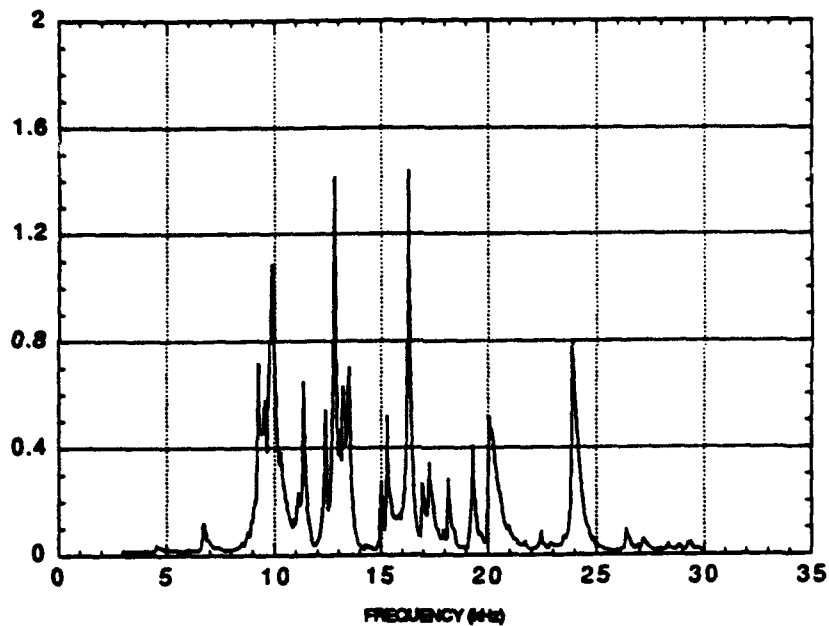

Figure 3-21. Typical resonant frequency response.

Figure 3-22 shows the overlay of four different objects that are essentially identical. Note that the general structure of each overlaid plot is basically the same, but there are minor differences that appear above the noise floor. This indicates that it is possible to categorize objects and perhaps to tell the difference between ostensibly identical objects. These objects were rather small (less than a meter in height and approximately .1 meter in diameter). Localized resonances may be observed on large objects that may offer easily detectable differences in the frequency spectra. Currently, LANL is working on statistical correlation techniques for determining whether or not any given two objects are identical.

Figure 3-23 shows the results of looking at three different objects similar to those in figure 3-22. The major difference here is that each of the objects is filled with a different substance. Two of the substances were very similar in mechanical properties, yet major differences can clearly be seen. This indicates great promise for being able to use this technique for differentiating between objects that are very similar in nature, but that have minor differences in structure.

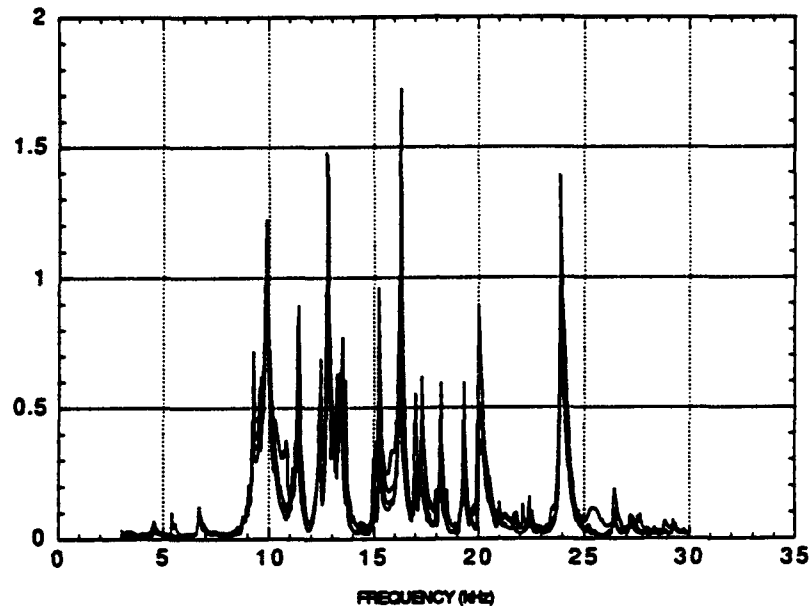

Figure 3-22. Overlay of the resonance signatures of four "identically" manufactured "small" items.

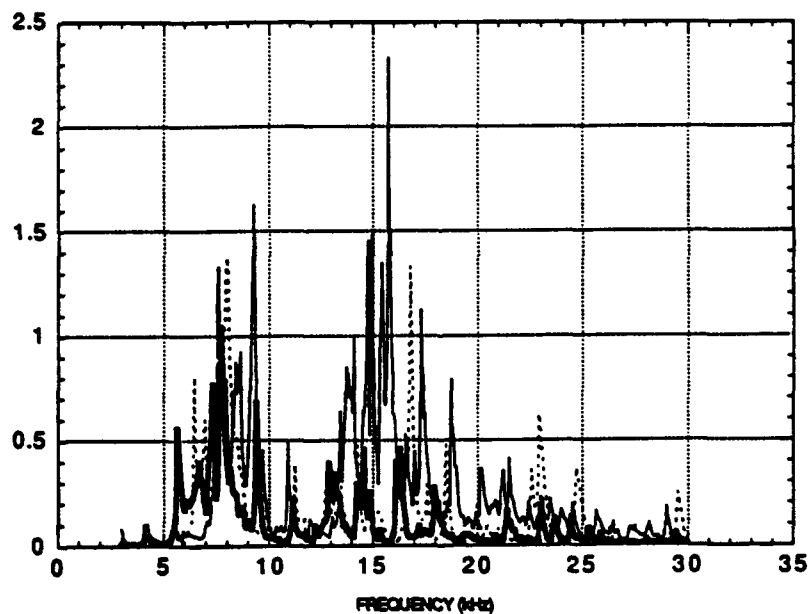

Figure 23. Overlay of the resonance signatures of three "identically" manufactured "small" objects filled with different substances.

3.5.4 Activity Description.

The activities described in the following paragraphs are essentially in chronological order and represent a concise, but complete summary of the work performed by BDM during the ARS assessment. Contractual information is also provided where appropriate.

On July 29, 1991, DNA tasked BDM to assess ARS for its potential use as a tag in treaty verification. The program developed by BDM for this assessment involved four phases:

- (1) An examination of the basic physics and engineering concepts (Phase I)
- (2) Analysis of ARS spectra behavior and signature correlation (Phase II)
- (3) Laboratory readings of various materials associated with weapon system construction (Phase III)
- (4) Field readings of weapon systems (Phase IV).

3.5.4.1 Phase I. Using technical information provided by LANL, BDM examined the ARS system's basic physics and engineering concepts and published a system description. The system description was coordinated with LANL prior to being published as the "System Description for the Los Alamos National Laboratory (LANL) Acoustic Resonance Spectroscopy (ARS) System," on October 7, 1991.

3.5.4.2 Phase II. In this phase, BDM conducted preliminary analyses of ARS signal characteristics and signature correlation approaches using modeling and statistical techniques. Dynamic finite element analysis methods were used to analyze the response signature of a simple structural model. In addition, two correlation algorithms were developed as ways of quantifying the differences (or similarities) of two given ARS signatures. The two methods used were the Pearson correlation coefficient, and a "peak-by-peak" method based upon comparison of the frequencies at which individual spectral peaks occurred. The results of these analyses were published as the "Acoustic Resonance System (ARS) Assessment Modeling and Simulation Results - Interim Report," on February 5, 1992.

3.5.4.3 Phase III. During this phase, laboratory readings of samples of representative composite and metallic weapon system construction materials were conducted jointly with LANL. Analysis of the spectra was conducted independently by both BDM and LANL. Data from these readings were used to validate models, identify any additional data needed prior to conducting field measurements, refine signature correlation techniques, and modify the field measurement plan taking into account signal characteristics that became evident during laboratory measurements.

3.5.4.4 Phase IV. In this phase a team of BDM and LANL personnel made ARS field readings at Hill AFB, Utah on training missiles installed in test launch facilities and on Minuteman (MM) II and III operational stages and assembled missiles in storage. This final stage of the assessment process had the following objectives:

- (1) To determine if ARS measurement signatures are repeatable
- (2) To determine if individual classes of missiles produce the same basic resonance signatures
- (3) To determine if individual missiles or missile stages produce unique signatures
- (4) To determine the optimum ARS excitation and pick-up techniques.

An independent analysis was made by both BDM and LANL of the spectra collected in the field. The BDM report the "Acoustic Resonance Spectroscopy (ARS) Assessment Report (Final)," published January 31, 1993, completed the BDM assessment of the prototype ARS system.

3.5.5 Results.

3.5.5.1 Analysis of Signal Characteristics and Correlation Methods. During the initial phase of the assessment process, it was necessary to explore the potential viability of this technique to provide unique signatures and to determine whether or not these signatures could be correlated. Initially, sample measurement data provided by LANL was used to address some aspects of correlation in determining uniqueness. However, the data were insufficient to address repeatability (i.e., sensitivity to probe placement, noise effects, and sensitivity to minor structural

differences caused by manufacturing variations). It became apparent that to initially assess the potential for this technique to uniquely identify objects or changes in objects, the best course of action was to perform modeling in which parametric variations could be performed (i.e., probe placement and material variations within specified manufacturing tolerances). This approach allowed BDM to vary parameters in a highly controlled manner that was more efficient at this point in the assessment than sorting through additional LANL data to find the optimum set.

The structural modeling and analysis effort that was executed to characterize the response signature of a simple structural model used dynamic finite element analysis techniques. Systematic variations in material properties and dimensions were introduced based on normal ranges and tolerances, and the effects on the response signatures were determined. The results of this parametric study indicated that normal variations are potentially significant enough to uniquely characterize a given component.

Two correlation algorithms were developed as ways of quantifying the difference (or similarity) between two given ARS signatures. The first method was based on the Pearson correlation coefficient of statistics. While easy to implement as a program, this method appeared to be too insensitive to slight differences in the resonant spectral signatures. The second method was based on analysis and comparison of the individual spectral peaks. The latter method was slightly harder to implement as a program, but yielded a more sensitive estimate of the differences between signatures. Both methods appeared to hold promise for use of ARS in verification technology.

At the completion of this phase of the assessment it was determined that further work remains in several areas, such as sensitivity of the correlation algorithms to system noise and probe locations, and the applicability of using phase information available from the ARS homodyne technique. More measurements of ARS responses on realistic objects would be required for further analysis of this technique. In particular, repeat measurements of the same object are needed (for both changing and unchanging probe locations).

3.5.5.2 Field Measurements and Assessment Conclusions. Coordination for an ARS field exercise at Hill AFB began in 1991 and culminated in measurements on MM II and MM III missiles and missile stages in July 1992. Over 1000 data sets on 16 different missile objects were collected. Analysis of that data concentrated on four areas of signature utility:

- (1) Instrumentation repeatability - the ability of the ARS instrumentation to reproduce a signature when the measurement setup is left undisturbed between readings
- (2) Measurement repeatability - the ability of the ARS instrumentation to reproduce a signature when the measurement device is either readjusted or removed and replaced between successive readings
- (3) Classification utility - the extent to which signatures of objects of different classes are distinct enough to permit recognition of the class to which a signature belongs
- (4) Identification utility - the extent to which signatures of different individual objects are distinct enough to permit recognition of the object to which a signature belongs.

Instrumentation repeatability was found to be quite good, while measurement repeatability was found to need considerable improvement. Although there was some separation between the distribution of like and unlike correlation values, the separation was weak, resulting in an inability to perform a classification or identification of these test objects with high confidence. However, the trend in the data was a reasonable one; like comparisons yielded the highest scores; unlike comparisons of signatures from different but similar objects produced somewhat lower scores; and comparisons among objects of different types generated even lower scores.

The ARS system is still in development. While the system has been found to be an excellent tool for chemical warhead analysis, its future for treaty verification involving other objects has not yet been determined. The measurements performed to date have identified areas that will need to be addressed as the system development continues. Efforts to improve the ARS system should concentrate on measurement repeatability because it may be that

improving repeatability alone may, in turn, improve the ability to perform classification and unique identification. Items that could assist in this end are:

- (1) Fixtures which can provide consistent pressure on the measurement transducers
- (2) Fixtures which can provide better contact between the transducer and the missile
- (3) Wider separation between the transmit and receive transducers
- (4) Correlation algorithms tuned specifically to ARS signatures.

3.6 ELECTRONIC IDENTIFICATION DEVICES (EIDs).

3.6.1 Overview.

With the recent focus on treaties and agreements other than START, new technical requirements for arms control verification have become apparent. Under the early bilateral START negotiations, relatively few, very valuable deployed strategic assets were to be controlled. With the multilateral CWC treaty, the number of items to be controlled is orders of magnitude greater than for START. Further, the tactical importance of each controlled item under CWC is much less than the strategic military significance of START items. In summary, for control of the production of chemical and biological weapons and of existing weapons, the problem of verification is quite different from START. Also, inventory and tracking of nuclear materials after dismantlement in order to avoid proliferation is yet a different task with a different set of ground rules and priorities.

In the very high standards of START, limited confidence in the non-spoofability of electronic identification devices (EIDs) was of much concern. Also, the potential use of EIDs for covert data gathering was of concern to intelligence agencies. These intelligence concerns are irrelevant to the identification and tracking of many other arms control applications, particularly in the case of dismantled weapons and materials.

For on-site inspection there is a need for positive, but rapid and convenient identification of treaty controlled items using very lightweight, portable equipment. EIDs are inexpensive and offer the potential of: (1) rapid contact or stand-off readings, (2) small, fast readers, and (3) low data burden. A secure EID would typically include an ID number, a simple microprocessor, and some computer memory. Some of the integrated circuit chips used in EIDs provide adequate memory capacity to store all information of interest, including: identification number, location information, inspector identification, time of installation, and other information that is useful for detection of tampering. All access to the stored information can be encrypted for data security. Tamper protection can be provided with careful packaging of the EID system, inclusion of tamper sensors, and careful application to the tagged item.

Rapid contact and stand-off reading is illustrated in figure 3-24 for two forms of EIDs. One form is read by making contact with a simple reader that is about the size of a small flashlight. The other form exists with various ranges of remote readings using radio frequency (RF) transmission for querying the EID. Both the contact and RF EIDs can be implemented in active (battery-powered) or passive (unpowered) form.

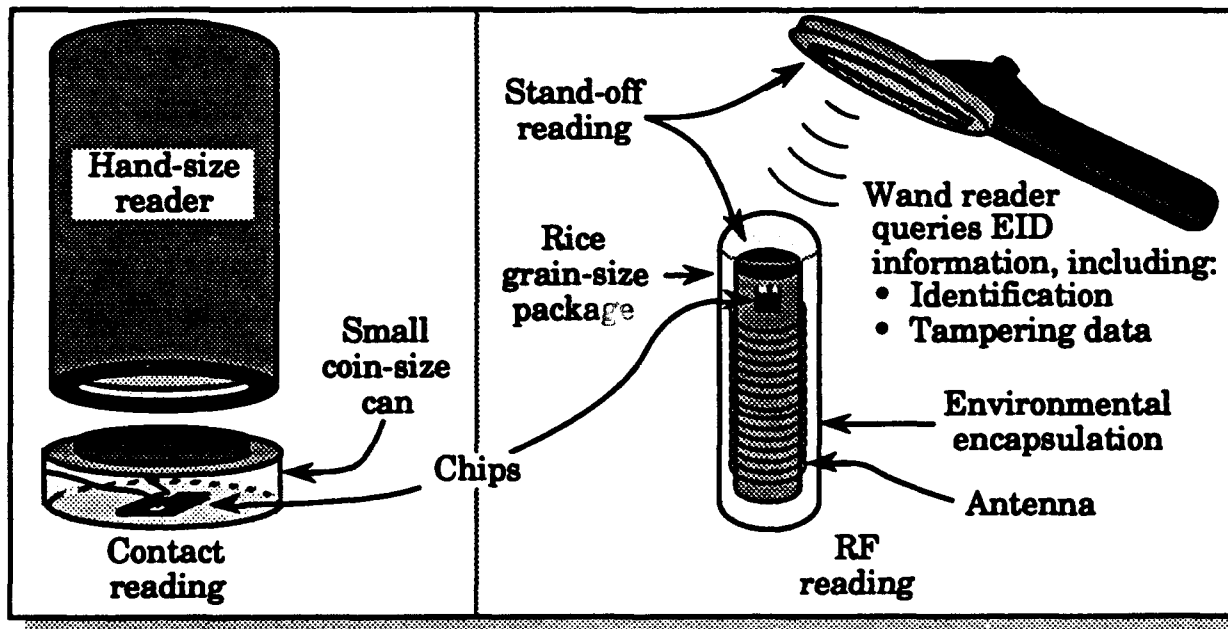

Figure 3-24. Depiction of two types of electronic identification devices

RF EIDs offer the capability of remote communication between the tag and reader. The strengths of RF EIDs include:

- (1) No requirement to physically touch the tag,**
- (2) Operational in harsh environments,**
- (3) No requirement for line-of-sight (LOS) between the reader and tag,**
- (4) Readability of the tag while it is moving rapidly relative to the reader,**
- (5) Relatively large data capacity,**
- (6) Use as an automatic data collection tool,**
- (7) Difficulty to duplicate, and**
- (8) Capability to remotely query over large distances.**

Note that the RF capabilities of an EID depend heavily on the packaging of the antennas in both the EID and the reader, and that not all of the strengths listed above are available in any one EID system at this time. The term "RF tags" is somewhat a misnomer, since these tags do not necessarily use radio frequencies. The communication is done at frequencies from below 500 kHz to above 2 GHz. Equipment for lower frequency EIDs is less expensive, safer than equipment for the higher frequencies, and is relatively free of license requirements. High frequencies generally allow greater directivity of the reader, and therefore longer reading ranges at low power levels. For use in foreign countries, different RF EID frequencies from those appropriate in the U.S. may be needed, because of different frequency allocations in the various countries for commercial purposes.

BDM's work in assessing the potential of EIDs (a miniature integrated circuit (IC) microprocessor that can be read directly or remotely) for treaty verification applications was conducted in two phases. The first phase involved a review of the Cornerstone EID development underway at Lawrence Livermore National Laboratories (LLNL). The second phase involved a survey of the EIDs available on the commercial market today and the development of concepts for EID system designs specifically to support the requirements of arms control treaty verification.

The LLNL Cornerstone concept combines unique identification, data encryption, and tamper detection in a single EID chip design. Data would be

encrypted using the Data Encryption Standard (DES) method. A capacitance sensor is used for tamper detection. At the time of the BDM review of the Cornerstone concept, this chip had been designed, but had not yet been placed into production.

In the second phase of this assessment, BDM determined that EIDs offer potential for arms control applications due to their flexibility, simplicity of deployment, and low cost when produced in volume. There are a number of EID designs available and in use in the commercial market today but most, if not all, of these would require modifications to be acceptable for use in treaty verification. These modifications center on data security and methods of securing the EID to the controlled item, so that tampering cannot go undetected.

3.6.1.1 Documentation Produced. "An Introduction to the Lawrence Livermore National Laboratory Electronic Identification Device (EID) Program - with a preamble dedicated to Radio Frequency-Based EIDs," was published in May 1992, and showed the assessment of the LLNL Cornerstone concept. Results of the second phase of the Cornerstone assessment are included in this report.

3.6.1.2 Expenditures.

The EID tag assessment effort began on October 24, 1991, and was completed in April 1993. Results of the EID assessment are provided in this Final Report. Table 3-9 lists the labor hours, the associated loaded labor costs (without fee and tax) plus the ODC's expended during both phases of the EID assessment.

Table 3-9. EID tag assessment expenditures.

TI	Hours	Loaded Labor Costs	ODC's	Total Costs
FY91-13	3,019	\$467,386	\$10,692	\$478,078

3.6.2 Schedule.

Figure 3-25 depicts the schedule of activities during the assessments of the LLNL Cornerstone concept and commercial-off-the-shelf (COTS) EID systems.

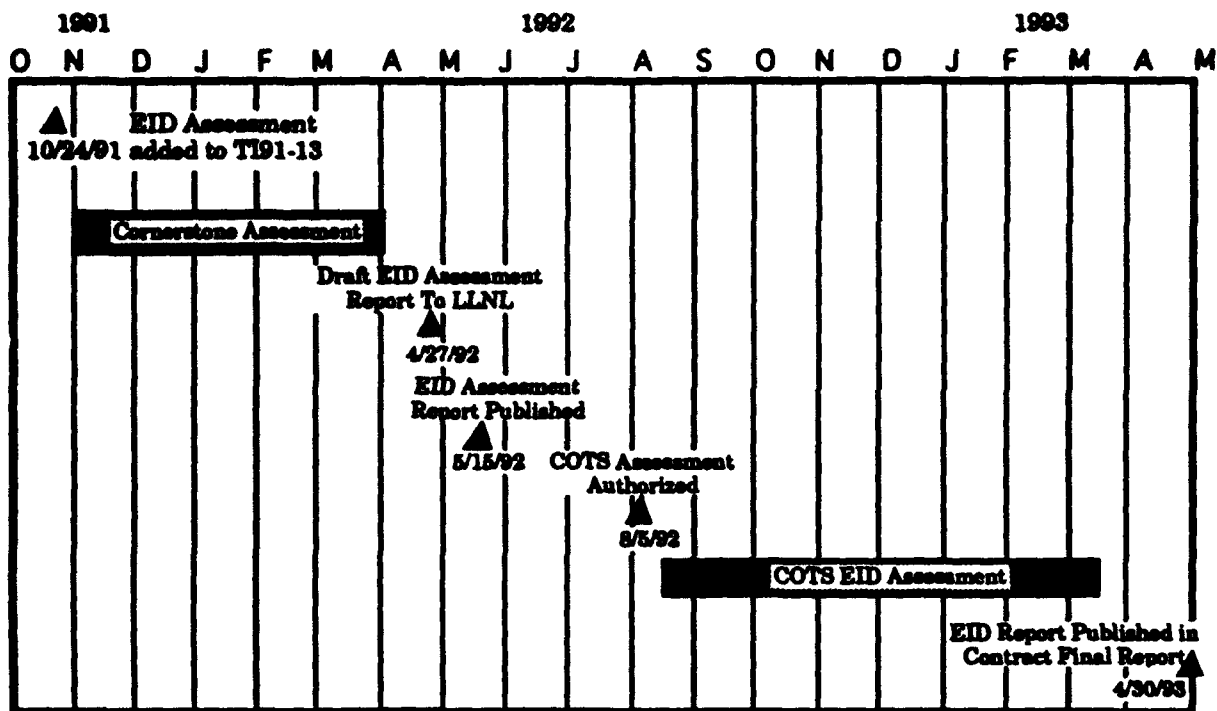

Figure 3-25. EID concept assessment schedule.

3.6.3 System Description.

3.6.3.1 LLNL Cornerstone Concept. LLNL has concentrated on developing a very secure EID tag based around a Motorola 6805 microprocessor. The term Cornerstone is used because the LLNL EID does not have rigidly defined input/output (I/O) and power formats. LLNL has built a secure, passive tag employing triple data encryption using the DES method. LLNL selected DES, because it is widely known and well understood. Other encryption systems could be implemented without altering in any way the operation of the device. The tag features unambiguous identification implying a very low false-reading probability. The tag can also feature a built-in capacitance tamper sensor with less than 10 micron movement sensitivity. Figure 3-26 is a simplified block diagram of this device and serves to illustrate the LLNL building block idea. In figure 3-26, the five major tag "building blocks" are shown within an overall "tag" box. Typical I/O and power stimulus to the tag that LLNL is developing are listed to illustrate the I/O and power options that could be applied. In their view, these interface functions can best be engineered when operational requirements are imposed. LLNL separated these functions to achieve maximum flexibility in operational deployments.

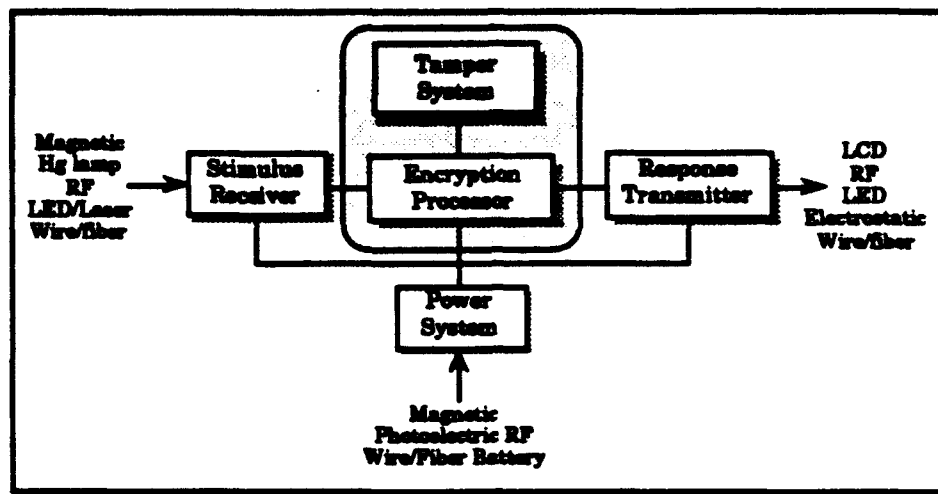

Figure 3-26. Block diagram of EID tag - the building block concept.

Among the attractive features of the Cornerstone EID are:

- (1) Physical security of the chip provided through LLNL-developed coatings
- (2) Triple encryption using a common, worldwide standard
- (3) Passive (no batteries) or active design
- (4) Immediate, on-site, unambiguous validation of the tagged item
- (5) Operational flexibility using existing modes and the inherent power available with the ability to "pre-condition" the tag
- (6) Functionality as a "unique-tag" or as a "class-tag"
- (7) An integrated electronic tamper sensor
- (8) High reliability and long operational life
- (9) Multiple fabrication and communications options
- (10) Small portable, COTS readers requiring only minor modifications.

The current design requires two integrated circuits (ICs). One circuit is the basic microprocessor (M6805). The second provides the intelligence for the tamper detection subsystem, part number SYLVAC M7125. Figure 3-27 is a diagram of the two IC EID prototype tag with tamper detection. Note that the EID case is large, but could be reduced in size with integration of the two ICs. In this configuration, the I/O port is located on the side of the tag. The complete tag would be encased and/or potted into one package. To facilitate the tamper detection feature, the flat plate with the window would be positioned over the conductor that is bonded to the controlled item.

The next generation configuration will be different from that shown in figure 3-27. The M6805 will be positioned directly above the SYLVAC M7125 position sensor and centered in the case. This places the fiducial hole directly in the center of the device. LLNL has designed and fabricated the circuit boards for this next generation device.

3.6.3.2 EIDs Available in the Commercial Market. Electronic identification devices exist in many implementations on the commercial market, and are becoming more common. For example, EID uses include: automatic billing on vehicle expressways, inventory control in manufacturing and warehouse

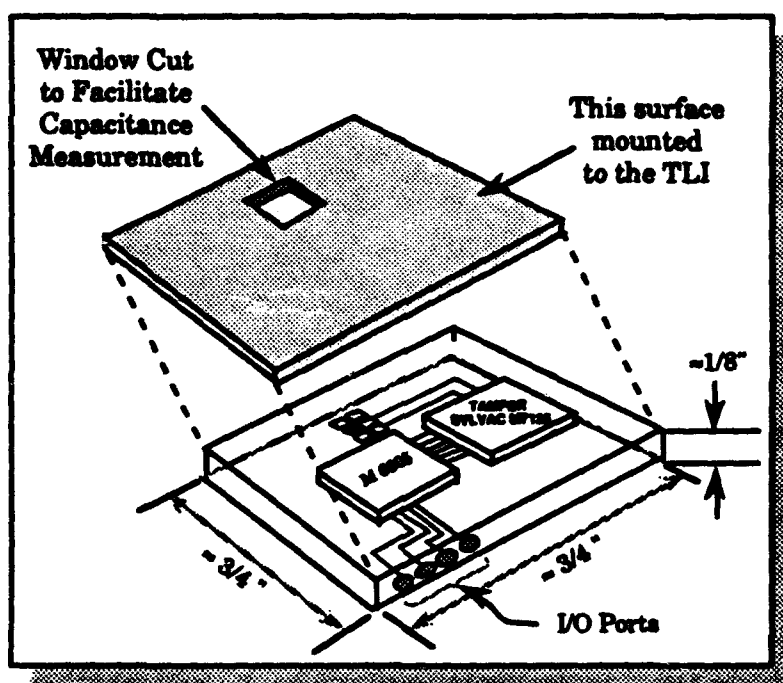

Figure 3-27. EID with separate microprocessor and tamper detection integrated circuits.

environments, and physical and personnel security applications. All of the EIDs have the ability to communicate data very rapidly. Some have adequate on-board memory capacity to store any data of interest in arms control treaty or agreement verification. For example, the Dallas Semiconductor DS1993 has 4K bits of non-volatile random-access memory (NVRAM), in addition to an ID and family code. The Dallas DS1991 chip has an eight-digit password that offers 1.8×10^{19} combinations, which would take billions of years to discover at a trial and error rate of 100 systematic readings per second, a typical reading rate.

Many different technologies are presently in use in the commercial sector for automatic identification and data collection to reduce data entry labor time and cost and to improve data entry accuracy. Automatic ID and data collection are two independent tasks. Barcode labels, magnetic stripes, magnetic ink characters, and EIDs are examples of electronic ID technologies used to uniquely mark or identify an object or person. Electronic automatic data collection occurs without a human intermediary between the data source and input device. Readers for barcodes, biometric IDs, magnetic stripes, magnetic ink, radio frequency EIDs, contact EIDs, optical character readers, mark readers, touchscreens, voice recognition, smart card readers, and optical card readers are examples of methods of automatically capturing data without having a human interpret or input the data first. None of the currently available COTS EID designs incorporate both physical and data security features adequate for arms control verification. However, several design concepts have been proposed that would address these requirements. The following paragraphs describe some of these concepts.

One very simple EID packaging concept is to bury an EID between layers of tamper tape as shown in figure 3-28. This concept relies on the EID to provide the unique signature and data protection and the tamper tape to provide evidence of relocation. An RF EID would normally be used for this design, so that contact with the EID is unnecessary.

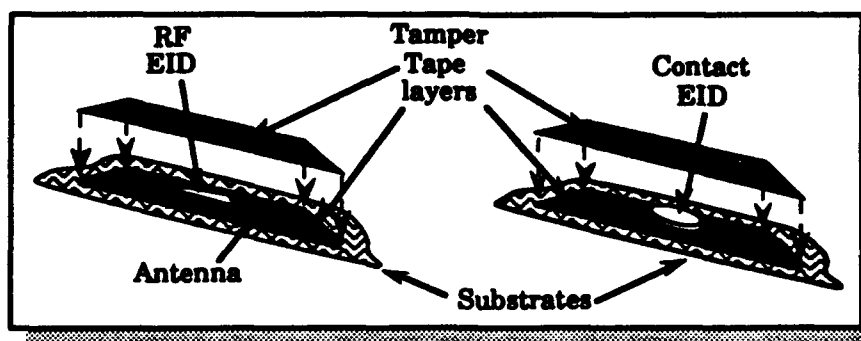

Figure 3-28. An EID with Tamper Tape. The Tamper Tape provides the secure method of attachment and the EID provides the secure data protection.

Associating an EID with tamper tape synthesizes a tag concept with a unique signature, while tamper tape alone does not. It has all the advantages of tamper tape (easy installation, etc.), yet provides a robust signature. The design is limited in its ability to indicate relocation and physical tampering by the capability of tamper tape and by the data security of the EID for signature integrity. Very little development time would be required to implement this concept.

A variation on the tamper tape design is an EID with fragile wiring in the tamper tape. This design increases the security of the system by using break wiring on the tamper tape's inner layers. The tag is adhered to a surface, and any attempts to lift the tape or access the EID would break the wiring path and remove power or alter the EID data. Figure 3-29 depicts such a design.

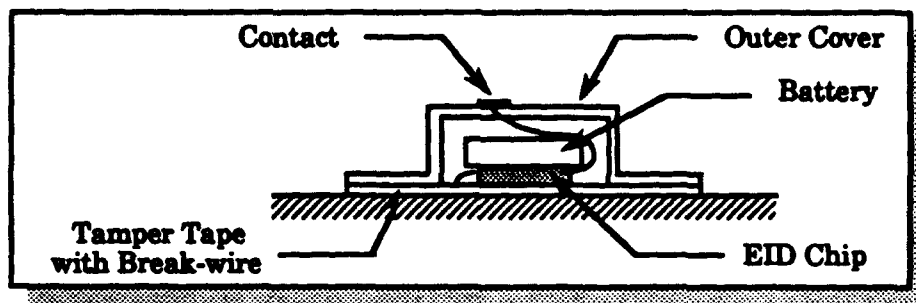

Figure 3-29. A contact EID with wiring in Tamper Tape. The wiring placed within the Tamper Tape gives added protection against intrusion or removal of the EID.

Random wiring patterns would be used, and the wiring would be located both above and below the EID. The wiring above the EID provides protection against bypassing the EID security, and the wiring below the EID detects attempts to lift the tape from the surface. The EID would probably be an RF type to reduce the difficulties associated with exposing wires on the top tape surface for communications. However, a contact type EID could be used if needed, as illustrated in figure 3-29.

The tamper tape adhesive must bond well in low temperatures and must fall apart if a solvent is used. With all tamper tape tag/seals, adhesives must be

selected to provide maximum adhesion to each type of surface on which it is to be applied.

For some arms control applications, a loop tag is required. Examples are objects with holes or paths that accommodate loop seals, including: doors, gates, and storage containers. In order to use an EID in a loop tag/seal, the loop and EID must be incorporated into a complete system so that the loop cannot be opened without detection. The basic idea used in the following EID loop tag/seals is to establish uniqueness and tamper detection and to protect the EID by encasing it in some form of protective block or barrier for the loop closure. This closure joint would be checked each time the EID is read or removed.

One approach to an EID in a loop seal is what might be termed the "EID with Mechanical or Membrane Switches" concept. The attachment of an EID with encrypted data to an item is accomplished by using an inspectable loop, such as that used in SLITS (see section 4.1). The loop is secured to the EID by a simple mechanical or membrane switch that is held closed by two polycarbonate blocks screwed together that contain distinct random patterns. This design is depicted in figure 3-30. The tag/seal could be opened and closed during each inspection to check for loop integrity and tampering attempts. The tag pieces could be returned to a lab for closer inspection and new pieces provided to retag or reseal the controlled item. This tag concept is reusable, low cost, simple, and convenient to apply and read.

The outer block pattern could be a simple reflective particle (RP) pattern or a multicolored swirl pattern in the injection molded plastic pieces. The RP or swirl pattern would be recorded before the part is sent to the field, and the field inspector could take a picture of the pattern to the field to be used as a quick reference after the EID is read.

The adaptations of commercial EID devices described above are suggestive of the potential for developing secure EID tag/seals from commercially available products. Many other, more sophisticated designs have been conceived and could be developed.

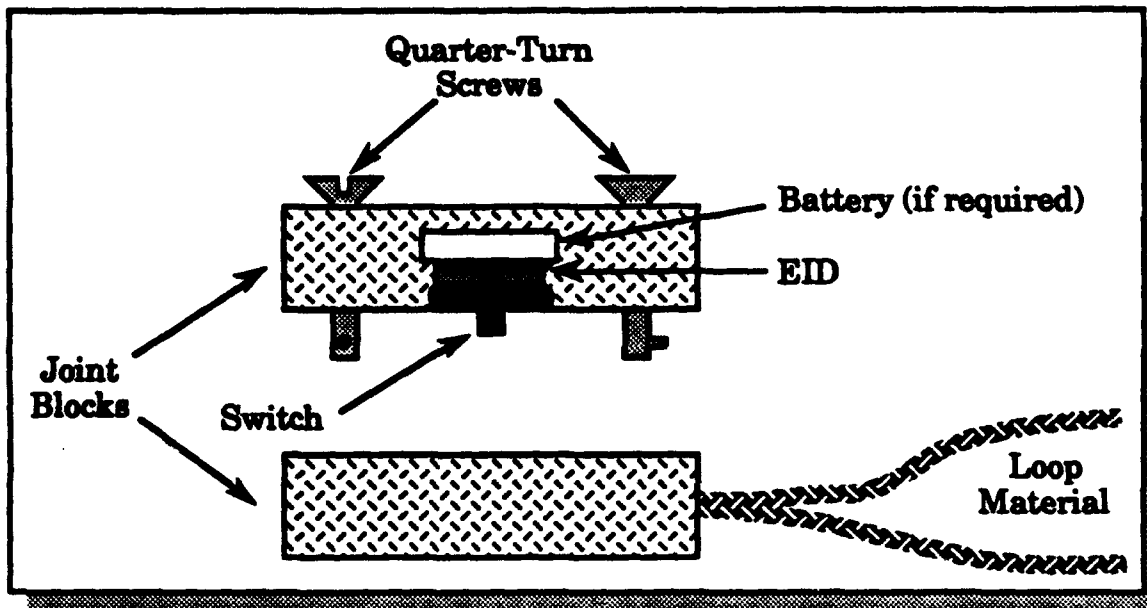

Figure 3-30. EID loop tag/seal with a mechanical switch.

3.6.4 Activity Description.

3.6.4.1 LLNL Cornerstone Concept. BDM was tasked by DNA on October 24, 1991, to assess the LLNL EID tag for potential use for treaty verification. BDM made an initial evaluation of the tag concept without having community-established specific operational requirements for an electronic device. In fact, some of the present EID tag limitations arise from LLNL not having specific operational requirements against which to design a more complete and fieldable system.

Since LLNL has concentrated on the Cornerstone for a tagging system, it was not possible for BDM to perform a complete system assessment as it has with other DOE-developed systems. However, upon completion of the concept assessment, BDM concluded that the LLNL programmable electronic device has the potential of supporting a wide variety of tagging applications.

BDM learned that for the past 18 months, LANL has been conducting an internal "black-hat" audit of the mainline EID tag. A "black-hat" audit is equivalent to adversarial analysis by DoD. Since BDM was not given access to the

results of the "black hat" audit, it was not possible to consider these findings in the assessment.

3.6.4.2 COTS EID Assessment. Assessment of COTS EIDs was authorized by DNA under TI 91-13 on August 5, 1992. BDM began the market survey portion of the task on August 15, 1992. Although the BDM assessment approach involved generating a user requirements document focussed specifically on EID applications in arms control verification, potential users were unable to identify performance requirements beyond those already established for verification equipment. Accordingly, requirements already established, particularly those relating to signature uniqueness, counterfeit resistance, and resistance to undetected transfer were used to assess current COTS EID designs.

The general conclusion from the market survey was that present COTS equipment is designed primarily for non-adversarial applications such as inventory control and tracking. Available EID systems have little or no tamper detection features. Vendors stated that presently there is not a large enough market for secure tags, therefore there is little incentive to develop tags with such features. Tamper detection and data protection add cost and complexity to an EID, which is very undesirable in the commercial market.

3.6.5 Results.

3.6.5.1 LLNL Cornerstone Concept. The LLNL-developed programmable electronic device has the capability to support a wide variety of tagging applications. Some of these are enumerated in section 3.6.5.3. Only the passive EID design that DOE chartered LLNL to develop was assessed. Like any design choice, the passive tag concept provides both advantages and disadvantages. Obviously, eliminating the need for battery maintenance is an advantage. However, without "on-board" power, the tag is not capable of employing some of its potential for tamper detection. Some of those features, such as recording when a tamper event occurred, could be useful for some verification scenarios.

Although only the passive tag developed by LLNL was assessed, the potential of active, programmable devices should not be overlooked in future development of EID-based verification tools.

3.6.5.2 EIDs Available in the Commercial Market. During the survey of available technology, it became obvious that COTS EID technology was not developed to prevent high technology tampering and relocation attempts. The majority of commercial tags have little identification protection, although virtually all the vendors contacted thought that this capability could be provided by redesigning the chip and/or through some form of encryption. It should be noted that encrypting the data is the same data security approach that LLNL proposed for their secure EID "Cornerstone" technology.

The problem of relocation prevention and tamper detection is more difficult. Most EIDs are attached using a simple adhesive or some mechanical attachment scheme. Presently, only a few active COTS EIDs have the ability to detect an attempt at relocation and existing COTS EIDs could be defeated by a determined adversary. High confidence tamper detection is the difficult problem that the LLNL Cornerstone EID, VACOSS, and the innovative EID concepts discussed in this report are designed to address.

The difficulties and complications associated with developing a method or system that provides secure data protection (unique identification) and prevention of covert relocation are important reasons that EIDs have not been used in arms control verification. The main issue with EID relocation detection is the problem of being able to closely couple the EID chip to the tagged item. Relocation tamper protection is more difficult for EIDs than for tags such as SLITS and RPT because the EID electronic circuitry is encased within protective packaging. SLITS and RPT reveal physical damage when tampering occurs, and this damage can be detected by inspection. In contrast, the data stored in an EID is not physically connected to the surface or loop material, and is not necessarily directly damaged by tampering. Instead, the data is stored in a silicon IC that might be moved, or the data could be read electronically and duplicated in another EID (i.e., counterfeited) without signs of tampering. It is possible to design EID packaging and data protection that imposes significant risk to an adversary attempting to defeat the function of the tag. However, user acceptance of EIDs for high security/confidence arms control tagging applications will be achieved only when EIDs have been carefully evaluated for tamper resistance, an adversarial analysis performed, and found to be acceptable. Each separate design must address these concerns to the level of security required.

3.6.5.3 Potential Applications - Background and Assumptions. The political environment in the FSU will compress timelines so that some level of arms control will be required immediately. The goals of the individual republics are different, and stable relationships among them do not yet exist. This instability within the FSU leads to the conclusion that the presence of trained military personnel as a primary security system for storage and transport is doubtful. Objective controls, such as tags and seals can provide significant enhancement to confidence in security of controlled items. The technical problems associated with tag/seal attachments on operational systems is mitigated as more and more systems are scheduled for dismantlement.

Both passive and active EID tags with lower confidence tamper detection can be made available in large quantities in less than six months. These EID tag systems would not include an integrated tamper detection system. If warranted, the timeline for the integrated system could be shortened. EID-based tags and seals with high confidence tamper detection could be developed in somewhat longer timeframes. Once a decision is made that an EID tag is acceptable for arms control applications, the power and flexibility that programmability provides can be applied in many ways. Encryption of ID data, and inclusion of location information, inventory controls, and special responses are all possible.

The potential applications for EID tags include:

- (1) **Non-Nuclear Treaty Controlled Items - All Logistical Phases.** The size, cost, and simplicity of the EID tag make it ideal for all non-nuclear control scenarios. The automatic features and immediate validation of data means that the inspector need not make on-the-spot decisions regarding authenticity of a reading response. As was shown in figure 3-26, the I/O and power options for the LLNL Cornerstone and commercial EIDs are numerous, and can be tailored to satisfy most application scenarios. The low cost of individual EIDs, when produced in large quantities, makes EID tags very attractive for large scale, low-to-moderate security applications.
- (2) **Nuclear Treaty Controlled Items - Initial Inventory.** The current inventory system in the FSU consists of serial numbers and a logbook for each weapon. Also, serial numbers for each sub-assembly are

available and are changed over time as maintenance occurs. Location information, always considered important data, becomes increasingly important as the various republics deal individually with weapons shipment and storage. For nuclear weapons and materials, tamper detection is critical.

Programmable, tamper-detecting EID tags, such as those described above could be installed at the baseline inventory to establish ownership (which republic) and initial location. Memory available in the storage capacity of the EID could be used to track weapon and sub-assembly serial numbers.

- (3) Nuclear Treaty Controlled Items - Weapons Transport. Today, potential nuclear weapons dismantlement facilities are located in the Russian republic at great distances from many deployed weapons. The need for transportation to the dismantlement site creates two additional requirements for seals and tags. Weapons being shipped must be identified and tracked. With programmability, relocation audits of items can be stored in a tag and read at any location whenever necessary. In addition, the shipping containers and transport vehicles (holds of ships, railcars, aircraft weapons bays, air transport cargo bays, etc.) could be sealed during transport for security. For example, an active EID with a fiber optic pulse train system could secure these compartments and shipping vehicles. In an operational setting, the seals could be opened at the destination (or intermediate sites if desired) and the individual tags read for validation. When all tagged items being shipped were verified, new location data could be entered into the tag. Seals could be removed and replaced as often as necessary, with all events recorded electronically for easy entry into larger notification system databases.
- (4) Nuclear Treaty Controlled Items - Interim Storage. Temporary storage of weapons, as they await dismantlement, would be a natural application of EID-based tags and seals. The limited time that these devices would need to be tagged, the potential for fewer restrictions on where tags would be placed on devices, and the ability to remove the tag and read any stored data into a database, make EIDs a very convenient operational choice for interim storage.

It should be understood that there will not be an EID-based tagging system available until specific operational requirements have been established and the LLNL "Cornerstone" EID, or an adaptation of a commercial design with similar capabilities are developed to satisfy that requirement.

3.7 MICROVIDEOGRAPHY (MV).

3.7.1 Overview.

The microvideography (MV) system developed by Pacific Northwest Laboratories (PNL) is intended to be a simple, low cost means of verifying the authenticity of printed labels or other identifying marks using the surface microstructure of the label or mark as a signature. The system hardware consists of a microscope/video camera system for recording magnified video images of the labels being examined, and a computer for examining and comparing those images. During an inspection, video images of either intrinsic or applied surface features are recorded. These are visually compared to a reference image to determine the authenticity of the item or label. BDM's assessment of the MV technology was limited to analysis of bar code imagery supplied by PNL. PNL provided BDM with a system demonstration, however they retained the equipment for PNL work. Consequently, BDM analysts were not able to test the MV hardware.

Based on this limited examination of the system, BDM observed that MV might be appropriate for applications where an inventorying technique combined with tamper detection capability would be useful. However, additional testing and analysis would be required to determine the adequacy of the system's performance. In addition, the current system design relies on an inspector's subjective judgement to determine the authenticity of an image. BDM recommends that if further development of the MV concept is pursued, an objective technique be employed for image comparison since some of the differences in label images can be very subtle.

3.7.1.1 Documentation Produced. The results of BDM's assessment was published in the "Microvideography Assessment Final Report," March, 1992.

3.7.1.2 **Expenditures.** The MV assessment effort began on October 24, 1991, and was completed when the final report was delivered in March 1992. The following table (table 3-10) lists the labor hours, the associated loaded labor costs (without fee and tax) plus the ODC's expended during the conduct of the MV assessment.

Table 3-10. MV assessment expenditures.

TI	Hours	Loaded Labor Costs	ODC's	Total Costs
FY91-13	295	\$17,890	\$66	\$17,956

3.7.2 Schedule.

Figure 3-31 depicts the schedule of activities that were performed during the MV system assessment efforts under TI FY91-13.

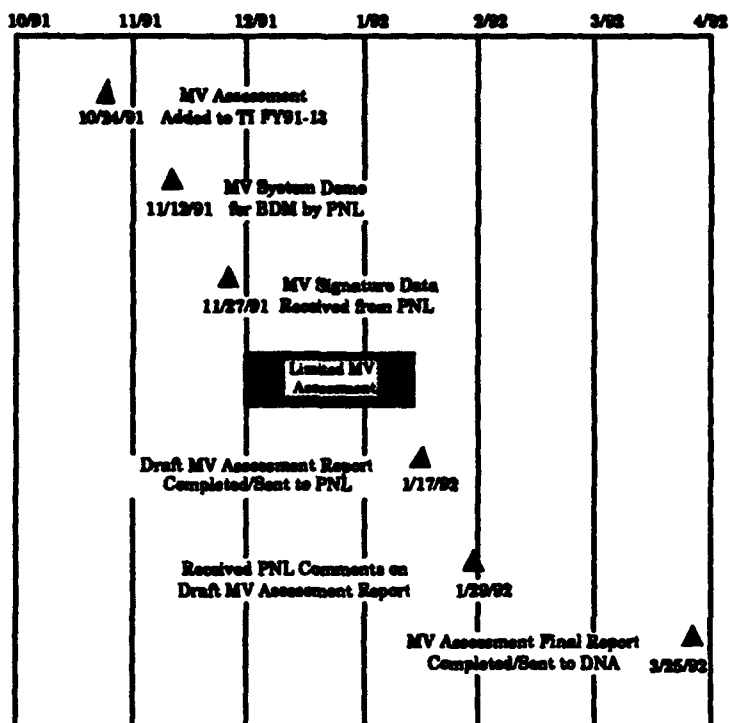

Figure 3-31. Microvideography schedule of activities.

3.7.3 System Description.

When printed labels or other identifying marks are made, they have unique features because of non-uniformities in production. The MV system takes

advantage of these non-uniformities by making microvideographic images of parts of the labels or marks and recording them for comparison with readings taken at a later inspection. Figure 3-32 shows an illustration of a microvideographic image of a bar code taken with the MV system.

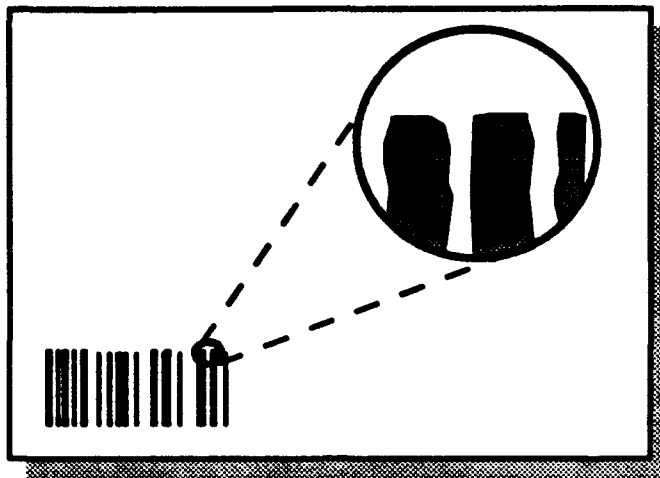

Figure 3-32. Illustration of a microvideographic image of a bar code.

The MV physical hardware consists of a microscope/video camera system for recording magnified video images of the labels being examined, and a computer system for examining and comparing those images qualitatively. These components are all commercially available. Figure 3-33 shows the video head and monitor being used to acquire the image of a bar code.

The video head consists of a commercial video camera mounted behind a microscope objective and a light shield/spacer to maintain the proper object-to-microscope distance. Two LEDs are mounted inside the light shield/spacer to provide consistent, uniform illumination. The video monitor is used to align the image being taken (black alignment marks appear on the video screen).

Figure 3-34 shows additional components of the system; the video system is on the right. The video head is shown attached to a video camera controller and a battery box for the LEDs. The portable computer is used to digitize and compare images of the surface using image processing hardware and software. The computer is equipped with a digitizer board and can acquire images directly from the camera or from some video storage medium. Therefore, the system has the capability of making comparisons in the field, during the inspection, or at a base



Figure 3-33. Video head and video monitor used to acquire the image of a bar code.



Figure 3-34. Microvideography additional components.

station after the inspection. The computer has database software installed for manipulating both images and text. At the left is the bar code reading system which is interfaced to the computer for database access. The bar code reading components are part of the system only to the extent that bar codes are strong candidates to image since they provide an inventorying capability with large numbers of items.

During a routine inspection, the inspector would acquire an image of a bar code or some other designated point on the item of interest, and then compare that image to a previously acquired reference image of the same point. The comparison of the two images is currently accomplished by subjectively evaluating the two images as they are displayed simultaneously on the computer monitor. One image is superimposed on the other, thus highlighting whatever differences there may be between the two images. If, in the inspector's judgement, whatever differences may exist are insignificant, then the images are considered to have come from the same label or surface feature.

3.7.4 Activity Description.

On October 24, 1991, BDM was tasked by DNA to assess the use of the MV concept for potential use in support of tagging for treaty verification. An MV system could not be made available for BDM's use during the assessment; however, BDM was given a system demonstration on November 12, 1991. The scope of the analysis would be limited since PNL could not provide BDM with an MV system.

In late November 1991, PNL provided BDM with signature data from previous MV tests to be used for the assessment. BDM conducted the limited assessment during December 1991 and January 1992. The assessment consisted of some qualitative and quantitative tests on the PNL-supplied signature data.

The system, as evaluated, is still under development, and PNL has proposed a number of modifications. No adversarial analysis has been performed on the system and the BDM evaluation of the signature uniqueness was preliminary and not supported by a full set of data. MV system development

continues and BDM expects that a number of changes will be required to satisfy laboratory prototype definition requirements.

3.7.5 Results.

BDM believes that this system shows potential for treaty verification applications where large numbers of items must be tagged and inventoried and a moderate level of tamper resistance is appropriate. However, a more comprehensive assessment of the total system, including the proposed bar coded label, should be conducted prior to any final decision regarding further development and application. This assessment should include independent signature data acquisition.

BDM normally assesses potential treaty verification tagging systems against a wide range of pertinent areas including:

- (1) Practicality
- (2) Suitability for intended purpose
- (3) Soundness of approach
- (4) Uniqueness of signature
- (5) Signature repeatability
- (6) Probability of false positive or negative
- (7) Counterfeit difficulty
- (8) Tamper resistance/detection
- (9) Durability, compatibility with TLI
- (10) Ease of operation
- (11) Environmental/interface requirements
- (12) Field assembly, field validation
- (13) System readiness/reliability/maintainability
- (14) Portability, technology transfer
- (15) Producibility
- (16) Cost.

Due to the already-mentioned constraints, only partial assessments were possible in some areas, and none in others. Although no issues were identified in these partial assessments that make the MV system unusable or preclude further

development of the system, additional testing and evaluation is suggested in many areas to more thoroughly characterize system performance.

3.7.5.1 Qualitative Assessment. BDM examined the qualitative signature data provided by PNL. Conclusions from this assessment can be summarized as follows:

- (1) Significant training and written guidelines are necessary for an operator to visually make a consistent interpretation of the differences between very similar images (signatures).**
- (2) Images of bar codes with some tamper resistant features were judged to be much more difficult to interpret than others. BDM recommends an evaluation of different bar code designs be accomplished as part of any further system development.**
- (3) BDM considered the differences demonstrated in some of the comparisons to be too subtle for consistently accurate qualitative comparison. The use of mathematical techniques to generate a quantitative correlation measure, or the use of a bar code design that more easily accommodates visual correlation could eliminate this problem.**

Although the system was developed by PNL with qualitative signatures based on the inspector's comparison of images in mind, quantitative measures of signature correlation could significantly enhance performance. Such quantitative signatures seem feasible. The addition of this capability would make the MV system a flexible tool for certain treaty verification and tagging applications. It would combine an inventory tool with a tag that offers the inspector a choice of a visual comparison of the tag signature or a more rigorous numerical comparison.

BDM's examination of the signature image data supplied by PNL indicates that there are three candidate areas on a bar code image that are useful for determining unique identification of the MV tags. The first area, those regions outside the code bars, appear to be highly correlated (therefore, less prone to

provide unique signatures) for tags printed in a given printing run. The properties of these areas for different printing runs of tags and for different tag printing processes should be examined and evaluated.

The second area, the regions contiguous to the code bar boundaries, has the potential for high information content if its structure is examined in detail. Unfortunately, this region appears to share the same high correlation of images from a particular printing process as areas outside the bar codes. The questions applicable to those areas outside the code bars should also be addressed for regions contiguous to the code bar boundaries.

The third area, that within the code bar, appears to have the desirable quality of low correlation for different images, even though the images were created in one printing run from a particular printer. More data are necessary for different images for different printing processes to assess code bar detail properties. In addition, multiple images of given like and unlike tags need to be examined to assess measures of identification for the tags.

A need for intensity normalization of the image data has been noted. A complementary need exists for spatial registration of image data if quantitative measures are used to identify like from unlike images. The alignment issues are not critical if visual, qualitative assessments are used with MV images.

The security or tamper detection capabilities of the system rely on comparing field images with reference images that were taken prior to the inspection or when the bar code is applied to the TLI. In an environment involving large numbers of items, the capability to check an item is limited to those items for which this reference image exists. Thus, in order to conduct a truly random check involving a few labels, the inspector would have to have reference images of the entire population of applied bar code labels.

3.7.5.2 Recommended System Development. BDM recommends that if the system is developed further, the approach should be used documented in the "Microvideography Assessment Final Report," (section 5). PNL has suggested changes that could improve the capabilities of the MV system, such as: a color camera; upgraded frame grabber; upgraded computer; upgraded image

processing software; an upgraded monitor; and a VCR. Most of these modifications are straightforward and should be made prior to a full system evaluation.

After the MV system has been thoroughly tested we expect that a number of changes in the system will be needed to address the following issues: quantitative performance measures; ruggedization; adversarial analysis issues; bar code selection and protection schemes; image alignment issues; and tag illumination.

3.7.5.3 Recommended Testing. The preliminary work on the MV system has raised questions that can only be answered after a complete program of hands-on evaluation and analysis of the MV hardware and process is completed. The program should be based on two areas of activity. The first activity concerns the respective qualitative and quantitative measures of system behavior. The second activity concerns the processes for determining the utility and operational characteristics of the MV system and process.

- (1) **Qualitative and Quantitative Measures** - The MV system has the potential to allow the use of both qualitative and quantitative measurement techniques. Rather than lose the advantages of either measurement approach, we should consider identifying relationships between the qualitative and quantitative measures as they might be used for the MV process. A test approach is proposed that would determine a dual capable operation of the MV system, which would use the most appropriate measurement technique for the operational situation. Also additional signature tests are recommended in the areas of: uniqueness of signature, signature repeatability, and probability of false positive or negative determinations.
- (2) **Determining Utility and Operational Characteristics** - The second activity uses the results of the work on performance measurement. Specifically it evaluates the utility and operational characteristics of the MV system for tagging applications.

Additionally, adversarial analysis is recommended in areas such as: tamper resistance and detection; counterfeit resistance; and tag transferability. This analysis must include the specific bar code label that will be used.

Based on this preliminary effort, BDM believes that the Microvideography concept has a potential application where a combination of an inventorying technique and moderate tamper detection capability is appropriate, such as in support of CFE, CWC, and the dismantlement of auxiliary systems under START.

3.8 NONLINEAR JUNCTION (NLJ) SYSTEM

3.8.1 Overview.

The nonlinear junction (NLJ) concept makes use of the exponential relationship between current and voltage in semiconductor diodes to produce a characteristic signature for each tag. A tag containing a number of Schottky diodes is exposed to a high frequency electromagnetic source. Each diode rectifies the signal and produces harmonics to the fundamental frequency. The diodes also interact with each other, creating a more complex response to the excitation source. The tag then re-radiates a portion of the fundamental frequency, along with harmonics of that frequency. This re-radiated complex harmonic signal, when captured and measured, forms the unique signature for each tag.

The BDM assessment of the NLJ system was conducted in two phases. In the first phase it was determined that the NLJ concept showed promise for the unique identification of TLIs. However, testing identified three areas which required further investigation.

- (1) Alternatives to the tag's hard ceramic backing material are desirable to reduce the probability that the tag could be transferred from one TLI to another without detection.**
- (2) The signature of a tag, created by affixing a Schottky diode network to a backing material, exhibited great sensitivity to temperature.**
- (3) Refinements in the correlation algorithm are desired that could account for slight shifts in tag signature frequency.**

Following the completion of the first phase, DNA authorized additional BDM effort to examine the three areas noted above. Instead of mounting the circuit components on ceramic backing material, these components were applied directly to the TLI and epoxied in place. These tags did not generate harmonic responses as well as those mounted on ceramic. Signature variations due to temperature for directly applied tags were similar to those experienced for tags mounted on ceramic during phase one testing. Additional correlation approaches were used, but none of them were able to handle the large signature changes resulting from temperature variations. With the completion of this second phase of testing, the NLJ laboratory prototype system was returned to the Idaho National Engineering Laboratory.

3.8.1.1 Documentation Produced. The results of the NLJ assessment were published in the "Nonlinear Junction (NLJ) Tag Assessment (Draft) in May 1992. Additional tests were conducted following this assessment and were reported as appendix B, dated July 1992.

3.8.1.2 Expenditures. The NLJ assessment effort began on October 24, 1991, and was completed in July 1992, when appendix B of the NLJ Assessment Report was completed and sent to DNA. The following table (table 3-11) lists the labor hours, the associated loaded labor costs (without fee and tax) plus the ODC's expended during the conduct of the NLJ assessment.

Table 3-11. NLJ system expenditures.

TI	Hours	Loaded Labor Costs	ODC's	Total Costs
FY91-13	2,057	\$133,845	\$2,041	\$135,886

3.8.2 Schedule.

Figure 3-35 depicts the schedule of activities that were performed during the NLJ assessment effort under TI FY91-13.

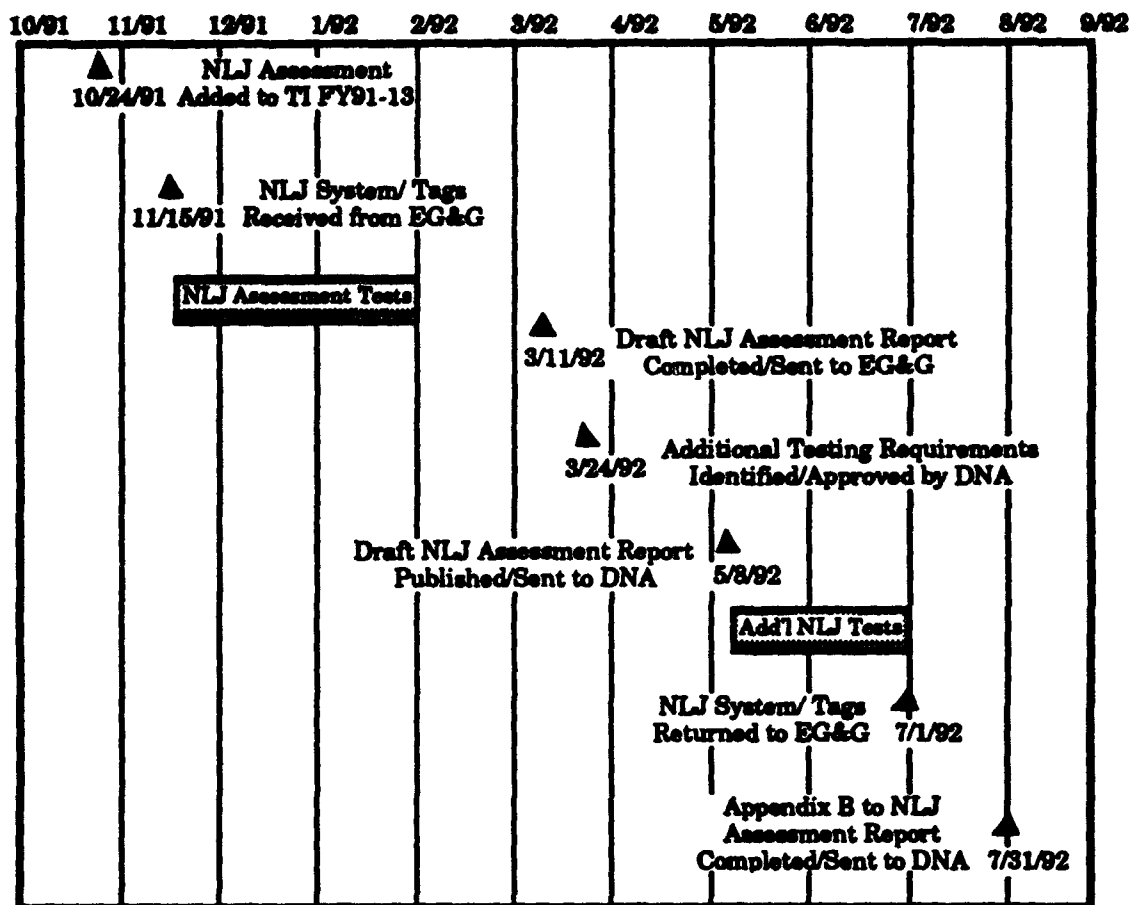

Figure 3-35. NLJ schedule of activities.

3.8.3 System Description.

The NLJ tag makes use of the exponential relationship between current and voltage in semiconductor diodes to produce a characteristic signature for each tag. A tag, containing a number of Schottky diodes, is exposed to a high frequency electromagnetic source. Each diode rectifies the signal and produces harmonics to the fundamental frequency. The diodes also interact with each other, creating a more complex response to the excitation source. The tag then re-radiates a portion of the fundamental frequency, along with harmonics of that frequency. This re-radiated harmonic signal, when captured and measured, forms the unique signature for each tag. Each tag has a circuit containing Schottky diodes similar to the tag depicted in figure 3-36.

The tag reader system consists of a microwave transceiver and a computer. The transmitter produces an amplitude modulated signal which is swept from 2.7

to 4.0 GHz. This output is used to excite the tag. The horizontal and vertical components of the tag response signal are received, filtered and amplified. The result is a waveform containing the third harmonic of the fundamental frequency. This third harmonic signal is measured and converted into a digital format and sent to the computer. Signature correlation is a modified root-mean-square (RMS) calculation, comparing the measured signature with a reference signature for the tag. The tag reader system is shown in figure 3-37.

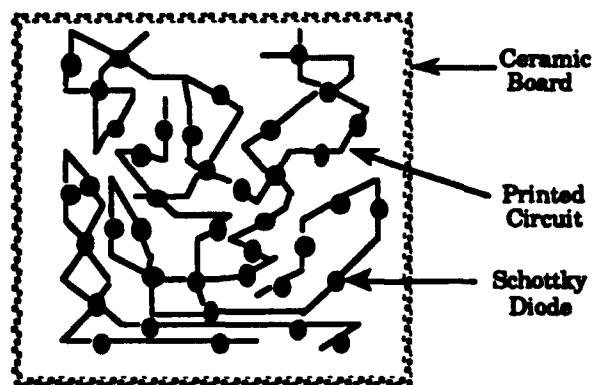

Figure 3-36. NLJ tag.

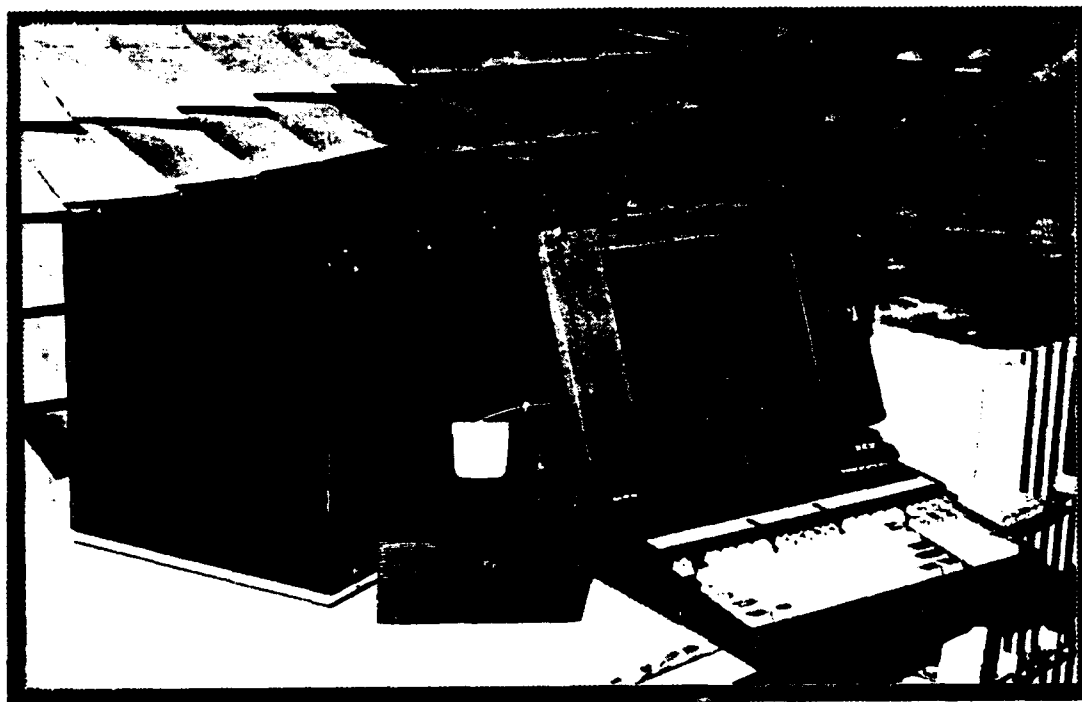

Figure 3-37. NLJ tag reader system.

3.8.4 Activity Description.

On October 24, 1991, BDM was tasked by DNA to assess the suitability of the NLJ system as a tag for treaty verification. EG&G provided BDM a prototype NLJ system, and tags for the assessment on November 15, 1991. BDM began conducting tests using the system and tags that same month.

BDM tested the NLJ system during the period November 1991 through January 1992. The goal of the laboratory phase of the assessment test effort was to acquire data which could be used to determine:

- (1) Tag signature repeatability
- (2) Tag signature uniqueness
- (3) Tag system operational considerations.

The tests included baseline readings for each tag, and tests to determine variations in readings as a result of slight reader/tag misalignment. A background materials test was conducted to determine the effects on the tag signature as a result of mounting the tag on various types of materials. Tests were also conducted to measure tag signature changes at various temperatures, and to determine signature variations when the tag was installed, removed, and reinstalled on a simulated TLI.

The initial assessment test results identified several areas in which additional testing would provide data that would be valuable to EG&G in continued development of the NLJ system. The additional testing recommendations were based upon the following three factors:

- (1) The tag and associated ceramic backing were not suitable for field use and could be removed without detection.
- (2) The tag exhibited sensitivity to temperature variations when mounted on a simulated TLE.
- (3) The correlation algorithm was not as robust as desired.

The recommended additional testing listed below was approved by DNA:

- (1) Test a direct application tag (a tag circuit without a circuit board) on a simulated TLI**
- (2) Measure the signature variations of this tag during a temperature cycle test**
- (3) Perform the following correlation algorithm tasks:**
 - (a) Implement both the Pearson correlation algorithm, and the frequency comparison algorithm**
 - (b) Use existing NLJ data to compare the performance of each algorithm**
 - (c) Use both algorithms to perform correlations on the new tag temperature data**
- (4) Document the results of the investigation, and add them as appendix B to the NLJ assessment report.**

Upon completion of the testing included in the original assessment plan and analysis of the results, a draft "Nonlinear Junction (NLJ) Tag Assessment Report" was written. A copy was sent to EG&G for comment on March 11, 1992.

On April 15, 1992, BDM wrote to Amtech Corporation., Dallas, Texas, requesting five *TollTags*[®] to test with the NLJ System to determine whether or not the system can distinguish individual *TollTags*[®], one from another, based upon subtle differences in component characteristics, and manufacturing tolerances.

Upon receipt of comments from EG&G, the "Nonlinear Junction (NLJ) Tag Assessment (Draft) was finalized, and sent to DNA on May 8, 1992.

The additional NLJ testing described above and tests in which the NLJ diodes were attached to *TollTags*[®] were completed by July 1, 1992. The results of the tests were published as appendix B to the NLJ Tag Assessment (Draft) and delivered to DNA on July 31, 1992.

NLJ is currently in the proof-of-concept stage and it has not yet been determined if there will be further development. A preliminary assessment of the current prototype identified several areas where further development would be

needed prior to any decision regarding the utility of the concept as a verification tool.

3.8.5 Results.

Additional development work is required in several areas before a fieldable system will be available. In the NLJ assessment report, BDM made the following recommendations for future development.

3.8.5.1 Correlation Algorithm Recommendations. An alternative decision measure for the NLJ data can be computed that provides shape discrimination. In addition, the alternative measure provides an interpretation in terms of the inferred correlation-like properties of the NLJ data.

Tests should be performed to determine the characteristic shapes of the correlation-like function for the NLJ data. Such tests will help determine whether the alternative measure has practical utility for the NLJ data.

3.8.5.2 Tag Development Recommendations. The present tag consists of a Schottky diode circuit mounted on a ceramic board. This arrangement is useful for the laboratory phase of the program, but is not representative of the type of tag that should be fielded. The reasons for changing the tag design are as follows:

- (1) The ceramic board is not flexible and will not conform to curved surfaces.
- (2) The ceramic board can be removed from a given surface and moved to another surface of similar material without being detected.

Alternate tag configurations may prove to be more useful in the field. Such configurations include:

- (1) A tag circuit, without a circuit board that can be epoxied to the TLI.
- (2) A tag circuit mounted on a thin, extremely flexible circuit board that could be mounted on the TLI.

Since any tag can conceivably be removed from a TLI, and since a rigid board will make it difficult or impossible to detect such movement, then any new

tag approach should include some mechanism for ensuring that the tag removal will permanently alter the tag characteristics. Thin, extremely flexible boards, or no board at all will serve this purpose. If the adversary attempts to remove the tag, the circuit geometry will be changed. This has the effect of permanently altering the tag signature characteristics. An additional benefit is to further increase the difficulties associated with any attempt to counterfeit a tag.

3.8.5.3 Hardware Recommendations. The NLJ tag equipment consists of several standard, off-the-shelf modules, and some unique hardware. The basic design is an excellent tool for laboratory testing. There are perhaps some improvements in the basic design, but they are believed to be minor and would be part of a development program. The areas of most improvement are felt to be in the antenna design, integration of the computer into the hardware, and an evaluation of increasing the operating frequency of the system.

A program to investigate the feasibility of miniaturizing the system should be implemented before full scale development begins. An engineering trade study should be implemented which would investigate the issues of the physical dimensions, weight, and the stability of the system. Another study to investigate the impact of changing the RF spectrum of the reader should also be accomplished. After these trades are completed, then the system architecture should be defined.

3.8.5.4 Software Recommendations. If the present system, using a PC-controlled reader, is used then recommendations concerning the present software are appropriate. The software could be improved in the areas of flexibility and error checking. Some of the flexibility improvements would be:

- (1) Allow selective comparison of the tag data rather than always comparing against the entire tag list**
- (2) Allow the tag to be identified, i.e., defined before the data are taken**
- (3) Allow the data to be stored in binary and ASCII formats, in case disk space is a consideration**
- (4) Provide another display type, possibly a split screen which would better differentiate the parallel, and perpendicular traces**

- (5) Label the plot axes with units, so it is more obvious what the plot represents.

In the area of error checking, a previously saved data file currently may be overwritten by accident when one hits the F2 instead of the F3 function key. It would be wise to check for the existence of a file name before writing data to disk.

3.9 TAMPER TAPE ASSESSMENT.

3.9.1 Overview.

Commercial tamper tapes consist of an adhesive backing on one or more layers of vinyl composites or sheet plastic. After proper application, this type of seal is difficult to remove without an indication that tampering has occurred (tearing or delamination of the multiple layers). An RP disk was added by PNL to increase the difficulty of counterfeiting the tag and to make each tag unique. Micaceous hematite, the same material used in the RPT, was used to generate the RP signature. At the request of DNA, BDM conducted some limited testing of the prototype tapes with the RP signature.

The results of BDM testing indicated that tapes with high RP densities had greater signature stability during temperature shock experiments, than did those with lower particle densities. This was particularly noticeable during testing at low temperatures (14°F). Correlations using reference readings obtained before the tape was applied to a substrate tended to be lower than when the reference reading was obtained after the tape was applied to the substrate. Again, cold temperature and low particle density accentuated this effect. Tamper tape + RP development continues at PNL.

3.9.1.1 Documentation Produced. The following documentation was produced during the Tamper Tape assessment:

- (1) Tamper Tape Experiment Report, dated June 1992
- (2) Tamper Tape - Phase 2 Report, dated June 1992.

3.9.1.2 Expenditures. The Tamper Tape assessment effort began on October 24, 1991, and was completed when the final report was delivered in June 1992. The following table (table 3-12) lists the labor hours, the associated loaded labor costs (without fee and tax) plus the ODC's expended during the conduct of the Tamper Tape assessment.

Table 3-12. Tamper tape assessment expenditures.

TI	Hours	Loaded Labor Costs	ODC's	Total Costs
FY91-13	291	\$14,590	\$181	\$14,771

3.9.2 Schedule.

Figure 3-38 depicts the schedule of activities that were performed during the Tamper Tape assessment effort under TI FY91-13.

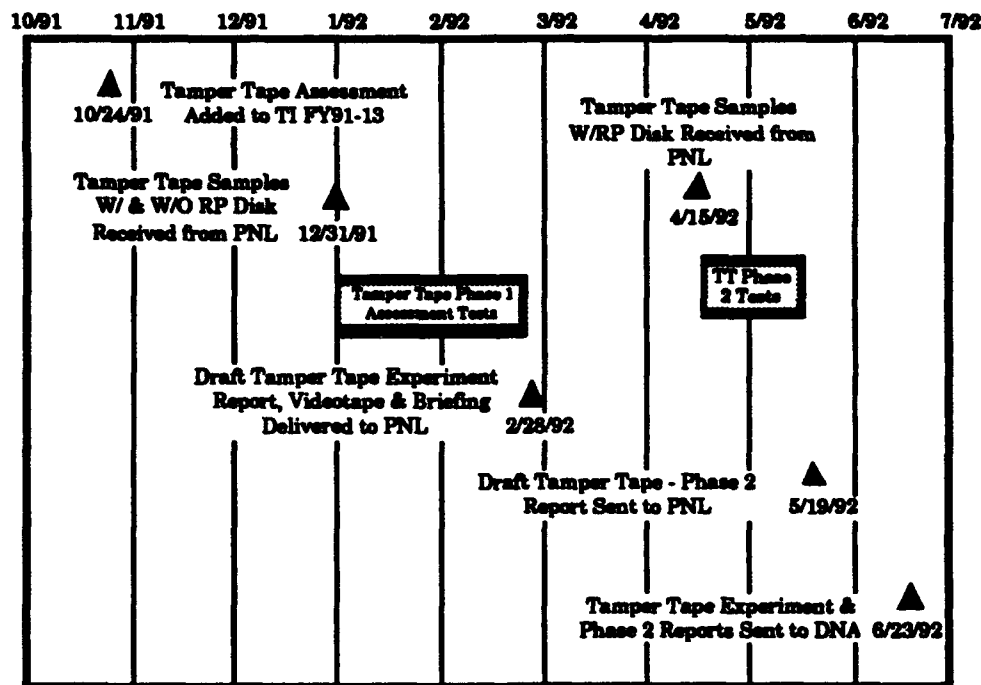

Figure 3-38. Tamper tape schedule of activities.

3.9.3 System Description.

This system, being developed by PNL, incorporates an RP signature area (micaceous hematite) within the layers of film and adhesives of a composite

material similar to commercially available tamper tapes. PNL is working with 3M Manufacturing Company, using their CONFIRM™ product, to develop the technology for commercially producing a modified tamper tape tag that includes an RP area for unique signature purposes. This is an extension of the technology developed by SNL for the RPT described above in section 3.1. Following application of a tamper tape tag to a controlled item, a series of reference images (signatures) are taken and recorded for use as a basis of comparison with images acquired during subsequent inspections. The images are recorded using the UR (described later in section 4.4 of this report; procedures are similar to those used for reading the RPT). Attempts to transfer the tag cause readily observed changes in the film/print/adhesive layers of the tamper tape. Because of its similarity to the RPT, the tamper tape tag (with an RP signature area) could provide an equivalent level of unique identity, but have better operational utility because it will be easier to install. A prototype version of a tamper tape tag is shown in figure 3-39.

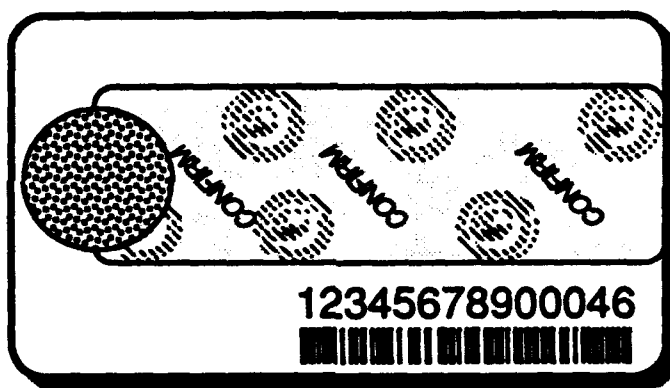

Figure 3-39. Prototype version of a tamper tape tag.

3.9.4 Activity Description.

On October 24, 1991, DNA tasked BDM to conduct a concept assessment of a tamper tape tag label with an added RP signature area as a tag for treaty verification.

The tamper tape with an added RP signature area evolved from commercially available tamper tape. The commercial tamper tapes consist of an adhesive backing on one or more layers of vinyl composites or sheet plastic. After proper application, this type of seal is difficult to remove without an indication that tampering has occurred (tearing or delamination of the multiple layers). An

RP signature area was added to increase the difficulty in counterfeiting the tag, and to make each tag unique. The design of this concept is still evolving. The results of the BDM Phase 2 testing provided data that will be useful in improving the most recent design of a tamper tape tag with an added RP signature area.

The first samples of tamper tape were delivered to BDM by PNL on December 31, 1991. They included versions of two types of RP signature areas. BDM was to test the samples and address two primary issues; the operability and fieldability of the design with a one-inch window, and the readability and signature characteristics of the design with an RP disk (larger RP area than the version with the one-inch window). BDM coordinated with PNL regarding testing details.

Phase 1 operational and signature tests were conducted on the tamper tape samples during January and February 1992. The operational tests were videotaped to provide a complete record of the handling of the tapes. Upon analysis of the test results, BDM wrote a draft Tamper Tape Experiment Report and briefing describing the tests, and their results. The draft report, videotape and briefing were provided to PNL for comment on February 28, 1992.

In mid-April 1992, BDM received six additional copies of the tamper tape with an RP disc from PNL. PNL and BDM initially defined four tasks to characterize the six samples (labels) and determine the effects of heat and cold on their signatures. A fifth task was subsequently added. The five tasks and observations on their results are described in paragraph 3.9.5.2 below.

After completion of testing and analysis of results, a draft Tamper Tape - Phase 2 report was written and provided to PNL for comment on May 19, 1992. PNL called and said they had no comments on the draft reports, the reports were published, and copies sent to DNA on June 23, 1992. This work was performed under TI FY91-13.

3.9.5 Results.

The Phase 1 experiments were defined prior to the start of BDM's efforts. Refinements were made as the first experiments produced conclusions. The descriptions which follow reflect each experiment as it was finally performed.

3.9.5.1 Phase 1 Experiments Results. For Phase 1 of the assessment, PNL and BDM devised several experiments to look at two primary issues: operability and fieldability of the label design window; and readability and signature characteristics of the larger RP area (RP disk) on the label.

Operability and fieldability of the label design window included adhesive migration time. Adhesive migration time is defined as the amount of time required for the label to adhere to the substrate to which it was applied. The following paragraphs provide general and specific observations of their results:

(1) Operability Observations:

- (a) Operability experiments were done with labels that contained no RP disc.**
- (b) Labels with both small and large windows were used for the adhesive migration time evaluation and heat effect on migration time.**
- (c) For the fiberglass-epoxy substrate, there was insufficient adhesive migration after 72 hours for both small and large windows.**

(2) Operability Specific Observations.

- (a) Procedure 1a: Material Types versus Adhesive Migration Time Evaluation. Placed 3 small window tamper tape labels on one plate of fiberglass-epoxy, graphite-epoxy, stainless steel and aluminum. Tag size was easy to handle; tags placed on fiberglass-epoxy were easily removed even after 72 hours migration time. Label did adhere to painted aluminum surface, but takes longer than 48 hours.**
- (b) Procedure 1b: Material Types versus Adhesive Migration Time Evaluation. Same experiment as 1a, but used large window tamper tape labels. Tag size was easy to handle. Large window tag still did not adhere to fiberglass-epoxy substrate. Tags adhered well to other substrate surfaces.**
- (c) Procedure 2a: Surface Temperature Evaluation. Cooled one graphite-epoxy and one stainless steel plate to -20°F for two hours. Attempted to place two tags, one small and one large window tag,**

on each substrate. Tags would not adhere to cold surface. Experiment was terminated.

- (d) Procedure 2b: Surface Temperature Evaluation. Heated one graphite-epoxy and one stainless steel plate to +115°F for two and one-half hours. Placed two tags, one small and one large window tag, on each substrate. Tags adhered very quickly to hot surface. Adhesive and window tended to stay on the substrate surface when tag removal was attempted.
- (e) Procedure 3: Heat Effect on Migration Time. Placed two tags, one small and one large window tag, on stainless steel plate. Tags were easily applied to surface and then heat was applied for two minutes to tag surface with heat gun. Substrate and tags were then immersed in liquid nitrogen. Both tags shattered into fragments as was expected.

(3) **Readability Observations:**

- (a) Readability experiments were done with labels that contained a RP disc on the label and were read with the Universal videographic Reader system developed by BDM (readings taken at room temperature).
- (b) The tags need to have greater particle density in the RP disc.
- (c) The tags need to have some type of fiducial to provide better alignment during image acquisition.
- (d) Hematite particles remained stable when subjected to extreme cold or heat.
- (e) The RP disc appeared to be very brittle after being subjected to extreme cold, brittle enough to be peeled off with little effort.
- (f) The RP disc became slightly sticky when subjected to extreme heat.

3.9.5.2 Phase 2 - Experiment Results. For Phase 2 of the assessment, PNL and BDM defined four tasks to characterize the six samples of tamper tape with the RP disc. The following paragraphs provide general and specific observations of their results, along with those for an added fifth task:

(1) General Observations:

- (a) The criteria used was based on the typical minimum median correlation factors for like and unlike correlations of applied RPT tags on a substrate. A like correlation is the comparison of a verification signature to a reference signature of the same tag. An unlike correlation is the comparison of a verification signature against the signature of a different tag. A like comparison correlates acceptably with a median value of .63 or greater. An unlike comparison yields a correlation factor less than 0.20. For the purpose of this preliminary data, this typical decision statistic was deemed sufficient. The majority of the label correlations did meet this typical criteria. It is possible, however, and desirable, to determine the best criteria for the combination of reader system, substrate and, tag type.**
- (b) Three of the labels were of noticeably higher particle density than the other three. These consistently correlated with higher values than did the lower density labels. The less dense labels had inconsistent correlations.**
- (c) The temperature variations had a greater effect when the labels were applied to the substrate than it did when they were still on the original backing. This was most pronounced when test images taken with the labels removed from the original backing were correlated with reference images taken when the labels were still on the backing. When test images were correlated against a reference acquired with the labels on the substrate, the correlation factors were higher. The operational significance of this difference is not clear, however, it implies that one might have to take baseline readings after the label has been placed on the item. A more attractive operational feature would permit baseline readings prior to dispatching the labels to the operational site. Further statistical analysis of the "like" and "unlike" distributions and the subsequent selection of a decision threshold value for these labels is needed.**
- (d) The RP disc on the label did cause the label to stretch when it was applied to the substrate.**

(2) Specific Observations:

(a) Task 1 Description - Take signature images, select one as the reference signature for the label. Then acquire a verification signature with a subsequent reading. Perform like and unlike correlations to determine if the RP signature meets the criteria.

Task 1 Results Summary - All like and unlike correlations were acceptable. The labels with the highest like correlations were those with the greater particle density .

(b) Task 2 Description - Subject the labels to heat (122°F) and to cold (14°F), taking images when at the extremes and then again when they had returned to room temperature. Perform a like correlation of each of these readings to its reference from Task 1. Then perform an unlike correlation of the reference to the hot and cold images of different labels.

Task 2 Results Summary - The like correlations performed, comparing the "hot" images to the original reference images and the "returned to room temperature" images to the original references, all met the criteria for like correlation ($\geq .63$). This was not true of the "cold" image correlations. When the "cold" images and the associated "room temperature" images were correlated with the original references, three of the labels met the criteria and three did not. The three labels with the least particle density did not meet the correlation factor required for an acceptable correlation. The labels with more dense particles did meet the criteria. The unlike comparisons were acceptable for all comparisons made.

(c) Task 3 Description - Take images after applying the labels to a substrate. Perform like and unlike correlations of these with the original references.

Task 3 Results Summary - The like correlations for the three less dense labels did not meet the criteria. The three more dense labels were acceptable, but the correlation values were not as high as those done before the labels were applied to the substrate. See Task 5 description, and results as it selected a reference image after the labels were applied to the substrate and then performed the correlations.

- (d) **Task 4 Description** - Subject the labels on the substrate to heat and cold, taking images when at temperature extremes and then again when returned to room temperature. Perform a like correlation of each of these readings to its reference from Task 1. Then perform an unlike correlation of the reference to the hot and cold images of different labels.

Task 4 Results Summary - The like correlations performed, comparing the "hot" images to the original reference images and the "returned to room temperature" images to the original references, all met the criteria for like correlation ($\geq .63$). This was not true of the "cold" image correlations. When the "cold" images and the associated "room temperature" images were correlated with the original references, three of the labels met the criteria and three did not. The three labels with the least particle density, did not meet the correlation factor required for an acceptable correlation. The labels with more dense particles did meet the criteria. The unlike comparisons were acceptable for all comparisons made.

- (e) **Task 5 Description** - Take readings, and select a reference image of labels on the substrate, not the backing. Then repeat the correlations done on Task 1 to compare the results.

Task 5 Results Summary - The like correlations improved when the reference was established on the substrate. Statistical analysis would need to be performed in order to quantify the improvement noted by observation. Figure 3-40 illustrates the correlation values for the Task 5 tags.

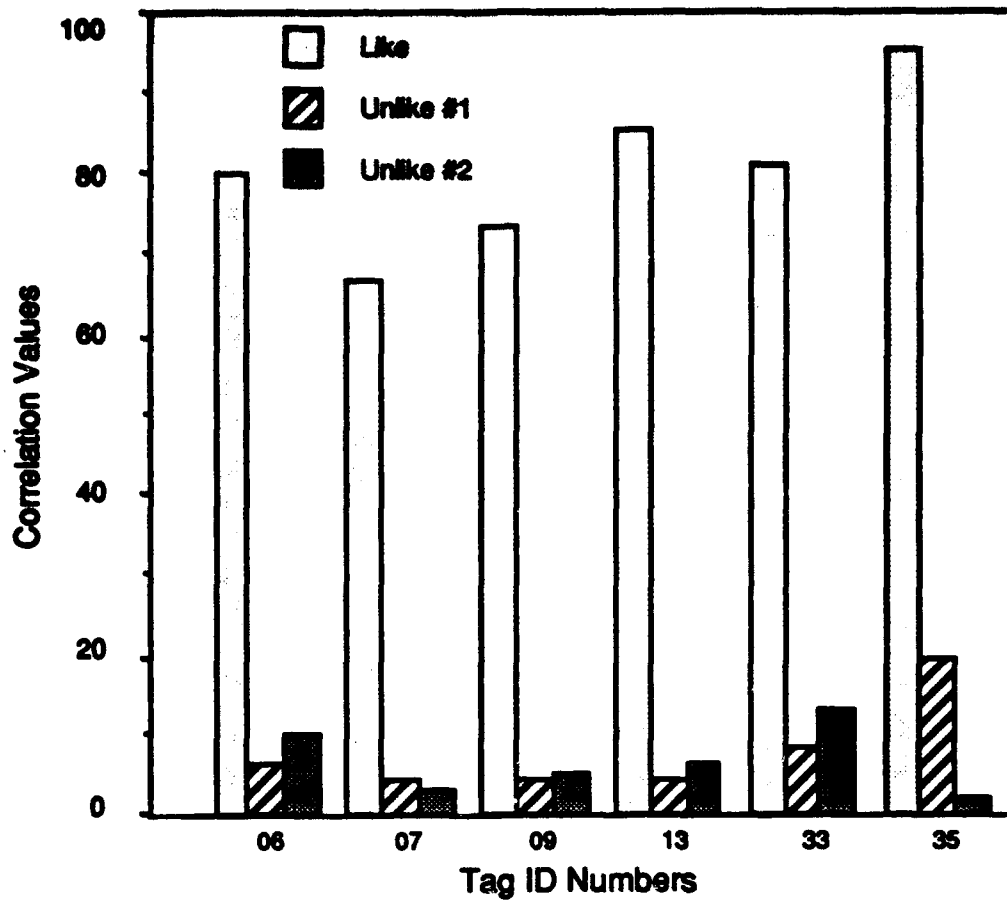

Figure 3-40. Task 5 correlation summary.

SECTION 4

BDM-DEVELOPED SYSTEMS

The approach used by BDM to develop concepts for Innovative Tags and seals was to first focus on the tag application and inspection as *operational functions in support of operational requirements* and then to identify the physical features of the overall tag or seal design that would be needed to accommodate those requirements and functions. A host of alternative, specific technologies that were both capable of embodying those physical features and were desirable from a practical perspective were entertained. The advantage of this operationally responsive approach was that it allowed unbiased, comparative evaluations of many different applicable technologies without placing undue attachment to a "favorite son" technology and without resulting in loss of command over the basic operational objectives and developmental constraints of tag or seal application. In the pursuit of Innovative Tags/Seals, BDM gave preference to and concentrated on concepts that were technologically simple. Although the design objectives always emphasized lower complexity, the new tags and seals still had to meet the extremely high standards and ground rule requirements of START. The START requirements included uniqueness, repeatability and non-counterfeitability of the signature, high confidence tamper detectability, and environmental and handling robustness. Finally, in the interest of fielding the tag or seal as rapidly as possible and to provide high reliability, preference was given to concepts that were able to use COTS components.

All of the BDM Innovative Tag work operated under the ground rules and confidence standards of START. However, some of the independent assessments of systems from other developers involved tag concepts (e.g., ARS, NLJ, MIKOS, EIDs, VACOSS-S, and Tamper Tape+RP) which would not have been acceptable for START. Specifically, constraints under START forbade the use of active tag systems; tags were required to have a very high degree of uniqueness, non-counterfeitability, repeatability, and assurance of tamper resistance. Had the extremely rigorous requirements imposed on tags and seals for START been relaxed during the Innovative Tags task, very likely a significantly different list of tag and seal concepts would have been pursued. Consideration of the EID technology, that might have been applicable to a wide variety of new tag or seal concepts, was specifically disallowed early in the Innovative Tag task, because of

security concerns. It should be noted that intrusiveness concerns are often diminished or irrelevant in tag and seal applications different from deployed START systems. Further, it is BDM's assertion (albeit an undemonstrated assertion since no secure EID concepts were actually developed) that unauthorized access to stored information in an EID can be denied to adversaries at a high level of confidence with appropriate tamper resistant design.

Three fundamental classes of tags (see figure 4-1) were identified for the Innovative Tag initiative:

- (1) **Intrinsic tags** (using some topological or material properties of the TLI itself for identification)
- (2) **Adhered tags** (a uniquely identifiable object that is attached to the TLI, with an adhesive, for example)
- (3) **Loop tag/seals** (using a uniquely identifiable closed loop to capture some topological feature of the TLI).

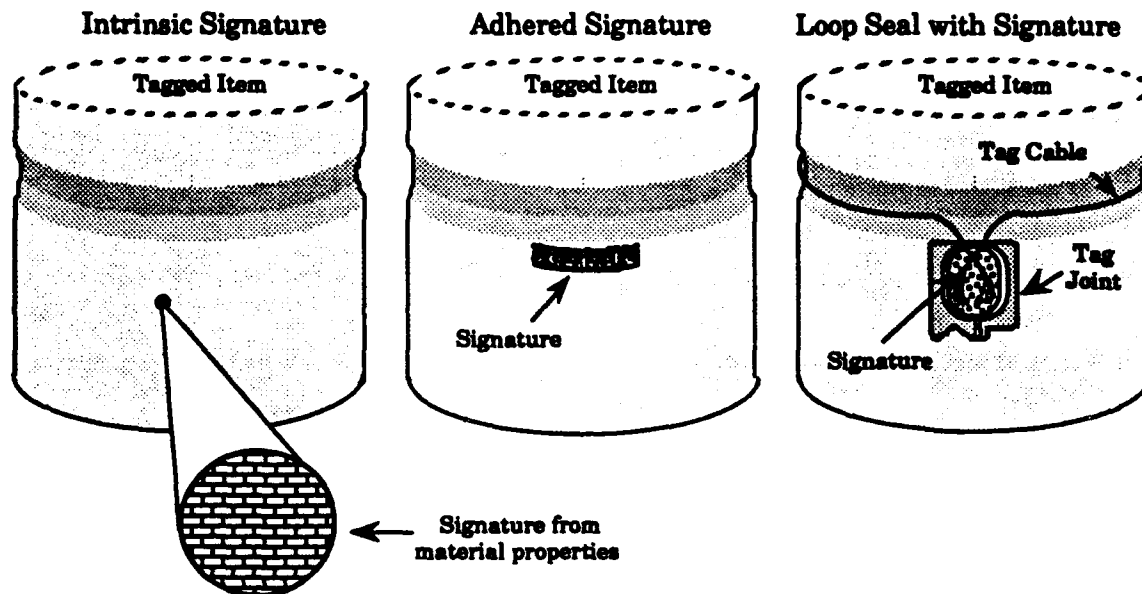

Figure 4-1. Generic classes of tags.

Intrinsic tags present particularly difficult reliability challenges because of instabilities and unknown variability in the material properties or surface properties of the TLIs. Also intrinsic tag design requires detailed knowledge of

the material properties of treaty participants weapon systems. That type of information is not always available. BDM briefly investigated only two intrinsic tag concepts, Fourier optical imaging, and a scanning electromagnetic/acoustic measurement (SEAM) technique, to support the TI-15 creative task.

After consideration of several candidate alternatives for adhered tags, BDM concluded that none of the new adhered tag candidates (excluding adhered EID concepts, which were disqualified for START consideration) would have any significant advantage over the RPT, developed by SNL. The RPT was already well developed, inexpensive, was very simple in concept, and had already undergone an extensive adversarial analysis by LLNL. Early on, brief consideration was given to incorporating an RP signature into a commercially available tamper tape. However, the daunting technical problems associated with achieving stability of the RP signature within the flexible layers of a stick-on tape, manufacturing challenges, and limited confidence in the detectability of tampering with tamper tape against an adversary with unlimited resources, caused BDM to reject pursuit of RPs in tamper tape as an adhered tag concept for START applications in the Innovative Tag program. Subsequently, however, LLNL did develop some prototype versions of tamper tapes with an RP signature (see section 3.9)

In the judgement of BDM, loop tag/seals offered the greatest flexibility of application of any tag or seal concept, and the most fertile ground for Innovative Tag research. The loop in a loop tag/seal can be configured in many forms to accommodate a variety of tagging and sealing applications. Just as in the case of the adhered tag, BDM concluded that the RP signature was the simplest and most robust signature available for a loop tag/seal (excluding consideration of EID concepts). Furthermore, an RP signature was the most likely to gain rapid community acceptance as a signature concept in a new tag/seal. Therefore, a generic design of loop closure embedded in an RP signature was assumed for most of the loop tag/seal concepts, and the major research effort focused on selecting material and design configurations that would promote operationally sound tamper detection for different levels of inspector access to the loop.

This section limits its discussion to only those tag/seal concepts that were developed by BDM for DNA beyond the proof-of-concept stage to actual prototype systems. The two concepts that fall into this class are the Secure Loop Inspectable

Tag/Seal (SLITS) and the Secure Loop Optical Tag/Seal (SLOTS), that has since been re-named the Passive Tamper Indicating Loop Seal (PTILS). While it is correct to surmise that these two concepts are winners in the Innovative Tag selection process, it is incorrect to conclude that all of the other proposed concepts were losers. Some of the tag concepts were not pursued to prototype stages because they were conceived too late in the process; some would have required developmental funding beyond the contract budget; and some were excellent concepts that either were inappropriate for the rigorous START requirements or were simply preempted by a good concept that was at a more advanced stage of development.

4.1 SECURE LOOP INSPECTABLE TAG/SEAL (SLITS).

4.1.1 Overview.

The SLITS is a high confidence, environmentally robust loop tag and/or seal that emphasizes *simplicity* in concept, construction, installation, and inspection. The hands-on, intuitive inspection procedure for SLITS requires no high-tech equipment and allows tamper determination to be made on-site with very high confidence. The combination of environmental robustness, passive design, tamper detectability, and a non-counterfeitable signature make SLITS applicable within the rigorous requirements of START.

The materials used in SLITS were selected to be very robust to environmental or handling damage but to be intrinsically difficult to repair if damaged. These properties, combined with the physical construction of SLITS, ensure that any tamper-induced evidence will be revealed easily and positively to a trained inspector during an on-site inspection. Simple visual and tactile examination, aided by small hand tools such as a magnifying lens, needle probe, and flashlight are the methods by which an inspector performs on-site tamper detection. This form of on-site tamper detection involves two operational precepts that must be understood if confidence in the tag or seal integrity of SLITS is to be maintained: 1) the on-site inspector must have intimate physical access to all parts of the installed loop, and 2) determination of tampering is a subjective judgement made by the inspector. To detect tampering in the loop, the inspector visually examines the loop materials for anomalies in surface appearance, he

runs his fingers along the loop to reveal lumps or unusual roughness, pulls on the loop with significant force to reveal regions of weakness, and tactilely manipulates loop materials in other nondestructive ways to reveal evidence of a covert splice. Similarly, tampering in the joint block is detected by close visual examination of the localized region surrounding the loop closure for anomalies under a variety of illumination and magnification conditions. With proper inspection, chances are extremely remote that an adversary could successfully conceal an adversarial attack in which the loop is opened and rejoined. Evidence of tampering in SLITS discovered by the inspector can be documented on-site using the video microscope image recording feature of the UR.

Additional confidence in tamper detection beyond that achievable on-site by the inspector (if it is allowed by the treaty or agreement) can be obtained by removing individual SLITS, either at random or at the option of the inspecting party, for detailed examination in a tamper inspection laboratory. With laboratory examination, the potential for any adversarial tampering to go undetected is nil.

4.1.1.1 Documentation Produced. Several BDM reports on Innovative Tags developments were prepared and submitted to DNA. These are listed in table 4-1.

Table 4-1. Innovative Tags reports to DNA.

<u>Report Title</u>	<u>Date of Submission</u>
Gentler, Simpler Tags	August 30, 1990
TI-10 Assessment Report	August 30, 1990
Innovative Tags Interim Report	November 11, 1990
Analysis & Proof-of-Principle - Innovative Tags	January 31, 1991
Interim Report on Innovative Tags	April 22, 1992
Interim Report on PTILS	July 30, 1992
IOT&E of the UR Combined with RPT-2 and SLITS Final Test Report	January 7, 1993
Use of Aluminized Mylar as the Reflective Particle Material in PTILS	March 12, 1993

4.1.1.2 Expenditures. The SLITS development effort began on November 28, 1990, and was completed in February 1993. The following table (table 4-2) lists the

labor hours, the associated loaded labor costs (without fee and tax) plus the ODC's expended during the conduct of the SLITS assessment.

Table 4-2. SLITS expenditures.

TI	Hours	Loaded Labor Costs	ODC's	Total Costs
FY90-10	*	*	*	*
FY90-15	*	*	*	*
FY91-15	*	*	*	*
Total	*	*	*	*

* All costs will be provided at contract closeout.

4.1.2 Schedule.

The Innovative Tags developments began July 17, 1990, and continued through the Fall 1990. Mr. Paul Boren of DNA/OPAC was briefed on some early Innovative Tag concepts in August 1990. This early work was performed under TI FY90-10 and its amendments. Eventually, most of this effort focused on the two BDM tag/seal concepts, SLITS and SLOTS. These and concepts that were rejected were briefed extensively to Col. Bob Davie and several others from the DNA/OPAC office on January 16, 1991. It was proposed at the January 16 briefing that SLITS and SLOTS be developed to laboratory prototypes. Further proof-of-concept assessments were conducted from January through early March 1991.

On March 1, 1991, TI FY91-15 was issued authorizing prototype development of SLITS and SLOTS, as well as the development of the UR. The UR was to be an improvement of the SNL RPT reader system. The improvements of the reader system included designing and fabricating a more versatile and portable system emphasizing COTS components, with some improvements in the design of the reader head. TI-15 also authorized the continuation of creative work to pursue possible additional Innovative Tag concepts.

On May 7, 1991, TI FY91-15 was amended to include only the prototype developments for SLITS and SLOTS and the creative work. The UR development was moved to TI-14. Laboratory prototypes of SLITS were delivered to INEL on September 1, 1991, for adversarial analysis. Industrial prototypes of SLITS were

developed between September 1991 and July 1992. On March 27, 1992, five industrial prototypes of SLITS were delivered to INEL, including a Kynar overbraid version and a plastic optical fiber version.

During April 20-29, 1992, an IOT&E of the UR system was conducted at BDM in Albuquerque, using the latest design of SNL's RPT-2, and SLITS. On May 6, 1992, ten more SLITS (five of each type) were delivered to INEL, along with one complete assembly jig, an inspection kit, 12 packages of pre-measured epoxy/hematite, and a complete UR system. On July 26, 1992, L&M Tool of Albuquerque delivered 500 injection-molded SLITS joints to BDM. On August 7, 1992, the environmental tests of SLITS were completed by National Technical Services of Saugus, CA and the tested tag/seals were returned to BDM. Innovative Tag developments, including SLITS activities, are summarized in figure 4-2.

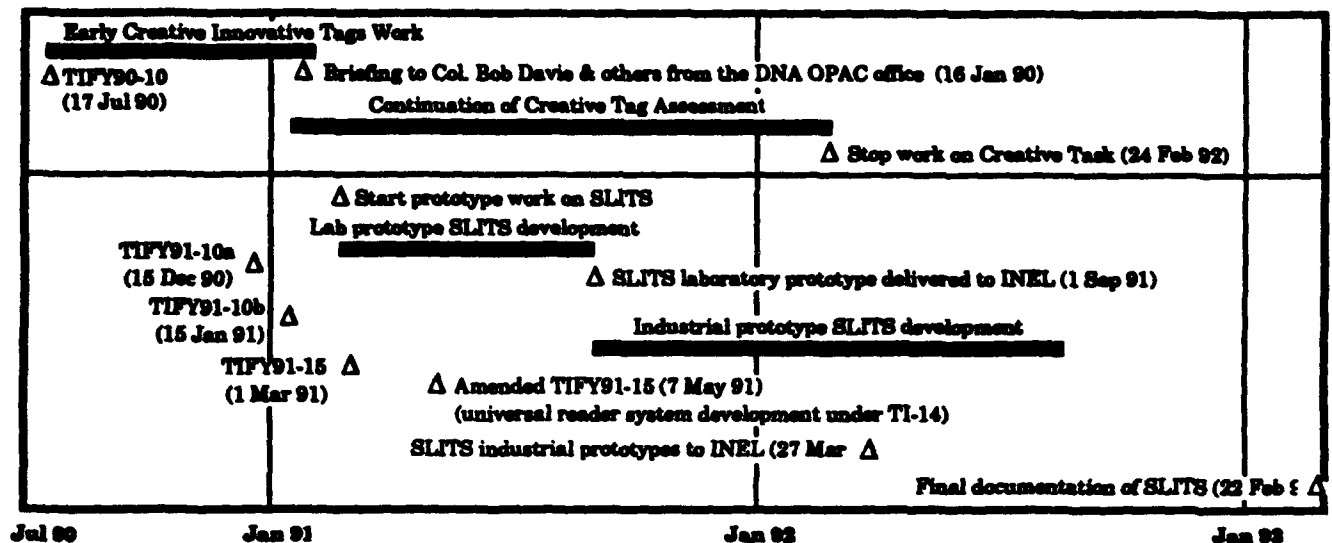

Figure 4-2. Schedule of Innovative Tags and SLITS development.

4.1.3 System Description.

A SLITS is, very simply, a tamper revealing "rope" of material secured into a closed loop by a non-counterfeitable signature. As a loop tag/seal, the arrangement is intended to be conceptually simple, easy to install, easy to inspect, and be extremely difficult to defeat by an adversary with unlimited resources. An annotated drawing of the SLITS design is shown in figure 4-3.

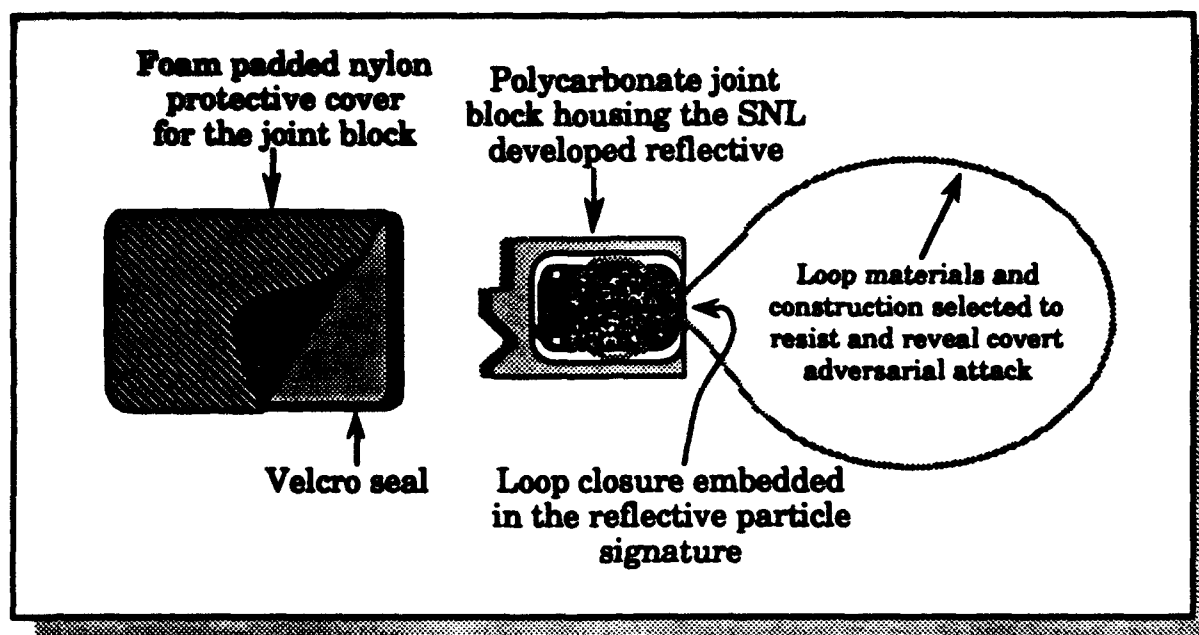

Figure 4-3. SLITS design including the protective cover.

The transparent polycarbonate SLITS joint block embeds the closure of the loop within a signature well filled with a mixture of reflective particles and epoxy. Polycarbonate was chosen for the joint block material because it has good optical clarity, is very mechanically robust (i.e., resistant to impact and stress fractures), has good chemical resistance, and is an excellent material for injection molding in mass production. Because polycarbonate is susceptible to surface scratches and to degradation from prolonged exposure to ultraviolet (UV) light, the joint block of an installed SLITS will normally be stored in a protective foam padded, fleece lined, nylon pouch. The protective pouch also aids in keeping the optical surfaces of the joint block clean and in protecting the joint block from handling abuse. Epoxy was selected for a suspension/closure medium because it cures uniformly throughout the volume of the signature well, via chemical reaction; epoxy is not subject to partial or incomplete curing as would be the case with evaporative or UV-cured adhesives. Devcon 5-minute epoxy, in particular, was selected for SLITS because of the epoxy brands commercially available, Devcon 5-minute epoxy has good optical clarity, hardens rapidly with good adhesion to the polycarbonate well walls, the thermal expansion coefficients of the epoxy and polycarbonate are very nearly equal, and it has a viscosity appropriate to allow adequate mixing and suspension of the dense hematite particles throughout the well.

The three-dimensional micaceous hematite particle suspension surrounding the loop closure within the SLITS signature well forms two unique, non-counterfeitable RP signatures, one on each of the opposing faces of the joint block, in a manner exactly analogous to the RPT, developed by SNL. The odd shape of the SLITS joint block was designed to fit into a three point kinematic alignment jig to ensure accurate image registration of the signature region by the UR reader head.

Much of the design of the joint block was included specifically to discourage adversarial attack and to reveal tampering in any form. The joint block is transparent with polished surfaces on both sides, and all relevant edges are designed for maximum inspection clarity for the inspector. The closure of the loop is embedded in the signature region to complicate the actions of any adversary who might attempt to open the loop within the joint block. The options of an adversary for concealing a covert attack in the joint block are limited by constraining the closure of the loop to a very small region near the entry points of the loop material into the joint block. If an adversary is to defeat the loop tag/seal, he must open the loop. If the adversary chooses to attack the loop inside the joint block, he must attack the joint block in the localized region between the entry points and the loop closure. The inspector knows this, however, and will direct extra attention, with 10x magnification and special lighting, to that localized region where tampering of any consequence must occur. The forward localization of the loop closure is controlled and standardized in every SLITS through the use of guide channels for the loop material on either side of the signature region (see figure 4-3). These guide channels also serve to facilitate assembly of SLITS by holding the loop ends in position while the epoxy and lid are applied. Finally, the entry holes where the loop enters the joint block are square, not round, to reveal tampering. If an adversary attempts to drill or pry in these regions, any damage introduced will be difficult to repair effectively and will be easily noticed by the inspector.

The loop in SLITS is composed of materials and constructions that are very robust environmentally and are particularly difficult to splice without obvious degradation once cut. The construction of the loop is shown in figure 4-4.

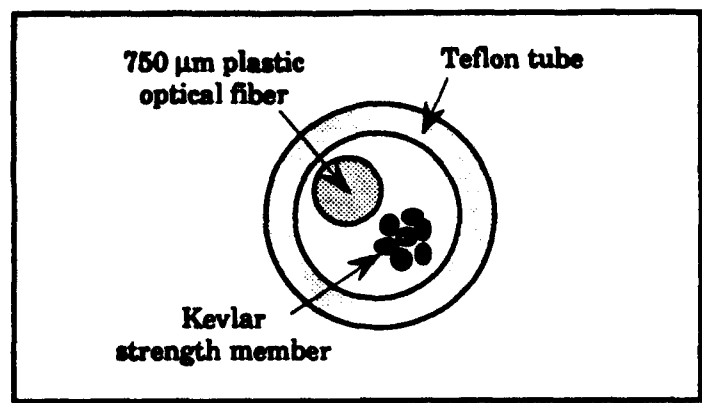

Figure 4-4. The SLITS loop design.

The basic element of the loop is flexible, thin-walled tubing made of Teflon FEP. Teflon is DuPont's registered trademark for a family of fluorocarbon resins, monofilaments, fibers, film, and tubing. Teflon FEP (fluorinated ethylenepropylene) is a fluorocarbon (copolymer) resin (tetrafluoroethylene hexafluoropropylene) with excellent chemical resistance to inorganic compounds, such as strong acids and bases and to organic compounds such as hydrocarbons, ketones, and chlorinated solvents. Teflon FEP has good mechanical strength (tensile modulus of 40,000 PSI, tensile strength of 3000 PSI) and excellent thermal stability in high and low temperature environments (melting point of 500°F to 545°F and workable at cryogenic temperatures), and has excellent resistance to UV light. The tubular construction of the Teflon member in the SLITS loop minimizes the surface contact area available to an adversary in a restorative butt joint, which in turn minimizes the strength of the joint for any possible bonding agent. Minimal contact area combined with Teflon's well-known inability to be bonded by adhesives makes the flexible tube portion of the loop extremely difficult to restore after cutting without obvious degradation or weakness. The Teflon tube has a nominal OD of 0.074 inch and ID of 0.066 inch.

To enhance the normal tensile strength of the SLITS loop and to inhibit stretching, a twisted, two-ply, 1,500 denier multifilament strength member composed of Kevlar 49 is included inside the Teflon tube. Kevlar is the registered trademark for DuPont's family of high temperature-resistant aromatic polyamide (aramid) fibers that combine toughness, extra-high tenacity and elastic modulus, and excellent thermal stability. Kevlar 49 twisted yarn has a tensile strength of 400,000 PSI, a tensile modulus of 18×10^6 PSI, and elongation of 2.5% at break. The

average filament diameter in the multifilament core is 12 microns. Kevlar 49 exhibits virtually no shrinkage or expansion between room temperature and 320°F and exhibits essentially no embrittlement or degradation of fibrous properties at cryogenic temperatures of about -320°F. The Teflon tube walls in the SLITS loop protect the fine multifilament fibers from degradation by fraying, chemicals, and UV light.

Tensile strength, the ability to reveal adversarial attack, and resistance to surface abrasion are further enhanced in the SLITS loop by the uniform, diamond braid of 0.010 inch diameter monofilament Kynar overbraided on the Teflon tube. Kynar, otherwise known as PVDF (polyvinylidene fluoride), is a registered trademark for Atochem North America Plastics fluoropolymers. Kynar has excellent dimensional stability under thermal and mechanical stress, with a tensile strength of about 53,000 PSI, a tensile modulus of 175,000 PSI, and an elongation at break of about 40 to 50%. Kynar also has excellent thermal stability, with a melting point of 320°F and a safe continuous operating temperature maximum of 265°-300°F. Kynar fluoropolymers are resistant to weathering and are widely used as base resins for long-lasting exterior coatings, because they are very stable to long exposures to sunlight and other sources of UV radiation. Because of their tough abrasion and excellent chemical resistance, Kynar monofilaments have been used successfully in industrial applications to replace stainless steel in corrosive environments. These physical properties of Kynar ensure that the uniformity and flexibility of the overbraid in the SLITS loop will be maintained for long periods of tag/seal installation even in the rigorous installation environments envisioned for START. If the SLITS loop is cut by an adversary attempting to defeat the tag/seal with a cut-and-splice attack, the open, monofilament structure of the Kynar braid will force the adversary to form independent butt splices with low mechanical strength on each individual monofilament in the braid, if the flexible characteristics of the braid are to be preserved. Attempting to bond the fibers in the braid in any manner other than as individual strands will be detected tactilely by an inspector as an obvious non-uniformity. Not only must the adversary bond individual monofilaments with strength and without observable accumulation of adhesive or defects in any of the individual fiber splices, but the adversary must also accurately preserve the correct braid organization, the length of each cut fiber, and the twist tension of

each individual fiber, if the highly uniform appearance and tactile feel of the braid is to be restored in the overall splice.

As a historical footnote, it should be mentioned that a second type of loop construction, shown in figure 4-5, was considered in the SLITS industrial prototype development. In this alternate loop construction, the Kynar overbraid was deleted and a single strand of 750 μm diameter polymethylmethacrylate (PMMA) plastic optical fiber, along with a Kevlar strength member, was included inside the Teflon tube. The fiber optic SLITS loop design shifted emphasis in tamper detection from appearance and tactile feel of the outer braid to the visual indication of scattered light at any tamper-induced defect in the plastic optical fiber. During the UR/RPT-2/SLITS IOT&E it was found, however, that the visual indicator of scattered light at a break in the optical fiber was not used effectively in some cases by the inspectors. Furthermore, the optical fiber was prone to handling degradation (kinking and breakage), making the fiber optic SLITS loop design significantly less reliable than the Kynar braided tube design. Therefore, based on these operational observations, the fiber optic loop design was shelved and the braided Kynar loop construction was selected by BDM, with DNA's concurrence, to represent the preferred SLITS loop configuration.

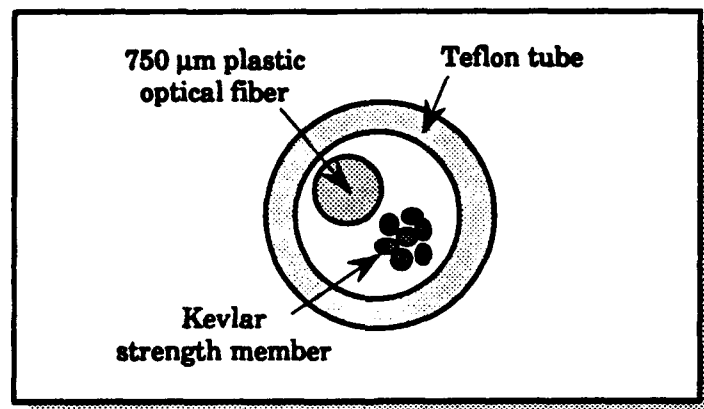

Figure 4-5. Cross-sectional view of alternative SLITS loop design incorporating a plastic optical fiber.

The SLITS installation procedure involves threading the loop (taken from a long reel of loop material) through or around the tagged item, cutting the loop to an appropriate length, crossing the loop ends in the signature well in the lower portion of the joint block, mixing and pouring the epoxy bonding agent (premixed with reflective particles) over the loop closure, snapping on the lid of the joint

block, and waiting less than five minutes for the epoxy to cure. A heating wrap could be used to promote curing in cold weather. Once the epoxy has cured, the initial signature reading is taken using the UR. SLITS installation is complete after the protective cover is slipped over the joint block. In outdoor installations, particularly if long term UV exposure is likely (on the order of a year or more), a split neoprene tube can be slipped over exposed portions of the loop as a sheath for additional environmental protection.

The reading operation for SLITS involves simply snapping the joint block into the SLITS alignment jig, snapping the alignment jig onto the reader head, and commanding the UR to read and record the signature. This process is repeated for the opposite side of the tag. During the automated SLITS signature reading operation, the randomly-oriented reflective particles within the joint block are sequentially illuminated from a predetermined set of directions by lights in the reader head. The set of specular reflection patterns produced by the reflective particles, one image pattern per light direction, is recorded as the tag's unique signature. The signature is correlated by the UR against the baseline reading of the tag made at the time of installation to validate the identity of the tag/seal. Use of the UR in relation to inspection of SLITS is described in detail in the report, "IOT&E of the UR Combined with RPT-2 and SLITS Final Test Report," BDM/ABQ-93-0002-TR, dated January 7, 1993.

A positive correlation in a verification reading proves that the tag is the same tag that was installed (the signature is so complex that it cannot be counterfeited) but does not indicate whether or not tampering has occurred. On-site tamper detection in SLITS is a separate operation involving careful visual and tactile inspection of the loop and visual inspection of the loop closure region inside the joint block. All parts of the SLITS loop and joint block must be accessible for inspection, both visually and tactilely, by a trained inspector. The inspector is aided with simple tools such as needle probes, magnifying lenses, and a small flashlight to detect tampering. Evidence of tampering may be documented on-site with the video microscope feature of the UR. The capabilities of the UR are discussed in detail in section 4.4 of this report. The basic operations involved in a SLITS inspection are depicted in figures 4-6 and 4-7. Detailed inspection procedures and a full list of tools available to the inspector in the inspection kit are given in the UR IOT&E Final Report and in the inspection report, entitled

"Results of Simulated Field Inspections of Red Teamed Industrial Prototype SLITS," BDM/ABQ-93-0010-TR, dated February 3, 1993.

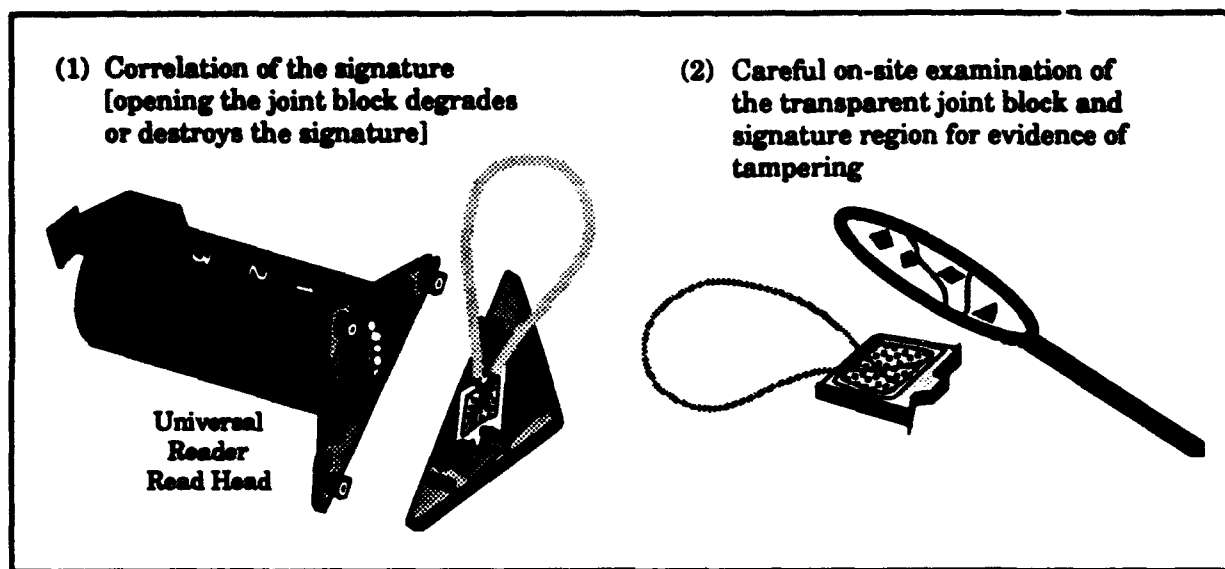
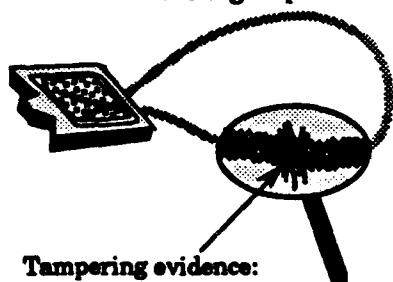

Figure 4-6. Tamper detection in the SLITS joint block.

Visual and tactile on-site examination of the tag loop



Tampering evidence:

- (1) pattern break
- (2) free ends
- (3) misalignment
- (4) tactile anomaly

An Option:

The tag/seal could be retrieved and examined at a high technology analysis laboratory

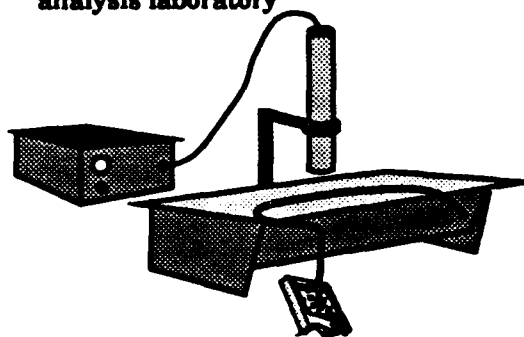

Figure 4-7. Tamper detection in the SLITS loop.

The on-site determination of tampering in SLITS is a subjective judgement made by the inspector at the time of inspection. The validity of the tamper assessment depends on the quality of the inspection. Proper training of inspectors in tamper detection technique is necessary to achieve high confidence against

sophisticated adversarial attacks in an on-site inspection. This observation is obviously true of all tags and seals inspected on-site, not just SLITS. With training, an inspector can become an expert in the installation, reading, and tamper detection of SLITS in less than two days. To aid the inspector in the tamper detection task, the materials used in and the design configuration of SLITS were carefully selected to make covert adversarial attack (such as cutting and splicing the loop or tampering with the loop joint block in an attempt to open the loop seal) extremely difficult to perform at all. These same design features simultaneously serve to starkly *reveal* tampering in every form.

The inspector's ability to detect tampering in the joint block is further enhanced by use of the software version of the Universal Comparator Blinker provided in the UR, and accessible in the eyepiece of the UR reader head. The blinker uses the human psychovisual system by displaying, alternately, a baseline image and a reference or verification image, to emphasize differences in the two images. The software blinker rapidly alternates reference and current preview images of the signature region in the eyepiece monitor of the UR reader head so that any change, even the movement of a single particle, is immediately apparent as a blinking signal. Thus, an adversary attempting to defeat SLITS will be forced to use very sophisticated, delicate, time-consuming operations to pursue the attack, and will always be faced with significant risk of detection by the on-site inspector. If, in addition to or in lieu of on-site tamper inspection, the SLITS is removed by the inspector and returned to a home base for examination for tampering in a well-equipped laboratory, the potential for tampering to go undetected is nil.

4.1.4 Activity Description.

Research on the BDM Innovative Tags task began formally on July 17, 1990. Work on Innovative Tags was first performed under TI FY90-10, and later under TI-15. The change in TI numbers occurred not because of a change in the definition or scope of the Innovative Tags pursuit, but rather to simplify the management task by consolidating a broad range of tagging activities under a smaller number of open TIs. The tasking under Innovative Tags was for BDM to conceive and show proof-of-principle for tag/seal concepts for use in arms control verification that would be more technically and operationally sound than concepts

already proposed in the verification community. Work on Innovative Tags began in a search, research, and demonstrate mode, and continued in that mode until January 16, 1991, when the most promising concepts were briefed in detail to Col. Bob Davie and several others from the DNA/OPAC office. The less successful tag/seal concepts that had been considered and assessed were also surveyed in this briefing. Two loop tag/seal concepts, the SLITS and the SLOTS, were recommended in the Davie briefing for laboratory prototype development, with the expectation that industrial prototype development would follow if no insurmountable pitfalls were encountered.

Approval was received from DNA for prototype development of SLITS and SLOTS shortly after the Davie briefing with the authorization of TI-15 in March 1991. The SLITS concept underwent steady design improvement and refinement through the industrial prototype stage, culminating in successful completion of environmental tests, an IOT&E, and an adversarial analysis. Results of the environmental testing on SLITS are summarized in table 4-3. Basic development of SLITS as an operationally sound tag/seal was completed in late October 1992.

In addition to formal reports on progress in the Innovative Tag task, many briefings and laboratory demonstrations were held after January 1991 that included discussion of the Innovative Tags. Audiences for briefings at BDM in Albuquerque included: HQDNA, FCDNA, the On-site Inspection Agency (OSIA), the OUSD(A), the National Security Agency (NSA), and the Central Intelligence Agency (CIA). A briefing on Innovative Tags was held at the Center for Verification Research in April 1991 with Dr. Swingle (OUSD(A)) and Dr. Fuller (DOE) as the primary audience. The BDM-developed Innovative Tags were included in many briefings in Washington at HQDNA, OUSD(A), OUSD(P), and the Department of State during December 1991 and January 1992. These briefing activities are reflected in the list in table 4-4.

Throughout the SLITS development, a design objective in the SLITS loop was to use materials and physical configurations that would make cut-and-splice operations especially difficult for an adversary to conceal. One design tactic pursued was that of using anti-complementary materials (e.g., stainless steel, which can only be bonded by high temperature welding, placed in close proximity with materials having much lower melting temperatures). After several

unsuccessful attempts, it was concluded that stainless steel could not be braided uniformly enough and in close enough proximity with monofilament polymer materials to achieve the anti-complementary feature. No other acceptable anti-complementary sets of materials were identified. However, this research effort identified several very attractive braid configurations and monofilament materials that, in fact, accomplished the original objectives of making covert splices extremely difficult to form at all. It is extremely important to maintain uniformity in the appearance and tactile feel of a SLITS loop if anomalies introduced by covert adversarial attack are to be easily discovered in an on-site inspection. Several braiding companies (including Atkins-Pearce, Bentley-Harris Manufacturing, and Hyspan Precision Products) provided sample runs of various braid constructions for evaluation and possible use in SLITS. Eventually, a diamond braid of monofilament Kynar emerged as the configuration best able to meet both adversarial and environmental design objectives.

Table 4-3. Environmental test results on SLITS.

UR & SLITS ENVIRONMENTAL TEST SUMMARY CHART						
UR EQUIPMENT RESULTS				SLITS RESULTS		
TEST PERFORMED	PASS	FAIL	COMMENTS	NO EFFECT	EFFECT	COMMENTS
ALTITUDE	X			X		
HIGH TEMPERATURE	X				X	CRACKING AND DEBONDING
LOW TEMPERATURE	X			X		
TEMPERATURE SHOCK	X				X	
HUMIDITY	X		LITTLE RUST ON STEEL SCREWS		X	
FUNGUS	X		TESTED BY MANUFACTURER		X	
SALT FOG	X		TESTED BY MANUFACTURER	X		
RAIN	N/A				X	
ICING/FREEZING RAIN	N/A				X	
SAND AND DUST	N/A				X	
VIBRATION	X				X	
SHOCK	X				X	
SOLAR RADIATION	N/A				X	
CONDUCTED EMISSIONS 03	X			NA	NA	CRACKING AND DEBONDING
CONDUCTED EMISSIONS 07		X	LARGE TURN ON SPIKES	NA	NA	
CONDUCTED SUSCEPTIBILITY 02		X	CROSS COUPLING OF CABLES	NA	NA	
CONDUCTED SUSCEPTIBILITY 08	X			NA	NA	
RADIATED EMISSIONS 02		X	MONITOR, READER HEAD, MILTOPE	NA	NA	
RADIATED SUSCEPTIBILITY 02	X			NA	NA	
RADIATED SUSCEPTIBILITY 03		X	POWER SHUT DOWN	NA	NA	

Table 4-4. Briefings by BDM that discussed Innovative Tags developments.

Primary Audience	Date of Briefing	Location
Mr. Boren (HQDNA/OPAC)	August 10, 1990	Albuquerque
Mr. Boren (HQDNA/OPAC)	November 1, 1990	Albuquerque
Col. Davie and staff (HQDNA/OPAC)	January 16, 1991	Albuquerque
Dr. Swingle, OUSD(A) & Dr. Fuller (DOE)	April 3, 1991	CVR
Col. Evenson & Col. Davie (HQDNA/OPAC)	April 18, 1991	Albuquerque
Cmdr. Pech and Mr. Bland (NSA)	May 14 1991	Albuquerque
Mr. Minichiello, OUSD(A)	May 23, 1991	Albuquerque
Dr. Tsang (INEL)	May 24, 1991	Albuquerque
Lt. Col. Sharples (FCDNA)	June 3, 1991	Albuquerque
Mr. Spaulding (CIA)	June 10, 1991	Albuquerque
Ms. Andreozzi-Beckman (HQDNA/OPAC)	June 12, 1991	Albuquerque
INEL Red Team Staff (first briefing on SLOTS)	June 26, 1991	Albuquerque
Gen. Johnson and Ms. Steinberger, OUSD(A)	July 17, 1991	Albuquerque
Lt. Col. Sharples (FCDNA)	July 31, 1991	Albuquerque
Col. Evenson (HQDNA/OPAC)	August 29, 1991	Albuquerque
INEL Red Team Staff (Kickoff briefing on SLITS)	September 9, 1991	Idaho Falls
Lt. Col. Sharples (FCDNA)	September 11, 1991	Albuquerque
Lt. Col. Sharples (FCDNA)	November 18, 1991	Albuquerque
Mr. Celic (HQDNA)	November 20, 1991	Washington
Ms. Andreozzi-Beckman (HQDNA/OPAC)	November 22, 1991	Washington
Gen. Johnson & Ms. Horn, OUSD(P)	November 25, 1991	Washington
INEL Red Team Staff (Kickoff briefing on SLOTS)	November 25, 1991	Albuquerque
Dr. Richardson, OUSD(A)	December 4, 1991	Washington
Mr. Miller, OUSD(P)	December 6, 1991	Washington
Col. Rhoads (OSIA)	December 18, 1991	Albuquerque
Ambassador Courtney (Dept. of State)	December 30, 1991	Washington
Mr. Crouch, OUSD(P)	January 8, 1992	Washington
Lt. Col. Sharples (FCDNA)	February 11, 1992	Albuquerque
Col. Evenson (HQDNA/OPAC)	February 27, 1992	Albuquerque
Col. Roszak (DNA) and Dr. Swingle, OUSD(A)	March 31, 1992	Albuquerque
Lt. Col. Bjurstrom (HQDNA/OPAC)	May 5, 1992	Albuquerque
INEL Red Team Staff	May 6, 1992	Idaho Falls
DNA Arms Control Convention	June 3, 1992	Williamsburg
Capt. Nelson (FCDNA)	June 26, 1992	Albuquerque
Ms. Monte (HQDNA/OPAC)	July 1, 1992	Albuquerque
ESC/DNA study group on adjunct monitoring	August 26, 1992	Kirtland AFB
Maj. Petito and Maj. Simelton (DNA/OPAC)	October 6, 1992	Albuquerque
Capt. Nelson (FCDNA, on SLITS inspection)	October 15, 1992	Albuquerque
Red Team Review, DNA, OUSD(A), and DOE	January 7, 1993	Albuquerque

Early prototype joint blocks were fabricated by machining polycarbonate sheet stock. After initial design of SLITS was evaluated, tested, and accepted using machined polycarbonate closure joints, BDM designed equivalent joint blocks that possessed the subtle mold release features necessary for mass production by injection-molding. Injection-molding was pursued to provide for

low cost production of SLITS in large quantities. L&M Tool, an Albuquerque injection mold maker, with extensive experience in making molds for precision parts, was contracted to design and construct the mold. After much testing, the joint blocks manufactured by injection molding have been shown to be adequate in all respects for the SLITS application. The estimated cost of the injection-molded joint blocks is in the range of \$2 to \$4 per joint block (lid and base). Thus, injection molding allows SLITS to be produced, including the joint block, loop material, epoxy/hematite kit, and protective cover, for less than \$10 per tag/seal.

Using polarized light examination, BDM observed that, as is common in the production of plastic parts, the polycarbonate joint blocks (both machined and injection-molded) contained stresses. Although there have been no cases of injection molded joint failure from internal stresses observed (except due to degradation caused by experimentation with a coupling agent, the use of which has been discontinued for other reasons), the observation sample to date is small and it is conceivable that some joint blocks may crack from internal stresses in field use. If cracking of injection molded joint blocks is in fact observed to occur, the internal stresses can be relieved or greatly reduced prior to field deployment through a carefully controlled annealing process. The annealing procedure was investigated and documented by BDM in the laboratory, and is described in appendix A to this report, "Procedure for Annealing to Reduce Residual Stress in Injection-Molded Polycarbonate SLITS Joint Blocks."

An IOT&E was conducted by BDM to determine the operational effectiveness and suitability of the UR/SLITS combinations when used for on-site inspections of treaty compliance. Every effort was made to ensure that the planning, conduct, and analysis of this IOT&E would provide an objective operational assessment. Detailed test plans were reviewed by the CVR and approved by FCDNA, and several government agencies were invited to provide test participants; they were not able to do so because of scheduling conflicts and funding restrictions. However, observers from FCDNA and the CVR were present during portions of the testing and approved all results reported. Six operational issues relating to the effectiveness and suitability of SLITS were fully or partially addressed during the test. These were:

- (1) **Tag/seal application - SLITS and attaching them to various items**
- (2) **Tamper detection - the ability of inspectors to detect simulated tampering/damage to SLITS**
- (3) **Quality of readings - the ability of the UR to provide readings of SLITS that can determine tag authenticity**
- (4) **Environmental factors - the effects of extreme heat or cold and direct/indirect sunlight on readings**
- (5) **Human factors**
- (6) **Transportability**

The following conclusions relating to SLITS were cited in the IOT&E report:

- (1) *SLITS are relatively easy to construct and apply to various tagged items. No major problems were experienced by the test participants in these operations. Due to breakage of the optical fiber in tight mounting scenarios, Kynar SLITS should be used in installation scenarios where tag/seal ruggedization is a primary concern.*
- (2) *SLITS are easy to read with the UR. Positioning the joint block in the tag jig is simple and straightforward, and the jig eliminates the need to precisely position and hold the reader head.*
- (3) *The combination of UR/SLITS fully meets operational requirements, despite the influence of several test factors. Tag/seal and equipment set differences increased the variance of the MCN, and cold and sunlight environments lowered the MCN slightly, relative to control conditions. While these effects were statistically significant, they do not impair operational effectiveness.*
- (4) *The UR/SLITS decision rule provides operationally acceptable false rejection and false acceptance rates. The MCN distributions for like tags and unlike tags are widely separated and allow excellent discrimination between the two classes of tags. Using an MCN of 32.5 as the critical value for accepting/rejecting a SLITS signature, the false rejection rate is 10^{-6} and the false acceptance rate is essentially zero ($\approx 10^{-13}$).*

- (5) *Two-person teams are adequate for all UR/SLITS construction, reading, and inspection activities.* SLITS were constructed as two-man team efforts. This was considered to be a satisfactory approach, although many acceptable SLITS have constructed unassisted by experienced individuals. Inspections of SLITS with short loops were easily carried out by one team member. For the longer loops, the inspections were a two-person effort.

- (6) *There are no limitations on the transportability of the UR or SLITS equipment and materials.* Approval for export of the prototype UR can be obtained from the Department of Commerce. If the UR is developed beyond the prototype stage, then another Commodity Jurisdiction Determination will be required.

The test objectives, procedures, findings and conclusions are fully described in the IOT&E report mentioned earlier.

One additional conclusion was that *SLITS tamper inspection provisions and procedures require more thorough testing than was possible in this IOT&E.* Limitations in time and resources in the IOT&E meant that only superficial simulated tampering/damage could be applied to SLITS for inspection purposes. However, certain essential conclusions regarding tamper detection did emerge. First, any loop-type tag/seal that requires visual/tactile inspections to establish integrity is vulnerable to human error and carelessness. This caution applies to not only to SLITS, but to Python, Cobra-II, Brooks Seal, and the latest LLNL Star tag concept last reviewed by BDM (1991). The risks associated with a subjective, on-site tamper determination can be reduced by inspector training, but cannot be eliminated. The geometry of installation has a significant influence on the best inspection approach, and the inspection methodology emphasized depends on the tactics that are likely to be used by an adversary attempting to defeat the tag/seal. It was concluded from the IOT&E that isolating optimal inspection approaches and determining the adequacy of tamper detectability in SLITS would require realistic operational testing on tag/seals that have been attacked by a formal adversarial analysis team. Inspection of SLITS that had been attacked by a formal team was accomplished to some degree subsequent to the IOT&E, as described in the following paragraphs.

Idaho National Engineering Laboratory (INEL) was chosen as the adversarial analysis team for SLITS. Laboratory prototype SLITS loop materials were delivered to INEL on August 16, 1991. Laboratory prototype completed SLITS and a UR were delivered to INEL on September 9, 1991. On September 9, INEL personnel were briefed on operation of the UR and the design of SLITS. Additional laboratory prototype SLITS were delivered to INEL on September 13 and 17, 1991. INEL published an interim report of their findings on potential vulnerabilities of the laboratory prototype version of SLITS and provided DNA with an attacked tag/seal. BDM set up a formal, simulated inspection with three independent teams of "inspectors" to determine whether the attacks on the tag/seal would be discovered by an inspector using normal inspection procedures. All teams easily identified numerous forms of tampering, including the method by which the loop had been opened.

Based on the fact that the attack attempts were easily caught by all inspection teams using normal inspection procedures, the laboratory prototype version SLITS passed adversarial analysis. However, the inspection experience revealed to BDM several design deficiencies that unnecessarily complicated or impeded the tamper inspection process. Therefore, the joint block design was modified to increase visual accessibility to the loop entry region, and the loop materials and construction were modified to increase tamper revealing uniformity and to reduce degradation from normal handling.

Five copies of the initial industrial prototype version SLITS were shipped to INEL on March 27, 1992. Four were assembled tag/seals (two of each design type); the other SLITS was shipped unassembled. On May 6, 1992, ten more SLITS tags (five of each type), one complete assembly jig, an inspection tool kit, a detailed description of SLITS tamper inspection procedures, and twelve packages of epoxy/hematite were provided the INEL adversarial analysis team along with a complete UR system for adversarial analysis and testing. Although no report was made available, the INEL team did supply to DNA two SLITS with an inference that at least one had been adversarially attacked. Again, BDM set up a formal, mock inspection with two independent teams of "inspectors" to determine whether the attack or attacks on the tag/seal would be discovered by an inspector using normal in-field inspection procedures. The details of this October 15, 1992, inspection exercise are also described in the inspection report, entitled ("Results of

Simulated Field Inspections of Red Teamed Industrial Prototype SLITS," BDM/ABQ-93-0010-TR, dated February 3, 1983). In this inspection exercise, which was carefully monitored by Captain Roy Nelson of DNA, the methods of attack were quickly and correctly identified by both inspection teams independently, wherein it is concluded that the industrial prototype configuration of SLITS easily passed this second round of adversarial analysis.

On January 7, 1993, a meeting was held at BDM in Albuquerque to discuss primarily the INEL adversarial analysis work on SLITS and the inspection results from the October 15, 1992, inspection exercise. This meeting was chaired by Ms. Alane Andreozzi-Beckman of HQDNA/OPAC. Also in attendance were Maj Scott Evans of ACIS/TMC, Capt. Roy Nelson of FCDNA, Steve Dupree of OUSD(A)/SAC&C, James Jones and Sherrie Sorensen of INEL, Halvor Udem and Mary Bliss of Pacific Northwest Laboratories (PNL), Christos Makris of HQDOE, Jon Nadler of the Idaho Falls DOE office, and Robert DesJardin of the Center for Verification Research. The leader of the INEL adversarial analysis team, James Jones, announced that he originally intended to return for inspection all ten SLITS that had been provided on November 5, 1992, to INEL for adversarial analysis; however, because of problems encountered in attacking these SLITS, only six tampered and one that had not been attacked were brought to the meeting. Four of the tampered tag/seals were assessed by James Jones and Capt. Nelson to be too obviously attacked to challenge inspector teams, hence the remaining three were selected for formal inspection, using normal inspection procedures, concurrently with the meeting.

All of the SLITS inspected on January 7, 1993, were of the preferred SLITS loop design that includes a Kynar braid over a Teflon tube with a twisted Kevlar strength member inside the Teflon. In the afternoon, the results of the BDM inspections were reported, including final assessments by the two teams of which SLITS had been tampered. Each team, working independently and not communicating with each other, correctly determined which tag/seals had been tampered and which had not been tampered. Detection of the tampered tag/seals by either team required a maximum of 5 minutes, and generally much less. James Jones confirmed that the BDM inspection findings were consistent with actual tampering performed by INEL. Hence, SLITS was shown to have no proven vulnerabilities in that tampering attempts were quickly discovered upon

inspection. Further description of the activities and conclusions of this adversarial analysis meeting can be found in the inspection report. There was no final decision on whether to adopt the Kynar overbraid version of SLITS as the only design, as recommended by BDM based on the IOT&E results.

Subsequent to announcing the results of the inspection activities, the Universal Blink Comparator, or "blinker," was demonstrated using signature data from the January 7 inspection and several other comparison signature images. The blinker uses the human psychovisual system by displaying, alternately, a baseline image and a reference or verification image, to emphasize differences in the two images. Tamper evidence was clearly evident in the tampered tags; although, in all cases the BDM inspection teams discovered the tampering before the blinker was used. It was observed by the inspectors that the blinker was especially helpful as a confidence builder that no tampering is present when no evidence of tampering is found by direct inspection.

In an effort to scope the tamper detection procedures that might be used if SLITS were removed and returned for follow-up examination, the University of Texas at El Paso (UTEP) was contracted to propose high technology tamper detection means that could be used on SLITS in a home base laboratory. Laboratory analysis techniques considered by UTEP included X-ray fluorescence and chemical analysis, optical interference gating and analysis, scanning electron microscopy (SEM), X-radiography, acoustic tomography, mechanical tensile and bending tests, continuous scan neutron diffraction, and surface etchant/dye discrimination analysis. Those recommended by UTEP included continuous scan neutron diffraction and surface etchant/dye discrimination analysis. For these or other robust laboratory procedures to be useful, negotiated treaties and agreements must allow SLITS to be routinely or randomly removed to be brought home for tampering examination.

4.1.5 Results.

SLITS is available for manufacture in quantity when the need for high confidence in a tag or seal arises in arms control verification or elsewhere. Vendors that can supply SLITS loop materials are readily available, and various companies are capable of performing the Kynar braiding. Engineering drawings

are available for procurement of the SLITS joints (either in machined or injection-molded form), the reader jig, and the assembly jig. An injection mold for mass production of the joint has been fabricated and demonstrated. All other assembly and inspection materials and tools are readily available commercially. With injection molding, the production cost of SLITS will be less than \$10 per tag. Even though SLITS is particularly inexpensive in comparison with other tag or seal technologies, SLITS offers the highest level of confidence in the security of sealed or tagged items against a dedicated adversary with unlimited resources.

High confidence in SLITS is supported by formal, independent adversarial analysis by INEL. After months of study and in two separate attempts on the industrial prototype, the adversarial analysis failed to demonstrate any vulnerabilities in SLITS when examined by trained inspectors using standard inspection procedures. The signature in SLITS is based on a proven, non-counterfeitable RP signature concept that, in the form of RPT, has undergone and passed formal adversarial analysis by LLNL. Moreover, the addition of the Universal Comparator Blinker software to the UR as an inspection tool allows an on-site inspector to make tamper assessments in the joint block beyond the confidence limits that would be possible by direct visual examination.

Assembly and inspection of SLITS have been shown to be operationally sound under simulated field conditions in a formal IOT&E. The main operational drawbacks of SLITS are the relatively long time required for assembly (10 to 20 minutes, depending on conditions and on the skill of the inspector) and the need to manipulate small objects during assembly. Experience with the operational aspects of SLITS, combined with the obvious nature of adversarial analysis attacks has revealed that some of the complication in the SLITS assembly could be removed through small design changes in the joint block. These changes would enhance, not compromise the adversarial robustness of SLITS, and would reduce the difficulty, hence the time required by the inspector, in the assembly process.

4.1.5.1 Potential Improvements in the SLITS Design and Inspection Procedures. Although no vulnerabilities of SLITS in its present design were revealed by the adversarial analysis, several minor design or operational improvements have been identified that would enhance the tamper detectability in SLITS, and thereby enhance the operational ease of the inspection process for the on-site inspector.

Visibility, and therefore detectability of tampering in the signature region of SLITS could be enhanced dramatically by substituting a different type of RP from micaceous hematite. Three-dimensional RP signatures of extremely high complexity can be achieved with shredded aluminized mylar that have the advantage of making the signature region semi-transparent. Semi-transparency eliminates any tampering strategy that would hide defects or foreign materials behind particles inside the signature well. In the present SLITS construction the signature region is made largely opaque by the dark, absorptive micaceous hematite particles. Conversion to aluminized mylar particles in the SLITS signature would require no changes in the SLITS hardware (except for substitution of the particle type), and has been demonstrated in sample SLITS by BDM. A detailed examination of the viability of aluminized mylar signatures is documented in published report delivered to DNA, entitled "Use of Aluminized Mylar as the Reflective Particle Material in PTLIS," BDM/ABQ-93-0011-TR, dated March 12, 1993. An aluminized mylar signature version of SLITS was not announced or forwarded to DNA or the adversarial analysis team as a candidate design within the Tagging RDT&E contract because the change from micaceous hematite would have represented a new variable complicating the adversarial analysis. Unless future environmental tests uncover a signature stability issue, aluminized mylar SLITS appears to be clearly superior to hematite SLITS because of the dramatically improved inspectability within the signature region.

Introducing into the SLITS a locking lid that would obviously and irreparably damage the signature region if it were opened would eliminate concerns over whether covert removal of the lid represents a potential vulnerability. Inclusion of a locking lid is a very straightforward engineering enhancement to the SLITS joint block design and has been considered since early in the design process. It was not included in the industrial prototype SLITS joint block because locking part shapes increase the cost of the mold for producing injection molded parts. Once the mold is machined, however, the cost per SLITS in production would be essentially unchanged from its present cost of approximately \$2 - \$4 per joint block (including the lid), depending on the number produced. A possible design for a locking lid SLITS is shown in figure 4-8. This design incorporates two separate locking features - a dovetail feature that displaces signature material in the signature well and a dovetailed edge feature that allows the lid to be removed only by sliding the lid across the signature face.

The combination of these two features would make lid removal impossible without major disruption of the signature after the epoxy has hardened.

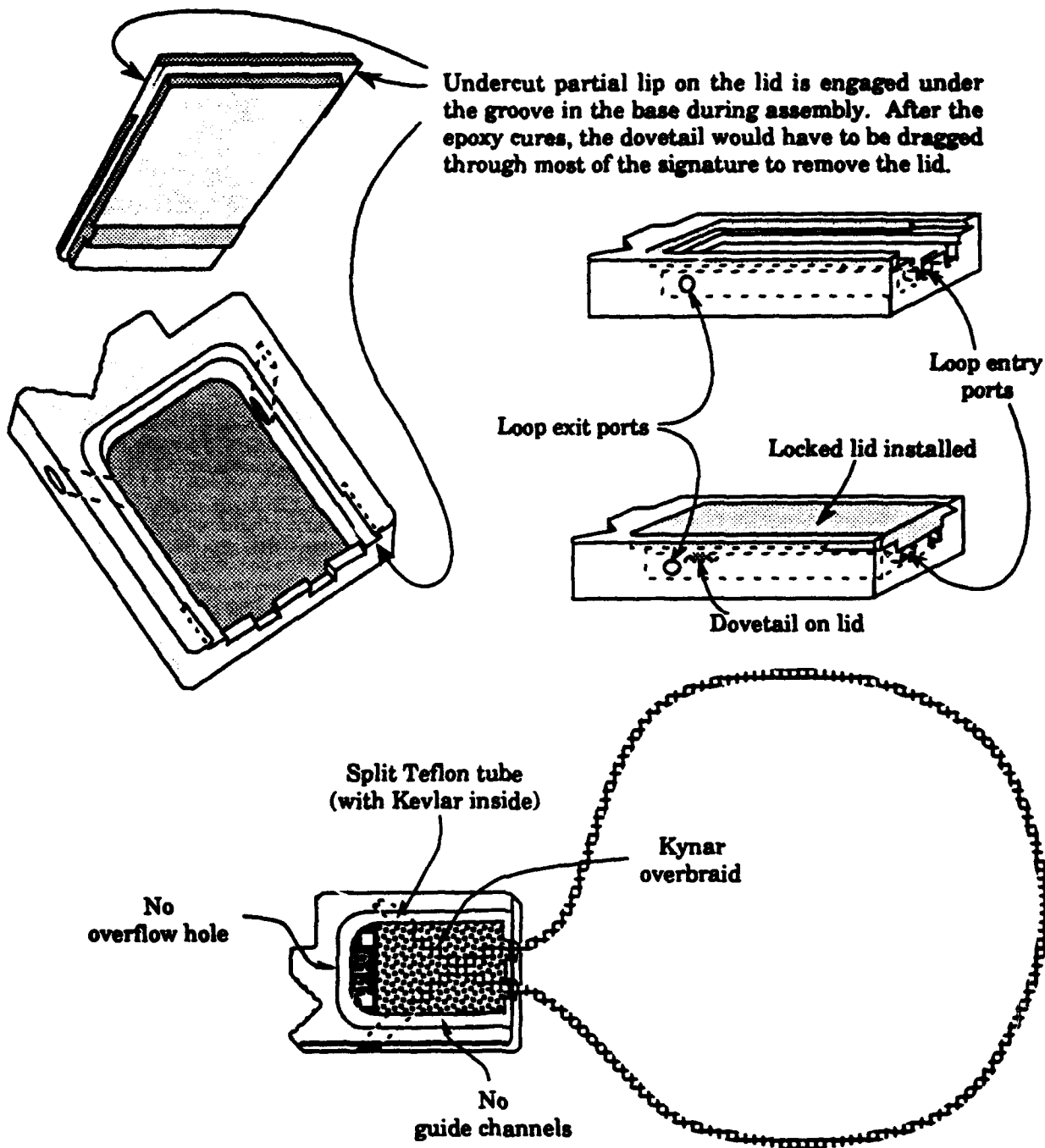

Figure 4-8. Modified SLITS with loop exit ports and a locking lid.

The loop exit ports shown in figure 4-8 replace the guide channels on the industrial prototype design (see figure 4-3). Experience has shown that the most difficult step in assembling SLITS is holding the loop material in the well while the epoxy is being added and while the lid is being positioned. This step is a classic case of needing three hands. Extending a split portion of the Teflon tube out through the exit ports in this new design would hold the loop material in place inside the well more naturally and positively than the guide channels. Excess loop material extending out of the exit ports would be clipped off after assembly is complete.

An alternative approach to eliminating the potential for removing the lid is to modify the joint block design so that there is no lid at all. A proposed design for a one piece SLITS is shown in figure 4-9. In this design, the signature well is machined out of the center of a solid SLITS-shaped blank of polycarbonate so that the entry port for the loop material is the only entry into the joint block. Epoxy/RP mixture is injected into the signature well and then the loop ends are inserted into the well. The order of these operations may be reversed if a suitable means of injecting the epoxy/particle mixture can be devised. The loop is held in place until the epoxy cures. This design also eliminates the problem of holding the loop material in the well while the glue is being added; the loop ends are stuffed into the one piece block and cannot pop out.

Finally, there is the potential to improve the operational versatility of SLITS by developing a stand-alone, analog version of the Universal Comparator Blinker that would replace the function of the UR. A hand held, battery operated, analog blinker could be based on photographic or video tape designs. The advantage of pursuing a blinker-reader approach would be that the SLITS reader could be made even more lightweight and portable than the UR. The operations of signature identification and tamper detection in the joint block would also involve the same equipment and would be done essentially simultaneously. Displacement of the objective correlation calculation of the UR with a subjective correspondence assessment by an inspector using the blinker to confirm tag identity will require community acceptance and demonstration by operational test. However, it should be noted that the blinker is a far more sensitive identification tool than the correlation algorithm in terms of its ability to detect differences and corroborate similarities between complex signatures. The

subjectivity is only a temporary condition on-site: reference and verification images returned by the inspector can be compared by other means at a home base. It should also be noted that other widely used tag/seals, such as the Cobra seal and the Brooks seal, use subjective comparison without the aid of a blinker for identity confirmation.

The industrial prototype SLITS as it is presently configured is an operationally sound, environmentally robust tag/seal design that, as evidenced by this inspection exercise, has no demonstrated vulnerabilities after formal adversarial analysis. The improvements discussed in this section are not necessary for immediate deployment of SLITS, but would enhance confidence and operational convenience for the inspector in on-site inspections.

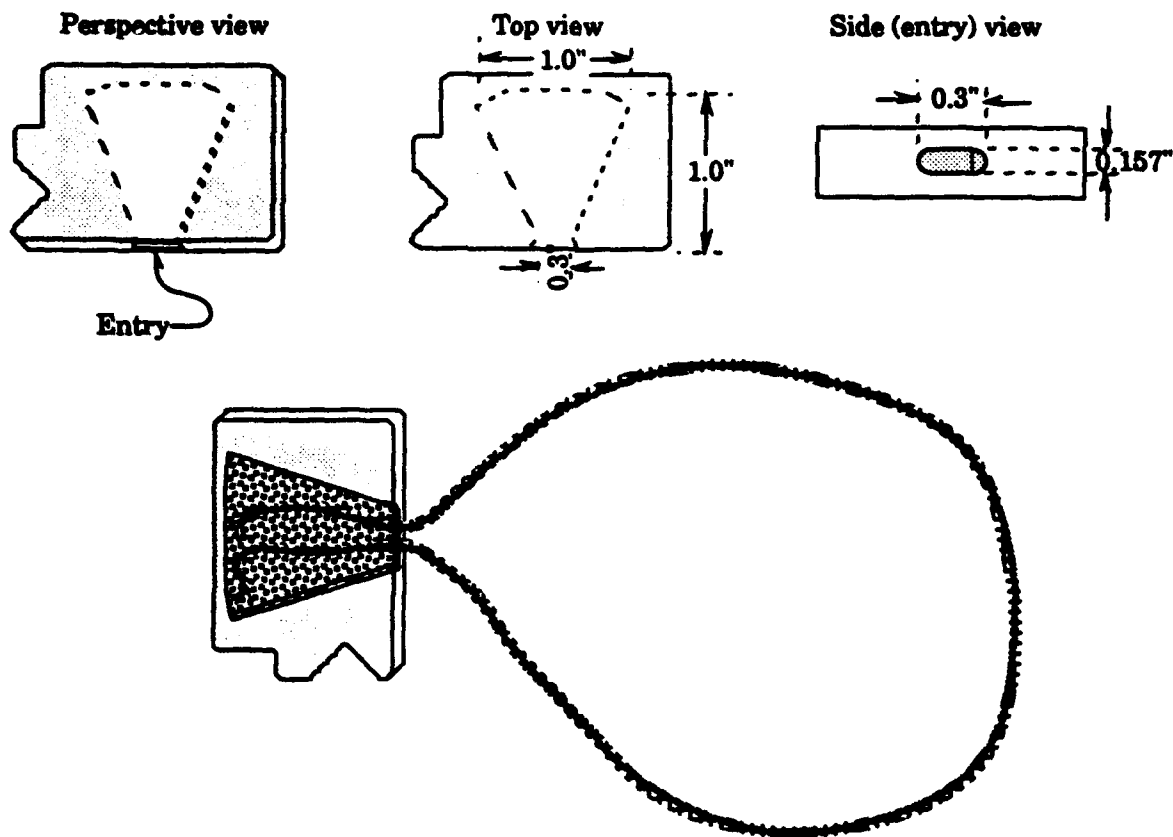

Figure 4-9. One piece SLITS joint block design.

4.2 SECURE LOOP OPTICAL TAG/SEAL (SLOTS) / PASSIVE TAMPER INDICATING LOOP SEAL (PTILS).

4.2.1 Overview.

Tagging or sealing circumstances may arise in which parts of the tag/seal loop may not be readily accessible for close visual and tactile inspection, or when objective, rather than subjective, on-site tamper determination is required or desirable. The Secure Loop Optical Tag/Seal (SLOTS) was developed to address these very difficult tagging and sealing scenarios with as simple a tag/seal design as possible. The conceptual form of SLOTS was envisioned as a loop of optical fiber whose closure is secured by a joint block containing an attached¹ signature, with an associated foolproof method of optically detecting tampering in the loop. With this conceptual design as a guide, many different optical fiber types, signature types, joint block materials, joint block configurations, and optoelectronic tamper detection options were evaluated on the basis of relative merit in the process of converging to prototype configurations. Most of the activity in SLOTS development was directed toward demonstrating whether it is physically possible for an adversary to successfully conceal a splice from various candidate optical tamper detection systems.

As a tag/seal concept, SLOTS offers the unique capability of objective, on-site tamper assessment and documentation in a passive (unpowered) loop tag/seal design. With SLOTS, on-site assessment of whether the loop has been cut and spliced does not have to rely on the subjective assessment of the inspector. Furthermore, all parts of the loop do not have to be accessible to the inspector for a definitive assessment of the loop integrity to be made; SLOTS remains fully effective as a tag/seal even if the loop is installed such that part of the loop is hidden from view and cannot be visually inspected. Remote tamper detection by optical means allows SLOTS to be used in situations that would be unacceptably laborious, intrusive, or hazardous to inspect with loop tag/seals whose loop must be physically inspected to retain high confidence against tampering. The tamper detection method of SLOTS automatically records the fiber characteristics over the

¹ *Attached* in this usage emphasizes that the signature is external to and distinct from the light signal carried in the optical fiber. Counter examples are the Cobra II and the Star tag/seals, whose signatures are carried as light intensity information in the optical fibers.

entire length of the tag/seal loop. The record of the tamper inspection containing the evidence of any covert splice is stored as a small digitized file on a magnetic floppy disk alongside the signature data. This record not only shows whether any tampering has occurred, but exactly where it occurred. Also, the potential exists for the record to be analyzed on-site in software to provide a "red light/green light" tamper assessment, relieving the inspector of having to make subjective judgements the tampering call. Unlike active (powered) tag/seals that also might be capable of providing objective, on-site documentation of tampering events, the relatively inexpensive, passive design of SLOTS provides high reliability over extended time periods for tagging or sealing applications subject to severe environmental stress.

Many different designs were proposed that embodied the SLOTS concept. Two of these—the Multiple Wrap Glass (MWG) and the Single Wrap Plastic (SWP) SLOTS designs—emerged as worthy of pursuit to the laboratory prototype stage of development. Glass and plastic in these titles refer to the type of optical fiber used in the loop. Both designs were demonstrated as laboratory prototypes to provide positive tamper detectability in the loop, and each design had certain recommending and detracting features. However, difficulties in manufacturing the MWG SLOTS loop, together with the high cost of the MWG loop design led to downselection in favor of the SWP SLOTS design. Appropriately, most of the SLOTS discussion in this report refers to the SWP design, although adequate description of the MWG design is provided for completeness.

Late in the Tagging program, SWP SLOTS, the "winner" in the downselection, was renamed the Passive Tamper Indicating Loop Seal (PTILS) to emphasize its use as a seal. No change in the philosophy behind SLOTS was implied by the name change and, in fact, no design change occurred at all at the time of the name change. After the name change, the design of PTILS evolved as necessary to fulfill design requirements of the industrial prototype. Henceforth in this discussion, SLOTS will be used to reference the SWP or MWG tag/seal concepts in their laboratory prototype phase prior to the name change, whereas the industrial prototype SWP SLOTS after the name change will be referenced by its new name, PTILS.

The materials used in PTILS were selected to be very robust to environmental or handling damage but to be intrinsically difficult to repair if damaged. These properties, combined with the physical construction of PTILS, ensure that any tamper-induced evidence will be revealed easily and definitively to a trained inspector during an on-site inspection. Cut and splice tamper detection is accomplished in PTILS with a sensitive optical time-domain reflectometer (OTDR) connected to the optical fiber at the time of tag/seal inspection. The OTDR launches very fast light pulses into the loop optical fiber and records the reflected or backscattered light in the form of a trace on a computer screen. Any covert splice inserted in the PTILS loop by an adversary will be evident in an inspection as an obvious deviation from the reference OTDR trace taken at the time of tag/seal installation. Simple visual examination, aided by small hand tools such as a magnifying lens and flashlight are the method by which an inspector performs on-site tamper detection in the joint block. Unlike SLITS, cutting and splicing of the loop material inside the PTILS joint block will be discovered by the OTDR, thus the attack options available to a potential adversary are very limited in PTILS compared to SLITS. Evidence of tampering in the PTILS loop discovered by the inspector is automatically documented as a digital file of the OTDR trace on disk in the UR system. Two PTILS-related software utility programs are used (see appendix B to this report, "PTILS Software Utilities") for a description of the programs and operating instructions) to control the OFM20 OTDR (OFM20TST) and to view logarithmic plots (CLPLOT) of the resulting traces. Evidence of tampering in the PTILS joint block can be documented on-site using the video microscope image recording feature of the UR.

As in all tags and seals, additional confidence in tamper detection beyond that achievable on-site by the inspector (if it is allowed by the treaty or agreement) can be obtained by removing individual PTILS, either at random or at the option of the inspecting party, for detailed examination in a tamper inspection laboratory. With laboratory examination, the potential for any adversarial tampering to go undetected is nil.

Every specific feature of the industrial prototype PTILS design has been thoughtfully included to 1) promote tamper detectability, 2) aid in the operational ease of installation and inspection, and/or 3) promote environmental ruggedness. The result is a simple, robust, high confidence tag/seal that addresses the severe

design requirements placed upon it. The combination of environmental robustness, passive design, tamper detectability, and a non-counterfeitable signature make PTILS applicable within the rigorous requirements of START.

4.2.1.1 Documentation Published. The following documents (see table 4-5) were delivered to DNA in conjunction with the SLOTS/PTILS development efforts.

Table 4-5. SLOTS/PTILS reports to DNA.

<u>Report Title</u>	<u>Date of Submission</u>
Interim Report on Innovative Tags	November 5, 1990
Analysis and Proof-of-Principle for Innovative Tags	January 31, 1991
Interim Technical Report on PTILS	August 1, 1992
Use of Aluminized Mylar as the Reflective Particle Material in PTILS	March 12, 1993

4.2.1.2 Expenditures. The SLOTS/PTILS development effort began on November 28, 1990, and was completed in April 1993. The following table (table 4-6) lists the labor hours, the associated loaded labor costs (without fee and tax) plus the ODC's expended during the conduct of the SLOTS/PTILS development.

Table 4-6. SLOTS/PTILS expenditures.

TI	Hours	Loaded Labor Costs	ODC's	Total Costs
FY90-10	*	*	*	*
FY91-15	*	*	*	*
FY91-15	*	*	*	*
Total	*	*	*	*

* All costs will be provided at contract closeout.

4.2.2 Schedule.

The concept of SLOTS came out of the early creative efforts under TI-10 as described in section 4.1.1.2. SLITS, SLOTS, and other tag/seals concepts that were

rejected were briefed extensively to Col. Bob Davie and several others from the DNA/OPAC office on January 16, 1991. It was proposed at this briefing that SLITS and SLOTS be developed to laboratory prototypes. Further proof-of-concept assessments were conducted from January through early March 1991. On March 1, 1991, TI FY91-15 was issued authorizing prototype development of SLITS and SLOTS, as well as the development of the UR. The May 7, 1991, amendment of TI-15 included the continued laboratory prototype development of SLOTS.

The two laboratory prototype versions of SLOTS, the single wrap plastic (SWP) optical fiber and the multiple wrap glass (MWG) optical fiber versions, were developed from January 1991, until BDM received instruction from DNA on February 27, 1992, to stop work on all SLOTS development. Because of difficulties encountered in manufacturing the multiwrap cable (not technical feasibility of tamper detection), further pursuit of the MWG SLOTS concept was discontinued at that time. However, the high potential for the SWP SLOTS design was recognized, and continued development was recommended by BDM to DNA. The viability of tamper detectability in the SWP SLOTS design had been demonstrated by BDM through:

- (1) Very careful cutting, polishing, and high intensity pulsed laser measurements on micro-positioned "splices" in the BDM optics laboratory in McLean, VA
- (2) OTDR measurements on carefully polished and aligned "splices" in the BDM optics laboratory in Albuquerque
- (3) Optical and scanning electron microscope studies of polished PMMA fibers by the University of Texas at El Paso
- (4) Theoretical and computational modeling of the performance of the Opto-Electronics OFM20 OTDR.

During the period of stopped work, the SWP version of SLOTS was renamed the Passive Tamper Indicating Loop Seal (PTILS) to emphasize its robust ability to indicate tampering when used as a seal. Work was authorized for industrial prototype development of PTILS on August 27, 1992, and continued until all technical activities on the Tagging RDT&E contract were completed on January 22, 1993. These developments are summarized in figure 4-10.

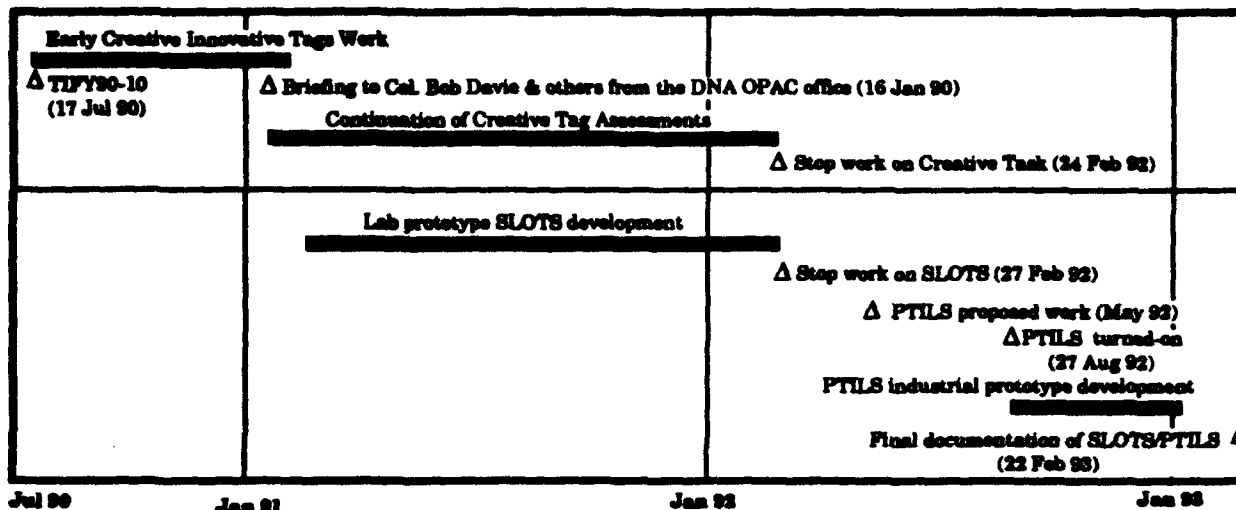

Figure 4-10. Schedule of SLOTS/PTILS development.

4.2.3 System Description.

4.2.3.1 PTILS (Formerly SWP SLOTS). The PTILS loop is a jacketed, single strand of 250 micron (μm) polymethylmethacrylate (PMMA) plastic optical fiber whose closure is secured inside a transparent joint block. The optical fiber is terminated at one end in a high quality optical connector to allow simple plug-in inspection of the optical fiber by an OTDR. The other end of the optical fiber is cut to length and inserted into the joint block at the time of tag/seal installation. The industrial prototype PTILS design is shown in figure 4-11.

Plastic optical fiber was selected for PTILS primarily because the two components critical to creating high quality splices in glass optical fiber—excellent cleavage and electric spark fusion—are inapplicable with plastic optical fiber. Plastic optical fiber also possesses excellent bending characteristics and has good resistance to environmental degradation. Use of plastic optical fiber forces an adversary to resort to difficult polishing techniques for splice surface preparation, and to inferior mechanical splices for alignment and adhesives for bonding of the splice. Depictions of fusion and mechanical splicing are shown in figure 4-12. The poor splice preparation properties of plastic optical fiber combined with the extreme sensitivity of the OTDR as a detection system for covert splices, form the foundation for the very high tamper detection confidence in PTILS.

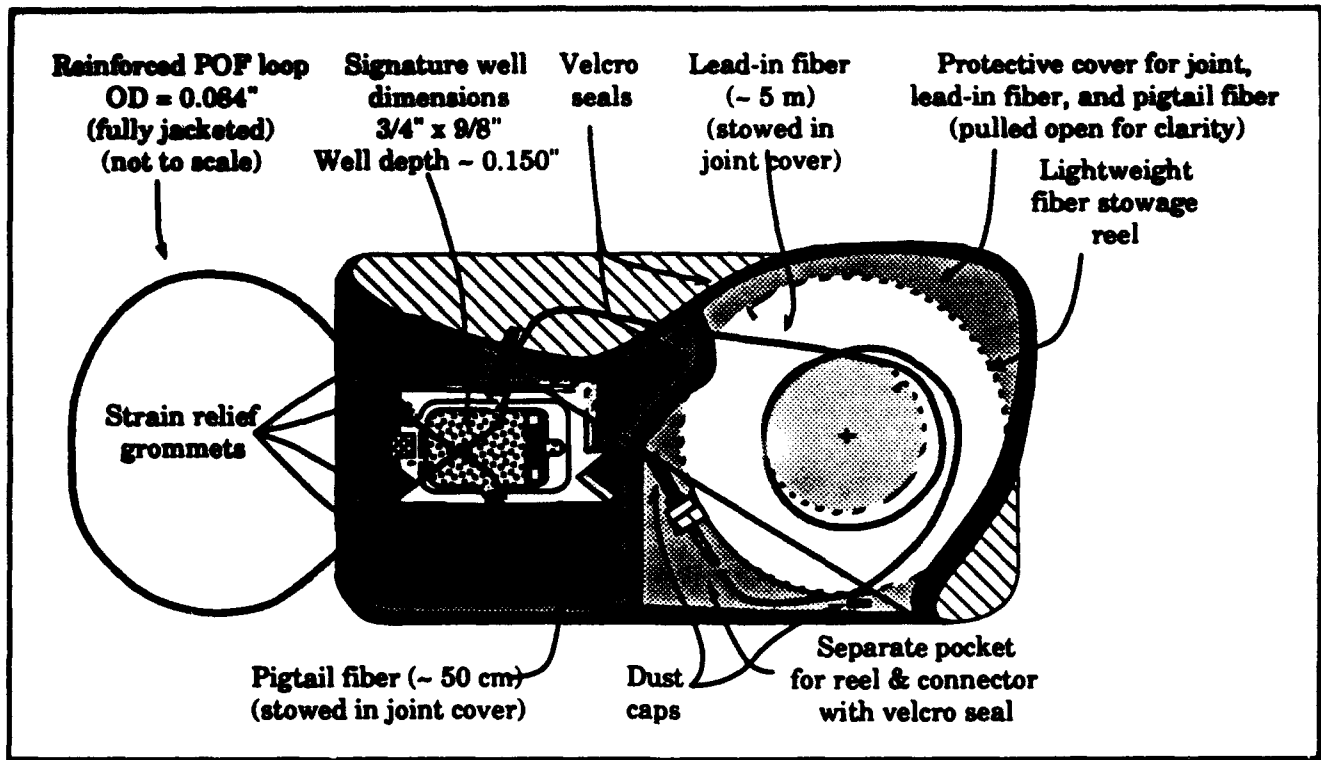

Figure 4-11. Industrial prototype PTILS design.

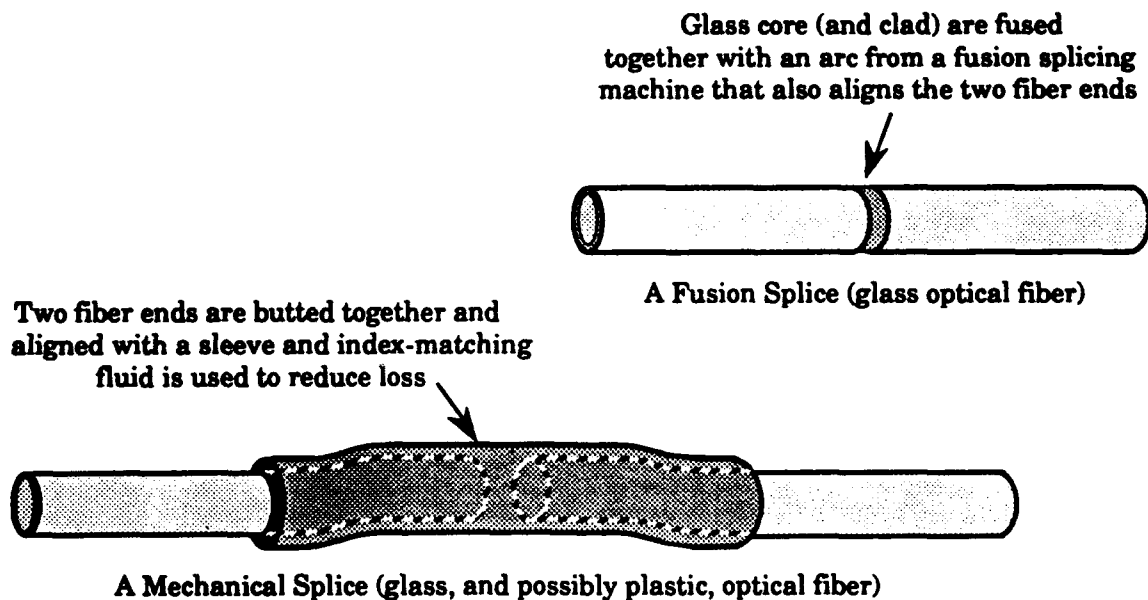

Figure 4-12. Types of splices in optical fibers.

The PTILS loop is constructed as depicted in figure 4-13. The inner polyethylene jacket is extruded onto the optical fiber when the fiber is manufactured. Eska Extra 250 μm optical grade PMMA fiber, manufactured by the Mitsubishi Corporation, was selected for PTILS because it satisfied the requirements of correct core size, minimal absorptive loss, quality manufacture, and availability in jacketed form. Surrounding the inner jacket is a braid of Kevlar for tensile strength and resistance to stretching and an outer polyethylene jacket for UV protection, resistance to abrasion, and protection from other forms of environmental degradation. The outer jacketing (Kevlar and polyethylene) in the PTILS industrial prototype was provided by Cortland Cable Corporation.

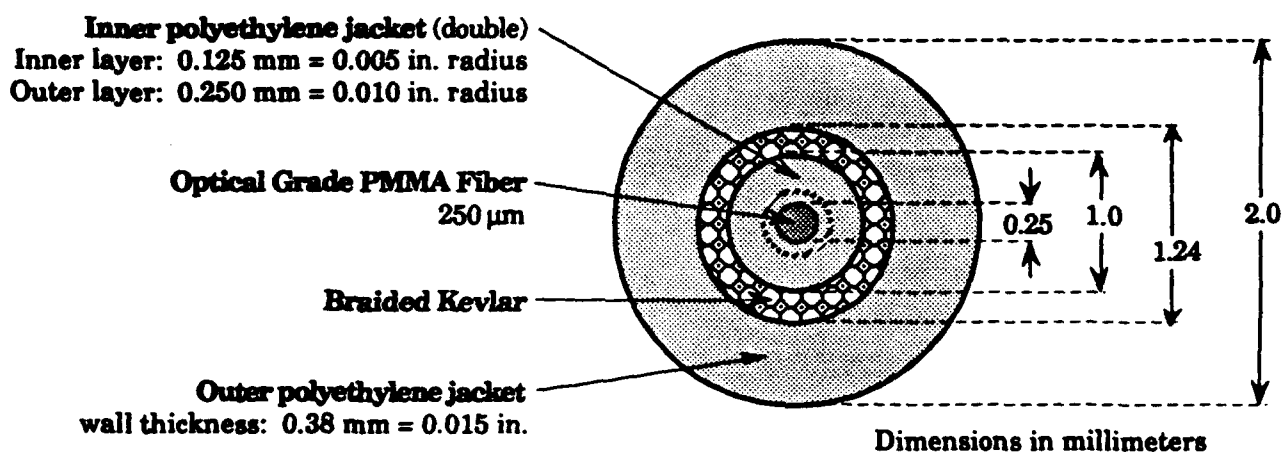

Figure 4-13. Cross-sectional view of loop construction in the industrial prototype PTILS.

The clear polycarbonate joint block securing the PTILS loop embeds the critical loop closure region inside a signature well filled with a three-dimensional suspension of reflective particles in epoxy. By embedding the loop closure inside the signature, the PTILS design forces an adversary attempting to covertly open the loop, without cutting the fiber, to risk disrupting the complicated, random particle distribution that uniquely identifies the tag/seal.

The signature well is centered between the opposing faces of the transparent joint block so that both the RP suspension and the loop closure are

visible to inspection and have equivalent optics when imaged from either of the opposing faces by the UR. Thus, both faces of the joint block are used to verify two separate RP signatures associated with each tag/seal. The shape the PTILS joint block provide positive, three point kinematic alignment in the alignment jig of the UR to ensure accurate image registration during the signature reading operation. The size and shape of the joint block makes PTILS compatible with the existing SLITS alignment jig. Polycarbonate was selected as the joint block material because 1) it is extremely tough to handling abuse, 2) it is resistant to environmental degradation, particularly to chemical environments, 3) it has good optical clarity, and 4) it has excellent machining and injection molding properties that lend themselves to both prototype development and eventual mass production.

The RP signature of PTILS is conceptually identical to the RPT, developed by SNL. This signature concept has had an adversarial analysis performed by LLNL and has been accepted in the tagging community as non-counterfeitable. Unlike RPT or SLITS which use micaceous hematite as the specularly reflecting particle, PTILS uses an epoxy suspension of aluminized mylar flakes. Aluminized mylar is semi-transparent, which promotes visibility of features embedded within the signature well, and is less dense as a suspended particle, which allows greater suspension uniformity of particles throughout the signature well. The attributes and acceptability of using aluminized mylar in PTILS is examined in detail in a separate report ("Use of Aluminized Mylar as the Reflective Particle Material in PTILS," BDM/ABQ-93-0011-TR, March 12, 1993).

A small spool is included in the protective pouch as part of the PTILS assembly so that 5 meters of lead-in optical fiber (external to, but continuous with, the secure loop region) can be stored in a compact form. The lead-in fiber provides sufficient optical path distance to totally contain the OTDR dead zone following the Fresnel reflection at the optical connector, and thereby removes any dead zone insensitivity in the OTDR trace in any part of the secure loop region of the optical tag/seal. Winding of the lead-in fiber on the spool, adhering the windings to the spool, and preparing the optical connector at the spooled end of the optical fiber are operations that are performed at the time of manufacture of the tag/seal. The only assembly operation that must be performed on-site by the inspector is closure of the loop in the signature well.

On-site installation of PTILS is a straightforward procedure involving the following steps:

- (1) Thread the unspooled end of the loop material through or wrap the loop material around the tagged or sealed item and cut the loop material to an appropriate length (length sufficient to close the loop plus about 0.5 meter for the fiber pigtail) .**
- (2) Strip the outer jacket off from a point just before signature well and thread the inner jacketed fiber through the appropriate holes in the joint block to form loop closure inside the signature well.**
- (3) Weaken the inner jacket in the signature well region with the nicking tool provided, and gently loop each of the crossed fiber sections in the signature well as shown in figure 4-11.**
- (4) Mix and pour the epoxy bonding agent (premixed with reflective particles) over the loop closure, snap on the joint block cover piece, and clamp until cured. A heating wrap may be necessary to promote curing in cold weather.**

Once the epoxy has set, a reference signature reading is taken using the UR PTILS utility programs (see appendix B) and a reference OTDR trace is recorded. A light-tight cap on the distal end of the fiber (the pigtail end) must be provided during the OTDR reading to prevent entry of stray light into the fiber that might corrupt the reading. A simple cover of black tape has been shown to be sufficient as a light blocking cap. PTILS installation is complete when the joint block is slipped back into the protective cover.

Step (2) in the installation procedure is necessary because the inner jacket is not bonded to the outer jacket: if the outer jacket was left unstripped in the signature well, an adversary could slide the fiber out of the outer jacket and defeat the loop closure without damaging the fiber. Step (3) in the installation procedure is necessary because epoxy does not bond well to the inner polyethylene jacket. BDM has shown that, if the inner jacketed fiber is not weakened, it may be extracted from the signature region without damage using mild tension,

stretching, flexing, and lubrication. If the inner jacketed fiber is deliberately weakened at some point within the signature well during installation, however, fiber extraction attacks fail (the fiber breaks at the weakened point) and the loop closure in PTILS is secure. Weakening the inner jacket was the best countermeasure to fiber extraction found in the limited development time available. Other techniques, such as twisting the fibers around each other or anchoring the fibers inside the well with a crimp, generated reflections that caused undesirable deflections in the OTDR trace. Introducing a controlled nick that creates a weak point in the inner jacket of the fiber is operationally straightforward to accomplish on-site without trace degradation, but is an extra, delicate operation that could perhaps be eliminated with a more advanced loop closure design.

The signature reading operation in PTILS involves simply snapping the joint block into the PTILS alignment jig (which is also the SLITS alignment jig), snapping the alignment jig onto the reader head, and commanding the UR to read and record the signature. This process is repeated on the opposite face of the joint block. During the automated PTILS reading operation, the randomly oriented reflective particles within the joint block are sequentially illuminated from a predetermined set of directions by light-emitting diodes in the reader head. The set of specular reflection patterns produced by the reflective particles, one pattern image per light direction, is recorded as the tag's unique signature. In a verification inspection, the signature is correlated by the UR against the reference reading of the tag to validate the identity of the tag/seal.

A positive correlation in a verification reading proves that the tag is the same tag that was installed (the signature is so complex that it cannot be counterfeited), but does not indicate definitively whether or not tampering has occurred in the joint block. Tamper detection in the joint block is a simple operation of careful visual inspection of the loop closure region for evidence of cuts. A hand lens may be used to assist in the inspection and the video microscope feature of the UR can be used to document the findings on magnetic media. An adversary attempting to open the fiber optic loop inside the joint block without cutting the optical fiber will disturb joint block appearance or the appearance of RP distribution in the signature region in a way that is visually detectable. An adversary attempting to open the fiber optic loop inside the joint

block by cutting the optical fiber will be caught by the OTDR. The fact that the loop material is invulnerable to splicing both inside and outside the joint block severely limits the options available to an adversary attempting to attack the joint block.

The optical fiber in the PTILS loop is examined for evidence of splices by the OTDR. An OTDR trace is a record of the backscatter characteristics of the optical fiber over the entire length of the fiber. Comparison of a reference OTDR trace to a verification trace (using CLPLOT) not only shows whether a covert splice is present in the tag/seal loop, but exactly where the splice is located. Evidence of any tampering uncovered by the OTDR examination is definitive by itself, but can also be corroborated by physically inspecting the loop at the identified location either on-site or at any later time.

The operational principles of an OTDR are shown in figure 4-14. Light pulses of very short duration are fired from a laser diode into the optical fiber to be inspected. The emitted photons pass through an optical coupler in the OTDR that allows light to pass in both directions: into the fiber from the laser diode and back to the detector from the fiber. At every point in the fiber, some light is scattered by Rayleigh scattering in the fiber core. The backscattered component of this low amplitude, distributed Rayleigh scattering in regions of undisturbed optical fiber is observed in the OTDR trace as a relatively smooth, monotonically decreasing slope that is nominally linear when displayed on a decibel (dB) scale. Regions of the OTDR trace produced by normal Rayleigh backscatter are referred to as the Rayleigh backscatter floor. If the light pulses launched by the OTDR encounter a connector or splice, anomalous scattering is introduced due to index mismatch, contaminants, or imperfections. Scattering from the connector or splice introduces power loss in the light that propagates forward, which is observable in the OTDR trace as a drop in the level of the Rayleigh backscatter floor. Photons backscattered or reflected from the connector or splice return to the OTDR and are revealed in the trace as a characteristic "bump" superimposed on the Rayleigh backscatter floor. Both the power throughput loss (ratio of loss in transmitted light power to the input light power, typically 0.01 dB to 0.2 dB) and the reflectivity (ratio of reflected light power to the input light power, -30 dB to -50 dB for very well polished, index-matched, micropositioned splices) are useful indicators of a splice in the OTDR trace.

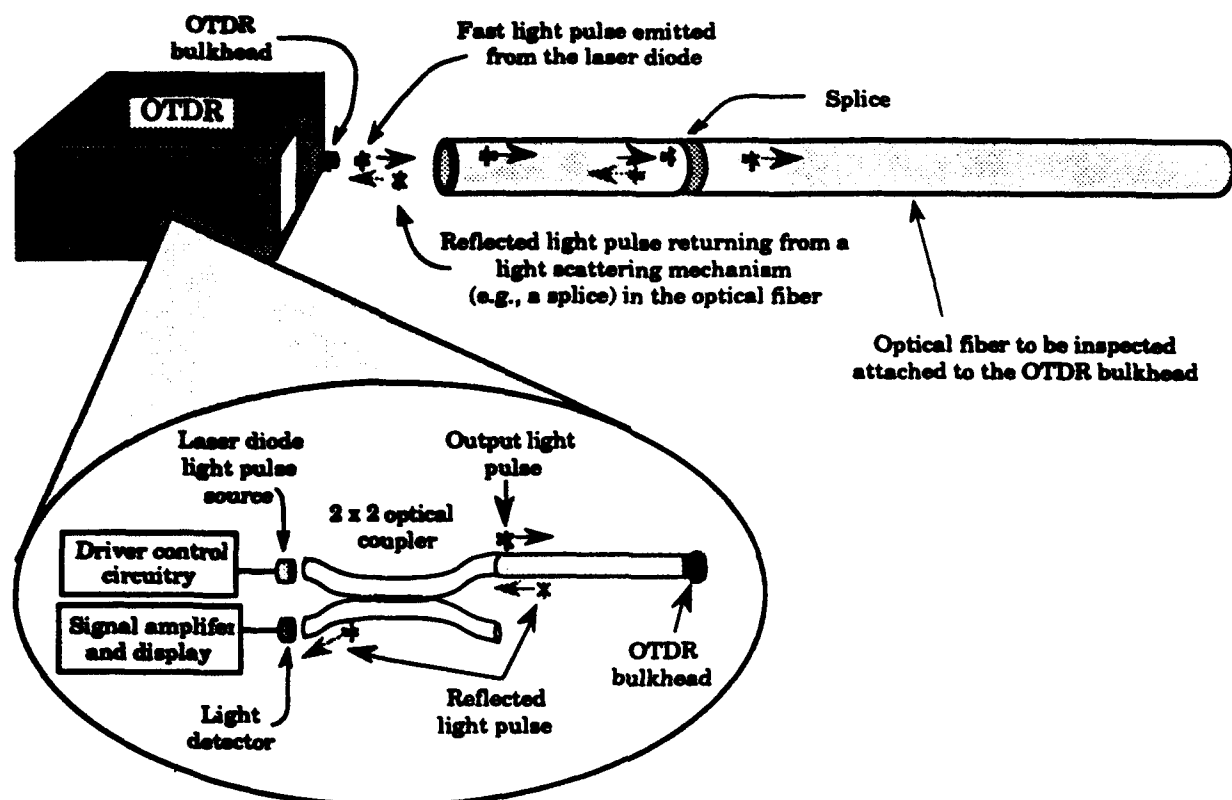

Figure 4-14. Operational principles of an OTDR.

The particular OTDR selected for splice detection in the laboratory prototype version of PTILS design is the COTS OFM20 Optical Fiber Monitor manufactured by Opto-Electronics, Inc. The OFM20 was chosen for PTILS because 1) it has sufficient spatial resolution to examine the very short haul of optical fiber found in a loop tag/seal, 2) it has a short pulse width of ~40 picoseconds (ps) that lowers the Rayleigh backscatter floor sufficiently to reveal very small amplitude Fresnel-like events,² 3) it has sufficient sensitivity to display the Rayleigh backscatter floor even with a short pulse width, so that small Fresnel-like events are easily recognizable as gross deviations from the nominally monotonic slope of the Rayleigh backscatter floor, and 4) it is commercially available in a wavelength 680 nanometers (nm) at which the attenuation in plastic optical fiber is low enough

² The term "Fresnel-like" is used to describe the appearance of covert splices in an OTDR trace, and in particular, to distinguish the appearance of covert splices from small perturbations in the Rayleigh backscatter floor. The appearance of the localized backscatter of a splice in an OTDR trace is identical to that of a fiber event producing a Fresnel reflection, but the optical mechanism of backscatter in a splice may or may not have anything to do with Fresnel reflection in a formal optical sense.

(~250 dB/km) to allow a useful maximum secure loop length (~15 m). The OFM20 is the only OTDR that provides these capabilities as a COTS instrument, and is therefore the most conservative and prudent selection available at this time to ensure that PTILS is undefeatable. A photograph of the OFM10 (external appearance identical to the OFM20, except for the label) is provided in figure 4-15.

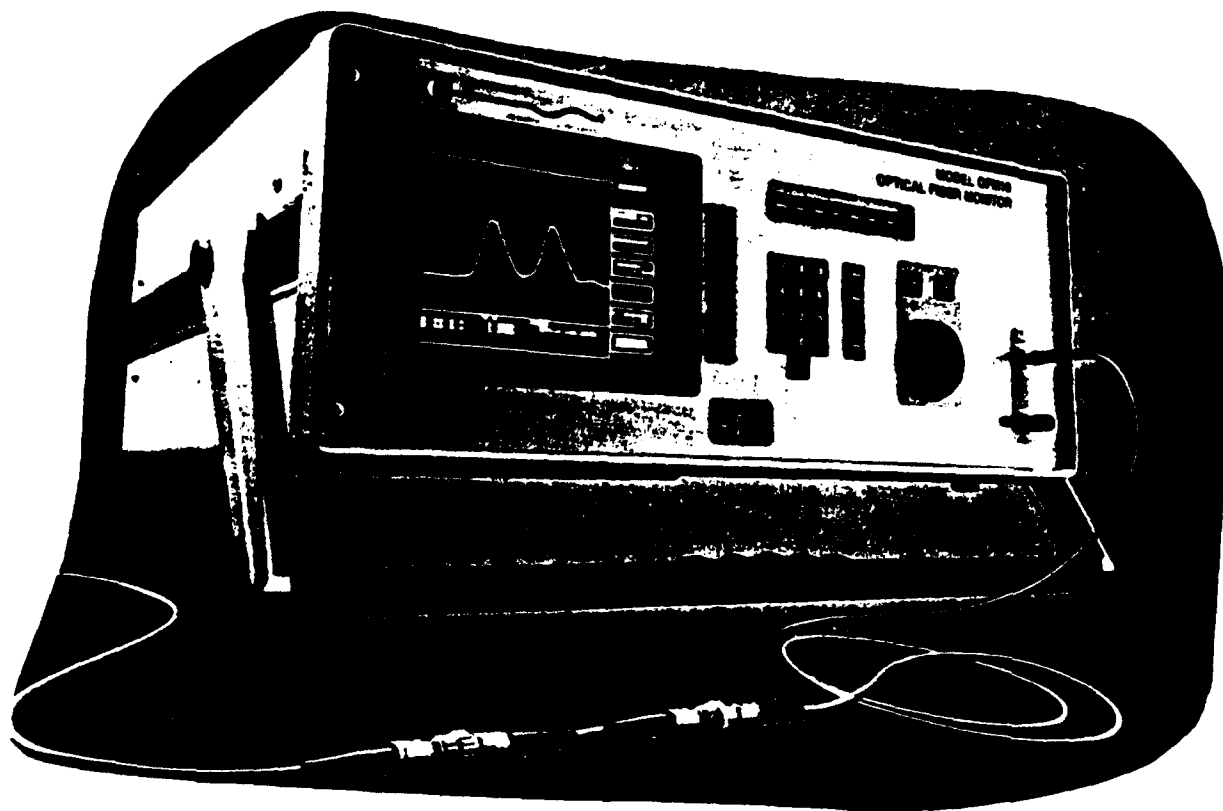

Figure 4-15. Photograph of the OFM10 OTDR manufactured by Opto-Electronics, Inc., identical in appearance to the OFM20.

The on-site tamper detection operation consists of simply connecting the tag to the OTDR via a fiber optic "extension cord," and commanding the OFM20TST utility program to commence the OTDR tamper detection sequence. Through a GPIB communications interface between the OFM20 OTDR and the UR system, the following operations are executed automatically by software: 1) the OTDR parameter setup, 2) recording of the OTDR measurement on disk in the UR

system, 3) display on the UR computer screen (using CLPLOT utility program) of the reference and verification traces for this tag/seal. The traces are displayed simultaneously on log scale for clarity. Tampering is indicated by an obvious difference in the two traces. A covert splice is revealed as a large "bump" at some point within the secure loop region on the verification trace. It would be straightforward to automate the tampering determination to a "red light/green light" assessment made in software, thereby relieving the inspector of having to make any interpretation of the traces at all. This final step to total objectivity in tamper detection in the loop was not provided in the industrial prototype PTILS because of insufficient development time.

The steps involved in the on-site inspection of PTILS are summarized below in figure 4-16.

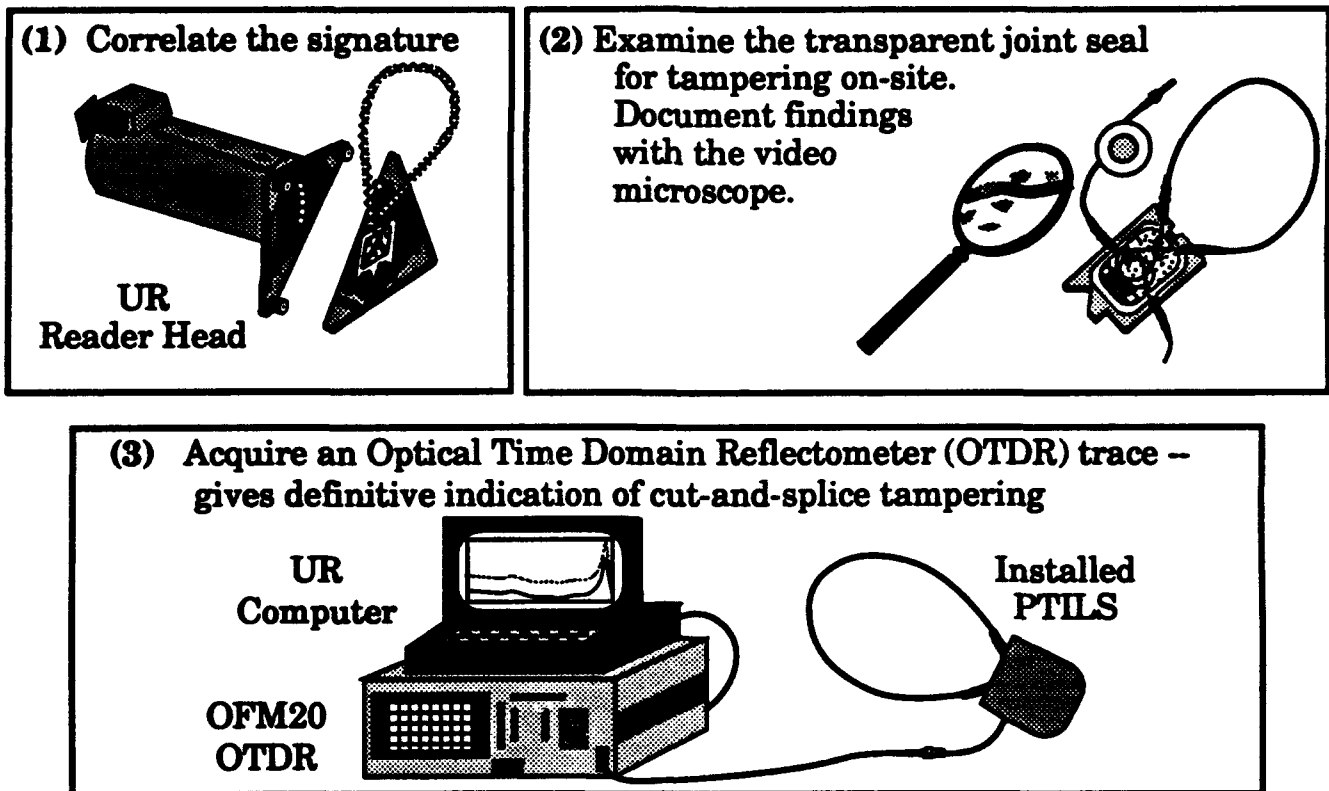

Figure 4-16. Steps in the on-site inspection of PTILS.

4.2.3.2 Multiple Wrap Glass (MWG) SLOTS. The other design considered for SLOTS was a multiply-wrapped, single jacketed glass optical fiber. The multiwrap design would force an adversary to form many splices in series on the same optical fiber, in which case the composite, distributed insertion losses of even excellent splices could be detected with an OTDR. Alternatively, if an adversary attempted to short circuit the multiple wraps with a single splice, the change in fiber length would be immediately apparent in an OTDR trace. The MWG SLOTS design is shown in figure 4-17.

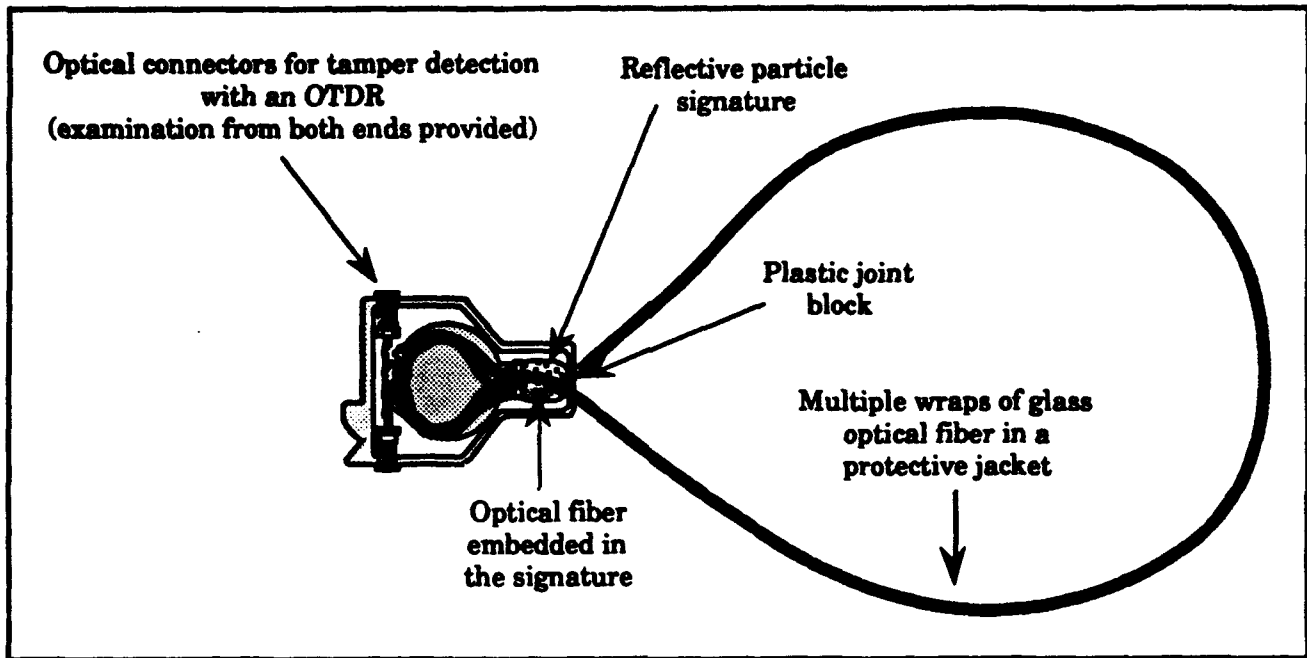

Figure 4-17. Multiple wrap SLOTS design.

Restoration of the loop in a cut-and-splice attack of MWG SLOTS requires an adversary to splice the same fiber as many times as there are wraps in the loop. Through analysis of measured data, BDM showed that the cumulative insertion loss from a limited number of splices in series (~10 to 50), even if state-of-the-art splicing equipment and skill were used, would be detectable with a COTS LANprobe™ 850 nm OTDR board by Antel Optronics. The Antel OTDR board is particularly attractive operationally because it is packaged as a computer card that fits into a single full sized expansion slot of a portable personal computer. Thus, addition of an Antel OTDR board to the UR to service MWG SLOTS would represent no increase in bulk and negligible increase in transport weight. A

photograph of the Antel board OTDR is shown in figure 4-18. The Antel OTDR board is acceptable for MWG SLOTS but not in the SWP SLOTS application for two main reasons. First, an 850 nm laser diode with a peak light output of 1 watt could be used in glass fiber (a 670 nm laser diode with a 20 mW peak output must be used in plastic optical fiber), with gives an adequate signal-to-noise ratio for meaningful OTDR measurements. Secondly, the MWG SLOTS loop is a relatively long haul (10s to 100s of meters) compared to the very short haul (<10 meters) of SWP SLOTS, which makes the longer pulse width and relatively narrow bandwidth of the Antel board OTDR acceptable. The process and criteria used to select an OTDR adequate for SWP SLOTS are discussed further in section 4.2.4.

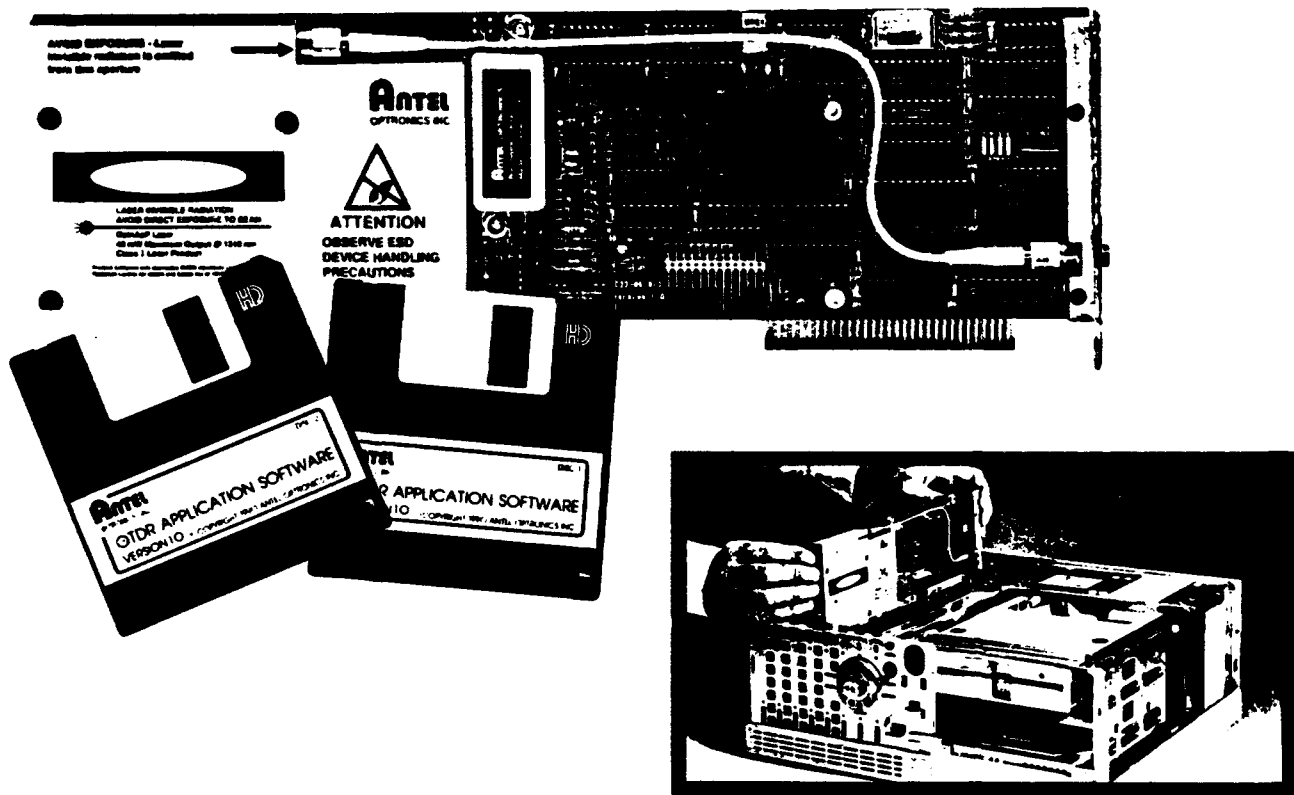

Figure 4-18. Photograph of the OTDR board manufactured by Antel Optronics.

Figure 4-19 shows how the many wraps are laid out in the loop, before and after jacketing, and how connectors would be terminated onto the optical fiber.

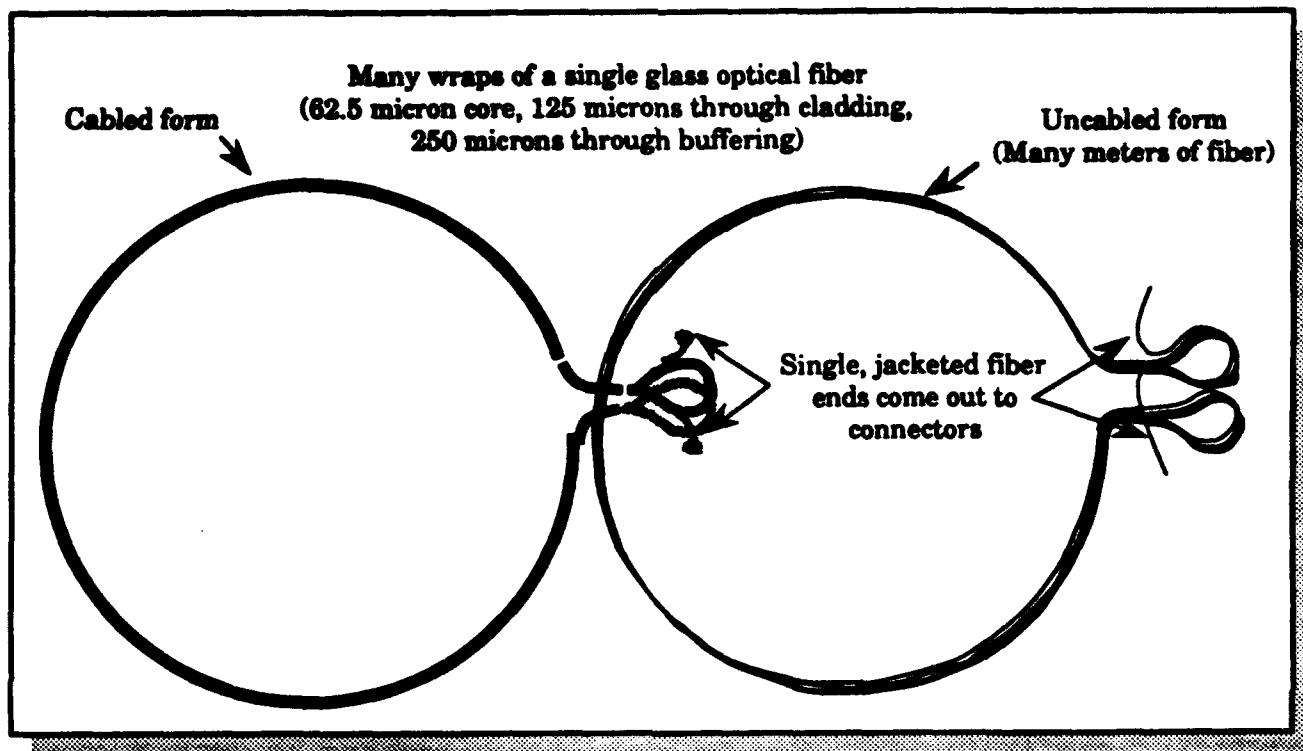

Figure 4-19. The multiple wrap SLOTS cable layout concept.

A possible manufacturing design of the MWG loop is shown in figure 4-20. This cross-section includes 100 wraps of 62.5/125 micron (250 microns through the outer buffer) optical fiber. Analysis performed by BDM, using data on the best possible splice quality, shows that 100 wraps is likely to be far more than the minimum required to assure detection of an adversarial attack. Nevertheless, packaging of the multiwrap cable was found by BDM to be a severe manufacturing challenge for major vendors of fiber optic cables. This manufacturing challenge is so daunting that BDM does not recommend developing the MWG SLOTS further unless its need over PTILS is clearly indicated.

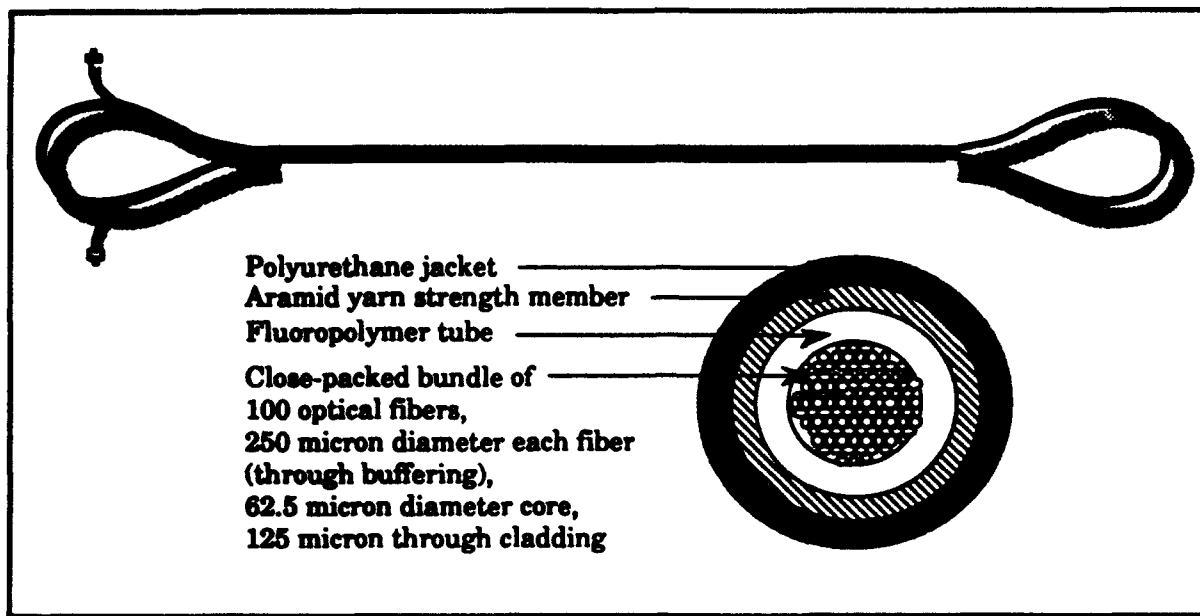

Figure 4-20. Possible jacketing configuration of the multiple wrap SLOTS loop.

4.2.4 Activity Description.

Research on BDM Innovative Tags began formally on July 17, 1990. Work on Innovative Tags was first performed under this contract under TI FY90-10, and later under TI-15. The change in TI numbers occurred not because of a change in the definition or scope of the Innovative Tags pursuit, but rather to simplify the management task by consolidating a broad range of tagging activities under a smaller number of open TIs. The tasking under Innovative Tags was for BDM to conceive of and show proof-of-principle for tag/seal concepts for use in arms control verification that would be more technically and operationally sound than concepts already proposed in the verification community. Work on Innovative Tags began in a search, research, and demonstrate mode, and continued in that mode until January 16, 1991, when the most promising concepts were briefed in detail to Col. Bob Davie and several others from the DNA/OPAC office. The less successful tag/seal concepts that had been considered and assessed were also surveyed in this briefing. Two loop tag/seal concepts, the SLITS and the SLOTS were recommended in the Davie briefing for laboratory prototype development, with the expectation that industrial prototype development would follow if no insurmountable pitfalls were encountered. The names of these

tag/seal concepts were chosen to identify and emphasize the means used by the inspector for tamper detection in the loop.

Approval was received from DNA for prototype development of SLITS and SLOTS shortly after the Davie briefing. Prototype development of SLOTS pursued several competing strategies for optical detection of tampering in the loop, and converged on two very different approaches to the same basic concept. The single wrap plastic (SWP) SLOTS emphasized simplicity and versatility of the tag/seal (a single wrap of plastic optical fiber) but required an expensive, stand-alone OTDR. The multiwrap glass (MWG) SLOTS, on the other hand, had the attractive feature of using an inexpensive OTDR packaged as a computer board inside a personal computer for the tamper detection system, but the multiple wraps of glass optical fiber had the disadvantage of forcing the individual tag/seals to be rather large and expensive. Both concepts were completed through the laboratory prototype stage. Although both SLOTS approaches were shown to be technically and operationally sound, BDM recommended and DNA concurred in December of 1991 that only the SWP SLOTS concept be pursued to the industrial prototype stage of development. This downselect decision was motivated mostly by the comparatively large size and unwieldy shape of the MWG SLOTS joint block and because of difficulty and expense encountered by several vendors in attempting to manufacture a multiply stranded cable composed of a single, unbroken strand of glass optical fiber.

DNA stopped work on all SLOTS activity at end of the laboratory prototype stage of development on February 27, 1992. Industrial prototype development of SWP SLOTS was initiated under TI-15 in August 1992, under the new name of Passive Tamper Indicating Loop Seal (PTILS).

Idaho National Engineering Laboratories (INEL) was chosen as the adversarial analysis team for SLITS and SLOTS. Team members were briefed in detail on both the SWP and MWG SLOTS designs on November 25, 1991, at BDM/Albuquerque. Loop materials for SWP SLOTS were delivered to INEL on February 13, 1992. Although no formal adversarial analysis activity was pursued by INEL on either SLOTS concept, the team leader did announce to the TAGLAG in December 1992, that fusion splicing had been successfully performed on PMMA optical fiber in a manner that would not be detected by the OFM30 OTDR.

(The OFM30 OTDR is a rack-mounted, laboratory version of the OFM20, with similar capabilities except for a slower sampling rate). In the course of the INEL/BDM adversarial analysis meeting of January 7, 1993, however, INEL briefed that they had based their conclusion on OTDR trace data displayed on a linear scale, not a logarithmic scale. BDM pointed out that a logarithmic display, with 4 to 5 orders of magnitude of real dynamic range in the trace, would reveal the backscatter deflection from the splice very clearly, and that the conclusion that the splice was not detectable was erroneous. In fact, the splice in question would have been obvious if correctly displayed. The OTDR trace display on the screen of the microcomputer of the UR system (using the CLPLOT utility program) in the PTILS system is on a logarithmic scale for proper interpretation by an on-site inspector.

4.2.4.1 Development Activities Associated with PTILS (Formerly SWP SLOTS)

Early in the innovative tags task, BDM investigated the possibility of providing strong butt splices in PMMA using adhesives. Various commercial adhesives were tried and none were found that provided appreciable mechanical strength in the splice. BDM also investigated solvents for use with PMMA directly in an attempt to make an adhesive. This effort was more successful than the use of commercial adhesives; however, these PMMA-based adhesives did not provide significant mechanical strength either.³ Fusion splicing in PMMA using hot knife techniques was briefly investigated and quickly abandoned as infeasible because of catastrophic degradation of the fiber. It was concluded, therefore, that an adversary must use mechanical sleeve splices to achieve sufficient mechanical strength in a covert splice. Sleeve splices would of course be obvious if the loop is visually inspectable. Commercially produced sleeves of the correct dimensions are not available for producing mechanical splices in plastic optical fiber. Furthermore, the cladding on plastic optical fiber is very thin (~ 5 μm), requiring extraordinary alignment accuracy that is not easily attained in mechanical splices.

Regardless of the splice preparation procedure used in plastic optical fiber, significant scattering of light was observed in the region surrounding a splice. This scattering, if truly uncontrollable by an adversary, could be the foundation

³ Carson, S. and R. Salazar, "Splicing Plastic Optical Fibers," SPIE Proceedings, Volume 1592 (1991).

for a robust tamper detection method. It was conjectured that when plastic optical fiber is cleaved, the very long PMMA polymer molecules are damaged in the region of the cut and cause backscattering of light into the fiber. BDM performed extensive investigations and experiments to determine how well cut plastic optical fibers can be polished and index of refraction matched to mitigate the damage and consequent reflectivity from cut fiber. These investigations included extremely careful grinding, polishing (down to 0.05 micron deagglomerated aluminum oxide grit), micropositioning, and use of index-matching fluids to create laboratory "splices" of minimal optical reflectivity. The reflectivities from these "splices" were measured using a very fast pulsed Nd:YAG laser and corresponding fast response detectors. The experimental setup and measurements in essence replicated an OTDR, except with more power, pulse width, and wavelength flexibility than would have been available with commercial units. A variety of splice preparation techniques were pursued and a number of different experimental setups and parameter variations were investigated. The essential conclusions of these experiments that bear on the question of splice detectability were:

- (1) Although dramatic improvements in splice preparation technique were accomplished during the course of these experiments, no polishing, surface preparation, and index matching methods were found that could eliminate a measurable, residual reflectivity in spliced PMMA fiber.
- (2) The lowest small-to-large fiber "splice" reflectivity achieved was -55 dB. The small-to-large "splice" configuration eliminates core misalignment as a source of splice reflectivity, and therefore represents an ideal, minimum reflectivity splicing circumstance that is not achievable in real splices.
- (3) The lowest reflectivity achieved in a same-size fiber "splice" was -44 dB. This "splice" was a highly polished, index matched, micropositioned, laboratory setup, and is probably of much higher quality than could be achieved with 250 μm fiber bonded with a mechanical sleeve strength member under conditions found on-site.

The experimental methodology used to establish the lower limit of splice reflectivity in PMMA fibers and further details of the conclusions reached are documented in appendix C to this report, "SLOTS Optical Time Domain Reflectometry Measurements."

In a further effort to identify the mechanism of light scattering on the polished fiber ends, nine polished fiber samples were forwarded to the University of Texas at El Paso (UTEP) Department of Metallurgical and Materials Engineering for imaging under a scanning electron microscope (SEM). The SEM images, which varied from 35 to 9700 magnification, revealed the consistent presence of numerous structures, including residual polishing compound or balled or flaked polymer, that would be capable of causing significant backscatter detectable by an OTDR. Some images showed fiber degradation, such as separation of the cladding from the core, buckling, and pitting caused by the polishing operation. Several samples showed structures that were either imperfections in the fiber itself that were apparently exposed by the cut or were deep damage driven into the surface during polishing. When rejoined into a splice, truncated structures like this would become refractive index discontinuities capable of causing Fresnel scattering. Sample SEM images and further discussion of these images may be found in the "Interim Technical Report on the Passive Tamper Indicating Loop Seal (PTILS)," dated August 1, 1992. Although no one structure seen in these SEM images could be identified as "the cause" of scattering in a "splice," the set of images demonstrated that splice preparation methods even more extraordinary than those used would have to be developed to further reduce splice reflectivities. All of the structures identified in these images were large compared with the wavelength of light ($0.68 \mu\text{m}$), so they would have been capable of acting as scattering centers, both individually and in aggregate. Even if the polishing technique could be improved, there would be no guarantee that splice reflectivities would be significantly reduced in either laboratory "splices" or in real splices. Edge degradation, exposure of natural flaws, contamination, and intrinsic polymer damage (if it exists) would all act to limit the ability of an adversary to improve on the splice results described above.

In a separate experimental/theoretical effort, the cause of splice reflectivity was investigated using a steady state, rather than pulsed, measurement approach. This measurement technique would have given insight into the

angular distribution of light scattered from regions of damage, which may have provided more definitive resolution of whether a physical limit of repairability had been reached (i.e., polymer damage), or whether the scattering was caused by artifacts of the polishing method and therefore might be reduced through procedural refinement. A body of theory was developed to determine both the magnitude and angular distribution of light scattered from polished end surfaces of the fiber, and various experimental setups were pursued. Unfortunately, insurmountable difficulties were encountered in collimating an incoherent Gaussian beam to a diameter smaller than the optical fiber core, so the steady state experimental approach was abandoned.

In addition to the laboratory measurements of splice detectability, BDM performed extensive numerical modeling of the transmission, reflection, and backscattering of light in optical fibers to determine the limits of detectability of various candidate OTDRs. The modeling effort simulated the performance of OTDRs in detecting high quality splices in lossy fiber, given the design specifications and various measured performance characteristics of the OTDR. A detailed analysis of the performance evaluation of the OFM20 OTDR is provided in appendix D to this report, "Analysis of the Limits of Splice Detectability in Plastic Optical Fiber Using the OFM20 OTDR." Modeling also allowed the establishment of performance requirements that an OTDR must meet for use in the field during on-site inspections. An enumeration of these requirements, how they are adequately met by the OFM20, and the deficiencies and potential for other OTDRs to meet these requirements are discussed in section 4.2.5.1.

Measurements of reflectivities from polished, index matched, butt "splices" were made using the actual tamper detection system selected for PTILS, the Opto-Electronics OFM20 OTDR. An OTDR trace of the lowest reflectivity "splice" achieved in 250 μm fiber (-44 dB) is shown in figure 4-21. This particular "splice" was configured (i.e., the index matching fluid and alignment were adjusted) to minimize the backscattered signal at the expense of increasing the throughput loss; consequently the throughput loss is a rather large 0.7 dB. The deviation from a uniform slope of the Rayleigh backscatter floor caused by both reflected signal and throughput loss is obviously detectable. Even though the quality of this and other laboratory "splices" was excellent for PMMA fiber, all of the "splices" attempted were easily detectable. Furthermore, none of these were real splices

with any mechanical strength, as would be required of an adversary preparing splices in the field. It should be noted that an adversary would be required to perform at least the final bonding phase of the splice preparation, which includes the fiber alignment procedure, in situ on a TLI to accomplish his covert task.

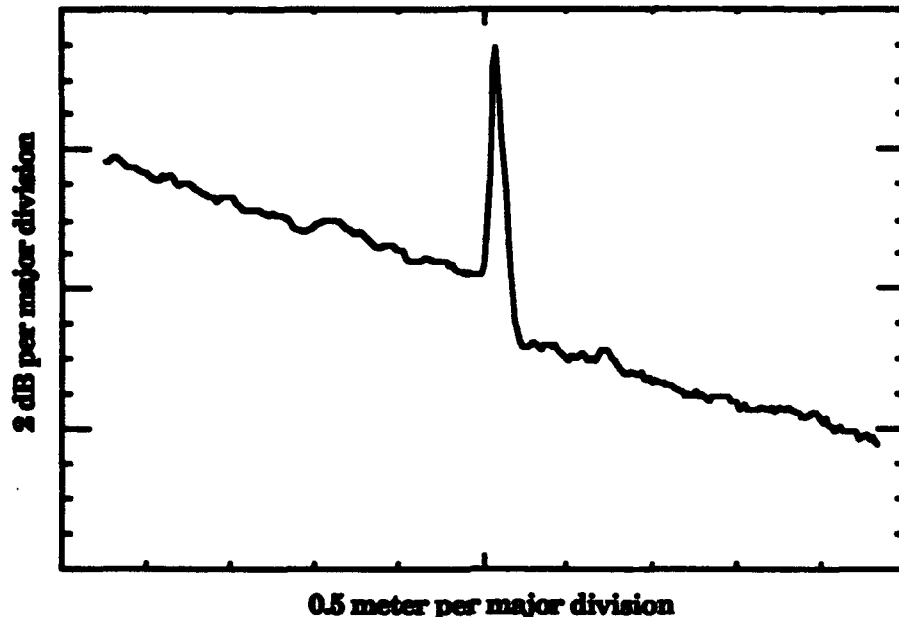

Figure 4-21. An OFM20 OTDR trace of a -44 dB reflectivity, 0.7 dB throughput loss "splice" in 250 μm PMMA fiber.

Several candidate OTDRs were investigated for use in splice (tampering) detection in optical fibers. The early design expectation was to use a single board OTDR that could be mounted in a portable computer, such as the LANprobe™ board by Antel Optronics. The COTS OTDR boards manufactured by Antel operate at one or more of the communications industry standard infrared wavelengths (850, 1300, and 1550 nm). These wavelengths are optimal for use in glass optical fiber with attenuation rates of less than 2 dB/km, but are ineffective for use in plastic fiber because of the high attenuation of light power in the infrared (> 2000 dB/km). Wavelengths in the visible region of the spectrum are needed to minimize light absorption in plastic optical fiber (POF). More specifically, a transmission window (~ 200 dB/km) exists in POF at about 650 nm. Since laser diodes suitable for use in OTDRs at wavelengths in the vicinity of 670 nm were commercially available, BDM procured from Antel an OTDR board specially reconfigured with a 670 nm laser diode for evaluation in the SWP SLOTS application. The purchase price was \$10,000 plus a non-recurring engineering

fee (NRE) of \$3500. After testing the board performance in POF, it was concluded that the 20 mW peak light power output of the 670 nm laser diode (50 times less than the typical 1 watt peak light power output of infrared laser diodes) was insufficient to raise the signal level of the Rayleigh backscatter floor above noise. Further, the Antel OTDR board was found to have other shortcomings including: limited dynamic range, very limited bandwidth in the detector amplifier circuit, and unacceptable noise levels during operation due to electromagnetic interference with other components inside the computer box. Some of these deficiencies could have been corrected by re-engineering the electronics on the board, but the implied cost and schedule delay, plus commercial preferences of the vendor made upgrading the Antel board both risky and unresponsive for SLOTS development. The Antel board OTDR was therefore rejected as the prototype choice for the SWP SLOTS tamper detection system.

The considerations influencing whether an OTDR is acceptable for use in short haul applications in POF are illustrated in figure 4-22 by comparing the relative performance of various OTDRs through numerical simulation. In these simulations, the pulse shape and launching geometry remain constant for all wavelengths; only the peak power output of the light pulse, the fiber absorptivity, the Rayleigh backscatter amplitude, and detector sensitivity change with wavelength. The pulse shape is arbitrarily assumed to be an 8 ns FWHM Gaussian and the bandwidth of the OTDR is assumed to be sufficient to impose negligible distortion in the detected trace (not the case in the Antel board). Bandwidth limitation would smear the pulse appearance, and thereby extend the dead zone following the input connector to the tag/seal and degrade the distinguishability of the covert splice against noise perturbations in the Rayleigh backscatter floor. Noise is neglected in these trace simulations. The loss per unit length in the fiber depicted in these traces is 240 dB/km at 670 nm, 740 dB/km at 770 nm, 1000 dB/km at 780 nm, and 2200 dB/km at 850 nm. The relative detector sensitivities are 0.84 at 670 nm, 0.98 at 770 nm, 0.99 at 780 nm, and 1.00 at 850 nm, based on the actual silicon detector type in the Antel Board (NEC NDL1202 photodiode). Other OTDR brands may vary from these sensitivities somewhat. The -44 dB reflectivity, lossless splice is the lowest reflectivity, constant core size, indexed matched butt splice achieved by BDM at 680 nm, without any means to maintain the splice except laboratory micropositioners. Actual splices are expected to be degraded from these ideal conditions (i.e., more reflective and some

throughput loss). These traces show that an 850 nm OTDR is attenuated too quickly in POF to be useful in a 10 m tag/seal, that a 770 or 780 nm OTDR would be possible but marginal, and that a 670 nm OTDR is feasible in terms of the slope of the trace, but that the noise reduction and dynamic range must be superior to that delivered by the Antel OTDR board to be viable. Although it is not apparent in these plots, the detectability of a covert splice against the Rayleigh backscatter floor improves as the pulse width is narrowed. Whether the 8 ns pulse width depicted is sufficiently narrow for robust splice detection depends on trace repeatability, noise amplitude, fiber stability over time, wavelength drift of the OTDR, and other considerations.

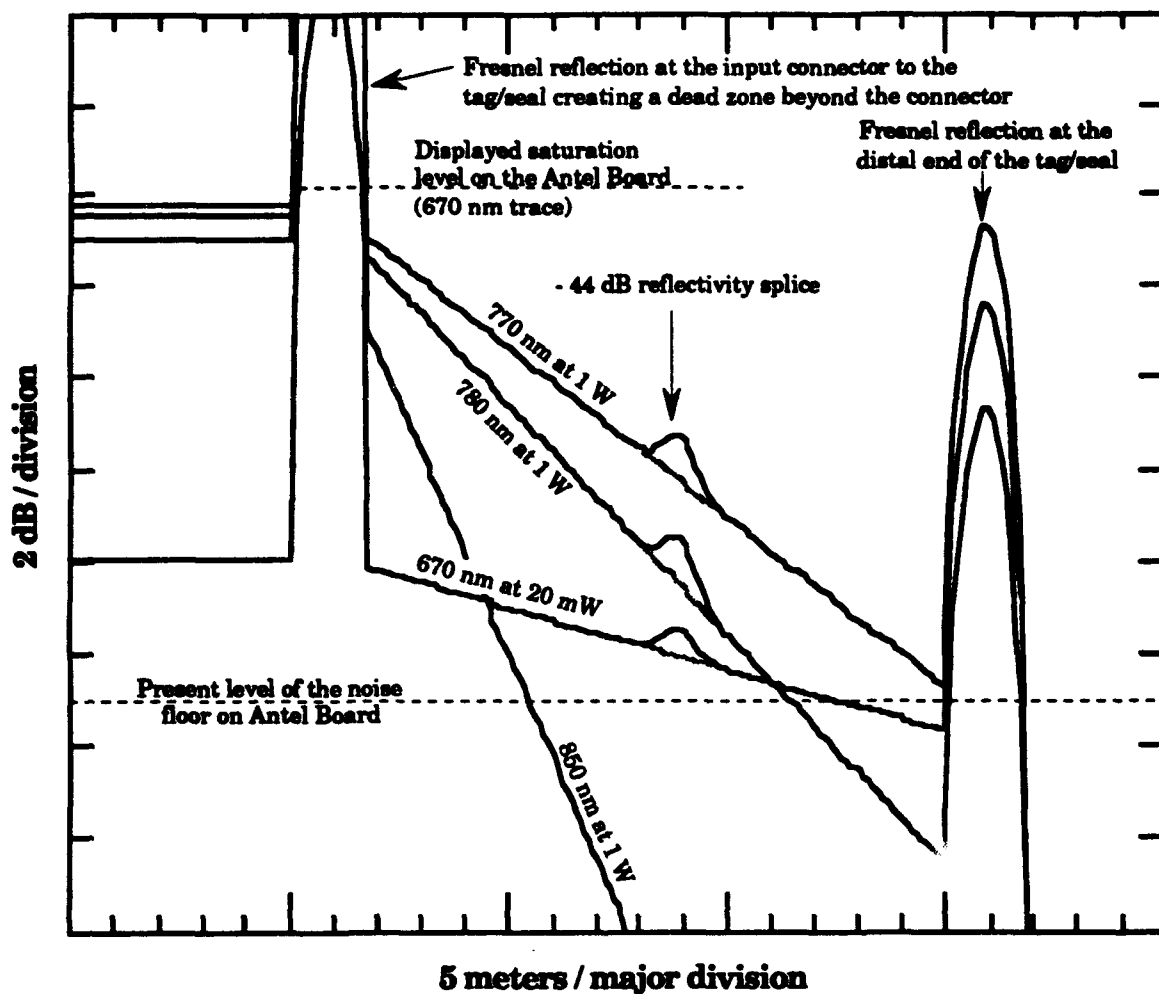

Figure 4-22. Comparison of OTDR performance at different wavelengths accounting for differences in the peak power output of the laser diode.

BDM investigated the potential of other brands of OTDRs for use in POF through published specifications, and received demonstrations of OTDR equipment from Tektronix. The Tektronix Fibermaster™, with a one nanosecond pulse width capability and sufficient sensitivity, noise reduction, and bandwidth to support its use in very short haul applications, appeared to be an acceptable candidate for SWP SLOTS. Sample traces of these capabilities were provided by Tektronix that substantiated the specifications published in their advertising literature. However, the Fibermaster™ does not support a 670 nm laser module and Tektronix was not interested in developing a 670 nm capability. If the Fibermaster™ were offered at some point with a 670 nm capability then with a purchase price of approximately \$20,000 the Fibermaster™ would be a leading candidate to displace the OFM20 as the tamper detection instrument for PTILS.

The OFM20 OTDR manufactured by Opto-Electronics differs from other commercially available OTDRs in that it uses an extremely short pulse width (~ 40 ps) and operates in a photon-counting mode. A detailed description of photon counting detection is provided in appendix D to this report. The Opto-Electronics equipment is stable in operation, has large dynamic range, and can be interfaced with a portable computer. Software in the computer provides the proper commands to operate to the OTDR and receives data from the OTDR via a GPIB bus. The Opto-Electronics OTDR is housed in a separate box and is not presently available in other (more portable) forms. BDM procured one Opto-Electronics OFM20 OTDR for \$54,500. There is another, non-photon-counting OTDR model manufactured by Opto-Electronics, the OFM10, available for the same cost that has many potential advantages in the PTILS application. These and other potential substitutions for the OFM20 are discussed in section 4.2.5.1

4.2.4.2 Development Activities Associated with MWG SLOTS. Much research was done to show proof-of-principle in the MWG SLOTS concept. Early measurements demonstrating that losses from multiple mechanical splices in series on the same fiber accumulate additively, measurements quantifying bending losses as a function of fiber type (singlemode or multimode of various core sizes), measurements quantifying bend radius in the bend regions of the tag, and a statistical study of cumulative multiple splice losses based on published data on a fusion splice loss distribution were documented in "Analysis and Proof-of-Principle for Innovative Tags," BDM/ABQ-91-0072-TR, January 31, 1991. A

mathematical model of Rayleigh backscatter in glass optical fibers physically configured as MWG tags was developed and used to show how the OTDR trace of an adversarially attacked tag would appear. The model was intended to be used as an engineering design tool for determining the minimum number of wraps necessary to ensure detectability of splices, given the resolution of the Antel OTDR board and assuming of the highest possible quality fusion splices that could be achieved by an adversary using state-of-the-art splicing equipment. The model derivation and numerical simulations of multiply spliced fibers are presented in appendix E to this report, "Analysis of the Rayleigh Backscattered Power in a Multiwrap Glass SLOTS Optical Fiber with Bends and Splices."

A preliminary methodology for quantitatively comparing reference to verification OTDR traces was also developed so that an inspector could make an automated tamper determination on-site. The methodology included a statistical model that accounted for trace noise and the effects of wavelength drift (from both laser diode lot variation and temperature variation) and would have used actual trace performance data from the Antel board OTDR, in conjunction with the backscatter model, to determine the required number of wraps in a high confidence MWG tag/seal. However, work was discontinued on the MWG SLOTS concept before this integrated analysis was completed or documented.

The viability of the MWG SLOTS concept was convincingly demonstrated experimentally just before the stop work order was issued. BDM gained access to and was able to generate numerous splices using the Fujikura FSM-20CS fusion splicer, which is arguably the finest splicing machine available today. The fiber cleaving device recommended by Fujikura to obtain the highest quality results was also obtained and used. After an initial training period, twenty-two fusion splices of excellent quality were made by BDM in series at roughly 12 meter intervals on a single, 62.5/125 graded index multimode glass optical fiber. The cumulative loss on the fiber was recorded after each splice using the Antel OTDR board. These splices had typical throughput losses of about 0.02 dB or less, with the worst splice being 0.07 dB. Figure 4-23 shows OTDR trace overlays from the Antel OTDR board of the optical fiber before and after splicing with the Fujikura machine. These experimental results demonstrate that a spliced fiber is easily distinguishable from an unspliced fiber using the Antel OTDR board even when only a few of the highest quality splices attainable are present.

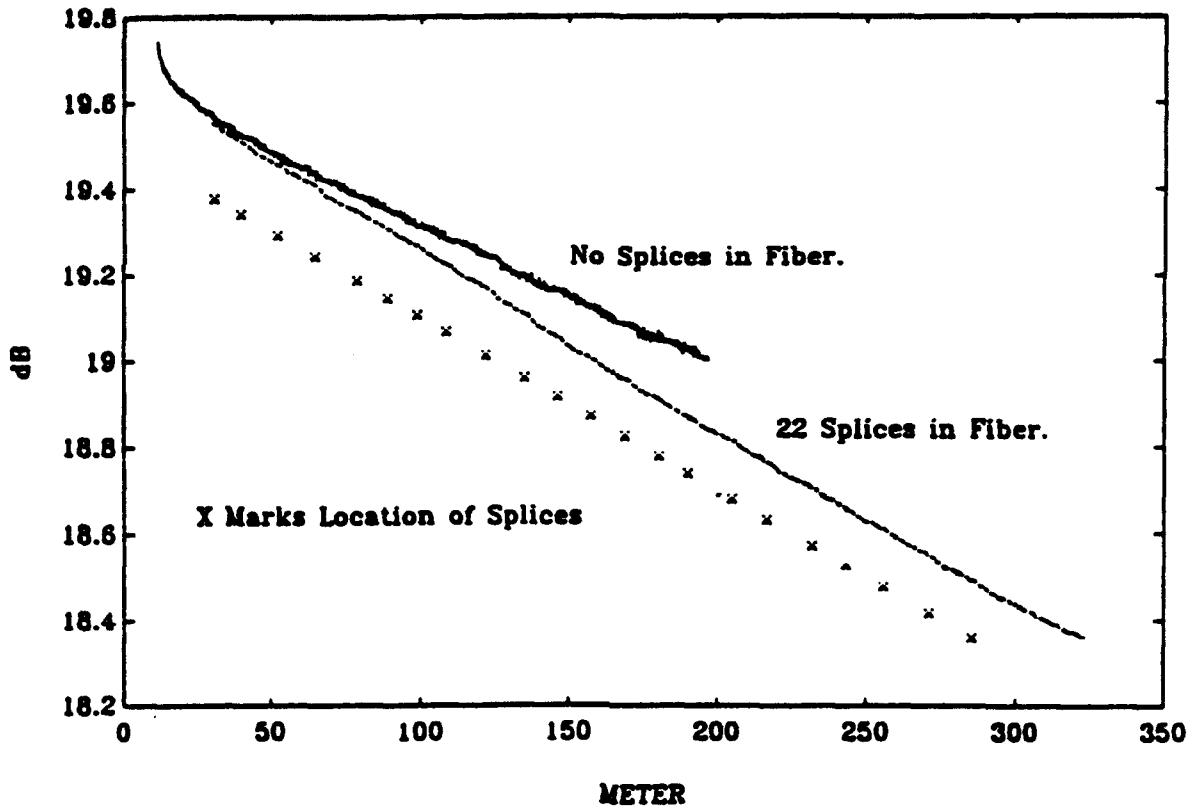

Figure 4-23. Comparison of Antel board OTDR traces on an optical fiber before and after splicing multiple times with the Fujikura splicing machine.

4.2.5 Results.

Due to the stop work on SLOTS or PTILS, this system is unavailable as a fully tested, final configuration system. This is due to reinforced, final design optical loop cable not having been procured and tested. The OD final loop cable could impact the design requirements of the loop closure joint block. The concept of tamper detection for SLOTS/PTILS is fully proven. An OTDR of adequate sensitivity is commercially available from Opto-Electronics. A more convenient OTDR packaging may become available from Opto-Electronics, Tektronix, Antel, or others in the future.

When mass produced, PTILS will be relatively inexpensive at \$50 - \$100 per tag/seal, depending on the length of the secure loop. This is quite competitive with other tag or seal technologies, especially when one considers the very high level of confidence that is offered with this technology. Cost per tag/seal may be an extremely important consideration if large quantities are needed.

PTILS offers the unique capability of a high confidence, objective tamper detection on-site for the entire loop of a passive loop tag/seal. High confidence, objective on-site tamper determination against an adversary with unlimited resources is not offered in the Cup and Wire (Type E) seal, the Cobra II seal, the Python seal, SLITS, the Brooks fiber optic seals, or in any other passive loop tag/seal. The tamper detection mechanism in all of these other designs relies on external examination incrementally along the length of the loop, either subjectively on-site or as an off-site determination in an analysis laboratory.

The remote tamper detection capability of PTILS allows positive tamper determination in regions of the loop that may be visually obscured or inaccessible to an inspector. This feature gives PTILS the potential to verify the seal integrity in regions of the loop that may be intrusive to access directly or that may be hazardous to approach without cumbersome protective gear. Remote tamper detection with high confidence is not available in any other passive tag/seal. PTILS is compatible with the UR (version 6.0) in its present form, and software to support proper accessing of PTILS signature files has been incorporated into the UR software. The software for driving the OFM20 OTDR (OFM20TST) so that no optoelectronic expertise is required of the inspector is available as well as a logarithmic plot, overlay and differencing display program (CLPLOT). See appendix B to this report for further details.

Several other features recommend PTILS in certain applications. PTILS is adaptable in loop length on-site. Adjustable length is critical if the tag/seal loop is to be versatile in capturing necked down regions of tagged or sealed items in tight wrap installation scenarios. The passive design of PTILS gives it excellent reliability over long time periods between inspections and excellent robustness in hostile natural environments, particularly extreme cold. The passive design of PTILS makes it benign for intelligence gathering in strategically sensitive tagging or sealing applications. The absence of electronics in combination with

its high confidence tamper detection capabilities makes PTILS attractive for use in the inspection of deployed nuclear weapons should the need for this capability arise in the future.

4.2.5.1 Possible Future Upgrades to PTILS. Three different scenarios are presented through which PTILS as a field portable system could be improved. None of these improvements are necessary to make PTILS viable; PTILS is already an industrialized tag/seal system that has excellent potential as an aid in arms control. These scenarios illustrate how, through completion of the adversarial analysis and with further development, features of the PTILS system could be made even more attractive to the needs of on-site inspectors.

Substitution of the OFM20 by an Alternative OTDR. It is possible that other optoelectronic instruments (COTS or otherwise) also could be undefeatable as tamper detection devices, even though they may not possess all of the capabilities of the OFM20. The performance requirements of candidate replacement OTDRs that have emerged for the PTILS tamper detection application in plastic optical fiber are:

- (1) The spatial resolution has to be on the order of centimeters to allow examination of the short length of optical fiber in the secure loop region of the tag/seal.**
- (2) The pulse width has to be less (preferably much less) than 10 ns so that the amplitude of the Rayleigh backscatter will be sufficiently small so as not to swamp the small reflections from covert splices.**
- (3) The detector sensitivity has to be great enough and the trace noise low enough to allow display of the Rayleigh backscatter floor (even with the very short pulse width) so that small Fresnel-like events will be recognizable as deviations from the monotonic slope of the Rayleigh backscatter floor.**
- (4) The OTDR has to have enough dynamic range at a commercially available wavelength to allow examination of the Rayleigh backscatter floor for at least 10 meters of secure loop length beyond the connector dead zone in highly attenuating plastic optical fiber.**

- (5) The OTDR has to have sufficient amplifier bandwidth (~GHz) in the detection/amplification circuit to crisply resolve the fast pulse reflected signal within the short length of the secure loop.
- (6) The OTDR has to acquire a quality trace with sufficient averaging in only a few minutes.
- (7) The OTDR has to be as lightweight, rugged, and portable as possible.

Prior to the selection of the OFM20 for PTILS, several candidate OTDRs were investigated for use in splice (tampering) detection in plastic optical fiber. A particularly promising alternate choice was the Fibermaster™ made by Tektronix, which featured an extremely wide bandwidth, low noise, reasonable cost (~\$20,000), and a 1 ns pulse width. Sample traces provided by Tektronix using the 1 ns pulse setting in glass fiber at 850 nm gave all appearances of meeting the requirements for this application, provided that the Fibermaster™ could be converted to 680 nm. However, at the time when these inquiries were being made (fall of 1991), the Fibermaster™ did not offer a 680 nm wavelength source module, and Tektronix was not interested in developing this capability. Since that time, both laser diode and OTDR technology has advanced significantly. Whether Tektronix or some other manufacturer of an OTDR with adequate specifications now offers a 680 nm wavelength as a COTS option is not known, but the question could be answered by performing a new market survey.

Conversion of the OTDR from the OFM20 TO THE OFM10. The present design of PTILS and selection of the OFM20 photon counting OTDR for tamper detection was driven by the very low reflectivity of the "splices" that has been achieved under laboratory conditions using index matching fluid and micropositioners. The OFM20 is the only COTS OTDR available that has the capability to see Fresnel-like reflections this low in amplitude. BDM has not relaxed the OTDR sensitivity requirements for tamper detection imposed by these laboratory results to account for the practical difficulties an adversary would face when attempting to actually bond the fiber into a mechanical splice in a realistic defeat scenario. If the INEL adversarial analysis team were unable to produce actual splices of the same quality as the laboratory butt "splices," then the extreme sensitivity provided by the OFM20 OTDR may not be necessary to assure positive splice detection in PTILS. *If the INEL adversarial analysis team could assert*

with confidence from their analysis that any real splice in plastic optical fiber will have a reflectivity of no less than x dB, and if reflectivities of x dB produce Fresnel-like reflections that are easily detectable by the OFM10 OTDR, then there would be great advantage in declaring the OFM10 as the optimal OTDR for splice detection in PTILS.

Unlike the photon counting OFM20, the OFM10 OTDR uses the avalanche photodiode (APD) as an analog receiving detector, and therefore acquires a full 8-bit amplitude data point in a single pulse return sample at each spatial location on the fiber. The 2-bit (photon/no photon) sampling of the OFM20 requires 256 pulse return samples at each location to accrue the same amplitude information, but with more random noise (and higher sensitivity), which requires more averaging to smooth the trace to a usable, stable condition. The implication is that the net acquisition rate of the OFM10 is much faster, so the time required to generate a well-averaged OTDR trace is tens of seconds, rather than the several minutes required by the OFM20.

Conversion from the OFM20 to the OFM10, if it is endorsed by adversarial analysis findings, would result in two other dramatic improvements to PTILS. First, the OFM10 has an effective dead zone of about 2 cm, compared to the 5 m allotted to get past the pulse echo train effective dead zone in the OFM20. Conversion to the OFM10 would allow elimination of the lead-in fiber spool (see figure 4-11), which would result in a smaller and simpler PTILS product. Secondly, since the pulse launching rate of the OFM10 is much less than the OFM20 (it does not have to be as fast to obtain a rapid trace acquisition), the OFM10 can be used to examine a tag/seal through an "extension cord" fiber up to a kilometer in length, compared to the 30 meter maximum fiber length (including the length of both the tag/seal and the extension fiber) with the OFM20.⁴ Conversion from the OFM20 to the OFM10 would restore a truly remote read capability to PTILS by allowing the PTILS tamper detection system (the OTDR box)

⁴ The maximum fiber length restrictions cited in this context relate to avoiding the condition of having more than one pulse launched in the fiber at a time, not to the fiber loss-per-length consideration. Note that the "extension cord" fiber is made of glass, not plastic, and therefore has very low loss over long distances. The reason the maximum fiber length of this type exists is that if all "echoes" from one pulse have not returned to the OTDR detector before the next pulse is launched, then the timing of the various reflected signals cannot be meaningfully interpreted.

to be co-located with the computer box of the UR, as was originally envisioned when the PTILS concept was first proposed. The OFM10 OTDR could examine the tag/seal for splices remotely using the low-loss, 240 μm core glass fiber in the communication cable connecting the reader station to the computer in the UR system. This OTDR "extension cord" fiber is already included in the UR communication cable specifically to support the PTILS remote tamper detection procedure. The maximum fiber length limitation of the OFM20 precludes use of this remote reading configuration, and requires that the OTDR be placed very near to the tag/seal.

Conversion from Plastic to Specialty Glass Optical Fiber. Another approach to improving the single wrap PTILS concept would be to replace plastic optical fiber in the loop with a specialized glass fiber, that by its chemistry and fabrication, resists splicing and reveals splices to an OTDR. Use of a specialty glass optical fiber has the potential of removing the three major criticisms of PTILS using plastic fiber optics with a tamper detection system based on either the OFM20 or the OFM10:

- (1) Either the OFM20 or OFM10 OTDRs would have to be packaged as a box separate from and in addition to the UR used to read the PTILS RP signature. The number of boxes to be transported in the reading system of a tag or seal is a very important practical concern from the point of view of a field-mobile end user.
- (2) Both the OFM20 and OFM10 are reasonably expensive (\$54,500 each).
- (3) The maximum loop length that can be interrogated is limited by the lossiness of plastic optical fiber (~250 dB/km at 680 nm, the minimum attenuation of all wavelengths available in commercially produced laser diodes).

Splice-revealing specialty optical fiber with low attenuation in at least one of the standard wavelengths of commercially available OTDRs (850, 1310, or 1550 nm) could allow a smaller, more portable, less expensive OTDR of lesser capability to be used with equivalent confidence in on-site inspections. If the fiber attenuation were low enough, the maximum useful length of the PTILS loop might also be extended.

No commercially available forms of glass fiber appear to offer any improvement in splice detectability over plastic optical fiber. However, BDM has established contact through DNA with a group at Pacific Northwest Laboratories (PNL) that is fabricating unusual glass optical fiber that is particularly difficult to splice. Prior to the direction to stop work on PTILS, BDM planned to collaborate with PNL to investigate the potential for adapting this glass fiber optic technology into a form that has relatively low loss at wavelengths available in COTS OTDRs while retaining the difficult splicing characteristics. Whether the technology that PNL is pursuing is adaptable to successfully meet the requirements of this application, and whether the cost per unit length of a successful specialty fiber can be made low enough to be attractive for use in tags and seals, has not yet been determined.

The leading replacement candidate for the OFM20 (or OFM10), if it were made possible by a suitable specialty glass optical fiber, is the OTDR board made by Antel Optronics. The attractive features of the Antel board are that it is small, lightweight, relatively inexpensive (\$8500 - \$15,000, depending on the wavelength of the laser diode), and it is designed to fit in a full sized expansion slot of an IBM AT compatible personal computer (PC). A photograph of the Antel board OTDR is shown in figure 4-18 above.

The PTILS tamper detection system based on an Antel OTDR board would reside inside the UR computer, and therefore would not introduce a separate box. The Antel board is, however, much inferior as an OTDR for short haul applications compared to the OFM20, for several reasons. First, it has a relatively long pulse width (10 ns minimum) compared to the OFM20 (~40 ps). The main penalty for the longer pulse width is that the amplitude of the Rayleigh backscatter floor increases with the duration of the light pulse. A longer pulse width tends to obscure the small Fresnel-like reflection of a covert splice, and thereby significantly decreases the splice detection sensitivity of the OTDR. Secondly, the dynamic range of the Antel board is very limited (less than 10 dB for the round trip light path, compared to greater than 20 dB round trip for the OFM20) because of limitations in placing all of the requisite electronics on a single PC board. Limited dynamic range severely constrains the length of optical fiber that can be interrogated for a given loss per length of fiber. Thirdly, the bandwidth of the Antel board amplifier/digitizer circuit (~4 MHz compared to

many GHz for the OFM20) degrades the quality of the OTDR trace by extending and smearing the shape of reflected pulses on the trace, thereby making covert splices much more difficult to distinguish against the Rayleigh backscatter floor. Even with these deficiencies, the Antel board could be made to work (probably requiring a bandwidth upgrade) for PTILS *if* the loss per unit length of the fiber were small enough and *if* covert splices were guaranteed to provide sufficiently large Fresnel-like reflections because of the splice-revealing characteristics of the specialty optical fiber. Since the time when BDM conducted a market survey of existing OTDRs and evaluated the performance characteristics of the Antel OTDR board, another OTDR board that fits into a PC, manufactured by Exfo, has appeared on the market. The performance adequacy of this new OTDR board compared to the Antel board is not known.

4.3 THE INNOVATIVE TAGS CREATIVE TASK.

4.3.1 Overview.

The purpose of the Creative Task was to survey technologies for viable tags and seals as alternatives to those being pursued in the DOE national laboratories. These survey efforts included invention of concepts, analysis of the physical principles involved, and system engineering feasibility analysis. BDM staff from a variety of scientific and engineering disciplines were used to create concepts and perform internal adversarial analysis of the concepts. Many ideas were considered and assessed. Few survived this internal BDM adversarial analysis.

BDM concluded early that there were three classes of tags and seals that could be developed. These include: 1) intrinsic tags; 2) adhered tags; and 3) loop tags. The intrinsic tag/seals attempt to use some inherent material properties or topological features of a tagged item to provide a unique identifier (signature) of the item. Adhered or "stick-on" tags use an independent signature (e.g., reflective particles) to provide a unique identity that can be irremovably associated with an item to be controlled. In some circumstances, adhered tags may be useful as seals. Loop tag/seals have the widest range of applications. Loop tags may be attached around or through tagged or sealed item features such that they cannot be removed without detection. A loop tag/seal includes the loop material, a loop

closure joint, and a signature. The loop tag system must resist (reveal) tampering in the loop or the closure joint. These three options for tags are shown in figure 4-24.

BDM chose to concentrate Creative Task work on loop tags; although, two intrinsic tag concepts were investigated. The decision to emphasize loop tags was influenced by BDM's belief that stable and repeatable signature readings are difficult to accomplish for intrinsic tags. Further, BDM recognized that the RPT developed at SNL was a very robust adhered tag and offered high resistance to counterfeit. START constraints drove BDM to consider only passive tags.

One reason that so few Creative Task concepts proved attractive was the rather tight set of constraints imposed by the bilateral START Treaty. Under the START ground rules, relatively few, very high value assets were being considered for arms control verification. Tagging and inspection of operational, deployed systems were possible. Tags could be fielded for years with few inspections per year. Therefore, the demands on tags for this purpose were severe. Due to relations that existed between the U.S. and the Soviet Union at the time, there were serious operational constraints for inspection procedures and application of tags. Both the U.S. and the USSR wanted non-intrusive verification. These START constraints imposed the following tag/seal requirements:

- (1) Unique, non-counterfeitable, repeatable signatures with environmental robustness
- (2) Strong tamper detectability with confident determination on-site with a low probability of false calls
- (3) Limitations on missile intelligence data collection capability
- (4) Non-impairment of the operational effectiveness of the tagged item.

Access to parts of the tag during inspections may be limited. The tag must be durable for a period of years, easily installed, verified with as simple and direct means as possible, and preferably be based on commercially-available and reasonably-priced equipment. Only data necessary for verification could be recorded and all data had to be shared between inspecting and inspected parties, including tag construction and technical principles. No active (powered) tags or

seals could be used. These constraints eliminated active systems, such as electronic identification devices or active fiber optic systems. Designs that might be perceived as including an antenna were of concern to the National Security Agency. Further design constraints were imposed from the necessity to field tags and seals in challenging environmental conditions (e.g., low or high temperatures, high humidity, blowing sand, rain, hail, freezing rain, etc.). Finally, BDM emphasized operational simplicity, and use of as much COTS implementation as possible.

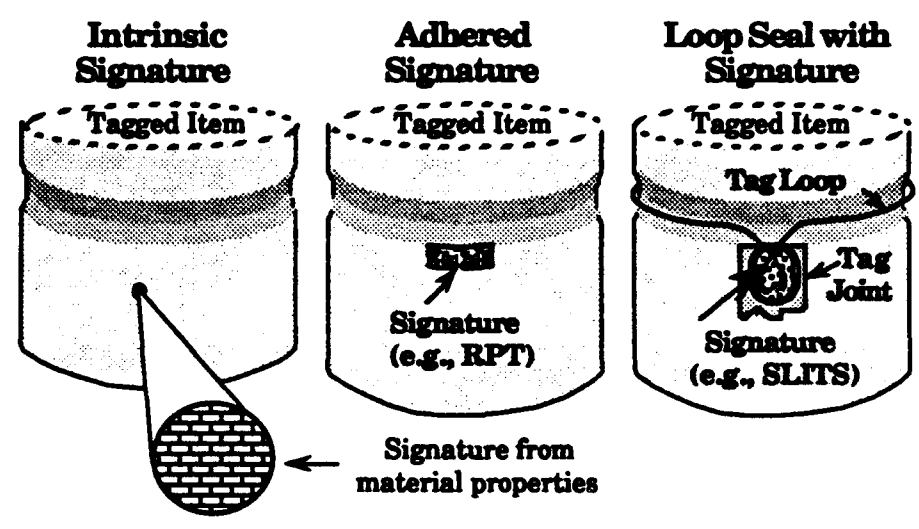

Passive
 No on-board power
 Potential for greatest long-term reliability
 Potential for lowest cost and smallest size

Active
 Requires continuous power (battery)
 Maximum flexibility for tamper detection

- Timed event documentation
- Interface to larger security systems

Potential for remote (RF) communication

Figure 4-24. Types of tags and seals that can be developed.

During the execution of the Tagging contract, the requirements for arms control verification have changed. A "New World Order" now exists. There is no USSR and, in its place, there are unstable CIS economies and governments. There is an unstable third world and multilateral participation in arms control negotiations. For verification of treaties and agreements other than START (e.g., Bilateral Destruction Agreement (BDA), Chemical Weapon Convention (CWC), Biological Weapon Convention (BWC), non-proliferation, dismantlement and destruction of non-deployed systems), many of the START constraints have been relaxed. In general, a much larger number of less valuable assets must be controlled. Shorter-term tag or seal deployment may be permitted. Operational deployment of tags and seals in more severe environments is possible. Requirements different from those for START become more important. Examples of the requirements in the New World Order include:

- (1) Rapid installation of tags and seals
- (2) Rapid readings
- (3) Smaller, more lightweight reading equipment
- (4) Very low cost, operationally simple technologies for tags, seals, and reading systems.

Had these new requirements been available earlier, the suite of tags and seals pursued under the Creative Task effort might have been very different. BDM identified many radically new concepts in the waning months of the contract that were not part of the Creative Task effort (since the Creative Task work had ended a year earlier), but which would be responsive to the new requirements.

The Creative Task work is more fully documented in appendix F to this report, "Creative Task Final Report - Innovative Tags."

4.3.1.1 Documentation Produced. BDM presented an initial briefing to DNA/OPAC and DNA Field Command in August 1990. Additional briefings were given to DNA Field Command through the Fall of 1990. On January 16, 1991, a large briefing was given to several representatives from DNA, including Col. Bob Davie of OPAC. This early work was documented to DNA in an Initial Report on Innovative Tags in August and Interim Reports in October 1990 and

January 1991. Throughout 1991 and early 1992, BDM briefed representatives from a large number of agencies on the innovative tags work; most of these briefings included discussions of Creative Task concepts. Individuals and groups briefed include: DNA, the On-site Inspection Agency (OSIA), NSA, CIA, OUSD(A), OUSD(P), an ambassador in the Department of State, and representatives from DOE. All of these briefings were supported with copies of the slides presented in the briefings.

4.3.1.2 Expenditures. Isolating Creative Task costs is difficult since the work started with TI-FY90-10 in July 1990, and led to the work on SLITS and SLOTS. Creative Task work continued with both versions of TI-FY91-15. The following table (table 4-7) lists the labor hours, the associated loaded labor costs (without fee and tax) plus the ODC's expended during the conduct of the Creative Task development.

4.3.2 Schedule.

The "Creative Task" was performed under the Innovative Tags Technical Instructions (TI90-10 - July 17, 1990, and its amendments, and TI91-15 - March 1, 1991, and its replacement TI91-15 - May 7, 1991). The innovative tags work began

Table 4-7. Creative Task expenditures.

TI	Hours	Loaded Labor Costs	ODC's	Total Costs
TI FY90-10	*	*	*	*
TI FY91-15 (Original)	*	*	*	*
TI FY91-15 (New)	*	*	*	*
Totals	*	*	*	*

* All costs will be provided at contract closeout.

with the authorization of TI90-10. The innovative tags work was in a general creative task mode until after a briefing given to Col. Bob Davie and others from the DNA/OPAC office on January 16, 1991. There was some proof-of-concept laboratory work during this first phase of the innovative tags work. Most of the very early concepts were filtered out as a result of the laboratory analysis scope.

This early work was documented in an Initial Innovative Tags Report in August 1990, and Interim Reports in October 1990 and January 1991. After the issuance of TI91-15 in March 1991 which directed the laboratory prototype developments of the SLITS, the SLOTS, and the UR system, the Creative Task also continued in an attempt to invent other tag or seal concepts. Additional concepts were created and proof-of-concept analyses performed. Laboratory proof-of-concept measurements were performed for some of them. The schedule for the Innovative Tags work is shown in figure 4-25.

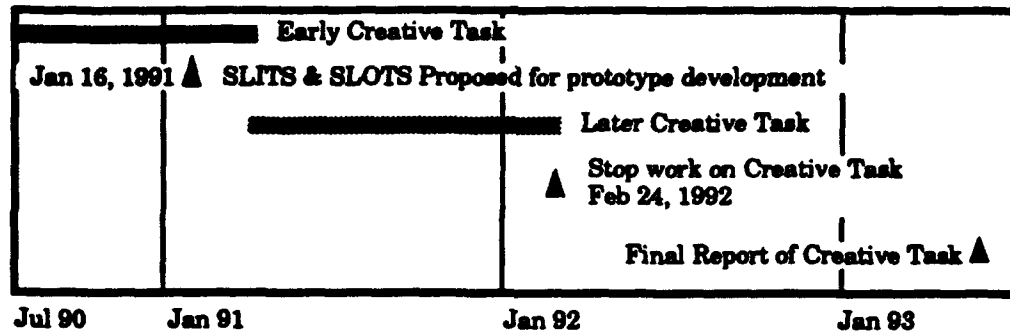

Figure 4-25. BDM Creative Task schedule.

Late in 1990, two loop tag/seal concepts began to emerge as primary candidates for prototype development. These were the SLITS and the SLOTS, which later was known as PTILS. Both of these concepts were developed through the industrial prototype stage as described in sections 4.1 and 4.2.

4.3.3 System Descriptions.

The following systems were not developed to laboratory prototypes. The fact that these concepts were not developed to prototypes does not necessarily imply that they were flawed or deficient. The reasons for not pursuing some of these include schedule constraints, budget constraints, and lack of direct applicability to START. In some cases, breadboard configurations were assembled in the laboratory in order to make proof-of-concept measurements. In other cases, the concepts were extensively assessed through analysis. In each case where the concepts were feasible for development, candidate system designs are described.

4.3.3.1 The Magnetostrictively Interrogated Loop Seal (MILS). One of the technologies explored during the Creative Task effort was the use of magnetostrictive wires or ribbons as possible loop material for tag/seals. It is a

candidate loop technology that may provide very robust, objective, "binary" loop tamper detection. That is, by simple measurement and with simple instrumentation, it may be possible to determine objectively on-site whether or not covert tampering has occurred in the loop. Magnetostrictive materials change dimensions slightly during the application of a magnetic field, and it is possible to exploit this effect to indicate adversarial tampering in the loop of a loop tag/seal. The motivation for research into magnetostrictive materials in the Creative Task came from the historic use of arrays of magnetostrictive wires for ion detection in spark chambers. Development of these materials has progressed significantly in the last decade. Magnetostrictive ribbons and wires of high quality and exact specifications are available commercially. The Metglas Products division of Allied Signal Inc. (Parsippany, NJ) produces or distributes several kinds of magnetostrictive materials. Most of these materials are made of amorphous (noncrystalline) glassy metals. They are routinely used for magnetic shielding, magnetostrictive delay lines, distance sensors, vibration and stress sensors, identification markers, digitizing tablet sensors, small transformer windings, and so forth. Small samples of both ribbon and wire were obtained from Allied Signal. The magnetostrictive ribbons were found to be easily spliced with solder, while the magnetostrictive wires were very difficult to solder together. Therefore, attention was focused on magnetostrictive wires. The wire samples investigated are Unitika's iron-based "Sency" wires, type AF-10, produced by Unitika Ltd. of Japan. They have a diameter of 125 μm (microns) and are described in greater detail (see appendix F). These amorphous magnetostrictive wires, called a-wires for short, have a high resistance per unit length (on the order of 150 ohms per meter), which helps to reduce eddy-current losses for some applications.

The MILS concept of tamper detection in the loop materials of a loop tag/seal is based on the ferromagnetic large Barkhausen effect in magnetostrictive materials. The Barkhausen effect occurs when a ferromagnetic material is magnetized. The ferromagnetic material produces a nonlinear magnetic induction response, B , with applied external magnetic field intensity, H . Over the steep parts of the B - H curve, local magnetic domains can suddenly change in both size or magnetization orientation. These small, discontinuous changes in the domains, some of which are indicated in the typical B - H (hysteresis) curve for normal ferromagnetic material is shown in figure 4-26(a), constitute the Barkhausen effect. The discontinuous change is very pronounced

in magnetostrictive materials, in which just a few domains can occupy the entire wire. In certain amorphous magnetostrictive wires, the vertical portions of the hysteresis loop are formed by just one or two major domain reversals, or "Large Barkhausen Jumps" as reported by Mohri, et. al. A typical B-H curve for a magnetostrictive material appears in figure 4-26(b).

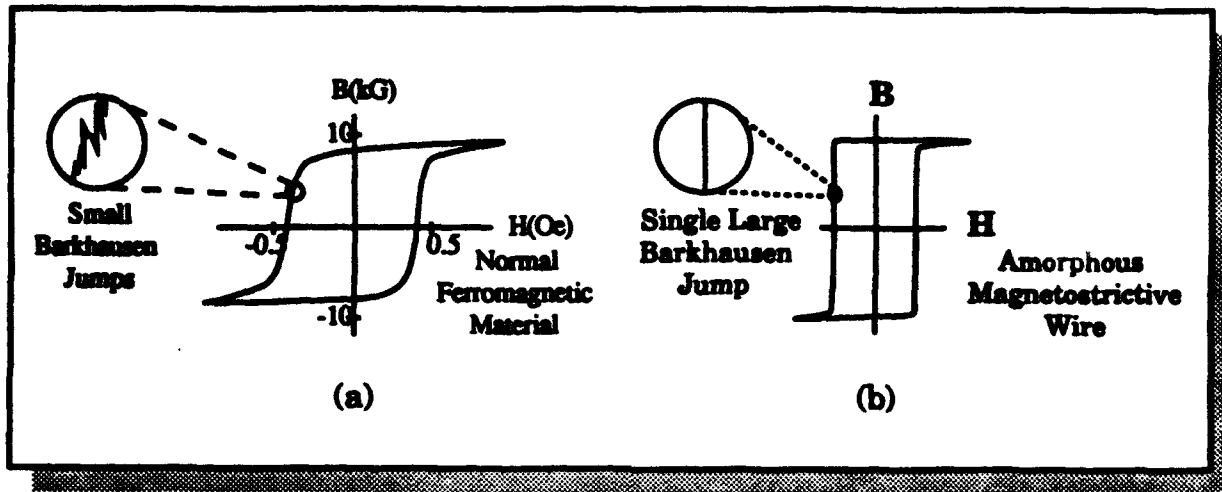

Figure 4-26. Typical hysteresis curves for normal ferromagnetic materials and amorphous magnetostrictive materials.

If an amorphous magnetostrictive wire (a-wire) is exposed to an external magnetic field, and a small pickup coil is placed around the a-wire, a Barkhausen effect induced voltage will appear across the terminals of the pickup coil as the domain wall propagates through the coil. The propagation of a domain wall down the axis of an a-wire is shown in figure 4-27. In the figure, the entire wire consists of just two domains, labeled "North" and "South." As the domain wall moves down the wire, portions of the "North" domain flip polarity and become part of the "South" domain. The propagation of domain walls depends on many factors (including wire composition and size, and the strength of the applied magnetic field). The velocities of the domain boundaries are typically in the acoustic range (100 to 400 meters per second). Through the phenomenon of magnetostriction, the propagating domain boundaries are coincident with magnetoelastic waves.

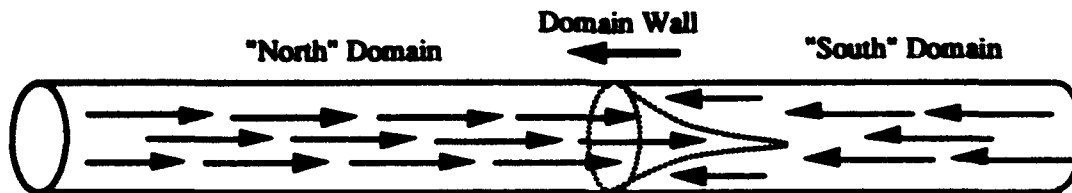

Figure 4-27. Propagation of a domain wall in an amorphous wire.

An a-wire that is subjected to a suitable external magnetic field will possess only a few domains instead of many domains, as would be the case for conventional materials. If the external field is uniform, and is raised above a critical intensity, domain walls will spontaneously nucleate and begin propagating from both ends of the wire toward the center of the wire. Magnetoelastic waves from just one end of the wire can be obtained by adding a small driving field to the main external field at that end of the wire. This is accomplished by using a long coil for the main external field, and including a small driving coil (connected in series with the main coil) at the desired end of the a-wire. The enhanced local field ensures that domain nucleation will occur only at the end of the wire near the drive coil.

The propagation of magnetic domains is a surface effect rather than a volume effect, and depends critically on the uniform composition and shape of the amorphous material. *If an a-wire is damaged, spliced, or even bent too sharply, magnetic domain wall propagation ceases entirely at the point of damage.* That is, the "magnetic and mechanical uniformity of the wire is of utmost importance with respect to large Barkhausen discontinuities" as reported by Sixtus and Tonks. Thus, the Barkhausen effect is interrupted if a cut-and-splice operation is performed on the a-wire. The Barkhausen signal is present on continuous, unspliced wire and fails to appear for a spliced wire, as shown in the measured result of figure 4-28.

A MILS system design would use a jacketed magnetostrictive a-wire as its loop with the closure of the loop embedded in a joint block such that the ends cannot be undetectably removed. The signature of the tag/seal could be provided with an RP/epoxy matrix (similarly to SLITS) or an EID securely embedded in the joint block. These design alternatives are depicted in figure 4-29.

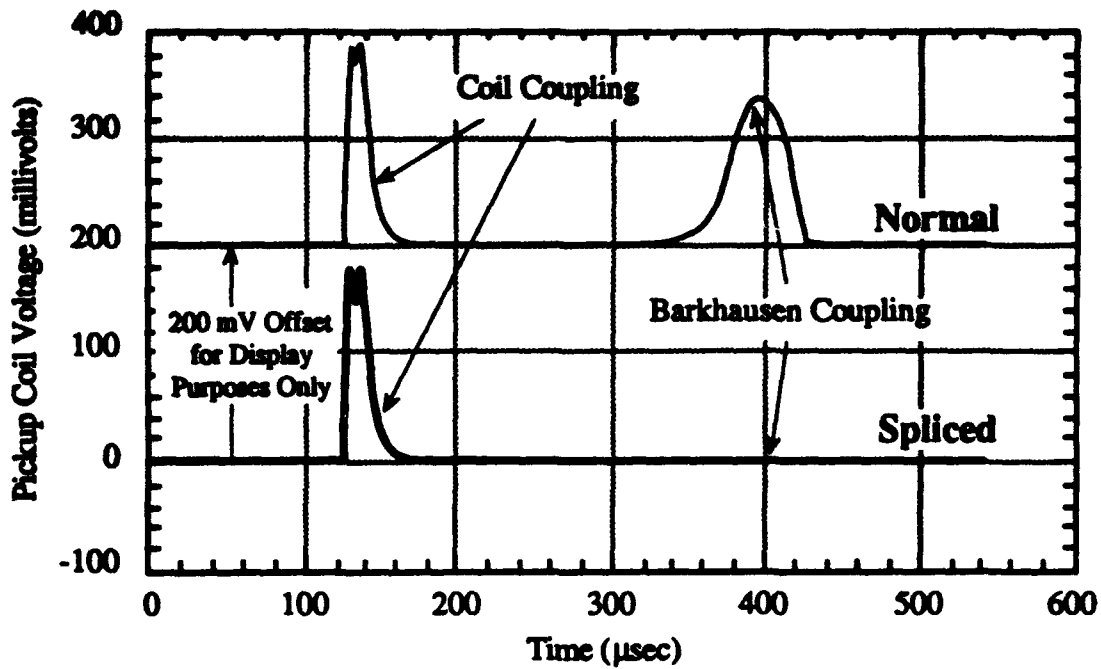

Figure 4-28. BDM laboratory measurement of the Barkhausen jump for normal and spliced amorphous magnetostrictive wires.

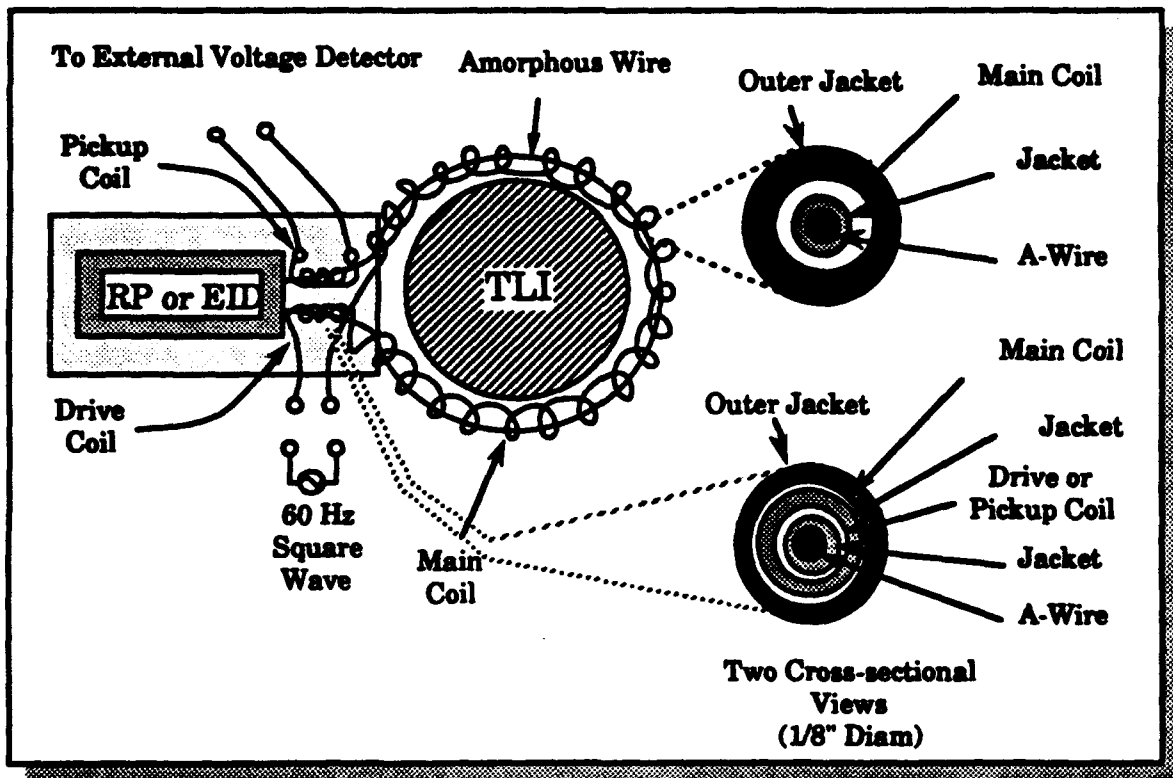

Figure 4-29. One possible implementation of a tag/seal utilizing the large Barkhausen effect in amorphous wire.

Although the experimental studies of the properties of the magnetostrictive materials were too limited to permit adequate determination of their tagging potential, the preliminary results strongly suggest that the materials could be very useful for some tamper-detection and, possibly, identification applications.

Further, the reading system would be a small digital pulse generator and pulse detector that would not require fast electronics. That is, the reader would use well-developed technology and could be packaged in very lightweight, portable form.

4.3.3.2 Read-at-Home Tag/Seals. In order to avoid the necessity of carrying bulky, heavy equipment to the field for inspections, it may be desirable to have tags and seals that do not require the use of a reader in the field at all. An additional benefit would be to reduce the on-site inspection time required for each tag/seal. The concept of read-at-home tags or "readerless" (in the field) tags was suggested by Dr. Buddy Swingle of OUSD(A). For a short period of time, and with relatively low level of effort, BDM pursued creative activities to accomplish this concept.

Read-at-home tag/seals would be routinely removed and replaced during a verification inspection. Therefore, their cost must be small. This concept offers the following benefits:

- (1) The highest confidence of any loop tag/seal (because of very high technology capability to detect tampering in a well-equipped, at-home laboratory)
- (2) Quick and easy inspection procedures
- (3) Minimal equipment and data transport
- (4) Compatibility with the UR system (used at home)
- (5) Long-term reliability at very low cost.

BDM considered several different types of read-at-home tags. They may be broken into two general families; 1) composite signature tags, and 2) dual independent signature tags. Both families share the common general feature of having a re-entrant topology of the mating surfaces between the two halves. The re-entrant surface increases tag security by avoiding a single separation plane that might be cut to separate the two halves in a tamper attempt. The read-at-

home tag assessed by BDM is based on a composite RP signature, where some percentage of the composite signature resides on each half of the tag. The optimum contribution to the signature from each half of the tag will most likely be 50/50%, although variations as wide as 20/80% may be acceptable. Further investigation is required to determine the ideal mix. This type of tag requires that the two halves of the tag have some mechanism for ensuring that the alignment of the two halves is repeatable so that the two halves have the same alignment in the field after they are bonded that they had in the laboratory where they were temporarily assembled for the initial reading. One concept of the design and application of a composite signature read-at-home tag is shown in figure 4-30. The family of dual independent signature tags employs independent signatures formed in each half of the seal block. Each half of the seal block has complementary mating surfaces with multiple metal film layers between the seal block halves to aid in tamper detection. The advantage of this type of tag is that precise alignment of the two seal block halves is not required.

Only preliminary work on the read-at-home concept was performed prior to the stop work on February 24, 1992. Several experiments were performed to study the properties of a composite tag and a limited number of tags were fabricated. The best read-at-home tag was fabricated using a polycarbonate SLITS joint block for the two halves of the tag. Kevlar rope was used for the loop for initial tests due to its ease of use. Development of the composite signature read-at-home tag system was pursued since it was felt that it was both a more secure system and potentially a less expensive tag than the dual independent signature concept. There are several different possible configurations for a composite read-at-home tag. A read-at-home tag based on a SLITS joint is shown in figure 4-31.

The tag shown in figure 4-31 utilizes the SLITS joint block, and relies on a tight fit between the lid and base to ensure repeatable registration of the composite signature. Since fabrication of re-entrant mating surfaces seems rather straightforward, this study concentrated only on the more pressing question of making approximately equal contributions to the composite signature from the top and bottom parts of the tag block.

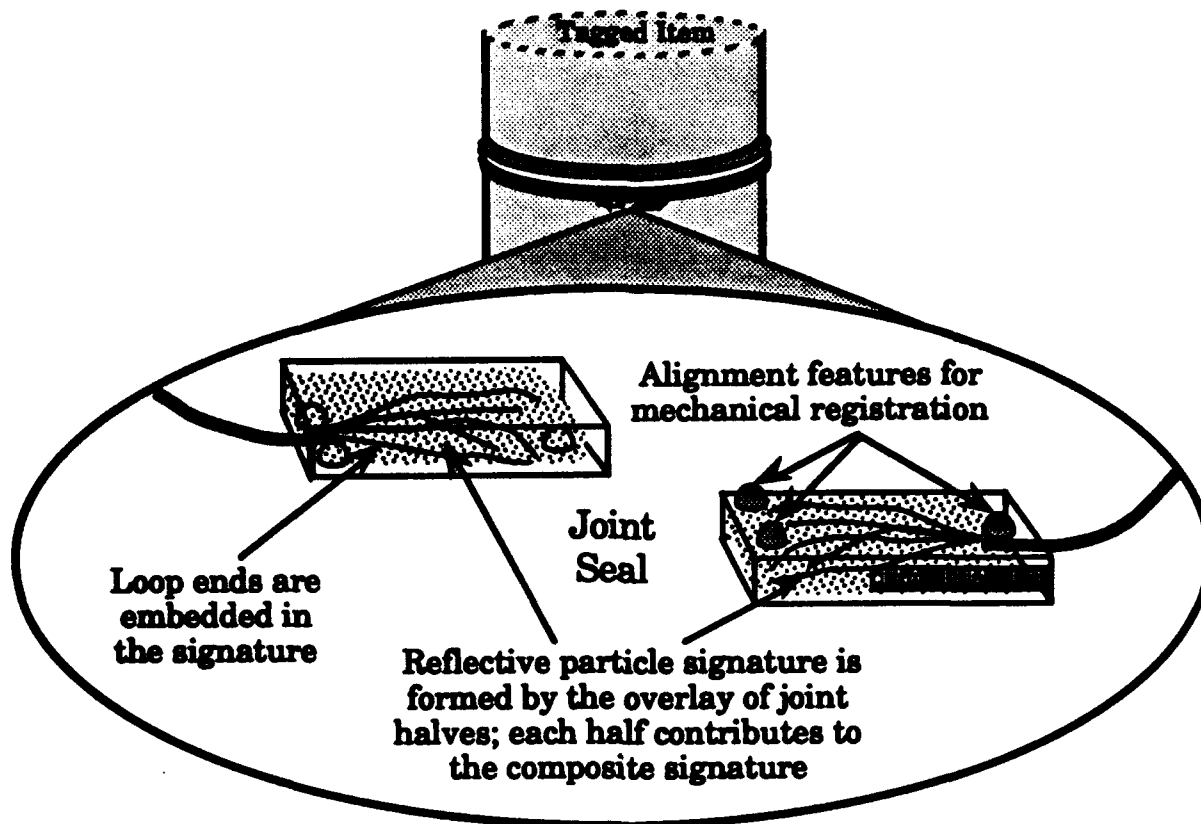

Figure 4-30. Conceptual design of a composite signature read-at-home tag/seal.

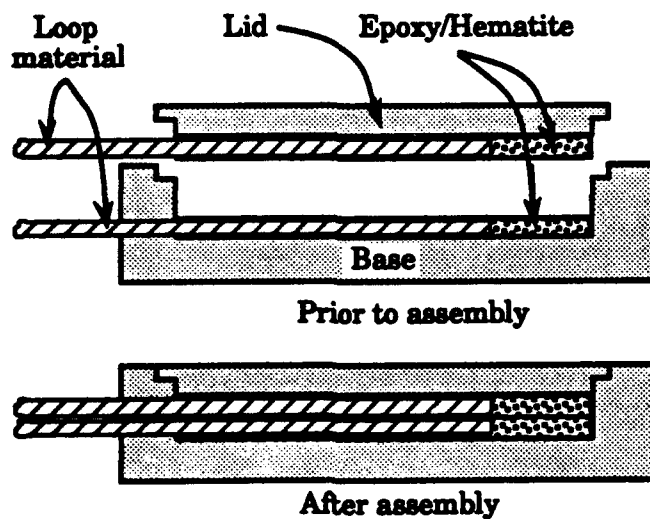

Figure 4-31. SLITS modified as a read-at-home tag/seal.

4.3.3.3 The Scanning Electromagnetic/Acoustic Measurement (SEAM). One of the classes of tag concepts is an intrinsic tag. For such tags, an identity or signature is obtained from some inherent property of the controlled item. For example, the intrinsic property may be obtained from materials on the tagged item or from the structure of the item. Whatever is used for identity, the tag must provide a unique, non-counterfeitable, and repeatable or stable signature. Any covert tampering that occurs must be unambiguously detectable. During the emphasis on START objectives, the SEAM was proposed by BDM as a means of obtaining an intrinsic tag.

The SEAM concept uses microwaves to measure images of the internal structure of materials with a finer resolution than is expected from the usual wavelength-limited diffraction techniques. The images obtained arise from variations in the electromagnetic properties of the material (e.g., dielectric constant). SEAM is able to obtain super resolution by using a small aperture in a microwave resonant cavity with the aperture separated from the target material by much less than one wavelength (the near field condition). To enhance the signal-to-noise quality of the detected signal, either the material or the cavity resonator is acoustically vibrated to provide the opportunity to use phase-sensitive detection.

The SEAM method is fundamentally an electromagnetic probe that may detect minute imperfections in a non-conducting material, such as a plastic or a largely non-metallic composite. (The sample *may* contain localized pieces of metals or other conductors, so long as they do not dominate the entire target area to be scanned.) If these imperfections have a distinct pattern, then SEAM could provide an unique identification of the material. If this material were a non-removable part of some treaty controlled system such as a missile, then SEAM could provide an intrinsic tag for this missile.

Until recently, electromagnetic imaging of either surface or subsurface features of dielectric materials has been wavelength limited in terms of resolution by diffraction from the source. Classical electromagnetic techniques are not attractive for an intrinsic tag for precisely this reason. Further, a surface image is too vulnerable to counterfeit or transfer.

The SEAM concept, measuring images using acoustically modulated microwave techniques, was first reported by Ash and Nicholls in a paper entitled "Super-resolution Aperture Scanning Microscope." In one experiment, they deposited a thin metal film on a glass substrate, so that this sample contained a high spatial contrast in dielectric properties between the metal and glass. Their SEAM instrument was able to image letters whose size was 1/15 inch (2 mm) with an aperture diameter as small as 1/60 inch (0.5 mm). In a second experiment, they prepared a dielectric sample consisting of Perspex (polymethylmethacrylate (PMMA), relative dielectric constant of $\epsilon_r=2.58$) and polythene (polyethylene, $\epsilon_r=2.28$), thus giving a low spatial contrast in this sample's dielectric properties. Ash and Nicholls' measurements could distinguish these relatively similar material dielectric constants. These results led BDM to adapt the original concept to allow it to be used as an intrinsic tag measurement system.

The original idea to utilize near-field optics to overcome diffraction limitations in microscopy was due to Synge. Recently this idea has seen considerable development at optical wavelengths (Lewis, et. al., Reddick, et. al., and Betzig, et. al.), and a photon scanning microscope which works on similar near-field principles is now commercially available (see Murday).

SEAM, as originally conceived, was to be deployed for START treaty verification. The SEAM reading head would be scanned over a fiducially indicated area of a composite rocket motor bottle, e.g., stage one of a Peacekeeper or SS-18. Unique, robust signature information would be obtained by reading through the environmental protection material (EPM).

Figure 4-32 shows a notional description of the SEAM principle of operation in the proof-of-concept measurement system. Major components include the microwave system and the test sample mechanical support system. The mechanical support system positions the test sample surface close to the aperture of the microwave cavity probe. In this way, electromagnetic energy can interact with a local volume of the test material close to the cavity aperture. The amount of interaction depends on material composition and density which can change throughout the material due to manufacturing imperfections such as air-bubbles, etc. The amount of interaction influences the probe response.

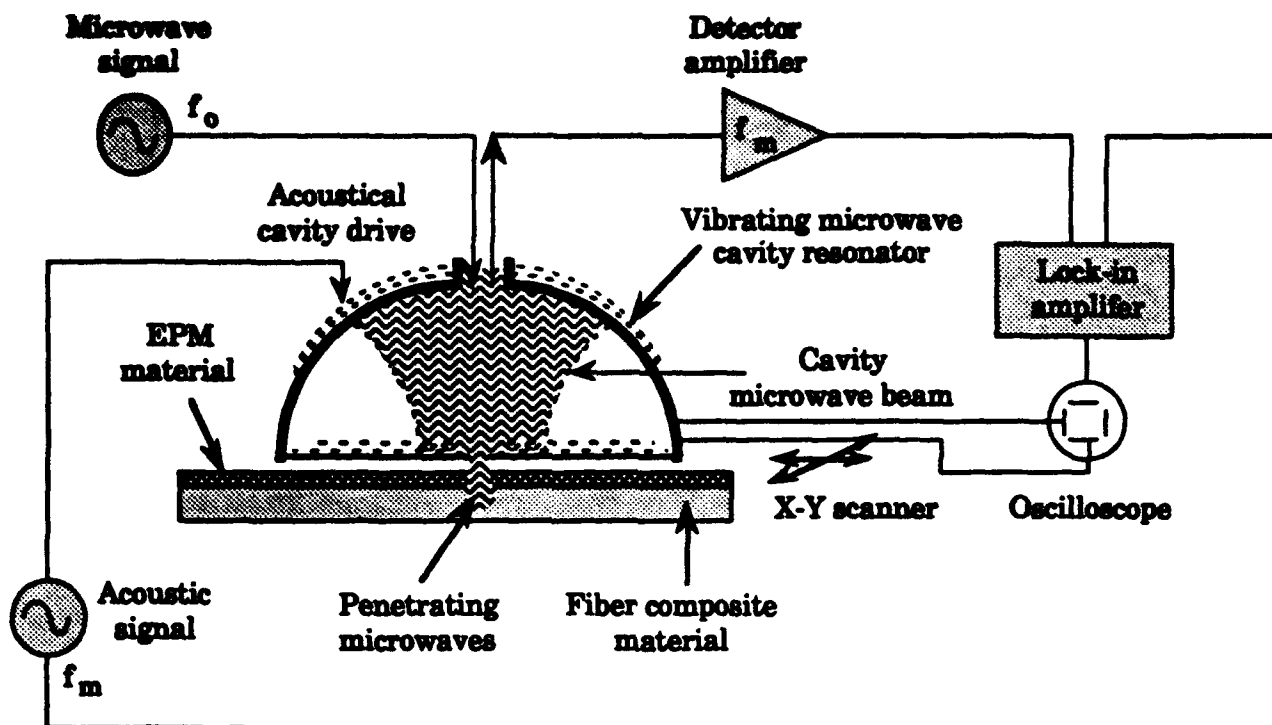

Figure 4-32. The SEAM proof-of-concept system.

The support system varies the separation distance between the cavity aperture and the sample surface. The amount of electromagnetic interaction also depends on separation distance. Thus modulating (vibrating) the separation distance by a known amount and at a fixed frequency, f_m , will cause the probe response to vary with the same fixed frequency, f_m . This induced fluctuation in probe response is necessary to separate the material interaction component from the total microwave system response. The support system also scans the probe aperture across the sample surface to develop a two dimensional map of the amount of electromagnetic interaction versus position. If the map is unique to a given material sample, then an intrinsic tag exists.

The microwave system has three major components, a source, a cavity with a small aperture used to illuminate the material sample, and a microwave receiver. The source produces a low amplitude signal of frequency, f_0 . This signal is fed to a microwave cavity with a small aperture used to illuminate the test material. The higher the source frequency, the smaller is the cavity and the cavity aperture size. A frequency of 10 GHz, with a corresponding wavelength of

$\lambda=3$ cm, produces convenient results. A high performance hemispherical cavity needs a diameter equal to several wavelengths so that diameters of 10-20 cm are required. A 10-20 cm cavity size is small enough to provide convenient physical handling and access to material samples. An aperture located on the flat side of the hemispherical cavity can be as small as $0.02-0.05 \lambda$ or 0.6-1.5 mm. Since resolution will be proportional to aperture size, then material resolutions in the vicinity of 1 mm are expected. The material information is contained in the signal reflected from the cavity and observed by the microwave receiver. If the test sample is vibrated at a frequency of f_m , then the reflected signal has power at frequencies of f_0 and $f_0 \pm f_m$. A detector or mixer will convert a fraction of the power in the offset frequencies to a frequency of f_m which is monitored by the receiver.

These concepts are illustrated in an alternate way in figure 4-33 which portrays the hardware, an equivalent circuit and the resulting image. The equivalent circuit shows that varying the aperture-material separation distance causes a variation of the termination impedance of the microwave circuit. Figures 4-33 and 4-34 show a static cavity with the test sample being vibrated. This configuration is convenient for test purposes, but eventually it would be the cavity that would be vibrated and the cavity would be scanned across the material to obtain the signature, leaving the TLI unperturbed. Variation of the termination impedance ΔZ produces a corresponding variation in the reflected power, ΔP . ΔP is proportional to the material properties so that a two dimensional map of ΔP , an image as produced by the receiver, provides a potential intrinsic tag signature of the material.

The major advantage of SEAM over other microwave or optical probe techniques is that one obtains test sample spatial resolution at a fraction of a operating system wavelength. Classical imaging systems including microscopes and synthetic aperture radar (SAR) probe their targets in the far-field regime, and thus produce images whose resolution is about one wavelength or larger.

The SEAM advantage arises from probing its target in the near-field regime, and is useful because it exploits the material penetration depth available at longer wavelengths while preserving the resolution usually available only at much shorter wavelengths. Thus, the volumetric properties of a non-conducting

material can be mapped close to the surface, which would be opaque at optical frequencies and would have poor (inadequate) contrast with an X-ray transmission imaging system.

Hardware Configuration (Proof-of-concept only)

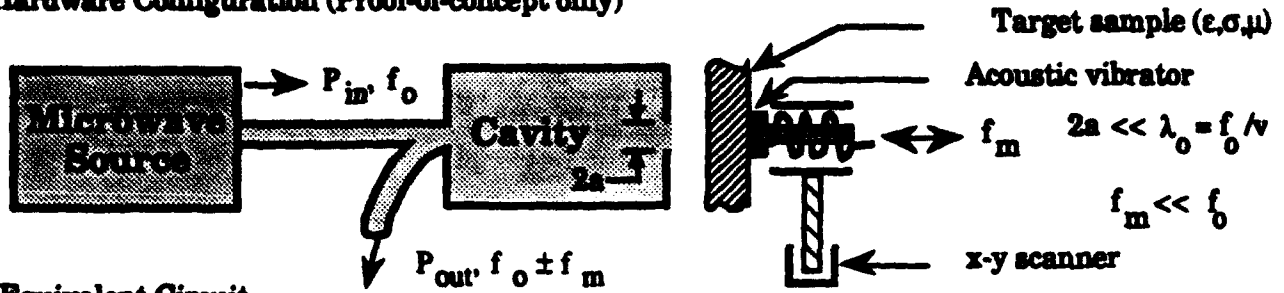

Equivalent Circuit

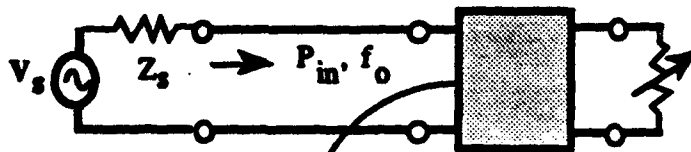

$$Z_L = Z_{L0} + \Delta Z(x_0, y_0) \sin[2\pi f_m t]$$

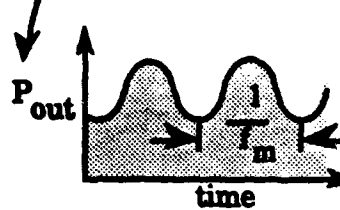

$$\Delta P(x_0, y_0) = \Delta Z_L(x_0, y_0)$$

$\Delta Z_L(x_0, y_0)$ depends on (ϵ, σ, μ) near (x_0, y_0)

Image Generation

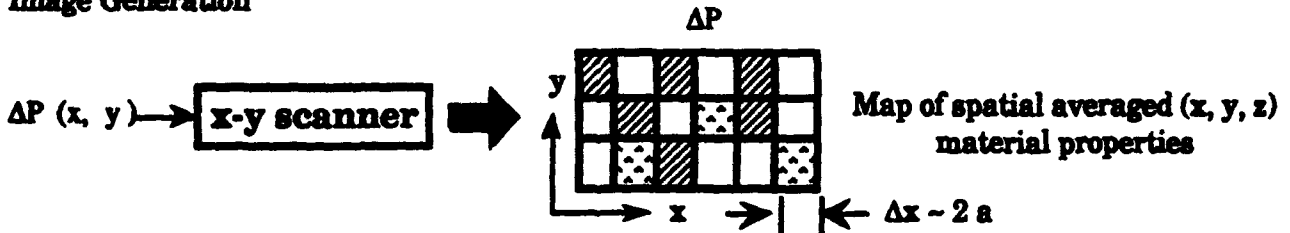

Figure 4-33. SEAM produces a scan of target material properties.

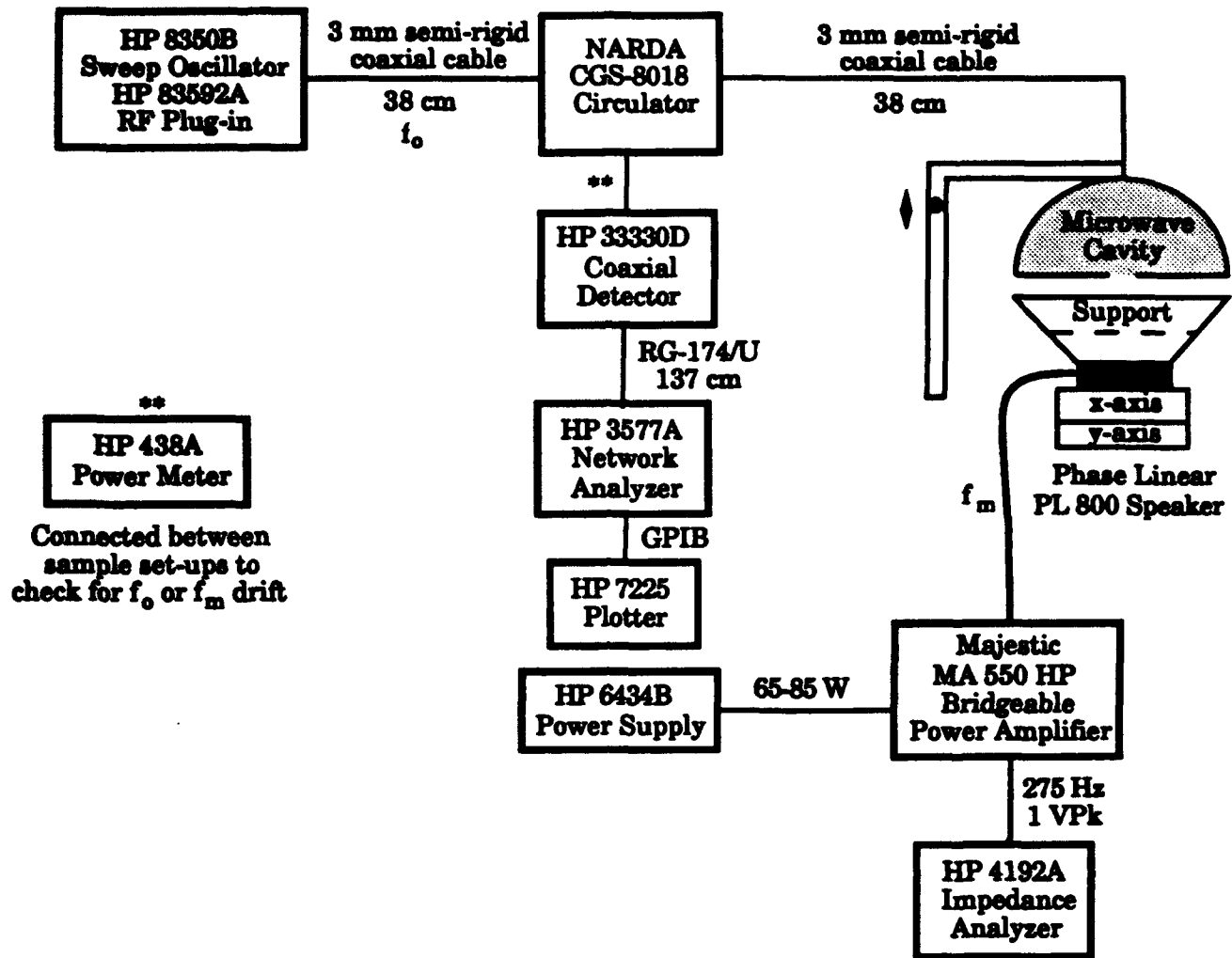

Figure 4-34. The SEAM experimental configuration.

During work on the Creative Task, SEAM measurements were conducted on several samples to determine resolution and depth sensitivity on metallic and dielectric materials, including a Kevlar™-epoxy material from the Peacekeeper missile. The measurements consisted of mounting various samples onto the experiment test bed. The test bed (PLS800 speaker) provided the means to vibrate the sample near the cavity aperture.

Measurements were made with the instrumentation shown in figure 4-34. The 20.3 cm diameter hemispherical cavity was fabricated from aluminum stock at a local machine shop. The inner cavity surface was copper plated to reduce losses. The Phase Linear speaker and the Majestic audio amplifier were purchased from a local audio components store. The rest of the equipment was available from the BDM laboratory.

The HP power supply was nominally set at 9.45 VDC, so the Majestic power amplifier provided 85W output to the speaker to vibrate the sample. During the experiment, the power supply output was intentionally varied between 65 and 85 watts to corroborate the proportional relationship of dB with changes in the f_m power levels. The modulation frequency (f_m) was varied from 250 Hz to 400 Hz to find the optimal sample drive frequency. Eventually, 275 Hz was selected for f_m because the risks of the sample breaking loose were minimized and the signal stability was greatest at this frequency.

The initial Q of the resonant microwave cavity was 25,703, where:

$$Q = \frac{f_r}{f_2 - f_1} = \frac{\text{Resonant Frequency}}{3 \text{ dB Bandwidth}}$$

The cavity response was measured again after completion of all the tests. The Q was then calculated from the return loss test data and the Q value decreased to 14,626. The various test apertures in the cavity baseplate, 0.5, 0.75, 1.0 and 1.5 mm, were made by filling the previous aperture in the aluminum plate with solder and drilling out the new aperture diameter for each test.

A series of measurements were taken to characterize SEAM system performance. Four types of "intrinsic tag" samples were used: (1) parallel copper strips laid on a glass substrate; (2) layered fiberglass with holes drilled in the material parallel to the surface to be measured; (3) glass and PMMA plastic strips laid on a polystyrene foam substrate; and (4) a sample section of the Peacekeeper motor bottle covered with its environmental protection material (EPM). The first

sample type showed the greatest SEAM response contrast between the various component materials in the sample (copper, a conductor, and glass, a dielectric) The second sample type showed SEAM contrast due to large voids in the sample. The third sample type showed SEAM contrast due to relatively small, localized inhomogeneities in the material's dielectric constant. The fourth sample type provided a real-world sample of arms control interest, to examine whether detectable response contrast can be obtained with such items using SEAM.

Representative SEAM response results from the high contrast samples are exemplified by the copper-on-glass material sample shown in figure 4-35. The six positions shown in the figure are where measurements were made of the reflected microwave power. Representative data for these measurements are shown in figures 4-36 and 4-37. The ordinate shows the variations in power returning from the cavity resonator, due to variations in the electromagnetic properties of the sample. These variations in power are due to changes in loading of the cavity arising from the sample. These data are for the microwave cavity aperture standing off the mean sample position by 1.0 mm in each case and aperture diameters of 1.0 mm and 1.5 mm respectively. These results show that the material variations are detectable and may therefore be able to produce the intrinsic signature.

Figure 4-38 is a depiction of the data point locations relative to the Peacekeeper motor bottle material. The measurement consisted of scanning a piece of a motor bottle material with the EPM attached. Variations in structure were readily apparent when the material was viewed with the unaided eye. The largest variation is in the thickness of the adhesive layer between the EPM and the motor bottle wall. The adhesive varies in thickness along the surface by as much as 0.5 mm (0.020 in.). The various layers of the motor bottle wall have slightly smaller variations in observable thickness. Figures 4-39 and 4-40 show typical SEAM results with 1 mm and 1.5 mm apertures, respectively. Five measurements at each of eight locations were made.

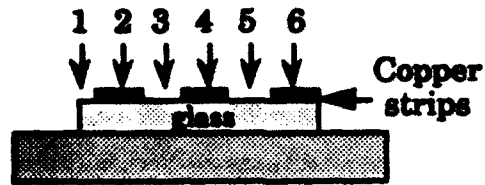

Figure 4-35. High contrast sample – copper strips on glass.

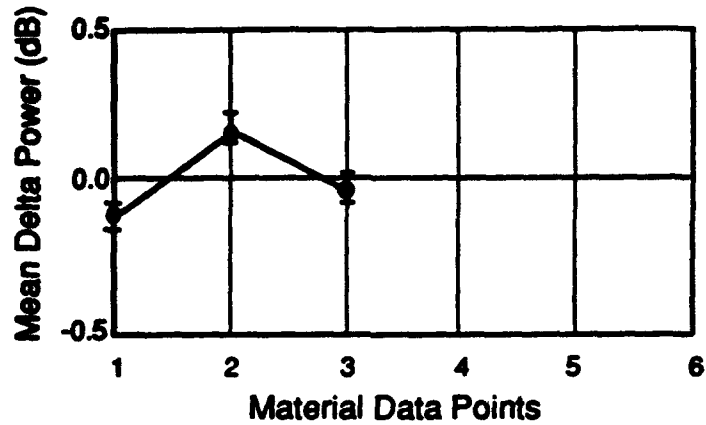

Figure 4-36. Scan across a 2 mm x 2 mm copper-on-glass sample (aperture = 1 mm, standoff = 1 mm).

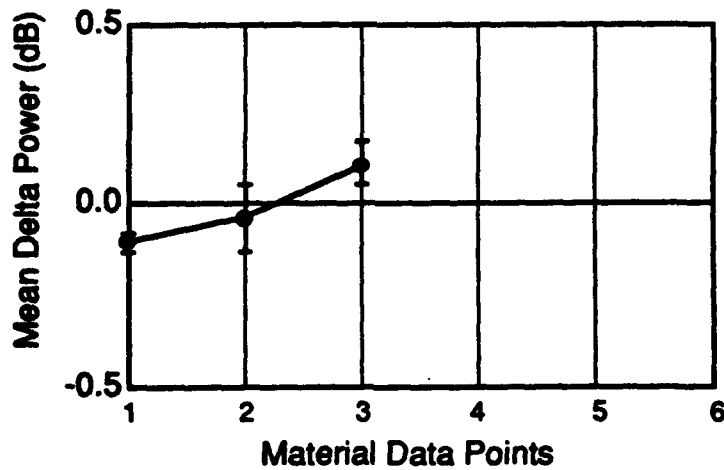

Figure 4-37. Scan across a 2 mm x 2 mm copper-on-glass sample (aperture = 1.5 mm, standoff = 1 mm).

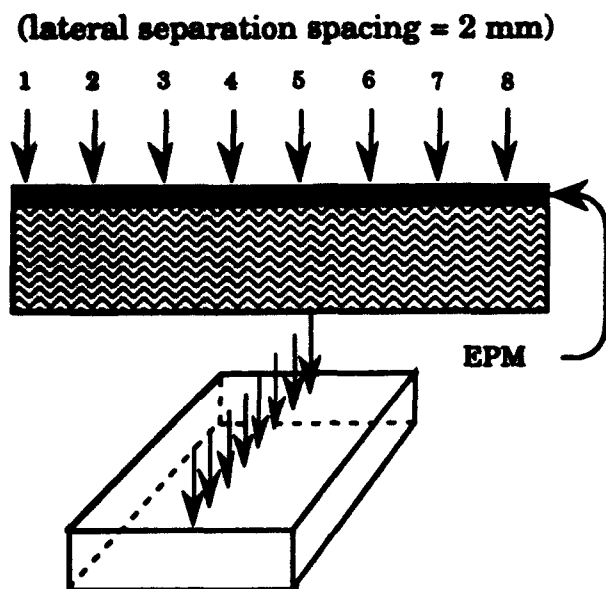

Figure 4-38. Sampling locations on Peacekeeper motor bottle material.

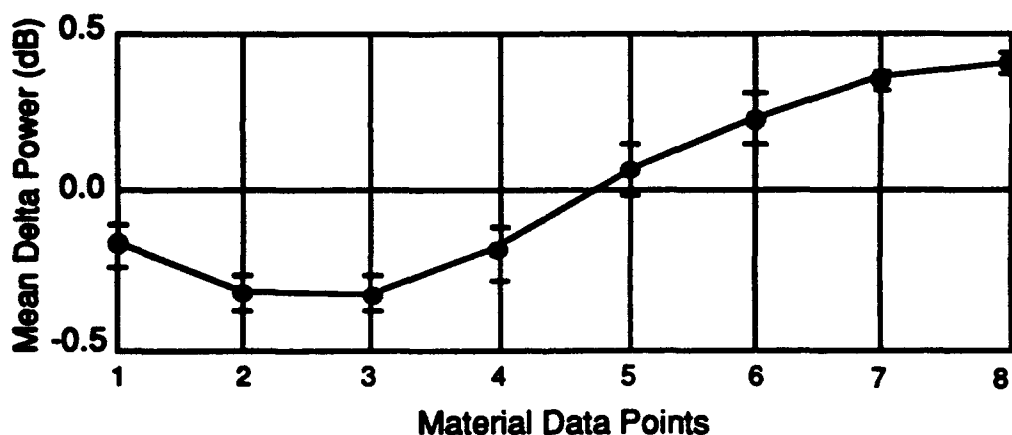

Figure 4-39. Scan of Peacekeeper motor bottle material (aperture = 1 mm, standoff = 1 mm).

The presence of the EPM made the set-up difficult and resulted in the standoff, Δh , changing slightly along the scan path (tilt of 0.075 mm in 12.5 mm traverse or a tilt angle of 0.34°). Consequently, in both figures there is an upward data trend that may be attributed to changes in Δh . Despite this overall upward trend, large enough local power variations occurred to create a non-uniform map of the sample.

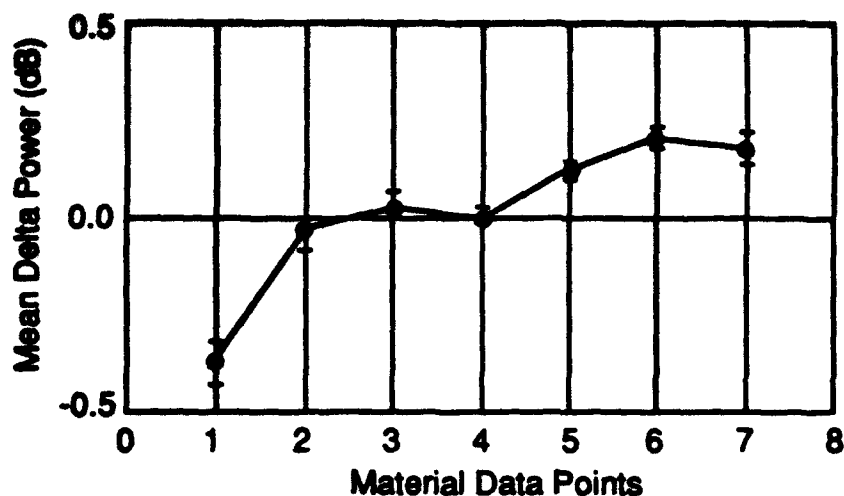

Figure 4-40. Scan of Peacekeeper motor bottle material, with larger aperture (aperture = 1.5 mm, standoff = 1 mm).

The span of the error bars at each scan point is a measure of the random error or "noise" in the measurement system. For the copper-on-glass sample this was about 0.1 dB. The contrast, or relative change, between the aperture being centered over a copper strip and the aperture being over glass midway between two copper strips is about 0.2 dB for the 1 mm diameter aperture and 0.3 dB for the 1.5 mm aperture. The choice of aperture size involves a trade-off between sensitivity and spatial resolution: larger aperture provides a larger response signal, or better sensitivity, while the smaller aperture yields more abrupt changes in response versus spatial position. The data were sensitive to sample placement and deviations from constancy in Δh , the standoff of the microwave resonator aperture from the sample. We observed that a 0.7° tilt in the sample holder produced a systematic 0.3 dB drift in the measured response over a scan traversal.

For the layered fiberglass sample with a void, the span of the error bars at each point was about 0.15 dB, while the contrast between the aperture over homogeneous material response and the aperture over the buried void response was about 0.3 dB. Sensitivity to sample alignment and deviations from constant Δh was similar to that observed in the copper-on-glass sample.

The error bars spans at each scan point for the glass and PMMA on polystyrene foam were in the 0.1 to 0.15 dB range. The contrast between the aperture over glass response versus the response with the aperture over the polystyrene foam between the glass and PMMA elements was about 0.35 dB for the 1.5 mm aperture, and 0.50 dB for the 1 mm aperture. This case thus shows a clear superiority in the contrast resolution of a smaller aperture, whereas the contrast resolution in the copper-on-glass case was less differentiated with the aperture size variation.

For the Peacekeeper motor bottle with EPM covering, the smaller aperture, 1 mm, provides about 0.2 dB change in the point-to-point scan, while the error bar span at each point was also about 0.2 dB. The larger aperture, 1.5 mm, reduced the size of both the point-to-point variation and the random data spread. Since in the present study only one sample was measured, one cannot say with assurance whether these point-to-point variations in signal amount to a unique signature for such items.

These preliminary measurements show that material inhomogeneities are measurable with a SEAM system in the laboratory. The random variations ("noise") in the SEAM signal, using available equipment assembled in the BDM laboratory, was 0.1 - 0.15 dB. This noise could be reduced significantly by optimizing the choice of components. For example, the use of a phase-locked-loop receiver, which is readily available commercially would greatly reduce the random noise level and thus the width of the error bar. Such a phase sensitive detector was not available for use in the BDM measurements. Our results indicate that for repeatable results to be achieved, care is required in sample alignment and registration. Further measurements are needed to characterize minimum detectable material differences. Also, a survey is needed of representative types of tagged item materials to determine if the materials have sufficiently unique variations to serve as unique signatures for individual items.

The prototype SEAM system should have some attention given to a design for use in a non-permanent, non-benign environment. That is, the system should support field activities and the environment encountered during mobile on-site inspections. This would require the system to be readily field-transportable by one or two individuals and be capable of being set-up and calibrated very quickly. A

calibration would be required to ensure accurate results and the calibration results would become a part of the inspection report. Similarly, the system would require means of taking and storing baseline signatures for the TLIs and for taking inspection signatures and comparing them with the baseline signature. Therefore, the system should provide immediate hard (permanent) copies of the calibration test results and of the signature reading and comparison results.

The equipment necessary to support the requirements would include an RF source (f_0 signal generator and amplifier), a directional coupler or circulator, the cavity, an RF receiver, the cavity support mechanism (including the audio frequency drive and scan traversal subsystems), and means to record calibration and signature data and to compare baseline and inspection signatures. The cabling is a made-to-order part of this system, but it can be obtained at competitive prices from companies such as Belden or Andrews.

Preliminary results of the SEAM measurements are inconclusive. Further research using better apparatus is required to show proof-of-concept. The COTS items that could be assembled into a prototype system are identified in figure 4-41.

Component	Manufacturer	Model
RF Source and PLL Receiver	Watkins Johnson	WJ Mini-Series model
Circulator	Narda Microwave	Model CGS-8018
Cavity	Allied Plastic Eng., Inc	Custom requirements
Support (incorporates AF source and cavity shaker)	Mayco, Inc.	Several models available
Controller for Support and Positioner	Reliance Electric Co.	X Series programmable controller
Positioner	Pacific Precision Labs.	TransLine Dual Axis ST-TL1414
Power Supply	Best Power	X Series FERRUPS

Figure 4-41. Suggested COTS components of prototype SEAM system.

4.3.3.4 Fourier Optical Images. The Fourier optical concept is an example of an intrinsic tag. The concept is to use optical features of the materials of a treaty-limited item to provide its unique identity. The hope was to be able to obtain scattered or reflected light from below the surface of transparent material, such as fiberglass/epoxy materials. Return from only the surface might offer an adversary the opportunity to counterfeit the surface features, and thereby the identity of the item. Therefore, the Fourier optical imaging technique would always be questionable for opaque materials. Also, surface-only intrinsic signatures are susceptible to environmental degradation and increased probability of false indication of tamper. Only a low level-of-effort was expended on the Fourier work because the outcome of the first stage of proof-of-concept analysis was that Fourier imaging was not likely to provide an acceptable level of security. The Fourier optical tag work was performed during May 1991.

The concept of Fourier optics is fundamental in image formation from optical components such as a lens, particularly when coherent light is used to illuminate the object. Propagation of light from a point source in the front focal plane of a converging lens and through the lens produces a plane wave behind the lens. Therefore, propagation of coherent light from a complex object, composed of many point sources, and through a lens results in the interference pattern (Fraunhofer diffraction) in the back focal plane. This diffraction image is the Fourier transform image of the object. These concepts are depicted in figure 4-42.

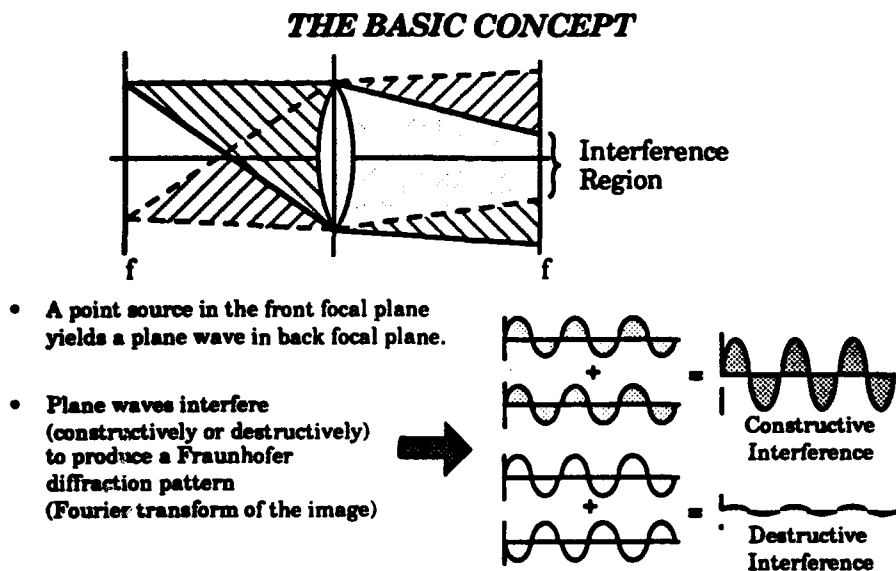

Figure 4-42. Fourier transforms with a lens.

Ideally, the Fourier optical image would provide detailed information of the optical features of a material, including its subsurface features. Initially perceived advantages of the Fourier optical intrinsic signature include:

- (1) Operationally simplicity**
- (2) Minimal intrusiveness**
- (3) Potential robustness against counterfeiting**
- (4) Potentially unique, high-resolution information about material structural detail**
- (5) Potential robustness against environmental degradation**
- (6) Micron resolution (due to the use of visible light wavelengths)**
- (7) Inexpensive production costs.**

Perceived disadvantages include: 1) surface features are potentially counterfeitable, 2) appropriate resolution must be proven (too much resolution could result in excessive sensitivity to extraneous information), and 3) environmental degradation (e.g., dust, grease, moisture) could be a problem, including possible moisture condensation in voids around glass fibers.

The Fourier optical imaging method takes advantage of the Fourier transform concept in mathematics. Physically, an optical system produces an image that is the Fourier transform of the original object appearance that is being examined. A very simple example of this phenomenon is shown in figure 4-43. Here a small aperture or pinhole is illuminated uniformly with parallel light and the lens forms the Fourier transform or the Fraunhofer diffraction pattern on a screen.

A prototype system was not developed because of the results of proof-of-concept measurements. At the time of this work, the arms control treaty verification scenario that drove the development of tags and seals was START. The proof-of-concept measurements showed that only surface features of the materials examined determined the Fourier images obtained. However, if a scenario exists where surface information is adequate and potential environmental degradation of a signature can be controlled, a possible prototype Fourier optical imaging system is represented in figure 4-44.

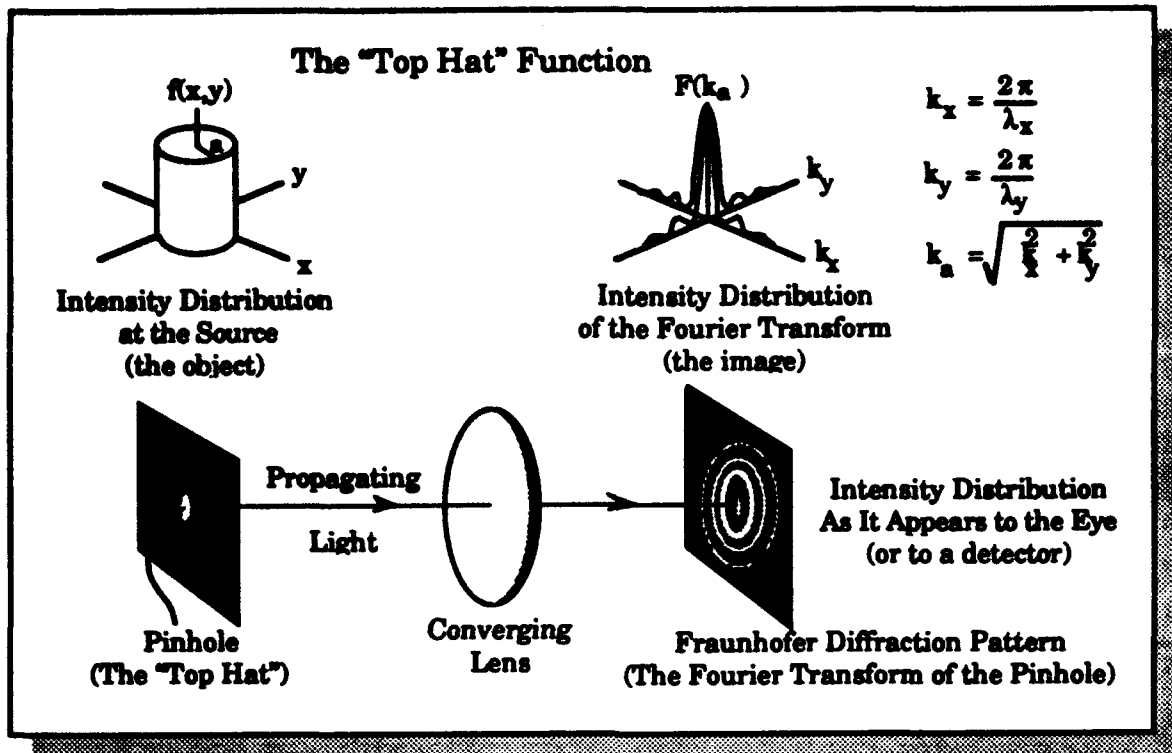

Figure 4-43. A simple illustration of how a Fourier transform happens.

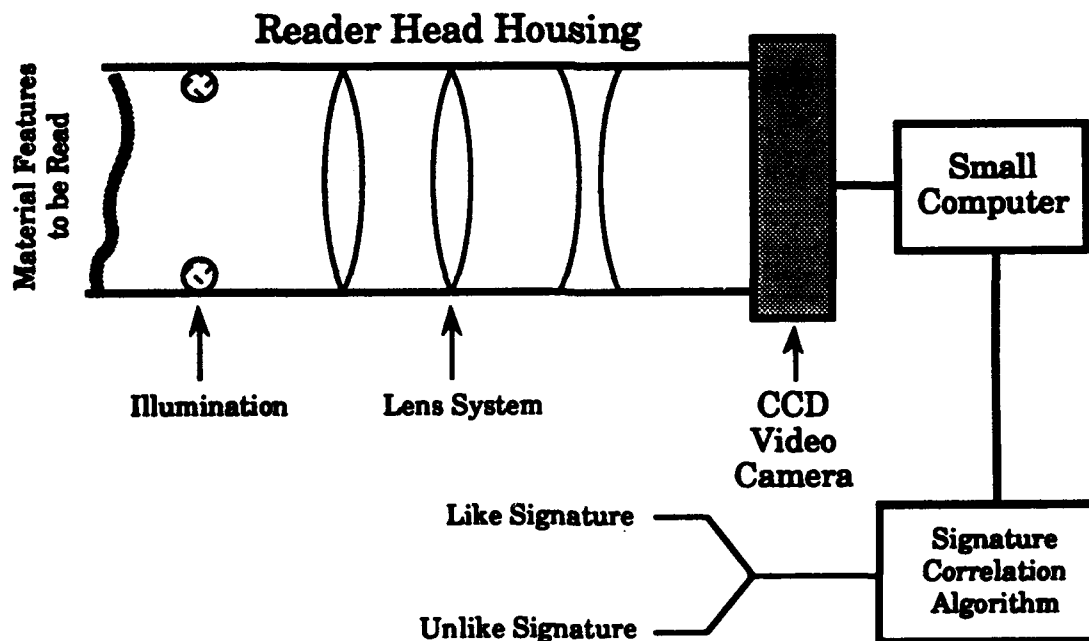

Figure 4-44. Conceptual Fourier optical imaging system design.

4.3.3.5 Nonlinear and other specialty optical fibers. The work on nonlinear and other specialty optical fibers had as its principal goal the identification of concepts and development of means for improving the detectability of tampering (via splicing) in the optical fiber loop of the PTILS. At the time this work was performed, PTILS was known by its earlier name the (single wrap plastic) SLOTS. It must be made clear at the outset that the currently-developed PTILS was not at risk of compromise. Developmental testing of PTILS (based on short-haul communications grade polymer fiber) showed that state-of-the-art splices are clearly detectable with the OTDRs identified for use as field inspection instruments. On the other hand, there are substantial technological incentives toward improving the current state-of-the-art in optical fiber splicing, driven by the needs of the communications industries. In addition, there are incentives arising from the desire of adversaries to defeat the purposes of tags and seals. Substantial resources might be dedicated to devising technological means of defeating tags and seals. Hence, there is some long-term technical risk that the state-of-the-art for optical fiber splicing could be advanced eventually to the point that the currently-developed PTILS tamper detection technology might not be capable of detecting tamper attempts at a sufficiently high level of confidence. It is to mitigate this potential technical risk that the work described here was undertaken.

In addition to the principal goal, a secondary goal was to seek means for making use of the Antel OTDR board in the UR system in PTILS (see section 4.2.5.1). Use of the OTDR board would reduce the number of pieces and weight of on-site inspection equipment.

BDM undertook a search for potential phenomena, materials, and fiber configurations that might support these goals, and evaluated candidate items identified in this search. The search followed several guidelines, including the following:

- (1) New approaches identified in phenomena and materials must be available in optical fiber configurations for use in the loop of PTILS.
- (2) The PTILS configuration resulting from new approaches identified must be inspectable by relatively simple on-site equipment. It is

preferable that the currently identified OTDR equipment would serve, with little or no change.

- (3) Samples of optical fiber representative of new approaches must be obtainable for developmental PTILS testing with no extraordinary costs. The PTILS development effort could not undertake the cost burden of commissioning fabrication of materials and fiber. It was planned to take advantage of COTS availability of attractively featured fiber wherever it could be found. If developmental testing proved its usefulness for PTILS, attractively featured fiber that was available only in experimental lots would be required to have the potential of reasonable cost production.
- (4) Because PTILS configurations and instrumentation were based on multimode fiber, the search for new fiber configurations was biased toward similar characteristics. The bias toward multimode fiber was compelling. The larger fibers are more easily handled, the connectors are less sensitive and expensive, and PTILS instrumentation uses multimode components.
- (5) The search for new approaches and the evaluations of those identified occurred in a short time frame. Consequently, the search and evaluations were of necessity kept rather tightly focused and limited. A consequence of such limitation was that approaches that might have great potential, but would require greater development time, were not considered. Detailed analysis was also restricted for the same reasons.

The search for new approaches with enhanced tamper detection involved nonlinear optical effects (NLOE), specialty optical fibers, and potential exploitation of complex fiber configurations. The following sections contain more detail of these topics.

The arena of NLOE is a very rich one, with a great deal of research and development activity going on in the application of NLOE to communications and to the prospect of optical computation. A major effort covered by this report was

to: 1) evaluate the potential for NLOE enhancing splice detection with an OTDR; 2) search for optical fiber materials with enhanced nonlinear properties and potential suppliers of such fiber; and 3) attempt to identify other NLOE that could be used to simplify splice detection in PTILS.

Nonlinear optical effects arise from a polarization response \vec{P} of an optical material to the electric field \vec{E} of a light wave that has contributions proportional not only to the first power of \vec{E} but also to the second and third powers of \vec{E} as follows:

$$\vec{P} = \epsilon_0 [\vec{\chi}^{(1)} \cdot \vec{E} + \vec{\chi}^{(2)} : \vec{E}\vec{E} + \vec{\chi}^{(3)} : \vec{E}\vec{E}\vec{E}]$$

The linear susceptibility $\chi^{(1)}$ gives rise to the usual refractive index n_0 . The zero subscript is added to this electric field independent quantity in anticipation of the appearance of a nonlinear contribution to the total refractive index that is proportional to the square of the electric field. The second-order susceptibility $\chi^{(2)}$ gives rise to such phenomena as second harmonic generation (frequency doubling). However, because $\chi^{(2)}$ is present only in those media that lack inversion symmetry (especially certain complex crystals), it is not likely to be significant in most optical fibers because of the amorphous structure of glasses and randomly polymerized plastics. It is possible to induce a second-order susceptibility into optical fibers of some materials by the process of "poling." Poling is heat treatment in the presence of a strong applied electric field. This adds an extra processing step, and in many materials such as polymers, the poling is susceptible to degradation by fairly low environmental temperatures such as might be experienced by PTILS in the field. For such reasons, materials having second-order susceptibility were not pursued. For the purposes of PTILS, the most useful nonlinearity is that embodied in the third-order susceptibility $\chi^{(3)}$.

The total dispersive refractive index at frequency ω is:

$$n(\omega) = n_0(\omega) + n_2(\omega) I(\omega),$$

where $n_2(\omega)$ is the nonlinear index of refraction and $I(\omega)$ is the intensity of light in the fiber.

The first task undertaken was to evaluate the potential for NLOE to enhance splice detection with an OTDR. Backscattering from a splice in optical fiber is a complex phenomenon in detail because of the cylindrical geometry of the core/clad system, the breaking of cylindrical symmetry by the lateral and angular misalignments at a splice, and the potential effects of multiple reflection interference between the two adjacent faces of the fibers being joined at the splice. Fusion splicing of silica fiber eliminates the multiple reflection complication, but introduces other complications of its own.

The nonlinear refractive index effect is the one was examined in most of the analysis of nonlinear effects for PTILS. To demonstrate the range of nonlinear refractive indices that has been observed, figure 4-45 gives a sample of various materials, including as a baseline the standard optical fiber materials of silica and polymethylmethacrylate (PMMA). Note that the n_2 tabulated is the coefficient for intensity, as opposed to the coefficients for $|E_{\max}|^2$ or for $\langle |E(t)|^2 \rangle$, as are frequently reported in the literature.

Figure 4-45 also includes several recently reported materials exhibiting considerably enhanced nonlinearity, including three with very large values. These large values were found under very unusual conditions:

- (1) The "DAN" crystal fiber was only 4 mm long
- (2) The 514 nm wavelength used for determining n_2 for the Er-doped silica bi-core fiber was a resonance line or very close to it for the Er ion system
- (3) The determination of n_2 was reported only for the spectral region very close to the Z_3 exciton resonance of the CuCl material used in the doping of the glass.

Thus the two largest values of n_2 correspond to resonant or near resonant absorption wavelengths, where large attenuation would be expected. Most of the large values have been reported in the research literature only recently, and little has been learned about how far significant enhancements of n_2 persist away from the resonant wavelengths where the attenuation would be more moderate. This question was pursued with the researchers that published the high values of n_2 , but no definitive results have been received.

Material	Reference	Wavelength (nm)	n_2 ($10^{16} \text{ m}^2 \text{ W}^{-1}$)	Attenuation (m^{-1})	n_o	Notes
Lucite (crystalline PMMA)	Smith (1986)	1.064	0.77		1.49	Derived from data by Moran (1978).
SiO ₂	Kuzyk (1991) (quartz) (1978)	0.51	0.37	2.3×10^{-3}		
Lead glass	Kuzyk (1991) (quartz) (1978)	1.06	2.2	0.46		
PMMA	Kuzyk (1991)	1.3	40.8	4.6		Fiber
PMMA	Kuzyk (1991)	1.3	97.7	4.6		No fiber.
As dye attached to acrylics and copolymerized with PMMA	Matsumoto (1987)	2.05 (in) 0.60 (out)	90 (est.)			This film measurement for THG, yielding $I_{THG} = 1.36 \times 10^{12}$ cps at 28.9 mW/cm ² on dye in copolymer. n estimated from n_o value and $n = 1.49$ (PMMA).
DANS [4-dimethylamino-4'-nitro-stilbene]	Marques (1991)	1.064	70 ± 10		1.616 TE 1.604 TM	Thin film. Resonant effect.
DANS [4-dimethylamino-4'-nitro-diphenyl-methane]	Marques (1991)	1.064	100 ± 10		1.628 TE 1.616 TM	Thin film. Resonant effect.
DAN [4-(N,N-dimethylamino)-3-carbamoyl-1-butene]	Yamashita (1990)	0.625	5.2×10^3		1.778	Single crystal of DAN in flint glass capillary; crystal length 2.9 mm; crystal diameter 4.6 μm .
Er-doped silica	Betts (1991)	0.514	$6.9 \pm 1.5 \times 10^4$			Thin core fiber, one core doped; no coupling between cores. Probable resonant effect.
CuCl-doped borosilicate glass	Justus (1990)	0.370 to 0.385	4×10^7			Thin film. CuCl microcrystals (ca. 4.4 nm diameter) dispersed in glass; 0.8% CuCl by weight. Resonant effect (Bolt Z ² section peak at 0.384 μm).

Figure 4-45. Selected values of the nonlinear refractive index coefficient n_2 .

References for figure 4-45:

- Betts, R. A., Tjugiarto, T., Xue, Y. L., and Chu, P. L. (1991) *IEEE J. Quantum Electron.*, 27, 908-913.
- Justus, B. L., Seaver, M. E., Ruller, J. A., and Campillo, A. J. (1990) *Appl. Phys. Lett.*, 57, 1381-1383.
- Kuzyk, M. B., Paek, U. C., and Dirk, C. W. (1991) *Appl. Phys. Lett.*, 59, 902-904.
- Marques, M. B., Assanto, G., Stegeman, G., Moehlmann, G. R., Erdhuisen, E. W. P., and Horsthuis, W. H. G. (1991) *Appl. Phys. Lett.*, 58, 2613-2615.
- Matsumoto, S., Kubodera, K., Kurihara, T., and Kaino, T. (1987) *Appl. Phys. Lett.*, 51, 1-2.
- Moran, M. J., She, C.-Y., and Carman, R. L. (1975) *IEEE J. Quantum Electron.*, 11, 259-263.
- Newhouse, M. A., Weidman, D. L., and Hall, D. W. (1990) *Opt. Lett.*, 15, 1185-1187.
- Smith, W. L. (1986) *Handbook of Laser Science and Technology*, Vol. 3, Section 1.3, ed. M. J. Weber. Boca Raton, FL: CRC Press.
- Stolen, R. H., and Lin, C. (1978) *Phys. Rev. A*, 17, 1448-1453.
- Yamashita, M., Torizuka, K., and Uemiya, T. (1990) *Appl. Phys. Lett.*, 57, 1301-1303.

A first step in the evaluation was to consider the Fresnel reflection at the planar interface between two optical media such as that of the core material and that of air or an "index-matching" medium. Consideration of this simple case determined whether more complex analysis was required.

The next step was to estimate whether NLOE can be detected in Fresnel reflection such as might appear in a butt joint splice with reasonable care to fill the gap with index-matching fluid. The problem was simplified by assuming normal incidence and considering the fiber core material (medium A) to be nonlinear with $n_2 = 100 \times 10^{-19} \text{ m}^2/\text{W}$, which is slightly more nonlinear than the BSQ/PMMA material in figure 4-45. The index matching fluid material (medium B) was assumed to be linear. Analysis showed that NLOE can be a significant source of Fresnel reflection enhancement in a splice only when n_2 is much larger than $100 \times 10^{-19} \text{ m}^2/\text{W}$. This conclusion is driven by the low power output of laser diodes in OTDRs. Materials with nonlinear indices of refraction as large as indicated by this analysis are not known. The nonlinear enhancement of Fresnel reflection at a splice is small because it is being produced in a very small interaction volume. The interface of the splice is smaller in the direction of propagation than the light wavelength itself. To be observable, the nonlinear effect would have arisen from a large interaction volume, such as the entire length of the fiber, so that the cumulative nonlinear effect would be significant.

Late in the period covered by this report BDM made contact with the group working on "secure fibers" at PNL. The specialty fibers they have been developing show some promise for application to PTILS with intrinsic tamper resistance.

The PNL fibers are a lithium alumino-silicate glass core coated with a silicone polymer as the clad. The glass material has its composition adjusted and nucleating agents added so that, after the process of drawing (from the melt) and adding the polymer clad, the glass is on the verge of devitrification. Tamper resistance is enhanced in several ways in this system. In the PNL formulation at the time of the stop-work order on the Creative Task, there were intended to be needle-shaped (acicular) micro-crystallites present in the as-drawn fiber, which would prevent good cleaves of the core of the fiber, and so inhibit high quality splices. Since the end of the Creative Task, PNL's design compositions have moved slightly farther away from the verge of devitrification so the acicular

crystals do not form in the as-drawn fiber. The modification was introduced to increase the light transmission through the fiber. The original soft polymer clad also acts to inhibit high quality splices. It does not strip well, and when the fiber is cleaved through the clad, it tends to smear and contaminate the glass end. The same effect occurs under polishing actions. Recently, PNL has done some work with harder polymer clad materials in order to reduce water infiltration through the clad and thus increase the corrosion resistance of the fiber. This evolution has reduced somewhat the tamper-resistance contributed by the clad. Finally and most strongly, the glass will devitrify to the point of opacity under attempts to heat it to a melting point to attempt a fusion splice, as depicted in figure 4-46, thus ensuring the detection of such a splice with an OTDR. Also, the polymer clad is not compatible with such heating.

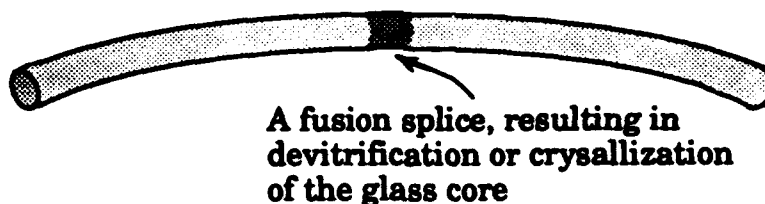

Figure 4-46. Illustration of devitrification of the PNL optical fiber at fusion splice.

The tamper resistant properties of such fibers indicate that it would be useful to pursue a collaborative effort with PNL to determine the feasibility of applying such fiber to PTILS. Some of the points to be pursued further are the following:

- (1) Can the attenuation in the fiber be made low enough to be compatible with the PTILS inspection instruments (OTDRs)? This implicitly involves an assessment of optical properties of the fibers at the operating wavelength(s) of COTS OTDRs.
- (2) Can the use of this fiber in a single-wrap configuration make the Antel OTDR board hosted inside the Universal videographic Reader

computer feasible for tamper detection, thereby making the separate OTDR unit unnecessary?

- (3) Are the long term environmental responses of the fiber compatible with the PTILS environmental requirements?**
- (4) In view of the tamper-resistant features of the fibers, can optical connectors be applied that are adequate for the purposes of PTILS?**
- (5) What kinds of coating/jacketing are necessary to protect the soft polymer clad, and how can it be applied?**
- (6) What life-cycle costs are to be expected for adoption of such fiber for the PTILS application?**

The largest reason for pursuit of the specialty fibers is to reduce the requirements of the OTDR, thereby creating a more fieldable overall PTILS system.

4.3.3.6 Null B-field Loops. Another concept for loop seal/tags were originated during the exploratory phase that led to the MILS. This null field concept was not developed to the same level as MILS. The null-field loop tag concept was aimed at providing high tamper resistance in loop tag/seals.

The null-field loop tag/seal is a device that uses cancellation of magnetic fields around an array of conductors for tamper detection. If this type of array is designed so that a very small, or null, field is obtained when currents are introduced into the conductors, then tampering may be detected simply by measurement of a magnetic field above a threshold (null) value. This idea was not pursued through laboratory tests, but the preliminary analyses described below indicated that it may have potential use if developed further. The array of wires could be used to encircle the tagged item, and the ends of the network could be locked into a tamper-proof connector which itself contains a unique tag for the controlled item. The purpose of the conductor array would thus be to seal the unique connector to the tagged item, and to provide evidence of tampering.

The magnetic fields surrounding a long bundle of current-carrying thin wires depend strongly on the configuration of the wires. The configuration is determined by both the direction of the currents and the distribution of the wires within the bundle. For this effort, the magnetic fields around long arrays of 16 wires were studied. Figure 4-47 shows this array, for which the wires are placed in a 4 x 4 arrangement.

A concept of how to detect the variations from a null (threshold) magnetic field is shown in figure 4-48.

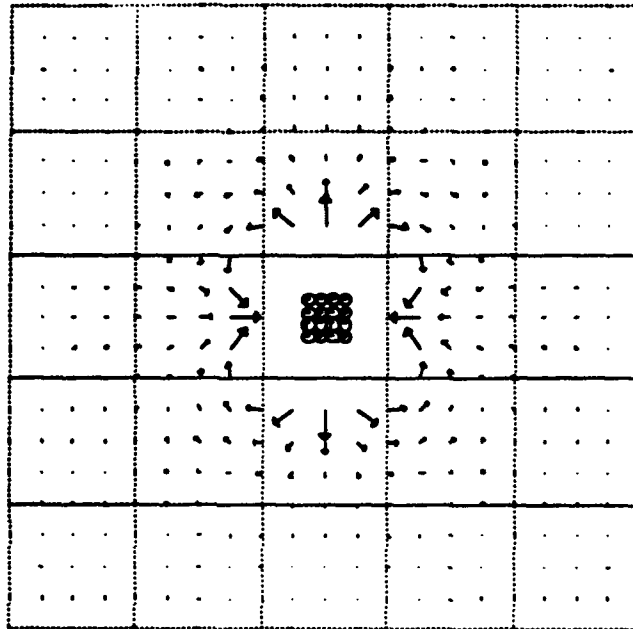

Figure 4-47. Checkerboard current array with 1 mm separation.

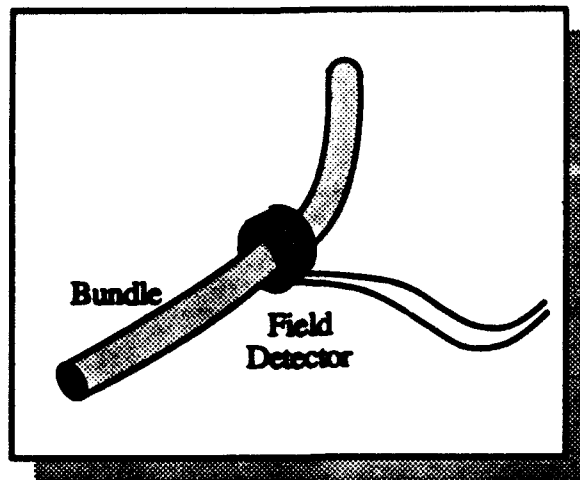

Figure 4-48. Null-field array with a movable field detector (mouse).

The null-field loop tag/seal concept is preliminary; only a very limited series of measurements was performed, and total system definition of the suggested tag was not carried out in detail. The null-field tag looks quite promising, but a number of questions remain, including construction of a device for measurement of the fields, and termination of the conductor array to prevent its use as an antenna.

4.3.4 Activity Description.

The Creative Task work involved an in-depth process of inventing new tagging and sealing concepts. BDM used personnel from a wide range of scientific and engineering disciplines with critical approaches to problem solving. Even people who were not working on the Tagging program were invited to contribute ideas for tags. Of notable value in the Creative tags work was the strong internal criticism (adversarial analysis) that occurred among the staff. This included:

- (1) Examining the physics to determine if the concept could work, reviewing the stability, repeatability, and counterfeitability potential of the signature, and evaluating the tamper detectability of the tag**

- (2) **Examining the engineering to determine commercial availability of the system or parts of it, system design, manufacturability, and instrumentation required.**

On occasion, BDM even sought and received advise on materials concerns from personnel at SNL. When a concept survived analysis, and with DNA's approval, proof-of-concept laboratory measurements were performed to assure that the tag system concept behaved as expected from the analysis. All concepts were iteratively analyzed until the team decided that either a concept could not work or that it deserved prototype development. There were critical BDM assessments of outcomes of the analyses and laboratory experiments. BDM routinely reported results of the Creative Task to DNA and made every effort to have no prejudice for or against any concept considered.

A key factor which influenced the investigation of several potential tagging technologies was the lack of clearly defined operational requirements. Specifically, there was no agreement on what would be tagged and where the tag would be located. Decisions on these two critical questions would define the tag's operating environment, and thus, the conditions against which the tag system would have to be designed. In order to pursue the development of a tagging system beyond the proof of concept stage, without knowing the operational environment, results in costly over-design to meet the full range of possible operating conditions.

4.3.5 Results.

The products of the Innovative Tags work include, but are not limited to, three operational industrial prototype systems and several technologies that have shown high probability of positive proof-of-concept. Three industrial prototype systems are available, including SLITS, PTILS, and the UR system. The SLITS is a very low cost tag/seal when injection-molded joints are used (less than \$10 each). SLITS has had an adversarial analysis performed by INEL, and all of their attacks were easily detected in less than five minutes (most in less than two minutes) per tag upon inspection. PTILS provides robust tamper resistance and objective splice detection for a relatively low cost of less than \$100 each. Because of the late start on industrialization, PTILS needs further environmental and

operational testing, and needs an adversarial analysis performed. The UR can record any videographic image and can be used to correlate any RP signature (RPT, SLITS, PTILS, etc.). The microcomputer for the UR is interchangeable; laptop or ruggedized computer versions can be assembled. The UR also implements a software "blinker" feature for psychovisual tamper detection and a video microscope is available for microvideographic documentation.

Other outcomes of the Creative Task included the invention and assessment of additional concepts that hold promise as tags or seals. These concepts were assessed late in the Creative Task. There was no time remaining on the Tagging RDT&E contract, before the stop work for the Creative Task to either complete assessments or to do prototype development of the new, potentially winning concepts. The most promising concepts include:

- (1) MILS, a candidate loop technology that may provide very robust, objective "binary" loop tamper detection
- (2) Read-at-home tag/seals that do not require the use of a reader in the field at all, but offer very robust signature repeatability and tamper detection
- (3) SEAM, an intrinsic tag concept
- (4) Adaptation of specialty optical fibers for use in PTILS.

All of these technologies are discussed in more detail in see appendix F to this report. Appendix F also includes discussions of a Fourier optical image technique, which was tried as an intrinsic signature and failed proof-of-concept measurements, and other novel concepts that were envisioned and failed analysis or for which inadequate time was available for full assessment. Many other concepts were considered and assessed under the Creative Task work. These are listed in table 4-8 and the primary reasons for their rejection or "shelving" for later consideration are also listed.

4.3.5.1 The Magnetostrictively Interrogated Loop Seal (MILS). MILS is not available in prototype form. It requires further proof-of-concept measurements to confirm that the magnetostrictive phenomenon is robust and undefeatable and that designing a laboratory prototype would involve only packaging issues. The a-wire would require proper protective jacketing to avoid inadvertent kinking or

other damage that could be misinterpreted as tampering. The current source for the main magnetic field, the signal generator, and the detection electronics are available commercially in packages that probably could be adapted for field implementation of the MILS technology.

Table 4-8. List of other concepts assessed.

Concept	Type of Tag	Assessment
<ul style="list-style-type: none"> • Optical Interference and Diffraction Techniques <ul style="list-style-type: none"> - holography - Fourier optics imaging - diffraction grating strip loop 	Intrinsic or Adhered	These techniques are so sensitive that they do not offer stable signatures because of contaminants and material changes.
<ul style="list-style-type: none"> • Acoustic Interference 	Loop	Unstable due to temperature and pressure variations.
<ul style="list-style-type: none"> • Differential Pressure tubes 	Loop	Cannot hold the differential pressure reliably for years.
<ul style="list-style-type: none"> • Binary chemicals - "scratch and sniff" 	Loop or Adhered	Technology not COTS. Unstable at high temperature.
<ul style="list-style-type: none"> • Special ropes and inspection with a fiberscope 	Loop	20 micron fiberscope resolution available, but 10 meter inspection would require unreasonable time.
<ul style="list-style-type: none"> • Nonlinear Optical Fibers 	Loop	Requires more optical power to drive the nonlinear effects than can be obtained from a laser diode
<ul style="list-style-type: none"> • Low-loss Coaxial Cables 	Loop	Measurements showed that tamper detection was indecisive.
<ul style="list-style-type: none"> • Early Consideration of Electronic Identification Devices (EIDs) 	Adhered or Loop	Concerns of intelligence agencies discouraged consideration of EIDs by BDM for START.
<ul style="list-style-type: none"> • Smart skins 	Adhered or Loop	Ordinarily an active (powered) system; therefore, unacceptable for START.
<ul style="list-style-type: none"> • Tamper tape 	Adhered	None with unique signature available in this COTS technology; therefore, unacceptable for START.
<ul style="list-style-type: none"> • Hollow fiber optic cables 	Loop	Needs a long wavelength, laser light source that is difficult to obtain in any fieldable configuration.
<ul style="list-style-type: none"> • Other signatures 	NA	None found that had any advantage over the reflective particle signature concept.

4.3.5.2 The Scanning Electromagnetic/Acoustic Measurement (SEAM). SEAM is not available in prototype form. It needs further proof-of-concept measurements to confirm that adequate resolution and penetration of materials of interest on tagged items can be achieved. Further, SEAM is likely to be of interest in arms control only for very high value assets, such as expensive missiles of high military value (e.g., START-like arms control verification). Designing a laboratory prototype would involve a full trade study of available hardware in the most portable form possible. It is desirable to optimize the equipment design to give maximum signal sensitivity and operational simplicity. The microwave resonant cavity is likely to require special fabrication, although cavity fabrication is a well-known technology and is readily available commercially.

4.3.5.3 Read-at-home tag/seals. Due to cancellation of the Creative Task, the read-at-home tag/seals are not fully developed and are not available for use. Additional testing and development are required to complete a prototype read-at-home tag/seal. SLITS-like designs could be accomplished and tested with reasonably low level of effort. More exotic designs would require further engineering and testing to assure stability of the signature and adequate tamper detectability. For RP signature read-at-home concepts, the particle type and density required to achieve a 50 percent contribution from each part of the composite RP signature needs to be determined. It may be that the particle density for the bottom RP signature contribution needs to be greater than the top particle density, due to the presence of the loop ends. The best type of particle or particle mix needs to be determined.

4.3.5.4 Fourier optical images. A Fourier optical intrinsic tag system is unavailable. The decision to drop this concept was based on the need in high asset arms control for unique, non-counterfeitable, repeatable signatures with significant contribution from subsurface features.

4.3.5.5 Nonlinear and other specialty optical fibers. Nonlinear fibers with sufficiently high third-order nonlinear coefficients in the index of refraction to yield adequate tamper sensitivity for detection with commercial OTDRs are not available. Laser diodes (used in OTDRs) simply do not deliver enough light power output. The specialty fiber being studied and developed at PNL may offer high

tamper resistant loop possibilities. This remains to be proven and the best choice of instrumentation remains to be determined.

4.3.5.6 Null B-field loops. Concepts for loop tags using perturbation of null magnetic fields to detect tampering could be easily implemented with minimal technology and simple instrumentation. However, the analysis that was performed on the Creative Task needs to be confirmed with fabricated loop materials and testing, and adversarial analysis of the concept must be performed.

4.3.5.7 Lessons Learned. The Creative Task very was productive. High productivity resulted from drawing on a group of people representing a broad range of scientific and engineering disciplines and intensive internal mini-adversarial analysis of all concepts proposed. The following summarizes the critical features of the program contributing to its success:

- (1) Maintenance of a "critical mass" of people so that intensive debate could ensue**
- (2) Thorough analysis of the physical principles involved**
- (3) Analysis of how the concept will be operationally employed**
- (4) Adequate engineering design work to assess concept feasibility**
- (5) A strong orientation toward delivery of functional systems.**

The productivity of the creative process is indicated by the fact that three industrial prototype systems (SLITS, PTILS, and the UR) came from this effort. The SLITS system easily survived the adversarial analysis performed. That is, all adversarial attacks were readily detected upon inspection by minimally-trained inspectors. This outcome was the result of strong debate during development on optimal selection of materials and design features that would frustrate covert adversarial actions. All three of the prototype systems have performed well during functional, operational, and environmental tests.

Several other rather promising concepts were identified that should be pursued further to functional prototypes. These concepts, which have been discussed in this report passed preliminary analysis and/or proof-of-concept demonstration.

BDM learned that interaction with end-users and other interested agencies is critical to understanding real operational needs and requirements, as well as gaining an understanding of field environments of the technologies.

Finally, as one would expect, it was observed during the Innovative Tags work that learning was progressive. The staff became much more aware of the needs of verification and more knowledgeable of the various technologies as the work proceeded. This experience led to more rapid assessment and creation of new ideas later in the Tagging program.

The creative process can be of benefit to the government in developing arms control verification technologies and other technologies. With direct input from intended users, appropriate technologies can be and were developed. The inventive and developmental philosophy of making maximal use of COTS equipment to produce low cost and simple, but robust technologies resulted in products and systems of high maintainability that are operationally attractive (user friendly).

A major conclusion of the work on Tagging RDT&E is that one technology cannot meet all needs of verification of compliance with all treaties. Several technologies are needed. On-going development of technologies is prudent in order to be ready when the need arises. Such readiness will give negotiators much more meaningful options during the development of treaties and agreements. It is important that the negotiators and their technical advisors be well aware of what options are and are not available.

4.3.6 References to Section 4.3.

Ash, E. A., and Nicholls, G., Nature, "Super-resolution aperture scanning microscope", vol. 237, 1972, pp. 510-512.

Betzig, E., Trautman, J. K., Harris, T. D., Weiner, J. S., and Kostelak, R. L., Science, "Breaking the diffraction barrier: Optical microscopy on a nanometer scale", vol. 251, 1991, pp. 1468-1470.

Collin, R. E., Ultramicroscopy, vol. 13, 1984, pp. 227-231, Foundations for Microwave Engineering, McGraw-Hill Book Co., New York, 1966.

Lewis, A., Issacson, M., Harootunian, A., and Muray, A., "Development of a 500 Å spatial resolution light microscope. I. Light is efficiently transmitted through 1/16 diameter aperture", Ultramicroscopy, vol. 13, 1984, pp. 227-231.

Mohri, K., Humphrey, F. B., Yamasaki, J., and Kinoshita, F., "Large Barkhausen Effect and Matteucci Effect in Amorphous Magnetostrictive Wires for Pulse Generator Elements," IEEE Trans. Magnetics, vol. MAG-21, pp. 2017-2019, 1985.

Mohri, K., Humphrey, F. B., Yamasaki, J., and Okamura, K., "Jitter-less Pulse Generator Elements Using Amorphous Bistable Wires," IEEE Trans. Magnetics, vol. MAG-20, pp. 1409-1411, 1984.

Murday, J. S., "Nanometer science and technology", in APS News, vol. 1, no. 3, 1992, Physics News in 1991 Supplement, pp. 71-74.

Reddick, R. C., Warmack, R. J., and Ferrell, T. L., "New form of scanning optical microscope", Phys. Rev. B, vol. 39, 1989, pp. 767-770.

Sixtus, K. J., and Tonks, L., "Propagation of Large Barkhausen Discontinuities," Phys. Rev., vol. 37, pp. 930-958, 1931.

Synge, E. H., "A suggested method for extending microscopic resolution into the ultra-microscopic region", Phil. Mag., series 7, vol. 6, 1928, pp. 356-362.

4.4 UNIVERSAL VIDEOGRAPHIC READER (UR).

4.4.1 Overview.

The UR is an extremely flexible reader system capable of capturing and processing digital video images with microprocessor controlled illumination. The UR was designed from an earlier SNL design so that, with appropriate tailoring of the reader head hardware and the controller software, it could be adapted to service any videographic application. The specific configuration developed for the tagging application allows the UR to read RPT, SLITS, PTILS, and Tamper Tape + RP. The UR records video images of reflective particle signatures at standardized illumination angles, and computes how well these video images compare to previously-recorded images of the same tag to determine, with a high level of confidence, the authenticity of the inspected tag. With the video microscope feature and the Universal Blink Comparator software feature, only minor modifications (such as jiggling) would be required for the UR to read Cobra II, Python, and all varieties of microvideographic identifiers.

The process of comparing the original reference image and the current (verification) image is called correlation. Correlation values equal to or greater than a predetermined threshold value indicate that the current tag signature and the reference signature came from the same tag. A correlation value less than the threshold value indicates that these signatures came from different, damaged, gross tamper, or attempted counterfeit tags. Presently threshold values are established at levels that ensure that the probability of a decision error, e.g., determining that signatures from the same tag are from different tags (false rejection), or that signatures from different tags are from the same tag (false acceptance), is less than 10^{-6} .

The UR system consists of a field deployable equipment set and a separate calibration set used in a laboratory. The field equipment is made up of three subsystems:

- (1) Computer. An IBM-PC compatible 286 with a math coprocessor, 8 megabytes of RAM, 20 megabyte hard drive, and VGA monitor or better.

- (2) **Connecting Cable.** A 150-foot military tactical fiber optic interface cable, that provides video, audio, and data transmission between the computer and the reader-end during operations or a junction box that connects the reader-end directly to the computer.
- (3) **Reader-End.** The reader-end includes a fiber optic interface, battery, belt box, tag reader head (with a CCD camera), microscope head (also with a CCD camera), video monitor, and audio headset.

BDM conducted an IOT&E of the UR system and determined that the system is capable of being used in the field. Several modifications were made to the system after IOT&E to improve user friendliness and versatility. INEL has conducted an adversarial analysis assessment of SLITS tags using this system. Upon completion of the Tagging RDT&E contract, the documented UR system was to be delivered to DNA.

4.4.1.1 **Documentation Produced.** Figure 4-49 lists each UR document produced under the tagging contract, including date, and a brief description.

Document Produced	Date	Description
Universal Reader IOT&E Test Plan (Draft)	April 9, 1992	Describes the plan of activities to occur during the IOT&E to meet all measures of performance for the UR system.
Operations Manual for the UR IOT&E	April 20, 1992	Describes how to operate the UR system, how to apply RPT-2's and SLITS.
IOT&E of the Universal videographic Reader Combined with RPT-2 and SLITS Final Test Report	January 9, 1993	Describes the results of the UR pertaining to both SLITS and RPT-2's. Also describes the tag verification decision rule regarding both SLITS and RPT-2's.
Prime Item Fabrication Spec	March 31, 1993	Describes the fabrication of components to the UR system.

Figure 4-49. Documents produced during the UR system assessment.

4.4.1.2 **Expenditures.** The UR assessment effort began on March 21, 1991, and was completed when the final report was delivered in January 1993. The following table (table 4-9) lists the labor hours, the associated loaded labor costs

(without fee and tax) plus the ODC's expended during the conduct of the UR assessment.

Table 4-9. UR system expenditures.

TI	Hours	Loaded Labor Costs	ODC's	Total Costs
FY91-14	26,128	\$1,015,015	\$163,742	\$1,178,757

4.4.2 Schedule.

Figure 4-50 depicts the schedule of activities that were performed during the UR system assessment efforts under TI FY91-14.

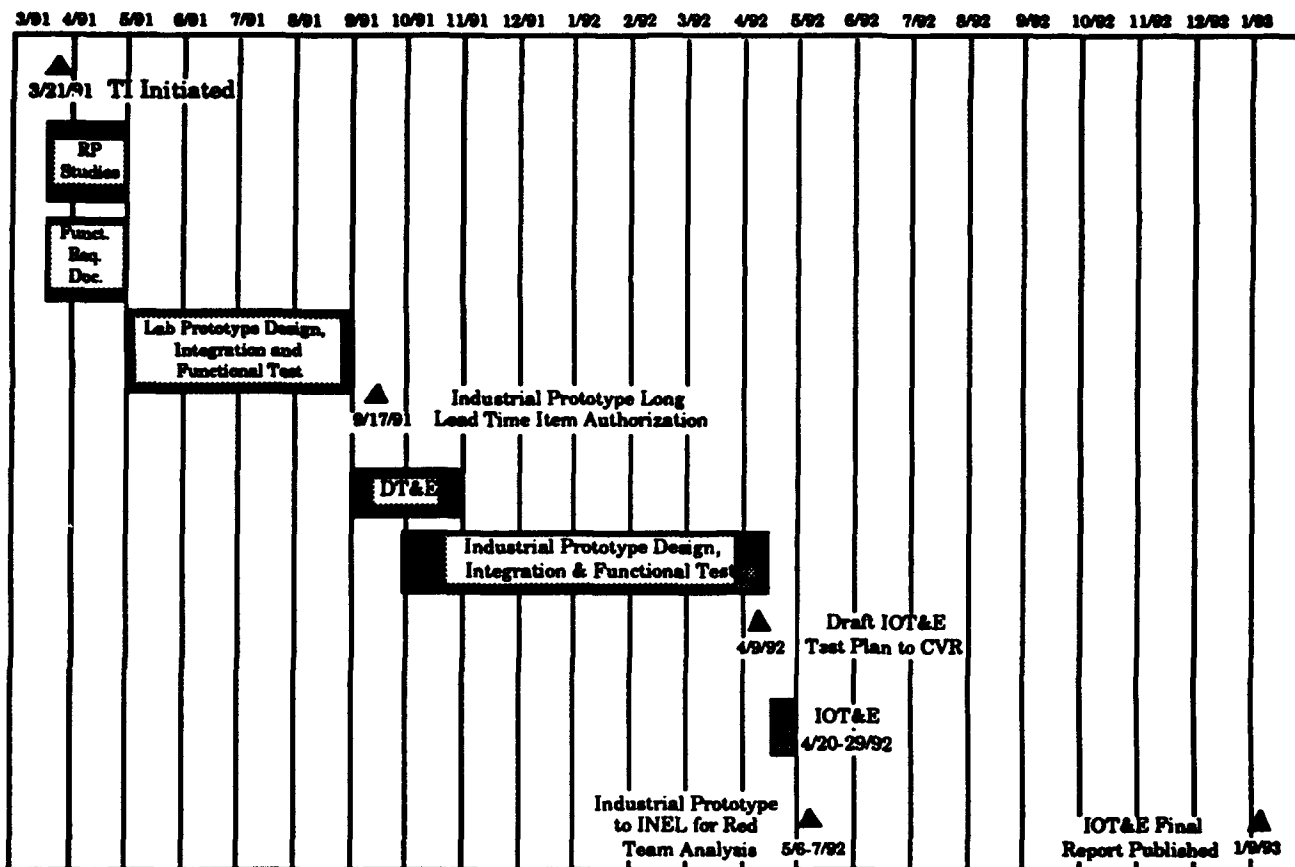

Figure 4-50. UR assessment schedule of activities.

4.4.3 System Description.

The UR records video images of RP signatures and computes how well these video images compare to previously recorded images of the same tag to determine the authenticity of the inspected tag. This process of comparing the original reference images and the current (verification) images is called correlation. A high correlation indicates that the current tag signature is a good match to the original and that the tag is most likely authentic. A low correlation number indicates a poor match and can mean a different tag, tag damage, signature alteration (tampering), improper system operation, or equipment malfunction.

The UR system consists of a field deployable equipment set and a separate calibration set used in a laboratory. The field equipment set, that is ruggedized for storage and operation under adverse environmental conditions, is made up of three subsystems:

- (1) **Computer.** A Miltope Tiger 2, 386 computer (see figure 4-51) is used that contains a removeable hard disk; a fiber optic interface; a video digitizing board; a data compression board; heating strips and thermostats; a hard disk low temperature interlock; an audio headset; and a soft case for low temperature operation. The air tight, hard shipping/storage case is normally not taken into the field, but kept in a storage area.
- (2) **Fiber Optic Connecting Cable.** A 150 ft, four fiber (3 - 62.5 micron, 1 - 200 micron) military tactical fiber optic interface cable connects the computer and the reader-end during operations. It is stored on an aluminum take up reel. The connection provides video, audio, and data transmission.
- (3) **Optional Junction Box.** For convenience while working in an office or laboratory environment an electronic interface box was developed to provide an interface between the computer and the standard or microscope reader head cameras. It is powered by connection to a standard 110V AC outlet rather than batteries. It permits either wire

or fiber optic connection to the camera(s) and video monitor. Audio headset connection is also available if needed.

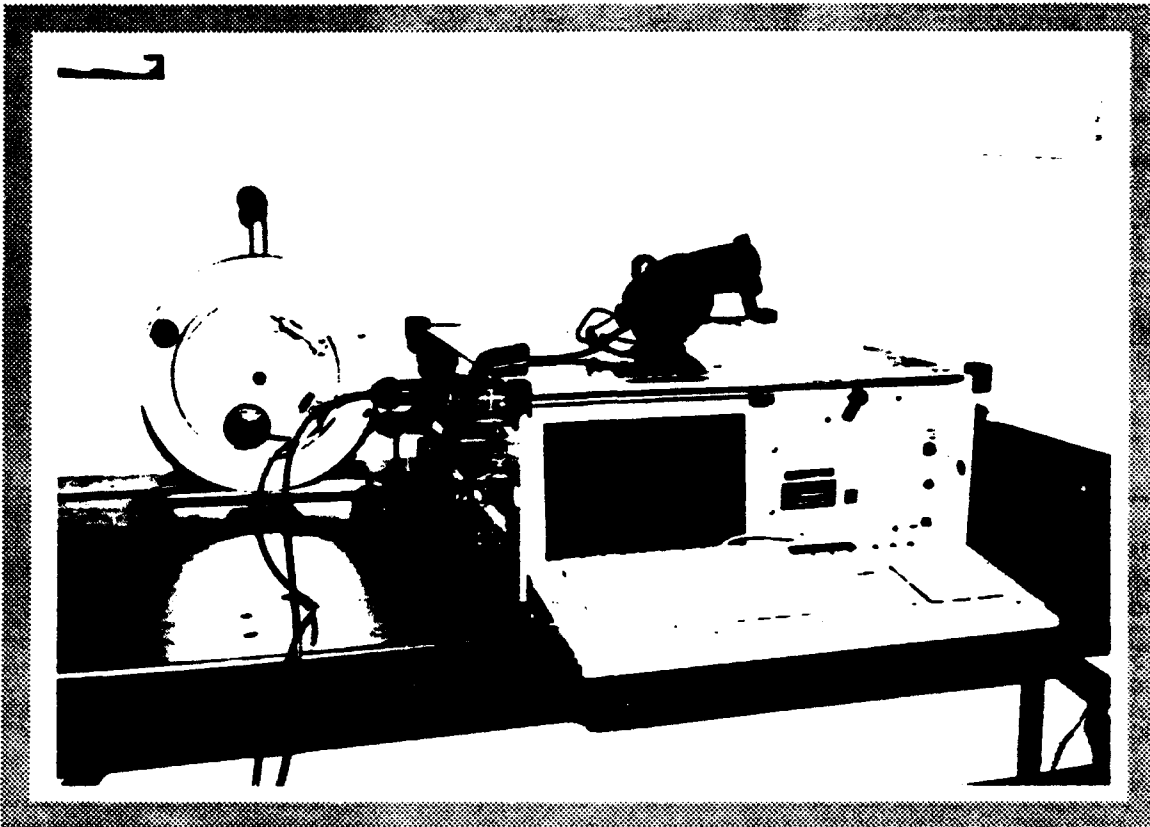

Figure 4-51. Miltope Tiger 2 computer.

- (4) **Reader-End.** As shown in figure 4-52, the reader-end includes:
- (a) A fiber optic interface and power/temperature control PC board electronic interface box
 - (b) A man pack for the electronic interface box and 12 VDC battery.
 - (c) A connector belt box connected by cable to the electronic interface box in the man pack
 - (d) A tag reader head (incorporating a CCD camera) with two jigs (one to hold SLITS and one to hold the target jig used to perform the system's functional test)
 - (e) A microscope head (also with a CCD camera) and tag jig
 - (f) A small video monitor, that attaches to either the reader head, or microscope
 - (g) An audio headset

- (h) An air tight, hard shipping/storage case with a heating pad, power conversion box, shoulder carrying bag, and case mounted power connector.

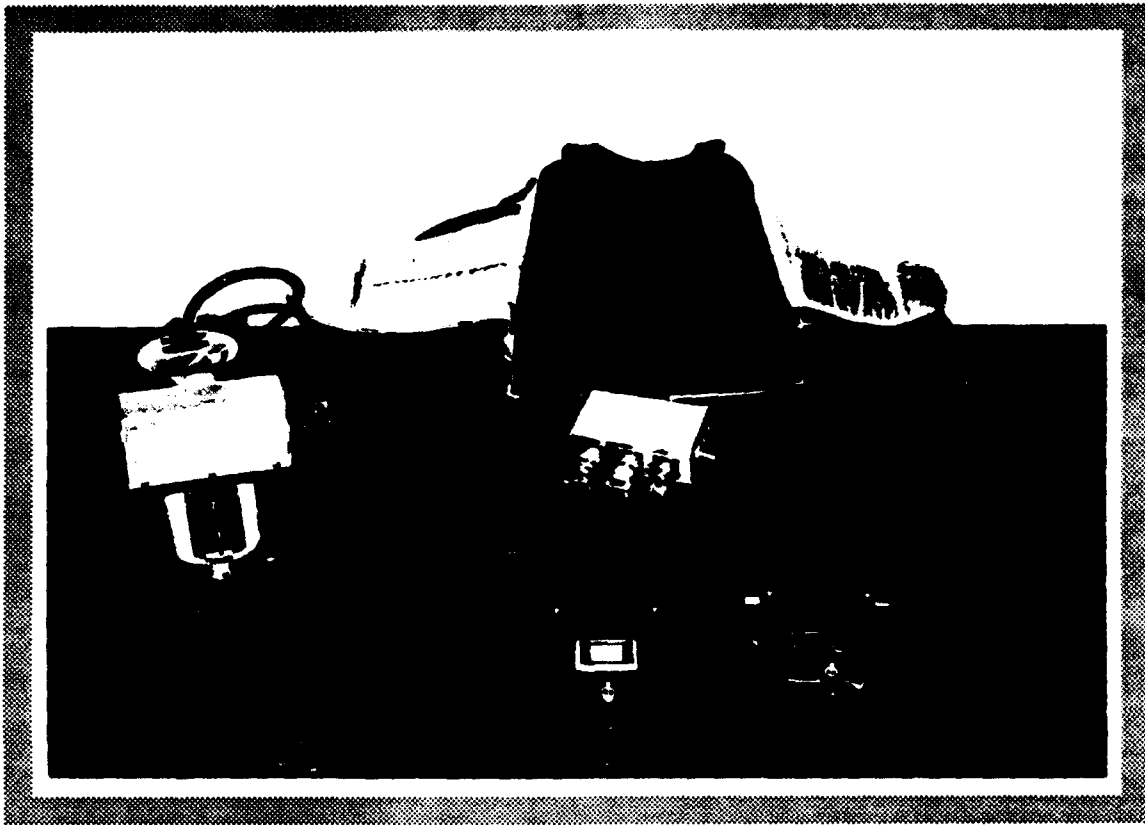

Figure 4-52. UR reader-end equipment.

The laboratory calibration subsystem is used for predeployment system calibration and maintenance. The calibration subsystem consists of:

- (1) A desk top 33 MHZ, 386 computer with 8 MB RAM
- (2) A high resolution video monitor
- (3) Optical fixture equipment and optical targets (see figure 4-53)
- (4) Measurement tools
- (5) An adjustment shim set
- (6) A read end equipment interface box
- (7) COTS and custom software
- (8) Air tight, hard shipping/storage cases.

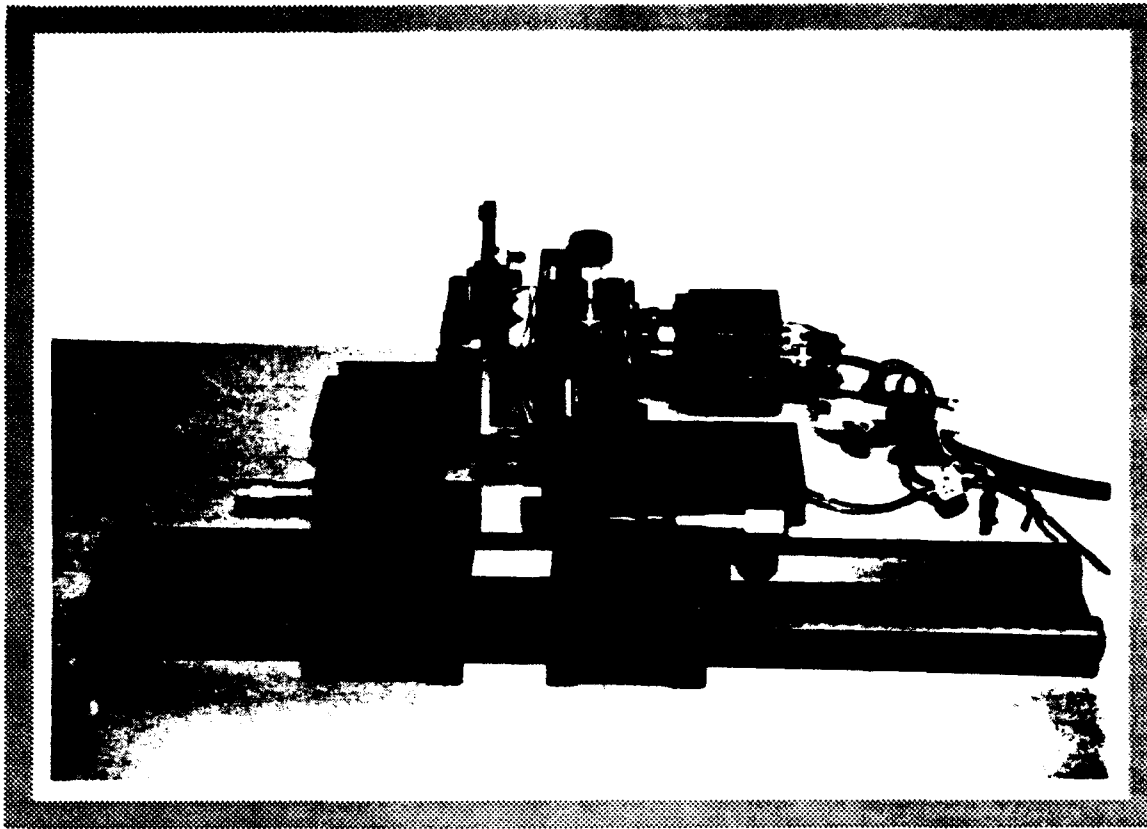

Figure 4-53. Optical fixture equipment of the UR calibration subsystem.

4.4.3.1 Calibration During Equipment Assembly. The signature of a given tag must essentially be identical when read with different equipment sets. Therefore, great care must be taken with reference to focus, magnification, alignment, and camera gain when the UR reader head and microscope are first assembled. These procedures are accomplished using the calibration subsystem.

The calibration subsystem is also used to establish calibration data for the reader head operational functional check target jig. Each system has unique target, and calibration data. These allow a system operator to check proper focus, magnification, alignment, gain, black level intensity, and lens cleanliness prior to taking video images.

4.4.3.2 Tag Readings. During a tag reading, the reader-end operator uses an alignment jig or uses the image in the video monitor to align the reader head cross hairs with the tag fiducials. The operator then activates the reading sequence in which 20 images, each one illuminated from a different angle by one

of 20 LEDs in the reader head, are recorded for a single fiducial position along with archival data such as the date, time, tag and fiducial number, etc. Each image consists of a 484 x 512 pixel array, with each pixel assigned an intensity value from a 256 level gray scale. From this 247,808 byte image, the brightest 2,500 (approximately 1%) pixels are retained and used for image correlation. This process, termed "thresholding," excludes the image background and causes the image correlation process to be based totally on the light reflected from the reflecting particles.

If the reader-end operator deems it necessary, video microscope images of the tag may also be taken. A video microscope image may be made of any area of the tag that the reader-end operator thinks is appropriate.

4.4.3.3 Correlation Procedures. A tag's authenticity, or lack thereof, is determined by comparing a reading made in the field (a verification reading) with one made at the time the tag was constructed (the reference reading) and determining the degree to which the two readings are alike, or correlated. A complete tag reading will consist of readings at one, two, or all three fiducial marks on an RPT; or readings at one or both fiducials on a SLITS or PTILS, depending on the inspection protocol in use.

For each fiducial, each image from the verification reading is compared with its corresponding (same LED) image from the reference reading and their degree of similarity is computed by using a correlation algorithm. Then, using the 20 individual correlation numbers, a single decision statistic, the median correlation number, is calculated. It is used to represent the overall signature correlation for the set of 20 correlation numbers.

A fine adjustment procedure, described in the UR IOT&E Final Test Report (see section 4.4.4) is used for a reading's first reference/verification image pair. When an RPT is being read, the same procedure is used for the remaining 19 image pairs. However, when a SLITS is being read, this procedure is not repeated for the remaining 19 image pairs because a SLITS is held in a jig and is not expected to move between images. Therefore, the fine adjustment computed for the first image pair can be used for the remaining 19 images, resulting in a considerable savings in computation time (approximately 50 percent).

4.4.3.4 System Environmental Specifications. The environmental specifications for verification systems, including those modifications approved by OSD in January, 1993, are shown below in table 4-10. These specifications relate to all tagging, and tag reading systems. They are drawn primarily from MIL-STD-810, *Environmental Test Methods and Engineering Guidelines*.

Table 4-10. Specifications applicable to the UR system.

Parameter	Storage/Transport	Operating
Temperature	-60°F to +60°F	14°F to 122°F
Altitude	Up to 45,000 ft	Up to 11,000 ft
Relative Humidity	100% @ 85°F	90% @ 85°F
Fungus	MIL-STD 810D, 508.3	Same
Salt Fog	4 - 6%, MIL-STD-810D, 509.2	Same
Acceleration	40 g's, 6-9 ms, 45 Hz	n/a
Vibration	MIL-STD-810D, 514.3	n/a
Shock	MIL-STD-810D, 516.3	n/a
Lightning	n/a	n/a
Rain	n/a	n/a
Ice	n/a	n/a
Sand & Dust	n/a	n/a
Solar Radiation	n/a	n/a
Winds	n/a	n/a
EMR	n/a	Various bond, shielding, rad characteristics, MIL-E-6051
EMI	n/a	n/a
Corrosion	MIL-STD-1568,808, 1250, & 889	n/a
Dissimilar metals	MIL-STD-889	n/a
ESD	n/a	MIL-STD-1866
Safety	MIL-STD-1472, MIL-E-6051	Same
Shipping Weight	35 lbs	n/a
Service Life	10 years with support	Same

4.4.3.5 Design Evolution. Lessons learned from the RPT reader development, the RPT IOT&E, and suggestions from BDM, and SNL staff members served as guidelines for the development of the UR laboratory and industrial prototypes (SNL's RPT reading equipment is described in paragraph 3.1.3 above). The following paragraphs list the primary differences between the RPT reader system and the UR system:

- (1) Use of a more powerful COTS computer to increase speed of correlations, and make available additional PC board slots to allow use of an Antel OTDR board plus a video digitizer card.
- (2) Incorporation of a remote capability so that the computer can be located separately from the reader head during readings. This also allows the computer to remain in a vehicle or fixed location, reducing setup, and teardown times, and keeping the computer out of adverse environmental conditions.
- (3) Angling the camera's LEDs to aim at the center of the tag rather than mounting the LEDs perpendicular to the tag. Also, providing diffusers that introduce less attenuation in light intensity. Both changes increase the light levels on the tag plus provide illumination across the entire signature area rather than portions of it.
- (4) Increased cable flexibility and reduced size of connecting cables to improve ease of use.

The differences between the RPT reader system and the UR system are described in more detail in the following paragraphs:

Computer Type. There was general agreement among various agencies that a 386 or 486 type computer would be desirable to provide more computing power. A market survey of available computers of these types resulted in selecting the ruggedized Miltope Tiger 2, 386 computer as the best choice short of prohibitively priced militarized computers. (At the time of the survey, smaller laptop or other lightweight 386 or 486 ruggedized computers with expansion slots were not available on the market.) Three Tiger 2 computers were purchased for the UR laboratory prototype system, though their weight was not considered optimal. The computers were modified by addition of fiber optic communication equipment and a DC power supply.

During the latter part of the UR laboratory prototype DT&E, a subsequent market survey identified a new laptop Miltope TopCat 486 unit with 1, 2, and 5 slot boxes and an SAIC lightweight computer unit, as candidates that

would meet the desired specifications for the industrial prototype. However, since neither unit was in production at the time of equipment selection for the industrial prototype system, the three Tiger 2's were retained. The Tiger 2's were further modified for use in the industrial prototype with more rugged fiber optic communication modules; heating strips and temperature controls; a soft case, with ventilation air recirculation capability for low temperature operation; and a hard disk low temperature lockout circuit.

It should be noted that the UR can be used with most 286 or better PC clones if properly configured and the junction box is used.

Remote Operations Support. The need for remote operations, where the system's computer is not located near the tag, had by far the most impact on the design changes from the RPT system to the UR system. The remote requirement added the following components:

- (1) Computer and read end fiber optic communication modules
- (2) Multichannel fiber optic cable (150 ft) and fiber optic connectors
- (3) Man pack, with batteries; belt box; and separate electronic power and temperature control PC board
- (4) Audio headsets
- (5) Battery charger
- (6) Monitor computer message display feature.

Light Plate Design. The laboratory prototype light plate design was changed from the SNL design to provide angled holes for the LEDs (so they aim at the center of the tag), use a new multi-layered diffuser arrangement (less light attenuation), use wider base plate leg spacing (provides improved stability), and use a kinematic alignment system on the base plate (provides excellent mechanical alignment with tag jig plates). The industrial prototype design fixed the base plate to the light plate with 1/4 turn fasteners to allow the base plate to be removed for future jig changes.

Cable Design. Microcontroller PC boards in the reader heads and microscopes were installed for LED and switch control. The microcontroller boards reduced the number of conductors in the reader head and microscope

connecting cables; therefore decreasing the cable size and improving flexibility and ease of use. The microcontroller boards also eliminated the need for a LED driver PC board in the computer.

In the laboratory prototype, the camera video was looped through the video monitor before transmitting the signal to the computer via a one way fiber optic link. This eliminated any need to install additional fiber optic modules and an additional fiber to transmit the video signal from the computer back out to the monitor. The laboratory prototype thus used one fiber optic link and fiber for the video image from the camera to the computer plus a fiber optic data modem link using two fibers for the data communications between the computer and control boards at the reader-end.

The industrial prototype allows the video monitor to display the computer digitized image and electronic cross hairs and provides computer generated messages for improved communication between the computer and reader-end operators. A multiplexed fiber optic system was required to reduce the cable size while passing video, data, and audio signals in both directions across the fiber optic link. The multiplexed fiber optic system can send one way video plus bi-directional data and audio across one fiber and a separate analog one way video link across another fiber.

Other Design Changes. Other design changes from the UR laboratory prototype to the industrial prototype were:

- (1) Including audio headsets for improved communications during remote operations
- (2) Including smaller diameter fiber optic cable and more rugged multichannel fiber optic connectors
- (3) Placing the small video monitor in an aluminum box for better protection and RF shielding
- (4) Using custom fabricated, low temperature, polyurethane coated cables for the reader head, microscope, monitor, belt box, and man pack box

- (5) Designing a smaller pack, a new pack electronic box, and a belt box to allow more convenient connections, even while wearing cold weather clothing
- (6) Incorporating improvements to the jig and reader head mechanical design
- (7) Providing air tight, hard cases for the computer, tag reading equipment, and calibration subsystem
- (8) Including a focusing microscope
- (9) Designing a functional check tag for system checkout
- (10) Incorporating corrections, improvements, and additions to the system's software
- (11) Including two fiber optic fibers in the main cable for OTDR measurements. (At the time of the industrial prototype design, it was not known whether the glass fiber multiwrap or plastic fiber design would be used for PTILS. To handle both cases, a 200 micron glass fiber was included in the main cable for use with a plastic PTILS tag and a separate 62.5 micron glass fiber was included for a glass fiber PTILS tag. These two OTDR fibers plus the two video/data/audio fibers brought the number of fibers in the main cable to four.)

4.4.4 Activity Description.

BDM was tasked by DNA, in TI FY91-15, on March 21, 1991, to research, develop, test proof of concept, and prototype mature innovative tags/seals, including the reader system, for use in treaty verification applications. Specifically, for the reader system, BDM was to develop a universal RP reader system to the level of laboratory prototype. It was to serve as the reading system for the SLOTS, the PTILS, and any other verification system using reflective particles for a signature. It was designated the Universal videographic Reader.

In the first several months of the work, various issues related to quality RP signatures were studied, including the number of light sources needed to provide adequate complexity in the signature correlation, the necessary pixel resolution needed in the reading video camera, the desirable angle of illumination, and the intensity of light needed for a signature area that is imbedded in the tag joint/seal.

Measurements of pre-prototype signatures for innovative tags were made with the RPT reader head (discussed in paragraph 3.1.3 above) to assist in answering the necessary signature size, and depth of field design questions.

During this period, a draft functional requirements document was prepared for the innovative tags (SLITS and PTILS) and the UR and a request was made to DNA for changes in the environmental specifications for the UR with rationale for the changes. The innovative tags and the UR were briefed at the CVR in Washington, D.C. on April 3, 1991. BDM also presented a high level briefing and laboratory displays to personnel from DNA on April 18, 1991, that included innovative tags and the UR.

Design of several equipment items and associated interfaces was initiated in May 1991. Among them were the reader head; man pack; communications/power interface between the computer and the reader head; and the software design (mods to the RPT software). Upon completion of the design work, parts were ordered, including three Miltope Tiger 2 computers.

Testing of equipment also occurred at this time, including laboratory testing of the reader head to support design issues; alignment repeatability for the reader head; varying the light conditions for RPT, and innovative tag joints; and testing a new frame grabber board and Pulnix video camera. Tag mock ups were built to read and correlate innovative tag signatures to address design issues, including depth of focus, light intensities, and angles of illumination.

In July and August 1991, several demonstrations and briefings of the UR were given including:

- (1) BGen Johnson, OUSD(A), was briefed on the UR and given a short demonstration of the available components on July 17**
- (2) Lt.Col. Sharples was given an updated demonstration of the UR system on July 31**
- (3) The final laboratory prototype UR was demonstrated to Lt.Col. Sharples on August 16, 1991**
- (4) The UR was also briefed during the DNA contractor status briefing on August 29, 1991.**

Three UR laboratory prototypes were completed by September 8, 1991, and DT&E was initiated; laboratory prototype SLITS and RPTs were used during DT&E. At the same time, conceptual development of the industrial prototype UR began. On September 17, 1991, BDM was authorized to begin long lead item procurements for the industrial prototype UR system.

The data acquisition phase of the UR laboratory prototype DT&E was completed by November 1991. Preliminary analysis on data from RPTs and laboratory prototype SLITS using the UR showed promising results. SLITS readings appeared satisfactory at this time, but analysis continued. Like RPT tag correlations were at least as good as those gathered during the RPT IOT&E; unlike RPT tags had not been analyzed at this time. Also, a correlation variance attributable to different UR equipment sets still existed, but the variance was small and was not considered operationally significant. In general, reader-to-reader variance was about the same order of magnitude as previously measured for the SNL-developed RP reading systems.

Several meetings and demonstrations were held to determine the best computer for the industrial prototype system. These included a trip to Miltope to see their TopCat portable computer and an in house demonstration of the SAIC ruggedized pre-prototype computer. The Miltope Tiger 2 was selected to be the standard computer for the industrial prototype. This decision was made due to anticipated delays in receiving other possible ruggedized computer systems.

In addition, BDM planned to design the industrial prototype system so that the computer was an independent subsystem, and not an integral part of the industrial prototype. With this design, any properly configured computer can be used in conjunction with the other components of the UR system. Since only three Tiger 2's were available, BDM planned to use desk top computers for the remaining two UR systems required for the IOT&E.

On September 9, 1991, a laboratory prototype UR was delivered to INEL. BDM briefed and trained the INEL staff on use of the UR in support of their pending adversarial analysis of SLITS. A similar briefing was given to JAYCOR on November 5, 1991, in order to support their environmental adversarial analysis of SLITS.

By March 1992, the five industrial UR systems were completed and functional testing was initiated. IOT&E planning was well underway. A draft of the IOT&E Test Plan was delivered to the CVR on April 9, 1992.

The IOT&E of the industrial prototype system was conducted at BDM during April 20-29, 1992. The most recent SNL RPT tag and two SLITS tag designs were used during the IOT&E. Since outside agencies (e.g., OSIA and the services) were unable to provide personnel for the IOT&E, the participants included eight BDM employees who had no involvement in the development of the UR. A representative from the CVR observed a portion of the test.

On May 6-7, 1992, BDM delivered a complete UR system to the INEL team for adversarial analysis.

Environmental testing for the UR system was performed during February 1992. The environmental testing for the UR system covered Altitude, High Temperature, Low Temperature, Temperature Shock, Humidity, Fungus, Salt Fog, Vibration, Shock, and Electromagnetic Interference effects. The UR system performed well under the physical environments induced. The Hardigg cases provided good environmental protection for the UR system components while in storage mode. The UR system functional checkout performed correctly before and after each test. The UR system passed all MIL-STD tests except for portions of the Electromagnetic Interference test (CE07, CS02, RE02, and RS03). Slight rust was seen on steel screws of the monitor and reader head during the operational humidity test, but was not considered significant.

During the Conducted Emissions 07 test, large "turn on" spikes were seen. At 120V/60Hz the peak exceeded the standard by 25.5V. At 220V/60Hz the peak exceeded the standard by 37V.

The Conducted Susceptibility 02 test found some cross coupling of cables. The UR showed susceptibility on all four (unshielded) power leads. The 1 kHz modulation signal could be heard on the Miltope headset. Readings could still be taken, however, communication between the operators could be limited.

Radiated Emissions 02 test found excess emissions from the monitor (from 14kHz to 700kHz), reader head (100MHz to 260MHz), and Miltope computer (5.3MHz to 5.7MHz and 32MHz to 260MHz).

A power shut-down of the manpack power system was seen during the Radiated Susceptibility 03 test due to electric field induced noise at many points between 14.1kHz through 321.4 MHz.. Also during this test a 1kHz tone was heard in the headsets (from 14kHz through 5.5GHz).

4.4.5 Results.

Upon completion of the UR IOT&E Final Report, a number of suggestions were made for improving the equipment before it is deployed in an operational environment. The following paragraphs describe the modifications to the UR's hardware and software that were suggested as a result of the IOT&E, with particular emphasis on those modifications that were implemented. It is significant that none of the proposed changes to either the hardware or software involved a major change in design philosophy or resulted in a radical redesign.

4.4.5.1 Hardware Modifications. The suggestions for changes to the system's hardware came from three sources: 1) comments by the test participants during the course of the test; 2) the response of participants during the final debrief when asked what single item each would most like to see changed; and 3) the observations of the UR design team. Changes that were implemented are described first, followed by changes that were not implemented because of dollar and time constraints, system incompatibility or because the ability to meet the requirement could be met by other means.

- (1) Shoulder straps were provided for the man pack in addition to the waist strap already available. The straps were made wide enough to be comfortable and have a cross piece on the back. This change was made to accommodate the system to operators with diverse physical characteristics. Although most of the operators liked the waist strap, several thought the shoulder straps would make the man pack more comfortable, especially when it had to be worn for long periods of time. Operators now have a choice of which to use.**

- (2) The test participants commented that the lanyard that held the reader head around their neck was not long enough to have the reader head comfortably reach RPTs/SLITSs in awkward positions. A longer lanyard replaced the current one.
- (3) The lanyard's D clip hole was too small, which made it difficult to attach the lanyard to the reader head or microscope. The hole was enlarged to eliminate this problem.
- (4) The buttons on the reader head were difficult to locate by feel alone. This action was necessary when the location of the RPTs prevented the operator from seeing the buttons. The old, smooth membrane has been replaced with one that has holes at the button positions to provide a tactile indication to the operator that his finger is in fact on a button.
- (5) The knurled wheel used to tighten the video monitor to the reader head was difficult to use, especially in cold temperatures when the operators were wearing gloves. The wheel has been replaced with a snap in design on both the reader head and the video microscope. This makes it much easier to attach the monitor to either component.
- (6) The light blocking foam on the SLITS jig degraded noticeably through use during the test. To reduce this effect, beveled foam has been installed on the jig.
- (7) The push button power switch would sometimes turn ON/OFF accidentally when some operators turned or bent over. Furthermore, there was no indicator of ON/OFF status. The push button has been replaced with a toggle switch, that should be much harder to switch accidentally. An ON/OFF template has been added to indicate the power status.
- (8) The cable strain relief screws were too long and could cut an operator. They were replaced with shorter screws to eliminate the potential danger.

- (9) **The slots in the jig used to hold a SLITS for video microscope images were too narrow for the Kynar loop material. The slots have been widened to eliminate this problem.**
- (10) **The functional check jig could fall off the reader head base plate because it was not attached firmly enough. An improved attachment for the functional check jig spring pin was installed to prevent the jig from falling off.**
- (11) **The two hold down spring pins on each SLITS jig were too fragile; one broke during the test. These were replaced with a better attachment.**
- (12) **Due to a manufacturer's design flaw, the 3710 fiber optic communication modules did not work well at high temperatures. These have been returned to Optelecom for the required modifications to correct the design deficiency.**
- (13) **The reader head, video microscope, temperature control, and frame grabber boards were not conformal coated. These boards are now conformal coated for added environmental protection.**

The following hardware modifications were proposed for the UR system, but have not been implemented. A brief note explains why each item has not been included in the UR system at this time. Many of these changes could have been made if time and money had been available.

- (1) **It was suggested that the microscope's buttons be reversed (so they would have the same pattern as the reader head's) and be placed on top of the microscope's shroud. This would have required redesigning the shroud and procurement of more switches.**
- (2) **Although a single jig to replace the three used in the system would reduce the number of components, the additional design effort would be too costly for now and may not be effective.**

- (3) Operators with glasses complained that too much ambient light entered the video monitor eyepiece. This can be corrected by taking off the glasses or by putting edge shades on them.
- (4) A jig lanyard was suggested, but the design team sees this as just another part to keep track of and one of questionable utility.
- (5) Some suggested that separate belt box connectors be provided for the reader head and microscope. Another connector on the belt box would mean at least a rewiring job and, more likely, a redesign. Time and cost preclude either at this time.
- (6) One operator complained that the belt box clip did not work well. However, the consensus was that the clip worked adequately as is. It can be clipped over a belt if desired.
- (7) One operator thought that a side tone in the headsets would be useful. However, neither the headsets nor the 3710 fiber optic communication modules have a side tone capability and the consensus was that they work well as is.
- (8) Some operators thought the headset should be made more comfortable. This cannot be done without a new headband or a completely new headset. Replacement of the headset could be accomplished at any time if necessary.
- (9) It was suggested that there should be some type of feedback to tell the operator that microscope lights were on. However, the operator already knows he has four lights on at default and can turn the microscope around and look at the lights for information at other times.
- (10) It was suggested that a camera with a variable focal length would be useful. This would require a system redesign.

- (11) It is desirable to provide a black background for microscope images. This can be provided by holding a black cloth behind the tag/seal being imaged.
- (12) It was suggested that a microscope comments capability be provided and that the comments be stored in the image files. It was concluded that the software effort to achieve this would be too great at this time.
- (13) Adding a frame to the man pack was rejected because it would make the pack difficult to wear under a coat and be too rigid for comfort.
- (14) Lighter, more flexible cables for the reader head would be very difficult considering the environmental and shielding design issues. They would be cost prohibitive for now.
- (15) A suggestion of acquiring better monitor display and resolution was based on one system's monitor problem. The problem was identified as a low power budget on the fiber optic link on the one system. This problem has been corrected.
- (16) One individual suggested that the system be modified so that it can be operated by one person. The system can be operated by one person if the computer is placed near the tag/seal being investigated. However, the client driven design philosophy was to provide for remote operation and this requires a two person team. A one person system has been implemented by designing a direct reader head connection to a laptop computer used for demonstrations.

4.4.5.2 Software Modifications. The suggestions for changes to the system's software came from the same sources as those who provided the hardware ones. Changes that have been implemented are described first, followed by changes that were not implemented because of dollar and time constraints, system incompatibility, or because the ability to meet the requirement can be met by other means.

- (1) Reversed position of data display windows to make displays less confusing to the equipment operator.
- (2) Provided a flashing visual cue on monitor to tell operator that system was awaiting data input.
- (3) More abort capabilities were added so that the operator was able to abort more conveniently.

The test participants also requested several other software changes that were not implemented, but would benefit the equipment operator if added.

- (1) Operator would like the opportunity to rename the image file.
- (2) Operators requested that non-essential keys be inactivated during processing .
- (3) Operators also liked the idea of using "Y" for Yes and "N" for No instead of the <RETURN> and <ESC> keys.

4.4.5.3 Software Utilities. To assist inspection of tags for tamper detection, a number of computer programs were adapted or developed. The primary technique implemented is termed a "blink" comparison. This is accomplished by alternately displaying a reference (baseline) image and an inspection image on a video monitor at high speed. Appendix G to this report, "Utility Programs Used for Blink Comparator Process," describes the programs involved and gives general operating procedures. The primary programs used are BLINK1 and BLINK2. BLINK1 helps compare an archived (recorded) reference image of a tag to a "live" image seen by the camera. BLINK2 compares a recorded reference image to a recorded inspection image taken at a later time.

By rapidly switching (more than once per second) the reference and inspection images on a display, any differences (either gross or subtle) between the two images appear to "blink" on and off thus calling attention to themselves visually. This technique is similar to the optical "blink comparator" developed by astronomers in the late 1800s for finding subtle differences in photographs of star fields to identify variable stars, moving asteroids, planets, novae, etc. (Pluto was discovered by Clyde Tombaugh in January 1930 using this type of device). The visual similarity of RP tags and star fields suggested this approach that has proved to be quite sensitive to very small differences due to the capability of the

human eye to detect apparent motion and slight fluctuations in intensity. The blinker software in its current form can be looked at as a simple two-frame animation sequence where any change in intensity or position of reflective particles, rope, matrix, etc. is made more obvious than a simple visual inspection.

The blinker software was found to be very useful in confirming an inspector's detection of tampering or training inspectors to recognize tampering, but was not used as the primary tool (to replace simple visual inspection) due to the time (approximately two minutes) needed to exit the UR software, set up the commands to run the blinker software and then return to the UR software, as well as the lack of testing of the blinker system under field conditions. All cases (to date) where SLITS tags were examined by BDM for possibility of tampering, it took approximately the same amount of time to find the tamper evidence by simple inspection. To enhance it's usability, the blinker technology could be merged into the UR software to speed up its application. Further enhancements to make it an even more useful tool would be:

- (1) Addition of more precise image alignment before display**
- (2) Use of false color display to enhance small intensity differences**
- (3) Use of more capable frame-grabber board to increase blinker speed**
- (4) Allowing more than two frames to be displayed in the animation sequence to allow the visualization of a tag's "history". This would permit evaluation of environmental affects as well as tamper attempts on a tag that remains in place over a long period of time (through multiple inspections).**

SECTION 5
COMMERCIALY-DEVELOPED SYSTEMS

5.1 VARIABLE CODING SEAL SYSTEM - SERIES ASSESSMENT.

5.1.1 Overview.

The VArIable COding Seal System-Series (VACOSS-S) active, reusable, battery powered electro-optic seal is presently in use by the International Atomic Energy Agency (IAEA). The seal consists of a fiber optic cable attached at both ends to a seal case forming a loop. A light pulse is generated by the seal case and transmitted in one end of the fiber optic cable at either 125 millisecond (8/sec) or 250 millisecond (4/sec) intervals. When that pulse is not detected at the other end of the cable, a tamper event is recorded. In addition to the seal and fiber optic loop, system hardware consists of a palm-held reader (HP-95LX) and a serial interface unit used to link the reader with the seal.

In accomplishing its assessment of the VACOSS-S, BDM conducted functional and environmental tests and also evaluated the systems capability to operate under field conditions. In general, the VACOSS-S meets the manufacturer's specifications and operates as expected. One of the seals that underwent rain and salt fog environmental testing experienced corrosion problems with the fiber optic loop connectors and subsequent difficulties with loop tamper event recording. In addition, one of the two models of lithium batteries used to power the seal failed prematurely. Both of these problems are being addressed by Aquila Technologies Group, Inc. (Aquila) in a modified version of the seal.

5.1.1.1 Documentation Produced. The following list of documents represents those delivered to DNA during the VACOSS-S assessment.

- (1) Functional Test Plan for the Variable coding Seal System-Series (VACOSS-S), April 1992
- (2) Functional Test Report for the Variable coding Seal system-Series (VACOSS-S), August 1992.

5.1.1.2 Expenditures. The VACOSS-S assessment effort began on January 21, 1992, and was completed when the final report was delivered in August 1992. The following table (table 5-1) lists the labor hours, the associated loaded labor costs (without fee and tax) plus the ODC's expended during conduct of the VACOSS-S assessment.

Table 5-1. VACOSS-S expenditures.

TI	Hours	Loaded Labor Costs	ODC's	Total Costs
FY91-13	2,382	\$127,952	\$21,436	\$149,388

5.1.2 Schedule.

Figure 5-1 depicts the schedule followed to perform the VACOSS-S assessment under TI FY91-13.

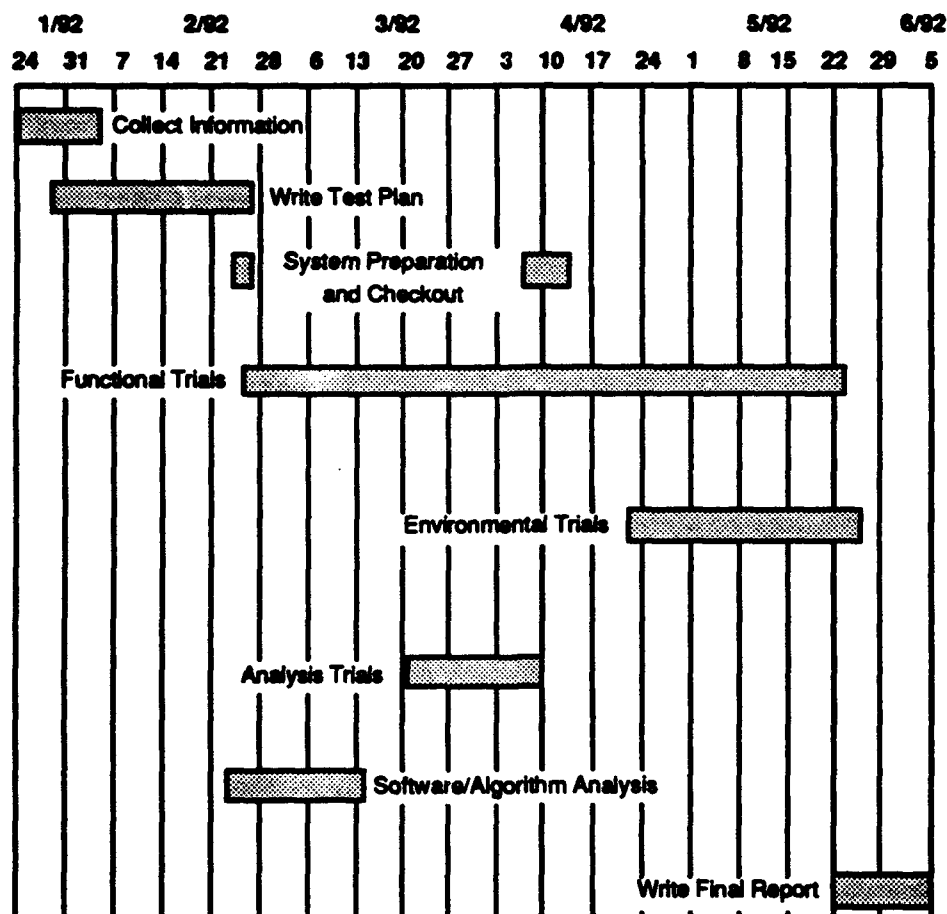

Figure 5-1. VACOSS-S schedule of activities.

5.1.3 System Description.

The VACOSS-S is an active, CPU-based tamper detection device. It is intended for high reliability, long duration surveillance in those applications that require periodic access. The VACOSS-S has four major components: a seal case, a fiber optic loop cable, a prototype serial interface unit connecting the reader and the seal, and a reader that is an HP-95LX palm-held computer with a special serial interface and software. Figure 5-2 shows the VACOSS-S.

The VACOSS-S incorporates tamper detection for both the seal box and the fiber loop. If the seal box is opened, the message "Seal Box Opened" with the date and time appears on the reader display when the seal is interrogated. Also, any opening or breaking of the fiber optic loop will be reported with the date and time, when interrogated.



Figure 5-2. The VACOSS-S.

5.1.4 Activity Description.

On January 21, 1992, DNA tasked BDM to perform an assessment and conduct an FT&E of the VACOSS-S under TI FY91-13. The BDM FT&E evaluated the VACOSS-S based on the manufacturer's specifications and the requirements provided in the *Environmental Specification for the Strategic Arms Reduction Treaty (START) Verification System*.

Beginning January 24 through the beginning of March 1992, data about the VACOSS-S was collected and the Functional Test Plan was written.

5.1.5 Results.

In general, the VACOSS-S meets the manufacturer's specifications and operates as expected. Each of the test seals recorded and reported the induced tamper events accurately when initially checked out. Those seals that were subjected to the varying functional environments continued to function during both the hot and cold cycles. The majority of the seals subjected to the environmental trials done at Wyle Laboratories, such as fungus exposure, rain, dust, etc., also continued to function properly.

Seal SN0020 did not pass the post-test verification check after it was returned from Wyle to BDM. This seal was subjected to two of the harsher environments, first rain and then salt fog. The seal showed rust on the connector springs and inside the connectors. Since it passed the post-trial Standard Operating Test (SOT) at Wyle, it can only be speculated that the corrosive effect continued to degrade the performance of the seal. By the time it was shipped back to Albuquerque, it was experiencing serious problems. When the fiber was opened to induce a tamper event, the seal recorded multiple tamper events when, in fact, only one occurred. The number of tamper events recorded varied with the amount of time the fiber optic loop was left open. This problem of multiple recorded events did not occur when a box tamper event (rather than a loop tamper event) was induced. Additional testing and analysis is required to determine the exact effect of the corrosion which caused this problem.

The other area that requires further investigation, as it affects the long term expected operability of the seal and reader system, is the battery issue. Realizing that during the FT&E, the seals were read in a shorter time than they would be read in fielded operation, the batteries still require further testing and evaluation. The batteries used in the seal itself and the serial interface adaptor between the reader and the seal caused several delays during testing. Often there would be no low battery indication, but the system would experience failure. The failure would, however, be intermittent and difficult to diagnose. When trying to diagnose the problem by measuring the battery voltage, it would measure 3.5V or greater. This is an acceptable charge voltage; however, during operation, the battery failed. This battery uncertainty should either be corrected or there should be established guidelines for operator use in the field that provides a quick diagnosis and solution to the problem.

5.1.5.1 Hardware.

Seal and Fiber Optic Loop. Both the seal case and the multi-mode glass fiber optic loop proved durable during the extensive handling at BDM and Wyle. The seal case was routinely opened as part of the SOT and the fiber optic loop was frequently disconnected and reconnected.

As currently designed, the fiber optic connectors allow for easy opening and closing of the fiber optic loop. The fact that the securing nut is part of the seal connector and the threaded shaft is part of the fiber optic loop enabled trouble-free operation throughout the FT&E test sequence.

The seal case has a two-position threaded shaft which secures case closure. The first position is intended to permit easy battery replacement and the second position allows complete removal of the case. On the first unit received (SN0016), it was very difficult to replace or remove the batteries when the seal case was opened only to the first position. This seal case generally required complete removal for battery replacement. It was later determined that the battery bracket was installed improperly in this unit.

HP Reader and Prototype Serial Interface Unit/Cable. Since both the new version HP-95LX palm-held reader and its Dornier predecessor were used

during the test, it was possible for some comparisons to be made. One advantage of the new reader is that it's smaller and more versatile than the Dornier predecessor.

Both of the readers have a serial adaptor interface to the seal. In the Dornier design, it is internally integrated with the reader. The HP-95LX reader used the prototype serial interface unit. When the seal is interrogated by either of the readers, the reader provides the battery power for seal operation. Both the Dornier reader and the Prototype Serial Interface Unit use the same type batteries as used in the seal, to provide the serial interface with the correct supply voltage. There are indications of a current draw on the seal batteries when either reader extracts the data.¹ This was measured during the FT&E in an effort to determine why the batteries were failing. There is further discussion of this problem in the following section.

Aquila provided BDM with several serial interconnect cables of different lengths for testing support. The cables were 24 inches and 10 feet in length. The longer cable was required for temperature testing to remotely access seals that were in the chamber. There were no problems with the short cables, but the 10 foot cable had some communication errors due to twisted wires inside the cable connectors. This cable was not the same design that Aquila would normally provide for routine operation so it does not represent any system deficiency. These difficulties were easily corrected and the cable was used throughout the temperature tests.

Batteries. The system batteries were a problem during the test. The first seal delivered contained SAFT size AA lithium batteries. These same batteries were used in the Dornier reader, in the prototype serial interface unit connecting the HP-95LX reader to the seal, and were supplied as two spare

¹ **Note:** The seal batteries normally draw a nominal 45-80 μ A during operation. During a seal data read using the Dornier reader, the seal draws its power from the reader, not from its own batteries. If the seal is connected to the Dornier reader but no read access is occurring, the seal is self-powered. When the seal is connected to the HP-95LX reader, the seal batteries draw only 10 μ A, because there is power supplied by the serial interface unit. This draw is constant whether or not a read access is being accomplished.

batteries. These represented eight of the 20 original AA batteries used for testing. The remaining batteries (eight in the other four seals plus four spare batteries) were manufactured by Tadiran. The seal with the SAFT batteries was Part Number VS001 Rev A, while the seals with the Tadiran batteries were Part Number 010AS-01. This information may have bearing on future analysis of the test data.

Of the original eight SAFT batteries, only two functioned throughout the entire test process. Most failed due to a feature unique to lithium, inorganic batteries. A passivation film of lithium chloride develops on the anode that causes internal ohmic resistance. Passivation is a voltage delay phenomenon that occurs when the operating voltage of the battery slowly recovers after a load is applied. This load, as was mentioned earlier, was measured when the reader was connected to the seal to extract the data. The SAFT batteries did not always recover completely. Of the original eight batteries, only three measured more than one volt open circuit after the test process. The twelve Tadiran batteries also experienced slow recovery problems; however, all twelve were fully functional during this test.

During the FT&E, the VACOSS-S seals were probably read much more often than would be the case in an operational scenario. Every time either reader is used to access the data in the seal, there is a large seal battery current draw, or load ($>300 \mu\text{A}$). Five of the SAFT batteries now have no measurable output at all and were expected to last two years or more in an operational environment. It may be that the SAFT batteries could not fully recover from this frequent intense load. The Tadiran batteries also experienced some voltage fluctuations causing a "low battery indication" on the seal. When these batteries were removed from the seal and the output was measured, voltage recovery could be observed using a digital volt meter. On two occasions, the voltage initially measured 3.1 VDC on batteries that gave "Low Battery" indications. Over a period of two to three minutes, the voltage returned to 3.6 VDC, the normal operating voltage for these batteries.

5.1.5.2 Software. BDM had the opportunity to use not only the current version of the VACOSS-S reader software, but also the original Dornier reader version. The current PC-based system was more user-friendly. Its menus and hierarchical

structure were easily understood and quickly learned. Also, more data are available with the new software. For example, the Dornier reader made no attempt to report event times after a seal box opening. The HP reader does report the time deltas of events that occur after a seal box opening. Since the palm-held also gives the operator the power of an MS/DOS machine, the upgrade capabilities are extensive. One could envision a database management system resident on the reader that could log an operator's entire inspection day.

Another advantage for the new reader is the fact that the software is written in the higher order C language, and can be executed on a normal desktop system if required. It should prove to be more easily maintained and upgraded, though these issues were not part of the FT&E and were not addressed in this VACOSS-S test report. There are some modifications that might be considered, but overall, the software functioned as designed. These suggested software modifications are discussed in the following section. They pertain more to how the system can or will be operated than they do to the capability of the software.

5.1.5.3 Operability.

Hardware. The VACOSS-S seal generally operated without difficulty. Opening and closing the fiber optic loop was easily accomplished under all conditions. However, connecting the seal interface unit to the seal was not as trouble-free. The LEMO-style, 4-pin connector used for this connection is required by IAEA for interface compatibility with other units they employ. The interface connection to the reader caused no problems, but aligning the connector ends to the seal was difficult. Additionally, connecting the cable to the seal requires dexterity because of the tight clearance between the fiber optic connector and the serial interface connector. In a field environment where the operator might be wearing gloves, this could be especially difficult.

During exposure to sand, dust, rain, and fungus, the environmental seal on the LEMO connector leaked. The leakage resulted in a thin film of dust or rust that made it difficult to connect and disconnect the cable. The seal still functioned normally, so the difficulty was more mechanical than electrical.

Software. Currently, when a seal box tamper occurs, any fiber optic loop tamper event stored in the seal is lost.² The software currently indicates the seal box tamper by setting a default password and recording the date and time of the tamper. From this record on, any future fiber loop tampers are recorded with a delta time indicating how much time had passed between the seal box tamper that caused the reset and the event that just occurred. When these delta times are being recorded after a box tamper, the system no longer reports the correct date.³ These reported delta times are an improvement over the Dornier capability, that made no attempt to report event times after a seal box tamper. It would appear beneficial, however, to retain data regarding any loop tamper event recorded prior to a seal box tamper event. One approach would be to not reset the event log and password at all. Simply record a seal box tamper like any other tamper event and report them as such. This would provide a complete chronology of the events when the seal is read.

The software currently allows the operator, under the "Read Seal Data" menu, access to the encrypted data without password knowledge.⁴ Encrypted data should only be available to an operator with the password privilege.

Finally, it would be useful if the seal serial number was included in the displayed information when decrypting the encrypted data, thus enabling an operator to verify that the correct seal is being read.⁵

² **Note:** According to Aquila, this is a function of the seal software design. Changes to the seal software are not straightforward, but are under consideration.

³ **Note:** Aquila has determined this may be a software bug in the VACOSS-S reader.

⁴ **Note:** The software can be changed not to display the encrypted data until a password has been entered.

⁵ **Note:** The seal ID is not stored as part of the encrypted data making it impossible to know what seal it came from. Changing this would again require modification of the software in the seal itself.

5.2 MIKOS PROCESS ASSESSMENT.

5.2.1 Overview.

The MIKOS process is based on using the image of a random, complex mosaic, applied tag to create a reference image. The reference image is subsequently compared to the applied tag to establish the identity of the tagged object, assuming that the applied tag has not been transferred to another object. Overlaying the reference image on the tag or a positive image of the tag results in a visual phenomenon that MIKOS calls the Flash Correlation Artifact (FCA). The FCA is a type of Moire pattern that appears when the reference image transparency is brought into near registration with the tag or its positive image.

Unfortunately, MIKOS would not permit BDM to have access to proprietary data that would permit a full assessment of the MIKOS concept. The limited BDM assessment did conclude, however, that, pending further analysis addressing the vulnerability of the process to counterfeiting or transfer and the determination of acceptable ranges of values for tag particle parameters (e.g., size, shape, specular reflection, etc.), the process might have potential as an inexpensive tagging concept.

5.2.1.1 Documentation Produced. The report "MIKOS Process Assessment," March 18, 1992, was produced under this task.

5.2.1.2 Expenditures. The MIKOS process assessment effort began on October 24, 1991, and was completed when the final report was published in March 1992. The following table (table 5-2) lists the labor hours, the associated loaded labor costs (without fee and tax) plus the ODC's expended during the conduct of the MIKOS assessment.

Table 5-2. MIKOS process assessment expenditures.

TI	Hours	Loaded Labor Costs	ODC's	Total Costs
FY91-15	487	\$24,167	\$81	\$24,248

5.2.2 Schedule.

Figure 5-3 outlines the schedule followed to perform the MIKOS Process Assessment under TI FY91-15.

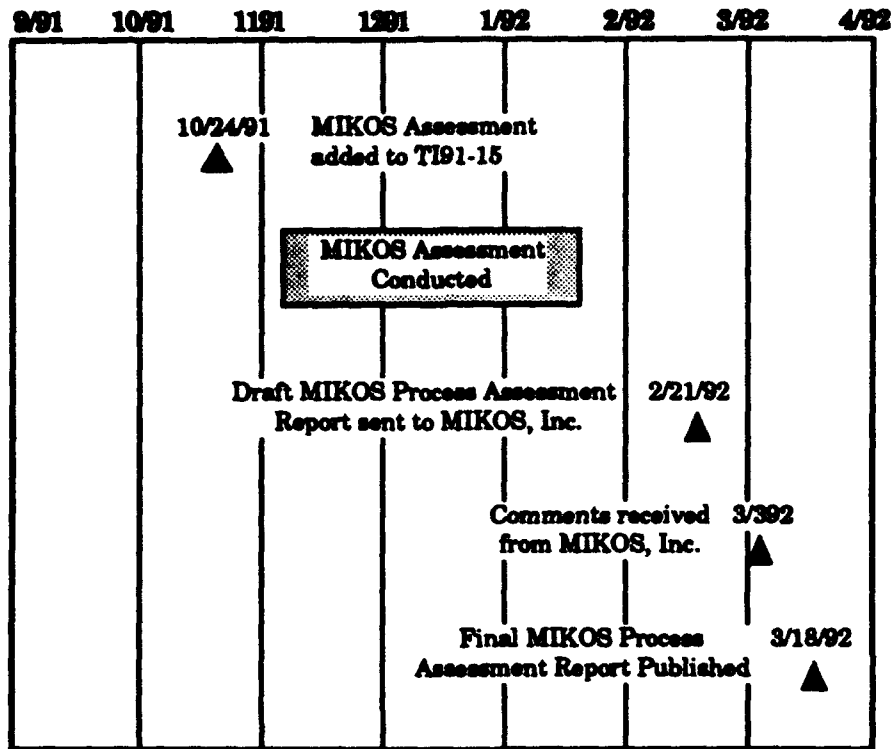

Figure 5-3. MIKOS process assessment schedule.

5.2.3 System Description.

In the MIKOS process, a physical surface (tag) is constructed for a controlled item by affixing a random distribution of particles by size and groupings on a contrasting background. The tag then serves as a reference image field that is the basis for test images. Test images are created using photographic or computer scan techniques. A test image is overlaid on the reference image to create a compound image that shows Moire-like patterns when the images are close to being aligned; These patterns being called FCAs by MIKOS developers. The important property of the FCA is that its appearance is dependent on the similarity of the reference surface and the test image. If the image fields are identical, the FCA is most visible. Thus, when a MIKOS type tag placed on a controlled item is overlaid by a test image created from it, the FCA

phenomenon can be used to show if the tag is the original one or not. Figure 5-4 is an FCA created by overlaid images showing the Moire pattern.

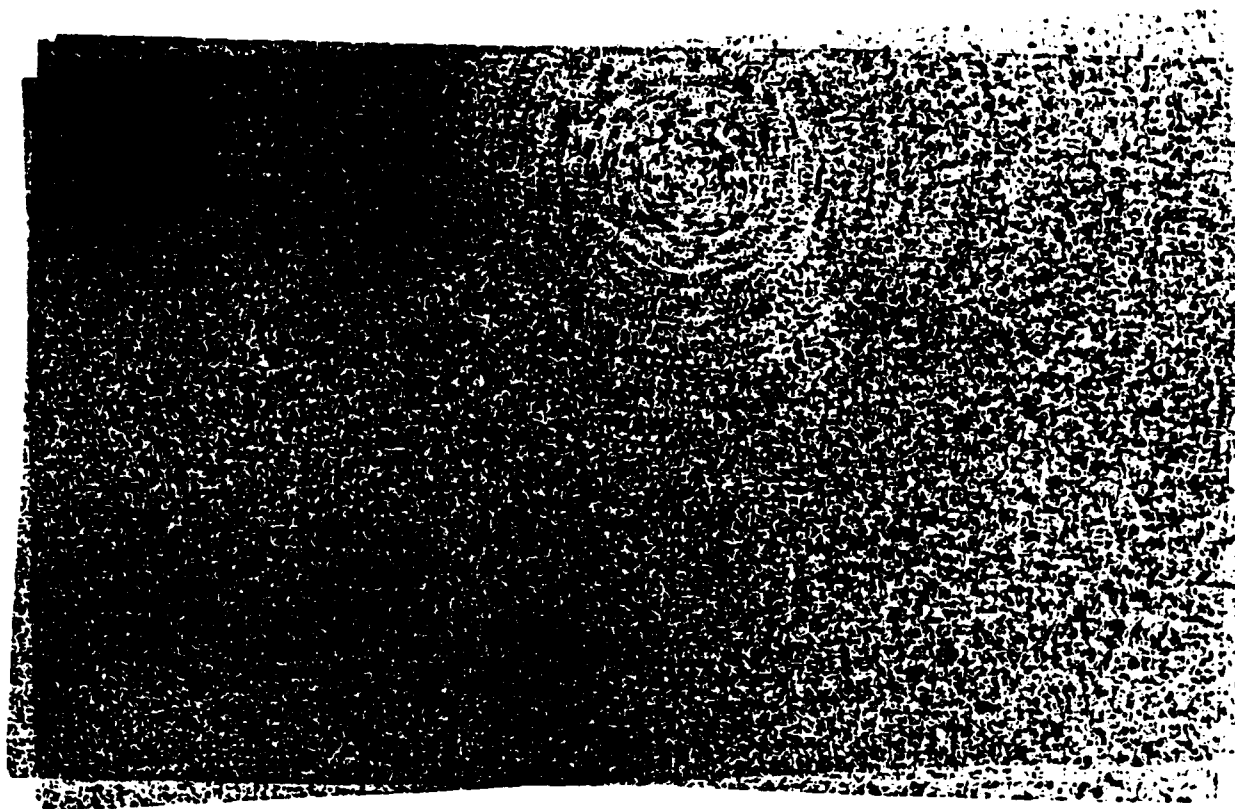

Figure 5-4. Example of an FCA showing the Moire pattern.

The methodology for producing FCAs using two similar images has been demonstrated. However, the additional developmental work listed in paragraph 5.2.5 below must be completed before the concept can be used in the field.

5.2.4 Activity Description.

On October 24, 1991, DNA tasked BDM to assess the MIKOS process to determine its potential use as a tag for treaty verification. BDM was provided samples, and descriptions for concept evaluation by MIKOS, Inc. Since MIKOS, Inc. is a private company and considers the process to be proprietary information, BDM was required to sign a non-disclosure agreement prior to beginning the

assessment. However, the restrictions imposed by MIKOS, Inc. constrained the experimental evaluations that BDM could perform.

Two types of experiments were conducted to help assess the properties of the MIKOS process and tags. The first set of experiments concerned the creation of data sets in a computer. These data sets were subsequently used to create image transparencies for testing the MIKOS process. The second set of experiments concerned the creation of physical tags. The physical and computer-based tag operations complemented each other and helped to provide a broader understanding of the MIKOS process and operations.

Upon completion of the assessment, BDM documented its results in a report (see paragraph 5.2.5 below). BDM provided a draft copy of the report to MIKOS, Inc. for comment prior to publication. All work for the MIKOS process assessment was accomplished under TI FY91-15.

5.2.5 Results.

BDM's assessment of the MIKOS process was limited since MIKOS, Inc. is a private company and considers the process to be proprietary information. The restrictions imposed by MIKOS, Inc. because of this factor constrained the experimental evaluations that BDM could perform. The conclusions and recommendations of BDM's limited assessment follow:

5.2.5.1 MIKOS Assessment Conclusions. The combination of a reference image overlaid with its positive, Xerox-generated test image transparency was the best method BDM found for producing the most apparent and easily obtainable signature, the FCA. Although the computer exercises confirmed the ability of the MIKOS process to encode messages into image data that are sufficiently dense, message signatures are not only more difficult to obtain and read than the FCA, but are computer-dependent, and therefore, compete with other computer-dependent tagging techniques that are more reliable and secure. Scanner imaging systems were also rejected because they are computer-dependent. The use of multiple overlays to obtain a message was found to be technically unattractive and have no operational value. Biometric methods of tag

identification, such as retinal scans, palm and fingerprints were also rejected as not compatible with the FCA signature.

Overall, the FCA, for the images examined, showed reasonable tolerance to displacements, rotations, and relative scale of the reference and test images. The results for the physically-generated MIKOS surfaces, and photographic images did not show the same degree of readily visible FCAs as the computer-generated images. The marginal results with photographic images, however, strongly contrasted with the easily visible FCAs when physical surfaces were overlaid with Xerox-generated test images. The test exercises were not sufficient to determine the parameter ranges of the tolerance values and the reference surface and test image conditions that promote the appearance of the FCA, while minimizing the possibility of counterfeiting.

On the basis of BDM's experiments and analyses, BDM believes that the MIKOS process, in the form of the FCA produced by a three-dimensional reference surface and a Xerox positive transparency test image, may demonstrate potential for an inexpensive and counterfeit resistant tagging system. However, as indicated in the following section, considerable work remains before this potential can be realized.

5.2.5.2 MIKOS Assessment Recommendations. Although computer-generated tags using the MIKOS process have the advantage of being relatively easy to create and analyze, their ease of creation raises serious doubt concerning the resistance of computer-generated tags to counterfeiting. Beyond this assertion, BDM's work does not directly address questions about the reproducibility of MIKOS computer-generated tags. Rather, BDM's work here was primarily concerned with two issues. The first issue was to confirm some of the attributes of the MIKOS tags. The second issue was to get some sense of the behavior of the FCA phenomenon, and the parameter sensitivities of the MIKOS process. The computer-generated tags allowed a more quantitative approach to these issues, than was afforded by the physically-generated tags. The hands-on exercises were also important since MIKOS only provided descriptions of the logical operations to encode messages in the tag. There were, however, no quantitative descriptions of the ranges of parameter values that could be used to construct tags. The MIKOS data left the following questions about the process unanswered:

- (1) What is the precision and accuracy of the pixel elements for the FCA to be readily visible? To assure the appearance of the FCA requires that the pixel element density and pixel spatial and intensity distribution of the tag be known.
- (2) Is there image stability and robustness to environmental influences when dealing with a physically created tag? Computer simulations with different tag parameters can help determine limits on tag characteristics. These limits must then be related to the expected environmental influences to which a tag is likely to be exposed. These factors may also be important in terms of tags that might be subject to frequent examination with test images.
- (3) What image dimensionality and information content is needed as they relate to the uniqueness of the tag and its potential resistance to tampering and counterfeiting?

Computer-based models of the MIKOS tagging process and use can help provide answers to these questions. In addition, subsequent computer-based analyses could help determine the operational scenarios, and associated logistical procedures, and program cost to use the tag effectively.

The questions listed above discuss the basis of the work necessary to thoroughly evaluate the MIKOS process. The specific tasks are outlined below.

- (1) Define the expected operational use of the MIKOS process
- (2) Obtain MIKOS approval for in-depth duplication and testing of the process without restraints
- (3) Resolve the issues concerning the three-dimensional properties desired for tags and the MIKOS process (e.g., what makes them unique or difficult to counterfeit)
- (4) Objectively measure the qualities of the reference tags and test images in terms of pixel densities, distributions, and intensities that are associated with specified probabilities of tag identification for combinations of false and true test image acceptance and dismissal

- (5) Use the quantitative data to determine the image characteristics that are present when like and unlike reference and test images are read**
- (6) Quantify the properties of the FCA in terms of the spatial and intensity correlation properties of the reference and test image**
- (7) Quantify the presence of the FCA in terms usable for computer assessment to support objective analyses of the MIKOS process**
- (8) Determine the environmental sensitivities of the MIKOS process "three-dimensional" tags, and determine how they affect the field utility of MIKOS tags.**

If the decision is made to proceed with the development and evaluation of the MIKOS tag concept, BDM recommends a cooperative effort with MIKOS to optimize the non-reproducible tag in terms of particle size, shape, concentration, and reflectance, matrix material, overlay medium, tag construction, reading illumination, tamper detection and registration procedures. This effort could also provide operational assessments of the MIKOS tags.

SECTION 6
SUPPORTING STUDIES / DEVELOPMENTS

6.1 STANDARDS AND SPECIFICATIONS DEVELOPMENT.

6.1.1 Overview.

On June 1, 1990, BDM delivered to DNA a proposed "Environmental Specification for the Strategic Arms Reduction Treaty (START) Verification System." This specification was based on the requirements specified for equipment associated with the Peacekeeper Rail Garrison System and MIL-STD-810, *Environmental Test Methods and Engineering Guidelines*. The initial objective of this effort was to develop a set of environmental specifications applicable to the RPT system. These specifications were later broadened to include performance requirements and environmental specifications for all tagging systems designed for use in START verification.

In April 1991, after evaluating several tagging concepts for START, and taking into consideration the uncertainties associated with the eventual inspection protocols that would govern the use of tags and seals in any arms control agreement, BDM recommended to DNA that several of the more severe environmental specifications be modified. These modifications would permit the consideration of more COTS components, and avoid disqualifying some concepts prior to determining the nature of the environment that the treaty provisions would specify for that concept's use. These modifications have been approved by DoD agencies and were published in January 1993.

6.1.1.1 Documentation Produced. Several specifications, briefings and other documents were generated during the course of TI FY90-03. These include:

- (1) Drafts of the RPT specific, and generic verification specification were produced and circulated in late 1989 and the Spring of 1990. The RPT-specific document is the "Draft Environmental Specification for the Reflective Particle Tag (RPT)," dated December 31, 1989. The generic

document is the "Draft Environmental Specification for the Strategic Arms Reduction Treaty (START)," dated January 31, 1990.

- (2) The document, "Reflective Particle Tag Environmental Specification Rationale," was produced on December 21, 1989.**
- (3) An environmental specification briefing was included in the February 5, 1990, RPT Program Review and an updated specification, "Draft Environmental Specification for the Strategic Arms Reduction Treaty (START) Verification System," February 15, 1990, was circulated following this review.**
- (4) The approved baseline specification, "Environmental Specification for the Strategic Arms Reduction Treaty (START) Verification System", (BDM/ABQ-90-0492-TR), was published on June 1, 1990.**
- (5) A recommendation to modify the baseline specification was presented in April 1991. This recommendation went to OSIA for comment on May 16, 1991. OSIA approval was received on June 11, 1991.**
- (6) A response to the SAIC/CVR comments (dated June 24, 1991) on the recommendations for modification was published on July 24, 1991.**
- (7) The environmental specification decision paper was sent to DNA on July 30, 1991.**
- (8) A complete coordination package was prepared in December 1991 and forwarded to DNA for formal coordination.**

6.1.1.2 Expenditures. The Environmental Specification tasks performed under FY90-03 began in February 1990 and continued through June 1991. The small efforts performed before or after those dates supporting environmental specification development tasks were accomplished under other TIs. The following table (table 6-1) lists the labor hours, the associated loaded labor costs (without fee and tax) plus the ODC's expended during the conduct of the environmental specification development efforts under FY90-03 only.

Table 6-1. Environmental specification expenditures.

T I	Hours	Loaded Labor Costs	ODC's	Total Costs
FY90-03	263	\$12,478	\$423	\$12,901

6.1.2 Schedule.

Table 6-2 below depicts the key events associated with this effort.

Table 6-2. Environmental specification schedule milestones.

Date	Milestone
November 1989	Work began on the environmental specification as part of the draft RPT Transition Plan. (FY90-01)
December 21, 1989	BDM published the "Reflective Particle Tag Environmental Specification Rationale" document. It was sent to DNA for review on January 11, 1990. (FY90-01)
December 31, 1989	BDM published the first Environmental Specification for the Reflective Particle Tag System. It was sent to SNL for review and comment. It was also forwarded to DNA on January 11, 1990. (FY90-01)
January 11, 1990	DNA requested that a generic specification be produced, in addition to the RPT-specific specification. (FY90-01)
January 31, 1990	A generic environmental specification was published and sent to PNL, SNL, and LLNL for comment. (FY90-01)
February 5, 1990	The specification parameters were briefed to DNA during a RPT Program Review. (FY90-01)
February 15, 1990	An updated generic specification was sent to the DOE laboratories for comment. (FY90-03)
April 15, 1990	Suggestions received from SNL were incorporated into the April 15, 1990 specification and were distributed for final review. (FY90-03)
June 1, 1990	The baseline version of the specification was published and sent to DNA and the DOE laboratories for use as a design requirements document. (FY90-03)
April 24, 1991	A BDM-developed modification recommendation and executive summary was sent to DNA for approval. (FY90-03)
May 16, 1991	BDM sent a modified generic specification to OSIA for review and comment. (FY90-03)
June 11, 1991	BDM received written approval from OSIA for the recommended modifications. (FY90-03)
June 24, 1991	SAIC/CVR sent DNA comments regarding BDM's recommendations for modifying the June 1, 1990 specification. (FY90-03)
July 24, 1991	BDM responded to the SAIC/CVR comments, forwarding the response to DNA. (FY90-13)
July 30, 1991	BDM sent DNA a specification change decision paper. (FY90-13)

Table 6-2. Environmental specification schedule milestones (concluded).

Date	Milestone
November 1, 1991	DNA received a letter from OUSD(A) requesting that the recommended changes be formally coordinated. The earlier OSIA approval letter dated, June 11, 1991, had been addressed to BDM directly. (FY90-13)
December 1, 1991	A new coordination specification was produced and a coordination package was forwarded to DNA to support OUSD(A) guidance. (FY90-13)
July 27, 1992	DNA sent the specification coordination package to OSIA for approval. (FY90-13)
October 1992	OSIA approved package. (FY90-13)
January 1993	Final OSD approval of revised environmental specification. (FY90-13)

Work associated with this effort was sporadic due to the nature of specification development. Draft specifications must be reviewed, in this case by several agencies, then updated to reflect the comments received. There were often unpredictable delays between activities.

6.1.3 Objective and Scope.

DNA and BDM recognized at program initiation that the START verification regime did not have established requirements or standards. So, as BDM prepared the RPT Transition Plan, a task was included (Task 7), to define the operational environment. The initial objective of this effort was to develop a set of environmental specifications applicable to the RPT system. This system was being developed primarily for tagging U.S. and Soviet mobile missile systems limited under START. The scope of this effort was later broadened to include all tagging systems developed for use in START verification.

6.1.4 Activity Description.

Based on DNA direction to proceed with the tasks called out in the RPT Transition Plan, BDM began the process of defining the verification environment. The first draft specification, published in December 1989, was RPT-specific. It contained tailored requirements that were generated using both the Rail Garrison Weapon System Specification and MIL-STD-810, *Environmental Test Methods and Engineering Guidelines*. The MIL-STD-810 defines worldwide environmental parameters for electronic equipment, so the use of this document provided the

expected Soviet Union environments. Tailoring these specifications was necessary as extensive use of COTS hardware was desirable. Time constraints and cost considerations precluded a lengthy and costly development process.

In January 1990, DNA requested that a "generic" tag specification be produced. In February 1990, DNA issued TI FY90-03, directing BDM to produce the generic specification for verification equipment. The specification was drafted and coordinated with DNA and the DOE laboratories (SNL, PNL, LLNL) for comment in April. SNL recommended some changes that were made and circulated in May 1990. The baseline version published in June 1990, stated that future changes to the June 1, 1990, approved baseline environmental specification were now under DNA change control. The specification was organized to conform to relevant requirements of a Type C product specification. This was done to facilitate development of a product specification to support a procurement package, when appropriate.

Since the tags might be affixed on a TLI (a benign environment) or be affixed externally to a canister as a seal (a harsh environment), the specification addressed both situations. The reader system could be protected, so the harshest environments of MIL-STD-810D were modified. For example, the coldest temperature environment expected in the Soviet Union was -60°F. Obviously, specifying that temperature would require a major redesign of existing COTS hardware, and would increase costs significantly. In addition, it is unlikely inspectors would take readings in that environment. Consequently, the specification for the temperature at which the verification equipment must survive and operate was changed to -20°F. If colder temperatures were experienced, protective measures would have to be employed.

On April 24, 1991, BDM, in a paper to DNA, proposed modifications to the June 1, 1990, specification. These changes were suggested to better take advantage of COTS equipment. These recommended changes were also sent to OSIA for their comment on May 16, 1991. OSIA responded on June 11, 1991, agreeing with these changes; SAIC/CVR provided their comments to our recommendations in a June 24, 1991, letter to DNA. On July 24, 1991, BDM responded to the SAIC comments.

On July 30, 1991, BDM sent an environmental specification point paper to DNA for HQDNA and OUSD(A) consideration. The specification was formerly updated and provided to DNA for coordination on December 1, 1991. These changes were briefed to the DOE Tagging Liaison Group (TAGLAG) with favorable results by a representative from CVR. On July 27, 1992, DNA sent this package to OSIA for comment; OSIA then provided formal approval of the revised specifications in October 1993, and in January 1993, these specifications were approved for use by OUSD.

6.1.5 Conclusions and Recommendations.

The December 1, 1991, version of the Verification Environmental Specification continues to be the baseline specification. It was used to test the UR, SLITS, and RPT-2 (the improved SNL adhered tag). This specification has had wide acceptance and it appears to be appropriate for these applications.

Development of standards and specifications for a system when the specific application and operating environment is, to a large degree undefined, presents the developer with a significant challenge. While at the onset of the Tagging RDT&E effort, the U.S. proposals for tagging in START provided a reasonable basis upon which to develop such specifications; subsequent changes in both U.S. and Soviet attitudes towards the use of unique identifiers left the issues of application and operating environment very unclear. In such a situation it appears reasonable to limit the scope of specifications to only those that are necessary to clearly define what is expected of a laboratory prototype for demonstration of proof-of-concept. As specifics of the application and the operating environment begin to emerge, specifications for the field employment equipment can be developed; the costs of over/under design can be avoided, and if available, suitable COTS equipment can be used in lieu of the costly and time consuming process of design, development, and testing of customized equipment. Table 6-3 shows the results of the environmental specification for START.

Table 6-3. Results of the environmental specification for START.

Parameter		Storage/Transport	Operating
Temperature	Equip	-60°F to 160°F	14°F to 122°F
	Tag	-60°F to 160°F	-60°F to 160°F
Altitude	Equip	up to 45,000 ft	up to 11,000 ft
	Tag	up to 45,000 ft	up to 11,000 ft
Relative Humidity	Equip	100% @ 85°F	90% @ 85°F
	Tag	100% @ 85°F	90% @ 85°F
Fungus	Equip	MIL-STD-810, 508.3	MIL-STD-810, 508.3
	Tag	MIL-STD-810, 508.3	MIL-STD-810, 508.3
Salt Fog	Equip	4-6% MIL-STD-810, 509.2	N/A
	Tag	4-6% MIL-STD-810, 509.2	4-6% MIL-STD-810, 509.2
Acceleration	Equip	See Shock	See Shock
	Tag	See Shock	See Shock
Vibration	Equip	MIL-STD-810, 514.3, Cat 1	N/A
	Tag	Rail Garrison Vibration	N/A
Shock	Equip	MIL-STD-810, 516.3 Proc I, III, VI	N/A
	Tag	MIL-STD-810, 508.3, Proc VIII	N/A
Lightning	Equip	N/A	N/A
	Tag	Rail Garrison, extreme rise time 2Ms	N/A
Rain	Equip	N/A	N/A
	Tag	MIL-STD-810, 506.2, Proc I	N/A
Ice	Equip	N/A	N/A
	Tag	MIL-STD-810, 521.0	N/A
Sand & Dust	Equip	N/A	N/A
	Tag	MIL-STD-810, 510.2	N/A
Solar Radiation	Equip	N/A	N/A
	Tag	MIL-STD-810, 505.2	N/A
Winds	Equip	N/A	N/A
	Tag	Rail Garrison W.S. Spec 132 feet per second steady 154 feet per second gusts	N/A

6.2 CONVENTIONAL FORCES IN EUROPE (CFE).

A number of tagging concepts and verification techniques examined for possible application to START also had potential for use in CFE. Accordingly, DNA tasked BDM under four different TIs to examine and report on specific tagging issues in the context of CFE. The following sections address these reports.

6.2.1 Tagging of START Mobile Missile Transporter, Erector, Launchers (TELS) CFE Treaty Limited Equipment (TLE).

6.2.1.1 Overview. The purpose of this August 23, 1990, report was to examine tagging systems and concepts and determine their suitability for the tagging of mobile TELS used by weapon systems limited under the START treaty, and items of equipment limited under the CFE treaty. The report considered 17 tagging systems, weighed them subjectively against broad tag system requirements, and recommended candidates for each application. The report recommended that:

- (1) CFE tagging requirements be defined. This would provide clearer focus to R&D efforts.
- (2) Operational concepts be developed for commercially available tagging systems such as adhesive labels, bar codes, serial number tracking, and license plates/credit cards.
- (3) A tagging systems field demonstration be held as soon as possible.
- (4) DoD investigate possible locations for tags on all types of CFE TLE to include aircraft so that operational factors could be assessed as well as the technical aspects of any tagging system.

6.2.1.2 Documentation Produced. "Recommendations Regarding Tagging of START Mobile TELS and CFE TLE," dated August 23, 1990.

6.2.1.3 Expenditures. Table 6-4 lists the labor hours, the associated loaded labor costs (without fee and tax) plus the ODC's expended during the conduct of the START Mobile TELS and CFE TLE effort under FY90-02.

Table 6-4. START Mobile TELS and CFE TLE expenditures.

TI	Hours	Loaded Labor Costs	ODC's	Total Costs
FY90-02	2080	\$162,403	\$7,675	\$170,078

6.2.1.4 Schedule.

- (1) TI FY90-02 issued - December 6, 1989
- (2) Draft plan submitted and verbally approved - December 10, 1989
- (3) CFE Tags Program Review - February 6, 1990
- (4) Briefing presented to DNA, and to the OSD CFE Working Group (CFEWG) - February 8, 1990
- (5) RPT/CFE applications White Paper briefing presented to DNA, and OSD CFEWG - February 23, 1990
- (6) Conventional Forces in Europe (CFE) Feasibility Study - August 23, 1990.

6.2.1.5 Objective and Scope. The objective of this report was to examine a wide variety of tagging systems and determine their suitability for application to the TEL units for those mobile missiles limited under START and equipment items limited under the CFE treaty.

6.2.1.6 Activity Description. DNA tasking for this effort was received on December 6, 1989. BDM began the evaluation by collecting technical data on various tagging concepts. Interviews were also completed with Dr. Howard Heu, DOE; Mr. Stan Rodnick, DOE; Dr. Alex Devolpi, ANL; and several knowledgeable SNL employees. During the process, BDM noted a lack of formal documentation on a number of tagging concepts which complicated the data collection effort.

BDM submitted a draft plan to DNA on December 10, 1989, which was verbally approved. DNA conducted a CFE Tagging Program Review at BDM in Albuquerque on February 6, 1990.

BDM presented evaluation results to DNA and the CFEWG on February 8, 1990. Since a decision had been made that tags would not be used for CFE, DNA was considering at what level to continue CFE tagging work. To show how RPT technology might apply to the CFE tagging requirements, BDM prepared a White Paper addressing RPT complexity issues. Information on CFE credit card applications was also integrated into the White Paper. BDM presented a briefing based upon the contents of the White Paper to DNA, and the CFEWG on February 23, 1990.

BDM completed a final report that expanded upon, and updated the information presented at the two briefings referenced previously, and sent it to DNA on August 23, 1990. DNA subsequently requested, and received 65 additional copies of the report.

In early November 1990, DNA advised BDM that DOE believed the report should be classified; DOE requested OUSD guidance. The OUSD(P) decided the final report on CFE tagging should be classified. However, written guidance has never been developed. BDM had complied with the applicable DD Form 254, *Contract Security Classification Specification Guidelines*; however, OUSD(P) believed the more restrictive DOE guideline should be followed. BDM collected all existing copies of the final report in their possession, and stored them as classified material pending further classification guidance from DNA.

On November 5, 1990, BDM sent a letter to the CVR that discussed the differences between DNA and DOE security classification guidance, and requested that coordination be effective immediately to develop a single tagging security guideline. In it, BDM also recommended that existing DNA security guidance on tagging issues remain unchanged.

BDM sent a follow-up letter to CVR on January 8, 1991. In response, BDM was advised by Dr. Kincaid of the CVR, that a draft security guide had been sent to DNA for processing. On May 29, 1992, BDM requested FCDNA to conduct a review of the report using the most recent security classification guidance to determine its classification. On March 23, 1993, BDM received a letter from Captain Nelson, DNA/FCPRC, directing us to treat the August 23, 1990 report as UNCLASSIFIED.

Work on this task was performed under TI FY90-02, which was closed effective March 23, 1991.

6.2.1.7 Conclusions and Recommendations. The report considered 17 tagging systems, weighed them subjectively against broad tag system requirements, and recommended candidates for each application. The report recommended that:

- (1) CFE tagging requirements be defined. This would provide clearer focus to R&D efforts.
- (2) Operational concepts be developed for commercially available tagging systems such as adhesive labels, bar codes, serial number tracking, and license plates/credit cards.
- (3) A field demonstration to include selected available tagging systems be held as soon as possible.
- (4) DoD investigate possible locations for tags on all types of CFE TLE to include aircraft so that operational factors could be assessed as well as the technical aspects of any tagging system.

6.2.2 Serial Number Tracking for CFE Destruction Verification.

6.2.2.1 Overview. One approach to identifying and tracking military equipment is to use the manufacturer's serial number applied when the equipment is produced. In the report "Assessment of Serial Number Tracking for CFE Destruction Verification," dated June 28, 1991, BDM assessed the application of this approach to monitoring the destruction of TLE under the provisions of CFE.

This report addressed the applicable CFE treaty provisions; U.S. objectives and the potential needs for verification of TLE destruction; issues related to the reciprocal application of serial number tracking; and how a serial number tracking system might be applied to U.S. and NATO forces. The report concluded that serial number tracking for verification of TLE destruction could make a significant contribution to the verification process and provided recommendations regarding specific implementation provisions.

6.2.2.2 Documentation Produced. The final report was not published under TI FY90-12 because of a delay in scheduling a briefing date with the CFE Task Force (CFETF). DNA subsequently closed TI FY90-12 and authorized this report to be written under TI FY91-16, CFE Wrap-up.

6.2.2.3 Expenditures. The Serial Number Tracking (SNT) task performed under TI FY90-12 began in August 1990 and continued through March 1991. The following table (table 6-5) lists the labor hours, the associated loaded labor costs (without fee and tax) plus the ODC's only expended during the conduct of TI FY90-12. Approximate expenditures from TI FY91-16 would bring the total cost of expenditures to \$100,000 (total expenditures of TI FY91-16 divided by 5 tasks).

Table 6-5. Serial Number Tracking expenditures.

TI	Hours	Loaded Labor Costs	ODC's	Total Costs
FY90-12	858	\$64,144	\$2,280	\$66,424

6.2.2.4 Schedule. The milestones associated with this effort are listed below.

- (1) August 1, 1990: TI FY90-12 issued
- (2) August 15, 1990: BDM presented study plan briefing at HQ DNA
- (3) August 14 and 30, 1990: BDM met with DoD agencies to discuss SNT concepts
- (4) September 11-14, 1990: BDM visited military installations to examine serial numbers on a variety of proposed U.S. CFE TLEs
- (5) February 4, 1991: BDM briefed the CFETF on study results.

6.2.2.5 Objectives and Scope. The purpose of this effort was to assess the feasibility of using serial numbers applied to major components of limited equipment at the time of manufacture as a means of tracking equipment destroyed under the provisions of CFE.

The CFE treaty specifies that the inspected party must establish a working register containing the serial numbers of equipment planned for destruction and must provide this working register to any inspection team for use during the

duration of the inspection. The treaty also specifies that an inspecting party may freely read serial numbers on TLE undergoing destruction processing and can place special tags on such TLE.

Manufacturer's serial numbers are ubiquitous on military equipment and often are used by the owning nation for internal inventory purposes. The CFE treaty requires providing comprehensive lists of serial numbers only for lots of TLE being processed for destruction during Calendar Reporting Periods and only to destruction monitoring teams on arrival. The treaty does not require providing this serial number data for destruction lots which are not inspected or for equipment which remains in operational units. This effectively limits the utility of using serial numbers to support CFE verification of other than TLE reductions.

In assessing the usefulness of SNT, BDM examined the applicable treaty provisions, U.S. requirements for destruction monitoring, reciprocal applications to U.S. and NATO forces, and various associated verification methodologies that might be employed.

6.2.2.6 Activity Description. On August 1, 1990, BDM received the task to examine the modalities of using equipment serial numbers as an accounting methodology. BDM presented a study plan briefing at HQDNA on August 15, 1990. In conjunction with the briefing, BDM met with appropriate DoD agencies, including JCS staff members, to discuss SNT concepts on August 14, and 30, 1990.

In September 1990, BDM personnel visited Davis-Monthan AFB, Arizona, Nellis AFB, Nevada, and the National Training Center at Fort Irwin, California, to examine the locations, and types of manufacturer serial numbers on a variety of proposed U.S. CFE TLEs.

On February 4, 1991, after a delay in scheduling a briefing date, BDM briefed the CFETF on the feasibility of using equipment serial numbers as an accounting methodology for CFE TLE.

6.2.2.7 Conclusions and Recommendations. Since the final report on SNT was written prior to the breakup of the Soviet Union, the results and recommendations were framed primarily around monitoring the destruction of Soviet equipment.

The major conclusions of the SNT assessment were:

- (1) Verification of Soviet TLE destruction under CFE deserves to be a major NATO priority, and serial number tracking can make a significant contribution to this process.**
- (2) Destruction of ground TLE need not be observed directly in all cases but can be adequately confirmed by pre- and post-destruction inspections, or possibly only by post-destruction monitoring, of primary component serial numbers.**
- (3) Careful counting of destruction lots by TLE type will be important to destruction monitoring regardless of the extent of serial number verification.**
- (4) Inspection team on-site comparison of TLE destruction lists with a database on previously destroyed TLE is worthwhile and can be automated.**
- (5) For ground equipment serial number verification, it makes sense to encompass all TLE categories and sub-categories but put special emphasis on battle tanks and self-propelled artillery and rocket launchers.**

Based on SNT analysis and the above conclusions, BDM made the following recommendations:

- (1) Develop a detailed plan for using serial number tracking to monitor Soviet ground TLE destruction, and coordinate combined implementation with NATO allies.**
- (2) Choose and plan to employ cost effective tamper-proof tags to monitor Soviet combat aircraft and attack helicopter destruction. Coordinate joint use with allies.**

- (3) Together with allies, plan to monitor all Soviet TLE destruction primarily by employing pre- and post-destruction inspections.
- (4) For all destruction lots, plan to verify TLE counts comprehensively by type against the working register, even when serial numbers are sampled.
- (5) With allied cooperation, maintain a database of destroyed TLE serial numbers and check against this database all serial numbers of Soviet TLE recently identified for destruction.
- (6) For larger ground TLE destruction lots, sample primary component serial numbers and compliance with destruction criteria with particular emphasis on battle tanks and self-propelled artillery and rocket systems. Sample size should be based on the objective of 95 percent confidence that 5 percent cheating would be detected.

6.2.3 Overview of the Pros and Cons of Tagging for CFE.

6.2.3.1 Overview. The purpose of this report was, in light of previous BDM studies of tagging applications for CFE, to examine the overall utility of tagging as a means of verifying compliance with the provisions of CFE. The report provided to DNA on August 16, 1991, generally concluded that tagging large numbers of TLE was not negotiable in future CFE discussions, but that tagging of combat aircraft and attack helicopters along with serial number tracking of destroyed TLE would assist in verifying compliance.

6.2.3.2 Documentation Produced. The report was published, "Overview of the Pros and Cons of Tagging for CFE," dated August 16, 1991.

6.2.3.3 Expenditures. Expenditures for this effort were included as part of the overall expenditures for TI FY91-16 and were not broken out separately. The total expenditures for TI FY91-16 are shown in paragraph 6.2.5.3.

6.2.3.4 Schedule.

- (1) TI FY91-16 issued - March 21, 1991
- (2) Report issued - August 16, 1991.

6.2.3.5 Objective and Scope. The purpose of this report was to update and extend earlier work on the utility of using tagging approaches and technologies to enhance the effectiveness of monitoring compliance with the CFE Treaty. The report also addresses the use of serial number monitoring as an alternative to more technical approaches to tags and seals.

6.2.3.6 Activity Description. On March 21, 1991, BDM was issued TI FY91-16 which, as noted elsewhere, addressed several other tasks besides analysis of the overall pros and cons of tagging for CFE verification.

The first step was to review a previous BDM briefing addressing the overall logic of using tags and seals as CFE verification aids. The briefing was prepared and presented by BDM to the CFE Working Group on December 20, 1990, under tasking in TI FY90-12. The action options and rationale in the original briefing were updated taking into consideration the intervening CFE negotiating history and evolution of the treaty provisions. The conclusions and recommendations offered were based on a balance of U.S. and NATO verification interests, technical and operational suitability, costs, and political feasibility.

On August 16, 1991, the final report was submitted to DNA.

6.2.3.7 Conclusions and Recommendations.

- (1) It was unlikely that tagging approaches, including serial number tracking, could be successfully negotiated during CFE follow-on talks.
- (2) Tagging of a large subset of TLE in operational units is impractical and probably non-negotiable.

- (3) Serial number tracking should be employed to track TLE destruction, conversion, recategorization, and reclassification except for attack helicopters and combat aircraft, which should be tagged.
- (4) Future negotiations should attempt to obtain agreement on routine data exchange of all destroyed and converted TLE serial numbers.
- (5) Follow-on negotiations should aim to extend CFE 1 to explicitly permit close inspection and serial number tracking of ground TLE in designated permanent storage, of TLE decommissioned and awaiting disposal, and the provision of working registers of serial numbers to visiting inspectors.

6.2.4 CFE Field Demonstration.

6.2.4.1 Overview. This report examined how a field demonstration could contribute to determining the usefulness of tagging CFE TLE. The report proposed a limited field demonstration that would focus on the application and reading of selected tagging systems to determine their ruggedness, reliability, and signature repeatability under field conditions.

Participating tagging systems would be selected by an inter-agency group from those tags available at that time and both government and commercially developed tagging systems could be included. The demonstration would involve the tagging of 20 - 40 TLE and could be conducted in conjunction with an already scheduled unit field training exercise. The report was provided to DNA on September 18, 1991.

6.2.4.2 Documentation Produced. Publication of the report on this study effort, "CFE Field Demonstration," dated September 18, 1991, was accomplished under TI FY90-16 CFE Wrap Up (see section 6.2.5).

6.2.4.3 Expenditures. Table 6-6 lists the labor hours, the associated loaded labor costs (without fee and tax) plus the ODC's expended during the conduct of the CFE Field Demonstration study under FY90-07.

Table 6-6. CFE field demonstration expenditures.

TI	Hours	Loaded Labor Costs	ODC's	Total Costs
FY90-07	1637	\$98,897	\$3,292	\$102,189

6.2.4.4 Schedule.

- (1) TI FY90-07 issued - April 26, 1990
- (2) BDM concept for demonstration discussed at DOE TAGLAG- August 7-8, 1990
- (3) Demonstration planning package prepared for Director, DNA - October 22, 1990
- (4) Work placed in abeyance - November 1990.

6.2.4.5 Objective and Scope. This effort examined the potential utility of a small scale field demonstration to aid in determining the practicality of tagging equipment items limited under the terms of the CFE Treaty. The tagging systems used in the demonstration would be selected from those available at the time of the demonstration. The equipment used for the field demonstration would be part of an already scheduled training exercise and tagging activities were not to interfere with unit training.

6.2.4.6 Activity Description. On April 26, 1990, DNA tasked BDM to develop the specific requirements and parameters for a field demonstration of potential CFE/CFE II tagging candidates on U.S. TLE.

BDM reviewed COTS seals and tagging systems that it considered appropriate for use for tagging CFE TLE, and that should be considered as candidates for the demonstration. BDM reviewed 65 products to determine their applicability for this requirement. They included tamper tape, fiber optic seals, electronic smart cards, and RF tags. Most of the vendors whose products were screened displayed some interest in participating in the demonstration, and many of them offered to supply/loan the required components to the government for the demonstration at no cost.

A priority activity early in the task was to identify a location for the demonstration. This effort was severely hampered by the strong opposition of members of the HQ U.S. Army and JCS staffs to such a demonstration. BDM discussed the demonstration concept with members of the U.S. Armor Center and School, Ft. Knox, Kentucky. BDM's opinion was that they would agree to the demonstration, but only if they were satisfied that one was useful, and that it would not interfere with their training activities. BDM prepared a draft letter from the Director, DNA, to the Commandant, U.S. Army Armor Center and School explaining the purpose and concept of the demonstration.

As a result of BDM's activities in reviewing potential tagging systems that might meet CFE tagging requirements, BDM prepared a draft evaluation of a concept using a serial number tracking (SNT) technique as a unique tag to meet the requirements (this resulted in the issue of TI FY90-12 to evaluate this concept).

On August 7-8, 1990, BDM attended a DOE TAGLAG meeting to discuss the BDM concept for the demonstration. On October 22, 1990, BDM prepared a package on the demonstration planning for the Director, DNA.

In November, 1990, work on the TI was placed in abeyance pending DoD sponsorship for the demonstration.

The work was performed under TI FY90-07, which was closed, effective March 23, 1991.

6.2.4.7 Conclusions and Recommendations. The report found that a field demonstration would be useful. It proposed a limited field demonstration that would focus on the application and reading of selected tagging systems to determine their ruggedness, reliability, and signature repeatability under field conditions.

6.2.5 CFE Wrap-Up.

6.2.5.1 Overview. BDM was tasked by DNA to finalize and complete all analyses and assessments in support of the CFE Treaty. During the performance of this

tasking, BDM finalized and completed all work in support of the CFE Treaty, published the following reports, and delivered them to DNA:

- (1) "Assessment of Serial Number Tracking for CFE Destruction Verification"
- (2) "Innovative Tag Applications To CFE"
- (3) "CFE Field Demonstration"
- (4) "Overview of the Pros and Cons of Tagging for CFE."

BDM was directed not to prepare a CFE Final Report but to include it in the contract final report.

6.2.5.2 Documents Produced.

- (1) "Assessment of Serial Number Tracking for CFE Destruction Verification," dated June 28, 1991
- (2) "Overview of the Pros and Cons of Tagging for CFE," dated August 16, 1991
- (3) "CFE Field Demonstration," dated September 18, 1991
- (4) "Innovative Tag Applications To CFE", dated October 21, 1991.

6.2.5.3 Expenditures. Table 6-7 lists the labor hours, the associated loaded labor costs (without fee and tax) plus the ODC's expended during the CFE Wrap-Up conducted under FY91-16.

Table 6-7. CFE wrap-up expenditures.

TI	Hours	Loaded Labor Costs	ODC's	Total Costs
FY91-16	1996	\$142,083	\$1,487	\$143,570

6.2.5.4 Schedule.

- (1) TI FY91-16 issued - March 21, 1991
- (2) Other key schedule dates primarily follow the publication dates for various reports published as shown in paragraph 6.2.5.2.

6.2.5.5 Objective and Scope. The purpose of this effort was to complete the CFE related analyses and assessments tasked under other TIs, but put on hold pending decisions relative to pursuing the use of tagging in CFE.

6.2.5.6 Activity Description. On March 21, 1991, TI FY91-16 was issued to BDM. During the performance of this tasking, BDM finalized and completed all work in support of the CFE Treaty, published the reports, and delivered them to DNA.

On June 26, 1991, DNA authorized BDM to examine the use of tagging for CFE as primarily an accounting/inventory control support system under task six of TI FY91-16, "Other Assessments Deemed Applicable." BDM was directed to present an outline of a study to DNA for approval prior to initiating a detailed investigation. BDM presented the outline of the study to DNA for approval.

BDM conducted an assessment of using tags as an accounting/inventory control support system to aid CFE inspection accuracy and speed, and circulated an initial draft report for comment by the BDM tagging staff. BDM was informed by DNA to discontinue work on the assessment due to decisions not to pursue tagging in CFE.

The work was performed under TI FY91-16, which was closed, effective April 2, 1992.

6.2.5.7 Conclusions and Recommendations. BDM finalized and completed all analyses, and assessments in support of the CFE Treaty, and published their results in the reports prescribed by the task listing in TI FY91-16. Based upon direction provided by DNA in October 1991, a CFE Final Report was not written but will consist of the summaries of CFE-related activities documented in this contract draft final report.

6.3 CASTING PITS.

6.3.1 Overview.

During the course of the START negotiations the U.S. Government believed that the treaty might require the inspection of rocket motor production facilities to determine if these facilities were in compliance with any treaty limitations on the production of certain missile motors. Accordingly, DNA tasked BDM to examine means by which casting vessels used in the production of solid rocket motors (SRM) might be sealed to either prevent their undetected use or to limit the size of the motor that could be cast using that vessel.

BDM evaluated several layered approaches for sealing casting pits including: external vessel seals that would prevent removal of the casting pit lid; vessel access seals that would prevent removal of an SRM from a casting enclosure; SRM size limiting seals that would limit the dimensions of cast SRMs; SRM size/weight detection systems; seals that would disable hoists and or hydraulic systems used for removing SRMs from the casting pit; and seals on casting pit ingress/egress control systems.

The sealing approach considered best was a "monitored external vessel seals scheme." This sealing scheme involves sealing the casting pit lid to the casting vessel with two seals - a fiber optic seal with a visual signature and a rigid seal with an ultrasonic signature. Both seals would be monitored by a secure video surveillance system which covers the seal installation area thus increasing the difficulty of bypassing the seals without detection.

6.3.1.1 Documentation Produced. "Development and Evaluation of Solid Rocket Motor Casting Pit Sealing Schemes (U)," was published by BDM on November 27, 1990. This report is classified SECRET.

6.3.1.2 Expenditures. The Casting Pits tasks performed under TI FY90-09 began in July 1990 and continued through November 1990. The following table (table 6-8) lists the labor hours, the associated loaded labor costs (without fee and tax) plus the ODC's expended during the conduct of the casting pits conceptual design effort.

Table 6-8. Casting Pits expenditures.

TI	Hours	Loaded Labor Costs	ODC's	Total Costs
FY90-09	722	\$43,462	\$5,218	\$48,680

6.3.2 Schedule.

This study was initiated on July 17, 1990. Visits to United Technologies, Chemical Systems Division (CSD) and Thiokol were conducted in August 1990. The task report was written and published in November 1990.

6.3.3 Objectives and Scope.

Casting pits are large vessels in which the most critical SRM production operation is performed - casting the propellant into the motor casing. As a follow-on to a study conducted by the CVR which examined the use of commercial seals to seal casting pits, BDM was tasked to develop and evaluate "layered (use more than one seal/detection technology)" approaches to sealing casting pits.

The monitoring procedures to detect production of treaty limited SRMs may include short notice, "suspect site" inspections, which could allow inspector access to SRM casting vessels. Opening a casting vessel during certain process steps can ruin a motor, significantly increase process times, and/or violate production facility safety rules. Consequently, SRM manufacturers have recommended that the inspection process be augmented with security sealing schemes to be executed at casting pits. These sealing schemes would allow inspectors to confirm the treaty status of the contents of casting vessels without immediate, on-demand access inside the vessel. The main thrust of this effort was not the evaluation of specific seals and monitors, but the development of conceptual, layered pit sealing schemes.

There were three main objectives to this effort. The first was to develop conceptual approaches for detecting production of treaty limited SRMs at casting pits. These approaches were required to meet all SRM production facility safety and security requirements; they must be capable of surviving in the operational

environment; and the sealing schemes must be generic, that is, applicable to different facilities without fundamental changes in the approach.

The second objective of this study was to evaluate and compare the sealing schemes. This included the assessment of factors such as the probability of detecting a treaty violation, the difficulty of defeating the seal schemes, and other operational and logistics related issues. Finally, this study was to develop recommendations for future work leading toward casting pit sealing schemes which would meet the needs of both the verification community and the SRM production facilities.

This program was an analysis effort. No experimental data were required to design or assess the effectiveness of the sealing schemes. However, field trips to casting pit facilities at Thiokol Strategic Systems, Ogden, Utah, and United Technologies CSD, San Jose, California, were conducted to gather information regarding casting pit operations and to aid in the development of sealing schemes. All designs, assessments, conclusions, and recommendations were based on the results of the CVR program, engineering judgement, and the information obtained during the field trips.

6.3.4 Concepts Examined.

This task was primarily a data gathering and system synthesis effort. Data on the various sealing approaches was gathered from manufacturers and other sources. BDM evaluated several layered schemes for sealing casting pits including:

- (1) External vessel seals that prevent removal of the casting pit lid**
- (2) Vessel access seals that prevent removal of an SRM from a casting enclosure**
- (3) SRM size limiting seals inside casting pits that limit the dimensions of cast SRMs**
- (4) SRM size/weight electronic detection systems that detect the dimensions and/or weight of cast SRMs**

- (5) Hoist seals that disable hoists and/or hydraulic systems used for removing SRMs from casting pits
- (6) Seals on casting pit ingress/egress control systems.

A visit was made to two major solid rocket motor manufacturing facilities where all-day tours of each facility were conducted by site manufacturing engineers. Extensive photographic documentation of the casting pit geometry was obtained. This information was then examined and analyzed. Several candidate sealing schemes were proposed and critiqued. Attributes such as level of security, intrusiveness to the manufacturing process, and practicality were used to select a suggested sealing method. That approach, supporting procedures, and the analysis process were then documented in the final report. SNL (Mr Pat Fleming) acted as the adversarial analyst for the effort. Adversarial analyses were conducted at two points during the study to allow an interchange of ideas on problems and solutions associated with the designs. The comments from the adversarial analysis and BDM's responses and solutions were documented.

6.3.5 Results.

6.3.5.1 Final Status. Solid rocket motor casting pit sealing is feasible if required by treaty provisions. Currently no treaty language is being seriously considered that would mandate this measure.

6.3.5.2 Conclusions and Recommendations. The recommended casting pit sealing scheme is the monitored external vessels seals scheme. The recommended seal installation mode is the combined flange seal/custom bracket installation shown in figure 6-1. The third layer of security for this sealing scheme is a secure video surveillance/recording system which records the seal installation and immediate surrounding area. The surveillance system should have an authenticated video system, its own light source to act as backup to facility light, and a lens that adjusts for different light conditions. Camera and recording equipment should include high security, "private" tamper detection features.. This system should record "scenes" (several video frames) showing the seal and its attachment points every 1 to 5 minutes, with extra scenes recorded on a random basis. Incorporation of a motion sensor into the video system may

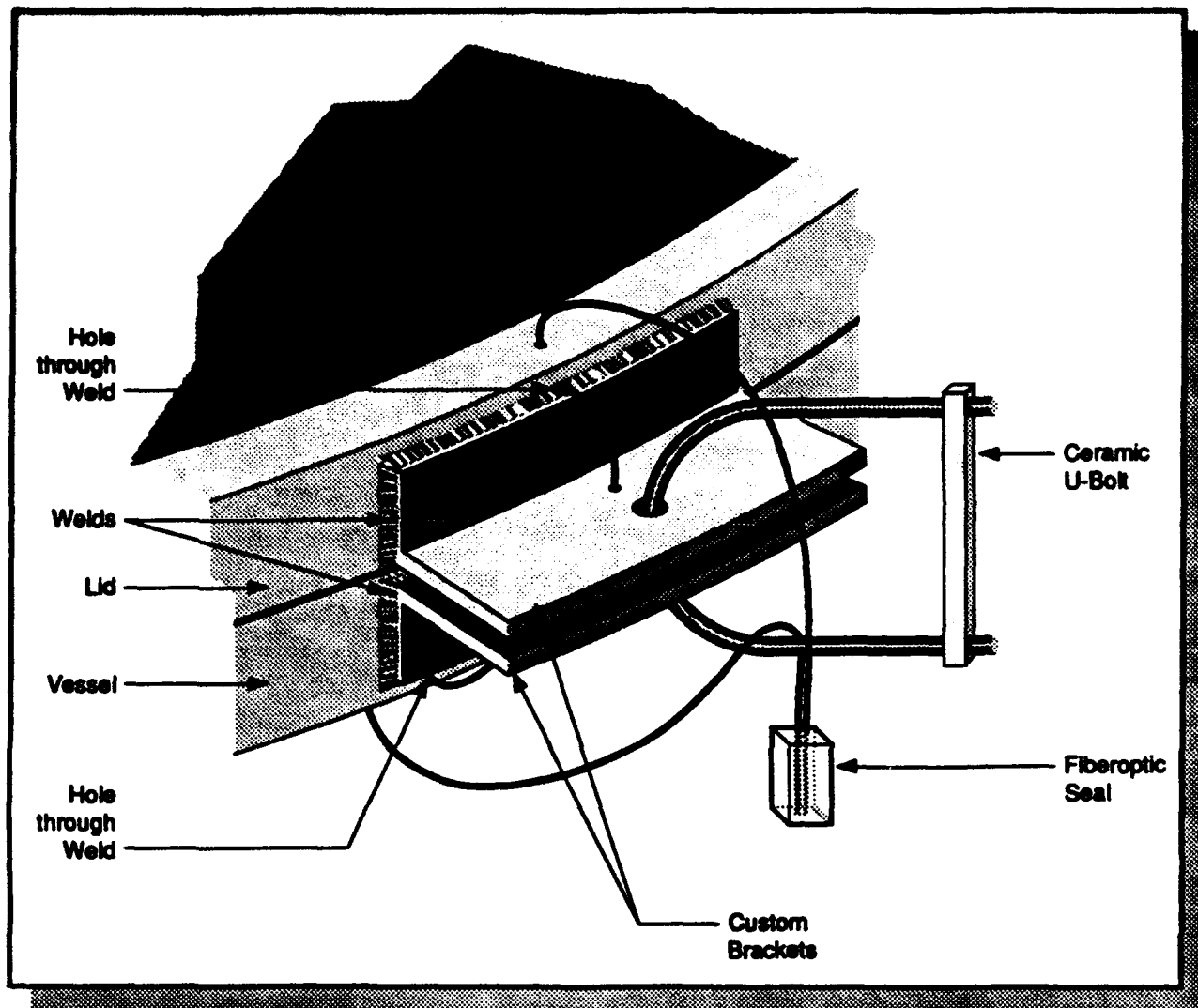

Figure 6-1. Combined flange seal/custom bracket installation mode.

provide increased security. Figure 6-2 illustrates the monitored external vessel seal concept. The following factors led to the selection of the monitored external vessel seals scheme as the "best candidate":

- (1) It is the most direct and secure casting pit sealing technique.
- (2) There are fewer seal bypass modes for this scheme as compared with the other schemes.
- (3) It is the most generic technique.
- (4) It allows for seal installations which will cause minimal impediment to SRM production operations.



Figure 6-2. Video surveillance installation location and field-of-view at a Thiokol Peacekeeper casting pit.

The monitored external vessel seals approach to sealing casting pits is feasible for most SRM manufacturing operations. However, at some facilities, during certain "remote operations," no personnel are allowed to approach the casting building for safety reasons. Hence, applying seals to casting pits, or even the exterior surface of casting buildings will not be possible during these

operations. If suspect site inspections are to be conducted during these remote operations, some other approach must be developed to monitor the perimeter of the casting enclosure, until access is allowed. Perimeter monitoring techniques could include video and/or visual surveillance of the building's exterior and other remote sensing technologies that can be executed from a safe distance. This issue should be studied further in future efforts.

Recommended procedures for the monitored external vessel seals scheme are listed in the task report. These instructions are not meant to be all-inclusive or comprehensive. They are meant to provide the general procedural framework in which this detection scheme would operate. A "two-inspector-rule" should be required for all inspection activities.

BDM recommends surveys of additional SRM manufacturing facilities in the United States and surveys of existing data regarding Soviet SRM production facilities to determine the applicability of the monitored external vessel seals scheme to a wider variety of production facilities. A study of existing and in-development seal technologies is also recommended to determine which seals are best suited for the casting pit applications. BDM recommends a survey of existing video surveillance/recording systems to determine which systems are appropriate for casting pit applications, and what modifications are necessary to meet the unique environmental requirements. BDM recommends that detailed, clearly defined procedures for installation, validation and inspection, and removal be developed for both the seals and the video system. Finally, BDM recommends field trials of the monitored external vessel seals scheme using the aforementioned detailed procedures. The objectives of these field trials should be to develop detailed designs for seal and video system installations; to perform actual seal installation, verification, and inspection, and removal procedures to evaluate their effect on cast/cure operations; to refine procedures based on lessons learned; and to evaluate vulnerabilities in the sealing scheme.

6.4 TAGGING BALLISTIC MISSILE SYSTEMS.

6.4.1 Overview.

Under TI FY90-11, BDM analyzed the structural and material properties of Soviet missiles and their canisters to determine the effectiveness and suitability of U.S. and Soviet concepts for tagging U.S. and Soviet system components. Relevant missile intelligence was obtained through visits to bases to collect data and by contacting Defense Intelligence Agency (DIA) and U.S. Air Force Foreign Technology Division (FTD) analysts. The best combination of a U.S. tag concept and missile system location was selected with the assistance of BDM personnel possessing expertise in missile design and operations and on the basis of intelligence estimates. Information on Soviet tagging concepts was obtained from DOE sources and evaluated for satisfaction of technical and safety issues. Requirements for additional, hard intelligence and recommendations for DT&E and OT&E were provided.

6.4.1.1 Documentation Produced. The report, "Evaluation of the Effectiveness and Suitability of Tags on Ballistic Missile Systems (U)," was provided to DNA on October 15, 1990. This report is classified SECRET.

6.4.1.2 Expenditures. Table 6-9 below lists the labor hours, the associated loaded labor costs (without fee and tax) plus the ODC's expended during the conduct of TI FY90-11, Soviet Concepts.

Table 6-9. Tagging ballistic missile systems expenditures.

TI	Hours	Loaded Labor Costs	ODC's	Total Costs
FY90-11	525	\$22,703	\$1,837	\$24,540

6.4.2 Schedule.

Effort on this task performed under TI FY90-11, Soviet Concepts, began in July 1990 and continued through October 1990.

6.4.3 Objective and Scope.

The objective of this effort was to determine the suitability and effectiveness of tagging U.S. and Soviet missile systems with currently identified U.S. tagging systems and some tagging concepts proposed by the Soviets. The scope was limited to those ballistic missile systems proposed for limitation under START and focused on tag/item interoperability concerns that could affect fastening of the tag and transferability of a tag in working condition to another item of the same type.

6.4.4 Activity Description.

The initial effort was to identify and obtain access to relevant missile intelligence through FCDNA. The principal sources used were:

- (1) DIA and FTD missile intelligence reports
- (2) SNL and LLNL adversarial analysis reports
- (3) The Joint Draft Text of the Treaty between the USA and the USSR on the Reduction and Limitation of Strategic Offensive Arms (START), April 6, 1990, (SECRET)
- (4) Initial Evaluation of Soviet Tagging Concepts (U), SNL-D-89-7095, 1989 (SECRET)

A visit was also made to DIA to determine the accuracy of published intelligence and the availability of missing or more conclusive information. Permission from FCDNA was obtained to attend a briefing by FTD missile intelligence analysts. Discussions with SNL personnel provided information on Soviet tagging concepts and the results of adversarial analysis on U.S. adhesive tags. A meeting of knowledgeable BDM personnel provided insight into the design and capabilities of missile materials, components and structures.

From the data acquired from these sources, the effectiveness of each type of tag, based on its design and interaction with missile materials, and its suitability, based on the conditions for applying the tag, were derived. Material and structural details were extracted, organized, and then evaluated for consistency and completeness. Since the objective of the report was to evaluate various U.S.

and Soviet methodologies proposed within the provisions of the START treaty, the structural and material properties of Soviet ballistic missiles and their canisters were compared with the design features of three classes of U.S. tags to determine the most promising locations for tags on Soviet systems.

Locations for U.S. tags were evaluated primarily for feasibility of tag attachment and vulnerability to removal and transfer or reattachment in an intact state. Other tag location attributes, such as ease of access for tag attachment and inspection, interference with normal operations, intrusiveness and potential impact on weapon system performance, were also considered. Soviet tagging concepts were evaluated for satisfaction of technical and safety issues. The best combination of tag type and location was then selected. In addition, the advantages and disadvantages of tagging missiles, canisters, or both were evaluated.

6.4.5 Conclusions and Recommendations.

The report concluded with recommendations for further DT&E and OT&E testing and actions for DoD agencies that are needed to answer remaining questions. Specific conclusions and recommendations resulting from this analysis are included in the classified report.

In addition to these findings, three considerations came forward that should be taken into account if this work is continued or if similar intelligence efforts are to be done in the future.

- (1) Obtaining the most current, complete and accurate information required for an analysis of foreign weapon systems is increasingly dependent on the cooperation of administrative, security and intelligence officials. Fortunately, this cooperation was, in all cases, available for the preparation of this report. However, for future efforts of this type, it should not be assumed that it will always be readily obtainable.**
- (2) Correct analysis of technical intelligence, particularly in an area requiring knowledge of a broad spectrum of information, requires the**

input of personnel with relevant operational experience, both to aid in the interpretation and to arrive at feasible conclusions. Therefore, an analysis of this type should be a team effort. Again, BDM was fortunate that such people were available and willing to assist.

- (3) The application of technical intelligence to design problems, except that obtained from exploitation of genuine equipment, involves risk. At best, intelligence estimates provide a basis for bounding the technical options. To expedite and optimize design decisions on equipment required to verify a treaty, hard data in the form of engineering drawings and material samples of TLEs, obtained through appropriate channels, is necessary.

6.5 CANISTER APPLICATIONS.

6.5.1 Overview.

BDM identified and characterized the components of U.S. and Soviet missile canisters which required disassembly in order to withdraw a treaty limited missile stage. The properties of four categories of tags were evaluated for tag-sealing applications. Resistance to stress and tampering were evaluated. The best tag design for canister tag-sealing was selected, based on available engineering data. Opportunities and limitations for applying and inspecting tag-seals at assembly and maintenance facilities were identified. Conclusions are stated in the classified annex.

6.5.1.1 Documentation Produced. A technical report, entitled "Evaluation of the Effectiveness of Tags on Ballistic Missile Canisters (U)," dated July 3, 1991. This report has a separate annex classified SECRET.

6.5.1.2 Expenditures. The Canister Application tasks performed under TI FY91-13 began in March 19, 1991, and continued through July 3, 1991. The following table (table 6-10) lists the labor hours, the associated loaded labor costs (without fee and tax) plus the ODC's expended during the conduct of the Canister Application efforts.

Table 6-10. Canister application expenditures.

TI	Hours	Loaded Labor Costs	ODC's	Total Costs
FY91-13	448	\$23,066	\$195	\$23,261

6.5.2 Schedule.

Work on this report began on March 20, 1991. The report was published on July 3, 1991.

6.5.3 Objectives and Scope.

The objectives of the report were to identify potential locations for sealing U.S. and Soviet missile canisters to prevent undetected removal of TLI and to evaluate identified tagging methodologies for sealing those locations. The available information on canister designs and assembly/disassembly procedures was analyzed to identify and characterize the components whose disassembly would be required to withdraw a treaty limited missile stage from its canister. The properties of fifteen types of tag-seals under four categories were then evaluated to determine whether and how they could be employed to seal the canisters and their probable resistance to operationally induced stress and tampering. Information on missile maintenance cycles and locations for canisterization and decanisterization was used to identify opportunities and limitations for tag-seal application, removal and replacement. An appropriate tag-seal design was then selected for the purpose, based on the conclusions reached concerning the technical and operational feasibility of canister sealing, but recognizing that none of the tagging methodologies or proposed sealing applications had been subjected to engineering and environmental testing.

The following sources were utilized:

- (1) Engineering drawings of canisters and descriptions of the missile canisterization process provided by BMO/MGS (AFSC) or filed in BDM archives
- (2) DIA and FTD missile intelligence reports
- (3) Photographs of Soviet missile canisters published in defense journals
- (4) Tag design descriptions extracted from developer reports.

6.5.4 Activity Description.

After reviewing available drawings and assembly and check-out descriptions for U.S. missile systems, BMO/MGS provided further information. The Soviet missile intelligence material contained in the FTD electronic and microfiche data base was re-examined, but provided no additional information. Although construction details of U.S. canister components were available from engineering drawings, analysis and correlation of open source photographs and unclassified missile design literature were required to produce similar Soviet design characteristics. (A Soviet canister photograph published after this report was completed supported BDM's assessment.) With this information, the general U.S. missile system canisterization method was established and the critical step required to seal each type of missile in its canister was identified. Similar conclusions were inferred for Soviet canisters from photography and limited intelligence data. The tag-seal designs, which were evaluated for compatibility with known or postulated canister design and material characteristics, were provided by the developers or extracted from their reports.

6.5.5 Conclusions and Recommendations.

The results of this study are classified SECRET. DNA review and distribution of this report are being delayed until an opinion has been received from BMO/MGS regarding the feasibility of an alternate means for removing a missile from its canister.

6.5.5.1 Lessons Learned. Validated intelligence, properly applied, is normally a requirement for intelligence intensive tasks. However, when it is lacking or so caveated that it would support any position, a technical decision made on the basis of available unclassified and classified information may be better than no decision at all. Useful inferences can often be derived from unclassified sources because:

- (1) Design groups in different countries tend to independently develop, similar solutions for similar problems.
- (2) Design groups tend to rely on their own proven designs for similar applications.

6.6 TECHNOLOGY TRANSFER

6.6.1 Overview.

BDM initiated a procedure in June 1990 to assure DNA that the technology transfer issue would not impede export of treaty verification equipment to the Soviet Union. DNA gave BDM permission to submit the specifications of tagging equipment components directly to the Defense Technology Security Administration (DTSA) for transferability/exportability determination. Under this procedure, which requires an average of only ten days, DTSA has approved component specifications for four major DOE and BDM tagging equipment designs through all development stages to date, thereby eliminating exportability as a concern in the design process. Subsequently, BDM has requested clarification from DTSA regarding the requirement for an export license from the Department of Commerce.

6.6.1.1 Documentation Produced. The following list represents both BDM documentation delivered, and also government sources used as references.

- (1) BDM letter to FCDNA, dated June 21, 1990, with list of RPT tagging equipment components
- (2) BDM letter to DNA/OPAC, dated October 29, 1990, requesting permission to establish direct communications with DTSA
- (3) BDM letter to OUSD(P)/DSTA/STT, Attn: Mr. Robert Gamino, dated January 22, 1991, with attached list of components for a fiber optic tag/seal and its associated reading equipment
- (4) BDM letter to OUSD(P)/DSTA/STT, Attn: Mr. Robert Gamino, dated January 29, 1991, with attached tentative components list and specifications for the UIT
- (5) BDM letter to FCDNA, dated March 13, 1991, with draft letter for OUSD(P) on the issue of technology transfer and proprietary limitations for tag processing software

- (6) **BDM letter to OUSD(P)/DTSA/STT, Attn: Mr. Robert Gamino, dated March 25, 1991, with attached list and specifications of candidate equipment for universal tag reader**
- (7) **BDM letter to OUSD(P)/DTSA/TD, Attn: Mr. Robert Gamino, dated April 25, 1991, with attached list and specifications of additional equipment required for the universal tag reader**
- (8) **BDM letter to OUSD(P)/DTSA/TD, Attn: Mr. Robert Gamino, dated September 19, 1991, with attached list and specifications of additional equipment required for the universal tag reader**
- (9) **BDM letter to OUSD(P)/DTSA/TD, Attn: Mr. Robert Gamino, dated January 6, 1992, requesting clarification on guidance given by Mr. Gamino on requirements for an export license for various items of tagging equipment.**

Government Sources:

- (1) **The Militarily Critical Technologies List, Volume 1, List of Militarily Critical Technologies, (Short Title: MCTL), OUSD/A, Washington D.C., dated October 1989**
- (2) **Deputy Undersecretary for Defense, Trade Security Policy (OUSD/TSP) Memorandum for Director DNA, Subj: START Treaty Tagging Technology, dated 10 August 1990**
- (3) **Specification sheets for candidate tagging system components provided by system designers**
- (4) **Several responses received from the Defense Technology Security Administration (DTSA), Technology Directorate under the subject: Technology Review for DNA Contract DNA001-89-C-0189**
- (5) **Export Administration Regulations (EAR), October, 1990.**

6.6.1.2 Expenditures. Costs were allocated to the equipment design, development, and evaluation tasks, and not to this activity, so further cost breakout is not available. The effort associated with this work is modest.

6.6.2 Objective and Scope.

The objective of this effort was to assure DNA that the transfer of tag reading, and inspection equipment to the Soviet Union for use in treaty verification would not be prohibited or impeded because of export, and technology transfer limitations. The sections of the MCTL concerning computer processors, software, and optical fiber applications indicated that a transfer problem might exist. Although a response from OUSD/TSP to a DNA request stated that they saw no problem related to export control regulations with respect to export of RPT tagging system components, it was not clear which government agency's regulations applied, and whether further documentation was required to obtain permission to export. Further, there was a question whether requests for export approval should be made at the completion of the design cycle to reduce the administrative burden on DNA or earlier to reduce risk. The procedure developed by BDM was to establish direct contact with DTSA, the office within OUSD/TSP which makes technology transfer determinations for DNA, and to request that all tagging equipment export questions be sent through BDM for DTSA review. This approach was approved by DNA. The DTSA determined that no export license from the Department of Commerce will be required since the equipment will be shipped by U.S. Government carrier or under a U.S. Government Bill of Lading (Export Administration Regulation 770.3(a)(2), dated October 1990). DTSA also provided useful recommendations concerning the protection of copyrighted material, and manufacturer's proprietary rights.

Subsequently, when BDM was researching the requirements for the temporary export of the Universal Reader system to the former Soviet Union for a demonstration, several issues were raised related to the DTSA determination that an export license would not be required. EAR paragraph 770.3(a)(2) states that an export license is not required if the export is "for the official use ofU.S. Armed Forces." BDM noted that a strict interpretation of this clause may not encompass a demonstration of equipment to foreign nationals. BDM also noted that a demonstration will necessarily entail a disclosure of technical information. Even if a demonstration were permitted under the clause, BDM questioned whether disclosure would also be authorized. Finally, BDM questioned the applicability of the clause in the case of permanent transfer of the equipment to foreign nationals and whether the "official use ofU.S. Armed Forces" would apply.

Based upon the questions raised that were discussed in the previous paragraph, BDM sent a letter to DTSA on January 6, 1992, requesting guidance.

6.6.3 Activity Description.

The initial step was to determine which government agency was authorized to make export and technology transfer decisions and whose control list or regulations applied: OUSD(P) through the MCTL, Department of Commerce through the Commodity Control List, and export licenses or Department of State through the International Traffic in Arms Regulations (ITAR). It was inferred from the OUSD/TSP memorandum to DNA, dated 10 August 1990 that an employee within DTSA was authorized to determine the transferability/exportability of technology to the Soviet Union by DNA. Subsequent conversations with DTSA personnel confirmed that DTSA is responsible for these determinations for all DoD agencies under DoD Dir. 2040.2 and 5105.51. BDM requested DNA authorization to establish direct communication with DTSA on October 29, 1990, citing the need for a technology determination as early as possible in the design cycle. Permission was granted on November 2, 1990, and BDM requested that all tagging equipment designers provide vendor specification sheets for candidate off-the-shelf equipment as soon as they were identified. The Chief of Strategic Technology Trade, DTSA provided BDM the name of the engineer he had appointed to process BDM requests on December 7, 1990.

6.6.4. Conclusions and Recommendations.

Technology transfer has proved very effective. The turn-around time for a typical request received by BDM from a designer is about ten days. All components have been approved by DTSA for technology security and exportability thus far.

6.6.4.1 Final Status. Component lists and specification sheets for the RPT, Innovative Tag, UIT, and the UR system were forwarded to DTSA, reviewed and determined to be acceptable for release to the Soviets. The question of technology transfer, and proprietary limitations for tag processing software was separately referred to OUSD(P), OSD/ISP/VP, through FCDNA on March 18, 1991. A response has not been received.

6.6.4.2 Lessons Learned. When there are overlapping areas of responsibility between agencies, it is difficult to identify the government agency responsible for an action or function.

6.7 HAZARDOUS MATERIAL TRANSPORTATION.

6.7.1 Overview.

BDM identified RPT application kit materials which were hazardous for transportation and provided DNA guidance on the packaging, package testing, marking, labeling, and shipping document preparation requirements contained in applicable federal and international regulations. A combination of government contracted surface and military air transport was recommended for shipments to the Soviet Union.

6.7.1.1 Documentation Produced. Appendix F - Transportability of RPT Hazardous Materials, RPT IOT&E Final Test Report, BDM/ABQ-91-0070-TR, dated February 15, 1991. The following lists the government sources used.

Government Sources:

- (1) AFR 71-4/TM 38-250/NAVSUP PUB 505/MCO P4130.19E/DLAM 4135.3, Preparing Hazardous Materials for Military Air Shipments, published 15 January 1988 (Short Title: AFR 71-4)**
- (2) Military Standard 129L, Marking for Shipment and Storage, DoD, published 15 October 1990**
- (3) Technical Instructions for the Safe Transportation of Dangerous Goods by Air, International Civil Aviation Organization (ICAO), as incorporated in the Dangerous Goods Regulations, 32nd Edition, International Air Transportation Association, Effective 1 January 1991 (Short Title: IATA DGR)**
- (4) Code of Federal Regulations, Transportation, 49 Parts 100-199, Revised as of October 1, 1989 (Short Title: 49 CFR 100-199), and 49 CFR Parts 107-179, compliance authorized after January 1, 1990, Department of Transportation**

- (5) Occupational Safety and Health Standards for General Industry, 29 CFR Part 1910, with Amendments as of September 5, 1989, Department of Labor**
- (6) Material Safety Data Sheets (MSDSs) for RPT application materials.**

6.7.1.2 Expenditures. Costs were allocated to TI-1. Consequently, costs are not available for this activity. The effort was modest.

6.7.2 Schedule.

This effort began approximately August 14, 1990, and was completed on January 31, 1991.

6.7.3 Objective and Scope.

The objective of this effort was to assure DNA that there would be no limitations on the transport of the RPT application kit or other RPT tagging equipment components to the Soviet Union or within the CONUS due to the presence of hazardous materials. An examination of the Material Safety Data Sheets (MSDSs) indicated that three of the preparations included in the tagging application kit consisted entirely or partly of materials defined in DoD, DoT and international regulations as hazardous for transportation. BDM extracted detailed requirements for packaging, package testing, marking, labeling, and preparation of shipping documents from the applicable regulations, for each of the hazardous materials. To avoid repackaging and double marking and labeling, BDM recommended that all shipments be transported under the authority of one set of regulations, the International Air Transportation Association Dangerous Goods Regulations (IATA DGR), and in accordance with certain additional requirements of AFR 71-4 and 29 CFR 1910.

6.7.4 Activity Description.

The effort was complicated by the number of U.S., foreign and international agencies which regulate the transportation of hazardous materials and recent and impending changes in their regulations. The sources listed in section 6.7.1.1 above, and discussions with the IATA, Department of Transportation (DoT), and

Air Force Logistics Command (AFLC) officials clarified, until the next change occurred, which agencies had authority over the carriers under consideration. The transportation offices of Sandia National Laboratories, Kirtland AFB, NM and Hughes Aircraft Company provided additional information on packaging, marking/labeling and routing of shipments to the Soviet Union. The IATA DGR was selected as the packaging authority when AFLC required all overseas military air shipments to comply with United Nations International Civic Aviation Organization (UN/ICAO) performance oriented packaging (POP) requirements.

6.7.5 Conclusions and Recommendations.

The hazardous materials contained in the RPT application kit can be transported to the Soviet Union provided they are packaged, package tested, marked, and labeled in accordance with applicable IATA, DoD and OSHA regulations and shipped under government contracted surface and military air transport. Surface shipments within CONUS should comply with 49 CFR 107-179, which incorporates the POP requirements of the IATA DGR. The U.S. commercial air carriers contacted by BDM will not accept methyl alcohol, one of the RPT hazardous materials. The procedures recommended in this report apply to shipments of other tagging equipment components.

6.7.5.1 Final Status. TI-1 completed. Since the report in which this information was documented was published in February, 1991, and because of the changing nature of these requirements, BDM contacted Dr. Daniel Murphy, HQ USAF/LETT, proponent of AFR 71-4, "Preparing Hazardous Materials for Military Air Shipments," to verify that the procedures recommended in the report continue to be valid. He validated BDM's recommended procedures.

6.7.5.2 Lessons Learned. Analysis during a period of major changes in the relevant government and international regulations is subject to repeated, time consuming revisions and the product is perishable.

6.8 SIMPLE MULTI-ATTRIBUTE RATING TECHNIQUE (SMART) ANALYSIS.

6.8.1 Overview.

The tagging Simple Multi-Attribute Rating Technique (SMART) project was employed to respond to DNA's need to evaluate and compare tagging concepts applicable for various treaty verification scenarios. This issue became important in October 1990 and resulted in briefings to policy makers on October 24, 1990. Based on questions that were raised during an OUSD(A) visit to BDM Albuquerque on May 23, 1991, a new analysis was conducted in June 1991. The results of this analysis were sent to DNA on June 21, 1991. It suggested that the SLITS best satisfied START canister tagging requirements based on the SMART process.

BDM had used this process successfully on several contracts. It was used to compare various security systems for Rockwell International in support of the Rail Garrison Program. That analysis was approved by both Rockwell and the Air Force Ballistic Missile Office (BMO). The SMART process was also used to successfully support a Human Systems Division, Aircraft Mishap Prevention Program requirement.

6.8.1.1 Documentation Produced. In October 1990, BDM produced a SMART package that evaluated tagging canisters. On October 24, 1990, a SMART briefing package and criteria scoring sheet was developed and presented to OUSD(A), OUSD(P), JCS, and DNA personnel.

In June 1991, BDM supported DNA's preparation of a new SMART analysis that evaluated tagging TLIs. This analysis was sent to DNA on June 21, 1991.

BDM provided the SMART analysis process to LLNL on May 14, 1992, to assist them with work they were accomplishing.

We forwarded the SMART analysis process to the Electronic Systems Center (ESC), Hanscom Air Force Base, and OSIA on May 14, 1992.

6.8.1.2 Expenditures. This activity was not TI specific. The effort to develop this information was allocated to all active TIs. The period of performance was roughly October 1990 through June 1991. Since the work was not tracked separately, as is the case of specific TIs, the best estimate of the expenditures associated with this effort is approximately 400 hours with a cost of approximately \$30,000.

6.8.2 Schedule.

The SMART analysis efforts are best shown by reflecting the milestones of the activity. Table 6-11 presents these milestones.

Table 6-11. SMART analysis schedule milestones.

Date	Milestone
October 5, 1990	Met with Major Sharples, FCDNA, to discuss various tagging concepts and potential application for canisters. Decision was made to use the SMART process to systematically evaluate options.
October 8-12, 1990	FCDNA/BDM prepared assessments, ranked and defined criteria. Considering canister applications, 12 concepts were scored by 15 subject matter experts.
October 15-19, 1990	FCDNA forwarded the analysis and definitions/descriptions to HQDNA. This analysis was also sent to SNL for review and comment.
October 24, 1990	BDM presented a SMART Tagging Briefing to OUSD(A), OUSD(P), JCS, and HQDNA personnel in Washington, D.C.
October 29, 1990	BDM sent a SMART Tagging package to DOE HQ for their consideration and review. It consisted of a SMART description, including brief descriptions of 26 proposed criteria. The package also contained the scores for the DOE concepts that were considered in the October 1990, SMART assessment done in conjunction with FCDNA.
June 21, 1991	BDM performed a SMART analysis point paper for FCDNA to provide to HQDNA. It responded to issues discussed during the May 23, 1991, OUSD(A) visit to BDM. This analysis assumed that the inspectors would have access to the TLI. Six elements were provided in the package: (1) A description of each tagging concept evaluated (2) A matrix of scores for each of the concepts for 25 criteria (3) A SMART methodology fact sheet (4) The description of the tag system requirements and desired characteristics (5) The matrix with the weighting factors for the 25 criteria (6) The rationale for the scores assigned for each concept.

6.8.3 System Description.

SMART is a structured decision making process for evaluating various options based on multiple evaluation criteria. This process defines a value structure for decision making based on input from people who are experts in the problem area, measures possible solutions against that value structure, and produces a measure of value for each possible solution. The solution with the highest value score is the best or "most favored" solution.

The SMART evaluation process DNA and BDM used for evaluating various solutions for the verification program consisted of the following seven steps:

- (1) Develop Evaluation Criteria. The first step in the SMART process is to define the criteria on which the candidate systems will be measured. BDM developed 25 different criteria for this analysis. The criteria were titled: Uniqueness of Signature, Counterfeit Resistance, Indication of Transfer or Tampering, Durability, Compatibility of Tag and TLI Materials, Non Interference, Signature Repeatability, Probability of False Decision, System Readiness, No Damage to the TLI, Availability, Software, Technology Transfer, Transportation Restrictions, Ease of Operations, Electrical Power, Environmental Specifications, Concept Simplicity, Non-Intrusive, Field Check of Data Quality, Field Assembly of Tag, Stand-Off Read Capability, Light Weight, Low Cost, and Confidence in System Description.**
- (2) Identify Subject Matter Experts (SMEs). Eleven BDM tagging personnel and one DNA Field Command Officer were used as the SMEs for this analysis. The SMEs defined the relative importance of the criteria used to evaluate candidate systems, and the value points that were assigned to levels of performance on each of the evaluation criteria.**
- (3) Rank Evaluation Criteria. Each SME independently ranked the evaluation criteria in the order of importance, with the most important criterion being assigned with the smallest number (1), and the least**

important criterion receiving the largest number (25). It was important to provide each SME with a clear definition for each criteria.

- (4) **Determine Relative Importance of Criteria.** After ranking the criteria, the SMEs assigned each criterion an importance rating on a scale of 0 to 100. No two criteria may be assigned the same rating, and higher numbers indicated more important criteria. The SMEs were required to make their importance ratings consistent with the ranks they had assigned in Step 2, thus the criterion ranked number one should receive the highest importance rating, and the lowest ranked criterion received the lowest importance rating.
- (5) **Derive Weighting Factors.** The importance ratings provided by the SMEs in Step 3 were averaged and normalized to produce weighing factors for the set of evaluation criterion.
- (6) **Translate Performance Levels to Values.** A relatively small group of SMEs (9) then scored each of the eleven different technologies against each of the twenty criteria. This was accomplished as a group, agreeing on a score (1-10) for each technology against each criteria.
- (7) **Calculate Overall Values for Each System.** The overall value score for each system was calculated by multiplying the weighting factors developed in Step 5 by the performance values established in Step 6 and summing the products for each candidate system. The systems were then ranked according to their overall score.

6.8.4 Activity Description.

During early October 1990, BDM, along with FCDNA personnel, used the SMART analysis process to consider canister applications of tagging concepts. The concepts scored were EID, Innovative Tags/Retrievable, Innovative Tag/Remote Detection, Modified Cobra, Python, RPT-Bolt, RPT-Seal, STAR FOT, Tamper Tape, Ultrasonic Bolt, Ultrasonic Seal, and the UIT. Twenty tag criteria were considered and ranked by 15 subject matter experts. These original criteria included:

- (1) Availability**
- (2) Difficulty to Counterfeit**
- (3) Tamper Resistance/Detection**
- (4) Durability**
- (5) Interference with Operations/Maintenance**
- (6) Ease of Use/Operations**
- (7) Acquisition Costs of Readers**
- (8) Acquisition Costs of Tags**
- (9) Portability, Risk Assessment**
- (10) Confidence in System Description**
- (11) Producibility, Canister Application Utility**
- (12) Uniqueness of Signature**
- (13) Repeatability, Maintenance Costs**
- (14) Field Evaluation**
- (15) Concept Complexity**
- (16) Intrusiveness**
- (17) Signature Created in Field.**

This analysis and definitions and descriptions were sent to HQDNA and SNL.

On October 24, 1990, Dr. Mark R. Fischer, BDM, briefed the SMART process to JCS and OUSD(A) personnel without weighting factors assigned. Mr. Paul Boren, DNA Contract Technical Monitor encouraged the participants to rank order the criteria and develop the weighting factors. Credible comparisons are largely influenced by use of valid weighting factors. The package Dr. Fischer left with the meeting participants included definitions for each of the criteria and blank scoring forms in a document titled "Tag System and Requirements and Desired Characteristics." Brief descriptions of each of the concepts considered were also sent to DNA Headquarters in October.

On October 29, 1990, BDM sent a SMART Tagging package to HQDOE for their consideration and review. It consisted of a SMART description, brief descriptions of the 25 criteria described above in section 6.8.3, plus Canister Application Utility.

On May 23, 1991, BDM hosted a meeting with OUSD(A), DNA, SAIC, and LANL, to discuss the tagging program. Questions were raised regarding the relative merits of each of the tagging concepts. Consequently, FCDNA recommended that BDM update the data and produce a new SMART analysis. The SLITS, SLOTS, RPT system, and UIT system were evaluated. These were the most mature high security tagging concepts and consequently received scoring attention. The application scenario for this analysis assumed that TLIs would be tagged and access would be provided through a port hole. The June 21, 1991, point paper submitted to FCDNA captured the essence of this analysis. Enclosed with the point paper were six attachments: 1) System Descriptions; 2) System Score Sheet; 3) SMART Methodology Fact Sheet; 4) Tag System Requirements Desired Characteristics; 5) DNA Weighting Factor Computation Table; and 6) Rationale for Comparison Scores TLI Scenario.

FCDNA provided HQDNA the SMART Analysis point paper with six attachments on June 21, 1991. Based on this analysis, SLITS had the best score; SLOTS, RPT, and UIT, in that order, achieved lower scores.

6.8.5 Conclusions and Recommendations.

The SMART process concluded that SLITS best met the verification requirement to validate tag/seals through a canister porthole. The other systems, SLOTS, RPT, and UIT, ranked in that order, below SLITS. The criteria order (most important to least important) were: Uniqueness of Signature, Counterfeit Resistance, Signature Repeatability, Indication of Transfer or Tampering, No Damage to the TLI, Compatibility of Tag and TLI Materials, Technology Transfer, Probability of False Decision, Non Interference, Field Check of Data Quality, Non-Intrusive, Field Assembly of Tag System, Ease of Operations, Durability, Light Weight, Electrical Power, Concept Simplicity, Environmental Specifications, System Readiness, Availability, Confidence in System Description, Transportation Descriptions, Stand-off Read Capability, Software, and Low Cost. Definitions for these criteria can be found in the June 21, 1992, point paper.

The SMART process received a favorable response and it appeared to provide decision makers with a way to document comparative analyses of various tagging concepts. Critical to this process, and in a large way fundamental to

achieving widespread acceptance, is obtaining relevant subject matter expert (SME) involvement. For example, in order for the Air Force to embrace the results, Air Force SMEs must rank the criteria so that weighted scoring is applied in accordance with Air Force value systems. FCDNA and BDM scoring was only as good as the resultant weighting assigned to the considered criteria. The distinctive advantage that SMART provides is the ability for evaluators to understand the elements that contribute to the qualitative results.

6.8.5.1 Final Status. The SMART analysis technique provides DoD officials with the tools to assess tagging concepts and to weigh criteria in a methodical way. As new concepts are introduced, they can be added to the decision matrices as required. Modifications to the criteria list are possible and assignment of new weights for each would produce updated results.

6.8.5.2 Lessons Learned. The single most important activity associated with identifying the best tagging concept for treaty verification is to obtain participation from policy makers. They are most qualified to establish the criteria and the respective weights for each of the criteria. Once DoD mandates that this takes place, procedures are in place to complete the analysis.

SECTION 7

RECOMMENDATIONS AND CONCLUSIONS

7.1 CONCLUSIONS.

After 44 months of contract effort developing, testing, and evaluating tag and seal technologies for application during verification inspections in support of arms control treaties and agreements, several conclusions can be drawn concerning the status of this work.

A broad range of technologies are available to address the tag and seal requirements of treaty verification for arms control. Numerous tag and seal concepts have been developed to the prototype stage and represent a wide spectrum of performance attributes. Commercial tag and seal systems also exist that may be appropriate for some treaty verification applications. In order to assess the suitability or effectiveness of these systems and concepts, requirements on specific tag and seal installation scenarios must be defined.

Changes in world order, and the resulting increase in the numbers of arms control treaties and agreements have dramatically expanded the scope of verification requirements. When this program began, the focus was clearly, and exclusively, on START. Without specific scenario definitions, the implicit application for all tags and seals was in support of START, which imposed a logical set of requirements to identify and control a relatively small number of items, each possessing great strategic value. Over the past three years, the emphasis has changed to recognize the verification needs of multilateral treaties and agreements that seek to control very large numbers of items, each with limited tactical value. The inspection environment has extended beyond remote military installations to encompass commercial production facilities with proprietary technology and data concerns. Also, the technology requirements for tags and seals with regard to non-proliferation and counter-proliferation have not been addressed.

With decreasing super power tensions, all costs associated with national security are receiving closer scrutiny and shrinking support. Constrained budgets and expanding requirements will force limited numbers of inspectors to

become more capable and efficient. System designs for tags and seals must emphasize rapid application and inspection, automated data acquisition and processing, report generation, and other labor-saving functions.

Additional development effort will be required to provide effective, economical tags and seals to meet the requirements of existing and anticipated arms control treaties and agreements. The available concepts must be assessed against *specific treaty/agreement verification requirements* and, where necessary, the designs modified or completed to produce production prototypes that can be rigorously, functionally, operationally, and environmentally tested to satisfy the needs of the users.

7.2 RECOMMENDATIONS.

Based on the experience gained during the Tagging RDT&E Contract, the following recommendations are made:

- (1) That periodic technical briefings on the progress and status of tag and seal technologies be presented to the treaty/agreement negotiating teams. Negotiators must be current on technology capabilities and limitations to propose appropriate, effective verification procedures. In turn, those responsible for technology development must be briefed on the direction of negotiations to understand what items are likely to be controlled and under what special circumstances and conditions. Developers can then fabricate prototype systems tailored to expected needs. At the earliest opportunity, the developers would demonstrate the prototype systems' performance to the negotiating team and explain their capabilities and limitations. This process would keep the development of verification equipment in closer step with the negotiations regarding verification methods.**

- (2) That immediate actions be taken to define specific tag and seal requirements for existing arms control treaties and agreements. As a minimum, representatives from policy, acquisition, and implementing agencies must actively participate in this process. Until**

this action is taken, the best, and in some cases even adequate, tag and seal systems will not be available to satisfy verification requirements.

- (3) That there be early and frequent interactions between user personnel and the tag/seal system developers. Design alternatives must be evaluated at each step in the development process. Participation of the end user in these decisions will ensure that the designs evolve to practical systems that meet real user requirements.**
- (4) That user agencies be required to actively support operational testing of systems destined for implementation by their organization. Only the user agency's field personnel can accurately identify the problems, constraints, opinions, and biases of the verification inspector. Their participation in the evaluation process is invaluable and irreplaceable.**
- (5) That a "layered approach" be taken to securing treaty-limited items wherever feasible. The benefits of forcing an adversary to defeat two or more security devices greatly outweigh the additional costs.**
- (6) That a "watchdog" organization be identified and funded to monitor technical developments or operational practices that could compromise the security of deployed tag/seals and associated verification equipment.**

DISTRIBUTION LIST

DNA-TR-93-69-V1

DEPARTMENT OF DEFENSE

ASSISTANT SECRETARY OF DEFENSE
INTERNATIONAL SECURITY POLICY
ATTN: VERIFICATIONS POLICY

DEFENSE INTELLIGENCE AGENCY

ATTN: DB
ATTN: DI-5
ATTN: DIW-4
ATTN: DT
ATTN: PAM-1D

DEFENSE NUCLEAR AGENCY

ATTN: DFRA JOAN MA PIERRE
ATTN: NASF
ATTN: OPAC CATHY MONTIE
5 CY ATTN: OPAC LT COL BLANCHETTE
ATTN: OPNA
2 CY ATTN: TITL

DEFENSE SYSTEMS SUPPORT ORGANIZATION

ATTN: C-332
ATTN: JNGO

DEFENSE TECHNICAL INFORMATION CENTER

2 CY ATTN: DTIC/OC

FIELD COMMAND DEFENSE NUCLEAR AGENCY

10 CY ATTN: FCPRC
ATTN: FCTO

OASD

ATTN: BRIG GEN JOHNSON
ATTN: MS BUCKLEY
ATTN: USD/P

OFFICE OF THE GENERAL COUNSEL

3 CY ATTN: MR HADAD

ON-SITE INSPECTION AGENCY

ATTN: COL GILBERT

OUSD ACQUISITION

ATTN: DR J FREEDMAN
ATTN: L MINICHELLO
ATTN: M EVANS

U S EUROPEAN COMMAND/ECJ2-T

ATTN: ECJ-3
ATTN: ECJ2-T

DEPARTMENT OF THE ARMY

ARMY RESEARCH LABORATORIES

ATTN: TECH LIB

DEP CH OF STAFF FOR OPS & PLANS

ATTN: DAMO-SWN

U S ARMY BALLISTIC RESEARCH LAB

ATTN: SLCBR-SS-T

U S ARMY CONCEPTS ANALYSIS AGENCY

ATTN: TECHNICAL INFO CENTER

U S ARMY MATERIAL COMMAND

ATTN: AMCAN-CN COL NIKAI

U S ARMY NUCLEAR & CHEMICAL AGENCY

ATTN: MONA-NU DR D BASH

U S ARMY WAR COLLEGE

ATTN: LIBRARY

US ARMY MATERIEL SYS ANALYSIS ACTVY

ATTN: AMXSY-CR

USA CML & BIOLOGICAL DEFENSE AGENCY

ATTN: AMSCB-TC MR COLBURN

DEPARTMENT OF THE NAVY

NAVAL AIR FORCE

ATTN: COMMANDER

NAVAL AIR FORCE

ATTN: COMMANDER

NAVAL POSTGRADUATE SCHOOL

ATTN: CODE 52 LIBRARY

NAVAL RESEARCH LABORATORY

ATTN: CODE 5227 RESEARCH REPORT

NAVAL SURFACE FORCE

ATTN: COMMANDER

NAVAL TECHNICAL INTELLIGENCE CTR

ATTN: NTIC-DA30

NAWCWPNSDIV DETACHMENT

ATTN: CLASSIFIED LIBRARY

OFFICE OF CHIEF OF NAVAL OPERATIONS

ATTN: NUC AFFAIRS & INT'L NEGOT BR

DEPARTMENT OF THE AIR FORCE

AFIS/INT

ATTN: INT

AIR FORCE CTR FOR STUDIES & ANALYSIS

ATTN: AFSAA/SAI

AIR UNIVERSITY LIBRARY

ATTN: AUL-LSE

DEPUTY CHIEF OF STAFF FOR PLANS & OPERS

ATTN: AFXOOS
ATTN: AFXOXI COL ENGSTROM

DEPARTMENT OF ENERGY

ARGONNE NATIONAL LABORATORY

ATTN: DR A DEVOLPI

BROOKHAVEN NATIONAL LABORATORY

ATTN: DR J INDUSI

EG&G IDAHO INC

ATTN: DR J JONES

LAWRENCE LIVERMORE NATIONAL LAB

ATTN: P SOKKAPPA
ATTN: DR R ANDREWS

LOS ALAMOS NATIONAL LABORATORY

ATTN: K APT
ATTN: H T HAWKINS
ATTN: REPORT LIBRARY

OAK RIDGE NATIONAL LABORATORY

ATTN: J DOOLEY

PACIFIC NORTHWEST LABORATORY

ATTN: DR J FULLER
ATTN: DR H UNDEM

SANDIA NATIONAL LABORATORIES

ATTN: DEPT 9208 B COURTNEY
ATTN: DEPT 9208 P DOBRANICH
ATTN: TECH LIB 3141

US DEPARTMENT OF ENERGY

ATTN: IC MAKRIS
ATTN: M O'CONNELL
ATTN: V ALESSI

OTHER GOVERNMENT

CENTRAL INTELLIGENCE AGENCY

ATTN: MR SPALDING
ATTN: STRATEGIC SYS

U S ARMS CONTROL & DISARMAMENT AGCY

ATTN: A LIEBERMAN
ATTN: MR MIKULAK
ATTN: MR STAPLES

U S DEPARTMENT OF STATE

ATTN: PM/TMP

DEPARTMENT OF DEFENSE CONTRACTORS

BATTELLE EDGEWOOD OPERATIONS

ATTN: MS BRLETICH

BDM FEDERAL INC

2 CY ATTN: P SULLIVAN

BDM FEDERAL INC

ATTN: A WRIGHT
ATTN: B J BANKS
ATTN: B J HILL

10 CY ATTN: DR M FISCHER

ATTN: E M DRESSSEL
ATTN: G P ALLDREDGE
ATTN: J A TROLLINGER
ATTN: J J CORCORAN
ATTN: J J DICKENS
ATTN: M C ROGERS
ATTN: R E CABEEN
ATTN: R I MCCANN
ATTN: D THOMAS
ATTN: M JOHNSON
ATTN: R SMITH
ATTN: R SALAZAR
ATTN: W T HEDIN

DNA FIELD OFFICE

ATTN: DR EUGENE GOODWIN

JAYCOR

ATTN: CYRUS P KNOWLES

KAMAN SCIENCES CORP

ATTN: D ALDERSON
ATTN: DASIAC
ATTN: DR B SEIDERS

KAMAN SCIENCES CORPORATION

ATTN: DASIAC

LOGICON R & D ASSOCIATES

ATTN: D CARLSON

SCIENCE APPLICATIONS INTL CORP

2 CY ATTN: DR R DESJARDIN

SCIENCE APPLICATIONS INTL CORP

12 CY ATTN: CVR MR WATTAWA

TELEDYNE INDUSTRIES, INC

ATTN: M STEUSSY