

AD-A245 487



NAVAL POSTGRADUATE SCHOOL Monterey, California

u
②



THESIS

DTIC
ELECTE
FEB 04 1992
S B D

NUCLEATE POOL BOILING OF R-114 AND R-114/OIL
MIXTURES FROM SINGLE ENHANCED TUBES

by

Dean C. Sugiyama

SEPTEMBER 1991

Thesis Advisor: Paul J. Marto
Thesis Co-Advisor: Stephen B. Memory

Approved for public release: Distribution is unlimited

02 1 00 070

92-02557
■■■■■■■■■■

THIS DOCUMENT HAS MISSING PAGES AND CONTRIBUTOR CANNOT PROVIDE
THEM. PER TELECON

Unclassified

SECURITY CLASSIFICATION OF THIS PAGE

REPORT DOCUMENTATION PAGE				Form Approved OMB No 0704-0188	
1a. REPORT SECURITY CLASSIFICATION Unclassified		1b. RESTRICTIVE MARKINGS			
2a. SECURITY CLASSIFICATION AUTHORITY		3. DISTRIBUTION/AVAILABILITY OF REPORT Approved for public release: Distribution is unlimited			
2b. DECLASSIFICATION/DOWNGRADING SCHEDULE					
4. PERFORMING ORGANIZATION REPORT NUMBER(S)		5. MONITORING ORGANIZATION REPORT NUMBER(S)			
6a. NAME OF PERFORMING ORGANIZATION Naval Postgraduate School		6b. OFFICE SYMBOL (If applicable) ME	7a. NAME OF MONITORING ORGANIZATION Naval Postgraduate School		
6c. ADDRESS (City, State and ZIP Code) Monterey, CA 93943-5000		7b. ADDRESS (City, State, and ZIP Code) Monterey, CA 93943-5000			
8a. NAME OF FUNDING/SPONSORING ORGANIZATION		8b. OFFICE SYMBOL (If applicable)	9. PROCUREMENT INSTRUMENT IDENTIFICATION NUMBER		
8c. ADDRESS (City, State, and ZIP Code)		10. SOURCE OF FUNDING NUMBER			
		PROGRAM ELEMENT NO.	PROJECT NO.	TASK NO.	WORK UNIT ACCESSION NO.
11. TITLE (Include Security Classification) NUCLEATE POOL BOILING OF R-114 AND R-114/OIL MIXTURES FROM SINGLE ENHANCED TUBES					
12. PERSONAL AUTHORS DEAN C. SUGIYAMA					
13a. TYPE OF REPORT Master's Thesis		13b. TIME COVERED FROM _____ TO _____	14. DATE OF REPORT (Year, Month, Day) SEPTEMBER 1991		15. PAGE COUNT 228
16. SUPPLEMENTARY NOTATION The views expressed are those of the author and do not reflect the official policy or position of the Department of Defense or the U.S. Government					
17. COSATI CODES			18. SUBJECT TERMS (Continue on reverse if necessary and identify by block numbers)		
FIELD	GROUP	SUB-GROUP	heat transfer, nucleate pool boiling, R-114/oil mixtures		
19. ABSTRACT (Continue on reverse if necessary and identify by block numbers) Nucleate pool boiling heat transfer is an integral part of any vapor-compression refrigeration cycle. With a view to improving overall cycle efficiency, the heat transfer performance in the evaporator can be improved by using enhanced boiling surfaces. This thesis looks at the pool boiling characteristics of R-114 (presently used in large shipboard AC systems) from 10 enhanced single copper tubes and compares performance with a smooth copper tube. Since small amounts of oil escape into the refrigerant as it passes through the compressor of a refrigeration system, tests have also been conducted with up to 10% (by weight) of a miscible oil to see what effect this may have on overall evaporator performance.					
20. DISTRIBUTION/AVAILABILITY OF ABSTRACT XX UNCLASSIFIED/UNLIMITED _ SAME AS RPT _ DTIC USERS			21. ABSTRACT SECURITY CLASSIFICATION unclassified		
22a. NAME OF RESPONSIBLE INDIVIDUAL Paul J. Marto			22b. TELEPHONE (Include Area Code) (408) 646-3241		22c. OFFICE SYMBOL ME/Mx

Approved for public release: Distribution is unlimited

Nucleate Pool Boiling of R-114 and R-114/Oil Mixtures
from Single Enhanced Tubes

by

Dean C. Sugiyama
Lieutenant, United States Navy
B.A., University of California of Berkeley, 1985

Submitted in partial fulfillment of the
requirements for the degree of

MASTER OF SCIENCE
IN MECHANICAL ENGINEERING

from the

NAVAL POSTGRADUATE SCHOOL

SEPTEMBER 1991

Author:

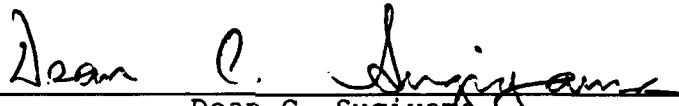

Dean C. Sugiyama

Approved by:



Paul J. Marto, Thesis Advisor



Stephen B. Memory, Thesis Co-Advisor

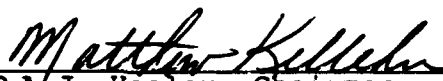

for A.J. Healey, Chairman
Department of Mechanical Engineering

ABSTRACT

Nucleate pool boiling heat transfer is an integral part of any vapor-compression refrigeration cycle. With a view to improving overall cycle efficiency, the heat transfer performance in the evaporator can be improved by using enhanced boiling surfaces. This thesis looks at the pool boiling characteristics of R-114 (presently used in large shipboard AC systems) from 10 enhanced single copper tubes and compares performance with a smooth copper tube. Since small amounts of oil escape into the refrigerant as it passes through the compressor of a refrigeration system, tests have also been conducted with up to 10% (by weight) of a miscible oil to see what effect this may have on overall evaporator performance.



Accession For	
NTIS GRA&I	<input checked="" type="checkbox"/>
DTIC TAB	<input type="checkbox"/>
Unannounced	<input type="checkbox"/>
Justification	
By _____	
Distribution/	
Availability Codes	
Dist	Avail and/or Special
A-1	

TABLE OF CONTENTS

I.	INTRODUCTION	1
	A. BACKGROUND	1
	B. ADVANTAGES OF USING R-114	1
	C. THESIS OBJECTIVES	2
II.	REVIEW OF REFRIGERANT AND REFRIGERANT/OIL POOL BOILING BEHAVIOR	3
	A. NUCLEATE POOL BOILING PERFORMANCE OF PURE R-114	3
	B. NUCLEATE POOL BOILING PERFORMANCE OF REFRIGERANT-OIL MIXTURES	5
III.	DESCRIPTION OF EXPERIMENTAL APPARATUS	8
	A. OVERVIEW OF THE SYSTEM	8
	B. BOILING TEST SECTION	11
	1. Evaporator	11
	2. Test Tube	11
	3. Boiling Tubes	12
	C. CONDENSER SECTION	14
	D. OIL ADDING SECTION	14
	E. COOLING SECTION	15
	1. Water-Ethylene Glycol Mixture Tank	15
	2. R-502 Refrigeration Plant	16
	3. Pump and Control Valve	16
	F. R-114 RESERVOIR	17
	G. CHAMBER	17
	H. INSTRUMENTATION	18
	1. Power Measurement	18
	2. Temperature Measurement	18
IV.	DATA ACQUISITION AND REDUCTION	33
	A. DATA ACQUISITION AND STORAGE	33
	B. DATA REDUCTION	33
	C. STEPWISE DATA-COLLECTION AND SOLUTION PROCEDURE	34

V.	EXPERIMENTAL PROCEDURE	36
	A. PREPARATION	36
	1. Vacuum test of the Apparatus	36
	2. Pressure Test of the Apparatus	36
	3. Charging the Apparatus with R-114	36
	4. Degassing and Data Acquisition Channel Check.	37
	B. NORMAL OPERATION	37
VI.	RESULTS AND DISCUSSION	43
	A. REPRODUCIBILITY	43
	B. COMPARISON OF DATA WITH PREDICTION	43
	C. EFFECTS OF DEGASSING	44
	D. BOILING PERFORMANCE OF ENHANCED TUBES IN PURE R-114 AND R-114/OIL MIXTURES	45
	1. Boiling Performance of Smooth Tube	45
	2. Boiling Performance of Finned/Modified Finned Tubes	46
	3. Boiling Performance of High Flux Tube	51
	4. Boiling Performance of the Thermoexcel Tubes	53
	5. Boiling Performance of the Turbo-B Tube	54
	6. Overall Performance of Smooth and Enhanced Surfaces	55
VII.	CONCLUSIONS	139
VIII.	RECOMMENDATIONS	140
	APPENDIX A: THERMOPHYSICAL PROPERTIES OF R-114	141
	APPENDIX B: DATA ACQUISITION APPARATUS CALIBRATION	147
	APPENDIX C: AN EXAMPLE OF REPRESENTATIVE DATA RUN	153
	APPENDIX D: SAMPLE CALCULATION	158
	APPENDIX E: UNCERTAINTY ANALYSES	162
	APPENDIX F: SETUP PROGRAM	167
	APPENDIX G: DATA REDUCTION PROGRAM	171
	LIST OF REFERENCES	210
	INITIAL DISTRIBUTION LIST	212

LIST OF TABLES

TABLE I.	HP 3497A CHANNEL ASSIGNMENTS	35
TABLE II.	LISTING OF DATA RUNS	39
TABLE III.	HEAT TRANSFER COEFFICIENT ENHANCEMENT RATIOS FOR SMOOTH VERSUS ENHANCED SURFACES	138
TABLE IV.	DIMENSIONS OF BOILING TUBES	161
TABLE V.	UNCERTAINTY ANALYSIS OF FOUR DATA POINTS	165

LIST OF FIGURES

Figure 3.1	Schematic of Single Tube Apparatus	20
Figure 3.2	Photograph of Experimental Apparatus . . .	21
Figure 3.3	Schematic of the Pyrex Glass Evaporator .	22
Figure 3.4	Schematic of the Boiling Test Tube	23
Figure 3.5	Schematic and Photograph of GEWA-K and GEWA-T Fins	24
Figure 3.6	Photographs of GEWA-YX Tube and Fin . . .	25
Figure 3.7	Schematic and Photograph of High Flux Surface	26
Figure 3.8	Schematic and Photograph of Thermoexcel-HE Surface	27
Figure 3.9	Photographs of Thermoexcel-E and Turbo-B Surfaces	28
Figure 3.10	Positions of the Thermocouples	29
Figure 3.11	Schematic of R-502 Refrigeration System .	30
Figure 3.12	Schematic of the Power Measurement	31
Figure 3.13	Sketch of a Thermocouple Well	32
Figure 6.1	Repeatability Comparison for Pure R-114 Boiling From GEWA-T 19 fpi Tube	57
Figure 6.2	Performance Comparison for Pure R-114 Boiling From a Smooth Tube with Known Correlations	58
Figure 6.3	Performance Comparison for Pure R-114 Boiling From Thermoexcel-E Tube Effect of De-gassing Surface/Fluid	59
Figure 6.4	Performance Comparison for Pure R-114 Boiling From Smooth Tube Surface	60
Figure 6.5	Performance Comparison for R-114/3% Oil Mixture Boiling From Smooth Tube Surface	61
Figure 6.6	Performance Comparison for R-114/10% Oil Mixture Boiling From Smooth Tube Surface	62

Figure 6.7	Performance Comparison for Boiling R-114/0%, 3% & 10% Oil Mixtures From Smooth Tube Surface Increasing Flux . . .	63
Figure 6.8	Performance Comparison for Boiling R-114/0%, 3% & 10% Oil Mixtures From Smooth Tube Surface Decreasing Flux . . .	64
Figure 6.9	Performance Comparison for Pure R-114 Boiling From GEWA-K 26 fpi Tube	65
Figure 6.10	Performance Comparison for R-114/3% Oil Mixture Boiling From GEWA-K 26 fpi Tube .	66
Figure 6.11	Performance Comparison for R-114/10% Oil Mixture Boiling From GEWA-K 26 fpi Tube .	67
Figure 6.12	Performance Comparison for Boiling R-114/0%, 3% & 10% Oil Mixtures From GEWA-K 26 fpi Tube Increasing Flux	68
Figure 6.13	Performance Comparison for Boiling R-114/0%, 3% & 10% Oil Mixtures From GEWA-K 26 fpi Tube Decreasing Flux	69
Figure 6.14	Performance Comparison for Pure R-114 Boiling From GEWA-K 40 fpi Tube	70
Figure 6.15	Performance Comparison for R-114/3% Oil Mixture Boiling From GEWA-K 40 fpi Tube .	71
Figure 6.16	Performance Comparison for R-114/10% Oil Mixture Boiling From GEWA-K 40 fpi Tube .	72
Figure 6.17	Performance Comparison for Boiling R-114/0%, 3% & 10% Oil Mixtures From GEWA-K 40 fpi Tube Increasing Flux	73
Figure 6.18	Performance Comparison for Boiling R-114/0%, 3% & 10% Oil Mixtures From GEWA-K 40 fpi Tube Decreasing Flux	74
Figure 6.19	Performance Comparison for Pure R-114 Boiling From GEWA-K 26 & 40 fpi Tubes Increasing Flux	75
Figure 6.20	Performance Comparison for Pure R-114 Boiling From GEWA-K 26 & 40 fpi Tubes Decreasing Flux	76

Figure 6.21	Performance Comparison for R-114/3% Oil Mixture Boiling From GEWA-K 26 & 40 fpi Tubes Increasing Flux	77
Figure 6.22	Performance Comparison for R-114/3% Oil Mixture Boiling From GEWA-K 26 & 40 fpi Tubes Decreasing Flux	78
Figure 6.23	Performance Comparison for R-114/10% Oil Mixture Boiling From GEWA-K 26 & 40 fpi Tubes Increasing Flux	79
Figure 6.24	Performance Comparison for R-114/10% Oil Mixture Boiling From GEWA-K 26 & 40 fpi Tubes Decreasing Flux	80
Figure 6.25	Performance Comparison for Pure R-114 Boiling From GEWA-T 19 fpi Tube	81
Figure 6.26	Performance Comparison for R-114/3% Oil Mixture Boiling From GEWA-T 19 fpi Tube	82
Figure 6.27	Performance Comparison for R-114/10% Oil Mixture Boiling From GEWA-T 19 fpi Tube	83
Figure 6.28	Performance Comparison for Boiling R-114/0%, 3% & 10% Oil Mixtures From GEWA-T 19 fpi Tube Increasing Flux	84
Figure 6.29	Performance Comparison for Boiling R-114/0%, 3% & 10% Oil Mixtures From GEWA-T 19 fpi Tube Decreasing Flux	85
Figure 6.30	Performance Comparison for Pure R-114 Boiling From GEWA-T 26 fpi Tube	86
Figure 6.31	Performance Comparison for R-114/3% Oil Mixture Boiling From GEWA-T 26 fpi Tube	87
Figure 6.32	Performance Comparison for R-114/10% Oil Mixture Boiling From GEWA-T 26 fpi Tube	88
Figure 6.33	Performance Comparison for Boiling R-114/0%, 3% & 10% Oil Mixtures From GEWA-T 26 fpi Tubes Increasing Flux	89
Figure 6.34	Performance Comparison for Boiling R-114/0%, 3% & 10% Oil Mixtures From GEWA-T 26 fpi Tube Decreasing Flux	90

Figure 6.35	Performance Comparison for Pure R-114 Boiling From GEWA-T 19 & 26 fpi Tubes Increasing Flux	91
Figure 6.36	Performance Comparison for Pure R-114 Boiling From GEWA-T 19 & 26 fpi Tubes Decreasing Flux	92
Figure 6.37	Performance Comparison for R-114/3% Oil Mixture Boiling From GEWA-T 19 & 26 fpi Tubes Increasing Flux	93
Figure 6.38	Performance Comparison for R-114/3% Oil Mixture Boiling From GEWA-T 19 & 26 fpi Tubes Decreasing Flux	94
Figure 6.39	Performance Comparison for R-114/10% Oil Mixture Boiling From GEWA-T 19 & 26 fpi Tubes Increasing Flux	95
Figure 6.40	Performance Comparison for R-114/10% Oil Mixture Boiling From GEWA-T 19 & 26 fpi Tubes Decreasing Flux	96
Figure 6.41	Performance Comparison for Pure R-114 Boiling From GEWA-YX 26 fpi Tube	97
Figure 6.42	Performance Comparison for R-114/3% Oil Mixture Boiling From GEWA-YX 26 fpi Tube	98
Figure 6.43	Performance Comparison for R-114/10% Oil Mixture Boiling From GEWA-YX 26 fpi Tube	99
Figure 6.44	Performance Comparison for Boiling R-114/0%, 3% & 10% Oil Mixtures From GEWA-YX 26 fpi Tube Increasing Flux . . .	100
Figure 6.45	Performance Comparison for Boiling R-114/0%, 3% & 10% Oil Mixtures From GEWA-YX 26 fpi Tube Decreasing Flux . . .	101
Figure 6.46	Performance Comparison for Pure R-114 Boiling From GEWA-K/T/YX 26 fpi Tubes Increasing Flux	102

Figure 6.47	Performance Comparison for Pure R-114 Boiling From GEWA-K/T/YX 26 fpi Tubes Decreasing Flux	103
Figure 6.48	Performance Comparison for R-114/3% Oil Mixture Boiling From GEWA-K/T/YX fpi Tubes Increasing Flux	104
Figure 6.49	Performance Comparison for R-114/3% Oil Mixture Boiling From GEWA-K/T/YX fpi Tubes Decreasing Flux	105
Figure 6.50	Performance Comparison for R-114/10% Oil Mixture Boiling From GEWA-K/T/YX 26 fpi Tubes Increasing Flux	106
Figure 6.51	Performance Comparison for R-114/10% Oil Mixture Boiling From GEWA-K/T/YX 26 fpi Tubes Decreasing Flux	107
Figure 6.52	Performance Comparison for Pure R-114 Boiling From High Flux Tube	108
Figure 6.53	Performance Comparison for R-114/3% Oil Mixture Boiling From High Flux Tube	109
Figure 6.54	Performance Comparison for R-114/10% Oil Mixture Boiling From High Flux Tube	110
Figure 6.55	Performance Comparison for Boiling R-114/0%, 3% & 10% Oil Mixtures From High Flux Tube Increasing Flux	111
Figure 6.56	Performance Comparison for Boiling R-114/0%, 3% & 10% Oil Mixtures From High Flux Tube Increasing Flux	112
Figure 6.57	Performance Comparison for Pure R-114 Boiling From Thermoexcel-E Tube	113
Figure 6.58	Performance Comparison for R-114/3% Oil Mixture Boiling From Thermoexcel-E Tube	114
Figure 6.59	Performance Comparison for R-114/10% Oil Mixture Boiling From Thermoexcel-E Tube	115
Figure 6.60	Performance Comparison for Boiling R-114/0%, 3% & 10% Oil Mixtures From Thermoexcel-E Tube Increasing Flux	116

Figure 6.61	Performance Comparison for Boiling R-114/0%, 3% & 10% Oil Mixtures From Thermoexcel-E Tube Decreasing Flux	117
Figure 6.62	Performance Comparison for Pure R-114 Boiling From Thermoexcel-HE Tube	118
Figure 6.63	Performance Comparison for R-114/3% Oil Mixture Boiling From Thermoexcel-HE Tube	119
Figure 6.64	Performance Comparison for R-114/10% Oil Mixture Boiling From Thermoexcel-HE Tube	120
Figure 6.65	Performance Comparison for Boiling R-114/0%, 3% & 10% Oil Mixtures From Thermoexcel-HE Tube Increasing Flux . . .	121
Figure 6.66	Performance Comparison for Boiling R-114/0%, 3% & 10% Oil Mixtures From Thermoexcel-HE Tube Decreasing Flux . . .	122
Figure 6.67	Performance Comparison for Pure R-114 Boiling From Thermoexcel-E/HE Tubes Increasing Flux	123
Figure 6.68	Performance Comparison for Pure R-114 Boiling From Thermoexcel-E/HE Tubes Decreasing Flux	124
Figure 6.69	Performance Comparison for R-114/3% Oil Mixture Boiling From Thermoexcel-E/HE Tubes Increasing Flux	125
Figure 6.70	Performance Comparison for R-114/3% Oil Mixture Boiling From Thermoexcel-E/HE Tubes Decreasing Flux	126
Figure 6.71	Performance Comparison for R-114/10% Oil Mixture Boiling From Thermoexcel-E/HE Tubes Increasing Flux	127
Figure 6.72	Performance Comparison for R-114/10% Oil Mixture Boiling From Thermoexcel-E/HE Tubes Decreasing Flux	128
Figure 6.73	Performance Comparison for Pure R-114 Boiling From Turbo-B Tube	129

Figure 6.74	Performance Comparison for R-114/3% Oil Mixture Boiling From Turbo-B Tube	130
Figure 6.75	Performance Comparison for R-114/10% Oil Mixture Boiling From Turbo-B Tube	131
Figure 6.76	Performance Comparison for Boiling R-114/0%, 3% & 10% Oil Mixtures From Turbo-B Tube Increasing Flux	132
Figure 6.77	Performance Comparison for Boiling R-114/0%, 3% & 10% Oil Mixtures From Turbo-B Tube Decreasing Flux	133
Figure 6.78	Performance Comparison for Pure R-114 Boiling From Smooth and Enhanced Surfaces	134
Figure 6.79	Performance Comparison for R-114/3% Oil Mixture Boiling From Smooth and Enhanced Surfaces	135
Figure 6.80	Performance Comparison for R-114/10% Oil Mixture Boiling From Smooth and Enhanced Surfaces	136
Figure 6.81	Performance Comparison for Pure R-114 Boiling From GEWA-K 26 fpi Using Actual Wetted Surface Area	137
Figure A.1	Liquid Density of R-114	142
Figure A.2	Liquid Dynamic Viscosity of R-114	143
Figure A.3	Liquid Thermal Conductivity of R-114	144
Figure A-4	Liquid Specific Heat of R-114	145
Figure A-5	Latent Heat of R-114	146
Figure B.1	Schematic of Calibration Setup	150
Figure B.2	Cartridge Heater Resistance For High Flux Tube	151
Figure B.3	Variac Current Calibration Using High Flux Tube	152
Figure E.1	Uncertainty Analysis Error Bands for Heat Flux and Superheat	162

NOMENCLATURE

A	area
Ab	tube outside surface area of active boiling section
Ac	cross-sectional area of tube
Cp	specific heat
D	diameter
Di	tube inside diameter
Do	tube outside diameter
D1	diameter at the position of the thermocouple
D2	outer diameter of the boiling tube
g	gravitational acceleration
h	heat-transfer coefficient
hfg	latent heat of vaporization
I	current
Is	current reading by AC Current Sensor
k	thermal conductivity of liquid
kc	thermal conductivity of copper
L	active boiling tube length
Lu	non-boiling length of the test tube
Nu	Nusselt number
p	tube outside wall perimeter
Pr	Prandtl Number
Q	heat-transfer rate from boiling surface
Qf	heat-transfer rate through one nonboiling end
Qh	heat-transfer rate from cartridge heater
q"	heat flux
Ra	Rayleigh number
T	temperature
Tavg	average wall temperature at the thermocouple location
Tc	critical temperature
Tf	film temperature

T_n	temperature of the thermocouple location
T_{sat}	saturation temperature
T_{wo}	outer wall temperature of the boiling test tube
V	voltage across the cartridge heater
V_s	voltage reading by AC-DC true RMS converter
α	thermal diffusivity
β	volumetric thermal expansion coefficient
δ	uncertainty in measurement and calibration
θ	superheat
μ	dynamic viscosity
ν	kinematic viscosity
ρ	density

I. INTRODUCTION

A. BACKGROUND

The United States Navy currently uses R-114 in approximately 950 centrifugal chilled-water air-conditioning plants. Ongoing efforts to reduce the cost and increase the efficiency of these plants have been directed towards the use of enhanced heat-transfer tube surfaces and alternative refrigerants. The choice of alternative refrigerant must be "ozone friendly." A possible "drop in" replacement for R-114 has been identified: R-124. Studies of the boiling performance of R-124 would be complemented well by a baseline of data on R-114.

B. ADVANTAGES OF USING R-114

The use of R-114 in Naval applications has been driven by concerns for both cost and safety. R-114 operates under moderate pressures and has one of the lowest toxicity ratings among all refrigerants. System components are significantly smaller and more lightweight which is desirable for shipboard use and maintenance. While R-11 is widely used in industry, its operating requirements make it unsuitable onboard ship. R-11 operates under vacuum and has a tendency to absorb ambient moisture. This acidic combination of R-11 and moisture attacks tubes and causes corrosion. R-114 is considerably stable to

heat and may be used with all standard ferrous and non-ferrous metals except zinc, magnesium and aluminum alloys containing appreciable amounts of zinc and magnesium. The thermophysical properties of R-114 are provided in Appendix A.

C. THESIS OBJECTIVES

Safety requirements for future studies of R-124 necessitated the disassembly and relocation of the single-tube apparatus described in this thesis. Past studies using the apparatus have varied considerably in operating procedure, thus it became desirable to establish a consistent operating procedure in the acquisition of all data on R-114. With the foregoing discussion in mind, the objectives of this thesis were to:

1. Relocate and calibrate the single tube apparatus.
2. Operate the apparatus to produce repeatable data and confirm earlier results.
3. Obtain boiling data for R-114 and R-114/oil mixtures on ten tube surfaces to be used as a database for future studies on enhanced surfaces and alternative "ozone safe" refrigerants.

II. REVIEW OF REFRIGERANT AND REFRIGERANT/OIL POOL BOILING BEHAVIOR

A. NUCLEATE POOL BOILING PERFORMANCE OF PURE R-114

The heat-transfer performance of pure R-114 on a smooth tube in the natural convection region of its boiling curve can be reasonably predicted using well known correlations, Churchill and Chu [Ref. 1] and more recently Churchill and Usagi [Ref. 2]. A lack of complete understanding of the nucleate boiling mechanism makes it more difficult to predict the performance in the nucleate boiling region. Well known correlations, such as that by Rohsenow [Ref. 1], and more recently, Stephan-Adelsalam [Ref. 3] are approximate and should be compared with experimental data whenever possible.

Many pool-boiling experiments have been carried out on finned tubes (typically 19 to 40 fpi) in pure refrigerants. For various refrigerants, tube material, fin density and system pressure, typical enhancements in the heat transfer coefficient (over smooth tubes values) of up to 3 have been reported, the refrigerants with better wetting characteristics giving the greater enhancement. Interestingly enough, the boiling performance of finned tubes becomes very similar to that of smooth tubes, if the heat flux is recalculated on the basis of total outside wetted surface area (rather than root diameter, which is commonly used).

Re-entrant cavity surfaces differ from finned surfaces in that they provide a higher density of stable nucleation sites with minimum wall superheat (Yilmaz and Westwater [Ref. 4] Carnavos [Ref. 5], Marto and Lepere [Ref. 6] and Wanniarachchi et al. [Refs. 7, 8]). Significant improvements in heat transfer over both finned and smooth tubes have been shown for re-entrant cavity surfaces.

Boiling enhancements were as large as 14.6 and 6.4 for High Flux and Turbo-B tubes, respectively, compared to smooth tube data.

Webb [Ref. 9] stated that the key to the high performance of the re-entrant surfaces can be attributed to three factors: (1) re-entrant cavity within a critical size range, (2) interconnected cavities, and (3) nucleation sites of a re-entrant shape. If the cavities are interconnected, adjacent cavities can activate each other. Re-entrant cavities provide a stable vapor trap, which can remain active at low values of superheat.

During nucleate boiling of R-114 at one atmosphere, Wanniarachchi et al. [Refs. 7 and 8] reported data for four enhanced tubes: a porous coated High Flux, Thermoexcel-E, Thermoexcel-HE and a 26 fpi GEWA-T. Enhancements of 9.1, 8.2, 6.8 and 4.4 respectively were obtained at a heat flux of 30 kW/m². The enhancement provided by the High Flux tube reduced to 6 at higher fluxes of about 100 kW/m², but it still outperformed the other three tubes. At heat fluxes below 18

kW/m², both the Thermoexcel tubes performed the best. However, they noted that the uncertainty in the data increased as both superheat and heat flux decreased.

Whereas the majority of pool-boiling experiments use electrically heat tubes, McManus et al. [Ref. 10] used hot water to heat both a High Flux and Turbo-B tube in a pool of R-114. The range of heat flux was very limited. However, at a heat flux of 40 Kw/m², enhancements of 14.6 and 6.4 respectively, were obtained over smooth tube values.

B. NUCLEATE POOL BOILING PERFORMANCE OF REFRIGERANT-OIL MIXTURES

Most refrigeration systems use hermetically sealed compressors which allow small quantities of oil to escape into the working fluid. This oil tends to collect in the flooded evaporator, giving up to 10% oil in some cases. The nucleate pool boiling mechanism is further complicated when a less volatile component, such as miscible refrigerant oil, is mixed with the refrigerant. Design and modelling rely heavily on accurate experimental data covering a wide range of operating conditions.

Compared with pure refrigerants, there is little data for boiling of refrigerant/oil mixtures from finned surfaces. Chaddock [Ref. 11] gives a thorough summary of such mixtures through 1975. Sauer et al. [Ref. 12] report data from 19 fpi copper tube using R-11 with two different oils. For oil

concentrations less than 3%, their results indicated no difference in boiling heat transfer performance from that of the pure refrigerant. For oil concentrations greater than 5%, significant degradation in performance was shown. They concluded that finned tubes performed best at low wall superheats and that this performance was not impaired by up to 3% oil addition.

Murphy [Ref. 13] carried out experiments on a 26 and 40 fpi tube using R-114/oil mixtures. Similar to Sauer [Ref. 11], no difference in performance was observed for oil concentrations up to 3%. Indeed in some cases, at a higher heat flux of about 100 kW/m^2 , a 3% oil concentration showed a small increase in performance over the pure refrigerant case. The mechanism for this improvement is not well understood, but has been found by a number of investigators for both flow and pool boiling. At a 10% oil concentration, both tubes exhibited a 30% degradation in performance versus the pure refrigerant case, which agreed with Sauer's findings.

Wanniarachi et al. [Refs. 7, 8] reported the performance of High Flux, Thermoexcel-E, Thermoexcel-HE and GEWA-T tubes in R-114/oil mixtures at one atmosphere. Oil concentrations up to 10% (by weight) were studied. A marked increase in the wall superheat values required for the incipience of nucleate boiling was observed in the presence of oil. Enhancements mentioned previously for pure R-114 were reduced at a 3% oil concentration, to 7.5, 5.5, 5.5 and 3.8 respectively. With 10%

oil concentrations, further reductions to 5.5, 3.8, 3,8 and 2.9 were observed. At the highest heat fluxes ($> 45 \text{ kW/m}^2$) and for oil concentrations greater than 6%, the performance of the High Flux tube degraded at a rate that left the GEWA-T tube as the best performer.

III. DESCRIPTION OF EXPERIMENTAL APPARATUS

A. OVERVIEW OF THE SYSTEM

Wanniarachchi et al. [Ref. 7], Murphy [Ref. 13] and Karasabun [Ref. 14] provide complete details of the original apparatus used in previous studies. Disassembly of the original apparatus to facilitate relocation and subsequent modifications to meet present site requirements justify a full description of the apparatus. The original R-12 cooling subsystem was supplanted by a more efficient R-502 system. The auxiliary heaters and plastic shield were removed, however power extensions were kept available for their use in future studies. The Variac power supply to the tube heater was calibrated and emplaced into a panel enclosure. See Appendix D, Apparatus Calibration for more details. A more modern Hewlet-Packard Computer/Data Acquisition system was installed and the data reduction program DRP8 was updated to account for variac calibration and program language changes.

An overall schematic representation of the experimental apparatus is shown in Figure 3.1, and a photograph is shown in Figure 3.2. The apparatus essentially consists of 8 (components: 1) a Pyrex-glass tee for the pool boiling of the R-114 liquid, "the evaporator"; (2) a Pyrex-glass tee for the condensing of the R-114 vapor, "the condenser"; (3) a R-114

liquid reservoir; (4) a refrigerant/oil subsystem composed of an oil reservoir and a graduated oil cylinder; (5) a cooling subsystem composed of a 1/2 ton R-502 refrigeration plant, 2 positive displacement pumps and a 30 gallon water/ethylene glycol sump; (6) a vacuum pump; (7) a data acquisition and instrumentation system; (8) an aluminum/Plexi-glass framework within which components (1) through (4) were housed.

The apparatus was operated as follows: liquid R-114 was boiled in the evaporator (1), passed as vapor through the aluminum L-shaped connection and condensed in the condenser (2). R-114 condensate was returned by gravity via the distribution tube to the condenser. The R-502 refrigeration plant maintained the water/ethylene glycol mixture in the sump between -12 and -18 °C. Cooling of the sump was accomplished by a countercurrent flow heat exchanger through which an 8-gpm turbine-type pump recirculated the water/ethylene glycol mixture. An identical positive displacement pump circulated the cooled mixture through the copper condensing coils in the condenser via the control valve VC.

Prior to dismantling the evaporator in order to change out boiling tubes, the liquid R-114 was boiled out of the evaporator, condensed on the coils of the condenser then recovered to the R-114 liquid reservoir rather than returned to the evaporator. Upon reassembly, the evaporator was recharged with liquid R-114 by gravity from the reservoir. The

level in the reservoir could be topped off via the condenser from an external supply cylinder through valve V10.

Exact quantities of oil could be added to the liquid R-114 in the lower glass tee from the graduated cylinder (5) by gravity. The graduated cylinder was filled with oil by gravity from the oil reservoir through valves V14 and V2. Refilling the oil reservoir was done through valve V3 located at the top of the framework. All oil left over from the recovery of the liquid R-114 was drained out of the lower glass tee and disposed of.

The boiling tube was mounted horizontally in the evaporator and held in place by Teflon bushings with O-ring inserts. The whole system was connected to the vacuum pump (6) through valve V8 in order to remove noncondensable gases. A relief valve mounted on the aluminum L connection was set to a gage pressure limit of 20 psi, which is 50% less than the manufacturer-recommended working pressure limit of the Pyrex glass tees. All connections were assembled with Swagelok fittings sealed with Teflon ferrules to ensure leak tightness. Copper tubing of 3/8 inch diameter was used for all piping, except in the oil section, where 1/4 inch copper tubing was used.

B. BOILING TEST SECTION

1. Evaporator

The evaporator is a T-shaped container made of Corning Pyrex glass. Figure 3.3 shows a schematic of the evaporator with dimensions. Pyrex glass has several advantages: it is corrosion-resistant, transparent, has a smooth interior surface (this minimized nucleate boiling at the inner surface of the container) and is stronger with temperature and pressure variations compared to ordinary glass. The manufacturer recommended operating pressure limit of the Pyrex glass tee is 30 psi gage. Each end of the evaporator was fitted with a cast-iron flange and a gasket. A detailed sketch of the cast-iron flange is shown in Figure 3.3 also. To reduce weight upon the glass tees, two aluminum flanges, 210 mm in diameter and 12.7 mm in thickness, were bolted to the cast-iron flanges. All fittings were connected through the aluminum flanges to the Pyrex-glass evaporator.

2. Test Tube

A schematic drawing of the test tube is shown in Figure 3.4. The boiling tube was held in place by two Teflon bushings, which were attached to the aluminum flanges at both ends of the T-shaped evaporator. Four studs were used in order to attach the Teflon bushing on the aluminum flange. The Teflon bushing and both ends of the test tube were sealed by

means of two viton O-rings that were placed between the aluminum flange and the Teflon plug at each end.

3. Boiling Tubes

A smooth, hard-copper tube, 15.9 mm (5/8 in.) in outer diameter, 12.7 mm (1/2 in) in inside diameter and 431.3 mm (17 in.) in length, was used to provide comparison data for the nucleate pool boiling heat-transfer performance of the enhanced tubes tested. All of the tubes were heated and instrumented identically. Dimensions of each tube are provided in Table V of Appendix E, Sample Calculations. Wanniarachchi et al. [Refs. 8, 9] and Murphy [Ref. 14] provide complete details of the tube surfaces.

The ten tubes tested were:

1. Smooth
2. GEWA-K 26 fpi (Figure 3.5)
3. GEWA-K 40 fpi (Figure 3.5)
4. GEWA-T 19 fpi (Figure 3.5)
5. GEWA-T 26 fpi (Figure 3.5)
6. GEWA-YX 26 fpi (Figure 3.6)
7. High Flux (Figure 3.7)
8. Thermoexcel-HE (Figure 3.8)
9. Thermoexcel-E (Figure 3.9)
10. Turbo-B (Figure 3.9)

The heater was a 1000-Watt, 240-Volt stainless-steel cartridge, 6.35 mm (1/4 in.) in outer diameter and 203.2 mm (8 in) in length. It was inserted into a copper sleeve, which was 1/4 inch in inside diameter, 1/2 inch in outer diameter and 8 inches in length. In order to provide a uniform heat flux, the cartridge heater and the copper sleeve were soldered together. To minimize the thermal contact resistance, the copper sleeve was then tinned (the cartridge heater was used to maintain the solder in molten state) and inserted as a unit into the middle portion of the test tube. The active boiling length of the test tube was therefore eight inches in the middle portion of the boiling tube. In order to compute the actual average heat flux in the heated portion of the tube, a suitable correction was applied for the heat lost by natural convection out both ends. See Appendix E, Sample Calculation for details.

To measure the wall surface temperature of the boiling tube, 8 thermocouples (Type-T Teflon coated copper-constantan; 0.01 inch in diameter) were inserted into eight grooves machined on the outside of the copper sleeve. As shown in Figure 3.10, these thermocouples were located at different axial and circumferential locations. The exact locations of the thermocouples and dimensions of the thermocouple grooves are given in Figure 3.10. All the thermocouple grooves were axially machined from the location of the thermocouple hot junctions to the nearest end of the copper sleeve.

C. CONDENSER SECTION

The condenser was also a T-shaped container made of Corning Pyrex glass. It was identical to the evaporator. The position of the condenser can be seen in Figure 3.1. R-114 was condensed on a helical copper coil, which was inserted in the Pyrex-glass condenser. Copper tubing (3/8 inch outer diameter) was fabricated into a three inch diameter coil. The active condensation length was estimated to be 15 ft.

The top portion of the condenser was connected to a portable, mechanical vacuum pump to remove noncondensable gases from the apparatus. The bottom of the condenser was connected to the evaporator via valve V5 in order to return the condensed R-114 liquid to either the evaporator or the reservoir. The coolant, i.e., water/ethylene glycol mixture, entered from the top portion of the condenser. The condenser was placed vertically and connected to the vapor outlet of the evaporator using a fabricated, L-shaped aluminum tube, two inches in diameter. A Bourdon gage with a range up to a gage pressure of 150 psi and a relief valve which was set to 20 psi gage were mounted on the L-tube.

D. OIL ADDING SECTION

To study the boiling performance of R-114/oil mixtures, a cylindrical aluminum oil reservoir, 6 inches in diameter and 6 inches in height, and a graduated glass oil cylinder were installed above the evaporator as shown in Figure 3.1. The

graduated cylinder was 355 mm in length and had a diameter of 25.4 mm. A resolution of 0.5 ml was achieved with the graduated cylinder. The oil reservoir was connected to the oil cylinder through valves V14 and V2. Refilling the oil reservoir was accomplished through valve V3 located on top of the reservoir. The addition of oil into the evaporator was achieved through V1 by gravity. The oil cylinder was refilled by gravity from the oil reservoir located above.

E. COOLING SECTION

1. Water-Ethylene Glycol Mixture Tank

In order to store the water-ethylene glycol mixture, a special tank was manufactured. The total volume of the tank was 9243 in³ (18.84 in x 18.84 in x 26.04 in) and it was made of 0.5 inch thick Plexiglas sheet. All sides of the tank were glued together with methylene chloride solution. The joints were held together with small screws for extra strength. The low thermal conductivity of Plexiglas was especially suited to minimize heat transfer (from room to water-ethylene glycol mixture) through the tank walls. The tank was placed on top of square wood platform on the floor and all sides were insulated with 7/8 in thick rubber sheets. The cooling mixture contained 13 gallons of ethylene-glycol and 25 gallons of distilled water. The freezing point of this mixture was about -25 deg C.

2. R-502 Refrigeration Plant

A 1/2 ton R-502 refrigeration plant was installed to cool the water/ethylene glycol mixture. Figure 3.12 shows a schematic of the R-502 refrigeration plant. It consists of a compact-type, air-cooled condenser, a compressor, a receiver, a filter-drier unit, a pressure regulator, a temperature control switch and a thermostatic expansion valve. The evaporator of the R-502 refrigeration plant was constructed using a 3.8 inch copper tube which was run through a countercurrent heat exchanger opposite the water-ethylene glycol mixture. The temperature of the water/ethylene glycol mixture was controlled by both a thermostatic expansion valve and a temperature control switch. The R-502 refrigeration plant was adjusted to keep the temperature of the cooling liquid at about -17 deg C.

3. Pump and Control Valve

An 8 gpm, 115 VAS Burks turbine-type, positive-displacement pump was installed on the floor and the 1 inch diameter suction side of the pump was directly connected to the water/ethylene glycol tank. Cooling liquid was pumped from the tank to the condenser through the control valve VC. Also, a by-pass valve V9 was placed before the control valve VC on the discharge line. The use of the by-pass line served two important purposes: (1) it avoided overloading the pump in the event valve VC is completely closed, and (2) it provided

proper mixing for the "warm" stream returning from the condenser. The by-pass valve required adjustment only at the highest heat fluxes to 'satisfy' proper cooling of the condenser.

F. R-114 RESERVOIR

An aluminum cylindrical reservoir, 9 inches in diameter and 10 inches in height, was placed vertically between the evaporator and condenser in order to store R-114 as a liquid. The liquid level of the R-114 could be observed by means of a sight glass attached on the reservoir. The R-114 reservoir was connected to the vapor line through valve V7 and to the liquid line through valve V6. See Figure 3.1 for the arrangement of the reservoir.

G. CHAMBER

An aluminum frame (42.13 in x 20.07 in x 24.02 in) was constructed to locate all the parts of the apparatus, except the cooling section. All four vertical sides of the frame were covered with 1/2 inch thick Plexiglas sheets and both left and right sides were provided with hinges to enable easy access to the components of the apparatus. Aluminum and plywood plates were used to cover the bottom and top sides of the frame, respectively. The valve bodies of V1 through V8 were placed inside of the front Plexiglass box. The whole frame was placed

above the water-ethylene glycol tank with aluminum supports so that the system was very compact.

One of the main advantages of this chamber was that the temperature surrounding the evaporator could be reduced relative to the ambient temperature. Also, in case of emergency, the thick Plexiglas chamber provides a safety barrier to personnel and data acquisition equipment.

H. INSTRUMENTATION

1. Power Measurement

A 240 volt AC source was used as the power supply, and it was adjusted by a variac in the range of 0-220 volts and 0-5 amperes according to the desired heat flux at the surface of the boiling tube. Power input to the boiling tube was measured with an AC current inductive sensor (output in volts) and a voltage sensor directly coupled to the variac output. The voltage sensor was run through a AC-DC true R.M.S. converter which output a proportional signal in volts. Figure 3.12 shows a schematic representation of the power-measurement setup. Both the AC current sensor and the AC-DC true R.M.S. converter were connected to the data acquisition/control unit.

2. Temperature Measurement

Various temperatures were monitored throughout the system to include:

1. Boiling tube wall (8 thermocouples at various longitudinal and circumferential positions)

2. Liquid temperature (one thermocouple)
3. Vapor temperature (two thermocouples), and
4. Water/ethylene glycol mixture temperature (one thermocouple)

The locations of the wall thermocouples in the sleeve of the boiling tube are shown in Figure 3.5. The liquid and vapor thermocouples were inserted into the three specially manufactured thermocouple housings. Figure 3.14 shows a schematic of these thermocouple housings. The stainless-steel portion minimizes (owing to low thermal conductivity) errors resulting from the axial conduction of heat from the surroundings. The copper tip of the housing helps to minimize the temperature drop from the area being measured to the thermocouple location (owing to the high thermal conductivity of copper).

All the temperature measurements were accomplished by 30 gage copper-constantan thermocouples. Each thermocouple measurement was read directly by a Hewlett-Packard 3497A data acquisition system, which was controlled by a Hewlett-Packard 9826 computer. Each thermocouple was scanned twenty times over 5 seconds and the readings averaged to obtain a more accurate measurement.

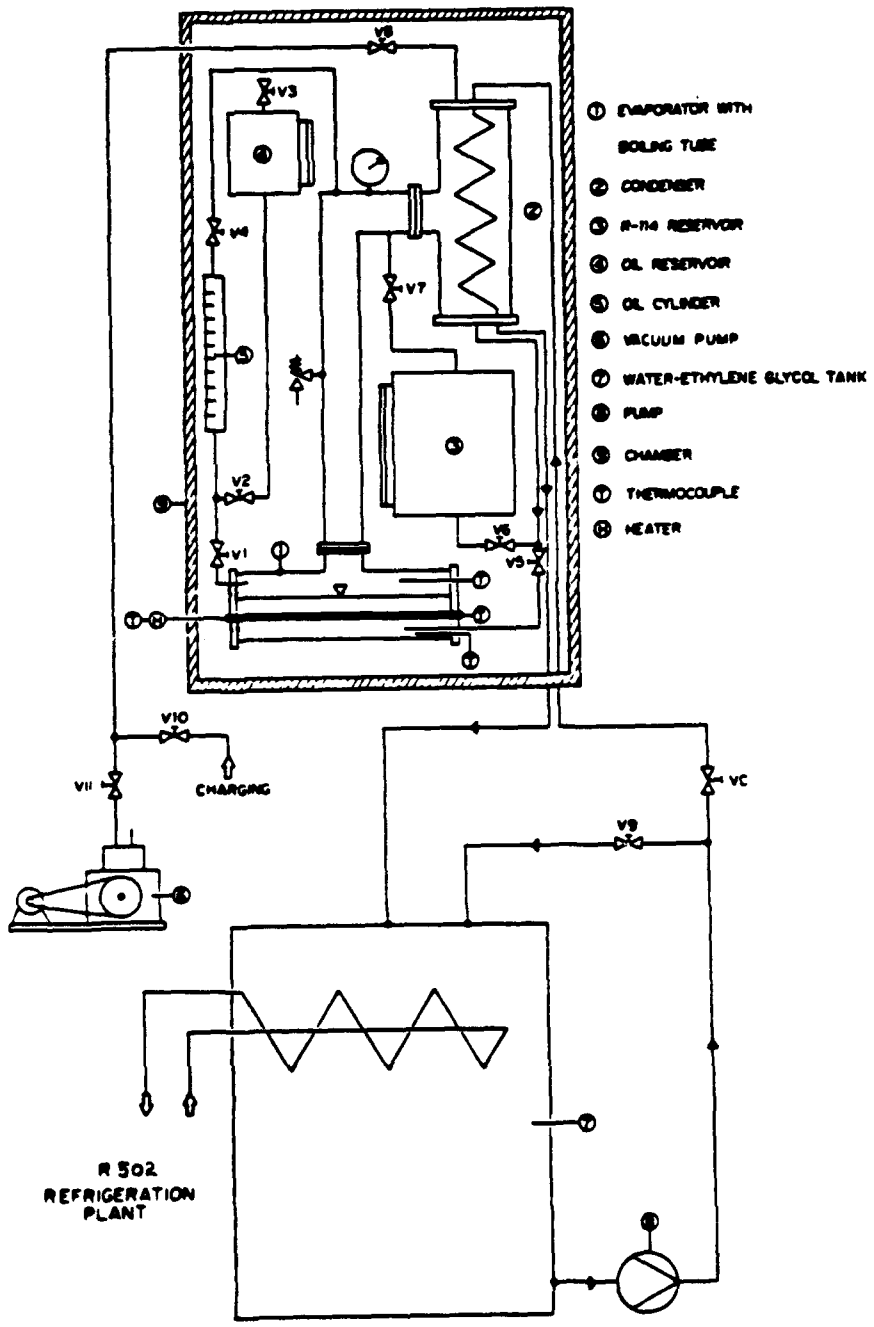
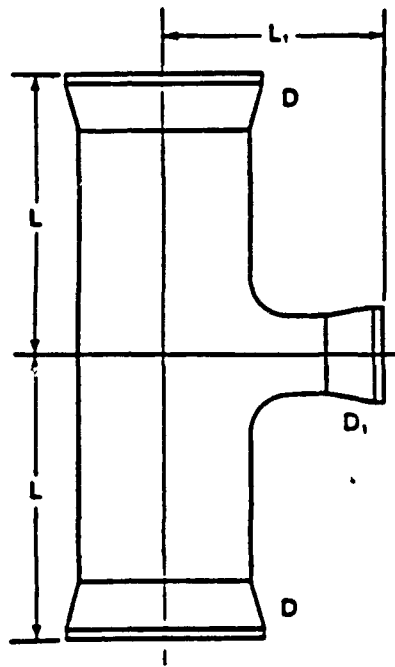

Figure 3.1 Schematic of Single Tube Apparatus



Figure 3.2 Photograph of Experimental Apparatus



a) Corning Pyrex Glass Evaporator ($D \times D_1 = 402 \times 51$ mm,
 $L = 178$ mm, $L_1 = 127$ mm)

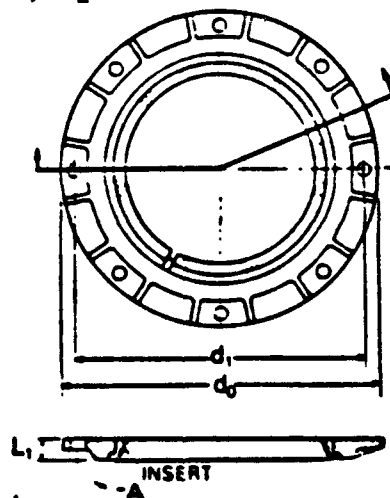

b) Cast Iron Flange and Gasket ($d_1 = 190$ mm, $d_0 = 210$ mm,
 $L_1 = 14$ mm, $A = 21^\circ$)

Figure 3.3 Schematic of the Pyrex Glass Evaporator

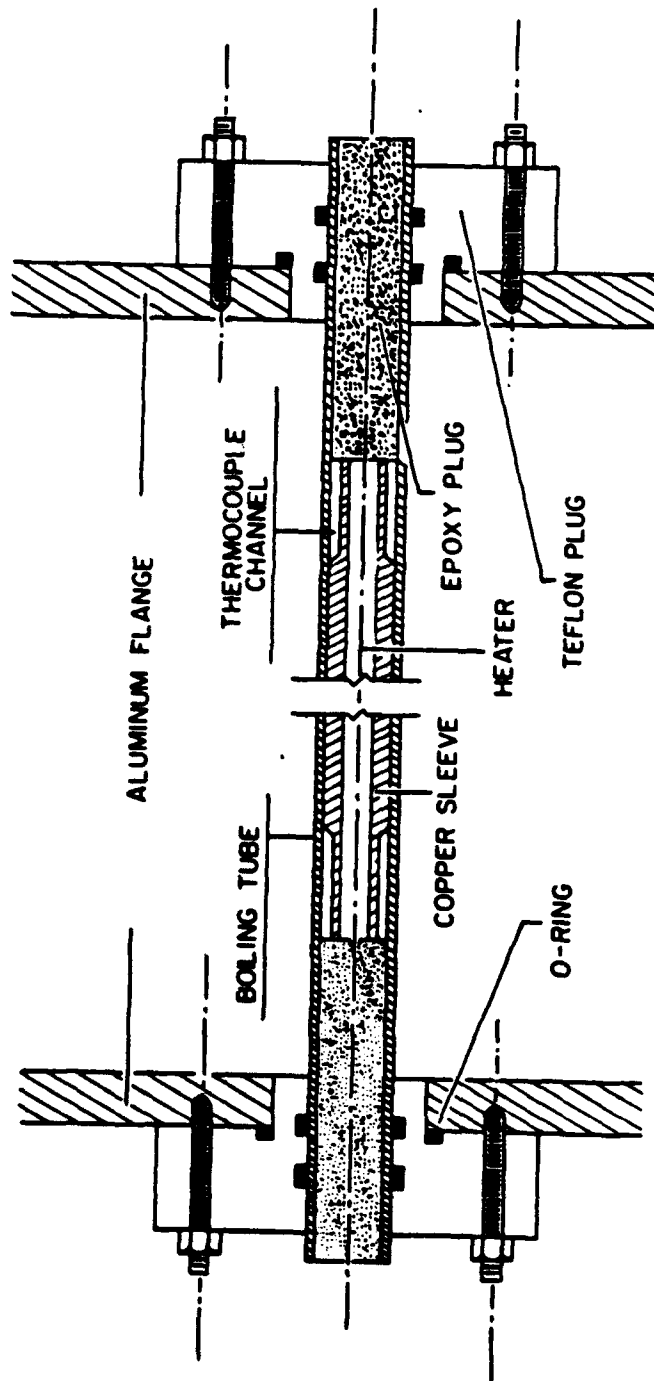
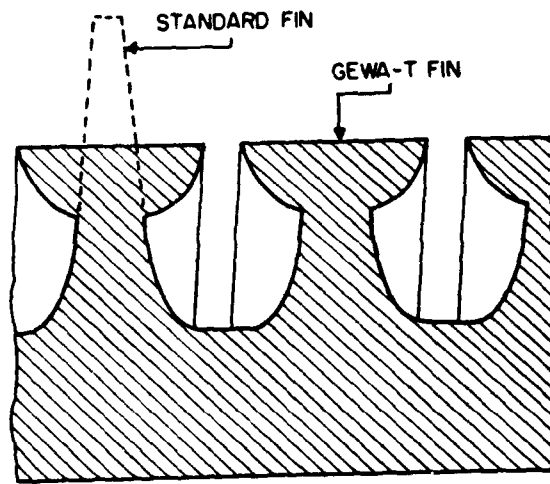
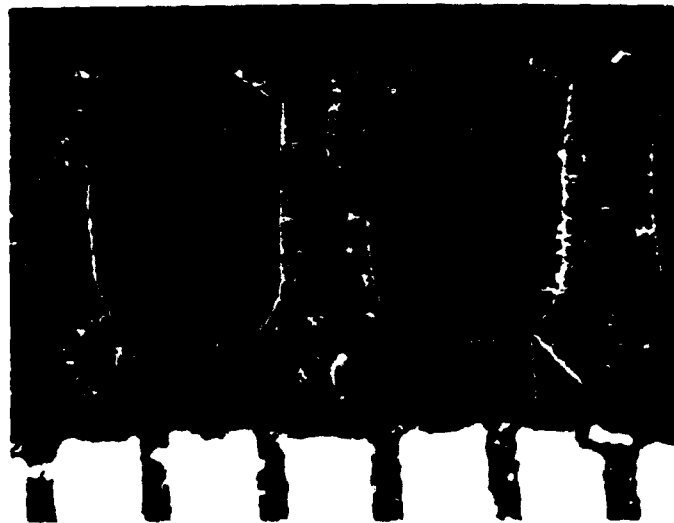

Figure 3.4 Schematic of the Boiling Test Tube



(a) Standard fin (GEWA-K) and GEWA-T fin



(b) GEWA-T fin

Figure 3.5 Schematic and Photograph of Fins

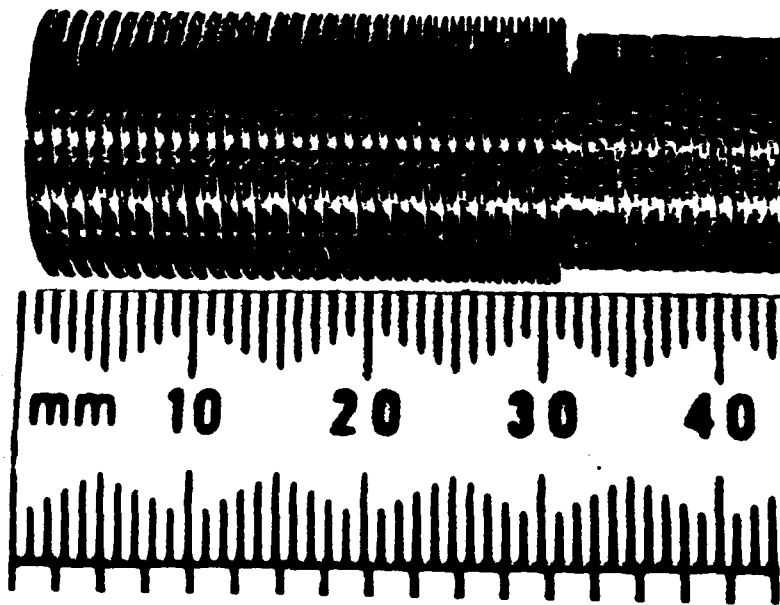

(a) GEWA-YX tube

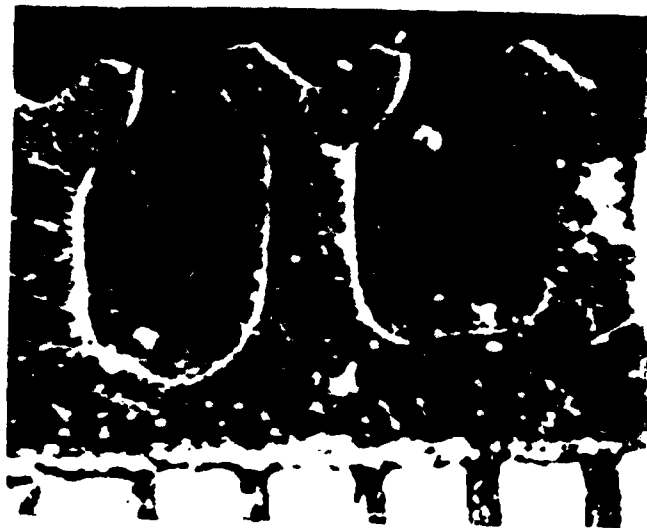

(b) GEWA-YX fin

Figure 3.6 Photographs of GEWA-YX Tube and Fin

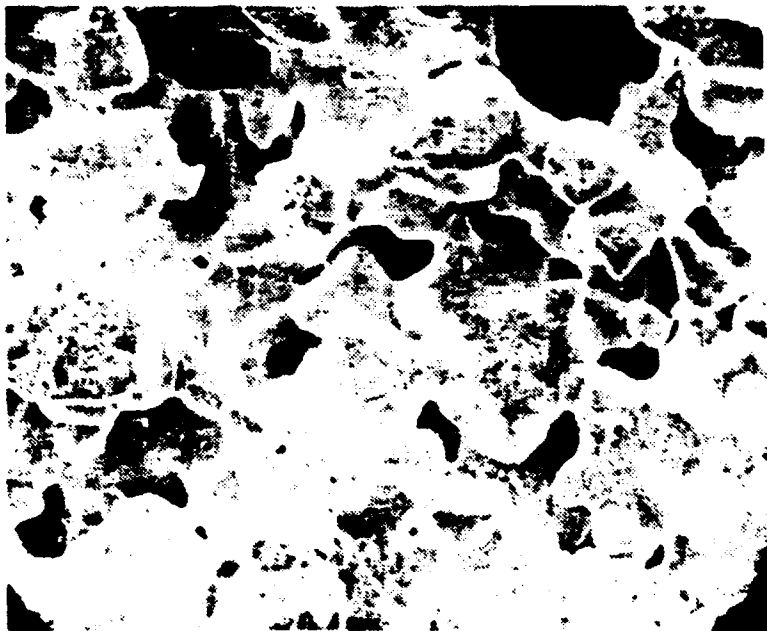
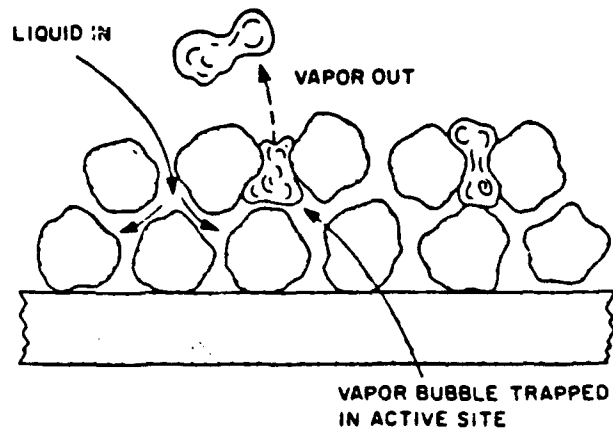

Figure 3.7 Schematic and Photograph of High Flux Surface

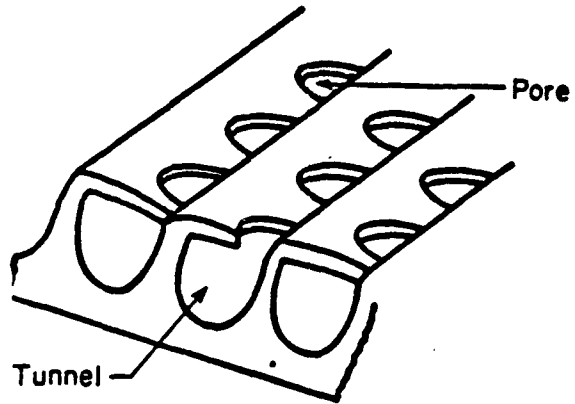
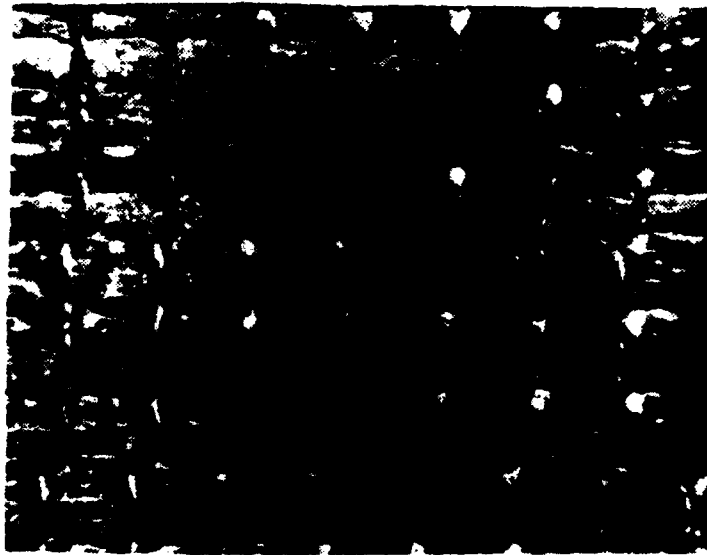

Figure 3.8 Schematic and Photograph of Thermoexcel-HE Surface



(a) Thermoexcel-E



(b) Turbo-B

Figure 3.9 Photographs of Re-Entrant Cavity Surfaces

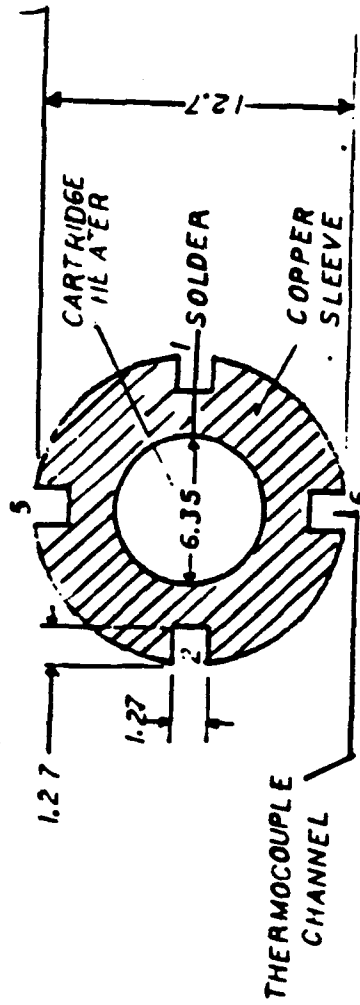
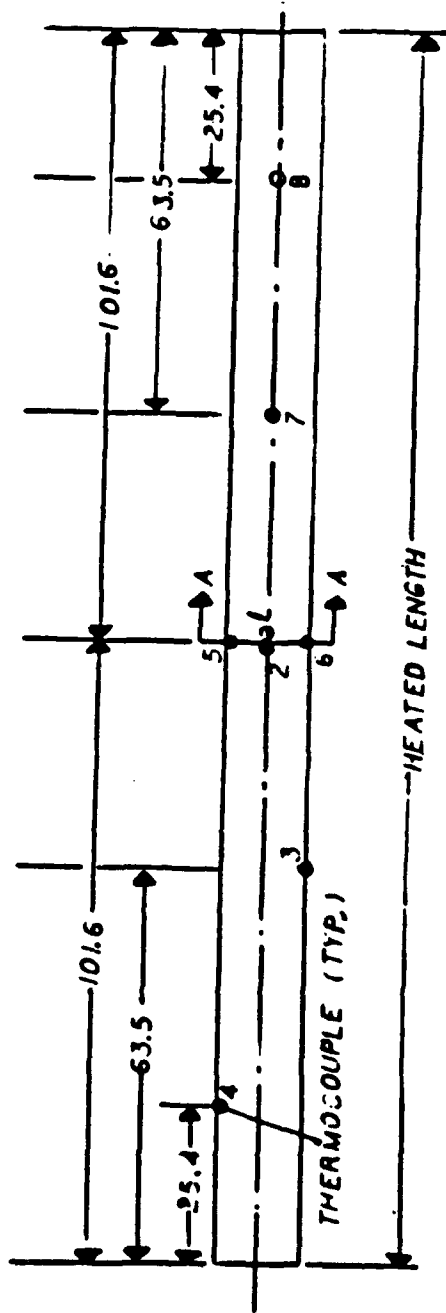

SECTION A-A (DIMENSIONS IN MM)

Figure 3.10 Positions of the Thermocouples

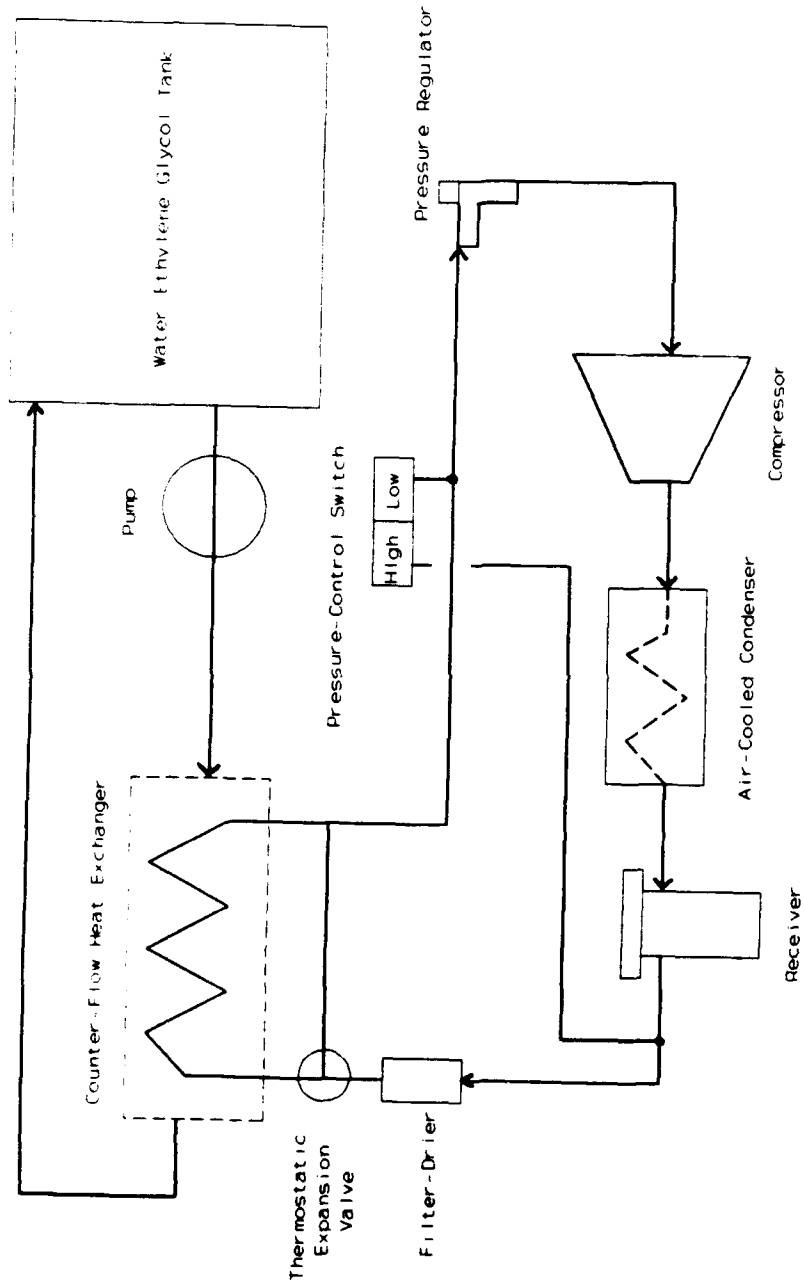

Figure 3 11 Schematic of R-502 Refrigeration System

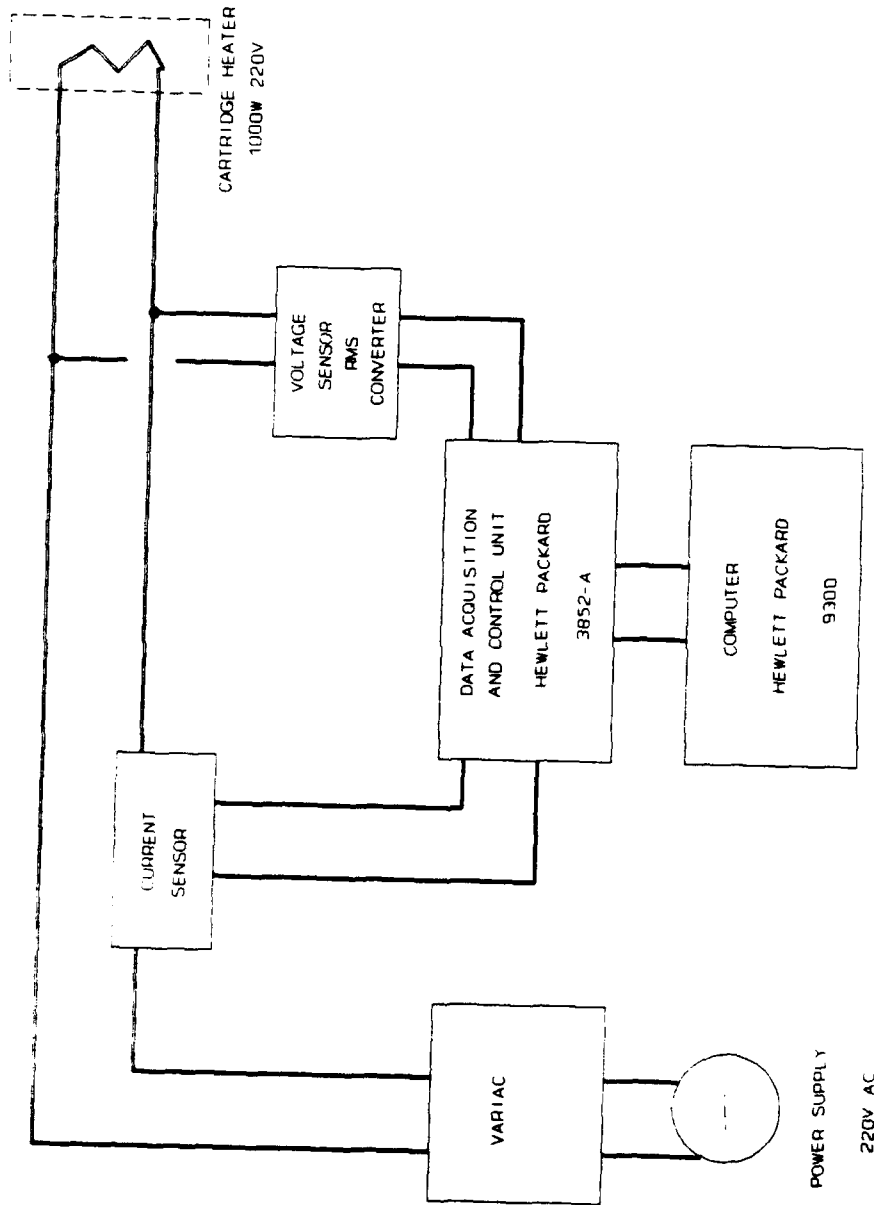

Figure 3.12. Schematic of the Power Measurement

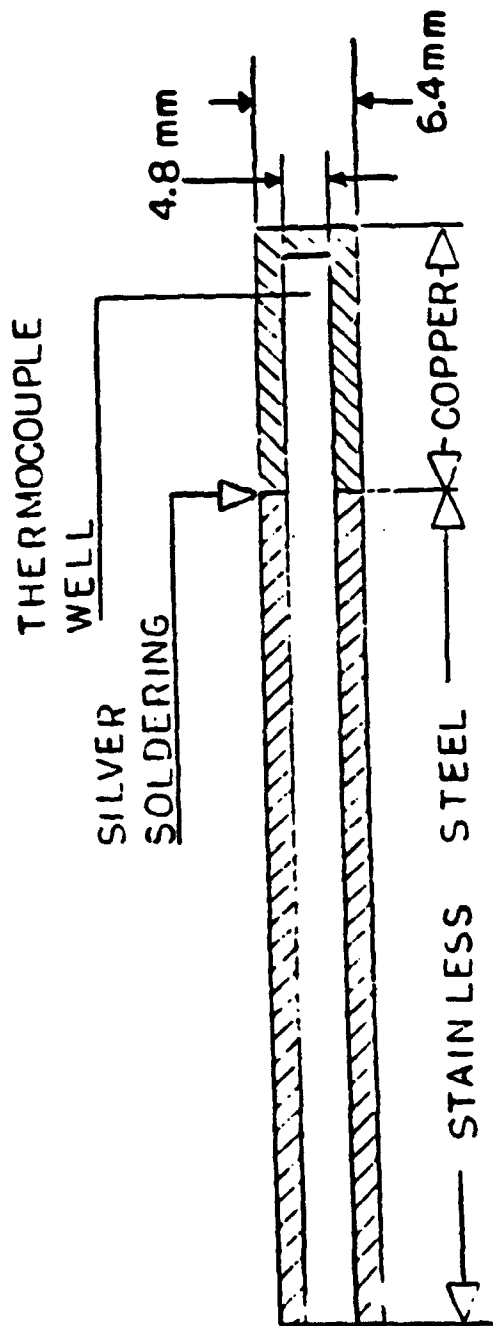

Figure 3.13 Sketch of a Thermocouple Well

IV. DATA ACQUISITION AND REDUCTION

A. DATA ACQUISITION AND STORAGE

A Hewlett-Packard 3852A automatic data acquisition unit was used to read temperatures from the thermocouples and to read current and voltage values of the cartridge heater from the AC current sensor and the AC-DC true RMS converter. A Hewlett-Packard 9000 Series computer was used to control the measurements done by the 3852A, analyze the collected data and store it.

The iterative data collection/reduction program DRP8 was loaded and run. Information was entered through the keyboard to prompt the data acquisition unit when to take data. Channel assignments are listed in Table I. The raw data was processed and transferred to a file on the computer's hard drive. A printout of the data reduction was also provided.

B. DATA REDUCTION

Following data acquisition for each data point, results were computed according to the stepwise procedure outlined in the next section, and then printed out using a Hewlett-Packard Inkjet printer. Graphs were plotted using commercial software.

C. STEPWISE DATA-COLLECTION AND SOLUTION PROCEDURE

1. Input name of user-specified file to be stored on computer hard drive.
2. Select tube type (all dimensions of the boiling test tube are included).
3. Input desired heat flux (W/m^2) and saturation temperature ($^{\circ}C$) of the boiling liquid.
4. Set desired heat flux by adjusting VARIAC rheostat.
5. Set saturation temperature by adjusting flow of coolant through condenser coils with control valve VC.
6. Once saturation temperature is achieved, wait for steady-state conditions (at least 5 minutes) prior to taking data readings.
7. Prompt data acquisition unit to scan all channels listed in Table I (thermocouples, AC current sensor and AC-DC true RMS voltage converter). All channel readings are made in volts and stored in user specified file.
8. Convert these voltage readings to corresponding units (temperature in $^{\circ}C$, current in amperes, voltage in volts). Karasabun [Ref. 15] describes in detail conversion equation for temperature. See Appendix B-Data Acquisition Apparatus Calibration for details of current and voltage conversion.
9. Compute the heat-transfer rate from the cartridge heater. See Appendix D-Sample Calculations.
10. Compute the average wall temperature of the boiling tube and calculate the wall superheat of the current data set. See Appendix D-Sample Calculations.
11. Compute the physical properties of R-114 using given correlations at film temperature. See Appendix D-Sample Calculations.
12. Compute the natural-convection heat-transfer coefficient of R-114 from the smooth non-boiling ends of the test tube. See Appendix D-Sample Calculations.
13. Compute heat losses from the non-boiling ends of the boiling tube. See Appendix D-Sample Calculations.

14. Calculate the heat flux from tube to the refrigerant. See Appendix D-Sample Calculations.
15. Calculate the heat transfer coefficient of the R-114 from the boiling tube. See Appendix D-Sample Calculations.
16. Store the heat flux versus wall superheat values for each data set in user-specified file.
17. Use commercial software, Harvard Graphics, to plot data.

TABLE I. HP 3497A CHANNEL ASSIGNMENTS

Channel	Assignment
500-507	Boiling tube wall temperature
508-509	Boiling liquid temperature
510	Vapor temperature
511	Sump temperature
512	RMS voltage Tube heaters
513	Tube heater current sensor
514	Auxiliary heater current sensor

V. EXPERIMENTAL PROCEDURE

A. PREPARATION

1. Vacuum test of the Apparatus

Upon changing the tube and reassembling the apparatus, the system was evacuated down to approximately 25 in. Hg. by a portable mechanical vacuum pump through valves V11 and V8. The apparatus was allowed to stand for 30 minutes under vacuum to observe any possible leaks. During this period, thermocouples were connected to the data acquisition system, the electrical integrity of the tube heater was checked and the tube heater connected to the variac panel. If a leak was detected (i.e. an observed rise in pressure), a pressure test was conducted to isolate the source. (See V.A.2.)

2. Pressure Test of the Apparatus

In order to detect sources of leaks, the apparatus was pressurized with air up to 15 psi gage and a soap/water bubble test was carried out upon suspect joints. All detected leaks were successfully and systematically fixed.

3. Charging the Apparatus with R-114

Upon completing the pressure tests (if any), the evaporator of the apparatus was filled with R-114 liquid up to a marked position (20 mm above the top of the boiling tube) using the following procedure.

1. Valve V7 was opened to allow the pressures within the reservoir and the evacuated apparatus to equalize. It was noted that the liquid R-114 within the reservoir boiled since the equilibrium pressure was less than the R-114 vapor pressure at room temperature.
2. Valve V6 was opened to allow the liquid R-114 to drain into the evaporator by gravity.
3. At the designated evaporator level, valves V6 and V7 were closed to isolate the reservoir.

4. Degassing and Data Acquisition Channel Check.

1. With the condenser operating, the boiling tube was run at a high flux of about 100 kW/m^2 for ten minutes in order to de-gas both the tube surface and refrigerant. Care was taken not to exceed a pressure of 15 psi gage (well below manufacturer recommendation) within the apparatus.
2. Any noncondensable gases present collected in the top of the condenser. These were then removed using the vacuum pump through valves, V8 and V11.
3. The program, SETUP8, was run to check output on all thermocouple channels as well as power output. If an erroneous reading was detected, then appropriate action was taken. In the case of a faulty boiling tube wall thermocouple, the faulty thermocouple was tagged for future exclusion in data acquisition procedure. (Each thermocouple had X thermocouples embedded in its tube wall and the loss of one made no difference to the average wall temperature).
4. The apparatus was shut down and the boiling tube allowed to soak in the refrigerant overnight. This allowed for the surface to become wetted.

B. NORMAL OPERATION

The following procedure was followed to obtain the heat-transfer coefficient of pure R-114 and R-114/oil mixtures from the boiling tube being tested:

1. The R-502 refrigeration unit was operated 1-2 hours in advance in order to reduce the temperature of the water-ethylene glycol sump to a minimum of $-8\text{ }^{\circ}\text{C}$.
2. The data acquisition/control unit, computer and variac panel were switched on.
3. The computer program Setup8 was loaded and run:
 - a. All the data acquisition channels were rechecked.
 - b. A power output of approximately 5W was input to the boiling tube. This has been measured to produce a heat flux of 500 to 600 W/m^2 in all tubes tested which facilitated reaching the first data point on the increasing flux run.
 - c. The temperature of the refrigerant was slowly reduced down to $2.2\text{ }^{\circ}\text{C}$ by circulating a small amount of coolant through the condenser, regulated by control valve, VC. This reduction was monitored to coincide with the reduction in sump temperature.
4. The iterative computer program DRP8 was loaded and run.
5. Two data runs were made: an increasing heat flux run and a decreasing heat flux run wherein the heat flux was incrementally increased or decreased. Ten different heat fluxes (0.6, 1, 2, 3.5, 6, 10, 20, 35, 60, and 100 kW/m^2) were selected for each increasing or decreasing heat flux data run.
6. The desired heat flux and saturation temperature were input to the program as reference points for each data point.
7. The variac was adjusted to set the actual heat flux which was continuously compared to the desired heat flux by the program until they agreed within 2 percent.
8. The control valve VC was adjusted to regulate the flow of cooling liquid through the condenser to maintain nearly constant saturation temperature at a given heat flux. Desired versus actual saturation temperatures were monitored continuously by the program until they agreed $\pm 0.1\text{ }^{\circ}\text{C}$.
9. For each data point, conditions in the evaporator were allowed to stabilize for at least 5 minutes prior to measuring the raw data. The following raw data were measured and stored in a user specified file: boiling tube wall thermocouple readings, liquid bulk

thermocouple readings, vapor thermocouple readings, sump thermocouple readings, current sensor readings, and voltage sensor readings.

10. Two data points were taken at a given heat flux and saturation temperature to comprise a data set. The following processed data were recorded as a printout: wall temperatures of the boiling section, liquid bulk temperatures, vapor temperature, sump temperature, wall superheat, heat transfer coefficient of the R-114/R-114-oil mixture and the actual heat flux.
11. For each data set, the above procedure beginning with step 5 was repeated.
12. Table II provides a listing of all data runs.

TABLE II. LISTING OF DATA RUNS

Data Run #	Data File	Tube	Heat Flux	Oil (%)	Purpose
1	DATA630I5	HF	I	0	CAL
2	DATA630D5	HF	D	0	CAL
3	DATA702I5	HF	I	0	CAL
4	DATA702D5	HF	D	0	CAL
5	DATA0705I5	HF	I	0	CAL\DATA
6	DATA0705D5	HF	D	0	CAL\DATA
7	DATA0709I4	SM	I	0	DATA
8	DATA0709D4	SM	D	0	DATA
9	DAT0710I6	GK-40	I	0	DATA
10	DAT0710D6	GK-40	D	0	DATA
11	DAT0711I7	GK-26	I	0	DATA
12	DAT0711D7	GK-26	D	0	DATA
13	DAT0715I8	GT-19	I	0	DATA
14	DAT0715D8	GT-19	D	0	DATA
15	DAT0716I9	GT-26	I	0	DATA

Data Run #	Data File	Tube	Heat Flux	Oil (%)	Purpose
16	DAT0716D9	GT-26	D	0	DATA
17	DAT0717I11	T-HE	I	0	DATA\DG
18	DAT0717D11	T-HE	D	0	DATA
19	DAT0722I12	TB	I	0	DATA
20	DAT0722D12	TB	D	0	DATA
21	DAT0723I09	GY-26	I	0	DATA
22	DAT0723D09	GY-26	D	0	DATA
23	DAT0724I11	T-HE	I	0	DATA\DG
24	DAT0724D11	T-HE	D	0	DATA\REP
25	DAT0803I4	SM	I	0	DATA\REP
26	DAT0803D4	SM	D	0	DATA\REP
27	DAT0804I4	SM	I	3	DATA
28	DAT0804D4	SM	D	3	DATA
29	DAT0805I4	SM	I	10	DATA
30	DAT0805D4	SM	D	10	DATA
31	DAT0806I7	GK-26	I	0	DATA\REP
32	DAT0806D7	GK-26	D	0	DATA\REP
33	DAT0807I7	GK-26	I	3	DATA
34	DAT0807D7	GK-26	D	3	DATA
35	DAT0808I7	GK-26	I	10	DATA
36	DAT0808D7	GK-26	D	10	DATA
37	DAT0809I6	GK-40	I	0	DATA\REP
38	DAT0809D6	GK-40	D	0	DATA\REP
39	DAT0810I6	GK-40	I	3	DATA
40	DAT0810D6	GK-40	D	3	DATA
41	DAT0812I6	GK-40	I	10	DATA
42	DAT0812D6	GK-40	D	10	DATA
43	DAT0815I8	GT-19	I	0	DATA\REP

Data Run #	Data File	Tube	Heat Flux	Oil (%)	Purpose
44	DAT0815D8	GT-19	D	0	DATA\REP
45	DAT0816I8	GT-29	I	3	DATA
46	DAT0816D8	GT-19	D	3	DATA
47	DAT0820I8	GT-19	I	10	DATA
48	DAT0820D8	GT-19	D	10	DATA
49	DAT0821I9	GT-26	I	3	DATA
50	DAT0821D9	GT-26	D	3	DATA
51	DAT0822I9	GT-26	I	10	DATA
52	DAT0822D9	GT-26	D	10	DATA
53	DAT0823I10	T-E	I	3	DATA
54	DAT0823D10	T-E	D	3	DATA
55	DAT0824I10	T-E	I	10	DATA
56	DAT0824D10	T-E	D	10	DATA
57	DAT0825I9	GY-26	I	3	DATA
58	DAT0825D9	GY-26	D	3	DATA
59	DAT0826I9	GY-26	I	10	DATA
60	DAT0826D9	GY-26	D	10	DATA
61	DAT0827I5	HF	I	3	DATA
62	DAT0827D5	HF	D	3	DATA
63	DAT0828I5	HF	I	10	DATA
64	DAT0828D5	HF	D	10	DATA
65	DAT0829I12	TB	I	3	DATA
66	DAT0829D12	TB	D	3	DATA
67	DAT0830I12	TB	I	10	DATA
68	DAT0830D12	TB	D	10	DATA
69	DAT0831I11	T-HE	I	3	DATA
70	DAT0831D11	T-HE	D	3	DATA
71	DAT0901I11	T-HE	I	10	DATA

Data Run #	Data File	Tube	Heat Flux	Oil (%)	Purpose
72	DAT0901D11	T-HE	D	10	DATA
73	DAT0906I10	T-E	I	0	DATA
74	DAT0906D10	T-E	D	0	DATA

SM = Smooth GK-26 = GEWA-K 26 fpi GK-40 = GEWA-K 40 fpi
 HF = High Flux GT-19 = GEWA-T 19 fpi GT-26 = GEWA-T 26 fpi
 TB = Turbo-B GY-26 = GEWA-YX 26 fpi T-E = Thermoexcel-E
 T-HE = Thermoexcel-HE
 I = Increasing Flux D = Decreasing Flux

CAL = CALIBRATION DATA
 REP = REPEATABILITY DATA

DATA = BASELINE DATA
 DG = DEGASSING DATA

VI. RESULTS AND DISCUSSION

A. REPRODUCIBILITY

To test the reproducibility of the experimental data, 9 data runs were repeated on different days. All data runs were conducted at a saturation temperature of 2.2 °C. Figure 6.1 shows a comparison of two pairs of runs, 13, 14, and 43, 44 for increasing and decreasing heat flux. It can be seen that there is excellent agreement between both the increasing and decreasing heat flux runs.

B. COMPARISON OF DATA WITH PREDICTION

To check the general validity of the data obtained, four well-known correlations, two for natural convection and two for nucleate pool boiling, were plotted and compared with the smooth tube data for pure R-114. The two natural convection correlations used were Churchill and Chu [Ref. 1] and a more recent update Churchill and Usagi [Ref. 2]. The two nucleate pool boiling correlations used were: Rohsenow [Ref. 1] and Stephan-Abdelsalam [Ref. 3]. One of the first correlations developed, the Rohsenow correlation is based upon the physics of pool boiling heat transfer. It applies only for clean surfaces and when used to estimate heat flux, errors can amount to $\pm 100\%$. The Stephan-Abdelsalam correlation for refrigerants was developed from application of regression

analysis to a large amount of existing data. Application to a large number of pure substances of widely differing thermal properties is remarkably simple. Figure 6.2 shows the plotted data and correlations. It can be seen from the plot that there is excellent agreement for natural convection and not bad agreement in the nucleate boiling region. The slightly worse agreement for nucleate boiling can be attributed to the more complex mechanisms at work in this region.

C. EFFECTS OF DEGASSING

Early experiments (Runs 1-6) conducted with the High Flux tube pointed out the significant effect of degassing both the tube surface and refrigerant. It was observed that tubes that were not vigorously boiled after placement into the apparatus and not allowed to settle overnight, tended to nucleate at very low heat fluxes the following day when conducting an increasing heat flux run. Similar effects were observed if the apparatus was allowed to stand undisturbed for several days. The most extreme effects were seen for the re-entrant cavity tubes. Figure 6.3 shows the change in behavior (i.e. for gassed and degassed) for a Thermoexcel-E tube for an increasing heat flux run. For the degassed case, an extreme temperature overshoot was observed, which indicates a large number of nucleation sites were deactivated. Once all nucleation sites were activated, the performance of both cases was identical. It can be surmised that the entrapment of vapor

bubbles in surface cavities as well as the outgassing from the Teflon O-rings of the rig over time, enhanced the nucleation on the tube surfaces. Vigorous boiling removed those gases from both surface and liquid.

D. BOILING PERFORMANCE OF ENHANCED TUBES IN PURE R-114 AND R-114/OIL MIXTURES

The results of the 74 data runs are discussed with references to the figures (Figures 6.1 to 6.80) that are provided at the end of this chapter. Performance of each tube will be presented and discussed as follows:

1. For pure R-114
2. For R-114/oil mixtures (3% and 10% by weight)
3. Comparison of pure R-114 and R-114/oil mixtures for increasing heat flux runs.
4. Comparison of pure R-114 and R-114/oil mixtures for decreasing heat flux runs.
5. Comparison to similar tube types (i.e. finned - as applicable for each R-114/oil mixture for both increasing and decreasing heat flux runs)

1. Boiling Performance of Smooth Tube

Figures 6.4, 6.5 and 6.6 show the heat transfer performance of pure R-114, R-114/3% oil mixture and R-114/10% oil mixture respectively, boiling from a smooth copper tube. Figures 6.7 and 6.8 show the comparative performance for the three refrigerant/oil mixtures on increasing and decreasing heat flux respectively. It can be seen that in Figure 6.7 in the natural convection region there is slight degradation with

increases in oil. However, in the nucleate boiling region there is significant degradation with increasing oil concentration. Wanniarachi et al. [Ref. 6] reported similar behavior for smooth tubes. This behavior was attributed to two competing effects: (1) the 'choking' of the tube surface by an oil rich layer which develops as the more volatile refrigerant is boiled off; (2) the diffusion of the miscible oil rich layer back into the bulk fluid. In the natural convection region it can be surmised that the diffusion effect predominates while in the nucleate boiling region the 'choking' effect eventually overwhelms the diffusion. This degradation is seen again in Figure 6.8. It can be seen that in Figure 6.8 that as conditions approach natural convection along the decreasing heat flux curve, the three mixtures perform similarly as nucleation sites die out.

2. Boiling Performance of Finned/Modified Finned Tubes

Figures 6.9, 6.10 and 6.11 show the heat transfer performance of pure R-114, R-114/3% oil mixture and R-114/10% oil mixture respectively, boiling from a standard 26 fpi tube, (GEWA-K). At a heat flux of 35 kW/m², heat transfer enhancement compared to the smooth tube for pure R-114, R-114/3% oil and R-114/10% oil was 2.4, 2.9 and 3.2 respectively. Figures 6.12 and 6.13 show the comparative performance of the three refrigerant/oil mixtures on increasing heat flux and decreasing heat flux runs

respectively. On increasing heat flux and decreasing heat flux runs, the finned tube only shows a small degradation in both the natural convection and nucleate boiling regions. The smooth tube only shows small degradation in the natural convection region. Also, at the higher heat fluxes, the R-114/3% oil mixture shows a slightly better performance than the pure R-114 and R-114/10% oil mixture. This phenomenon was observed for all finned tubes, however, the reasons for such behavior are not fully understood; it may be due to bubble 'scouring' between the fins. This small increase in performance at low oil concentrations agrees with results reported by Stephan and Mitrovic [Ref. 15].

Figures 6.14, 6.15 and 6.16 show the heat transfer performance of pure R-114, R-114/3% oil mixture and R-114/10% oil mixture respectively, boiling from a GEWA-K 40 fpi tube. Figures 6.17 and 6.18 show the comparative performance of the three refrigerant/oil mixtures on increasing heat flux and decreasing heat flux respectively. Similar behavior to the GEWA-K 26 fpi tube was observed including the improved performance at higher fluxes at low oil concentrations (3%).

Figures 6.19, 6.21, and 6.23 show the comparative performance of the three R-114/oil mixtures boiling from GEWA-K 26 and 40 fpi tubes on increasing heat flux. For all three oil concentrations, the GEWA-K 40 fpi tube outperforms the GEWA-K 26 fpi and smooth tubes consistently in the nucleate boiling region. At a heat flux of 35 kW/m^2 the GEWA-K 40 fpi

and the GEWA-K 26 fpi had heat transfer enhancements of 4.1 and 3.1 respectively over the smooth tube for pure R-114. Similar enhancements were seen at R-114/3% oil and R-114/10% oil mixtures. See Table III at end of this chapter. In the natural convection region, the results were mixed. Neither tube predominated consistently for pure R-114 and R-114/oil mixtures. Figures 6.20, 6.22 and 6.24 show similar comparisons on decreasing heat flux. It can be seen that the GEWA-K 40 fpi performs best in all three cases except at very low fluxes where results were less certain. However, the calculation for the heat flux did not take into account the actual increases in surface area for the finned tubes over the smooth tube. A fin root diameter was used to calculate surface area. The actual area increase is of the same magnitude as the heat transfer enhancements seen, indicating that both smooth and finned tubes give similar heat transfer performance. To demonstrate this, Figure 6.9, the GEWA-K 26 fpi tube in pure R-114, is replotted in Figure 6.81 using the actual fin surface area. The ratio of actual fin surface area to root diameter area was a factor of 4. Actual surface heat flux was calculated by dividing the root diameter surface heat flux by four. It can be seen in Figure 6.81 that in the natural convection region the GEWA-K 26 fpi tube performs comparably to the smooth tube. However, in the mixed boiling and nucleate boiling regions the GEWA-K 26 fpi tube shows an enhanced performance over the smooth tube up to three, which indicates

there are other mechanisms involved besides increased surface area.

Figures 6.25, 6.26 and 6.27 show the heat transfer performance of pure R-114, R-114/3% oil mixture and R-114/10% oil mixture respectively, boiling from a modified fin tube, GEWA-T 19 fpi. At a heat flux of 35 kW/m^2 , the heat transfer enhancement compared to the smooth tube for pure R-114, R-114/3% oil mixture and R-114/10% oil mixture was 3.1, 4.3 and 5.2 respectively. Figures 6.28 and 6.29 show the comparative performance of the three refrigerant/oil mixtures on increasing and decreasing heat fluxes respectively. Similar to the GEWA-K type tube, only a slight degradation is observed in both the natural convection and nucleate boiling regions. Again at higher heat fluxes, the R-114/3% oil mixture performed best.

Figures 6.30, 6.31 and 6.32 show the heat transfer performance of pure R-114, R-114/3% oil mixture and R-114/10% oil mixture respectively, boiling from a GEWA-T 26 fpi tube. At a heat flux of 35 kW/m^2 , heat transfer enhancement compared to the smooth tube for pure R-114, R-114/3% oil mixture and R-114/10% oil mixture was 3.7, 4.6 and 4.8 respectively. Figures 6.33 and 6.34 show the comparative performance of the three refrigerant/oil mixtures on increasing and decreasing oil mixtures respectively. It can be seen that at higher heat fluxes, the R-114/3% oil mixture performed best and there was significant degradation in performance for the R-114/10% oil

mixture compared to the smooth tube. At lower heat fluxes, the pure R-114 outperformed the refrigerant/oil mixtures. It can be surmised that the 'choking' effect predominates for the refrigerant/oil mixtures.

Figures 6.35, 6.37 and 6.39 show the comparative heat transfer performance of each refrigerant/oil mixture boiling from the GEWA-T 19 and 26 fpi tubes for increasing heat fluxes. Figures 6.36, 6.38 and 6.40 show similar comparisons for decreasing heat fluxes. It can be seen that in the nucleate boiling region at the higher heat fluxes that the GEWA-T 26 fpi tube performed best. At the lower heat fluxes, in the natural convection region for an increasing heat flux run the tubes performed equally. For a decreasing heat flux run, the GEWA-T 19 fpi performed best. Recalling the channel structure of the GEWA-T tube suggests more complex phenomena than simple increase in surface area. Indeed Marto et al. [Ref. 16] have found that the gap width with GEWA-T tubes has a significant effect on boiling performance. Down to some limiting value, decreasing the gap width generally increases heat transfer coefficient. The enhancement can be attributed to strong interaction between heat transfer and hydrodynamic effects within GEWA-T channels.

Figures 6.41, 6.42 and 6.43 show the heat transfer performance of pure R-114, R-114/3% oil mixture and R-114/10% oil mixture respectively, boiling from another modified fin tube, GEWA-YX 26 fpi. At a heat flux of 35 kW/m², heat

transfer enhancement compared to the smooth tube for pure R-114, R-114/3% oil mixture and R-114/10% oil mixture was 3.4, 4.3 and 4.4 respectively. Figures 6.44 and 6.45 show comparative performance for the three refrigerant/oil mixtures on increasing and decreasing heat fluxes respectively. It can be seen that in the natural convection region slight degradation in performance occurs. At the higher fluxes in the nucleate boiling region, the R-114/3% oil mixture performed best as seen with other types of finned tubes.

Figures 6.46, 6.48 and 6.50 show the comparative performance for each refrigerant/oil mixture boiling from the GEWA-K, GEWA-T and GEWA-YX 26 fpi tubes for increasing heat fluxes. Figures 6.47, 6.49 and 6.51 show similar comparisons for decreasing heat fluxes. Both the modified finned tubes, GEWA-T and GEWA-YX, show marked increases in performance over the standard finned tube, GEWA-K, in the nucleate boiling region. Results were not so clear however in the natural convection region, possibly due to variation in surface area.

3. Boiling Performance of High Flux Tube

Figures 6.52, 6.53 and 6.54 show the heat transfer performance of pure R-114, R-114/3% oil mixture and R-114/10% oil mixture respectively, boiling from the High Flux tube. At a heat flux of 35 kW/m^2 , heat transfer enhancement compared to the smooth tube for pure R-114, R-114/3% oil mixture and R-114/10% oil mixture was 6.4, 6.2 and 3.8. The High Flux tube

displays a much larger relative temperature overshoot compared to the smooth tube and its point of incipience occurs at a much lower heat flux. Accuracy of the data was greatest at high heat flux and large superheat values ($\pm 3.8\%$) and most uncertain at low heat flux and small superheat values ($\pm 17.15\%$). See Uncertainty Analysis-Appendix E. It can be seen that at higher heat fluxes that the High Flux tube in the R-114/10 oil mixture performed almost equally to the smooth tube. At a heat flux of 100 kW/m^2 the heat transfer enhancement compared to the smooth tube was 1.1. Wanniarachchi *et al.* [Ref. 7] reported similar results. The marked decrease in boiling performance was attributed to the creation of an oil-rich layer within the boiling pores. The superior boiling performance for R-114/10% oil mixture compared to the smooth tube is completely recovered when the heat flux is decreased. It can be seen that in the natural convection region the performance of the High Flux tube is comparable at all oil concentrations to the smooth tube which indicates there is no effect of either tube type or oil concentration in this region. Figures 6.55 and 6.56 show the comparative performance of the three refrigerant/oil mixtures on increasing and decreasing heat fluxes respectively. The extreme rate of degradation of performance of the High Flux surface at 10% oil concentration with increasing heat flux is clearly seen as well as its complete recovery as the heat flux is decreased.

4. Boiling Performance of the Thermoexcel Tubes

Figures 6.57, 6.58 and 6.59 show the heat transfer performance of pure R-114, R-114/3% oil mixture and R-114/10% oil mixture respectively, boiling from the Thermoexcel-E Tube. At a heat flux of 35 kW/m^2 , heat transfer enhancement compared to the smooth tube for pure R-114, R-114/3% oil mixture and R-114/10% oil mixture was 5.7, 5.3 and 5.2 respectively. Figures 6.60 and 6.61 show the comparative performance of the three refrigerant/oil mixtures on increasing and decreasing heat fluxes respectively. As seen with the High Flux tube, the Thermoexcel-E tube performed equally to the smooth tube in the natural convection region for all refrigerant/oil mixtures.

Figures 6.62, 6.63 and 6.64 show the heat transfer performance of pure R-114, R-114/3% oil mixture and R-114/10% oil mixture respectively, boiling from the Thermoexcel-HE tube. At a heat flux of 35 kW/m^2 , heat transfer enhancement compared to the smooth tube for pure R-114, R-114/3% oil mixture and R-114/10% oil mixture was 4.8, 5.1 and 4.8. Similar performance to the Thermoexcel-E tube was observed. Figures 6.65 and 6.66 show the comparative performance of the three refrigerant/oil mixtures on increasing and decreasing heat flux respectively. At a higher heat flux of 100 kW/m^2 the heat transfer enhancements compared to the smooth tube for the R-114/3% oil mixture and R-114/10% oil mixture was reduced to 2.2 and 1.9.

Figures 6.67, 6.69 and 6.71 show the comparative performance of each refrigerant/oil mixture boiling from both the Thermoexcel-E and HE tubes for increasing heat fluxes. Figures 6.68, 6.70 and 6.72 show similar comparisons on decreasing heat fluxes. As discussed earlier both tubes showed improved performance over the smooth tube in the nucleate boiling region. It can be seen that the Thermoexcel-HE tube performed marginally better than the Thermoexcel-E at high heat fluxes. In the natural-convection region both tubes performed comparably to the smooth tube. Wanniarachchi et al [Ref. 8] reported similar behavior for Thermoexcel-E and Thermoexcel-HE tubes. It can be surmised that in the natural convection region the small re-entrant cavities of both tubes do not increase the total boiling surface area like fins. The Thermoexcel-E and HE tubes 'appear' smooth and would be expected to perform comparably to the smooth tube which was indeed seen.

5. Boiling Performance of the Turbo-B Tube

Figures 6.73, 6.74 and 6.75 show heat transfer performance of pure R-114, R-114/3% oil mixture and R-114/10% oil mixture respectively, boiling from the Turbo-B tube. At a heat flux of 35 kW/m^2 , heat transfer enhancement compared to the smooth tube for pure R-114, R-114/oil mixture and R-114/10% oil mixture was 6.2, 6.7 and 5.6 respectively. As seen with all previous re-entrant tubes tested, comparable

performance with the smooth tube is observed in the natural convection region and marked improved performance over the smooth tube is observed in the nucleate boiling region. Figures 6.76 and 6.77 show the comparative performance of each refrigerant/oil mixtures boiling from the Turbo-B tube on increasing and decreasing heat fluxes respectively. Similar to the other re-entrant cavity surfaces tested, the R-114/10% oil mixture had the greatest rate of degradation for increasing heat flux in the nucleate boiling region.

6. Overall Performance of Smooth and Enhanced Surfaces

Figures 6.78, 6.79 and 6.80 show the comparative performance of 8 of the 10 tube surfaces tested. The other two, Thermoexcel-E and GEWA-T 19 fpi, performed similarly to the Thermoexcel-HE and GEWA-T 26 fpi respectively, and so are not included. Three distinct groups of tubes can be identified based upon boiling heat transfer performance at all oil concentrations. These are: (1) smooth, (2) finned/modified finned and (3) re-entrant cavity. Within the finned/modified finned group, it can be seen that the GEWA-T is the best performer. Its enhanced performance was attributed to its channel geometry. The High Flux tube in R-114/10% oil mixture performed comparably to the smooth tube (heat transfer enhancement was 1.1) at a heat flux of 100 kW/m^2 . The severe degradation in performance for the High Flux tube can be attributed to the 'choking' of the porous surface. Table III

shows numerically the enhancement in performance over the smooth tube for all three refrigerant/oil mixtures boiling from each of the tubes for three heat fluxes of 10, 35 and 100 kW/m². It can be seen at the moderate heat flux of 35 kW/m², the finned/modified finned tubes show enhanced performances of 2.4 to 5.2 over the smooth tube while the re-entrant cavity tubes show enhancements of 3.8 to 6.7 over the smooth tube. The effect of oil concentration is significant at high heat fluxes. At a heat flux of 100 kW/m² for pure R-114, the finned and re-entrant cavity tubes show comparable enhancement compared to the smooth tube. For R-114/10% oil mixtures at a heat flux of 100 kW/m², the finned tubes performed best.

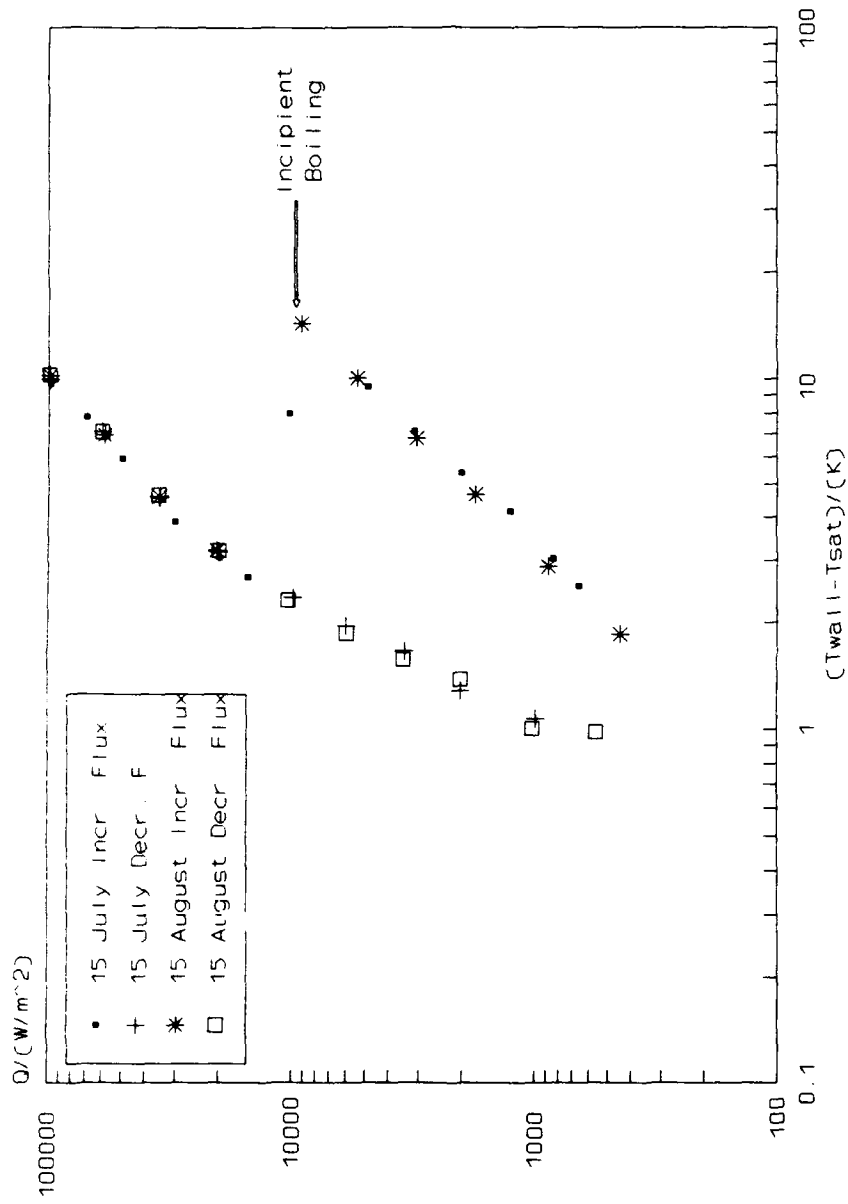

Figure 6.1 Repeatability Comparison For Pure R-114 Boiling From GEWA-T 19 psi Tube

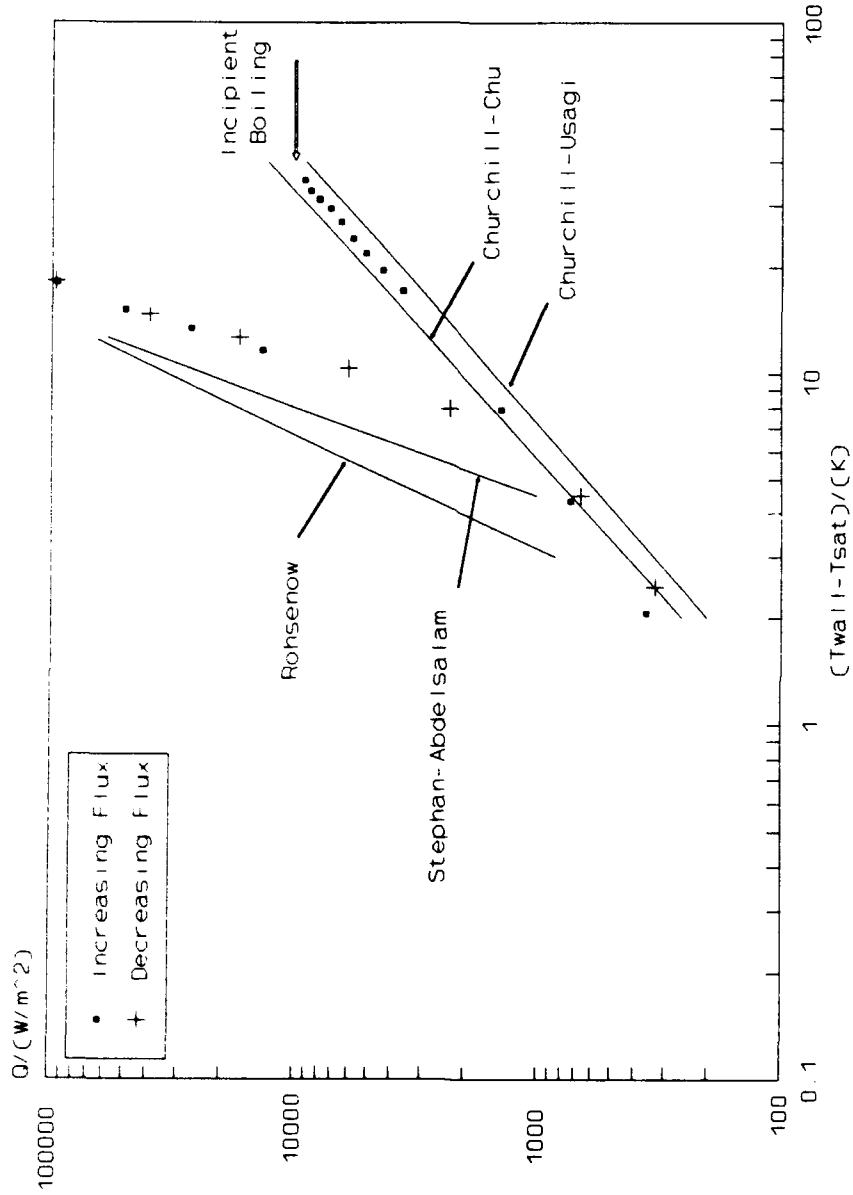

Figure 6.2 Performance Comparison for Pure R-114 Boiling from a Smooth Tube With Known Correlations

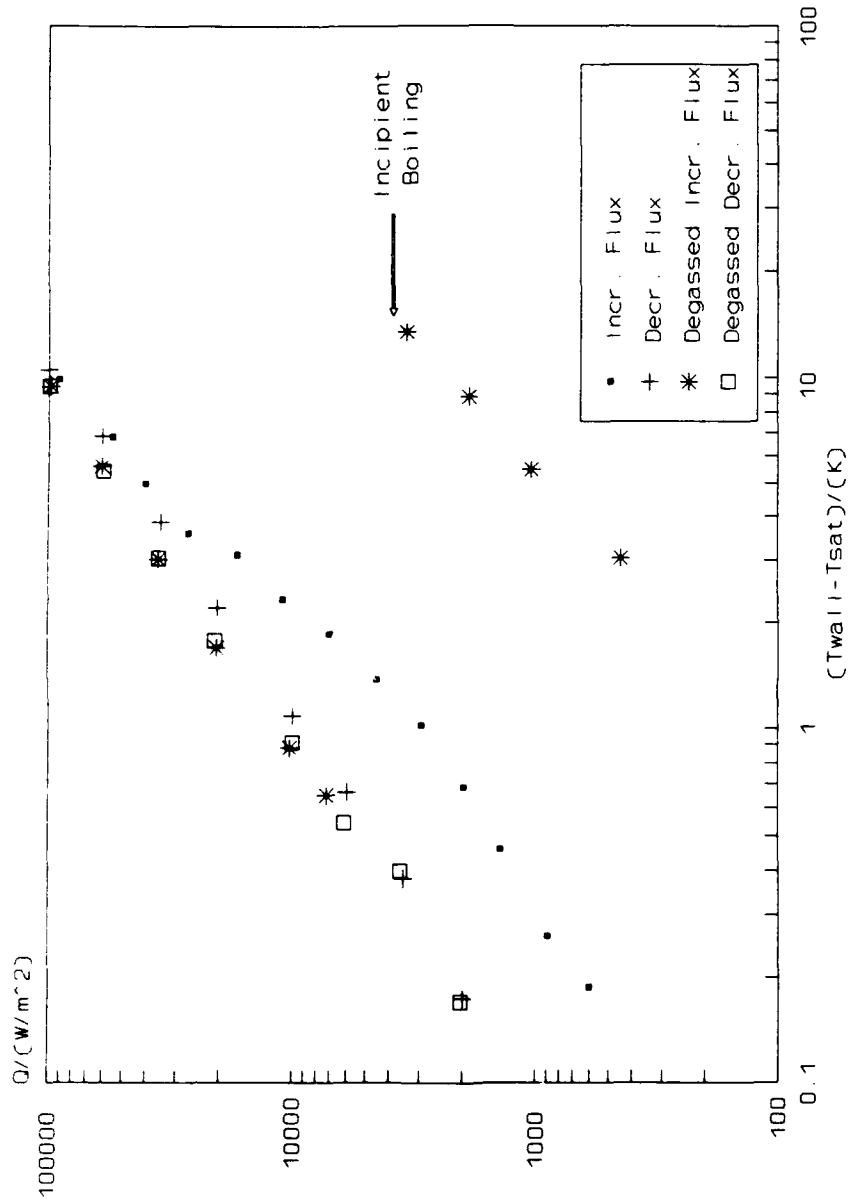

Figure 6.3 Performance Comparison For Pure R-114 Boiling From Thermocouple-E Effect of De-gassing Surface/Fluid

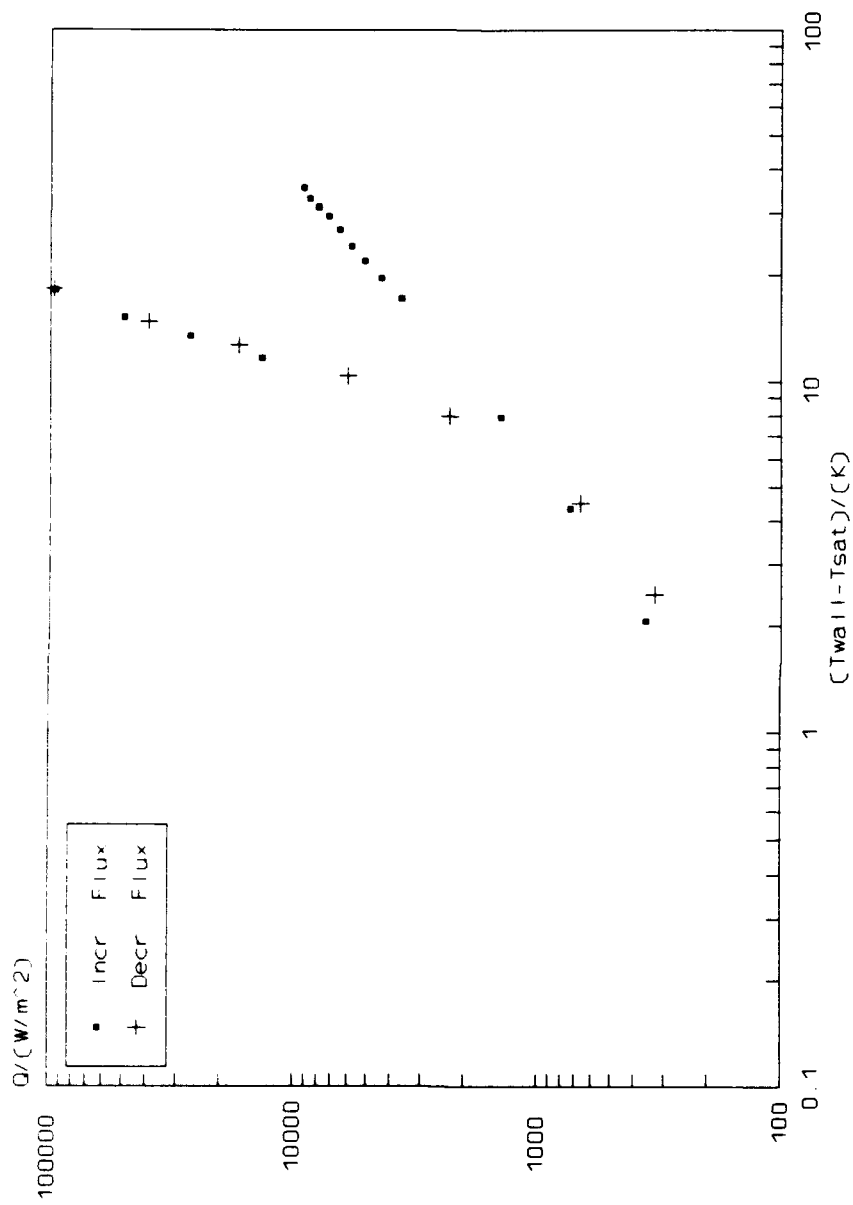

Figure 6.4 Performance Comparison for Pure R-114 Boiling From Smooth Tube Surface

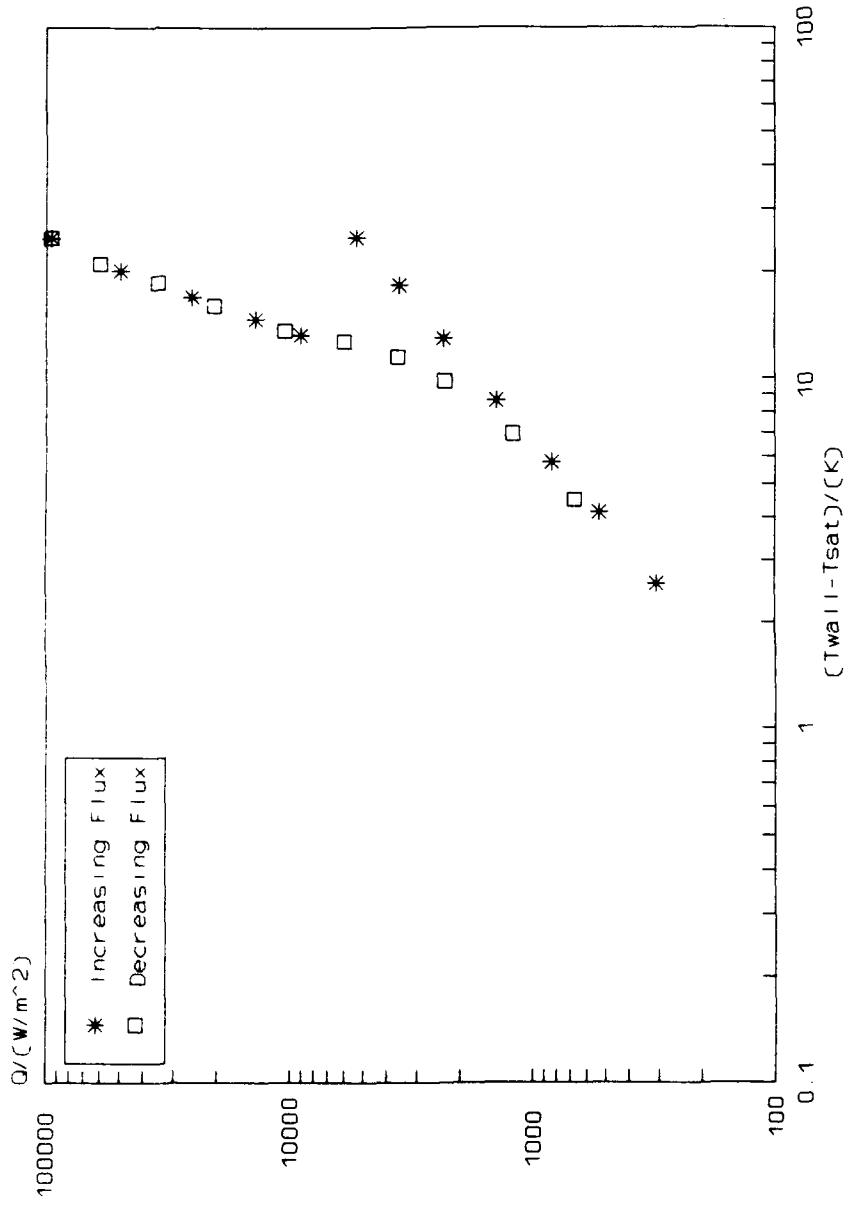

Figure 6.5 Performance Comparison for R-114/3% Oil Mixture Boiling From Smooth Tube Surface

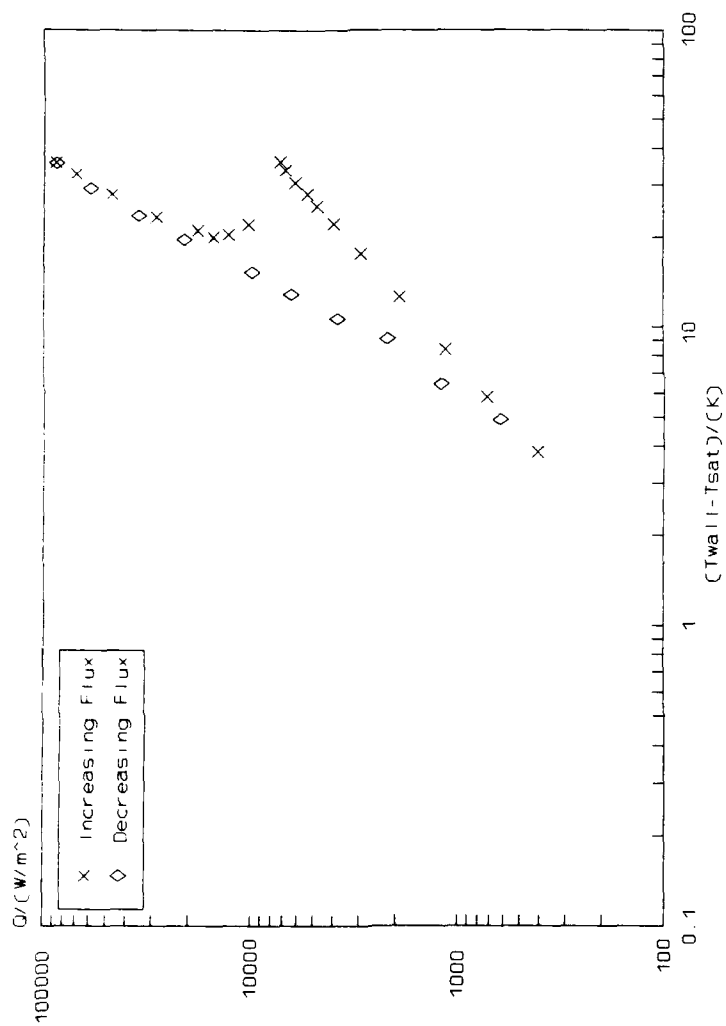

Figure 6.6 Performance Comparison for Pure R-114/10% Oil Mixture Boiling From Smooth Tube Surface

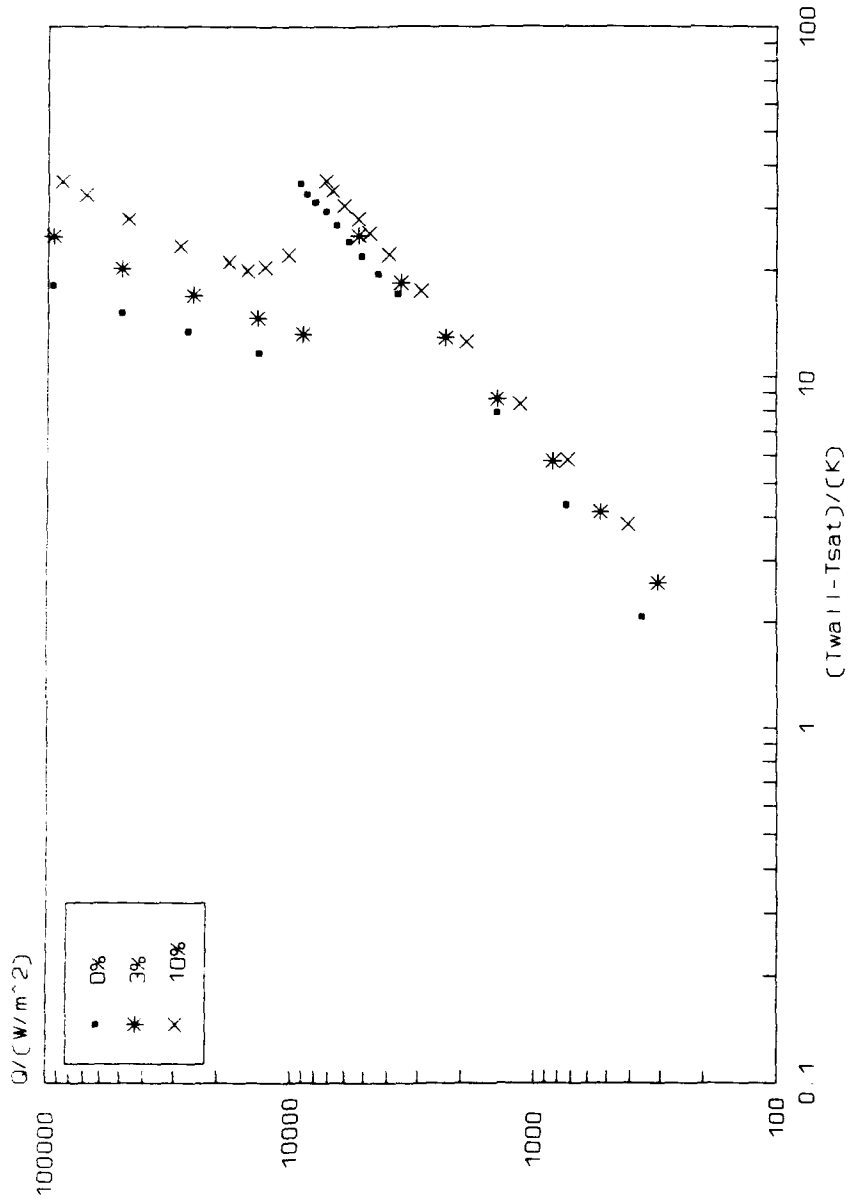

Figure 6.7 Performance Comparison for Boiling R-114/ 0%, 3% & 10% Oil Mixtures Increasing Flux From Smooth Tube

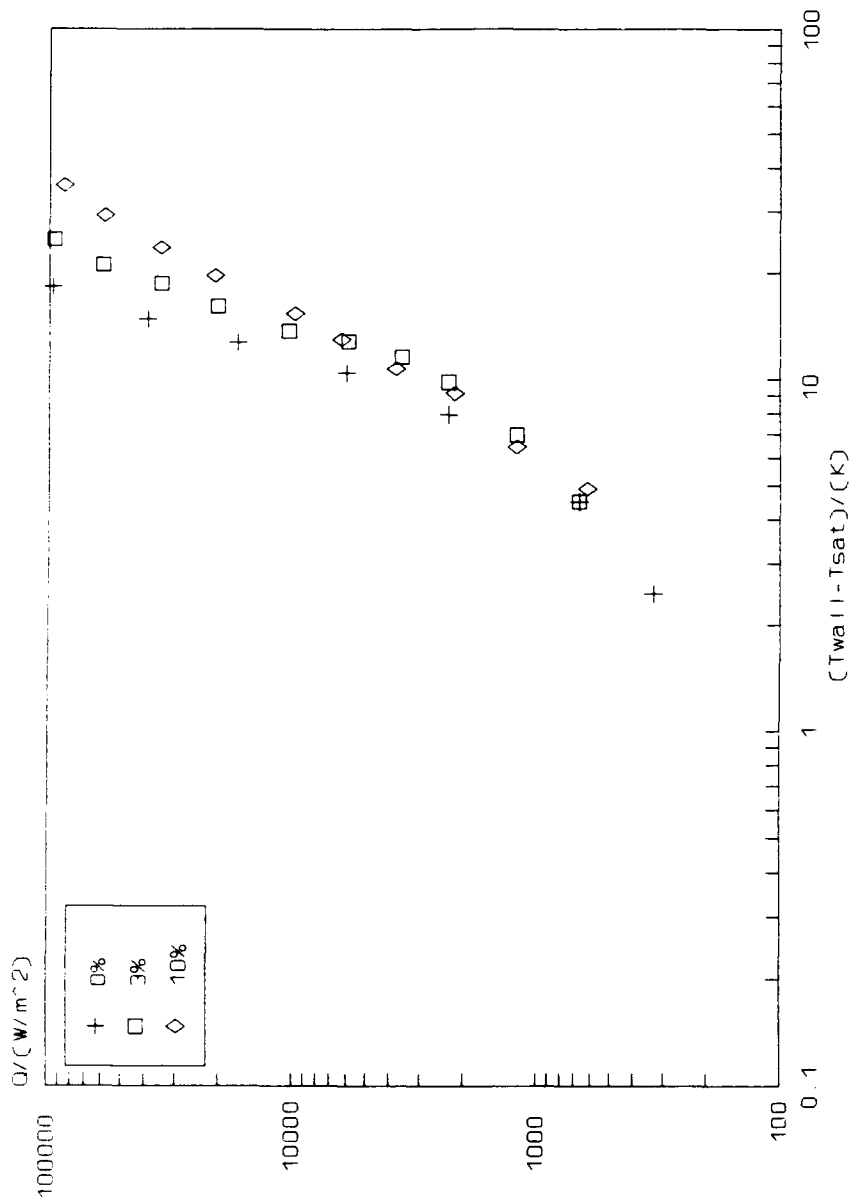

Figure 6.8 Performance Comparison For Boiling R-114/ 0%, 3% & 10% Oil Mixtures Decreasing Flux From Smooth Tube Surface

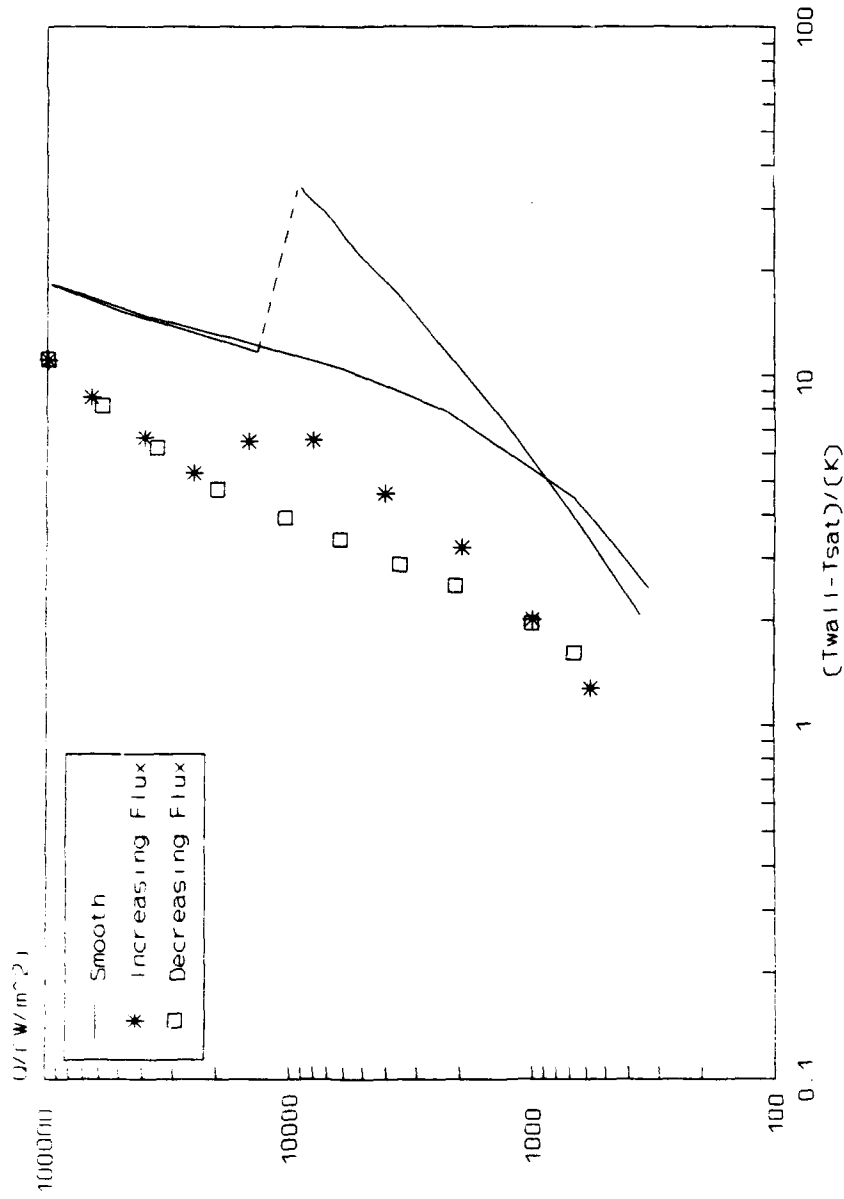

Figure 6.9 Performance Comparison For
 Pure R-114 Boiling From
 GEWA-K 26 fpi Tube

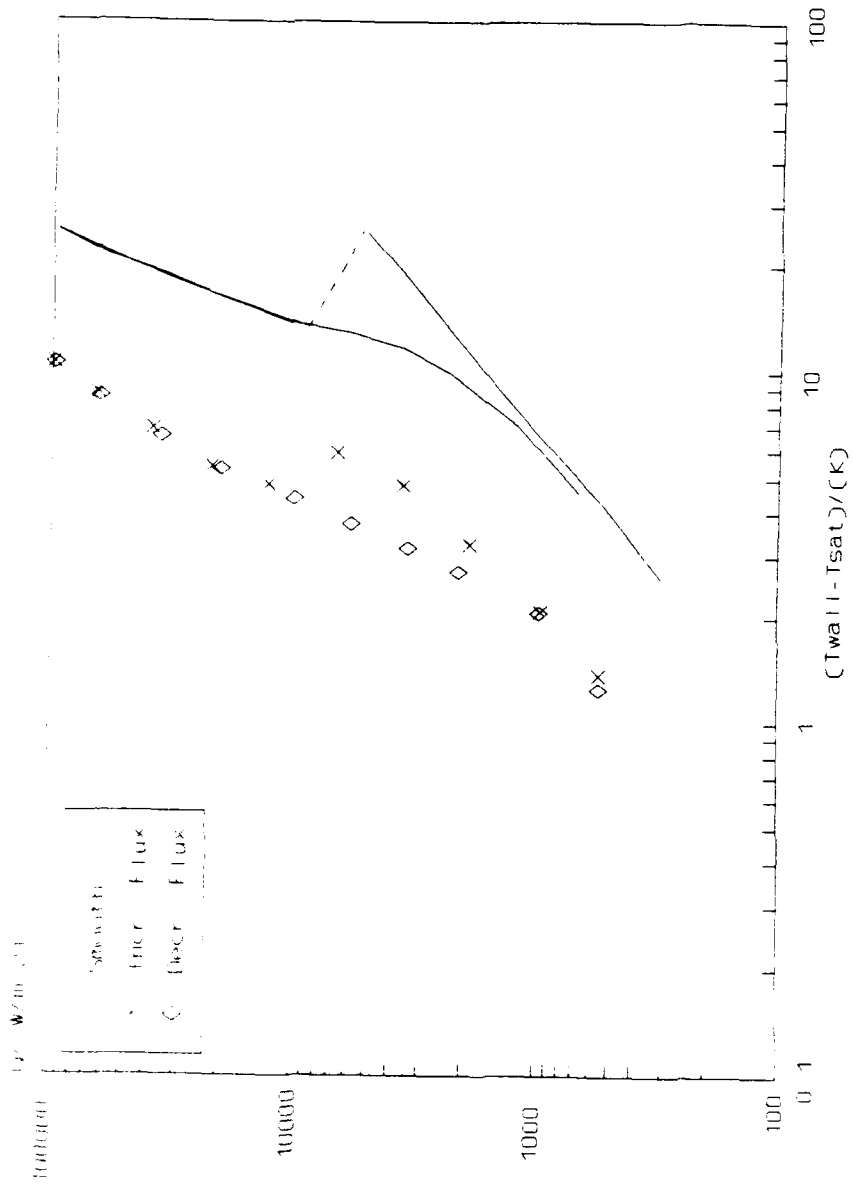

Figure 6.10 Performance Comparison For Boiling R-114/3% Oil Mixture From GEWA-K 26 fpi Tube

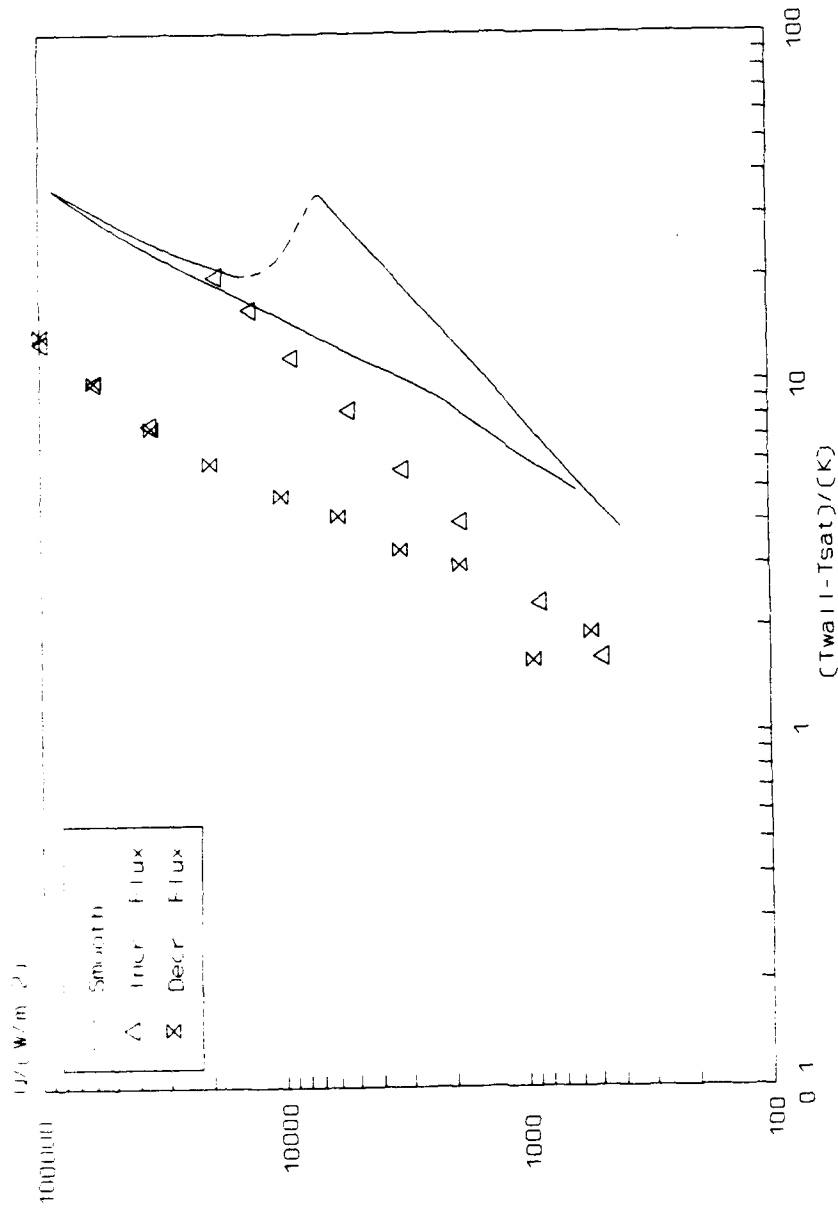

Figure 6.11 Performance Comparison For
 Boiling R-114/10% Oil Mixture From
 GEWA-K 25 fpi Tube

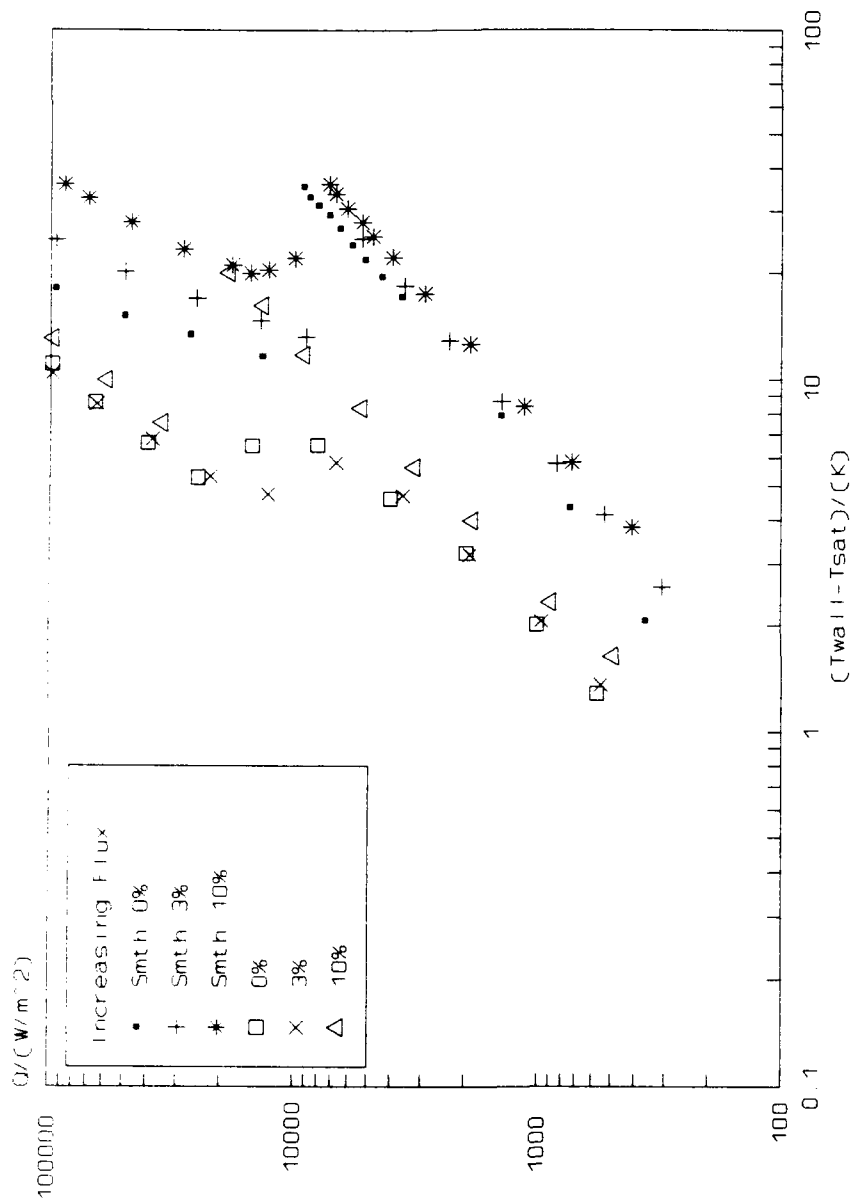

Figure 6.12 Performance Comparison For Boiling R-114/ 0%, 3% & 10% Oil Mixtures From GEWA-K 25 fpi Tube

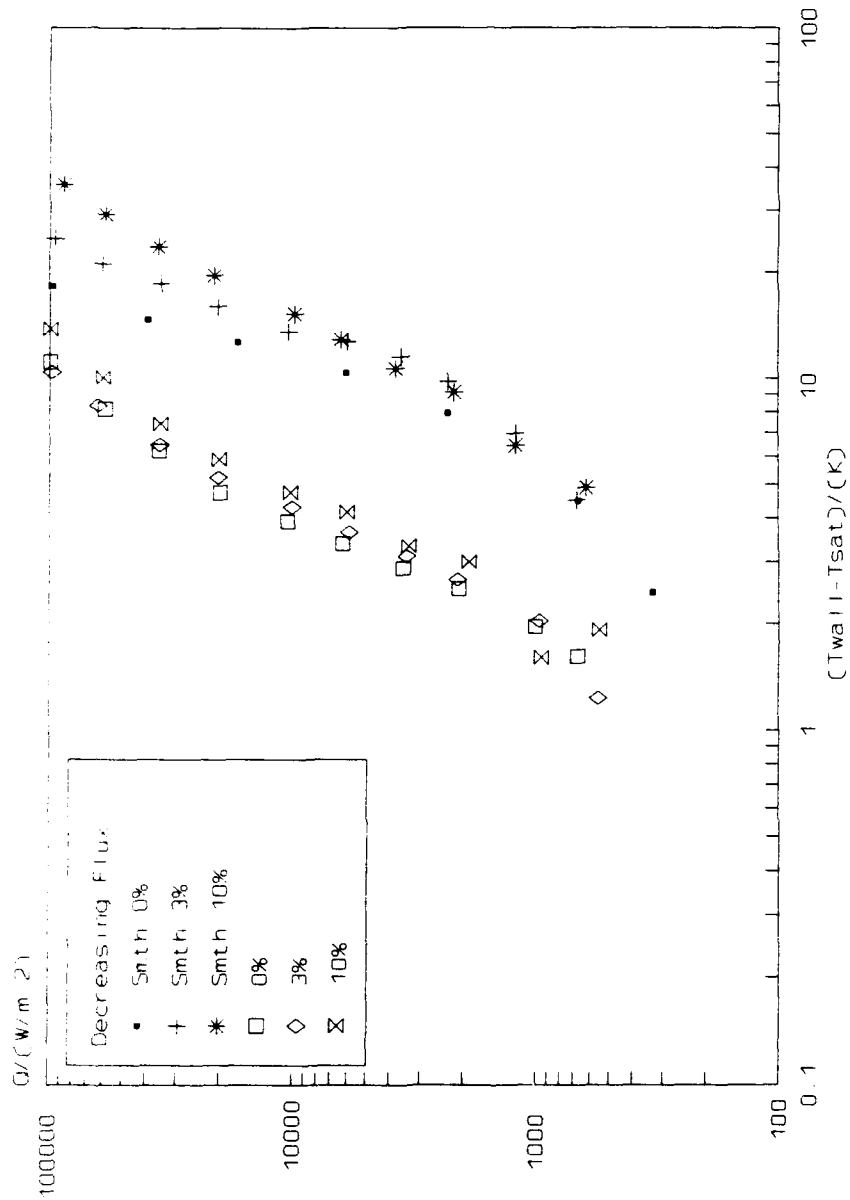

Figure 6.13 Performance Comparison For
Boiling R-114/ 0%, 3% & 10% Oil Mixtures
From GEWA-K 26 fpi Tube

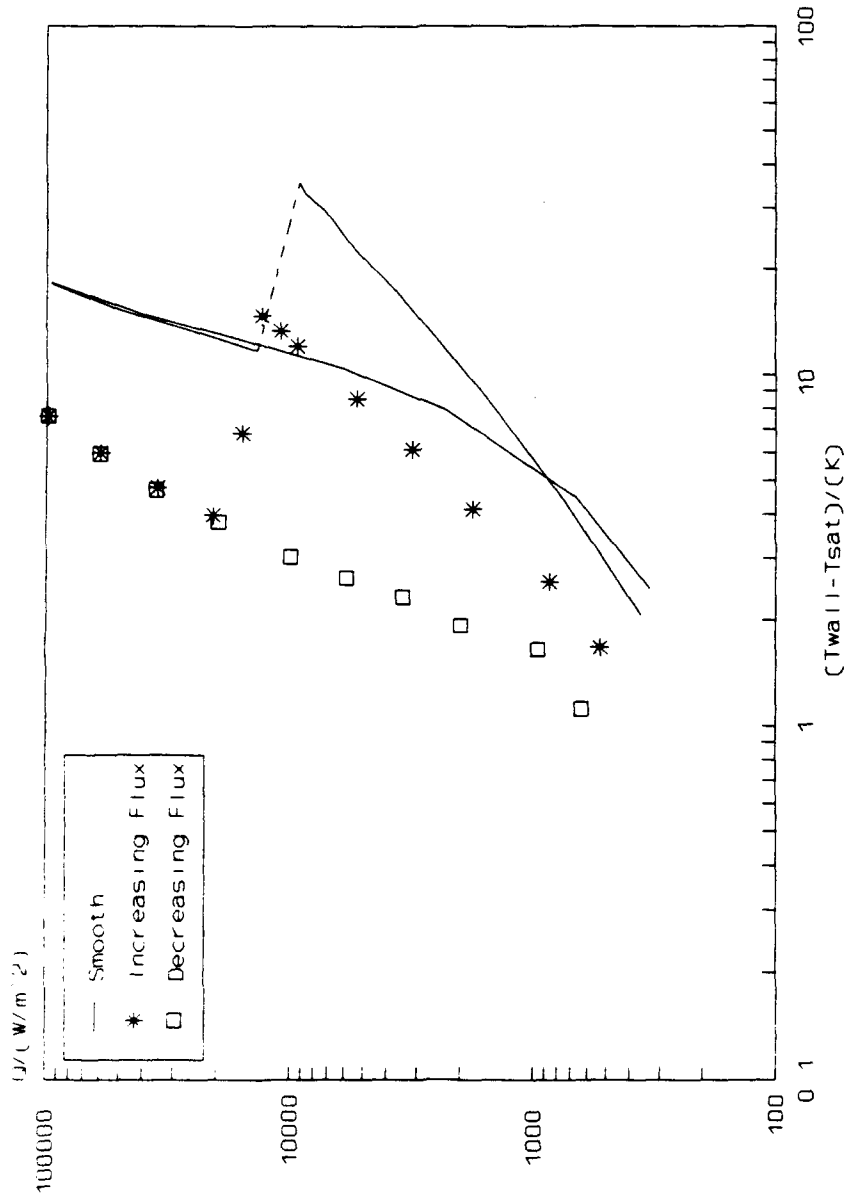

Figure 6.14 Performance Comparison For
 Pure R-114 Boiling From
 GEWA-K 40 fpi Tube

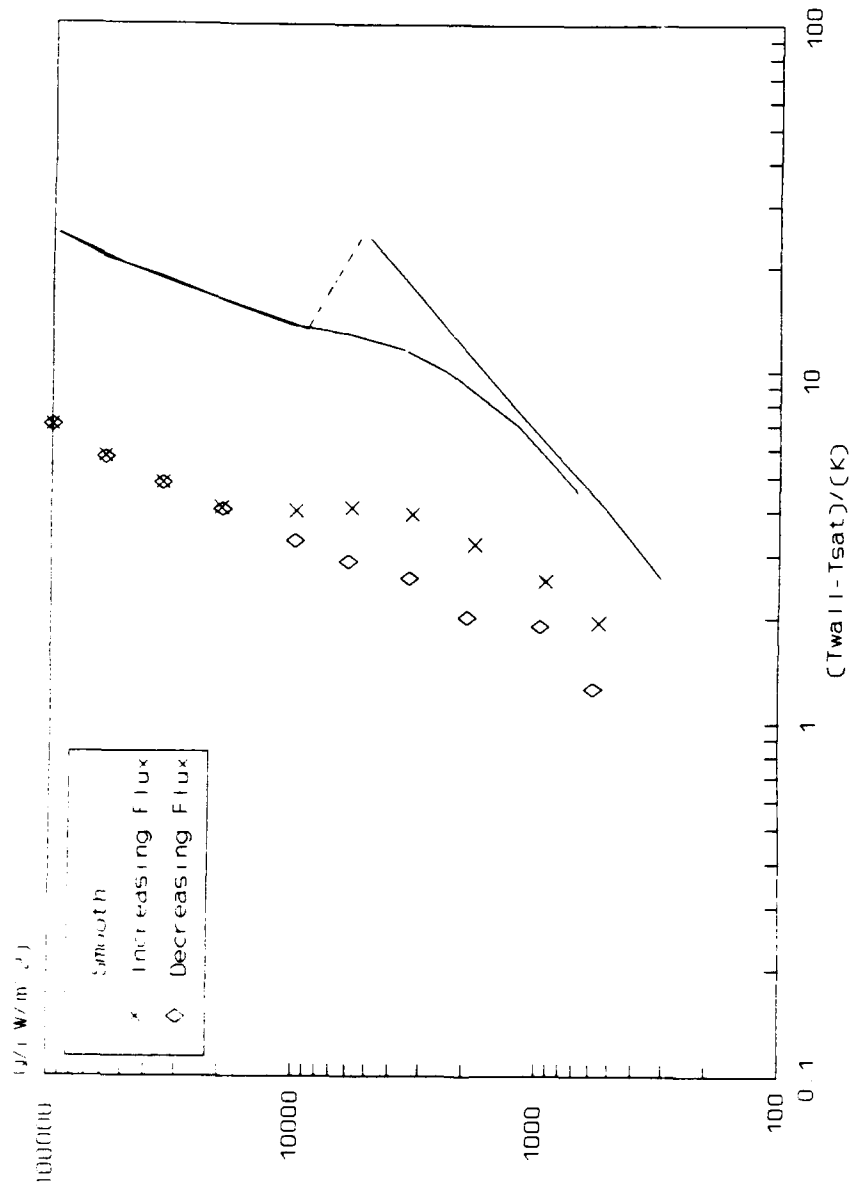

Figure 6.15 Performance Comparison For Boiling R-114/3% Oil Mixture From GEWA-K 40 fpi Tube

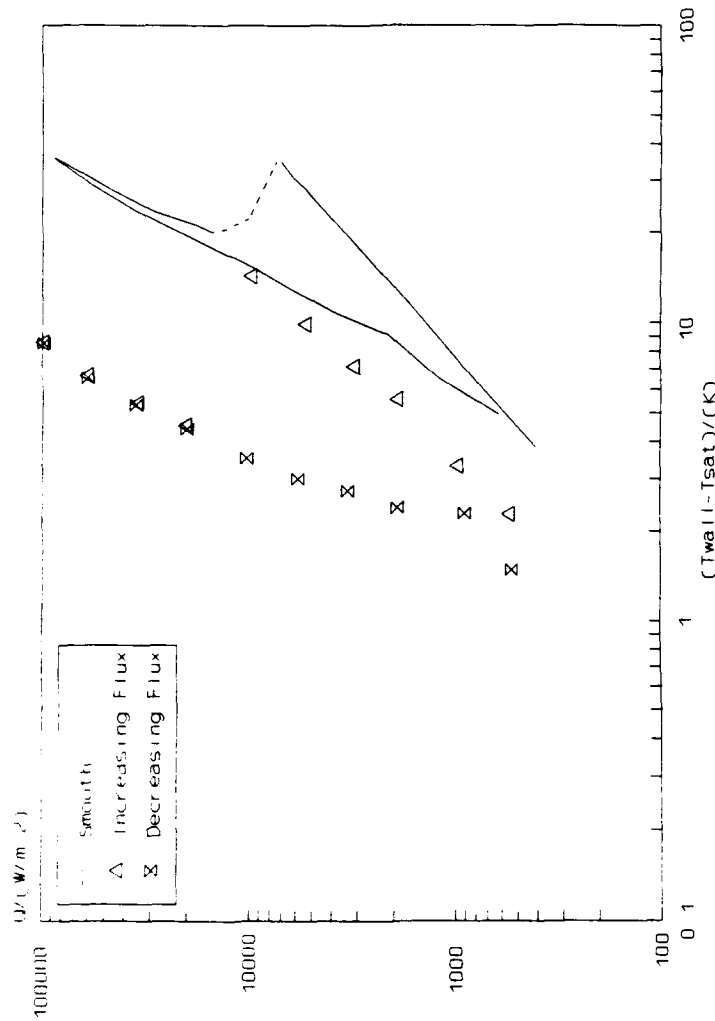

Figure 6-16 Performance Comparison For Boiling R-114/10% Oil Mixture From GEWA-K 40 fpi Tube

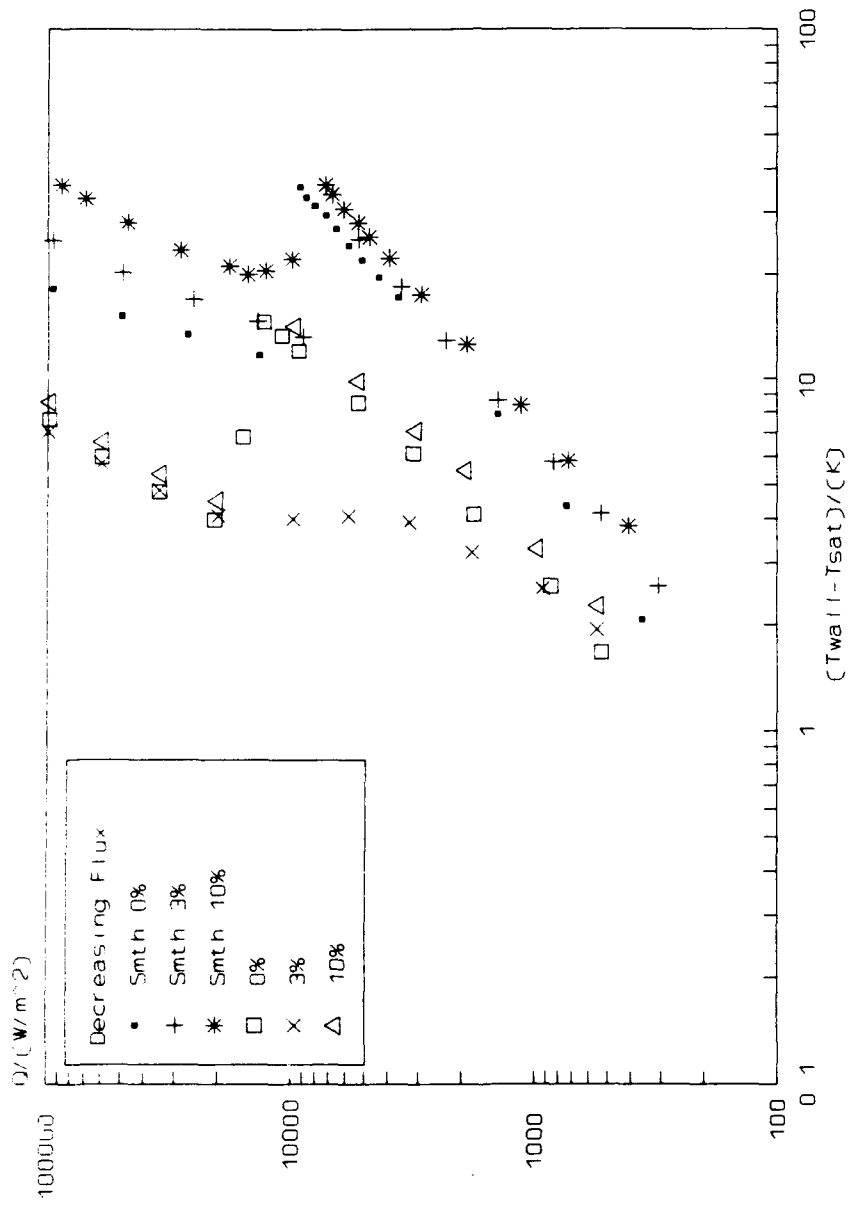

Figure 6.17 Performance Comparison For
 Boiling R-114/ 0%, 3% & 10% Oil Mixtures
 From GEWA-K 40 fpi Tube

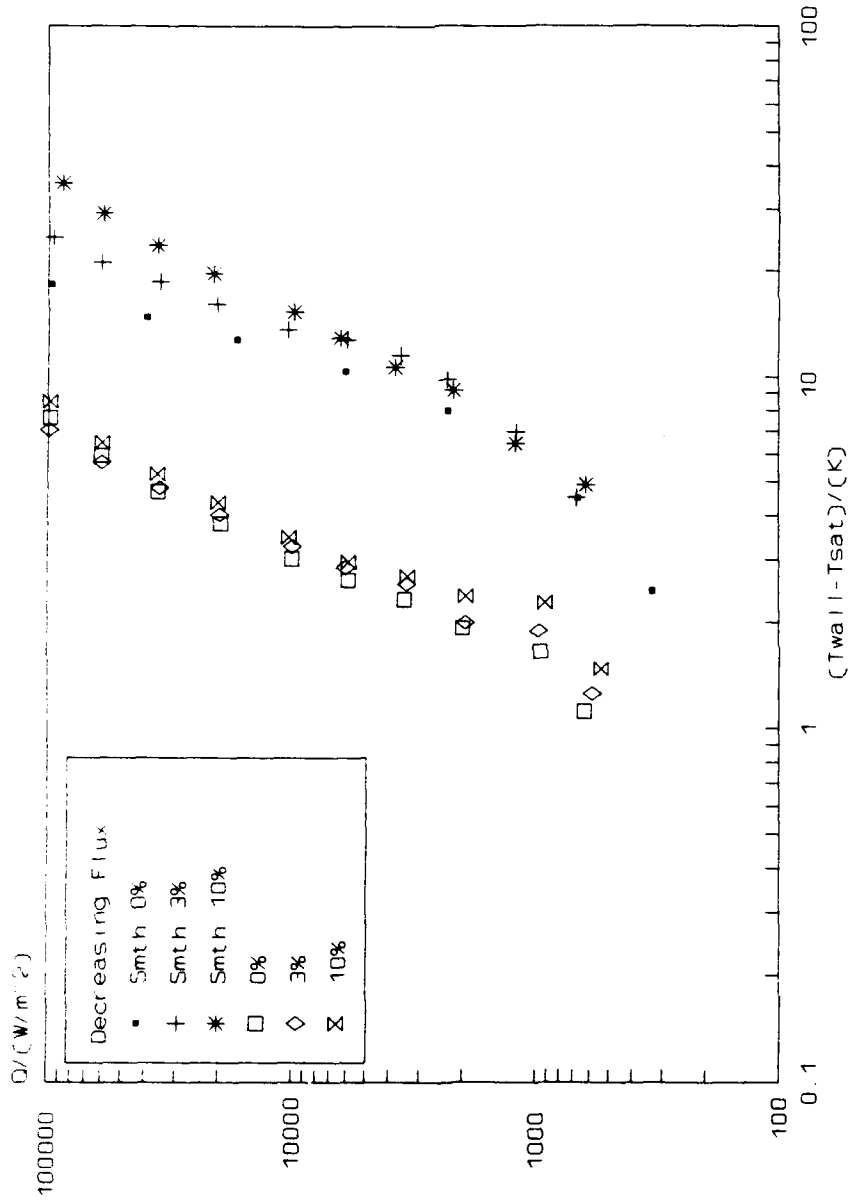

Figure 6.18 Performance Comparison For Boiling R-114/0%, 3% & 10% Oil Mixtures From GEWA-K 40 fpi Tube

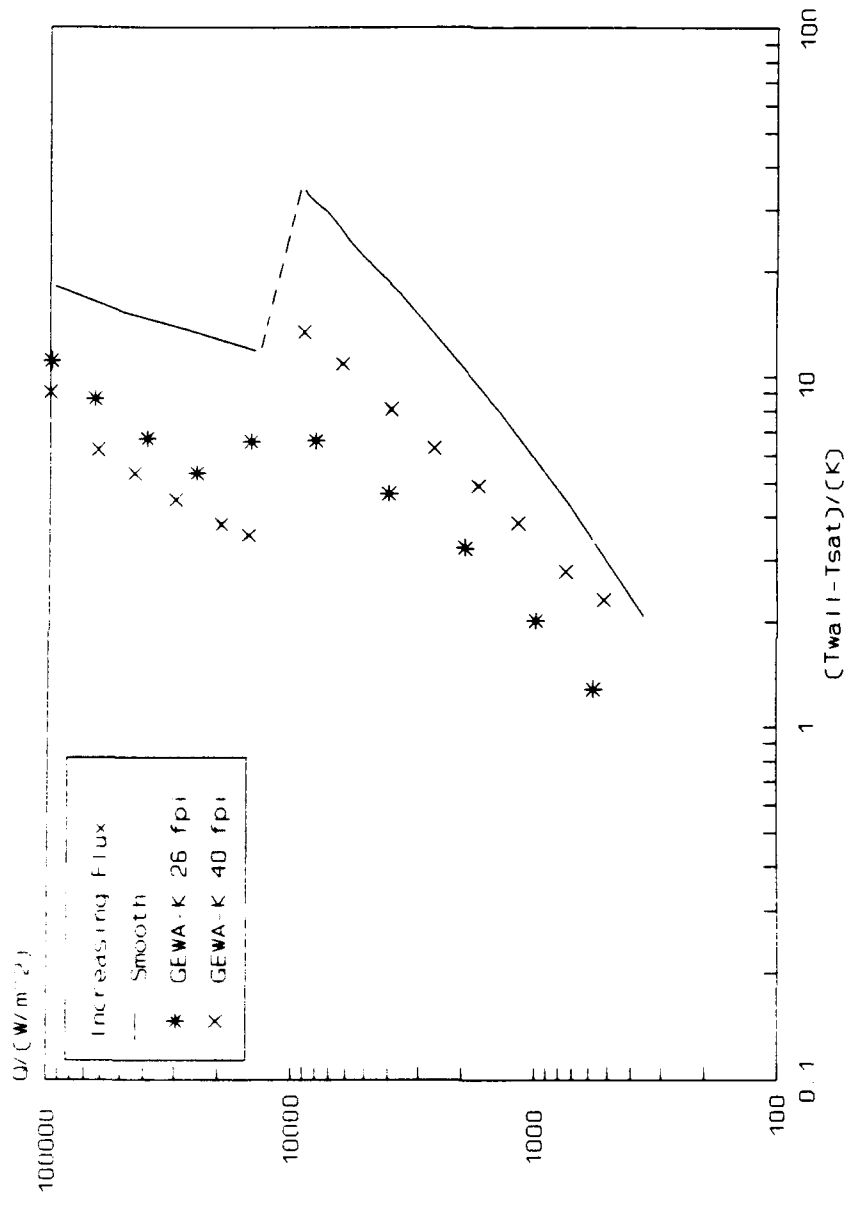

Figure 6.19 Performance Comparison For Boiling Pure R-114 From GEWA-K 26/40 fpi Tubes

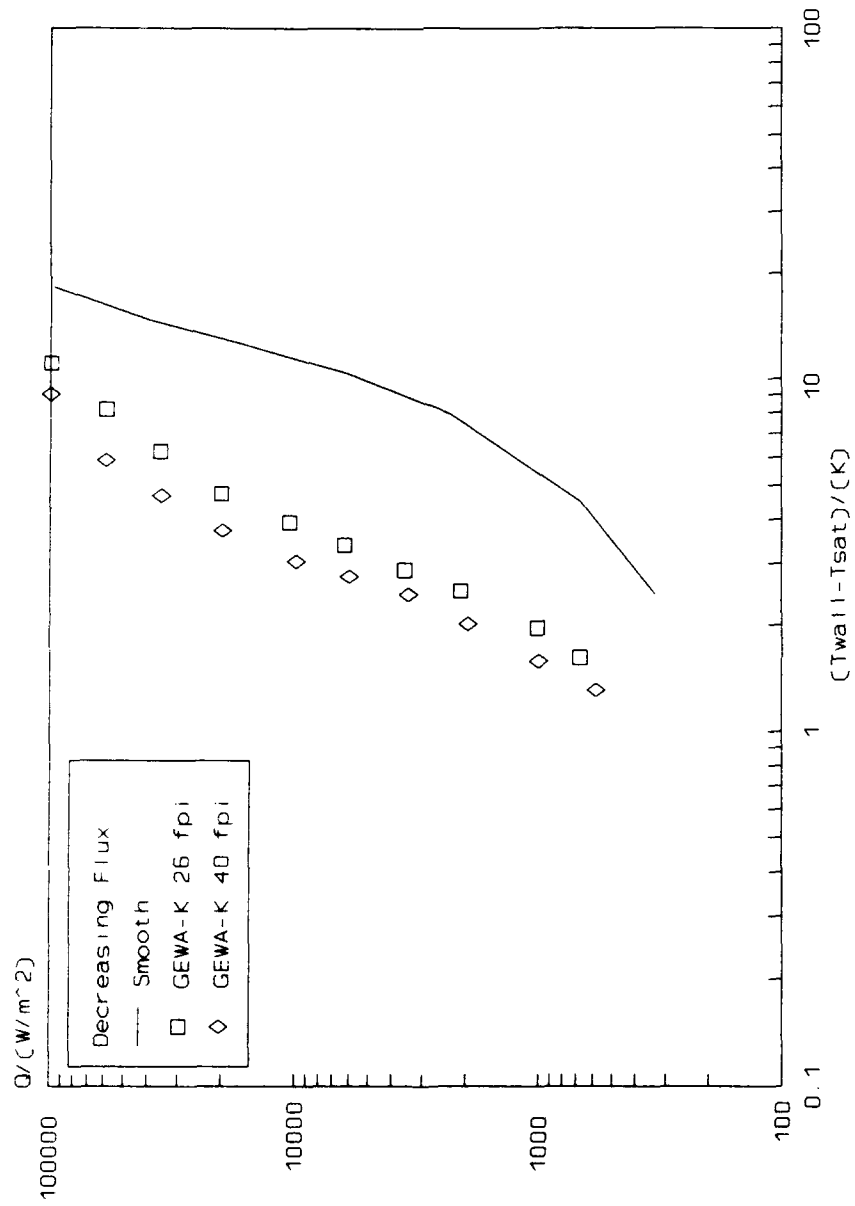

Figure 6.20 Performance Comparison For Boiling Pure R-114 From GEWA-K 26/40 fpi Tubes

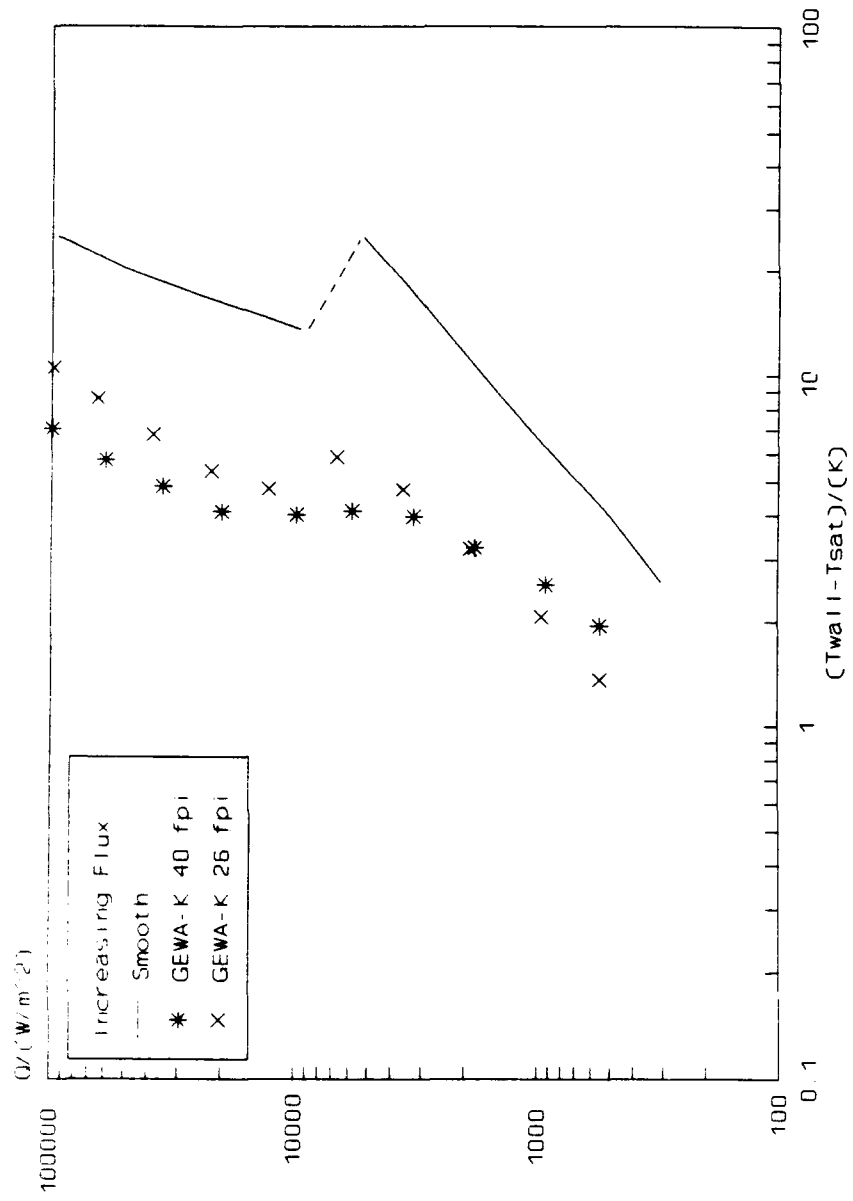

Figure 6.21 Performance Comparison For Boiling R-114/3% Oil Mixture From GEWA-K 26/40 fpi Tubes

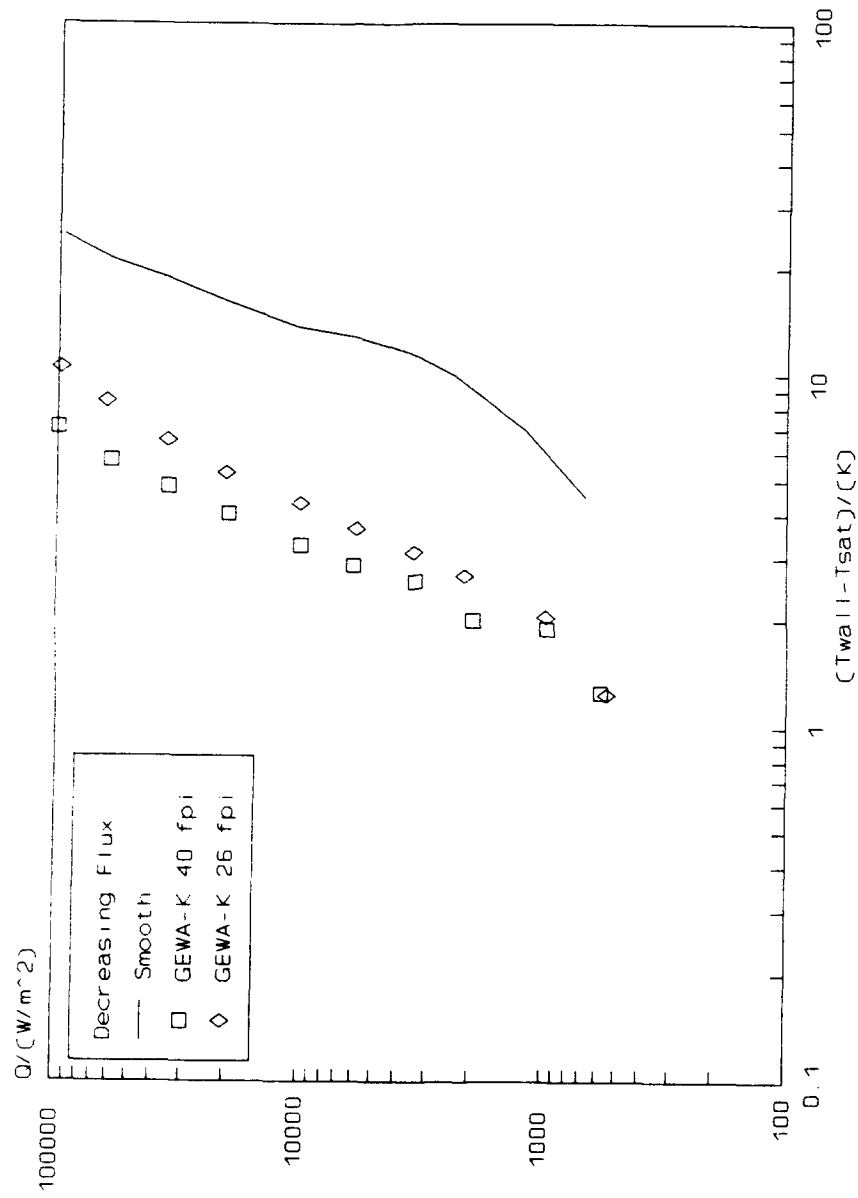

Figure 6.22 Performance Comparison For Boiling R-114/3% Oil Mixture From GEWA-K 26/40 fpi Tubes

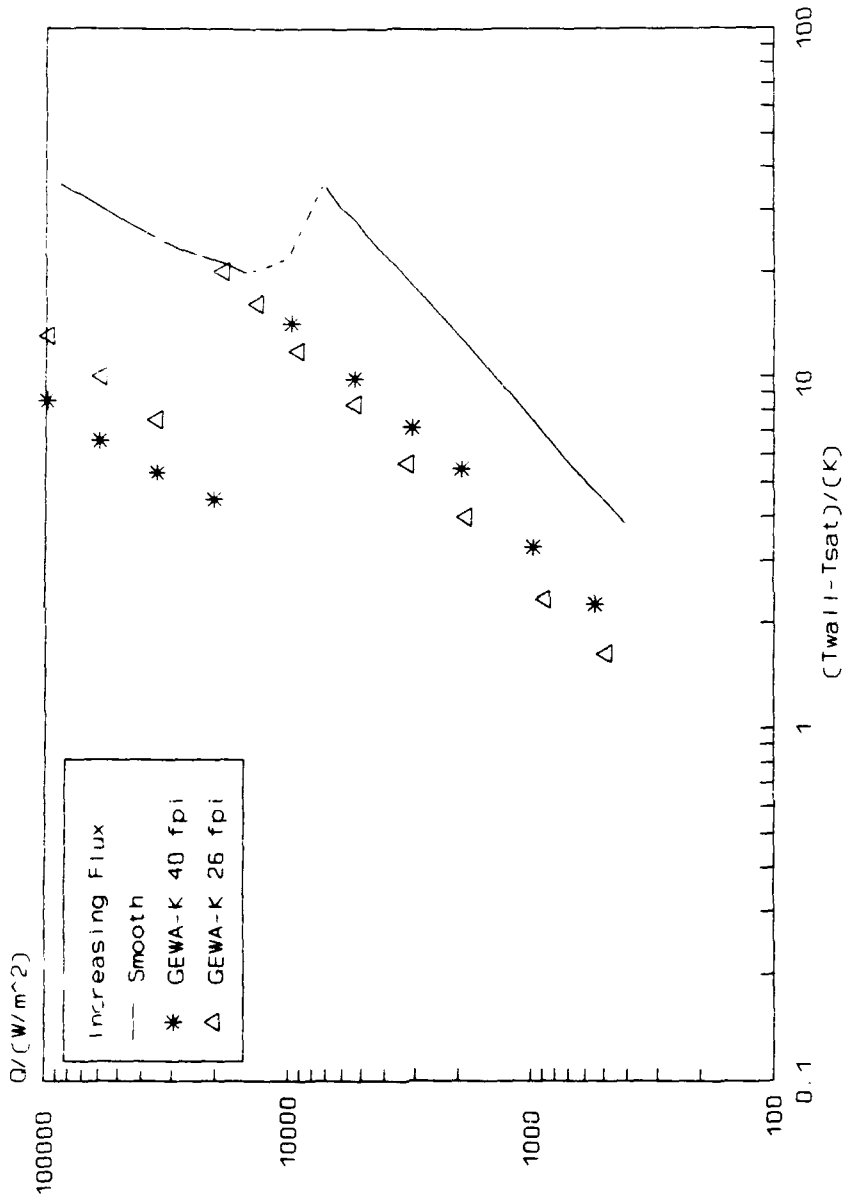

Figure 6.23 Performance Comparison For
 Boiling R-114/10% Oil Mixture From
 GEWA-K 26/40 fpi Tubes

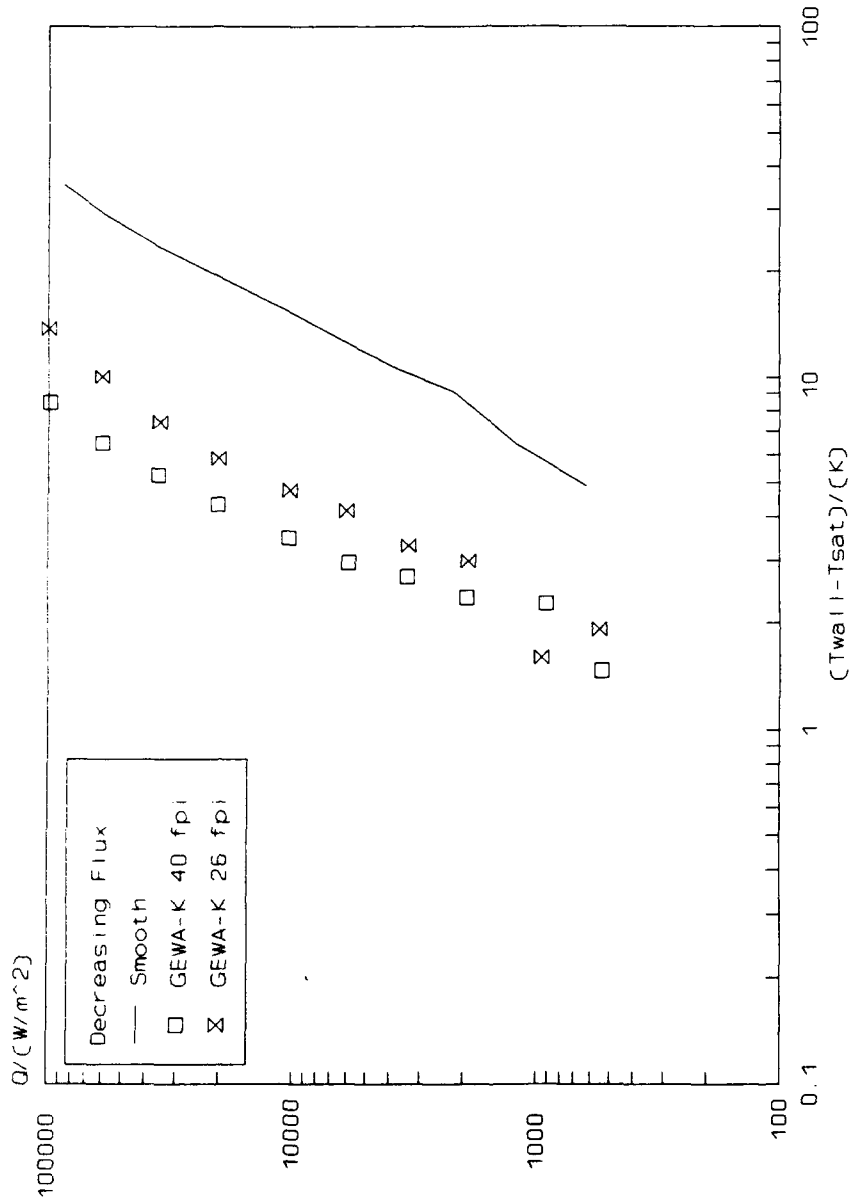

Figure 6.24 Performance Comparison For Boiling R-114/10% Oil Mixture From GEWA-K 26/40 fpi Tubes

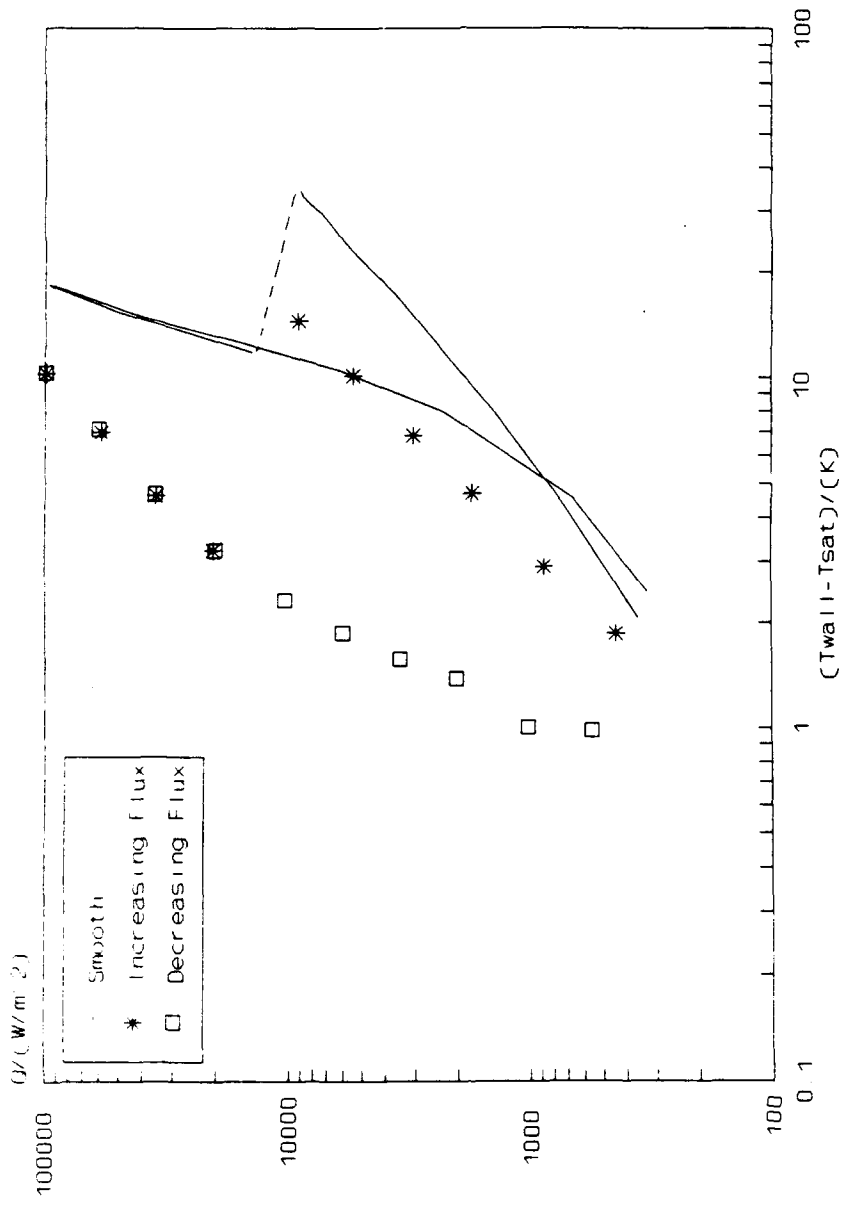

Figure 6.25 Performance Comparison For Pure R-114 Boiling From GEWA-T 19 fpi Tube

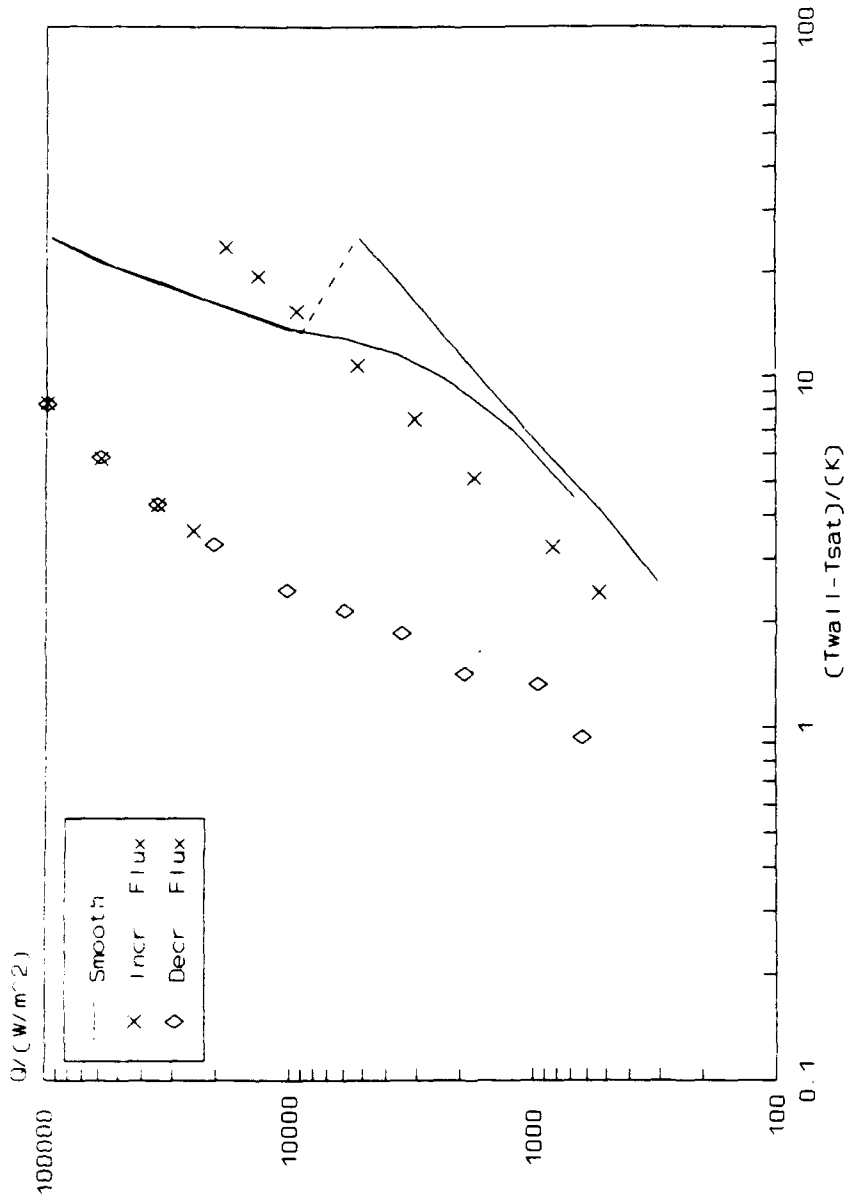

Figure 6.26 Performance Comparison For Boiling R-114/3% Oil Mixture From GEWA-T 19 fpi Tube

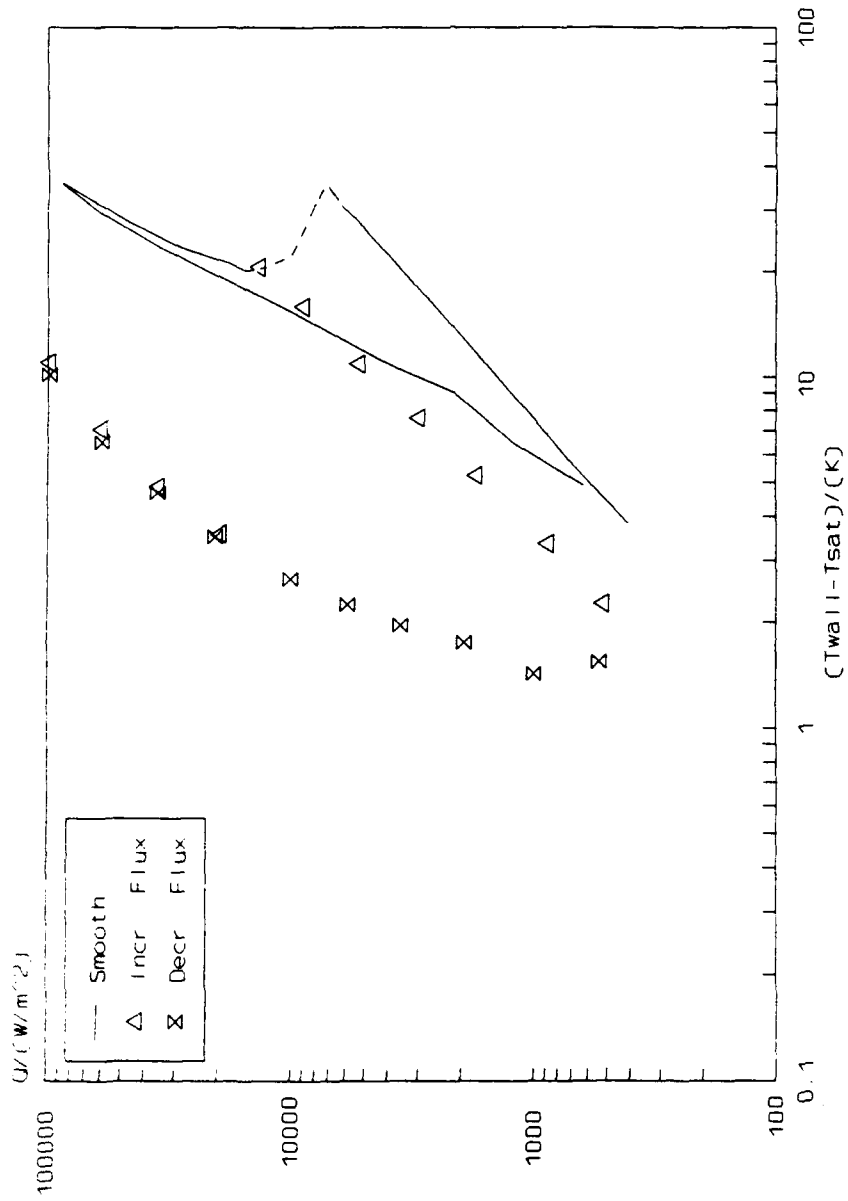

Figure 5.27 Performance Comparison For Boiling R-114/10% Oil Mixture From GEWA-T 19 fpi Tube

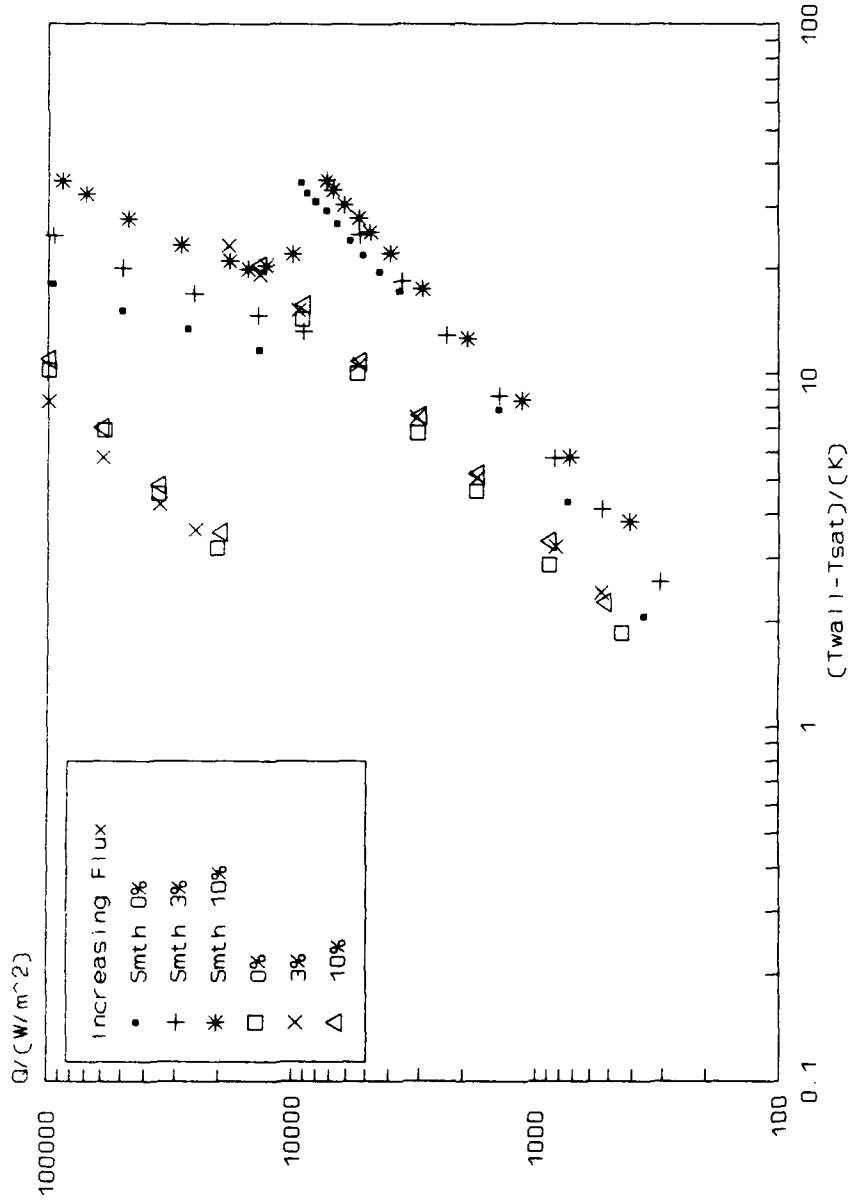

Figure 6.28 Performance Comparison For
 Boiling R-114/ 0%, 3% & 10% Oil Mixtures
 From GEWA-T 19 fpi Tube

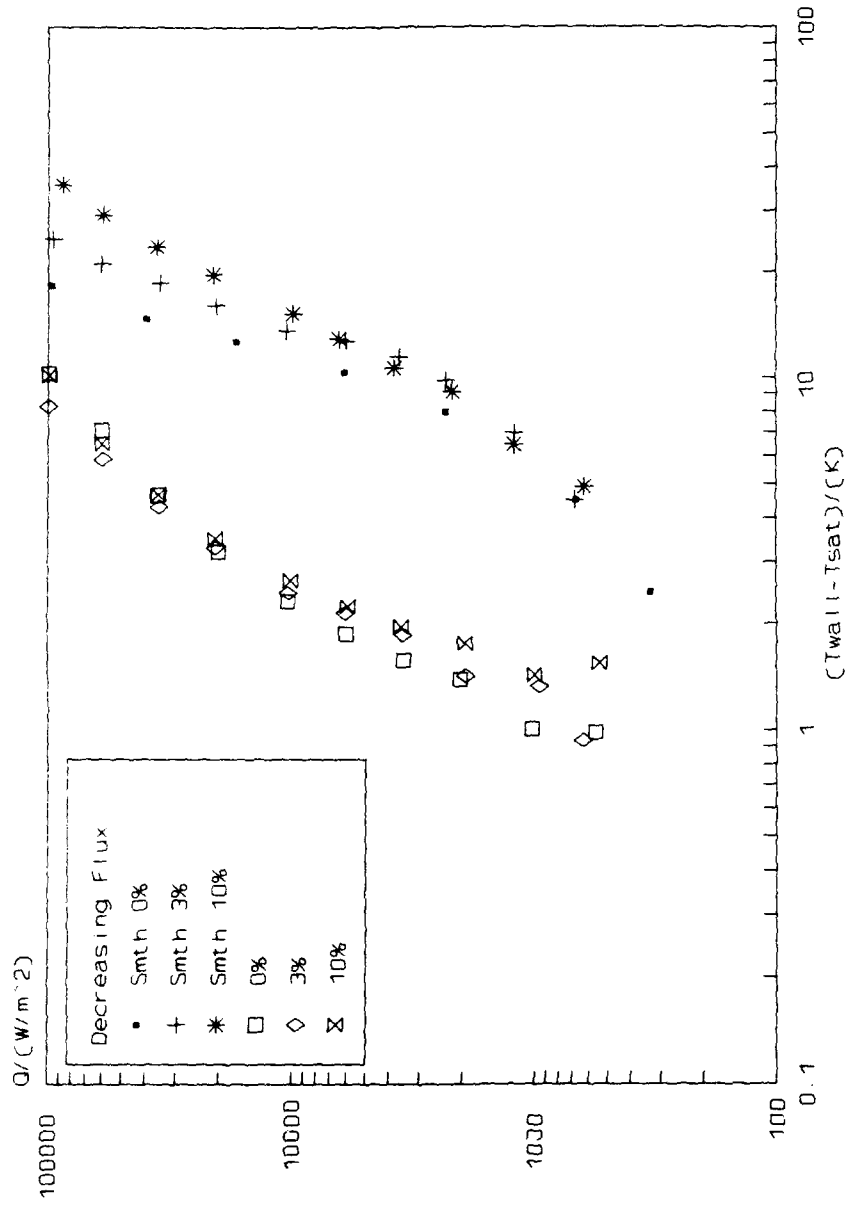

Figure 6.29 Performance Comparison For Boiling R-114/ 0%, 3% & 10% Oil Mixtures From GEWA-T 19 fpi Tube

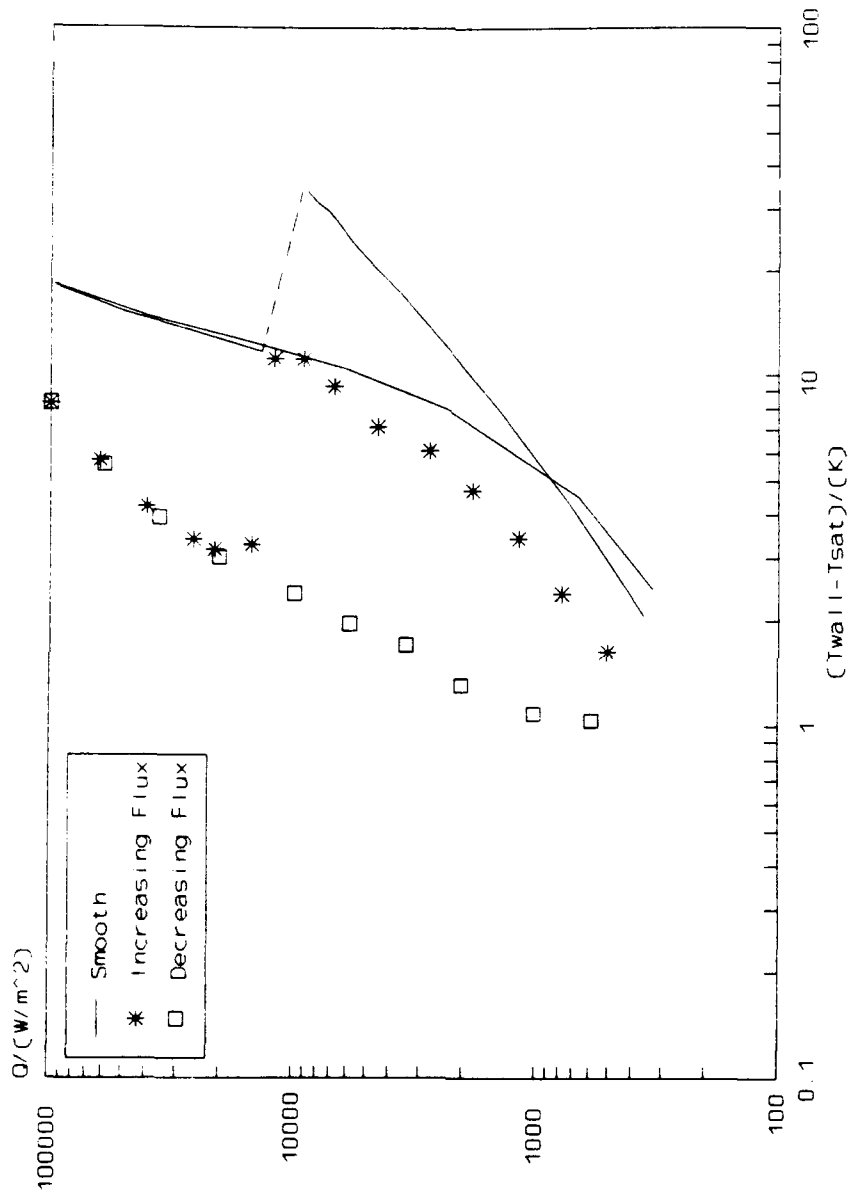

Figure 6.3D Performance Comparison For
 Pure R-114 Boiling From
 GEWA-T 26 fpi Tube

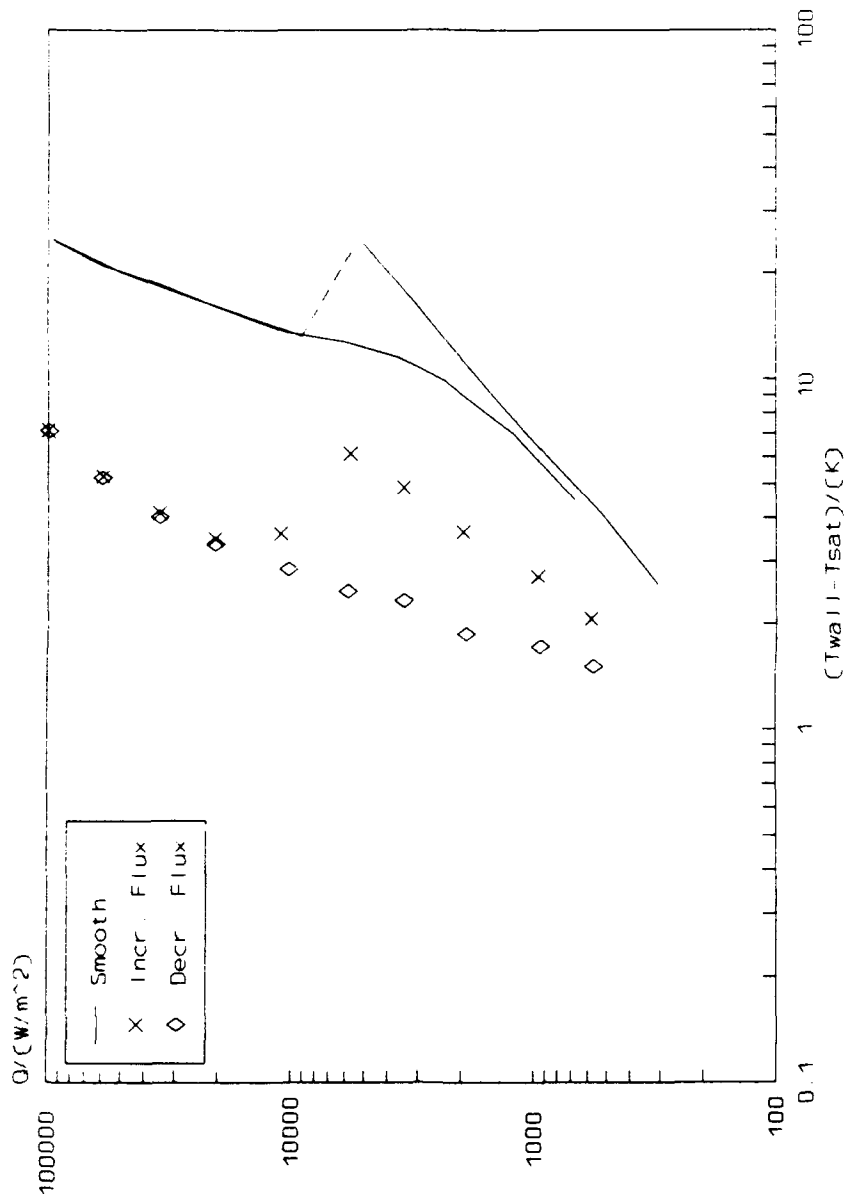

Figure 6.31 Performance Comparison For Boiling R-114/3% Oil Mixture From GEWA-T 26 fpi Tube

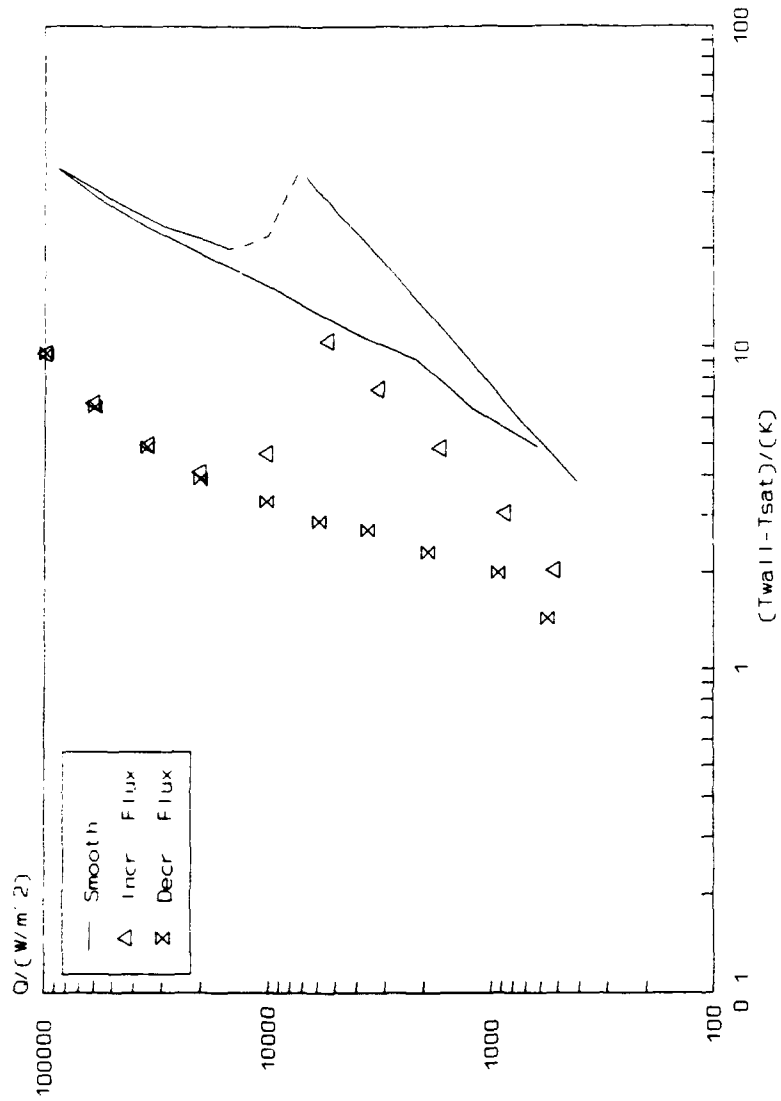

Figure 6.32 Performance Comparison For
Boiling R-114/10% Oil Mixture From
GEWA-T 26 fpi Tube

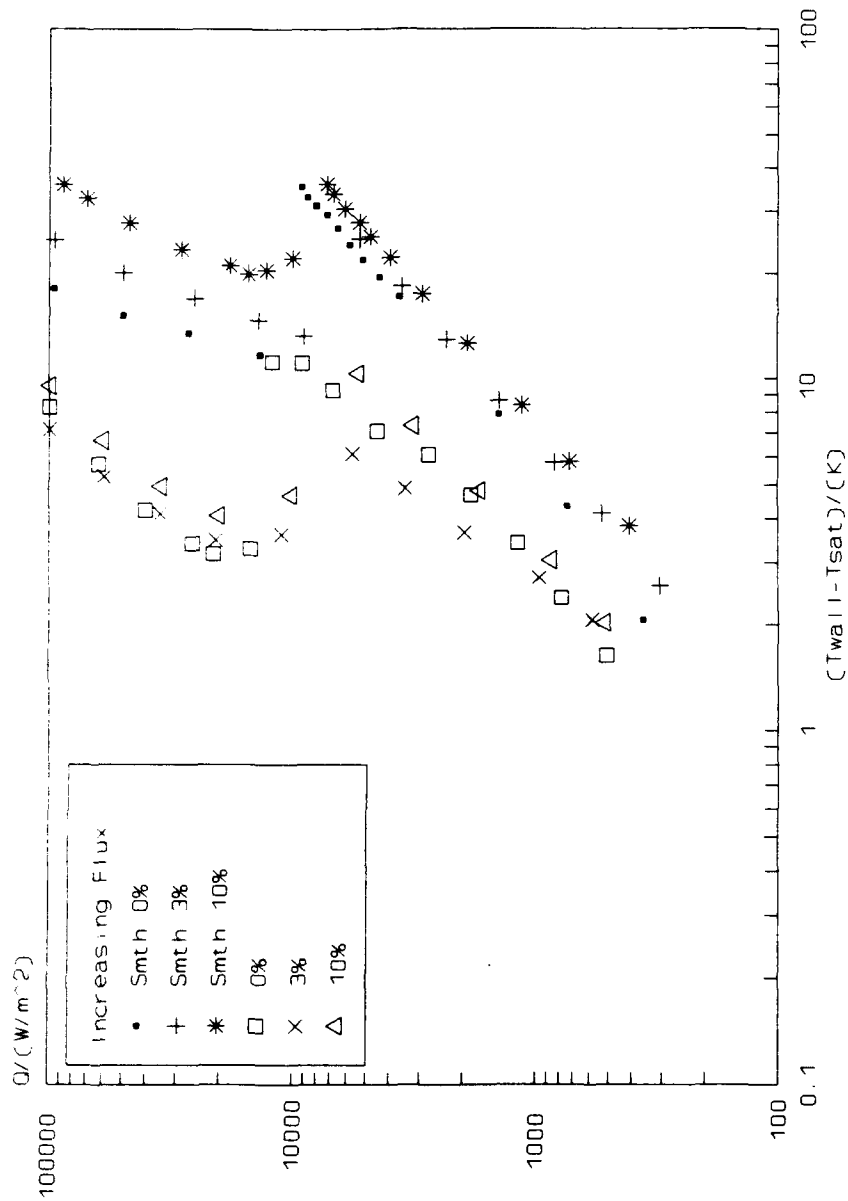

Figure 6.33 Performance Comparison For Boiling R-114/ 0%, 3% & 10% Oil Mixtures From GEWA-T 26 fpi Tube

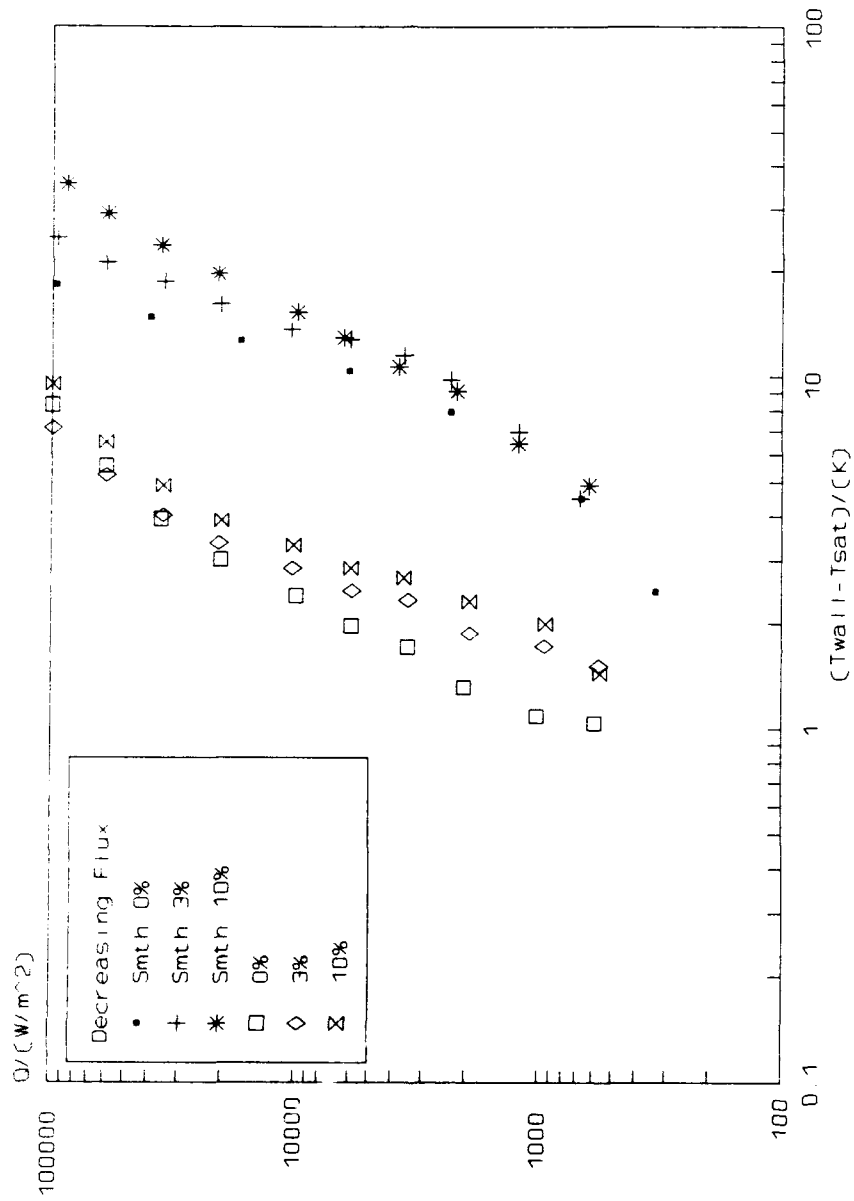

Figure 6.34 Performance Comparison For Boiling R-114/ 0%, 3% & 10% Oil Mixtures From GEWA-T 26 fpi Tube

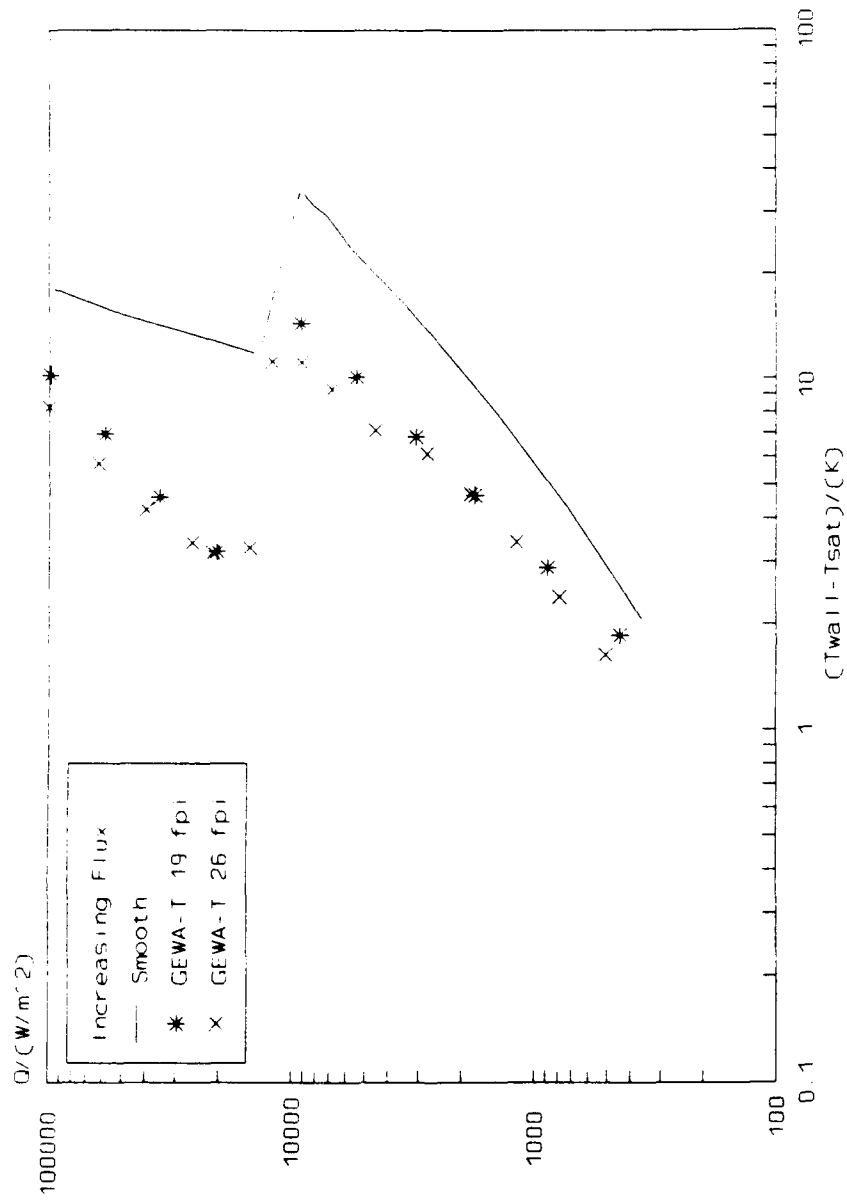

Figure 6.35 Performance Comparison For Boiling Pure R-114 From GEWA-T 19/26 fpi Tubes

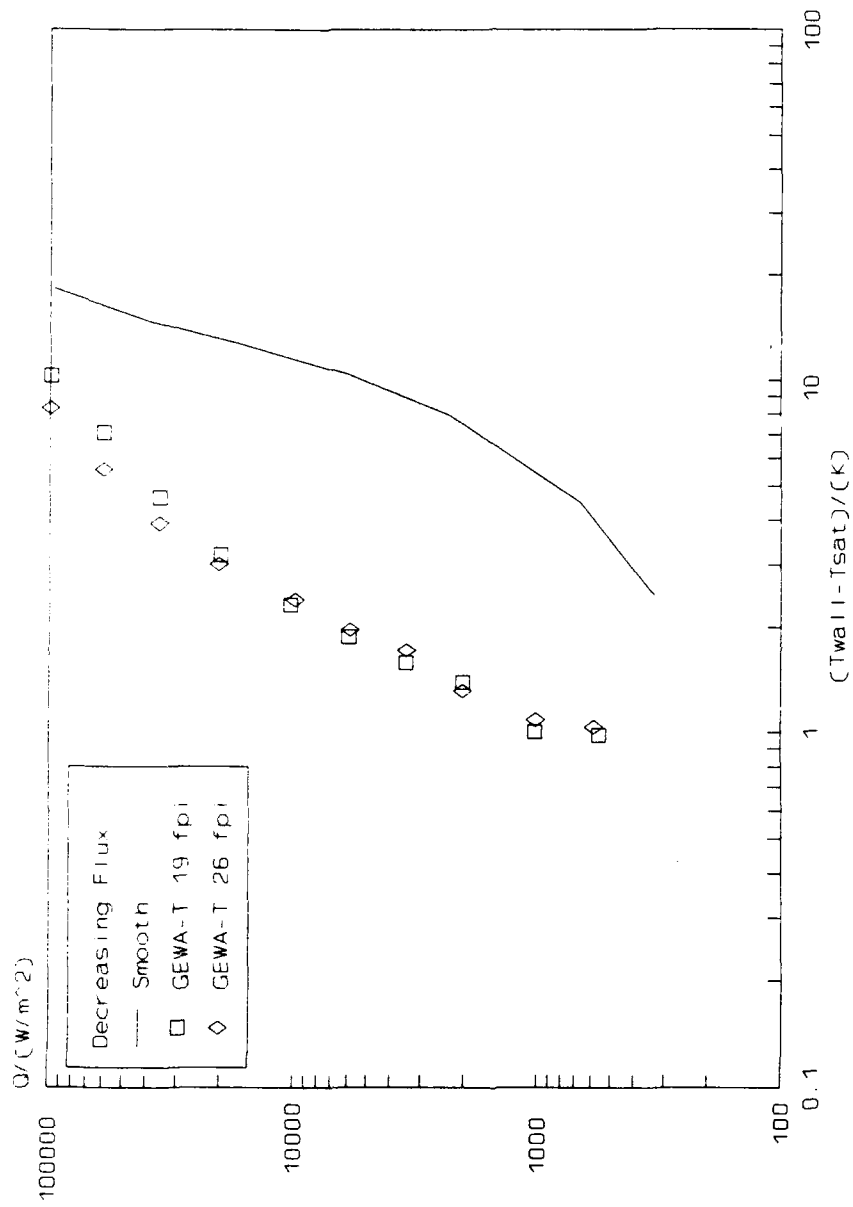

Figure 6.36 Performance Comparison For Boiling Pure R-114 From GEWA-T 19/26 fpi Tubes

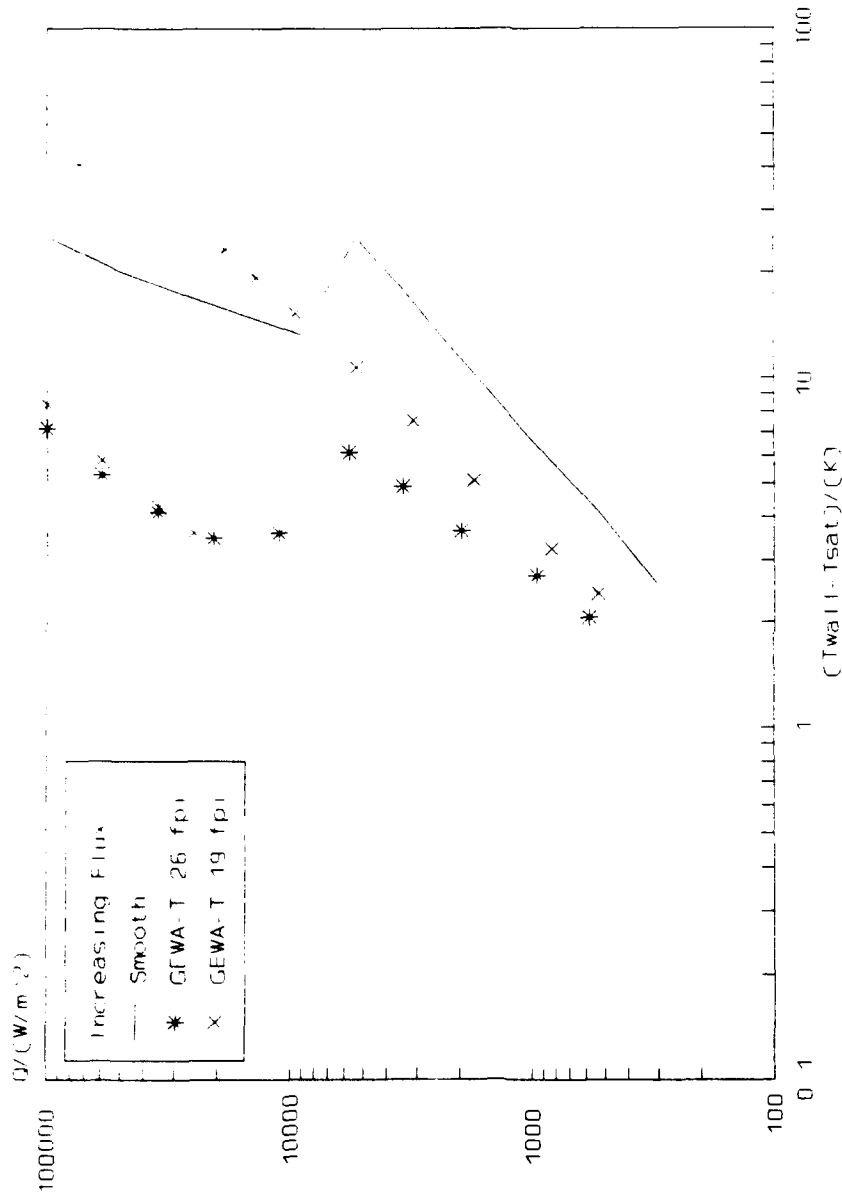

Figure 6.37 Performance Comparison for Boiling R-114/3% Oil Mixture From GEWA-T 19/26 fpi Tubes

0W

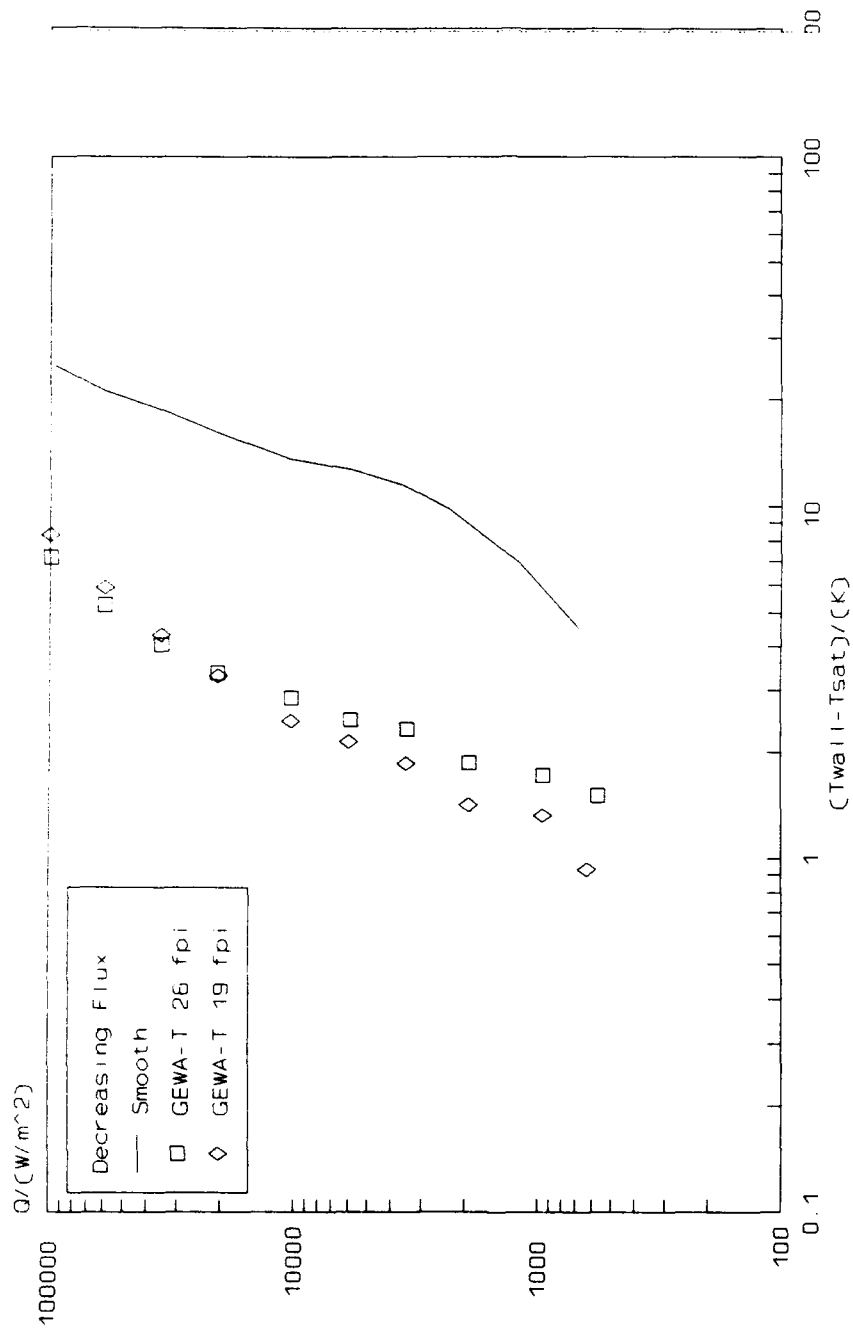

Figure 6.38 Performance Comparison For Boiling R-114/3% Oil Mixture From GEWA-T 19/26 fpi Tubes

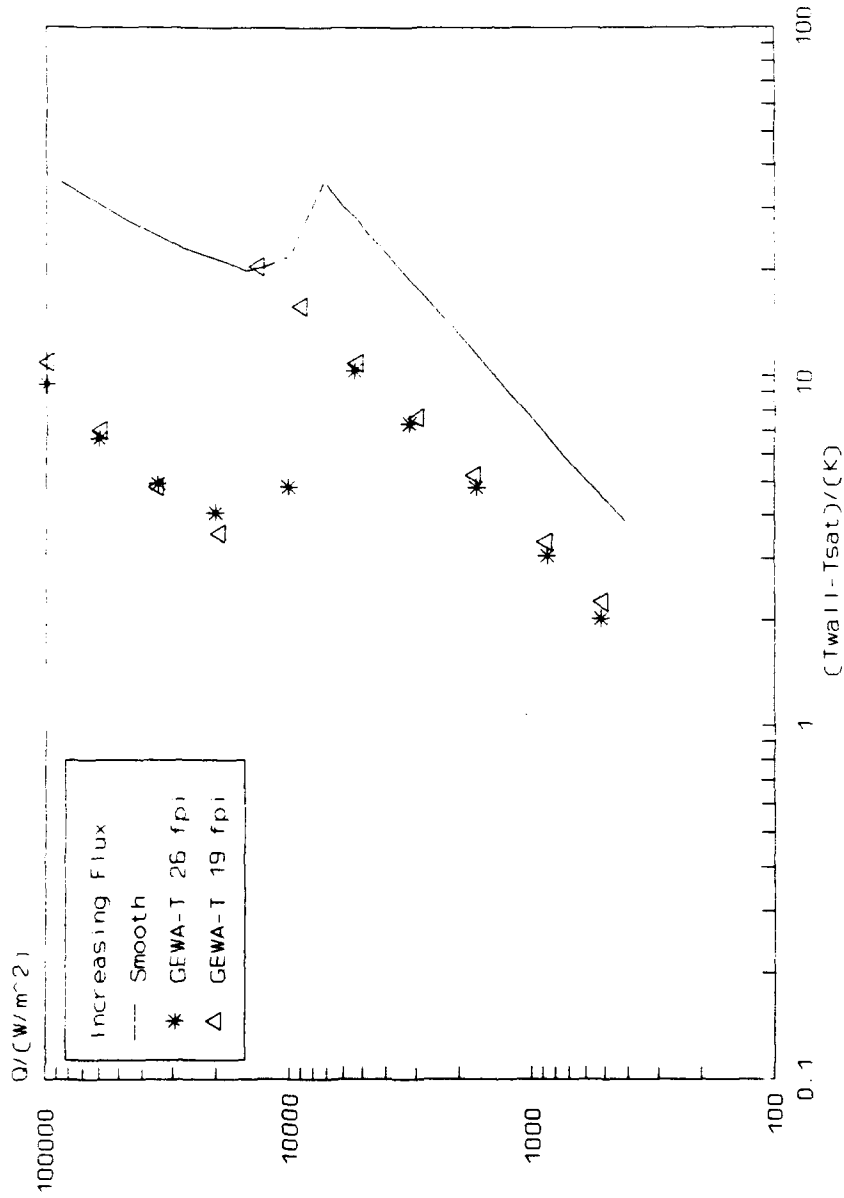

Figure B.39 Performance Comparison For
 Boiling R-114/10% Oil Mixture from
 GEWA-T 19/26 fpi Tubes

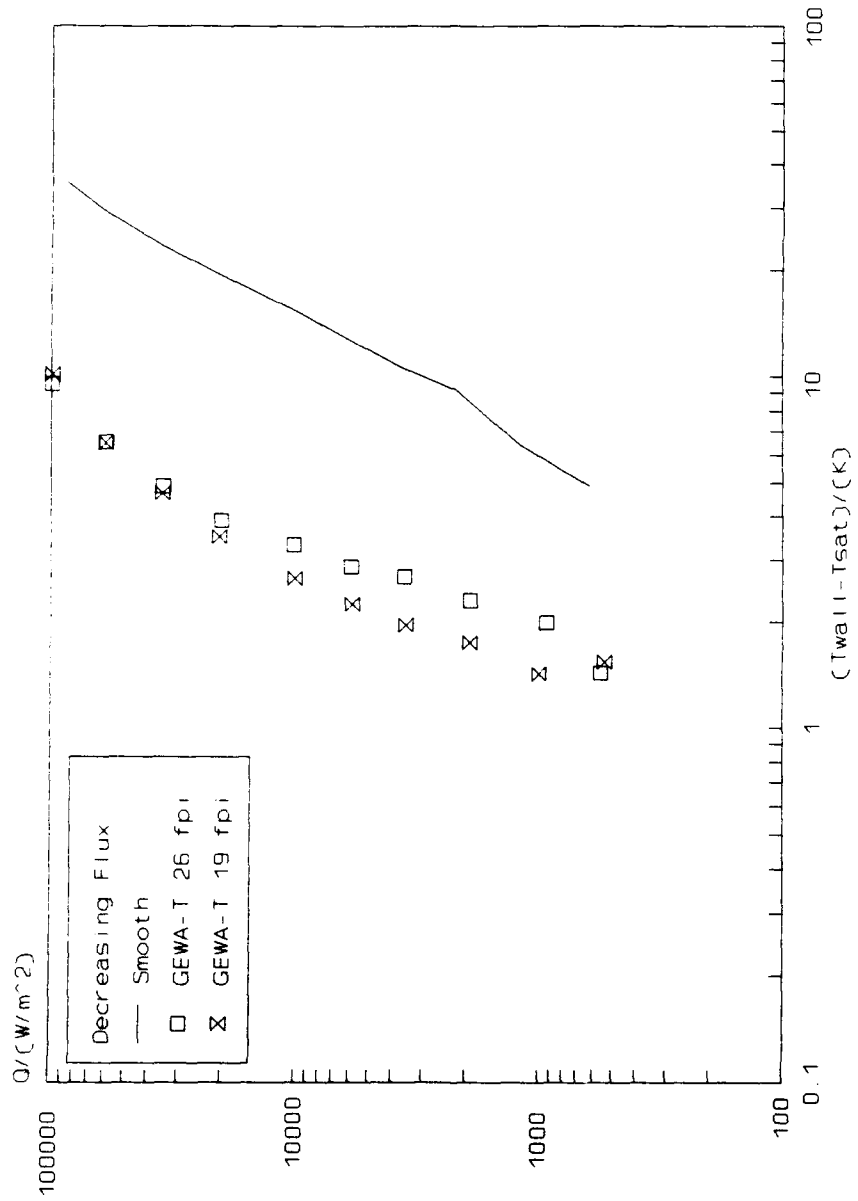

Figure 6 40 Performance Comparison For Boiling R-114/10% Oil Mixture From GEWA-T 19/26 fpi Tubes

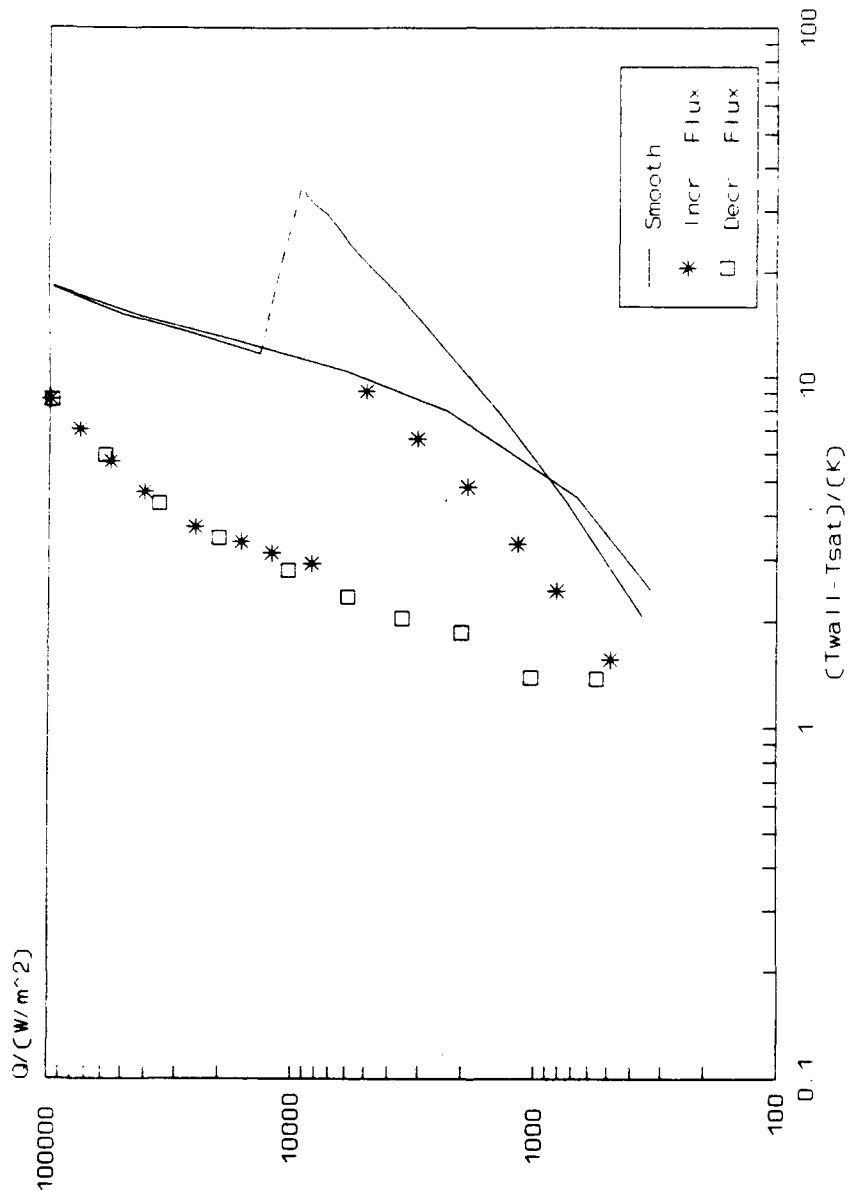

Figure 6.41 Performance Comparison For
Boiling Pure R-114 From
GEWA-YX 26 fpi Tube

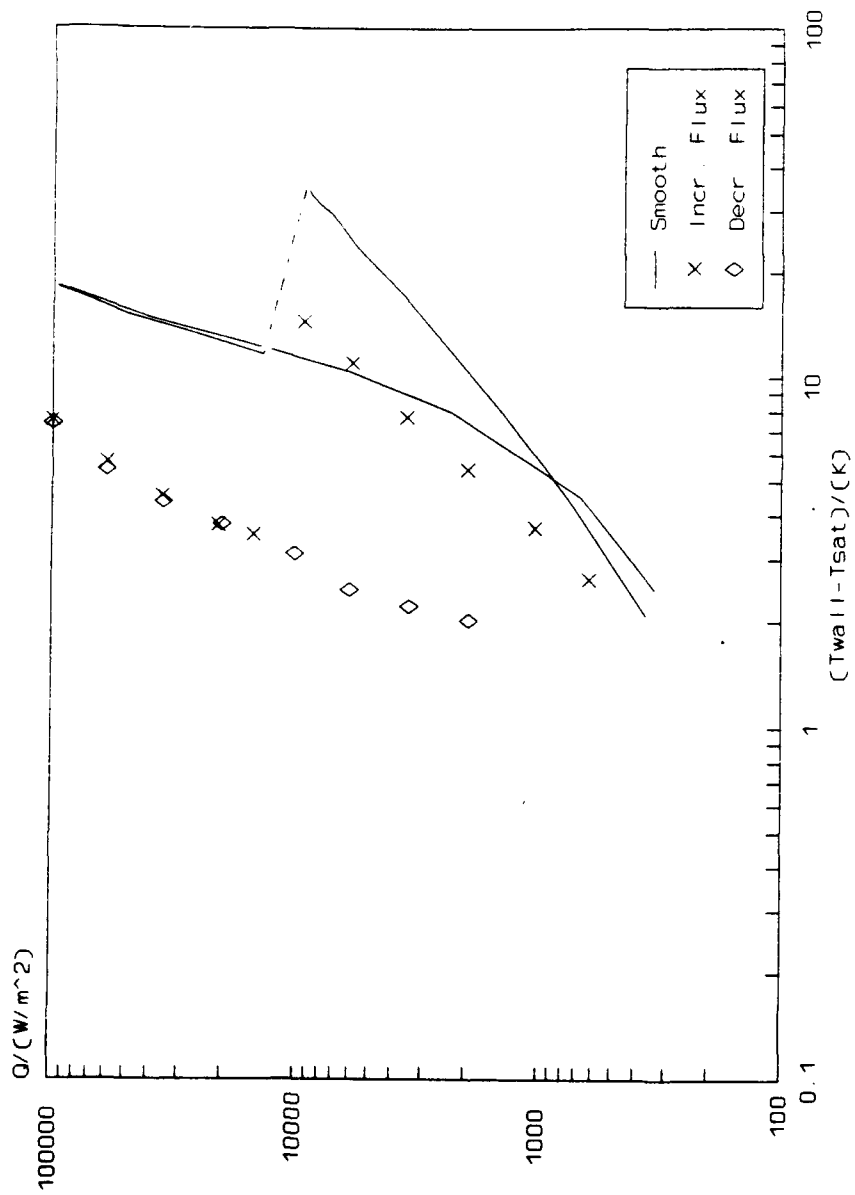

Figure 6-42 Performance Comparison For
Boiling R-114/3% Oil Mixture From
GEWA-YX 26 fpi Tube

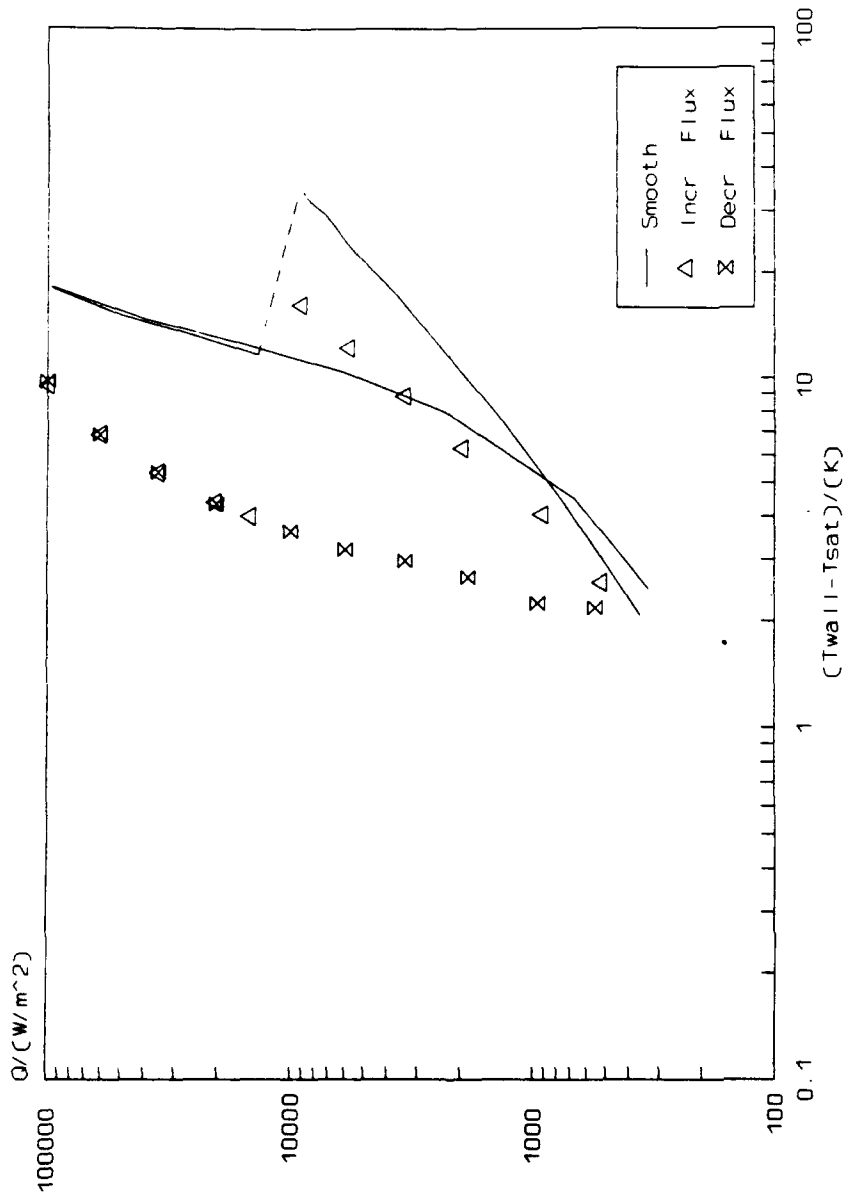

Figure 6.43 Performance Comparison For Boiling R-114/10% Oil Mixture From GEWA-YX 26 fpi Tube

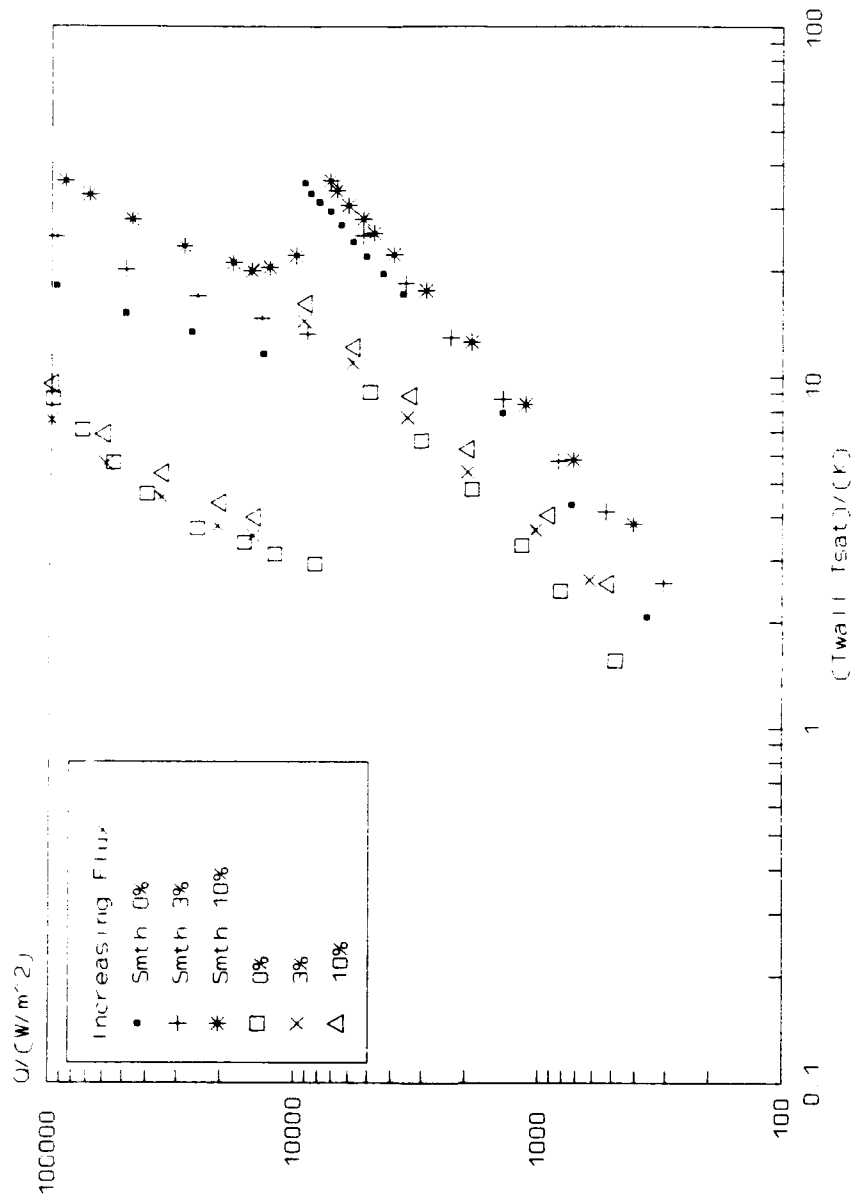

Figure 6.14 Performance Comparison For
 Boiling R-114/ 0%, 3% & 10% Oil Mixtures
 From GEWA-IX 26 for Tube

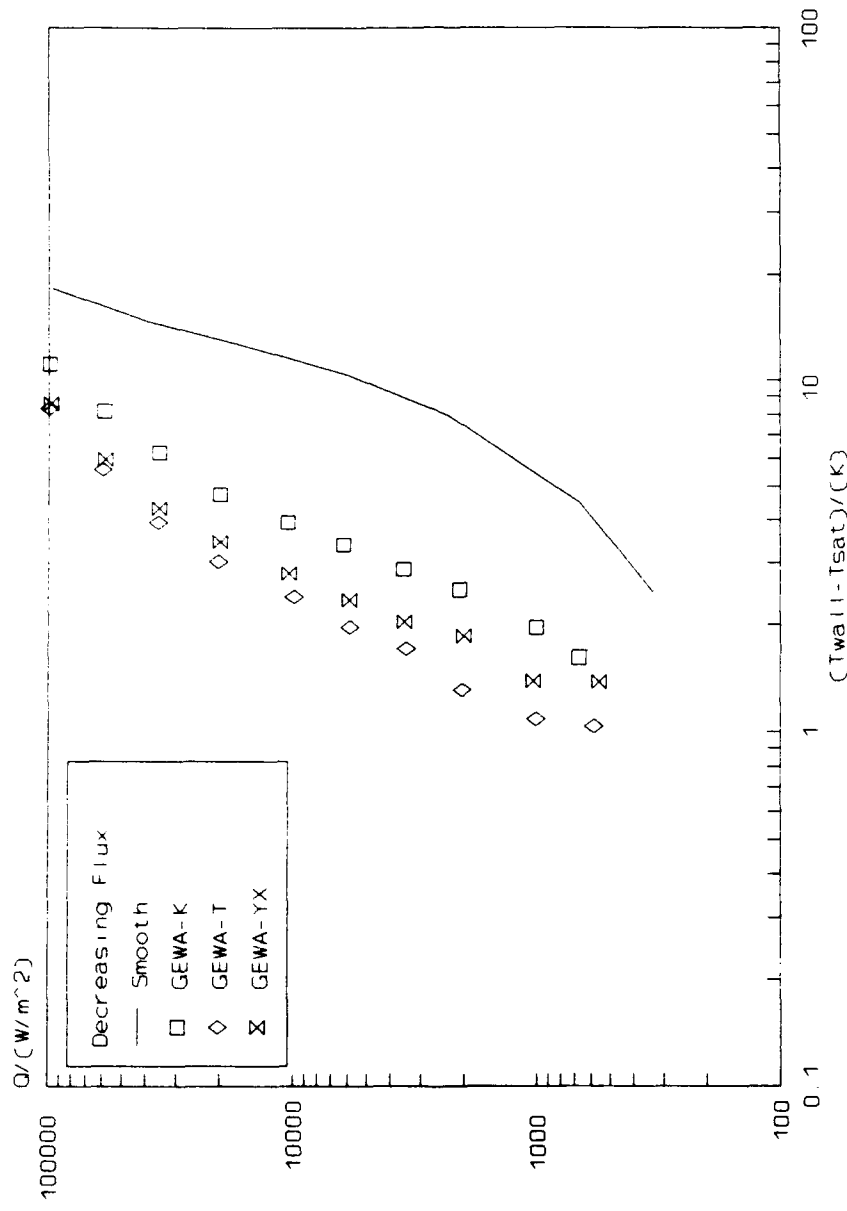

Figure 6.47 Performance Comparison For Boiling Pure R-114 From GEWA-K/T/YX 26 fpi Tubes

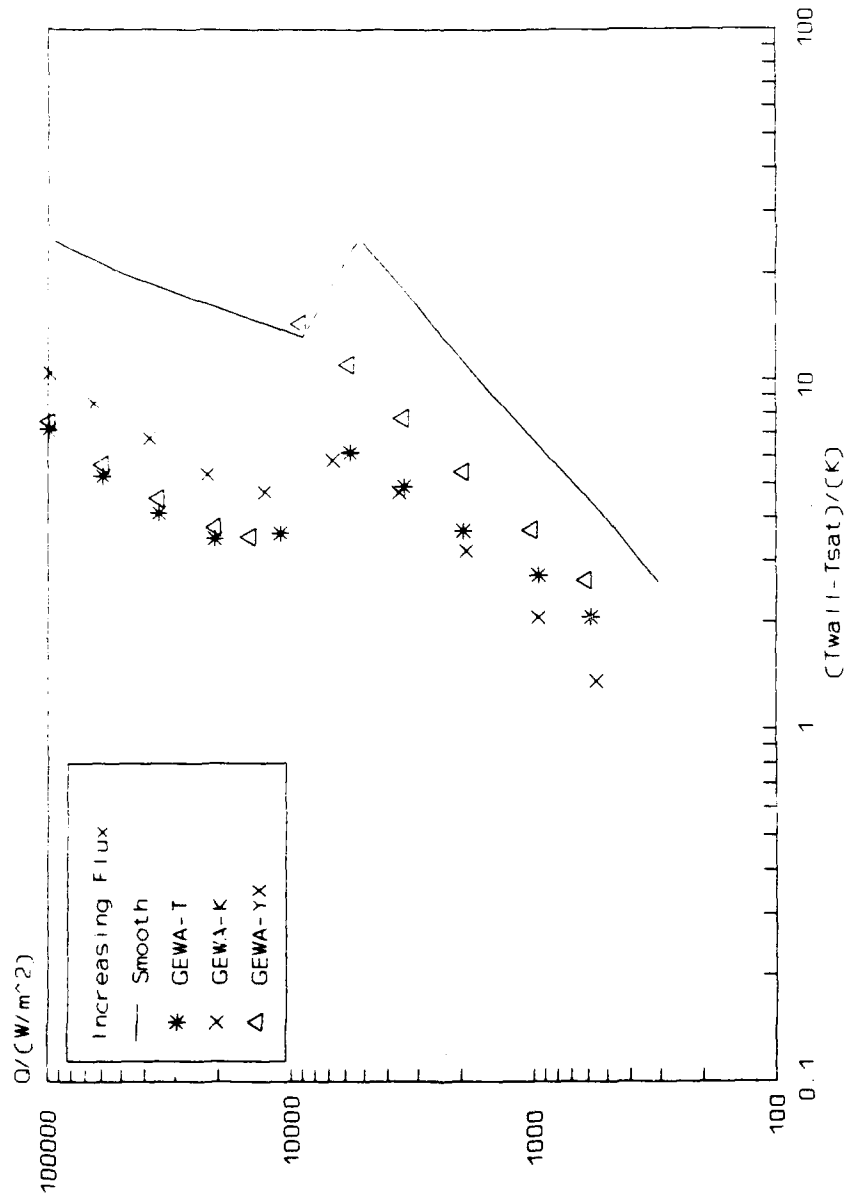

Figure 6.48 Performance Comparison For Boiling R-114/3% Oil Mixture from GEWA-K/T/YX 26 fpi Tubes

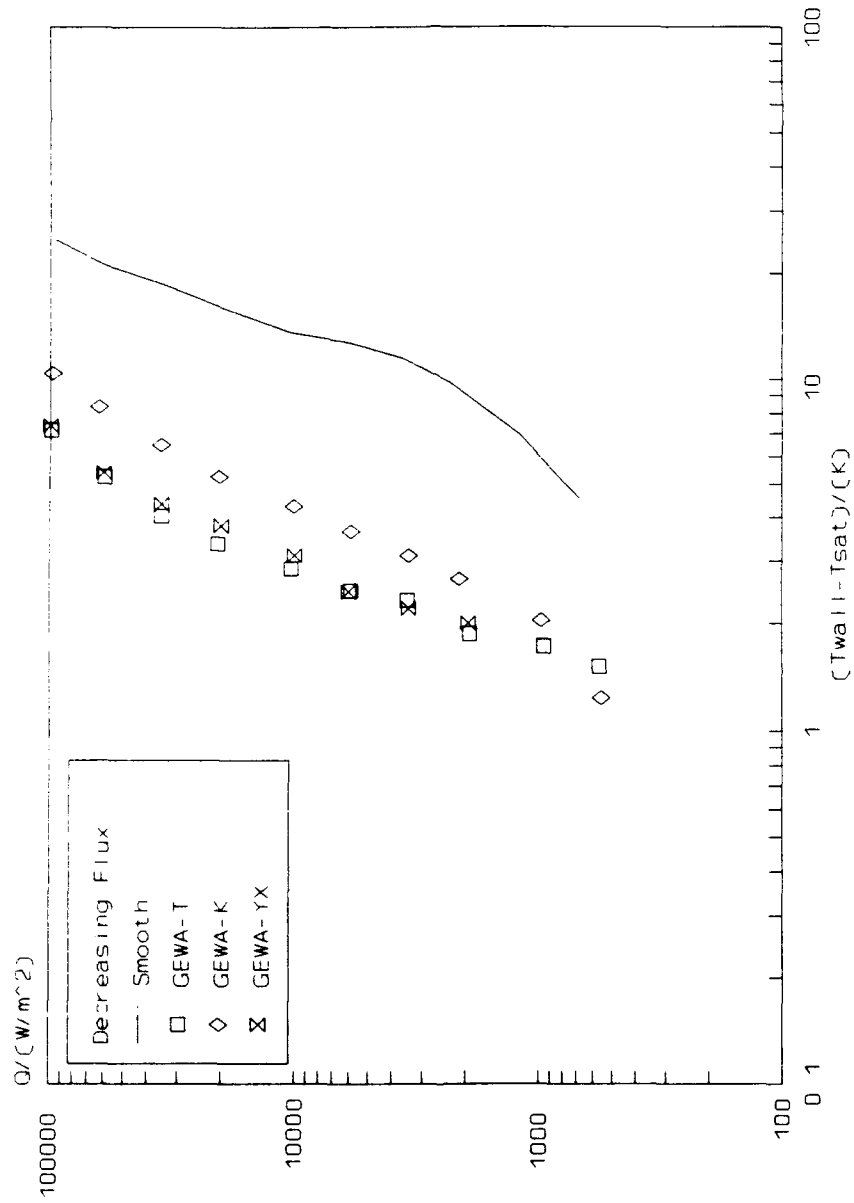

Figure 6.49 Performance Comparison For Boiling R-114/3% Oil Mixture From GEWA-K/T/YX 26 fpi Tubes

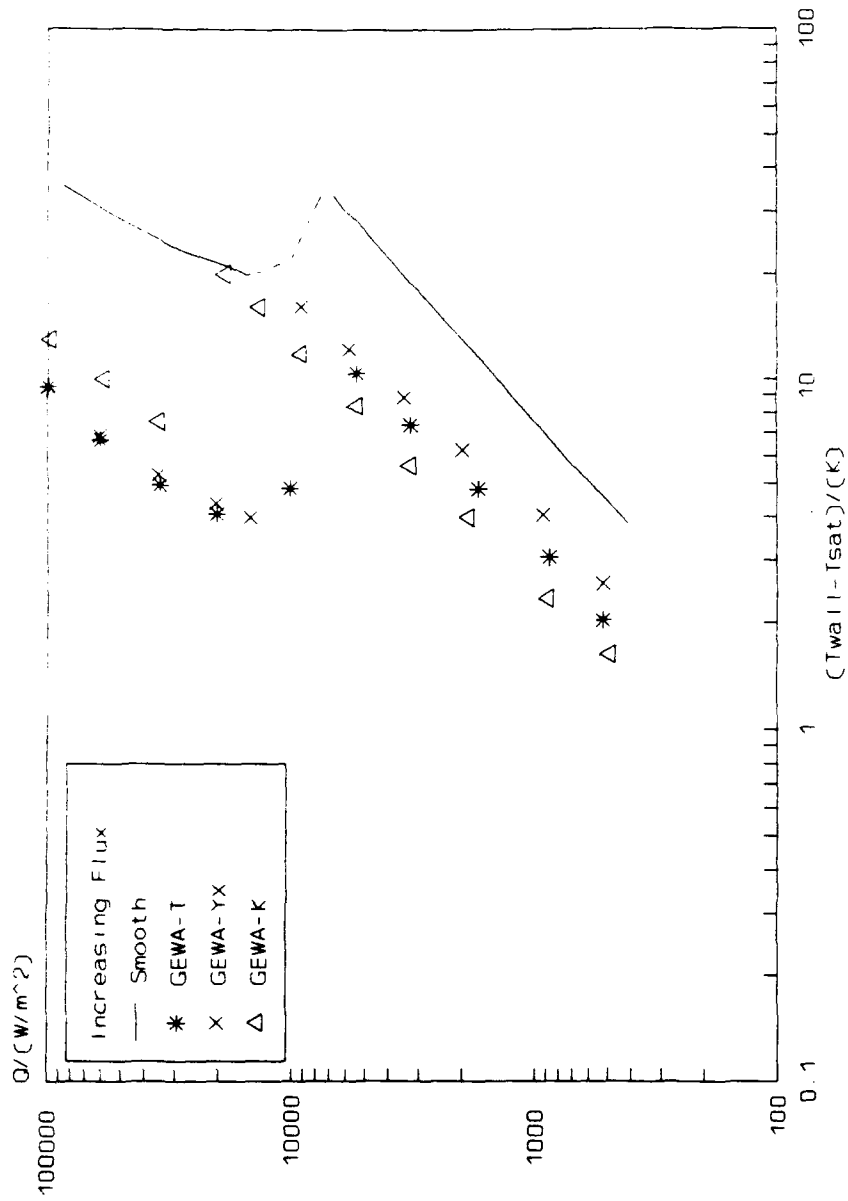

Figure 6.50 Performance Comparison For Boiling R-114/10% Oil Mixture From GEWA-K/T/YX 26 fpi Tubes

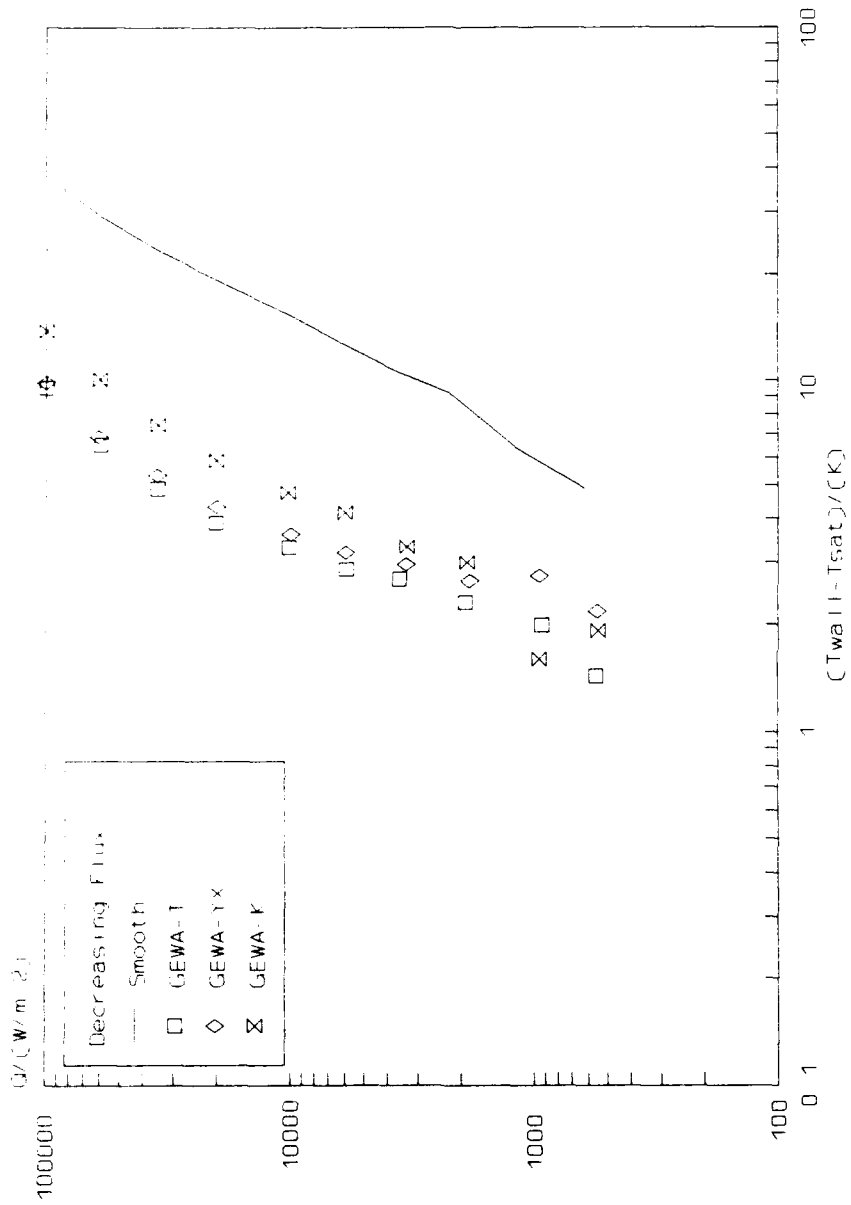

Figure 6.51 Performance Comparison For Boiling R-114/10% Oil Mixture From GEWA-K/T/YX 26 fpi

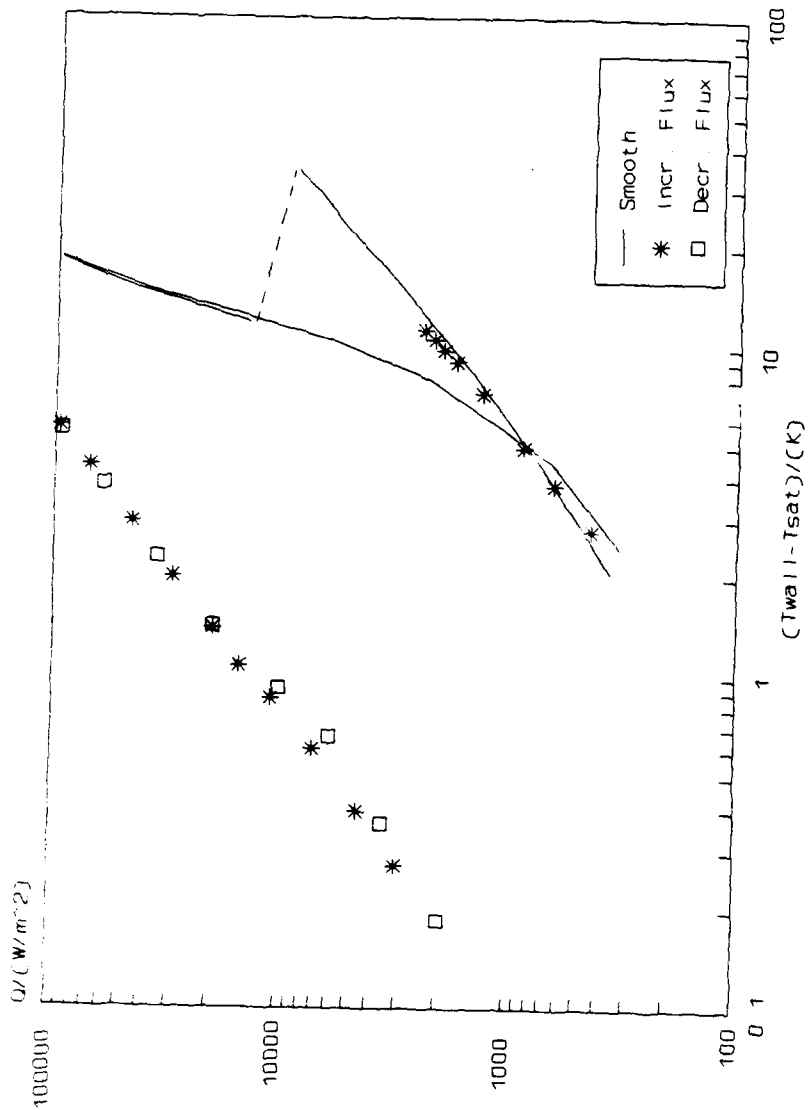

Figure 6.52 Performance Comparison for Pure R-114 Boiling from High Flux Tube

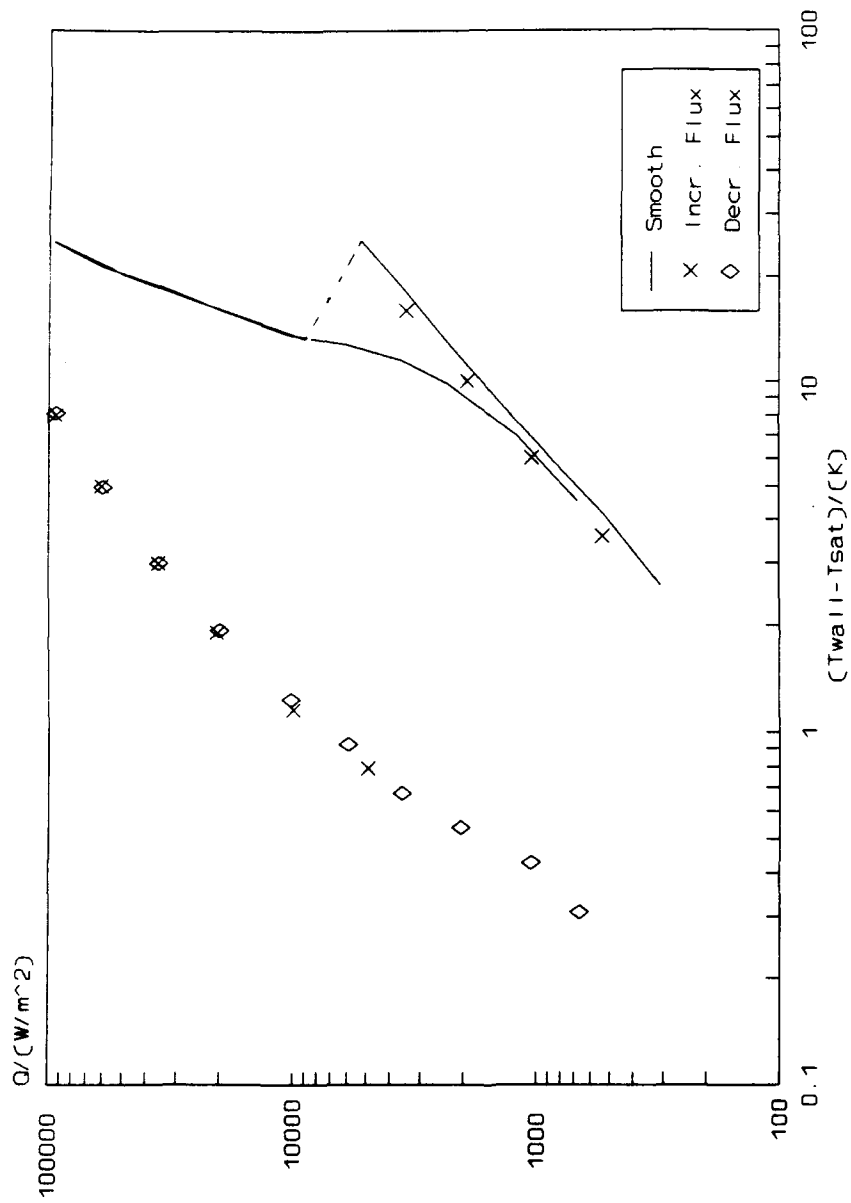

Figure 6.53 Performance Comparison For Boiling R-114/3% Oil Mixture From High Flux Tube

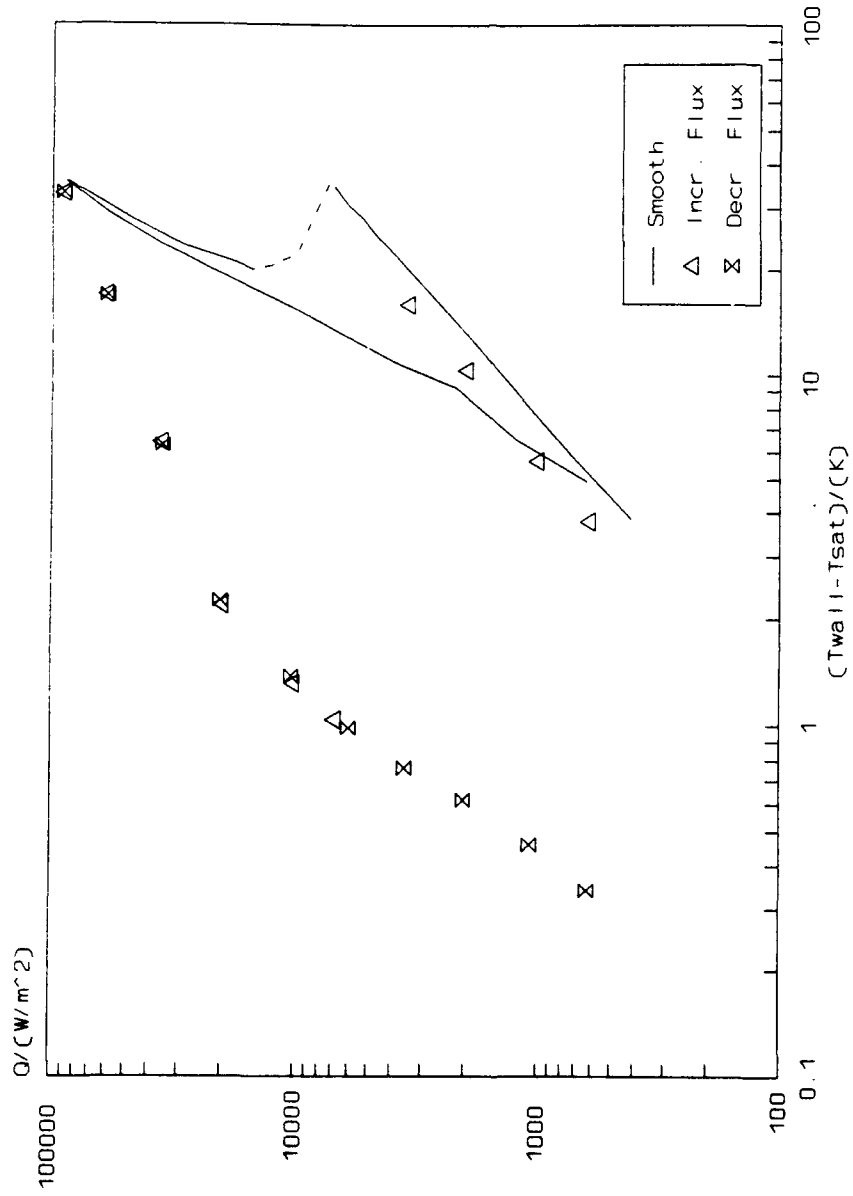

Figure 6.54 Performance Comparison For Boiling R-114/10% Oil Mixture From High Flux Tube

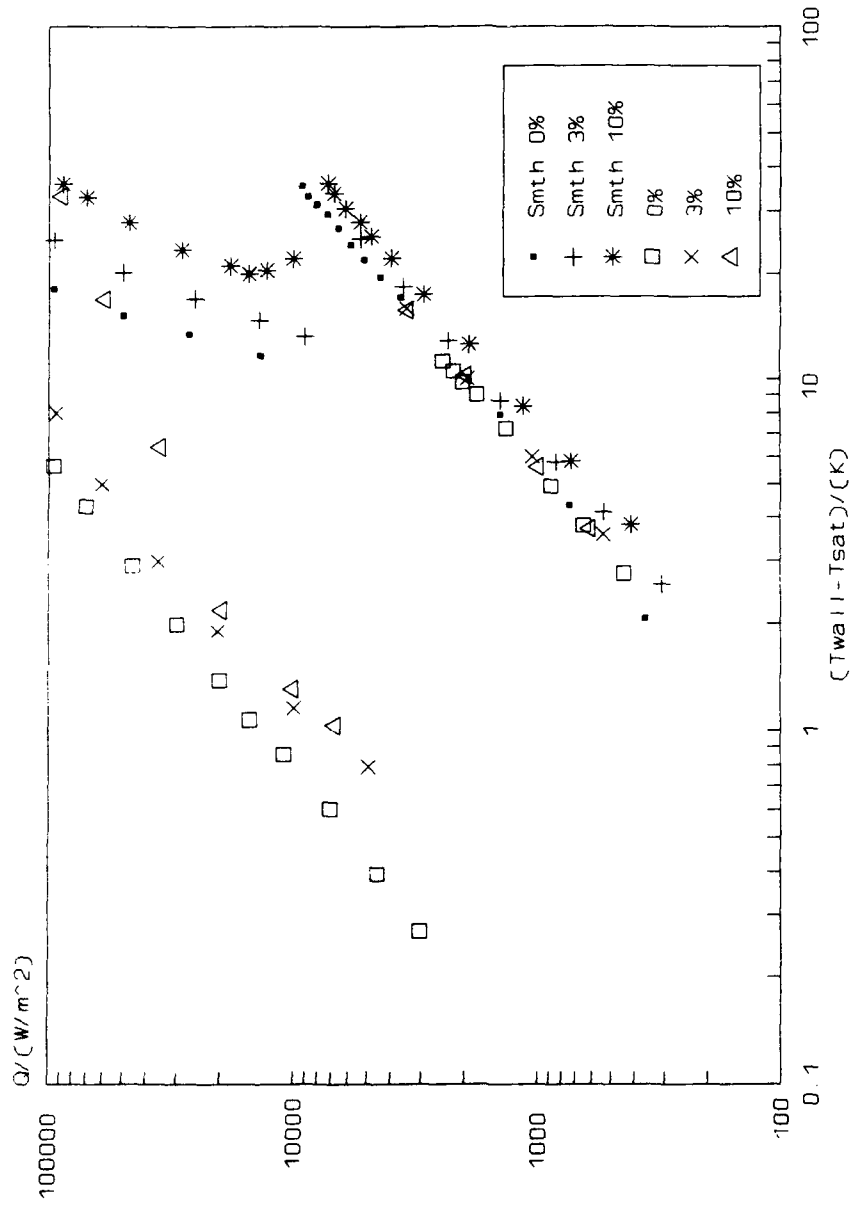

Figure 6.55 Performance Comparison For Boiling R-114/ 0%, 3% & 10% Oil Mixtures Increasing Flux From High Flux Tube

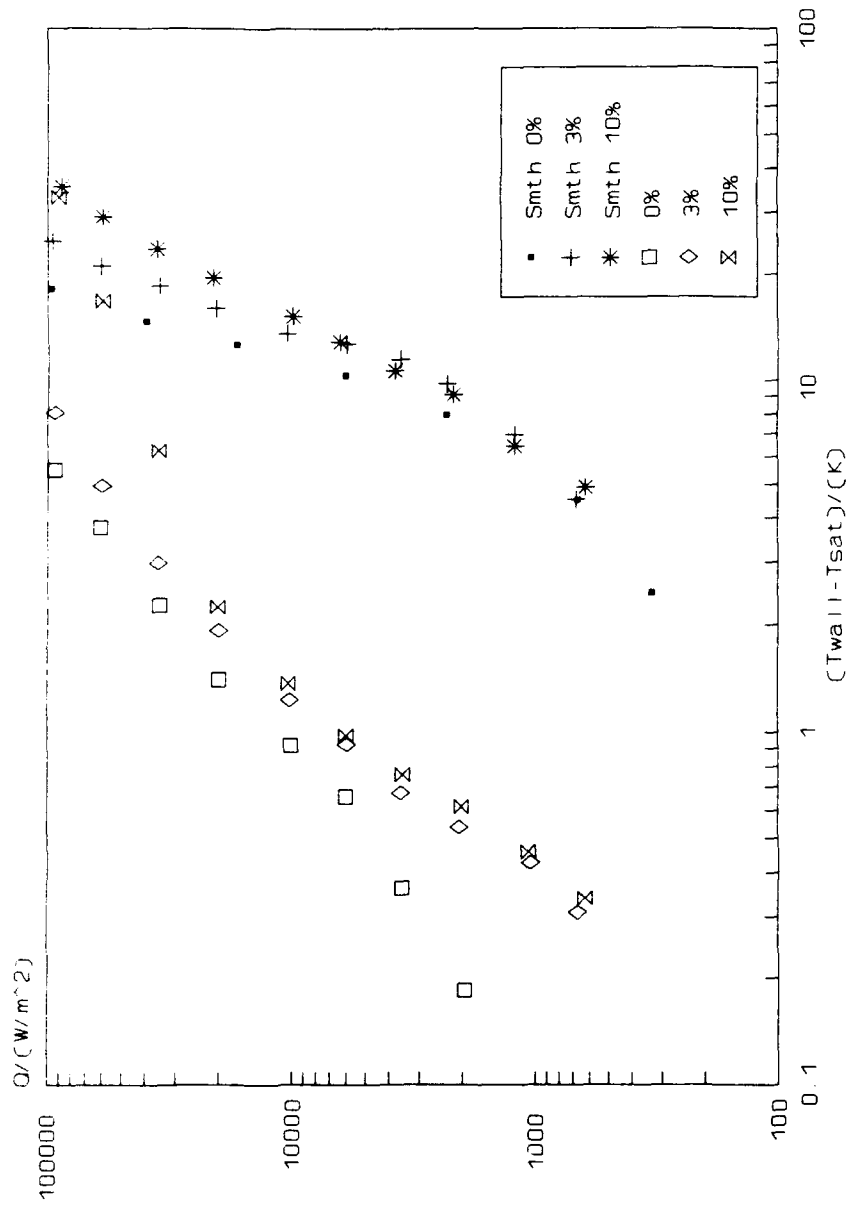

Figure 6.56 Performance Comparison For Boiling R-114/ 0%, 3% & 10% Oil Mixtures Decreasing Flux From High Flux Tube

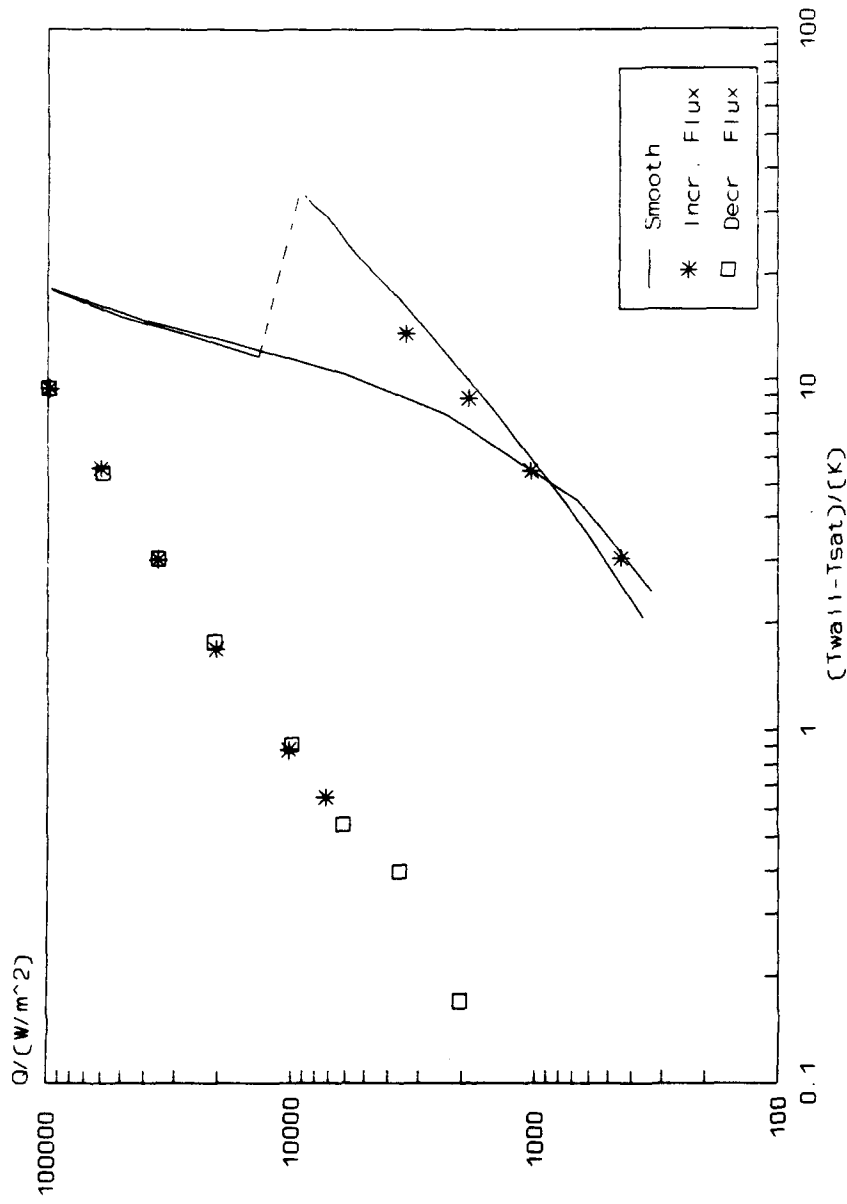

Figure 6.57 Performance Comparison For Pure R-114 Boiling From Thermexcel-E Tube

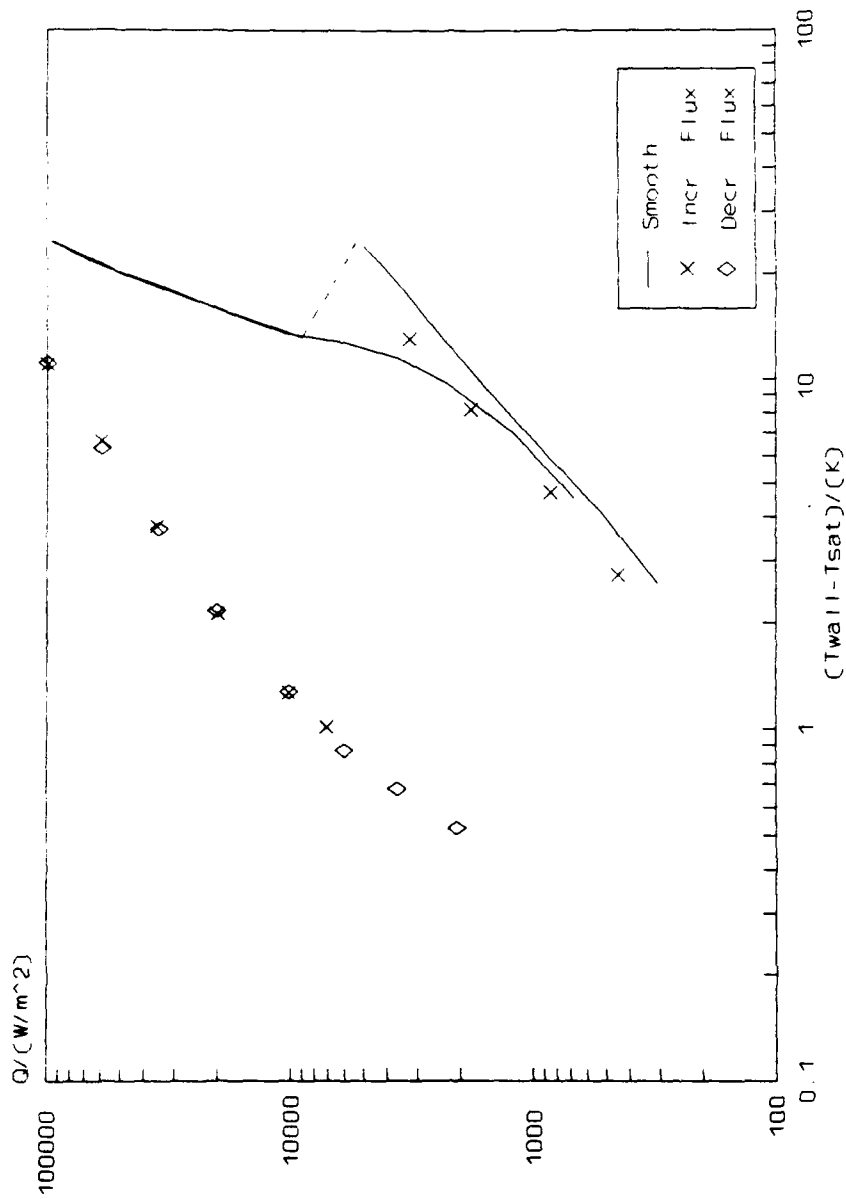

Figure 6.58 Performance Comparison For Boiling R-114/3% Oil Mixture From Thermoexcel-E Tube

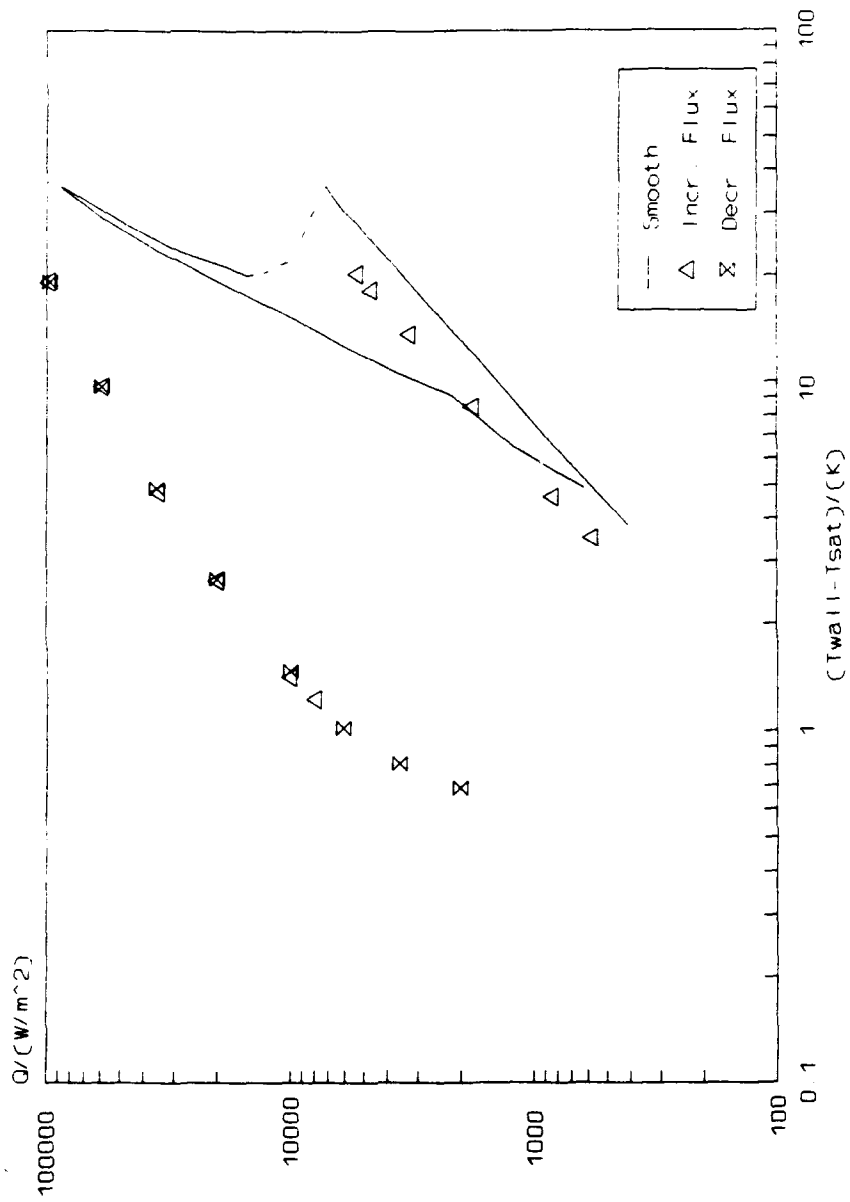

Figure 6.59 Performance Comparison For Boiling R-114/10% Oil Mixture From Thermocel-E Tube

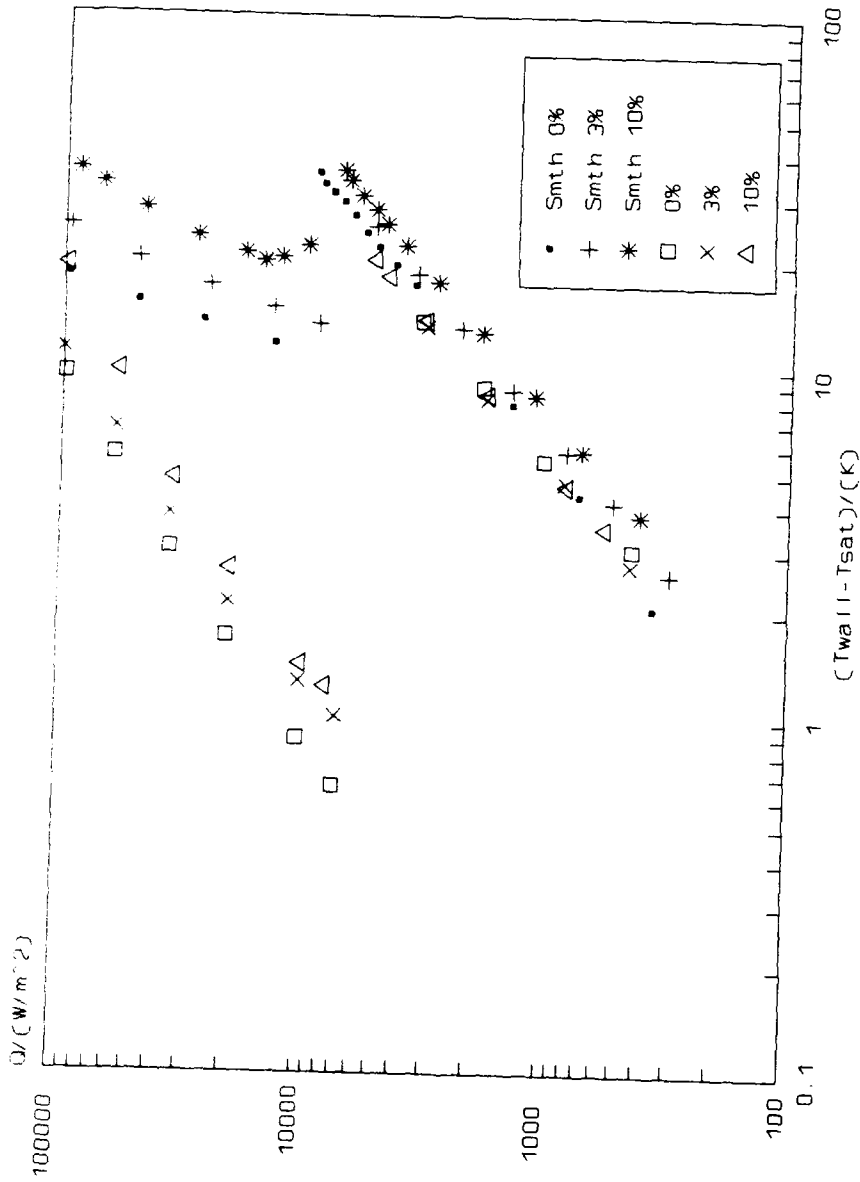

Figure 6.60 Performance Comparison For Boiling R-114/ 0%, 3% & 10% Oil Mixtures Increasing Flux From Thermoexcel-E Tube

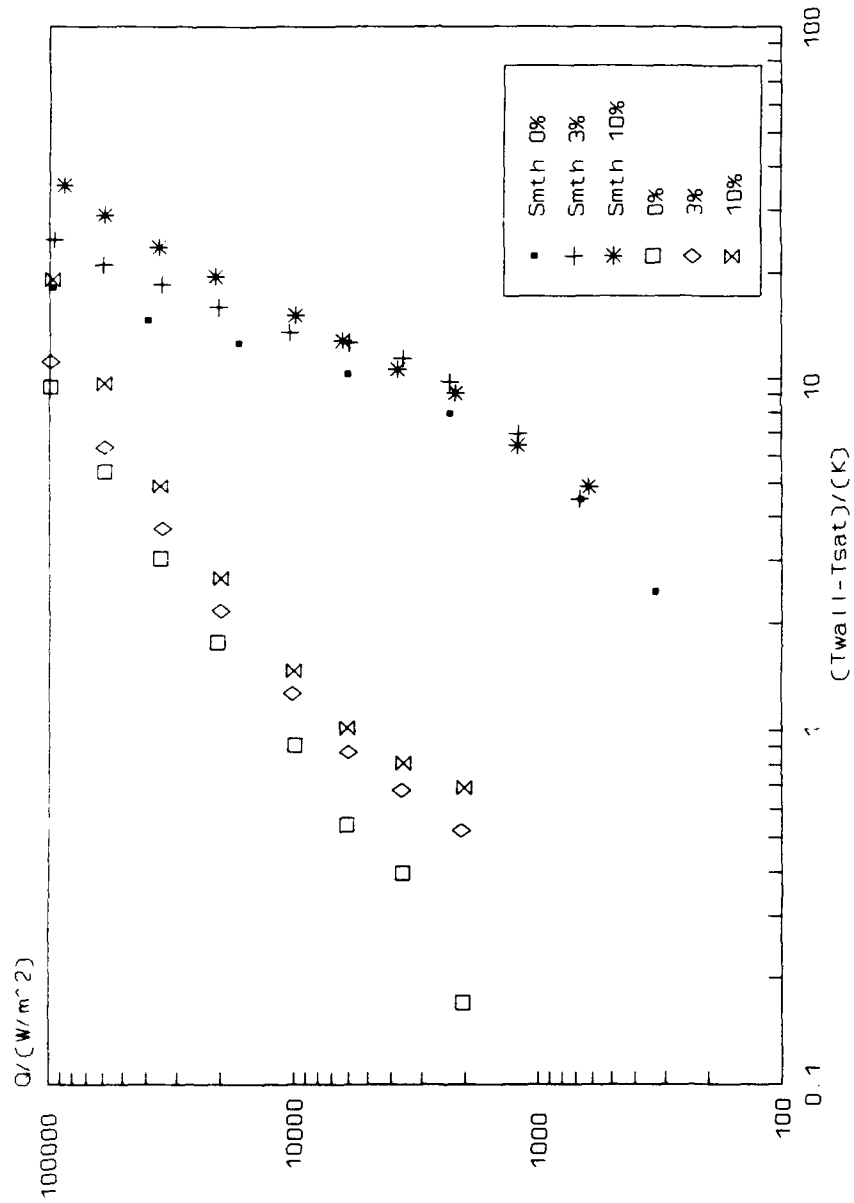

Figure 6.61 Performance Comparison For Boiling R-114/ 0%, 3% & 10% Oil Mixtures Decreasing Flux From Thermocel-E Tube

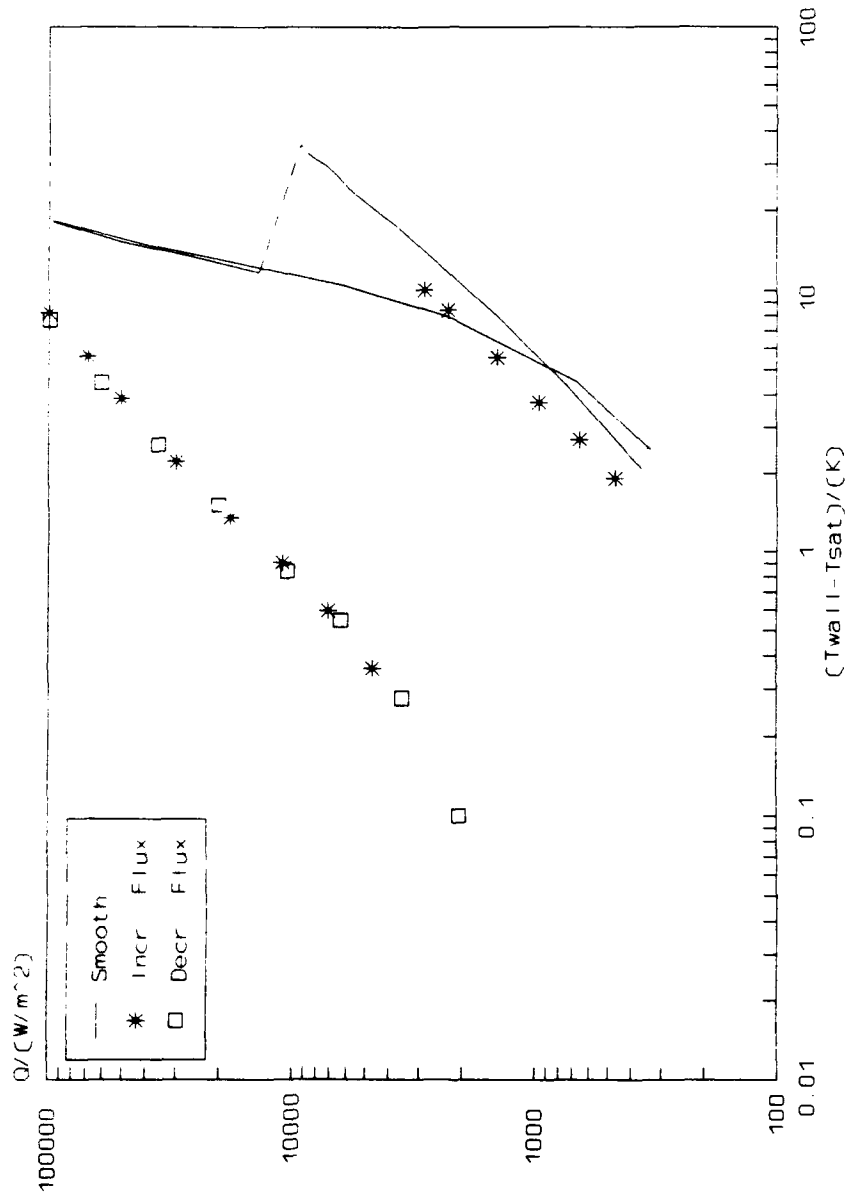

Figure 6.62 Performance Comparison For Pure R-114 Boiling From Thermexcel-HE Tube

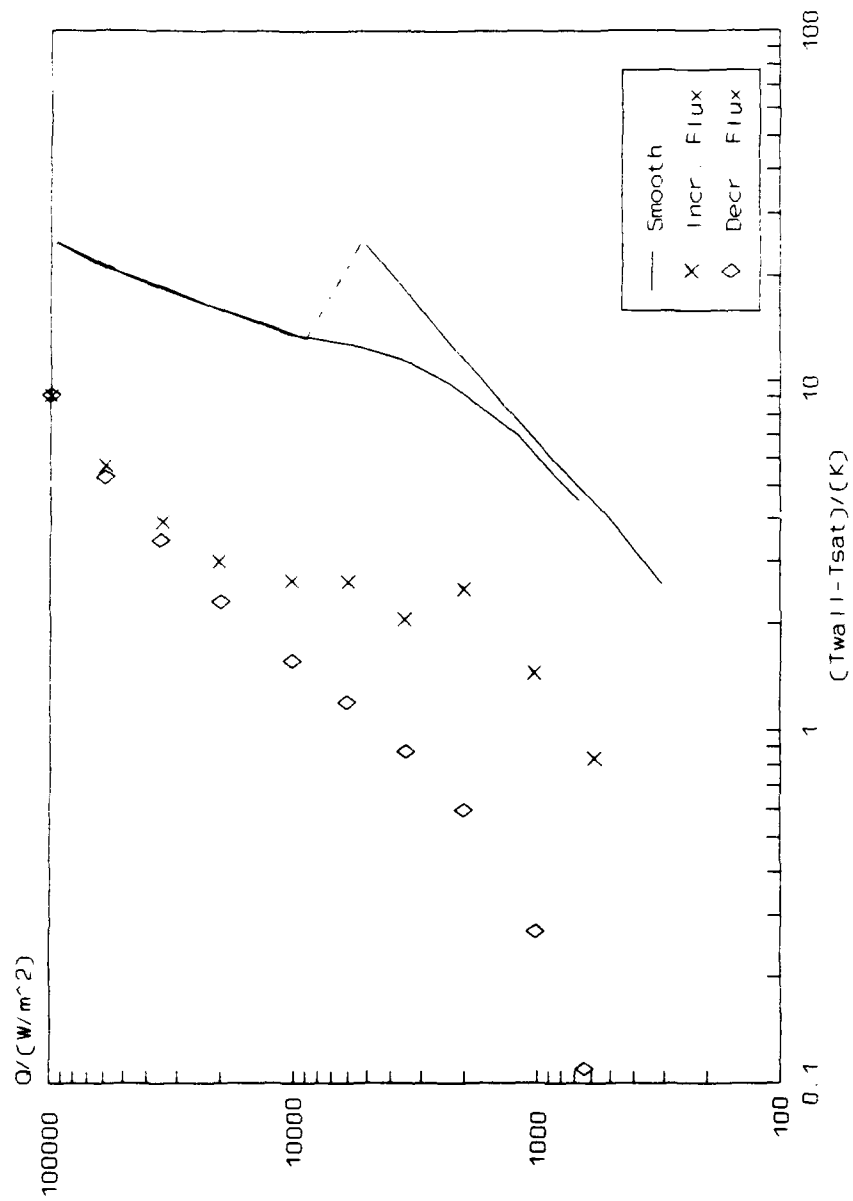

Figure 6.63 Performance Comparison For Boiling R-114/3% Oil Mixture From Thermexcel-HE Tube

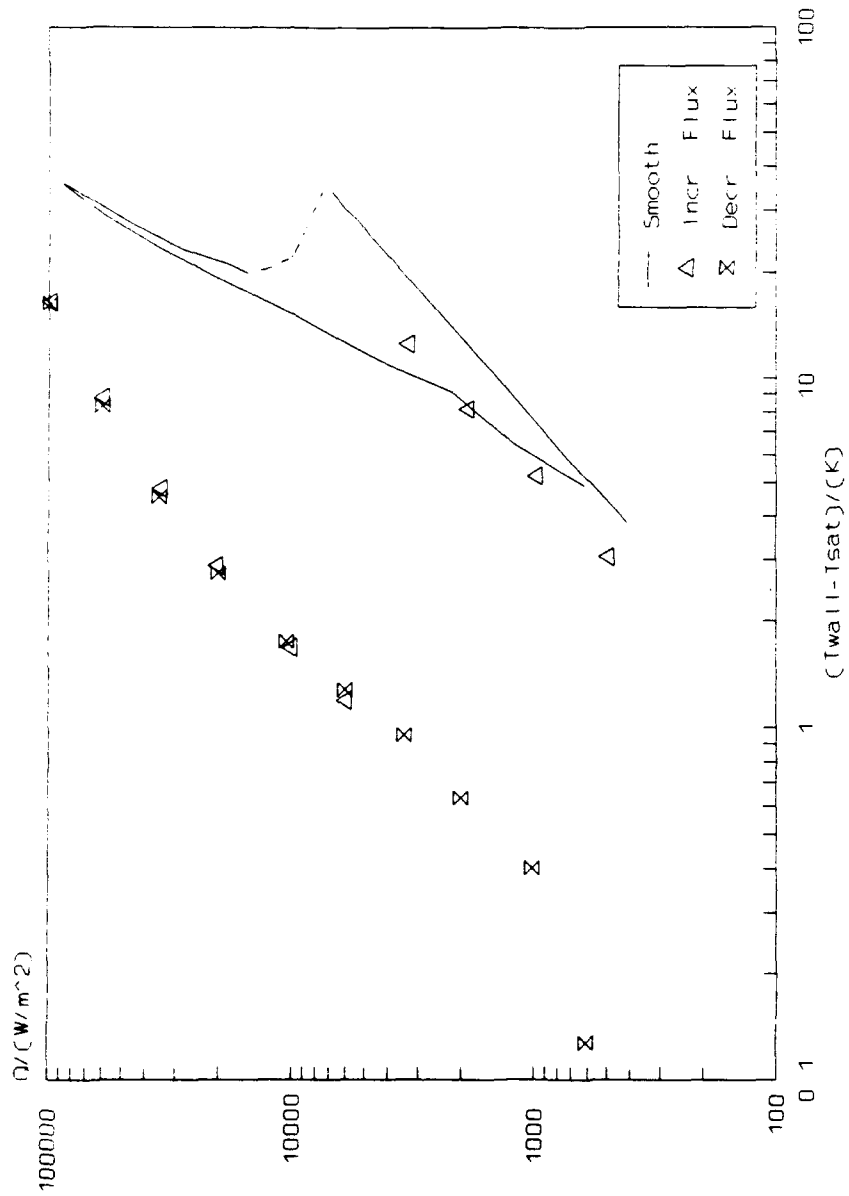

Figure 6.64 Performance Comparison For Boiling R-114/10% Oil Mixture From Thermexcel-HE Tube

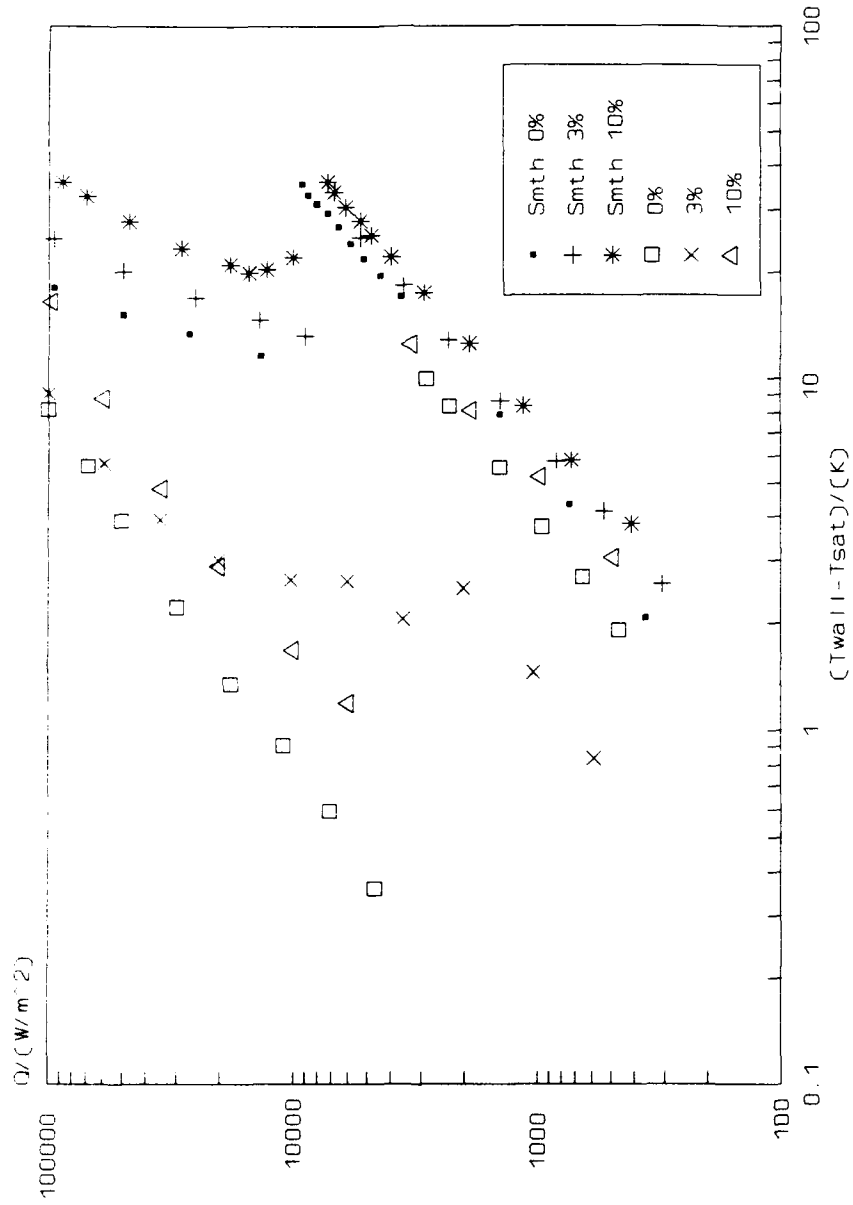

Figure 6.65 Performance Comparison For Boiling R-114/ 0%, 3% & 10% Oil Mixtures Increasing Flux From Thermexcel-HE Tube

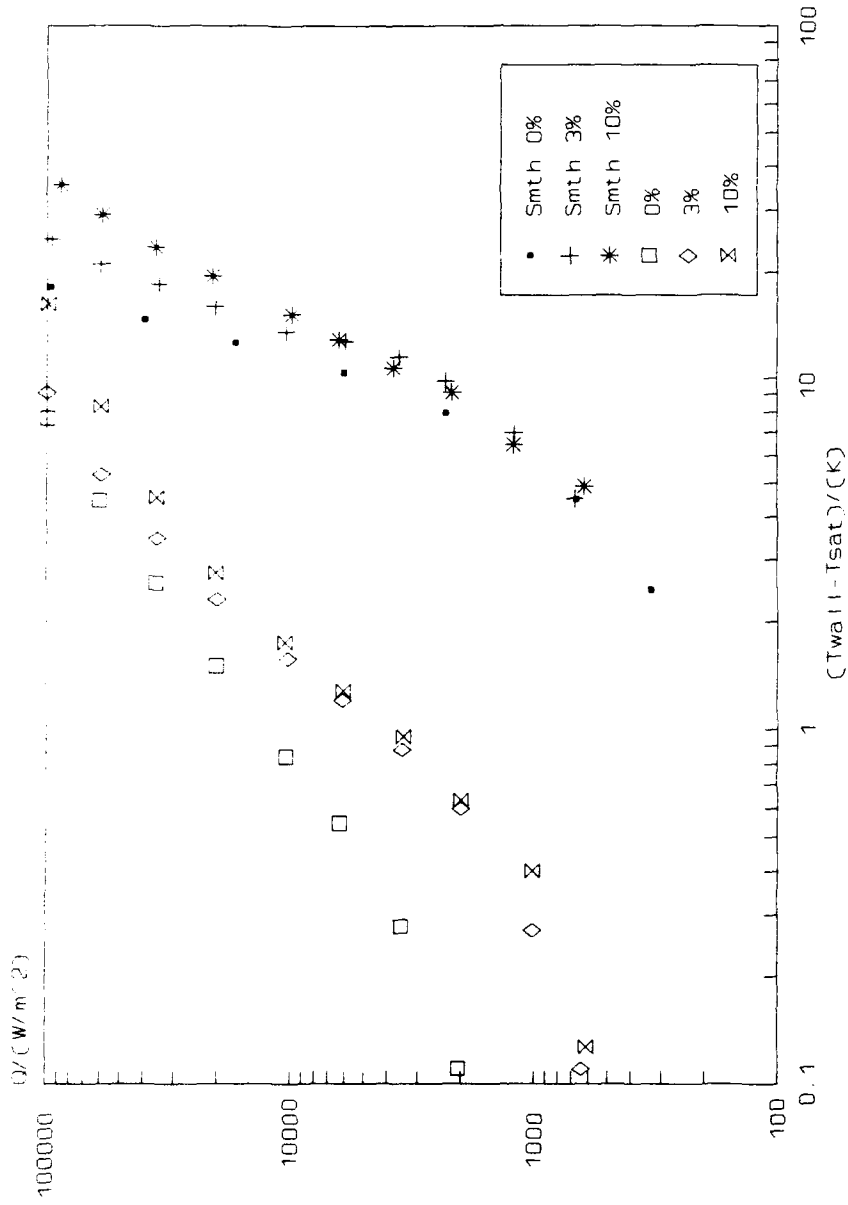

Figure 6.66 Performance Comparison For Boiling R-114/ 0%, 3% & 10% Oil Mixtures Decreasing Flux From Thermoexcel-HE Tube

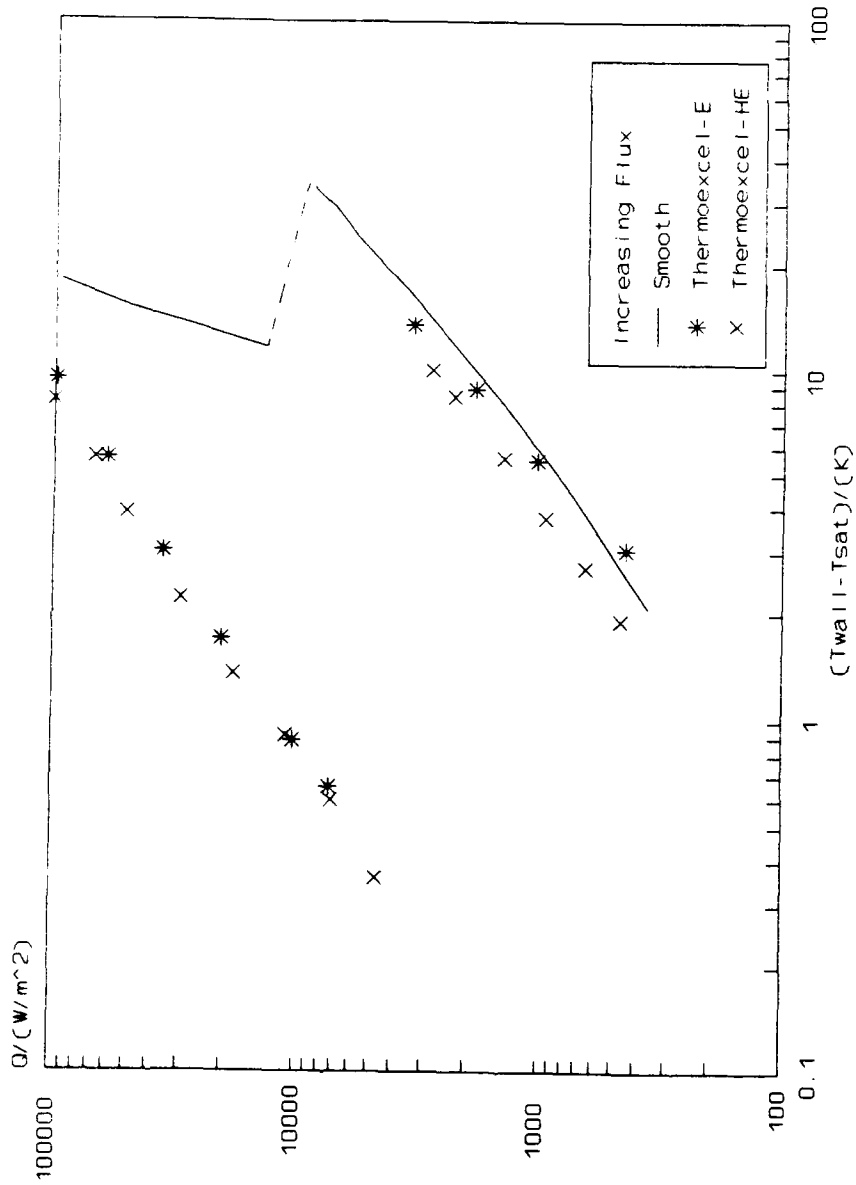

Figure 6.67 Performance Comparison For Boiling Pure R-114 From Thermoexcel-E/HE Tubes

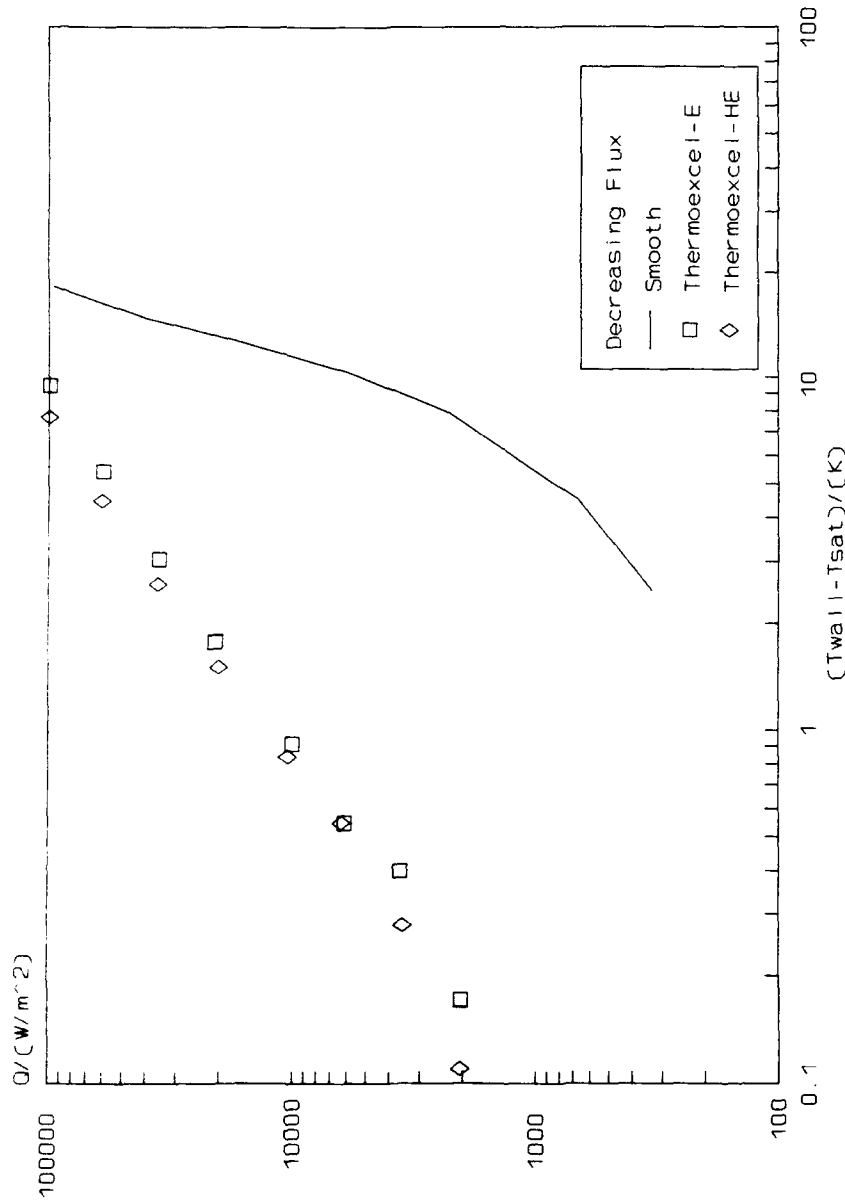

Figure 6.68 Performance Comparison for Boiling Pure R-114 From Thermexcel-E/HE Tubes

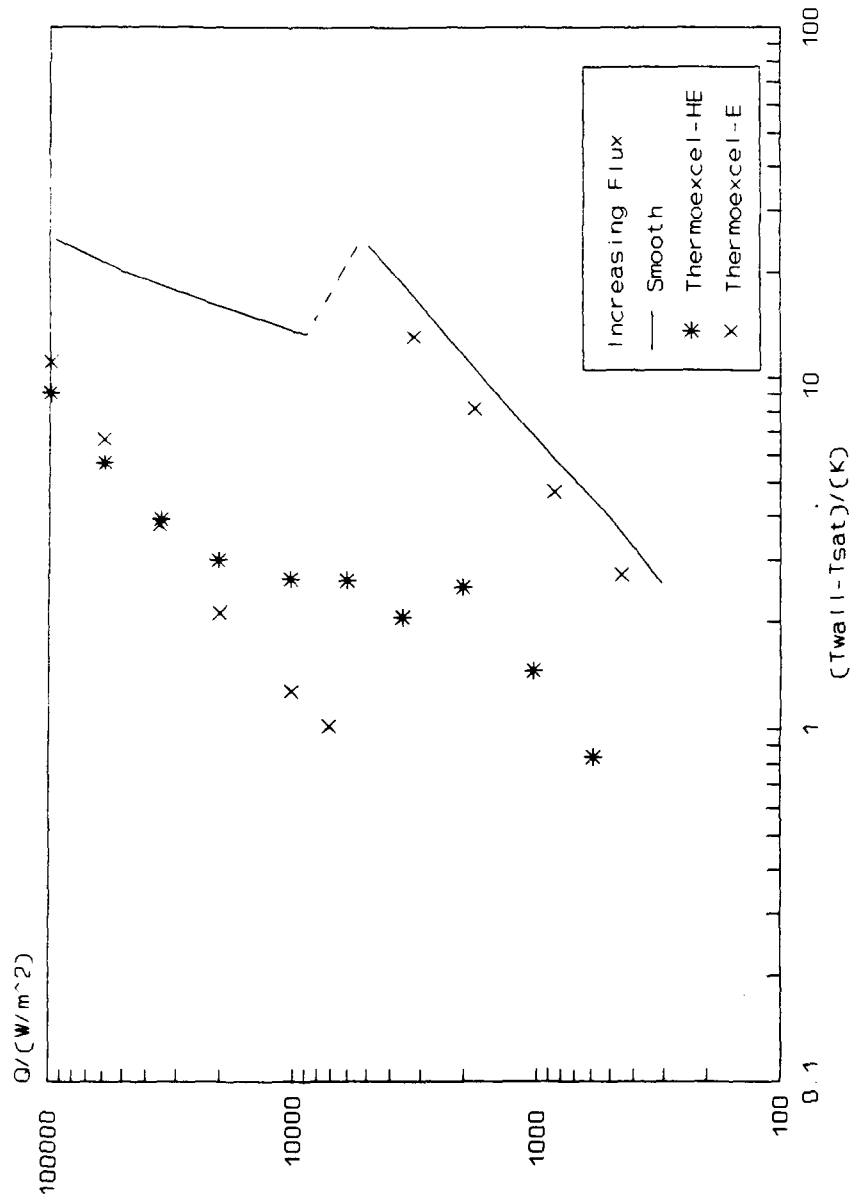

Figure 6.69 Performance Comparison For Boiling R-114/3% Oil Mixture From Thermocel-E/HE Tubes

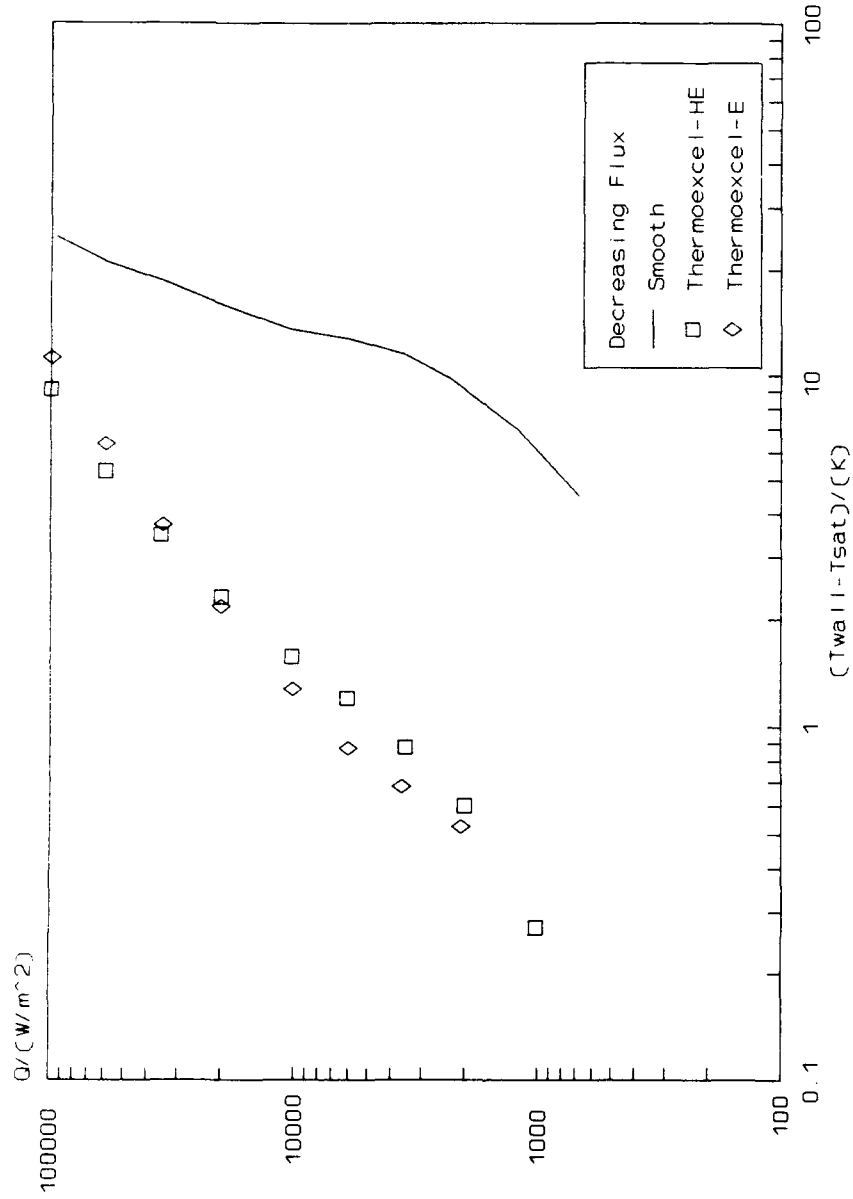

Figure 6.70 Performance Comparison For Boiling R-114/3% Oil Mixture From Thermoexcel-E/HE Tubes

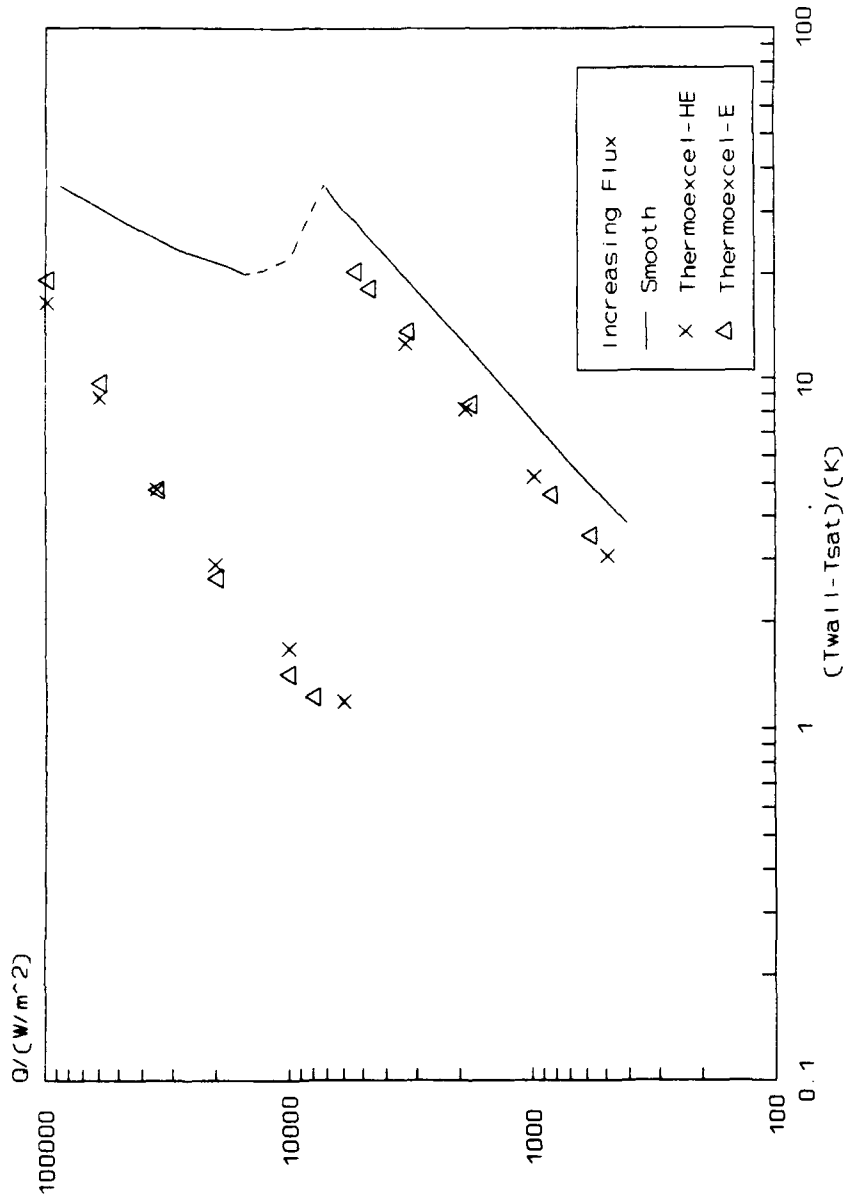

Figure 6.71 Performance Comparison For Boiling R-114/10% Oil Mixture From Thermoexcel-E/HE Tubes

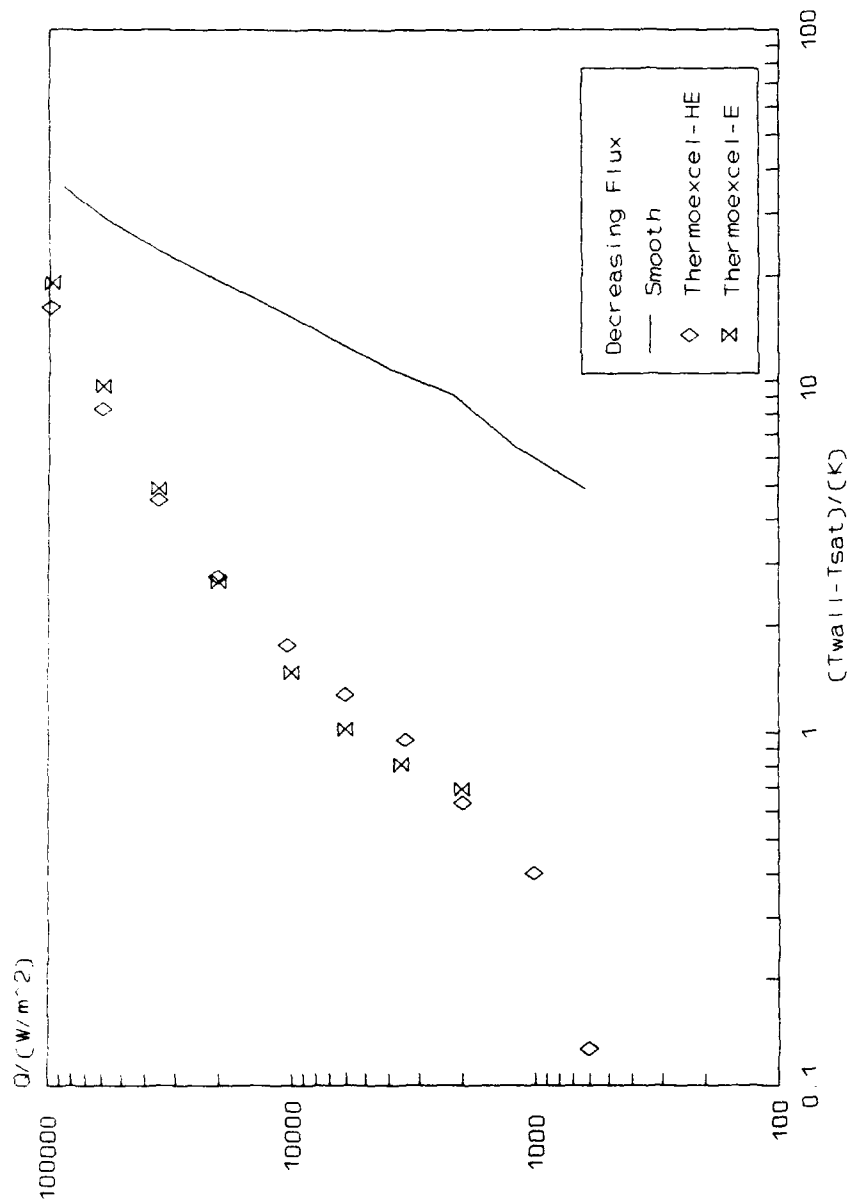

Figure 6.72 Performance Comparison For Boiling R-114/10% Oil Mixture From Thermexcel-E/HE Tubes

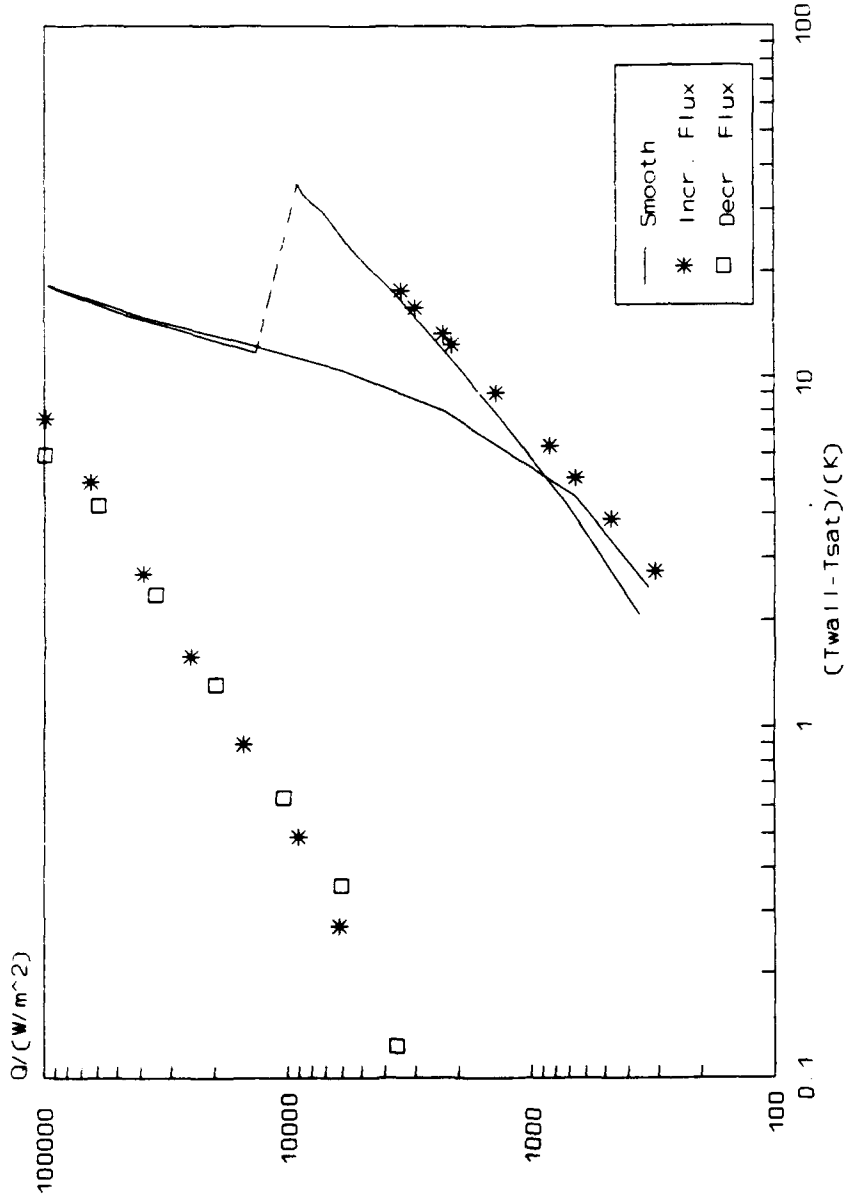

Figure 6.73 Performance Comparison For Pure R-114 Boiling From Turbo-B Tube

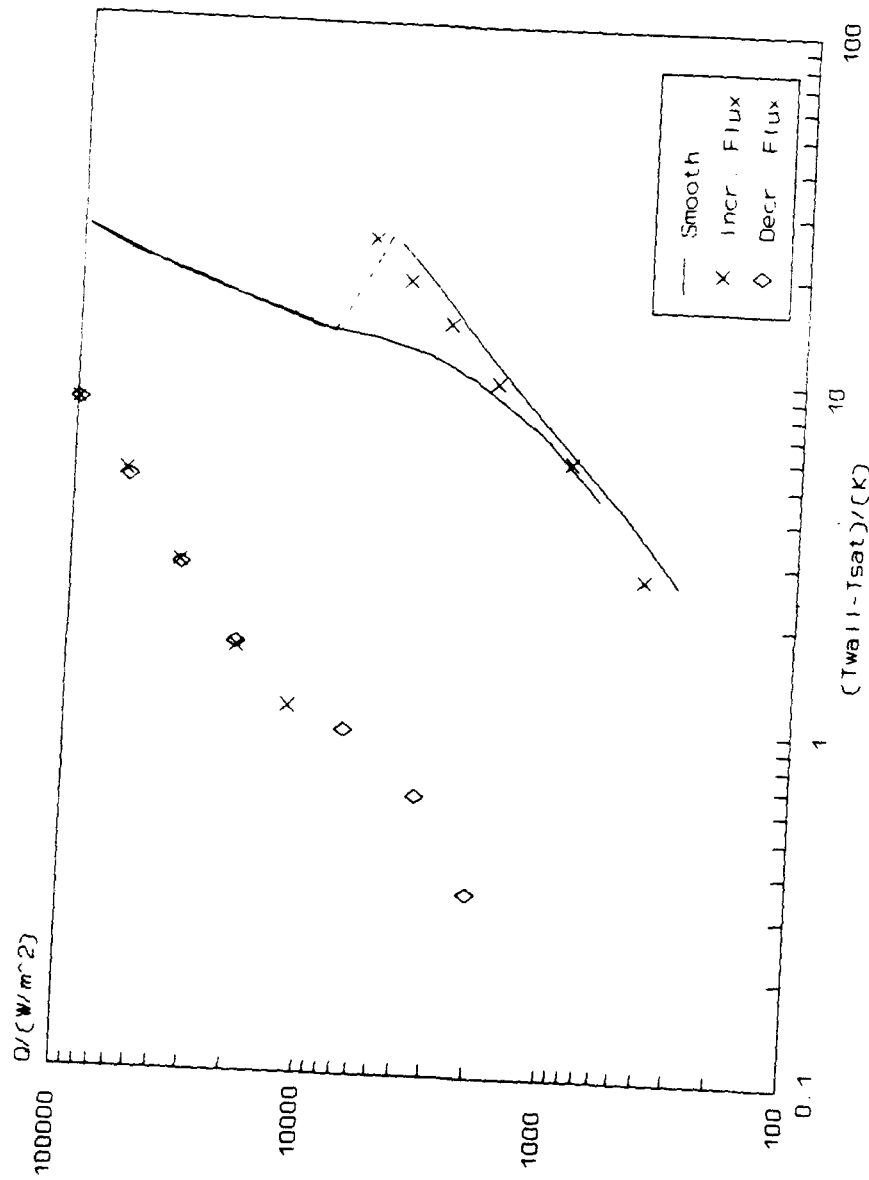

Figure 6.74 Performance Comparison For Boiling R-114/3% Oil Mixture From Turbo-B Tube

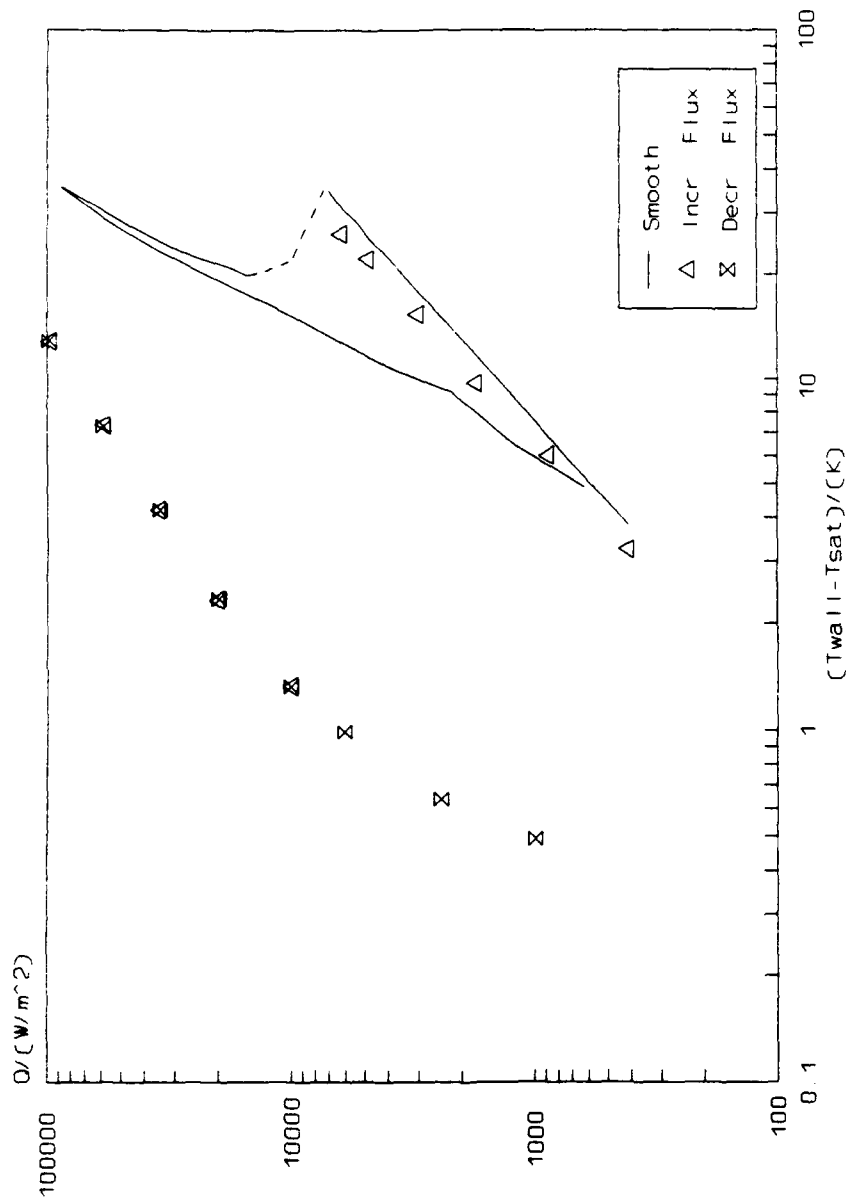

Figure 6.75 Performance Comparison For Boiling R-114/10% Oil Mixture From Turbo-B Surface

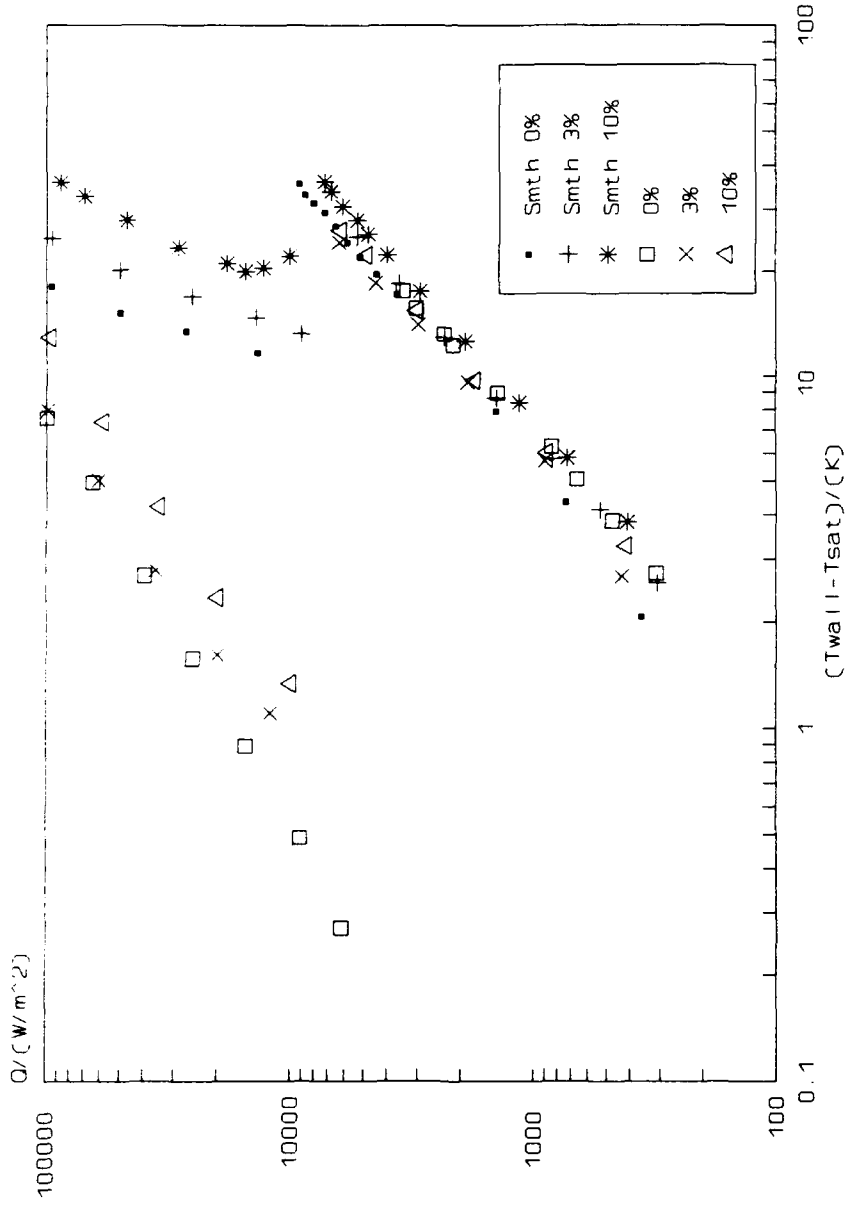

Figure 6.76 Performance Comparison For Boiling R-114/ 0%, 3% & 10% Oil Mixtures Increasing Flux From Turbo-B Tube

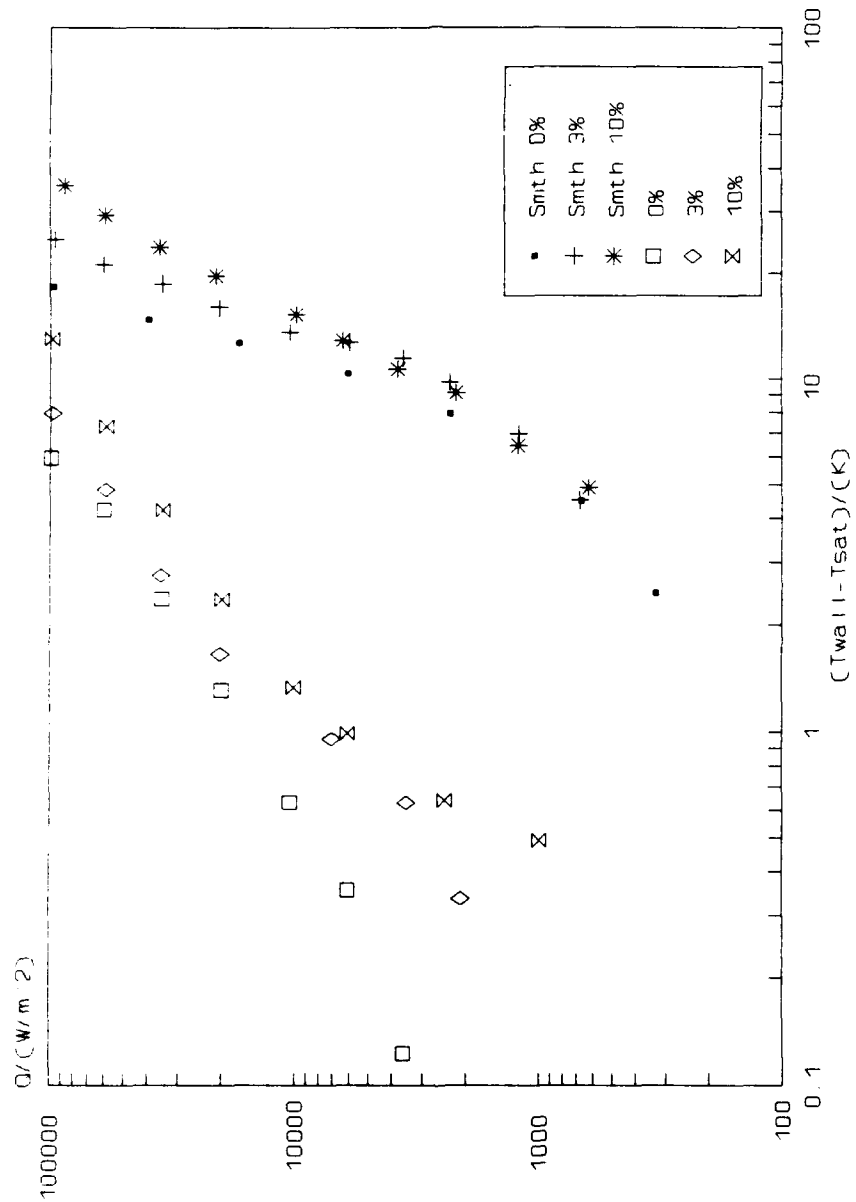

Figure 6.77 Performance Comparison For Boiling R-114/ 0%, 3% & 10% Oil Mixtures Decreasing Flux From Turbo-B Tube

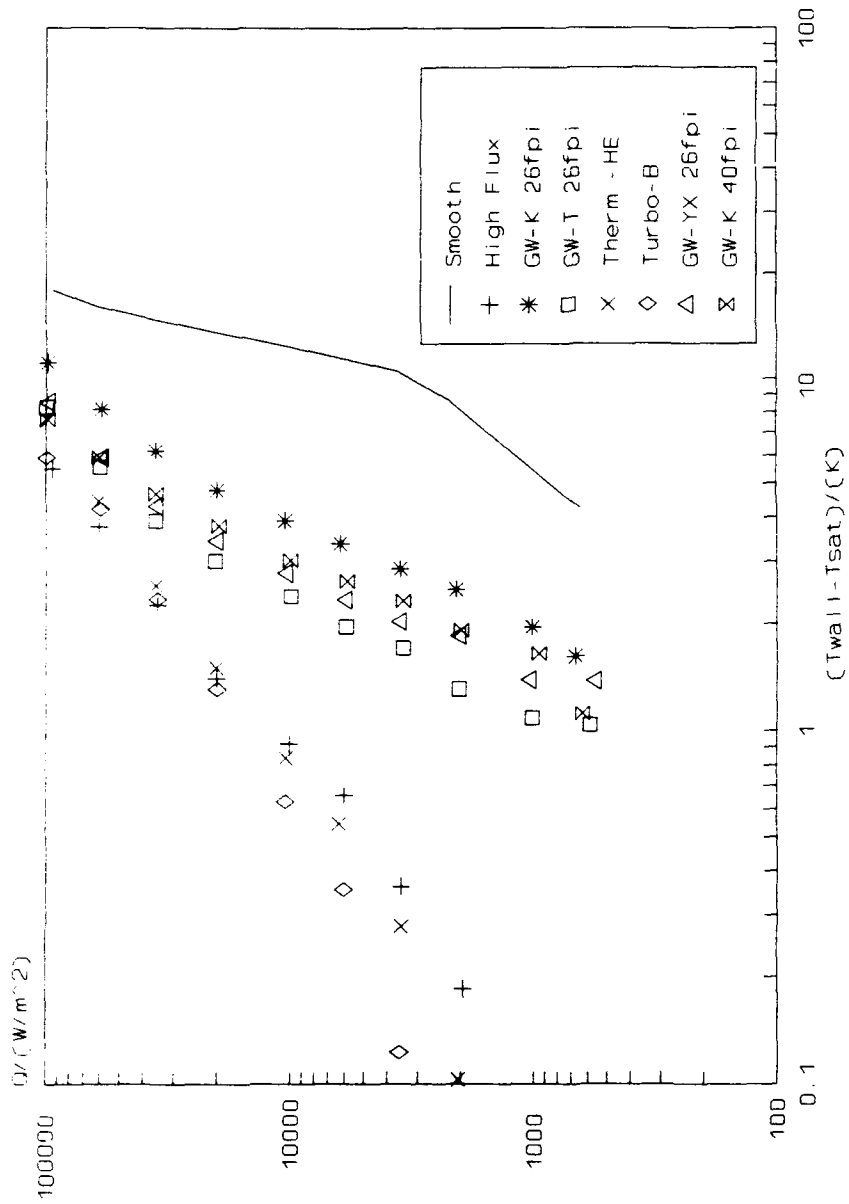

Figure 6.78 Performance Comparison For Boiling Pure R-114 Boiling From Smooth and Enhanced Tubes

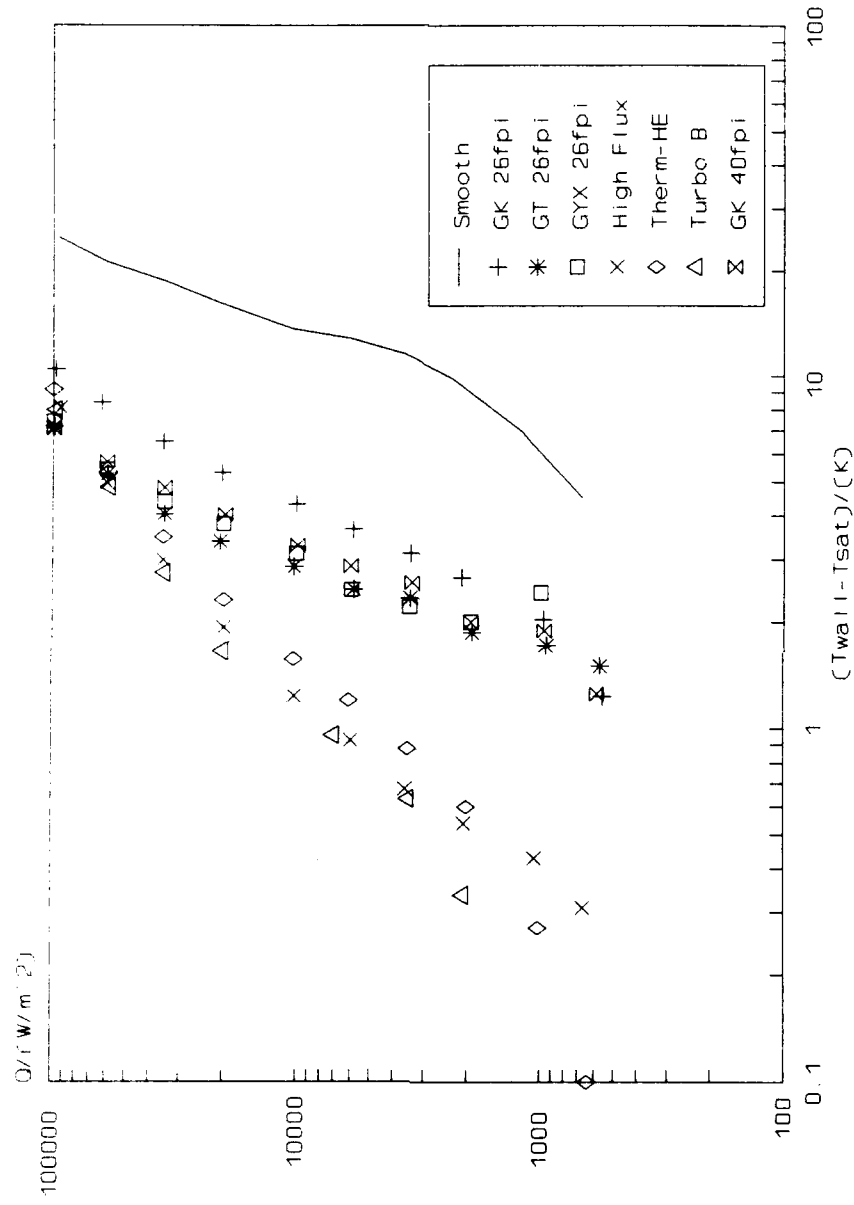

Figure 6.79 Performance Comparison For Boiling R-114/3% Oil Mixture From Smooth and Enhanced Tubes

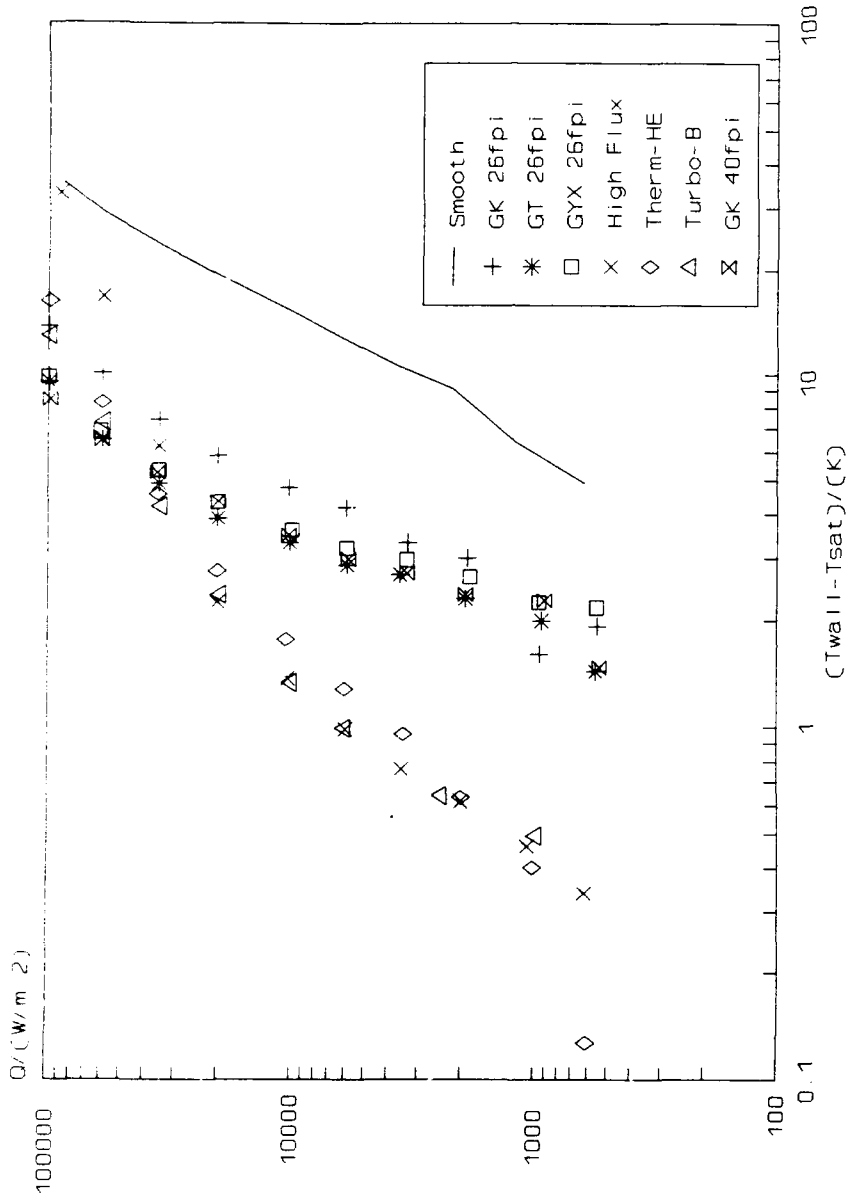

Figure 6.80 Performance Comparison For Boiling R-114/10% Oil Mixture From Smooth and Enhanced Tubes

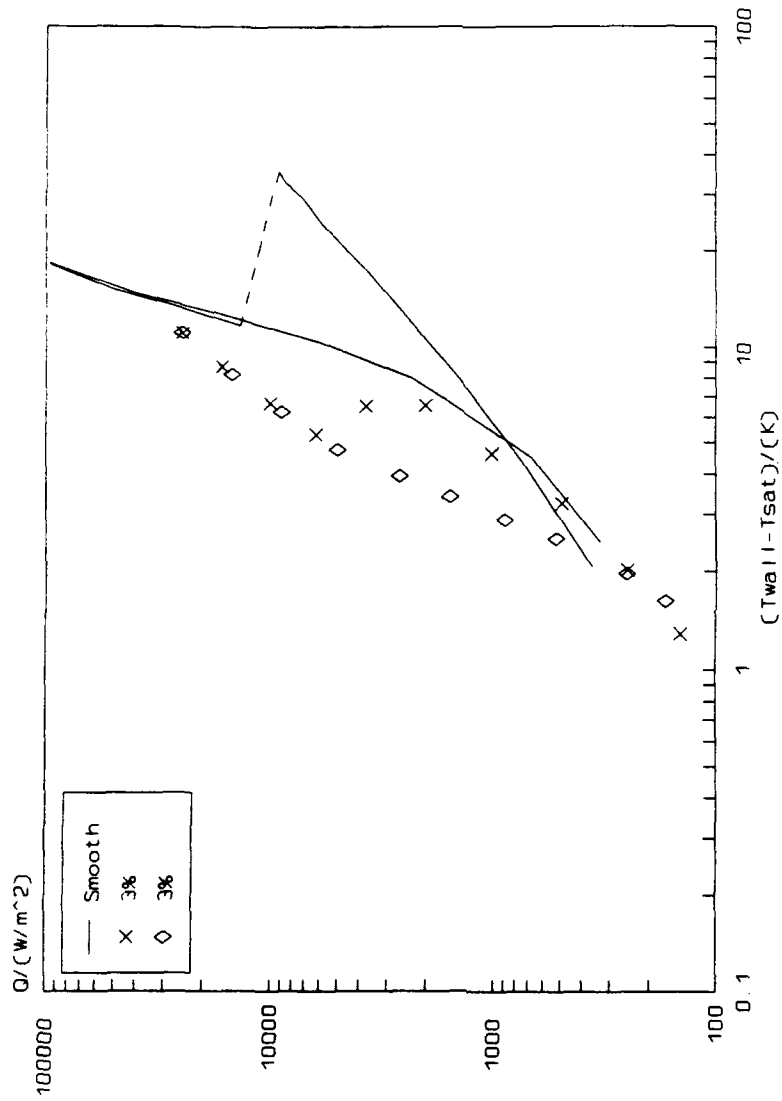

Figure 6.81 Performance Comparison For
 Pure R-114 Boiling From GEWA-K 25 fpi
 Using Actual Wetted Surface Area

Heat Flux (KW/m^2)	3.5			10			35			100		
	0	3	10	0	3	10	0	3	10	0	3	10
Oil Conc. (%)												
Tube Type												
Smooth	1	1	1	1	1	1	1	1	1	1	1	1
GK-26fpi	3.6	3.8	3.2	3.1	3.1	3.3	2.4	2.9	3.2	1.6	2.4	2.6
GK-40fpi	4.6	4.4	4	4.1	4.1	4.4	3.1	3.9	4.6	2.4	3.6	4.2
GT-19fpi	6.6	6.1	5.3	5.4	5.4	5.7	3.1	4.3	5.2	1.8	3	3.5
GT-26fpi	6.2	5	3.9	5.2	4.7	4.6	3.7	4.6	4.8	2.2	3.5	3.7
GX-26fpi	5.3	5.2	3.5	4.4	4.4	4.3	3.4	4.3	4.4	2.1	3.4	3.6
High Flux	30.9	17.2	13.6	13.5	11.3	10.9	6.4	6.2	3.8	3.3	3.1	1.1
T-HE	26.3	17.4	12.8	13.6	10.5	10.2	4.8	5.1	4.8	1.9	2.2	1.9
T-E	38.9	13.1	10.9	14.6	8.5	8.5	5.7	5.3	5.2	2.6	2.7	2.2
Turbo-B	105	18	14.2	19.4	12.1	11.8	6.2	6.7	5.6	3.1	3.1	2.7

GK = GEWA-K GT = GEWA-T GX = GEWA-YX T-HE = Thermocool-HE T-E = Thermocool-E

TABLE III. HEAT TRANSFER COEFFICIENT ENHANCEMENT RATIOS FOR SMOOTH VERSUS ENHANCED SURFACES

VII. CONCLUSIONS

1. Accurate and repeatable boiling heat-transfer data using R-114 and R-114/oil mixtures was obtained on ten enhanced tube surfaces.
2. Three distinct groups of boiling tubes can be identified by structure and boiling performance: smooth, finned and reentrant cavity.
3. Significant increase in performance was observed for reentrant cavity surfaces versus either the finned or smooth surfaces within the nucleating regime at all heat fluxes tested.
4. Degradation in boiling performance accompanied increases in oil concentration within the nucleating regime. Most notably, the high flux surface performed comparably to a smooth surface at the highest flux tested.
5. Within the convection regime all tube surfaces tested performed equally well. No significant effect of oil concentration can be observed up to incipient nucleation.
6. Distinct temperature overshoot within the convection regime occurs repeatably in all tube surfaces tested. The reentrant cavity surfaces exhibit the most extreme overshoot versus either the finned or smooth surfaces. Oil concentration has no significant effect.

VIII. RECOMMENDATIONS

1. Due to the way a real flooded evaporator operates, it would be preferable to heat the tube within the single tube apparatus with hot water.
2. As a complement to present single tube and bundle tube studies, the present single tube apparatus should be modified to accommodate two vertically aligned boiling tubes in order to study the effects of multiple tubes and variation of tube pitch to diameter ratios.
3. The physical properties of the R-114/oil mixtures tested should be measured for comparison to the predictions used in the data reduction program and for better understanding of the mechanisms driving the degradation in heat transfer performance.
4. Neutrally buoyant particles should be placed in the pool to facilitate study of the circulation patterns within the flooded evaporator in more detail.
5. A high speed camera should be used to study the nucleation process and circulation patterns in more detail.

APPENDIX A: THERMOPHYSICAL PROPERTIES OF R-114

The following thermophysical properties of saturated R-114 are plotted versus temperature °C:

1. Liquid Density (kg/m ³)
2. Liquid Dynamic Viscosity (Pa*s)
3. Liquid Thermal Conductivity (W/m*K)
4. Liquid Specific Heat (J/kg*K)
5. Latent Heat (J/kg)

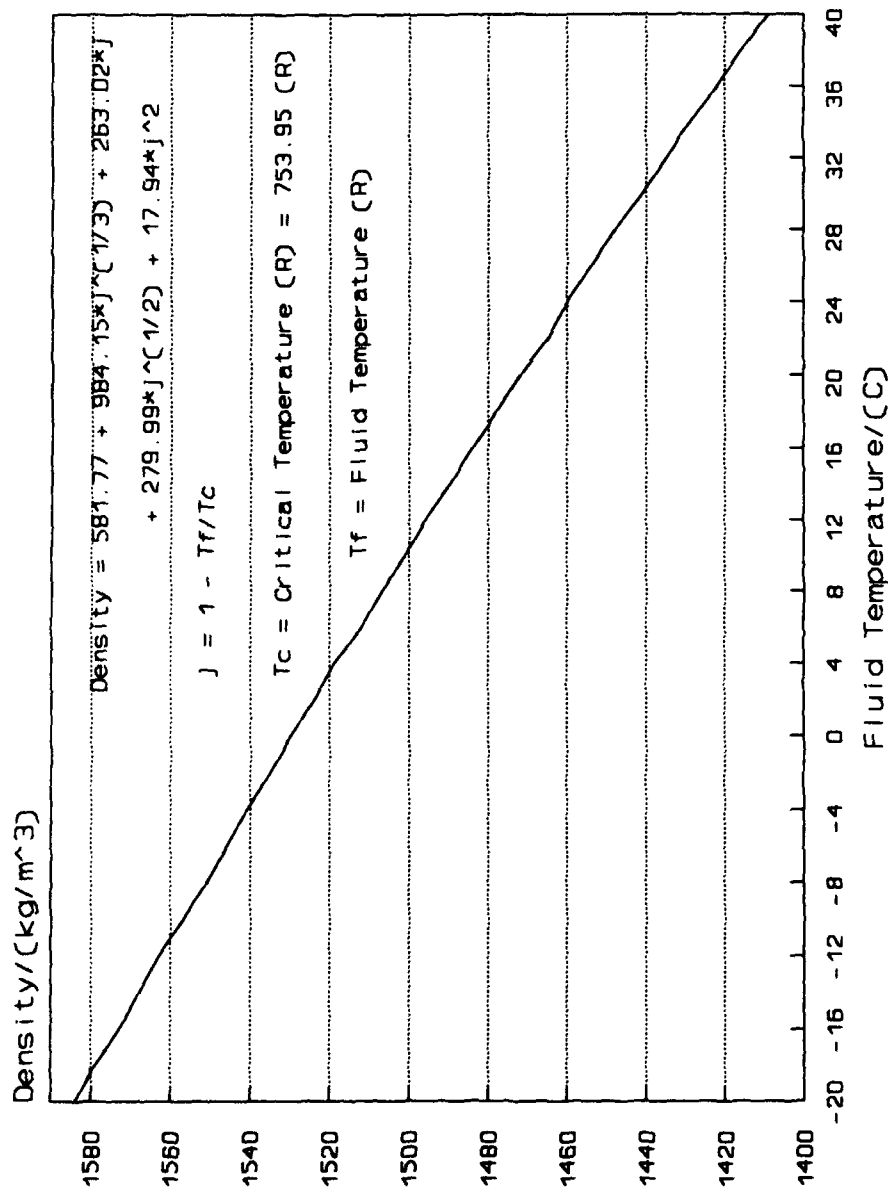

Figure A.1 Density of R-114

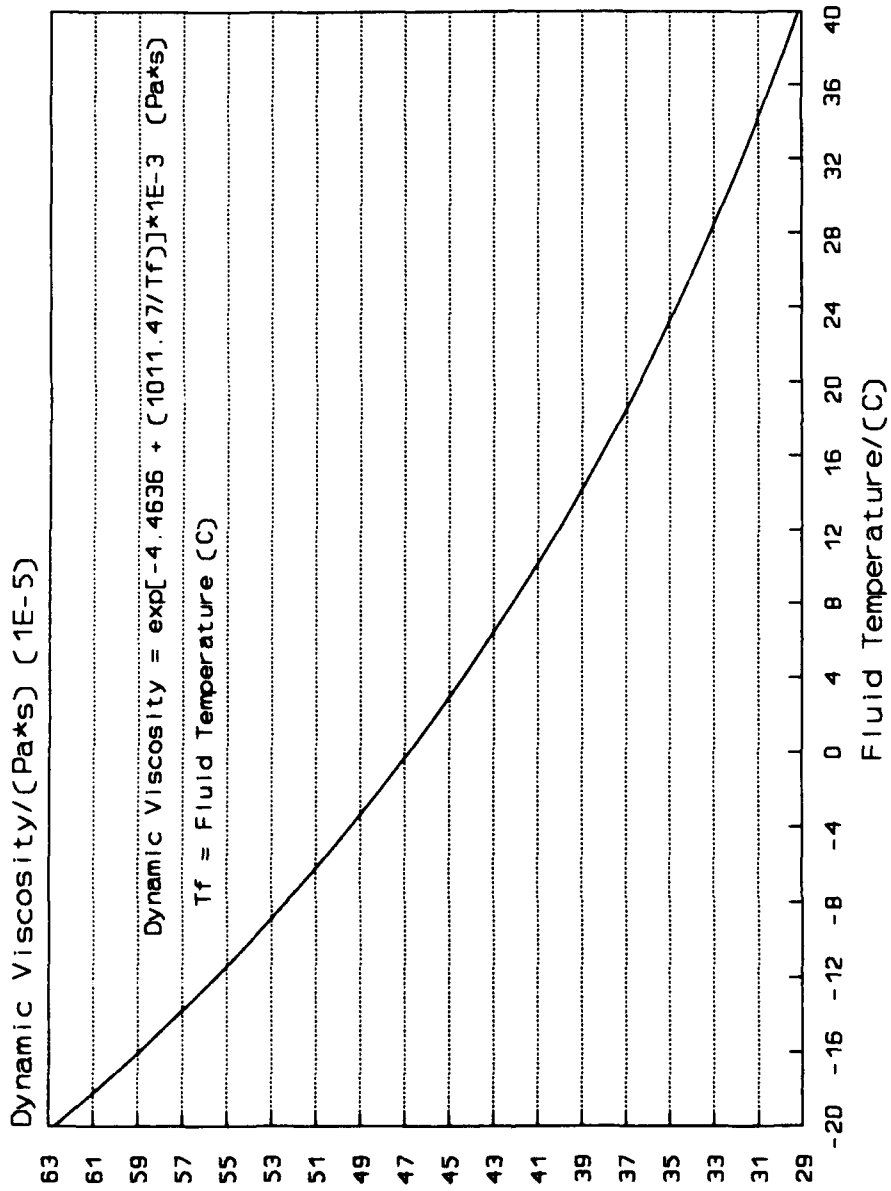

Figure A.2 Dynamic Viscosity of R-114

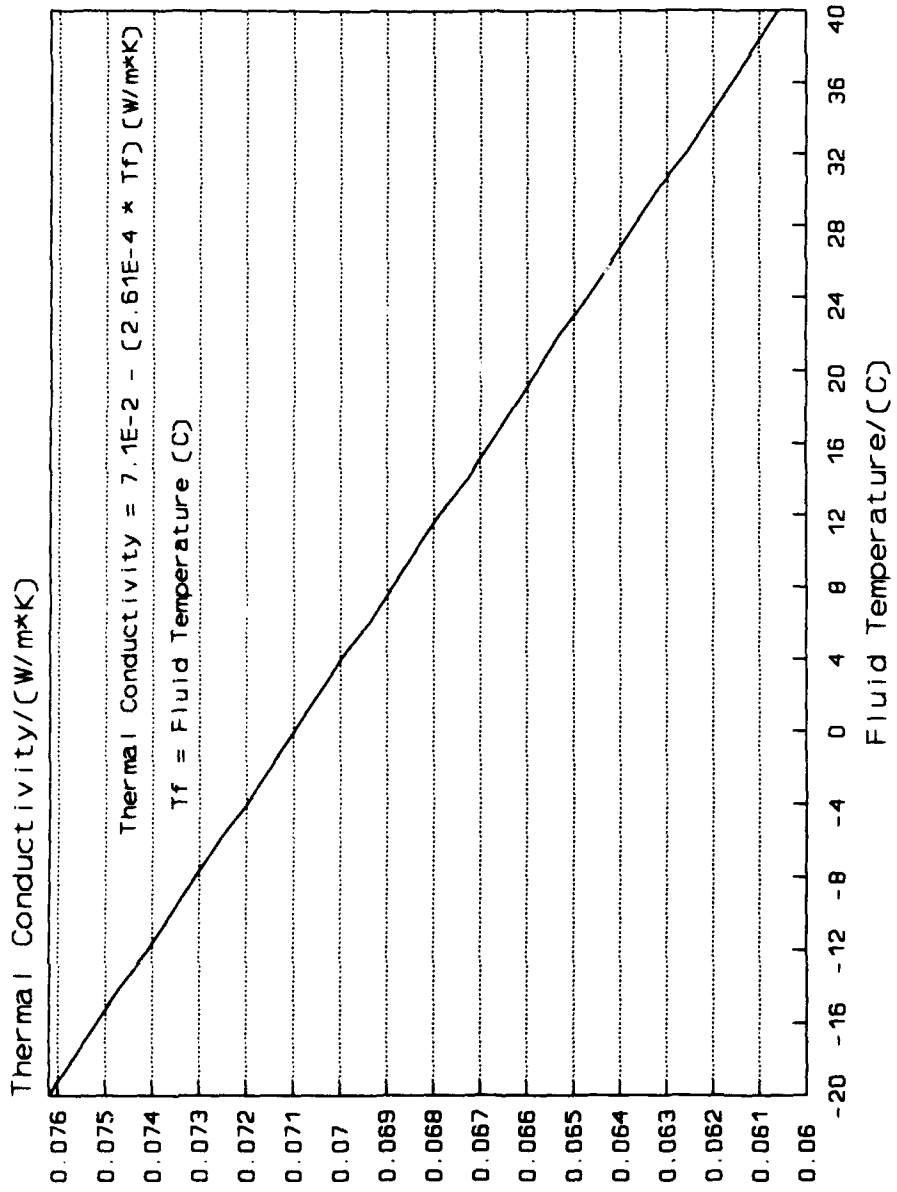

Figure A.3 Thermal Conductivity of R-114

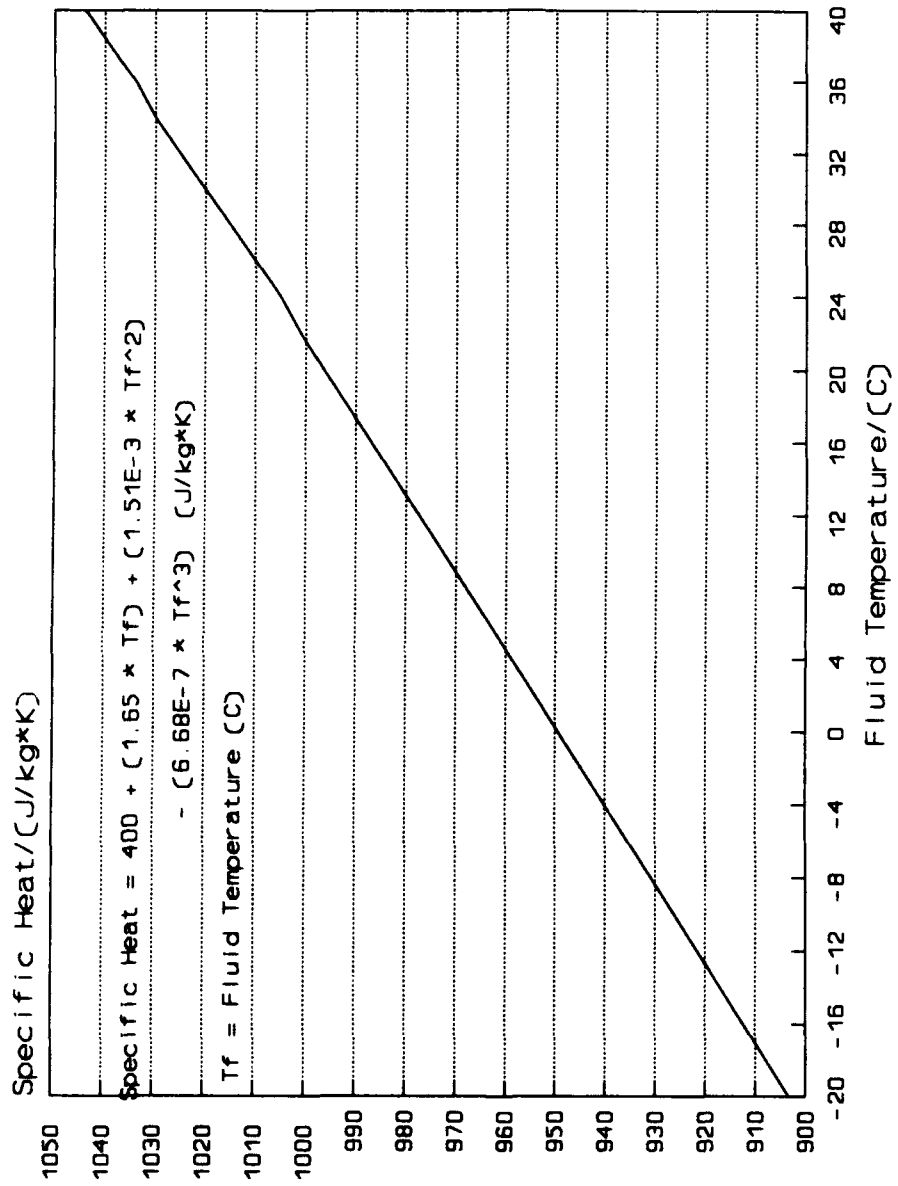

Figure A.4 Specific Heat of R-114

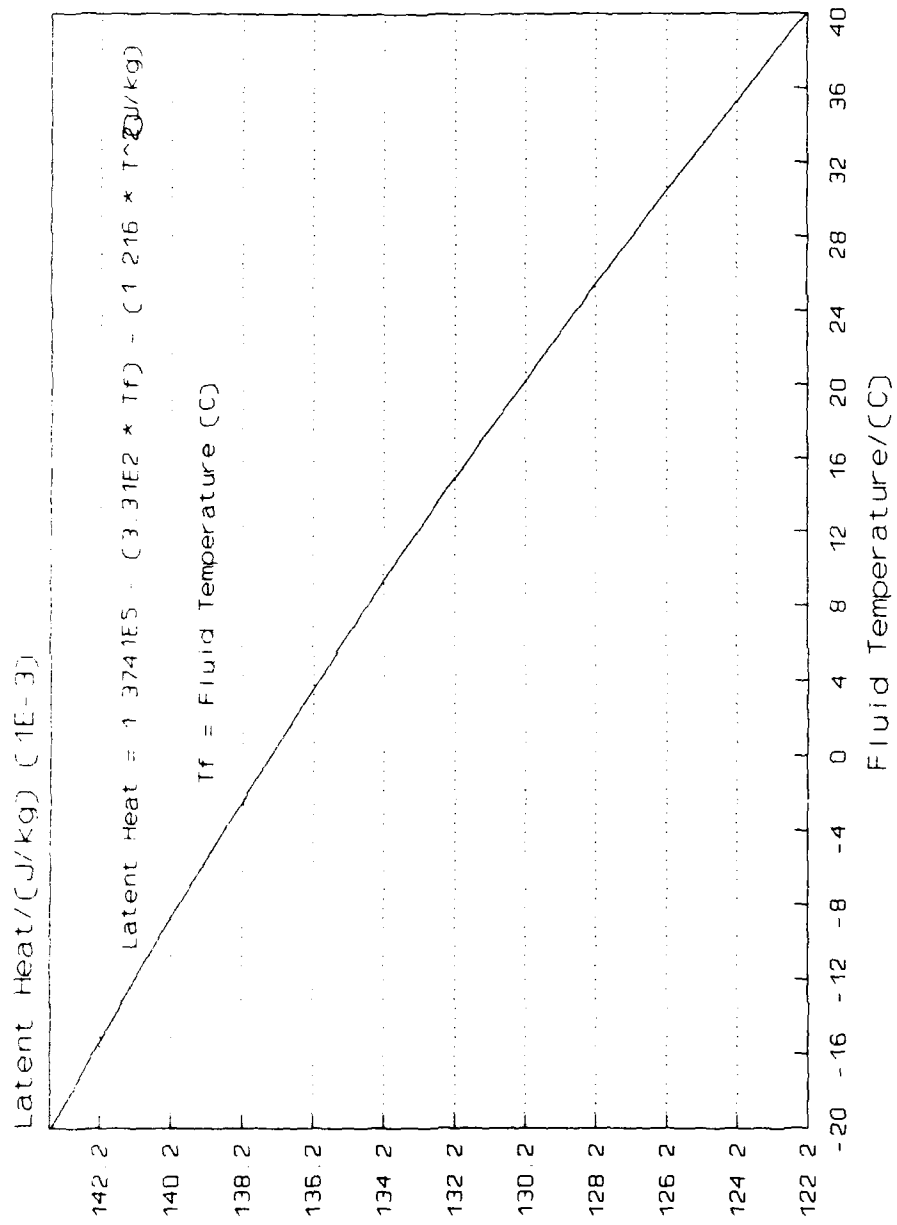

Figure A.5 Latent Heat of R-114

APPENDIX B: DATA ACQUISITION APPARATUS CALIBRATION

A. BACKGROUND

Early data runs revealed a disparity in calculated values between previously reported theses and those presently obtained for heat flux and heat-transfer coefficients. The thermocouple channels were checked for validity of temperature readings using other programs and data acquisition equipment. Their readings were found to be as accurate as possible ($\pm 3\%$). Voltage readings originating from the RMS converter were also checked out as accurate. The RMS converter converts true voltage measured into a proportional voltage output (0-10 volts) to the data acquisition unit. The proportionality constant to convert RMS voltage readings, V_s , to real tube heater voltage, V , was equal to 25. This was verified using a standard voltmeter across the power leads of the cartridge heater measured over several power settings. The discrepancy was identified to be the measurement of the current supplied to the tube cartridge heater by the VARIAC unit as measured by the inductive pickup (Figure 3.13). The inductive measurement of current (in proportional volts) is no longer run through the RMS converter. Instead, it is run directly to the Data Acquisition Unit. A procedure to measure the true current and calculate the proportionality constant for converting the

inductive current, I_s , to the true current, I , was established as follows:

B. EQUIPMENT USED

1. Voltmeter
2. 2 ohm resistor
3. HP-3852A Data Acquisition Unit
4. Computer - HP-9300 Series
5. Current Sensor (Inductive Pickup)
6. Voltage Sensor/RMS Converter
7. Cartridge Heater - 1kW, 220V rating
8. VARIAC - power supply 220V AC
9. SETUP8 program

C. CALIBRATION PROCEDURE

1. Ensure all power is turned off to the VARIAC.
2. Insert the standard 2 ohm resistor in series with the cartridge heater as shown in Figure C.1.
3. Connect leads of voltmeter across the 2 ohm resistor to measure the drop in voltage. At any given power setting, the current through the resistor will equal the current through the cartridge heater. This assumes the resistances of both heater and resistor are constant. This was verified as shown in Figure C.2. The total resistance of the heater/resistor rapidly and asymptotically approached a constant value.
4. Connect power to the VARIAC.
5. Load and run SETUP8 program to provide the voltage and current readings made by the data acquisition unit. Note the SETUP8 program used in calibration differed

from that listed in Appendix G. A proportionality constant of 2.0 was assumed for calibration then modified once the true value was calculated.

6. Starting with the VARIAC set at zero volts, incrementally increase the voltage up to the maximum of 220V.
7. At each voltage, measure the drop in voltage across the resistor. The current (amps) is calculated:
$$I = \text{Drop in voltage (volts)} / 2 \text{ ohms}$$
8. Note and compare the current provided by the program.
9. At the maximum 220V, incrementally decrease voltage down to 0, taking comparative current readings as before, in order to detect any hysteresis effect. None was observed.
10. Plot current (amps) vs. voltage (volts). See Figure C.3. Note the linearity of both data sets. The true meter reading is some factor smaller than the data acquisition readings.
11. The calibration constant, C, is calculated by:
$$C = \frac{(\sum \text{Meter current})}{(\sum \text{Data acquisition current})} * 2$$

C = 1.9182

D. DISCUSSION

A disparity between the previous reported theses values and those presently obtained still exists. Calculated values reported in previous theses for the heat flux and the heat transfer coefficient are consistently higher. No previous thesis reports such a calibration as carried out above and it is thought that this is the cause of the discrepancy.

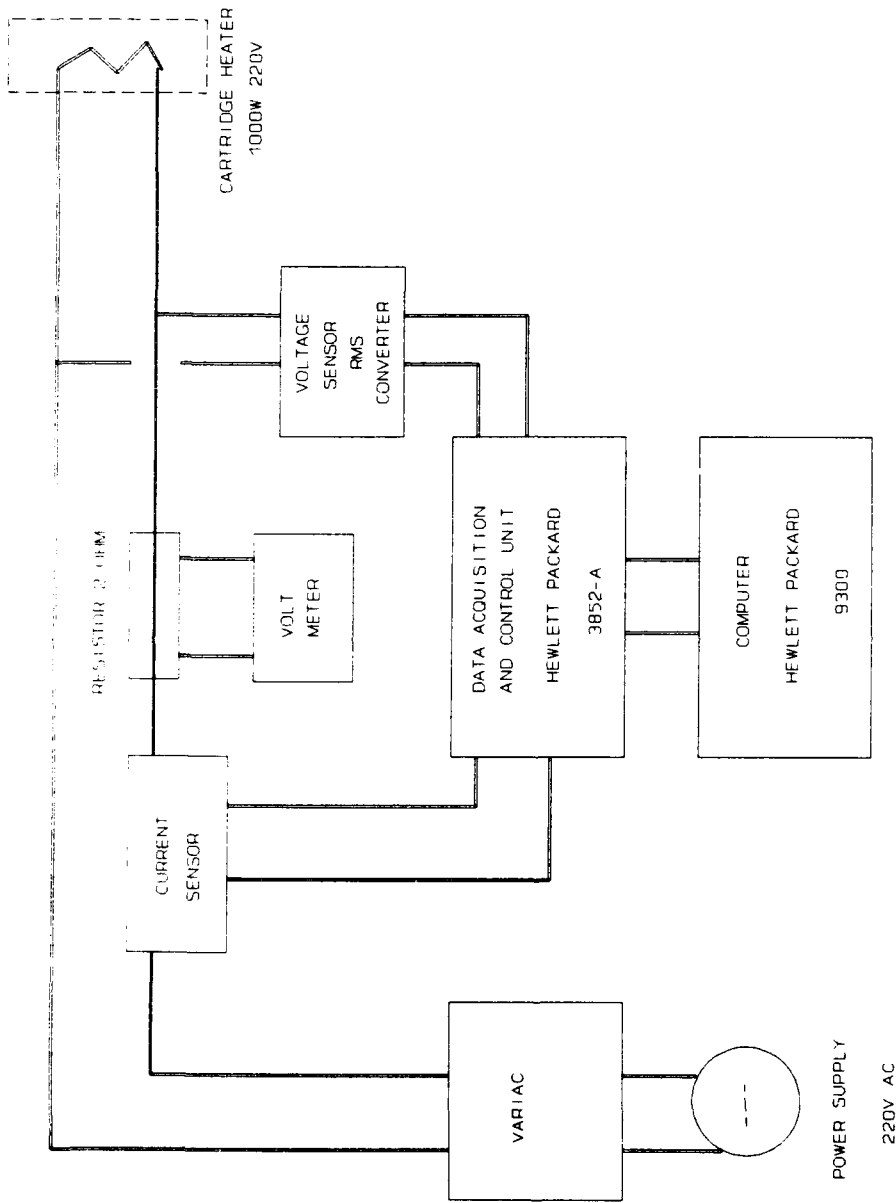

Figure B 1 Schematic of Calibration Setup

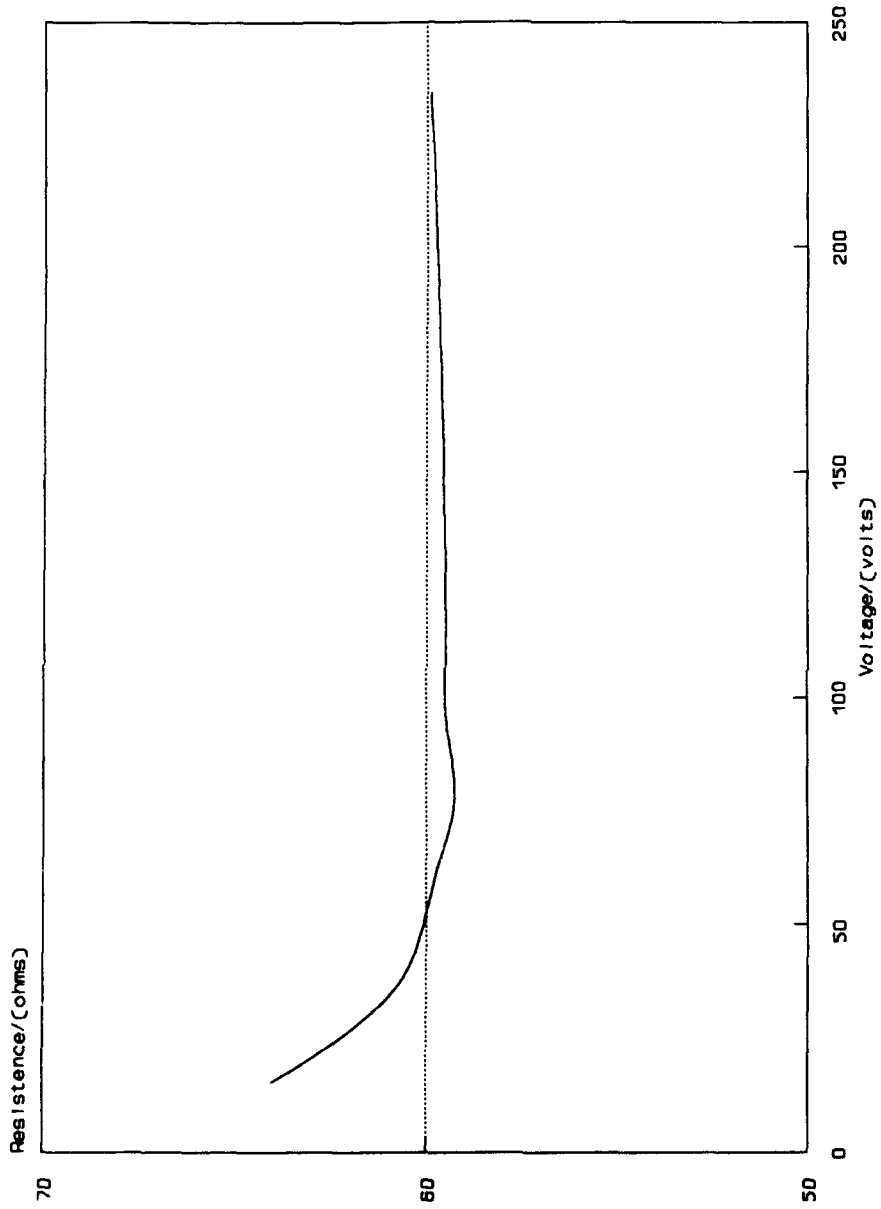

Figure B.2 Cartridge Heater Resistance
For High Flux Tube

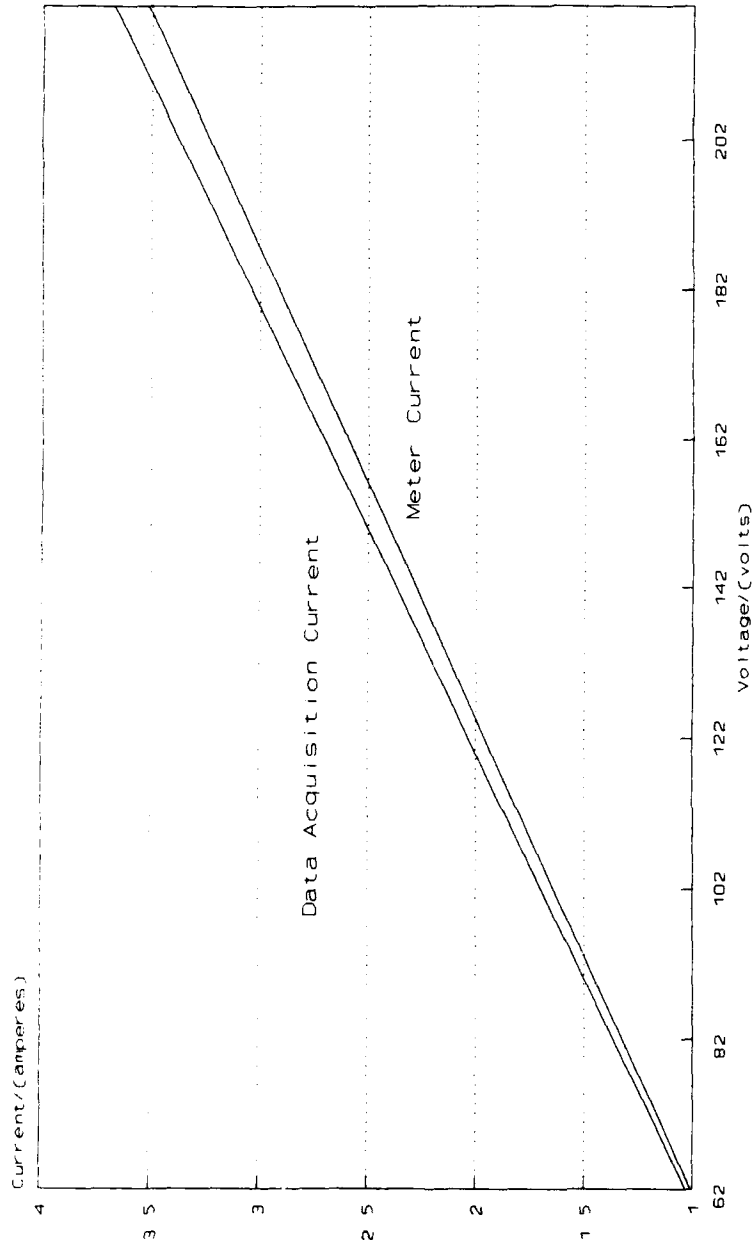

Figure B.3 Variac Current Calibration
Using High Flux Tube

APPENDIX C: AN EXAMPLE OF REPRESENTATIVE DATA RUN

Month, date and time : 5 Jul 1991 17:21:51

NOTE: Program name : DRP8
 Disk number = 01
 New file name: DATA070515
 TC is defective at location 2
 Tube Number: 5

Data Set Number = 1 Bulk Oil % = 0.0 2.11545538805
 TC No: 1 2 3 4 5 6 7 8
 Temp : 5.11 0.00 5.15 5.01 5.12 5.08 5.09 5.11
 Twa Tliqd Tliqd2 Tvaer Peat Tsump
 5.08 2.36 2.26 3.91 -1.65 -13.6
 Thetab Htube Qdp
 2.770 1.590E+02 4.406E+02

Data Set Number = 2 Bulk Oil % = 0.0 2.11545539033
 TC No: 1 2 3 4 5 6 7 8
 Temp : 4.94 0.00 5.04 4.87 4.99 4.95 4.96 4.98
 Twa Tliqd Tliqd2 Tvaer Peat Tsump
 4.95 2.23 2.18 3.29 -1.76 -13.7
 Thetab Htube Qdp
 2.740 1.603E+02 4.391E+02

Data Set Number = 3 Bulk Oil % = 0.0 2.11545539756
 TC No: 1 2 3 4 5 6 7 8
 Temp : 5.00 0.00 5.19 5.06 5.14 5.09 5.11 5.15
 Twa Tliqd Tliqd2 Tvaer Peat Tsump
 5.07 2.38 2.16 3.27 -1.69 -13.6
 Thetab Htube Qdp
 3.006 1.594E+02 5.446E+02

Data Set Number = 4 Bulk Oil % = 0.0 2.11545539780
 TC No: 1 2 3 4 5 6 7 8
 Temp : 5.12 0.00 5.23 5.02 5.19 5.14 5.15 5.18
 Twa Tliqd Tliqd2 Tvaer Peat Tsump
 5.12 2.39 2.19 3.29 -1.67 -13.6
 Thetab Htube Qdp
 3.020 1.602E+02 5.439E+02

Data Set Number = 5 Bulk Oil % = 0.0 2.11545540620
 TC No: 1 2 3 4 5 6 7 8
 Temp : 7.13 0.00 7.27 6.97 7.24 7.15 7.17 7.25
 Twa Tliqd Tliqd2 Tvaer Peat Tsump
 7.13 2.24 2.16 2.92 -1.77 -13.6
 Thetab Htube Qdp
 4.934 1.791E+02 8.834E+02

Data Set Number = 6 Bulk Oil % = 0.0 2.11545540655
 TC No: 1 2 3 4 5 6 7 8
 Temp : 7.09 0.00 7.25 6.95 7.21 7.13 7.15 7.20
 Twa Tliqd Tliqd2 Tvaer Peat Tsump
 7.11 2.20 2.12 2.91 -1.81 -13.5
 Thetab Htube Qdp
 4.945 1.786E+02 8.834E+02

Data Set Number = 7 Bulk Oil % = 0.0 2.11545541023
 TC No: 1 2 3 4 5 6 7 8
 Temp : 9.55 0.00 9.74 9.26 9.71 9.60 9.62 9.75
 Twa Tliqd Tliqd2 Tvaer Peat Tsump
 9.57 2.47 2.22 2.94 -1.51 -13.5
 Thetab Htube Qdp
 7.223 1.863E+02 1.346E+03

Data Set Number = 8 Bulk Oil % = 0.0 2.11545541165
 TC No: 1 2 3 4 5 6 7 8
 Temp : 9.33 0.00 9.52 9.11 9.49 9.37 9.39 9.60
 Tws Tliqd Tliqd2 Tvepr Pstat Tsump
 9.33 2.21 2.13 2.02 -1.00 -13.5
 Thetab Htube Qdp
 7.165 1.074E+02 1.343E+03

Data Set Number = 9 Bulk Oil % = 0.0 2.11545541546
 TC No: 1 2 3 4 5 6 7 8
 Temp : 10.99 0.00 11.53 11.09 11.50 11.30 11.40 11.40
 Tws Tliqd Tliqd2 Tvepr Pstat Tsump
 11.26 2.30 2.16 2.66 -1.73 -13.5
 Thetab Htube Qdp
 9.026 1.963E+02 1.772E+03

Data Set Number = 10 Bulk Oil % = 0.0 2.11545541509
 TC No: 1 2 3 4 5 6 7 8
 Temp : 11.00 0.00 11.52 11.09 11.50 11.37 11.40 11.41
 Tws Tliqd Tliqd2 Tvepr Pstat Tsump
 11.26 2.32 2.22 2.67 -1.69 -13.5
 Thetab Htube Qdp
 9.988 1.977E+02 1.777E+03

Data Set Number = 11 Bulk Oil % = 0.0 2.11545541809
 TC No: 1 2 3 4 5 6 7 8
 Temp : 11.45 0.00 12.32 11.93 12.30 12.10 12.21 12.10
 Tws Tliqd Tliqd2 Tvepr Pstat Tsump
 11.99 2.24 2.17 2.67 -1.76 -13.5
 Thetab Htube Qdp
 9.783 2.074E+02 2.029E+03

Data Set Number = 12 Bulk Oil % = 0.0 2.11545541913
 TC No: 1 2 3 4 5 6 7 8
 Temp : 11.50 0.00 12.30 11.87 12.35 12.24 12.25 12.14
 Tws Tliqd Tliqd2 Tvepr Pstat Tsump
 12.04 2.26 2.19 2.69 -1.74 -13.5
 Thetab Htube Qdp
 9.814 2.065E+02 2.027E+03

Data Set Number = 13 Bulk Oil % = 0.0 2.11545542290
 TC No: 1 2 3 4 5 6 7 8
 Temp : 12.00 0.00 13.11 12.71 13.09 12.90 12.99 12.02
 Tws Tliqd Tliqd2 Tvepr Pstat Tsump
 12.74 2.22 2.20 2.96 -1.75 -13.5
 Thetab Htube Qdp
 10.527 2.112E+02 2.223E+03

Data Set Number = 14 Bulk Oil % = 0.0 2.11545542315
 TC No: 1 2 3 4 5 6 7 8
 Temp : 12.02 0.00 13.06 12.67 13.03 12.82 12.94 12.75
 Tws Tliqd Tliqd2 Tvepr Pstat Tsump
 12.60 2.20 2.17 2.96 -1.70 -13.5
 Thetab Htube Qdp
 10.494 2.110E+02 2.214E+03

Data Set Number = 15 Bulk Oil % = 0.0 2.11545542511
 TC No: 1 2 3 4 5 6 7 8
 Temp : 12.55 0.00 13.03 13.53 13.02 13.72 13.73 13.43
 Tws Tliqd Tliqd2 Tvepr Pstat Tsump
 13.42 2.19 2.16 2.92 -1.79 -13.5
 Thetab Htube Qdp
 11.239 2.102E+02 2.452E+03

Data Set Number = 16 Bulk Oil % = 0.0 2.11545542534
 TC No: 1 2 3 4 5 6 7 8
 Temp : 12.62 0.00 13.05 13.61 13.83 13.75 13.75 13.47
 Tss Tliqd Tliqd2 Tvepr Paat Tsump
 13.46 2.26 2.22 2.91 -1.72 -13.5
 Thetab Htube Odp
 11.217 2.183E+02 2.449E+03

Data Set Number = 17 Bulk Oil % = 0.0 2.11545543206
 TC No: 1 2 3 4 5 6 7 8
 Temp : 2.89 0.00 2.74 2.69 2.69 2.59 2.57 2.60
 Tss Tliqd Tliqd2 Tvepr Paat Tsump
 2.58 2.44 2.19 2.01 -1.64 -13.5
 Thetab Htube Odp
 .270 1.126E+04 3.036E+03

Data Set Number = 18 Bulk Oil % = 0.0 2.11545543229
 TC No: 1 2 3 4 5 6 7 8
 Temp : 2.86 0.00 2.71 2.66 2.67 2.56 2.55 2.65
 Tss Tliqd Tliqd2 Tvepr Paat Tsump
 2.56 2.39 2.15 1.98 -1.69 -13.5
 Thetab Htube Odp
 .288 1.052E+04 3.029E+03

Data Set Number = 19 Bulk Oil % = 0.0 2.11545543435
 TC No: 1 2 3 4 5 6 7 8
 Temp : 3.15 0.00 2.97 2.92 2.92 2.79 2.75 2.91
 Tss Tliqd Tliqd2 Tvepr Paat Tsump
 2.76 2.41 2.17 2.09 -1.67 -13.5
 Thetab Htube Odp
 .472 9.576E+02 4.523E+03

Data Set Number = 20 Bulk Oil % = 0.0 2.11545543508
 TC No: 1 2 3 4 5 6 7 8
 Temp : 3.12 0.00 2.93 2.89 2.89 2.75 2.72 2.80
 Tss Tliqd Tliqd2 Tvepr Paat Tsump
 2.73 2.47 2.19 2.00 -1.62 -13.5
 Thetab Htube Odp
 .394 1.144E+04 4.506E+03

Data Set Number = 21 Bulk Oil % = 0.0 2.11545543579
 TC No: 1 2 3 4 5 6 7 8
 Temp : 3.02 0.00 2.83 2.79 2.79 2.64 2.62 2.77
 Tss Tliqd Tliqd2 Tvepr Paat Tsump
 2.62 2.37 2.09 1.98 -1.74 -13.5
 Thetab Htube Odp
 .394 1.149E+04 4.525E+03

Data Set Number = 22 Bulk Oil % = 0.0 2.11545543829
 TC No: 1 2 3 4 5 6 7 8
 Temp : 3.45 0.00 3.20 3.16 3.15 2.96 2.91 3.14
 Tss Tliqd Tliqd2 Tvepr Paat Tsump
 2.89 2.41 2.15 2.76 -1.67 -13.5
 Thetab Htube Odp
 .603 1.178E+04 7.099E+03

Data Set Number = 23 Bulk Oil % = 0.0 2.11545543855
 TC No: 1 2 3 4 5 6 7 8
 Temp : 3.44 0.00 3.19 3.15 3.14 2.96 2.90 3.13
 Tss Tliqd Tliqd2 Tvepr Paat Tsump
 2.88 2.39 2.15 2.87 -1.69 -13.5
 Thetab Htube Odp
 .612 1.158E+04 7.092E+03

Data Set Number = 24 Bulk Oil % = 0.0 2.11545544709
 TC No: 1 2 3 4 5 6 7 8
 Temp : 3.95 0.00 3.56 3.55 3.50 3.29 3.20 3.52
 Twa Tliad Tliad2 Tvepr Psat Tsump
 3.12 2.36 2.17 2.71 -1.69 -13.6
 Thetab Htube Qdp
 .057 1.279E+04 1.096E+04

Data Set Number = 25 Bulk Oil % = 0.0 2.11545544732
 TC No: 1 2 3 4 5 6 7 8
 Temp : 3.95 0.00 3.56 3.55 3.49 3.28 3.19 3.52
 Twa Tliad Tliad2 Tvepr Psat Tsump
 3.12 2.36 2.16 2.75 -1.70 -13.6
 Thetab Htube Qdp
 .059 1.279E+04 1.098E+04

Data Set Number = 26 Bulk Oil % = 0.0 2.11545545094
 TC No: 1 2 3 4 5 6 7 8
 Temp : 4.49 0.00 3.92 3.95 3.85 3.62 3.49 3.92
 Twa Tliad Tliad2 Tvepr Psat Tsump
 3.36 2.38 2.19 2.07 -1.67 -13.6
 Thetab Htube Qdp
 1.073 1.411E+04 1.514E+04

Data Set Number = 27 Bulk Oil % = 0.0 2.11545545119
 TC No: 1 2 3 4 5 6 7 8
 Temp : 4.45 0.00 3.89 3.93 3.83 3.60 3.46 3.89
 Twa Tliad Tliad2 Tvepr Psat Tsump
 3.33 2.33 2.15 2.04 -1.72 -13.6
 Thetab Htube Qdp
 1.092 1.385E+04 1.512E+04

Data Set Number = 28 Bulk Oil % = 0.0 2.11545545460
 TC No: 1 2 3 4 5 6 7 8
 Temp : 5.12 0.00 4.37 4.43 4.27 4.04 3.86 4.40
 Twa Tliad Tliad2 Tvepr Psat Tsump
 3.65 2.35 2.17 2.00 -1.70 -13.6
 Thetab Htube Qdp
 1.300 1.437E+04 1.996E+04

Data Set Number = 29 Bulk Oil % = 0.0 2.11545545484
 TC No: 1 2 3 4 5 6 7 8
 Temp : 5.12 0.00 4.36 4.42 4.26 4.03 3.84 4.39
 Twa Tliad Tliad2 Tvepr Psat Tsump
 3.64 2.34 2.16 2.07 -1.71 -13.6
 Thetab Htube Qdp
 1.393 1.433E+04 1.996E+04

Data Set Number = 30 Bulk Oil % = 0.0 2.11545546220
 TC No: 1 2 3 4 5 6 7 8
 Temp : 5.47 0.00 5.25 5.39 5.11 4.90 4.68 5.33
 Twa Tliad Tliad2 Tvepr Psat Tsump
 4.23 2.31 2.18 2.10 -1.72 -13.6
 Thetab Htube Qdp
 1.909 1.585E+04 2.993E+04

Data Set Number = 31 Bulk Oil % = 0.0 2.11545546240
 TC No: 1 2 3 4 5 6 7 8
 Temp : 5.45 0.00 5.23 5.37 5.09 4.90 4.67 5.31
 Twa Tliad Tliad2 Tvepr Psat Tsump
 4.22 2.27 2.15 2.08 -1.75 -13.6
 Thetab Htube Qdp
 2.003 1.497E+04 2.998E+04

Data Set Number = 32 Bulk Dil % = 0.0 2.11545546659
 TC No: 1 2 3 4 5 6 7 8
 Temp : 8.99 8.88 6.66 6.92 6.39 6.17 5.57 6.63
 Twa Tliqd Tliqd2 TvaPr Psat Tsump
 5.16 2.33 2.18 2.13 -1.71 -13.4
 Thetab Htube Odp
 2.918 1.559E+04 4.535E+04

Data Set Number = 33 Bulk Dil % = 0.0 2.11545546682
 TC No: 1 2 3 4 5 6 7 8
 Temp : 8.97 8.88 6.64 6.98 6.37 6.14 5.56 6.62
 Twa Tliqd Tliqd2 TvaPr Psat Tsump
 5.15 2.38 2.17 2.18 -1.73 -13.3
 Thetab Htube Odp
 2.911 1.556E+04 4.531E+04

Data Set Number = 34 Bulk Dil % = 0.0 2.11545546951
 TC No: 1 2 3 4 5 6 7 8
 Temp : 12.55 8.88 8.88 9.39 8.54 8.86 6.96 8.56
 Twa Tliqd Tliqd2 TvaPr Psat Tsump
 6.53 2.29 2.15 2.15 -1.74 -13.2
 Thetab Htube Odp
 4.385 1.632E+04 7.828E+04

Data Set Number = 35 Bulk Dil % = 0.0 2.11545546986
 TC No: 1 2 3 4 5 6 7 8
 Temp : 12.59 8.88 9.81 9.42 8.57 8.89 6.99 8.68
 Twa Tliqd Tliqd2 TvaPr Psat Tsump
 6.56 2.31 2.19 2.18 -1.71 -13.2
 Thetab Htube Odp
 4.315 1.627E+04 7.819E+04

Data Set Number = 36 Bulk Dil % = 0.0 2.11545547257
 TC No: 1 2 3 4 5 6 7 8
 Temp : 16.86 8.88 11.35 11.79 10.57 10.84 8.26 10.43
 Twa Tliqd Tliqd2 TvaPr Psat Tsump
 7.84 2.23 2.15 2.14 -1.77 -12.9
 Thetab Htube Odp
 5.549 1.694E+04 8.568E+04

Data Set Number = 37 Bulk Dil % = 0.0 2.11545547281
 TC No: 1 2 3 4 5 6 7 8
 Temp : 16.11 8.88 11.39 11.81 10.59 10.87 8.28 10.46
 Twa Tliqd Tliqd2 TvaPr Psat Tsump
 7.87 2.26 2.18 2.17 -1.75 -12.8
 Thetab Htube Odp
 5.556 1.692E+04 8.572E+04

NOTE: 37 data runs were stored in file DATA078515

NOTE: 37 X-Y pairs were stored in plot data file PLOT078515

APPENDIX D: SAMPLE CALCULATION

Data run number 9 (saturation temperature was 2.22 °C and heat flux was 20.14 kW/m²) was chosen for the sample calculation.

A. TEST-SECTION DIMENSIONS

Do = 0.01588 m
Di = 0.01270 m
D1 = 0.01143 m
D2 = 0.01588 m
L = 0.20320 m
Lu = 0.07620 m

B. MEASURED PARAMETERS

V = 112.08 volts
I = 1.94 volts
T1 = 16.51 °C
T2 = 15.80 °C
T3 = 15.88 °C
T4 = 15.93 °C
T5 = not read due to defective thermocouple
T6 = 15.94 °C
T7 = 15.63 °C
T8 = 16.16 °C
Tsat = 2.22 °C
kc = 344.00 (W/m·K)

C. OUTER WALL TEMPERATURE OF THE BOILING TUBE

p = $\pi \cdot Do = 3.1416 \cdot 0.01588 = 0.0499$ (m)
Ac = $\pi (Do^2 - Di^2) / 4 = 3.1416 \cdot [(0.01588)^2 - (0.0127)^2] / 4$
Ac = 7.14E-5 (m²)
Qh = VI = 112.08 · 1.94 = 217.44 (W)
Tavg = $\sum T_n / n = 15.97$ (°C)
Two = $T_{avg} - Qh \cdot [\ln(D2/D1) / (2 \cdot \pi \cdot L \cdot kc)]$
Two = 15.97 - 217.44 ·
[ln(15.88/11.43) / (2 · 3.1416 · 0.203 · 344)]

$$\begin{aligned} T_{wo} &= 15.80 \text{ (}^\circ\text{C)} \\ \theta &= T_{wo} - T_{sat} = 15.80 - 2.22 = 13.58 \text{ }^\circ\text{C} \end{aligned}$$

D. PROPERTIES OF R-114 AT FILM TEMPERATURE

$$\begin{aligned} T_f &= (T_{wo} + T_{sat})/2 = (15.80 + 2.22)/2 = 9.01 \text{ }^\circ\text{C} \\ \mu &= \exp[-4.4636 + (1011.47/T_f)] \cdot 1E-3 \\ \mu &= \exp[-4.4636 + (1011.47/9.01)] \cdot 1E-3 = 4.16E-4 \\ &\quad (\text{N} \cdot \text{s}/\text{m}^2) \\ T_c &= \text{Critical Temperature (R)} = 753.95 \text{ (R)} \\ T_f &= 9.01 \text{ (}^\circ\text{C)} = 507.89 \text{ (R)} \\ j &= 1 - T_f(\text{R})/T_c(\text{R}) = 1 - 507.89/753.95 = 0.33 \\ \rho &= 581.77 + 984.15 \cdot j^{(1/3)} + 263.02 \cdot j + 279.99 \cdot j^{1/2} + \\ &\quad 17.94 \cdot j^2 \text{ (kg}/\text{m}^3) \\ \rho &= 1504.22 \text{ (kg}/\text{m}^3) \\ v &= \mu/\rho = 4.16E-4/1504.22 = 2.77E-7 \\ k &= 7.10E-2 - (2.61E-4 \cdot T_f(\text{ }^\circ\text{C})) \\ k &= 7.10E-2 - (2.61E-4 \cdot 9.01) = 6.86E-2 \text{ (W}/\text{m} \cdot \text{K)} \\ T_f &= 9.01 \text{ (}^\circ\text{C)} = 282.16 \text{ (K)} \\ C_p &= 400 + (1.65 \cdot T_f) + (1.51E-3 \cdot T_f^2) - (6.68E-7 \cdot \\ &\quad T_f^3) \\ C_p &= 970.43 \text{ (J}/\text{kg} \cdot \text{K)} \\ \alpha &= k/\rho \cdot C_p = 6.86E-2/(1504.22 \cdot 970.43) = 4.7E-8 \text{ (m}^2/\text{s)} \\ \beta &= -(\Delta\rho/\Delta T)/\rho = 1.92E-3 \text{ (1}/\text{K)} \\ Pr &= v/\alpha = 5.88 \end{aligned}$$

E. HEAT-FLUX CALCULATION

Average natural-convection heat transfer coefficient at non-boiling ends:

$$h = \frac{k}{D_o} \cdot 0.60 + 0.387 \cdot \left\{ \frac{\left(\frac{g \cdot \beta \cdot (D_o^3) \cdot \theta \cdot \text{Tanh}(m \cdot Lu)}{v \cdot \alpha \cdot Lu \cdot m} \right)^{1/6}}{[1 + (0.559/Pr)^{9/16}]^{8/27}} \right\}^2$$

$$m = [h \cdot p / (k_c \cdot A_c)]^{1/2}$$

$$h = 235.4 \text{ (W}/\text{m}^2 \cdot \text{K)}$$

The value for h was computed iteratively. A value for h of 190 (W/m²·K) was assumed at start of iteration.

Heat-transfer rate through non-boiling ends:

$$\begin{aligned} m &= 21.87 \text{ (1}/\text{m)} \\ Q_f &= (h \cdot p \cdot k_c \cdot A_c)^{1/2} \cdot \theta \cdot \text{Tanh}(m \cdot Lu) = 6.79 \text{ (W)} \end{aligned}$$

Heat flux through active boiling surface

$$\begin{aligned} Q &= Q_h - 2 \cdot Q_f = 217.44 - 2 \cdot 6.79 = 203.85 \text{ (W)} \\ A_b &= \pi \cdot D_o \cdot L = 3.1416 \cdot 0.015875 \cdot 0.2032 = 1.01E-2 \text{ (m}^2\text{)} \\ q'' &= Q/A_b = 203.85/1.02E-2 = 20,108 \text{ (W/m}^2\text{)} \\ h &= q/\theta = 20,108/13.59 = 1480 \text{ (W/m}^2 \cdot \text{K)} \end{aligned}$$

The following are the results obtained from the computer by running the data reduction program DRP8 (See Appendix H).

$$\begin{aligned} q'' &= 20,140 \text{ (W/m}^2\text{)} \\ \theta &= 13.64 \text{ (}^\circ\text{C)} \\ h &= 1477 \text{ (W/m}^2 \cdot \text{K)} \end{aligned}$$

TABLE IV. DIMENSIONS OF BOILING TUBES

	D1 (mm)	D2 (mm)	Di (mm)	Do (mm)	L (mm)	Lu (mm)	Kcu $\frac{(W)}{m^2 \cdot K}$
Smooth	12.44	15.88	12.70	15.88	203.2	76.20	344
GEWA-K 26 fpi	10.1	12.7	11.11	12.7	203.2	76.2	344
GEWA-K 40 fpi	10.1	12.7	11.11	12.7	203.2	76.2	344
GEWA-T 19 fpi	11.57	13.8	11.8	13.31	203.2	76.2	398
GEWA-T 26 fpi	11.57	13.8	11.8	13.31	203.2	76.2	398
GEWA-YX 26 fpi	11.57	13.8	11.8	13.31	203.2	76.2	398
Thermoexcel- E	11.57	13.8	11.8	13.31	203.2	76.2	398
Thermoexcel- HE	11.57	13.8	11.8	13.31	203.2	76.2	398
Turbo-B	11.57	13.8	11.8	15.8	203.2	76.2	398
High Flux (Copper/ Nickel 95/5)	12.95	15.82	13.2	15.82	203.2	76.2	45

APPENDIX E: UNCERTAINTY ANALYSES

Four data points from two data runs were chosen for the uncertainty analysis: data run number 8 (smooth tube, 0% oil, 100,000 & 3500 W/m²) and data run number 74 (Thermoexcel-E, 0% oil, 6000 & 100,000 W/m²). The dimensions of the boiling tubes can be found in Appendix D, Table IV. The measured and calculated parameters used in this analysis were obtained as shown in Appendix D and are listed in Table V of this appendix. All uncertainties are presented as a percentage of the calculated parameter. What follows is a sample calculation for data run number 8: smooth tube, 0% oil at a heat flux of 93,130 W/m² using the methods outlined by Kline and McClintock [Ref. 17]. All other data point uncertainties were calculated similarly, the results of which are listed in Table V of this appendix.

A. UNCERTAINTY IN SOURCE HEAT-TRANSFER RATE

$$\begin{aligned} Q_h &= VI \text{ W} \\ I_s &= 2.122 \text{ volts} & \delta I &= \pm 0.025 \text{ amp} \\ V_s &= 9.45 \text{ volts} & \delta V &= \pm 0.05 \text{ volts} \\ I &= 1.9182 \cdot I_s = 4.07 \text{ amp} \\ V &= 25 \cdot V_s = 236.26 \text{ volts} \end{aligned}$$

where:

δ = uncertainty in measurement and calculation

$$\begin{aligned} \delta Q_h / Q_h &= ((\delta V / V_s)^2 + (\delta I / I_s)^2)^{1/2} \\ \delta Q_h / Q_h &= ((0.05 / 9.45)^2 + (0.025 / 2.122)^2)^{1.2} \\ \delta Q_h / Q_h &= 1.29 \text{ percent} \end{aligned}$$

B. UNCERTAINTY IN SURFACE AREA

$$\begin{aligned} A_b &= \pi \cdot D_o \cdot L \\ D_o &= 15.88 \text{ (mm)} & \delta D_o &= 0.1 \text{ (mm)} \\ L &= 203.20 \text{ (mm)} & \delta L &= 0.1 \text{ (mm)} \end{aligned}$$

$$\begin{aligned} \delta A_b / A_b &= ((\delta D_o / D_o)^2 + (\delta L / L)^2)^{1/2} \\ \delta A_b / A_b &= ((0.1/15.88)^2 + (0.1/203.2)^2)^{1/2} \\ \delta A_b / A_b &= 0.63 \text{ percent} \end{aligned}$$

C. UNCERTAINTY IN WALL SUPERHEAT

$$\Delta T = T_{wo} - T_{sat}$$

$$T_{sat} = 2.22 \text{ }^\circ\text{C} \quad \delta T = 0.01 \text{ }^\circ\text{C}$$

$$T_{wo} = T_{avg} - Q_h [(\ln(D_2/D_1)) / (2 \cdot \pi \cdot L \cdot k_c)]$$

$$T_{avg} = (\sum T_n / 8) \text{ where } n = 1 \text{ to } 8$$

T_n = thermocouple readings

$$T_1 = 23.86 \text{ }^\circ\text{C} \quad T_2 = 19.62 \text{ }^\circ\text{C} \quad T_3 = 20.38 \text{ }^\circ\text{C}$$

$$T_4 = 19.87 \text{ }^\circ\text{C} \quad T_5 = \text{Defective thermocouple}$$

$$T_6 = 20.18 \text{ }^\circ\text{C} \quad T_7 = 20.16 \text{ }^\circ\text{C} \quad T_8 = 20.20 \text{ }^\circ\text{C}$$

$$T_{avg} = 20.18 \text{ }^\circ\text{C}$$

$$\begin{aligned} \text{S.D.} &= ((\sum (T_n - T_{avg})^2) / 7)^{1/2} = 0.19 \text{ }^\circ\text{C} \\ &\text{where S.D.} = \text{standard deviation} \end{aligned}$$

The logarithmic term in equation of T_{wo} is very small compared to the standard deviation, this term can be neglected for the uncertainty analysis.

$$T_{wo} = T_{avg} = 18.72 \text{ }^\circ\text{C} \quad \delta T_{wo} = \text{S.D.} = 0.19 \text{ }^\circ\text{C}$$

$$\Delta T = 17.96 \text{ }^\circ\text{C}$$

$$\begin{aligned} \delta \Delta T / \Delta T &= ((\delta T_{wo} / \Delta T)^2 + (-\delta T_{sat} / \Delta T)^2)^{1/2} \\ \delta \Delta T / \Delta T &= ((0.93/16.5)^2 + (0.01/16.5)^2)^{1/2} \\ \delta \Delta T / \Delta T &= 1.06 \text{ percent} \end{aligned}$$

D. UNCERTAINTY IN HEAT FLUX

$$q = (Q_h - 2Q_f) / A_b$$

$$Q_h = 961.58 \text{ W} \quad \delta Q_h = 12.42 \text{ W}$$

Assuming the same proportion in the uncertainty for Q_f :

$$Q_f = 8.99 \text{ W} \qquad \delta Q_f = 0.12 \text{ W}$$

$$Q_h - 2Q_f = 943.6 \text{ W}$$

$$\delta q/q = [(\delta Q_h / (Q_h - 2Q_f))^2 + (2\delta Q_f / (Q_h - 2Q_f))^2 + (\delta A_b / A_b)^2]^{1/2}$$

$$\delta q/q = [(12.42/943.6)^2 + (0.24/943.6)^2 + (0.0063)^2]^{1/2}$$

$$\delta q/q = 1.46 \text{ percent}$$

E. UNCERTAINTY IN BOILING HEAT-TRANSFER COEFFICIENT

$$h = q/\Delta T$$

$$\delta h/h = [(\delta q/q)^2 + (\delta \Delta T/\Delta T)^2]^{1/2}$$

$$\delta h/h = [(0.0146)^2 + (0.0106)^2]^{1/2}$$

$$\delta h/h = 1.8 \text{ percent}$$

TABLE V. UNCERTAINTY ANALYSIS OF FOUR DATA POINTS

PARAMETERS	SMOOTH 100 kW/m ²	SMOOTH 3500 W/m ²	THERMO-E 6000 W/m ²	THERMO-E 100 kW/m ²
I _s (amp)	2.122	0.454	0.494	2.06
V _s (volts)	9.45	2.09	2.20	8.88
I (amp)	4.07	0.90	0.98	3.95
δI (amp)	0.025	0.025	0.025	0.025
V (volts)	236.26	52.29	55.28	222.05
δV (volts)	0.05	0.05	0.05	0.05
Q _h (W)	961.58	47.06	54.17	877.1
δQ _h (W)	12.42	2.83	3.00	7.43
δQ _h /Q _h (%)	1.29	6.00	5.55	0.85
D _o (mm)	15.88	15.88	13.31	13.31
δD _o (mm)	0.1	0.1	0.1	0.1
L (mm)	203.2	203.2	203.2	203.2
δL (mm)	0.1	0.1	0.1	0.1
A _b (m ²)	1.014E-2	1.014E-2	8.50E-3	8.50E-3
δA _b /A _b (%)	0.63	0.63	0.75	0.75
δT _{sat} (°C)	0.01	0.01	0.01	0.01
T _{wo} (°C)	20.18	12.92	2.77	11.13
δT _{wo} (°C)	0.19	0.28	8.53E-2	0.36
ΔT (°C)	17.96	10.70	0.53	9.80
δΔT/ΔT (%)	1.06	2.62	16.20	3.67
Q _f (W)	8.99	5.02	5.69	2.91
δQ _f	0.12	0.03	0.15	2.48E-2
Q _h -2Q _f (W)	943.60	37.02	54.06	871.3
q (W/m ²)	93,081	3664	6109	102,542
δq/q (%)	1.46	7.67	5.63	1.14
h (W/m ² •K)	5182	342.4	11,200	10,463
δh/h (%)	1.80	8.10	17.15	3.84

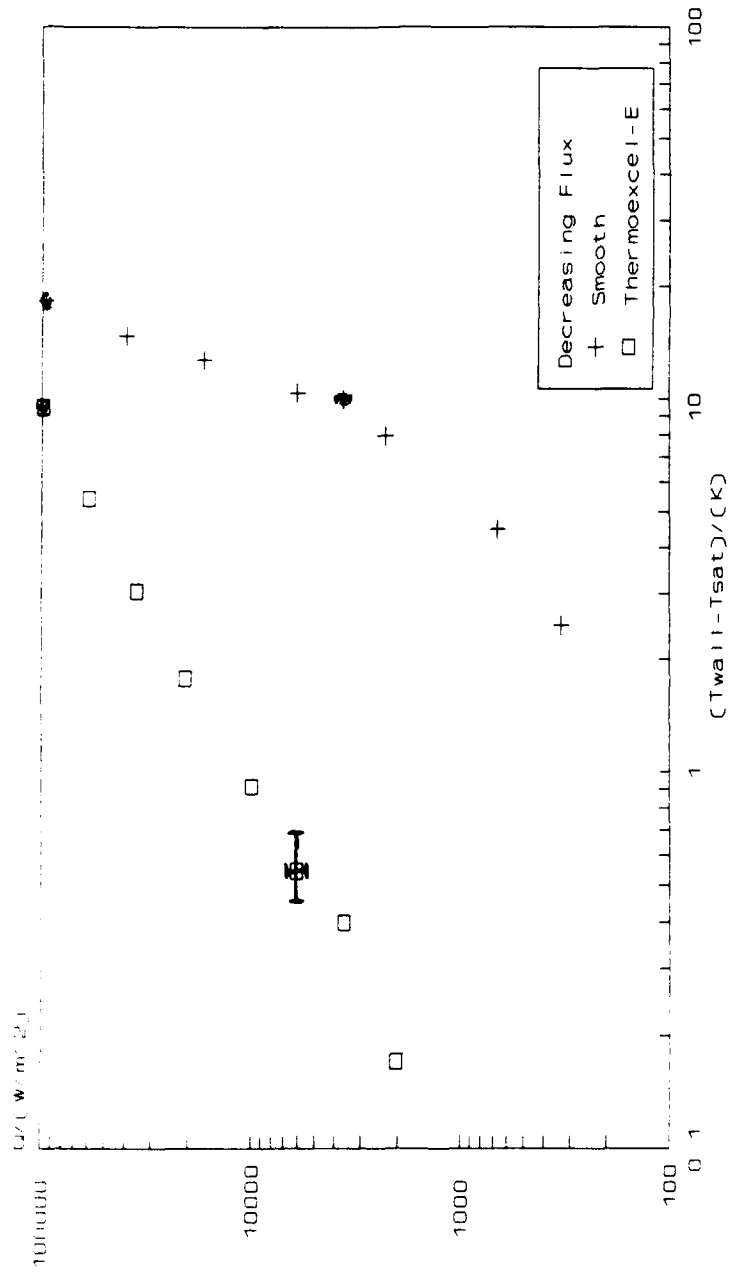

Figure E 1. Uncertainty Analysis Error Bands for Heat Flux and Superheat

APPENDIX F: SETUP PROGRAM

The following is a listing of the complete setup program used in the preparation of the apparatus for testing. It consists of five sections:

1. Monitor the Sump temperature
2. Monitor the evaporator liquid temperature
3. Measurement and readout of all thermocouple channels.
4. Measurement and readout of the power supplied to the tube cartridge heater.
5. Measurement and readout of the power supplied to the auxilliary heaters if used.

The program was written in Hewlett-Packard Basic 5.0 for both the Hewlett-Packard 9300 series computer and 9852A series data acquisition/control unit.

```

1 | PROGRAM: SETUP PROGRAM FOR HP 3852A
2 | DATE: AUGUST 13,1991
3 | PROGRAMMER: LT DEAN SUGIYAMA
13 REAL T(0:12),Sum(0:12),Temp(0:12),E(1:3)
23 ON KEY 0,15 GOTO 27
25 PRINTER IS 1
27 PRINT
28 PRINT
30 PRINT USING "4X, ""SELECT OPTION""
31 PRINT USING "6X, ""0-MONITOR SUMP""
32 PRINT USING "6X, ""1-MONITOR LIQUID""
33 PRINT USING "6X, ""2-CHECK THERMOCOUPLES""
34 PRINT USING "6X, ""3-CHECK MAIN HEATER""
35 PRINT USING "6X, ""4-CHECK AUX HEATERS""
36 PRINT USING "6X, ""5-EXIT PROGRAM""
37 PRINT USING "4X, ""NOTE: KEY 0 = ESCAPE""
38 BEEP
40 INPUT Ido
41 IF Ido>5 THEN Ido=5
42 IF Ido=0 THEN 50
43 IF Ido=1 THEN 155
44 IF Ido=2 THEN 185
45 IF Ido=3 THEN 208
46 IF Ido=4 THEN 208
47 IF Ido=5 THEN 252
48 PRINT
49 |
50 PRINT
51 PRINT "SUMP TEMPERATURE DEG C "
53 PRINT
54 OUTPUT 709,"RST"
55 Tot=0
56 FOR J=1 TO 5
60 OUTPUT 709,"CONFMEAS TEMPT,511,USE 600"
80 ENTER 709,A
100 Tot=Tot+A
110 NEXT J
120 Tavg=Tot/5
140 PRINT USING "4X,MOD.DD",Tavg
141 BEEP
142 PRINT
150 WAIT 60
151 GOTO 50
152 |
155 PRINT
156 PRINT "LIQUID TEMPERATURE DEG C"
158 PRINT
159 OUTPUT 709,"RST"
160 FOR I=1 TO 2
162 Sum(I)=0
163 T(I)=0
165 NEXT I
166 FOR J=1 TO 5
167 OUTPUT 709,"CONFMEAS TEMPT,500-509,USE 600"
168 FOR I=1 TO 2
169 ENTER 709,T(I)
170 Sum(I)=Sum(I)+T(I)
171 NEXT I
172 NEXT J
173 FOR I=1 TO 2

```

```

174 Temp(I)=Sum(I)/5
175 NEXT I
176 Tavg=(Temp(1)+Temp(2))/2
180 PRINT USING "4X,MOD.00";Tavg
181 BEEP
182 WAIT 60
183 GOTO 155
184
185 PRINT
186 PRINT "CHANNEL      TEMPERATURE DEG C"
187 OUTPUT 709;"RST"
188 FOR I=1 TO 12
189   Sum(I)=0
190   T(I)=0
191 NEXT I
192 FOR J=1 TO 5
193   OUTPUT 709;"CONFMEAS TEMPT,500-511,USE 600"
194   FOR I=1 TO 12
195     ENTER 709;T(I)
196     Sum(I)=Sum(I)+T(I)
197   NEXT I
198 NEXT J
199 FOR I=1 TO 12
200   Temp(I)=Sum(I)/5
201   PRINT TAB(3);I;TAB(15);Temp(I)
202 NEXT I
203 BEEP
204 WAIT 5
205 GOTO 185
206
207 PRINT
208 OUTPUT 709;"RST"
209 FOR I=1 TO 3
210   Sum(I)=0
211 NEXT I
212 FOR J=1 TO 5
213   OUTPUT 709;"CONFMEAS DCV,512-514,USE 600"
214   FOR I=1 TO 3
215     ENTER 709;E(I)
216     Sum(I)=Sum(I)+E(I)
217   NEXT I
218 NEXT J
219 Amp=0
220 FOR I=1 TO 3
221   IF I=1 THEN Volt=Sum(I)/5
222   IF I=2 AND Ide=3 THEN
223     PRINT "MAKE SURE VOLTAGE BOX IS SET TO MAIN HEATERS"
224     Amp=Sum(I)/5
225   END IF
226   IF I=3 AND Ide=4 THEN
227     PRINT "MAKE SURE VOLTAGE BOX IS SET TO AUX HEATERS"
228     Amp=Sum(I)/5
229   END IF
230 NEXT I
231 Amp=ABS(Amp*1.9182)
232 Volt=ABS(Volt*25)
233 Power=Volt*Amp
234 Resistance=Volt/Amp
235 IF Amp=0 THEN Resistance=0
236 PRINT

```



```
246 BEEP
247 PRINT " VOLTAGE(V) CURRENT(A) RESISTANCE(ohms) POWER(W)"
248 PRINT
249 PRINT USING "1X,5(1000000.000,3X)";Volt,Amp,Resistance,Power
250 WAIT 5
251 GOTO 209
252 BEEP
253 PRINT
254 PRINT
255 END
```

APPENDIX G: DATA REDUCTION PROGRAM

The following is a listing of the complete data-reduction program, DRP8, written in Hewlett-Packard Basic 5.0 for both the Hewlett-Packard 9300 series computer and 9852A series data acquisition/control unit.

```

1000 FILE NAME: DRP8
1004 DATE: October 19, 1984
1008 REVISED: August 14, 1991 by LT Dean Sugiyana
1012
1016 COM /Idp/ Idp
1020 PRINTER IS 1
1024 CALL Select
1028 INPUT "WANT TO SELECT ANOTHER OPTION (1=Y,0=N)?" ,Isel
1032 IF Isel=1 THEN GOTO 1024
1036 BEEP
1040 BEEP
1044 PRINTER IS 1
1048 PRINT "DATA COLLECTION/REPROCESSING COMPLETED"
1052 END
1056 SUB Main
1060 COM /Idp/ Idp
1064 COM /Cc/ C(7),Ical
1068 COM /W1/ D2,Di,Do,L,Lu,Kcu
1072 DIM Ew(12),T(12),Dia(13),D2a(13),Dia(13),Doa(13),La(13),Lua(13),Kcu(13),
E1(20),E2(20),Tn(4)(15),Sum(20),Tt(12),Ta(12),Vt(2),Va(2),Eliq(12),E(12)
1076 DATA 0.1000001,25727.94369,-767345.8295,70025595.81
1080 DATA -9247406509,6.97600E+11,-2.65192E+13,3.94078E+14
1084 READ C(*)
1088 DATA "Smooth","High Flux","Thermoexel-E","Thermoexel-HE"
1092 DATA Smooth,High Flux,Turbo-B,High Flux Mod,Turbo-B Mod
1096 READ Tn(*)
1100 PRINTER IS 701
1104 BEEP
1108 IF Idp=4 THEN PRINTER IS 1
1112 IF Idp=4 THEN GOTO 2032
1116 OUTPUT 709;"RST"
1120 OUTPUT 709;"SET TIMEDATE",TIMEDATE
1124 OUTPUT 709;"TIMEDATE"
1128 ENTER 709;Dt
1132 PRINT
1136 PRINT " Month, date and time :";DATE@Dt),TIME@Dt)
1140 PRINT
1144 PRINT USING "10X,""NOTE: Program name : DRP8""
1148 BEEP
1152 INPUT "ENTER DISK NUMBER",Dn
1156 PRINT USING "16X,""Disk number = "" ,22",Dn
1160 BEEP
1164 INPUT "ENTER INPUT MODE (0=3052A,1=FILE)",In
1168 BEEP
1172 INPUT "SELECT HEATING MODE (0=ELEC,1=WATER)",Ihm
1176 BEEP
1180 INPUT "ENTER THERMOCOUPLE TYPE (0=NEW,1=OLD)",Ical
1184 IF In=0 THEN
1188 BEEP
1192 INPUT "GIVE A NAME FOR THE RAW DATA FILE",D2_file0
1196 PRINT USING "16X,""New file name: "" ,14A",D2_file0
1200 Size1=20
1204 CREATE BDATA D2_file0,Size1
1208 ASSIGN @file2 TO D2_file0
1212
1216 DUMMY FILE UNTIL Mrun KNOWN
1220 D1_file0="DUMMY"
1224 CREATE BDATA D1_file0,Size1
1228 ASSIGN @file1 TO D1_file0

```

```

1232 OUTPUT @file1;Dt
1236 IF Ihw=0 THEN
1240 BEEP
1244 INPUT "ENTER NUMBER OF DEFECTIVE TCS (0=DEFAULT)",Idtc
1248 IF Idtc=0 THEN
1252 Ldtc1=0
1256 Ldtc2=0
1260 PRINT USING "16X,""No defective TCs exist""
1264 END IF
1268 IF Idtc=1 THEN
1272 BEEP
1276 INPUT "ENTER DEFECTIVE TC LOCATION",Ldtc1
1280 PRINT USING "16X,""TC is defective at location """,DD";Ldtc1
1284 Ldtc2=0
1288 END IF
1292 IF Idtc=2 THEN
1296 BEEP
1300 INPUT "ENTER DEFECTIVE TC LOCATIONS",Ldtc1,Ldtc2
1304 PRINT USING "16X,""TC are defective at locations """,DD,4X,DD";Ldtc1,Ldtc2
1308 END IF
1312 IF Idtc>2 THEN
1316 BEEP
1320 PRINTER IS 1
1324 BEEP
1328 PRINT "INVALID ENTRY"
1332 PRINTER IS 701
1336 GOTO 1240
1340 END IF
1344 END IF
1348 OUTPUT @file1;Ldtc1,Ldtc2
1352 Iw=1 option
1356 ELSE
1360 BEEP
1364 INPUT "GIVE THE NAME OF THE EXISTING DATA FILE",OZ_file0
1368 PRINT USING "16X,""Old file name: """,14A";OZ_file0
1372 ASSIGN @file2 TO OZ_file0
1376 ENTER @file2;Nrun
1380 ENTER @file2;Dt
1384 PRINT USING "16X,""This data set taken on : """,11A";DATE0(Dt)
1388 ENTER @file2;Ldtc1,Ldtc2
1392 IF Ldtc1>0 OR Ldtc2>0 THEN
1396 PRINT USING "16X,""Thermocouples were defective at locations: """,2(3D,4X);
Ldtc1,Ldtc2
1400 END IF
1404 ENTER @file2;Itt
1408 END IF
1409 Idtc=0
1411 IF Ldtc1>0 THEN Idtc=Idtc+1
1412 IF Ldtc2>0 THEN Idtc=Idtc+1
1413 IF Iw=0 AND Ihw=1 THEN 1505
1416 BEEP
1420 INPUT "WANT TO CREATE A PLOT FILE? (0=N,1=Y)",Iplot
1424 IF Iplot=1 THEN
1428 BEEP
1432 INPUT "GIVE NAME FOR PLOT FILE",P_file0
1436 CREATE BDAT P_file0,4
1440 ASSIGN @plot TO P_file0
1444 END IF
1448 IF Ihw=1 THEN
1452 BEEP

```

```

1456 INPUT "WANT TO CREATE Uo FILE? (0=N,1=Y)",Iuf
1460 IF Iuf=1 THEN
1464 BEEP
1468 INPUT "ENTER Uo FILE NAME",Ufile0
1472 CREATE BOAT Ufile0,4
1476 ASSIGN @Ufile TO Ufile0
1480 END IF
1484 BEEP
1488 INPUT "WANT TO CREATE Re FILE? (0=N,1=Y)",Ire
1492 IF Ire=1 THEN
1496 BEEP
1500 INPUT "ENTER Re FILE NAME",Refile0
1504 CREATE BOAT Refiles,10
1508 ASSIGN @Refile TO Refiles
1512 END IF
1516 END IF
1520 PRINTER IS 1
1524 IF In=0 THEN
1528 BEEP
1532 PRINT USING "4X,""Select tube number""
1536 IF In=0 THEN
1540 PRINT USING "6X,""0 Smooth 4 inch Ref""
1544 PRINT USING "6X,""1 Smooth 4 inch Cu (Press/Slide)""
1548 PRINT USING "6X,""2 Soft Solder 4 inch Cu""
1552 PRINT USING "6X,""3 Soft Solder 4 inch HIGH FLUX""
1556 PRINT USING "6X,""4 Wieland Hard 8 inch""
1560 PRINT USING "6X,""5 HIGH FLUX 8 inch""
1564 PRINT USING "6X,""6 GEWA-K 40 Fins/in""
1568 PRINT USING "6X,""7 GEWA-K 26 Fins/in""
1572 PRINT USING "6X,""8 GEWA-T 19 Fins/in""
1576 PRINT USING "6X,""9 GEWA-T OR GEWA-TY 26 Fins/in""
1580 PRINT USING "6X,""10 THERMOEXCEL-E""
1584 PRINT USING "6X,""11 THERMOEXCEL-HE""
1588 PRINT USING "6X,""12 TURBO-B""
1592 PRINT USING "6X,""13 GEWA-K 19 Fins/in""
1596 ELSE
1592 PRINT USING "6X,""0 Smooth tube""
1596 PRINT USING "6X,""1 High Flux""
1600 PRINT USING "6X,""2 Turbo-B""
1604 PRINT USING "6X,""3 High Flux Mod""
1608 PRINT USING "6X,""4 Turbo-B Mod""
1612 END IF
1616 INPUT Itt
1620 OUTPUT @File1;Itt
1624 END IF
1628 PRINTER IS 701
1632 IF Itt<10 THEN PRINT USING "16X,""Tube Number:  ",D",Itt
1636 IF Itt>9 THEN PRINT USING "16X,""Tube Number:  ",DD",Itt
1640 IF In=1 THEN PRINT USING "16X,""Tube Type:  ",1SA",Tn0(Itt)
1644 BEEP
1648 INPUT "ENTER OUTPUT VERSION (0=LONG,1=SHORT,2=NONE)",Iov
1652 BEEP
1656 INPUT "SELECT (0=LIQ,1=VAP,2=(LIQ+VAP)/2)",Ilov
1660
1664 DIMENSIONS FO TESTED TUBES
1668 ELECTRIC HEATED MODE
1672 D1=Diameter at thermocouple positions
1676 DATA .0111125,.0111125,.0111125,.0129540,.012446,.0129540,.0100965
1680 DATA .0100965,.01157,.01157,.01157,.01157,.01157,.0100965
1684 READ D1a(*)

```

```

1688 Di=Dia(I+1)
1692!
1696! D2=Diameter of test section to the base of fins
1700 DATA .015875,.015875,.015875,.015875,.015875,.015875,.01270
1704 DATA .0127,.0138,.0138,.0138,.0138,.0138,.0127
1708 READ D2a(*)
1712!
1716! Di=Inside diameter of unenhanced ends
1720 DATA .0127,.0127,.0127,.0132,.0127,.0132,.011125,.011125
1724 DATA .0118,.0118,.0118,.0118,.0118,.0118,.011125
1728 READ Di(*)
1732!
1736! Do=Outside diameter of unenhanced ends
1740 DATA .015875,.015875,.015875,.015875,.015875,.015875,.01270,.01270
1744 DATA .01331,.01331,.01331,.01331,.0158,.0127
1748 READ Do(*)
1752!
1756! L=Length of enhanced surface
1760 DATA .1016,.1016,.1016,.1016,.2032,.2032,.2032,.2032,.2032,.2032,.2032,.2032,.2032,.2032
1764 READ L(*)
1768!
1772! Lu=Length of unenhanced surface at the ends
1776 DATA .0254,.0254,.0254,.0254,.0762,.0762,.0762,.0762,.0762,.0762,.0762,.0762,.0762,.0762
1780 READ Lu(*)
1784!
1788! Kcu=Thermal Conductivity of tube
1792 DATA 398,344,344,45,344,45,344,344,398,398,398,398,398,344
1796 READ Kcu(*)
1800! IF Ihw=1 THEN
1804! Data statements for water heating mode
1808!
1812! DATA 0,.015875,0,.015875,0,.0169,0,.0138,0,.0169,0,0,0,0,0
1816! READ D2a(*)
1820! DATA 0,.0127,0,.0127,0,.0145,0,.0127,0,.0145,0,0,0,0,0
1824! READ Di(*)
1828! DATA 0,.015875,0,.015875,0,.0169,0,.015875,0,.0169,0,0,0,0,0
1832! READ Do(*)
1836! DATA 0.3048,0.3048,0.3048,0.3048,0.3048,0,0,0,0,0
1840! READ L(*)
1844! DATA 0.0254,0.0254,0.0254,0.0254,0.0254,0,0,0,0,0
1848! READ Lu(*)
1852! DATA 398,45,398,45,398,0,0,0,0,0
1856! READ Kcu(*)
1860! END IF
1864! D2=D2a(I+1)
1868! Di=Di(I+1)
1872! Do=Doa(I+1)
1876! L=L(I+1)
1880! Lu=Lu(I+1)
1884! Kcu=Kcu(I+1)
1888! Xn=.8
1892! Fr=.3
1896! IF I+1=0 THEN Cf=1.70E+9
1900! IF I+1>0 THEN Cf=3.7037E+10
1904! A=PI*(Do^2-Di^2)/4
1908! P=PI*Do
1912! IF Ihw=1 THEN

```

```

1912 BEEP
1916 INPUT "TUBE INITIATION MODE. (1=HOT WATER,2=STEAM,3=COLD WATER)",Itm
1920 IF Itm=1 THEN PRINT USING "16X,""Tube Initiate: Hot Water""
1924 IF Itm=2 THEN PRINT USING "16X,""Tube Initiate: Steam""
1928 IF Itm=3 THEN PRINT USING "16X,""Tube Initiate: Cold Water""
1932 INPUT "TEMP/VEL MODE: (0=T-CONST,V-DEC;1=T-DEC,V-CONST; 2=T-INC,V-CONST)",
Itv
1936 IF Itv=0 THEN PRINT USING "16X,""Temp/Vel Mode: Constant/Decreasing""
1940 IF Itv=1 THEN PRINT USING "16X,""Temp/Vel Mode: Decreasing/Constant""
1944 IF Itv=2 THEN PRINT USING "16X,""Temp/Vel Mode: Increasing/Constant""
1948 INPUT "WANT TO RUN WILSON PLOT? (1=Y,0=N)",Iw1
1952 IF Ihw=1 AND Iw1=0 THEN
1956 IF Itt=0 THEN Ci=.032
1960 IF Itt=1 OR Itt=3 THEN Ci=.059
1964 IF Itt=2 OR Itt=4 THEN Ci=.062
1968 BEEP
1972 INPUT "ENTER CI (DEF: WH=.032,HF=.059,TB=.062)",Ci
1976 PRINT USING "16X,""Sieder-Tate ""
1980 PRINT USING "16X,"" Constant = "" ,Z.40",Ci
1984 END IF
1988 END IF
1992 IF Ihw=1 AND Im=1 AND Iw1=1 THEN
1996 IF Itt=0 THEN Ci=.032
2000 IF Itt=1 OR Itt=3 THEN Ci=.059
2004 IF Itt=2 OR Itt=4 THEN Ci=.062
2008 ASSIGN @File2 TO *
2012 CALL Wilson(Cf,Ci)
2016 ASSIGN @File2 TO D2_file@
2020 ENTER @File2;Nrun,Dold@,Ldrc1,Ldrc2,Itt
2024 END IF
2028 Nsub=0
2032 IF Idp=4 THEN Ihw=1
2036 IF Ihw=1 THEN Nsub=0
2040 Ntc=6
2044 IF Ihw=0 THEN Ntc=12
2044 J=1
2048 Sx=0
2052 Sy=0
2056 Sxs=0
2060 Sxy=0
2064 Repeat: |
2068 IF Im=0 THEN
2072 Dtd=2.22
2076 Ido=2
2080 ON KEY @,15 RECOVER 2064
2084 PRINTER IS |
2088 PRINT USING "4X,""SELECT OPTION""
2092 PRINT USING "6X,""0-TAKE DATA""
2096 IF Ihw=0 THEN PRINT USING "6X,""1-SET HEAT FLUX""
2100 IF Ihw=1 THEN PRINT USING "6X,""1-SET WATER FLOW RATE""
2104 PRINT USING "6X,""2-SET Test""
2108 PRINT USING "4X,""NOTE: KEY @ = ESCAPE""
2112 BEEP
2116 INPUT Ido
2120 IF Ido>2 THEN Ido=2
2124 IF Ido=0 THEN 2724
2128|
2132| LOOP TO SET HEAT FLUX OR FLOWMETER SETTING
2136 IF Ido=1 THEN
2140 IF Ihw=0 THEN

```

```

2148 BEEP
2152 INPUT "ENTER DESIRED Qdp",Dqdp
2156 PRINT USING "4X,""DESIRED Qdp ACTUAL Qdp""
2160 Err=1000
2164 FOR I=1 TO 2
2165 Sum(I)=0
2166 Vt(I)=0
2168 NEXT I
2169 OUTPUT 709;"RST"
2176 FOR J1=1 TO 5
2180 OUTPUT 709;"CONFMEAS DCV,512-513,USE 600"
2181 FOR I=1 TO 2
2182 ENTER 709;Vt(I)
2184 Sum(I)=Sum(I)+Vt(I)
2185 NEXT I
2188 NEXT J1
2189 FOR I=1 TO 2
2192 IF I=1 THEN Volt=Sum(I)/5
2196 IF I=2 THEN Amp=Sum(I)/5
2200 NEXT I
2201 Amp=ABS(Amp*1.9182)
2202 Volt=ABS(Volt*25)
2204 Aqdp=Volt*Amp/(PI*D2*L)
2208 IF ABS(Aqdp-Dqdp)>Err THEN
2212 IF Aqdp>Dqdp THEN
2216 BEEP 4000,.2
2220 BEEP 4000,.2
2224 BEEP 4000,.2
2228 ELSE
2232 BEEP 250,.2
2236 BEEP 250,.2
2240 BEEP 250,.2
2244 END IF
2248 PRINT USING "4X,MZ.3DE,2X,MZ.3DE";Dqdp,Aqdp
2252 WAIT 2
2256 GOTO 2164
2260 ELSE
2264 BEEP
2268 PRINT USING "4X,MZ.3DE,2X,MZ.3DE";Dqdp,Aqdp
2272 Err=500
2276 WAIT 2
2280 GOTO 2164
2284 END IF
2288 ELSE
2292 BEEP
2296 INPUT "ENTER FLOWMETER SETTING",Fms
2300 GOTO 2000
2304 END IF
2308 END IF
2312!
2316! LOOP TO SET Test
2320 IF Ido=2 THEN
2324 IF Ikdt=1 THEN 2344
2328 BEEP
2332 INPUT "ENTER DESIRED Test",DtId
2336! PRINT USING "4X,"" DTest ATest Rate Tv Rate""
2340 Ikdt=1
2344 Old1=0
2348 Old2=0
2352 Nr=1

```



```

2356 Nrs=Nn MOD 15
2360 Nn=Nn+1
2364 IF Nrs=1 THEN
2365 IF Ihm=0 THEN PRINT USING "4X," Tset Tld1 Tld2 Tv Tsum
p""
2368 IF Ihm=1 THEN PRINT USING "4X," Tset Tld1 Tld2 Tv Tsump Tinle
t Tpile Tout""
2372 END IF
2373 FOR I=1 TO 6
2374 Sum(I)=0
2375 NEXT I
2376 OUTPUT 709,"RST"
2377 FOR Ji=1 TO 20
2379 IF Ihm=0 THEN OUTPUT 709,"CONFMEAS TEMPT,508-511,USE 600"
2380 IF Ihm=1 THEN OUTPUT 709,"CONFMEAS TEMPT,300-305,USE 600"
2384 FOR I=1 TO 6
2388 IF Ihm=0 AND I>4 THEN 2401
2392 ENTER 709,Eliq(I)
2396 Sum(I)=Sum(I)+Eliq(I)
2400 NEXT I
2401 NEXT Ji
2402 FOR I=1 TO 6
2403 IF Ihm=0 AND I>4 THEN 2496
2416 Eliq(I)=Sum(I)/20
2424 IF I=1 THEN Tld1=Eliq(I)
2428 IF I=2 THEN Tld2=Eliq(I)
2432 IF I=3 THEN Tv=Eliq(I)
2436 IF I=4 THEN Tsump=Eliq(I)
2440 IF I=5 THEN Tinlet=Eliq(I)
2444 IF I=6 THEN Tout=Eliq(I)
2448 NEXT I
2452 IF Ihm=1 THEN
2456 Sum1=0
2460 OUTPUT 709,"RST"
2468 FOR Kk=1 TO 20
2469 OUTPUT 709,"CONFMEAS TEMPT,320,USE 600"
2472 ENTER 709,E1
2476 Sum1=Sum1+E1
2480 NEXT Kk
2484 Enf(7)=ABS(Sum1/20)
2488 Tpile=Enf(7)/3.96E-4
2492 END IF
2496 Atld=(Tld1+Tld2)*.5
2500 IF ABS(Atld-Dtld)>.2 THEN
2504 IF Atld>Dtld THEN
2508 BEEP 4000,.2
2512 BEEP 4000,.2
2516 BEEP 4000,.2
2520 ELSE
2524 BEEP 250,.2
2528 BEEP 250,.2
2532 BEEP 250,.2
2536 END IF
2540 Err1=Atld-Old1
2544 Old1=Atld
2548 Err2=Tv-Old2
2552 Old2=Tv
2553 IF Tld1>100. THEN 2572
2556 IF Ihm=0 THEN PRINT USING "4X,5(MODD.00,2X)",Dtld,Tld1,Tld2,Tv,Tsump
2560 IF Ihm=1 AND Idp=0 THEN PRINT USING "4X,7(MODD.00,2X)",Dtld,Tld1,Tld2,Tv,Ts

```

```

ump,Tinlet,Tpile
2564 IF Ihw=1 AND Idp=4 THEN PRINT USING "4X,5(M00.00,2X),3(M30.00,2X)";Otld,Tl
d1,Tld2,Tv,Tsump,Tinlet,Tpile,Tout
2568 WAIT 2
2572 GOTO 2356
2576 ELSE
2580 IF ABS(Atld-Otld)>.1 THEN
2584 IF Atld>Otld THEN
2588 BEEP 3000,.2
2592 BEEP 3000,.2
2596 ELSE
2600 BEEP 800,.2
2604 BEEP 800,.2
2608 END IF
2612 Err1=Atld-Otld
2616 Old1=Atld
2620 Err2=Tv-Old2
2624 Old2=Tv
2628 IF Ihw=0 THEN PRINT USING "4X,5(M000.00,2X)";Otld,Tld1,Tld2,Tv,Tsump
2632 IF Ihw=1 THEN PRINT USING "4X,5(M00.00,2X),3(M30.00,1X)";Otld,Tld1,Tld2,Tv
,Tsump,Tinlet,Tpile,Tout
2636 WAIT 2
2640 GOTO 2356
2644 ELSE
2648 BEEP
2652 Err1=Atld-Old1
2656 Old1=Atld
2660 Err2=Tv-Old2
2664 Old2=Tv
2668 IF Ihw=0 THEN PRINT USING "4X,5(M000.00,2X)";Otld,Tld1,Tld2,Tv,Tsump
2672 IF Ihw=1 THEN PRINT USING "4X,8(M00.00,2X)";Otld,Tld1,Tld2,Tv,Tsump,Tinlet
,Tpile,Tout
2676 WAIT 2
2680 GOTO 2356
2684 END IF
2688 END IF
2692 END IF
2696 ERROR TRAP FOR Ido OUT OF BOUNDS
2700 IF Ido>2 THEN
2704 BEEP
2708 GOTO 2088
2712 END IF
2716
2720 TAKE DATA IF Iw=0 LOOP
2724 IF Ikol=1 THEN 2737
2728 BEEP
2732 INPUT "ENTER BULK OIL X",Bop
2736 Ikol=1
2737 FOR I=1 TO Ntc
2738 E(I)=0
2739 Sum(I)=0
2740 NEXT I
2741 OUTPUT 709;"RST"
2742 FOR J1=1 TO 20
2744 IF Ihw=0 THEN OUTPUT 709;"CONFMEAS TEMPT,500-511,USE 800"
2745 IF Ihw=1 THEN OUTPUT 709;"CONFMEAS TEMPT,300-305,USE 600"
2748 IF Ihw=0 THEN Ntc=12
2752 FOR I=1 TO Ntc
2756 ENTER 709;E(I)
2760 Sum(I)=Sum(I)+E(I)

```

```

2776 IF I=(9-Nsub) THEN Et1(Ji-1)=E(I)
2777 IF I=(10-Nsub) THEN Et2(Ji-1)=E(I)
2778 NEXT I
2780 NEXT Ji
2784 Kd1=0
2785 FOR I=1 TO Ntc
2788 IF I=(9-Nsub) OR I=(10-Nsub) THEN
2792 Eave=Sum(I)/20
2797 Sum(I)=0
2798 END IF
2800 IF I=(9-Nsub) THEN
2801 FOR Jk=0 TO 19
2804 IF ABS(Et1(Jk)-Eave)<.1 THEN
2808 Sum(I)=Sum(I)+Et1(Jk)
2812 ELSE
2816 Kd1=Kd1+1
2817 END IF
2819 NEXT Jk
2820 END IF
2822 IF I=(10-Nsub) THEN
2823 FOR Jk=0 TO 19
2825 IF ABS(Et2(Jk)-Eave)<.1 THEN
2826 Sum(I)=Sum(I)+Et2(Jk)
2828 ELSE
2829 Kd1=Kd1+1
2830 END IF
2832 NEXT Jk
2833 END IF
2836 IF I=(9-Nsub) OR I=(10-Nsub) THEN PRINT USING "4X, ""Kd1 = "",00";Kd1
2837 IF Kd1>10 THEN
2838 BEEP
2840 BEEP
2844 PRINT USING "4X, ""Too much scattering in data - repeat data set""
2848 GOTO 2084
2852 END IF
2860 Erf(I)=Sum(I)/(20-Kd1)
2864 NEXT I
2868 IF Ihw=1 THEN
2872 Sum(I)=0
2876 OUTPUT 709;"CONFMEAS TEMPT,320,USE 600"
2884 FOR Kk=1 TO 20
2888 ENTER 709;E(Kk)
2892 Sum(I)=Sum(I)+E(Kk)
2896 NEXT Kk
2900 Erf(7)=ABS(Sum(I))/20
2904 END IF
2908 IF Ihw=0 THEN
2909 FOR I=1 TO 2
2910 Sum(I)=0
2911 NEXT I
2912 OUTPUT 709;"RST"
2913 FOR Ji=1 TO 5
2915 OUTPUT 709;"CONFMEAS DCV,512-513,USE 600"
2916 FOR I=1 TO 2
2920 ENTER 709;E(I)
2926 Sum(I)=Sum(I)+E(I)
2937 NEXT I
2940 NEXT Ji
2941 FOR I=1 TO 2
2944 IF I=1 THEN Vr=Sum(I)/5

```

```

2948 IF I=2 THEN Ir=Sum(I)*1.9182/5
2952 NEXT I
2956 END IF
2960 ELSE
2964 IF Ihw=0 THEN ENTER @File2;Bop,Told,Emf(*),Vr,Ir
2968 IF Ihw=1 THEN ENTER @File2;Bop,Told,Emf(*),Fms
2972 END IF
2976)
2980) CONVERT emf'S TO TEMP,VOLT,CURRENT
2984 Twa=0
2988 FOR I=1 TO Ntc
2992 IF Idtc>0 THEN
2996 IF I=Ld1 OR I=Ld2 THEN
3000 T(I)=0
3004 GOTO 3044
3008 END IF
3012 END IF
3016 IF Itt<4 AND Ihw=0 THEN
3020 IF I>4 AND I<9 THEN
3024 T(I)=0
3028 GOTO 3044
3032 END IF
3036 END IF
3040 T(I)=Emf(I)
3044 NEXT I
3048 IF Itt<4 THEN
3052 FOR I=1 TO 4
3056 IF I=Ld1 OR I=Ld2 THEN
3060 Twa=Twa
3064 ELSE
3068 Twa=Twa+T(I)
3072 END IF
3076 NEXT I
3080 Twa=Twa/(4-Idtc)
3084 ELSE
3088 IF Ihw=1 THEN 3128
3092 FOR I=1 TO 8
3096 IF I=Ld1 OR I=Ld2 THEN
3100 Twa=Twa
3104 ELSE
3108 Twa=Twa+T(I)
3112 END IF
3116 NEXT I
3120 Tw=Twa/(8-Idtc)
3124 END IF
3128 Tid=T(9-Nsub)
3132 Tid2=T(10-Nsub)
3136 Tide=(Tid+Tid2)*.5
3140 Tv=T(11-Nsub)
3158 Tsump=T(12-Nsub)
3160 IF Ihw=0 THEN 3176
3168 Tinlet=T(13-Nsub)
3172 Tout=T(14-Nsub)
3176 IF Ihw=0 THEN
3180 Amp=ABS(Ir)
3184 Volt=ABS(Vr)*25
3188 Q=Volt*Amp
3192 END IF
3196 IF Itt=0 AND Ihw=0 THEN
3200 Kcu=FMKcu(Tw)

```

```

3204 ELSE
3208 Kcu=Kcus(Itt)
3212 END IF
3216!
3220! FOURIER CONDUCTION EQUATION WITH CONTACT RESISTANCE NEGLECTED
3224 IF Ihm=0 THEN Tu=Tu-Q*LOG(D2/D1)/(2*PI*Kcu*L)
3228 IF Ilqv=0 THEN Tst=Tida
3232 IF Ilqv=1 THEN Tst=(Tida+Tv)*.5
3236 IF Ilqv=2 THEN Tst=Tv
3244 IF Ihm=1 THEN
3248 Tavg=Tinlet
3252 Grad=37.9853+.104388*Tavg
3256 Tdrop=ABS(Enf(7))*1.E+6/(10*Grad)
3260 Tavgc=Tinlet-Tdrop*.5
3264 IF ABS(Tavg-Tavgc)>.01 THEN
3268 Tavg=(Tavg+Tavgc)*.5
3272 GOTO 3252
3276 END IF
3280!
3284! COMPUTE WATER PROPERTIES
3288 IF Ihm=1 THEN
3292 Ku=FNKu(Tavg)
3296 Muu=FNMuu(Tavg)
3300 Cpu=FNCPu(Tavg)
3304 Pru=FNPru(Tavg)
3308 Rhuu=FNHhuu(Tavg)
3312 Tui=Tavg
3316!
3320! Compute MDOT
3324 Mdot=3.9657E-3+Fms*(3.61955E-3-Fms*(8.82006E-6-Fms*(1.23688E-7-Fms*4.31897
E-10)))
3328! Mdot=Mdot*(1.0365-Tinlet*(1.96644E-3-Tinlet*5.252E-6))/1.0037
3332 Kdt=0
3336 Q=Mdot*Cpu*Tdrop
3340 Lntd=Tdrop/LOG((Tinlet-Tst)/(Tinlet-Tdrop-Tst))
3344 Uo=Q/(PI*Do*L*Lntd)
3348 Ru=Do*LOG(Do/D1)/(2.*Kcu)
3352 Tu=Tst+Fr*Lntd
3356 Vu=Mdot/(Rhuu*PI*Di^2/4)
3360 Reu=Rhuu*Vu*Di/Muu
3364 Hi=Ci*Ku/Di*Reu*.8*Pru*(1/3.)*(Muu/FNMuu(Tui))^-.14
3368 Twc=Tavg-Q/(PI*Do*L*Hi)
3372 IF ABS(Tui-Twc)>.01 THEN
3376 Tui=(Tui+Twc)*.5
3380 GOTO 3364
3384 END IF
3388 Tui=(Tui+Twc)*.5
3392 Ho=1/(1/Uo-Do/(Di*Hi)-Ru)
3396 END IF
3397 END IF
3399 IF Ihm=1 THEN
3400 Thetab=Q/(Ho*PI*Do*L)
3404 Tu=Tst+Thetab
3406 ELSE
3408 Thetab=Tu-Tst
3411 END IF
3413 IF Thetab<0 THEN
3416 BEEP
3420 INPUT "TWALL<TSAT (0=CONTINUE, 1=END)",Iev
3424 IF Iev=0 THEN GOTO 2068

```

```

3428 IF Iev=1 THEN 3832
3432 END IF
3440!
3444! COMPUTE VARIOUS PROPERTIES
3452 Tfilm=(Tu+Tsat)*.5
3456 Rho=FNrho(Tfilm)
3460 Mu=FNmu(Tfilm)
3464 K=FNk(Tfilm)
3468 Cp=FNcp(Tfilm)
3472 Beta=FNbeta(Tfilm)
3476 Hfg=FNhfg(Tsat)
3480 Ni=Mu/Rho
3484 Alpha=K/(Rho*Cp)
3488 Pr=Ni/Alpha
3492 Peat=FNpeat(Tsat)
3496!
3500! COMPUTE NATURAL-CONVECTIVE HEAT-TRANSFER COEFFICIENT
3504! FOR UNENHANCED END(S)
3508 Hbar=190
3512 Fe=(Hbar*P/(Kcu*A))*.5*Lu
3516 Tanh=FNtanh(Fe)
3520 Theta=Thetab*Tanh/Fe
3524 Xa=(9.81*Beta*Thetab*Do^3*Tanh/(Fe*Ni*Alpha))*.168667
3528 Yy=(1+.559/Pr)^(9/16)^(8/27)
3532 Hbarc=K/Do*(.6+.387*Xa/Yy)^2
3536 IF ABS((Hbar-Hbarc)/Hbarc)>.001 THEN
3540 Hbar=(Hbar+Hbarc)*.5
3544 GOTO 3512
3548 END IF
3552!
3556! COMPUTE HEAT LOSS RATE THROUGH UNENHANCED END(S)
3560 Q1=(Hbar*P*Kcu*A)*.5*Thetab*Tanh
3564 Qc=Q-2*Q1
3568 As=PI*OZ*L
3572!
3576! COMPUTE ACTUAL HEAT FLUX AND BOILING COEFFICIENT
3580 Qdp=Qc/As
3584 Hhbc=Qdp/Thetab
3588 Csf=(Cp*Thetab/Hfg)/(Qdp/(Mu*Hfg)+(.014/(9.81*Rho)^.5)^(1/3)+Pr^1.7)
3592!
3596! RECORD TIME OF DATA TAKING
3600 IF Im=0 THEN
3604 OUTPUT 709,"TINEDATE"
3608 ENTER 709,Told
3612 END IF
3616!
3620! OUTPUT DATA TO PRINTER
3624 PRINTER IS 701
3628 IF Iov=0 THEN
3632 PRINT
3636 PRINT USING "10X,""Data Set Number = ",DOO,2X,""Bulk Oil z = ",DO.D,5X,1
4A",J,Bop,TIME0(Told)
3640 IF Ihw=0 THEN
3644 PRINT USING "10X,""TC No: 1 2 3 4 5 6 7
8""
3648 PRINT USING "10X,""Temp :",8(1X,MOD.OO)"",T(1),T(2),T(3),T(4),T(5),T(6),T(
7),T(8)
3652 PRINT USING "10X,"" Tu Tliqd Tliqd2 Tvepr Peat Tsump""
3656 PRINT USING "10X,2(MOD.OO,1X),1X,MOD.OO,1X,2(1X,MOD.OO),2X,MOD.O",Tu,Tld,T
ld2,Tv,Peat,Tsump

```

```

3660 PRINT USING "10X, "" Thetab Htube Qdp""
3664 PRINT USING "10X,MOD.3D,1X,MZ.3DE,1X,MZ.3DE";Thetab,Htube,Qdp
3668 ELSE
3672 PRINT USING "10X, "" Fms Vu Tset Tini Tdrop Thetab q Uo
Ho""
3676 PRINT USING "10X,4(2D.0D,1X),2.3D,1X,0D.0D,1X,3(MZ.3DE,1X)";Fms,Vu,Tset,Ti
niet,Tdrop,Thetab,Qdp,Uo,Ho
3680 END IF
3684 END IF
3688 IF Iov=1 THEN
3692 IF J=1 THEN
3696 PRINT
3700 IF Ihw=0 THEN
3704 PRINT USING "10X, "" RUN No OilX Tset Htube Qdp Thetab""
3708 ELSE
3712 PRINT USING "10X, "" FMS OILX TSAT HTUBE QDP THETAB""
3716 END IF
3720 END IF
3724 IF Ihw=0 THEN
3728 PRINT USING "12X,3D,4X,0D,2X,MOD.0D,3(1X,MZ.3DE)";J,Bop,Tset,Htube,Qdp,The
tab
3732 ELSE
3736 PRINT USING "12X,3D,4X,0D,2X,MOD.0D,3(1X,MZ.3DE)";Fms,Bop,Tset,Htube,Qdp,T
hetab
3740 END IF
3744 END IF
3748 IF In=0 THEN
3752 BEEP
3756 INPUT "OK TO STORE THIS DATA SET (1=Y,0=N)?" ,Ok
3760 END IF
3764 IF Ok=1 OR In=1 THEN J=J+1
3768 IF Ok=1 AND In=0 THEN
3772 IF Ihw=0 THEN OUTPUT @File1:Bop,Told,Enf(*),Vr,Ir
3776 IF Ihw=1 THEN OUTPUT @File1:Bop,Told,Enf(*),Fms
3780 END IF
3784 IF Iuf=1 THEN OUTPUT @UFile:Vu,Uo
3788 IF Ire=1 THEN OUTPUT @RFile:Fms,Rev
3792 IF (In=1 OR Ok=1) AND Iplot=1 THEN OUTPUT @Plot:Qdp,Thetab
3796 IF In=0 THEN
3800 BEEP
3804 INPUT "WILL THERE BE ANOTHER RUN (1=Y,0=N)?" ,Go_on
3808 Nrun=J
3812 IF Go_on=0 THEN 3832
3816 IF Go_on<>0 THEN Repeat
3820 ELSE
3824 IF J<Nrun+1 THEN Repeat
3828 END IF
3832 IF In=0 THEN
3836 BEEP
3840 PRINT USING "10X, ""NOTE: "" ,ZZ, "" data runs were stored in file "" ,10A",J-
1,DZ_file@
3844 ASSIGN @File1 TO *
3848 OUTPUT @File2:Nrun-1
3852 ASSIGN @File1 TO D1_file@
3856 ENTER @File1:Dt,Ldta1,Ldta2,Itt
3860 OUTPUT @File2:Dt,Ldta1,Ldta2,Itt
3864 FOR I=1 TO Nrun-1
3868 IF Ihw=0 THEN
3872 ENTER @File1:Bop,Told,Enf(*),Vr,Ir
3876 OUTPPT @File2:Bop,Told,Enf(*),Vr,Ir

```

```

3880 ELSE
3884 ENTER @File1;Bop,Told,Emf(*),Fms
3888 OUTPUT @File2;Bop,Told,Emf(*),Fms
3892 END IF
3896 NEXT I
3900 ASSIGN @File1 TO *
3904 PURGE "DUMMY"
3908 END IF
3912 BEEP
3916 PRINT
3920 IF Iplot=1 THEN PRINT USING "10X,"NOTE: """,ZZ,"" X-Y pairs were stored in
plot data file "",10A";J-1,P_files
3924 ASSIGN @File2 TO *
3928 ASSIGN @Plot TO *
3932 IF Iuf=1 THEN ASSIGN @Ufile TO *
3936 IF Ire=1 THEN ASSIGN @Rfile TO *
3940 CALL Stats
3944 BEEP
3948 INPUT "LIKE TO PLOT DATA (I=Y,0=N)?",Ok
3952 IF Ok=1 THEN CALL Plot
3956 SUBEND
3960
3964 CURVE FITS OF PROPERTY FUNCTIONS
3968 DEF FNKcu(T)
3972 OFHC COPPER 250 TO 300 K
3976 Tk=T+273.15 IC TO K
3980 K=434-.112*Tk
3984 RETURN K
3988 FNEND
3992 DEF FNMu(T)
3996 170 TO 360 K CURVE FIT OF VISCOSITY
4000 Tk=T+273.15 IC TO K
4004 Mu=EXP(-4.4636+(1011.47/Tk))*1.0E-3
4008 RETURN Mu
4012 FNEND
4016 DEF FNCp(T)
4020 100 TO 400 K CURVE FIT OF Cp
4024 Tk=T+273.15 IC TO K
4028 Cp=.40188+1.65007E-3*Tk+1.51494E-6*Tk^2-6.67853E-10*Tk^3
4032 Cp=Cp+1000
4036 RETURN Cp
4040 FNEND
4044 DEF FNRho(T)
4048 Tk=T+273.15 IC TO K
4052 X=1-(1.0*Tk/753.95) IK TO R
4056 Ro=36.32+61.145414*X^(1/3)+16.410015*X+17.476838*X*.5+1.119828*X^2
4060 Ro=Ro/.062428
4064 RETURN Ro
4068 FNEND
4072 DEF FNPp(T)
4076 Pp=FNCp(T)*FNMu(T)/FNK(T)
4080 RETURN Pp
4084 FNEND
4088 DEF FNK(T)
4092 T<300 K WITH T IN C
4096 K=.071-.000261*T
4100 RETURN K
4104 FNEND
4108 DEF FNTanh(X)
4112 P=EXP(X)

```



```

4116 Q=1/P
4120 Tanh=(P-Q)/(P+Q)
4124 RETURN Tanh
4128 FNEND
4138!
4184 DEF FNBeta(T)
4188 Rop=FNRho(T+.1)
4192 Row=FNRho(T-.1)
4196 Beta=-2/(Rop+Row)*(Rop-Row)/.2
4200 RETURN Beta
4204 FNEND
4208 DEF FNMfg(T)
4212 Hfg=1.3741344E+5-T*(3.3094361E+2+T*1.2165143)
4216 RETURN Hfg
4220 FNEND
4224 DEF FNPast(Tc)
4228! @ TO 00 deg F CURVE FIT OF Past
4232 Tf=1.8*Tc+32
4236 Pa=5.945525+Tf*(.15352002+Tf*(1.4040963E-3+Tf*9.6150671E-6))
4240 Pg=Pa-14.7
4244 IF Pg>0 THEN I +=PSIG,--in Hg
4248 Past=Pg
4252 ELSE
4256 Past=Pg*29.92/14.7
4260 END IF
4264 RETURN Past
4268 FNEND
4272 DEF FNMsmooth(X,Bop,Iset)
4276 DIM A(5),B(5),C(5),D(5)
4280 DATA .20526,.25322,.319048,.55322,.79909,1.00258
4284 DATA .74515,.72992,.73189,.71225,.68472,.64197
4288 DATA .41092,.17726,.25142,.54006,.81916,1.00845
4292 DATA .71403,.72913,.72565,.696691,.665867,.61889
4296 READ A(*),B(*),C(*),D(*)
4300 IF Bop<6 THEN I=Bop
4304 IF Bop<6 THEN I=4
4308 IF Bop=10 THEN I=5
4312 IF Iset=1 THEN
4316 Hs=EXP(A(I)+B(I)*LOG(X))
4320 ELSE
4324 Hs=EXP(C(I)+D(I)*LOG(X))
4328 END IF
4332 RETURN Hs
4336 FNEND
4340 DEF FNPoly(X)
4344 COM /Cply/ A(10,10),C(10),B(5),Nop,Iprnt,Opo,Ilog,Ifn,Ijoin,Njoin
4348 X1=X
4352 Poly=B(0)
4356 FOR I=1 TO Nop
4360 IF Ilog=1 THEN X1=LOG(X)
4364 Poly=Poly+B(I)*X1^I
4368 NEXT I
4372 IF Ilog=1 THEN Poly=EXP(Poly)
4376 RETURN Poly
4380 FNEND
4384 SUB Poly
4388 DIM R(10),S(10),Sy(12),Sx(12),Xx(100),Yy(100)
4392 COM /Cply/ A(10,10),C(10),B(5),N,Iprnt,Opo,Ilog,Ifn,Ijoin,Njoin
4396 COM /Xxyy/ Xp(25),Yp(25)
4400 FOR I=0 TO 4

```

```

4404 B(I)=0
4408 NEXT I
4412 BEEP
4416 INPUT "SELECT (0=FILE,1=KEYBOARD,2=PROGRAM)",Im
4420 Im=Im+1
4424 BEEP
4428 INPUT "ENTER NUMBER OF X-Y PAIRS",Np
4432 IF Im=1 THEN
4436 BEEP
4440 INPUT "ENTER DATA FILE NAME",D_file$
4444 BEEP
4448 INPUT "LIKE TO EXCLUDE DATA PAIRS (1=Y,0=N)?",Ied
4452 IF Ied=1 THEN
4456 BEEP
4460 INPUT "ENTER NUMBER OF PAIRS TO BE EXCLUDED",IpeX
4464 END IF
4468 ASSIGN @file TO D_file$
4472 ELSE
4476 BEEP
4480 INPUT "WANT TO CREATE A DATA FILE (1=Y,0=N)?",Yes
4484 IF Yes=1 THEN
4488 BEEP
4492 INPUT "GIVE A NAME FOR DATA FILE",D_file$
4496 CREATE BOAT D_file$.5
4500 ASSIGN @file TO D_file$
4504 END IF
4508 END IF
4512 BEEP
4516 INPUT "ENTER THE ORDER OF POLYNOMIAL",N
4520 FOR I=0 TO N+2
4524 Sy(I)=0
4528 Sx(I)=0
4532 NEXT I
4536 IF Ied=1 AND Im=1 THEN
4540 FOR I=1 TO IpeX
4544 ENTER @file: X,Y
4548 NEXT I
4552 END IF
4556 FOR I=1 TO Np
4560 IF Im=1 THEN
4564 IF Opo=2 THEN ENTER @file: X,Y
4568 IF Opo<2 THEN ENTER @file: Y,X
4572 IF Opo=1 THEN Y=Y/X
4576 IF Ilog=1 THEN
4580 IF Opo=2 THEN Xt=X/Y
4584 X=LOG(X)
4588 IF Opo=2 THEN Y=LOG(Xt)
4592 IF Opo<2 THEN Y=LOG(Y)
4596 END IF
4600 END IF
4604 IF Im=2 THEN
4608 BEEP
4612 INPUT "ENTER NEXT X-Y PAIR",X,Y
4616 IF Yes=1 THEN OUTPUT @file: X,Y
4620 END IF
4624 IF Im<3 THEN
4628 Xx(I)=X
4632 Yy(I)=Y
4636 ELSE
4640 X=Xp(I-1)

```

```

4644 Y=Yp(I-1)
4648 END IF
4652 R(0)=Y
4656 Sy(0)=Sy(0)+Y
4660 S(1)=X
4664 Sx(1)=Sx(1)+X
4668 FOR J=1 TO N
4672 R(J)=R(J-1)*X
4676 Sy(J)=Sy(J)+R(J)
4680 NEXT J
4684 FOR J=2 TO N+2
4688 S(J)=S(J-1)*X
4692 Sx(J)=Sx(J)+S(J)
4696 NEXT J
4700 NEXT I
4704 IF Yes=1 AND Im=2 THEN
4708 BEEP
4712 PRINT USING "12X,00," X-Y pairs were stored in file "",10A";Np,D_files
4716 END IF
4720 Sx(0)=Np
4724 FOR I=0 TO N
4728 C(I)=Sy(I)
4732 FOR J=0 TO N
4736 A(I,J)=Sx(I+J)
4740 NEXT J
4744 NEXT I
4748 FOR I=0 TO N-1
4752 CALL Divide(I)
4756 CALL Subtract(I+1)
4760 NEXT I
4764 B(N)=C(N)/A(N,N)
4768 FOR I=0 TO N-1
4772 B(N-1-I)=C(N-1-I)
4776 FOR J=0 TO I
4780 B(N-1-I)=B(N-1-I)-A(N-1-I,N-J)*B(N-J)
4784 NEXT J
4788 B(N-1-I)=B(N-1-I)/A(N-1-I,N-1-I)
4792 NEXT I
4796 IPRINTER IS 701
4800 IPRINT B(*)
4804 IPRINTER IS 705
4808 IF Iprnt=0 THEN
4812 PRINT USING "12X," "EXPONENT    COEFFICIENT"
4816 FOR I=0 TO N
4820 PRINT USING "15X,00,5X,MD.70E";I,B(I)
4824 NEXT I
4828 PRINT " "
4832 PRINT USING "12X," "DATA POINT    X            Y            Y(CALCULATED) DISCR
EPANCY"
4836 FOR I=1 TO Np
4840 Yc=B(0)
4844 FOR J=1 TO N
4848 Yc=Yc+B(J)*Xx(I)^J
4852 NEXT J
4856 D=Yy(I)-Yc
4860 PRINT USING "15X,3D,4X,4(MD.5DE,1X)";I,Xx(I),Yy(I),Yc,D
4864 NEXT I
4868 END IF
4872 ASSIGN @file TO *
4876 SUBEND

```

```

4880 SUB Divide(M)
4884 COM /Cply/ A(10,10),C(10),B(5),N,Iprnt,Opo,Ilog,Ifn,Ijoin,Njoin
4888 FOR I=M TO N
4892 Ao=A(I,M)
4896 FOR J=M TO N
4900 A(I,J)=A(I,J)/Ao
4904 NEXT J
4908 C(I)=C(I)/Ao
4912 NEXT I
4916 SUBEND
4920 SUB Subtract(K)
4924 COM /Cply/ A(10,10),C(10),B(5),N,Iprnt,Opo,Ilog,Ifn,Ijoin,Njoin
4928 FOR I=K TO N
4932 FOR J=K-1 TO N
4936 A(I,J)=A(K-1,J)-A(I,J)
4940 NEXT J
4944 C(I)=C(K-1)-C(I)
4948 NEXT I
4952 SUBEND
4956 SUB Plin
4960 COM /Cply/ A(10,10),C(10),B(5),N,Iprnt,Opo,Ilog,Ifn,Ijoin,Njoin
4964 COM /Xyy/ Xx(25),Yy(25)
4968 PRINTER IS 705
4972 BEEP
4976 INPUT "WANT TO PLOT Uo vs Vu? (1=Y,0=N)",Iuo
4980 IF Iuo=0 THEN
4984 BEE?
4988 INPUT "SELECT (0=h/h0% same tube,1=h(HF)/h(sm)",Irt
4992 BEEP
4996 INPUT "SELECT h/h RATIO (1=FILE,0=COMPUTED)",Ihrat
5000 IF Ihrat=0 THEN
5004 BEEP
5008 INPUT "WHICH Test (1=6.7,0=-2.2)",Iast
5012 END IF
5016 Xmin=0
5020 Xmax=10
5024 Xstep=2
5028 IF Irt=0 THEN
5032 Ymin=0
5036 Ymax=1.4
5040 Ystep=.2
5044 ELSE
5048 Ymin=0
5052 Ymax=15
5056 Ystep=5
5060 END IF
5064 ELSE
5068 Opo=2
5072 Ymin=0
5076 Ymax=12
5080 Ystep=3
5084 Xmin=0
5088 Xmax=4
5092 Xstep=1
5096 END IF
5100 IF Ihrat=1 THEN
5104 Ymin=0
5108 Ymax=18
5112 Ystep=3
5116 Xmin=0

```

```

5120 Xmax=9
5124 Xstep=2
5128 END IF
5132 BEEP
5136 PRINT "IN;SP1;IP 2300,2200,8300,6000;"
5140 PRINT "SC 0,100,0,100;TL 2,0;"
5144 Sfx=100/(Xmax-Xmin)
5148 Sfy=100/(Ymax-Ymin)
5152 PRINT "PU 0,0 PD"
5156 FOR Xa=Xmin TO Xmax STEP Xstep
5160 X=(Xa-Xmin)*Sfx
5164 PRINT "PA";X,"",0;XT;"
5168 NEXT Xa
5172 PRINT "PA 100,0;PU;"
5176 PRINT "PU PA 0,0 PD"
5180 FOR Ya=Ymin TO Ymax STEP Ystep
5184 Y=(Ya-Ymin)*Sfy
5188 PRINT "PA 0,";Y,"YT"
5192 NEXT Ya
5196 PRINT "PA 0,100 TL 0 2"
5200 FOR Xa=Xmin TO Xmax STEP Xstep
5204 X=(Xa-Xmin)*Sfx
5208 PRINT "PA";X,"",100;XT;"
5212 NEXT Xa
5216 PRINT "PA 100,100 PU PA 100,0 PD"
5220 FOR Ya=Ymin TO Ymax STEP Ystep
5224 Y=(Ya-Ymin)*Sfy
5228 PRINT "PD PA 100,";Y,"YT"
5232 NEXT Ya
5236 PRINT "PA 100,100 PU"
5240 PRINT "PA 0,-2 SR 1.5,2"
5244 FOR Xa=Xmin TO Xmax STEP Xstep
5248 X=(Xa-Xmin)*Sfx
5252 PRINT "PA";X,"",0;"
5256 IF Iuo=0 THEN PRINT "CP -2,-1;LB";Xa;"
5260 IF Iuo=1 THEN PRINT "CP -1.5,-1;LB";Xa;"
5264 NEXT Xa
5268 PRINT "PU PA 0,0"
5272 FOR Ya=Ymin TO Ymax STEP Ystep
5276 IF ABS(Ya)<1.E-5 THEN Ya=0
5280 Y=(Ya-Ymin)*Sfy
5284 PRINT "PA 0,";Y,""
5288 IF Iuo=0 THEN PRINT "CP -4,-.25;LB";Ya;"
5292 IF Iuo=1 THEN PRINT "CP -3,-.25;LB";Ya;"
5296 NEXT Ya
5300 Xlabel="Oil Percent"
5304 IF Iuo=0 THEN
5308 IF Irt=0 THEN
5312 Ylabel="h/h0X"
5316 ELSE
5320 Ylabel="h/hsmooth"
5324 END IF
5328 PRINT "SR 1.5,2;PU PA 50,-10 CP";-LEN(Xlabel)/2;"0;LB";Xlabel;"
5332 PRINT "PA -11,50 CP 0,"; -LEN(Ylabel)/2*5/6;"DI 0,1;LB";Ylabel;"
5336 PRINT "CP 0,0"
5340 ELSE
5344 PRINT "SP0;SP2"
5348 PRINT "SR 1.2,2.4;PU PA -8,35;DI 0,1;LBU;PR 1,0.5;LBO;PR -1,0.5;LB (kW/m
"
5352 PRINT "PR -1,0.5;SR 1,1.5;LB2;SR 1.5,2;PR .5,.5;LB.1;PR .5,0;LBK)"

```

```

5356 PRINT "PA 42,-10;DI 1,0;LBV;PR .4,-1;LBW;PR 1,.5;LB(m/s)"
5360 PRINT "SP0;SP1"
5364 END IF
5368 Ipn=0
5372 BEEP
5376 INPUT "WANT TO PLOT DATA FROM A FILE (I=Y,0=N)?" ,Okp
5380 Icn=0
5384 IF Okp=1 THEN
5388 BEEP
5392 INPUT "ENTER THE NAME OF THE DATA FILE",D_file$
5396 IF Iuo=0 THEN
5400 BEEP
5404 INPUT "SELECT (0=LINEAR, 1=LOG(X,Y))",Ilog
5408 END IF
5412 ASSIGN @File TO D_file$
5416 BEEP
5420 INPUT "ENTER THE BEGINNING RUN NUMBER",Md
5424 BEEP
5428 INPUT "ENTER THE NUMBER OF X-Y PAIRS STORED",Npairs
5432 IF Iuo=0 AND Ihrat=0 THEN
5436 BEEP
5440 INPUT "ENTER DESIRED HEAT FLUX",Q
5444 END IF
5448 BEEP
5452 PRINTER IS 1
5456 PRINT USING "4X, ""Select a symbol: ""
5460 PRINT USING "4X, ""1 Star 2 Plus sign""
5464 PRINT USING "4X, ""3 Circle 4 Square""
5468 PRINT USING "4X, ""5 Rombus""
5472 PRINT USING "4X, ""6 Right-side-up triangle""
5476 PRINT USING "4X, ""7 Up-side-down triangle""
5480 INPUT Sym
5484 PRINTER IS 705
5488 PRINT "PU DI"
5492 IF Sym=1 THEN PRINT "SM*"
5496 IF Sym=2 THEN PRINT "SM+"
5500 IF Sym=3 THEN PRINT "SMo"
5504 Nn=4
5508 IF Ilog=1 THEN Nn=1
5512 IF Md>1 THEN
5516 FOR I=1 TO (Md-1)
5520 ENTER @File;Xa,Ya
5524 NEXT I
5528 END IF
5532 IF Ihrat=0 THEN
5536 Q1=Q
5540 IF Ilog=1 THEN Q=LOG(Q)
5544 END IF
5548 FOR I=1 TO Npairs
5552 IF Iuo=0 AND Ihrat=0 THEN
5556 ENTER @File;Xa,B(*)
5560 Ya=B(*)
5564 FOR K=1 TO Nn
5568 Ya=Ya+B(K)*Q^K
5572 NEXT K
5576 END IF
5580 IF Iuo=1 OR Ihrat=1 THEN
5584 ENTER @File;Xa,Ya
5588 IF Iuo=1 THEN Ya=Ya/1000
5592 END IF

```

```

5596 IF Iuo=0 AND Ihrat=0 THEN
5600 IF Ilog=1 THEN Ya=EXP(Ya)
5604 IF Ilog=0 THEN Ya=Q1/Ya
5608 IF Irt=0 THEN
5612 IF Xa=0 THEN
5616 Yo=Ya
5620 Ya=1
5624 ELSE
5628 Ya=Ya/Yo
5632 END IF
5636 ELSE
5640 Hm=FNHsmooth(Q,Xa,Isst)
5644 Ya=Ya/Hm
5648 END IF
5652 END IF
5656 Xx(I-1)=Xa
5660 Yy(I-1)=Ya
5664 X=(Xa-Xmin)*Sfx
5668 Y=(Ya-Ymin)*Sfy
5672 IF Sym>3 THEN PRINT "SM"
5676 IF Sym<4 THEN PRINT "SR 1.4,2.4"
5680 PRINT "PA",X,Y,""
5684 IF Sym>3 THEN PRINT "SR 1.2,1.6"
5688 IF Sym=4 THEN PRINT "UC2,4.99,0,-8,-4,0,0,8,4,0,1"
5692 IF Sym=5 THEN PRINT "UC3,0.99,-3,-6,-3,6,3,6,3,-6,"
5696 IF Sym=6 THEN PRINT "UC0,5.3,99,3,-8,-6,0,3,8,"
5700 IF Sym=7 THEN PRINT "UC0,-5.3,99,-3,8,6,0,-3,-8,"
5704 NEXT I
5708 BEEP
5712 ASSIGN #File TO *
5716 END IF
5720 PRINT "PU SM"
5724 BEEP
5728 INPUT "WANT TO PLOT A POLYNOMIAL (I=Y,0=N)?" ,Okp
5732 IF Okp=1 THEN
5736 BEEP
5740 PRINTER IS 1
5744 PRINT USING "4X,""Select line type:""
5748 PRINT USING "6X,""0 Solid line""
5752 PRINT USING "6X,""1 Dashed""
5756 PRINT USING "6X,""2,,,5 Longer line - dash""
5760 INPUT Ipn
5764 PRINTER IS 705
5768 BEEP
5772 INPUT "SELECT (0=LINEAR,1=LOG(X,Y))",Ilog
5776 Iprint=1
5780 CALL Poly
5784 IF Iuo=1 THEN
5788 BEEP
5792 INPUT "DESIRE TO SET X Lower and Upper Limit (I=Y,0=N)?" ,Ixlim
5796 IF Ixlim=0 THEN
5800 Xll=0
5804 Xul=7
5808 END IF
5812 IF Ixlim=1 THEN
5816 BEEP
5820 INPUT "ENTER X Lower Limit",Xll
5824 BEEP
5828 INPUT "ENTER X Upper Limit",Xul
5832 END IF

```

```

5836 END IF
5840 FOR Xa=X11 TO Xu1 STEP Xstep/25
5844 Icn=Icn+1
5848 Ya=FNPoly(Xa)
5852 IF Iuo=1 THEN Ya=Ya/1000
5856 Y=(Ya-Ymin)*Sfy
5860 X=(Xa-Xmin)*Sfx
5864 IF Y<0 THEN Y=0
5868 IF Y>100 THEN GOTO 5908
5872 Pu=0
5876 IF Ipn=1 THEN Idf=Icn MOD 2
5880 IF Ipn=2 THEN Idf=Icn MOD 4
5884 IF Ipn=3 THEN Idf=Icn MOD 8
5888 IF Ipn=4 THEN Idf=Icn MOD 16
5892 IF Ipn=5 THEN Idf=Icn MOD 32
5896 IF Idf=1 THEN Pu=1
5900 IF Pu=0 THEN PRINT "PA",X,Y,"PD"
5904 IF Pu=1 THEN PRINT "PA",X,Y,"PU"
5908 NEXT Xa
5912 PRINT "PU"
5916 GOTO 5372
5920 END IF
5924 BEEP
5928 INPUT "WANT TO QUIT (1=Y,0=N)?" ,Iquit
5932 IF Iquit=1 THEN 5940
5936 GOTO 5372
5940 PRINT "PU SP0"
5944 SUBEND
5948 SUB Stats
5952 PRINTER IS 701
5956 J=0
5960 K=0
5964 BEEP
5968 IF Iplot=1 THEN ASSIGN @file TO P_file0
5972 BEEP
5976 INPUT "LAST RUN No?(0=QUIT)" ,Nn
5980 IF Nn=0 THEN 6124
5984 Nn=Nn-J
5988 Sx=0
5992 Sy=0
5996 Sz=0
6000 Sxs=0
6004 Sys=0
6008 Szs=0
6012 FOR I=1 TO Nn
6016 J=J+1
6020 ENTER @file,Q,T
6024 H=Q/T
6028 Sx=Sx+Q
6032 Sxs=Sxs+Q^2
6036 Sy=Sy+T
6040 Sys=Sys+T^2
6044 Sz=Sz+H
6048 Szs=Szs+H^2
6052 NEXT I
6056 Qave=Sx/Nn
6060 Tave=Sy/Nn
6064 Have=Sz/Nn
6068 Sdevq=SQR(ABS((Nn*Sxs-Sx^2)/(Nn*(Nn-1))))
6072 Sdevt=SQR(ABS((Nn*Sys-Sy^2)/(Nn*(Nn-1))))

```



```

6076 Sdevh=SQR(ABS((Nn*Szs-Sz^2)/(Nn*(Nn-1))))
6080 Sh=100*Sdevh/Have
6084 Sq=100*Sdevq/Qave
6088 St=100*Sdevt/Tave
6092 IF K=1 THEN G116
6096 PRINT
6100 PRINT USING "11X, ""DATA FILE: "" ,14A":File#
6104 PRINT
6108 PRINT USING "11X, ""RUN Htube      SdevH  Qdp      SdevQ  Thetab SdevT""
"
6112 K=1
6116 PRINT USING "11X,DD,2(2X,D.3DE,1X,3D.2D),2X,DD.3D,1X,3D.2D":J,Have,Sh,Qave
,Sq,Tave,St
6120 GOTO 5972
6124 ASSIGN @File1 TO *
6128 PRINTER IS 1
6132 SUBEND
6136 SUB Coef
6140 COM /Cply/ A(10,10),C(10),B(5),N,Iprnt,Opo,Ilog,Ifn,Ijoin,Njoin
6144 BEEP
6148 INPUT "GIVE A NAME FOR CROSS-PLOT FILE",Cpf#
6152 CREATE BDAT Cpf#,2
6156 ASSIGN @File TO Cpf#
6160 BEEP
6164 INPUT "SELECT (0=LINEAR,1=LOG(X,Y))",Ilog
6168 BEEP
6172 INPUT "ENTER OIL PERCENT (-1=STOP)",Bop
6176 IF Bop<0 THEN G192
6180 CALL Poly
6184 OUTPUT @File:Bop,B(*)
6188 GOTO 6168
6192 ASSIGN @File TO *
6196 SUBEND
6200 SUB Wilson(Cf,C1)
6204 COM /W11/ D2,D1,Do,L,Lu,Kcu
6208 DIM Emf(12)
6212) WILSON PLOT SUBROUTINE DETERMINE CF AND CI
6216 BEEP
6220 INPUT "ENTER DATA FILE NAME",File#
6224 BEEP
6228 PRINTER IS 1
6232 PRINT USING "4X, ""Select option: ""
6236 PRINT USING "4X, "" 0 Vary Cf and C1""
6240 PRINT USING "4X, "" 1 Fix Cf Vary C1""
6244 PRINT USING "4X, "" 2 Vary Cf Fix C1""
6248 INPUT "ENTER OPTION",Icfix
6252 PRINTER IS 701
6256 IF Icfix=0 THEN G272
6260 IF Icfix>0 THEN BEEP
6264 IF Icfix=1 THEN INPUT "ENTER Cf",Cef
6268 IF Icfix=2 THEN INPUT "ENTER CI",C1
6272 PRINTER IS 1
6276 INPUT "Want To Vary Coeff?(1=Y,0=N)",Iccoef
6280 IF Iccoef=1 THEN INPUT "ENTER COEFF",R
6284 PRINTER IS 701
6288 IF Icfix=0 OR Icfix=2 THEN Cfa=.004
6292 IF Icfix=1 THEN Cfa=Cef
6296 C1=C1
6300 Km=.8
6304 Fr=.3

```

```

6300 Jj=0
6312 Rr=3.
6316 IF Iccoef=1 THEN Rr=R
6320 PRINTER IS 1
6324 PRINT Do,Di,Kcu
6328 ASSIGN @File TO File@
6332 ENTER @File;Nrun,Dt,Ldct1,Ldct2,Itt
6336 Ru=Do*LOG(Do/Di)/(2*Kcu)
6340 Sx=0
6344 Sy=0
6348 Sxy=0
6352 Sx2=0
6356 Sy2=0
6360 FOR I=1 TO Nrun
6364 ENTER @File;Bop,TIME@ (Told),Emf(*),Fms
6368! CONVERT EMF'S TO TEMPERATURE
6372 FOR J=1 TO 5
6376 T(J)=FNTvav(Emf(J))
6380 NEXT J
6384 Teat=(T(1)+T(2))*0.5
6388 Tavg=T(5)
6392 Grad=37.9853+.104388*Tavg
6396 Tdrop=Emf(7)*1.E+6/(10.*Grad)
6400 Tavgc=T(5)-Tdrop*0.5
6404 IF ABS(Tavg-Tavgc)>.01 THEN
6408 Tavg=(Tavg+Tavgc)*0.5
6412 GOTO 6392
6416 END IF
6420!
6424! Compute properties of water
6428 Ku=FNKu(Tavg)
6432 Muw=FNMuw(Tavg)
6436 Cpw=FNCPw(Tavg)
6440 Prw=FNPrw(Tavg)
6444 Rhow=FNrhoW(Tavg)
6448!
6452! Compute properties of Freon-114
6456 Lntd=Tdrop/LOG((T(5)-Teat)/(T(5)-Tdrop-Teat))
6460 IF Jj=0 THEN
6464 Tu=Teat+Fr*Lntd
6468 Thetab=Tu-Teat
6472 Jj=1
6476 END IF
6480 Tf=(Tu+Teat)*0.5
6484 Rho=FNrho(Tf)
6488 Mu=FNmu(Tf)
6492 K=FNk(Tf)
6496 Cp=FNcp(Tf)
6500 Beta=FNbeta(Tf)
6504 Hfg=FNHfg(Teet)
6508 Ni=Mu/Rho
6512 Alpha=K/(Rho*Cp)
6516 Pr=Ni/Alpha
6520!
6524! Analysis
6528! COMPUTE MDOT
6532 A=PI*(Do^2-Di^2)/4
6536 P=PI*Do
6540 Mdot=3.9857E-3+Fms*(3.81955E-3-Fms*(8.82006E-6-Fms*(1.23888E-7-Fms*4.31897
E-10)))

```

```

6544 Q=Mdot*Cpw*Tdrop
6548 COMPUTE NATURAL-CONVECTIVE HEAT-TRANSFER COEFFICIENT
6552 FOR UNENHANCED END(S)
6556 Hbar=190
6560 Fe=(Hbar*P/(Kcu*A))^*.5*Lu
6564 Tanh=FNtanh(Fe)
6568 Theta=Thetab*Tanh/Fe
6572 Xx=(9.81*Beta*Thetab*Do^3*Tanh/(Fe*Ni*Alpha))^*.16667
6576 Yy=(1+(.559/Pr)^(9/16))^(8/27)
6580 Hbarc=K/Do*(.6+.387*Xx/Yy)^2
6584 IF ABS((Hbar-Hbarc)/Hbar)>.001 THEN
6588 Hbar=(Hbar+Hbarc)*.5
6592 GOTO 6560
6596 END IF
6600
6604 COMPUTE HEAT LOSS RATE THROUGH UNENHANCED ENDS
6608 Q1=(Hbar*P*Kcu*A)^.5*Thetab*Tanh
6612 Qc=Q-2*Q1
6616 As=PI*D2*L
6620 COMPUTE ACTUAL HEAT FLUX
6624 Qdp=Qc/As
6628 IF Icfix=0 OR Icfix>1 THEN Cef=1/Cf^(1./Rr)
6632 Thetab=Cef/Cp*Hfg*(Qdp/(Mu*Hfg))^(.014/(9.81*Rho))^*.5^(1./Rr)*Pr^1.7
6636 Ho=Qdp/Thetab
6640 Omega=Ho/Cf
6644 Uo=Q/(PI*Do*L*Lrtd)
6648 Vu=Mdot/(Rhou*PI*Di^2/4)
6652 Rew=Rhou*Vu*Di/Muwa
6656 Tu1=Tu+Q/Rw/(PI*Do*L)
6660 Gama=Ku/Di*Rew*.8*Prw^(1/3.)*(Muwa/FNmuw(Tu1))^*.14
6664 PRINTER IS 1
6668 Yu=(1./Uo-Rw)*Omega
6672 Xu=Omega*Do/(Gama*Di)
6676 Sx=Sx+Xu
6680 Sy=Sy+Yu
6684 Sxy=Sxy+Yu*Xu
6688 Sx2=Sx2+Xu*Xu
6692 Sy2=Sy2+Yu*Yu
6696 NEXT I
6700 ASSIGN @File TO *
6704 M=(Sx*Sy-Nrun*Sxy)/(Sx*Sx-Nrun*Sx2)
6708 C=(Sy-Sx*M)/Nrun
6712 IF Icfix=0 OR Icfix=3 OR Icfix=4 THEN
6716 Cic=1/M
6720 Cfc=1/C
6724 END IF
6728 IF Icfix=1 THEN
6732 Cic=1/M
6736 Cfc=Cf
6740 END IF
6744 IF Icfix=2 THEN
6748 Cic=C1
6752 Cfc=1/C
6756 END IF
6760 IF ABS((C1-Cic)/Cic)>.001 OR ABS((Cf-Cfc)/Cfc)>.001 THEN
6764 C1=(C1+Cic)*.5
6768 Cf=(Cf+Cfc)*.5
6772 PRINTER IS 1
6776 PRINT USING "2X," Cef = "",N2.3DE,2X," C1 = "",N2.3DE",Cef,C1
6780 PRINTER IS 701

```

```

6784 GOTO 6328
6788 END IF
6792 PRINT
6796 PRINTER IS 701
6800 PRINT USING "23X, "" Cf          C1""
6804 PRINT USING "8X, ""ASSUMED      "" ,MZ.3DE,3X,MZ.3DE" ;Cfa,C1a
6808 PRINT USING "8X, ""CALCULATED   "" ,MZ.3DE,3X,MZ.3DE" ;Caf,C1
6812 PRINT
6816 SumZ=Sy2-2*M*Sxy-2*C*Sy+M^2*Sx2+2*M*C*Sx+Nrun*C^2
6820 PRINT USING "10X, ""Sum of Squares = "" ,Z.3DE" ;SumZ
6824 PRINT USING "10X, ""Coefficient = "" ,D.DDD" ;Rr
6828 SUBEND
6832 DEF FNMu(T)
6836 A=247.8/(T+133.15)
6840 Mu=2.4E-5*10^A
6844 RETURN Mu
6848 FNEND
6852 DEF FNCpu(T)
6856 Cpu=4.2112858-T*(2.26826E-3-T*(4.42361E-5+2.71428E-7*T))
6860 RETURN Cpu*1000
6864 FNEND
6868 DEF FNRho(T)
6872 Rr=999.52946+T*(.01269-T*(5.482513E-3-T*1.234147E-5))
6876 RETURN Rr
6880 FNEND
6884 DEF FNRu(T)
6888 Ru=FNCpu(T)*FNMu(T)/FNKu(T)
6892 RETURN Ru
6896 FNEND
6900 DEF FNKu(T)
6904 Ku=(T+273.15)/273.15
6908 Ku=-.92247+Ku*(2.8395-Ku*(1.0007-Ku*(.52577-.07344*Ku)))
6912 RETURN Ku
6916 FNEND
6920 SUB Plot
6924 COM /Cply/ A(10,10),C(10),B(5),Nop,Iprnt,Opo,Ilog,Ifn,Ijoin,Njoin
6928 DIM B(3)
6932 INTEGER Ii
6936 PRINTER IS 1
6940 Idv=0
6944 BEEP
6948 INPUT "LIKE DEFAULT VALUES FOR PLOT (1=Y,0=N)?",Idv
6952 Opo=0
6956 BEEP
6960 PRINT USING "4X, ""Select Option: ""
6964 PRINT USING "6X, ""0 q versus delta-T""
6968 PRINT USING "6X, ""1 h versus delta-T""
6972 PRINT USING "6X, ""2 h versus q""
6976 INPUT Opo
6980 BEEP
6984 INPUT "SELECT UNITS (0=SI,1=ENGLISH)",Iun
6988 PRINTER IS 705
6992 IF Idv<>1 THEN
6996 BEEP
7000 INPUT "ENTER NUMBER OF CYCLES FOR X-AXIS",Cx
7004 BEEP
7008 INPUT "ENTER NUMBER OF CYCLES FOR Y-AXIS",Cy
7012 BEEP
7016 INPUT "ENTER MIN X-VALUE (MULTIPLE OF 10)",Xmin
7020 BEEP

```

```

7024 INPUT "ENTER MIN Y-VALUE (MULTIPLE OF 10)",Ymin
7028 ELSE
7032 IF Opo=0 THEN
7036 Cy=3
7040 Cx=3
7044 Xmin=.1
7048 Ymin=100
7052 END IF
7056 IF Opo=1 THEN
7060 Cy=2
7064 Cx=2
7068 Xmin=.1
7072 Ymin=100
7076 END IF
7080 IF Opo=2 THEN
7084 Cy=3
7088 Cx=2
7092 Xmin=1000
7096 Ymin=100
7097 ELSE
7098 Cy=3
7099 Cx=3
7100 Xmin=100
7101 Ymin=10
7102 END IF
7104 END IF
7105 END IF
7106 BEEP
7112 PRINT "IN:SP1:IP 2300,2200,8300,5800;"
7116 PRINT "SC 0,100,0,100;TL 2,0;"
7120 Sfx=100/Cx
7124 Sfy=100/Cy
7128 BEEP
7132 INPUT "WANT TO BY-PASS CASE? (1=Y,0=N)",Ibyp
7136 IF Ibyp=1 THEN 7632
7140 PRINT "PU 0,0 PD"
7144 Nn=9
7148 FOR I=1 TO Cx+1
7152 Xat=Xmin*10^(I-1)
7156 IF I=Cx+1 THEN Nn=1
7160 FOR J=1 TO Nn
7164 IF J=1 THEN PRINT "TL 2 0"
7168 IF J=2 THEN PRINT "TL 1 0"
7172 Xa=Xat*J
7176 X=LGT(Xa/Xmin)*Sfx
7180 PRINT "PA";X,".0; XT;"
7184 NEXT J
7188 NEXT I
7192 PRINT "PA 100,0;PU;"
7196 PRINT "PU PA 0,0 PD"
7200 Nn=9
7204 FOR I=1 TO Cy+1
7208 Yat=Ymin*10^(I-1)
7212 IF I=Cy+1 THEN Nn=1
7216 FOR J=1 TO Nn
7220 IF J=1 THEN PRINT "TL 2 0"
7224 IF J=2 THEN PRINT "TL 1 0"
7228 Ya=Yat*J
7232 Y=LBT(Ya/Ymin)*Sfy

```

```

7236 PRINT "PA 0,";Y;"YT"
7240 NEXT J
7244 NEXT I
7248 PRINT "PA 0,100 TL 0 2"
7252 Nn=9
7256 FOR I=1 TO Cx+1
7260 Xat=Xmin*10^(I-1)
7264 IF I=Cx+1 THEN Nn=1
7268 FOR J=1 TO Nn
7272 IF J=1 THEN PRINT "TL 0 2"
7276 IF J>1 THEN PRINT "TL 0 1"
7280 Xa=Xat*J
7284 X=LGT(Xa/Xmin)*Sfx
7288 PRINT "PA";X;"",100;XT"
7292 NEXT J
7296 NEXT I
7300 PRINT "PA 100,100 PU PA 100,0 PD"
7304 Nn=9
7308 FOR I=1 TO Cy+1
7312 Yat=Ymin*10^(I-1)
7316 IF I=Cy+1 THEN Nn=1
7320 FOR J=1 TO Nn
7324 IF J=1 THEN PRINT "TL 0 2"
7328 IF J>1 THEN PRINT "TL 0 1"
7332 Ya=Yat*J
7336 Y=LGT(Ya/Ymin)*Sfy
7340 PRINT "PD PA 100,";Y;"YT"
7344 NEXT J
7348 NEXT I
7352 PRINT "PA 100,100 PU"
7356 PRINT "PA 0,-2 SR 1.5,2"
7360 I1=LGT(Xmin)
7364 FOR I=1 TO Cx+1
7368 Xa=Xmin*10^(I-1)
7372 X=LGT(Xa/Xmin)*Sfx
7376 PRINT "PA";X;"",0;
7380 IF I1>=0 THEN PRINT "CP -2,-2;LB;PR -2,2;LB";I1;"
7384 IF I1<0 THEN PRINT "CP -2,-2;LB;PR 0,2;LB";I1;"
7388 I1=I1+1
7392 NEXT I
7396 PRINT "PU PA 0,0"
7400 I1=LGT(Ymin)
7404 Y1=10
7408 FOR I=1 TO Cy+1
7412 Ya=Ymin*10^(I-1)
7416 Y=LGT(Ya/Ymin)*Sfy
7420 PRINT "PA 0,";Y;"
7424 PRINT "CP -4,-.25;LB;PR -2,2;LB";I1;"
7428 I1=I1+1
7432 NEXT I
7436 BEEP
7440 INPUT "WANT USE DEFAULT LABELS (1-Y,0-N)?",Id1
7444 IF Id1<>1 THEN
7448 BEEP
7452 INPUT "ENTER X-LABEL",Xlabel0
7456 BEEP
7460 INPUT "ENTER Y-LABEL",Ylabel0
7464 END IF
7468 IF Op0<2 THEN
7472 PRINT "SR 1,2;PU PA 40,-14;"

```

```

7476 PRINT "LB(T;PR -1.6,3 PD PR 1.2,0 PU;PR .5,-4;LBwo;PR .5,1;"
7480 PRINT "LB-T;PR .5,-1;LBso;PR .5,1;"
7484 IF Iun=0 THEN
7488 PRINT "LB) (K)"
7492 ELSE
7496 PRINT "LB) (F)"
7500 END IF
7504 END IF
7508 IF Opo=2 THEN
7512 IF Iun=0 THEN
7516 PRINT "SR 1.5,2;PU PA 40,-14;LBq (W/m;SR 1,1.5;PR 0.5,1;LB2;SR 1.5,2;PR
0.5,-1;LB)"
7520 ELSE
7524 PRINT "SR 1.5,2;PU PA 34,-14;LBq (Btu/hr;PR .5,.5;LB.i;PR .5,-.5)"
7528 PRINT "LBft;PR .5,1;SR 1,1.5;LB2;SR 1.5,2;PR .5,-1;LB);"
7532 END IF
7536 END IF
7540 IF Opo=0 THEN
7544 IF Iun=0 THEN
7548 PRINT "SR 1.5,2;PU PA -12,40;DI 0,1;LBq (W/m;PR -1,0.5;SR 1,1.5;LB2;SR 1
.5,2;PR 1,.5;LB)"
7552 ELSE
7556 PRINT "SR 1.5,2;PU PA -12,32;DI 0,1;LBq (Btu/hr;PR -.5,.5;LB.i;PR .5,.5)"
7560 PRINT "LBft;SR 1,1.5;PR -1,.5;LB2;PR 1,.5;SR 1.5,2;LB)"
7564 END IF
7568 END IF
7572 IF Opo>0 THEN
7576 IF Iun=0 THEN
7580 PRINT "SR 1.5,2;PU PA -12,38;DI 0,1;LBh (W/m;PR -1,.5;SR 1,1.5;LB2;SR 1.
5,2;PR .5,.5)"
7584 PRINT "SR 1.2,2.4;PU PA -12,37;DI 0,1;LBh;PR 1,0.5;LB0;PR -1,0.5;LB (W/m
"
7588 PRINT "PR -1,.5;SR 1,1.5;LB2;SR 1.5,2;PR .5,.5;LB.i;PR .5,0;LBK)"
7592 ELSE
7596 PRINT "SR 1.5,2;PU PA -12,28;DI 0,1;LBh (Btu/hr;PR -.5,.5;LB.i;PR .5,.5)"
7600 PRINT "LBft;PR -1,.5;SR 1,1.5;LB2;SR 1.5,2;PR .5,.5;LB.i;PR .5,.5;LBF)"
7604 END IF
7608 END IF
7612 IF Id1=0 THEN
7616 PRINT "SR 1.5,2;PU PA 50,-16 CP";-LEN(Xlabel0)/2;"0;LB";Xlabel0;"
7620 PRINT "PA -14,50 CP 0,";-LEN(Ylabel0)/2+5/6;"DI 0,1;LB";Ylabel0;"
7624 PRINT "CP 0,0 DI"
7628 END IF
7632 Ipn=0
7636 X11=-1.E+6
7640 Xul=-1.E+6
7644 Icn=0
7648 Ifn=0
7652 Ijoin=1
7656 BEEP
7660 INPUT "WANT TO PLOT DATA FROM A FILE (Y=0-N)?",O1
7664 IF O1=1 THEN
7668 BEEP
7672 INPUT "ENTER THE NAME OF THE DATA FILE",D_file0
7676 ASSIGN @file TO D_file0
7680 BEEP
7684 BEEP
7688 INPUT "ENTER THE BEGINNING RUN NUMBER",Md
7692 BEEP
7696 INPUT "ENTER THE NUMBER OF X-Y PAIRS STORED",Npairs

```

```

77001 BEEP
77041 INPUT "CONNECT DATA WITH LINE (1-Y,0-N)?",Icl
7708 BEEP
7712 PRINTER IS 1
7716 PRINT USING "4X,""Select a symbol:"""
7720 PRINT USING "6X,""1 Star 2 Plus sign""
7724 PRINT USING "6X,""3 Circle 4 Square""
7728 PRINT USING "6X,""5 Rombus""
7732 PRINT USING "6X,""6 Right-side-up triangle""
7736 PRINT USING "6X,""7 Up-side-down triangle""
7740 INPUT Syn
7744 PRINTER IS 705
7748 PRINT "PU DI"
7752 IF Syn=1 THEN PRINT "SM+"
7756 IF Syn=2 THEN PRINT "SM+"
7760 IF Syn=3 THEN PRINT "SMo"
7764 IF Md>1 THEN
7768 FOR I=1 TO (Md-1)
7772 ENTER @File:Ya,Xa
7776 NEXT I
7780 END IF
7784 FOR I=1 TO Npairs
7788 ENTER @File:Ya,Xa
7792 IF I=1 THEN Q1=Ya
7796 IF I=Npairs THEN Q2=Ya
7800 IF Opo=1 THEN Ya=Ya/Xa
7804 IF Opo=2 THEN
7808 Q=Ya
7812 Ya=Ya/Xa
7816 Xa=Q
7820 END IF
7824 IF Xa<X11 THEN X11=Xa
7828 IF Xa>Xul THEN Xul=Xa
7832 IF Iun=1 THEN
7836 IF Opo<2 THEN Xa=Xa*1.8
7840 IF Opo>0 THEN Ya=Ya*.1761
7844 IF Opo=0 THEN Ya=Ya*.317
7848 IF Opo=2 THEN Xa=Xa*.317
7852 END IF
7856 X=LGT(Xa/Xmin)*Sfx
7860 Y=LGT(Ya/Ymin)*Sfy
7864 Kj=0
7868 CALL Symb(X,Y,Syn,Icl,Kj)
7872 GOTO 7924
7876 IF Syn>3 THEN PRINT "SM"
7880 IF Syn<4 THEN PRINT "SR 1.4,2.4"
7884 IF Icl=0 THEN
7888 PRINT "PA",X,Y,""
7892 ELSE
7896 PRINT "PA",X,Y,"PD"
7900 END IF
7904 IF Syn>3 THEN PRINT "SR 1.2,1.6"
7908 IF Syn=4 THEN PRINT "UC2,4,99,0,-8,-4,0,0,8,4,0;"
7912 IF Syn=5 THEN PRINT "UC3,0,99,-3,-6,-3,6,3,6,3,-6;"
7916 IF Syn=6 THEN PRINT "UC0,5,3,99,3,-8,-6,0,3,8;"
7920 IF Syn=7 THEN PRINT "UC0,-5,3,99,-3,8,6,0,-3,-8;"
7924 NEXT I
7928 PRINT "PU"
7932 BEEP
7936 INPUT "WANT TO LABEL? (1-Y,0-N)",Ilab

```



```

7940 IF I1ab=1 THEN
7944 PRINT "SP0,SP2"
7948 BEEP
7952 IF K1ab=0 THEN
7956 X1ab=5
7960 Y1ab=85
7964 INPUT "ENTER INITIAL X,Y LOCATIONS",X1ab,Y1ab
7968 Xtt=X1ab-5
7972 Ytt=Y1ab+8
7976 PRINT "SR 1,1.5"
7980 PRINT "SM,PA",Xtt,Ytt,"LB      X Heat File"
7984 Ytt=Ytt-3
7988 PRINT "PA",Xtt,Ytt,"LB      Oil Flux Name"
7992 IF Sym=1 THEN PRINT "SM+"
7996 IF Sym=2 THEN PRINT "SM+"
8000 IF Sym=3 THEN PRINT "SMo"
8004 K1ab=1
8008 END IF
8012 Kj=1
8016 CALL Symb(X1ab,Y1ab,Sym,Icl,Kj)
8020 PRINT "SR 1,1.5,SM"
8024 IF Sym<4 THEN PRINT "PR 2,0"
8028 BEEP
8032 INPUT "ENTER BOP",Bop
8036 IF Bop<10 THEN PRINT "PR 2,0:LB":Bop:""
8040 IF Bop>9 THEN PRINT "PR .5,0:LB":Bop:""
8044 Ihf=0
8048 IF Q1>Q2 THEN Ihf=1
8052 IF Ihf=0 THEN PRINT "PR 4,0:LBInc"
8056 IF Ihf=1 THEN PRINT "PR 4,0:LBDec"
8060 PRINT "PR 2,0:LB":ID_file:""
8064 PRINT "SP0,SP1:SR 1.5,2"
8068 Y1ab=Y1ab-5
8072 END IF
8076 BEEP
8080 ASSIGN @File TO *
8084 X11=X11/1.2
8088 Xul=Xul*1.2
8092 GOTO 8040
8096 END IF
8100 PRINT "PU SM"
8104 BEEP
8108 INPUT "WANT TO PLOT A POLYNOMIAL (I=Y,0=N)?",Go_on
8112 IF Go_on=1 THEN
8116 BEEP
8120 PRINTER IS 1
8124 PRINT USING "4X,""Select line type:"""
8128 PRINT USING "6X,""0 Solid line""
8132 PRINT USING "6X,""1 Dashed""
8136 PRINT USING "6X,""2,...5 Longer line - dash""
8140 INPUT Ipn
8144 PRINTER IS 705
8148 BEEP
8152 INPUT "SELECT (0=LIN,1=LOG(X,Y))",Ilog
8156 Iprnt=1
8160 CALL Poly
8164 IF Ifn=0 THEN
8168 BEEP
8172 INPUT "ENTER NUMBER OF FILES TO JOIN?",Njoin
8176 END IF

```

```

8180 Ijoin=0
8184 IF Ifn<Njoin THEN Ijoin=1
8188 IF Ifn=0 OR Ijoin=1 THEN
8192 FOR Ij=0 TO 3
8196 Bs(Ij)=Bs(Ij)+B(Ij)
8200 NEXT Ij
8204 Ifn=Ifn+1
8208 END IF
8212 IF Njoin=Ifn THEN
8216 FOR Ij=0 TO 3
8220 B(Ij)=Bs(Ij)/Njoin
8224 Bs(Ij)=0
8228 NEXT Ij
8232 Ifn=0
8236 ELSE
8240 GOTO 7656
8244 END IF
8248 BEEP
8252 INPUT "ENTER Y LOWER AND UPPER LIMITS",Yll,Yul
8256 FOR Xx=0 TO Cx STEP Cx/200
8260 Xa=Xmin+I0*Xx
8264 IF Xa<Xll OR Xa>Xul THEN 8372
8268 Icn=Icn+1
8272 Pu=0
8276 IF Ipn=1 THEN Idf=Icn MOD 2
8280 IF Ipn=2 THEN Idf=Icn MOD 4
8284 IF Ipn=3 THEN Idf=Icn MOD 8
8288 IF Ipn=4 THEN Idf=Icn MOD 16
8292 IF Ipn=5 THEN Idf=Icn MOD 28
8296 IF Idf=1 THEN Pu=1
8300 IF Opo=0 THEN Ya=FNPoly(Xa)
8304 IF Opo=2 AND Ilog=0 THEN Ya=Xa/FNPoly(Xa)
8308 IF Opo=2 AND Ilog=1 THEN Ya=FNPoly(Xa)
8312 IF Opo=1 THEN Ya=FNPoly(Xa)
8316 IF Ya<Ymin THEN 8372
8320 IF Ya<Yll OR Ya>Yul THEN 8372
8324 IF Iun=1 THEN
8328 IF Opo<2 THEN Xa=Xa*.18
8332 IF Opo>0 THEN Ya=Ya*.1761
8336 IF Opo=0 THEN Ya=Ya*.317
8340 IF Opo=2 THEN Xa=Xa*.317
8344 END IF
8348 Y=LGT(Ya/Ymin)*Sfy
8352 X=LGT(Xa/Xmin)*Sfx
8356 IF Y<0 THEN Y=0
8360 IF Y>100 THEN GOTO 8372
8364 IF Pu=0 THEN PRINT "PA",X,Y,"PD"
8368 IF Pu=1 THEN PRINT "PA",X,Y,"PU"
8372 NEXT Xx
8376 PRINT "PU"
8380 GOTO 7656
8384 END IF
8388 BEEP
8392 INPUT "WANT TO PLOT REILLY'S DATA? (I=Y,0=N)",IrlY
8396 IF Opo=0 OR Opo=1 THEN
8400 Xll=3
8404 Xul=20
8408 END IF
8412 IF Opo=2 THEN
8416 Xll=10000

```

```

8420 Xul=100000
8424 END IF
8428 IF Irly=1 THEN
8432 Yll=20
8436 Yul=70
8440 BEEP
8444 INPUT "ENTER LOWER AND UPPER Y-LIMITS FOR PLOTTING",Yll,Yul
8448 FOR Xx=0 TO Cx STEP Cx/200
8452 Xa=Xmin*10^Xx
8456 IF Xa<Xll OR Xa>Xul THEN 8500
8460 Xl=LOG(Xa)
8464 IF Opo=0 THEN Yl=-2.5402037E-1+Xl*(4.9720151-Xl*2.5134707E-1)
8468 IF Opo=1 THEN Yl=-2.5402037E-1+Xl*(3.9720151-Xl*2.5134707E-1)
8472 IF Opo=2 THEN Yl=-3.7073001E-1+Xl*(8.7259190E-1-Xl*6.8826842E-3)
8476 Ya=EXP(Yl)
8480 Y=LGT(Ya/Ymin)*5fy
8484 X=LGT(Xa/Xmin)*5fx
8488 Ipu=0
8492 IF Y<Yll THEN Ipu=1
8496 IF Y>Yul THEN GOTO 8500
8500 IF Ipu=0 THEN PRINT "PA",X,Y,"PD"
8504 IF Ipu=1 THEN PRINT "PA",X,Y,"PU"
8508 NEXT Xx
8512 PRINT "PU"
8516 END IF
8520 BEEP
8524 INPUT "WANT TO PLOT ROHSENOW CORRELATION? (I=Y,0=N)",Irohs
8528 IF Irohs=1 THEN
8532 Yll=15
8536 Yul=80
8540 BEEP
8544 INPUT "ENTER Tsat (Deg C)",Tsat
8548 Csf=.0040
8552 BEEP
8556 INPUT "ENTER Csf (DEF=0.004)",Csf
8560 Tf=Tsat+Z
8564 FOR Xx=0 TO Cx STEP Cx/200
8568 Xa=Xmin*10^Xx
8572 IF Xa<Xll OR Xa>Xul THEN 8604
8576 Xl=LOG(Xa)
8580 IF Opo<2 THEN Tf=Tsat+Xa/2
8584 Rho=FNrho(Tf)
8588 K=FNK(Tf)
8592 Mu=FNmu(Tf)
8596 Cp=FNcp(Tf)
8600 Hfg=FNhfg(Tsat)
8604 Ns=Mu/Rho
8608 Pr=Cp*Mu/K
8612 Omega=Csf*Hfg/Cp*((.014/(9.81*Rho))^*.5/(Mu*Hfg))^(1./3)*Pr^1.7
8616 IF Opo=0 THEN Ya=(Xa/Omega)^3
8620 IF Opo=1 THEN Ya=(Xa/Omega)^3/Xa
8624 IF Opo=2 THEN Ya=Xa^(2./3)/Omega
8628 IF Opo=2 THEN
8632 Tfc=Tsat+Xa/Ya*.5
8636 IF ABS(Tf-Tfc)>.01 THEN
8640 Tf=(Tf+Tfc)*.5
8644 GOTO 8584
8648 END IF
8652 END IF
8656 Y=LGT(Ya/Ymin)*5fy

```

```

0650 X=LGT(Xa/Xmin)*Sfx
0654 Ipu=0
0658 IF Y<Y11 THEN Ipu=1
0672 IF Y>Yul THEN 0684
0676 IF Ipu=0 THEN PRINT "PA",X,Y,"PD"
0680 IF Ipu=1 THEN PRINT "PA",X,Y,"PU"
0684 NEXT Xx
0688 PRINT "PU"
0692 END IF
0696 BEEP
0700 INPUT "WANT TO QUIT (1=Y,0=N)",Iqt
0704 IF Iqt=1 THEN 0712
0708 GOTO 7636
0712 PRINT "PU PA 0,0 SP0"
0716 SUBEND
0720 SUB Symb(X,Y,Sym,Icl,Kj)
0724 IF Sym>3 THEN PRINT "SM"
0728 IF Sym<4 THEN PRINT "SR 1.4,2.4"
0732 Yad=0
0736 IF Kj=1 THEN Yad=.8
0740 IF Icl=0 THEN
0744 PRINT "PA",X,Y+Yad,""
0748 ELSE
0752 PRINT "PA",X,Y+Yad,"PD"
0756 END IF
0760 IF Sym>3 THEN PRINT "SR 1.2,1.6"
0764 IF Sym=4 THEN PRINT "UC2,4.99,0,-8,-4,0,0,8,4,0;"
0768 IF Sym=5 THEN PRINT "UC3,0.99,-3,-6,-3,6,3,6,3,-6;"
0772 IF Sym=6 THEN PRINT "UC0,5.3,99,3,-8,-6,0,3,0;"
0776 IF Sym=7 THEN PRINT "UC0,-5.3,99,-3,8,6,0,-3,-8;"
0780 IF Kj=1 THEN PRINT "SM:PR 0,-.8"
0784 SUBEND
0788 SUB Purp
0792 BEEP
0796 INPUT "ENTER FILE NAME TO BE DELETED",File0
0800 PURGE File0
0804 GOTO 0792
0808 SUBEND
0812 SUB Tdcn
0816 COM /Cc/ C(7),Ical
0820 DIM Enf(1)
0824 DATA 0.10006091,25727.94369,-767345.0295,70025595.81
0828 DATA -9247406589,6.97680E+11,-2.66192E+13,3.94070E+14
0832 READ C(*)
0836 BEEP
0840 INPUT "GIVE A NAME FOR FILE TO BE CREATED",File0
0844 BEEP
0848 INPUT "SELECT TUBE (0=WH,1=HF,2=WT)",Itt
0852 BEEP
0856 INPUT "SELECT THERMOCOUPLE TYPE (0=NEW,1=OLD)",Ical
0860 IF Itt<2 THEN Di=.0127
0864 CREATE BOAT File0,4
0868 ASSIGN @File TO File0
0872 OUTPUT @File:Itt
0876 J=0
0880 BEEP
0884 OUTPUT 709;"TIMEDATE"
0888 ENTER 709:Di
0890 PRINTER IS 1
0894 PRINT

```

```

8908 PRINT "          Month, date and time: ";DATE$(Dt),TIME$(Dt)
8912 PRINT
8916 PRINT USING "10X," Fms      Tin      Tev      Vu^2      Tdrop""
8920 IF K=0 THEN
8924 PRINTER IS 701
8928 PRINT
8932 PRINT "          Month, date and time: ";DATE$(Dt),TIME$(Dt)
8936 IF Itt=0 THEN PRINT USING "10X," Tube Type:      Wieland Smooth""
8940 IF Itt=1 THEN PRINT USING "10X," Tube Type:      High Flux""
8944 IF Itt=2 THEN PRINT USING "10X," Tube Type:      Turbo-B""
8948 PRINT
8952 PRINT USING "10X," Fms      Tin      Tev      Vu^2      Tdrop""
8956 PRINTER IS 1
8960 K=1
8964 END IF
8968 BEEP
8972 INPUT "ENTER FLOWMETER READINGS",Fms
8976 OUTPUT 709;"AR AF0 AL4 VR1"
8980 FOR L=0 TO 4
8984 OUTPUT 709;"AS SA"
8988 IF L>0 AND L<4 THEN 9020
8992 S=0
8996 FOR I=0 TO 9
9000 ENTER 709;E
9004 S=S+E
9008 NEXT I
9012 IF L=0 THEN Enf(0)=ABS(S/10)
9016 IF L=4 THEN Enf(1)=ABS(S/10)
9020 NEXT L
9024 OUTPUT 709;"AR AF20 AL20 VR1"
9028 OUTPUT 709;"AS SA"
9032 Etp=0
9036 FOR I=0 TO 9
9040 ENTER 709;Et
9044 Etp=Etp+Et
9048 NEXT I
9052 Etp=Etp/10
9056 Tin=FNTVsv(Enf(1))
9060 Tev=FNTVsv(Enf(0))
9064 Grad=37.9853+.104388*Tin
9068 Hdot=3.9657E-3+Fms*(3.61955E-3-Fms*(8.82006E-6-Fms*(1.23688E-7-Fms*4.31897
E-10)))
9072 Vu=Hdot/(1000*PI*D1^2)*4
9076 Tdrop=Etp*1.E+6/(10*Grad)
9080 PRINT USING "10X,3(DD.DD,4X),1X,2.DD,4X,MZ.4D";Fms,Tin,TeV,Vu^2,Tdrop
9084 BEEP
9088 INPUT "WANT TO ACCEPT THIS DATA SET? (1=Y,0=N)",Ok
9092 J=J+1
9096 IF Ok=0 THEN
9100 J=J-1
9104 GOTO 8988
9108 ELSE
9112 OUTPUT @File;Fms,Enf(0),Etp
9116 PRINTER IS 701
9120 PRINT USING "10X,3(DD.DD,4X),1X,2.DD,4X,MZ.4D";Fms,Tin,TeV,Vu^2,Tdrop
9124 PRINTER IS 1
9128 BEEP
9132 INPUT "WILL THERE BE ANOTHER DATA SET? (1=Y,0=N)",Go_on
9136 IF Go_on=1 THEN 8968
9140 END IF

```

```

9144 ASSIGN @File TO *
9148 PRINTER IS 701
9152 PRINT
9156 PRINT USING "10X,""NOTE: "" ,ZZ,"" data sets are stored in file "" ,15A" ;J,F
1le0
9160 PRINTER IS 1
9164 SUBEND
9168 SUB Uoprt
9172 PRINTER IS 1
9176 BEEP
9180 INPUT "Enter Uo File Name",File0
9184 BEEP
9188 INPUT "Number of Data Runs",Nrun
9192 INPUT "Do You Want a Plot File?(1=Y,0=N)",Iplot
9196 BEEP
9200 IF Iplot=1 THEN
9204 INPUT "Give Plot File Name",P_file0
9208 CREATE BOAT P_file0,4
9212 ASSIGN @Plot TO P_file0
9216 END IF
9220 PRINTER IS 701
9224 PRINT
9228 PRINT
9232 PRINT USING "10X,"" Water Vel      Uo""
9236 ASSIGN @File TO File0
9240 IF Iplot=1 THEN ASSIGN @File1 TO P_file0
9244 FOR I=1 TO Nrun
9248 ENTER @File1;Vu,Uo
9252 IF Iplot=1 THEN OUTPUT @File1;Vu,Uo
9256 PRINT USING "15X,D.DD,6X,MZ.3DE";Vu,Uo
9260 NEXT I
9264 ASSIGN @File TO *
9268 ASSIGN @File1 TO *
9272 PRINT USING "10X,""NOTE: "" ,ZZ,"" data sets are stored in file "" ,15A" ;Nru
n,File0
9276 IF Iplot=1 THEN
9280 PRINT USING "10X,""NOTE: "" ,ZZ,"" X-Y Pairs are stored in file "" ,15A" ;Nru
n,P_file0
9284 END IF
9288 PRINTER IS 1
9292 SUBEND
9296 SUB Select
9300 COM /Idp/ Idp
9304 BEEP
9308 PRINTER IS 1
9312 PRINT USING "4X,""Select option:""
9316 PRINT USING "6X,"" 0 Taking data or re-processing previous data""
9320 PRINT USING "6X,"" 1 Plotting data on Log-Log ""
9324 PRINT USING "6X,"" 2 Plotting data on Linear""
9328 PRINT USING "6X,"" 3 Make cross-plot coefft file""
9332 PRINT USING "6X,"" 4 Re-circulate water""
9336 PRINT USING "6X,"" 5 Purge""
9340 PRINT USING "6X,"" 6 T-Drop correction""
9344 PRINT USING "6X,"" 7 Print Uo File""
9348 PRINT USING "6X,"" 8 Modify X-Y file""
9352 PRINT USING "6X,"" 9 Move""
9356 PRINT USING "6X,""10 Comb/Fixup""
9360 INPUT Idp
9364 IF Idp=0 THEN CALL Main
9368 IF Idp=1 THEN CALL Plot

```

```

9360 IF Idp=2 THEN CALL Plin
9364 IF Idp=3 THEN CALL Coef
9368 IF Idp=4 THEN CALL Main
9372 IF Idp=5 THEN CALL Purg
9376 IF Idp=6 THEN CALL Tdcn
9380 IF Idp=7 THEN CALL Uoprt
9381 IF Idp=8 THEN CALL Xymod
9382 IF Idp=9 THEN CALL Move
9383 IF Idp=10 THEN CALL Comb
9385 SUBEND
9394 SUB Xymod
9434 PRINTER IS 1
9444 BEEP
9454 INPUT "ENTER FILE NAME",File0
9464 ASSIGN @File1 TO File0
9474 BEEP
9484 INPUT "ENTER NUMBER OF X-Y PAIRS",Np
9494 BEEP
9504 INPUT "ENTER NEW FILE NAME",File20
9514 CREATE BOAT File20,5
9524 ASSIGN @File2 TO File20
9534 BEEP
9544 INPUT "ENTER NUMBER OF X-Y PAIRS TO BE DELETED",Ndel
9554 IF Ndel=0 THEN 9594
9564 FOR I=1 TO Ndel
9574 BEEP
9584 INPUT "ENTER DATA SET NUMBER TO BE DELETED",Nd(I)
9594 NEXT I
9604 FOR J=1 TO Np
9614 ENTER @File1;X,Y
9624 FOR I=1 TO Ndel
9634 IF Nd(I)=J THEN 9674
9644 NEXT I
9654 OUTPUT @File2;X,Y
9664 PRINT J,X,Y
9674 NEXT J
9676 PRINTER IS 701
9684 ASSIGN @File1 TO *
9694 ASSIGN @File2 TO *
9704 SUBEND
9714 SUB Move
9718 FILE NAME: MOVE
97221
9726 DIM Bop(66),A(66),B(66),C(66),D(66),E(66),F(66),G(66),H(66),J(66),K(66),L(
66),M(66)
9730 DIM Told(66),M(66),Vr(66),Ir(66)
9734 BEEP
9738 INPUT "OLD FILE TO MOVE",O2_file0
9742 ASSIGN @File2 TO O2_file0
9746 ENTER @File2;Nrun,Dt,Ldtc1,Ldtc2,Itt
9750 FOR I=1 TO Nrun
9754 ENTER @File2;Bop(I),Told(I)
9758 ENTER @File2;A(I),B(I),C(I),D(I),E(I),F(I),G(I),H(I),J(I),K(I),L(I),M(I),N
(I)
9762 ENTER @File2;Vr(I),Ir(I)
9766 NEXT I
9770 ASSIGN @File2 TO *
9774 BEEP
9778 INPUT "SHIFT DISK AND HIT CONTINUE",O4
9782 BEEP

```

```

9786 INPUT "INPUT BOAT SIZE",Size
9790 CREATE BOAT D2_file@,Size
9794 ASSIGN @file1 TO D2_file@
9798 OUTPUT @file1;Nrun,Dt,Ldtc1,Ldtc2,Itt
9807 FOR I=1 TO Nrun
9806 OUTPUT @file1;Bop(I),Told(I)
9810 OUTPUT @file1;A(I),B(I),C(I),D(I),E(I),F(I),G(I),H(I),J(I),K(I),L(I),M(I),
N(I)
9814 OUTPUT @file1;Vr(I),Ir(I)
9818 NEXT I
9822 ASSIGN @file1 TO *
9826 RENAME "TEST" TO D2_file@
9830 BEEP 2000,.2
9834 BEEP 4000,.2
9838 BEEP 4000,.2
9842 PRINT "DATA FILE MOVED"
9846 SUBEND
9874 SUB Comb
9878 FILE NAME: COMB
9882
9886 DIM Emf(12)
9890 BEEP
9894 INPUT "OLD FILE TO FIXUP",D2_file@
9898 ASSIGN @file2 TO D2_file@
9902 D1_file@="TEST"
9906 CREATE BOAT D1_file@,20
9910 ASSIGN @file1 TO D1_file@
9914 ENTER @file2;Nrun,Dt,Ldtc1,Ldtc2,Itt
9915 Nrun=20
9918 IF K=0 THEN OUTPUT @file1;Nrun,Dt,Ldtc1,Ldtc2,Itt
9922 FOR I=1 TO Nrun
9926 ENTER @file2;Bop,Told,Emf(*),Vr,Ir
9930 OUTPUT @file1;Bop,Told,Emf(*),Vr,Ir
9934 NEXT I
9938 ASSIGN @file2 TO *
9942 RENAME "TEST" TO D2_file@
9946 BEEP 2000,.2
9950 BEEP 4000,.2
9954 BEEP 4000,.2
9958 BEEP
9962 INPUT "WANT TO ADD ANOTHER FILE (1=Y,0=N)?",Ok@
9966 IF Ok@=1 THEN
9970 K=1
9974 BEEP
9978 INPUT "GIVE NEW FILE NAME",Nfile@
9982 ASSIGN @file2 TO Nfile@
9986 GOTO 9914
9990 END IF
9994 ASSIGN @file2 TO *
9998 SUBEND

```

LIST OF REFERENCES

1. Incropera, F.P., and DeWitt, D.P., *Fundamentals of Heat Transfer*, 2nd Ed. John Wiley and Sons, Inc., New York, 1990, pp. 554 and 509.
2. Churchill, S.W., and Usagi, R., "A General Expression for the Correlation of Rates of Transfer and Other Phenomena," *A.J.Ch.E.* J1 18, 1972, pp. 1121-1128.
3. Stephan, K., and Abdelsalam, M., "Heat-Transfer Correlations for Natural Convection Boiling," *Int. J. Heat Mass Transfer*, Vol. 23, 1980, pp. 73-87.
4. Yilmaz, K., and Westwater, J.W., "Effects of Commercial Enhanced Surfaces on the Boiling Heat Transfer Curve," *Advances in Heat Transfer-1981*, HTD-Vol. 18, ASME, 1981, pp. 73-92.
5. Carnavos, T.C., "An Experimental Study: Pool Boiling R-11 with Augmented Tubes," *Advances in Enhanced Heat Transfer*, ed. R.L. Webb et al., ASME Publications, 1981, pp. 103-108.
6. Marto, P.J., and Lepere, V.J., "Pool Boiling Heat Transfer from Enhanced Surfaces to Dielectric Fluids," *Journal of Heat Transfer*, Vol. 104, May 1982, pp. 292-299.
7. Wanniarachchi, A.S., Marto, P.J. and Reilly, J.T., "The Effect of Oil Contamination on the Nucleate Pool-Boiling Performance of R-114 from a Porous-Coated Surface," *ASHRAE Transactions*, Vol. 92, pt. 2, 1986.
8. Wanniarachchi, A.S., Sawyer, L.M., and Marto, P.J., "Effect of Oil on Pool-Boiling Performance of R-114 from Enhanced Surfaces," *Proceedings 2nd ASME-JSME Thermal Engineering Joint Conference*, Honolulu, Hawaii, Vol.1, 1987, pp. 531-537.
9. Webb, R.L., "The Evolution of Enhanced Surface Geometries for Nucleate Boiling," *Heat Transfer Engineering*, Vol. 2, nos. 3-4, 1981, pp. 46-69.

10. McManus, S.M., Marto, P.J., and Wanniarachchi, A.S., "An Evaluation of Enhanced Heat Transfer Tubing for Use in R-114 Water Chillers," *Heat Transfer in Air Conditioning and Refrigeration Equipment*, HTD-Vol. 65, ASME, pp. 11-19.
11. Chaddock, J.B., "Influence of Oil on Refrigerant Evaporator Performance," *ASHRAE Transactions*, Vol. 82, pt. 1, pp. 474-486.
12. Sauer, H.J. Jr., Davidson, G.W., and Chongrungreong, S., "Nucleate Boiling of Refrigerant-Oil Mixtures from Finned Tubing," *Joint ASME/AIChE National Heat Transfer Conference*, Paper No. 80-HT-111, Orlando, 1980.
13. Murphy, T.J., "Pool Boiling of R-114/Oil Mixtures from Single Tubes and Tube Bundles," Master's Thesis, Naval Postgraduate School, Monterey, California.
14. Karasabun, M., "An Experimental Apparatus to Study Nucleate Pool Boiling of R-114 and Oil Mixtures," Master's Thesis, Naval Postgraduate School, Monterey, California.
15. Stephan, K., and Mitrovic, J., "Heat Transfer in Natural Convective Boiling of Refrigerants and Refrigerant-Oil Mixtures in Bundles of T-shaped Finned Tubes," *Advances in Enhanced Heat Transfer*, ed. R.L. Webb et al., ASME Publications, 1981, pp. 131-146.
16. Marto, P.J., Wanniarachchi, A.S. and Pulido, R.J., "Augmenting the Nucleate Pool-Boiling Characteristics of GEWA-T Finned Tubes in R-113," *Advances in Enhanced Heat Transfer*, HTD-Vol. 18, ASME, pp. 67-73.
17. Kline, S.J., and McClintock, F.A., "Describing Uncertainties in Single-Sample Experiments," *Mechanical Engineering*, January 1953, p. 3.