

AD-A208 234

R, M & S STANDARDS PRIMER

Guidelines for DoD Reliability,
Maintainability and Safety Standards

PRIM-1

This document has been approved
for public release and sale in
distribution is unlimited.

DTIC
ELECTE
MAY 12 1989
S E P





Ordering No. PRIM-1

A PRIMER FOR DOD RELIABILITY, MAINTAINABILITY AND SAFETY STANDARDS

Prepared by:

James W. Wilbur and Norman B. Fuqua
The Reliability Analysis Center

Under Contract to:

Rome Air Development Center
Griffiss AFB, NY 13441-5700

| | |
|---------------------------|-------------------------------------|
| Accession For | |
| NTIS GRA&I | <input checked="" type="checkbox"/> |
| DTIC TAB | <input type="checkbox"/> |
| Unannounced | <input type="checkbox"/> |
| Justification | |
| By <i>NTIS-PC \$95.00</i> | |
| Distribution/ | |
| Availability Codes | |
| Dist | Avail and/or Special |
| <i>A-1</i> | <i>24</i> |

Reliability Analysis Center

A DoD Information Analysis Center

DTIC
ELECTE
MAY 12 1989
S E D

Approved for Public Release, Distribution Unlimited

89 0 1 0 12

The Reliability Analysis Center (RAC) is a Department of Defense Information Analysis Center sponsored by the Defense Logistics Agency, managed by the Rome Air Development Center (RADC), and operated at RADC by IIT Research Institute (IITRI). RAC is chartered to collect, analyze and disseminate reliability information pertaining to electronic systems and parts used therein. The present scope includes integrated circuits, hybrids, discrete semiconductors, microwave devices, opto-electronics and non-electronic parts employed in military, space and commercial applications.

Data is collected on a continuous basis from a broad range of sources, including testing laboratories, device and equipment manufacturers, government laboratories and equipment users (government and non-government). Automatic distribution lists, voluntary data submittals and field failure reporting systems supplement an intensive data solicitation program.

Reliability data and analysis documents covering most of the device types mentioned above are available from the RAC. Also, RAC provides reliability consulting, training, technical and bibliographic inquiry services which are discussed at the end of this document.

**REQUEST FOR TECHNICAL
ASSISTANCE AND INFORMATION
ON AVAILABLE RAC SERVICES
AND PUBLICATIONS MAY BE
DIRECTED TO:**

Reliability Analysis Center
P.O. Box 4700
Rome, NY 13440-8200

Technical Inquiries (315) 337-9933
Non-Technical Inquiries: (315) 330-4151
Autovon: 587-4151
TeleFax: (315) 337-9932

**ALL OTHER REQUESTS
SHOULD BE DIRECTED TO:**

Rome Air Development Center
RBE/Preston R. MacDiarmid
Griffiss AFB, NY 13441-5700

Telephone: (315) 330-4920
Autovon: 587-4920

REPORT DOCUMENTATION PAGE

Form Approved
OMB No. 0704-0188

| | | | |
|---|--|---|-------------------------------------|
| 1a REPORT SECURITY CLASSIFICATION Unclassified | | 1b. RESTRICTIVE MARKINGS | |
| 2a. SECURITY CLASSIFICATION AUTHORITY | | 3. DISTRIBUTION / AVAILABILITY OF REPORT Approved for public release; distribution unlimited. Available from RAC or DTIC; through DTIC in Microfiche only. | |
| 2b DECLASSIFICATION / DOWNGRADING SCHEDULE | | 4. PERFORMING ORGANIZATION REPORT NUMBER(S) PRIM-1 | |
| 4. PERFORMING ORGANIZATION REPORT NUMBER(S) PRIM-1 | | 5. MONITORING ORGANIZATION REPORT NUMBER(S) | |
| 6a NAME OF PERFORMING ORGANIZATION Reliability Analysis Center | 6b. OFFICE SYMBOL (if applicable) RADC/RAC | 7a. NAME OF MONITORING ORGANIZATION RADC/RBE | |
| 6c. ADDRESS (City, State, and ZIP Code) P.O. Box 4700 Rome, NY 13440-8200 | | 7b. ADDRESS (City, State, and ZIP Code) Griffiss AFB, NY 13441-5700 | |
| 8a NAME OF FUNDING / SPONSORING ORGANIZATION DLA/DTIC | 8b. OFFICE SYMBOL (if applicable) DTIC-A1 | 9 PROCUREMENT INSTRUMENT IDENTIFICATION NUMBER F30602-87-C-0228 | |
| 8c. ADDRESS (City, State, and ZIP Code) DTIC Cameron Station Alexandria, VA 22314-6145 | | 10. SOURCE OF FUNDING NUMBERS | |
| | | PROGRAM ELEMENT NO. | PROJECT NO. |
| | | TASK NO. | WORK UNIT ACCESSION NO. |
| 11. TITLE (Include Security Classification) A Primer for DoD Reliability, Maintainability and Safety Standards | | | |
| 12 PERSONAL AUTHOR(S) James W. Wilbur, Norman B. Fuqua | | | |
| 13a. TYPE OF REPORT | 13b TIME COVERED FROM _____ TO _____ | 14. DATE OF REPORT (Year, Month, Day) 1988, March 2 | 15. PAGE COUNT |
| 16 SUPPLEMENTARY NOTATION Hard copies available from Reliability Analysis Center, P.O. Box 4700, Rome, NY 13440-8200 (Price: to be determined). DTIC will provide microfiche copies at standard microfiche price DTIC Source Code: | | | |
| 17. COSATI CODES | | 18. SUBJECT TERMS (Continue on reverse if necessary and identify by block number) | |
| FIELD | GROUP | SUB-GROUP | |
| | | | Reliability MIL-STDs DoD-STDs |
| | | | Maintainability MIL-HDBKs DoD-HDBKs |
| | | | Safety |
| 19 ABSTRACT (Continue on reverse if necessary and identify by block number) This publication provides brief resumes of the most pertinent Military Specifications, Standards and Handbooks dealing with Reliability, Maintainability and Safety (R, M & S). It is addressed to program managers and other individuals who need to get a good quick overview of the most important applicable military documents in the field. It provides the user with a single reference guide to the applicability and use of the most pertinent R, M & S documents, thereby avoiding the separate ordering and review of each document to determine its application to his program. This feature should be especially helpful in proposal writing efforts by relatively new companies in the field, or companies who may not be familiar with government contracting procedures. | | | |
| 20 DISTRIBUTION / AVAILABILITY OF ABSTRACT <input checked="" type="checkbox"/> UNCLASSIFIED/UNLIMITED <input type="checkbox"/> SAME AS RPT <input type="checkbox"/> DTIC USERS | | 21 ABSTRACT SECURITY CLASSIFICATION | |
| 22a NAME OF RESPONSIBLE INDIVIDUAL Steven J. Flint, Technical Director (RAC) | | 22b. TELEPHONE (Include Area Code) (315)330-4151 AV: 4151 | 22c OFFICE SYMBOL RADC/RAC |

FOREWORD

This publication is intended to provide brief resumes of the most pertinent Military Specifications, Standards and Handbooks dealing with Reliability, Maintainability and Safety (R, M & S). It is addressed to program managers and other individuals who need to get a good quick overview of the most important applicable military documents in the field. It provides the user with a single reference guide to the applicability and use of the most pertinent R, M & S documents, thereby avoiding the separate ordering and review of each document to determine its application to his program. This feature should be especially helpful in proposal writing efforts by relatively new companies in the field, or companies who may not be familiar with government contracting.

The book consists of thirty-eight chapters. The chapters average ten pages or less in length and each focuses on a single specification or handbook. Each chapter gives a brief description of the specification or handbook, explains its significance to the program and/or phase of the program, describes its purpose, lists any applicable DID's and gives a brief explanation of how to use the document and, if necessary, how to tailor the requirements of the document. It also differentiates between those specifications which are tri-service approved and those which are unique to a specific branch of the military.

Chapter 1 provides the reader with additional general information on specifications, standards and handbooks and the important distinctions between them and provides guidance to the section of the Primer most appropriate to the reader's interest.

Since many government specifications and handbooks are in a constant state of flux it is anticipated that this publication will be updated as necessary.

The authors gratefully acknowledge the contributions of the following persons in the preparation of this publication: Mr. Steven J. Flint and Ms. Shawn T. Gentile.

TABLE OF CONTENTS

| | <u>PAGE</u> |
|--|--------------------|
| SECTION 1: INTRODUCTION | |
| CHAPTER 1: INTRODUCTION | 1-1 |
| 1.1 PURPOSE | 1-2 |
| 1.2 SCOPE | 1-2 |
| 1.3 GENERAL INFORMATION REGARDING MILITARY SPECIFICATIONS, STANDARDS AND HANDBOOKS | 1-2 |
| 1.4 RELIABILITY PROGRAM SPECIFICATIONS | 1-6 |
| 1.5 RELIABILITY PART/DESIGN APPLICATION SPECIFICATIONS | 1-7 |
| 1.6 MAINTAINABILITY AND SAFETY PROGRAM SPECIFICATIONS | 1-8 |
| 1.7 FORMAT OF SUCCEEDING CHAPTERS | 1-8 |
| SECTION 2: RELIABILITY PROGRAM SPECIFICATIONS | |
| CHAPTER 2: MIL-STD-721C DEFINITIONS OF TERMS FOR RELIABILITY AND MAINTAINABILITY | 2-1 |
| CHAPTER 3: MIL-STD-785B RELIABILITY PROGRAM FOR SYSTEMS AND EQUIPMENT DEVELOPMENT AND PRODUCTION | 3-1 |
| SECTION 3: RELIABILITY ASSESSMENT SPECIFICATIONS | |
| CHAPTER 4: MIL-STD-756B RELIABILITY MODELING AND PREDICTION | 4-1 |
| CHAPTER 5: MIL-HDBK-217E RELIABILITY PREDICTION OF ELECTRONIC EQUIPMENT | 5-1 |
| CHAPTER 6: MIL-STD-2155(AS) FAILURE REPORTING ANALYSIS AND CORRECTIVE ACTION SYSTEM | 6-1 |
| CHAPTER 7: MIL-STD-781D RELIABILITY TESTING FOR ENGINEERING DEVELOPMENT, QUALIFICATION AND PRODUCTION | 7-1 |
| CHAPTER 8: MIL-HDBK-781 RELIABILITY TEST METHODS, PLANS, AND ENVIRONMENTS FOR ENGINEERING DEVELOPMENT, QUALIFICATION, AND PRODUCTION | 8-1 |
| CHAPTER 9: MIL-HDBK-189 RELIABILITY GROWTH MANAGEMENT | 9-1 |
| CHAPTER 10: MIL-STD-2164 (EC) ENVIRONMENTAL STRESS SCREENING PROCESS FOR ELECTRONIC EQUIPMENT | 10-1 |

TABLE OF CONTENTS (CONT'D)

| | <u>PAGE</u> |
|--|--------------------|
| CHAPTER 11: DOD-HDBK-344 (USAF) ENVIRONMENTAL STRESS SCREENING OF ELECTRONIC EQUIPMENT | 11-1 |
| SECTION 4: RELIABILITY DESIGN SPECIFICATIONS | |
| CHAPTER 12: MIL-STD-1629A PROCEDURES FOR PERFORMING A FAILURE MODE EFFECTS AND CRITICALITY ANALYSIS | 12-1 |
| CHAPTER 13: MIL-HDBK-251 RELIABILITY/DESIGN THERMAL APPLICATIONS | 13-1 |
| CHAPTER 14: MIL-HDBK-338 ELECTRONIC RELIABILITY DESIGN HANDBOOK VOLUME I | 14-1 |
| CHAPTER 15: MIL-HDBK-338 ELECTRONIC RELIABILITY DESIGN HANDBOOK VOLUME II | 15-1 |
| CHAPTER 16: MIL-STD-810 ENVIRONMENTAL TEST METHODS AND ENGINEERING GUIDELINES | 16-1 |
| CHAPTER 17: DOD-STD-1686A ELECTROSTATIC DISCHARGE CONTROL PROGRAM FOR PROTECTION OF ELECTRICAL AND ELECTRONIC PARTS, ASSEMBLIES AND EQUIPMENT (EXCLUDING ELECTRICALLY INITIATED EXPLOSIVE DEVICES) | 17-1 |
| CHAPTER 18: DOD-HDBK-263 ELECTROSTATIC DISCHARGE HANDBOOK FOR PROTECTION OF ELECTRICAL AND ELECTRONIC PARTS, ASSEMBLIES AND EQUIPMENT (EXCLUDING ELECTRICALLY INITIATED EXPLOSIVE DEVICES) | 18-1 |
| CHAPTER 19: MIL-STD-454K STANDARD GENERAL REQUIREMENTS FOR ELECTRONIC EQUIPMENT | 19-1 |
| SECTION 5: MAJOR PARTS SPECIFICATIONS | |
| CHAPTER 20: MIL-STD-1562R LISTS OF STANDARD MICROCIRCUITS | 20-1 |
| CHAPTER 21: MIL-M-38510H GENERAL SPECIFICATON FOR MICROCIRCUITS | 21-1 |
| CHAPTER 22: MIL-STD-883C TEST METHODS AND PROCEDURES FOR MICROELECTRONICS | 22-1 |
| CHAPTER 23: MIL-STD-1772A CERTIFICATION REQUIREMENTS FOR HYBRID MICROCIRCUIT FACILITY AND LINES | 23-1 |

TABLE OF CONTENTS (CONT'D)

| | <u>PAGE</u> |
|---|--------------------|
| CHAPTER 24: MIL-S-19500H GENERAL SPECIFICATION FOR SEMICONDUCTOR DEVICES | 24-1 |
| CHAPTER 25: MIL-STD-750C TEST METHODS FOR SEMICONDUCTOR DEVICES | 25-1 |
| CHAPTER 26: MIL-STD-701M LISTS OF STANDARD SEMICONDUCTOR DEVICES | 26-1 |
| CHAPTER 27: MIL-STD-198E SELECTION AND USE OF CAPACITORS | 27-1 |
| CHAPTER 28: MIL-STD-199D SELECTION AND USE OF RESISTORS | 28-1 |
| CHAPTER 29: MIL-STD-790D RELIABILITY ASSURANCE PROGRAM FOR ELECTRONIC PART SPECIFICATIONS | 29-1 |
| CHAPTER 30: MIL-STD-965A PARTS CONTROL PROGRAM | 30-1 |
| CHAPTER 31: MIL-STD-1556B GOVERNMENT/INDUSTRY DATA EXCHANGE PROGRAM (GIDEP) CONTRACTOR PARTICIPATION REQUIREMENTS | 31-1 |
| CHAPTER 32: MIL-STD-202F TEST METHODS FOR ELECTRONIC AND ELECTRICAL COMPONENT PARTS | 32-1 |
| SECTION 6: MAINTAINABILITY PROGRAM SPECIFICATIONS | |
| CHAPTER 33: MIL-STD-470A MAINTAINABILITY PROGRAM FOR SYSTEMS AND EQUIPMENT | 33-1 |
| SECTION 7: MAINTAINABILITY DESIGN SPECIFICATIONS | |
| CHAPTER 34: MIL-STD-2165 TESTABILITY PROGRAM FOR ELECTRONIC SYSTEMS AND EQUIPMENTS | 34-1 |
| CHAPTER 35: MIL-STD-2084(AS) GENERAL REQUIREMENTS FOR MAINTAINABILITY | 35-1 |
| SECTION 8: MAINTAINABILITY ASSESSMENT SPECIFICATIONS | |
| CHAPTER 36: MIL-STD-471A MAINTAINABILITY DEMONSTRATION | 36-1 |
| CHAPTER 37: MIL-HDBK-472 MAINTAINABILITY PREDICTION | 37-1 |
| SECTION 9: SAFETY-RELATED SPECIFICATIONS | |
| CHAPTER 38: MIL-STD-882B SYSTEM SAFETY PROGRAM REQUIREMENTS | 38-1 |
| APPENDIX A: ADDITIONAL RAC SERVICES | A-1 |

LIST OF TABLES

| | | <u>PAGE</u> |
|-------------|--|--------------------|
| TABLE 3.1: | MIL-STD-785 APPLICATION MATRIX | 3-3 |
| TABLE 4.1: | USES OF RELIABILITY MODELS AND PREDICTIONS | 4-2 |
| TABLE 5.1: | DEVICE MODEL TYPES CONTAINED IN MIL-HDBK-217 | 5-2 |
| TABLE 5.2: | ENVIRONMENTAL MODE FACTORS | 5-5 |
| TABLE 5.3: | π_R , RESISTANCE FACTOR | 5-5 |
| TABLE 5.4: | π_Q , QUALITY FACTOR | 5-5 |
| TABLE 5.5: | MIL-R-39008 AND MIL-R-11 RESISTORS, FIXED, COMPOSITION, BASE FAILURE RATES, λ_b | 5-6 |
| TABLE 13.1: | FAILURE RATE REDUCTION BY TEMPERATURE REDUCTION | 13-2 |
| TABLE 14.1: | ENVIRONMENTAL STRESS, EFFECTS AND RELIABILITY IMPROVEMENT TECHNIQUES IN ELECTRONIC EQUIPMENT | 14-11 |
| TABLE 14.2: | STRESS SCREENING GUIDELINES MATRIX | 14-21 |
| TABLE 14.3: | FEATURES OF CURRENT WARRANTY-GUARANTEE PLANS | 14-24 |
| TABLE 15.1: | GROUND RULES FOR PARTS SELECTION AND CONTROL | 15-6 |
| TABLE 15.2: | MICROCIRCUIT SELECTION CRITERIA | 15-7 |
| TABLE 15.3: | LSI TECHNOLOGY CHARACTERISTICS | 15-8 |
| TABLE 15.4: | SEMICONDUCTOR SELECTION CRITERIA | 15-9 |
| TABLE 15.5: | DERATING FACTORS FOR TRANSISTORS | 15-9 |
| TABLE 15.6: | DIODE DERATING | 15-10 |
| TABLE 15.7: | USAGE AND SELECTION GUIDELINES FOR RESISTORS | 15-12 |
| TABLE 15.8: | RELATIVE FAILURE RATE DIFFERENCES | 15-13 |
| TABLE 15.9: | FAILURE MODES ENCOUNTERED WITH ELECTRONIC COMPONENTS DURING STORAGE | 15-17 |
| TABLE 17.1: | ESD CONTROL PROGRAM REQUIREMENTS | 17-5 |

LIST OF TABLES (CONT'D)

| | <u>PAGE</u> |
|---|--------------------|
| TABLE 18.1: TYPICAL PRIME CHARGE SOURCES | 18-3 |
| TABLE 18.2: TYPICAL ELECTROSTATIC VOLTAGES | 18-4 |
| TABLE 18.3: LISTS OF ESDS PARTS BY PART TYPE | 18-5 |
| TABLE 20.1: POTENTIAL STANDARDIZATION CANDIDATE | 20-4 |
| TABLE 20.2: INACTIVE OR SUSPENDED MILITARY ACTIVITY | 20-5 |
| TABLE 20.3: NOT RECOMMENDED UNDER ANY CIRCUMSTANCE | 20-6 |
| TABLE 21.1: QUALITY ASSURANCE PROGRAM REQUIREMENTS | 21-3 |
| TABLE 21.2: MIL-M-38510 LTPD SAMPLING PLANS | 21-4 |
| TABLE 22.1: MIL-STD-883 TEST METHODS | 22-2 |
| TABLE 23.1: SUBSTRATE AND CIRCUIT ELEMENT ATTACHMENT CHECK LIST | 23-3 |
| TABLE 23.2: AUDIT PLAN FOR FACILITIES AND LINE CERTIFICATION | 23-4 |
| TABLE 23.3: QUALIFICATION OF MATERIALS AND MANUFACTURING CONSTRUCTION TECHNIQUES | 23-5 |
| TABLE 23.4: SUBSTRATE AND CIRCUIT ELEMENTS ATTACH QUALIFICATION | 23-6 |
| TABLE 24.1: MIL-S-19500 PRODUCT ASSURANCE REQUIREMENTS | 24-3 |
| TABLE 24.2: MIL-S-19500 SCREENING REQUIREMENTS | 24-3 |
| TABLE 24.3: MIL-S-19500 LTPD SAMPLING PLANS | 24-6 |
| TABLE 25.1: MIL-STD-750 TEST METHODS | 25-2 |
| TABLE 26.1: MIL-STD-701 SEMICONDUCTOR DEVICE LISTINGS | 26-2 |
| TABLE 26.2: THYRISTORS (SILICON CONTROLLER RECTIFIERS) LISTINGS | 26-3 |
| TABLE 26.3: NUMERICAL LISTING OF TRANSISTORS | 26-4 |
| TABLE 27.1: CROSS REFERENCE (CAPACITOR STYLE TO MIL SPECIFICATIONS) | 27-3 |
| TABLE 27.2: PRINCIPAL CAPACITOR APPLICATIONS | 27-4 |
| TABLE 27.3: CAPACITOR TYPES AVAILABLE BY DIELECTRIC | 27-5 |

LIST OF TABLES (CONT'D)

| | <u>PAGE</u> |
|--|--------------------|
| TABLE 29.1: MIL-STD-790 AUDIT REQUIREMENTS CHECKLIST | 29-5 |
| TABLE 31.1: GIDEP UTILIZATION | 31-4 |
| TABLE 32.1: MIL-STD-202 TEST METHODS | 32-2 |
| TABLE 32.2: SEQUENCE OF TESTS | 32-4 |
| TABLE 33.1: MIL-STD-470 TASK LIST AND APPLICATION MATRIX | 33-6 |
| TABLE 35.1: MIL-STD-2084 REQUIREMENTS LIST AND APPLICATION MATRIX | 35-3 |
| TABLE 37.1: COMPARISON MATRIX OF MAINTAINABILITY PREDICTION PROCEDURES | 37-5 |
| TABLE 38.1: APPLICATION MATRIX FOR SYSTEM PROGRAM DEVELOPMENT | 38-6 |
| TABLE 38.2: APPLICATION MATRIX FOR FACILITIES ACQUISITION | 38-7 |

LIST OF FIGURES

| | <u>PAGE</u> |
|--|--------------------|
| FIGURE 1.1: RELIABILITY PROGRAM SPECIFICATIONS | 1-6 |
| FIGURE 1.2: RELIABILITY PART/DESIGN-APPLICATION SPECIFICATIONS | 1-6 |
| FIGURE 1.3: MAINTAINABILITY PROGRAM SPECIFICATIONS | 1-7 |
| FIGURE 6.1: CLOSED LOOP FAILURE REPORTING AND CORRECTIVE ACTION SYSTEM | 6-2 |
| FIGURE 6.2: CLOSED LOOP FAILURE REPORTING AND CORRECTIVE ACTION SYSTEM WITH FAILURE REVIEW BOARD | 6-3 |
| FIGURE 9.1: RELIABILITY GROWTH MANAGEMENT MODEL (ASSESSMENT) | 9-3 |
| FIGURE 9.2: PLANNED GROWTH AND ASSESSMENTS | 9-4 |
| FIGURE 9.3: RELIABILITY GROWTH MANAGEMENT MODEL (MONITORING) | 9-5 |
| FIGURE 10.1: ENVIRONMENTAL STRESS SCREENING CONSTITUENTS | 10-3 |
| FIGURE 10.2: RANDOM VIBRATION SPECTRUM | 10-4 |
| FIGURE 10.3: TEMPERATURE CYCLING PROFILE FOR AMBIENT COOLED AND SUPPLEMENTARY COOLED EQUIPMENT | 10-5 |
| FIGURE 11.1: TASK SEQUENCE PLANNING, MONITORING AND CONTROLLING AN ESS PROGRAM | 11-6 |
| FIGURE 12.1: EXAMPLE OF FMEA WORKSHEET FORMAT | 12-3 |
| FIGURE 12.2: EXAMPLE OF CRITICALITY WORKSHEET FORMAT | 12-5 |
| FIGURE 13.1: COMPARISON OF METHODS OF COOLING | 13-4 |
| FIGURE 13.2: BASIC HEAT PIPE | 13-5 |
| FIGURE 13.3: THERMOELECTRIC JUNCTIONS | 13-6 |
| FIGURE 14.1: NEW-GENERATION COST PROGRESSION FOR SYSTEMS SHOWN | 14-7 |
| FIGURE 14.2: SUMMARY OF BASIC RELIABILITY CONCEPTS | 14-8 |
| FIGURE 14.3: THE RELATIONSHIP BETWEEN INSTANTANEOUS, MISSION AND STEADY STATE AVAILABILITIES AS A FUNCTION OF OPERATING TIME | 14-8 |

LIST OF FIGURES (CONT'D)

| | <u>PAGE</u> |
|--|--------------------|
| FIGURE 14.4: RELIABILITY-MAINTAINABILITY TRADE-OFFS | 14-9 |
| FIGURE 14.5: COMPARISON OF CUMULATIVE LIFE CYCLE COSTS, WITH AND WITHOUT SPECIFIED RELIABILITY GROWTH TESTREQUIREMENTS | 14-14 |
| FIGURE 14.6: DECOMPOSED SOFTWARE SYSTEM | 14-16 |
| FIGURE 14.7: PRINCIPAL TASKS REQUIRED FOR EVALUATION OF SYSTEM EFFECTIVENESS | 14-17 |
| FIGURE 14.8: LIFE CYCLE COSTS VS. RELIABILITY | 14-18 |
| FIGURE 14.9: RELIABILITY LIFE CYCLE DEGRADATION AND GROWTH CONTROL | 14-20 |
| FIGURE 14.10: COMPARATIVE COSTS OF DEFECT DETECTION WITH INCREASED ASSEMBLY LEVELS | 14-19 |
| FIGURE 14.11: LIFE CYCLE COST ACTIVITIES | 14-23 |
| FIGURE 15.1: PROPERTIES OF SILICON AND GaAs AT 300°K | 15-4 |
| FIGURE 15.2: DIODE PROTECTION | 15-11 |
| FIGURE 15.3: RESISTOR DERATING CURVE | 15-14 |
| FIGURE 15.4: FLOW CHART OF THERMAL SYSTEMS MANAGEMENT PROGRESS | 15-16 |
| FIGURE 15.5: SCREENING COST EFFECTIVENESS | 15-19 |
| FIGURE 16.1: GENERALIZED LIFE CYCLE HISTORIES FOR MILITARY HARDWARE | 16-2 |
| FIGURE 16.2: ENVIRONMENTAL TAILORING PROCESS FOR MILITARY HARDWARE | 16-6 |
| FIGURE 21.1: MIL-M-38510 DETAIL SPECIFICATION EXAMPLE | 21-6 |
| FIGURE 21.2: PROCEDURE TO RECEIVE QPL-38510 LISTING | 27-7 |
| FIGURE 21.3: MIL-M-38510 QPL EXAMPLE | 21-8 |
| FIGURE 21.4: MIL-M-38510 QML EXAMPLE | 21-9 |
| FIGURE 21.5: MIL-M-38510 QML ATTACHMENT EXAMPLE | 21-10 |

LIST OF FIGURES (CONT'D)

| | <u>PAGE</u> |
|--|--------------------|
| FIGURE 21.6: MIL-M-38510 SUPPLEMENT EXAMPLE | 21-12 |
| FIGURE 22.1: MIL-STD-883 SCREENING REQUIREMENTS | 22-8 |
| FIGURE 24.1: ORDER OF PROCEDURE DIAGRAM FOR JAN, JANTX, JANTXV DEVICE TYPES | 24-5 |
| FIGURE 24.2: MIL-S-19500 DETAIL SPECIFICATION EXAMPLE | 24-8 |
| FIGURE 24.3: MIL-S-19500 QPL EXAMPLE | 24-9 |
| FIGURE 24.4: MIL-S-19500 SUPPLEMENT EXAMPLE | 24-10 |
| FIGURE 28.1: MILITARY RESISTOR SPECIFICATION CATEGORIES | 28-3 |
| FIGURE 29.1: TYPICAL PROCESS FLOW CHART | 29-7 |
| FIGURE 30.1: SAMPLE FORMAT FOR PROGRAM PARTS SELECTION LIST | 30-3 |
| FIGURE 30.2: EXAMPLE OF SELECTION OF PARTS FOR PROGRAM PARTS SELECTION LIST | 30-2 |
| FIGURE 34.1: MODEL TESTABILITY REQUIREMENTS, SYSTEM SPECIFICATION | 34-6 |
| FIGURE 36.1: MAINTAINABILITY TEST METHOD MATRIX | 36-6 |

SECTION 1

INTRODUCTION

**GENERAL INFORMATION ON MILITARY SPECIFICATIONS,
STANDARDS AND HANDBOOKS**

**CHAPTER 1:
INTRODUCTION**

CHAPTER 1: INTRODUCTION

1.1 PURPOSE

When first introduced to a major system or equipment development/procurement program having formal contractual Reliability, Maintainability and Safety requirements (R, M & S), it is easy to become dismayed by the number and the sheer volume of the applicable military R, M & S specifications, standards and handbooks. To further complicate matters, not all of the applicable documents will be explicitly referenced in the contract and the statement of work (SOW), the request for proposal, or the invitation to bid. Frequently it will be necessary to dig through successive layers of documents to uncover references to other equally applicable R, M & S documents.

The purpose of this publication is to assist the reader in this arduous task by pulling together in a single location summaries of all of the most commonly referenced military specifications, standards and handbooks on reliability, maintainability and safety.

It is the intent of the publication to lead the reader through this maze of paper by summarizing some thirty-eight different R, M & S specifications, standards and handbooks which, collectively, contain thousands of pages. The documents addressed vary in length from five pages to over one thousand pages and together they contain fifty or more different appendices. (Indeed in a few cases the appendices to the documents are more significant to the program than the documents themselves.)

1.2 SCOPE

The specifications, standards and handbooks synopsisized in this document are applicable (with suitable tailoring) to system and equipment development and procurement programs of all three of the service branches, Army, Navy and Air Force.

Since all of the documents are continually undergoing change, this publication is necessarily a single snap-shot in time; thus we have endeavored to indicate clearly the most current issue of each document, the revision letter, and its date of release **at the time of this publication**. Because of the frequency with which (change) notices are issued to the documents we have not (with a few exceptions) attempted to identify the current applicable (change) notice to each document. Therefore the reader is cautioned to verify the revision letter, release date and all applicable (change) notices of his required program documentation, prior to use.

All of the material in this publication is only an advisory to the use of the specifications, standards and handbooks it addresses. This document does not supersede, modify, replace or curtail any of the requirements of these specifications, standards and handbooks nor should it be used in their stead.

1.3 GENERAL INFORMATION REGARDING MILITARY SPECIFICATIONS AND HANDBOOKS

Before looking at each of the individual detailed specifications, standards and handbooks (Specs, Stds & Hdbks) we should address some more general topics which will have an effect upon all of the documents to be studied. For instance, some general questions which might be raised by the user of military specifications, standards and handbooks, are:

1. How do I determine exactly which (Specs, Stds & Hdbks) apply to my contract/program?
2. Which version, (revision letter, change notice, etc.) applies for each (Spec, Std & Hdbk)?

CHAPTER 1: INTRODUCTION

3. Is there any significant difference between a MIL-STD and a MIL-HDBK?
4. What is the difference between a "tri-service approved" document and a "limited approval" document?
5. What are "Contractor Program Plans" and what impact do they have upon my contract/program?
6. What does "Tailoring" of specification requirements refer to? When, where and how is tailoring used?
7. What are Data Item Descriptions (DIDs) and what bearing do they have upon each specific task?
8. How and where can I obtain the applicable copies of all of these necessary documents?

The answer to these and other, similar questions may be found in the following portions of this chapter.

● Documents Requirements Hierarchy

It is important to understand the derivation of the reliability, maintainability and safety program requirements and the hierarchical structure by which the applicable document requirements are established. In contracts for the design or development of equipment for the military services the applicability of some military specifications and handbooks will be stated explicitly in the Statement of Work (SOW) or in the contract itself. The inclusion of other pertinent documents, however, may be overlooked. It may be necessary to trace the requirements flow in a hierarchical manner through a number of successive documents to determine the applicability of a specific military specification or handbook to the program.

For additional information regarding the exact order of precedence of the various military specifications and standards the reader is referred to MIL-STD-143, "Standards and Specifications, Order of Precedence for the Selection of,".

● Contract, SOW, Approved Plans, Specification

The contract (of which the SOW is a part) is the top document in the hierarchical structure.

Next in line, depending upon the nature of the program, may be a formally approved operating plan, which the contractor has submitted with his proposal (such as the Reliability Program Plan called for in MIL-STD-785, Task 101 or the Maintainability Program Plan called for in MIL-STD-470, Task 101). This document may in fact modify specific requirements found later in military specifications and handbooks. This approach will frequently be utilized where tailoring of specification requirements to meet the needs of a specific program is encouraged.

CHAPTER 1: INTRODUCTION

● "Tailoring" of MIL-STD-Requirements

In accordance with DoD Directive 4120.21 most modern MIL-STDs are written with the intent of being tailored for each individual program application. These standards are written as a series of specific tasks; thus, they are intentionally structured to discourage indiscriminate blanket applications. "Tailoring" these task requirements will help to ensure that only the most applicable specific tasks will be selected and that the procuring activity will provide essential information for the completion of each of these specific tasks.

These "tailorable" standards also frequently incorporate an appendix containing guidelines for tailoring the requirements of the standard to the needs of a specific program. This tailoring is usually a function of the unique characteristics of that program and its applicable life-cycle phases.

● Data Item Descriptions (DIDs)

Each military standard will generally list one or more DIDs that are applicable to the specific task or tasks. The DIDs define in detail the data products which are to be prepared and delivered by the contractor in fulfillment of that task. A complete up-to-date listing of all applicable DIDs related to any specific military standard can be found in the Acquisition Management Systems and Data Requirements Control List (AMSDL), DoD 5000.19-1 Volume II.

● MIL-STD vs. MIL-HDBK

It is also important to distinguish between Military Standards and Military Handbooks. Standards are primarily requirements documents which must be adhered to while Handbooks are primarily guidance documents and do not generally include specific mandated requirements.

● Submission of Contractor Program Plans

A number of R, M & S standards require the submission of a contractor's proposed operating plan. Some of these operating plans are required as a portion of the proposal while others are required to be submitted at some later date in the program. When such a plan is submitted to and subsequently approved by the procuring agency it then becomes a part of the contract and must be strictly adhered to by the contractor.

Some of these detailed contractor plans, which may be required for a specific program, and the applicable document reference requiring their submittal, are as follows:

- Reliability Program Plan (MIL-STD-785B, Task 101)
- Parts Control Program Plan (MIL-STD-965A)
- Integrated Reliability Test Plan Document (MIL-STD-781D, Task 101)
- Failure Reporting, Analysis and Corrective Action Plan (MIL-STD-2155)
- System Safety Program Plan (MIL-STD-882, Task 102)
- Maintainability Program Plan (MIL-STD-470A, Task 101)
- Maintainability Demonstration Plan (MIL-STD-471A)

CHAPTER 1: INTRODUCTION

- FMECA Plan (MIL-STD-1629A)
- Testability Program Plan (MIL-STD-2165, Task 101)
- Electrostatic Discharge Control Program Plan (DOD-STD-1686A)

● **Applicable Specification Revision**

Military specifications and standards, and to a lesser degree, handbooks are continually being revised and updated. As defined in MIL-STD-721, on any specific program the applicable revision of a specification is the revision which was approved as of the date of "the invitation for bid," or "the request for proposal". The use of any later version of the document is a matter for negotiation between the contractor and the procuring agency. In some cases it may be to the benefit of both parties to use a subsequent version of the document. For example, this is frequently the case with MIL-HDBK-217 but each instance is handled on an exception basis and must be negotiated.

● **Tri-Service vs. Limited Approval Documents**

Military standards and specifications may be released as either a tri-service approved document or as a limited usage document. If an additional suffix appears in parentheses after the basic document number, for example (EC), it is a limited approval document i.e., it is approved by only a single service as indicated by the preparing activity suffix. If there is no parenthetical suffix to the basic document number the document is tri-service approved.

● **Specification Changes, Revisions and Updates**

Military specifications and handbooks are frequently revised, corrected and updated. Therefore it is important to always identify the correct version of the applicable specification or handbook. Major revisions i.e., those which entail a reissue of the complete document are identified by a single letter suffix following the basic document number, for example MIL-HDBK-217E. A minor revision or update is referred to as a "Change Notice". This is an addition of new or revised pages which the user must incorporate into the document, and not a reissue of the document.

A complete listing of the latest version of all military specifications, standards and handbooks as well as many non-government specifications and standards is published periodically. This list is known as the Department of Defense Index of Specifications and Standards (DODISS).

● **Other Significant R&M Military Documentation**

There are also available military documents dealing with Reliability, Maintainability, Logistics and related subjects with which the reader may wish to be familiar other than MIL-Specs, Stds, and Hdbks. For example: 1) there are high-level DOD Directives such as; DOD Directive 5000.40, dated July 8, 1980, dealing specifically with Reliability and Maintainability, 2) the Air Force series of Regulations and Pamphlets such as; Air Force Regulation 800-18, "Air Force Reliability and Maintainability Program," and AFSC Pamphlet 800-27, "Part Derating Guidelines," 3) similar documentation from other service branches such as the Navy publication TE000-AB-GTP-010, "Parts Application and Reliability Information Manual For Navy Electronic Equipment." These publications are just a small sampling of other available R & M documentation.

CHAPTER 1: INTRODUCTION

Two other documents of significance are the "DOD Reliability Standardization Document Program Plan" and its companion "DOD Maintainability Standardization Document Program Plan," which were developed by Rome Air Development Center to define, schedule, plan and control current and future reliability and maintainability standardization activities, including all applicable R & M specifications, standards and handbooks within the DOD. RADC is the Lead Service Activity within the DoD for the standardization of R&M requirements, procedures and documentation. RADC updates and issues its R&M Programs Plans bi-annually.

● Availability of MIL Specs, Stds, Hdbks and Other Documents

All military specifications, standards and handbooks are available to holders of military contracts from:

Naval Publications and Forms Center
5801 Tabor Ave.
Philadelphia, PA 19120

The DODISS is also available on microfiche as a monthly service from Naval Publications and Forms Center.

Military specifications, standards and handbooks may also be purchased from licensed reprinting services such as:

Global Engineering Documentation Services, Inc.
3301 W. MacArthur Blvd.
P. O. Box 5020
Santa Ana, CA 92704

or

Documentation, Inc.
P. O. Box 1240
Melbourne, FL 32901

1.4 RELIABILITY PROGRAM SPECIFICATIONS

Most reliability program requirements are derived from a single military standard, MIL-STD-785, "Reliability Program For Systems and Equipment Development and Production." This standard addresses various specific "numbered reliability tasks." These tasks are described in some detail in the standard which also contains, in its Appendix A, detailed guidelines for the tailoring of the tasks to the needs of a specific program.

In most cases, however, one must turn to additional, more detailed standards and/or handbooks to identify specific procedures and to derive sufficient information to actually complete the applicable task. Some of these detailed standards and/or handbooks are specifically referenced in MIL-STD-785; others are not. There may also be significant changes to existing documents or issuance of new documents, which may not be immediately reflected in MIL-STD-785, e.g., the issuance of MIL-STD-781D (replacing MIL-STD-781C) and the issuance of MIL-HDBK-781.

Figure 1.1 illustrates the relationship between the specific "numbered reliability tasks" in MIL-STD-785 and the applicable detailed standard or handbook, where one can be identified, whether or not that standard or handbook is actually referenced in MIL-STD-785.

CHAPTER 1: INTRODUCTION

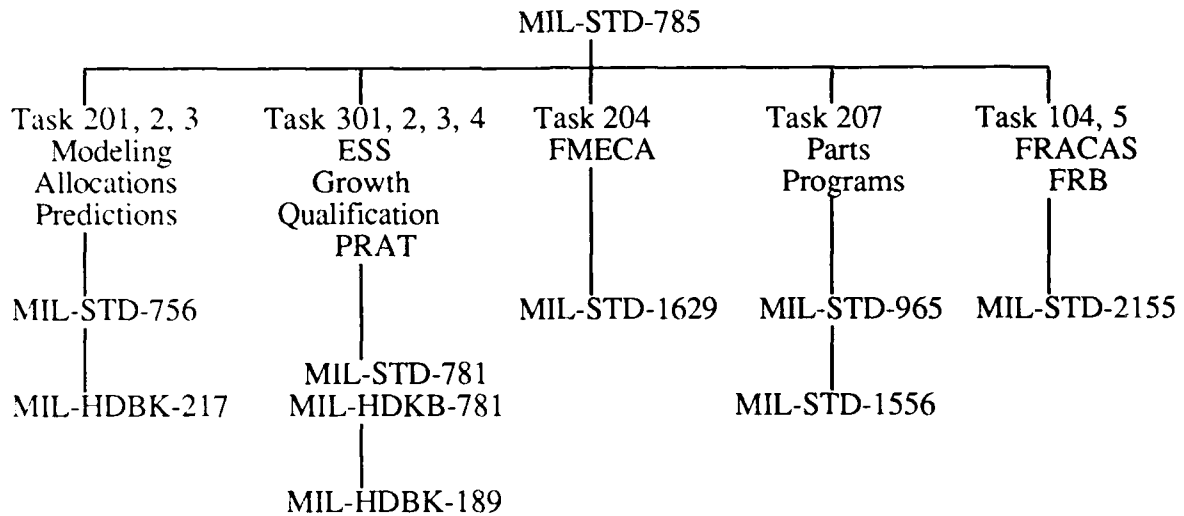
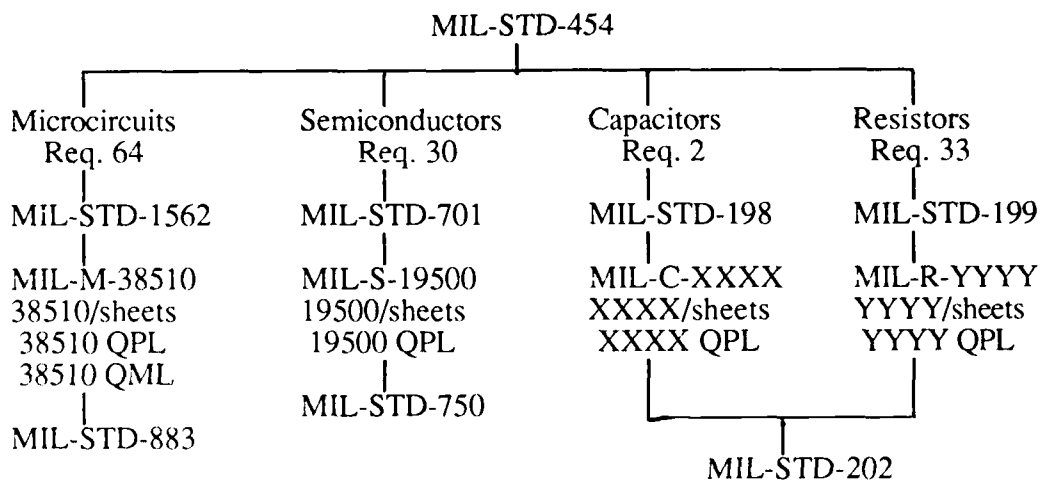

**FIGURE 1.1:
RELIABILITY PROGRAM SPECIFICATIONS**

1.5 RELIABILITY PART/DESIGN-APPLICATION SPECIFICATIONS

Most of the requirements dealing with design specifics and detailed part applications are ultimately derived from a single military standard, MIL-STD-454, "Standard General Requirements for Electronic Equipment." This is not primarily a reliability specification; however, the requirements which it invokes do have significant reliability impact. The standard addresses various "numbered requirements" each dealing with a particular area of concern related to the design.

Figure 1.2 depicts the relationship between the specific "numbered requirements" in MIL-STD-454 and a few of the principal detailed standards or handbooks, which most strongly influence reliability. The figure obviously portrays only a small portion of the applicable part specifications. Others which could also have been included deal with; relays (both conventional and solid state), inductors and transformers, connectors, switches, etc.



**FIGURE 1.2:
RELIABILITY PART/DESIGN-APPLICATION SPECIFICATIONS**

CHAPTER 1: INTRODUCTION

1.6 MAINTAINABILITY AND SAFETY PROGRAM SPECIFICATIONS

● Maintainability and Safety Program Specifications

As with reliability, most maintainability program requirements are derived from a single military standard, MIL-STD-470, "Maintainability Program For Systems and Equipment." This standard addresses various specific "numbered maintainability tasks." These tasks are then described in some detail together with guidelines for the tailoring of these tasks to the needs of a specific program.

In some cases, however, one must turn to additional, more detailed standards and/or handbooks to derive sufficient information to actually complete the applicable task. Some of these detailed standards and/or handbooks are specifically referenced in MIL-STD-470, others are not.

Figure 1.3 portrays the relationship between the the specific "numbered maintainability tasks" in MIL-STD-470 and the applicable detailed standard or handbook, (where one can be identified) whether or not that standard or handbook is actually referenced in MIL-STD-470. In general, the maintainability standards and handbooks are not as current as the reliability documents.

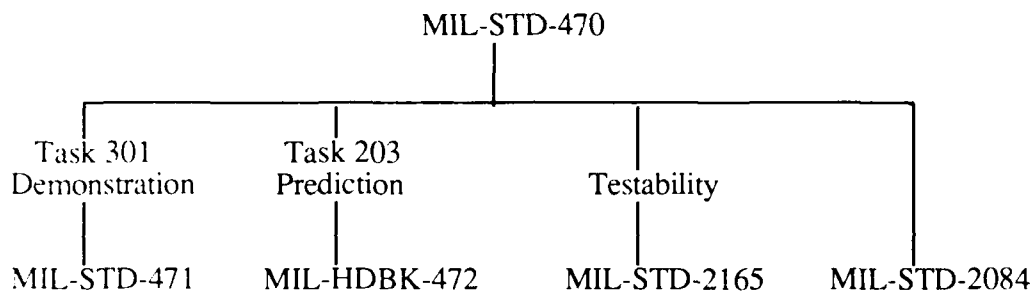

**FIGURE: 1.3:
MAINTAINABILITY PROGRAM SPECIFICATIONS**

● Safety

At present, the only military standard dealing with program safety requirements is MIL-STD-882, "System Safety Program Requirements." It is a very comprehensive document, containing numerous specific safety-related tasks. Obviously not all of these tasks will be applicable to every program, therefore, tailoring of these safety-related tasks and requirements to the needs of the program is absolutely necessary for every application of MIL-STD-882. Guidance for such tailoring is found in Appendix A of the standard.

1.7 FORMAT OF SUCCEEDING CHAPTERS

The material in each of the succeeding chapters of this publication has been organized into a common format to assist the reader in quickly finding the information which he desires. This format together with a brief description of the type of material to be found in each applicable section is summarized as follows:

CHAPTER 1: INTRODUCTION

| <u>SECTION</u> | <u>TITLE & CONTENTS</u> |
|----------------|--|
| X.0 | Introduction - General introductory material such as: tri-service approved or limited approval, latest revision letter and date of release, preparing activity and address thereof. |
| X.1 | Reference Documents - A listing of complementary or supplementary documents (usually other military standards, specifications and handbooks) which describe the subject matter in greater detail. |
| X.2 | Definitions - A glossary of terms and acronyms which may be unique to a specific discipline, given to assist the reader. (This section is not applicable to all chapters.) |
| X.3 | Applicability - A general description of the intent of the document and any major restrictions relative to its applicability. |
| X.4 | Physical Description of the Document - A brief description of the size of the document (page count) and the number and subject nature of all applicable appendices. |
| X.5 | How to Use the Document - A succinct summary explanation of the document together with examples and sample illustrative excerpts from the document. |
| X.6 | Tailoring - A statement regarding the relevancy of tailoring to this specific document and general guidance for performing such tailoring where applicable. |
| X.7 | Contract Data Requirements List - A listing of those deliverable data items most frequently required relative to this task. |

SECTION 2

RELIABILITY PROGRAM SPECIFICATIONS

- CHAPTER 2 MIL-STD-721C: DEFINITION OF TERMS FOR
RELIABILITY AND MAINTAINABILITY**
- CHAPTER 3 MIL-STD-785B: RELIABILITY PROGRAM FOR
SYSTEMS AND EQUIPMENT DEVELOPMENT
AND PRODUCTION**

CHAPTER 2:

**MIL-STD-721C
DEFINITIONS OF TERMS FOR
RELIABILITY AND MAINTAINABILITY**

CHAPTER 2: MIL-STD-721C

MIL-STD-721 is a tri-service approved document used by all branches of the military in the specification and acquisition of quality-assured systems and equipment. The current version is Revision "C" dated June 12, 1981. The preparing activity is:

Department of the Navy
Engineering Specifications and Standards Dept.
(SESD) (Code 5313)
Naval Air Engineering Center
Lakehurst, NJ 08733-5100

This chapter is only an advisory to the use of MIL-STD-721. It does not supersede, modify, replace or curtail any requirements of MIL-STD-721 nor should it be used in lieu of that standard.

2.1 REFERENCE DOCUMENTS

Additional reference documents are not applicable to MIL-STD- 721.

2.2 DEFINITIONS

This paragraph is not applicable to this chapter.

2.3 APPLICABILITY

MIL-STD-721 defines those words and terms most commonly used in association with Reliability and Maintainability (R&M). The standard is intended to be used as a common base for R&M definitions and to reduce the possibility of conflicts, duplications, and incorrect interpretations either expressed or implied elsewhere in other documentation. The definitions address the intent and policy of DoD Directive 5000.40. Statistical and mathematical terms which have gained wide acceptance are not defined in this standard since they are adequately addressed in other documents. The intent of MIL-STD- 721 is to standardize meanings of terms for the particular application and not to compile a handbook of terms.

2.4 PHYSICAL DESCRIPTION OF MIL-STD-721

MIL-STD-721 is a very simple document composed of only thirteen pages. There are no appendices to this standard.

2.5 HOW TO USE MIL-STD-721

By including MIL-STD-721 as a contract requirement document the most germane R&M terms are standardized and fully defined for use throughout a specific program and commonality between different programs is assured. Terms and their definitions included in the standard are those which are:

1. Important in the acquisition of weapon systems for precise definition of reliability and maintainability criteria.
2. Unique in their definitions, allowing no other meaning.
3. Expressed clearly, preferably without mathematical symbols.

CHAPTER 2: MIL-STD-721C

Examples of terms that were intentionally avoided in the standard are those which are:

1. Found in ordinary technical, statistical, or standard dictionary or text having a singularly acceptable meaning when used in the context.
2. Terms which already exist in other Military Standards outside of the project scope.
3. Multiple word terms, unless they are needed for uniqueness.

2.6 TAILORING GUIDELINES

MIL-STD-721 was written for the sake of standardization of terms and definitions both across different programs and within a specific program. It was not written with the intent of modifying these terms and definitions for a specific application, therefore the basic concept of "tailoring" does not apply to MIL-STD-721.

2.7 CONTRACT DATA REQUIREMENTS LIST (CDRL)

No deliverable data items are required by MIL-STD-721.

CHAPTER 3:

MIL-STD-785B

**RELIABILITY PROGRAM FOR SYSTEMS AND
EQUIPMENT DEVELOPMENT AND PRODUCTION**

CHAPTER 3: MIL-STD-785B

As was shown in Chapter 1.0, Figure 1.1, MIL-STD-785 is the top specification in the reliability hierarchy of specifications. It is a tri-service approved document and is used by all branches of the military in the specification and acquisition of quality-assured electronic systems and equipment. The current version is Revision "B" dated September 15, 1980. The preparing activity is:

Aeronautical Systems Division
Attn: ASD/ENESS
Wright-Patterson AFB, OH 45433-6503

This chapter is only an advisory to the use of MIL-STD-785. It does not supersede, modify, replace or curtail any of the requirements of MIL-STD-785 nor should it be used in lieu of that standard.

3.1 REFERENCE DOCUMENTS

Each of the individual tasks described in MIL-STD-785 is usually addressed by one or more specific military standard.

For example, Task 104, "Failure Reporting, Analysis and Corrective Action System (FRACAS)" is specifically addressed by MIL-STD-2155.

The following related documents are referenced in MIL-STD-785 and further detail these tasks.

- MIL-STD-781 Reliability Testing for Engineering Development Qualification and Production
- MIL-STD-965 Parts Control Program
- MIL-STD-1521 Technical Reviews and Audits for Systems, Equipment and Computer Programs
- MIL-STD-1556 Government/Industry Data Exchange Program Contractor Participation Requirements
- MIL-HDBK-217 Reliability Prediction of Electronic Equipment
- MIL-STD-756 Reliability Modeling and Prediction
- MIL-STD-2155 (AS) Failure Reporting, Analysis and Corrective Action System (FRACAS)
- MIL-STD-1629 Procedures for Performing a Failure Mode, Effects and Criticality Analysis (FMECA)
- MIL-STD-2164 (EC) Environmental Stress Screening Process for Electronic Equipment
- DOD-HDBK-344 (USAF) Environmental Stress Screening (ESS) of Electronic Environment
- MIL-HDBK-781 Reliability Test Methods, Plans, and Environments for Engineering Development, Qualification and Production

CHAPTER 3: MIL-STD-785B

3.2 DEFINITIONS

This paragraph is not applicable to this chapter.

3.3 APPLICABILITY

MIL-STD-785, "Reliability Program for Systems and Equipment, Development and Production" provides both general requirements and specific tasks for managing reliability programs. It provides specific guidelines for the preparation and implementation of a comprehensive reliability program.

The standard may be helpful to producers of industrial and commercial systems and equipments as well as to the producers of military and aerospace systems and equipments.

3.4 PHYSICAL DESCRIPTION OF MIL-STD-785

MIL-STD-785 is composed of eighteen different "Reliability Tasks" together with a detailed description of each task. The standard itself contains approximately fifty-six pages. There is also an additional thirty-one page appendix dealing with tailoring of the specification requirements.

3.5 HOW TO USE MIL-STD-785

MIL-STD-785 addresses three different type of tasks: (1) Reliability Accounting Tasks, (2) Reliability Engineering Tasks and (3) Reliability Management Tasks. These three types of tasks may be defined as follows:

- (1) Reliability Accounting Tasks focus on providing the information essential to the acquisition, operation, and support management of the system/equipment.
- (2) Reliability Engineering Tasks focus on the prevention, detection, and correction of reliability design deficiencies, weak parts, and workmanship defects. An effective reliability program stresses early investment in reliability engineering tasks to avoid subsequent additional costs and schedule delays.
- (3) Reliability Management Tasks are those that relate more to the management responsibilities dealing with the program and less to the technical details.

Table 3.1 (reproduced from MIL-STD-785) contains a listing, by task number, of each of the specific reliability tasks defined in MIL-STD-785. Each of these reliability tasks is explained in more detail in the following section.

3.5.1 Program Surveillance and Control Tasks

● Task 101: Reliability Program Plan

A reliability program plan is based upon an analysis of the specified reliability requirements and is developed during the program conceptual design phase. The reliability program plan is a basic design tool to:

- (1) Assist in managing an effective reliability program
- (2) Determine, direct and control the execution of, the applicable reliability tasks

CHAPTER 3: MIL-STD-785B

TABLE 3.1: MIL-STD-785 APPLICATION MATRIX

| TASK | TITLE | TASK TYPE | PROGRAM PHASE | | | |
|------|--|-----------|---------------|---------|---------|----------|
| | | | CONCEPT | VALID | FSED | PROD |
| 101 | RELIABILITY PROGRAM PLAN | MGT | S | S | G | G |
| 102 | MONITOR/CONTROL OF SUBCONTRACTORS AND SUPPLIERS | MGT | S | S | G | G |
| 103 | PROGRAM REVIEWS | MGT | S | S(2) | G(2) | G(2) |
| 104 | FAILURE REPORTING, ANALYSIS, AND CORRECTIVE ACTION SYSTEM (FRACAS) | ENG | NA | S | G | G |
| 105 | FAILURE REVIEW BOARD (FRB) | MGT | NA | S(2) | G | G |
| 201 | RELIABILITY MODELING | ENG | S | S(2) | G(2) | GC(2) |
| 202 | RELIABILITY ALLOCATIONS | ACC | S | G | G | GC |
| 203 | RELIABILITY PREDICTIONS | ACC | S | S(2) | G(2) | GC(2) |
| 204 | FAILURE MODES, EFFECTS, AND CRITICALITY ANALYSIS (FMECA) | ENG | S | S(1)(2) | G(1)(2) | GC(1)(2) |
| 205 | SNEAK CIRCUIT ANALYSIS (SCA) | ENG | NA | NA | G(1) | GC(1) |
| 206 | ELECTRONIC PARTS/CIRCUITS TOLERANCE ANALYSIS | ENG | NA | NA | G | GC |
| 207 | PARTS PROGRAM | ENG | S | S(2)(3) | G(2) | G(2) |
| 208 | RELIABILITY CRITICAL ITEMS | MGT | S(1) | S(1) | G | G |
| 209 | EFFECTS OF FUNCTIONAL TESTING, STORAGE, HANDLING, PACKAGING, TRANSPORTATION, AND MAINTENANCE | ENG | NA | S(1) | G | GC |
| 301 | ENVIRONMENTAL STRESS SCREENING (ESS) | ENG | NA | S | G | G |
| 302 | RELIABILITY DEVELOPMENT/GROWTH TESTING | ENG | NA | S(2) | G(2) | NA |
| 303 | RELIABILITY QUALIFICATION TEST (RQT) PROGRAM | ACC | NA | S(2) | G(2) | G(2) |
| 304 | PRODUCTION RELIABILITY ACCEPTANCE ACCEPTANCE TEST (PRAT) PROGRAM | ACC | NA | NA | S | G(2)(3) |

CODE DEFINITIONS

TASK TYPE:

ACC - RELIABILITY ACCOUNTING
 ENG - RELIABILITY ENGINEERING
 MGT - MANAGEMENT

PROGRAM PHASE

S - SELECTIVELY APPLICABLE
 G - GENERALLY APPLICABLE
 GC - GENERALLY APPLICABLE TO DESIGN CHANGES ONLY
 NA - NOT APPLICABLE
 (1) - REQUIRES CONSIDERABLE INTERPRETATION OF INTENT TO BE COST EFFECTIVE
 (2) - MIL-STD-785 IS NOT THE PRIMARY IMPLEMENTATION REQUIREMENT. OTHER MIL-STDs OR STATEMENT OF WORK REQUIREMENTS MUST BE INCLUDED TO DEFINE THE REQUIREMENTS.

CHAPTER 3: MIL-STD-785B

- (3) Determine that the documented procedures for implementing and controlling reliability tasks are adequate
- (4) Determine organizational adequacy to assure that appropriate attention will be focused on reliability activities and/or problems

● Task 102: Monitor/Control of Subcontractors and Suppliers

Continual visibility of subcontractors' activities is essential so that timely and appropriate management action can be taken as the need arises. Contractual provisions must be included which permit the procuring activity to participate in appropriate formal prime/subcontractor meetings. Information gained at these meetings can provide a basis for follow-up actions necessary to maintain adequate visibility of subcontractors' progress including technical, cost, and schedule considerations.

● Task 103: Program Reviews

Program reviews and Design Reviews are important management and technical tools used to insure adequate staffing and funding. Typical program reviews are held to:

- (1) Evaluate program progress; including both technical adequacy and the reliability of a selected design and test approach (Preliminary Design Review).
- (2) Determine the acceptability of the detail design approach, including reliability, before commitment to production (Critical Design Review)
- (3) Periodically review progress of the reliability program, i.e., the progress of each specified reliability task

MIL-STD-1521 provides direction for technical reviews and audits.

● Task 104: Failure Reporting, Analyses, and Corrective Action Systems (FRACAS)

Early elimination of failure causes is a major contributor to reliability growth. The sooner failure causes can be identified the easier it is to implement effective corrective action. A closed-loop FRACAS must be employed early in the development phase, particularly for complex systems/equipments.

FRACAS must also assure that the disposition of failed hardware is properly controlled to preclude premature disposal. This will help to insure that the actual failed parts are subjected to the required analyses.

MIL-STD-2155 provides direction for the implementation of FRACAS.

CHAPTER 3: MIL-STD-785B

- **Task 105: Failure Review Board (FRB)**

Acquisition of expensive, complex, or critical equipment or systems may require formalized FRACAS proceedings controlled by a Failure Review Board. The FRB team consists of representatives of the procuring agency and the contractor's engineering, quality assurance and manufacturing personnel. FRB is intended to insure that FRACAS is properly implemented; providing additional assurance of tightly controlled reporting, analyses, and corrective actions taken on identified failures.

MIL-STD-2155 provides direction for the implementation of FRB.

3.5.2 Design and Evaluation Tasks

- **Task 201: Reliability Modeling**

Reliability models of the system/subsystem/equipment are required to make numerical apportionments and estimates. These models are also required for evaluating the complex equipment arrangements typical of modern systems. Models should be developed as early as program definition permits, even if usable numerical input data are not yet available. Early modeling can reveal conditions where management action may be required. Models should be continually expanded to the detail level for which planning, mission, and system definition are firm.

Reliability models are used, together with duty cycle and mission duration information, to develop mathematical equations which utilize the appropriate failure rate and probability of success data to provide apportionments, estimates, and assessments of mission reliability.

MIL-STD-756 provides the necessary instructions for reliability modeling.

- **Task 202: Reliability Allocations**

Reliability allocations convert the system reliability requirement to specific reliability requirements for each of the black boxes and lower-level items. Being one of the first reliability tasks to be performed, it will probably require later updating or "reallocation". Reallocation of the requirements is performed as more detailed information regarding the design becomes known.

- **Task 203: Reliability Predictions**

Prediction is performed early in the acquisition phase to determine the feasibility of the reliability requirement. Updates during the development and production phases determine reliability attainability. Predictions are important in providing engineers and management with quantitative reliability information for day-to-day activities.

CHAPTER 3: MIL-STD-785B

Early predictions based on the parts count method are inherently unrefined; however, they do provide feedback to designers and managers on the feasibility of meeting the reliability requirements. As the design progresses to the hardware stage, predictions mature as actual design data becomes available and is integrated into the calculations. Reliability predictions also provide essential inputs to other related activities, i.e., maintainability, safety, quality engineering, logistics and test planning. They establish a baseline for estimating progress and performance. Predictions may also be used to detect overstressed parts and pinpoint critical areas for redesign or application of redundancy.

MIL-STD-756 and MIL-HDBK-217 provide the detailed methodology for reliability prediction.

● **Task 204: Failure Modes, Effects, and Criticality Analysis (FMECA)**

FMECA allows potential design weaknesses to be identified and appropriately analyzed and evaluated using engineering schematics and mission considerations. It provides systematic identification of likely modes of failure, possible effects of each failure, and the criticality of each failure with regard to safety, system readiness, mission success, demand for maintenance/logistic support, or other factors.

An initial FMECA can be performed at the conceptual phase. Since limited design definition is available, only the more obvious failure modes will be identified. As design definition grows in the validation and development phases, the FMECA can be expanded to successively more detail levels and ultimately, if required, to the part level.

FMECA can suggest areas where the judicious use of redundancy can significantly improve mission reliability without unacceptable impact on basic reliability and where other analyses, e.g., electronic parts analyses, should be made. FMECA results should be used to confirm the validity of the models used in computing reliability estimates and subsystem or functional equipment groupings, particularly where some form of redundancy is included.

Detailed methodology for performing an FMECA can be found in MIL-STD-1629.

● **Task 205: Sneak Circuit Analysis (SCA)**

SCA is used to identify latent paths which may cause unwanted functions or inhibit desired functions. It assumes that all components are functioning properly. SCA is expensive, and is usually performed late in the design cycle after design documentation is complete. This makes subsequent changes difficult and costly to implement. SCA should be considered only for items and functions which are critical to safety or mission success or where other techniques are not effective.

● **Task 206: Electronic Parts/Circuit Tolerance Analysis**

This analysis examines the effects of parts/circuits' electrical tolerances and parameters over the range of specified operating temperatures. It considers expected component value variations due to manufacturing tolerance variations and also their drift with time and temperature. The analysis uses equivalent circuits and mode-matrix analysis techniques to prove that the circuit or equipment will meet specification requirements under all required conditions. This analysis is expensive, and its application may thus be limited to critical circuits only.

CHAPTER 3: MIL-STD-785B

● **Task 207: Parts Program**

Parts are the building blocks from which the system is constructed. System optimization can be achieved only by paying particular attention to parts selection, control, and application. This task should start early in the validation phase and continue throughout the entire development and production life of the system.

A comprehensive parts program consists of the following elements:

- a parts control program in accordance with MIL-STD-965
- parts standardization
- documented parts application and derating guidelines
- part testing, qualification and screening
- participation in GIDEP as documented in MIL-STD-1556

The objective of the parts program is to control the selection and use of both standard and nonstandard parts. An effective parts program requires knowledgeable parts engineers in the employ of both the procuring activity and the contractor.

● **Task 208: Reliability-Critical Items**

Reliability-Critical Items are those whose failure can significantly affect safety, mission success, or total maintenance/logistics support costs. These items are identified during the part selection and application process. Critical items are prime candidates for detailed analyses, growth testing, reliability qualification testing, reliability stress analyses, and similar techniques to reduce the reliability risk.

● **Task 209: Effects of Functional Testing, Storage, Handling, Packaging, Transportation, and Maintenance**

Procedures must be established, maintained, and implemented to determine by test and analysis (or estimation), the effects of storage, handling, packaging, transportation, maintenance and repeated exposure to functional testing on the design and reliability of the hardware. The results of this effort are used to support long-term failure rate predictions, design trade-offs, definition of allowable test exposures, retest after storage decisions, packaging, handling, or storage requirements, and refurbishment plans. They provide some assurance that these items can successfully tolerate foreseeable operational and storage influences.

CHAPTER 3: MIL-STD-785B

3.5.3 Development and Production Test Tasks

- **Task 301: Environmental Stress Screening (ESS)**

ESS is a test or series of tests specifically designed to disclose weak parts and workmanship defects requiring correction. It may be applied to parts, components, subassemblies, assemblies, or equipment (as appropriate and cost-effective). The intent is to remove defects which would otherwise cause failure during later testing or field service. ESS has significant potential return on investment during both development and production.

ESS procedures are found in MIL-STD-2164(EC), DOD-HDBK-344(USAF), MIL-STD-781D and MIL-HDBK-781.

- **Task 302: Reliability Development/Growth Testing (RDGT) Program**

RDGT is a planned prequalification test-analyze-and-fix (TAAF) process in which equipments are tested under actual, simulated, or accelerated environments to disclose design deficiencies and defects. It is intended to provide a basis for early incorporation of corrective actions and for verification of their effectiveness, thus promoting reliability growth.

RDGT is intended to correct failures that reduce operational effectiveness and failures that increase maintenance and logistics support costs. RDGT should be conducted using the first prototype items available. RDGT procedures are found in MIL-HDBK-189, MIL-STD-781D and MIL-HDBK-781.

- **Task 303: Reliability Qualification Test (RQT) Program**

RQT is intended to provide to the customer reasonable assurance that the design meets minimum acceptable reliability requirements before items are committed to production. RQT must be operationally realistic and must provide an estimate of demonstrated reliability. The statistical test plan identified therein must adequately define successful and unsuccessful operation and define acceptance criteria which limit the probability that the true reliability of the item is less than the minimum acceptable reliability requirement. RQT is a preproduction test; it must be completed in time to provide management information for the production decision.

RQT procedures are documented in MIL-STD-781.

- **Task 304: Production Reliability Acceptance Test (PRAT) Program**

PRAT is a reliability sample testing of production hardware "as delivered." Its purpose is to assure that the hardware has not been degraded as the result of changes in tooling, processes, work flow, design or parts quality.

PRAT is intended to simulate in-service evaluation of the delivered item or production lot. It must be operationally realistic and its use may be required to provide estimates of demonstrated reliability.

PRAT procedures are documented in MIL-STD-781.

CHAPTER 3: MIL-STD-785B

3.6 TAILORING GUIDELINES

Tailoring of a reliability program involves primarily the planning and selection of specific reliability tasks and the determination of the rigor with which each of these tasks will be applied.

3.6.1 When and How to Tailor

MIL-STD-785 is written as a series of specific tasks to assist the contractor in the development and establishment of a unique cost effective reliability program, thus tailoring of the requirements is implicit in this approach.

Specific directions for the tailoring of the requirements of MIL-STD-785 are found in Appendix A of the standard.

3.7 CONTRACT DATA REQUIREMENTS LIST (CDRL)

Each individual task in MIL-STD-785 has its own list of CDRL items.

The following is a list of data item descriptions associated with the reliability tasks specified herein:

| <u>Task</u> | <u>Applicable DID</u> | <u>Data Requirement</u> |
|-------------|-----------------------|---|
| 101 | DI-R-7079 | Reliability Program Plan |
| 103 | DI-R-7080 | Reliability Status Report |
| 104 | DI-R-7041 | Report, Failure Summary and Analysis |
| 201 | DI-R-7081 | Reliability Mathematical Model(s) |
| 202 | DI-R-2114 | Report, Reliability Allocation |
| 203 | DI-R-7082 | Reliability Predictions Report |
| 204 | DI-R-1734 | Report, Failure Modes, Effects and Criticality Analysis Report |
| | DI-R-2115A | Report, Failure Mode and Effect Analysis (FMEA) (DI-R-2115A is to be used only when MIL-STD-1629 to be used only when MIL-STD-1629 has been designated as the basic for MIL-STD-785B, Task 204 |
| 205 | DI-R-7083 | Sneak Circuit Analysis Report |
| 206 | DI-R-7084 | Electronic Parts/Circuits Tolerance Analysis Report |
| 208 | DI-R-35011 | Plan, Critical Item Control |
| | DI-R-3547 | Reliability and Maintainability Report on Commercial Equipment |

CHAPTER 3: MIL-STD-785B

| <u>Task</u> | <u>Applicable DID</u> | <u>Data Requirement</u> |
|----------------|-----------------------|--|
| | DI-R-1724 | Quality Inspection Test, Demonstration and Evaluation Report |
| 301 | DI-R-7040 | Report, Burn-in Test |
| 302,303 304 | DI-R-7033 | Plan, Reliability Test |
| 303,304 | DI-R-7035 | Procedures, Reliability Test and Demonstration |
| 303,304 | DI-R-7034 | Reports, Reliability Test and Demonstration (Final Report) |

NOTES: Only data items specified in the CDRL are deliverable. Therefore, those data requirements identified in the Reliability Program Plan must also appear in the CDRL.

SECTION 3

RELIABILITY ASSESSMENT SPECIFICATIONS

- CHAPTER 4** **MIL-STD-756B:** RELIABILITY MODELING AND PREDICTION
- CHAPTER 5** **MIL-HDBK-217E:** RELIABILITY PREDICTION OF ELECTRONIC EQUIPMENT
- CHAPTER 6** **MIL-STD-2155(AS):** FAILURE REPORTING, ANALYSIS AND CORRECTIVE ACTION SYSTEM
- CHAPTER 7** **MIL-STD-781D:** RELIABILITY TESTING FOR ENGINEERING DEVELOPMENT, QUALIFICATION AND PRODUCTION
- CHAPTER 8** **MIL-HDBK-781:** RELIABILITY TEST METHODS, PLANS, AND ENVIRONMENTS FOR ENGINEERING DEVELOPMENT, QUALIFICATION, AND PRODUCTION
- CHAPTER 9** **MIL-HDBK-189:** RELIABILITY GROWTH MANAGEMENT
- CHAPTER 10** **MIL-STD-2164(EC):** ENVIRONMENTAL STRESS SCREENING PROCESS FOR ELECTRONIC EQUIPMENT
- CHAPTER 11** **DOD-HDBK-344(USAF):** ENVIRONMENTAL STRESS SCREENING OF ELECTRONIC EQUIPMENT

CHAPTER 4:

**MIL-STD-756B
RELIABILITY MODELING AND PREDICTION**

CHAPTER 4: MIL-STD-756B

MIL-STD-756 is a tri-service approved document used by all branches of the military in the specification and acquisition, of quality-assured electronic systems and equipment. The current version is Revision "B" dated November 18, 1981. The preparing activity is:

Department of the Navy
Engineering Specifications and Standards Department
(SESD) (Code 5313)
Naval Air Engineering Center
Lakehurst, NJ 08733-5100

This chapter is only an advisory to the use of MIL-STD-756. It does not supersede, modify, replace or curtail any requirements of MIL-STD-756 nor should it be used in lieu of that standard.

4.1 REFERENCE DOCUMENTS

The following related documents also impact and further detail these tasks:

- MIL-STD-785 Reliability Program for Systems and Equipment Development and Production (and specifically the following tasks herein)
 - Task 201 Reliability Modeling
 - Task 203 Reliability Predictions
- MIL-HDBK-217 Reliability Prediction of Electronic Equipment

4.2 DEFINITIONS

This paragraph is not applicable to this chapter.

4.3 APPLICABILITY

MIL-STD-756 covers the tasks of mathematically modeling and quantitatively predicting the reliability of an equipment design prior to fabrication. Such modeling and prediction are essential functions in evaluating a design. The real worth of the quantitative expression lies in the information conveyed with the value and the use which is made of that information. Reliability models and predictions do not, in themselves, contribute significantly to system reliability.

They do, however, provide a rational basis for design decisions such as the choice between alternative concepts, choice of part quality levels, derating to be applied, use of proven versus state-of-the-art techniques, and other factors. Some of the important uses of reliability models and predictions are summarized in Table 4.1.

Reliability models and predictions are not used as a basis for determining the attainment of reliability requirements. Attainment of these requirements is based on representative test results such as those obtained by the use of MIL-STD-781, "Reliability Testing for Engineering Development, Qualification and Production."

MIL-STD-756 establishes the procedures and ground rules for the techniques and data sources to be used in the formulation of reliability models and predictions so that the modeling and prediction techniques may be uniformly applied and interpreted.

CHAPTER 4: MIL-STD-756B

**TABLE 4.1:
USES OF RELIABILITY MODELS AND PREDICTIONS**

| |
|--|
| (1) Establishment of firm reliability requirements in planning documents, preliminary design specifications and requests for proposals, as well as determination of the feasibility of a proposed reliability requirement. |
| (2) Comparison of an established reliability requirement with state-of-the-art feasibility, and guidance in budget and schedule decisions. |
| (3) Provide a basis for uniform proposal preparation and evaluation and ultimate contractor selection. |
| (4) Evaluation of potential reliability through predictions submitted in technical proposals and reports in precontract transactions. |
| (5) Identification and ranking of potential problem areas and the suggestion of possible solutions. |
| (6) Allocation of reliability requirements among the subsystems and lower-level items. |
| (7) Evaluation of the choice of proposed parts, materials, units, and processes. |
| (8) Conditional evaluation of the design for prototype fabrication during the development phase. |
| (9) Provide a basis for trade-off analysis. |

4.4 PHYSICAL DESCRIPTION OF MIL-STD-756

MIL-STD-756 is composed of four different reliability and prediction "Tasks" and nine distinct reliability modeling and prediction "Methods" for completing these four tasks. The standard contains approximately ninety pages. It also has an additional three page appendix dealing with tailoring of the specification requirements.

4.5 HOW STD-756 IS USED

MIL-STD-756 describes two different types of tasks: Reliability Modeling and Reliability Prediction. It also addresses two different types of reliability models, various modeling methods and a variety of prediction techniques. The two types of models are the Basic Reliability Model (Task 101) and the Mission Reliability Model (Task 102). Two reliability predictions are then performed based upon these two models (1) the Basic Reliability Prediction (Task 201) and (2) the Mission Reliability Prediction (Task 202).

CHAPTER 4: MIL-STD-756B

4.5.1 Reliability Models and Modeling Methods

The basic reliability model (Task 101) and its associated prediction (Task 201) considers all of the equipment in the system while the mission reliability model (Task 102) and its associated prediction (Task 202) consider only those equipments essential to complete the mission. Both types of reliability must be addressed since the mission reliability does not necessarily give any indication of the frequency of maintenance required to keep the system operational.

Four different reliability modeling methods are presented in MIL- STD-756. They may be described briefly as follows:

- **Method 1001: Conventional Probability**

The purpose of the conventional probability method is to prepare a reliability mathematical model from a reliability block diagram by means of conventional probability relationships. The conventional probability method is the method most commonly used and is applicable to both single function and multifunction systems.

- **Method 1002: Boolean Truth Table**

The Boolean Truth Table method prepares the reliability mathematical model by means of Boolean algebra. The Boolean Truth Table method is applicable to both single function and multifunction systems. This method is more tedious than the conventional probability method but is useful when there is familiarity with Boolean algebra.

- **Method 1003: Logic Diagram**

The purpose of the logic diagram method is to prepare a reliability block diagram using logic diagrams. The logic diagram method is applicable to both single function and multifunction systems. This method is also more tedious than the conventional probability method but it is a short-cut method compared to the Boolean truth table approach in combining terms to simplify the Mission Reliability equation.

- **Method 1004: Monte Carlo Simulation**

The purpose of the Monte Carlo simulation method is to synthesize a system reliability prediction from a reliability block diagram by means of random sampling. The Monte Carlo simulation method is employed in instances where individual equipment probabilities (or equivalent reliability parameter) are known but the mission reliability model is too complex to derive a general equation for solution.

The Monte Carlo simulation method does not result in a general probability of success equation but computes the system probability of success from the individual equipment probabilities and the reliability block diagram. A Monte Carlo simulation can be performed manually but is invariably performed by a computer due to the large number of repetitive trials and calculations required to obtain a significant result. The Monte Carlo simulation method is applicable to both single function and multifunction systems.

Selection of a specific modeling method is usually up to the discretion of the individual doing the modeling (whichever he/she is most comfortable with) since all four methods should yield similar results.

4.5.2 Reliability Prediction Models

Five different prediction methods are presented in MIL-STD-756. They may be described briefly as follows:

- **Method 2001: Similar Item Method**

This prediction method utilizes specific experience on similar items. The most rapid way of estimating item reliability is to compare the item under consideration with a similar item whose reliability has previously been determined by some means and has undergone field evaluation. This method has a continuing and meaningful application for items undergoing orderly evolution. Not only is the contemplated new design similar to the old design, but small differences can easily be isolated and evaluated. In addition, difficulties encountered in the old design are signposts to improvements in the new design. The similar circuit method should be considered if a similar item comparison cannot be made.

- **Method 2002: Similar Circuit Method**

This prediction method utilizes specific experience on similar circuits such as oscillators, discriminator amplifiers, modulators, pulse transforming networks, etc. This method is employed either when only one circuit is being considered or the similar item method cannot be utilized. The most rapid way of estimating circuit reliability is to compare the circuits of the item under consideration with similar circuits whose reliability has previously been determined by some means and has undergone field evaluation. Individual circuit reliabilities can be combined into an item reliability prediction. This method has a continuing and meaningful application for circuits undergoing orderly evolution. Not only is the contemplated new design similar to the old design but small differences can be easily isolated and evaluated. In addition, difficulties encountered in the old design are signposts to improvements in the new design.

- **Method 2003: Active Element Group Method**

The active element group method is termed a feasibility estimating procedure because it is useful for gross estimates of a design in the concept formulation and preliminary design stages. Only an estimate of the number of series elements required to perform the design function is needed. This method relates item functional complexity (active element groups) and application environment to failure rates experienced in other known equipment in the field.

- **Method 2004: Parts Count Method**

The parts count method is used in the preliminary design stage when the number of parts in each generic type class such as capacitors, resistors, etc., are reasonably fixed and the overall design complexity is not expected to change appreciably during later stages of development and production. The parts count method assumes that the time of failure of the parts is exponentially distributed (i.e., a constant hazard rate).

CHAPTER 4: MIL-STD-756B

● Method 2005: Parts Stress Analysis Method

The parts stress analysis method is used in the detailed design stage when there are few or no assumptions necessary about the part used, their stress derating, their quality factors, their operating stresses or their environment in order to determine part failure rates. These should be known factors or factors capable of being determined, based upon the state of hardware definition for which the part stress analysis method is applicable. Where unique parts are used, any assumptions regarding their failure rate factors should be identified and justified. The parts stress analysis method is the most accurate method of reliability prediction prior to measurement of reliability under actual or simulated use conditions. The parts stress analysis method assumes that the time to failure of the parts is exponentially distributed (i.e., a constant hazard rate).

Method 2003, Active Element Group Method, however, is an obsolete method and is not recommended.

Choice of a specific prediction method among the other four available methods is the primary means of tailoring this task (see Paragraph 4.6).

4.6 TAILORING GUIDELINES

4.6.1 When to Tailor

Since the reliability prediction process is iterative in nature, tailoring of the reliability model and prediction is based primarily upon the program procurement phase. As the design progresses, the hardware relationships become better defined, thus the mathematical model of the system depicting the relationship between basic reliability and mission reliability is refined and must be exercised iteratively to provide reliability predictions up through the system level.

4.6.2 How to Tailor

Tailoring of these tasks involves primarily the selection of the prediction method utilized and the rigor with which it is applied. Also, for relatively simple systems containing no redundant elements and without alternate modes of operation or degraded modes of operation the basic reliability model and the mission reliability model will be identical and a single reliability prediction will suffice.

An example of tailoring based upon the procurement phase would be as follows: During the conceptual design phase reliability predictions may be based primarily upon comparison with similar equipment (Method 2001 and 2002). Later, during the preliminary design phase, a simple part count prediction (Method 2004) may be used. In the final design phase, as more detailed design information becomes available, a more accurate and detailed stress reliability prediction (Method 2005) would probably be made. (The data required for performing the part count prediction and the part stress prediction and a much more detailed description of the methodology for both can be found in MIL- HDBK-217).

CHAPTER 4: MIL-STD-756B

The following is a list of data items description associated with reliability, modeling and prediction.

| | |
|-----------|---|
| DI-R-7081 | Reliability Mathematical Model(s) |
| DI-R-7982 | Reliability Predictions Report(s) |
| DI-R-7094 | Reliability Block Diagrams and Mathematical Models Report |
| DI-R-7095 | Reliability Prediction and Documentation of Supporting Material |
| DI-R-7100 | Reliability Report for Exploratory Advanced Development Model |

CHAPTER 5:

MIL-HDBK-217E

RELIABILITY PREDICTION OF ELECTRONIC EQUIPMENT

CHAPTER 5: MIL-HDBK-217E

MIL-HDBK-217 is a tri-service-approved document used by all branches of the military in the specification and acquisition of quality-assured electronic equipment. The current version of the standard is Revision "E" dated 27 October, 1986. The preparing activity is:

Rome Air Development Center (RADC)
ATTN: RBE-2
Griffiss AFB, NY 13441-5700

This chapter is only an advisory to the use of MIL-HDBK-217. It does not supersede, modify, replace or curtail any methods or requirements of MIL-HDBK-217, nor should it be used in lieu of that handbook.

5.1 REFERENCE DOCUMENTS

The following documents are cited in this chapter as having detailed applicability to the reliability prediction procedures of MIL-HDBK-217:

- MIL-STD-785 Reliability Program for Systems and Equipment Development and Production (and specifically the following task therein)

 Task 203 Reliability Prediction
- MIL-STD-756 Reliability Modeling and Prediction (specifically, the following methods therein)

 Method 2004 Parts Count
 Method 2005 Parts Stress Analysis
- NPRD-3 Nonelectronic Parts Reliability Data
- RADC-TR-85-91 The Impact of Nonoperating Periods on Equipment Reliability

5.2 DEFINITIONS

This paragraph is not applicable to this chapter.

5.3 APPLICABILITY

Reliability prediction provides a rational basis for design decisions such as choice between alternative concepts, choice of part quality levels, derating to be applied, use of proven versus state-of-the-art techniques and other factors. It can provide an indication of the expected inherent reliability of a given design. Designers of equipment intended for military use are often required to predict a specified reliability level as a means of reducing reliability qualification test risk and as a means of assuring a certain level of attained reliability.

It is essential that standards be established for techniques and data sources used in the formulation of reliability models and predictions so that they may be applied and interpreted uniformly. MIL-HDBK-217 establishes ground rules intended to achieve this purpose.

CHAPTER 5: MIL-HDBK-217E

MIL-HDBK-217 contains methods for calculating predicted failure rates for electronic and electro-mechanical components. Table 5.1 illustrates the types of devices that MIL-HDBK-217 considers.

**TABLE 5.1:
DEVICE MODEL TYPES CONTAINED IN MIL-HDBK-217**

| | |
|-------------------------|--|
| Microcircuit | Random Logic Random Access Memory (all types) Read Only Memory (all types) Microprocessor Linear (Op Amp, Regulator, etc.) |
| Hybrid | All types |
| Discrete Semiconductors | Transistors (Bipolar and FET) Diodes (all types) Optoelectronic devices |
| Tubes | All types |
| Lasers | Helium/Neon Carbon Dioxide Solid State |
| Resistors | All types |
| Capacitors | All types |
| Inductive Devices | Transformers, Coils |
| Rotating Devices | Motors, Synchros, Resolvers, Elapsed Time Meters |
| Relays | All types |
| Switches | All types |
| Connectors | All types |

For devices that are not contained in MIL-HDBK-217E there are other appropriate data sources. A frequently used reference is Nonelectronic Parts Reliability Data (NPRD-3) available from the Reliability Analysis Center, IIT Research Institute, P.O. Box 4700, Rome, NY 13440-8200.

5.4 PHYSICAL DESCRIPTION OF MIL-HDBK-217

MIL-HDBK-217 is a voluminous document containing approximately five hundred and seventy pages. There are no appendices to this handbook.

CHAPTER 5: MIL-HDBK-217E

5.5 HOW TO USE MIL-HDBK-217

MIL-HDBK-217 has two methods for calculating the predicted failure rates of component parts. They are the **Part Stress Analysis (PSA)** and the **Part Count Analysis (PCA)**. The PSA is a thorough and accurate assessment of a part's reliability due to construction and application. It utilizes specific attribute data such as component technology, package type, complexity and quality, as well as application-specific data such as electrical and environmental stresses. The PCA is a less-refined estimator relying on default values of most of the part and application-specific parameters. The result is that the PSA is more accurate but requires more time (and thus cost) to perform than does the PCA. The determination of which method to use requires consideration for tailoring (see Section 5.6).

Additionally, it should be noted that the PSA and PCA methods of MIL-HDBK-217 calculate predicted failure rates for devices that are operating. In the case in which a dormant mode is being analyzed, non-operating failure rate models should be determined from RADC-TR-85-91, entitled "The Impact of Non-Operating Periods on Electronic Reliability."

5.5.1 Failure Rate Models

The quality of a part has a direct effect on the part failure rate and appears in the part models as a factor π_Q . Many parts are covered by specifications that have several quality levels, hence, the part models have values of π_Q that are keyed to these quality levels.

All part reliability models include the effects of environmental stresses through the environmental factor, π_E , except for the effects of ionizing radiation. Descriptions of these environments are shown in Table 5.2 taken from MIL-STD-217. The π_E factor is quantified within each part failure model. These environments encompass the major areas of equipment use. Some equipment will experience more than one environment during its normal use, e.g., equipment in spacecraft. In such a case, the reliability analysis should be segmented, namely, missile launch (M_L) conditions during boost into and return from orbit, and space flight (S_F) while in orbit.

Failure rate models for **microelectronic** parts are significantly different from those for other parts, since they include a temperature acceleration factor π_T , a circuit complexity factor (C_1), a package complexity factor (C_2) and a device learning factor (π_L), which do not appear in failure rate models for non-microelectronic parts.

The operating failure rate model is basically the same for all monolithic microelectronic devices, i.e.:

$$\lambda_p = \pi_Q (C_1 \pi_T \pi_V + C_2 \pi_E) \pi_L \text{ failures}/10^6 \text{ hours}$$

where:

λ_p is the device failure rate in F/10⁶ hours

π_Q is the quality factor

π_T is the temperature acceleration factor, based on technology

π_V is the voltage stress derating factor

CHAPTER 5: MIL-HDBK-217E

π_E is the application environment factor

C_1 is the circuit complexity failure rate based on bit count

C_2 is the package complexity failure rate

π_L is the device learning factor

Variations (per device type) to this model occur largely in the circuit complexity failure rate which may be based upon bit, gate or transistor count and technology.

The exception to the above failure rate model is the model for monolithic bipolar or MOS analog microprocessor devices, which contain an additional π_A analog signal factor (= 1.24).

A typical example of a **non-microelectronic** part failure rate model is the following one for discrete semiconductors:

$$\lambda_p = \lambda_b (\pi_E \times \pi_A \times \pi_{S2} \times \pi_C \times \pi_Q)$$

where:

λ_p is the part failure rate

λ_b is the base failure rate usually expressed by a model relating the influence of electrical and temperature stresses on the part

π_E and the other factors modify the base failure rate for the category of environmental application and other parameters that affect the part reliability

The π_E and π_Q factors are used in all models and other π factors apply only to specific models. The applicability of π factors is identified in each subsection. An overall list of π factors used in models other than microelectronics is presented in Table 5.3 excerpted from MIL-HDBK-217.

The base failure rate (λ_b) models are presented in each part subsection along with identification of the applicable model factors. Tables of calculated λ_b values are also provided for use in manual calculations. The model equations can, of course, be incorporated into computer programs for machine processing. The tabulated values of λ_b are cut off at the part ratings with regard to temperature and stress, hence, use of parts beyond these cut-off points will overstress the part. The use of the λ_b models in a computer program should take the part limits into account. The λ_b equations are mathematically continuous beyond the part ratings but are invalid in the overstressed regions.

All MIL-HDBK-217 part models include both catastrophic and drift failures and are based upon a constant failure rate, except for some rotary devices that show an increasing failure rate. Failures associated with connection of parts into circuit assemblies are not included within the part failure rate models.

CHAPTER 5: MIL-HDBK-217E

TABLE 5.2: ENVIRONMENTAL SYMBOL AND DESCRIPTION

| ENVIRONMENT | Π _E SYMBOL | DESCRIPTION |
|----------------------|--------------------------|--|
| Ground, Benign | G _B | Nonmobile, laboratory environment readily accessible to maintenance; includes laboratory instruments and test equipment, medical electronic equipment, business and scientific computer complexes. |
| Ground, Missile Silo | G _{MS} | Missiles and support equipment in ground silos. |
| Ground, Fixed | G _F | Conditions less than ideal such as installation in permanent racks with adequate cooling air and possible installation in unheated buildings; includes permanent installation of air traffic control, radar and communications facilities. |
| Ground, Mobile | G _M | Equipment installed on wheeled or tracked vehicles; includes tactical missile ground support equipment, mobile communication equipment, tactical fire detection systems. |
| Space, Flight | S _F | Earth orbital. Approaches benign ground conditions. Vehicle neither under powered flight nor in atmospheric reentry; includes satellites and shuttles. |
| Manpack | M _P | Portable electronic equipment being manually transported while in operation; includes portable field communications equipment and laser designators and rangefinders. |
| Naval, Sheltered | N _S | Sheltered or below deck conditions, protected from weather; includes surface ships communication, computer, and sonar equipment. |
| Naval, Unsheltered | N _U | Nonprotected surface shipborne equipment exposed to weather conditions; includes most mounted equipment and missile/projectile fire control equipment. |

CHAPTER 5: MIL-HDBK-217E

TABLE 5.2: ENVIRONMENTAL SYMBOL AND DESCRIPTION (Cont'd)

| ENVIRONMENT | ΠE SYMBOL | DESCRIPTION |
|--------------------------------|-----------|---|
| Naval, Undersea Unsheltered | NUU | Equipment immersed in salt water; includes sonar sensors and special purpose anti-submarine warfare equipment. |
| Naval, Submarine | NSB | Equipment installed in submarines; includes navigation and launch control systems. |
| Naval, Hydrofoil | NH | Equipment installed in hydrofoil vessel. |
| Airborne, Inhabited, Cargo | AIC | Typical conditions in cargo compartments occupied by aircrew without environment extremes of pressure, temperature, shock and vibration and installed on long mission transport aircraft. |
| Airborne, Inhabited, Trainer | AIT | Same as AIC but installed on high performance aircraft such as trainer aircraft. |
| Airborne, Inhabited Bomber | AIB | Typical conditions in bomber compartments occupied by aircrew without environment extremes of pressure, temperature, shock and vibration and installed on long mission transport aircraft. |
| Airborne, Inhabited Attack | AIA | Same as AIC but installed on high performance aircraft such as used for ground support. |
| Airborne, Inhabited Fighter | AIF | Same as AIC but installed on high performance aircraft such as fighters and interceptors. |
| Airborne, Uninhabited, Cargo | AUC | Bomb bay, equipment bay, tail, or where extreme pressure, vibration, and temperature cycling may be aggravated by contamination from oil, hydraulic fluid and engine exhaust. Installed on long mission transport aircraft. |
| Airborne, Uninhabited, Trainer | AUT | Same as AUC but installed on high performance aircraft such as used for trainer aircraft. |

CHAPTER 5: MIL-HDBK-217E

TABLE 5.2: ENVIRONMENTAL SYMBOL AND DESCRIPTION (Cont'd)

| ENVIRONMENT | Π _E SYMBOL | DESCRIPTION |
|-------------------------------|--------------------------|--|
| Airborne, Uninhabited Bomber | A _{UB} | Bomb bay, equipment bay, tail or where extreme pressure, vibration and temperature cycling may be aggravated by contamination from oil, hydraulic fluid and engine exhaust. Installed on long mission bomber aircraft. |
| Airborne, Uninhabited Attack | A _{UA} | Same as A _{UC} but installed on high performance aircraft such as used for ground support. |
| Airborne, Uninhabited Fighter | A _{UF} | Same as A _{UC} but installed on high performance aircraft such as fighters and interceptors. |
| Airborne, Rotary Winged | A _{RW} | Equipment installed on helicopters; includes laser designators and fire control systems. |
| Missile, Launch | M _L | Severe conditions related to missile launch (air or ground), and space vehicle boost into orbit, vehicle re-entry and landing by parachute. Conditions may also apply to rocket propulsion powered flight. |
| Cannon, Launch | C _L | Extremely severe conditions related to cannon launching of 155 mm. and 5 inch guided projectiles. Conditions apply from launch to target impact. |
| Undersea, Launch | U _{SL} | Conditions related to undersea torpedo mission and missile launch. |
| Missile, Free Flight | M _{FF} | Missiles in non-powered free flight. |
| Airbreathing Missile, Flight | M _{FA} | Conditions related to powered flight of air breathing missile; includes cruise missiles. |

CHAPTER 5: MIL-HDBK-217E

TABLE 5.3: Π FACTORS FOR PART FAILURE RATE MODELS EXCEPT MICROELECTRONICS

| Π FACTOR | DESCRIPTION |
|--|--|
| Common Factors - Used in all or many part categories | |
| Π_E | Environment - Accounts for influence of undefined environmental variables including temperature variability. Related to application categories (Table 5.2) |
| Π_Q | Quality - Accounts for effects of different quality levels |
| Discrete Semiconductors | |
| Π_A | Application - Accounts for effect of application in terms of circuit function. |
| Π_R | Rating - Accounts for effect of maximum power or current rating. |
| Π_C | Complexity - Accounts for effect of multiple devices in a single package. |
| Π_{S2} | Voltage Stress - Adjusts model for a second electrical stress (application voltage) in addition to wattage included within λ_b . |
| Π_F | Frequency and peak operating power factor, also pulsed duty cycle factor. |
| Π_I | Forward peak current factor. |
| Π_T | Temperature - Accounts for effects of temperature. |
| Π_M | Matching networks - Accounts for effects of type of matching networks. |
| Lasers | |
| Π_O | Gas overfill factor. |
| Π_B | Ballast factor. |
| Π_{OS} | Active optical surface factor. |

CHAPTER 5: MIL-HDBK-217E

TABLE 5.3: Π FACTORS FOR PART FAILURE RATE MODELS EXCEPT MICROELECTRONICS (Cont'd)

| Π FACTOR | DESCRIPTION |
|-----------------|---|
| Lasers (Cont'd) | |
| Π_C | Cleanliness factor. |
| Π_{REP} | Factor to convert pulse rate to time for pulsed lasers. |
| Π_{COOL} | Flashlamp cooling factor. |
| Tubes | |
| Π_C | Construction factor. |
| Π_L | Learning factor. |
| Π_u | Utilization factor. |
| Resistors | |
| Π_R | Resistance - Adjusts model for the effect of resistor ohmic values. |
| Π_C | Construction Class - Accounts for influence of construction class of variable resistors as defined in individual part specifications. |
| Π_V | Voltage - Adjusts for effect of applied voltage in variable resistors in addition to wattage included within λ_b . |
| Π_{TAPS} | Tap Connections on Potentiometers - Accounts for effect of multiple taps on resistance element. |
| Capacitors | |
| Π_{SR} | Series Resistance - Adjusts model for the effect of series resistance in circuit application of some electrolytic capacitors. |
| Π_{CV} | Capacitance Values - Adjusts model for effect of capacitance related to case size. |

CHAPTER 5: MIL-HDBK-217E

TABLE 5.3: Π FACTORS FOR PART FAILURE RATE MODELS EXCEPT MICROELECTRONICS (Cont'd)

| Π FACTOR | DESCRIPTION |
|---------------------|--|
| Capacitors (Cont'd) | |
| Π_C | Construction Factor - Accounts for effects of hermetic and nonhermetic seals on CL & CLR capacitors. |
| Π_{CF} | Configuration Factor - Accounts for effects of fixed and variable constructions on CG capacitors. |
| Inductive Devices | |
| Π_Q | Family - Adjusts model for influence of family type as defined by individual part specifications. |
| Π_C | Construction Factor - Accounts for effects of fixed and variable constructions. |
| Rotating Devices | |
| Π_S | Factor related to size of synchros & resolvers. |
| Π_N | Factor related to number of brushes on synchros & resolvers. |
| Π_T | Temperature factor for elapsed-time meters. |
| Relays | |
| Π_C | Contacts - Accounts for contact quantity and form. |
| Π_{CYC} | Cycling - Accounts for time rate of actuation. |
| Π_L | Load - Accounts for type of contact load. |
| Π_F | Family - Accounts for construction and application. |
| Switches | |
| Π_C | Contacts - Accounts for contact quantity and form. |

CHAPTER 5: MIL-HDBK-217E

TABLE 5.3: Π FACTORS FOR PART FAILURE RATE MODELS EXCEPT MICROELECTRONICS (Cont'd)

| Π FACTOR | DESCRIPTION |
|--------------------|--|
| Switches (Cont'd) | |
| Π_{CYC} | Cycling - Accounts for time rate of actuation. |
| Π_L | Load - Accounts for type of contact load. |
| Connectors | |
| Π_P | Contacts - Accounts for quantity of contacts. |
| Π_K | Cycling - Accounts for time rate of mating and unmating. |
| Meters | |
| Π_A | Application factor. |
| Π_F | Function factor. |
| Incandescent Lamps | |
| P_u | Utilization factor. |
| P_A | Application factor. |

CHAPTER 5: MIL-HDBK-217E

5.5.2 Failure Rate Calculation Example

There follows a short example of a failure rate calculation applicable to MIL-R-39008 style RCR fixed, composition, established reliability (ER) resistors and MIL-R-11 style RC fixed, composition, resistors and where the factors are as shown in Tables 5.4 - 5.7, excerpted from MIL-HDBK-217E.

Given: A 0.5 watt, type RCR fixed, composition, 12,000 ohm resistor per MIL-R-39008, Level M, is being used in an airborne inhabited cargo (A_{IC}) environment. The resistor is operating in an ambient temperature of 60°C and it is dissipating 0.2 watts.

Step 1: The failure rate information for this resistor is in Section 5.1.6.1 of MIL-HDBK-217E. The part failure rate is:

$$\lambda_p = \lambda_b \times \pi_E \times \pi_R \times \pi_Q \text{ (Failures/10}^6 \text{ hrs.)}$$

Step 2: Stress ratio, $S = P_{\text{APPLIED}}/P_{\text{RATED}}$
 $= 0.2/0.5$
 $= 0.4$

Step 3: From Table 5.7, entering with $T = 60^\circ\text{C}$ and $S = 0.4$

$$\lambda_b = .0012 \text{ (Failures/10}^6 \text{ hrs.)}$$

Note: If T&S were at values showing no λ_b value (such as $T = 90^\circ\text{C}$ & $S = 0.8$), the resistor would be operating **above** rated conditions. Redesign would be necessary to bring the resistor within rating.

Step 4: From Table 5.4 $\pi_E = 3$ for A_{IC}

Step 5: From Table 5.5 $\pi_R = 1$ for 12,000 ohms

Step 6: From Table 5.6 $\pi_Q = 1$ for level M

Step 7: $\lambda_p = \lambda_b \times \pi_E \times \pi_R \times \pi_Q$
 $= 0.0012$

$$\lambda_p = 0.0036 \text{ F/10}^6 \text{ hrs.}$$

CHAPTER 5: MIL-HDBK-217E

**TABLE 5.4:
ENVIRONMENTAL MODE
FACTORS**

| Environmental | π_E |
|---------------|---------|
| GB | 1 |
| GMS | 1.2 |
| GF | 2.9 |
| GM | 8.3 |
| MP | 8.5 |
| NSB | 4.0 |
| NS | 5.2 |
| NU | 12 |
| NH | 13 |
| NUU | 14 |
| ARW | 19 |
| AIC | 3 |
| AIT | 3.5 |
| AIB | 5 |
| AIA | 3.5 |
| AIF | 6.5 |
| AUC | 5 |
| AUT | 7 |
| AUB | 10 |
| AUA | 7 |
| AUF | 15 |
| SF | 1 |
| MEF | 8.6 |
| USL | 25 |
| ML | 29 |
| CL | 490 |

**TABLE 5.5:
 π_R , RESISTANCE FACTOR**

| Resistance Range (ohms) | π_R |
|----------------------------|---------|
| Up to 100K | 1.0 |
| > 0.1M to 1M | 1.1 |
| < 1.0M to 10 M | 1.6 |
| > 10M | 2.5 |

**TABLE 5.6:
 π_Q , QUALITY FACTOR**

| Failure Rate Level | π_Q |
|--------------------|---------|
| S | 0.03 |
| R | 0.1 |
| P | 0.3 |
| M | 1.0 |
| MIL-R-11 | 5.0 |
| LOWER | 15. |

5.6 TAILORING GUIDELINES

MIL-HDBK-217 provides two cookbook reliability prediction procedures but does not allow the tailoring of these procedures. The basic choice in tailoring lies between the use of Parts Count Analysis (PCA) and Parts Stress Analysis (PSA) methods of reliability prediction in accordance with the requirements of MIL-STD-756.

5.7 CONTRACTS DATA REQUIREMENTS LIST (CDRL)

There are no data item description (DIDs) required by MIL-HDBK- 217. MIL-STD- 756 is the basic governing document relative to the task of reliability prediction.

TABLE 5.7: MIL-R-39008 & MIL-R-11 RESISTORS,
FIXED COMPOSITION BASE FAILURE RATES, λ_b

| TEMP (°C) | .1 | .2 | .3 | .4 | .5 | .6 | .7 | .8 | .9 | 1.0 |
|--------------|--------|--------|--------|--------|--------|--------|--------|--------|--------|--------|
| 0 | .00007 | .00009 | .00010 | .00012 | .00015 | .00017 | .00020 | .00024 | .00028 | .00033 |
| 10 | .00011 | .00013 | .00015 | .00018 | .00021 | .00025 | .00030 | .00036 | .00043 | .00051 |
| 20 | .00015 | .00018 | .00022 | .00026 | .00031 | .00037 | .00045 | .00053 | .00064 | .00076 |
| 30 | .00022 | .00026 | .00031 | .00038 | .00046 | .00055 | .00066 | .00079 | .00096 | .0011 |
| 40 | .00031 | .00038 | .00045 | .00055 | .00067 | .00081 | .00098 | .0012 | .0014 | .0017 |
| 50 | .00044 | .00054 | .00066 | .00080 | .00098 | .0012 | .0014 | .0018 | .0021 | .0026 |
| 60 | .00063 | .00078 | .00095 | .0012 | .0014 | .0017 | .0021 | .0026 | .0032 | .0039 |
| 70 | .00090 | .0011 | .0014 | .0017 | .0021 | .0026 | .0032 | .0039 | .0048 | .0059 |
| 80 | .0013 | .0016 | .0020 | .0025 | .0031 | .0038 | .0047 | .0058 | | |
| 90 | .0018 | .0023 | .0029 | .0036 | .0045 | .0056 | | | | |
| 100 | .0026 | .0033 | .0041 | .0052 | .0065 | | | | | |
| 110 | .0038 | .0047 | .0060 | | | | | | | |
| 120 | .0054 | | | | | | | | | |

CHAPTER 6:

**MIL-STD-2155(AS)
FAILURE REPORTING ANALYSIS
AND
CORRECTIVE ACTION SYSTEM**

CHAPTER 6: MIL-STD-2155(AS)

MIL-STD-2155(AS) is currently a limited usage document. It is only approved by the Navy and is used in the specification and acquisition of quality-assured systems and equipment. The current version is the initial release dated July 24, 1985. The preparing activity is:

Department of the Navy
Engineering Specifications and Standards Department
(SESD) (Code 5313)
Naval Air Engineering Center
Lakehurst, NJ 08733-5100

This chapter is only an advisory to the use of MIL-STD-2155. It does not supersede, modify, replace or curtail any requirements of MIL-STD-2155 nor should it be used in lieu of that standard.

6.1 REFERENCE DOCUMENTS

The following related documents also impact and further detail these tasks:

- MIL-STD-470 Maintainability Program for Systems and Equipment (and specifically the following task therein)
 - Task 104 Data Collection, Analysis and Corrective Action System
- MIL-STD-785 Reliability Program for Systems and Equipment Development and Production (and specifically the following tasks therein)
 - Task 104 Failure Reporting, Analysis and Corrective Action System (FRACAS)
 - Task 105 Failure Review Board (FRB)
- MIL-STD-781 Reliability Test Methods, Plans and Environments for Engineering Development, Qualification and Production

6.2 DEFINITIONS

This paragraph is not applicable to this chapter.

6.3 APPLICABILITY

MIL-STD-2155 addresses two distinct and separate functions, (1) the Failure Reporting Analysis and Corrective Action System (FRACAS) and (2) the Failure Review Board (FRB). Of the two activities the FRACAS is the more universal in its application and would apply in most procurement programs. FRB is far more limited in application and would apply to relatively few procurement programs.

6.3.1 FRACAS Description

FRACAS is a closed-loop management tool established to identify and correct deficiencies in equipment and software and thus prevent further recurrence of these deficiencies. It is based upon the systematic reporting and analysis of equipment failures and software faults during manufacturing, inspection and test.

The closed-loop feature of FRACAS requires that the information obtained during the failure analysis be disseminated to all decision-making engineers and managers in the program. A normal FRACAS is illustrated in Figure 6.1.

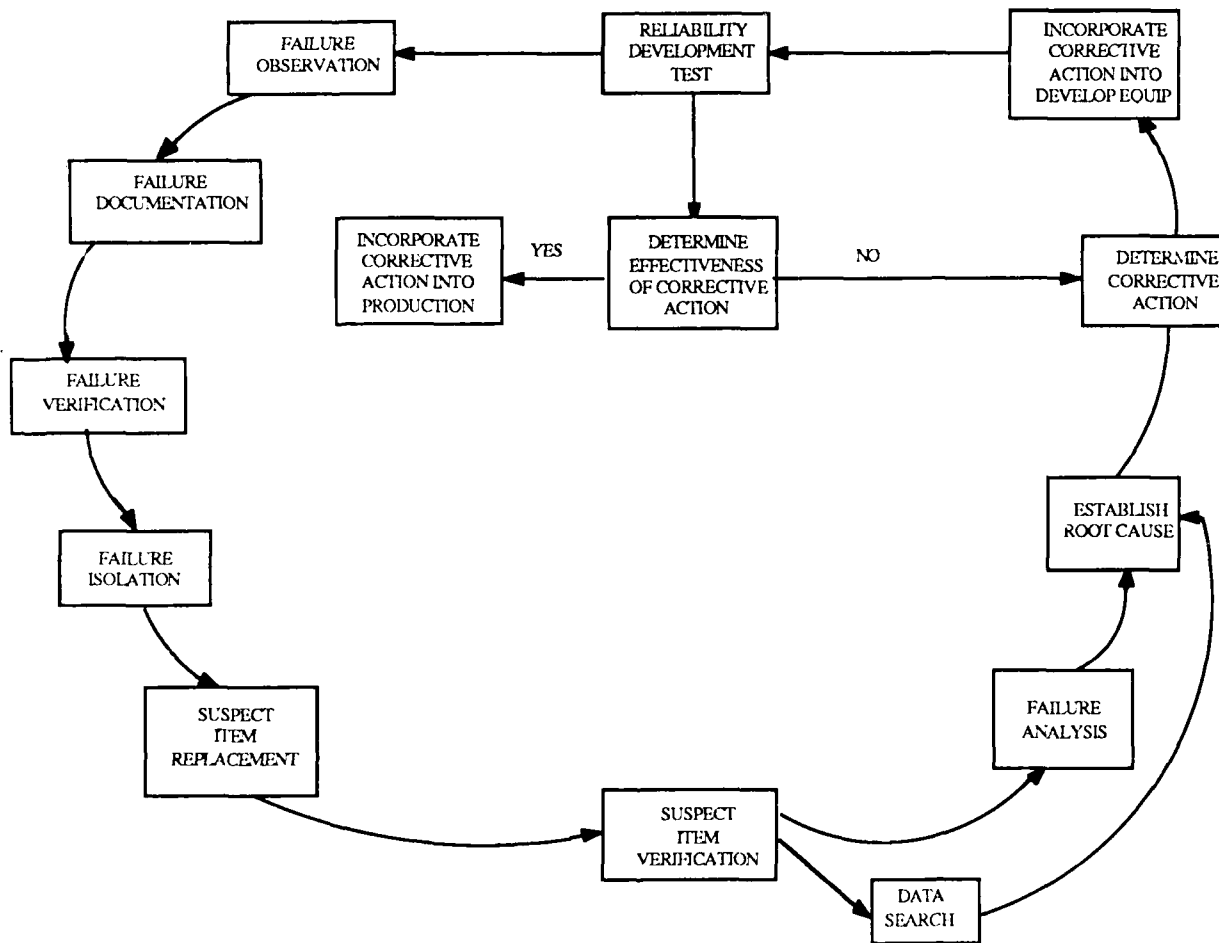

FIGURE 6.1:
CLOSED LOOP FAILURE REPORTING AND
CORRECTIVE ACTION SYSTEM

6.3.2 Failure Review Board (FRB) Description

For the acquisition of certain critical (extremely expensive and complex) systems and equipments a separate Failure Review Board may sometimes also be established to oversee the effective functioning of the FRACAS. A closed loop FRACAS with an FRB is illustrated in Figure 6.2

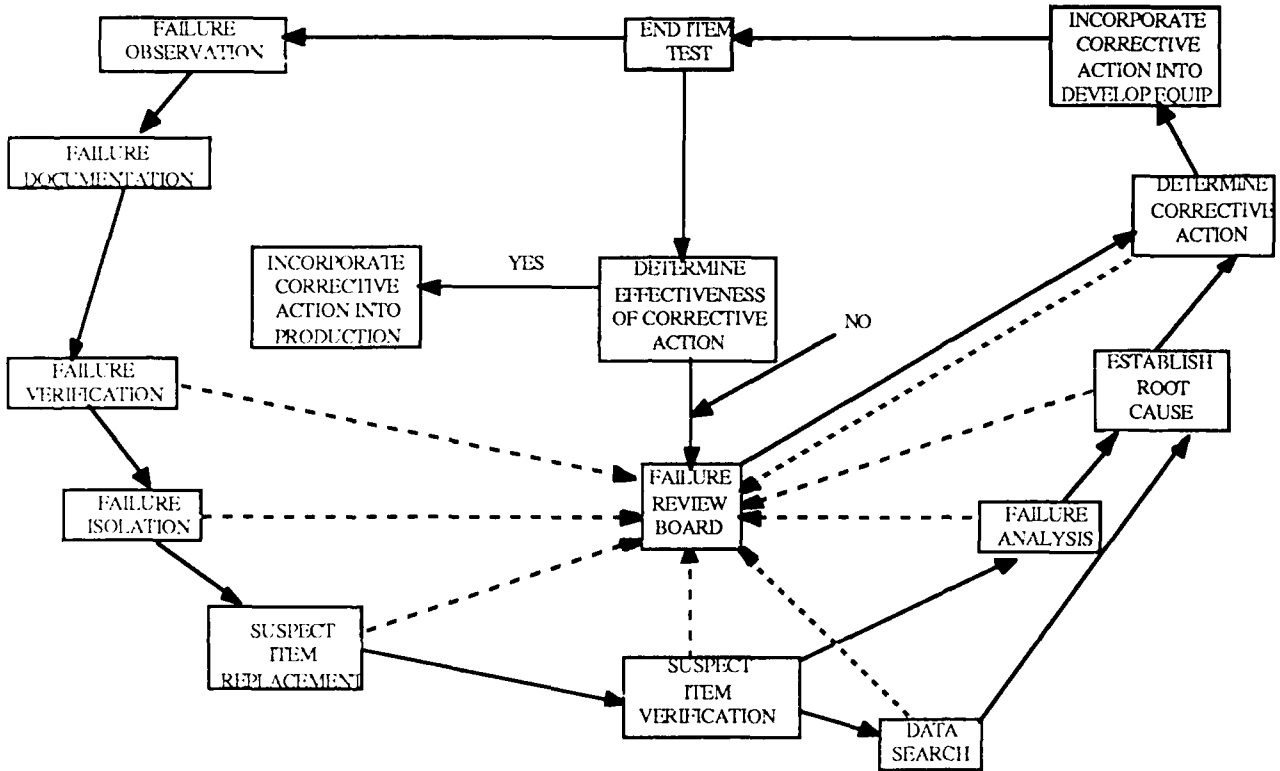

FIGURE 6.2:
CLOSED LOOP FAILURE REPORTING AND
CORRECTIVE ACTION SYSTEM WITH FAILURE REVIEW BOARD

The purpose of the Failure Review Board is to provide increased management visibility and control of the FRACAS. Its intent is the reliability and maintainability improvement of hardware and associated software by the timely and disciplined utilization of failure and maintenance data to generate and implement effective corrective actions which are intended to prevent failure recurrence and to simplify or reduce the maintenance tasks.

6.4 PHYSICAL DESCRIPTION OF MIL-STD-2155(AS)

MIL-STD-2155 is a simple document consisting of only five pages. There is also an additional four page appendix dealing with tailoring of the specification requirements.

CHAPTER 6: MIL-STD-2155(AS)

6.5 HOW TO USE MIL-STD-2155(AS)

Critical to the effective implementation of a FRACAS is the orderly and timely performance of specific procedures which have as their total purpose the identification, illumination, and elimination of equipment faults and their causes. Such procedures are detailed in Paragraphs 6.5.1 through 6.5.8.

6.5.1 Failure Documentaton

A closed-loop FRACAS system requires that each failure or discrepancy that occurs during the specified inspections and tests be documented and reported. The failure report must include sufficient information to permit identification of the failed item, the symptoms of the failure, the test conditions at the time of the failure, any built-in-test (BIT) indications and the item operating time at the time of failure (when applicable).

Failure documentation should include a uniform reference identification system to provide complete traceability of all records and actions taken for each reported failure. Specific failure report details should be in accordance with the requirements of DI-R-21598 for hardware failures or DI-R-2178 for software faults.

6.5.2 Failure Verification

After a failure has been documented it must be verified before further action can be taken. Failure verification is established either by repeating the failure mode on the reported item or by actual evidence of failure (leakage residue, damaged hardware, BIT indication, etc.). Each time the failure is traced to a lower level replaceable assembly the failure should be verified again at that level before proceeding further with the analysis.

6.5.3 Failure Data

Failure reports together with any associated documentation should be gathered together and controlled to assure data integrity and availability. Records to be maintained should include all reported failures, failure investigations and analyses, assignable failure causes, corrective actions taken, and the effectiveness of these corrective actions.

Records should be organized to permit efficient data retrievability for the purpose of establishing failure trends, providing failure summaries and status reports, utilizing knowledge of previous failures and failure analyses, and for corrective action monitoring.

6.5.4 Failure Data Summaries

In large development programs, FRACAS can produce data in sufficient quantities to overwhelm program management. Therefore concise data summaries must be compiled so that progress may be quickly gauged during program reviews.

One simple technique is to require a monthly report on the ten most significant failures, including the status of their corrective action. Whether this report covers ten or twenty failures and whether it is weekly rather than monthly depends upon the size and needs of the program. The failure data center should be responsible for the generation and distribution of periodic failure summary information in accordance with the requirements of DI-R-21599.

CHAPTER 6: MIL-STD-2155(AS)

6.5.5 Failure Analysis

Each reported failure is evaluated as appropriate to determine the root cause of failure. Investigations and analysis should consist of any applicable method (e.g., electrical tests, mechanical tests, chemical tests, engineering study, laboratory dissection, X-ray analysis, microscopic inspection, etc.) that may be necessary to determine the failure cause. The results and conclusions of failure investigations are documented and made retrievable together with the failure reports for future reference.

Formal laboratory failure analysis including dissection of the parts in question may be conducted when necessary to determine the physics of failure and develop corrective action to prevent recurrence.

Detailed laboratory failure analysis is important throughout a program, but the bulk of this activity normally takes place during the validation and full scale development phases when most reliability growth occurs. During production and operation, laboratory failure analysis will still be used but its use will be limited to the correction of deficiencies which may jeopardize the achieved reliability.

6.5.6 Corrective Action

When the root cause of a failure has been determined, a suitable corrective action is developed which will prevent recurrence of this failure in this or similar equipments. Examples of corrective actions include, but are not limited to, design changes, part derating changes, test procedure changes, manufacturing technique changes, material changes, packaging changes, etc.

In those instances where no corrective action is taken the rationale for this decision should also be documented.

6.5.7 Failure Report Close-out

Upon formal concurrence on the adequacy of the corrective action, failure reports are to be closed-out. Close-out signifies that a sound corrective action has been identified and an implementation plan has been developed. In those cases where a corrective action cannot be identified the failure report may be closed-out with the consent of the cognizant quality engineer and the project engineer and the concurrence of their respective managers. The primary consideration in such cases is the thoroughness of the investigation and analyses performed. Procedures should provide for the reopening of "closed-out" failure reports in the event subsequent failures occur.

Close-out of the failure report should include a final failure cause classification, a relevant or nonrelevant classification and a chargeable or nonchargeable classification in addition to a statement of the corrective action taken and its effectiveness. All closed-out failure reports should receive a final failure cause classification.

6.5.8 Failed Equipment Disposition

A major risk in a closed loop FRACAS is the loss of pertinent data due to the premature disposition of the failed equipment. Therefore, all failed items should be conspicuously marked or tagged and controlled to assure proper disposition. Failed items should not be opened, distributed, or mishandled to the extent of obliterating facts which might be pertinent to the analysis. Failed items should be controlled pending authorized disposition after completion of failure analysis.

CHAPTER 6: MIL-STD-2155(AS)

6.6 TAILORING GUIDELINES

A single FRACAS program cannot be mandated for all procurements. There are definite limits to the resources in time, money and engineering manpower to be expended on an analysis of a particularly complex failure occurrence or the implementation of preferred corrective action. FRACAS must be tailored to the unique limits of a given procurement. These limits are determined by the criticality of the system and/or equipment as well as by the available technology and other resources.

6.6.1 When and How to Tailor

General directions for the tailoring of the requirements of MIL- STD-2155 are found in Appendix A of the standard.

6.7 CONTRACT DATA REQUIREMENTS LIST (CDRL)

The following data item descriptions (DIDs) are associated with FRACAS, FRB and MIL-STD-2155 requirements.

| | |
|------------|---|
| DI-R-21597 | Failure Reporting, Analysis and Corrective Action System Plan |
| DI-R-21598 | Failure Report |
| DI-E-2178A | Computer Software Trouble Report |
| DI-R-21599 | Development and Production Failure Summary Report |

CHAPTER 7:

MIL-STD-781D

**RELIABILITY TESTING FOR ENGINEERING DEVELOPMENT,
QUALIFICATION AND PRODUCTION**

CHAPTER 7: MIL-STD-781D

MIL-STD-781 is a tri-service-approved document used by all branches of the military in the specification and acquisition of quality-assured electronic systems and equipment. The current version is Revision "D" dated October 17, 1987. The preparing activity is:

Department of the Navy
Space and Naval Warfare Systems Command
ATTN: SPAWAR 003-121
Washington, DC 20363-5100

This chapter is only an advisory to the use of MIL-STD-781. It does not supersede, modify, replace or curtail any requirements of MIL-STD-781 nor should it be used in lieu of that standard.

7.1 REFERENCE DOCUMENTS

The following documents also impact and further detail these tasks:

- MIL-STD-785 Reliability Program for Systems and Equipment Development and Production (and specifically the following tasks therein)
 - Task 301 Environmental Stress Screening (ESS)
 - Task 302 Reliability Development/Growth Test (RDGT) Program
 - Task 303 Reliability Qualification Test (RQT) Program
 - Task 304 Production Reliability Acceptance Test (PRAT) Program
- MIL-HDBK-781 Reliability Test Methods, Plans, and Environments for Engineering Development, Qualification, and Production
- MIL-HDBK-189 Reliability Growth Management

7.2 DEFINITIONS

The meanings of many of the terms and acronyms used in reliability testing are unique to the field. Therefore, the following terms and acronyms are defined here to clarify their meanings as used in MIL-STD-781 and MIL-HDBK-781.

Consumer's Risk (β) - This is the probability of accepting equipment with a true mean-time-between-failures (MTBF) equal to the lower test MTBF (θ_1). The probability of accepting equipment with a true MTBF less than the lower test MTBF (θ_1) will be less than (β).

Producer's Risk (α) - This is the probability of rejecting equipment with a true MTBF equal to the upper test MTBF (θ_0). The probability of rejecting equipment with a true MTBF greater than the upper test MTBF will be less than (α).

Discrimination Ratio (d) - This is one of the standard (MIL-HDBK-781) test plan parameters; it is the ratio of the upper test MTBF (θ_0) to the lower test MTBF (θ_1); that is, $d = \theta_0/\theta_1$.

Lower Test MTBF (θ_1) - This is the MTBF value that is unacceptable. The standard (MIL-HDBK-781) test plans will reject, with high probability, equipment with a true MTBF that approaches (θ_1).

CHAPTER 7: MIL-STD-781D

Upper Test MTBF (θ_2) - This is an acceptable value of MTBF equal to the discrimination ratio times the lower test MTBF (θ_1). The standard (MIL-HDBK-781) test plans will accept, with high probability, equipment with a true MTBF that approaches (θ_0). This value (θ_0) must be realistically attainable, based on experience and information.

7.3 APPLICABILITY

MIL-STD-781 specifies the general requirements and specific tasks for reliability testing during development, qualification, and production of systems and equipment. It establishes the tailorable requirements for reliability testing performance during integrated test programs specified in MIL-STD-785. Task descriptions for Reliability Development/Growth (RDGT), Reliability Qualification Testing (RQT), Production Reliability Acceptance Tests (PRAT), and Environmental Stress Screening (ESS) are defined in the standard. Tasks specified in this standard are to be selectively applied in DOD contracted procurements, requests for proposals, statements of work (SOWs), and Government in-house developments which require reliability testing of systems and equipment.

7.4 PHYSICAL DESCRIPTION OF MIL-STD-781

MIL-STD-781 is composed of eleven different reliability-testing-related "Tasks". The standard is approximately fifty-seven pages in length and there are no appendices to this standard.

7.5 HOW TO USE MIL-STD-781

MIL-STD-781 addresses four different types of tasks: (1) Test Planning and Control, (2) Development Testing, (3) Reliability Accounting Tests and (4) Environmental Stress Screening. These four types of tasks may be described briefly as follows:

- (1) Test Planning and Control tasks cover the detailed planning, continuous control and proper documentation of the status and final results of the tests.
- (2) Development Testing is performed to identify thermal and vibration characteristics of the equipment prior to formal qualification testing, it is also used to identify weaknesses and errors in the design and to institute effective corrective actions.
- (3) Reliability Accounting Tests are those which determine compliance with specified performance and reliability requirements.
- (4) Environmental Stress Screening covers those tasks designed to detect and correct latent manufacturing defects.

CHAPTER 7: MIL-STD-781D

7.5.1 Test Planning and Control Tasks

- **Task 101: Integrated Reliability Test Plan Document**

The purpose of this task is to develop an integrated test plan which identifies the reliability tests required by the contract and integrates them into a comprehensive reliability test program. It identifies and integrates all tests that provide data for evaluating the reliability of systems and equipment.

- **Task 102: Reliability Test Procedure**

This task develops detailed test procedures for each reliability test included in the integrated reliability test plan document after its approval by the procuring activity. Usually a separate test procedure is prepared for each test in the integrated test plan document.

- **Task 103: Reliability Growth Planning**

The purpose of this task is to develop a reliability growth planning curve which details the plan for achieving specified reliability values and which provides a means for tracking reliability growth and monitoring progress as the test proceeds. This is usually a graphical portrayal to indicate what the reliability value is and what it should be at various points in a full-scale development if conformance to the reliability requirements is to be achieved.

The reliability growth planning curve is based upon data from previous development programs for items of the same type being developed. These data are analyzed to determine the length of the reliability growth period and to provide management with a means of monitoring progress during the test.

- **Task 105: Joint Test Group**

A joint test group (JTG) is established to provide coordination throughout the reliability test program and to periodically review all test data including subcontractor reliability qualification, and acceptance test data. The JTG, composed of both government and contractor personnel, may approve on-the-spot changes to previously-approved preventive maintenance schedules and detailed test procedures.

- **Task 106: Reliability Test Reports**

This task provides for the preparation of reliability test reports which periodically summarize test results obtained to date and other pertinent information including summaries of failures, failure analyses, and recommended or implemented corrective actions. The final reliability test report also includes a general analysis of equipment reliability and applicable graphical presentation of the pertinent data.

CHAPTER 7: MIL-STD-781D

7.5.2 Development Testing Tasks

- **Task 201: Survey Testing**

Thermal and vibration survey testing are to be conducted on a sample of the equipment to determine the level of equipment thermal stabilization (identify hot spots and establish the time- temperature relationships) and to search for resonant conditions and other design weaknesses. This survey testing must be performed prior to the start of reliability growth testing and, when specified, prior to the commencement of reliability qualification testing and ESS. Equipment samples selected for reliability testing are not normally used for survey testing unless specifically authorized by the procuring activity.

- **Task 202: Reliability Development/Growth Test**

The reliability development/growth test (RDGT), also known as test, analyze, and fix (TAAF) provides the basis for resolving reliability problems and incorporating corrective actions into the equipment design. The RDGT test incorporates performance monitoring, failure detection, failure analysis, and verification of design corrections which minimize the recurrence of equipment failures in the future. Additional details may be found in MIL-HDBK-189 and MIL-STD-2155.

7.5.3 Reliability Accounting Tasks

- **Task 301: Reliability Qualification Test**

The purpose of this task is to demonstrate that the equipment design conforms to specified performance and reliability requirements under the specified combined environmental conditions. The test plans utilized and the appropriate α , β , and discrimination ratio are selected from those found in MIL-HDBK-781, Section 4 and approved by the procuring activity.

- **Task 302: Production Reliability Acceptance Test**

Production Reliability Acceptance Test (PRAT) is typically conducted upon samples of production equipment to determine that they continue to conform to the specified performance and reliability requirements under specified environmental conditions. PRAT is normally conducted under the same combined environmental test conditions used in the reliability qualification tests.

Lot sizes and the rules for sample selection are specified by the procuring activity. The test plans utilized and the appropriate α , β , and discrimination ratio are selected from those found in MIL-HDBK-781, Section 4 and approved by the procuring activity.

7.5.4 Environmental Stress Screening

- **Task 401: Environmental Stress Screening**

This task formulates and implements environmental stress screening (ESS) to detect and correct latent manufacturing defects (marginal and defective parts, and other anomalies) before the initiation of reliability accounting tests. ESS may be performed at various levels of assembly and at different assembly levels at different times in the program.

CHAPTER 7: MIL-STD-781D

7.6 TAILORING GUIDELINES

Tailoring is implicit in MIL-STD-781. The standard is written as a series of specific tasks, and the first tailoring decision is the choice of the specific tasks to be performed. This decision is dependent primarily upon the nature of the program and the applicable life-cycle phase of the program. Then each of the selected tasks must also be tailored as outlined below.

7.6.1 When and How to Tailor

- **RDQT Tailoring**

Tailoring of reliability development/growth testing involves the selection of the combination of environmental test conditions to be applied and the duration of the test.

- **RQT Tailoring**

Tailoring of reliability qualification testing involves primarily the planning and selection of a specific predetermined test plan from MIL-HDBK-781, Section 4 and the applicable environmental test profile.

- **PRAT Tailoring**

Tailoring of production reliability acceptance testing involves the selection of a specific predetermined test plan from MIL-HDBK-781, Section 4 and determination of the sampling plan to be utilized in sample selection.

- **ESS Tailoring**

Tailoring of ESS involves first the determination of the assembly level or levels at which ESS will be performed and the selection of the environmental stresses and stress levels which will be utilized.

7.7 CONTRACT DATA REQUIREMENTS LIST (CDRL)

The following is a list of data item descriptions associated with reliability testing in accordance with MIL-STD-781D together with each DID utilized with each applicable task.

| <u>TASK</u> | <u>DID</u> | <u>DATA REQUIREMENT</u> |
|-------------|---|---|
| 101 | DI-RELI-80250 | Reliability Test Plan |
| 102 | DI-RELI-80251 | Reliability Test Procedures |
| 103 | DI-RELI-80250 | Reliability Test Plan |
| 106 | DI-RELI-80252 | Reliability Test Report |
| 201 | DI-RELI-80247 DI-RELI-80248 | Thermal Survey Report Vibration Survey Report |
| 202 | DI-RELI-80250 DI-RELI-80251 DI-RELI-80252 | Reliability Test Plan Reliability Test Procedures Reliability Test Report |

CHAPTER 7: MIL-STD-781D

| <u>TASK</u> | <u>DID</u> | <u>DATA REQUIREMENT</u> |
|-----------------|--|---|
| 202 (Cont'd) | DI-RELI-80253 DI-RELI-80254 DI-RELI-80255 | Failed Item Analysis Report Corrective Action Plan Failure Summary and Analysis Report |
| 301 | DI-RELI-80250 DI-RELI-80251 DI-RELI-80252 DI-RELI-80253 DI-RELI-80254 DI-RELI-80255 | Reliability Test Plan Reliability Test Procedures Reliability Test Report Failed Item Analysis Report Corrective Action Plan Failure Summary and Analysis Report |
| 302 | DI-RELI-80250 DI-RELI-80251 DI-RELI-80252 DI-RELI-80253 DI-RELI-80254 DI-RELI-80255 | Reliability Test Plan Reliability Test Procedures Reliability Test Report Failed Item Analysis Report Corrective Action Plan Failure Summary and Analysis Report |
| 401 | DI-RELI-80249 DI-RELI-80250 DI-RELI-80251 DI-RELI-80253 DI-RELI-80255 | Environmental Stress Screening Report Reliability Test Plan Reliability Test Procedures Failed Item Analysis Report Failure Summary and Analysis Report |

CHAPTER 8:

MIL-HDBK-781

**RELIABILITY TEST METHODS, PLANS, AND ENVIRONMENTS FOR
ENGINEERING DEVELOPMENT, QUALIFICATION, AND PRODUCTION**

CHAPTER 8: MIL-HDBK-781

MIL-HDBK-781 is a tri-service approved document used by all branches of the military in the specification and acquisition of quality-assured electronic systems equipment. The current version is the initial release dated July 14, 1987. The preparing activity is:

Department of the Navy
Space and Naval Warfare Systems Command
ATTN: SPAWAR 003-121
Washington, DC 20363-5100

This chapter is only an advisory to the use of MIL-HDBK-781. It does not supersede, modify, replace or curtail any requirements of MIL-HDBK-781 nor should it be used in lieu of that handbook.

8.1 REFERENCE DOCUMENTS

The following documents also impact and further detail these tasks:

- MIL-STD-785 Reliability Program for Systems and Equipment Development and Production (and specifically the following tasks therein)
 - Task 301 Environmental Stress Screening (ESS)
 - Task 302 Reliability Development/Growth Test (RDGT) Program
 - Task 303 Reliability Qualification Test (RQT) Program
 - Task 304 Production Reliability Acceptance Test (PRAT) Program
- MIL-STD-781 Reliability Testing for Engineering Development, Qualification, and Production
- MIL-STD-2164 Environmental Stress Screening Process for Electronic Equipment
- MIL-HDBK-189 Reliability Growth Management

8.2 DEFINITIONS

The meanings of many of the terms and acronyms used in reliability testing are unique to the field and thus may be unfamiliar to the reader. Therefore, the following terms and acronyms are defined here to clarify their meanings as used in MIL-HDBK-781.

Consumer's Risk (β) - This is the probability of accepting equipment with a true mean-time-between-failures (MTBF) equal to the lower test MTBF (θ_1). The probability of accepting equipment with a true MTBF less than the lower test MTBF (θ_1) will be less than (β).

Producer's Risk (α) - This is the probability of rejecting equipment with a true MTBF equal to the upper test MTBF (θ_0). The probability of rejecting equipment with a true MTBF greater than the upper test MTBF will be less than (α).

CHAPTER 8: MIL-HDBK-781

Discrimination Ratio (d) - This is one of the standard (MIL-HDBK-781) test plan parameters; it is the ratio of the upper test MTBF (θ_0) to the lower test MTBF (θ_1); that is, $d = \theta_0/\theta_1$.

Pattern Failure - The occurrence of two or more failures of the same part in identical or equivalent applications when the failures are caused by the same basic failure mechanism and the failures occur at a rate which is inconsistent with the part's predicted failure rate.

Chargeable Failure - A relevant, independent failure of equipment under test and any dependent failures caused thereby which are classified as one failure and used to determine contractual compliance with acceptance and rejection criteria.

Lower Test MTBF (θ_1) - This is the MTBF value that is unacceptable. The standard test plans (as defined in MIL-HDBK-781) will reject, with high probability, equipment with a true MTBF that approaches (θ_1).

Upper Test MTBF (θ_0) - This is an acceptable value of MTBF equal to the discrimination ratio times the lower test MTBF (θ_1). The standard test plans (as defined in MIL-HDBK-781) will accept, with high probability, equipment with a true MTBF that approaches (θ_0). This value (θ_0) must be realistically attainable, based on experience and information.

8.3 APPLICABILITY

MIL-HDBK-781 is designed to be used in conjunction with MIL-STD-781. It explains the techniques used in reliability testing and also provides reliability engineers and managers with a menu of test methods, test plans and test environmental profiles which can be utilized to tailor the reliability testing performed during the development, qualification, and production of systems and equipment as specified in MIL-STD-785. The most appropriate material may be selected for each program and incorporated into the tailored reliability test programs, derived from MIL-STD-781, for Reliability Development/Growth (RDGT), Reliability Qualification Testing (RQT), Production Reliability Acceptance Tests (PRAT), and Environmental Stress Screening (ESS).

8.4 PHYSICAL DESCRIPTION OF MIL-HDBK-781

MIL-HDBK-781 contains the supporting material for the eleven different reliability-testing-related "Tasks" which are defined in MIL-STD-781. The handbook is approximately three hundred and sixty pages in length. It has no appendices as such, but rather it contains seventy-two pages of basic text followed by approximately two hundred and ninety pages of reference tables and figures.

8.5 HOW TO USE MIL-HDBK-781

Section 4 of MIL-HDBK-781 provides the technical and mathematical background for selecting the test methods and test plans required to implement the test programs specified in MIL-STD-781. The handbook provides test methods and test plans which can be used when performing the reliability test programs specified in Tasks 200, 300, and 400 of MIL-STD-781. Methods are also provided in the handbook for evaluating data generated during RDGT and ESS programs. Test plans are provided for MTBF assurance, fixed-duration and sequential reliability demonstration, assessment test and all-equipment reliability tests. These test plans can be selected for use in RQT and PRAT.

8.5.1 Test Methods

● Growth Monitoring Methods

Two growth monitoring (data evaluation) methods are described in the handbook: the Duane method and the Army Material Systems Analysis Agency (AMSAA) method. The Duane Method is a nonstatistical technique which can be used to graphically plot changes in reliability. The AMSAA Method is based on the assumption that times between successive failures can be modeled as the intensity function of a nonhomogenous Poisson process. This intensity function is expressed as a multiple of the cumulative test time raised to some power. The Duane and AMSAA methods are described in greater detail in MIL-HDBK-189.

● ESS Evaluation Methods

The handbook describes two ESS evaluation methods which may be used to provide a means to determine when the ESS procedures should be terminated. One of the methods also provides a technique for calculating a required ESS time interval (which must be satisfied to stop screening) prior to the start of the ESS. The decision in the second method is determined by the use of arbitrary times based on historical data.

8.5.2 Test Plans

The MTBF assurance tests and the standard test plans described in this handbook provide a wide selection of tests suitable for tailoring to conform to the requirements of any reliability program.

● MTBF Assurance Tests

The MTBF assurance tests use a failure-free interval concept to verify MTBF. These tests provide a desired assurance that a minimum specified MTBF level is achieved in addition to providing assurance that early defect failures have been eliminated. The tests can be used on production equipments which have previously passed qualification testing. The MTBF assurance test provides the producer with a high probability of success.

● Standard Test Plans

The standard test plans contain statistical criteria for determining compliance with specified reliability requirements. These are based on the assumption that the underlying distribution of times-between-failures is exponential. The exponential assumption implies that the equipment exhibits a constant failure rate; therefore, these tests cannot be used for the purpose of eliminating either design defects or infant mortality failures. The standard test plans defined in this handbook are categorized as follows:

- a. Probability Ratio Sequential Test Plans (PRST)
(Test Plans I-D through VI-D)
- b. Short-run high-risk PRST Plans
(Test Plans VII-D through VIII-D)
- c. Fixed-duration Test Plans
(Test Plans IX-D through XVII-D and XIX-D through XXI-D)
- d. All-equipment Reliability Test Plan
(Test Plan XVIII-D)

CHAPTER 8: MIL-HDBK-781

These statistical test plans are to be used to determine contractual compliance with pre-established acceptance-reject criteria and should not be used to project equipment MTBF.

8.5.3 Test Method and Test Plan Selection

The test methods and test plans to be used in RDGT, RQT, PRAT, and ESS are selected from the following material. The test methods or test plans should be specified in the contract and the equipment specification and described, in detail, in the reliability test plan documentation.

- **Reliability Growth Monitoring**

The reliability growth monitoring method should be selected under conditions where parameters of the time-to-failure distribution are expected to be changing with time.

- **ESS**

The ESS methods are to be used to eliminate early defects (infant mortality). The Standard Environmental Stress Screen is a form of ESS used when it must be verified that equipment, which has passed previous reliability testing, has not been degraded by the production process.

- **MTBF Assurance**

The MTBF assurance test can be used to provide assurance that a minimum specified MTBF has been achieved and that early defect failures have been eliminated.

- **Fixed Duration Test**

A fixed-duration test plan must be selected when it is necessary to obtain an estimate of the true MTBF demonstrated by the test, as well as accept- reject decision, or when total test time must be known in advance.

- **PRST**

A sequential test plan may be selected when it is desired to accept or reject predetermined MTBF values (θ_0, θ_1) with predetermined risks of error (α, β), and when uncertainty in total test time is relatively unimportant. This test will save test time, as compared to fixed-duration test plans having similar risks and discrimination ratios, when the true MTBF is much greater than (θ_0) or much less than (θ_1).

- **All Equipment Test**

The all-equipment test plan may be selected when all units of the production run must undergo a reliability lot acceptance test.

These statistical test plans are to be used to determine contractual compliance with pre-established accept-reject criteria and should not be used to project equipment MTBF.

8.5.4 Test Method and Test Plan Parameter Selection

- **Equipment Performance**

The parameters to be measured during reliability tests and the acceptance limits should be determined by the performance requirements of the equipment design control specification and should be included in the test procedures.

- **Equipment Quantity**

The number of equipments to be tested, not necessarily simultaneously, shall be determined as described in the handbook or as specified in the contract.

- **Test Duration**

The test duration for RDGT should be specified in advance, by the government. During the test program, additional test time may be specified if needed to achieve reliability goals. ESS time is a variable, which depends on lot size, failure distribution of early failures, types of environmental stress applied, and stress levels. Some maximum allowable test time should be used for test planning. For sequential test plans, test duration should be planned on the basis of maximum allowable test time (truncation), rather than the expected decision point, to avoid the probability of unplanned test cost and schedule overruns. Testing should continue until the total unit hours together with the total count of relevant equipment failures permit either an accept or reject decision in accordance with the specified test plan. However, for the all-equipment reliability test, testing should continue until a reject decision is made or all contractually required equipment has been tested. Equipment ON time (that is, equipment operating time) should be used to determine test duration and compliance with accept-reject criteria. Testing should be monitored so that the times of failure may be recorded accurately. The monitoring instrumentation and techniques and the method of estimating MTBF should be included in the proposed reliability test procedures. Each equipment should operate at least one-half the average operating time of all equipment on test. The duration of fixed-time tests should be specified in the request for proposal, contract, and equipment specification. This test duration should be the maximum allowed by the schedule and fiscal constraints of the program.

- **Decision Risks**

The consumer's risk (β) is the probability that equipment with MTBF equal to the lower test MTBF will be accepted by the test plan. The producer's risk (α) is the probability that equipments with MTBF equal to the upper test MTBF will be rejected by the test plan. In general, the use of low risk decision will result in longer test time. However, low risk decisions provide protection against the rejection of satisfactory equipment or acceptance of unsatisfactory equipment. For each of the truncated sequential plans (PRST), the exact risks were calculated. Shifts in the accept-reject lines and truncation points were then made to bring the true risks closer to the designated risks and to make the two risks more nearly equal for each plan. The decision risks of the all-equipment reliability test vary with the total test time and have little significance as a reason for choosing this plan.

CHAPTER 8: MIL-HDBK-781

- **Discrimination Ratio**

The discrimination ratio (d) is a measure of the power of the test to reach a decision quickly and, together with the decision risks, defines a sequential test's accept-reject criteria. In general, the higher the discrimination ratio, the shorter the test. The discrimination ratio (and the corresponding test plan) must be chosen carefully to prevent the resulting (θ_0) from becoming unattainable due to design limitations.

8.6 TAILORING GUIDELINES

Tailoring is implicit in MIL-HDBK-781. MIL-STD-781 the companion document to MIL-HDBK-781, is written as a series of specific tasks, and the first tailoring decision is the choice of the specific tasks to be performed. This decision is dependent primarily upon the nature of the program and the applicable life-cycle phase of the program. Then each of the selected tasks must also be tailored as outlined below.

8.6.1 When and How to Tailor

- **RDGT Tailoring**

Tailoring of reliability development/growth testing involves the selection of the combination of environmental test conditions to be applied, and the duration of the test.

- **RQT Tailoring**

Tailoring of reliability qualification testing primarily involves the planning and selection of a specific predetermined test plan from MIL-HDBK-781, Section 4, and the applicable environmental test profile.

- **PRAT Tailoring**

Tailoring of production reliability acceptance testing involves the selection of a specific predetermined test plan from MIL-HDBK-781, Section 4 and determination of the sampling plan to be utilized in sample selection.

- **ESS Tailoring**

Tailoring of ESS involves first the determination of the assembly level or levels at which ESS will be performed and then determination of the environmental stresses and stress levels which will be utilized.

8.7 CONTRACT DATA REQUIREMENTS LIST (CDRL)

There are no data item descriptions required by MIL-HDBK-781.

CHAPTER 9:

**MIL-HDBK-189
RELIABILITY GROWTH MANAGEMENT**

CHAPTER 9: MIL-HDBK-189

MIL-HDBK-189 is a tri-service-approved document used by all branches of the military in the specification and acquisition of quality-assured electronic systems and equipment. The current version is the initial release dated February 13, 1981. The preparing activity is:

U.S. Army Communications Research and Development Command
ATTN: AMSEL-ED-TO
Fort Monmouth, NJ 07703-5000

This chapter is only an advisory to the use of MIL-HDBK-189. It does not supersede, modify, replace or curtail any requirements of MIL-HDBK-189 nor should it be used in lieu of that handbook.

9.1 REFERENCE DOCUMENTS

- MIL-STD-499 Engineering Management
- MIL-STD-721 Definitions of Terms for Reliability and Maintainability
- MIL-STD-756 Reliability Prediction
- MIL-STD-785 Reliability Program for Systems and Equipment Development and Production
- MIL-STD-781 Reliability Testing for Engineering Development, Qualification, and Production
- MIL-HDBK-781 Reliability Test Methods, Plans and Environments for Engineering Development, Qualification, and Production

9.2 DEFINITIONS

This paragraph is not applicable to this chapter.

9.3 APPLICABILITY

Reliability growth is the positive improvement in a reliability parameter over a period of time due to changes in product design or manufacturing process.

Reliability growth management is the systematic planning for and the control of reliability achievement as a function of time and by the reallocation of resources based on comparison between planned and assessed reliability values.

MIL-HDBK-189 provides procuring activities and development contractors with an understanding of the concepts and principles of reliability growth, and the advantages of, and guidelines and procedures for, managing reliability growth.

This handbook is not intended to serve as a specific reliability growth plan to be applied to a program without tailoring. The handbook, when used with knowledge of the system and its development program, provides the means to develop a reliability growth management plan for a system that meets its requirements at a reduced life cycle cost. This handbook is intended for use by both contractor and government personnel during the development phase of systems and equipment.

CHAPTER 9: MIL-HDBK-189

9.4 PHYSICAL DESCRIPTION OF MIL-HDBK-189

MIL-HDBK-189 contains approximately ninety-four pages. There are also four supporting appendices with an additional fifty-four pages. Appendix A addresses Engineering Analysis, Appendix B overviews seventeen different reliability growth mathematical models, Appendix C evaluates, in more detail, a single mathematical model (the AMSAA reliability growth model) and Appendix D is a Bibliography.

9.5 HOW TO USE MIL-HDBK-189

Reliability growth management is part of the system engineering process as described in MIL-STD-499. It does not take the place of the other basic reliability program activities described in MIL-STD-785 such as predictions, apportionments, failure mode and effect analysis, and stress analysis. Instead, reliability growth management provides a means of viewing all the reliability program activities in an integrated manner.

MIL-HDBK-189 provides methodology and concepts to assist in reliability growth planning and a structured approach for reliability growth assessments. The planning aspects in this handbook address the planned growth curve and related milestones. The assessment techniques are based on demonstrated and projected values which are designed to realistically evaluate reliability in the presence of a changing configuration.

The handbook presents two basic methods to evaluate the reliability growth process. The Assessment Method (quantitative evaluations of the current reliability status) and the Monitoring (or qualitative) Method.

The Assessment Method is based on information from the detection of failure sources and is results-oriented, i.e., quantitative estimates of planned and achieved reliability are made as the program progresses. The Monitoring Method simply monitors the various reliability-oriented activities (FMEA's, stress analysis, etc.) in the growth process to assure that the activities are being accomplished in a timely manner and that the level of effort and quality of work are in compliance with the program plan. It is activities-oriented, and should be used in addition to assessments. The monitoring approach may have to be relied on early in a program, before the detection of failure sources is adequate for the generation of objective assessments. Each of these methods complement the other in controlling the growth process.

- **Assessment Management Model**

Figure 9.1, excerpted from MIL-HDBK-189, illustrates how assessments may be used in controlling the growth process.

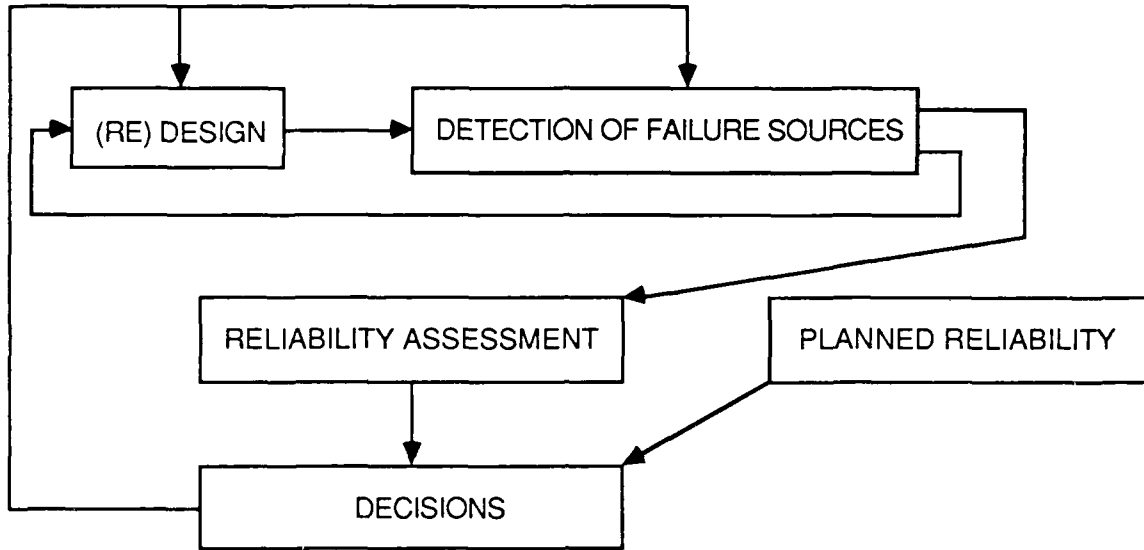

**FIGURE 9.1:
RELIABILITY GROWTH MANAGEMENT MODEL
(ASSESSMENT)**

Reliability growth management differs from conventional reliability program management in two ways. First there is a more objectively-developed growth standard against which assessments are compared. Second, the assessment methods can provide more accurate evaluations of the reliability of the present configuration.

Figure 9.2 taken from MIL-HDBK-189, illustrates an example of both the planned reliability growth and assessments. A comparison between the assessment and the planned value will suggest whether the program is progressing as planned, or not as well as planned. If the progress is falling short, new strategies should be developed. These strategies may involve the reassignment of resources to work on identified problem areas or may result in adjustment of the time frame or a re-examination of the validity of the requirement.

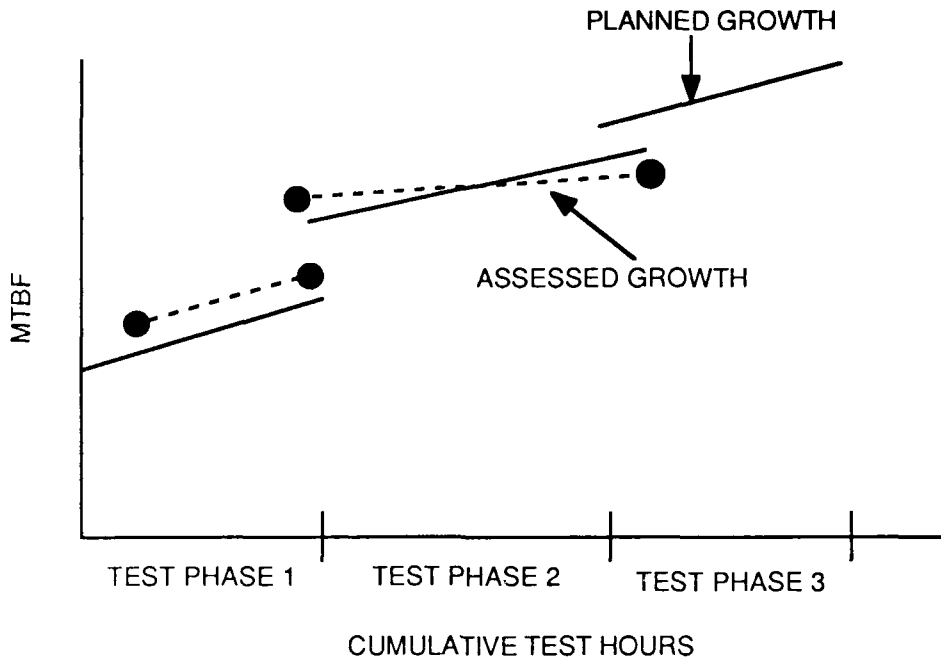
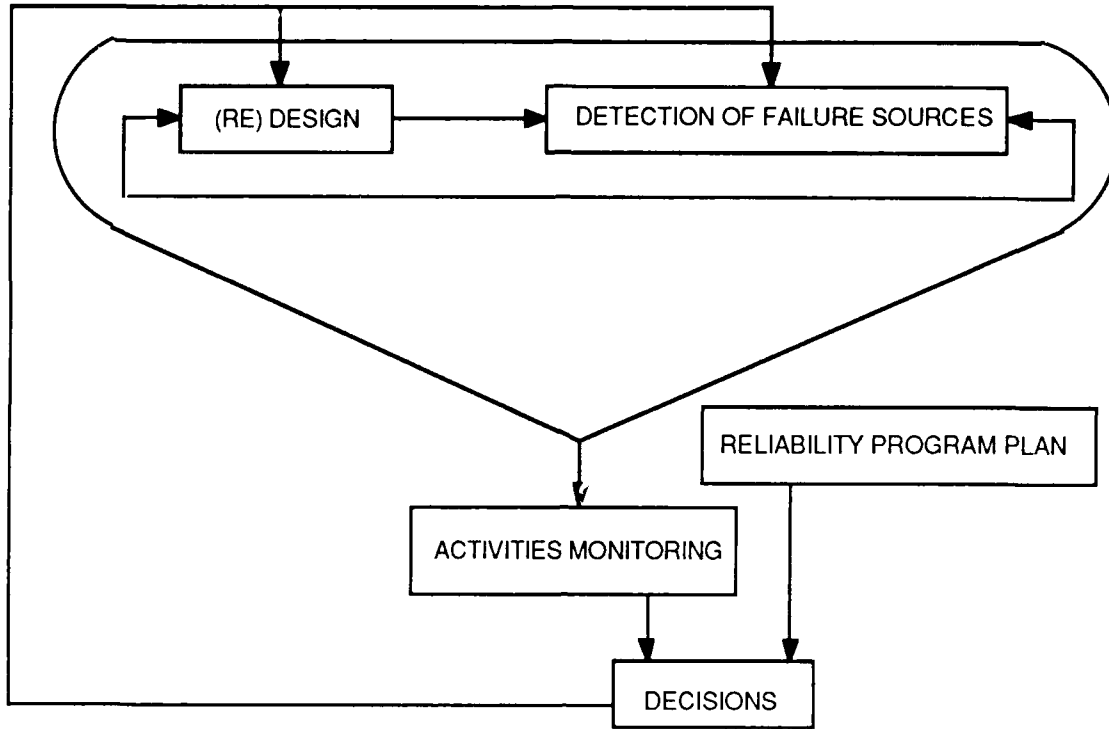

**FIGURE 9.2:
PLANNED GROWTH AND ASSESSMENTS**

- **Monitoring Management Model**

Figure 9.3, excerpted from MIL-HDBK-189, illustrates control of the growth process by monitoring the growth activities. Since there is no simple way to evaluate the performance of activities, management based on monitoring is less definitive than management based on assessments. Nevertheless, this method is a valuable alternative when assessments are not practical. The reliability growth program plan serves, at least partially, as a standard against which the activities being performed can be compared. Standards for level of effort and quality of work accomplished must rely heavily on the technical judgement of the evaluator.

Monitoring is intended to assure that the activities have been performed within schedule, and that they meet appropriate standards of engineering practice.



**FIGURE 9.3:
RELIABILITY GROWTH MANAGEMENT MODEL (MONITORING)**

One of the best examples of a monitoring activity is design review. The design review is a planned monitoring of the product design to assure that it will meet the performance requirements during operational use. Such reviews of the design effort serve to determine the progress being made in achieving the design objectives. One of the most significant aspects of design review is its emphasis on technical judgements, rather than quantitative assessments of progress.

9.6 TAILORING GUIDELINES

MIL-HDBK-189 does not contain requirements. It is a guidance document only, which recognizes that each application of the material therein will be different. Therefore, tailoring is inherent in the use of this handbook. MIL-HDBK-189 does not contain a separate section dealing with specific guidelines for tailoring as do some military standards.

9.7 CONTRACT DATA REQUIREMENTS LIST (CDRL)

There are no deliverable data item descriptions required by this handbook.

CHAPTER 10:

**MIL-STD-2164(EC)
ENVIRONMENTAL STRESS SCREENING PROCESS
FOR ELECTRONIC EQUIPMENT**

CHAPTER 10: MIL-STD-2164(EC)

MIL-STD-2164(EC) is currently a limited usage document. It is approved by the Navy and is used in the specification and acquisition of quality-assured electronic systems and equipment. The current version is the initial release dated April 5, 1985. The preparing activity is:

Department of the Navy
Space and Naval Warfare Systems Command
ATTN: SPAWAR 003-121
Washington, D.C. 20363-5100

This chapter is only an advisory to the use of MIL-STD-2164(EC) . It does not supersede, modify, replace or curtail any of the requirements of MIL-STD-2164 nor should it be used in lieu of that standard.

10.1 REFERENCE DOCUMENTS

The following related documents impact and further detail these tasks and should also be referenced.

- MIL-STD-785 Reliability Program for Systems and Equipment Development and Production (and specifically the following task therein)
 - Task 301 Environmental Stress Screening (ESS)
- MIL-STD-781 Reliability Testing For Engineering Development, Qualification and Production (and specifically the following task therein)
 - Task 401 Environmental Stress Screening (ESS)
- MIL-HDBK-781 Reliability Test Methods, Plans and Environments for Engineering Development, Qualification and Production

10.2 DEFINITIONS

This paragraph is not applicable to this chapter.

10.3 APPLICABILITY

Environmental Stress Screening (sometimes described as preconditioning or burn-in) is a procedure, or a series of procedures, specifically designed to identify weak parts, workmanship defects and other conformance anomalies so that they can be removed from the equipment prior to delivery. It may be applied to parts or components, boards, subassemblies, assemblies, or equipment (as appropriate and cost effective), to remove defects which would otherwise cause failures during higher-level testing or during early field operation.

ESS must not be confused with Production Reliability Assurance Test (PRAT). ESS employs less expensive test facilities, and is recommended for application to each and every production item. In contrast, PRAT is essentially a sampling plan which requires more realistic simulation of the life profile, and more expensive test facilities, and therefore is not recommended for performance on 100% of the product.

CHAPTER 10: MIL-STD-2164(EC)

MIL-STD-2164(EC) establishes procedures and ground rules for the selection of the proper type of stress, the amount of stress, and the duration of the stress or stresses to be used in the formulation of a cost effective environmental stress screening program for a specific item of equipment.

10.4 PHYSICAL DESCRIPTION OF MIL-STD-2164(EC)

MIL-STD-785 is a simple document containing only twenty-seven pages. There are also two appendices; Appendix A, "ESS Test Duration, Reduced Testing and Sampling," and Appendix B, "ESS Troubleshooting Plan." Together these two appendices contain fifteen additional pages.

10.5 HOW TO USE MIL-STD-2164(EC)

Historically there have been two basic approaches to the application of environmental stress screening. In one approach, the government explicitly specifies the screens and screening parameters to be used at various assembly levels. Failure-free periods are sometimes attached to these screens, as an acceptance requirement, in order to provide assurance that the product is reasonably free of defects. This is the approach documented in MIL-STD- 2164(EC).

The second approach is to have the contractor develop and propose an environmental stress screening program which is tailored to that product and is subject to the specific approval of the procuring activity. This is the approach taken in DOD-HDBK-344(USAF). This handbook then provides guidelines for the contractor to assist him in the development and establishment of an effective ESS program. DOD-HDBK-344 is described in Chapter 11 of this Primer.

MIL-STD-2164 defines specific requirements for ESS of electronic equipment, including environmental test conditions, durations of exposure, procedures, equipment operation, actions taken upon detection of defects, and test documentation. The standard provides for a uniform ESS to be utilized for effectively disclosing manufacturing defects in electronic equipment

The process described herein is applied to electronic assemblies, equipment and systems, in six broad categories as distinguished according to their field service application:

| <u>Category</u> | <u>Service Application</u> |
|-----------------|--|
| 1 | Fixed ground equipment |
| 2 | Mobile ground vehicle equipment |
| 3 | Shipboard equipment |
| 3A | ● Sheltered |
| 3B | ● Exposed to atmospheric environments |
| 4 | Jet aircraft equipment |
| 5 | Turbo-propeller and rotary-wing aircraft equipment |
| 6 | Air launched weapons and assembled external stores |

The standard utilizes thermal cycling and vibration as shown in (Figure 10.1) and defines a specific Random Vibration Spectrum (Figure 10.2) and a Temperature Cycling Profile (Figure 10.3) to accomplish ESS.

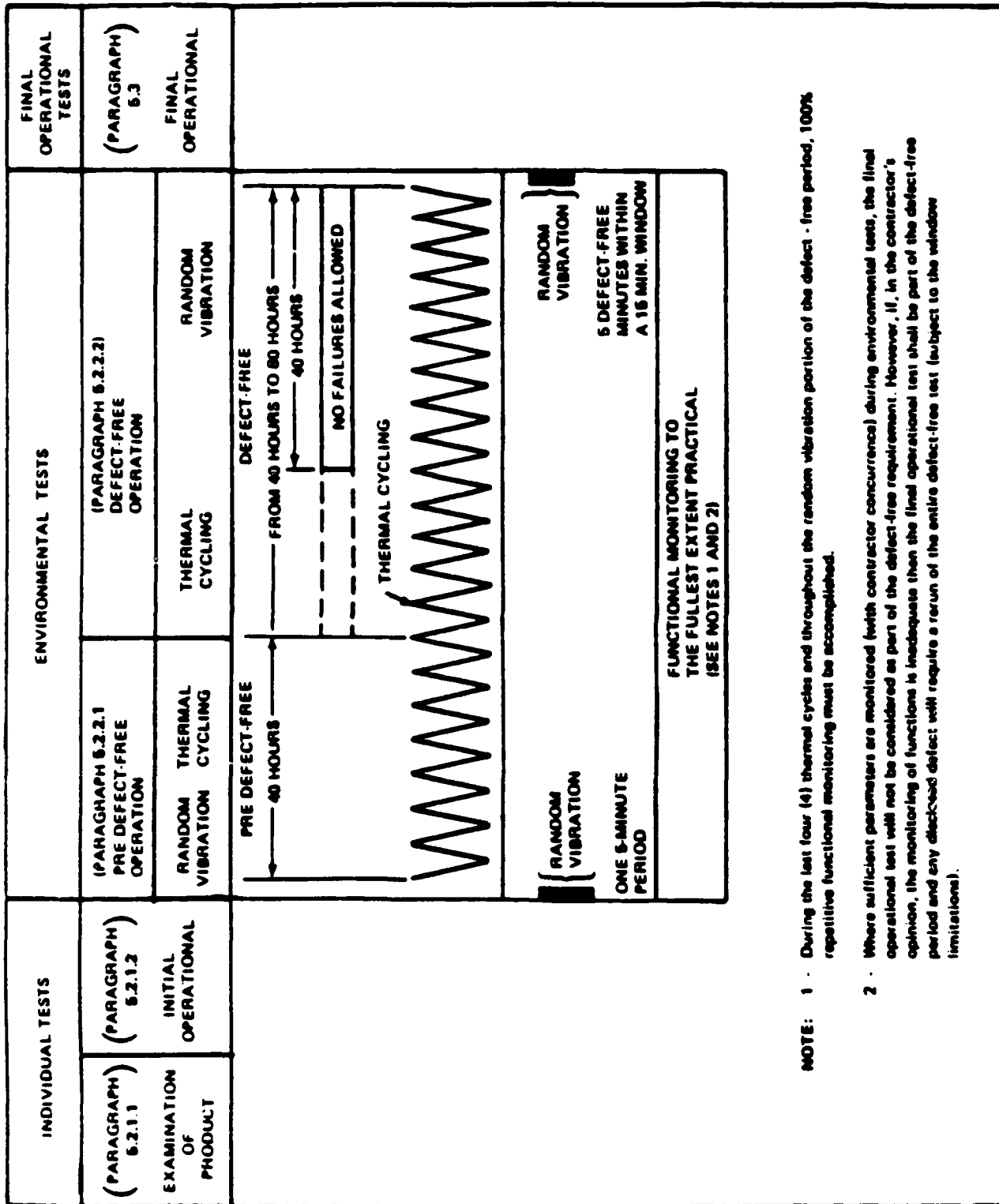

- NOTE: 1 - During the last four (4) thermal cycles and throughout the random vibration portion of the defect-free period, 100% repetitive functional monitoring must be accomplished.
- 2 - Where sufficient parameters are monitored (with contractor concurrence) during environmental tests, the final operational test will not be considered as part of the defect-free requirement. However, if, in the contractor's opinion, the monitoring of functions is inadequate then the final operational test shall be part of the defect-free period and any detected defect will require a rerun of the entire defect-free test (subject to the window limitations).

FIGURE 10.1:
ENVIRONMENTAL STRESS TEST CONSTITUENTS

CHAPTER 10: MIL-STD-2164(EC)

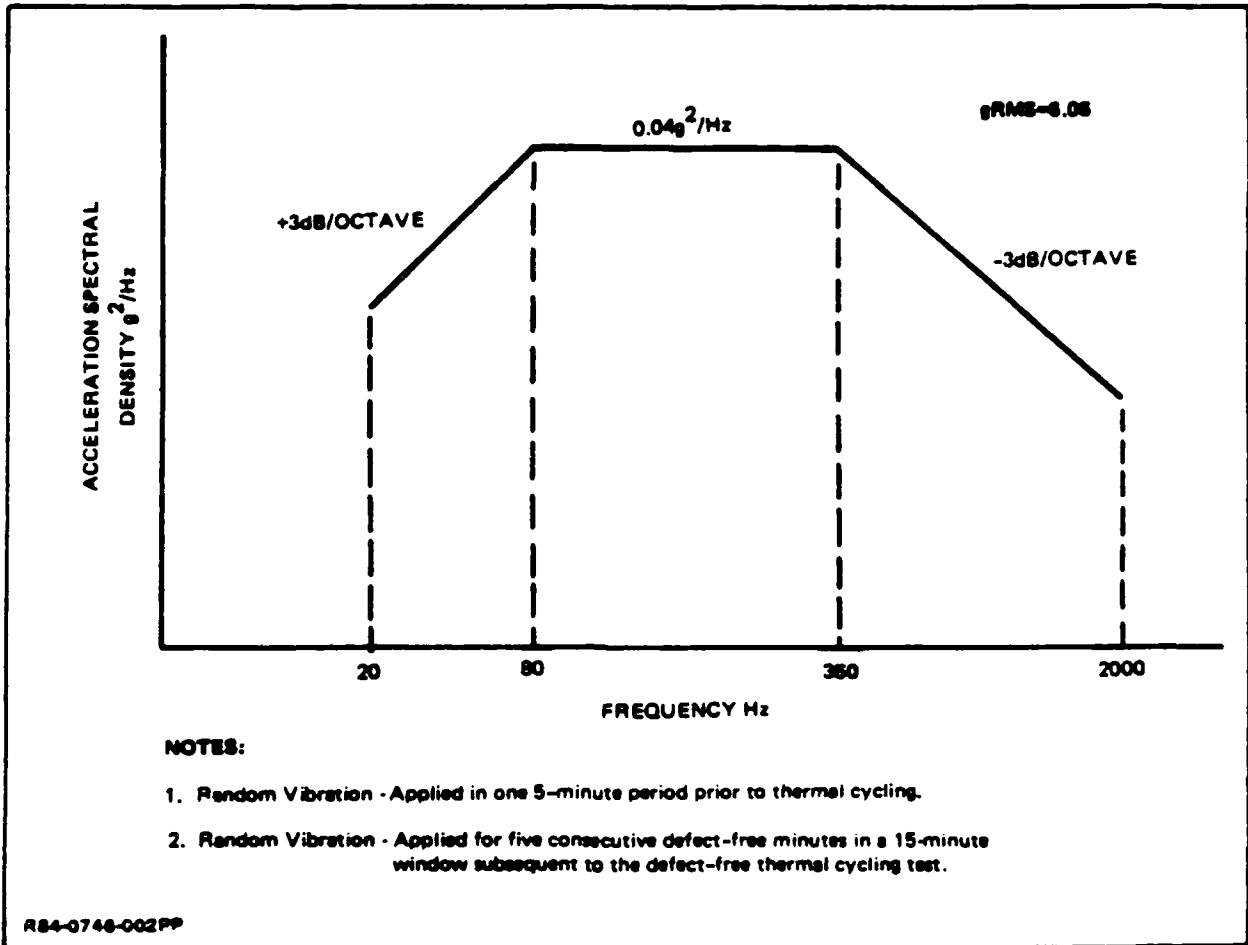

FIGURE 10.2:
RANDOM VIBRATION SPECTRUM

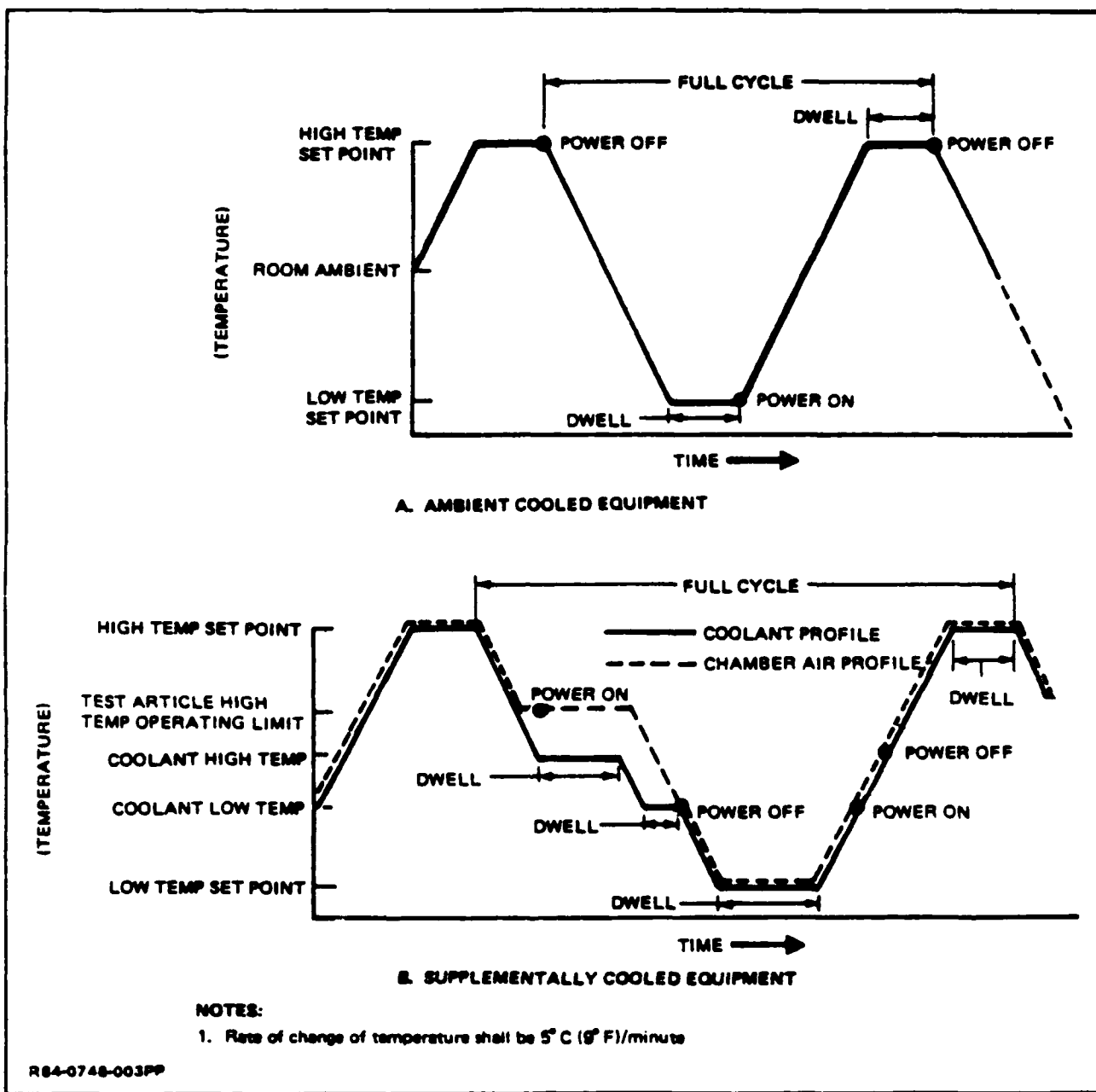

FIGURE 10.3:
 TEMPERATURE CYCLING PROFILE FOR AMBIENT
 COOLED AND SUPPLEMENTALLY COOLED EQUIPMENT

CHAPTER 10: MIL-STD-2164(EC)

10.6 TAILORING GUIDELINES

Tailoring of ESS involves primarily the selection of the screening method utilized, the rigor with which this method is applied, the time duration of the applied stress and the applicability and length of a "failure free operation" requirement.

10.6.1 When and How to Tailor

Appendix A to MIL-STD-2164(EC) describes the approach, ground rules and assumptions used to tailor the requirements of this specification. Specific tailoring goals are to optimize the times for pre-defect-free (PDF) and subsequent defect-free (DF) testing under environmental conditions, and to define ground rules and techniques for reduced testing and possible product sampling.

The primary purpose of the appendix is to present the background that led to the test times stipulated in the main body of the standard, and to define statistical plans for reduced testing and sampling options. Specific reference is made to MIL-STD-1235 relative to sampling techniques.

10.7 CONTRACT DATA REQUIREMENTS LIST (CDRL)

The following data item description is associated with Environmental Stress Screening.

DI-ENVR-80172

Environmental Stress Screening (ESS) Report

CHAPTER 11:

DOD-HDBK-344(USAF)

ENVIRONMENTAL STRESS SCREENING OF ELECTRONIC EQUIPMENT

CHAPTER 11: DOD-HDBK-344(USAF)

DOD-HDBK-344(USAF) is currently a limited usage document. It is approved by the Air Force and is used in the specification and acquisition of quality-assured electronic systems and equipment. The current version is the initial release dated October 20, 1986. The preparing activity is:

Rome Air Development Center (RADC)
Attn: RBE-2
Griffiss AFB, NY 13441-5700

This chapter is only an advisory to the use of DOD-HDBK-344(USAF). It does not supersede, modify, replace or curtail any of the requirements of DOD-HDBK-344(USAF) nor should it be used in lieu of that handbook.

11.1 REFERENCE DOCUMENTS

The following related documents impact and further detail this task and should also be referenced.

- MIL-STD-785 Reliability Program for Systems and Equipment Development and Production (and specifically the following task therein)
 - Task 301 Environmental Stress Screening (ESS)
- MIL-STD-781 Reliability Testing For Engineering Development, Qualification and Production (and specifically the following task therein)
 - Task 401 Environmental Stress Screening (ESS)
- MIL-HDBK-781 Reliability Test Methods, Plans and Environments for Engineering Development, Qualification and Production

11.2 DEFINITIONS

The meanings of many of the terms and acronyms used in ESS are unique to the field. Therefore, the following terms and acronyms are defined here to clarify their meanings as used in DoD-HDBK-344(USAF).

Detectable Failures - A failure that can be detected with 100% test detection efficiency.

Failure-Free Period - A contiguous period of time during which an item is to operate without the occurrence of a failure while under environmental stress.

Failure-Free Test - A test to determine if an equipment can operate without failure for a predetermined time period under specific stress conditions.

Fallout (F) - Failures observed during or immediately after, and attributed to stress screens.

Part Fraction Defective - The number of defects contained in a part population divided by the total number of parts in the population expressed in Parts Per Million (PPM).

CHAPTER 11: DOD-HDBK-344(USAF)

Latent Defect - An inherent or induced weakness, not detectable by ordinary means, which will either be precipitated to early failure under environmental stress screening conditions or eventually fail in the intended use environment.

Patent Defect - An inherent or induced weakness which can be detected by inspection, functional test, or other defined means without the need for stress screens.

Precipitation (of Defects) - The process of transforming a latent defect into a patent defect through the application of stress screens.

Screening Effectiveness - Generally, a measure of the ability of a screen to precipitate latent defects to failure. Sometimes used specifically to mean screening strength.

Screen Parameters - Parameters in screening strength equations which relate to screening strength, (e.g., vibration g-level, temperature rate of change and time duration).

Screening Regimen - a combination of stress screens applied to an equipment, identified in the order of application (i.e., assembly, unit and system screens).

Screening Strength (SS) - The probability that a screen will precipitate a latent defect to failure, given that a latent defect susceptible to the screen is present.

Selection and Placement - The process of systematically selecting the most effective stress screens and placing them at the appropriate levels of assembly.

Stress Screening - The process of applying mechanical, electrical and/or thermal stresses to an equipment item for the purpose of precipitating latent part and workmanship defects to early failure.

Test Detection Efficiency (DE) - A measure of test thoroughness or coverage which is expressed as the fraction of patent defects detectable, by a defined test procedure, to the total possible number of patent defects which can be present. Used synonymously as the probability of detection.

Test Strength (TS) - The product of screening strength and test detection efficiency. The probability that a defect will be precipitated by a screen and detected in a test.

Yield - The probability that an equipment is free of screenable latent defects when offered for acceptance.

Defect Density (D_{IN} for incoming D_{OUT} for outgoing, D_R for remaining D_O for observed) - Average number of defects per item.

Escapes (D_{out}) - A proportion of incoming defect density which is not detected by a screen and test and which is passed on to the next level.

11.3 APPLICABILITY

Environmental Stress Screening (sometimes known as preconditioning or burn-in) is a procedure, or a series of procedures, specifically designed to identify weak parts, workmanship defects and other conformance anomalies so that they can be removed from the equipment prior to delivery. It may be applied to boards, subassemblies, assemblies, or equipment (as appropriate and cost

CHAPTER 11: DOD-HDBK-344(USAF)

effective), to remove defects which would otherwise cause failures during higher-level testing or during early field operation.

DOD-HDBK-344(USAF) establishes a set of procedures and ground rules for the selection of the proper type of stress, the amount of stress, and the duration of the stress or stresses to be used in the formulation of a cost effective environmental stress screening program for a specific item of equipment.

11.4 PHYSICAL DESCRIPTION OF DOD-HDBK-344 (USAF)

DOD-HDBK-344(USAF) is a complex document describing nine different ESS planning, monitoring and control procedures and containing one hundred and twenty-four pages. There are also three appendices: Appendix A, "Stress Screening Mathematical Models," Appendix B, "Establishing Goals for Remaining Defect Density," and Appendix C "Development of Failure-Free Acceptance Test Requirements." Together these three appendices contain an additional eighteen pages.

11.5 HOW TO USE DOD-HDBK-344 (USAF)

There are two basic approaches to the application of environmental stress screening. In one approach, the government explicitly specifies the screens and screening parameters to be used at various assembly levels. Failure-free periods are sometimes attached to these screens, as an acceptance requirement, in order to provide assurance that the product is reasonably free of defects. This is the approach documented in MIL-STD- 2164(EC). MIL-STD-2164 is described in Chapter 10 of this Primer.

The second approach is to have the contractor develop and propose an environmental stress screening program which is tailored to that product and is subject to the specific approval of the procuring activity. This is the approach taken in DOD-HDBK-344(USAF). This handbook then provides guidelines for the contractor to assist him in the development and establishment of an effective ESS program.

DOD-HDBK-344(USAF) describes general techniques for planning and evaluating Environmental Stress Screening (ESS) programs. The guidance contained therein departs from other approaches to ESS in that quantitative methods are used to plan and control both the cost and effectiveness of ESS programs.

ESS is an emerging technology and there are various approaches associated with the application of stress screens. Regardless of the approach used, the fundamental objective of ESS remains the same i.e. to remove latent defects from the product prior to field delivery. The quantitative methods contained in this handbook extend this objective by focusing on the defects which remain in the product at delivery and their impact on field reliability.

The handbook is organized according to the general sequence of events to be undertaken by the contractor in planning, monitoring and controlling a screening program. Five detailed procedures are used to assist the user in accomplishing ESS planning and evaluation activities. The detailed procedures may be briefly described as follows:

CHAPTER 11: DOD-HDBK-344(USAF)

- **Procedure A - Part Fraction Defective - Air Force Action Plan R&M 2000 Goals and Incoming Defect Density**

This procedure is used to control the part fraction defective and to obtain estimates of D_{IN} . Two procedures are contained in Procedure A. Procedure A1 provides control of incoming defective density for electronic components (diodes, transistors, etc.) by limiting the part fraction defective to the R&M 2000 goals of no greater than 1000 PPM and 100 PPM. Methods for sampling part lots to determine if the part fraction defective exceeds the R&M 2000 goals are included in the procedure. Procedure A2 contains tabled values of part, board and connection fraction defective as a function of quality level and field environmental stress. The tables are used to estimate incoming defect density. Other factors which impact incoming defect density, such as maturity and packaging density, should be factored into the estimates based upon experience and the recommendation contained in the handbook.

- **Procedure B - Screen Selection and Placement**

This procedure uses the results obtained from Procedure A, to plan a screening program to achieve objectives on remaining defect density. The procedure contains tabled values of screening strength and defect failure rates as a function of the screen parameters and duration. Other factors which effect screen selection and placement, such as the quantity of defect type susceptible to temperature vs vibration screens, must be factored into the procedure based upon the manufacturer's experience and the recommendations contained in the guideline. Procedure B must be performed in conjunction with the following two procedures C and D, to develop a screening plan.

- **Procedure C - Failure-Free Acceptance Test**

This procedure is used to establish failure-free acceptance periods which provide a lower confidence bound on yield or equivalently, the remaining defect density. The failure-free acceptance test can be made a part of the end item (system) level screen or used as a part of a separate acceptance test procedure. In either case, the costs of conducting the FFAT must be factored into the screen selection and placement, and cost estimating procedures.

- **Procedure D - Cost Effectiveness Analysis**

This procedure is used to estimate and compare the costs of various screen selection and placement alternatives in order to arrive at a cost effective screening program. The manufacturer's cost of conducting the screening program is normalized to a cost per defect eliminated. Comparison of the cost per defect eliminated by the screening program against a cost threshold value is used to determine cost effectiveness.

- **Procedure E - Monitoring, Evaluation and Control**

This procedure is used to obtain estimates of the defect density based upon the observed screen fallout data and to establish whether the observed defect density falls within or outside of predetermined control limits. Comparisons of observed part fraction defective and defect density are made against baseline criteria to priorities and determine the need for corrective actions which improve manufacturing or screening process capability.

CHAPTER 11: DOD-HDBK-344(USAF)

The product development phase is used to experiment with stress screens using an R&M 2000 initial screening regimen, and to then define and plan a cost effective screening program for production. Controls are used to assure that the manufacturing process begins with electronic parts with fraction defective levels which are consistent with R&M 2000 goals. After the screening program is implemented during production, stress screening results are used to evaluate the screening process to establish whether program objectives are being achieved.

Quantitative objectives for the screening program must be established early. Appendix B of the handbook provides the rationale used for establishing quantitative goals which are related to reliability requirements for the product. Appendix A contains the mathematical relations and model descriptions used in the handbook. A review of Appendix A will help the interested reader in gaining a quick understanding of the rationale and methodology of the handbook. Appendix C provides the derivation of the Failure Free Acceptance Test (FFAT). A typical task sequence in Planning, Monitoring and Controlling an ESS Program in accordance with DOD-HDBK-344(USAF) is shown in Figure 11.1.

11.6 TAILORING GUIDELINES

Tailoring of ESS involves primarily the selection of the screening method utilized, the rigor with which this method is applied, the time duration of the applied stress and the applicability and length of a "failure free operation" requirement.

11.6.1 When and How to Tailor

Since DOD-HDBK-344(USAF) is written as a series of guidelines to assist the contractor in the development and establishment of a unique cost effective ESS program, tailoring of the requirements is inherent in this approach.

11.7 CONTRACT DATA REQUIREMENTS LIST (CDRL)

The following data item descriptions is associated with Environmental Stress Screening.

| | |
|---------------|---|
| DI-ENVR-80172 | Environmental Stress Screening (ESS) Report |
|---------------|---|

CHAPTER 11: DOD-HDBK-344(USAF)

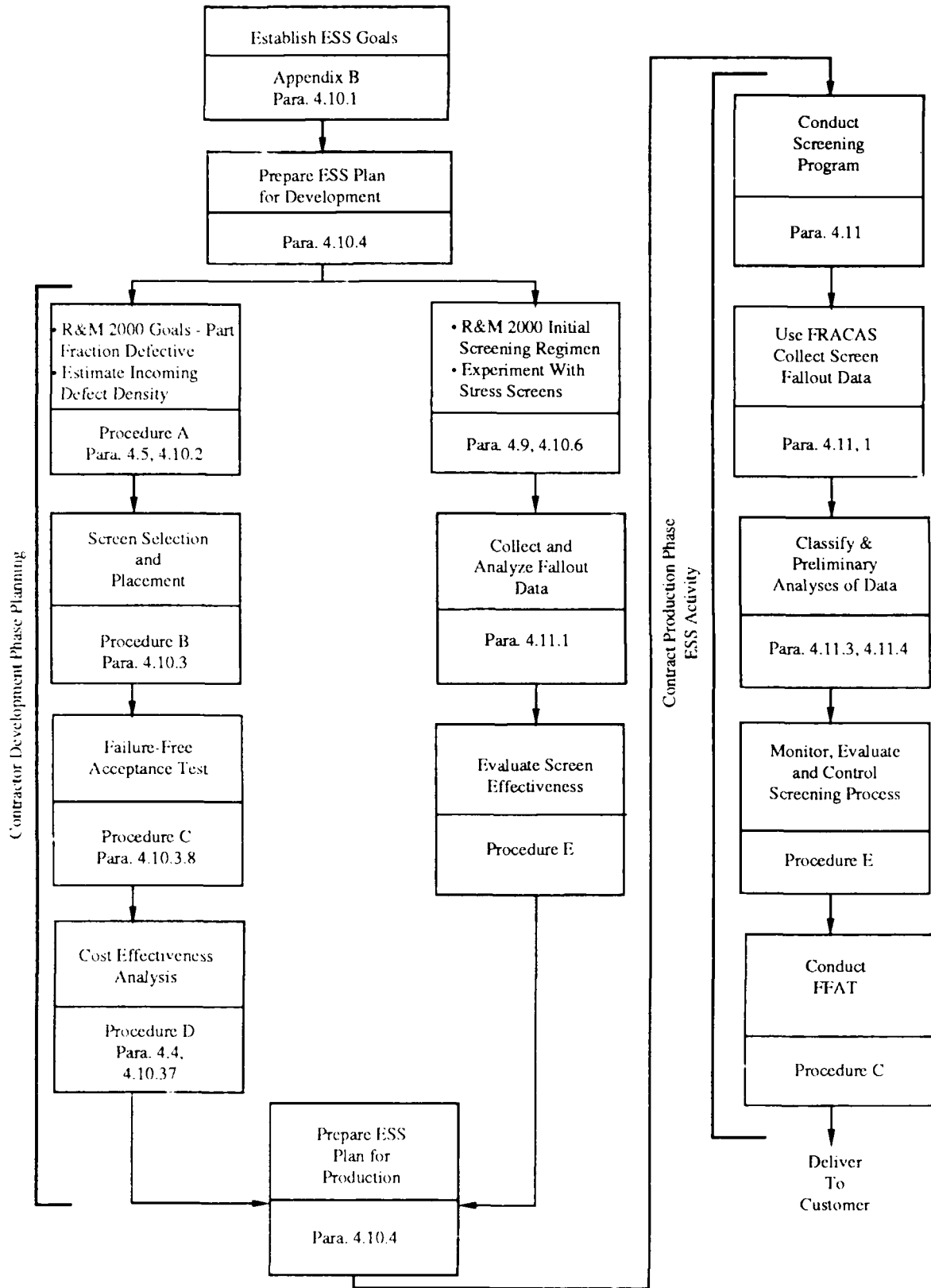

FIGURE 11.1: TASK SEQUENCE IN PLANNING, MONITORING AND CONTROLLING AN ESS PROGRAM

SECTION 4

RELIABILITY DESIGN SPECIFICATIONS

- CHAPTER 12 MIL-STD-1629A: PROCEDURES FOR PERFORMING A FAILURE MODE EFFECTS AND CRITICALITY ANALYSIS**
- CHAPTER 13 MIL-HDBK-251: RELIABILITY/DESIGN THERMAL APPLICATIONS**
- CHAPTER 14 MIL-HDBK-338: ELECTRONIC RELIABILITY DESIGN HANDBOOK VOLUME I**
- CHAPTER 15 MIL-HDBK-338: ELECTRONIC RELIABILITY DESIGN HANDBOOK VOLUME II**
- CHAPTER 16 MIL-STD-810: ENVIRONMENTAL TEST METHODS AND ENGINEERING GUIDELINES**
- CHAPTER 17 DOD-STD-1686A: ELECTROSTATIC DISCHARGE CONTROL PROGRAM FOR PROTECTION OF ELECTRICAL AND ELECTRONIC PARTS, ASSEMBLIES AND EQUIPMENT (EXCLUDING ELECTRICALLY INITIATED EXPLOSIVE DEVICES)**
- CHAPTER 18 DOD-HDBK-263: ELECTROSTATIC DISCHARGE HANDBOOK FOR PROTECTION OF ELECTRICAL AND ELECTRONIC PARTS, ASSEMBLIES AND EQUIPMENT (EXCLUDING ELECTRICALLY INITIATED EXPLOSIVE DEVICES)**
- CHAPTER 19 MIL-STD-454K: STANDARD GENERAL REQUIREMENTS FOR ELECTRONIC EQUIPMENT**

CHAPTER 12:

MIL-STD-1629A

**PROCEDURES FOR PERFORMING A FAILURE MODE,
EFFECTS AND CRITICALITY ANALYSIS**

CHAPTER 12: MIL-STD-1629A

MIL-STD-1629 is a tri-service-approved document used by all branches of the military in the specification and acquisition of quality-assured systems and equipment. The current version is Revision "A" dated November 24, 1980. The preparing activity is:

Department of the Navy
Engineering Specifications and Standards Dept.
(SESD) (Code 5313)
Naval Air Engineering Center
Lakehurst, NJ 08733-5100

This chapter is only an advisory to the use of MIL-STD-1629. It does not supersede, modify, replace or curtail any requirements of MIL-STD-1629 nor should it be used in lieu of that standard.

12.1 REFERENCE DOCUMENTS

The following related documents impact and further detail these tasks and should also be referenced.

- MIL-STD-785 Reliability Program for Systems and Equipment Development and Production (and specifically the following task therein)
 - Task 204 Failure Modes, Effects and Criticality Analysis
- MIL-STD-882 System Safety Program Requirements
- MIL-STD-1388 Logistic Support Analysis
- MIL-HDBK-266(AS) Application of Reliability-Centered Maintenance to Naval Aircraft Weapon Systems and Support Equipment

12.2 DEFINITIONS

This paragraph is not applicable to this chapter.

12.3 APPLICABILITY

MIL-STD-1629 defines the methodology for performing a failure modes, effects and criticality analysis (FMECA) as required by MIL-STD-785, Task 204. The FMECA is an analytical procedure which: a) documents probable failures in the system using specific ground rules, b) determines the effect of each failure on system operation, c) identifies single failure points, and d) ranks each failure according to a severity classification of failure effects.

The MIL-STD-1629 FMECA procedure is one of the most beneficial and productive tasks in a well-structured reliability program. Since the procedure requires the listing and evaluation of individual failure modes in an orderly, organized fashion the FMECA serves to verify design integrity, identify and quantify sources of undesirable failure modes, and document the reliability risks.

Results of an FMECA can be used to provide the rationale for changes in operating procedures, for detecting the incipience of, or ameliorating effects of, undesirable failure modes. The FMECA is an essential reliability task, it supplements and supports other engineering tasks through identification of areas in which effort should be concentrated.

CHAPTER 12: MIL-STD-1629A

FMECA results not only provides design guidance, but are used advantageously in maintenance planning analysis, logistics support analysis, survivability and vulnerability assessments, safety and hazards analyses (see MIL-STD-882), and for fault detection and isolation design. Inadvertent, coincident use of the FMECA must be considered in FMECA planning and every means taken to prevent duplication of effort by the program elements which utilize FMECA results.

12.4 PHYSICAL DESCRIPTION OF MIL-STD-1629

MIL-STD-1629 is composed of five detailed reliability analysis "Tasks" and contains approximately fifty-two pages. There is also an additional six page appendix dealing with tailoring of the specification requirements.

12.5 HOW TO USE MIL-STD-1629

The FMECA analysis as defined in MIL-STD-1629 is the result of two distinct tasks which, when combined, provide the FMECA. These two tasks are:

- (1) Failure Modes and Effects Analysis (Task 101)
- (2) Criticality Analysis (Task 102)

A properly performed FMECA is invaluable to those who are responsible for making program decisions regarding the feasibility and adequacy of a design approach.

MIL-STD-1629 also defines three additional tasks. The first two of these tasks build upon and extend the results of the FMECA while the third defines and documents the overall approach to the job. These three tasks are:

- (1) FMECA-Maintainability Information (Task 103)
- (2) Damage Mode and Effects Analysis (Task 104)
- (3) FMECA Plan (Task 105)

Each of these five tasks is described in more detail in the following sections.

12.5.1 Failure Modes and Effects Analysis (FMEA) Description

The FMEA is an analytical procedure by which each potential failure mode in a system is analyzed to determine the results or effects thereof on the system and to classify each potential failure mode according to its severity. The initial FMEA should be performed early in the conceptual phase when design criteria, mission requirements, and conceptual designs are being developed to evaluate the design approach and to compare the benefits of competing design configurations.

The FMEA will provide quick visibility of the most obvious failure modes and identify potential single failure points, some of which can be eliminated with minimal design effort. As mission and design definition becomes more refined, the FMEA can be expanded to more detailed levels. When changes are made in system design to remove or reduce the impact of the identified failure modes, the FMEA must be repeated for the redesigned portions to ensure that all predictable failure modes in the new design are considered. A sample FMEA worksheet, from MIL-STD-1629, is shown in Figure 12.1.

FAILURE MODE AND EFFECTS ANALYSIS

DATE _____
 SHEET _____ OF _____
 COMPILED BY _____
 APPROVED BY _____

SYSTEM _____
 INDENTURE LEVEL _____
 REFERENCE DRAWING _____
 MISSION _____

| IDENTIFICATION NUMBER | ITEM/FUNCTIONAL IDENTIFICATION (NOMENCLATURE) | FUNCTION | FAILURE MODES AND CAUSES | MISSION PHASE/ OPERATIONAL MODE | FAILURE EFFECTS | | | FAILURE DETECTION METHOD | COMPENSATING PROVISIONS | SEVERITY CLASS | REMARKS |
|-----------------------|---|----------|--------------------------|---------------------------------|-----------------|-------------------|-------------|--------------------------|-------------------------|----------------|---------|
| | | | | | LOCAL EFFECTS | NEXT HIGHER LEVEL | END EFFECTS | | | | |
| | | | | | | | | | | | |
| | | | | | | | | | | | |
| | | | | | | | | | | | |
| | | | | | | | | | | | |
| | | | | | | | | | | | |
| | | | | | | | | | | | |
| | | | | | | | | | | | |
| | | | | | | | | | | | |
| | | | | | | | | | | | |

FIGURE 12.1: EXAMPLE OF FMEA WORKSHEET FORMAT

CHAPTER 12: MIL-STD-1629A

The specific approach to be used in the FMEA will generally be dictated by variations in design complexity and the available data. There are two primary approaches for accomplishing an FMEA. One, the functional approach, recognizes that every item is designed to perform a number of output functions. The outputs are listed and their failure modes analyzed. The second, the hardware approach, lists individual hardware items and analyzes their possible failure modes. For complex systems, a combination of the functional and hardware approaches may be considered. The FMEA may be performed as a hardware analysis, a functional analysis, or a combination analysis and may be initiated at either the highest indenture level and proceed through decreasing indenture levels (top-down approach) or at the part or circuit level and proceed through increasing indenture levels (bottom-up approach) until the FMEA for the system is complete.

12.5.2 Criticality Analysis (CA) Description

The CA associates failure probabilities with each failure mode. It supplements the FMEA and is dependent upon information developed in that analysis, so it should not be attempted before completing the FMEA. The CA is probably most valuable for maintenance and logistic support purposes since failure modes which have a high probability of occurrence (high criticality numbers) require investigation to identify changes which can be made to reduce the potential impact on the maintenance and logistic support requirements for the system. Criticality numbers are established based upon subjective judgements, therefore, they should only be used as indicators of relative priorities. A sample *Criticality Worksheet*, from MIL-STD-1629, is shown in Figure 12.2.

The analysis approach used for the CA will generally be dictated by the availability of specific configuration data and failure rate data. There are two approaches used in accomplishing the CA. The qualitative approach is appropriate when specific failure rate data are not available; the quantitative approach may be used where failure rate data are available.

12.5.3 FMECA-Maintainability Information Description

This analysis is an extension of the FMECA and is dependent upon FMEA generated information; therefore, the FMECA-Maintainability Information Analysis should not be imposed as a requirement without imposition of the FMEA. The identification of how each failure will be detected and localized will provide information for evaluation of item testability. The failure mode listing should be utilized to provide this required data for logistic support analyses (LSA) (see MIL-STD-1388), maintenance plan analysis (MPA), and reliability centered maintenance (RCM) (see MIL-HDBK-266 (AS)).

12.5.4 Damage Model Effects Analysis (DMEA) Description

The DMEA provides inputs for the vulnerability assessment of a weapon system essential to the identification of deficiencies and the evaluation of designs for enhancing survivability. Since the DMEA utilizes the failure mode information from the FMEA, it should not be imposed as a requirement without imposition of the FMEA. The DMEA, like the initial FMEA, should be done early in the conceptual phase to provide data on the capability of the conceptual weapon system design to survive the effects of specified hostile threats.

Development of this data before weapon system design configuration is finalized will provide significant survivability benefits with minimal impact on cost and schedule.

CRITICALITY ANALYSIS

DATE _____
 SHEET _____ OF _____
 COMPILED BY _____
 APPROVED BY _____

SYSTEM _____
 INDENTURE LEVEL _____
 REFERENCE DRAWING _____
 MISSION _____

| IDENTIFICATION NUMBER | ITEM/FUNCTIONAL IDENTIFICATION (NOMENCLATURE) | FUNCTION | FAILURE MODES AND CAUSES | MISSION PHASE/ OPERATIONAL MODE | SEVERITY CLASS. | FAILURE PROBABILITY FAILURE RATE DATA SOURCE | FAILURE EFFECT PROBABILITY (β) | FAILURE MODE RATIO (α) | FAILURE RATE (λ_p) | OPERATING TIME (t) | FAILURE MODE CRIT # $C_m = \beta \alpha \lambda_p$ | ITEM CRIT # $C_r = \sum(C_m)$ | REMARKS |
|-----------------------|---|----------|--------------------------|---------------------------------|-----------------|--|--|---------------------------------|------------------------------|--------------------|--|-------------------------------|---------|
| | | | | | | | | | | | | | |
| | | | | | | | | | | | | | |
| | | | | | | | | | | | | | |
| | | | | | | | | | | | | | |
| | | | | | | | | | | | | | |
| | | | | | | | | | | | | | |
| | | | | | | | | | | | | | |
| | | | | | | | | | | | | | |
| | | | | | | | | | | | | | |
| | | | | | | | | | | | | | |

FIGURE 12.2: EXAMPLE OF CA WORKSHEET FORMAT

CHAPTER 12: MIL-STD-1629A

12.5.5 FMECA Plan Description

The FMECA plan demonstrates the contractor's plans and activities for implementing the FMECA tasks. When approved by the procuring activity the plan is used for monitoring contractor implementation of the tasks. The plan can be required as a separate document submittal or as part of the Reliability Program Plan. The FMECA plan includes a description of the contractor's procedures for implementing the tasks and provides a cross index showing the relationship of coincident performance and use of the FMEA tasks to preclude duplication of effort. Sample contractor formats used in the performance of each FMECA task are included as a part of each task specified in the contract statement of work.

12.6 TAILORING GUIDELINES

The FMECA is an essential function in design from concept through deployment. To be effective, the FMECA must be iterative to correspond with the design process itself. The extent of effort and sophistication of approach used in the FMECA will be dependent upon the nature and requirements of the individual program. This makes it necessary to tailor the requirements for an FMECA to each individual program. Tailoring requires that, regardless of the degree of system sophistication, the FMECA must contribute meaningfully to program decisions.

12.6.1 When and How to Tailor

Specific guidelines for tailoring the requirements of MIL-STD-1629 are given in Appendix A to the standard.

The tailoring of FMECA requirements may take the form of deletion, addition, or alteration of the various tasks. The details for this tailoring are documented in the FMEA Plan which the contractor submits in accordance with Task 105.

12.7 CONTRACTS DATA REQUIREMENTS LIST (CDRL)

The following data item descriptions (DIDs) are associated with FMECA.

| | |
|-----------|--|
| DI-R-7085 | Failure Modes, Effects and Criticality Analysis Report |
| DI-R-7086 | Failure Modes, Effects and Criticality Analysis Plan |

CHAPTER 13:

MIL-HDBK-251

RELIABILITY/DESIGN THERMAL APPLICATIONS

CHAPTER 13: MIL-HDBK-251

MIL-HDBK-251 is a tri-service approved document used by all branches of the military in the specification and acquisition of quality-assured electronic systems and equipment. The current version is the initial release dated January 19, 1978. The preparing activity is:

Department of the Navy
Space and Naval Warfare Systems Command
ATTN: SPAWAR 003-121
Washington, DC 20363-5100

The chapter is only an advisory to the use of MIL-HDBK-251. It does not supersede, modify, replace or curtail any requirements of MIL-HDBK-251 nor should it be used in lieu of that handbook.

13.1 REFERENCE DOCUMENTS

The following related documents impact and further detail these guidelines and should also be referenced.

- MIL-E-16400 General Specification for Naval Ship and Shore: Electronic Interior Communication and Navigation Equipment
- MIL-M-28787 General Specification for Standard Electronic Module Program
- MIL-STD-1378 Requirements for Employing Standard Electronic Modules
- MIL-STD-1389 Design Requirements for Electronic Modules
- MIL-HDBK-217 Reliability Prediction of Electronic Equipment

13.2 DEFINITIONS

This paragraph is not applicable to this chapter.

13.3 APPLICABILITY

MIL-HDBK-251 has been prepared to guide design engineers in the thermal design of electronic equipment with improved reliability. The primary purposes are: 1) to permit engineers and designers, who are not heat transfer experts, to design electronic equipment with adequate thermal performance and with a minimum of effort; 2) to assist heat transfer experts who are not electronic experts; 3) to aid engineers in better understanding the thermal sections of Department of Defense specifications and standards for equipment; and 4) to assist military personnel in evaluating thermal design during the various stages of equipment development and procurement.

This handbook recommends and presents electronic parts stress analysis methods which lead to the selection of maximum safe temperatures for parts so that the ensuing thermal design is consistent with the required equipment reliability. These maximum part temperatures must be properly selected since they are the sine qua non of the thermal design, a fact which is often overlooked. Many thermal designs are inadequate because improper maximum part temperatures were selected as design goals. Consequently, the necessary parts stress analysis procedures have been emphasized. Specific step by step thermal design procedures are given in Section 4 of the handbook.

CHAPTER 13: MIL-HDBK-251

Examples of reliability improvement that can be obtained by reduced operating temperatures is illustrated in Table 13.1 taken from MIL-HDBK-251.

**TABLE 13.1:
FAILURE RATE REDUCTION BY TEMPERATURE REDUCTION**

| Part Description | λ_b Failures Per Million Hours Base Failure Rate | | $\Delta T^{\circ}\text{C}$ | Ratio of High to Low Failure Rate |
|--|---|---------------------------------|----------------------------|---|
| | High Temperature | Low Temperature | | |
| PNP Silicon Transistors | .063 at 130°C and 0.3 stress | .0096 at 25°C and 0.3 stress | 105 | 7:1 |
| NPN Silicon Transistors | .033 at 130°C and 0.3 stress | .0064 at 25°C and 0.3 stress | 105 | 5:1 |
| Glass Capacitors | .047 at 120°C and 0.5 stress | .001 at 25°C and 0.5 stress | 95 | 47:1 |
| Transformers and Coils MIL-T-27 Class Q | .0267 at 85°C | .0008 at 25°C | 60 | 33:1 |
| Resistors Carbon Comp. | .0065 at 100°C and 0.5 stress | .0003 at 25°C and 0.5 stress | 75 | 22:1 |

13.4 PHYSICAL DESCRIPTION OF MIL-HDBK-251

MIL-HDBK-251 is a voluminous document containing approximately six hundred and thirty pages. There are also ten appendices included with this handbook dealing with subjects such as: Numerical Conversion Factors, Physical and Thermal Properties of Materials, etc. These appendices contain an additional seventy pages.

(Much of the more pertinent and useful material in MIL-HDBK-251, has been extracted from this document and published in abbreviated form in RADC-TR-82-172, "RADC Thermal Guide for Reliability Engineers," AD-A118839. Many readers may find the latter document to be handier for their specific purposes than the military handbook itself.)

13.5 HOW TO USE MIL-HDBK-251

This handbook provides fundamental and detailed information on the thermal design of military electronic equipment. This information may be used by the procuring agency to help establish thermal design requirements or by the equipment designer in fulfilling the requirement. Major topics addressed by applicable sections in the handbook are as follows:

CHAPTER 13: MIL-HDBK-251

- Section 4: Approaches to Thermal Design
- Section 5: Determination of the Thermal Requirements
- Section 6: Thermal Design Requirements
- Section 7: Selection of Optimum Cooling Methods

A comparison of the effectiveness of some of the different methods of cooling is shown in Figure 13.1, taken from MIL-HDBK-251.

- Section 8: Natural Methods of Cooling
- Section 9: Thermal Design of Forced Air Cooled Electronic Equipment
- Section 10: Thermal Design of Liquid Cooled Electronic Equipment
- Section 11: Thermal Design of Vaporization Cooled Electronic Equipment
- Section 12: Special Cooling Techniques (methods such as: heat pipes, thermoelectric cooling, absorptive refrigeration, etc.)

An illustration of a heat pipe is shown in Figure 13.2 and a view of the principal of thermoelectric cooling is illustrated in Figure 13.3. Both figures were taken from MIL-HDBK-251.

- Section 13: Standard Hardware Program (SHP) Thermal Design (modular portions are also known as Standard Electronic Modules (SEMs))
- Section 14: Equipment Installation Requirements and Considerations
- Section 15: The Thermal Evaluation of Electronic Equipment
- Section 16: Improving the Thermal Performance of Existing Equipment
- Section 17: Thermal Characteristics of Parts
(such as: semiconductors, electron tubes, magnetic core devices, resistors, capacitors, and more specialized parts)
- Section 18: Design of Equipment for Operation at Elevated Temperatures

13.6 TAILORING GUIDELINES

13.6.1 When and How to Tailor

MIL-HDBK-251 does not contain requirements. It is a guidance document only, and hence the concept of tailoring does not apply.

13.7 CONTRACT DATA REQUIREMENTS LIST (CDRL)

There are no data item descriptions required by this handbook.

CHAPTER 13: MIL-HDBK-251

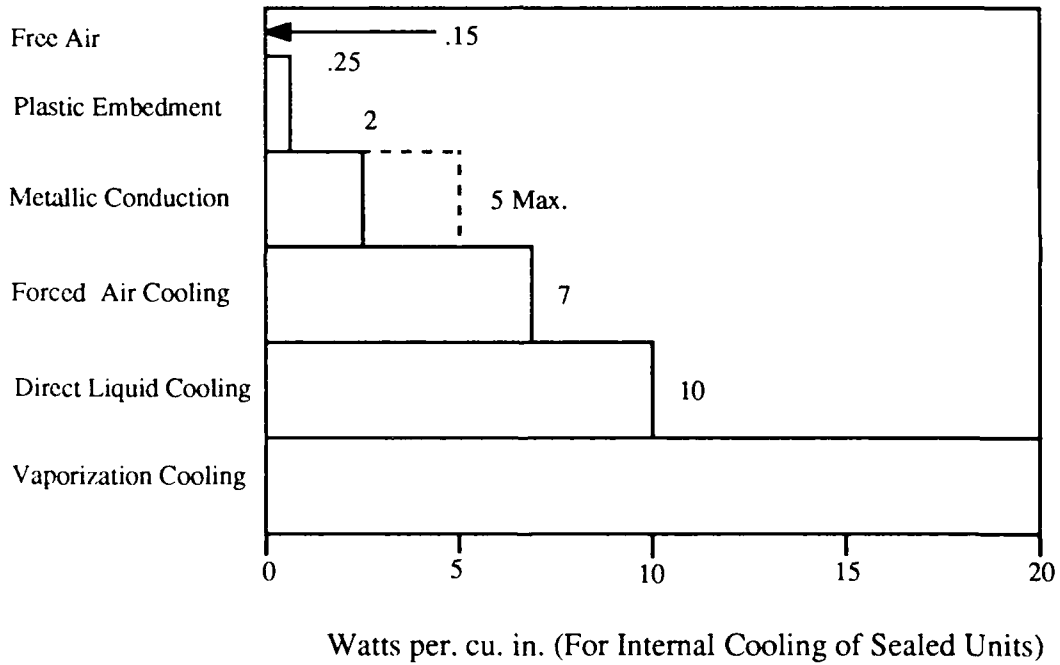
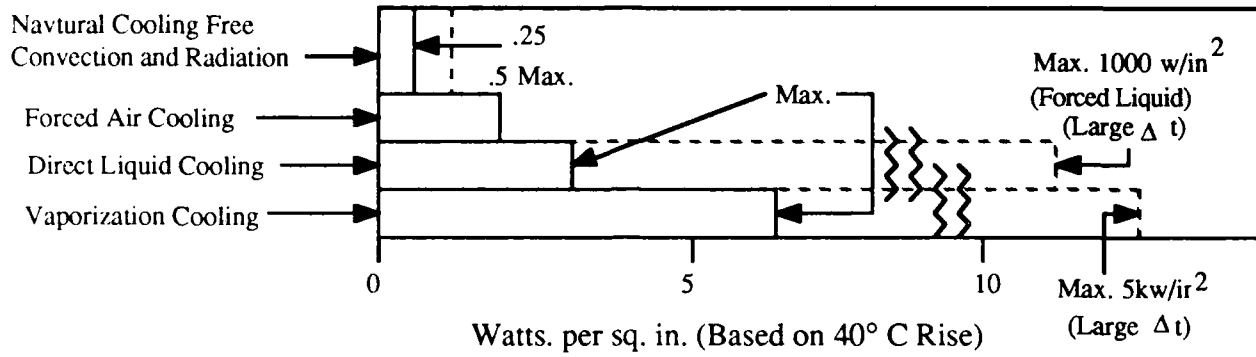
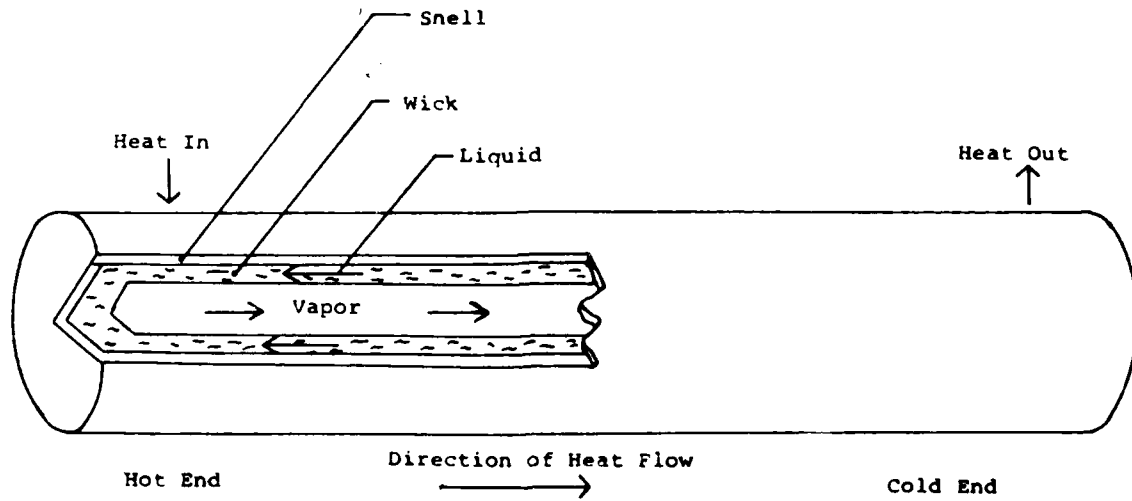
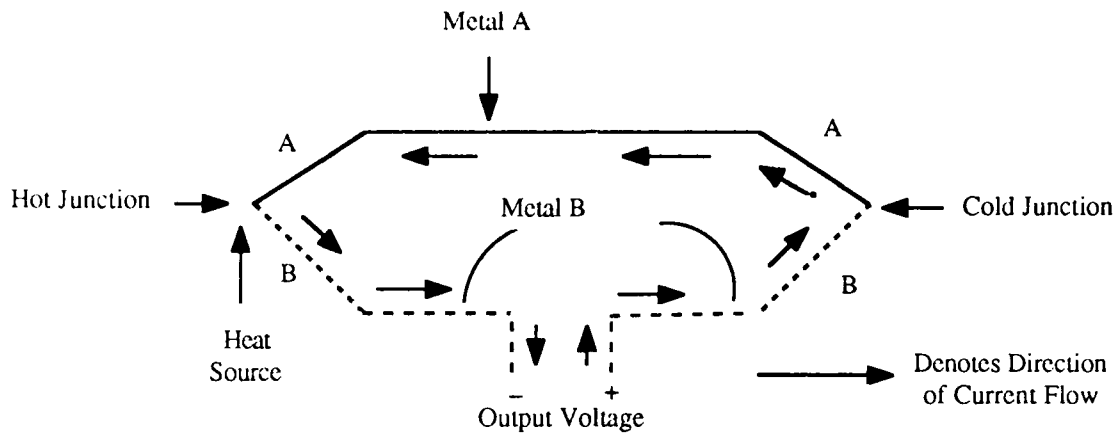

FIGURE 13.1:
COMPARISON OF METHODS OF COOLING



**FIGURE 13.2:
BASIC HEAT PIPE**



Configuration of a Simple Thermoelectric Generator

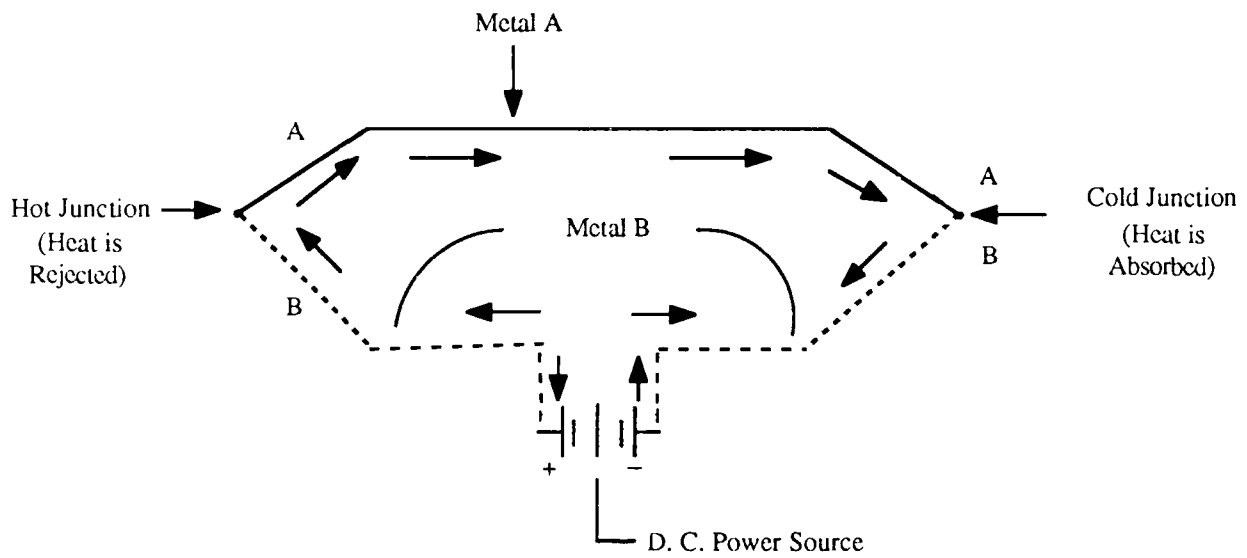

Peltier Cooling Arrangement

FIGURE 13.3:
THERMOELECTRIC JUNCTIONS

CHAPTER 14:

MIL-HDBK-338

ELECTRONIC RELIABILITY DESIGN HANDBOOK

VOLUME I

CHAPTER 14: MIL-HDBK-338, VOLUME I

MIL-HDBK-338 is a two-volume tri-service-approved document used by all branches of the military as a procedural guide in the design, specification, acquisition and development of quality-assured electronic equipment and systems. The current version of MIL-HDBK-338 is the initial version, dated 15 October 1984. The preparing activity is:

Rome Air Development Center
RADC/RBRA
Griffiss AFB, NY 13441-5700

This chapter is only an advisory to the use of Volume I of MIL-HDBK-338. It does not supersede, modify, replace or curtail any requirements of MIL-HDBK-338 nor should it be used in lieu of that standard.

14.1 REFERENCE DOCUMENTS

The following documents form a part of MIL-HDBK-338, to the extent specified therein.

SPECIFICATIONS

| | |
|-------------|--|
| MIL-E-2036 | Enclosures for Electric and Electronic Equipment, Naval Shipboard |
| MIL-E-4158 | Electronic Equipment Ground, General Requirements for |
| MIL-E-5400 | Electronic Equipment, Aerospace, General Specifications for |
| MIL-Q-9858 | Quality Program Requirements |
| MIL-E-16400 | Electronic, Interior Communication and Navigation Equipment, Naval Ship and Shore: General Specification for |
| MIL-E-17555 | Electronic and Electrical Equipment, Accessories and Repair Part, Packaging and Packing of |
| MIL-S-19500 | Semiconductor Devices, General Specification for |
| MIL-M-28787 | Module, Electronic, Standard Electronic, General Specification for |
| MIL-M-38510 | Microcircuit, General Specification for |
| MIL-I-45208 | Inspection System Requirements |
| MIL-H-46855 | Human Engineering Requirements for Military Systems, Equipment and Facilities |

CHAPTER 14: MIL-HDBK-338, VOLUME I

STANDARDS

| | |
|---------------|---|
| MIL-STD-105 | Sampling Procedures and Tables for Inspection by Attributes |
| MIL-STD-210 | Climatic Extremes for Military Equipment |
| MIL-STD-454 | Standard General Requirements for Electronic Equipment |
| MIL-STD-470 | Maintainability Program Requirements (for Systems and Equipment) |
| MIL-STD-471 | Maintainability Verification/Demonstration/Evaluation |
| MIL-STD-499 | Engineering Management |
| MIL-STD-721 | Definitions of Effectiveness Terms for Reliability, Maintainability, Human Factors and Safety |
| MIL-STD-756 | Reliability Prediction |
| MIL-STD-781 | Reliability Test Methods, Plans and Environments for Engineering Development, Qualification, and Production |
| MIL-STD-785 | Reliability Program for Systems and Equipments Development and Production |
| MIL-STD-810 | Environmental Test Methods |
| MIL-STD-883 | Test Methods and Procedures for Microelectronics |
| MIL-STD-1472 | Human Engineering Design Criteria for Military Systems, Equipment and Facilities |
| MIL-STD-1556 | Government/Industry Data Exchange Program Contractor Participation Requirements |
| MIL-STD-1629 | Procedures for Performing a Failure Mode Effects and Criticality Analysis |
| MIL-STD-1670 | Environmental Criteria and Guidelines for Air Launched Weapons |
| DOD-STD-1686 | Electrostatic Discharge Control Program for Protection of Electrical and Electronic Parts, Assemblies and Equipment, (Excluding Electrically Initiated Explosive Devices) |
| MIL-STD-45662 | Calibration Systems Requirements |

CHAPTER 14: MIL-HDBK-338, VOLUME I

HANDBOOKS

| | |
|--------------|---|
| MIL-HDBK-5 | Aerospace Vehicle Structures, Metallic Materials and Elements for |
| DOD-H-108 | Sampling Procedures and Tables for Life and Reliability Testing |
| MIL-HDBK-189 | Reliability Growth Management |
| MIL-HDBK-217 | Reliability Prediction of Electronic Equipment |
| MIL-HDBK-251 | Reliability/Design Thermal Application |
| DOD-HDBK-263 | Electrostatic Discharge Control Handbook or Protection of Electrical and Electronic Parts, Assemblies, and Equipment (Excluding Electrically Initiated Explosive Devices) |
| MIL-HDBK-472 | Maintainability Prediction |

14.2 DEFINITIONS

Basic system terminology applicable to MIL-HDBK-338, Volume I and to this chapter of the Primer are given below:

- **System Effectiveness (General)** - The probability that the system can successfully meet an operational demand within a given time when operated under specified conditions.
- **System Effectiveness (One-shot)** - The probability that the system (missile or space vehicle) will operate successfully when called upon to do so under specified conditions
- **Reliability** - The probability that an item will perform its intended function for a specified interval under stated conditions.
- **Mission Reliability** - The ability of an item to perform its required functions for the duration of a specified "mission profile."
- **Availability** - A measure of the degree to which an item is in an operable and committable state at the start of a mission when the mission is called for at an unknown (random) time. (Includes operating time, active repair time, administrative time, and logistic time, but excludes mission time.)
- **Operational Readiness** - The ability of an item (military unit) to respond to its operation plan(s) upon receipt of an operations order. (Total calendar time is the basic for computation of operational readiness.)
- **Design Adequacy** - The probability that a system will accomplish its mission, given that the system is operating within design specifications.
- **Repairability** - The probability that a failed system will be restored to operable condition in a specified active repair time.

CHAPTER 14: MIL-HDBK-338, VOLUME I

- **Maintainability** - The measure of the ability of an item to be retained in, or restored to, specified condition when maintenance is performed by personnel having specified skill levels, using prescribed procedures and resources, at each prescribed level maintenance and repair.
- **Serviceability** - The degree of ease or difficulty with which an equipment can be repaired.
- **Intrinsic Availability** - The probability that an equipment or system is operating satisfactorily at any point in time when used under stated conditions, where the time considered is operating time and active repair time.

14.2.1 Definitions of Time Concept

Time is of fundamental importance in the qualification of the basic terms defined above. In general, the interval of interest is the total calendar time in which an item or system is in use. This interval may be divided into required time and non-required time. **Active time** is that during which an item is in an operational inventory; **inactive time** is that during which an item is in reserve. Active time may be further broken down into **up-time** (during which an item is in a condition to perform a required function) and **downtime** (during which an item is not in a condition to perform a required function). Downtime may be further subdivided into **maintenance time** (that downtime which excludes modification and delay time), **modification time** (that downtime necessary to introduce any specific change(s) to an item to improve its characteristics, or to add new ones), and **delay time** (that downtime during which no maintenance is being accomplished on the item because of either supply or administrative delay). Delay time may be further subdivided into **supply delay time** (that element of delay time during which a needed replacement item is being obtained) and **administrative time** (that element of delay time not included in supply delay time).

Maintenance time can be broken down into **corrective maintenance time** (during which corrective maintenance is performed on an item), and **preventive maintenance time** (during which preventive maintenance is performed on an item).

Uptime can be further subdivided into: **not operating time** (during which the item is not required to operate), **alert time** (during which an item is assumed to be in specified operating condition, and is awaiting a command to perform its intended mission), **reaction time** (that element of uptime needed to initiate a mission, measured from the time command is received), and **mission time** (during which an item is required to perform a stated mission profile).

14.3 APPLICABILITY

MIL-HDBK-338 provides both the government procuring activity and its equipment-development contractors with all of the information necessary for an understanding of the concepts, principles and methodologies covering all aspects of electronic systems reliability engineering and cost analysis as they relate to the design, acquisition and deployment of DoD equipment and systems. It is intended for use by government and contractor during the conceptual, validation, full-scale development and production phases of an equipment/system life cycle. This chapter of the Primer synthesizes only Volume I of MIL-HDBK-338.

CHAPTER 14: MIL-HDBK-338, VOLUME I

14.4 PHYSICAL DESCRIPTION OF MIL-HDBK-338

MIL-HDBK-338 is a two-volume document of approximately 1500 pp. which is intended for use in two loose-leaf binders. Volume I consists of approximately 1020 pp. and contains 115 tables and 311 figures. Volume II contains approximately 420 pps., 86 tables and 118 figures.

14.5 HOW TO USE MIL-HDBK-338, VOLUME I

Volume I of the handbook should be used by both the contracting agency and the contractor as a basic guidance document in the specification and implementation of engineering principles and practices leading to the development of reliable, cost-effective electronic equipment and systems. Where further amplification of the contents of the handbook is desired the user should refer to the source documents listed at the end of each section.

14.5.1 Nature and Organization of Volume I

MIL-HDBK-338, Volume I is an encyclopedic treatment of system-level reliability and maintainability considerations and disciplines which portrays in immediately useful fashion effective R&M techniques, their origins in time, the historical needs which prompted their development and their mathematical derivation. Volume I is organized into twelve sections as follows:

- (1) Scope
- (2) Reference Documents
- (3) Definitions
- (4) Preface
- (5) Reliability and Maintainability Theory
- (6) Reliability Specification, Allocation and Prediction
- (7) Reliability Engineering Design Guidelines
- (8) Reliability Data Collection and Analysis, Demonstration and Growth
- (9) Software Reliability
- (10) Systems Reliability Engineering
- (11) Production and Use (Deployment) R&M
- (12) R&M Management Considerations

Thumbnail summaries of the contents of these twelve sections (together with some illustrations selected from the handbook and depicting one or more reliability element(s) are given below:

CHAPTER 14: MIL-HDBK-338, VOLUME I

14.5.2 Sections 1-3 are as described above

14.5.3 Section 4: Preface

This section introduces the "system reliability problem" in terms of increasing complexity and sophistication and, consequentially, cost. It deals with complex system reliability theory; defines system reliability (as a quantitative, probabilistic factor which must be predictable and maintainable in the field), discusses reliability versus unit production cost; new generation cost progression; system effectiveness; R&M considerations in system effectiveness; availability; dependability; interrelationships among various system properties; and techniques for the optimization of system effectiveness. Figure 14.1 illustrates the steady increase in cost experienced over the past several decades for new generation systems and subsystems, respectively. (The average cost of weapon systems increased by a factor of 5 to 1 per decade and the average cost of electronic subsystems increased by a factor of 10 to 1). It discusses the four basic steps of the system engineering process, i.e.:

- (1) Translate system requirements into functional requirements.
- (2) Analyze functions and translate into requirements for design, facilities, personnel, training and procedures.
- (3) Perform system/design engineering trade-off studies.
- (4) Integrate requirements into contract end items, training, and technical procedures.

14.5.4 Section 5: Reliability and Maintainability Theory

This section asserts that R&M disciplines are based upon probabilistic or stochastic models, and that probabilistic parameters such as random variables, density functions and distribution functions are utilized in the development of reliability theory. It defines Mean-Time-to-Failure (MTTF), Mean Life (θ) and Mean-Time-Between-Failure (MTBF) and summarizes these basic reliability concepts in Figure 14.2.

There are many standard statistical distributions which may be used to model various reliability parameters. Section 5 discusses and provides examples of continuous distributions (a) normal (or Gaussian), (b) log-normal, (c) exponential, (d) gamma and (e) Weibull, plus discrete distributions (a) binomial and (b) Poisson.

It addresses the typical "bathtub" failure rate curve utilizing the exponential distribution; stabilization of failure frequency; reliability modeling; Bayesian statistics in reliability analysis (simple prior/posterior continuous distribution); maintainability theory; comparison of basic reliability and maintainability functions; applicable maintainability distributions; availability theory, i.e., instantaneous/mission/steady-state (see Figure 14.3); availability modeling (Markov Process Approach), and R&M trade-off techniques (see Figure 14.4).

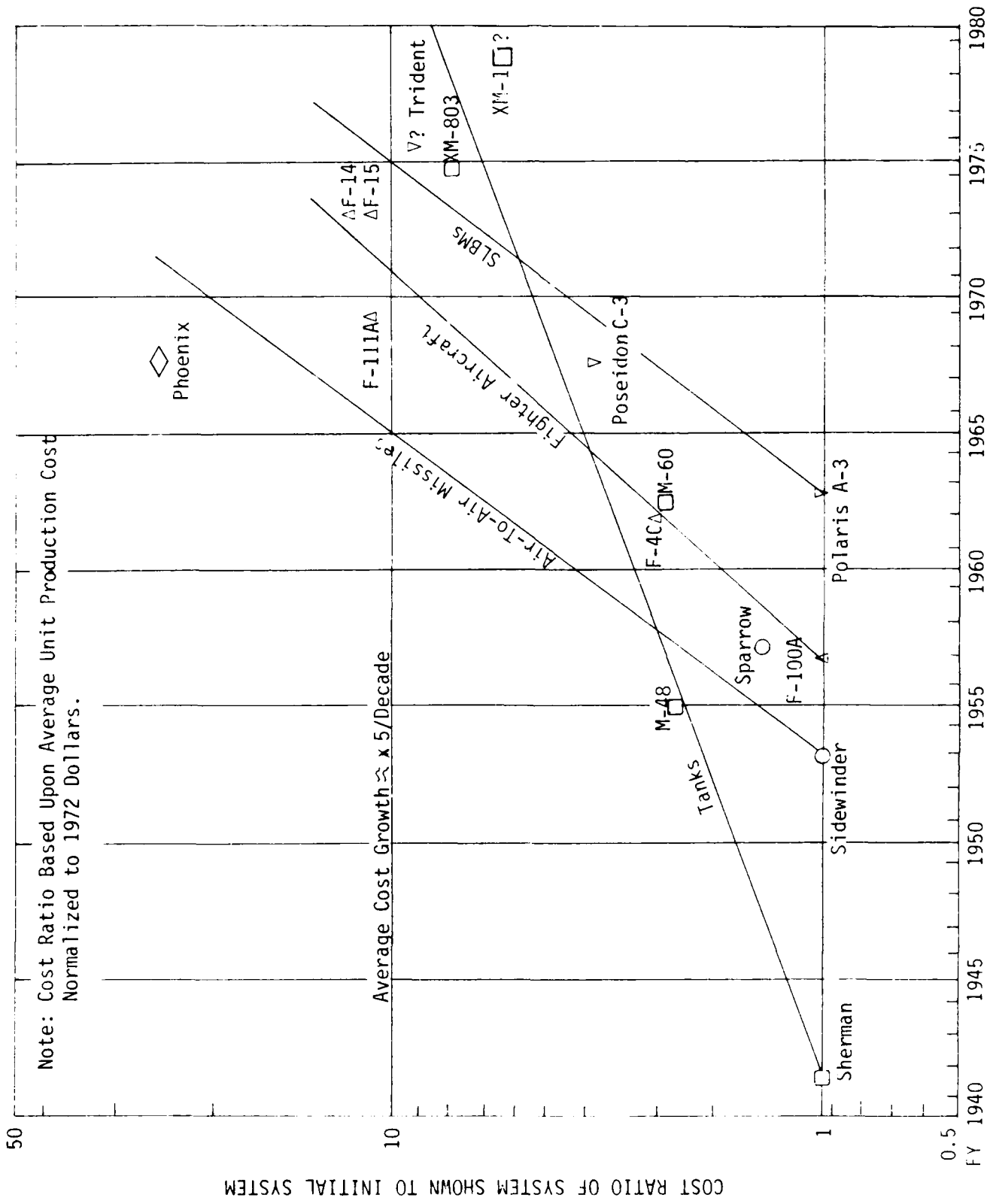

FIGURE 14.1:
NEW GENERATION COST PROGRESSION FOR SYSTEMS SHOWN

CHAPTER 14: MIL-HDBK-338, VOLUME I

| | |
|--|---|
| Failure Density Function (time to failure) | $f(t)$ |
| Reliability Function | $R(t) = \int_0^{\infty} f(t)dt = \exp [-\int_0^t h(t)dt]$ |
| Hazard Rate (Failure Rate) | $h(t) = f(t)/R(t)$ $[\lambda(t)] = \int_0^t h(t)dt$ |
| Expected Value (MTTF) (no repair) | $MTTF = \int_0^{\infty} R(t)dt$ |
| Mean-Time-Between-Failure (constant failure rate, λ , with repair) | $MTTF = \frac{T(t)}{r}$ $= 1/\lambda$ |

FIGURE 14.2:
SUMMARY OF BASIC RELIABILITY CONCEPTS

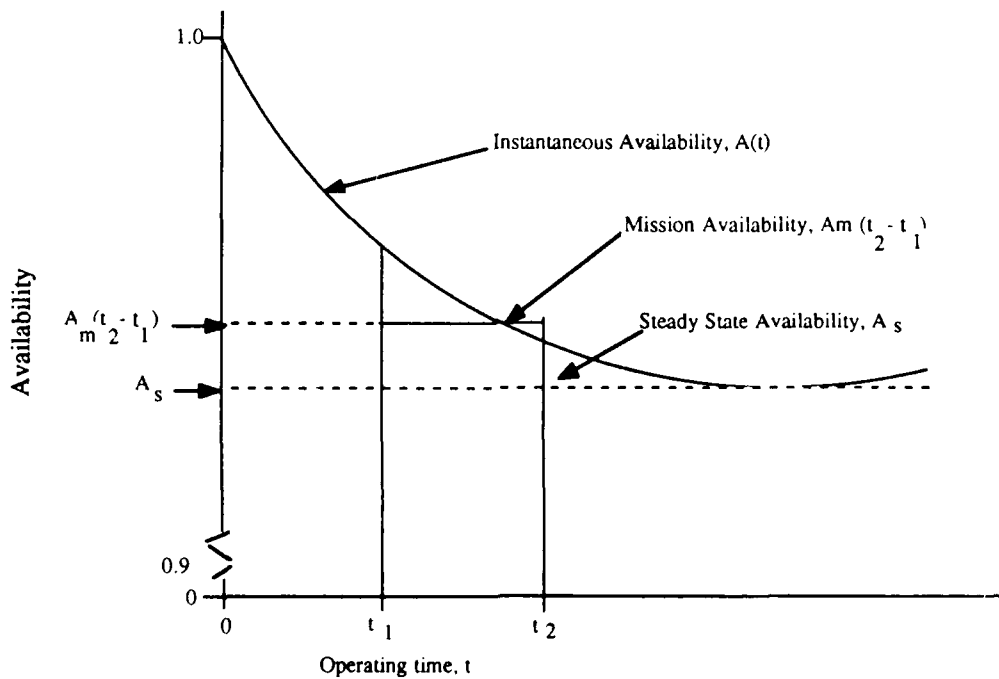

FIGURE 14.3:
THE RELATIONSHIP BETWEEN INSTANTANEOUS, MISSION, AND STEADY STATE AVAILABILITIES AS A FUNCTION OF OPERATING TIME

CHAPTER 14: MIL-HDBK-338, VOLUME I

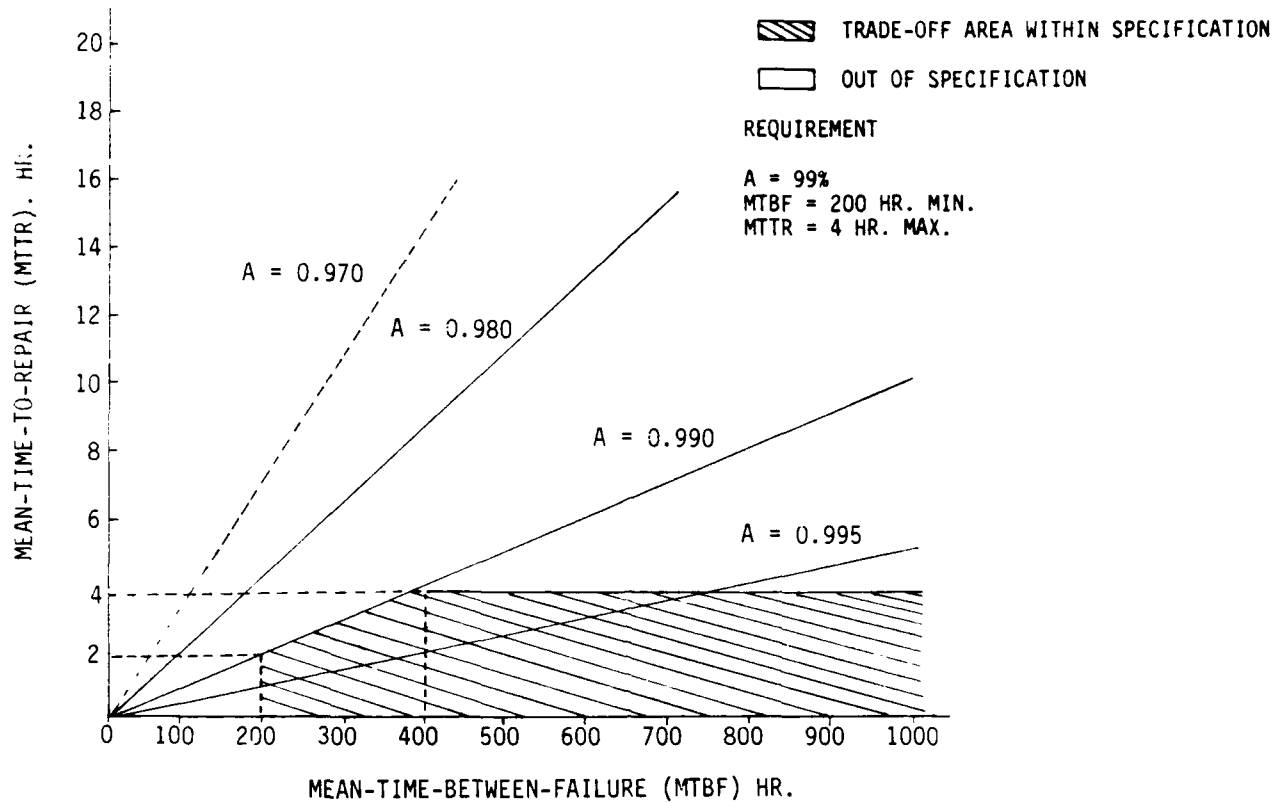

FIGURE 14.4:
RELIABILITY-MAINTAINABILITY TRADE-OFFS

14.5.5 Section 6: Reliability Specification, Allocation and Prediction

While Section 5.0 of the Handbook establishes the theoretical, mathematical foundation for the reliability engineering disciplines, Section 6.0 emphasizes the practical approaches to specifying, allocating and predicting equipment/system reliability.

Four principal methods by which a reliability requirement may be specified are: (1) "Mean Life" or MTBF, (2) Probability of survival, (3) Probability of success, and (4) Failure rate determination. The reliability specification must cover all aspects of the use environment to which the item will be exposed and which can influence the probability of failure.

Reliability apportionment/allocation is the first step in the design process to translate overall system requirements into reliability requirements for each of the subsystems. The allocation process is approximate. The reliability parameters apportioned to the subsystems are used as guidelines to determine design feasibility. Six different approaches to reliability allocation are given in Section 6.0 along with illustrative examples.

Reliability prediction is the process of quantitatively assessing whether a proposed or actual equipment/system design will meet a specified reliability requirement. Predictions are most useful in producing decision criteria for selecting courses of action affecting reliability. A hierarchy of reliability prediction techniques have been developed to accommodate the reliability study and analysis requirements and the detailed data developed as the system progresses.

More detailed information on these techniques can be found in Chapters 4.0 and 5.0 of the Primer.

14.5.6 Section 7: Reliability Engineering Design Guidelines

Reliability engineering is the technical discipline of estimating, controlling and managing the probability of failure in devices, equipment and systems. Design principles and tools which should be utilized by the designer include:

- (1) Part Selection and Control
- (2) Part Derating
- (3) Reliable Circuit Design
- (4) Redundancy
- (5) Environmental Design
- (6) Human Factors Design
- (7) Failure Modes, Effects and Criticality Analysis (FMECA)
- (8) Fault Tree Analysis (FTA)
- (9) Sneak Circuit Analysis
- (10) Design Reviews

Items (1) and (2) are addressed in Section 7 largely by reference to MIL-HDBK- 338, Volume II.

Discussion of reliable circuit design includes design simplification, use of standard circuits, transient and overstress protection, parameter degradation and analysis, minimizing design errors and fundamental design limitations. Redundancy techniques addressed include simple parallel, bimodal, majority vote and standby, plus examples of redundant systems used in sophisticated aircraft and space vehicles. Appendix A to Section 7 gives multiple examples of these techniques.

Designing for the environment considers measures of protection against high and low temperatures, shock and vibration, moisture, sand and dust, explosion, electromagnetic and nuclear radiation. Table 14.1 demonstrates the relationship among stresses, their effects, and reliability improvement techniques. Appendix B to Section 7 details environmental effects, including air-launched weapon environmental criteria.

Discussion of human factors active in the design of electronic equipment addresses the motor responses and physical capabilities of operators, human performance reliability, the relationship between human factors and reliability, the three factors affecting human behavior, i.e., stimulus-input (S), internal reaction (O) and output response (R), and man-machine interaction and trade-offs.

Failure Modes, Effects and Criticality Analysis (FMECA) is discussed in detail which includes a step-by-step procedure, demonstration requirements, failure mode distribution, determination of criticality, use of computer analysis and its limitations. Note: FMECA is also addressed in Chapter 12.0 of this Primer.

Fault Tree Analysis (FTA) the "top-down" corollary to the FMEA "bottom-up" reliability risk analysis technique is thoroughly investigated. Step-by-step procedures for the performance of an FTA are detailed, including the three basic methods for solving fault trees, i.e., (1) direct simulation (2) Monte Carlo and (3) direct analysis.

A sneak circuit is defined as an unexpected path or logic flow within a system, which, under certain conditions, can initiate an undesired function or inhibit a desired function. Sneak Circuit Analysis (SCA) is the term applied to analytical techniques used to detect and identify sneak circuits in a system. The point is made that unlike other reliability analyses, SCA concentrates on the interconnections, interrelationships and interactions of system components rather than the components themselves.

**TABLE 14.1:
ENVIRONMENTAL STRESSES, EFFECTS AND RELIABILITY
IMPROVEMENT TECHNIQUES IN ELECTRONIC EQUIPMENT**

| Environmental Stress | Effects | Reliability Improvement Techniques |
|----------------------|---|---|
| High Temperature | Parameters of resistance, inductance, capacitance, power factor, dielectric constant, etc. will vary; insulation may soften; moving parts may jam due to expansion; finishes may blister; devices suffer thermal aging; oxidation and other chemical reactions are enhanced; viscosity reduction and evaporation of lubricants are problems; structural overloads may occur due to physical expansions. | Heat dissipation devices, cooling systems, thermal insulation, heat-withstanding materials. |
| Low Temperature | Plastics and rubber lose flexibility and become brittle; electrical constants vary; ice formation occurs when moisture is present; lubricants gel and increase viscosity; high heat losses; finishes may crack; structures may be overloaded due to physical contraction. | Heating devices, thermal insulation, cold-withstanding materials. |
| Thermal Shock | Materials may be instantaneously overstressed causing cracks and mechanical failure; electrical properties may be permanently altered. Cracking, delamination, ruptured seals. | Combination of techniques for high and low temperatures. |
| Shock | Mechanical structures may be overloaded causing weakening or collapse; items may be ripped from their mounts; mechanical functions may be impaired. | Strengthened members, reduced inertia and moments, shock absorbing mounts. |
| Vibration | Mechanical strength may deteriorate due to fatigue or overstress; electrical signals may be mechanically and erroneously modulated; materials and structures may be cracked, displaced, or shaken loose from mounts; mechanical functions may be impaired; finishes may be scoured by other surfaces; wear may be increased. | Stiffening, control of resonance. |

**TABLE 14.1:
ENVIRONMENTAL STRESSES, EFFECTS AND RELIABILITY
IMPROVEMENT TECHNIQUES IN ELECTRONIC EQUIPMENT (CONT'D)**

| Environmental Stress | Effects | Reliability Improvement Techniques |
|------------------------------|--|---|
| Humidity | Penetrates porous substances and causes leakage paths between electrical conductors; causes oxidation which leads to corrosion; moisture causes swelling in materials such as gaskets; excessive loss of humidity causes embrittlement and granulation. | Hermetic sealing, moisture-resistant material, dehumidifiers, protective coatings. |
| Salt Atmosphere and Spray | Salt combined with water is a good conductor which can lower insulation resistance; causes galvanic corrosion of metals; chemical corrosion of metals is accelerated. | Nonmetal protective covers, reduced use of dissimilar metals in contact, hermetic sealing, dehumidifiers. |
| Electromagnetic Radiation | Causes spurious and erroneous signals from electrical and electronic equipment and components; may cause complete disruption of normal electrical and electronic equipment such as communication and measuring systems. | Shielding, material selection, part type selection. |
| Nuclear/Cosmic Radiation | Causes heating and thermal aging; can alter chemical, physical and electrical properties of materials; can produce gases and secondary radiation; can cause oxidation and discoloration of surfaces; damages electrical and electronic components especially semiconductors. | Shielding, component selection, nuclear hardening. |
| Sand and Dust | Finely finished surfaces are scratched and abraded; friction between surfaces may be increased; lubricants can be contaminated; clogging of orifices, etc.; materials may be worn, cracked, or chipped; abrasion, contaminates insulations, corona paths. | Air-filtering, hermetic sealing. |
| Low Pressure (High Altitude) | Structures such as containers, tanks, etc. are overstressed and can be exploded or fractured; seals may leak; air bubbles in materials may explode causing damage; internal heating may increase due to lack of cooling medium; insulations may suffer arcing and breakdown; ozone may be formed; outgassing is more likely. | Increased mechanical strength of containers, pressurization, alternate liquids (low volatility), improved insulation, improved heat transfer methods. |

CHAPTER 14: MIL-HDBK-338, VOLUME I

Design reviews are characterized as essential ingredients of the reliability design process whose purpose is to improve the equipment item where necessary and to provide assurance that the most satisfactory design has been selected to meet the specified requirements. The need for, purpose and use of (a) informal reliability design verification (b) formal design reviews, including preliminary design review (PDR), critical design review (CDR) and preproduction reliability design review (PRDR), and (c) design review checklists, are explained and examples given.

14.5.7 Section 8: Reliability Data Collection and Analysis, Demonstration and Growth

- **Data Collection and Analysis**

The feedback of information obtained from the analysis of failures is essential to reliability improvement. Reliability data consist of reports of failures and of the duration of successful operation of monitored equipment/systems. Failure data may be analyzed either by graphical methods or statistical analysis. Graphical methods do not require knowledge of the statistical mathematics used. Examples of theoretical reliability functions which will plot as straight lines on special graph paper are those based on the exponential, normal, log-normal and Weibull distributions. Where large sample sizes are available the chi-square (X^2) test for Goodness-of-Fit should be used. Where sample sizes are small, the Kolmogorov-Smirnov test provides some assurance.

- **Reliability Demonstration**

A reliability demonstration test should determine conformance to specified, quantitative reliability requirements as a basis for qualification or acceptance. Assuming an exponential failure rate (constant λ) a test of 10 devices for 100 hours is mathematically equivalent to a test of 1 device for 1000 hours. If each component tested is merely classified as acceptable or non-acceptable, the demonstration test is an attributes test. If the service life of the items under test is recorded in time and assumed to have a specific probability distribution, the test is a variable test. MIL-STD-785 (See Chapter 3.0 of the Primer) specifies elements to be included in a reliability test plan for development and production testing. MIL-STD-781D and MIL-HDBK-781 (see Chapters 7.0 and 8.0 of the Primer) cover the requirements for development and production reliability tests for equipment that experiences a distribution of time-to-failure that is exponential.

- **Reliability Growth**

Reliability growth is defined as the positive improvement of the reliability of an equipment through the systematic and permanent removal of failure mechanisms. It is the result of an iterative design process. There are three essential elements in achieving reliability growth (1) detection of failure sources (by analysis and test), (2) feedback of problems identified and (3) effective redesign effort to eliminate the identified problems. The Duane reliability growth model is the model most widely used. A comparison of the Duane and other models may be found in Appendix B to Section 8. The formal reliability growth test is to be performed near the end of full-scale development after successful completion of environmental qualification testing and prior to reliability demonstration testing. The economic purpose of reliability growth testing is to save the Department of Defense money during the planned service life of the equipment. Figure 14.5 compares cumulative life cycle costs with (and without) specified reliability growth test requirements.

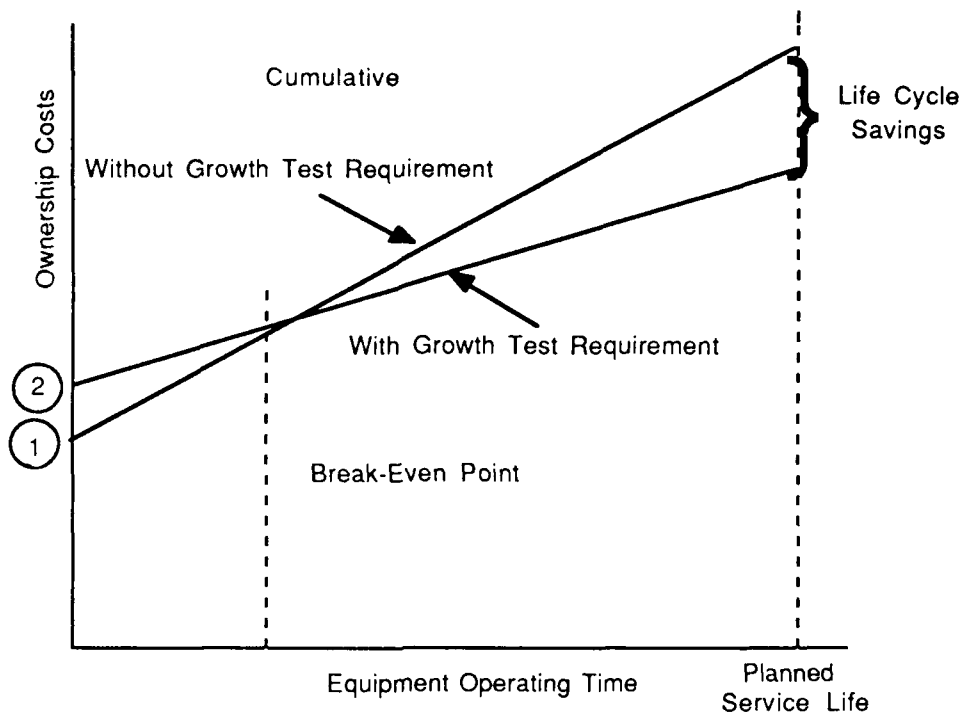

**FIGURE 14.5:
COMPARISON OF CUMULATIVE LIFE CYCLE COSTS:
WITH AND WITHOUT SPECIFIED RELIABILITY GROWTH TEST
REQUIREMENTS**

Appendix A to Section 8 provides fifty pages of explicit and detailed instructions on the use of reliability demonstration test plans. The information provided includes explanation, derivation and examples of both attributes demonstration tests and variables demonstration tests.

14.5.8 Section 9: Software Reliability

Unlike the hardware area where procedures are well established for predicting, specifying and measuring equipment reliability and maintainability, the current status of software R/M is as follows:

- (1) There is disagreement on basic definitions
- (2) Methods for quantitative specification are not available or used
- (3) An abundance of prediction models have been prepared, but are not adequately validated
- (4) Demonstration procedures are not available
- (5) Some basic design procedures, e.g., top-down design, structured programming, etc., are available

Software errors can arise from the specification, from the software design, and from the coding process. Specification errors result whenever there exists a discrepancy between the statement of specifications and the statement of user requirements. Typically, more than half of software errors recorded originate in the specification.

CHAPTER 14: MIL-HDBK-338, VOLUME I

Software system design follows from the specification. System design may be a flow chart defining the program structure, test points, limits, etc. Errors can result from incorrect interpretation of the specification or incomplete or incorrect logic. Typical coding errors can be typographical errors, incorrect numerics, omission of symbols, and the inclusion of expressions which can become indeterminate.

There are two types of software reliability models (1) failure rate based models and (2) non-failure rate based models. The failure rate based models assume that any error detected is immediately corrected and that the correction process does not alter the program by introducing new errors. Non-failure rate based models require that a number of known errors be seeded into the program which is then tested. The number of original, indigenous errors can be estimated from the number of indigenous and seeded errors uncovered during the test.

The most effective technique for dealing with system complexity is top-down design. Upon identification of the system's various levels of abstraction and of the connections between them, top-down design achieves a decomposition of the system into a number of highly dependent modules, resulting in a significantly simpler structure. Figure 14.6 portrays a decomposed software system.

Software is part of the operating system in an increasing range of engineered products, including large systems such as process plants, more compact systems such as numerical control machine tools, and individual products such as domestic appliances and a wide variety of electronic equipment. It is relatively easy to write a paragraph to perform a simple, defined function. To ensure that the program will operate successfully under all conditions that might occur and be easily adaptable to change or correction when necessary, is a more difficult manner, requiring careful checking of the specification, planning the program structure and assessing the design against the specification.

Software that is reliable from the beginning is cheaper and quicker to develop, so the goal must always be to minimize the possibilities of early errors and to eliminate errors before proceeding to the next phase.

14.5.9 Section 10: Systems Reliability Engineering

The worth of an equipment/system is determined primarily by the effectiveness with which it does its job, that is, its operational effectiveness. Of major concern, however, is how system effectiveness can be predicted while system design concepts are being formulated and when the system is being designed and evaluated. Thus system effectiveness methodologies deal more with the predictive design and test aspects of system effectiveness than with the later use of the system.

The evaluation of system effectiveness and its R&M parameters is an iterative process that continues through all life cycle phases of a system. System R&M models are essential tools for the quantitative evaluation of system effectiveness and for designing effective weapon systems. Figure 14.7 illustrates the eight tasks required for the evaluation of system effectiveness.

In complex system effectiveness mathematical models, the attempt is made to relate the impact of system reliability, maintainability and performance to mission profile, scenario, use, and logistic support. Numerous complex computerized models exist.

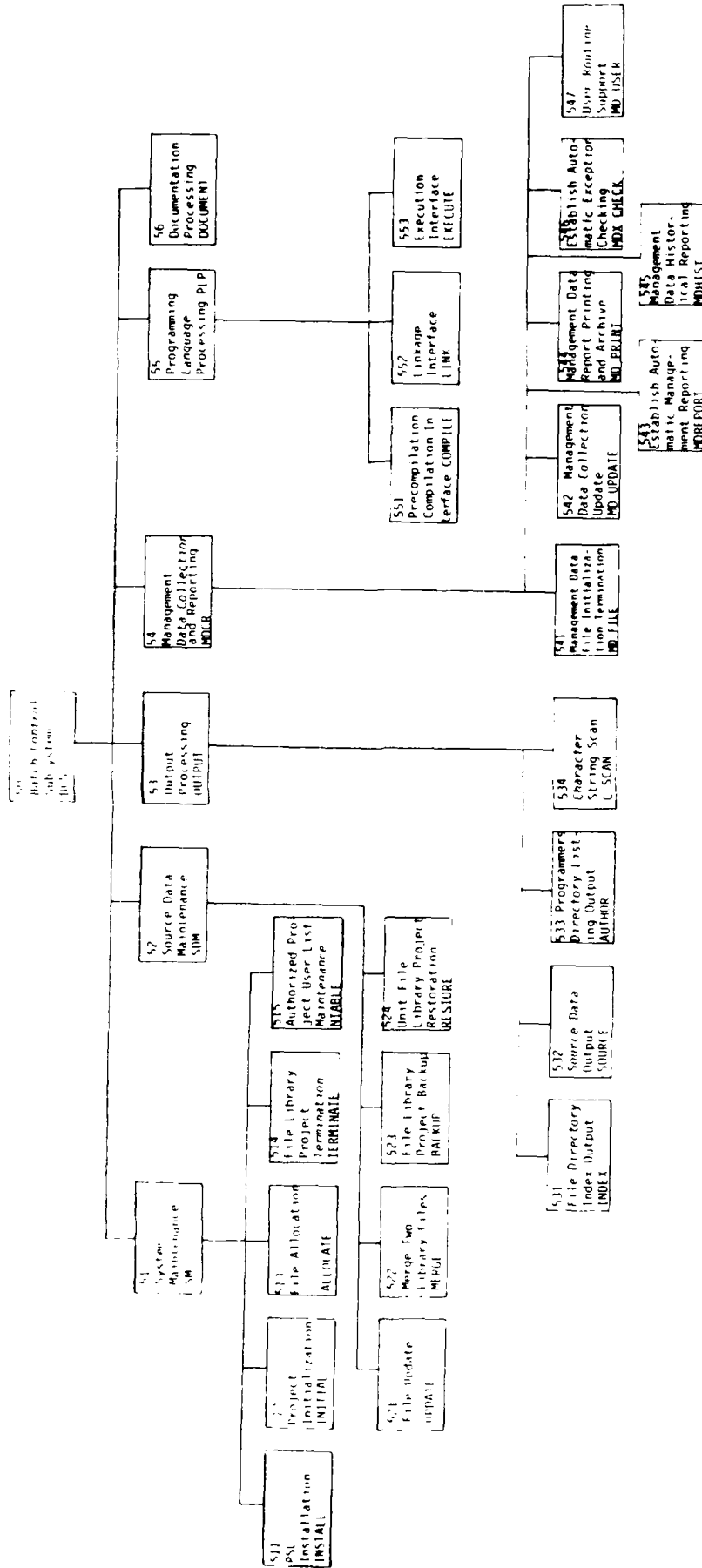

FIGURE 14.6: DECOMPOSED SOFTWARE SYSTEM

CHAPTER 14: MIL-HDBK-338, VOLUME I

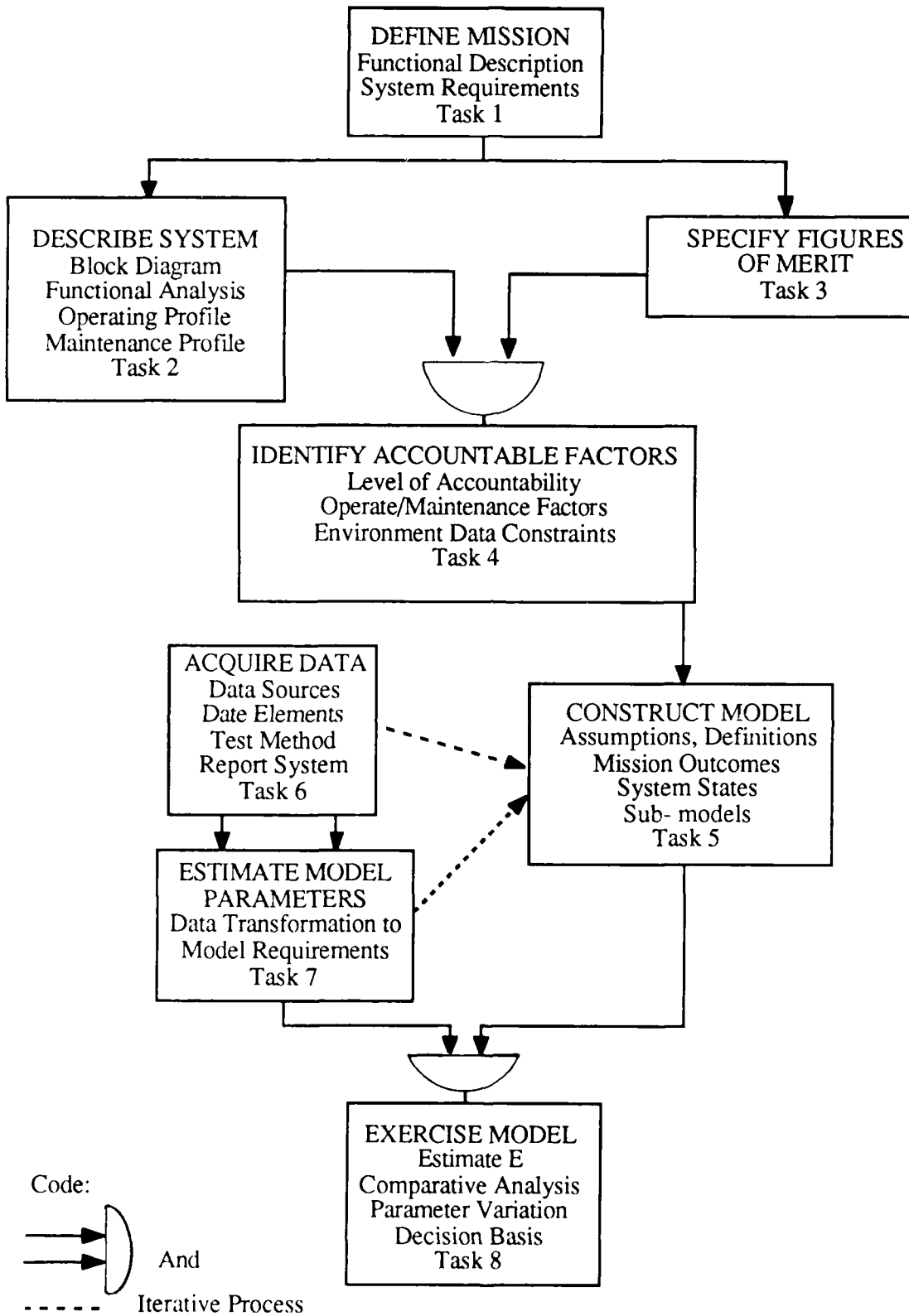
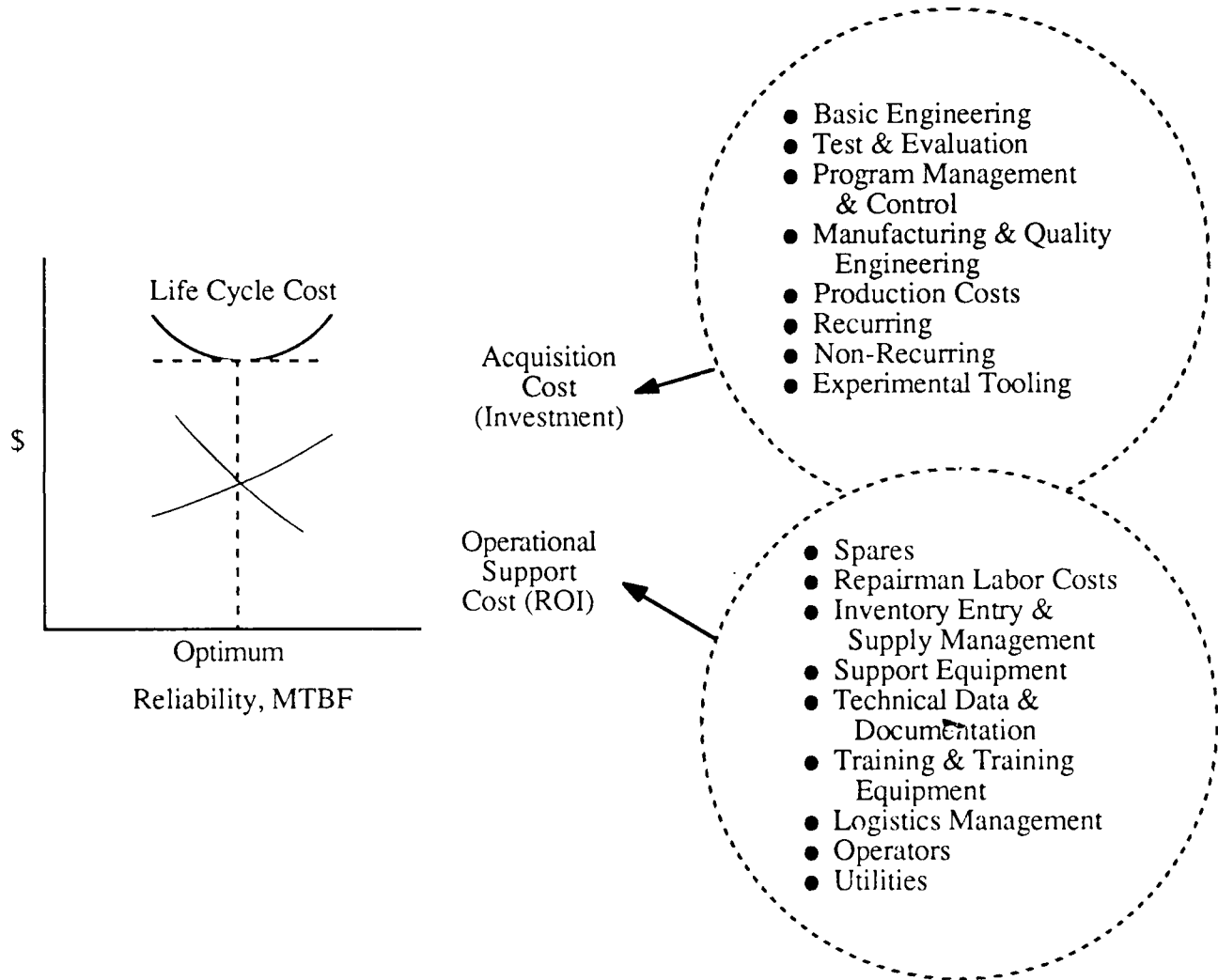

FIGURE 14.7:
PRINCIPAL TASKS REQUIRED FOR EVALUATION
OF SYSTEM EFFECTIVENESS

CHAPTER 14: MIL-HDBK-338, VOLUME I

Life cycle (LCC) cost is the total cost of acquiring and utilizing a system over its entire life span. LCC models range from simple, informal engineering/cost relationships to complex mathematical statements derived from empirical data. Figure 14.8 conceptually illustrates the reliability/cost relationship. The figure shows that as a system is made more reliable (all other factors being held constant) support cost will decrease, since there are fewer failures. At the same time, acquisition cost increases to attain improved reliability. At a certain point the amount of money spent to improve reliability will equal the amount saved in support cost. This point represents the reliability for which total cost is at a minimum. Thus reliability can be considered as an investment during acquisition for which the return on investment (ROI) is a substantial reduction of the need for maintenance support.



**FIGURE 14.8:
LIFE CYCLE COSTS VS. RELIABILITY**

14.5.10 Section 11: Production and Use (Deployment) R&M

Engineering design establishes the inherent R&M potential of an equipment or system. The degree of degradation from the inherent level experienced by the equipment/system is directly related to the inspectability and maintainability features designed and built into the system as well as the effectiveness of the measures applied during production and storage, prior to deployment, to eliminate potential failures, manufacturing flaws and deterioration factors. Lack of attention to these areas can result in actual system reliability as low as 10% of its inherent reliability potential.

The impact of production, shipment, storage, operation and maintenance degradation factors on the reliability of a typical system or equipment item and the life cycle growth that can be achieved is conceptually illustrated in Figure 14.9. The figure depicts a hardware item in its progress through life cycle stages. The figure shows that an upper limit of reliability is established by design; that, as the item is released to manufacturing, its reliability will be degraded and as production progresses, with resultant process improvements and manufacturing learning factors, reliability will grow; that when the item is released to the field, its reliability will again be degraded; and that as field operations continue and operational personnel become more familiar with the equipment and acquire maintenance experience, reliability will again grow.

Quality, like reliability, is a controllable attribute which can be planned during development, measured during production and sustained during storage and field repair actions. MIL-Q-9858 (Quality Program Requirements) is the basic standard for planning quality programs for DoD development and product contracts. MIL-I-45208A (Inspection System Requirement) applies to contracts in which control of quality by in-process as well as final end-item inspection, is required.

Environmental stress screening is the keystone of an effective production reliability assessment and control program. Such screening is applied on a 100 percent basis to reveal inherent as well as workmanship and process induced defects without weakening or destroying the product. Screens for known latent defects should be performed as early in the assembly process as possible. They are most cost effective at this stage. Figure 14.10 depicts comparative costs of defect detection with increased levels of assembly while Table 14.2 is a reproduction of one page of a three-page table in the handbook which addresses the stress tests, their application, expected failure rate reduction and trade-off considerations at the module, unit (i.e., equipment), and system level. Screening at the part level is discussed in detail in Volume II of MIL-HDBK-338 (see Chapter 15 of the Primer).

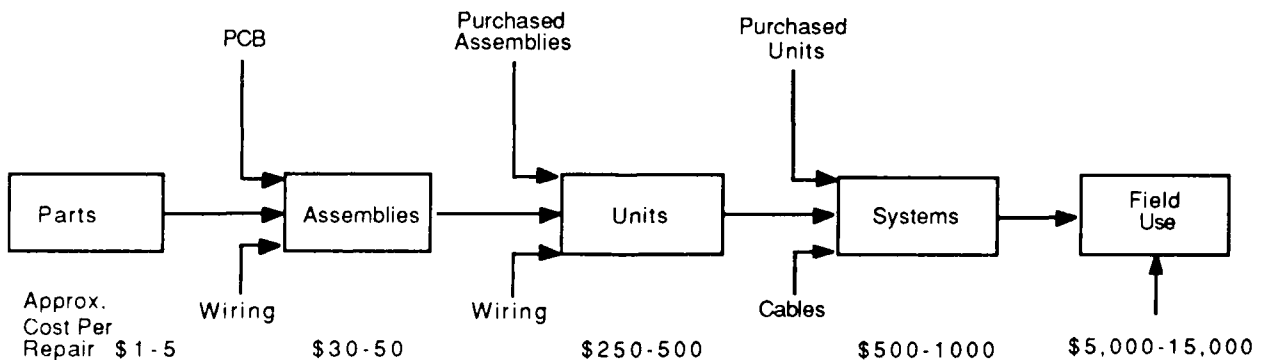

FIGURE 14.10:
COMPARATIVE COSTS OF DEFECT DETECTION AND
CORRECTION AT INCREASED ASSEMBLY LEVELS

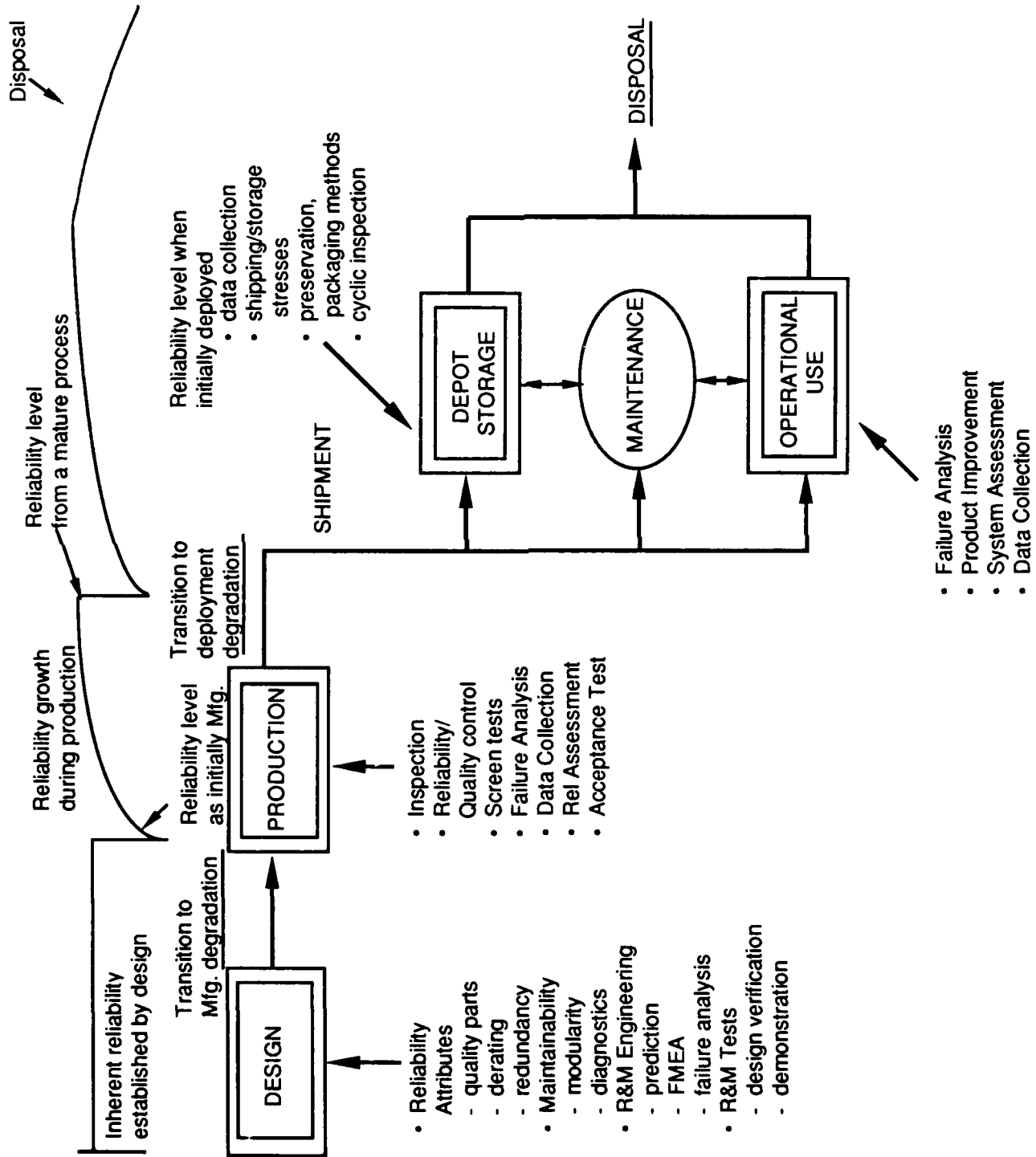

FIGURE 14.9: RELIABILITY LIFE CYCLE COST DEGRADATION & GROWTH CONTROL

TABLE 14.2:
STRESS SCREENING GUIDELINES MATRIX

| Stress Environment | Recommended Application | Expected Failure Rate Reduction | Trade-Offs |
|--|--|--|--|
| THERMAL CYCLING, MODULE LEVEL | | | |
| o Temp Range | Max: -55 to +125°C (180°C) Nom: -40 to +95°C (135°C) Min: -40 to +75°C (115°C) | In-House: 0 to 50% Field: 20 to 75% | In-house failure rates may in some cases be increased at next assembly level; hence, equipment behavior under proposed stress screening environment should be evaluated prior to implementation. |
| o Temp Rate | Max: 20°C/min. Nom: 15°C/min. Min: 5°C/min. | | Temperature rates of change are as measured by thermocouple on components mounted on modules. |
| o No. of Cycles | Max: 40 Nom: 30 Min: 20 | | Power-ON screening may be continued into early production until latent design problems are exposed and production processes and test procedures are proven. |
| o Power | Power ON (Devel. Phase) Power OFF (Produc'n Phase) | | Power-OFF screening is considerably cheaper and is effective on mature production hardware. |
| THERMAL CYCLING UNIT AND SYSTEM LEVEL | | | |
| o Temp Range | Max: -55 to +125°C (180°C) Nom: -40 to 95°C (135°C) Min: -40 to 75°C (115°C) | In-House: 0 to 75% Field: 20 to 90% | In-house failure rate may in some cases be increased at next assembly level; hence, equipment behavior under proposed stress screening environment should be evaluated prior to implementation. |
| o Temp Rate | Max: 20°C/min. Nom: 15°C/min. Min: 5°C/min. | | Higher temperature rates may require open-unit exposure with higher air flow rate to overcome slower temperature response of higher mass. |
| o No. Cycles | Max: 12 Nom: 10 Min: 8 | | Functional testing at high and low temperature increases failures detectability. |
| o Power | Power ON | | |

CHAPTER 14: MIL-HDBK-338, VOLUME I

Three major control factors are necessary to provide proper protection against damage and deterioration to components and equipment during shipment and storage. They are: (1) The level of preservation packaging and packing applied in the preparation of material items for shipment and storage, (2) the actual storage environment, and (3) the need and frequency of cyclic inspection. MIL-E-17555 is the governing document for the degree of preservation and packaging which will afford adequate protection against corrosion, deterioration, and physical damage during shipment, handling and world-wide redistribution.

14.5.11 Section 12: R&M Management Considerations

The successful development and fielding of reliable and maintainable equipment and systems requires the combined application of technical and management disciplines during all five life cycle phases, i.e., concept, validation, full scale engineering development, production, and deployment.

The most basic of management functions is planning. Planning is deciding in advance what to do, how and when to do it, and who is to do it. Budgeting, which goes hand in-hand with planning, involves insuring that adequate resources, financial or otherwise, are available to carry out the plan. Without proper budgeting, planning is a futile exercise.

Most military equipment/system acquisition managers must cope with the four basic and frequently conflicting criteria of performance, cost, schedule and risk. The goal is to achieve a balance of these criteria to develop a system with minimum life cycle costs (LCC) consistent with required performance. A manager must keep in mind the fact that early design decisions "lock-in" a major portion of LCC. It is held that for U.S. Dept. of Defense equipment the design and development phase typically consumes only 15% of the total cost, as opposed to 35% for production and 50% for the *in-service* phase. However, during the design and development stage, 90-95% of the life cycle costs are determined.

LCC is defined as the total cost to the government of acquisition and ownership of a system over its full life. Figure 14.11 supplies the acquisition manager a guide for the activities that should be performed at each phase of a system's life cycle to minimize LCC.

One relatively new tool developed to reduce life cycle costs of DoD equipment is the use of Product Performance Agreements (PPA's) in the form of warranties/guarantees. Among the most commonly-used and cost-effective are the Reliability-Improvement Warranty (RIW), the Logistic Support Cost (LSC) commitment and the MTBF guarantee. Table 14.3 depicts features of these warranty-guarantee plans.

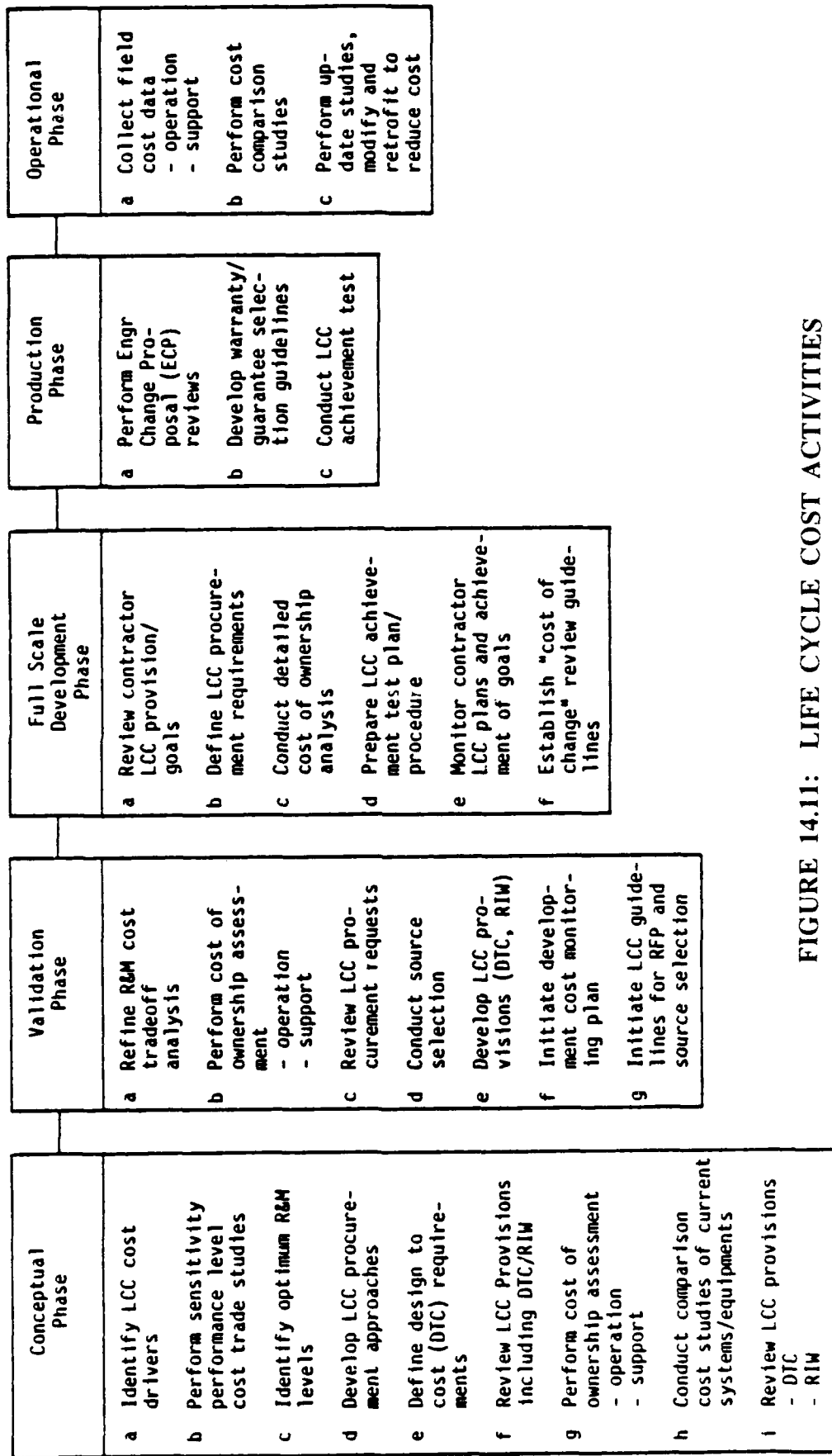

FIGURE 14.11: LIFE CYCLE COST ACTIVITIES

CHAPTER 14: MIL-HDBK-338, VOLUME I

**TABLE 14.3:
FEATURES OF CURRENT WARRANTY-GUARANTEE PLANS**

| Features | RIW | RIW/MTBF | LSC |
|-----------|--|--|---|
| Objective | Secure reliability improvement/reduce support costs | Achieve stated reliability requirements/reduce support costs | Achieve stated logistic-cost goal |
| Method | Contractor repairs or replaces all applicable items that fail during coverage period; implements no-cost ECPs to improve reliability | Same as RIW; in addition, contractor provides additional spare units to maintain logistic pipeline when MTBF goals are not met | Normal Air Force maintenance; operational test performed to assess LSC; penalty or corrective action required if goals are not achieved |
| Pricing | Fixed price | Fixed price cost sharing for correction of deficiencies | Fixed price or limited |
| Incentive | Contractor profits if repair costs are lower than expected because of improved R&M | Similar to RIW, plus possible severe penalty for low MTBF | Award fee if goal is bettered; penalties for poor cost performance |

As with reliability, once maintainability has been quantitatively specified, tasks which can aid in attaining program maintainability requirements must be selected. MIL-STD-470 establishes uniform criteria for a maintainability program and provides guidelines for the preparation and implementation of a maintainability program plan.

MIL-STD-470 is the subject of Chapter 33.0 of the Primer.

14.6 TAILORING GUIDELINES

MIL-HDBK-338, Volume I is a guidance document only. It does not contain enforceable requirements. As can be seen in Paragraph 14.1 (Reference Documents) it deals with a large number of military specifications and standards, many of which are the subjects of Chapters of this Primer wherein specific tailoring instructions are given.

14.7 CONTRACT DATA REQUIREMENTS LIST (CDRL)

There are no deliverable data items required by this Handbook, although Section 12 contains a listing of DIDs, unique to R&M software, which have been extracted from AMSDL (DoD Acquisition Management Systems and Data Requirements Control List) and are presented for guidance purposes only.

CHAPTER 15:

MIL-HDBK-338

ELECTRONIC RELIABILITY DESIGN HANDBOOK

VOLUME II

CHAPTER 15: MIL-HDBK-338

MIL-HDBK-338 (Electronic Reliability Design Handbook) is a two-volume tri-service-approved document used by all branches of the military as a procedural guide in the design, specification, acquisition and development of quality-assured electronic equipment and systems. The current version of MIL-HDBK-338 is the original document, dated 15 October 1984. The preparing activity is:

Rome Air Development Center
RADC/RBRA
Griffiss AFB, NY 13441-5700

Volume II of the Handbook has been designed to provide as much practical and useful information as possible on the considerations and procedures to be employed in the selection, specification, application and control of electronic parts in order to achieve reliable electronic equipment.

This chapter is only an advisory to the use of Volume II of MIL-HDBK-338. It does not supersede, modify, replace or curtail any requirements of MIL-HDBK-338 nor should it be used in lieu of that standard.

15.1 REFERENCE DOCUMENTS

There are 145 specifications, 34 standards and 10 handbooks referenced in MIL-HDBK-338, Volume II. A listing of these documents consumes 10 pages. In the interest of brevity these documents are not being shown here. In the following pages, each specification, standard or handbook used in describing the contents of Volume II will be fully identified by number and title the first time it is referenced, thereafter only the number will be given.

15.2 DEFINITIONS

Basic terminology particularly applicable to MIL-HDBK-338, Volume II and used in this Chapter of the Primer is presented below:

- **Reliability:** The probability that a component will perform its intended function for a specified time interval under stated conditions.
- **Failure Rate:** The total number of failures within a population, divided by the total number of life units expended by that population, during a particular measurement interval under stated conditions.
- **Inherent Reliability:** A measure of reliability that includes only the effects of an item design and its application, and assumes an ideal operation and support environment.
- **Mean-Time-Between-Failure (MTBF):** A basic measure of reliability for repairable items. The mean number of life units (e.g. hours $\times 10^6$) during which the component performs to specification, in a particular measurement interval under stated conditions.

CHAPTER 15: MIL-HDBK-338

15.3 APPLICABILITY

MIL-HDBK-338 Volume II provides both the government procuring activities and their equipment-development contractors with information necessary for an understanding of the concepts, principles and methodologies covering all aspects of electronic parts reliability engineering and cost analysis as they relate to the design, acquisition and deployment of DoD equipment and systems. It is intended for use by both government and contractor during the conceptual, validation, full-scale development and production phases of an equipment/system life cycle.

15.4 PHYSICAL DESCRIPTION OF MIL-HDBK-338

MIL-HDBK-338 is a two-volume document of approximately 1500 pp. which is intended for use in two loose-leaf binders. Volume I consists of approximately 1020 pp. and contains 115 tables and 311 figures. Volume II contains approximately 420 pps., 86 tables and 118 figures.

15.5 HOW TO USE MIL-HDBK-338, VOLUME II

Volume II of the handbook should be used by both the contracting agency and the contractor as a basic guidance document in the specification and implementation of engineering principles and practices leading to the development of reliable, cost-effective electronic equipment and systems. Where further amplification of the contents of the handbook is desired the user should refer to the source documents listed at the end of each section.

15.5.1 Nature and Organization of Volume II

MIL-HDBK-338, Volume II is an encyclopedic treatment of parts-level reliability and maintainability considerations and disciplines which portrays in immediately-useful fashion effective R&M techniques; their origins in time; the historical needs which prompted their development and to a minor degree, their mathematical derivation. Volume II is organized into nine sections as follows:

- (1) Scope and General Information
- (2) Referenced Documents
- (3) Definitions
- (4) Reliability Theory
- (5) Component Reliability Design Considerations
- (6) Applications Guidelines
- (7) Specification and Control During Acquisition
- (8) Logistic Support
- (9) Failure Reporting and Analysis

Brief summaries of the contents of these nine sections (coupled with some randomly-selected illustrations taken from the Handbook and depicting one or more reliability element(s)) are given below.

CHAPTER 15: MIL-HDBK-338

15.5.2 Section 1 - Scope and General Information

This section traces the history of component reliability, points out the need for reliable components, discusses the technologies, materials, packaging and testing methods employed in current state-of-the-art devices, and describes predictable trends for the future development of component parts.

With World War II came the demand for increasingly complex equipment which could withstand higher levels of environmental stress, and a major concern in this period was vacuum tube reliability. The need for a proximity fuze for munitions resulted in the development of ruggedized subminiature tubes and thick film hybrid technology which, in turn, led to the modular circuit designs of the 1950's.

The 1950-1960 decade witnessed development of the MIL series of established reliability (ER) specifications on electronic parts; MIL-STD-202 (Test Methods for Electronic Components and Parts); the Air Force's RADC Reliability Notebook (Chapter 8 of which was the forerunner of MIL-HDBK-217 (Reliability Prediction of Electronic Equipment)); the etched printed circuit board and the implementation of the transistor.

The 1960-1970 decade saw the first application of microcircuits in the Air Force's improved Minuteman Missile System, and the issuance of MIL-M-38510 (General Specification for Microcircuits) and MIL-STD-883 (Test Methods and Procedures for Microcircuits).

The 70's saw the evolution of the large-scale integrated circuit (LSI); the establishment of the Defense Electronics Supply Center (DESC) as the responsible agency for the standardization of all electronic parts used by the three services; the issuance of MIL-STD-965 (Parts Control Program); the application of LSI devices as microprocessors and the miniaturization of resistors, capacitors, networks, reed relays, switches and NiCd batteries to fit into dual-in-line packages. Connector technology advanced with the development of fiber optic connectors, the zero insertion force requirement and the use of tin-lead solder in gas tight, high pressure connectors.

The 80's gave rise to the initiation by the Department of Defense (DoD) of the very high speed integrated circuit (VHSIC) program to develop very large scale (VLSI) signal processors on a single chip containing one-quarter-million gates (10^6 transistors) operating at clock speeds of 25 MHz and performing several million operations per second.

Miniaturization of electronic circuitry over the past thirty years has resulted in a tremendous reduction in size coupled with an impressive increase in complexity, and more change is yet to come.

Silicon has for years dominated integrated circuit technology development as the primary semiconductor material. The only minor variation of silicon as a basic substrate material uses a layer of silicon epitaxially grown on sapphire substrates and is commonly referred to as Silicon-On-Sapphire (SOS).

In recent years however, attention has focused on Gallium Arsenide (GaAs) as a substrate material destined to achieve performance superior to that of silicon. Figure 15.1 reveals the increased capability of GaAs over silicon. Electron mobility of GaAs is between five and six times that of silicon. This characteristic, coupled with the semi-insulating substrate of GaAs, leads to the increased performance of GaAs versus silicon in both speed and power consumption.

CHAPTER 15: MIL-HDBK-338

| Properties | Silicon | GaAs |
|--|-----------------------|--|
| 1. Mobility (cm ² /V-sec) n (Electrons) p (Holes) | 1500 600 | 8500 400 |
| 2. Maximum Operating Temperature (c) | 200 | 350 |
| 3. Minor Carrier Lifetime (sec) | 2.5 x 10 ³ | 2 x 10 ⁸ |
| 4. Energy Gap (eV) | 1.12 | 1.43 |
| 5. Breakdown Field (V/cm) | 3 x 10 ⁵ | 4 x 10 ⁸ |
| 6. Relative Abundance in Earth's Crust | 227,200 | $\frac{\text{Ga}}{15}$ $\frac{\text{As}}{5}$ |

**FIGURE 15.1:
PROPERTIES OF SILICON AND GaAs AT 300°K**

15.5.3 Section 2 and 3:

Referenced Documents and Definitions are as described in Paragraphs 15.1 and 15.2 above

15.5.4 Section 4: Reliability Theory

This short section, addresses probability density functions i.e, the mathematical expression of the graph of probability against the random variable; probability distributions frequently used in reliability modeling, i.e., exponential, normal, log-normal, Weibull and gamma; confidence intervals, confidence levels and sampling plans.

When buying component parts in bulk there is a chance that some are defective. It is not often practical to test each unit and so a sample of a production lot is tested. Statistical sampling plans define the sample size upon which to base a decision on whether the batch is good or bad and the acceptable number of defectives per sample. In this process there are both producer risk (a) the probability that a good batch will be rejected, and consumer risk (b) the probability that a bad batch will be accepted. Sampling plans have been established in which both producer and consumer risks are incorporated. These plans are usually based upon the Poisson (or exponential) distribution and use an acceptable quality level (AQL), or a lot tolerance percent defective (LTPD) approach. AQL is the maximum percent defective (or the number of defects per hundred units, which may not be the same thing) which can be considered acceptable as a process average. LTPD is defined as some chosen limiting value of percent defective in a lot. The LTPD is selected such that components of quality worse than the LTPD are rejected, with high probability. Section 4 concludes with a discussion of the temperature dependence of the rate of failures, including the Arrhenius and Eyring models, and activation energy.

CHAPTER 15: MIL-HDBK-338

15.5.5 Section 5: Component Reliability Design Considerations

Paragraphs 5.1 through 5.1.6.1 of Volume II of the handbook address parts selection and control considerations and techniques, including tasks for the standardization, approval, qualification and specification of parts which meet performance, reliability and other requirements of the evolving equipment design. Table 15.1 depicts simplified procedural steps for the selection and control of electronic parts.

Wherever possible, preferred parts should be used. Such devices may be defined as those which by virtue of systematic testing programs and a history of successful use in equipment have demonstrated their ability to consistently function within specific electrical, mechanical and environmental limits and, as a result, have become the subject of military (MIL) specifications and standards. MIL specifications which thoroughly delineate a parts' substance, form and operating characteristics exist, or are in preparation, for almost every type of electronic component. Standards also exist which describe test methods applicable to all parts and which list by MIL style those parts or devices which are preferred for use in military equipment. For example:

- MIL-STD-202, Test Methods for Electronic Parts
- MIL-STD-750, Test Methods for Semiconductor Devices
- MIL-STD-883, Test Methods for Microelectronic Devices
- MIL-STD-199, Selection and Use of Resistors
- MIL-STD-198, Selection and Use of Capacitors
- MIL-STD-1132, Switches and Associated Hardware, Selection and Use of
- MIL-STD-1562, Standard Microcircuits, Lists of
- MIL-STD-701, Standard Semiconductors, Lists of

In cases where the use of standard parts or devices is not feasible, MIL-STD-965 delineates explicit procedures by which the user may obtain approval for the use of non-standard parts. These procedures consider such factors as use justification, part application, identification of non-standard parameters and criticality of part application.

Guidelines are given in the handbook for the selection and use of specific types of the following parts, devices and modules:

- | | |
|----------------------------|-------------------------------------|
| a) Microcircuits | g) Switches |
| b) Discrete Semiconductors | h) Electrical connectors |
| c) Resistors | i) Electron Tubes |
| d) Capacitors | j) Cables |
| e) Magnetic Devices | k) Electro Optics/Fibre Optics |
| f) Relays | l) Printed Circuitry |
| | m) Standard Electronic Module (SEM) |

CHAPTER 15: MIL-HDBK-338

**TABLE 15.1:
GROUND RULES FOR PARTS SELECTION AND CONTROL**

| |
|---|
| a) Determine part type needed to perform the required function and the environment in which it is expected to operate. |
| b) Determine part criticality. <ul style="list-style-type: none">- Does part perform critical functions, i.e., safety or mission critical?- Does part have limited life?- Does part have long procurement lead time?- Is the part reliability sensitive?- Is the part a high cost item, or does it require formal qualification testing? |
| c) Determine part availability. <ul style="list-style-type: none">- Is the part preferred?- Is the part a Standard MIL item available from a qualified vendor?- What is the part's normal delivery cycle?- Will the part continue to be available throughout the life of the equipment?- Is there an acceptable part procurement specification?- Are there multiple sources available? |
| d) Estimate expected part stress in its circuit application. |
| e) Determine reliability level required for the part in its application. |
| f) Determine appropriate screening/quality conformance inspection (QCI) methods. |
| g) Prepare an accurate and explicit part procurement specification. Specification shall include specific screening/QCI provisions to ensure adequate reliability. |
| h) Determine actual stress level of the part in its intended circuit application. Perform failure rate calculation per MIL-HDBK-217. |
| i) Employ appropriate derating factors consistent with reliability prediction studies. |
| j) Determine need for nonpreferred part and prepare a request for approval as outlined in MIL-STD-965. |

CHAPTER 15: MIL-HDBK-338

● Microcircuits

Microcircuit selection is governed by the criteria depicted in Table 15.2.

**TABLE 15.2:
MICROCIRCUIT SELECTION CRITERIA**

| |
|---|
| 1. MIL-STD-454 Requirement No. 64 |
| 2. MIL-M-38510 JAN Microcircuits listed in MIL-STD-1562 |
| 3. Other MIL-M-38510 JAN microcircuits |
| 4. Other microcircuits subject to procuring activity approval based upon MIL-STD-965 procedures |

Paragraph 5.2.1 through 5.2.1.6 supply guidelines for the selection and application of microcircuits. Application notes for commonly used digital microcircuits address logic gates, buffer/drivers, receivers, transceivers, and Schmitt triggers; also multivibrator flip-flops, shift registers, data registers and counters. Uses of the three basic types of flip-flop, the latch, the D type and the JK are described in detail, as is the use of error detection and correction codes such as the parity check and the Hamming code.

Detailed application notes for commonly-used linear IC's address operational amplifiers voltage comparators, voltage followers, current amplifiers, line drivers, line receivers, analog switches, multiplexers, voltage regulators, voltage references, D/A converters, A/D converters and timers.

LSI device technologies discussed include: TTL, Schottky TTL, ECL, I²L, P-Channel MOS, Si Gate PMOS, Si Gate N-Channel MOS, complimentary MOS (CMOS) and Silicon-on-sapphire (SOS). Table 15.3 illustrates essential operating characteristics for these LSI technologies.

Detailed application data for commonly-used LSI devices address ROMS, PROMS, Erasable PROMS, UV PROMS, EEPROMS, RAMS and Bubble Memories. ROMS are permanently programmed during fabrication and are used to replace complex logic functions having multiple inputs and outputs. PROMS are ROMS which can be programmed by the user. There are two varieties of erasable PROMS, i.e., UV PROMS which can be erased by UV light, and EEPROMS which can be erased by means of an electrical signal. EEPROMS can be programmed quicker and easier than UV PROMS. There are static RAMS and dynamic RAMS. Static RAMS can be bipolar or MOS, the bipolar device being faster than the MOS. Dynamic RAMS are all MOS and operate like a charged capacitor which must be refreshed periodically to compensate for leakage current. Bubble memories, while not true semiconductor memories, are analogous in operation and interfacing. Bubble memories compete with other magnetic storage devices such as tapes and discs, but unlike tapes and discs, bubble memories require no moving parts to store or retrieve data.

TABLE 15.3: LSI TECHNOLOGY CHARACTERISTICS

| Parameter/ Technology | Typical Propagation Delay (ns) | Timing Pulse Required for LSI (ns) | Typical Power Dissipation Per Gate (μ W) | Chip Density Gates/MIL ² |
|--------------------------|---|---|--|--|
| PMOS | 30-100 | 1,000-2,000 | 20-700 | 0.5 |
| NMOS | 20-70 | 200-1,000 | 20-700 | 0.5 |
| CMOS | 40-100 | 50-200 | 1-1,000 | 0.2 - 0.3 |
| PMOS/SOS | 30-100 | 100-500 | 70-700 | 0.5 |
| NMOS/SOS | 25-50 | 80-250 | 70-700 | 0.5 |
| CMOS/SOS | 10-40 | 70-200 | 90-100 | 0.3 |
| I ² L | 15-40 | 80-200 | 100-200 | 1.0 - 2.0 |
| Lower Power TTL | 30-50 | 400 | 1,000 | 0.2 |
| TTL | 8-12 | 70 | 10,000 | 0.2 |
| Low Power Schottky | 8-12 | 70 | 2,000 | 0.1 - 0.2 |
| Schottky | 3-5 | 50 | 20,000 | 0.1 - 0.2 |
| ECL FAST | 1-2 3-4 | 40 70 | 20,000-30,000 4,000 | 0.1 - 0.2 .01 - .02 |
| ALS | 6-7 | 70 | 1,000 | .01 - .02 |

CHAPTER 15: MIL-HDBK-338

o Discrete Semiconductor Devices

This subsection focuses on the selection and application of types of diodes, i.e., rectifiers, Schottky barrier rectifiers, varactors, and silicon controlled rectifiers (SCR's); transistors (i.e., bipolar, field effect transistor (FET), and power MOSFET) and microwave semiconductor devices such as the Impact device and the Gunn or transferred electron device (TED).

Discrete semiconductor selection is governed by the criteria depicted in Table 15.4.

**TABLE 15.4:
SEMICONDUCTOR SELECTION CRITERIA**

| |
|--|
| 1. MRAP/SRAP "Microcircuit/Semiconductor Reliability Assessment Program" |
| 2. MIL-STD-701 "Lists of Standard Semiconductors" |
| 3. MIL-S-19500 "Semiconductor Devices, General Specification for" |
| 4. MIL-STD-1547 "Parts, Materials and Processes for Space and Launch Vehicles, Technical Requirements for" |

Special application considerations for semiconductors include derating as shown in Tables 15.5 and 15.6, and transient suppression techniques for use in the protection of diodes as illustrated in Figure 15.2.

**TABLE 15.5:
DERATING FACTORS FOR TRANSISTORS**

| Transistor Type | Parameter | Environmental Derating Factor | |
|-------------------|----------------------|-------------------------------|--------|
| | | Benign | Severe |
| All Silicon Types | Power | 0.70 | 0.50 |
| | Max. Junc. Temp (°C) | 125 | 0.95 |
| | Breakdown Volt | 0.70 | 0.60 |

CHAPTER 15: MIL-HDBK-338

TABLE 15.6:
DIODE DERATING

| Diode Type | Environmental Derating Factor | | Parameter |
|----------------------|-------------------------------|----------------------------|---|
| | Benign | Severe | |
| Light Emitting | 110 0.75 | 95 0.50 | Max. Junc. Temp (°C) Avg. Forward Current |
| Rectifier (Power) | 125 0.70 0.75 | 95 0.70 0.50 | Max. Junc. Temp (°C) PIV Forward Current |
| Switching | 0.70 0.70 125 0.75 | 0.50 0.70 95 0.50 | Power PIV Max. Junc. Temp (°C) Forward Current |
| Varactor | 0.50 0.75 0.75 | 0.70 0.80 | Power PIV Forward Current |
| Voltage Reference* | 125 0.70 | 95 0.50 | Max. Junc. Temp (°C) Power |
| Transient Suppressor | 0.75 0.70 125 | 0.50 0.50 95 | Avg. Current Power Max. Junc. Temp (°C) |
| Microwave | 125 0.70 0.70 | 95 0.70 0.50 | Max. Junc. Temp (°C) PIV or Power |

*The zener current should be limited to no more than $I_Z = I_Z \text{ nominal} + 0.5 (I_{Z\text{max}} - I_{Z\text{nominal}})$, but do not derate to the point where the device is operating at the knee.

The worst case combination of ac, dc, and transient voltages shall be no greater than the allowed percentage of rated voltage.

CHAPTER 15: MIL-HDBK-338

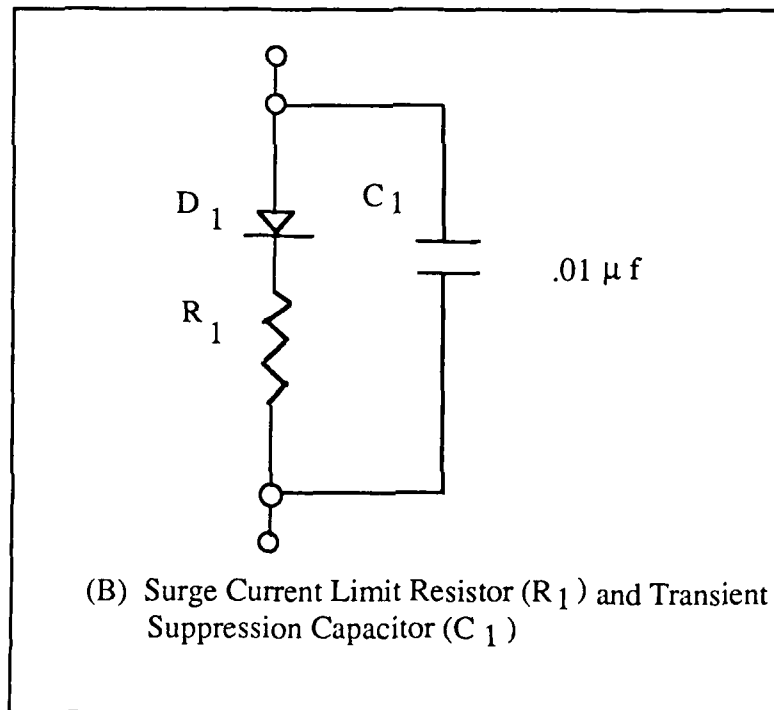
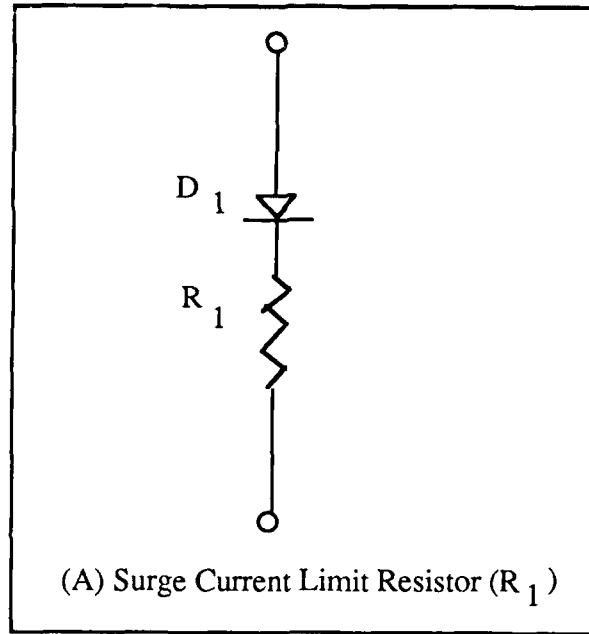

Note: The best protection for a diode is sufficient overrating of the Reverse Breakdown Voltage (PIV), Forward Surge Current (I_S) and Power Dissipation Capability (P).

FIGURE 15.2: DIODE PROTECTION

CHAPTER 15: MIL-HDBK-338

● Resistors

Resistors are functionally classified as fixed and variable. Resistor construction is of three general types: composition, film or wirewound, and consists of a resistive element mounted on a base with environmental protective coating and external electrical leads to allow insertion into an electrical circuit. Composition resistors are made from a mixture of resistive material and a binder and are molded into a resistive film deposited inside or outside an insulating cylinder. The wirewound type is composed of resistive wire wound on an insulative body. These three basic types of resistors differ from each other in reliability, size, cost, resistance range, power rating and general operating characteristics. No one type has all the best characteristics. The choice among them depends on initial and long-term operating requirements, the environment in which they must exist, and other factors. Resistor selection is governed by the criteria of Table 15.7.

**TABLE 15.7:
RESISTOR SELECTION CRITERIA**

| |
|--|
| 1. MIL-STD-199 "Resistors, Selection and Use of" |
| 2. The 39000 series of Established Reliability military specifications |
| 3. MIL specifications on resistors |
| 4. Historical test data (similar application) or other engineering information and/or data that provides assurance that the device is sufficiently rugged and reliable for the application (e.g., previous use in military equipment, comparable application or GFE) |

NOTE: For selecting particular resistors for specific applications, the qualified product list should be consulted for a list of qualified sources prior to procurement commitment.

Table 15.8 is a reproduction of one page of a four-page table in the handbook which provides selection, usage and failure modes information for MIL-specification resistors.

Figure 15.3 taken from Volume II of MIL-HDBK-338 portrays recommended derating for fixed, composition resistors.

TABLE 15.8: Usual AND SELECTION GUIDELINES FOR RESISTORS USAGE AND SELECTION

| Military Specifications | Type | Styles | Usage Notes | Failure Modes |
|-------------------------|---|--|---|--|
| Fixed Resistors | | | | |
| MIL-R-39008 | Composition (insulated) ESTABLISHED RELIABILITY | RCR05 RCR07 RCR20 RCR32 RCR42 | Use for general application where initial tolerance needs to be no tighter than +5% and long term stability under fully rated operating conditions needs to be no better than +15%. Resistance increased up to 20% during storage in humidity. Operation of the resistor at rated load will drive out the moisture and bring the resistor value back to within tolerance. | Both shorts and opens very rarely occur unless resistor is so over-loaded or overheated as to cause the phenolic case or thermo-setting binder material to carbonize. In high impedance circuits, the failure mode is generally a short; in low impedance circuits, the failure mode is open. High "JOHNSON" noise levels are present in resistor values above 1.0 megohm. DRIFT - RF will produce capacitance effects end-to-end. Operation at VHF or higher frequency reduces effective resistance due to dielectric losses (the "Boello" effect). |
| MIL-R-39009 | Wire-wound (power type) ESTABLISHED RELIABILITY | RER40 RER60 RER45 RER65 RER50 RER70 RER55 RER75 | Use where a lower tolerance and a greater power dissipation is required for a given unit size than is provided by MIL-R-39007 resistors and where ac performance is not critical. The power dissipation capacity of these resistors is dependent upon the area of heat sink upon which it is mounted. | SHORTS - May occasionally occur due to in-trawinding insulation breakdown. OPENS - May occasionally occur due to damage to the winding, poor winding to terminal connection, etc., suffered during fabrication. |
| MIL-R-39017 | Film (insulated) ESTABLISHED RELIABILITY | RLR05 RLR07 RLR20 RLR32 RLR42 | Resistors have semi-precision characteristics and small sizes. The sizes and wattage ratings are comparable to MIL-R-39008 and MIL-R-55182. Full power operating temperature should not exceed 70°C. Resistance-temperature characteristic is +200 PPM/°C. | SHORTS or OPENS may occur if resistor is poorly fabricated or over-loaded in application. Operation at RF above 100 MHz may produce inductive effects on spiral-cut types. |
| MIL-R-55182 | Film ESTABLISHED RELIABILITY | RNR50 RNR55 RNR60 RNR65 RNR70 | Use where high stability, long life, reliable operation and accuracy are required. Resistors are particularly suited for high frequency applications. Application examples include: high-frequency, tuned circuit loaders, television side-band filters, rhombic antenna terminators, radar pulse equipment, and metering circuits. | SHORTS - May occasionally occur because of protuberances on adjacent resistance spirals. OPENS - May occasionally occur due to non-uniform spirals resulting in a too-thin resistance path. Operation at 400 MHz and above will result in resistance decrease due to shunt capacitance effects. |
| MIL-R-55432 | Film, chip ESTABLISHED RELIABILITY | RM0502 RM0505 RM0705 RM1005 RM1505 RM2208 | Use in hybrid microelectronic circuits. These resistors are uncased leadless chip devices and shall not be procured for logistics support. | Subject to excessive loss of resistance (> 50%) due to electrostatic discharge effects. |

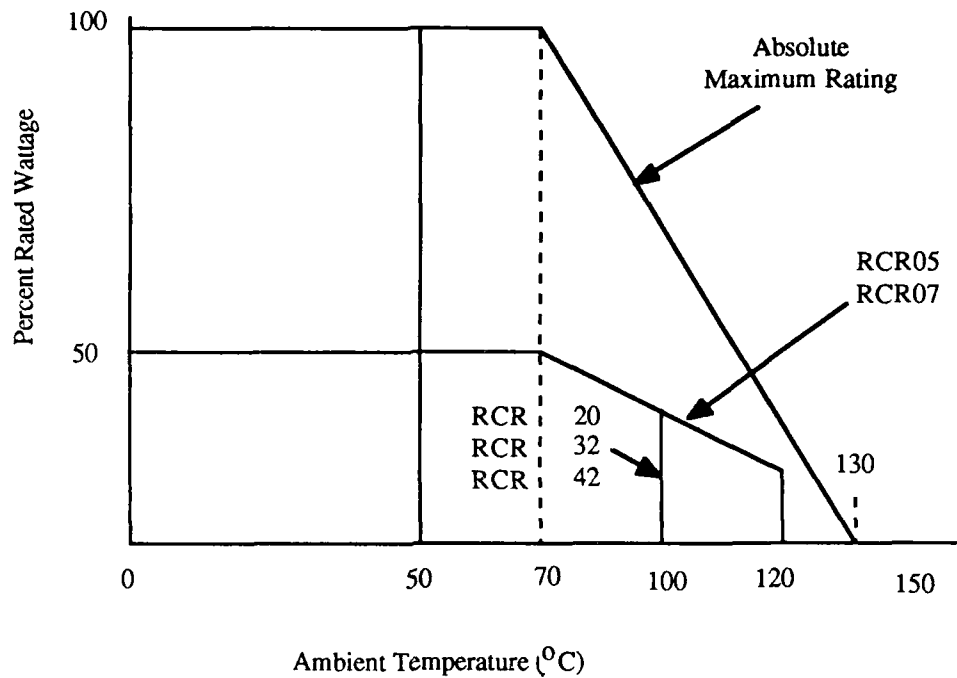

FIGURE 15.3: RESISTOR DERATING CURVE

- Capacitors, Magnetic Devices, Relays, Switches, Connectors, Tubes, Cables, Electro-and-Fibre Optics, Printed Circuitry and SEMs.

As with the preceding subsections on microcircuits, semiconductors and resistors, tabulations of selection criteria, usage guidance and special application considerations are provided for all of the above parts, devices or electronic modules. Examples of special application considerations include (for capacitors) such characteristics as capacitance tolerance, operating frequency, insulation resistance, temperature coefficient, dielectric absorption, reverse voltage, polarization, ac operation, Q, seal and mounting; for magnetic devices special application considerations include load current, operating frequency, core saturation, capability of accommodating dc input or pulse current, size, weight, operating temperature class, construction grade, taps, ESD or electromagnetic shielding; etc.

15.5.6 Section 6.0: Applications Guidelines

Section 6.0 concerns itself with the influence of environmental stress conditions on the reliability of electronic parts and equipments and the means commonly employed to blunt or evade their harmful effects.

In order to reap the benefits of a reliability oriented design, consideration must be given early in the design process to the required environmental resistance of the equipment being designed. Environmental resistance, both intrinsic and that provided by specifically directed design features, will determine the ability of the equipment to withstand the stresses imposed by its operational environment. The first step in determining the required environmental resistance is identification of the environments in which the equipment must operate. The next step is determination of the performance of the equipment's components and materials when exposed to the degrading stresses of the identified environments. When such performance is inadequate or marginal with regard to

CHAPTER 15: MIL-HDBK-338

the equipment reliability goals, corrective measures such as derating, redundancy, protection from adverse environments, or selection of more resistant materials and components must be employed. The preferred method for evaluating the thermal performance of electronic equipment (with respect to reliability) is a parts stress analysis method which determines the maximum safe temperatures for constituent parts. A reduction in the operating temperature of components is a primary method for achieving improved reliability levels. This is generally possible by provision of a thermal design which reduces heat input to minimally achievable levels and provides low thermal resistance paths from heat producing elements to an ultimate heat sink of reasonably low temperature. Thermal design is often as important as circuit design in obtaining the necessary performance and reliability characteristics of electronic equipment.

Most thermal designs are based on optimization of one of the three basic heat transfer technologies (radiation, convection and conduction).

Conduction cooling is capable of handling all but the most severe thermal design problems. By appropriate material selection a very low thermal impedance path is provided from the heat source to an appropriate thermal reservoir. Since thermal conductivity is a bulk material property, it is relatively immune to degradation, unlike convective and radiative techniques which are strongly dependent on the surface conditions and therefore subject to degradation over time.

Convection cooling is often adequate where thermal densities are moderate. The most common convective medium is air, with air flow resulting from either forced air or natural convection currents. Natural convection refers to the flow of air created by the existence of thermal gradients. The efficiency of natural convection cooling may be optimized by proper selection of air flow paths and by the use of fans to increase the amount of thermal energy transferred to the air per unit time.

Radiation based techniques are seldom used except in space applications where convective and conductive techniques are impractical. For most military systems, radiative heat transfer is seldom a significant factor in the overall thermal characterization of an equipment.

Paragraphs 6.2.3 - 6.2.3.3 of the handbook provide explicit information relating to cooling techniques commonly employed, including data on maximum dissipation per unit heat transfer area; maximum cooling capacity for modular microelectronic parts; "do's and don'ts" of parts layout for maximum reliability; the mounting of parts to minimize thermal resistance between a microcircuit case and a sink; the use of large mounting areas and the use of highly conductive materials to minimize resistance to heat conduction.

The importance of thermal design in the achievement of predictable and reliable system operation coupled with the importance of selecting the optimum thermal control technique from a multitude of alternatives emphasizes the necessity of implementing a thermal design management program. A flow chart of a typical thermal management program is presented in Figure 15.4.

Quality and screening tests can be employed to eliminate incipient part failures from the manufacturing process. Quality tests reduce the number of defective parts from production lines by inspection and conventional testing. Screens remove inferior parts and reduce hazard rate by means of the application of stress to the parts.

The term "screening" can be said to mean the application to an electronic part of a stress test, or tests, which will reveal inherent weaknesses (and thus incipient failures) of the device without destroying its integrity. This procedure, when applied equally to a group of similar devices manufactured by the same processes, is used to identify sub-par members of the group without impairing the structure or functional capability of the "good" members of the group. Screening can be done (a) by the part manufacturer, (b) by the user in his own facilities, or (c) by an independent testing laboratory.

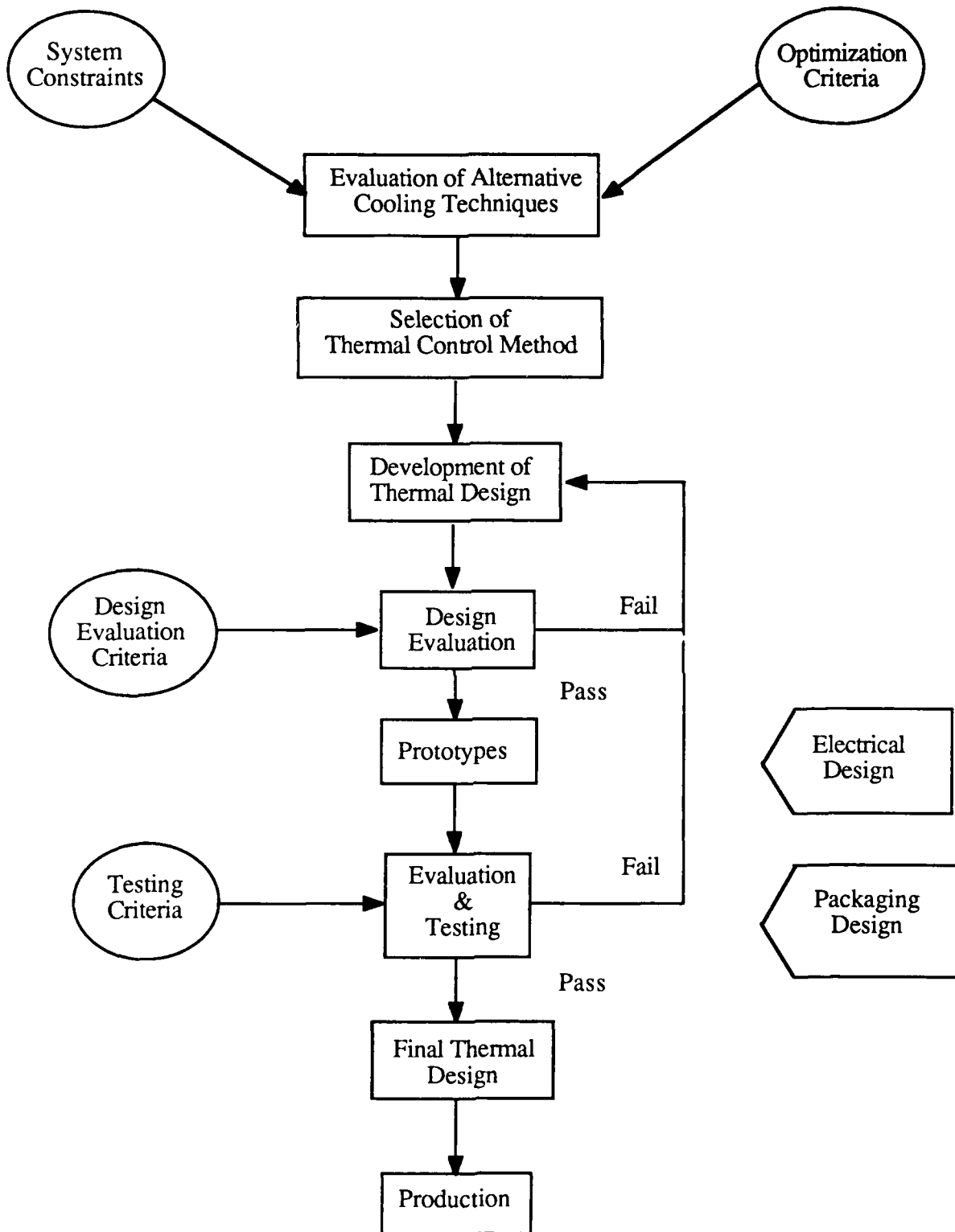

FIGURE 15.4: FLOW CHART OF THERMAL SYSTEMS MANAGEMENT PROGRESS

CHAPTER 15: MIL-HDBK-338

Since every part drawing which requires special nonstandard screening processes adds greatly to the equipment program logistic burden, every effort should be made to use standard screening processes.

There are three ways in which reliability screening levels are specified for three distinct categories of military parts: (1) screened military grade passive electrical parts (e.g., relays, coils, connectors, resistors and capacitors) are procurable to Established Reliability (ER) Military Specifications categorized as to ER failure rate level (L through T); (2) screened military grade semiconductor devices are procurable to MIL-S-19500 and its detailed slash sheets and are categorized as JANTX, JANTXV, and JANS screening levels; (3) screened military grade SSI, MSI and some LSI microcircuits are procurable to MIL-M-38510, are labeled JAN, and categorized as to screening class (i.e., S, B).

JAN semiconductor types are those which have passed the minimum qualification tests of MIL-S-19500. The TX suffix to JAN designates "Testing Extra" (i.e., screening). JANTX parts, in addition to JAN processing, undergo specific process and power conditioning tests on a 100% basis to enable further elimination of defective parts. JANTXV quality level semiconductors are subject to all testing performed on JANTX devices plus an internal visual PRECAP inspection to further eliminate defective parts. JANS quality level while requiring all the test performed on JANTXV parts, also requires particle impact noise detection (PIND) testing, failure analysis, serialization and traceability to a wafer lot. Relative failure rates for various types of semiconductors for a given temperature and electrical stress level and based upon JAN as 1.0 are shown in Table 15.9.

**TABLE 15.9:
RELATIVE FAILURE RATE DIFFERENCES**

| Screening Level | All Semiconductors Except Microwave | Microwave Detectors and Mixers (Si &Ge) |
|-----------------|--|--|
| JANS | .05 | .05 |
| JANTXV | .1 | .1 |
| JANTX | .2 | .3 |
| JAN | 1.0 | 1.0 |
| Lower* | 5.0 | 5.0 |

*Hermetic packaged devices

In selecting a meaningful screen at reasonable cost, understanding of the device's operating characteristics and the materials, packaging and fabrication techniques employed in its construction is essential. Devices that perform the same function may be fabricated with different materials (e.g., aluminum leads instead of gold on an integrated circuit). The wirebond stress level that is effective for gold may be ineffective for aluminum because of the difference in mass. The X-ray screen is effective for gold, but aluminum and silicon are transparent to X-rays.

CHAPTER 15: MIL-HDBK-338

There are two classes of screening provided for military JAN microcircuits: MIL-M-38510 JAN Classes S and B with S being the highest quality level and B the lower quality level. Only microcircuits procured per MIL-M-38510 may have the "JAN" designation. MIL-M-38510 Class S and B microcircuits require screening tests in accordance with MIL-STD-883 Method 5004 (for monolithic) or Method 5008 (for hybrid) devices. Manufacturers of microcircuits per Classes S, and B of MIL-M-38510 must meet specific qualification requirements to acquire and maintain listing on the qualified products list (QPL).

This qualification requires a manufacturer certification (including a government approved Product Assurance Program Plan), production line certification, and qualification and quality conformance inspection testing per Method 5005 or Method 5008 of MIL-STD-883.

Many microcircuits are procured to MIL-STD-883 Classes S, and B screening. These devices have been subjected to the tests of MIL-STD-883 Method 5004 or Method 5008 but have not been qualified to MIL-M-38510 nor had the in-process controls required by MIL-M-38510. They generally exhibit higher failure rates than MIL-M-38510 devices. There are also various vendor "equivalents," and lower grade commercial parts which exhibit much higher failure rates than the MIL-M-38510 and MIL-STD-883 screened units. MIL-M-38510 Class S or B quality levels are required for all microcircuits used in the new design of military equipment.

In order to develop a cost-effective screen, the cost of a failure at the various levels of assembly (component, board, system, field) must be considered. The chart below gives the relative cost of a failure at component board, system, and field levels for consumer, industrial, military and space applications.

| | Consumer | Industrial | Military | Space |
|-----------|----------|------------|----------|--------|
| Component | \$ 2 | \$ 4 | \$ 7 | \$ 15 |
| Board | \$ 5 | \$ 25 | \$ 50 | \$ 75 |
| System | \$ 5 | \$ 45 | \$ 120 | \$300 |
| Field | \$50 | \$215 | \$1000 | \$200M |

Figure 15.5 shows relative cost estimates for various part classes. It is apparent that the most cost effective screen is Class B of MIL-STD-883.

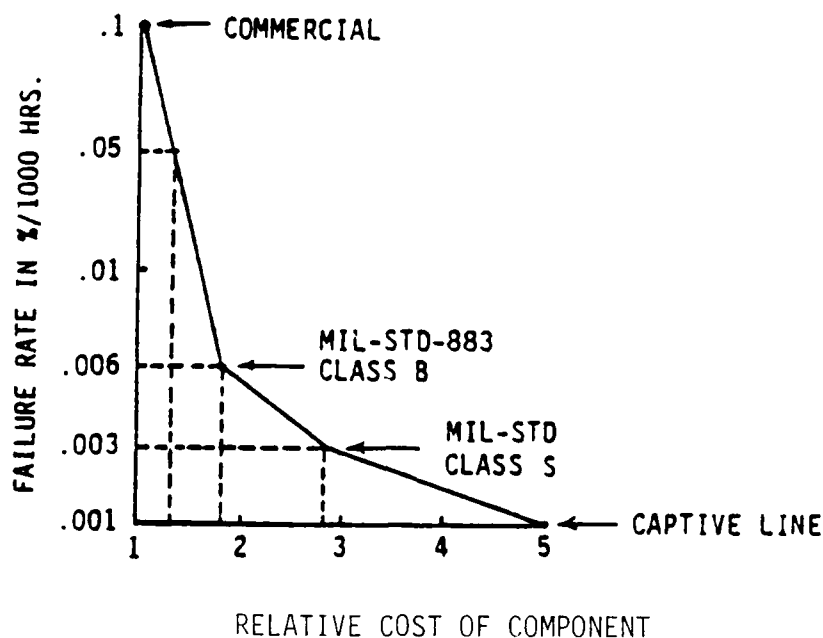

**FIGURE 15.5:
SCREENING COST EFFECTIVENESS**

15.5.8 Section 8.0: Logistic Support

Once an equipment is delivered to the user another aspect of parts control becomes of primary importance, namely those considerations which most directly affect logistic support of the equipment:

- a) the effects of storage on parts
- b) parts provisioning methods

In the making of reliability predictions the assumption that the failure rate of an electronic equipment and/or its constituent parts is insignificantly small or even zero during the time when the equipment is nonoperational, is fallacious. Evidence in the field shows that the failure rates of many components are still very significant even when no electrical stresses are applied. This is because when the electrical stresses are removed, many other stresses such as temperature, acceleration, shock, corrosive influences, humidity, etc., are still present. For some components, the storage failure rate is even greater than the operating failure rate at the lower stress levels. This is so for carbon composition resistors where, under storage conditions, there is no internal heat generation to eliminate humidity effects. Also, electrolytic capacitors need a reforming process after a long period of storage. MIL-STD-1131, "Storage Shelf Life and Reforming Procedures for Aluminum Electrolytic Fixed Capacitors," covers procedures for prolonging the serviceability of aluminum electrolytic capacitors during storage.

CHAPTER 15: MIL-HDBK-338

Electronic components age and deteriorate over long storage periods due to numerous failure mechanisms. For example, the electrical contacts of relays, switches, and connectors are susceptible to the formation of oxide or contaminant films or the attraction of particulate matter that adheres to the contact surface. During active use, the mechanical sliding or wiping action of a contact arm can produce a generally stable contact surface, but during a long period of non-operational storage the contaminants may increase to such a level that the mechanical wiping forces cannot produce a low resistance contact. Other causes for the deterioration of electronic parts during storage can include: faulty hermetic seals resulting from flexing caused by temperature and atmospheric pressure changes; the methods of preservation, packaging and packing (PP&P) used; and rough handling during shipment and at the storage depot. A summary of some of the failure modes encountered with electronic components during storage is given in Table 15.10.

Protection against damage and deterioration to components and equipment during shipment and storage requires the evaluation of a large number of interactive factors and the use of tradeoff analysis to arrive at a cost effective combination of protective controls. These factors can be grouped into three major control parameters: (1) the level of preservation, packaging and packing (PP&P) applied during the preparation of material items for shipment and storage; (2) the actual storage environment; and (3) the need for and frequency of in-storage cyclic inspection. These parameters must be evaluated and balanced to meet the specific characteristics of the individual equipment and materiel items.

Once the equipment enters the operational phase of its life cycle, spare parts provisioning becomes an essential consideration. Techniques for determining the most desirable levels of spares provisioning vary according to the complexity and costs of the system support problem.

It is obvious, for example, that spares provisioning for equipment used in nuclear submarines during whose 4-5 month underseas voyages no repair work is undertaken and equipment failure is overcome by the replacement of complete assemblies or modules, or for unmanned space vehicles where neither replacement nor repair of equipment is possible, differs from that for land based equipment which is easily accessible for repair. It is also apparent that the level of replacement or repair required (i.e., failed assembly, module or part) and the need for and availability of automatic test equipment, are factors which strongly influence the spare provisioning methods and levels used.

Some major weapons systems having high reliability requirements and controlled by a Strategic Project Office (SPO) may apply parts control during deployment via these offices. Requirements for spares and spare parts within the Air Force are contained in AFLC manual 800.1, Chapter 31 of this Primer which stipulates two types of spare parts support, i.e. initial spares to be procured from the equipment contractor, or replenishment spares which are procured competitively under separate AFLC contracts from the commodity industry, wherever practical. Requirements for these spares cover support beyond the initial support period and are progressively computed throughout the life of the system.

CHAPTER 15: MIL-HDBK-338

**TABLE 15.10:
FAILURE MODES ENCOUNTERED WITH
ELECTRONIC COMPONENTS DURING STORAGE**

| COMPONENT | FAILURE MODES |
|---------------------------------------|---|
| Batteries | Dry batteries have limited shelf life. They become unusable at low temperatures above 350°C. The output of storage batteries drops as low as 10 percent at very low temperatures. |
| Capacitors | Moisture permeates solid dielectrics and increases losses which may lead to breakdown. Moisture on plates of an air capacitor changes the capacitance. |
| Coils | Moisture causes changes in inductance and loss in Q. Moisture swells phenolic forms. Wax coverings soften at high temperatures. |
| Connectors | Corrosion causes poor electrical contact and seizure of mating members. Moisture causes shorting at the ends. |
| Relays and Solenoids | Corrosion of metal parts causes malfunction. Dust and sand damage the contacts. Fungi grow on coils. |
| Resistors | Fixed composition resistors drift, and these resistors are not suitable at temperatures above 85°C. Enameled and cement-coated resistors have small pinholes which bleed moisture, accounting for eventual breakdown. Precision wire-wound fixed resistors fail rapidly when exposed to high humidities and to temperatures at about 125°C. |
| Diodes, Transistors | Plastic encapsulated devices offer poor hermetic seal resulting in shorts, or opens caused by chemical corrosion or moisture. |
| Motors, Blowers, and Dynamotors | Swelling and rupture of plastic parts and corrosion of metal parts. Moisture absorption and fungus growth on coils. Sealed bearings are subject to failure. |
| Plugs, Jacks, Dial-Lamp Sockets, etc. | Corrosion and dirt produce high resistance contacts. Plastic insulation absorbs moisture. |
| Switches | Metal parts corrode, and plastic bodies and wafers warp owing to moisture absorption. |
| Transformers | Windings corrode, causing shorts or open circuits. |

CHAPTER 15: MIL-HDBK-338

A specific and detailed example demonstrating the hows and whys employed for the optimization of spares and maintenance facilities as applied to an airborne radar set concludes Section 8 of Chapter 15 of this Primer.

15.5.9 Section 9: Failure Reporting and Analysis

Failure Reporting and analysis is a necessary operation to insure that a product's reliability and maintainability will be achieved and sustained. The Failure Reporting, Analysis and Corrective Action System (FRACAS) program is a key element in "failure recurrence" control for newly developed and production equipment. A FRACAS program includes provisions to assure that failures are accurately reported and thoroughly analyzed and that corrective actions are taken on a timely basis to reduce or prevent recurrence.

For military programs, MIL-STD-785, Task 104 calls for the establishment of a FRACAS program. The purpose of this task is to establish a closed loop failure reporting system, procedures to determine cause, and documentation for recording corrective action taken. It requires the contractor to have a system that collects, analyzes and records failures that occur for specified levels of assembly prior to acceptance of the hardware by the procuring activity. MIL-STD-785 is the subject of Chapter 3 of this Primer.

It is essential that failure reporting and resultant corrective actions be documented. Therefore, failure reporting and corrective actions forms must be designed to meet the needs of the individual system development and production program as well as the organizational responsibilities, requirements, and constraints of the manufacturer.

Minimally, three forms are necessary:

- a) Failure Report
- b) Failure Analysis Report
- c) Corrective Action Request Form

When the system/equipment is deployed by the customer (i.e., a branch of the DoD) its data reporting system goes into effect. Most military data reporting systems are based upon logistic, rather than design considerations.

Military Maintenance Data Collection (MDC) systems are designed to inform commanders of the availability of airborne, shipside and ground support electronic equipment. Data from these programs are also essential to logisticians in order to procure spare parts for the maintenance inventory. A few examples of these programs are:

- **Air Force**

System Effectiveness Data System (SEDS) - The Reliability and Maintainability data acquisition, storage and retrieval and analysis system used by Air Force Systems Command (AFSC) during the Development, Test and Evaluation (DT&E).

Maintenance Experience Data (AFM 66-1) - The Maintenance Data Collection (MDC) system was designed primarily as a base level production credit and management information system.

Data Products (DO56) - DO56 data products are computerized reports derived from AFM 66-1 data residing in computers at base, command and HQ AFLC Wright Patterson AFB, OH. Some examples of these reports are:

CHAPTER 15: MIL-HDBK-338

- Materiel Safety Deficiency Report, RCS: LOG-MMO (AR) 7178
- Failure Rate Data for Selected Work Unit Codes; RCS: LOG-MMO (AR) 7184
- Maintenance Man hours per Flying Hours by Weapon, Command and System
RCS: LOG-MMO (AR) 7185
- Selected Part Number Action Summary, RCS: LOG-MMO (AR) 7188
- Parts Replaced during Field or Depot Repair, RCS: LOG-MMO (AR) 7190

● Army

The Army Equipment Record System (TAERS) - The TAERS is designed to provide field commanders, commodity command managers, project managers and top level headquarters with problem solving data for improved material readiness. It is an official Army method for reporting information necessary for control of operation and maintenance support of Army equipment.

● Navy

Ships Maintenance Material Management (3M) - The Navy Ship 3M is composed of two subsystems: the Planned Maintenance Subsystem (PMS) and the Maintenance Data Collection Subsystem (MDCS). PMS details procedural instructions to be followed in performing routine maintenance and periodic operational checks. MDCS is the means by which maintenance personnel report corrective action maintenance actions on specific categories of equipment. Submarines report corrective maintenance actions on all equipment.

Avionic Maintenance Materiel Management (3M) - The Navy Avionic Maintenance Data Collection System (MDCS) collects data from these levels of maintenance: Organization (on equipment), Intermediate (off equipment) and Depot. Data products prepared are similar to AFM 66-1.

● Marine Corps

Marine Corps Integrated Maintenance Management Systems (MIMMS) - MIMMS is an automated information system which is designed to assist commanders at all command levels of both the operating forces and supporting establishments of the Marine Corps in the execution of the ground equipment maintenance functions. Inputs to the system are prepared at the information source by maintenance, supply and operational personnel.

The failure analysis should be sufficiently stringent to adequately support conclusions as to the cause or relevancy of failure, the initiation of corrective actions in device design, test, application, or production processing and to eliminate the cause or prevent the recurrence of the reported failure mode or mechanism. Flow diagrams illustrating recommended procedures for failure analysis, and a list of the minimum equipment deemed necessary to equip a beginning failure analysis laboratory (including estimated costs) are given in section 9 of the handbook. Appendices A and B to Section 9 tabulate factors affecting the failure rates of parts and devices; comment on the limitations of MIL-HDBK-217 (Reliability Prediction of Military Equipment) in establishing true failure rates, i.e., MIL-HDBK-217 does not consider the effect of transients on failure rate prediction; describe additional failure rate factors for monolithic and hybrid microcircuits and introduce the concept of learning factors failure rate multipliers for microcircuits.

CHAPTER 15: MIL-HDBK-338

15.6 TAILORING GUIDELINES

MIL-HDBK-338, Volume II is a guidance document only. It does not contain enforceable requirements. As noted in paragraph 15.1 it deals with a large number of military specifications and standards, many of which are the subjects of Chapters of this Primer, wherein specific tailoring instructions are given.

15.7 CONTRACT DATA REQUIREMENT LIST (CDRL)

There are no deliverable data items required by this Handbook.

CHAPTER 16:

MIL-STD-810

ENVIRONMENTAL TEST METHODS AND ENGINEERING GUIDELINES

CHAPTER 16: MIL-STD-810

MIL-STD-810 is a tri-service approved document used by all branches of the military in the specification and acquisition, of quality-assured electronic systems and equipment. The current version is revision "D", dated July 19, 1981. The preparing activity is:

Aeronautical Systems Division
ATTN: ASD/ENES
Wright Patterson AFB, OH 45433-6503

This chapter is only an advisory to the use of MIL-STD-810. It does not supersede, modify, replace or curtail any requirements of MIL-STD-810 nor should it be used in lieu of that standard.

16.1 REFERENCE DOCUMENTS

The following related documents form a part of MIL-STD-810 to the extent specified therein.

- MIL-S-901 Shock Tests, H.I. (High Impact), Ship Machinery, Equipment and Systems
- MIL-STD-167 Mechanical Vibrations of Shipboard Equipment
- MIL-STD-210 Climatic Extremes for Military Equipment
- MIL-STD-781 Reliability Testing for Engineering Development, Qualification and Production
- MIL-STD-1165 Glossary of Environmental Terms

16.2 DEFINITIONS

This paragraph is not applicable to this chapter.

16.3 APPLICABILITY

MIL-STD-810 provides: a) Guidelines for conducting environmental engineering tasks to tailor environmental tests to end-item equipment applications, and b) Test methods for determining the effects of natural and induced environments on equipment used in military applications. Figure 16.1, reproduced from MIL-STD-810, relates the various environments (both natural and induced) to which the equipment will be exposed during applicable portions of the equipment's life cycle. MIL-STD-810 is composed largely of detailed test methods and detailed test procedures each dealing with exposure to a specific type of environment.

These test methods and test procedures are to be selectively applied primarily in the early development phase of the DOD acquisition process. Selected application at other points in the acquisition process may also be appropriate.

16.4 PHYSICAL DESCRIPTION OF MIL-STD-810

MIL-STD-810 is a voluminous document comprised of twenty different detailed environmental "Test Methods" and containing approximately four hundred and sixteen pages. There are no appendices to this standard.

CHAPTER 16: MIL-STD-810

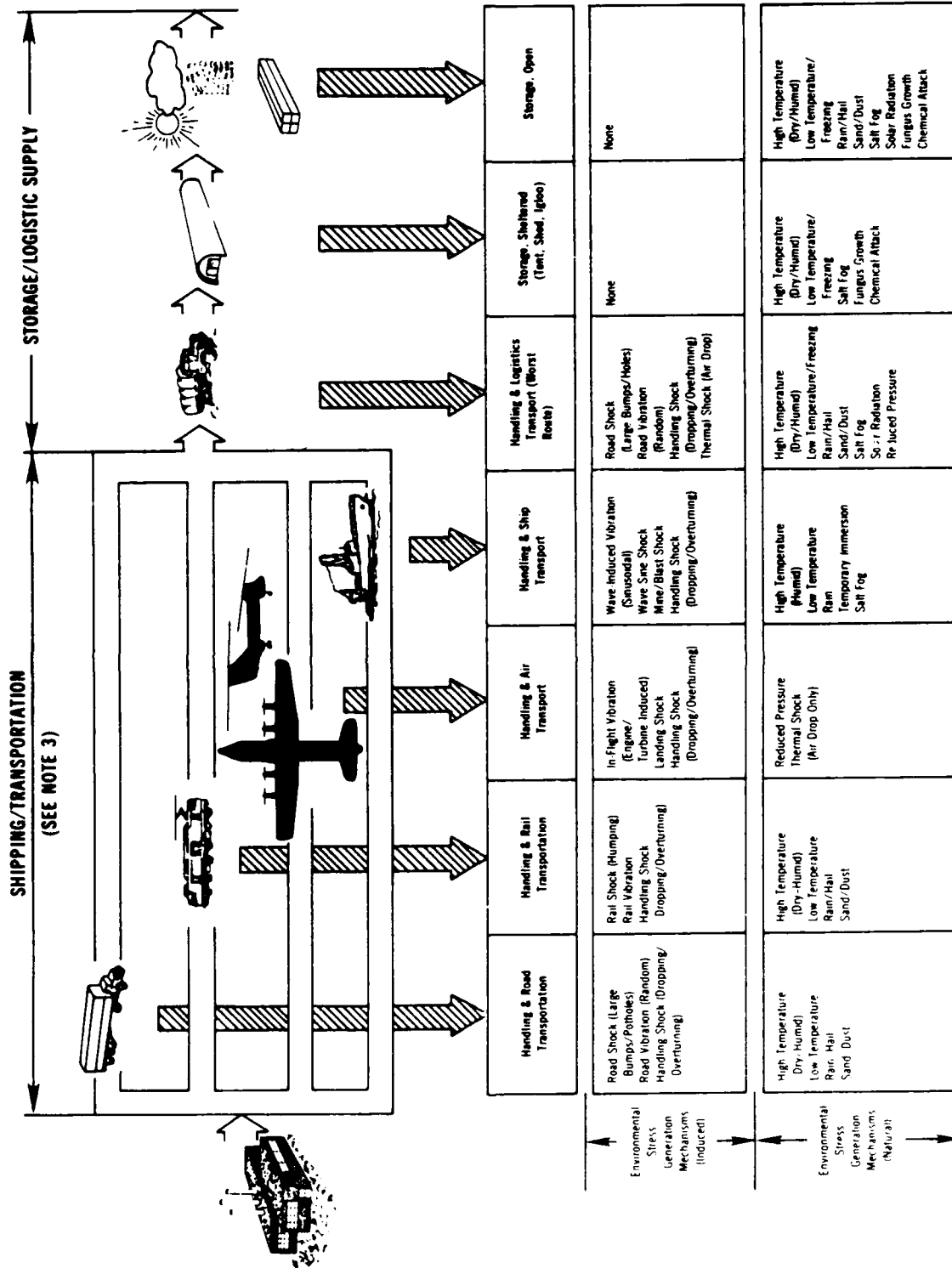

(See Note 5)

FIGURE 16.1: GENERALIZED LIFE CYCLE HISTORIES FOR MILITARY HARDWARE

CHAPTER 16: MIL-STD-810

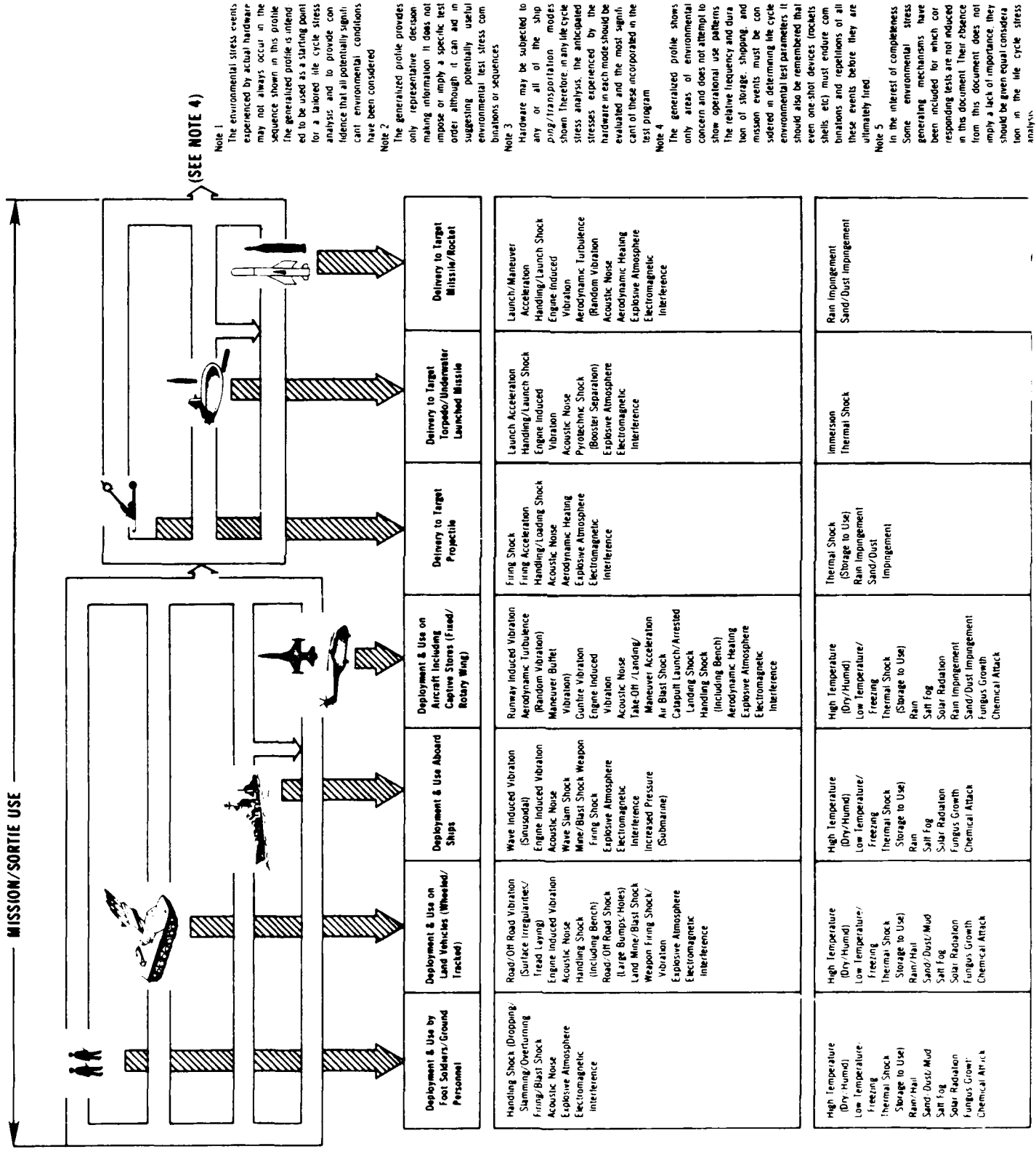

Note 1
The environmental stress events experienced by actual hardware may not always occur in the sequence shown in this profile. The generalized profile is intended to be used as a starting point for a tailored life cycle stress analysis and to provide confidence that all potentially significant environmental conditions have been considered.

Note 2
The generalized profile provides only representative decision making information. It does not impose or imply a specific test order although it can aid in suggesting potentially useful environmental test stress combinations or sequences.

Note 3
Hardware may be subjected to any or all of the shipping/transportation modes shown. Therefore, in any life cycle stress analysis, the anticipated stresses experienced by the hardware in each mode should be evaluated and the most significant of these incorporated in the test program.

Note 4
The generalized profile shows only areas of environmental concern and does not attempt to show operational use patterns. The relative frequency and duration of storage, shipping, and mission events must be considered in determining life cycle environmental test parameters. It should also be remembered that even one-shot devices (rockets, shells, etc.) must endure combinations and repetitions of all these events before they are ultimately fired.

Note 5
In the interest of completeness, some environmental stress generating mechanisms have been included for which corresponding tests are not included in this document. Their absence from this document does not imply a lack of importance. They should be given equal consideration in the life cycle stress analysis.

FIGURE 16.1: GENERALIZED LIFE CYCLE HISTORIES FOR MILITARY HARDWARE (CONT'D)

CHAPTER 16: MIL-STD-810

16.5 HOW TO USE MIL-STD-810

MIL-STD-810 includes a series of "numbered test methods" with various detailed test procedures and different equipment categories within each "numbered test method."

The test methods of this standard are intended to be applied in order to:

- a. Disclose deficiencies and defects and verify corrective action.
- b. Assess equipment suitability for its intended operational environment.
- c. Verify contractual compliance.

Each test method is divided into two sections: Section I provides guidance for choosing and tailoring a particular test procedure; Section II includes step-by-step test procedures.

Thus the "numbered test methods" provide: a) engineering guidelines for the establishment of specific equipment environmental design criteria, b) direction for specific environmental tests to be performed, c) specific test procedures to be followed in conducting each environmental test and d) specific criteria for the acceptance of the subsequent test results.

The following is a listing of the different test methods found in MIL-STD-810.

- Test Method 501: High Temperature
- Test Method 502: Low Temperature
- Test Method 503: Temperature Shock
- Test Method 504: (deleted)
- Test Method 505: Solar Radiation (Sunshine)
- Test Method 506: Rain
- Test Method 507: Humidity
- Test Method 508: Fungus
- Test Method 509: Salt Fog
- Test Method 510: Sand and Dust
- Test Method 511: Explosive Atmosphere
- Test Method 512: Leakage (Immersion)
- Test Method 513: Acceleration
- Test Method 514: Vibration
- Test Method 515: Acoustic Noise
- Test Method 516: Shock

CHAPTER 16: MIL-STD-810

- Test Method 517: (deleted)
- Test Method 518: (deleted)
- Test Method 519: Gunfire
- Test Method 520: Temperature, Humidity, Vibration, Altitude
- Test Method 521: Icing/Freezing Rain
- Test Method 522: (to be added later)
- Test Method 523: Vibro-Acoustic, Temperature

16.6 TAILORING GUIDELINES

MIL-STD-810 is written as a series of "numbered test methods," with various test procedures and equipment categories within each test method.

This assortment of options is intended to better assist in the development of a specific environmental design and test program uniquely applicable for a given system or equipment procurement.

Thus tailoring the environmental design criteria and test program by the selection of specific "numbered test methods," detailed test procedures and specific equipment categories, is implicit in the process.

16.6.1 When and How to Tailor

Tailoring of the environmental design and test program in accordance with MIL-STD-810 involves the selection of: a) the appropriate environmental design criteria, b) the appropriate environmental test methods, c) the appropriate detailed test procedures and d) the appropriate equipment categories within each test method .

Figure 16.2, reproduced from MIL-STD-810, is a summary of the environmental tailoring process for military hardware. Specific directions for tailoring of the requirements of MIL-STD-810 are found in section 4 of the standard.

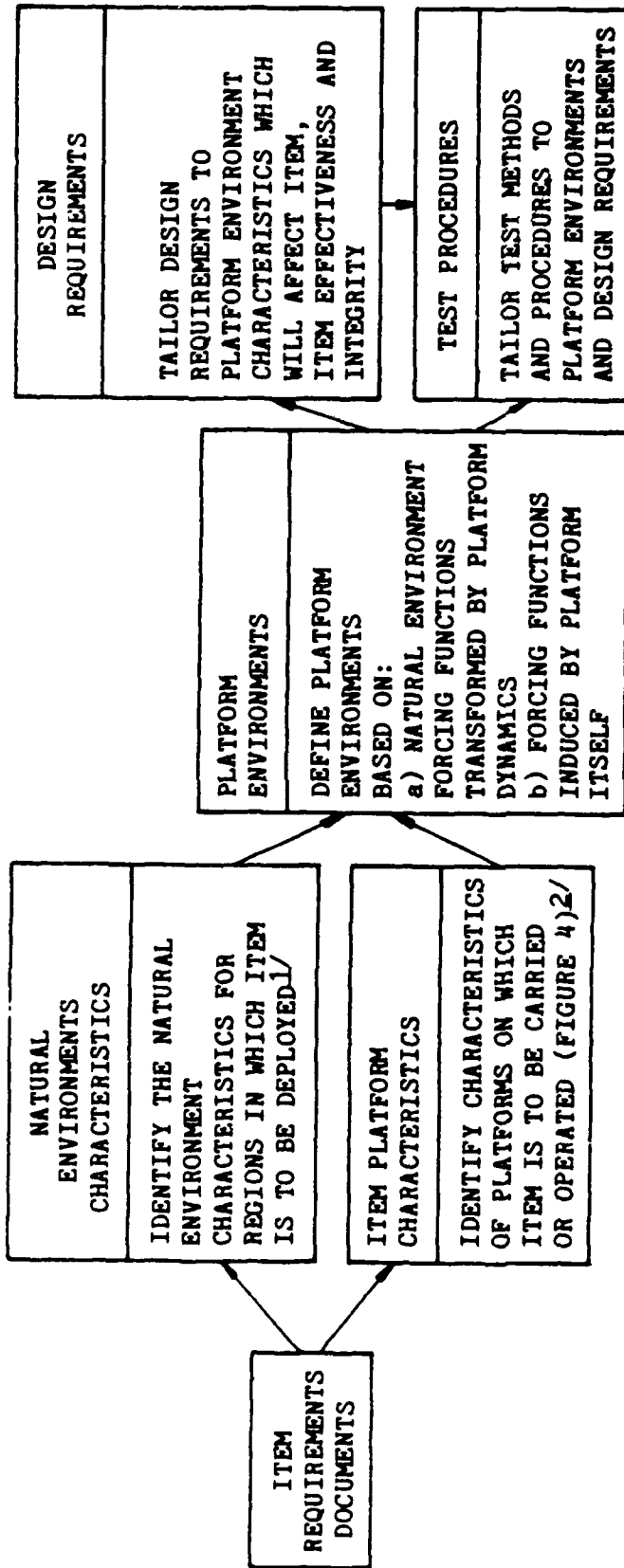

1/ CONVENTIONAL METEOROLOGICAL DATA ARE NOT COLLECTED WITH MILITARY HARDWARE IN MIND. GREAT CARE MUST BE TAKEN TO ENSURE THAT THE METEOROLOGICAL DATA USED ARE RELEVANT TO THE SPECIFIC HARDWARE ITEMS.

2/ IN THIS CONTEXT, A PLATFORM IS ANY VEHICLE, SURFACE, OR MEDIUM THAT CARRIES THE HARDWARE. FOR EXAMPLE, AN AIRCRAFT IS THE CARRYING PLATFORM FOR AN AVIONICS POD, THE LAND ITSELF FOR A GROUND RADAR, AND A MAN FOR A HAND-CARRIED RADIO.

FIGURE 16.2: ENVIRONMENTAL TAILORING PROCESS FOR MILITARY HARDWARE

CHAPTER 16: MIL-STD-810

16.7 CONTRACT DATA REQUIREMENTS LIST (CDRL)

The following data item descriptions are applicable to the environmental design and test requirements of MIL-STD-810.

| | |
|-----------|---|
| DI-R-2063 | Electromagnetic Environment Test Report |
| DI-R-7123 | Environmental Management Plan |
| DI-R-7124 | Life Cycle Environmental Profile Plan |
| DI-R-7125 | Environmental Design Criteria and Test Plan |
| DI-R-7126 | Operational Environment Verification Plan |
| DI-R-7127 | Environmental Test Report |

CHAPTER 17:

DOD-STD-1686A

**ELECTROSTATIC DISCHARGE CONTROL PROGRAM FOR
PROTECTION OF ELECTRICAL AND ELECTRONIC PARTS,
ASSEMBLIES AND EQUIPMENT (EXCLUDING ELECTRICALLY
INITIATED EXPLOSIVE DEVICES)**

CHAPTER 17: DOD-STD-1686A

DOD-STD-1686 is a tri-service approved document used by all branches of the military in the specification and acquisition of quality-assured electronic systems and equipment. The current official version of the standard is the initial release dated May 2, 1980.

However, this standard and its associated handbook, DOD-HDBK-263, which is covered in Chapter 15, are currently undergoing extensive modification. Since we have endeavored in this Primer to give the reader the most current information available, **the material in this chapter reflects the information contained in the unofficial industry coordination draft version of DOD-STD-1686A distributed for comments in September 1987.** Thus the information contained herein, while approximately seven years more up-to-date than the initial release document, may be substantially different than that eventually found in the officially released "A" version when it is issued. Therefore, the reader is cautioned to verify whether or not DOD-STD-1686A has been officially released prior to using the guidance material contained in this chapter.

The preparing activity for both documents is:

Dept. of the Navy
Naval Sea Systems Command
ATTN: SEA 55Z3
Washington, DC 20362-5101

This chapter is only an advisory to the use of DOD-STD-1686. It does not supersede, modify, replace or curtail any requirements of DOD-STD-1686 and nor should it be used in lieu of that standard.

17.1 REFERENCE DOCUMENTS

The following related documents impact and further detail these tasks and should also be referenced.

- MIL-E-17555 Packaging of Electronic and Electrical Equipment, Accessories, and Provisioned Items (Repair Parts)
- MIL-M-38510 General Specification for Microcircuits
- MIL-STD-883 Test Methods and Procedures for Microelectronics
- DOD-HDBK-263 Electrostatic Discharge Control Handbook for Protection of Electrical and Electronic Parts, Assemblies and Equipment (Excluding Electrically Initiated Explosive Devices)
- MIL-STD-1285 Marking of Electrical and Electronic Parts
- RS-471 Electronic Industries Association (EIA) Symbol and Label for Electrostatic Sensitive Devices

17.2 DEFINITION

The definitions of applicable terms and acronyms may be found in DOD-HDBK-263.

CHAPTER 17: DOD-STD-1686A

17.3 APPLICABILITY

DOD-STD-1686 covers the **requirements** for the establishment and implementation of an ESD control program for any activity that designs, tests, inspects, services, manufactures, processes, assembles, installs, packages, labels, or otherwise handles electrical and electronic parts, assemblies, and equipment susceptible to damage from ESD. (A companion document DOD-HDBK-263 in Chapter 18 of the Primer provides **guidance** for developing, implementing, and monitoring the requirements of an ESD control program.)

Parts, as used in these documents, applies to both electrical and electronic parts. Assemblies applies to subassemblies and all higher assemblies up to but not including the equipment level. Parts, assemblies and equipment are collectively referred to in these documents as items.

Electrostatic charges are generated by the relative motion, physical separation of materials or the flow of solids, liquids, or gases. Common sources of ESD include personnel, items made of plain plastics, and processing equipment. ESD can damage parts by direct contact with a charged source or by charges induced from electrostatic fields. ESD-susceptible parts include microcircuits, discrete semiconductors, thick and thin film resistors, chips, hybrid devices and piezoelectric crystals depending upon the magnitude and shape of the ESD pulse.

17.4 PHYSICAL DESCRIPTION OF DOD-STD-1686A

The industry coordination draft of DOD-STD-1686A distributed in September 1987 contains only twelve pages. The document also includes two supporting appendices; Appendix A, "Classification Testing" and Appendix B, "ESDS Parts." These appendices contain an additional ten pages.

17.5 HOW TO USE DOD-STD-1686

The standards cover the identification, testing, and classification of ESD- susceptible (ESDS) items, design criteria, protected work areas, handling procedures, personnel training and the development of training materials, marking of documentation and hardware, selection and application considerations for ESD protective material and equipments, intra-plant protective covering, packaging and marking, installation, quality assurance and certification provisions, data requirements, audits and reviews. For the purpose of the standard and handbook, only items sensitive to discharges of 16,000 volts or less are considered.

DOD-STD-1686 includes a series of twelve specific program control elements that may be used for the preparation and implementation of a comprehensive ESD control program. Table 17.1 (derived from the draft DOD-STD-1686A) contains a listing of each of the specific program control elements defined in DOD-STD- 1686 together with a guideline matrix for the selection or deletion of each element based upon the type of acquisition. Each of these control elements is explained in more detail in the following section.

17.5.1 ESD Control Program Elements Description

- **ESD Control Program Plan**

The ESD control program plan addresses the application and implementation of each of the functions and elements required in this specific ESD control program. The plan is prepared by the contractor and is then submitted for to the acquiring activity for approval.

CHAPTER 17: DOD-STD-1686A

● Identification and Classification of ESDS Items

The ESD susceptibility classification shall be determined for each applicable item. There are three major classification levels:

| | |
|---------|---------------------------|
| Class 1 | From 0 to 2,000 volts |
| Class 2 | From 2,000 to 4,000 volts |
| Class 3 | Greater than 4,000 volts |

The ESD susceptibility classification level of the item will have a major impact upon the extent of the ESD control program. The lower the classification level the more rigorous the control program must be, e.g., class 1 parts will require a more rigorous program than class 2 parts.

● Design of ESD Protective Circuitry

ESDS items shall incorporate protective circuitry, where possible, to reduce the vulnerability of the item to possible ESD damage. Any external equipment cabinet surface, external connector, or test point, shall normally be able to withstand an ESD event of up to 4,000 volts.

● Establishment of Protected Areas for the Handling and Safekeeping of ESDS Items

Electrostatic voltages in areas where class 1, class 2 and class 3 items are handled without protective covering shall be limited to the lowest voltage susceptibility of these items. Handling of ESDS items, without ESD protective covering, shall be performed in protected areas in accordance with detailed ESD protective handling procedures.

● Establishment of Detailed Handling Procedures for ESDS Items

Detailed procedures for handling ESDS items shall be developed, documented, and implemented. The details of the procedures shall be related to the susceptibility of the ESDS item being handled and the degree of control afforded by the protected area. The more susceptible the item, and the fewer controls afforded by the protected area, the more detailed the procedures shall be to provide the required protection from damage due to ESD.

● Protective Covering for ESDS Items

When not being worked on or when outside protected areas, ESDS parts and assemblies shall be enclosed in ESD protective covering or packaging.

● Personnel Training

All personnel who perform or supervise any applicable function listed in Table 17.1 or who have any contact with ESDS items shall receive recurrent ESD training.

● Physical Marking of all Hardware Containing ESDS Items

All ESDS parts shall be marked in accordance with MIL-STD-1285. ESDS assemblies and equipment shall be marked in a readily visible manner in accordance with either MIL-STD-1285 or EIA standard RS-471. Equipment susceptible to ESD damage shall also bear an additional cautionary note.

CHAPTER 17: DOD-STD-1686A

● Deliverable and Non-deliverable Documentation

Both deliverable and non-deliverable documentation shall identify class 1, class 2 and class 3 items and external terminals which are ESDS, collectively as ESDS. Deliverable documentation shall include or refer to documented ESD protective procedures. Non-deliverable documentation may utilize exact classification data in lieu of collective classification information.

● Protective Packaging for ESDS Items

ESD protective packaging for delivery shall be in accordance with MIL-E- 1755, for ESDS items. In addition to limiting the ESD susceptibility of equipment to 4,000 volts, provisions for ESD protective caps shall be made so that discharge cannot occur on unprotected pins.

● ESD Control Program Quality Assurance Provisions

Quality assurance requirements shall be established to verify conformance with DOD-STD-1686 as tailored by the SOW. QA provisions shall include certification, monitoring and auditing of ESD requirements invoked on subcontractors and suppliers.

● Formal Reviews and Audits

Formal reviews and audits are to be conducted at specified intervals. The contractor's scheduled design and program reviews shall include ESD control program requirements. The acquiring activity or his designated representative shall be accorded the option to attend such reviews.

● Failure Analysis of Failed ESDS Items

Failure analysis data shall be prepared in accordance with the data ordering document included in the contract or order and should include as a factor, ESD-related failure modes and effects analysis, and recommendations for corrective action.

17.6 TAILORING GUIDELINES

Tailoring of an ESD Control program primarily involves the planning and selection of specific control elements and the determination of the rigor with which each of these elements will be applied.

17.6.1 When and How to Tailor

DOD-STD-1686 is written as a series of specific control elements to assist the contractor in the development and establishment of a unique, cost effective ESD control program. This includes the selection and the possible deletion of certain control elements based upon the type of acquisition (as was shown in Table 17.1), thus tailoring of the requirements is implicit in this approach.

TABLE 17.1: ESD CONTROL PROGRAM REQUIREMENTS

Control Program Elements

| Functions | See 5.1 | See 5.2 | See 5.3 | See 5.4 | See 5.5 | See 5.6 | See 5.7 | See 5.8 | See 5.9 | See 5.10 | See 5.11-5.12 | See 5.13 |
|----------------------|--------------------------|---------------------------------|-------------------|-----------------|---------------------|---------------------|----------|---------------------|---------------|-----------|----------------------------------|------------------|
| | ESD Control Program Plan | Identification & Classification | Design Protection | Protected Areas | Handling Procedures | Protective Covering | Training | Marking of Hardware | Documentation | Packaging | QA Provisions & Audits & Reviews | Failure Analysis |
| Design | ✓ | ✓ | ✓ | | ✓ | | ✓ | ✓ | ✓ | ✓ | ✓ | ✓ |
| Production | ✓ | | | ✓ | ✓ | ✓ | ✓ | ✓ | ✓ | | ✓ | ✓ |
| Inspection & Test | ✓ | | | ✓ | ✓ | ✓ | ✓ | ✓ | ✓ | ✓ | ✓ | ✓ |
| Storage & Shipment | ✓ | | | ✓ | ✓ | ✓ | ✓ | ✓ | ✓ | ✓ | ✓ | |
| Installation | ✓ | | | ✓ | ✓ | ✓ | ✓ | ✓ | ✓ | ✓ | ✓ | |
| Maintenance & Repair | ✓ | | | ✓ | ✓ | ✓ | ✓ | ✓ | ✓ | ✓ | ✓ | ✓ |

CHAPTER 17: DOD-STD-1686A

17.7 CONTRACT DATA REQUIREMENTS LIST (CDRL)

The following is a list of data item descriptions associated with the tasks specified herein:

| <u>Applicable DID</u> | <u>Data Requirement</u> |
|-----------------------|---|
| DI-RELI-8XXXX | Electrostatic Discharge Control Program Plan |
| DI-RELI-8XXXX | Handling Procedures for Electrostatic Discharge Sensitive Items |
| DI-RELI-8XXXX | Reporting Results of Electrostatic Discharge Sensitivity Tests of Electrical and Electronic Parts |
| DI-R-7039 | Failed Item Analysis Report |
| DI-R-7132 | Electrostatic Discharge Testing of Electronic Parts, Assemblies and Equipment |

CHAPTER 18:

DOD-HDBK-263

**ELECTROSTATIC DISCHARGE CONTROL HANDBOOK FOR PROTECTION
OF ELECTRICAL AND ELECTRONIC PARTS,
ASSEMBLIES AND EQUIPMENT
(EXCLUDING ELECTRICALLY INITIATED EXPLOSIVE DEVICES)**

CHAPTER 18: DOD-HDBK-263

DOD HDBK-263 is a tri-service approved document used by all branches of the military in the specification and acquisition of quality-assured electronic systems and equipment. The current version of the handbook is the initial release dated May 2, 1980.

(At the time of the printing of this Primer an "A" revision of DOD-HDBK-263, incorporating substantial changes from the material contained in the original release version, was in preparation. Unfortunately the draft copies of Revision "A", dated 23 January 1987, were not yet available for review. Therefore, before using this chapter the reader is cautioned to determine whether or not the "A" version of DOD-HDBK-263 has been released.)

The preparing activity for both documents is:

Dept. of the Navy
Naval Sea Systems Command
Att: SEA 55Z3
Washington, DC 20362-5101

This chapter is only an advisory to the use of DOD-HDBK-263. It does not supersede, modify, replace or curtail any requirements of DOD-HDBK-263 nor should it be used in lieu of that handbook.

18.1 REFERENCE DOCUMENTS

The following related documents impact and further detail these tasks and should also be referenced.

- MIL-M-38510 General Specification for Microcircuits
- MIL-STD-883 Test Methods and Procedures for Microelectronics
- MIL-STD-1285 Marking of Electrical and Electronic Parts
- DOD-STD-1686 Electrostatic Discharge Control Program for Protection of Electrical and Electronic Parts, Assemblies and Equipment (Excluding Electrically Initiated Explosive Devices)

18.2 DEFINITIONS

The definitions contained in the initial version of DOD-HDBK-263 are not repeated here because many of these definitions have since been modified.

18.3 APPLICABILITY

DOD-HDBK-263 provides **guidance** for developing, implementing, and monitoring the requirements of an ESD control program.

CHAPTER 18: DOD-HDBK-263

Electrostatic charges are generated by the relative motion, physical separation of materials, or the flow of solids, liquids, or gases. Common sources of ESD include personnel, items made of plain plastics, and processing equipment as shown in Table 18.1 taken from DOD-HDBK-263. Typical electrostatic voltages that can be generated by commonly performed functions is shown in Table 18.2 also taken from DOD-HDBK-263. ESD can damage parts by direct contact with a charged source or by charges induced from electrostatic fields. ESD susceptible parts include microcircuits, discrete semiconductors, thick and thin film resistors, chip hybrid devices and piezoelectric crystals. The nature and the extent of their possible damage depends upon the magnitude and shape of the ESD pulse.

18.4 PHYSICAL DESCRIPTION OF DOD-HDBK-263

DOD-HDBK-263 contains seventy pages. There are no appendices to this handbook.

18.5 HOW TO USE DOD-HDBK-263

This handbook cover the identification, testing, and classification of ESD Susceptible (ESDS) items, detailed device damage descriptions, protected work areas, handling procedures, personnel training and the development of training materials, marking of documentation and hardware, selection and application considerations for ESD protective material and equipments, protective covering, packaging, certification and monitoring procedures. For the purpose of the handbook, only items sensitive to discharges of 15,000 volts or less are considered.

- **Identification and Classification of ESDS Items**

The ESD susceptibility classification must be determined for each applicable item. Three major classification levels are contained in the initial release of DOD-HDBK-263 as follows, however, it should be noted that these classifications do not reflect the current thinking on the subject (for more current information see Chapter 17 in this Primer):

- Class 1: From 0 to 1,000 volts
- Class 2: From 1,000 to 4,000 volts
- Class 3: From 4,000 volts to 15,000 volts

The ESD susceptibility classification level of the item will have a major impact upon the extent of the ESD control program. The lower the classification level the more rigorous the control program must be. Table 18.3 taken from DOD-HDBK-263 gives a generic listing of part types susceptible to ESD together with their susceptibility range.

- **ESD Susceptibility Testing**

Procedures for performing ESD susceptibility testing using the human body model are illustrated in DOD-HDBK-263, however, MIL-STD-883, Method 3015 has since replaced the methodology described in the initial release of DOD-HDBK-263 as the preferred testing method.

- **Establishment of Protected Areas for the Handling and Safe Keeping of ESDS Items**

Electrostatic voltages in areas where class 1, class 2 and class 3 items are handled without protective covering should be limited to the lowest voltage susceptibility of these items. Handling of ESDS items, without ESD protective covering, must be performed in protected areas in accordance with detailed ESD protective operating and handling procedures.

CHAPTER 18: DOD-HDBK-263

TABLE 18.1:
TYPICAL PRIME CHARGE SOURCES

| Object or Process | Material or Activity |
|---|---|
| Work Surfaces | <ul style="list-style-type: none"> ● Waxed, painted or varnished surfaces ● Common vinyl or plastics |
| Floors | <ul style="list-style-type: none"> ● Sealed concrete ● Waxed, finished wood ● Common vinyl tile or sheeting |
| Clothes | <ul style="list-style-type: none"> ● Common clean room smocks ● Common synthetic personnel garments ● Non-conductive shoes ● Virgin cotton ^{1/} |
| Chairs | <ul style="list-style-type: none"> ● Finished wood ● Vinyl ● Fiberglass |
| Packaging and Handling | <ul style="list-style-type: none"> ● Common plastic - bags, wraps, envelopes ● Common bubble pack, foam ● Common plastic trays, plastic tote boxes, vials, parts bins |
| Assembly, Cleaning, Test and Repair Areas | <ul style="list-style-type: none"> ● Spray cleaners ● Common plastic solder suckers ● Solder irons with ungrounded tips ● Solvent brushes (synthetic bristles) ● Cleaning or drying by fluid or evaporation ● Temperature chambers ● Cryogenic sprays ● Heat guns and blowers ● Sand blasting ● Electrostatic copiers |

^{1/} Virgin cotton can be a static source at low relative humidities such as below 30 percent.

CHAPTER 18: DOD-HDBK-263

TABLE 18.2:
TYPICAL ELECTROSTATIC VOLTAGE

| Means of Static Generation | Electrostatic Voltage | |
|--|------------------------------------|------------------------------------|
| | 10 to 20 Percent Relative Humidity | 65 to 90 Percent Relative Humidity |
| Walking across carpet | 35,000 | 1,500 |
| Walking over vinyl floor | 12,000 | 250 |
| Worker at bench | 6,000 | 100 |
| Vinyl envelopes for work instructions | 7,000 | 600 |
| Common poly bag picked up from bench | 20,000 | 1,200 |
| Work chair padded with polyurethane foam | 18,000 | 1,500 |

CHAPTER 18: DOD-HDBK-263

**TABLE 18.3:
LIST OF ESDS PARTS BY PART TYPE**

| CLASS 1: SENSITIVITY RANGE 0 TO ≤ 1000 VOLTS |
|--|
| <ul style="list-style-type: none">● Metal Oxide Semiconductor (MOS) devices including C, D, N, P, V and other MOS technology without protective circuitry, or protective circuitry having Class 1 sensitivity● Surface Acoustic Wave (SAW) devices● Operational Amplifiers (OP AMP) with unprotected MOS capacitors● Junction Field Effect Transistors (JFETs) (Ref.: Similarity to MIL-STD-701: Junction field effect, transistors and junction field effect transistors, dual unitized)● Silicon Controlled Rectifiers (SCRs) with $I_o < 0.175$ amperes at 100° Celsius ($^\circ\text{C}$) ambient temperature (Ref.: Similarity to MIL-STD-701: Thyristors (silicon controlled rectifiers))● Precision Voltage Regulator Microcircuits: Line or Load Voltage Regulation < 0.5 percent● Microwave and Ultra-High Frequency Semiconductors and Microcircuits: Frequency > 1 gigahertz● Thin Film Resistors (Type RN) with tolerance of ≤ 0.1 percent; power > 0.05 watt● Thin Film Resistors (Type RN) with tolerance of > 0.1 percent; power ≤ 0.05 watt● Large Scale Integrated (LSI) Microcircuits including microprocessors and memories without protective circuitry, or protective circuitry having Class 1 sensitivity (Note: LSI devices usually have two to three layers of circuitry with metallization crossovers and small geometry active elements)● Hybrids utilizing Class 1 parts |
| CLASS 2: SENSITIVITY RANGE > 1000 TO ≤ 4000 VOLTS |
| <ul style="list-style-type: none">● MOS devices or devices containing MOS constituents including C, D, N, P, V, or other MOS technology with protective circuitry having Class 2 sensitivity● Schottky diodes (Ref.: Similarity to MIL-STD-701: Silicon switching diodes (listed in order of increasing t_r))● Precision Resistor Networks (Type RZ)● High Speed Emitter Coupled Logic (ECL) Microcircuits with propagation delay ≤ 1 nanosecond |

TABLE 18.3:
LIST OF ESDS PARTS BY PART TYPE (CONT'D)

| CLASS 2: SENSITIVITY RANGE > TO ≤4000 VOLTS (CONT'D) |
|---|
| <ul style="list-style-type: none"> ● Transistor-Transistor Logic (TTL) Microcircuits (Schottky, low power, high speed, high speed, and standard) ● Operational Amplifiers (OP AMP) with MOS capacitors with protective circuitry having Class 2 sensitivity ● LSI with input protection having Class 2 sensitivity ● Hybrids utilizing Class 2 parts |
| CLASS 3: SENSITIVITY RANGE >4000 TO ≤15,000 VOLTS |
| <ul style="list-style-type: none"> ● Lower Power Chopper Resistors (Ref.: Similarity to MIL-STD-701: Silicon Low Power Chopper Transistors) ● Resistors Chips ● Small Signal Diodes with power ≤1 watt excluding Zeners (Ref.: Similarity to MIL-STD-701: Silicon Switching Diodes (listed in order of increasing trr)) ● General Purpose Silicon Rectifier Diodes and Fast Recovery Diodes (Ref.: Similarity to MIL-STD-701: Silicon Axial Lead Power Rectifiers, Silicon Power Diodes (listed in order of maximum DC output current), Fast Recovery Diodes (listed in order of trr)) ● Low Power Silicon Transistors with power ≤5 watts at 25°C (Ref.: Similarity to MIL-STD-701: Silicon Switching Diodes (listed in order of increasing trr), Thyristors (bi-directional triodes), Silicon PNP Low-Power Transistors (Pc ≤5 watts @TA = 25°C), Silicon RF Transistors) ● All other Microcircuits not included in Class 1 or Class 2 ● Piezoelectric Crystals ● Hybrids utilizing Class 3 parts |

● **Establishment of Operating Procedures for ESDS Items**

Detailed procedures for handling ESDS items must be developed, documented, and implemented. The details of the procedures should be related to the susceptibility of the ESDS item being handled and the degree of controls afforded by the protected area. The more susceptible the item, and the fewer controls afforded by the protected area, the more detailed the procedures should be to provide the required protection from damage due to ESD.

CHAPTER 18: DOD-HDBK-263

- **Personnel Training**

All personnel who perform or supervise any applicable function related to ESD Susceptible parts or who have any contact with ESDS items should receive recurrent ESD training.

- **ESD Control Program Quality Assurance Provisions**

Quality assurance requirements are to be established to verify conformance to DOD-STD-1686 as tailored by the SOW. These provisions should include certification, monitoring and auditing of ESD requirements and they should also be invoked on subcontractors and suppliers.

18.6 TAILORING GUIDELINES

Tailoring of an ESD Control program primarily involves the planning and selection of specific control elements and the determination of the rigor with which each of these elements will be applied.

18.7 CONTRACT DATA REQUIREMENTS LIST (CDRL)

There are no data item descriptions specified in the initial release of DOD-HDBK-263. See DOD-STD-1686 (Chapter 17 in this Primer) for a listing of the applicable DID's.

CHAPTER 19:

MIL-STD-454K

**STANDARD GENERAL REQUIREMENTS FOR
ELECTRONIC EQUIPMENT**

CHAPTER 19: MIL-STD-454K

MIL-STD-454 is a tri-service approved document used by all branches of the military in the specification and acquisition of quality-assured electronic systems and equipment. The current version of the standard is revision "K" dated February 14, 1986. The preparing activity is:

Aeronautical Systems Division
ATTN: ASD/ENES
Wright-Patterson AFB, OH 45433-6503

This chapter is only an advisory to the use of MIL-STD-454. It does not supersede, modify, replace or curtail any of the requirements of MIL-STD-454 nor should it be used in lieu of that standard.

19.1 REFERENCE DOCUMENTS

MIL-STD-454 draws heavily on the following twelve military documents and on industrial standards as well. In addition to these twelve documents each of the seventy-five individual "Numbered Requirements" in MIL-STD-454 has its own list of applicable military or industrial standards and other reference documents.

19.1.1 Military Standards

- MIL-I-983 Interior Communication Equipment, Naval Shipboard, Basic Design Requirements for
- MIL-E-4158 Electronic Equipment, Ground, General Requirement for
- MIL-E-5400 Electronic Equipment, Airborne, General Specification for
- MIL-E-8189 Electronic Equipment, Missiles, Boosters and Allied Vehicles, General Specification for
- MIL-E-8983 Electronic Equipment, Aerospace, Extended Space Environment, General Specification for
- MIL-P-11268 Parts, Materials, and Processes Used in Electronic Equipment
- MIL-E-11991 Electrical-Electronic Equipment, Surface Guided Missile Weapon Systems, General Specification for
- MIL-E-16400 Electronic Interior Communication and Navigation Equipment, Naval Ship and Shore, General Specification for
- MIL-F-18870 Fire Control Equipment, Naval Ship and Shore, General Specification for
- MIL-T-21200 Test Equipment for Use with Electronic and Electrical Equipment, General Specification for
- MIL-T-28800 Test Equipment for Use with Electrical and Electronic Equipment, General Specification for
- FAA-G-2100 Electronic Equipment, General Requirements

CHAPTER 19: MIL-STD-454K

19.1.2 Industrial Standards

| | |
|------|--|
| AGMA | American Gear Manufacturers Association 1330 Massachusetts Ave., NW Washington, DC 20005 |
| ANSI | American National Standards Institute 1430 Broadway New York, NY 10018 |
| ASM | American Society for Metals Metals Park, OH 44073 |
| ASTM | American Society for Testing and Materials Race Street Philadelphia, PA 19103 |
| AWS | American Welding Society 2501 NW 7th Street Miami, FL 33125 |
| EIA | Electronic Industries Association Eye Street NW Washington, DC 20006 |
| IEEE | Institute of Electrical and Electronic Engineers Standards Operations 345 East 47th Street New York, NY 10017 |
| NAS | National Standards Association 1321 Fourteenth Street, NW Washington, DC 20005 |
| NFPA | National Fire Protection Association 470 Atlantic Avenue Boston, MA 02210 |
| UL | Underwriters Laboratory, Incorporated 207 E. Ohio Street Chicago, IL 60611 |

19.2 DEFINITIONS

This paragraph is not applicable to this chapter.

19.3 APPLICABILITY

As was shown in Chapter 1, Figure 1.2, MIL-STD-454 is a key document in the requirements hierarchy of specifications and standards on electronic parts. This standard is the technical baseline for the design and construction of electronic equipment for the Department of Defense. It captures in a single document, under suitable headings, fundamental design requirements from the twelve general electronic specifications listed in paragraph 19.1.1. A major advantage of this approach is

CHAPTER 19: MIL-STD-454K

the fact that it allows the contractor to focus on a single requirements document rather than twelve or more separate documents thus resulting in substantial program savings to the Government.

This document provides uniform requirements applicable to all types of electronic equipment. These requirements are incorporated into the program by reference to the specific MIL-STD-454 "Numbered Requirement" in the general equipment/program specifications.

19.4 PHYSICAL DESCRIPTION OF MIL-STD-454

MIL-STD-454 is composed of seventy-five specific "design requirements" and contains approximately two hundred and forty pages. There are no appendices; however, it has an additional four-page "Index of Documents Applicable to the Standard."

19.5 HOW TO USE MIL-STD-454

MIL-STD-454 includes a series of seventy-five specific "Numbered Requirements" that are used to provide general guidelines for the design and construction of various types of electronic equipments. These "Numbered Requirements" are as follows:

- Requirement 1 - Safety (Personnel Hazard)
- Requirement 2 - Capacitors
- Requirement 3 - Flammability
- Requirement 4 - Fungus-Inert Materials
- Requirement 5 - Soldering
- Requirement 6 - Bearings
- Requirement 7 - Interchangeability
- Requirement 8 - Electrical Overload Protection
- Requirement 9 - Workmanship
- Requirement 10 - Electrical Connectors
- Requirement 11 - Insulating Materials, Electrical
- Requirement 12 - Fastener Hardware
- Requirement 13 - Structural Welding
- Requirement 14 - Transformers, Inductors, and Coils
- Requirement 15 - Ferrous Alloys, Corrosion Resistance
- Requirement 16 - Dissimilar Metals
- Requirement 17 - Printed Wiring
- Requirement 18 - Derating of Electronic Parts and Materials
- Requirement 19 - Terminations
- Requirement 20 - Wire, Hookup, Internal
- Requirement 21 - Castings
- Requirement 22 - Parts Selection and Control
- Requirement 23 - Adhesives
- Requirement 24 - Welds, Resistance, Electrical Interconnections
- Requirement 25 - Electrical Power
- Requirement 26 - Arc-Resistant Materials
- Requirement 27 - Batteries
- Requirement 28 - Controls
- Requirement 29 - Electron Tubes
- Requirement 30 - Semiconductor Devices
- Requirement 31 - Moisture Pockets
- Requirement 32 - Test Provisions
- Requirement 33 - Resistors
- Requirement 34 - Nomenclature
- Requirement 35 - Reliability

CHAPTER 19: MIL-STD-454K

- Requirement 36 - Accessibility
- Requirement 37 - Circuit Breakers
- Requirement 38 - Quartz Crystals and Oscillator Units
- Requirement 39 - Fuses, Fuse Holders, and Associated Hardware
- Requirement 40 - Shunts
- Requirement 41 - Springs
- Requirement 42 - Tuning Dial Mechanisms
- Requirement 43 - Lubricants
- Requirement 44 - Fibrous Material, Organic
- Requirement 45 - Corona and Electrical Breakdown Prevention
- Requirement 46 - Motors, Dynamotors, Rotary Power Converters and Motor-Generators
- Requirement 47 - Encapsulation and Embedment (Potting)
- Requirement 48 - Gears
- Requirement 49 - Hydraulics
- Requirement 50 - Indicator Lights
- Requirement 51 - Meters, Electrical Indicating, and Accessories
- Requirement 52 - Thermal Design
- Requirement 53 - Waveguides and Related Devices
- Requirement 54 - Maintainability
- Requirement 55 - Enclosures
- Requirement 56 - Rotary Servo Devices
- Requirement 57 - Relays
- Requirement 58 - Switches
- Requirement 59 - Brazing
- Requirement 60 - Sockets and Accessories
- Requirement 61 - Electromagnetic Interference Control
- Requirement 62 - Human Engineering
- Requirement 63 - Special Tools
- Requirement 64 - Microelectronic Devices
- Requirement 65 - Cable, Coaxial (RF)
- Requirement 66 - Cable, Multiconductor
- Requirement 67 - Marking
- Requirement 68 - Readouts and Displays
- Requirement 69 - Internal Wiring Practices
- Requirement 70 - Electrical Filters
- Requirement 71 - Cable and Wire, Interconnection
- Requirement 72 - Substitutability
- Requirement 73 - Standard Electronic Modules
- Requirement 74 - Grounding, Bonding, and Shielding
- Requirement 75 - Electrostatic Discharge Control

Each requirement is intended to cover some discipline in the design of equipment, such as a procedure, a process or the selection and application of parts and materials. Many of these disciplines, however, cannot retain a clear-cut separation or isolation from others so that when requirements of MIL-STD-454 are referenced in a specification some will undoubtedly have a direct interrelationship with other requirements. This circumstance should be taken into consideration when invoking or using MIL-STD-454.

CHAPTER 19: MIL-STD-454K

19.6 TAILORING GUIDELINES

Tailoring of standard general requirements for electronic equipment involves the selection of specific "Numbered Requirements" and the rigor with which each of these "Numbered Requirements" is applied on a specific program.

19.6.1 When and How to Tailor

MIL-STD-454 is written as a series of specific "Numbered Requirements" to assist the contractor in the development and establishment of a cost effective design. Tailoring of the requirements is implicit in this approach.

19.7 CONTRACTS DATA REQUIREMENTS LIST (CDRL)

No Deliverable Data Items are required by MIL-STD-454.

SECTION 5

MAJOR PARTS SPECIFICATIONS

- CHAPTER 20 MIL-STD-1562R: LISTS OF STANDARD
MICROCIRCUITS**
- CHAPTER 21 MIL-M-38510H: GENERAL SPECIFICATION FOR
MICROCIRCUITS**
- CHAPTER 22 MIL-STD-883C: TEST METHODS AND
PROCEDURES FOR MICROELECTRONICS**
- CHAPTER 23 MIL-STD-1772A: CERTIFICATION REQUIREMENTS
FOR HYBRID MICROCIRCUIT FACILITY AND
LINES**
- CHAPTER 24 MIL-S-19500: GENERAL SPECIFICATION FOR
SEMICONDUCTOR DEVICES**
- CHAPTER 25 MIL-STD-750C: TEST METHODS FOR
SEMICONDUCTOR DEVICES**
- CHAPTER 26 MIL-STD-701M: LISTS OF STANDARD
SEMICONDUCTOR DEVICES**
- CHAPTER 27 MIL-STD-198E: SELECTION AND USE OF
CAPACITORS**
- CHAPTER 28 MIL-STD-199D: SELECTION AND USE OF
RESISTORS**
- CHAPTER 29 MIL-STD-790D: RELIABILITY ASSURANCE
PROGRAM FOR ELECTRONIC PARTS
SPECIFICATION**
- CHAPTER 30 MIL-STD-965A: PARTS CONTROL PROGRAM**
- CHAPTER 31 MIL-STD-1556B: GOVERNMENT/INDUSTRY DATA
EXCHANGE PROGRAM (GIDEP) CONTRACTOR**
- CHAPTER 32 MIL-STD-202F: TEST METHODS FOR ELECTRONIC
AND ELECTRICAL COMPONENT PARTS**

CHAPTER 20:

MIL-STD-1562R

LISTS OF STANDARD MICROCIRCUITS

CHAPTER 20: MIL-STD-1562R

MIL-STD-1562 is a tri-service approved document used by all branches of the military in the specification and acquisition of quality-assured electronic equipment. The current version is Revision "R" dated February 3, 1988. The preparing activity is:

Rome Air Development Center
ATTN: RBE-2, Product Evaluation Section
Griffiss AFB, NY 13441-5700

This chapter is only an advisory to the use of MIL-STD-1562. It does not supersede, modify, replace or curtail any requirements of MIL-STD-1562 nor should it be used in lieu of that standard.

20.1 REFERENCE DOCUMENTS

The following related documents impact and further detail these requirements and should also be referenced.

- MIL-M-38510 General Specification for Microcircuits
- MIL-STD-1331 Parameters to be Controlled for the Specification of Microcircuits

20.2 DEFINITIONS

This paragraph is not applicable to this chapter.

20.3 APPLICABILITY

This document contains the requirements established by the Department of Defense for the selection of standard microcircuits used in the design, manufacture and support of military equipment. It also identifies those devices which are less acceptable for new designs due to non-availability, obsolescence or problems of performance, reliability, etc.

MIL-STD-1562 provides equipment designers and manufacturers with lists of standard microcircuits for use in military and space applications. The following points delineate the primary intent of the document:

- To provide the equipment designers, manufacturers and users with the most acceptable microcircuits available for use in space and military applications
- To control and minimize the variety of microcircuits used in military equipment in order to facilitate logistic support of equipment in the field
- To concentrate economic support, improvement and production on those microcircuits currently listed in the standard

20.4 PHYSICAL DESCRIPTION OF MIL-STD-1562

MIL-STD-1562 contains approximately one hundred and twenty-two pages. The standard contains lists of microcircuit devices grouped into five different tables by their approval status, and a cross reference table. There are no appendices to this standard.

CHAPTER 20: MIL-STD-1562R

20.5 HOW MIL-STD-1562 IS USED

It is generally a Department of Defense requirement that all microcircuits used in the design and manufacture of military equipment must be selected from those listed in MIL-STD-1562. The following criteria are stipulated for a microcircuit's inclusion in this standard as a preferred part for a new design.

- The microcircuit is considered by representatives of the military departments to be the best available type for current applications.
- The microcircuit is currently in production and continued availability is reasonably certain.
- The microcircuit has an approved military detail specification or DESC- issued Military Standardized Drawing.

Military equipment is to be designed so that it will meet the specified equipment performance and reliability requirements when using the microcircuits listed in MIL-STD-1562. Device characteristics and parameters applicable to the microcircuits listed in MIL-STD-1562 are specifically defined in the detail device specifications of MIL-M-38510. Satisfactory equipment performance must not depend on characteristics or parameters which are not controlled by the applicable MIL-M-38510 detail specification.

20.5.1 Outline of MIL-STD-1562

The microcircuits listed in MIL-STD-1562 are categorized according to their approval status for use in military applications. The approval status distinctions are given in the following Tables:

- **Table I: Preferred Devices**

All devices in this group have a dated military specification and a QPL source. These devices have no known reliability or availability problems and are recommended and preferred for new design.

- **Table II: Potential Standardization Candidates**

Devices listed in this table are those that have been selected for electrical characterization and are potential candidates for MIL-M-38510 specification or have an active DESC drawing. This table also includes devices that have a dated military specification but as yet have no QPL source. These devices may be considered for use in systems or equipment designs if a QPL source is anticipated.

- **Table III: Logistics or Continuous Replacement Only**

This table contains devices which are not recommended for new designs because of diminishing sources, obsolete technology, or the fact that a preferred device, listed in tables I or II, is now available which performs the same function.

- **Table IV: Inactive or Suspended Military Activity**

This table contains devices which are not recommended for new design, it also includes devices which have had a QPL status that has been canceled or expired and there is no indication that a device manufacturer intends to re-qualify that device.

CHAPTER 20: MIL-STD-156..R

- **Table V: Not Recommended Under Any Circumstances**

Devices listed in this table should not be used. The listing will also identify a preferred device to be used for new design.

- **Table VI: Cross Reference**

This table is a cross reference for all of the parts addressed by the standard (regardless of their approval status), between the generic/industrial number and the military part number (MIL-M-38510 or DESC drawing or Military drawing), table number, function grouping, and NATO status.

The applicable device specification documents identified with each device listed in the above tables should be referred to for more detailed information. In the event of conflict between the device's technical description in MIL-STD-1562 and the applicable detail specification description, the detail specification shall govern.

Sample portions of MIL-STD-1562P Tables II (Potential Standardization Candidate), IV (Inactive or Suspended Military Activity) and V (Not Recommended Under Any Circumstances) are shown in Tables 20.1, 20.2, 20.3, respectively.

20.6 TAILORING GUIDELINES

MIL-STD-1562 was not written with the intent of tailoring. In the event that equipment or system requirements cannot be met by the microcircuits listed in Table I or Table II of MIL-STD-1562, the equipment manufacturer is encouraged to do the following:

- Determine if an item listed in Table III of MIL-STD-1562 can meet the system or equipment requirements.
- Contact the Military Parts Control Advisory Group (MPCAG) at the Defense Electronic Supply Center, Dayton, OH 45444 for approval to use such parts.

The requirements in MIL-STD-1562 are not intended to be modified without such explicit approval.

20.7 CONTRACT DATA REQUIREMENTS LIST (CDRL)

There are no data item descriptions applicable to MIL-STD-1562.

CHAPTER 20: MIL-STD-1562R

TABLE 20.1: POTENTIAL STANDARDIZATION CANDIDATE

(Devices listed in this table are those that have been selected for electrical characterization and are potential candidates for MIL-M-38510 specification or that have an active Military drawing (DESC). This table also includes devices that have dated military specifications but as yet have no QPL source. These devices shall be considered for use in systems or equipment designs if a QPL source is anticipated).

| General industry drawing number | Military drawing or DESC drawing number | Proposed MIL-M-38510 part no. | Circuit description |
|---------------------------------|---|-------------------------------|--|
| Gates | | | |
| 10H503 | 5962-87565 | XXXXX | Quad 2-input OR gate |
| 10H506 | 5962-87564 | XXXXX | Triple 4-3-3 input NOR gate |
| 10H513 | 5962-87558 | XXXXX | Quad exclusive OR gate |
| 10H509 | 5962-87569 | XXXXX | Dual 4-5 input OR NOR gate |
| 14584 | 5962-85501 | XXXXX | Hex Schmitt trigger |
| 40009 | | 05251** | Dual 3-input NOR gate plus inverter |
| 40106B | 5962-85501 | 17702** | Hex Schmitt trigger |
| 4148B | | 05354** | 8-input multifunctional gate (expandable) |
| 4078B | 77044 | XXXXX | 8-input NOR gate |
| 54AC00 | 5962-87549 | 75001 | Quad 2-input NAND gate |
| 54HC00 | 5962-86831 | XXXXX | Quad 2-input NAND gate |
| 54-103 | 5962-87647 | XXXXX | Quad 2-input NAND gate with open drain outputs |
| 54AC04 | 5962-87609 | XXXXX | Hex inverter |
| 54HC04 | | 65751** | Hex inverter |
| 54HC004 | 86010 | XXXXX | Unbuffered hex inverter |
| 54AC08 | 5962-87615 | XXXXX | Quad 2-input AND gate |
| 54C08 | 77036 | XXXXX | Quad 2-input AND gate |
| 54HC08 | 5962-86883 | XXXXX | Quad 2-input AND gate |
| 54ALS09 | 84142 | XXXXX | Quad 2-input AND gate (Open Collector) |
| 54AC10 | | 75002 | Triple 3-input NAND gate |
| 54AC11 | 5962-87611 | XXXXX | Triple 3-input AND gate |
| 54AC11000 | 5962-87549 | XXXXX | Quad 2-input NAND gate |
| 54AC11020 | 5962-87613 | 750XX | Dual 4-input NAND gate |
| 54AC133 | 5962-87723 | XXXXX | 13-input NAND gate |
| 54AC14 | 5962-87624 | XXXXX | Hex inverter (with Schmitt trigger) |
| 54HC14 | 5962-86890 | 65752** | Hex inverter Schmitt trigger |
| 54AC21 | 5962-87613 | 75003 | Dual 4-input NAND gate |
| 54ALS21 | 84143 | XXXXX | Dual 4-input AND gate |
| 54AC21 | 5962-87804 | XXXXX | Dual 4-input positive AND gate |
| 54AC30 | | 75004 | 8-input NAND gate |
| 54HC32 | 5962-86852 | XXXXX | Quad 2-input OR gate |
| 54HC4075 | 5962-87722 | XXXXX | Triple 3-input OR gate |
| 54HC1266 | 84043 | 65105** | Quad 2-input exclusive NOR gate |
| Buffers | | | |
| 255240 | 5962-86724 | XXXXX | Data inverting buffer (3 State) |
| AM255241 | 5962-86725 | XXXXX | Non-inverting buffer (3 State) |
| AM255244 | 5962-87536 | XXXXX | Data non-inverting buffer (3 State) |

CHAPTER 20: MIL-STD-1562R

TABLE 20.2: INACTIVE OR SUSPENDED MILITARY ACTIVITY

(This table contains devices which are not recommended for new design, it also includes devices which have had QPL status that has been cancelled or expired and there is no indication that a device manufacturer intends to re-qualify).

| Generic/ Industry number | MIL-M- 38510/ type | Device type | Circuit description |
|--------------------------------|--------------------------|----------------|--|
| <u>Gates 1/</u> | | | |
| MC3101 | 155 | 01 | Quad 2 input AND gate |
| MC3106 | 155 | 02 | Triple 3 input AND gate |
| MC3111 | 155 | 03 | Dual 4 input AND gate |
| 54H08 | 155 | 01 | Quad 2 input AND gate |
| 54H08 | 155 | 04 | Quad 2 input AND gate |
| 54S09 | 080 | 04 | Quad 2 input AND gate (Open Collector) |
| 54H11 | 155 | 02 | Triple 3 input AND gate |
| 54S134 | 070 | 10 | 12 input NAND gate (3 State) |
| 54S15 | 080 | 02 | Triple 3 input AND gate (Open Collector) |
| 54H21 | 155 | 03 | Dual 4 input AND gate |
| 54H50 | 040 | 01 | Dual 2 wide 2 input AND-OR-invert gate (expandable) |
| 54H51 | 040 | 02 | Dual 2 wide 2 input AND-OR-invert gate |
| 54L51 | 041 | 01 | Dual 2 wide AND-OR-invert gate |
| 54H53 | 040 | 03 | 2-2-2-3 input AND-OR-invert gate (expandable) |
| 54H54 | 040 | 04 | 2-2-2-3 input AND-OR-invert gate |
| 54L54 | 041 | 02 | 4 wide 3-2-2-3 input AND-OR-invert gate |
| 54H55 | 040 | 05 | 2 wide 4 input AND-OR-invert gate (expandable) |
| 54L55 | 041 | 03 | 2 wide 4 input AND-OR-invert gate |
| <u>Buffers 2/</u> | | | |
| 1856 | 476 | 01 | 4 bit memory data bus buffer/separator |
| 1857 | 476 | 02 | 4 bit input/output bus buffer/separator |
| 5428 | 162 | 01 | Quad 2 input NOR gate buffer |
| 54H40 | 024 | 01 | Dual 4 input NAND gate buffer (high speed) |
| 932 | 031 | 01 | Dual 4 input NAND buffer (expandable) |
| 933 | 031 | 05 | Dual 4 input extender |
| 944 | 031 | 02 | Dual 4 input NAND buffer (expandable, Open Collector) |
| 957 | 031 | 03 | Quad 2 input NAND buffer |
| 958 | 031 | 04 | Quad 2 input NAND buffer (Open Collector) |
| <u>Flip-Flops 3/</u> | | | |
| 54L121 | 042 | 01 | Monostable multivibrator |
| 54L122 | 042 | 02 | Monostable multivibrator (retriggerable, with clear) |
| 9093 | 033 | 04 | Dual JK flip-flop |
| 945 | 033 | 01 | Clocked RS/JK flip-flop |
| 948 | 033 | 02 | Clocked RS/JK flip-flop |
| 950 | 033 | 03 | Pulse-triggered binary flip-flop |
| 951 | 032 | 01 | Monostable multivibrator |
| <u>Combinational gates 4/</u> | | | |
| 54147 | 156 | 01 | 10 to 4 line data encoder (without enable) |
| 54148 | 156 | 02 | 8 to 3 line data encoder (with enable) |

CHAPTER 20: MIL-STD-1562R

TABLE 20.3: NOT RECOMMENDED UNDER ANY CIRCUMSTANCES

(Devices listed in this table will also have a preferred device for new design).

| Generic/ Industry number | MIL-M- 38510/ | Device type | Circuit description | Preferred device for new designs |
|---|------------------|----------------|--|-------------------------------------|
| Microprocessors and interface peripherals/FIFO 8/ | | | | |
| SBP9900A | 460 | 01 | 16 bit fixed instruction microprocessor (3.0 MHz) | 8086, /53001* |

CHAPTER 21:

MIL-M-38510H

GENERAL SPECIFICATION FOR MICROCIRCUITS

CHAPTER 21: MIL-M-38510H

MIL-M-38510 is a tri-service-approved document used by all branches of the military in the specification and acquisition of quality-assured electronic equipment. The current version is revision "H" dated February 12, 1988. The preparing activity is:

Rome Air Development Center (RADC)
ATTN: RBE-2
Griffiss AFB, NY 13441-5700

This chapter is only an advisory to the use of MIL-M-38510. It does not supersede, modify, replace or curtail any requirements of MIL-M-38510 nor should it be used in lieu of that standard.

21.1 REFERENCE DOCUMENTS

The following related documents impact and further detail these requirements and should also be referenced.

- MIL-M-55565 Packaging of Microcircuits
- MIL-STD-883 Test Methods and Procedures for Microelectronics
- MIL-STD-976 Certification Requirements for Microcircuits
- MIL-STD-1285 Marking of Electrical and Electronic Parts
- MIL-STD-1331 Parameters to be controlled for the Specification of Microcircuits
- MIL-STD-1562 Lists of Standard Microcircuits
- MIL-STD-1772 Certification Requirements for Hybrid Microcircuits facilities and Lines
- EIA-STD-541 Packaging Material Standards for ESD Sensitive Items
- EIA-STD-RS-471 Symbol and Label for Electrostatic Sensitive Devices

21.2 DEFINITIONS

This paragraph is not applicable to this chapter.

21.3 APPLICABILITY

MIL-M-38510 provides criteria and methodology for the characterization of standard JAN microcircuits jointly approved by the three military services, Army, Navy and Air Force, for use in the design and manufacture of military systems and equipment.

The specification establishes the general design and product assurance requirements necessary for the qualification and acquisition of military approved (JAN) monolithic, multichip, and hybrid microcircuits. It also includes detailed provisions which are specific to the particular device type. This data is specified in the applicable device specification (frequently referred to as a slash sheet).

Two levels of product assurance requirements and control are provided in this specification. These quality grades are Class S for space applications and Class B for all other military applications.

CHAPTER 21: MIL-M-38510H

The purpose of MIL-M-38510 is three-fold:

- To provide the equipment designer with standard JAN microcircuits for use in space and military applications
- To control and minimize the variety of microcircuits used in military equipment in order to facilitate logistic support of equipment in the field
- To establish specific criteria for the qualification and production of JAN microcircuits for use in space applications and in military systems and equipment

21.4 PHYSICAL DESCRIPTION OF MIL-M-38510

MIL-M-38510 consists of a complex group of different types of documentation: a) the Basic Specification, b) an extensive series of Individual Device Specifications (slash sheets), c) a summary Supplement, d) the Qualified Products List (QPL) and e) the Qualified Manufacturers List (QML) for Custom Hybrid Products. The following is a brief description of each of these different types of documents.

- **Basic Specification**

The MIL-M-38510 Basic Specification contains the general design guidelines, product assurance and packaging requirements necessary for the qualification, product screening and continuing quality conformance assurance of all microcircuits regardless of type and technology used in their fabrication. An example of the quality assurance program requirements is shown in Table 21.1 taken from MIL-M-38510 Appendix A. An example of the Lot Tolerance Percent Defective (LTPD) sampling plan required to meet the continuing quality conformance assurance requirements is shown in Table 21.2 taken from MIL-M-38510 Appendix B.

The basic specification is forty-nine pages in length. It also has seven supporting appendices and an index for a total of one hundred and thirty additional pages. These seven appendices are titled as follows:

Appendix A: Quality Assurance Program

Appendix B: Statistical Sampling, Test and Inspection Procedures

Appendix C: Case (Package) Outlines

Appendix D: Material and Test Data Required for Listing of Microcircuits in the Qualified Products List and to Receive Authorization to Test

Appendix E: Microcircuit Group Assignments for Quality Conformance Inspection and Technology Group Assignments for Qualification

Appendix F: Requirements for the Preparation of Device Specifications or Drawings

Appendix G: General Requirements for Custom Hybrid and Multichip Microcircuits

TABLE 21.1: QUALITY ASSURANCE PROGRAM REQUIREMENTS

| In-house documentation covering these areas (30.1.1) | In-house records covering these areas (30.1.2) | A program plan covering these areas (30.1.3) | Self audit plan covering these areas (40.3) |
|---|--|---|---|
| a. Conversion of customer requirements into manufacturer's internal instructions (30.1.1.1) | a. Personnel training and testing (30.1.2.1) | a. Functional block organization chart (30.1.3.1) | a. Self audit program (40.3.1) |
| b. Personnel training and testing (30.1.1.2) | b. Inspection operations (30.1.2.2) | b. Examples of manufacturing flowchart (30.1.3.2) | b. Self audit representatives (40.2.2) |
| c. Inspection of incoming materials and utilities and of work in-process (30.1.1.3) | c. Failure and defect reports and analyses (30.1.2.3) | c. Proprietary-documents (30.1.3.3) | c. Audit deficiencies (40.3.3) |
| d. Quality-control operations (30.1.1.4) | d. Change in design, materials, or processing (30.1.2.4) | d. Examples of design, material, equipment, and process instructions (30.1.3.4) | d. Audit follow-up (40.3.4) |
| e. Quality assurance operations (30.1.1.5) | e. Equipment calibrations (30.1.2.5) | e. Examples of records (30.1.3.5) | e. Audit schedules (40.3.5) |
| f. Design, processing, manufacturing equipment and materials instructions (30.1.1.6) | f. Process utility and material controls (30.1.2.6) | f. Examples of design, material and process change control documents (30.1.1.8) and as required in 3.4.1.2.3 and 3.4.2) | f. Self audit areas (40.3.6) |
| g. Cleanliness and atmosphere control in work areas (30.1.1.7) | g. Product lot identification (30.1.2.7) | g. Examples of failure and defect analysis and feedback documents (30.1.1.10) | g. Self audit checklist (40.3.7) |
| h. Design, material, and process change control (30.1.1.8) | h. Product traceability (30.1.2.8) | h. Examples of corrective action and evaluation documents (30.1.1.11) | h. Deficiency review (40.3.8) |
| i. Tool and test equipment maintenance and calibration (30.1.1.9) | | i. Manufacturer's internal instructions for internal visual inspection (30.1.3.6) | |
| j. Failure and defect analysis and feedback (30.1.1.10) | | j. Examples of test travelers (30.1.3.7) | |
| k. Corrective action and evaluation (30.1.1.11) | | k. Examples of design and construction baseline (30.1.3.8) | |
| l. Incoming, in process, and outgoing inventory control (30.1.1.12) | | l. Manufacturer's self audit (30.1.3.9) | |
| m. Schematics (30.1.1.13) | | | |
| n. ESD handling control program (30.1.1.14) | | | |

TABLE 21.2:
MIL-M-38510H LTPD SAMPLING PLAN. 1/2/

Minimum size of sample to be tested to assure, with a 90 percent confidence, that a lot having percent-defective equal to the specified LTPD will not be accepted (single sample).

| Max. percent defective (LTPD) or A | 50 | 30 | 20 | 15 | 10 | 7 | 5 | 3 | 2 | 1.5 | 1 | 0.7 | 0.5 | 0.3 | 0.2 | 0.15 | 0.1 |
|------------------------------------|--------|--------|--------|--------|--------|--------|--------|--------|--------|---------|---------|---------|---------|---------|---------|---------|---------|
| 0 | 5 | 8 | 11 | 15 | 22 | 32 | 45 | 76 | 116 | 153 | 231 | 328 | 461 | 767 | 1152 | 1534 | 2303 |
| | (1.03) | (0.64) | (0.46) | (0.34) | (0.23) | (0.16) | (0.11) | (0.07) | (0.04) | (0.03) | (0.02) | (0.02) | (0.01) | (0.007) | (0.005) | (0.003) | (0.002) |
| 1 | 8 | 13 | 18 | 25 | 38 | 55 | 77 | 129 | 195 | 258 | 390 | 555 | 778 | 1296 | 1946 | 2592 | 3891 |
| | (1.4) | (2.7) | (2.0) | (1.4) | (0.94) | (0.65) | (0.46) | (0.28) | (0.18) | (0.14) | (0.09) | (0.06) | (0.045) | (0.027) | (0.018) | (0.013) | (0.009) |
| 2 | 11 | 18 | 25 | 34 | 52 | 75 | 105 | 176 | 266 | 354 | 533 | 759 | 1065 | 1773 | 2662 | 3547 | 5323 |
| | (1.74) | (4.5) | (3.4) | (2.24) | (1.6) | (1.1) | (0.78) | (0.47) | (0.31) | (0.23) | (0.15) | (0.11) | (0.080) | (0.045) | (0.031) | (0.022) | (0.015) |
| 3 | 13 | 22 | 32 | 43 | 65 | 94 | 132 | 221 | 333 | 444 | 668 | 953 | 1337 | 2226 | 3341 | 4452 | 6681 |
| | (10.5) | (6.2) | (4.4) | (3.2) | (2.1) | (1.5) | (1.0) | (0.62) | (0.41) | (0.31) | (0.20) | (0.14) | (0.10) | (0.062) | (0.041) | (0.031) | (0.018) |
| 4 | 16 | 27 | 38 | 52 | 78 | 113 | 158 | 265 | 398 | 531 | 798 | 1140 | 1599 | 2663 | 3997 | 5327 | 7994 |
| | (12.3) | (7.3) | (5.3) | (3.9) | (2.6) | (1.8) | (1.3) | (0.75) | (0.50) | (0.37) | (0.25) | (0.17) | (0.12) | (0.074) | (0.049) | (0.037) | (0.025) |
| 5 | 19 | 31 | 45 | 60 | 91 | 131 | 184 | 308 | 462 | 617 | 927 | 1323 | 1855 | 3090 | 4638 | 6181 | 9275 |
| | (13.6) | (8.4) | (6.0) | (4.4) | (2.9) | (2.0) | (1.4) | (0.85) | (0.57) | (0.42) | (0.28) | (0.20) | (0.14) | (0.085) | (0.056) | (0.042) | (0.028) |
| 6 | 21 | 35 | 51 | 68 | 104 | 149 | 209 | 349 | 528 | 707 | 1054 | 1503 | 2107 | 3509 | 5267 | 7019 | 10533 |
| | (15.6) | (9.4) | (6.6) | (4.9) | (3.2) | (2.2) | (1.6) | (0.94) | (0.62) | (0.47) | (0.31) | (0.22) | (0.155) | (0.093) | (0.062) | (0.047) | (0.031) |
| 7 | 24 | 39 | 51 | 77 | 116 | 166 | 234 | 390 | 589 | 783 | 1178 | 1680 | 2355 | 3922 | 5686 | 7845 | 11771 |
| | (16.6) | (10.2) | (7.2) | (5.3) | (3.5) | (2.4) | (1.7) | (1.0) | (0.67) | (0.51) | (0.34) | (0.24) | (0.17) | (0.101) | (0.067) | (0.051) | (0.034) |
| 8 | 26 | 43 | 63 | 85 | 128 | 184 | 258 | 431 | 648 | 864 | 1300 | 1854 | 2599 | 4329 | 6498 | 8660 | 12992 |
| | (18.1) | (10.9) | (7.7) | (5.6) | (3.7) | (2.6) | (1.8) | (1.1) | (0.72) | (0.54) | (0.38) | (0.25) | (0.18) | (0.108) | (0.072) | (0.054) | (0.036) |
| 9 | 28 | 47 | 69 | 93 | 140 | 201 | 282 | 471 | 709 | 945 | 1421 | 2027 | 2842 | 4733 | 7103 | 9468 | 14206 |
| | (19.4) | (11.5) | (8.1) | (6.0) | (3.9) | (2.7) | (1.9) | (1.2) | (0.77) | (0.58) | (0.38) | (0.27) | (0.19) | (0.114) | (0.077) | (0.057) | (0.038) |
| 10 | 31 | 51 | 75 | 100 | 152 | 218 | 306 | 511 | 770 | 1025 | 1541 | 2199 | 3082 | 5133 | 7704 | 10268 | 15407 |
| | (19.9) | (12.1) | (8.4) | (6.3) | (4.1) | (2.9) | (2.0) | (1.2) | (0.80) | (0.50) | (0.40) | (0.28) | (0.20) | (0.120) | (0.080) | (0.060) | (0.040) |
| 11 | 33 | 54 | 83 | 111 | 166 | 238 | 332 | 555 | 832 | 1109 | 1664 | 2378 | 3323 | 5546 | 8319 | 11092 | 16638 |
| | (21.0) | (12.8) | (8.3) | (6.2) | (4.2) | (2.9) | (2.1) | (1.2) | (0.83) | (0.62) | (0.42) | (0.29) | (0.21) | (0.12) | (0.083) | (0.062) | (0.042) |
| 12 | 36 | 59 | 89 | 119 | 178 | 254 | 356 | 594 | 890 | 1187 | 1781 | 2544 | 3562 | 5936 | 8904 | 11872 | 17808 |
| | (21.4) | (13.0) | (8.6) | (6.5) | (4.3) | (3.0) | (2.2) | (1.3) | (0.86) | (0.65) | (0.43) | (0.3) | (0.22) | (0.13) | (0.086) | (0.065) | (0.043) |
| 13 | 38 | 63 | 95 | 125 | 190 | 271 | 379 | 632 | 948 | 1264 | 1896 | 2709 | 3793 | 6321 | 9482 | 12643 | 18964 |
| | (22.3) | (13.4) | (8.9) | (6.7) | (4.5) | (3.1) | (2.26) | (1.3) | (0.89) | (0.67) | (0.44) | (0.31) | (0.22) | (0.134) | (0.089) | (0.067) | (0.045) |
| 14 | 40 | 67 | 101 | 134 | 201 | 288 | 403 | 672 | 1007 | 1343 | 2015 | 2878 | 4029 | 6716 | 10073 | 13431 | 20146 |
| | (23.1) | (13.8) | (9.2) | (6.9) | (4.6) | (3.2) | (2.3) | (1.4) | (0.92) | (0.69) | (0.46) | (0.32) | (0.23) | (0.138) | (0.092) | (0.069) | (0.046) |
| 15 | 43 | 71 | 107 | 142 | 213 | 305 | 426 | 711 | 1086 | 1422 | 2133 | 3046 | 4265 | 7108 | 10662 | 14216 | 21324 |
| | (23.3) | (14.1) | (9.4) | (7.1) | (4.7) | (3.3) | (2.36) | (1.4) | (0.94) | (0.71) | (0.47) | (0.33) | (0.235) | (0.141) | (0.094) | (0.070) | (0.047) |
| 16 | 45 | 74 | 112 | 150 | 225 | 321 | 450 | 750 | 1124 | 1499 | 2219 | 3212 | 4497 | 7496 | 11244 | 14992 | 22487 |
| | (24.1) | (14.6) | (9.7) | (7.2) | (4.8) | (3.37) | (2.4) | (1.44) | (0.96) | (0.72) | (0.48) | (0.337) | (0.241) | (0.144) | (0.096) | (0.072) | (0.048) |
| 17 | 47 | 79 | 118 | 158 | 236 | 338 | 473 | 788 | 1182 | 1576 | 2364 | 3377 | 4728 | 7880 | 11819 | 15759 | 23639 |
| | (24.7) | (14.7) | (9.86) | (7.36) | (4.93) | (3.44) | (2.46) | (1.48) | (0.98) | (0.74) | (0.49) | (0.344) | (0.246) | (0.148) | (0.098) | (0.074) | (0.049) |
| 18 | 50 | 83 | 124 | 165 | 248 | 354 | 496 | 826 | 1239 | 1652 | 2478 | 3540 | 4956 | 8260 | 12390 | 16520 | 24780 |
| | (24.9) | (15.0) | (10.0) | (7.54) | (5.02) | (3.51) | (2.51) | (1.51) | (1.0) | (0.75) | (0.50) | (0.351) | (0.251) | (0.151) | (0.100) | (0.075) | (0.050) |
| 19 | 52 | 86 | 130 | 173 | 259 | 370 | 518 | 864 | 1296 | 1728 | 2591 | 3702 | 5183 | 8638 | 12957 | 17276 | 25914 |
| | (25.5) | (15.4) | (10.2) | (7.76) | (5.12) | (3.58) | (2.56) | (1.53) | (1.02) | (0.77) | (0.52) | (0.358) | (0.256) | (0.153) | (0.102) | (0.077) | (0.051) |
| 20 | 54 | 90 | 135 | 180 | 271 | 386 | 541 | 902 | 1353 | 1803 | 2705 | 3864 | 5410 | 9017 | 13526 | 18034 | 27051 |
| | (26.1) | (15.6) | (10.4) | (7.82) | (5.19) | (3.65) | (2.60) | (1.56) | (1.04) | (0.78) | (0.52) | (0.364) | (0.260) | (0.156) | (0.104) | (0.078) | (0.052) |
| 25 | 65 | 109 | 163 | 217 | 326 | 466 | 652 | 1086 | 1629 | 2173 | 3259 | 4656 | 6518 | 10863 | 16295 | 21726 | 32589 |
| | (27.0) | (16.1) | (10.8) | (8.08) | (5.38) | (3.76) | (2.69) | (1.61) | (1.08) | (0.807) | (0.538) | (0.376) | (0.269) | (0.161) | (0.108) | (0.081) | (0.054) |

Minimum sample sizes
(For device-hours required for life test, multiply by 1000)

1/ Sample sizes are based upon the Poisson exponential binomial limit.
2/ The minimum quality (approximate AQL) required to accept (on the average) 19 to 20 lots is shown in parenthesis for information only.

CHAPTER 21: MIL-M-38510H

- **Individual Device Specification**

The MIL-M-38510 individual device specifications or slash sheets contain specific device parameters, general design guidelines and product assurance requirements which are unique to a specific device or group of devices. Each slash sheet addresses a small family of such devices. The devices on a given slash sheet must all be similar in their design, complexity and function, and all must utilize identical technology in their fabrication.

Each slash sheet is an individual, separately-maintained document. New slash sheets are continually being issued and older slash sheets modified. As of April 1988 there are 235 active MIL-M-38510 slash sheets covering 1047 devices. Individual Slash sheets vary in length. Many contain sixty or more pages. An example of a portion of a detailed slash sheet is shown in Figure 21.1.

- **Qualified Products List**

The MIL-M-38510 QPL provides a detailed listing of each specific device, its quality grade, package configuration and pin finish together with identification of the specific manufacturer and his facility(s) that has met all of the necessary certification and qualification, product screening and quality conformance requirements and is thus an approved source for that device. An example of the procedure for QPL listing is shown in Figure 21.2, taken from MIL-M-38510 Appendix D.

The QPL is divided into two sections: Part I and Part II. Part II is a temporary listing. It indicates that the manufacturer has not yet completed the entire qualification program but has been given a temporary certification to supply a given part. In contrast, a Part I listing indicates that the manufacturer has completed the full qualification program and that he will be allowed to continue to supply that part to the military for as long as he continues to meet all of the requirements of MIL-M-38510. The QPL is updated quarterly and is approximately seventy-two pages in length. An example of a portion of a QPL is shown in Figure 21.3.

- **Qualified Manufacturers List**

The MIL-M-38510 QML provides a listing of custom hybrid device manufacturers and their specific facility(s) which have been qualified under the requirements for the production of such products as specified in the latest issue of MIL-M-38510, Appendix G. Despite their listing on the QML these products do not bear the "JAN" certification mark or the "J" abbreviation.

The QML is divided into two sections: The basic document and Attachment I. Attachment I identifies, by code, the materials and manufacturing construction techniques applicable to each manufacturer and facility to which the qualification applies.

The QML is updated approximately quarterly and is presently three pages in length. Attachment I contains an additional three pages. The QML is a very new document, however, and it is anticipated that this document will grow significantly in size in the future. Examples of a portion of the basic QML and Attachment I to the QML are shown in Figures 21.4 and 21.5.

CHAPTER 21: MIL-M-38510H

MIL-M-38510/610
25 FEBRUARY 1987

MILITARY SPECIFICATION

MICROCIRCUITS, DIGITAL, VHSIC, CMOS,
65,536-BIT SELECTABLE MODE, STATIC RANDOM ACCESS MEMORY (SRAM),
MONOLITHIC SILICON

This specification is approved for use by all Departments and Agencies of the Department of Defense.

1. SCOPE

1.1 Scope. This specification covers the detail requirements for monolithic silicon, CMOS, 65,536-bit selectable operating mode, static random access memory microcircuits. These microcircuits conform to the functional throughput rate as defined in the phase 1 Very High Speed Integrated Circuit (VHSIC) program. Two product assurance classes and a choice of case outlines and lead finishes are provided and are reflected in the complete part number.

1.2 Part number. The part number shall be in accordance with MIL-M-38510.

1.2.1 Device types. The device types shall be as follows:

| Device type | Circuit organization | Access time | Modes |
|-------------|----------------------|-------------|---------|
| 01 | 8192 words x 8 bits | 35 ns | 1,2,3,4 |
| 02 | 8192 words x 8 bits | 45 ns | 1,2,3,4 |
| 03 | 8192 words x 8 bits | 55 ns | 1,2,3,4 |

1.2.2 Device class. The device class shall be the product assurance level as defined in MIL-M-38510.

1.2.3 Case outline. The case outline shall be designated as follows:

| Outline letter | Case outline (see MIL M 38510, appendix C) |
|----------------|---|
| Q | U-5 (40-lead, 9/16" x 2 1/16"), dual-in-line package. |

* WARNING *
* This document contains technical data whose export is restricted by the ARMS Export *
* Control Act (title 22 U.S.C., Sec. 2751 (et seq.) or executive order 12470. *
* Shipping, mailing or carrying of this technical data outside the United States or *
* disclosure, by whatever means, through visits abroad or to any person in the United *
* States other than a US Citizen, US National or an Immigrant Alien to the United *
* States violates United States criminal law and carries a penalty upon conviction *
* of a fine or imprisonment or both. Include this notice with any reproduced portion *
* of this document. *

Beneficial comments (recommendations, additions, deletions) and any pertinent data which may be of use in improving this document should be addressed to: Rome Air Development Center, RBE-2, Griffiss AFB, NY 13441, by using the self-addressed Standardization Document Improvement Proposal (DD Form 1426) appearing at the end of this document or by letter.

AMSC N/A

FSC 5962

* DISTRIBUTION STATEMENT C. Distribution authorized to US Government agencies and *
* their contractors only: Critical Technology, February 26 1987. Other requests *
* for this document shall be referred to Director (VHSIC/ED) OUSDRE. *

FIGURE 21.1: MIL-M-38510 DETAIL SPECIFICATION EXAMPLE

CHAPTER 21: MIL-M-38510H

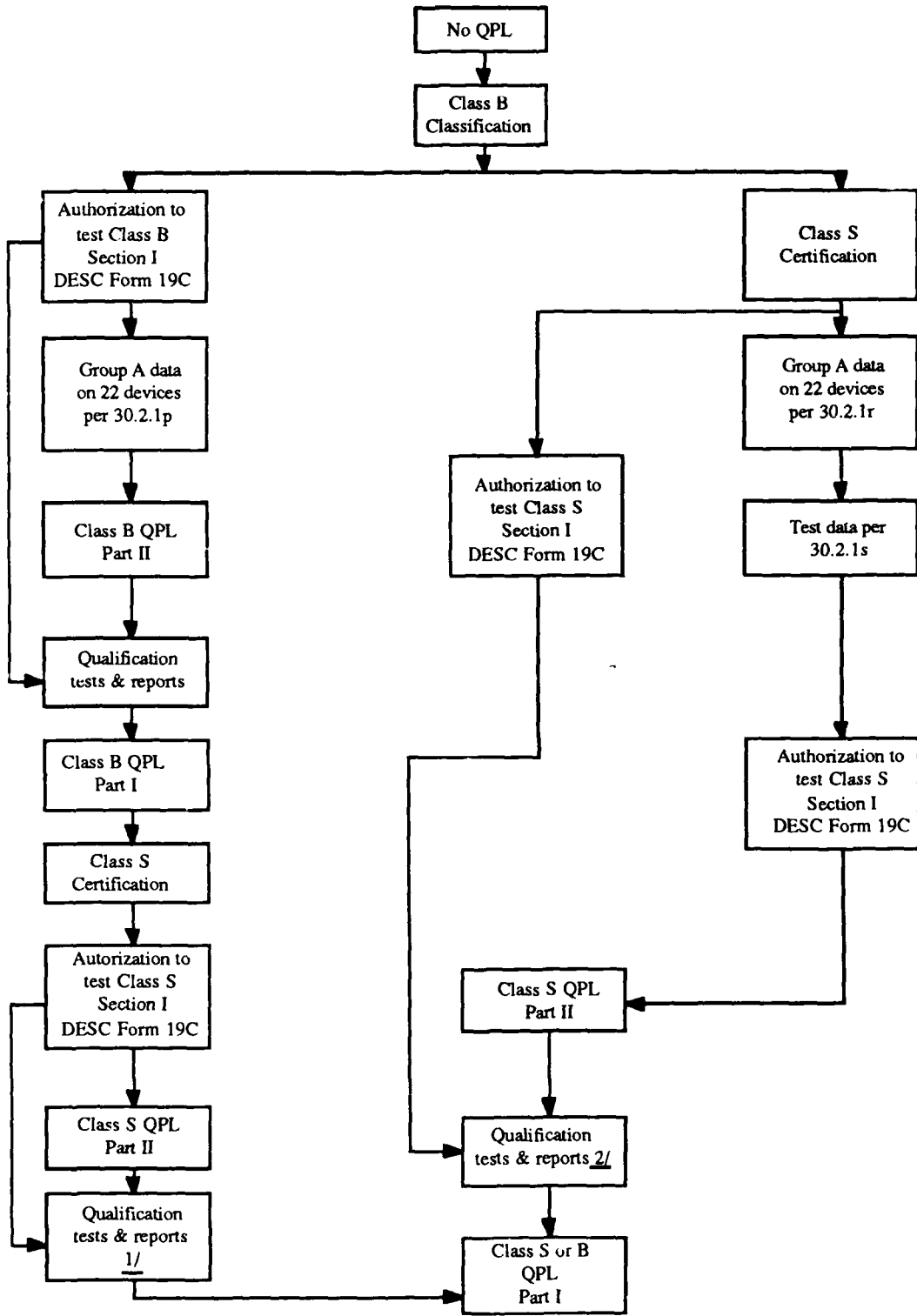

1/ Qualification using MIL-STD-883, method 5005, tables I and IIa only.

2/ Qualification using MIL-STD-883, method 5005, tables I, IIa and IV

FIGURE 21.2: PROCEDURE TO RECEIVE QPL-38510 LISTING

CHAPTER 21: MIL-M-38510H

QUALIFICATIONS VALIDATED
ANNUALLY

QPL-38510-70
16 January 1987
~~SUPERSEDING~~
QPL-38510-69
17 October 1986

QUALIFIED PRODUCTS LIST

OF

FSC 5962

PRODUCTS QUALIFIED UNDER MILITARY SPECIFICATION

MIL-M-38510

MICROCIRCUITS

GENERAL SPECIFICATION FOR

This list has been prepared for use by or for the Government in the acquisition of products covered by Specification MIL-M-38510. Listing of a product is not intended to and does not connote endorsement of the product by the Department of Defense. This list is subject to change without notice. Revision or amendment of this list will be issued as necessary. The listing of a product does not release the supplier from compliance with the specification requirements.

THE ACTIVITY RESPONSIBLE FOR THIS QUALIFIED PRODUCTS LIST IS THE UNITED STATES AIR FORCE, CODE 17, ROME AIR DEVELOPMENT CENTER (RADC-RBR), GRIFFISS AIR FORCE BASE, NEW YORK 13441. The Defense Electronics Supply Center (DESC-EQ), Dayton, OH 45444 (513-296-6355), has been designated as agent for the establishment and maintenance of this QPL, and information pertaining to qualification of products may be obtained from this Center.

If a manufacturer desires to have test data considered for qualification to a U.S. specification, he must perform all required qualification tests; the product must be produced on a certified line acceptable to DESC for the same technology group; and he must comply with the requirements specified in Appendix D, MIL-M-38510, prior to the start of any testing.

The listing of microcircuits in Qualified Products List 38510 applies only to products produced in the plant(s) specified on the QPL. Therefore, only those products that have been manufactured, assembled, and tested within the United States and its territories can be supplied as QPL devices unless otherwise indicated herein for international agreements.

Products listed in Part II, Qualified Products List 38510 are considered qualified products. Therefore, manufacturers listed on QPL-38510 shall "JAN" mark and ship the specified part numbered devices for which they are listed, providing all required groups A, B, C, and D quality conformance inspections are performed as specified in paragraphs 3.4.4. and 4.5 of MIL-M-38510. The groups A, B, C, and D quality conformance inspections must be completed and passed for the inspection period before any JAN lots are shipped (paragraph 6.3.1.1 of MIL-M-38510).

To obtain MIL-M-38510 qualified microcircuits, the procurement document must specify that the microcircuits must be approved for inclusion in Qualified Products List QPL-38510 and that the microcircuits shall be marked in accordance with the applicable specifications. Ordering data is contained in paragraph 6.1 of MIL-M-38510.

Devices listed in Part I or Part III under specific international agreements (e.g., NATO STANAG 4093) shall be marked in accordance with the applicable specifications and standards. In addition to this marking, the country of origin, identification name and code of the country requesting reciprocal listing shall be on each device. Also, the certification marks of the country should be placed on the devices.

For zero source QPL items, it shall be permissible and, in fact, is encouraged for orders to be placed with manufacturers willing to pursue part I qualification during the processing of the order so that the delivered product is part I qualified. The attention of the manufacturers is called to this requirement, and manufacturers are urged to arrange to have the products that they propose to offer to the Federal Government tested for qualification in order that they may be eligible to be awarded contracts or orders for the products covered by this specification (paragraph 6.3.1 of MIL-M-38510). For qualification removals, except for quality or reliability problems, a comprehensive explanation on the procedures that must be followed is contained in paragraph 6.3.2 of MIL-M-38510. In addition, devices that have an end-of-life notice issued by the manufacturer are listed in the notes section at the end of the QPL for your information and convenience.

DISTRIBUTION STATEMENT A. Approved for public release; distribution is unlimited.

AMSC N/A

1 of 70
QPL-38510-70

FIGURE 21.3: MIL-M-38510 QPL EXAMPLE

CHAPTER 21: MIL-M-38510H

All products using the materials and manufacturing construction techniques listed herein have been qualified under the requirements for the production of custom hybrid products as specified in the latest effective issue of MIL-M-38510, Appendix G.

| MANUFACTURER AND ADDRESS | SYMBOL/CAGE CODE | TEST REPORT NUMBER | PRODUCT ASSURANCE LEVEL | SUBSTRATE FABRICATION |
|--|------------------|-------------------------------------|-------------------------|----------------------------------|
| Micra Corporation 120 Ricefield Lane Hauppauge, NY 11788 | CETZ/63071 | 1772-44-87 | B | A, G, 11(1), 30, 43, 62, 71 |
| SUBSTRATE ATTACH | | DIE AND ELEMENT ATTACH | | BONDING, INTERNAL |
| A(.926), S(Au), Z, 80, 92, 104 | | A(92), N(Au), Z, 110, 120, 140, 150 | | A, J(1), Z, 160, 170, 181, 230 |
| | | | | SEALING, DELIDDING AND RESEALING |
| | | | | D, H, L(1.12), Z, 202, 210, 220 |

| MANUFACTURER AND ADDRESS | SYMBOL/CAGE CODE | TEST REPORT NUMBER | PRODUCT ASSURANCE LEVEL | SUBSTRATE FABRICATION |
|--|------------------|---------------------------------------|-------------------------|----------------------------------|
| National Semiconductor 5900 S. Calle Santa Cruz Tucson, AZ 85706 | CCXP/27014 | 1772-762-87 | B | A, G, 11(1), 43, 65, 71 |
| SUBSTRATE ATTACH | | DIE AND ELEMENT ATTACH | | BONDING, INTERNAL |
| A(.56), T(AuSn), Z, 80, 96, 100 | | A(80), N(AuSi), Z, 110, 120, 140, 150 | | A, J(1), Y, 162, 170, 181, 230 |
| | | | | SEALING, DELIDDING AND RESEALING |
| | | | | A, L(.942), Z, 202, 212 |

| MANUFACTURER AND ADDRESS | SYMBOL/CAGE CODE | TEST REPORT NUMBER | PRODUCT ASSURANCE LEVEL | SUBSTRATE FABRICATION |
|--|------------------|---|-------------------------|----------------------------------|
| Raytheon Company Microwave & Power Tube Division Industrial Components Operation P.O. Box 5300 465 Centre Street Quincy, MA 02269 | CETX/94144 | 1772-408-87 | B | A, G, 11(1), 30, 43, 62, 71 |
| SUBSTRATE ATTACH | | DIE AND ELEMENT ATTACH | | BONDING, INTERNAL |
| A(2.02), V, Z, 80, 92, 104 | | A(226), P, Y, 110, 120, 140 B(250), P, Q, Y, 110, 120, 140 | | A, J(1), Y, 160, 170, 181, 230 |
| | | | | SEALING, DELIDDING AND RESEALING |
| | | | | A, J(2.76), 202, 210 |

FIGURE 21.4: MIL-M-38510 QML EXAMPLE

CHAPTER 21: MIL-M-38510H

ATTACHMENT I

MATERIALS AND MANUFACTURING CONSTRUCTION TECHNIQUES CODE TABLE

| C O D E | PRODUCT ASSURANCE LEVEL | C O D E | SUBSTRATE FABRICATION | | | | C O D E | SUBSTRATE ATTACH | | | | |
|------------------|-------------------------------|------------------|--------------------------|------------------|------------------|---------------------------|-------------------|---------------------------|-----------|-----------------------------------|------|--|
| | | | TYPE | | CONDUCTOR 1/ | MATERIAL 2/ | | METHOD | | | | |
| B S | Class B Class S | A | Thick Film | 11 | Gold | A | Alumina | 80 | Manual | | | |
| | | B | Thin Film | 12 | Aluminum | B | Beryllia | 81 | Automatic | | | |
| | | C | Co-fired | 13 | Au/Ni Barrier | | C | Silicon | | | | |
| | | | | 14 | Copper | | | | | | | |
| | | | | 15 | Silver | | | | | | | |
| | | | | 16 | Pt Au | | | | | | | |
| | | | | 17 | Pd Ag | | | | | | | |
| | | | | <u>MATERIAL</u> | | | <u>INSULATION</u> | | | <u>BACKING MATERIAL</u> | | |
| | | | | G | Alumina | 30 | Glass | | | 90 | Gold | |
| | | H | Beryllia | 31 | SiO | | | 91 | Copper | | | |
| | | I | Silicon | 32 | Silicon-nitride | | | 92 | Alumina | | | |
| | | | | 33 | Polyimide | | | 93 | Beryllia | | | |
| | | | | | | | | 94 | Au/NiCr | | | |
| | | | | | | | 95 | Pt Au | | | | |
| | | | | | | | 96 | Pd Ag | | | | |
| | | | | | <u>RESISTORS</u> | | | <u>ATTACH MATERIAL 3/</u> | | | | |
| | | | | | 40 | Nickel-chromium | S | Eutectic | 100 | Type A ^{5/} /Nickel | | |
| | | | | | 41 | Chrome-silver | T | Solder | 101 | Copper | | |
| | | | | | 42 | Tantalum | U | Polymer-conductive | 102 | Ceramic Package | | |
| | | | | | 43 | Cermet | V | Polymer-nonconductive | 103 | Alumina Substrate | | |
| | | | | | | | | | 104 | Type A ^{5/} /Nickel/Gold | | |
| | | | <u>CAPACITORS</u> | | | <u>REATTACH QUALIFIED</u> | | | | | | |
| | | | 50 | Glass | Y | Yes | | | | | | |
| | | | 51 | TaM | Z | No | | | | | | |
| | | | 52 | SiO | | | | | | | | |
| | | | 53 | SiO ₂ | | | | | | | | |
| | | | <u>BACKING MATERIAL</u> | | | | | | | | | |
| | | | 60 | Gold | | | | | | | | |
| | | | 61 | Silicon | | | | | | | | |
| | | | 62 | Alumina | | | | | | | | |
| | | | 63 | Au/NiCr | | | | | | | | |
| | | | 64 | Pt Au | | | | | | | | |
| | | | 65 | Pd Ag | | | | | | | | |
| | | | <u>RESISTOR TRIMMING</u> | | | | | | | | | |
| | | | 70 | Abrasive | | | | | | | | |
| | | | 71 | Laser-passive | | | | | | | | |

NOTES:

- 1/ Maximum number of levels successfully tested indicated in parenthesis next to number on QML.
- 2/ Largest perimeter successfully tested in inches indicated in parenthesis next to letter on QML.
- 3/ All adhesive and polymeric material shall be approved by acquiring activity.
- 5/ See MIL-M-38510, paragraph 3.5.6.1.
- 6/ Type of solder or eutectic in parenthesis.

FIGURE 21.5: MIL-M-38510 QML ATTACHMENT I EXAMPLE

CHAPTER 21: MIL-M-38510H

• Supplement

The MIL-M-38510 Supplement is a summary document. It contains a detailed listing all of the devices currently covered by MIL-M-38510 together with a description of the device function, the technology used in its fabrication and the current revision of the applicable slash sheet. In the first half of the supplement the devices are listed by military detail specification number. In the second half of the document they are listed by generic/industry part number. The supplement is updated semiannually and is approximately forty-five pages in length.

In FY 86 there were approximately 1000 different microcircuit part types specified in MIL-M-38510. Approximately 72% of these part types had one or more qualified supplier(s) and were listed in the QPL. An example of a portion of the supplement is shown in Figure 21.6.

21.5 HOW TO USE MIL-M-38510

MIL-M-38510 is a source of general design and product assurance information on microcircuits of standardized construction whose electrical, mechanical and environmental ratings are governed by MIL (JAN) specifications.

This information provides the design engineer the capability of determining which JAN microcircuit procured in which configuration and possessed of which electrical, and package characteristics will best fit his intended application needs.

21.5.1 MIL-M-38510 Part Number Decoding

Each MIL-M-38510 part is marked with the complete part number. The part number is as shown in the following example:

| M38510 | H or / | 001 | 01 | B | A | C |
|-------------------------------|-------------------|--------------------------------------|----------------|----------------------------|-----------------|----------------|
| JAN military designator | RHA designator | Detail specification (/ sheet) | Device Type | Device quality grade | Case outline | Lead finish |

RHA indicates the level of radiation hardness assurance. A "/" indicates none.

21.6 TAILORING GUIDELINES

MIL-M-38510 was not written with the intent of tailoring. It establishes firm requirements which are necessary for JAN device qualification, product screening and continuing quality conformance. These requirements are not intended to be modified.

21.7 CONTRACT DATA REQUIREMENTS LIST (CDRL)

There are no data item descriptions applicable to MIL-M-38510.

CHAPTER 21: MIL-M-38510H

MIL-M-38510F
 SUPPLEMENT 1J
 1 May 1987
~~SUPERSEDING~~
 SUPPLEMENT 1M
 7 November 1986

MILITARY SPECIFICATION

MICROCIRCUITS

GENERAL SPECIFICATION FOR

This supplement forms a part of MIL-M-38510F, dated 31 October 1983.

| DETAIL SPECIFICATIONS | | Military device type 1/ M38510/ | Micro- circuit 2/ group |
|----------------------------------|---|---------------------------------------|-------------------------------|
| MIL-M-38510/1E (Amendment 2) | Microcircuits, Digital, TTL, NAND Gates, Monolithic Silicon. | 00101 thru 00109 | 1 |
| MIL-M-38510/2E (Amendment 7) | Microcircuits, Digital, TTL, Flip-Flops, Monolithic Silicon. | 00201 thru 00207 | 3 |
| MIL-M-38510/3F | Microcircuits, Digital, TTL, NAND Buffers, Monolithic Silicon. | 00301 thru 00303 | 2 |
| MIL-M-38510/4C | Microcircuits, Digital, TTL, Multiple NOR Gates, Monolithic Silicon. | 00401 thru 00404 | 1 |
| MIL-M-38510/5C | Microcircuits, Digital, TTL, AND-OR-INVERT Gates, Monolithic Silicon. | 00501 thru 00504 | 1 |
| MIL-M-38510/6C (Amendment 2) | Microcircuits, Digital, TTL, Binary Full Adders, Monolithic Silicon. | 00601 thru 00604 | 4 |
| MIL-M-38510/7B (Amendment 2) | Microcircuits, Digital, TTL, Exclusive - OR Gates, Monolithic Silicon. | 00701 | 1 |
| MIL-M-38510/8D | Microcircuits, Digital, TTL, Buffers/ Drivers, Open Collector Output, High Voltage, Monolithic Silicon. | 00801 thru 00805 | 2 |
| MIL-M-38510/9D (Amendment 5) | Microcircuits, Digital, TTL, Shift Registers, Monolithic Silicon. | 00901 thru 00906 | 5 |
| MIL-M-38510/10C | Microcircuits, Digital, TTL, Decoders, Monolithic Silicon. | 01001 thru 01009 | 4 |
| MIL-M-38510/11C | Microcircuits, Digital, TTL, Arithmetic Logic Units/Function Generators Monolithic Silicon. | 01101 01102 | 4 |
| MIL-M-38510/12G | Microcircuits, Digital, TTL, Monostable Multivibrators Monolithic Silicon. | 01201 thru 01205 | 3 |
| MIL-M-38510/13F (Amendment 5) | Microcircuits, Digital, TTL, Counters, Monolithic Silicon. | 01301 thru 01309 | 5 |
| MIL-M-38510/14D (Amendment 2) | Microcircuits, Digital, TTL, Data Selectors/Multiplexers, Monolithic Silicon. | 01401 thru 01406 | 4 |

See footnotes at end of supplement.

AMSC N/A
 DISTRIBUTION STATEMENT A. Approved for public release, distribution is unlimited.

1 of 45

FSC 5962

FIGURE 21.6: MIL-M-38510 SUPPLEMENT EXAMPLE

CHAPTER 22:

MIL-STD-883C

TEST METHODS AND PROCEDURES FOR MICROELECTRONICS

CHAPTER 22: MIL-STD-883C

MIL-STD-883 is a tri-service-approved document used by all branches of the military in the specification and acquisition of quality-assured systems and equipment. The current version is revision "C" dated August 25, 1983. The preparing activity is:

Department of the Navy
Engineering Specifications and Standards Dept.
(SESD) Code 5313
Naval Air Engineering Center
Lakehurst, NJ 08733-5100

This chapter is only an advisory to the use of MIL-STD-883. It does not supersede, modify, replace or curtail any requirements of MIL-STD-883, nor should it be used in lieu of that standard.

22.1 REFERENCE DOCUMENTS

The following documents are complementary to MIL-STD-883 in the establishment of styles, electrical characteristics, screening and test methods for microelectronic devices.

- MIL-M-38510 General Specification for Microcircuits
- MIL-HDBK-217 Reliability Prediction of Electronic Equipment
- DoD-STD-1686 Electrostatic Discharge Control Program for Protection of Electrical and Electronic Parts, Assemblies and Equipment (Excluding Electrically Initiated Explosive Devices)
- DoD-HDBK-263 Electrostatic Discharge Control Handbook for Protection of Electrical and Electronic Parts, Assemblies and Equipment (Excluding Electrically Initiated Explosive Devices)

22.2 DEFINITIONS

This paragraph is not applicable to this chapter.

22.3 APPLICABILITY

MIL-STD-883 establishes uniform methods and procedures for testing microelectronic devices, including basic environmental tests to determine resistance to deleterious effects of natural elements and conditions surrounding military and space operations, and physical and electrical tests. This standard applies only to microelectronic devices. The test methods described therein have been prepared to serve several purposes:

- a. To specify suitable conditions obtainable in the laboratory and at the device level which give test results equivalent to the actual service conditions which may exist in the field, and to obtain reproducibility of the results of tests.
- b. To describe in one standard all of the test methods of a similar character which now appear in the various joint-services and NASA microelectronic device specifications, so that these methods may be kept uniform and thus result in conservation of equipment, manhours, and testing facilities.
- c. The test methods described in MIL-STD-883 for the environmental, physical and electrical testing of devices shall also apply when appropriate, to parts not covered by an approved Military/NASA specification, standard, specification sheet, or drawing.

CHAPTER 22: MIL-STD-883C

22.3.1 Structure of MIL-STD-883

MIL-STD-883 was developed by the Air Force in the mid-to-late 1960's to address the need for testing microelectronic devices. Since it was the primary microelectronic testing document, preceding the General Specification for Microcircuits (MIL-M-38510), it includes information on qualification, quality conformance and screening sequences.

MIL-STD-883 is structured into five classes of Test Methods: the 1000 Class addresses Environmental Tests, 2000 Class addresses Electrical Tests; 3000 Class addresses Electrical Tests for Digital Circuits; 4000 Class addresses Electrical Tests for Linear Circuits; and the 5000 Class addresses Test Procedures.

A complete list of MIL-STD-883 (Revision C, Notice 7) test methods, current as of 12 February 1988 is given in Table 22.1 below:

TABLE 22.1: MIL-STD-883 TEST METHODS

| <u>Method No.</u> | <u>Environmental Tests</u> |
|-------------------|---|
| 1001 | Barometric pressure, reduced (altitude operation) |
| 1002 | Immersion |
| 1003 | Insulation resistance |
| 1004.7 | Moisture resistance |
| 1005.6 | Steady state life |
| 1006 | Intermittent life |
| 1007 | Agree life |
| 1008.2 | Stabilization bake |
| 1009.7 | Salt atmosphere (corrosion) |
| 1010.7 | Temperature cycling |
| 1011.7 | Thermal shock |
| 1012 i | Thermal characteristic |
| 1013 | Dew point |
| 1014.8 | Seal |
| 1015.7 | Burn-in test |
| 1016 | Life/reliability characterization tests |
| 1017.2 | Neutron irradiation |

CHAPTER 22: MIL-STD-883C

| <u>Method No.</u> | <u>Environmental Tests (Cont'd)</u> |
|-------------------|--|
| 1018.2 | Internal water-vapor content |
| 1019.3 | Steady state total dose irradiation procedures |
| 1020 | Radiation induced latchup test procedure |
| 1021.1 | Dose rate threshold for upset of digital microcircuits |
| 1022 | MOSFET threshold voltage |
| 1023.1 | Dose rate response of linear microcircuits |
| 1030.1 | Preseal burn-in |
| 1031 | Thin film corrosion test |
| 1032 | Soft error test procedure |
| 1033 | Endurance life |
| | <u>Mechanical Tests</u> |
| 2001.2 | Constant acceleration |
| 2002.3 | Mechanical shock |
| 2003.5 | Solderability |
| 2004.5 | Lead integrity |
| 2005.2 | Vibration fatigue |
| 2006.1 | Vibration noise |
| 2007.1 | Vibration, variable frequency |
| 2008.1 | Visual and mechanical |
| 2009.8 | External visual |
| 2010.9 | Internal visual (monolithic) |
| 2011.6 | Bond strength |
| 2012.6 | Radiography |
| 2013.1 | Internal visual |
| 2014 | Internal visual and mechanical |
| 2015.8 | Resistance to solvents |

CHAPTER 22: MIL-STD-883C

| <u>Method No.</u> | <u>Mechanical Tests (Cont'd)</u> |
|-------------------|--|
| 2016 | Physical dimensions |
| 2017.5 | Internal visual (hybrid) |
| 2018.2 | Scanning electron microscope (SEM inspection of metallization) |
| 2019.5 | Die shear strength |
| 2020.6 | Particle impact noise detection test |
| 2021.3 | Glassivation layer integrity |
| 2022.2 | Meniscograph solderability |
| 2023.3 | Nondestructive bond pull |
| 2024.2 | Lid torque for glass-frit-sealed packages |
| 2025.3 | Adhesion of lead finish |
| 2026 | Random vibration |
| 2027.1 | Substrate attach strength |
| 2028 | Pin-grid package destructive lead pull test |
| 2029 | Ceramic chip carrier bond strength (destructive push test) |
| 2030 | Ultrasonic inspection of die attach |
| 2031 | Flip-chip pull-off test |
| | <u>Electrical Tests (Digital)</u> |
| 3001.1 | Drive source, dynamic |
| 3002.2 | Load conditions |
| 3003.1 | Delay measurements |
| 3004.1 | Transition time measurements |
| 3005.1 | Power supply current |
| 3006.1 | High level output voltage |
| 3007.1 | Low level output voltage |
| 3008.1 | Breakdown voltage, input or output |
| 3009.1 | Input current, low level |

CHAPTER 22: MIL-STD-883C

| <u>Method No.</u> | <u>Electrical Tests (Digital) (Cont'd)</u> |
|-------------------|--|
| 3010.1 | Input current, high level |
| 3011.1 | Output short circuit current |
| 3012.1 | Terminal capacitance |
| 3013.1 | Noise margin measurements for digital microelectronic devices |
| 3014 | Functional testing |
| 3015.6 | Electrostatic discharge sensitivity classification |
| 3016 | Activation time verification |
| 3017 | Microelectronics package digital signal transmission |
| 3018 | Cross talk measurements for digital microelectronics device package |
| 3019 | Ground and power supply impedance measurements for microelectronics device package |
| 3020 | High impedance (off-state) low-level output leakage current |
| 3021 | High impedance (off-state) high-level output leakage current |
| 3022 | Input clamp voltage |
| | <u>Electrical Tests (linear)</u> |
| 4001 | Input offset voltage and current and bias current |
| 4002 | Phase margin and slew rate measurement |
| 4003 | Common mode input voltage range Common mode rejection ratio Supply voltage rejection ratio |
| 4004 | Open loop performance |
| 4005 | Output performance |
| 4006 | Power gain and noise figure |
| 4007 | Automatic gain control range |

CHAPTER 22: MIL-STD-883C

| <u>Method No.</u> | <u>Test Procedures</u> |
|-------------------|--|
| 5001 | Parameter mean value control |
| 5002.1 | Parameter distribution control |
| 5003 | Failure analysis procedures for microcircuits |
| 5004.9 | Screening procedures |
| 5005.11 | Qualification and quality conformance procedures |
| 5006 | Limit testing |
| 5007.5 | Wafer lot acceptance |
| 5008.5 | Test procedures for hybrid and multi-chip microcircuits |
| 5009.1 | Destructive physical analysis |
| 5010.2 | Test procedures for custom monolithic microcircuits |
| 5011 | Evaluation and acceptance procedures for polymeric adhesives |

22.4 PHYSICAL DESCRIPTION OF MIL-STD-883

MIL-STD-883 is a voluminous document composed of ninety-seven different detailed "Test Methods." It contains approximately five hundred pages. There are no appendices to this standard.

22.5 HOW MIL-STD-883 IS USED

MIL-STD-883 includes requirements and procedures for device qualification and quality conformance, and for screening.

In the tidy little world of documents which establish standard test methods for electrical and electronic parts, MIL-STD-883 is unique in that three of its test methods i.e., Test Method 5004, 5005 and 5008 address requirements and procedures for microelectronic device qualification and quality conformance, and screening. Methods 5004 and 5005 cover standard, epitaxially-grown microcircuits, while Method 5008 covers hybrids, surface acoustic wave (SAW) and multi-chip microcircuits whose elements require assembly.

22.5.1 Qualification and Quality Conformance Procedures

Microcircuit device manufacturers and/or original equipment manufacturers (OEM's) who seek to gain approval of specific devices from the military services will find procedural instructions for achieving this goal in Method 5005. This method also includes instructions on the quality conformance inspection procedures applicable to both Class S and Class B devices. Five groups of testing are specified: Group A covers Electrical Test requirements; Group B addresses Mechanical and Environmental Tests; Group C addresses die-related Mechanical and Environmental Tests; Group D addresses package-related Mechanical and Environmental Tests and Group E addresses Radiation Hardness Assurance Tests.

CHAPTER 22: MIL-STD-883C

The instructions include quality conformance inspection sequence; acceptance numbers (or LTPD); provision for resubmission and criteria for acceptance or rejection of inspection lots and for sample selection. In the Group A Electrical Tests, clear distinction is made among static, dynamic, functional and switching tests. These terms are defined in Section 3 of MIL-STD-883.

22.5.2 Screening Procedures

Method 5004 establishes screening procedures as shown in Figure 22.1 (taken from MIL-STD-883C) for total lot screening of microelectronics. The method must be used in conjunction with other documentation such as MIL-M-38510 and/or an applicable device specification to establish the design, material, performance, control and documentation requirements which are needed to achieve prescribed levels of device quality and reliability. Since it is not possible to prescribe an absolute level of quality or reliability which would result from a particular screening level or to make a precise value judgment on the cost of a failure in an anticipated application, two levels (Class S and Class B) have been arbitrarily chosen. Method 5004 provides flexibility in the choice of conditions and stress levels to allow the screens to be further tailored to a particular source, product or application based on user experience. Selection of a level better than that required for the specific product and application will result in unnecessary expense, and a level less than that required will result in an unwarranted risk that reliability and other requirements will not be met. Guidance in selecting screening levels for predicting the anticipated reliability for microcircuits may be found in MIL-HDBK-217.

22.5.3 Other Notable MIL-STD-883 Test Methods

Samples of other notable test methods of MIL-STD-883 usually associated with microelectronic reliability are listed below for illustration purposes.

- In Class 1000:** Methods 1005 and 1006 covering Steady State and Intermittent Life; Method 1014, Seal Test; Method 1008, High Temperature Storage; Method 1015, Burn-in Test.
- In Class 2000:** Method 2010 covers Internal Visual (monolithic); Method 2017 covers Internal Visual (hybrid); Method 2011, Bond Strength; and Method 2018, Scanning Electron Microscope (SEM) Inspection of Metallization.
- In Class 3000:** Method 3013 covers Noise Margin Measurements for Digital Microelectronic Devices; and Method 3015, Electrostatic Discharge Sensitivity Classification.
- In Class 4000:** Method 4001 covers Input Offset Voltage and Current and Bias Current; Method 4006 covers Power Gain and Noise Figure for a linear amplifier.

As discussed in 22.4.2, above, the 5000 Class Test Methods cover Screening Procedures, (Method 5004) and Qualification and Quality Conformance Procedures (Method 5005).

22.5.4 Test Procedures for Hybrid and Multi-chip Microcircuits

Method 5008 establishes screening and quality conformance procedures for the testing of hybrids, surface acoustic wave (SAW) and multi-chip microcircuits and microwave/hybrid/integrated circuits to assist in achieving two levels (Class S and Class B) of quality and reliability.

Since hybrids consist of three basic construction elements, i.e., microcircuit and semiconductor dice; passive elements (resistors, capacitors and inductors) and packages, their characteristics must be evaluated before assembly of the device.

CHAPTER 22: MIL-STD-883C

| Screen | Class S | | Class B | |
|---|--|-------------------|---|-------------------|
| | Method | Reqmt | Method | Reqmt |
| 3.1.1 Wafer lot acceptance <u>1/</u> | 5007 | All lots | | --- |
| 3.1.2 Nondestructive bond pull | 2023 | 100% | | --- |
| 3.1.3 Internal visual <u>2/</u> | 2010, test condition A | 100% | 2010, test condition B | 100% |
| * 3.1.4 Stabilization bake (see 3.4.1) no end point measurements required <u>3/</u> | 1008 Condition C | 100% | 1008 Condition C | 100% |
| 3.1.5 Temperature cycling <u>4/</u> | 1010, test condition C | 100% | 1010, test condition C | 100% |
| 3.1.6 Constant acceleration (see 3.2 and 3.4.2) | 2001, test condition E (min) Y ₁ orientation only | 100% | 2001, test condition E (min), Y ₁ orientation only | 100% |
| 3.1.7 Visual inspection <u>5/</u> | | 100% | | 100% |
| 3.1.8 Particle impact noise detection (PIND) | 2020, test condition A | 100% <u>6/</u> | | |
| 3.1.9 Serialization | | 100% <u>7/</u> | | --- |
| 3.1.10 Pre-burn-in electrical parameters (see 3.5.1) | Per applicable device specification | 100% <u>8/</u> | Per applicable device specification | 100% <u>9/</u> |
| 3.1.11 Burn-in test (see 3.4.2) | 1015 <u>10/</u> 240 hrs @ 125°C min | 100% | 1015 160 hrs @ 125°C min | 100% |
| 3.1.12 Interim (post-burn-in) electrical parameters (see 3.5.1) | Per applicable device specification | 100% <u>8/</u> | | --- |
| 3.1.13 Reverse bias burn-in <u>11/</u> (see 3.4.2) | 1015; test condition A or C, 72 hrs @ 150°C min | 100% | | --- |
| 3.1.14 Interim (post-burn-in) electrical parameters (see 3.5.1) | Per applicable device specification | 100% <u>8/</u> | Per applicable device specification | 100% <u>9/</u> |
| 3.1.15 Percent defective allowable (PDA) calculation | 5%, see 3.5.1 3%, functional parameters @ 25°C | All lots | 5%, see 3.5.1 | All lots |

FIGURE 22.1: MIL-STD-883 SCREENING REQUIREMENTS

CHAPTER 22: MIL-STD-883C

| Screen | Class S | | Class B | |
|---|-------------------------------------|------------|-------------------------------------|------------|
| | Method | Reqmt | Method | Reqmt |
| 3.1.16 Final electrical test (see 3.5.2) | Per applicable device specification | | Per applicable device specification | |
| (a) Static tests | | 100% | | 100% |
| (1) 25°C (subgroup 1, table I, 5005) | | | | |
| (2) Maximum and minimum rated operating temp. (subgroups 2, 3, table I, 5005) | | 100% | | 100% |
| * (b) Dynamic or functional tests <u>13/</u> | | | | |
| (1) 25°C (subgroup 4 or 7, table I method 5005) | | 100% | | 100% |
| (2) Minimum and maximum rated operating temperature (subgroups 5 and 6, or 8 table I method 5005) | | 100% | | 100% |
| (c) Switching tests at 25°C (subgroup 9, table I method 5005) | | 100% | | 100% |
| 3.1.17 Seal | 1014 | 100% | 1014 | 100% |
| (a) Fine | | <u>12/</u> | | <u>12/</u> |
| (b) Gross | | | | |
| 3.1.18 Radiographic <u>14/</u> | 2012 two views <u>15/</u> | 100% | | --- |
| 3.1.19 Qualification or quality conformance inspection test sample selection | | <u>16/</u> | | <u>16/</u> |
| 3.1.20 External visual <u>17/</u> | 2009 | 100% | 2009 | 100% |

- 1/ All lots shall be selected for testing in accordance with the requirements of method 5007 herein.
- 2/ Unless otherwise specified, at the manufacturer's option, test samples for group B, bond strength (method 5005) may be randomly selected prior to or following internal visual (method 5004), prior to sealing provided all other specification requirements are satisfied (e.g. bond strength requirements shall apply to each inspection lot, bond failures shall be counted even if the bond would have failed internal visual exam).
- 3/ Stabilization bake shall be performed in any sequence after 3.1.3 and prior to 3.1.10.
- 4/ For class B devices, this test may be replaced with thermal shock method 1011, test condition A, minimum.
- 5/ At the manufacturer's option, visual inspection for catastrophic failures may be conducted after each of the thermal/mechanical screens, after the sequence or after seal test. Catastrophic failures are defined as missing leads, broken packages or lids off.
- 6/ See MIL-M-38510 4.6.3. The PIND test may be performed in any sequence after 3.1.5 and prior to 3.1.14.

FIGURE 22.1: MIL-STD-883 SCREENING REQUIREMENTS (CONT'D)

CHAPTER 22: MIL-STD-883C

22.6 TAILORING

Tailoring of MIL-STD-883 test methods and procedures is accomplished principally in the choice made among 1) Class S, 2) Class B, 3) MIL-STD- 883-marked device, and 4) non-compliant, non-JAN device quality conformance levels and the screening procedures selected to accomplish these levels. Paragraph 1.2.1 and 1.2.2 of MIL-STD-883 outline the provisions for the use of MIL-STD-883 in conjunction with compliant, non-JAN devices and non-compliant, non-JAN devices, respectively.

22.6.1 When and How to Tailor

Identification of the desired microelectronic devices by quality conformance level designator, i.e., 1), 2), 3), or 4) above, shall be specified in the device procurement document. As stated in paragraph 22.5.2 for non-compliant devices the conditions and stress levels of screens applied to the device can be tailored based upon user experience and agreement with the device manufacturer, to a particular source, product or application.

22.7 CONTRACT DATA REQUIREMENTS LIST (CDRL)

No deliverable data items are required by MIL-STD-883.

CHAPTER 23:

MIL-STD-1772A

**CERTIFICATION REQUIREMENTS FOR HYBRID MICROCIRCUIT
FACILITY AND LINES**

CHAPTER 23: MIL-STD-1772A

MIL-STD-1772 is a tri-service-approved document used by all branches of the military in the specification and acquisition of quality-assured electronic equipment. The current version is the "A" revision dated May 15, 1987. The preparing activity is:

Rome Air Development Center (RADC)
ATTN: RBE-2
Griffiss AFB, NY 13441-5700

This chapter is only an advisory to the use of MIL-STD-1772. It does not supersede, modify, replace or curtail any requirements of MIL-STD-1772 nor should it be used in lieu of that standard.

23.1 REFERENCE DOCUMENTS

The following related documents impact and further define this task:

- MIL-STD-883 Test Methods and Procedures for Microelectronics
- MIL-STD-750 Test Methods for Semiconductor Devices
- MIL-M-38510 Microcircuit, General Specifications For

23.2 DEFINITIONS

This paragraph is not applicable to this chapter.

23.3 APPLICABILITY

MIL-STD-1772 establishes minimum requirements governing certification and qualification of manufacturing construction techniques and materials for hybrid microcircuits as required by MIL-M-38510. It is intended to standardize the documentation and testing for hybrid microcircuits for use in military and aerospace applications. Definitive criteria will assure that hybrid microcircuits are manufactured under conditions which have been demonstrated to be capable of continuously producing highly reliable products.

This goal is accomplished by evaluating the manufacturer's capability for holding critical processes within established limits at specified critical points and continuously maintaining this capability during production. MIL-STD-1772 covers the interface between the user and the device manufacturer and it is not intended to be a complete set of documentation required to build hybrid microcircuits.

The certification, qualification and the maintenance procedures documented in MIL-STD-1772 are performed in advance of delivery of product and are independent of acquisition.

23.4 PHYSICAL DESCRIPTION OF MIL-STD-1772

MIL-STD-1772 is approximately fifty-eight pages in length and has no appendices; however, it does have an attachment entitled "Materials and Manufacturing Construction Techniques Code Table." This attachment provides the basis for the QML (Qualified Manufacturers' Listing) which has been established by the implementation of MIL-STD-1772.

CHAPTER 23: MIL-STD-1772A

23.5 HOW TO USE MIL-STD-1772

MIL-STD-1772 consists of two major sections: Section A dealing with Auditing and Line Certification and Section B dealing with Qualification.

It also addresses three different operating activities: The Certifying activity, The Qualifying activity, and the Acquiring activity and defines the responsibilities of each of these activities.

- **Section A: Audit Plan for Facilities and Line Certification**

This section consists primarily of a detailed audit plan checklist to be used by the **certifying activity**. A copy of one such checklist from MIL-STD-1772 is shown in Table 23.1. The purpose of the audit plan is to provide a systematic method for determining a manufacturer's conformance to the product assurance requirements of MIL-M-38510 and MIL-STD-883. The plan contains audit requirements that serve as the basis for initial and continuing certification for manufacturers of custom hybrid microcircuits.

The specific elements of this audit plan are as shown in Table 23.2. The standard contains a detailed checklist for each of these elements.

The **acquiring activity** shall review audit results (maintained by the certifying activity) to verify that the manufacturing construction techniques and materials used at the time of the audit adequately represent those to be used in the impending procurement.

- **Section B: Qualification of Materials and Manufacturing Construction Techniques**

Section B deals primarily with testing and with test methods. It is used by the **qualifying activity** to document a systematic and uniform method for qualifying various manufacturer's construction techniques. This section provides two methods to establish a baseline and thus evaluate proposed changes in construction techniques, materials, or design to assure that such changes will maintain or enhance instead of degrade the quality or reliability of the hybrid.

The specific elements of concern are as shown in Table 23.3. There is detailed evaluation criteria given for each of these tests in the standard. A sample of this detailed evaluation criteria taken from MIL-STD-1772 is shown in Table 23.4.

23.6 TAILORING GUIDELINES

MIL-STD-1772 was not written with the intent of tailoring.

23.7 CONTRACT DATA REQUIREMENTS LIST (CDRL)

There are no data item descriptions associated with MIL-STD-1772.

CHAPTER 23: MIL-STD-1772A

TABLE 23.1:
SUBSTRATE AND CIRCUIT ELEMENT ATTACHMENT CHECKLIST

AUDIT
SECTION
NUMBER
A-9

TITLE

SUBSTRATE AND CIRCUIT ELEMENT ATTACHMENT

Requirement: The documentation and performance of the process steps by which circuit elements are incorporated into the assembly of a hybrid microcircuit shall be evaluated.

References: Methods 2017 and 5008 of MIL-STD-883.
Appendix G of MIL-M-38510.

DETAILS: Verify conformance to the following as applicable:

| | <u>APPROVAL</u> | <u>N/A</u> | <u>COMMENTS</u> |
|--|-----------------|------------|-----------------|
| Substrate and circuit elements are attached: | | | |
| a. In accordance with layout. | _____ | | |
| b. In accordance with method 2017. | _____ | | |
| c. Rework. | _____ | | |
| Process controls: | | | |
| a. Conformance to documentation. | _____ | | |
| b. Applicable revision. | _____ | | |
| Polymer adhesives for attachment: | | | |
| a. Shelf life control. | _____ | | |
| b. Process conforms to documentation in terms of time, temperature, and effectiveness. | _____ | | |
| Metallic material attachment: | | | |
| a. Material is in accordance with documentation. | _____ | | |
| b. Process conforms to documentation in terms of time, temperature, and effectiveness. | _____ | | |

Company audited: _____

Performed by: _____

Date: _____

Comments: _____

CHAPTER 23: MIL-STD-1772A

**TABLE 23.2:
AUDIT PLAN FOR FACILITIES AND LINE CERTIFICATION**

- 1) Quality Assurance Program
 - 2) Design Guidelines and Documentation
 - 3) Quality Conformance Evaluation
 - 4) Workmanship
 - 5) Cleanliness and Atmospheric Control
 - 6) Incoming Material Control
 - 7) Substrate Fabrication
 - 8) Polymeric Materials
 - 9) Substrate and Circuit Element Attachments
 - 10) Internal Visual
 - 11) Wire Bond
 - 12) Cleaning
 - 13) Package Seal
 - 14) Screening
 - 15) Acceptance for Shipment
 - 16) Handling and Storage
 - 17) Failure Analysis
 - 18) Training
 - 19) Certification/Qualification Program
-

CHAPTER 23: MIL-STD-1772A

TABLE 23.3: QUALIFICATION OF MATERIALS AND MANUFACTURING CONSTRUCTION TECHNIQUES

- 1) Thick and Thin Film Fabrication
- 2) Substrate and Element Attachment
- 3) Bonding, Internal
- 4) Sealing, Delidding, and Resealing

CHAPTER 23: MIL-STD-1772A

TABLE 23.4:
SUBSTRATE AND CIRCUIT ELEMENT ATTACH QUALIFICATION

| Subgroup | Test | MIL-STD-883 | | Quantity (accept no.) | Reference paragraph (see 2.2) |
|----------------------|-----------------------------------|--------------|---|--------------------------|-------------------------------------|
| | | Method | Condition | | |
| Precondi- tioning | Internal visual | 2017 | C (100 hours at 150°C) | 12 (0) | 2.2.2.5 |
| | Stabilization bake | 1008 | | | |
| | Temperature cycling | 1010 | | | |
| | Constant acceleration | 2001 | A, Y ₁ axis only | | 2.2.2.6 |
| | Internal visual | 2017 | | | 2.2.2.5 |
| | Rework | | | | 2.2.1.1 |
| | Seal | 1014 | | | |
| External visual | 2009 | | | | |
| 1 | VCE (SAT) or VF | 3071 4011 | C (100 cycles) | 6 (0) | 2.2.2.1 |
| | Temperature cycling | 1010 | | | |
| | Constant acceleration | 2001 | | | |
| | PIND test | 2020 | B | | 2.2.2.6 |
| | VCE (SAT) or VF | 3071 4011 | | | 2.2.2.2 |
| | Radiography | 2012 | | | 2.2.2.1 |
| | Internal water- vapor | 1018 | | 3(0) or 5(1) | 2.2.2.3 |
| | Loose particle recovery | | | | 2.2.2.4 |
| | | | | | 2.2.2.2 |
| 2 | VCE (SAT) or VF | 3071 4011 | C (1000 hours at 150°C) | 6 (0) | 2.2.2.1 |
| | Stabilization bake | 1008 | | | |
| | Constant acceleration | 2001 | | | |
| | PIND test | 2020 | B | | 2.2.2.6 |
| | VCE (SAT) or VF | 3071 4011 | | | 2.2.2.2 |
| | Radiography | 2012 | | | 2.2.2.1 |
| | Internal water- vapor | 1018 | | 3(0) or 5(1) | 2.2.2.3 |
| | Loose particle recovery | | | | 2.2.2.4 |
| | | | | | 2.2.2.2 |
| 3 | Mechanical shock | 2002 | C | 6 (0) | |
| | VCE (SAT) or VF | 3071 4011 | | | 2.2.2.1 |
| | Internal visual | 2017 | | | 2.2.2.5 |
| | Die shear | 2019 | | | |
| 4 | Constant acceleration | 2001 | C (minumum) Y ₁ axis only | 6 (0) | 2.2.2.6 |
| | External visual | 2009 | | | |
| | Internal visual and mechanical | 2017 | | | 2.2.2.7 |

CHAPTER 24:

MIL-S-19500G

GENERAL SPECIFICATION FOR SEMICONDUCTOR DEVICES

CHAPTER 24: MIL-S-19500G

MIL-S-19500 is a tri-service-approved document used by all branches of the military in the specification and acquisition of quality-assured electronic equipment. The current version is revision "G" dated February 16, 1984. The preparing activity is:

Department of the Navy
Space and Naval Warfare Systems Command
ATTN: SPAWAR 003-121
Washington, DC 20363-5100

This chapter is only an advisory to the use of MIL-S-19500. It does not supersede, modify, replace, or curtail any requirements of MIL-S-19500 nor should it be used in lieu of that standard.

24.1 REFERENCE DOCUMENTS

The following related documents impact and further detail these requirements and should also be referenced.

- MIL-S-19491 Packaging of Semiconductor Devices
- MIL-STD-105 Sampling Procedures and Tables for Inspection by Attributes
- MIL-STD-701 Lists of Standard Semiconductor Devices
- MIL-STD-750 Test Methods and Procedures for Semiconductor Devices
- MIL-STD-1285 Marking of Electrical and Electronic Parts

24.2 DEFINITIONS

This paragraph is not applicable to this chapter.

24.3 APPLICABILITY

MIL-S-19500 provides for the characterization of standard JAN semiconductor devices jointly approved by the three military services, Army, Navy and Air Force for use in the design and manufacture of military systems and equipment.

The specification establishes the general design and product assurance requirements necessary for the qualification and acquisition of military approved (JAN) semiconductor devices. It also includes detailed provisions which are specific to the particular device type. This data is specified in the applicable device specification (frequently referred to as a slash sheet).

Four levels of product assurance requirements and control are provided in this specification. These quality grades are JANS for space applications and JANTXV, JANTX, and JAN for various military applications.

CHAPTER 24: MIL-S-19500G

The purpose of MIL-S-19500 is three-fold:

- To provide the equipment designer with standard JAN semiconductor devices for use in space and military applications
- To control and minimize the variety of semiconductor devices used in military equipment in order to facilitate logistic support of equipment in the field
- To establish specific criteria for the qualification and production of JAN semiconductor devices for use in space applications and in military systems and equipment

24.4 PHYSICAL DESCRIPTION OF MIL-S-19500

MIL-S-19500 consists of a complex group of different types of documentation: a) the Basic Specification, b) an extensive series of Individual Device Specifications (slash sheets), c) a summary Supplement, and the Qualified Products List (QPL). The following is a brief description of each of these documents.

● Basic Specification

The MIL-S-19500 Basic Specification contains the general design guidelines, product assurance and packaging requirements necessary for the qualification, product screening, and continuing quality conformance assurance of all semiconductor devices regardless of type and the technology used in their fabrication. An example of the product assurance requirements is shown in Table 24.1, taken from MIL-S-19500. An example of a portion of the device screening requirements is shown in Table 24.2, taken from MIL-S-19500. The procedure for testing and Screening of devices is shown in Figure 24.1, taken from MIL-S-19500. An example of the Lot Tolerance Percent Defective (LTPD) sampling plan required to meet the continuous quality conformance assurance requirements is shown in Table 24.3, taken from MIL-S-19500 Appendix C.

The basic specification is thirty-eight pages in length. It also has five supporting appendices and an index for a total of forty additional pages. These five appendices are titled as follows:

Appendix A: Definitions

Appendix B: Abbreviations and Symbols

Appendix C: Statistical Sampling and Life Test Procedures

Appendix D: Product Assurance Program and Manufacturing Certification Requirements

Appendix E: Provisions Governing the Qualification of Semiconductors Assembled at a Foreign Plant

● Individual Device Specification

The MIL-S-19500 individual device specifications or slash sheets contain specific device parameters, general design guidelines and product assurance requirements which are unique to a specific device or group of devices. Each slash sheet addresses a small family of such devices. The devices on a given slash sheet must all be similar in design and function, and all must utilize identical technology in their fabrication.

CHAPTER 24: MIL-S-19500G

TABLE 24.1:
MIL-S-19500G PRODUCT ASSURANCE REQUIREMENTS

| Requirement | Reference | JANS | JANSM JANSR JANSH | TXV | TXVM TXVD TXVR TXVH | TX | JAN |
|---|---------------------------|------|-------------------------|-----|------------------------------|----|-----|
| | | | | | (X = Required) | | |
| Qualification: | 4.5 | | | | | | |
| a. Product assurance program and survey | 3.4.2 and Appendix D | X | X | X | X | X | X |
| b. Manufacturer certification | 3.4.2.2 and Appendix D | X | X | | | | |
| c. Inspection and testing | 4.5 and 4.6 | X | X | X | X | X | X |
| Inspection lot | 4.3.1.1 and 4.3.1.2 | X | X | X | X | X | X |
| Traceability | 4.3.1.4 | X | X | X | X | X | X |
| Inspection during manufacture | 4.8 | X | X | | | | |
| Screening | 4.6 and Table II | X | X | X | X | X | |
| Quality conformance inspection: | | | | | | | |
| a. Group A (each lot) | 4.7.4 and Table III | X | X | X | X | X | X |
| b. Group B (each lot) | 4.7.5 Table IVa Table IVb | X | X | X | X | X | X |
| c. Group C (every 6 months) | 4.7.6 and Table V | X | X | X | X | X | X |
| d. Group D (each lot) | 4.7.7 and Table VI | | X | | X | | |

CHAPTER 24: MIL-S-19500G

TABLE 24.2:
MIL-S-19500G SCREENING REQUIREMENTS

| Screen | MIL-STD-750 method | Condition | JANS requirements | JANTX requirements | JANTX requirements |
|--|----------------------|--|--------------------------------|--------------------|--------------------|
| 1. Internal visual (precap) inspection | 2072 2073 2074 | For transistors. For diodes when specified. For diodes. | 100% | 100% | --- |
| 2. High temp life (LTPD) (stabilization bake) | 1032 | 24 hrs min at max rated storage temp. | 100% | 100% | 100% |
| 3. Thermal shock (temp cycling) | 1051 | No dwell is required at 25°C. Test condition C, 20 cycles, t (extremes) > 10 min. | 100% | 100% | 100% |
| 4. Constant acceleration <u>1/</u> (see 4.6) | 2006 | Y ₁ direction at 20,000 G min except at 10,000 G min for devices with power rating of > 10 watts at T _c = 25°C. The 1 min hold time requirement shall not apply. | 100% | 100% | 100% |
| 5. Particle impact noise detection (for all devices with an internal cavity) | 2052 | Condition A. | 100% | | |
| Instability shock test (axial lead diodes only) <u>1/ 4/</u> | | | | | |
| a. Forward instability shock test (FIST) | 2081 | | 100% | --- | --- |
| b. Backward instability shock test (BIST) | 2082 | | 100% | --- | --- |
| 17. Hermetic seal | | | | | |
| a. Fine <u>1/</u> | 1071 | a. Test condition G for H, max leak rate = 5x10 ⁻⁸ atm cc/s except 5x10 ⁻⁷ atm cc/s for devices with internal cavity > 0.3 cc. | Optional if done in screen 14. | 100% <u>6/</u> | 100% <u>6/</u> |
| b. Gross | | b. Test condition A, C, D, E, or F. | Optional | 100% <u>6/</u> | 100% <u>6/</u> |
| 18. Serialization | | See 3.7.9. | 100% | --- | --- |
| 19. Interim electrical parameters | | As specified. | 100% (Read and record) | --- | --- |

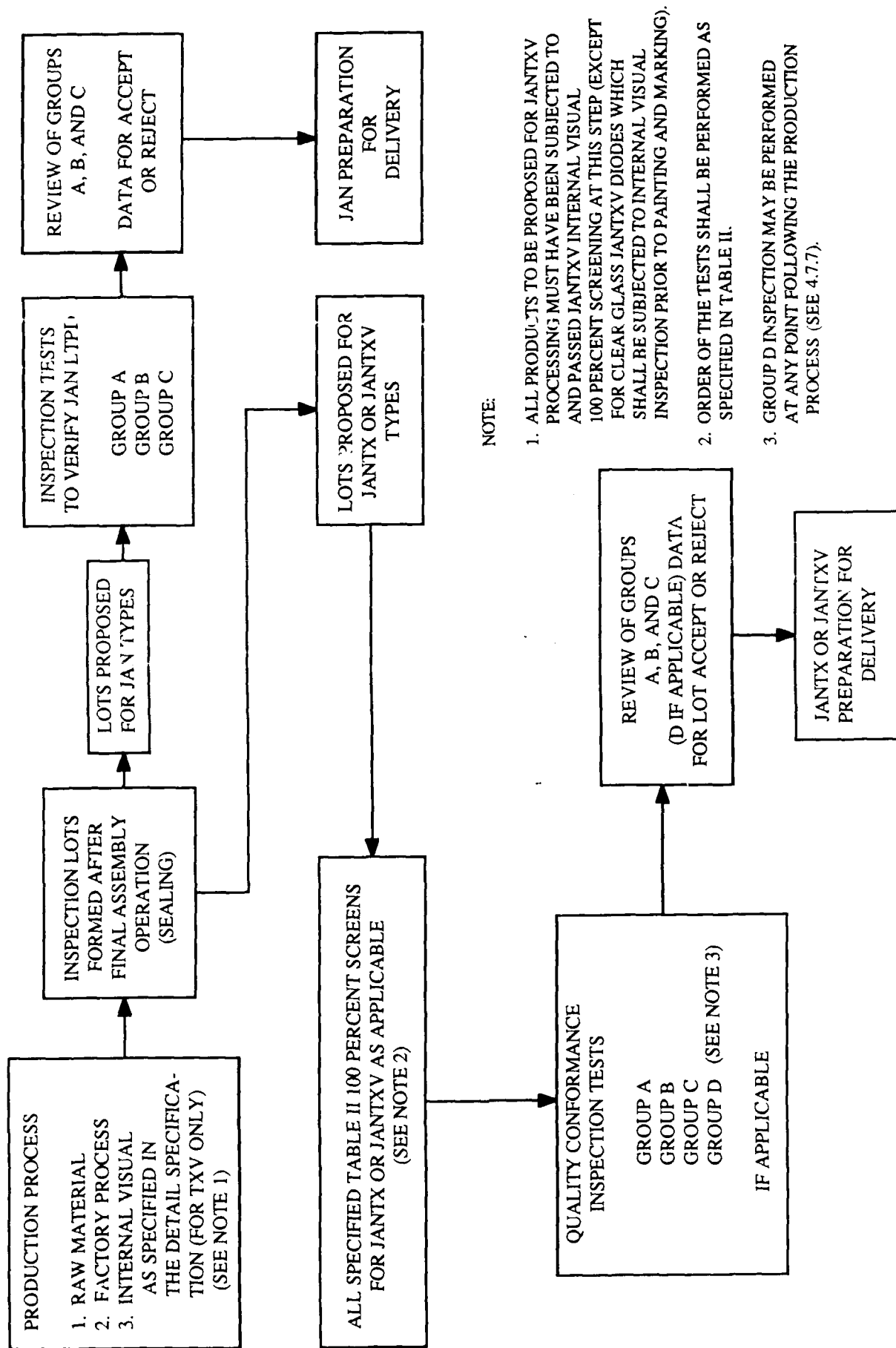

NOTE:

1. ALL PRODUCTS TO BE PROPOSED FOR JANTXV PROCESSING MUST HAVE BEEN SUBJECTED TO AND PASSED JANTXV INTERNAL VISUAL 100 PERCENT SCREENING AT THIS STEP (EXCEPT FOR CLEAR GLASS JANTXV DIODES WHICH SHALL BE SUBJECTED TO INTERNAL VISUAL INSPECTION PRIOR TO PAINTING AND MARKING).
2. ORDER OF THE TESTS SHALL BE PERFORMED AS SPECIFIED IN TABLE II.
3. GROUP D INSPECTION MAY BE PERFORMED AT ANY POINT FOLLOWING THE PRODUCTION PROCESS (SEE 4.7.7).

FIGURE 24.1: ORDER OF PROCEDURE DIAGRAM FOR JAN, JANTX, AND JANTXV DEVICE TYPES

TABLE 24.3:
MIL-S-19500 LTPD SAMPLING PLANS 1/ 2/

Minimum size of sample to be tested to assure, with a 90 percent confidence, that a lot having percent-defective equal to the specified LTPD will not be accepted (single sample).

| Max. Percent Defective (LTPD) or λ Acceptance Number (c) (F = C + 1) | Minimum Sample Sizes (For device-hours required for life test, multiply by 1000) | | | | | | | | | | | | | | | | |
|--|---|---------------|---------------|--------------|--------------|--------------|---------------|---------------|----------------|-----------------|-----------------|-----------------|-----------------|----------------------------|------------------|------------------|------------------|
| | 50 | 30 | 20 | 15 | 10 | 7 | 5 | 3 | 2 | 1.5 | 1 | 0.7 | 0.5 | 0.3 | 0.2 | 0.15 | 0.1 |
| 0 | 5 (1.03) | 8 (0.64) | 11 (0.46) | 15 (0.34) | 22 (0.23) | 32 (0.16) | 45 (0.11) | 76 (0.07) | 116 (0.04) | 153 (0.03) | 231 (0.02) | 328 (0.02) | 461 (0.01) | 76 ⁶ (0.007) | 1152 (0.005) | 1534 (0.003) | 2303 (0.002) |
| 1 | 8 (4.4) | 13 (2.7) | 18 (2.0) | 25 (1.4) | 38 (0.94) | 55 (0.65) | 77 (0.46) | 129 (0.28) | 195 (0.18) | 258 (0.14) | 390 (0.09) | 555 (0.06) | 778 (0.045) | 1296 (0.027) | 1946 (0.018) | 2592 (0.013) | 3891 (0.009) |
| 2 | 11 (7.4) | 18 (4.5) | 25 (3.4) | 34 (2.24) | 52 (1.6) | 75 (1.1) | 105 (0.78) | 176 (0.47) | 266 (0.31) | 354 (0.23) | 533 (0.15) | 759 (0.11) | 1065 (0.080) | 1773 (0.045) | 2682 (0.031) | 3547 (0.022) | 5323 (0.015) |
| 3 | 13 (10.5) | 22 (6.2) | 32 (4.4) | 43 (3.2) | 65 (2.1) | 94 (1.5) | 132 (1.0) | 221 (0.62) | 333 (0.41) | 444 (0.31) | 668 (0.20) | 953 (0.14) | 1337 (0.10) | 2226 (0.062) | 3341 (0.041) | 4452 (0.031) | 6681 (0.018) |
| 4 | 16 (12.3) | 27 (7.3) | 38 (5.3) | 52 (3.9) | 78 (2.6) | 113 (1.8) | 158 (1.3) | 265 (0.75) | 398 (0.50) | 531 (0.37) | 798 (0.25) | 1140 (0.17) | 1599 (0.12) | 2663 (0.074) | 3997 (0.049) | 5327 (0.037) | 7994 (0.025) |
| 5 | 19 (13.8) | 31 (8.4) | 45 (6.0) | 60 (4.4) | 91 (2.9) | 131 (2.0) | 184 (1.4) | 308 (0.85) | 462 (0.57) | 617 (0.42) | 927 (0.28) | 1323 (0.20) | 1855 (0.14) | 3090 (0.085) | 4638 (0.056) | 6181 (0.042) | 9275 (0.028) |
| 6 | 21 (15.6) | 35 (9.4) | 51 (6.6) | 68 (4.9) | 104 (3.2) | 149 (2.2) | 209 (1.6) | 349 (0.94) | 528 (0.62) | 700 (0.47) | 1054 (0.31) | 1503 (0.22) | 2107 (0.155) | 3509 (0.093) | 5267 (0.062) | 7019 (0.047) | 10533 (0.031) |
| 7 | 24 (18.6) | 39 (10.2) | 57 (7.2) | 77 (5.3) | 116 (3.5) | 166 (2.4) | 234 (1.7) | 390 (1.0) | 589 (0.67) | 783 (0.51) | 1178 (0.34) | 1680 (0.24) | 2355 (0.17) | 3922 (0.101) | 5886 (0.067) | 7845 (0.051) | 11771 (0.034) |
| 8 | 26 (18.1) | 43 (10.9) | 63 (7.7) | 85 (5.6) | 128 (3.7) | 184 (2.6) | 258 (1.8) | 431 (1.1) | 648 (0.72) | 864 (0.54) | 1300 (0.36) | 1854 (0.25) | 2599 (0.18) | 4329 (0.108) | 6498 (0.054) | 8660 (0.054) | 12995 (0.036) |
| 9 | 28 (19.4) | 47 (11.5) | 69 (8.1) | 93 (6.5) | 140 (3.9) | 201 (2.7) | 282 (1.9) | 471 (1.2) | 709 (0.77) | 945 (0.58) | 1421 (0.38) | 2027 (0.27) | 2842 (0.19) | 4733 (0.114) | 7103 (0.057) | 9468 (0.038) | 14206 (0.031) |
| 10 | 31 (19.9) | 51 (12.1) | 75 (8.4) | 100 (6.3) | 152 (4.1) | 218 (2.9) | 306 (2.0) | 511 (1.2) | 770 (0.80) | 1025 (0.60) | 1541 (0.40) | 2199 (0.28) | 3082 (0.20) | 5133 (0.120) | 7704 (0.080) | 10268 (0.060) | 15407 (0.040) |
| 11 | 33 (21.0) | 54 (12.8) | 83 (8.3) | 111 (6.2) | 166 (4.2) | 238 (2.9) | 332 (2.1) | 555 (1.2) | 832 (0.83) | 1109 (0.62) | 1664 (0.42) | 2378 (0.29) | 3323 (0.21) | 5546 (0.12) | 8319 (0.083) | 11092 (0.062) | 16638 (0.042) |
| 12 | 36 (21.4) | 59 (13.0) | 89 (8.6) | 119 (6.5) | 178 (4.3) | 254 (3.0) | 356 (2.2) | 594 (1.3) | 890 (0.86) | 1187 (0.65) | 1781 (0.43) | 2544 (0.3) | 3562 (0.22) | 5936 (0.13) | 8904 (0.086) | 11872 (0.065) | 17808 (0.043) |
| 13 | 38 (22.3) | 63 (13.4) | 95 (8.9) | 126 (6.7) | 190 (4.5) | 271 (3.1) | 379 (2.2) | 632 (1.3) | 948 (0.89) | 1264 (0.67) | 1896 (0.44) | 2709 (0.31) | 3793 (0.22) | 6321 (0.134) | 9482 (0.089) | 12643 (0.067) | 18964 (0.045) |
| 14 | 40 (23.1) | 67 (13.8) | 101 (9.2) | 134 (6.9) | 201 (4.6) | 288 (3.0) | 403 (2.3) | 672 (1.4) | 1007 (0.92) | 1343 (0.69) | 2015 (0.46) | 2878 (0.32) | 4029 (0.23) | 6716 (0.138) | 10073 (0.092) | 13431 (0.069) | 20146 (0.046) |
| 15 | 43 (23.3) | 71 (14.1) | 107 (9.4) | 142 (7.1) | 213 (4.7) | 305 (3.3) | 426 (2.3) | 711 (1.4) | 1066 (0.94) | 1422 (0.71) | 2133 (0.47) | 3046 (0.33) | 4265 (0.235) | 7108 (0.141) | 10662 (0.094) | 14216 (0.070) | 21324 (0.047) |
| 16 | 45 (24.1) | 74 (14.6) | 112 (9.7) | 150 (7.2) | 225 (4.8) | 321 (3.3) | 450 (2.4) | 750 (1.4) | 1124 (0.96) | 1499 (0.72) | 2249 (0.48) | 3212 (0.337) | 4497 (0.241) | 7496 (0.144) | 11244 (0.096) | 14992 (0.072) | 22487 (0.048) |
| 17 | 47 (24.7) | 79 (14.7) | 118 (9.8) | 158 (7.3) | 236 (4.9) | 338 (3.4) | 473 (2.4) | 788 (1.48) | 1182 (0.98) | 1576 (0.74) | 2364 (0.49) | 3377 (0.344) | 4728 (0.246) | 7880 (0.148) | 11819 (0.098) | 15759 (0.074) | 23639 (0.049) |
| 18 | 50 (24.9) | 83 (15.0) | 124 (10.0) | 165 (7.5) | 248 (5.0) | 354 (3.5) | 496 (2.5) | 826 (1.5) | 1239 (1.0) | 1652 (0.75) | 2478 (0.50) | 3540 (0.351) | 4956 (0.251) | 8260 (0.151) | 12390 (0.100) | 16520 (0.075) | 24780 (0.050) |
| 19 | 52 (25.5) | 86 (15.4) | 130 (10.2) | 173 (7.7) | 259 (5.1) | 370 (3.5) | 518 (2.5) | 864 (1.5) | 1296 (1.0) | 1728 (0.77) | 2591 (0.52) | 3702 (0.358) | 5183 (0.256) | 8638 (0.153) | 12957 (0.102) | 17276 (0.077) | 25914 (0.051) |
| 20 | 54 (26.1) | 90 (15.6) | 135 (10.4) | 180 (7.8) | 271 (5.1) | 386 (3.6) | 541 (2.6) | 902 (1.5) | 1353 (1.0) | 1803 (0.78) | 2705 (0.52) | 3864 (0.364) | 5410 (0.260) | 9017 (0.156) | 13526 (0.104) | 18034 (0.078) | 27051 (0.052) |
| 25 | 65 (27.0) | 109 (16.1) | 163 (10.8) | 217 (8.0) | 326 (5.3) | 466 (3.7) | 652 (2.6) | 1086 (1.6) | 1629 (1.0) | 2173 (0.807) | 3259 (0.538) | 4656 (0.376) | 6518 (0.269) | 10863 (0.161) | 16295 (0.108) | 21726 (0.081) | 32589 (0.054) |

1/ Sample sizes are based upon the Poisson exponential binomial limit.

2/ The minimum quality (approximate AQL) required to accept on the average) 19 of 20lots is shown in parenthesis for information only.

CHAPTER 24: MIL-S-19500G

Each slash sheet is an individual, separately-maintained document. New slash sheets are continually being issued and older slash sheets modified. The individual slash sheets vary in length but may contain sixty or more pages. An example of a portion of a detail specification is shown in Figure 24.2.

● Qualified Products List

The MIL-S-19500 QPL provides a detailed listing of each specific device, quality grade and package configuration together with the specific manufacturer and facility(s) that has met all of the necessary qualification, product screening and quality conformance requirements and is thus an approved source for that device. The QPL is updated quarterly and is approximately seventy-one pages in length. An example of a portion of the QPL is shown in Figure 24.3.

● Supplement

The MIL-S-19500 Supplement is a summary document. It contains a detailed listing of all the devices currently covered by MIL-S-19500 together with the current revision of the applicable slash sheet. Part I of the supplement lists devices by the detail specification number and in Part II they are listed by device type(s). The supplement is approximately twelve pages in length. An example of a portion of the supplement is shown in Figure 24.4.

24.5 HOW TO USE MIL-S-19500

MIL-S-19500 is a source of general design and product assurance information on semiconductor devices of standardized construction whose electrical, mechanical and environmental ratings are governed by MIL (JAN) specifications.

This information provides the design engineer with the capability of determining which JAN semiconductor device, procured in which configuration and possessed of which electrical, mechanical, environmental and package characteristics, will best fit his intended application needs.

24.6 TAILORING GUIDELINES

MIL-M-19500 was not written with the intent of tailoring. It establishes firm requirements which are necessary for JAN device qualification, product screening and continuing quality conformance. These requirements are not intended to be modified.

24.7 CONTRACT DATA REQUIREMENTS LIST (CDRL)

There are no data item descriptions applicable to MIL-S-19500.

CHAPTER 24: MIL-S-19500G

MIL-S-19500/323C
9 Jul 87
~~SUPERSEDING~~
MIL-S-19500/323B
22 June 1984

MILITARY SPECIFICATION

SEMICONDUCTOR DEVICE, TRANSISTOR, PNP, SILICON, SWITCHING
TYPES 2N3250A AND 2N3251A
JAN, JANTX, JANTXV, AND JANS

This specification is approved for use by all Departments and Agencies of the Department of Defense.

1. SCOPE
 - 1.1 Scope. This specification covers the detail requirements for PNP, silicon, switching transistors. Four levels of product assurance are provided for each device type as specified in MIL-S-19500.
 - 1.2 Physical dimensions. See figure 1.
 - 1.3 Maximum ratings.

| $\frac{P_T}{T_A} = 1/$ $T_A = 25^\circ\text{C}$ | $\frac{P_T}{T_C} = 2/$ $T_C = 25^\circ\text{C}$ | V_{CB0} | V_{CEO} | V_{EBO} | I_C | T_{op} and T_{STG} | $R_{\theta JA}$ |
|--|--|-------------|-------------|-------------|--------------|---------------------------|-----------------|
| <u>W</u> | <u>W</u> | <u>V dc</u> | <u>V dc</u> | <u>V dc</u> | <u>mA dc</u> | <u>°C</u> | <u>°C/W</u> |
| 0.36 | 1.2 | 60 | 60 | 5 | 200 | -65 to +200 | 485.4 |

1/ Derate linearly 2.06 mW/°C for $T_A > 25^\circ\text{C}$.
2/ Derate linearly 6.90 mW/°C for $T_C > 25^\circ\text{C}$.

1.4 Primary electrical characteristics.

| h_{FE} at $V_{CE} = 1.0$ V dc | | | | | | h_{fe} | $r_{b'c}$ | | |
|---------------------------------|---------|---------------------|---------|---------------------|---------|--------------------|--------------------|-----|-----------|
| $I_C = 0.1$ mA dc | | $I_C = 10$ mA dc 1/ | | $I_C = 50$ mA dc 1/ | | $f = 100$ MHz | $V_{CE} = 20$ V dc | | |
| | | | | | | $V_{CE} = 20$ V dc | $I_C = 10$ mA dc | | |
| | | | | | | $I_C = 10$ mA dc | $f = 31.8$ MHz | | |
| | 2N3250A | 2N3251A | 2N3250A | 2N3251A | 2N3250A | 2N3251A | 2N3250A 2N3251A | | |
| Min | 40 | 80 | 50 | 100 | 15 | 30 | 2.5 | 3.0 | <u>ps</u> |
| Max | --- | --- | 150 | 300 | --- | --- | 9.0 | 9.0 | 5 |

1/ Pulsed (see 4.5.1).

| | $V_{CE(sat)}$ | C_{obo} | t_{on} | t_{off} | NF |
|-----|---------------------------------------|--|---------------------------------------|---------------------------------------|---|
| | $I_C = 10$ mA dc $I_B = 1.0$ mA dc | 100 kHz $\leq f \leq 1$ MHz $V_{CB} = 10$ V dc $I_E = 0$ | $I_C = 10$ mA dc $I_B = 1.0$ mA dc | $I_C = 10$ mA dc $I_B = 1.0$ mA dc | $V_{CE} = 5.0$ V dc $I_C = .1$ mA dc $R_g = 1$ k Ω $f = 100$ Hz |
| | <u>V dc</u> | <u>pF</u> | <u>ns</u> | <u>ns</u> | <u>dB</u> |
| Min | --- | --- | --- | --- | --- |
| Max | 0.25 | 6 | 70 | 225 | 250 |

Beneficial comments (recommendations, additions, deletions) and any pertinent data which may be of use in improving this document should be addressed to: Commander, Space and Naval Warfare Systems Command, ATTN: SPAWAR 81112, Washington, DC 20363, by using the self-addressed Standardization Document Improvement Proposal (DD Form 1426) appearing at the end of this document or by letter.

AMSC N/A

FSC 5961

DISTRIBUTION STATEMENT A. Approved for public release; distribution is unlimited.

FIGURE 24.2: MIL-S-19500G DETAIL SPECIFICATION EXAMPLE

CHAPTER 24: MIL-S-19500G

QUALIFICATIONS VALIDATED ANNUALLY

QPL-19500-103
9 July 1987
~~SUPERSEDING~~
QPL-19500-102
9 April 1987

QUALIFIED PRODUCTS LIST
OF
PRODUCTS QUALIFIED UNDER MILITARY SPECIFICATION
MIL-S-19500
SEMICONDUCTOR DEVICES
GENERAL SPECIFICATION FOR

FSC 5961

This list has been prepared for use by or for the Government in the acquisition of products covered by Specification MIL-S-19500. Listing of a product is not intended to and does not connote endorsement of the product by the Department of Defense. All products listed herein have been qualified under the requirements for the product as specified in the latest effective issue of the applicable specification. This list is subject to change without notice. Revision or amendment of this list will be issued as necessary. The listing of a product does not release the supplier from compliance with the specification requirements.

THE ACTIVITY RESPONSIBLE FOR THIS QUALIFIED PRODUCTS LIST IS THE SPACE AND NAVAL WARFARE SYSTEMS COMMAND. The Defense Electronics Supply Center (DESC-EQ) has been designated as agent for the establishment and maintenance of this QPL.

NOTE: When the detail specification requires qualification and there are no products listed or approved for listing on the QPL or when suppliers of those products on the QPL are nonresponsive to an IFB, the qualification requirement of paragraph 3.3 of MIL-S-19500 may be waived for procurement of Semiconductor Devices, only by the Preparing Activity. When qualification is waived, procuring activities shall invoke first article inspection. First article inspection shall consist of performing all qualification tests. The sample size and allowable defects shall be in accordance with the detail specification. MIL-S-19500 qualification sampling and acceptance criteria. A copy of the test data shall be forwarded to the qualifying activity.

| GOVERNMENT DESIGNATION | MANUFACTURER'S DESIGNATION TYPE NUMBER | TEST OR QUALIFICATION REFERENCE | DETAIL SPECIFICATION | MANUFACTURER'S NAME (ADDRESS ON LAST PAGE) |
|------------------------|--|---------------------------------|----------------------|--|
|------------------------|--|---------------------------------|----------------------|--|

- NOTES: The Government designation includes the JAN prefix.
 * Includes JAN and JANTX product assurance levels
 ** Includes JAN, JANTX and JANTXV product assurance levels
 § Includes JAN, JANS, JANTX, and JANTXV product assurance levels
 §§ Includes JANS, JANTX, and JANTXV product assurance levels only
 + Includes JANTX product assurance level only
 ++ Includes JANTX and JANTXV product assurance levels only

| | | | | |
|-----------------------|------|--------------|------|----------------------------|
| 1N21WE, WEM, and WEMR | CDAP | 19500-203-80 | /232 | Alpha Industries, Inc. |
| 1N21WE, WEM, and WEMR | CBYI | 19500-207-81 | /232 | Microwave Associates, Inc. |
| 1N21WG, WGM, and WGMR | CDAP | 19500-203-80 | /321 | Alpha Industries, Inc. |
| 1N21WG, WGM, and WGMR | CBYI | 19500-207-81 | /321 | Microwave Associates, Inc. |

1 of 72
QPL-19500-103

AMSC N/A

DISTRIBUTION STATEMENT A. Approved for public release; distribution is unlimited.

FIGURE 24.3: MIL-S-19500G QPL EXAMPLE

CHAPTER 24: MIL-S-19500G

MIL-S-19500G
SUPPLEMENT 1A
3 March 1986

MILITARY SPECIFICATION

SEMICONDUCTOR DEVICES GENERAL SPECIFICATION FOR

This supplement forms a part of MIL-S-19500G, dated 16 February 1984.

This is a two-part supplement. Part I is listed by detail specification and part II is listed by device type(s). Devices listed may be covered in amendments or "in lieu of" documents associated with the detail specification referenced.

- NOTES: The device type(s) include JAN product assurance level.
 *Includes JAN and JANTX product assurance level.
 **Includes JAN, JANTX, and JANTXV product assurance level.
 †Includes JAN, JANTX, JANTXV and JANS product assurance level.
 ‡Qualification is not required.
 +Includes JANTX product assurance level only.
 ++Includes JANTX and JANTXV product assurance levels only.
 ††Includes JANTX, JANTXV, and JANS product assurance levels only.

PART I

| Detail specification MIL-S-19500/ | Device type(s) | Detail specification MIL-S-19500/ | Device type(s) |
|--------------------------------------|---------------------------------|--------------------------------------|---|
| #1A | 2N220 | 64D | 2N396A |
| #2B | 2N117 thru 2N119 | 65B | 2N388 |
| 4D | 2N331 | #66B | 2N422 |
| 6B | 2N43A, 2N44A | 67A | 2N1011 |
| 9B | 2N128 | 68A | 2N1120 |
| 11C | 2N167A | 69E | 2N337, 2N338 |
| 13B | 2N174A | 70A | 2N463 |
| 16E | 2N342, A, 2N343 | 71D | 2N1195 |
| 20C | 2N404, A | #72C | 2N499, A |
| 24D | 2N158 | 73B | 2N560 |
| 25B | 2N240 | 74E | 2N497, 2N498, 2N656, 2N657 |
| 27E | 2N384 | 75B | *2N489A thru 2N494A |
| 30A | 2N123 | 76C | 2N1412, A |
| 31C | 2N341 | #77C | 2N393 |
| 36C | 2N297A | 78C | 2N1025, 2N1026, 2N1469 |
| 37D | 2N333, A, 2N335, A, 2N336, A | 80E | 3N35 |
| 38C | 2N539, A | 84A | 2N545 |
| 40B | 2N326 | 86A | 2N705 |
| 41B | 2N425 thru 2N427 | 87A | 2N1142 |
| 44D | 2N428 | #88 | 2N1046 |
| #46B | 2N574, 2N575, A, 2N1157A | 89D | 2N1039, 2N1041, 2N2553, 2N2555, 2N2557, 2N2559 |
| 49C | 2N464, 2N465, 2N467 | 91 | 1N2153 |
| 51E | 2N466 | 99E | 2N696, 2N697 |
| #56B | 2N416, 2N417 | #100A | 2N537 |
| 58D | 2N665 | 102A | 2N1016B, C, D |
| 60E | 2N526 | 104C | 1N1124A, RA, 1N1126A, RA, 1N1128A, RA, 1N3649, R, 1N3650, R |
| #62B | 2N501A | | |
| 63D | 2N358A | | |

AMSC N/A

DISTRIBUTION STATEMENT A.

1 of 12

Approved for public release; distribution is unlimited.

PSC 5961

FIGURE 24.4: MIL-S-19500 SUPPLEMENT EXAMPLE

CHAPTER 25:

MIL-STD-750C

TEST METHODS FOR SEMICONDUCTOR DEVICES

CHAPTER 25: MIL-STD-750C

MIL-STD-750 is a tri-service-approved document used by all branches of the military in the specification and acquisition of quality-assured systems and equipment. The current version is revision "C" dated February 23, 1983. The preparing activity is:

Department of the Navy
Space and Naval Warfare Systems Command
ATTN: SPAWAR 003-121
Washington, DC 20363-5100

This chapter is only an advisory to the use of MIL-STD-750. It does not supersede, modify, replace or curtail any requirements of MIL-STD-750, nor should it be used in lieu of that standard.

25.1 REFERENCE DOCUMENTS

The following documents are complementary to MIL-STD-750 in the establishment of styles, electrical characteristics, screening and test methods for microelectronic devices.

- MIL-S-19500 General Specification for Semiconductor Devices
- MIL-STD-202 Test Methods for Electronic and Electrical Component Parts
- MIL-HDBK-217 Reliability Prediction of Electronic Equipment
- DoD-STD-1686 *Electrostatic Discharge Control Program for Protection of Electrical and Electronic Parts, Assemblies and Equipment (Excluding Electrically Initiated Explosive Devices)*
- DoD-HDBK-263 *Electrostatic Discharge Control Handbook for Protection of Electrical and Electronic Parts, Assemblies and Equipment (Excluding Electrically Initiated Explosive Devices)*
- MIL-STD-45662 Calibration System Requirements

25.2 DEFINITIONS

For the purposes of MIL-STD-750, the abbreviations, symbols and definitions in MIL-S-19500 shall apply.

25.3 APPLICABILITY

MIL-STD-750 establishes uniform methods and procedures for testing semiconductor devices, including basic environmental tests to determine resistance to deleterious effects of natural elements and conditions surrounding military and space operations, and physical and electrical tests. This standard applies only to semiconductor devices. The test methods described therein have been prepared to serve several purposes:

- a. To specify suitable conditions obtainable in the laboratory and at the device level which give test results equivalent to the actual service conditions which may exist in the field, and to obtain reproducibility of the results of tests.
- b. To describe in one standard all of the test methods of a similar character which now appear in the various joint-services and NASA semiconductor device specifications, so that these methods may be kept uniform and thus result in conservation of equipment, manhours, and testing facilities.

CHAPTER 25: MIL-STD-750C

- c. The test methods described in MIL-STD-750 for the environmental, physical and electrical testing of devices shall also apply when appropriate, to parts not covered by an approved Military/NASA specification, standard, specification sheet, or drawing.

25.4 PHYSICAL DESCRIPTION OF MIL-STD-750

MIL-STD-750 is a voluminous document composed of one hundred and fifty-six different detailed "Test Methods." It contains approximately five hundred pages. There are no appendices to this standard.

25.5 HOW TO USE MIL-STD-750

The test methods of MIL-STD-750 are used in performing the qualification, inspection and screening tests, the Group A, B, and C quality conformance tests and the radiation hardness tests (as applicable for JAN, JANTX, JANTXV, and JAN S devices) in accordance with the requirements of MIL-S-19500, "General Specification for Semiconductor Devices."

Paragraph 4.0 of MIL-STD-750 establishes general requirements applicable to the use of MIL-STD-750 test methods. These requirements, which shall be in force unless otherwise specified in MIL-STD-750 or in the individual device specification include: standard test conditions; temperature control in test chambers; electrical test frequency; accuracy of test; calibration and certification of test equipment; exclusion of conditions in which transients cause the device ratings to be exceeded; conditions for electrical measurements; "pulse" measurements; standard test circuits; soldering precautions; order of lead connection; radiation precautions; handling precautions for UHF and microwave devices and for ESD-susceptible devices; and the physical orientation of cylindrical and non-cylindrical devices to the direction of the accelerating force during test.

MIL-STD-750 includes both destructive and nondestructive type tests. No devices subjected to destructive tests shall be designated for use in equipment delivered to the government.

MIL-STD-750 is structured into five general classes of Test Methods: the 1000 Class addresses Environmental Tests, 2000 Class addresses Mechanical Characteristics Tests; 3000 Class addresses Electrical Characteristics Tests for Transistors; 4000 Class addresses Electrical Characteristics Tests for Diodes; and the 5000 Class addresses High Reliability Space Application Tests.

A complete list of MIL-STD-750C test methods is given in Table 25.1 below:

**TABLE 25.1:
MIL-STD-750 TEST METHOD**

| <u>Method No.</u> | <u>Environmental Tests</u> |
|-------------------|---|
| 1001.1 | Barometric pressure, reduced |
| 1011 | Immersion |
| 1015 | Steady-state primary photocurrent irradiation procedure (electron beam) |
| 1016 | Insulation resistance |

CHAPTER 25: MIL-STD-750C

**TABLE 25.1:
MIL-STD-750 TEST METHOD (CONT'D)**

| <u>Method No.</u> | <u>Environmental Tests (Cont'd)</u> |
|-------------------|---|
| 1017 | Neutron Irradiation |
| 1019 | Steady-state total dose irradiation procedure |
| 1021.1 | Moisture resistance |
| 1022.1 | Resistance to solvents |
| 1026.3 | Steady-state operation life |
| 1027.1 | Steady-state operation life (LTPD) |
| 1031.4 | High-temperature life (nonoperating) |
| 1032.1 | High-temperature (nonoperating) life (LTPD) |
| 1036.3 | Intermittent operation life |
| 1037 | Intermittent operation life (LTPD) |
| 1038 | Burn-in (for diodes and rectifiers) |
| 1039 | Burn-in (for transistors) |
| 1040 | Burn-in (for thyristors (controlled rectifiers) |
| 1041.1 | Salt atmosphere (corrosion) |
| 1046.2 | Salt spray (corrosion) |
| 1051.2 | Thermal shock (temperature cycling |
| 1056.1 | Thermal shock (glass strain) |
| 1061.1 | Temperature measurement, case and stud |
| 1066.1 | Dew point |
| 1071.2 | Hermetic seal |
| | <u>Mechanical Tests</u> |
| 2005 | Axial lead tensile test |
| 2006 | Constant acceleration |
| 2016.2 | Shock |

CHAPTER 25: MIL-STD-750C

**TABLE 25.1:
MIL-STD-750 TEST METHOD (CONT'D)**

| <u>Method No.</u> | <u>Mechanical Tests (Cont'd)</u> |
|-------------------|--|
| 2017 | Die shear strength |
| 2026.4 | Solderability |
| 2031.1 | Soldering heat |
| 2036.3 | Terminal strength |
| 2037 | Bond strength |
| 2046.1 | Vibration fatigue |
| 2051.1 | Vibration noise |
| 2052 | Particle impact noise detection test |
| 2056 | Vibration, variable frequency |
| 2057.1 | Vibration, variable frequency (monitored) |
| 2066 | Physical dimensions |
| 2071 | Visual and mechanical examination |
| 2072.2 | Internal visual transistor (pre-cap) inspection |
| 2073 | Visual inspection for die (semiconductor diode) |
| 2074 | Internal visual inspection (discrete semiconductor diodes) |
| 2075 | Decap internal visual design verification |
| 2076.1 | Radiography |
| 2077 | Scanning electron microscope (SEM) inspection of metallization |
| 2081 | Forward instability, shock (FIST) |
| 2082 | Backward instability, vibration (BIST) |
| | <u>Electrical Tests for Transistors</u> |
| 3001.1 | Breakdown voltage, collector to base |
| 3005.1 | Burnout by pulsing |
| 3011.1 | Breakdown voltage, collector to emitter |

CHAPTER 25: MIL-STD-750C

**TABLE 25.1:
MIL-STD-750 TEST METHOD (CONT'D)**

| <u>Method No.</u> | <u>Electrical Tests for Transistors (Cont'd)</u> |
|-------------------|---|
| 3015 | Drift |
| 3020 | Floating potential |
| 3026.1 | Breakdown voltage, emitter to base |
| 3030 | Collector to emitter voltage |
| 3036.1 | Collector to base cutoff current |
| 3041.1 | Collector to emitter cutoff current |
| 3051 | Safe operating area (continuous dc) |
| 3052 | Safe operating area (pulsed) |
| 3053 | Safe operating area (switching) |
| 3061.1 | Emitter to base cutoff current |
| 3066.1 | Base emitter voltage (saturated or nonsaturated) |
| 3071 | Saturation voltage and resistance |
| 3076.1 | Forward-current transfer ratio |
| 3086.1 | Static input resistance |
| 3092.1 | Static transconductance |
| | <u>Circuit-Performance and Thermal Resistance Measurements</u> |
| 3126 | Thermal resistance (collector-cutoff-current method) |
| 3131.1 | Thermal resistance (emitter to base forward voltage, emitter-only switching method) |
| 3132 | Thermal resistance (dc forward voltage drop, emitter base continuous method) |
| 3136 | Thermal resistance (forward voltage drop, collector to base, diode method) |
| 3141 | Thermal response time |
| 3146.1 | Thermal time constant |
| 3151 | Thermal resistance, general |

CHAPTER 25: MIL-STD-750C

**TABLE 25.1:
MIL-STD-750 TEST METHOD (CONT'D)**

| <u>Method No.</u> | <u>Circuit-Performance and Thermal Resistance Measurements (Cont'd)</u> |
|-----------------------------|--|
| 3181 | Thermal resistance for thyristors |
| <u>Low Frequency Tests</u> | |
| 3201.1 | Small-signal short-circuit input impedance |
| 3206.1 | Small-signal short-circuit forward-current transfer ratio |
| 3211 | Small-signal open-circuit reverse-voltage transfer ratio |
| 3216 | Small-signal open-circuit output admittance |
| 3221 | Small-signal short-circuit input admittance |
| 3231 | Small-signal short-circuit output admittance |
| 3236 | Open circuit output capacitance |
| 3240.1 | Input capacitance (output open-circuited or short- circuited) |
| 3241 | Direct interterminal capacitance |
| 3246.1 | Noise figure |
| 3251.1 | Pulse response |
| 3255 | Large signal power again |
| 3256 | Small signal power gain |
| 3261.1 | Extrapolated unity gain frequency |
| 3266 | Real part of small-signal short circuit input impedance |
| <u>High Frequency Tests</u> | |
| 3301 | Small-signal short-circuit forward-current transfer-ratio cutoff frequency |
| 3306.2 | Small-signal short-circuit forward-current transfer ratio |
| 3311 | Maximum frequency of oscillation |
| 3320 | Power output, RF power gain, and collector efficiency |

CHAPTER 25: MIL-STD-750C

**TABLE 25.1:
MIL-STD-750 TEST METHOD (CONT'D)**

| <u>Method No.</u> | <u>Electrical Tests for Field-Effect Transistors</u> |
|-------------------|--|
| 3401 | Breakdown voltage, gate to source |
| 3403 | Gate to source voltage or current |
| 3404 | Mosfet threshold voltage |
| 3405 | Drain to source "on-state" voltage |
| 3407 | Breakdown voltage, drain to source |
| 3411 | Gate reverse current |
| 3413 | Drain current |
| 3415 | Drain reverse-current |
| 3421 | Static drain to source "on-state" resistance |
| 3423 | Small-signal, drain to source "on-state" resistance |
| 3431 | Small-signal, common-source, short circuit, input capacitance |
| 3433 | Small-signal, common-source, short-circuit, reverse-transfer capacitance |
| 3453 | Small-signal, common-source, short-circuit, output admittance |
| 3455 | Small-signal, common-source, short-circuit, output admittance |
| 3457 | Small-signal, common-source, short-circuit, reverse transfer admittance |
| 3459 | Pulse response (FET) |
| 3461 | Small-signal, common-source, short-circuit, input admittance |
| | <u>Electrical Tests for Diodes</u> |
| 4001.1 | Capacitance |
| 4011.4 | Forward voltage |
| 4016.3 | Reverse current leakage |
| 4021.2 | Breakdown voltage (diodes) |
| 4022 | Breakdown voltage (voltage regulators and voltage-reference diodes) |

CHAPTER 25: MIL-STD-750C

**TABLE 25.1:
MIL-STD-750 TEST METHOD (CONT'D)**

| <u>Method No.</u> | <u>Electrical Tests for Diodes (Cont'd)</u> |
|-------------------|---|
| 4026.2 | Forward recovery voltage and time |
| 4031.1 | Reverse recovery time |
| 4036.1 | "Q" for voltage variable capacitance diodes |
| 4041.2 | Rectification efficiency |
| 4046.1 | Reverse current, average |
| 4051.3 | Small-signal reverse breakdown voltage impedance |
| 4056.2 | Small-signal forward impedance |
| 4061.1 | Stored charge |
| 4066.2 | Surge current |
| 4071.1 | Temperature coefficient of breakdown voltage |
| 4076.1 | Saturation current |
| 4081.2 | Thermal resistance of lead mounted diodes (forward voltage, switching method) |
| | <u>Electrical Tests for Microwave Diodes</u> |
| 4101.3 | Conversion loss |
| 4102 | Microwave diode capacitance |
| 4106 | Detector power efficiency |
| 4111.1 | Figure of merit (current sensitivity) |
| 4116.1 | Intermediate frequency (IF) impedance |
| 4121.2 | Output noise ratio |
| 4126.2 | Overall noise figure and noise figure of the IF amplifier |
| 4131.1 | Video resistance |
| 4136.1 | Standing wave ratio |
| 4141.1 | Burnout by repetitive pulsing |

CHAPTER 25: MIL-STD-750C

**TABLE 25.1:
MIL-STD-750 TEST METHOD (CONT'D)**

| <u>Method No.</u> | <u>Electrical Tests for Microwave Diodes (Cont'd)</u> |
|-------------------|---|
| 4146.1 | Burnout by single pulse |
| 4151 | Rectified microwave diode current |
| | <u>Electrical Tests for Thyristors</u> |
| 4201.2 | Holding current |
| 4206.1 | Forward blocking current |
| 4211.1 | Reverse blocking current |
| 4216 | Pulse response |
| 4219 | Reverse gate current |
| 4221.1 | Gate-trigger voltage or gate-trigger current |
| 4223 | Gate-controlled turn-on time |
| 4224 | Circuit-commutated turn-off time |
| 4225 | Gate-controlled turn-off time |
| 4226.1 | Forward "on" voltage |
| 4231.2 | Exponential rate of voltage rise |
| | <u>Electrical Tests for Tunnel Diodes</u> |
| 4301 | Junction capacitance |
| 4306.1 | Static characteristics of tunnel diodes |
| 4316 | Series inductance |
| 4321 | Negative resistance |
| 4326 | Series resistance |
| 4331 | Switching time |
| | <u>High Reliability and Space Application Tests</u> |
| 5001 | Wafer lot acceptance testing |

CHAPTER 25: MIL-STD-750C

25.6 TAILORING

Tailoring of MIL-STD-750 test methods and procedures is accomplished principally in the choice made among 1) JAN, 2) JANTX, 3) JANTXV, and 4) JAN-S device quality conformance levels and the screening procedures selected to accomplish these levels.

25.6.1 When and How to Tailor

Identification of the desired microelectronic devices by quality conformance level designator, i.e., 1), 2), 3), or 4) above, shall be specified in the device procurement document.

25.7 CONTRACT DATA REQUIREMENTS LIST (CDRL)

No deliverable data items are required by MIL-STD-750.

CHAPTER 26:

MIL-STD-701M

LISTS OF STANDARD SEMICONDUCTOR DEVICES

CHAPTER 26: MIL-STD-701M

MIL-STD-701 is a tri-service approved document used by all branches of the military in the specification and acquisition of quality-assured electronic systems and equipment. The current version is revision "M" dated June 9, 1986. The preparing activity is:

Department of the Navy
Space and Naval Warfare Systems Command
ATT: SPAWAR 003-121
Washington, DC 20363-5100

This chapter is only an advisory to the use of MIL-STD-701. It does not supersede, modify, replace or curtail any of the requirements of MIL-STD-701 nor should it be used in lieu of that standard.

26.1 REFERENCED DOCUMENTS

The following related documents impact and further detail these requirements and should also be referenced.

- MIL-STD-19500 Semiconductor Devices, General Specification for
- MRAP/SRAP Microcircuit/Semiconductor Reliability Assessment Program

26.2 DEFINITIONS

This paragraph is not applicable to this chapter.

26.3 APPLICABILITY

MIL-STD-701 provides equipment designers and manufacturers with lists of semiconductor devices considered by the Army, Navy and Air Force as standard for military applications. The purpose of this listing is two-fold.

- 1) To control and minimize the variety of semiconductor devices used in order to facilitate effective logistic support of fielded equipment.
- 2) To maximize the economic support of, and concentrate improvement on, the production of the semiconductors currently listed.

26.4 PHYSICAL DESCRIPTION OF MIL-STD-701

MIL-STD-701 is a very simple document of approximately forty pages. The standard simply contains lists of approved semiconductor devices tabulated and presented in two different formats; in the first they are grouped by device type, or function, and in the second they are presented in numerical part number order. There are no appendices to this standard.

26.5 HOW TO USE MIL-STD-701

Semiconductors are listed in MIL-STD-701 in thirty-one different tables both by device type and in numerical order as shown in Table 26.1.

CHAPTER 26: MIL-STD-701M

TABLE 26.1:
MIL-STD-701 SEMICONDUCTOR DEVICES LISTINGS

| <u>Table</u> | <u>Device Types</u> |
|--------------|--|
| I | Switching Diodes |
| II | Axial-Lead Power Rectifiers |
| III | Fast-Recovery Rectifiers |
| IV | Power Rectifiers |
| V | Schottky Rectifiers |
| VI | High-Voltage Rectifier Assemblies |
| VII | High-Current, Full Wave, Bridge Rectifiers |
| VIII | Multiple Diode Arrays |
| IX | Voltage Reference Diodes |
| X | Voltage Regulator Diodes |
| XI | Voltage-Variable Capacitor Diodes |
| XII | Current Regulator Diodes |
| XIII | Transient Suppression Diodes |
| XIV | Light Emitting Diodes |
| XV | Thyristors (Silicon Controlled Rectifiers) |
| XVI | Optical Coupled Isolators |
| XVII | NPN Low-Power Transistors |
| XVIII | PNP Low-Power Transistors |
| XIX | NPN Power Transistors |
| XX | PNP Power Transistors |
| XXI | RF Transistors |
| XXII | Dual Transistors (Differential Amplifier) |
| XXIII | Dual Transistors |
| XXIV | Darlington Transistors |
| XXV | Unijunction Transistors |
| XXVI | Junction Field Effect Transistors |
| XXVII | Low-Power Chopper Transistors |
| XXVIII | MOS FET, Power |
| XXIX | Numerical Listing of Diodes, Diode Arrays, and Bridge Rectifiers |
| XXX | Numerical Listing of Thyristors |
| XXXI | Numerical Listing of Transistors |

The JANTX and JANTXV semiconductor devices listed in Tables I - XXXI of MIL-STD-701 have been approved for use in military equipment. Pertinent information associated with each device such as device ratings, primary electrical characteristics and applicable MIL-S-19500 specification document (i.e., slash sheet) references are provided in Tables I - XXVIII. (All devices listed in these tables are silicon types except for devices listed in Tables XIV and XV.) In addition, wherever applicable, mechanical configurations of devices are given in terms of JEDEC outlines.

The following Table 26.2 (excerpted from MIL-STD-701) is shown here, as a typical example, to demonstrate the type of information provided in Tables I - XXVIII of MIL-STD-701M. An example of the type of information provided in Tables XXIX through XXXI is shown in Table 26.3 (also excerpted from MIL-STD-701).

TABLE 26.2: THYRISTORS (SILICON CONTROLLED RECTIFIERS) LISTING

| Device type no. | I_0 | | Max ratings $V_{ORM} \frac{1}{V}$ | I_{TSM} (surge) (amps) | t_{on} (μs) | t_{off} (μs) | dv/dt (V/ μs) | V_{GT} (V dc) | I_{GT} (mA dc) | JEDEC outline ^{2/} | Specification MIL-S-19500/ |
|-----------------|-----------------|-------|-----------------------------------|--------------------------|----------------------|-----------------------|-----------------------|-----------------|------------------|-----------------------------|----------------------------|
| | (amps) at T_C | T_A | | | | | | | | | |
| 2N3027 | 0.175 | 100 | 30 | 8 | 2 | 30.0 | .4/.8 | 0.20 | T018 | 419 | |
| 2N3028 | 0.175 | 100 | 60 | 8 | 2 | 15.0 | .4/.8 | 0.20 | T018 | 419 | |
| 2N3029 | 0.175 | 100 | 100 | 8 | 2 | 10.0 | .4/.8 | 0.20 | T018 | 419 | |
| 2N2323AS | 0.22 | 80 | 50 | 15 | | 0.7 | .35/.6 | 0.20 | T05 | 276 | |
| 2N2324AS | 0.22 | 80 | 100 | 15 | | 0.7 | .35/.6 | 0.20 | T05 | 276 | |
| 2N2326AS | 0.22 | 80 | 200 | 15 | | 0.7 | .35/.6 | 0.20 | T05 | 276 | |
| 2N2328AS | 0.22 | 80 | 300 | 15 | | 0.7 | .35/.6 | 0.20 | T05 | 276 | |
| 2N2329S | 0.22 | 80 | 400 | 15 | | 1.8 | .35/.8 | 0.20 | T05 | 276 | |
| 2N1774A | 4.7 | 105 | 200 | 60 | 30 | 5.0 | 2.0 | 15.0 | T064 | 168 | |
| 2N1777A | 4.7 | 105 | 400 | 60 | 30 | 5.0 | 2.0 | 15.0 | T064 | 168 | |
| 2N685 | 16.0 | 65 | 200 | 150 | 30 | 20.0 | 3.0 | 35.0 | T048 | 108 | |
| 2N688 | 16.0 | 65 | 400 | 150 | 30 | 20.0 | 3.0 | 35.0 | T048 | 108 | |
| 2N690 | 16.0 | 65 | 600 | 150 | 40 | 20.0 | 3.0 | 35.0 | T048 | 108 | |
| 2N692 | 16.0 | 65 | 800 | 150 | 60 | 20.0 | 3.0 | 35.0 | T048 | 108 | |
| 2N1913 | 50.0 | 83 | 200 | 1000 | 40 | 20.0 | 3.0 | 70.0 | T094 | 204 | |
| 2N1916 | 50.0 | 83 | 400 | 1000 | 40 | 20.0 | 3.0 | 70.0 | T094 | 204 | |
| 2N1806 | 50.0 | 83 | 600 | 1000 | 40 | 20.0 | 3.0 | 70.0 | T094 | 204 | |
| 2N1795 | 50.0 | 83 | 200 | 1000 | 40 | 20.0 | 3.0 | 70.0 | T083 | 204 | |
| 2N1798 | 50.0 | 83 | 400 | 1000 | 40 | 20.0 | 3.0 | 70.0 | T083 | 204 | |
| 2N1800 | 50.0 | 83 | 600 | 1000 | 40 | 20.0 | 3.0 | 70.0 | T083 | 204 | |
| 2N3093 | 50.0 | 83 | 800 | 1000 | 40 | 20.0 | 3.0 | 70.0 | T094 | 280 | |
| 2N3095 | 50.0 | 83 | 1000 | 1000 | 40 | 20.0 | 3.0 | 70.0 | T094 | 280 | |
| 2N3097 | 50.0 | 83 | 1200 | 1000 | 40 | 20.0 | 3.0 | 70.0 | T094 | 280 | |

1/ This parameter is identified at VFBXM or VFBOM in older specifications.
 2/ Mechanical configurations of devices are equal or similar to referenced JEDEC outlines.

CHAPTER 26: MIL-STD-701M

TABLE 26.3: NUMERICAL LISTING OF TRANSISTORS

| Device type no. | Table | Device type no. | Table |
|-----------------|-----------|-----------------|------------|
| 2N918 | XVII, XXI | 2N4957 | XXVI |
| 2N2060 | XXII | 2N4858 | XXVI |
| 2N2151 | XIX | 2N4948 | XXV |
| 2N2219A | XVII | 2N4957 | XXI, XVIII |
| 2N2222A | XVII | 2N5005 | XX |
| 2N2359A | XVII | 2N5038 | XIX |
| 2N2432A | XXVII | 2N5039 | XIX |
| 2N2484 | XVII | 2N5109 | XXI |
| 2N2605 | XVIII | 2N5114 | XXVI |
| 2N2814 | XIX | 2N5115 | XXVI |
| 2N2857 | XXI | 2N5116 | XXVI |
| 2N2880 | XIX | 2N5153 | XVII |
| 2N2905A | XVIII | 2N5154 | XVII |
| 2N2907A | XVIII | 2N5157 | XIX |
| 2N2920 | XXII | 2N5237 | XVII |
| 2N2945A | XXVII | 2N5241 | XIX |
| 2N2946A | XXVII | 2N5250 | XIX |
| 2N3013 | XVII | 2N5251 | XIX |
| 2N3019 | XVII | 2N5302 | XIX |
| 2N3251A | XVIII | 2N5303 | XIX |
| 2N3375 | XXI | 2N5416 | XVIII |
| 2N3421 | XVII | 2N5545 | XXVI |
| 2N3439 | XVII | 2N5546 | XXVI |
| 2N3440 | XVII | 2N5582 | XVII |
| 2N3442 | XIX | 2N5664 | XIX |
| 2N3467 | XVIII | 2N5665 | XIX |
| 2N3486A | XVIII | 2N5666 | XVII |
| 2N3501 | XVII | 2N5667 | XVII |
| 2N3507 | XVII | 2N5672 | XIX |
| 2N3553 | XXI | 2N5683 | XX |
| 2N3585 | XIX | 2N5684 | XX |
| 2N3537 | XVIII | 2N5685 | XIX |
| 2N3700 | XVII | 2N5686 | XIX |
| 2N3716 | XIX | 2N5745 | XX |
| 2N3735 | XVII | 2N5794 | XXIII |
| 2N3737 | XVII | 2N5796 | XXIII |
| 2N3739 | XIX | 2N6033 | XIX |
| 2N3741 | XX | 2N6051 | XXIV |
| 2N3743 | XVIII | 2N6052 | XXIV |
| 2N3762 | XVIII | 2N6058 | XXIV |
| 2N3764 | XVIII | 2N6059 | XXIV |
| 2N3767 | XIX | 2N6116 | XXV |
| 2N3792 | XX | 2N6283 | XXIV |
| 2N3810 | XXII | 2N6284 | XXIV |
| 2N3811 | XXII | 2N6286 | XXIV |
| 2N3821 | XXVI | 2N6287 | XXIV |
| 2N3822 | XXVI | 2N6299 | XXIV |
| 2N3823 | XXVI | 2N6301 | XXIV |
| 2N3866A | XXI | 2N6350 | XXIV |
| 2N3868 | XVIII | 2N6351 | XXIV |
| 2N3879 | XIX | 2N6352 | XXIV |
| 2N3960 | XVII | 2N6353 | XXIV |
| 2N3997 | XIX | 2N6384 | XXIV |
| 2N4033 | XVIII | 2N6385 | XXIV |
| 2N4150 | XVII | 2N6437 | XX |
| 2N4261 | XVIII | 2N6546 | XIX |
| 2N4399 | XX | 2N6547 | XIX |
| 2N4449 | XVII | 2N6603 | XXI |
| 2N4854 | XXIII | 2N6604 | XXI |
| 2N4856 | XXVI | | |

CHAPTER 26: MIL-STD-701M

The applicable device specification documents should be utilized when more detailed information about a particular device is required. In the event of conflict between the device technical description presented in MIL-STD-701 and the applicable detailed specification description, the detailed specification shall govern.

Semiconductor devices which are subjected to and have passed special process- conditioning, testing and screening, e.g., JANTX and JANTXV are upgraded versions of the original JAN devices and only these are considered approved for use. (The prefix JANTX applies to devices which have been subjected to and passed special process-conditioning, testing and screening; the prefix JANTXV is used on devices which have been subjected to pre-cap visual inspection in addition to the process conditioning, testing and screening.) Reverse polarity versions of the standard components presented in this document are also approved for use.

26.5.1 Part selection

The semiconductor devices used in the design and manufacture of military equipment must be selected from those listed in MIL-STD-701 (See para. 26.5.2).

The following criteria are stipulated for a semiconductor's inclusion:

- Each semiconductor device is considered by representatives of the military services to be the best available type for current application
- Continued availability of the devices listed is reasonably certain
- Each semiconductor device has an approved military specification associated with it

26.5.2 Use Limitations

Because of the difficulty and time entailed in updating a tri-service MIL document such as MIL-STD-701, and because of changes in semiconductor technology, the development of new devices capable of higher and greater performance levels and the discontinuance of superseded semiconductor devices by the manufacturer, the document known as MRAP/SRAP* has been promulgated by the Air Force. The SRAP portion of this document provides a complete listing of all the devices currently covered under MIL-S-19500, and it is intended to be used along with MIL-STD-701 as the semiconductor baseline for military system usage.

The SRAP listing is divided into three sections: (1) devices which are preferred and recommended for use, (2) devices not recommended for new design for which there are substitutes, and (3) devices which will not be approved for new designs. In the first section, the devices are listed in order of their EIA/JEDEC registration number and accompanied by all pertinent information including QPL status. The second section of the SRAP listing is composed of a series of tables which are broken out by device function. The devices are listed by part number within each table. For devices which are not recommended for use, an alternate preferred device is indicated.

Use of the above concisely-organized information in toto enables the contracting activity to easily and precisely specify the devices the contractor shall use in the end-item equipment. It also enables the contractor - with equal ease - to select, purchase and use the semiconductors which he knows are acceptable to the contracting activity.

*MRAP/SRAP (Microcircuit Reliability Assessment Program/Semiconductor Reliability Assessment Program) is a quarterly-updated document which can be purchased from the Reliability Analysis Center, RADC/RAC, Griffiss AFB, NY 13441.

CHAPTER 26: MIL-STD-701M

26.6 TAILORING

MIL-STD-701 was not written with the intent of tailoring. Tailoring of the use of this document is only possible by the application of the additional guidelines in MRAP/SRAP.

26.7 CONTRACT DATA REQUIREMENTS LIST (CDRL)

There are no deliverable data items required by MIL-STD-701.

CHAPTER 27:

**MIL-STD-198E
CAPACITORS, SELECTION AND USE OF**

CHAPTER 27: MIL-STD-198E

MIL-STD-198 is a tri-service approved document used by all branches of the military in the specification and acquisition, of quality-assured electronic systems and equipment. The current version is revision "E" dated May 29, 1984. The preparing activity is:

U.S. Army Laboratory Command
ATTN: SLCET-R-S
Fort Monmouth, NJ 07703-5302

This chapter is only an advisory to the use of MIL-STD-198. It does not supersede, modify, replace or curtail any requirements of MIL-STD-198 nor should it be used in lieu of that standard.

27.1 REFERENCE DOCUMENTS

Except for the capacitor specifications listed in Table 27.1 additional reference documents are not applicable to MIL-STD-198.

27.2 DEFINITIONS

This paragraph is not applicable to this chapter.

27.3 APPLICABILITY

MIL-STD-198 provides a listing and characterization of standard capacitor types as selected jointly by the three military services, Army, Navy and Air Force for use in the design and manufacture of military equipment. It also provides detailed guidelines for the choice and application of capacitors used in military equipment.

The purpose and use of MIL-STD-198 is three-fold:

- To provide the equipment designer with a selection of standard capacitors for use in most military applications
- To control and minimize the variety of capacitors used in military equipment in order to facilitate logistic support of equipment in the field
- To outline criteria pertaining to the use, choice and application of capacitors in military equipment

The proper selection of parts is the first step in building reliable equipment. To properly select the capacitors to be used, the user must know as much as possible about the types from which he can choose. He must know their advantages and disadvantages; their behavior under various environmental conditions; their construction; and their effect on circuits and the effect of circuits on them. He should know what makes capacitors fail. He should also have an intimate working knowledge of the applicable military specifications.

27.4 PHYSICAL DESCRIPTION OF MIL-STD-198

MIL-STD-198 is a voluminous document composed of thirty individual sections. Each section deals with a specific type of capacitor e.g., Fixed, Mica, Button Style. It describes the primary usages and construction of that type of capacitor and then gives other technical data relative to the application of that specific type of capacitor. The standard is approximately three hundred and fifty eight pages in length. There are no appendices to this standard.

CHAPTER 27: MIL-STD-198E

27.5 HOW TO USE MIL-STD-198

The standard is used as a source of design information on the availability of capacitors of standardized construction whose electrical, mechanical and environmental ratings are governed by MIL specifications.

Capacitors of the types widely used in electronic equipment can be grouped into one of six basic types: namely, 1) glass and mica, 2) electrolytic, 3) paper and plastic, 4) ceramic, 5) air, and vacuum. These basic types differ from each other in size, cost, capacitance, and general characteristics. Some are better than others for a particular purpose; no one type has all of the best characteristics. The choice among them, therefore, depends on the electrical requirements, both initial and long-term, the environment in which they must exist, and numerous other factors. The designer must realize that the summaries of the general characteristics contained in the following table are *relative, not absolute*, and that all the requirements of a particular application must be taken into consideration and compared with the advantages and disadvantages of each of the several types before a final choice is made.

Taken from MIL-STD-198E and shown below in Table 27.1 is a tabulation of military-approved capacitor styles, their applicable MIL-C-specifications, brief description, class, i.e., - garden variety (Non-ER), established reliability (ER) and Hi-Rel, status for new design, and replacement style, where applicable.

Use of this table will lead the design engineer to the MIL or EIA specification governing the capacitor style approved by the military services.

Table 27.2 (also taken from MIL-STD-198) gives a thumbnail description of the principal applications of these MIL capacitors listed by type of dielectric.

This information, when used in concert with supplementary discussions provided in MIL-STD-198 on definition of applicable terminology, capacitor types and recommended usage; environmental effects on characteristics and life including temperature, pressure, shock, vibration, moisture and aging; current, stability and retrace; initial tolerance, peak voltages, stray capacitances and leakage currents; size, volume and cost, etc., provide guidance to assist the design engineer in making his initial part selection decisions.

In addition, Table 27.3 also taken from MIL-STD-198E provides a short-form guide for the selection of fixed and variable capacitors included in that standard. The Table demonstrates specification designation, capacitor type, applicable MIL specification, capacitance range available, capacitance tolerance, 2000 hour life stability, DC rated voltage, operating temperature range, temperature coefficient, relative size and relative cost for equivalent CV rating, and dissipation factor.

Finally, detailed application notes on the capacitors listed in Table 27.3 are provided. Such considerations as construction, Q, capacitance drift, dimensions, mounting, stability of variable capacitors during shock and vibration, polarity, rms ripple current, etc. are presented. This information, when used in its totality provides the design engineer the capability of determining which MIL specification style capacitor procured in which configuration and possessed of which electrical, mechanical and environmental characteristics will best fit his intended application needs.

CHAPTER 27: MIL-STD-198E

TABLE 27.1: CROSS REFERENCE (CAPACITOR STYLE TO MIL SPECIFICATION)

| STYLE | SPECIFICATION | DESCRIPTION | CLASS | STATUS | REPLACEMENT |
|-------|---------------|-----------------------------------|--------|--------|-------------|
| CA | 12889 | Paper, By-Pass | Non-ER | I | 19978 |
| CB | 10950 | Mica, Button, Feed-Thru | Non-ER | A | |
| CC | 20 | Ceramic, Encap., Temp. Comp. | Non-ER | PI | CCR |
| CCR | 20 | Ceramic, Encap., Temp. Comp. | ER | A | |
| CDR | 55681 | Ceramic, Chip | ER | A | |
| CE | 62 | Aluminum Electrolytic | Non-ER | PI | 39018 |
| CFR | 55514 | Plastic, Non-Herm. Sealed | ER | A | |
| CG | 23183 | Vacuum or Gas, Variable | Non-ER | A | |
| CH | 18312 | Metallized Paper, or Plastic | Non-ER | I | 39022 |
| CHR | 39022 | Metallized Plastic, Herm. Sealed | ER | A | |
| CJ | 3871 | Aluminum, Motor Start | Non-ER | C | EIA RS-463 |
| CK | 11015 | Ceramic, Encapsulated | Non-ER | PI | 39014 |
| CKR | 39014 | Ceramic, Encapsulated | ER | A | |
| CKS | 123 | Ceramic, Encapsulated and Chip | Hi-Rel | A | |
| CL | 3965 | Tantalum, Foil and Wet Slug | Non-ER | I | 39006 |
| CLR | 39006 | Tantalum, Foil and Wet Slug | ER | A | |
| CM | 5 | Mica, Molded, Silvered, and RF | Non-ER | PI | 39001 |
| CMR | 39001 | Mica, Silvered | ER | A | |
| CMS | 87164 | Mica, Silvered | Hi-Rel | A | |
| CN | 91 | Paper, Non-Metal Cases | Non-ER | C | 55514 |
| CP | 25 | Paper, Herm. Sealed | Non-ER | I | 19978 |
| CPV | 14157 | Paper or Plastic, Herm. Sealed | Non-ER | C | 19978 |
| CQ | 19978 | Paper or Plastic, Herm. Sealed | Non-ER | I | CQR |
| CQR | 19978 | Paper or Plastic, Herm. Sealed | ER | A | |
| CRH | 83421 | Metallized Plastic, Herm. Sealed | ER | A | |
| CRL | 83500 | Tantalum, Wet Slug | Non-ER | A | |
| CS | 26655 | Tantalum, Solid, Herm. Sealed | Non-ER | C | 39003 |
| CSR | 39003 | Tantalum, Solid, Herm. Sealed | ER | A | |
| CSS | 39003 | Tantalum, Solid, Herm. Sealed | Hi-Rel | A | |
| CT | 92 | Air, Variable | Non-ER | A | |
| CTM | 27287 | Plastic, Non-Metal Case | Non-ER | I | 55514 |
| CU | 39018 | Aluminum Electrolytic | Non-ER | PI | CUR |
| CUR | 39018 | Aluminum Electrolytic | ER | A | |
| CV | 81 | Ceramic, Variable | Non-ER | A | |
| CWR | 55365 | Tantalum, Solid, Chip | ER | A | |
| CX | 49137 | Tantalum, Solid, Non-Herm. Sealed | Non-ER | A | |
| CY | 11272 | Glass | Non-ER | I | 23269 |
| CYR | 23269 | Glass | ER | A | |
| CZ | 11693 | Metallized Paper or Plastic F.T. | Non-ER | I | CZR |
| CZR | 11693 | Metallized Paper or Plastic F.T. | ER | A | |
| PC | 14409 | Piston Trimmer | Non-ER | A | |

A = Active for design
 C = Canceled
 I = Inactive for design
 PI = Partially Inactive for design

This cross reference is for general information only; some styles are not preferred standards and therefore not included in this standard.

CHAPTER 27: MIL-STD-198E

TABLE 27.3:
CAPACITOR TYPES

| DIELECTRIC | APPLICABLE SPECIFICATION | CAPACITANCE | | | DC rated voltage (Volts) |
|---|--------------------------|--------------------------------|--|--|--------------------------|
| | | Range | Tolerance | Stability after 2,000 hours life test | |
| GLASS | | | | | |
| Fixed | MIL-C-27269(ER) | .5 to 10,000 pF | .25 pF to 5% | .5% or 0.5 pF whichever is greater | 100, 300, 500 |
| Variable | MIL-C-14409 | 0.3 to 1.2 pF thru 1 to 120 pF | --- | Cap. change vs rotation: $\leq 10\%$ | 125 to 1,250 |
| MICA | | | | | |
| Button style | MIL-C-10950 | .5 to 2,400 pF | $\pm 1, \pm 2, \pm 5,$ or $\pm 10\%$ | $\leq 1\%$ or .5 pF whichever is greater | 500 |
| General purpose | MIL-C-5 | .47 to 27,000 pF | $\pm 1, \pm 2,$ or $\pm 5\%$ | ≤ 5 or 1 pF whichever is greater | 300 to 2,500 |
| | MIL-C-39001(ER) | 1 to 91,000 pF | .5 pF, $\pm 1, \pm 2,$ or $\pm 5\%$ | ≤ 1 or 1 pF whichever is greater | 50 to 500 |
| ELECTROLYTIC | | | | | |
| Aluminum | MIL-C-62 | 1 to 1,000 μ F | -10, +50 | $\leq 15\%$ | 400 & 450 |
| Tantalum (nonsolid) | MIL-C-39006(ER) | .1 to 1,200 μ F | -15; +30, +50, +75, $\pm 5\%$ to $\pm 20\%$ | $\leq 15\%$ | 6 to 450 |
| Tantalum (solid) | MIL-C-39003(ER) | .0023 to 330 μ F | $\pm 5, \pm 10,$ or $\pm 20\%$ | $\leq 2\%$ | 6 to 100 |
| Aluminum oxide | MIL-C-39018(ER) | .68 to 220,000 μ F | -10; +30, +50, +75 | $\leq 15\%$ | 5 to 350 |
| Tantalum (solid) chip | MIL-C-55365(ER) | .068 to 100 μ F | $\pm 5, \pm 10,$ or $\pm 20\%$ | --- | 3 to 50 |
| PAPER-PLASTIC | | | | | |
| Polycarbonate | MIL-C-19978(ER) | .001 to 1 μ F | ± 5 or $\pm 10\%$ | $\leq 6\%$ | 50 to 600 |
| Paper & polyethylene terephthalate | MIL-C-19978(ER) | .001 to 1 μ F | $\pm 2, \pm 5,$ or $\pm 10\%$ | $\leq 6\%$ | 200 to 1,000 |
| Plastic or metallized plastic | MIL-C-55514(ER) | .001 to 50 μ F | $\pm 1, \pm 2, \pm 5,$ or $\pm 10\%$ | $\leq 5\%$ | 50 to 600 |
| Polyethylene terephthalate | MIL-C-19978(ER) | .001 to 10 μ F | $\pm 2, \pm 5,$ or $\pm 10\%$ | $\leq 6\%$ | 30 to 1,000 |
| Metallized polycarbonate | MIL-C-83421(ER) | .001 to 22 μ F | $\pm .25, \pm .5, \pm 1, \pm 2, \pm 5,$ or $\pm 10\%$ | $\leq 2\%$ | 30 to 400 |
| Metallized paper & polyethylene terephthalate | MIL-C-39022(ER) | .01 to 10 μ F | ± 10 or $\pm 20\%$ | $\leq 10\%$ | 600 & 800 to 400 Vrms |
| CERAMIC | | | | | |
| Fixed, general purpose | MIL-C-11015 | 2.2 to 15,000 pF | $\pm 10, \pm 20$ | $\leq 20\%$ | 500 |
| | MIL-C-39014(ER) | 1.0 to 11,000,000 pF | $\pm .5$ pF, $\pm 1, \pm 5, \pm 10$ or $\pm 20\%$ | $\leq 20\%$ | 11,600 to 11,600 |
| Temp compensating | MIL-C-20 (ER) | 1.0 to 68,000 pF | $\pm .1$ pF, $\pm .25$ pF, $\pm .5$ pF $\pm 1\%, \pm 2\%, \pm 5\%$ or $\pm 10\%$ | $\pm 3\%$ or .5 pF whichever is greater | 150 to 200 |
| Variable | MIL-C-81 | 1.5 to 7 thru 15 to 60 pF | --- | --- | 200 to 500 |
| Fixed, chip | MIL-C-55681(ER) | .10 to 180,000 pF | $\pm .1$ pF, $\pm .25$ pF, $\pm .5$ pF, $\pm 1\%, \pm 2, \pm 5, \pm 10,$ or $\pm 20\%$ | --- | 50 & 100 |
| GAS or VACUUM | | | | | |
| Variable | MIL-C-23183 | .5 to 750 thru 50 to 3,000 pF | --- | --- | 2 & 3 kV |

1/ Where "C" = Capacitance and "V" = Voltage.

CHAPTER 27: MIL-STD-198E

TABLE 27.3
CAPACITOR TYPES (CONT'D)

| Operating temperature (in °C) | TEMPERATURE Temperature coefficient (in % or ppm/°C) | RELATIVE COST FOR EQUIV CV 1/ RATING | RELATIVE SIZE | | DISSIPATION FACTOR (%) | | |
|-------------------------------|---|--------------------------------------|--------------------|---------------------|------------------------|--|--------|
| | | | Varies as | For equiv CV rating | 60 Hz | 1,000 Hz | 1 MHz |
| -55 to +125 | ±140 ±25, 105 ±25, or 0 ±25 | Medium | CV ² | Large | --- | <.001 | --- |
| -65 or -55 to +125 or +150 | ±20, ±50, ±75, ±100, ±150, ±50 -0, and ±50 ±50 | Medium high | C | Large | --- | --- | --- |
| -55 to +85 or +150 | ±100, -20 to +100, ±60, and Not specified | Medium high | CV ² | Large | --- | <.17 | <1.2 |
| -55 to +125 or +150 | 0 to +70, -20 to +100, ±100, ±200, and Not specified | Medium low | CV ² | Large | --- | <.18 | <.12 |
| -55 to +125 or +150 | 0 to +70, -20 to +100, and ±200. | Medium low | CV ² | Large | --- | <.1 | <1,000 |
| -40 to +85 | Capacitance drops from 30 to 60% at -40°C | Medium | CV | Very small | --- | 15 to 18% at 120 Hz; varies with V | --- |
| -55 to +85, derated to +125 | Capacitance drops from 12 to 50% at -55°C | High | CV | Very small | --- | 10 to 32% at 120 Hz; varies with C and V | --- |
| -55 to +85, derated to +125 | Capacitance drops 10% max at -55°C | Medium | CV | Very small | --- | 13 to 8% at 120 Hz; varies with V | --- |
| -40 to -85, derated to +125 | --- | Medium | CV | Very small | --- | 10 to 35% at 120 Hz; varies with C and V | --- |
| -55 to +125 | --- | Medium | CV | Very small | --- | 14 to 10% at 120 Hz; varies with V | --- |
| -55 to +125 | Capacitance change ±2% at -55°C | High | CV ² | Large | <.1 | <.1 | Higher |
| -65 to +125 | ±10% | High | CV ² | Medium large | <.1 | <.1 | --- |
| -55 to +85 or +125 | --- | Medium | CV ² | Small | --- | <2.0 | --- |
| -65 to +85 | -7 to +5% | High | CV ² | Small | <.6 | <.6 | --- |
| -65 to +100 | -2.5% to +1.2% | Medium | CV ² | Small | <.15 | <.15 | --- |
| -55 to +85 or +125 | Capacitance drops <10% at -55°C | Medium | CV ² | Small | --- | <1 | --- |
| -55 to +85 or +125 | Capacitance change <±30, -80% at -55°C | Very low | CV ² +k | Small | --- | <2.5 | <2.5 |
| -55 to +85 or +125 | Capacitance change <±30, -80% at -55°C | Very low | CV ² +k | Small | --- | <2.5 | <2.5 |
| -55 to +125 | 0 ±30, 0 ±60 | Very low | CV ² +k | Small | --- | 0.15 | <.10 |
| -55 to +85 | Capacitance change <-4.5, +2% at -55°C | Medium low | CV ² +k | Large | --- | --- | 0.2 |
| -55 to +125 | 0 ±30 or 0 ±15 | Low | CV | Small | --- | <2.5 | <2.5 |
| -55 to +85 | --- | High | --- | Large | --- | <0.001 | --- |

CHAPTER 27: MIL-STD-198E

27.6 TAILORING GUIDELINES

Tailoring is a redundant term when applied to MIL-STD-198, since the selection and use of capacitors is what the standard is all about. MIL-STD-198 provides information and guidance in how to select and use (i.e., tailor) capacitive devices in a manner best suited to the equipment program's needs.

27.7 CONTRACT DATA REQUIREMENTS LIST (CDRL)

There are no data item descriptions (DIDs) required by MIL-STD-198.

CHAPTER 28:

**MIL-STD-199D
RESISTORS, SELECTION AND USE OF**

CHAPTER 28: MIL-STD-199D

MIL-STD-199 is a tri-service approved document used by all branches of the military in the specification and acquisition of quality-assured electronic systems and equipment. The current version is revision "D" dated March 16, 1987. The preparing activity is:

U.S Army Laboratory Command
Attn: SLCET-R-S
Fort Monmouth, NJ 07703-5302

This chapter is only an advisory to the use of MIL-STD-199. It does not supersede, modify, replace or curtail any requirements of MIL-STD-199 nor should it be used in lieu of that standard.

28.1 REFERENCE DOCUMENTS

Except for the resistor specifications listed in Table 28.1 additional reference documents are not applicable to MIL-STD-199.

28.2 DEFINITIONS

This paragraph is not applicable to this chapter.

28.3 APPLICABILITY

MIL-STD-199 provides a listing and characterization of standard resistor types as selected jointly by the three military services, Army, Navy and Air Force for use in the design and manufacture of military equipment. It also provides detailed guidelines for the choice and application of resistors used in military equipment.

The purpose and use of MIL-STD-199 is three-fold:

- To provide the equipment designer with a selection of standard resistors for use in most military applications
- To control and minimize the variety of resistors used in military equipment in order to facilitate logistic support of equipment in the field
- To outline criteria pertaining to the use, choice and application of resistors in military equipment

28.4 PHYSICAL DESCRIPTION OF MIL-STD-199

MIL-STD-199 is composed of twenty-three sections. Each section deals with a specific type of resistor e.g., Fixed, Film (Insulated), Established Reliability. It describes the primary usages and construction of the resistor and gives other technical data relative to the application of that specific type of resistor. The standard is approximately two hundred and thirty-eight pages in length. There are no appendices to this standard.

28.5 HOW TO USE MIL-STD-199

The standard is used as a source of design information on the availability of resistors of standardized construction whose electrical, mechanical and environmental ratings are governed by MIL specifications.

CHAPTER 28: MIL-STD-199D

Figure 28.1, which duplicates Figure 2 of MIL-STD-199C, depicts applicable military specifications by resistor categories, i.e., fixed, variable, or adjustable; type of resistive element (wirewound, non-wirewound, composition or film); accuracy (precision, semi-precision); special types (networks) and established reliability (ER). A brief statement of the principal applications of these MIL specification resistors is given below:

- a. MIL-R-19, RA, variable, wirewound (low operating temperature). Use primarily for noncritical, low power, low frequency applications where characteristics of wirewound resistors are more desirable than those of composition resistors.
- b. MIL-R-22, RP, variable wirewound (power type). Use in such applications as motor speed control, generator field control, lamp dimming, heater and oven control, potentiometer uses, and applications where variations of voltage and current are expected.
- c. MIL-R-26, RW, fixed, wirewound (power type). Use where large power dissipation is required and where ac performance is relatively unimportant (i.e., when used as voltage divider or bleeder resistors in dc power supplies, or for series dropping). They are generally satisfactory for use at frequencies up to 20 kilohertz (kHz) even though the ac characteristics are controlled. Neither the wattage rating nor the rated continuous working voltage may be exceeded.
- d. MIL-R-94, RV, variable, composition. Use where initial setting stability is not critical and long-term stability needs to be no better than +20 percent.
- e. MIL-R-122, RFP, fixed, film, established reliability. Use in circuits requiring higher stability than provided by composition resistors or film, insulated, resistors and where ac frequency requirements are critical. Operation is satisfactory from dc to 100 megahertz (MHz). Metal films are characterized by low temperature coefficients and are usable for ambient temperatures of 125°C or higher with small degradation. High precision, lower RTC than MIL-R-55182.
- f. MIL-R-12934, RR, variable, wirewound (precision). Use in servo-mounting applications requiring precise electrical and mechanical output and performance. Used in computer, antenna, flight control, and bomber navigation systems, etc.
- g. MIL-R-18546, RE, fixed, wirewound (power type, chassis mounted). Use where greater power tolerance and relatively large power dissipation is required for a given unit size than is provided by MIL-R-26 resistors, and where ac performance is noncritical (i.e., voltage divider or bleeder resistors in dc power supplies or series-dropping circuits).
- h. MIL-R-22097, RJ, variable, non-wirewound (adjustment type). Use for matching, balancing, and adjusting circuit variables in computers, telemetering equipment, and other critical applications.
- i. MIL-R-22684, RL42...TX, fixed, film, insulated. These film resistors have semi-precision characteristics and small sizes. The sizes and wattage ratings are comparable to those of MIL-R-39008 and stability is between MIL-R-39008 and MIL-R-55182. Design parameter tolerances are looser than those of MIL-R-55182 but good stability makes them desirable in most electronic circuits. See MIL-R-39017.

CHAPTER 28: MIL-STD-199D

- j. MIL-R-23285, RVC, variable, metal film, non-wirewound. Use where initial setting stability is not critical and long-term stability needs to be no better than +5 percent. RVC resistors have low noise and long life characteristics.
- k. MIL-R-27208, RT, variable, wirewound (adjustment type). Use for matching, balancing, and adjusting circuit variables in computers, telemetering equipment, and other critical applications.

CHAPTER 28: MIL-STD-199D

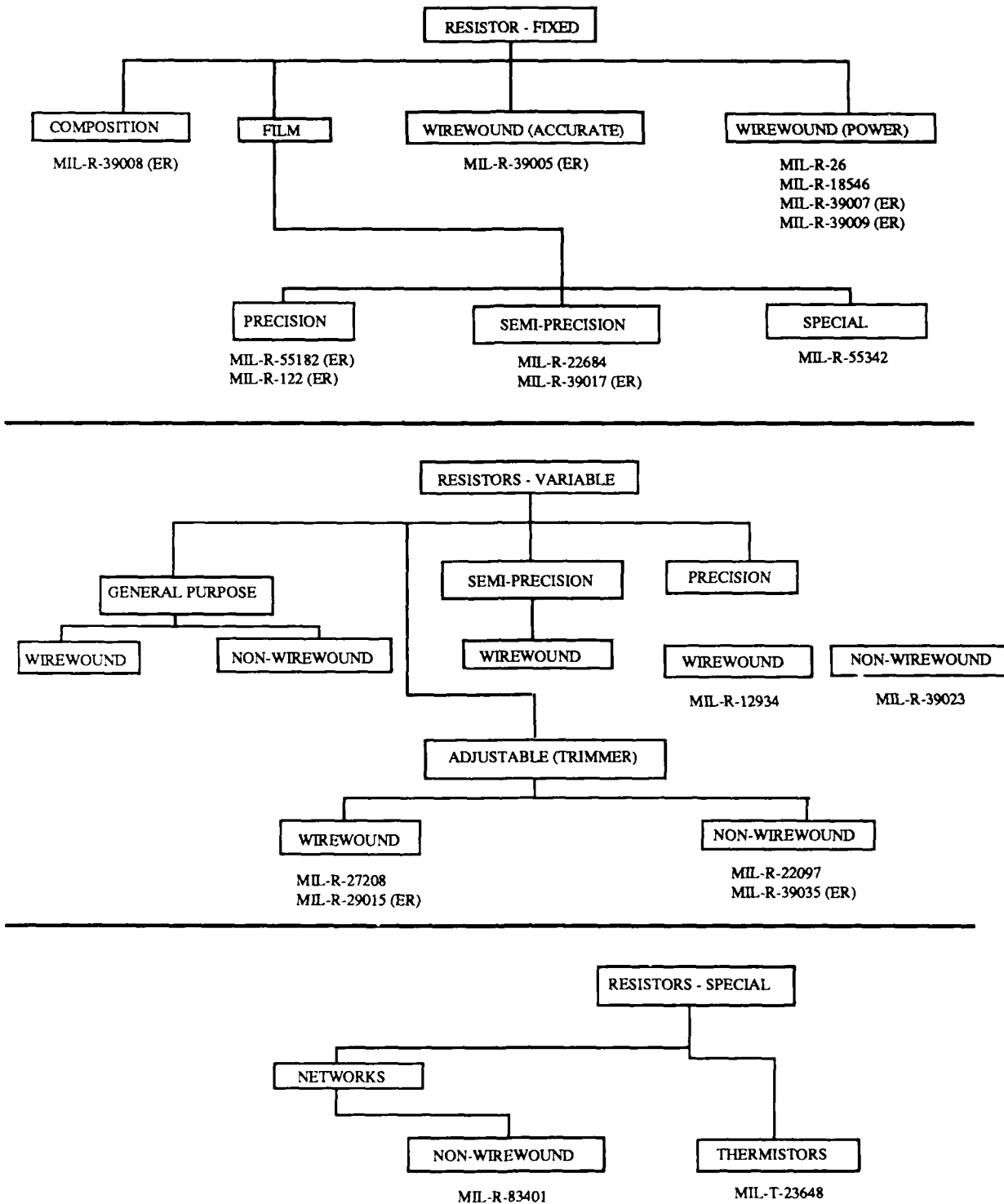

FIGURE 28.1:
MILITARY RESISTOR SPECIFICATION CATEGORIES

CHAPTER 28: MIL-STD-199D

- l. MIL-R-39002, RK, variable, wirewound, semi-precision. See MIL-R-27208.
- m. MIL-R-39005, RBR, fixed, wirewound (accurate). Use in circuits requiring higher stability than provided by composition or film resistors, and where ac frequency performance is not critical. Operation is satisfactory from dc to 50kHz. Replaces MIL-R-93, RB (wirewound (accurate)).
- n. MIL-R-39007, RWR, fixed, wirewound (power type). See MIL-R-26.
- o. MIL-R-39008, RCR, fixed, composition (insulated). Use insulated resistors for general purpose resistor applications where the initial tolerance needs to be no closer than +5 percent and long term stability needs to be no better than +15 percent under fully rated operating conditions. Replaces MIL-R-11, RC (fixed, composition (insulated)).
- p. MIL-R-39009, RER, fixed, wirewound (power type, chassis mounted). Use where power tolerance and relatively large power dissipation required for a given unit size is greater than is provided by MIL-R-39007 resistors, and where ac performance is noncritical (i.e., voltage divider or bleeder resistors in dc power supplies or series-dropping circuits).
- q. MIL-R-39015, RTR, variable, wirewound (lead screw actuated). See MIL-R-27208.
- r. MIL-R-39017, RLR, fixed, film (insulated). These film resistors have semi-precision characteristics and small sizes. The sizes and wattage ratings are comparable to those of MIL-R-39008 and stability is between MIL-R-39008 and MIL-R-55182. Design parameter tolerances are looser than those of MIL-R-55182 but good stability makes them desirable in most electronic circuits. Replaces MIL-R-22684, RL (fixed film (insulated)).
- s. MIL-R-39023, RO, variable, non-wirewound (precision). Use in servo-mounting applications requiring precise electrical and mechanical output and performance. Used in computer, antenna, flight control, and bomber navigation systems, etc.
- t. MIL-R-39035, RJR, variable, non-wirewound (adjustment type). See MIL-R-22097.
- u. MIL-R-55182, RNR, fixed film (high stability). Use in circuits requiring higher stability than provided by composition resistors or film, insulated, resistors and where ac frequency requirements are critical. Operation is satisfactory from dc to 100 megahertz (MHz). Metal films are characterized by low temperature coefficients and are usable for ambient temperatures of 125°C or higher with small degradation. Replaces MIL-R-10509, RN (fixed, film (high stability)).
- v. MIL-R-55342, RM, chip, fixed, film. These chip resistors are primarily intended for incorporation into hybrid microelectronic circuits. They are designed for use in critical circuitry where stability, long life, reliable operation, and accuracy are of prime importance.

CHAPTER 28: MIL-STD-199D

- w. MIL-R-83401, RZ, network, fixed, film. These networks are designed for use in critical circuitry where stability, long life, reliable operation, and accuracy are of prime importance. They are particularly desirable for use where miniaturization is important and ease of assembly is desired. They are useful where a number of resistors of the same resistance value are required in the circuit.

This information, when coupled with supplementary discussions provided in MIL-STD-199 on stress mounting, circuit packaging, standard resistance values, power rating, self-generated heat, "Johnson" noise, high frequency "Boella" effect, power rating, rating vs life, rating under pulsed conditions, high frequency operation, mechanical design effects, terminations, effect of soldering, method of mounting, resistor body insulation or coating, resistor heating, etc., provide guidance to assist the design engineer in making his initial part selection decisions.

In addition, Tables 1 through 3 of MIL-STD-199D provide a short-form guide for the selection of fixed and variable resistors included in that standard. The tables delineate specification designation, resistor type, resistor styles available, power and maximum voltage ratings, resistance tolerance, ohmic range, operating temperature range, resistance temperature coefficient, maximum body size and configuration.

Finally, detailed application notes on the resistors covered by the resistor specifications listed above is provided. Such considerations as construction, derating, preferred resistance values, linear and non-linear tapers, shelf-life characteristics, shaft and mounting styles, and supplementary insulation, as applicable, are presented.

This information, when used in its totality, provides the design engineer with the capability of determining which MIL specification style resistor procured in which configuration and with which *electrical, mechanical and environmental* characteristics will best fit his intended application needs.

28.6 TAILORING GUIDELINES

Tailoring is a redundant term when applied to MIL-STD-199, since the selection and use of resistors is what the standard is all about. MIL-STD-199 provides information and guidance on how to select and use (i.e., tailor) resistive devices in a manner best suited to the equipment program's needs.

28.7 CONTRACT DATA REQUIREMENTS LIST (CDRL)

No Deliverable Data Items are required by MIL-STD-199.

CHAPTER 29:

MIL-STD-790D

**RELIABILITY ASSURANCE PROGRAM FOR
ELECTRONIC PART SPECIFICATIONS**

CHAPTER 29: MIL-STD-790D

MIL-STD-790 is a tri-service-approved document used by all branches of the military in the specification and acquisition of quality-assured electronic equipment. The current version is the "D" revision dated May 30, 1986. The preparing activity is:

Department of the Navy
Space and Naval Warfare Systems Command
ATTN: SPAWAR 003-121
Washington, DC 20363-5100

This chapter is only an advisory to the use of MIL-STD-790. It does not supersede, modify, replace or curtail any requirements of MIL-STD-790 nor should it be used in lieu of that standard.

29.1 REFERENCE DOCUMENTS

The following related documents impact and further define this task:

- FED-STD-209 Clean Room and Work Station Requirements, Controlled Environment
- MIL-STD-721 Definitions of Effectiveness Terms for Reliability, Maintainability, Human Factors, and Safety
- MIL-STD-456652 Calibration Systems Requirements

29.2 DEFINITIONS

The meanings of some terms used with respect to part reliability are unique to the field and thus may be unfamiliar to the reader. Therefore, the following terms are defined here to clarify their meanings as used in MIL-STD-790.

Assembly plant - A plant established by a manufacturer or operated by a distributor authorized by the manufacturer to perform specified functions pertaining to the manufacturer's identified qualified products in accordance with specified assembly procedures, test methods, processes, controls, and storage, handling, and packaging techniques.

Defect analysis - The process of examining technical or management (nontechnical) data, manufacturing techniques, processes, or materials to determine the cause of variations of electrical, mechanical, or physical characteristics outside the limitations established at any manufacturing checkpoint.

Distributor, Category A - An organization contractually authorized by a manufacturer to store, repackage, and distribute completely finished parts. These parts shall have been inspected by the manufacturer to all of the requirements of the ER specification.

Distributor, Category B - An organization contractually authorized by a manufacturer to perform one or more final operations on uncompleted parts. These parts shall have been inspected by the manufacturer to all of the requirements of the ER specification prior to shipment to the distributor.

CHAPTER 29: MIL-STD-790D

Distributor, Category C - An organization contractually authorized by a manufacturer to perform one or more assembly operations on uncompleted parts which shall be inspected by the distributor to all the requirements of the ER specification. Category C distributors shall be considered as an assembly plant of the manufacturer and shall be treated as such on the QPL.

Electronic parts - Basic circuit elements which cannot be disassembled and still perform their intended function, such as capacitors, connectors, filters, resistors, switches, relays, transformers, crystals, electron tubes, and semiconductor devices.

Established reliability - A quantitative maximum failure rate demonstrated under controlled test conditions specified in a military specification and usually expressed as percent failures per thousand hours of test.

Failure activating cause - The stresses or forces, thermal, electrical shock, vibration, etc., which induce or activate a failure mechanism.

Failure analysis - The process of examining electronic parts to determine the cause of variations of performance characteristics outside of previously established limits with the end result that failure modes, failure mechanisms and failure activating causes will be identified.

Failure mechanism - The process of degradation or chain of event which results in a particular failure mode.

Failure mode - The abnormality of an electronic part performance which causes the part to be classified as failed.

Inspection lot - A group of electronic parts offered for inspection at one time and in combinations authorized by the applicable ER specification.

Manufacturer - The actual producer of electronic parts.

Production lot - A group of electronic parts manufactured during the same period from the same basic raw materials processed under the same specifications and procedures, produced with the same equipment, and identified by the documentation defined in the manufacturer's reliability assurance program through all significant manufacturing operations, including final assembly operations. Final assembly operations shall be considered the last major assembly operations such as casing, hermetic sealing, or lead attachment rather than painting or marking.

Qualification - The entire procedure by which electronic parts are examined and tested to obtain and maintain approval at specified failure rate levels, and then identified on the qualified products lists.

Qualifying activity - The military preparing activity or its government agent delegated to administer the qualification program.

Reliability assurance - The management and technical integration of the reliability activities essential in maintaining reliability achievements, including design, production and product assurance.

Quality assurance - Activities used to establish a degree of certainty that the quality function was performed adequately.

CHAPTER 29: MIL-STD-790D

Quality control operations - The regulatory processes during manufacture through which actual quality performance is measured and compared with standards and the difference is acted upon.

Sub-assembly manufacturer - A manufacturing facility, owned by the manufacturer qualifying a product and authorized, by both him and the qualifying activity, to perform manufacturing steps in accordance with processing procedures contained in the program plan.

29.3 APPLICABILITY

MIL-STD-790 establishes guidelines to assure the uniform evaluation of electronic part manufacturers' reliability assurance programs. Of particular concern are: a) adequate production and test facilities, and b) sound procedures for process control.

The standard is intended for direct reference in electronic parts established reliability (ER) specifications. It establishes the criteria for electronic parts reliability assurance programs which are to be met by manufacturers qualifying electronic parts to the ER specifications. It also provides the qualifying activity with the means to evaluate, accept, and monitor the reliability assurance program as a requisite for electronic part qualification approval.

29.4 PHYSICAL DESCRIPTION OF MIL-STD-790

MIL-STD-790 is a relatively simple document containing only thirteen pages. There is also a single appendix "Self-Audit Requirements" containing an additional six pages.

29.5 HOW TO USE MIL-STD-790

The reliability assurance program as outlined in MIL-STD-790 integrates all design, planning, manufacturing, inspection, and test functions related to the manufacture and distribution of electronic ER parts. It addresses the concerns of both the electronic part manufacturer and any associated part distributors.

Basic elements of the electronic part reliability assurance program as outlined in MIL-STD-790 include:

- An detailed program plan approved by the qualifying activity
- Prerequisite documentation requirements for qualification
- Program implementation details including:
 - a. training
 - b. calibration
 - c. Proprietary processes and procedures
 - d. Failure and defect analysis programs
 - e. Corrective plan-of-action
 - f. Clean rooms
 - g. Description of production processes and controls

CHAPTER 29: MIL-STD-790D

- h. Acquisition and production control documentation
 - i. Process control
 - j. Inspection of incoming materials and work in-process
 - k. Handling and packaging procedures
 - l. Materials
 - m. Product traceability
 - n. Controlled storage area
 - o. Quality control and quality assurance operations
 - p. Manufacturing flow chart
 - q. Manufacturer's internal audit activities
 - r. Sub-assembly manufacturer
 - s. Production line audits
- Self-Audit Program (Appendix A)

Appendix A is a mandatory part of the standard intended to assure continued conformance to the requirements of MIL-790. It contains a detailed self-audit checklist as shown in Table 29.1.

Definitive audit criteria will help to assure that critical processes are held within established limits at specified critical points and that this is continuously maintained during production. A sample of a typical process flow chart taken from MIL-STD-790 is shown in Figure 29.1.

29.6 TAILORING GUIDELINES

The requirements of MIL-STD-790 must be tailored to the type of part and the peculiarities of the manufacturer's over-all method of operation. However, as a minimum, compliance with section 5, "Detailed Requirements" and Appendix A, "Self-Audit" is necessary.

29.7 CONTRACT DATA REQUIREMENTS LIST (CDRL)

There are no data item descriptions associated with MIL-STD-790.

CHAPTER 29: MIL-STD-790D

TABLE 29.1:
MIL-STD-790 AUDIT REQUIREMENTS CHECK LIST

| Requirements | Satisfactory | Unsatisfactory | Comments |
|--|--------------|----------------|----------|
| a. Diagram of organizational structure | | | |
| b. Manufacturing flow chart contains: | XX | XX | |
| (1) Every process performed | | | |
| (2) Every quality control station | | | |
| (3) Internal document control number pertaining to each | | | |
| c. Maintain document control system | | | |
| d. Incoming inspection: | XX | XX | |
| (1) Segregation conforming and nonconforming material | | | |
| (2) Traceability | | | |
| (3) Adherence to material specifications | | | |
| e. Travellers: | XX | XX | |
| (1) Contains all steps of manufacturing process | | | |
| (2) Being filled out and signed off | | | |
| (3) Time in and time out must be on each traveller when tests require it | | | |
| f. Logs on voltage and temperature checks in ovens and chambers | | | |
| g. Voltages and temperatures checked at least once a week on life test | | | |
| h. Overvoltage and thermal runaway protectors | | | |
| i. Environmental control | | | |

CHAPTER 29: MIL-STD-790D

**TABLE 29.1:
MIL-STD-790 AUDIT REQUIREMENTS CHECK LIST (CONT'D)**

| Requirements | Satisfactory | Unsatisfactory | Comments |
|---|--------------|----------------|----------|
| j. Operating instructions: | XX | XX | |
| (1) Operators must use controlled document for procedures | | | |
| (2) No informal instructions | | | |
| k. Review process control records | | | |
| l. Records must show actions to be taken during out-of-control conditions | | | |
| m. Failure and defect analysis programs: | XX | XX | |
| (1) Must have documented program | | | |
| (2) Written report submitted every six months | | | |
| (3) Submit corrective action evaluation | | | |
| n. Check that operators are following controlled documents | | | |
| o. Distributors are being controlled | | | |
| p. Calibration system checked | | | |
| q. Cross-reference requirement paragraph onto internal control document | | | |
| r. Ability to perform required tests | | | |
| s. Training: | XX | XX | |
| (1) Training program for production personnel | | | |
| (2) Training records maintained | | | |
| t. All original entries readable and initiated when changed | | | |

Signature of Quality Manager _____ Date _____

CHAPTER 29: MIL-STD-790D

COMPANY ABC

SPECIFICATION MIL-C-55681 PROCESS FLOW CHART

NUMBER 55681 REV. N/A

MIL-C-55681 FLOW CHART
(BX CAPACITOR)

MIL-C-55681 FOW SHEET
TESTING AND FINISHING
OF BX CAPACITORS

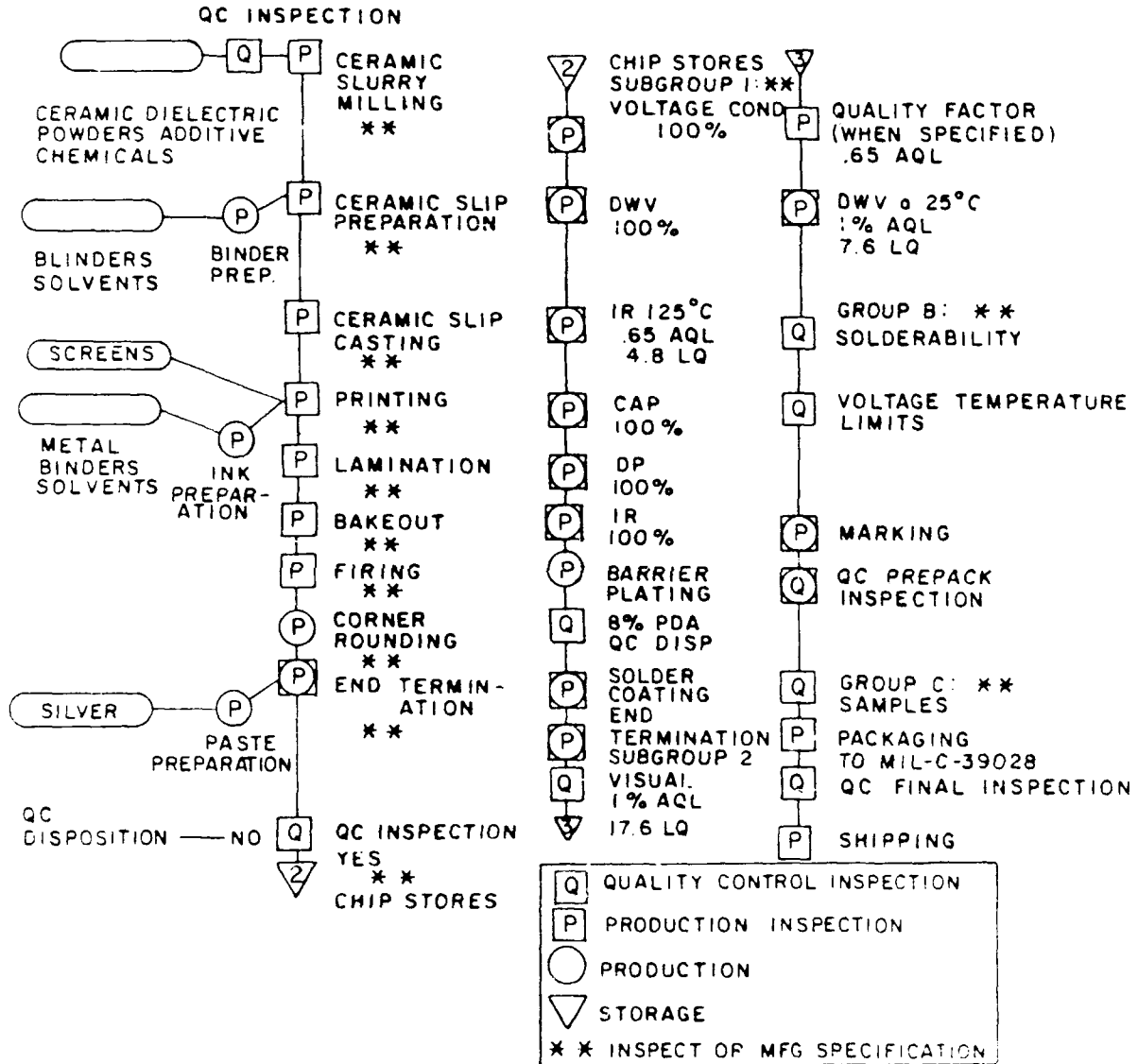

NOTES:

1. Specification revisions and dates must be current at the time of audit. This information need not be placed on the flow chart. However, this information must be made available to the verification team during the audit.
2. This flow chart is not complete and is used as an example to show the type of information which shall be included. Different symbols can be utilized if defined.

FIGURE 29.1: TYPICAL PROCESS FLOW CHART

CHAPTER 30:

**MIL-STD-965A
PARTS CONTROL PROGRAM**

CHAPTER 30: MIL-STD-965A

MIL-STD-965 is a tri-service approved document used by all branches of the military in the specification of acquisition, of quality-assured electronic systems and equipment. The current version is the "A" revision dated December 13, 1985. The preparing activity is:

Headquarters Air Force Systems Command
ATTN: PLEQ
Andrews AFB
Washington, DC 20334-5000

This chapter is only an advisory to the use of MIL-STD-965. It does not supersede, modify, replace or curtail any requirements of MIL-STD-965 nor should it be used in lieu of that standard.

30.1 REFERENCE DOCUMENTS

The following related document also impacts this task:

- MIL-STD-143 Order of Precedence for the Selection of Standards and Specifications

30.2 DEFINITIONS

The meanings of some terms and acronyms are unique to this standard and are therefore included to clarify their meanings as used in MIL-STD-965.

Military Parts Control Advisory Group (MPCAG) - A Department of Defense organization which provides advice to the military departments and military contractors on the selection of parts in assigned commodity classes, and collects data on nonstandard parts for developing or updating military specifications and standards.

Program Parts Selection List (PPSL) - A list of all parts approved for design selection in a specific contract.

Standard Part - A part covered by contractually-required general equipment specifications, or as otherwise stated in the contract.

General Application Part - A part approved for listing on the PPSL without a restriction on its use.

Limited Application Part - A part approved for listing on a PPSL with a restriction on its use.

Nonstandard Part - Any part which does not meet the definition of a standard part.

Parts Control Board (PCB) - A formal organization established by contract to assist the prime contractor in controlling the selection and documentation of parts used in equipment, systems or subsystems designs.

Off-the-shelf equipment - An item which has been developed and produced, to military or commercial standards and specifications, is readily available for delivery from an industrial source, and may be procured without change to satisfy a military requirement.

CHAPTER 30: MIL-STD-965A

30.3 APPLICABILITY

This standard provides guidelines and requirements for parts control and is applicable to new design as well as to the modification of existing design. It may also be used, with care, in exploratory development programs.

The standard establishes two procedures covering the submission, review, and approval of Program Parts Selection Lists and changes thereto. Procedure I is applicable to those contracts that do not require a Parts Control Board while Procedure II is applicable to contracts that include a Parts Control Board. Both procedures contain provisions for processing of requests for approval to use parts both within, and external to, the Military Parts Control Advisory Group assigned commodity classes.

The objective of this task is to achieve life cycle cost savings and cost avoidances by: 1) assisting equipment or system managers and their contractors in the selection of parts commensurate with contractual requirements, 2) minimizing the variety of parts used in new design, 3) enhancing interchangeability, reliability, and maintainability of military equipments and supplies, and 4) conserving resources.

30.4 PHYSICAL DESCRIPTION OF MIL-STD-965

MIL-STD-965 is a relatively simple document containing only twenty-five pages. There is also an additional six page appendix dealing with tailoring of the specification requirements.

30.5 HOW TO USE MIL-STD-965

The contracting activity may use MIL-STD-965 to establish parts control requirements; the contractor may use MIL-STD-965, Method I to achieve the parts control required by the contracting activity.

MIL-STD-965 addresses three different subtasks. The first subtask is that of the generation of a Program Parts Selection List (PPSL). A sample format for the PPSL is shown in Figure 30.1 (taken from MIL-STD-965). This list defines, for the design engineer, those parts from which he can select for use in his design. The second task is that of processing the requests for approval for the use of specific parts in the design (both those on the PPSL and those not on the PPSL). The third task is that of the identification of those parts that are recognized as "critical" to the program.

Figure 30.2 (taken from MIL-STD-965) is one example of the selection of parts for the PPSL. As can be seen from this figure a key element in the generation of the PPSL is the use of MIL-STD-143, "Order of Precedence for the Selection of Standards and Specifications."

Once the PPSL has been established the contractor is responsible for ensuring compliance with the PPSL, both by himself and by any applicable subcontractors, i.e., that only those parts approved for listing on the PPSL are used in the design, and that all equipment, system, or subsystem drawings specify the parts approved for listing on the PPSL.

The contractor may be required to prepare proper part documentation where necessary. This may be in the form of a draft of a military specification, a military specification exception, or a control drawing when such is requested by the procuring activity. The contractor may also be required to submit test data and/or other evidence to the procuring activity that a specific part complies with the requirements of the applicable part documentation.

CHAPTER 30: MIL-STD-965A

| SECTION I - GENERAL APPLICATION PARTS SUBSECTION A - MECHANICAL | | | | | | | |
|---|---|---------------------|-------------|--------------------------------------|-------------------------|--|-----------------|
| CONTRACT No: F12345-84-C-1234 | | | | | | FSC ABCD | |
| (Verbal description of items covered in this section) | | | | | | | |
| <u>Index no.</u> | <u>Description</u> | <u>Document no.</u> | <u>FSCM</u> | <u>Part number</u> | <u>FSCM</u> | <u>Remarks</u> | <u>Use code</u> |
| A0001B ^{1/} | Adptr, al al, .250 fem pipe thd to .250 male fld | 2A156 | 99999 | 2A156-4-4 62742-12 | 99999 12346 | | |
| 0002 | Adptr. tube to hose, lp nose, part of AN6270 1/2 tube size | MIL-A-38726 | 96906 | MS27404-8D | 96906 | Critical part, long lead time | |
| SECTION I - GENERAL APPLICATION PARTS SUBSECTION B - ELECTRICAL AND ELECTRONIC | | | | | | | |
| CONTRACT NO: F12345-84-C-1234 | | | | | | FSC 5910 | |
| CAPACITORS, TANTALUM | | | | | | | |
| <u>Index no.</u> | <u>Description</u> | <u>Document no.</u> | <u>FSCM</u> | <u>Part number</u> | <u>FSCM</u> | <u>Remarks</u> | <u>Use code</u> |
| 0006 | Cap, ta, sld, 22 - 330 μ F, 6-100 V dc, CSR-13 | MIL-C-39003/1 | 81349 | M39003/01-**** | 81349 | Failure rate level S, QPL available, critical part, reverse voltage | |
| 0007A | Cap, ta, sld 0.47 - 18 μ F 6-75 V dc, CSR-09 | MIL-C-39003/2 | 81349 | M39003/02-**** | 81349 | Failure rate level S, QPL available | |
| A0010 | Cap, ta, foil, 4 - 500 μ F 15 - 150 V dc | 92A643 | 99999 | 92A643-1-2 130J46-3 439X-72J20 | 99999 12345 23456 | Critical part, high cost and long lead time | |

^{1/} Alpha prefix may be used to denote subcontractor, subsystem, board, etc. Alpha suffix should be used to denote resubmissions for reconsideration, document changes, etc.

**FIGURE 30.1:
SAMPLE FORMAT FOR PROGRAM PARTS SELECTION LIST (PPSL)**

CHAPTER 30: MIL-STD-965A

| SECTION II - LIMITED APPLICATION PARTS SUBSECTION A - MECHANICAL | | | | | | | |
|--|--|---------------------|-------------|-----------------------------------|-------------------------|--|-----------------|
| CONTRACT No: F12345-84-C-1234 | | | | | FSC 1234 | | |
| (Description of items covered in this section: example - Bearing, Ball End) | | | | | | | |
| <u>Index no.</u> | <u>Description</u> | <u>Document no.</u> | <u>FSCM</u> | <u>Part number</u> | <u>FSCM</u> | <u>Remarks</u> | <u>Use code</u> |
| A0101 | Bearing, Ball End, Prcn, Self-Align, .250 Bore | XYZM140 | 98765 | XYZM140-1 | 98765 | Use restricted to XYZ Co. only | |
| B0102 | Bearing, Ball End, Prcn, .50 Bore | XYZM240 | 98765 | XYZM240-1 | 98765 | This application only | |
| B0103 | Bearing, Ball End, Prcn, .575 Bore | XYZM240 | 98765 | XYZM240-2 | 98765 | Restricted to this application only; see same index no. in section I for standard part | |
| SECTION II - LIMITED APPLICATION PARTS SUBSECTION B - ELECTRICAL AND ELECTRONIC | | | | | | | |
| CONTRACT NO: F12345-84-C-1234 | | | | | FSC 5910 | | |
| CAPACITORS, Fixed Plastic | | | | | | | |
| <u>Index no.</u> | <u>Description</u> | <u>Document no.</u> | <u>FSCM</u> | <u>Part number</u> | <u>FSCM</u> | <u>Remarks</u> | <u>Use code</u> |
| 0101 | Cap, fixed, plastic | 717057 | 05869 | 717057-1 MM104PJ2 R54F104J2 | 05869 54795 12517 | Limited to ground applications only | |
| FSC 5962 | | | | | | | |
| Microcircuits, Amplifiers | | | | | | | |
| B0209 | MCKT, OP AMP | | | LM111 | 12040 | This contract only; for production use M38510/103048XX | 1/ |

1/ The design of the equipment system shall encompass the parameters of the approved part listed in Section I.

FIGURE 30.1:
SAMPLE FORMAT FOR PROGRAM PARTS SELECTION LIST (PPSL) CONT'D)

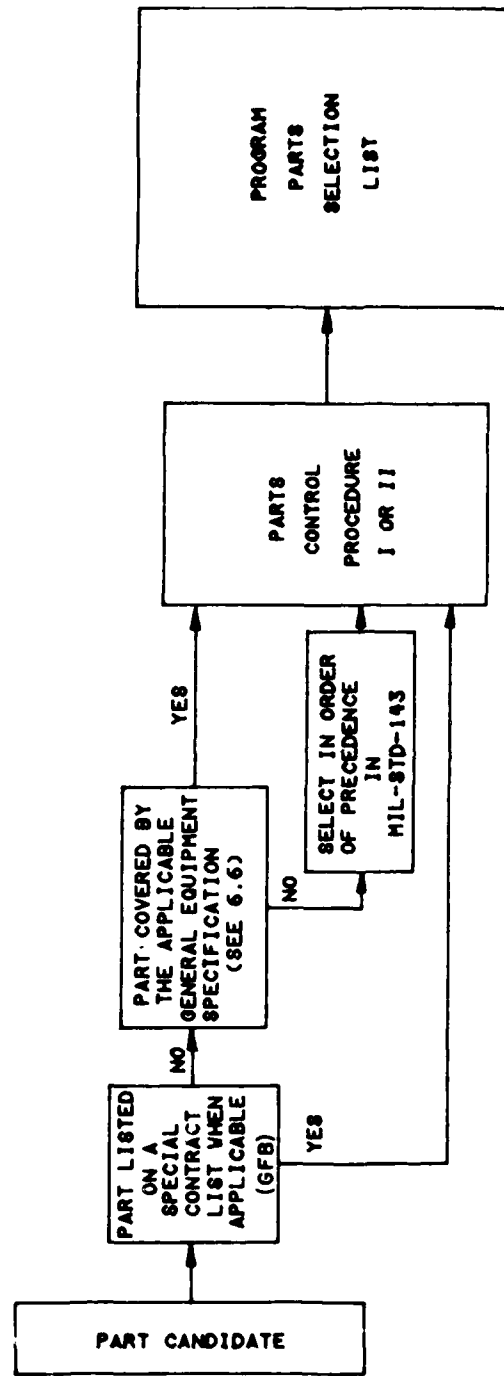

FIGURE 30.2:
EXAMPLE FOR SELECTION OF PARTS FOR PROGRAM PARTS
SELECTION LIST (PPSL)

CHAPTER 30: MIL-STD-965A

Critical parts identification in MIL-STD-965 is based upon technical risks, high costs or procurement lead time.

30.6 TAILORING GUIDELINES

A single parts control program cannot be mandated for all procurements. MIL-STD-965 should not be contractually invoked without detailed tailoring of the requirements. Details for tailoring the requirements are found in the appendix to the standard.

30.6.1 WHEN AND HOW TO TAILOR

The choice between Procedure I and Procedure II is the primary way of tailoring the requirements of MIL-STD-965. Procedure I is applicable to the majority of contracts. Procedure II may be used when there is an aggregation of contractors/subcontractors.

30.7 CONTRACT DATA REQUIREMENTS LIST (CDRL)

The following data item descriptions (DIDs) are associated with Parts Control in accordance with the requirements of MIL-STD-965.

| | |
|---------------|---|
| DI-E-7026A | Parts Control Program Plan |
| DI-E-7029 | Military Detail Specifications and Specification Sheets |
| DI-E-7030 | Test Data for Nonstandard Parts |
| DI-MISC-80071 | Part Approval Requests |
| DI-MISC-80072 | Program Parts Selection List (PPSL) |

CHAPTER 31:

MIL-STD-1556B

**GOVERNMENT/INDUSTRY DATA EXCHANGE PROGRAM (GIDEP)
CONTRACTOR PARTICIPATION REQUIREMENTS**

CHAPTER 31: MIL-STD-1556B

MIL-STD-1556 is a tri-service approved document used by all branches of the military and NASA in the specification and acquisition of quality-assured systems and equipments. The current version is the "B" revision dated February 24, 1986. The preparing activity is:

Naval Ordnance Station
Standardization Branch (Code 3730)
Indian Head, MD 20640-5000

This chapter is only an advisory to the use of MIL-STD-1556. It does not supersede, modify, replace or curtail any requirements of MIL-STD-1556 nor should it be used in lieu of that standard.

31.1 REFERENCE DOCUMENTS

The following related document also impacts and further defines this task:

- MIL-STD-785 Reliability Program for Systems and Equipment Development and Production (and specifically the following task therein)

Task 207 Parts Program

31.2 DEFINITIONS

This paragraph is not applicable to this chapter.

31.3 APPLICABILITY

GIDEP is a cooperative data interchange among Government and Industry participants seeking to reduce or eliminate expenditures of time and money by making maximum use of existing knowledge. GIDEP provides a means to exchange certain types of data essential during the life cycle of systems and equipment.

GIDEP was established to minimize testing of parts and materials through the interchange of environmental test data and technical information among contractors and Government agencies involved in design, development, and fabrication of Government-funded equipment. Information contained within the GIDEP storage and retrieval system includes environmental test reports and procedures, reliability specifications, failure analysis data, failure rate data, calibration procedures, and other technical information related to the application, reliability, quality assurance, and testing of parts and related materials.

31.4 PHYSICAL DESCRIPTION OF MIL-STD-1556

MIL-STD-1556 is a relatively simple document containing only sixteen pages. There are also two appendices (A and B), the first containing more detailed GIDEP Information and the second dealing with tailoring of the specification requirements. The two appendices comprise an additional ten pages.

31.5 HOW TO USE MIL-STD-1556

MIL-STD-1556 establishes the requirements for contractor participation in the GIDEP program. It presents the responsibilities of GIDEP participants and also outlines the types of services and data available from GIDEP.

CHAPTER 31: MIL-STD-1556B

Each GIDEP participant submits data into the program and has free access to the entire contents of the program. Any Government or industry participant may voluntarily submit test reports, calibration procedures, failure rate/mode data, failure experience data and related technical information to GIDEP.

There are two levels of participation in GIDEP. A full participant is expected to maintain within his organization a microfilmed data bank which is immediately available for use by all elements of the organization. A partial participant does not maintain a data bank at his facility but may request needed data from GIDEP.

To enable immediate data access, all information is computer-indexed and recorded on microfilm. Indices of specific data retrievable from the microfilm cartridges are available in various formats depending upon anticipated usage. Data searches and other assistance in use of the program is also available by contacting the GIDEP operations center.

Direct computer access to (GIDEP) information may also be authorized to participants with properly-equipped remote terminal facilities. Remote terminal equipment requirements are: teletype compatibility, ASCII Character Set, half-duplex or batch mode, 300 or 1200 bawd, and even parity.

Unclassified and non-proprietary test reports and other technical information generated by a participant are submitted to the GIDEP operations center. This information is reviewed for program applicability, indexed for computer retrieval, processed for microfilming, and then automatically distributed to all contractors and Government agencies participating in GIDEP.

A GIDEP participant may have access to any of four major data interchanges described as follows:

- **Engineering Data Interchange (EDI)**

EDI contains engineering evaluation and qualification test reports, nonstandard parts justification data, parts and materials specifications, manufacturing processes and other related engineering data on parts, components, materials and processes. This data interchange also includes a section on specific engineering methodology and techniques, air and water pollution reports, alternate energy sources and other diverse subjects.

- **Failure Experience Data Interchange (FEDI)**

FEDI contains objective information generated when significant problems are identified on parts, component materials, equipment, processes or safety conditions. This data interchange includes ALERT and SAFE-ALERT data, failure analysis and problem information, and the diminishing manufacturing sources and material shortages data required by DOD Directive 4005.16.

- **Reliability-Maintainability Data Interchange (RMDI)**

RMDI contains failure rate/mode and replacement rate data on parts, component assemblies, subsystems and materials based on field performance information and reliability test of equipment, subsystems and systems. This data interchange also contains reports on theories, methods, techniques and procedures related to reliability and maintainability practices.

CHAPTER 31: MIL-STD-1556B

● Metrology Data Interchange (MDI)

MDI contains metrology related engineering data on test systems, calibration systems, measurement technology and testing equipment calibration procedures. GIDEP has also been designated as a data repository for the National Bureau of Standards (NBS) data.

A summary of the types of data to be found in each of the data interchanges together with suggestions as to those using disciplines which might benefit most from specific types of data, can be found in Table 31.1 (taken from MIL-STD-1556).

In addition to the data interchanges, three special services are provided within GIDEP: ALERT, Urgent Data Request (UDR) and Metrology Information Service (MIS). The ALERT system provides the participant with identification and notification of actual or potential problems on parts, components, materials, manufacturing processes, test equipment, or safety conditions.

The UDR system permits any participant with a technical problem to rapidly query the scientific and engineering expertise of all participating organizations.

The MIS provides rapid response to GIDEP participants on queries related to test equipment and measurement services.

Data from the GIDEP may be used during planning and performance of the contract in the areas of research, engineering, design development, testing, production, logistics support, and maintenance, to avoid duplication of effort and unnecessary expenditures of resources.

31.6 TAILORING GUIDELINES

31.6.1 When and How to Tailor

The primary tailoring decision relative to MIL-STD-1556 is that of either "Full" or of "Partial" GIDEP participation.

A secondary tailoring decision may well be that of which (one or more) of the four Data Interchanges should be utilized. This decision will probably give different answers in different phases of the life cycle of the program. Appendix B of MIL-STD-1556 gives specific guidance in the tailoring of applicable GIDEP participation requirements.

31.7 CONTRACT DATA REQUIREMENTS LIST (CDRL)

The following data item descriptions (DID) are associated with GIDEP participation in accordance with the requirements of MIL-STD-1556.

| | |
|---------------|---------------------------------|
| DI-QCIC-80127 | GIDEP Annual Progress Report |
| DI-QCIC-80125 | ALERT/SAFE-ALERT |
| DI-QCIC-80126 | Response to an ALERT/SAFE-ALERT |

CHAPTER 31: MIL-STD-1556B

TABLE 31.1: GIDEP UTILIZATION

| <u>Types of Data</u> | <u>Data Interchanges</u> | <u>Using Disciplines</u> |
|---|--------------------------|--|
| Technical Reports Research Engineering Production Methodology | EDI | Research, Engineering, Design, Production Consulting, Industrial Engineering |
| Energy Data Solar Coal Nuclear Petroleum Wind Hydroelectric Geotherm | EDI | Energy Research, Development, Design Production, Nuclear Consulting |
| Quality Data Test Data, QA Plans, Specifications, Storage Life Data, First Article Tests, Failure Analysis Data | EDI FEDI | Engineering, Quality Assurance, Purchasing Test Engineers, Industrial Engineers |
| Test and Evaluation Qualification Tests, Development Tests, Production Test Methods, Evaluation Tests, Demonstration Tests, Test plans, Part Justification Tests | EDI RMDI | Test Engineers, Quality Assurance, Reliability, Maintainability, Product Engineers, Human Engineering, Industrial Engineering, Components Engineering |
| Nonstandard Parts Justification | EDI | Design, Quality Assurance, Printed Cir- cuit Boards, Comp- onents Reliability, Purchasing, Engineering |
| Calibration Procedures Measurements Technology Precision Measurement | MDI | Calibration Technicians Industrial, Test and Maintenance Engineers, Metrologists |
| Maintenance Manual Test Equipment | MDI | Test, Logistics Engineering, Main- tenance and Calibra- tion Technicians |

CHAPTER 31: MIL-STD-1556B

TABLE 31.1: GIDEP UTILIZATION (CONT'D)

| <u>Types of Data</u> | <u>Data Interchanges</u> | <u>Using Disciplines</u> |
|---|--------------------------|---|
| Failure Experience Data ALERTs, SAFE-ALERTs, Problem Information, Failure Analysis, Diminishing Manufacturing Resources and Material Shortages Information | FEDI | All Disciplines |
| Failure Rate/Failure Mode Environmental Stress | RMDI | Reliability, Maintain- ability, Logistics, and Maintenance |
| Reliability/Maintainability Plans, Specifications, Models, Statistics, Prediction Techniques | RMDI EDI | Reliability, Maintain- ability Logistics Engineers |
| Computers Hardware, Peripherals, Storage Devices, Software | EDI RMDI MDI | Engineers, Pro- grammers, Systems Analysis, Test Pro- grammers |

CHAPTER 32:

MIL-STD-202F

**TEST METHODS FOR ELECTRONIC
AND ELECTRICAL COMPONENT PARTS**

CHAPTER 32: MIL-STD-202F

MIL-STD-202 is a tri-service-approved document used by all branches of the military in the specification and acquisition of quality-assured systems and equipment. The current version is revision "F" dated April 1, 1980. The preparing activity is:

U.S. Army Laboratory Command
ATTN: SLCET-R-S
Ft. Monmouth, NJ 07703-5302

This chapter is only an advisory to the use of MIL-STD-202. It does not supersede, modify, replace or curtail any requirements of MIL-STD-202, nor should it be used in lieu of that standard.

32.1 REFERENCE DOCUMENTS

There are no reference documents addressed in MIL-STD-202.

32.2 DEFINITIONS

This paragraph is not applicable to this chapter.

32.3 APPLICABILITY

MIL-STD-202 establishes uniform methods for testing electronic and electrical component parts, including basic environmental tests to determine resistance to deleterious effects of natural elements and conditions surrounding military operations, and physical and electrical tests. For the purpose of this standard, the term "component parts" includes such items as capacitors, resistors, switches, relays, transformers, and jacks. This standard is intended to apply only to small parts, such as transformers and inductors, weighing up to 300 pounds or having a root mean square test voltage up to 50,000 volts unless otherwise specifically invoked. The test methods described therein have been prepared to serve several purposes:

- a. To specify suitable conditions obtainable in the laboratory which give test results equivalent to the actual service conditions existing in the field, and to obtain reproducibility of the results of tests. The tests described are not to be interpreted as an exact and conclusive representation of actual service operation in any one geographic location, since it is known that the only true test for operation in a specific location is an actual service test at that point.
- b. To describe in one standard (1) all of the test methods of a similar character which now appear in the various joint or single-service electrical component part specifications, (2) those newly developed test methods which are feasible for use in several specifications, and (3) the recognized extreme environments, particularly temperatures, barometric pressures, etc., at which component parts will be tested under some presently-standardized testing procedures. By so consolidating, these methods may be kept uniform and thus result in conservation of equipment, man-hours, and testing facilities. In achieving these objectives, it is necessary to make each of the general tests adaptable to a broad range of electrical and electronic parts.
- c. The test methods described in MIL-STD-202 for the environmental, physical and electrical testing of devices shall also apply, when appropriate, to parts not covered by an approved military specification, military sheet form standard, specification sheet, or drawing.

CHAPTER 32: MIL-STD-202F

32.3.1 Structure of MIL-STD-202

MIL-STD-202 is structured into three classes: Test methods numbered 100 to 199 inclusive, address environmental tests; those numbered 200 to 299 inclusive, address physical characteristic tests; those numbered 300 to 399 inclusive, address electrical characteristic tests.

A complete list of MIL-STD-202 (Revision F, Notice 8) test methods, current as of April 11, 1986 is given in Table 32.1 below:

**TABLE 32.1:
MIL-STD-202 TEST METHODS**

| <u>Method No.</u> | <u>Environmental Tests</u> |
|-------------------|--|
| 101D | Salt Spray (corrosion) |
| 102A | (Canceled) |
| 103B | Humidity (steady state) |
| 104A | Immersion |
| 105C | Barometric Pressure (reduced) |
| 106E | Moisture Resistance |
| 107G | Thermal Shock |
| 108A | Life (at elevated ambient temperature) |
| 109B | Explosion |
| 110A | Sand and Dust |
| 111A | Flammability (external flame) |
| 112D | Seal |
| | <u>Physical-Characteristics Tests</u> |
| 201A | Vibration |
| 202D | Shock (specimens weighing not more than 4 pounds) (Superseded by method 213.) |
| 203B | Random Drop |
| 204D | Vibration, High Frequency |
| 205E | Shock, Medium Impact (Superseded by method 213.) |
| 206 | Life (rotational) |

CHAPTER 32: MIL-STD-202F

**TABLE 32.1:
MIL-STD-202 TEST METHODS (CONT'D)**

| <u>Method No.</u> | <u>Physical-Characteristics Tests (Cont'd)</u> |
|-------------------|---|
| 207A | High-impact Shock |
| 208F | Solderability |
| 209 | Radiographic Inspection |
| 210A | Resistance to Soldering Heat |
| 211A | Terminal Strength |
| 212A | Acceleration |
| 213B | Shock (specific pulse) |
| 214A | Random Vibration |
| 215E | Resistance to Solvents |
| 216 | (Canceled) |
| 217 | Particle Impact Noise Detection (PIND) |
| | <u>Electrical-Characteristics Tests</u> |
| 301 | Dielectric Withstanding Voltage |
| 302 | Insulation Resistance |
| 303 | DC Resistance |
| 304 | Resistance-temperature Characteristic |
| 305 | Capacitance |
| 306 | Quality Factor (Q) |
| 307 | Contact Resistance |
| 308 | Current-noise Test for Fixed Resistors |
| 309 | Voltage Coefficient of Resistance Determination Procedure |
| 310 | Contact-chatter Monitoring |
| 311 | Life, Low Level Switching |
| 312 | Intermediate Current Switching |

CHAPTER 32: MIL-STD-202F

32.4 PHYSICAL DESCRIPTION OF MIL-STD-202

MIL-STD-202 is a substantial document composed of forty-one different detailed "Test Methods." It contains approximately two hundred pages. There are no appendices to this standard.

32.5 HOW TO USE MIL-STD-202

The requirements which must be met by the component parts subjected to the test methods described in MIL-STD-202 are specified in the individual specifications, as applicable, and the tests shall be applied as specified therein. When MIL-STD-202 conflicts with the individual specification, the latter shall govern.

The following table, Table 32.2, is presented as a suggested sequence of tests. The philosophy is that parts ideally should be mechanically and thermally stressed prior to being subjected to a moisture resistance test. Within any of the three groups and subgroups which follow, the order is preferred but not mandatory. It is recommended that this sequence be followed in all new specifications and when feasible, in revisions of existing specifications. In the case of hermetically sealed parts, when a moisture resistance test is not required, a high sensitivity seal test may be used in lieu of the moisture resistance test.

**TABLE 32.2:
SEQUENCE OF TESTS**

Group I (all of the samples)

Visual inspection
Mechanical inspection
Electrical measurements
Hermetic seal test (if applicable)

Group IIa (part of sample)

Shock
Acceleration
Vibration

Group IIb (balance of sample)

Resistance to soldering heat
Terminal strength
Thermal shock

Group III (all units which have passed group II tests)

Moisture resistance or seal test on hermetically sealed parts

32.5.2 Some Notable MIL-STD-202 Test Methods

Samples of some notable test methods of MIL-STD-202 usually associated with component part reliability are listed below for illustration purposes.

In Class 100: Method 107, covers Thermal Shock; Method 108, Life (at elevated ambient temperature); and Method 112, Seal Test.

In Class 200: Method 204 covers Vibration, high frequency; Method 213 covers Shock (specified pulse) and Method 217, Particle impact noise detection (PIND)

CHAPTER 32: MIL-STD-202F

32.6 TAILORING

Tailoring of MIL-STD-202 test methods is accomplished by reference to the applicable test methods, by number, in the detailed component part specification.

32.7 CONTRACT DATA REQUIREMENTS LIST (CDRL)

No deliverable data items are required by MIL-STD-202.

SECTION 6

MAINTAINABILITY PROGRAM SPECIFICATIONS

**CHAPTER 33 MIL-STD-470A: MAINTAINABILITY PROGRAM
FOR SYSTEMS AND EQUIPMENT**

CHAPTER 33:

MIL-STD-470A

**MAINTAINABILITY PROGRAM FOR SYSTEMS
AND EQUIPMENT**

CHAPTER 33: MIL-STD-470A

As was shown in Chapter 1, Figure 3, MIL-STD-470 is the top specification in the hierarchy of maintainability specifications. It is a tri-service approved document and is used by all branches of the military in the specification and acquisition, of quality-assured systems and equipment. The current version is revision "A" dated January 3, 1983. However, a draft of MIL-STD-470B dated 21 December 1987 has been released for government and industry coordination.

The primary changes in the Draft B revision are: increased attention to Logistics Support Analysis (LSA) and to testability, specifically the integration of the requirements of MIL-STD-2165, Testability Program for Electronic Systems and Equipment. The Draft B revision does not add any new tasks to those enumerated in the A version of the standard.

The preparing activity is:

Rome Air Development Center
RADC/RBE-2
Griffiss AFB, NY 13441-5700

This chapter is only an advisory to the use of MIL-STD-470. It does not supersede, modify, replace or curtail any requirements of MIL-STD-470 nor should it be used in lieu of that standard.

33.1 REFERENCE DOCUMENTS

Each of the individual tasks described in MIL-STD-470 is usually addressed by one or more specific military standard(s).

For example, Task 104, "Data Collection, Analysis and Corrective Action System" is specifically addressed by MIL-STD-2155.

The following related documents impact and further detail these tasks and should also be referenced.

- MIL-STD-280 Definitions of Item Levels, Item Exchangeability, Models, and Related Terms
- MIL-STD-471 Maintainability Verification/Demonstration/Evaluation
- MIL-STD-721 Definitions of Terms for Reliability and Maintainability
- MIL-STD-785 Reliability Program for Systems and Equipment Development and Production
- MIL-STD-1388-1 Logistics Support Analysis
- MIL-STD-1338-2 DoD Requirements for Logistics Support Analysis Record
- MIL-STD-2155 Failure Reporting, Analysis and Corrective Action System (FRACAS)
- MIL-STD-2165 Testability Program for Electronic Systems and Equipment
- MIL-STD-1629 Procedures for Performing a Failure Mode, Effects and Criticality Analysis (FMECA)
- MIL-HDBK-472 Maintainability Prediction

CHAPTER 33: MIL-STD-470A

33.2 DEFINITIONS OF TERMS AND ACRONYMS

This paragraph is not applicable to this chapter.

33.3 APPLICABILITY

MIL-STD-470, "Maintainability Program for Systems and Equipment," provides both general requirements and specific task descriptions for maintainability programs. The tasks are applicable to systems and equipment development, acquisitions and modifications. Tasks described in this standard are to be selectively applied in DOD contract-defined procurements, requests for proposals (RFP's), statements of work (SOW's) and government in-house developments requiring maintainability programs for development and production of systems and equipments.

33.4 PHYSICAL DESCRIPTION OF MIL-STD-470

MIL-STD-470 is composed of thirteen different "Maintainability Tasks" together with detailed descriptions of each task. The standard itself contains forty- two pages. There is also an additional twenty-two page appendix dealing with tailoring of the specification requirements.

33.5 HOW TO USE MIL-STD-470

MIL-STD-470 includes a series of tasks that may be used to provide specific guidelines for the preparation and implementation of a comprehensive maintainability program.

The standard addresses three different types of tasks: Program Surveillance and Control Tasks, Design and Analysis Tasks and Evaluation and Test Tasks. These three types of tasks are defined as follows:

- a. Program Surveillance and Control Tasks focus on management/technical resources, plans, procedures, schedule, and controls for the work needed to assure achievement of maintainability requirements. These tasks provide the information essential to the operation and support management of the system/equipment.
- b. Design and Analysis Tasks focus on specific maintainability engineering and related technical tasks such as: Maintainability Modeling, Prediction and Allocation; Failure Mode and Effects Analysis (FMEA); Maintainability Analysis; Establishment of Design Criteria, and the Maintenance Plan.
- c. Evaluation and Test Tasks are those tasks designed to assure the procuring agency that the system/equipment is capable of meeting the specified qualitative and quantitative maintainability requirements.

Table 33.1 taken from MIL-STD-470A, Appendix A, contains a listing by task number, of each of the specific maintainability tasks defined in MIL-STD-470 together with a guideline matrix for the selection or deletion of each task based upon the program phase. Each of these maintainability tasks is explained in more detail in the following section.

CHAPTER 33: MIL-STD-470A

33.5.1 Program Surveillance and Control Tasks

● Task 101: Maintainability Program Plan

The maintainability program plan is intended to identify and tie together all of the maintainability tasks that are required to accomplish the program requirements. It is a basic design tool to:

- (1) Assist in managing an effective maintainability program
- (2) Determine, direct and control the execution of the applicable maintainability tasks
- (3) Determine that the documented procedures for implementing and controlling maintainability tasks are adequate
- (4) Determine organizational adequacy to assure that appropriate attention will be focused on maintainability activities and/or problems

● Task 102: Monitor/Control of Subcontractors and Vendors

Continual visibility of subcontractors' and vendors' activities is essential so that timely and appropriate management action can be taken as the need arises. Contractual provisions must be included which permit the procuring activity to participate in appropriate formal prime/subcontractor/vendor meetings. Information gained at these meetings can provide a basis for follow-up actions necessary to maintain adequate visibility of subcontractor's/vendor's progress including technical, cost, and schedule considerations.

● Task 103: Program Reviews

Program Reviews and Design Reviews are important management and technical tools used to insure adequate staffing and funding. Typical program reviews are held to:

- (1) Evaluate the program progress, consistency and technical adequacy of a selected design-and-test approach (Preliminary Design Review).
- (2) Determine the acceptability of the detail design approach toward meeting the quantitative and qualitative maintainability requirements before commitment to production (Critical Design Review)
- (3) Periodically review progress of the maintainability program, i.e., the progress of each specified maintainability element

● Task 104: Data Collection, Analyses, and Corrective Action Systems

The purpose of this task is to establish a data collection and analysis system to aid design, identify corrective action tasks and evaluate test results. It should identify and establish procedures for providing inputs to the the system; the analysis of problems; and feedback of corrective action into design, manufacturing and test processes.

33.5.2 Design and Analysis Tasks

- **Task 201: Maintainability Modeling**

Maintainability models of the system/subsystem/equipment are required to make numerical apportionments and estimates. Models are also required for evaluating complex equipment arrangements. Models should be developed as early as program definition permits, even if usable numerical input data are not yet available. Early modeling can be continually expanded to the detail level for which planning, mission, and system definition are firm.

Maintainability models are used to determine the effect a change in one variable has on acquisition or total system cost, or maintainability or maintenance characteristics.

- **Task 202: Maintainability Allocations**

Maintainability allocations convert the system maintainability requirement to specific maintainability requirements for lower-level items. Allocations need only be made to the level of hardware and maintenance which have a direct bearing on the value of the maintainability indices being allocated.

- **Task 203: Maintainability Prediction**

Maintainability predictions are made to estimate the maintainability of the system/subsystem/equipment and to make a determination of whether the maintainability required can be achieved with the proposed design within the prescribed support and personnel/skill requirements.

Initial prediction is performed early in the acquisition phase to determine the feasibility of the maintainability requirement. It is then updated during the development and production phases to determine the attainability of the maintainability goal. Predictions are important in providing engineers and management with quantitative maintainability information for day-to-day activities.

- **Task 204: Failure Modes and Effects Analysis (FMEA)**

FMEA allows potential failure modes and their effects on system, equipment, and item operation to be identified and appropriately analyzed. This procedure is necessary in order to establish the minimally-acceptable maintainability design characteristics including those that must be ascribed to fault detection and isolation subsystems.

FMEA provides systematic identification of likely modes of failure, and the possible effects of each failure, on safety, system readiness, reliability, and demand for maintenance/logistic support.

- **Task 205: Maintainability Analysis**

The purpose of this task is to translate data from contractor's studies, engineering reports and information which is available from the contracting activity into a detailed design approach and to provide inputs to the detailed maintenance and support plan, which is part of the logistics support analysis.

CHAPTER 33: MIL-STD-470A

The four main goals are: a) to establish design criteria that will provide the desired system features, b) to allow for design decisions to be made through the evaluation of alternatives and through the use of trade-off studies, c) to contribute toward establishing maintenance, repair and servicing policies and support maintainability achievement, and d) to verify that the design complies with the maintainability design requirements.

- **Task 206: Maintainability Design Criteria**

The goal of this task is to identify the design criteria that will be employed in translating the quantitative maintainability requirements and anticipated operational constraints into detailed hardware designs. Thus as a result of allocations, trade-offs, special analysis, and modeling, a firm basis is established for the selection of quantitative and qualitative design targets necessary to meet specification requirements.

- **Task 207: Preparation of Inputs to the Detailed Maintenance Plan and LSA**

This task identifies and prepares inputs for the detailed system or equipment maintenance plan and Logistics Support Analysis (LSA). Those inputs will be based on the results of the tasks which make up the maintainability program. This task effects coordination of the outputs of the maintainability program with the logistics support analysis. The intent is to avoid duplication of effort and to provide for traceability of maintainability inputs used for maintenance plan and LSA development.

33.5.3 Evaluation and Test Tasks

- **Task 301: Maintainability Demonstration**

Maintainability Demonstration (MD) is intended to provide to the customer reasonable assurance that the design meets minimum acceptable maintainability requirements before items are committed to production. MD must be operationally realistic and must provide an estimate of demonstrated maintainability. The specific approach used can range from limited controlled tests to an extensive controlled field test of the product. A MD test does not guarantee achieving the required maintainability requirements; however, it focuses the contractor's attention on incorporation of maintainability features in the design.

33.6 TAILORING GUIDELINES

Tailoring of a maintainability program involves primarily the planning and selection of specific maintainability tasks and the determination of the rigor with which each of these tasks will be applied.

33.6.1 When and How to Tailor

MIL-STD-470 is written as a series of specific tasks to assist the contractor in the development and establishment of a unique, cost effective maintainability program. This includes the selection and the possible deletion of specific tasks, based upon the program phase (as was shown in Table 33.1), thus tailoring of the requirements is implicit in this approach.

Specific directions for the tailoring of the requirements of MIL-STD-470 are found in Appendix A of the standard.

TABLE 33.1: MIL-STD-470 TASK LIST AND APPLICATION MATRIX

| TASK TITLE | TASK TYPE | PROGRAM PHASE | | | | OPERAT SYSTEM DEV (MODES) |
|---|-----------|---------------|----------------|-------------|-------------|---------------------------|
| | | CON-CEPT | VALID | FSD | PROD | |
| 101 Maintainability Program Plan | MGT | N/A | G(3) | G | G(3)(1) | G(1) |
| 102 Monitor/Control of Sub-contractors and Vendors | MGT | N/A | S | G | G | S |
| 103 Program Reviews | MGT | S | G(3) | G | G | S |
| 104 Data Collection, Analysis and Corrective Action System | ENG | N/A | S | G | G | S |
| 201 Maintainability Modeling | ENG | S | S(4) | G | C | N/A |
| 202 Maintainability Allocations | ACC | S | S(4) | G | C | S(4) |
| 203 Maintainability Predictions | ACC | N/A | S(2) | G(2) | C | S(2) |
| 204 Failure Modes and Effects Analysis (FMEA) Maintainability Information | ENG | N/A | S(2) (3)(4) | G(1) (2) | C(1) (2) | S(2) |
| 205 Maintainability Analysis | ENG | S(3) | G(3) | G(1) | C(1) | S |
| 206 Maintainability Design Criteria | ENG | N/A | S(3) | G | C | S |
| 207 Preparation of Inputs to Detailed Maintenance Plan and Logistics Support Analysis (LSA) | ACC | N/A | S(2) (3) | G(2) | C(2) | S |
| 301 Maintainability Demonstration (MD) | ACC | N/A | S(2) | G(2) | C(2) | S(2) |

CHAPTER 33: MIL-STD-470A

CODE DEFINITIONS FOR TABLE 33.1:

S - Selectively Applicable

G - Generally Applicable

C - Generally Applicable to design changes only

N/A - Not Applicable

ACC - Maintainability Accounting

ENG - Maintainability Engineering

MGT - Management

- (1) Requires considerable interpretation of intent to be cost effective.
- (2) MIL-STD-470 is not the primary implementation document. Other MIL-STDs or Statement of Work requirements must be included to define or rescind the requirements. For example, MIL-STD-471 must be imposed to describe maintainability demonstration details and methods.
- (3) Appropriate for those task elements suitable to definition during phase.
- (4) Depends on physical complexity of the system unit being procured, its packaging and its overall maintenance policy.

CHAPTER 33: MIL-STD-470A

33.7 CONTRACT DATA REQUIREMENTS LIST (CDRL)

Each individual task in MIL-STD-470 has its own list of CDRL items.

The following is a list of data item descriptions associated with the reliability tasks specified herein:

| <u>Task</u> | <u>Applicable DID</u> | <u>Data Requirement</u> |
|-------------|-----------------------|---|
| 101 | DI-R-7103 | Maintainability Program Plan |
| 103 | DI-R-7104 | Maintainability Status Report |
| 104 | DI-R-7105 | Data Collection, Analysis and Corrective Action System, Reports |
| 201 | DI-R-7106 | Maintainability Modelling Report |
| 202 | DI-R-7107 | Maintainability Allocations Report |
| 203 | DI-R-7108 | Maintainability Predictions Report |
| 204 | DI-R-7085 | Failure Mode, Effects and Criticality Analysis (FMECA) Report |
| 205 | DI-R-7109 | Maintainability Analysis Report |
| 206 | DI-R-7110 | Maintainability Design Criteria Plan |
| 207 | DI-R-7111 | Inputs to the Detailed Maintenance Plan and Logistics Support Analysis |
| 301 | DI-R-7112 | Maintainability Demonstration Test Plan |
| | DI-R-2129 | Maintainability Demonstration Plan (DI-R-2129 is to be used only when MIL-STD-471 is designated as the basis for MIL-STD-470A, Task 301) |
| | DI-R-7113 | Maintainability Demonstration Report (to be used only when MIL-STD-471 and its associated DI-R-2130A are not designated as a basis for MIL-STD-470A, Task 301) |

NOTES: Only data items specified in the CDRL are deliverable. Therefore, those data requirements identified in the Maintainability Program Plan must also appear in the CDRL.

SECTION 7

MAINTAINABILITY DESIGN SPECIFICATIONS

**CHAPTER 34 MIL-STD-2165: TESTABILITY PROGRAM FOR
SYSTEMS AND EQUIPMENT**

**CHAPTER 35 MIL-STD-2084(AS): GENERAL REQUIREMENTS
FOR MAINTAINABILITY**

CHAPTER 34:

MIL-STD-2165

**TESTABILITY PROGRAM FOR ELECTRONIC SYSTEMS
AND EQUIPMENTS**

CHAPTER 34: MIL-STD-2165

MIL-STD-2165 is a tri-service approved document used by all branches of the military in the specification and acquisition of quality-assured electronic systems and equipment. The current version is the initial release dated January 26, 1985. The preparing activity is:

Department of Navy
Space and Naval Warfare Systems Command
ATTN: SPAWAR 003-121
Washington, D.C. 20363-5100

This chapter is only an advisory to the use of MIL-STD-2165. It does not supersede, modify, replace or curtail any requirements of MIL-STD-2165 nor should it be used in lieu of that standard.

34.1 REFERENCE DOCUMENTS

The following related documents impact and further detail these tasks and should be referenced.

- MIL-STD-470 Maintainability Program for Systems and Equipment
- MIL-STD-471 Maintainability Verification/Demonstration/Evaluation
- MIL-HDBK-472 Maintainability Prediction
- MIL-STD-785 Reliability Program for Systems and Equipment Development and Production
- MIL-STD-1309 Definition of Terms, Measurement and Diagnostic Equipment
- MIL-STD-1388-1 Logistic Support Analysis
- MIL-STD-2077 General Requirements for Test Program Sets
- DARCOMP 9405 Built-In-Test Guide
- RADC-TR-82-189 RADC Testability Notebook

34.2 DEFINITIONS

The meanings of many of the terms and acronyms used in testability are unique to the field. Therefore, the following terms and acronyms are defined here to assist in better understanding the material in MIL-STD-2165. Further definition of applicable terms may be found in MIL-STD-721, MIL-STD-1309, and MIL-STD-2165, Appendix C.

Automatic Test Equipment (ATE) - Equipment that carries out a predetermined program of system testing for the detection, localization, or isolation of malfunctions to facilitate maintenance and the checkout of the system following maintenance to verify the performance status of the system.

Built-In-Test (BIT) - A test approach utilizing self test hardware or software to test all or part of an equipment or system.

Built-In-Test Equipment (BITE) - Any device that is a part of an equipment or system and is used for the express purpose of testing the equipment or system. BITE is normally an identifiable unit within the equipment or system.

CHAPTER 34: MIL-STD-2165

Computer Aided Testing (CAT) - A design technique which uses a computer to analyze the testability of a proposed design and to develop design solutions when shortcomings are identified. When hardware is produced and testing begins, CAT also encompasses a test concept which uses computers to control imposed test environments, monitor and analyze the UUT's response to those environments, and determine the UUT's design acceptability based on the measured test responses. Should the UUT fail to perform as specified during the test, the CAT also assists in the development of design solutions.

Controllability - An attribute of equipment design which defines or describes the degree of test control which may be realized at internal nodes of interest.

Design for Testability (DFT) - A design process or characteristic thereof such that deliberate effort is expended to assure that a product may be thoroughly tested with minimum effort, and that high confidence may be ascribed to test results.

External Test Equipment (ETE) - Test equipment which is physically separated from the UUT when the UUT is in its operational environment.

Fault Detection - One or more tests performed to determine if any malfunction or faults are present in a unit. A process which discovers or is designed to discover the existence of faults; the act of discovering the existence of a fault.

Fault Localization - Where a fault is known to exist, a process which identifies or is designed to identify the location of that fault within a general area of equipment. Fault localization is less specific than fault isolation.

Fault Isolation - Where a fault is known to exist, a process which identifies or is designed to identify the location of that fault pin-pointed to a specific item within the equipment.

General Purpose Electronic Test Equipment (GPETE) - Test equipment which is used for the measurement of a range of parameters common to two or more systems of basically different design.

Observability - An attribute of equipment design which describes the extent to which signals of interest may be observed.

Off-Line Test - Test of a UUT with the unit removed from its normal operating environment.

On-Line Test - Testing of a UUT in its operational environment.

Testability - A design characteristic that allows the operational status (operable, inoperable, or degraded) of a system or any of its subsystems to be confidently determined in a timely fashion.

Testability Figure-of-Merit - A measurable parameter that accurately evaluates the degree of testability designed into the equipment.

Troubleshooting - A procedure for locating and diagnosing malfunctions or breakdowns in equipment by means of systematic checking or analysis.

Unit Under Test (UUT) - Any system, set, subsystem, assembly, subassembly and so forth, undergoing testing.

CHAPTER 34: MIL-STD-2165

34.3 APPLICABILITY

34.3.1 General Testability/BIT Description

Testability represents the extent to which a system or a unit supports fault detection and fault isolation in a confident, timely and cost-effective manner. System testability implementation generally includes the use of built-in-test (BIT). Adequate recognition of the need to design for testability requires early, systematic attention on the part of management to specific testability requirements, design approaches, analysis and measurement.

BIT is defined as an automated or semi-automated, integral part of the operational system. BIT does not operate outside of the system environment. In its simplest form BIT verifies the operational integrity of the system by detecting anomalous system operation and then assisting the operator/maintenance person in isolating the fault to a specific replaceable assembly.

To contrast the two concepts, **testability** is a necessary system attribute while **BIT** is the implementation of a specific design approach.

The demonstration of system or equipment testability characteristics is addressed by MIL-STD-2165. The demonstration of specific BIT numerics, however, is normally accomplished in the Maintainability Demonstration Test which is performed in accordance with MIL-STD-471.

34.4 PHYSICAL DESCRIPTION OF MIL-STD-2165

MIL-STD-2165 is composed of seven testability related "Tasks" and contains nineteen pages. There are also three supporting appendices: Appendix A, "Testability Program Application Guidance," Appendix B, "Inherent Testability Assessment," and Appendix C, "Glossary of Terms." The three appendices contain an additional fifty-five pages.

34.5 HOW TO USE MIL-STD-2165

MIL-STD-2165 defines methodology for the incorporation of adequate and cost-effective Testability and BIT features into the equipment design. It sets the requirements and establishes guidelines for assessing the extent to which a system or a unit supports fault detection and fault isolation.

MIL-STD-2165 addresses three different types of tasks: a) Program Monitoring and Control tasks, b) Design and Analysis tasks and c) Test and Evaluation tasks. These three types of tasks may be defined as follows:

- a. Program Monitoring and Control tasks focus on providing the information essential to the acquisition, operation, and support management of the system/equipment. They relate more to the management responsibilities dealing with the program and less to the technical details.
- b. Design and Analysis tasks focus on the establishment of specific requirements, design practices, the prediction and analysis of testability parameters and other related engineering tasks.
- c. Test and Evaluation tasks are those that determine compliance with specified requirements and assess the validity of the previously made predictions.

CHAPTER 34: MIL-STD-2165

The following is a listing of the tasks contained in MIL-STD-2165. Each of these tasks is explained in greater detail in the following sections of this chapter.

- Task 101: Testability Program Planning
- Task 102: Testability Reviews
- Task 103: Testability Data Collection and Analysis Planning
- Task 201: Testability Requirements
- Task 202: Testability **Preliminary** Design and Analysis
- Task 203: Testability **Detail** Design and Analysis
- Task 301: Testability Inputs to Maintainability Demonstration

34.5.1 Program Monitoring and Control Tasks

● Task 101: Testability Program Planning

Testability program planning identifies and integrates all testability design management tasks required to accomplish the testability program requirements. It identifies testability design guides, analysis models and procedures to be imposed upon the design process.

The testability program plan presents the overall testing strategy including: operational checks, periodic on-line tests, and off-line test considerations. It also presents milestones to ensure that the final design achieves the required degree of testability. The plan includes the mechanisms for the reporting of progress, problems, trade-offs, and enforcement of the proper use of testability design features by designers and subcontractors.

Specific testability program plan details should be in accordance with the requirements of DI-T-7198 taking into account the applicable testability tailoring guidelines.

● Task 102: Testability Reviews

Testability reviews are held to provide formal documented review and assessment of all testability information in a timely and controlled manner. The review covers all pertinent aspects of the testability program.

The testability program reviews are conducted as integral parts of normal design reviews (SDR, PDR, CDR, etc.) as specified in the contract. They should also be coordinated with, and held in conjunction with, reliability, maintainability and logistics support reviews.

● Task 103: Testability Data Collection and Analysis Planning

Methods must be established to identify and track testability-related problems during system production and deployment and to identify appropriate corrective actions where necessary.

In the development of a data analysis and collection plan, the field and depot test systems available for production and deployment testing, and existing data collection systems in the using command must be considered. The relationship of Task 103 of MIL-STD-2165 to Task 104 of MIL-STD-785 and Task 104 of MIL-STD-470 should also be considered.

Specific testability data collection and analysis details should be in accordance with the Maintainability Demonstration Test Plan requirements of DI-T-7105.

34.5.2 Design and Analysis Tasks

● Task 201 Testability Requirements

The qualitative and quantitative testability requirements are based upon operational requirements of the prime system. They are established using an iterative process that optimizes the various testability requirements such as: BIT, ATE or manual test for system monitoring, and fault detection or isolation. It also optimizes the mix of BIT/BITE/ETE and the maintenance shop organization to satisfy the established maintenance concept and the operational availability requirements.

The qualitative and quantitative testability requirements must factor in the effects on safety, the numbers and skills of the operating and maintenance personnel, any existing logistics constraints, deployment scenarios, environmental conditions and planned maintenance facilities in accordance with MIL-STD-1388-1. An example of some specific testability requirements for the system specification are shown in Figure 34.1 taken from MIL-STD-2165, Appendix A.

This task must take into consideration the applicable Maintenance Concept and requires documentation in accordance with DI-T-7199.

● Task 202: Testability Preliminary Design and Analysis

Appropriate testability design concepts are to be incorporated into the preliminary design for each item in the system. The preliminary design and analysis evaluates and assesses the system or the equipment's inherent (intrinsic) testability figure-of-merit (as described in RADC-TR-189, Section II, Task Reference Number V4B). This assessment is performed in accordance with the procedures described in Appendix B of the standard or as described in RADC-TR-189. The preliminary design is then modified as necessary to assure compliance with the established inherent testability figure-of-merit requirement.

This is accomplished by: a) analyzing hardware/software BIT features; b) documenting the trade-offs made in selecting them; c) conducting a testability analysis of the projected UUTs in the preliminary design to determine the extent to which the recommended testability requirements and guidelines provided to the designers were incorporated into the design; and d) providing guidance for subsequent detailed design-for-testability.

The principle numeric of interest at this phase of the design effort is the "Inherent Testability Figure-of-Merit." This task requires documentation in accordance with DI-T-7199.

● Task 203: Testability Detail Design and Analysis

Specific features must be incorporated into the system or equipment design to satisfy the testability performance requirements. Test effectiveness utilizing these features are then predicted for the system/equipment. This includes an analysis of all critical functions of the prime equipment to assure that they are exercised by testing to the extent specified. Analysis is also to be made of the test effectiveness of the BIT and off-line test.

3.X.X Design for Testability

- a. Requirement for status monitoring.
- b. Definition of failure modes, including interconnecting failures, specified to be the basis for test design.
- c. Requirement for failure coverage (% detection) using full test resources.
- d. Requirement for failure coverage using BIT.
- e. Requirement for failure coverage using only the monitoring of operational signals by BIT.
- f. Requirement for maximum failure latency for BIT.
- g. Requirement for maximum acceptable BIT false alarm rate; definition of false alarm.
- h. Requirement for fault isolation to a replaceable item using BIT.
- i. Requirement for fault isolation times.
- j. Restrictions on BIT resources in items of hardware size, weight and power, memory size and test time.
- k. Requirement for BIT hardware reliability.
- l. Requirement for automatic error recovery.
- m. Requirement for fault detection consistency between hardware levels and maintenance levels.

**FIGURE 34.1:
MODEL TESTABILITY REQUIREMENTS, SYSTEM SPECIFICATION**

The purpose of this task is to assess the testability of a weapon system design, making use of a failure modes and effects analysis (FMEA) from MIL-STD-470, Task 204, to incorporate additional features into the design to satisfy testability performance requirements, and to predict the level of test effectiveness which will be achieved for the system or equipment.

Each configuration item (potential UUTs) is modeled for predicted failure population and analyzed in order to guide redesign of equipment and test programs as required.

CHAPTER 34: MIL-STD-2165

This task includes the test effectiveness prediction for the system and for each item documented in accordance with DI-T-7199. The task also provides specific data inputs for MIL-STD-470, Task 205 and MIL-STD-1388-1A, Task 401.

34.5.3 Test and Evaluation Tasks

- **Task 301: Testability Inputs to Maintainability Demonstrations**

The purpose of this task is to determine compliance with specified testability requirements and to assess the validity of testability predictions. It utilizes test methods and procedures documented in MIL-STD-471, Maintainability Demonstrations.

The testability demonstration plan should be documented in accordance with DI-T-7112. The testability inputs themselves should be documented in accordance with the Maintainability Demonstration Report requirements in DI-T-7113.

34.6 TAILORING GUIDELINES

A single testability program is not suitable for all programs. There are pragmatic limits to the resources in time, money and engineering manpower to expend on testability analysis. The testability program must therefore be tailored to the unique aspects and limits of a given procurement.

34.6.1 How and When to Tailor

The tailoring of a testability program is based primarily upon the phase of the program. The program phase will determine first which of the various testability tasks are applicable. The individual tasks then must be tailored based upon the specific program phase. A given task will not always be carried out in the same manner. It will vary from one program to another and it will also vary within a given program depending upon the program phase.

Appendix A of MIL-STD-2165 provides guidance in the selection and application of the various testability tasks i.e., for the tailoring of a specific testability program.

34.7 CONTRACTS DATA REQUIREMENTS LIST (CDRL)

The following is a list of data item descriptions (DID's) associated with Testability and MIL-STD-2165.

| | |
|-----------|---|
| DI-T-7198 | Testability Program Plan |
| DI-T-7199 | Testability Analysis Report |
| DI-T-7112 | Maintainability Demonstration Test Plan |
| DI-T-7113 | Maintainability Demonstration Results |
| DI-R-7105 | Data Collection and Analysis Plan |
| DI-E-5423 | Program Review Documentation |

CHAPTER 35:

MIL-STD-2084(AS)

GENERAL REQUIREMENTS FOR MAINTAINABILITY

CHAPTER 35: MIL-STD-2084(AS)

MIL-STD-2084 (AS) is currently a limited usage document. It is approved only by the Navy and is used in the specification and acquisition of quality-assured electronic systems and equipments. The current version is the initial release dated April 6, 1982. The preparing activity is:

Department of the Navy
Engineering Specifications and Standards Department
(SESD) (Code 5313)
Naval Air Engineering Center
Lakehurst, NJ 08733-5100

This chapter is only an advisory to the use of MIL-STD-2084. It does not supersede, modify, replace or curtail any of the requirements of MIL-STD-2084 nor should it be used in lieu of that standard.

35.1 REFERENCE DOCUMENTS

The following related documents impact and further detail these tasks and should also be referenced.

- MIL-STD-280 Definitions of Item Levels, Item Exchangeability, Models, and Related Terms
- MIL-STD-454 Standard General Requirements for Electronic Equipment
- MIL-STD-470 Maintainability Program Requirements for Systems and Equipment, Development and Production
- MIL-STD-471 Maintainability Verification/Demonstration/Evaluation
- MIL-STD-721 Definitions of Terms for Reliability and Maintainability
- MIL-STD-882 System Safety Program Requirements
- MIL-STD-1390(AS) Level of Repair
- MIL-STD-1472 Human Engineering Design Criteria for Military Systems, Equipment, and Facilities
- MIL-STD-1629 Procedures for Performing a Failure Mode, Effects and Criticality Analysis (FMECA)
- MIL-STD-2076 General Requirements for Unit Under Test Compatibility with Automatic Test Equipment
- MIL-HDBK-472 Maintainability Prediction
- NAVMAT-P-9405 Built-In-Test Design Guide

CHAPTER 35: MIL-STD-2084(AS)

35.2 DEFINITIONS

The meanings of many of the terms and acronyms used in this standard are unique to the field and thus may be unfamiliar to the reader. Therefore, the following terms and acronyms are defined here to assist the reader in better understanding the material in MIL-STD-2084.

Weapons Replaceable Assembly (WRA): A generic term which includes all replaceable packages of a system installed in the weapon system with the exception of cables, mounting provisions, and fuse boxes or circuit breakers. The WRA is generally modular in form and designed to facilitate an organizational level removal and replace maintenance concept. The preferred form of WRA is the light replaceable assembly (LRA) which is easily removed and replaced in the weapon system by one man in not more than 15 minutes.

Shop Replaceable Assembly (SRA): A generic term which includes all the packages within a WRA including the chassis and wiring as a unit.

Quick Replaceable Assembly (QRA): A preferred form of SRA which is easily removable from the WRA without complex operations or special tools and is typified by a plug-in design.

Bench Replaceable Assembly (BRA): A less desirable form of SRA which is not easily removable; e.g., item is bolted to chassis or heat sink or soldered in place.

Sub-Shop Replaceable Assembly (sub-SRA): A modular item packaged in an SRA.

35.3 APPLICABILITY

MIL-STD-2084(AS), "General Requirements for Maintainability of Avionic and Electronic Systems and Equipment" is intended to amplify the maintainability program requirements of MIL-STD-470. The purpose is to provide general design criteria requirements for maintainability programs which will minimize maintenance downtime, cost, complexity, and personnel requirements. The goal of the standard is to emphasize maintainability-by-design.

"Maintainability-by-design," places emphasis on those design procedures which most effectively produce ease of maintenance. These include requirements for modularization, replacement at higher levels, and increased depth of localization (i.e., determination of the general location of a fault to effect repair). These physical and technical considerations of maintainability design are necessary if complex electronic systems and equipment are to be supported efficiently at all levels of maintenance.

Requirements described in this standard are to be selectively applied in DOD contract-defined procurements, requests for proposals (RFP's), statements of work (SOW's) and government in-house activities requiring maintainability programs for development and production of electronic systems and equipments.

35.4 PHYSICAL DESCRIPTION OF MIL-STD-2084

MIL-STD-2084 is a relatively short document consisting of six different "Maintainability Requirements" and containing thirty-two pages. There is also an additional five page appendix dealing with tailoring of the specification requirements.

CHAPTER 35: MIL-STD-2084(AS)

35.5 HOW TO USE MIL-STD-2084

MIL-STD-2084 includes a series of "Numbered Requirements" which provide specific design criteria for the implementation of a "maintainability-by-design" approach.

Table 35.1 (excerpted from MIL-STD-2084, Appendix A) contains a listing, by requirement number, of each of the specific requirements defined in MIL-STD-2084 together with a guideline matrix for the selection or deletion of each requirement based upon the program phase (i.e., conceptual, validation, full-scale engineering development, and production). Each of these "Numbered Requirements" is explained in more detail in the following section.

**TABLE 35.1:
MIL-STD-2084 REQUIREMENTS LIST
AND APPLICATION MATRIX**

| | <u>Requirement Title</u> | <u>Concept</u> | <u>Valid</u> | <u>FSED</u> | <u>Prod</u> |
|-----|-----------------------------------|----------------|--------------|-------------|-------------|
| 101 | Maintainability Program | S | G(1) | G(1) | G(1) |
| 102 | Failure mode and effects analysis | S | G(1)(2) | G(1) | C |
| 103 | Physical design | S | G(2) | G | C |
| 104 | Built-in-test | S | G | G | C |
| 105 | Test points | S | G | G | C |
| 106 | Maintainability index | S | G(2) | G | C |

Code Definitions

- S - Selectively applicable
- G - Generally applicable
- C - Generally applicable to design changes only
- (1) - MIL-STD-2084 is not primary implementing document
- (2) - Depends on physical complexity of system being procured, its packaging, and maintenance policy

35.5.1 PROGRAM REQUIREMENTS DESCRIPTION

● Requirement 101: Maintainability Program

This requirement establishes criteria for the minimum elements of a maintainability program performed in accordance with MIL-STD-470. These specific elements are:

- a. Establishment of Quantitative Maintainability Requirements
- b. Performance of a Maintainability Analysis
- c. Performance of a Maintainability Prediction
- d. Establishment of Design Criteria and Guidelines

CHAPTER 35: MIL-STD-2084(AS)

● Requirement 102: Failure Modes and Effects Analysis (FMEA)

FMEA, performed in accordance with MIL-STD-1629, allows potential failure modes and their effects on systems, equipments, and item operation to be identified and appropriately analyzed. This procedure is necessary in order to establish the minimally-acceptable maintainability design characteristics including those that must accommodate fault detection and isolation.

FMEA provides systematic identification of likely modes of failure, and the possible effects of each failure, on safety, system readiness, reliability, and demand for maintenance support.

● Requirement 103: Physical Design

This requirement establishes criteria for the design of the physical characteristics which influence the maintainability features and maintenance requirements of the electronic system. This includes a level of repair (LOR) analysis performed in accordance with MIL-STD-1390(AS) to establish the most cost-effective method of logistically supporting the electronic system. The requirement addresses the design, construction and replacement of the WRA's, SRA's, QRA's, BRA's and sub-SRA's.

● Requirement 104: Built-In-Test

The establishment of criteria for design and application of built-in-test (BIT) which will adequately support the defined maintenance concept is the focus of this requirement. Specific guidance in the application of BIT may be found in NAVMAT-P-9405.

The BIT capability serves two basic functions. First, it provides a fault detection function, and second, it provides isolation to a specific defective item(s) or function(s).

● Requirement 105: Test Points

Test points are a consideration in both electronic system design and BIT design since Automatic Test Equipment (ATE) accessibility must be provided to both initiate BIT operation and to test the system. This requirement establishes the criteria for the design and application of test points which will adequately support the defined maintenance concept. Both external and internal test points are addressed. They must permit both functional and static parameters of a system to be monitored, evaluated, and isolated. BIT and ATE test points must be compatible and they must be harmonized i.e., brought into agreement.

● Requirement 106: Maintainability Index

A measure of how well an electronic system meets specific maintainability requirements can be assessed through various maintainability indices. This requirement establishes criteria for determining the specific maintainability indices most appropriate for a particular electronic system. It deals primarily with the application of MIL-STD-1390(AS) "Level of Repair."

CHAPTER 35: MIL-STD-2084(AS)

35.6 TAILORING GUIDELINES

Tailoring of a maintainability program involves the planning and selection of specific maintainability requirements and tasks and determining the rigor with which each of these requirements and tasks will be applied.

35.6.1 When and How to Tailor

MIL-STD-2084 is written as a series of "Numbered Requirements" to assist in the development and establishment of specific design criteria requirements for the maintainability program. It emphasizes maintainability-by-design. Thus tailoring of the requirements by the selection and the possible deletion of specific "numbered requirements" based upon the program phase (as was shown in Table 35.1) is implicit in this approach.

Specific directions for the tailoring of the requirements of MIL-STD-2084 are found in Appendix A of the standard.

35.7 CONTRACT DATA REQUIREMENTS LIST (CDRL)

No deliverable data is required by MIL-STD-2084; instead, MIL-STD-470 addresses the applicable deliverable data.

SECTION 8

MAINTAINABILITY ASSESSMENT SPECIFICATIONS

**CHAPTER 36 MIL-STD-471A: MAINTAINABILITY/
VERIFICATION/DEMONSTRATION/
EVALUATION**

CHAPTER 37 MIL-HDBK-472: MAINTAINABILITY PREDICTION

CHAPTER 36:

MIL-STD-471A

MAINTAINABILITY VERIFICATION/DEMONSTRATION/EVALUATION

CHAPTER 36: MIL-STD-471A

MIL-STD-471 is a tri-service approved document used by all branches of the military in the specification and acquisition, of quality-assured electronic systems and equipment. The current version is revision "A" dated March 27, 1973, however, Interim Notice 2 (USAF) dated December 8, 1978 is a very significant addition. The preparing activity is:

Rome Air Development Center
RADC/RBE
Griffiss AFB, NY 13441-5700

This chapter is only an advisory to the use of MIL-STD-471. It does not supersede, modify, replace or curtail any requirements of MIL-STD-471 nor should it be used in lieu of that standard.

36.1 REFERENCE DOCUMENTS

The following related documents impact and further detail these tasks and should also be referenced.

- MIL-STD-280 Definitions of Item Levels, Item Exchangeability, Models, and Related Terms
- MIL-STD-470 Maintainability Program Requirements For Systems and Equipments (and specifically the following task therein)
 - Task 301 Maintainability Demonstration
- MIL-STD-721 Definitions of Terms for Reliability and Maintainability
- MIL-STD-2155 Failure Reporting, Analysis and Corrective Action System (FRACAS)
- MIL-STD-2165 Testability Program for Systems and Equipment
- MIL-HDBK-472 Maintainability Prediction

36.2 DEFINITIONS

This paragraph is not applicable to this chapter.

36.3 APPLICABILITY

This standard establishes the policy and the basic requirements for maintainability demonstrations. It provides descriptions and application guidelines essential to the planning, testing, and reporting of system/equipment maintainability requirements. Successful achievement of these efforts will minimize system downtime.

Maintainability Demonstration (MD) is intended to provide to the customer reasonable assurance that the design meets the maintainability requirements before items are committed to production. MD must be operationally realistic and must provide an estimate of demonstrated maintainability.

CHAPTER 36: MIL-STD-471A

36.3.1 Maintainability Demonstration Description

Maintainability demonstration is a method of determining whether a development program or contractor has successfully met the maintainability quantitative and qualitative requirements to the satisfaction of the procuring activity. A successful maintainability demonstration is dependent on how well the equipment is designed for testability, how well maintenance manuals are written, and how well repair technicians are trained.

The specific test approach used can range from limited controlled tests to an extensive controlled field test of the product. A MD test does not guarantee achievement of the required maintainability requirements; however, it focuses the contractor's attention on incorporation of maintainability features in the design.

36.4 PHYSICAL DESCRIPTION OF MIL-STD-471

MIL-STD-471 is a very complex document consisting of twelve different maintainability "Test Methods." The standard itself is short, consisting of only twenty pages. The meat of the material, however, the test methods themselves, is to be found in the two appendices, Appendix A, "Maintenance Task Sampling for Use With Fault Simulation," Appendix B, "Test Methods and Data Analysis," and in Interim Notice 2, "Demonstration and Evaluation of Equipment/System Built-in-Test/External Test/Fault Isolation/Testability Attributes and Requirements." Together these supporting items have a total of seventy-eight additional pages.

36.5 HOW TO USE MIL-STD-471

This standard establishes the policy and provides the guidance for conducting maintainability demonstrations at specified points during the project. These demonstrations are intended to give evidence, and ensure, that the maintainability program is proceeding in accordance with program milestones, and that the equipment maintainability requirements are achieved.

Results of maintainability demonstrations must also be evaluated in order to determine and implement timely and effective corrective action (see MIL-STD-470, Task 104) for deficiencies disclosed.

The maintainability characteristics of systems and equipment can seldom be addressed by a single maintainability parameter as can, frequently, the reliability characteristics. MIL-STD-471A itself contains eleven specific test methods addressing various different maintainability parameters. Limited coordination Change Notice 2 contains another addendum directed toward demonstrating specific Built-in-Test (BIT) numerics. The addendum also deals with BIT/External Test/Fault Isolation and Testability questions.

Twelve different test methods, together with the mathematical basis for each test method, are described in detail in MIL-STD-471A and Interim Notice 2 (USAF). These descriptions are shortened as follows:

- **Method 1: Test on The Mean**

This test provides for the demonstration of maintainability when the requirement is stated in terms of a required mean value (μ_1) and a design goal value (μ_0) (or when the requirement is stated in terms of a required mean value (μ_1) and a design goal value (μ_0) is chosen by the contractor).

CHAPTER 36: MIL-STD-471A

The test plan is subdivided into two basic procedures, identified as Test Plan A and Test Plan B. Test Plan A makes use of the lognormal assumption for determining the sample size, whereas Test Plan B does not. Both tests are fixed sample tests, (minimum sample size of 20), which employ the statistical Central Limit Theorem and the asymptotic normality of the sample mean for their development.

For Test Method A the assumption is that the maintenance times can be adequately described by a lognormal distribution. It is also assumed that the variance, (d^2), of the logarithms of the maintenance times is known from prior information or that reasonably precise estimates can be obtained.

For Test Method B no specific assumption concerning the distribution of maintenance times is necessary. The variance (d^2) of the maintenance times is known from prior information, or reasonably precise estimates can be made.

● Method 2: Test on Critical Percentile

This test provides for the demonstration of maintainability when the requirement is stated in terms of both a required critical percentile (T_1) and a design goal value (T_0) (or when the requirement is stated in terms of a required percentile value (T_1) and a design goal value (T_0) is chosen by the contractor). If the critical percentile is set at 50%, then this test method is a test of a median.

The decision criteria is based upon the asymptotic normality of the maximum likelihood estimate of the percentile value. The method assumes that maintenance times can be adequately described by a lognormal distribution. It also assumes that the variance (d^2) of the logarithms of the maintenance times is known from prior information or that reasonably precise estimates can be obtained.

● Method 3: Test on Critical Maintenance Time or Manhours

This test provides for the demonstration of maintainability when the requirement is specified in terms of both a required critical maintenance time (or critical manhours) (X_{p_1}) and a design goal value (X_{p_0}) (or when the requirement is stated in terms of a required critical maintenance time (X_{p_1}) and a design goal value (X_{p_0}) is chosen by the contractor). The test is distribution-free and is applicable when it is desired to establish controls on a critical upper value on the time or manhours to perform specific maintenance tasks.

In this test both the null and alternate hypothesis refer to a fixed time and the percentile varies. It is different from Test Method 2 where the percentile value remains fixed and the time varies. No specific assumption concerning the distribution of maintenance time or manhours is necessary.

● Method 4: Test on the Median (ERT)

This method provides for demonstration of maintainability when the requirement is stated in terms of an equipment repair time (ERT) median, which will be specified in the detailed equipment specification.

The method assumes the underlying distribution of corrective maintenance task times is lognormal. The sample size required is 20. This sample size satisfies the equation described in the test method.

CHAPTER 36: MIL-STD-471A

● Method 5: Test on Chargeable Maintenance Downtime Per Flight

Chargeable downtime per flight can be thought of as the allowable time (hours) for performing maintenance given that the aircraft has levied on it a certain availability or operational readiness requirement. The Central Limit Theorem is employed in this test method.

● Method 6: Test on Manhour Rate

This test for demonstrating manhour rate (manhours per flight hour) is based on a determination during Phase II test operation of the total accumulative chargeable maintenance manhours and the total accumulative flight hours. In using this test method, care must be exercised in assuring that the predicted manhour rate pertains to flight time and not equipment operating time. The contractor must develop appropriate ratios of equipment operating time to flight time.

● Method 7: Test on Manhour Rate (Using Simulated Faults)

This test for demonstrating manhour rate (manhours per operating hour) is based on (a) the predicted total failure rate of the equipment, and (b) the total accumulative chargeable maintenance manhours and the total accumulative simulated demonstration operating hours.

● Method 8: Test on Combined Mean/Percentile Requirement

This test provides for the demonstration of maintainability when the specification is couched in terms of a dual requirement for the mean and either the 90th or 95th percentile of maintenance times when the distribution of maintenance time is lognormal.

● Method 9: Test for Mean Maintenance Time (Corrective Preventive Combination of Corrective and Preventative) and M_{\max}

This method is applicable to demonstration of the following indices of maintainability: Mean Corrective Maintenance Time (μ_c), Mean Preventive Maintenance Time (μ_{pm}), Mean Maintenance Time (includes preventive and corrective maintenance actions $\mu_{p/c}$), and M_{\max} (percentile of repair time).

The procedures of this method for demonstration of μ_c , are based on the Central Limit Theorem. No information relative to the variance (d^2) of maintenance times is required. It may therefor be applied whatever the form of the underlying distribution, provided the sample size is adequate. The minimum sample size is set at 30.

The procedure for demonstrating M_{\max} is valid for those cases where the underlying distribution of corrective maintenance task times is lognormal.

● Method 10: Tests for Percentiles and Maintenance Time (Corrective Preventive Maintenance)

This method employs a test of proportion to demonstrate achievement of \widetilde{M}_{ct} , \widetilde{M}_{pm} , M_{\max_c} and $M_{\max_{pm}}$ when the distribution of corrective and preventive maintenance repair time is unknown.

CHAPTER 36: MIL-STD-471A

This method is intended for use in cases where no information is available on the underlying distribution of maintenance times. The plan holds the confidence level at 75% or 90%, as may be desired, and requires a minimum sample size (N) of 50 tasks.

- **Method 11: Test for Preventative Maintenance Times**

This method provides for maintainability demonstration when the specified index involves μ_{pm} and or $M_{max_{pm}}$ and when all possible preventive maintenance tasks are to be performed. All possible tasks are to be performed and no allowance need be made for underlying distribution.

- **Interim Demonstration and Evaluation of Equipment/System Built-In-Notice 2: Test/External Test/Fault Isolation/Testability Attributes and Requirements**

This test method is intended to supplement the more conventional maintainability test requirements (which deal with accessibility, time, and human factors) with tests appropriate to the Built-in-Test, External Test, and Fault Isolation capabilities of the system or subsystem. It provides evaluation and demonstration procedures for use at the equipment/system Operational (organizational) Level, at the Shop Maintenance Level and the Depot Maintenance Level.

Figure 36.1 (taken from MIL-STD-471A) is presented on the following pages to assist the reader in differentiating between the attributes of this assortment of different available maintainability demonstration test methods.

36.6 TAILORING GUIDELINES

The requirements for maintainability demonstration test must always be tailored. Such tailoring involves the selection of appropriate maintainability parameters and the planning and selection of applicable test methods to verify such requirements.

36.6.1 When and How to Tailor

Tailoring the requirements of MIL-STD-471 consists primarily of selecting the quantitative and qualitative parameters most appropriate for demonstrating the equipment's maintainability characteristics and then selecting the applicable test methods for those specific parameters from the available of test methods. Additional guidance for tailoring of the requirements of MIL-STD-471 may be found in Appendix A of MIL-STD-470.

| Test Method | Test Index | Assumptions | Sample Size | Sample Selection | Spec. Requirement |
|-------------|------------------------------------|---|-----------------|--|---|
| 1-A | Mean | Log Normal Dist. Prior Knowledge of Variance | See Test Method | Natural Occurring Failures or Appendix | $H_0, H_1, \alpha, \beta(1)$ |
| 1-B | " | No Distribution Assumption, Prior Knowledge of Variance | " | " | " |
| 2 | Critical Percentile | Log Normal Dist. Prior to Knowledge of Variance | " | " | " |
| 3 | Critical Maint. Time or Manhours | None | " | " | " |
| 4 | Median | A Specific Var. Log Normal | 20 | " | ERT |
| 5 | Chargeable Maint. Down-time/Flight | None | See Test Method | Natural Occurring Failures | ORR or A NCMDT, NOF DDT, α, β NOF, |
| 6 | Manhours Rate | None | " | " | Manhour Rate ΔMR |

- (1) See B.10.7 for definitions of α, β, H_0, H_1
- (2) Test Method 5 is an indirect method for demonstrating operational ready rate (ORR) or Availability (A).
- (3) Test Method 6 is intended for use with aeronautical systems and subsystems.
- (4) Test Method 7 is intended for use with ground electronic systems where it may be necessary to simulate faults.

FIGURE 36.1: MAINTAINABILITY TEST METHOD MATRIX

| Test Method | Test Index | Assumptions | Sample Size | Sample Selection | Spec. Requirement |
|-------------|--|-------------------|--------------------|---|---|
| 7 | (4) Manhour Rate | None | " | Natural Occurring Failures or Appendix A | μ, R, α |
| 8 | Mean and Percentile Dual Percentile | Lognormal None | See Test Method | Natural Occurring or Simple Random Sampling | Mean, M_{max} Dual percentile |
| 9 | Mean (Corrective Task Time, Prev. Maint. Time, Downtime) M_{max} (90 or 95) percentile | None | 30 minimum | Natural Occurring or Appendix A | $\mu_c, \mu_{pm}, \mu_{p/c}$ M_{maxc} |
| 10 | Median (Correct Task Time, Prev. Maint. Task Time) M_{max} (95 percentile) Corrective Maint. Task Time, Preventive Maint. Task Time | None | 50 minimum | Natural Occurring or Appendix A | $\tilde{M}_{ct}, \tilde{M}_{dt}$ M_{maxc}, M_{maxpm} |
| 11 | Mean (preventive maint. task time) M_{max} (preventive maintenance task time, at any percentile) | None | All possible tasks | All | μ_{pm} M_{maxpm} |

FIGURE 36.1: MAINTAINABILITY TEST METHOD MATRIX (CONT'D)

CHAPTER 36: MIL-STD-471A

36.7 CONTRACT DATA REQUIREMENTS LIST (CDRL)

The following is a list of data item descriptions associated with the maintainability demonstration test.

| | |
|-----------|--|
| DI-R-2129 | Maintainability Demonstration Plan |
| DI-R-7112 | Maintainability Demonstration Test Plan (Procedures) |
| DI-R-7113 | Maintainability Demonstration Report |
| DI-R-6170 | Demonstration and Evaluation Plan Verification |
| DI-R-1724 | Quality Inspection Test, Demonstration and Evaluation Report |

CHAPTER 37:
MIL-HDBK-472
MAINTAINABILITY PREDICTION

CHAPTER 37: MIL-HDBK-472

MIL-HDBK-472 is a tri-service approved document used by all branches of the military in the specification and acquisition of quality-assured systems and equipment. The current version is the initial release dated May 24, 1966, however Notice 1 dated January 1984 is a very significant addition. The preparing activity is:

Department of the Navy
Naval Air Systems Command
(AIR) Code 51122
Washington, DC 20361-5110

This chapter is only an advisory to the use of MIL-HDBK-472. It does not supersede, modify, replace or curtail any requirements of MIL-HDBK-472 nor should it be used in lieu of that handbook.

37.1 REFERENCE DOCUMENTS

The following related documents impact and further detail these tasks and should also be referenced.

- MIL-STD-470 Maintainability Program Requirements For Systems and Equipments (and specifically the following task therein)
 - Task 203 Maintainability Prediction
- MIL-STD-721 Definitions of Terms for Reliability and Maintainability
- MIL-STD-756 Reliability Modeling and Prediction
- MIL-STD-2165 Testability Program for Systems and Equipment
- MIL-HDBK-217 Reliability Prediction of Electronic Equipment

37.2 DEFINITIONS

This paragraph is not applicable to this chapter.

37.3 APPLICABILITY

The purpose of MIL-HDBK-472 is to familiarize project managers and design engineers with various maintainability prediction procedures. Maintainability prediction facilitates an early assessment of the maintainability design and enables decisions to be made concerning the compatibility of a proposed design with specified requirements, or indicates the choice of better alternatives.

The use of this handbook facilitates the design, development, and production of equipment and systems requiring a high order of maintainability. Through the use of this handbook, maintainability engineers, working with a new development, can select and utilize the most applicable maintainability prediction procedure for a specific equipment or system.

CHAPTER 37: MIL-HDBK-472

37.4 PHYSICAL DESCRIPTION OF MIL-HDBK-472

MIL-HDBK-472 is composed of five different maintainability prediction "Methods" and contains approximately two hundred and twelve pages. It also has four appendices A, B, C, and D which give repair time estimates and supporting mathematics and Tables of Distribution values. These appendices add a total of sixty-six pages.

37.5 HOW TO USE MIL-HDBK-472

Maintainability predictions are made to estimate the various maintainability parameters and requirements of the system/subsystem/equipment and to make a determination of whether the maintainability required can be achieved with the proposed design within the prescribed support and personnel/skill requirements.

Initial prediction is performed early in the acquisition phase to determine the feasibility of the maintainability requirement. It is then updated during the development and production phases to determine maintainability attainability. Predictions are important in providing engineers and management with quantitative maintainability information for day-to-day activities.

One significant advantage of the maintainability prediction is that it highlights for the designer those areas of poor maintainability which justify product improvement, modification, or a change of design. Another useful feature is that it permits the user to make an early assessment of whether the predicted downtime, the quality and quantity of maintenance personnel, tools and test equipment are adequate and consistent with the needs of system operational requirements.

The maintainability characteristics of systems and equipment can seldom be addressed by a single maintainability parameter as can, frequently, the reliability characteristics. MIL-HDBK-472 is composed of five distinct maintainability prediction methods each of which addresses different maintainability parameters. All five of these maintainability prediction methods are dependent upon at least two parameters, namely:

- a. Failure rates of components at the specific assembly level of interest. (This data is obtained from a MIL-STD-785, Task 203, reliability prediction.)
- b. Repair time required at the maintenance level involved.

The five maintainability prediction methods described in detail in MIL-STD-472 are:

- | | |
|-------------|---|
| Method I: | Flight-line Maintenance of Airborne Electronic and Electromechanical Systems Involving Modular Replacement |
| Method II: | Shipboard and Shore Electronic Equipment and Systems and Some Mechanical Systems |
| Method III: | Mean and Maximum Active Corrective Maintenance Downtime and Preventive Maintenance Downtime for Air Force Ground Electronic Systems and Equipment |
| Method IV: | Mean and/or Corrective and Preventive Maintenance Downtime for Systems and Equipments |
| Method V: | Maintainability Parameters of Avionics, Ground and Shipboard Electronics at the Organizational, Intermediate and Depot Levels of Maintenance |

CHAPTER 37: MIL-HDBK-472

A comparison matrix of the specific maintainability parameters addressed and the various other attributes of each of the five maintainability prediction methods is shown in Table 37.1.

In summary, maintainability prediction procedures I and III are applicable solely to electronic systems and equipment. Procedures II and IV can be used for all systems and equipments. In applying procedure II to non-electronic equipments, however, the appropriate task times must be estimated. Procedure V can be used to predict maintainability parameters of avionics, ground and shipboard electronics at the organizational, intermediate and depot levels of maintenance.

37.6 TAILORING GUIDELINES

Tailoring of a maintainability prediction primarily involves the planning and selection of specific maintainability parameters to be addressed and the determination of the maintainability prediction method which will be employed.

37.6.1 When and How to Tailor

MIL-HDBK-472 is written as a series of specific prediction methods to assist the contractor in the development and establishment of a unique, cost-effective maintainability program. Tailoring of the prediction requirements is implicit in this approach.

Guidance for the tailoring of the requirements of MIL-HDBK-472 i.e., the selection of specific maintainability parameters to be addressed and the prediction method to be employed, are found in Table 37.1 of this chapter and in Appendix A of MIL-STD-470, Task 203.

37.7 CONTRACT DATA REQUIREMENTS LIST (CDRL)

The following data item description is associated with the maintainability prediction.

| | | |
|-----|-----------|------------------------------------|
| 203 | DI-R-7108 | Maintainability Predictions Report |
|-----|-----------|------------------------------------|

TABLE 37.1:
COMPARISON MATRIX OF MAINTAINABILITY PREDICTION PROCEDURES

| Procedure | Applicability | Point of Application | Basic Parameters of Measure | Information Required | Correlation | Caution |
|-----------|--|--|---|--|---|--|
| I | To predict flight-line maintenance of airborne electronic and electromechanical systems involving modular replacement. | After establishment of the design concept provided that data as listed in the column entitled "Information Required" is available. | Distribution of downtime for various Elemental Activities, Maintenance categories, Repair times, and System Downtime. | (a) Location & failure rate of components (b) Number of: 1. Replaceable components 2. Readouts 3. Spares 4. Test Points 5. Magnetrons (c) Duration of Average mission (d) Maintenance schedules, etc. | See Figure 1-1 to 1-6 for correlation between the observed and predicted values of various maintainability parameters. | It may be necessary to identify additional elemental activities and derive their appropriate parameters for application to equipments other than those indicated under Applicability. |
| II | To predict the maintainability of shipboard and shore electronic equipment and systems. It can also be used to predict the maintainability of mechanical systems provided that required task times and functional levels can be established. | Applicable during the final design stage. | Part A of procedure: Corrective maintenance expressed as an arithmetic or geometric mean time to repair in hours. Part B of procedure: Active maintenance in terms of: (a) Mean corrective maintenance time in manhours (b) Mean preventive maintenance time in manhours (c) Mean active maintenance time in terms of mean manhours per maintenance action. | For corrective maintenance (Part A): (a) Packaging: to the extent that detailed hardware configurations can be established (b) Diagnostic procedure (c) Repair methods (d) Parts listing (e) Operating Stresses (f) Mounting methods (g) Functional levels at which alignment and checkout occur. For active maintenance (Part B): The respective maintenance task times for corrective and preventive maintenance must have been determined. | A validation study of the AN/URC-32 Transceiver and the AN/SRT-16 Transmitter, which were used on many ship types from destroyers to submarines, showed good correlation between predicted and observed corrective maintenance results. | The tabulated task times are not applicable to all types of equipments and situations. For a particular application, when the validity of the task times is in question, additional data sources may have to be used or estimates made by the analyst. |
| III | To predict the mean and maximum active corrective maintenance downtime for Air Force ground electronic systems and equipment. It may also be used to predict preventive maintenance downtime. | Applied during the Design Development and Control Stages. | (a) Mean and maximum active corrective downtime (95th percentile) (b) Mean and maximum preventive downtime (c) Mean downtime | The evaluator must have accessibility to and be familiar with at least the following: (a) Schematic diagrams (b) Physical layouts (c) Functional operation (d) Tools and test equipment (e) Maintenance aids (f) Operational and Maintenance environment. | Correlation between predicted and observed values can be good if: (a) Adequate information is available (b) Experienced analysts are used to select maintenance tasks to be evaluated. | The scoring of the respective checklists must be performed by analysts who are well familiar with the equipment. It is reasonable to expect variation in the regression coefficients as maintenance situations and equipments change. The extent of this variation has not as yet been determined. |

TABLE 37.1:
COMPARISON MATRIX OF MAINTAINABILITY PREDICTION PROCEDURES
(CONT'D)

| Procedure | Applicability | Point of Application | Basic Parameters of Measure | Information Required | Correlation | Caution |
|-----------|--|---|--|---|--|---|
| IV | To predict the mean and/or total corrective and preventive maintenance downtime of systems and equipments. | Applicable throughout the design, development cycle with various degrees of detail. | (a) Mean system maintenance downtime (b) Mean corrective maintenance downtime per operational period (c) Total corrective maintenance downtime per operational period (d) Total preventive maintenance downtime per operational period | Complete system documentation portraying: (a) Functional diagrams (b) Physical layouts (c) Front panel layouts (d) End item listings with failure rates. | Among similar procedures correlation between predicted and observed values has been good. | Care must be exercised in the estimation of times where data is not available. Sufficient equipment disclosure must be available to establish reasonable estimates. |
| V | To predict maintainability parameters of avionics, ground and shipboard electronics at the organizational, intermediate and depot levels of maintenance. | Applied at any equipment or system level, at any level of maintenance concept pertinent to avionics, ground electronics, and shipboard electronics. | (a) Mean time to repair (MTTR). (b) Maximum corrective maintenance time (Max ϕ). (c) Mean maintenance manhours per repair (MRR/repair). (d) Mean maintenance manhours per operating hour (MRR/OH). (e) Mean maintenance manhours per flight hour (MRR/FH). | Early Prediction (a) Primary Replaceable Items (b) Failure Rates (c) Fault Isolation Strategy (d) Replacement Concept (e) Packaging Philosophy (f) Fault Isolation Resolution Detailed Prediction (a) Replacement Concept (b) Fault Detection and Isolation Outputs (c) Failure Rate (d) Maintenance Procedure | Correlation between the predictions and the observed are limited by the quality of the input data (Design Data). | Selection of appropriate elemental maintenance action times from Appendix A (Time Standards). |

CHAPTER 38:

MIL-STD-882B

SYSTEM SAFETY PROGRAM REQUIREMENTS

CHAPTER 38: MIL-STD-882B

MIL-STD-882 is a tri-service-approved document used by all branches of the military in the specification and acquisition of all types of systems including ships and facilities. The current version is the "B" revision dated March 30, 1984 (with Notice 1 dated July 1 1987). The preparing activity is:

Headquarters Air Force Systems Command
ATTN: IGFS
Andrews AFB, Washington DC 20334-5000

This chapter is only an advisory to the use of MIL-STD-882. It does not supersede, modify, replace or curtail any requirements of MIL-STD-882 nor should it be used in lieu of that standard.

38.1 REFERENCE DOCUMENTS

The following referenced documents are addressed by the 300 series of tasks in MIL-STD-882. Other referenced documents required to supplement this standard must be specified in the system specification and other contractual documents.

| | |
|--------------|--|
| DOD-STD-2167 | Defense System Software Development |
| DOD-STD-2168 | Software Quality Evaluation |
| MIL-STD-483 | Configuration Management Practices for Systems, Equipment, Munitions and Computer Programs |
| MIL-STD-1521 | Review and Audits for Systems, Equipment, and Computer Programs |
| DOD-HDBK-287 | Defense System Software Development Handbook |

38.2 DEFINITIONS

The meanings of some terms unique to MIL-STD-882 and this chapter are given below.

Hazard - A condition that is prerequisite to a mishap.

Hazardous Event - An occurrence that creates a hazard.

Managing Activity - The organizational element of DoD assigned the acquisition management responsibility for the system, or prime or associate contractors or subcontractors who wish to impose system safety tasks on their suppliers.

Mishap - An unplanned event or series of events that result in death, injury, occupational illness, or damage to or loss of equipment or property.

Off-the-shelf equipment - An item which has been developed and produced to military or commercial standards and specifications, is readily available for delivery from an industrial source, and may be procured without change to satisfy a military requirement.

Risk - An expression of the possibility of a mishap in terms of hazard severity and hazard probability.

CHAPTER 38: MIL-STD-882B

Safety - Freedom from those conditions that can cause death, injury, occupational illness, or damage to, or loss of, equipment or property.

Safety-Critical Computer Software components - Those computer software components (processes, functions, values or computer program states) whose errors (inadvertent or unauthorized occurrence, failure to occur when required, occurrence out of sequence, occurrence in combination with other functions, or erroneous value) can result in a potential hazard, or loss of predictability or control of a system.

System Safety - The application of engineering and management principles, criteria, and techniques to optimize safety within the constraints of operational effectiveness, time, and cost throughout all phases of the system life cycle.

38.3 APPLICABILITY

MIL-STD-882 provides uniform requirements for developing and implementing a system safety program of sufficient comprehensiveness to identify the hazards of a system and to impose design requirements and management controls to prevent mishaps by eliminating hazards or reducing the associated risk to a level acceptable to the managing activity. Managing activity usually refers to Government procuring activity, but may also include prime or associate contractors or subcontractors who wish to impose system safety tasks on their suppliers.

The principal objective of a system safety program is to make sure that safety, consistent with mission requirements, is designed into systems, subsystems, equipment and facilities, and their interfaces.

This standard applies to DoD systems and facilities including test, maintenance and support, and training equipment. It applies to all activities of a system life cycle; e.g., research, design, technology development, test and evaluation, production, construction, operation and support, modification and disposal. The requirements also apply to DoD in-house programs

38.4 PHYSICAL DESCRIPTION OF MIL-STD-882

MIL-STD-882 is composed of twenty-eight safety-related "Tasks" and contains approximately sixty-nine pages. There are also three supporting appendices: Appendix A, "Guidance for Implementation of System Safety Program Requirements", Appendix B, "System Safety Program Requirements Related to Life Cycle Phases", and Appendix C, "Data Requirements for MIL-STD-882." The three appendices contain an additional thirty-six pages.

38.5 HOW TO USE MIL-STD-882

MIL-STD-882 Addresses two different types of tasks: Program Management and Control tasks and Design and Evaluation Tasks.

- a. Program Management and Control tasks are those tasks relating primarily to the management responsibilities dealing with the safety of the program and less to the technical details involved.
- b. Design and Evaluation tasks focus on the identification, evaluation, prevention, detection, and correction or reduction in the associated risk of safety hazards by the use of specific technical procedures.

CHAPTER 38: MIL-STD-882B

38.5.1 Program Management and Control Tasks

- **Task 100: System Safety Program**

This is the initial task that sets up a basic system safety program. It is the precursor to all of the following safety related tasks. This task, as tailored, is required to be used if MIL-STD-882 is imposed; all other tasks are optional depending on the specific acquisition program.

- **Task 101: System Safety Program Plan**

The purpose of this task is to describe in detail the tasks and activities of safety system management and system safety engineering required to identify, evaluate, and eliminate hazards, or reduce the associated risk to a level acceptable to the managing activity throughout the system life cycle. It will include a description of the planned methods to be used by the contractor to implement the tailored requirements of this standard, including organizational responsibilities, resources, methods of accomplishment, milestones, depth of effort, and integration with other program engineering and management activities and related systems.

- **Task 102: Integration/Management of Associate Contractors, Subcontractors, and Architect and Engineering Firms**

The purpose of this task is to provide the system integrating contractor and managing activity with appropriate management surveillance of other contractors' system safety programs, and the capability to establish and maintain uniform integrated system safety program requirements.

- **Task 103: System Safety Program Reviews**

This task establishes a requirement for the contractor to present system safety program reviews, to periodically report the status of the system safety program, and, when needed, to support special requirements such as certifications and first flight readiness reviews.

- **Task 104: System Safety Group/System Safety Working Group Support**

The purpose of this task is to require contractors to support system safety groups (SSGs) and system safety working groups (SSWGs) which are established in accordance with service regulations or as otherwise defined by the managing activity.

- **Task 105: Hazard Tracking and Risk Resolution**

The task establishes the requirement for a single closed-loop hazard tracking system. This method or procedure will document and track hazards from identification until the hazard is eliminated or the associated risk is reduced to a level acceptable to the managing activity, thus providing an audit trail of hazard resolution.

- **Task 106: Test and Evaluation Safety**

The purpose of this task is to make sure safety is considered in test and evaluation, to provide existing analysis reports and other safety data, and to respond to all safety requirements necessary for testing in-house, at other contractor facilities, and at Government ranges, centers, or laboratories.

CHAPTER 38: MIL-STD-882B

- **Task 107: Safety Progress Summary**

This task provides for a periodic progress report summarizing the pertinent system safety management and engineering activity that occurred during the reporting period.

- **Task 108: Qualification of Key Contractor System Safety Engineers/Managers**

The purpose of this task is to establish qualifications for key contractor system safety engineers and managers, i.e., those who possess coordination or approval authority for contractor documentation.

38.5.2 Design and Evaluation Tasks

- **Task 201: Preliminary Hazard List**

This task compiles a preliminary hazard list (PHL) very early in the system acquisition life cycle to enable the managing activity to identify any especially hazardous areas for added management emphasis.

- **Task 202: Preliminary Hazard Analysis**

The purpose of this task is to perform and document a preliminary hazard analysis (PHA) to identify safety critical areas, evaluate hazards, and identify the safety design criteria to be used.

- **Task 203: Subsystem Hazard Analysis**

This task performs and documents a subsystem hazard analysis (SSHA) to identify hazards associated with design of subsystems including component failure modes, critical human error inputs, and hazards resulting from functional relationships between components and equipments comprising each subsystem.

- **Task 204: System Hazard Analysis**

The purpose of this task is to perform and document a system hazard analysis (SHA) to determine the primary safety problem areas of the total system design including potential safety critical human errors.

- **Task 205: Operating and Support Hazard Analysis**

This task performs and documents an operating and support hazard analysis (O&SHA) to identify associated hazards and to recommend alternatives which may be utilized during all phases of intended system use.

- **Task 206: Occupational Health Hazard Assessment**

The purpose of this task is to perform and document an occupational health hazard assessment (OHHA) to identify human health hazards and to propose protective measures to reduce the associated risks to levels acceptable to the managing activity.

CHAPTER 38: MIL-STD-882B

- **Task 207: Safety Verification**

This task defines and performs tests and demonstrations or uses other verification methods on safety critical hardware, software, and procedures to verify compliance with safety requirements.

- **Task 208: Training**

The purpose of this task is to provide the training necessary for certification of contractor and Government personnel who will be involved with contractor activities. Specific areas of concern are subjects such as hazard types and their recognition, causes, effects, and preventive and control measures; procedures, checklists, and human error; safeguards, safety devices, protective equipment; monitoring and warning devices; and contingency procedures.

- **Task 209: Safety Assessment**

This task performs and documents a comprehensive evaluation of the mishap risk which is being assumed prior to the test or operation of a system or at the contract completion.

- **Task 210: Safety Compliance Assessment**

The purpose of this task is to perform and document a safety compliance assessment to verify compliance with all military, federal, national, and industry codes imposed contractually or by law. This is to ensure the safe design of a system, and to comprehensively evaluate the safety risk which is being assumed prior to any test or operation of a system or at the completion of the contract.

- **Task 211: Safety Review of Engineering Change Proposals and Requests for Deviation/Waiver**

This task performs and documents the analyses of engineering change proposals (ECPs) and requests for deviation/waiver to determine the safety impact, if any, upon the system.

- **Task 212: (not presently used)**

- **Task 213: GFP/GFE System Safety Analysis**

The intent of this task is to make sure that any applicable system safety analyses of GFE/GFP are considered for integration into the system.

38.5.3 Software System Safety Tasks

The 300 series of tasks are recommended for programs which involve large or complicated software packages. For other programs, for which these tasks are not appropriate, the software can be considered within selected 200 series tasks.

- **Task 301: Software Requirements Hazard Analysis**

This task requires the contractor to perform and document a Software Requirements Hazard Analysis (SRHA). The contractor shall examine system and software requirements and design in order to identify unsafe modes for resolution, such as out-of-sequence, wrong

CHAPTER 38: MIL-STD-882B

event, inappropriate magnitude, inadvertent command, adverse environment, deadlocking, failure-to-command modes, etc.

- **Task 302: Top-Level Design Hazard Analysis**

The intent of this task is to require the contractor to perform and document a Top-Level Design Hazard Analysis (TDHA). The Contractor shall analyze the Top-level Design, using the results of the SRHA (Task 301), if previously accomplished.

- **Task 303: Detailed Design Hazard Analysis**

This task requires the contractor to perform and document a Detailed Design Hazard Analysis (DDHA). The contractor shall analyze the Software Detailed Design, using the results of the SRHA (Task 301) and the TDHA (Task 302) (if previously accomplished) to verify the correct incorporation of safety requirements and to analyze the Safety-Critical Computer Software Components (SCSCs).

- **Task 304: Code-Level Software Hazard Analysis**

The purpose of this task is to require the contractor to perform and document a Code-Level Software Hazard Analysis (CSHA). Using the results of the DDHA (Task 303), if previously accomplished, the contractor shall analyze program code and systems interfaces for events, faults, and conditions which could cause or contribute to undesired events affecting safety.

- **Task 305: Software Safety Testing**

This task requires the contractor to perform and document Software Safety Testing to ensure that all hazards have been eliminated or controlled to an acceptable level of risk.

- **Task 306: Software/User Interface Analysis**

The intent of this task is to require the contractor to perform and document a Software/User Interface Analysis and the development of Software Users Procedures.

- **Task 307: Software Change Hazard Analysis**

The purpose of this task is to require the contractor to perform and document the Software Change Hazard Analysis. The contractor shall analyze all changes, modifications, and patches made to the Software for safety hazards.

38.6 TAILORING GUIDELINES

A system safety program needs to be matched to the scope and complexity of each acquisition program. MIL-STD-882 must not be contractually invoked without detailed tailoring of these requirements. Details for tailoring the requirements are found in the Appendix A to the standard.

38.6.1 When and How to Tailor

The requirements of MIL-STD-882 are tailored primarily by the selection of the applicable tasks and by the rigor with which these tasks are subsequently applied. Tables 38.1, 38.2 and 38.3, taken from MIL-STD-882, Appendix A, are task application matrices and are used to select the

CHAPTER 38: MIL-STD-882B

applicable tasks for development programs and for facilities acquisition programs and for software system safety, respectively.

TABLE 38.1: APPLICATION MATRIX FOR SYSTEM PROGRAM DEVELOPMENT

| TASK | TITLE | TASK TYPE | CONCEPT | PROGRAM PHASE | | |
|------|---|-----------|---------|---------------|------|------|
| | | | | VALID | FSED | PROD |
| 100 | System Safety Program | MGT | G | G | G | G |
| 101 | System Safety Program Plan | MGT | G | G | G | G |
| 102 | Integration/Management of Associate contractors, Subcontractors, and AE Firms | MGT | S | S | S | S |
| 103 | System Safety Program Reviews | MGT | S | S | S | S |
| 104 | SSG/SSWG Support | MGT | G | G | G | G |
| 105 | Hazard Tracking and Risk Resolution | MGT | S | G | G | G |
| 106 | Test and Evaluation Safety | MGT | G | G | G | G |
| 107 | System Safety Progress Summary | MGT | G | G | G | G |
| 108 | Qualifications of Key System Safety Personnel | MGT | S | S | S | S |
| 201 | Preliminary Hazard List | ENG | G | S | S | N/A |
| 202 | Preliminary Hazard Analysis | ENG | G | G | G | GC |
| 203 | Subsystem Hazard Analysis | ENG | N/A | G | G | GC |
| 204 | System Hazard Analysis | ENG | N/A | G | G | GC |
| 205 | Operating and Support Hazard Analysis | ENG | S | G | G | GC |
| 206 | Occupational Health Hazard Assessment | ENG | G | G | G | GC |
| 207 | Safety Verification | ENG | S | G | G | GC |
| 208 | Training | MGT | N/A | S | S | S |
| 209 | Safety Assessment | MGT | S | S | S | S |
| 210 | Safety Compliance Assessment | MGT | S | S | S | S |
| 211 | Safety Review of ECPs and Waivers | MGT | N/A | G | G | G |
| 212 | - RESERVED - | -- | -- | - | - | - |
| 213 | GFE/GFP System Safety Analysis | ENG | S | G | G | G |
| 301 | Software Req. Hazard Analysis | ENG | S | G | G | GC |
| 302 | Top-Level Design Hazard Analysis | ENG | S | G | G | GC |
| 303 | Detailed Design Hazard Analysis | ENG | S | G | G | GC |
| 304 | Code-Level Software Hazard Analysis | ENG | S | G | G | GC |
| 305 | Software Safety Testing | ENG | S | G | G | GC |
| 306 | Software/User Interface Analysis | ENG | S | G | G | GC |
| 307 | Software Change Hazard Analysis | ENG | S | G | G | GC |

Notes: TASK TYPE

ENG - System Safety Engineering
MGT - Management

PROGRAM PHASE

CONCEPT - Conceptual
VALID - Validation
FSED - Full-Scale Engineering Development
PROD - Production

APPLICABILITY CODES

S - Selectively Applicable
G - Generally Applicable
GC - Generally Applicable to Design changes only
N/A - Not Applicable

TABLE 38.2: APPLICATION MATRIX FOR FACILITIES ACQUISITION

| TASK | TITLE | TASK TYPE | P&R DEV | PROGRAM PHASE | | |
|------|---|-----------|---------|---------------|---------|-----|
| | | | | CON DES | FIN DES | CON |
| 100 | System Safety Program | MGT | G | G | G | G |
| 101 | System Safety Program Plan | MGT | S | G | G | S |
| 102 | Integration/Management of Associate contractors, Subcontractors, and AE Firms | MGT | S | S | S | S |
| 103 | System Safety Program Reviews | MGT | G | G | G | G |
| 104 | SSG/SSWG Support | MGT | G | G | G | G |
| 105 | Hazard Tracking and Risk Resolution | MGT | G | G | G | G |
| 106 | Test and Evaluation Safety | MGT | G | G | G | G |
| 107 | System Safety Progress Summary | MGT | S | S | S | S |
| 108 | Qualifications of Key System Safety Personnel | MGT | S | S | S | S |
| 201 | Preliminary Hazard List | ENG | G | N/A | N/A | N/A |
| 202 | Preliminary Hazard Analysis | ENG | G | S | N/A | N/A |
| 203 | Subsystem Hazard Analysis | ENG | N/A | S | G | GC |
| 204 | System Hazard Analysis | ENG | N/A | G | G | GC |
| 205 | Operating and Support Hazard Analysis | ENG | S | G | G | GC |
| 206 | Occupational Health Hazard Assessment | ENG | G | S | N/A | N/A |
| 207 | Safety Verification | ENG | N/A | S | S | S |
| 208 | Training | MGT | S | S | S | S |
| 209 | Safety Assessment | MGT | N/A | S | G | S |
| 210 | Safety Compliance Assessment | MGT | N/A | S | S | S |
| 211 | Safety Review of ECPs and Waivers | MGT | S | S | S | S |
| 212 | - RESERVED - | -- | - | - | - | - |
| 213 | GFE/GFP System Safety Analysis | ENG | S | S | S | S |
| 301 | Software Req. Hazard Analysis | ENG | S | S | S | GC |
| 302 | Top-Level Design Hazard Analysis | ENG | S | S | S | GC |
| 303 | Detailed Design Hazard Analysis | ENG | S | S | S | GC |
| 304 | Code-Level Software Hazard Analysis | ENG | S | S | S | GC |
| 305 | Software Safety Testing | ENG | S | S | S | GC |
| 306 | Software/User Interface Analysis | ENG | S | S | S | GC |
| 307 | Software Change Hazard Analysis | ENG | S | S | S | GC |

Notes: TASK TYPE

ENG - System Safety Engineering
MGT - Management

PROGRAM PHASE

P&R DEV - Programming and Requirements Development
CON DES - Concept Design
FIN DES - Final Design
CON - Construction

APPLICABILITY CODES

S - Selectively Applicable
G - Generally Applicable

GC - Generally Applicable to Design changes only
N/A - Not Applicable

TABLE 38.3: RELATIONSHIPS BETWEEN THE MIL-STD-882B SOFTWARE HAZARD ANALYSES, THE MIL-STD-1521B REVIEWS AND AUDITS, AND THE DOD-STD-2167 SOFTWARE DEVELOPMENT DOCUMENTS

| Hardware and Software Hazard Analyses Phases (MIL-STD-882B) | | Reviews and Audits (MIL-STD-1521B) | Software Documents (DOD-STD-2167) | | |
|--|---------------------------------------|---------------------------------------|--------------------------------------|---------------------------------|------|
| PHA (Preliminary) | PHL | SRR | | | |
| PHA (Update) | | SDR | | SSS | |
| SHA | SRHA (Preliminary) | SSR | IRS | | SRS |
| SSHA O&SHA | SRHA (Final) | PDR | | STLDD | |
| SAR SCA | TDHA | CDR | IDD | SDDD | DBDD |
| | DDHA | TRR | | SPA (Preliminary) | |
| Change Analysis | CSHA | FCA | | SPS (Final) | |
| | Testing | PCA | | | |
| | Software/User Interface Anal. | FQR | | | |
| | | | | VDD | |
| | | | | ECP | |
| SRHA | Software Requirements Hazard Analysis | | | | |
| TDHA | Top-Level Design Hazard Analysis | | | | |
| DDHA | Detailed Design Hazard Analysis | | | | |
| CSHA | Code-Level Software Hazard Analysis | | | | |
| SSR | System Requirements Review | | SSS | System/Segment Specification | |
| SDR | System Design Review | | SRS | Software Require.Specs | |
| SSR | Software Specification Review | | IRS | Interface Require. Specs | |
| PDR | Preliminary Design Review | | STLDD | Software Top-Level Design Docu. | |
| CDR | Critical Design Review | | SDDD | Software Detailed Design Docu. | |
| TRR | Test Readiness Review | | DBDD | Data Base Design Document | |
| FCA | Functional Configuration Audit | | IDD | Interface Design Document | |
| PCA | Physical Configuration Audit | | SPS | Software Product Specs | |
| FQR | Formal Qualification Review | | VDD | Version Description Docu. | |
| | | | ECP | Engineering Change Proposal | |

CHAPTER 38: MIL-STD-882B

38.7 CONTRACT DATA REQUIREMENTS LIST (CDRL)

The following data item descriptions (DIDs) are associated with the requirements of MIL-STD-882.

| <u>Task</u> | <u>DID</u> |
|-------------|---------------------------------|
| 101 | DI-SAFT-80100 |
| 102 | DI-SAFT-80100 |
| 103 | As per CDRL |
| 104 | As per CDRL |
| 105 | DI-SAFT-80105 |
| 106 | As per CDRL |
| 107 | DI-SAFT-80105 |
| 108 | As per CDRL |
| 201 | DI-SAFT-80101 |
| 202 | DI-SAFT-80101 |
| 203 | DI-SAFT-80101 |
| 204 | DI-SAFT-80101 |
| 205 | DI-SAFT-80101 |
| 206 | DI-SAFT-80106 |
| 207 | DI-SAFT-80102 |
| 208 | As per CDRL |
| 209 | DI-SAFT-80102 |
| 210 | DI-SAFT-80102 |
| 211 | DI-SAFT-80102/ DI-SAFT-80104 |
| 212 | N/A |
| 213 | DI-SAFT-80101 |
| 301 | DI-SAFT-80101 |
| 302 | DI-SAFT-80101 |
| 303 | DI-SAFT-80101 |
| 304 | DI-SAFT-80101 |
| 305 | DI-SAFT-80101 |
| 306 | DI-SAFT-80101 |
| 307 | DI-SAFT-80101 |

APPENDIX A:
ADDITIONAL RAC SERVICES

PRODUCT FEE SCHEDULE

| | | Price | Per Copy |
|---|--|--------|----------|
| | | U.S. | Non-U.S. |
| COMPONENT RELIABILITY DATA BOOKS | | | |
| DSR-4 | Discrete Semiconductor Device Reliability - 1988 | 100.00 | 120.00 |
| NPRD-3 | Nonelectronic Parts Reliability Data 1985 - (Printed Copy) | 80.00 | 90.00 |
| FNPRD-3 | Diskette of NPRD-3 Data (IBM PC Compatible) | 125.00 | 135.00 |
| VZAP-1 | Electrostatic Discharge Susceptibility Data - 1983 | 95.00 | 105.00 |
| MDR-21 | Trend Analysis Databook - 1985 | 95.00 | 105.00 |
| MDR-21A | Field Experience Databook - 1985 | 125.00 | 135.00 |
| FMDR-21A | Diskette of MDR-21A Data (IBM PC Compatible) | 175.00 | 185.00 |
| MDR-22 | Microcircuit Screening Analysis - 1987 | 125.00 | 135.00 |
| MDR-22A | Microcircuit Screening Data - 1987 | 75.00 | 90.00 |
| NONOP-1 | Nonoperating Reliability Data - 1987 | 150.00 | 160.00 |

EQUIPMENT DATABOOKS

| | | | |
|--------|--|-------|-------|
| EERD-2 | Electronic Equipment Reliability Data - 1986 | 80.00 | 95.00 |
| EEMD-1 | Electronic Equipment Maintainability Data - 1980 | 60.00 | 70.00 |

HANDBOOKS

| | | | |
|---------|--|--------|--------|
| RDH-376 | Reliability Design Handbook | 36.00 | 46.00 |
| MFAT-1 | Microelectronics Failure Analysis Techniques Procedural Guide | 125.00 | 135.00 |
| NPS-1 | Analysis Techniques for Mechanical Reliability | 56.00 | 66.00 |
| PRIM-1 | A Primer for DoD Reliability, Maintainability and Safety Standards | 95.00 | 115.00 |

PRODUCTS FOR PERSONAL COMPUTERS

| | | | |
|----------|---|---------|---------|
| RAC-NRPS | Nonoperating Reliability Prediction Software (Price includes NONOP-1 listed above) | 1400.00 | 1450.00 |
|----------|---|---------|---------|

STATE-OF-THE-ART REPORTS

| | | | |
|--------|---|-------|-------|
| SOAR-2 | Practical Statistical Analysis for the Reliability Engineer | 36.00 | 46.00 |
| SOAR-3 | IC Quality Grades: Impact on System Reliability and Life Cycle Cost | 46.00 | 56.00 |
| SOAR-4 | Confidence Bounds for System Reliability | 46.00 | 56.00 |
| SOAR-5 | Surface Mount Technology: A Reliability Review | 56.00 | 66.00 |
| SOAR-6 | ESD Control in the Manufacturing Environment | 56.00 | 66.00 |

TECHNICAL RELIABILITY STUDIES

| | | | |
|--------|--|-------|-------|
| TRS-2 | Search and Retrieval Index to IRPS Proceedings - 1968 to 1978 | 24.00 | 34.00 |
| TRS-2A | Search and Retrieval Index to IRPS Proceedings - 1979 to 1984 | 24.00 | 34.00 |
| TRS-3A | EOS/ESD Technology Abstracts - 1982 | 36.00 | 46.00 |
| TRS-4 | Search and Retrieval Index to EOS/ESD Proceedings - 1979 to 1984 | 36.00 | 46.00 |
| TRS-5 | Search and Retrieval Index to ISTFA Proceedings - 1978 to 1985 | 36.00 | 46.00 |

ADDITIONAL RAC SERVICES

Literature Searches

Literature Searches are conducted at a flat fee of \$50. For best results, please call or write for assistance in formulating your search question. An extra charge, based on engineering time and costs, will be made for evaluating, extracting or summarizing information from the cited references.

Consulting Services - Call for Quote!

Use order form and send payment, (check or money order), payable to **IITRI/RAC**.

ORDER FORM

ORDERED BY: (Please Print)

Name: _____
 Company: _____
 Divison: _____
 Address: _____
 City: _____
 State: _____ Zip: _____
 Country: _____
 Phone: _____ Ext: _____

| QTY. | DESCRIPTION | UNIT PRICE | | TOTAL |
|--|-------------|------------|--------|-------|
| | | U.S. | NON-US | |
| | | | | |
| | | | | |
| PRIORITY HANDLING - INSTRUCTIONS BELOW | | | | |
| QUANTITY DISCOUNT - INSTRUCTIONS BELOW | | | | |
| TOTAL OF ORDER | | | | |

MAKE CHECKS PAYABLE TO IITRI/RAC

Return to:
Reliability Analysis Center
P.O. Box 4700 • Rome, NY 13440-8200

Place orders or obtain additional information directly from the Reliability Analysis Center. Specify the publications and services desired. Except for blanket purchase orders, **prepayment is required**. All Non-U.S. orders must be accompanied by a check drawn on a US bank. **Please make checks payable to IITRI/RAC.**

Priority Handling - Add \$15.00 per book (Non-U.S.) for Air Mail, add \$3.00 per book (U.S.) for First Class

Quantity Discounts - are available, when ordering 10 or more copies. For details call or write Gina Nash at the Reliability Analysis Center, P.O. Box 4700, Rome, NY 13440-8200 (315) 337-0900.

Military Agencies - Blanket Purchase Agreement, DD Form 1155, may be used for ordering RAC reports and/or services. Please indicate maximum dollar amount authorized and cutoff date on your order. Also specify services (i.e., publications, search services, etc.) to be provided. **Identify vendor as IIT Research Institute/Reliability Analysis Center.**

ORDER FORM

ORDERED BY: (Please Print)

Name: _____
 Company: _____
 Divison: _____
 Address: _____
 City: _____
 State: _____ Zip: _____
 Country: _____
 Phone: _____ Ext: _____

| QTY. | DESCRIPTION | UNIT PRICE | | TOTAL |
|--|-------------|------------|--------|-------|
| | | U.S. | NON-US | |
| | | | | |
| | | | | |
| PRIORITY HANDLING - INSTRUCTIONS BELOW | | | | |
| QUANTITY DISCOUNT - INSTRUCTIONS BELOW | | | | |
| TOTAL OF ORDER | | | | |

MAKE CHECKS PAYABLE TO IITRI/RAC

Return to:
Reliability Analysis Center
P.O. Box 4700 • Rome, NY 13440-8200

Place orders or obtain additional information directly from the Reliability Analysis Center. Specify the publications and services desired. Except for blanket purchase orders, **prepayment is required**. All Non-U.S. orders must be accompanied by a check drawn on a US bank. **Please make checks payable to IITRI/RAC.**

Priority Handling - Add \$15.00 per book (Non-U.S.) for Air Mail, add \$3.00 per book (U.S.) for First Class

Quantity Discounts - are available, when ordering 10 or more copies. For details call or write Gina Nash at the Reliability Analysis Center, P.O. Box 4700, Rome, NY 13440-8200 (315) 337-0900.

Military Agencies - Blanket Purchase Agreement, DD Form 1155, may be used for ordering RAC reports and/or services. Please indicate maximum dollar amount authorized and cutoff date on your order. Also specify services (i.e., publications, search services, etc.) to be provided. **Identify vendor as IIT Research Institute/Reliability Analysis Center.**