

AD-R128 614

INVESTIGATION OF RESOLUTION FOR GROUP 4 FACSIMILE(U)
DELTA INFORMATION SYSTEMS INC JENKINTOWN PA AUG 82
NC5-T1B-82-5 DCA100-81-C-0042

1/2

UNCLASSIFIED

F/G 17/2

NL

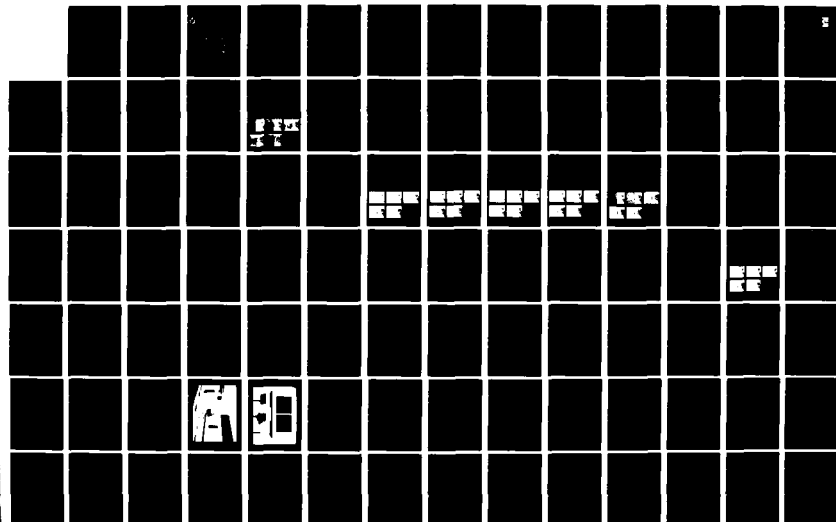

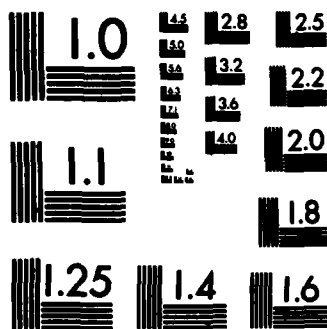

MICROCOPY RESOLUTION TEST CHART
NATIONAL BUREAU OF STANDARDS-1963-A

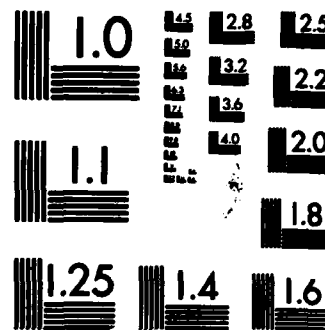

MICROCOPY RESOLUTION TEST CHART
NATIONAL BUREAU OF STANDARDS-1963-A

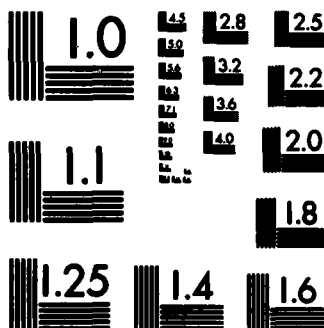

MICROCOPY RESOLUTION TEST CHART
NATIONAL BUREAU OF STANDARDS-1963-A



MICROCOPY RESOLUTION TEST CHART
NATIONAL BUREAU OF STANDARDS-1963-A

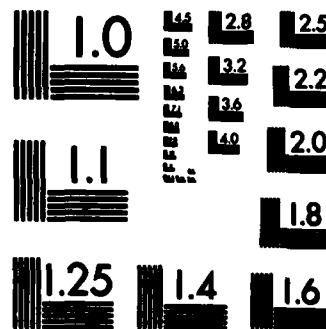

MICROCOPY RESOLUTION TEST CHART
NATIONAL BUREAU OF STANDARDS-1963-A

ADA 120614

DTIC FILE COPY

REPORT DOCUMENTATION PAGE		READ INSTRUCTIONS BEFORE COMPLETING FORM
1. REPORT NUMBER NCS TIB 82-5	2. GOVT ACCESSION NO. 2 AD-A120614	3. RECIPIENT'S CATALOG NUMBER
4. TITLE (and Subtitle) Investigation of Resolution for Group 4 Facsimile	5. TYPE OF REPORT & PERIOD COVERED FINAL	
	6. PERFORMING ORG. REPORT NUMBER	
7. AUTHOR(s)	8. CONTRACT OR GRANT NUMBER(s) DCA100-81-C-0042	
9. PERFORMING ORGANIZATION NAME AND ADDRESS Delta Information Systems, Inc. 310 Cottman Street Jenkintown, PA 19046	10. PROGRAM ELEMENT, PROJECT, TASK AREA & WORK UNIT NUMBERS	
11. CONTROLLING OFFICE NAME AND ADDRESS National Communications System Office of Technology and Standards Washington, DC 20305	12. REPORT DATE AUGUST 1982	
	13. NUMBER OF PAGES 120	
14. MONITORING AGENCY NAME & ADDRESS (if different from Controlling Office)	15. SECURITY CLASS. (of this report) UNCLASSIFIED	
	15a. DECLASSIFICATION/DOWNGRADING SCHEDULE	
16. DISTRIBUTION STATEMENT (of this Report) Approved for Public Release; Distribution Unlimited		
17. DISTRIBUTION STATEMENT (of the abstract entered in Block 20, if different from Report)		
18. SUPPLEMENTARY NOTES		
19. KEY WORDS (Continue on reverse side if necessary and identify by block number) Facsimile Modified Read Code Group 4 Modified Huffman Code Resolution Legibility Data Compression Half Tone		
20. ABSTRACT (Continue on reverse side if necessary and identify by block number) The objective of this study is to analyze alternative resolution rates for Group 4 facsimile. Four test documents were scanned at five candidate resolutions and the results of all twenty scans were printed. One of the test charts (the Legibility Test Chart) was developed on this project and is designed to measure the legibility of a visual communication system. The legibility of various character fonts at alternative resolutions was measured. In addition the compression ratio for the Modified Read Code for each of the 20 scans was measured.		

DTIC
EXTRACTED
OCT 21 1982
M

P
NCS TIB 82-5



NATIONAL COMMUNICATIONS SYSTEM

TECHNICAL INFORMATION BULLETIN

82-5

**INVESTIGATION OF
RESOLUTION FOR
GROUP 4 FACSIMILE**

H

AUGUST 1982

**APPROVED FOR PUBLIC RELEASE
DISTRIBUTION UNLIMITED**

82 10 21 099

NCS TECHNICAL INFORMATION BULLETIN 82-5

INVESTIGATION OF RESOLUTION REQUIREMENTS

FOR GROUP 4 FACSIMILE APPARATUS

AUGUST 1982

PROJECT OFFICER

DENNIS BODSON
Senior Electronics Engineer
Office of NCS Technology
and Standards

APPROVED FOR PUBLICATION:

Marshall L. Cain

MARSHALL L. CAIN
Assistant Manager
Office of Technology
and Standards

FOREWORD

Among the responsibilities assigned to the Office of the Manager, National Communications System, is the management of the Federal Telecommunication Standards Program. Under this program, the NCS, with the assistance of the Federal Telecommunication Standards Committee identifies, develops, and coordinates proposed Federal Standards which either contribute to the interoperability of functionally similar Federal telecommunication systems or to the achievement of a compatible and efficient interface between computer and telecommunication systems. In developing and coordinating these standards a considerable amount of effort is expended in initiating and pursuing joint standards development efforts with appropriate technical committees of the Electronic Industries Association, the American National Standards Institute, the International Organization for Standardization, and the International Telegraph and Telephone Consultative Committee of the International Telecommunication Union. This Technical Information Bulletin presents an overview of an effort which is contributing to the development of compatible Federal, national, and international standards in the area of digital facsimile standards. It has been prepared to inform interested Federal activities of the progress of these efforts. Any comments, inputs or statements of requirements which could assist in the advancement of this work are welcome and should be addressed to:

Office of the Manager
National Communications System
ATTN: NCS-TS
Washington, D.C. 20305
(202) 692-2124

INVESTIGATION OF RESOLUTION REQUIREMENTS
FOR GROUP 4 FACSIMILE APPARATUS

FINAL REPORT

Submitted To:

NATIONAL COMMUNICATIONS SYSTEM
Office of Technology and Standards
Washington, D.C. 20305

Contracting Agency:

DEFENSE COMMUNICATIONS AGENCY

Contract Number

DCA100-81-C-0042

August 16, 1982

Submitted by:

DELTA INFORMATION SYSTEMS, INC.

310 Cottman Street

Jenkintown, Pennsylvania 19046



Accession For	
NTIS GRA&I	<input checked="" type="checkbox"/>
DTIC TAB	<input type="checkbox"/>
Unannounced	<input type="checkbox"/>
Justification	
By _____	
Distribution/	
Availability Codes	
Avail and/or	
Dist	Special
A	

TABLE OF CONTENTS

<u>Section</u>		<u>Page</u>
1.0	Introduction	1-1
2.0	Selection of Candidate Scanning Resolutions	2-1
3.0	Selection of Test Documents	3-1
4.0	Image Scanning	4-1
5.0	Image Processing	5-1
5.1	Reformat the Scanned Data	5-1
5.2	Measurement of Compression-Modified READ Code	5-3
5.3	Alternate Line Interpolation	5-7
6.0	Image Printing	6-1
7.0	Image Analysis	7-1
7.1	Measurement of Legibility	7-1
7.2	Evaluation of Half Tone in Legibility Test Chart	7-9
7.3	Quality of CCITT Images	7-9
7.4	Subjective Evaluation of Interpolation	7-10
8.0	Conclusions	8-1

APPENDICES

A.	Image Scanning and Writing System
B.	EIA RS465 - Group 3 Facsimile Apparatus for Document Transmission
C.	Procedure for Extended Run Lengths
D.	Code Listing for Extended Run Lengths
E.	Scan Line Statistics for Modified READ Code Data
F.	Code Listing for the Interpolation Program
G.	Code Listing for the Convert Program
H.	Legibility Test Data

1.0 INTRODUCTION

This document summarizes work performed by Delta Information Systems, Inc. for the office of Technology and Standards of the National Communications System, an organization of the U.S. Government, under contract number DCA100-81-C-0042. The Office of Technology and Standards, headed by National Communications System Assistant Manager Marshall L. Cain, is responsible for the management of the Federal Telecommunications Standards Program, which develops telecommunication standards whose use is mandatory by all Federal agencies.

Work is now actively underway by the EIA and CCITT to develop standards for Group 4 facsimile equipment. One of the most fundamental parameters for any facsimile system is the resolution since this issue has a major impact on many other system parameters such as image quality, transmission time, cost, complexity, and compatibility with other systems such as TELETEX. The purpose of this study is to analyze alternative resolution standards for Group 4 facsimile as a contribution to the overall standardization process.

Four test documents were scanned at five candidate resolutions and the results of all twenty scans were printed. One of the test charts (the Legibility Test Chart) was developed on this project and is designed to measure the

legibility of a visual communication system. The legibility of various character fonts at alternative resolutions was measured. In addition the compression ratio for the Modified Read Code for each of the 20 scans was measured.

Work on the Group 4 Resolution study was divided into the six tasks listed below. The work accomplished on each task is described in the section noted. Conclusions are drawn in Section 8.

Section

Task

2.0	Selection of Candidate Scanning Resolution
3.0	Selection of Test Documents
4.0	Image Scanning
5.0	Image Processing
6.0	Image Printing
7.0	Image Analysis
8.0	Conclusion

2.0 SELECTION OF CANDIDATE SCANNING RESOLUTIONS

The scanning resolutions which were selected are listed below along with a brief rationale for the selection of each. These candidate resolutions were reviewed with the TR-29 Facsimile committee of the EIA to insure they were in agreement with the selection.

No.	Pels/Inch	
	Vertical	Horizontal
1	200	200
2	240	240
3	300	300
4	400	400
5	480	480
6	200	400

200 x 200

This resolution was chosen because it is the high resolution option for Group 3 facsimile systems. Since most Group 3 equipments provide this optional capability this resolution in Group 4 equipment would contribute to the compatibility between Group 3 and Group 4 systems.

240 x 240

This resolution was chosen because it is more compatible with proposed TELETEX standards and because there is some digital printing equipment in the field operating at this resolution. TELETEX standards call for textual characters to be printed at a nominal pitch of 10 characters/inch horizontally and

6 rows/inch. If an integral number of pels are to be positioned within the character space of 1/10 in x 1/6 in the resolution must be divisible by 60. This candidate resolution conforms to that requirement.

300 x 300

This resolution was chosen for the three reasons listed below.

- o It provides a significantly higher quality output image than 200 x 200. Some studies have shown that images which are scanned/printed at 300 x 300 lines/inch will usually pass as "originals".
- o It meets the TELETEX compatibility requirement-divisible by 60.
- o There are several digital printing systems in the field using this resolution

400 x 400

Some believe that Group 4 must provide a very high quality output image relative to Group 3 if it is to be successful as a new and distinctive service. Some also believe that it is important to be downward compatible with Group 3. This resolution satisfies these two requirements.

480 x 480

Some argue that the 240 x 240 resolution should be the low resolution mode for Group 3 rather than 200 x 200 since it is compatible with TELETEX. These people would also advocate

a high resolution mode and it is natural that this higher resolution be double the low resolution.

200 x 400

This resolution is selected to provide an intermediate mode between 200 x 200 and 400 x 400.

3.0 SELECTION OF TEST DOCUMENTS

Four images were selected to be used as test documents in the subject program. Three of the pages were chosen from the 8 standard CCITT test documents shown in Figure 3-1. It is advantageous to use CCITT test documents because the test results may be readily compared with other data developed by facsimile investigators. The three CCITT documents selected are listed below. The selections of these test documents were reviewed with the TR-29 Facsimile committee of the EIA to insure they agreed with the choice.

<u>CCITT NO.</u>	<u>Name</u>	<u>Figure NO.</u>
1	English letter	3-2
5	French Text Figures	3-3
7	Kanji	3-4

Documents 1, 5, and 7 are representative of a wide range of detail which is likely to be encountered in facsimile systems. Pages 1 and 7 are representative of documents which contain relatively small and large amounts of information respectively. Image 5 contains an intermediate amount of detail. Document 4 is also commonly used in studies of this type. The test results for documents 4 and 7 are usually very similar.

A new test chart was developed on this project to permit the quantitative measurement of image legibility. The test chart was first prepared as an offset plate. This plate was used to print a number of high quality test images. One of these offset prints was scanned as part of this resolution project. Another one of

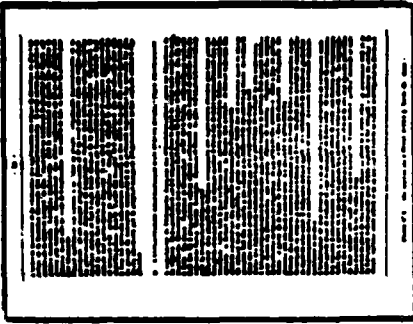

DOC NO. 4

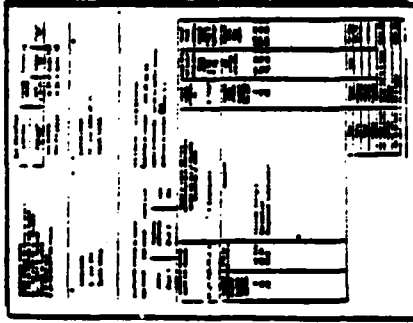

DOC NO. 3

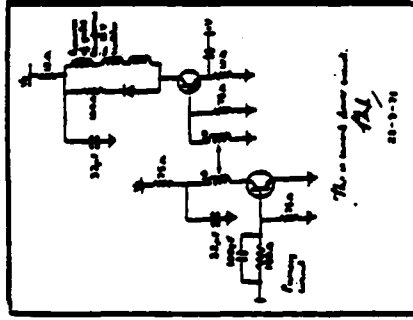

DOC NO. 2

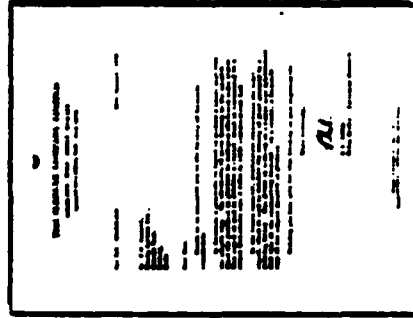

DOC NO. 1

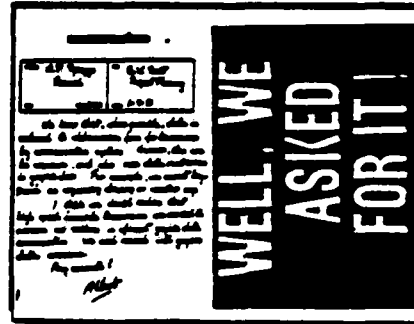

DOC NO. 8

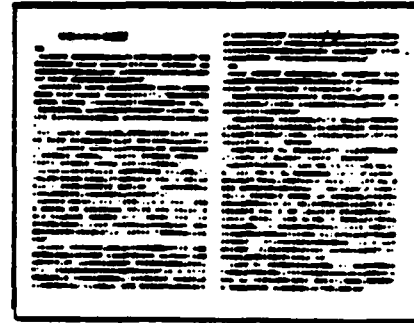

DOC NO. 7

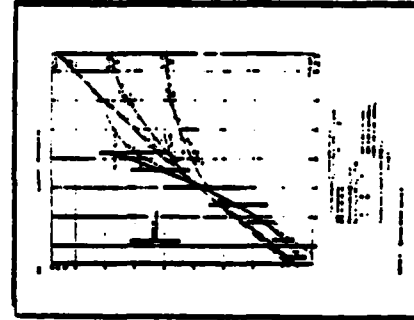

DOC NO. 6

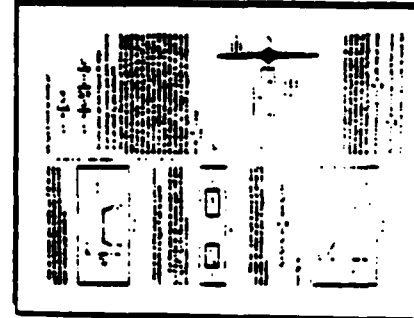

DOC NO. 5

CCITT Standard Documents for Data Compression Analysis

Figure 3-1

THE SLEREXE COMPANY LIMITED

SAPORS LANE . BOOLE . DORSET . BH 25 8 ER

TELEPHONE BOOLE (945 13) 51617 - TELEX 123456

Our Ref. 350/PJC/EAC

18th January, 1972.

Dr. P.N. Cundall,
Mining Surveys Ltd.,
Holroyd Road,
Reading,
Berks.

Dear Pete,

Permit me to introduce you to the facility of facsimile transmission.

In facsimile a photocell is caused to perform a raster scan over the subject copy. The variations of print density on the document cause the photocell to generate an analogous electrical video signal. This signal is used to modulate a carrier, which is transmitted to a remote destination over a radio or cable communications link.

At the remote terminal, demodulation reconstructs the video signal, which is used to modulate the density of print produced by a printing device. This device is scanning in a raster scan synchronised with that at the transmitting terminal. As a result, a facsimile copy of the subject document is produced.

Probably you have uses for this facility in your organisation.

Yours sincerely,

Phil.

P.J. CROSS
Group Leader - Facsimile Research

Figure 3-2
CCITT IMAGE NO. 1

Cela est d'autant plus valable que $T\Delta f$ est plus grand. A cet égard la figure 2 représente la vraie courbe donnant $|\phi(f)|$ en fonction de f pour les valeurs numériques indiquées page précédente.

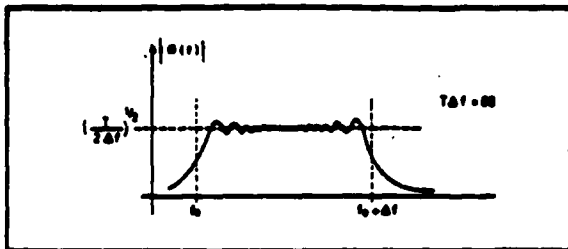

FIG. 2

Dans ce cas, le filtre adapté pourra être constitué, conformément à la figure 3, par la cascade :

— d'un filtre passe-bande de transfert unité pour $f_0 \leq f \leq f_0 + \Delta f$ et de transfert quasi nul pour $f < f_0$ et $f > f_0 + \Delta f$, filtre ne modifiant pas la phase des composants le traversant ;



FIG. 3

— filtre suivi d'une ligne à retard (L.A.R.) dispersive ayant un temps de propagation de groupe T_R décroissant linéairement avec la fréquence f suivant l'expression :

$$T_R = T_0 + (f_0 - f) \frac{T}{\Delta f} \quad (\text{avec } T_0 > T)$$

(voir fig. 4).

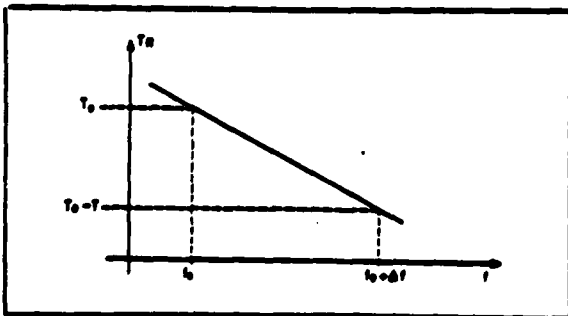

FIG. 4

telle ligne à retard est donnée par :

$$\phi = -2\pi \int_0^f T_R df$$

$$\phi = -2\pi \left[T_0 + \frac{f_0 T}{\Delta f} \right] f + \pi \frac{T}{\Delta f} f^2$$

Et cette phase est bien l'opposé de $|\phi(f)|$,

à un déphasage constant près (sans importance) et à un retard T_0 près (inévitabile).

Un signal utile $S(t)$ traversant un tel filtre adapté donne à la sortie (à un retard T_0 près et à un déphasage près de la porteuse) un signal dont la transformée de Fourier est réelle, constante entre f_0 et $f_0 + \Delta f$, et nulle de part et d'autre de f_0 et de $f_0 + \Delta f$, c'est-à-dire un signal de fréquence porteuse $f_0 + \Delta f/2$ et dont l'enveloppe a la forme indiquée à la figure 5, où l'on a représenté simultanément le signal $S(t)$ et le signal $S_1(t)$ correspondant obtenu à la sortie du filtre adapté. On comprend le nom de récepteur à compression d'impulsion donné à ce genre de filtre adapté : la « largeur » (à 3 dB) du signal comprimé étant égale à $1/\Delta f$, le rapport de compression est de $\frac{T}{1/\Delta f} = T\Delta f$

$$\frac{T}{1/\Delta f} = T\Delta f$$

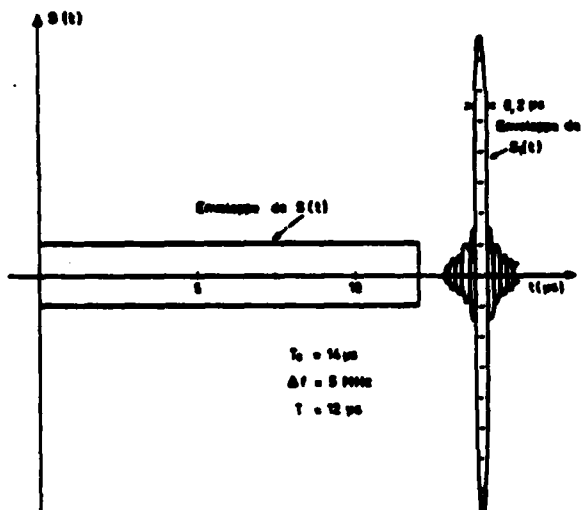

FIG. 5

On saisit physiquement le phénomène de compression en réalisant que lorsque le signal $S(t)$ entre dans la ligne à retard (L.A.R.) la fréquence qui entre la première à l'instant 0 est la fréquence basse f_0 , qui met un temps T_0 pour traverser. La fréquence f entre à l'instant $t = (f - f_0) \frac{T}{\Delta f}$ et elle met un temps

$T_0 - (f - f_0) \frac{T}{\Delta f}$ pour traverser, ce qui la fait ressortir à l'instant T , également. Ainsi donc, le signal $S(t)$

CCITTの概要

沿革

CCITTは、国際電気通信連合(ITU)の四つの常設機関(事務総局、国際無線電波委員会、CCIR、CCITT)の一つとして、ITUの中でも、世界の国際通信上の諸問題を真先に取上げ、その解決方法を見出して行く重要な機関である。日本名は、国際電信電話諮問委員会と称する。

CCITTの前身は、CCIF(国際電話諮問委員会)とCCIT(国際電信諮問委員会)である。CCIFは、1924年にヨーロッパに「国際長距離電話諮問委員会」が設置され、これが1925年のパリ電信電話会議のとき、正式に、「国際電話諮問委員会」として万国電信連合の公式機関となったものである。CCITは、同じく1925年の会議のとき、CCIFと併立するものとして設置された。

そして、CCIFは、1956年の12月に第18回総会が開催されたのち、CCITは、同年同月に第8回総会が開催されたのち、併合されて現在のCCITTとなった。このCCITTは、CCIFとCCITが解散した直後、第1回総会を開催し、第2回総会は、1960年にニューナリーで、第3回総会は、1964年、ジュネーブで、第4回総会は、1968年、アルゼンチンで開催された。

CCIFとCCITが合併したのは、有線電気通信の分野、とくに伝送路について電信回線と電話回線とを技術的に分ける意味がなくなってきたこと、各国とも大體において、電信部門と電話部門は同一組織内にあること、CCIFの事務局とCCITの事務局の合併による効率増進等がおもな理由であった。

CCITTは、上述のように、ヨーロッパ内の国々によって、ヨーロッパ内の電信・電話の技術・運用・料金の基準を定め、あるいは統一をはかってきたので、現在でも、その影響を受け、金参加国は、ヨーロッパの国が多く、ヨーロッパで生起する問題の研究が多い。たとえば、1960年のCCITT勧告の中で、技術上配慮する距離は約2,500kmであったが、これはヨーロッパ内領域を想定したものである。

しかしながら、1956年9月に敷設された大西洋横断電話ケーブルは、大陸間電信通信の自動化および半自動化への技術的可能性を与え、CCITTがこの問題を取り上げるに及び、CCITTの性格は漸次、汎世界的色彩を實質的に帯びるに至った。この汎世界的性格は第2次世界大戦後益々大きくなったアジア・アフリカ植民地の独立に伴ってITUの構成員の中にこれらの国が加わり、ITUの中に新しい意見が導入されたことにも起因して、技術面、政治面の双方から導入されてき

た。CCITTの汎世界化は、1960年の第2回総会がニューナリーで開催されたことにもあらわれている。この総会までは、CCIT、CCIFのいずれにしても、アメリカやアジアで総会が開催されたことがなく、CCITT委員長も、ニューナリー総会の準備文書で、この点には注目すべきであるとのべている。

任務

ITUは、全権委員会、主管庁会議を始めとして、七つの機関をもち、それらの機関の権限と任務は国際電気通信条約に明記されている。そこで条約を参照してみるならば、CCITTの任務は、つぎのとおりとなっている。

「国際電信電話諮問委員会(CCITT)は、電信および電話に関する技術、運用および料金の問題について研究し、および意見を表明することを任務とする。」(1965年モントルー条約第187号)

「各国際諮問委員会は、その任務の遂行に当たって、新しい国または発展の途上にある国における地域的および国際的分野にわたる電気通信の創設、発達および改善に直接関連のある問題について研究し、および意見を作成するように妥当な注意を払わなければならない。」(同第188号)

「各国際諮問委員会は、また、関係国の要請に基づき、その国内電気通信の問題について研究し、かつ、勧告を行なうことができる。」(同第189号)

上記第187号と第188号にいわゆる「意見」とは、フランス語の Avis から訳したもので、英語では、「勧告(Recommendation)」となっている。CCITTの表明する意見は、国際法的には強制力をもたないものであって、この点が、条約、電信規則、電話規則等各国を拘束する力をもっているものと異なる。もっとも意見とは称しても、技術的分野では、電信規則のとき、各国政府が承認してその内容を実施する強制規則をもたないので、実際にある機器の仕様を定める場合には、多くの国の意見が統一されたこの「意見」に従わなければ、円滑な国際通信を行なうことができない場合が多い。この意見(または勧告)は、国際通信を行なう場合各国が直面する問題について、具体的意見を表明するもので、たとえば、大陸間ケーブルで大陸間通信を半自動化しようとする場合、その信号方式や取り扱う通話の種類および料金は、どのようにするかを研究して意見を表明する。したがって、CCITTの活動は、つねに時代の最先端を行くもので、CCITTの活動方向は、そのまま世界の国際通信の活動方向であるといえる。

この意見は、また、電信規則以下のその他の規則のごとく、数年以上の間隔をもって開催される主管庁会議というような大会議の決定をまたなくても表明することができ、また、その改正も容易であるので、現在のように進歩の早い国際通信界では、関係国の意見を統一した国際的見解としては非常に便利である。

Figure 3-4

these same offset prints is included as Figure 3-5. The legibility chart consists of two parts. The top half of the test chart is divided into five parts each assigned a different size or point of text. Four lines of text are included for each point. Each line contains random text including numbers, upper case, and lower case characters. The text is organized in groups of five characters with a single space between the five character groups. Each of the four lines is a different type font. The four fonts are Helvetica, Times Roman, American Typewriter, and Bodoni Bold.

The bottom half of the test chart is devoted to half-tone imagery. Five different half-tone screen densities are included - 65, 85, 120, 133, and 150 lines/inch. Each of the five half-tone test areas is divided into two parts. The right side is a half-tone of a typical scene. The left side is a uniform half-tone designed to illustrate beat patterns which may appear when the image is scanned. The five different half-tone screen densities are included to represent different input material ranging from newspapers to high quality magazines.

10 Point

dKfje giewo s1weo xcaqp cNvbm xiuyt rEdv2 dkfJe giewo s1W3o xcaQp c9vbm xiuy dKfje giewo s1weo xcaqp cNvbm xiuyt rEdv2 dkfJe rFdvj dkfj5 giewo sLweo xca4G cnvbm x8uyt redVJ dkfje Gie6o slwXo xcaqp dKfje giewo s1weo xcaqp cNvbm xiuyt rEdv2 dkfJe Cnvbm xiuyt redvJ d45je giewo s1BUo xc2Fp cnvbm xiWyt redOj dkfje giEwo slweo xCa7p cnvbm xi26t redvj KJfje giewo Slweo xc5Tp cnvbm xiuyt Redvj dkfje gVew dKfje giewo s1weo xcaqp

3 Point

dKfje giewo s1weo xcaqp cNvbm xiuyt rEdv2 dkfJe giewo s1W3o xcaQp c9vbm xiuy eikjf kJK56 defge 83fdKfje giewo s1weo xcaqp cNvbm xiuyt rEdv2 dkfJe rEdvj dkfj5 giewo sLweo xca4G cnvbm x8uyt redVJ dkfje Gie6o slwXo xcaqp KL3er keich 3ksOd dKfje giewo s1weo xcaqp Cnvbm xiuyt redvJ d45je giewo s1BUo xc2Fp cnvbm xiWyt redOj dkfje giEwo 3kdoo kdKod 34Ker cNvbm xiuyt rEdv2 dkfJe cNvbm xiuyt slweo xCa7p cnvbm xi26t redvj KJfje giewo Slweo xc5Tp cnvbm xiuyt Redvj dkfje gVew 3paje kwmeJ el cNvbm xiuyt rEdv2 dkfJe cNvbm xiuyt

3 Point

dKfje giewo s1weo xcaqp cNvbm xiuyt rEdv2 dkfJe giewo s1W3o xcaQp c9vbm xiuy eikjk kJK56 defge 83fek pckch Kwici bev03 dKfje giewo s1weo xcaqp cNvbm xiuyt rE dKfje giewo redvj dkfj5 giewo sLweo xca4G cnvbm x8uyt redVJ dkfje Gie6o slwXo xcaqp KL3er keich 3ksOd hckGH 2301s 3kchl Paroh alihc dKfje giewo s1weo xcaqp cNvbm xiuyt rE keich Cnvbm xiuyt redvJ d45je giewo s1BUo xc2Fp cnvbm xiWyt redOj dkfje giEwo 3kdoo kdKod 34Ker opusu 36agZ qarvp du0oh lasbn dKfje giewo s1weo xcaqp cNvbm xiuyt rE kdKod slweo xCa7p cnvbm xi26t redvj KJfje giewo Slweo xc5Tp cnvbm xiuyt Redvj dkfje gVew 3paje kwmeJ elqm ha-1s 3hhaj aha3e kech3 plank dKfje giewo s1weo xcaqp cNvbm xiuyt rE kwmeJ ha-1

4 Point

dKfje giewo s1weo xcaqp cNvbm xiuyt rEdv2 dkfJe giewo s1W3o xcaQp c9vbm xiuy eikjk kJK56 defge 83fek pckch Kwici bev03 dKfje giewo s1weo xcaqp cNvbm xiuyt rE dKfje giewo s1weo xcaqp cNvbm xiuyt rEdv2 dkfJe rEdvj dkfj5 giewo sLweo xca4G cnvbm x8uyt redVJ dkfje Gie6o slwXo xcaqp KL3er keich 3ksOd hckGH 2301s 3kchl Paroh alihc dKfje giewo s1weo xcaqp cNvbm xiuyt rE keich Cnvbm xiuyt redvJ d45je giewo s1BUo xc2Fp cnvbm xiWyt redOj dkfje giEwo 3kdoo kdKod 34Ker opusu 36agZ qarvp du0oh lasbn dKfje giewo s1weo xcaqp cNvbm xiuyt rE kdKod slweo xCa7p cnvbm xi26t redvj KJfje giewo Slweo xc5Tp cnvbm xiuyt Redvj dkfje gVew 3paje kwmeJ elqm ha-1s 3hhaj aha3e kech3 plank dKfje giewo s1weo xcaqp cNvbm xiuyt rE kwmeJ ha-1

3 Point

dKfje giewo s1weo xcaqp cNvbm xiuyt rEdv2 dkfJe giewo s1W3o xcaQp c9vbm xiuy eikjk kJK56 defge 83fek pckch Kwici bev03 dKfje giewo s1weo xcaqp cNvbm xiuyt rE dKfje giewo s1weo xcaqp cNvbm xiuyt rEdv2 dkfJe rEdvj dkfj5 giewo sLweo xca4G cnvbm x8uyt redVJ dkfje Gie6o slwXo xcaqp KL3er keich 3ksOd hckGH 2301s 3kchl Paroh alihc dKfje giewo s1weo xcaqp cNvbm xiuyt rE keich Cnvbm xiuyt redvJ d45je giewo s1BUo xc2Fp cnvbm xiWyt redOj dkfje giEwo 3kdoo kdKod 34Ker opusu 36agZ qarvp du0oh lasbn dKfje giewo s1weo xcaqp cNvbm xiuyt rE kdKod slweo xCa7p cnvbm xi26t redvj KJfje giewo Slweo xc5Tp cnvbm xiuyt Redvj dkfje gVew 3paje kwmeJ elqm ha-1s 3hhaj aha3e kech3 plank dKfje giewo s1weo xcaqp cNvbm xiuyt rE kwmeJ ha-1

2 Point

dKfje giewo s1weo xcaqp cNvbm xiuyt rEdv2 dkfJe giewo s1W3o xcaQp c9vbm xiuy eikjk kJK56 defge 83fek pckch Kwici bev03 dKfje giewo s1weo xcaqp cNvbm xiuyt rE dKfje giewo s1weo xcaqp cNvbm xiuyt rEdv2 dkfJe rEdvj dkfj5 giewo sLweo xca4G cnvbm x8uyt redVJ dkfje Gie6o slwXo xcaqp KL3er keich 3ksOd hckGH 2301s 3kchl Paroh alihc dKfje giewo s1weo xcaqp cNvbm xiuyt rE keich Cnvbm xiuyt redvJ d45je giewo s1BUo xc2Fp cnvbm xiWyt redOj dkfje giEwo 3kdoo kdKod 34Ker opusu 36agZ qarvp du0oh lasbn dKfje giewo s1weo xcaqp cNvbm xiuyt rE kdKod slweo xCa7p cnvbm xi26t redvj KJfje giewo Slweo xc5Tp cnvbm xiuyt Redvj dkfje gVew 3paje kwmeJ elqm ha-1s 3hhaj aha3e kech3 plank dKfje giewo s1weo xcaqp cNvbm xiuyt rE kwmeJ ha-1



65 Line Screen



85 Line Screen



120 Line Screen



133 Line Screen



150 Line Screen

Facsimile Test Chart

Figure 3-5

Legibility Test Chart

4.0 IMAGE SCANNING

The four images described in section 3.0 were each scanned with five different resolutions to provide a total of twenty separate files of scanned images on magnetic tape. The scanning process was performed by the Applied Physics Laboratory of Johns Hopkins University. The scanning equipment, described in detail in Appendix A, was manufactured by Optronics International, Inc. and is designated as Model P-1700.

The P-1700 scanning equipment is a highly precise device which employs a square aperture and samples the images in a rectilinear fashion; i.e. the sampling density in the horizontal and vertical directions is identical. The scanner has two limitations which constrained the scanning procedure. First, the maximum size of the input copy to be scanned is 10 inches by 10 inches. Second, the number of spot sizes which are available is limited.

Due to these limitations, all input images were photographically reduced prior to being scanned. Table 4-1 shows the reduced image size and spot size for each scan.

Table 4-1
Scanning Parameters

<u>Resolution</u> <u>lines/inches</u>	<u>Optical</u> <u>Reduction</u> <u>Ratio</u>	<u>Size of</u> <u>Scanned Image</u> <u>In. by In.</u>	<u>Scanned</u> <u>Spot Size</u> <u>μm</u>
200	1.274	6.67 x 8.63	100
240	2.117	4.02 x 5.20	50
300	1.693	5.02 x 6.50	50
400	1.274	6.67 x 8.63	50
480	2.117	4.02 x 5.20	25

The output of the scanner was fed to an 8 bit analog-to-digital converter and each pixel was stored on magnetic tape.

5.0 IMAGE PROCESSING

The Image Processing Task was divided into the three subtasks listed below each of which is discussed in a separate subsection.

- o Reformat the Scanned Data
- o Measurement of Compression - Modified READ Code
- o Alternate Line Interpolation

5.1 Reformat the Scanned Data

The scanned data was reformatted in three different ways as listed below.

1. Each pel was converted from the 8 bit gray scale form to the 1 bit black-white form by merely selecting the most significant bit.
2. A specific number of pels per scan line was selected for each resolution, and the scanned data was truncated at that point. See table 5-1.
3. A specific number of scan lines per image was selected for each resolution, and the scanned data, was truncated accordingly. See Table 5-1.

The binary data after having been reformatted was stored on magnetic tape in the format shown in Table 5-1.

Table 5-1
 BINARY IMAGE FORMAT

<u>PELS/ INCH</u>	<u>PELS/ LINE</u>	<u>BYTES/ LINE</u>	<u>LINES/ BLOCK</u>	<u>BLOCK SIZE</u>	<u>LINES/ IMAGE</u>	<u>NO. OF BLOCKS</u>
200	1728 (8.64")	216	8	1728	2336 (11.68)	292
240	2048 (8.53)	256	8	2048	2800 (11.67)	350
300	2560 (8.53)	320	4	1208	3500 (11.67)	875
400	3456 (8.64")	432	4	1728	4672 (11.68)	1168
480	4096 (8.53)	512	4	2048	5600 (11.67)	1400

5-2 Measurement of Compression - Modified READ Code

It is likely that the basic coding technique which will be chosen for the Group 4 facsimile standard will be a version of the Modified READ code (MRC). For that reason it was decided to measure the compression ratio for the three CCITT images when coded by the MRC. Since Group 4 facsimile equipment will operate over data circuits having error control the K-factor in the simulation was made infinite. It is also anticipated that Group 4 equipment will transmit from memory to memory. Therefore the minimum scan line time was set at zero.

The basic description of the standard Modified READ code is contained in CCITT Recommendation T.4 (EIA Standard RS-465; Fed. Std. 1062). The coding portion of this standard is included in Appendix B for reference purposes. Page 6 of this document shows that the maximum run length defined by the standard is 2,560 pels. Since the high resolution images have line lengths longer than this it was necessary to use a coding procedure for run lengths beyond 2,560. The coding procedure which was used in this simulation is included in Appendix C. A computer program was written to implement this procedure, and the code listing for this program is included in Appendix D.

Measurement of MRC Compression

The formatted scan data for the three CCITT documents (Number 1, 5, 7) was entered into the DCA computer system in Reston, VA. The computer program, previously written to measure

MRC compression, as modified for long run lengths, was used to measure the number of MRC code bits. To repeat, the K-factor was set at infinity, and the minimum scan line time was set at zero. The test results for the simulation process are summarized in Table 5-2 and Figure 5-1. Note that the bits-per-page is essentially a linear function of the resolution. To a very close approximation, if the resolution doubles the number of bits/page is doubled. This occurs in spite of the fact that, if the resolution doubles, the number of pels/page increases by four to one. The reduced bits/page occurs because the compression ratio increases as a function of the resolution. This in turn is due to the increased correlation between pels as the resolution increases.

Statistical measures describing the Modified READ code data for the twenty scanned images is contained in Appendix E. The statistical data applies to the number of coded bits per scan line. The following statistical data is provided in the Appendix.

- o Minimum bits/line
- o Maximum
- o Median
- o Mean
- o Standard Deviation

TABLE 5-2
Compressed BITS/PAGE
MODREAD Coding

CCITT DOC. NO		1	5	7	1,5,7
TEST CHART RESOLUTION lpi	Legibility	English Letter	French Journal	Kanji Text	Avg. CCITT Documents
200lpi	1,136,952	132,034	229,204	531,754	297,664
240	2,170,245	156,880	273,026	628,793	352,899
300	3,148,214	197,476	350,538	798,924	448,979
400	4,476,998	272,312	468,005	1,041,862	594,059
480	5,264,170	326,473	570,302	1,262,734	719,836

DRAWING PAPER NO. 1599-10
 TRACING PAPER NO. 1517-10
 CROSS SECTION-10X10 TO 1 INCH
 ADVANCE
 MADE IN USA

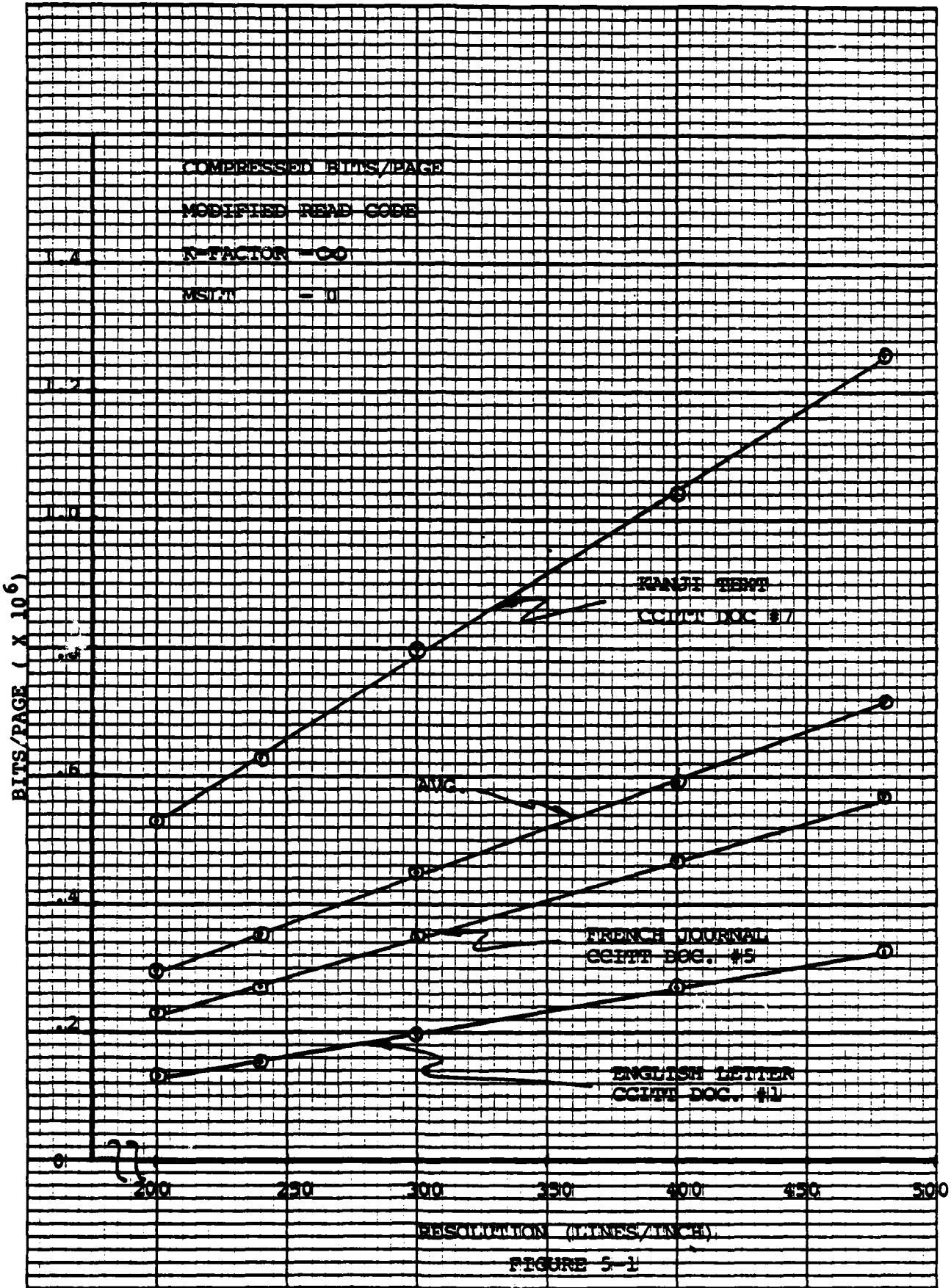

FIGURE 5-1

5.3 Alternate Line Interpolation

Compression techniques are used in digital facsimile systems to minimize the time required for document transmission. Source coding -- a technique which reduces redundancy inherent in the input document -- is the most common compression technique which is used. The Modified Huffman Code and Modified READ code are examples of source coding techniques. One fundamental characteristic of source coding is that, assuming no transmission errors, the output document is identical to the input digital image. No approximations or degradation occurs relative to the original digitized image. Another characteristic of source coding is that the compression ratio is highly dependent upon the complexity of the input document. Complex documents require more transmission time than documents containing little information. Alternate Line Interpolation is a compression technique which achieves a fixed compression ratio of 2 to 1 by deleting alternate scan lines from transmission. At the receiver the missing scan lines are interpolated from the transmitted data.

Consider a typical digital facsimile system which scans, and prints, with the same resolution in both the horizontal and vertical direction. For example, the one resolution being considered for Group 4 facsimile equipment employs a resolution of 400 lines/in. in both directions. Figure 5-2 illustrates the general concept of line interpolation where each square represents one pixel in the input and output images (e.g. 1/400 inch x 1/400 inch). As shown in the diagram every

ALTERNATE LINE INTERPOLATION

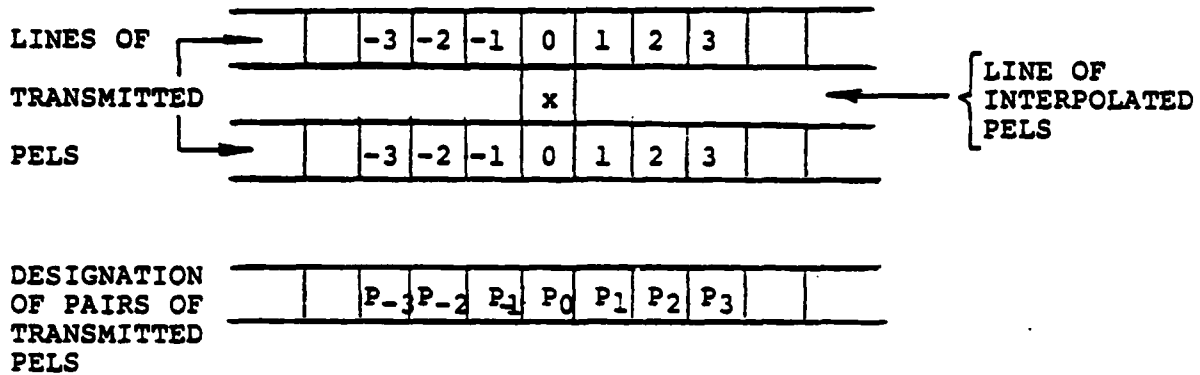

The pel to be interpolated is designated as "x". The first step in the interpolation process is to consider the pair of transmitted pels (P₀) which are adjacent to "x" in the line above and below. If the P₀ pels are both black interpolate "x" to be black. If the P₀ pels are both white interpolate "x" to be white. If the two P₀ pels are of different color, adjacent pairs (P_{±1}, P_{±2}, etc.) are examined to determine the color of the nearest pair where both pels are black or white. Pel "x" is interpolated to be the color of the nearest pair which is all black or all white. For example, if pairs P₋₂, P₋₁, P₀, and P₁ all have differing colored pels in each pair, but the pels in P₂ are both white then "x" is interpolated to be white. If opposite colors are found equidistant from "x" then "x" is interpolated to be white. For example, under the following conditions "x" is interpolated to be white.

- P₋₂ - both black
- P₋₁ } - pairs have different colored pels
- P₀ }
- P₁ }
- P₂ - both white

Figure 5-2

other line of pixels is transmitted, and those lines which were not transmitted are interpolated at the receiver. It is anticipated that the pixels would be interpolated sequentially by a hardware and/or software processor. In Figure 5-2 the pixel which is labelled "x" is being interpolated using the transmitted information from the lines above and below.

It should be noted that the proposed system will occasionally interpolate pixels incorrectly. Therefore the interpolation scheme differs from source coding in two respects. First, the compression ratio is fixed at 2 to 1 regardless of the redundancy of the input image. Second, the interpolation technique does not reproduce the input digital image exactly; errors will occasionally be made.

The above discussion views the proposed system from a data compression perspective. It is also possible to consider the interpolation proposal from an "image enhancement" viewpoint. Consider Figure 5-3 which illustrates the typical "stairstep" distortion in a conventional digital facsimile system when scanning a black-white edge which is nearly parallel with the scanning track. This ragged edge distortion is very visible to the naked eye and significantly reduces the acceptability of digital facsimile. It is possible to enhance the appearance of the output image by artificially creating, or interpolating twice as many scan lines on the output copy as were scanned and transmitted. If this were done the size of the ragged stairstep distortion would be reduced 2 to 1 and the image would be more pleasing to the eye. The proposed interpolation algorithm

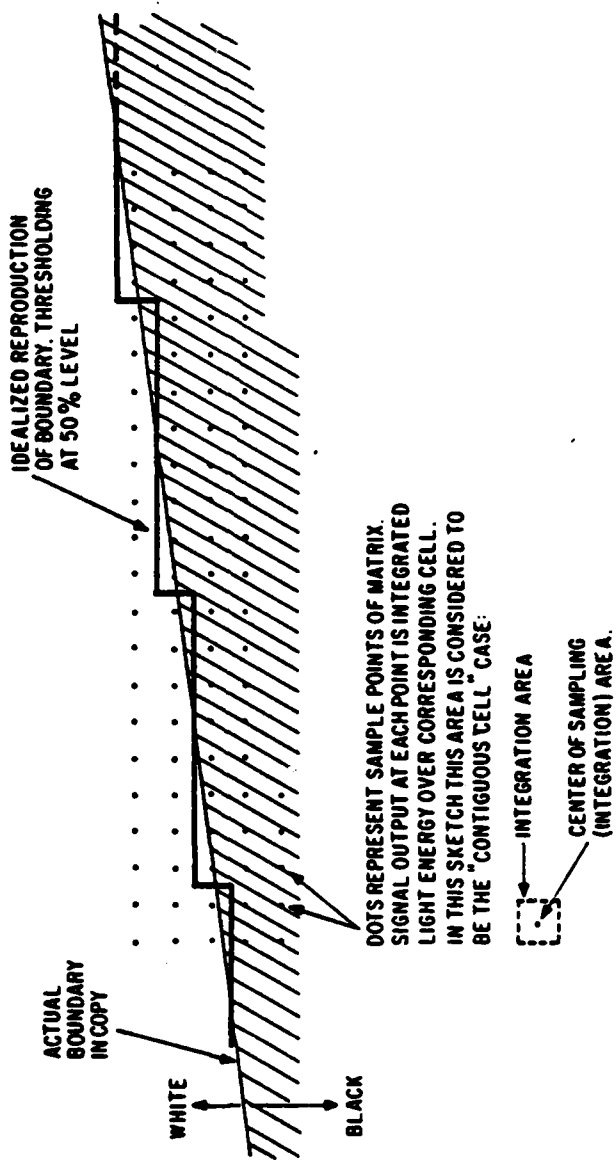

Stairstep Generation in Sampled Two-Level System

Figure 5-3

would automatically position the stairstep transitions on the interpolated lines in the optimum position -- halfway between the steps on the above and below transmitted lines.

A computer program was written to simulate the Alternate Line Interpolation algorithm. The code listing for the program is included in Appendix F. The algorithm was run on all four test images at 400 x 400 line resolution. Every other scan line of the 400 x 400 line image was deleted. The missing lines were then replaced by interpolated lines. A CONVERT program was then written to permit the interpolated image to be printed on the Johns Hopkins printer. A code listing for the CONVERT program is included in Appendix G.

6.0 IMAGE PRINTING

A total of 20 images were printed consisting of all combinations of the four test images (CCITT Nos 1, 5, 7 and Legibility Chart) and five resolutions (200, 240, 300, 400, 480 lpi). Four additional images were also printed for the Alternate Line Interpolation algorithm; all four test pages at 400 x 400 lpi. A print of each of the 24 images is included in this report. Table 6-1 lists the figure numbers and the parameters for each. Of course the quality of the images in this report is not representative of the original images which were photographically printed. Dennis Bodson, the COTR on this project, has a complete set of the original photographic prints.

The images were first printed on the Johns Hopkins system described in Appendix A. A reduced size photographic transparency was produced by the printer. In general the size of the output transparency and the aperture size corresponded to the parameters listed in Table 4-1. The Johns Hopkins transparencies were then photographically enlarged to the full 8½ in. x 11 in. size.

Table 6-1
List of Printed Images

<u>Figure No.</u>	<u>Subject</u>	<u>Resolution</u>	<u>Interpolation</u>
6-1	Legibility	200	
2	"	240	
3	"	300	
4	"	400	
5	"	480	
6	CCITT No. 1	200	
7	"	240	
8	"	300	
9	"	400	
10	"	480	
11	CCITT No. 5	200	
12	"	240	
13	"	300	
14	"	400	
15	"	480	
16	CCITT No. 7	200	
17	"	240	
18	"	300	
19	"	400	
20	"	480	
21	Legibility	400	Yes
22	CCITT No. 1	400	Yes
23	CCITT No. 5	400	Yes
24	CCITT No. 7	400	Yes

10 Point

dkfje giewo sl weo xcaqp cNvbm xiuyt rEdv2 dkfje giewo slW3o xcaOp c9vbm xiuy dkfje giewo sl weo xcaqp cNvbm xiuyt rEdv2 dkfje rEdvj dkf5 giewo sl weo xca4G cnvbm x8uyt redVJ dkfje Gie6o shwXo xcaqp dkfje giewo sl weo xcaqp cNvbm xiuyt rEdv2 dkfje Cnvbm xiuyt redVJ d45je giewo slBUo xc2Fp cnvbm xiWyt redOj dkfje glweo dwee xCa7p cnvbm xi26t redvj KJfe giewo Slwee xc5Tp cnvbm xiuyt Redvj dkfje gVew dkfje giewo sl weo xcaqp

8 Point

dkfje giewo sl weo xcaqp cNvbm xiuyt rEdv2 dkfje giewo slW3o xcaOp c9vbm xiuyt eikj kJK56 dege 83fdKfje giewo sl weo xcaqp cNvbm xiuyt rEdv2 dkfje rEdvj dkf5 giewo sl weo xca4G cnvbm x8uyt redVJ dkfje Gie6o shwXo xcaqp KL3er kaich 3kaOd dkfje giewo sl weo xcaqp Cnvbm xiuyt redvj d45je giewo slBUo xc2Fp cnvbm xiWyt redOj dkfje glweo Sladoc lndKod 34Ker cNvbm xiuyt rEdv2 dkfje cNvbm xiuyt dwee xCa7p cnvbm xi26t redvj KJfe giewo Slwee xc5Tp cnvbm xiuyt Redvj dkfje gVew 3paje bwmaJ ol cNvbm xiuyt rEdv2 dkfje cNvbm xiuyt

6 Point

dkfje giewo sl weo xcaqp cNvbm xiuyt rEdv2 dkfje giewo slW3o xcaOp c9vbm xiuyt eikj kJK56 dege 83fdKfje giewo sl weo xcaqp cNvbm xiuyt rEdv2 dkfje giewo sl weo xca4G cnvbm x8uyt redVJ dkfje Gie6o shwXo xcaqp KL3er kaich 3kaOd dkfje giewo sl weo xcaqp Cnvbm xiuyt redvj d45je giewo slBUo xc2Fp cnvbm xiWyt redOj dkfje glweo Sladoc lndKod 34Ker cNvbm xiuyt rEdv2 dkfje cNvbm xiuyt dwee xCa7p cnvbm xi26t redvj KJfe giewo Slwee xc5Tp cnvbm xiuyt Redvj dkfje gVew 3paje bwmaJ ol cNvbm xiuyt rEdv2 dkfje cNvbm xiuyt

4 Point

dkfje giewo sl weo xcaqp cNvbm xiuyt rEdv2 dkfje giewo slW3o xcaOp c9vbm xiuyt eikj kJK56 dege 83fdKfje giewo sl weo xcaqp cNvbm xiuyt rEdv2 dkfje giewo sl weo xca4G cnvbm x8uyt redVJ dkfje Gie6o shwXo xcaqp KL3er kaich 3kaOd dkfje giewo sl weo xcaqp Cnvbm xiuyt redvj d45je giewo slBUo xc2Fp cnvbm xiWyt redOj dkfje glweo Sladoc lndKod 34Ker cNvbm xiuyt rEdv2 dkfje cNvbm xiuyt dwee xCa7p cnvbm xi26t redvj KJfe giewo Slwee xc5Tp cnvbm xiuyt Redvj dkfje gVew 3paje bwmaJ ol cNvbm xiuyt rEdv2 dkfje cNvbm xiuyt

3 Point

dkfje giewo sl weo xcaqp cNvbm xiuyt rEdv2 dkfje giewo slW3o xcaOp c9vbm xiuyt eikj kJK56 dege 83fdKfje giewo sl weo xcaqp cNvbm xiuyt rEdv2 dkfje giewo sl weo xca4G cnvbm x8uyt redVJ dkfje Gie6o shwXo xcaqp KL3er kaich 3kaOd dkfje giewo sl weo xcaqp Cnvbm xiuyt redvj d45je giewo slBUo xc2Fp cnvbm xiWyt redOj dkfje glweo Sladoc lndKod 34Ker cNvbm xiuyt rEdv2 dkfje cNvbm xiuyt dwee xCa7p cnvbm xi26t redvj KJfe giewo Slwee xc5Tp cnvbm xiuyt Redvj dkfje gVew 3paje bwmaJ ol cNvbm xiuyt rEdv2 dkfje cNvbm xiuyt

2 Point

dkfje giewo sl weo xcaqp cNvbm xiuyt rEdv2 dkfje giewo slW3o xcaOp c9vbm xiuyt eikj kJK56 dege 83fdKfje giewo sl weo xcaqp cNvbm xiuyt rEdv2 dkfje giewo sl weo xca4G cnvbm x8uyt redVJ dkfje Gie6o shwXo xcaqp KL3er kaich 3kaOd dkfje giewo sl weo xcaqp Cnvbm xiuyt redvj d45je giewo slBUo xc2Fp cnvbm xiWyt redOj dkfje glweo Sladoc lndKod 34Ker cNvbm xiuyt rEdv2 dkfje cNvbm xiuyt dwee xCa7p cnvbm xi26t redvj KJfe giewo Slwee xc5Tp cnvbm xiuyt Redvj dkfje gVew 3paje bwmaJ ol cNvbm xiuyt rEdv2 dkfje cNvbm xiuyt

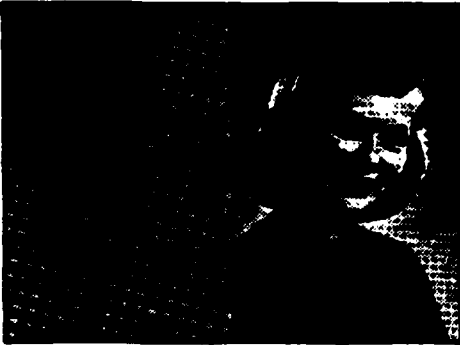

65 Line Screen



85 Line Screen



120 Line Screen



133 Line Screen



150 Line Screen

Facsimile Test Chart

Figure 6-1
200 lpi

10 Point

dKfje giewo s1weo xcaqp cNvbm xiuyt rEdv2 dkfJe giewo s1W3o xcaQp c9vbm xiuy dKfje giewo s1weo xcaqp cNvbm xiuyt rEdv2 dkfJe rEdvj dkfj5 giewo sLweo xca4G cnvbm x8uyt redVJ dkfje Gie6o s1wXo xcaqp dKfje giewo s1weo xcaqp cNvbm xiuyt rEdv2 dkfJe Cnvbm xiuyt redvj d48je giewo s1BUo xo2Fp cnvbm xiWyt redOj dkfje g1Ewo s1weo xCa7p cnvbm xi26t redvj KJfje giewo Siweo xe5Tp cnvbm xiuyt Redvj dkfje gVew dKfje giewe s1weo xcaqp

8 Point

dKfje giewo s1weo xcaqp cNvbm xiuyt rEdv2 dkfJe giewo s1W3o xcaQp c9vbm xiuyt eikif kJK56 dege 83fdKfje giewo s1weo xcaqp cNvbm xiuyt rEdv2 dkfJe rEdvj dkfj5 giewo sLweo xca4G cnvbm x8uyt redVJ dkfje Gie6o s1wXo xcaqp KL3er kaich 3kaOd dKfje giewo s1weo xcaqp Cnvbm xiuyt redvj d48je giewo s1BUo xo2Fp cnvbm xiWyt redOj dkfje g1Ewo 3idoc kIKod 34Ker cNvbm xiuyt rEdv2 dkfJe cNvbm xiuyt s1weo xCa7p cnvbm xi26t redvj KJfje giewo Siweo xe5Tp cnvbm xiuyt Redvj dkfje gVew 3paje kwmaJ ei cNvbm xiuyt rEdv2 dkfJe cNvbm xiuyt

6 Point

dKfje giewo s1weo xcaqp cNvbm xiuyt rEdv2 dkfJe giewo s1W3o xcaQp c9vbm xiuyt eikif kJK56 dege 83fdKfje giewo s1weo xcaqp cNvbm xiuyt rEdv2 dkfJe rEdvj dkfj5 giewo sLweo xca4G cnvbm x8uyt redVJ dkfje Gie6o s1wXo xcaqp KL3er kaich 3kaOd hokDH 2301e 3epH. Paroh aihc dKfje giewo s1weo xcaqp cNvbm xiuyt rEdv2 dkfJe Cnvbm xiuyt redvj d48je giewo s1BUo xo2Fp cnvbm xiWyt redOj dkfje g1Ewo 3idoc kIKod 34Ker opusu 38agz qavp daOch iasin dKfje giewo s1weo xcaqp cNvbm xiuyt rEdv2 dkfJe cNvbm xiuyt s1weo xCa7p cnvbm xi26t redvj KJfje giewo Siweo xe5Tp cnvbm xiuyt Redvj dkfje gVew 3paje kwmaJ ei cNvbm xiuyt rEdv2 dkfJe cNvbm xiuyt

4 Point

dKfje giewo s1weo xcaqp cNvbm xiuyt rEdv2 dkfJe giewo s1W3o xcaQp c9vbm xiuyt eikif kJK56 dege 83fdKfje giewo s1weo xcaqp cNvbm xiuyt rEdv2 dkfJe rEdvj dkfj5 giewo sLweo xca4G cnvbm x8uyt redVJ dkfje Gie6o s1wXo xcaqp KL3er kaich 3kaOd hokDH 2301e 3epH. Paroh aihc dKfje giewo s1weo xcaqp cNvbm xiuyt rEdv2 dkfJe Cnvbm xiuyt redvj d48je giewo s1BUo xo2Fp cnvbm xiWyt redOj dkfje g1Ewo 3idoc kIKod 34Ker opusu 38agz qavp daOch iasin dKfje giewo s1weo xcaqp cNvbm xiuyt rEdv2 dkfJe cNvbm xiuyt s1weo xCa7p cnvbm xi26t redvj KJfje giewo Siweo xe5Tp cnvbm xiuyt Redvj dkfje gVew 3paje kwmaJ ei cNvbm xiuyt rEdv2 dkfJe cNvbm xiuyt

3 Point

dKfje giewo s1weo xcaqp cNvbm xiuyt rEdv2 dkfJe giewo s1W3o xcaQp c9vbm xiuyt eikif kJK56 dege 83fdKfje giewo s1weo xcaqp cNvbm xiuyt rEdv2 dkfJe rEdvj dkfj5 giewo sLweo xca4G cnvbm x8uyt redVJ dkfje Gie6o s1wXo xcaqp KL3er kaich 3kaOd hokDH 2301e 3epH. Paroh aihc dKfje giewo s1weo xcaqp cNvbm xiuyt rEdv2 dkfJe Cnvbm xiuyt redvj d48je giewo s1BUo xo2Fp cnvbm xiWyt redOj dkfje g1Ewo 3idoc kIKod 34Ker opusu 38agz qavp daOch iasin dKfje giewo s1weo xcaqp cNvbm xiuyt rEdv2 dkfJe cNvbm xiuyt s1weo xCa7p cnvbm xi26t redvj KJfje giewo Siweo xe5Tp cnvbm xiuyt Redvj dkfje gVew 3paje kwmaJ ei cNvbm xiuyt rEdv2 dkfJe cNvbm xiuyt

2 Point

dKfje giewo s1weo xcaqp cNvbm xiuyt rEdv2 dkfJe giewo s1W3o xcaQp c9vbm xiuyt eikif kJK56 dege 83fdKfje giewo s1weo xcaqp cNvbm xiuyt rEdv2 dkfJe rEdvj dkfj5 giewo sLweo xca4G cnvbm x8uyt redVJ dkfje Gie6o s1wXo xcaqp KL3er kaich 3kaOd hokDH 2301e 3epH. Paroh aihc dKfje giewo s1weo xcaqp cNvbm xiuyt rEdv2 dkfJe Cnvbm xiuyt redvj d48je giewo s1BUo xo2Fp cnvbm xiWyt redOj dkfje g1Ewo 3idoc kIKod 34Ker opusu 38agz qavp daOch iasin dKfje giewo s1weo xcaqp cNvbm xiuyt rEdv2 dkfJe cNvbm xiuyt s1weo xCa7p cnvbm xi26t redvj KJfje giewo Siweo xe5Tp cnvbm xiuyt Redvj dkfje gVew 3paje kwmaJ ei cNvbm xiuyt rEdv2 dkfJe cNvbm xiuyt



65 Line Screen



85 Line Screen



120 Line Screen



133 Line Screen



150 Line Screen

Facsimile Test Chart

Figure 6-2
240 lpi

10 Point

dKfje giewo slweo xcaqp cNvbm xiuyt rEdv2 dKfje giewo slW3o xcaQp c9vbm xiuy dKfje giewo slweo xcaqp cNvbm xiuyt rEdv2 dKfje rEdvj dKfj5 giewo slweo xca4G crvbm x8uyt redVJ dKfje Gie6o slwXo xcaqp dKfje giewo slweo xcaqp cNvbm xiuyt rEdv2 dKfje Crvbm xiuyt redvj d45je giewo slBUo xca2P crvbm xiWyt redOj dKfje giewo slweo xCa7p crvbm xi26t redvj KJfje giewo Slweo xca5Tp crvbm xiuyt Redvj dKfje gVew dKfje giewo slweo xcaqp

8 Point

dKfje giewo slweo xcaqp cNvbm xiuyt rEdv2 dKfje giewo slW3o xcaQp c9vbm xiuyt eikij kjK56 dafje 83fdKfje giewo slweo xcaqp cNvbm xiuyt rEdv2 dKfje rEdvj dKfj5 giewo slweo xca4G crvbm x8uyt redVJ dKfje Gie6o slwXo xcaqp KL3er keich 3kaOd dKfje giewo slweo xcaqp Crvbm xiuyt redvj d45je giewo slBUo xca2P crvbm xiWyt redOj dKfje giewo 3idoo indKod 34Ker cNvbm xiuyt rEdv2 dKfje cNvbm xiuyt slweo xCa7p crvbm xi26t redvj KJfje giewo Slweo xca5Tp crvbm xiuyt Redvj dKfje gVew Spaje kwmaJ el cNvbm xiuyt rEdv2 dKfje cNvbm xiuyt

6 Point

dKfje giewo slweo xcaqp cNvbm xiuyt rEdv2 dKfje giewo slW3o xcaQp c9vbm xiuyt eikij kjK56 dafje 83fdKfje giewo slweo xcaqp cNvbm xiuyt rEdv2 dKfje giewo slweo xca4G crvbm x8uyt redVJ dKfje Gie6o slwXo xcaqp KL3er keich 3kaOd hahGH 2301e 3kchL. Peron alho dKfje giewo slweo xcaqp cNvbm xiuyt rEdv2 dKfje Crvbm xiuyt redvj d45je giewo slBUo xca2P crvbm xiWyt redOj dKfje giewo 3idoo indKod 34Ker cNvbm xiuyt rEdv2 dKfje cNvbm xiuyt slweo xCa7p crvbm xi26t redvj KJfje giewo Slweo xca5Tp crvbm xiuyt Redvj dKfje gVew Spaje kwmaJ el cNvbm xiuyt rEdv2 dKfje cNvbm xiuyt

4 Point

dKfje giewo slweo xcaqp cNvbm xiuyt rEdv2 dKfje giewo slW3o xcaQp c9vbm xiuyt eikij kjK56 dafje 83fdKfje giewo slweo xcaqp cNvbm xiuyt rEdv2 dKfje giewo slweo xca4G crvbm x8uyt redVJ dKfje Gie6o slwXo xcaqp KL3er keich 3kaOd hahGH 2301e 3kchL. Peron alho dKfje giewo slweo xcaqp cNvbm xiuyt rEdv2 dKfje Crvbm xiuyt redvj d45je giewo slBUo xca2P crvbm xiWyt redOj dKfje giewo 3idoo indKod 34Ker cNvbm xiuyt rEdv2 dKfje cNvbm xiuyt slweo xCa7p crvbm xi26t redvj KJfje giewo Slweo xca5Tp crvbm xiuyt Redvj dKfje gVew Spaje kwmaJ el cNvbm xiuyt rEdv2 dKfje cNvbm xiuyt

3 Point

2 Point



65 Line Screen



85 Line Screen



120 Line Screen



133 Line Screen



150 Line Screen

Facsimile Test Chart
Figure 6-3
300 lpi

10 Point

dKfje giewo sIweo xcaqp cNvbm xiuyt rEdv2 dkfJe giewo sIW3o xcaOp c9vbm xiuy dKfje giewo sIweo xcaqp cNvbm xiuyt rEdv2 dkfJe rEdvj dkfj5 giewo sLweo xca4G cnvbm xBuyt redVJ dkfje Gie6o slwXo xcaqp dKfje giewo sIweo xcaqp cNvbm xiuyt rEdv2 dkfJe Cnvbm xiuyt redvj d45je giewo sIBUo xc2Fp cnvbm xiWyt redOj dkfje gIweo slweo xCa7p cnvbm xi26t redvj KJfje giewo Siweo xe5Tp cnvbm xiuyt Redvj dkfje gVew dKfje giewo sIweo xcaqp

8 Point

dKfje giewo sIweo xcaqp cNvbm xiuyt rEdv2 dkfJe giewo sIW3o xcaOp c9vbm xiuyt eikjf kJK56 delge 83fdKfje giewo sIweo xcaqp cNvbm xiuyt rEdv2 dkfJe rEdvj dkfj5 giewo sLweo xca4G cnvbm xBuyt redVJ dkfje Gie6o slwXo xcaqp KL3er keich 3ksOd dKfje giewo sIweo xcaqp Cnvbm xiuyt redvj d45je giewo sIBUo xc2Fp cnvbm xiWyt redOj dkfje gIweo 3ksOd kdKod 34Ker cNvbm xiuyt rEdv2 dkfJe cNvbm xiuyt slweo xCa7p cnvbm xi26t redvj KJfje giewo Siweo xe5Tp cnvbm xiuyt Redvj dkfje gVew 3paje kwmal ol cNvbm xiuyt rEdv2 dkfJe cNvbm xiuyt

6 Point

dKfje giewo sIweo xcaqp cNvbm xiuyt rEdv2 dkfJe giewo sIW3o xcaOp c9vbm xiuyt eikjf kJK56 delge 83fdKfje giewo sIweo xcaqp cNvbm xiuyt rEdv2 dkfJe rEdvj dkfj5 giewo sLweo xca4G cnvbm xBuyt redVJ dkfje Gie6o slwXo xcaqp KL3er keich 3ksOd dKfje giewo sIweo xcaqp Cnvbm xiuyt redvj d45je giewo sIBUo xc2Fp cnvbm xiWyt redOj dkfje gIweo 3ksOd kdKod 34Ker cNvbm xiuyt rEdv2 dkfJe cNvbm xiuyt slweo xCa7p cnvbm xi26t redvj KJfje giewo Siweo xe5Tp cnvbm xiuyt Redvj dkfje gVew 3paje kwmal ol cNvbm xiuyt rEdv2 dkfJe cNvbm xiuyt

4 Point

dKfje giewo sIweo xcaqp cNvbm xiuyt rEdv2 dkfJe giewo sIW3o xcaOp c9vbm xiuyt eikjf kJK56 delge 83fdKfje giewo sIweo xcaqp cNvbm xiuyt rEdv2 dkfJe rEdvj dkfj5 giewo sLweo xca4G cnvbm xBuyt redVJ dkfje Gie6o slwXo xcaqp KL3er keich 3ksOd dKfje giewo sIweo xcaqp Cnvbm xiuyt redvj d45je giewo sIBUo xc2Fp cnvbm xiWyt redOj dkfje gIweo 3ksOd kdKod 34Ker cNvbm xiuyt rEdv2 dkfJe cNvbm xiuyt slweo xCa7p cnvbm xi26t redvj KJfje giewo Siweo xe5Tp cnvbm xiuyt Redvj dkfje gVew 3paje kwmal ol cNvbm xiuyt rEdv2 dkfJe cNvbm xiuyt

3 Point

dKfje giewo sIweo xcaqp cNvbm xiuyt rEdv2 dkfJe giewo sIW3o xcaOp c9vbm xiuyt eikjf kJK56 delge 83fdKfje giewo sIweo xcaqp cNvbm xiuyt rEdv2 dkfJe rEdvj dkfj5 giewo sLweo xca4G cnvbm xBuyt redVJ dkfje Gie6o slwXo xcaqp KL3er keich 3ksOd dKfje giewo sIweo xcaqp Cnvbm xiuyt redvj d45je giewo sIBUo xc2Fp cnvbm xiWyt redOj dkfje gIweo 3ksOd kdKod 34Ker cNvbm xiuyt rEdv2 dkfJe cNvbm xiuyt slweo xCa7p cnvbm xi26t redvj KJfje giewo Siweo xe5Tp cnvbm xiuyt Redvj dkfje gVew 3paje kwmal ol cNvbm xiuyt rEdv2 dkfJe cNvbm xiuyt

2 Point

dKfje giewo sIweo xcaqp cNvbm xiuyt rEdv2 dkfJe giewo sIW3o xcaOp c9vbm xiuyt eikjf kJK56 delge 83fdKfje giewo sIweo xcaqp cNvbm xiuyt rEdv2 dkfJe rEdvj dkfj5 giewo sLweo xca4G cnvbm xBuyt redVJ dkfje Gie6o slwXo xcaqp KL3er keich 3ksOd dKfje giewo sIweo xcaqp Cnvbm xiuyt redvj d45je giewo sIBUo xc2Fp cnvbm xiWyt redOj dkfje gIweo 3ksOd kdKod 34Ker cNvbm xiuyt rEdv2 dkfJe cNvbm xiuyt slweo xCa7p cnvbm xi26t redvj KJfje giewo Siweo xe5Tp cnvbm xiuyt Redvj dkfje gVew 3paje kwmal ol cNvbm xiuyt rEdv2 dkfJe cNvbm xiuyt



65 Line Screen



85 Line Screen



120 Line Screen



133 Line Screen



150 Line Screen

Facsimile
Test Chart
Figure 6-4
400 lpi

10 Point

dKfje giewo slweo xcaqp cNvbm xiuyt rEdv2 dKfJe giewo slW3o xcaQp c9vbm xiuy dKfje giewo slweo xcaqp cNvbm xiuyt rEdv2 dKfJe rEdvj dKfj5 giewo slweo xca4G cnvbm x8uyt redVJ dKfje Gie6o slwXo xcaqp dKfje giewo slweo xcaqp cNvbm xiuyt rEdv2 dKfJe Cnvbm xiuyt redvJ d48Je giewo slBUo xc2Fp cnvbm xlWyt redOj dKfje glEwo slweo xCa7p cnvbm xi26t redvj KJfje giewo Slweo xc5Tp cnvbm xiuyt Redvj dKfje gVew dKfje giewo slweo xcaqp

8 Point

dKfje giewo slweo xcaqp cNvbm xiuyt rEdv2 dKfJe giewo slW3o xcaQp c9vbm xiuy eikj kjK56 defge 83ldKfje giewo slweo xcaqp cNvbm xiuyt rEdv2 dKfJe rEdvj dKfj5 giewo slweo xca4G cnvbm x8uyt redVJ dKfje Gie6o slwXo xcaqp KL3er keich 3ksOd dKfje giewo slweo xcaqp Cnvbm xiuyt redvj d48Je giewo slBUo xc2Fp cnvbm xlWyt redOj dKfje glEwo 3kdoe kdKod 34Ker cNvbm xiuyt rEdv2 dKfJe cNvbm xiuyt slweo xCa7p cnvbm xi26t redvj KJfje giewo Slweo xc5Tp cnvbm xiuyt Redvj dKfje gVew 3paJe hwmaJ el cNvbm xiuyt rEdv2 dKfJe cNvbm xiuyt

6 Point

dKfje giewo slweo xcaqp cNvbm xiuyt rEdv2 dKfJe giewo slW3o xcaQp c9vbm xiuy eikj kjK56 defge 83Mek gwKch Kwic: herOj dKfje giewo slweo xcaqp cNvbm xiuyt rE dKfje giewo rEdvj d48Je giewo slweo xca4G cnvbm x8uyt redVJ dKfje Gie6o slwXo xcaqp KL3er keich 3ksOd hckGH 2301s 3kchL Paroh slhc dKfje giewo slweo xcaqp cNvbm xiuyt rE hench Cnvbm xiuyt redvj d48Je giewo slBUo xc2Fp cnvbm xlWyt redOj dKfje glEwo 3kdoe kdKod 34Ker cNvbm xiuyt rEdv2 dKfJe cNvbm xiuyt rE kdKod slweo xCa7p cnvbm xi26t redvj KJfje giewo Slweo xc5Tp cnvbm xiuyt Redvj dKfje gVew 3paJe hwmaJ elqam ba- l u 3kchJ ebndc scab8 plach dKfje giewo slweo xcaqp cNvbm xiuyt rE hwmaJ ba- l

4 Point

dKfje giewo slweo xcaqp cNvbm xiuyt rEdv2 dKfJe giewo slW3o xcaQp c9vbm xiuy eikj kjK56 defge 83Mek gwKch Kwic: herOj dKfje giewo slweo xcaqp cNvbm xiuyt rE dKfje giewo rEdvj d48Je giewo slweo xca4G cnvbm x8uyt redVJ dKfje Gie6o slwXo xcaqp KL3er keich 3ksOd hckGH 2301s 3kchL Paroh slhc dKfje giewo slweo xcaqp cNvbm xiuyt rE hench Cnvbm xiuyt redvj d48Je giewo slBUo xc2Fp cnvbm xlWyt redOj dKfje glEwo 3kdoe kdKod 34Ker cNvbm xiuyt rEdv2 dKfJe cNvbm xiuyt rE kdKod slweo xCa7p cnvbm xi26t redvj KJfje giewo Slweo xc5Tp cnvbm xiuyt Redvj dKfje gVew 3paJe hwmaJ elqam ba- l u 3kchJ ebndc scab8 plach dKfje giewo slweo xcaqp cNvbm xiuyt rE hwmaJ ba- l

3 Point

dKfje giewo slweo xcaqp cNvbm xiuyt rEdv2 dKfJe giewo slW3o xcaQp c9vbm xiuy eikj kjK56 defge 83Mek gwKch Kwic: herOj dKfje giewo slweo xcaqp cNvbm xiuyt rE dKfje giewo rEdvj d48Je giewo slweo xca4G cnvbm x8uyt redVJ dKfje Gie6o slwXo xcaqp KL3er keich 3ksOd hckGH 2301s 3kchL Paroh slhc dKfje giewo slweo xcaqp cNvbm xiuyt rE hench Cnvbm xiuyt redvj d48Je giewo slBUo xc2Fp cnvbm xlWyt redOj dKfje glEwo 3kdoe kdKod 34Ker cNvbm xiuyt rEdv2 dKfJe cNvbm xiuyt rE kdKod slweo xCa7p cnvbm xi26t redvj KJfje giewo Slweo xc5Tp cnvbm xiuyt Redvj dKfje gVew 3paJe hwmaJ elqam ba- l u 3kchJ ebndc scab8 plach dKfje giewo slweo xcaqp cNvbm xiuyt rE hwmaJ ba- l

2 Point

dKfje giewo slweo xcaqp cNvbm xiuyt rEdv2 dKfJe giewo slW3o xcaQp c9vbm xiuy eikj kjK56 defge 83Mek gwKch Kwic: herOj dKfje giewo slweo xcaqp cNvbm xiuyt rE dKfje giewo rEdvj d48Je giewo slweo xca4G cnvbm x8uyt redVJ dKfje Gie6o slwXo xcaqp KL3er keich 3ksOd hckGH 2301s 3kchL Paroh slhc dKfje giewo slweo xcaqp cNvbm xiuyt rE hench Cnvbm xiuyt redvj d48Je giewo slBUo xc2Fp cnvbm xlWyt redOj dKfje glEwo 3kdoe kdKod 34Ker cNvbm xiuyt rEdv2 dKfJe cNvbm xiuyt rE kdKod slweo xCa7p cnvbm xi26t redvj KJfje giewo Slweo xc5Tp cnvbm xiuyt Redvj dKfje gVew 3paJe hwmaJ elqam ba- l u 3kchJ ebndc scab8 plach dKfje giewo slweo xcaqp cNvbm xiuyt rE hwmaJ ba- l



65 Line Screen



85 Line Screen



120 Line Screen



133 Line Screen



150 Line Screen

Facsimile Test Chart
Figure 6-5
480 lpi

THE SLEREXE COMPANY LIMITED

SAPORS LANE . BOOLE . DORSET . BH 25 8 ER

TELEPHONE BOOLE (945 13) 51617 - TELEX 123456

Our Ref. 350/PJC/EAC

18th January, 1972.

Dr. P.N. Cundall,
Mining Surveys Ltd.,
Holroyd Road,
Reading,
Berks.

Dear Pete,

Permit me to introduce you to the facility of facsimile transmission.

In facsimile a photocell is caused to perform a raster scan over the subject copy. The variations of print density on the document cause the photocell to generate an analogous electrical video signal. This signal is used to modulate a carrier, which is transmitted to a remote destination over a radio or cable communications link.

At the remote terminal, demodulation reconstructs the video signal, which is used to modulate the density of print produced by a printing device. This device is scanning in a raster scan synchronised with that at the transmitting terminal. As a result, a facsimile copy of the subject document is produced.

Probably you have uses for this facility in your organisation.

Yours sincerely,

Phil.

P.J. CROSS
Group Leader - Facsimile Research

Figure 6-6
200 lpi

6-8

THE SLEREXE COMPANY LIMITED

SAPORS LANE . BOOLE . DORSET . BH 25 8 ER

TELEPHONE BOOLE (945 13) 51617 . TELEX 123456

Our Ref. 350/PJC/EAC

18th January, 1972.

Dr. P.N. Cundall,
Mining Surveys Ltd.,
Holroyd Road,
Reading,
Berks.

Dear Pete,

Permit me to introduce you to the facility of facsimile transmission.

In facsimile a photocell is caused to perform a raster scan over the subject copy. The variations of print density on the document cause the photocell to generate an analogous electrical video signal. This signal is used to modulate a carrier, which is transmitted to a remote destination over a radio or cable communications link.

At the remote terminal, demodulation reconstructs the video signal, which is used to modulate the density of print produced by a printing device. This device is scanning in a raster scan synchronised with that at the transmitting terminal. As a result, a facsimile copy of the subject document is produced.

Probably you have uses for this facility in your organisation.

Yours sincerely,

Phil.

P.J. CROSS
Group Leader - Facsimile Research

Figure 6-7
240 lpi

6-9

THE SLEREXE COMPANY LIMITED

SAPORS LANE . BOOLE . DORSET . BH 25 8 ER

TELEPHONE BOOLE (945 13) 51617 . TELEX 123456

Our Ref. 350/PJC/EAC

18th January, 1972.

Dr. P.N. Cundall,
Mining Surveys Ltd.,
Holroyd Road,
Reading,
Berks.

Dear Pete,

Permit me to introduce you to the facility of facsimile transmission.

In facsimile a photocell is caused to perform a raster scan over the subject copy. The variations of print density on the document cause the photocell to generate an analogous electrical video signal. This signal is used to modulate a carrier, which is transmitted to a remote destination over a radio or cable communications link.

At the remote terminal, demodulation reconstructs the video signal, which is used to modulate the density of print produced by a printing device. This device is scanning in a raster scan synchronised with that at the transmitting terminal. As a result, a facsimile copy of the subject document is produced.

Probably you have uses for this facility in your organisation.

Yours sincerely,

Phil.

P.J. CROSS
Group Leader - Facsimile Research

Figure 6-8
300 lpi

6-10

THE SLEREXE COMPANY LIMITED

SAPORS LANE · BOOLE · DORSET · BH 25 8 ER

TELEPHONE BOOLE (945 13) 51617 · TELEX 123456

Our Ref. 350/PJC/EAC

18th January, 1972.

Dr. P.N. Cundall,
Mining Surveys Ltd.,
Holroyd Road,
Reading,
Berks.

Dear Pete,

Permit me to introduce you to the facility of facsimile transmission.

In facsimile a photocell is caused to perform a raster scan over the subject copy. The variations of print density on the document cause the photocell to generate an analogous electrical video signal. This signal is used to modulate a carrier, which is transmitted to a remote destination over a radio or cable communications link.

At the remote terminal, demodulation reconstructs the video signal, which is used to modulate the density of print produced by a printing device. This device is scanning in a raster scan synchronised with that at the transmitting terminal. As a result, a facsimile copy of the subject document is produced.

Probably you have uses for this facility in your organisation.

Yours sincerely,

Phil.

P.J. CROSS
Group Leader - Facsimile Research

Figure 6-9
400 lpi

6-11

THE SLEREXE COMPANY LIMITED

SAPORS LANE . BOOLE . DORSET . BH 25 8 ER

TELEPHONE BOOLE (945 13) 51617 - TELEX 123456

Our Ref. 350/PJC/EAC

18th January, 1972.

Dr. P.N. Cundall,
Mining Surveys Ltd.,
Holroyd Road,
Reading,
Berks.

Dear Pete,

Permit me to introduce you to the facility of facsimile transmission.

In facsimile a photocell is caused to perform a raster scan over the subject copy. The variations of print density on the document cause the photocell to generate an analogous electrical video signal. This signal is used to modulate a carrier, which is transmitted to a remote destination over a radio or cable communications link.

At the remote terminal, demodulation reconstructs the video signal, which is used to modulate the density of print produced by a printing device. This device is scanning in a raster scan synchronised with that at the transmitting terminal. As a result, a facsimile copy of the subject document is produced.

Probably you have uses for this facility in your organisation.

Yours sincerely,

Phil.

P.J. CROSS
Group Leader - Facsimile Research

Figure 6-10
480 lpi

6-12

Cela est d'autant plus valable que $T\Delta f$ est plus grand. A cet égard la figure 2 représente la vraie courbe donnant $|\phi(f)|$ en fonction de f pour les valeurs numériques indiquées page précédente.

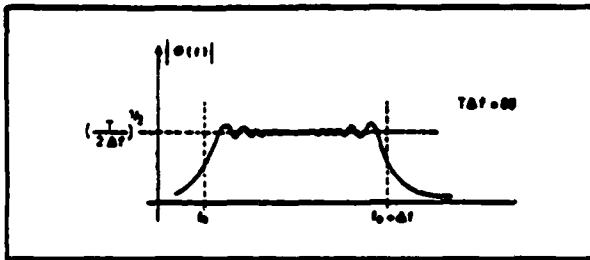

FIG. 2

Dans ce cas, le filtre adapté pourra être constitué, conformément à la figure 3, par la cascade :

— d'un filtre passe-bande de transfert unité pour $f_0 \leq f \leq f_0 + \Delta f$ et de transfert quasi nul pour $f < f_0$ et $f > f_0 + \Delta f$, filtre ne modifiant pas la phase des composants le traversant ;



FIG. 3

— filtre suivi d'une ligne à retard (LAR) dispersif ayant un temps de propagation de groupe T_R décroissant linéairement avec la fréquence f suivant l'expression :

$$T_R = T_0 + (f_0 - f) \frac{T}{\Delta f} \quad (\text{avec } T_0 > T)$$

(voir fig. 4).

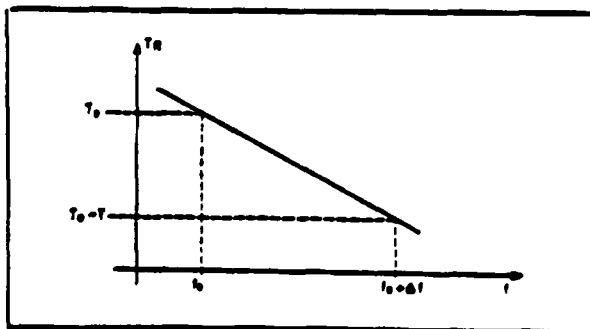

FIG. 4

telle ligne à retard est donnée par :

$$\phi = -2\pi \int_0^f T_R df$$

$$\phi = -2\pi \left[T_0 + \frac{f_0 T}{\Delta f} \right] f + \pi \frac{T}{\Delta f} f^2$$

Et cette phase est bien l'opposé de $|\phi(f)|$,

à un déphasage constant près (sans importance) et à un retard T_0 près (inévitabile).

Un signal utile $S(t)$ traversant un tel filtre adapté donne à la sortie (à un retard T_0 près et à un déphasage près de la porteuse) un signal dont la transformée de Fourier est réelle, constante entre f_0 et $f_0 + \Delta f$, et nulle de part et d'autre de f_0 et de $f_0 + \Delta f$, c'est-à-dire un signal de fréquence porteuse $f_0 + \Delta f/2$ et dont l'enveloppe a la forme indiquée à la figure 5, où l'on a représenté simultanément le signal $S(t)$ et le signal $S_1(t)$ correspondant obtenu à la sortie du filtre adapté. On comprend le nom de récepteur à compression d'impulsion donné à ce genre de filtre adapté : la « largeur » (à 3 dB) du signal comprimé étant égale à $1/\Delta f$, le rapport de compression

$$\text{est de } \frac{T}{1/\Delta f} = T\Delta f$$

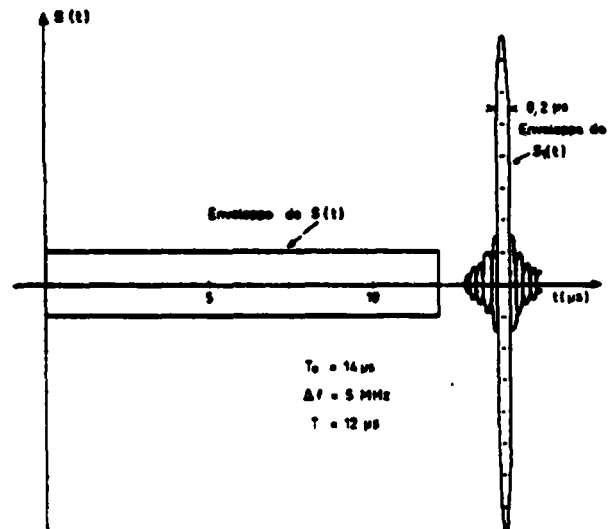

FIG. 5

On saisit physiquement le phénomène de compression en réalisant que lorsque le signal $S(t)$ entre dans la ligne à retard (LAR) la fréquence qui entre la première à l'instant 0 est la fréquence basse f_0 , qui met un temps T_0 pour traverser. La fréquence f entre à l'instant $t = (f - f_0) \frac{T}{\Delta f}$ et elle met un temps

$T_0 - (f - f_0) \frac{T}{\Delta f}$ pour traverser, ce qui la fait ressortir à l'instant T_0 , également. Ainsi donc, le signal $S(t)$

Cela est d'autant plus valable que $T\Delta f$ est plus grand. A cet égard la figure 2 représente la vraie courbe donnant $|\phi(f)|$ en fonction de f pour les valeurs numériques indiquées page précédente.

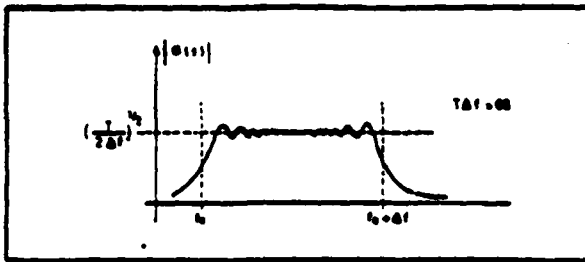

FIG. 2

Dans ce cas, le filtre adapté pourra être constitué, conformément à la figure 3, par la cascade :

— d'un filtre passe-bande de transfert unité pour $f_0 \leq f \leq f_0 + \Delta f$ et de transfert quasi nul pour $f < f_0$ et $f > f_0 + \Delta f$, filtre ne modifiant pas la phase des composants le traversant ;



FIG. 3

— filtre suivi d'une ligne à retard (LAR) dispersive ayant un temps de propagation de groupe T_R décroissant linéairement avec la fréquence f suivant l'expression :

$$T_R = T_0 + (f_0 - f) \frac{T}{\Delta f} \quad (\text{avec } T_0 > T)$$

(voir fig. 4).

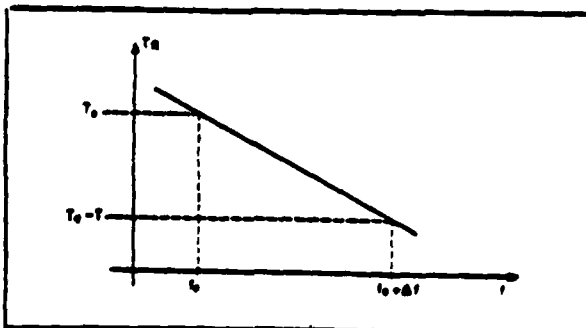

FIG. 4

telle ligne à retard est donnée par :

$$\phi = -2\pi \int_0^f T_R df$$

$$\phi = -2\pi \left[T_0 + \frac{f_0 T}{\Delta f} \right] f + \pi \frac{T}{\Delta f} f^2$$

Et cette phase est bien l'opposé de $|\phi(f)|$.

à un déphasage constant près (sans importance) et à un retard T_0 près (inévitabile).

Un signal utile $S(t)$ traversant un tel filtre adapté donne à la sortie (à un retard T_0 près et à un déphasage près de la porteuse) un signal dont la transformée de Fourier est réelle, constante entre f_0 et $f_0 + \Delta f$, et nulle de part et d'autre de f_0 et de $f_0 + \Delta f$, c'est-à-dire un signal de fréquence porteuse $f_0 + \Delta f/2$ et dont l'enveloppe a la forme indiquée à la figure 5, où l'on a représenté simultanément le signal $S(t)$ et le signal $S_1(t)$ correspondant obtenu à la sortie du filtre adapté. On comprend le nom de récepteur à compression d'impulsion donné à ce genre de filtre adapté : la « largeur » (à 3 dB) du signal comprimé étant égale à $1/\Delta f$, le rapport de compression

$$\text{est de } \frac{T}{1/\Delta f} = T\Delta f$$

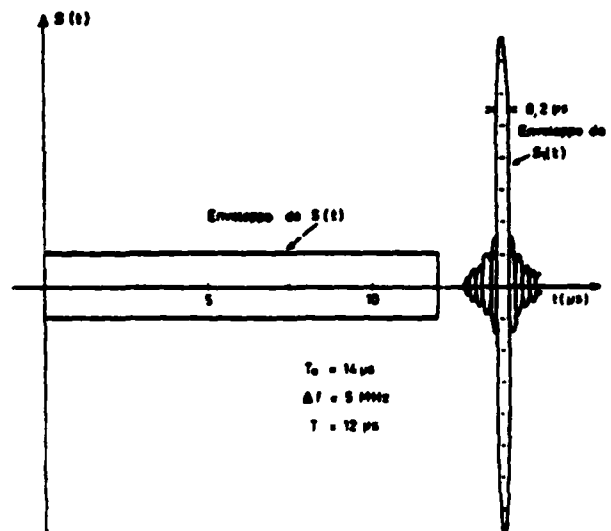

FIG. 5

On saisit physiquement le phénomène de compression en réalisant que lorsque le signal $S(t)$ entre dans la ligne à retard (LAR) la fréquence qui entre la première à l'instant 0 est la fréquence basse f_0 , qui met un temps T_0 pour traverser. La fréquence f entre à l'instant $t = (f - f_0) \frac{T}{\Delta f}$ et elle met un temps

$T_0 - (f - f_0) \frac{T}{\Delta f}$ pour traverser, ce qui la fait ressortir à l'instant T_0 également. Ainsi donc, le signal $S(t)$

Cela est d'autant plus valable que $T\Delta f$ est plus grand. A cet égard la figure 2 représente la vraie courbe donnant $|\phi(f)|$ en fonction de f pour les valeurs numériques indiquées page précédente.

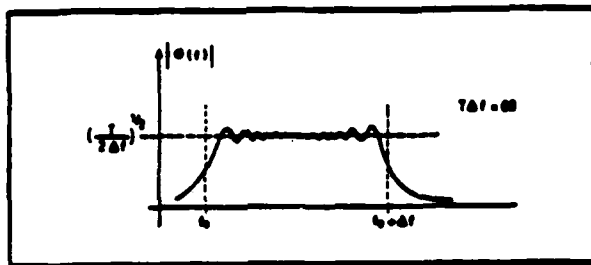

FIG. 2

Dans ce cas, le filtre adapté pourra être constitué, conformément à la figure 3, par la cascade :

— d'un filtre passe-bande de transfert unité pour $f_0 \leq f \leq f_0 + \Delta f$ et de transfert quasi nul pour $f < f_0$ et $f > f_0 + \Delta f$, filtre ne modifiant pas la phase des composants le traversant ;



FIG. 3

— filtre suivi d'une ligne à retard (LAR) dispersive ayant un temps de propagation de groupe T_R décroissant linéairement avec la fréquence f suivant l'expression :

$$T_R = T_0 + (f_0 - f) \frac{T}{\Delta f} \quad (\text{avec } T_0 > T)$$

(voir fig. 4).

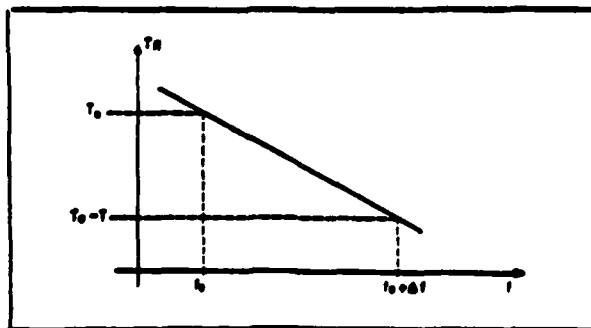

FIG. 4

Figure 6-13
300 lpi

telle ligne à retard est donnée par :

$$\phi = -2\pi \int_0^f T_R df$$

$$\phi = -2\pi \left[T_0 + \frac{f_0 T}{\Delta f} \right] f + \pi \frac{T}{\Delta f} f^2$$

Et cette phase est bien l'opposé de $|\phi(f)|$,

à un déphasage constant près (sans importance) et à un retard T_0 près (inévitabile).

Un signal utile $S(t)$ traversant un tel filtre adapté donne à la sortie (à un retard T_0 près et à un déphasage près de la porteuse) un signal dont la transformée de Fourier est réelle, constante entre f_0 et $f_0 + \Delta f$, et nulle de part et d'autre de f_0 et de $f_0 + \Delta f$, c'est-à-dire un signal de fréquence porteuse $f_0 + \Delta f/2$ et dont l'enveloppe a la forme indiquée à la figure 5, où l'on a représenté simultanément le signal $S(t)$ et le signal $S_1(t)$ correspondant obtenu à la sortie du filtre adapté. On comprend le nom de récepteur à compression d'impulsion donné à ce genre de filtre adapté : la « largeur » (à 3 dB) du signal comprimé étant égale à $1/\Delta f$, le rapport de compression

$$\text{est de } \frac{T}{1/\Delta f} = T\Delta f$$

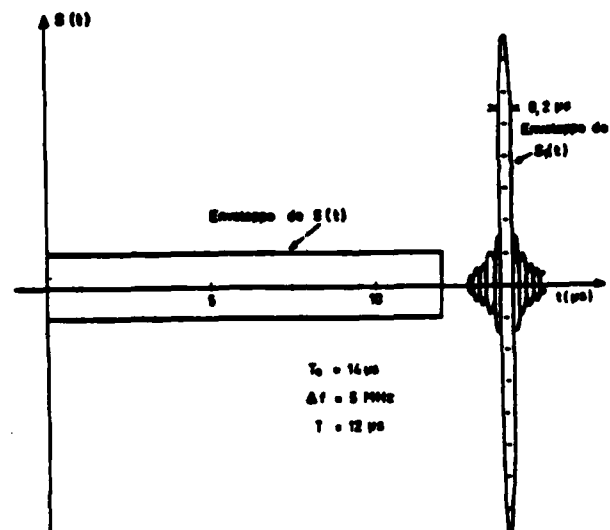

FIG. 5

On saisit physiquement le phénomène de compression en réalisant que lorsque le signal $S(t)$ entre dans la ligne à retard (LAR) la fréquence qui entre la première à l'instant 0 est la fréquence basse f_0 , qui met un temps T_0 pour traverser. La fréquence f entre à l'instant $t = (f - f_0) \frac{T}{\Delta f}$ et elle met un temps

$T_0 - (f - f_0) \frac{T}{\Delta f}$ pour traverser, ce qui la fait ressortir à l'instant T_0 également. Ainsi donc, le signal $S(t)$

Cela est d'autant plus valable que $T\Delta f$ est plus grand. A cet égard la figure 2 représente la vraie courbe donnant $|\phi(f)|$ en fonction de f pour les valeurs numériques indiquées page précédente.

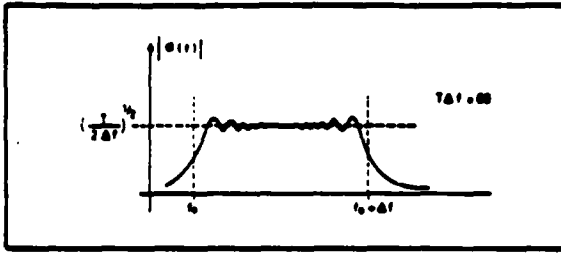

FIG. 2

Dans ce cas, le filtre adapté pourra être constitué, conformément à la figure 3, par la cascade :

— d'un filtre passe-bande de transfert unité pour $f_0 \leq f \leq f_0 + \Delta f$ et de transfert quasi nul pour $f < f_0$ et $f > f_0 + \Delta f$, filtre ne modifiant pas la phase des composants le traversant ;



FIG. 3

— filtre suivi d'une ligne à retard (LAR) dispersive ayant un temps de propagation de groupe T_R décroissant linéairement avec la fréquence f suivant l'expression :

$$T_R = T_0 + (f_0 - f) \frac{T}{\Delta f} \quad (\text{avec } T_0 > T)$$

(voir fig. 4).

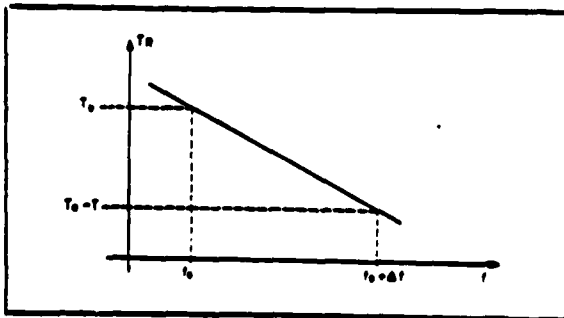

FIG. 4

telle ligne à retard est donnée par :

$$\phi = -2\pi \int_0^f T_R df$$

$$\phi = -2\pi \left[T_0 + \frac{f_0 T}{\Delta f} \right] f + \pi \frac{T}{\Delta f} f^2$$

Et cette phase est bien l'opposé de $|\phi(f)|$.

à un déphasage constant près (sans importance) et à un retard T_0 près (inévitabile).

Un signal utile $S(t)$ traversant un tel filtre adapté donne à la sortie (à un retard T_0 près et à un déphasage près de la porteuse) un signal dont la transformée de Fourier est réelle, constante entre f_0 et $f_0 + \Delta f$, et nulle de part et d'autre de f_0 et de $f_0 + \Delta f$, c'est-à-dire un signal de fréquence porteuse $f_0 + \Delta f/2$ et dont l'enveloppe a la forme indiquée à la figure 5, où l'on a représenté simultanément le signal $S(t)$ et le signal $S_1(t)$ correspondant obtenu à la sortie du filtre adapté. On comprend le nom de récepteur à compression d'impulsion donné à ce genre de filtre adapté : la « largeur » (à 3 dB) du signal comprimé étant égale à $1/\Delta f$, le rapport de compression est de $\frac{T}{1/\Delta f} = T\Delta f$

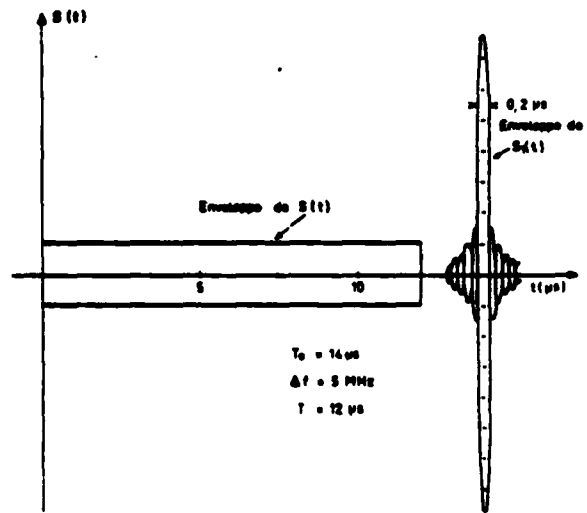

FIG. 5

On saisit physiquement le phénomène de compression en réalisant que lorsque le signal $S(t)$ entre dans la ligne à retard (LAR) la fréquence qui entre la première à l'instant 0 est la fréquence basse f_0 , qui met un temps T_0 pour traverser. La fréquence f entre à l'instant $t = (f - f_0) \frac{T}{\Delta f}$ et elle met un temps

$T_0 - (f - f_0) \frac{T}{\Delta f}$ pour traverser, ce qui la fait ressortir à l'instant T_0 , également. Ainsi donc, le signal $S(t)$

Cela est d'autant plus valable que $T\Delta f$ est plus grand. A cet égard la figure 2 représente la vraie courbe donnant $|\phi(f)|$ en fonction de f pour les valeurs numériques indiquées page précédente.

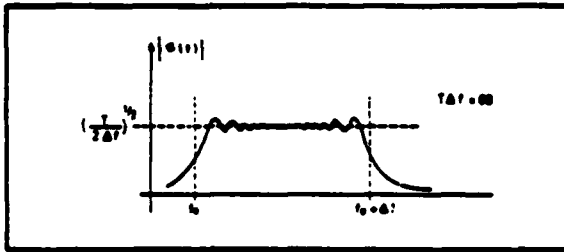

FIG. 2

Dans ce cas, le filtre adapté pourra être constitué, conformément à la figure 3, par la cascade :

— d'un filtre passe-bande de transfert unité pour $f_0 \leq f \leq f_0 + \Delta f$ et de transfert quasi nul pour $f < f_0$ et $f > f_0 + \Delta f$, filtre ne modifiant pas la phase des composants le traversant ;



FIG. 3

— filtre suivi d'une ligne à retard (LAR) dispersive ayant un temps de propagation de groupe T_R décroissant linéairement avec la fréquence f suivant l'expression :

$$T_R = T_0 + (f_0 - f) \frac{T}{\Delta f} \quad (\text{avec } T_0 > T)$$

(voir fig. 4).

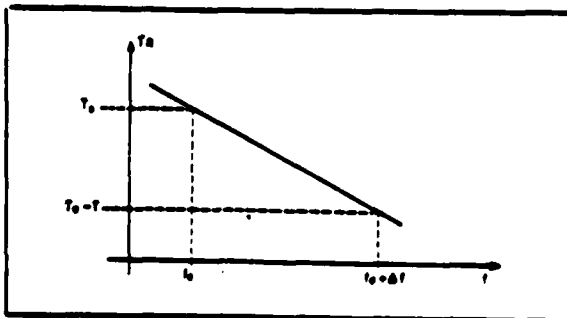

FIG. 4

telle ligne à retard est donnée par :

$$\varphi = -2\pi \int_0^f T_R df$$

$$\varphi = -2\pi \left[T_0 + \frac{f_0 T}{\Delta f} \right] f + \pi \frac{T}{\Delta f} f^2$$

Et cette phase est bien l'opposé de $|\phi(f)|$,

à un déphasage constant près (sans importance) et à un retard T_0 près (inévitabile).

Un signal utile $S(t)$ traversant un tel filtre adapté donne à la sortie (à un retard T_0 près et à un déphasage près de la porteuse) un signal dont la transformée de Fourier est réelle, constante entre f_0 et $f_0 + \Delta f$, et nulle de part et d'autre de f_0 et de $f_0 + \Delta f$, c'est-à-dire un signal de fréquence porteuse $f_0 + \Delta f/2$ et dont l'enveloppe a la forme indiquée à la figure 5, où l'on a représenté simultanément le signal $S(t)$ et le signal $S_1(t)$ correspondant obtenu à la sortie du filtre adapté. On comprend le nom de récepteur à compression d'impulsion donné à ce genre de filtre adapté : la « largeur » (à 3 dB) du signal comprimé étant égale à $1/\Delta f$, le rapport de compression

$$\text{est de } \frac{T}{1/\Delta f} = T\Delta f$$

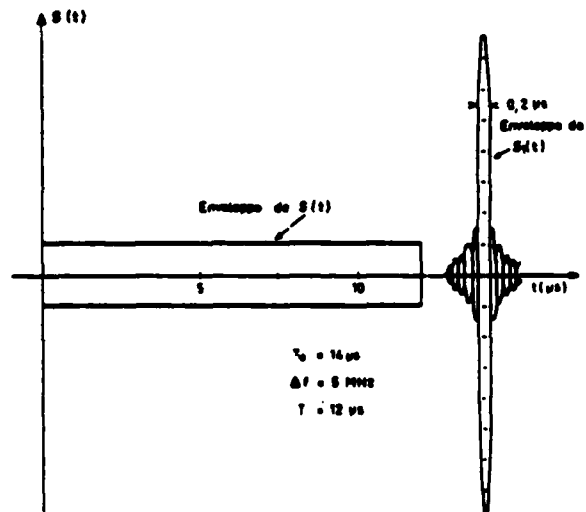

FIG. 5

On saisit physiquement le phénomène de compression en réalisant que lorsque le signal $S(t)$ entre dans la ligne à retard (LAR) la fréquence qui entre la première à l'instant 0 est la fréquence basse f_0 , qui met un temps T_0 pour traverser. La fréquence f entre à l'instant $t = (f - f_0) \frac{T}{\Delta f}$ et elle met un temps

$T_0 - (f - f_0) \frac{T}{\Delta f}$ pour traverser, ce qui la fait ressortir à l'instant T_0 également. Ainsi donc, le signal $S(t)$

Figure 6-15

480 lpi

5-17

CCITTの概要

沿革

CCITTは、国際電気通信連合(ITU)の四つの常設機関(事務総局、国際周波数登録委員会、CCIR、CCITT)の一つとして、ITUの中でも、世界の国際通信上の諸問題を真先に取上げ、その解決方法を見出して行く重要な機関である。日本名は、国際電信電話諮問委員会と称する。

CCITTの前身は、CCIF(国際電話諮問委員会)とCCIT(国際電信諮問委員会)である。CCIFは、1924年にヨーロッパに「国際長距離電話通信諮問委員会」が設置され、これが1925年のパリ電信電話会議のとき、正式に「国際電話諮問委員会」として万国電信連合の公式機関となったものである。CCITは、同じく1925年の会議のとき、CCIFと併立するものとして設置された。

そして、CCIFは、1956年の12月に第18回総会が開催されたのち、CCITは、同年同月に第8回総会が開催されたのち、併合されて現在のCCITTとなった。このCCITTは、CCIFとCCITが解散した直後、第1回総会を開催し、第2回総会は、1960年にニューアリーで、第3回総会は、1964年、ジュネーブで、第4回総会は、1968年、アルゼンチンで開催された。

CCIFとCCITが合併したのは、有線電気通信の分野、とくに伝送路について電信回線と電話回線とを技術的に分ける意味がなくなってきたこと、各国とも大體において、電信部門と電話部門は同一組織内にあること、CCIFの事務局とCCITの事務局の合併による効率増進等がおもな理由であった。

CCITTは、上述のように、ヨーロッパ内の国々によつて、ヨーロッパ内の電信・電話の技術・運用・料金の基準を定め、あるいは統一をはかっていたので、現在でも、その影響を受け、金参加国は、ヨーロッパの国が多く、ヨーロッパで生起する問題の研究が多い。たとえば、1960年のCCITT勧告の中で、技術上配慮する距離は約2,500kmであったが、これはヨーロッパ内領域を想定したものである。

しかしながら、1956年9月に敷設された大西洋横断電話ケーブルは、大陸間電話通信の自動化および半自動化への技術的可能性を与え、CCITTがこの問題を取り上げるに及び、CCITTの性格は漸次、汎世界的色彩を實質的に帯びるに至った。この汎世界的性格は第2次世界大戦後益々ましくなったアジア・アフリカ植民地の独立に伴ってITUの構成員の中にこれらの国が加わり、ITUの中に新しい意見が導入されたことにも起因して、技術面、政治面の双方から導入されてき

た。CCITTの汎世界的化は、1960年の第2回総会がニューアリーで開催されたことにもあらわれている。この総会までは、CCIT、CCIFのいずれにしろ、アメリカやアジアで総会が開催されたことがなく、CCITT委員長も、ニューアリー総会の準備文書で、この点には注目すべきであるとのべている。

任務

ITUは、全権委員会、主管庁会議を始めとして、七つの機関をもち、それぞれの機関の権限と任務は国際電気通信条約に明記されている。そこで条約を参照してみるならば、CCITTの任務は、つぎのとおりとなっている。

「国際電信電話諮問委員会(CCITT)は、電信および電話に関する技術、運用および料金の問題について研究し、および意見を表明することを任務とする。」(1965年セントルー条約第187号)

「各国際諮問委員会は、その任務の遂行に当たって、新しい国または発展の途上にある国における地域的および国際的分野にわたる電気通信の創設、発達および改善に直接関連のある問題について研究し、および意見を作成するように妥協を注意を払わなければならない。」(同第188号)

「各国際諮問委員会は、また、関係国の要請に基づき、その国内電気通信の問題について研究し、かつ、勧告を行なうことができる。」(同第189号)

上記第187号と第188号にいわゆる「意見」とは、フランス語の Avis から訳したもので、英語では、「勧告(Recommendation)」となっている。CCITTの表明する意見は、国際法には強制力をもたないものであって、この点が、条約、電信規則、電話規則等各国を拘束する力をもっているものと異なる。もっとも意見とは称しても、技術的分野では、電信規則のとき、各国政府が承認してその内容を実施する強制規則をもたないので、実際にある機器の仕様を定める場合には、多くの国の意見が統一されたこの「意見」に従わなければ、円滑な国際通信を行なうことができない場合が多い。この意見(または勧告)は、国際通信を行なう場合各国が直面する問題について、具体的意見を表明するもので、たとえば、大陸間ケーブルで大陸間通話を半自動化しようとする場合、その信号方式や取り扱う通話の種類および料金は、どのようにするかを研究して意見を表明する。したがって、CCITTの活動は、つねに時代の最先端を行くもので、CCITTの活動方向は、そのまま世界の国際通信の活動方向であるともいえる。

この意見は、また、電信規則以下のその他の規則のごとく、数年以上の間隔をもって開催される主管庁会議というような大会議の決定をまたなくとも表明することができ、また、その改正も容易であるので、現在のように進歩の早い国際通信界では、関係国の意見を統一した国際的見解としては非常に便利である。

Figure 6-16

200 lpi

6-18

CCITTの概要

沿革

CCITTは、国際電気通信連合(ITU)の四つの常設機関(事務総局、国際電報登録委員会、CCIR、CCITT)の一つとして、ITUの中でも、世界の国際通信上の諸問題を真先に取上げ、その解決方法を見出して行く重要な機関である。日本名は、国際電信電話諮問委員会と称する。

CCITTの前身は、CCIF(国際電信諮問委員会)とCCIT(国際電信諮問委員会)である。CCIFは、1924年にヨーロッパに「国際長距離電話諮問委員会」が設置され、これが1925年のパリ電信電話会議のとき、正式に、「国際電信諮問委員会」として万国電信連合の公式機関となったものである。CCITは、同じく1925年の会議のとき、CCIFと併立するものとして設置された。

そして、CCIFは、1956年の12月に第18回総会が開催されたのち、CCITは、同年同月に第8回総会が開催されたのち、併合されて現在のCCITTとなった。このCCITTは、CCIFとCCITが解散した直後、第1回総会を開催し、第2回総会は、1960年にニューデリーで、第3回総会は、1964年、ジュネーブで、第4回総会は、1968年、アルゼンチンで開催された。

CCIFとCCITが合併したのは、有線電気通信の分野、とくに伝送路について電信回線と電話回線とを技術的に分ける意味がなくなってきたこと、各国とも大體において、電信部門と電話部門は同一組織内にあること、CCIFの事務局とCCITの事務局の合併による効率増進等がおもな理由であった。

CCITTは、上述のように、ヨーロッパ内の国々によつて、ヨーロッパ内の電信・電話の技術・運用・料金の基準を定め、あるいは統一をはかっていたので、現在でも、その影響を受け、会合参加国は、ヨーロッパの国が多く、ヨーロッパで生起する問題の研究が多い。たとえば、1960年のCCITT勧告の中で、技術上配慮する距離は約2,500kmであったが、これはヨーロッパ内領域を想定したものである。

しかしながら、1956年9月に敷設された大西洋横断電話ケーブルは、大陸間電話通信の自動化および半自動化への技術的可能性を与え、CCITTがこの問題を取り上げるに及び、CCITTの性格は漸次、汎世界的色彩を實質的に帯びるに至った。この汎世界的性格は第2次世界大戦後目ざましくなったアジア・アフリカ植民地の独立に伴ってITUの構成員の中にこれらの国が加わり、ITUの中に新しい意見が導入されたことにも起因して、技術面、政治面の双方から導入されてき

た。CCITTの汎世界化は、1960年の第2回総会がニューデリーで開催されたことにもあらわれている。この総会までは、CCIT、CCIFのいずれにしろ、アメリカやアジアで総会が開催されることがなく、CCITT委員長も、ニューデリー総会の準備文書で、この点には注目すべきであるとのべている。

任務

ITUは、全権委員会、主管庁会議を始めとして、七つの機関をもち、それぞれの特長と任務は国際電気通信条約に明記されている。そこで条約を参照してみれば、CCITTの任務は、つぎのとおりとなっている。

「国際電信電話諮問委員会(CCITT)は、電信および電話に関する技術、運用および料金の問題について研究し、および意見を表明することを任務とする。」(1965年モントルー条約第187号)

「各国際諮問委員会は、その任務の遂行に当たって、新しい国または発展の途上にある国における地域的および国際的分野にわたる電気通信の創設、発達および改善に直接関連のある問題について研究し、および意見を作成するように妥當な注意を払わなければならない。」(同第188号)

「各国際諮問委員会は、また、関係国の要請に基づき、その国内電気通信の問題について研究し、かつ、勧告を行なうことができる。」(同第189号)

上記第187号と第188号にいわゆる「意見」とは、フランス語の Avis から訳したもので、英語では、「勧告(Recommendation)」となっている。CCITTの表明する意見は、国際法的には強制力をもたないものであって、この点が、条約、電信規則、電話規則等各国を拘束する力をもっているものと異なる。もっとも意見とは称しても、技術的分野では、電信規則のごとき、各国政府が承認してその内容を実施する強制規則をもたないので、実際にある機器の仕様を定める場合には、多くの国の意見が統一されたこの「意見」に従わなければ、円滑な国際通信を行なうことができない場合が多い。この意見(または勧告)は、国際通信を行なう場合各国が直面する問題について、具体的意見を表明するもので、たとえば、大陸間ケーブルで大陸間通話を半自動化しようとする場合、その信号方式や取り扱う通話の種類および料金は、どのようにするかを研究して意見を表明する。したがって、CCITTの活動は、つねに時代の最先端を行くもので、CCITTの活動方向は、そのまま世界の国際通信の活動方向であるといえる。

この意見は、また、電信規則以下のその他の規則のごとく、数年以上の間隔をもって開催される主管庁会議というような大會議の決定をまたなくても表明することができ、また、その改正も容易であるので、現在のように進歩の早い国際通信界では、関係国の意見を統一した国際的見解としては非常に便利である。

CCITTの概要

沿革

CCITTは、国際電気通信連合(ITU)の四つの常設機関(事務総局、国際電報検査委員会、CCIR、CCITT)の一つとして、ITUの中でも、世界の国際通信上の諸問題を真先に取上げ、その解決方法を見出して行く重要な機関である。日本名は、国際電信電話諮問委員会と称する。

CCITTの前身は、CCIF(国際電話諮問委員会)とCCIT(国際電信諮問委員会)である。CCIFは、1924年にヨーロッパに「国際長距離電話通信諮問委員会」が設置され、これが1925年のパリ電信電話会議のとき、正式に「国際電話諮問委員会」として万国電信連合の公式機関となったものである。CCITは、同じく1925年の会議のとき、CCIFと併立するものとして設置された。

そして、CCIFは、1956年の12月に第18回総会が開催されたのち、CCITは、同年同月に第8回総会が開催されたのち、併合されて現在のCCITTとなった。このCCITTは、CCIFとCCITが解散した直後、第1回総会を開催し、第2回総会は、1960年にニューアリーで、第3回総会は、1964年、ジュネーブで、第4回総会は、1968年、アルゼンチンで開催された。

CCIFとCCITが合併したのは、有線電気通信の分野、とくに伝送路について電信回線と電話回線とを技術的に分ける意味がなくなってきたこと、各国とも大體において、電信部門と電話部門は同一組織内にあること、CCIFの事務局とCCITTの事務局の合併による効率増進等がおもな理由であった。

CCITTは、上述のように、ヨーロッパ内の国々によって、ヨーロッパ内の電信・電話の技術・運用・料金の基準を定め、あるいは統一をはかっていたので、現在でも、その影響を受け、会合参加国は、ヨーロッパの国が多く、ヨーロッパで生起する問題の研究が多い。たとえば、1960年のCCITT勧告の中で、技術上配慮する距離は約2,500kmであったが、これはヨーロッパ内領域を想定したものである。

しかしながら、1956年9月に敷設された大西洋横断電話ケーブルは、大陸間電話通信の自動化および半自動化への技術的可能性を与え、CCITTがこの問題を取り上げるに及び、CCITTの性格は漸次、汎世界的色彩を實質的に帯びるに至った。この汎世界的性格は第2次世界大戦後益々ましくなったアジア・アフリカ植民地の独立に伴ってITUの構成員の中にこれらの国が加わり、ITUの中に新しい意見が導入されたことにも起因して、技術面、政治面の双方から導入されてき

た。CCITTの汎世界的化は、1960年の第2回総会がニューアリーで開催されたことにもあらわれている。この総会までは、CCIT、CCIFのいすれにしろ、アメリカやアジアで総会が開催されることがなく、CCITT委員長も、ニューアリー総会の準備文書で、この点には注目すべきであるとのべている。

任務

ITUは、全権委員会、主管庁会議を始めとして、七つの機関をもち、それらの機関の権限と任務は国際電気通信条約に明記されている。そこで条約を参照してみるとならば、CCITTの任務は、つぎのとおりとなっている。

「国際電信電話諮問委員会(CCITT)は、電信および電話に関する技術、運用および料金の問題について研究し、および意見を表明することを任務とする。」(1965年モントルー条約第187号)

「各国際諮問委員会は、その任務の遂行に当たって、新しい国または発展の途上にある国における地域的および国際的分野にわたる電気通信の創設、発達および改善に直接関連のある問題について研究し、および意見を作成するように妥當な注意を払わなければならない。」(同第188号)

「各国際諮問委員会は、また、関係国の要請に基づき、その国内電気通信の問題について研究し、かつ、勧告を行なうことができる。」(同第189号)

上記第187号と第188号にいわゆる「意見」とは、フランス語の Avis から訳したもので、英語では、「勧告(Recommendation)」となっている。CCITTの表明する意見は、国際法的には強制力をもたないものであって、この点が、条約、電信規則、電話規則等各国を拘束する力をもっているものと異なる。もっとも意見とは称しても、技術的分野では、電信規則のとき、各国政府が承認してその内容を実施する強制規則をもたないので、実際にある機器の仕様を定める場合には、多くの国の意見が統一されたこの「意見」に従わなければ、円滑な国際通信を行なうことができない場合が多い。この意見(または勧告)は、国際通信を行なう場合各国が直面する問題について、具体的意見を表明するもので、たとえば、大陸間ケーブルで大陸間電話を半自動化しようとする場合、その信号方式や取り扱う通話の種類および料金は、どのようにするかを研究して意見を表明する。したがって、CCITTの活動は、つねに時代の最先端を行くもので、CCITTの活動方向は、そのまま世界の国際通信の活動方向であるといえる。

この意見は、また、電信規則以下のその他の規則のごとく、数年以上の間隔をもって開催される主管庁会議というような大会議の決定をまたなくても表明することができ、また、その改正も容易であるので、現在のように進歩の早い国際通信界では、関係国の意見を統一した国際的見解としては非常に便利である。

CCITTの概要

沿革

CCITTは、国際電気通信連合(IITU)の四つの常設機関(事務総局、国際周波数登録委員会、CCIR、CCITT)の一つとして、IITUの中でも、世界の国際通信上の諸問題を真先に取上げ、その解決方法を見出して行く重要な機関である。日本名は、国際電信電話諮問委員会と称する。

CCITTの前身は、CCIF(国際電話諮問委員会)とCCIT(国際電信諮問委員会)である。CCIFは、1924年にヨーロッパに「国際長距離電話通信諮問委員会」が設置され、これが1925年のパリ電信電話会議のとき、正式に、「国際電話諮問委員会」として万国電信連合の公式機関となったものである。CCITは、同じく1925年の会議のとき、CCIFと併立するものとして設置された。

そして、CCIFは、1956年の12月に第18回総会が開催されたのち、CCITは、同年同月に第8回総会が開催されたのち、併合されて現在のCCITTとなった。このCCITTは、CCIFとCCITが解散した直後、第1回総会を開催し、第2回総会は、1960年にニューナリーで、第3回総会は、1964年、ジュネーブで、第4回総会は、1968年、アルゼンチンで開催された。

CCIFとCCITが合併したのは、有線電気通信の分野、とくに伝送路について電信回線と電話回線とを技術的に分ける意味がなくなってきたこと、各国とも大體において、電信部門と電話部門は同一組織内にあること、CCIFの事務局とCCITの事務局の合併による効率増進等がおもな理由であった。

CCITTは、上述のように、ヨーロッパ内の国々によって、ヨーロッパ内の電信・電話の技術・運用・料金の基準を定め、あるいは統一をはかってきたので、現在でも、その影響を受け、金参加国は、ヨーロッパの国が多く、ヨーロッパで生起する問題の研究が多い。たとえば、1960年のCCITT勧告の中で、技術上配慮する距離は約2,500kmであったが、これはヨーロッパ内領域を想定したものである。

しかしながら、1956年9月に敷設された大西洋横断電話ケーブルは、大陸間電信通信の自動化および半自動化への技術的可能性を与え、CCITTがこの問題を取り上げるに及び、CCITTの性格は漸次、汎世界的色彩を實質的に帯びるに至った。この汎世界的性格は第2次世界大戦後目ざましくなったアジア・アフリカ植民地の独立に伴ってIITUの構成員の中にこれらの国が加わり、IITUの中に新しい意見が導入されたことにも起因して、技術面、政治面の双方から導入されてき

た。CCITTの汎世界化は、1960年の第2回総会がニューナリーで開催されたことにもあらわれている。この総会までは、CCIT、CCIFのいずれにしろ、アメリカやアジアで総会が開催されたことがなく、CCITT委員長も、ニューナリー総会の準備文書で、この点には注目すべきであるとのべている。

任務

IITUは、全権委員会、主管庁会議を始めとして、七つの機関をもち、それらの機関の権限と任務は国際電気通信条約に明記されている。そこで条約を参照してみるならば、CCITTの任務は、つぎのとおりとなっている。

「国際電信電話諮問委員会(CCITT)は、電信および電話に関する技術、運用および料金の問題について研究し、および意見を表明することを任務とする。」(1965年セントルー条約第187号)

「各国際諮問委員会は、その任務の遂行に当たって、新しい国または発展の途上にある国における地域および国際的分野にわたる電気通信の創設、発達および改善に直接関連のある問題について研究し、および意見を作成するように妥当な注意を払わなければならない。」(同第188号)

「各国際諮問委員会は、また、関係国の要請に基づき、その国内電気通信の問題について研究し、かつ、勧告を行なうことができる。」(同第189号)

上記第187号と第188号にいわゆる「意見」とは、フランス語の Avis から訳したもので、英語では、「勧告(Recommendation)」となっている。CCITTの表明する意見は、国際法的には強制力をもたないものであって、この点が、条約、電信規則、電話規則等各国を拘束する力をもっているものと異なる。もっとも意見とは林しても、技術的分野では、電信規則のとき、各国政府が承認してその内容を実施する強制規則をもたないので、実際にある機器の仕様を定める場合には、多くの国の意見が統一されたこの「意見」に従わなければ、円滑な国際通信を行なうことができない場合が多い。この意見(または勧告)は、国際通信を行なう場合各国が直面する問題について、具体的意見を表明するもので、たとえば、大陸間ケーブルで大陸間通話を半自動化しようとする場合、その信号方式や取り扱う通話の種類および料金は、どのようにするかを研究して意見を表明する。したがって、CCITTの活動は、つねに時代の最先端を行くもので、CCITTの活動方向は、そのまま世界の国際通信の活動方向であるといえる。

この意見は、また、電信規則以下のその他の規則のごとく、数年以上の間隔をもって開催される主管庁会議というような大会議の決定をまたなくても表明することができ、また、その改正も容易であるので、現在のように進歩の早い国際通信界では、関係国の意見を統一した国際的見解としては非常に便利である。

Figure 6-19
400 lpi

CCITTの概要

沿革

CCITTは、国際電気通信連合（ITU）の四つの常設機関（事務総局、国際周波数登録委員会、CCIR、CCITT）の一つとして、ITUの中でも、世界の国際通信上の諸問題を真先に取上げ、その解決方法を見出して行く重要な機関である。日本名は、国際電信電話諮問委員会と称する。

CCITTの前身は、CCIF（国際電話諮問委員会）とCCIT（国際電信諮問委員会）である。CCIFは、1924年にヨーロッパに「国際長距離電話通信諮問委員会」が設置され、これが1925年のパリ電信電話会議のとき、正式に「国際電話諮問委員会」として万国電信連合の公式機関となったものである。CCITは、同じく1925年の会議のとき、CCIFと併立するものとして設置された。

そして、CCIFは、1956年の12月に第18回総会が開催されたのち、CCITは、同年同月に第8回総会が開催されたのち、併合されて現在のCCITTとなった。このCCITTは、CCIFとCCITが解散した直後、第1回総会を開催し、第2回総会は、1960年にニューデリーで、第3回総会は、1964年、ジュネーブで、第4回総会は、1968年、アルゼンチンで開催された。

CCIFとCCITが合併したのは、有線電気通信の分野、とくに伝送路について電信回線と電話回線とを技術的に分ける意味がなくなってきたこと、各国とも大體において、電信部門と電話部門は同一組織内にあること、CCIFの事務局とCCITの事務局の合併による効率増進等がおもな理由であった。

CCITTは、上述のように、ヨーロッパ内の国々によって、ヨーロッパ内の電信・電話の技術・運用・料金の基準を定め、あるいは統一をはかってきたので、現在でも、その影響を受け、会合参加国は、ヨーロッパの国が多く、ヨーロッパで生起する問題の研究が多い。たとえば、1960年のCCITT勧告の中で、技術上配慮する距離は約2,500kmであったが、これはヨーロッパ内領域を想定したものである。

しかしながら、1956年9月に敷設された大西洋横断電話ケーブルは、大陸間電話通信の自動化および半自動化への技術的可能性を与え、CCITTがこの問題を取り上げるに及び、CCITTの性格は漸次、汎世界的色彩を實質的に帯びるに至った。この汎世界的性格は第2次世界大戦後目ざましくなったアジア・アフリカ植民地の独立に伴ってITUの構成員の中にこれらの国が加わり、ITUの中に新しい意見が導入されたことにも起因して、技術面、政治面の双方から導入されてき

た。CCITTの汎世界化は、1960年の第2回総会がニューデリーで開催されたことにもあらわれている。この総会までは、CCIT、CCIFのいずれにしろ、アメリカやアジアで総会が開催されることがなく、CCITT委員長も、ニューデリー総会の準備文書で、この点には注目すべきであるとのべている。

任務

ITUは、全権委員会議、主管庁会議を始めとして、七つの機関をもち、それぞれの機関の権限と任務は国際電気通信条約に明記されている。そこで条約を参照してみるとならば、CCITTの任務は、つぎのとおりとなっている。

「国際電信電話諮問委員会（CCITT）は、電信および電話に関する技術、運用および料金の問題について研究し、および意見を表明することを任務とする。」（1965年モントルー条約第187号）

「各国際諮問委員会は、その任務の遂行に当たって、新しい国または発展の途上にある国における地域的および国際的分野にわたる電気通信の創設、発達および改善に直接関連のある問題について研究し、および意見を表明するように妥当な注意を払わなければならない。」（同第188号）

「各国際諮問委員会は、また、関係国の要請に基づき、その国内電気通信の問題について研究し、かつ、勧告を行なうことができる。」（同第189号）

上記第187号と第188号にいわれる「意見」とは、フランス語の Avis から訳したもので、英語では、「勧告（Recommendation）」となっている。CCITTの表明する意見は、国際法には強制力をもちたないものであって、この点が、条約、電信規則、電話規則等各国を拘束する力をもっているものと異なる。もともと意見とは称しても、技術的分野では、電信規則のごとき、各国政府が承認してその内容を実施する強制規則をもたないもので、実際にある機器の仕様を定める場合には、多くの国の意見が統一されたこの「意見」に従わなければ、円滑な国際通信を行なうことができない場合が多い。この意見（または勧告）は、国際通信を行なう場合各国が直面する問題について、具体的意見を表明するもので、たとえば、大陸間ケーブルで大陸間通話を半自動化しようとする場合、その信号方式や取り扱う通話の種類および料金は、どのようにするかを研究して意見を表明する。したがって、CCITTの活動は、つねに時代の最先端を行くもので、CCITTの活動方向は、そのまま世界の国際通信の活動方向であるともいえる。

この意見は、また、電信規則以下のその他の規則のごとく、数年以上の間隔をもって開催される主管庁会議というような大会議の決定をまたなくとも表明することができ、また、その改正も容易であるので、現在のように進歩の早い国際通信界では、関係国の意見を統一した国際的見解としては非常に便利である。

10 Point

dKfje giewo s1weo xcaqp cNvbm xiuyt rEdv2 dKfJe giewo s1W3o xcaQp c9vbm xiuy dKfje giewo s1weo xcaqp cNvbm xiuyt rEdv2 dKfJe rEdvj dKfj5 giewo s1Lweo xca4G cnvbm x8uyt redVJ dKfje Gie6o s1wXo xcaqp dKfje giewo s1weo xcaqp cNvbm xiuyt rEdv2 dKfJe Cnvbm xiuyt redvj d48je giewo s1BUo xc2Fp cnvbm xiWyt redOj dKfje giEwo s1weo xCa7p cnvbm xi26t redvj KJfje giewo S1weo xc5Tp cnvbm xiuyt Redvj dKfje gVew dKfje giewo s1weo xcaqp

8 Point

dKfje giewo s1weo xcaqp cNvbm xiuyt rEdv2 dKfJe giewo s1W3o xcaQp c9vbm xiuy eikjf kJK56 defge 8JfdKfje giewo s1weo xcaqp cNvbm xiuyt rEdv2 dKfJe rEdvj dKfj5 giewo s1Lweo xca4G cnvbm x8uyt redVJ dKfje Gie6o s1wXo xcaqp KL3er keich 3kaOd dKfje giewo s1weo xcaqp Cnvbm xiuyt redvj d48je giewo s1BUo xc2Fp cnvbm xiWyt redOj dKfje giEwo 3kdoc kdKod 34Ker cNvbm xiuyt rEdv2 dKfJe cNvbm xiuyt s1weo xCa7p cnvbm xi26t redvj KJfje giewo S1weo xc5Tp cnvbm xiuyt Redvj dKfje gVew 3paje kwacj el cNvbm xiuyt rEdv2 dKfJe cNvbm xiuyt

6 Point

dKfje giewo s1weo xcaqp cNvbm xiuyt rEdv2 dKfJe giewo s1W3o xcaQp c9vbm xiuy eikjf kJK56 defge 8JfdKfje giewo s1weo xcaqp cNvbm xiuyt rEdv2 dKfJe giewo s1Lweo xca4G cnvbm xiuyt redVJ dKfje Gie6o s1wXo xcaqp KL3er keich 3kaOd hokGH 2301s 3kchL Paron ahnc dKfje giewo s1weo xcaqp cNvbm xiuyt rE keich Cnvbm xiuyt redvj d48je giewo s1BUo xc2Fp cnvbm xiWyt redOj dKfje giEwo 3kdoc kdKod 34Ker opazu 3kagz qazvp duCoh keich dKfje giewo s1weo xcaqp cNvbm xiuyt rE kdKod s1weo xCa7p cnvbm xi26t redvj KJfje giewo S1weo xc5Tp cnvbm xiuyt Redvj dKfje gVew 3paje kwacj el cNvbm xiuyt rEdv2 dKfJe cNvbm xiuyt

4 Point

...

3 Point

...

2 Point

...



65 Line Screen



85 Line Screen



120 Line Screen



133 Line Screen



150 Line Screen

Facsimile
Test Chart

Figure 6-21
400 lpi

THE SLEREXE COMPANY LIMITED

SAPORS LANE . BOOLE . DORSET . BH 25 8 ER

TELEPHONE BOOLE (945 13) 51617 - TELEX 123456

Our Ref. 350/PJC/EAC

18th January, 1972.

Dr. P.N. Cundall,
Mining Surveys Ltd.,
Holroyd Road,
Reading,
Berks.

Dear Pete,

Permit me to introduce you to the facility of facsimile transmission.

In facsimile a photocell is caused to perform a raster scan over the subject copy. The variations of print density on the document cause the photocell to generate an analogous electrical video signal. This signal is used to modulate a carrier, which is transmitted to a remote destination over a radio or cable communications link.

At the remote terminal, demodulation reconstructs the video signal, which is used to modulate the density of print produced by a printing device. This device is scanning in a raster scan synchronised with that at the transmitting terminal. As a result, a facsimile copy of the subject document is produced.

Probably you have uses for this facility in your organisation.

Yours sincerely,

Phil.

P.J. CROSS
Group Leader - Facsimile Research

Figure 6-22
400 lpi

6-24

Cela est d'autant plus valable que $T\Delta f$ est plus grand. A cet égard la figure 2 représente la vraie courbe donnant $|\phi(f)|$ en fonction de f pour les valeurs numériques indiquées page précédente.

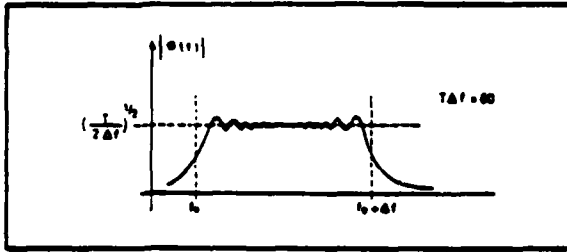

FIG. 2

Dans ce cas, le filtre adapté pourra être constitué, conformément à la figure 3, par la cascade :

— d'un filtre passe-bande de transfert unité pour $f_0 \leq f \leq f_0 + \Delta f$ et de transfert quasi nul pour $f < f_0$ et $f > f_0 + \Delta f$, filtre ne modifiant pas la phase des composants le traversant ;

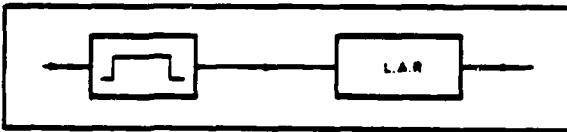

FIG. 3

— filtre suivi d'une ligne à retard (LAR) dispersive ayant un temps de propagation de groupe T_R décroissant linéairement avec la fréquence f suivant l'expression :

$$T_R = T_0 + (f_0 - f) \frac{T}{\Delta f} \quad (\text{avec } T_0 > T)$$

(voir fig. 4).

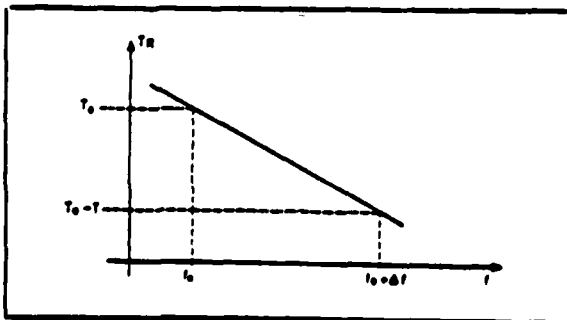

FIG. 4

telle ligne à retard est donnée par :

$$\varphi = -2\pi \int_0^f T_R df$$

$$\varphi = -2\pi \left[T_0 + \frac{f_0 T}{\Delta f} \right] f + \pi \frac{T}{\Delta f} f^2$$

Et cette phase est bien l'opposé de $|\phi(f)|$.

à un déphasage constant près (sans importance) et à un retard T_0 près (inévitabile).

Un signal utile $S(t)$ traversant un tel filtre adapté donne à la sortie (à un retard T_0 près et à un déphasage près de la porteuse) un signal dont la transformée de Fourier est réelle, constante entre f_0 et $f_0 + \Delta f$, et nulle de part et d'autre de f_0 et de $f_0 + \Delta f$, c'est-à-dire un signal de fréquence porteuse $f_0 + \Delta f/2$ et dont l'enveloppe a la forme indiquée à la figure 5, où l'on a représenté simultanément le signal $S(t)$ et le signal $S_1(t)$ correspondant obtenu à la sortie du filtre adapté. On comprend le nom de récepteur à compression d'impulsion donné à ce genre de filtre adapté : la « largeur » (à 3 dB) du signal comprimé étant égale à $1/\Delta f$, le rapport de compression

$$\text{est de } \frac{T}{1/\Delta f} = T\Delta f$$

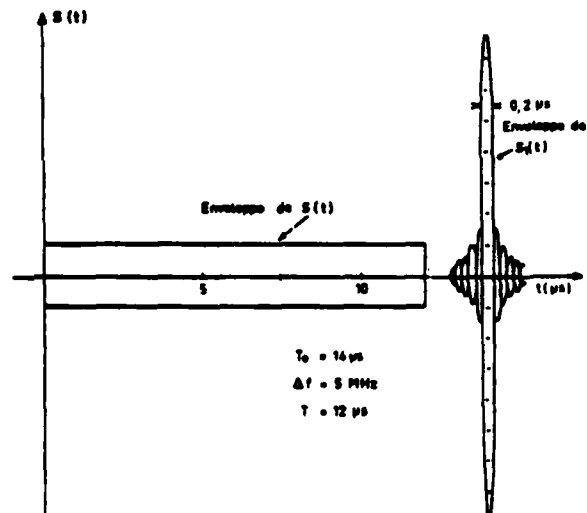

FIG. 5

On saisit physiquement le phénomène de compression en réalisant que lorsque le signal $S(t)$ entre dans la ligne à retard (LAR) la fréquence qui entre la première à l'instant 0 est la fréquence basse f_0 , qui met un temps T_0 pour traverser. La fréquence f entre à l'instant $t = (f - f_0) \frac{T}{\Delta f}$ et elle met un temps

$T_0 - (f - f_0) \frac{T}{\Delta f}$ pour traverser, ce qui la fait ressortir à l'instant T_0 également. Ainsi donc, le signal $S(t)$

CCITTの概要

沿革

CCITTは、国際電気通信連合(ITU)の四つの常設機関(事務総局、国際電報登録委員会、CCIR、CCITT)の一つとして、ITUの中でも、世界の国際通信上の諸問題を真先に取上げ、その解決方法を見出して行く重要な機関である。日本名は、国際電信電話諮問委員会と称する。

CCITTの前身は、CCIF(国際電信諮問委員会)とCCIT(国際電信諮問委員会)である。CCIFは、1924年にヨーロッパに「国際長距離電信諮問委員会」が設置され、これが1925年のパリ電信電話会議のとき、正式に、「国際電信諮問委員会」として万国電信連合の公式機関となったものである。CCITは、同じく1925年の会議のとき、CCIFと併立するものとして設置された。

そして、CCIFは、1956年の12月に第18回総会が開催されたのち、CCITは、同年同月に第8回総会が開催されたのち、併合されて現在のCCITTとなった。このCCITTは、CCIFとCCITが解散した直後、第1回総会を開催し、第2回総会は、1960年にニューアリーで、第3回総会は、1964年、ジュネーブで、第4回総会は、1968年、アルゼンチンで開催された。

CCIFとCCITが合併したのは、有線電気通信の分野、とくに伝送路について電信回線と電話回線とを技術的に分ける意味がなくなってきたこと、各国とも大體において、電信部門と電話部門は同一組織内にあること、CCIFの事務局とCCITの事務局の合併による効率増進等がおもな理由であった。

CCITTは、上述のように、ヨーロッパ内の国々によって、ヨーロッパ内の電信・電話の技術・運用・料金の基準を定め、あるいは統一をはかってきたので、現在でも、その影響を受け、金参加国は、ヨーロッパの国が多く、ヨーロッパで生起する問題の研究が多い。たとえば、1960年のCCITT勧告の中で、技術上配慮する距離は約2,500kmであったが、これはヨーロッパ内領域を想定したものである。

しかしながら、1956年9月に敷設された大西洋横断電話ケーブルは、大陸間電話通信の自動化および半自動化への技術的可能性を与え、CCITTがこの問題を取り上げるに及び、CCITTの性格は漸次、汎世界的色彩を實質的に帯びるに至った。この汎世界的性格は第2次世界大戦後目ざましくなったアジア・アフリカ植民地の独立に伴ってITUの構成員の中にこれらの国が加わり、ITUの中に新しい意見が導入されたことにも起因して、技術面、政治面の双方から導入されてき

た。CCITTの汎世界化は、1960年の第2回総会がニューアリーで開催されたことにもあらわれている。この総会までは、CCIT、CCIFのいずれにしろ、アメリカやアジアで総会が開催されることがなく、CCITT委員長も、ニューアリー総会の準備文書で、この点には注目すべきであるとのべている。

任務

ITUは、全権委員会議、主管庁会議を始めとして、七つの機関をもち、それらの機関の権限と任務は国際電気通信条約に明記されている。そこで条約を参照してみるならば、CCITTの任務は、つぎのとおりとなっている。

「国際電信電話諮問委員会(CCITT)は、電信および電話に関する技術、運用および料金の問題について研究し、および意見を表明することを任務とする。」(1965年モントルー条約第187号)

「各国際諮問委員会は、その任務の遂行に当たって、新しい国または発展の途上にある国における地域的および国際的分野にわたる電気通信の創設、発達および改善に直接関連のある問題について研究し、および意見を作成するように妥當な注意を払わなければならない。」(同第188号)

「各国際諮問委員会は、また、関係国の要請に基づき、その国内電気通信の問題について研究し、かつ、勧告を行なうことができる。」(同第189号)

上記第187号と第188号にいわれる「意見」とは、フランス語の Avis から訳したもので、英語では、「勧告(Recommendation)」となっている。CCITTの表明する意見は、国際法的には強制力をもたないものであって、この点が、条約、電報規則、電話規則等各国を拘束する力をもっているものと異なる。もっとも意見とは称しても、技術的分野では、電信規則のときも、各国政府が承認してその内容を実施する強制規則をもたないので、実際にある機器の仕様を定める場合には、多くの国の意見が統一されたこの「意見」に従わなければ、円滑な国際通信を行なうことができない場合が多い。この意見(または勧告)は、国際通信を行なう場合各国が直面する問題について、具体的意見を表明するもので、たとえば、大陸間ケーブルで大陸間電話を半自動化しようとする場合、その信号方式や取り扱った通話の種類および料金は、どのようにするかを研究して意見を表明する。したがって、CCITTの活動は、つねに時代の最先端を行くもので、CCITTの活動方向は、そのまま世界の国際通信の活動方向であるともいえる。

この意見は、また、電信規則以下のその他の規則のごとく、数年以上の間隔をもって開催される主管庁会議というような大会議の決定をまたなくとも表明することができ、また、その改正も容易であるので、現在のように進歩の早い国際通信界では、関係国の意見を統一した国際的見解としては非常に便利である。

7.0 IMAGE ANALYSIS

Four different types of image analysis were performed. The procedures and results of each analysis are summarized in the following subsections.

- o Measurement of legibility using the Legibility Test Document
- o Evaluation of Half-tone performance using the Legibility Test Document
- o Evaluation of the relative quality of the 3 CCITT images as a function of resolution
- o Subjective evaluation of effectiveness of the Alternate Line Interpolation algorithm

7.1 Measurement of Legibility

The objective of this test was to obtain a quantitative measure of the legibility or intelligibility of a hypothetical Group 4 facsimile system as a function of resolution. The textual portions of the Legibility Test Chart was used for this purpose.

Test Procedure

A number of subjects were used to read the random characters in the Legibility Test Chart. This, of course, is necessary to insure the test results are not dependent upon a particular subject. The subjects were required to illuminate the characters with a special lamp, but special viewing optics are not used. If the subject normally wears reading glasses they were worn in the test. If he does not use glasses no optical aids were used.

Before a subject took the test he was given a set of instructions to read. The instructions are reproduced in the following two pages.

The instructions refer to a yellow sheet with a number of rectangular holes to expose the 5-character nonsense words. There are four different masks and a copy of Mask #1 is included in Figure 7-1. The instructions also refer to a score sheet. Figure 7-2 is a copy of the score sheet which was used in the test.

Test Schedule

Table 7-1 is a summary of the tests which were performed. A "trial" is defined as the set of readings taken when a subject reads one test page. In a trial the subject reads 48 sets of 5 characters using a particular combination of resolution and mask. The maximum number of trials performed by one subject is 8. A total of nine subjects were involved in the test to varying degrees.

Test Results

The raw test data has been accumulated and tabulated in Appendix H. The final test results are plotted in Figure 7-3. On the ordinate is plotted the percentage of characters which were correctly read for any particular resolution and font size. The following conclusions are drawn from the data.

- o The legibility of 6, 8, and 10 point type is near 100% for all resolutions down to 200 x 200.
- o For 4 point type there is a greater variation in legibility but even at 200 x 200 the legibility is 90%.

INSTRUCTIONS

The U. S. Defense Communications Agency has awarded a contract to Delta Information Systems to measure the legibility of a series of test documents. Although all the test documents may look alike to the casual observer they are different, and it is these differences which we are measuring. The results of these tests will be used to help set international standards for future facsimile equipment. These facsimile equipments will be designed to transmit documents over digital communication networks.

You will be given a page with varying sizes and styles of printing, and asked to read the characters to the best of your ability. This is not a test of your visual acuity, but rather a test of various methods of processing graphic data.

The yellow sheet has holes in it that expose 5-character nonsense words. Attempt to read the characters in each word, starting at the bottom with the smallest print. Beside each hole is a number, usually to the left. Record the characters you read on the score sheet opposite the same number.

Keep in mind the following rules and information:

1. If you are not sure about a character, guess.
2. With a sheet of paper, cover all the words above the one you are working on.
3. After you have completed a word do not go back and make any changes.

4. Use your normal reading glasses, but not a magnifier.
5. Use the high-intensity lamp to provide as much light as you need.
6. You may get as close as you wish to the page to try to identify the characters.
7. You may take as much time as you feel is needed to identify the characters. It should not take more than 15 minutes to complete the test.
8. The character set is upper and lower case letters, and numerals.
9. Do not be concerned with distinguishing between "zero" and upper case "O", or between "one" and lower case "L".
10. Your entries on the score sheet may be upper or lower case, and do not have to correspond with the case of the character you have read.

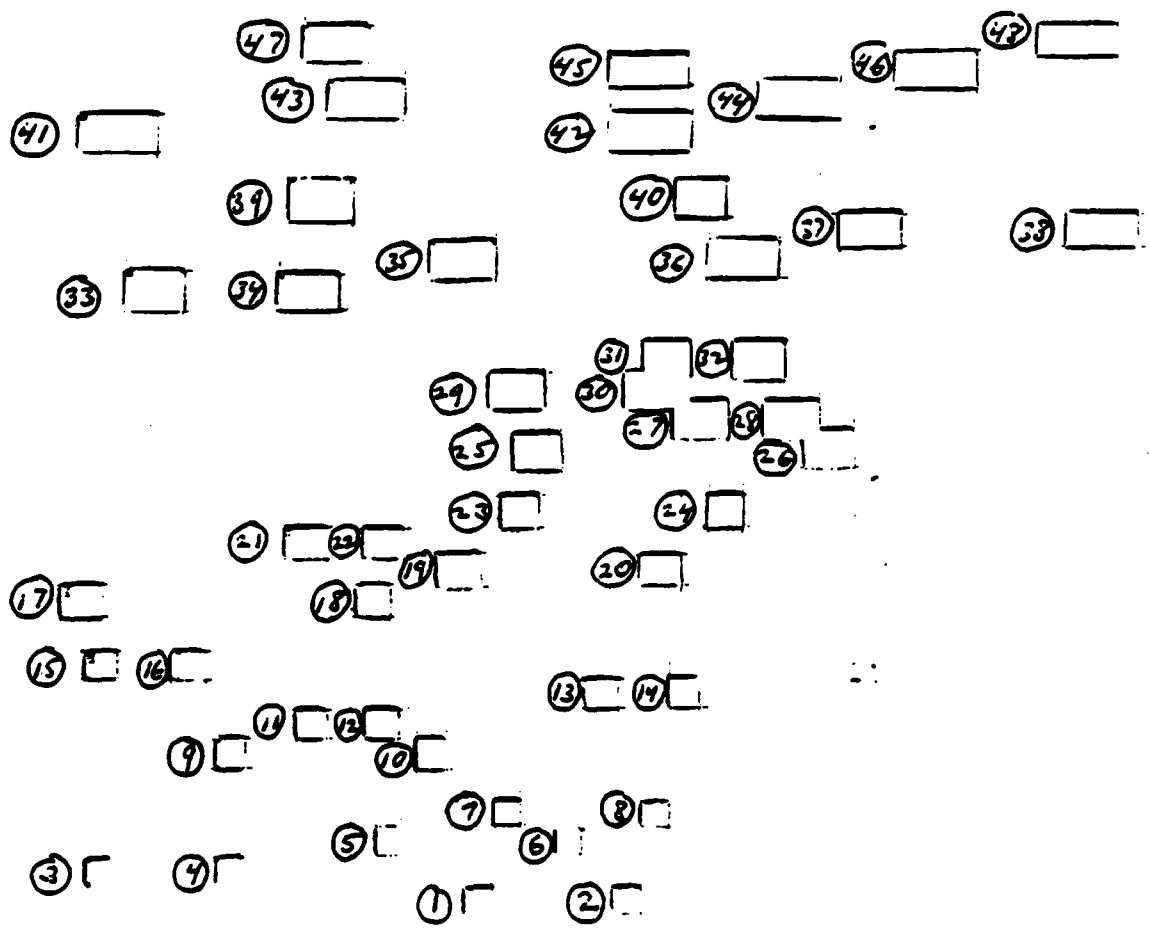

Figure 7-1
Mask for Legibility Test

LEGIBILITY SCORE SHEET

Figure 7-2

WORD NO.	CHARACTERS	WORD NO.	CHARACTERS	DO NOT MARK IN THESE COLUMNS
1		2		2pt.
3		4		
5		6		
7		8		
9		10		3pt.
11		12		
13		14		
15		16		
17		18		4pt.
19		20		
21		22		
23		24		
25		26		6pt.
27		28		
29		30		
31		32		
33		34		8pt.
35		36		
37		38		
39		40		
41		42		10pt.
43		44		
45		46		
47		48		

Date: _____
 Subject: _____
 Pattern No.: _____
 Tester: _____
 Processing: _____

SUBJ.		TRIAL							
		1	2	3	4	5	6	7	8
1	RESOL	200	240	300	400	480	ORIG	400I	
	MASK	2	3	4	1	2	3	1	
2	RESOL	200	240	300	400	480	ORIG	400I	
	MASK	3	4	2	1	3	2	1	
3	RESOL	200	200	240	300	400	480	ORIG	400I
	MASK	4	3	1	2	1	4	2	3
4	RESOL	200							
	MASK	2							
5	RESOL	240	300						
	MASK	3	4						
6	RESOL	240	200	300	480	480	400		ORIG
	MASK	1	2	4	2	3	1		3
7	RESOL	240	300	400	480				
	MASK	4	2	1	3				
8	RESOL	240	200	ORIG	400	400I	ORIG	480	
	MASK	2	3	4	1	3	2	1	
9	RESOL	300	240	400	480	ORIG	200	400I	
	MASK	2	3	1	4	2	1	3	

Table 7-1
LEGIBILITY TEST SCHEDULE

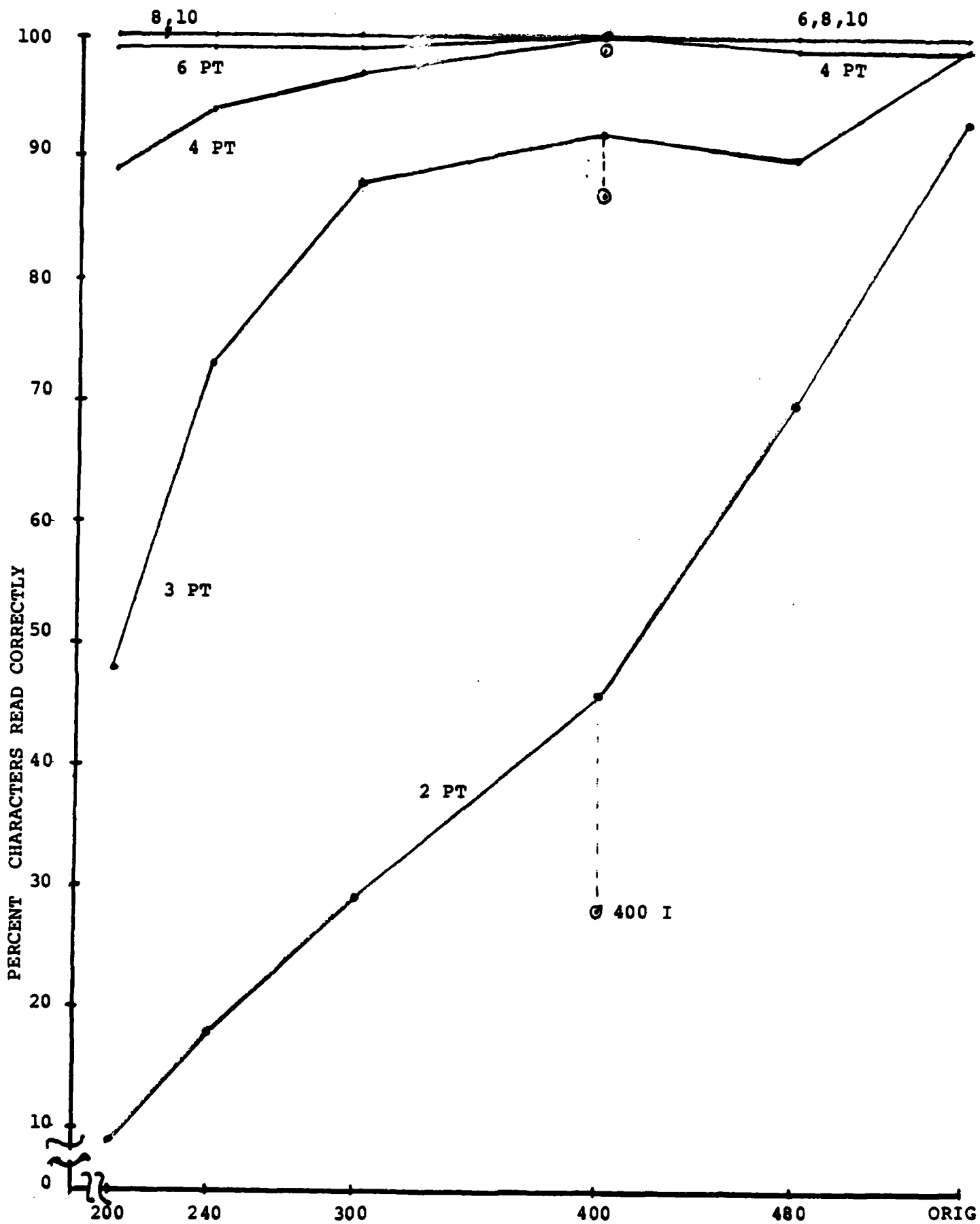

Figure 7-3

- o The legibility curve for 3 point type is most interesting. There is a large increase in intelligibility from 200 x 200 to 300 x 300 - 40%. On the other hand the increase from 300 x 300 to 400 x 400 is only 4%.
- o The intelligibility of the interpolated image for 3 point text drops only 5% relative to the original 400 x 400 image. It would seem highly advantageous to reduce the transmitted bits in half while impacting the intelligibility so little.

7.2 Evaluation of Half Tone in Legibility Test Chart

- o 200 x 200 - The distortions in the 133 and 150 line screen image of the girl is quite severe.
- o 240 x 240 - The distortion in the 85 line screen of the girl is quite severe.
- o 300 x 300 - The beat distortions in the girl pictures are greatly reduced relative to the lower resolutions.
- o 400 x 400 - Good quality for 65, 85, 120 line screens - almost free of beats.
- o 480 x 480 - More distortion than 400 x 400

7.3 Quality of CCITT Images

CCITT No. 1 (Figures 6-6 through 6-10)

The most noticeable variation in quality as a function of resolution appears in the logo and signature. The raggedness of the logo and signature is quite perceptible at 200 x 200 and 240 x 240 line resolutions. It is marginally

perceptible at 300 x 300 and virtually imperceptible at 400 x 400 and 480 x 480.

CCITT No. 5 (Figure 6-11 through 6-15)

This image is most useful for evaluation of quality due to the large number of vertical and horizontal lines. The eye is most sensitive to raggedness on these lines. The improvement of 300 x 300 over 200 x 200 is very significant. However, the raggedness on the 300 x 300 image is still perceptible. It is unlikely that the raggedness on the 400 x 400 image would be noticed by the casual user.

CCITT No. 7 (Figures 6-16 through 6-20)

Several of the delicate Kanji characters are seriously distorted by the 200 x 200 and 240 x 240 resolutions. Most of the significant distortion is eliminated at 300 x 300 lines but the clarity at 400 x 400 and 480 x 480 is visibly superior to 300 x 300.

7.4 Subjective Evaluation of Interpolation (Figure 6-21 through 6-24)

Legibility Test Chart

The half-tone scenes are significantly distorted by the interpolation process when the interpolated image is compared with the 400 x 400 original.

CCITT No. 1

The interpolated image appears quite comparable to the 400 x 400 original. The interpolation on the logo and signature appears to perform very well.

CCITT No. 5

The interpolated image compares quite favorably with the 400 x 400 original.

CCITT No. 7

The interpolated image distorts many of the Kanji characters quite seriously. In many cases the quality is comparable to the 200 x 200 lpi images.

8.0 CONCLUSIONS

It is inappropriate for this report to draw any firm conclusions or recommendations regarding resolution for Group 4 facsimile systems. This is due to the fact that technical factors such as intelligibility and quality are merely one issue to be considered in selecting a standard. Other issues such as compatibility with other facsimile groups and word processing standards could have a great impact on the standard selected.

The purpose of this study is merely to provide a base of technical data to those groups deliberating upon the Group 4 standard. The technical data which has been generated by this study and which should be useful for these deliberations are listed below.

- o Perhaps the most important output of the study is the set of 24 images which are included in Figures 6-1 through 6-24. The copies in this report are of limited value since the quality at the high resolution has been reduced by the printing process. Dennis Bodson, the COTR on the project, has a high quality set of prints.
- o Compression Analysis - Section 5.0 provides data on the compression ratios for the modified READ Code at varying resolutions.
- o Legibility - Section 7.1 provides data on the legibility/intelligibility of a facsimile system as a function of resolution.

o Quality - Sections 7.2, 7.3, and 7.4 provide general subjective comments on image quality for a facsimile system as a function of resolution.

APPENDIX A

IMAGE SCANNING AND WRITING SYSTEM

Image Scanning and Writing System

The image scanning and writing system provides a unique capability within APL for the computer processing of color and black and white photographic data. A photographic image on either film or opaque paper can be scanned and digitized, and the resultant data then written on a computer storage medium such as magnetic tape or disk. Conversely, properly formatted computer data can be written on film (either ordinary silver halide film or Polaroid film) to construct a photographic image. Computer processing of the data provides a powerful means for image analysis, manipulation, and enhancement. The computer processing can be performed by either the PDP-11/70 or the central computing system. The choice depends on the characteristics of the processing to be performed. Standard image processing programs are available now, and special application programs can be prepared on request.

The system uses two units of equipment purchased from Optronics International, Inc. One unit (a P-1700) scans both black and white (B/W) and color images and also writes B/W images; the other unit (a C-4300) writes both B/W and color images, but is used ordinarily for writing only color images. The P-1700 is shown in Figure 3. The C-4300 (not shown) is similar to the P-1700 but does not include scanning components.

Data are transmitted between the PDP-11/70 and the scanning or writing device as eight-bit bytes at a rate of 28 kilobytes per second. Each byte represents the density of one square picture element, a "pixel." Pixel sizes are selectable in six geometrically increasing steps from 12.5 micrometers to 400 micrometers. With eight-bit bytes, 256 density levels can be represented. For scanning operations, one may confidently expect a density resolution approaching that number. For writing operations, 64 repeatable density levels for B/W and 32 for each primary color can be achieved.

Both the P-1700 and the C-4300 employ electro-mechanical rotating drums for scanning and writing. Color scan and color write operations are performed using filters for the three (additive) primary colors, red, green, and blue. Color operations, therefore, require three passes for scanning or writing.

Both units accommodate media in sizes up to 10-in. by 10-in., but the maximum usable image area is 9-in. by 9-in. in the P-1700 and 9-in. by 10-in. in the C-4300. Film types stocked for the image writer are as follows: Linagraph Shellburst 2474 (B/W, 10-in. by 10-in.); Ektachrome SO-278, emulsion equipment to 27-160 amateur film, process E-6 (color transparency, 10-in. by 10-in.); and Polacolor 2, type 808 (fast color prints, 8-in. by 10-in.).



Figure 2. Dicomed D48C and PDP-11/70
A-2

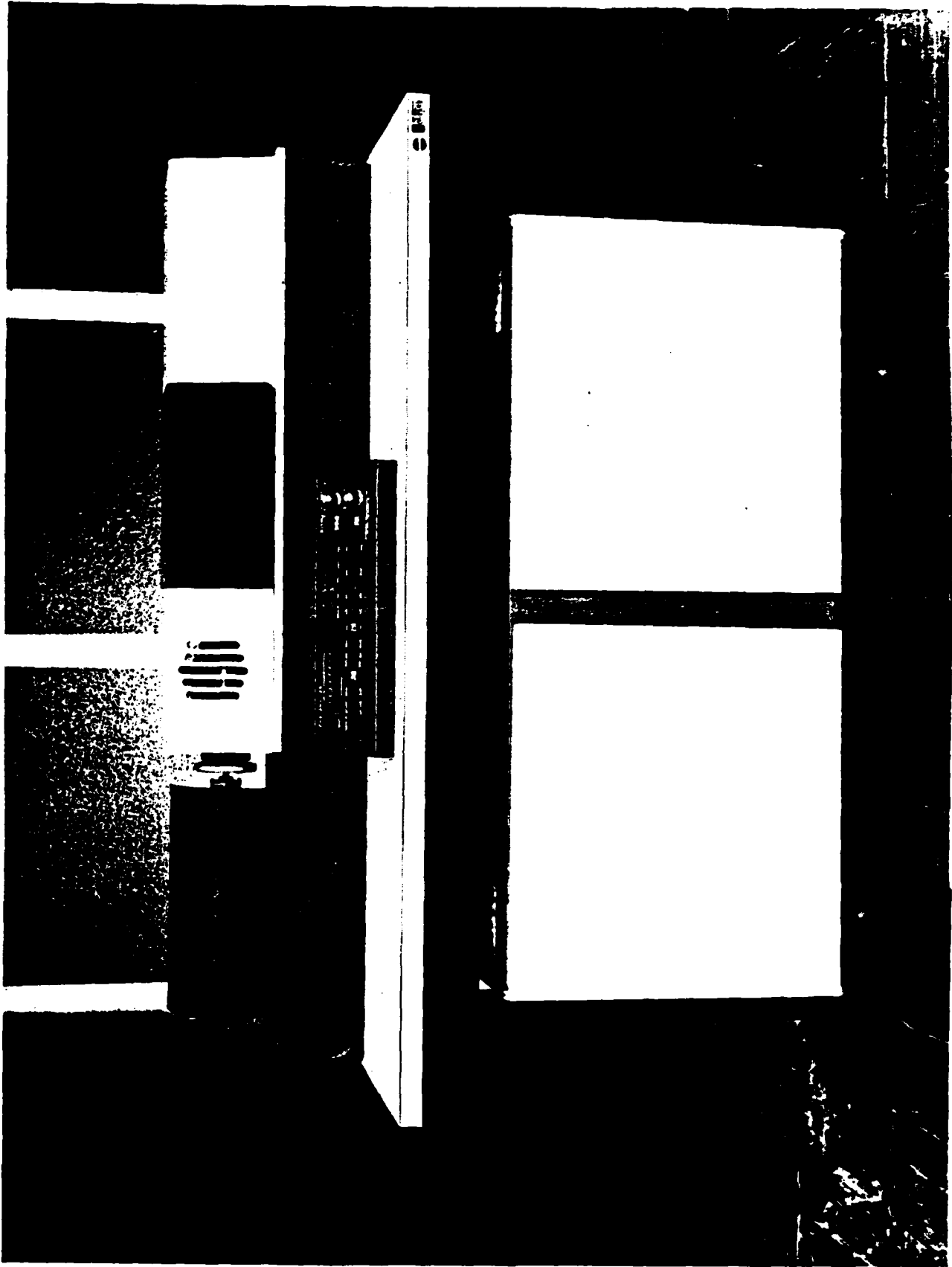

Figure 3. P-1700 Image Scanning and Writing System

Scanning Operations

The scanning portion of the P-1700 (used for both B/W and color) consists of a rotating, horizontally aligned drum and a movable "C" carriage. One arm of the carriage moves into and out of the open-ended drum along a line parallel to the drum's axis. The other arm of the carriage, rigid with respect to the first arm, is located outside the drum. The medium to be scanned is attached to the periphery of the drum where a section of the wall has been removed. Drum rotation and carriage movement provide the Y and X scanning motions, respectively.

The light source is a halogen-filled incandescent lamp located away from the carriage area; light is transmitted from the source to the carriage area by means of fiber optics bundles. For scanning transparencies, the light is emitted from the end of the arm within the carriage and transmitted through the transparency to a photodetector mounted on the carriage arm outside the drum. For scanning opaque media, the light is emitted from the carriage arm outside the drum and reflected from the medium to the detector.

Before it is emitted, the light is transmitted through an optical system that ensures uniform illumination, focusing, and spot size selection. Before its intensity is measured by the densitometer photodetector, the light passes through an imaging aperture. Each measurement defines the density of one pixel. The output from the photodetector is amplified logarithmically (giving a selectable density range of 0-2D or 0-3D) or linearly (giving a transmittance range of 0 to 100 percent).

Around the circumference of the drum (Y direction), the optical density is measured at the selected pixel interval. After each drum revolution, a precision lead screw and stepping motor move the "C" carriage axially (in the X direction) by the raster width (pixel dimension) until the entire area of interest has been scanned. Pixel positional accuracy in both X and Y is ± 2 micrometers rms/cm. Once per revolution, the densitometer photodetector is reset to an optical density of 0 as defined by the air path through an opening in the drum, or from a reflector on the drum if an opaque medium is being scanned.

Writing Operations

For write operations, eight-bit bytes from the computer are converted to analog signals, which modulate a light source to expose the photosensitive medium. The P-1700 is used for writing B/W images, and the C-4300 is used for writing color images. The writing portion of each device includes a rotating drum to which the unexposed medium is attached in a darkroom. The drum is enclosed in a light-tight cassette, which can be easily attached to and removed from the device proper. (A slide opening on the cassette permits exposure of the medium when the cassette is

attached.) The optical system that writes on the film is located on a carriage under the cassette, and it is moved by the same precision lead screw and stepping motor as the scanning carriage.

For the C-4300 (color writing), the optical system consists of a white-light glow crater tube, a color-filter select assembly, a selectable aperture, and a lens system to focus the beam onto the film plane. The film is exposed at every selected raster point along the circumference of the drum (Y direction) by pulse modulation of the light beam, and the optical carriage is stepped in the axial (X) direction by the raster width after each revolution of the drum. The C-4300 is capable of writing up to 32 repeatable density levels for each primary color and has a dynamic range of 0-2D.

The writing portion of the P-1700 (B/W writing) differs from the C-4300 principally in that a red light-emitting diode is used as the source, rather than a white-light glow crater tube. This difference in light source allows B/W imagery to be written with greater or lesser resolution (smaller or larger pixel sizes) than color imagery. The P-1700 is capable of writing up to 64 repeatable density levels and has a dynamic range of 0-2.5D.

Functional characteristics and specifications of the image processing system are summarized in Figure 4. A chart of the scan and write times as a function of specimen size (at different resolutions) is given in Figure 5.

Figure 4
Image Processing System
Functional Characteristics and Specifications

Operation	Pixel/Raster Size in μm	Range*	Resolvable Levels
SCANNING Black & White and Color (P-1700)	12.5, 25, 50, 100, 200 & 400	0-2D or 0-3D or 0-100XT	256
WRITING Black & White (P-1700)	12.5, 25, 50, 100, 200 & 400	0-2.5D	64
WRITING Color (C-4300)	25, 50, 100 & 200	0-2D	32/Color

* D (density) = $\text{Log}_{10} [I(i)/I(t)]$,
T (transmittance) = $[I(t)/I(i)]$,
where I(i) = incident light and
I(t) = transmitted light

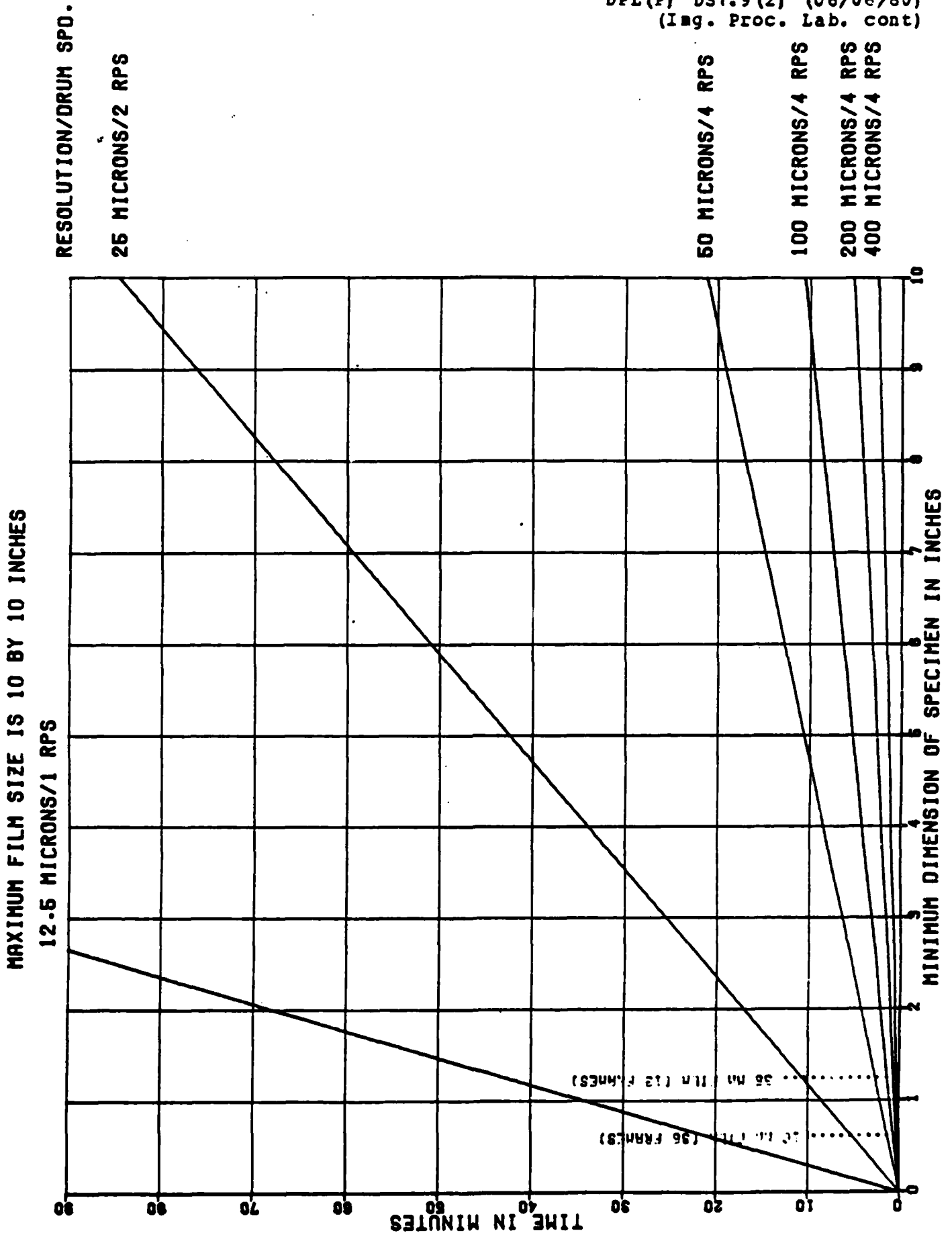

Figure 5. Scan and Write Times

APPENDIX B

EIA RS 465

Group 3 Facsimile Apparatus for
Document Transmission

GROUP 3 FACSIMILE APPARATUS FOR DOCUMENT TRANSMISSION

(From EIA Standards Proposal No. 1301-A, formulated under the cognizance of EIA TR-29 Committee on Facsimile Systems and Equipment.)

INTRODUCTION

This standard is based upon the International Telegraph and Telephone Consultative Committee (CCITT) Recommendation T.4 approved by CCITT Study Group XIV. It conforms in all essential aspects with this CCITT Recommendation.

SCOPE

This standard is concerned with the characteristics of inter-operability affecting Group 3 facsimile equipment operating on voice band analog circuits. This equipment incorporates means for reducing the redundancy in its message information prior to the modulation process and thus achieves a nominal transmission time of one minute for a typical full-page typescript document. Where options are indicated, the identification and choice of these options is to be made in the pre-message portion of the control procedures as standardized in EIA Standard RS-466.

1. Scanning Track

The message area shall be scanned in the same direction in the transmitter and receiver. Viewing the message area in a vertical plane, the picture elements shall be processed as if the scanning direction were from left to right with subsequent scans adjacent and below the previous scan.

2. Dimensions of Apparatus

The following dimensions shall be used :

2.1 A standard resolution and an optional higher resolution of 3.85 line/mm $\pm 1\%$ and 7.7 line/mm $\pm 1\%$ respectively in vertical direction;

2.2 1728 black and white picture elements along the standard scan line length of 215 mm $\pm 1\%$;

2.3 Optionally, 2048 black and white picture elements along a scan line length of 255 mm $\pm 1\%$;

2.4 Optionally, 2432 black and white picture elements along a scan line length of 303 mm $\pm 1\%$.

Input documents up to a minimum of 216 x 297 mm size shall be accepted.

3. Transmission Time Per Total Coded Scan Line

For the standard one-dimensional coding scheme as described in paragraph 4.1, the total coded scan line is defined as the sum of DATA bits plus any required FILL bits plus the EOL bits.

For the optional two-dimensional coding scheme as described in paragraph 4.2, the total coded scan line is defined as the sum of DATA bits plus any required FILL bits plus the EOL bits plus a tag bit.

3.1 To handle various printing methods, several minimum total coded scan line times are possible. The minimum transmission times of the total coded scan line shall conform to the following:

3.1.1 Alternative 1, where the minimum transmission time of the total coded scan line is same both for the standard resolution and for the optional higher resolution,

3.1.1.1 20 milliseconds standard,

3.1.1.2 10 milliseconds option with a mandatory fall-back to the 20 milliseconds standard,

3.1.1.3 5 milliseconds option with a mandatory fall-back to the 10 milliseconds option and the 20 milliseconds standard,

3.1.1.4 0 millisecond option with a mandatory fall-back to the 5 milliseconds option, and the 10 milliseconds option and the 20 milliseconds standard and an optional fall-back to the 40 milliseconds option,

3.1.1.5 40 milliseconds option,

3.1.2 Alternative 2, where the minimum transmission time of the total coded scan line for the optional higher resolution is half of that for the standard resolution (see note). These figures refer to the standard resolution.

3.1.2.1 10 milliseconds option with a mandatory fall-back to the 20 milliseconds standard,

3.1.2.2 20 milliseconds standard,

3.1.2.3 40 milliseconds option.

The identification and choice of this minimum transmission time shall be made in the pre-message (Phase B) portion of the EIA Standard RS-466 control procedure.

Note: Alternative 2 applies to equipment with printing mechanisms which achieve the standard vertical resolution by printing two consecutive, identical higher resolution lines. In this case, the minimum transmission time of the total coded scan line for the standard resolution is double the minimum transmission time of the total coded scan line for the higher resolution.

3.2 The maximum transmission time of any total coded scanning line shall be less than 5 seconds. When this transmission time exceeds 5 seconds, the receiver shall proceed to disconnect the line.

4. Coding Scheme

4.1 One-dimensional Coding Scheme

The standard one-dimensional run length coding scheme for Group 3 apparatus is as follows :

4.1.1 DATA

A line of DATA is composed of a series of variable length code words. Each code word represents a run length of either all white or all black. White runs and black runs alternate. A total of 1728 picture elements represent one horizontal scan line of 215 mm length. In order to insure that the receiver maintains colour synchronization, all DATA lines will begin with a white run length code word. If the actual scan line begins with a black run, a white run length of zero will be sent. Black or white run lengths, up to a maximum length of one scan line (1728 picture elements or pels) are defined by the code words in Tables 1 and 2. The code words are of two types: Terminating Code words and Make Up Code words. Each run length is represented by either one Terminating Code word or one Make Up Code word followed by a Terminating Code word.

Run lengths in the range of 0 to 63 pels are encoded with their appropriate Terminating Code word. Note that there is a different list of code words for black and white run lengths.

Run lengths in the range of 64 to 1728 pels are encoded first by the Make Up Code word representing the run length which is equal to or shorter than that required. This is then followed by the Terminating Code word representing the difference between the required run length and the run length represented by the Make Up Code.

4.1.2 End of Line (EOL)

This code word follows each line of DATA. It is a unique code word that can never be found within a valid line of DATA; therefore, resynchronization after an error burst is possible.

In addition, this signal will occur prior to the first DATA line of a page.

Format: 000000000001

4.1.3 FILL

A pause may be placed in the message flow by transmitting FILL. FILL may be inserted between a line of DATA and an EOL, but never within a line of DATA. FILL must be added to insure that the transmission time of DATA, FILL and EOL is not less than the minimum transmission time of the total coded scan line established in the pre-message control procedure.

Format: variable length string of 0's.

4.1.4 Return to Control (RTC)

The end of a document transmission is indicated by sending six consecutive EOL's. Following this RTC signal, the transmitter will send the post message commands in the framed format and the data rate of the control signals defined in EIA Standard RS-466.

Format: 000000000001-----000000000001
(total of 6 times)

Figures 1 and 2 clarify the relationship of the signals defined herein. Figure 1 shows several scan lines of data starting at the beginning of a transmitted page. Figure 2 shows the last coded scan line of a page.

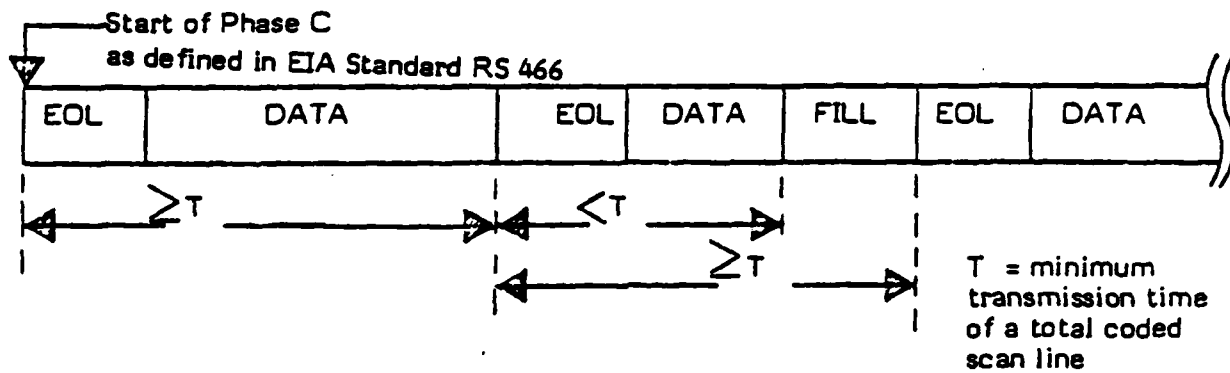

FIGURE 1

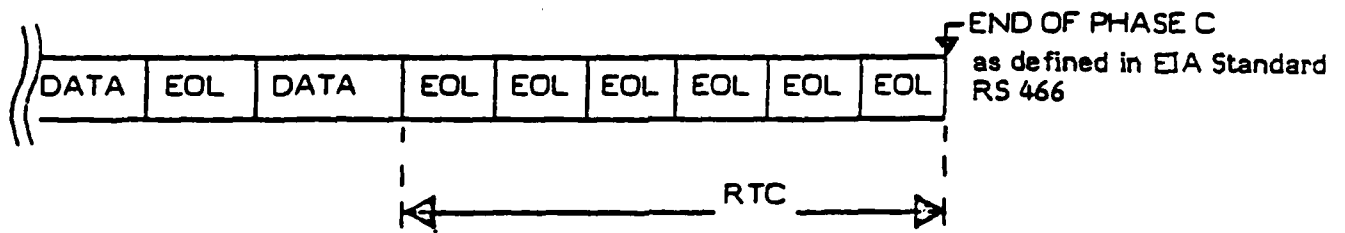

FIGURE 2

TABLE 1
Terminating Codes

White Run Length	Code Word	Black Run Length	Code Word
0	00110101	0	0000110111
1	000111	1	010
2	0111	2	11
3	1000	3	10
4	1011	4	011
5	1100	5	0011
6	1110	6	0010
7	1111	7	00011
8	10011	8	000101
9	10100	9	000100
10	00111	10	0000100
11	01000	11	0000101
12	001000	12	0000111
13	000011	13	00000100
14	110100	14	00000111
15	110101	15	000011000
16	101010	16	0000010111
17	101011	17	0000011000
18	0100111	18	0000001000
19	0001100	19	00001100111
20	0001000	20	00001101000
21	0010111	21	00001101100
22	0000011	22	00000110111
23	0000100	23	00000101000
24	0101000	24	00000010111
25	0101011	25	00000011000
26	0010011	26	000011001010
27	0100100	27	000011001011
28	0011000	28	000011001100
29	00000010	29	000011001101
30	00000011	30	000001101000
31	00011010	31	000001101001
32	00011011	32	000001101010
33	00010010	33	000001101011
34	00010011	34	000011010010
35	00010100	35	000011010011
36	00010101	36	000011010100
37	00010110	37	000011010101
38	00010111	38	000011010110
39	00101000	39	000011010111
40	00101001	40	000001101100
41	00101010	41	000001101101
42	00101011	42	000011011010
43	00101100	43	000011011011
44	00101101	44	000001010100
45	00000100	45	000001010101
46	00000101	46	000001010110
47	00001010	47	000001010111
48	00001011	48	000001100100
49	01010010	49	000001100101
50	01010011	50	000001010010
51	01010100	51	000001010011
52	01010101	52	000000100100
53	00100100	53	000000110111
54	00100101	54	000000111000
55	01011000	55	000000100111
56	01011001	56	000000101000
57	01011010	57	000001011000
58	01011011	58	000001011001
59	01001010	59	000000101011
60	01001011	60	000000101100
61	00110010	61	000001011010
62	00110011	62	000001100110
63	00110100	63	000001100111

TABLE 2
Make Up Codes

White Run Lengths	Code Word	Black Run Lengths	Code Word
64	11011	64	000001111
128	10010	128	000011001000
192	010111	192	000011001001
256	0110111	256	000001011011
320	00110110	320	000000110011
384	00110111	384	000000110100
448	01100100	448	000000110101
512	01100101	512	0000001101100
576	01101000	576	0000001101101
640	01100111	640	0000001001010
704	011001100	704	0000001001011
768	011001101	768	0000001001100
832	011010010	832	0000001001101
896	011010011	896	0000001110010
960	011010100	960	0000001110011
1024	011010101	1024	0000001110100
1088	011010110	1088	0000001110101
1152	011010111	1152	0000001110110
1216	011011000	1216	0000001110111
1280	011011001	1280	0000001010010
1344	011011010	1344	0000001010011
1408	011011011	1408	0000001010100
1472	010011000	1472	0000001010101
1536	010011001	1536	0000001011010
1600	010011010	1600	0000001011011
1664	011000	1664	0000001100100
1728	010011011	1728	0000001100101
EOL	000000000001	EOL	000000000001

Note: It is recognized that some machines may choose to accommodate larger paper widths while maintaining the standard horizontal resolution. This option has been provided for by the addition of the Make Up Code Set defined as follows:

<u>Run Length</u> <u>(Black and White)</u>	<u>Make Up Codes</u>
1792	00000001000
1856	00000001100
1920	00000001101
1984	000000010010
2048	000000010011
2112	000000010100
2176	000000010101
2240	000000010110
2304	000000010111
2368	000000011100
2432	000000011101
2496	000000011110
2560	000000011111

The identification and choice of either the standard code table or the extended code table is to be made in the pre-message (Phase B) portion of the control procedures defined in EIA Standard RS-466.

4.2 Two-dimensional Coding Scheme

The two-dimensional coding scheme is an optional extension of the one-dimensional coding scheme specified in Paragraph 4.1 and is as follows:

4.2.1 DATA

4.2.1.1 Parameter K

In order to limit the disturbed area in the event of transmission errors, after each line coded one-dimensionally at most $K-1$ successive lines shall be coded two-dimensionally. A one-dimensionally coded line may be transmitted more frequently than every K line. After a one-dimensional line is transmitted, the next series of $K-1$ two-dimensional lines is initiated. The maximum value of K shall be set as follows:

Standard vertical resolution: $K = 2$

Optional higher vertical resolution: $K = 4$

4.2.1.2 One-dimensional Coding

This conforms with the description of DATA, Paragraph 4.1.1.

4.2.1.3 Two-dimensional Coding

This is a line-by-line coding method in which the position of each changing picture element on the current or coding line is coded with respect to the position of a corresponding reference element situated on either the coding line or the reference line which lies immediately above the coding line. After the coding line has been coded it becomes the reference line for the next coding line.

a) Definition of changing picture elements (see Figure 3)

A changing element is defined as an element whose color (i.e. black or white) is different from that of the previous element along the same scan line.

a_0 The reference or starting changing element on the coding line. At the start of the coding line a_0 is set on an imaginary white changing element situated just before the first element on the line. During the coding of the coding line, the position of a_0 is defined by the previous coding mode. (See Paragraph 4.2.1.3,b)

a_1 The next changing element to the right of a_0 on the coding line.

a_2 The next changing element to the right of a_1 on the coding line.

b_1 The first changing element on the reference line to the right of a_0 and of opposite color to a_0 .

b_2 The next changing element to the right of b_1 on the reference line.

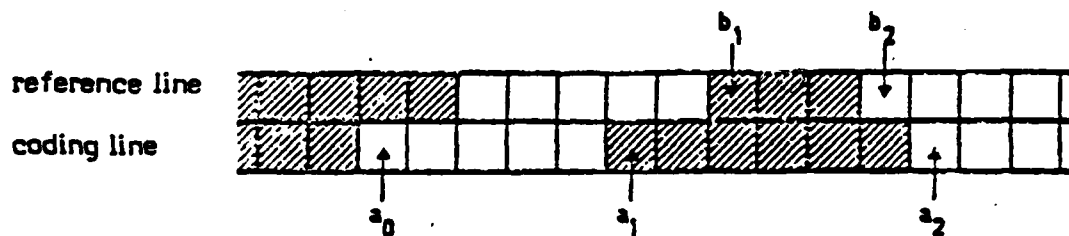

FIGURE 3 - Changing Picture Elements

b) Coding Modes

One of three coding modes are chosen according to the coding procedure described in Paragraph 4.2.1.3,c to code the position of each changing element along the coding line. Examples of the three coding modes are given in Figures 4, 5 and 6.

(i) Pass mode

This mode is identified when the position of b_2 lies to the left of a_1 .

When this mode has been coded, a_0 is set on the element of the coding line below b_2 in preparation for the next coding. (i.e. on a_0')

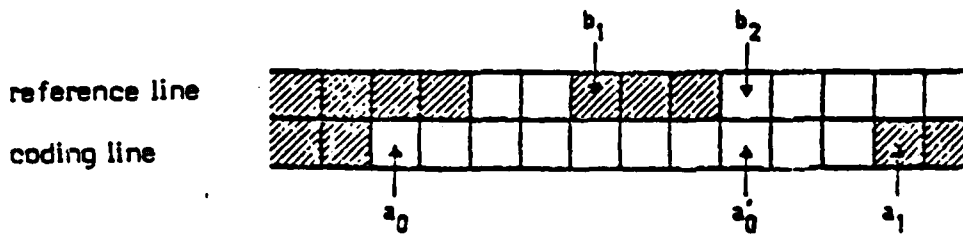

FIGURE 4 - Pass mode

However, the state where b_2 occurs just above a_1 , as shown in Figure 5, is not considered as a Pass mode.

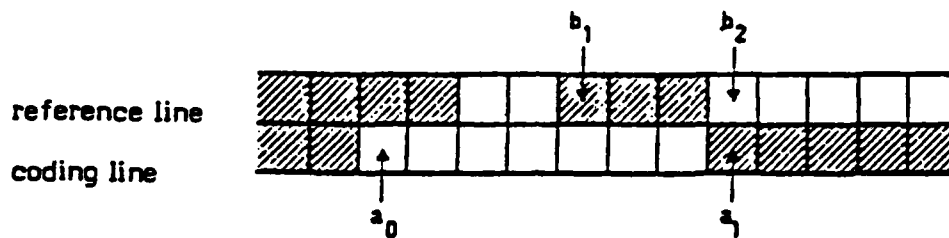

FIGURE 5 - An example not corresponding to a Pass mode

(ii) Vertical mode

When this mode is identified, the position of a_1 is coded relative to the position of b_1 . The relative distance $a_1 b_1$ can take on one of seven values $V(0)$, $V_R(1)$, $V_R(2)$, $V_R(3)$, $V_L(1)$, $V_L(2)$ and $V_L(3)$, each of which is represented by a separate code word. The subscripts R and L indicate that a_1 is to the right or left respectively of b_1 , and the number in brackets indicates the value of the distance $a_1 b_1$. After vertical mode coding has occurred, the position of a_0 is set on a_1 . (see Figure 6)

(iii) Horizontal mode

When this mode is identified, both the run-lengths $a_0 a_1$ and $a_1 a_2$ are coded using the code words $H + M(a_0 a_1) + M(a_1 a_2)$. H is the flag code word '001' taken from the two-dimensional code table (Table 3). $M(a_0 a_1)$ and $M(a_1 a_2)$ are code words which represent the length and color of the runs $a_0 a_1$ and $a_1 a_2$ respectively and are taken from the appropriate white or black one-dimensional code tables (Tables 1 and 2). After a horizontal mode coding, the position of a_0 is set on a_2 . (see Figure 6)

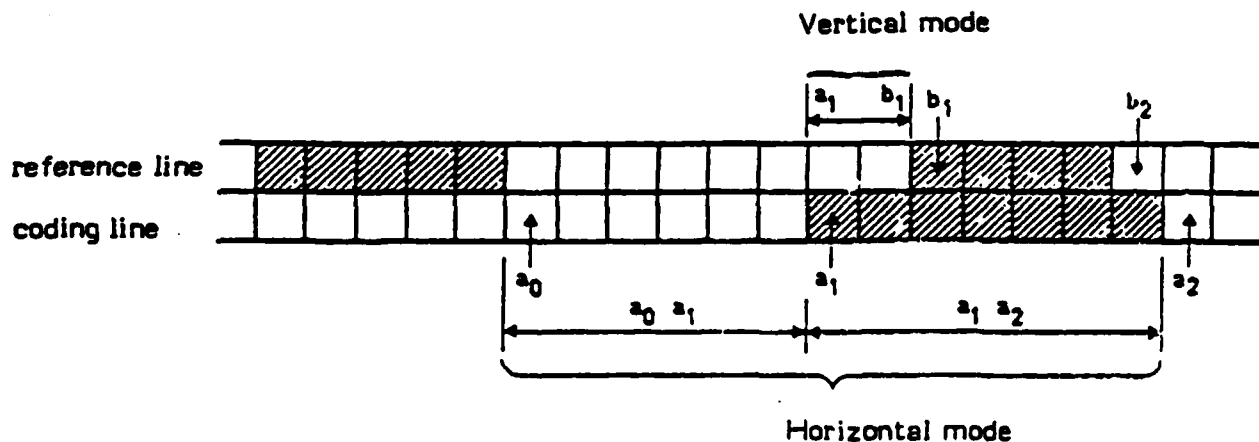

FIGURE 6 - Vertical mode and Horizontal mode

c) Coding Procedure

The coding procedure identifies the coding mode that is to be used to code each changing element along the coding line. When one of the three coding modes has been identified according to Step 1 or Step 2 mentioned below, an appropriate code word is selected from the code table given in Table 3. The coding procedure is as shown in the flow diagram of Figure 9.

Note: It does not affect compatibility to restrict the use of Pass mode in the encoder to a single Pass mode.

Step 1

- i) If a pass mode is identified this is coded using the code word '0001' (Table 3). After this processing, picture element a_0' just under b_2 is regarded as the new starting picture element a_0 for the next coding. (see Figure 4)
- ii) If a pass mode is not detected then proceed to Step 2.

Step 2

- i) Determine the absolute value of the relative distance a_1b_1 .
- ii) If $|a_1b_1| \leq 3$, as shown in Table 3, a_1b_1 is coded by Vertical mode, after which position a_1 is regarded as the new starting picture element a_0 for the next coding.
- iii) If $|a_1b_1| > 3$, as shown in Table 3, following Horizontal mode code '001', a_0a_1 and a_1a_2 are respectively coded by one-dimensional coding. After this processing position a_2 is regarded as the new starting picture element a_0 for the next coding.

TABLE 3
Two-dimensional code table

MODE	ELEMENTS TO BE CODED		NOTATION	CODE WORD
PASS	b_1, b_2		P	0001
HORIZONTAL	$a_0 a_1, a_1 a_2$		H	$001 + M(a_0 a_1) + M(a_1 a_2)$ Note 1
VERTICAL	a_1 just under b_1	$a_1 b_1 = 0$	$V(0)$	1
	a_1 to the right of b_1	$a_1 b_1 = 1$	$V_R(1)$	011
		$a_1 b_1 = 2$	$V_R(2)$	000011
		$a_1 b_1 = 3$	$V_R(3)$	0000011
	a_1 to the left of b_1	$a_1 b_1 = 1$	$V_L(1)$	010
		$a_1 b_1 = 2$	$V_L(2)$	000010
		$a_1 b_1 = 3$	$V_L(3)$	0000010
EXTENSION		2-D (extensions) 1-D (extensions)	Note 2 0000001xxx 000000001xxx	

Note 1 Code M () of Horizontal mode represents the code words in Tables 1 and 2, Paragraph 4.1.1.

Note 2 The Uncompressed mode is an optional extension of the two-dimensional coding scheme for Group 3 apparatus. The bit assignment for the xxx bits is 111 for the Uncompressed mode of operation whose code table is given in Table 4.

Note 3 If the suggested uncompressed mode is used on a line designated to be one-dimensionally coded, the coder must not switch into the uncompressed mode following any codeword ending in the sequence "000". This is because any codeword ending in "000" followed by a switching code "000000001" will be mistaken for an end-of-line code."

TABLE 4
Uncompressed mode code table

	<u>Image Pattern</u>	<u>Code Word</u>
	1	1
	01	01
	001	001
	0001	0001
	00001	00001
	00000	000001
<u>Exit</u>	<u>Image Pattern</u>	<u>Code Word</u>
	0	0000001T
	00	00000001T
	000	000000001T
	0000	0000000001T

T denotes a tag bit which indicates the color of the next run. (black = 1, white = 0)

d) Processing the first and last picture elements in a line

(i) Processing the first picture element

The first a_0 element on each coding line is imaginarily set at a position just before the first actual picture element, and is regarded as a white picture element. (4.2.1.3,a)

The first run length on a line $a_0 a_1$ is replaced by $a_0 a_1 - 1$. Therefore, if the first run is black and is deemed to be coded by horizontal mode coding, then the first code word $M(a_0 a_1)$ corresponds to a white run of zero length. (see Figure 10, Example 5)

(ii) Processing the last picture element

The coding of the coding line continues until the position of the imaginary changing element situated just after the last actual element has been coded. This may be coded as a_1 or a_2 . Also, if b_1 and/or b_2 are not detected at any time during the coding of the line, they are positioned on the imaginary changing element situated just after the last actual picture element on the reference line.

4.2.2 Line Synchronization Code Word

To the end of every coded line the end-of-line (EOL) code word '00000000001' is added. The EOL codeword is followed by a single tag bit which indicates whether one- or two-dimensional coding is used for the next line. In addition, EOL plus the tag bit "1" signal will occur prior to the first DATA line of a page.

Format:

- EOL + 1 : one-dimensional coding of next line
- EOL + 0 : two-dimensional coding of next line

4.2.3 FILL

FILL is inserted between a line of DATA and the line synchronization signal, EOL + tag bit, but is not inserted in DATA. FILL must be added to insure that the transmission time of DATA, FILL and EOL plus tag bit is not less than the minimum transmission time of the total coded scan line.

Format : variable length string of 0's.

4.2.4 Return To Control (RTC)

The format used is six consecutive Line Synchronization Code Words, i.e., 6 X (EOL+1).

To further clarify the relationship of the signals defined herein, Figures 7 and 8 are offered in the case of K = 2. Figure 7 shows several scan lines of data starting at the beginning of a transmitted page. Figure 8 shows the last several lines of a page.

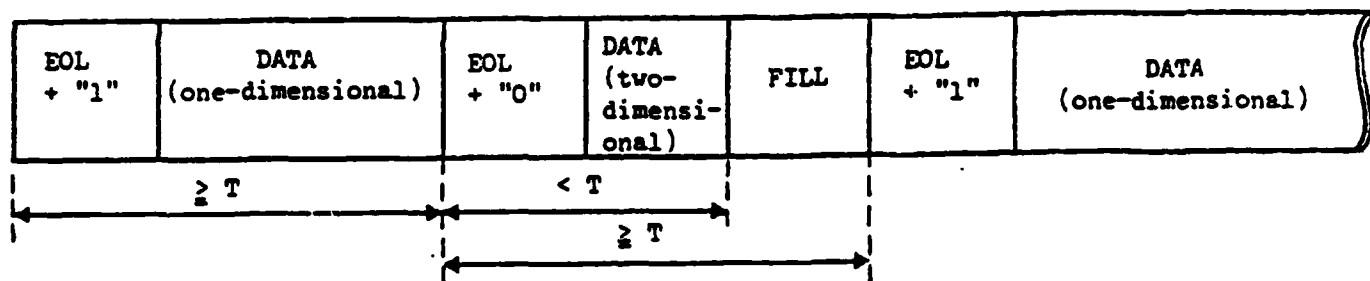

T: minimum transmit time of a total coded scan line

FIGURE 7 - Message transmission (first part of page)

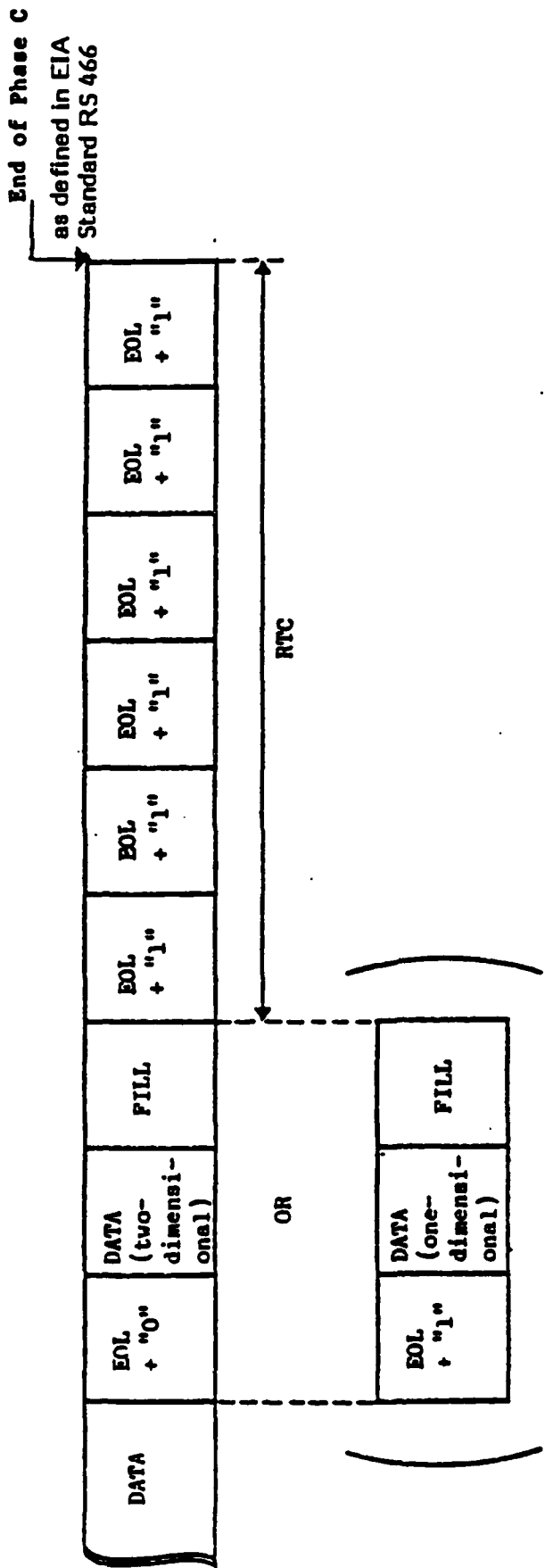

FIGURE 8 - Message transmission (last part of page)

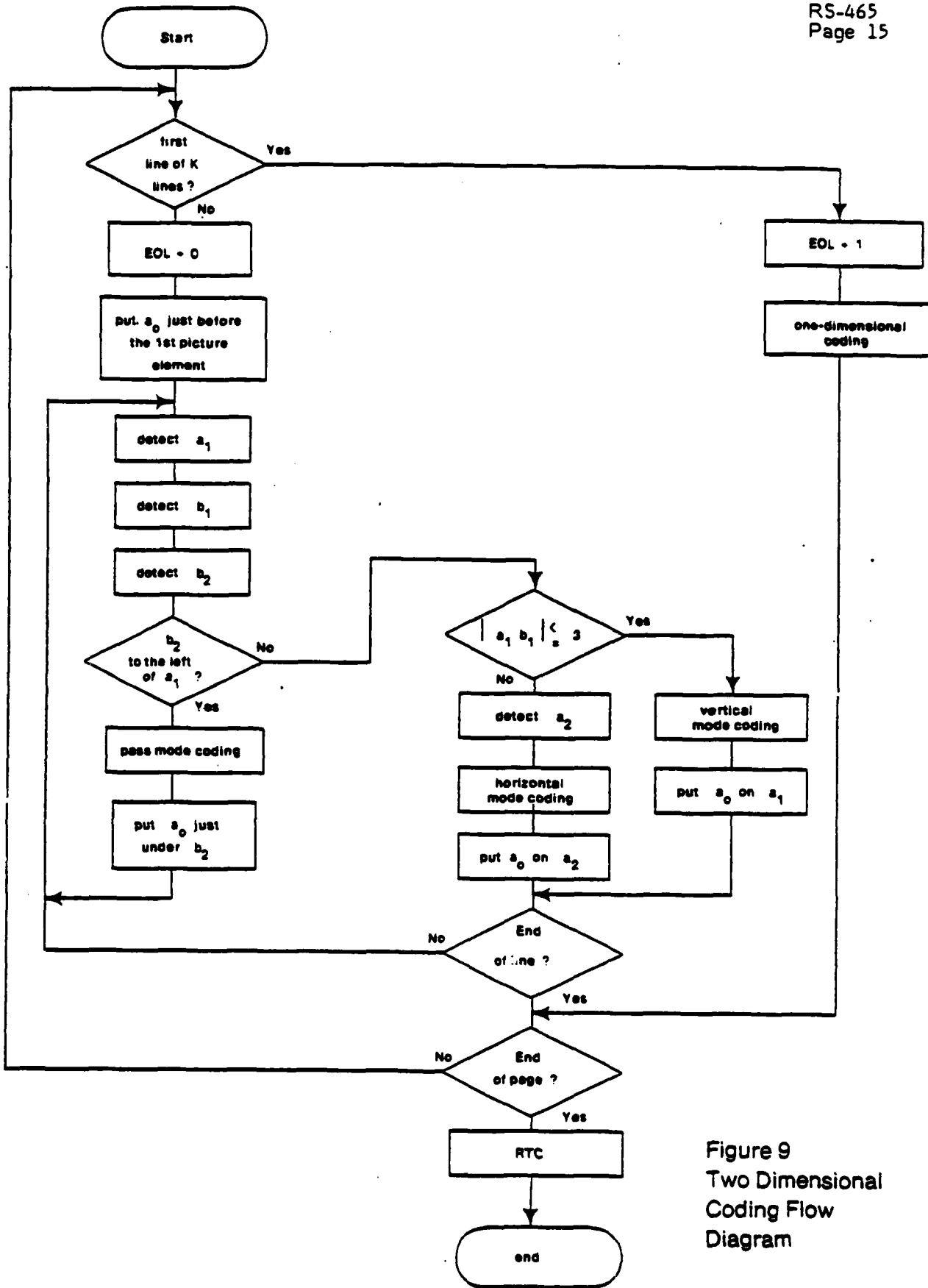

Figure 9
Two Dimensional
Coding Flow
Diagram

4.2.5 Coding Examples

Figure 10 shows coding examples of the first part of scanning lines and Figure 11 coding examples of the last part, while Figure 12 shows other coding examples. The notations P, H and V in the figures are, as shown in Table 3, the symbols for Pass mode, Horizontal mode and Vertical mode respectively. The picture elements marked with black spots indicate the changing picture elements to be coded.

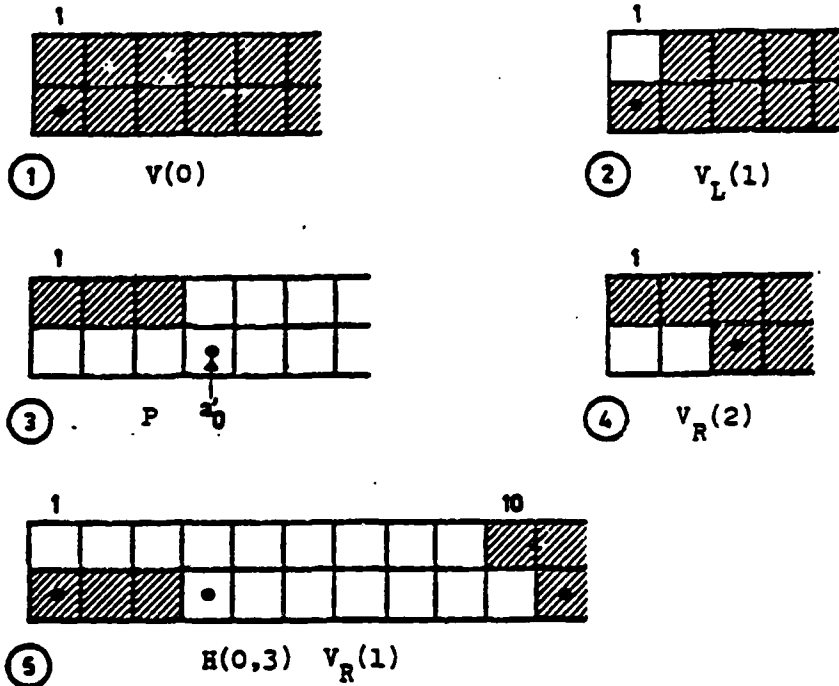

FIGURE 10 - Coding examples: first part of scan line

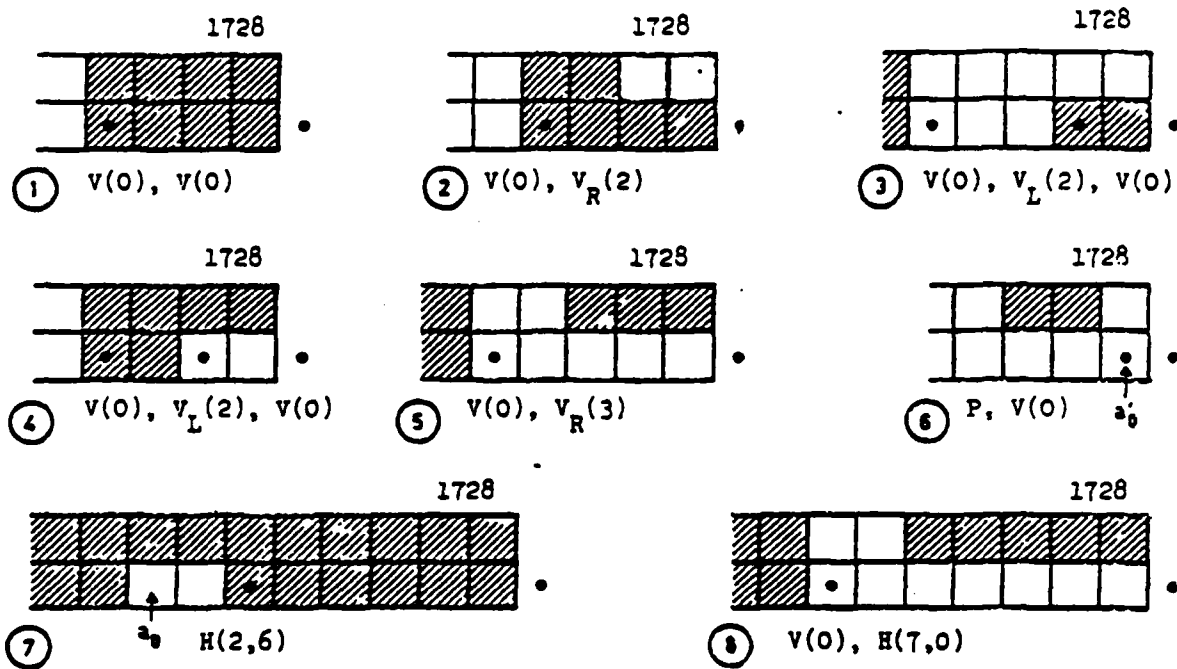

FIGURE 11 - Coding examples : last part of scan line

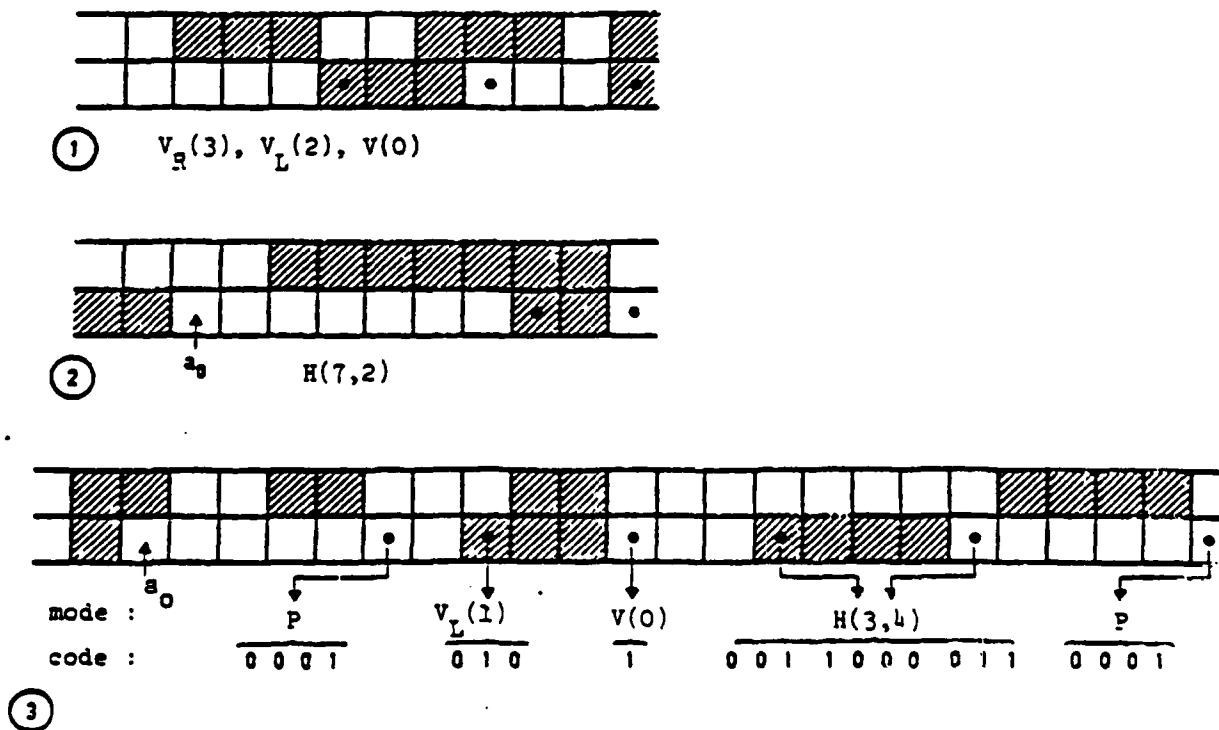

FIGURE 12 - Coding examples
B-17

APPENDIX C

Procedure for Extended Run Lengths

AD-R120 614

INVESTIGATION OF RESOLUTION FOR GROUP 4 FACSIMILE(U)
DELTA INFORMATION SYSTEMS INC JENKINTOWN PA AUG 82
NCS-TIB-82-5 DCA100-81-C-0042

272

UNCLASSIFIED

F/G 17/2

NL

END

FILMED
1
DNC

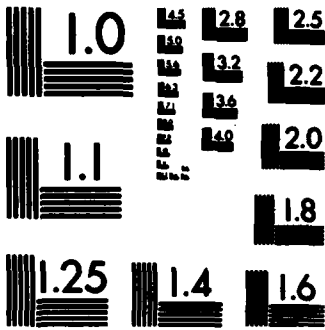

MICROCOPY RESOLUTION TEST CHART
NATIONAL BUREAU OF STANDARDS-1963-A

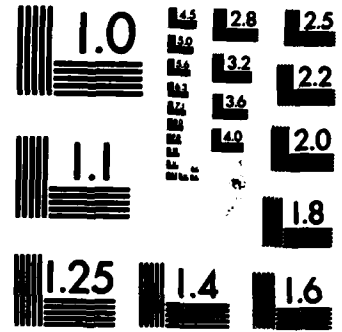

MICROCOPY RESOLUTION TEST CHART
NATIONAL BUREAU OF STANDARDS-1963-A

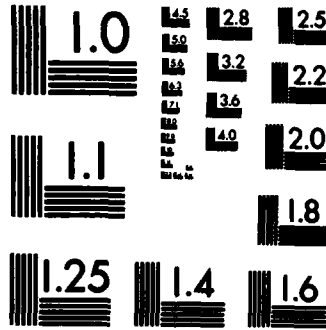

MICROCOPY RESOLUTION TEST CHART
NATIONAL BUREAU OF STANDARDS-1963-A

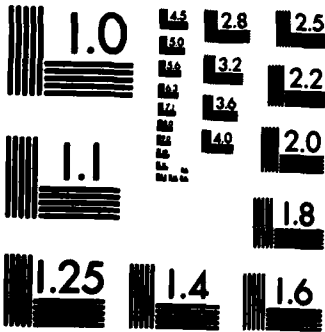

MICROCOPY RESOLUTION TEST CHART
NATIONAL BUREAU OF STANDARDS-1963-A

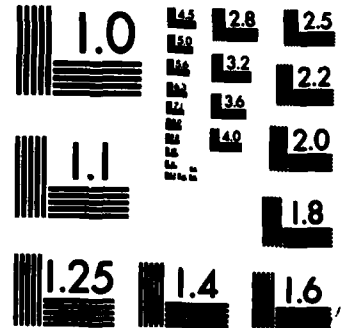

MICROCOPY RESOLUTION TEST CHART
NATIONAL BUREAU OF STANDARDS-1963-A

C. PROCEDURE FOR EXTENDED RUN LENGTHS

Run Lengths up to and including 2560 pels are coded as described in EIA RS-465. If the run length is greater than 2560, the Make Up Code for 2560 is output followed by one or more Make Up Codes of the same color if the remaining part of the run is greater than 63 followed by the appropriate Terminating Code in the same color for the remaining part of the run (0-63). Thus, a very long run will have a number of Make Up codes for 2560 followed by a Make Up Code in the range 64 to 2496 if required followed by a Terminating Code in the range 0-63, all in the same color.

APPENDIX D

CODE LISTING FOR EXTENDED RUN LENGTHS

LIST CODELN.FORT

DSNAME='D0031.CODELN.FORT

```

000010 -SUBROUTINE COBELN(LENGTH,POLAR,CDELCT,CDDATA,CODE)
000020 C
000030 C <2/14/80 ADDED PASSING PARAMETER - CODE>
000040 C <2/14/80 ADDED INTEGER CODE(3,92,2)>
000050 C <2/14/80 DELETED COMMON/HUFF/CODE(3,92,2),CODE(3,11)>
000060 C <2/14/80 DELETED COMMON/ERAY/ERRORS(10000)>
000070 C
000080 IMPLICIT INTEGER(A-Z)
000090 INTEGER CODE(3,105,2)
000100 COMMON/HUFF/PELBUF(130,2),CDBUF(520),DTBUF(130,2),
000110 * STFBUF(520),STAT(6000)
000120 C
000130 C*****-BEGIN PROGRAM *****
000140 C
000150 C
000160 C CHECK INPUTS
000170 C
000180 IF(POLAR.LT.1.OR.POLAR.GT.2) CALL EXIT
000190 IF(LENGTH.LT.0.OR.LENGTH.GT.4160) CALL EXIT
000200 C
000210 IF(LENGTH.LE.63) GO TO 40
000220 C
000230 C CALCULATE MAKE UP CODE INDEX
000240 C
000250 INDEX=LENGTH/64+64
000260 20 IF(INDEX.LE.104) GO TO 30
000270 INDEX=INDEX-40
000280 DEX=104
000290 ASSIGN 20 TO CODESW
000300 GO TO 1000
000310 30 DEX=INDEX
000320 ASSIGN 40 TO CODESW
000330 GO TO 1000
000340 C
000350 C CALCULATE TERMINATING CODE INDEX
000360 C
000370 40 DEX=MOD(LENGTH,64)+1
000380 ASSIGN 60 TO CODESW
000390 GO TO 1000
000400 60 RETURN
000410 C
000420 C CODE LOOK-UP AND INSERTION ROUTINE
000430 C
000440 1000 TCODE=CODE(3,DEX,POLAR)
000450 TLENG=CODE(1,DEX,POLAR)
000460 CALL MI2B(TCODE,CDBUF,CDELCT+1,TLENG)
000470 CDELCT=CDELCT+TLENG
000480 CDDATA=CDDATA+TLENG
000490 C
000500 GO TO CODESW,(20,40,60)
000510 E N D
END OF DATA
READY

```

APPENDIX E

SCAN LINE STATISTICS FOR MODIFIED READ CODE DATA

	<u>Page</u>
CCITT No. 1	1-4
Legibility Test Chart	5-8
CCITT No. 5	9-13
CCITT No. 7	14-17

ENG. 200

INPUT PARAMETERS:

MAXIMUM NUMBER OF PELS PER LINE = 1728

VERTICAL SAMPLING: N = 1

PARAMETER K = 6000

ERRUN PATTERN PHASE = 0

MINIMUM COMPRESSED LINE LENGTH = 0 BITS

NUMBER OF SCAN LINES TO BE PROCESSED = 6000

ERROR CORRECTION MODE = 0

RECORD SIZE = 54

NO ERRORS INSERTED

END OF MESSAGE DETECTED (3 EOL'S)

TOTAL NUMBER OF CODED BITS = 162480

TOTAL NUMBER OF CODED DATA BITS = 132034

TOTAL NUMBER OF 2-DIM LINES = 2335

TOTAL NUMBER OF INPUT LINES PROCESSED = 2336

BIT ERROR RATE = .0

MINIMUM TRANSMISSION TIME (4800 RPS)

CODED LINE

LENGTH

STATISTICS:

	0 MS	5 MS	10 MS	20 MS	40 MS
MINIMUM	14	24	48	96	192
MAXIMUM	654	654	654	654	654
MEDIAN	14	24	48	96	192
SAMPLE MEAN	69.52	75.25	91.33	128.31	209.46

STANDARD DEVIATION 110.87 108.08 100.86 86.04 58.88

COMPRESSION FACTOR FOR G3 MACHINE (CF3) = 24.9437

COMPRESSION FACTOR FOR G4 MACHINE (CF4) = 30.5725

ENG. 300

CODED BITS = 243854.

CODED DATA BITS = (197476.)

2-DIM LINES = 3499

INPUT LINES PROCESSED = 3500

BIT ERROR RATE = .000000E+00

(CF3) = 36.8642

(CF4) = 45.3726

NUMBER OF INCORRECT PELS =

NUMBER OF BITS IN ERROR TRANSMITTED = 0

ERROR SENSITIVITY FACTOR = .0000

TOTAL NUMBER OF OUTPUT LINES PROCESSED = 3500
EOF: 3500 RECORDS READ.

MINIMUM TRANSMISSION TIME (4000 BPS)

CODED LINE
LENGTH
STATISTICS:

	0 MS	5 MS	10 MS	20 MS	40 MS
MINIMUM	14	24	48	96	192
MAXIMUM	773	773	773	773	773
MEDIAN	14	24	48	96	192

SAMPLE MEAN 69.42 75.46 92.02 129.47 211.33

STANDARD DEVIATION 118.37 115.61 108.61 94.46 68.57

ENTER INPUT RECORD SIZE:
 ENTER ERROR CORRECTION MODE:
 DIAGNOSTIC PRINTOUT? (Y OR N):
 ENTER MAXIMUM NUMBER OF PELS PER LINE:
 ENTER VERTICAL SAMPLING:
 ENTER PARAMETER K:
 ENTER ERROR PATTERN PHASE:
 ENTER MINIMUM COMPRESSED LINE LENGTH:
 NUMBER OF SCAN LINES TO BE PROCESSED=?
 ERROR MODE=? (M=MANUAL, T=TAPE, N=NO ERRORS)
 INPUT PARAMETERS:
 MAXIMUM NUMBER OF PELS PER LINE = 3456
 VERTICAL SAMPLING: N = 1
 PARAMETER K = 6000
 ERROR PATTERN PHASE = 0
 MINIMUM COMPRESSED LINE LENGTH = 0 BITS
 NUMBER OF SCAN LINES TO BE PROCESSED = 6000
 ERROR CORRECTION MODE = 0
 RECORD SIZE = 108
 NO ERRORS INSERTED
 END OF MESSAGE DETECTED (3 EOL'S)
 TOTAL NUMBER OF CODED BITS = 333124
 TOTAL NUMBER OF CODED DATA BITS = 272312
 TOTAL NUMBER OF 2-DIM LINES = 4671
 TOTAL NUMBER OF INPUT LINES PROCESSED = 4672
 BIT ERROR RATE = .0

ENG. 400

MINIMUM TRANSMISSION TIME (4800-RFS)

CODED LINE LENGTH STATISTICS:	0 MS	5 MS	10 MS	20 MS	40 MS
MINIMUM	14	24	48	96	192
MAXIMUM	693	693	693	693	693
MEDIAN	14	24	48	96	192

SAMPLE MEAN 71.29 76.79 92.72 129.92 211.03

STANDARD DEVIATION 115.24 112.59 105.53 90.77 63.54
 COMPRESSION FACTOR FOR G3 MACHINE (CF3) = 48.4694
 COMPRESSION FACTOR FOR G4 MACHINE (CF4) = 59.2939
 NUMBER OF INCORRECT PELS = 0
 NUMBER OF BITS IN ERROR TRANSMITTED = 0
 ERROR SENSITIVITY FACTOR = 0.0

ENG. 480

ENLX LKKK UNKELIUN MUE;
 DIAGNOSTIC PRINTOUT? (Y OR N):
 ENTER MAXIMUM NUMBER OF PELS PER LINE:
 ENTER VERTICAL SAMPLING:
 ENTER PARAMETER K:
 ENTER ERROR PATTERN PHASE:
 ENTER MINIMUM COMPRESSED LINE LENGTH:
 NUMBER OF SCAN LINES TO BE PROCESSED=?
 ERROR MODE=? (M=MANUAL, T=TAPE, N=NO ERRORS)
 INPUT PARAMETERS:
 MAXIMUM NUMBER OF PELS PER LINE= 4096
 VERTICAL SAMPLING: N= 1
 PARAMETER K =6000
 ERROR PATTERN PHASE = 0
 MINIMUM COMPRESSED LINE LENGTH = 0 BITS
 NUMBER OF SCAN LINES TO BE PROCESSED = 6000
 ERROR CORRECTION MODE = 0
 RECORD SIZE = 128
 NO ERRORS INSERTED
 END OF MESSAGE DETECTED (3 EOL'S)
 TOTAL NUMBER OF CODED BITS = 399351
 TOTAL NUMBER OF CODED DATA BITS = 326473
 TOTAL NUMBER OF 2-DIM LINES = 5599
 TOTAL NUMBER OF INPUT LINES PROCESSED = 5600
 BIT ERROR RATE = .0

MINIMUM TRANSMISSION TIME (4800 BPS)

CODED LINE LENGTH STATISTICS:	0 MS	5 MS	10 MS	20 MS	40 MS
MINIMUM	14	24	48	96	192
MAXIMUM	672	672	672	672	672
MEDIAN	14	24	48	96	192
SAMPLE MEAN	71.30	77.41	93.96	131.14	211.83

STANDARD DEVIATION 117.30 114.38 106.99 91.97 64.16
 COMPRESSION FACTOR FOR G3 MACHINE (CF3) = 70.2598
 COMPRESSION FACTOR FOR G4 MACHINE (CF4) = 70.2598
 NUMBER OF INCORRECT PELS = 0
 NUMBER OF BITS IN ERROR TRANSMITTED = 0
 ERROR SENSITIVITY FACTOR = 0.0
 TOTAL NUMBER OF OUTPUT LINES PROCESSED = 5600

END OF DATA

FAX. 200

ENTER INPUT RECORD SIZE:
 ENTER ERROR CORRECTION MODE:
 DIAGNOSTIC PRINTOUT (Y OR N):
 ENTER MAXIMUM NUMBER OF PELS PER LINE:
 ENTER VERTICAL SAMPLING:
 ENTER PARAMETER K:
 ENTER ERROR PATTERN PHASE:
 ENTER MINIMUM COMPRESSED LINE LENGTH:
 NUMBER OF SCAN LINES TO BE PROCESSED=?
 ERROR MODE=? (M=MANUAL, T=TAPE, N=NO ERRORS)
 INPUT PARAMETERS:
 MAXIMUM NUMBER OF PELS PER LINE= 1728
 VERTICAL SAMPLING= N= 1
 PARAMETER K =6000
 ERROR PATTERN PHASE = 0
 MINIMUM COMPRESSED LINE LENGTH = 0 BITS
 NUMBER OF SCAN LINES TO BE PROCESSED = 6000
 ERROR CORRECTION MODE = 0
 RECORD SIZE = 54
 NO ERRORS INSERTED
 END OF MESSAGE DETECTED (3 EOL'S)
 TOTAL NUMBER OF CODED BITS = 1167398
 TOTAL NUMBER OF CODED DATA BITS = 1136952
 TOTAL NUMBER OF 2-DIM LINES = 2335
 TOTAL NUMBER OF INPUT LINES PROCESSED = 2336
 BIT ERROR RATE = .0

MINIMUM TRANSMISSION TIME (4800 BPS)

CODED LINE LENGTH STATISTICS:	0 MS	5 MS	10 MS	20 MS	40 MS
MINIMUM	14	24	48	96	192

MAXIMUM	2572	2572	2572	2572	2572
---------	------	------	------	------	------

MEDIAN	114	114	114	114	192
--------	-----	-----	-----	-----	-----

SAMPLE MEAN	499.71	503.79	514.15	536.66	586.74
-------------	--------	--------	--------	--------	--------

STANDARD DEVIATION 708.24 705.45 698.47 683.70 652.46
 COMPRESSION FACTOR FOR G3 MACHINE (CF3) = 3.4578
 COMPRESSION FACTOR FOR G4 MACHINE (CF4) = 3.5504
 NUMBER OF INCORRECT PELS = 0
 NUMBER OF BITS IN ERROR TRANSMITTED = 0
 ERROR SENSITIVITY FACTOR = 0.0

FAX. 300

NIBK INPUT MESSAGES SIZE:
 ENTER ERROR CORRECTION MODE:
 DIAGNOSTIC PRINTOUT? (Y OR N):
 ENTER MAXIMUM NUMBER OF PELS PER LINE:
 ENTER VERTICAL SAMPLING:
 ENTER PARAMETER K:
 ENTER ERROR PATTERN PHASE:
 ENTER MINIMUM COMPRESSED LINE LENGTH:
 NUMBER OF SCAN LINES TO BE PROCESSED=?
 ERROR MODE=? (M=MANUAL, T=TAPE, N=NO ERRORS)
 INPUT PARAMETERS:
 MAXIMUM NUMBER OF PELS PER LINE= 2560
 VERTICAL SAMPLING: N= 1
 PARAMETER K =6000
 ERROR PATTERN PHASE = 0
 MINIMUM COMPRESSED LINE LENGTH = 0 BITS
 NUMBER OF SCAN LINES TO BE PROCESSED = 6000
 ERROR CORRECTION MODE = 0
 RECORD SIZE = 80
 NO ERRORS INSERTED
 END OF MESSAGE DETECTED (3 EOL'S)
 TOTAL NUMBER OF CODED BITS = 3193792
 TOTAL NUMBER OF CODED DATA BITS = 3148214
 TOTAL NUMBER OF 2-DIM LINES = 3499
 TOTAL NUMBER OF INPUT LINES PROCESSED = 3500
 BIT ERROR RATE = .0

MINIMUM TRANSMISSION TIME (4800 BPS)

CODED LINE LENGTH STATISTICS:
 0 MS 5 MS 10 MS 20 MS 40 MS
 MINIMUM 14 24 48 96 192
 MAXIMUM 3793 3793 3793 3793 3793

MEDIAN 168 168 168 168 192
 SAMPLE MEAN 912.49 916.34 926.31 948.15 995.20

STANDARD DEVIATION 1120.72 1117.63 1109.71 1092.55 1056.32
 COMPRESSION FACTOR FOR G3 MACHINE (CF3) = 2.8054
 COMPRESSION FACTOR FOR G4 MACHINE (CF4) = 2.8461
 NUMBER OF INCORRECT PELS = 0
 NUMBER OF BITS IN ERROR TRANSMITTED = 0
 ERROR SENSITIVITY FACTOR = 0.0
 TOTAL NUMBER OF OUTPUT LINES PROCESSED = 3500

FAX.400

PROGRAMS: INPUT (-17) OR DEFAULT (-1)

ENTER INPUT RECORD SIZE:
 ENTER ERROR CORRECTION MODE:
 DIAGNOSTIC PRINTOUT? (Y OR N):
 ENTER MAXIMUM NUMBER OF PELS PER LINE:
 ENTER VERTICAL SAMPLING:
 ENTER PARAMETER K:
 ENTER ERROR PATTERN PHASE:
 ENTER MINIMUM COMPRESSED LINE LENGTH:
 NUMBER OF SCAN LINES TO BE PROCESSED=?
 ERROR MODE=? (M=MANUAL, T=TAPE, N=NO ERRORS)
 INPUT PARAMETERS:
 MAXIMUM NUMBER OF PELS PER LINE= 3456
 VERTICAL SAMPLING: N= 1
 PARAMETER K =6000
 ERROR PATTERN PHASE = 0
 MINIMUM COMPRESSED LINE LENGTH = 0 BITS
 NUMBER OF SCAN LINES TO BE PROCESSED = 6000
 ERROR CORRECTION MODE = 0
 RECORD SIZE = 108
 NO ERRORS INSERTED
 END OF MESSAGE DETECTED (3 EOL'S)
 TOTAL NUMBER OF CODED BITS = 4537812
 TOTAL NUMBER OF CODED DATA BITS = 4476798
 TOTAL NUMBER OF 2-DIM LINES = 4671
 TOTAL NUMBER OF INPUT LINES PROCESSED = 4672
 NET ERROR RATE = .0

MINIMUM TRANSMISSION TIME (4800 BPS)

CODED LINE LENGTH STATISTICS:	0 MS	5 MS	10 MS	20 MS	40 MS
MINIMUM	14	24	48	96	192
MAXIMUM	4130	4130	4130	4130	4130
MEDIAN	134	134	134	134	192
SAMPLE MEAN	971.26	975.17	985.40	1007.82	1056.03

STANDARD DEVIATION 1188.40 1185.26 1177.08 1159.34 1121.82
 COMPRESSION FACTOR FOR G3 MACHINE (CF3) = 3.5582
 COMPRESSION FACTOR FOR G4 MACHINE (CF4) = 3.6065
 NUMBER OF INCORRECT PELS = 0
 NUMBER OF BITS IN ERROR TRANSMITTED = 0
 ERROR SENSITIVITY FACTOR = 0.0

FAX. 480

NUMBER OF SCAN LINES TO BE PROCESSED=?
 ERROR MODE=? (M=MANUAL, T=TAPE, N=NO ERRORS)
 INPUT PARAMETERS:
 MAXIMUM NUMBER OF PELS PER LINE= 4096
 VERTICAL SAMPLING: N= 1
 PARAMETER K =6000
 ERROR PATTERN PHASE = 0
 MINIMUM COMPRESSED LINE LENGTH = 0 BITS
 NUMBER OF SCAN LINES TO BE PROCESSED = 6000
 ERROR CORRECTION MODE = 0
 RECORD SIZE = 128
 NO ERRORS INSERTED
 END OF MESSAGE DETECTED (3 EOL'S)
 TOTAL NUMBER OF CODED BITS = 5337048
 TOTAL NUMBER OF CODED DATA BITS = 5264170

TOTAL NUMBER OF 2-DIM LINES = 5599
 TOTAL NUMBER OF INPUT LINES PROCESSED = 5600
 BIT ERROR RATE = .0

MINIMUM TRANSMISSION TIME (4800 BPS)

CODED LINE LENGTH STATISTICS:	0 MS	5 MS	10 MS	20 MS	40 MS
MINIMUM	14	24	48	96	192
MAXIMUM	3839	3839	3839	3839	3839
MEDIAN	137	137	137	137	192

SAMPLE MEAN 953.03 956.95 967.31 989.95 1038.04

STANDARD DEVIATION 1159.30 1156.12 1147.80 1129.78 1092.13
 COMPRESSION FACTOR FOR G3 MACHINE (CF3) = 4.2978
 COMPRESSION FACTOR FOR G4 MACHINE (CF4) = 4.3573
 NUMBER OF INCORRECT PELS = 0
 NUMBER OF BITS IN ERROR TRANSMITTED = 0
 ERROR SENSITIVITY FACTOR = 0.0
 TOTAL NUMBER OF OUTPUT LINES PROCESSED = 5600

ENTER INPUT RECORD SIZE:
 ENTER ERROR CORRECTION MODE:
 DIAGNOSTIC PRINTOUT? (Y OR N):
 ENTER MAXIMUM NUMBER OF PELS PER LINE:
 ENTER VERTICAL SAMPLING:
 ENTER PARAMETER K:
 ENTER ERROR PATTERN PHASE:
 ENTER MINIMUM COMPRESSED LINE LENGTH:
 NUMBER OF SCAN LINES TO BE PROCESSED=
 ERROR MODE? (M=MANUAL,T=TAPE,N=NO ERRORS)

PARAMETER N = 1
 MINIMUM NUMBER OF PELS PER LINE = 1728
 VERTICAL SAMPLING = N = 1
 PARAMETER K = 6000
 ERROR PATTERN PHASE = 0
 MINIMUM COMPRESSED LINE LENGTH = 0 BITS
 NUMBER OF SCAN LINES TO BE PROCESSED = 6000
 ERROR CORRECTION MODE = 0
 RECORD SIZE = 54
 NO ERRORS INSERTED
 END OF MESSAGE DETECTED (3 EOL'S)

TOTAL NUMBER OF CODED BITS = 259650
 TOTAL NUMBER OF CODED DATA BITS = 229204
 TOTAL NUMBER OF 2-DIM LINES = 2335
 TOTAL NUMBER OF INPUT LINES PROCESSED = 2336
 RECORD RATE = .0

MINIMUM TRANSMISSION TIME (8000 FPS)

CODED LINE LENGTH STATISTICS:
 0 MS 5 MS 10 MS 20 MS 40 MS

MINIMUM	14	24	48	96	192
MAXIMUM	920	920	920	920	920
MEDIAN	48	48	48	96	192

SAMPLE MEAN 111.12 113.26 123.23 151.30 221.79

STANDARD DEVIATION 132.51 131.00 124.66 109.24 78.25
 COMPRESSION FACTOR FOR 03 MACHINE (CF3) = 15.5463
 COMPRESSION FACTOR FOR 04 MACHINE (CF4) = 17.6114
 NUMBER OF INCORRECT PELS = 0
 NUMBER OF BITS IN ERROR TRANSMITTED = 0
 ERROR SENSITIVITY FACTOR = 10.0

FRE. 200

ENTER ERROR CORRECTION MODE:
 DIAGNOSTIC PRINTOUT? (Y OR N):
 ENTER MAXIMUM NUMBER OF PELS PER LINE:
 ENTER VERTICAL SAMPLING:
 ENTER PARAMETER K:
 ENTER ERROR PATTERN PHASE:
 ENTER MINIMUM COMPRESSED LINE LENGTH:
 NUMBER OF SCAN LINES TO BE PROCESSED=?
 ERROR MODE=? (M=MANUAL, T=TAPE, N=NO ERRORS):
 INPUT PARAMETERS:

MAXIMUM NUMBER OF PELS PER LINE= 2560
 VERTICAL SAMPLING: N= 1
 PARAMETER K=6000
 ERROR PATTERN PHASE = 0
 MINIMUM COMPRESSED LINE LENGTH = 0 BITS
 NUMBER OF SCAN LINES TO BE PROCESSED = 6000
 ERROR CORRECTION MODE = 0
 RECORD SIZE = 80

FR. 300

NO ERRORS INSERTED
 END OF MESSAGE DETECTED (3 EOL'S)
 TOTAL NUMBER OF CODED BITS = 396116
 TOTAL NUMBER OF CODED DATA BITS = 350538
 TOTAL NUMBER OF 2-DIM LINES = 3499
 TOTAL NUMBER OF INPUT LINES PROCESSED = 3500
 BIT ERROR RATE = 0.0

MINIMUM TRANSMISSION TIME (4800 BPS)

CODED LINE LENGTH STATISTICS:	0 MS	5 MS	10 MS	20 MS	40 MS
MINIMUM	14	24	48	96	192
MAXIMUM	939	939	939	939	939
MEDIAN	48	48	48	96	192
SAMPLE MEAN	113.15	115.20	125.05	153.05	221.77

STANDARD DEVIATION 129.22 127.70 121.13 104.76 71.88
 COMPRESSION FACTOR FOR G3 MACHINE (CF3) = 22.6196
 COMPRESSION FACTOR FOR G4 MACHINE (CF4) = 25.5607
 NUMBER OF INCORRECT PELS = 0
 NUMBER OF BITS IN ERROR TRANSMITTED = 0
 ERROR SENSITIVITY FACTOR = 0.0
 TOTAL NUMBER OF OUTPUT LINES PROCESSED = 3500

PROBABILITY INPUTS - 17 ON DELTA - 177

ENTER INPUT RECORD SIZE:
 ENTER ERROR CORRECTION MODE:
 DIGITISTIC PRINTOUT? (Y OR N):
 LINE COMPRESSION NUMBER OF PELS PER LINE:
 LINE VERTICAL SAMPLING:
 ENTER PARAMETER K:
 ENTER ERROR PATTERN PHASE:
 ENTER MINIMUM COMPRESSED LINE LENGTH:
 NUMBER OF SCAN LINES TO BE PROCESSED-7
 ENTER MODE (M-MANUAL/T-AUTOMATIC/NO ERROR)
 LINE PARAMETERS:
 MAXIMUM NUMBER OF PELS PER LINE = 5400
 VERTICAL SAMPLING: N
 PARAMETER K = 6000
 ERROR PATTERN PHASE = 0
 RETURN COMPRESSED LINE LENGTH = 0 LINES
 NUMBER OF SCAN LINES TO BE PROCESSED = 6000
 ERROR CORRECTION MODE = 0
 RECORD SIZE = 108
 NO ERRORS INSERTED
 END OF MESSAGE DETECTED (3 EOL'S)
 TOTAL NUMBER OF CODED BITS = 528819
 TOTAL NUMBER OF CODED DATA BITS = 466000
 TOTAL NUMBER OF 2-DIM LINES = 4671
 TOTAL NUMBER OF INPUT LINES PROCESSED = 4672
 BIT ERROR RATE = .0

FRE. 400

MINIMUM TRANSMISSION TIME (4800 EPS)

CODED LINE LENGTH STATISTICS:
 0 MS 5 MS 10 MS 20 MS 40 MS

MINIMUM	14	24	48	96	192
MAXIMUM	1137	1137	1137	1137	1137
MEDIAN	47	47	48	96	192

SAMPLE MEAN 113.17 115.24 125.13 153.53 224.27

STANDARD DEVIATION 138.59 137.17 131.04 115.78 84.97
 COMPRESSION FACTOR FOR G3 MACHINE (CF3) = 30.5330
 COMPRESSION FACTOR FOR G4 MACHINE (CF4) = 34.5005
 NUMBER OF INCORRECT PELS = 0
 NUMBER OF BITS IN ERROR TRANSMITTED = 0
 FREQUENCY FACTOR = 0.0

PRE.480

ENTER MINIMUM COMPRESSED LINE LENGTH:
 NUMBER OF SCAN LINES TO BE PROCESSED=7
 ERROR MODE=? (M=MANUAL,T=TAPE,N=NO ERRORS)
 INPUT PARAMETERS:
 MAXIMUM NUMBER OF PELS PER LINE = 4096
 VERTICAL SAMPLING: N= 1
 PARAMETER K =6000
 ERROR PATTERN PHASE = 0
 MINIMUM COMPRESSED LINE LENGTH = 0 BITS
 NUMBER OF SCAN LINES TO BE PROCESSED = 6000
 ERROR CORRECTION MODE = 0
 RECORD SIZE = 128
 NO ERRORS INSERTED
 END OF MESSAGE DETECTED (-3 EOL'S)
 TOTAL NUMBER OF CODED BITS = 643180
 TOTAL NUMBER OF CODED DATA BITS = 570302
 TOTAL NUMBER OF 2-DIM LINES = 5599
 TOTAL NUMBER OF INPUT LINES PROCESSED = 5600
 BIT ERROR RATE = .0

MINIMUM TRANSMISSION TIME (4800 BPS)

CODED LINE LENGTH STATISTICS:

	0 MS	5 MS	10 MS	20 MS	40 MS
MINIMUM	14	24	40	96	192
MAXIMUM	1269	1269	1269	1269	1269
MEDIAN	46	46	46	96	192

SAMPLE MEAN

	0 MS	5 MS	10 MS	20 MS	40 MS
MINIMUM	14	24	40	96	192
MAXIMUM	1269	1269	1269	1269	1269
MEDIAN	46	46	46	96	192
SAMPLE MEAN	114.84	116.95	127.05	155.51	226.28

STANDARD DEVIATION 143.95 142.53 136.38 121.31 90.75
 COMPRESSION FACTOR FOR G3 MACHINE (CF3) = 38.6628
 COMPRESSION FACTOR FOR G4 MACHINE (CF4) = 40.2301
 NUMBER OF INCORRECT PELS = 0
 NUMBER OF BITS IN ERROR TRANSMITTED = 0
 ERROR SENSITIVITY FACTOR = 0.0
 TOTAL NUMBER OF OUTPUT LINES PROCESSED = 5600

OUTREAD3.DATA

PARAMETERS: INPUT(=I), OR DEFAULT(=D)?
 ENTER INPUT RECORD SIZE:
 ENTER ERROR CORRECTION MODE:
 DIAGNOSTIC PRINTOUT? (Y OR N):
 ENTER MAXIMUM NUMBER OF PELS PER LINE:
 ENTER VERTICAL SAMPLING:
 ENTER PARAMETER K:
 ENTER ERROR PATTERN PHASE:
 ENTER MINIMUM-COMPRESSED LINE LENGTH:
 NUMBER OF SCAN LINES TO BE PROCESSED=
 ERROR MODE=? (M=MANUAL, T=TAPE, N=NO ERRORS)
 INPUT PARAMETERS:
 MAXIMUM NUMBER OF PELS PER LINE= 1728
 VERTICAL SAMPLING: N= 1
 PARAMETER K =6000
 ERROR PATTERN PHASE = 0
 MINIMUM COMPRESSED LINE LENGTH = 0 BITS
 NUMBER OF SCAN LINES TO BE PROCESSED = 6000
 ERROR CORRECTION MODE = 0
 RECORD SIZE = 54
 NO ERRORS INSERTED
 END OF MESSAGE DETECTED (3 EOL'S)
 TOTAL NUMBER OF CODED BITS = 562200
 TOTAL NUMBER OF CODED DATA BITS = 531754
 TOTAL NUMBER OF 2-DIM LINES = 2335
 TOTAL NUMBER OF INPUT LINES PROCESSED = 2336
 BIT ERROR RATE = 0

CHI. 200

MINIMUM TRANSMISSION TIME (4800 RPS)

CODED LINE LENGTH STATISTICS:

	0 MS	5 MS	10 MS	20 MS	40 MS
MINIMUM	14	24	48	96	192
MAXIMUM	520	520	520	520	520
MEDIAN	274	274	274	274	274
SAMPLE MEAN	240.63	242.46	246.90	255.99	275.41

MINIMUM TRANSMISSION TIME (4800 RPS)

MINIMUM

MAXIMUM

MEDIAN

SAMPLE MEAN

STANDARD DEVIATION 123.23 119.89 111.89 96.22 67.69
 COMPRESSION FACTOR FOR G3 MACHINE (CF3) = 7.1800
 COMPRESSION FACTOR FOR G4 MACHINE (CF4) = 7.5911
 NUMBER OF INCORRECT PELS = 0
 NUMBER OF BITS IN ERROR TRANSMITTED = 0

CHI. 300

ENTER INPUT RECORD SIZE:
 ENTER ERROR CORRECTION MODE:
 DIAGNOSTIC PRINTOUT? (Y OR N):
 ENTER MAXIMUM NUMBER OF PELS PER LINE:
 ENTER VERTICAL SAMPLING:
 ENTER PARAMETER K:
 ENTER ERROR PATTERN PHASE:
 ENTER MINIMUM COMPRESSED LINE LENGTH:
 NUMBER OF SCAN LINES TO BE PROCESSED=?
 ERROR MODE=? (M=MANUAL, T=TIME, N=NO ERRORS)

INPUT PARAMETERS:
 MAXIMUM NUMBER OF PELS PER LINE = 2560
 VERTICAL SAMPLING: N = 1
 PARAMETER K = 6000
 ERROR PATTERN PHASE = 0
 MINIMUM COMPRESSED LINE LENGTH = 0 BITS
 NUMBER OF SCAN LINES TO BE PROCESSED = 6000
 ERROR CORRECTION MODE = 0

RECORD SIZE = 80
 NO ERRORS INSERTED
 END OF MESSAGE DETECTED (3 EOL'S)
 TOTAL NUMBER OF CODED BITS = 844502
 TOTAL NUMBER OF CODED DATA BITS = 798924
 TOTAL NUMBER OF 2-DIM LINES = 3499
 TOTAL NUMBER OF INPUT LINES PROCESSED = 3500
 BIT ERROR RATE = .0

MINIMUM TRANSMISSION TIME (4800-BPS)

CODED LINE LENGTH STATISTICS:
 0 MS 5 MS 10 MS 20 MS 40 MS
 MINIMUM 14 24 48 96 192
 MAXIMUM 3918 3918 3918 3918 3918
 MEDIAN 270 270 270 270 270

SAMPLE MEAN 241.26 243.14 247.68 256.90 277.95

STANDARD DEVIATION 164.41 161.85 155.85 144.79 126.01
 COMPRESSION FACTOR FOR G3 MACHINE (CF3) = 10.6098
 COMPRESSION FACTOR FOR G4 MACHINE (CF4) = 11.2151
 NUMBER OF INCORRECT PELS = 0
 NUMBER OF BITS IN ERROR TRANSMITTED = 0
 ERROR SENSITIVITY FACTOR = 0.0

CHI. 400

ENTER INPUT RECORD SIZE:
 ENTER ERROR CORRECTION MODE:
 DIAGNOSTIC PRINTOUT? (Y OR N):
 ENTER MAXIMUM NUMBER OF PELS PER LINE:
 ENTER VERTICAL SAMPLING:
 ENTER PARAMETER K:
 ENTER ERROR PATTERN PHASE:
 ENTER MINIMUM COMPRESSED LINE LENGTH:
 NUMBER OF SCAN LINES TO BE PROCESSED=?
 ERROR MODE=? (M=MANUAL,T=TAPE,N=NO ERRORS)
 INPUT PARAMETERS:
 MAXIMUM NUMBER OF PELS PER LINE= 3456
 VERTICAL SAMPLING: N= 1
 PARAMETER K =6000
 ERROR PATTERN PHASE = 0
 MINIMUM COMPRESSED LINE LENGTH = 0 BITS
 NUMBER OF SCAN LINES TO BE PROCESSED = 6000
 ERROR CORRECTION MODE = 0
 RECORD SIZE = 108
 NO ERRORS INSERTED
 END OF MESSAGE DETECTED (3 EOL'S)
 TOTAL NUMBER OF CODED BITS = 1102676
 TOTAL NUMBER OF CODED DATA BITS = 1041862
 TOTAL NUMBER OF 2-DIM LINES = 4674
 TOTAL NUMBER OF INPUT LINES PROCESSED = 4572
 BIT ERROR RATE = .0

MINIMUM TRANSMISSION TIME (4800 SPS)

CODED LINE LENGTH STATISTICS:
 0 MS 5 MS 10 MS 20 MS 40 MS

	14	24	48	96	192
MINIMUM	572	572	572	572	572
MAXIMUM	267	267	267	267	267
MEDIAN	236.00	237.78	242.18	251.28	271.30

STANDARD DEVIATION = 123.19 120.00 112.27 97.09 69.34
 COMPRESSION FACTOR FOR G3 MACHINE (CF3) = 14.6430
 COMPRESSION FACTOR FOR G4 MACHINE (CF4) = 15.4977
 NUMBER OF INCORRECT PELS = 0
 NUMBER OF BITS IN ERROR TRANSMITTED = 0
 ERROR SENSITIVITY FACTOR = 0.0

CHI. 480

ENTER ERROR CORRECTION MODE:
 DIAGNOSTIC PRINTOUT? (Y OR N):
 ENTER MAXIMUM NUMBER OF PELS PER LINE:
 ENTER VERTICAL SAMPLING:
 ENTER PARAMETER K:
 ENTER ERROR PATTERN PHASE:
 ENTER MINIMUM COMPRESSED LINE LENGTH:
 NUMBER OF SCAN LINES TO BE PROCESSED=7
 ERROR MODE=7 (M=MANUAL, T=TAPE, N=NO ERRORS)
 INPUT PARAMETERS:
 MAXIMUM NUMBER OF PELS PER LINE= 4096
 VERTICAL SAMPLING: N= 1
 PARAMETER K =6000
 ERROR PATTERN PHASE = 0
 MINIMUM COMPRESSED LINE LENGTH = 0 BITS
 NUMBER OF SCAN LINES TO BE PROCESSED = 6000
 ERROR CORRECTION MODE = 0
 RECORD SIZE = 128
 NO ERRORS INSERTED
 END OF MESSAGE DETECTED (3 EOL'S)
 TOTAL NUMBER OF CODED BITS = 1335612
 TOTAL NUMBER OF CODED DATA BITS = 1262734
 TOTAL NUMBER OF 2-DIM LINES = 5599
 TOTAL NUMBER OF INPUT LINES PROCESSED = 5600
 BIT ERROR RATE = .0

MINIMUM TRANSMISSION TIME (4800 BPS)

CODED LINE LENGTH STATISTICS:	0 MS	5 MS	10 MS	20 MS	40 MS
MINIMUM	14	24	48	96	192
MAXIMUM	618	618	618	618	618
MEDIAN	268	268	268	268	268
SAMPLE MEAN	238.49	240.28	244.66	253.61	273.82

STANDARD DEVIATION 126.10 122.93 115.35 100.66 73.42
 COMPRESSION FACTOR FOR G3 MACHINE (CF3) = 17.1738
 COMPRESSION FACTOR FOR G4 MACHINE (CF4) = 18.1650
 NUMBER OF INCORRECT PELS = 0
 NUMBER OF BITS IN ERROR TRANSMITTED = 0
 ERROR SENSITIVITY FACTOR = 0.0
 TOTAL NUMBER OF OUTPUT LINES PROCESSED = 5600

END OF DATA

APPENDIX F

CODE LISTING FOR THE INTERPOLATION PROGRAM

LIST BIGTERP.FORT

DSNAME='D0031.BIGTERP.FORT'

000010 C PROGRAM TERPOL

000020 IMPLICIT INTEGER(A-Z)

000030 COMMON/G32BIT/MASK(32),COMASK(32),LIBIT(32),LZBIT(32)

000040 COMMON/FILES/TERM,LPFIL,PELFIL,DTFIL,ERFIL

000050 DIMENSION PELBUF(130,2),OTBUF(130),UNPK(4160,2)

000060 DIMENSION INTERM(4081)

000070 LOGICAL DIAG

000080 DATA NN,YY/'N','Y'//

000090 TERM=5

000100 LPFIL=6

000110 PELFIL=1

000120 DTFIL=2

000130 DIAG=.FALSE.

000140 NBPW=32

000150 C

000160 C READ INPUT PARAMETERS

000170 C

000180 C READ DIAGNOSTIC SWITCH

000190 C

000200 114 WRITE(LPFIL,115)

000210 115 FORMAT('\$DIAGNOSTIC PRINTOUT? (Y OR N): ')

000220 READ(TERM,110) INSW

000230 110 FORMAT(A1)

000240 IF(INSW.EQ.YY) GO TO 116

000250 IF(INSW.EQ.NN) GO TO 20

000260 GO TO 114

000270 116 CONTINUE

000280 DIAG=.TRUE.

000290 C

000300 C READ INPUT RECORD SIZE

000310 C

000320 20 WRITE(6,30)

000330 30 FORMAT('\$ENTER INPUT RECORD SIZE: ')

000340 READ(5,140,ERR=20) BUFDIM

000350 IF(BUFDIM.GE.0.AND.BUFDIM.LE.130) GO TO 120

000360 WRITE(6,150) BUFDIM

000370 GO TO 20

000380 C

000390 C READ MAXIMUM NUMBER OF PELS PER LINE

000400 C

000410 120 CONTINUE

000420 WRITE(LPFIL,130)

000430 130 FORMAT('\$ENTER MAXIMUM NUMBER OF PELS PER LINE: ')

000440 READ(TERM,140,ERR=120) PELMAX

000450 140 FORMAT(I4)

000460 IF(PELMAX.GE.1.AND.PELMAX.LE.4160) GO TO 160

000470 WRITE(LPFIL,150) PELMAX

000480 150 FORMAT('NUMBER OUT OF RANGE (=,I6,')')

000490 GO TO 120

000500 C

000510 C READ VERTICAL SAMPLING

000520 C

000530 160 CONTINUE

000540 WRITE(LPFIL,170)

000550 170 FORMAT('\$ENTER VERTICAL SAMPLING: ')

000560 READ(TERM,180,ERR=160) VRES

000570 180 FORMAT(I2)

000580 IF(VRES.GE.1.AND.VRES.LE.10) GO TO 350

000590 WRITE(LPFIL,150) VRES

000600 GO TO 160

000610 C

```

000630 C
000640 C   WRITE INPUT PARAMETERS
000650 C
000660       WRITE(LPEFIL,400) BUFDIM, PELMAX,VRES
000670 400 FORMAT('INPUT PARAMETERS:/'
000675 *       'ORECORD SIZE =',I6/
000680 *       'OMAXIMUM NUMBER OF PELS PER LINE=',I6/
000690 *       'OVERTICAL SAMPLING: N=',I4)
000700 C***** BEGIN PROGRAM *****
000710 C
000720 C   INITIALIZE
000730 C
000740       ERRCNT=0
000750       INLNCT=0
000760       INREF=1
000770       INCOD=2
000780       OTREF=1
000790       OTCOD=2
000800       DO 850 I=1,BUFDIM
000810         OTBUF(OTREF)=0
000820         OTBUF(OTCOD)=0
000830         PELBUF(I,INREF)=0
000840         PELBUF(I,INCOD)=0
000850 850 CONTINUE
000860 C
000870 C   READ,WRITE, UNPACK FIRST LINE
000880 C
000890       READ(PELFIL,END=3000,ERR=4000)
000900 *INLNNO,INELCT,(PELBUF(I,INREF),I=1,BUFDIM)
000910 IF(INELCT.NE.PELMAX)CALL EXIT
000920 INLNCT=1
000930 WRITE(OTFIL)INLNCT,PELMAX,(PELBUF(I,INREF),I=1,BUFDIM)
000940 INLNCT=INLNCT+1
000950 DO 900 I=1,PELMAX
000960 UNPK(I,INREF)=I4B(PELBUF(1,INREF),I,1)
000970 900 CONTINUE
000980 1000 CONTINUE
000990 C
001000 C   READ BOTTOM LINE MODULO VRES AND UNPACK
001010 C
001020       READ(PELFIL,END=3000,ERR=5000)
001030 *INLNNO,INELCT,(PELBUF(I,INCOD),I=1,BUFDIM)
001040 IF(MOD(INLNNO-1,VRES).NE.0)GO TO 1000
001050 IF(INELCT.NE.PELMAX)CALL EXIT
001060 DO 1100 I=1,PELMAX
001070 UNPK(I,INCOD)=I4B(PELBUF(1,INCOD),I,1)
001080 1100 CONTINUE
001090 C
001100 C   CONSTRUCT INTERMEDIATE LINE
001110 C
001120       DO 1200 I=1,PELMAX
001130 IF(UNPK(I,INREF).NE.UNPK(I,INCOD))GO TO 1160
001140 IF(UNPK(I,INREF).EQ.1)GO TO 1150
001150 INTERM(I)=0
001160 GO TO 1200
001170 1150 INTERM(I)=1
001180 GO TO 1200
001190 1160 INTERM(I)=2
001200 1200 CONTINUE
001210 INTERM(PELMAX+1)=0
001220 C
001230 C   INTERPOLATE
001240 C
001250       LEFT=0

```

```

001260      RIGHT=1
001270      DO 1300 I=1,BUFDIM
001280      OTBUF(I)=0
001290 1300 CONTINUE
001300      DO 2000 X=1,PELMAX
001310      IF(RIGHT.GT.X)GO TO 1500
001320 1400 RIGHT=RIGHT+1
001330      IF(INTERM(RIGHT).EQ.2)GO TO 1400
001340 1500 CONTINUE
001350      IF(INTERM(X).EQ.2)GO TO 1600
001360      LEFT=X
001370      IF(INTERM(X).EQ.0)GO TO 2000
001380      CALL MI2B(INTERM(X),OTBUF,X,1)
001390      GO TO 2000
001400 1600 CONTINUE
001410      DL=X-LEFT
001420      DR=RIGHT-X
001430      IF(DR-DL)1700,1800,1900
001440 1700 CONTINUE
001450 C
001460 C SAME COLORS CLOSER TO RIGHT
001470 C
001480      CALL MI2B(INTERM(RIGHT),OTBUF,X,1)
001490      GO TO 2000
001500 1900 CONTINUE
001510 C
001520 C SAME COLOR CLOSER TO LEFT
001530 C
001540      CALL MI2B(INTERM(LEFT),OTBUF,X,1)
001550      GO TO 2000
001560 1800 CONTINUE
001570 C
001580 C SAME COLORS EQUIDISTANT
001590 C
001600      IF(INTERM(LEFT).NE.INTERM(RIGHT))GO TO 2000
001610      GO TO 1900
001620 2000 CONTINUE
001630 C
001640 C WRITE INTERPOLATED LINE
001650 C
001660      WRITE(OTFIL)INLNCT,PELMAX,(OTBUF(I),I=1,BUFDIM)
001670      INLNCT=INLNCT+1
001680 C
001690 C WRITE BOTTOM LINE
001700 C
001710      WRITE(OTFIL)INLNCT,PELMAX,(PELBUF(I,INCOD),I=1,BUFDIM)
001720      INLNCT=INLNCT+1
001730 C
001740 C SWITCH TOP AND BOTTOM LINES
001750 C
001760      TEMP=INREF
001770      INREF=INCOD
001780      INCOD=TEMP
001790      GO TO 1000
001800 3000 CONTINUE
001810 C
001820 C WRAP UP; SET OUTPUT=WHITE AND WRITE
001830 C
001840      DO 3100 I=1,BUFDIM
001850      OTBUF(I)=0
001860 3100 CONTINUE
001870      WRITE(OTFIL)INLNCT,PELMAX,(OTBUF(I),I=1,BUFDIM)
001880      WRITE(LPFIL,3200)INLNCT
001890 3200 FORMAT(10, 'OUTPUT LINES WRITTEN', 10)

```

```
001900      VRES=1
001910      CALL ERRMES(PELBUF,OTBUF,PELMAX,VRES,ERRCNT,DIAG,BUFDIM)
001920      STOP
001930  4000 STOP 4000
001940  5000 STOP 5000
001950      E N D
END OF DATA
READY
```

APPENDIX G

CODE LISTING FOR THE CONVERT PROGRAM

```

LIST 10 9999
00010 C PROGRAM CVRTJH3
00020 C
00030 IMPLICIT INTEGER(A-Z)
00040 INTEGER INBUF(405)
00050 INTEGER OUTBUF(81,5)
00060 LOGICAL DIAG
00070 EQUIVALENCE (INBUF(1),OUTBUF(1,1))
00080 C
00090 LZERO=6
00100 RZERO=6
00110 OUTLIN=3500
00120 OTLNNO=1
00130 INPEL=81
00140 OUTPEL=80
00150 DIAG=.TRUE.
00165 TOP=30
00170 BOTTOM=3400
00180 C
00190 C READ INPUT BLOCK
00200 C
00210 100 READ(1,END=230,ERR=220) INBUF
00220 C
00230 DO 200 J=1,5
00231 C
00232 C CHANGE LINES AT TOP TO WHITE IF SPECIFIED
00233 C
00234 IF(OTLNNO.GT.TOP) GO TO 110
00235 DO 115 I=1,OUTPEL
00236 115 OUTBUF(I,J)=0
00237 110 CONTINUE
00240 C
00250 C ZERO LEFT PELS
00260 C
00270 DO 120 I=1,LZERO
00280 120 OUTBUF(I,J)=0
00290 C
00300 C ZERO RIGHT PELS
00310 C
00320 RIGHT=INPEL-RZERO+1
00330 DO 130 I=RIGHT,INPEL
00340 130 OUTBUF(I,J)=0
00350 C
00360 C WRITE OUTPUT LINE
00370 C
00380 WRITE(2) OTLNNO,PELMAX,(OUTBUF(I,J),I=1,OUTPEL)
00390 IF(.NOT.DIAG) GO TO 160
00400 C
00410 C PRINT EVERY 100TH LINE
00420 C

```

```

00430         IF (MOD(OTLNNO,100).NE.0) GO TO 160
00440         WRITE(6,140) OTLNNO
00450 C       WRITE(6,150) (OUTBUF(I,J),I=1,OUTPEL)
00460         140 FORMAT(I8)
00470         150 FORMAT(8Z9)
00480         160 OTLNNO=OTLNNO+1
00490         IF(OTLNNO.GT.BOTTOM) GO TO 230
00500         IF(OTLNNO.GT.OUTLIN) GO TO 210
00510         200 CONTINUE
00520         GO TO 100
00530         210 STOP 210
00540         220 STOP 220
00550 C
00560 C       FILL WITH WHITE LINES AT BOTTOM IF NECESSARY
00570 C
00580         230 CONTINUE
00590         DO 240 I=1,OUTPEL
00600         240 OUTBUF(I,1)=0
00610 C
00620         250 IF(OTLNNO.GT.OUTLIN) STOP 240
00630         WRITE(2) OTLNNO,PELMAX,(OUTBUF(I,1),I=1,OUTPEL)
00640         OTLNNO=OTLNNO+1
00650         GO TO 250
00660         E N D
END OF DATA
END
READY

```

APPENDIX H

LEGIBILITY TEST DATA

200 lpi

Subj	Pattern	2	3	4	6	8	10
KHR	2	34	24	4	1		
PWR	3	38	18	3	1		
PWR	4	40	24	7	1		
CBR	3	39	22	4			
ARD	2	40	36	4			
CZ	2	30	16	4			
JL	3	34	5	4	1		

H-1

255/7

145/7

30/7

4/7

99%

43%

89%

99%

100%

100%

240 lpi

Subj	Pattern	2	3	4	6	8	10
KHR	1	26	7	1			
PWR	1	40	16	1			
CBR	4	39	13	2	2		
AJD	3	28	5	3			
PS	4	40	25	6	1		
RAS	2	30	6	3			
GU	3	22	5	1	1		
RAS	3	38	10	1			

H-2

263/8 37/8 18/8 4/8
18% 73% 94% 99% 100% 100%

300 lpi

Subj	Pattern	2	3	4	6	8	10
KHR	4	7	2	1			
PWR	2	40	2				
CBR	2	40	14		2		
ARD	4	26	1	5			
PS	2	40	6				
GU	2	12	2				
PAS	4	34	7	3	1		

H-3

149/7 34/7 9/7 7/7
29% 88% 97% 99% 100% 100%

-20 /oi

Subj	P ²	2	3	4	6	8	10
KHR	1	4					
CLR	1	40	11	1			
ARJ	1	28	1				
PS	1	40	5				
JL	1	13	1		1		
GU	1	5	1				
PWR	1	14	0	1			

H-4

132/6 171/6 1/6 1/6
46 % 92 % 100 % 100 % 100 % 100 %

480 100

City	Pattern	2	3	4	6	8	10
KHR	2	2					
HR	3	4	1				
ARD	2	18	3				
PS	3	40	21	1			
JL	1	5		2			
GU	4	2					
CBR	3	40	36	6			
PWR	4	2	3				

H-5

71/6 25/6 3/6
70% 90% 99% 100% 100% 100%

ORIGINAL

SLB;	Pattern	2	3	4	6	8	10
ARE	3	5					
JL	4	4		1			
JL	2	3	1				
GU	2						
KHR	3	1	1				
CBR	2	40	22	2			
PWR	2	1					

H-6

12/4 1/4 1/4
 93% 97% 99% 100% 100% 100%

400 I

Subj	Pattern	2	3	4	6	8	10
ARD	1	38	6				
JL	3	29	7				
GU	3	19	3	1			
CBR	1	40	40	4	2		
PWR	3	40	3	1			

H-7

2312 16 1/2 1/3
2 90 37 50 90 50 100 50 100 50

END

FILMED

10 00