

AD-A110 567

BAND LAVIS AND ASSOCIATES INC SEVERNA PARK MD
DEVELOPMENT OF INTACT STABILITY STANDARDS FOR RIGID-SIDEWALL SU--ETC(U)
DEC 81 D R LAVIS, E O BAND, E D HOYT

F/G 13/10

DTC023-80-C-20042

UNCLASSIFIED

BLA-WP-155-2

USCG-D-83-81

NL

1-2



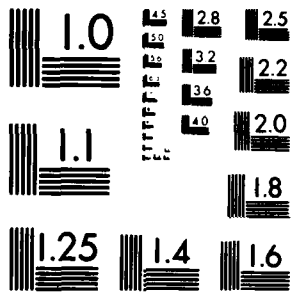

MICROCOPY RESOLUTION TEST CHART
NATIONAL BUREAU OF STANDARDS 1963-A.

Report No. CG-N-53-81

LEVEL II (12)

DEVELOPMENT OF INTACT STABILITY STANDARDS
FOR
RIGID-SIDEHULL SURFACE-EFFECT SHIPS

David R. Lavis
Edward G.U. Band
Edgar D. Hoyt

BAND, LAVIS & ASSOCIATES, INC.
670 Ritchie Highway
Severna Park, Maryland 21146

AD A110567



FINAL REPORT
DECEMBER 1981

DTIC
ELECTE
FEB 4 1982
S D

Document is available to the public through the
National Technical Information Service,
Springfield, Virginia 22161

[Faded text, likely a signature or stamp]

NOTICE

This document is disseminated under the sponsorship of the Department of Transportation in the interest of information exchange. The United States Government assumes no liability for its contents or use thereof.

The contents of this report do not necessarily reflect the official view or policy of the Coast Guard; and they do not constitute a standard, specification, or regulation.

This report, or portions thereof may not be used for advertising or sales promotion purposes. Citation of trade names and manufacturers does not constitute endorsement or approval of such products.

Technical Report Documentation Page

1. Report No. CG-D-53-81	2. Government Accession No. JD-A110567	3. Recipient's Catalog No.	
4. Title and Subtitle DEVELOPMENT OF INTACT STABILITY STANDARDS FOR RIGID-SIDEHULL SURFACE-EFFECT SHIPS		5. Report Date December 1981	6. Performing Organization Code
		8. Performing Organization Report No. BLA-W.P. No. -155-2	
7. Author(s) D.R. Lavis, E.G.U. Band, E.D. Hoyt		10. Work Unit No. (TRAIS)	
9. Performing Organization Name and Address BAND, LAVIS & ASSOCIATES, INC. 670 Ritchie Highway Severna Park, Maryland 21146		11. Contract or Grant No. DTCG23-80-C-20042	
		13. Type of Report and Period Covered FINAL REPORT DECEMBER 1981	
12. Sponsoring Agency Name and Address U.S. Department of Transportation United States Coast Guard 2100 Second Street, S.W. Washington, D.C. 20590		14. Sponsoring Agency Code	
15. Supplementary Notes			
16. Abstract This report was prepared under Contract No. DTCG 23-80-C-20042, entitled "DEVELOPMENT OF SPECIFIC STANDARDS TO JUDGE THE LIMITS UNDER WHICH A DYNAMICALLY SUPPORTED VESSEL WILL REMAIN UPRIGHT WITH NO DAMAGE IN AN OPEN SEAWAY," issued by the Commandant, U.S. Coast Guard, Effective 1 October 1980. The program under study was a continuation of work performed by BAND, LAVIS & ASSOCIATES, INC. for the U.S. COAST GUARD in 1979 (USCG APR 79 and USCG OCT 79). In this present phase of work emphasis has been directed towards developing INTACT STABILITY STANDARDS FOR RIGID-SIDEHULL SURFACE-EFFECT SHIPS (SES). The study effort was divided into two (2) technical tasks: Task I, Evaluation of SES Stability Parameters Task II, Formulation of SES Stability Standards The progress achieved in the pursuit of both these tasks is described herein.			
17. Key Words Stability Standards Criteria Surface-Effect Ships		18. Distribution Statement	
19. Security Classif. (of this report) Unclassified	20. Security Classif. (of this page) Unclassified	21. No. of Pages	22. Price

METRIC CONVERSION FACTORS

Approximate Conversions to Metric Measures

Approximate Conversions from Metric Measures

Symbol	When You Know	Multiply by	To Find	Symbol	When You Know	Multiply by	To Find	Symbol
LENGTH								
in	inches	2.5	centimeters	cm	centimeters	0.4	inches	in
ft	feet	30	centimeters	cm	meters	3.3	feet	ft
yd	yards	3	meters	m	kilometers	1.1	yards	yd
mi	miles	1.6	kilometers	km	kilometers	0.6	miles	mi
AREA								
sq in	square inches	6.5	square centimeters	cm ²	square centimeters	0.16	square inches	in ²
sq ft	square feet	0.09	square meters	m ²	square meters	1.2	square yards	yd ²
sq yd	square yards	0.8	square meters	m ²	square kilometers	0.4	square miles	mi ²
ac	acres	2.5	hectares	ha	hectares (10,000 m ²)	2.5	acres	ac
MASS (weight)								
oz	ounces	28	grams	g	grams	0.035	ounces	oz
lb	pounds	0.45	kilograms	kg	kilograms	2.2	pounds	lb
	short tons (2000 lb)	0.9	tonnes	t	tonnes (1000 kg)	1.1	short tons	st
VOLUME								
teaspoon	teaspoons	5	milliliters	ml	milliliters	0.03	fluid ounces	fl oz
tablespoon	tablespoons	15	milliliters	ml	liters	2.1	pints	pt
fluid ounce	fluid ounces	30	milliliters	ml	liters	1.06	quarts	qt
cup	cups	0.24	liters	l	liters	0.76	gallons	gal
pint	pints	0.47	liters	l	cubic meters	35	cubic feet	ft ³
quart	quarts	0.75	liters	l	cubic meters	1.1	cubic yards	yd ³
gallon	gallons	3.8	cubic meters	m ³				
cubic foot	cubic feet	0.03	cubic meters	m ³				
cubic yard	cubic yards	0.76	cubic meters	m ³				
TEMPERATURE (exact)								
F	Fahrenheit temperature	5/9 (after subtracting 32)	C	Celsius temperature	C	Celsius temperature	9/5 (after adding 32)	F

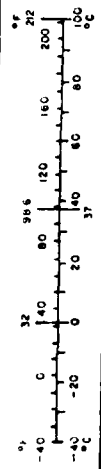

Accession For

REF ID: A61118

UNCLASSIFIED

Classification

Availability Codes

Special

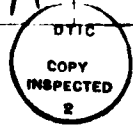

8204030

FOREWORD

When a Surface-Effect Ship (SES) is off-cushion, its stability characteristics are similar to those of a displacement ship and its stability requirements can be formulated in the traditional manner. ~~When the SES is on-cushion, traveling at high speed, a very different set of circumstances apply and the displacement ship's stability requirements can no longer be used.~~ In view of the growing interest in operating SES and other high-performance ships in commercial service in U.S. waters, the United States Coast Guard (USCG) has initiated a program of study to develop stability standards for these ships when operating at high speed. This report summarizes the most recent phase of this work which concerns the stability of the rigid-sidehull SES in normal operation.

The USCG objective is to provide guidelines to SES designers that will enable them to determine, during the design stages, whether or not a proposed SES has adequate inherent stability. Care must be taken that the guidelines do not constrain the designer unnecessarily.

The types of hazard and types of instability which SES can encounter in normal operation are identified. Corresponding requirements for certification of safe operation are recommended.

Results of developing a non-linear, five-degree-of-freedom, mathematical representation of SES response to certain hazards are presented to show the effect of changing normalized stability parameters. Correlation with SES-100B trials results is presented to establish modeling validity. Computed time histories of ship response in pitch, roll, yaw, sway and forward speed are used to determine whether or not the ship's behavior is, or is not, acceptable. Acceptable combinations of pitch, roll and yaw stability, that can be applied to a wide range of configurations, are presented in non-dimensional form.

The study was accomplished for the U.S. Coast Guard's Office of Research and Development, Safety and Advanced Technology Division, as part of its Commercial Vessel Safety Program. The views expressed by this report are, however, those of the authors and do not necessarily reflect the official views or policy of the Coast Guard. This report does not constitute a standard, specification or regulation.

TABLE OF CONTENTS

	Page
1. INTRODUCTION.....	1
2. APPROACH.....	4
2.1 IDENTIFICATION OF CRITICAL OPERATIONAL SITUATIONS.....	4
2.2 IDENTIFICATION OF TYPES OF STABILITY STANDARDS.....	4
2.3 SES INSTABILITIES IN CALM WATER.....	6
2.4 SES INSTABILITIES IN ROUGH WATER.....	8
3. SES STABILITY IN CALM WATER.....	9
3.1 EQUATIONS OF MOTION.....	9
3.2 NON-DIMENSIONAL COEFFICIENTS.....	22
3.3 LIMITS OF STABLE OPERATION.....	24
3.4 EFFECTS OF STABILITY VARIATIONS.....	30
3.4.1 Full-Scale Stability Coefficients.....	30
3.4.2 Rudder-Reversal Maneuvers.....	30
3.4.3 Rudder Reversals with 16° Rudder.....	33
3.4.4 Rudder Reversals with Constant Turn Radius ($R/L_c = 30$).....	35
3.4.5 Effect on Rudder-Reversal Maneuver of Forward Movement of Center of Gravity.....	40
3.4.6 Effect of a Pitch-Down Disturbance in a Turn.....	40
3.5 SURVEY OF CURRENT AND PRIOR SES.....	45
3.5.1 Conditions for Stable, Rudder-Reversal Maneuver ($F_N = 1.9, R/L_c = 30$).....	49
3.5.2 Conditions for Stable, Rudder-Reversal Maneuver at Other Turn Radii ($F_N = 1.9$).....	50
3.5.3 Conditions for Stable, Rudder-Reversal Maneuvers at Other Speeds.....	51
4. SES STABILITY IN ROUGH WATER.....	52
4.1 LINEAR TOWING TANK TESTS.....	53
4.1.1 Testing in Regular Waves.....	53

320486

4.1.2	Testing in Irregular Waves.....	54
4.2	FREE-RUNNING MODEL TESTS.....	55
4.3	MINIMUM ROUGH-WATER TEST REQUIREMENTS.....	56
4.3.1	General Requirements for Model Tests.....	56
5.	RECOMMENDED STABILITY STANDARDS.....	62
5.1	AUTHORITY FOR REGULATIONS.....	64
5.2	APPLICATION.....	64
5.3	PURPOSE.....	65
5.4	DEFINITIONS.....	65
5.5	STABILITY AND CONTROL OFF-CUSHION.....	72
5.5.1	General Provisions.....	72
5.5.2	Intact Buoyancy.....	72
5.5.3	Intact Stability.....	73
5.6	STABILITY AND CONTROL ON-CUSHION.....	84
5.6.1	General Provisions.....	84
5.6.2	Determination of Acceptable Stability and Controllability.....	87
5.7	PROOF OF COMPLIANCE AND CERTIFICATION.....	95
6.	REFERENCES	96
7.	LIST OF SYMBOLS.....	100
	APPENDIX A - EXPERIMENTAL DATA.....	A-1
	APPENDIX B - DERIVATION OF SES EQUATIONS OF MOTION.....	B-1
	B-1 - KINEMATICS.....	B-1
	B-2 - CONSTRAINED VERTICAL MOTION.....	B-4
	B-3 - THE FORCE EQUATIONS.....	B-6
	B-4 - THE MOMENT EQUATIONS.....	B-7
	B-5 - EXPANSION OF THE MOMENT EQUATION.....	B-9
	B-6 - COORDINATE TRANSFORMATION OF THE MOMENTAL DYADIC.....	B-12

1. INTRODUCTION

In 1978 the U.S. Coast Guard initiated a program of study to develop intact stability standards for high-performance craft, with emphasis placed on their high-speed mode of operation. Although some important contributions had previously been made to recognize the special needs of high performance craft, notably NAVSEA 25 JUN 76 and IMCO 2 MAY 78*, this prior work had concentrated, for the most part, on the more tractable problem of assessing stability in the low-speed, displacement mode of operation.

The U.S. Coast Guard work, started in 1978, was organized to consist of two major phases; both of which have been performed by BAND, LAVIS and ASSOCIATES of Severna Park, Maryland. Both phases were confined to analytic investigations without support from model or full-scale experimentation. Phase I, completed in July 1979, was a background study encompassing a technical interpretation of the state-of-the-art of assessing the stability of high-performance craft. Craft considered in the Phase I study included Air-Cushion Vehicles (ACV), Surface-Effect Ships (SES), Hydrofoil Craft and Planing Craft. Types of hazard and types of instability to which such craft could be subjected were identified and approaches to stability assessment were evaluated. A six-volume, annotated and categorized bibliography of relevant reports was also prepared. The results of the Phase I study were reported in USCG APR 79, USCG OCT 79 and BLA JUN 80.

The second phase of the study, which is reported herein, was aimed at providing specific stability standards for one selected class of high performance craft: the rigid-sidehull SES. Intact stability in the hullborne and cushionborne modes of operation were to be treated. Standards were sought which could protect an SES from the hazards of normal operation and of operation in extreme sea conditions.

SES configurations vary considerably. The hydrodynamic features affecting stability include the sidehull length and deadrise, the types of bow and stern seals, the size and location of skegs, fences and rudders, the type of propulsion system and the type of maneuvering system. All of these variations render the task of developing universally applicable stability standards more difficult.

Capsizing was considered to be the most serious stability-related casualty which an SES could suffer. The principal objective of the Phase II study was, therefore, directed to the development of standards intended to assure adequate resistance to capsizing. The primary circumstances leading to a risk of capsizing include high-speed turning maneuvers, running with wind and seas on the beam and operation in following or quartering seas with risk of broaching.

It was clearly recognized that SES behavior approaching the limits of capsize was extremely complex and in many cases would defy analytic treatment. In

* Reports referred to here and elsewhere in the text are listed in alphabetical order in the References at the end of the report. Each reference in the text and Reference list is identified by a code name and date.

normal operation an SES only deviates a few degrees from zero angles of roll, sideslip and pitch. When any of these angles depart too much from the zero value a number of undesirable phenomena can occur. The sidehulls are designed to run at zero or very small angles of sideslip and shallow immersion so that they act as a seal for the air cushion without causing undesirable levels of drag. As sideslip increases, the sidehulls tend to raise the water level on their upstream sides and may ventilate on their downstream sides. The water pile-up may reach the wet deck inside the cushion and then move aft to impact the rear seal, or it may flow over the craft top sides. If the bow of the sidehull digs in due to pitch-down then directional instability may occur. Finally excessive angular displacement in any direction may cause the cushion to vent.

Since the early SES design investigations in the late '50s, the nonlinearities in forces and moments which result from such behavior have been assessed principally from the results of model towing-tank tests. Although a wealth of such test experience has been accumulated over the past twenty years, these tests have mostly been limited to the characterization of specific designs with little attempt or opportunity to explore, systematically, any wide variation in hull form or basic stability parameters. Even the model testing which followed the only known capsize of an SES (the U.S. Navy's experimental test craft, XR-1, on the Delaware River in December of 1964) was limited principally to the exploration of craft beam and sidehull deadrise. The beam of the XR-1 was increased to improve roll stability as a result of the model tests.

Many of the early analyses of the dynamic stability of SES addressed stability using linearized equations of motion. The studies were limited to calm-water operation and considered either longitudinal or lateral stability modes. In general, the essential properties, or possible modes, of transient response and stability were determined by the nature of the roots of the characteristic equation. Although in most cases, forces and moments were decidedly non-linear, dynamic stability could at least be assessed for small angular displacements. These early studies were concerned, therefore, not so much in predicting the ultimate non-linear response, but rather with predicting those conditions and configurations for which unstable behavior could build up, so that such motions (and configurations) could be avoided.

In recent years, advances in computer-aided analysis have permitted more ambitious methods to be developed for treating the non-linear behavior of the SES. Such methods are, however, not only difficult and expensive to use but are also very difficult to validate in an adequate manner. They often rely heavily on experimental data.

One basic purpose of the present study was to establish relatively simple prediction techniques which could be used by SES designers during the design process. It was also deemed undesirable to force the SES designer to resort to elaborate and expensive mathematical modeling of stability behavior as a necessary prerequisite for certification.

The Phase II study was divided into two tasks. The first task involved an evaluation of SES stability parameters. The second task was the formulation of stability standards.

The first problem faced in task I was, therefore, to determine which of the SES hazards and types of instability identified in Phase I were of a type for which analytic techniques could provide a reliable understanding and which hazards and types of instability could only adequately be assessed from direct testing of a scaled model.

Hazards were divided into calm and rough water types. Only the treatment of calm-water hazards were considered possible by analytic methods in the current study and it was deemed more appropriate to address the SES rough-water hazards by proposing a series of scale-model tests.

Significant advances have been made in recent years in the understanding of the non-linear behavior of displacement ships in extreme sea conditions. For the more complex geometry and operation of an SES it was not considered to be advisable to attempt a direct analytical treatment of the rough-water cases until the calm-water behavior was better understood and until more experimental evidence became available.

For the analytic treatment of SES motion in calm water, a non-linear dynamic representation of the response of an SES to realistic hazards and maneuvers was developed. Results were checked against the measured maneuvering behavior of a full-scale craft to validate predictive accuracy. The effects on craft behavior of changing normalized stability levels in pitch, roll and yaw were then explored. Acceptable combinations of pitch, roll and yaw stability, that could be applied to a wide range of SES configurations, were identified and safe limits expressed in simple algebraic terms wherever this was found to be possible.

For assuring safe operation in rough water scale-model tests have been recommended. Both tow-tank tests and self-propelled, free-flight model tests have been discussed and minimum requirements established.

The results of task II have been expressed as recommended, safe, stability standards for craft certification. Requirements for hullborne and cushionborne modes of operation and for adequate craft maneuvering and control were also considered. The proposed standards were prepared using a format which would permit their inclusion within an overall framework for SES standards of safety.

Both general and specific standards have been proposed. At this stage in the development of the specific standards it is recommended that they be used for guidance only until further operational experience has been gained and until the results of task I have been more completely validated by model tests.

2. APPROACH TO FORMULATION OF STANDARDS

2.1 IDENTIFICATION OF CRITICAL OPERATIONAL SITUATIONS

Studies under Phase I, USCG OCT 79, have served to identify the operational situations which may be critical for a Surface-Effect Ship. In every case the eventual climax is a capsize in roll but the progression to that termination can occur in a number of ways.

In calm water the danger of capsizing results from high-speed turning maneuvers, leading to the development of excessive sideslip while the speed remains high. Such excessive sideslip angles can develop only as a result of a loss of directional stability to such a degree that steering authority is inadequate. Directional stability can be adversely affected by bow-down pitch attitudes which can result from wake-crossing or other irregular surface disturbance. Thus, three critical calm-water instabilities can be identified:

- (a) Plow-in due to inadequate pitch stability
- (b) Broaching-to due to pitch down and loss in directional stability
- (c) Tripping, in roll, as a result of high sideslip operation.

In rough water, speed will normally be lower and wave action is the decisive feature leading to capsize. Three circumstances can be critical:

- (a) Broaching-to when operating in high following or quartering seas
- (b) Roll-capsize as a result of synchronous rolling in high beam seas
- (c) Aggravation of any of the calm-water maneuvers due to wave action.

In the first of these a significant increase in speed may result from the action of the waves so that considerable kinetic energy is available when excessive sideslip develops, leading to tripping and capsize. In beam seas considerable lateral velocity can develop so that tripping may be a factor in this case also.

2.2 IDENTIFICATION OF TYPES OF STABILITY STANDARDS

Six candidate types of stability standards for SES were defined in Phase I. These are summarized in Table 2-1.

The first three types of standards involve consideration of static stability characteristics of the craft: They require progressively more complete determination of these characteristics beginning with the initial stiffness, which may be sufficiently well estimated by analytic methods or from a parametric series of model tests, and progressing to a degree of detail which would require tests of a specific model under constrained conditions with model seals and an active cushion air supply.

Simulation requires definition of force/motion relations, including the effects of angular velocities and accelerations, which presupposes very extensive constrained model tests or very sophisticated analysis. The results, which can readily be extended beyond the range of anticipated severity of motion, must be progressively verified by full-scale tests up to the limits of

TABLE 2-1. POSSIBLE TYPES OF SES STABILITY STANDARDS.

TYPES OF STANDARD	CALM WATER			ROUGH WATER	
	PITCH DOWN - PLOW-IN	DIRECTIONAL BROACHING TO	ROLL - TRIPPING AND CAPSIZE	BROACHING IN FOLLOWING/QUARTERING SEAS	BEAM SEAS CAPSIZE
1. MIN.ACCEPTABLE INITIAL STIFFNESS					
2. MIN.ACCEPTABLE RESTORING MOMENTS					
3. MIN.ACCEPTABLE ENERGY AREA RATIOS	✓	✓	✓		
4a. ANGULAR DISPLACEMENT & RATE LIMITS USING REDUCED D.O.F. SIMULATION	✓	✓	✓	✓	✓
4b. ANGULAR DISPLACEMENT & RATE LIMITS USING 6-D.O.F. SIMULATION		✓			
5. FREE FLIGHT OR RESTRAINED MODEL TESTS	✓	✓	✓	✓	✓
6. FULL SCALE TESTS	✓				

 Judged not to be applicable.

✓ Applicable.

desired maneuverability. The simulation, then, assures the safety of each advance and, if proven, assures a margin beyond service limits. These procedures have been followed in U.S. Navy advanced developments, but are probably beyond the means of a small designer and manufacturer.

Free-flight model tests, or tests in waves in a basin under light restraint, can be used to explore and exhibit the stability of a new design to almost any desired extent. The cost, however, is not inconsiderable and as yet unresolved problems of scaling leave the results open to question.

It is, of course, anticipated that full-scale trials of any new design will be addressed to the verification of safety of operation. Unfortunately the approach to a hazardous situation cannot surely be foreseen, so that expansion of the operational envelope without comparable simulation studies or model testing involves a substantial risk. The possible cost of a discovered need for redesign and modification must be balanced against the more predictable costs of satisfying the previously discussed standards.

2.3 SES INSTABILITIES IN CALM WATER

The activities which have been given most consideration in this phase of the program have concentrated upon those types of SES instabilities that can occur in calm water. From the outset, it was believed that standards should not place limits on craft geometry but should rather place limits on the character of exhibited stability or on the behavior of the craft as a whole. It was considered important not to develop standards which would tell the designer what stabilizing contribution he should have each component of his design exhibit but, rather, place minimum acceptable limits on the total contribution from all stability sources included in his design.

In conformity with the conclusion of Phase I of the Study of Dynamically Supported Craft (USCG OCT 79 and USCG APR 79), it was believed that limits, such as minimum acceptable static restoring moments or areas under righting-arm curves (as used for displacement-ship standards), could also be used to form the basis of cushionborne stability standards for SES. An overall approach to selecting standards was, therefore, developed to involve five (5) distinct steps as follows:

- (i) Develop a data base of SES static and dynamic stability characteristics, derived from model- and full-scale testing, which would describe, for a range of SES types, the nonlinear behavior of forces and moments and coupled forces and moments as a function of forward speed, angular displacements and rates of angular displacements.
- (ii) Develop for each stability problem a mathematical representation of SES dynamic response to realistic (and measurable) disturbances, for solution in the time-domain; the equations of motion to include a non-linear idealization of the characteristics developed in subtask (i).
- (iii) Using the math model developed in subtask (ii) explore the effect on craft dynamic behavior of varying parameters such as peak righting moments and areas under righting arm curves.
- (iv) Compare the results (input characteristic parameters vs. response) of subtask (iii) with the observed safe and unsafe behavior of existing operational SES.
- (v) Select characteristic parameters which can be demonstrated to be safe for each type of SES instability explored.

As shown in sections 3 and Appendix A, significant progress has been made in developing a base of stability data and in developing the necessary mathematical representations. During Phase I a representation of SES pitch-surge motions was applied to the analysis of SES calm-water plow-in, as described in BLA 1 DEC 80.

It was recognized that plow-in alone is not necessarily a seriously hazardous event for an SES. If craft motion during the plow-in can be restricted to the pitch-heave-surge plane, then the danger is confined to:

- (a) the peak longitudinal decelerations (and/or vertical accelerations due to wet deck slamming) that the craft, crew, passengers and cargo can be subjected to; the likelihood of an SES capsizing in pitch (pitch-polling) is considered extremely remote.
- (b) the dangerous effect that an unanticipated plow-in might have upon craft navigation in relation to other craft in restricted waters.

However, any plow-in at high forward speed which results in fairly large pitch-down angles, can cause a serious loss in overall directional stability. This is particularly serious if the event occurs while the craft is operating at high sideslip angles as would be the situation during a tight turning maneuver. This situation, in turn, can create large upsetting (tripping) moments in roll and a danger of roll capsizing.

To guard against such behavior, the SES must exhibit a certain minimum combination of pitch, yaw and roll stability. (Pitch, yaw and roll stability must eventually be considered together in view of the possible tradeoff and strong coupling that could exist between them.)

In a further effort to relate the more readily determined static stability characteristics to craft dynamic behavior a more complete simulation, excepting only the heave component, was established. This has been used to explore turning maneuvers involving a rudder reversal, and to investigate the effect of variations in the static stability in pitch, roll and yaw. In addition, the pitch-surge studies were extended to the representation of a pitch-down in a turn.

As a result of these studies, described in Section 3 of this report, it has been possible to derive tentative standards for static stability which are expected to assure safe calm-water operations.

It should be noted here that the terms "static" and "dynamic" stability have connotations for dynamically supported craft (aircraft, hydrofoils, ACVs and SES) that may be confusing to those readers who are used to dealing with displacement ships. "Static" stability does not refer to a zero-forward-speed condition; it refers to the stability of the craft moving ahead at a steady forward speed with a fixed displacement in yaw, roll or pitch; the craft is "static" with respect to rotation about the pitch, roll or yaw axes, and with respect to lateral or vertical translation. Static stability forces, therefore, may be readily measured in towing-tank tests. "Dynamic" stability, on the other hand, refers to the stability of the craft when it has freedom to rotate about one or more axes and/or to move laterally or vertically. When a dynamically stable craft is disturbed (by encountering a ship's wake, for example), it may oscillate but will eventually return to its original, undisturbed condition; a dynamically unstable craft will diverge, or oscillate to increasingly large angles, until a dangerous situation is reached--ultimately, it may flip or capsize.

2.4 SES INSTABILITIES IN ROUGH WATER

Any of the unstable situations that can develop in calm water can develop also in rough water. The presence of wind and waves will usually act to aggravate any unstable situations that develop. Behavior in waves, however, is much more complex and difficult to analyze. The approach recommended in this report for treatment of rough water instabilities is to resort to specially designed model test programs. Full-scale experience of SES in rough water is very limited; there is no record of any stability related accident having occurred in these conditions. Further experimental evidence should therefore be acquired to determine what constitutes good design and operational practice to ensure adequately stable behavior in rough water. These considerations are discussed at more length in section 4 of this report.

3. SES STABILITY IN CALM WATER

Capsizing is the most serious stability related casualty which an SES can suffer. The initial effort in the Phase II study was, therefore, directed to the development of stability standards intended to assure adequate resistance to capsizing. This involved dynamic analysis of the relevant motion components for craft whose performance is known, and a search for the critical factors which distinguish safe performance.

The circumstances leading to a risk of capsizing include high-speed turning maneuvers, running with beam wind and sea, or operation in following or quartering seas with risk of broaching. Attention in this section is focused on maneuvering in calm water. The approach to assessing stability in heavy seas is discussed in Section 4.

A typical capsize in a turn involves a sequence including:

- . a severe pitch-down response to some disturbance
- . resulting directional instability leading to excessive turning velocity and sideslip
- . development of roll beyond the angle of vanishing righting moment.

It appears, therefore, that capsize can be prevented by providing sufficient resistance to the development of a bow-down pitch attitude, by maintenance of directional stability at the extreme pitch-down attitude attained and by achievement of a substantial margin of roll-righting moment under the conditions present in the most severe turning maneuver required. The stability characteristics about each of the three axes are closely interrelated. It seems probable that an increase in pitch stability will permit some relaxation of the directional stability envelope so that a basis for trade-offs will exist. In any event, the two aspects must be jointly considered. Roll stability requirements must cover both directed turning maneuvers and inadvertent transients.

As a first step in the analysis, a simulation of the pitching response to different types of disturbances was established and used to explore the behavior of the SES-100B, a craft for which a substantial data base is available as well as extensive operational experience which has established safe operating envelopes with respect to speed, trim and maneuvering. This work was described in BLA DEC 80.

The analysis was then extended to the yaw/sideslip and roll modes of stability by using model test and full-scale trials data. The results are described in Section 3.2 of this report.

3.1 EQUATIONS OF MOTION

The behavior of an SES at the large angular displacements approaching capsize is very non-linear, and comprehensive, analytical representation of the restoring-force and moment characteristics is extremely complex. The analyst may circumvent some of the complexity by making use of experimental model data with the attendant problem of establishing realistic full-scale representation.

The motion of a craft, and hence its stability, depends on the hydrodynamic and aerodynamic forces and moments imposed on the craft by motion through the water and as a result of the operation of controls and propulsors. The wind and the waves also influence the system of forces to which the craft is subjected. Analysis of motion should represent the six degrees of freedom of the hull as a rigid body in space. Additional degrees of freedom are introduced by the control deflections and also by control command devices (steering wheel, roll-control lever, etc.) and perhaps by other intermediate variables within an automatic, servo-control system. In general, a description of the total system requires as many equations as there are degrees of freedom.

The simplest form of the equations of motion of the craft, considered as a rigid body, is obtained with body axes coincident with the principal axes of inertia, and the origin at the center of mass, C.G. (See Figure 3-1). For this case, the equations are

$$\begin{aligned}
 X &= m (\dot{u} + qw - rv) \\
 Y &= m (\dot{v} + ru - pw) \\
 Z &= m (\dot{w} + pv - qu) \\
 K &= I_x \dot{p} + (I_z - I_y) qr \\
 M &= I_y \dot{q} + (I_x - I_z) rp \\
 N &= I_z \dot{r} + (I_y - I_x) pq
 \end{aligned}
 \tag{3.1}$$

where the symbols are illustrated and defined in Figures 3-1 and 3-2. The first three equations are simply the representation in body axes of the fundamental Newtonian equation, $\bar{F} = m\bar{a}$ where \bar{F} is the force vector, m is the mass and \bar{a} the acceleration vector of the body. The expressions within parentheses on the right hand sides are the components of the acceleration of the body along the body axes.

The last three, known as Euler's equations, express the moments about the body axes. The expressions on the right-hand side are complete only if the body axes are the principal axes of inertia. The symbols I_x , I_y and I_z designate moments of inertia about the x, y, z body axes. For most craft no serious error results if the x axis is chosen parallel to the designer's baseline, y normal to the central plane of symmetry and z normal to x and y.

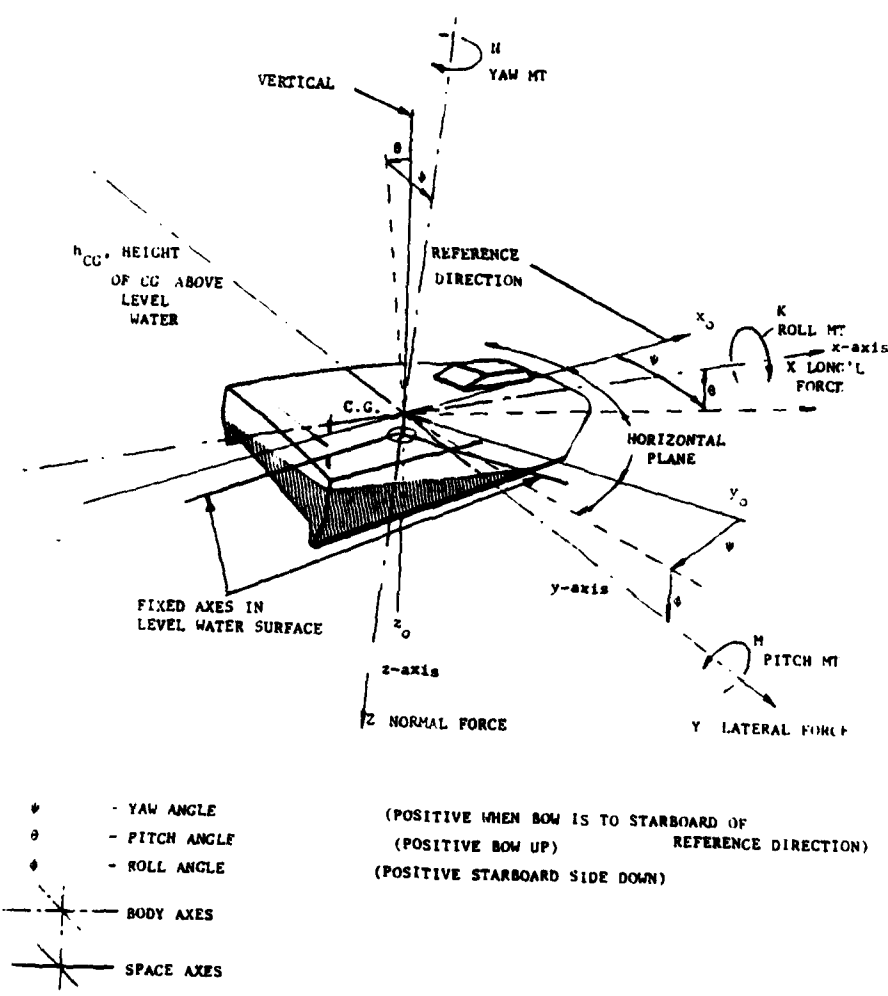

(POSITIVE WHEN BOW IS TO STARBOARD OF REFERENCE DIRECTION)
 (POSITIVE BOW UP)
 (POSITIVE STARBOARD SIDE DOWN)

FIGURE 3-1. DEFINITION OF AXIS SYSTEM.

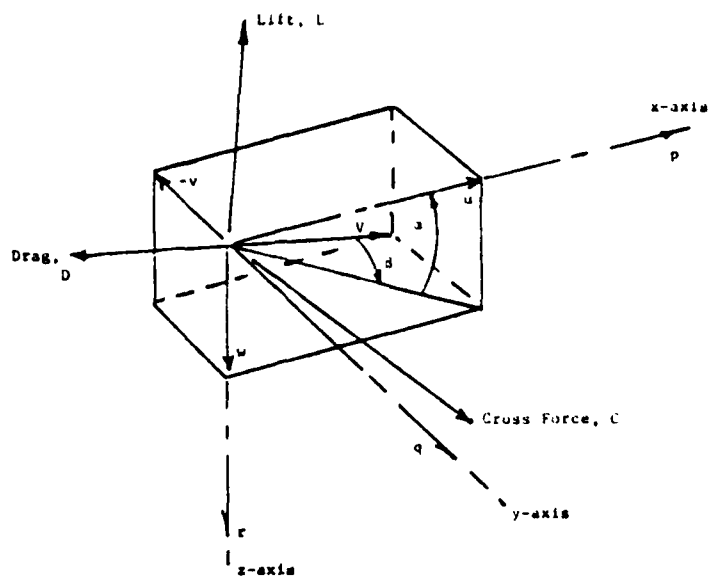

- V -- velocity of origin of body axes relative to fluid
 u, v, w -- components of V in body axes
 p, q, r -- components in the the body axes of the angular velocity of the vehicle
 α --The angle of attack; the angle to the longitudinal body axis from the projection into the principal plane of symmetry of the velocity of the origin of the body axes relative to the fluid, positive in the positive sense of rotation about the y-axis.
 δ --The drift or sideslip angle; the angle to the principal plane of symmetry from the velocity of the origin of the body axes relative to the fluid, positive in the positive sense of rotation about the z-axis.
 D --drag, opposite to V along line of V
 L --lift, in x-z plane normal to V , positive upward
 C -- cross force, normal to V and L , positive to starboard.

FIGURE 3-2. VELOCITY AND FORCE RELATIONSHIPS.

* This definition of the lift, L , is consistent with the conventions followed in aircraft and submarine stability and control literature. The term lift is much used, however, in a looser sense to mean:

- A force in the z body axis direction
- A vertical force
- A force normal to a wing or foil
- A force normal to a rudder or strut

Some freedom of usage appears justified for the sake of brevity and is employed in this document when clarity of meaning is not sacrificed.

If the c.g. is not at the origin but at a point (x_G, y_G, z_G) then the equations of motion are as shown below, provided the axes are parallel to principal axes for the center of gravity. See Appendix B.

$$\begin{aligned}
 X &= m (\dot{u} + qw - rv - x_G(q^2 + r^2) + y_G(pq - \dot{r}) + z_G(pr + \dot{q})) \\
 Y &= m (\dot{v} + ru - pw - y_G(r^2 + p^2) + z_G(qr - \dot{p}) + x_G(qp + \dot{r})) \\
 Z &= m (\dot{w} + pv - qu - z_G(p^2 + q^2) + x_G(rp - \dot{q}) + y_G(rq + \dot{p})) \\
 K &= I_x \dot{p} + (I_z - I_y) qr + m (y_G(\dot{w} + pv - qu) - z_G(\dot{v} + ru - pw) \\
 &\quad - x_G y_G(\dot{q} - pr) - y_G z_G(q^2 - r^2) - z_G x_G(\dot{r} + pq)) \\
 M &= I_y \dot{q} + (I_x - I_z) rp + m (z_G(\dot{u} + qw - rv) - x_G(\dot{w} + pv - qu) \\
 &\quad - y_G z_G(\dot{r} - qp) - z_G x_G(r^2 - p^2) - x_G y_G(\dot{p} + qr)) \\
 N &= I_z \dot{r} + (I_y - I_x) pq + m (x_G(\dot{v} + ru - pw) - y_G(\dot{u} + qw - rv) \\
 &\quad - z_G x_G(\dot{p} - rq) - x_G y_G(p^2 - q^2) - y_G z_G(\dot{q} + rp))
 \end{aligned} \tag{3.2}$$

The equations were used in this form in the motion simulation program.

The kinematic variables in equations 3.1 and 3.2 are the linear and angular velocities, u, v, w, p, q and r . In order to solve the equations of motion in the above form, it is necessary to express the forces and moments in terms of these variables and their respective linear or angular displacements. For craft operating on the sea surface, the forces and moments depend principally on the craft's velocity, its attitude with respect to the sea surface and on the draft. The following equations relate the angular velocities about the body axes to the angles of roll (ϕ), pitch (θ), yaw (ψ), and their derivatives with respect to time (SNAME APR 50):

$$\begin{aligned}
 p &= \dot{\phi} - \dot{\psi} \sin \theta \\
 q &= \dot{\psi} \cos \theta \sin \phi + \dot{\theta} \cos \phi \\
 r &= \dot{\psi} \cos \theta \cos \phi - \dot{\theta} \sin \phi
 \end{aligned} \tag{3.3}$$

A comprehensive set of stability characteristics, obtained by testing the model of the SES-100B shown in Figures 3-3 and 3-4, is contained in SIT JUN 74. In a series of tow-tank experiments run at the Davidson Laboratory of Stevens Institute of Technology, the forces and moments acting on the model were measured for a range of combinations of pitch, roll and yaw angles at three different speeds (corresponding to full-scale speeds of 35, 50 and 65 knots). As this set of data was the most complete available it was decided to make use of it to simulate the motions of the SES-100B. In SIT JUN 74 the data were fitted by a set of fourth-order polynomials.

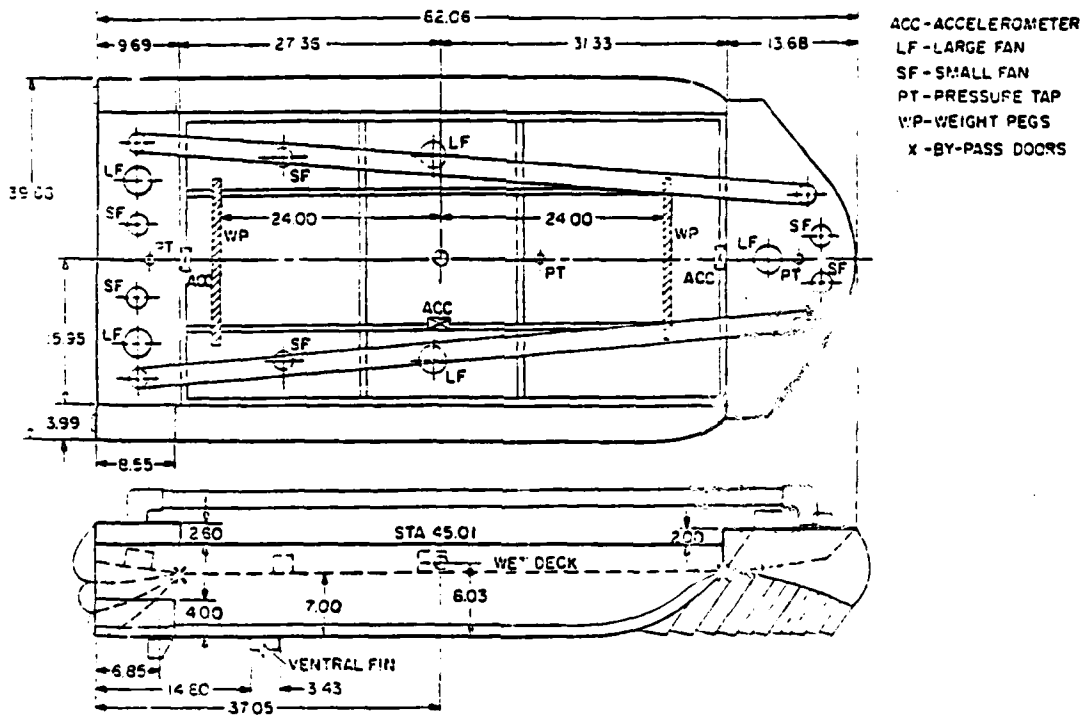

FIGURE 3-3. GENERAL ARRANGEMENT OF SES-100B MODEL. (SIT JUN 74)

Thus, if a generalized dependent variable, E, is assumed to represent either F_x , F_y , M_x , M_y or M_z , its value can be defined by the following expression:

$$E = \sum_{i=0}^4 \sum_{j=0}^4 \sum_{k=0}^4 c_{E_{ijk}} \phi^i \theta^j \psi^k, \quad 0 \leq (i + j + k) \leq 4 \quad (3.4)$$

$$= c_{E_{000}} + c_{E_{001}} \psi + c_{E_{002}} \psi^2 + c_{E_{003}} \psi^3 + c_{E_{004}} \psi^4 + c_{E_{010}} \theta + c_{E_{011}} \theta \psi \dots \text{etc.}$$

where

$-F_x$ = Drag force

F_y = Side force

M_x = Rol' moment

M_y = Pitch moment

M_z = Yaw moment

$c_{E_{ijk}}$ = a series of thirty-five coefficients listed for each of the five variables and for three model speeds in Tables 8-1, 8-2 and 8-3 of SIT JUN 74.

and θ is the pitch angle, degrees

ϕ is the roll angle, degrees

ψ is the yaw angle (= sideslip angle for towing tank tests), degrees

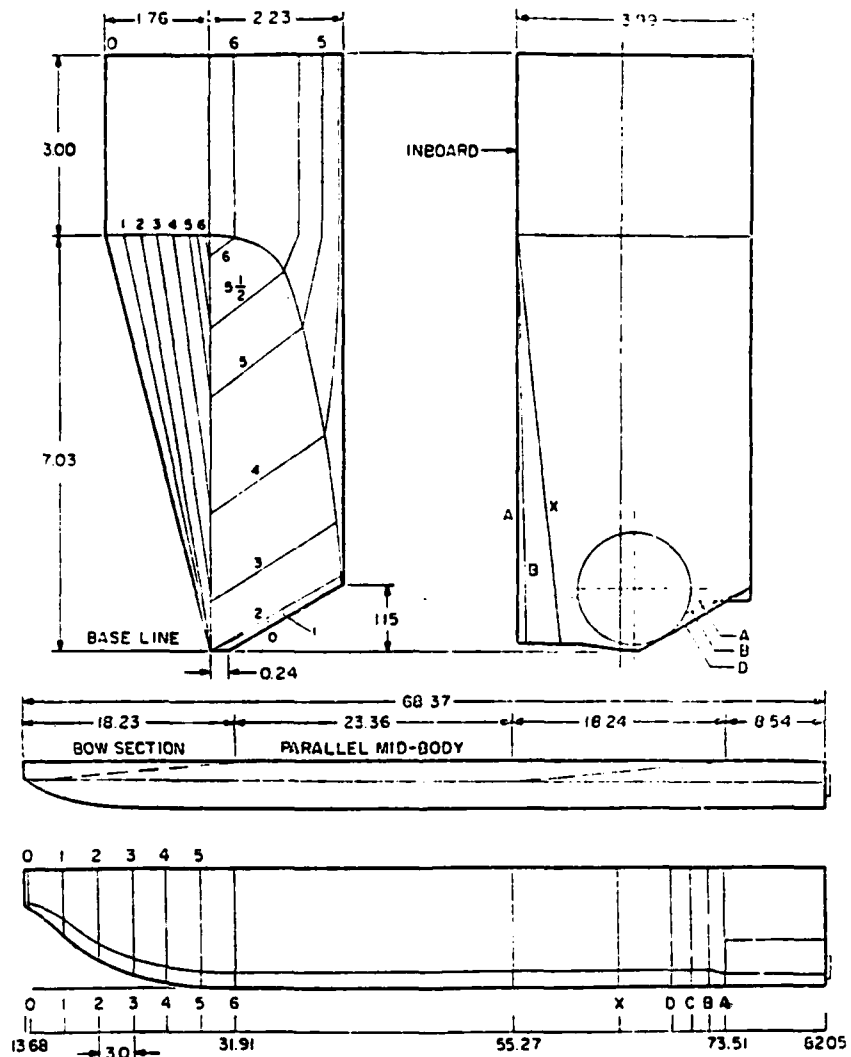

FIGURE 3-4. LINE PLAN OF SES-100B SIDEWALL. (SIT JUN 74)

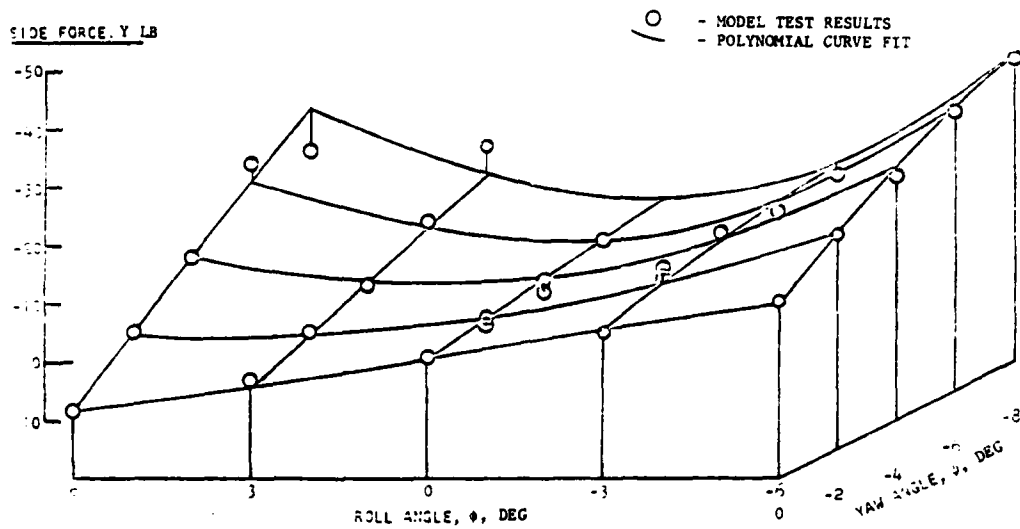

FIGURE 3-5. COMPARISON OF SES-100B MODEL SIDEFORCE DATA WITH CURVE FIT.
TRIM = 1 DEG, SPEED = 18.2 FPS (SIT JUN 74)

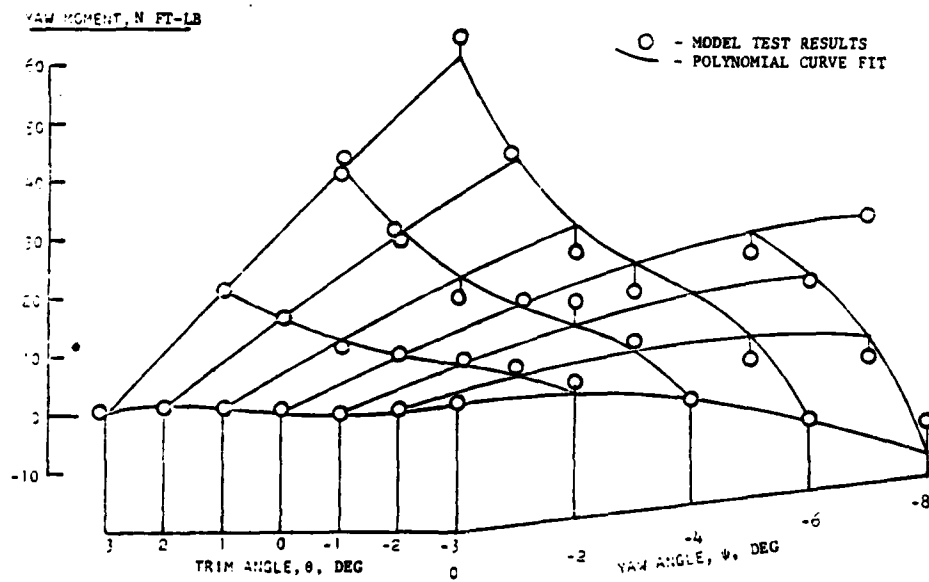

FIGURE 3-6. COMPARISON OF SES-100B MODEL YAW MOMENT DATA WITH CURVE FIT.
ROLL = 0 DEG, SPEED = 18.2 FPS (SIT JUN 74)

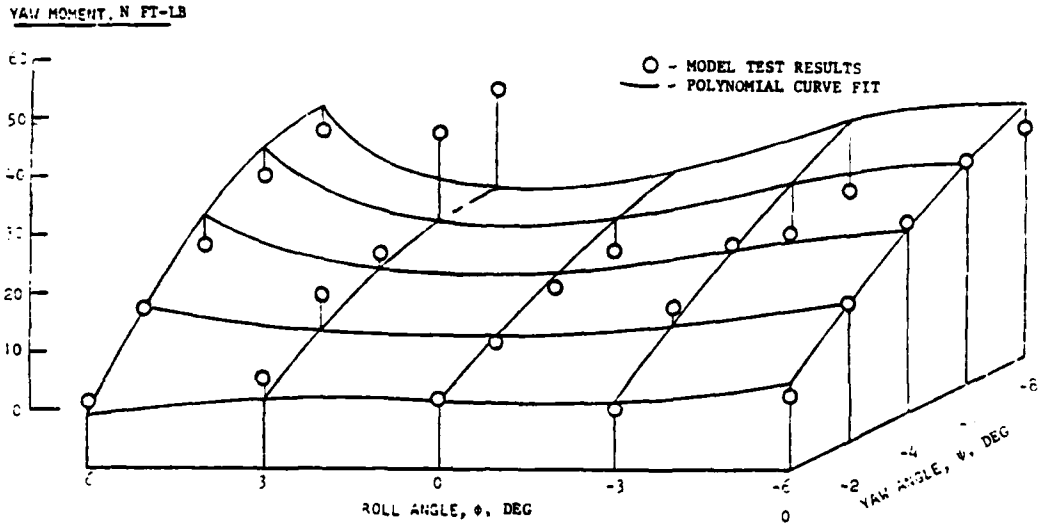

FIGURE 3-7. COMPARISON OF SES-100B MODEL YAW MOMENT DATA WITH CURVE FIT. TRIM = 1 DEG, SPEED = 18.2 FPS (SIT JUN 74)

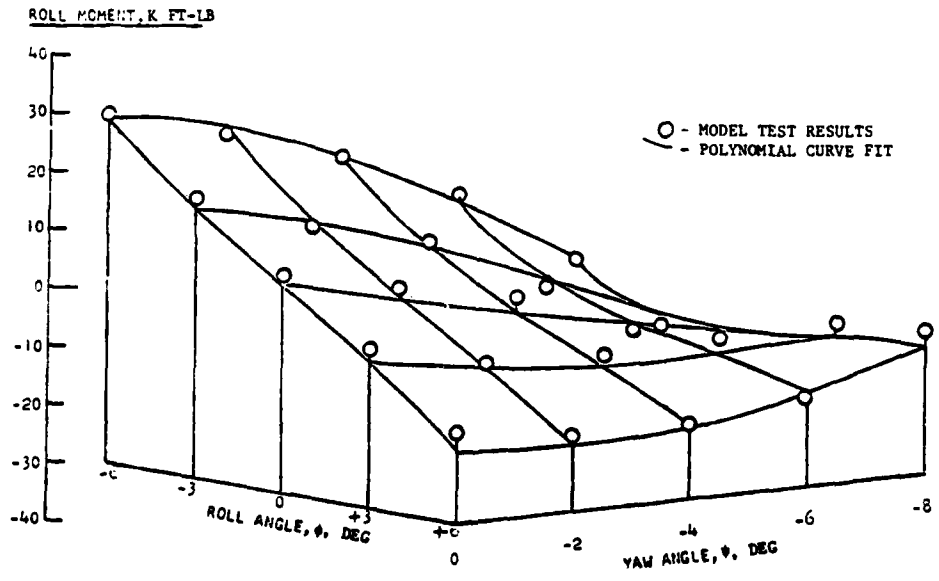

FIGURE 3-8. COMPARISON OF SES-100B MODEL ROLL MOMENT DATA WITH CURVE FIT. TRIM = 1 DEG, SPEED = 18.2 FPS (SIT JUN 74)

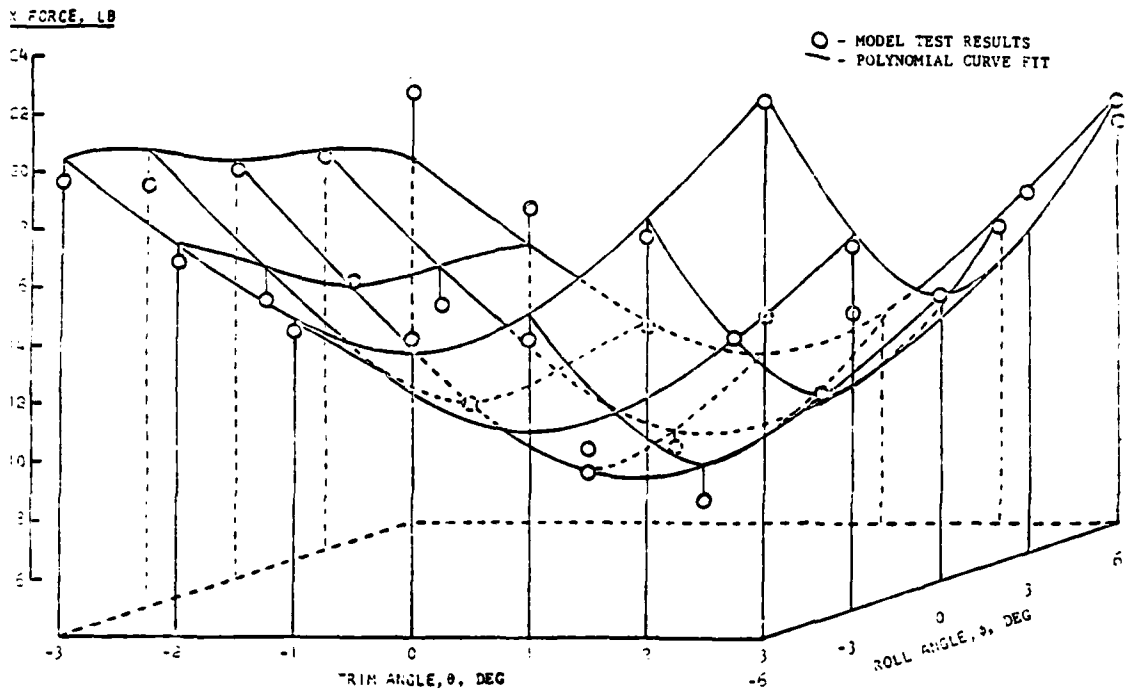

FIGURE 3-9. COMPARISON OF SES-100B MODEL DRAG DATA WITH CURVE FIT.
YAW = 0 DEG, SPEED = 18.2 FPS (SIT JUN 74)

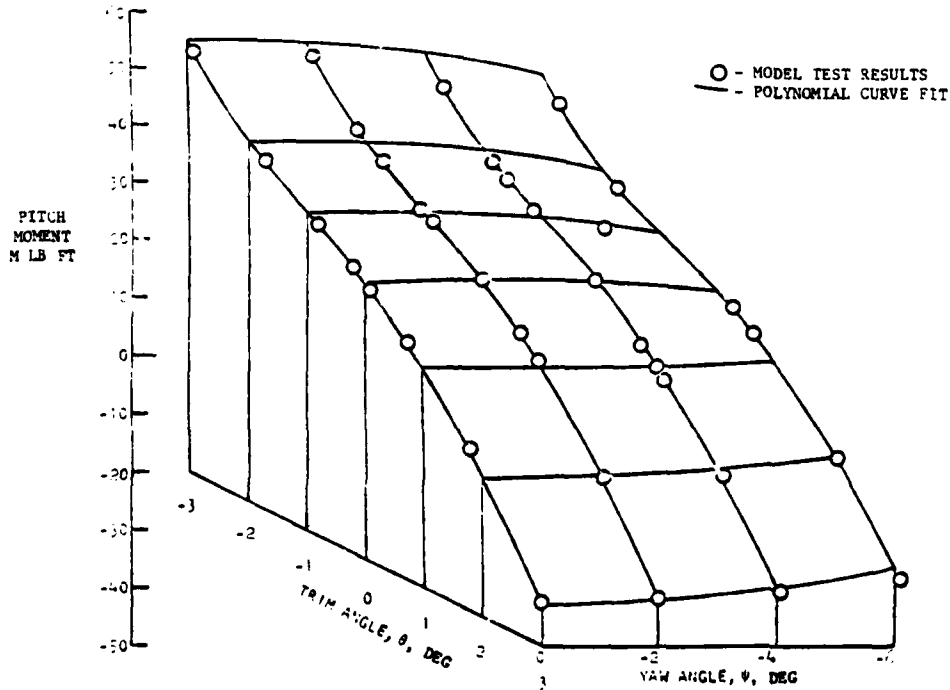

FIGURE 3-10. COMPARISON OF SES-100B MODEL PITCH MOMENT DATA WITH CURVE FIT.
ROLL = 0 DEG, SPEED = 18.2 FPS (SIT JUN 74)

All these forces and moments are referred to body axes. Some of the forces and moments resulting from this formula are shown in Figures 3-5 to 3-10. The agreement with the experimentally measured points is quite good.

These tests were steady-state runs in calm water so that, as the model was free to heave, the vertical force always equaled the weight of the model.

The forces and moments acting on a full-scale vehicle are the following:

- . Steady-state hydrodynamic and aerodynamic forces and moments--these are assumed to be represented by the five forces and moments (F_x , F_y , M_x , M_y and M_z)
- . Damping forces dependent on the rates of change of translational and angular displacements
- . Propulsive thrust force (T), assumed to be equal to the measured drag force at some appropriate steady state condition
- . Rudder forces, also derived from tank tests
- . Craft weight
- . Air cushion lift.

The six, body-axis forcing functions (three forces X, Y, Z and three moments K, M, N) are then defined as follows:

$$\begin{aligned}
 X &= T + F_x + k_x \cdot u^2 \cdot \delta^2 \\
 Y &= F_y + k_y u^2 \cdot \delta \\
 Z &, \text{ not prescribed} \\
 K &= M_x + k_K u^2 \delta + C_K \cdot p \\
 M &= M_y + k_M u^2 \delta^2 + C_M \cdot q \\
 N &= M_z + k_N u^2 \delta + C_N \cdot r
 \end{aligned}
 \tag{3.5}$$

where δ is the angular deflection of the rudder

k_x , k_y are the rudder drag and sideforce constants

k_K , k_M , k_N are the constants defining the contribution of the rudder to roll, pitch and yaw moments

C_K , C_M , C_N are damping constants in roll, pitch and yaw

In SIT JUN 74 it was found that the contributions of the rudder to drag and to pitch moment varied approximately as δ^2 and that the rudder contributions to side force, roll moment and yaw moment varied approximately as δ .

By substituting from equations 3.5 and 3.4 in equations 3.2 and rearranging it is possible to solve for the body axis accelerations \dot{u} , \dot{v} , \dot{p} , \dot{q} and \dot{r} at successive instants of time.

The body axis accelerations can then be integrated to provide body axis velocities:

$$u_{t+\Delta t} = u_t + \int_t^{t+\Delta t} \dot{u} dt \quad (3.6)$$

$$\approx u_t + (\dot{u}_t + \dot{u}_{t+\Delta t}) \Delta t / 2$$

etc.

where Δt is a small interval of time.

Due to the lack of information about the normal force F_z , as indicated by equation 3.5, it is not possible to determine the derivative \dot{w} nor the velocity component w from equations 3.2 and 3.6. It is known, nevertheless, that the height of the ship, which depends primarily on the integral of w , is not in fact fugitive. On the basis of the observation that the vertical acceleration of an SES is a minimum at some point near the stern, it has seemed reasonable to apply, as a constraint, the condition that the vertical velocity--and hence also the vertical acceleration--be identically zero at all times for some point A on the x-axis with coordinate x_A . This condition is expressed by the following equations (see derivation in appendix B-2)

$$w = u \frac{\tan \theta}{\cos \phi} + q x_A - (v + r x_A) \tan \phi$$

and

$$\dot{w} = (\dot{q} - rp) x_A + qu - pv$$

$$+ (\dot{u} + qw - rv - (q^2 + r^2) x_A) \frac{\tan \theta}{\cos \phi}$$

$$- (\dot{v} + ru - qw + (\dot{r} + qp) x_A) \tan \phi$$

These values of w and \dot{w} are used in equations 3.2, for the calculation of \dot{u} , \dot{v} , \dot{p} , \dot{q} and \dot{r} , and in equation 3.7 below. A value $x_A = -16.5$ feet has been used.

The body axis displacements (the time integrals of u , v , w , p , q , r) are of no interest so were not calculated. Instead the body axis velocities were transformed to fixed axis velocities, \dot{x}_0 , \dot{y}_0 , \dot{z}_0 , $\dot{\phi}$, $\dot{\theta}$ and $\dot{\psi}$, and the fixed axis displacements were calculated:

$$\begin{aligned}
\dot{x}_0 &= u \cos \theta \cos \psi - v (\cos \phi \sin \psi - \sin \theta \sin \phi \cos \psi) \\
&\quad + w (\sin \phi \sin \psi + \sin \theta \cos \phi \cos \psi) \\
\dot{y}_0 &= u \cos \theta \sin \psi + v (\cos \phi \cos \psi + \sin \theta \sin \phi \sin \psi) \\
&\quad - w (\sin \phi \cos \psi - \sin \theta \cos \phi \sin \psi) \\
\dot{z}_0 &= -u \sin \theta + v \cos \theta \sin \phi + w \cos \theta \cos \phi \\
\dot{\phi} &= p + (q \sin \phi + r \cos \phi) \tan \theta \\
\dot{\theta} &= q \cos \phi - r \sin \phi \\
\dot{\psi} &= (r \cos \phi + q \sin \phi) / \cos \theta
\end{aligned}
\tag{3.7}$$

Thus

$$\begin{aligned}
x_{t+\Delta t} &= x_t + (\dot{x}_t + \dot{x}_{t+\Delta t}) \Delta t / 2 \\
y_{t+\Delta t} &= y_t + (\dot{y}_t + \dot{y}_{t+\Delta t}) \Delta t / 2 \\
\psi_{t+\Delta t} &= \psi_t + (\dot{\psi}_t + \dot{\psi}_{t+\Delta t}) \Delta t / 2
\end{aligned}
\tag{3.8}$$

These equations were solved using a digital computer. The time histories of a number of maneuvers were calculated by imposing pre-determined, time-dependent rudder movements on the model and following the calculated track of the craft until it either settled down to a steady condition or became unacceptably unstable. These calculations are described in section 3.4 of this report.

The model was tested at three speeds (equivalent to 35, 50 and 65 knots for the full-scale SES-100B) and the coefficients c_{ijk} listed in Tables 8-1, 8-2 and 8-3 correspond to these three speeds. For other speeds the forces and moments were estimated by using a quadratic interpolating routine. Thus, if X_1 , X_2 and X_3 are three forces corresponding to the three sets of tabulated coefficients at three equally spaced velocities V_1 , V_2 and V_3 respectively, then the value of the force, X , used for any other speed, V , was assumed to be given by:

$$\begin{aligned}
X &= a + bV + cV^2 \\
\text{where } c &= (X_1 + X_3 - 2X_2) / (2\Delta V^2) \\
\Delta V &= V_3 - V_2 = V_2 - V_1 \\
b &= (X_3 - X_1) / (2\Delta V) - 2cV_2 \\
a &= X_2 - bV_2 - cV_2^2
\end{aligned}
\tag{3.9}$$

The main drawback to the use of experimental data in this manner is that it provides no information beyond the range of the test points. In these particular tests the ranges for all of the independent variables was rather limited. The reason for this was that the tests were carried out to determine the stability characteristics of the model rather than to determine its behavior under extreme conditions.

3.2 NON-DIMENSIONAL COEFFICIENTS

The experimental data discussed so far in this report relates only to the SES-100B. In an attempt to make wider use of the data they were reduced to a series of non-dimensional coefficients. The purpose of this was two-fold:

- 1) The data can then be used for geometrically similar SES of whatever size. This procedure is well-established and is the basis of all model test work.
- 2) The data can be used, with more reservations, for SES of different geometrical form.

The non-dimensional coefficients used to achieve this are shown in Table 3-1.

TABLE 3-1. NON-DIMENSIONAL COEFFICIENTS.

Parameter	Scale Factor	Non-dimensional Coefficient
Length x	λ	$x_N = x/L_c$ (L_c = cushion length, see Fig. 3-11)
Force X	λ^3	$X_N = X/W$ (W = craft gross weight) (2)
Time t	$\lambda^{1/2}$	$T_N = t/(L_c/g)^{1/2}$
Velocity V	$\lambda^{1/2}$	$F_N = V/(L_c g)^{1/2}$ (Froude Number)
Roll Angle $\phi(1)$	1	$\phi_N = \phi/(H_c/B_c)$ (B_c = cushion beam) (3)
Pitch Angle θ	1	$\theta_N = \theta/(H_c/L_c)$ (H_c = cushion height) (3)
Sideslip Angle* ψ	1	$\psi_N = \psi/(B_c/L_c)$ (3)
Roll Rate $\dot{\phi}(1)$	$\lambda^{1/2}$	$\dot{\phi}_N = \dot{\phi} (L_c/g)^{1/2}/(H_c/B_c)$ (3)
Pitch Rate $\dot{\theta}$	$\lambda^{1/2}$	$\dot{\theta}_N = \dot{\theta} (L_c/g)^{1/2}/(H_c/L_c)$ (3)
Yaw Rate $\dot{\psi}$	$\lambda^{1/2}$	$\dot{\psi}_N = \dot{\psi} (L_c/g)^{1/2}/(B_c/L_c)$ (3)
Roll Moment K	λ^4	$K_N = K/(WB_c)$ (2)
Pitch Moment M	λ^4	$M_N = M/(WL_c)$ (2)
Yaw Moment N	λ^4	$N_N = N/(WL_c)$ (2)

Notes:

1. For the purpose of this table all angular measurements are in radians and angular velocities in radians per second.
2. Weight, W , is used as the non-dimensionalizing force, rather than a term of the form $\frac{1}{2} \rho v^2 S$, because of its direct relevance to accelerations.
3. The inclusion of the geometric ratios in these quantities allows some rational comparison to be made between craft of different proportions.

* The sideslip angle, β , is essentially the same as the yaw angle, ψ , for towing-tank tests.

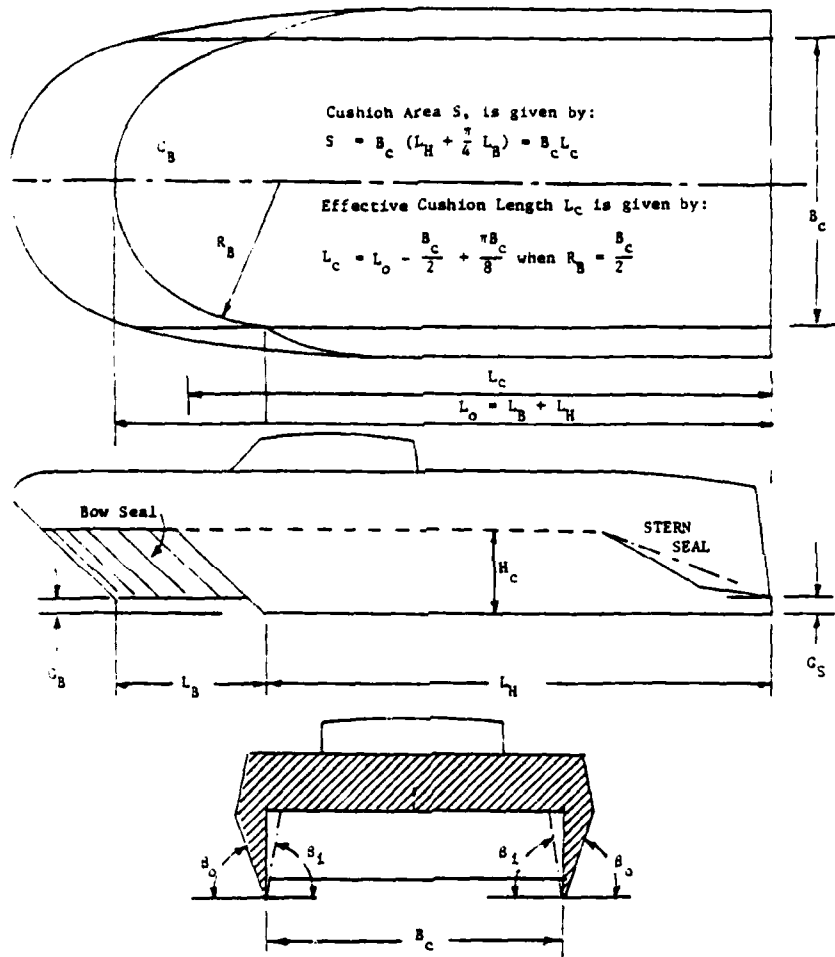

FIGURE 3-11. SES CUSHION, SEAL AND SIDEHULL DIMENSIONS.

3.3 LIMITS OF STABLE OPERATION

In normal operation an SES only deviates a few degrees from zero angles of roll, sideslip and pitch. When any of these angles depart too much from the zero value a number of undesirable phenomena can occur, which are described at length in SIT JUN 74. The sidehulls are designed to run at zero or very small angles of sideslip and shallow immersion so that they may act as a seal for the air cushion without causing undesirable levels of drag. As sideslip increases the side hulls tend to raise the water level on the upstream side of the side hull and may ventilate on the downstream side. The water pile-up may hit the wet deck, if the upstream side is inside the cushion, and then move aft to impact the rear seal, or it may flow over the craft top sides. If the bow of the side hull digs in due to pitch down, then directional instability may occur. Finally excessive angular displacement in any direction may cause the cushion to vent.

Some of these eventualities are shown in Figures 3-12 to 3-14 (from SIT JUN 74) for the three speeds tested. Comparison of the three diagrams shows that the limits of stable operation become more restricted as speed increases.

The limits of stable operation for the SES-100B are, very approximately, the following (ϕ , θ and ψ are measured in degrees):

Limit of Test Range in Roll:

$$- 6 < \phi < 6, \text{ degrees}$$

(No test data are presented in SIT JUN 74 for roll angles greater than 6°)

Limit of Stable Pitch Range:

$$(- 4.9 + V/22.5) < \theta < (5.3 - V/15) \quad \begin{array}{l} (V \text{ is in knots, full-scale} \\ \theta \text{ is in degrees} \\ \psi \text{ is in degrees}) \end{array}$$

Marginal Pitch Range:

$$(- 4.0 + V/22.5) < \theta < (5.3 - V/15)$$

Onset of Flow Separation:

$$(- 11 + V/7.5) < \psi < (11 - V/7.5 + \phi\theta/9) \quad (3.10)$$

Cushion Venting:

$$(- 21 + V/3.75) < \psi < (21 - V/3.75 + \phi\theta/9)$$

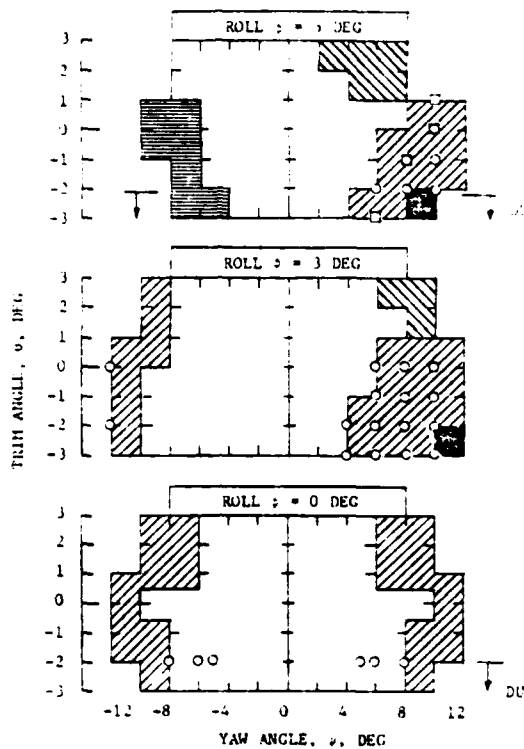

KEY			
	water over top sides		water impinging on wet deck
	flow separation		cushion venting
	data well behaved		DU - directionally unstable
			LU - longitudinally unstable

FIGURE 3-12. RANGE OF PARAMETRIC INVESTIGATION AT 18.2 FPS.
(EQUIVALENT TO 35 KNOTS FULL-SCALE SPEED) (SIT JUN 74)

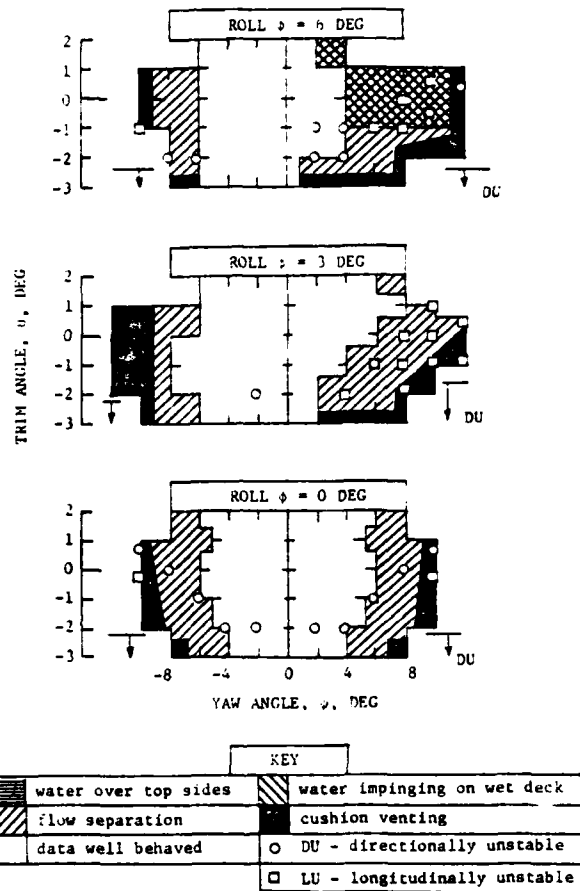

FIGURE 3-13. RANGE OF PARAMETRIC INVESTIGATION AT 26 FPS.
(EQUIVALENT TO 50 KNOTS FULL-SCALE SPEED) (SIT JUN 74)

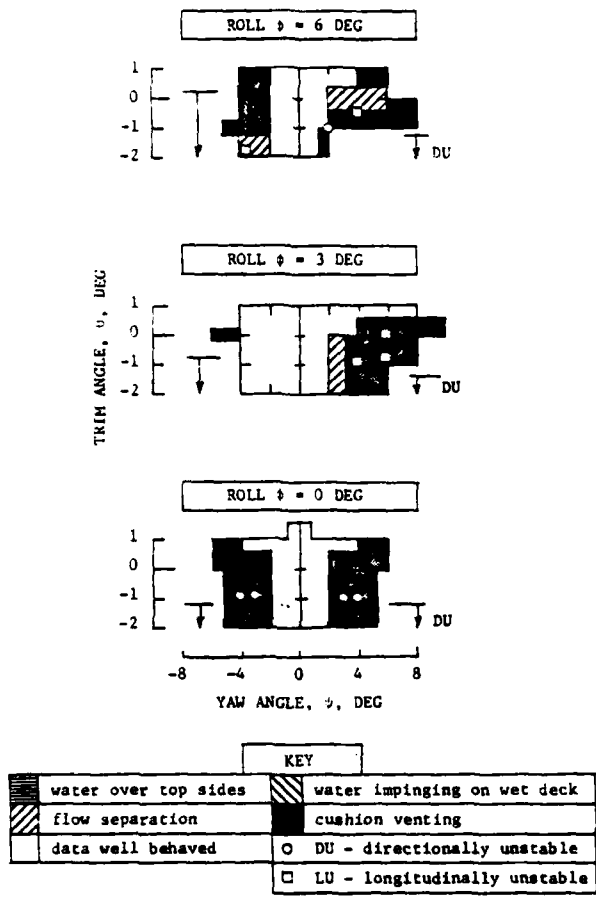

FIGURE 3-14. RANGE OF PARAMETRIC INVESTIGATION AT 33.8 FPS.
 (EQUIVALENT TO 65 KNOTS FULL-SCALE SPEED) (SIT JUN 74)

Expressed in terms of the non-dimensional coefficients developed in section 3.2 these limits become:

Limit of Test Range in Roll:

$$-.53 < \phi_N < .53$$

Marginal Pitch Range:

$$(-.698 + .203 F_N) < \theta_N < (.925 - .305 F_N)$$

Limit of Stable Pitch Range:

$$(-.855 + .203 F_N) < \theta_N < (.925 - .305 F_N)$$

Marginal Sideslip Range:

$$(-.385 + .122 F_N) < \psi_N < (.385 - .122 F_N + .254 \theta_N \phi_N) \text{ for } \phi_N \geq 0$$

$$(-.385 + .122 F_N + .254 \theta_N \phi_N) < \psi_N < (.385 - .122 F_N) \text{ for } \phi_N \leq 0$$

Limit of Stable Sideslip Range:

$$(-.735 + .244 F_N) < \psi_N < (.735 - .244 F_N + .254 \theta_N \phi_N) \text{ for } \phi_N \geq 0$$

$$(-.735 + .244 F_N + .254 \theta_N \phi_N) < \psi_N < (.735 - .244 F_N) \text{ for } \phi_N \leq 0$$

(3.11)

It should be noted that these limits can only be regarded as approximately correct within the range covered by the data from which they were developed namely for Froude numbers (F_N) in the range

$$1.3 \leq F_N \leq 2.5$$

Similar limits developed for Rohr Marine 3KSES are shown in Figure 3-15. The limits shown in the figure can be approximated by the following expressions which have been non-dimensionalized in the same way as equations 3.11.

Limit of Test Range in Roll:

$$-.247 < \phi_N < +.247$$

Limit of Stable Sideslip Range:

$$(-.51 + .163 F_N + .134 \phi_N) < \psi_N < (.51 - .163 F_N + .134 \phi_N)$$

(3.12)

The similarity between the limits of stable sideslip angle ψ_N in equations 3.11 and 3.12 is quite remarkable. Equations 3.11 are based on the SES-100B which has partial side hulls with low deadrise and equations 3.12 are based on the 3KSES with full-length side hulls with very high deadrise. The good agreement between the two expressions suggest that either expression may apply to wide range of SES types.

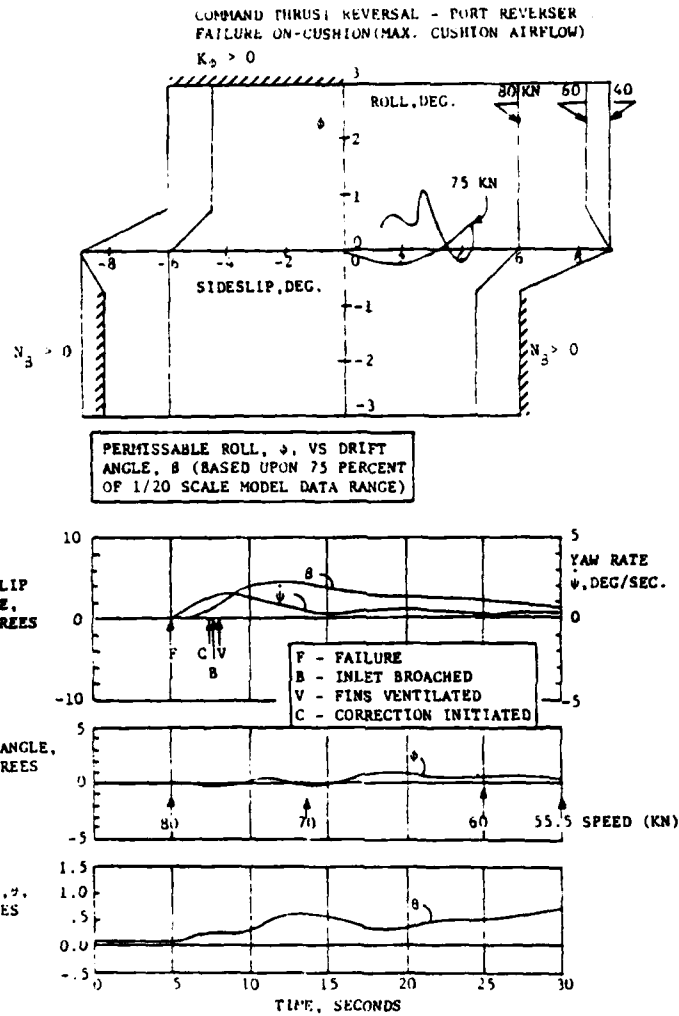

FIGURE 3-15. 3KSES RESPONSE TO ASSYMETRIC REVERSE THRUST WITH SUBSEQUENT CORRECTIVE ACTION. (ROHR 31 AUG 78)

3.4 EFFECTS OF STABILITY VARIATIONS

In order to explore and exhibit the effects of variations in craft stability characteristics, simulated maneuvers were calculated with altered stability. With recognition that reversal of the rudder, when in a turn, can be a necessary collision avoidance action, and of comments from Bell Aerospace that this could constitute a severe test of the stability and controllability of the craft, this maneuver was chosen as the principal test. The effect of an impulsive pitch down, such as could occur after a wake crossing, during a steady turn was also examined.

3.4.1 Full-Scale Stability Coefficients

In preparation for these studies an attempt was first made to simulate the pull out from a steady turn for which a record was available from trials of the SES-100B. A comment in the report of these trials that the ship appeared to develop more side force, for a given sideslip angle, than was predicted from the results of model tests was allowed for in the simulation by multiplying the sideslip angle by 1.25 for calculation of the side force. Adjustments were also made to the rotary damping derivatives to improve the simulation of the observed turn pull out. These adjusted coefficients are referred to in this report as "Revised Standard Coefficients" (RSC). They were used to represent the basic SES-100B on which this study is based. Craft with different stability characteristics were represented by varying one or more of the standard coefficients. A list of the simulated maneuvers discussed in the following sections is given in Table 3-2.

3.4.2 Rudder-Reversal Maneuvers

Rudder-reversal maneuvers were started by allowing the ship to steady in a turn. For some of the tests this was accomplished with the rudder fixed. It was found that, by setting the initial attitude and yaw rate, a very nearly steady turn could be achieved in 10 seconds of ship time. During this 10-second steadying phase the speed was held constant by equating the thrust to the drag. The rudder reversal was made at a 10-degree-per-second rate, beginning at $t = 10$ seconds. Current values of the forces, accelerations, velocities, attitude angles and path coordinates were printed out every 1/5 second so that time histories could be plotted. The pitch, roll and sideslip angles were monitored and diagnostic statements printed out when excessive values were reached.

A number of the rudder reversal maneuvers were started by using an automatic steering algorithm to bring the ship to a steady rate of turning. In almost every case this corresponded to a turning radius 30 times the ship's cushion length at a speed of 50 knots (the corresponding Froude number is 1.90). The rudder reversal was made at 10 degrees per second, beginning at $t = 10$ seconds, the final angle being the reverse of that obtaining at $t = 10$ seconds.

Figure 3-16 shows the time histories of the rudder angle, the yaw rate, the roll angle and the sideslip angle for this maneuver for the ship with "Revised Standard Coefficients" (Run #1 in Table 3-2). For the first ten seconds of the run, a steady turn is simulated; very steady conditions are established by $t = 10$ secs., at which point rudder deflection is begun, achieving full reverse rudder at $t = 13.3$ secs. The plots in Figures 3-16 (and 3-18) begin at the point of initiation of rudder reversal. The final rudder angle was -16.15 degrees. As the time histories show, the ship is very stable in the turn with fixed rudder.

TABLE 3-2. LIST OF SIMULATED MANEUVERS.

RUN NO.	REF. FIG.	RESULT (1)	DUR. (2) SEC.	XCG (FT.)	ROLL (4) STABILITY FRACTION K	PITCH (4) STABILITY FRACTION M	YAW (4)		RUDDER ANGLE δ (°)
							STABILITY FRACTION N	DAMPING FRACTION	
SERIES 1: RUDDER REVERSAL AT 50 KNOTS; INITIAL TURNING RADIUS = 30 TIMES CUSHION LENGTH (R/L _c =30)									
1	3.16	(3)		0	1.0	1.0	1.0	1.0	16.15
2	3.17								
3	3.18								
4	3.17	Unstable	17.0	0	1.0	1.0	<u>1.4</u>	<u>1.4</u>	-
5	"			0	1.0	1.0	<u>1.3</u>	<u>1.3</u>	23.3
6	"			0	1.0	1.0	<u>0.66</u>	1.0	10.1
7	"			0	1.0	1.0	<u>0.4</u>	1.0	-
8	"			0	1.0	1.0	<u>0.4</u>	<u>0.4</u>	5.6
9	"			0	1.0	1.0	<u>0.25</u>	1.0	-
10	"			0	1.0	1.0	<u>0.25</u>	<u>0.25</u>	3.4
11	3.17			0	1.0	<u>0.7</u>	1.0	1.0	18.0
12	3.18	Marginal		0	1.0	<u>0.5</u>	1.0	1.0	21.0
13	3.18	Unstable	3.2	0	<u>0.5</u>	<u>1.2</u>	1.0	1.0	-
14	"			0	<u>0.7</u>	1.0	1.0	1.0	14.3
15	"			0	<u>0.6</u>	1.0	1.0	1.0	13.7
16	"	Unstable	6.2	0	<u>0.5</u>	1.0	1.0	1.0	-
17	"			0	<u>0.7</u>	<u>0.7</u>	1.0	1.0	17.6
18	"	Marginal		0	<u>0.6</u>	<u>0.6</u>	1.0	1.0	24.4
19	"	Unstable	3.8	0	<u>0.5</u>	<u>0.5</u>	1.0	1.0	-
20	3.21	Unstable	16.0	<u>0.842</u>	1.0	1.0	1.0	1.0	-
21	3.20	Unstable	16.4	<u>0.643</u>	1.0	1.0	1.0	1.0	21.3
22	3.21			<u>0.643</u>	1.0	1.0	<u>0.66</u>	<u>0.66</u>	11.0
23	3.21			<u>0.643</u>	1.0	1.0	<u>0.25</u>	<u>0.25</u>	-
SERIES 2: RUDDER REVERSAL OF 50 KNOTS; INITIAL AND FINAL RUDDER ANGLE = 16°									
24	3.16	Marginal		0	1.0	<u>1.2</u>	<u>0.5</u>	1.0	16.0
25	3.19								
26	3.16	Unstable	17.8	0	1.0	1.0	<u>0.66</u>	1.0	19.7
27	"			0	1.0	1.0	<u>0.4</u>	1.0	-
28	"	Unstable	8.8	0	1.0	<u>0.8</u>	<u>0.8</u>	1.0	24.0
29	"			0	1.0	<u>0.7</u>	<u>0.7</u>	1.0	-
30	"	Unstable	2.4	0	1.0	<u>0.7</u>	<u>1.2</u>	1.0	55.7
31	"	Unstable	2.4	0	1.0	<u>0.6</u>	<u>1.2</u>	1.0	-
32	"	Unstable (20° Rudder)	2.4	0	1.0	<u>0.6</u>	<u>1.5</u>	1.0	-
33	"	Unstable	1.8	0	1.0	<u>0.5</u>	1.0	1.0	-
34	3.16			<u>0.643</u>	1.0	<u>1.0</u>	<u>1.0</u>	1.0	30.0
35	3.22			<u>0.643</u>	1.0	1.0	1.0	1.0	16.0
36				<u>0.643</u>	1.0	1.0	<u>0.8</u>	1.0	16.0
37	3.23	Unstable	12.8	<u>0.643</u>	1.0	1.0	<u>0.7</u>	1.0	16.0
SERIES 3: 10°/SEC. PITCH-DOWN DISTURBANCE DURING STEADY TURN AT 50 KNOTS WITH RUDDER ANGLE FIXED AT 16°									
35	3.22			<u>0.643</u>	1.0	1.0	1.0	1.0	16.0
36				<u>0.643</u>	1.0	1.0	<u>0.8</u>	1.0	16.0
37	3.23	Unstable	12.8	<u>0.643</u>	1.0	1.0	<u>0.7</u>	1.0	16.0

- Notes: 1. If no comment is given, the maneuver was successfully accomplished.
 2. The time given is that at which the instability becomes obvious.
 3. Configuration with Revised Standard Coefficients.
 4. Roll, Pitch and Yaw moment characteristics were varied from run to run by multiplying the roll, pitch or yaw angles used to calculate these moments by the factors shown. The yaw damping coefficient was also varied by multiplying by the factor shown.

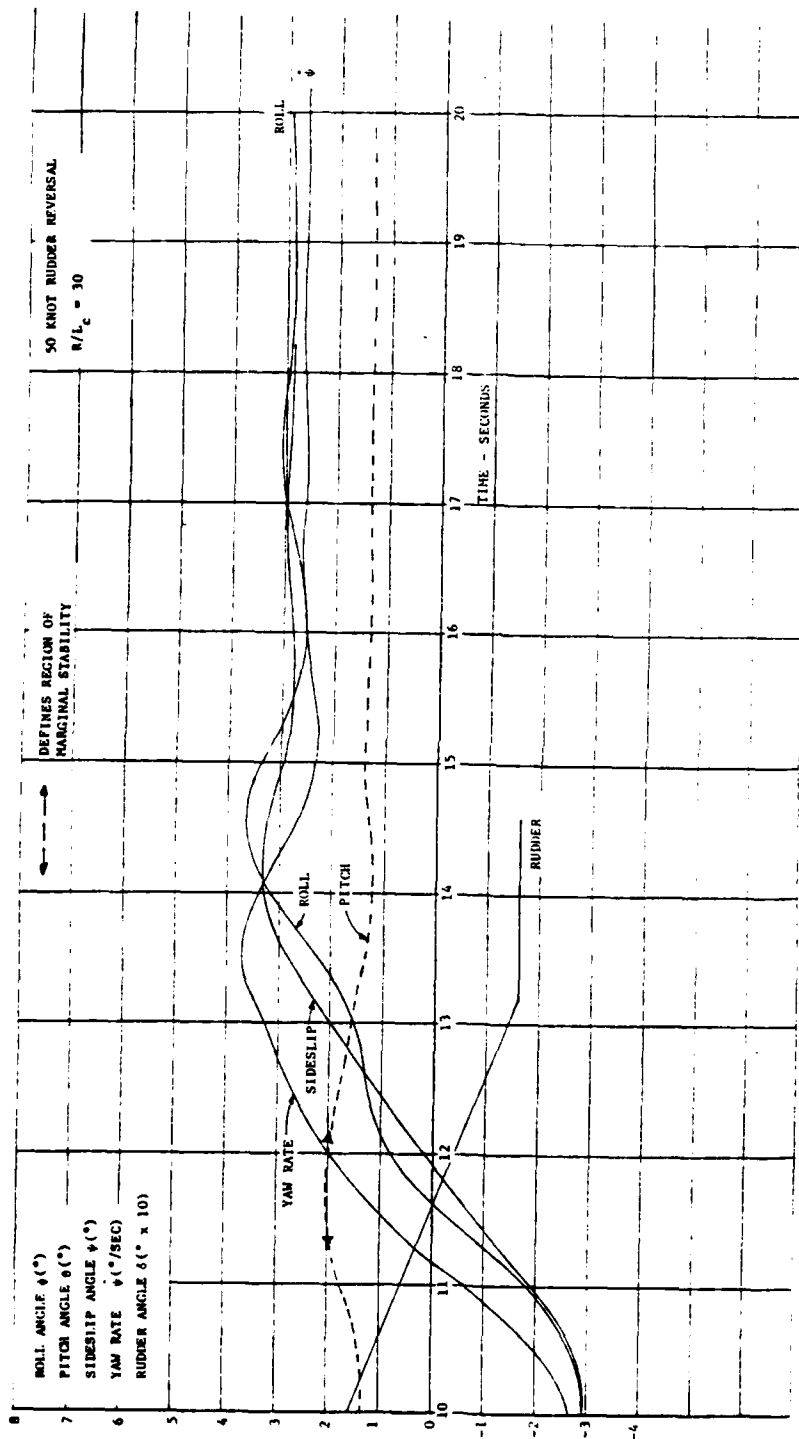

FIGURE 3-16. SIMULATED SES-100B MANEUVER #1 50 KNOT TURN ($R/L_c=30$) WITH RUDDER REVERSAL FOR REVISED STANDARD COEFFICIENTS. (STABLE)

3.4.3 Rudder Reversals with 16° Rudder

Rudder reversals with 16° initial and final rudder angles were simulated primarily to explore the effects of varying the pitch and yaw stability. Because of the inherently non-linear representation of the pitching and yawing moments in terms of the pitch, roll and sideslip angles (see Section 3.1), the variation of stability was simulated by calculating the yawing moment, for example, for a sideslip angle equal to a fraction of that actually obtaining. Thus, if the drag (X), sideforce (Y), roll moment (K), pitching moment (M) and yaw moment (N) are represented by the polynomials given in equation 3.4, the "Revised Standard Coefficients," which are mentioned in paragraph 3.4.1, and which were scaled to represent the full-scale craft, can be represented by the same expressions except for the side force equation which now appears, in revised form, shown below. In order to represent craft with different stability characteristics, the roll, pitch and yaw algorithms were modified and the final form of the equations used to define the forces and moments are as follows:

$$F_x = \sum_{i=0}^4 \sum_{j=0}^4 \sum_{k=0}^4 c_{x_{ijk}} \phi^i \theta^j \psi^k$$

$$F_y = \sum_{i=0}^4 \sum_{j=0}^4 \sum_{k=0}^4 c_{y_{ijk}} \phi^i \theta^j (1.25\psi)^k$$

$$M_x = \sum_{i=0}^4 \sum_{j=0}^4 \sum_{k=0}^4 c_{k_{ijk}} (\bar{K}\phi)^i \theta^j \psi^k$$

$$M_y = \sum_{i=0}^4 \sum_{j=0}^4 \sum_{k=0}^4 c_{m_{ijk}} \phi^i (\bar{M}\theta)^j \psi^k$$

$$M_z = \sum_{i=0}^4 \sum_{j=0}^4 \sum_{k=0}^4 c_{n_{ijk}} \phi^i \theta^j (\bar{N}\psi)^k$$

where \bar{K} , \bar{M} , \bar{N} are the roll, pitch and yaw "stability fractions." The values of \bar{K} , \bar{M} and \bar{N} used in the different computations are shown in Table 3.2. The yaw angle, ψ , used in these equations is measured from the projection of the ship's total velocity vector onto the horizontal plane.

In Figure 3-17 the scales of pitch and yaw stability show the corresponding fractions. The figure shows, by the type of plotting symbol, whether or not the resulting maneuver is stable. The point with coordinates 1.0, 1.0 represents the RSC craft in the maneuver for which time histories are shown in Figure 3-16 and which is evidently stable. If the yaw stability fraction is reduced to 2/3, the simulated maneuver steadies rapidly after the completion of the rudder reversal into a turn with radius about 19.7 gushion lengths (Run #25). For a short time with the rudder angle $-6^\circ < \delta < 6^\circ$ the pitch angle is slightly greater than the range of the model tests. Somewhat later in the maneuver, for less than one second, the sideslip angle is in the marginal range.

When the yaw stability fraction, \bar{N} , is reduced to 0.4 (Run #26), the ship is unstable, exhibiting a divergent oscillation. Thus, it appears that, with standard pitch stability, a yaw stability fraction of .67 defines a boundary of safe operation as is indicated in Figure 3-17.

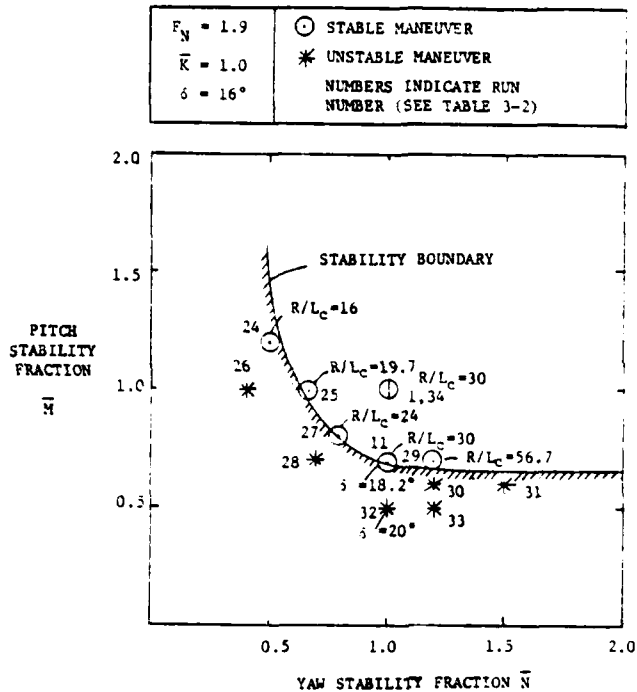

FIGURE 3-17. EFFECT ON 50 KNOT ($F_N = 1.9$) 16° RUDDER REVERSAL MANEUVER OF VARYING PITCH AND YAW STABILITY OF SES-100B.

A reduction of the pitch stability fraction, \bar{M} , to 0.7, with standard yaw stability ($\bar{N} = 1.0$), leads to a maneuver with excessive pitch during the rudder reversal and again, briefly, while steadying into the reversed turn (Run #11).* When the yaw stability fraction is increased to 1.2, with a 0.7 pitch stability fraction, the turning radius is increased to 56.7 times the cushion length and the ship steadies rapidly into the initial turn (Run #29). This suggests that the reversal maneuver could be safely accomplished, though the trajectory has not been calculated. When the yaw stability fraction is reduced to 0.7, with an 0.7 pitch stability fraction, the ship is divergent in yaw and will not steady in a turn with 16° fixed rudder.

An increase in both pitch and yaw stability fractions to 0.8 results in a stable maneuver with only slightly excessive (positive) pitch angle during the rudder reversal.**

With the pitch stability fraction reduced to 0.5, or even to 0.6, the ship is so unstable in yaw that a steady turn cannot be obtained from which to start the rudder reversal.

* Run at $R/L_c = 30$. The rudder angle is $\delta = 18.7^\circ$.

** This results from the reduction of rudder drag as the rudder is moved through the small angle range. It could probably have been avoided by running the simulation with a more forward C.G. position.

A simulation with the yaw stability fraction reduced to 0.5 and the pitch stability fraction increased to 1.2 (Run #24) resulted in a successful maneuver with a turning radius of 16 ship cushion lengths which exhibited a large, slowly damped oscillation following the completion of the rudder reversal. The sideslip angle was in the marginal range during the steady part of the maneuver and beyond the stable range on the first overshoot after rudder reversal. This provides an example of a marginal run, as shown in Figure 3-18.

In reviewing the results of the rudder reversals with 16° rudder angle the increase of turning rate with reduction of yaw stability is notable. This is accompanied by an increase in the sideslip angle and the inward roll. With a reduction of the yaw stability fraction to 0.4 a divergent oscillation in yaw develops which prevents establishment of steady conditions in preparation for the rudder reversal.

Reduction of the pitch stability fraction results in the development of excessive pitch in the steady turn, the more so the greater the pitch stability reduction. A bow up pitch excursion occurs during the rudder reversal because of the reduction of rudder drag at small angles. At the same time a loss of speed occurs because of the increase of total drag associated with increased bow up pitch. On the whole, the increased pitch seems not to be hazardous in itself. There appears, however, to be an associated increase in static yaw stability evidenced by an increase in the turning radius. At the same time the stability on course is adversely affected to the extent that the ship will not steady on a turn with fixed rudder, with an 0.6 pitch stability fraction, even with enhanced yaw stability.

On the basis of these results an approximate stability boundary has been drawn on Figure 3-17. This shows that the minimum acceptable pitch stability fraction is 0.7 and then only if the yaw stability is at least equal to the standard value. A yaw-stability fraction as low as 0.6 can be tolerated if the pitch stability is greater than the standard value. A combined reduction to a 0.3 stability fraction in both pitch and yaw is acceptable.

3.4.4 Rudder Reversals with Constant Turn Radius ($R/L_c = 30$)

A simulation of a steady turn with specified turning rate was achieved by the use of an automatic steering algorithm. A turn radius of 30 times the ship length and a speed of 50 knots at the start of the rudder reversal were used for all the tests reported here.

A study of the effect of varying the pitch and yaw stability is illustrated in Figure 3-19. With standard pitch stability, a reduction in yaw stability is benign at least down to a yaw stability fraction 0.25.* The ship steadies

* As indicated in the figure the yaw damping was, in many cases, varied in proportion to the yaw stability fraction.

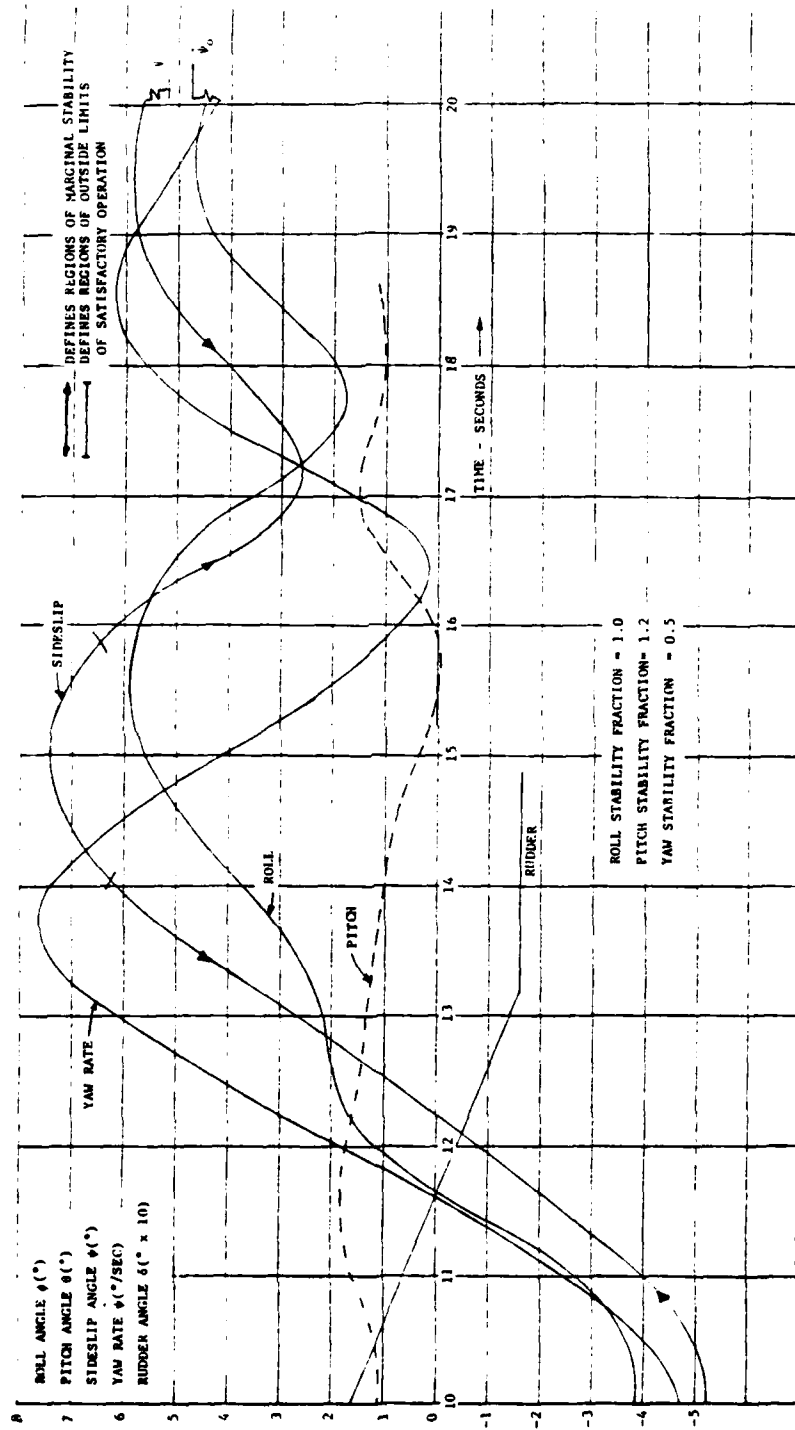

FIGURE 3-18. SIMULATED SES MANEUVER #24 50 KNOT, 16° RUDDER-ANGLE TURN WITH RUDDER REVERSAL. (STABLE)

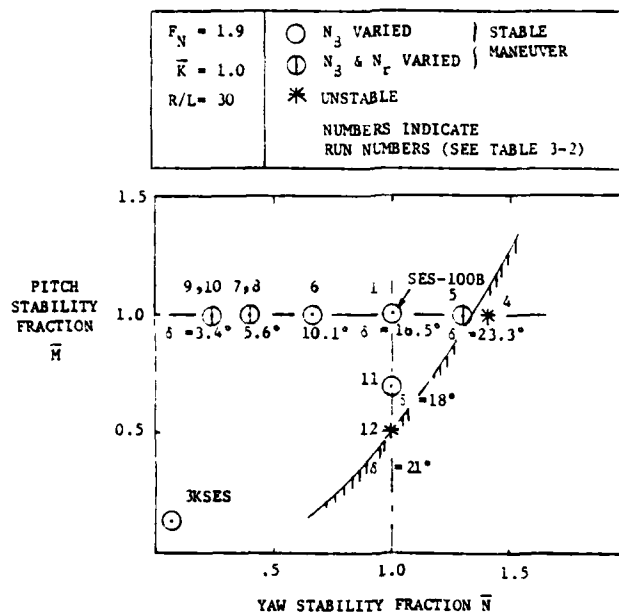

FIGURE 3-19. EFFECT ON 50 KNOT ($F_N=1.9$) RUDDER REVERSAL MANEUVER AT CONSTANT TURN ($R/L_c=30$) RADIUS OF VARYING PITCH AND YAW STABILITY OF SES-100B.

rapidly in the commanded turn and damps rapidly into the opposite turn after completion of the rudder reversal. The rudder angle required for the specified turn is reduced as the yaw stability is reduced. With increased yaw stability progressively greater rudder angles are required to maintain the commanded turn rate. This results in increased inward roll in the steady part of the turn and a substantial overshoot after the rudder reversal. At a yaw stability fraction of 1.4 the ship is unable to stabilize in a steady turn after the rudder reversal.

It is apparent that the effects of yaw stability variation are quite different for preset rudder angle and for preassigned turning rate. In the first case the operational boundary is related to an inadequacy in yaw stability. In the latter case problems arise because of the excessive roll and sideslip caused by excessive rudder force.

With reduction in the pitch stability, with standard yaw stability, the responses are similar in the two cases down to a pitch stability fraction of 0.7. At a pitch stability fraction of 0.5 the ship will not stabilize in a steady turn with fixed rudder before the rudder reversal. With automatic steering the rudder reversal is accomplished and the ship stabilizes in a steady turn with fixed rudder. A substantial loss of speed occurs, due to the large drag associated with prolonged positive pitch during the rudder reversal, and the ship apparently achieves course stability at the lower speed. Before the rudder reversal the ship is not stable on course but exhibits a "Limit cycle" oscillation about the commanded turn rate.

A tentative operational boundary has been drawn on Figure 3-19 despite the lack of tests with simultaneous variation of both pitch and yaw stability. The effect of varying roll stability, on the rudder reversal maneuver with specified turn radius, is illustrated in Figure 3-20. At a fraction of 0.5, with standard pitch stability, it is impossible to achieve a steady turn in preparation for the rudder reversal. With a roll stability fraction of 0.6 the maneuver is highly stable, exhibiting an only momentary, slightly excessive positive pitch.

Simultaneous reduction of both pitch and roll stability fractions to 0.7 results in a satisfactorily stable maneuver although the pitch angle reaches +3.3 degrees, about 1.3° above the limit of the model tests. Reducing both stability fractions further to 0.6 results in yaw/rudder limit cycle oscillations prior to the rudder reversal. With both fractions set at 0.5, the ship is strongly unstable in yaw.

A fairly well defined stability boundary can be drawn on Figure 3-20.

A stability limit in the roll/yaw plane is shown in Figure 3-21, based on a series of runs with nominal pitch stiffness. Low values of roll stiffness and high values of yaw stiffness cause instabilities when a constant radius turn reversal maneuver is attempted.

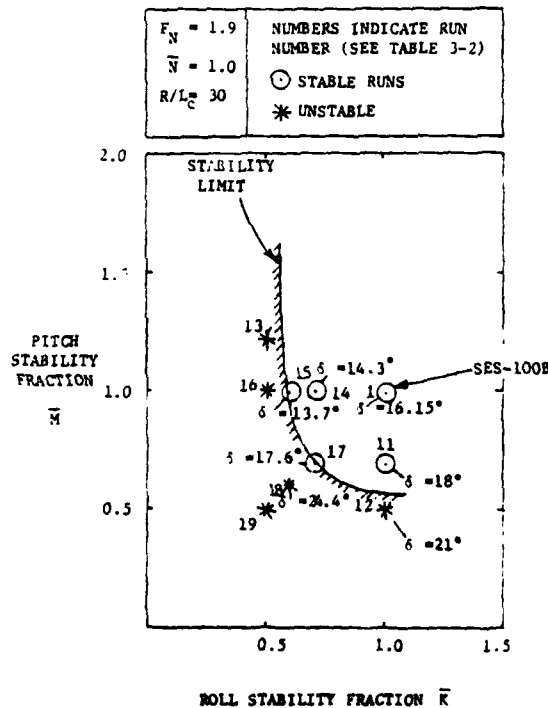

FIGURE 3-20. EFFECT ON 50 KNOT ($F_N=1.9$) RUDDER REVERSAL MANEUVER AT CONSTANT RADIUS ($R/L_c=30$) OF VARYING PITCH AND ROLL STABILITY OF SES-100B.

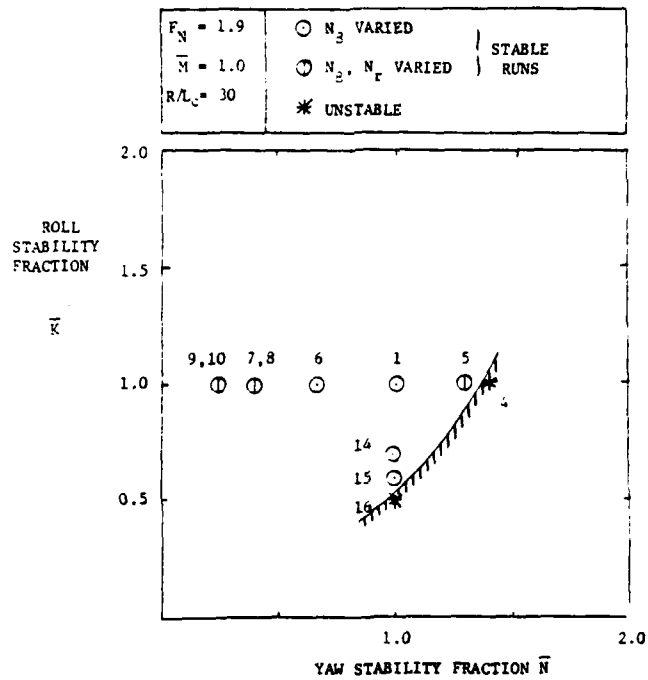

FIGURE 3-21. EFFECT OF VARIATION OF ROLL AND YAW STABILITY ON SIMULATED SES-100B RUDDER REVERSAL MANEUVERS AT CONSTANT TURN RADIUS ($R/L_c=30$) AND SPEED (50 KNOTS, $F_N=1.9$).

3.4.5 Effect on Rudder-Reversal Maneuver of Forward Movement of Center of Gravity

When the center of gravity is moved forward, in run 20, by an amount estimated to produce a 1° bow-down change in pitch trim (0.842 ft.), with the "Revised Standard Coefficients" ($K = M = N = 1.0$), the trim in an $R/L_c = 30$ turn was actually reduced about 1.34° and the rudder angle required was increased from 16.15° to 23.23° . The sideslip increased 50% and the roll angle doubled in the steady turn before rudder reversal. Rudder reversal leads ultimately to gross instability soon after completion of the rudder movement, characterized by extreme bow-down pitch, divergence in yaw and finally an outward roll in the reversed turn.

A somewhat smaller forward shift of the center of gravity (0.643 ft.) leads to an instability only slightly less violent than the previous maneuver. The required rudder angle was 21.3 degrees. This maneuver (Run #21) is shown in Figure 3-22.

With the same center of gravity position, 0.643 feet forward, but with a yaw stability fraction of $2/3$ and correspondingly reduced yaw damping, the required rudder angle was reduced to 11.09° , for an $R/L = 30$ turn, and a satisfactorily stable maneuver is achieved (Run #22). These results are shown on Figure 3-23.

By using a fixed 16° rudder angle, the turn radius was increased to 35.83 times the ship length (Run #34). A stable maneuver was achieved but with a 27% increase in the roll overshoot compared with that with the same rudder angle and initial, "standard" center of gravity position (Run #1).

3.4.6 Effect of a Pitch-Down Disturbance in a Turn

In view of the known effect of pitch attitude on the lateral stability, it was anticipated that a pitch-down excursion during a turn might seriously modify the character of the maneuver. Accordingly simulations were made in which a 10-degree/second pitch-down impulse was imparted after a 10-second initial period which allowed the ship to steady in a turn with a 16-degree rudder angle. The impulse was applied as a moment about the y -body axis, resulting in a step in the q velocity. This has the effect of a step in the pitch rate and, to a lesser degree, in the yaw rate. The condition of the ship, for the first simulation (run 35), was with the "Revised Standard Coefficients" ($K = M = N = 1.0$) but with the center of gravity 0.643 feet forward of the origin of body axes. The time history for the resulting, stable maneuver (Run #35) is shown in Figure 3-24. The rudder was held fixed throughout the run.

A reduction in yaw stability to an 0.8 fraction also results in a stable maneuver with, however, noticeably increased pitch, roll and yaw rate oscillations (Run #36). At an 0.7 yaw stability fraction, however, the ship becomes markedly unstable as is evident in the time history in Figure 3-25 (Run #37). It may be noted from Figure 3-23 that, with this configuration, a successful maneuver was accomplished in Run #22, by reducing the range of rudder angle change from $\pm 16^\circ$ to $\pm 11^\circ$.

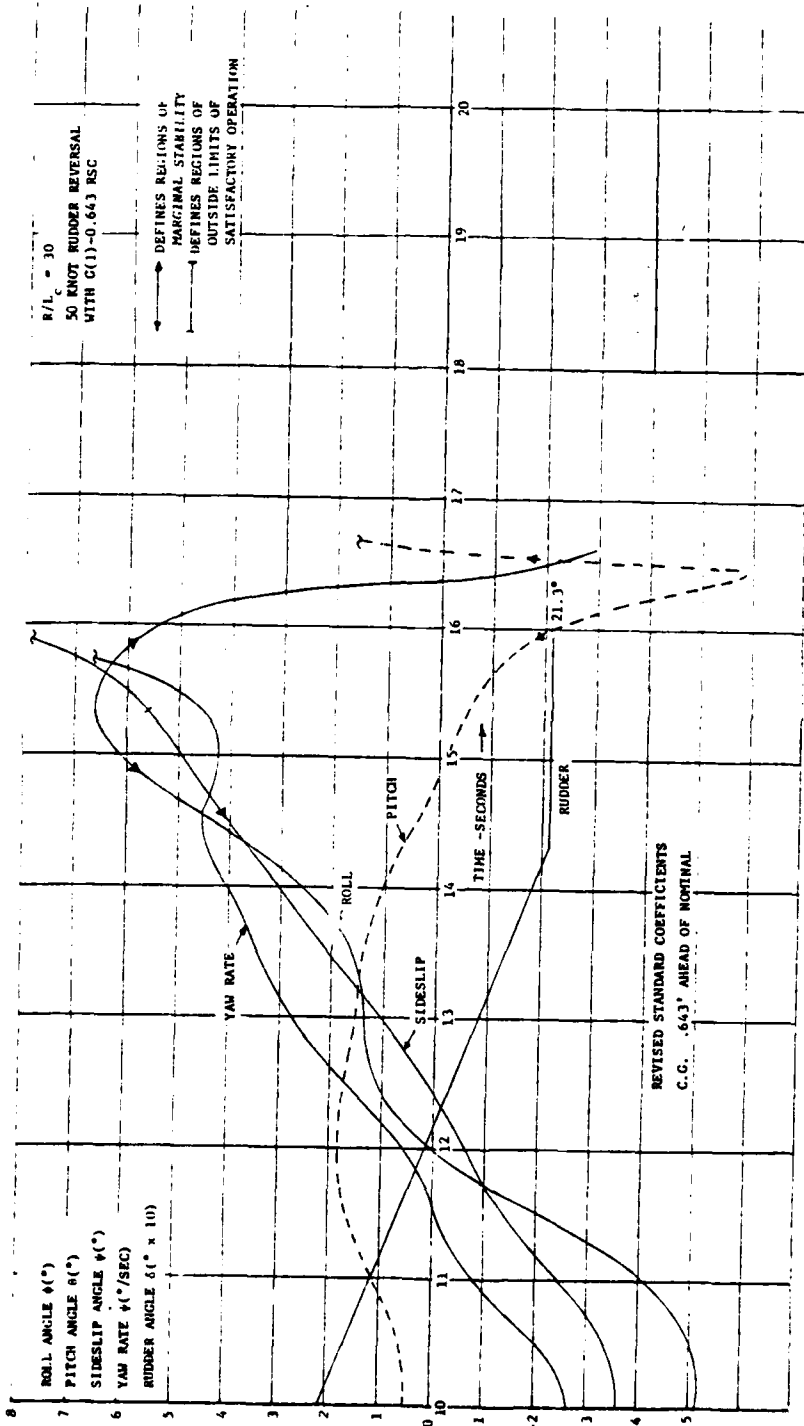

FIGURE 3-22. SIMULATED SES-100B MANEUVER #21 - 50 KNOT, (R/L_c = 30) RUDDER REVERSAL WITH FORWARD C.G. (UNSTABLE)

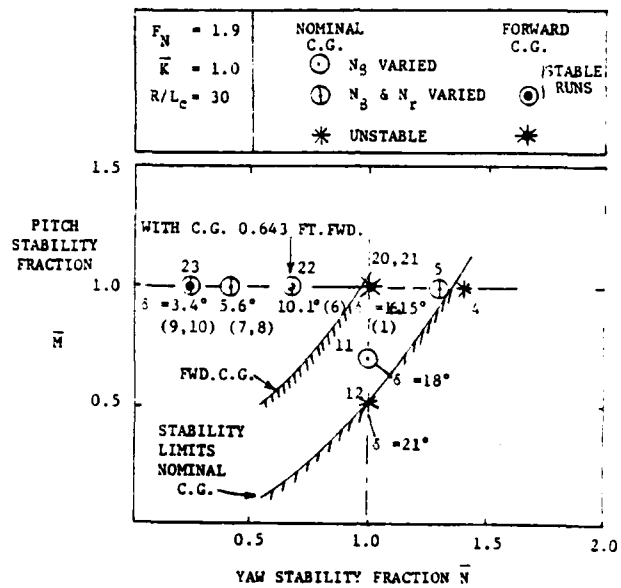

FIGURE 3-23. EFFECT OF VARIATION OF PITCH AND YAW STABILITY AND C.G. POSITION ON SIMULATED SES-100B RUDDER-REVERSAL MANEUVERS AT CONSTANT TURN RADIUS ($R/L_c = 30$) AND SPEED (50 KNOTS, $F_N = 1.9$).

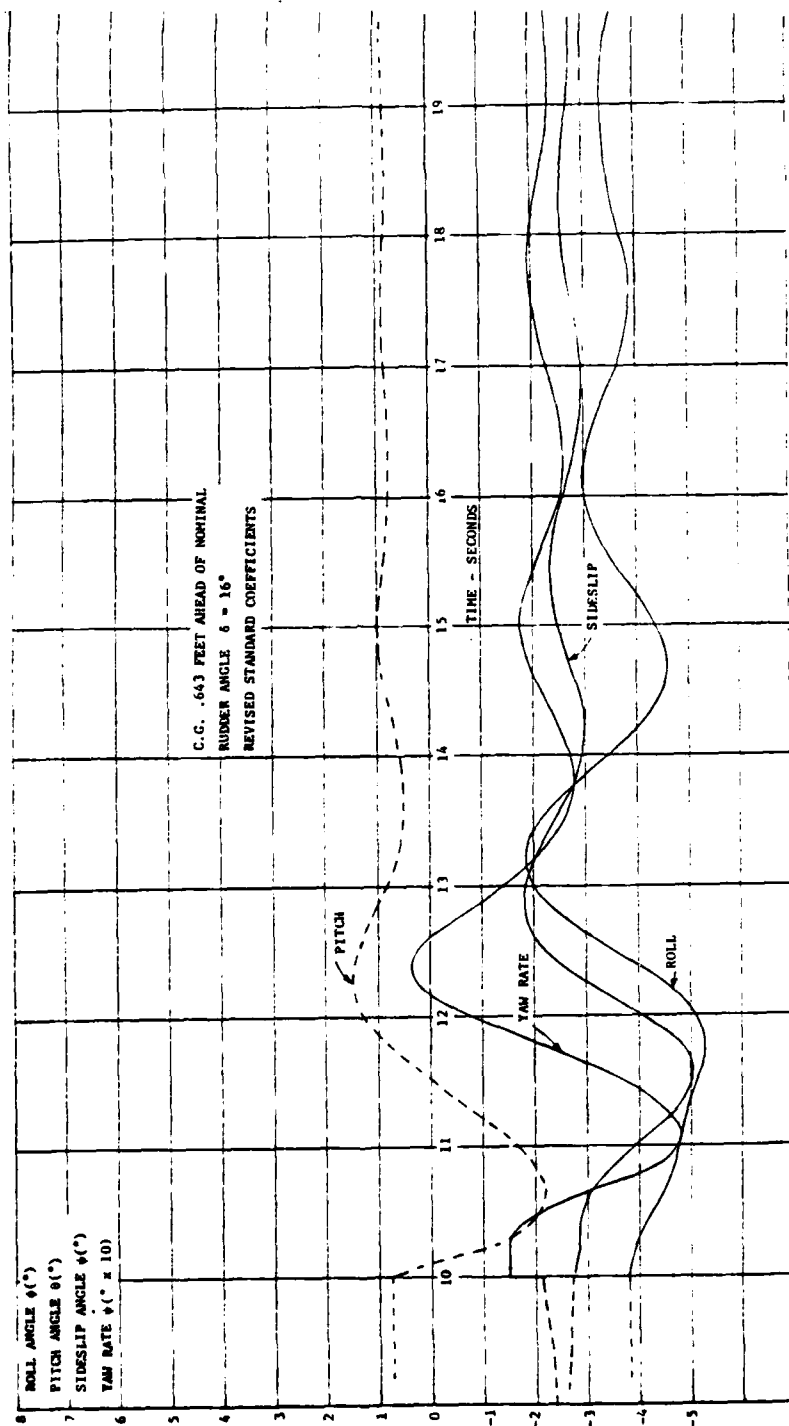

FIGURE 3-24. SIMULATED SES-100B MANEUVER #35 - 10°/SEC IMPULSIVE PITCH DOWN DURING STEADY TURN AT 50 KNOTS. (STABLE)

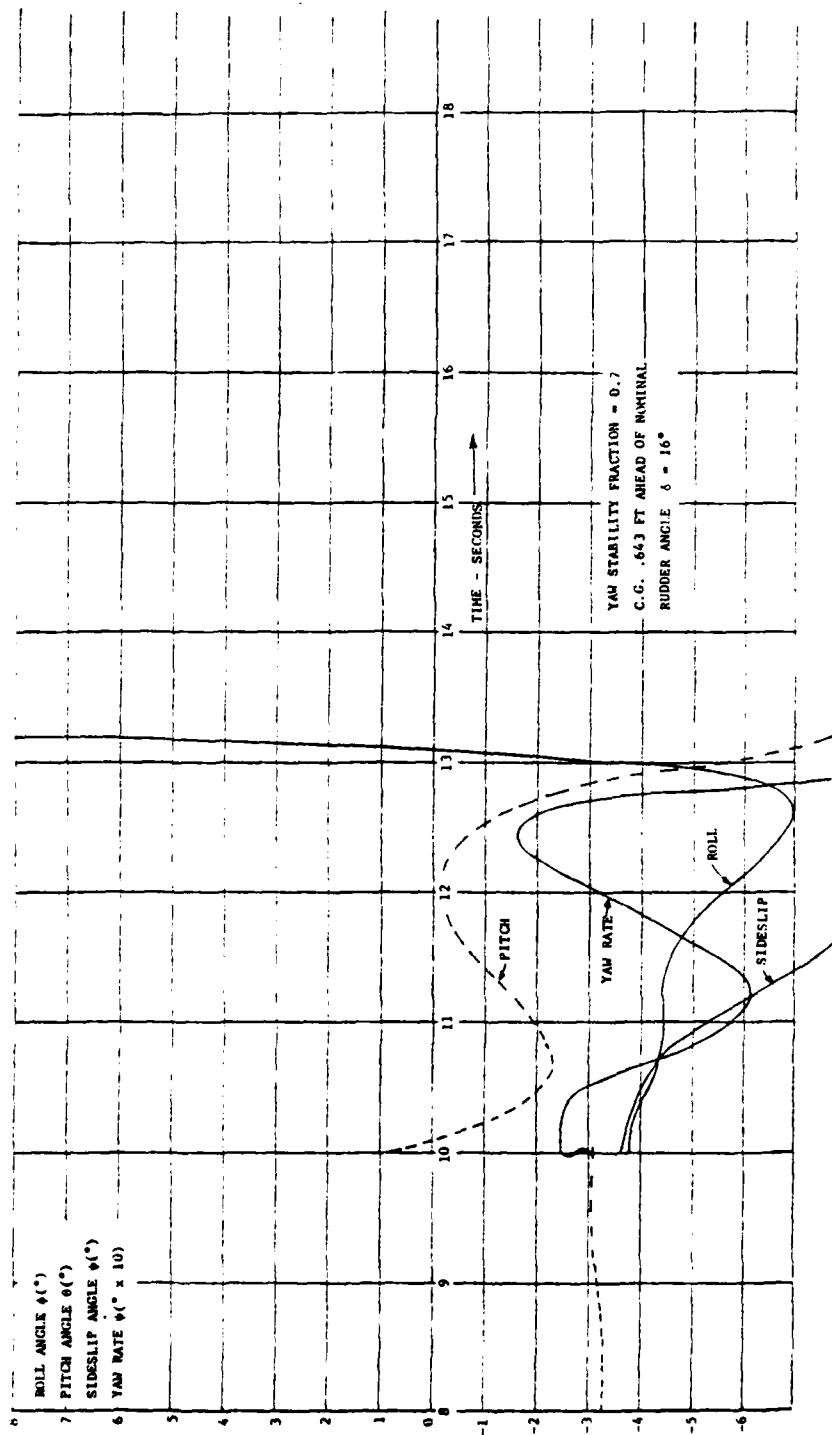

FIGURE 3-25. SIMULATED SES MANEUVER #37 - IMPULSIVE PITCH DOWN ($10^{\circ}/\text{SEC}$) DURING STEADY TURN AT 50 KNOTS WITH REDUCED YAW STIFFNESS. (UNSTABLE)

3.5 SURVEY OF CURRENT AND PRIOR SES

The development of adequate stability criteria for Surface Effect Ships is dependent to a large extent on the experience gained with earlier SES designs. This experience appears in many forms expressed as analytical results or the results of model or full-scale test programs. An extensive search of the pertinent bibliography has been made to determine what data are available from these programs. The SES model- and full-scale data which have been applied to this effort are derived from the following craft:

U.S. Navv XR-1:	- Model Data
U.S. Navv SES-100A:	- Model- and Full-Scale Data
U.S. Navv SES-100B:	- Model- and Full-Scale Data
Rohr Marine 2KSES:	- Model Data
Rohr Marine 3KSES:	- Model Data
Vosper Hovermarine HM-2:	- Full-Scale Data
Bell 2KSES:	- Model Data

Data are available for off-cushion operation, operation at stationary hover, and for operation underway.

The principal characteristics of these and other hard-sidehull Surface Effect Ships are shown in Appendix A. All of them, except for the Vosper Hovermarine HM-2, are experimental craft. The Bell-Halter BH110 is in the early stages of being produced for commercial service. The SES-100A has been scrapped. The SES-100B has been laid up at the SES Test Facility (SESTF) at the Patuxent River Naval Air Station. The XR-1 has been drastically modified several times; the latest version is the XR-1D which is approximately a 1/5th scale model of the RMI 3KSES; the XR-1D is still being tested at SESTF. The 2KSES and 3KSES are U.S. Navy projects which were never built.

The population of SES in the western world, therefore, is very small. Only one of these craft has suffered a serious, stability-related event; this occurred when the XR-1 capsized in the Delaware River. Almost all of the model- and full-scale experimental work that has been carried out, to date, has been of a developmental nature, related to specific prototype craft, and it has concentrated on ensuring that the craft would have adequate stability for minimum drag penalties, rather than exploring the outer limits of stable behavior and the sensitivity of these limits to variations in basic craft parameters.

Stability related test programs that have been performed are listed in Appendix A, which also includes some of the results of these experiments.

In an attempt to interrelate the experience during a number of these tests use has been made of the non-dimensional coefficients described earlier in this report. The non-dimensional stability coefficients have been converted to restoring energy coefficients by integrating the stability coefficients with respect to the corresponding non-dimensional angles as shown in Figure 3-26. These restoring-moment curves differ from those of a conventional ship in that these curves represent the moments acting while the craft is underway in a dynamically supported condition, whereas those for a conventional ship normally represent a zero speed condition.

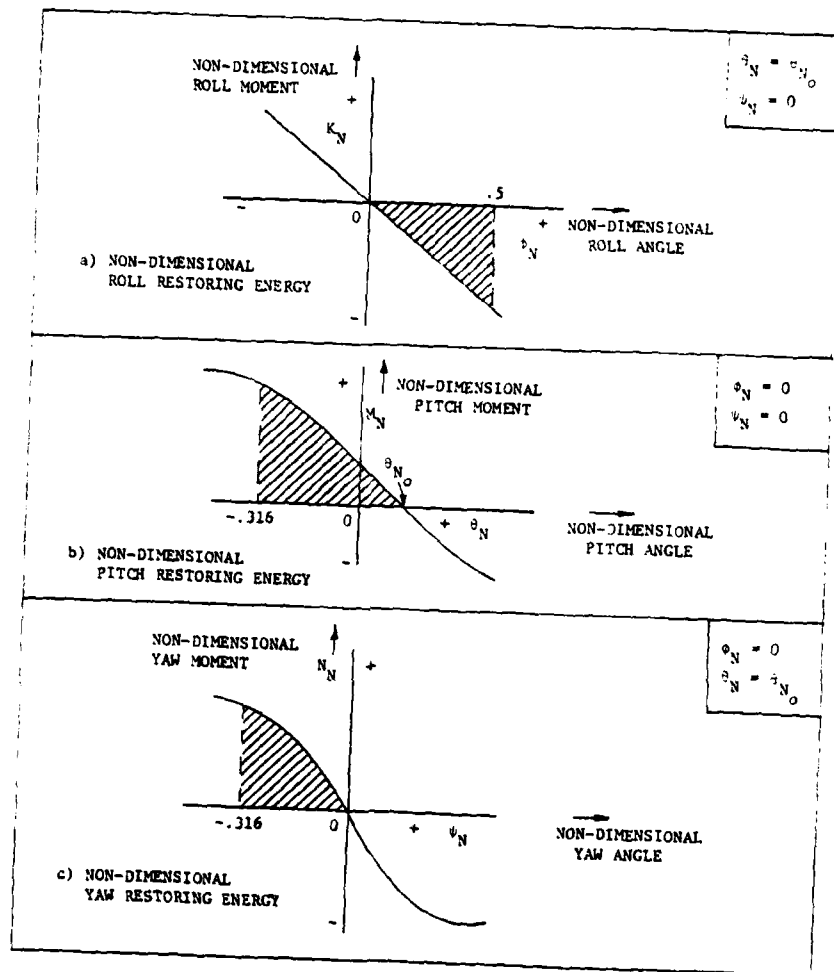

FIGURE 3-26. ILLUSTRATION OF METHOD OF DETERMINING NON-DIMENSIONAL ROLL, PITCH AND YAW RESTORING ENERGY.

The non-dimensional roll, pitch and yaw angles (ϕ_N , θ_N , ψ_N) are defined in Table 3-1.

Each of the non-dimensional angles has a value of unity which corresponds to a physical limitation on motion. Thus $\phi_N = \pm 1$ when the craft is rolled to the point where one sidehull keel is just skimming the surface and the other sidehull is buried to the wet deck. Similarly $\theta_N = \pm 1$ when the forward part of the wet deck is just striking the water if the sidehull keels are at the water surface at the rear seal, and $\psi_N = \pm 1$ when the leading edge of one sidehull is tracking directly in front of the trailing edge of the other.

It was the original intention, therefore, to integrate the restoring moment coefficients from zero to unity on the non-dimensional angle axis, but this could not be carried out because of the limited range of the available data. The limits of integration that were used in this comparative study were the following:

Roll: $\phi_N = 0$ to ϕ_c , $\phi_c = 0.5$

Pitch: $\theta_N = \theta_c$ to θ_{N_0} , $\theta_c = -0.316$, θ_{N_0} is the angle for zero pitching moment

Yaw: $\psi_N = 0$ to ψ_c , $\psi_c = 0.316$

These integrations have been carried out for all of the model and full-scale data that could be located. The uniformity and quality of the data leave a great deal to be desired. For some craft the only data available is from full-scale experiments which do not allow yaw stability data to be generated. In the case of the HM-2 the only roll data available is at zero speed.

The available information is listed in Table 3-4. The values quoted are for the non-dimensional restoring energy E defined as follows:

Roll-Restoring Energy:
$$E_{\phi_c} = \int_0^{\phi_c} K_N \cdot d\phi_N$$

Pitch-Restoring Energy:
$$E_{\theta_c} = \int_{\theta_c}^{\theta_{N_0}} M_N \cdot d\theta_N$$

Yaw-Restoring Energy:
$$E_{\psi_c} = \int_0^{\psi_c} N_N \cdot d\psi_N$$

TABLE 3-4. NON-DIMENSIONAL RESTORING ENERGY FOR MODEL AND FULL-SCALE SES.

	Limit of Integration			Froude Number	Non-dimensional Restoring Energy		
	θ_c	β_c	ψ_c		Roll	Pitch	Yaw
	θ_c	β_c	ψ_c	F_N	E_{θ_c}	E_{β_c}	E_{ψ_c}
SES-100B	5.56°	1.3°	8.5°	1.33 1.9 2.47	.0147 .0138 (7) .0140	.0088 .0096 (7) .0080	.0087 .0167 (7) .0213
SES-100A (Strut-pod waterjet inlet)	5.36°	1.72°	8.42°	1.31 1.69 1.87 2.06 2.44	.0023 (2) .011 (Model Pred.) .0119 (3)	.0754 (2) .0064 (2) .00126 (2)	.0254 (3)
SES-100A (with flush inlet and fences)				1.87		.0076 (1)	.0098 (9)
HM-2	4.87°	1.35°		0 1.45 1.59	.0067 (8)	.00275 (8) .00334 (8)	
XR-1B	5.68°	1.44°	6.86°	1.58 1.9	.022 (4)	.004 (5)	.0051 (5)
3KSES	6.07°	1.49°	7.16°	.804 1.206 1.61	.00886 (6) .00912 (6) .00977 (6)	.0092 .0028 (6) .00125	.00074 .00098 (6) .00127

- References:
- | | |
|-------------------|-------------------|
| 1. MDI OCT 76 | 6. ROHR 31 AUG 78 |
| 2. AGC 22 MAY 74 | 7. SIT JUN 74 |
| 3. AGC 17 SEP 73 | 8. HTL 12 JUL 72 |
| 4. DTNSRDC JUL 69 | 9. SIT OCT 75A |
| 5. SIT DEC 69 | |

The values shown in Table 3-4 are taken from the nine references listed under the table. In many cases the data are not consistent in that the pitch data are reported at one speed and weight condition and the yaw and roll data are reported for different conditions. Enough data is available, however, to allow the stability characteristics of different SES to be compared. This is attempted in Figure 3-27 a), b) and c). In each of the roll-pitch, roll-yaw and yaw-pitch planes the appropriate stability limits developed in Figures 3-17, 3-19, 3-20 and 3-21 are repeated. The general result of this comparison is confusing; the stability limits based on investigating departures from SES-100B stability do not appear to be relevant to the other vehicles even when the Froude numbers are similar. A more appropriate method of interrelating the characteristics of the different SES is introduced in the next paragraph.

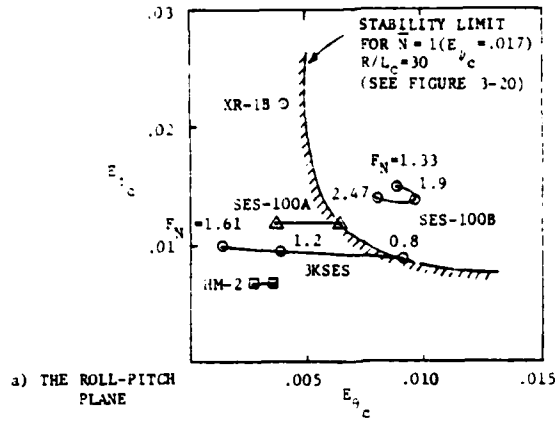

a) THE ROLL-PITCH PLANE

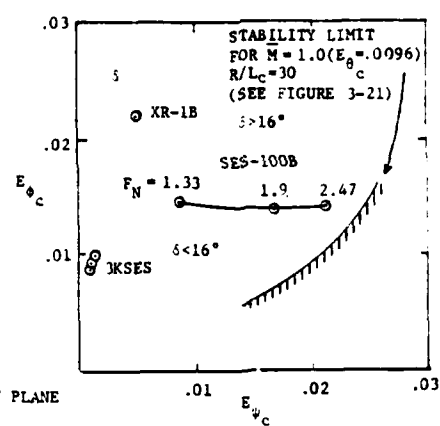

b) THE ROLL-YAW PLANE

FIGURE 3-27. COMPARISON OF SES STABILITY CHARACTERISTICS WITH STABILITY LIMITS FOR $F_N = 1.9$ and $R/L_c = 30$.

3.5.1 Conditions for Stable, Rudder-Reversal Maneuver ($F_N = 1.9$, $R/L_c = 30$)

It was realized, therefore, that the two-dimensional plots were not appropriate and a three-dimensional plot was attempted to present the pitch, roll and yaw information on one diagram. When this was accomplished, as shown in Figure 3-28, the picture became much clearer. For clarity, only the $R/L_c = 30$ limits are shown in Figure 3-28. They have been transferred from Figures 3-27 a), b) and c) into the planes represented by $\bar{N} = 1$, $\bar{M} = 1$ and $\bar{K} = 1$ respectively. $\bar{K} \bar{M}$ planes have been sketched in to represent the \bar{N} values corresponding to each of the 3KSES, XR-1B, SES-100A and SES-100B, and the values of \bar{K} and \bar{M} have been identified for each of these vehicles corresponding as nearly as possible to Froude Numbers of 1.9.

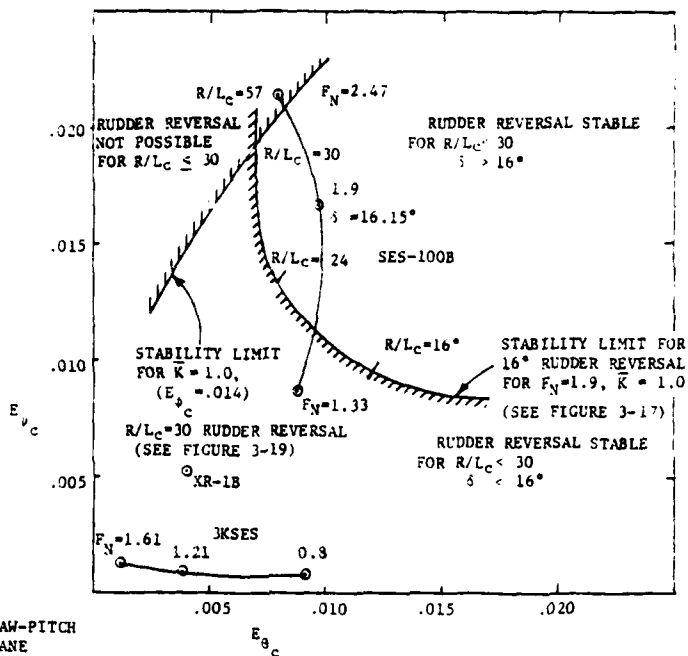

c) THE YAW-PITCH PLANE

FIGURE 3-27. CONTINUED.

The stability limit for the rudder-reversal maneuver at $R/L_c = 30$ now appears as a three-dimensional surface which contains the positive \bar{K} and \bar{M} axes when $\bar{N} = 0$. It is intriguing to note that all of the points representing full-scale and model SES now lie above this surface, suggesting that all of them could, in fact, safely perform the rudder-reversal maneuver when operating at $F_N = 1.9$ in a turn with a radius-to-length ratio less than or equal to thirty.

The stability requirement represented by the surface shown in Figure 3-28 can be approximated by an expression of the form

$$\bar{K} \bar{M} \geq 0.5 \bar{N}^{1.3}$$

In terms of the non-dimensional restoring energies E_{ϕ_c} , E_{θ_c} and E_{ψ_c} this expression becomes:

$$E_{\phi_c} \cdot E_{\theta_c} \geq 0.0135 (E_{\psi_c})^{1.3}$$

3.5.2 Conditions for Stable Rudder-Reversal Maneuver at Other Turn Radii ($F_N = 1.9$)

By using the very limited amount of information available for other turning radii (see Table 3-2) it is possible to introduce the turn-radius-to-length ratio (R/L_c) into the above expression to obtain a tentative condition for stable turn-reversal maneuvers at other radii:

$$E_{\phi_c} E_{\theta_c} \geq 93.5 (E_{\psi_c} (R/L_c)^2)^{1.3}$$

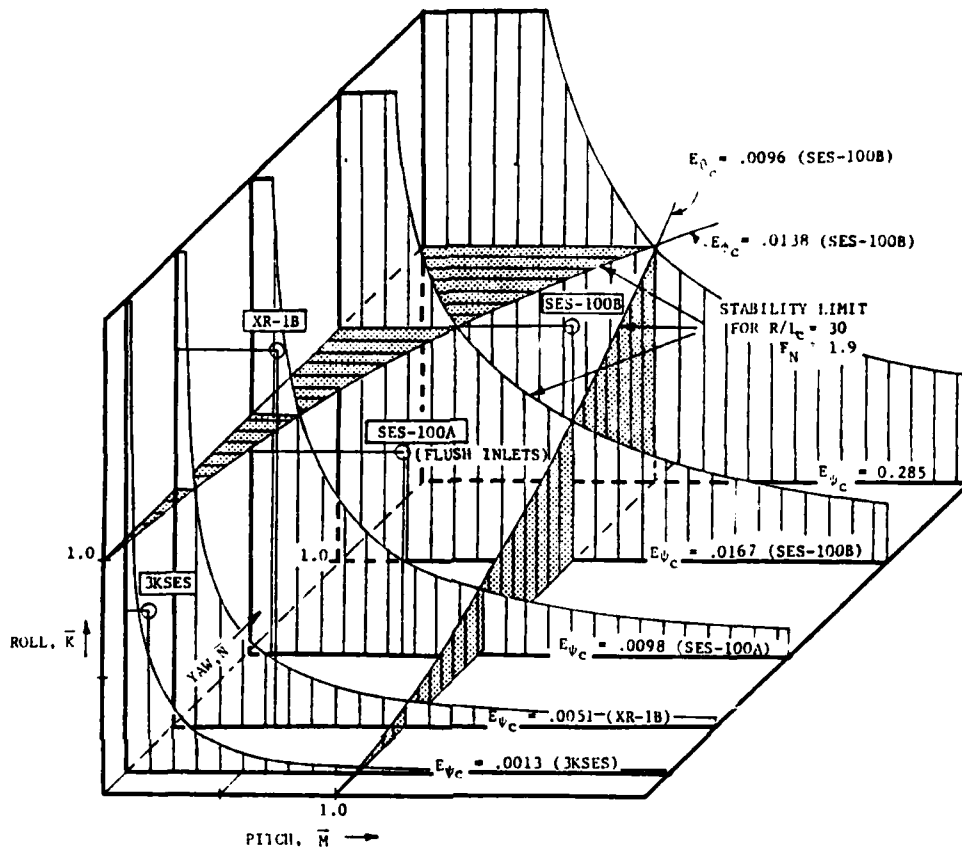

FIGURE 3-28. LIMITS OF SES PITCH, ROLL AND YAW STABILITY IN COMPARISON WITH STABILITY CHARACTERISTICS OF DIFFERENT SES ($F_N \approx 1.9$, $R/L_c = 30$).

3.5.3 Conditions for Stable, Rudder-Reversal Maneuvers at Other Speeds

The information available on the variation of SES stability characteristics with speed is rather limited. The data provided for the SES-100B in SIT OCT 75A suggest that the stability characteristics themselves do not vary markedly with speed but the limits of stable operation become considerably more restricted as speed increases. This is illustrated in Figure 3-12 through 3-15. It is considered that insufficient work has been completed at different speeds to allow an algorithm to be developed to represent the effect of speed variation. The algorithms presented in the previous paragraphs should be considered as being appropriate to Froude Numbers of about 1.9. For Froude numbers exceeding this value by a wide margin consideration should be given to conducting model tests, or to carrying out a more extensive analysis than has been possible to date.

4. SES STABILITY IN ROUGH WATER

The preceding section explored the subject of turning maneuvers in calm water. Even the presence of wind in an otherwise sheltered sea can accentuate the likelihood of a downwind capsize situation and aggravate any adverse roll which might develop during a high-speed turn. The possibility of capsize is further accentuated as waves become larger relative to the cushion depth and as the waves become steeper due to changes in local tide, wind and water depth. Although danger of capsize exists for all severe sea conditions the danger is enhanced when waves approach twice the cushion depth in height and are of one craft length between crests (SMTRB 80). Of particular concern is the danger of broaching-to in high following or quartering seas which could result in beam-wise motion and danger of sidehull tripping. At speeds above a Froude number of unity an SES has sufficient kinetic energy from forward motion alone to create a capsizing situation once angular displacements become very large. Capsizing can also result from synchronous roll motion while the SES is wallowing in high beam seas.

In fact, it is impossible to design an SES that cannot be capsized if conditions are severe enough. Craft are always designed and certified for a particular operational envelope which places a limit on the sea state, speed and other operating conditions to which the craft would be permitted to be exposed. We are therefore interested in determining what the safe envelope should be for a particular design.

The determination of SES behavior in heavy seas must be one of the most fundamental design requirements to be considered. This must be especially so, when the SES is comparatively small and is required to operate in exposed regions. At the same time, it is one of the least well understood areas of SES behavior. Although theoretical predictions of SES seakeeping behavior are possible, they cannot be applied for extreme wave and craft motions with any expectation of obtaining realistic results. Where the theory is inadequate, model testing is the only satisfactory approach.

Measuring the motions of a model in conditions which are as realistic as possible in simulating severe sea conditions offers the best means of evaluating SES stability in rough water. Types of tests which are well established include captive-model towing-tank tests and self-propelled, remotely-controlled, free-running model tests. Each type of test has its advantages and its limitations.

In most towing tanks, captive-model tests are usually restricted to head seas, following seas or beam seas (the latter at zero model speed) having unidirectional, long-crested waves. Model excitation is therefore often restricted to essentially two, or, at most, three degrees of freedom at a time. Thus, many important coupling effects cannot be explored. Also, the infrequent nature of capsizing makes it statistically an extreme event. If tests are conducted in random seas then the results must be based on a large statistical sample of wave encounters. This usually requires combining data from several runs.

Testing a free-running, self-propelled, model in a maneuvering basin, in which multi-directional seas can be generated, can adequately produce model excitation in all six-degrees of freedom. Limitations on the available size of maneuvering basins, however, makes the model running time even more restrictive than in a linear towing tank, which compounds the problem of gaining sufficient statistical significance from the measured data.

Testing a free-running model in open water in natural wind-generated waves is an alternative to tank testing. Although realistic short-crested waves and essentially unlimited length of runs are available, there are inevitable problems in controlling test conditions.

Despite these shortcomings, both tank testing and free-running model tests can be used to provide a considerably more reliable assessment of craft resistance to capsize in rough water than is possible with current theoretical predictions. The various testing techniques designed to investigate capsizing behavior are discussed below. In all cases the model must represent the full scale craft as closely as is practical in terms of geometry, weight, C.G., moments of inertia and cushion flow.

4.1 LINEAR TOWING TANK TESTS

4.1.1 Testing in Regular Waves

Structural load testing of SES models in random seas have shown that the most severe motions (and loads) often occur when the model encounters a particular group of two or three especially large regular and steep waves within the spectrum of waves being generated. This suggests that the investigation of capsizing limits would benefit from testing in regular waves having the particular height and length most critical to capsizing. The application of extreme-value statistics may then be applied to determine, from the sea spectra of interest, the probability of occurrence of wave groups having the same critical characteristics. In this way, the frequency of occurrence of a capsizing in one or more ship lives may be determined. However, exposing a model to a continuous series of critical regular waves (as opposed to a few critical waves within a spectrum of random waves) is expected to accentuate the possibility of capsizing. Results would therefore include a degree of conservatism.

All regular-sea tests could be conducted, at zero or constant forward speed, with the model attached, at its center of gravity, to a carriage heave staff, with the model having freedom to heave, pitch, roll and yaw (and with freedom of limited surge if possible). Large excursions in model motions would be limited by safety wires to prevent the model from completely capsizing and protect it from serious damage.

Tests could include the measurement of model motions (and accelerations) for a limited combination of:

- (a) Head seas and following seas
- (b) Beam seas (with model constrained in yaw, sway and surge)
- (c) Off cushion, partial cushion and full cushion
- (d) Various forward speeds

- (e) Various displacements
- (f) Various applied upsetting moments in roll to simulate a range of operational hazards such as cargo movement and beam winds, etc. (tank-side wind generators have been used in the past with some success)
- (g) Various longitudinal and vertical C.G. (and corresponding towing point) locations
- (h) Various wave heights and lengths

Conditions which exhibit a tendency for the model to capsize or behave in an unacceptable manner would be recorded.

The probability of occurrence of such conditions in combination with the probability of encountering critical wave combinations could then lead to the determination of the joint probability of a capsize or a particular type of unsafe behavior.

To cover all aspects of conditions (a) through (h) stated above would, of course, be extremely ambitious. Test plans would normally be very selective in the range of conditions that could economically be explored.

4.1.2 Testing in Irregular Waves

Most linear towing tanks are equipped with computer-controlled wave makers capable of generating a wide range of wave spectra. The selection of a route or region for which a craft is to be certified would dictate the general wave spectra of interest within which the magnitude (or energy) of the sea state would be varied. Test conditions similar to those listed for regular waves could be investigated and the time histories of model motion recorded. Because of limited towing tank length, several tests underway may be required for like conditions to establish statistical significance. Time histories would be analyzed to yield the frequency of motion level exceedances which, in turn, would be used to derive curves (and empirical equations) to describe the short-term cumulative probability distribution of motion excursions for each test condition. These results, combined with a prediction of the probability of occurrence of each test condition, based on a lifetime assessment of expected craft use, could then yield a long-term distribution of motion exceedances. From this, the lifetime probability of capsize (or unacceptable behavior) could be determined for a particular threshold of acceptable motion (i.e. selected maximum roll and pitch angles).

The approach used in the analysis of the recorded data would, therefore, be very similar to that used in extrapolating structural loads data acquired from model tests to predict full-scale loads. Techniques for this approach are well established as evidenced by the extensive tests which, over the past six years, or so, have supported developments within the U.S. Navy's SES program and, in which respect, BAND, LAVIS and ASSOCIATES have played a leading roll in conjunction with Rohr Marine Inc. (BLA JUN 77).

4.2 FREE-RUNNING MODEL TESTS

The design of radio-controlled models and the techniques employed in testing them, in maneuvering basins or in open water, have been well established (BHC JUL 80). Such models are self-propelled, fully instrumented and can be equipped with automatic steering to assist the operator in establishing a consistent heading which can otherwise be difficult to achieve from a remote station. Free-running tests of a model of the Bell-Halter BH-110 SES, for example, helped demonstrate to the USCG, the suitability of this design for crew-boat service in the Gulf of Mexico. Since 1966 the British Hovercraft Corporation (BHC) have tested, on average, a total of four free-running models per year. During 1980 they tested a total of nine. These tests have included seakeeping trials, maneuvering trials, and tests in which side-by-side comparisons of two models were made. Also, the advantages in testing the capsizing and broaching tendencies of free-running displacement ship models have been well demonstrated in the USCG sponsored work in San Francisco Bay by the University of California, Berkeley (USCG DEC 74).

Procedures for selecting the appropriate model size and test area, the type of model construction, power units, control system, and instrumentation that are also applicable to SES models, is well summarized in BHC JUL 80. This report by BHC also describes recommended techniques for measuring waves in the test area and procedures for data analysis. Experience in testing free-running SES and ACV models in the U.S. has demonstrated considerable realism in comparison to full-scale craft which have been subsequently built and tested.

In view of the severe sea conditions to which a free-running model would be subjected, for capsize investigations, particular attention would be necessary to assure adequate structural strength, flotation and watertight integrity. Design requirements would dictate that the model be capable of capsize without total loss or major failure of important functions.

The general test philosophy recommended is similar to that employed for full-scale ship trials. Thus, plans must always be flexible to allow full advantage to be taken of natural changes in the weather. Ideally, the free-running tests could be conducted in conjunction with a series of towing-tank or maneuvering basin tests using the same, or similar, model. Here, the tank or basin tests would allow direct control of the sea spectra. Also, the tank tests, in particular, would consistently allow tests to proceed to the limit of capsize, constrained only by the model safety wires. On the other hand, although the free-running model would be designed to survive a capsize, this would likely be avoided under most circumstances. In view of this, the comparison of model behavior between the various types of tests would enhance the overall understanding of model capsizing limits.

4.3 MINIMUM ROUGH-WATER TEST REQUIREMENTS

Model testing can represent a large expenditure of time and effort. The design and construction of a 6 ft. dynamic model of an SES, fully instrumented for use in a towing tank, for example, can cost at least \$50,000 at today's prices. A 12 ft. free-running, radio-controlled, SES model could well cost five times this much. To this must be added the cost of a two- or three-week test series supported by test equipment, test technicians and the engineering effort for test planning, data reduction, analysis and report writing, which could result in a total test-program cost of between \$150,000 and \$350,000. However, the needed assessment of craft rough-water behavior could not be achieved more economically (or indeed could not be achieved adequately) using any other method.

In view of the cost involved, it is important to identify minimum requirements. Since there are several different types of suitable model test techniques, they may be considered as options, depending upon the availability of test facilities. General requirements for such tests are outlined below.

4.3.1 General Requirements for Model Tests

(a) Model Geometry -

The linear dimensions of the model should be as large as possible. The model size must be selected to be appropriate to the test facility. Most model tanks have found that the smallest successful models of ACV's or SES are about 6 feet in length. Every effort should be made to have the hull, appendages, seals and superstructure represent the hydrodynamic features of the full-scale craft. Where it can be shown that no significant loss in realism will occur, simplification in design should be permitted, particularly with regard to craft superstructure. Where water can be trapped (even momentarily) on deck, or can penetrate openings within the hull or superstructure, features which effect such an eventuality should be represented.

(b) Model Functions -

The inherent dynamic properties of the bow and stern seals should be faithfully represented within the practical limits of current model-making technology. The air supply to seals and cushion should be the scaled equivalent of full scale in terms of the head-versus-flow relationship, total flow and distribution of flow. Inflated seal structures should have the scaled equivalent pressures. Air flow rate-versus-pressure relationships should be measured and verified.

(c) Mass Properties -

The scaled-equivalent mass moments-of-inertia in pitch, roll and yaw should be measured to be within $\pm 20\%$ of calculated full-scale values, at design gross weight. The minimum scaled-equivalent model weight (with heave staff* for tank models) should be no more than 1.15 times the light craft weight (which

* Tank testing with compensating weights, mechanically attached to the heave staff, to off-load model effective weight, should not be permitted.

is the design full-load weight less payload and fuel). Ballast should be provided to permit testing at design overload conditions. Model center of gravity (CG) should be adjusted to represent the full-scale craft in longitudinal, transverse and vertical position. There should be provision to explore variations in CG location to values which are at least 20% outside of the CG envelope for which the craft is to be certified. There should also be provision to simulate, with off-set weights or by other means, the upsetting moment due to operation in beam winds.

(d) Test Equipment -

For captive towing-tank tests the model should be equipped with a heave staff attachment which permits the model to heave, pitch, roll and yaw. A rigid constraint should be provided to rigidly lock the model in yaw for tests in ahead and beam seas, but which could be disengaged to allow freedom to yaw in following seas. Means of continuously recording pitch, heave, roll and yaw motions and vertical accelerations, should be provided. The towing carriage should be equipped with a constant speed drive with an option to include a free-to-surge rig if possible. A wave maker at one end of the tank should be capable of providing regular and random waves and be controllable to generate appropriate wave spectra.

Free-running models should be self-propelled with propulsion, lift and rudder controlled via a radio-link. Means of measuring and recording pitch, roll, heading and rudder angle, should be provided. The vertical acceleration of the model should be measured and recorded for at least two locations. A maneuvering basin or suitable test area should be selected in which waves of sufficient severity can be generated or expected and in which an adequate continuous record of wave height can be provided. In open water, wave recording buoys can be deployed from a chase boat which can also be used as the model control station. To assist in steering and minimizing the deviations from a selected heading due to wave action, consideration should be given to incorporating, within the model, a directional gyro and autopilot. The rudder should, at all times, be arranged to operate at the correct scale rate. Motion picture records of selected conditions should also be provided to assist in data analysis.

(e) Test Procedures -

The objective of all rough water tests would be to establish stability boundaries. Prior to rough-water testing, however, the model dimensions, weight, C.G., and mass-moments-of-inertia and cushion and seal air-flow characteristics should be checked. For both captive and free-running models, tests should first be conducted in calm water to check-out model functions, correct running trim and any tendencies for calm-water instabilities such as plow-in or porpoising. Tests in rough water should proceed in steps with increasing sea state, forward speed and model weight. However, the test plan should be arranged so that the majority of test time is devoted to the extreme sea states and model weight of interest. Three types of towing-tank tests, to be conducted with regular or random waves, are recommended:

- . Head-sea tests
- . Beam-sea tests
- . Following-sea tests.

Progression to the most severe sea state condition should be accomplished on-cushion as quickly as possible, at which point, operation off-cushion, at low forward speed, should also be explored. For head seas and beam seas, the model should be constrained in yaw and have freedom to pitch, heave and roll. In beam seas, the model should operate at zero speed (with limited freedom of sway if possible). Heeling moments should be applied to determine the limit of capsize. For following seas, the model should be given freedom to yaw so that broaching tendencies can be investigated. It is believed that this type of SES broaching test in following seas, with freedom to yaw, has not been tried in the past. Thus, some development of the technique would likely be required to protect the model from serious damage in the event of serious broaching action while being towed at constant speed. Provision for towing the model slightly ahead of the C.G. may well be necessary. It may also be necessary to adjust the safety wires to determine the most appropriate and safe limit of maximum yaw angle allowed.

Tests in regular waves should be aimed at seeking, in each case, the most critical combination of wave height and length (see section 4.1.1). The sea spectra selected for tests in random waves should be appropriate to the operational area(s) for which certification is required. Tests in random waves should be aimed at providing sufficient statistical motion data to permit the derivation of the probability of capsize (or dangerous motion) within the lifetime of the full-scale craft.

Testing a free-running model in a maneuvering basin or open sea should be conducted in a manner similar to that normally employed in full-scale rough-water trials. The ability to safely maneuver the model in close quarters and during turning maneuvers at low and high speeds should be evaluated. Particular attention should be given to the level of control authority available and any tendencies that this might have on model unstable behavior. Trials should commence at low speed in calm water. Underway transition from the displacement mode to the fully on-cushion mode should be checked. In the on-cushion mode any tendencies for the craft to roll-out during turning maneuvers should be evaluated. Craft yaw response to yaw-control inputs should be evaluated and the general work-load of the controller, during turns in calm and rough water, should be assessed. Ditching tests should be conducted at speeds up to and just beyond those ditching speeds for which the craft is to be certified.

Sea trials should be conducted off and on-cushion in the most severe sea conditions available during the trials period, up to (and beyond) conditions for which the full-scale craft is to be certified. Tests should include wallowing at low speed in beam and quartering seas. Particular attention should be given to assessing the severity and frequency of bottom slamming and the extremes of angular excursions and accelerations of the model. Tests in the light and overload displacement condition should also be considered.

Opportunity should be taken to assess the effect on craft stability of simulated system failures and control mishandling. The failures selected for evaluation should, in general, be those which are expected to result in the largest motions to the model or the highest loads on the structure. The time histories of craft angular excursions and vertical accelerations during each test should be recorded.

Particular attention should be given to the likelihood of broaching stabilizers, rudders and propellers and the amount of green water taken on board deck. Motion picture records would be particularly advantageous in this respect.

Tests employing a five-sided course, to subject the model to a range of headings, should be considered. One or more continuously-recording wave buoy(s) should be deployed within, or in, very close proximity to the test area.

Data Reduction and Analysis -

For tests in regular waves the motion and acceleration records should be processed to identify those conditions which have caused the model to exceed particular thresholds. Angular motion thresholds should be established as those beyond which a capsize would most certainly have taken place. Vertical acceleration thresholds should be established as those which could cause harm to crew, passengers and/or hull structure and cargo. The probability of exceeding these thresholds, within the life of the full-scale craft, should then be assessed. This should be obtained from the joint probability of encountering, successively, a group of waves having the same critical dimensions as tested, in conjunction with the probability of the full-scale craft experiencing the operating conditions which caused the model to exceed its motion or acceleration threshold.

During random wave tests in a tank, or open water, the analysis of motion, acceleration and wave records, will require a test for statistical significance. This will dictate, for tank tests, the extent to which data from similar runs must be combined or, in the case of open-sea tests with a free-running model, the length of run required. Again, the overall objective should be to determine the probability of exceeding motion and acceleration thresholds.

The result of each test in any given set of conditions will be an estimate of the probability of the SES capsizing under those specific set of conditions of speed, sea state, heading to wave etc. The way in which these can be combined for all conditions of speed, sea state, heading and mode of operation has been defined, for example in BAND 20 SEP 76. BAND 20 SEP 76 refers, principally, to extreme structural loads but, the same principles can be applied to extreme motions such as capsize.

Each run in the test tank, of a free-running model or of the full-scale craft is, necessarily, a short-term event. During each short-term event, it is assumed that the craft's speed and heading and the sea state remain constant. The operational life of an SES can be considered to be a summation of a very large number of short-term events. If the behavior in each short-term event is known, and also if the manner of distribution of short-term events throughout the craft's life is known, then a long-term picture of the craft's life can be built up.

This is the method suggested here to predict the long-term behavior of the SES so that, eventually, a single, long-term probability of capsize can be established to represent the craft's total experience in all speeds, sea states, headings and loading conditions. In order to accomplish this, use is made of the description of the operational environment given, for example, in BLA JUN 77.

If the probability of exceeding a given critical roll angle ϕ_x (for example) at a speed V, in sea state S, at heading H and gross weight W, is $P_{VHSW}(\phi_x)$, then the total probability $P(\phi_x)$ of exceeding the angle ϕ_x is given by summing the component probabilities for all conditions.

$$P(\phi_x) = \sum_V \sum_H \sum_S \sum_W P_V \cdot P_H \cdot P_S \cdot P_W \cdot P_{VHSW}(\phi_x)$$

where P_V , P_H , P_S , P_W are the probabilities of occurrence of each velocity, heading, sea state and gross weight.

The number of cases selected from the operational envelope shown, for example in Figure 4-1, is limited by the test and computational time available. It may be misleadingly conservative to use the points at the top right-hand corner of each section of the operational envelope to define the conditions pertaining within that segment. A method of treating this problem is presented in BAND 20 SEP 76.

As a result of these computations a single, long-term probability distribution is generated that can include on-cushion and off-cushion cases under all conditions and combinations of gross weight, speed, sea state and heading that the SES is expected to encounter during its operational life. This procedure is described in BAND 20 SEP 76 and BLA JUN 77.

The single probability distribution can be used to estimate the probability that the SES will capsize during its lifetime. Due to the catastrophic nature of a capsize it is presumed that the probability of capsize must be kept to a very low level such as one in one thousand SES lives. If the SES model under test displays a more frequent tendency to capsize then, either the design should be modified or, the operational envelope should be reduced. The effect of reducing the operational envelope can be assessed by recomputing the long-term probability of capsize using a rearranged version of Figure 4-1.

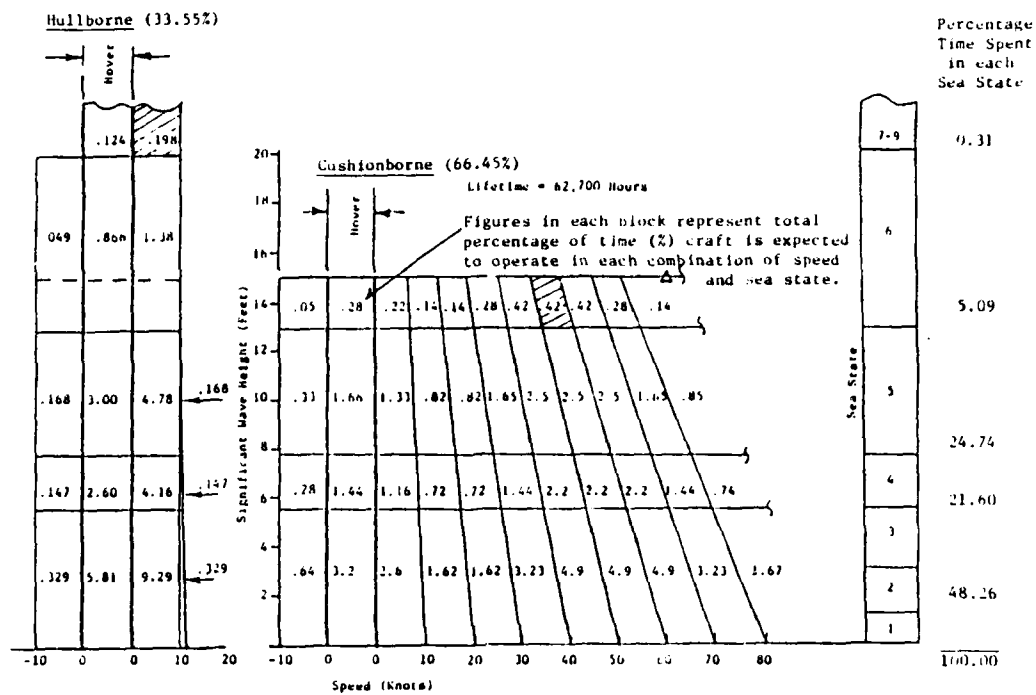

FIGURE 4-1. 2KSES 20-YEAR OPERATIONAL ENVELOPE.

5. PROPOSED STABILITY STANDARDS

This section of the report presents the results of task II and constitutes a preliminary recommendation for SES Intact Stability Standards that are considered necessary to meet all hazards including the capsize hazards described in the preceding sections.

The proposed standards include consideration for both off- and on-cushion modes of operation, and treat separately the requirements for stability, controllability and maneuverability, all of which contribute to the safety of an operational SES.

In some instances, where pertinent, consideration has been given to craft safety under system failure conditions. This has been noted as being out of the scope of the present study of intact stability, but has been included for future reference.

In the preparation of these standards, every effort has been made to be consistent with, and to take advantage of, previous work performed in this area. In particular, the following references have proved to be particularly useful:

- . "Design Data Sheet (DDS) 079-1", NAVSEA 25 JUN 76.
- . "British Hovercraft Safety Requirements", CAA 27 AUG 80.
- . "Code of Safety for Dynamically Supported Craft", IMCO 2 MAY 78.
- . "SES-100A Stability and Control Analysis Report", AGC 8 NOV 73.

However, where specific information or values have been proposed. They do not necessarily coincide with values previously established in other work, such as in the references listed above.

The proposed stability standards have been prepared using a format which would permit their inclusion within an overall framework for SES Standards of Safety. Both general and specific stability requirements are treated in turn as indicated in the following list of contents.

Until further operational experience has been gained with full-scale SES and until the results of task II have been more completely validated by the model tests, the specific stability requirements, proposed herein, should be regarded as tentative and should be used for guidance only.

LIST OF CONTENTS FOR PROPOSED STABILITY STANDARDS

- 5.1 AUTHORITY FOR REGULATIONS
- 5.2 APPLICATION
- 5.3 PURPOSE
- 5.4 DEFINITIONS
- 5.5 STABILITY AND CONTROL OFF-CUSHION
 - 5.5.1 General Provisions
 - 5.5.1.1 Buoyancy and Stability
 - 5.5.2 Intact Buoyancy
 - 5.5.3 Intact Stability
 - 5.5.3.1 Beam Winds Combined with Rolling
 - 5.5.3.2 Lifting of Heavy Weight Over the Side
 - 5.5.3.3 Tow Line Pull
 - 5.5.3.4 Crowding of Passengers to One Side
 - 5.5.3.5 Turning
 - 5.5.3.6 Topside Icing
 - 5.5.3.7 Forward Speed Hullborne
- 5.6 STABILITY AND CONTROL ON-CUSHION
 - 5.6.1 General Provisions
 - 5.6.1.1 Stability
 - 5.6.1.2 Controllability
 - 5.6.1.3 Maneuverability
 - 5.6.1.4 Craft Conditions
 - 5.6.2 Determination of Acceptable Stability and Controllability
 - 5.6.2.1 Stability
 - (1) Heave Stability Requirements
 - (2) Pitch Stability Requirements
 - (3) Roll Stability Requirements
 - (4) Directional Stability Requirements
 - (5) Combined Pitch/Roll/Yaw Stability Requirements
 - 5.6.2.2 Trim
 - 5.6.2.3 Controllability
- 5.7 PROOF OF COMPLIANCE AND CERTIFICATION

5. PROPOSED STABILITY STANDARDS (CONT'D.)

5.1 AUTHORITY

(Citations of applicable law.)

5.2 APPLICATION

The provisions of this part shall apply to all rigid sidehull surface-effect ships contracted for on or after *(date)*. Craft of this type contracted for prior to *(date)* shall comply substantially with this part, and a record of safe operation may constitute proof of substantial compliance. Waivers of the provisions of this part may be granted to experimental craft not intended for commercial service.

In addition, the provisions of this part are based in part on the following conditions:

- (1) the distances from shelter and the worst intended environmental conditions in which operations are permitted will be restricted
- (2) the craft will, at all times, be in reasonable proximity to a place of refuge
- (3) the requisite maintenance facilities, as well as means to obtain weather forecasts and to communicate continuously with the craft when underway, will be available at the base port from which the craft operates
- (4) the U.S. Coast Guard will be able to exercise strict control over the operation of the craft
- (5) the requisite rescue facilities will be rapidly available at all points in the intended service
- (6) seats will be provided for all passengers
- (7) the facilities for rapid evacuation into suitable survival craft will be provided.

While operating in the displacement mode, the craft will comply substantially with pertinent Safety of Life at Sea (SOLAS) and Load-Line Conventions, at the discretion of the Officer in Charge of Marine Inspection (OCMI), based on the specific craft type, route and intended service.

While operating in the cushionborne mode, the craft will comply with these additional requirements. *(specified by the OCMI)*

The provisions of this part apply to all rigid-sidehull surface-effect ships regardless of site, service, or builder. This includes recreational and commercial craft, passenger or freight or a combination thereof. The only exceptions are experimental or developmental craft used to advance the SES state-of-the-art which will be operated under the cognizance of the appropriate OCMI, but with a waiver of the requirements of this part.

5.2 APPLICATION (CONT'D.)

For craft involved in international voyages, these standards apply to craft which:

- (1) carry more than 12 passengers, but not over 450 passengers, with all passengers seated
- (2) do not proceed in the course of their voyage more than 100 nautical miles from a place of refuge
- (3) may be provided within the limits of subparagraphs (1) and (2) with special category spaces intended to carry motor vehicles with fuel in their tanks.

These standards may be extended to a craft which is intended to carry passengers and cargo, or solely cargo, or to a craft which exceeds the limits stipulated above. In such cases, the OCMI should determine the extent to which the provisions of this part are applicable to these craft and, if necessary, develop additional requirements which provide the appropriate level of safety.

5.3 PURPOSE

SES of several types have been successfully demonstrated at model and full scale. Many are in commercial service and have been for some time. Reliable and safe passenger service has been well-proven. The purpose of the regulations in this subchapter is to provide minimum requirements for intact stability for rigid-sidehull, surface-effect ships, to remain upright in an open seaway, both on- and off-cushion.

5.4 DEFINITIONS

For the purpose of this Code, unless expressly provided otherwise, the terms used herein have the meanings defined in the following paragraphs. All definitions are given in alphabetical order. Additional definitions are given in the general parts of the various chapters.

5.4.1 Administration. The United States Coast Guard.

5.4.2 Applicant. A person applying for the issue, variation, or renewal of a certificate of approval.

5.4.3 Base Port is a port with:

- (1) appropriate facilities providing continuous radio communication with the craft at all times, while in port and at sea, if required
- (2) where Very High Frequency (VHF) is required for the craft:
 - (a) appropriate facilities providing VHF radio communication at all times with the craft while in the vicinity of the port
 - (b) access to facilities providing radio communication with the craft at all times when operating beyond the range of the VHF facilities provided in subparagraph (a)

5.4 DEFINITIONS (CONT'D)

- (3) means for obtaining a reliable weather forecast for the corresponding region and its due transmission to all craft in operation
- (4) access to facilities provided with appropriate rescue and survival equipment
- (5) access to craft maintenance services with appropriate equipment.

5.4.4 Boating Mode. Craft in the off-cushion, displacement or hullborne mode of operation.

5.4.5 Bottom Slamming. The action of water impacting upon the underside of the craft, the severity of which normally increases as forward speed and the height of encountered waves is increased. Bottom slamming is usually of greatest concern to the structural designer, with emphasis placed on the application of extreme-value statistics to the assessment of hull-bottom ultimate design pressures and loads. Although the crew of a craft will undoubtedly reduce speed when slamming becomes uncomfortable, unexpectedly severe bottom impacts have been known to occur because of the random nature of the sea. These impacts have, in the past, occasionally caused injury and craft damage.

5.4.6 Broaching-to. An event in which the craft is suddenly and unintentionally thrown, or caused to turn, broadside to its intended direction of motion and become in danger of rolling over. This can result from excessive pitch-down attitude, wave (or surf) action, or inadvertent control-force action and can be aggravated by other service hazards. It is a loss in directional stability which is not, or cannot be, counteracted by available control forces. Broaching-to is most likely to occur in severe following seas, when the craft runs down the face of one wave and buries its bow in the next wave.

5.4.7 Continuous Power. The total engine shaft horsepower developed under standard, sea-level, static conditions under the maximum conditions of rotational speed and exhaust-gas temperature (in the case of turbine engines) or induction manifold pressure (in the case of piston engines) approved for use during periods of unrestricted duration.

5.4.8 Effect. A situation arising as a result of an occurrence.

- (1) Minor Effect. An effect which may arise from a failure, an event, or an error which can be readily compensated for by the operating crew; it may involve:
 - (a) a small increase in the operational duties of the crew or in their difficulty in performing their duties, or
 - (b) a moderate degradation in handling characteristics, or
 - (c) slight modification of the permissible operating conditions.
- (2) Major Effect. An effect which produces:
 - (a) a significant increase in the operational duties of the crew or in their difficulty in performing their duties

DEFINITIONS (CONT'D)

which, by itself, should not be outside the capability of a competent crew provided that another major effect does not occur at the same time, or

- (b) significant degradation in handling characteristics, or
 - (c) significant modification of the permissible operating conditions, but which will not remove the capability to complete a safe journey without demanding more than normal skill on the part of the operating crew.
- (3) Hazardous Effect. An effect which produces:
- (a) a dangerous increase in the operational duties of the crew or in their difficulty in performing their duties of such magnitude that they cannot reasonably be expected to cope with them and will probably require outside assistance, or
 - (b) dangerous degradation of handling characteristics, or
 - (c) dangerous degradation of the strength of the craft, or
 - (d) marginal conditions for, or injury to, occupants, or
 - (e) an essential need for outside rescue operations.
- (4) Catastrophic Effect. An effect which results in the loss of the craft and/or in fatalities.

5.4.9

Environmental Conditions. Conditions such as wind speed, sea state and climate. There are three levels of these conditions defined as follows (in order of decreasing severity):

- (1) Design Environmental Condition. The limiting specified conditions chosen for design purposes, which should be at least as severe as the "Emergency Environmental Conditions" of 4.9(2) and may, at the discretion of the designer, be more severe.
- (2) Worst Intended Environmental Conditions. The specified environmental conditions within which the intentional operation of the craft is provided for in the certification of the craft. This should take into account parameters such as the worst conditions of wind force, allowable wave height (including unfavorable combinations of length and direction of waves), minimum air temperature, visibility and depth of water for safe operation and such other parameters as the Administration may require in considering the type of craft in the area of operation.
- (3) Emergency Environmental Condition. The envelope of Environmental Conditions which are likely to be met due to unexpected changes occurring during an operation. There will be an adequate margin between the Emergency Environmental Conditions and the Worst Intended Environmental Conditions of 4.9(3) so that the probability of encountering the Emergency Environmental Conditions is acceptably low.

5.4 DEFINITIONS (CONT'D)

- 5.4.10 Heave Limit Cycle. Sustained oscillatory heave motion of near constant amplitude caused by the interaction of the air-supply characteristic and the rate of change of cushion-air leakage from the cushion. Although high heave accelerations have been recorded on occasions, it is perhaps the least dangerous type of instability for an SES. For an SES, it occurs in near-calm water when running at high speed, near minimum sidehull immersion and at the optimum trim for minimum drag. It is most likely to occur when the rate-of-change of cushion-air leakage with heave motion is maximized by operating close to level trim over smooth water. It can be stopped by reducing cushion flow rate or operating in an out-of-trim condition. It is minimized (and in most cases prevented) in the design state by the correct choice of fan characteristics.
- 5.4.11 Information. That content of the Type Operating Manual of which the operator needs to take proper account if he is to operate the craft to the level of safety intended in certification, but with which non-compliance does not of itself render the Safety Certificate of the particular craft invalid.
- 5.4.12 Intact. Craft hull and systems in the undamaged, non-failed and fully operational condition.
- 5.4.13 Light Weight (Unladen Weight). The displacement of the craft without cargo, fuel, lubricating oil, ballast water, fresh water and feed-water in tanks, consumable stores, passengers and crew and their effects.
- 5.4.14 Limitations (or Approved Operating Limitations). Limitations (e.g. engine data, craft speed, weight, sea state) scheduled in the Technical Manual within which compliance with the Requirements has been established.
- 5.4.15 Load Line. The International Convention on Load Lines, in force.
- 5.4.16 Maximum Operational Weight (Design Overload Weight). The overall weight up to which operation in the intended mode is permitted by the Administration.
- 5.4.17 Passenger. Every person other than:
(1) the master and members of the crew or other persons employed or engaged in any capacity on board a craft on the business of that craft; and
(2) a child under one year of age.
- 5.4.18 Place of Refuge. Any naturally or artificially sheltered area which may be used as a shelter by a craft under conditions likely to endanger its safety. Suitable communication and transport facilities should be available.
- 5.4.19 Flow-in. An abrupt, involuntary, bow-down motion leading to (but not necessarily resulting in) hull wet-deck impact with the water, involving sustained increase in drag at speed, usually associated with partial collapse of the bow-seal.

5.4 DEFINITIONS (CONT'D)

5.4.20 Probability of Occurrence.

- (1) Frequent. Likely to occur often during the operational life of a particular craft.
- (2) Reasonably Probable. Unlikely to occur often but which may occur several times during the total operational life of a particular craft.
- (3) Recurrent. A term embracing the total range of Frequent and Reasonably Probable.
- (4) Remote. Unlikely to occur to every craft but may occur to a few craft of a type over the total operational lives of a number of craft of the same type.
- (5) Extremely Remote. Unlikely to occur when considering the total operational life of a number of craft of the type, but nevertheless has to be considered as being possible.
- (6) Extremely Improbable. So Extremely Remote that it does not have to be considered as possible to occur.

Where numerical probabilities are used in assessing compliance with requirements using the terms similar to those given above, the following approximate values may be used as guidelines to assist in providing a common point of reference. The probabilities quoted should be on an hourly or per journey basis depending on which is more appropriate to the assessment in question:

Frequent	Greater than 10^{-3}
Reasonably Probable	10^{-3} to 10^{-5}
Remote	10^{-5} to 10^{-7}
Extremely Remote	10^{-7} or less
Extremely Improbable	Whilst no approximate numerical probability is given for this, the figures used should be substantially less than 10^{-7} .

Thus, during the life of a particular craft (say 20,000 hours or "journeys"), a "frequent" event may be expected to occur at least 20 times, a "reasonably probable" event may be expected to occur less than 20 times but more than once in the life of five similar craft, and so on.

Different occurrences may have different acceptable probabilities according to the severity of their consequences.

5.4.21 Rigid-Sidehull SES. (See 5.4.22)

5.4.22 SES. "Surface Effect Ship." A craft more precisely referred to as a "Rigid-Sidehull (or Sidewall) Surface Effect Ship", which is a craft designed to operate with permanently immersed rigid hulls extending along its sides and to have a significant part of its weight sup-

5.4 DEFINITIONS (CONT'D)

ported by air pressure from a continuously generated cushion of air dependent for its effectiveness on the proximity of the water over which the craft operates.

5.4.23 Safety Convention. The International Convention for the Safety of Life at Sea, in force.

5.4.24 Stability. For the purpose of stability investigations, the following definitions of static and dynamic stability will apply:

(1) Static Stability. A system is termed statically stable if, when it is moved from an initial equilibrium condition, the moments resulting from the displacement tend to restore the system to its initial position. In mathematical terms, it applies to a system of homogenous equations of motion where only the terms involving the zero-order derivatives of the dependent variables are retained. Note that this definition is independent of the craft vertical position (off-cushion, partial-cushion, or on-cushion) and may apply to any constant speed or steady turn. For the usual discussions of craft static stability, this is further restricted to apply to the restoring moments about the three craft axes taken independently. The pitching moment vs. trim, roll moment vs. heel, and yaw moment vs. sideslip become the primary quantities of interest. A negative slope in the moment versus angular displacement plot indicates a stabilizing characteristic. In this light, the influences of the other steady-state dependent variables on these moment characteristics are of interest.

(2) Dynamic Stability. A craft is said to possess dynamic stability if, when it is perturbed from an initial equilibrium condition, the forces and moments generated by the displacements, velocities, and accelerations resulting from the perturbation tend to restore the craft to its initial condition. The dynamic stability, then, relates to the full craft equations of motion, specifically including higher order derivatives of the dependent variables. Dynamic stability may be considered at any speed (including zero) or any craft operating condition.

Proof of static or dynamic stability does not insure the existence of the other, i.e. a statically stable craft may not be dynamically stable and, conversely, a statically unstable craft may be dynamically stable (e.g., off-cushion directional stability)

5.4.25 Stabilization System. A system intended to stabilize the main parameters of the craft's attitude: heel, trim, course and height and minimize the craft's motion: roll, pitch, yaw and heave.

5.4.26 Synchronous Roll Motion. Roll motion caused by operation in beam seas having an encounter frequency which is close to the craft's damped natural frequency in roll. Dangerously large roll angles may develop under these circumstances.

5.4 DEFINITIONS (CONT'D)

5.4.27 Technical Manual. A term used in the Requirements when reference is needed to one or more of the Type Maintenance Manual, the Type Operating Manual or the Type Servicing Schedule as defined below:

- (1) Type Maintenance Manual. The Manual produced as part of the Type certification which contains information necessary to Maintain a type of SES or Item, including scheduled maintenance in accordance with the Type Servicing Schedule.
- (2) Type Operating Manual. The Manual produced as part of the Type certification which contains Limitations and Information relating to the operating of the craft such that adherence to it will enable the level of safety which is intended by the Requirements to be regularly achieved by the type of SES or Item.
- (3) Type Servicing Schedule. The Manual produced as part of the Type certification which defines the frequency of actions considered necessary to maintain the serviceability of a type of SES or Item, and the life limitations to be observed for any Lifer Item.

5.4.28 Trim Point. The steady-state pitch (roll, heave and sideslip) attitude of a craft in static force and moment equilibrium which is normally selected to maximize craft performance underway.

5.4.29 Tripping. An unstable roll motion resulting from operation at high sideslip angles or, as a result of (or in combination with) the action of excessive and inappropriate control action, which causes a large upsetting moment in roll due to large hydrodynamic side forces generated at the lower portions of the sidehulls. Roll capsize or dangerous roll motions have been known to occur from such events in both displacement and non-displacement modes of operation.

5. PROPOSED STABILITY STANDARDS (CONT'D.)

5.5 STABILITY AND CONTROL OFF-CUSHION

5.5.1 General Provisions

Stability standards in this part apply to the intact condition for an SES in the off-cushion, displacement, boating or hullborne mode of operation.

5.5.1.1 Buoyancy and Stability

- (a) The design and distribution of hull buoyancy shall be such that the craft will remain upright when intact and off-cushion in the Emergency Environmental condition at craft gross weights up to the design overload weight.
- (b) Particular consideration should be given to the following potential hazards:
 - (i) Beam winds combined with rolling
 - (ii) Low freeboard with the potential of shipping and trapping of sea water on deck
 - (iii) Lifting of heavy off-center weights
 - (iv) Tow-line pull (with craft towing or being towed)
 - (v) Crowding of passengers to one side
 - (vi) Turning
 - (vii) Topside icing.

In view of the great divergence among existing and potential SES types as to size and operational requirements, specific loading details are not provided. Instead, the following guidelines should be followed:

- (a) The complete spectrum of loading conditions should be considered. Stability should be analyzed for at least the full-load condition (departure condition), and a minimum operating condition. Additionally, any other loading condition should be investigated which is likely to result in less stability than in the full-load or minimum-operating conditions.
- (b) For craft where off-center loading of cargo is likely, this adverse effect should be considered in developing and analyzing stability.

5.5.2 Intact Buoyancy*

The craft should have a designed reserve of buoyancy when floating in seawater of not less than 100 percent at the maximum operational (certified) weight. The Coast Guard may require a larger reserve of buoyancy to permit the craft to operate in any of its intended modes. The reserve of buoyancy should be calculated by including only those compartments which are:

* For the purpose of these requirements, the density of water shall normally be taken as 64 lb/ft³ (1025 kg/m³).

5.5 STABILITY AND CONTROL OFF-CUSHION (CONT'D.)

- (a) watertight
- (b) considered by the Coast Guard to have scantlings and arrangements adequate to maintain their watertight integrity
- (c) situated below a datum, which may be a watertight deck or equivalent structure watertight longitudinally and transversely and from at least part of which the passengers could be disembarked in an emergency.

Means should be provided for checking the watertight integrity of buoyancy compartments. The inspection procedures adopted and the frequency at which they are carried out should be to the satisfaction of the Coast Guard and shall be stated in the Technical Manual.

Where entry of water into structures above the datum as defined in 6.2(c) would significantly influence the stability and buoyancy of the craft, such structures should be of adequate strength to maintain the weathertight integrity or be provided with adequate drainage arrangements. A combination of both measures may be adopted to the satisfaction of the Coast Guard. The means of closing of all openings in such structures should be such as to maintain the weathertight integrity.

5.5.3 Intact Stability

The stability standards which are detailed in the following paragraphs are intended to provide an SES with the capability of withstanding the previously discussed hazards to which it may be exposed. The standards are those which are considered attainable in good designs and do not significantly increase the cost of the craft.

It is important to note that the measures of adequate off-cushion stability, stated herein, are based on static conditions with allowances made for the dynamic effects of wind, sea, and craft rolling. While this method of analysis is not rigorous, it represents the best state-of-the art techniques currently available to naval architects. The method has merit in that it provides a measure of relative capability of craft of similar size and service, is easy to follow, and provides useful guidelines to the designer.

The off-cushion stability of an SES is expressed by the intact stability curves for the previously mentioned loading conditions and hazards. At certain times, such as during refueling, the craft may have less than normal stability. In such extreme unusual cases, the craft is not expected to withstand all the hazards previously outlined. It would be prudent, therefore, to carry out operations such as refueling under relatively favorable wind and sea conditions.

In all cases of stability analysis, the righting-arm curves shall reflect the combined trim and heel effects.

The destabilizing effects that occur in the intact condition as a result of the previously mentioned hazards, is compared with the initial intact stability for the standard operating conditions as outlined in the following paragraphs.

5.5 STABILITY AND CONTROL OFF-CUSHION (CONT'D.)

5.5.3.1 Beam Winds Combined With Rolling

(a) Effect of Beam Winds and Rolling

Beam winds and rolling are considered simultaneously since a fairly rough sea is to be expected when winds of high velocity exist. If the water were still, the craft would require only sufficient righting moment to overcome the heeling moment produced by the action of the wind on the craft's lateral "sail area." When the probability of wave action is taken into account, an additional allowance of dynamic stability is required to absorb the energy imparted to the craft by the rolling motion.

(b) Wind Velocities

The wind velocity which an intact craft is expected to withstand depends upon its service. The wind velocities used in determining whether a craft has satisfactory intact stability with respect to this hazard are given in Table 6-1. The extent of rolling is assumed to be caused by fully-arisen seas based on the sea states for which the craft is to be certified. The selected local beam wind will generally be in excess of the winds normally associated with the required sea state. Little information is available at this time about actual rolling behavior of SES in different sea states. For a given design, the assumed rolling should be based on model tests or the best data available from previous craft of the same or similar type.

(c) Wind Heeling Arm

A general formula to be used to describe the unit pressure on a craft due to beam winds is as follows:

$$P = C_w \rho_a \frac{V_w^2}{2g}$$

where

P = wind pressure, lb/ft².

C_w = dimensionless coefficient for the craft type.

ρ_a = mass density of air, slugs/ft³.

g = acceleration due to gravity, ft/sec².

V_w = wind velocity, ft/sec or knots, depending on definition for C.

There is always considerable uncertainty regarding the value of C_w. Similarly, the variation of the wind velocity at different heights above the waterline is not always exactly defined.

5.5 STABILITY AND CONTROL OFF-CUSHION (CONT'D.)

Table 5-1. WIND VELOCITIES.

Service	Minimum * wind velocity for design purposes V_w (knots)	Minimum Acceptable ** wind velocity for craft after 5 years in service V_w (knots)
1. Ocean		
(a) Craft which must be expected to weather full force of tropical cyclones.	100	90
(b) Craft which will be expected to avoid centers of tropical disturbances.	80	70
2. Coastwise		
(a) Craft which will be expected to weather full force of tropical cyclones.	100	90
(b) Craft which will be expected to avoid centers of tropical disturbances, but to stay at sea under all other circumstances of weather.	80	70
(c) Craft which will be recalled to protected anchorages if winds over Force 8 are expected.	60	50
3. Harbor	60	50

* Craft built to Craft specifications dated subsequent to (date) shall meet this wind throughout its service life.

** Craft built to Craft specifications dated prior to (date) shall meet this wind after five years of service.

The most widely used value for P, in English units, lb/ft², has been:

$$P = 0.004 V_w^2, \text{ with } V_w \text{ in knots.}$$

$$\text{Therefore, heeling arm due to wind}^* = \frac{0.004 V_w^2 (A L \cos^2 \phi)}{2240 W}$$

* The heeling arm is defined as the heeling moment divided by the weight of the ship.

where:

- A = projected lateral sail area, ft²
- L_A = lever arm from half draft to centroid of sail area, ft
- V_w = nominal wind velocity, knots (see Figure 5-1)
- φ = angle of roll, degrees
- W = displacement in long tons

It is recognized that as the craft heels to large angles, the use of the term $(AL \cos^2 \phi)$ is not rigorous, since the exposed area varies with heel and is not a cosine function. However, other effects are also ignored and the above approach should be considered as a useful design comparative tool to obtain gross effects. Recent wind tunnel tests at the David W. Taylor Naval Ship Research and Development Center on models representing different craft types and superstructure forms have indicated that an average coefficient of 0.0035 rather than 0.004 should be used in the foregoing formula which assumes a variation of wind speed with height. Full-scale experience suggests that a variation of such as that shown in Figure 5-1 should be used. This curve is a composite of various values described in the literature. The nominal velocity is assumed to occur at about 33 ft. above the waterline. Use of Figure 5-1 for determining V_H in the formula for heeling arm due to wind, properly favors the smaller craft which normally would be affected by the velocity gradient and would also be somewhat sheltered from the wind by the accompanying waves.

For craft with large beam, such as most SES, the projected sail area can increase rapidly with angle of heel. However, even with the increased sail area, no problem with regard to beam winds combined with rolling is expected for most SES types because of their typically very large off-cushion righting arms.

The most accurate method of determining wind-pressure effects would be to conduct wind-tunnel tests for each design. This is not generally done since damage stability criteria are usually governing.

(d) Criteria for Adequate Stability

When the plot of heeling arm due to wind heel is superimposed on the plot of the craft's righting arm as shown on Figure 5-2 and an assumption is made for the angle of the craft's rolling into the wind, φ_r, the following must be satisfied:

- (i) The heeling arm at the intersection of the heeling arm and righting-arm curves (point C) must not exceed six tenths of the maximum righting arm (RA, MAX).
- (ii) Area A₁ is not less than 1.4A₂, where A₂ extends φ_r degrees to windward from point C. As noted earlier, φ_r should be determined by model tests or from the best data available from earlier craft of this type. φ_r is the roll angle

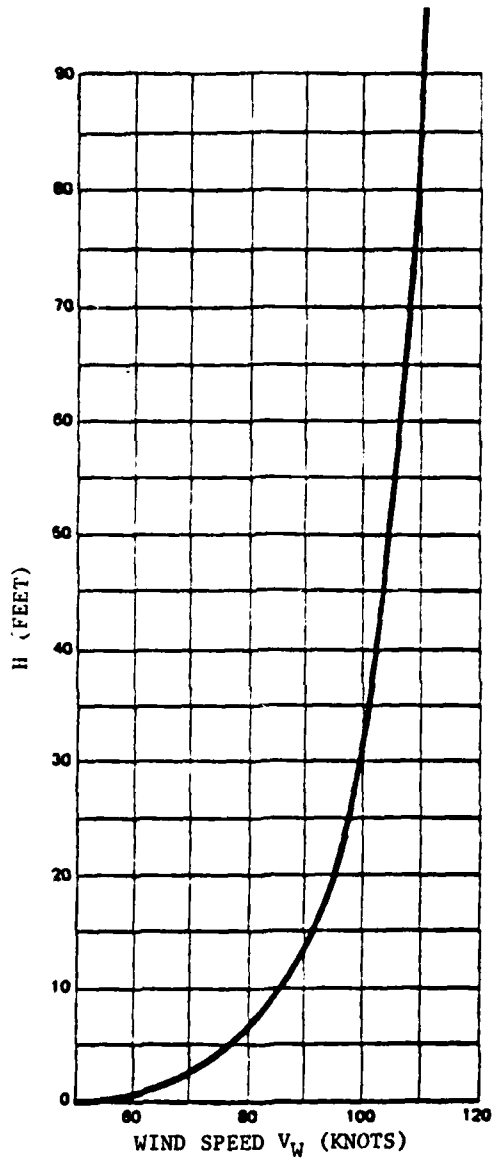

FIGURE 5-1. ACTUAL WIND VELOCITIES AT VARYING HEIGHTS ABOVE WL FOR A NOMINAL 100-KNOT WIND AT 33 FT ABOVE WL.

5.5 STABILITY AND CONTROL OFF-CUSHION (CONT'D.)

associated with fully arisen seas commensurate with the conditions for which the craft is to be certified.

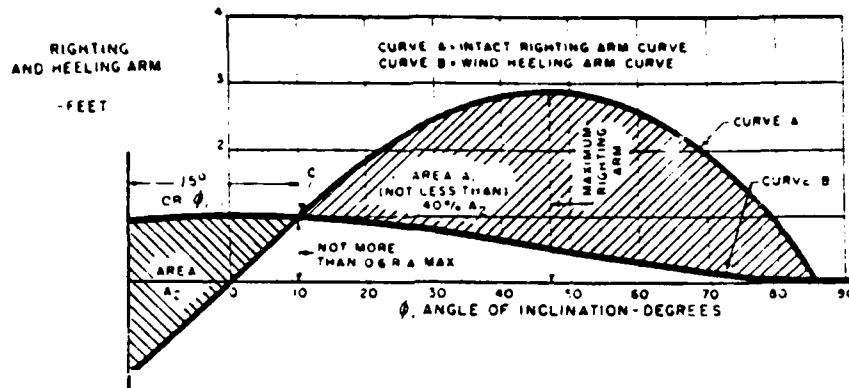

FIGURE 5-2. INTACT RIGHTING-ARM AND WIND HEELING-ARM CURVES.

Limited experience to date indicates that certain SES in the displacement mode exhibit considerable damping in their rolling and that a value of 15° for ϕ_p is typical.

(e) Rationale for the Above Criteria

- (1) The six tenths of the maximum righting arm is intended to provide a margin for gusts as well as for the inaccuracies in the calculations.
- (2) Area A_2 is a measure of the energy imparted to the craft by the wind and the craft's righting arm in returning to point C. The margin of 40% in A_1 is intended to take account of gusts and calculation inaccuracies.

5.5.3.2 Lifting of Heavy Weight Over the Side

(a) Effect of Lifting Weights

Lifting of weights will be a governing factor in required stability only on craft from which heavy items are required to be lifted over the side. Lifting of weights has a two-fold effect upon transverse stability. First, the added weight, which acts at the upper end of the boom, will raise the craft's center of gravity and thereby reduce the righting arm. The second effect will be the heel caused by the transverse moment when lifting over the side.

(b) Heeling Arms

For the purpose of applying the criteria, the craft's righting arm curve is modified by correcting VCG and displacement to show the effect of the added weight at the end of the boom. The heeling arm curve is calculated by the formula:

$$\text{Heeling Arm} = \frac{(w_L a_L \cos \phi)}{W}, \text{ ft.}$$

where

w_L = weight of lift, tons

a_L = transverse distance from centerline to end of boom, ft

W = displacement, tons including weight of lift

ϕ = angle of inclination, deg

(c) Criteria for Adequate Stability

The criteria for adequate stability when lifting weights are based on a comparison of the righting arm and heeling arm curves, Figure 6-3. The following must be satisfied:

- (i) The angle of heel, as indicated by point C, does not exceed 15 deg.
- (ii) The heeling arm at the intersection of the righting-arm and the heeling-arm curves (point C) is not more than six tenths of the maximum righting arm; and
- (iii) The reserve of dynamic stability (shaded area) is not less than four tenths of the total area under the righting arm curve, as shown on Figure 6-3.

(d) Rationale for the Above Criteria

- (i) Angles of heel in excess of 15 deg will interfere with safe operations aboard the craft.
- (ii) The requirements that the heeling arm be not more than six tenths of the maximum righting arm and that the reserve of dynamic stability be not less than four tenths of the total area under the righting-arm curve are intended to provide a margin against capsizing. This margin allows for wave action and calculation inaccuracies.

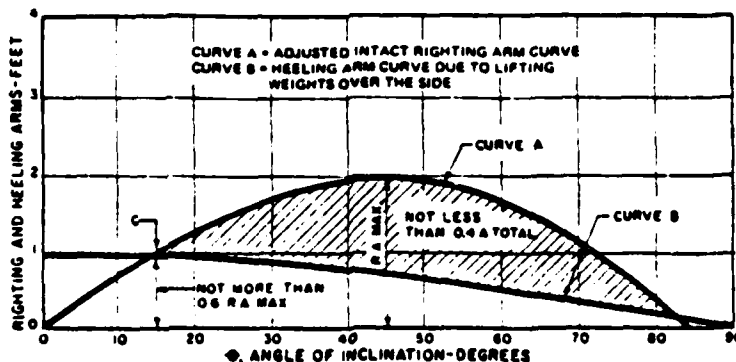

FIGURE 5-3. INTACT RIGHTING-ARM CURVE AND HEELING ARM DUE TO LIFTING WEIGHTS OVER THE SIDE.

5.5 STABILITY AND CONTROL OFF-CUSHION (CONT'D.)

5.5.3.3 Tow Line Pull

It is unlikely that an SES will be used as a towing vehicle. It is more likely that a disabled SES will require to be towed. In the event that either design requirement is likely to arise, a heeling arm formula for tow line pulls should be applied. No specific methodology is presented here. Guidance will be provided to the designer, if necessary, on a case basis.

5.5.3.4 Crowding of Passengers to One Side

(a) Effect of Crowding of Passengers

The movement of passengers will have an important effect only on small craft which carry a large number of passengers. The concentration of passengers on one side of a small craft can produce a heeling moment which results in a significant reduction of residual dynamic stability.

(b) Heeling Arms

The heeling arm produced by the transverse movement of passengers is calculated by:

$$\text{Heeling Arm} = \frac{w_p a_p}{W} \cos \phi, \text{ ft.}$$

where:

w_p = weight of passengers, tons

a_p = net transverse center of gravity of passengers

W = craft displacement, tons

ϕ = craft angle of inclination, deg

In determining the heeling moment produced by the passengers, it is assumed that all passengers have moved to one side as far as possible. Each person is assumed to occupy 2 sq ft of deck space.

(c) Criteria for Adequate Stability

The criteria for adequate stability are based on the angle of heel, and a comparison of the craft's righting arm and the heeling arm curve, Figure 5-3. The following must be satisfied:

- (i) The angle of heel, as indicated by point C, does not exceed 15 deg.
- (ii) The heeling arm at the intersection of the righting-arm and heeling-arm curves (point C) is not more than six tenths of the maximum righting arm RA, MAX, and
- (iii) The reserve of dynamic stability (shaded area) is not less than four tenths of the total area under the righting-arm curve.

(d) Rationale for the Above Criteria

- (i) The angle of heel of 15 deg. is considered the maximum acceptable from the standpoint of personnel safety.

5.5 STABILITY AND CONTROL OFF-CUSHION (CONT'D.)

- (ii) The requirements that the heeling arm be not more than six tenths of the righting arm and that the reserve of dynamic stability be not less than four tenths of the total area under the righting-arm curve are intended to provide a margin against capsizing. This margin allows for wave action and calculation inaccuracies.

5.5.3.5 Turning

(a) Heeling Arms Produced by Turning

The centripetal force acting on a craft during an off-cushion turning maneuver may be expressed by the formula:

$$\text{Centripetal force} = \frac{WV^2}{gR}, \text{ tons}$$

Where

W = displacement of craft, tons
V = linear velocity of craft in the turn, ft/sec
g = acceleration due to gravity, ft/sec²
R = radius of turning circle, ft

The lever arm used in conjunction with this force to obtain the heeling moment is the vertical distance between the craft's center of gravity and the off-cushion center of lateral resistance of the sidehulls and appendages in the displacement mode. The off-cushion center of lateral resistance can be taken vertically at the half draft.

If the centripetal force is multiplied by the lever arm and divided by the craft's displacement, an expression for heeling arm is obtained:

$$\text{Heeling arm} = \frac{V^2 a_c \cos \phi}{gR}, \text{ ft.}$$

Where

a_c = distance between craft's center of gravity and off-cushion center of lateral resistance (half draft) with craft upright, ft.

ϕ = angle of inclination, deg

For all practical purposes R may be assumed to be one half of the off-cushion tactical diameter. If the off-cushion tactical diameter is not available from model- or full-scale data, an estimate should be made.

(b) Criteria for Adequate Stability

The criteria for adequate stability in off-cushion turning are based on the relationship between the righting-arm curve and the heeling-arm curve, Figure 5-3. The following must be satisfied:

- (i) The angle of steady heel as indicated by point C does not exceed 15 deg.

5.5 STABILITY AND CONTROL OFF-CUSHION (CONT'D.)

- (ii) The heeling arm at the intersection of the righting-arm and heeling-arm curves (point C) is not more than six tenths of the maximum righting arm.
- (iii) The reserve of dynamic stability (shaded area) is not less than four tenths of the total area under the righting-arm curve.

(c) Rationale for the Above Criteria

- (i) An angle of heel of 15 deg is considered the maximum acceptable from the standpoint of comfort. Passengers aboard would become apprehensive if the angle of heel were greater than 15 deg.
- (ii) The requirements that the heeling arm be not more than six tenths of the maximum righting arm and that the reserve of dynamic stability be not less than four tenths of the total area under the righting-arm curve are intended to provide a margin against capsizing. This margin allows for the action of winds and waves and for possible inaccuracies resulting from the empirical nature of the heeling arm calculations.

It should be noted that data on velocities and turning circle radii for SES off-cushion are lacking. As data on turning characteristics becomes available, the significance of this potential problem will indicate if consideration must be given to increasing the righting arms at small angles (a metacentric height (GM) increase is one way) in an actual design.

5.5.3.6 Topside Icing

Unless specific operation in potential ice areas is specified in the characteristics for a new design, the amount of topside icing a craft may accumulate and still have satisfactory stability in intact conditions is determined after the design has been fixed. The design approach to topside icing is to determine the maximum allowable beam winds combined with icing for a craft whose stability has been established from other governing criteria. The design would be considered satisfactory if the allowable wind at time of icing was in excess of winds which are likely to be encountered when operating in an icing area.

As a preliminary estimate of ice accumulation, assume three inches of ice on horizontal and vertical surfaces on the weather deck and above. For this weight of ice, determine the beam winds for which the craft would satisfy the previously outlined criteria for beam winds combined with rolling. The approximate specific volume for accumulated ice may be taken as 39.5 cubic feet per ton.

5.5 STABILITY AND CONTROL OFF-CUSHION (CONT'D.)

5.5.3.7 Forward Speed Hullborne

At zero speed, off-cushion, and up to the maximum speed which the craft will experience off-cushion, there is no practical hydrodynamic means of resisting pitch-and-roll moments. The craft, therefore, shall have a main hull and sidehulls which combined provide ample pitch-and-roll hydrostatic stiffness. At high propulsive power levels off-cushion, there may be a tendency for the bow to be sucked down at higher off-cushion speeds. This problem must be avoided, for example, by red-lining craft speed off-cushion and by keeping the center of gravity aft of normal if high off-cushion speeds are to be authorized. The off-cushion pitch-and-roll moment slopes will be established by the hydrostatic properties of the sidehulls and main hull as discussed previously.

5. PROPOSED STABILITY STANDARDS (CONT'D.)

5.6 STABILITY AND CONTROL ON-CUSHION

5.6.1 General Provisions

Stability and control standards in this part apply to intact conditions for an SES in the on-cushion mode and an SES in the transition from, or to, the on-cushion mode of operation.

An environmental operating envelope shall be prescribed for the craft, within which all stability and control criteria are met and the safety of passengers and crew is assured. The operating envelope shall be posted at the craft control station and in the passenger crew space(s).

5.6.1.1 Stability

For all situations within, and up to, the approved operating limitations, the craft shall be provided with:

- (a) stability characteristics and/or stabilization systems which tend to return the vessel to its initial state of roll, pitch, yaw and heave subsequent to any disturbance.
- (b) behavior such that oscillatory disturbances in roll, pitch, yaw, and heave or combinations thereof, are damped and no divergent oscillations occur.

If, in a particular condition of operation within the Operating Limitations, the requirements of 5.6.1.1(a) and (b) are not met, it may be acceptable to demonstrate that any oscillations or divergences are either readily avoidable and are controllable, or are not such as to cause a hazard.

5.6.1.2 Controllability

The craft shall be controllable in all operational conditions for which certification is sought. Sufficient control shall be available to:

- (a) correct disturbances from the steady state and to maneuver the craft within the Worst Intended Environmental Conditions
- (b) permit essential maneuvers to be performed in Emergency Environmental Conditions for on-cushion operation.

The loads required to operate the controls during operation of the craft within the Worst Intended Environmental Conditions shall not be such that the driver will be unduly fatigued or distracted by the effort necessary for safe operation of the craft.

When a craft is fitted with control trimming devices to reduce control forces, the requirements of 5.6.1.2(a) and (b) shall be met with the devices set in any position.

5.6.1.3 Maneuverability

The craft shall be capable of performing those maneuvers which are considered essential to the safe operation of the craft within the Worst Intended and Emergency Environmental Conditions. The use of outside assistance to maneuver

5.6 STABILITY AND CONTROL ON-CUSHION (CONT'D.)

in confined spaces is acceptable provided that suitable provisions are made on the craft and reference to these provisions is made in the Technical Manual.

(a) Turning

The craft shall be capable of carrying out controlled turns in both directions within the Worst Intended and Emergency Environmental Conditions.

Any roll-out in turns shall not be such as to hazard the occupants or to mask the onset of hazardous conditions.

If, in order to comply with these requirements it is necessary to limit the angle of sideslip of the craft for given speeds and Environmental Conditions, information regarding these limits shall be provided in the Technical Manual.

(b) Stopping

It shall be possible to bring the craft to a controlled stop during all modes of operation within the Worst Intended and Emergency Environmental Conditions up to the Craft Limitations. The normal stopping distances and the applicable techniques shall be determined and scheduled under such conditions. (Normal stopping is that which may be employed without restriction.) Techniques and/or systems for use in emergencies which give a shorter stopping distance shall be scheduled in the Technical Manual.

It shall be demonstrated that the worst likely deceleration of the craft, when operated within the Worst Intended and Emergency Environmental Conditions and following any likely control mishandling, is not hazardous.

5.6.1.4 Craft Conditions

(a) Weight and Center of Gravity

Compliance with each of the requirements of this Chapter shall be established for all practical combinations of weight and C.G. position in the range of weights up to the maximum permissible weight.

(b) Longitudinal Trim

An acceptable range of longitudinal trim attitude, taking into account avoidance of plow-in and of controllability and stability, shall be determined. The applicant may, if he so desires, determine a different range of longitudinal trim attitudes for different wind and sea conditions.

Where the achievable longitudinal trim attitude exceeds the acceptable range, then the acceptable range shall be scheduled in the Technical Manual and an adequate means of attitude indication shall be available.

(c) Change of Operating Mode

There shall be no unacceptable change in the stability, controllability or attitude of the craft during transition from one

mode of operation to another. Any significant degradation in the behavior characteristics of the craft during transition from one operating mode to another shall be scheduled in the Technical Manual.

(d) Speeds

The following speeds shall, as appropriate, be determined and scheduled in the Technical Manual:

- (i) Maximum permissible craft forward speed over calm water.
- (ii) Maximum permissible craft forward speed in the worst intended environmental condition.

Account should be taken of the need to avoid hazards arising from any contact with the water following an emergency stop.

- (iii) Towing Speed. The maximum permissible towing speed at which the craft may be towed while on-cushion over water shall be established, where towing the craft while on-cushion is part of the intended craft operation. The maximum permissible towing speed shall not be less than 4 knots relative to the water.
- (iv) Maximum permissible linear or rotational speeds at which control devices may be operated.

Where the safety of the craft or its occupants is not materially dependent on the precise observance of any of the speeds listed above, they may be regarded as Approved Information.

(e) Sideslip Angle vs. Speed

The permissible craft sideslip angle at various craft forward speeds shall be established which shall not exceed the values for which compliance has been demonstrated.

(f) Draft

Sufficient information shall be determined and scheduled to enable craft characteristics relating to necessary or desirable depth of water to be taken fully into account in operation. For this purpose the draft, both on- and off-cushion, shall be stated.

Other information (e.g., additional continuous water depth to permit proper functioning of water propellers) may be necessary. It is not intended that any of the information should include operational margins (e.g., for rough water or chart inaccuracies).

(g) Hard-Structure Clearance

The clearance of the lowest point of the hard-structure wet-deck between the sidehulls above the local calm-water level within the cushion shall be determined and scheduled for normal craft operating weight and trim conditions.

5.6 STABILITY AND CONTROL ON-CUSHION (CONT'D.)

5.6.2 Determination of Acceptable Stability and Controllability

5.6.2.1 Stability

The following sections prescribe requirements for heave, pitch, roll, and directional stability.

(1) Heave Stability Requirements

The heave stability requirement is that the craft shall be capable of maintaining a constant, time-averaged sidehull immersion throughout its operational envelope and that such an immersion can be controlled by means such as the adjustment of cushion air flow and/or by the adjustment of bow and stern seals.

(2) Pitch Stability Requirements

The longitudinal (pitch) stability characteristics of the craft shall be such that, when measured from the trim point, at all forward speeds, in calm water, positive pitch attitudes will result in bow-down pitching moments and negative pitch attitudes result in bow-up moments. The pitch moment shall be restoring throughout the minimum angular ranges specified in Table 5-1.

TABLE 5-1. STATIC PITCH ANGLE LIMITS

CONFIGURATION	Minimum Pitch Angle Range for Restoring Moment
(Cushionborne hover) - Propulsion devices inoperative and power provided to lift fans. CB(H)	\pm 8 degrees
(Cushionborne cruise) - Forward propulsion operative and power provided to lift fans. CB(CR)	$\theta_{N_{min}}$ to $\theta_{N_{max}}$

For configuration CB(CR), $\theta_{N_{min}}$ and $\theta_{N_{max}}$ define the attitudes beyond which either diving or yawing divergence occurs for the bow-down attitude, and dangerous porpoising or swamping follows for the bow-up attitude. The range of values of θ shall be sufficiently large to assure safe operation throughout the operational envelope, over the range of attainable water sideslip angles, and in the event of control commands or control or propulsion system failures which affect pitch trim.

The acceptable positive and negative peak pitch angles induced by seaway operation are the same as those shown in Table 5-1. The following non-dimensional relationships may be used to define $\theta_{N_{min}}$ and $\theta_{N_{max}}$:

$$\theta_{N_{min}} \leq \theta_N \leq \theta_{N_{max}}$$

5.6 STABILITY AND CONTROL ON-CUSHION (CONT'D.)

$$\text{where } \theta_{N \min} = -1.05 + .25 F_N$$

$$\text{and } \theta_{N \max} = 1.14 - .38 F_N$$

$$\theta_N = \theta / (H_c / L_c) \quad (\theta \text{ in radians})$$

$$F_N = V / (L_c g)^{1/2} \quad (\text{Froude Number})$$

The dynamic pitch oscillations produced by isolated waves or changes in trim-adjustment devices (aft seal, hydrodynamic surfaces, shifting of ballast, etc.), shall damp to 1/2 amplitude in one cycle or less and the magnitude of angular attitude shall not be objectionable and shall not adversely affect the utility of the craft. Any longitudinal oscillations with periods less than 6 seconds shall be governed by this requirement. When a longitudinal control surface or other device is abruptly moved and released or readjusted, its motion following release shall be essentially deadbeat, unless its oscillations are of such frequency and amplitude that it does not result in objectionable craft oscillations. There shall be no tendency for a sustained or uncontrollable oscillation resulting from efforts of the operator to maintain the nominal desired pitch angle. Long-period oscillations of longitudinal modes shall be stable, and there shall be no objectionable characteristics attributable to apparent inadequate damping. These requirements shall apply both in straight travel and in turns.

The level of horizontal deceleration (during a plow-in, ditching or other similar event) that would not be considered hazardous will depend on the extent to which provision is made for the restraint of passengers, as follows:

- (i) Where decelerations exceed 0.65g, the U.S. Coast Guard may require the provision of adequate means of restraint, e.g., safety belts.
- (ii) When the involuntary movement of passengers is adequately limited, e.g., by the provision of handholds and barriers and passengers do not normally leave their seats, decelerations should not exceed 0.65g.
- (iii) When the involuntary movement of passengers is limited as in (ii) but passengers are likely to leave their seats, the decelerations should not exceed 0.5g.
- (iv) When certification is sought for craft in which the movement of passengers is not restricted (e.g., in open bar areas), the deceleration should be less than 0.5g by an amount to be agreed with the U.S. Coast Guard.

The rate of application and removal of deceleration should not, in any of the above cases, exceed 1g per second.

During changes in adjustment or settings of craft subsystems, the craft shall respond in pitch as follows. The minimum time to adjust trim-control devices shall not unduly restrict the acceleration from low speed to cruise speed.

5.6 STABILITY AND CONTROL ON-CUSHION (CONT'D.)

Increase in power at any speed shall not cause sustained or uncontrollable pitch oscillations. The settings and adjustments of all longitudinal trim control devices shall allow emergency decelerations to be made without imposing hazardous attitudes or motions on the craft. The peak pitch attitude change following a rapid command of the lift fan control shall not be within 2° of θ_{\max} or θ_{\min} . Throughout the range of speeds, turning radii and sea states, the attendant sideslip shall not cause adverse changes or undamped oscillations in pitch attitude. The bow-up pitching moment change due to sideslip is preferred.

During key subsystem failures, the following pitch-response requirements shall be met. A sudden failure of the lift system can create a dangerous situation in which the craft is traveling at very high speeds with only a small portion of the lift provided by displacement and hydrodynamic forces on the side hulls. These high speeds far exceed the normal hullborne operating speeds. Means shall be incorporated to insure that the peak change in pitch attitude, following any lift-system failure, be within 2° of θ_{\max} or θ_{\min} where θ_{\max} and θ_{\min} here refer to the most critical configuration hullborne, cushionborne, or transitional. Failure of a stern seal shall not cause the peak change in pitch attitude to be within 2° of θ_{\max} or θ_{\min} . The above requirements pertain during turning as well as straight-line operation. *

In addition, the coupled pitch/roll and pitch/yaw response shall be stable throughout the specified operational envelope. (See also paragraph 5.)

There is also an instability which may occur during a transitional stage; when going between displacement and on-cushion operation. Usually the severest instabilities have occurred during a reduction in lift-fan speed which accompanied a turn or a high-sideslip mode of travel. Sudden speed changes, especially reductions, have also promoted this unstable condition, due to the effects of wind and wave from directions other than dead ahead.

(3) Roll Stability Requirements

Lateral craft trim (roll) may be provided by transverse C.G. control through the placement of fuel within the trim-control system. In addition, hydrodynamic trim devices may be employed. Sufficient control shall be available to trim the craft to zero degrees of heel.

The roll-stability characteristics of the craft shall be such that when measured from an initial zero heel angle, the rolling moments generated by rolling to either side cause the craft to roll back toward zero roll angle. Such a condition shall exist over the roll-angle excursions shown in Table 5-2.

* NOT APPLICABLE TO INTACT OPERATION.

AD-A110 567

BAND LAVIS AND ASSOCIATES INC SEVERNA PARK MD

F/G 13/10

DEVELOPMENT OF INTACT STABILITY STANDARDS FOR RIGID-SIDEHULL SU--ETC(U)

DTC83-80-C-20042

DEC 81 D R LAVIS, E G BANO, E D HOYT

USC6-0-83-81

BLA-WP-155-2

NL

UNCLASSIFIED

2-2

END
 DATE 3 82
 DTIC

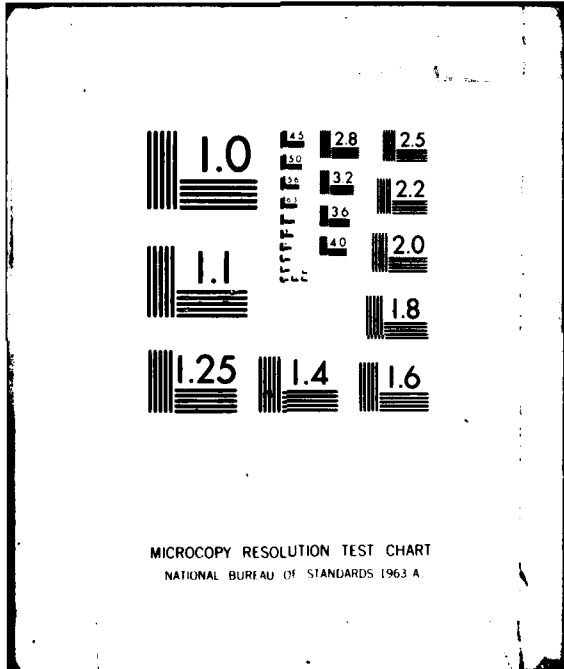

MICROCOPY RESOLUTION TEST CHART
NATIONAL BUREAU OF STANDARDS 1963 A

5.6 STABILITY AND CONTROL ON-CUSHION (CONT'D.)

TABLE 5-2. STATIC ROLL ANGLE LIMITS

Configuration	Minimum Roll Angle Range for Restoring Moment
CB(H)	± 30 degrees
CB(CR)	$\pm \phi_{N_{max}}$

For configuration CB(CR), $\pm \phi_{N_{max}}$ defines the roll-attitude divergence angles at each speed and indicates the attitudes beyond which either roll or yaw divergence occurs.

The values of $\pm \phi_{N_{max}}$ shall also be sufficiently large to assure safe operation throughout the operational envelope, so that the roll angles reached over the range of attainable sideslip angles, and in the event of control commands or control or propulsion system mishandling which affect roll trim do not exceed $\phi_{N_{max}}$. The following non-dimensional relationship* may be used to define $\phi_{N_{max}}$.

$$-\phi_{N_{max}} \leq \phi_N \leq + \phi_{N_{max}}$$

when $\phi_{N_{max}} = .247$

$$\phi_N = \phi / (H_c / B_c) \quad (\phi \text{ in radians})$$

and $\phi_{N_{max}} = \phi_{max} / (H_c / B_c)$

The remaining roll-stability requirements pertain to limitations placed on roll angle during turning. The craft shall exhibit stable directional stability at all transient and steady-state sideslip and roll angles required to conform with collision-avoidance turning requirements over the entire range of permissible pitch angles. The craft, when traveling at any attainable speed above hump in calm water, shall be able to enter or leave a minimum radius turn without rolling inward or outward more than $0.5 \phi_{max}$ in calm water, or $0.7 \phi_{max}$ in rough water. During a minimum radius turn, the craft shall stabilize in an inward roll attitude with ϕ in the range between zero and $0.5 \phi_{max}$ in calm water and between $\pm 0.5 \phi_{max}$ in rough water. For all cruise speeds following transition into or from a turn, any calm water roll oscillation shall damp to 1/2 amplitude in one cycle or less.

* Based on the present extent of model-test experience and may be expanded when further data becomes available.

5.6 STABILITY AND CONTROL ON-CUSHION (CONT'D.)

Throughout the speed range, the craft motions following the loss of any combination of propulsion and lift-fan power shall be such that dangerous conditions can be avoided throughout the resulting deceleration by normal operator corrective action. Devices intended for use following a failure may be used. Steering-system failure or lock during a turn will not cause any abrupt or dangerous changes in rate of turn, yaw, pitch, or roll angles. *

(4) Directional Stability Requirements

The craft shall have such directional stability properties that it can be controlled within the following limits. In on-cushion operation in calm seas, the craft shall be controllable to within ± 2 degrees of the desired heading. Within the speed range corresponding to operation in the Worst Intended Environmental Conditions, the operator shall be able to hold a desired heading within ± 7 degrees. For full-cushion operation in the Emergency Environmental Condition, the craft shall be controllable to within $\pm 15^\circ$ of the desired heading.

The craft shall exhibit directional stability at all transient and steady-state sideslip-and-roll angles required to conform with specified turning requirements over the entire range of permissible pitch angles.

Above hump speed, the craft shall possess wheel-free directional stability, such that right (clockwise) wheel force is required for right turns and left-wheel force for left turns. The variation of sideslip angle with wheel force shall be essentially linear. For extreme wheel deflections which may not further increase the sideslip angle, a leveling of the wheel force is acceptable, but the wheel force shall not decrease. Similar below-hump characteristics are desirable but not required. For an SES being turned with variable-immersion steering skegs, these requirements shall be revised to state that immersion of the starboard skeg shall produce turns to port, and immersion of the port skeg shall produce turns to starboard. In addition, the variation of turn radius with skeg immersion shall be roughly linear up to skeg saturation. Skeg immersion past saturation shall not be permitted.

Under all conditions of operation, including normal and emergency operations, and after any single-equipment failure other than catastrophic hull damage, the vehicle design shall preclude divergent motion in heading or course. For all emergency conditions including the simultaneous failure of the propulsion and lift systems, the vehicle design shall include provisions to allow the crew to hold the vehicle into the wind and waves for environments of severity equal to or less than the Design Environmental Condition. In addition, the failure of the steering system during a turn will not cause an abrupt change in turn rate, yaw, pitch, or roll angles. *

In addition to sizing the directional stabilizers to provide directional stability at trim angles down to θ_{min} and at roll angles to ϕ_{max} , the directional stabilizers shall be capable of providing directional stability at zero degrees trim if half the stabilizer's total yaw stiffness is eliminated by flash ventilation.

* NOT APPLICABLE TO INTACT OPERATION.

5.6 STABILITY AND CONTROL ON-CUSHION (CONT'D.)

Maximum allowable sideslip angles may be determined from the following non-dimensional relationships:

$$\psi_{N \min} < \psi_N < \psi_{N \max}$$

where $\psi_N = \psi / (B_c / L_c)$ (ψ in radians)

$$\psi_{N \min} = -.74 + .244 F_N$$

$$\psi_{N \max} = .74 - .244 F_N + .25 \theta_N \phi_N$$

(5) Combined Pitch/Roll/Yaw Stability Requirements

In high-speed vehicles such as the SES, stability about one axis is closely coupled with stability about other axes. If an SES encounters a wake while turning, for example, the wake may cause the SES to pitch up and then down; the downward pitch angle will bury the forward part of the sidehulls and may cause momentary instability in yaw; as the sideslip angle increases a rolling moment may be produced which will cause the SES to roll. Thus separate stability criteria are not, in themselves, sufficient to determine satisfactory behavior. Only the proper analysis of the total behavior of the SES with freedom to respond to all degrees of freedom can determine whether or not the SES has sufficient stability. In the preliminary analysis described in this report the following interrelationship was found to be necessary to provide acceptable behavior:

$$E_{\phi_c} E_{\theta_c} \geq 93.5 (E_{\psi_c} (R/L_c)^2)^{1.3}$$

where $E_{\phi_c} = \int_0^{.5} K_N \cdot d\phi_N$

$$E_{\theta_c} = \int_{-.316}^{\theta_N} M_N \cdot d\theta_N$$

$$E_{\psi_c} = \int_0^{.316} N_N \cdot d\psi_N$$

$$K_N = K / (WB_c)$$

$$M_N = M / (WL_c)$$

$$N_N = N / (WL_c)$$

This relationship is consistent with prior, successful, SES operating at a Froude number F_N of up to about 2.0. If Froude numbers much higher than 2.0 are contemplated then additional assurance of acceptable stability should be sought in the form of more advanced analyses or model tests.

5.6 STABILITY AND CONTROL ON-CUSHION (CONT'D.)

5.6.2.2 Trim Requirements

Longitudinal (craft) trim may be provided by C.G. control through the placement of fuel within the trim-control system. A separate water-ballast system may be employed. In addition, hydrodynamic-trim devices may also be employed. Cross-coupling shall not exist between pitch-and-heave position to such a degree that large trim-control adjustments are required with changes in sidehull immersio. .

The primary trim requirements are such that large changes in trim do not result from changes in immersion and changes in power setting. The craft shall be inherently designed to possess such pitch-moment characteristics at varying immersions that once the selected trim condition is achieved (primarily by C.G. control), changes in immersion and speed will generate trim changes easily controlled by fuel or water-ballast transfer. Also, the lift and propulsion systems shall be designed so that adjustments in power setting do not produce trim changes difficult to control.

5.6.2.3 Controllability and Maneuverability

The craft must be able to maintain a constant speed at all conditions on-cushion in all environmental conditions within the operational envelope.

The steering system turning requirements are as follows:

- (1) In order to provide satisfactory control at hover, when hovering will be a necessary function for the type of service intended, it is recommended that the steady rate of turn in still air and calm water with the craft stationary should be not less than 4 degrees per second. Special attention should be given to providing an adequately high rate of angular acceleration and deceleration.
- (2) On-cushion above-hump speed, the minimum-turn radius required is 30 boat lengths.
- (3) This turn radius, (R), is to be maintained within $\pm 10\%$ under all operating conditions.

During all on-cushion operations with normal trim for conditions within the Worst Intended Environmental Condition and the speeds defined in Table 5-3, the craft must, within 10 boat lengths of travel, enter into or exit from, a steady-state turn of the radius indicated in the table. In conjunction with this requirement is the preference that the advance and transfer distances for the turn maneuver be approximately equal to the turn radius, and that the tactical and final diameter distances be approximately equal to twice the steady-state turn radius.

While entering, leaving, or during the actual turn, roll and sideslip are to remain within the limits of Table 5-3.

5.6 STABILITY AND CONTROL ON-CUSHION (CONT'D.)

TABLE 5-3. TURNING DESIGN GOALS.

Operating Speed (knots)	Minimum Required Turning Radius (boat lengths)	Roll Angle (degrees)	Sideslip (degrees)
Hump + 10	20	ϕ_{max}	ψ_{max}
50	30	ϕ_{max}	ψ_{max}

5. PROPOSED STABILITY STANDARDS (CONT'D)

5.7 PROOF OF COMPLIANCE AND CERTIFICATION

The safety of an SES can only be fully established and, therefore, certified by exhaustive and perhaps dangerous full-scale trials.

Since these regulations concern only intact stability, the usual design review and structural hull and machinery inspections are implicit rather than specified; the craft must be structurally sound and properly fitted for the intended route and service if she is to remain intact.

The principal causes of instability in the displacement mode are readily identified and evaluated by well-established techniques, except perhaps for the high-speed/displacement mode loss of directional stability which occurs in SES as the bow tends to be drawn down. This directional instability, which can lead to sudden high sideslip followed by rollover, can be identified by analysis and model tests; but full-scale verification of the safe operating envelope will be required before certification. Mandatory C.G. locations and "avoid" speeds will probably be prescribed, based on the tests made.

6. REFERENCES

- AGC 17 SEP 73 "SES-100A Program Status Report", Aerojet Surface Effect Ships Division, Report No. AGC-T-409, 17 September 1973.
- AGC 22 MAY 74 "SES-100A Test Craft Program Group VII and VIII Test and Evaluation Report", Aerojet Surface Effect Ships Division, Report No. AGC-T-517, 22 May 1974.
- AGC 21 JUN 74 "SES-100A Testcraft Program Systems Evaluation Report", Addendum for Period August 1973 through March 1974 (U) Classified Confidential Aerojet Surface Effect Ship Division, Report No. AGC-T-456 (ADD1), 21 June 1974.
- AGC 8 NOV 73 "SES-100A Stability and Control Analysis", Aerojet General Corporation, Report No. AGC-T-414 for Department of the Navy SES Project Office (PM-17), 8 November 1973.
- BAND 20 SEP 76 "Prediction of Hydrodynamic Impact Loads Acting on SES and ACV Structures" by E.G.U. Band, D.R. Lavis and J.G. Giannotti, AIAA Paper No. 76-868, Arlington, Virginia, September 20-22, 1976.
- BAT 17 SEP 73 "SES-100B Test and Evaluation Program Report", Bell Aerospace Textron, Report No. 7308-948010, September 17, 1973.
- BHC JUL 80 "The Use of Free-Running Models at Sea in the Assessment of Seakeeping and Other Aspects of Performance", by W.A. Crago Experimental and Electronics Laboratories, British Hovercraft Corporation, presented at the 19th American Towing Tank Conference, University of Michigan, July 1980.
- BLA JUN 77 "The Derivation of SES Structural Design Loads Using Extreme Value Statistics Applied to Experimental Loads and Motion Data", D.R. Lavis and E.G.U. Band; Band, Lavis and Associates Working Paper No. 102-2, for Rohr Marine Inc. Surface Effect Systems Division, June 1977.
- BLA JUN 80 "The Development of Stability Standards for Dynamically Supported Craft, A Progress Report", by David R. Lavis, Band, Lavis & Associates, Inc., High Speed Surface Craft Exhibition and Conference, Brighton, U.K., June 1980.

BOGDANOV 75 "Results of Experimental Investigations into the Initial Stability of a Sidewall ACV at Constant Speed in Calm Water", by Bogdanov and Voynarovskiy, 1975.

CAA 27 AUG 80 "British Hovercraft Safety Requirements", Issue 3, (April 1979) with approved additions, dated 27 August 1980, by the British Civil Aviation Authority.

DTNSRDC 67 "Captured Air Bubble Vehicle Stability Tests", by R.A. Wilson, DTNSRDC AIAA/SNAME Paper 67-349.

DTNSRDC SEP 68 "Systematic Variation of Design Parameters Affecting Turn Stability of a Captured Air Bubble (CAB) Vehicle and their Experimental Evaluation", by R. A. Wilson, David W. Taylor Naval Ship Research and Development Center, DTNSRDC Technical Note: SDO-H23-04, September 1968. Edited and reissued as DTNSRDC Report 2965, March 1969.

DTNSRDC MAR 69

DTNSRDC JUL 69 "XR-1B Turn Stability Analysis", R.A. Wilson, DTNSRDC, Tech Note SDO-OH23-44, July 1969.

DTNSRDC APR 70 "A Stability Analysis of the XR-1B Test Craft with Ram and Flush Waterjet Inlets", by R. A. Wilson and C. W. Harry, David W. Taylor Naval Ship Research and Development Center, Technical Note: SDO-OH23-54, April 1970.

HTL 12 JUL 72 "Report on Performance and Habitability Trials on the Hovermarine HM2 MK.3: XW555", Hovermarine Transport Limited Docement No. 72/D111 of 12 July 1972.

IMCO 2 MAY 78 "Intergovernmental Maritime Consultative Organization Code of Safety for Dynamically Supported Craft", IMCO Resolution A.373(X) adopted on 14 November 1977.

JANES 79 "Jane's Surface Skimmers, Hovercraft and Hydrofoils", Twelfth Edition, by Hovermarine Transport Ltd., p. 86, 1979.

MDI OCT 76 "Group Analysis Report for SES-100A Group X1 Test Series", Maritime Dynamics, Inc. Report No. MDR 1048-46, October 1976.

NAVSEA 25 JUN 76 "Design Data Sheet (DDS079-1) - Stability and Buoyancy of U.S. Naval Surface Ships, Part III Advanced Marine Vehicles (in Waterborne Displacement Mode)", NAVSEA 6121 Ser. 147, 25 June 1976.

OCEANICS MAY 73 "An Experimental Study of SES Lateral Hydrodynamic Forces and Moments", Oceanics Report No. 73-97, May 1973.

ROHR 31 AUG 78 "Stability and Maneuverability Report", by E.H. Price, et al, Rohr Marine, Inc. Report No. TTP 00013A, 31 August 1978.

SIT DEC 69 "Further Tests of a 1/7 Scale XR-1B Surface Effect Ship Model with Ventral Fins", R.L. Van Dyck, Stevens Institute of Technology, Letter Report SIT-DL-69-1440, December 1969.

SIT APR 71 "Stability Tests on the PLS-Series of SES Models to Determine the Effect of Sidewall Length", Stevens Institute of Technology Report SIT-DL-71-1517, April 1971.

SIT SEP 71 "Stability Tests on a PLS-Series of SES Models with Newly Configured Bow Seals", Gerard Fridsma, Stevens Institute of Technology, Letter Report SIT-DL-71-1545, September 1971.

SIT FEB 73 "Performance and Stability Tests of XR-1B SES Model", P. W. Brown and W. Klosinski, Stevens Institute of Technology, Davidson Laboratory, Report No. SIT-DL-73-1619, February 1973.

SIT DEC 73 "Stability and Seakeeping Tests of Bell B-28 Model 2KSES", R.L. Van Dyck, Stevens Institute of Technology, Letter Report SIT-DL-73-1712, December 1973.

SIT JUN 74 "Performance, Stability and Seakeeping Characteristics of a Model of the 100-B SES Testcraft, Part 1: Performance and Stability Characteristics", by Gerard Fridsma, Stevens Institute of Technology, Report SIT-DL-74-1673, June 1974.

SIT OCT 75A "Stability and Performance Tests of SES-100A Model with Modified Sidewalls and Various Size Stern Fins", by R. Van Dyck, Stevens Institute of Technology, Davidson Laboratory, Report No. SIT-DL-75-1784, October 1975.

SIT OCT 75B "Performance, Stability and Seakeeping Characteristics of a Model of the 100-B SES Testcraft, Part 3: Stability Characteristics at High Flow Rates", J.D. Adams, Stevens Institute of Technology, Report No. SIT-DL-75-1786, October 1975.

SMTRB 80 "Stability and Control of Hovercraft; Notes for Commanders", issued by the Ship and Marine Technology Requirements Board, U.K. Government Department of Industry, London 1980.

- SNAME APR 50 "Nomenclature for Treating the Motion of a Submerged Body Through a Fluid", Technical and Research Bulletin No. 1-5, Society of Naval Architects and Marine Engineers, April 1950.
- USCG DEC 74 "Ship Motions and Capsizing in Astern Seas", S.J. Chou et al., California University, Berkeley, USCG Report No. CG-D-103-75, December 1974.
- USCG APR 79 "A Background Study of Intact Stability Standards for Dynamically Supported Craft", Volumes I through VI, United States Coast Guard, Task 1 Report No. CG-D-75-79, April 1979.
- USCG OCT 79 "Classification of Intact Stability Standards for Dynamically Supported Craft", United States Coast Guard, Task 2 Report No. CG-D-76-79, October 1979.

7. LIST OF SYMBOLS

A	projected side ("sail") area of craft
A_1	area under righting-arm curve (see Figures 5-2 and 5-3)
A_2	area under heeling-arm curve (see Figures 5-2 and 5-3)
\bar{a}	constant used in equation 3.9
\underline{a}	acceleration vector
a_c	vertical distance between craft's center of gravity and off-cushion center of lateral resistance
a_L	transverse distance from craft centerline to end of boom for over-the-side lift calculations
a_p	distance moved by center of gravity of passengers in crossing-to-one-side calculation
B_c	cushion beam
b	constant used in equation 3.9
C	cross force (see Figure 3-2)
C_K	roll-damping constant
C_M	pitch-damping constant
C_N	yaw-damping constant
C_W	wind-pressure coefficient
C.P.	center-of-pressure location for hydrodynamic appendages
c	constant used in equation 3.9
$c_{E_{ijk}}$	coefficient used in generalized polynomial curve fit (see equation 3.4)
D	drag force (see Figure 3-2)
E	generalized dependent variable (see equation 3.4)
E_{θ_L}	non-dimensional pitch-restoring energy
E_{ϕ_c}	non-dimensional roll-restoring energy
E_{ψ_c}	non-dimensional yaw-restoring energy
\underline{F}	force vector
F_N	Froude number
F_X	forcing formation component in X direction (see equation 3.5)
F_Y	forcing formation component in Y direction (see equation 3.5)
F_Z	forcing formation component in Z direction (see equation 3.5)

G_B	air gap at bow seal (see Figure 3-11)
G_S	air gap at stern seal (see Figure 3-11)
g	gravitational acceleration
H_c	cushion height
h_{CG}	height of center of gravity above water level
I_X	Moment of inertia about body x axis
I_Y	Moment of inertia about body y axis
I_Z	Moment of inertia about body z axis
i	index (see equation 3.4)
j	index (see equation 3.4)
K	roll moment about body x axis (positive starboard down)
\bar{K}	roll stability fraction (see Table 3-2)
k	index (see equation 3.4)
k_K	constant defining rudder contribution to roll moment (see equation 3.5)
k_M	constant defining rudder contribution to pitch moment (see equation 3.5)
k_N	constant defining rudder contribution to yaw moment (see equation 3.5)
k_x	rudder drag constant (see equation 3.5)
k_y	rudder side force constant (see equation 3.5)
L	lift force (see Figure 3-2)
L_A	lever arm of sail area A from centroid of A to half draft point
L_B	length of bow forward of sidehulls (see Figure 3-11)
L_C	effective cushion length
L_H	length of side hulls (see Figure 3-11)
L_O	overall cushion length (see Figure 3-11)
LCG	longitudinal center-of-gravity position expressed as a percentage of L_C forward of the sidehull transom
M	pitching moment about body y axis (positive bow up)
M_x	body axis forcing moment about x axis (see equation 3.5)
M_y	body axis forcing moment about y axis (see equation 3.5)
M_z	body axis forcing moment about z axis (see equation 3.5)
\bar{M}	pitch stability fraction (see Table 3-2)
m	craft mass

N	yaw moment about body z axis (positive bow to starboard)
\bar{N}	yaw stability factor (see Table 3-2)
P	wind pressure
$P(\phi_x)$	total probability of exceeding an angle ϕ_x
P_H	probability of occurrence of a given range of heading angles
P_S	probability of occurrence of a given range of sea states
P_V	probability of occurrence of a given range of velocities
P_W	probability of occurrence of a given range of gross weights
$P_{VHSW}(\phi_x)$	probability of ϕ_N exceeding a value of ϕ_x under given combination of heading, H, velocity, V, sea state, S, and gross weight, W
p	component of angular velocity about body x axis (positive starboard down)
\dot{p}	component of angular acceleration about body x axis (positive starboard down)
p_c	cushion pressure
\bar{p}_c	position vector of center of gravity, C, with respect to space origin 0
Q	cushion air flow rate
Q_N	dimensionless cushion air-flow rate = $\frac{Q}{S} \left[\frac{\rho_a}{2p_c} \right]^{1/2}$
q	component of angular velocity about body y axis (positive bow-up)
\dot{q}	component of angular acceleration about body y axis (positive bow up)
R	radius of turning circle
r	component of angular velocity about body z axis (positive bow to starboard)
\dot{r}	component of angular acceleration about body z axis (positive bow to starboard)
\bar{r}_c	position vector of center of gravity, C, with respect to body axis origin, Q
S	cushion area
STA	station
T_N	non-dimensional time
t	time

u	component of velocity along body x axis (positive forward)
\dot{u}	component of acceleration along body x axis (positive forward)
V	velocity of origin of body axes relative to fluid (see Figure 3-2)
V_W	wind velocity
VCG	vertical center of gravity
v	component of velocity along body y axis (positive to starboard)
\dot{v}	component of acceleration along body y axis (positive to starboard)
\vec{v}	velocity vector of body origin, Q, with respect to space origin, O
W	gross weight of craft
w	component of velocity along body z axis (positive down)
\dot{w}	component of acceleration along body z axis (positive down)
w_L	weight of over-the-side lift for heeling calculations
w_p	weight of passengers
X	force along body x axis (positive forward)
X_N	non-dimensional force
x	distance in direction of body x axis
x_o	distance in direction of horizontal space axis
x_G	x coordinate of center of gravity
x_N	non-dimensional length
y	distance in direction of body y axis
y_o	distance in direction of horizontal space axis
y_G	y coordinate of center of gravity
z	distance in direction of body z axis
z_o	distance in direction of vertical space axis
z_G	z coordinate of center of gravity
α	angle of attack (see Figure 3-2)
β	drift or sideslip angle (see Figure 3-2)
β_i	deadrise on inboard side of sidehulls
β_o	deadrise on outboard side of sidehulls
Δt	time increment
δ	rudder angle

θ	pitch angle (see Figure 3-1)
$\dot{\theta}$	pitch rate
θ_c	critical value of θ_N
θ_N	non-dimensional pitch angle (see Table 3-1)
λ	linear scale
\vec{p}	position vector of body origin, Q, with respect to space origin, O
ρ_a	mass density of air
ϕ	roll angle (see Figure 3-1)
$\dot{\phi}$	roll rate
ϕ_c	critical value of ϕ_N
ϕ_N	non-dimensional roll angle (see Table 3-1)
ϕ_r	roll angle into wind (see Figure 5-2)
ψ	yaw angle (see Figure 3-1). When the x_0 -axis is tangent to the path, $\psi = \beta$.
$\dot{\psi}$	yaw rate
ψ_c	critical value of ψ_N
ψ_N	non-dimensional yaw angle (see Table 3-1)
ω	angular velocity

APPENDIX A - EXPERIMENTAL DATA

A-1. EXPERIMENTAL DATA SOURCES

In preparation for the analysis carried out under Task I, an extensive collection of reports was assembled covering the results of both model and full-scale testing of Rigid Sidehull Surface Effect Ships. Operational craft for which at least some data are available are:

U.S. Navy XR-1:	- Model Data
U.S. Navy SES-100A:	- Model- and Full-Scale Data
U.S. Navy SES-100B:	- Model- and Full-Scale Data
Rohr Marine 2KSES:	- Model Data
Hover Marine HM-2:	- Full-Scale Data
U.S. Navy XR-5 High L/B Test Craft	- Model Data

In addition to the above, model test data and design studies and analyses concerning the following programs have been reviewed:

Bell Aerospace 2KSES
Aerojet General 2KSES
Rohr Marine 3KSES
U.S. Navy High L/B SES

General characteristics of these craft are presented in Table A-1 for both the displacement and cushionborne modes of operation. These include identification of the craft, the intended service, the displacement and C.G. location, mass moments of inertia, the principal dimensions of the hull and appendages, cushion characteristics and dimensions, and the design sea-state/speed envelope. Available data on the Bell-Halter BH-110 craft have been included.

Documents identified as useful sources of stability-related data have been cataloged in Table A-2. This includes identification of the craft covered, the document title and source and a brief description of the type and scope of data included. In addition, the data are categorized in terms of the force and motion components addressed.

TABLE A-1a. SES GENERAL CHARACTERISTICS.

		SES 100A	SES 100B	XR-1	XR-1B	XR-5	HM-2	RMI 2KSES	RMI 3KSES	BH-110
Type of Service		R&D	R&D	R&D	R&D	R&D	Ferry	USN Project	USN Project	Crew-boat
Service Location		Puget Sound & Chesapeake	Gulf of Mexico & Chesapeake	Delaware River	San Diego	Chesapeake	World Wide (Coastal Routes)	Ocean Going	Ocean	Gulf of Mexico
<u>Geometric Properties</u>										
<u>Length:</u>										
Hull overall	Ft.	81.9	72.0	52	51.5	46.75	51.0	236.5	266.2	110
Side hull at waterplane										
- on cushion	Ft.									
- off cushion	Ft.									
Cushion length on Q_c (L_c)	Ft.	64	61.39	35.0	37.7	41.4	40.4	192.0	221.0	90
<u>Beam:</u>										
Hull overall	Ft.	41.9	35.0	13.5	19.0	8.25	20.0	108	108	19
Side hull outside waterplane										
- on cushion	Ft.					6.75				
- off cushion	Ft.			13.5		8.25				
Side hull inside waterplane										
- on cushion (cushion beam B_c)	Ft.	31.66	31.06	10.0	15.0	6.33	16.5	85	85	30
- off cushion	Ft.									
<u>Height:</u>										
Hull overall on-cushion	Ft.		19.05			6.21	11.87			28
Hull overall off-cushion	Ft.		13.15				8.87			22.6
Cushion Height	Ft.	6.00	6.14	3.71	3.28	3.00		18	18	
Draft on-cushion	Ft.	6.7	4.2			1.37	2.83			4.5
Draft off-cushion	Ft.		10.1		3.2		4.8			7.75
Cushion length-to-beam ratio	-	1.95	1.98	3.5	2.51	6.54	2.13	2.26	2.6	3.0
Craft C.G. height-to-beam ratio	-									
Hull wet deck height-to-beam ratio	-	.190	.1978	.371	0.22	1.03		.212	.212	25@bow 17@stern
Sidehull deadrise angle	Deg.	60°	30°	60°	45°	55°				36°
Sidehull width-to-cushion beam ratio†										
Sidehull width-to-sidehull length ratio†										
<u>Directional stability fins</u>										
Area per fin	Ft. ²	12	9.0	N/A	5.9		2.7(steep)		12.27	
Fin cant angle measured from vertical	Deg.	26°	30°	N/A	45°		0°		28°	

* Scaled from model.
 † Sidehull dimensions taken at wet deck.

9 2 1 1 0 8 0

TABLE A-1b. SES GENERAL CHARACTERISTICS.

		SES 100A	SES 100B	XR-1	XR-1B	XR-5	MP-2	RMI 2KSES	RMI 3KSES	BH-110
Stability fin centroid position fwd. of transom	Ft.			N/A						
Rudder area per rudder	Ft. ²	N/A	6.36		N/A	N/A	2.0	N/A	N/A	
Rudder centroid position fwd. of transom	Ft.						.8			
Hull freeboard	Ft.									
Hull lateral sail area	Ft. ²									
Deadrise angle of wet deck hardstructure at bow	Deg.	0	5.5°		13°	16.5°	0	12.8	11.8°	
Height of towing bits	Ft.									
Center of Gravity:										
C.G. Station (fwd. of transom)	Ft.	32.5	33	19.53	18.93	20.6±.1		120.33		
C.G. Butt	Ft.	0.1	0	0	0			0		
C.G. height above keel plane, H _z	Ft.	7.6	8	5.32	3.98			26.41		
H _z /B _C	-	0.240	0.258	0.532	0.265			0.311		
H _z /L _C	-	0.119	0.131	0.152	0.106			0.138		
Craft C.G. shift capability	Ft.									
Weight of payload which can inadvertently move	Lb.									
Number of passengers	-						65			65
Payload & passenger deck area	Ft. ²						CABIN 352			1672
Weight										
Design displacement, full load	Lt.	89.3	93.8	10	17.0	3.35	18.5	2200	3000	107
Displacement, overload	Lt.		102.7							138
Displacement, light ship	Lt.	65.3	49.6						1699	80
Moment of Inertia										
Radius of gyration in roll	Ft.	14.5	11.7					34.43		
Radius of gyration in pitch	Ft.	18.943	17.6					65.45		
Radius of gyration in yaw	Ft.	23.208	20.3					71.51		

TABLE A-1c. SES GENERAL CHARACTERISTICS.

		SES 100A	SES 100B	XR-1	XR-1B	XR-5	HM-2	RMI 2KSES	RMI 0KSES	BH-110	
<u>Cushion Properties</u>											
Bow seal type	-	PLANING SEAL (P.S.)	BAG- FINGER	PLANING SEAL	PLANING SEAL			BAG- FINGER	PLANING SEAL	PLANING SEAL	FINGER
Angle at waterplane *	Deg.		1 LOBED FLEX BAG	3°	4°			35°	19°	25°	45
Stern seal type	-	P.S.		P.S.	P.S.			BAG	P.S.	P.S.	BAG
Angle at waterplane *	Deg.				4°	22°					
Bow seal height to wet deck	Ft.	5.5		3.71							7.5
Stern seal height to wet deck	Ft.	5.0		3.71		2.33					5.0
Cushion area, A_c	Ft. ²	2000	1905	350	566	262	627	16320	8785	2700	
Equivalent cushion length = A_c/B_c	Ft.	63.17	61.33	35	37.7	41.4	38	192	221.0	90	
Cushion pressure, p_c (full load)	Lb/Ft. ²	100	105	64	67	30.5	66	313	358	88.8	
Cushion length density (full load), p_c/L_c	Lb/Ft. ³	1.56	1.71	1.83	1.78	0.74	1.63	1.69	1.62	0.99	
Bow seal pressure ratio (full load), p_b/p_c	-	1.08	1.25				1.10				
<u>Lift Air Supply System:</u>											
Cushion air flow rate, Q_c	Ft. ³ /sec	6000	5845			145	900	49280			
dQ/dp at design point	Ft. ⁵ /lb/sec										
Flow distribution:											
bow seal	%										
stern seal	%										
cushion	%										

* Measured from Horizontal

TABLE A-2. CATALOG OF SES MODEL STABILITY DATA SOURCES.

CRAFT OR MODEL	REPORT TITLE AND COMMENTS	INDEPENDENT VARIABLE						
		V	β	α	δ	p	q	r
XR-1 & XR-3 MODELS	"Design Parameters Affecting Turn Stability of CAB Vehicle". R.A. Wilson, DTNSRDC 2965, March 1969 (Fixed yaw and sway at constant speed showing effect of L/B, fin size, fin angle, sidehull width, deadrise, seal type, compartmentation)							X
					12°			Y
					12°			Z
								K
								M
					12°			N
DTNSRDC 2K SES MODELS No.1 and No.2	"An Experimental Study of SES Lateral Hydrodynamic Forces and Moments", Oceanics Rpt. No. 73-97, May 1973 (Fully constrained FMM tests at Lyngby, Denmark)				12°	✓	✓	X
		✓			12°	✓	✓	Y
					12°	✓	✓	Z
		✓		✓	✓			K
		✓			12°	✓	✓	M
DTNSRDC 2K SES MODEL WITH VARYING PLS	"Stability Tests on the PLS-Series of SES Models to Determine the Effect of Sidewall Length", SIT Report SIT-DL-71-1517, April 1971	✓		✓	✓			X
					✓			Y
					✓			Z
					✓			K
					✓			M
RUSSIAN SES MODEL	"Results of Experimental Investigations into the Initial Stability of a Sidewall ACV at Constant Speed in Calm Water", by Bogdanov & Vognarovskiy, 1975	✓						X
								Y
								Z
		✓	30°					K
								M
						N		

* Values, where shown, indicate range of test data.

TABLE A-2. CATALOG OF SES MODEL STABILITY DATA SOURCES. (CONT'D)

CRAFT OR MODEL	REPORT TITLE AND COMMENTS	INDEPENDENT VARIABLE							
		V	δ	ϵ	$\frac{z}{V}$	$\frac{p}{V}$	q	$\frac{r}{V}$	
ROHR JKSES (On Cushion)	"Stability and Maneuverability Report" Rohr TTP 0013A CDRL No. E03L 31 August, 1978 Stability Predictions Based on Model Tests Stability Criteria Ref. RPT T2200 0001A								X
					+12°				Y
									Z
		40 KT, 0°							K
		80 KT, 0°							M
ROHR JKSES (Off Cushion)	"Stability and Maneuverability Report" Rohr TTP 0013A CDRL No. E03L 31 August 1978 Stability Predictions Based on Model Tests Stability Criteria Ref. RPT T2200 0001A							X	
								Y	
									Z
									K
									M
XR-1 AND VARIATIONS	"Captured Air Bubble Vehicle Stability Tests", by R.A. Wilson, DTNSRDC AIAA/SNAME Paper 67-349 (BIA #3763) Speed: Fn = 1.57 Varied: Beam, sidehull shape, bow & stern seals, centerboard and ventral fin							X	
								Y	
									Z
									K
									M
SES-100B MODEL DATA	"SES-100B Test and Evaluation Program Report", Bell Aerospace Company 17 September 1973				0° 16°			X	
		50	+6°	+1°	-4°			Y	
									Z
		80	+6°	+1.5°	-6°				K
		50	+6°	+1°	-4°				M
							N		
								X	
								Y	
								Z	
								K	
								M	
								N	

TABLE A-2. CATALOG OF SES MODEL STABILITY DATA SOURCES. (CONT'D)

CRAFT OR MODEL	REPORT TITLE AND COMMENTS	INDEPENDENT VARIABLE						
		v	α	β	γ	δ	ε	ζ
XR-1B & XR-1A MODELS	"XR-1B Turn Stability Analysis", R.A. Wilson, DTNSRDC, Tech Note SDO-OH23-44, July 1969	20 fps	2°					X
		20 fps			12°			Y
								Z
		20 fps	4°					K
		20 fps	4°					N
XR-1B MODEL	"Further Tests of a 1/7 Scale XR-1B Surface Effect Ship Model with Ventral Fins", R.L. Van Dyck, SIT, Letter Report SIT-DL-69-1440, December 1969	30.66 fps	12°		5°			X
		30.66 fps	12°		5°			Y
		30.66 fps	12°		5°			K
		30.66 fps	12°		5°			N
SES-100A	"SES-100A Testcraft Program Systems Evaluation Report", Addendum for Period August 1973 through March 1974 (U) Classified Confidential Aerojet Surface Effect Ship Division, Report No. AGC-T-456 (ADD1), 21 June 1974							X
								Y
								Z
		55 KT	1°					K
		65 KT		3°				M
SES-100A	"SES-100A Program Status Report", Aerojet Surface Effect Ships Division, Report No. AGC-T-409, 17 September 1973							X
								Y
								Z
		55 KT	6°	1.2°				K
		85 KT		4°				M
		70 KT		1.2° -0.9°	2.5°			N

TABLE A-2. CATALOG OF SES MODEL STABILITY DATA SOURCES. (CONT'D)

CRAFT OR MODEL	REPORT TITLE AND COMMENTS	INDEPENDENT VARIABLE								
		V	α	β	δ	ρ	q	r		
SES-100B Note: Data ranges shown are nominal values. In some cases the range was somewhat greater.	"Performance, Stability and Seakeeping Characteristics of a Model of the 100-B SES Testcraft, Part 3: Stability Characteristics at High Flow Rates". J.D. Adams, Stevens Institute of Technology, Report No. SIT-DL-75-1786, October 1975 (included fixed trim, free to heave tests @ 3 flow rates & 3 speeds covering an extensive matrix of yaw roll and trim angles. Additional tests were made in the hovering mode and with the model free to trim)	41.6 fps	4.1°	-1.5° to 1.5°	-6°					X
		41.6 fps	4.1°	-1.5° to 1.5°	-6°					Y
										Z
		41.6 fps	4.1°	-1.5° to 1.5°	-6°					K
		41.6 fps	4.1°	-1.5° to 1.5°	-6°					M
XR-1 & XR-3 MODELS	"Systematic Variation of Design Parameters Affecting Turn Stability of a Captured Air Bubble (CAB) Vehicle and Their Experimental Evaluation", R.A. Wilson, DTNSRDC, Tech Note SDO-W23-D4, September 1968								X	
					16°				Y	
					16°				Z	
									K	
					16°				N	
DTNSRDC ZK SES MODEL WITH 2 BOW SEAL CONFIGURATIONS	"Stability Tests on a PLS-Series of SES Models with Newly Configured Bow Seals", Gerard Fridman, SIT, Letter Report SIT-DL-71-1545, September 1971	35.1 fps	-10°	-2.6°	-8°				X	
		35.1 fps	-10°	-2.6°	-8°				Y	
									Z	
		35.1 fps	-10°	-2.6°	-8°				K	
				-2.6°	-8°				M	
ZK SES MODEL (BELL MODEL B-28)	"Stability and Seakeeping Tests of Bell B-28 Model ZKSES", R.L. Van Dyck, SIT, Letter Report SIT-DL-73-1712, December 1973	20.3 fps	4.1°	3.4°	-12°				X	
		20.3 fps	4.1°	3.4°	-12°				Y	
									Z	
		20.3 fps	4.1°	3.4°	-12°				K	
		20.3 fps	4.1°	3.4°	-12°				M	
							N			

TABLE A-2. CATALOG OF SES MODEL STABILITY DATA SOURCES. (CONT'D)

CRAFT OR MODEL	REPORT TITLE AND COMMENTS	INDEPENDENT VARIABLE								
		V	ϕ	α	β	p	q	r		
XR-1B MODEL	"Performance and Stability Tests of XR-1B SES Model", P.W. Brown W. Klosinski, SIT Report No. SIT-DL-73-1619, February 1973	30 fps		3°	10°				X	
		30 fps		+1°	10°				Y	
									Z	
					10°				K	
		30 fps		3°	10°				M	
					10°				N	
SES-100A MODEL	"Stability and Performance Tests of SES-100A Model with Modified Sidewalls and Various Size Stern Fins", R. Van Dyck, SIT, Report No. SIT-DL-75-1784, October 1975	39 fps		1.5°				X		
		39 fps			6°			Y		
								Z		
								K		
		39 fps		1.5°				M		
		39 fps	1°	1.5°	6°			N		
XR-1B MODEL	"A Stability Analysis of the XR-1B Testcraft With Ram and Flush Waterjet Inlets", R.A. Wilson, C.W. Harry, DINSRDC, Tech. Note SDO-OH23-54, April 1970	30 fps						X		
		30 fps			10°			Y		
								Z		
		30 fps	5°					K		
								M		
		30 fps	5°		8°			N		
SES-100B $\frac{61.39}{10.53} = 5.83$	"Performance, Stability and Seakeeping Characteristics of a Model of the 100-B SES Testcraft", by Gerard Fridsma, SIT Report SIT-DL-74-1673, June 1974 Tested at $F_M = 1.33, 1.90^*, 2.47$ $\lambda = 10.53$	*	+6.5°	+3.0°	0	0	0	0	X	
		*	-6.3°	-3.2°	-12°					Y
									Z	
		*	+6.5°	+3.0°	0	0	0	0	K	
		*	-6.3°	-3.2°	-12°				M	
		*	"	"	"	"	"	"	N	

A-2. EXPERIMENTAL DATA BASE

This appendix presents a selection of the most significant force and moment stability characteristics which were compiled for this present study. The most important data presented were obtained from tests of three different SES models representing craft (the XR-1B, SES-100A and SES-100B) which have seen more full-scale operational experience in U.S. waters than any other craft. All three were built for U.S. Navy research and development activities, from which a very large body of model- and full-scale experimental data have been developed.

Leading particulars of these, and other relevant craft, are presented in Table A-1.

The model data presented here were obtained from constant-forward-speed, linear-towing-tank tests, with the models free to heave but constrained in sway and pitch, roll and yaw attitude. Forces and moments at each test condition were measured using a five (5) component balance.

The three craft, their principal characteristics, the model scales, the section of this appendix in which their data is presented and the source references are given below:

SUBSECTION	CRAFT	LENGTH FT.	GROSS WT. L. TONS	MODEL SCALE, 1/λ	SOURCES	PAGE
A-2.1	XR-1B	51.5	10.0	1/7.0	DTNSRDC SEP 68 DTNSRDC APR 70 SIT FEB 73	A-11
A-2.2	SES-100A	81.9	89.3	1/12.0	AGC 17 SEP 73 SIT OCT 75A	A-18
A-2.3	SES-100B	72	93.8	1/10.53	BAT 17 SEP 73	A-23

All data presented in this appendix have been non-dimensionalized to allow a direct comparison between data from different models.

Side hull section lines are included for each model and are all drawn to a common scale to facilitate ease of comparison. The geometry of important appendages are also included for reference, in each case.

The results of a later series of tests of the SES-100B model were reported in SIT JUN 74. Wide ranges of roll, pitch and sideslip angles were covered for Froude Numbers of 1.33, 1.90 and 2.47 and the drag, side force and roll, pitch and yaw moments were measured. A fourth degree polynomial in the roll, pitch and sideslip angles was fitted to each force and moment component at each of the three tested speeds, and the results have been used in the simulation studies described in Section 3 of this report, where typical examples of the variation of force components are shown.

A-2.1 XR-1B GEOMETRY AND STABILITY CHARACTERISTICS

PAGE

(a)	Drawing of Sidehull Lines	A-11
(b)	1/7 Scale XR-1B Model Flush Inlet Fin	A-11
(c)	Drag Vs. Pitch Angle and Froude No.	A-12
(d)	Drag Vs. Yaw and Pitch Angle and Froude No.	A-12
(e)	Pitch Moment Vs. Pitch Angle and Froude No.	A-13
(f)	Pitch Moment Vs. Yaw and Pitch Angle and Froude No.	A-14
(g)	Side Force Vs. Yaw and Pitch Angle and Froude No.	A-15
(h)	Yaw Moment Vs. Yaw and Pitch Angle and Froude No.	A-16
(i)	Roll Moment Vs. Yaw and Pitch Angle and Froude No.	A-17

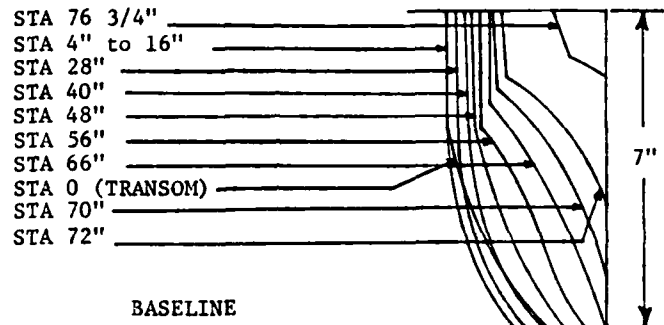

FIGURE A-2.1(a). 1/7 SCALE XR-1B MODEL FLUSH-INLET SIDEHULL LINES
(ALL STATIONS ARE IN INCHES FORWARD OF THE TRANSOM)

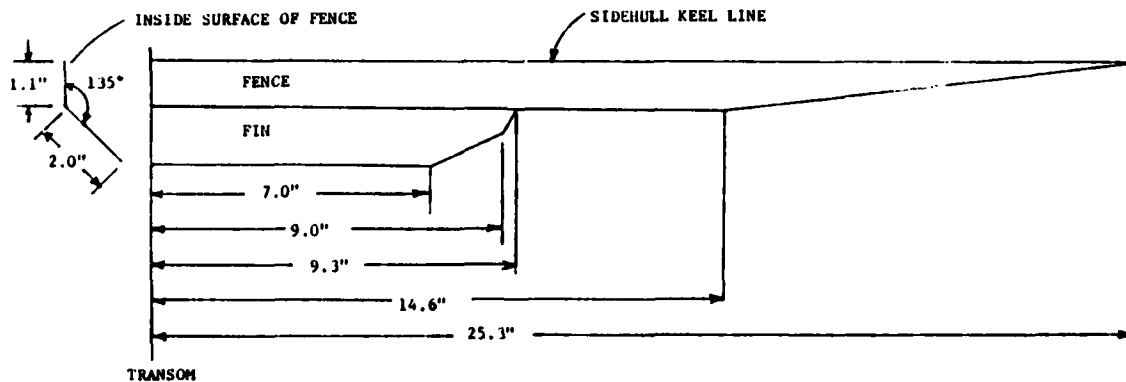

FIGURE A-2.1(b). 1/7 SCALE XR-1B MODEL FLUSH-INLET FAN.

KR-1B MODEL W = 99 LB $L_C = 5.39$ FT $H_C = 0.43$ FT $\dot{Q} = 0.0054$	$\psi = \phi = 0$, FREE TO HEAVE $L.C.G. = 52.57\% L_C$ FWD OF TRANSOM $V.C.G. = 126\%$ OF H_C ABOVE KEEL
---	--

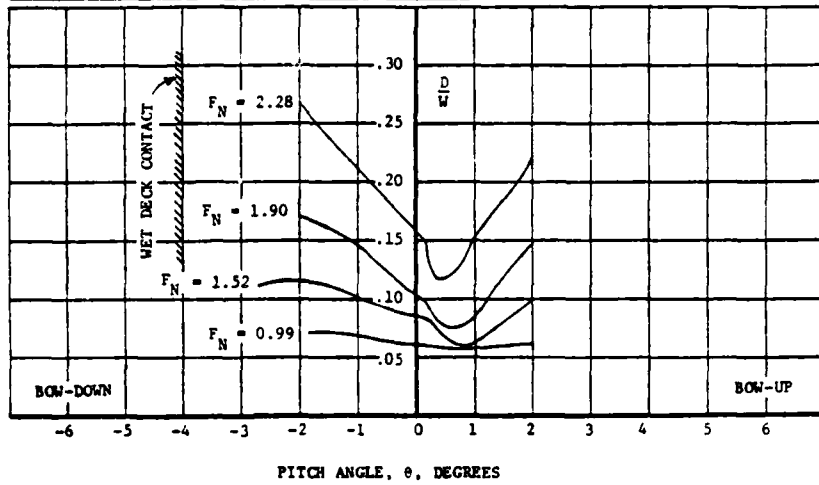

FIGURE A-2.1(c). DRAG V. PITCH ANGLE AND FROUDE NO.

KR-1B MODEL W = 99 LB $L_C = 5.39$ FT $H_C = 0.43$ FT $\dot{Q} = 0.0054$	——— $\theta = 1^\circ$ $\phi = 0$ - - - - $\theta = -1^\circ$ $\phi = 0$ $V.C.G. = 126\%$ OF H_C ABOVE KEEL $L.C.G. = 52.57\%$ OF L_C FWD OF TRANSOM. FREE TO HEAVE
---	---

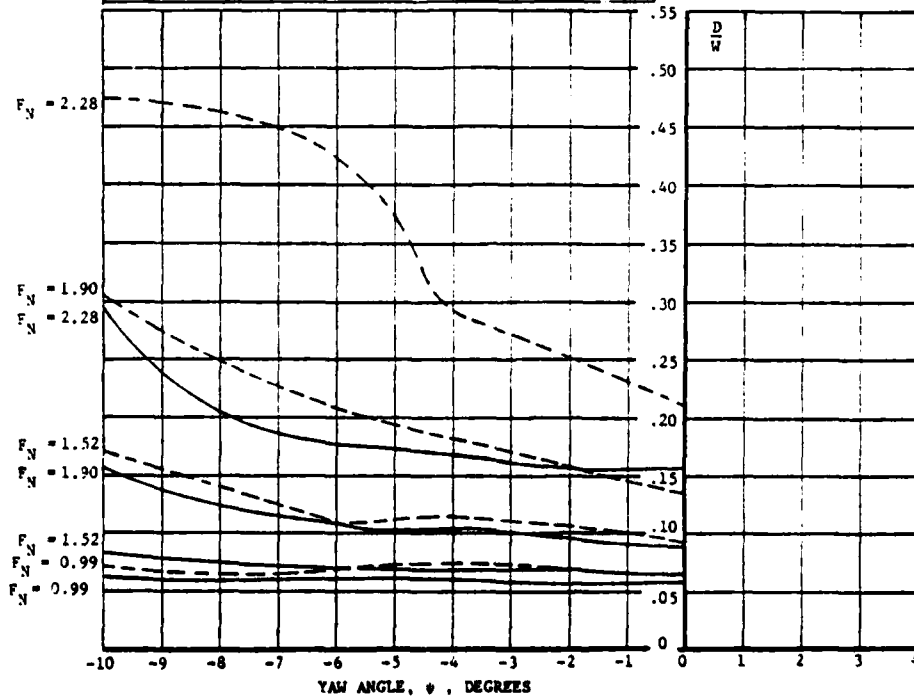

FIGURE A-2.1(d). DRAG V. YAW AND PITCH ANGLE AND FROUDE NO.

XR-1B MODEL	LCG = 52.57% OF L_c FWD OF TRANSON
$W = 99$ LB	VCG = 126% OF H_c ABOVE KEEL
$L_c = 5.39$ FT	$\psi = \dot{\psi} = 0$
$H_c = 0.43$ FT	FREE TO HEAVE
$\dot{Q} = 0.0054$	

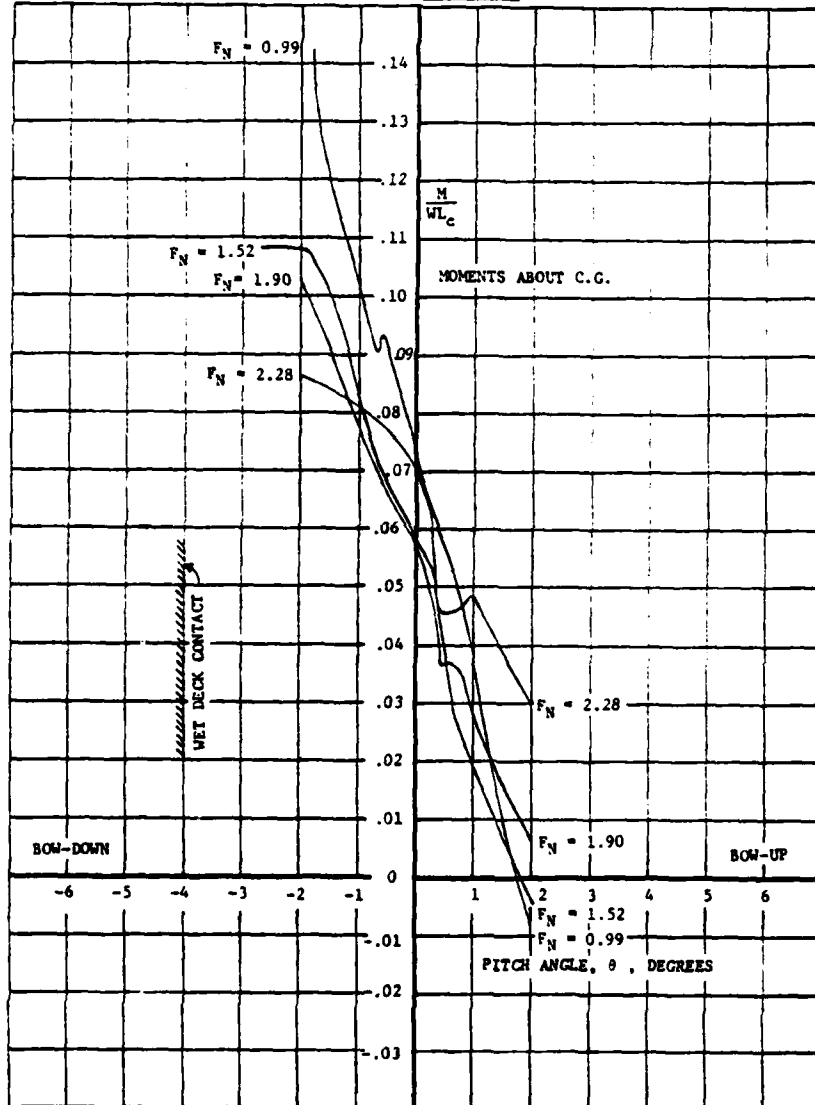

FIGURE A-2.1(e). PITCH MOMENT V. PITCH ANGLE AND FROUDE NO.

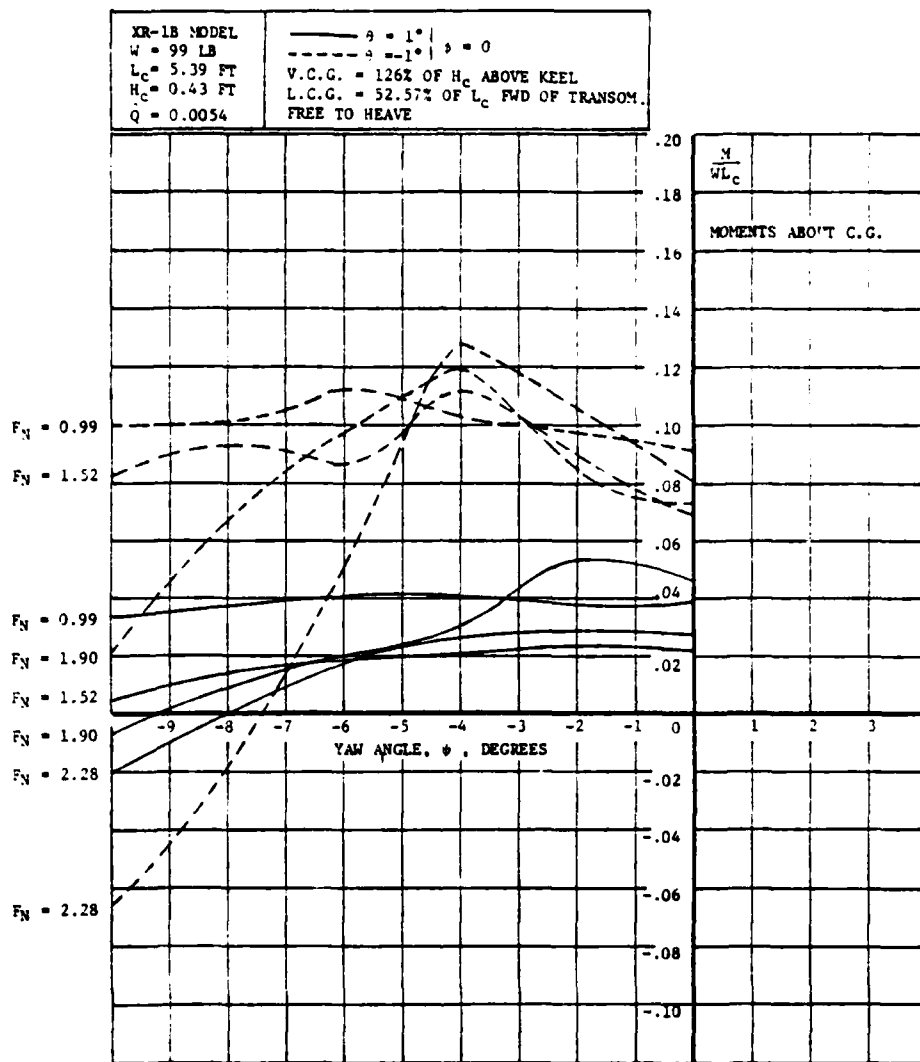

FIGURE A-2.1(f). PITCH MOMENT V. YAW AND PITCH ANGLE AND FROUDE NO.

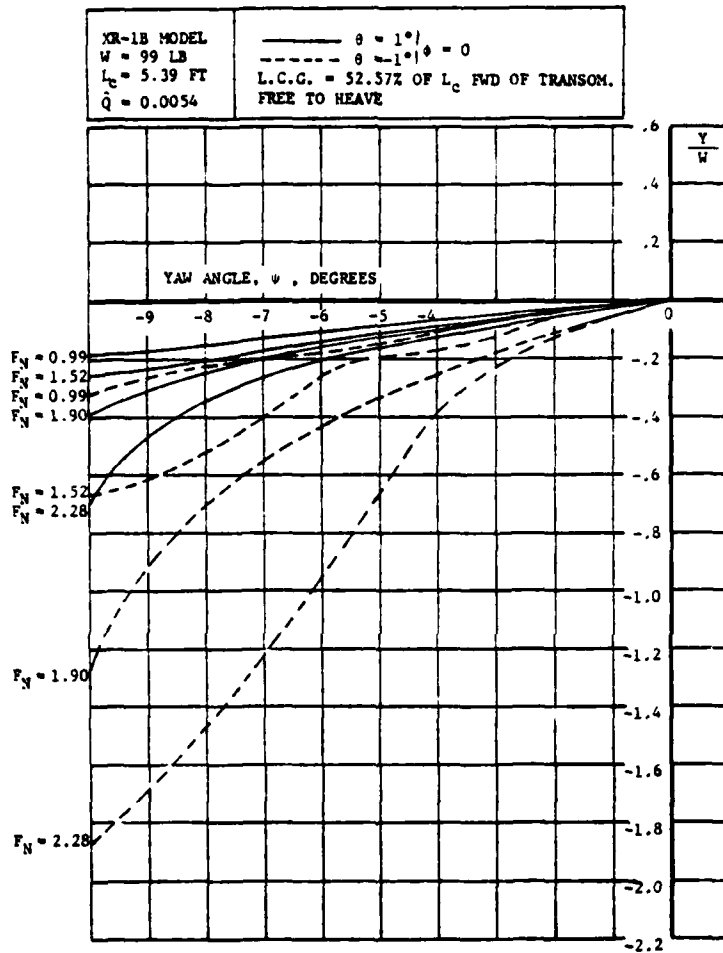

FIGURE A-2.1(g). SIDE FORCE V. YAW AND PITCH ANGLE AND FROUDE NO.

XR-1B W = 99 LB L _C = 5.39 FT H _C = 0.43 FT Q = 0.0054	———— $\theta = 1^\circ$ $\phi = 0$ - - - - - $\theta = -1^\circ$ $\phi = 0$ L.C.G. = 52.57% OF L _C FWD OF TRANSOM V.C.G. = 126% OF H _C ABOVE KEEL. FREE TO HEAVE
--	--

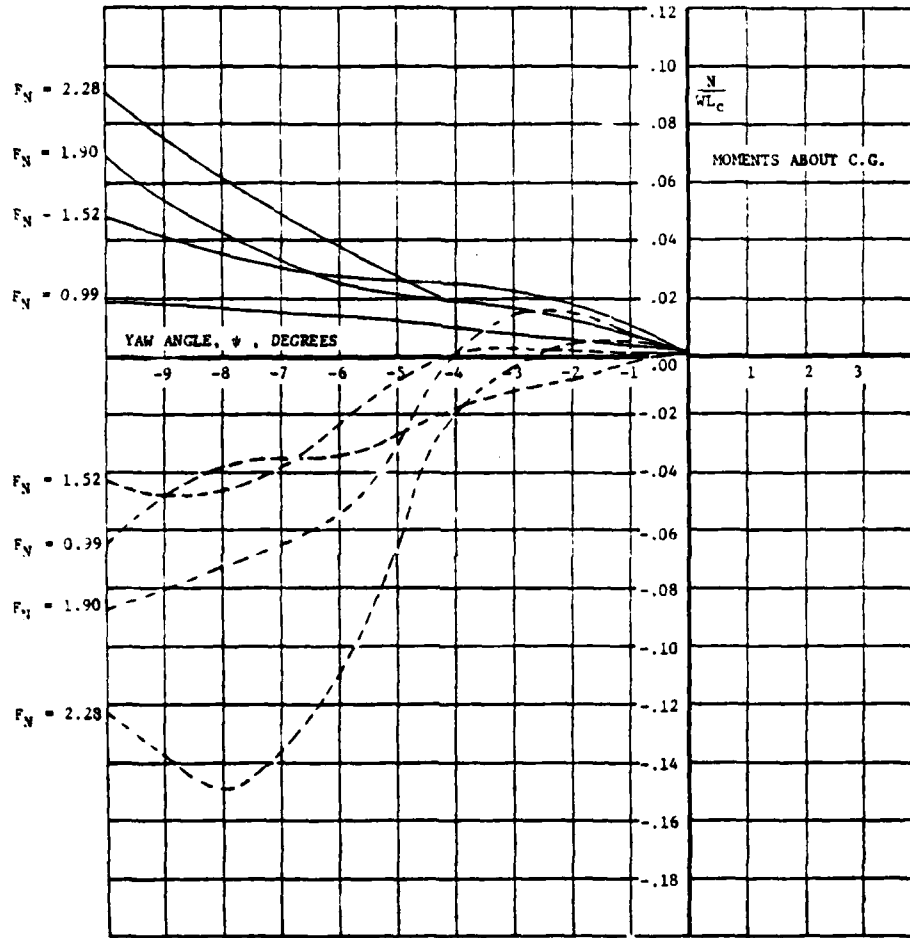

FIGURE A-2.1(h). YAW MOMENT V. YAW AND PITCH ANGLE AND FROUDE NO.

XR-1B MODEL W = 99 LB B _c = 2.14 FT L _c = 5.39 FT H _c = 0.43 FT Q = 0.0054	———— $\theta = 1^\circ$ $\phi = 0$ - - - - - $\theta = 1^\circ$ $\phi = 0$ L.C.G. = 52.57% OF L _c FWD OF TRANSOM V.C.G. = 126% OF H _c ABOVE KEEL. FREE TO HEAVE
--	---

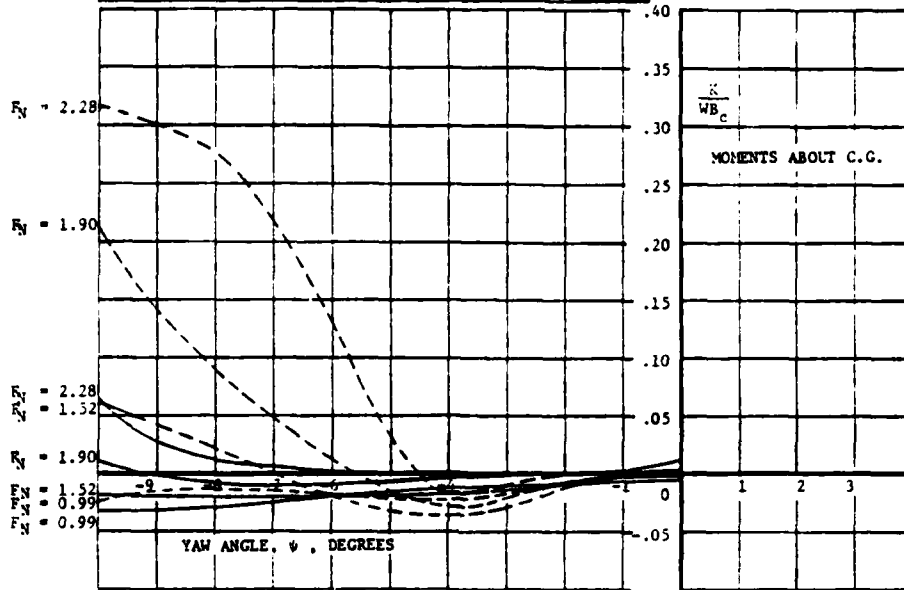
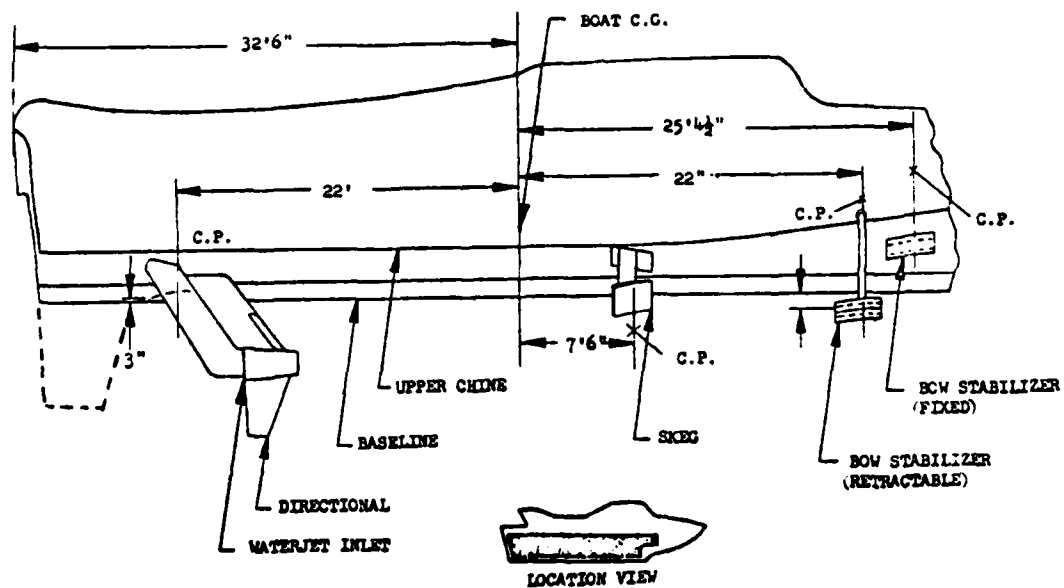

FIGURE A-2.1(i). ROLL MOMENT V. YAW AND PITCH ANGLE AND FROUDE NO.

A-2.2 SES-100A GEOMETRY AND STABILITY CHARACTERISTICS

PAGE

(a)	Location of SES-100A Appendages	A-18
(b)	1/12 Scale Model Sidehull Lines	A-19
(c)	1/12 Scale Model Stability Fins	A-19
(d)	Pitch Moment and Drag Vs. Pitch Angle and Froude No. (Flush Inlets)	A-20
(e)	Pitch Moment Vs. Pitch Angle and Froude No. (Pods)	A-21
(f)	Yaw Moment Vs. Yaw Angle and Pitch Angle @ $F_N = 1.50$ (Pods)	A-22
(g)	Yaw Moment Vs. Yaw Angle and Pitch Angle @ $F_N = 2.06$ (Pods)	A-22
(h)	Yaw Moment Vs. Yaw Angle and Pitch Angle @ $F_N = 2.62$ (Pods)	A-22



Notes: (Directional stability fin, shown dotted, now replaces pod inlet shown above, as the principal, directional stability appendage).

FIGURE A-2.2(a). LOCATION OF SES-100A APPENDAGES.

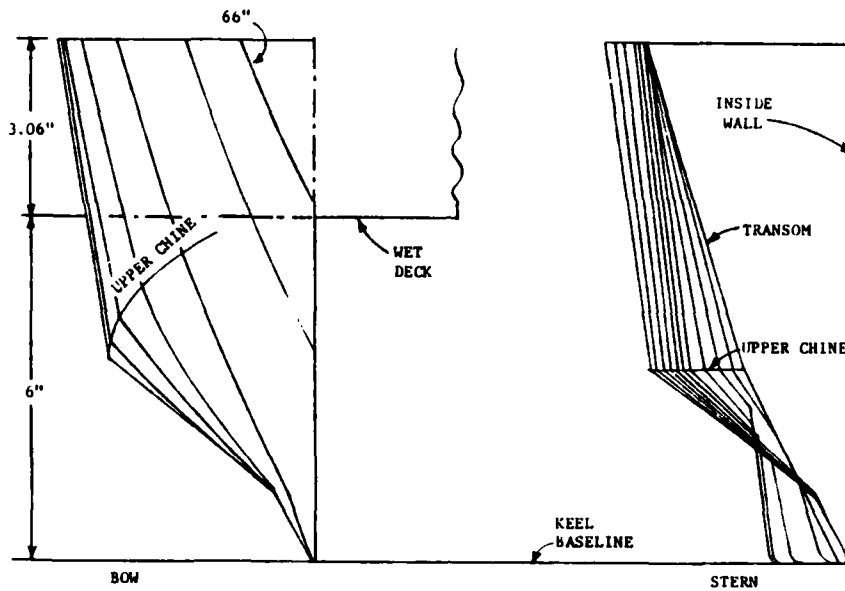

FIGURE A-2.2(b). 1/12 SCALE MODEL SES-100A FLUSH-INLET SIDEHULL LINES.

NOTE: STATIONS ARE IN 4" INCREMENTS FORWARD OF THE TRANSOM EXCEPT AS NOTED.

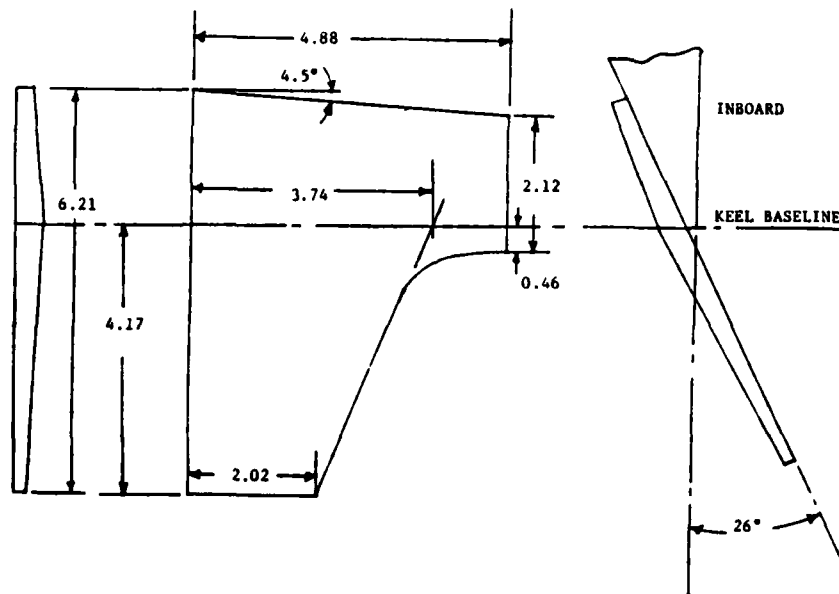

FIGURE A-2.2(c). 1/12 SCALE SES-100A MODEL STABILITY FIN LINES.
(ALL DIMENSIONS IN MODEL SCALE INCHES)

SES-100A MODEL W = 116 LB L _C = 5.26 FT H _C = 0.5 FT Q = .0103	L.C.G. = 57% OF L _C FWD OF TRANSOM V.C.G. = 136.7% OF H _C ABOVE KEEL ψ = φ = 0	WITH FLUSH INLETS
---	--	-------------------

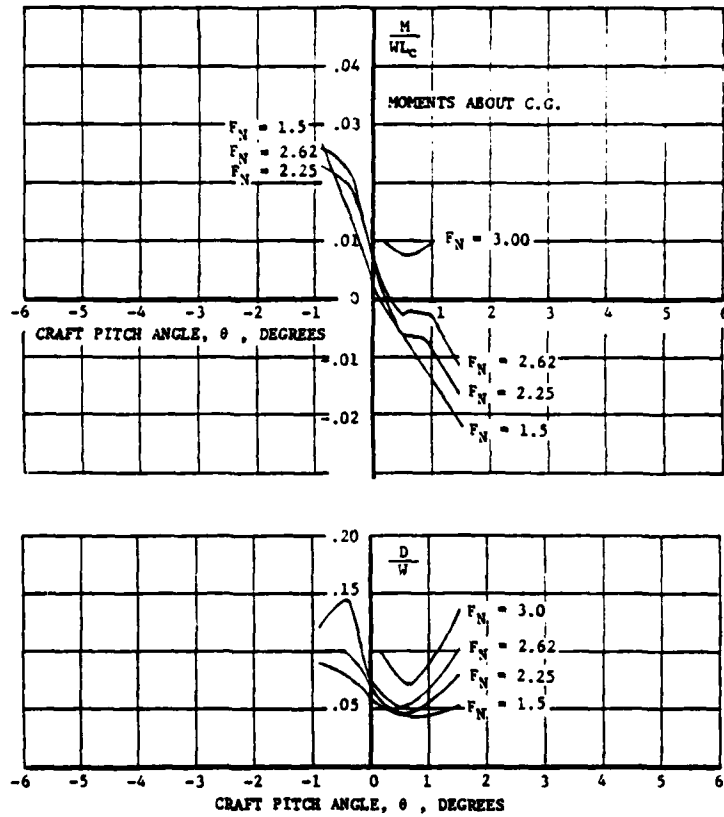

FIGURE A-2.2(d). PITCH MOMENT AND DRAG V. PITCH ANGLE AND FROUDE NO.

SES-100A MODEL W = 119.6 LB L _C = 5.26 FT H _C = 0.5 FT Q = 0.0102	L.C.G. = 55.5% OF L _C FWD OF TRANSOM V.C.G. = 136.7% OF H _C ABOVE KEEL ψ = φ = 0	WITH STRUT-MOUNTED PODS
--	--	----------------------------

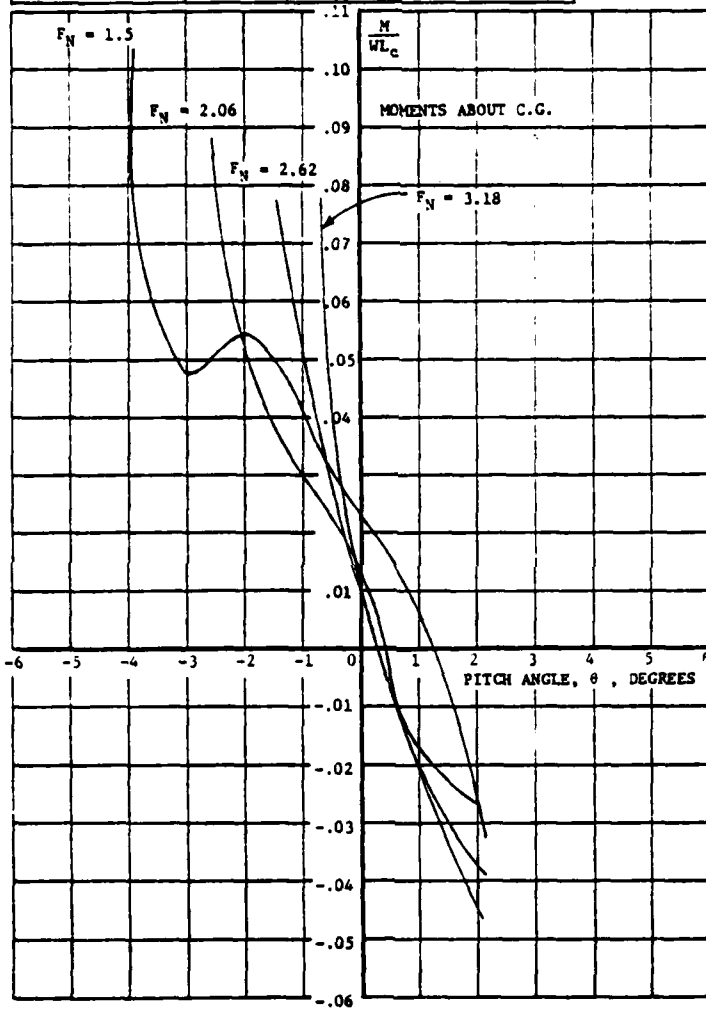

FIGURE A-2.2(e). PITCH MOMENT V. PITCH ANGLE AND FROUDE NO.

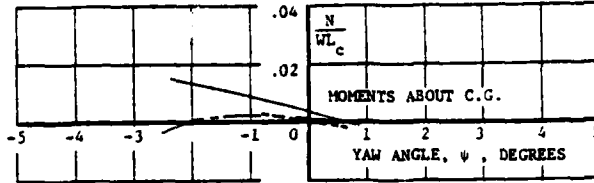
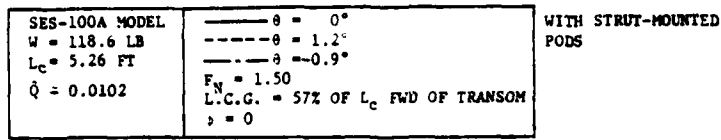

FIGURE A-2.2(f). YAW MOMENT V. YAW ANGLE AND PITCH ANGLE @ $F_N = 1.50$ (PODS).

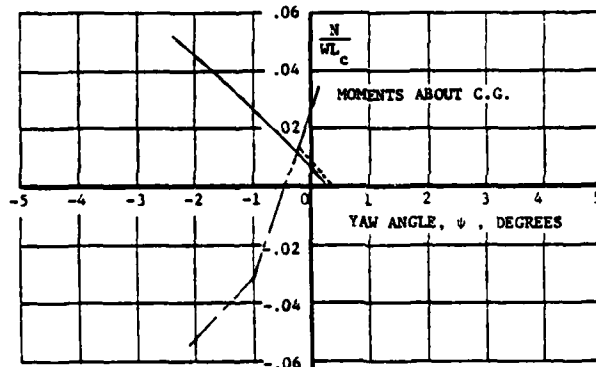
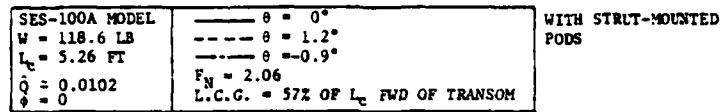

FIGURE A-2.2(g). YAW MOMENT V. YAW ANGLE AND PITCH ANGLE @ $F_N = 2.06$ (PODS).

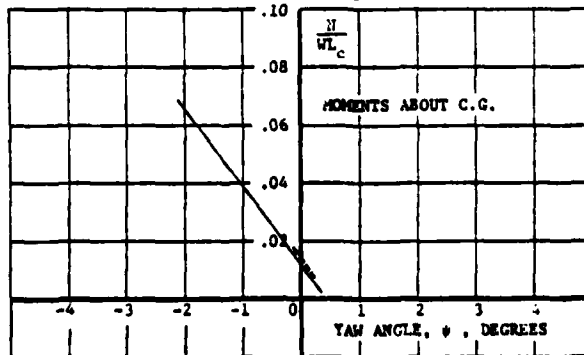
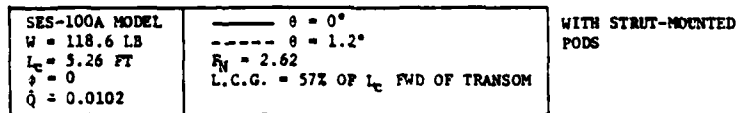

FIGURE A-2.2(h). YAW MOMENT V. YAW ANGLE AND PITCH ANGLE @ $F_N = 2.62$ (PODS).

<u>A-2.3 SES-100B GEOMETRY AND STABILITY CHARACTERISTICS</u>		<u>PAGE</u>
(a)	1/10.53 Scale Model Sidehull Lines	A-24
(b)	Station Locations for 1/10.53 Scale Model	A-24
(c)	Arrangement and Location of Stability Fins and Rudders	A-25
(d)	Drag and Pitch Moment Vs. Pitch Angle and Froude No.	A-26
(e)	Pitch Moment Vs. Roll and Yaw Angle ($\theta = +1^\circ$, $F_N = 1.90$)	A-27
(f)	Pitch Moment Vs. Roll and Yaw Angle ($\theta = -1^\circ$, $F_N = 1.90$)	A-27
(g)	Side Force Vs. Roll and Yaw Angle ($\theta = +1^\circ$, $F_N = 1.90$)	A-28
(h)	Side Force Vs. Roll and Yaw Angle ($\theta = -1^\circ$, $F_N = 1.90$)	A-28
(i)	Yaw Moment Vs. Roll and Yaw Angle ($\theta = +1^\circ$, $F_N = 1.90$)	A-29
(j)	Yaw Moment Vs. Roll and Yaw Angle ($\theta = -1^\circ$, $F_N = 1.90$)	A-29
(k)	Yaw Moment Vs. Yaw and Roll Angle ($\theta = +1.5^\circ$, $F_N = 2.47$)	A-30
(l)	Yaw Moment Vs. Yaw and Roll Angle ($\theta = +0.5^\circ$, $F_N = 2.47$)	A-30
(m)	Yaw Moment Vs. Yaw and Roll Angle ($\theta = -0.5^\circ$, $F_N = 2.47$)	A-31
(n)	Yaw Moment Vs. Yaw and Roll Angle ($\theta = -1.5^\circ$, $F_N = 2.47$)	A-31
(o)	Yaw Moment Vs. Yaw and Roll Angle ($\theta = +1.5^\circ$, $F_N = 3.04$)	A-32
(p)	Yaw Moment Vs. Yaw and Roll Angle ($\theta = +0.5^\circ$, $F_N = 3.04$)	A-32
(q)	Yaw Moment Vs. Yaw and Roll Angle ($\theta = -0.5^\circ$, $F_N = 3.04$)	A-33
(r)	Yaw Moment Vs. Yaw and Roll Angle ($\theta = -1.5^\circ$, $F_N = 3.04$)	A-33
(s)	Roll Moment Vs. Roll and Yaw Angle ($\theta = +1^\circ$, $F_N = 1.90$)	A-34
(t)	Roll Moment Vs. Roll and Yaw Angle ($\theta = -1^\circ$, $F_N = 1.90$)	A-34
(u)	Roll Moment Vs. Roll and Yaw Angle ($\theta = +1.5^\circ$, $F_N = 2.47$)	A-35
(v)	Roll Moment Vs. Roll and Yaw Angle ($\theta = +0.5^\circ$, $F_N = 2.47$)	A-35
(w)	Roll Moment Vs. Roll and Yaw Angle ($\theta = -0.5^\circ$, $F_N = 2.47$)	A-36
(x)	Roll Moment Vs. Roll and Yaw Angle ($\theta = -1.5^\circ$, $F_N = 2.47$)	A-36
(y)	Roll Moment Vs. Roll and Yaw Angle ($\theta = +1.5^\circ$, $F_N = 3.04$)	A-37
(z)	Roll Moment Vs. Roll and Yaw Angle ($\theta = +0.5^\circ$, $F_N = 3.04$)	A-37
(aa)	Roll Moment Vs. Roll and Yaw Angle ($\theta = -0.5^\circ$, $F_N = 3.04$)	A-38
(bb)	Roll Moment Vs. Roll and Yaw Angle ($\theta = -1.5^\circ$, $F_N = 3.04$)	A-38

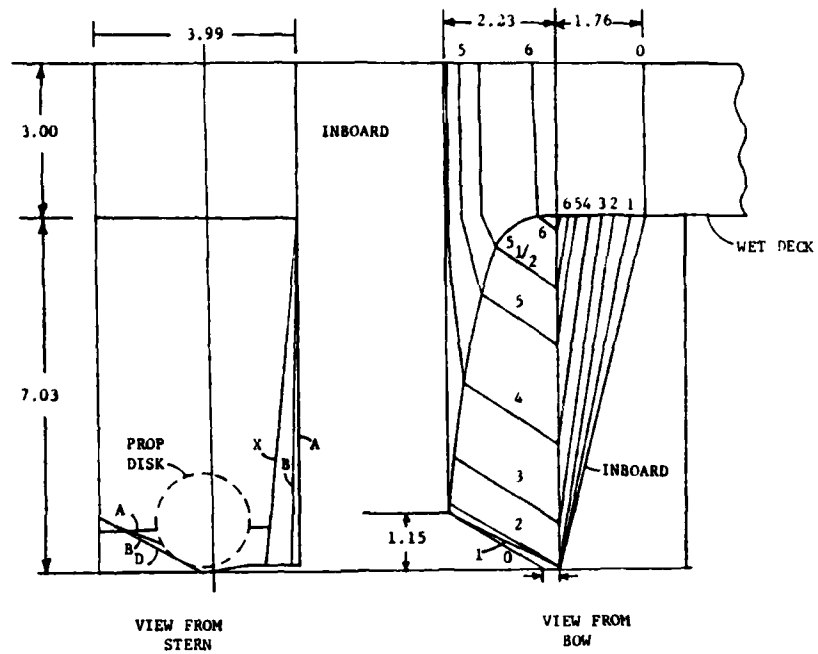

FIGURE A-2.3(a). 1/10.53 SCALE SES-100B MODEL SIDEHULL LINES.
(ALL MODEL DIMENSIONS IN INCHES)

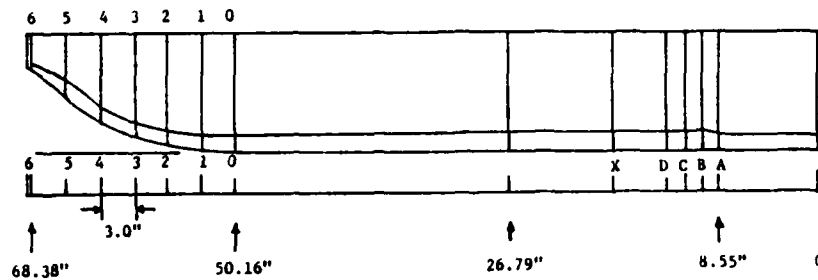

FIGURE A-2.3(b). 1/10.53 SCALE SES-100B MODEL SIDEHULL STATION LOCATIONS.

$$C_{V_R} = \frac{\text{RUD. NORMAL FORCE (LBS)}}{q_w S_R}$$

$$C_{M_R} = \frac{\text{RUD. POST MOMENT (FT.LBS)}}{q_w S_R \bar{c}}$$

$$q_w = \text{CRAFT WATER DYNAMIC PRESS. (LB/FT}^2\text{)}$$

$$S_F = \text{FIN AREA} = 9.0 \text{ FT}^2$$

$$S_R = \text{RUD. AREA} = 6.36 \text{ FT}^2$$

$$\bar{c} = \text{RUD. MEAN CHD} = 2.06 \text{ FT}^2$$

$$\beta_c = \text{CORRECTED SIDESLIP AT CG}$$

$$= \beta_m - \left(\frac{15}{1.689 V} \right) r \text{ (DEG)}$$

$$R_c = \text{EFFECTIVE FIN ASPECT RATIO}$$

$$= 2.0$$

$$dC_{N_F}/d\alpha_f = 3.10/\text{RAD.}^*$$

$$e_f = \frac{(dC_{N_F}) \cos(\tau)}{d\alpha_f + R_c}$$

$$e_R = 2.0 e_f \cos(\tau)$$

$$= .74$$

THEN

$$\alpha_R = (1 - e_R) \beta_c - \delta_R + \left(\frac{26.0}{1.689 V} \right) r$$

$$= .26 \beta_c - \delta_R + 15.3 \frac{r}{V}$$

WHERE r = YAW RATE (DEG/SEC) V = SPEED (kts)

* ASSUMED SAME AS FOR RUDDER VALUE MEASURED IN WATER CHANNEL TESTS

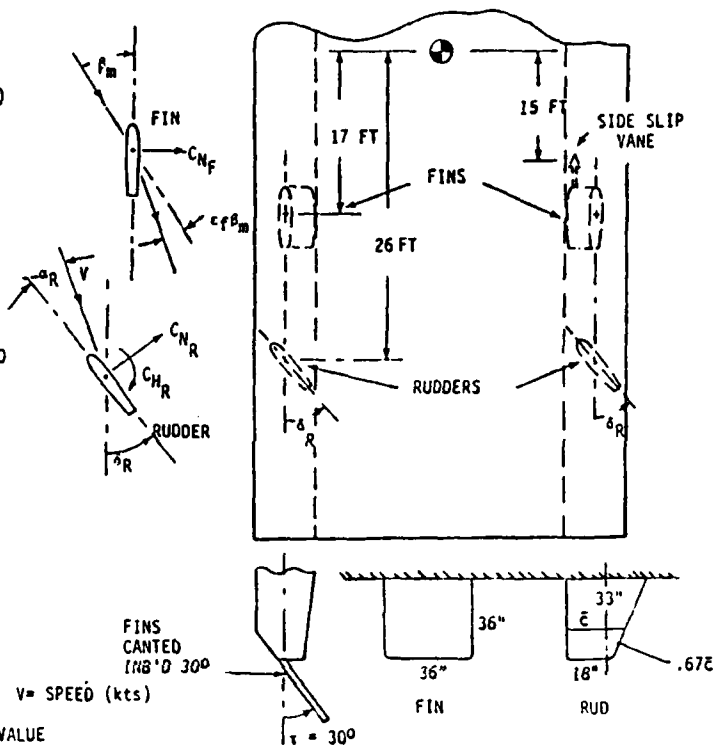

EQUATIONS USED TO CALCULATE RUDDER COEFFICIENTS

FIGURE A-2.3(c). ARRANGEMENT AND LOCATION OF SES-100B STABILITY FINS AND RUDDERS.

SES-100B MODEL	$\psi = \dot{\psi} = 0$
W = 153 LB	FREE TO HEAVE
$L_c = 5.82$ FT	L.C.G. = 53.05 L_c FWD OF TRANSOM
$H_c = 0.58$ FT	V.C.G. = 114.7% OF H_c ABOVE KEEL
$\dot{Q} = 0.0077$	

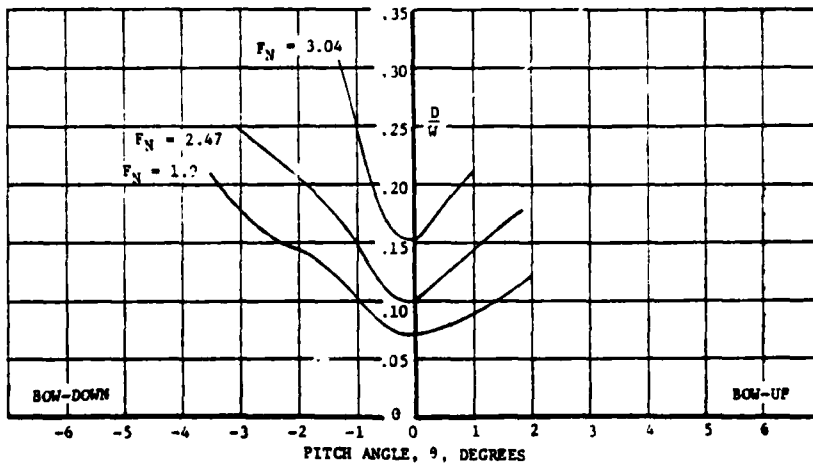
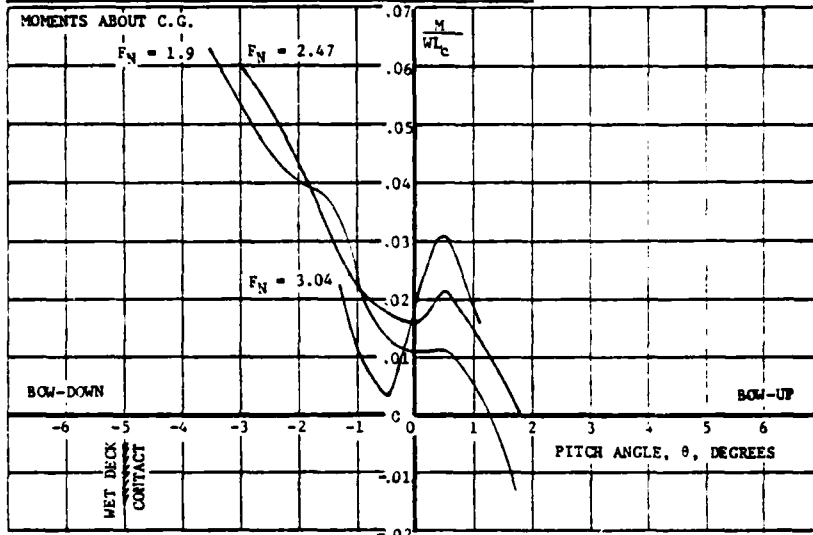

FIGURE A-2.3(d). DRAG AND PITCH MOMENT V. PITCH ANGLE AND FROUDE NO.

SES-100B MODEL	<table border="0"> <tr> <td>—————</td> <td>$\psi = 0^\circ$</td> <td rowspan="3">} $\theta = +1^\circ$</td> </tr> <tr> <td>- - - - -</td> <td>$\psi = -2^\circ$</td> </tr> <tr> <td>—————</td> <td>$\psi = -4^\circ$</td> </tr> </table>	—————	$\psi = 0^\circ$	} $\theta = +1^\circ$	- - - - -	$\psi = -2^\circ$	—————	$\psi = -4^\circ$
—————	$\psi = 0^\circ$	} $\theta = +1^\circ$						
- - - - -	$\psi = -2^\circ$							
—————	$\psi = -4^\circ$							
W = 153 LB	$F_N = 1.90$							
$L_c = 5.72$ FT	L.C.G. = 53.05% OF L_c FWD OF TRANSON.							
$H_c = 0.58$ FT	V.C.G. = 114.7% OF H_c ABOVE KEEL.							
$Q = 0.0077$	FREE TO HEAVE							

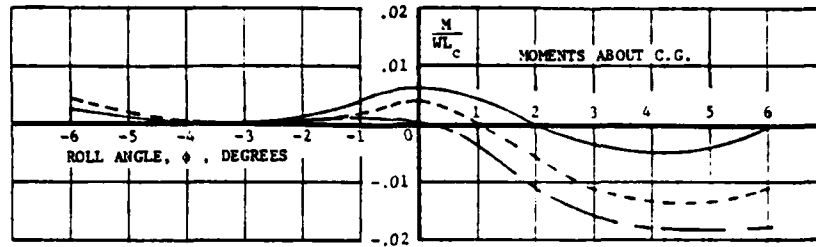

FIGURE A-2.3(e). PITCH MOMENT V. ROLL AND YAW ANGLE, $\theta = +1^\circ$.

SES-100B MODEL	<table border="0"> <tr> <td>—————</td> <td>$\psi = 0^\circ$</td> <td rowspan="3">} $\theta = -1^\circ$</td> </tr> <tr> <td>- - - - -</td> <td>$\psi = -2^\circ$</td> </tr> <tr> <td>—————</td> <td>$\psi = -4^\circ$</td> </tr> </table>	—————	$\psi = 0^\circ$	} $\theta = -1^\circ$	- - - - -	$\psi = -2^\circ$	—————	$\psi = -4^\circ$
—————	$\psi = 0^\circ$	} $\theta = -1^\circ$						
- - - - -	$\psi = -2^\circ$							
—————	$\psi = -4^\circ$							
W = 153 LB	$F_N = 1.9$							
$L_c = 5.82$ FT	L.C.G. = 53.05% OF L_c FWD OF TRANSON							
$H_c = 0.58$ FT	V.C.G. = 115.7% OF H_c ABOVE KEEL.							
$Q = 0.0077$	FREE TO HEAVE							
$F_n = 1.9$								

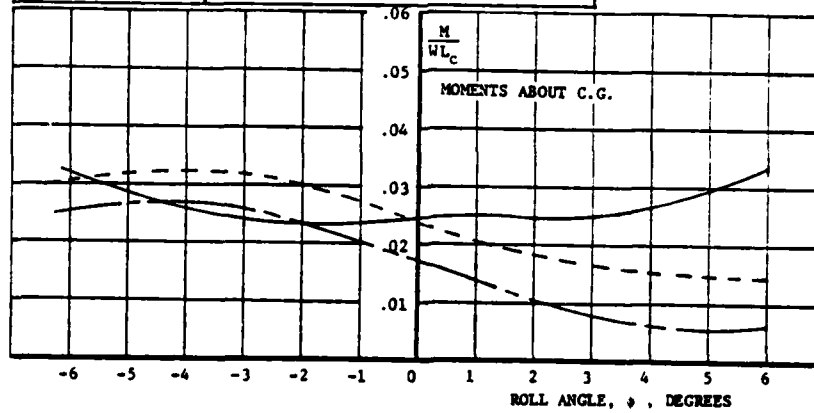

FIGURE A-2.3(f). PITCH MOMENT V. ROLL AND YAW ANGLE, $\theta = -1^\circ$.

SES-100B MODEL	<table border="0"> <tr> <td>—</td> <td>$\psi = 0^\circ$</td> <td rowspan="3">} $\theta = 1^\circ$</td> </tr> <tr> <td>- - -</td> <td>$\psi = -2^\circ$</td> </tr> <tr> <td>- - -</td> <td>$\psi = -4^\circ$</td> </tr> </table>	—	$\psi = 0^\circ$	} $\theta = 1^\circ$	- - -	$\psi = -2^\circ$	- - -	$\psi = -4^\circ$
—	$\psi = 0^\circ$	} $\theta = 1^\circ$						
- - -	$\psi = -2^\circ$							
- - -	$\psi = -4^\circ$							
W = 153 LB	$F_N = 1.90$							
Q = 0.0077	FREE TO HEAVE							

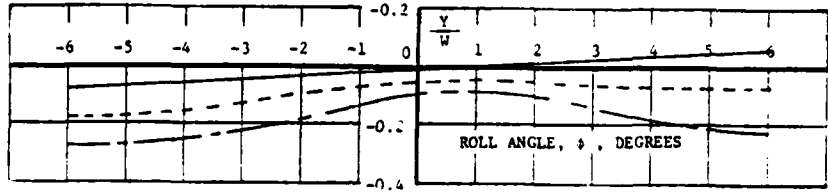

FIGURE A-2.3(g). SIDE FORCE V. ROLL AND YAW ANGLE, $\theta = 1^\circ$.

SES-100B MODEL	<table border="0"> <tr> <td>—</td> <td>$\psi = 0^\circ$</td> <td rowspan="3">} $\theta = -1^\circ$</td> </tr> <tr> <td>- - -</td> <td>$\psi = -2^\circ$</td> </tr> <tr> <td>- - -</td> <td>$\psi = -4^\circ$</td> </tr> </table>	—	$\psi = 0^\circ$	} $\theta = -1^\circ$	- - -	$\psi = -2^\circ$	- - -	$\psi = -4^\circ$
—	$\psi = 0^\circ$	} $\theta = -1^\circ$						
- - -	$\psi = -2^\circ$							
- - -	$\psi = -4^\circ$							
W = 153 LB	$F_N = 1.9$							
$L_c = 5.82$ FT								
Q = 0.0077	FREE TO HEAVE							

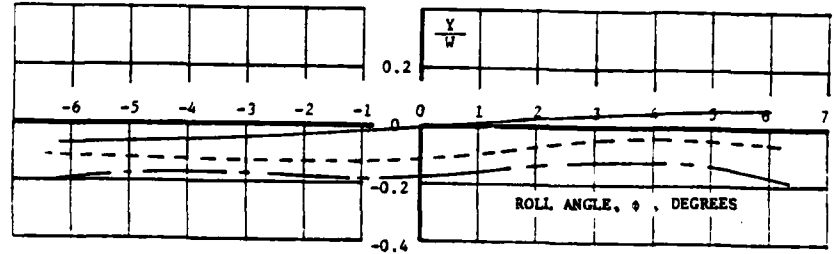

FIGURE A-2.3(h). SIDE FORCE V. ROLL AND YAW ANGLE, $\theta = -1^\circ$.

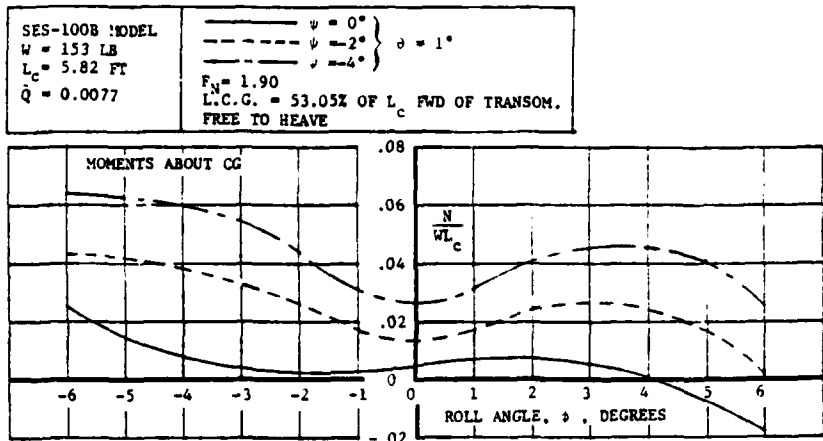

FIGURE A-2.3(i). YAW MOMENT V. ROLL AND YAW ANGLE, $\theta = 1^\circ$

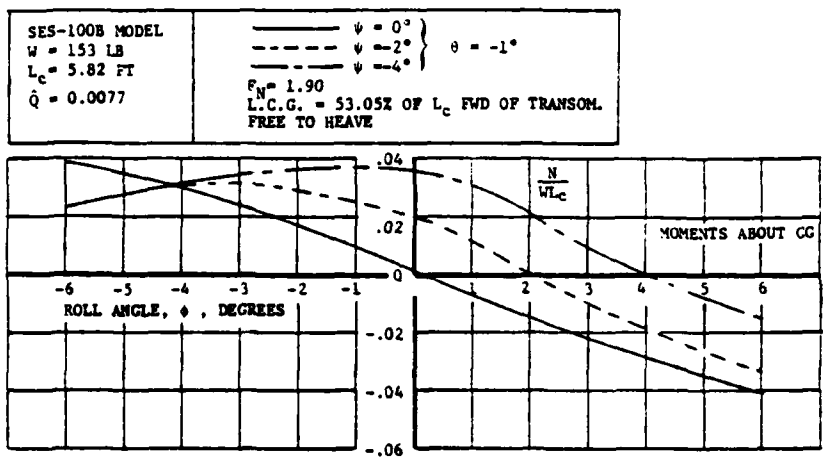

FIGURE A-2.3(j). YAW MOMENT V. ROLL AND YAW ANGLE, $\theta = -1^\circ$

SES-100B MODEL	$\theta = +1.5^\circ$ $F_N = 2.47$ L.C.G. = 53.05% OF L_C FWD OF TRANSON. FREE TO HEAVE
$W = 153$ LB	
$L_C = 5.82$ FT	
$\dot{Q} = 0.0077$	

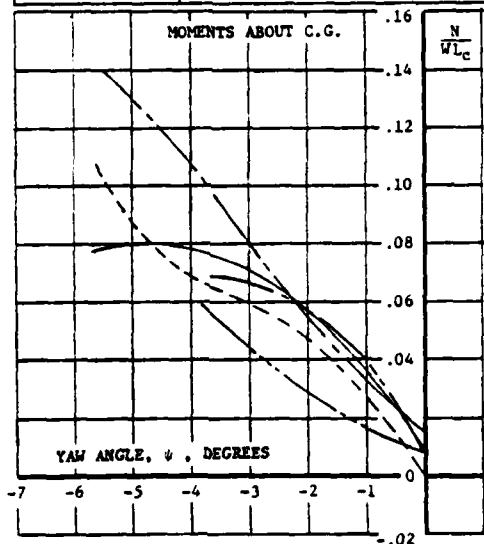

FIGURE A-2.3(k). YAW MOMENT V. YAW AND ROLL ANGLE, $\theta = +1.5^\circ$.

SES-100B MODEL	$\theta = +0.5^\circ$ $F_N = 2.47$ L.C.G. = 53.05% OF L_C FWD OF TRANSON. FREE TO HEAVE
$W = 153$ LB	
$L_C = 5.82$ FT	
$\dot{Q} = 0.0077$	

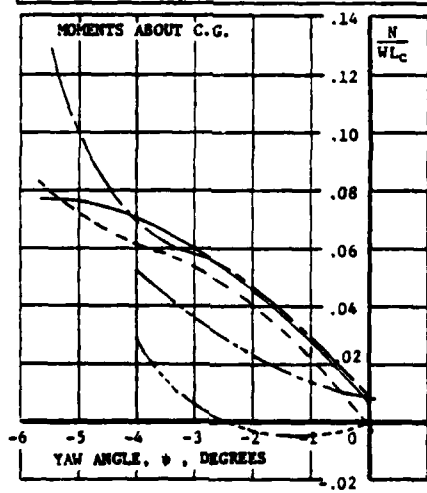

FIGURE A-2.3(l). YAW MOMENT V. YAW AND ROLL ANGLE, $\theta = +1.5^\circ$.

SES-100B MODEL	$\left. \begin{array}{l} \text{---} \phi = 0^\circ \\ \text{- - -} \phi = 2^\circ \\ \text{- - -} \phi = 4^\circ \\ \text{- - -} \phi = -2^\circ \\ \text{- - -} \phi = -4^\circ \end{array} \right\} \theta = -0.5^\circ$
W = 153 LB	
L _c = 5.82 FT	
Q̇ = 0.0077	
	$F_N = 2.47$ L.C.G. = 53.05% OF L _c FWD OF TRANSON. FREE TO HEAVE

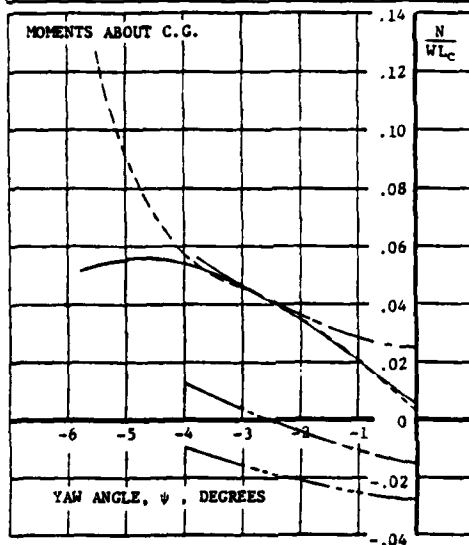

FIGURE A-2.3(m). YAW MOMENT V. YAW AND ROLL ANGLE, $\theta = -0.5^\circ$.

SES-100B MODEL	$\left. \begin{array}{l} \text{---} \phi = 0^\circ \\ \text{- - -} \phi = 2^\circ \\ \text{- - -} \phi = 4^\circ \\ \text{- - -} \phi = -2^\circ \\ \text{- - -} \phi = -4^\circ \end{array} \right\} \theta = -1.5^\circ$
W = 153 LB	
L _c = 5.82 FT	
Q̇ = 0.0077	
	$F_N = 2.47$ L.C.G. = 53.05% OF L _c OF FWD OF TRANSON. FREE TO HEAVE

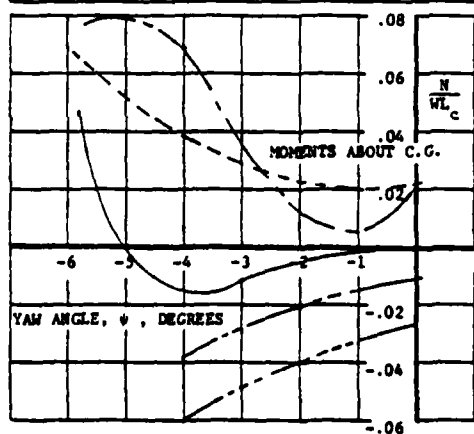

FIGURE A-2.3(n). YAW MOMENT V. YAW AND ROLL ANGLE, $\theta = -1.5^\circ$.

SES-100B MODEL $W = 153 \text{ LB}$ $L_c = 5.82 \text{ FT}$ $\dot{Q} = 0.0077$	<table border="0"> <tr> <td>—</td> <td>$\phi = 0^\circ$</td> <td rowspan="6">} $\theta = +1.5^\circ$</td> </tr> <tr> <td>- - -</td> <td>$\phi = 2^\circ$</td> </tr> <tr> <td>- - -</td> <td>$\phi = 4^\circ$</td> </tr> <tr> <td>- - -</td> <td>$\phi = -2^\circ$</td> </tr> <tr> <td>- - -</td> <td>$\phi = -4^\circ$</td> </tr> <tr> <td>- - -</td> <td>$\phi = -4^\circ$</td> </tr> </table>	—	$\phi = 0^\circ$	} $\theta = +1.5^\circ$	- - -	$\phi = 2^\circ$	- - -	$\phi = 4^\circ$	- - -	$\phi = -2^\circ$	- - -	$\phi = -4^\circ$	- - -	$\phi = -4^\circ$
—	$\phi = 0^\circ$	} $\theta = +1.5^\circ$												
- - -	$\phi = 2^\circ$													
- - -	$\phi = 4^\circ$													
- - -	$\phi = -2^\circ$													
- - -	$\phi = -4^\circ$													
- - -	$\phi = -4^\circ$													
$F_N = 3.04$ L.C.G. = 53.05% OF L_c FWD OF TRANSON. FREE TO HEAVE														

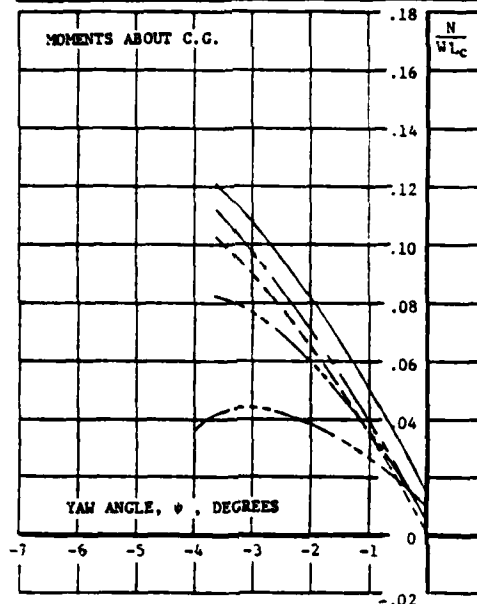

FIGURE A-2.3(o). YAW MOMENT V. YAW AND ROLL ANGLE, $\theta = +1.5^\circ$.

SES-100B MODEL $W = 153 \text{ LB}$ $L_c = 5.82 \text{ FT}$ $\dot{Q} = 0.0077$	<table border="0"> <tr> <td>—</td> <td>$\phi = 0^\circ$</td> <td rowspan="6">} $\theta = +0.5^\circ$</td> </tr> <tr> <td>- - -</td> <td>$\phi = 2^\circ$</td> </tr> <tr> <td>- - -</td> <td>$\phi = 4^\circ$</td> </tr> <tr> <td>- - -</td> <td>$\phi = -2^\circ$</td> </tr> <tr> <td>- - -</td> <td>$\phi = -4^\circ$</td> </tr> <tr> <td>- - -</td> <td>$\phi = -4^\circ$</td> </tr> </table>	—	$\phi = 0^\circ$	} $\theta = +0.5^\circ$	- - -	$\phi = 2^\circ$	- - -	$\phi = 4^\circ$	- - -	$\phi = -2^\circ$	- - -	$\phi = -4^\circ$	- - -	$\phi = -4^\circ$
—	$\phi = 0^\circ$	} $\theta = +0.5^\circ$												
- - -	$\phi = 2^\circ$													
- - -	$\phi = 4^\circ$													
- - -	$\phi = -2^\circ$													
- - -	$\phi = -4^\circ$													
- - -	$\phi = -4^\circ$													
$F_N = 3.04$ L.C.G. = 53.05% OF L_c FWD OF TRANSON. FREE TO HEAVE														

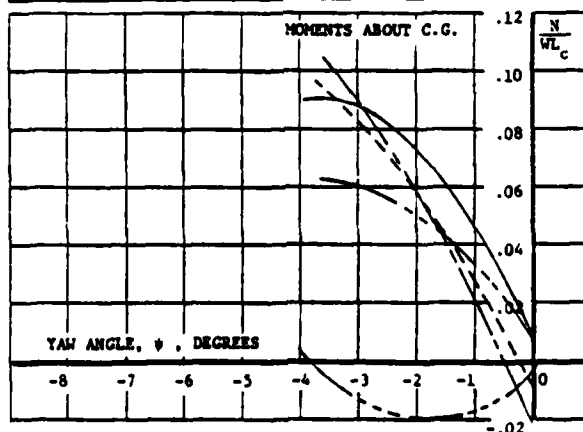

FIGURE A-2.3(p). YAW MOMENT V. YAW AND ROLL ANGLE, $\theta = +0.5^\circ$.

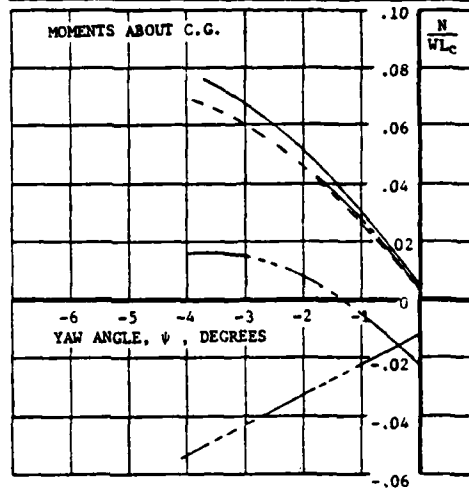
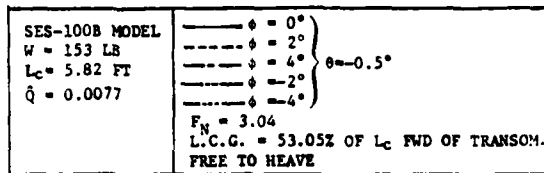

FIGURE A-2.3(q). YAW MOMENT V. YAW AND ROLL ANGLE, $\theta = -0.5^\circ$.

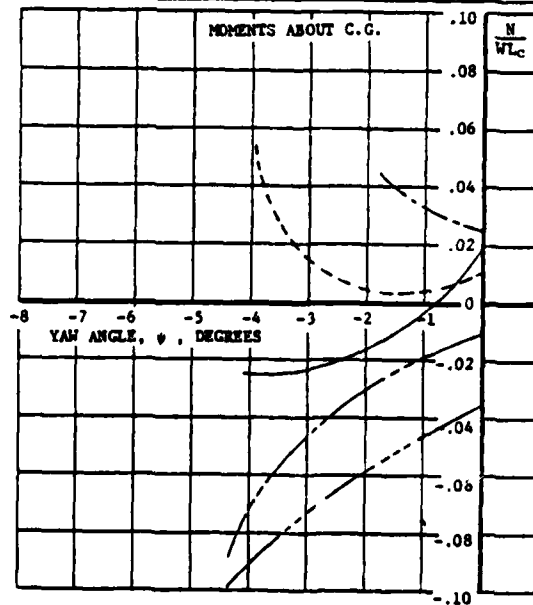
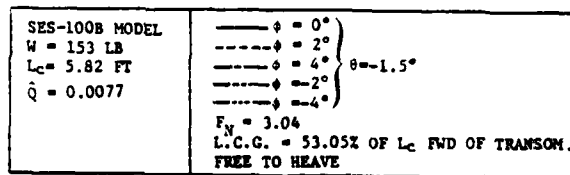

FIGURE A-2.3(r). YAW MOMENT V. YAW AND ROLL ANGLE, $\theta = -1.5^\circ$.

SES-100B MODEL	$\psi = 0^\circ$ $\psi = -2^\circ$ $\psi = -4^\circ$	$\theta = +1^\circ$
$W = 153 \text{ LB}$ $B_c = 2.95 \text{ FT}$ $H_c = 0.58 \text{ FT}$ $Q = 0.0077$	$F_N = 1.90$ $V.C.G. = 114.7\% H_c \text{ ABOVE KEEL.}$ FREE TO HEAVE	

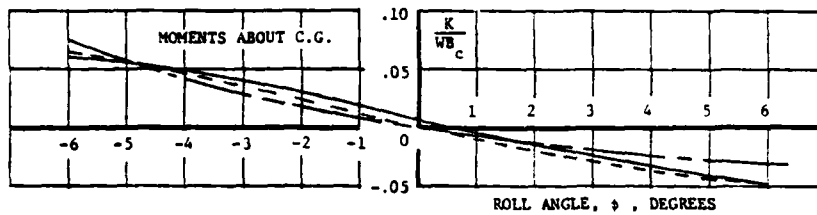

FIGURE A-2.3(s). ROLL MOMENT V. ROLL AND YAW ANGLE, $\theta = +1^\circ$.

SES-100B MODEL	$\psi = 0^\circ$ $\psi = -2^\circ$ $\psi = -4^\circ$	$\theta = -1^\circ$
$W = 153 \text{ LB}$ $B_c = 2.95 \text{ FT}$ $H_c = 0.58 \text{ FT}$ $Q = 0.0077$	$F_N = 1.90$ $V.C.G. = 114.7\% \text{ of } H_c \text{ ABOVE KEEL.}$ FREE TO HEAVE	

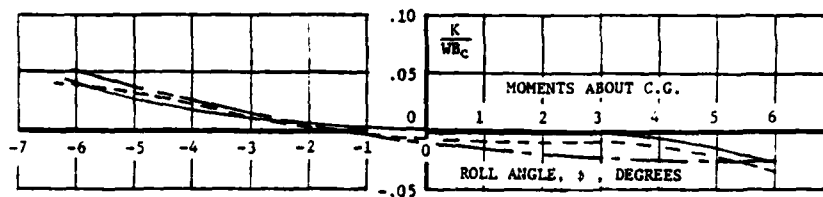

FIGURE A-2.3(t). ROLL MOMENT V. ROLL AND YAW ANGLE, $\theta = -1^\circ$.

SES-100B MODEL	$\psi = 0^\circ$ $\psi = -2^\circ$ $\psi = -4^\circ$ $\psi = -6^\circ$	$\theta = +1.5^\circ$
$W = 153 \text{ LB}$ $B_c = 2.95 \text{ FT}$ $H_c = 0.58 \text{ FT}$ $\bar{Q} = 0.0077$	$F_N = 2.47$ V.C.G. = 114.7% OF H_c ABOVE KEEL. FREE TO HEAVE	

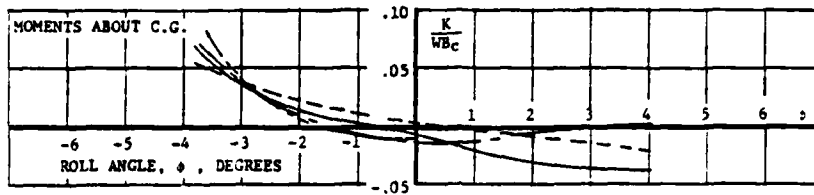

FIGURE A-2.3(u). ROLL MOMENT V. ROLL AND YAW ANGLE, $\theta = +1.5^\circ$;
 $F_N = 2.47$.

SES-100B MODEL	$\psi = 0^\circ$ $\psi = -2^\circ$ $\psi = -4^\circ$ $\psi = -6^\circ$	$\theta = +0.5^\circ$
$W = 153 \text{ LB}$ $B_c = 2.95 \text{ FT}$ $H_c = 0.58 \text{ FT}$ $\bar{Q} = 0.0077$	$F_N = 2.47$ V.C.G. = 114.7% OF H_c ABOVE KEEL. FREE TO HEAVE	

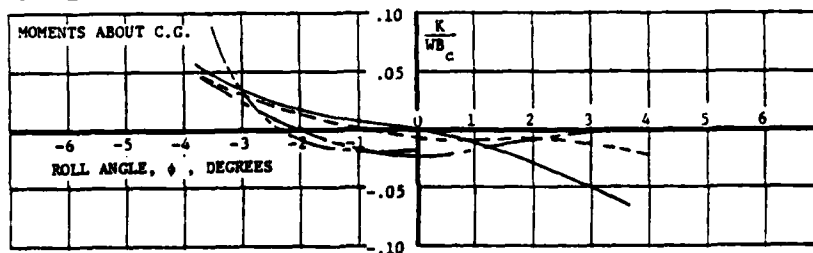

FIGURE A-2.3(v). ROLL MOMENT V. ROLL AND YAW ANGLE, $\theta = +0.5^\circ$;
 $F_N = 2.47$.

SES-100B MODEL	<table border="0"> <tr><td>—————</td><td>$\psi = 0^\circ$</td></tr> <tr><td>-----</td><td>$\psi = -2^\circ$</td></tr> <tr><td>-----</td><td>$\psi = -4^\circ$</td></tr> <tr><td>-----</td><td>$\psi = -6^\circ$</td></tr> </table>	—————	$\psi = 0^\circ$	-----	$\psi = -2^\circ$	-----	$\psi = -4^\circ$	-----	$\psi = -6^\circ$	$\theta = -0.5$
—————	$\psi = 0^\circ$									
-----	$\psi = -2^\circ$									
-----	$\psi = -4^\circ$									
-----	$\psi = -6^\circ$									
$W = 153 \text{ LB}$ $B_c = 2.95 \text{ FT}$ $H_c = 0.58 \text{ FT}$ $\bar{Q} = 0.0077$	$F_N = 2.47$ V.C.G. = 114.7% OF H_c ABOVE KEEL. FREE TO HEAVE									

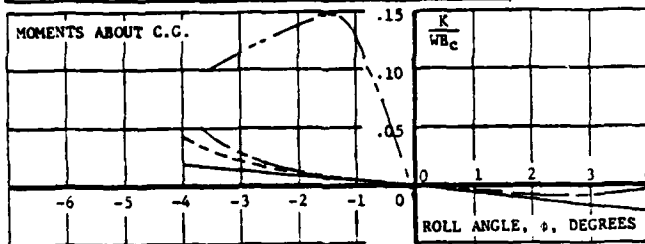

FIGURE A-2.3(w). ROLL MOMENT V. ROLL AND YAW ANGLE, $\theta = -0.5^\circ$; $F_N = 2.47$.

SES-100B MODEL	<table border="0"> <tr><td>—————</td><td>$\psi = 0$</td></tr> <tr><td>-----</td><td>$\psi = -2^\circ$</td></tr> <tr><td>-----</td><td>$\psi = -4^\circ$</td></tr> <tr><td>-----</td><td>$\psi = -6^\circ$</td></tr> </table>	—————	$\psi = 0$	-----	$\psi = -2^\circ$	-----	$\psi = -4^\circ$	-----	$\psi = -6^\circ$	$\theta = -1.5^\circ$
—————	$\psi = 0$									
-----	$\psi = -2^\circ$									
-----	$\psi = -4^\circ$									
-----	$\psi = -6^\circ$									
$W = 153 \text{ LB}$ $B_c = 2.95 \text{ FT}$ $H_c = 0.58 \text{ FT}$ $\bar{Q} = 0.0077$	$F_N = 2.47$ V.C.G. = 114.7% OF H_c ABOVE KEEL. FREE TO HEAVE									

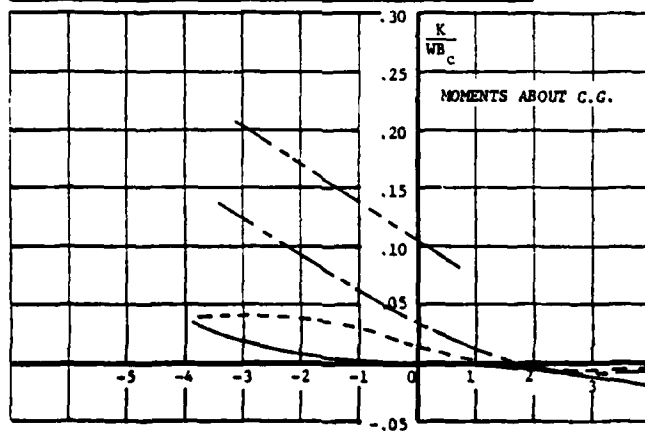

FIGURE A-2.3(x). ROLL MOMENT V. ROLL AND YAW ANGLE, $\theta = -1.5^\circ$; $F_N = 2.47$.

SES-100B MODEL	$\psi = 0^\circ$ $\psi = -2^\circ$ $\psi = -4^\circ$	$\theta = +1.5^\circ$ $F_N = 3.04$ V.C.G. = 114.7% OF H_c ABOVE KEEL. FREE TO HEAVE
$W = 153$ LB $B_c = 2.95$ FT $H_c = 0.58$ FT $\dot{Q} = 0.0077$		

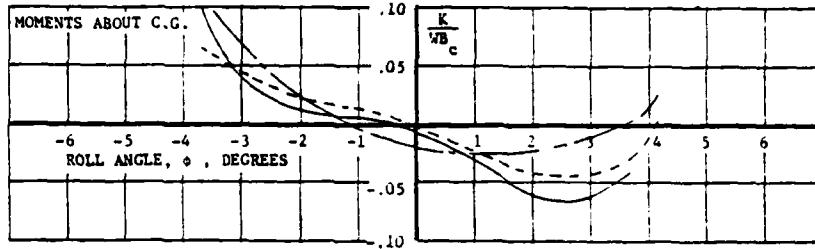

FIGURE A-2.3(y). ROLL MOMENT V. ROLL AND YAW ANGLE, $\theta = +1.5^\circ$; $F_N = 3.04$.

SES-100B MODEL	$\psi = 0^\circ$ $\psi = -2^\circ$ $\psi = -4^\circ$	$\theta = +0.5^\circ$ $F_N = 3.04$ V.C.G. = 114.7% OF H_c ABOVE KEEL. FREE TO HEAVE
$W = 153$ LB $B_c = 2.95$ FT $H_c = 0.58$ FT $\dot{Q} = 0.0077$		

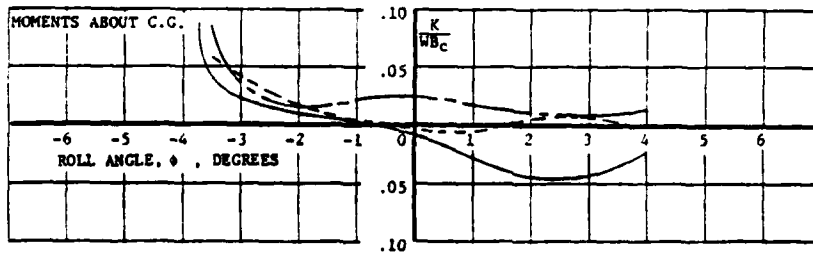

FIGURE A-2.3(z). ROLL MOMENT V. ROLL AND YAW ANGLE, $\theta = +0.5^\circ$; $F_N = 3.04$.

SES-100B MODEL	$\psi = 0^\circ$ $\psi = -2^\circ$ $\psi = -4^\circ$	$\theta = -1.5^\circ$
$W = 153 \text{ LB}$ $B_c = 2.95 \text{ FT}$ $H_c = 0.58 \text{ FT}$ $Q = 0.0077$	$F_N = 3.04$ V.C.G. = 114.7% OF H_c ABOVE KEEL. FREE TO HEAVE	

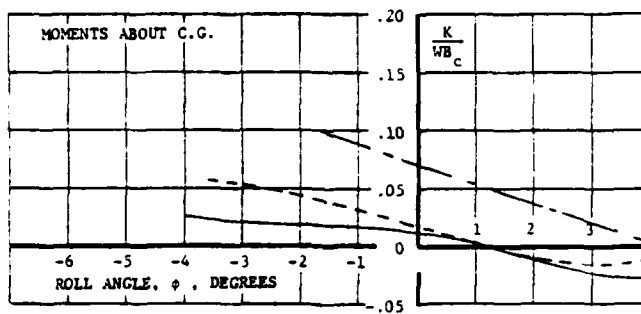

FIGURE A-2.3(aa). ROLL MOMENT V. ROLL AND YAW ANGLE, $\theta = -1.5^\circ$; $F_N = 3.04$.

SES-100B MODEL	$\psi = 0^\circ$ $\psi = -2^\circ$ $\psi = -4^\circ$	$\theta = -0.5^\circ$
$W = 153 \text{ LB}$ $B_c = 2.95 \text{ FT}$ $H_c = 0.58 \text{ FT}$ $Q = 0.0077$	$F_N = 3.04$ V.C.G. = 114.7% OF H_c ABOVE KEEL. FREE TO HEAVE	

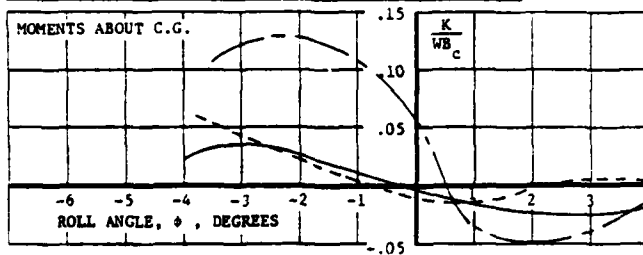

FIGURE A-2.3(bb). ROLL MOMENT V. ROLL AND YAW ANGLE, $\theta = -0.5^\circ$; $F_N = 3.04$.

APPENDIX B - DERIVATION OF SES EQUATIONS OF MOTION

B-1. KINEMATICS

The motion of the ship is considered in response to a system of forces whose resultant is a force and a moment about a specified moment center. The origin of these forces and their variation with time are not here considered. (See Section 3.)

The description of the motion of the ship and of the driving forces is accomplished with reference to a system of orthogonal axes, x , y and z , fixed in the ship with arbitrary directions and origin Q .^{*} The resultant force is represented by its components X , Y and Z parallel to the corresponding ship axes. The resultant moment is represented by the moment components K , M and N about the x , y and z ship axes respectively.

Reference is also made to a set of fixed, orthogonal axes, x_0 , y_0 and z_0 , with origin O . The z_0 -axis is taken vertical, positive downward. The position of the body is described by the position vector, ρ , of Q with respect to O and a set of orientation angles, θ , ϕ and ψ , defined by the illustration in Figure A-1. The position of the ship can be achieved, starting with the ship axes coincident with the fixed axes, by first yawing through the angle ψ , then pitching about the y -axis through the angle θ , then rolling about the x -axis through the angle ϕ , then translating the origin to Q .

The velocity $\bar{v} = \dot{\rho}$ of Q with respect to O is described by its components u , v and w in the ship axes x , y and z respectively. Rotation of the ship is described by the angular velocity vector $\bar{\omega}$, whose components in the ship axes are p , q and r respectively.

^{*} For the analysis of ship dynamics it is customary to take the x - and z -axes in the plane of symmetry with the x -axis parallel to the keel or base line, positive forward. The z -axis is taken positive downward and the y -axis positive to starboard.

Since the exact position of the center of gravity cannot be known before the ship is built, and in any event will change with changing load, whereas a frame of reference is needed throughout the design period for weight accounting and for hydrodynamical calculations, the origin of ship axes can be chosen arbitrarily. No loss of rigor need result. A point at mid-length and in the design water plane may be convenient for many of the calculations and may make the products of inertia small enough to be ignored without serious error while simplifying the equations of motion.

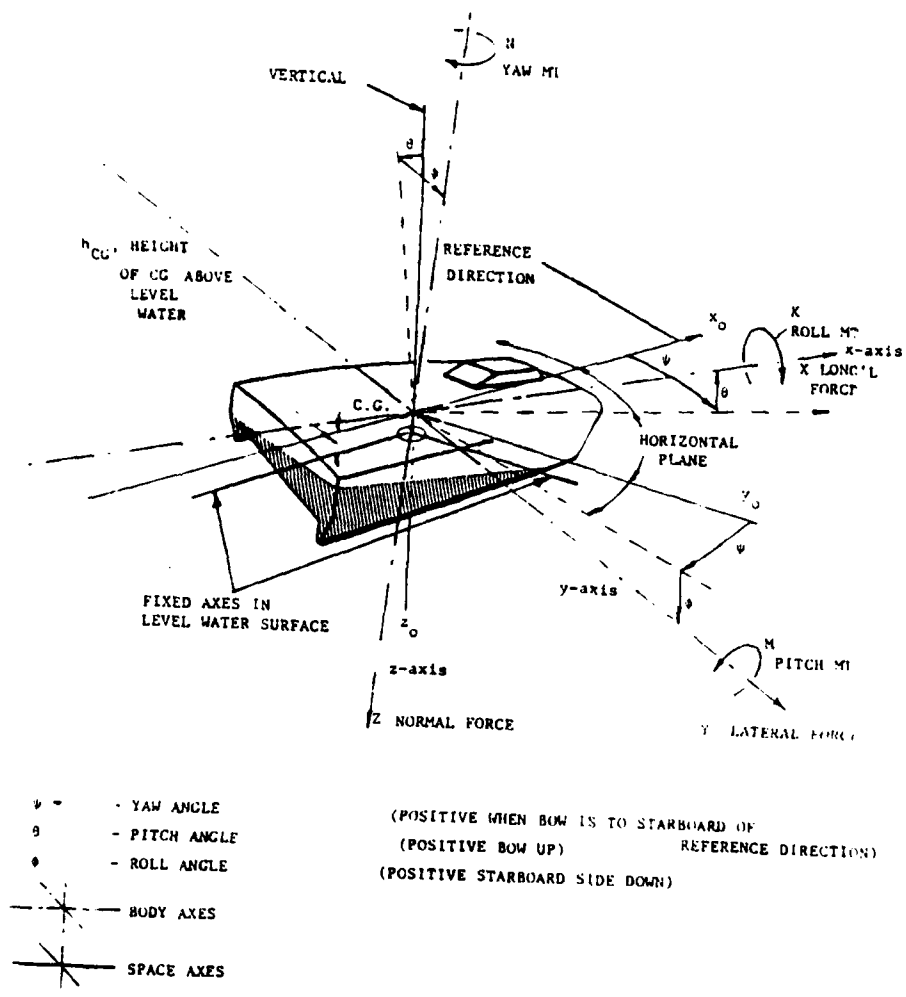
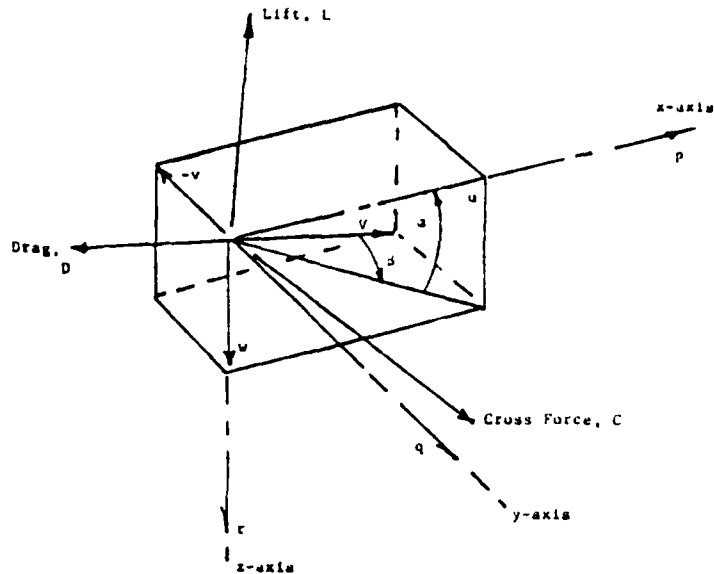

FIGURE B-1(a). DEFINITION OF AXIS SYSTEM.



- V -- velocity of origin of body axes relative to fluid
 u, v, w -- components of V in body axes
 p, q, r -- components in the the body axes of the angular velocity of the vehicle
 α --The angle of attack; the angle to the longitudinal body axis from the projection into the principal plane of symmetry of the velocity of the origin of the body axes relative to the fluid, positive in the positive sense of rotation about the y -axis.
 β --The drift or sideslip angle; the angle to the principal plane of symmetry from the velocity of the origin of the body axes relative to the fluid, positive in the positive sense of rotation about the z -axis.
 D --drag, opposite to V along line of V
 L --lift, in $x-z$ plane normal to V , positive upward
 C -- cross force, normal to V and L , positive to starboard.

FIGURE B-1(b). VELOCITY AND FORCE RELATIONSHIPS.

* This definition of the lift, L , is consistent with the conventions followed in aircraft and submarine stability and control literature. The term lift is much used, however, in a looser sense to mean:

- A force in the z body axis direction
- A vertical force
- A force normal to a wing or foil
- A force normal to a rudder or strut

Some freedom of usage appears justified for the sake of brevity and is employed in this document when clarity of meaning is not sacrificed.

The position of the center of gravity of the ship, C, relative to Q is described by the vector \bar{r}_C whose components in the ship axes are x_C, y_C, z_C . Thus the position of C with respect to O is

$$\bar{p}_C = \bar{\rho} + \bar{r}_C$$

and the velocity of C relative to the fixed axes is

$$\frac{d\bar{p}_C}{dt} = \dot{\bar{p}}_C = \bar{v} + \bar{\omega} \times \bar{r}_C \quad (1)$$

B-2. CONSTRAINED VERTICAL MOTION

Similarly, the position, with respect to O, of a point A on the x-axis (at which both vertical velocity and vertical acceleration are zero at all times), is defined by:

$$\bar{p}_A = \bar{\rho} + \bar{r}_A$$

and the velocity of A is

$$\begin{aligned} \dot{\bar{p}}_A &= \bar{v} + \bar{\omega} \times \bar{r}_A \\ &= \bar{i} (u + qz_A - ry_A) + \bar{j} (v + rx_A - pz_A) + \bar{k} (w + py_A - qx_A) \\ &= \bar{i} u + \bar{j} (v + rx_A) + \bar{k} (w - qx_A) \quad \text{since } y_A = z_A \equiv 0 \end{aligned}$$

The vertical velocity of A may then be expressed in terms of \bar{k}_O , the vertical unit vector:

$$\bar{k}_O \cdot \dot{\bar{p}}_A \equiv 0$$

where $\bar{k}_O = -\bar{i} \sin \theta + \bar{j} \cos \theta \sin \phi + \bar{k} \cos \theta \cos \phi$ (SNAME APR 50, p. 7)

* The velocity \bar{v} of Q relative to O has already been defined by its components u, v and w in the body axes. The derivative $\dot{\bar{r}}_C$ is calculated by the formula $\frac{d\bar{V}}{dt} = \dot{\bar{V}} = \dot{\bar{V}}_r + \bar{\omega} \times \bar{V}$ where $\dot{\bar{V}}$ is the time derivative of the the vector \bar{V} with respect to the fixed axes and $\dot{\bar{V}}_r$ (sometimes called the relative derivative) is the time derivative of \bar{V} with respect to the ship axes. Thus if $\bar{V} = \bar{i}V_x + \bar{j}V_y + \bar{k}V_z$ where $\bar{i}, \bar{j}, \bar{k}$ are unit vectors in the ship axes, then $\dot{\bar{V}}_r = \bar{i}\dot{V}_x + \bar{j}\dot{V}_y + \bar{k}\dot{V}_z$. Note that the relative derivative of \bar{r}_C is $\dot{\bar{r}}_{C_r} \equiv 0$.

Thus, by expansion of the scalar product

$$(v + rx_A) \cos \theta \sin \phi + (w - qx_A) \cos \theta \cos \phi = u \sin \theta$$

which can be solved for w; i.e.

$$w = u \frac{\tan \theta}{\cos \phi} + qx_A - (v + rx_A) \tan \phi$$

The acceleration of point A is

$$\ddot{\mathbf{p}}_A = \dot{\mathbf{v}}_r + \bar{\omega} \times \bar{v} + \dot{\bar{\omega}} \times \bar{r}_A + \bar{\omega} \times \dot{\bar{r}}_A \quad (\text{See Equation (2), pp. B-6})$$

$$= \dot{\mathbf{v}}_r + \bar{\omega} \times \bar{v} + \dot{\bar{\omega}} \times \bar{r}_A + \bar{\omega} \times (\bar{\omega} \times \bar{r}_A) \quad \text{since } \dot{\bar{r}}_A \equiv 0$$

$$= \dot{\mathbf{v}}_r + \bar{\omega} \times \bar{v} + \dot{\bar{\omega}} \times \bar{r}_A + (\bar{\omega} \cdot \bar{r}_A) \bar{\omega} - \bar{\omega}^2 \bar{r}_A$$

Upon expansion, this becomes, noting $\bar{r}_A = \bar{i} x_A$

$$\begin{aligned} \ddot{\mathbf{p}}_A &= \bar{i} \left[\dot{u} + qw - rv - x_A (q^2 + r^2) \right] \\ &\quad + \bar{j} \left[\dot{v} + ru - qw + x_A (\dot{r} + qp) \right] \\ &\quad + \bar{k} \left[\dot{w} + pv - qu + x_A (rp - \dot{q}) \right] \end{aligned}$$

The vertical acceleration of A is then

$$\bar{k}_0 \cdot \ddot{\mathbf{p}}_A \equiv 0$$

Thus, by expansion of the scalar product, as above, and solving for \dot{w} , the following conditional equation is obtained:

$$\begin{aligned} \dot{w} &= (\dot{q} - rp) x_A + qu - pv \\ &\quad + (\dot{u} + qw - rv - (q^2 + r^2) x_A) \frac{\tan \theta}{\cos \phi} \\ &\quad - (\dot{v} + ru - qw + (\dot{r} + qp) x_A) \tan \phi \end{aligned}$$

These expressions for w and \dot{w} are included on page 20 of this report.

B-3. THE FORCE EQUATIONS

The center of gravity moves as if it were a point mass of mass, m , equal to that of the body. Thus by Newton's equation

$$\begin{aligned}\bar{F} &= m \bar{p}_c & (2) \\ &= m(\dot{\bar{v}}_r + \bar{\omega} \times \bar{v} + \dot{\bar{\omega}}_r \times \bar{r}_c + \bar{\omega} \times \dot{\bar{r}}_c + \bar{\omega} \times (\bar{\omega} \times \bar{r}_c)) \\ &= m(\dot{\bar{v}}_r + \bar{\omega} \cdot \bar{v} + \dot{\bar{\omega}}_r \times \bar{r}_c + (\bar{\omega} \cdot \bar{r}_c) \bar{\omega} - \bar{\omega}^2 \bar{r}_c) \text{ since } \dot{\bar{r}}_c \equiv 0\end{aligned}$$

Noting that:

$$\begin{aligned}\bar{v} &= \bar{i}u + \bar{j}v + \bar{k}w & \bar{r}_c &= \bar{i}x_c + \bar{j}y_c + \bar{k}z_c \\ \dot{\bar{v}}_r &= \bar{i}\dot{u} + \bar{j}\dot{v} + \bar{k}\dot{w} & \bar{\omega} &= \bar{i}p + \bar{j}q + \bar{k}r\end{aligned}$$

It follows that:

$$\begin{aligned}\bar{\omega} \times \bar{v} &= \bar{i}(qw - rv) + \bar{j}(ru - pw) + \bar{k}(pv - qu) \\ \dot{\bar{\omega}}_r \times \bar{r}_c &= \bar{i}(\dot{q}z_c - \dot{r}y_c) + \bar{j}(\dot{r}x_c - \dot{p}z_c) + \bar{k}(\dot{p}y_c - \dot{q}x_c) \\ (\bar{\omega} \cdot \bar{r}_c)\bar{\omega} &= (\bar{i}p + \bar{j}q + \bar{k}r)(\bar{i}x_c + \bar{j}y_c + \bar{k}z_c) \\ \bar{\omega}^2 \bar{r}_c &= (\bar{i}x_c + \bar{j}y_c + \bar{k}z_c)(p^2 + q^2 + r^2)\end{aligned}$$

Thus:

$$\begin{aligned}X &= m(\dot{u} + qw - rv - x_c(q^2 + r^2) + y_c(pq - \dot{r}) + z_c(rp + \dot{q})) \\ Y &= m(\dot{v} + ru - pw + x_c(pq + \dot{r}) - y_c(r^2 + p^2) + z_c(qr - \dot{p})) \\ Z &= m(\dot{w} + pv - qu + x_c(rp - \dot{q}) + y_c(qr + \dot{p}) - z_c(p^2 + q^2))\end{aligned} \quad (3)$$

B-4. THE MOMENT EQUATIONS

Each constituent particle must be acted upon by a force $m_i \ddot{p}_i$ to ensure its motion. These forces will include interior forces, acting between particles, which, since they occur in opposing pairs, must sum to zero. Hence the sum of the forces on all the particles must equal the sum of all applied forces. Likewise, the sum of the moments must equal the sum of applied moments. Thus the sum of the moments about Q of all applied forces is

$$\begin{aligned}\bar{L}_Q &= \sum_i m_i \bar{r}_i \times \ddot{p}_i \\ &= \sum_i m_i \bar{r}_i \times \dot{v} + \sum_i m_i \bar{r}_i \times \ddot{r}_i\end{aligned}\quad (4)$$

where:

$$\begin{aligned}\ddot{p}_i &= \ddot{p} + \ddot{r}_i \\ \dot{p}_i &= \dot{v} + \dot{r}_i\end{aligned}$$

As $\sum_i m_i \bar{r}_i = m\bar{r}_c$

and $\frac{d}{dt}(\bar{r}_i \times \dot{r}_i) = \bar{r}_i \times \ddot{r}_i$ since $\dot{r}_i \times \dot{r}_i \equiv 0$

$$\begin{aligned}\text{Therefore } \bar{L}_Q &= m\bar{r}_c \times \dot{v} + \frac{d}{dt} \sum_i m_i \bar{r}_i \times \dot{r}_i \\ &= m\bar{r}_c \times \dot{v} + \frac{d}{dt} \sum_i m_i (\bar{r}_i \times (\bar{\omega} \times \bar{r}_i)) \text{ since } \dot{r}_i \times \dot{r}_i \equiv 0\end{aligned}\quad (5)$$

The summation in the second term is the moment of momentum, \bar{H}_Q associated with rotation of the body about Q. That is

$$\begin{aligned}\bar{H}_Q &= \sum_i m_i (\bar{r}_i \times (\bar{\omega} \times \bar{r}_i)) \\ &= \phi_Q \cdot \bar{\omega}\end{aligned}\quad (6)$$

where ϕ_Q , known as the momental dyadic, is derived in Section B-2.

$$\text{Thus } \bar{L}_Q = m\bar{r}_c \times \dot{v} + \frac{d\bar{H}_Q}{dt}\quad (7)$$

$$= m\bar{r}_c \times \dot{v} + \phi_Q \cdot \dot{\bar{\omega}} + \bar{\omega} \times (\phi_Q \cdot \bar{\omega})^*$$

(See footnote to page B-4.)

* If Q is at the center of gravity, then \bar{r}_c is zero and $\bar{L}_c = \frac{d}{dt} \bar{H}_c$. If Q is fixed in space, then \dot{v} is zero and $\bar{L}_o = \frac{d}{dt} \bar{H}_o$. For any other point Q as origin of body axes, the complete equation for \bar{L}_Q must be used.

The moment \bar{L}_Q may be resolved into components along the body axes. Thus

$$\bar{L}_Q = \bar{i} K + \bar{j} M + \bar{k} N \quad (9)$$

where

$$K = I_x \dot{p} + (I_z - I_y) qr + m (y_c (\dot{w} + pv - qu) - z_c (\dot{v} + ru - pw)) \\ - I_{xy} (\dot{q} - rp) - I_{yz} (q^2 - r^2) - I_{zx} (\dot{r} + pq)$$

$$M = I_y \dot{q} + (I_x - I_z) rp + m (z_c (\dot{u} + qw - rv) - x_c (\dot{w} + pv - qu)) \\ - I_{yz} (\dot{r} - pq) - I_{zx} (r^2 - p^2) - I_{xy} (\dot{p} + qr)$$

$$N = I_z \dot{r} + (I_y - I_x) pq + m (x_c (\dot{v} + ru - pw) - y_c (\dot{u} + qw - rv)) \\ - I_{zx} (\dot{p} - qr) - I_{xy} (p^2 - q^2) - I_{yz} (\dot{q} + rp)$$

and I_x , I_y and I_z are the moments of inertia of the ship about the x, y and z axes, respectively, and I_{xy} , I_{yz} and I_{zx} are the cross products of inertia.

The expansion of the right-hand sides of these equations is carried out in Section B-5.

These equations express the components of the applied moment in terms of the ship's velocities and accelerations. Taken with the force equations (3) they constitute a set of simultaneous, first order differential equations in the six velocity components, u, v, w, p, q and r. Their solution requires that the applied forces and moments be either known functions of the time, or expressible as functions of the velocities and their derivatives.

The simplifications which may be achieved if the origin of body axes is at the center of gravity and if the body axes are principal axes for the origin are evident. However, the use of such axes requires the transformation of the moments of inertia and cross products of inertia, and the transfer of the moments to the new axes. If several changes of mass and moments of inertia are to be made, it is easier to maintain the original origin and body axes.

Formulas for the calculation of moments of inertia and cross products of inertia in transformed ship axes are given in Section B-3.

B-5. EXPANSION OF THE MOMENT EQUATION

It is clear from Equation (7) that the principal part of the moment derives from the rate of change of the moment of momentum, \bar{H}_Q , which is defined in equation (6) as

$$\begin{aligned}\bar{H}_Q &= \sum_i m_i (\bar{r}_i \times (\bar{\omega} \times \bar{r}_i)) \\ &= \sum_i m_i (r_i^2 \bar{\omega} - (\bar{r}_i \cdot \bar{\omega}) \bar{r}_i)\end{aligned}\quad (6)$$

The second term may be rearranged as $\bar{r}_i (\bar{r}_i \cdot \bar{\omega})$ and this may be interpreted as the scalar product of the dyadic, $\bar{r}_i \bar{r}_i$, and the vector $\bar{\omega}$. As the product $I \cdot \bar{\omega} = \bar{\omega}$, where I is the identity dyadic or idemfactor, the first term may be written as

$$\begin{aligned}& r_i^2 I \cdot \bar{\omega} \\ \text{Thus } \bar{H}_Q &= \sum_i m_i (r_i^2 I - \bar{r}_i \bar{r}_i) \cdot \bar{\omega}\end{aligned}$$

Since $\bar{\omega}$ is invariant in the summation, this may be written

$$\begin{aligned}\bar{H}_Q &= \phi_Q \cdot \bar{\omega} \\ \text{where } \phi_Q &= \sum_i m_i (r_i^2 I - \bar{r}_i \bar{r}_i),\end{aligned}\quad (10)$$

known as the momental dyadic, is a constant characteristic of the body since \bar{r}_i does not vary with time.

To expand the momental dyadic

$$\phi_Q = \sum_i m_i (r_i^2 I - \bar{r}_i \bar{r}_i)$$

we note that

$$\begin{aligned}\bar{r}_i &= \bar{i}x_1 + \bar{j}y_1 + \bar{k}z_1 \\ r_i^2 &= x_1^2 + y_1^2 + z_1^2 \\ \text{and } I &= \bar{i}\bar{i} + \bar{j}\bar{j} + \bar{k}\bar{k} \\ \text{so that } r_i^2 I &= \bar{i}\bar{i}r_1^2 + \bar{j}\bar{j}r_1^2 + \bar{k}\bar{k}r_1^2\end{aligned}\quad (11)$$

$$\text{and } \bar{r}_i \bar{r}_i = \begin{cases} \bar{i}\bar{i}x_1^2 + \bar{i}\bar{j}x_1y_1 + \bar{i}\bar{k}x_1z_1 \\ + \bar{j}\bar{i}x_1y_1 + \bar{j}\bar{j}y_1^2 + \bar{j}\bar{k}y_1z_1 \\ + \bar{k}\bar{i}z_1x_1 + \bar{k}\bar{j}y_1z_1 + \bar{k}\bar{k}z_1^2 \end{cases}\quad (12)$$

Thus

$$\phi_Q = \sum m_i \begin{cases} \bar{I}(y_1^2 + z_1^2) - \bar{I}jx_1y_1 - \bar{I}kz_1x_1 \\ - \bar{J}ix_1y_1 + \bar{J}j(x_1^2 + z_1^2) - \bar{J}ky_1z_1 \\ - \bar{K}iz_1x_1 - \bar{K}jy_1z_1 + \bar{K}k(x_1^2 + y_1^2) \end{cases}$$

Denoting:

$$\begin{aligned} I_x &= \sum m_i (y_1^2 + z_1^2) & I_{xy} &= \sum m_i x_1 y_1 \\ I_y &= \sum m_i (x_1^2 + z_1^2) & I_{yz} &= \sum m_i y_1 z_1 \\ I_z &= \sum m_i (x_1^2 + y_1^2) & I_{zx} &= \sum m_i z_1 x_1 \end{aligned}$$

we have

$$\phi_Q = \begin{cases} \bar{I}I_x - \bar{I}jI_{xy} - \bar{I}kI_{zx} \\ - \bar{J}I_{xy} + \bar{J}jI_y - \bar{J}kI_{yz} \\ - \bar{K}I_{zx} - \bar{K}jI_{yz} + \bar{K}kI_z \end{cases}$$

and

$$\begin{aligned} \phi_Q \cdot \bar{\omega} &= \bar{I}(I_x p - I_{xy} q - I_{zx} r) \\ &+ \bar{J}(-I_{xy} p + I_y q - I_{yz} r) \\ &+ \bar{K}(-I_{zx} p - I_{yz} q + I_z r) \end{aligned}$$

Thus $\bar{\omega} \times (\phi_Q \cdot \bar{\omega}) =$

$$\begin{aligned} &\bar{I} \{ I_{xy} r p + I_{yz} (r^2 - q^2) - I_{zx} p q + (I_z - I_y) q r \} \\ &+ \bar{J} \{ I_{yz} p q + I_{zx} (p^2 - r^2) - I_{xy} q r + (I_x - I_z) r p \} \\ &+ \bar{K} \{ I_{zx} q r + I_{xy} (q^2 - p^2) - I_{yz} r p + (I_y - I_x) p q \} \end{aligned} \quad (13)$$

$$\begin{aligned} \phi_Q \cdot \dot{\bar{\omega}} &= \bar{I} (I_x \dot{p} - I_{xy} \dot{q} - I_{zx} \dot{r}) \\ &+ \bar{J} (-I_{xy} \dot{p} + I_y \dot{q} - I_{yz} \dot{r}) \\ &+ \bar{K} (-I_{zx} \dot{p} - I_{yz} \dot{q} + I_z \dot{r}) \end{aligned} \quad (14)$$

The first term in Equation (7) may be expanded, noting

$$\begin{aligned} \bar{r}_c &= \bar{i}x_c + \bar{j}y_c + \bar{k}z_c \\ \bar{v} &= \bar{i}u + \bar{j}v + \bar{k}w \\ \dot{\bar{v}} &= \dot{\bar{v}}_r + \bar{\omega} \times \bar{v} \\ &= \bar{I}(\dot{u} + qv - rv) + \bar{I}(\dot{v} + ru - pw) + \bar{K}(\dot{w} + pv - qu) \end{aligned}$$

$$\begin{aligned}
\bar{m}_c \dot{\mathbf{v}} &= \bar{m}_i (y_c (\dot{w} + pv - qu) - z_c (\dot{v} + ru - pw)) \\
&+ \bar{m}_j (z_c (\dot{u} + qw - rv) - x_c (\dot{w} + pv - qu)) \\
&+ \bar{m}_k (x_c (\dot{v} + ru - pw) - y_c (\dot{u} + qw - rv))
\end{aligned} \tag{15}$$

By collecting terms the expressions for K, M, and N in equation (9) are obtained.

B-6. COORDINATE TRANSFORMATION OF THE MOMENTAL DYADIC

Since the initial calculation of the components of the momental dyadic may be made for a set of ship axes different from those preferred for statement of the equations of motion, it may be necessary to carry out a transformation of coordinates to derive the components in a new set of axes.* Only a translation of the origin will be considered; the determination of the directions of principal axes and the rotational transformation of the hydrodynamic forces and moments are thereby avoided.

For axes with the origin at the center of gravity, C, let

$$\begin{aligned} \phi_C &= \bar{ii} I'_x - \bar{ij} I'_{xy} - \bar{ik} I'_{zx} \\ &\quad - \bar{ji} I'_{xy} - \bar{jj} I'_y - \bar{jk} I'_{yz} \\ &\quad - \bar{ki} I'_{zx} - \bar{kj} I'_{yz} + \bar{kk} I'_z \end{aligned}$$

Then for axes with origin at Q, so that the coordinates of C are x_c , y_c and z_c

$$\begin{aligned} \phi_Q &= \bar{ii} I_x - \bar{ij} I_{xy} - \bar{ik} I_{zx} \\ &\quad - \bar{ji} I_{xy} + \bar{jj} I_y - \bar{jk} I_{yz} \\ &\quad - \bar{ki} I_{zx} - \bar{kj} I_{yz} + \bar{kk} I_z \end{aligned} \tag{16}$$

where:

$$\begin{aligned} I_x &= I'_x + m(y_c^2 + z_c^2) & I_{xy} &= I'_{xy} + m x_c y_c \\ I_y &= I'_y + m(z_c^2 + x_c^2) & I_{yz} &= I'_{yz} + m y_c z_c \\ I_z &= I'_z + m(x_c^2 + y_c^2) & I_{zx} &= I'_{zx} + m z_c x_c \end{aligned} \tag{17}$$

The transformation from a non-central origin, Q', to another non-central origin, Q, is made in two steps. In the first step, the equations (17) are inverted to obtain the primed components for central axes. The equations (17) are then applied with the new coordinates x_c , y_c and z_c to obtain the components of ϕ_Q .

* The weight analyst may, for example, prefer an origin in the base line.

B-6. COORDINATE TRANSFORMATION OF THE MOMENTAL DYADIC

Since the initial calculation of the components of the momental dyadic may be made for a set of ship axes different from those preferred for statement of the equations of motion, it may be necessary to carry out a transformation of coordinates to derive the components in a new set of axes.* Only a translation of the origin will be considered; the determination of the directions of principal axes and the rotational transformation of the hydrodynamic forces and moments are thereby avoided.

For axes with the origin at the center of gravity, C, let

$$\begin{aligned} \phi_C &= \bar{ii} I'_x - \bar{ij} I'_{xy} - \bar{ik} I'_{zx} \\ &- \bar{ji} I'_{xy} - \bar{jj} I'_y - \bar{jk} I'_{yz} \\ &- \bar{ki} I'_{zx} - \bar{kj} I'_{yz} + \bar{kk} I'_z \end{aligned}$$

Then for axes with origin at Q, so that the coordinates of C are x_c , y_c and z_c

$$\begin{aligned} \phi_Q &= \bar{ii} I_x - \bar{ij} I_{xy} - \bar{ik} I_{zx} \\ &- \bar{ji} I_{xy} + \bar{jj} I_y - \bar{jk} I_{yz} \\ &- \bar{ki} I_{zx} - \bar{kj} I_{yz} + \bar{kk} I_k \end{aligned} \quad (16)$$

where:

$$\begin{aligned} I_x &= I'_x + m (y_c^2 + z_c^2) & I_{xy} &= I'_{xy} + m x_c y_c \\ I_y &= I'_y + m (z_c^2 + x_c^2) & I_{yz} &= I'_{yz} + m y_c z_c \\ I_z &= I'_z + m (x_c^2 + y_c^2) & I_{zx} &= I'_{zx} + m z_c x_c \end{aligned} \quad (17)$$

The transformation from a non-central origin, Q', to another non-central origin, Q, is made in two steps. In the first step, the equations (17) are inverted to obtain the primed components for central axes. The equations (17) are then applied with the new coordinates x_c , y_c and z_c to obtain the components of ϕ_Q .

* The weight analyst may, for example, prefer an origin in the base line.

END

DATE
FILMED

3-82

DTIC