

Reproduced by
AIR DOCUMENTS DIVISION



HEADQUARTERS AIR MATERIEL COMMAND

WRIGHT FIELD, DAYTON, OHIO

The
U.S. GOVERNMENT

IS ABSOLVED

FROM ANY LITIGATION WHICH MAY
ENSUE FROM THE CONTRACTORS IN-
FRINGING ON THE FOREIGN PATENT
RIGHTS WHICH MAY BE INVOLVED.

WRIGHT FIELD, DAYTON, OHIO

REEL - C

402

A.I.I.

1 1 3 6 6

T

9

UNCLASSIFIED

U.S. ARMY AIR FORCES
AIR MATERIEL COMMAND
CONTRACT W33-038 AC5238

ATI No. 11366

HELICOPTER BLADE ANALYSIS

BY A. A. NIKOLSKY AND E. SECKEL

PRINCETON UNIVERSITY

AERONAUTICAL ENGINEERING LABORATORY

REPORT NO. 100

The U. S. Government is absolved from any litigation
which may ensue from the contractor's infringing on
the foreign patent rights which may be involved.

THE ANALYSIS OF HELICOPTER BLADES

REPORT NO. 100

A.A.F. Contract W33-038 ac 5238

January 31, 1947

Prepared by:

A. A. Nikolsky

A. A. Nikolsky

E. Seckel

E. Seckel

A. A. Nikolsky

A. A. Nikolsky
Director of Project

PREFACE

This report has been prepared at the request of the Army Air Forces Air Materiel Command at Wright Field as one phase of its program to determine a reliable and practical set of design criteria for helicopters.

An attempt has been made to make the report as self-contained as possible for use in the structural analysis of helicopter rotor blades in any steady forward flight condition. The material can easily be extended to accelerated flight conditions.

The actual establishment of a set of design criteria has not been undertaken. It is, however, thought that the material here presented may prove to be of such general nature and completeness that, by its applications to design problems, it may help toward the establishment of such design criteria.

TABLE OF CONTENTS

| | PAGE |
|---|--------|
| Summary, Description, and Discussion of Material | 1 |
| Part I - General Material | |
| General Assumptions | I-1 |
| Nomenclature | I-5 |
| Numerical Solution of Linear Differential Equations by the Method of Approximation to Functions | I-17 |
| The Geometry of Rotor Blade Hinges | I-26 |
| Part II - Fully Articulated Blades | |
| Applied Blade Loads: | |
| Dynamic | II-1 |
| Gravity | II-8 |
| Air Loads (in Z direction) | II-9 |
| Fourier Coefficients of Flapping Motion | II-25 |
| Air Loads (in Y direction) | II-33 |
| Solution for Inflow Factor, λ , (Equation of Torque) | II-41 |
| Fourier Coefficients of Hunting Motion | II-57 |
| Calculation of Z Direction Bending Moments and Blade Deflections | II-65 |
| Solution by Collocation of the Equation for Z Direction Bending Moments and Blade Deflections | II-80 |
| Tabular Method of Finding Z Direction Bending Moments and Blade Deflections | II-90 |
| Calculations of Y Direction Bending Moments and Blade Deflections | II-106 |
| Solution by Collocation of the Equation for Y Direction Bending Moments and Blade Deflections | II-116 |
| Tabular Method of Finding Y Direction Bending Moments and Blade Deflections | II-119 |
| Torsion on the Blades | II-121 |

TABLE OF CONTENTS

| | PAGE |
|--|--------|
| Effect of Blade Flexure | II-142 |
| Sample Calculations | II-146 |
| Physical Constants Assumed | II-146 |
| Solution for λ | II-149 |
| Flapping Coefficients | II-150 |
| Z Direction Air Loads | II-151 |
| Adjustment of Z Direction Air Loads | II-153 |
| Z Direction Bending Moments and Deflections by Collocation | II-157 |
| Z Direction Bending Moments and Deflections by Tabular Method | II-171 |
| Discussion of Y Direction Air Loads, Bending Moments, and Deflections | II-174 |
| Part III - Center-Hinged Blades, Rigid in the Plane of Rotation (See-Saw Type) | III-1 |
| Part IV - Single Bladed Rotors | IV-1 |
| Part V - Rigidly Attached Blades | V-1 |
| Part VI - Design Criteria Considerations | VI-1 |

List of References.

- 1) Coleman, Fiengold and Stempin
"Evaluation of the Induced Velocity Field of an Idealized Helicopter Rotor". NACA Memorandum Report L5C12 for the AAF, ATSC. March 19, 1945
- 2) Wheatley, John B.
"An Aerodynamic Analysis of the Autogiro Rotor with a Comparison between Calculated and Experimental Results". NACA Technical Report 487. 1934
- 3) Glauert, H.
"On the Horizontal Flight of a Helicopter". British Report and Memoranda 1157. March, 1928.
- 4) Bailey, F. J., Jr.
"A Simplified Theoretical Method of Determining the Characteristics of a Lifting Rotor in Forward Flight". NACA Technical Report 716. 1941.
- 5) Sissingh, G.
"Contribution to the Aerodynamics of Rotating-Wing Aircraft - Part II ". NACA Technical Memorandum 990. October, 1941.
- 6) Durand, W. F.
"Aerodynamic Theory" - Vol. IV, p. 261.
- 7) Wald, Q.
"The Effect of Planform on Static Thrust Performance". Sikorsky Aircraft, SER 442. November, 1944.
- 8) Talkin, H. W.
"Charts for Helicopter Performance Estimation". NACA Memorandum Report L5C13 for the AAF, ATSC.
- 9) Seely and Ensign
"Analytical Mechanics for Engineers" - 3rd Edition.
- 10) Coleman, Fiengold and Stempin
"Evaluation of the Induced Velocity Field of an Idealized Helicopter Rotor". NACA Advance Restricted Report L5E10. June, 1945.

- 11) Stuart, Joseph, III
"A Tabular Method of Propeller Blade Stress Analysis".
Journal of the Aeronautical Sciences. April, 1943
(Vol. 10, no. 4)
- 12) Owen, J. B. B.
"The Stressing of Gyroplane Blades in Steady Flight".
British Reports and Memoranda 1875. April, 1938.
- 13) Frazer, Jones and Skan
"Approximations to Functions and to the Solutions of
Differential Equations". British Reports and Memo-
randa 1799. March, 1937
- 14) Hufton, Nutt, Big, and Beavan
"General Investigation into the Characteristics of
the C.30 Autogiro". British Reports and Memoranda
1859. March, 1939.

Analysis of Helicopter Rotor Blades.

Summary:

The purpose of this report is to give all the theory and derivations necessary for the structural analysis of helicopter rotor blades in steady forward flight. These data can easily be made applicable to accelerated flight.

Description and Discussion of Material.

Four different types of blade attachment of the rotor hub are considered:

- a) Feathered, articulated blades equipped with mechanical damping devices.
- b) Feathered blades, center-hinged, rigid in the plane of rotation (see-saw type).
- c) Single blade (for type of attachments see discussion, Part IV.)
- d) Feathered blades with completely rigid attachment.

The description of the report, which is divided into six parts, is as follows:

Part I

This part contains material of general nature applicable to all types of rotors:

- 1) Description of the assumptions used in this report which are applicable to all four rotor types.
- 2) General symbols, reference axes and definition of the initial position of the blades.
- 3) Discussion of methods for solving the linear differential equations with variable coefficients by use of approximations to functions. Demonstrations

of collocation, Least square, and Galerkin's methods, are given by a simple example.

- 4) Geometry of angular displacement of blades - change of blade incidence due to blade angular displacement about the alpha and delta hinges. The most general cases are considered separately for articulated and see-saw types. Working charts are also presented for the case when $\alpha_3 = 0$ and the hinges are mutually perpendicular.

Part II

This part covers the theory and derivations necessary for the structural analysis of articulated blades equipped with mechanical damping devices:

- 1) Dynamic loads acting on a blade element. Accelerations imposed on a mass particle of a blade element are first derived. The load acting on a blade element is obtained by integrating over the total mass of the element. The expressions derived are applicable to any type of attachment. The assumption is made that both hinges are in the same plane, their intersection coinciding with the center of the rotor hub.
- 2) Gravity loads
- 3) Aerodynamic loads. This chapter is subdivided into several sections:
 - a) Discussion of the effect of blade deformation on aerodynamic loads.
 - b) Angle of attack of a blade element on an infinitely stiff blade; the change of incidence due to angular motion of a blade about its hinges and due to application of cyclic pitch control (the variations of incidence due to small periodic oscillation of the blade in the plane of rotation

and due to second harmonic flapping are neglected.)

The distribution of induced velocity is assumed to be triangular along fore and aft diameter of the rotor.

- c) The distribution of the Z component of air load along a stiff blade is given in terms of the "flapping" coefficients and parameters λ and μ . The first two harmonics are considered.
- d) The "flapping" coefficients are determined, taking into consideration the mechanical damping of the blade motion at the "flapping" hinge. Two sets of expressions are given: In the first set the effect of change of incidence due to motion of the blade is combined with the effect of change due to cyclic pitch control. The second set of expressions considers these effects separately.
- e) The distribution of Y components of air load along a stiff blade. The load is given in terms of the "flapping" coefficients, λ and μ . The first two harmonics are considered. The expression for the profile drag coefficient is taken from ref. (4) and is $C_{D_0} = \delta_0 + \delta_1 \theta_r + \delta_2 \theta_r^2$, where θ_r is the angle of attack of the element under consideration.
- f) Aerodynamic torque equation. This equation is obtained by integrating from tip to root the moment about the alpha hinge of the Y components of air forces acting on the blade. The mean value of torque is obtained by integrating the torque from 0 to 2π .
- g) Extension of ref. (4) to account for the variation of pitch due to angular motion of the blade and due to cyclic pitch control; and also to account for

the triangular distribution of induced velocity through the rotor. Charts are given to help calculate quickly the axial flow coefficient λ .

- h) "Hunting" coefficients. The coefficients of Fourier series representing the harmonic motion of the blade in the plane of rotation are called "hunting" coefficients. These coefficients are determined from the dynamic equation of motion of the blade in the plane of rotation.
- The effect of mechanical damping is considered in writing these equations. The damping moment is assumed to be proportional to the angular velocity of the periodic oscillation of the blade in the plane of rotation.

4) Calculation of bending moments and deflection curve in Z direction.

a) Loads on a blade element

External - Aerodynamic, gravity, inertia
Internal - Shears, moments, tension forces

Complete expressions for the external Z loads are also given in this chapter.

- b) The equations of equilibrium (motion) of an element of flexible and stiff blades.
- c) Derivation of the differential equation for the deflection. Variable moment of inertia of the blade is considered. As a first approximation the effect of blade flexibility on air loads is neglected.
- d) Solution of the differential equation for deflection by "collocation" method. A polynomial is chosen to satisfy the boundary conditions of

- the blade, including mechanical damping moment at the "flapping" hinge. A five point solution is put into convenient tabular form. Explanations are given for the constant and harmonic parts. First and second harmonics are considered.
- e) Step-by-step tabular method of finding the bending moments in the Z direction. The complete physical picture is given in deriving and explaining this method. The solution is set into tabular form for ten points. Tables are given for the constant and harmonic parts. The first and second harmonics are considered. The effect of blade flexibility on air loads is neglected.
- 5) Calculation of bending moments and deflection curve in the Y direction.
- a) Loads on a blade element. The effect of eccentricity of the alpha hinge is taken into consideration in evaluating the load components acting on a blade element. Complete expressions for the external Y loads are also given in this chapter.
- b) The equations of equilibrium (motion) of an element are given for flexible and stiff blades.
- c) Solution of the differential equation for deflection by "collocation" method is given. The assumed solution is of the same form as for bending in the Z direction. The tables derived for the Z direction bending are applicable for the Y direction bending.
- d) Step-by-step tabular method for finding the bending moments in the Y direction. The theory and tables are the same as for the Z direction bending.

6) Torsion on the blades.

a) Torsion due to dynamic forces on stiff blades.

Expressions are derived for distributed and concentrated weights.

In deriving these expressions, it was assumed that the elastic center and the center of gravity of any blade section lay on the zero lift chord line of that section. Periodic torsion includes the second harmonic.

b) Torsion due to aerodynamic forces.

c) Torsion due to Z and Y deflections. Expressions are derived to account for the torsional deformations due to bending of the blade in the Z and Y directions.

d) Total torsion is calculated as the sum of torsions found in sections a, b, and c.

7) The effect of blade flexure on the distribution of load along the blade in the Z direction; the "flapping" coefficients are corrected to account for the deflection of the blade.

8) Sample calculation.

A sample calculation of bending and deflection in the Z direction is given by both "collocation" and "tabular" methods.

Calculations of all the necessary parameters, such as the "flapping" coefficients, λ , air and dynamic loads, are also given. The constant and harmonic parts of the moments and deflections are calculated and plotted. The complete procedure (in all detail) is explained for all calculations.

Many practical points are outlined. For example: use of faired curves for EI; adjustment of the air loads to satisfy the actual boundary conditions of the blade, which may not be quite satisfied due to approximations

13

involved in deriving our expressions for the "flapping" coefficients; slow convergence of solutions of the deflection differential equations, by "collocation" method, in cases when the slope of the deflection curve is known at $X_r = 0$. Discussion of Y direction air loads, bending moments and deflections, is also given in this chapter.

Part III

Center-hinged blades rigid in the plane of rotation (see-saw type) are considered in this part. The blades are assumed to have a " δ " hinge and built-in coning.

- 1) "Flapping" coefficients are determined in a manner similar to the one used for the articulated blades by writing the equation of motion about the flapping hinge.
- 2) Solution for λ ; it is assumed for all practical purposes that sufficient accuracy is obtained if λ is determined by the use of the charts given in Part II for articulated blades.
- 3) "Hunting" coefficients are found in terms of "flapping" coefficients, built-in coning and δ_3 .
- 4) Calculation of the Z and Y direction bending moments and deflections for the "see-saw" type blades. Only the "tabular" method is given, since the "collocation" method becomes not practical because of the boundary conditions. All tables prepared in Part II are applicable.
- 5) Torsion and the effect of flexibility. All expressions derived in Part II are applicable for the "see-saw" type.

17-1

8

Part IV

Single blade rotors are considered, with five types of blade attachment to the hub:

- 1) Fully articulated with counterweight rigidly attached to hub (fig IV-1 p. IV-7). This case is treated in every detail as a special case of the fully articulated multi-bladed rotors of Part II.
- 2) Fully articulated with counterweight rigidly attached to the blade (fig IV-1 p. IV-7). This case is also treated as a special case of the fully articulated, multi-bladed, rotors of Part II, except that some of the equations therein must be modified to account for the inertia of the counterweight. These modifications are given in detail. The air loads on the counterweight are neglected.
- 3) Single hinge attachment with counterweight attached to hub, (fig IV-1 p. IV-7). This case is treated in a manner similar to that for the "see-saw" type blades of Part III. Deviations therefrom are noted and given in detail.
- 4) Single hinge attachment with counterweight rigidly attached to the blade (fig IV-1 p. IV-7). This case is treated the same as case 3, except that the modifications to account for the inertia of the counterweight are included.
- 5) Rigid blade attachment. This is in every detail covered by the analysis of Part V for multi-bladed rigid rotors.

Part V

Rotors with the blades rigidly attached to the hub. "Built-in" coning and lag angles are considered. The solution for λ of Part II is considered adequate. The equations and theory of Part II are generally applicable, upon substitution of the proper flapping and hunting coefficients, which are, of course, known at the outset. The method recommended for finding the

bending moments and deflections is the tabular method, and its application to rigid blades is discussed in detail.

If the theory and methods of this report be extended to accelerated flight conditions, the gyroscopic forces, on blades rigidly attached, must be considered. Therefore, expressions for the accelerations on the blades are given, for a maneuver involving angular velocity in roll.

Part VI. Design Criteria Considerations.

A brief discussion is given of some factors which will influence the establishment of a set of design criteria for helicopter rotor blades.

The significance of the material in this report toward such a task is briefly evaluated.

PART I
GENERAL MATERIAL APPLICABLE
TO ALL TYPES OF BLADES

Part I

I. General Assumptions

The assumptions used in this report, which are applicable to all rotor types investigated, are as follows:

- A.1. The approximated distribution of induced velocity along a blade is given by expression

$$(I-1) \quad V_1 = \bar{V}_1 (1 + x_r \cos \theta_{z_a})$$

Ref. 1, 2

- A.2. The magnitude of mean induced velocity \bar{V}_1 is given by

$$(I-2) \quad \bar{V}_1 = - \frac{T}{2\pi R^2 \rho V_A}$$

Ref. 3

- A.3. The radial component of the resultant air velocity at a blade element may be neglected.

Ref. 2

- A.4. It is assumed that in a steady flight, any satisfactory design will avoid stalling of the tips.

- A.5. It will be assumed that compressibility shock wave on the advancing blades is avoided. The limiting maximum speed given by Bailey is

$$(I-3) \quad (V_A)_{\max} = 573 \frac{\mu}{\mu + 1}$$

Ref. 4

A.6. The calculation of the tip loss factor, B, is based on the Prandtl theory (ref. 5 and 6) modified to account for the induced losses due to the necessarily large deviation from a constant induced velocity in a practical design. The additional correction was calculated on the basis of several existing designs by Quentin Wald and presented in the Sikorsky Report, ref. 7

$$(I-4) \quad B = 1 - \frac{\sqrt{2c_T}}{b} - .6 (x_r)_t \sqrt{2c_T}$$

where $(x_r)_t$ is x_r where the taper of the blade begins.

This expression is only valid for

$$(x_r)_t > .5$$

for $(x_r)_t \leq .5$, $.6 (x_r)_t$ is replaced by $.3$ and the expression for the tip loss factor becomes for $(x_r)_t \leq .5$

$$(I-4a) \quad B = 1 - \sqrt{2c_T} \left(\frac{1}{b} + .3 \right)$$

A.7. The slope of the blade section lift coefficient is a straight line.

Ref. 2

A.8. All harmonics above the second one are neglected (the effect of higher harmonics on lower ones is taken into account).

Ref. 2

A.9. The reversed flow region is treated in a manner similar to ref. 2, i.e., the trailing edge of each blade element in that region is treated as the leading edge and vice versa, the effect of stall disregarded.

A.10. In calculating the inflow coefficient and harmonic coefficients of the blade motion, the blade is infinitely stiff.

A.11. In calculating the inflow coefficient and harmonic coefficients of the blade motion, the blade chord is constant, equal to the mean chord defined as

$$(I-5) \quad \bar{c} = 4 \int_0^1 c x_r^3 dx_r$$

Ref. 8

A.12. For all calculations except when it is specified, all rotor hinges intersect at the center of the hub O' .

A.13. The root chord is assumed to be extended to the center of the hub.

A.14. All angles except azimuth θ_{za} are small, so that

$$\sin \theta = \tan \theta = \theta$$

$$\cos \theta = 1.0$$

A.15. The blade drag contributes a negligible amount to the thrust of both the blade element and the rotor.

A.16. As far as the flow through the rotor is concerned, the number of blades is infinite. Among other things, this implies that the inertia of the air is negligible.

The Reversed Flow Region

In the region of reversed flow, the air loads are negative relative to the region of straight flow, and the equations for the airloads are discontinuous at $x_r = -\mu \sin \theta_{z_a}$. Unless discontinuity can be eliminated, the bending moments and deflections of the blades must be found separately at each azimuth angle. This eliminates the possibility of finding the harmonic parts of the deflections and bending moments, which prevents solving the second approximation for the effect of blade flexibility on the air loads, and even prevents accounting for the inertia loads due to deflections of the blade (the term Rmz_r , equation II-93).

In this case the step-by-step tabular solution for the bending moments is recommended since it appears to be shorter than the "collocation" method.

Mathematical means of avoiding this impasse may exist, but it is felt that the problem is not of sufficient importance to warrant investigations of these means, considering their complexities.

In any case, it is well to bear in mind these further limitations of the theory presented herein, when it is applied to a blade in the reversed flow region, $\pi < \theta_{z_a} < 2\pi$. Although not strictly justifiable, it is thought that a good compromise solution for the bending moments of a blade in reversed flow might be obtained by considering that the air loads inboard of $x_r = \mu$ are zero at any azimuth angle. This assumption at least would permit an approximate calculation of the effect of the inertia loads due to bending (see pp. III-6 to III-11).

2. Nomenclature.

Forward:

Nomenclature adopted in this report is based on the so-called "rational" system. Since many references mentioned here use the "classical" system, that system is also presented, when possible, side by side with the "rational".

I. Coordinate Axes

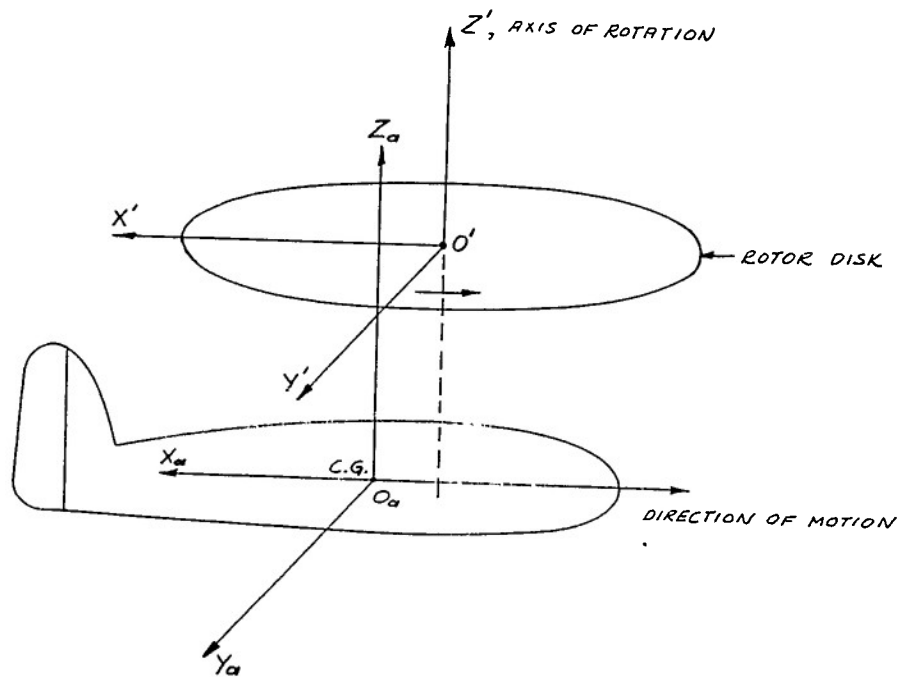

FIG. I-1

- a. The X_a , Y_a and Z_a axes are fixed to aircraft as shown above. X_a axis is horizontal when the aircraft is on the ground.
- b. The X' , Y' and Z' axes are also fixed to the aircraft but have the origin passing through the center of the rotor hub. Z' axis coincides with the rotor shaft.

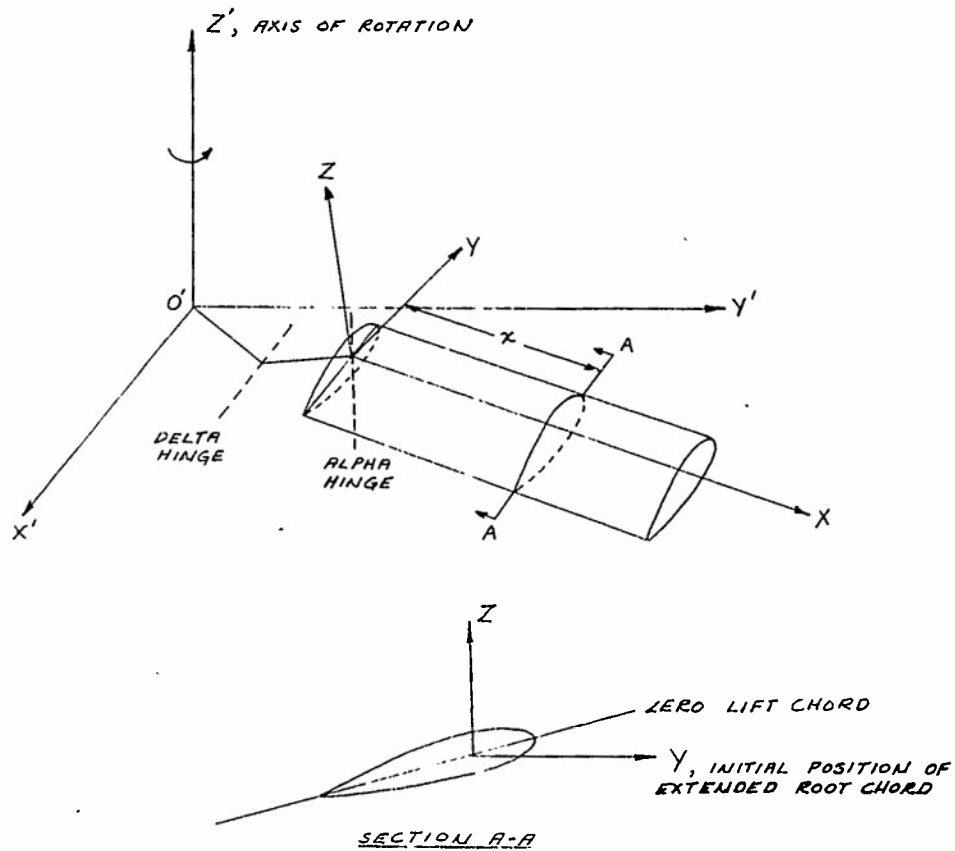

FIG. I-2

- c. The X, Y and Z axes are rotating axes with their origin, O, at the drag hinge. The X axis is coincident with the pitch changing axis (feathering axis) of the blade when the blade is assumed to be infinitely stiff. The Y axis is perpendicular to

X axis and coincides with extended zero lift root chord of the blade (extended to "0") when the blade is in its initial position. The Z axis is perpendicular to both the Y and X axes, as shown.

II. Initial position of X Y Z axes.

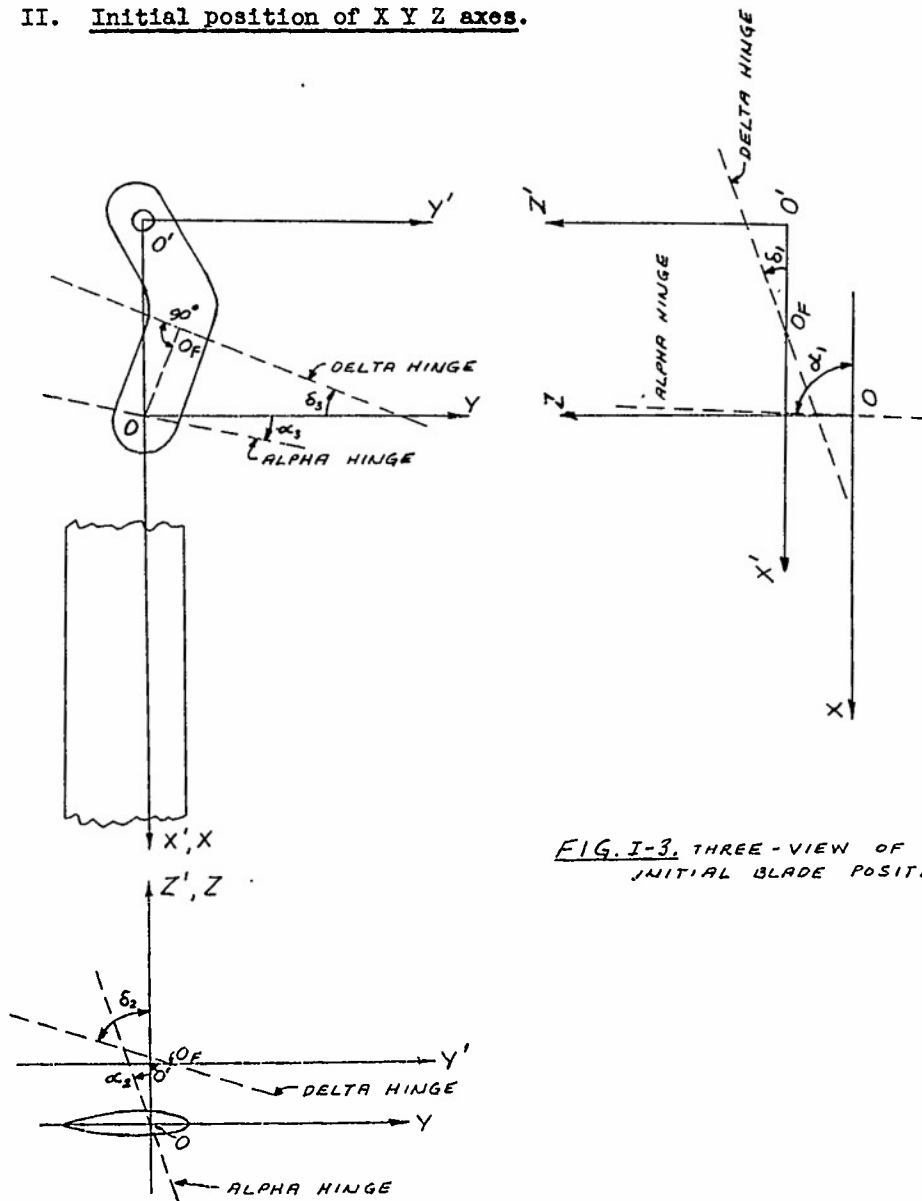

FIG. I-3. THREE-VIEW OF INITIAL BLADE POSITION

The initial position of the blade is defined as follows:
 The X Y plane is parallel to X'Y' plane, the projection of
 X axis on X'Y' plane lies along X' axis.

III. Linear Dimensions.

| | <u>"Rational" System</u> | <u>"Classical" System</u> |
|---|------------------------------|-------------------------------|
| Distance from the origin "O" (drag hinge) to a blade element | x | r |
| Chordwise distance of a particle on a blade from the pitch changing axis (X axis) | y | |
| Distance of a particle from the X Y plane | z | |
| Distance of a blade element from Z' axis when the blade is in the initial position. | r | r |
| Blade radius--Distance of the tip of the blade from Z' axis when the blade is in the initial position. | R | R |
| Delta link length is equal to $O'O_f$ (Fig I-3) | e_1 | |
| Alpha link length is equal to O_fO (Fig I-3) | e_2 | |
| Chord of a blade element | c | c |
| Mean chord | \bar{c} | |
| Extended root chord | c_0 | |
| Extended tip chord | c_1 | |
| Blade structural deflection parallel to X Y Z axes respectively | x, y, z | |

IV. Angular Dimensions.

Total angular displacement about
 the X axis of the X Y plane from its
 initial position--Total blade incidence
 at the drag hinge

θ_x

θ

| | "Rational" System | "Classical" System |
|---|----------------------|-----------------------|
| Total angular displacement about the Y axis of the Y X plane from its initial position-- Flapping angle | θ_Y | β |
| Total angular displacement about the Z axis of Z X plane from its initial position. | θ_Z | ψ |
| Angular displacement about the Z axis of the Z X plane from its initial position due to the rotation of the drive shaft | θ_{Za} | ψ |
| Angular displacement about the Z axis of the Z X plane from its initial position due to the motion about drag hinge | θ_{Zb} | ξ |
| Absolute angle of attack of a blade element | α_r | α_r |
| Induced angle of attack of a blade element | α_i | ϕ |
| Total twist of the blade--between the extended root chord and the tip | θ_t | θ_1 |
| Blade incidence at the drag hinge due to collective pitch control | θ_{xo} | |
| Maximum (minimum) blade incidence at the drag hinge due to cyclic pitch control | θ_{xc} | |
| Control phase azimuth angle | θ_{zc} | |
| Effective blade incidence | θ_{xoe} | |
| Angle of incidence of a particle on a blade element | θ_{xe} | |
| Angular displacement about the X' axis of the X'Y' plane from its initial position--Roll | $\theta_{X'}$ | |

| | <u>"Rational" System</u> | <u>"Classical" System</u> |
|---|------------------------------|-------------------------------|
| Angular displacement about the Y' axis of the X'Y' plane from its initial position--Pitch | $\theta_{y'}$ | α |
| Angular displacement about the Z' axis of Z'X' plane from its initial position--Yaw | $\theta_{z'}$ | |
| Angular dimensions of Delta (Flapping) axis and Alpha (Drag) axis respectively as shown in Fig. (I-3) | | |
| Measured in Z X plane from X | δ_1, α_1 | δ_1, α_1 |
| Measured in Z Y plane from Z | δ_2, α_2 | δ_2, α_2 |
| Measured in X Y plane from Y | δ_3, α_3 | δ_3, α_3 |
| V. <u>Linear Velocities.</u> | | |
| Resultant air velocity at Rotor | V_R | V |
| Absolute velocity of aircraft | V_A | V |
| Resultant velocity at a blade element | V | |
| Components of velocity at a blade element due to motion of the blade | $\dot{x}, \dot{y}, \dot{z}$ | |
| Component of V_R parallel to X'Y'Z' axes respectively | $V_{Rx'}, V_{Ry'}, V_{Rz'}$ | |
| Components of V_A parallel to the X'Y'Z' axes respectively | $V_{Ax'}, V_{Ay'}, V_{Az'}$ | |
| Components of V parallel to the X Y Z axes respectively | V_x, V_y, V_z | |
| Induced velocity at any point of the Rotor | V_i | $v + v_i$ |
| Mean induced velocity of Rotor | $\overline{V_i}$ | v |

VI. Angular Velocities.

Angular velocities are designated by dotting corresponding angular displacement
(i.e. $\dot{\theta}_z, \dot{\theta}_{z_b}, \dot{\theta}_x$)

"Rational"
System

"Classical"
System

$n, \dot{\xi}$

VII. Linear Accelerations:

Linear accelerations are designated by double dotting the corresponding linear dimensions
(i.e., \ddot{x}, \ddot{y})

VIII. Angular Accelerations.

Angular accelerations are designated by double dotting the corresponding angular displacements
(i.e., $\ddot{\theta}_z, \ddot{\theta}_{z_a}, \ddot{\theta}_{z_b}$)

IX. Forces.

Force acting on Rotor

Force acting on a blade

Components of F_R parallel to the $X'Y'Z'$ axes respectively

Components of F parallel to the $X Y Z$ axes respectively

F_R
 F

R

$F_{R_x'}, F_{R_y'}, F_{R_z}'$

F_x, F_y, F_z

X. Moments.

Total moment

Moments about $X'Y'Z'$ axes respectively

Moments about $X Y Z$ axes respectively

Moments about axes parallel to the $X'Y'Z'$ axes respectively

M

$M_{x'}, M_{y'}, M_{z}'$

L', M, Q

M_x, M_y, M_z

$M_{x'i}, M_{y'i}, M_{z'i}$

Moments about axes parallel to
the X Y Z axes respectively

| | |
|--------------------------|-----------------------|
| "Rational" System | "Classical" System |
| M_{xi}, M_{yi}, M_{zi} | |

XI. Series Expansions.

Flapping Angle:

"Rational" $\theta_y = a_0 - a_1 \cos \theta_{z_a} - b_1 \sin \theta_{z_a} - a_2 \cos 2\theta_{z_a} -$
 $- b_2 \sin 2\theta_{z_a}$

"Classical" $\beta = a_0 - a_1 \cos \psi - b_1 \sin \psi - a_2 \cos 2\psi -$
 $- b_2 \sin 2\psi$

Feathering Angle:

"Rational" $\theta_x = c_0 - c_1 \cos \theta_{z_a} - d_1 \sin \theta_{z_a} - c_2 \cos 2\theta_{z_a} -$
 $- d_2 \sin 2\theta_{z_a}$

"Classical" $\theta = \theta_0 - A_1 \cos \psi - B_1 \sin \psi - A_2 \cos 2\psi -$
 $- B_2 \sin 2\psi$

Lag Angle:

"Rational" $\theta_{z_b} = e_0 - e_1 \cos \theta_{z_a} - f_1 \sin \theta_{z_a} - e_2 \cos 2\theta_{z_a} -$
 $- f_2 \sin 2\theta_{z_a}$

"Classical" $\xi = E_0 - E_1 \cos \psi - F_1 \sin \psi - E_2 \cos 2\psi -$
 $- F_2 \sin 2\psi$

+

| XII. Coefficients | "Rational" System | "Classical" System |
|----------------------------|---|--|
| Rotor lift | $L = C_L \pi R^2 \frac{1}{2} \rho V_A^2$ | $L_2 = C_{L_2} \pi R^2 \frac{1}{2} \rho V^2$ |
| Rotor drag | $D = C_D \pi R^2 \frac{1}{2} \rho V_A^2$ | $D_2 = C_{D_2} \pi R^2 \frac{1}{2} \rho V^2$ |
| Rotor lateral force | $F_{Ry'} = C_{y'} \pi R^2 \frac{1}{2} \rho V_A^2$ | $Y = C_y \pi R^2 \frac{1}{2} \rho V^2$ |
| Rotor thrust | $T = C_T \rho \dot{\omega}_{z_a}^2 \pi R^4$ | $T = C_T \rho \Omega^2 \pi R^4$ |
| Mean inflow factor | $\lambda = \frac{V_{Az'} + \bar{V}_i}{R \dot{\omega}_{z_a}}$ | $\lambda = \frac{V \sin \alpha - v}{\Omega R}$ |
| Mean induced inflow factor | $\lambda_1 = \frac{\bar{V}_i}{R \dot{\omega}_{z_a}}$ | $\frac{v}{\Omega R}$ |
| Tip speed ratio | $\mu = \frac{V_{Ax'}}{R \dot{\omega}_{z_a}}$ | $\mu = \frac{V \cos \alpha}{\Omega R}$ |
| Solidity ratio | $\sigma = \frac{b\bar{c}}{\pi R}$ | $\sigma = \frac{b\bar{c}}{\pi R}$ |
| Rotor torque | $M_{z'} = C_Q \rho \dot{\omega}_{z_a}^2 \pi R^5$ | $Q = C_Q \rho \Omega^2 \pi R^5$ |
| Rotor rolling moment | $M_{x'} = C_{\zeta} \pi R^3 \frac{1}{2} \rho V_A^2$; $L' = C_{\zeta} \pi R^3 \frac{1}{2} \rho V^2$ | |

| | <u>"Rational" System</u> | <u>"Classical" System</u> |
|---|--|--|
| Rotor pitching moment | $= M_y = C_m \pi R^3 \frac{1}{2} \rho V_A^2$ | $M = C_m \pi R^3 \frac{1}{2} \rho V^2$ |
| Ratio of V components to rotational tip speed | u_x, u_y, u_z | u_R, u_T, u_P |
| Ratio of distance of an element from origin, 0, to blade radius | $X_r = \frac{x}{R}$ | |

XIII. Miscellaneous

| | | |
|--|------------------|-------|
| Number of blades | b | b |
| Tip loss factor | B | B |
| Moment of inertia about Delta hinge | I_F | I_1 |
| Moment of inertia about Alpha hinge | I_D | I_2 |
| Moment of inertia about Y axis | I_y | |
| Moment of inertia about Z axis | I_z | |
| Blade sections moments of inertia about their axes parallel to Y and Z axes respectively | I_{y1}, I_{z1} | I |

| | <u>"Rational"</u> <u>System</u> | <u>"Classical"</u> <u>System</u> |
|--|---|-------------------------------------|
| Mass constant of rotor blade (Flapping hinge) | $\gamma_F^* = \frac{\bar{c} \rho a R^4}{I_F}$ | $= \frac{c \rho a R^4}{I_1}$ |
| Mass constant of rotor blade (drag hinge) | $\gamma_D = \frac{\bar{c} \rho a R^4}{I_D}$ | |
| Slope of lift curve per radian | = a | a |
| Mean profile drag coefficient | δ | δ |
| Subscript used in connection with a flexible blade | () _F | |
| Mass per foot length of blade | = m | |
| Weight per foot length of the blade | = w | |
| Total weight of each blade | = W _b | |

Numerical Solution of Linear Differential Equations of Higher Order

Since the calculation of blade deflections involve the solution of linear differential equations of fourth order, the outline of several known methods for solving that type of equation is given in the following.

Three methods listed below are considered:

Collocation
Least square
Galerkin

The type of differential equation considered is of the form

$$(I-6) \quad G_n(x) \frac{d^n z}{dx^n} + G_{n-1}(x) \frac{d^{n-1} z}{dx^{n-1}} + \dots + G_1(x) \frac{dz}{dx} + G_0(x)z = f(x)$$

or in a more brief form

$$(I-6a) \quad G(p)z - f(x) = 0$$

where $p = \frac{d}{dx}$

$$(I-6b) \quad G(p) = G_n p^n + G_{n-1} p^{n-1} + \dots + G_1 p + G_0$$

and x is an independent variable.

The problem consists in finding the unique solution in one interval of $a \leq x \leq b$.

The solution can be assumed to be given by a polynomial which can be written in a form

$$(I-7) \quad Z(x) = X_0(x) + \sum_{j=1}^S X_j(x) a_j$$

where $X_0(x)$ and $X_j(x)$ are functions of x which are chosen in such a way as to satisfy as many boundary conditions for $Z(x)$ and its derivatives as possible, inherently, i.e., independently of the values of the coefficients a_j . Sometimes it is not possible to satisfy all the boundary conditions without introducing difficulties in the subsequent integrations. In such cases it is better not to satisfy a boundary condition than to satisfy a false one.

The constants a_j must be such as to get the assumed solution $Z(x)$ to fit the actual one z as closely as possible. The main difference between methods of solving the equation is the way the constants a_j are determined.

It is obvious that for a given differential equation and boundary conditions there may be a number of polynomials which can be chosen. Some of them may satisfy all the conditions, others may satisfy them only partially, but may be preferred because of their simplicity in integrating.

Once a polynomial is chosen, the problem is then reduced to determination of constants a_j .

If the assumed solution happened to be the exact solution of the given differential equation we would have

$$(I-8) \quad G(p) Z(x) - f(x) = 0$$

but since it is only an approximate solution we have

$$(I-8a) \quad G(p) Z(x) - f(x) \neq 0 \equiv \epsilon(x)$$

where $\epsilon(x)$ is a function obtained when $Z(x)$ is substituted for z in the left hand side of the differential equation (I-6). The above equation can also be written in the form

$$(I-8b) \quad \epsilon(x) = \sum_{j=1}^S A_j(x) a_j + X_0(x) - f(x)$$

where $A_j(x) = G(p) X_j(x)$ for $j = 0, 1, 2, \dots, S$ (I-8c)

The three methods now can be outlined

Collocation

The constants a_j are chosen so that $Z(x)$ satisfies the differential equation exactly at S selected points X_1, X_2, \dots, X_S , i.e., $\mathcal{L}(Z) = 0$ at those selected points.

$$\sum_{j=1}^S A_j(x_1) a_j + X_0(x_1) = f(x_1) \quad (I-9)$$

for $i = 1, 2, 3, \dots, S$.

To illustrate the method, consider, for example, a simple cantilever beam uniformly loaded and constant EI

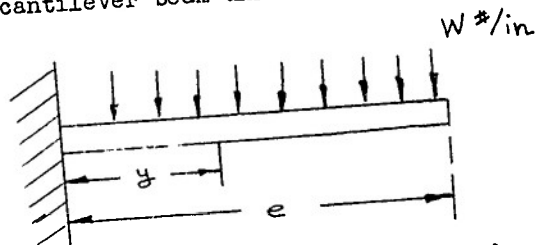

FIG. I-4

The equation for the moment at each point distant y from the root will be

$$EI \frac{d^2 z}{dy^2} = \frac{W}{2} (e - y)^2 \quad (I-10)$$

if we let $\frac{y}{e} = x$ and $\frac{e^4 W}{2EI} = 1$ (I-11)

the equation becomes

$$\frac{d^2 z}{dx^2} = (1 - x)^2 \quad (I-10a)$$

With the boundary conditions

$$z = \frac{dz}{dx} = 0 \text{ at } x = 0 \quad (I-12)$$

$$\frac{d^2z}{dx^2} = \frac{d^3z}{dx^3} = 0 \text{ at } x = 1 \quad (I-12a)$$

The exact solution of the equation is

$$z = \frac{x^2}{2} - \frac{x^3}{3} + \frac{x^4}{12} \quad (I-13)$$

Assume the solution to be given by a polynomial

$$(I-14) \quad Z(x) = a_1 \left[\frac{x^2}{2} - \frac{2x}{\pi} + \left(\frac{2}{\pi}\right)^2 \sin \frac{\pi}{2} x \right] + a_2 \left[\frac{x^2}{2} - \frac{2x}{5\pi} + \left(\frac{2}{5\pi}\right)^2 \sin \frac{5\pi}{2} x \right] \\ + \dots + a_8 \left[\frac{x^2}{2} - \frac{2x}{(48-3)\pi} + \frac{1}{(48-3)^2} \left(\frac{2}{\pi}\right)^2 \sin \frac{(48-3)}{2} \pi x \right]$$

$$(I-14a) \quad X_0(x) = 0$$

$$(I-14b) \quad X_j(x) = \left[\frac{x^2}{2} - \frac{2x}{(4j-3)\pi} + \frac{1}{(4j-3)^2} \left(\frac{2}{\pi}\right)^2 \sin \frac{(4j-3)}{2} \pi x \right]$$

Retaining first three terms we have $S = 3$ and

$$(I-14c) \quad Z(x) = a_1 \left[\frac{x^2}{2} - \frac{2x}{\pi} + \left(\frac{2}{\pi}\right)^2 \sin \frac{\pi}{2} x \right] + a_2 \left[\frac{x^2}{2} - \frac{2x}{5\pi} + \left(\frac{2}{5\pi}\right)^2 \sin \frac{5\pi}{2} x \right] \\ + a_3 \left[\frac{x^2}{2} - \frac{2x}{9\pi} + \left(\frac{2}{9\pi}\right)^2 \sin \frac{9}{2} \pi x \right]$$

$$\text{for } x = 0, \quad Z(x) = 0$$

$$(I-14d) \dot{Z}(x) = a_1 \left[x - \frac{2}{\pi} + \frac{2}{\pi} \cos \frac{\pi}{2} x \right] + a_2 \left[x - \frac{2}{5\pi} + \frac{2}{5\pi} \cos \frac{5\pi}{2} x \right] \\ + a_3 \left[x - \frac{2}{9\pi} + \frac{2}{9\pi} \cos \frac{9}{2} \pi x \right]$$

$$\text{for } x = 0, \dot{Z}(x) = 0$$

$$(I-14e) \ddot{Z}(x) = a_1 (1 - \sin \frac{\pi}{2} x) + a_2 (1 + \sin \frac{5\pi}{2} x) + a_3 (1 - \sin \frac{9\pi}{2} x);$$

$$\text{for } x = 1, \ddot{Z}(x) = 0$$

$$(I-14f) \dddot{Z}(x) = -a_1 \frac{\pi}{2} \cos \frac{\pi}{2} x - a_2 \frac{5\pi}{2} \cos \frac{5\pi}{2} x - a_3 \frac{9\pi}{2} \cos \frac{9\pi}{2} x$$

$$\text{for } x = 1, \dddot{Z}(x) = 0$$

Substituting $\ddot{Z}(x)$ into the differential equation,
we have

$$(I-15) a_1 (1 - \sin \frac{\pi}{2} x) + a_2 (1 - \sin \frac{5\pi}{2} x) + a_3 (1 - \sin \frac{9\pi}{2} x) \\ - (1 - x)^2 = \epsilon(x)$$

Choosing three points where $\epsilon(x) = 0$, we have at points
(chosen at random)

$$x_1 = 0 \quad x_2 = 1/2 \quad x_3 = 2/3$$

$$(I-16a) \quad a_1 + a_2 + a_3 - 1 = 0 \quad (x = 0)$$

$$(b) \quad .293 a_1 + 1.707 a_2 + .293 a_3 - .25 = 0 \quad (x = 1/2)$$

$$(c) \quad .134 a_1 + 1.866 a_2 + a_3 - .1109 = 0 \quad (x = 2/3)$$

Solving, we have

$$a_1 = .9963$$

$$a_2 = -.0304$$

$$a_3 = .0341$$

Therefore, the equation for deflection becomes:

$$(I-17) \quad Z(x) = .9963 \left[\frac{x^2}{2} - \frac{2x}{\pi} + \left(\frac{2}{\pi}\right)^2 \sin \frac{\pi}{2} x \right] - .0304 \left[\frac{x^2}{2} - \frac{2x}{5\pi} \right. \\ \left. + \left(\frac{2}{5\pi}\right)^2 \sin \frac{5\pi}{2} x \right] + .0341 \left[\frac{x^2}{2} - \frac{2x}{9\pi} + \left(\frac{2}{9\pi}\right)^2 \sin \frac{9\pi}{2} x \right]$$

Calculating at several points and comparing with the exact solution, we have,

| x | Z collocation | z exact |
|-----|---------------|---------|
| 0 | 0 | 0 |
| .25 | .02386 | .0264 |
| .50 | .089 | .0887 |
| .75 | .1801 | .1665 |
| 1.0 | .2716 | .25 |

If more terms are taken, the approximation will be even closer than above.

Least Square

In this method each constant, a_j , is determined in such a way that the mean squared error ϵ^2 , in the interval from a to b in the differential equation is minimum; or

$$(I-18) \quad \frac{\partial}{\partial a_j} \int_a^b \epsilon^2 dx = 2 \int_a^b \epsilon \frac{\partial \epsilon}{\partial a_j} dx = 0$$

Using the same example as in collocation

$$(I-10a) \quad \frac{d^2 z}{dx^2} = (1-x)^2$$

we had,

$$(I-15) \quad \epsilon = a_1 (1 - \sin \frac{\pi}{2} x) + a_2 (1 - \sin \frac{5\pi}{2} x) \\ + a_3 (1 - \sin \frac{9\pi}{2} x) - (1-x)^2$$

The least square equations are

$$(I-19) \quad 0 = \int_0^1 \epsilon (1 - \sin \frac{\pi}{2} x) dx = \int_0^1 \epsilon (1 - \sin \frac{5\pi}{2} x) dx \\ = \int_0^1 \epsilon (1 - \sin \frac{9\pi}{2} x) dx ;$$

or, evaluating these integrals

$$(I-20) \quad .226 a_1 + .235 a_2 + .291 a_3 - .2133 = 0 \\ .235 a_1 + 1.245 a_2 + .802 a_3 - .2118 = 0 \\ .291 a_1 + .802 a_3 + 1.358 a_3 - .2631$$

Solving

$$a_1 = .95 \\ a_2 = -.0339 \\ a_3 = -.00268$$

Galerkin's Method

In Galerkin's method the constants, a_j , are determined in such a way as to satisfy the condition

$$(I-21) \quad \int_a^b \epsilon X_j(x) dx = 0$$

$X(x)$ is obtained from equation I-14. In general, any arbitrary multiplier can be used instead of $X_j(x)$, provided the number of terms taken is large. Using the same example as in the previous two methods we have

$$(I-15) \quad \epsilon = a_1 (1 - \sin \frac{\pi}{2} x) + a_2 (1 - \sin \frac{5\pi}{2} x) + a_3 (1 - \sin \frac{9\pi}{2} x) - (1-x)^2;$$

$$(I-22) \quad X_j(x) = \frac{x^2}{2} - \frac{2x}{(4s-3)\pi} + \frac{1}{(4s-3)^2} \left(\frac{2}{\pi}\right)^2 \sin \frac{(4s-3)\pi x}{2}$$

Therefore, the equations which determine the coefficients a_j are

$$(I-23a) \quad \int_0^1 \epsilon \left[\frac{x^2}{2} - \frac{2x}{\pi} + \left(\frac{2}{\pi}\right)^2 \sin \frac{\pi}{2} x \right] dx = 0$$

$$(b) \quad \int_0^1 \epsilon \left[\frac{x^2}{2} - \frac{2x}{5\pi} + \left(\frac{2}{5\pi}\right)^2 \sin \frac{5\pi}{2} x \right] dx = 0$$

$$(c) \quad \int_0^1 \epsilon \left[\frac{x^2}{2} - \frac{2x}{9\pi} + \left(\frac{2}{9\pi}\right)^2 \sin \frac{9\pi}{2} x \right] dx = 0$$

Again, these integrals can be evaluated and result in three linear simultaneous equations in a_1 , a_2 , and a_3 which can be solved in a straightforward manner.

Trials of the three methods have shown that the first, collocation, requires the least computation to find the coefficients for a given approximation, and since neither of the other methods appears to have any advantage in rate of convergence, collocation is the one chosen for the solution of the differential equations for the harmonic parts of the blade deflections.

Geometry of the Rotor Blade Hinges.

On helicopters which have blades attached to the hub by one or two hinges (generally called the " δ ", or flapping hinge and/or the " α ", or drag hinge) it is desirable to interrelate the flapping angle, lag angle, and incidence ($\theta_y, \theta_z, \theta_x$) analytically by means of expressions involving only those variables and constants which depend only on the geometry of the hinges. In this chapter, a method of obtaining these expressions is given, and graphs showing the relation between the variables for some typical hinge configurations are given.

There are at least three methods of obtaining the desired expressions:

1. Descriptive geometry
2. Analytic geometry
3. Spherical trigonometry

It is believed that the third, spherical trigonometry, is best suited to this particular problem.

The analysis is in two parts: The first deals with the case of only one (the " δ ", or flapping) hinge. The second deals with the more general case where both " δ " and " α " hinges are used. The results of the first part could be obtained as a particular solution to the second part. Consideration of the case of only one hinge as a separate problem is, however, simpler and clearer.

Special notation for this chapter is the following;

- θ_δ The angle between the flapping, or " δ ", hinge and the X'Y' plane.
- θ_α The angle between the drag, or " α ", hinge, in its initial position, and the X'Y' plane.

θ_x in this chapter means only the change in blade angle of attack due to flapping or lagging from the initial position.

\underline{a} , \underline{a}' , \underline{b} , \underline{b}' , \underline{c} are arcs constructed on the surface of the sphere to form the spherical triangles on which the solution depends - (see fig. I-5 and I-6).

D, E, F are angles in the spherical triangles on which the solution depends. (see fig. I-5 and I-6)

In the text, $\Delta \underline{a}, \underline{b}, \underline{c}$ is the spherical triangle whose sides are \underline{a} , \underline{b} and \underline{c} .

Single hinged rotor.

Fig. I-5 shows the X axis and the δ hinge starting at O' , origin of $X'Y'Z'$ axes and projecting out thru the surface of a sphere whose center is at O' . The initial positions of the XYZ axes are coincident with the $X'Y'Z'$ axes shown in the figure. The angle θ_δ is the angle between the δ hinge and the $X'Y'$ plane. δ_3 is the angle between the Y' axis and the $X'Y'$ projection of the hinge.

Construct great circle arcs \underline{a} and \underline{a}' on the surface of the sphere thru the X axis and the δ hinge. It should not require proof that $\underline{a} = \underline{a}'$ and that the change in the angle between the arc \underline{a} and the meridian thru the X axis, is the variable, $-\theta_x$. Thus the angle in the lower left corner of $\Delta (90 - \theta_y), (90 - \theta_\delta), \underline{a}'$, is marked $90 - F - \theta_x$.

From $\Delta \underline{a}, (90 - \delta_3), \theta_\delta$:

$$(I-24) \quad \cos \underline{a} = \cos (90 - \delta_3) \cos \theta_\delta = \sin \delta_3 \cos \theta_\delta$$

From $\Delta \underline{a}'$, $(90 - \theta_y)$, $(90 - \theta_\delta)$:

$$\cos (90 - \theta_{z_b} - \delta_3) \sin (90 - \theta_\delta) \sin (90 - \theta_y) = \cos a - \cos (90 - \theta_\delta) \cos (90 - \theta_y)$$

or

$$(I-25) \quad \sin (\delta_3 + \theta_{z_b}) \cos \theta_\delta \cos \theta_y = \sin \delta_3 \cos \theta_\delta - \sin \theta_\delta \sin \theta_y$$

$$(I-26) \quad \therefore \sin (\delta_3 + \theta_{z_b}) = \frac{\sin \delta_3}{\cos \theta_y} - \tan \theta_\delta \tan \theta_y$$

Solving for $\sin \theta_{z_b}$:

$$(I-27) \quad \sin \theta_{z_b} = \frac{\cos \delta_3}{\cos \theta_y} (\sin \delta_3 - \tan \theta_\delta \sin \theta_y)$$

$$\pm \frac{\sin \delta_3}{\cos \theta_y} \sqrt{\cos^2 \delta_3 - \sin^2 \theta_y - \tan^2 \theta_\delta \sin^2 \theta_y + 2 \sin \delta_3 \tan \theta_\delta \sin \theta_y}$$

Since $\theta_{z_b} = 0$ when $\theta_y = 0$, the minus (-) sign in the above is correct.

If $\delta_3 = 0$:

$$(I-28) \quad \sin \theta_{z_b} = - \tan \theta_y \tan \theta_\delta$$

or, if $\theta_\delta = 0$:

$$(I-29) \quad \sin \theta_{z_b} = \frac{\sin \delta_3 \cos \delta_3}{\cos \theta_y} \left(1 - \sqrt{1 - \left(\frac{\sin \theta_y}{\cos \delta_3} \right)^2} \right) \approx 0$$

From $\Delta (90 - \theta_y)$, $(90 - \theta_\delta)$, \underline{a}' :

$$\frac{\sin (90 - \theta_y - \theta_x)}{\sin (90 - \theta_\delta)} = \frac{\sin (90 - \delta_3 - \theta_{z_b})}{\sin \underline{a}}$$

or

$$(I-30) \begin{cases} \cos (F + \theta_x) = \frac{\cos \theta_\delta \cos (\delta_3 + \theta_{z_b})}{\sin a} \\ \sin (F + \theta_x) = \sqrt{1 - \frac{\cos^2 \theta_\delta \cos^2 (\delta_3 + \theta_{z_b})}{\sin^2 a}} \end{cases}$$

From Δa , $(90 - \delta_3)$, θ_δ :

$$(I-31) \quad \sin F = \frac{\sin \theta_\delta}{\sin a}, \quad \cos F = \sqrt{1 - \frac{\sin^2 \theta_\delta}{\sin^2 a}}$$

From (I-24):

$$(I-32) \quad \sin^2 a = 1 - \sin^2 \delta_3 \cos^2 \theta_\delta$$

From (I-26):

$$(I-33) \quad \cos (\delta_3 + \theta_{z_b}) = \sqrt{1 - \left(\frac{\sin \delta_3}{\cos \theta_y} - \tan \theta_\delta \tan \theta_y \right)^2}$$

Now, $\theta_x = (F + \theta_x) - F$

$$(I-34) \quad \sin \theta_x = \sin (F + \theta_x) \cos F - \sin F \cos (F + \theta_x)$$

Substituting (I-30), (I-31), (I-32), (I-33) in (I-34) and reducing, we find

$$(I-35) \quad \sin \theta_x = \frac{-\cos \theta_\delta / \cos \theta_y}{1 - \sin^2 \delta_3 \cos^2 \theta_\delta} \left\{ \cos \delta_3 \sin \theta_y \sin \delta_3 \cos \theta_\delta \right. \\ \left. - \sin \theta_\delta \left[\cos \delta_3 \sqrt{\cos^2 \theta_y - (\sin \delta_3 - \tan \theta_\delta \sin \theta_y)^2} \right] \right\}$$

If $\theta_\delta = 0$:

$$(I-36) \quad \sin \theta_x = -\tan \delta_3 \tan \theta_y$$

If $\delta_3 = 0$:

$$(I-37) \quad \sin \theta_x = \sin \theta_\delta \cos \theta_\alpha \left\{ \frac{1}{\cos \theta_y} \sqrt{1 - \tan^2 \theta_y \tan^2 \theta_\delta} \right\} \approx 0$$

Double Hinged Blades.

The analysis for the case of both "a" and "δ" hinges may proceed in a manner similar to that for the singly hinged blades.

Figure I-6 shows the X axis, δ hinge, and α hinge all starting at O', origin of the X'Y'Z' axes and projecting out thru the surface of a sphere whose center is at O'. The initial positions are shown as solid lines.

The angle θ_δ is the angle between the δ hinge and the X'Y' plane. θ_α is the angle between the α hinge and the X'Y' plane before any rotation has occurred about the δ hinge. Similarly, the angles δ_3 and α_3 are the angles between the Y' axis and the X'Y' projections of the hinge, and the initial position of the α hinge, respectively. The necessary constructions are as follows:

1. Construct great-circle-arc a on the sphere thru the δ hinge and initial position of the α hinge.
2. Construct great-circle-arc b on the sphere thru the X' axis and the initial position of α hinge.
3. Construct the great-circle-arc c on the sphere thru the δ hinge and the final, or general, position of the X axis.
4. Swing small circles on the sphere of radii b and a about the X axis and δ hinge axis respectively, and from their intersection draw radii b' and a' to the X axis and δ hinge.

It may now be supposed that the way in which the X axis arrived at its general position from the initial one was as follows:

1. The blade and the α hinge, maintaining their initial angle to one another, rotated together about the δ hinge, so that the arc \underline{a} rotated to the position \underline{a}' , and the arc \underline{b} moved to some new position not shown.
2. Finally the blade rotated about the α hinge sufficiently to move arc \underline{b} down to its position \underline{b}' when the X axis was at the general position shown.

It is now apparent that the change in the angle between the arc \underline{b} and the meridian at the X axis, is the change in incidence, $-\theta_x$:

$$\text{or, } D + E = (90 - F) - \theta_x$$

$$\theta_x = [(90 - E) - (D + F)]$$

$$(I-38) \quad \therefore \sin \theta_x = -\cos E (\sin F \sin D - \cos F \cos D) \\ - \sin E (\sin F \cos D + \cos F \sin D)$$

From $\Delta \underline{b}, \theta_\alpha, 90 - \alpha_3$:

$$\sin F = \frac{\sin \theta_\alpha}{\sin \underline{b}}, \quad \cos \underline{b} = \cos (90 - \alpha_3) \cos \theta_\alpha = \sin \alpha_3 \cos \theta_\alpha$$

$$(I-39) \quad \therefore \sin F = \frac{\sin \theta_\alpha}{\sqrt{1 - \sin^2 \alpha_3 \cos^2 \theta_\alpha}},$$

$$\cos F = \frac{\pm \cos \theta_\alpha \cos \alpha_3}{\sqrt{1 - \sin^2 \alpha_3 \cos^2 \theta_\alpha}}$$

From $\Delta \underline{a}$, $(90 - \theta_\alpha)$, $(90 - \theta_\delta)$:

$$\begin{aligned} \cos \underline{a} &= \cos (\alpha_3 - \delta_3) \sin (90 - \theta_\alpha) \sin (90 - \theta_\delta) \\ &\quad + \cos (90 - \theta_\alpha) \cos (90 - \theta_\delta) \end{aligned}$$

or

$$(I-40) \quad \cos \underline{a} = \cos (\alpha_3 - \delta_3) \cos \theta_\alpha \cos \theta_\delta + \sin \theta_\alpha \sin \theta_\delta$$

From $\Delta \underline{c}$, $(90 - \theta_y)$, $(90 - \theta_\delta)$:

$$\begin{aligned} \cos \underline{c} &= \cos (90 - \theta_{z_b} - \delta_3) \sin (90 - \theta_y) \sin (90 - \theta_\delta) \\ &\quad + \cos (90 - \theta_y) \cos (90 - \theta_\delta) \end{aligned}$$

$$(I-41) \quad \cos \underline{c} = \sin (\delta_3 + \theta_{z_b}) \cos \theta_y \cos \theta_\delta + \sin \theta_y \sin \theta_\delta$$

$$\text{also } \frac{\sin D}{\sin (90 - \theta_\delta)} = \frac{\sin (90 - \theta_{z_b} - \delta_3)}{\sin \underline{c}}$$

$$(I-42) \quad \sin D = \frac{\cos \theta_\delta \cos (\delta_3 + \theta_{z_b})}{\sin \underline{c}} = \frac{\cos \theta_\delta \cos (\delta_3 + \theta_{z_b})}{\sqrt{1 - \cos^2 \underline{c}}}$$

From $\Delta \underline{b}'$, \underline{c} , \underline{a}' :

$$(I-43) \quad \cos E = \frac{\cos \underline{a} - \cos \underline{b} \cos \underline{c}}{\sin \underline{b} \sin \underline{c}} = \frac{\cos \underline{a} - \cos \underline{b} \cos \underline{c}}{\sqrt{(1 - \cos^2 \underline{b})(1 - \cos^2 \underline{c})}}$$

Substituting (I-40) and (I-41) in (I-42) and (I-43), the following expressions are derived:

$$(I-44) \sin D = \frac{\cos \theta_S \cos (\theta_Z + \theta_{Z_p})}{\sqrt{1 - [\sin (\theta_Z + \theta_{Z_p}) \cos \theta_Y \cos \theta_S + \sin \theta_Y \sin \theta_S]^2}}$$

$$(I-45) \cos D = \frac{\cos^2 \theta_S \cos^2 (\theta_Z + \theta_{Z_p})}{1 - [\sin (\theta_Z + \theta_{Z_p}) \cos \theta_Y \cos \theta_S + \sin \theta_Y \sin \theta_S]^2}$$

$$= \frac{+ (\cos \theta_S \sin (\theta_Z + \theta_{Z_p}) \sin \theta_Y - \sin \theta_S \cos \theta_Y)}{\sqrt{1 - [\sin (\theta_Z + \theta_{Z_p}) \cos \theta_Y \cos \theta_S + \sin \theta_Y \sin \theta_S]^2}}$$

$$(I-46) \cos E = \frac{\cos (\alpha - \theta_Z) \cos \theta_a \cos \theta_S + \sin \theta_a \sin \theta_S - (\sin (\theta_Z + \theta_{Z_p}) \cos \theta_Y \cos \theta_S + \sin \theta_Y \sin \theta_S) \sin \theta_a \cos \theta_a}{\sqrt{\left\{ 1 - [\sin (\theta_Z + \theta_{Z_p}) \cos \theta_Y \cos \theta_S + \sin \theta_Y \sin \theta_S]^2 \right\} \left\{ 1 - [\sin \alpha \cos \theta_a]^2 \right\}}}$$

$$(I-47) \sin B = \frac{1 - \frac{A^2}{[1 - (\sin(\delta_3 + \theta_{z_b}) \cos \theta_y \cos \theta_\delta + \sin \theta_y \sin \theta_\delta)^2][1 - (\sin \alpha_3 \cos \theta_\alpha)^2]}}{A^2}$$

$$\text{where } A = \left\{ \cos(\alpha_3 - \delta_3) \cos \theta_\alpha \cos \theta_\delta + \sin \theta_\alpha \sin \theta_\delta \right.$$

$$\left. - [\sin(\delta_3 + \theta_{z_b}) \cos \theta_y \cos \theta_\delta + \sin \theta_y \sin \theta_\delta][\sin \alpha_3 \cos \theta_\alpha] \right\}$$

Finally, substituting (I-44), (I-45), (I-46), (I-47) and (I-39) in (I-38), we obtain the final expression for θ_x , and, with some rearranging and the use of well-known trigonometric identities, it reduces to:

$$(I-48) \sin \theta_x = - \frac{(I)(II) + (III)(IV)}{(V)}$$

where

$$(I) = \cos(\alpha_3 - \delta_3) \cos \theta_\alpha \cos \theta_\delta + \sin \theta_\alpha \sin \theta_\delta \\ - \sin \alpha_3 \cos \theta_\alpha [\sin(\delta_3 + \theta_{z_b}) \cos \theta_y \cos \theta_\delta \\ + \sin \theta_y \sin \theta_\delta]$$

$$(II) = \sin \theta_\alpha \cos \theta_\delta \cos(\delta_3 + \theta_{z_b}) \begin{matrix} \oplus \\ \pm \end{matrix} \cos \theta_\alpha \cos \alpha_3 \times \\ \times [\cos \theta_\delta \sin \theta_y \sin(\delta_3 + \theta_{z_b}) - \sin \theta_\delta \cos \theta_y]$$

$$(III) = \begin{matrix} \oplus \\ \pm \end{matrix} \sin \theta_\alpha [\sin \theta_y \cos \theta_\delta \sin(\delta_3 + \theta_{z_b}) - \sin \theta_\delta \cos \theta_y] \\ \begin{matrix} \oplus \\ \pm \end{matrix} \cos \theta_\alpha \cos \alpha_3 \cos \theta_\delta \cos(\delta_3 + \theta_{z_b})$$

$$(IV) = \begin{matrix} \oplus \\ \pm \end{matrix} \left\{ 1 - [\cos \theta_y \cos \theta_\delta \sin(\delta_3 + \theta_{z_b}) + \sin \theta_y \sin \theta_\delta]^2 \right. \\ \left. - \sin^2 \alpha_3 \cos^2 \theta_\alpha - [\cos \theta_\alpha \cos \theta_\delta \cos(\alpha_3 - \delta_3)] + \right.$$

(continued on next page)

$$\begin{aligned}
 & + \sin \theta_\alpha \sin \theta_\delta]^2 + 2 \sin \alpha_3 \cos \theta_\alpha \cdot \\
 & \cdot [\cos \theta_\alpha \cos \theta_\delta \cos (\alpha_3 - \delta_3) + \sin \theta_\alpha \sin \theta_\delta] \cdot \\
 & \cdot [\cos \theta_y \cos \theta_\delta \sin (\delta_3 + \theta_{z_b}) + \sin \theta_y \sin \theta_\delta] \Big\}^{1/2} \\
 (V) = & (1 - \sin^2 \alpha_3 \cos^2 \theta_\alpha) \Big\{ 1 - \\
 & - [\cos \theta_y \cos \theta_\delta \sin (\delta_3 + \theta_{z_b}) + \sin \theta_y \sin \theta_\delta]^2 \Big\}
 \end{aligned}$$

Now, when $\theta_y = \theta_{z_b} = 0$, θ_x must = 0.

I, II, III and IV reduce to the following:

$$\begin{aligned}
 I & = \cos \alpha_3 \cos \delta_3 \cos \theta_\alpha \cos \theta_\delta + \sin \theta_\alpha \sin \theta_\delta \\
 II & = \sin \theta_\alpha \cos \theta_\delta \cos \delta_3 \pm \cos \theta_\alpha \cos \alpha_3 \sin \theta_\delta \\
 III & = \pm \sin \theta_\alpha \sin \theta_\delta \pm \cos \theta_\alpha \cos \alpha_3 \cos \theta_\delta \cos \delta_3 \\
 IV & = \pm (\sin \theta_\alpha \cos \theta_\delta \cos \delta_3 = \sin \theta_\delta \cos \theta_\alpha \cos \alpha_3)
 \end{aligned}$$

If we choose the positive root for IV, then the negative sign in II is correct, and the two negatives in III are required in order that (I)(II) + (III)(IV) = 0. Thus, the signs shown circled on p. I-35 are correct.

There are important special cases in the arrangement of the hinges. For instance, if $\theta_\alpha = 90^\circ$:

$$\begin{aligned}
 \text{(I)} &= \sin \theta_{\delta} \\
 \text{(II)} &= \cos \theta_{\delta} \cos (\delta_3 + \theta_{z_b}) \\
 \text{(I-49) (III)} &= \sin \theta_y \cos \theta_{\delta} \sin (\delta_3 + \theta_{z_b}) - \sin \theta_{\delta} \cos \theta_y \\
 \text{(IV)} &= \left\{ \cos^2 \theta_{\delta} - [\cos \theta_y \cos \theta_{\delta} \sin (\delta_3 + \theta_{z_b}) \right. \\
 &\quad \left. + \sin \theta_y \sin \theta_{\delta}]^2 \right\}^{1/2} \\
 \text{(V)} &= 1 - [\cos \theta_y \cos \theta_{\delta} \sin (\delta_3 + \theta_{z_b}) \\
 &\quad + \sin \theta_y \sin \theta_{\delta}]^2
 \end{aligned}$$

If, in addition, $\theta_{\delta} = 0$, it reduces to:

$$\text{(I-50) } \sin \theta_x = \frac{-\sin \theta_y \sin (\delta_3 + \theta_{z_b})}{\sqrt{1 - \cos^2 \theta_y \sin^2 (\delta_3 + \theta_{z_b})}}$$

Another frequently used configuration has the drag hinge initially in the Y'Z' plane ($\alpha_3 = 0$) and perpendicular to the flapping hinge

$$(\tan \theta_{\alpha} = \frac{\cos \delta_3}{\tan \theta_{\delta}})$$

Substituting $\alpha_3 = 0$

$$\sin \theta_{\alpha} = \frac{\cos \delta_3 \cos \theta_{\delta}}{\sqrt{\cos^2 \theta_{\delta} \cos^2 \delta_3 + \sin^2 \theta_{\delta}}}$$

$$\cos \theta_{\alpha} = \frac{\sin \theta_{\delta}}{\sqrt{\cos^2 \theta_{\delta} \cos^2 \delta_3 + \sin^2 \theta_{\delta}}}$$

We get,

(see next page)

$$(I-5) \quad (I) = \frac{2 \cos \delta_3 \cos \theta_8 \sin \theta_6}{\sqrt{\cos^2 \theta_8 \cos^2 \delta_3 + \sin^2 \theta_8}}$$

$$(II) = \frac{\cos \delta_3 \cos^2 \theta_8 \cos(\delta_3 + \theta_{z0}) + \sin \theta_8 [\cos \theta_8 \sin \theta_y \sin(\delta_3 + \theta_{z0}) - \sin \theta_8 \cos \theta_y]}{\sqrt{\cos^2 \theta_8 \cos^2 \delta_3 + \sin^2 \theta_8}}$$

I - 38

$$(III) = \frac{\cos \delta_3 \cos \theta_8 [\sin \theta_y \cos \theta_8 \sin(\delta_3 + \theta_{z0}) - \sin \theta_8 \cos \theta_y]}{\sqrt{\cos^2 \theta_8 \cos^2 \delta_3 + \sin^2 \theta_8}}$$

$$(V) = 1 - [\cos \theta_y \cos \theta_8 \sin(\delta_3 + \theta_{z0}) + \sin \theta_y \sin \theta_8]^2$$

$$(IV) = \sqrt{(V) - (I)^2}$$

where, as before,

$$\sin \theta_x = - \frac{(I)(II) + (III)(IV)}{(V)}$$

There are, of course, other hinge configurations in use, for which the general formula (I-48) becomes simplified. The simplifications involved, will, however, usually be immediately obvious.

Since, on most designs, the independent variables θ_y , θ_{z_b} , θ_δ , δ_3 , and $(\theta_\alpha - 90)$ are not greatly different from zero, we write a Taylor expansion, in operator form, as follows:

$$\begin{aligned}
 \text{(I-52) } \sin \theta_x &= \sin \theta_x + \\
 &+ [\theta_y D_{\theta_y} + \theta_{z_b} D_{\theta_{z_b}} + \theta_\delta D_{\theta_\delta} + (\theta_\alpha - 90) D_{\theta_\alpha} + \delta_3 D_{\delta_3}] \sin \theta_x \\
 &+ \frac{1}{2} [\theta_y D_{\theta_y} + \theta_{z_b} D_{\theta_{z_b}} + \theta_\delta D_{\theta_\delta} + (\theta_\alpha - 90) D_{\theta_\alpha} + \delta_3 D_{\delta_3}]^2 \sin \theta_x \\
 &+ \frac{1}{6} [\theta_y D_{\theta_y} + \theta_{z_b} D_{\theta_{z_b}} + \theta_\delta D_{\theta_\delta} + (\theta_\alpha - 90) D_{\theta_\alpha} + \delta_3 D_{\delta_3}]^3 \sin \theta_x \\
 &+ \dots
 \end{aligned}$$

In the above, D is the differential operator, and all terms on the right side are taken at $\theta_y = \theta_{z_b} = \theta_\delta = (\theta_\alpha - 90) = \delta_3 = 0$.

Evaluating the terms indicated above by differentiating (I-48), we find the approximate formula for θ_x :

$$\begin{aligned}
 \theta_x &= -\theta_y (\delta_3 + \theta_{z_b} + \frac{1}{2} \theta_y \theta_\delta) + (\frac{\pi}{2} - \theta_\alpha) \left\{ (\theta_{z_b} + \theta_y \theta_\delta) \sin \alpha_3 \right. \\
 &\quad \left. - \theta_{z_b} (+\delta_3 + \frac{1}{2} \theta_{z_b}) \cos \alpha_3 \right\}
 \end{aligned}$$

This approximation formula may be used for preliminary work where θ_y , θ_{z_b} , θ_δ , $(\theta_\alpha - 90)$, and δ_3 are not greater than roughly 30°. In the formula, all angles are, of course, in radians.

Assuming $\alpha_3 = 0$ and $\tan \theta_\alpha = \frac{\cos \delta_3}{\tan \theta}$ (hinges mutually

perpendicular, (formulas (I-51)) θ_x has been computed and plotted as a function of δ_3 , θ_δ , θ_y and θ_{z_b} . These graphs are included

as figs. I-7, I-8.

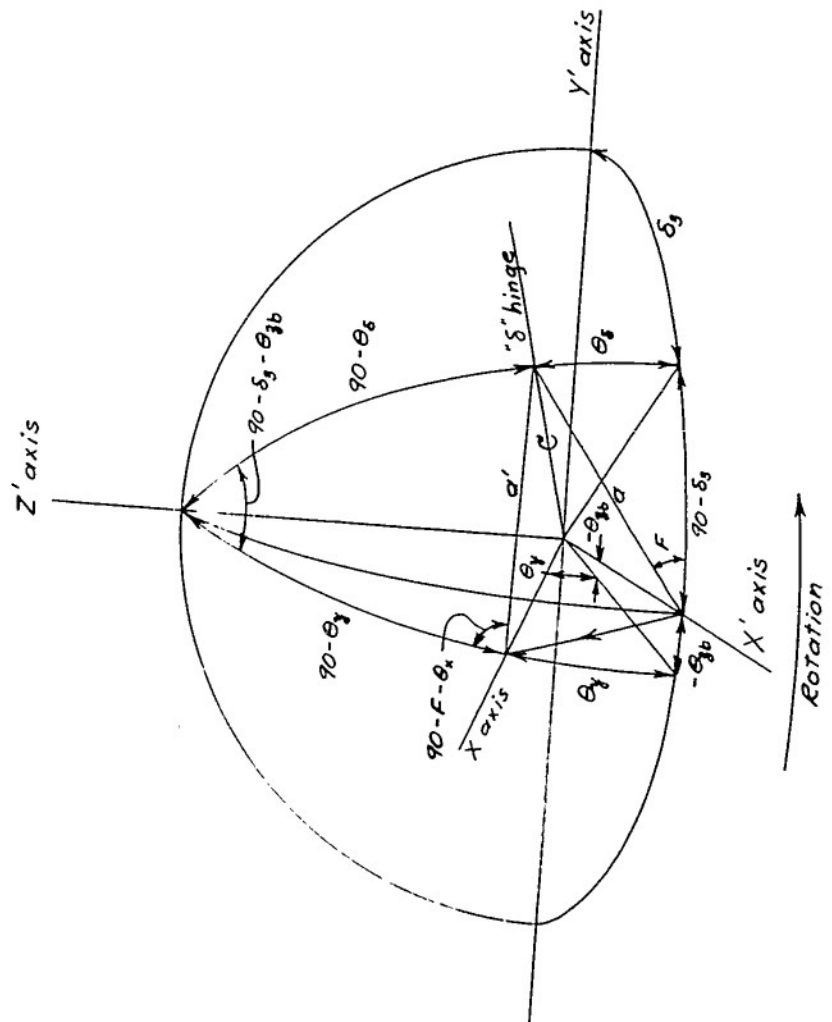

FIG. I-5

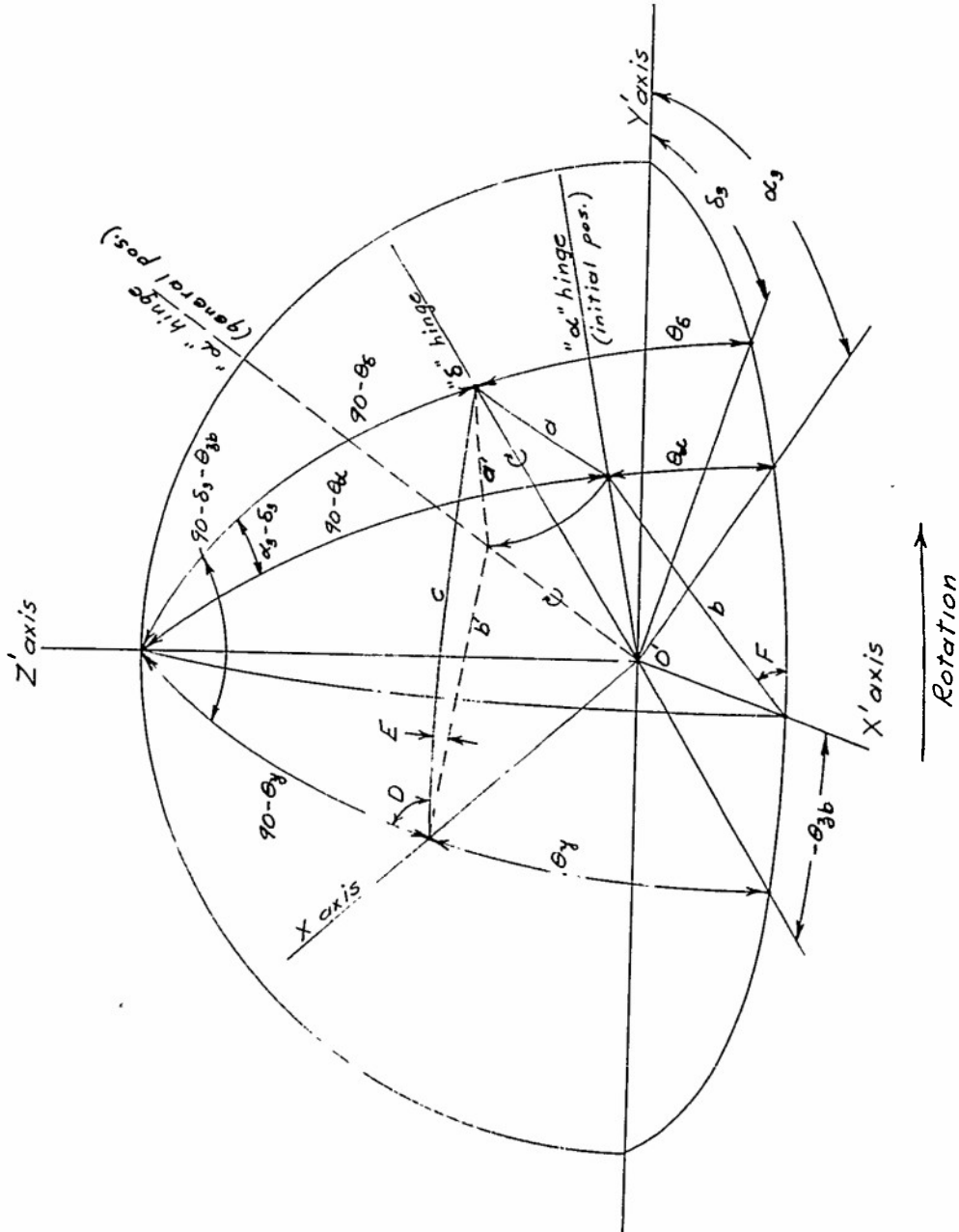
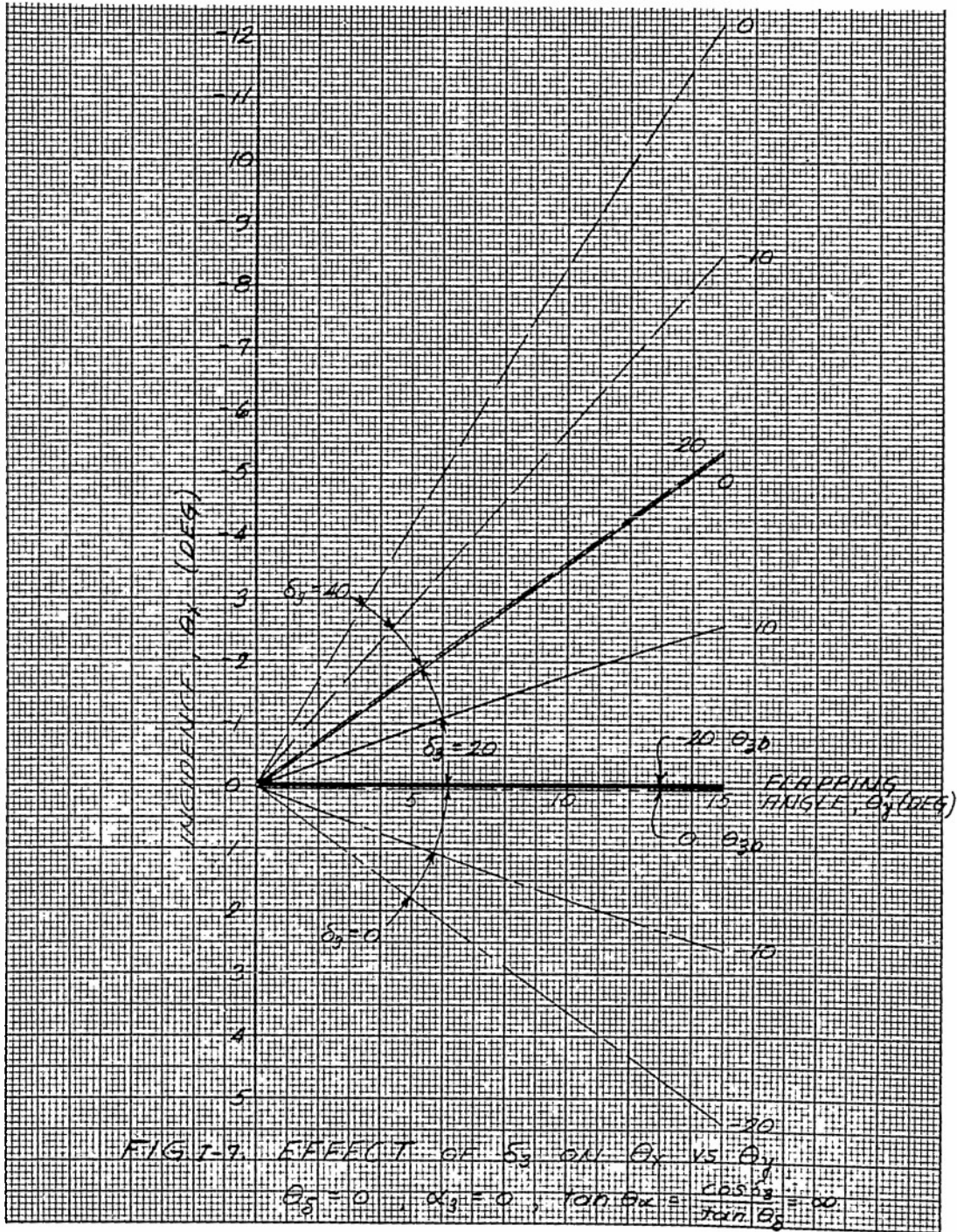
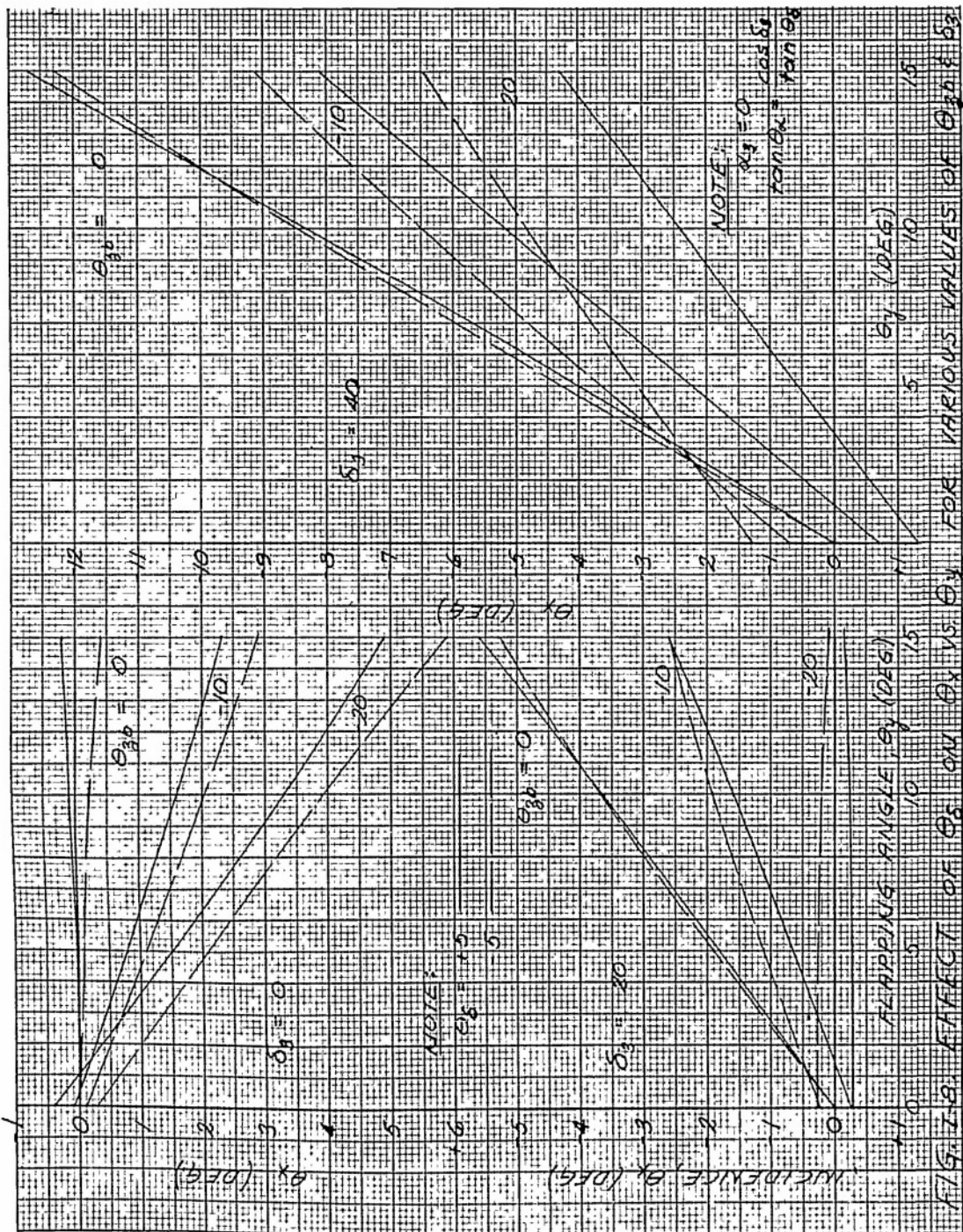

FIG. I-6

5





PART II
FULLY ARTICULATED BLADES

1. General:

Feathered hinged blades possess three degrees of freedom of motion; they can move freely (or restrained by dampers) about the flapping pin, drag pin and feathering axis of the blade.

2. Applied loads acting on each blade element in a steady forward flight:

The loads imposed on each blade element are:

- a. Dynamic loads
- b. Gravity loads
- c. Aerodynamic loads

a. Dynamic loads

The dynamic loads acting on each blade element are due to absolute accelerations to which each mass particle of a blade element is subjected while moving in the space.

This acceleration can be resolved along XYZ axes, the definition of which was given in Part I of this report. Reproducing Fig. I-2 of Part I, we have

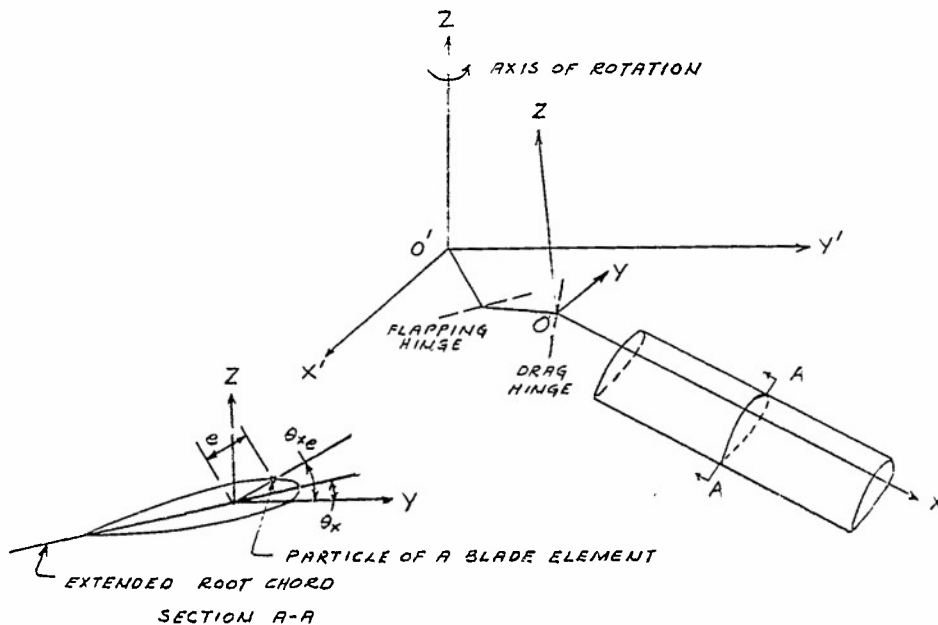

FIG. II-1

By definition from Part I, X axis coincides with the feathering axis of the blade, Y axis coincides with the initial position of the root chord extended to the origin (drag pin) "O", Z axis is perpendicular to plane YX.

In order to simplify the problem of calculating the accelerations and air loads (liftloads), it will be assumed that the drag hinge and flapping hinge coincide with the origin O'. The assumption is easily justifiable since both dynamic and aerodynamic loads are much smaller near the root than those near the tip. Therefore, Fig. II-2 shows the simplified rotor diagram which is used for the derivation of the loads mentioned above:

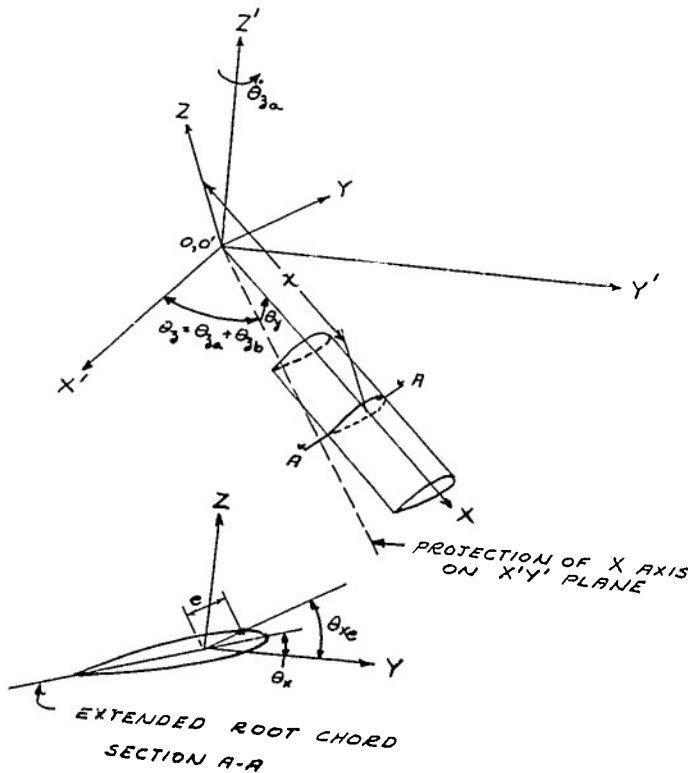

FIG. II-2

The coordinates of a particle on a blade element referred to XYZ axes are:

$$(x-1a) \quad z = e \sin \theta_{x_e}$$

$$(b) \quad x = r$$

$$(c) \quad y = e \cos \theta_{x_e}$$

The coordinates of a particle on a blade element referred to X'Y'Z' axes are:

$$(x-2a) \quad z' = x \sin \theta_y + e \sin \theta_{x_e} \cos \theta_y$$

$$(b) \quad x' = x \cos \theta_z \cos \theta_y - e \cos \theta_{x_e} \sin \theta_z - e \sin \theta_{x_e} \sin \theta_y \cos \theta_z$$

$$(c) \quad y' = x \sin \theta_z \cos \theta_y + e \cos \theta_{x_e} \cos \theta_z - e \sin \theta_{x_e} \sin \theta_y \sin \theta_z$$

To obtain the components, along XYZ axes, of absolute velocities and accelerations relative to X'Y'Z' axes, acting on a particle, the first and second derivatives of z' , x' , y' , in respect to time, are first taken and later resolved along XYZ axes. Classical methods also can be used, such as the one described on page 390 of ref. 9

ZXY components of absolute velocities (relative to X'Y'Z' axes of a particle):

$$(x-3a) \quad \dot{z} = x \dot{\theta}_y + y (\dot{\theta}_z \sin \theta_y + \dot{\theta}_x)$$

$$(b) \quad \dot{x} = -z \dot{\theta}_y - y \dot{\theta}_z \cos \theta_y$$

$$(c) \quad \dot{y} = x \dot{\theta}_z \cos \theta_y - z (\dot{\theta}_x + \dot{\theta}_z \sin \theta_y)$$

Accelerations:

As in the case of the velocities, all acceleration terms containing y and z are considerably smaller than those containing x, except near the root, and therefore may be neglected except when calculating the moments about the x axis.

It can be assumed that

$$\sin \theta = \theta \quad \text{and} \quad \cos \theta = 1.0$$

It will be of interest and importance to compare the magnitude of all component terms with the square of the angular velocity, $\dot{\theta}_{z_a}^2$:

$$\dot{\theta}_z^2 - \text{by definition, } \dot{\theta}_z = \dot{\theta}_{z_a} + \dot{\theta}_{z_b}$$

Neglecting higher harmonics, we can write an expression for θ_{z_b} as follows:

$$\theta_{z_b} = e_0 - r_1 \cos(\theta_{z_a} - \theta_{z_r})$$

and

$$(\dot{\theta}_{z_b})_{\max} = r_1 \dot{\theta}_{z_a}$$

On most normal designs, r_1 is no greater than 1.5° and therefore

$$(\dot{\theta}_z)_{\max}^2 = (1 \pm \frac{1.5}{57.3})^2 \dot{\theta}_{z_a}^2$$

In other words the variation of $\dot{\theta}_z^2$ is no greater than 5 per cent, and therefore, for all practical purposes, may be neglected.

Hence, we may assume

$$\dot{\theta}_z^2 = \dot{\theta}_{z_a}^2$$

$(\dot{\theta}_x)^2$ and $(\dot{\theta}_y)^2$ are both functions of $(\dot{\theta}_{z_a})^2$ and their maximums can be expressed in a similar manner to $(\dot{\theta}_{z_b})_{\max}^2$.

$$(\dot{\theta}_y)_{\max}^2 = (\beta_1 \dot{\theta}_{z_a})^2$$

$$(\dot{\theta}_x)_{\max}^2 = (\theta'_{x_c} \dot{\theta}_{z_a})^2$$

with maximum values of β_1 and θ'_{x_c} very seldom exceeding 10° on actual designs, or

$$(\dot{\theta}_y)_{\max}^2 \leq .04 \dot{\theta}_{z_a}^2$$

$$(\dot{\theta}_x)_{\max}^2 \leq .04 \dot{\theta}_{z_a}^2$$

which is evidently negligible in comparison with $\dot{\theta}_{z_a}^2$:

$\dot{\theta}_x \dot{\theta}_y$ is of the same order of magnitude as $\dot{\theta}_y^2$ and $\dot{\theta}_x^2$ and therefore is negligible.

$\dot{\theta}_x \dot{\theta}_z$ and $\dot{\theta}_y \dot{\theta}_z$ both are quite high, about 20% of $\dot{\theta}_{z_a}^2$ and probably cannot be neglected in cases where calculations involve M_x , torsional moments.

$(\ddot{\theta}_x)_{\max}$ and $(\ddot{\theta}_y)_{\max}$ are of the same order as $(\dot{\theta}_x)_{\max}^2$ and $(\dot{\theta}_y)_{\max}^2$ which is 4 % of $\dot{\theta}_{z_a}^2$.

$\ddot{\theta}_z$ is of the same order as $\dot{\theta}_{x_b}^2$ and is 2.5 % of $\dot{\theta}_{x_a}^2$.

On the basis of the above, the expressions for accelerations given in equations (x-4a), (b) and (c) can be reduced to:

$$(x-6a) \quad \ddot{z} = x(\theta_y \dot{\theta}_{x_a}^2 + \dot{\theta}_y^2)$$

$$(b) \quad \ddot{x} = -x\dot{\theta}_{x_a}^2$$

$$(c) \quad \ddot{y} = x(-2\theta_y \dot{\theta}_y \dot{\theta}_{x_a} + \ddot{\theta}_x)$$

The dynamic loads:

The dynamic loads acting on a blade element due to accelerations imposed on each particle of this element are obtained by integrating over its volume.

Therefore, if the mass of each particle is called Δm , we have

$$(x-7a) \quad (F_z)_m = -\Sigma \ddot{z} \Delta m$$

$$(b) \quad (F_x)_m = -\Sigma \ddot{x} \Delta m$$

$$(c) \quad (F_y)_m = -\Sigma \ddot{y} \Delta m$$

where \ddot{z} , \ddot{x} , \ddot{y} are component accelerations of a particle and $(F_z)_m$, $(F_x)_m$, $(F_y)_m$ are the component inertia forces of a blade element mass "mdx".

For all purposes except the calculations involving torsional moment M_x , combining (II-6a), (b), (c), (II-7a), (b), (c), we have

$$(II-8a) \quad (F_x)_m = -mx(\dot{\theta}_y \dot{\theta}_{z_a}^2 + \ddot{\theta}_y) dx$$

$$(b) \quad (F_x)_m = mx \dot{\theta}_{z_a}^2 dx$$

$$(c) \quad (F_y)_m = mx(2\dot{\theta}_y \dot{\theta}_y \dot{\theta}_{z_a} - \ddot{\theta}_z) dx$$

b. Gravity loads

x,y,z components of gravity loads acting on a blade element of weight w are:

$$(II-9a) \quad (F_x)_w = -w \cos \theta_y$$

$$(b) \quad (F_x)_w = -w \sin \theta_y$$

$$(c) \quad (F_y)_w = 0$$

These are, in general, small and may be neglected.

c. Aerodynamic loads acting on a blade element in steady forward flight.

In calculating the aerodynamic loads imposed on a blade in forward flight, it is common practice to neglect the effect of flexibility of the blade. However, if the evaluation of that effect is desired, the following procedure involving successive approximations is suggested:

1. Calculate the coefficients of the harmonic motion of the blade, assuming that the blade is infinitely stiff.
2. Calculate the total deflection of the blade in the ZX and ZY planes, using the dynamic and airload distribution on the basis of the assumption in (1).
3. Calculate the structural twist of the blade, using the dynamic and airload distribution on the basis of the assumption in (1).
4. Calculate the structural twist of the blade due to bending in the ZX and ZY planes.
5. Correct the airload distribution for the flexural deflection found in (2) and the twist found in (3) and (4).
6. Repeat the procedure if necessary.

The angle of attack of a blade element on an infinitely stiff blade:

The angle of attack of a blade element is:

$$(x-10) \quad \theta_T = \theta_x + \theta_t x_T + \theta_1$$

where

$$(x-11) \quad \theta_x = \theta_{x_0} + \theta_{x_c} \cos(\theta_{z_a} - \theta_{z_c}) + \theta_x(\theta_y, \theta_{z_b})$$

7

- θ_x - the angle of incidence at the root
- θ_{x_c} - the minimum control pitch
- θ_{z_c} - the control, phase, azimuth angle
- $\theta_i = -\tan \frac{V_z}{V_y} = -\frac{V_z}{V_y}$
- $\theta_x(\theta_y, \theta_{z_b})$ - the change of pitch due to flapping and hunting.

From charts I-7, I-8, Part I, in typical designs, where the flapping hinge is cocked in horizontal and vertical planes and the drag hinge lies in the plane of the root chord and is perpendicular to the flapping hinge, the change of pitch due to flapping, in the angular range where flapping occurs ($0^\circ - 20^\circ$), for a given value of θ_{z_b} , can be closely approximated by a straight line and can be written in the form:

(II-12)

$$\theta_x(\theta_y, \theta_{z_b}) = \tau_1 \theta_y$$

where τ_1 is a function of θ_{z_b} .

The variation of pitch due to cyclic variation of flapping is very small and also due to the second harmonic of flapping can be neglected. Therefore, τ_1 in equation (II-12) can be treated as a constant for a given flight condition and depends on "e₀", constant part of θ_{z_b} .

A sufficiently accurate value of "e₀", the constant part of θ_{z_b} , (the lag angle of the blade in "power on" flight) can be obtained from

$$(II-3) \quad \sin e_0 \approx e_0 = \frac{M_z}{b(e_1 \cos \gamma + e_2 \cos \delta_3) (F_{x_0})_m}$$

where

M_z is the total rotor torque

b is the number of blades

$(e_1 \cos \gamma + e_2 \cos \delta_3)$ is the distance from "∞" hinge to the axis of rotation when $\theta_y = 0$.

$(F_{x_0})_m$ is the total inertia force acting along X axis at "∞" hinge.

For reference, see page II-63 and Fig. (I-3) below which is part of Fig. (I-3):

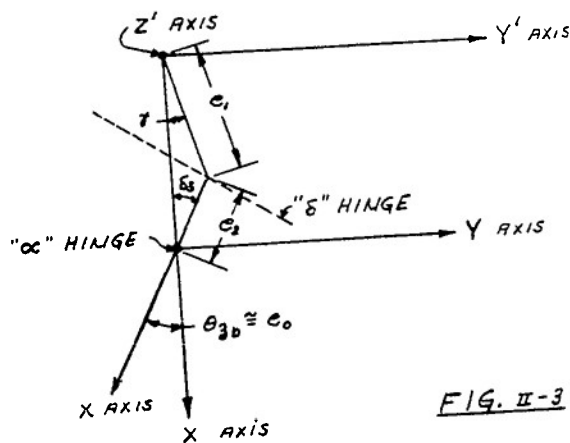

FIG. II-3

If we let

$$(x-14a) \quad \theta_{x_c} \cos \theta_{z_c} = \psi_1$$

$$(b) \quad \theta_{x_c} \sin \theta_{z_c} = \psi_2$$

and since by definition

$$\theta_y = a_0 - a_1 \cos \theta_{z_a} - b_1 \sin \theta_{z_a} - a_2 \cos 2\theta_{z_a} - b_2 \sin \theta_{z_a}$$

the equation (x-10) becomes

$$(x-15) \quad \theta_r = \theta_{x_0} + a_0 \tau_1 + (\psi_1 - \tau_1 a_1) \cos \theta_{z_a} + (\psi_2 - \tau_1 b_1) \sin \theta_{z_a} + \theta_{t r} + \theta_i ;$$

In the region of reversed flow, following ref. 2, the angle of attack θ_{rr} can be expressed as

$$\theta_{rr} = -\theta_r$$

General expressions for the distribution of air forces along the blade:

From fundamental aerodynamics the distribution of lift and drag forces along the blade is:

$$(x-16a) \quad \frac{dL}{dx} = \frac{1}{2} \rho c C_l V^2$$

and

$$(b) \quad \frac{dD_0}{dx} = \frac{1}{2} \rho c C_{D_0} V^2$$

where C_{l_1} and C_{D_0} are the section lift and the profile drag coefficients.

If we let $(F_z)_a$ and $(F_y)_a$ be the component airforces acting along Z and Y axes respectively, the distribution of these forces along the blade can be expressed by:

$$(II-17a) \quad \frac{d(F_z)_a}{dx} = \frac{dL}{dx} \cos \theta_1 + \frac{dD_0}{dx} \sin \theta_1$$

$$(b) \quad \frac{d(F_y)_a}{dx} = \frac{dL}{dx} \sin \theta_1 - \frac{dD_0}{dx} \cos \theta_1$$

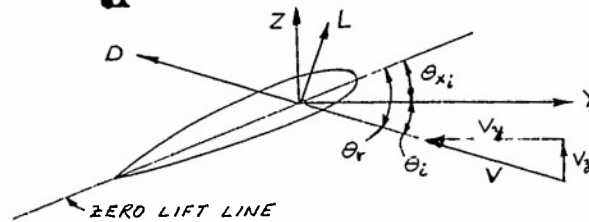

FIG. II-4

where

$$(II-18a) \quad \theta_{x_1} = \theta_x + \theta_t \alpha_r$$

$$(b) \quad \theta_1 \approx \frac{V_z}{-V_y}$$

Since all angles except θ_{x_1} are small, we take

$$\sin \theta = \tan \theta \approx \theta$$

$$\cos \theta = 1.0$$

Also, the Z component of the drag forces, except near the stall, is very small in comparison with the component due to the lift; therefore, the equations (II-17a)

and (II-17b) can be simplified and become

$$(II-19a) \quad \frac{d(F_z)_a}{dx} = \frac{dL}{dx}$$

$$(b) \quad \frac{d(F_y)_a}{dx} = \theta_1 \frac{dL}{dx} - \frac{dD_o}{dx}$$

Resultant velocity components V_x, V_y, V_z acting at a blade element.

Velocity components due to motion of the blades:

The velocity components acting at a blade element due to the motion of the blades are

$$(II-20a) \quad \dot{x} = -x\dot{\theta}_y$$

$$(b) \quad \dot{y} = 0$$

$$(c) \quad \dot{z} = -x\dot{\theta}_z$$

Velocity components due to the motion of the rotor disk:

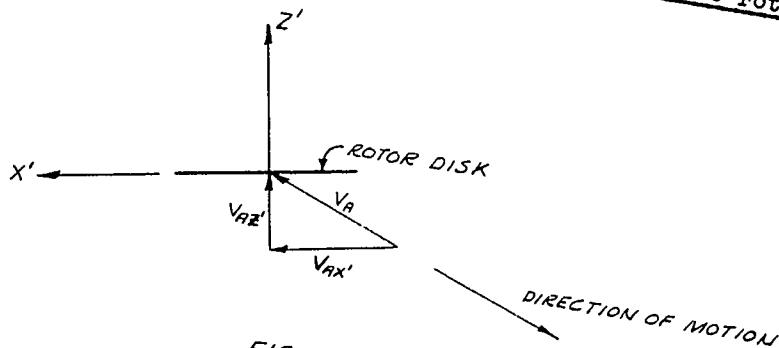

FIG. II-5

The above Fig. (II-5) shows the resolution of rotor velocity V_A into its X' and Z' components.

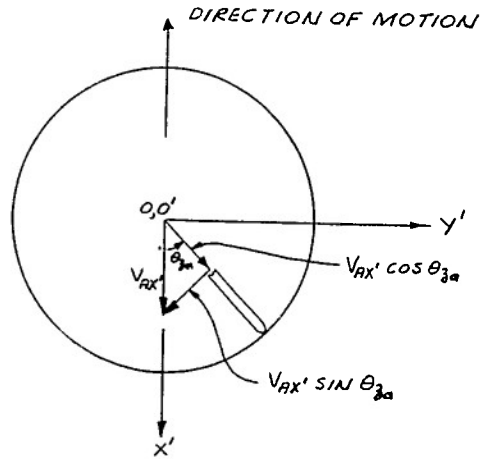

FIG. II-6

Fig (II-6) shows the velocity components due to V_A acting at a blade element projected on $X' Y'$ plane.

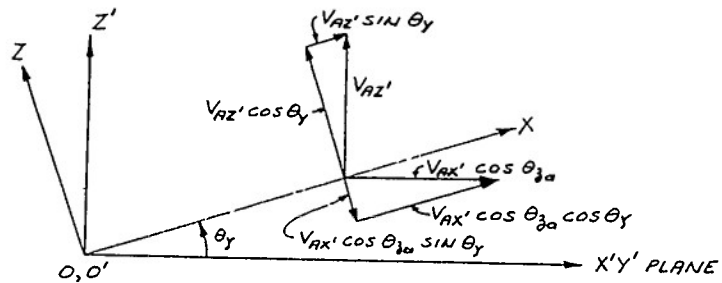

FIG. II-7

Fig. (II-7) shows the velocity components acting at a blade element in the ZX plane due to the rotor velocity V_A .

The total velocity components along ZXY due to rotor velocity V_A are

$$(x-21a) \quad V_{AZ} = V_{AZ}' \cos \theta_y - V_{AX}' \sin \theta_y \cos \theta_{z_B}$$

$$(b) \quad V_{AX} = V_{AZ}' \sin \theta_y + V_{AX}' \cos \theta_y \cos \theta_{z_B}$$

$$(c) \quad V_{AY} = V_{AX}' \sin \theta_{z_B}$$

Following the usual assumption that the effect of the radial velocity component on the lift and drag is negligible and since $\sin \theta_y = \theta_y$ and $\cos \theta_y = 1.0$, the above equations become

$$(x-22a) \quad V_{AZ} = V_{AZ}' - V_{AX}' \theta_y \cos \theta_{z_B}$$

$$(b) \quad V_{AX} = \text{neglected}$$

$$(c) \quad V_{AY} = V_{AX}' \sin \theta_{z_B}$$

Velocity components due to induced velocity V_i :

In accordance with ref. 10 it is sufficiently accurate to assume the distribution of induced velocity in forward motion along the fore and aft diameter to be triangular as shown on Fig (x-8):

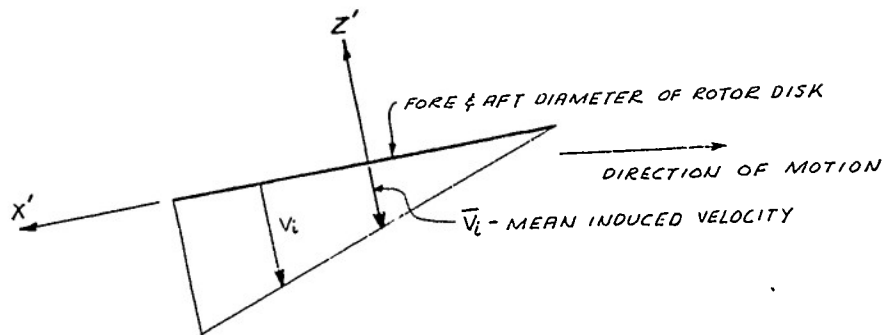

FIG. II-8

At any point of the blade the distribution can be approximated by equation.

$$(II-23) \quad V_i = \bar{V}_i + \overline{V}_i x_r \cos \theta_{z_B}$$

Therefore, remembering $\cos \theta_y = 1$, and neglecting the radial component, the velocity components due to V_i are:

$$(II-24a) \quad V_{iz} = \bar{V}_i + \overline{V}_i x_r \cos \theta_{z_B}$$

$$(b) \quad V_{ix} = \text{neglected}$$

$$(c) \quad V_{iy} = 0$$

The total velocity components at a blade element are:

$$(II-25a) \quad \underline{V}_z = \dot{z} + V_{AZ} + V_{iz}$$

$$(II-25b) \quad V_x = \dot{x} + V_{Ax} + V_{1x}$$

$$(c) \quad V_y = \dot{y} + V_{Ay} + V_{1y}$$

From nomenclature we have

$$(II-26a) \quad \lambda = \frac{V_{Ax'} + \overline{V_1}}{R \dot{\theta}_{z_a}}$$

$$(b) \quad \lambda_1 = \frac{\overline{V_1}}{R \dot{\theta}_{z_a}}$$

$$(c) \quad \mu = \frac{V_{Ax'}}{R \dot{\theta}_{z_a}}$$

Substituting into equations (II-25a) to (c) the expressions of their component terms and using the parameters given by equations (II-26a) to (c) we have

$$(II-2/a) \quad V_x = -x \dot{\theta}_y + \lambda R \dot{\theta}_{z_a} + \lambda_1 R \dot{\theta}_{z_a} x_r \cos \theta_{z_a} - \\ - \mu R \dot{\theta}_{z_a} \theta_y \cos \theta_{z_a}$$

$$(b) \quad V_x = \text{neglected}$$

$$(c) \quad V_y = -x_r R \dot{\theta}_{z_a} - \mu R \dot{\theta}_{z_a} \sin \theta_{z_a}$$

where from notations, Part I

$$(II-28a) \quad \theta_y = a_0 - a_1 \cos \theta_{z_a} - b_1 \sin \theta_{z_a} - a_2 \cos 2\theta_{z_a} - b_2 \sin 2\theta_{z_a}$$

$$(b) \quad \dot{\theta}_y = a_1 \dot{\theta}_{z_a} \sin \theta_{z_a} - b_1 \dot{\theta}_{z_a} \cos \theta_{z_a} + 2a_2 \sin 2\theta_{z_a} - 2b_2 \cos 2\theta_{z_a}$$

and therefore

$$(c) \quad \ddot{\theta}_y = a_1 \dot{\theta}_{z_a}^2 \cos \theta_{z_a} + b_1 \dot{\theta}_{z_a}^2 \sin \theta_{z_a} + 4a_2 \cos 2\theta_{z_a} + 4b_2 \sin 2\theta_{z_a}$$

Substituting θ_y and $\dot{\theta}_y$ into equations (II-27a) and (II-27c), and dividing by $R \dot{\theta}_{z_a}$ we have

$$(II-29a) \quad u_z = \frac{V_z}{R \dot{\theta}_{z_a}} = \lambda + \frac{1}{2} \mu a_1 + (-\mu a_0 + x_r b_1 + \frac{1}{2} \mu a_2 + \lambda_1 x_r) \cos \theta_{z_a} + (-x_r a_1 + \frac{1}{2} \mu b_2) \sin \theta_{z_a} + (\frac{1}{2} \mu a_1 + 2x_r b_2) \cos 2\theta_{z_a} + (\frac{1}{2} \mu b_1 - 2x_r a_2) \sin 2\theta_{z_a} + \frac{1}{2} \mu a_2 \cos 3\theta_{z_a} + \frac{1}{2} \mu b_2 \sin 3\theta_{z_a};$$

$$(II-29b) \quad u_y = \frac{V_y}{R \theta_{z_a}} = -x_r - \mu \sin \theta_{z_a}$$

The distribution of air load along a stiff blade.

"Z" component of the airload:

Considering the equations (II-16a) and (II-19a) we have

$$(II-30) \quad \frac{d(F_z)_a}{dx} = \frac{1}{2} \rho c C_l V^2$$

where

c is a chord

$C_l = a \theta_r$ is the section lift coefficient

$V \approx V_y$ is the air velocity at a blade element

Substituting into equation (II-30) the values of θ_r from (II-15) we have

$$(II-31) \quad \frac{d(F_z)_a}{dx_r} = \frac{1}{2} \rho c a u_y^2 \theta_{z_a}^2 R \left[\theta_{x_0}' + \psi_1' \cos \theta_{z_a} + \psi_2' \sin \theta_{z_a} + \theta_{t x_r} + \theta_1 \right]$$

where

$$(II-32a) \quad \theta_{x_0}' = \theta_{x_0} + a_0 \tau_1$$

$$(b) \quad \psi_1' = \psi_1 - \tau_1 a_1$$

$$(c) \quad \psi_2' = \psi_2 - \tau_1 b_1$$

$$(II-33) \quad \theta_1 = \frac{v_z}{-v_y} = \frac{u_z}{-u_y}$$

$$x_r = \frac{x}{R}$$

The sign minus is used for all values of θ_z from π to 2π .

Substituting from (II-29a) and (b) the expressions for u_y and u_z into (II-31) and neglecting after that substitution all harmonic terms above the second, we have the distribution of the Z component of the air load:

$$(II-34) \quad \frac{d(F_z)_a}{dx_r} \frac{1}{\rho c C_{z_a}} = A_{0a} + A_{1a} \cos \theta_{z_a} + B_{1a} \sin \theta_{z_a} + \\ + A_{2a} \cos 2\theta_{z_a} + B_{2a} \sin 2\theta_{z_a};$$

where

$$(II-35) \quad C_{z_a} = \frac{1}{2} \rho a \theta_{z_a}^2 R^3$$

$$(II-34a) \quad A_{0a} = \left(\theta'_{x_0} + \frac{b_2}{2} \right) \frac{\mu^2}{2} + \left(\frac{\mu \theta_t}{2} + \psi'_2 + \frac{\lambda}{\mu} \right) \mu x_r + \\ + \left(\theta'_{x_0} + x_r \theta_t \right) x_r^2$$

$$(b) \quad A_{1a} = (b_1 + \psi'_1) \frac{\mu^2}{4} + \left(a_0 + \frac{a_2}{2} \right) \mu x_r + (b_1 + \psi'_1 + \lambda_1) x_r^2$$

$$(c) \quad B_{1a} = (3\psi'_2 + 4 \frac{\lambda}{\mu} + a_1) \frac{\mu^2}{4} + \left(2\theta'_{x_0} - \frac{b_2}{2} \right) \mu x_r + \\ + (2\mu \theta_t + \psi'_2 - a_1) x_r^2$$

$$(II-34d) \quad A_{2a} = -\theta'_{x_0} \frac{\mu^2}{2} + (a_1 - \psi'_2 - \frac{\mu \theta_t}{2}) \mu x_r + 2b_2 x_r^2$$

$$(e) \quad B_{2a} = -a_0 \frac{\mu^2}{2} + (b_1 + \psi'_1 + \frac{\lambda_1}{2}) \mu x_r - 2a_2 x_r^2$$

The above equation gives the distribution of the airload along the blade in "Z" direction for any azimuth angle θ_{z_a} and is expressed in terms of flapping coefficients, blade incidence, cyclic control, angular velocity of the shaft, and μ , λ , and λ_1 .

The underlined terms, being small, can be neglected.

Total average thrust produced by the rotor in forward flight.

$$\text{Total thrust } T = b(F_z)_a$$

where $(F_z)_a$ is the average thrust produced by one blade.

$$(F_z)_a \approx (F_z)_a$$

Therefore

$$T = b(F_z)_a$$

where $(F_z)_a$ is obtained by integrating $d(F_z)_a$ from the root to the tip of the blade and from 0 to 2π .

$$(II-36) \quad (F_z)_a = \frac{1}{2\pi} \int_0^{2\pi} d\theta_{z_a} \int_0^B \frac{d(F_z)_a}{dx_r} dx_r -$$

$$- \frac{1}{\pi} \int_{\pi}^{2\pi} d\theta_{z_a} \int_0^{-\mu \sin \theta_{z_a}} \frac{d(F_z)_a}{dx_r} dx_r$$

The second term represents the effect of reversed flow. The blades are in the region of the reversed flow from $\theta_{z_a} = \pi$ to $\theta_{z_a} = 2\pi$ and from $x = 0$ to $x = -\mu R \sin \theta_{z_a}$.

Integrating and neglecting the terms of the order above μ^3 , the thrust expression for uniformly tapered blades is:

$$\begin{aligned}
 (x-37) \quad T = & \frac{1}{2} b c_0 \rho a \dot{\theta}_{z_a}^2 R^3 \left\{ \left[\frac{1}{2} \lambda (B^2 + \frac{1}{2} \mu^2) + \right. \right. \\
 & + \theta'_{x_0} \left(\frac{1}{3} B^3 + \frac{1}{2} \mu^2 B \right) + \theta_t \left(\frac{1}{4} B^4 + \frac{1}{4} \mu^2 B^2 \right) + \\
 & + \psi'_2 \left(\frac{\mu B^2}{2} - \frac{\mu^3}{8} \right) \left. \right] - t \left[\lambda \left(\frac{B^3}{3} + \frac{\mu^2}{4} \right) + \right. \\
 & + \theta'_{x_0} \left(\frac{B^4}{4} + \frac{1}{4} \mu^2 B \right) + \theta_t \left(\frac{B^5}{5} + \frac{1}{6} \mu^2 B^3 \right) + \\
 & \left. \left. + \psi'_2 \left(\frac{\mu B^3}{3} - \frac{\mu^3}{8} \right) \right] \right\}
 \end{aligned}$$

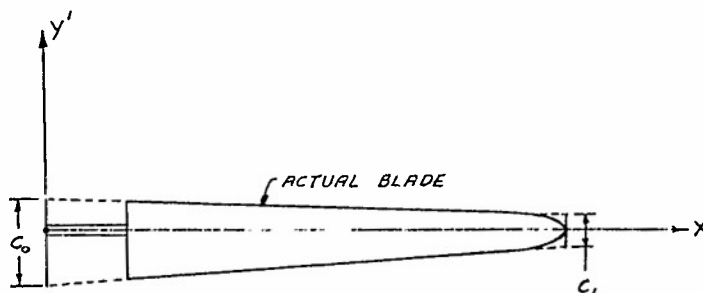

FIG. II-9

where

c_0 is the root chord extended to "0".

c_1 is the extended tip chord

$$t = 1 - \frac{c_1}{c_0} \quad \text{taper ratio}$$

$$c = c_1 (1 - x_r t) \quad \text{equation of the chord}$$

For convenience of calculation, the actual chord c may be expressed by the mean chord \bar{c} in the expression of thrust, and the equation (x-37) becomes

$$\begin{aligned} \text{(x-38)} \quad T = & \frac{1}{2} b \bar{c} \rho a \dot{\theta}_{z_a}^2 R^3 \left[\frac{1}{2} \lambda (B^2 + \frac{1}{2} \mu^2) + \right. \\ & + \theta_{x_0}' \left(\frac{1}{3} B^3 + \frac{1}{2} \mu^2 B \right) + \theta_t' \left(\frac{1}{4} B^4 + \right. \\ & \left. \left. + \frac{1}{4} \mu^2 B^2 \right) + \psi_2' \left(\frac{\mu B^2}{2} - \frac{\mu^3}{8} \right) \right] \end{aligned}$$

Flapping coefficients of " θ_y "

From p. I-13 we have

$$\theta_y = a_0 - a_1 \cos \theta_{z_a} - b_1 \sin \theta_{z_a} - a_2 \cos 2\theta_{z_a} - b_2 \sin 2\theta_{z_a}$$

The expressions for flapping coefficients in terms of other parameters are found from equations derived from the dynamic equation of the motion of the blade in flapping.

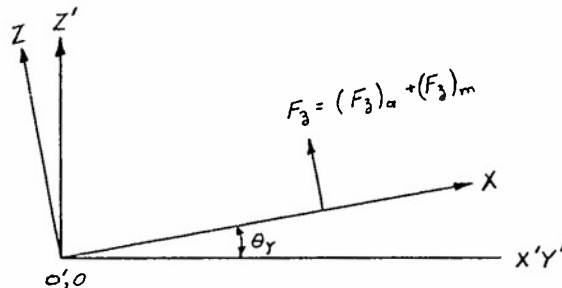

FIG. II-10

Taking the moment of all forces acting on the blade about the y axis, we have:

$$(II-39) \quad \Sigma M_y = 0 = (M_y)_a + (M_y)_m + (M_y)_g + (M_y)_d + (M_y)_{oo'}$$

where

$(M_y)_a$ is the moment due to air loads

$(M_y)_m$ is the moment due to dynamic loads

$(M_y)_g$ is the moment due to weight

$(M_y)_d$ is the moment due to mechanical damping devices. This moment will be assumed to be proportional to angular velocity of the flapping $\dot{\theta}_y$.

$$(II-40) \quad (M_y)_d = K_y \dot{\theta}_y$$

This assumption, in most of the cases, represents a good approximation. It can easily be seen that any other assumption except completely disregarding that term does not give any practical solution.

$(M_y)_{oo'}$ is the moment due to the eccentricity of the flapping pin with respect to the origin "O".

Moment due to air loads $(M_y)_a$:

From (II-19a, II-16a, II-14a, II-14b, II-10) and following the derivations of ref. 2

$$(II-41) \quad + (M_y)_a = \int_0^B \frac{1}{2} \rho c a \dot{\theta}_{z_a}^2 R^4 \left\{ \theta_{x_0}' + \psi_1' \cos \theta_{z_a} + \right. \\ \left. + \psi_2' \sin \theta_{z_a} + \theta_t x_r \left(u_y^2 - u_y u_x \right) x_r^2 dx_r - \right. \\ \left. - 2 \int_0^{-\mu \sin \theta_{z_a}} \frac{1}{2} \rho c a z_a R^4 \dot{\theta}_{z_a}^2 \left\{ \theta_{x_0}' + \psi_1' \cos \theta_{z_a} + \psi_2' \sin \theta_{z_a} + \right. \right. \\ \left. \left. + \theta_t x_r \left(u_y^2 - u_y u_x \right) x_r^2 dx_r \right|_{\pi}^{2\pi}$$

The second integral is the reversed flow term and enters $(M_y)_a$ only from $\theta_{z_a} = \pi$ and $\theta_{z_a} = 2\pi$.

B is the tip loss factor.

Substituting u_x and u_y into the above equation, integrating, combining and dropping all terms of order above μ^4 , we have

$$\begin{aligned}
 (\text{II-42}) \quad \frac{+(M_y)_a}{\bar{c} C_{z_a}} &= \left\{ \frac{1}{3} \lambda B^3 + .080 \mu^3 \lambda + \right. \\
 &+ \frac{1}{4} \theta_{x_0}' (B^4 + \mu^2 B^2 - \frac{1}{8} \mu^4) + \frac{1}{5} \theta_t (B^5 + \frac{5}{6} \mu^2 B^3) + \\
 &+ \frac{1}{8} \mu^2 b_2 B^2 + \psi_2' \left(\frac{\mu B^3}{3} + .0332 \mu^4 \right) \left. \right\} + \\
 &+ \sin \theta_{z_a} \left\{ \frac{2}{3} \mu \theta_{x_0}' B^3 + .053 \mu^4 \theta_{x_0}' + \frac{1}{2} \mu \theta_t B^4 - \right. \\
 &- \frac{1}{4} a_1 B^4 - \frac{1}{6} \mu b_2 B^3 + \frac{1}{2} \mu \lambda B^2 - \frac{1}{8} \mu^3 \lambda + \\
 &+ \frac{1}{8} \mu^2 a_1 B^2 - \psi_2' \left(\frac{5}{96} \mu^4 - \frac{B^4}{4} - \frac{3}{8} B^2 \mu^2 \right) \left. \right\} + \\
 &+ \cos \theta_{z_a} \left\{ -\frac{1}{3} \mu a_0 B^3 - .035 \mu^4 a_0 + \frac{1}{4} b_1 B^4 - \right. \\
 &- \frac{1}{6} \mu a_2 B^3 + \frac{1}{8} \mu^2 b_1 B^2 - \psi_1' \left(\frac{1}{96} \mu^4 - \frac{B^4}{4} - \right. \\
 &- \left. \frac{\mu^2 B^2}{8} \right) + \frac{1}{4} \lambda_1 B^4 \left. \right\} + \sin 2\theta_{z_a} \left\{ \frac{1}{3} \mu b_1 B^3 - \right. \\
 &- \frac{1}{2} a_2 B^4 - \frac{1}{4} \mu^2 a_0 B^2 + \frac{1}{24} \mu^4 a_0 + \\
 &+ \psi_1' \left(\mu \frac{B^3}{3} + .00885 \mu^4 \right) + \frac{1}{6} \mu \lambda_1 B^3 \left. \right\} + \\
 &+ \cos 2\theta_{z_a} \left\{ -\frac{1}{4} \mu^2 \theta_{x_0}' B^2 + \frac{1}{32} \mu^4 \theta_{x_0}' - \frac{1}{6} \mu^2 \theta_t B^3 + \right. \\
 &+ \frac{1}{2} b_2 B^4 + \frac{1}{3} \mu a_1 B^3 - .053 \mu^3 \lambda - \psi_2' \left(\frac{\mu B^3}{3} + \right. \\
 &+ .0221 \mu^4 \left. \right\}
 \end{aligned}$$

where c , the actual chord of the blade, is replaced, for convenience of calculations, by the mean chord \bar{c} .

Moment due to dynamic loads $(M_y)_m$:

From equations

$$(II-43) \quad (M_y)_m = \int_0^l -m x_r^2 R^3 (\theta_y \dot{\theta}_{z_a}^2 + \ddot{\theta}_y) dx_r$$

where "m" is the unit mass of the blade.

$$\text{Since } I_y \cong I_F = \int_0^l m x_r^2 R^3 dx_r$$

and substituting θ_y and $\ddot{\theta}_y$

$$(II-44) \quad (M_y)_m = -I_F \dot{\theta}_{z_a}^2 (a_0 + 3a_2 \cos 2\theta_{z_a} + 3b_2 \sin 2\theta_{z_a})$$

Moment due to weight of the blade $(M_y)_g$:

$$(II-45) \quad (M_y)_g = - \int_0^l w x_r^2 R^3 dx_r$$

where "w" is the unit weight of the blade and is usually quite small.

Moment due to mechanical damping $(M_y)_d$:

$$(II-46) \quad (M_y)_d = -K_y \dot{\theta}_y = -K_y \dot{\theta}_{z_a} (a_1 \sin \theta_{z_a} - b_1 \cos \theta_{z_a} + 2 a_2 \sin 2\theta_{z_a} - 2 b_2 \cos 2\theta_{z_a})$$

where K_y is a constant depending upon the adjustment of the damper.

In the first case the effect of change of pitch due to the cyclic pitch control applied by the pilot will be combined with the change of pitch due to the flapping which is obtained because of the hinge arrangement.

The combined effect will be assumed to be known and can be called the effective pitch control.

In the second case it will be assumed that only the effect of actual pitch control is known.

In writing down these expressions in a similar manner to the procedure used in ref. 2, the expressions for a_0 , a_2 , and b_2 will be carried to the order of μ^2 , and a_1 and b_1 will be carried to the order of μ^3 .

Neglecting $(M_y)_g$ and $(M_y)_{00}$, substituting (X-42), (X-44), (X-46) into (X-39), and equating coefficients of identical trigonometric functions, we obtain the five equations below:

$$(X-47) \quad \text{Let } D_y = \frac{F^I}{K_y} \cdot \frac{\dot{\theta}_{x_a}}{R}$$

$$(X-48a) \quad a_0 = \frac{F}{2} \left\{ \frac{1}{3} \lambda B^3 + \frac{1}{4} \theta'_{x_0} (B^4 + \mu^2 B^2) + \frac{1}{5} \theta'_t (B^5 + \frac{5}{6} \mu^2 B^3) + \frac{\psi'_2 \mu B^3}{3} \right\}$$

$$(b) \quad a_1 = \frac{1}{\frac{B^4}{4} - \mu^2 \frac{B^2}{8} + \frac{2}{D_y}} \left\{ \mu \lambda \left(\frac{B^2}{2} - \frac{\mu^2}{8} \right) + \mu \theta'_{x_0} \cdot \frac{2B^3}{3} + \frac{1}{2} \mu \theta'_t B^4 - \frac{1}{6} \mu b_2 B^3 + \psi'_2 \left(\frac{B^4}{4} + \frac{3}{8} B^2 \mu^2 \right) \right\}$$

$$(II-48c) \quad b_1 = \frac{1}{\frac{B^4}{4} + \mu^2 \frac{B^2}{8} + \frac{D}{y}} \left\{ \mu a_0 \frac{B^3}{3} + \frac{1}{6} \mu a_2 B^3 - \right. \\ \left. - \frac{1}{4} \lambda_1 B^4 - \psi_1' \left(\frac{B^4}{4} + \frac{\mu^2 B^2}{8} \right) \right\}$$

$$(d) \quad \frac{B^4}{2} a_2 + \frac{6}{\gamma_F} b_2 = \mu \left\{ -a_0 \mu \frac{B^2}{4} + \frac{1}{3} b_1 B^3 + \frac{1}{6} \lambda_1 B^3 + \right. \\ \left. + \psi_1' \frac{B^3}{3} \right\}$$

$$(e) \quad \frac{B^4}{2} b_2 - \frac{6}{\gamma_F} a_2 = \mu \left\{ \theta_{x_0}' \mu \frac{B^2}{4} - \frac{1}{3} a_1 B^3 + \frac{1}{6} \mu \theta_t B^3 + \right. \\ \left. + \psi_2' \frac{B^3}{3} \right\}$$

To a first approximation (II-48a), (b), and (c) may be written:

$$(II-49a) \quad a_0 = \frac{\gamma_F}{2} \left\{ \frac{1}{3} \lambda B^3 + \theta_{x_0}' \frac{B^4}{4} + \theta_t \frac{B^5}{5} \right\}$$

$$(b) \quad a_1 = \frac{2\mu}{B^2} \left\{ \lambda + \theta_{x_0}' \frac{4B}{3} + \theta_t B^2 + \frac{B^2 \psi_2'}{2\mu} \right\}$$

$$(c) \quad b_1 = \frac{4}{3B} \mu a_0 - \lambda_1 - \psi_1'$$

Substituting (II-49a), (b), and (c) in (II-48d) and (e.), and solving for a_2 and b_2 :

$$(II-50a) \quad b_2 = \frac{-\mu^2 \gamma_F^2}{144 + B^8 \gamma_F^2} \left\{ \frac{5}{9} \lambda B^5 + \frac{25}{36} \theta'_{x_0} B^6 + \right. \\ \left. + \frac{8}{15} \theta_t B^7 + \frac{4B^3 \lambda}{\mu \gamma_F} \right\}$$

$$(b) \quad a_2 = \frac{\gamma_F \mu^2}{6} \left\{ \frac{2}{3} \lambda B + \frac{23}{36} \theta'_{x_0} B^2 + \frac{1}{2} \theta_t B^3 \right\} + \\ + \frac{1}{12} \gamma_F B^4 b_2$$

$$(c) \quad a_0 = \frac{\gamma_F}{2} \left\{ \frac{1}{3} \lambda B^3 + \frac{1}{4} \theta'_{x_0} (B^4 + \mu^2 B^2) + \right. \\ \left. + \frac{1}{5} \theta_t (B^5 + \frac{5}{6} \mu^2 B^3) + \frac{\psi_2' \mu B^3}{3} \right\}$$

$$(d) \quad a_1 = \frac{2\mu}{B^4 - \frac{\mu^2 B^2}{2} + \frac{8}{D_y}} \left\{ \lambda B^2 + \frac{4}{3} B^3 \theta'_{x_0} + \theta_t B^4 - \right. \\ \left. - \frac{1}{3} b_2 B^3 + \psi_2' \left(\frac{B^4}{2\mu} + \frac{3}{4} B^2 \mu \right) \right\}$$

$$(e) \quad b_1 = \frac{2\mu \cdot B^3}{B^4 + \frac{\mu^2 B^2}{2} + \frac{8}{D_y}} \left\{ \frac{2}{3} a_0 + \frac{1}{3} a_2 - \frac{1}{2} \lambda_1 B - \right. \\ \left. - \psi_1' \left(\frac{B}{2\mu} + \frac{\mu}{4B} \right) \right\}$$

where, as previously defined,

$$(x-32a) \quad \theta'_{x_0} = \theta_{x_0} + a_0 \tau_1$$

$$(b) \quad \psi'_1 = \psi_1 - \tau_1 a_1$$

$$(c) \quad \psi'_2 = \psi_2 - \tau_1 b_1$$

In order to find the values of the flapping coefficients with control and flapping terms separated, we substitute the expansions above for θ'_{x_0} , ψ'_1 , and ψ'_2 in equations (x-49a), (b), and (c), and obtain the following first approximation values for a_0 , a_1 , b_1 :

$$(x-51a) \quad a_0 = \frac{\frac{1}{3} \lambda B^3 + \frac{B^4}{4} (\theta_{x_0}) + \theta_t \frac{B^5}{5}}{\frac{2}{\tau_1} - \frac{B^4}{4} \tau_1}$$

$$(b) \quad a_1 = \frac{\tau_1}{1 + \tau_1^2} \left\{ \frac{2\mu}{\tau_1 B^2} \left[\lambda + \frac{4}{3} B (\theta_{x_0} + a_0 \tau_1) + \theta_t B^2 + \frac{B^2}{2\mu} \psi_2 \right] - \frac{4}{3B} \mu a_0 + \lambda_1 + \psi_1 \right\}$$

$$(c) \quad b_1 = \frac{4}{3B} \mu a_0 - \lambda_1 - \psi_1 + \tau_1 a_1$$

The first approximation values given by (x-51) may be used to solve for θ'_{x_0} , ψ'_1 , and ψ'_2 , which may then be used in equations (x-50) in the usual manner.

Y Components of Air Load

It was shown on p. X-14, equation (X-19b), that the air load acting on each blade element in the "Y" direction is:

$$(X-19b) \quad \frac{d(F_y)_a}{dx} = \rho_1 \frac{dL}{dx} - \frac{dD}{dx}$$

Combining with (X-16a) and (b) and replacing x by $x_r \cdot R$

$$(X-52) \quad \frac{d(F_y)_a}{dx_r} = \frac{\rho}{2} cC_1 \theta_1 RV^2 - \frac{\rho}{2} cC_{D_0} RV^2$$

From refs. 4 and 5 ,

$$(X-53) \quad C_{D_0} = \delta_0 + \delta_1 \theta_r + \delta_2 \theta_r^2$$

δ_0 , δ_1 , and δ_2 depend on the characteristics of the chosen airfoil and can be determined from the charts given in figures 1 and 2 of ref. 4 .

The angle of attack, θ_r , is given by equation (X-15) and the velocity components by equations (X-29a) and (b) .

Letting

$$(X-54a) \quad \frac{d(F_y)_{aL}}{dx_r} = \frac{\rho}{2} cC_1 \theta_1 RV^2$$

$$(b) \quad - \frac{d(F_y)_{aD}}{dx_r} = + \frac{1}{2} \rho cC_{D_0} RV^2$$

and expanding (X-54a), we have

$$(II-55) \quad \frac{d(F_y)_{a_L}}{dx_r} \cdot \frac{1}{cC_{z_a}} = A_0 a_L + A_1 a_L \cos \theta_{z_a} + B_1 a_L \sin \theta_{z_a} \\ + A_2 a_L \cos 2\theta_{z_a} + B_2 a_L \sin 2\theta_{z_a}$$

where the harmonic terms of higher order than the second are neglected, and $C_{z_a} = \frac{\rho}{2} a \dot{\theta}_{z_a}^2 R^3$. In the expressions given below for the coefficients, terms of order higher than μ^4 have been dropped. In determining the order of the terms, it is assumed that $a_0, a_1, b_1, \theta'_{x_0}, \psi'_1, \psi'_2, \lambda, \delta_2$ are of the order μ ; and that $\delta_0, \delta_1, a_2, b_2, \lambda_1$ are of the order μ^2 .

$$(II-55a) \quad A_0 a_L = \frac{\mu^2}{2} \left\{ \frac{\lambda}{\mu} (2 \frac{\lambda}{\mu} + \psi'_2 + 2a_1) + a_0^2 + \frac{3}{4} a_1^2 \right\} \\ + \mu x_r \left\{ \frac{\lambda}{\mu} \theta'_{x_0} - \frac{a_0 \psi'_1}{2} - a_0 \lambda_1 - a_0 b_1 - \frac{b_1 a_2}{2} + \frac{a_1 b_2}{2} \right\} \\ + x_r^2 \left\{ \lambda \theta_t + \frac{b_1 \psi'_1}{2} - \frac{a_1 \psi'_2}{2} + \frac{\lambda_1^2}{2} + \frac{a_1^2}{2} + \frac{b_1^2}{2} + 2a_2^2 + 2b_2^2 \right\} \\ + (\psi'_1 + 2b_1) \frac{\lambda_1}{2}$$

$$\begin{aligned}
 (\text{II-55b}) \quad A_{1a_L} &= \frac{\mu^2}{2} \left\{ \frac{2\lambda}{\mu} (a_2 - 2a_0) - 3a_1 a_0 \right\} + \mu x_r \left\{ \frac{\lambda}{\mu} (2b_1 + \psi_1') - a_0 \theta_{x_0}' \right. \\
 &+ \frac{a_1 \psi_1'}{2} + \frac{b_1 \psi_2'}{2} + a_1 b_1 + \frac{2\lambda \lambda_1}{\mu} + \frac{3}{2} \lambda_1 a_1 - \frac{a_2 \theta_{x_0}'}{2} \\
 &\left. - 2a_0 b_2 \right\} + x_r^2 \left\{ \theta_{x_0}' (b_1 + \lambda_1) - \mu \theta_t (a_0 + \frac{a_2}{2}) + b_2 \psi_1' \right. \\
 &\left. - a_2 \psi_2' + 2b_1 b_2 + 2a_1 a_2 + 2b_2 \lambda_1 \right\} + x_r^3 \left\{ \theta_t (b_1 + \lambda_1) \right\}
 \end{aligned}$$

$$\begin{aligned}
 (\text{II-55c}) \quad B_{1a_L} &= \frac{\mu^2}{2} \left\{ \frac{2\lambda}{\mu} (\theta_{x_0}' + b_2) - a_0 b_1 \right\} \\
 &+ \mu x_r \left\{ \frac{\lambda}{\mu} (\mu \theta_t - 2a_1) + \frac{b_1}{2} \psi_1' - \frac{5}{4} a_1 \psi_2' - \frac{a_1^2}{2} + \frac{b_1^2}{2} + \frac{b_1 \lambda_1}{2} \right. \\
 &\left. - \frac{b_2 \theta_{x_0}'}{2} + 2a_2 a_0 \right\} \\
 &+ x_r^2 \left\{ -a_1 \theta_{x_0}' - 2a_2 \lambda_1 - \frac{1}{2} \mu b_2 \theta_t - a_2 \psi_1' - b_2 \psi_2' \right. \\
 &\left. + 2a_1 b_2 - 2b_1 a_2 \right\} + x_r^3 (-\theta_t a_1)
 \end{aligned}$$

$$\begin{aligned}
 (\text{II-55d}) \quad A_{2a_L} &= \frac{\mu^2}{2} \left\{ \frac{\lambda}{\mu} (2a_1 - \psi_2^1) + a_0^2 + a_1^2 \right\} \\
 &+ \mu x_r \left\{ 4 \frac{\lambda}{\mu} b_2 + a_1 \theta_{x_0}' - \frac{a_0 \psi_1'}{2} - a_0 b_1 + \frac{a_2 \psi_4}{2} + b_2 \psi_2' \right. \\
 &\left. + 2a_1 b_2 + b_1 a_2 - a_0 \lambda_1 + a_2 \lambda_1 \right\} \\
 &+ x_r^2 \left\{ \frac{b_1 \psi_1'}{2} + \frac{a_1 \psi_2'}{2} - \frac{a_1^2}{2} + \frac{b_1^2}{2} + 2b_2 \theta_{x_0}' + a_1 \theta_t \mu + \frac{\lambda_1 \psi_1'}{2} \right. \\
 &\left. + b_1 \lambda_1 + \frac{\lambda_1^2}{2} \right\} \\
 &+ x_r^3 \left\{ 2\theta_t b_2 \right\}
 \end{aligned}$$

$$\begin{aligned}
 (\text{II-55e}) \quad B_{2a_L} &= \frac{\mu^2}{2} \left\{ \frac{\lambda}{\mu} (2b_1 + \psi_1') - a_0 \theta_{x_0}' + a_1 b_1 \right\} \\
 &+ \mu x_r \left\{ -4 \frac{\lambda}{\mu} a_2 + b_1 \theta_{x_0}' - \frac{a_0 \psi_2'}{2} - \frac{a_0 \mu \theta_t}{2} + a_1 a_0 + \frac{b_2 \psi_1'}{2} \right. \\
 &\left. + a_2 \psi_2^1 - 2a_1 a_2 + b_1 b_2 + \frac{\lambda_1 \theta_{x_0}'}{2} \right\}
 \end{aligned}$$

(continued on next page.)

$$\begin{aligned}
 & + x_r^2 \left\{ -\frac{a_1 \psi_1'}{2} + \frac{b_1 \psi_2'}{2} - a_1 b_1 - 2a_2 \theta_{x_0}' + b_1 \mu \theta_t + \frac{\lambda_1 \psi_2'}{2} \right. \\
 & \left. + \frac{\mu \lambda_1 \theta_t}{2} - \lambda_1 a_1 \right\} \\
 & + x_r^3 \left\{ -2a_2 \theta_t \right\}
 \end{aligned}$$

Also,

$$\begin{aligned}
 \text{(II-56)} \quad -\frac{d(F_y)_{a_D}}{dx_r} \cdot \frac{a}{cG_{z_a}} &= A_{0a_D} + A_{1a_D} \cos \theta_{z_a} + B_{1a_D} \sin \theta_{z_a} \\
 & + A_{2a_D} \cos 2\theta_{z_a} + B_{2a_D} \sin 2\theta_{z_a}
 \end{aligned}$$

$$\begin{aligned}
 \text{(II-56a)} \quad A_{0a_D} &= \frac{\mu^2}{2} \left\{ \delta_0 + \delta_2 \left[2 \frac{\lambda}{\mu} (\Delta + \psi_2' + a_1) \right] \right\} \\
 & + \mu x_r \left\{ \delta_1 \left[\frac{\lambda}{\mu} + \psi_2' \right] + \delta_2 \left[2\theta_{x_0}' \left(\frac{\lambda}{\mu} + \psi_2' \right) - a_0 (b_1 + \psi_1') \right] \right\} \\
 & + x_r^2 \left\{ \delta_0 + \delta_1 \theta_{x_0}' + \delta_2 \left[2\lambda \theta_t + 2\mu \theta_t \psi_2' - a_1 \psi_2' \right. \right. \\
 & \left. \left. + \psi_1' (b_1 + \lambda_1) + b_1 \lambda_1 + (\theta_{x_0}')^2 + \frac{\psi_2'^2}{2} + \frac{a_1^2}{2} \right] \right\}
 \end{aligned}$$

(continued on next page.)

$$\left. \frac{\psi_1'^2}{2} + \frac{b_1^2}{2} \right\}$$

$$+ x_r^3 \left\{ \delta_1 \theta_t + \delta_2 \cdot 2\theta_t \theta_{x_0}' \right\} + x_r^4 \left\{ \delta_2 \theta_t^2 \right\}$$

$$(II-56b) A_{1aD} = \frac{\mu^2}{2} \left\{ -\frac{4\delta_2 \lambda a_0}{\mu} \right\} + \mu x_r \left\{ -\delta_1 a_0 + \right.$$

$$\left. + \delta_2 \left[2 \frac{\lambda}{\mu} (\psi_1' + b_1 + \lambda_1) + (a_1 + \psi_2') (b_1 + \psi_1') - 2a_0 \theta_{x_0}' \right] \right\}$$

$$+ x_r^2 \left\{ \delta_1 [\psi_1' + b_1 + \lambda_1] + \delta_2 [2(b_2 + \theta_{x_0}') (\psi_1' + b_1 + \lambda_1) \right.$$

$$\left. + 2a_2 (a_1 - \psi_2') - 2\mu \theta_t a_0 \right\}$$

$$+ x_r^3 \left\{ \delta_2 [2\theta_t (\psi_1' + b_1 + \lambda_1)] \right\}$$

$$(II-56c) B_{1aD} = \frac{\mu^2}{2} \left\{ \delta_1 \frac{2\lambda}{\mu} + \delta_2 \frac{4\lambda \theta_{x_0}'}{\mu} \right\}$$

$$+ \mu x_r \left\{ 2\delta_0 + \delta_1 2\theta_{x_0}' + \delta_2 \left[2 \frac{\lambda}{\mu} (\psi_2' - a_1) \right. \right.$$

(continued on next page.)

$$\begin{aligned}
 & + \frac{1}{2} (\psi'_1 + b_1)(\psi'_1 + b_1) - \frac{a_1^2}{2} + \frac{3}{2} \psi_2'^2 + 2\theta_{x_0}'^2 \\
 & + 2\lambda\theta_t - a_1\psi_2' + 2a_1a_2] \} \\
 & + x_r^2 \left\{ \delta_1 [2\mu\theta_t + \psi_2' - a_1] + \delta_2 [2\theta_{x_0}' (2\mu\theta_t + \psi_2' - a_1) \right. \\
 & \left. + 2b_2(a_1 - \psi_2') - 2a_2(\psi_1' + b_1 + \lambda_1)] \right\} \\
 & + x_r^3 \left\{ \delta_2 2\theta_t (\psi_2' + \mu\theta_t - a_1) \right\}
 \end{aligned}$$

$$\begin{aligned}
 (\text{II-56d}) A_{2aD} & = \frac{\mu^2}{2} \left\{ -\delta_0 + \delta_2 \left[2 \frac{\lambda}{\mu} (a_1 - \psi_2') \right] \right\} \\
 & + \mu x_r \left\{ \delta_1 [a_1 - \psi_2'] + \delta_2 \left[4b_2 \frac{\lambda}{\mu} + 2a_1 (b_2 + \theta_{x_0}') \right. \right. \\
 & \left. \left. + 2\psi_2' (b_2 - \theta_{x_0}') - a_0 (b_1 + \psi_1') \right] \right\} \\
 & + x_r^2 \left\{ \delta_1 [2b_2] + \delta_2 \left[4b_2 \theta_{x_0}' + \mu\theta_t (2a_1 - 2\psi_2' - \frac{\mu\theta_t}{2}) \right. \right.
 \end{aligned}$$

(continued on next page.)

$$\begin{aligned}
 & -\frac{1}{2} (a_1 - \psi_2^i)^2 + \psi_1^i \left(\frac{\psi_1^i + b_1 + \lambda_1}{2} \right) \\
 & + \frac{1}{2} (b_1 + \lambda_1)^2 \Big\} \\
 & + x_T^3 \left\{ \delta_2 \cdot 4b_2 \theta_t \right\}
 \end{aligned}$$

$$\begin{aligned}
 \text{(II-56a)} \quad B_{2aD} &= \frac{\mu^2}{2} \left\{ \delta_2 \cdot \frac{2\lambda}{4} (\psi_1^i + b_1) \right\} \\
 & + \mu x_T \left\{ \delta_1 (\psi_1^i + b_1) + \delta_2 [2\theta_{x_0}^i (\psi_1^i + b_1) - 4 \frac{\lambda}{4} a_2 \right. \\
 & \left. - 2a_2 (a_1 + \psi_2^i) + a_0 (a_1 - \psi_2^i)] \right\} \\
 & + x_T^2 \left\{ -\delta_1 2a_2 + \delta_2 [2\mu \theta_t (\psi_1^i + b_1) \right. \\
 & \left. - (a_1 - \psi_2^i)(\psi_1^i + b_1 + \lambda_1) - 4a_2 \theta_{x_0}^i] \right. \\
 & \left. + x_T^3 \left\{ -\delta_2 \cdot 4a_2 \theta_t \right\} \right\}
 \end{aligned}$$

Torque Moment in the XY Plane About the Drag Pin Due to Aerodynamic Loads

The moment due to air loads about the axis of rotation is given by:

$$(II-57) \quad (M_z)_a = \left| \int_0^1 + R x_r \frac{d(F_y)_{aD}}{dx_r} dx_r + \int_0^B R x_r \frac{d(F_y)_{aL}}{dx_r} dx_r \right|_0^{2\pi}$$

$$\left| - 2 \int_0^\pi \sin \theta_{z_a} R x_r \left[+ \frac{d(F_y)_{aD}}{dx_r} + \frac{d(F_y)_{aL}}{dx_r} \right] dx_r \right|_\pi^{2\pi}$$

where $\int_\pi^{2\pi}$ means that the expression enters

into the moment only in the interval π to 2π . Evaluating these expressions, which are harmonic functions of θ_{z_a} , and combining into a single harmonic function of θ_{z_a} , continuous from 0 to 2π by the method of ref. 2, we find:

$$(II-58) \quad (M_z)_a \left(\frac{1}{R \bar{C} \theta_{z_a}} \right) = G_0 + G_1 \cos \theta_{z_a} + H_1 \sin \theta_{z_a} + G_2 \cos 2\theta_{z_a} + H_2 \sin 2\theta_{z_a}$$

where, neglecting terms of order μ^5 or higher:

$$\begin{aligned}
 (\pi-58a) \quad G_0 = & \lambda^2 \left\{ \frac{B^2}{2} - \frac{\delta_2}{2a} - \frac{\mu^2}{4} \right\} \\
 & + \lambda \left\{ -\frac{1}{a} \left(\frac{\delta_1}{3} + \frac{2}{3} \delta_2 \theta'_{x_0} + \frac{\delta_2 \theta_t}{2} \right) \frac{B^3 \theta'_{x_0}}{3} + \frac{B^4}{4} \theta_t \right. \\
 & \left. + \frac{\mu B^2}{4} (\psi'_2 + 2a_1) \right\} \\
 & + \left\{ -\frac{1}{a} \left[\frac{\delta_0}{4} + \frac{\delta_1 \theta'_{x_0}}{4} + \delta_2 \left(-\frac{a_1 \psi'_2}{4} + \frac{b_1 \psi'_1}{4} + \frac{\theta'^2_{x_0}}{4} + \frac{2}{5} \theta_t \theta'_{x_0} \right) \right] \right. \\
 & + \frac{\mu B^2}{4} (a_0^2 + \frac{3}{4} a_1^2) - \frac{\mu B^3 a_0}{3} (\lambda_1 + b_1 + \frac{\psi'_1}{2}) \\
 & \left. + \frac{B^4}{4} \left(\frac{b_1 \psi'_1}{2} + \frac{\lambda_1 \psi'_1}{2} + b_1 \lambda_1 - a_1 \psi'_2 + \frac{a_1^2}{2} + \frac{b_1^2}{2} + 2a_2^2 + 2b_2^2 \right) \right\}
 \end{aligned}$$

$$\begin{aligned}
 (\pi-58b) \quad G_1 = & \frac{\mu^2 B^2}{4} \left\{ 2 \frac{\lambda}{\mu} (a_2 - 2a_0) - 3a_1 a_0 \right\} \\
 & + \frac{\mu}{3} \left\{ \frac{\lambda}{\mu} [B^3 (2b_1 + \psi'_1 + 2\lambda_1) - \frac{2\delta_2}{a} (b_1 + \psi'_1)] \right\}
 \end{aligned}$$

(continued on next page.)

$$\begin{aligned}
 & + B^3 \left(\frac{a_1 \psi_1'}{2} + \frac{b_1 \psi_2'}{2} + a_1 b_1 + \frac{3}{2} \lambda_1 a_1 - 2a_0 b_2 - a_0 \theta_{x_0}' \right) \Bigg\} \\
 & + \frac{B^4}{4} \left\{ \theta_{x_0}' (b_1 + \lambda_1) + b_2 (\psi_1' + 2b_1 + 2\lambda_1) - a_2 (\psi_2' - 2a_1) \right. \\
 & \left. - a_0 \mu \theta_t \right\} \\
 & + \frac{B^5}{5} \theta_t (b_1 + \lambda_1)
 \end{aligned}$$

$$\begin{aligned}
 (\text{II-58c}) \quad H_1 &= \frac{\mu^2 B^2}{4} \left\{ 2 \frac{\lambda}{\mu} (\theta_{x_0}' + b_2) \right\} \\
 & + \frac{\mu}{3} \left\{ \frac{\lambda}{\mu} [B^3 (\mu \theta_t - 2a_1) - \frac{2\delta_2}{a} (\psi_2' - a_1)] - 2 \frac{\delta_0}{a} \right. \\
 & \left. + B^3 \left[\frac{b_1}{2} (b_1 + \psi_1') + 2a_0 a_2 - \frac{a_1^2}{2} - \frac{5}{4} a_1 \psi_2' \right] \right\} \\
 & + \frac{B^4}{4} \left\{ b_2 (2a_1 - \psi_2') - a_2 (2b_1 + 2\lambda_1 + \psi_1') - a_1 \theta_{x_0}' \right\} \\
 & - \frac{B^5}{5} a_1 \theta_t
 \end{aligned}$$

$$\begin{aligned}
 (\text{II-58d}) \quad G_2 = & \frac{\mu^2}{4} \left\{ B^2 \frac{\lambda}{\mu} (2a_1 - \psi_2') + \lambda^2 \right\} \\
 & + \frac{\mu B^3}{3} \left\{ 4 \frac{\lambda b_2}{\mu} + a_1 (2b_2 + \theta_{x_0}') - a_0 (b_1 + \frac{\psi_1'}{2}) \right\} \\
 & + \frac{B^4}{4} \left\{ b_1 (\lambda_1 + \frac{b_1}{2} + \frac{\psi_1'}{2}) + a_1 (\mu \theta_t + \frac{\psi_2'}{2} - \frac{a_1}{2}) \right. \\
 & \left. + 2b_2 \theta_{x_0}' + \frac{\lambda_1 \theta_{x_0}'}{2} \right\} + \frac{2}{5} B^5 b_2 \theta_t
 \end{aligned}$$

$$\begin{aligned}
 (\text{II-58e}) \quad H_2 = & \frac{\mu^2 B^2}{4} \left\{ \frac{\lambda}{\mu} (2b_1 + \psi_1') \right\} \\
 & + \frac{\mu B^3}{3} \left\{ -\frac{4\lambda a_2}{\mu} + b_1 \theta_{x_0}' - \frac{a_0 \psi_1'}{2} + a_1 a_0 - 2a_1 a_2 \right\} \\
 & + \frac{B^4}{4} \left\{ b_1 (\mu \theta_t + \frac{\psi_2'}{2} - a_1) - \frac{a_1 \psi_1'}{2} - 2a_2 \theta_{x_0}' + \frac{\lambda_1 \psi_2'}{2} \right\} \\
 & - \frac{2}{5} B^5 a_2 \theta_t
 \end{aligned}$$

Since the sum of the constant part of the aerodynamic torque and the engine torque should be zero, we write

$$(\text{II-59}) \quad G_0 + \frac{2C_Q}{a\sigma} = 0$$

Where G_0 is given by (II-58a).

Following the lead of Bailey in ref. 4, we substitute in the expansion for G_0 the expressions for the flapping coefficients given by equations (I-50).

The result is an equation in $\mu, \lambda, \lambda_1, \theta_t, \theta'_{x_0}, \psi'_1, \psi'_2, \chi'_F, \frac{2C_Q}{a\sigma}, \delta_0, \delta_1, \delta_2$, of which the unknowns are λ and θ'_{x_0} . Substituting into this equation the value of θ'_{x_0} from equation (I-38), we obtain an equation of the type below:

$$\begin{aligned}
 \text{(I-60)} \quad & \lambda^2 \left\{ t_1 + t'_1 \left(\frac{\delta_2}{a} \right) \right\} \\
 & + \lambda \left\{ t_{24} \left(\frac{\delta_1}{a} \right) + \left(\frac{2C_F}{a\sigma} \right) [t_2 + t'_2 \left(\frac{\delta_2}{a} \right)] + \theta_t [t_3 + t'_3 \left(\frac{\delta_2}{a} \right)] \right. \\
 & \quad + \psi'_1 [t_4 + t'_4 \left(\frac{\delta_2}{a} \right)] + \psi'_2 [t_5 + t'_5 \left(\frac{\delta_2}{a} \right)] \\
 & \quad \left. + \lambda_1 [t_6 + t'_6 \left(\frac{\delta_2}{a} \right)] \right\} \\
 & + \left(\frac{2C_F}{a\sigma} \right) \left\{ t_{23} \left(\frac{\delta_1}{a} \right) + \frac{2C_F}{a\sigma} [t_7 + t'_7 \left(\frac{\delta_2}{a} \right)] + \theta_t [t_8 + t'_8 \left(\frac{\delta_2}{a} \right)] \right. \\
 & \quad \left. + \psi'_1 [t_9 + t'_9 \left(\frac{\delta_2}{a} \right)] + \psi'_2 [t_{10} + t'_{10} \left(\frac{\delta_2}{a} \right)] \right\}
 \end{aligned}$$

(continued on next page.)

$$\begin{aligned}
 & + \lambda_1 \left[t_{11} + t'_{11} \left(\frac{\delta_2}{a} \right) \right] \\
 + \theta_t \left\{ & t_{25} \left(\frac{\delta_1}{a} \right) + \theta_t \left[t_{12} + t'_{12} \left(\frac{\delta_2}{a} \right) \right] + \psi_1' \left[t_{13} + t'_{13} \left(\frac{\delta_2}{a} \right) \right] \right. \\
 & \left. + \psi_2' \left[t_{14} + t'_{14} \left(\frac{\delta_2}{a} \right) \right] + \lambda_1 \left[t_{15} + t'_{15} \left(\frac{\delta_2}{a} \right) \right] \right\} \\
 + \psi_1' \left\{ & \psi_1' \left[t_{16} + t'_{16} \left(\frac{\delta_2}{a} \right) \right] + \psi_2' \left[t_{17} + t'_{17} \left(\frac{\delta_2}{a} \right) \right] \right. \\
 & \left. + \lambda_1 \left[t_{18} + t'_{18} \left(\frac{\delta_2}{a} \right) \right] \right\} \\
 + \psi_2' \left\{ & t_{26} \left(\frac{\delta_1}{a} \right) + \psi_2' \left[t_{19} + t'_{19} \left(\frac{\delta_2}{a} \right) \right] + \lambda_1 \left[t_{20} + t'_{20} \left(\frac{\delta_2}{a} \right) \right] \right\} \\
 + \lambda_1^2 \left\{ & t_{21} + t'_{21} \left(\frac{\delta_2}{a} \right) \right\} + t_{22} \left(\frac{\delta_0}{a} \right) + \frac{2C_Q}{a\sigma} = 0
 \end{aligned}$$

The coefficients t_n and t'_n are functions of μ , X_F , D_y , and B . As shown by Bailey, variations of X_F , D_y , B from average representative values do not affect the coefficients very much. The coefficients t_n and t'_n have therefore been computed as functions of μ for $X_F = 15$, $B = .97$, $D_y = \infty$. For the actual computation, a more complete expression than ($\pi-58a$) for G_0 was used, in which all terms in μ of μ^4 or lower order were retained. Where possible the numerical work presented by Bailey in ref. 4 was used. For the sake of brevity, we give only the results of these computations in figures II-11 to II-19.

λ is found by solving equation ($\pi-60$), and θ'_{x_0} by equation ($\pi-38$)

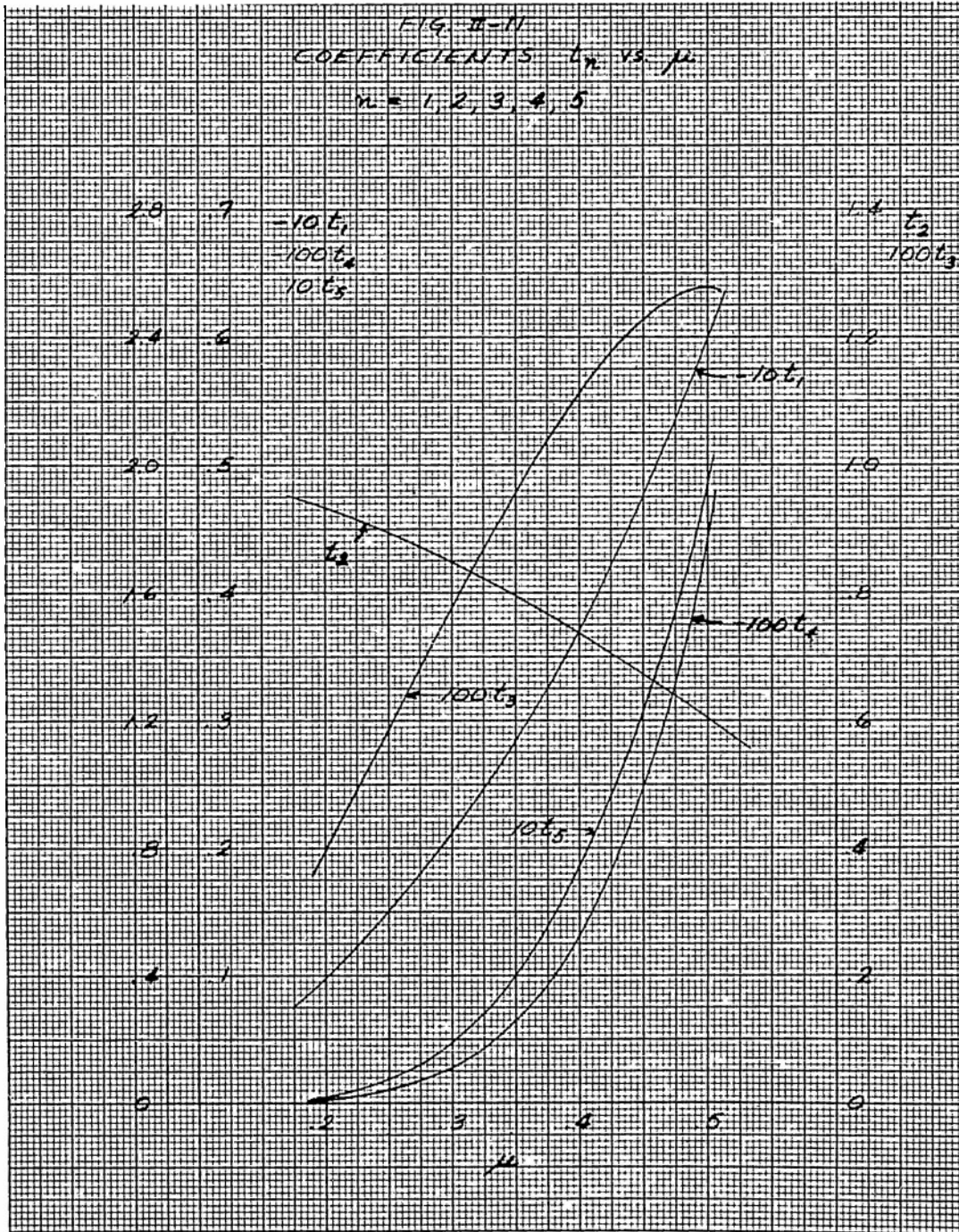

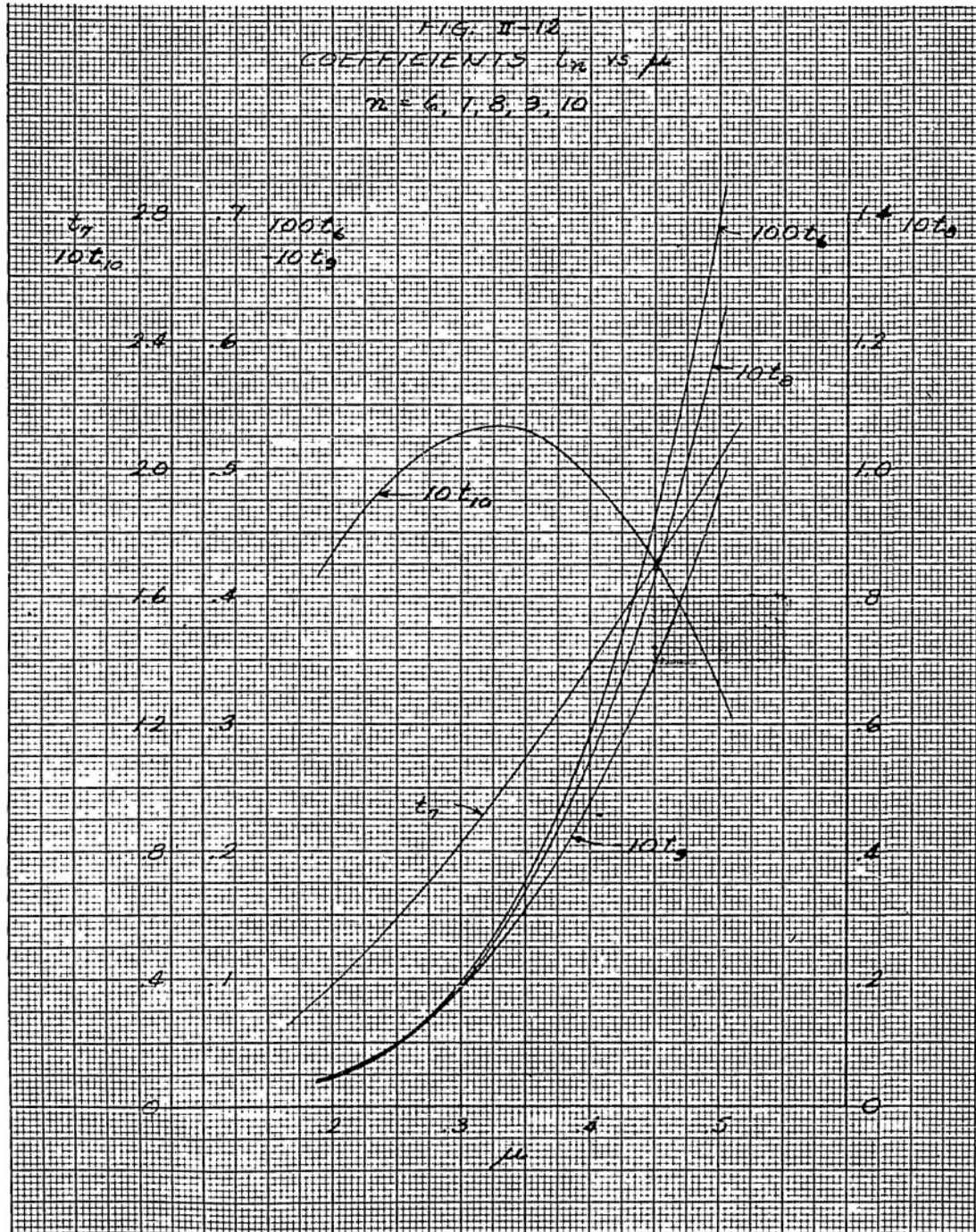

+

FIG. 2-13
 COEFFICIENTS t_n vs μ
 $n = 11, 12, 13, 14, 15$



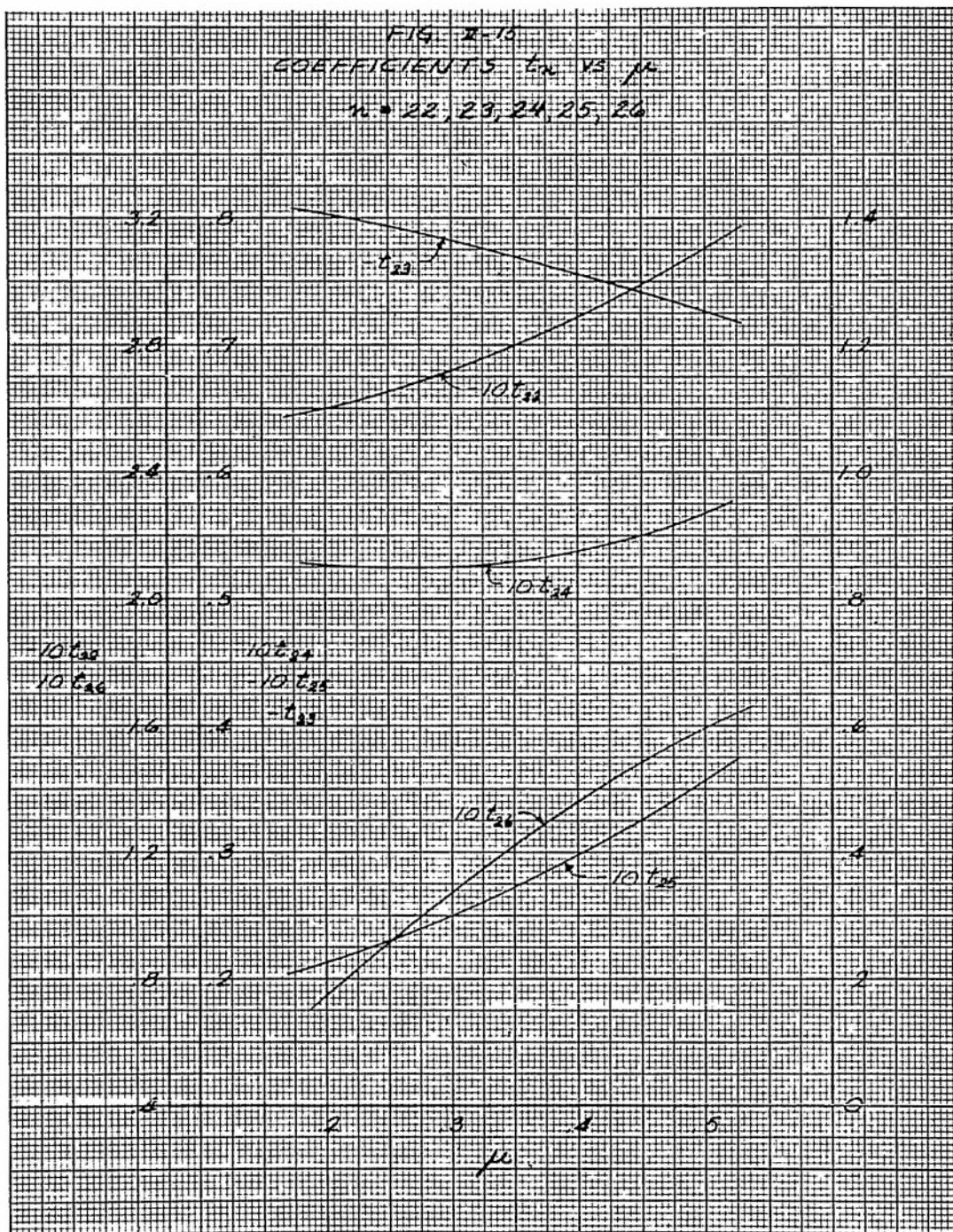

r

1

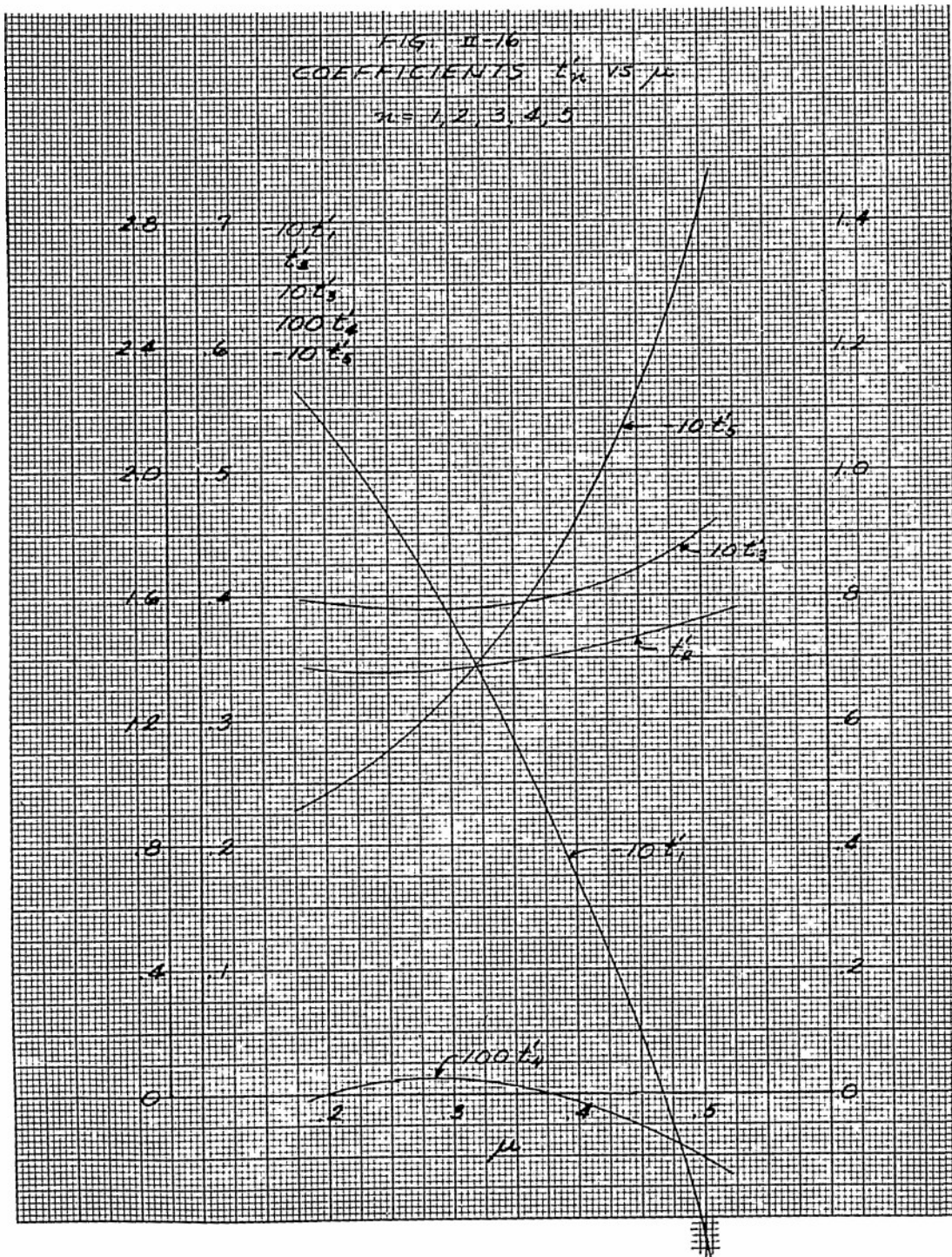

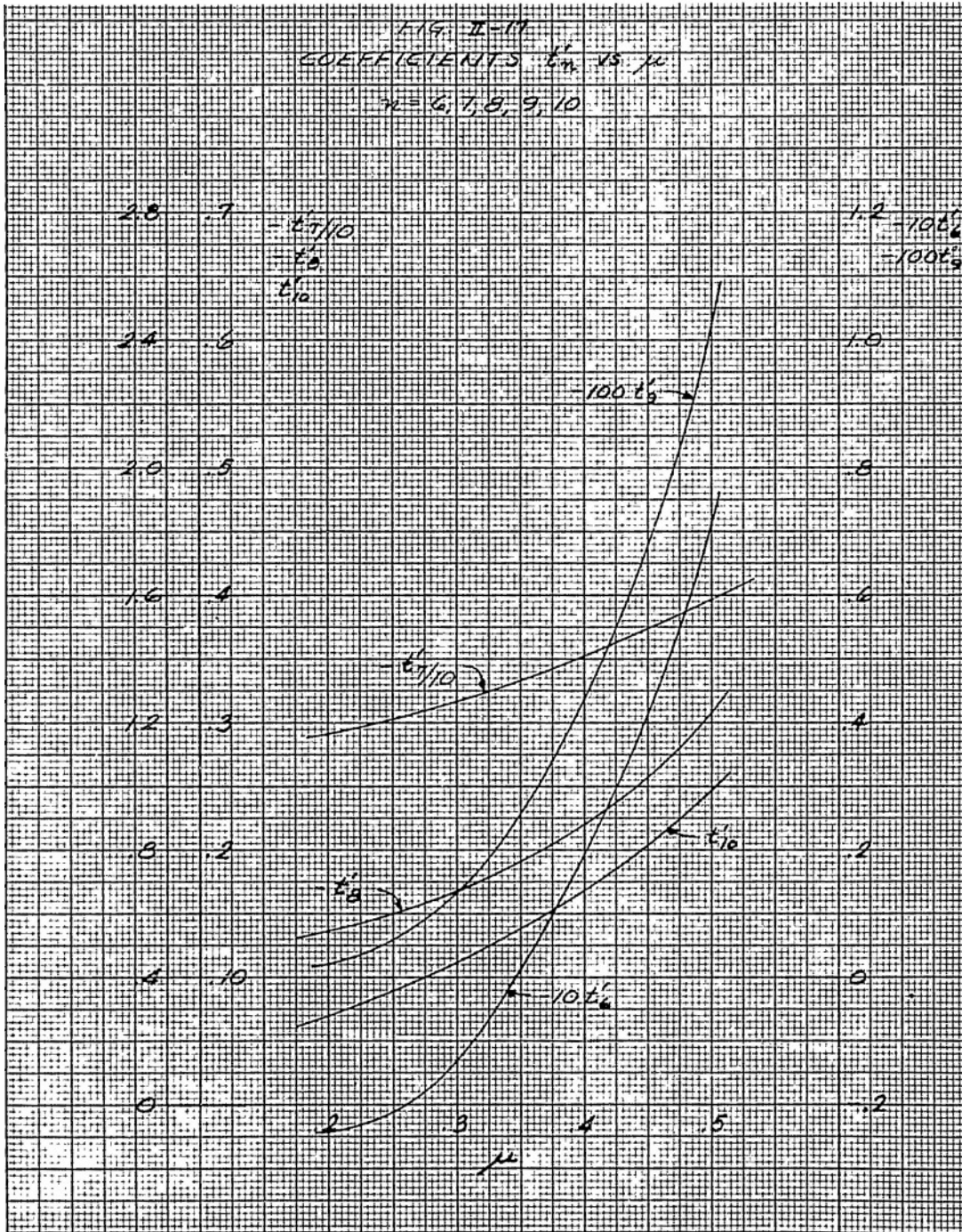

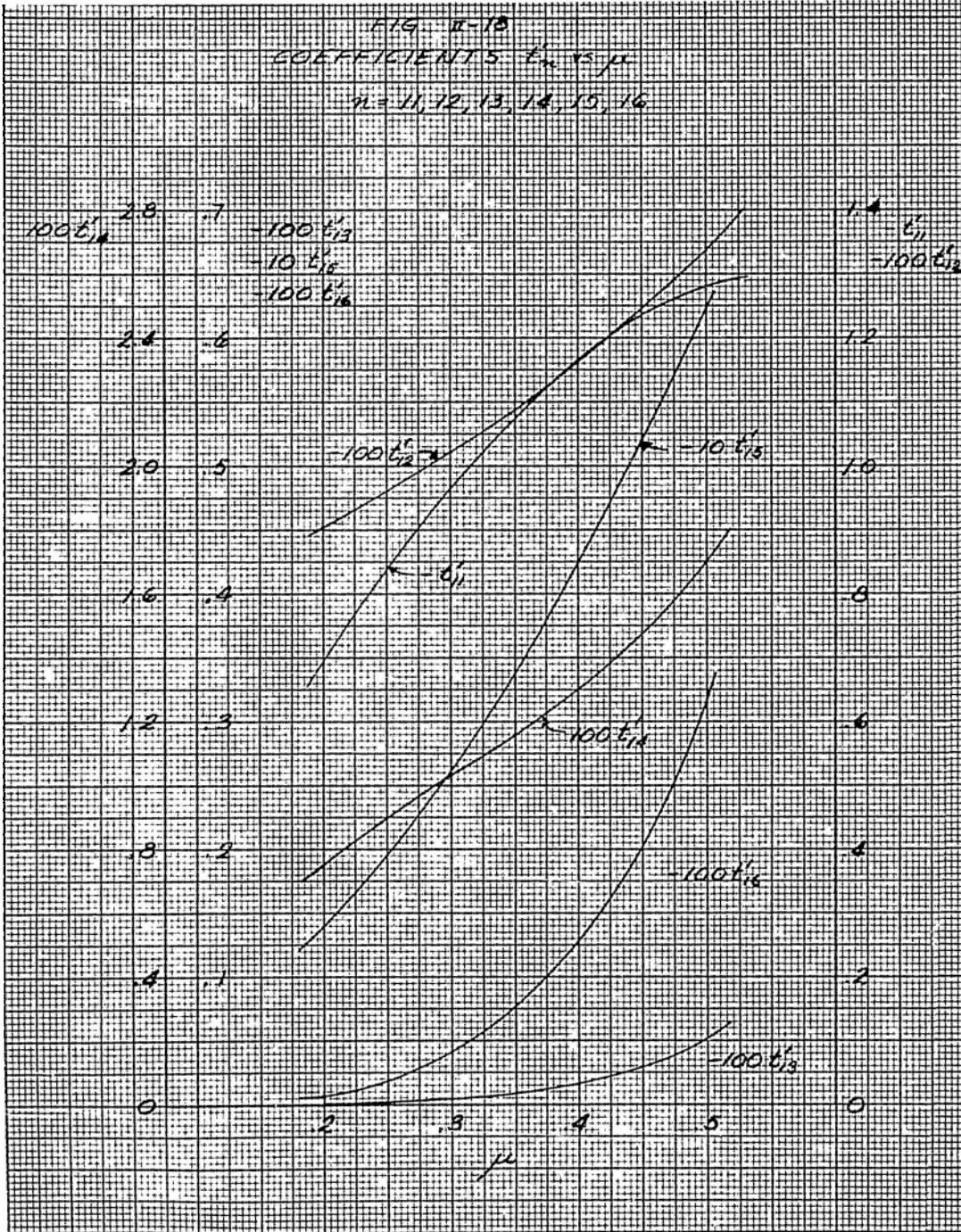

+

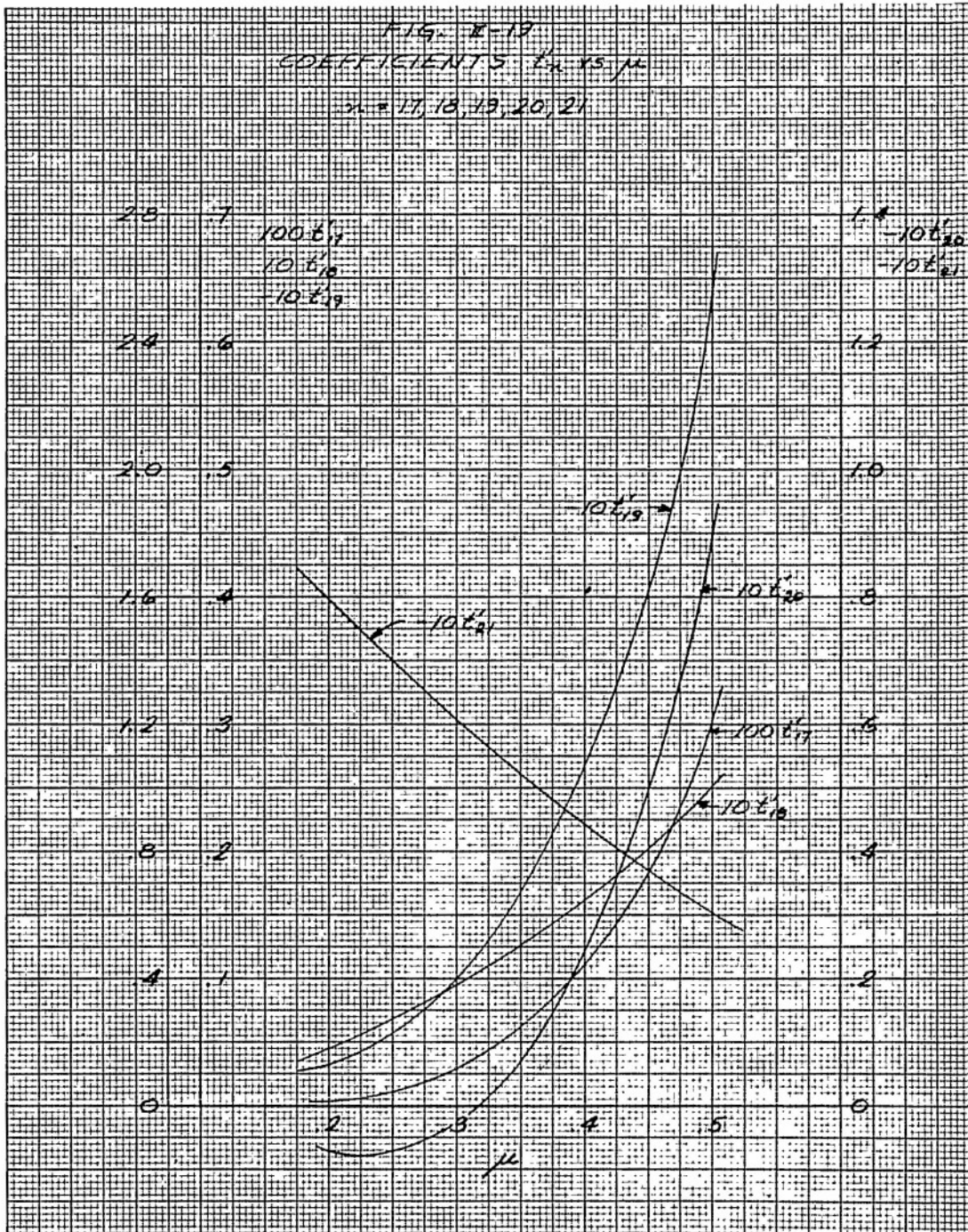

+

Equation of Motion of a Stiff Blade in the XY plane (The Hunting Coefficients)

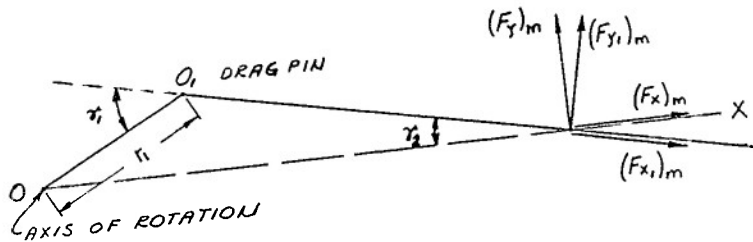

Fig. II-20

It was shown in the analysis for the flapping coefficients on p. II-17 that the effect of the eccentricity of the flapping pin would be small. It is therefore assumed again that the flapping pin and the axis of rotation coincide. The eccentricity of the drag pin, however, may be considerably larger, and will be considered.

In Fig. II-20, above, the actual blade position is sketched in solid lines, while dotted lines show the idealized position for which accelerations \ddot{x} and \ddot{y} have been derived on pp. II-1 to II-7. In the sketch, x_1 is the spanwise coordinate of a blade particle with the blade in its true position, while x is the spanwise coordinate of the same particle with the blade in the idealized position. From the sketch

$$(II-61) \quad x \sin \gamma_2 = r_1 \sin \gamma_1 \quad \text{or} \quad \sin \gamma_2 = \frac{r_1}{x} \sin \gamma_1$$

Since γ_1 is very nearly equal to $-\theta_{z_b}$ and is a fairly small angle, and since $\frac{r_1}{x}$ is small for the important

(large) values of x , γ_2 is a very small angle.

Now we write the expressions for the moments about the drag pin:

1.) Aerodynamic moment:

$$(II-62) \quad M_{O1a} = \int_{r_1}^R x_1 (F_y)_a dx_1$$

A more rigorous expression would be

$$\int_{r_1}^R x_1 \left\{ (F_y)_a \cos \gamma_2 + (F_x)_a \sin \gamma_2 \right\} dx_1$$

but we neglect the radial component, $(F_x)_a$, and since γ_2 is very small, except near the root where the forces are small, $\cos \gamma_2 \approx 1$. Further, since γ_2 is small, $x = x_1$ to a very close approximation, and since r_1 is small, we assume

$$(II-62a) \quad M_{O1a} \approx \int_0^R x (F_y)_a dx = (M_z)_a \quad \text{(given by equation (I-5c))}$$

2.) Dynamic Moment:

$$(II-63) \quad M_{O1m} = + \sum_{r_1}^R x_1 (F_{y_1})_m$$

From the sketch,

$$(II-64) \quad \begin{aligned} (F_{y_1})_m &= (F_y)_m \cos \gamma_2 + (F_x)_m \sin \gamma_2 \\ &\approx (F_y)_m + \frac{r_1}{x} (F_x)_m \sin \gamma_1 \end{aligned}$$

$$(II-64) \quad \approx (F_y)_m - (F_x)_m \frac{r_1}{x} \sin \theta_{z_b}$$

Now, from p. II-8 equations (II-8b) and (II-8c):

$$(II-8c) \quad (F_y)_m = mx \cdot (2\theta_y \dot{\theta}_y \dot{\theta}_{z_a} - \ddot{\theta}_z) dx$$

$$(II-8b) \quad (F_x)_m = mx \dot{\theta}_{z_a}^2 dx$$

Substituting the above for $(F_{y_1})_m$ and again assuming $x_1 = x$,

$$(II-65) \quad M_{O_1}_m = \int_{r_1}^R mx^2 (2\theta_y \dot{\theta}_y \dot{\theta}_{z_a} - \ddot{\theta}_z) dx$$

$$- \int_{r_1}^R mx r_1 \sin \theta_{z_b} \dot{\theta}_{z_a}^2 dx$$

where "m" is now the "line density" of the blade.

$\int_{r_1}^R mx^2 dx$ may be taken as I_z , the moment of inertia of the blade about the drag pin, and $\int_{r_1}^R mx dx$ is the "mass moment" of the blade, and is designated by the special symbol M_m .

Also, since

$$(II-66a) \quad \theta_z = \theta_{z_a} + \theta_{z_b}$$

$$(b) \quad \dot{\theta}_z = \dot{\theta}_{z_a} + \dot{\theta}_{z_b}$$

and $\ddot{\theta}_{z_a} = 0$ by definition,

therefore

$$(II-66c) \quad \ddot{\theta}_z = \ddot{\theta}_{z_b}$$

Therefore

$$(II-67) \quad M_{O_1m} = -I_z (\ddot{\theta}_{z_b} - 2\theta_y \dot{\theta}_y \dot{\theta}_{z_a}) - M_m r_l \sin \theta_{z_b} \dot{\theta}_{z_a}^2$$

3.) Damping Moment:

$$(II-68) \quad M_{O_1d} = -K_1 \dot{\theta}_{z_b}$$

The assumption of damping moment proportional to angular velocity is at best an approximation, but the difficulties of analysis with any other assumption are tremendous.

Summing the three moments about the drag pin, and equating to zero:

$$(II-69) \quad (M_z)_a - I_z (\ddot{\theta}_{z_b} - 2\theta_y \dot{\theta}_y \dot{\theta}_{z_a}) - M_m r_l \sin \theta_{z_b} \dot{\theta}_{z_a}^2$$

$$- K_1 \dot{\theta}_{z_b} = 0$$

We now assume that θ_{z_b} is an harmonic function of θ_{z_a} given by the Fourier series:

$$\theta_{z_b} = e_0 - e_1 \cos \theta_{z_a} - f_1 \sin \theta_{z_a} - e_2 \cos 2\theta_{z_a} - f_2 \sin 2\theta_{z_a}$$

Since θ_{z_b} is in itself a fairly small angle, and e_1, e_2, f_1, f_2 are very small, we assume that

(II-70)
$$\sin \theta_{z_b} = \sin e_0 - e_1 \cos \theta_{z_a} - f_1 \sin \theta_{z_a} - e_2 \cos 2\theta_{z_a} - f_2 \sin 2\theta_{z_a}$$

Substituting the Fourier expansions for $\theta_{z_b}, (M_z)_a,$ and $\theta_y,$ given by equations (II-58), (p.I-13), (II-70), into (II-69) and equating coefficients of identical trigonometric functions, we find that

(X-7/a)

$$e_1 = \frac{I_z \left\{ I_z (-2a_0b_1 - a_2b_1 + a_1b_2) + \frac{G_1^{RCC} z_a}{\dot{\theta}_{z_a}^2} + \frac{K_1}{\dot{\theta}_{z_a}} \right\} + I_z (2a_0a_1 - a_1a_2 - b_1b_2) + \frac{H_1^{RCC} z_a}{\dot{\theta}_{z_a}^2}}{I_z^2 + \left(\frac{K_1}{\dot{\theta}_{z_a}}\right)^2}$$

(X-7/b)

$$f_1 = \frac{I_z \left\{ I_z (2a_0a_1 - a_1a_2 - b_1b_2) + \frac{H_1^{RCC} z_a}{\dot{\theta}_{z_a}^2} - \frac{K_1}{\dot{\theta}_{z_a}} \right\} + I_z (-2a_0b_1 - a_2b_1 + a_1b_2) + \frac{G_1^{RCC} z_a}{\dot{\theta}_{z_a}^2}}{I_z^2 + \left(\frac{K_1}{\dot{\theta}_{z_a}}\right)^2}$$

(II-7/c)

$$e_2 = \frac{I_z \left\{ I_z (-4b_2a_0 + 2a_1b_1) + \frac{G_2^{RCC} z_a}{\theta_{z_a}^2} + \frac{K_1}{2\theta_{z_a}} \left(I_z (4a_0a_2 - a_1^2 + b_1^2) + \frac{H_2^{RCC} z_a}{\theta_{z_a}^2} \right) \right\}}{4 \left[I_z^2 + \left(\frac{K_1}{2\theta_{z_a}} \right)^2 \right]}$$

(II-7/d)

$$f_2 = \frac{I_z \left\{ I_z (4a_0a_2 - a_1^2 + b_1^2) + \frac{H_2^{RCC} z_a}{\theta_{z_a}^2} + \frac{K_1}{2\theta_{z_a}} \left(I_z (-4b_2a_0 + 2a_1b_1) + \frac{G_2^{RCC} z_a}{\theta_{z_a}^2} \right) \right\}}{4 \left[I_z^2 + \left(\frac{K_1}{2\theta_{z_a}} \right)^2 \right]}$$

(II-7/e)

$$\sin e_0 = \frac{G_0^{RCC} z_a}{r_{1m} \theta_{z_a}^2}$$

Calculation of Bending Moments and Deflection Curve in the Z Direction.

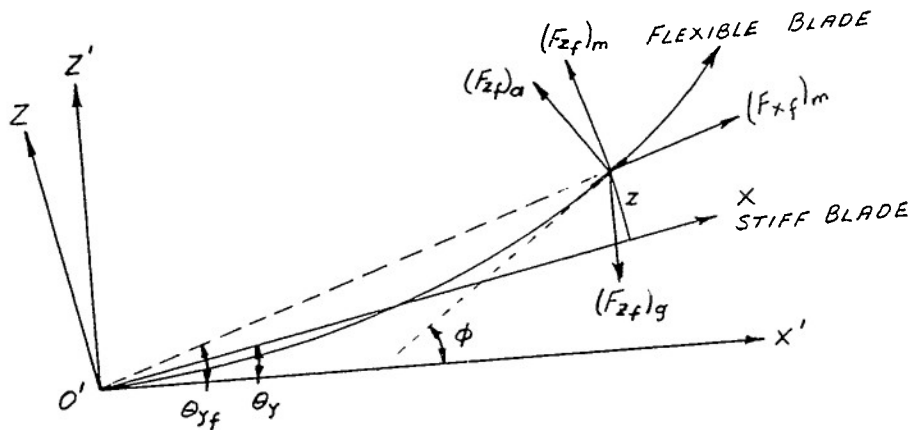

FIG. II-21

The reference line for calculation of the deflections is the instantaneous position of the infinitely stiff blade, which is defined by θ_z and, from the fig. II-21, θ_y . When the blade bends, the line connecting the blade element with the origin, O' , makes an angle θ_{yf} with the plane $X'Y'$. If the deflection of the blade element is z , to a close degree of approximation since z is small compared to x :

$$(II-73 a) \quad \theta_{yf} = \theta_y + \frac{z}{x}$$

$$(b) \quad \phi = \theta_y + \frac{dz}{dx}$$

Forces on the Blade Element

1) External Forces - (refer to fig. II-21)

a) $(F_{z_f})_a$ is the aerodynamic force acting perpendicular to the blade element.

$$(II-74) \quad (F_{z_f})_a = \frac{1}{2} \rho c V_f^2 C_{l_f} dx_f$$

where C_{l_f} is section lift coefficient

b) $(F_{z_f})_g$ is the gravity force acting parallel to the Z' axis. It is usually small and will be neglected.

c) $(F_{x_f})_m$ is the inertia force due to acceleration along the line $O'x_f$.

$$(II-75) \quad (F_{x_f})_m = + m x_f \ddot{\theta}_{z_a}^2 dx_f \quad (\text{ref. p. II-8, equ. II-8b.})$$

d) $(F_{z_f})_m$ is the inertia force due to acceleration perpendicular to the line $O'x_f$.

$$(II-76) \quad (F_{z_f})_m = - m x_f (\theta_{y_f} \dot{\theta}_{z_a}^2 + \ddot{\theta}_{y_f}) dx_f$$

(reference, p. II-8, equation II-8a.)

$$(II-79) \quad \Sigma (F_{x_f}) = (F_{z_f})_{\text{m}} \sin(\phi - \theta_{y_f}) + (F_{x_f})_{\text{m}} \cos(\phi - \theta_{y_f}) \\ - (F_{z_f})_{\text{g}} \sin \phi - dF_{x_f} = 0$$

Substituting into (II-78), (II-79) from (II-74) we find the equations of motion of the flexible blade:

$$(II-80) \quad \frac{1}{2} \rho c v_f^2 C_{1f} dx_f = mx_f (\theta_{y_f} \ddot{\theta}_{z_a}^2 + \ddot{\theta}_{y_f}) dx_f \cos(\phi - \theta_{y_f}) \\ - mx_f \ddot{\theta}_{z_a}^2 dx_f \sin(\phi - \theta_{y_f}) - (F_{z_f})_{\text{g}} \cos \phi + dS_f + F_{x_f} d\phi = 0$$

and

$$(II-81) \quad -mx_f (\theta_{y_f} \ddot{\theta}_{z_a}^2 + \ddot{\theta}_{y_f}) dx_f \sin(\phi - \theta_{y_f}) + mx_f \ddot{\theta}_{z_a}^2 dx_f \cos(\phi - \theta_{y_f}) \\ - (F_{z_f})_{\text{g}} \sin \phi - dF_{x_f} = 0$$

Since ϕ , θ_{y_f} , and θ_y are small angles we take

$$V_f = V, \quad x_f = x$$

$$\cos(\phi - \theta_{y_f}) = 1, \quad \sin(\phi - \theta_{y_f}) = (\phi - \theta_{y_f})$$

$$(\ddot{\theta}_{z_a}^2 \theta_{y_f} + \ddot{\theta}_{y_f}) \cdot \sin(\phi - \theta_{y_f}) = 0$$

Neglecting the gravity forces and using the above assumptions, (II-80) reduces to

$$(II-82) \quad \frac{1}{2} \rho c v_f^2 C_{1f} dx - mx (\phi \ddot{\theta}_{z_a}^2 + \ddot{\theta}_{y_f}) dx + dS_f + F_{x_f} d\phi = 0$$

†

and (II-81) reduces to

$$(II-83) \quad mx \dot{\theta}_{z_a}^2 dx - dF_{x_f} = 0$$

For a stiff blade, (II-82), by dropping subscript "f" and setting $\phi = \theta_y$, $d\phi = 0$, becomes

$$(II-84) \quad \frac{1}{2} \rho c v^2 C_1 dx - mx (\theta_y \dot{\theta}_{z_a}^2 + \ddot{\theta}_y) dx + dS = 0$$

Subtracting (II-84) from (II-82):

$$(II-85) \quad \frac{1}{2} \rho c v^2 (C_{1_f} - C_1) dx - mx \dot{\theta}_{z_a}^2 (\phi - \theta_y) dx - mx (\ddot{\theta}_{y_f} - \ddot{\theta}_y) dx + dS_f - dS + F_{x_f} d\phi = 0$$

Integrating (II-83)

$$(II-86) \quad F_{x_f} = + \dot{\theta}_{z_a}^2 \int_x^R mx dx = \dot{\theta}_{z_a}^2 M_{m_x}$$

where M_{m_x} is the "mass moment" of the blade outboard of station x .

Dividing thru (II-85) by dx , and substituting from (II-73a), (b) and (II-86),

$$(II-87) \quad \frac{1}{2} \rho c v^2 (C_{1_f} - C_1) - mx \dot{\theta}_{z_a}^2 \frac{dz}{dx} - mz + \frac{dS_f}{dx} - \frac{dS}{dx} + \dot{\theta}_{z_a}^2 M_{m_x} \frac{d^2z}{dx^2} = 0$$

However,

$$(II-88) \quad S_f = \frac{dM_{y_{1_f}}}{dx} \quad \text{and} \quad M_{y_{1_f}} = -EI \frac{d^2z}{dx^2}$$

+

where I is the structural moment of inertia of the blade element about the Y axis.

$$(II-89) \quad \therefore S_f = - \frac{d(EI)}{dx} \frac{d^2 z}{dx^2} - EI \frac{d^3 z}{dx^3}$$

and

$$(II-90) \quad + \frac{dS_f}{dx} = - \frac{d^2(EI)}{dx^2} \frac{d^2 z}{dx^2} - 2 \frac{d(EI)}{dx} \frac{d^3 z}{dx^3} - EI \frac{d^4 z}{dx^4}$$

The term $\frac{dS}{dx}$ represents the distribution of load on the stiff blade. It is in two parts - the aerodynamic thrust load and the inertia load. The aerodynamic load is given on p. II-21, equations II-34a to II-34e and the inertia load, by process similar to that used in obtaining equation II-44 (p. II-28), is

$$(II-91) \quad \frac{d(F_z)_m}{dx} = - mx \dot{\theta}_{z_a}^2 (a_0 + 3a_2 \cos 2\theta_{z_a} + 3b_2 \sin 2\theta_{z_a})$$

Substituting the appropriate expressions into $\frac{dS}{dx}$, and substituting $x_r = \frac{x}{R}$

$$(II-92) \quad \frac{dS}{dx_r} = - \frac{d(F_z)_a}{dx_r} - \frac{d(F_z)_m}{dx_r} = - \frac{d(F_z)_a}{dx_r} - R \frac{d(F_z)_m}{dx}$$

$$= (-A_{0_a} cC_{z_a} + mx_r \dot{\theta}_{z_a}^2 a_0 R^2) - (A_{1_a} cC_{z_a}) \cos \theta_{z_a}$$

$$- (B_{1_a} cC_{z_a}) \sin \theta_{z_a} - (A_{2_a} cC_{z_a} - 3mx_r \dot{\theta}_{z_a}^2 a_2 R^2) \cos 2\theta_{z_a}$$

(continued on next page)

$$- (B_{2a} c c_{z_a} - 3m x_r \dot{\theta}_{z_a}^2 b_2 R^2) \sin 2\theta_{z_a}$$

where A_{0a} , A_{1a} , B_{1a} , A_{2a} and B_{2a} are given by

(II-34a to e)

Let $z_r = \frac{z}{R}$, and substitute $x_r R$ and $z_r R$ for x and z in (II-87) and replace $\frac{dS_f}{dx}$ by its equal of (II-90):

$$(II-93) \quad + \frac{(EI)}{R^3} \frac{d^4 z_r}{dx_r^4} + \frac{2}{R^3} \frac{d(EI)}{dx_r} \frac{d^3 z_r}{dx_r^3} + \left(- \frac{\dot{\theta}_{z_a}^2 M_{mx}}{R} + \frac{1}{R^3} \frac{d^2(EI)}{dx_r^2} \right) \frac{d^2 z_r}{dx_r^2}$$

$$+ m R x_r \dot{\theta}_{z_a}^2 \frac{dz_r}{dx_r} + \frac{1}{R} \frac{dS}{dx_r} + R m z_r - \frac{1}{2} \rho c v^2 (C_{1f} - C_1) = 0$$

We are only interested in the "steady state" solution to the foregoing equation. Since the forcing function $\frac{dS}{dx_r}$ is a harmonic function of θ_{z_a} , the "particular integral" will also be a harmonic function of θ_{z_a} , and will be written

$$(II-94) \quad z_r = z_{r1} + z_{r2} \cos \theta_{z_a} + z_{r3} \sin \theta_{z_a} + z_{r4} \cos 2\theta_{z_a} + z_{r5} \sin 2\theta_{z_a}$$

$$(II-94a) \quad \text{and } \ddot{z}_r = - \dot{\theta}_{z_a}^2 (z_{r2} \cos \theta_{z_a} + z_{r3} \sin \theta_{z_a} + 4z_{r4} \cos 2\theta_{z_a} + 4z_{r5} \sin 2\theta_{z_a})$$

Substituting the expressions for z_r and $\frac{dS}{dx_r}$ given by equations (II-94) and (II-92) into (II-93), we obtain five differential equations in z_{r1} , z_{r2} , z_{r3} , z_{r4} and z_{r5} , by equating coefficients of identical trigonometric functions. Each of these equations can be solved approximately by any one of the methods described in Part I, pp. I-17 to I-25. Experience has shown that the easiest of these is the collocation method. The application of this method to these particular equations is illustrated on the following pages and is set up in tables which can be worked out by non-technical computers. The five differential equations are as follows; assuming as a first approximation that $C_{1f} = C_1$:

$$(II-95a) \quad \frac{EI}{R^3} \frac{d^4 z_{r1}}{dx_r^4} + \frac{2}{R^3} \frac{d(EI)}{dx_r} \frac{d^3 z_{r1}}{dx_r^3} + \left(\frac{1}{R^3} \frac{d^2(EI)}{dx_r^2} - \frac{\dot{\theta}_a^2 M_{mx}}{R} \right) \frac{d^2 z_{r1}}{dx_r^2} + mR \dot{\theta}_a^2 x_r \frac{dz_{r1}}{dx_r} = - m x_r \dot{\theta}_a^2 a_0 R + \frac{A_{0a} c C_{za}}{R}$$

$$(b) \quad \frac{EI}{R^3} \frac{d^4 z_{r2}}{dx_r^4} + \frac{2}{R^3} \frac{d(EI)}{dx_r} \frac{d^3 z_{r2}}{dx_r^3} + \left(\frac{1}{R^3} \frac{d^2(EI)}{dx_r^2} - \frac{\dot{\theta}_a^2 M_{mx}}{R} \right) \frac{d^2 z_{r2}}{dx_r^2} + mR \dot{\theta}_a^2 x_r \frac{dz_{r2}}{dx_r} - mR \dot{\theta}_a^2 z_{r2} = + \frac{A_{1a} c C_{za}}{R}$$

+

$$\begin{aligned}
 \text{(H-95c)} \quad & \frac{EI}{R^3} \frac{d^4 z_{r3}}{dx_r^4} + \frac{2}{R^3} \frac{d(EI)}{dx_r} \frac{d^3 z_{r3}}{dx_r^3} + \left(\frac{1}{R^3} \frac{d^2(EI)}{dx_r^2} - \frac{\dot{\theta}_z^2 M_{mx}}{R} \right) \frac{d^2 z_{r3}}{dx_r^2} \\
 & + mR \dot{\theta}_{z_a}^2 x_r \frac{dz_{r3}}{dx_r} - mR \dot{\theta}_{z_a}^2 z_{r3} = + \frac{B_{1a} c C_{z_a}}{R}
 \end{aligned}$$

$$\begin{aligned}
 \text{(d)} \quad & \frac{EI}{R^3} \frac{d^4 z_{r4}}{dx_r^4} + \frac{2}{R^3} \frac{d(EI)}{dx_r} \frac{d^3 z_{r4}}{dx_r^3} + \left(\frac{1}{R^3} \frac{d^2(EI)}{dx_r^2} - \frac{\dot{\theta}_{z_a}^2 M_{mx}}{R} \right) \frac{d^2 z_{r4}}{dx_r^2} \\
 & + mR \dot{\theta}_{z_a}^2 x_r \frac{dz_{r4}}{dx_r} - 4 mR \dot{\theta}_{z_a}^2 z_{r4} = \\
 & - 3 m x_r \dot{\theta}_{z_a}^2 a_2 R + \frac{A_{2a} c C_{z_a}}{R}
 \end{aligned}$$

$$\begin{aligned}
 \text{(e)} \quad & \frac{EI}{R^3} \frac{d^4 z_{r5}}{dx_r^4} + \frac{2}{R^3} \frac{d(EI)}{dx_r} \frac{d^3 z_{r5}}{dx_r^3} + \left(\frac{1}{R^3} \frac{d^2(EI)}{dx_r^2} - \frac{\dot{\theta}_{z_a}^2 M_{mx}}{R} \right) \frac{d^2 z_{r5}}{dx_r^2} \\
 & + mR \dot{\theta}_{z_a}^2 x_r \frac{dz_{r5}}{dx_r} - 4 mR \dot{\theta}_{z_a}^2 z_{r5} = \\
 & - 3 m x_r \dot{\theta}_{z_a}^2 b_2 R + \frac{B_{2a} c C_{z_a}}{R}
 \end{aligned}$$

It will be convenient to write these equations in the following way:

The equation for z_{r_1} becomes ($i = 1, 2, 3, 4, 5$):

$$(II-96) \quad A_1 \frac{d^4 z_{r_1}}{dx_r^4} + B_1 \frac{d^3 z_{r_1}}{dx_r^3} + C_1 \frac{d^2 z_{r_1}}{dx_r^2} + D_1 x_r \frac{dz_{r_1}}{dx_r} - E_1 z_{r_1} =$$

$$F_1 + G_1 x_r + H_1 x_r^2 + I_1 x_r^3 + J_1 x_r^4$$

where $A_1 = A_2 = A_3 = A_4 = A_5 = EI/R^3$

$$B_1 = B_2 = B_3 = B_4 = B_5 = \frac{2}{R^3} \frac{d(EI)}{dx_r}$$

$$C_1 = C_2 = C_3 = C_4 = C_5 = \frac{1}{R^3} \frac{d^2(EI)}{dx_r^2} - \dot{\theta}_{z_a}^2 \frac{M_{m_x}}{R}$$

$$D_1 = D_2 = D_3 = D_4 = D_5 = E_2 = E_3 = \frac{E_4}{4} = \frac{E_5}{4} = mR \cdot \dot{\theta}_{z_a}^2$$

$$E_1 = 0$$

$$F_1 = + \frac{cC_{z_a}}{R} \theta_{x_o}' \mu^2$$

$$G_1 = - mR a_o \dot{\theta}_{z_a}^2 + \frac{cC_{z_a}}{R} \mu \left(\frac{\mu \theta_t}{2} + \psi_2' + \frac{\lambda}{\mu} \right)$$

$$H_1 = \frac{cC_{z_a}}{R} \theta_{x_o}', \quad I_1 = \frac{cC_{z_a}}{R} \theta_t$$

$$F_2 = \frac{cC_{z_a}}{R} \frac{\mu^2}{4} (b_1 + \psi_1'), \quad G_2 = - \frac{cC_{z_a}}{R} \mu a_o$$

$$H_2 = \frac{cC_{z_a}}{R} (b_1 + \psi_1' + \lambda_1), \quad F_3 = \frac{cC_{z_a}}{R} \frac{\mu^2}{4} (3\psi_2' + \frac{4\lambda}{\mu} + a_1)$$

$$G_3 = \frac{cC_{z_a}}{R} 2\mu\dot{\theta}'_{x_0}, \quad H_3 = \frac{cC_{z_a}}{R} (2\mu\theta_t + \psi'_2 - a_1)$$

$$F_4 = -\frac{cC_{z_a}}{R} \frac{\mu^2}{2} \dot{\theta}'_{x_0}$$

$$G_4 = -3ma_2 R \dot{\theta}_{z_a}^2 + \frac{cC_{z_a}}{R} \mu (a_1 - \psi'_2 - \frac{\mu\theta_t}{2})$$

$$H_4 = 2 \frac{cC_{z_a}}{R} b_2, \quad F_5 = -\frac{cC_{z_a}}{R} \frac{\mu^2}{2} a_0$$

$$G_5 = -3mb_2 R \dot{\theta}_{z_a}^2 + \frac{cC_{z_a}}{R} \mu (b_1 + \psi'_1 + \frac{\lambda_1}{2})$$

$$H_5 = -2 \frac{cC_{z_a}}{R} a_2$$

$$I_2 = I_3 = I_4 = I_5 = 0$$

$$J_1 = J_2 = J_3 = J_4 = J_5 = 0$$

The end conditions are that the deflection, z_{r_1} , be zero at $x_r = 0$; that the moment and shear be zero at the

tip, $\frac{d^2 z_{r_1}}{dx_r^2} = \frac{d^3 z_{r_1}}{dx_r^3} = 0$ at $x_r = 1$;

and that the moment be that caused by the mechanical damper at the root,

$$\begin{aligned} \text{(II-98)} \quad \left(\frac{d^2 z_{r_1}}{dx_r^2} \right)_{x_r=0} &= -\frac{R}{(EI)_{x_r=0}} (M_y)_D \\ &= \frac{R}{(EI)_0} \dot{\theta}_{z_a} K_y (a_1 \sin \theta_{z_a} - b_1 \cos \theta_{z_a} \\ &\quad + 2a_2 \sin 2\theta_{z_a} - 2b_2 \cos 2\theta_{z_a}) \end{aligned}$$

(refer p. II-28)

We wish to find a solution of the form

$$(II-99) \quad z_r(x_r) = z_{r1}(x_r) + z_{r2}(x_r) \cos \theta_{z_a} + z_{r3}(x_r) \sin \theta_{z_a} \\ + z_{r4}(x_r) \cos 2\theta_{z_a} + z_{r5}(x_r) \sin 2\theta_{z_a}$$

which satisfies all the above end conditions.

Functions of x_r of the type below will satisfy the end conditions:

$$(II-100) \quad z_{r1} = S_1 \left\{ e^{(x_r - 1)^2} - x_r^2 - e \right\} \\ + \sum_{n_1}^{n_2} T_{n_1} x_r^{n_1} + 2 \left\{ \frac{1}{(n+1)(n+2)} - \frac{2x_r}{(n+2)(n+3)} + \frac{x_r^2}{(n+3)(n+4)} \right\}$$

in which we take five values of "n" for a "five point" solution by the collocation method.

Substituting $n = 0, 1, 2, 3, 4$, into (II-100) and taking successive derivatives,

$$(II-100a) \quad z_{r1} = S_1 \left(e^{(x_r - 1)^2} - x_r^2 - e \right) \\ + T_{0_1} x_r^2 \left(\frac{1}{2} - \frac{1}{3} x_r + \frac{1}{12} x_r^2 \right) \\ + T_{1_1} x_r^3 \left(\frac{1}{6} - \frac{1}{6} x_r + \frac{1}{20} x_r^2 \right) \\ + T_{2_1} x_r^4 \left(\frac{1}{12} - \frac{1}{10} x_r + \frac{1}{30} x_r^2 \right) \\ + T_{3_1} x_r^5 \left(\frac{1}{20} - \frac{1}{15} x_r + \frac{1}{42} x_r^2 \right) \\ + T_{4_1} x_r^6 \left(\frac{1}{30} - \frac{1}{21} x_r + \frac{1}{56} x_r^2 \right)$$

$$\begin{aligned}
 (\text{II-100b}) \quad \frac{dz_{r1}}{dz_r} &= S_1 \left\{ 2 [(x_r - 1) e^{(x_r - 1)^2} - x_r] \right\} \\
 &+ T_{0_1} x_r (1 - x_r + \frac{1}{3} x_r^2) \\
 &+ T_{1_1} x_r^2 (\frac{1}{2} - \frac{2}{3} x_r + \frac{1}{4} x_r^2) \\
 &+ T_{2_1} x_r^3 (\frac{1}{3} - \frac{1}{2} x_r + \frac{1}{5} x_r^2) \\
 &+ T_{3_1} x_r^4 (\frac{1}{4} - \frac{2}{5} x_r + \frac{1}{6} x_r^2) \\
 &+ T_{4_1} x_r^5 (\frac{1}{5} - \frac{1}{3} x_r + \frac{1}{7} x_r^2)
 \end{aligned}$$

$$\begin{aligned}
 (\text{II-100c}) \quad \frac{d^2 z_{r1}}{dx_r^2} &= S_1 \left\{ [2 (x_r - 1)^2 + 1] e^{(x_r - 1)^2} - 1 \right\} \\
 &+ (1 - 2x_r + x_r^2) (T_{0_1} + x_r T_{1_1} + x_r^2 T_{2_1} + x_r^3 T_{3_1} \\
 &+ x_r^4 T_{4_1})
 \end{aligned}$$

$$\begin{aligned}
 (\text{II-100d}) \quad \frac{d^3 z_{r1}}{dx_r^3} &= S_1 [8 (x_r - 1)^3 + 12 (x_r - 1)] e^{(x_r - 1)^2} \\
 &+ T_{0_1} (-2 + 2x_r) \\
 &+ T_{1_1} (1 - 4x_r + 3x_r^2) \\
 &+ T_{2_1} x_r (2 - 6x_r + 4x_r^2)
 \end{aligned}$$

(continued on next page.)

$$+ T_{3_1} x_r^2 (3 - 8x_r + 5x_r^2)$$

$$+ T_{4_1} x_r^3 (4 - 10x_r + 6x_r^2)$$

$$(II-100e) \quad \frac{d^4 z_{r1}}{dx_r^4} = S_1 [16 (x_r - 1)^4 + 48 (x_r - 1)^2 + 12] e^{(x_r - 1)^2}$$

$$+ T_{0_1} (2)$$

$$+ T_{1_1} (-4 + 6x_r)$$

$$+ T_{2_1} (2 - 12x_r + 12x_r^2)$$

$$+ T_{3_1} x_r (6 - 24x_r + 20x_r^2)$$

$$+ T_{4_1} x_r^2 (12 - 40x_r + 30x_r^2)$$

At the root, $x_r = 0$, from (II-100c):

$$(II-101) \quad \frac{d^2 z_{r1}}{dx_r^2} = S_1 (6e - 2) + T_{0_1}$$

And from the end conditions given by equations (II-98):

$$(II-101a) \quad S_1 (6e - 2) + T_{0_1} = 0 \quad = L_1$$

(continued on next page.)

$$(II-101b) \quad S_2 (6e - 2) + T_{02} = - \frac{b_1 \dot{\theta}_{x_a} K_y R}{(EI)_{x_r} = 0} = L_2$$

$$(c) \quad S_3 (6e - 2) + T_{03} = \frac{a_1 \dot{\theta}_{x_a} K_y R}{(EI)_o} = L_3$$

$$(d) \quad S_4 (6e - 2) + T_{04} = - \frac{2b_2 \dot{\theta}_{x_a} K_y R}{(EI)_o} = L_4$$

$$(e) \quad S_5 (6e - 2) + T_{05} = + \frac{2a_2 \dot{\theta}_{x_a} K_y R}{(EI)_o} = L_5$$

Substituting equations (II-100a), (b), (c), (d), (e), into (II-96), we get an equation in x_r , S_1 and T_{n_1} . Assuming that the equation is satisfied at five values of x_r , yields five equations which can be solved for S_1 and T_{n_1} . This work is discussed in more detail in the next section.

Solution of the Differential Equations for the Deflection and Bending Moment Curves in the Z Direction.

Substituting the assumed solution for z_{r_1} and its derivatives (given by $\pi-100a$ to e), into $(\pi-96)$, we obtain an equation of the following type:

$$\begin{aligned}
 (\pi-102) \quad & S_i \{ A_1 f_1(x_r) + B_1 f_2(x_r) + C_1 f_3(x_r) + D_1 f_4(x_r) + E_1 f_5(x_r) \} \\
 & + T_{0_1} \{ A_1 f_6(x_r) + B_1 f_7(x_r) + C_1 f_8(x_r) + D_1 f_9(x_r) + E_1 f_{10}(x_r) \} \\
 & + T_{1_1} \{ A_1 f_{11}(x_r) + \dots \dots \dots E_1 f_{15}(x_r) \} \\
 & + T_{2_1} \{ A_1 f_{16}(x_r) + \dots \dots \dots E_1 f_{20}(x_r) \} \\
 & + T_{3_1} \{ A_1 f_{21}(x_r) + \dots \dots \dots E_1 f_{25}(x_r) \} \\
 & + T_{4_1} \{ A_1 f_{26}(x_r) + \dots \dots \dots E_1 f_{30}(x_r) \} = \\
 & F_1 + G_1 x_r + H_1 x_r^2 + I_1 x_r^3 + J_1 x_r^4
 \end{aligned}$$

where

$$f_1(x_r) = [16 (x_r - 1)^4 + 48 (x_r - 1)^2 + 12] e^{(x_r - 1)^2}$$

$$f_2(x_r) = [8 (x_r - 1)^3 + 12 (x_r - 1)] e^{(x_r - 1)^2}$$

$$f_3(x_r) = [4 (x_r - 1)^2 + 2] e^{(x_r - 1)^2} - 2$$

$$f_4(x_r) = 2x_r [(x_r - 1) e^{(x_r - 1)^2} - x_r]$$

$$f_5(x_r) = - [e^{(x_r - 1)^2} - x_r^2 - e]$$

$$f_6(x_r) = 2$$

$$f_7(x_r) = -2 + 2x_r$$

$$f_8(x_r) = 1 - 2x_r + x_r^2$$

$$f_9(x_r) = x_r^2 (1 - x_r + \frac{1}{3} x_r^2)$$

$$f_{10}(x_r) = -x_r^2 (\frac{1}{2} - \frac{1}{3} x_r + \frac{1}{12} x_r^2)$$

$$f_{11}(x_r) = -4 + 6x_r$$

$$f_{12}(x_r) = 1 - 4x_r + 3x_r^2$$

$$f_{13}(x_r) = x_r (1 - 2x_r + x_r^2)$$

$$f_{14}(x_r) = x_r^3 (\frac{1}{2} - \frac{2}{3} x_r + \frac{1}{4} x_r^2)$$

$$f_{15}(x_r) = -x_r^3 (\frac{1}{6} - \frac{1}{6} x_r + \frac{1}{20} x_r^2)$$

$$f_{16}(x_r) = 2 - 12x_r + 12x_r^2$$

$$f_{17}(x_r) = x_r (2 - 6x_r + 4x_r^2)$$

$$f_{18}(x_r) = x_r^2 (1 - 2x_r + x_r^2)$$

$$f_{19}(x_r) = x_r^4 (\frac{1}{3} - \frac{1}{2} x_r + \frac{1}{5} x_r^2)$$

$$f_{20}(x_r) = -x_r^4 \left(\frac{1}{12} - \frac{1}{10} x_r + \frac{1}{30} x_r^2 \right)$$

$$f_{21}(x_r) = x_r (6 - 24x_r + 20x_r^2)$$

$$f_{22}(x_r) = x_r^2 (3 - 8x_r + 5x_r^2)$$

$$f_{23}(x_r) = x_r^3 (1 - 2x_r + x_r^2)$$

$$f_{24}(x_r) = x_r^5 \left(\frac{1}{4} - \frac{2}{5} x_r + \frac{1}{6} x_r^2 \right)$$

$$f_{25}(x_r) = -x_r^5 \left(\frac{1}{20} - \frac{1}{15} x_r + \frac{1}{42} x_r^2 \right)$$

$$f_{26}(x_r) = x_r^2 (12 - 40x_r + 30x_r^2)$$

$$f_{27}(x_r) = x_r^3 (4 - 10x_r + 6x_r^2)$$

$$f_{28}(x_r) = x_r^4 (1 - 2x_r + x_r^2)$$

$$f_{29}(x_r) = x_r^6 \left(\frac{1}{5} - \frac{1}{3} x_r + \frac{1}{7} x_r^2 \right)$$

$$f_{30}(x_r) = -x_r^6 \left(\frac{1}{30} - \frac{1}{21} x_r + \frac{1}{56} x_r^2 \right)$$

and $A_1, B_1, C_1, \dots, J_1$ are given on page II-74.

On account of the complexities of the equations for the flapping coefficients, it was necessary, in their solution, to make certain approximations. The result of these approximations is that the coefficients of the airloads, F_1 thru J_1 , p. II-74, do not quite satisfy the conditions that the moment, due to all forces acting,

be zero at the root (equation $\pi-39$). The bending moments as found by the collocation method appear to be quite sensitive to such discrepancies, and the loads computed by ($\pi-96$) should be modified so as to satisfy equation ($\pi-39$) . An arbitrary method of modification is presented in the Sample Calculations, pp. $\pi-153$ to $\pi-155$. The modified distribution of air load is then entered in Table $\pi-1$ in place of the first five rows of column (8).

Substitution of five values of x_r in equation gives five equations with six unknowns, which can be solved with the help of equations ($\pi-101$) . The solution has been arranged in tabular form on the following pages.

When the constants S_1 and T_{n_1} are known, it is only necessary to substitute them into equations ($\pi-100$) to obtain z_{r_1} and its derivatives as functions of x_r , and then to substitute those functions into equation ($\pi-99$) to obtain z_r as a function of x_r and azimuth angle.

The tables are arranged for a five point solution, which has been found adequate in most cases. It may, however, be found that the approximate solution, using five points, has not converged sufficiently toward the true solution. In that case, a larger number of "n"'s must be used, and equation ($\pi-102$) must be assumed to be satisfied by more values of x_r in order to obtain enough equations to solve for the increased number of coefficients, T_{n_1} . Tables $\pi-1$ and $\pi-3$ can be extended accordingly. In the case of the first harmonic, ($i = 2, 3$) the solution by collocation, using five points, has been found not to converge sufficiently. The failure to converge is due to the fact that in the choice of an approximate solution we impose the end condition of a definite slope at the root.

All the first harmonic inertia loads cancel out, leaving only the air loads to determine the position of the blade. But the air loads are treated as constants, independent of blade position, so that the blade slope at the root is arbitrarily determined by the approximate solution we choose to adopt. It is well known that the convergence of approximate solutions by collocation is very poor in cases where the blade slope at the root is a definite end condition, viz., case of rigidly attached blades, where the end condition is

$$\left(\frac{dz_r}{dx_r}\right)_0 = 0 .$$

We can, however, avoid this difficulty by writing the differential equation in the form

$$(x-103) \quad A_1 \frac{d^4 z_{r1}}{dx_r^4} + B_1 \frac{d^3 z_{r1}}{dx_r^3} + C_1 \frac{d^2 z_{r1}}{dx_r^2} + D_1 \frac{dz_{r1}}{dx_r} = F_1 + G_1 x_r +$$

$$H_1 x_r^2 + I_1 x_r^3 + J_1 x_r^4 + E_1 z_{r1}$$

and solving by successive approximation. In this form, the equations are similar for all values of i . The procedure is as follows:

- 1) Assume, in the first approximation, that $z_{r1} = 0$, and solve by the same method as for $i = 1$. Call the result $\frac{d^2(z_{r1})_1}{dx_r^2}$ and $(z_{r1})_1$.
- 2) For the second approximation, neglect F_1 thru $J_1 x_r^4$ and put the term $E_1 (z_{r1})_1$ on the right side, and solve by the same method to get the next approximation $\frac{d^2 \Delta_2 z_{r1}}{dx_r^2}$ and $\Delta_2 z_{r1}$.

3) If $\Delta_2 M_i$ and $\Delta_2 z_{r_i}$ are not within the desired accuracy, solve again with the term $\Delta_2 z_{r_i}$ on the right side, to get $\frac{d^2 \Delta_3 z_{r_i}}{dx_r^2}$ and $\Delta_3 z_{r_i}$;

and so on until desired accuracy is obtained.
The total moment and deflections are, then:

$$(II-104) \quad M_i = (M_i)_1 + \Delta_2 M_i + \Delta_3 M_i + \dots$$

$$(II-105) \quad z_{r_i} = (z_{r_i})_1 + \Delta_2 z_{r_i} + \Delta_3 z_{r_i} + \dots$$

The values of $E_i z_{r_i}$ are typically small enough (for $i = 2, 3$) compared to $F_i + G_i x_r + H_i x_r^2 + I_i x_r^3 + J_i x_r^4$ that two approximations are sufficient (see example calculations, page II-166).

This method is not so satisfactory for the second harmonic parts; $i = 4, 5$; since in this case $E_i z_{r_i}$ may be of about the same magnitude as $F_i + G_i x_r + H_i x_r^2 + I_i x_r^3 + J_i x_r^4$, so that the convergence of successive approximations is quite small. We, therefore, solve equation (II-96) for $i = 4, 5$ as it stands, and the difficulty with convergence of the collocation solution is not encountered because the blade slope at the root is here determined by the inertia loads.

TABLE II - COEFFICIENTS OF $T_{n,1}$

x = 1

| (1) | (2) $T_{0,1}$ | (3) $T_{1,1}$ | (4) $T_{2,1}$ | (5) $T_{3,1}$ | (6) $T_{4,1}$ | (7) S_1 | (8) Constant † |
|-----------|---------------------------------------|--|--|--|--|--|--|
| A_1 : | $\cdot f_6(x_p) =$ | $\cdot f_{11}(x_p) =$ | $\cdot f_{16}(x_p) =$ | $\cdot f_{21}(x_p) =$ | $\cdot f_{26}(x_p) =$ | $\cdot f_1(x_p) =$ | $-1 \cdot f_1 =$ |
| B_1 : | $\cdot f_7(x_p) =$ | $\cdot f_{12}(x_p) =$ | $\cdot f_{17}(x_p) =$ | $\cdot f_{22}(x_p) =$ | $\cdot f_{27}(x_p) =$ | $\cdot f_2(x_p) =$ | $-x_p \cdot a_1 =$ |
| C_1 : | $\cdot f_8(x_p) =$ | $\cdot f_{13}(x_p) =$ | $\cdot f_{18}(x_p) =$ | $\cdot f_{23}(x_p) =$ | $\cdot f_{28}(x_p) =$ | $\cdot f_3(x_p) =$ | $-\frac{1}{2} H_1 =$ † |
| D_1 : | $\cdot f_9(x_p) =$ | $\cdot f_{14}(x_p) =$ | $\cdot f_{19}(x_p) =$ | $\cdot f_{24}(x_p) =$ | $\cdot f_{29}(x_p) =$ | $\cdot f_4(x_p) =$ | $-\frac{3}{2} I_1 =$ |
| E_1 : | $\cdot f_{10}(x_p) =$ | $\cdot f_{15}(x_p) =$ | $\cdot f_{20}(x_p) =$ | $\cdot f_{25}(x_p) =$ | $\cdot f_{30}(x_p) =$ | $\cdot f_5(x_p) =$ | $-\frac{5}{2} J_1 =$ |
| See notes | No entry | No entry | No entry | No entry | No entry | No entry | ** |
| | $C_{T_{0,1}} =$ See notes • end ** | $C_{T_{1,1}} =$ Enter in Table x-3, Column 7 | $C_{T_{2,1}} =$ Enter in Table x-3, Column 2 | $C_{T_{3,1}} =$ Enter in Table x-3, Column 5 | $C_{T_{4,1}} =$ Enter in Table x-3, Column 4 | $C_{S_1} =$ Enter in Table x-3, Column 5 | $c =$ Enter in Table x-3, Column 6 |

* Multiply $C_{T_{0,1}}$ in column 2 by (2 - 6e) and enter here in column 7.

** Multiply $C_{T_{0,1}}$ in column 2 by L_1 and enter here in column 8. L_1 is given by equations (x-10), p. x-18.

† See p. II-82 for discussion of J_1, \dots, J_4 and pp. II-55 etc. for a method of their correction.

The values of $f_n(x_p)$ are given in Table x-2 for $x_p = 0, .25, .50, .75, 1.00$

The constants $A_1, B_1, C_1, D_1, E_1, F_1, G_1, H_1, I_1, J_1$ are defined on p. II-74.†

Make 25 solutions of this table, for five values of x_p and $i = 1, 2, 3, 4, 5$. (The computer will soon discover that many of these solutions have entries that are identical, and therefore, that the actual work sheets may be less lengthy. For the sake of clarity, these simplifications have not been presented here.)

TABLE II-2 - VALUES OF $r_n(x_T)$ FOR VARIOUS VALUES OF x_T

| n | x_T | | | | |
|----|------------|------------|-----------|-----------|-----------|
| | | .25 | .50 | .75 | 1.00 |
| 1 | 206.589432 | 77.332111 | 32.100625 | 16.033941 | 12.000000 |
| 2 | -54.365640 | -21.718206 | -8.988175 | -3.326544 | 0 |
| 3 | 14.309692 | 5.458984 | 1.852078 | .395112 | 0 |
| 4 | 0 | -.783146 | -1.142013 | -1.524185 | -2.000000 |
| 5 | 0 | 1.025726 | 1.684257 | 2.216288 | 2.718282 |
| 6 | 2.000000 | 2.000000 | 2.000000 | 2.000000 | 2.000000 |
| 7 | -2.000000 | -1.500000 | -1.000000 | -.500000 | 0 |
| 8 | 1.000000 | .562500 | .250000 | .062500 | 0 |
| 9 | 0 | .048177 | .145833 | .246094 | .333333 |
| 10 | 0 | -.026367 | -.088542 | -.166992 | -.250000 |
| 11 | -4.000000 | -2.500000 | -1.000000 | .500000 | 2.000000 |
| 12 | 1.000000 | .187500 | -.250000 | -.312500 | 0 |
| 13 | 0 | .140625 | .125000 | .046875 | 0 |
| 14 | 0 | .005452 | .028645 | .059326 | .033333 |
| 15 | 0 | -.002002 | -.011979 | -.029444 | -.050000 |
| 16 | 2.000000 | -.250000 | -1.000000 | -.250000 | 2.000000 |
| 17 | 0 | .187500 | 0 | -.187500 | 0 |
| 18 | 0 | .035156 | .062500 | .035156 | 0 |
| 19 | 0 | .000863 | .008333 | .022412 | .033333 |
| 20 | 0 | -.000236 | -.002604 | -.008569 | -.016667 |
| 21 | 0 | .312500 | -.500000 | -.562500 | 2.000000 |
| 22 | 0 | .082031 | .062500 | -.105469 | 0 |
| 23 | 0 | .008789 | .031250 | .026367 | 0 |
| 24 | 0 | .000157 | .002865 | .010382 | .016667 |
| 25 | 0 | -.000034 | -.000707 | -.003178 | -.007143 |
| 26 | 0 | .242188 | -.125000 | -.632813 | 2.000000 |
| 27 | 0 | .029297 | .062500 | -.052734 | 0 |
| 28 | 0 | .002197 | .015625 | .019775 | 0 |
| 29 | 0 | .000031 | .001079 | .005403 | .009524 |
| 30 | 0 | -.000006 | -.000218 | -.001364 | -.003571 |

TABLE II-3 - FOR THE SOLUTION OF THE FIVE LINEAR SIMULTANEOUS EQUATIONS IN FIVE UNKNOWNNS

1 =

| Column | 1 | 2 | 3 | 4 | 5 | 6 | Operation |
|--------|-------|--------------|--------------|--------------|--------------|-------|-----------|
| Row | x_T | T_{1_1} | T_{2_1} | T_{3_1} | T_{4_1} | S_1 | Constant |
| 1 | 1.0 | | | | | | E |
| 2 | | 1 | | | | | D |
| 3 | .75 | | | | | | E |
| 4 | | 1 | | | | | D |
| 5 | | 0 | | | | | S2 |
| 6 | | X | 1 | | | | D |
| 7 | .50 | | | | | | E |
| 8 | | 1 | | | | | D |
| 9 | | 0 | | | | | S2 |
| 10 | | X | 1 | | | | D |
| 11 | | X | 0 | | | | S6 |
| 12 | | X | X | 1 | | | D |
| 13 | .25 | | | | | | E |
| 14 | | 1 | | | | | D |
| 15 | | 0 | | | | | S2 |
| 16 | | X | 1 | | | | D |
| 17 | | X | 0 | | | | S6 |
| 18 | | X | X | 1 | | | D |
| 19 | | X | X | 0 | | | S12 |
| 20 | | X | X | X | 1 | | D |
| 21 | .0 | | | | | | E |
| 22 | | 1 | | | | | D |
| 23 | | 0 | | | | | S2 |
| 24 | | X | 1 | | | | D |
| 25 | | X | 0 | | | | S6 |
| 26 | | X | X | 1 | | | D |
| 27 | | X | X | 0 | | | S12 |
| 28 | | X | X | X | 1 | | D |
| 29 | | X | X | X | 0 | | S20 |
| 30 | | X | X | X | X | 1 | D |

Explanation on next page

Explanation of TABLE $\pi-3$, page $\pi-88$:

The operations are as follows:

- E - Enter the appropriate values from TABLE $\pi-1$.
- D - Divide the value in the same column, previous row, by the first (from the left) value in that row which is not zero. The first values in rows marked "D" are 1 , and are already entered.
- S - Subtract the value in same column, previous row, from the value in the same column, row denoted by the number following the "S" . The first values in rows marked "S" are zero, and are already so entered.

To illustrate, the value in row 13, column 4, would be taken from Table $\pi-1$, column 6 for $x = .250$. The value in column 4, row 14 would be the value in column 4, row 13 divided by the value in column 1, row 13. The value in column 7, row 26 is the value in column 7, row 25 divided by the value in column 3, row 25.

It may be observed that when the values in TABLE $\pi-3$ are multiplied by the " T_{n_1} " at the head of their respective columns, the sum of the terms so obtained in any row, plus the constant of column 8, equals zero. Thus row 30 provides the solution for S_1 , and T_{4_1} , T_{3_1} , etc. may be found by successively writing the equations corresponding to rows 28, 26, etc. The numerical work in the table may be checked by substituting the solutions obtained for T_{n_1} into the equations represented by rows 1, 7, 13, etc. T_{0_1} is found by the use of equations ($\pi-101$) , page $\pi-78$.

Table $\pi-3$ must be solved for each of the five values of "i" .

Step-by-Step Tabular Method of Finding the Bending Moments in the Z Direction.

The method to be presented here was first applied to propeller blades by Mr. Stuart in reference // , and was later refined by him so that it could be applied to rotor blades. An attempt is made to present a simple physical justification of the method, and tables are given for the detailed work involved. The method is extended so that the inertia loads due to periodic bending of the blade can be accounted for.

The differential equations for the constant and harmonic parts of the deflection and bending moment (equations (II 95a), (b), (c), (d), (e)) are linear, and, therefore, their complete solutions, by the principle of superposition, may be taken to be the sum of all the separate solutions to the various parts of the whole forcing function, (i.e., Z loads, end moments, etc.). Furthermore, on account of the linearity, the separate solutions can be worked out as the number of units of the forcing function times the solution per unit forcing function; (i.e., if the forcing function is A units, and the solution for a unit forcing function is B, then the solution for the actual forcing function is A times B).

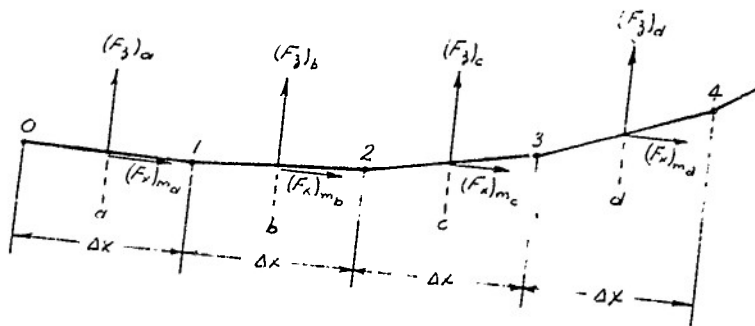

FIG. II-23

Referring to the sketch above, it is assumed that the blade is a series of straight segments, each of length Δx , the numbered points denoting the ends of the segments, and the letters denoting their mid-points. It is assumed that the bending moment is constant between lettered points, and that the running loads due to aerodynamic thrust and centrifugal force are constant between numbered points. If the bending moment be known at "1" (say), and the slope be known at "a" (say), then the change in slope from "a" to "b" is known to be $\Delta x \left(\frac{M}{EI} \right)_1$. The slope at "b" is,

therefore, known and the change in deflection between stations "2" and "1" can be found, from which M_2 can be evaluated in terms of M_1 , the aerodynamic shears, and inertia forces. This process can be continued out to the tip of the blade.

Considering now in detail one segment of the blade between stations 1 and 2, and neglecting for the moment the Z direction shears due to the inertia loads, we have

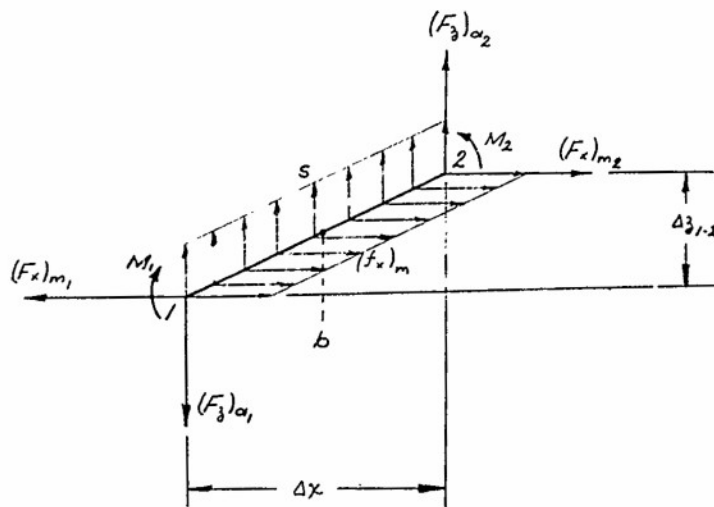

FIG. II-24

where $(F_x)_{m_1}$, and $(F_z)_{a_1}$, at the left are the total centrifugal force and aerodynamic shear at station 1, and s and $(f_x)_m$ are the constant (over the segment) running aerodynamic shear and centrifugal force.

By inspection

$$\begin{aligned}
 (\text{II-106}) \quad M_2 &= M_1 + \Delta z_{1-2} (F_x)_{m_1} - (f_x)_m \frac{(\Delta z_{1-2})^2}{2} - (F_z)_{a_1} \Delta x + s \frac{(\Delta x)^2}{2} \\
 &= M_1 + \Delta z_{1-2} [(F_x)_{m_1} - (f_x)_m \frac{\Delta z_{1-2}}{2}] - \Delta x [(F_z)_{a_1} - s \frac{\Delta x}{2}] \\
 &= M_1 + \Delta z_{1-2} (F_x)_{m_b} - \Delta x (F_z)_{a_b}
 \end{aligned}$$

where $(F_x)_{m_b}$ is the total centrifugal force at "b"
 and $(F_z)_{a_b}$, the total aerodynamic shear load at "b".

We now consider the effect of the inertia shear loads. The total bending moment and deflection are harmonic functions of azimuth angle, and are written

$$(\text{II-107}) \quad z = z_1 + z_2 \cos \theta_{z_a} + z_3 \sin \theta_{z_a} + z_4 \cos 2\theta_{z_a} + z_5 \sin 2\theta_{z_a}$$

and

$$(\text{II-108}) \quad M = M_1 + M_2 \cos \theta_{z_a} + M_3 \sin \theta_{z_a} + M_4 \cos 2\theta_{z_a} + M_5 \sin 2\theta_{z_a}$$

The principle of superposition allows us to compute the various harmonic parts separately and then add them together. The harmonic parts of the acceleration of a blade element are given by

$$(II-109) \quad a_1 = \frac{d^2}{dt^2} (z_1) = -P_1 z_1 \dot{\theta}_a^2$$

where 1 indicates the harmonic, and

$$(II-110) \quad P_1 = 0; P_2 = P_3 = 1; P_4 = P_5 = 4$$

The shear force due to this acceleration is

$$(II-111) \quad ds_1 = -m a_1 dx = +m P \dot{\theta}_a^2 z_1 dx$$

where m is the mass line density of the blade.

Isolating again the segment of blade between stations 1 and 2, as in figure II-24, we have

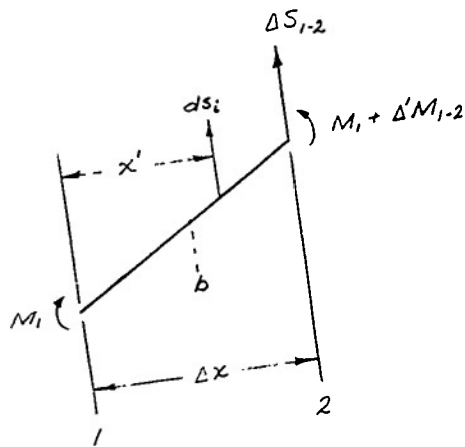

FIG. II-25

The change in moment at "2", $d(\Delta'M_{1-2})$, due to the inertia load, ds_1 , on the blade element shown is

$$(II-112) \quad d(\Delta'M_{1-2}) = ds (\Delta x - x') = P \dot{\theta}_a^2 m z (\Delta x - x') dx'$$

where x' is measured from station 1, as indicated

$$(II-113) \quad z = z_1 + x' \frac{\Delta z_{1-2}}{\Delta x}$$

since blade was assumed straight between 1 and 2.

Similarly, the change in shear at "2" is

$$(II-114) \quad d(\Delta S_2) = P \dot{\theta}_{z_a}^2 m z dx'$$

Substituting (II-113) for z , integrating from "1" to "2" for the total changes between "1" and "2" due to the inertia loads on the segment, we have

$$(II-115) \quad \Delta S_{1-2} = P \dot{\theta}_{z_a}^2 \int_0^{\Delta x} m (z_1 + x' \frac{\Delta z_{1-2}}{\Delta x}) dx'$$

and

$$(II-116) \quad \Delta M_{1-2} = P \dot{\theta}_{z_a}^2 \int_0^{\Delta x} m (z_1 + x' \frac{\Delta z_{1-2}}{\Delta x}) (\Delta x - x') dx'$$

Evaluating these integrals, assuming m constant at its value at "b",

$$(II-117) \quad \Delta S_{1-2} = P \dot{\theta}_{z_a}^2 m_b \Delta x (z_1 + \frac{\Delta z_{1-2}}{2})$$

$$(II-118) \quad \Delta M_{1-2} = P \dot{\theta}_{z_a}^2 m_b \Delta^2 x (\frac{z_1}{2} + \frac{\Delta z_{1-2}}{6})$$

Figure II-26 below shows these inertia loads and moments on each segment and their reaction at the root:

+

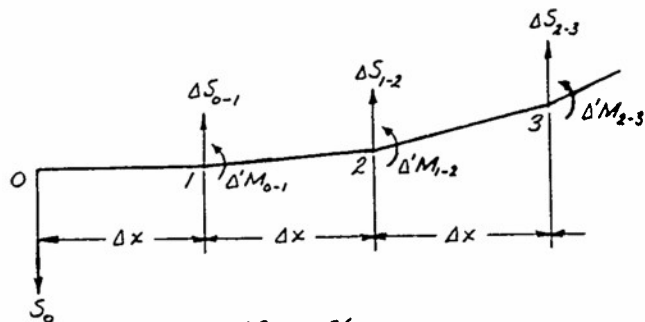

FIG. II-26

The increments in shear and moment shown acting at each station, and defined by equations (I-117) and (I-118), are due to the inertia loads on only the previous segment. For the present, we neglect the inertia shear reaction at the root (S_0), and then the total change in moment, say from (2) to (3), $\Delta M'_{2-3}$, due to the inertia load on all the segments is

$$(II-119) \quad \Delta M'_{2-3} = \Delta' M_{2-3} + \Delta x (\Delta S_{0-1} + \Delta S_{1-2})$$

But, from (I-117), (I-118):

$$(II-119a) \quad \Delta' M_{2-3} = P \dot{\theta}_a^2 m_c \Delta x^2 \left(\frac{z_2}{2} + \frac{\Delta z_{2-3}}{6} \right)$$

$$(b) \quad \Delta S_{0-1} = P \dot{\theta}_a^2 m_a \Delta x \left(z_0 + \frac{\Delta z_{0-1}}{2} \right)$$

$$(c) \quad \Delta S_{1-2} = P \dot{\theta}_a^2 m_b \Delta x \left(z_1 + \frac{\Delta z_{1-2}}{2} \right)$$

+

Hence,

$$(II-120) \quad \Delta M_{2-3} = P \dot{\theta}_z^2 \Delta^2 x \left[m_c \left(\frac{z_2}{2} + \frac{\Delta z_{2-3}}{6} \right) + m_a \left(z_0 + \frac{\Delta z_{0-1}}{2} \right) + m_b \left(z_1 + \frac{\Delta z_{1-2}}{2} \right) \right]$$

which, since $m_c = m_a + \Delta m_{a-b} + \Delta m_{b-c}$, $m_b = m_a + \Delta m_{a-b}$,

$z_2 = z_0 + \Delta z_{0-1} + \Delta z_{1-2}$, $z_1 = z_0 + \Delta z_{0-1}$, $z_0 = 0$;

can be written as follows:

$$(II-120a) \quad \Delta M_{2-3} = P \dot{\theta}_z^2 \Delta^2 x \left[z_1 \left(m_b - \frac{\Delta m_{a-b}}{2} \right) + z_2 \left(m_c - \frac{\Delta m_{b-c}}{2} \right) + m_c \frac{\Delta z_{2-3}}{6} \right]$$

However, $\left(m_b - \frac{\Delta m_{a-b}}{2} \right)$ and $\left(m_c - \frac{\Delta m_{b-c}}{2} \right)$ are respectively, the average line densities of the blade between stations a, b and b, c; and may be taken as the true values at stations (1) and (2).

Thus

$$(II-121) \quad \Delta M_{2-3} = P \dot{\theta}_z^2 \Delta^2 x \left(m_1 z_1 + m_2 z_2 + \frac{m_c \Delta z_{2-3}}{6} \right)$$

In neglecting the root shear reaction, S_0 , we have allowed the inertia shears to accumulate so that at the tip the inertia shear is the sum of all the

$$(II-122) \quad \Delta S = P \dot{\theta}_z^2 \Delta x \sum m z$$

from equations (II-119b) and (c), where the m 's are at the midpoints of the segments, and the z 's are the average z 's for the segments. The sum of all these terms we call S . It will be convenient to consider the quantity $\Delta x \cdot S$. Thus, for any of the parts into which the actual bending moment is separated,

$$(II-123) \quad \Delta x \cdot S = \sum P \theta_{z_a}^2 \Delta^2 x m z$$

where the mz 's are taken at the midpoints as above.

The change in deflection, Δz , may be seen to be the change in deflection for the previous segment plus Δx times the change in slope. The change in slope is $\Delta x \left(\frac{M}{EI} \right)$.

Thus,

$$(II-124) \quad \Delta z_{3-4} = \Delta z_{2-3} + \Delta^2 x \left(\frac{M}{EI} \right)_3$$

$$(II-124 a) \quad \Delta z_{2-3} = \Delta z_{1-2} + \Delta^2 x \left(\frac{M}{EI} \right)_2, \text{ etc.}$$

. . Δz between any two numbered stations is the sum of all the $\Delta^2 x \left(\frac{M}{EI} \right)$ for the previous numbered stations, and of course, z , at any station is the sum of all the previous Δz 's .

In equations (II-121), (II-106) and (II-124), we have the basis for table II-4, which has been arranged in order to allow an untrained computer to carry out the step-by-step process defined by the foregoing analysis. The table is set up for $\Delta x = .1R$ (i.e., 10 points).

The various parts into which the whole bending moment is divided, for any specific harmonic, are as follows:

M_1 : The bending moment due the known aerodynamic shear loads, the known part of the root moment (due to mechanical damping), and the known slope of the blade at the root (due to "built-in" coning), with

unknown root moment = 0
 unknown root slope = 0
 unknown inertia shear reaction at root = 0

Initial entries are

- (1)_o = known part of root moment
 (4)_{.05} = .1R · known part of root slope + (3)_o
 (7)_r = .1R · total aerodynamic shear at the station "r"

M_1' may be entered as the title for column 1 ,
 and the sum of column 13 may be subscripted $\Delta x \cdot S_M'$.

C₁: The bending moment due to a unit root slope,
 with
 root moment = 0
 aerodynamic loads = 0

inertia shear reaction at root = 0

Initial entries:

- (1)_o = 0
 (4)_{.05} = .1R
 (7)_r = 0

Column 1 should be headed "C₁" , and Σ (13)
 should be subscripted $\Delta x \cdot S_C$.

E₁: The bending moment due to a unit shear reaction
 at the root, with

root moment = 0
aerodynamic loads = 0
root slope = 0

Initial entries:

$$(1)_o = 0$$

$$(4)_{.05} = 0$$

$$(7)_r = .1R$$

Column 1 is headed "E₁", and $\Sigma (13)$ is subscripted $\Delta x \cdot S_E$.

A₁: The bending moment due to a unit root moment, with

aerodynamic loads = 0
root slope = 0
inertia shear reaction at root = 0

Initial entries:

$$(1)_o = 1.000$$

$$(4)_{.05} = (3)_o$$

$$(7)_r = 0$$

Column 1 is headed "A₁", and $\Sigma (13)$ is subscripted $\Delta x \cdot S_A$.

For the fully articulated rotor, we need not solve for A₁, since we know that the only root moment possible is that due to mechanical damping which is known at the beginning and included in M₁'.

In the solution for M'_1 , the initial entries are, in more detail:

(1)₀ = root moment due to mechanical damping,
 M'_{10} , From (E-46),

$$M'_{10} = 0$$

$$M'_{20} = \dot{\theta}_z K_y b_1$$

$$M'_{30} = -\dot{\theta}_z K_y a_1$$

$$M'_{40} = 2\dot{\theta}_z K_y b_2$$

$$M'_{50} = -2\dot{\theta}_z K_y a_2$$

(4).05: Since there is no known part of the root slope, (4).05 = (3)₀.

(7)_r, the total aerodynamic shear at the station x_r , is obtained by graphically integrating the airloads given by equation E-24):

$$(II-125a) (F_z)_1 = C_{za} \int_{x_r}^{1.0} c \left\{ \theta'_{x_0} \frac{\mu^2}{2} + \left(\frac{\mu \theta_t}{2} + \psi'_2 + \frac{\lambda}{\mu} \right) \mu x_r + (\theta'_{x_0} + x_r \theta'_t) x_r^2 \right\} dx_r$$

$$(b) (F_z)_2 = C_{za} \int_{x_r}^{1.0} c \left\{ (b_1 + \psi'_1) \frac{\mu^2}{4} - a_0 \mu x_r + (b_1 + \psi'_1 + \lambda_1) x_r^2 \right\} dx_r$$

$$(II-125c) \quad (F_z)_3 = C_{z_a} \int_{x_r}^{1.0} c \left\{ 3\psi'_2 + 4\frac{\lambda}{\mu} + a_1 \frac{\mu^2}{4} + 2\theta'_{x_0} \mu x_r + (2\mu\theta_t + \psi'_2 - a_1)x_r^2 \right\} dx_r$$

$$(d) \quad (F_z)_4 = C_{z_a} \int_{x_r}^{1.0} c \left\{ -\theta'_{x_0} \frac{\mu^2}{2} + (a_1 - \psi'_2 - \frac{\mu\theta_t}{2})\mu x_r + 2b_2 x_r^2 \right\} dx_r$$

$$(e) \quad (F_z)_5 = C_{z_a} \int_{x_r}^{1.0} c \left\{ -\frac{a}{b} \frac{\mu^2}{2} + (b_1 + \psi'_1 + \frac{\lambda_1}{2})\mu x_r - 2a_2 x_r^2 \right\} dx_r$$

It is not necessary in this case to arbitrarily modify the air load curves so that they exactly satisfy equation (I-39), since in the step-by-step method the inertia loads are determined simultaneously with the bending moments, and, therefore, the error in the bending moments should not exceed the error in the air loads. In the collocation method (pp. I-65) this was not the case, and errors in the bending moments due to inconsistencies in the flapping coefficients might be many times the error so caused in the air loads. In order to compare the results by collocation and the tabular methods, however, it is obvious that the same air loads should be used in both methods.

When M'_i , C_i , and E_i are known, the total moment at any station is

$$(II-126) \quad M_i = M'_i + C_i \left(\frac{dz}{dx} \right)_{o_i} + S_{o_i} E_i$$

where $\left(\frac{dz}{dx} \right)_{o_i}$ and S_{o_i} , the root slope and inertia shear reaction at the root, are as yet unknown.

However, at the tip $M_i = 0$; and the inertia shear is zero, so

$$S_{M'} + \left(\frac{dz}{dx}\right)_0 S_c + S_0 \cdot S_E - S_0 = 0$$

or, multiplying through by $\Delta x = .1R$,

$$(II-127) \quad (\Delta x S)_{M'} + \left(\frac{dz}{dx}\right)_0 (\Delta x S)_c + S_0 [(\Delta x S)_E - .1R] = 0$$

For $i = 1$; $P = 0$, $E = (\Delta x \cdot S)_{M'} = (\Delta x S)_c = S_0 = 0$

and

$$(II-128) \quad \left(\frac{dz}{dx}\right)_0 = -\frac{M'}{C} \text{ at the tip.}$$

For $i = 2, 3$; by setting

$$M = M' + C \left(\frac{dz}{dx}\right)_0 + S_0 E = 0 \text{ at tip,}$$

and solving with (II-127) we find

$$(II-129) \quad S_0 = \frac{(\Delta x S)_{M'}}{(\Delta x S)_E} \left\{ \frac{\frac{C}{(\Delta x S)_c} - \frac{M'}{(\Delta x S)_{M'}}}{\frac{E}{(\Delta x S)_E} - \frac{C}{(\Delta x S)_c} \left[1 - \frac{.1R}{(\Delta x S)_E} \right]} \right\}$$

$$(II-130) \quad \text{and } \left(\frac{dz}{dx}\right)_0 = -\frac{M' + S_0 E}{C}$$

It will, however, be found that equation (II-127) for S_0 reduces to the indeterminate form $\frac{0}{0}$, since

$$\frac{C}{(\Delta x S)_c} = \frac{M'}{(\Delta x S)_{M'}} = \frac{E}{(\Delta x S)_E - .1R}$$

This may be interpreted as meaning that any combination $\left(\frac{dz}{dx}\right)_0$ and S_0 which satisfies equation (II-130) could be chosen, without affecting the bending moments. If we choose $\left(\frac{dz}{dx}\right)_0 = 0$, then $S_0 = -\frac{M'}{E}$ (for $x_r = 1.00$, of course),

and

$$(II-131) \quad M = M' + S_0 E$$

at every station. Obviously, the solutions of table II-4 required are for M' and E .

For $i = 4, 5$; $P \neq 0$ and by setting $(a_{i+1}) = 0$ and solving with (II-121) we find

$$(II-129) \quad S_0 = \frac{(\Delta x S)_{M'}}{(\Delta x S)_E} \left\{ \frac{\frac{C}{(\Delta x S)_C} - \frac{M'}{(\Delta x S)_{M'}}}{\frac{E}{(\Delta x S)_E} - \frac{C}{(\Delta x S)_C} \left[1 - \frac{.1R}{(\Delta x S)_E} \right]} \right\}$$

and

$$(II-130) \quad \left(\frac{dz}{dx} \right)_0 = - \frac{M' + S_0 E}{C}$$

where C, E, M' are for $x_r = 1.00$.

Hence, M'_i is determined at every station.

There are some approximations involved in the method which may be pointed out -

- a) As in the collocation method, the air loads are computed assuming a stiff blade.
- b) The centrifugal forces are assumed to act parallel to the $X'Y'$ plane. For small coning and flapping angles, the errors so introduced would be negligible. These assumptions are also made in the collocation solution, pp 1-6 to 1-67. In fact, the tabular method is essentially a step-by-step solution of equation (1-22) which forms the basis for the collocation method.

TABLE X-4 - STEP BY STEP SOLUTION FOR BENDING MOMENTS

| 1 | 2 | 3 | 4 | 5 | 6 | 7 | 8 | 9 | 10 | 11 | 12 | 13 |
|-----------------|---------------------|-------------------------------|------------|--------------------|-----------------------------------|-------------|--------------------------|----------|---------------|---------------|-------------------------|-----------------------------|
| Sta. (x) | $\frac{0.1R^2}{EI}$ | $(1) \cdot \frac{0.1R^2}{EI}$ | Δs | $(F_x)_{\Delta s}$ | $\Delta s \cdot (F_x)_{\Delta s}$ | $.1R (r_x)$ | $F = \sum_{R}^2 (.1R)^2$ | Σ | $(s) \cdot s$ | $\Sigma (10)$ | $\frac{\Sigma (10)}{6}$ | $\Delta (\Delta x \cdot S)$ |
| 0 | | | | | | | | 0 | | | | |
| .05 | | | | | | | | | | | | |
| .10 | | | | | | | | | | | | |
| .15 | | | | | | | | | | | | |
| .20 | | | | | | | | | | | | |
| .25 | | | | | | | | | | | | |
| .30 | | | | | | | | | | | | |
| .35 | | | | | | | | | | | | |
| .40 | | | | | | | | | | | | |
| .45 | | | | | | | | | | | | |
| .50 | | | | | | | | | | | | |
| .55 | | | | | | | | | | | | |
| .60 | | | | | | | | | | | | |
| .65 | | | | | | | | | | | | |
| .70 | | | | | | | | | | | | |
| .75 | | | | | | | | | | | | |
| .80 | | | | | | | | | | | | |
| .85 | | | | | | | | | | | | |
| .90 | | | | | | | | | | | | |
| .95 | | | | | | | | | | | | |
| 1.00 | | | | | | | | | | | | |

See explanation on next page, ($\Delta x \cdot S$) =

7

Explanation for Table $\pi-4$.

Instructions for filling out the table:

Let $(n)_r$ be the value in column n , station r .

Columns 2, 5, 7, 8 depend on physical characteristics of blade, except that "p" depends on the harmonic being considered (p. $\pi-93$).

$$(1)_0 = \text{initial entry}; (3)_0 = (1)_0 \cdot (2)_0; (4)_{.05} = (3)_0$$

$$\text{or initial entry}; (6)_{.05} = (4)_{.05} \cdot (5)_{.05}; (9)_0 = 0;$$

$$(9)_{.05} = (9)_0 + \frac{1}{2} (4)_{.05}; (10)_0 = (8)_0 (9)_0;$$

$$(11)_{.05} = (10)_0; (12)_{.05} = (8)_{.05} \cdot \frac{1}{6} (4)_{.05};$$

$$(13)_{.05} = (8)_{.05} \cdot (9)_{.05}; (1)_{.10} = (1)_0 + (6)_{.05}$$

$$- (7)_{.05} + (11)_{.05} + (12)_{.05}; (3)_{.10} = (2)_{.10} \cdot (1)_{.10};$$

$$(4)_{.15} = (4)_{.05} + (3)_{.10}; (6)_{.15} = (4)_{.15} \cdot (5)_{.15};$$

$$(9)_{.10} = (9)_0 + (4)_{.05}; (9)_{.15} = (9)_{.10} + \frac{1}{2} (4)_{.15};$$

$$(10)_{.10} = (8)_{.10} \cdot (9)_{.10}; (11)_{.15} = (11)_{.05} + (10)_{.10};$$

$$(12)_{.15} = (8)_{.15} \cdot \frac{1}{6} \cdot (4)_{.15}; (13)_{.15} = (8)_{.15} \cdot (9)_{.15};$$

$$(1)_{.20} = (1)_{.10} + (6)_{.15} - (7)_{.15} + (11)_{.15} + (12)_{.15};$$

and so on. Finally, $\Delta X \cdot S = \Sigma (13)$

Column (1) should be labelled according to the part of the moment being computed. A discussion of the various end conditions and initial entries is given on page $\pi-97$.

Calculation of Bending Moments and Deflection Curve in Y Direction

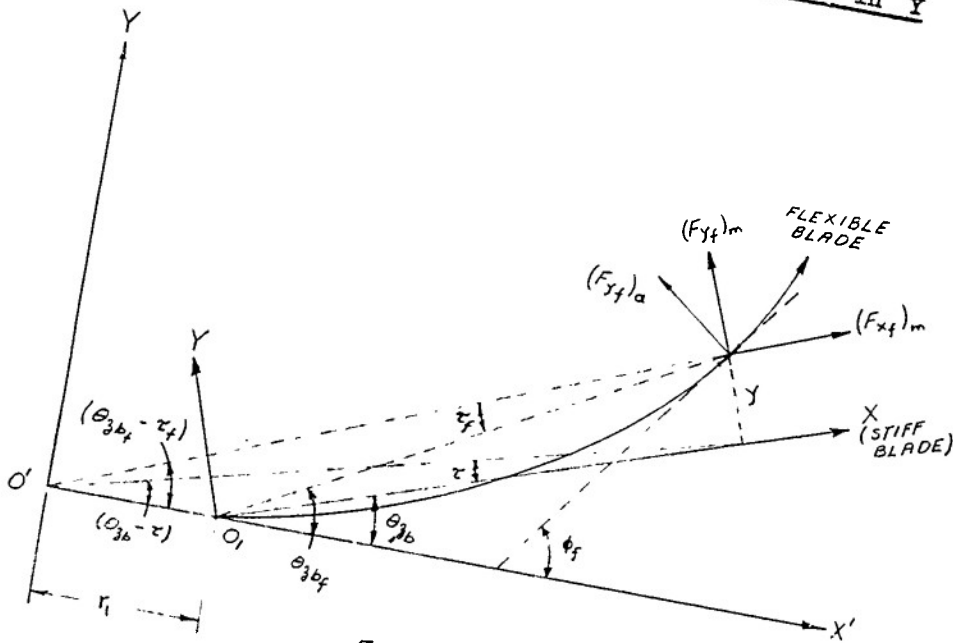

FIG. II-27

The theory for the "edgewise" deflections is very nearly the same as for the "flatwise" deflections, given on pp. II-65. As before, the reference line for the deflections is the instantaneous position of the infinitely stiff blade. When the blade bends, the line connecting the blade element with the drag hinge, O₁, makes an angle θ_{z_f} with the plane thru the Z' axis and the drag hinge, O₁. We assume that when the blade bends, the deflection, y, is small and, therefore, approximately,

$$(II-132 a) \quad \theta_{z_b f} = \theta_{z_b} + \frac{y}{x}$$

$$(b) \quad \theta_{z_b f} - \theta_{z_b} - (\gamma_f - \gamma) = \frac{y}{x+r_1}$$

$$(c) \quad \phi_f = \theta_{z_b} + \frac{dy}{dx}$$

Forces on the blade element

1) External forces (ref. fig. II-27)

a) $(F_{y_f})_a$ is the aerodynamic drag force -

$$(II-133) \quad (F_{y_f})_a = + \frac{1}{2} \rho c V_f^2 F(C_{1_f})$$

where $F(C_{1_f})$ contains the drag coefficient and is a function of C_{1_f} only, since the profile drag coefficient is a function of lift coefficient.

b) $(F_{y_f})_m$ is the inertia force due to acceleration perpendicular to line $O'x_f$ -

$$(II-134) \quad (F_{y_f})_m = mx_f (2\theta_{y_f} \dot{\theta}_{y_f} \dot{\theta}_{z_a} - \ddot{\theta}_z) dx_f$$

(ref. equation (II-8c) p. II-8)

c) $(F_{x_f})_m$ is the inertia force due to acceleration along the line $O'x_f$

$$(II-135) \quad (F_{x_f})_m = mx_f \dot{\theta}_{z_a}^2 dx_f$$

(ref. equation (II-8b) p. II-8)

2) Internal forces

Exactly as in the case of flatwise forces acting internally, p. II-67, we have

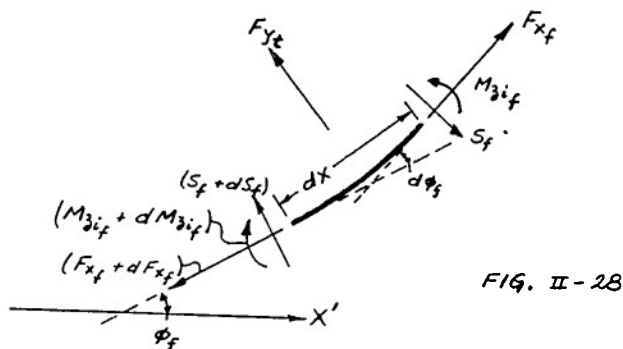

FIG. II-28

- a) Shear forces S_f and $(S_f + dS_f)$ acting on element as shown.
- b) Bending moments $M_{z_{1f}}$ and $(M_{z_{1f}} + dM_{z_{1f}})$ as shown.
- c) Longitudinal tensile forces, F_{x_f} and $(F_{x_f} + dF_{x_f})$ producing a forwards force $F_{y_t} = F_{x_f} d\phi_f$.

(II-136)

Equating the sum of all forces, dynamic and static, acting perpendicular to the blade element, to zero:

$$\begin{aligned}
 \text{(II-137)} \quad \Sigma(F_{y_f}) &= (F_{y_f})_a + (F_{y_f})_m \cos(\phi_f - \theta_{z_{b_f}} + \tau_f) \\
 &\quad - (F_{x_f})_m \sin(\phi_f - \theta_{z_{b_f}} + \tau_f) + dS_f + F_{y_t} = 0
 \end{aligned}$$

and equating forces parallel to blade element to zero:

$$\begin{aligned}
 \text{(II-138)} \quad \Sigma(F_{x_f}) &= (F_{y_f})_m \sin(\phi_f - \theta_{z_{b_f}} + \tau_f) \\
 &\quad + (F_{x_f})_m \cos(\phi_f - \theta_{z_{b_f}} + \tau_f) - dF_{x_f} = 0
 \end{aligned}$$

Substituting (II-133), (II-136) from (II-137),
 (II-138) we find the equations of motion
 of the flexible blade:

$$(II-139) \quad \frac{1}{2} \rho c V_f^2 F(C_{l_f}) + m x_f (2\theta_{y_f} \dot{\theta}_{y_f} \dot{\theta}_{z_a} - \ddot{\theta}_{z_f}) \cos(\phi_f - \theta_{z_{b_f}} + \zeta_f) dx_f \\
 - m x_f \dot{\theta}_{z_a}^2 \sin(\phi_f - \theta_{z_{b_f}} + \zeta_f) dx_f + dS_f + F_{x_f} d\phi_f = 0$$

and

$$(II-140) \quad m x_f (2\theta_{y_f} \dot{\theta}_{y_f} \dot{\theta}_{z_a} - \ddot{\theta}_{z_f}) \sin(\phi_f - \theta_{z_{b_f}} + \zeta_f) dx_f \\
 + m x_f \dot{\theta}_{z_a}^2 \cos(\phi_f - \theta_{z_{b_f}} + \zeta_f) dx_f - dF_{x_f} = 0$$

Since ϕ_f , $\theta_{z_{b_f}}$, ζ_f are small angles, we take

$$V_f = V, \quad x_f = x$$

$$\cos(\phi_f - \theta_{z_{b_f}} + \zeta_f) = 1.00,$$

$$\sin(\phi_f - \theta_{z_{b_f}} + \zeta_f) = (\phi_f - \theta_{z_{b_f}} + \zeta_f)$$

$$(2\theta_{y_f} \dot{\theta}_{y_f} \dot{\theta}_{z_a} - \ddot{\theta}_{z_f}) \sin(\phi_f - \theta_{z_{b_f}} + \zeta_f) = 0$$

Using these assumptions, (II-139) reduces to:

$$(II-141) \quad \frac{1}{2} \rho c V^2 F(C_{l_f}) + m x (2\theta_{y_f} \dot{\theta}_{y_f} \dot{\theta}_{z_a} - \ddot{\theta}_{z_f}) dx \\
 - m x \dot{\theta}_{z_a}^2 (\phi_f - \theta_{z_{b_f}} + \zeta_f) dx + dS_f + F_{x_f} d\phi_f = 0$$

and (II-140) to:

$$(II-142) \quad mx \dot{\theta}_{z_a}^2 dx - dF_{x_f} = 0$$

For a stiff blade, dropping subscript "f" and setting $\phi = \theta_{z_b}$, $d\phi = 0$, (II-141) becomes

$$(II-143) \quad \frac{1}{2} \rho c v^2 F(C_{1l}) + mx (2\theta_y \dot{\theta}_y \dot{\theta}_{z_a} - \ddot{\theta}_z) dx - mx \dot{\theta}_{z_a}^2 (z) dx + dS = 0$$

Integrating (II-142)

$$(II-144) \quad F_{x_f} = \dot{\theta}_{z_a}^2 \int_x^R mx dx = \dot{\theta}_{z_a}^2 M_{m_x}$$

where M_{m_x} is the "mass moment" of the blade outboard of station x , about the Z' axis (axis of rotation).

Subtracting (II-143) from (II-141):

$$(II-145) \quad \frac{1}{2} \rho c v^2 [F(C_{1f}) - F(C_{1l})] + mx [2\dot{\theta}_{z_a} (\theta_{y_f} \dot{\theta}_{y_f} - \theta_y \dot{\theta}_y) - (\dot{\theta}_{z_f} - \ddot{\theta}_z)] dx - mx \dot{\theta}_{z_a}^2 (\phi_f - \theta_{z_b_f} + z_f - z) dx + dS_f - dS + F_{x_f} d\phi_f = 0$$

Assuming $\theta_y \theta_y = \theta_{y_f} \theta_{y_f}$, and $C_1 = C_{1_f}$, and substituting from (II-132) and (II-144)

$$(II-146) \quad -m \frac{d^2 y}{dt^2} - m x \dot{\theta}_{z_a}^2 \frac{dy}{dx} + m \dot{\theta}_{z_a}^2 \frac{1}{1 + \frac{r_1}{x}} + \frac{dS_f}{dx} - \frac{dS}{dx} + \dot{\theta}_{z_a}^2 M_{m_x} \frac{d^2 y}{dx^2} = 0$$

As in the section on "Flatwise" deflections, p. II-70, the term $\frac{dS_f}{dx}$ is

$$(II-147) \quad \frac{dS_f}{dx} = -\frac{d^2(EI)}{dx^2} \cdot \frac{d^2 y}{dx^2} - 2 \frac{d(EI)}{dx} \frac{d^3 y}{dx^3} - EI \frac{d^4 y}{dx^4}$$

$\frac{dS}{dx}$ represents the distribution of load on the stiff blade and is in two parts, aerodynamic (given by equations (II-34) pp. II-21) and inertia. The inertia load is given by equation (II-8c) p. II-8

$$(II-148) \quad \begin{aligned} \frac{d(F_y)}{dx_r} m &= R^2 m x_r (2\theta_y \dot{\theta}_y \dot{\theta}_{z_a} - \ddot{\theta}_z) \\ &= 4mR^2 x_r \dot{\theta}_{z_a}^2 \left\{ \left(\frac{e_1}{4} - \frac{a_0 b_1}{2} - \frac{b_1 a_2}{2} + \frac{a_1 b_2}{2} \right) \cos \theta_{z_a} \right. \\ &\quad + \left(\frac{f_1}{4} + \frac{a_0 a_1}{2} - \frac{a_1 a_2}{4} - \frac{b_1 b_2}{4} \right) \sin \theta_{z_a} \\ &\quad + (e_2 - a_0 b_2 + \frac{a_1 b_1}{2}) \cos 2\theta_{z_a} \\ &\quad \left. + \left(f_2 + a_2 a_0 + \frac{b_1^2}{4} - \frac{a_1^2}{4} \right) \sin 2\theta_{z_a} \right\} \end{aligned}$$

Then

$$(II-149) \quad \frac{dS}{dx} = \left(\frac{d(F_y)}{dx_r} a_L + \frac{d(F_y)}{dx_r} a_D + \frac{d(F_y)}{dx_r} m \right) / R$$

Since the forcing function, $\frac{dS}{dx_r}$ is a harmonic function of θ_{z_a} , so is the steady state solution for y . We, therefore, let $y_r = y/R$ and

$$(II-150) \quad y_r = y_{r1} + y_{r2} \cos \theta_{z_a} + y_{r3} \sin \theta_{z_a} + y_{r4} \cos 2\theta_{z_a} + y_{r5} \sin 2\theta_{z_a}$$

$$\therefore \frac{d^2 y}{dt^2} = -R \dot{\theta}_{z_a}^2 (y_{r2} \cos \theta_{z_a} + y_{r3} \sin \theta_{z_a} + 4y_{r4} \cos 2\theta_{z_a} + 4y_{r5} \sin 2\theta_{z_a})$$

Substituting (x-147), (x-148), (x-149), (x-150), into (x-146), neglecting the $\frac{r_1}{x}$ term in (x-146), we obtain five differential equations for y_{r1} by equating coefficients of identical trigonometric functions. We can conveniently write these equations in the form given below:

$$(II-151) \quad A_1' \frac{d^4 y_{r1}}{dx_r^4} + B_1' \frac{d^3 y_{r1}}{dx_r^3} + C_1' \frac{d^2 y_{r1}}{dx_r^2} + D_1' x_r \frac{dy_{r1}}{dx_r} - E_1' y_{r1} = F_1' + G_1' x_r + H_1' x_r^2 + I_1' x_r^3 + J_1' x_r^4$$

where

$$A_1' = A_2' = A_3' = A_4' = A_5' = EI/R^3$$

$$B_1' = B_2' = B_3' = B_4' = B_5' = \frac{2}{R^3} \frac{d(EI)}{dx_r}$$

$$C_1' = C_2' = C_3' = C_4' = C_5' = \frac{1}{R^3} \frac{d^2(EI)}{dx_r^2} - \dot{\theta}_{z_a}^2 \frac{M_{xx}}{R}$$

$$D_1' = D_2' = D_3' = D_4' = D_5' = E_1' = \frac{E_2}{2} = \frac{E_3}{2} = \frac{E_4}{5} = \frac{E_5}{5} = Rm\dot{\theta}_{z_a}^2$$

$$F_1' = \frac{cC_{z_a}}{R} \frac{\mu^2}{2} \left\{ \frac{\lambda}{\mu} (2 \frac{\lambda}{\mu} + \psi_2' + 2a_1) + a_0^2 + \frac{3}{4} a_1^2 + \frac{\delta_0}{a} - \frac{\delta_2}{a} [2 \frac{\lambda}{\mu} (\frac{\lambda}{\mu} + \psi_2' + a_1)] \right\}$$

$$F_2' = \frac{cC_{z_a}}{R} \frac{\mu^2}{2} \left\{ \frac{2\lambda}{\mu} (a_2 - 2a_0) - 3a_1 a_0 + 4 \frac{\delta_2}{a} \frac{\lambda}{\mu} a_0 \right\}$$

$$F_3' = \frac{cC_{z_a}}{R} \frac{H^2}{2} \left\{ 2 \frac{\lambda}{\mu} (\theta_{x_0}' + b_2) - a_0 b_1 - \frac{\delta_1}{a} \geq \frac{\lambda}{\mu} - 4 \frac{\delta_2}{a} \frac{\lambda}{\mu} \theta_{x_0}' \right\}$$

$$F_4' = \frac{cC_{z_a}}{R} \frac{H^2}{2} \left\{ \frac{\lambda}{\mu} (2a_1 - \psi_2') + a_0^2 + a_1^2 + \frac{\delta_0}{a} - \frac{\delta_2}{a} \left[2 \frac{\lambda}{\mu} (a_1 - \psi_2') \right] \right\}$$

$$F_5' = \frac{cC_{z_a}}{R} \frac{H^2}{2} \left\{ \frac{\lambda}{\mu} (2b_1 + \psi_1') - a_0 \theta_{x_0}' + a_1 b_1 - 2 \frac{\delta_2}{a} \frac{\lambda}{\mu} (b_1 + \psi_1') \right\}$$

$$G_1' = \frac{cC_{z_a}}{R} \mu \left\{ \frac{\lambda}{\mu} \theta_{x_0}' - \frac{a_0 \psi_1'}{2} - a_0 \lambda_1 - a_0 b_1 - \frac{b_1 a_2}{2} + \frac{a_1 b_2}{2} - \frac{\delta_1}{a} (\frac{\lambda}{\mu} + \psi_2') - \frac{\delta_2}{a} [2 \theta_{x_0}' (\frac{\lambda}{\mu} + \psi_2') - a_0 (b_1 + \psi_1')] \right\}$$

$$G_2' = \frac{cC_{z_a}}{R} \mu \left\{ \frac{\lambda}{\mu} (2b_1 + \psi_1') - a_0 \theta_{x_0}' + \frac{a_1 \psi_1'}{2} + \frac{b_1 \psi_2'}{2} + a_1 b_1 + \frac{2\lambda\lambda_1}{\mu} + \frac{3}{2} \lambda_1 a_1 - \frac{a_2 \theta_{x_0}'}{2} - 2a_0 b_2 + \frac{\delta_1}{a} a_0 - \frac{\delta_2}{a} [2 \frac{\lambda}{\mu} (b_1 + \psi_1' + \lambda_1) + (a_1 + \psi_2')(b_1 + \psi_1') - 2a_0 \theta_{x_0}'] \right\} + mR \dot{\theta}_{z_a}^2 (e_1 - 2a_0 b_1 + 2a_1 b_2 - 2b_1 a_2)$$

$$G_3' = \frac{cC_{z_a}}{R} \mu \left\{ \frac{\lambda}{\mu} (\mu \theta_t - 2a_1) + \frac{b_1 \psi_1'}{2} - \frac{5}{4} a_1 \psi_2' - \frac{a_1^2}{2} + \frac{b_1^2}{2} + \frac{1}{2} b_1 \lambda_1 - \frac{1}{2} b_2 \theta_{x_0}' + 2a_2 a_0 - 2 \frac{\delta_0}{a} - 2 \frac{\delta_1}{a} \theta_{x_0}' - \frac{\delta_2}{a} [2 \frac{\lambda}{\mu} (\psi_2' - a_1) + \frac{1}{2} (b_1 + \psi_1')^2 - \frac{a_1^2}{2} + \frac{3}{2} \psi_2'^2 + 2 \theta_{x_0}'^2 + 2 \lambda \theta_t - a_1 \psi_2' + 2a_1 a_2] \right\} + mR \dot{\theta}_{z_a}^2 (f_1 + 2a_0 a_1 - a_1 a_2 - b_1 b_2)$$

$$G_4' = \frac{cC_{z_a}}{R} \mu \left\{ 4 \frac{\lambda}{\mu} b_2 + a_1 \theta'_{x_0} - \frac{a_0 \psi'_1}{2} - a_0 b_1 + \frac{1}{2} a_2 \psi'_1 + b_2 \psi'_2 \right. \\ + 2a_1 b_2 + b_1 a_2 - a_0 \lambda_1 + a_2 \lambda_1 - \frac{\delta_1}{a} (a_1 - \psi'_2) \\ - \frac{\delta_2}{a} [4 \frac{\lambda}{\mu} b_2 + 2a_1 (b_2 + \theta'_{x_0}) + 2\psi'_2 (b_2 - \theta'_{x_0}) \\ - a_0 (b_1 + \psi'_1)] \left. \right\} \\ + mR \dot{\theta}_{z_a}^2 (4e_2 - 4a_0 b_2 + 2a_1 b_1)$$

$$G_5' = \frac{cC_{z_a}}{R} \mu \left\{ 4 \frac{\lambda}{\mu} a_2 + b_1 \theta'_{x_0} - \frac{1}{2} a_0 \psi'_2 - \frac{1}{2} a_0 \mu \theta_t + a_1 a_0 \right. \\ + \frac{1}{2} b_2 \psi'_1 + a_2 \psi'_2 - 2a_1 a_2 + b_1 b_2 + \frac{1}{2} \lambda_1 \theta'_{x_0} \\ - \frac{\delta_1}{a} (b_1 + \psi'_1) - \frac{\delta_2}{a} [2\theta'_{x_0} (b_1 + \psi'_1) - 4 \frac{\lambda}{\mu} a_2 \\ - 2a_2 (a_1 + \psi'_2) + a_0 (a_1 - \psi'_2)] \left. \right\} \\ + mR \dot{\theta}_{z_a}^2 (4f_2 + 4a_0 a_2 + b_1^2 - a_1^2)$$

$$H_1' = \frac{cC_{z_a}}{R} \left\{ \lambda \theta_t + \frac{1}{2} b_1 \psi'_1 - \frac{1}{2} a_1 \psi'_2 + \frac{\lambda_1^2}{2} + \frac{a_1^2}{2} + \frac{b_1^2}{2} + 2a_2^2 \right. \\ + 2b_2^2 + \frac{1}{2} \lambda_1 (2b_1 + \psi'_1) - \frac{\delta_0}{a} - \frac{\delta_1}{a} \theta'_{x_0} \\ - \frac{\delta_2}{a} [2\lambda \theta_t + 2\mu \theta_t \psi'_2 - a_1 \psi'_2 + \psi'_1 (b_1 + \lambda_1) \\ + b_1 \lambda_1 + \theta_{x_0}'^2 + \frac{\psi_2'^2}{2} + \frac{a_1^2}{2} + \frac{\psi_1'^2}{2} + \frac{b_1^2}{2}] \left. \right\}$$

$$H_2' = \frac{cC_{za}}{R} \left\{ \theta_{x_0}' (b_1 + \lambda_1) - \mu\theta_t (a_0 + \frac{a_2}{2}) + b_2\psi_1' \right. \\ \left. - a_2\psi_2' + 2b_1b_2 + 2a_1a_2 + 2b_2\lambda_1 \right. \\ \left. - \frac{\int_1}{a} (b_1 + \lambda_1 + \psi_1') - \frac{\int_2}{a} [2(b_2 + \theta_{x_0}') (b_1 + \lambda_1 + \psi_1')] \right. \\ \left. + 2a_2(a_1 - \psi_2') - 2\mu\theta_t a_0 \right\}$$

$$H_3' = \frac{cC_{za}}{R} \left\{ -a_1\theta_{x_0}' - 2a_2\lambda_1 - \frac{1}{2}\mu\theta_t b_2 - a_2\psi_1' - b_2\psi_2' \right. \\ \left. + 2a_1b_2 - 2b_1a_2 - \frac{\int_1}{a} (2\mu\theta_t + \psi_2' - a_1) \right. \\ \left. - \frac{\int_2}{a} [2\theta_{x_0}' (2\mu\theta_t - a_1 + \psi_2') + 2b_2 (a_1 - \psi_2')] \right. \\ \left. - 2a_2(b_1 + \lambda_1 + \psi_1') \right\}$$

$$H_4' = \frac{cC_{za}}{R} \left\{ \frac{1}{2} b_1\psi_1' + \frac{1}{2} a_1\psi_2' - \frac{a_1^2}{2} + \frac{b_1^2}{2} + 2b_2\theta_{x_0}' + \mu\theta_t a_1 \right. \\ \left. + \frac{1}{2}\lambda_1\psi_1' + b_1\lambda_1 + \frac{\lambda_1^2}{2} - \frac{\int_1}{a} 2b_2 \right. \\ \left. - \frac{\int_2}{a} [4b_2\theta_{x_0}' + \mu\theta_t (2a_1 - 2\psi_2' - \frac{\mu\theta_t}{2}) - \frac{1}{2} (a_1 - \psi_2')^2] \right. \\ \left. + \psi_1' (b_1 + \lambda_1 + \frac{\psi_1'}{2}) + \frac{1}{2} (b_1 + \lambda_1)^2 \right\}$$

$$H_5' = \frac{cC_{za}}{R} \left\{ \frac{1}{2} b_1\psi_2' - \frac{1}{2} a_1\psi_1' - a_1b_1 - 2a_2\theta_{x_0}' + \mu\theta_t b_1 \right. \\ \left. + \frac{1}{2}\lambda_1\psi_2' + \frac{1}{2}\mu\theta_t\lambda_1 - \lambda_1a_1 + \frac{\int_1}{a} 2a_2 \right. \\ \left. - \frac{\int_2}{a} [2\mu\theta_t (b_1 + \psi_1') - (a_1 - \psi_2')(b_1 + \lambda_1 + \psi_1')] \right. \\ \left. - 4a_2\theta_{x_0}' \right\}$$

$$I_1' = \frac{cC_{z_a}}{R} \left\{ -\frac{\delta_1}{a} \theta_t - \frac{\delta_2}{a} \cdot 2\theta_t \theta_{x_0}' \right\}$$

$$I_2' = \frac{cC_{z_a}}{R} \left\{ \theta_t (b_1 + \lambda_1) - \frac{\delta_2}{a} [2\theta_t (b_1 + \lambda_1 + \psi_1')] \right\}$$

$$I_3' = \frac{cC_{z_a}}{R} \left\{ -a_1 \theta_t - \frac{\delta_2}{a} 2\theta_t (\mu \theta_t - a_1 + \psi_2') \right\}$$

$$I_4' = \frac{cC_{z_a}}{R} \left\{ 2\theta_t b_2 - \frac{\delta_2}{a} \cdot 4b_2 \theta_t \right\}$$

$$I_5' = \frac{cC_{z_a}}{R} \left\{ -2a_2 \theta_t + \frac{\delta_2}{a} \cdot 4a_2 \theta_t \right\}$$

$$J_1' = -\frac{cC_{z_a}}{R} \frac{\delta_2}{a} \theta_t^2, \quad J_2' = J_3' = J_4' = J_5' = 0$$

Solution of the Differential Equations for the Deflection and Bending Moments in the Y direction.

The assumed solution is of exactly the same form as for the Z direction deflection, z_{r1} , given by equation ($\pi-100$). The same tables may be used for the solution for the coefficients T'_{n1} and S'_{n1} in the solution

$$(\pi-152) \quad y_{r1} = S'_{n1} \left\{ e^{(x_r - 1)^2 - x_r^2 - e} + \sum_{n_1}^{n_2} T'_{n_1} x_r^{n+2} \left\{ \frac{1}{(n+2)(n+1)} - \frac{2x_r}{(n+2)(n+3)} + \frac{x_r^2}{(n+3)(n+4)} \right\} \right\}$$

The coefficients $A'_1, B'_1, C'_1, D'_1, E'_1, F'_1, G'_1, H'_1, I'_1, J'_1$ are given on pp. $\pi-112$ for the edgewise deflections, and must be used instead of the coefficients A_1, B_1, \dots, J_1 given for the flatwise loads.

The coefficients $L'_1, L'_2, L'_3, L'_4, L'_5$ are given below by equations corresponding to ($\pi-101$):

$$(\pi-153a) \quad S'_1 (6e - 2) + T'_{01} = 0 = L'_1$$

$$(b) \quad S'_2 (6e - 2) + T'_{02} = \frac{-f_1 \dot{\theta}_{z_a} K_1 R}{(EI)_0} = L'_2$$

$$(c) \quad S'_3 (6e - 2) + T'_{03} = \frac{e_1 \dot{\theta}_{z_a} K_1 R}{(EI)_0} = L'_3$$

$$(d) \quad S'_4 (6e - 2) + T'_{04} = \frac{-2f_2 \dot{\theta}_{z_a} K_1 R}{(EI)_0} = L'_4$$

$$(e) \quad S'_5 (6e - 2) + T'_{05} = \frac{2e_2 \dot{\theta}_{z_a} K_1 R}{(EI)_0} = L'_5$$

Hence, aside from priming the coefficients $A_1 \dots L_1$ and using the new definitions above and on pp $\pi-112$, the routine involved in solving the edgewise differential equations is exactly the same as that for the flatwise differential equations. The same tables ($\pi-1, \pi-2, \pi-3$) and pertinent remarks and instructions apply.

Step-by-Step tabular method of finding the bending moments in the Y direction

The theory for the step-by-step solution for the edgewise bending moments is exactly the same as for the flatwise bending moments given pp $\pi-90$.

Table $\pi-4$ can be used in the same manner as for the flatwise moments, except that the heading of col. 4 should be changed to

Δy

and the heading of col. 7 changed to

$.1R (F_y)_i$

The entries in col. 5, the centrifugal forces, are the same as for the flatwise case. The initial entries for the moment and deflection, cols. 1 and 4, may be made at sta. (.10) and (.15), respectively, to account for the eccentricity of the drag hinge.

Formulae giving the root bending moment, M'_{10} , and the aerodynamic shear forces, $(F_y)_{s,1}$, will of course be different, and are given below:

$$M'_{10} = 0$$

$$M'_{20} = \dot{\theta}_{z_a} K_1^f 1$$

$$M'_{30} = -\dot{\theta}_{z_a} K_1^e 1$$

$$M'_{40} = 2\dot{\theta}_{z_a} K_1^f 2$$

$$M'_{50} = -2\dot{\theta}_{z_a} K_1^e 2$$

(x-154a)
$$(F_y)_{a_1} = C_{za} \int_{x_r}^{1.0} c \left(A_{0a_L} - \frac{A_{0a_D}}{a} \right) dx_r$$

(b)
$$(F_y)_{a_2} = C_{za} \int_{x_r}^{1.0} c \left(A_{1a_L} - \frac{A_{1a_D}}{a} \right) dx_r$$

(c)
$$(F_y)_{a_3} = C_{za} \int_{x_r}^{1.0} c \left(B_{1a_L} - \frac{B_{1a_D}}{a} \right) dx_r$$

(d)
$$(F_y)_{a_4} = C_{za} \int_{x_r}^{1.0} c \left(A_{2a_L} - \frac{A_{2a_D}}{a} \right) dx_r$$

(e)
$$(F_y)_{a_5} = C_{za} \int_{x_r}^{1.0} c \left(B_{2a_L} - \frac{B_{2a_D}}{a} \right) dx_r$$

where A_{0a_L} , A_{0a_D} , A_{1a_L} , A_{1a_D} , etc., are given by equations (x-55) and (x-56). The integrations can probably best be done graphically.

Torsion on the blades.

a. Stiff blade:

A. Torsion due to dynamic forces:

It is assumed that the elastic center and the center of gravity of any blade section lie on the zero lift chord line of that section (see Fig. II-29)

The torque about the elastic center due to the inertia forces acting on a particle of the blade element is

$$(II-155) \quad dM_{x_d}^i = \ddot{z} (cD \cos \theta_x - y) dm + \ddot{y} (z - cD \sin \theta_x) dm$$

where dm is the mass of the particle, y and z are coordinates of the particle, and D is the distance in % chord from the elastic center to the feathering axis.

Substituting for the accelerations from equation (II-6a) and (II-6c):

$$(II-156) \quad dM_{x_d}^i = \left\{ \begin{array}{l} (Dc \cos \theta_x - y)x \text{ (I)} \\ -(Dc \cos \theta_x - y)z \text{ (II)} \\ +(Dc \cos \theta_x - y)y \text{ (III)} \\ +(z - Dc \sin \theta_x)x \text{ (IV)} \\ -(z - Dc \sin \theta_x)z \text{ (V)} \\ -(z - Dc \sin \theta_x)y \text{ (VI)} \end{array} \right\} dm$$

FIG. II-29

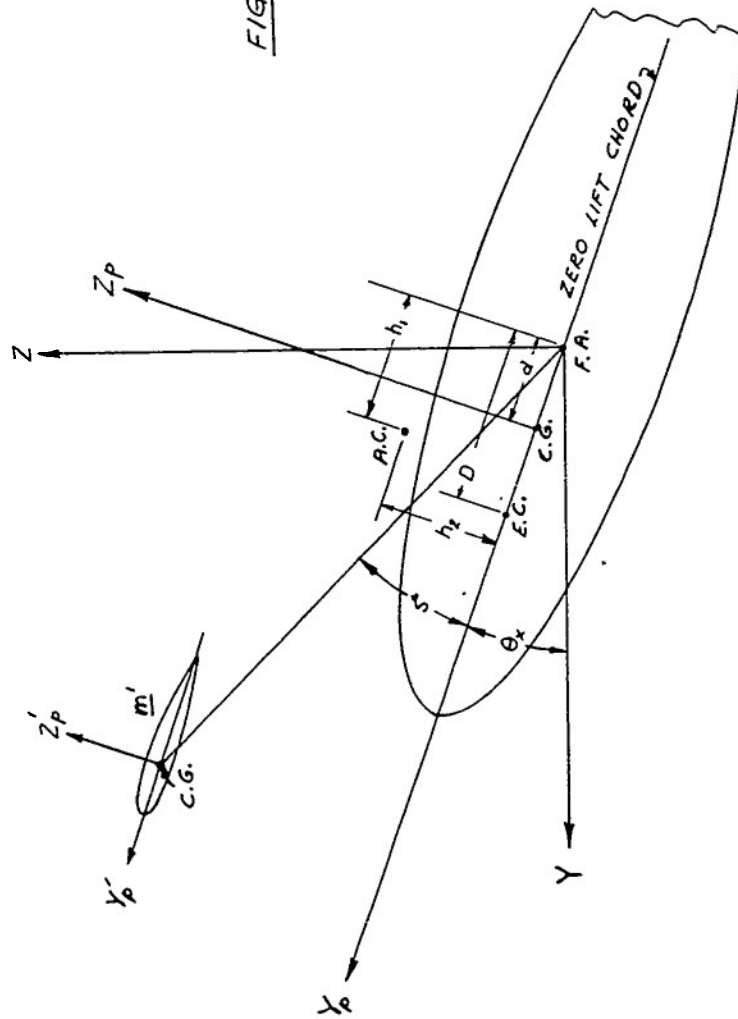

where

(x-156a)

$$(I) = \dot{\theta}_z^2 \sin \theta_y \cos \theta_y + \ddot{\theta}_y$$

(b)

$$(II) = \dot{\theta}_x^2 + \dot{\theta}_y^2 + 2\dot{\theta}_z \dot{\theta}_x \sin \theta_y + \dot{\theta}_z^2 \sin^2 \theta_y$$

(c)

$$(III) = \dot{\theta}_x + \ddot{\theta}_y \sin \theta_y$$

(d)

$$(IV) = -2 \dot{\theta}_z \dot{\theta}_y \sin \theta_y + \ddot{\theta}_z \cos \theta_y$$

(e)

$$(V) = \ddot{\theta}_x + \ddot{\theta}_z \sin \theta_y + 2\dot{\theta}_z \dot{\theta}_y \cos \theta_y$$

(f)

$$(VI) = 2\dot{\theta}_x \dot{\theta}_z \sin \theta_y + \dot{\theta}_z^2$$

Integrating equation (x-156) over the blade element, letting "m" be line density of the blade, the torsion due to the element is:

(x-157)

$$M'_{xd} = (I) xmc (D \cos \theta_x - d \cos \theta_x)$$

$$-(II) (c^2 Dmd \cos \theta_x \sin \theta_x - I_{yz})$$

$$+(III) (c^2 Dmd \cos^2 \theta_x - I_y)$$

$$+(IV) xmc (d \sin \theta_x - D \sin \theta_x)$$

$$-(V) (I_z - c^2 Dmd \sin^2 \theta_x)$$

$$-(VI) (I_{yz} - c^2 Dmd \cos \theta_x \sin \theta_x)$$

where I_y , I_z are mass moments of inertia about the Y and Z axes, and I_{yz} is the product of inertia, and d is the distance in % chord from the center of gravity to the feathering axis.

Assuming that the Y_p principal axis coincides with the zero lift chord line,

(II-158a)
$$I_y = I_{y_p} \cos^2 \theta_x + I_{z_p} \sin^2 \theta_x$$

(b)
$$I_z = I_{z_p} \cos^2 \theta_x + I_{y_p} \sin^2 \theta_x$$

(c)
$$I_{yz} = \frac{1}{2} (I_{y_p} - I_{z_p}) \sin 2\theta_x$$

where I_{y_p} and I_{z_p} are moments of inertia about the principal axes.

Substituting (II-158a) and (b), (c) in (II-157), since all angles are small, assuming

$$\sin \theta_x = \theta_x, \quad \cos \theta_x = 1.0$$

$$\sin \theta_y = \theta_y, \quad \cos \theta_y = 1.0$$

terms in θ^3 are negligible

$$\dot{\theta}_z^2 = \dot{\theta}_{z_a}^2, \quad \ddot{\theta}_z = \ddot{\theta}_{z_b}$$

$\dot{\theta}_y^2$ is small compared to $\dot{\theta}_z^2$

we obtain:

(II-159)
$$M'_{x_d} = \left[mxc (D - d) (\theta_y \dot{\theta}_{z_a}^2 + \ddot{\theta}_y - \theta_x \ddot{\theta}_{z_b}) \right. \\ \left. + mdc^2 (D - d) (\dot{\theta}_x + \theta_y \ddot{\theta}_{z_b} + \theta_x \dot{\theta}_{z_a}^2) \right. \\ \left. - I_{y_p} (\ddot{\theta}_x + \theta_y \ddot{\theta}_{z_b} + \theta_x \dot{\theta}_{z_a}^2) \right. \\ \left. - I_{z_p} (\ddot{\theta}_x + \theta_y \ddot{\theta}_{z_b} - \theta_x \dot{\theta}_{z_a}^2 + 2\dot{\theta}_y \dot{\theta}_{z_a}) \right]$$

Substituting

$$\theta_x = \theta'_{x_0} + \psi'_1 \cos \theta_{z_a} + \psi'_2 \sin \theta_{z_a} + \theta_t x_r \quad (\text{from (II-11)})$$

$$\dot{\theta}_x = -\dot{\theta}_{z_a}^2 (\psi'_1 \cos \theta_{z_a} + \psi'_2 \sin \theta_{z_a})$$

$$\theta_y = a_0 - a_1 \cos \theta_{z_a} - b_1 \sin \theta_{z_a} - a_2 \cos 2\theta_{z_a} - b_2 \sin 2\theta_{z_a}$$

$$\dot{\theta}_y = \dot{\theta}_{z_a} (a_1 \sin \theta_{z_a} - b_1 \cos \theta_{z_a} + 2a_2 \sin 2\theta_{z_a} - 2b_2 \cos 2\theta_{z_a})$$

$$\ddot{\theta}_y = +\dot{\theta}_{z_a}^2 (a_1 \cos \theta_{z_a} + b_1 \sin \theta_{z_a} + 4a_2 \cos 2\theta_{z_a} + 4b_2 \sin 2\theta_{z_a})$$

$$\ddot{\theta}_{z_b} = \dot{\theta}_{z_a}^2 (e_1 \cos \theta_{z_a} + f_1 \sin \theta_{z_a} + 4e_2 \cos 2\theta_{z_a} + 4f_2 \sin 2\theta_{z_a})$$

and integrating from x to the tip to get total torsion, neglecting harmonics higher than the second:

$$\begin{aligned}
 (\pi-160) \quad M_{x_d} &= \dot{\theta}_{z_a}^2 R \int_{x_r}^{1.0} (J_{0_d} + J_{1_d} \cos \theta_{z_a} + \\
 &+ L_{1_d} \sin \theta_{z_a} + J_{2_d} \cos 2\theta_{z_a} + \\
 &+ L_{2_d} \sin 2\theta_{z_a}) dx_r
 \end{aligned}$$

where

$$\begin{aligned}
 (\pi-160a) \quad J_{0_d} &= mR x_r c (D-d) (a_0 - \frac{1}{2} e_1 \psi_1' - \frac{1}{2} f_1 \psi_2') \\
 &+ (\theta_{x_0}' + \theta_t x_r) [m d c^2 (D-d) - I_{y_p} + I_{z_p}] \\
 &- [m d c^2 (D-d) - I_{y_p} - I_{z_p}] (\frac{1}{2} e_1 a_1 + \\
 &+ \frac{1}{2} b_1 f_1 + 2e_2 a_2 + 2b_2 f_2)
 \end{aligned}$$

$$\begin{aligned}
 (b) \quad J_{1_d} &= 2I_{z_p} (b_1 + \psi_1') - m x_r R c (D-d) [e_1 (\theta_{x_0}' + \\
 &+ \theta_t x_r) + 2e_2 \psi_1' + 2f_2 \psi_2'] \\
 &+ [m d c^2 (D-d) - I_{y_p} - I_{z_p}] (a_0 e_1 - \\
 &- 2a_1 e_2 - \frac{1}{2} e_1 a_2 - \frac{1}{2} b_2 f_1 - 2f_2 b_1)
 \end{aligned}$$

$$\begin{aligned}
 (c) \quad L_{1_d} &= -2I_{z_p} (a_1 - \psi_2') - m x_r R c (D-d) [f_1 (\theta_{x_0}' + \\
 &+ \theta_t x_r) + 2f_2 \psi_1' - 2e_2 \psi_2'] \\
 &+ [m d c^2 (D-d) - I_{y_p} - I_{z_p}] (a_0 f_1 + 2e_2 b_1 + \\
 &+ \frac{1}{2} a_2 f_1 - 2a_1 f_2 - \frac{1}{2} e_1 b_2)
 \end{aligned}$$

(II-160 d)

$$J_{2d} = 4b_2 I_{z_p} + m\bar{x}_R Rc (D - d) \left[3a_2 - 4e_2(\theta'_{x_0} + \theta'_{t x_R}) - \frac{1}{2} e_1 \psi'_1 + \frac{1}{2} f_1 \psi'_2 \right] + \left[mdc^2(D - d) - I_{y_p} - I_{z_p} \right] (4a_0 e_2 - \frac{1}{2} e_1 a_1 + \frac{1}{2} b_1 f_1)$$

(e)

$$L_{2d} = -4a_2 I_{z_p} + m\bar{x}_R Rc (D - d) \left[3b_2 - 4f_2 (\theta'_{x_0} + \theta'_{t x_R}) - \frac{1}{2} (e_1 \psi'_2 + f_1 \psi'_1) \right] + \left[mdc^2(D - d) - I_{y_p} - I_{z_p} \right] (4a_0 f_2 - \frac{1}{2} a_1 f_1 - \frac{1}{2} e_1 b_1)$$

The indicated integrations can usually best be done graphically, unless the blade chord and airfoil section are constant along the span. a_0, a_1, b_1, a_2, b_2 and e_0, e_1, f_1, e_2, f_2 are, of course, respectively, the flapping and hunting coefficients.

B. Torsion due to a concentrated mass:

If a concentrated mass, m' , is located at $x_R = x'_R$, the torsional moment produced by this mass due to motion of the blade can be evaluated by means of equation (II-156). Let d' be the distance between the mass and the Feathering axis of the blade and δ be the angle between this distance

and the zero lift line of the blade section at station x'_r (see sketch, Fig. II-29). Then in equation (II-136):

$$(II-161a) \quad y = d' \cos (\theta_x + \zeta)$$

$$(b) \quad z = d' \sin (\theta_x + \zeta)$$

$$(c) \quad dm = m'$$

Substituting (II-161), making the approximations of p. II-124, and substituting p. II-125, we obtain the expression for the torsion due to the dynamic forces on the concentrated mass,

$$(II-162a) \quad M'_{x_d} = m' \dot{\theta}_{z_a}^2 \left\{ J'_{o_d} + J'_{1_d} \cos \theta_{z_a} + L'_{1_d} \sin \theta_{z_a} + J'_{2_d} \cos 2\theta_{z_a} + L'_{2_d} \sin 2\theta_{z_a} \right\}$$

where

$$(II-162b) \quad J'_{o_d} = c'(D' - d' \cos \zeta) \left\{ R x'_r \left[a_o - \frac{1}{2}(\theta_1 \psi'_1 + f_1 \psi'_2) \right] + c'd' \cos \zeta (\theta'_{x_o} + \theta'_{t x'_r}) \right\} + c'd' \sin \zeta \left\{ R x'_r \left[a_o (\theta'_{x_o} + \theta'_{t x'_r}) \right] + D'c' \left[(\theta'_{x_o} + \theta'_{t x'_r})^2 + \psi_1'^2 + \psi_2'^2 + \frac{a_1^2}{2} + \frac{b_1^2}{2} + 2a_2^2 + 2b_2^2 \right] + c'd' \left[\cos \zeta - \sin \zeta (\theta'_{x_o} + \theta'_{t x'_r}) \right] \right\}$$

(II-162c)

$$J'_{1d} = c'(D' - d' \cos \zeta) \left\{ R_{x'_R} \left[-e_1(\theta'_{x_0} + \theta'_{t x'_R}) - 2(e_2 \psi'_1 + f_2 \psi'_2) \right] \right. \\ \left. + d'c' \sin \zeta \left\{ R_{x'_R} \left[a_0 \psi'_1 + \frac{3}{2}(a_2 \psi'_1 + b_2 \psi'_2) + 2a_0 b_1 + a_2 b_1 - a_1 b_2 + e_1 \right] - D'c' \left[2a_1 a_2 + 2b_1 b_2 + 2\psi'_1 (\theta'_{x_0} + \theta'_{t x'_R}) \right] + d'c' \sin \zeta \left[\psi'_1 - e_1 + 2b_1 \right] \right\} \right\}$$

(d)

$$L'_{1d} = c'(D' - d' \cos \zeta) \left\{ R_{x'_R} \left[-f_1(\theta'_{x_0} + \theta'_{t x'_R}) - 2(f_2 \psi'_1 - e_2 \psi'_2) \right] \right. \\ \left. + d'c' \sin \zeta \left\{ R_{x'_R} \left[a_0 \psi'_2 + \frac{3}{2}(b_2 \psi'_1 - a_2 \psi'_2) - 2a_0 a_1 + b_1 b_2 + a_1 a_2 + f_1 \right] - D'c' \left[2a_1 b_2 - 2a_2 b_1 + 2\psi'_2 (\theta'_{x_0} + \theta'_{t x'_R}) \right] + d'c' \sin \zeta \left[\psi'_2 - f_1 - 2a_1 \right] \right\} \right\}$$

(e)

$$J'_{2d} = c'(D' - d' \cos \zeta) \left\{ R_{x'_R} \left[3a_2 - 4e_2 (\theta'_{x_0} + \theta'_{t x'_R}) - \frac{1}{2}(e_1 \psi'_1 - f_1 \psi'_2) \right] \right. \\ \left. + d'c' \sin \zeta \left\{ R_{x'_R} \left[3a_2 (\theta'_{x_0} + \theta'_{t x'_R}) - 4a_0 b_2 - 2a_1 b_1 + 4e_2 \right] + d'c' \sin \zeta \left[-e_2 + 4b_2 \right] \right\} \right\}.$$

$$\begin{aligned}
 (II-162f) \quad I_{2d}' &= c' (D' - d' \cos \zeta) \left\{ R_{x_r}' \left[3b_2 - 4f_2 (\theta_{x_0}' + \theta_{t x_r}') - \right. \right. \\
 &\quad \left. \left. - \frac{1}{2} (e_1 \psi_2' + f_1 \psi_1') \right] \right\} \\
 &\quad + d' c' \sin \zeta \left\{ R_{x_r}' \left[3b_2 (\theta_{x_0}' + \theta_{t x_r}') - 4a_0 a_2' - \right. \right. \\
 &\quad \left. \left. - a_1^2 + b_1^2 + 4f_2 \right] \right. \\
 &\quad \left. + d' c' \sin \zeta \left[-f_2 - 4a_2 \right] \right\}
 \end{aligned}$$

where

c' is chord at sta. x_r' where the mass is located,
 D' is distance, in % of chord, from the blade elastic center to feathering axis, at sta. x_r' ;
 d' and ζ are as defined p. II-127.

If the mass, m' , concentrated at x_r' , is distributed in a ZY plane in such a way that its moments of inertia about its own axes should be considered, then the additional torsion due to the dynamic forces and the YZ distribution of m' is, from (II-160),

$$\begin{aligned}
 (II-163) \quad \Delta M_{x_d}' &= \dot{\theta}_z^2 \left\{ \Delta J_{o_d}' + \Delta J_{1_d}' \cos \theta_{z_a} + \Delta L_{1_d}' \sin \theta_{z_a} + \right. \\
 &\quad \left. + \Delta J_{o_d}' \cos 2\theta_{z_a} + \Delta L_{2_d}' \sin 2\theta_{z_a} \right\}
 \end{aligned}$$

where

$$\begin{aligned}
 (II-163a) \quad \Delta J_{o_d}' &= (I_{z_p}' - I_{y_p}') (\theta_{x_0}' + \theta_{t x_r}') \\
 &\quad + (I_{z_p}' + I_{y_p}') \left(\frac{1}{2} e_1 a_1 + \frac{1}{2} b_1 f_1 + 2e_2 a_2 + \right. \\
 &\quad \left. + 2b_2 f_2 \right)
 \end{aligned}$$

$$(II-163 b) \quad \Delta J_{1d}' = 2I_{z_p}' (b_1 + \psi_1') - (I_{z_p}' + I_{y_p}') (a_0 e_1 - 2a_1 e_2 - 2f_2 b_1 - \frac{1}{2} e_1 a_2 - \frac{1}{2} b_2 f_1)$$

$$(c) \quad \Delta L_{1d}' = -2I_{z_p}' (a_1 - \psi_2') - (I_{z_p}' + I_{y_p}') (a_0 f_1 + 2b_1 e_2 - 2a_1 f_2 + \frac{1}{2} a_2 f_1 - \frac{1}{2} e_1 b_2)$$

$$(d) \quad \Delta J_{2d}' = 4b_2 I_{z_p}' - (I_{z_p}' + I_{y_p}') (4a_0 e_2 - \frac{1}{2} e_1 a_1 + \frac{1}{2} b_1 f_1)$$

$$(e) \quad \Delta L_{2d}' = -4a_2 I_{z_p}' - (I_{z_p}' + I_{y_p}') (4a_0 f_2 - \frac{1}{2} a_1 f_1 - \frac{1}{2} e_1 b_1)$$

where I_{z_p}' and I_{y_p}' are the moments of inertia of the mass, m' , about axes through its own CG and parallel to the principal axes of the blade section at sta. x_r' .

The term involving the product of inertia of m' about these axes has been neglected. The term would, of course, be zero if the principal axes of the mass, m' , were parallel to those of the blade section at sta. x_r' .

C. Torsion due to aerodynamic forces:

It is assumed that the aerodynamic forces act at the aerodynamic center of the blade element. The distance of the a.c. from the feathering axis in the Y_p and Z_p directions is called h_1 and h_2 (% of chord), respectively. The torsion due to the Z

direction aerodynamic forces is

$$(II-164) \quad M_{x_{a_1}} = \int_{x_r}^{1.0} cR \cos \theta_x (D - h_1 + h_2 \tan \theta_x) \cdot \frac{d(F_z)_a}{dx_r} dx_r$$

where $\frac{d(F_z)_a}{dx_r}$ is given by equation (II-34).

Assuming $\cos \theta_x = 1.00$, $\sin \theta_x = \theta_x$

$$(II-165) \quad M_{x_{a_1}} = \int_{x_r}^{1.0} C_{z_a} c^2 R (J_{0_{a_1}} + J_{1_{a_1}} \cos \theta_{z_a} + L_{1_{a_1}} \sin \theta_{z_a} + J_{2_{a_1}} \cos 2\theta_{z_a} + L_{2_{a_1}} \sin 2\theta_{z_a}) dx_r$$

where

$$(II-165a) \quad J_{0_{a_1}} = A_{0_a} \left[D - h_1 + h_2(\theta'_{x_0} + \theta'_{t x_r}) \right] + \frac{1}{2} A_{1_a} \psi'_1 + \frac{1}{2} B_{1_a} \psi'_2$$

$$(b) \quad J_{1_{a_1}} = A_{1_a} \left[D - h_1 + h_2(\theta'_{x_0} + \theta'_{t x_r}) \right] + A_{0_a} \psi'_1 + \frac{1}{2} B_{2_a} \psi'_2 + \frac{1}{2} A_{2_a} \psi'_1$$

(X-165c)

$$L_{1a1} = B_{1a} \left[D - h_1 + h_2 (\theta'_{x_0} + \theta'_{tx_r}) \right] + A_{0a} \psi'_2 + \frac{1}{2} B_{2a} \psi'_1 - \frac{1}{2} A_{2a} \psi'_2$$

(d)

$$J_{2a1} = A_{2a} \left[D - h_1 + h_2 (\theta'_{x_0} + \theta'_{tx_r}) \right] + \frac{1}{2} A_{1a} \psi'_1 - \frac{1}{2} B_{1a} \psi'_2$$

(e)

$$L_{2a1} = B_{2a} \left[D - h_1 + h_2 (\theta'_{x_0} + \theta'_{tx_r}) \right] + \frac{1}{2} A_{1a} \psi'_2 + \frac{1}{2} B_{1a} \psi'_1$$

$A_{0a}, A_{1a}, B_{1a}, A_{2a}, B_{2a}$ are given by equation (X-34a), (b), (c), (d), (e), p. X-21. The integration can probably best be done graphically.

The torsion due to the Y direction aerodynamic forces is:

(X-166)

$$M_{x_{a2}} = - \int_{x_r}^{1.0} c R h_2 \cos \theta_x \cdot \frac{d(f_y)_a}{dx_r} \cdot dx_r$$

or, assuming $\cos \theta_x = 1.00$,

(X-167)

$$M_{x_{a2}} = - \int_{x_r}^{1.0} C_{z_a} c^2 R h_2 (J_{0a2} + J_{1a2} \cos \theta_{z_a} + L_{1a2} \sin \theta_{z_a} + J_{2a2} \cos 2\theta_{z_a} + L_{2a2} \sin 2\theta_{z_a}) dx_r$$

where

(II-167a)

$$J_{0a2} = A_{0aL} - \frac{A_{0aD}}{a}$$

(b)

$$J_{1a2} = A_{1aL} - \frac{A_{1aD}}{a}$$

(c)

$$L_{1a2} = B_{1aL} - \frac{B_{1aD}}{a}$$

(d)

$$J_{2a2} = A_{2aL} - \frac{A_{2aD}}{a}$$

(e)

$$L_{2a2} = B_{2aL} - \frac{B_{2aD}}{a}$$

ref. equations
(II-55) and (II-56)

The torsion due to the aerodynamic pitching moment coefficient (about a.c.) is

(II-168)

$$M_{x_{a3}} = \int_{x_r}^{1.0} \frac{1}{2} \rho c^2 C_m \frac{V^2}{y} R dx_r$$

where, from equation (II-27c), p. II-18 ,

(II-27c)

$$V_y = -R \dot{\theta}_{z_a} (x_r + \mu \sin \theta_{z_a})$$

(II-169)

$$V_y^2 = R^2 \dot{\theta}_{z_a}^2 \left[x_r^2 + \frac{\mu^2}{2} + 2x_r \mu \sin \theta_{z_a} - \frac{\mu^2}{2} \cos 2\theta_{z_a} \right]$$

The total torsion on the stiff blade is, then,

(II-170)

$$M_x = M_{x_d} + M'_{x_d} + \Delta M'_{x_d} + M_{x_{a_1}} + M_{x_{a_2}} + M_{x_{a_3}}$$

equ. (II-160) (II-162) (II-163) (II-165) (II-167) (II-168)

b. Flexible blade.

A. Torsion due to Z deflection.

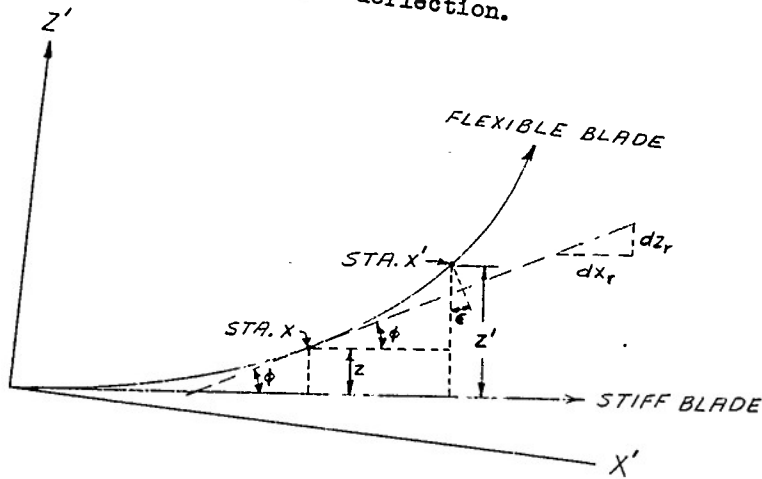

Fig. II-30

The torsion at station x due to a Y load, $d(F_y)$, at station x' , outboard of x , is

(II-171)

$$d(M_{x_z}) = [z' - z - (x' - x) \sin \phi] \cos \epsilon d(F_y) \quad \text{Fig. II-30}$$

For small deflections this reduces to

(II-171a)

$$d(M_{x_z}) = [(z' - z) - \left(\frac{dz}{dx}\right) (x' - x)] d(F_y)$$

Integrating from x to the tip to find the total torsion at x , and changing to x_r and z_r :

(II-172)

$$(M_{x_z}) = R \int_{x_r}^1 \frac{d(F_y)}{dx_r'} \left[(z_r' - z_r) - \left(\frac{dz_r}{dx_r'}\right) (x_r' - x_r) \right] dx_r'$$

$\frac{dz_r}{dx_r'}$ is the slope @ sta. x_r .

However,

$$(II-173) \quad \frac{d(F_y)}{dx'_r} = \frac{1}{R} \frac{d^2 M_z}{dx_r^2} \text{ at sta. } x'_r$$

The torsion at a station x'_r is, of course, a harmonic function of θ_{z_a} :

$$(II-174) \quad (M_{x_z}) = (M_{x_z 1}) + (M_{x_z 2}) \cos \theta_{z_a} + (M_{x_z 3}) \sin \theta_{z_a} + (M_{x_z 4}) \cos 2\theta_{z_a} + (M_{x_z 5}) \sin 2\theta_{z_a}$$

M_z and z_r have been found as harmonic functions of θ_{z_a} :

$$(II-175) \quad M_z = M_{z1} + M_{z2} \cos \theta_{z_a} + M_{z3} \sin \theta_{z_a} + M_{z4} \cos 2\theta_{z_a} + M_{z5} \sin 2\theta_{z_a}$$

$$(II-176) \quad z_r = z_{r1} + z_{r2} \cos \theta_{z_a} + z_{r3} \sin \theta_{z_a} + z_{r4} \cos 2\theta_{z_a} + z_{r5} \sin 2\theta_{z_a}$$

$$(II-177) \quad \text{Letting } \Delta z'_{r1} = (z'_{r1} - z_{r1}) - \left(\frac{dz_{r1}}{dx_r}\right)(x'_r - x_r) \text{ and}$$

substituting (II-173), (II-174), (II-175) and (II-176) into (II-172), and neglecting harmonics higher than the second, by equating coefficients of identical trigonometric functions:

$$(II-178a) \quad (M_{x_z 1}) = \int_{x_r}^1 \left[\frac{d^2 M_{z1}}{dx_r^2} \Delta z'_{r1} + \frac{1}{2} \left(\frac{d^2 M_{z2}}{dx_r^2} \cdot \Delta z'_{r2} + \frac{d^2 M_{z3}}{dx_r^2} \cdot \Delta z'_{r3} + \frac{d^2 M_{z4}}{dx_r^2} \Delta z'_{r4} + \frac{d^2 M_{z5}}{dx_r^2} \cdot \Delta z'_{r5} \right) \right] dx'_r$$

(X-178 b)

$$(M_{x_2})_2 = \int_{x_r}^1 \left[\frac{d^2 M_{z_1}}{dx_r^2} \Delta z'_{r_2} + \frac{d^2 M_{z_2}}{dx_r^2} \Delta z'_{r_1} + \frac{1}{2} \left(\frac{d^2 M_{z_5}}{dx_r^2} \Delta z'_{r_3} \right. \right.$$

$$\left. \left. + \frac{d^2 M_{z_3}}{dx_r^2} \Delta z'_{r_5} + \frac{d^2 M_{z_4}}{dx_r^2} \Delta z'_{r_2} + \frac{d^2 M_{z_2}}{dx_r^2} \Delta z'_{r_4} \right) \right] dx'_r$$

(c)

$$(M_{x_2})_3 = \int_{x_r}^1 \left[\frac{d^2 M_{z_1}}{dx_r^2} \Delta z'_{r_3} + \frac{d^2 M_{z_3}}{dx_r^2} \Delta z'_{r_1} + \frac{1}{2} \left(\frac{d^2 M_{z_5}}{dx_r^2} \Delta z'_{r_2} \right. \right.$$

$$\left. \left. + \frac{d^2 M_{z_2}}{dx_r^2} \Delta z'_{r_5} - \frac{d^2 M_{z_4}}{dx_r^2} \Delta z'_{r_3} - \frac{d^2 M_{z_3}}{dx_r^2} \Delta z'_{r_4} \right) \right] dx'_r$$

(d)

$$(M_{x_2})_4 = \int_{x_r}^1 \left[\frac{d^2 M_{z_4}}{dx_r^2} \Delta z'_{r_1} + \frac{d^2 M_{z_1}}{dx_r^2} \Delta z'_{r_4} + \frac{1}{2} \left(\frac{d^2 M_{z_2}}{dx_r^2} \Delta z'_{r_2} \right. \right.$$

$$\left. \left. - \frac{d^2 M_{z_3}}{dx_r^2} \Delta z'_{r_3} \right) \right] dx'_r$$

(e)

$$(M_{x_2})_5 = \int_{x_r}^1 \left[\frac{d^2 M_{z_5}}{dx_r^2} \Delta z'_{r_1} + \frac{d^2 M_{z_1}}{dx_r^2} \Delta z'_{r_5} + \frac{1}{2} \left(\frac{d^2 M_{z_2}}{dx_r^2} \Delta z'_{r_3} \right. \right.$$

$$\left. \left. + \frac{d^2 M_{z_3}}{dx_r^2} \Delta z'_{r_2} \right) \right] dx'_r$$

If the step-by-step tabular process has been used to find the M_z , it may be more convenient to use as a formula for $\Delta z'_{r_1}$, in place of (X-177),

$$(II-179) \quad \Delta z_{r1}' = \int_{x_r}^{x_r'} \int_{x_r}^{x_r'} \frac{M_{y1}}{EI_y} dx_r' dx_r'$$

The integrations indicated can probably best be done graphically.

B. Torsion due to deflection in Y direction.

The theory for M_{xy} is exactly similar to that for M_{xz} , and we can write, by inspection of (II-178),

if

$$M_y = M_{y1} + M_{y2} \cos \theta_{za} + M_{y3} \sin \theta_{za} + M_{y4} \cos 2\theta_{za} + M_{y5} \sin 2\theta_{za}$$

$$y_r = y_{r1} + y_{r2} \cos \theta_{za} + y_{r3} \sin \theta_{za} + y_{r4} \cos 2\theta_{za} + y_{r5} \sin 2\theta_{za}$$

then

$$(II-180) \quad M_{xy} = (M_{xy})_1 + (M_{xy})_2 \cos \theta_{za} + (M_{xy})_3 \sin \theta_{za} + (M_{xy})_4 \cos 2\theta_{za} + (M_{xy})_5 \sin 2\theta_{za}$$

where

(a-18(a))

$$(M_{xy})_1 = \int_{x_r}^1 \left[\frac{d^2 M_{y1}}{dx_r^2} \Delta y_{r1}' + \frac{1}{2} \left(\frac{d^2 M_{y2}}{dx_r^2} \Delta y_{r2}' + \frac{d^2 M_{y3}}{dx_r^2} \Delta y_{r3}' + \frac{d^2 M_{y4}}{dx_r^2} \Delta y_{r4}' + \frac{d^2 M_{y5}}{dx_r^2} \Delta y_{r5}' \right) \right] dx_r'$$

(b)

$$(M_{xy})_2 = \int_{x_r}^1 \left[\frac{d^2 M_{y1}}{dx_r^2} \Delta y_{r2}' + \frac{d^2 M_{y2}}{dx_r^2} \Delta y_{r1}' + \frac{1}{2} \left(\frac{d^2 M_{y3}}{dx_r^2} \Delta y_{r5}' + \frac{d^2 M_{y4}}{dx_r^2} \Delta y_{r2}' + \frac{d^2 M_{y5}}{dx_r^2} \Delta y_{r4}' \right) \right] dx_r'$$

(c)

$$(M_{xy})_3 = \int_{x_r}^1 \left[\frac{d^2 M_{y1}}{dx_r^2} \Delta y_{r3}' + \frac{d^2 M_{y3}}{dx_r^2} \Delta y_{r1}' + \frac{1}{2} \left(\frac{d^2 M_{y2}}{dx_r^2} \Delta y_{r5}' + \frac{d^2 M_{y4}}{dx_r^2} \Delta y_{r3}' - \frac{d^2 M_{y5}}{dx_r^2} \Delta y_{r4}' \right) \right] dx_r'$$

(d)

$$(M_{xy})_4 = \int_{x_r}^1 \left[\frac{d^2 M_{y4}}{dx_r^2} \Delta y_{r1}' + \frac{d^2 M_{y1}}{dx_r^2} \Delta y_{r4}' + \frac{1}{2} \left(\frac{d^2 M_{y2}}{dx_r^2} \Delta y_{r2}' - \frac{d^2 M_{y3}}{dx_r^2} \Delta y_{r3}' \right) \right] dx_r'$$

$$(II-181e) \quad (M_{xy})_5 = \int_{x_r}^1 \left[\frac{d^2 M_{y5}}{dx_r^2} \Delta y'_{r1} + \frac{d^2 M_{y1}}{dx_r^2} \Delta y'_{r5} + \frac{1}{2} \left(\frac{d^2 M_{y2}}{dx_r^2} \Delta y'_{r3} + \frac{d^2 M_{y3}}{dx_r^2} \Delta y'_{r2} \right) \right] dx'_r$$

For $\Delta y'_{r1}$ either

$$(II-182a) \quad \Delta y'_{r1} = (y'_{r1} - y_{r1}) - \frac{dy_{r1}}{dx_r} (x'_r - x_r)$$

$\left(\frac{dy_{r1}}{dx} \right)$ is slope at x_r

or

$$(II-182b) \quad \Delta y'_{r1} = \int_{x_r}^{x'_r} \int_{x_r}^{x'_r} \frac{M_{z1}}{EI_z} dx'_r dx'_r$$

may be used, whichever is most convenient.

The Effect of blade flexure on the distribution of load along the blade in the Z direction.

The effect of blade bending and twisting on the load distribution in the Z direction will arise from their effects on the dynamic pressure and angle of attack at any given station along the blade. The effect of change in dynamic pressure will be entirely negligible. The change in angle of attack may be appreciable, and is in two parts, that due to structural twist, and that due to change in downwash.

(II-183) From (II-73a) $\theta_{y_f} - \theta_y = \frac{z}{x}$

If we assume that the flapping coefficients for the flexible blade are

(II-184a) $a_{0_f} = a_0 + \Delta a_0$

(b) $a_{1_f} = a_1 + \Delta a_1$

(c) $b_{1_f} = b_1 + \Delta b_1$

(d) $a_{2_f} = a_2 + \Delta a_2$

(e) $b_{2_f} = b_2 + \Delta b_2$

where a_0, a_1, b_1, a_2, b_2 , are for the stiff blade, then it is apparent that

(II-185a) $\Delta a_0 = \frac{z_{r1}}{x_r}$

(b) $\Delta a_1 = - \frac{z_{r2}}{x_r}$

(c) $\Delta b_1 = - \frac{z_{r3}}{x_r}$

$$(II-185d) \quad \Delta a_2 = - \frac{z_{r4}}{x_r}$$

$$(e) \quad \Delta b_2 = - \frac{z_{r5}}{x_r}$$

From (II-29) it may be seen that the change in downwash angle, $\theta_1 = \frac{u_z}{u_y}$, is a linear function of the changes in the flapping coefficients, given above.

The change in angle of attack due to structural twist will be a harmonic function of θ_{z_a} and can be regarded as a change in θ'_{x_0} . Thus

$$(II-186) \quad \theta'_{x_{of}} = \theta'_{x_0} + \Delta\theta_{x_{s1}} + \Delta\theta_{x_{s2}} \cos \theta_{z_a} + \Delta\theta_{x_{s3}} \sin \theta_{z_a} + \Delta\theta_{x_{s4}} \cos 2\theta_{z_a} + \Delta\theta_{x_{s5}} \sin 2\theta_{z_a}$$

where

$$(II-186a) \quad \Delta\theta_{x_{s1}} = \int_0^x \frac{M_{x_1}}{GI_p} dx$$

where $\Delta\theta_{x_{s1}}$ is the structural twist at any station (reference is the root)

M_{x_1} is the total torsion at any station.

GI_p is the torsional rigidity of the blade.

Substituting from (II-185) and (II-186) in (I-34a) to (e), we obtain expressions for the Z load on the flexible blade. Upon subtracting equations (I-34a) to (e) from these expressions, we find the change in Z direction air load due to flexure to be:

$$(II-187) \quad \Delta \left[\frac{d(F_z)}{dx_r} \right] \cdot \frac{1}{cC_{z_a}} = \Delta A_{0_a} + \Delta A_{1_a} \cos \theta_{z_a} + \Delta B_{1_a} \sin \theta_{z_a} + \Delta A_{2_a} \cos 2\theta_{z_a} + \Delta B_{2_a} \sin 2\theta_{z_a}$$

where

$$(II-187a) \quad \Delta A_{0_a} = -\frac{\mu^2}{2} \left[+\Delta\theta_{x_{s1}} - \frac{1}{2} (\Delta\theta_{x_{s4}} + \frac{z_{r5}}{x_r}) \right] - \mu x_r (\Delta\theta_{x_{s3}}) - x_r^2 (\Delta\theta_{x_{s1}})$$

$$(b) \quad \Delta A_{1_a} = -\frac{\mu^2}{4} \left[\Delta\theta_{x_{s2}} - \frac{z_{r3}}{x_r} \right] - \mu x_r \left[\Delta\theta_{x_{s5}} - \frac{z_{r1}}{x_r} + \frac{z_{r4}}{x_r} \right] - x_r^2 \left[\Delta\theta_{x_{s2}} - \frac{z_{r2}}{x_r} \right]$$

$$(c) \quad \Delta B_{1_a} = -\frac{\mu^2}{4} \left[3\Delta\theta_{x_{s3}} - \frac{z_{r2}}{x_r} \right] - \mu x_r \left[2\Delta\theta_{x_{s1}} - \Delta\theta_{x_{s4}} + \frac{z_{r5}}{x_r} \right] - x_r^2 \frac{z_{r2}}{x_r}$$

$$(II-187 d) \quad \Delta A_{2a} = -\frac{\mu^2}{2} \left[\Delta\theta_{x_{s4}} - \Delta\theta_{x_{s1}} - \frac{1}{2} \Delta\theta_{x_{s2}} \right] + \\ + \mu x_r \left[\Delta\theta_{x_{s3}} + \frac{z_{r2}}{x_r} \right] - x_r^2 \left[\Delta\theta_{x_{s4}} - 2 \frac{z_{r5}}{x_r} \right]$$

$$(e) \quad \Delta B_{2a} = -\frac{\mu^2}{2} \left[\Delta\theta_{x_{s5}} - \frac{z_{r1}}{x_r} \right] - \mu x_r \left[\Delta\theta_{x_{s2}} - \frac{z_{r3}}{x_r} \right] \\ - x_r^2 \left[\Delta\theta_{x_{s5}} + 2 \frac{z_{r4}}{x_r} \right]$$

The additional air loads as found from the above relations can be added to the constant of col. 8, table II- / or added to the shear values in col. 7 of table II-4 in order to find the effect of blade flexure on bending moments and deflections.

PART II SAMPLE CALCULATIONS

It is the object of this section to illustrate how, by the methods given on pages $\pi-1$ to $\pi-145$, all the loads applied to a helicopter rotor blade of general type can be estimated.

Physical characteristics of the helicopter assumed for the example are as follows:

| | |
|---|-----------------------------|
| Gross weight, W | 2700 lbs. |
| Rotor radius, R | 19 ft. |
| Number of blades, b | 3 |
| Blade chord, c | 2.35 - .08x (ft.) |
| Blade twist, θ_t | 0 |
| Blade aerodynamic characteristics | |
| a | 5.75/rad |
| δ_0 | .0110 |
| δ_1 | -.0216 |
| δ_2 | .400 |
| Blade weight | 50 lbs. |
| Blade moment of inertia (root) | 151.2 slug-ft. ² |
| Distribution of blade mass and section moments of inertia | |
| Damping in flapping, K_y | fig. 0 |
| Damping in hunting, K_1 | ft-lbs. rad/sec |

The flight condition analyzed is described by the data below:

| | |
|--|--------|
| BHP delivered to rotor | 135 HP |
| Rotor rpm | 220 |
| Forward speed, V_a | 75 mph |
| Air density, ρ , slugs/ft. ³ | .00238 |

Control:

The usual procedure in analyses of this type is to assume that the total cyclic pitch change due to control and flapping is known in magnitude and phase angle. In this example the magnitude of the cyclic pitch is taken as 7.5° and the azimuth angle for maximum positive pitch is taken as 0° . Thus, $\psi'_1 = .131$ radians, $\psi'_2 = 0$.

Tip speed ratio, μ

.250

From equation (I-5)

$$\bar{c} = 4R \int_0^1 \frac{c}{R} x_r^3 dx_r$$

$$= 4 \cdot 19 \int_0^1 \left(\frac{2.35}{19} - .08 x_r \right) x_r^3 dx_r$$

$$= 2.35 - 19 \cdot .08 \cdot \frac{4}{5} = 1.135 \text{ ft.}$$

$$\sigma_e = \frac{b\bar{c}}{\pi R} = \frac{3 \cdot 1.135}{\pi 19} = .0571 \quad (\text{equ. p.I-14})$$

$$\dot{\theta}_{z_a} = \frac{220 \cdot 2\pi}{60} = 23.1 \text{ rad/sec.}$$

$$C_T = \frac{2700}{.00237 \cdot \pi \cdot 23.1^2 19^4} = .00523 \quad (\text{equ. p.I-14})$$

$$B = 1 - \frac{\sqrt{2 \cdot .00523}}{3} = .966 \quad (\text{equ. I-4})$$

(for simplicity, neglecting taper)

$$Q = \frac{135 \cdot 550}{23.1} = 3210 \text{ ft.-lbs.}$$

$$C_Q = \frac{3210}{.00237 \pi \cdot 23.1^2 \cdot 19^5} = .000327 \quad (\text{equ. p. I-14})$$

$$\frac{2C_Q}{a\sigma} = \frac{2 \cdot .000327}{5.75 \cdot .0571} = .00200$$

$$\frac{2C_T}{a\sigma} = \frac{2 \cdot .00523}{5.75 \cdot .0571} = .0318$$

$$\frac{\delta_0}{a} = \frac{.0110}{5.75} = .00191$$

$$\frac{\delta_1}{a} = \frac{-.0216}{5.75} = -.00376$$

$$\frac{\delta_2}{a} = \frac{.400}{5.75} = .0696$$

$$\lambda_1 = \frac{C_T \dot{\theta}_z a}{2RV_a} = \frac{.00523 \cdot 23.1}{2 \cdot 19 \cdot 75 \cdot 1.467} = .0000289 \quad (\text{equ. p. I-14})$$

Solution for λ :

From figures II-11 to II-19

$\mu = .250 ;$

- $t_1 = -.0151$
- $t_2 = .895$
- $t_3 = .00587$
- $t_4 = -.00010$
- $t_5 = .0019$
- $t_6 = .00050$
- $t_7 = .59$
- $t_8 = .0095$
- $t_9 = -.0050$
- $t_{10} = .198$
- $t_{11} = .0073$
- $t_{12} = .00005$
- $t_{13} = -.00014$
- $t_{14} = .00148$
- $t_{15} = .00019$
- $t_{16} = .0039$
- $t_{17} = -.00013$
- $t_{18} = -.0886$
- $t_{19} = -.0011$
- $t_{20} = .00007$
- $t_{21} = .0620$
- $t_{22} = -.265$
- $t_{23} = -.793$
- $t_{24} = .0525$
- $t_{25} = -.0230$
- $t_{26} = .0915$

- $t'_1 = -.0466$
- $t'_2 = .339$
- $t'_3 = .0390$
- $t'_4 = .00011$
- $t'_5 = -.0276$
- $t'_6 = .0212$
- $t'_7 = -3.02$
- $t'_8 = -.150$
- $t'_9 = -.00060$
- $t'_{10} = .089$
- $t'_{11} = -.838$
- $t'_{12} = -.00960$
- $t'_{13} = -.00002$
- $t'_{14} = .0090$
- $t'_{15} = -.0195$
- $t'_{16} = -.00019$
- $t'_{17} = .00011$
- $t'_{18} = .0068$
- $t'_{19} = -.0057$
- $t'_{20} = .0071$
- $t'_{21} = -.0700$

, for

- $t_n + (\frac{\delta_2}{a}) t'_n$
- .0183
- .919
- .00858
- .000092
- 0
- .00198
- .380
- .0009
- .00504
- .204
- .0510
- .000619
- .000142
- .00211
- .00117
- .00389
- .000122
- .0881
- .0015
- .000564
- .0571

substituting these coefficients into equation ($\pi-60$) and solving the quadratic for λ , we get

$$\lambda = -.067 \quad (\text{discarding the } + \text{ root}).$$

The tip-loss factor, B:

The tip-loss factor, B, was computed on page $\pi-147$, neglecting the blade taper, to be

$$B = .966 .$$

It will be noted that both the collocation method and tabular solutions for the bending moments and deflections involve air loads, the expressions for which are continuous out to $x_r = 1.00$. To modify the solutions for the bending moments so that the air loads consistently become zero at $x_r = B$ would involve great numerical complication. It is advisable, therefore, to compute the air loads in a manner consistent with the way in which they are treated in the later work; i.e., $B = 1.00$. Therefore, in the following calculations the value of the tip-loss factor, B, is taken as unity.

Solution for flapping coefficients:

Using equation ($\pi-38$) to solve for θ'_{x_0} , with $B = 1.00$, we find

$$\theta'_{x_0} = .182 \text{ radians.}$$

$$\gamma'_F = \frac{\bar{c} a \rho R^4}{I_F} = 13.387 \quad (\text{see definition})$$

Solving for the flapping coefficients, by equations (II-50) we find

$$b_2 = -.003091$$

$$a_2 = +.006538$$

$$a_0 = +.174107$$

$$a_1 = +.091199$$

$$b_1 = -.073674$$

Solution for Z direction air loads:

Solving now for the coefficients of the Z direction air loads, by equation (II-34), we find

$$A_{0a} = .005639 - .067 x_r + .182 x_r^2$$

$$A_{1a} = .000896 - .0044344 x_r + .057355 x_r^2$$

$$B_{1a} = -.015325 + .091387 x_r - .091199 x_r^2$$

$$A_{2a} = -.005688 + .022800 x_r - .006182 x_r^2$$

$$B_{2a} = -.005441 + .014335 x_r - .013076 x_r^2$$

We now find the harmonic parts of the air load distribution,

$$\frac{d(F_z)_{a1}}{dx_r} = \frac{cC_{za}}{R} A_{0a}$$

$$\frac{d(F_z)_{a2}}{dx_r} = \frac{cC_{za}}{R} A_{1a}$$

$$\frac{d(F_z)_{a_3}}{dx_r} = \frac{cC_{z_a}}{R} B_{1a}$$

$$\frac{d(F_z)_{a_4}}{dx_r} = \frac{cC_{z_a}}{R} A_{2a}$$

$$\frac{d(F_z)_{a_5}}{dx_r} = \frac{cC_{z_a}}{R} B_{2a}$$

From (x-35) , $C_{z_a} = 25,043.8$

and substituting $c = 2.35 - .08 R x_r$

we find the analytical expressions for the air loads as a function only of x_r :

$$\frac{d(F_z)_{a_1}}{dx_r} = 331.871 - 4157.797 x_r + 13,261.673 x_r^2 - 6928.106 x_r^3$$

$$\frac{d(F_z)_{a_2}}{dx_r} = 52.732 - 2643.878 x_r + 5063.526 x_r^2 - 2183.305 x_r^3$$

$$\frac{d(F_z)_{a_3}}{dx_r} = -901.920 + 5961.753 x_r - 8846.104 x_r^2 + 3471.628 x_r^3$$

$$\frac{d(F_z)_{a_4}}{dx_r} = -334.755 + 1558.367 x_r - 1231.745 x_r^2 + 235.327 x_r^3$$

$$\frac{d(F_z)_{a5}}{dx_r} = -320.218 + 1050.775 x_r - 1315.243 x_r^2 + 497.758 x_r^3$$

where, of course, the total air load at any station is

$$\begin{aligned} \frac{d(F_z)_a}{dx_r} = & \frac{d(F_z)_{a1}}{dx_r} + \frac{d(F_z)_{a2}}{dx_r} \cos \theta_{za} + \frac{d(F_z)_{a3}}{dx_r} \sin \theta_{za} \\ & + \frac{d(F_z)_{a4}}{dx_r} \cos 2\theta_{za} + \frac{d(F_z)_{a5}}{dx_r} \sin 2\theta_{za} \end{aligned}$$

We observe that the air loads given above fail, by more or less, to satisfy the equations from which they were derived, because of assumptions made to simplify the equations for the flapping coefficients. If one attempts to use the air loads in such a state to solve for the bending moments and deflections, one may find an error in the bending moments out of all proportion to the error in the air loads (particularly by the collocation method, which is especially sensitive to such inconsistencies). The equations which the air loads must satisfy come from equation (x-39), and are as follows:

$$(x-188a) \quad R \int_0^1 \frac{d(F_z)_{a1}}{dx_r} x_r dx_r - I_F \dot{\theta}_{za}^2 a_0 = 0$$

$$(b) \quad R \int_0^1 \frac{d(F_z)_{a2}}{dx_r} x_r dx_r + K_y \dot{\theta}_{za} b_1 = 0$$

$$(x-188c) \quad R \int_0^1 \frac{d(F_z)_{a3}}{dx_r} x_r dx_r - K_y \dot{\theta}_{z_a} a_1 = 0$$

$$(d) \quad R \int_0^1 \frac{d(F_z)_{a4}}{dx_r} x_r dx_r - 3I_F \dot{\theta}_{z_a}^2 a_2 + 2K_y \dot{\theta}_{z_a} b_2 = 0$$

$$(e) \quad R \int_0^1 \frac{d(F_z)_{a5}}{dx_r} x_r dx_r - 3I_F \dot{\theta}_{z_a}^2 b_2 - 2K_y \dot{\theta}_{z_a} a_2 = 0$$

These equations, of course, express the condition that the net root moment of the blade be zero. The correct procedure at this point would be to solve equations (x-188) for second approximation values of the flapping coefficients, recompute the air loads, resubstitute in equations (x-188) etc., until adequate accuracy be obtained. Such a procedure is rather laborious, however, even for the sample case considered here, and would be especially so if the variation of chord, c , with x_r were not a simple function, so that the integration indicated by equations (x-188) would have to be done graphically in each successive approximation. And so, instead, we arbitrarily modify the first coefficients in the expressions, p. I-152, for $\frac{d(F_z)_{a1}}{dx_r}$ so that

equations (x-188) are satisfied exactly. In order to do this we simply substitute the first approximation values of the flapping coefficients and air loads into equations (x-188), keeping the first coefficients in $\frac{d(F_z)_{a1}}{dx_r}$ as unknowns.

Upon performing the integrations, analytically in this case, and solving for the unknown coefficients, we find that the modified air load distributions are as follows:

$$\frac{d(F_z)_{a_1}}{dx_r} = 390.931 - 4157.797 x_r + 13,261.673 x_r^2 - 6928.106 x_r^3$$

$$\frac{d(F_z)_{a_2}}{dx_r} = 104.144 - 2643.878 x_r + 5063.526 x_r^2 - 2183.305 x_r^3$$

$$\frac{d(F_z)_{a_3}}{dx_r} = -940.101 + 5961.753 x_r - 8846.104 x_r^2 + 3471.628 x_r^3$$

$$\frac{d(F_z)_{a_4}}{dx_r} = -350.592 + 1558.367 x_r - 1231.745 x_r^2 + 235.327 x_r^3$$

$$\frac{d(F_z)_{a_5}}{dx_r} = -320.752 + 1050.775 x_r - 1315.243 x_r^2 + 497.758 x_r^3$$

These air load distributions are plotted in figure II-31,
page II-166.

FIG. II-31
 DISTRIBUTION OF THE HARMONIC PARTS
 OF THE Z DIRECTION AIR LOADS ALONG
 THE BLADE

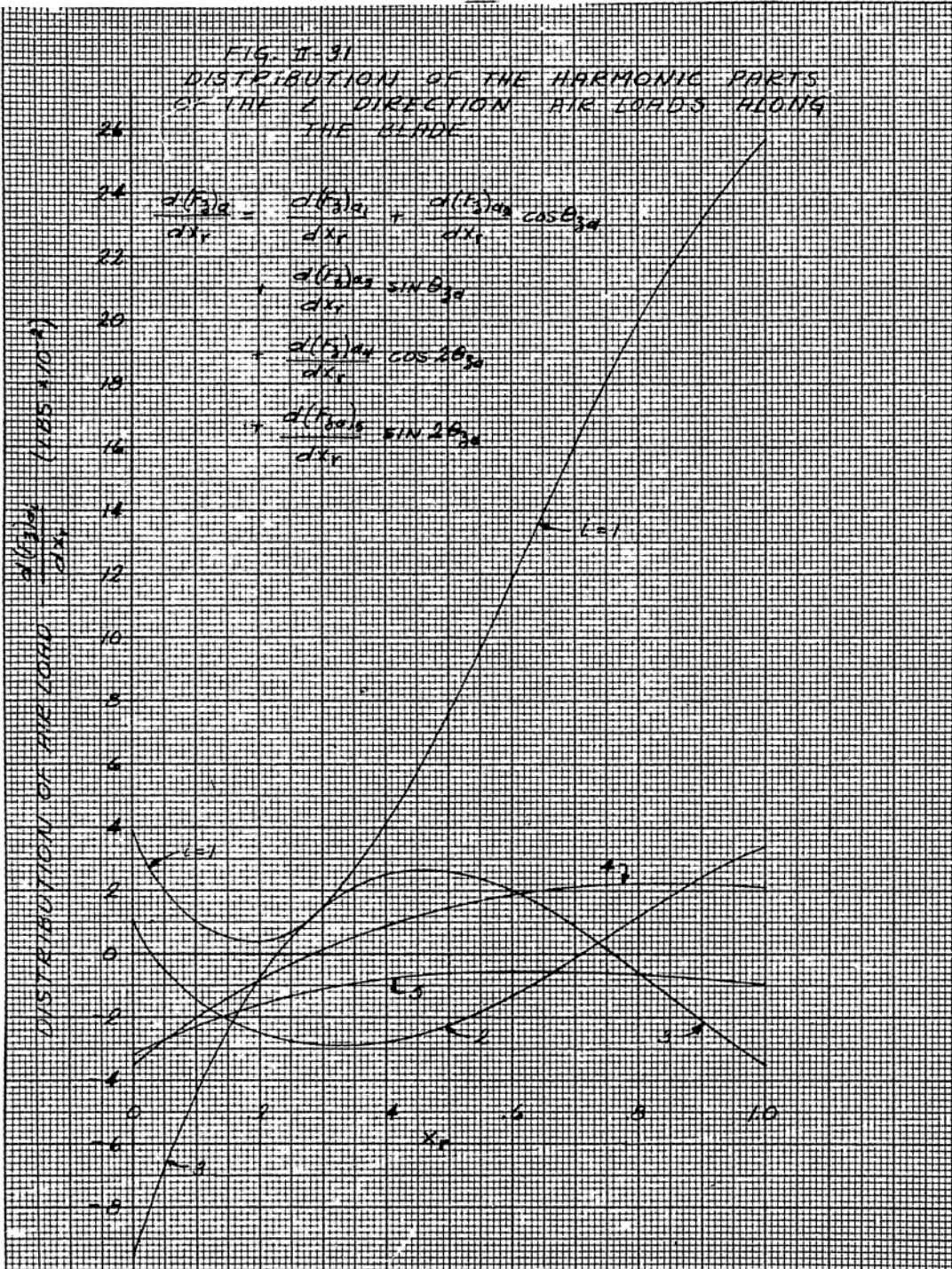

Solution for the Z Direction Bending Moments and Deflections:

a) Collocation method.

The moment of inertia distribution for the subject blades is given in figure II-32, page II-158. In general, the quantity EI_y is a discontinuous function of x_r . Before the derivatives of EI_y with respect to x_r are taken, obviously the curve must be approximated by a continuous function of x_r . The method of doing this is completely arbitrary. We simply fair as smooth a curve as possible thru the actual distribution of I_y , attempting to hit the mid-points of the straight segments (p. II-158). Mathematical means of arriving at this approximation have been suggested, such as the method of least squared error, but the complication involved therein does not seem to be justifiable. The curves of the faired EI_y and its derivatives with respect to x_r (obtained graphically) are shown in figure II-33, page II-159. It is important that the units be kept consistent in this case, we choose lbs., ft., sec., slugs.

In figure II-34, page II-160, we plot the weight distribution of the blade, and, by integrating graphically, obtain the mass moment, M_x , as a function of x_r .

We now can compute the coefficients A_1, B_1, C_1, D_1, E_1 of page II-74 of the differential equations (II-96). We tabulate these solutions below as functions of x_r . (p. II-161)

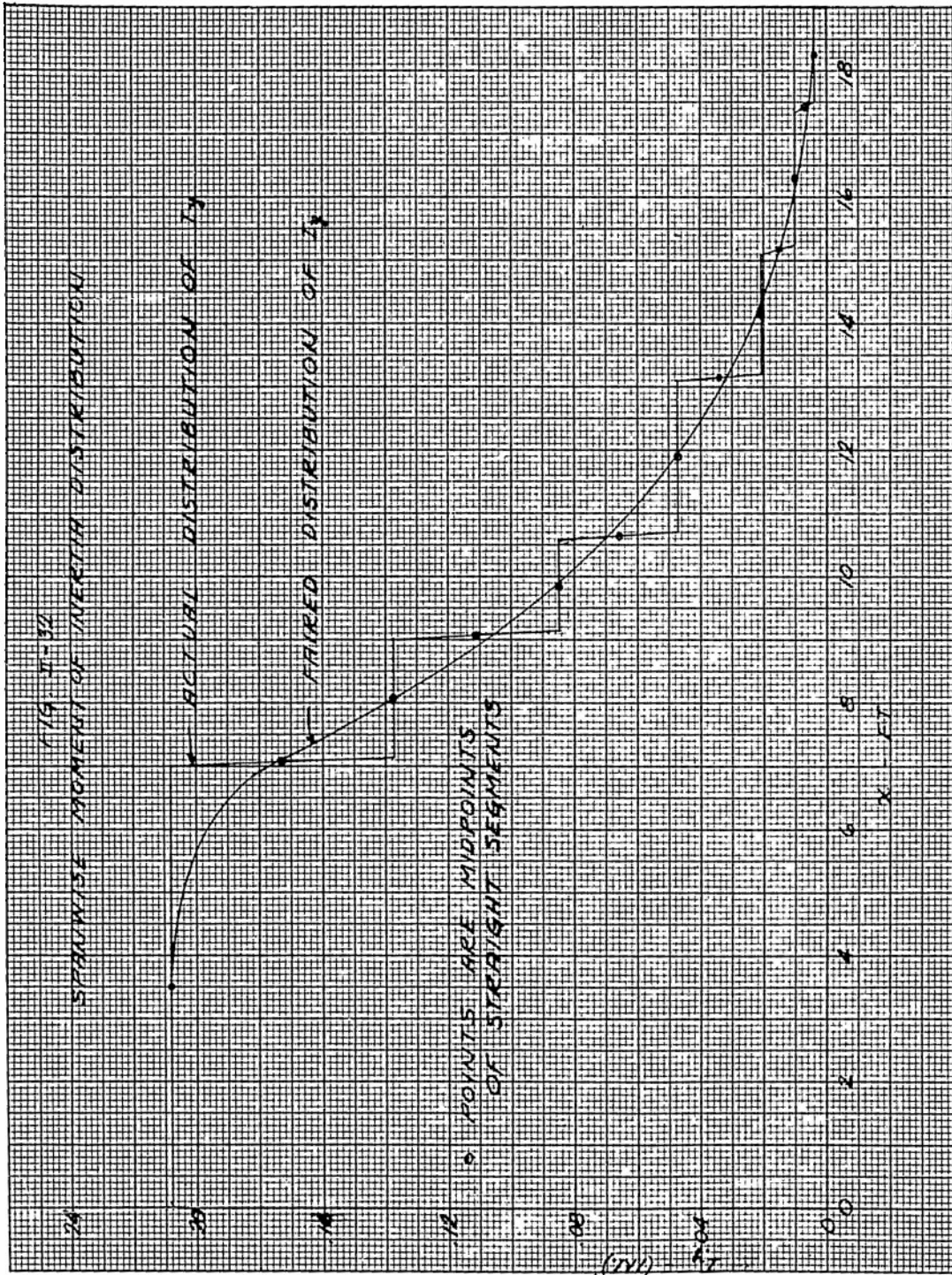

7

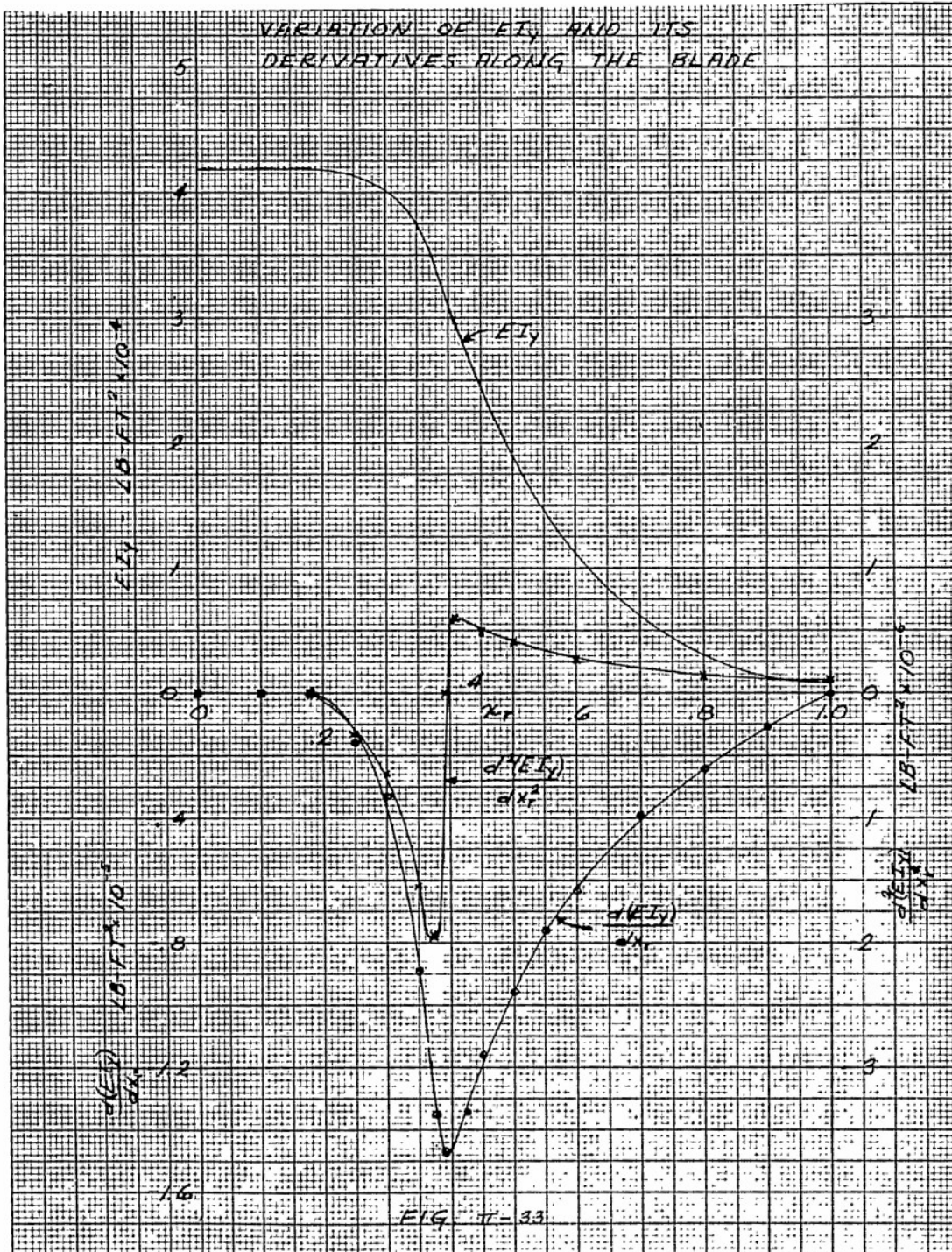

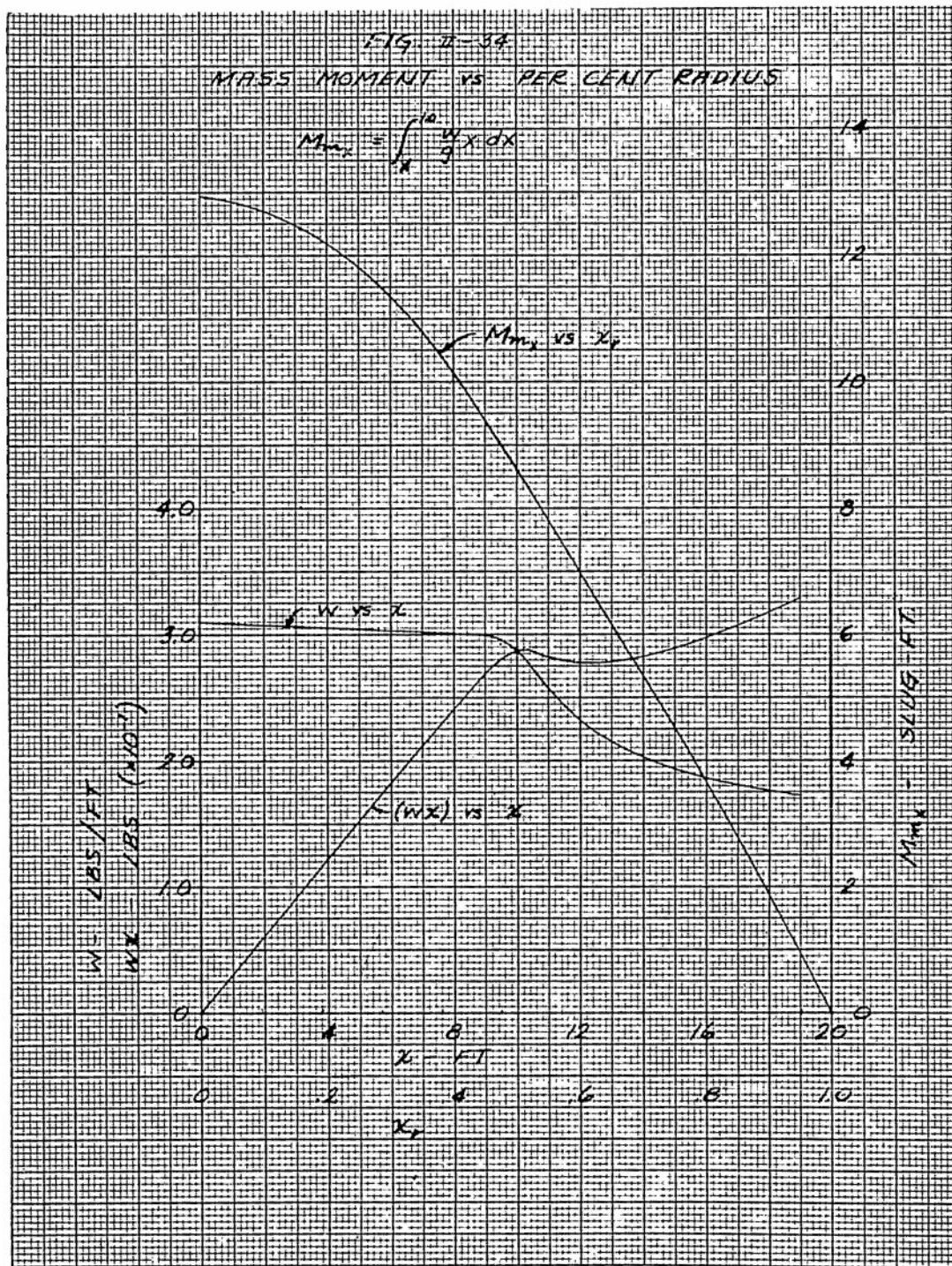

| | | | | | |
|-----------------------|-------|--------|---------|--------|-------|
| $x_r \longrightarrow$ | 0 | .25 | .50 | .75 | 1.00 |
| A_1 | 6.109 | 6.021 | 2.770 | .641 | .117 |
| B_1 | 0 | -3.499 | -27.978 | -9.335 | 0 |
| C_1 | -363 | -375 | -182 | -101.6 | +14.6 |
| D_1, E_2, E_3 | 975 | 956 | 905 | 610 | 545 |
| E_4, E_5 | 3900 | 3824 | 3620 | 2440 | 2180 |

$E_1 = 0$, and since $K_y = 0$, from (II-101) , $L_1 = 0$.

The procedure for the constant and second harmonic parts ($i = 1, 4, 5$) is from here on somewhat different from that for the first harmonic parts ($i = 2, 3$) .

$i = 1, 4, 5$:

The sum of the first five rows of column \mathcal{S} , Table II-1 , is simply the value of

$$-\frac{1}{R} \left\{ \frac{d(F_z)_{a_1}}{dx_r} + \frac{d(F_z)_{m_1}}{dx_r} \right\}$$

for the harmonic (value of i) and the x_r for which the table applies. That is, instead of the first five rows of column \mathcal{S} , Table II-1 , we enter

$$i = 1 ; -\frac{1}{R} \frac{d(F_z)_{a_1}}{dx_r} + mx_r \dot{\theta}_z^2 a_0 R$$

$$i = 4 ; -\frac{1}{R} \frac{d(F_z)_{a_4}}{dx_4} + 3mx_r \dot{\theta}_{z_a}^2 a_2 R$$

$$i = 5 ; -\frac{1}{R} \frac{d(F_z)_{a_5}}{dx_r} + 3mx_r \dot{\theta}_{z_a}^2 b_2 R$$

where $\frac{d(F_z)_{a_i}}{dx_r}$ are the adjusted values given on page II-155

We illustrate the solutions of Table II-1 by giving the solution for $i = 4$, $x_r = .25$ (table II-5, page II-167). Of course 14 other solutions must be made for the other combinations of $i = 1, 4, 5$ and $x_r = 0, .25, .50, .75,$ and 1.00 . Except for the constant of column S , the solutions of Tables II-1, for any x_r are identical for $i = 4$ and 5 . Finally, the results of these tables are entered in Tables II-3 (one for each value of i) as indicated on page II-86. The solution of Table II-3 for $i = 4$ is given on page II-168. Having Table II-6 we find the unknown coefficients T_{n_i} and S_i , in the assumed series for the z deflection. This is given below for $i = 4$:

from Table II-6, row 30 : $S_4 = .00230550$

row 28 : $T_{44} = + 3.397599$

row 26 : $T_{34} = -.061221$

row 24 : $T_{24} = -.791884$

row 22 : $T_{14} = +.461759$

and from equation (II-101d) : $T_{04} = -.032991$

It is advisable to check these values by substituting into the equations represented by 1, 3, 7, 13, 21, Table II-6, and seeing that they are satisfied to at least five significant figures.

These coefficients are then substituted back into equation (II-100c) for $\frac{d^2 z_r}{dx_r^2}$ to find the values of the second derivative as a function of x_r . Finally the bending moment at each station is

$$M = \frac{d^2 z_r}{dx_r^2} \cdot \frac{EI_y}{R}$$

where EI_y is from figure II-33, page II-159.

For $i = 4$, these last steps are given below:

| x_r | $\frac{d^2 z_{r4}}{dx_r^2}$ | $\frac{EI_y}{R}$ | M_4 (ft-lbs) |
|-------|-----------------------------|------------------|-------------------|
| 0 | 0 | 2210 | 0 |
| .125 | .0305 | 2210 | 67 |
| .250 | .0381 | 2180 | 83 |
| .375 | .0438 | 1820 | 80 |
| .500 | .0554 | 1000 | 55 |
| .625 | .0654 | 510 | 33 |
| .750 | .0582 | 237 | 14 |
| .875 | .0270 | 84 | 2 |
| 1.000 | 0 | 0 | 0 |

This, along with the other harmonic parts of the bending moments, is plotted in figure II-35, page II-169.

We now compute the blade deflections by substituting the coefficients T_n and S_1 into equation (II-100a), and solving for various values of x_r . The results of this are deflections measured from the position of the stiff blade, so that the total deflections, z'_1 , from the plane of rotation are

$$z'_1 = R (z_{r1} + a_0 x_r)$$

$$z'_4 = R (z_{r4} - a_2 x_r)$$

$$z'_5 = R (z_{r5} - b_2 x_r)$$

z'_1 is plotted in figure II-36.
1 = 2, 3:

Following the discussion of page II-83, we adopt, for the first harmonic parts, a procedure of successive approximation. The effect on the tables we have set up is simply that we neglect, in Tables II-1, the entries in row 5, columns 1 to 7, and in place of the first five rows of column 8 we put, for the first approximation, the value of

$$-\frac{1}{R} \frac{d(F_2)_{a_1}}{dx_r}$$

(given by equations p. II-155).

Solving Tables II-1 and II-3, and letting the resulting first approximation bending moments and deflections be $(M_1)_1$ and $(z_{r1})_1$, we find the second approximation $(\Delta_2 M_1)$ and $\Delta_2 z_{r1}$ by entering, for the first five rows of column 8, Table II-1, the value

$$- E_1 (z_{r_1})_1$$

which, upon solution, gives us

$$-E_1 \Delta_2 z_{r_1}$$

for the entry in column S , Table $\pi-1$, for the third approximation, $\Delta_3 M_1$ and $\Delta_3 z_{r_1}$. In the subject example, it was judged that the second approximation gave sufficient accuracy. It will be noted that the first five columns of Table $\pi-1$ are identical, for both $i = 2$ and 3 , and for all the approximations, with the corresponding columns in the solution for $i = 1$. This fact of course saves a great deal of computation. Finally, the bending moments and deflections are

$$M_1 = (M_1)_1 + \Delta_2 M_1 + \Delta_3 M_1 + \dots$$

$$z_{r_1} = (z_{r_1})_1 + \Delta_2 z_{r_1} + \Delta_3 z_{r_1} + \dots$$

Because of the indeterminacy of the blade position, we can determine only the deflections due to blade bending, that is, relative to the tangent at the root. This, when added to the deflection of a stiff blade, will at least give a rough approximation to the actual deflection.

Thus

$$z_2' = R \{ z_{r_2} + x_r [2e s_2 - a_1] \}$$

$$= R \{ (z_{r_2})_1 + \Delta_2 z_{r_2} + \Delta_3 z_{r_2} + \dots + x_r [2e ((s_2)_1 + \Delta_2 s_2 + \Delta_3 s_2 + \dots) - a_1] \}$$

and $z_3' = R \{ (z_{r_3}) + \Delta_2 z_{r_3} + \Delta_3 z_{r_3} + \dots + x_r [2e ((s_3)_1 + \Delta_2 s_3 + \Delta_3 s_3 + \dots) - b_1] \}$

The results of these approximations are tabulated below for $i = 2$:

| x_r | $(M_2)_1$ | $\Delta_2 M_2$ | M_2 | $(z_{r_2})_1$ | $\Delta_2 z_{r_2}$ | z_{r_2} | z_2' |
|-------|-----------|----------------|-------|---------------|--------------------|-----------|--------|
| 0 | 0 | 0 | 0 | 0 | 0 | | 0 |
| .125 | 48 | 10 | 58 | | | | |
| .250 | 69 | 12 | 81 | -.00220 | -.00025 | -.00245 | -.42 |
| .375 | 72 | 12 | 84 | | | | |
| .500 | 55 | 11 | 66 | -.00248 | -.00016 | -.00264 | -.80 |
| .625 | 38 | 8 | 46 | | | | |
| .750 | 17 | 4 | 21 | +.00075 | +.00061 | +.00136 | -1.10 |
| .875 | 3 | 1 | 4 | | | | |
| 1.000 | 0 | 0 | 0 | +.00782 | +.00234 | +.01016 | -1.31 |

These results, with those for $i = 3$, are plotted in figures $\pi-35$ and $\pi-36$.

TABLE 7-5 - COEFFICIENTS OF $T_{n,1}$

$x_1 = .25, 1 = 4$

| (1) | (2) $T_{0,4}$ | (3) $T_{1,4}$ | (4) $T_{2,4}$ | (5) $T_{3,4}$ | (6) $T_{4,4}$ | (7) $T_{5,4}$ | (8) Constant |
|-----------|---------------|---------------------------------------|---------------------------------------|---------------------------------------|---------------------------------------|---------------------------------------|---------------------------------------|
| 6.021000 | 12.042000 | -15.052500 | -1.505250 | 1.881563 | 1.458214 | 465.616640 | |
| -3.495000 | 5.248500 | -6.66063 | -6.66063 | -2.87026 | -10.2510 | 75.991102 | 6.545644 |
| -375 | -210.937500 | -52.734375 | -13.183500 | -3.293875 | -8.23875 | -2007.119000 | |
| 956 | 46.037212 | 5.212112 | .875028 | .150092 | .029636 | -748.687576 | |
| 3824 | -100.827408 | -7.656648 | -90.2464 | -13.0016 | -0.22844 | 3922.387696 | 0 |
| | -248.117196 | -70.886474 | -15.422249 | -1.681262 | 4.538521 | 3554.773562 | 6.545644 |
| | | Enter in Table 7-6, row 13, column 1. | Enter in Table 7-6, row 13, column 2. | Enter in Table 7-6, row 13, column 3. | Enter in Table 7-6, row 13, column 4. | Enter in Table 7-6, row 13, column 5. | Enter in Table 7-6, row 13, column 6. |

TABLE II-6 - FOR THE SOLUTION OF THE FIVE LINEAR SIMULTANEOUS EQUATIONS IN FIVE UNKNOWNNS

1 - 4 .

| Column | | 1 | 2 | 3 | 4 | 5 | 6 |
|--------|-------|------------|------------|-----------|------------|---------------|-------------|
| Row | X_r | T_{14} | T_{24} | T_{34} | T_{44} | S_4 | Constant |
| 1 | 1.00 | -63.349615 | -17.993411 | -6.254225 | -2.360200 | 10,033.100985 | - .444000 |
| 2 | | 1.0 | .283086 | .098726 | .037257 | -158.376669 | + .007009 |
| 3 | .75 | -37.179312 | -9.218827 | -3.476197 | -1.934831 | 8,167.409638 | -2.601306 |
| 4 | | 1.0 | .247956 | .095498 | .052041 | -219.676191 | + .069966 |
| 5 | | 0 | .035130 | .005228 | -.014784 | 61.299522 | -.062957 |
| 6 | | X | 1.0 | .148819 | -.420837 | 1,744.933732 | -1.792115 |
| 7 | .50 | -35.965755 | -16.030115 | -8.787640 | -4.751290 | 7,936.253762 | +1.221525 |
| 8 | | 1.0 | .445705 | .244334 | .132106 | -220.661398 | -.033964 |
| 9 | | 0 | -.162619 | -.145608 | -.094849 | 62.284729 | + .040973 |
| 10 | | X | 1.0 | .895394 | .583259 | -383.010159 | -.251957 |
| 11 | | X | 0 | -.746575 | -1.004096 | 2127.943891 | -1.540158 |
| 12 | | X | X | 1.0 | 1.344937 | -2850.274776 | +2.062965 |
| 13 | .25 | -70.886474 | -15.422249 | -1.681262 | .538521 | 9222.965424 | +6.545644 |
| 14 | | 1.0 | .217563 | .023718 | -.007597 | -73.680706 | -.092340 |
| 15 | | 0 | .065523 | .075008 | .044854 | -84.695963 | + .099349 |
| 16 | | X | 1.0 | 1.144758 | .684554 | -1292.614242 | +1.516246 |
| 17 | | X | 0 | -.995939 | -1.105391 | 3037.547974 | -3.308361 |
| 18 | | X | X | 1.0 | 1.109898 | -3049.933755 | +3.321851 |
| 19 | | X | X | 0 | .235039 | 199.658979 | -1.258886 |
| 20 | | X | X | 1.0 | 1.0 | 849.471700 | -5.356073 |
| 21 | 0 | -24.436000 | 12.218000 | 0 | 0 | 1087.219023 | +18.452200 |
| 22 | | 1.0 | -.500000 | 0 | 0 | -44.492512 | -.755124 |
| 23 | | 0 | .783086 | .098726 | .037257 | -113.884157 | + .762133 |
| 24 | | X | 1.0 | .126073 | .047577 | -145.429949 | + .973243 |
| 25 | | X | 0 | .022746 | -.468414 | 1890.363681 | -2.765358 |
| 26 | | X | X | 1.0 | -20.593247 | 83,107.521366 | -121.575574 |
| 27 | | X | X | 0 | 21.938184 | 85,957.796142 | +123.638539 |
| 28 | | X | X | X | 1.0 | -3918.181921 | +5.635769 |
| 29 | | X | X | X | 0 | 4767.653631 | -10.991842 |
| 30 | | X | X | X | X | 3225.997714 | -7.437549 |

Explanation on page II-89 .

FIG. II-35
 DISTRIBUTION ALONG THE BLADE
 OF THE HARMONIC PARTS OF THE
 BENDING MOMENTS IN X DIRECTION
 COLLOCATION METHOD.

$$M_x = M_1 + M_2 \cos 2\theta_{30} + M_3 \sin 2\theta_{30} + M_4 \cos 4\theta_{30} + M_5 \sin 4\theta_{30}$$

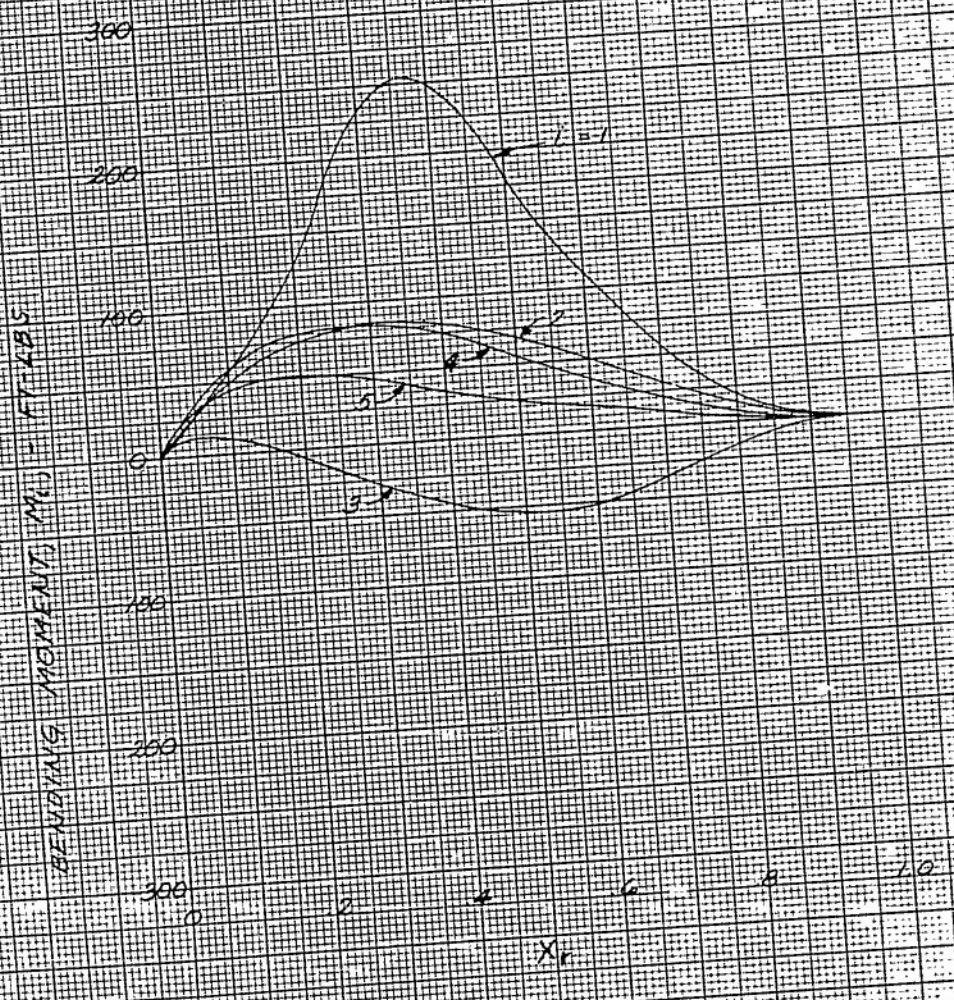
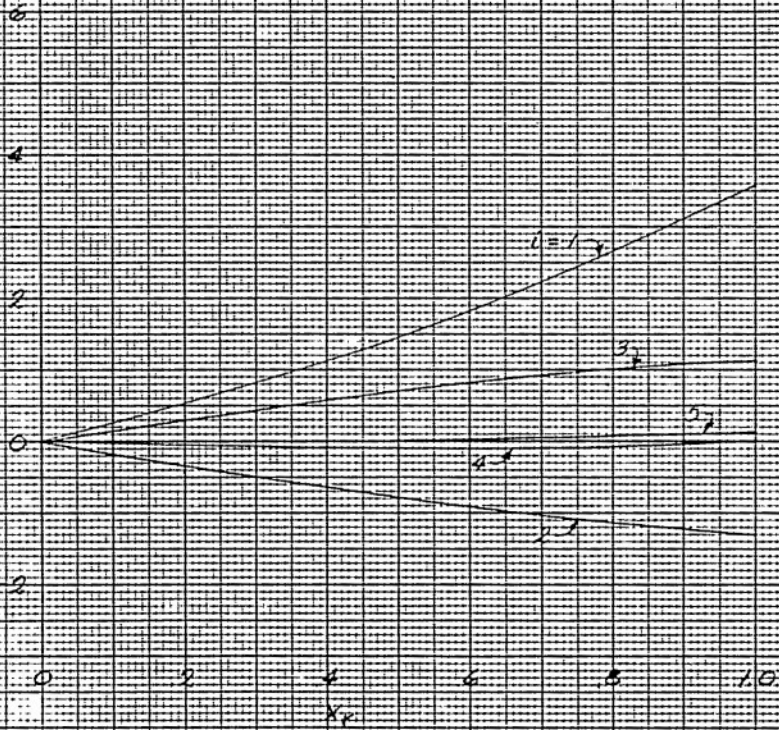

FIG. 1-36
 DISTRIBUTION OF THE HARMONIC
 PARTS OF THE DEFLECTIONS IN
 THE Z DIRECTION.
 COLOCATION METHOD

$$z' = z_1' + \frac{z_2'}{30} \cos 60_{30} + \frac{z_3'}{30} \sin 60_{30} + \frac{z_4'}{30} \cos 20_{30} + \frac{z_5'}{30} \sin 20_{30}$$

DEFLECTION FROM PLANE OF ROTATION

$z' - z_1'$



+

b) Tabular method.

The tabular method of finding the bending moments and deflections is considerably easier than the method of collocation. We present here the solution for $i = 4$, that is, the " $\cos 2\theta_{z_a}$ " part of the deflection and bending moment. The entries in Table $\pi-4$, common to all the different solutions of that table, are $\frac{.01R^2}{EI_y}$ (column 2) and $(F_x)_m$ (column 5). The distribution of EI_y is taken from the curve in figure $\pi-33$, as for the collocation method, and $(F_x)_m$ is simply

$$(F_x)_m = M_{m_x} \theta_{z_a}^2$$

where M_{m_x} is taken from figure $\pi-34$.

The entries in column 7 in the solutions for M' (see p. $\pi-100$) are computed from the modified distributions of air loads used in the collocation method:

$$.1R (F_z) = 1.9 \int_{x_r}^{1.0} \frac{d(F_z)_a}{dx_r} dx_r$$

where $\frac{d(F_z)_a}{dx_r}$ is given on page $\pi-155$, and in this case

the integrations have been performed analytically. The entries in column 8 are computed from figure II-34. In the case of $i = 4$, $P = 4$, and

$$P \dot{\omega}_z^2 (.1R)^2 = 4 \cdot 1.9^2 \cdot 23.1^2 \cdot \frac{v}{32.2}$$

The solutions of Table II-4 for $i = 4$, for M_4^i , E_4 , C_4 are given as tables II-7 to II-9. From these tables:

$$(\Delta x \cdot S)_M^i = -341,734.1$$

$$(\Delta x \cdot S)_c = 25,992,638$$

$$(\Delta x \cdot S)_E = -3319.738$$

and at $x_T = 1$,

$$M^i = -1,010,073.2$$

$$c = 76,798,564$$

$$E = -9815.914$$

Solving for $\left(\frac{dz}{dx}\right)_0$ and S_0 by equations (II-129) and (II-130),
page II-103,

$$\left(\frac{dz}{dx}\right)_0 = -.01415057$$

$$S_0 = -213.614$$

Then, at every station,

$$M = M' + \theta \left(\frac{dz}{dx}\right)_0 + S_0 E$$

Similarly, for the deflections,

$$z_1 = z_M' + z_c \left(\frac{dz}{dx}\right)_0 + S_0 z_E$$

where z_M' , z_c , z_E are column 9 in the solutions for M' , c , E , respectively.

The bending moments so computed are plotted in figure II-37. The deflections are given in figure II-38. As in the collocation solutions, the first harmonic parts of the deflection do not have physical significance, since for $i = 2, 3$ it was necessary to assume the value for $\left(\frac{dz}{dx}\right)_0$ (see p. II-102).

If we make the same assumption as in the collocation method, for z_2 and z_3 , we have

$$(II-189a) \quad z_2 = z_M' + S_0 z_E - R x_r a_1$$

$$(b) \quad z_3 = z_M' + S_0 z_E - R x_r b_1$$

z_2 and z_3 in figure II-38 were computed by these formulae.

Comparing the deflections and bending moments as computed by collocation and the tabular methods, we observe a considerable difference in the results by the two methods. We believe that this is attributable to insufficient convergence in either or both of the methods, and that more terms should be taken in the assumed solution by collocation, and/or smaller increments of blade radius (i.e., more stations) should be considered in the tabular method. Extension of the collocation method to more terms would seem impractical from the point of view of time required to complete the solution. It is desirable to obtain a solution of the differential equations involved by means of a "differential analyzer", which should definitely settle the question of relative accuracy of the two methods.

The hunting coefficients:

Since in later solutions for the Y direction bending moments, the air loads are taken to $x_r = 1$ rather than B, it is advisable to be consistent, and in the equations for the hunting coefficients, to set $B = 1.00$. The coefficients of aerodynamic torque, (G_0, G_1, H_1, G_2, H_2) are computed by equations (II-58), page II-42. Finally, the hunting coefficients, e_0, e_1, f_1, e_2, f_2 are computed by equations (II-71), page II-62.

The Y direction air loads:

The Y direction air loads can be computed as a function of x_r from

$$\frac{d(F_y)_a}{dx_r} = \frac{d(F_y)_{aL}}{dx_r} + \frac{d(F_y)_{aD}}{dx_r}$$

where the harmonic parts of $\frac{d(F_y)_{a_L}}{dx_r}$ and $\frac{d(F_y)_{a_D}}{dx_r}$ are given on pages II-34 to I-40. In these equations, of course, c , the chord, is a function of x_r . In general it will not be necessary to modify the air loads as it was in the case of the Z direction air loads, because severe approximations were not necessary in the solutions for the hunting coefficients

The Y Direction Bending Moments:

a) Collocation method:

The variation of I_z , the moment of inertia about the Z axis, with x_r , must be faired in the same way that I_y was faired in the solution for the Z direction bending moments. The solutions for the coefficients A'_1 to E'_1 for tables II-1 are similar to those for A_1 thru E_1 for the Z direction moments. Since the air loads in this case required no modification, the coefficients F'_1 thru J'_1 can be computed as functions of x_r and entered in tables II-1 as indicated. From this point on, the solution for the bending moments and deflections is exactly similar to that for the Z direction bending moments and deflections. The deflections of the blade relative to the X' axis are of course

$$y'_1 = R (y_{r1} + x_r \sin e_0)$$

$$y'_2 = R (y_{r2} + x_r [2e S'_2 - e_1])$$

$$y'_3 = R (y_{r3} + x_r [2e S'_3 - f_1])$$

$$y'_4 = R (y_{r4} - x_r e_2)$$

$$y'_5 = R (y_{r5} - x_r f_2)$$

b) Tabular method:

The solution by this method is exactly similar to that for the Z direction bending moments, except that, since the air loads were not modified in this case, the entries in column 7, table II-4, can be computed directly by the relations given on page II-120 (equations II-154a to II-154e). Finally, the relations corresponding to equations (II-159a) and (b), page II-173, for the first harmonic deflections, are

$$y_2 = y_M' + S_0 y_E - R x_r e_1$$

$$y_3 = y_M' + S_0 y_E - R x_r f_1$$

TABLE X-7 - STEP BY STEP Solution for Bending Moments

| 1 | 2 | 3 | 4 | 5 | 6 | 7 | 8 | 9 | 10 | 11 | 12 | 13 |
|------|---------------------|-------------------------------|----------------------------------|-----------|--------------------------|------------------|---|----------|-------------------------|---------------------|-------------------------|-----------------------------|
| M' | $\frac{0.1R^2}{EI}$ | $(1) \cdot \frac{0.1R^2}{EI}$ | $\Delta \cdot \frac{0.1R^2}{EI}$ | $(F_x)_m$ | $\Delta x \cdot (F_x)_m$ | $\cdot LR (P_x)$ | $P \approx \frac{6E_a}{L^3} (\Delta x)^2$ | Σ | $(\delta) \cdot \Sigma$ | $\Sigma (\Delta x)$ | $\Sigma \cdot (\delta)$ | $\Delta (\Delta x \cdot S)$ |
| .0 | 0 | 0 | 0 | 6860 | 0 | 175.7 | 744 | 0 | 0 | 0 | 0 | 0 |
| .05 | .0000864 | .0000864 | .0000864 | 6860 | -101.1 | 215.2 | 736 | -0.00759 | -11.1 | -11.1 | -1.9 | -5.586 |
| .10 | .0000864 | .0000864 | .0000864 | 6660 | -101.1 | 215.2 | 732 | -0.01411 | -22.2 | -22.2 | -3.8 | -11.112 |
| .15 | .0000864 | .0000864 | .0000864 | 6310 | -101.1 | 215.2 | 728 | -0.02063 | -33.3 | -33.3 | -5.7 | -16.644 |
| .20 | .0000864 | .0000864 | .0000864 | 5780 | -101.1 | 215.2 | 724 | -0.02715 | -44.4 | -44.4 | -7.6 | -22.176 |
| .25 | .0000864 | .0000864 | .0000864 | 5020 | -101.1 | 215.2 | 720 | -0.03367 | -55.5 | -55.5 | -9.5 | -27.708 |
| .30 | .0000864 | .0000864 | .0000864 | 4180 | -101.1 | 215.2 | 716 | -0.04019 | -66.6 | -66.6 | -11.4 | -33.240 |
| .35 | .0000864 | .0000864 | .0000864 | 3300 | -101.1 | 215.2 | 712 | -0.04671 | -77.7 | -77.7 | -13.3 | -38.772 |
| .40 | .0000864 | .0000864 | .0000864 | 2400 | -101.1 | 215.2 | 708 | -0.05323 | -88.8 | -88.8 | -15.2 | -44.304 |
| .45 | .0000864 | .0000864 | .0000864 | 1500 | -101.1 | 215.2 | 704 | -0.05975 | -99.9 | -99.9 | -17.1 | -49.836 |
| .50 | .0000864 | .0000864 | .0000864 | 600 | -101.1 | 215.2 | 700 | -0.06627 | -111.0 | -111.0 | -19.0 | -55.368 |
| .55 | .0000864 | .0000864 | .0000864 | 0 | -101.1 | 215.2 | 696 | -0.07279 | -122.1 | -122.1 | -20.9 | -60.900 |
| .60 | .0000864 | .0000864 | .0000864 | | -101.1 | 215.2 | 692 | -0.07931 | -133.2 | -133.2 | -22.8 | -66.432 |
| .65 | .0000864 | .0000864 | .0000864 | | -101.1 | 215.2 | 688 | -0.08583 | -144.3 | -144.3 | -24.7 | -71.964 |
| .70 | .0000864 | .0000864 | .0000864 | | -101.1 | 215.2 | 684 | -0.09235 | -155.4 | -155.4 | -26.6 | -77.496 |
| .75 | .0000864 | .0000864 | .0000864 | | -101.1 | 215.2 | 680 | -0.09887 | -166.5 | -166.5 | -28.5 | -83.028 |
| .80 | .0000864 | .0000864 | .0000864 | | -101.1 | 215.2 | 676 | -0.10539 | -177.6 | -177.6 | -30.4 | -88.560 |
| .85 | .0000864 | .0000864 | .0000864 | | -101.1 | 215.2 | 672 | -0.11191 | -188.7 | -188.7 | -32.3 | -94.092 |
| .90 | .0000864 | .0000864 | .0000864 | | -101.1 | 215.2 | 668 | -0.11843 | -199.8 | -199.8 | -34.2 | -99.624 |
| .95 | .0000864 | .0000864 | .0000864 | | -101.1 | 215.2 | 664 | -0.12495 | -210.9 | -210.9 | -36.1 | -105.156 |
| 1.00 | .0000864 | .0000864 | .0000864 | | -101.1 | 215.2 | 660 | -0.13147 | -222.0 | -222.0 | -38.0 | -110.688 |

See explanation on page X-05.

TABLE X-8 - STEP BY STEP Solution for Bending Moments

| i = 4 | 1 | 2 | 3 | 4 | 5 | 6 | 7 | 8 | 9 | 10 | 11 | 12 | 13 |
|----------|-----------|--------------------|------------------------------|-------------|-----------|--------------------------|--------------------|----------------------------------|-------------|---------------|---------------|------------------------------|------------------------------------|
| Sta. (x) | E | $\frac{dIR^2}{EI}$ | $(1) \cdot \frac{dIR^2}{EI}$ | Δs | $(F_x)_m$ | $\Delta x \cdot (F_x)_m$ | $\cdot IR (F_x)_m$ | $F = \frac{d^2}{2} \cdot (IR)^2$ | s | $(s) \cdot s$ | $\Sigma (10)$ | $\frac{\Sigma \cdot (8)}{6}$ | $\Delta(dx \cdot s)$ |
| .0 | 0 | .0000864 | 0 | | | | | 744 | 0 | 0 | | | |
| .05 | | | | 0 | 6860 | 0 | 1.9 | 740 | 0 | 0 | 0 | 0 | 0 |
| .10 | -1.900 | .0000864 | -.0001642 | | | | | 736 | 0 | 0 | | | |
| .15 | | | | -.0001642 | 6660 | -1.094 | 1.9 | 736 | -.0008821 | -1.20 | 0 | -0.070 | -0.060 |
| .20 | -4.914 | .0000864 | -.0004246 | | | | | 732 | -.0001642 | -1.20 | | | |
| .25 | | | | -.0008888 | 6310 | -3.715 | 1.9 | 728 | -.0004586 | -1.20 | -1.20 | -0.071 | -0.324 |
| .30 | -10.720 | .0000900 | -.0009648 | | | | | 724 | -.0007590 | -1.20 | | | |
| .35 | | | | -.0015536 | 5780 | -8.980 | 1.9 | 724 | -.0015988 | -1.661 | -.665 | -0.187 | -1.108 |
| .40 | -22.452 | .0001164 | -.0026124 | | | | | 720 | -.0023066 | -1.661 | | | |
| .45 | | | | -.0043670 | 5000 | -20.918 | 1.9 | 716 | -.0043901 | -4.583 | -2.326 | -0.697 | -3.143 |
| .50 | -48.093 | .0001900 | -.0091377 | | | | | 708 | -.0064736 | -4.583 | | | |
| .55 | | | | -.0133047 | 4180 | -55.614 | 1.9 | 696 | -.0131260 | -6.909 | -6.909 | -1.455 | -8.611 |
| .60 | -113.971 | .000325 | -.0370406 | | | | | 592 | -.0197783 | -11.709 | | | |
| .65 | | | | -.0902453 | 3900 | -166.139 | 1.9 | 592 | -.0449510 | -18.618 | -18.618 | -4.464 | -23.914 |
| .70 | -305.092 | .000882 | -.1779635 | | | | | 504 | -.0701236 | -35.342 | | | |
| .75 | | | | -.2279088 | 2400 | -546.981 | 1.9 | 480 | -.1840780 | -53.960 | -53.960 | -18.233 | -88.337 |
| .80 | -926.166 | .00116 | -.10743526 | | | | | 460 | -.2980324 | -137.095 | | | |
| .85 | | | | -.13022614 | 1470 | -1914.324 | 1.9 | 444 | -.9491631 | -191.095 | -191.095 | -96.347 | -421.428 |
| .90 | -3129.812 | .00278 | -.87008774 | | | | | 432 | -1.6002938 | -691.327 | -691.327 | | |
| .95 | | | | -10.0031388 | 510 | -5101.601 | 1.9 | 420 | -6.6018632 | -882.382 | -882.382 | -700.219 | -2772.783 |
| 1.00 | -9815.914 | | | | | | | | -11.6034326 | | | | |
| | | | | | | | | | | | | | $(\Delta x \cdot s)_E = -3719.728$ |

See explanation on page B-105.

TABLE II-9 - STEP BY STEP Solution for Beading Moments

| i = 4 | 1 | 2 | 3 | 4 | 5 | 6 | 7 | 8 | 9 | 10 | 11 | 12 | 13 |
|------------------------|------------|----------------------|--------------------------------|-------------|-----------|--------------------------|------------------|--------------------------------|-------------|--------------------|---------------|------------------------------|----------------------------|
| Sta. (x _i) | C | $\frac{0.01R^2}{EI}$ | $(1) \cdot \frac{0.01R^2}{EI}$ | Δs | $(F_x)_m$ | $\Delta s \cdot (F_x)_m$ | $\cdot IR (F_x)$ | $P = \frac{1}{2} \cdot (IR)^2$ | * | $(\delta) \cdot s$ | $\Sigma (10)$ | $\frac{E \cdot (\delta)}{6}$ | $\Delta(\Delta x \cdot s)$ |
| 0 | 0 | .0000864 | 0 | 1.9000 | 6660 | 13,034 | 0 | 744 | 0 | 0 | 0 | 294 | 703 |
| .05 | 13,268 | .0000864 | 1.1464 | 3.0464 | 6660 | 20,289 | 0 | 736 | 3,4232 | 1,398 | 1,398 | 374 | 2,519 |
| .10 | 35,329 | .0000864 | 3.0524 | 6.0988 | 6310 | 36,483 | 0 | 728 | 7,9958 | 3,621 | 5,019 | 740 | 5,821 |
| .15 | 79,571 | .0000900 | 7.1614 | 13.2602 | 5780 | 76,644 | 0 | 724 | 17,6753 | 7,997 | 13,016 | 1,600 | 12,797 |
| .20 | 170,831 | .0001164 | 19.8647 | 33.1449 | 5080 | 166,387 | 0 | 716 | 40,8779 | 17,500 | 30,516 | 3,955 | 29,269 |
| .25 | 371,689 | .0001900 | 70.6209 | 103.7658 | 4180 | 437,741 | 0 | 696 | 109,3332 | 95,440 | 166,631 | 34,789 | 190,133 |
| .30 | 887,966 | .000325 | 288.9890 | 392.3548 | 3500 | 1,294,771 | 0 | 592 | 357,3935 | 279,000 | 445,631 | 142,395 | 692,898 |
| .35 | 2,384,157 | .000582 | 1,387.5794 | 1,779,942 | 2400 | 4,271,812 | 0 | 480 | 1,443,5380 | 1,073,412 | 1,519,043 | 753,542 | 3,266,703 |
| .40 | 7,244,025 | .00116 | 8,403.0690 | 10,183,0032 | 1470 | 14,969,015 | 0 | 444 | 7,425,0067 | 5,407,132 | 6,926,175 | 5,477,713 | 21,690,072 |
| .45 | 21,485,625 | .00218 | 68,070.0375 | 78,253,0407 | 510 | 39,909,051 | 0 | 420 | 90,769,5490 | | | | 25,992,638 |
| .50 | 76,798,564 | | | | | | | | | | | | |

See explanation on page II-105.

FIG. II-17
 DISTRIBUTION ALONG THE BLADE
 OF THE HARMONIC PARTS OF THE
 BENDING MOMENTS IN X DIRECTION
 TABULAR METHOD

$$M = M_1 + M_2 \cos \theta_{21} + M_3 \sin \theta_{21} + M_4 \cos \theta_{22} + M_5 \sin \theta_{22}$$

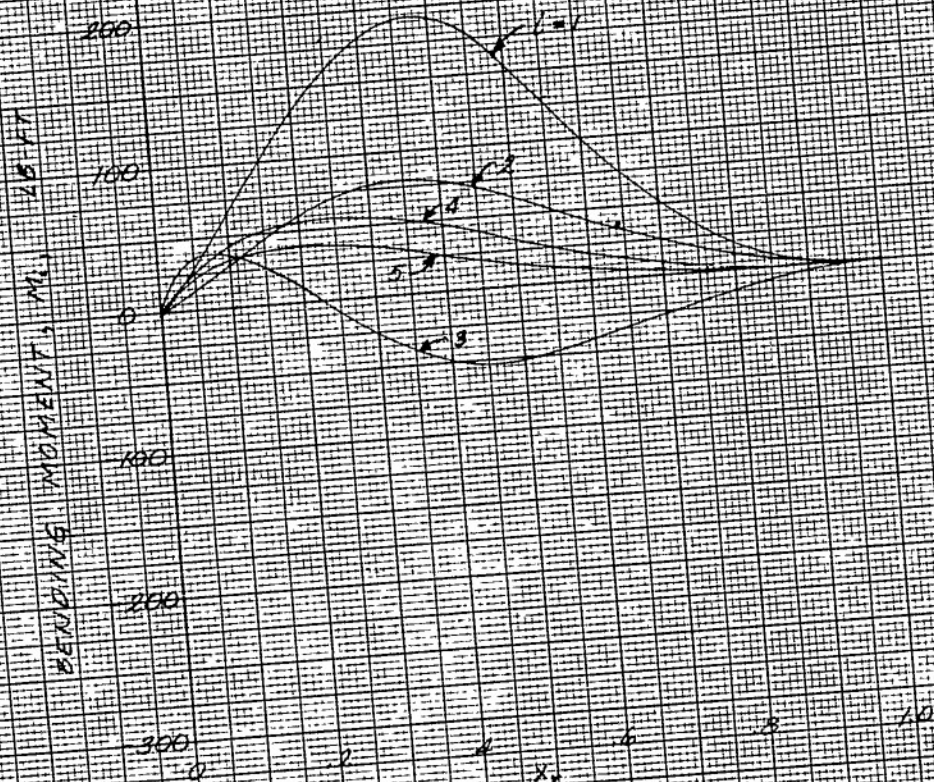
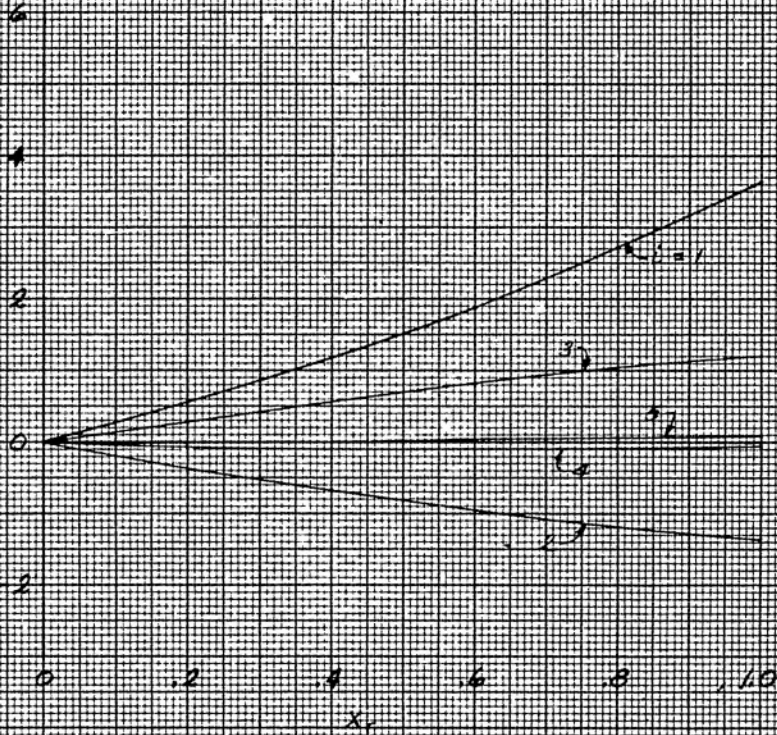

FIG. 7-38
DISTRIBUTION ALONG THE BLADE
OF THE HARMONIC PARTS OF THE
DEFLECTIONS IN THE Z DIRECTION
TABULAR METHOD

DEFLECTION FROM PLANE OF ROTATION - FT

$$z = z_1 + z_2 \cos \theta_{20} + z_3 \sin \theta_{20} + z_4 \cos 2\theta_{20} + z_5 \sin 2\theta_{20}$$



PART III
CENTER-HINGED BLADES RIGID IN THE PLANE
OF ROTATION
(SEE-SAW TYPES)

Center-Hinged Blades Rigid in the Plane of Rotation (See-Saw Type)

The subject blades are continuous from $x = -R$ to $x = R$, and are hinged at the hub by a hinge having its axis in the $X'Y'$ plane. The hinge axis may make an angle, δ_3 , with the blade Y axis, and the blades may have a "built-in coning angle", θ_{y_0} , as shown in the sketch below:

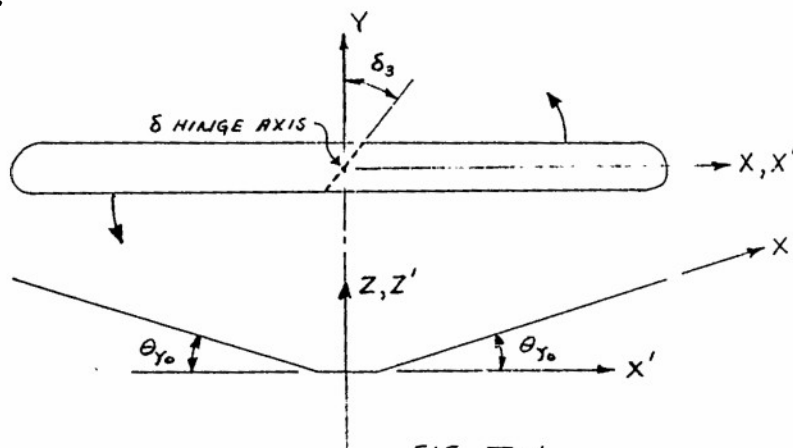

FIG. III - 1

The equations that have been derived in Part II for the accelerations, inertia and aerodynamic forces are, in general, applicable to the "see-saw" type blades. The expressions for the flapping coefficients need be modified, however, and the solution for the inflow factor, λ , should theoretically be somewhat different. It will be necessary to change some of the details in the solution for the blade bending moments, torsion, twist, etc.

If the flapping angle of the right half of the blade be $\theta_{y_r} = a_0 - a_1 \cos \theta_{z_a} - b_1 \sin \theta_{z_a} - a_2 \cos 2\theta_{z_a} - b_2 \sin 2\theta_{z_a}$ then the flapping angle of the left half is

$$\begin{aligned}
 (\text{II-2}) \quad \theta_{y_1} = 2\theta_{y_0} - \theta_{y_r} &= a_0 - a_1 \cos(\theta_{z_a} + \pi) - b_1 \sin(\theta_{z_a} + \pi) \\
 &\quad - a_2 \cos(2\theta_{z_a} + 2\pi) - b_2 \sin(2\theta_{z_a} + 2\pi)
 \end{aligned}$$

Substituting (II-1) in (II-2) and equating coefficients of identical trigonometric functions,

$$\begin{aligned}
 a_0 &= \theta_{y_0} \\
 a_2 &= 0 \\
 b_2 &= 0
 \end{aligned}
 \tag{II-3}$$

Flapping Coefficients, a_1 , b_1 .

As for the general type of blade, p. II-25, we take the sum of all moments on the blade about the flapping hinge,

$$(\text{II-4}) \quad \Sigma M_h = \left\{ (M_y)_a + (M_y)_m + (M_y)_g \right\} \cos \delta_3 + M_x \sin \delta_3 = 0$$

where, as before, $(M_y)_a$, $(M_y)_m$ and $(M_y)_g$ are the moments about the Y axis due to air, inertia and gravity loads, respectively; M_x is the torsion.

$$(\text{II-5}) \quad (M_y)_a = \underbrace{\int_0^B \frac{d(F_z)_a}{dx} \cdot x \, dx}_{\text{for } \theta_{z_a}} - \underbrace{\int_0^B \frac{dF_{z_a}}{dx} \cdot x \, dx}_{\text{for } (\theta_{z_a} + \pi)}$$

The values of the above integrals are given by equation II-42, p. II-27. Substituting for the above integrals the expressions from (II-42) and (II-3), we find

$$\begin{aligned}
 \text{(III-6)} \quad \frac{(M_y)_a}{RCC_{z_a}} &= \sin \theta_{z_a} \left[\frac{4}{3} \mu \theta'_{x_0} B^3 + .106 \mu^4 \theta'_{x_0} + \mu \theta_t B^4 - \frac{1}{2} a_1 B^4 \right. \\
 &+ \mu \lambda B^2 - \frac{1}{4} \mu^3 \lambda + \frac{1}{4} \mu^2 a_1 B^2 - \psi_2' \left(\frac{5}{48} \mu^4 - \frac{B^4}{2} - \frac{3}{4} B^2 \mu^2 \right) \Big] \\
 &+ \cos \theta_{z_a} \left[-\frac{2}{3} \mu \theta'_{y_0} B^3 - .070 \mu^4 \theta'_{y_0} + \frac{1}{2} b_1 B^4 + \frac{1}{4} \mu^2 b_1 B^2 \right. \\
 &\left. - \psi_1' \left(\frac{1}{48} \mu^4 - \frac{B^4}{2} - \frac{\mu^2 B^2}{4} \right) + \frac{1}{4} \lambda_1 B^4 \right]
 \end{aligned}$$

$$\text{(III-7)} \quad (M_y)_m = \underbrace{\int_0^1 \frac{d(F_z)_m}{dx} \cdot x \, dx}_{\text{for } \theta_{z_a}} - \underbrace{\int_0^1 \frac{d(F_z)_m}{dx} \cdot x \, dx}_{\text{for } (\theta_{z_a} + \pi)}$$

The values of the above integrals are given by equation (II-44), p. II-28, and, making appropriate substitutions,

$$\text{(III-8)} \quad (M_y)_m = 0.$$

$(M_y)_g$, the moment due to gravity loads, is obviously zero.

M_x , the torsion on the blade, will be small compared to M_y , and since δ_3 is seldom greater than 30° , we neglect the term $M_x \times \sin \delta_3$.

Substituting (III-5,6,7) into (III-4), and equating coefficients of identical trigonometric functions,

$$(m-9a) \quad a_1 = \frac{1}{\frac{B^4}{2} - \frac{1}{4}\mu^2 B^2} \left\{ \mu \lambda (B^2 - \frac{\mu^2}{4}) + \theta'_{x_0} \mu (\frac{4}{3} B^3 + \underline{.106\mu^3}) \right. \\ \left. + \theta_t \mu B^4 + \psi'_2 (\frac{B^4}{2} + \frac{3}{4} B^2 \mu^2 - \underline{\frac{5}{48} \mu^4}) \right\}$$

$$(m-9b) \quad b_1 = \frac{1}{\frac{B^4}{2} + \frac{1}{4}\mu^2 B^2} \left\{ \mu \theta_{y_0} (\frac{2}{3} B^3 + \underline{.070\mu^3}) - \frac{1}{4} \lambda_1 B^4 \right. \\ \left. - \psi'_1 (\frac{B^4}{2} + \frac{\mu^2 B^2}{4} - \underline{\frac{1}{48} \mu^4}) \right\}$$

With the exception of the underlined terms, which are small enough to be neglected, these expressions are identical with equations (m-50d) and (a), in which

$$a_0 = \theta_{y_0}, \quad a_2 = b_2 = 0, \quad D_y = \infty$$

Solution for λ :

Theoretically, λ can be shown to depend on μ , C_T and α (angle of attack of rotor disc) by the relation

$$(m-10) \quad \tan \alpha = \frac{\lambda}{\mu} + \frac{\frac{1}{2} C_T}{\sqrt{\lambda^2 + \mu^2}}$$

C_T and μ are, of course, independent of the blade hinge configuration, while α , a function of the L/D of the rotor, may be remotely affected by the flapping characteristics. For practical purposes, however, it will be sufficiently accurate to solve for λ by the method arranged in Part II for the general type of hinge configuration.

The Hunting Coefficients:

Theoretically, the relation between the lag angle and the flapping angle can be shown, by methods similar to those of Part I, pp. I-26 to I-43, to be:

$$(III-11) \quad \sin \theta_{z_b} = \frac{\cos \theta_{y_0}}{\cos \theta_y} \sin \delta_3 \cos \delta_3 \cdot \left\{ \sqrt{1 - \frac{1}{\cos^2 \theta_{y_0}} \left(1 - \frac{\sin^2 \theta_y}{\cos^2 \delta_3}\right) + \tan^2 \theta_{y_0} \tan^2 \delta_3} \right\}$$

Since θ_{z_b} , θ_{y_0} and θ_y are small angles, this relation is closely approximated by

$$(III-11a) \quad \theta_{z_b} = \tan \delta_3 (\theta_y^2 - \theta_{y_0}^2)$$

Substituting

$$\begin{aligned} \theta_{z_b} = e_0 - e_1 \cos \theta_{z_a} - f_1 \sin \theta_{z_a} - e_2 \cos 2\theta_{z_a} \\ - f_2 \sin 2\theta_{z_a} \end{aligned}$$

and

$$\theta_y = \theta_{y_0} - a_1 \cos \theta_{z_a} - b_1 \sin \theta_{z_a}$$

and equating coefficients of identical trigonometric functions, we find

$$(III-12a) \quad e_0 = \frac{1}{2} (a_1^2 + b_1^2) \tan \delta_3$$

$$(b) \quad e_1 = 2a_1 \theta_{y_0} \tan \delta_3$$

$$(c) \quad f_1 = 2b_1 \theta_{y_0} \tan \delta_3$$

$$(d) \quad e_2 = \frac{1}{2} (b_1^2 - a_1^2) \tan \delta_3$$

$$(e) \quad f_2 = -a_1 b_1 \tan \delta_3$$

Calculation of the Z Direction Bending Moments and Deflections for the "See-Saw" Type Blade.

On the subject type of blades the end conditions are not known to us for either half of the blade separately since the deflection curve for the right half is influenced by the left half, and vice versa. Therefore the solution must consider the blade as a whole (i.e., $x = R$ to $-R$). Furthermore, one half of the blade must be in the region of reversed flow, and in the equations ($\pi-34$) for the air loads, the plus must be used outboard of $x_r = -\mu \sin \theta_{z_a}$ and minus sign

inboard of $x_r = -\mu \sin \theta_{z_a}$. This requires that the solutions

for the bending moment and deflection curve be carried out separately for each azimuth angle, unless a simplifying assumption concerning the reversed flow region be made (see p. I-4). We, therefore, make the assumption that the airloads are zero inboard of the point $x_r = \mu$.

The collocation method of solution for the bending moments, when extended for the see-saw type blades, becomes much more lengthy than for the fully articulated blades, because of the fact that both blades must be considered. In view of this fact, only the step-by-step method is presented for the see-saw type blades.

The tabular method of finding the bending moments in the Z direction:

The theory which forms the basis of table $\pi-4$, page $\pi-104$ is entirely applicable to the subject blades. The details of the solution (that is, the parts into which the total moment is separated) are different from those for the fully articulated blades because of different end conditions. They are, in fact, different for the different harmonics.

$i = 1$ (Constant part).

For $i = 1$, by definition, the flapping and bending are constant, so that we immediately set $S_0 = 0$. By the same reasoning, we set

$\left(\frac{dz}{dx}\right)_0$, the unknown part of the root slope, $= 0$.

It is then obvious that since the loads on both halves of blades are identical,

$M_R = M_L$ at every station.

Referring to pp. $\pi-97$ to $\pi-99$, the necessary solutions are for M' and A . In more detail than is given on p. $\pi-97$, the initial entries for M' are,

$$(1)_0 = 0 \text{ (no mechanical damping)}$$

$$(4)_0 = .1R\theta_{y_0} + (3)_0$$

$(7)_R$ are given by the same formula as for fully articulated blades, p. $\pi-100$. It must be borne in mind, however, that inboard of $x_R = \mu$, we assume the air load $= 0$. Hence, in that region, $(7)_R$ is constant.

Finally,

$$M = M_R = M_L = AM_0 + M'$$

and

$$M_0 = -\frac{M'}{A} \text{ at the tip station.}$$

$i = 2, 3$ (First harmonic)

Physical reasoning tells us that since the air loads and slope at the root are exact opposites on left and right sides, $M_R = -M_L$ at every station.

Therefore, $x_r = 0$ is a point of inflection and $M_o = 0$.

Furthermore, for the same reason as for the fully articulated blades, p. II-102, the first harmonic inertia loads cancel out and $(\frac{dz}{dx})_o$ and S_o are indeterminate and must only satisfy equation (II-130). We, therefore, assume $(\frac{dz}{dx})_o = 0$, and the total bending moment is given by $M = M' + S_o E$. The initial entries for M' are

$$(1)_o = 0$$

$$(4)_{.05} = (3)_o$$

(7)_r same as on p. II-100 for fully articulated blades, except inboard of $x_r = \mu$, where aerodynamic running loads have been assumed equal to zero.

At the tip, of course,

$$M = 0, \text{ so } S_o = -\frac{M'}{E} \text{ (tip values).}$$

$i = 4, 5$ (Second harmonic)

Again, physical reasoning shows us that since the air loads are identical on right and left sides, the root slope, $(\frac{dz}{dx})_o = 0$ and $S_{oR} = S_{oL}$.

Therefore, $M_R = M_L$ at every station. The necessary solutions are for M', A, E . The initial entries for M' are,

$$(1)_O = 0$$

$$(4)_{.05} = (3)_O$$

(7)_r are again the same as for the articulated blades, p. *x-100*. At any station then,

$$M = M' + AM_O + ES_O$$

and at the tip

$$M' + AM_O + ES_O = 0$$

$$(\Delta x \cdot S)_{M'} + M_O (\Delta x \cdot S)_A + [(\Delta x \cdot S)_E - .1R] S_O = 0$$

Solving for M_O and S_O ,

$$S_O = \frac{(\Delta x \cdot S)_{M'}}{(\Delta x \cdot S)_E} \left\{ \frac{\frac{A}{(\Delta x \cdot S)_A} - \frac{M'}{(\Delta x \cdot S)_{M'}}}{\frac{E}{(\Delta x \cdot S)_E} - \frac{A}{(\Delta x \cdot S)_A} \left[1 - \frac{.1R}{(\Delta x \cdot S)_E} \right]} \right\}$$

and

$$M_O = - \frac{M' + S_O E}{A}$$

where M' , E , A are at $x_r = 1.00$

Calculation of the Bending Moments and Deflections in the Y Direction.

As for the Z direction bending moments, we present only the step-by-step method of finding the Y direction bending moment. Similarly, we make the assumption that the air loads are zero inboard of $x_r = \mu$. The end conditions for the Y direction bending moments are similar to those for the rigid rotors. The blade hunting is determined by the flapping, pp. *iii-15* and not by

the Y air loads, so that it is necessary to include with the aerodynamic shear loads, the inertia loads due to hunting.

i = 1 (Constant part)

We can immediately set $S_o = 0$, and also there is no unknown part of root slope; $(\frac{dy}{dx})_o = 0$. The necessary solutions of table X-4 are for M' and A (p. X-97). The initial entries for M' are,

$$(1)_o = 0$$

$$(4)_{.05} = (3)_o + .1R\theta_{z_{p_o}}$$

(7)_r are given by equation X-154 outboard of $x_r = \mu$. Inboard of this point, (7)_r is, of course, constant. The moment at any station is

$$M = M' + AM_o$$

and

$$M_o = -\frac{M'}{A} \text{ at the tip.}$$

i = 2, 3, 4, 5 (Harmonic parts)

As for $i = 1$, $(\frac{dy}{dx})_o = 0$, and the necessary solutions are for M' , A, and E (p. X-97). The initial entries for M' are,

$$(1)_o = 0$$

$$(4)_{.05} = (3)_o$$

$$(7)_r = .1R (F_y)_1$$

(X-13) where $(F_y)_1 = (F_y)_{a_1} + (F_y)_{m_1}$

$(F_y)_{a_1}$ are given by equations (II-154) and from (II-8c),

$$(III-14a) \quad (F_y)_{m_2} = R^2 \theta_z^2 (e_1 - 2b_1 \theta_{y_0}) \int_{x_r}^{1.0} m x_r dx_r$$

$$(b) \quad (F_y)_{m_3} = R^2 \theta_z^2 (f_1 + 2a_1 \theta_{y_0}) \int_{x_r}^{1.0} m x_r dx_r$$

$$(c) \quad (F_y)_{m_4} = R^2 \theta_z^2 (2a_1 b_1 + 4e_2) \int_{x_r}^{1.0} m x_r dx_r$$

$$(d) \quad (F_y)_{m_5} = R^2 \theta_z^2 (b_1^2 - a_1^2 + 4f_2) \int_{x_r}^{1.0} m x_r dx_r$$

The total moment at any station is

$$M = M' + AM_0 + ES_0$$

where, from the tip end conditions,

$$S_0 = \frac{(\Delta x \cdot S)_{M'}}{(\Delta x \cdot S)_E} \left\{ \frac{\frac{A}{(\Delta x \cdot S)_A} - \frac{M'}{(\Delta x \cdot S)_{M'}}}{\frac{E}{(\Delta x \cdot S)_E} - \frac{A}{(\Delta x \cdot S)_A} \left[1 - \frac{.1R}{(\Delta x \cdot S)_E} \right]} \right\}$$

and

$$M_0 = - \frac{M' + ES_0}{A}$$

where M' , A , E are for $x_r = 1.00$

Torsion

The expressions for the various parts of the torsion,
and for the

Effect of Blade Flexibility on the Air Loads,

which were developed in Pt. II for the fully articulated
blades, are entirely applicable to the see-saw type of blade.
See pp. *V-121* to *V-137*.

PART IV
SINGLE BLADED ROTORS

Single Blade Type

There are many hinge and counterweight arrangements possible for a single-bladed rotor. Some of these are discussed in detail below. (shown schematically fig. IV-1 p. IV-7).

1) Fully articulated hinge arrangement with counterweight attached to the hub.

This case may, in every detail, be treated as a special case of the fully articulated rotor discussed in Part II. All equations and discussions are applicable.

2) Fully articulated hinge arrangement with counterweight attached to the blade.

It is assumed that the center of gravity of the counterweight lies on the X axis. The aerodynamic loads acting on the counterweight are extremely small, and can be entirely neglected. In order to account for the inertia loads due to the counterweight, however, the following changes must be made in the equations of Part II.

(a) Equation (II-44) must be modified to

$$(IV-1) \quad (M_y)_m = - I_F' \dot{\theta}_a^2 (a_0 + 3a_2 \cos 2\theta_{z_a} + 3b_2 \sin 2\theta_{z_a})$$

$$\text{where } I_F' = I_F + I_{F_c}$$

I_{F_c} = moment of inertia of the counterweight about the flapping pin.

Similarly, in the equations for the flapping coefficients, γ_F must be replaced by γ_F' ,

$$(IV-2) \quad \text{where } \gamma_F' = \frac{\bar{c} \rho a R^4}{I_F'}$$

Also, in the equations for the hunting coefficients, pp. II-57 to II-64, it is necessary to replace I_z by I'_z ,

where $I'_z = I_z + I_{z_c}$

and M_m by M'_m

where $M'_m = M_m + M_{m_c}$;

I_{z_c} and M_{m_c} being the moment of inertia and mass moment of the counterweight about the drag hinge, respectively. M_{m_c} is negative.

(b) In the solutions for the bending moments and deflections, the contribution of the inertia forces on the counterweight to the root bending moments must be considered. Thus, equation (II-98), p. II-75 must be rewritten

$$\begin{aligned}
 \text{(II-3)} \quad \left(\frac{d^2 z_r}{dx_r^2} \right)_0 &= - \frac{R}{(EI)_0} \left[(M_y)_d + (M_y)_{m_c} \right] \\
 &= \frac{R}{(EI)_0} \left\{ \theta_{z_a} K_y (a_1 \sin \theta_{z_a} - b_1 \cos \theta_{z_a}) \right. \\
 &\quad \left. + 2a_2 \sin \theta_{z_a} - 2b_2 \cos 2\theta_{z_a} \right. \\
 &\quad \left. + I_{F_c} \ddot{\theta}_{z_a}^2 (a_0 + 3a_2 \cos 2\theta_{z_a}) \right. \\
 &\quad \left. + 3b_2 \sin 2\theta_{z_a} \right\}
 \end{aligned}$$

Thus, equations (II-10/a) to (c), p. II-78 become

$$(II-4 a) \quad L_1 = \frac{I_{F_c} \dot{\theta}_{z_a}^2 R}{(EI)_o} a_o$$

$$(b) \quad L_2 = - \frac{b_1 \dot{\theta}_{z_a} K_y R}{(EI)_o}$$

$$(c) \quad L_3 = \frac{a_1 \dot{\theta}_{z_a} K_y R}{(EI)_o}$$

$$(d) \quad L_4 = \frac{R}{(EI)_o} \dot{\theta}_{z_a} \left\{ 3a_2 I_{F_c} \dot{\theta}_{z_a} - 2b_2 K_y \right\}$$

$$(e) \quad L_5 = \frac{R}{(EI)_o} \dot{\theta}_{z_a} \left\{ 3b_2 I_{F_c} \dot{\theta}_{z_a} + 2a_2 K_y \right\}$$

or, if the tabular method be used,
equations for M'_{i_o} , p. II-100 become:

$$(II-5 a) \quad M'_{1_o} = - I_{F_c} \dot{\theta}_{z_a}^2 a_o$$

$$(b) \quad M'_{2_o} = K_y \dot{\theta}_{z_a} b_1$$

$$(c) \quad M'_{3_o} = - K_y \dot{\theta}_{z_a} a_1$$

$$(x-5d) \quad M'_{40} = \dot{\theta}_{z_a} (2K_y b_2 - 3I_{F_c} \dot{\theta}_{z_a} a_2)$$

$$(e) \quad M'_{50} = -\dot{\theta}_{z_a} (2K_y a_2 + 3I_{F_c} \dot{\theta}_{z_a} b_2)$$

Similarly, equations (x-5a) to (e), p. II-117, for the root moment about the Z axis become:

$$(x-6a) \quad L'_1 = \frac{R}{(EI)_0} e_0 r_1 M_c \dot{\theta}_{z_a}^2$$

$$(b) \quad L'_2 = \frac{R}{(EI)_0} \dot{\theta}_{z_a} \left\{ -f_1 K_1 + \dot{\theta}_{z_a} [I_{z_c} (2a_0 b_1 - a_1 b_2 + a_2 b_1) + e_1 (I_{z_c} - r_1 M_c)] \right\}$$

$$(c) \quad L'_3 = \frac{R}{(EI)_0} \dot{\theta}_{z_a} \left\{ e_1 K_1 + \dot{\theta}_{z_a} [I_{z_c} (-2a_0 a_1 + a_1 a_2 + b_1 b_2) + f_1 (I_{z_c} - r_1 M_c)] \right\}$$

$$(d) \quad L'_4 = \frac{R}{(EI)_0} \dot{\theta}_{z_a} \left\{ -2f_2 K_1 + \dot{\theta}_{z_a} [I_{z_c} (+4a_0 b_2 - 2a_1 b_1) + e_2 (4I_{z_c} - r_1 M_c)] \right\}$$

$$(e) \quad L'_5 = \frac{R}{(EI)_0} \dot{\theta}_{z_a} \left\{ 2e_2 K_1 + \dot{\theta}_{z_a} [I_{z_c} (-4a_0 a_2 + a_1^2 - b_1^2) + f_2 (4I_{z_c} - r_1 M_c)] \right\}$$

or, in the tabular method, equations for M'_{i0} , p. II-119, become

$$(x-7a) \quad M'_{10} = -\frac{(EI)_0}{R} L'_1$$

$$(b) \quad M'_{20} = -\frac{(EI)_0}{R} L'_2$$

$$(c) \quad M'_{30} = -\frac{(EI)_0}{R} L'_3$$

$$(IX-7d) \quad M_{4_0}' = - \frac{(EI)_0}{R} L_4'$$

$$(e) \quad M_{5_0}' = - \frac{(EI)_0}{R} L_5'$$

3) Single hinge attachment and counterweight attached to hub.

The equations and methods of finding the flapping coefficients derived in Part II are applicable. The solution for λ should theoretically be modified somewhat, but, as for the see-saw type blades, the method of Part II is sufficiently accurate for practical purposes.

The hunting coefficients are determined by the flapping and the hinge geometry, in a manner similar to Part III for the see-saw type blades. If $\theta_6 = 0$, from Part I,

$$(IX-8) \quad \sin \theta_{z_b} = \frac{\sin \delta_3 \cos \delta_3}{\cos \theta_y} \left(1 - \sqrt{1 - \left(\frac{\sin \theta_y}{\cos \delta_3} \right)^2} \right)$$

which, for small angles, is closely approximated by

$$(IX-8a) \quad \theta_{z_b} = \tan \delta_3 \cdot \theta_y^2$$

substituting the Fourier expansions for θ_{z_b} and θ_y into (IX-8a) and equating coefficients of identical trigonometric functions, we find

$$(IX-9a) \quad e_0 = \left\{ a_0^2 + \frac{1}{2} (a_1^2 + b_1^2 + a_2^2 + b_2^2) \right\} \tan \delta_3$$

$$(b) \quad e_1 = (2a_0 a_1 - a_1 a_2 - b_1 b_2) \tan \delta_3$$

$$(c) \quad f_1 = (2a_0 b_1 - a_1 b_2 + b_1 a_2) \tan \delta_3$$

$$(IV-9d) \quad e_2 = (2a_0a_2 - \frac{a_1^2}{2} + \frac{b_1^2}{2}) \tan \delta_3$$

$$(e) \quad f_2 = (2a_0b_2 - a_1b_1) \tan \delta_3$$

The solutions for the Z direction bending moments and deflections are identical with those for the fully articulated rotor, Part II; and either the step-by-step or collocation method may be used.

The solution for the Y direction bending moments and deflections, however, is identical with that for the saw type blade, and the tabular step-by-step method is recommended (pp. IV-9, 10, 11).

The expressions for torsion, and blade flexibility influence on the air loads, of Part II, are entirely applicable.

4) Single hinge attachment with counterweight mounted on the blade.

This type is, in general, treated in the same manner as case (3), which has the counterweight attached to the hub. It is, however, necessary, when computing the flapping coefficients, to replace I_F by $I'_F = I_F + I_{F_c}$ and χ_F by χ'_F as in case (2), p. IV-1. The hunting coefficients are computed by equations IV-9a to IV-9e, p. IV-5 (case 3).

The bending moments and deflections in the Z direction can be computed by either the collocation or step-by-step methods of Part II, except that the root bending moments must be modified and computed by equations IV-4a to IV-5e, p. IV-3 (case 2).

The bending moments in the Y direction are best computed by the step-by-step method given for the saw type blade (pp. IV-9 to IV-11, Part III). The method is entirely applicable.

The expressions given in Part II for the torsion and the effect of blade flexibility on the air loads, are also applicable.

5) Rigid blade attachment.

This type may, in every way, be considered the same as the multi-bladed, rigid rotor treated in Part V. All methods and equations are applicable.

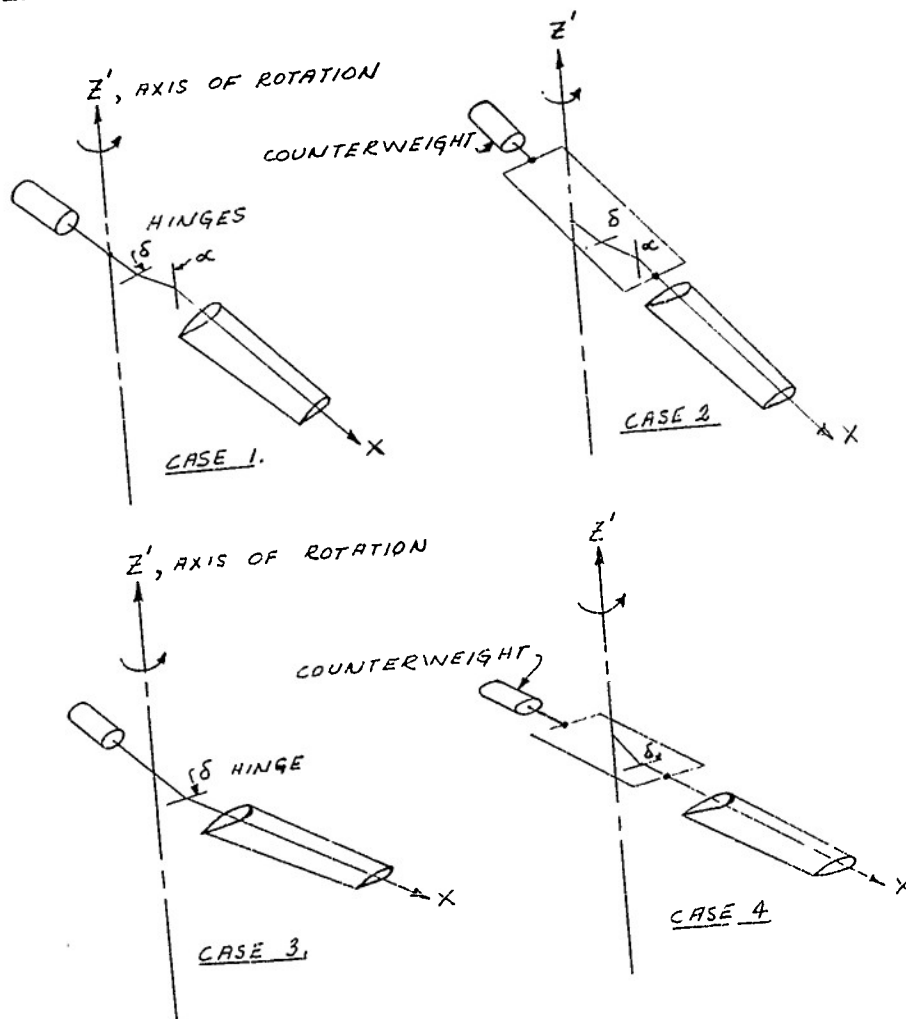

FIG. IV-1.

PRINCETON UNIVERSITY
AERONAUTICAL ENGINEERING LABORATORY

PAGE
REPORT

PART V
RIGIDLY ATTACHED BLADES

Part V Rigid Rotors

By "rigid" rotor, we mean that the blades are rigidly attached to the hub, i. e., flapping and drag hinges are not used. There may, however, be a built-in coning angle, θ_{y_0} , and/or a built-in lag angle, θ_{z_0} . In the first

approximation theory (stiff blade) it is obvious that for the flapping coefficients

$$(x-1) \quad a_0 = \theta_{y_0}$$

$$a_1 = a_2 = b_1 = b_2 = 0$$

and that for the hunting coefficients

$$(x-2) \quad e_0 = \theta_{z_0}$$

$$e_1 = e_2 = f_1 = f_2 = 0$$

As for the "see-saw" type of blade (Part III), it will be sufficiently accurate to solve for λ by the method given in Part II for the fully articulated blades.

All the equations developed in Part II for the air loads are applicable to the rigid rotors, with, of course, substitution of the proper flapping and hunting coefficients given above.

Step-by-step tabular solution for the Z direction bending moments and deflections

The details of the solution for the subject blades are nearly identical with those for the Y direction moments on the see-saw type blade. We can immediately set $(\frac{dz}{dx})_0$, the unknown part of the root slope, = 0. Referring to p. II-97,

for $i = 1$ (constant part)

The necessary solutions of table x-4 are for A and M'. The initial entries for M' are

$$(1)_0 = 0,$$

$$(4)_{.05} = (3)_0 + .1R \theta_{y_0},$$

(7)_r are given by equation ,
p. . Then

$$M = M' + AM_0$$

at any station where

$$M_0 = -\frac{M'}{A} \text{ at } x_r = 1.00$$

for 1 = 2, 3, 4, 5 (harmonic parts)

The necessary solutions are for M', A, and E (p. x-97). The initial entries for M' are

$$(1)_0 = 0,$$

$$(4)_{.05} = (3)_0,$$

(7)_r are given by equation (x-125), p. x-100.
The moment at any station is

$$M = M' + AM_0 + ES_0$$

where, from the tip conditions,

$$S_0 = \frac{(\Delta x S)_{M'}}{(\Delta x S)_E} \left\{ \frac{\frac{A}{(\Delta x S)_A} - \frac{M'}{(\Delta x S)_{M'}}}{\frac{E}{(\Delta x S)_E} - \frac{A}{(\Delta x S)_A} \left[1 - \frac{.1R}{(\Delta x S)_E} \right]} \right\}$$

and

$$M_0 = -\frac{M' + ES_0}{A} \text{ where } A, E, M' \text{ are for}$$

$$x_r = 1.00$$

Step-by-step tabular solution for the Y direction bending moments and deflections.

The solutions for the Y direction moments are identical with those for the Z direction moments, except, of course, that for M' in

$$\underline{i = 1}; \quad (4)_{.05} = (3)_o + .1R \theta_{z_{b_0}} :$$

and in

$$\underline{i = 2, 3, 4, 5}; \quad (7)_r \text{ are given by equation (II-154) p. II-120.}$$

The equations for torsion and the effect of blade flexibility on the air loads, which we developed in Part II, are applicable to the subject rotors.

9

Inertia forces acting on a rigid blade in hovering flight in a turnabout an axis lying in a plane of the rotor.

The action of gyroscopic forces becomes important in case of rigid blades. Only the case of vertical flight is considered in this report, but the major components of these forces calculated for vertical flight are also sufficiently accurate for the case of forward flight.

It is also assumed to be sufficiently accurate to neglect the variation of air forces in that maneuver although it is obviously not correct in some extreme cases. Consider the case of a rotor with a built-in coning angle = α_0 . Let us, for simplicity of analysis, assume that the mass of the blade is concentrated along the feathering axis $x-x$ of the blade.

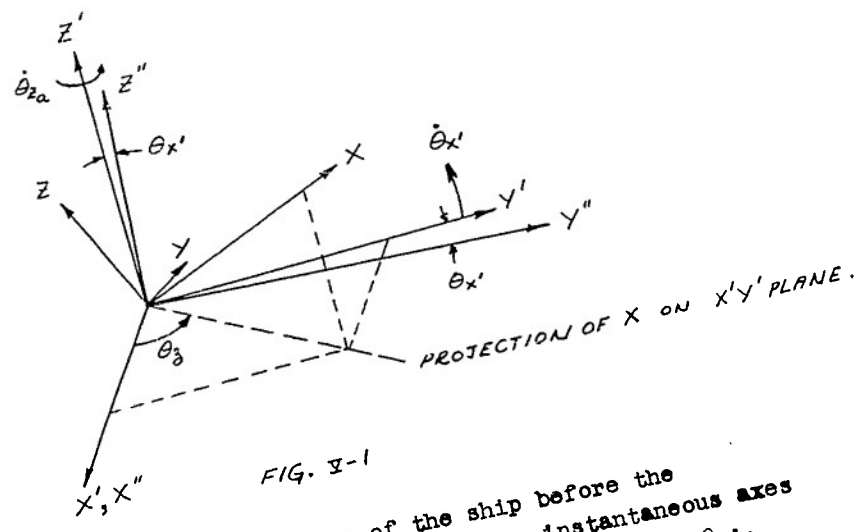

FIG. 5-1

Let z''', y''', x''' be the axes of the ship before the maneuver takes place. Z', Y', X' are the instantaneous axes of the ship while turning about X' axis, by an angle θ_x' .

$\dot{\theta}_z$ is the rate of change of angle measured in Y^1, X^1 plane.

ZYX are axes of the blade.

Using the method outlined on pages II-1 of Part II, the accelerations acting on each element of the blade, distance x from the origin are:

$$(x-3a) \quad \ddot{\frac{z}{x}} = \sin a_0 \cos a_0 \left(\dot{\theta}_z^2 - \frac{\dot{\theta}_{x^1}^2}{2} \right) + \ddot{\theta}_{x^1} \sin \theta_z + 2 \dot{\theta}_z \dot{\theta}_{x^1} \cos^2 a_0 \cos \theta_z - \frac{\dot{\theta}_{x^1}^2}{2} \sin a_0 \cos a_0 \cos 2\theta_z$$

$$(b) \quad \ddot{\frac{x}{x}} = -\ddot{\theta}_{x^1} \sin^2 a_0 - \cos^2 a_0 \left(\dot{\theta}_z^2 + \frac{\dot{\theta}_{x^1}^2}{2} \right) + 2 \dot{\theta}_z \dot{\theta}_{x^1} \sin a_0 \cos a_0 \cos \theta_z + \frac{\dot{\theta}_{x^1}^2}{2} \cos^2 a_0 \cos 2\theta_z$$

$$(c) \quad \ddot{\frac{y}{x}} = -\ddot{\theta}_{x^1} \sin a_0 \cos \theta_z - \frac{\dot{\theta}_{x^1}^2}{2} \cos a_0 \sin 2\theta_z$$

Letting

$$\begin{aligned} \sin a_0 &= a_0 & a_0^2 &= 0 \\ \cos a_0 &= \cos^2 a_0 = 1.0 \end{aligned}$$

we have

$$(x-4a) \quad \ddot{\frac{z}{x}} = a_0 \left(\dot{\theta}_z^2 - \frac{\dot{\theta}_{x^1}^2}{2} \right) + \ddot{\theta}_{x^1} \sin \theta_z + 2 \dot{\theta}_z \dot{\theta}_{x^1} \cos \theta_z - \frac{\dot{\theta}_{x^1}^2}{2} a_0 \cos 2\theta_z$$

$$v = -6$$

$$(v - 4b) \quad \ddot{\frac{x}{x}} = -\dot{\theta}_z^2 + \frac{\dot{\theta}_z^2}{2} + 2\dot{\theta}_z \dot{\theta}_{x'} a_o \cos \theta_z + \frac{\dot{\theta}_z^2}{2} \cos 2\theta_z$$

$$(c) \quad \ddot{\frac{y}{x}} = -\dot{\theta}_{x'} a_o \cos \theta_z - \frac{\dot{\theta}_z^2}{2} \sin 2\theta_z$$

PART VI
DESIGN CRITERIA CONSIDERATIONS

Design Criteria Considerations.

In designing any part of an aircraft structure, one must always consider two possible types of failure. The first type will occur due to a sudden application of a large load such as the structure of an aircraft gets in an accelerated maneuver or in hitting a gust of wind, and can be called a "strength" type failure. The second type is due to considerably smaller but cyclicly varying loads which the structure gets in steady flight and it is usually called a "fatigue" failure.

Stresses developed in the second type are the sum of constant and periodic stresses. The periodic stresses are often called "vibratory" stresses and are due to either mechanical vibrations or cyclic variation of external loads, or to both.

Usually, on almost all types of helicopter rotor blade designs (using metal construction), with the possible exception of the rigid type, the ratio of maximum applied stress in an accelerated flight condition (maneuver, gust) to the maximum stress in steady flight (forward) is smaller than the ratio of allowable yield stress to the allowable fatigue stress of the material. Therefore, as a rule, strength conditions can be disregarded. While the designer must think of avoiding as much as possible structure producing bad stress concentrations, the stress analyst must study carefully the fatigue conditions and magnitude of allowable fatigue stresses, especially in the region where an abrupt change in the cross section of the blade spars could not be avoided; as, for instance, one will find at the attachment of a blade to the hub or hinge fitting.

The refined methods used in calculating bending moments on the blades become valueless when the stress calculations disregard concentration factors due to cut outs and such, or when allowable stress is not determined accurately.

A great deal of effort and time was used in preparing in this report all equations necessary for calculating the external loading on the blades. It is felt, however, that while the expressions for dynamic loads could be determined quite correctly in terms of derivatives, the correctness of the aerodynamic loads was somewhat doubtful because of the questionable validity of some of the basic assumptions. These assumptions which were listed in Part I are

- 1) Induced velocity field
- 2) Unimportance of radial component of the resultant velocity at a blade element
- 3) The effect of air inertia
- 4) Flexibilities of the blades
- 5) Adjustment of loads to satisfy the boundary conditions in solving the equations for deflection and moments

Because of the foregoing reasons, the effort involved in calculating the loads acting on the blades does not seem to be justified and probably two empirical override loading conditions giving the extreme variation of stresses due to bending, could be just as safe, without penalizing severely the weight, as the doubtful and lengthy, so called "rational", load calculations.

In designing the rigid blades, the strength conditions may become also of importance because of the high inertia (gyroscopic) forces developed while the aircraft is rotating about any of the axes.

The methods for calculating the bending moments of the blades are based on straight-forward methods of solving linear differential equations of higher order with variable coefficients. Their accuracy depends, as in all cases involving approximations, on the number of terms used.

The tabular method seems to be easier to use than the "collocation" method. The discrepancy between the two is not very large in the case of articulated blades. The correct solution probably lies between the two sets of values. The "collocation" method becomes impractical because of the large number of terms required to obtain sufficient convergence when the slope of the deflection curve at the root of the blade is given a definite value as in the case of the see-saw type or rigid type of blades.

For preliminary calculations of the constant and first harmonic (setting as a first approximation $\frac{d^2 x}{dt^2} = 0$) parts of the bending moment on completely articulated blades, Reference 12, can be very useful, replacing variable EI by a mean \overline{EI} . Of course, the mean value of EI is somewhat hard to calculate and therefore a reasonable guess has to be used.