

QuickSpecs

HP ProLiant SL4540 Generation 8 (Gen8) Server

Overview

How are you going to scale out to petabytes with your current infrastructure?

Big data, largely unstructured such as messages, images, readings from sensors, and GPS signals from cell phones, are growing at an exponential rate. The HP ProLiant SL4540 Gen8 Server solves the traditional structured database problems when dealing with big data. Implementing a scale-out infrastructure will invariably result in challenges of data center capacity, spiraling energy costs, infrastructure complexity and inefficiencies because today's siloed infrastructure is not optimized for scale-out server workloads driven by big data. The SL4540 Gen8 Server is a server purpose-built for big data. A highly efficient converged design that delivers the right combination of capacity and performance, in the least amount of space and at lower cost, with the reliability and manageability you expect from HP ProLiant Gen8, the world's most intelligent servers.

SL4540 Gen8 1x60 Model

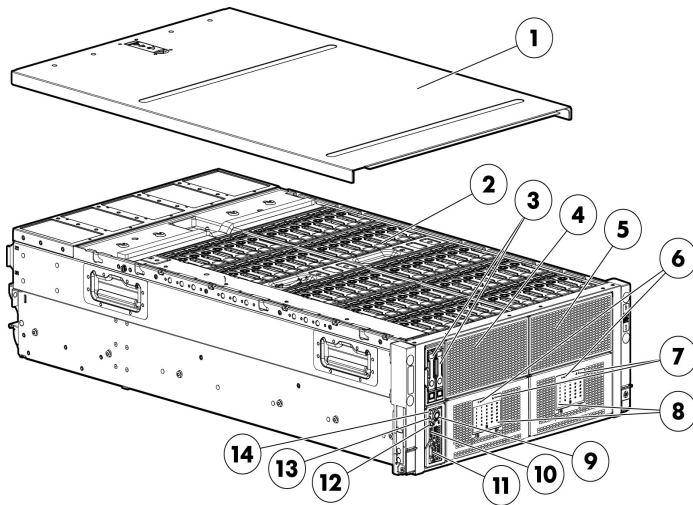

SL4540 Gen8 1x60 Model Front View:

1. Hood Cover
2. LFF 3.5" hard drives (60)
3. SFF 2.5" hard drives on node (2)
4. LFF hard drives connected to storage controller (Port 1i)
5. LFF hard drives connected to storage controller (Port 2i)
6. Hard drive backplane health LED
7. Storage UID
8. Hard drive LED display boards
9. Node ejection button
10. Node USB connectors (2)
11. Node video connector (VGA port)

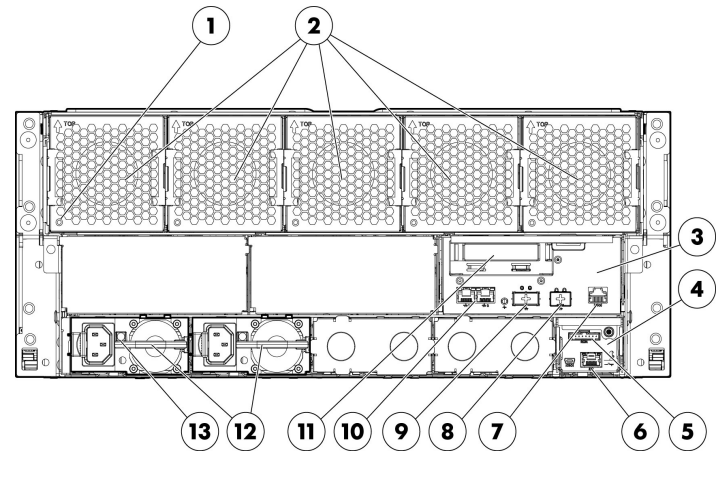

SL4540 Gen8 1x60 Model Rear View:

1. Fan LED
2. System fans
3. I/O Module
4. Management Module
5. SL Advanced Power Manager Distribution Module (SL-APMD) connector
6. iLO connector
7. Server Serial Port
8. 10Gb Ethernet SFP+ port
NOTE: Available only when 10G I/O module is ordered. 1G I/O Module has 2x1Gb Ethernet ports only.
9. 10Gb Ethernet QSFP port
NOTE: Available only when 10G I/O module is ordered. 1G I/O Module has 2x1Gb Ethernet ports only.
10. 2 X 1Gb Ethernet ports
11. Low profile PCI express slot
NOTE: Available only when the optional HP SL454x Storage Mezzanine to PCIe Enablement Kit is ordered

QuickSpecs

HP ProLiant SL4540 Generation 8 (Gen8) Server

Overview

- | | |
|---|----------------------|
| 12. Node power ON/Standby button and system power LED | 12. Power supplies |
| 13. Node health LED | 13. Power supply LED |
| 14. Node UID LED button | |

SL4540 Gen8 2x25 model

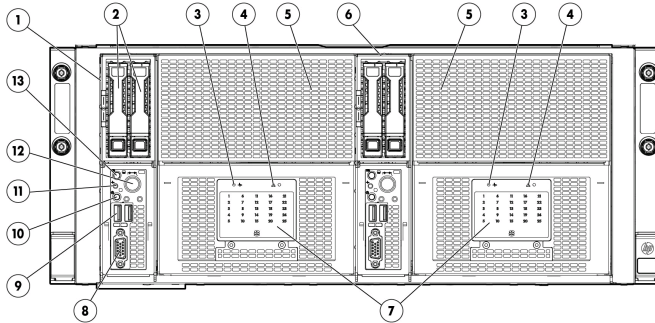

SL4540 Gen8 2x25 Model Front View:

1. Server Node 1
2. SFF 2.5" hard drives on node (2)
3. Hard drive backplane health LED
4. Storage UID
5. LFF hard drives
6. Server Node 2
7. Hard drive LED display boards
8. Node video connector (VGA port)
9. Node USB connectors (2)
10. Node power ON/Standby button and system power LED
11. Node health LED
12. Node ejection button
13. Node UID LED button

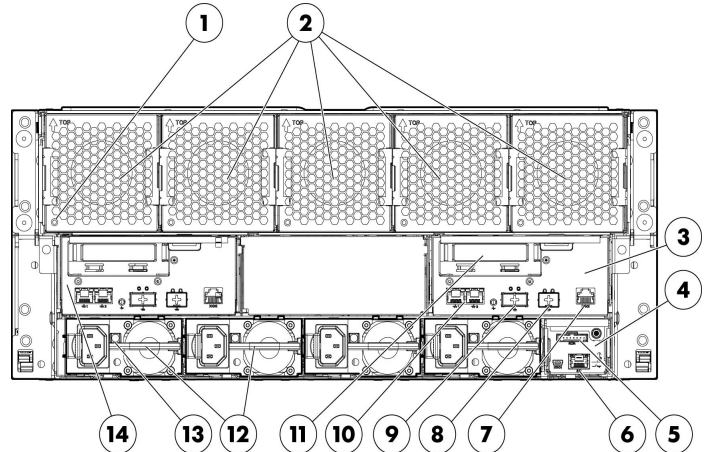

SL4540 Gen8 2x25 Model Rear View:

1. Fan LED
2. System fans
3. I/O Module Server Node 1
4. Management Module
5. SL Advanced Power Manager Distribution Module (SL-APMD) connector
6. iLO connector
7. Server Serial Port
8. 10Gb Ethernet SFP+ port
NOTE: Available only when 10G I/O module is ordered. 1G I/O Module has 2x1Gb Ethernet ports only.
9. 10Gb Ethernet QSFP port
NOTE: Available only when 10G I/O module is ordered. 1G I/O Module has 2x1Gb Ethernet ports only.
10. 2 X 1Gb Ethernet ports
11. Low profile PCI express slot
NOTE: Available only when the optional HP SL454x Storage Mezzanine to PCIe Enablement Kit is ordered
12. Power supplies
13. Power supply LED
14. I/O Module Server Node 2

SL4540 Gen8 3x15 model

QuickSpecs

HP ProLiant SL4540 Generation 8 (Gen8) Server

Overview

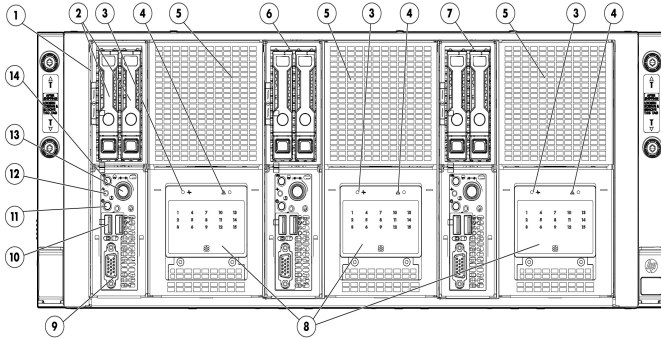

SL4540 Gen8 3x15 Model Front View:

1. Server Node 1
2. SFF 2.5" hard drives on node (2)
3. Hard drive backplane health LED
4. Storage UID
5. LFF hard drives connected to Server Node 1 (15)
6. Server Node 2
7. LFF hard drives connected to Server Node 2 (15)
8. Server Node 3
9. LFF hard drives connected to Server Node 3 (15)
10. Hard drive LED display boards
11. Node video connector (VGA port)
12. Node USB connectors (2)
13. Node power ON/Standby button and system power LED
14. Node health LED
15. Node ejection button
16. Node UID LED button

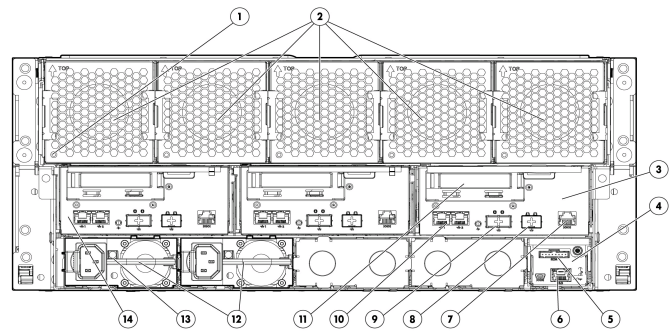

SL4540 Gen8 3x15 Model Rear View:

1. Fan LED
2. System fans
3. I/O Module Server Node 1
4. Management Module
5. SL Advanced Power Manager Distribution Module (SL-APMD) connector
6. iLO connector
7. Serial Port
8. 10Gb Ethernet SFP+ port
NOTE: Available only when 10G I/O module is ordered. 1G I/O Module has 2x1Gb Ethernet ports only.
9. 10Gb Ethernet QSFP port
NOTE: Available only when 10G I/O module is ordered. 1G I/O Module has 2x1Gb Ethernet ports only.
10. 2 X 1Gb Ethernet ports
11. Low profile PCI express slot
NOTE: Available only when the optional HP SL454x Storage Mezzanine to PCIe Enablement Kit is ordered
12. Power supplies
13. Power supply LED
14. I/O Module Server Node 3

What's New

- Intel® Xeon® Processor E5-2400 v2 Series
- HP SL4500 H220 Host Bus Adapter
- HP DDR3-1600) Low Voltage Memory Kit
- Hard Drive zoning via two P420i controller

QuickSpecs

HP ProLiant SL4540 Generation 8 (Gen8) Server

Standard Features

NOTE: For the Standard Features shipped in the Factory Integrated Models, please see the "Configuration Information - Factory Integrated Models" section.

Processor

E5-2400 v2 Series

One model of the following per server node

Ten-Core Processors

Intel® Xeon® E5-2470v2 (2.4GHz/10core/25MB/95W) Processor

Intel® Xeon® E5-2450Lv2 (1.7GHz/10core/25MB/60W) Processor

Eight-Core Processors

Intel® Xeon® E5-2450v2 (2.5GHz/8core/20MB/95W) Processor

Intel® Xeon® E5-2440v2 (1.9GHz/8core/20MB/95W) Processor

Six-Core Processors

Intel® Xeon® E5-2430v2 (2.5GHz/6core/15MB/80W) Processor

Intel® Xeon® E5-2430Lv2 (2.4GHz/6core/15MB/60W) Processor

Intel® Xeon® E5-2420v2 (2.2GHz/6core/15MB/80W) Processor

Quad-Core Processors

Intel® Xeon® E5-2407v2 (2.4GHz/4core/10MB/80W) Processor

E5-2400 series

Eight-Core Processors

Intel® Xeon® E5-2450 (2.1GHz/8-core/20MB/8GT-s QPI/95W, DDR3-1600, HT, Turbo2- 5/5/6/6/7/7/8/8) Turbo+

Intel® Xeon® E5-2470 (2.30GHz/8-core/20MB/8GT-s QPI/95W, DDR3-1600, HT, Turbo2- 5/5/6/6/7/7/8/8)

Six-Core Processors

Intel® Xeon® E5-2420 (1.9GHz/6-core/15MB/7.2GT-s QPI/95W, DDR3-1333, HT, Turbo2- 3/3/4/4/5/5)Turbo

Intel® Xeon® E5-2430 (2.2GHz/6-core/15MB/7.2GT-s QPI/95W, DDR3-1333, HT, Turbo2- 3/3/4/4/5/5)

Intel® Xeon® E5-2430L (2.0GHz/6-core/15MB/7.2GT-s QPI/60W, DDR3-1333, HT, Turbo2- 3/3/4/4/5/5)

Intel® Xeon® E5-2440 (2.40GHz/6-core/15MB/7.2GT-s QPI/95W, DDR3-1333, HT, Turbo2- 3/3/4/4/5/5)

Quad-Core Processors

Intel® Xeon® E5-2407 (2.2GHz/4-core/10MB/6.4GT-s QPI/80W, DDR3-1066)

NOTE: HT indicates that the processor model supports Intel® /Hyper-Threading Technology

NOTE: Turbo 2 indicates the maximum potential bin increments when using Intel® Turbo Boost Technology, with 8, 7, 6, 5, 4, 3, 2 and 1 cores active or with 6, 5, 4, 3, 2 and 1 as applicable.

NOTE: DDR3 speed is the maximum memory speed of the processor. Actual memory speed may depend on the quantity and type of DIMMs installed (options for 1333 and 1066MHz memory speed are available).

NOTE: Up to 2 processors supported. Mixing different processor models is not supported.

NOTE: For the Intel® C600 Chipset E5-2400 Series, the letter preceding the model number indicates the Product Line (E3, E5, E7); 2400x v#, 2 = number of CPUs in a Node, 4 is socket/segment designation, 00 = Processor SKU, x = L for low power SKUs and v# (not yet designated) = version number

QuickSpecs

HP ProLiant SL4540 Generation 8 (Gen8) Server

Standard Features

Cache Memory

One of the following depending on model

25MB (1x25MB) Level3

NOTE: For Ten-core processors.

20MB (1x20MB) Level3

NOTE: For Eight-core processors.

15MB (1x15MB) Level3

NOTE: For Six-core processors.

10MB (1x10MB) Level3

NOTE: For Quad-core processors.

Chipset

Intel® C600 Series Chipset

Intel® E5-2400 v2 Processor Family

Intel® E5-2400 Processor Family

NOTE: For more information regarding Intel® chipsets, please see the following URL:

<http://www.intel.com/products/server/chipsets/>.

Upgradeability

Upgradeable to two processors

NOTE: Processor upgrade available from Intel® Xeon® Processors E5-2400 to E5-2400 v2. Please contact HP Technology Sales (<http://www.hp.com/support>), your local HP Re-seller, or reference the following Customer Advisory: [ProLiant Servers-Instructions for Upgrading an HP ProLiant Gen8 Server from an Intel Xeon Processor E5-2400 to an Intel Xeon Processor E5-2400v2](#), regarding critical details before upgrading. An explanation of requirements and limitations are provided.

On System Management Processor

HP iLO (Firmware: HP iLO 4)

NOTE: For more information, visit: <http://www.hp.com/go/ilo>.

Memory Protection

Advanced ECC (multi-bit error protection)

Online Spare

Lock Step Mode

QuickSpecs

HP ProLiant SL4540 Generation 8 (Gen8) Server

Standard Features

Memory

Dedicated to each server node

Type	HP SmartMemory DDR3 Registered (RDIMM)
DIMM Slots Available	12 DIMM Slots available
Maximum (RDIMM) (per server tray)	192GB (12 x 16GB) Registered memory configurations

NOTE: HP SmartMemory is required to realize the memory performance improvements and enhanced functionality listed in this document for Gen8. For additional information, please see the HP SmartMemory QuickSpecs at: http://h18000.www1.hp.com/products/quickspecs/14225_div/14225_div.html

NOTE: HP certified SmartMemory must be used to guarantee full 1600 MHz speeds.

NOTE: Depending on the memory configuration and processor model, the memory speed may run at 1600, 1333MHz or 1066MHz. Please see the Online Memory Configuration Tool at: www.hp.com/go/ddr3memory-configurator.

Network Controller

One of the following dedicated to each server node

HP Ethernet 1Gb 2-port 361i
HP Ethernet 1Gb 2-port 361i and HP Ethernet 10Gb 2-Port 544i Adapter

NOTE: Dual port ConnectX-3 10GbE or QDR IB

NOTE: Network controller is hosted in the I/O Module

Expansion Slots

Primary Riser

Dedicated to each server node

Expansion Slots #	Technology	Bus Width*	Connector Width	Form Factor	Notes
1	PCIe 2.0	X8	X8	Low profile slot	

*Indicates the number of physical electrical lanes running to the connector.

NOTE: One PCIe 2.0 low profile expansion slot is enabled by HP Svr Storage Mezz to PCIe Option Kit 682632-B21 for adding one of the expansion options including an HP IO accelerator, networking options or external storage controller options.

NOTE: Expansion Slot is hosted in the I/O Module.

HP Server ROM

HP ROM (Read Only Memory) is now digitally signed using HP's Corporate Signing Service. This signature is verified before the flash process starts, reducing accidental programming and preventing malicious efforts to corrupt system ROM.

HP ROM provides for essential initialization and validation of hardware components before control is passed to the customer-installed operating system. The ROM also provides the capability of booting from various fixed media (HDD, CD-ROM) and removable media (USB), to continue operation to the operating system.

HP ROM performs very early configuration of the video controller, to allow monitoring of initialization progress via an attached monitor. If configuration or hardware errors are discovered during this early phase of hardware initialization, suitable messages are now displayed on the connected monitor. Additionally, these configuration or hardware errors are logged to the Integrated Management Log (IML) to assist in diagnosis.

HP's ProLiant ROM is used to configure the following:

- Processor and chipset status registers
- System memory, memory map, and memory initialization



QuickSpecs

HP ProLiant SL4540 Generation 8 (Gen8) Server

Standard Features

- System hardware configuration (Integrated PCI devices and optional PCIe cards).
- Customer-specific BIOS configuration (using the HP ROM-Based Setup Utility (RBSU)).

NOTE: For further information, please refer to HP's RBSU (ROM based setup utility) user guide: www.hp.com/support/rbsu.

Storage Controllers

Dedicated to each server node

HP Dynamic Smart Array B120i SATA RAID

NOTE: HP Dynamic Smart Array B120i SATA RAID is located on the server node and controls only the two small form factor (SFF/2.5") hard drives on the server node itself.

HP Ethernet 1Gb 2-port 361i and HP Ethernet 10Gb 2-Port 544i Adapter

NOTE: HP SL4500 H220 HBA is located in the I/O Module, which is located at the rear of the SL4540 chassis and controls the large form factor (LFF/ 3.5") hard drives.

HP Smart Array P420i Controller

NOTE: HP Smart Array P420i is located in the I/O Module, which is located at the rear of the SL4540 chassis and controls the large form factor (LFF/ 3.5") hard drives.

Internal Storage Devices

Diskette Drive

Via USB port, external support only

Optical Drive

Via USB port, external support only

Hard Drives

None ship standard

Drive Bays

2 SFF drive bays total for each node

60 LFF drive bays total in chassis for a 1x60 model

50 LFF drive bays total in chassis for a 2x25 model (25 drives per node)

45 LFF drive bays total in chassis for a 3x15 model (15 drives per node)

Maximum Internal Storage

1x60 Model - 60 LFF Drives per node

Hot Plug LFF SAS	240.0TB	60 x 4TB
Hot Plug LFF SATA	240.0TB	60 x 4TB
Hot Plug SFF SATA	2.0TB	2 x 1TB
Hot Plug LFF SATA SSD	48.0TB	60 x 800GB
Hot Plug SFF SATA SSD	1.6TB	2 x 800GB

NOTE: The node consists of two SFF (2.5") hard drive bays on the front of the server

NOTE: The main storage section in the chassis has 60 LFF (3.5") hard drive bays and they can be populated with any combination of SAS, SATA, or SATA SSD drives to achieve desired performance.

2x25 Model - 25 LFF Drives per node

Hot Plug LFF SAS	200.0TB	50 x 4TB
Hot Plug LFF SATA	200.0TB	50 x 4TB
Hot Plug SFF SATA	4.0TB	4 x 1TB
Hot Plug LFF SATA SSD	40.0TB	50 x 800GB
Hot Plug SFF SATA SSD	3.2TB	4 x 800GB



QuickSpecs

HP ProLiant SL4540 Generation 8 (Gen8) Server

Standard Features

NOTE: Each node contains two SFF (2.5") hard drive bays on the front of the node.

NOTE: The main storage section in the chassis has 50 LFF (3.5") hard drive bays, 25 bays per node, and they can be populated with any combination of SAS, SATA, or SATA SSD drives to achieve desired performance

3x15 Model - 15 LFF Drives per node, 45 LFF Drives per chassis

Hot Plug LFF SAS	180.0TB	45x 4TB
Hot Plug LFF SATA	180.0TB	45 x 4TB
Hot Plug SFF SATA	6.0TB	6 x 1TB
Hot Plug LFF SATA SSD	36.0TB	45 x 800GB
Hot Plug SFF SATA SSD	4.8TB	6 x 800GB

NOTE: Each node contains two SFF (2.5") hard drive bays on the front of the node.

NOTE: The main storage section in the chassis has 45 LFF (3.5") hard drive bays, 15 bays per node, and they can be populated with any combination of SAS, SATA, or SATA SSD drives to achieve desired performance.

Interfaces

Dedicated to each server node

Network RJ-45	Two 1GbE NIC ports (available in both 1GbE and 10GbE I/O Module) NOTE: Only one of either the 1GbE I/O Module or 10GbE I/O Module can be connected to the node.
SFP+ connector	One 10GbE SFP+ connector NOTE: 10GbE SFP+ and 10GbE/40Gb IB QSFP are additional networking interfaces available using optional 10GbE I/O Module.
QSFP connector	One 10GbE/40GbIB QSFP connector NOTE: 10 Gb Ethernet on the QSFP port requires the use of the QSFP to SFP+ adapter 655874-B21 NOTE: IB supported with addition of HP IB Enablement Kit
USB	2 front (external)
Serial	1 rear (external on I/O Module)
Video	1 front (external)
Management Network Port	10/100 Mb Dedicated (Optionally a 1GbE port can be dedicated to iLO) NOTE: Management port is shared
Health LED	2 front
Power	1 front
UID for node	1 front per node and 1 rear on management module)
UID for storage	1 per display board

QuickSpecs

HP ProLiant SL4540 Generation 8 (Gen8) Server

Standard Features

Industry Standard Compliance	ACPI 2.0b Compliant PCIe 2.0 Compliant WOL Support Microsoft® Logo certifications PXE Support USB 1.1 and 2.0 Compliant SMBIOS 2.6.1
-------------------------------------	--

Server Power Cords

6' Highline (IEC-IEC) power cord ships standard

NOTE: HP ProLiant SL servers are primarily connected to PDU's in data center racks so they ship standard with only a PDU power cord (416151-B21). If a user wishes to power a ProLiant SL server using a 110V receptacle (NEMA-15), the NEMA power cord must be ordered separately.

NOTE: If customers require a local power cord, they can check the power cord matrix for the appropriate cord. Please see the following power cord matrix: <http://www.hp.com/go/powercordmatrix>.

Power Specifications

To review typical system power ratings use the HP Power Advisor which is available via the online tool located at URL: www.hp.com/go/proliant-energy-efficient or www.hp.com/go/hppoweradvisor.

NOTE: Power Specification and Technical Content for supported power supplies can be found at: http://h18000.www1.hp.com/products/quickspecs/14209_div/14209_div.html

Common Slot Power Supply

HP's Common Slot (CS) power supplies allow for commonality of power supplies across a wide range of ProLiant and Integrity servers, as well as HP Storage solutions, and are designed to provide the highest power supply efficiency without degrading system performance. HP CS power supplies are tested by the Electric Power Research Institute (EPRI) and certified through the ECOS 80 Plus power supply program. HP CS power supply options provide efficiency ratings of up to 94% and are available in two power output options - 750W, and 1200W - allowing the user to "right-size" a power supply for their specific server configuration. All HP Common Slot power sources are UL, CE Mark Compliant, hot-plug and support redundant configurations. It is highly recommended that you use the HP Power Advisor in defining the "Right-Size" power supply for your needs. HP Power Advisor can be accessed at: www.hp.com/go/hppoweradvisor.

NOTE: Mixing of power supplies in the same server is not supported. All power supplies must be of the same output and efficiency rating. If non-matched power supplies are inserted you will get errors and operation will fail.

NOTE: The 80 PLUS program is a unique forum that unites electric utilities, the computer industry, and consumers in an effort to bring energy efficient technology solutions to the marketplace. 80 Plus independently tests power supply efficiency and publicly posts the results on www.80Plus.org.

NOTE: Redundant Power: Optional redundant power supplies can be purchased through power supply option kits (see Power Supplies for part numbers).



QuickSpecs

HP ProLiant SL4540 Generation 8 (Gen8) Server

Standard Features

System Fans System ships standard with 5 Dual fan modules.

Operating Systems and Virtualization Software Support for ProLiant Servers

[Microsoft Windows Server](#)
[Canonical Ubuntu](#)
[Red Hat Enterprise Linux \(RHEL\)](#)
[SUSE Linux Enterprise Server \(SLES\)](#)
[VMware](#)

NOTE: VMware is not supported using the SL4500 H220 Host Bus Adapter

NOTE: Only 64-bit versions of these operating systems are supported.

NOTE: For more information on HP's Certified and Supported ProLiant Servers for OS and Virtualization Software and latest listing of software drivers available for your server including how to purchase from HP, please visit our OS Support Site at: <http://www.hp.com/go/ossupport> and our driver download page: <http://www.hp.com/support/SL4540Gen8>

Graphics (per node) Integrated Matrox G200 video standard

- 1280 x 1024 (32 bpp)
 - 1920 x 1200 (16 bpp)
-

Form Factor 4.3U form factor
NOTE: Can be racked as either a 5U tall chassis or as three chassis in 13U

On System Management

HP iLO Management Engine

HP iLO Management Engine is a comprehensive set of embedded management features supporting the complete lifecycle of the server, from initial deployment, through ongoing management, to service alerting and remote support. HP iLO Management Engine comes standard on all HP ProLiant Gen8 servers. The HP iLO Management Engine portfolio includes:

- **HP iLO:** The HP iLO (Integrated Lights-Out) management processor is the core foundation for the HP iLO Management Engine
 - **HP Agentless Management:** Provides built in server health monitoring and alerting capability without OS agents, that starts working the moment a power cord and an Ethernet cable are connected.
 - **HP Active Health System:** Always on, continuous monitoring for increased stability and shorter downtimes; 100% configuration history; Health and service alerts and easy export and upload to Service and Support.
 - **HP Intelligent Provisioning:** Lets customers provision and configure a single server without any separate media. No more SmartStart CDs or Smart Update Firmware DVD are needed.
 - To start Intelligent Provisioning:
 - Press the F10 key during the ProLiant Gen8 server boot process (also known as power on self test or POST).
 - Please go to the Intelligent Provisioning website at www.hp.com/go/intelligentprovisioning for additional information and to view usage videos.
-



QuickSpecs

HP ProLiant SL4540 Generation 8 (Gen8) Server

Standard Features

- Use the Service Pack for ProLiant (SPP) at www.hp.com/go/spp to get firmware and software updates.
- **HP iLO Mobile App:** Enables the ability to access, deploy, and manage your server anytime from anywhere from select smartphones and mobile devices. For additional information please visit: www.hp.com/go/ilo/mobileapp

NOTE: For more information, visit: <http://www.hp.com/go/ilo> or HP iLO Management Engine technologies [whitepaper](#)

HP Insight Management HP Service Pack for ProLiant

HP Service Pack for ProLiant (SPP) and HP Smart Update Manager (HP SUM) provide a comprehensive approach to firmware and system software maintenance. Together they provide better operating stability and ensure maximum uptime. The SPP will be updated at a predictable cadence, typically coinciding with new HP server hardware launches. By enabling firmware to be updated online and integrating firmware and system software updates in one operation, HP SUM and the SPP offer faster updates of individual servers and dramatically faster updates of entire BladeSystem enclosures. Further improving system uptime and stability is the fact that HP provides 12 months of support for each Service Pack for ProLiant release.

The user experience around HP SUM and the SPP has been improved in several ways, starting with the web download. A single web page provides access to a single download containing both the latest version of HP SUM and the latest SPP. Optional smaller subsets with only specific types of servers or specific operating systems are offered to save on download time. The HP SUM application provides a straightforward, intuitive user interface that guides the user through the steps of discovery, analyses and update, providing comprehensive information on available updates, criticality and interdependencies. This information is also available in reports. By providing the option of multiple local or shared repositories which can be easily updated from hp.com, HP SUM provides the tools to optimize stability and consistency throughout the company. While HP SUM and the SPP recommend the combinations of firmware and system software that HP has found to be the best practice, the application gives customers the flexibility to set their own specific baseline.

The Service Pack for ProLiant has been rigorously tested with specific attention for interaction between firmware, drivers and agents both within the server as well as in interaction with the BladeSystem enclosure components (Onboard Administrator and Virtual Connect). This testing ensures the highest quality as well as providing the input for HP SUM to deploy updates taking into account all interdependencies, when determining the correct updates and order of update deployment.

NOTE: The Service Pack for ProLiant (which includes HP SUM) can be downloaded from www.hp.com/go/spp/download. More information can be found: <http://www.hp.com/go/SmartUpdate>, www.hp.com/go/spp and <http://www.hp.com/go/hpsum>



QuickSpecs

HP ProLiant SL4540 Generation 8 (Gen8) Server

Standard Features

Security

Power-on password
QuickLock, Network Server Mode
Serial interface control
Administrator's password
iLO 4 (Integrated Lights-Out 4) has 12 customizable user accounts and SSL encryption
iLO 4 can be disabled via a Global Setting
iLO Advanced supports directory services integration

Warranty

This product is covered by a global limited warranty and supported by HP Services and a worldwide network of HP Authorized Channel Partners resellers. Hardware diagnostic support and repair is available for three years from date of purchase. Support for software and initial setup is available for 90 days from date of purchase. Enhancements to warranty services are available through HP Care Pack services or customized service agreements. Hard drives have either a one year or three year warranty; refer to the specific hard drive QuickSpecs for details.

NOTE: Server Warranty includes 1-Year Parts, 1-Year Labor, 1-Year Onsite support with next business day response. Warranty repairs may be accomplished through the use of Customer Self Repair (CSR) parts. These parts fall into two categories: 1) Mandatory CSR parts are designed for easy replacement. A travel and labor charge will result when customers decline to replace a Mandatory CSR part; 2) Optional CSR parts are also designed for easy replacement but may involve added complexity. Customers may choose to have HP replace Optional CSR parts at no charge. Additional information regarding worldwide limited warranty and technical support is available at:

<http://h18004.www1.hp.com/products/servers/platforms/warranty/index.html>

QuickSpecs

HP ProLiant SL4540 Generation 8 (Gen8) Server

Optional Features

HP Insight management	HP Insight Control	<p>HP Insight Control, a product option, delivers essential infrastructure management that can help save time and money by making it easy to deploy, migrate, monitor, remote control, and optimize your IT infrastructure through a single, simple management console. For more information, see http://www.hp.com/go/insightcontrol.</p> <p>HP Insight Control includes one year of 24 x 7 HP Software Technical Support and Update Service ensuring rapid access to HP support staff and proactive delivery of software updates. For more information about this service, see: http://www.hp.com/services/insight.</p>
	HP iLO Advanced	<p>HP Integrated Lights-Out Advanced License a product option, providing smart remote server management without compromise. iLO Advanced unlocks the full set of remote administration functionality for all HP ProLiant servers by activating the full Virtual Keyboard Video and Mouse remote console, multi-user collaboration, console record and replay, GUI-based and scripted virtual media and virtual folders, and enhanced security and power management functionality. For more information, see: http://www.hp.com/go/iloadvance</p>
	HP iLO Scale-Out	<p>The HP iLO Scale-Out license ideal for web/hosting/cloud service providers and High Performance Computing environments. This license is a specific subset of iLO Advanced functionality, provides fast remote access through Text Console via SSH, lower operational cost with Dynamic power capping, and faster time to resolution through Email-based Alerting and proactive notifications. With this newly designed HP iLO Scale-Out license HPC customers now have a server management package solely design and priced for their massive data environments. HP iLO Scale-Out is available on all HP ProLiant Gen8 SL and BL and DL 160 servers. For more information, see: http://www.hp.com/go/iLO/scale-out</p>
	HP Matrix Operating Environment	<p>The HP Matrix Operating Environment (Matrix OE) for ProLiant and Integrity servers is an integrated command center that helps you instantly adjust to dynamic business demands. This advanced infrastructure management software lets you reduce the cost of common data center tasks by up to 40 percent while keeping pace with your changing business.</p> <p>The HP Matrix OE includes the automated provisioning, optimization, and recovery management capabilities for HP CloudSystem Matrix, the ideal platform for private cloud and Infrastructure as a Service (IaaS).</p> <p>NOTE: For more information, visit: http://www.hp.com/go/matrixoe</p>

QuickSpecs

HP ProLiant SL4540 Generation 8 (Gen8) Server

Optional Features

High Performance Clusters

HP HPC Interconnects

High Performance Computing (HPC) interconnect technologies are available for this server. These high-speed InfiniBand and 10 Gigabit interconnects are fully supported by HP.

<http://www.hp.com/techservers/clusters/ucp/index.html>

HP Insight Cluster Management Utility

HP Insight Cluster Management Utility (CMU) is an HP-licensed and HP-supported suite of tools that are used for lifecycle management of hyperscale clusters of Linux ProLiant systems. CMU includes software for the centralized provisioning, management and monitoring of nodes. CMU makes the administration of clusters user friendly, efficient, and effective.

<http://www.hp.com/go/cmu>

HP HPC Linux Value Pack

HP HPC Linux Value Pack (Value Pack) is an HP-licensed and HP-supported option to HP Insight CMU, for the development and deployment of applications on HPC Cluster Platforms. Value Pack includes the Platform LSF workload scheduler and Platform Application Center, as well as the HP-MPI parallelization library.

HP Insight Online

HP Insight Online is a new addition to the HP Support Center for one stop, secure access to product and HP support information personalized to your IT environment. Insight Online can automatically display devices remotely monitored by HP Insight Remote Support. With Insight Online's easy navigation you can efficiently track your IT support contracts and device status from anywhere and at anytime.

www.hp.com/go/insightonline

Factory Express Portfolio for Servers and Storage

HP Factory Express offers configuration, customization, integration and deployment services for HP servers and storage products. Customers can choose how their factory solutions are built, tested, integrated, shipped and deployed.

Factory Express offers service packages for simple configuration, racking, installation, complex configuration and design services as well as individual factory services, such as image loading, asset tagging, and custom packaging. HP products supported through Factory Express include a wide array of servers and storage: HP Integrity, HP ProLiant, HP ProLiant Server Blades, HP BladeSystem, HP 9000 servers as well as the MSAxxxx, VA7xxx, EVA, XP, rackable tape libraries and configurable network switches.

For more information on Factory Express services for your specific server model please contact your sales representative or go to: <http://www.hp.com/go/factory-express>.

HP Simple Configurator

SCE is a guided self service tool to help sales and non technical people provide customers with initial configurations in 3 to 5 minutes. You may then send the configuration on for configuration help, or use in your existing ordering processes. If you require "custom" rack configuration or configuration for products not available in SCE, please contact HP's Customer Business Center or an Authorized Partner for assistance. <http://www.hp.com/products/configurator>



QuickSpecs

HP ProLiant SL4540 Generation 8 (Gen8) Server

Service and Support

Service and Support

HP Technology Services for SL Server

Capitalizing on capabilities requires a service partner who understands your increasingly complex business technology environment. That's why it makes sense to team up with the people who know HP infrastructure hardware and software best - the experienced professionals at HP Services.

What HP SL Services can do for you

HP SL Services can help you design, deploy, test, integrate, support, and manage IT and infrastructure solutions. This way, HP proposes services solutions that include more than just uplift of base warranty. HP Services helps deliver high levels of application availability through proactive service management and advanced technical response

HP Technology Services meets business challenges with recommended services HP support solutions enable customers to optimize technology operations, minimize risk and drive better business outcomes with easy-to-buy, easy-to-use scalable support recommendations for servers, storage, networking and software. Protect your business beyond warranty with HP Care Pack Services: HP Care Pack services provide total care and support expertise with committed response choices designed to meet your IT and business needs

Recommended Support Solution

Supports maintaining servers at optimum performance availability

HP ProLiant Server Hardware Installation

Provides for the basic hardware installation of HP branded servers, storage devices and networking options to assist you in bringing your new hardware into operation in a timely and professional manner <http://h20195.www2.hp.com/V2/GetPDF.aspx/5981-9356EN.pdf>

HP Installation and Startup for Insight Control Software / HP SIM

Provides for the deployment and basic configuration of HP Insight Control or HP SIM (Systems Insight Manager) on HP ProLiant ML and DL series servers or HP BladeSystem servers or HP ProLiant SL servers <http://h20195.www2.hp.com/v2/GetPDF.aspx/4AA0-9972ENW.pdf>

For a Hyperscale Environment, Datacenter Care is our most flexible and comprehensive support offering. HP works in partnership with our customers to provide end-to-end tailored support for your existing IT environments while aiding you on your converged cloud journey. It leverages the integrated technology, people, processes, and partner ecosystem of HP to deploy, help operate, and evolve your data centers on their journey from traditional data centers to converged cloud. With the ability to configure support tailored to your needs, we offer you flexibility that is cost effective. Datacenter Care is made from "building blocks" of services, each tested and delivered globally. These can be combined to deliver the services that you require, and are monitored and updated to change as your needs change. Start with the core building blocks of an assigned account service manager, enhanced call handling, proactive and reactive support, and add on other services that are tailored to your specific needs. Proactive and reactive support are configured to deliver the level of support needed by the different components in a data center, to meet both SLA and cost targets.

For SMB to Enterprise customers HP Technology Services meets business challenges with the right services solution:

Recommended Services **3-Year HP 24x7 4 hour response, Proactive Care Service***

This service gives you combined reactive and proactive support including rapid access to our Advanced Solution Center to manage and prevent problems and a Technical Support Specialist with a broad level of technical knowledge that will engage with additional technical expertise as needed from HP's vast



QuickSpecs

HP ProLiant SL4540 Generation 8 (Gen8) Server

Service and Support

global resources.

<http://h20195.www2.hp.com/v2/GetPDF.aspx/4AA3-8855EEE.pdf>

HP ProLiant Server Hardware Installation

Provides for the basic hardware installation of HP branded servers, storage devices and networking options to assist you in bringing your new hardware into operation in a timely and professional manner

<http://h20195.www2.hp.com/V2/GetPDF.aspx/5981-9356EN.pdf>

Insight Remote Support

Provides 24 X 7 remote monitoring, proactive notifications, and problem resolution. Learn more

<http://www.hp.com/go/insightremotesupport>

HP Support Center

Personalized online support portal with access to information, tools and experts to support HP business products. Submit support cases online, chat with HP experts, access support resources or collaborate with peers. Learn more <http://www.hp.com/go/hpsc>

HP's Support Center Mobile App* allows you to resolve issues yourself or quickly connect to an agent for live support. Now, you can get access to personalized IT support anywhere, anytime.

HP Insight Remote Support and HP Support Center are available at no additional cost with a HP warranty, HP Care Pack or HP contractual support agreement.

*HP' Support Center Mobile App is subject to local availability

Warranty / Service Coverage

For ProLiant servers and storage systems, the services cover HP-branded hardware options qualified for the server, purchased at the same time or afterward, internal to the enclosure, as well as external monitors up to 22" and tower UPS products; these items will be covered at the same service level and for the same coverage period as the server unless the maximum supported lifetime and/or the maximum usage limitation has been exceeded. Coverage of the UPS battery is not included; standard warranty terms and conditions apply.

The defective media retention service feature option applies only to Disk or eligible SSD/Flash Drives replaced by HP due to malfunction. It does not apply to any exchange of Disk or SSD/Flash Drives that have not failed. SSD/Flash Drives that are specified by HP as consumable parts and/or that have exceeded maximum supported lifetime and/or the maximum usage limit as set forth in the manufacturer's operating manual or the technical data sheet are not eligible for the defective media retention service feature option.

For more information

To learn more on HP ProLiant servers and HP BladeSystem servers, please contact your HP sales representative or HP Authorized Channel Partner. Or visit: <http://www.hp.com/services/proliant>

QuickSpecs

HP ProLiant SL4540 Generation 8 (Gen8) Server

Pre-configured Models

HP ProLiant 3xSL4540 Gen8 1G Mezz HBA Server 748409-001	Processor(s)	(1) Intel Xeon® E5-2470 v2 (2.4GHz, 10 core, 25MB, 95W)
	Servers	Includes 3 nodes in 1 chassis
	Cache Memory	25MB L3 Cache per node
	Memory	32GB (8 x 4GB) per node
	Network Controller	(2) 1Gb Ethernet Ports per node
	Storage Controller	(1) HP SL4500 H220 Host Bus Adapter per node
	Hard Drive	None ship standard
	Expansion Slot	(1) available mezzanine slot per node
	Management	HP iLO Management Engine
	Form Factor	4.3U, comes with .66U spacer blank and rail kit
	Power Supply	(2) HP 1200W Common Slot Platinum Plus Hot Plug
	Warranty	1-1-1

QuickSpecs

HP ProLiant SL4540 Generation 8 (Gen8) Server

Configuration Information - Factory Integrated Models

NOTE: This section lists some of the steps required to configure a Factory Integrated Model. To ensure only valid configurations are ordered, HP recommends the use of an HP approved configurator. Contact your local sales representative for information on configurable product offerings and requirements.

NOTE: Factory Integrated Models must start with a CTO Server.

NOTE: FIO indicates that this option is only available as a factory installable option.

NOTE: All Factory Integrated Models will be populated with sufficient hard drive blanks based on the number of initial hard drives ordered with the server.

NOTE: Rack chosen is required to have 1200mm to provide space for cable management arm at the rear of the chassis and host PDU in the rear of the rack

Step 1: Base Configuration (choose one of the following configurable models)

HP Chassis - 1x60 Model	HP ProLiant SL454x 1x Node Chassis NOTE: Standard 5 dual fan modules included along with chassis. NOTE: Supports 60 LFF drives. One node total	663600-B21
HP Chassis - 2x25 Model	HP ProLiant SL454x 2x Node Chassis NOTE: Standard 5 dual fan modules included along with chassis. NOTE: Supports 50 LFF drives with up to 25 per node. Two nodes total	663600-B22
HP Chassis - 3x15 Model	HP ProLiant SL454x 3x Node Chassis NOTE: Standard 5 dual fan modules included along with chassis. NOTE: Supports 45 LFF drives with up to 15 per node. Three nodes total	663600-B23
HP Power Supplies	NOTE: Prior to making a power supply selection it is highly recommended that the HP Power Advisor is run to determine the right size power supply for your server configuration. The HP Power Advisor is located at: www.hp.com/go/hppoweradvisor HP Common Slot Platinum Plus Power Supply Kits NOTE: The following power supplies offer up to 94% efficiency. HP 750W Common Slot Platinum Plus Hot Plug Power Supply Kit HP 1200W Common Slot Platinum Plus Hot Plug Power Supply Kit HP Common Slot Gold Power Supplies NOTE: The following power supplies offer up to 92% efficiency. HP 750W Common Slot Gold Hot Plug Power Supply Kit NOTE: Kits contain optional power supply, an IEC power cable and PDU IEC cables.	656363-B21 656364-B21 512327-B21
HP Rail Kits	NOTE: One Rail Kit is required for every chassis in a rack. HP 4.3U Server Rail Kit HP 0.66U Spacer Blank Kit NOTE: A Spacer Blank kit may be ordered to make an even 5U (4.3U+0.66U) spacing in a rack. This would enable racking of up to 8 chassis in a 42U rack. It is also possible to rack up to 9 chassis in a 42U rack using an additional dense racking option kit. The Spacer Blank kit is not used when the dense racking option HP 13U FIO Rack Adapter Kit for 3x4.3U Chassis is used	681254-B21 681260-B21

Step 1A: Select Nodes

HP Server Nodes - 1x60 model	HP ProLiant SL4540 Gen8 Tray 1x Node Server NOTE: Select quantity of one	664644-B21
-------------------------------------	--	------------



QuickSpecs

HP ProLiant SL4540 Generation 8 (Gen8) Server

Configuration Information - Factory Integrated Models

HP Server Nodes - 2x25 model	HP ProLiant SL4540 Gen8 Tray 2x Node Server NOTE: Select quantity of two	664644-B22
HP Server Nodes - 3x15 model	HP ProLiant SL4540 Gen8 Tray 3x Node Server NOTE: Select quantity of three	664644-B23

Step 2: Choose Required Node Options (only one of the following from each list unless otherwise noted)

HP Processors

NOTE: If 2 processor servers are desired, select one xxxxx-L21 and one xxxxxx-B21 for every processor option chosen per node

E5-2400 v2 Series Processors

Ten-Core Processors

HP SL4540 Gen8 Intel® Xeon® E5-2470v2 (2.4GHz/10-core/25MB/95W) FIO Processor Kit 740674-L21

HP SL4540 Gen8 Intel® Xeon® E5-2450Lv2 (1.7GHz/10-core/25MB/60W) FIO Processor Kit 744134-L21

Eight-Core Processors

HP SL4540 Gen8 Intel® Xeon® E5-2450v2 (2.5GHz/8-core/20MB/95W) FIO Processor Kit 740695-L21

HP SL4540 Gen8 Intel® Xeon® E5-2440v2 (1.9GHz/8-core/20MB/95W) FIO Processor Kit 740677-L21

Six-Core Processors

HP SL4540 Gen8 Intel® Xeon® E5-2430v2 (2.5GHz/6-core/15MB/80W) FIO Processor Kit 740680-L21

HP SL4540 Gen8 Intel® Xeon® E5-2430Lv2 (2.4GHz/6-core/15MB/60W) FIO Processor Kit 740689-L21

HP SL4540 Gen8 Intel® Xeon® E5-2420v2 (2.2GHz/6-core/15MB/80W) FIO Processor Kit 740693-L21

Four-Core Processors

HP SL4540 Gen8 Intel® Xeon® E5-2407v2 (2.4GHz/4-core/10MB/80W) FIO Processor Kit 740691-L21

E5-2400 series Processors

Eight-Core Processors

HP SL4540 Gen8 Intel® Xeon® E5-2450 (2.1GHz/8-core/20MB/95W) FIO Processor Kit 730777-L21

HP SL4540 Gen8 Intel® Xeon® E5-2470 (2.3GHz/8-core/20MB/95W) FIO Processor Kit 684373-L21

Six-Core Processors

HP SL4540 Gen8 Intel® Xeon® E5-2420 (1.9GHz/6-core/15MB/95W) FIO Processor Kit 728427-L21

HP SL4540 Gen8 Intel® Xeon® E5-2430 (2.2GHz/6-core/15MB/95W) FIO Processor Kit 684379-L21

HP SL4540 Gen8 Intel® Xeon® E5-2430L (2.0GHz/6-core/15MB/60W) FIO Processor Kit 686169-L21

HP SL4540 Gen8 Intel® Xeon® E5-2440 (2.4GHz/6-core/15MB/95W) FIO Processor Kit 684376-L21

Quad-Core Processors

HP SL4540 Gen8 Intel® Xeon® E5-2407 (2.2GHz/4-core/10MB/80W) FIO Processor Kit 686166-L21

HP Memory

NOTE: Please choose memory options for the first processor of each server node. Up to 6 DDR3 DIMM slots are dedicated per processor socket.

NOTE: HP memory from previous generation servers are not qualified or warranted with this HP ProLiant Server. HP SmartMemory is required to realize the memory performance improvements and enhanced functionality listed in this document for



QuickSpecs

HP ProLiant SL4540 Generation 8 (Gen8) Server

Configuration Information - Factory Integrated Models

Gen8. For additional information, please see the HP SmartMemory QuickSpecs at: http://h18000.www1.hp.com/products/quickspecs/14225_div/14225_div.html

NOTE: HP certified SmartMemory must be used to guarantee full 1333MHz speeds.

NOTE: Depending on the memory configuration and processor model, the memory speed may run at 1600, 1333MHz or 1066MHz. Please see the Online Memory Configuration Tool at: www.hp.com/go/ddr3memory-configurator

Registered DIMMs (RDIMM) - For E5-2400 v2 Series Processors

NOTE: The Following memory is supported by E5-2400 v2 series processors

HP 4GB (1x4GB) Single Rank x4 PC3L-12800R (DDR3-1600) Registered CAS-11 Low Voltage Memory Kit 713981-B21

HP 8GB (1x8GB) Single Rank x4 PC3L-12800R (DDR3-1600) Registered CAS-11 Low Voltage Memory Kit 731765-B21

HP 8GB (1x8GB) Dual Rank x4 PC3L-12800R (DDR3-1600) Registered CAS-11 Low Voltage Memory Kit 713983-B21

HP 16GB (1x16GB) Dual Rank x4 PC3L-12800R (DDR3-1600) Registered CAS-11 Low Voltage Memory Kit 713985-B21

Registered DIMMs (RDIMM) - For E5-2400 Series Processors

NOTE: The Following memory is supported by E5-2400 series processors

HP 4GB (1x4GB) Single Rank x4 PC3L-10600R (DDR3-1333) Registered CAS-9 Low Voltage Memory Kit 647893-B21

HP 8GB (1x8GB) Dual Rank x4 PC3L-10600R (DDR3-1333) Registered CAS-9 Low Voltage Memory Kit 647897-B21

HP 16GB (1x16GB) Dual Rank x4 PC3L-10600R (DDR3-1333) Registered CAS-9 Low Voltage Memory Kit 647901-B21

NOTE: A maximum of 12 DDR3 based memory slots are available on the node tray.

HP I/O Module

NOTE: At least one I/O module must be selected per node. The HP ProLiant SL454x 1G FIO Module Kit supports two (2) embedded 1Gb NICs. The HP SL454x 10G FIO Input Output Module Kit supports two (2) embedded 1Gb NICs and two (2) embedded 10Gb NICs with an optional InfiniBand upgrade.

NOTE: 10 Gb Ethernet on the QSFP port requires the use of the QSFP to SFP+ (QSA) adapter 655874-B21.

NOTE: IB supported with addition of HP IB Enablement Kit

HP SL454x 1G FIO Input Output Module Kit 664647-B21

HP SL454x 10G Input Output Module Kit 664648-B21

NOTE: Quantity of I/O module is 1 for every 1x60 model, 2 for every 2x25 model and 3 for every 3x15 model.

HP Storage Controllers

NOTE: Each node can support up to two of the P420i Gen8 storage controllers to manage the LFF hard drives.

NOTE: Each node can support ONLY one HP SL4500 H220 HBA to manage the LFF hard drives

NOTE: If two P420i Gen8 storage controllers are ordered, the HP SL454x Storage Mezzanine to PCIe Enablement Kit cannot be ordered

NOTE: A cache module and the 12 inch Supercap kit must be selected per each P420i ordered.

NOTE: Zero Memory cache option is not supported.

Host Bus Adapter



QuickSpecs

HP ProLiant SL4540 Generation 8 (Gen8) Server

Configuration Information - Factory Integrated Models

HP SL4500 H220 FIO Host Bus Adapter	740326-B21
NOTE: Does not support VMware	
Smart Array P420i Controller	
HP Smart Array P420i Mezzanine Controller FIO Kit	692276-B21
Options for P420i	
NOTE: A cache module and the 12 inch Supercap kit must be selected per each P420i ordered	
NOTE: Zero Memory cache option is not supported	
HP 12in Super Capacity Option for Smart Array	668943-B21
HP 1GB P-series Smart Array Flash Backed Write Cache	631679-B21
HP 2GB P-series Smart Array Flash Backed Write Cache	631681-B21

Step 3: Choose Additional Factory Integratable Options (only one of the following from each list unless otherwise noted)

PCI Riser	HP SL454x Storage Mezzanine to PCIe Enablement Kit	682632-B21
	NOTE: Needed to enable Low Profile PCIe Slot in the I/O module. Required for ordering any additional PCI Express cards for adding one of the expansion options such as HP IO accelerator, networking options or external storage controller options	
	NOTE: If two P420i Gen8 storage controllers are ordered, the HP SL454x Storage Mezzanine to PCIe Enablement Kit cannot be ordered	

Rack Adapter	HP 13U FIO Rack Adapter Kit for 3X4.3U Chassis	681677-B21
	NOTE: Densely groups three SL4540 chassis into a 13U tall space. Order one per three chassis. The 0.66U spacer is not used when selecting this option.	

HP Insight Software	HP Insight Control including 1yr 24x7 Support ProLiant ML/DL/BL-bundle Single Server FIO License	C6N36A
	HP Insight Control for BladeSystem including 1yr 24x7 Support Enclosure 8 Svr FIO Electronic License	C6N32ABE
	NOTE: The Electronic software license is available in EMEA only	
	HP Insight Control for BladeSystem including 1yr 24x7 Support Enclosure 16Svr FIO Electronic License	C6N33ABE
	NOTE: The Electronic software license is available in EMEA only	
	HP Insight Control including 1yr 24x7 Support ProLiant ML/DL/BL-bundle FIO Electronic License	C6N36ABE
	NOTE: The Electronic software license is available in EMEA only	

Step 4: Choose Additional Options for Factory Integration

NOTE: For additional options, please refer to the "Core Options" and "Additional Options" section below.



QuickSpecs

HP ProLiant SL4540 Generation 8 (Gen8) Server

Core Options

NOTE: Some options may not be integrated at the factory. To ensure only valid configurations are ordered, HP recommends the use of an HP approved configurator. Contact your local sales representative for additional information.

HP Processors

NOTE: Please choose Processor options for the second processor of each server node.

E5-2400 v2 Series Processors

Ten-Core Processors

HP SL4540 Gen8 Intel® Xeon® E5-2470v2 (2.4GHz/10-core/25MB/95W) Processor Kit 740674-B21

HP SL4540 Gen8 Intel® Xeon® E5-2450Lv2 (1.7GHz/10-core/25MB/60W) Processor Kit 744134-B21

Eight-Core Processors

HP SL4540 Gen8 Intel® Xeon® E5-2450v2 (2.5GHz/8-core/20MB/95W) Processor Kit 740695-B21

HP SL4540 Gen8 Intel® Xeon® E5-2440v2 (1.9GHz/8-core/20MB/95W) Processor Kit 740677-B21

Six-Core Processors

HP SL4540 Gen8 Intel® Xeon® E5-2430v2 (2.5GHz/6-core/15MB/80W) Processor Kit 740680-B21

HP SL4540 Gen8 Intel® Xeon® E5-2430Lv2 (2.4GHz/6-core/15MB/60W) Processor Kit 740689-B21

HP SL4540 Gen8 Intel® Xeon® E5-2420v2 (2.2GHz/6-core/15MB/80W) Processor Kit 740693-B21

Four-Core Processors

HP SL4540 Gen8 Intel® Xeon® E5-2407v2 (2.4GHz/4-core/10MB/80W) Processor Kit 740691-B21

E5-2400 Series Processors

Eight-Core Processors

HP SL4540 Gen8 Intel® Xeon® E5-2450 (2.1GHz/8-core/20MB/95W) Processor Kit 730777-B21

HP SL4540 Gen8 Intel® Xeon® E5-2470 (2.3GHz/8-core/20MB/95W) Processor Kit 684373-B21

Six-Core Processors

HP SL4540 Gen8 Intel® Xeon® E5-2420 (1.9GHz/6-core/15MB/95W) Processor Kit 728427-B21

HP SL4540 Gen8 Intel® Xeon® E5-2430 (2.2GHz/6-core/15MB/95W) Processor Kit 684379-B21

HP SL4540 Gen8 Intel® Xeon® E5-2430L (2.0GHz/6-core/15MB/60W) Processor Kit 686169-B21

HP SL4540 Gen8 Intel® Xeon® E5-2440 (2.4GHz/6-core/15MB/95W) Processor Kit 684376-B21

Quad-Core Processors

HP SL4540 Gen8 Intel® Xeon® E5-2407 (2.2GHz/4-core/10MB/80W) Processor Kit 686166-B21

NOTE: DDR3 speed is the maximum memory speed of the processor. Actual memory speed may depend on the quantity and type of DIMMs installed.

QuickSpecs

HP ProLiant SL4540 Generation 8 (Gen8) Server

Core Options

HP Memory

NOTE: Please choose memory options for the second processor of each node. Up to 6 DDR3 DIMM slots are dedicated per socket.

NOTE: HP SmartMemory is required to realize the memory performance improvements and enhanced functionality listed in this document for Gen8. For additional information, please see the HP SmartMemory QuickSpecs at:

http://h18000.www1.hp.com/products/quickspecs/14225_div/14225_div.html

NOTE: HP certified SmartMemory must be used to guarantee full 1333MHz speeds.

NOTE: Depending on the memory configuration and processor model, the memory speed may run at 1600, 1333MHz or 1066MHz. Please see the Online Memory Configuration Tool at: www.hp.com/go/ddr3memory-configurator.

Registered DIMMs (RDIMM) - For E5-2400 v2 Series Processors

NOTE: The Following memory is supported by E5-2400 v2 series processors

HP 4GB (1x4GB) Single Rank x4 PC3L-12800R (DDR3-1600) Registered CAS-11 Low Voltage Memory Kit 713981-B21

HP 8GB (1x8GB) Single Rank x4 PC3L-12800R (DDR3-1600) Registered CAS-11 Low Voltage Memory Kit 731765-B21

HP 8GB (1x8GB) Dual Rank x4 PC3L-12800R (DDR3-1600) Registered CAS-11 Low Voltage Memory Kit 713983-B21

HP 16GB (1x16GB) Dual Rank x4 PC3L-12800R (DDR3-1600) Registered CAS-11 Low Voltage Memory Kit 713985-B21

Registered DIMMs (RDIMM) - For E5-2400 Series Processors

NOTE: The Following memory is supported by E5-2400 series processors

HP 4GB (1x4GB) Single Rank x4 PC3L-10600R (DDR3-1333) Registered CAS-9 Low Voltage Memory Kit 647893-B21

HP 8GB (1x8GB) Dual Rank x4 PC3L-10600R (DDR3-1333) Registered CAS-9 Low Voltage Memory Kit 647897-B21

HP 16GB (1x16GB) Dual Rank x4 PC3L-10600R (DDR3-1333) Registered CAS-9 Low Voltage Memory Kit 647901-B21

HP Hard Drives

NOTE: For the 1x60 model, choose up to a total of 60 LFF 3.5" hard drives from the following options using any mix of SAS/SATA/SSD hard drives for desired performance and up to a total of 2 SFF 2.5" hard drives from the following options for OS, boot or additional storage purposes.

NOTE: For the 2x25 model, choose up to a total of 25 LFF 3.5" hard drives per server node from the following options using any mix of SAS/SATA/SSD hard drives for desired performance and up to a total of 2 SFF 2.5" hard drives per server node from the following options for OS, boot or additional storage purposes.

NOTE: For the 3x15 model, choose up to a total of 15 LFF 3.5" hard drives per server node from the following options using any mix of SAS/SATA/SSD hard drives for desired performance and up to a total of 2 SFF 2.5" hard drives per server node from the following options for OS, boot or additional storage purposes.

NOTE: The components of a storage subsystem (e.g. the drive, the HBA/controller, firmware, and the server backplane) should operate at the same data transfer rate or the system bandwidth will be negotiated down to an acceptable level for all components for the subsystem.

NOTE: Hard drives have either a one year or three year warranty.



QuickSpecs

HP ProLiant SL4540 Generation 8 (Gen8) Server

Core Options

SAS Hot Plug SmartDrive LFF (3.5-inch) Enterprise Drives

HP 600GB 6G SAS 15K rpm LFF (3.5-inch) SC Enterprise 3yr Warranty Hard Drive	652620-B21
HP 450GB 6G SAS 15K rpm LFF (3.5-inch) SC Enterprise 3yr Warranty Hard Drive	652615-B21

SAS Hot Plug SmartDrive LFF (3.5-inch) Midline Drives

HP 4TB 6G SAS 7.2K rpm LFF (3.5-inch) SC Midline 1yr Warranty Hard Drive	695510-B21
HP 3TB 6G SAS 7.2K rpm LFF (3.5-inch) SC Midline 1yr Warranty Hard Drive	652766-B21
HP 2TB 6G SAS 7.2K rpm LFF (3.5-inch) SC Midline 1yr Warranty Hard Drive	652757-B21
HP 1TB 6G SAS 7.2K rpm LFF (3.5-inch) SC Midline 1yr Warranty Hard Drive	652753-B21

NOTE: Please see the QuickSpecs for Technical Specifications and additional information:

http://h18000.www1.hp.com/products/quickspecs/12244_div/12244_div.html
(Worldwide)

6G SATA Hot Plug with SmartDrive SFF (2.5-inch) Midline (MDL) Drives

HP 1TB 6G SATA 7.2K rpm SFF (2.5-inch) SC Midline 1yr Warranty Hard Drive	655710-B21
HP 500GB 6G SATA 7.2K rpm SFF (2.5-inch) SC Midline 1yr Warranty Hard Drive	655708-B21

6G SATA Hot Plug with SmartDrive LFF (3.5-inch) Midline (MDL) Drives

HP 4TB 6G SATA 7.2k rpm LFF (3.5-inch) SC Midline 1yr Warranty Hard Drive	693687-B21
HP 3TB 6G SATA 7.2K rpm LFF (3.5-inch) SC Midline 1yr Warranty Hard Drive	628061-B21
HP 2TB 6G SATA 7.2K rpm LFF (3.5-inch) SC Midline 1yr Warranty Hard Drive	658079-B21
HP 1TB 6G SATA 7.2K rpm LFF (3.5-inch) SC Midline 1yr Warranty Hard Drive	657750-B21
HP 500GB 6G SATA 7.2K rpm LFF (3.5-inch) SC Midline 1yr Warranty Hard Drive	658071-B21

NOTE: Please see the QuickSpecs for Technical Specifications and additional information:

http://h18000.www1.hp.com/products/quickspecs/13021_div/13021_div.html
(Worldwide)

6G SATA Value Endurance Hot Plug LFF (3.5-inch) Enterprise Value Solid State Drives

HP 800GB 6G SATA Value Endurance LFF 3.5-in SC Enterprise Value 3yr Wty Solid State Drive	718189-B21
HP 600GB 6G SATA Value Endurance LFF 3.5-in SC Enterprise Boot 3yr Wty Solid State Drive	739900-B21
HP 480GB 6G SATA Value Endurance LFF 3.5-in SC Enterprise Value 3yr Wty Solid State Drive	718183-B21
HP 300GB 6G SATA Value Endurance LFF 3.5-in SC Enterprise Boot 3yr Wty Solid State Drive	739890-B21
HP 240GB 6G SATA Value Endurance LFF 3.5-in SC Enterprise Value 3yr Wty Solid State Drive	718177-B21

6G SATA ME Hot Plug SFF (2.5-inch) Enterprise Mainstream Solid State Drives

HP 800GB 6G SATA Mainstream Endurance SFF 2.5-in SC Enterprise Mainstream 3yr Wty Solid State Drive	691868-B21
HP 400GB 6G SATA Mainstream Endurance SFF 2.5-in SC Enterprise Mainstream 3yr Wty Solid State Drive	691866-B21
HP 200GB 6G SATA Mainstream Endurance SFF 2.5-in SC Enterprise Mainstream 3yr Wty Solid State Drive	691864-B21



QuickSpecs

HP ProLiant SL4540 Generation 8 (Gen8) Server

Core Options

HP 100GB 6G SATA Mainstream Endurance SFF 2.5-in SC Enterprise Mainstream 3yr Wty Solid State Drive	691862-B21
6G SATA ME Hot Plug LFF (3.5-inch) Enterprise Mainstream Solid State Drives	
HP 800GB 6G SATA Mainstream Endurance LFF 3.5-in SC Enterprise Mainstream 3yr Wty Solid State Drive	691860-B21
HP 400GB 6G SATA Mainstream Endurance LFF 3.5-in SC Enterprise Mainstream 3yr Wty Solid State Drive	691856-B21
HP 200GB 6G SATA Mainstream Endurance LFF 3.5-in SC Enterprise Mainstream 3yr Wty Solid State Drive	691854-B21
HP 100GB 6G SATA Mainstream Endurance LFF 3.5-in SC Enterprise Mainstream 3yr Wty Solid State Drive	691852-B21
NOTE: Please see the QuickSpecs for Technical Specifications and additional information: http://h18000.www1.hp.com/products/quickspecs/14038_div/14038_div.html (Worldwide)	

HP Networking

Gigabit Ethernet Adapters

HP NC365T 4-port Ethernet Server Adapter	593722-B21
HP Ethernet 1Gb 4-port 331T Adapter	647594-B21
10 Gigabit Ethernet adapters	
HP Ethernet 10Gb 2-port 530SFP Adapter	652503-B21
HP Ethernet 10Gb 2-port 530T Adapter	656596-B21
HP Ethernet 10Gb 2-port 560SFP+ Adapter	665249-B21
HP Ethernet 10Gb 2-port 561T Adapter	716591-B21

NOTE: Need to order HP SL454x Storage Mezzanine to PCIe Enablement Kit to enable the low profile PCIe slot.

NOTE: These are additional expansion options and only one may be selected per server node.

NOTE: Please see the QuickSpecs for Technical Specifications and additional information: www.hp.com/go/ProLiantNICs

HP InfiniBand

HP InfiniBand Enablement Kit	614841-B21
NOTE: Please see the QuickSpecs for additional information: http://h18000.www1.hp.com/products/quickspecs/13078_div/13078_div.html	



QuickSpecs

HP ProLiant SL4540 Generation 8 (Gen8) Server

Core Options

HP Power Supplies

NOTE: Prior to making a power supply selection it is highly recommended that the HP Power Advisor is run to determine the right size power supply for your server configuration. The HP Power Advisor is located at: www.hp.com/go/hppoweradvisor.

HP Common Slot Platinum Plus Power Supply Kits

NOTE: The following Power Supplies offer 94% efficiency with support for Intelligent Power Discovery

HP 750W Common Slot Platinum Plus Hot Plug Power Supply Kit

656363-B21

HP 1200W Common Slot Platinum Plus Hot Plug Power Supply Kit

656364-B21

HP Common Slot Gold Power Supplies

NOTE: The following power supplies offer up to 92% efficiency.

HP 750W Common Slot Gold Hot Plug Power Supply Kit

512327-B21

NOTE: Option Kits contain optional power supply, an IEC power cable and PDU IEC cables.

NOTE: Power Specification and Technical Content for supported power supplies can be found at:

http://h18000.www1.hp.com/products/quickspecs/14209_div/14209_div.html

QuickSpecs

HP ProLiant SL4540 Generation 8 (Gen8) Server

Additional Options

HP SL Advanced Power Manager

The SL Advanced Power Manager is an optional rack level solution for the HP ProLiant SL4540 and SL4545 which enables server-level DC (or hardware) power on and off and server-level monitoring. In addition, the SL APM will automatically discover SL hardware components which are connected into the SL APM solution.

The SL APM does not replace rack PDUs, but is designed to enable the utilization of basic, low cost, rack PDUs while providing the functionality of 'switched' PDUs (which provide hardware power on/off of individual servers by turning off the AC power to the power supplies of a given server). Because the SL servers share power supplies to optimize power efficiency, using 'switched' PDUs to turn off all the power supplies in the chassis will result in the loss of all server nodes in that chassis. The SL APM solves this by allowing server node-level hardware power on/off of the DC power to the individual server node motherboards.

HP SL Advanced Power Manager Kit	538084-B21
HP SL Advanced Power Manager Distribution Module Kit	620002-B21

HP Insight Software

HP Insight Control

HP Insight Control including 1yr 24x7 Technical Support and Updates Electronic License	C6N28ABE
--	----------

NOTE: The Electronic software license is available in EMEA only.

HP Insight Control including 1yr 24x7 Technical Support and Updates Single Server License	C6N27A
---	--------

HP Insight Control Server Deployment including 1yr 24x7 Support Electronic License	T9082AAE
--	----------

HP Insight Control Server Deployment including 1yr 24x7 Support Single Server License	452151-B21
---	------------

HP Insight Control Server Provisioning Media Kit	BD883A
--	--------

HP Insight Management Media Kit	C6N31A
---------------------------------	--------

NOTE: Electronic and Flexible-Quantity licenses can be used to purchase multiple licenses with a single activation key.

NOTE: Customer will receive a license entitlement certificate. The license entitlement certificate must be redeemed online or via fax in order to obtain the license activation key(s). Includes one year of 24 x 7 HP Software Technical Support and Update Service.

NOTE: Licenses ship without media. The HP Insight Control Media Kit can be ordered separately, or can be downloaded at: <http://www.hp.com/go/insightupdates>.

NOTE: For additional license options please see the QuickSpecs at:

http://h18000.www1.hp.com/products/quickspecs/12631_div/12631_div.html

HP Integrated Lights-Out (iLO)

HP iLO Scale-Out

HP Integrated Lights-Out Scale-Out including 3yr 24x7 Tech Support and Updates Flex Qty E-LTU	BD776AAE
---	----------

HP Integrated Lights-Out Scale-Out 3yr 24x7 Tech Support and Updates Flex Quantity License	BD776A
--	--------

HP Integrated Lights-Out Scale-Out including 3yr 24x7 Tech Support and Updates Tracking License	BD777A
---	--------

HP Integrated Lights-Out Scale-Out including 1yr 24x7 Tech Support and Updates Flex Qty E-LTU	BD778AAE
---	----------



QuickSpecs

HP ProLiant SL4540 Generation 8 (Gen8) Server

Additional Options

HP Integrated Lights-Out Scale-Out 1yr 24x7 Tech Support and Updates Flex Quantity License BD778A

HP Integrated Lights-Out Scale-Out including 1yr 24x7 Tech Support and Updates Tracking License BD779A

NOTE: Electronic and Flexible-Quantity licenses can be used to purchase multiple licenses with a single set of activation keys.

NOTE: For additional license options please see the QuickSpecs at:

http://h18000.www1.hp.com/products/quickspecs/13019_div/13019_div.html

HP Integrated Lights-Out (iLO) Advanced for ProLiant

HP iLO Advanced including 1yr 24x7 Technical Support and Updates Electronic License E6U59ABE

NOTE: The Electronic software license is available in EMEA only.

HP iLO Advanced including 3yr 24x7 Tech Support and Updates Electronic License E6U64ABE

NOTE: The Electronic software license is available in EMEA only.

HP iLO Advanced including 1yr 24x7 Technical Support and Updates Single Server License 512485-B21

HP iLO Advanced for BladeSystem including 1yr 24x7 Support Eight Server License 512489-B21

HP iLO Advanced 1 Server License with 3yr 24x7 Tech Support and Updates BD505A

NOTE: For additional license options please see the QuickSpecs at:

http://h18004.www1.hp.com/products/quickspecs/14276_div/14276_div.html

NOTE: For more information, visit: <http://www.hp.com/go/ilo>.

High Performance Clusters

HP Cluster Management Utility

HP Insight Cluster Management Utility 1yr 24x7 Flexible License QL803B

HP Insight Cluster Management Utility 3yr 24x7 Flexible License BD476A

NOTE: These part numbers can be used to purchase one certificate for multiple licenses and support with a single activation key. Each license is for one node (server). Customer will receive a printed end user license agreement and license entitlement certificate via physical shipment. The license entitlement certificate must be redeemed online in order to obtain a license key. Customer also will receive a support agreement.

HP Insight Cluster Management Utility Media BD477A

NOTE: For additional license kits please see the QuickSpecs at:

http://h18004.www1.hp.com/products/quickspecs/12612_div/12612_div.html



QuickSpecs

HP ProLiant SL4540 Generation 8 (Gen8) Server

Additional Options

HP I/O Accelerator Options

Second Generation Accelerators

HP 365GB Multi Level Cell G2 PCIe ioDrive2 for ProLiant Servers 673642-B21

HP 785GB Multi Level Cell G2 PCIe ioDrive2 for ProLiant Servers 673644-B21

NOTE: Need to order HP SL454x Storage Mezzanine to PCIe Enablement Kit to enable the low profile PCIe slot.

NOTE: These are additional expansion options and only one may be selected per server node.

NOTE: Please see the QuickSpecs for Technical Specifications and additional information:

http://h18000.www1.hp.com/products/quickspecs/13587_div/13587_div.html
(Worldwide)

HP PCIe Workload Accelerator Options

Mainstream Endurance (ME) PCIe Workload Accelerators

HP 1.4TB HH/HL Mainstream Endurance (ME) PCIe Workload Accelerator 729307-B21

HP 700GB HH/HL Mainstream Endurance (ME) PCIe Workload Accelerator 729305-B21

High Endurance (HE) PCIe Workload Accelerators

HP 700GB HH/HL High Endurance (HE) PCIe Workload Accelerator 708090-B21

HP 350GB HH/HL High Endurance (HE) PCIe Workload Accelerator 708088-B21

NOTE: Please see the QuickSpecs for Technical Specifications and additional information:

http://h18000.www1.hp.com/products/quickspecs/14528_div/14528_div.html
(Worldwide)

HP Security

HP Trusted Platform Module Option 488069-B21

NOTE: The TPM (Trusted Platform Module) is a microcontroller chip that can securely store artifacts used to authenticate the server platform. These artifacts can include passwords, certificates and encryption keys. Windows® BitLocker™ Drive Encryption (BitLocker) is a data protection feature available in Windows Server® 2008. BitLocker leverages the enhanced security capabilities of a Trusted Platform Module (TPM) version 1.2. The TPM works with BitLocker to help protect user data and to ensure that a server running Windows Server 2008 has not been tampered with while the system was offline. For more information about TPM, including a white paper, go to: www.hp.com/go/TPM.

NOTE: ProLiant OS pre-installed units will come with the partition required for TPM deployment.

NOTE: The TPM key is unique to every TPM deployed server and must be retained. Misplacing or losing the key could result in data loss.

QuickSpecs

HP ProLiant SL4540 Generation 8 (Gen8) Server

Additional Options

HP Storage Controllers

SAS Controllers

Smart Array P421 Controller

HP Smart Array P421/1GB FBWC 6Gb 2-ports Ext SAS Controller 631673-B21

HP Smart Array P421/2GB FBWC 6Gb 2-ports Ext SAS Controller 631674-B21

Optional Upgrades

HP 12in Super Capacity Option for Smart Array 668943-B21

NOTE: The HP 12in Super Cap is a required option to implement a HP Smart Array Controller with Flash.

HP 1GB P-series Smart Array Flash Backed Write Cache 631679-B21

HP 2GB P-series Smart Array Flash Backed Write Cache 631681-B21

HP SmartCache No Media 24x7 Technical Support 1 Svr License D7S26A

HP SmartCache No Media 24x7 Technical Support Flexible License D7S27A

HP SmartCache No Media 24x7 Technical Support Electronic License D7S27AAE

NOTE: Please see the QuickSpecs for Technical Specifications and additional information:

http://h18000.www1.hp.com/products/quickspecs/14229_div/14229_div.html
(Smart Array P421 Controller)

http://h18000.www1.hp.com/products/quickspecs/14532_div/14532_div.html
(SmartCache)

Host Bus Adapter

HP H221 Host Bus Adapter 650931-B21

HP H221 PCIe 3.0 SAS Host Bus Adapter 729552-B21

NOTE: Need to order HP SL454x Storage Mezzanine to PCIe Enablement Kit to enable the low profile PCIe slot.

NOTE: These are additional expansion options and only one may be selected per server node.

NOTE: Please see the QuickSpecs for Technical Specifications and additional information:

http://h18004.www1.hp.com/products/quickspecs/14337_div/14337_div.html
(HBA 222)

QuickSpecs

HP ProLiant SL4540 Generation 8 (Gen8) Server

Additional Options

HP Power Cords

NOTE: HP ProLiant servers ships with an IEC-IEC power cord used for rack mounting with Power Distribution Units (PDUs).

HP C13 - C14 WW 250V 10A Gray 0.7m Jumper Cord	A0K03A
HP C13 - C14 WW 250V 10A Gray 1.37m Jumper Cord	A0K04A
HP C13 - SEV 1011 CH 250V 10Amp 1.83m Power Cord	AF565A
HP C13 - DK-2.5A DK 250V 10Amp 1.83m Power Cord	AF566A
HP C13 - CEE-VII EU 250V 10Amp 1.83m Power Cord	AF568A
HP C13 - SI-32 IL 250V 10Amp 1.83m Power Cord	AF564A
HP C13 - NBR-14136 BR 250V 10Amp 1.83m Power Cord	AF591A
HP C13 - BS-1363A UK/HK/SG 250V 10Amp 1.83m Power Cord	AF570A
HP C13 - CEI-23-50 IT/CL 250V 10Amp 1.83m Power Cord	AF571A
HP C13 - C14 WW 250V 10Amp 2.0m Jumper Cord	A0K02A
HP C13 - IS-1293 IN 250V 10Amp HV 2.5m Power Cord	SG579A
HP C13 - AS3112-3 AU 250V 10Amp 2.5m Power Cord	AF569A
HP C13 - SABS-164 ZA 250V 10Amp 2.5m Power Cord	AF567A
HP C13 - JIS C8303 JP 100V 12Amp 2.0m Power Cord	AF572A
HP C13 - C14 WW 250V 10A Gray 3.0m Jumper Cord	A0K06A
HP C13 - Nema 6-15P US 250V 15A JP 3.6m Power Cord	A0N33A
HP C13 - GB-1002 CN 250V 10Amp 1.83m Power Cord	AF557A
HP C13 - KSC- 8305 KR 250V 10Amp 1.83m Power Cord	AF560A
HP C13 - CNS-690 TW 110V 13Amp 1.83m Power Cord	AF561A
HP C13 - Nema 5-15P TH/PH 250V 10Amp 1.83m Power Cord	AF559A
HP C13 - Nema 5-15P US/CA 110V 10Amp 1.83m Power Cord	AF556A
HP C13 - IS-1293 IN 240V 6Amp LV 2.0m Power Cord	AF562A
HP C13 - IRAM -2073 AR 250V 10A 2.5m Power Cord	AF558A
HP C13 - C14 WW 250V 10Amp Flint Gray 2.0m Jumper Cord	AF573A

HP Tape Backup

NOTE: For the complete range of tape drives, autoloaders, libraries and media see: <http://www.hp.com/go/tape>. For hardware and software compatibility of HP tape backup products see: <http://www.hp.com/storage/SPOCK>

HP LTO Ultrium Half-Height Tape Drives

HP StoreEver LTO-6 Ultrium 6250 Tape Drive in 1U Rack-mount Kit	COL99A
---	--------

HP StoreEver 1/8 G2 Tape Autoloader

HP StoreEver 1/8 G2 LTO-6 Ultrium 6250 FC Tape Autoloader	COH19A
---	--------

HP StoreEver MSL6480

HP StoreEver MSL6480 Scalable Base Module	QU625A
---	--------



QuickSpecs

HP ProLiant SL4540 Generation 8 (Gen8) Server

Additional Options

HP Tape Storage Systems **HP StoreEver MSL6480**

HP StoreEver MSL6480 Scalable Base Module

QU625A

NOTE: Please see the QuickSpecs for Technical Specifications and additional information:

http://h18000.www1.hp.com/products/quickspecs/14604_div/14604_div.html
(Worldwide)

HP Disk Storage Systems **Disk Enclosures**

HP D2600 w/12 4TB 6G SAS 7.2K LFF Dual Port MDL HDD 48TB Bundle

E7W32A

NOTE: Please see the QuickSpecs for Technical Specifications and additional information:

http://h18000.www1.hp.com/products/quickspecs/13404_div/13404_div.html
(Worldwide)

HP Uninterruptible Power Systems **HP Rack-mountable UPS**

HP R1500 G3 Uninterruptible Power Supply (UPS)

HP R1.5kVA G3 1U NA Uninterruptible Power System

AF469A

HP R1.5kVA G3 1U JP/TW Uninterruptible Power System

AF470A

HP R1.5kVA G3 1U INTL Uninterruptible Power System

AF471A

NOTE: Please see the QuickSpecs for additional information:

http://h18000.www1.hp.com/products/quickspecs/14059_div/14059_div.html
(Worldwide)

HP R/T3000 G2 Uninterruptible Power System (UPS)

HP R/T3000 G2 2U L530 Low Voltage NA/JP Uninterruptible Power System

AF466A

HP R/T3000 G2 2U L620 High Voltage NA/JP Uninterruptible Power System

AF467A

HP R/T3000 G2 2U Detachable Cord High Voltage INTL Uninterruptible Power System

AF468A

NOTE: Please see the QuickSpecs for additional information:

http://h18000.www1.hp.com/products/quickspecs/14058_div/14058_div.html
(Worldwide)

R5000 Uninterruptible Power System (UPS)

HP R5KVA 3U IEC309-32A High Voltage INTL Uninterruptible Power System

AF461A

HP R5KVA 3U L630 High Voltage NA/JP Uninterruptible Power System

AF460A

NOTE: Please see the QuickSpecs for additional information:

http://h18000.www1.hp.com/products/quickspecs/14109_div/14109_div.html
(Worldwide)

R7000 Uninterruptible Power System (UPS)

HP R7KVA 4U 50A High Voltage NA/JP Uninterruptible Power System

AF462A

HP R7KVA 4U IEC-32A High Voltage INTL Uninterruptible Power System

AF463A

NOTE: Please see the QuickSpecs for additional information:

http://h18000.www1.hp.com/products/quickspecs/14110_div/14110_div.html
(Worldwide)

NOTE: For additional information on HP Uninterruptible Power Systems please go to:



QuickSpecs

HP ProLiant SL4540 Generation 8 (Gen8) Server

Additional Options

www.hp.com/servers/rackups.

NOTE: For additional information on sizing your server, please reference:

<http://www.upssizer.com>.

NOTE: Please see the UPS and PDU cable matrix's on the HP Power Protection and Management page. Under Power Cords, click on the "HP Power Cord Matrix" link. That link will list cable descriptions, requirements, and specifications for UPS and PDU units. Please see the following link: www.hp.com/products/powercords.

HP Basic Power

Distribution Units (bPDU)

HP Basic Power Distribution Unit: 1U/0U Version

HP 1.9kVA 120 Volt 12 Outlet NA/JP Basic Power Distribution Unit	H5M54A
HP 3.6kVA 200-240 Volt 12 Outlet WW Basic Power Distribution Unit	H5M56A

HP Basic Power Distribution Unit: Half Height Version

HP 2.8kVA 120 Volt 18 Outlet NA/JP Basic Power Distribution Unit	H5M55A
HP 3.6kVA 200-240 Volt 20 Outlet WW Basic Power Distribution Unit	H5M57A
HP 4.9kVA 208 Volt 20 Outlet NA/JP Basic Power Distribution Unit	H5M58A
HP 7.3kVA 230 Volt 20 Outlet INTL Basic Power Distribution Unit	H5M68A
HP 8.6kVA 208 Volt Three Phase 18 Outlet NA/JP Basic Power Distribution Unit	H5M61A

HP Basic Power Distribution Unit: Mid Height Version

HP 4.9kVA 208 Volt 30 Outlet NA/JP Basic Power Distribution Unit	H5M59A
HP 7.3kVA 230 Volt 30 Outlet INTL Basic Power Distribution Unit	H5M70A
HP 8.3kVA 208 Volt 36 Outlet NA/JP Basic Power Distribution Unit	H5M60A
HP 11kVA 230 Volt 36 Outlet INTL Basic Power Distribution Unit	H5M71A
HP Hardwired 200-240 Volt 36 Outlet WW Basic Power Distribution Unit	H5M75A
HP 5.7kVA 208 Volt Three Phase 27 Outlet NA/JP Dual Voltage Basic Power Distribution Unit	H5M63A
HP 8.6kVA 208 Volt Three Phase 30 Outlet NA/JP Dual Voltage Basic Power Distribution Unit	H5M64A
HP 8.6kVA 208 Volt Three Phase 30 Outlet NA/JP Basic Power Distribution Unit	H5M62A
HP 11kVA 400 Volt Three Phase 30 Outlet INTL Basic Power Distribution Unit	H5M72A

HP Basic Power Distribution Unit: Full Height Version

HP 11kVA 400 Volt Three Phase 42 Outlet INTL Basic Power Distribution Unit	H5M73A
HP 11kVA 400 Volt Three Phase 42 Outlet NA Basic Power Distribution Unit	H5M67A

HP Basic Power Distribution Unit: 480/277 Volt Version

HP 13.2kVA 480 Volt Three Phase 15 Outlet NA Basic Power Distribution Unit	H3X07A
HP 19.9kVA 480 Volt Three Phase 30 Outlet NA Basic Power Distribution Unit	H3X08A

NOTE: Please see the QuickSpecs for Technical Specifications and additional information:

http://h18000.www1.hp.com/products/quickspecs/14557_div/14557_div.html
(Worldwide)

NOTE: Additional HP Power Distribution Units are available. For a complete list of all HP PDUs and additional information please visit: www.hp.com/go/rackandpower



QuickSpecs

HP ProLiant SL4540 Generation 8 (Gen8) Server

Additional Options

HP Remote Monitoring Power Distribution Units (mPDU)

HP Remote Monitored Power Distribution Unit: 1U Version

HP 2.8kVA 120 Volt 12 Outlet NA/JP Monitored Power Distribution Unit	D9N43A
HP 3.6kVA 200-240 Volt 12 Outlet WW Monitored Power Distribution Unit	D9N46A
HP 4.9kVA 208 Volt 12 Outlet NA/JP Monitored Power Distribution Unit	D9N44A

HP Remote Monitored Power Distribution Unit: Half Height Version

HP 3.6kVA 200-240 Volt 16 Outlet WW Monitored Power Distribution Unit	D9N45A
---	--------

HP Remote Monitored Power Distribution Unit: Mid Height Version

HP 4.9kVA 208 Volt 24 Outlet NA/JP Monitored Power Distribution Unit	D9N47A
HP 7.3kVA 230 Volt 24 Outlet INTL Monitored Power Distribution Unit	D9N48A
HP 8.6kVA 208 Volt Three Phase 21 Outlet NA/JP Monitored Power Distribution Unit	D9N51A
HP 5.7kVA 208 Volt Three Phase 21 Outlet NA/JP Dual Voltage Monitored Power Distribution Unit	D9N52A
HP 8.6kVA 208 Volt Three Phase 24 Outlet NA/JP Dual Voltage Monitored Power Distribution Unit	D9N53A
HP 11kVA 400 Volt Three Phase 21 Outlet INTL Monitored Power Distribution Unit	D9N55A

HP Remote Monitored Power Distribution Unit: Full Height Version

HP 8.3kVA 208 Volt 33 Outlet NA Monitored Power Distribution Unit	D9N49A
HP 7.3kVA 230 Volt 36 Outlet INTL Monitored Power Distribution Unit	D9N50A
HP 11kVA 400 Volt Three Phase 33 Outlet INTL Monitored Power Distribution Unit	D9N57A
HP 14.4kVA 208 Volt Three Phase 24 Outlet NA Monitored Power Distribution Unit	D9N58A
HP 16.6kVA 400 Volt Three Phase 33 Outlet NA Monitored Power Distribution Unit	D9N61A
HP 17.3kVA 208 Volt Three Phase 27 Outlet NA/JP Monitored Power Distribution Unit	D9N54A
HP 17.3kVA 208 Volt Three Phase 24 Outlet NA/JP Monitored Power Distribution Unit	D9N59A
HP 22kVA 400 Volt Three Phase 24 Outlet INTL Monitored Power Distribution Unit	D9N60A
HP 22kVA 400 Volt Three Phase 33 Outlet INTL Monitored Power Distribution Unit	D9N56A
HP 16.6kVA 400 Volt Three Phase 24 Outlet NA Monitored Power Distribution Unit	D9N62A
HP 19.9kVA 480 Volt Three Phase 30 Outlet NA Monitored Power Distribution Unit	D9N63A

HP Environmental Sensor for Remote Monitored PDUs

HP Environmental Sensor for Remote Monitored PDUs	E2D53A
---	--------

NOTE: Please see the QuickSpecs for additional information:

http://h18000.www1.hp.com/products/quickspecs/14669_div/14669_div.html
(Worldwide)

QuickSpecs

HP ProLiant SL4540 Generation 8 (Gen8) Server

Additional Options

HP Intelligent Power Distribution Units (iPDU)	iPDU Core Units	
	HP 4.9kVA 24A Single Phase NA/JP Core Intelligent Modular Power Distribution Unit	AF520A
	HP 8.3kVA 40A Single Phase NA/JP Core Intelligent Modular Power Distribution Unit	AF521A
	HP 8.6kVA 24A Three Phase NA/JP Core Intelligent Modular Power Distribution Unit	AF522A
	HP 14.4kVA 40A Three Phase NA/JP Intelligent Modular Power Distribution Unit	AF533A
	HP 17.3kVA 48A Three Phase NA/JP Core Intelligent Modular Power Distribution Unit	AF523A
	HP 17.3kVA 24A 415V Three Phase L22-30 NA Core Intelligent Power Distribution Unit	AF902A
	HP 7.3kVA 32A Single Phase INTL Core Intelligent Modular Power Distribution Unit	AF525A
	HP 11kVA 16A Three Phase INTL Core Intelligent Modular Power Distribution Unit	AF526A
	HP 22kVA 32A Three Phase INTL Core Intelligent Modular Power Distribution Unit	AF527A
	HP 17.3kVA 48A 208V Three Phase 12 Outlet Core NA/JP Intelligent Power Distribution Unit	AF535A
	HP 17.3kVA 24A 415V Three Phase 12 Outlet Core NA/JP Intelligent Power Distribution Unit	AF537A
	HP 22kVA 32A 400V Three Phase 12 Outlet Core INTL Intelligent Power Distribution Unit	AF538A
	iPDU Kits with Standard Extension Bars	
	HP 4.9kVA 24A Single Phase NA/JP Intelligent Modular Power Distribution Kit	AF531A
	HP 8.6kVA 24A Three Phase NA/JP Intelligent Modular Power Distribution Kit	AF532A
	HP 7.3kVA 32A Single Phase INTL Intelligent Modular Power Distribution Kit	AF534A
	iPDU Extension Bars	
	HP 5x13 Intelligent PDU Extension Bar G2 Kit	AF547A
	HP 5x13 Outlets Power and UID LEDs Pair Standard Extension Bar	AF528A
	NOTE: Please see the QuickSpecs for Technical Specifications and additional information: http://h18000.www1.hp.com/products/quickspecs/13650_div/13650_div.html (Worldwide)	
	NOTE: Additional HP Power Distribution Units are available. For a complete list of all HP PDUs and additional information please visit: www.hp.com/go/rackandpower .	

QuickSpecs

HP ProLiant SL4540 Generation 8 (Gen8) Server

Additional Options

HP Rack Series

HP Intelligent Rack Series

HP 636 1200mm Pallet Intelligent Series Rack	BW899A
HP 636 1200mm Shock Intelligent Series Rack	BW900A
HP 642 1200mm Pallet Intelligent Series Rack	BW907A
HP 642 1200mm Shock Intelligent Series Rack	BW908A
HP 647 1200mm Pallet Intelligent Series Rack	BW913A
HP 647 1200mm Shock Intelligent Series Rack	BW914A

NOTE: Rack chosen is required to have a depth of 1200mm to provide space for cable management arm at the rear of the chassis and host PDU in the rear of the rack.

NOTE: Please see the QuickSpecs for Technical Specifications such as height, width, depth, weight, and color:

http://h18000.www1.hp.com/products/quickspecs/14223_div/14223_div.html
(Worldwide)

NOTE: For additional information regarding Rack Cabinets, please see the following URL: <http://www.hp.com/go/rackandpower>.

HP Rack Options

HP TFT7600 G2 KVM Console and Monitor (TFT7600 G2)

HP TFT7600 G2 KVM Console Rackmount Keyboard US Monitor	AZ870A
HP TFT7600 G2 KVM Console Rackmount Keyboard UK Monitor	AZ871A
HP TFT7600 G2 KVM Console Rackmount Keyboard DE Monitor	AZ872A
HP TFT7600 G2 KVM Console Rackmount Keyboard FR Monitor	AZ873A
HP TFT7600 G2 KVM Console Rackmount Keyboard IT Monitor	AZ874A
HP TFT7600 G2 KVM Console Rackmount Keyboard ES Monitor	AZ875A
HP TFT7600 G2 KVM Console Rackmount Keyboard DK Monitor	AZ876A
HP TFT7600 G2 KVM Console Rackmount Keyboard NO Monitor	AZ877A
HP TFT7600 G2 KVM Console Rackmount Keyboard SE/FI Monitor	AZ878A
HP TFT7600 G2 KVM Console Rackmount Keyboard CH Monitor	AZ879A
HP TFT7600 G2 KVM Console Rackmount Keyboard PT Monitor	AZ880A
HP TFT7600 G2 KVM Console Rackmount Keyboard BE Monitor	AZ881A
HP TFT7600 G2 KVM Console Rackmount Keyboard JP Monitor	AZ882A
HP TFT7600 G2 KVM Console Rackmount Keyboard RU Monitor	AZ883A
HP TFT7600 G2 KVM Console Rackmount Keyboard Intl Monitor	AZ884A
HP TFT7600 G2 KVM Console Rackmount Keyboard US TAA Monitor	AZ885A

NOTE: Please see the QuickSpecs for Technical Specifications and additional information:

http://h18000.www1.hp.com/products/quickspecs/13731_div/13731_div.html
(Worldwide)

HP Server Console Switches

HP Server Console 0x2x8 Port Analog Switch	AF616A
HP Server Console 0x2x16 Port Analog Switch	AF617A
HP TAA 0x2x16xKVM Server Console G2 Switch	AF626A



QuickSpecs

HP ProLiant SL4540 Generation 8 (Gen8) Server

Additional Options

NOTE: Please see the QuickSpecs for Technical Specifications and additional information:

http://h18000.www1.hp.com/products/quickspecs/11834_div/11834_div.html
(Worldwide)

HP Server Console Switch G2 with Virtual Media & CAC

HP 0x2x16 KVM Server Console Switch G2 with Virtual Media CAC Software	AF618A
HP 0x2x32 KVM Server Console Switch G2 with Virtual Media CAC Software	AF619A
HP KVM CAT5 1-pack USB Interface Adapter	336047-B21

NOTE: Please see the QuickSpecs for Technical Specifications and additional information:

http://h18000.www1.hp.com/products/quickspecs/13475_div/13475_div.html
(Worldwide)

HP IP Console Switch G2 with Virtual Media & CAC

HP 1x4 USB/PS2 KVM Console Switch	AF611A
HP 1x1Ex8 KVM IP Console Switch G2 with Virtual Media CAC Software	AF620A
HP 2x1Ex16 KVM IP Console Switch G2 with Virtual Media CAC Software	AF621A
HP 4x1Ex32 KVM IP Console Switch G2 with Virtual Media CAC Software	AF622A

NOTE: Please see the QuickSpecs for Technical Specifications and additional information:

http://h18000.www1.hp.com/products/quickspecs/13474_div/13474_div.html
(Worldwide)

HP Care Pack Services

Server Care Packs

HP 3 year Next business day SL454X Gen8 Tray 1x Node Hardware Support	U7K40E
HP 3 year Next business day Defective Media Retension SL454X Gen8 Tray 1x Node Hardware Support	U7K41E
HP 3 year Next business day SL454X Gen8 Tray 1x Node Proactive Service	U7K42E
HP 3 year Next business day Defective Media Retension SL454X Gen8 Tray 1x Node Proactive Service	U7K43E
HP 3 year 4 hour 13x5 SL454X Gen8 Tray 1x Node Hardware Support	U7K44E
HP 3 year 4 hour 13x5 with Defective Media Retension SL454X Gen8 Tray 1x Node Hardware Support	U7K45E
HP 3 year 4 hour 24x7 SL454X Gen8 Tray 1x Node Hardware Support	U7K48E
HP 3 year 4 hour 24x7 Defective Media Retension SL454X Gen8 Tray 1x Node Hardware Support	U7K49E
HP 3 year 4 hour 24x7 SL454X Gen8 Tray 1x Node Proactive Service	U7K50E
HP 3 year 4 hour 24x7 Defective Media Retension SL454X Gen8 Tray 1x Node Proactive Service	U7K51E
HP 3 year 24 hour 24x7 Call to Repair SL454X Gen8 Tray 1x Node Hardware Support	U7K54E
HP 3 year 24 hour 24x7 Defective Media Retension SL454X Gen8 Tray 1x Node Hardware Support	U7K55E
HP 3 year 6 hour 24x7 Call to Repair SL454X Gen8 Tray 1x Node Hardware Support	U7K56E



QuickSpecs

HP ProLiant SL4540 Generation 8 (Gen8) Server

Additional Options

HP 3 year 6 hour 24x7 Defective Media Retention SL454X Gen8 Tray 1x Node Hardware Support	U7K57E
HP 3 year 6 hour 24x7 SL454X Gen8 Tray 1x Node Call to Repair Proactive Service	U7K58E
HP 3 year 6 hour 24x7 Defective Media Retention SL454X Gen8 Tray 1x Call to Repair Proactive Service	U7K59E
Enclosure Care Packs	
HP 3 year Next business day SL454x 1 Node Chassis Hardware Support	U7J55E
HP 3 year Next business day Defective Media Retention SL454x 1 Node Chassis Hardware Support	U7J56E
HP 3 year Next business day SL454x 1 Node Chassis Proactive Service	U7J57E
HP 3 year Next business day Defective Media Retention SL454x 1 Node Chassis Proactive Service	U7J58E
HP 3 year 4 hour 13x5 SL454x 1 Node Chassis Hardware Support	U7J59E
HP 3 year 4 hour 13x5 with Defective Media Retention SL454x 1 Node Chassis Hardware Support	U7J60E
HP 3 year 4 hour 24x7 SL454x 1 Node Chassis Hardware Support	U7J63E
HP 3 year 4 hour 24x7 Defective Media Retention SL454x 1 Node Chassis Hardware Support	U7J64E
HP 3 year 4 hour 24x7 SL454x 1 Node Chassis Proactive Service	U7J65E
HP 3 year 4 hour 24x7 Defective Media Retention SL454x 1 Node Chassis Proactive Service	U7J66E
HP 3 year 24 hour 24x7 Call to Repair SL454x 1 Node Chassis Hardware Support	U7J69E
HP 3 year 24 hour 24x7 Defective Media Retention SL454x 1 Node Chassis Hardware Support	U7J70E
HP 3 year 6 hour 24x7 Call to Repair SL454x 1 Node Chassis Hardware Support	U7J71E
HP 3 year 6 hour 24x7 Defective Media Retention SL454x 1 Node Chassis Hardware Support	U7J72E
HP 3 year 6 hour 24x7 SL454x 1 Node Chassis Call to Repair Proactive Service	U7J73E
HP 3 year 6 hour 24x7 Defective Media Retention SL454x 1 Node Chassis Call to Repair Proactive Service	U7J74E

NOTE: For more information, customer/resellers can contact:

<http://www.hp.com/services/carepack>.

QuickSpecs

HP ProLiant SL4540 Generation 8 (Gen8) Server

Memory

HP ProLiant SL4540 (Gen8) server

NOTE: Memory configurations listed do not apply to "Factory Integrated Models".

NOTE: Chart does not represent all possible memory configurations.

For detailed memory configuration rules and guidelines, please use the Online DDR3 Memory Configuration Tool:

www.hp.com/go/ddr3memory-configurator

Memory Subsystem Architecture

Each Intel® Xeon® E5-2400 family processor socket contains three memory channels that support two DIMMs each for a total of six (6) DIMM per installed processor or a grand total of twelve (12) DIMMs for the server. Up to 16GB capacity DIMMs are supported for 192GB of memory (12 DIMM slots x 16GB per DIMM).

DIMM slot and configuration diagrams

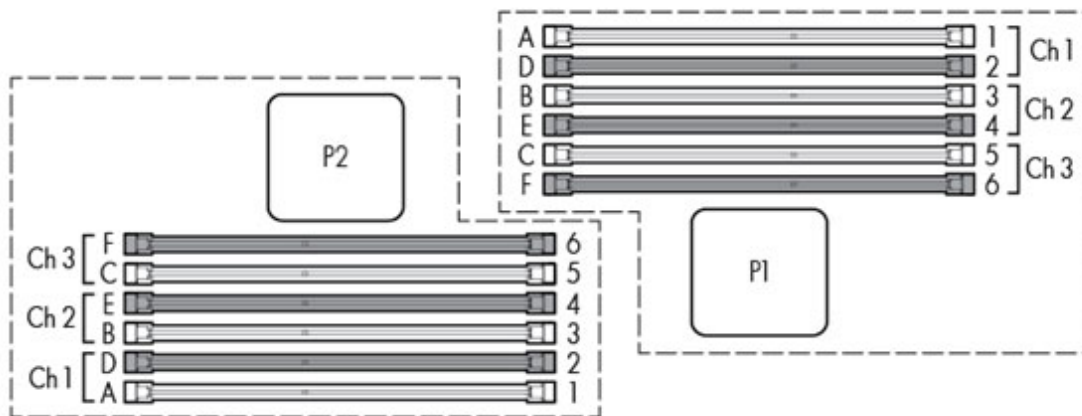

Memory population guidelines

General Memory Population Rules and Guidelines:

- Light DIMM slots denote the first slot of a channel. For 1 DPC (DIMM per channel) populate light slots only.
- Install DIMMs only if the corresponding processor is installed.
- If only one processor is installed in a two processor system, only half of the DIMM slots are available.
- To maximize performance, it is recommended to balance the total memory capacity between all installed processors and to load the channels similarly whenever possible.
- Populate DIMMs from heaviest load (dual-rank) to lightest load (single-rank) within a channel. Heaviest load (DIMM with most ranks) within a channel goes furthest from the processor
- The maximum memory speed is a function of the memory type, memory configuration, and processor model.
- The maximum memory capacity is a function of the memory type and number of installed processors.
- HP memory from previous generation servers is not qualified on the SL4540 Gen8 Server. Certain HP SmartMemory features such as memory authentication and enhanced performance may not be supported.
- To realize the performance memory capabilities listed in this document, HP SmartMemory is required. For additional information, please see the HP SmartMemory QuickSpecs at:
http://h18000.www1.hp.com/products/quickspecs/14225_div/14225_div.html.

QuickSpecs

HP ProLiant SL4540 Generation 8 (Gen8) Server

Memory

DIMM Type	Registered DIMMS for E5-2400 v2 Series Processors (RDIMMs)			
DIMM Rank	Single Rank (1R)		Dual Rank (2R)	
DIMM Capacity	4GB	8GB	8GB	16GB
DIMM Native Speed (MHz)	1600	1600	1600	1600
Voltage	LV	LV	LV	LV
SLOTS THAT CAN BE POPULATED				
12 slot server nodes	12	12	12	12
MAXIMUM CAPACITY (GB)*				
1 DIMM Per Channel	48	96	96	192
2 DIMM Per Channel	1600	1600	1600	1600
2 DIMM Per Channel	1600	1600	1600	1600
	<p>NOTE: Memory speed is a function of the processor QPI bus speed. * Maximum capacity will vary based on individual server platform qualification schedule</p> <p>NOTE: Capacity references are rounded to the common Gigabyte values:</p> <ul style="list-style-type: none"> • 4GB = 4096MB • 8GB = 8192MB • 16GB = 16384MB 			

DIMM Type	Registered DIMMS for E5-2400 Series Processors (RDIMMs)		
DIMM Rank	Single Rank (1R)	Dual Rank (2R)	
DIMM Capacity	4GB	8GB	16GB
DIMM Native Speed (MHz)	1333	1333	1333
Voltage	LV	LV	LV
SLOTS THAT CAN BE POPULATED			
12 slot server nodes	12	12	12
MAXIMUM CAPACITY (GB)*			
1 DIMM Per Channel	48	96	192
2 DIMM Per Channel	1333	1333	1333
2 DIMM Per Channel	1333	1333	1333
	<p>NOTE: Memory speed is a function of the processor QPI bus speed. * Maximum capacity will vary based on individual server platform qualification schedule</p> <p>NOTE: Capacity references are rounded to the common Gigabyte values:</p> <ul style="list-style-type: none"> • 4GB = 4096MB • 8GB = 8192MB • 16GB = 16384MB 		



QuickSpecs

HP ProLiant SL4540 Generation 8 (Gen8) Server

Memory

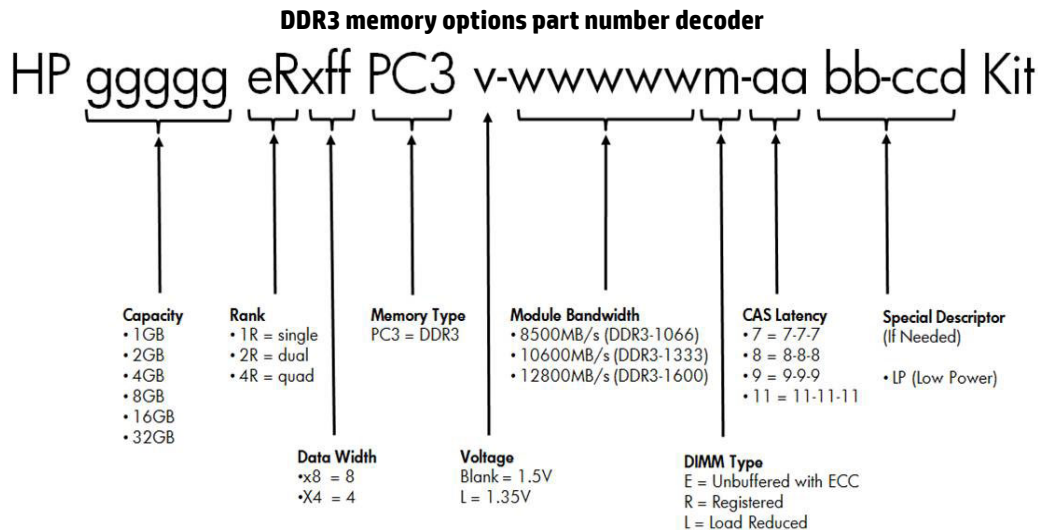

Following are memory options available from HP:

HP Memory

NOTE: Please choose memory options for socket 2 of each server node. Up to 6DDR3 DIMM slots dedicated per socket.

NOTE: HP SmartMemory is required to realize the memory performance improvements and enhanced functionality listed in this document for Gen8. For additional information, please see the HP SmartMemory QuickSpecs at:

http://h18000.www1.hp.com/products/quickspecs/14225_div/14225_div.html

NOTE: HP certified SmartMemory must be used to guarantee full 1333MHz speeds.

NOTE: Depending on the memory configuration and processor model, the memory speed may run at 1600MHz, 1333MHz or 1066MHz. Please see the Online Memory Configuration Tool at: www.hp.com/go/ddr3memory-configurator.

Registered DIMMs (RDIMM) - For E5-2400 v2 Series Processors

NOTE: The Following memory is supported by E5-2400 v2 series processors

HP 4GB (1x4GB) Single Rank x4 PC3L-12800R (DDR3-1600) Registered CAS-11 Low Voltage Memory Kit 713981-B21

HP 8GB (1x8GB) Single Rank x4 PC3L-12800R (DDR3-1600) Registered CAS-11 Low Voltage Memory Kit 731765-B21

HP 8GB (1x8GB) Dual Rank x4 PC3L-12800R (DDR3-1600) Registered CAS-11 Low Voltage Memory Kit 713983-B21

HP 16GB (1x16GB) Dual Rank x4 PC3L-12800R (DDR3-1600) Registered CAS-11 Low Voltage Memory Kit 713985-B21

Registered DIMMs (RDIMM) - For E5-2400 Series Processors

NOTE: The Following memory is supported by E5-2400 series processors

HP 4GB (1x4GB) Single Rank x4 PC3L-10600R (DDR3-1333) Registered CAS-9 Low Voltage Memory Kit 647893-B21

HP 8GB (1x8GB) Dual Rank x4 PC3L-10600R (DDR3-1333) Registered CAS-9 Low Voltage Memory Kit 647897-B21

HP 16GB (1x16GB) Dual Rank x4 PC3L-10600R (DDR3-1333) Registered CAS-9 Low Voltage Memory Kit 647901-B21



QuickSpecs

HP ProLiant SL4540 Generation 8 (Gen8) Server

Storage

1x60 Model

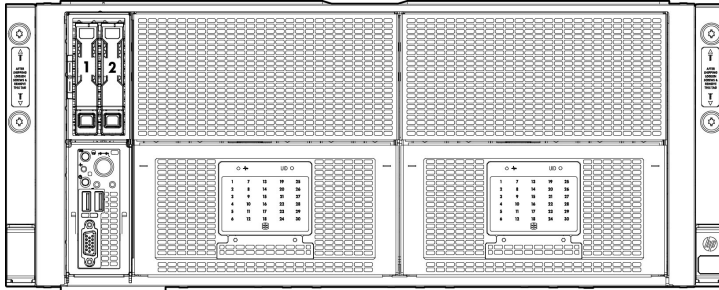

1-2 2 x SFF SATA/SATA SDD Hot Plug Hard Drive Bays

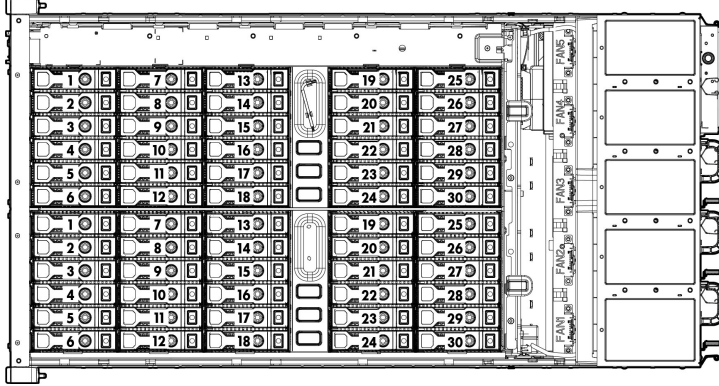

1-30 30 x LFF SATA/SAS/SDD Hot Plug Hard Drive Bays
Controller Port 1i

1-30 30 x LFF SATA/SAS/SDD Hot Plug Hard Drive Bays
Controller Port 2i

1x60:

Controller 1 will see drives 1-15 from one box/port 1i and drives 16-30 of the other box/port 2i
Same for controller 2; drives 16-30 from one box and drives 1-15 of the other box.

25	26	27	28	29	30	25	26	27	28	29	30
19	20	21	22	23	24	19	20	21	22	23	24
13	14	15	16	17	18	13	14	15	16	17	18
7	8	9	10	11	12	7	8	9	10	11	12
1	2	3	4	5	6	1	2	3	4	5	6

Front of Chassis

Top SA Mezz	IO Module
Bottom SA Mezz	

NOTE: This is simple drive zoning

NOTE: Requires second P420i FIO option

Maximum Storage Capacity - 1x60 Model

Internal (2 SFF Drive Cage)	2TB (2 x 1TB SATA SFF)
Internal (60 LFF Drive Cage)	240TB (60 x 4TB SATA LFF)
Total	242TB

QuickSpecs

HP ProLiant SL4540 Generation 8 (Gen8) Server

Storage

2x25 Model

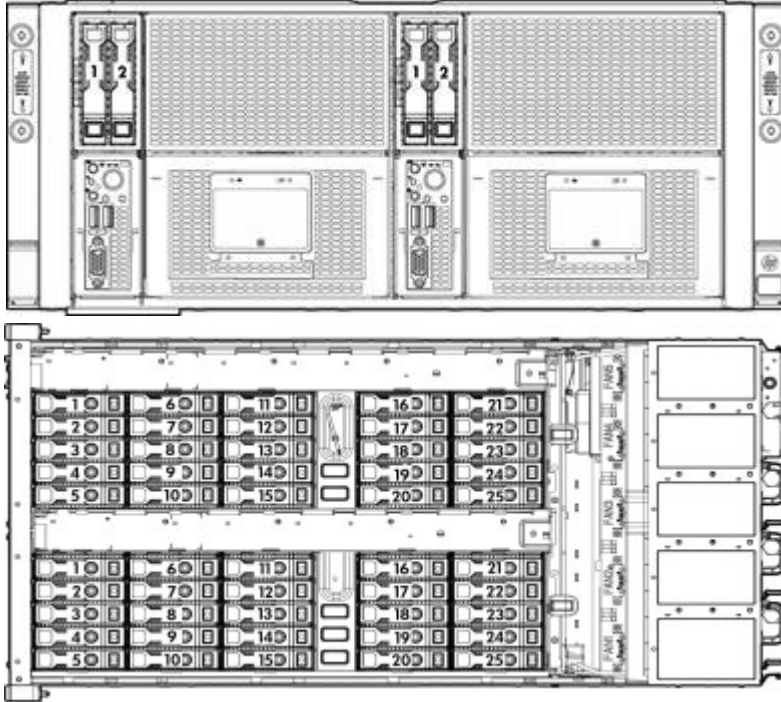

1-2 2 x SFF SATA/SATA SDD Hot Plug SFF Hard Drive Bays for server node 1

1-2 2 x SFF SATA/SATA SDD Hot Plug SFF Hard Drive Bays for server node 2

1-25 25 x LFF SATA/SAS/SDD Hot Plug Hard Drive Bays for server node 1

1-25 25 x LFF SATA/SAS/SDD Hot Plug Hard Drive Bays for server node 2

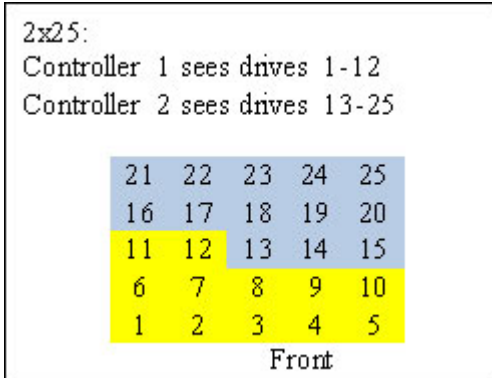

NOTE: This is simple drive zoning

NOTE: Requires second P420i FIO option

Maximum Storage Capacity - 2x25 Model

Internal (2 SFF Drive Cage)	4TB (4 x 1TB SATA SFF)
Internal (50 LFF Drive Cage)	200TB (50 x 4TB SATA LFF)
Total	204TB

QuickSpecs

HP ProLiant SL4540 Generation 8 (Gen8) Server

Storage

3x15 Model

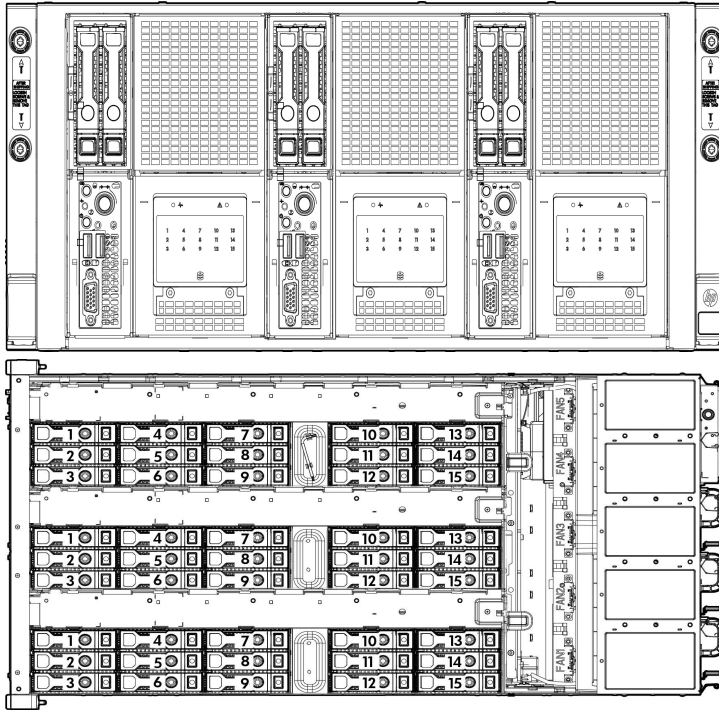

- 1-2 2 x SFF SATA/SATA SDD Hot Plug SFF Hard Drive Bays for server node 1
- 1-2 2 x SFF SATA/SATA SDD Hot Plug SFF Hard Drive Bays for server node 2
- 1-2 2 x SFF SATA/SATA SDD Hot Plug SFF Hard Drive Bays for server node 3
- 1-15 15 x LFF SATA/SAS/SDD Hot Plug Hard Drive Bays for server node 1
- 1-15 15 x LFF SATA/SAS/SDD Hot Plug Hard Drive Bays for server node 2
- 1-15 15 x LFF SATA/SAS/SDD Hot Plug Hard Drive Bays for server node 3

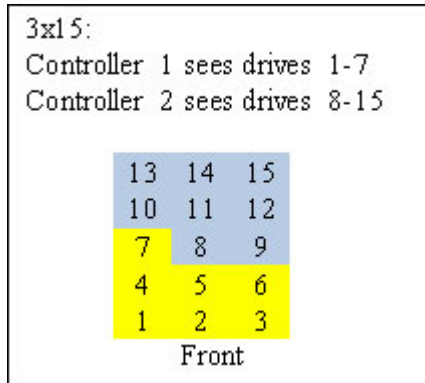

NOTE: This is simple drive zoning
NOTE: Requires second P420i FIO option

Maximum Storage Capacity - 3x15 Model

Internal (2 SFF Drive Cage)	6TB (6 x 1TB SATA SFF)
Internal (50 LFF Drive Cage)	180TB (45 x 4TB SATA LFF)
Total	186TB

QuickSpecs

HP ProLiant SL4540 Generation 8 (Gen8) Server

Technical Specifications

System Unit	Chassis Dimensions (H x W x D) Add fan extension kit (with bezel)	7.47 x 17.45 x 35.34in (18.96 x 44.33 x 89.97cm)
	Weight (approximate)	Maximum 220lb (99.8kg) (all hard drives, power supply, and processor installed)
Input Requirements (per power supply)	Rated Line Voltage	100 to 120 VAC 200 to 240 VAC
	Rated Input Current	For 1200 W Power Supply: 10 A (at 100 VAC), 4.9 A (at 200 VAC) For 750 W Power Supply: 8.9 A (at 100 VAC), 4.3 A (at 200 VAC)
	Rated Input Frequency	50 to 60 Hz
	Rated Input Power	For 1200 W Power Supply: 930 W (at 100 VAC), 1348 W (at 200 VAC) For 750 W Power Supply: 857 W (at 100 VAC), 824 W (at 200 VAC)
	Power Supply Output (per power supply)	Rated Steady-State Power
	Maximum Peak Power	For 1200 W Power Supply: 800 W (at 100 VAC), 900 W (at 120 VAC), 1200 W (at 200 to 240 VAC) For 750 W Power Supply: 750 W (at 100 to 120 VAC), 750 W (at 200 to 240 VAC)
Power Specifications	To review typical system power ratings use the HP Power Advisor which is available via the online tool located at URL: www.hp.com/go/proliant-energy-efficient or www.hp.com/go/hppoweradvisor .	
Power Supply Output (per power supply)	Rated Steady-State Power	
System Inlet Temperature	Operating	50° to 95° F (10° to 35° C) at sea level with an altitude derating of 1.8°F per every 1000 ft (1.0°C per every 304.8 m) above sea level to a maximum of 10,000 ft (3048 m), no direct sustained sunlight. Maximum rate of change is 18°F/hr (10°C/hr). The upper limit may be limited by the type and number of options installed. System performance may be reduced if operating with a fan

QuickSpecs

HP ProLiant SL4540 Generation 8 (Gen8) Server

Technical Specifications

		fault or above 86°F (30°C).
	Non-operating	-22° to 140° F (-30° to 60° C) Maximum rate of change is 36°F/hr (20°C/hr).
Relative Humidity (non-condensing)	Operating	10 to 90% relative humidity (Rh), 28°C (82.4°F) maximum wet bulb temperature, non-condensing.
	Non-operating	5 to 95% relative humidity (Rh), 38.7°C (101.7°F) maximum wet bulb temperature, non-condensing.
Altitude	Operating	10,000 ft (3048 m). This value may be limited by the type and number of options installed. Maximum allowable altitude change rate is 1500 ft/min (457 m/min).
	Non-operating	30,000 ft (9144 m). Maximum allowable altitude change rate is 1500 ft/min (457 m/min).
Acoustic Noise	Listed are the declared A-Weighted sound power levels (LWAd) and declared average bystander position A-Weighted sound pressure levels (LpAm) when the product is operating in a 23°C ambient environment. Noise emissions were measured in accordance with ISO 7779 (ECMA 74) and declared in accordance with ISO 9296 (ECMA 109).	
	Idle	
	L WAd	7.27 B
	L pAm	58.93 dBA
	Operating	
	L WAd	7.27 B
	L pAm	59.00 dBA
Emissions Classification (EMC)	FCC Rating	Class A
	Normative Standards	CISPR 22; EN55022; EN55024; FCC CFR 47, Pt 15; ICES-003; CNS13438; K22;K24; EN 61000-3-2; EN 61000-3-3; EN 60950-1; IEC 60950-1

NOTE: Product conformance to cited product specifications is based on sample (type) testing, evaluation, or assessment. This product or family of products is eligible to bear the appropriate compliance logos and statements.

QuickSpecs

HP ProLiant SL4540 Generation 8 (Gen8) Server

Technical Specifications

HP Ethernet 1Gb 2-port 361i Adapter	Network Interface	10Base-T/100Base-TX/1000Base-TX	
	Compatibility	IEEE 802.3 10Base-T IEEE 802.3ab 1000Base-T IEEE 802.3u 100Base-TX IEEE 1588, IEEE 802.1AS IEEE 802.3az - Energy Efficient Ethernet (EEE)	
	Data Transfer Method	PCI Express v 2.1, 5.0 GT/s and 2.5 GT/s bus speeds and supports for x1, x2, x4 links widths (Lanes)	
	Controller	I350 Powerville	
	Network Transfer Rate	10Base-T (Half-Duplex)	10 Mb/s per port, 20 Mb/s Combined
		10Base-T (Full-Duplex)	20 Mb/s per port, 40 Mb/s Combined
		100Base-TX (Half-Duplex)	100 Mb/s per port, 200 Mb/s Combined
		100Base-TX (Full-Duplex)	200 Mb/s per port, 400 Mb/s Combined
		1000Base-TX (Half and Full-Duplex)	1000Mb/s per port, 2000 Mb/s Combined
	Connector	RJ-45	
Cable Support	10Base-T	Categories 3, 4 or 5 UTP; up to 328 ft (100 m)	
	10/100/1000Base-TX	Category 5 UTP; up to 328 ft (100 m)	

HP Ethernet 10Gb 2-port 544i SFP Adapter	Data Transfer Method	Compliant to x8 PCIe Gen2 Specification	
	Network Transfer Rate	X4 IB: 10 Gb/s (SDR), 20 Gb/s (DDR), 40Gb/s (QDR) 10Gb/s Ethernet: Full-duplex single lane XFI	
	Connector	QSFP - IB SFP+ - 10Gb/s Ethernet.	
	Cable Support	IB: HP copper and optical IB cables.	NOTE: IB supported with addition of HP IB Enablement Kit
		10Gb/s: HP copper and optical SFP+ cables	

QuickSpecs

HP ProLiant SL4540 Generation 8 (Gen8) Server

Technical Specifications

HP Smart Array P420i Controller	Dimensions	Embedded
	Disk Drive and Enclosure Interface - Transfer rate	6Gb/s SAS (Serial Attached SCSI) 6Gb/s SATA (Serial ATA)
	SAS Connectors	2 internal 4X connectors
	Cache Memory Speed	1GB or 2GB FBWC DDR3-1333MHz with 72-bit wide bus
	Server Interface	x8 PCIe 3.0 operating at PCI 2.0
	SAS Speed	(8) 6Gb/s SAS links provide 4.8GB/s maximum bandwidth
	Cache Memory	72-bit 1GB FBWC or 72-bit 2GB FBWC
	Logical Drives Supported	Up to 64 logical drives with cache
	Host Memory Addressing	64-bit, supporting greater than 4GB server memory space
	RAID Support	RAID 6, 60 (Advanced Data Guarding) RAID 5, 50 (Distributed Data Guarding) NOTE: A minimum of 512 MB cache is required to enable RAID 5, 50, 6, 60 NOTE: HP Smart Array Advanced Pack (SAAP 2.0) is no longer required to enable RAID 6 & 60 (Advanced Data Guarding). However, controller must be in firmware version 4.68 (or later). RAID 1+0 (Striping & Mirroring) RAID 0 (Striping), RAID 1 (Mirroring)

Environment-friendly Products and Approach	End-of-life Management and Recycling	Hewlett-Packard offers end-of-life HP product return, trade-in, and recycling programs in many geographic areas. For trade-in information, please go to: http://www.hp.com/go/green . To recycle your product, please go to: http://www.hp.com/go/green or contact your nearest HP sales office. Products returned to HP will be recycled, recovered or disposed of in a responsible manner. The EU WEEE directive (2002/95/EC) requires manufacturers to provide treatment information for each product type for use by treatment facilities. This information (product disassembly instructions) is posted on the Hewlett Packard web site at: http://www.hp.com/go/green . These instructions may be used by recyclers and other WEEE treatment facilities as well as HP OEM customers who integrate and re-sell HP equipment.
---	---	---

© Copyright 2014 Hewlett-Packard Development Company, L.P.

The information contained herein is subject to change without notice.

Microsoft and Windows NT are US registered trademarks of Microsoft Corporation. Unix is a registered trademark of The Open Group. Intel, the Intel logo, Xeon and Xeon Inside are trademarks of Intel Corporation in the U.S. and other countries.

The only warranties for HP products and services are set forth in the express warranty statements accompanying such products and services. Nothing herein should be construed as constituting an additional warranty. HP shall not be liable for technical or editorial errors or omissions contained herein.

For hard drives, 1GB = 1 billion bytes. Actual formatted capacity is less.



QuickSpecs

HP ProLiant SL4540 Generation 8 (Gen8) Server

Technical Specifications