



HP Switch zl Modules

Installation Guide



Power over Ethernet

HP Switch zl Modules

Installation Guide

Manual Part Number

5998-4703
August 2013

Applicable HP Products

E5400 zl Management Module	J8726A
24-port Gig-T zl Module	J8702A
20-port Gig-T/SFP zl Module	J8705A
24-port mini-GBIC zl Module	J8706A
4-port 10Gig-X2 zl Module	J8707A
4-port 10Gig-CX4 zl Module	J8708A
24-Port 10/100/1000 PoE+ zl Module	J9307A
20-Port 10/100/1000 PoE+/4-Port MiniGBIC zl Module	J9308A
4-Port 10GbE SFP+ zl Module	J9309A
24-Port 10/100 PoE+ zl Module	J9478A
E5406 zl Switch	J8697A
E5406-48G zl Switch	J8699A
HP E5406-44G-PoE+/4SFP zl Switch	J9447A
HP E5406-44G-PoE+/4G-SFP v2 zl Switch with Premium Software	J9539A
HP E5406 zl Switch with Premium Software	J9642A
E5412 zl Switch	J8698A
E5412-96G zl Switch	J8700A
HP E5412-92G-PoE+/4SFP zl Switch	J9448A
HP E5412-92G-PoE+/2XG-SFP+ v2 zl Switch with Premium Software	J9532A
HP E5406-44G-PoE+/2XG-SFP+ v2 zl Switch with Premium Software	J9533A
HP E5412-92G-PoE+/4G-SFP v2 zl Switch with Premium Software	J9540A
HP E5412 zl Switch with Premium Software	J9643A
Switch E8200 zl Management Module	J9092A
Switch E8200 zl Fabric Module	J9093A
Switch E8200 zl System Support Module	J9095A
E8212 zl Switch (Base System)	J8715B
HP E8212-92G-PoE+/2XG-SFP+ v2 zl Switch with Premium Software	J9639A
HP E8212 v2 zl Switch with Premium Software	J9641A
E8206 zl Switch (Base System)	J9475A
HP E8206-44G-PoE+/2XG-SFP+ v2 zl Switch with Premium Software	J9638A
HP E8206 v2 zl Switch with Premium Software	J9640A

ONE Services zl Module	---
HP 24-port Gig-T PoE+ v2 zl Module	J9534A
HP 20-port Gig-T PoE+ / 4-port SFP v2 zl Module	J9535A
HP 20-port Gig-T PoE+ / 2-port 10-GbE SFP+ v2 zl Module	J9536A
HP 24-port SFP v2 zl Module	J9537A
HP 8-port 10-GbE SFP+ v2 zl Module	J9538A
HP 8-port 10GBase-T v2 zl Module	J9546A
HP 24-port 10/100 PoE+ v2 zl Module	J9547A
HP 20-port Gig-T / 2-port 10-GbE SFP+ v2 zl Module	J9548A
HP 20-port Gig-T / 4-port SFP v2 zl Module	J9549A
HP 24-port Gig-T v2 zl Module	J9550A
HP 12-port Gig-T / 12-port SFP v2 zl Module	J9637A
HP 5406 8p 10GBASE-T 8p 10GbE SFP+ v2 zl Switch with Premium Software	J9866A

Disclaimer

HEWLETT-PACKARD COMPANY MAKES NO WARRANTY OF ANY KIND WITH REGARD TO THIS MATERIAL, INCLUDING, BUT NOT LIMITED TO, THE IMPLIED WARRANTIES OF MERCHANTABILITY AND FITNESS FOR A PARTICULAR PURPOSE. Hewlett-Packard shall not be liable for errors contained herein or for incidental or consequential damages in connection with the furnishing, performance, or use of this material.

The information contained herein is subject to change without notice. The only warranties for HP products and services are set forth in the express warranty statements accompanying such products and services. Nothing herein should be construed as constituting an additional warranty. HP shall not be liable for technical or editorial errors or omissions contained herein.

Hewlett-Packard assumes no responsibility for the use or reliability of its software on equipment that is not furnished by Hewlett-Packard.

Warranty

For HP warranty information, visit

www.hp.com/networking/support

A copy of the specific warranty terms applicable to your Hewlett-Packard product and replacement parts can be obtained from your HP sales and service office or HP authorized reseller.

Contents

HP Switch v2 zl Modules	1
For the HP E5400 zl and E8200 zl Switches	1
HP Switch zl Modules	4
For the HP E5400 zl and E8200 zl Switches	4
For the HP E8200 zl Switches Only	7
E8200 zl Management Module Dependencies	7
Using a spare or E8212 zl Management Module in an E8206 zl switch	7
Updating Software and BootROMs to work in an E8206 zl Module	8
Steps to Update the E8212 zl Module Software	9
Network Interface Module LEDs	12
Network Connectivity Modules Port LEDs	12
Features	13
zl v2 Module Features	13
zl Module Features	14
The zl Modules have the following features:	15
Installing the Modules	16
Overview	16
Installing the Module in an Unused Slot	17
Installation Precautions:	17
Installation Procedures:	17
Installing or Removing a mini-GBIC or SFP transceiver	19
Install or Remove an X2 Transceiver	21
To remove the X2 transceiver:	21
Verifying the Module is Installed Correctly	22
Connecting the Network Cables	24
Connecting a fiber cable to an X2 transceiver	25
Connecting a copper cable to an X2 transceiver	25
Verifying the Network Connections Are Working	26
Default Port Configuration	27
Replacing or Removing a Module	28
Troubleshooting	29

Contents

Customer Support Services	29
Before Calling Support	29
Specifications	31
Environmental	32
Network Connectivity Speeds and Technologies	32
Technology Standards and Safety Compliance	34
Cabling and Technology Specifications	36
Technology Distance Specifications	38
Mode Conditioning Patch Cord	39
Installing the Patch Cord	40
EMC Regulatory Statements	41
U.S.A.	41
Canada	41
Australia/New Zealand	41
Japan	41
Korea	42
Taiwan	42
European Community Declaration of Conformity	42
Waste Electrical and Electronic Equipment (WEEE) Statements	43

HP Switch v2 zl Modules

For the HP E5400 zl and E8200 zl Switches

Descriptions. The HP Switch v2 zl Modules are the second generation zl modules and provide a variety of improved network connectivity options for any of the HP E5400 zl or E8200 zl switches. The following modules are currently available.

Compatibility Mode allows the inter-operation of v2 zl modules with the older zl modules in the same chassis switch. When in Compatibility Mode, the switch accepts either v2 zl or zl modules. The default is Compatibility Mode enabled. If Compatibility Mode is disabled by executing the “no allow-v1-modules” command, the switch will only power up v2 zl modules. For more information refer to the “Enhancement titled ‘Compatibility Mode’ in the latest Release Notes for your switch”.

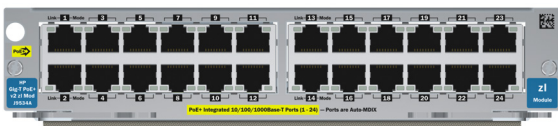
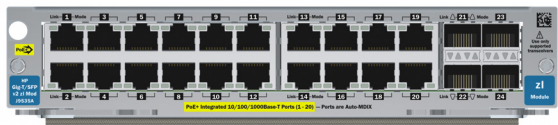
Module	Description
<p>HP 24-port Gig-T PoE+ v2 zl Module (J9534A)¹</p> 	<p>24 twisted-pair ports with RJ-45 connectors for 10/100/1000Base-T operation over Category 5 or better 100-ohm UTP or STP cable (category 5e recommended for Gigabit). All ports have the IEEE 802.3ab Auto MDI/MDI-X (HP Auto-MDIX) feature and support IEEE 802.3at PoE+.</p>
<p>HP 20-port Gig-T PoE+ / 4-port SFP v2 zl Module (J9535A)¹</p> 	<p>20 twisted-pair ports with RJ-45 connectors for 10/100/1000Base-T ports that support PoE+ and 4 ports for installing any of the supported HP transceivers. All RJ-45 ports have the IEEE 802.3ab Auto MDI/MDI-X (HP Auto-MDIX) feature and support PoE+. The mini-GBIC/SFP ports do not support IEEE 802.3at PoE+.</p>

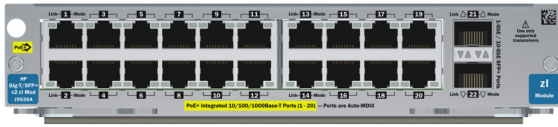
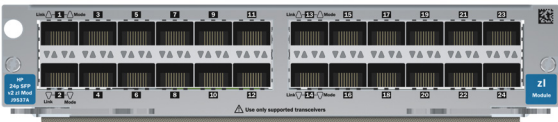
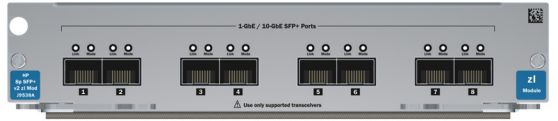
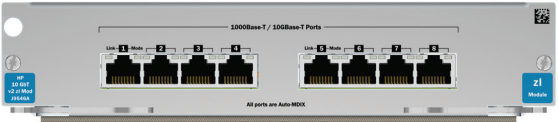
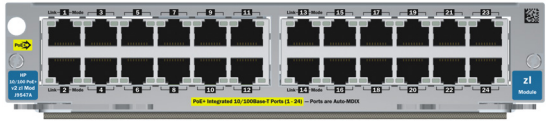
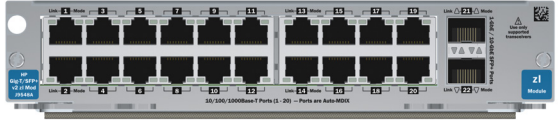
Module	Description
<p>HP 20-port Gig-T PoE+ /2-port 10-GbE SFP+ v2 zl Module (J9536A)¹</p> 	<p>20 twisted-pair ports with RJ-45 connectors for 10/100/1000Base-T ports that support PoE+ and 2 ports for installing any of the supported HP transceivers. All RJ-45 ports have the IEEE 802.3ab Auto MDI/MDI-X (HP Auto-MDIX) feature and support PoE+. The SFP+ ports do not support IEEE 802.3at PoE+.</p>
<p>HP 24-port SFP v2 zl Module (J9537A)¹</p> 	<p>24 mini-GBIC/SFP ports for connecting any of the supported HP transceivers. These ports do not support IEEE 802.3at PoE+.</p>
<p>HP 8-port 10-GbE SFP+ v2 zl Module (J9538A)¹</p> 	<p>8 ports for installing any of the supported HP transceivers. The SFP+ ports do not support IEEE 802.3at PoE+.</p>
<p>HP 8-port 10GbE-T v2 zl Module (J9546A)²</p> 	<p>8 twisted-pair ports with RJ-45 connectors for 10GbE-T operation over Category 6 or better 100-ohm UTP or STP cable. PoE is not supported on this module.</p>
<p>HP 24-port 10/100 PoE+ v2 zl Module (J9547A)¹</p> 	<p>24 twisted-pair ports with RJ-45 connectors for 10/100 Base-TX integrated operation over Category 5 or better 100-ohm UTP or STP cable. All ports have the IEEE 802.3ab Auto MDI/MDI-X (HP Auto-MDIX) feature and support IEEE 802.3at PoE+.</p>
<p>HP 20-port Gig-T / 2-port 10-GbE SFP+ v2 zl Module (J9548A)¹</p> 	<p>20 twisted-pair ports with RJ-45 connectors for 10/100/1000Base-T and 2 ports for installing any of the supported HP transceivers. All RJ-45 ports have the IEEE 802.3ab Auto MDI/MDI-X (HP Auto-MDIX) feature. This module does not support IEEE 802.3at PoE+.</p>

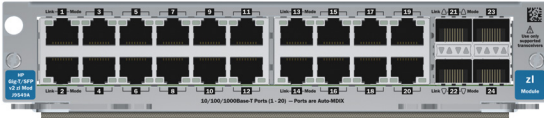
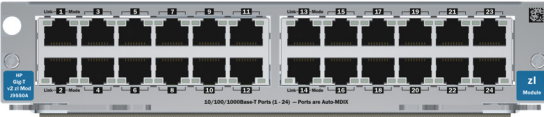
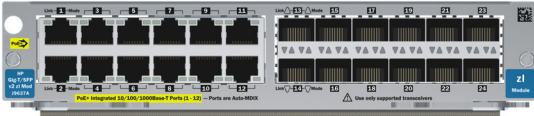

Module	Description
<p>HP 20-port Gig-T / 4-port SFP v2 zl Module (J9549A)¹</p> 	<p>20 twisted-pair ports with RJ-45 connectors for 10/100/1000Base-T and 4 ports for installing any of the supported HP transceivers. All RJ-45 ports have the IEEE 802.3ab Auto MDI/MDI-X (HP Auto-MDIX) feature. This module does not support IEEE 802.3at PoE+.</p>
<p>HP 24-port Gig-T v2 zl Module (J9550A)¹</p> 	<p>24 twisted-pair ports with RJ-45 connectors for 10/100/1000Base-T operation over Category 5 or better 100-ohm UTP or STP cable (category 5e recommended for Gigabit). All ports have the IEEE 802.3ab Auto MDI/MDI-X (HP Auto-MDIX) feature. This module does not support IEEE 802.3at PoE+.</p>
<p>HP 12-port Gig-T / 12-port SFP v2 zl Module (J9637A)¹</p> 	<p>12 twisted-pair ports with RJ-45 connectors for 10/100/1000Base-T operation over Category 5 or better 100-ohm UTP or STP cable (category 5e recommended for Gigabit) and 12 ports for installing any of the supported HP transceivers. All RJ-45 ports have the IEEE 802.3ab Auto MDI/MDI-X (HP Auto-MDIX) feature and support IEEE 802.3at PoE+.</p>
<p>For supported transceivers, visit www.hp.com/networking/support.</p> <ul style="list-style-type: none"> – In the first textbox, type J4858 (for 100-Mb and Gigabit information), or J8436 (for 10-Gigabit information). – Select any of the products that display in the dropdown list. – Select Product support information. Then click on Manuals and find the Transceiver Support Matrix. <p>For technical details of cabling and technologies see "Cabling and Technology Information" on page 36.</p>	
<p>¹ These modules require switch software version K.15.02 or greater on both the E5400 zl chassis and E8200 zl chassis.</p> <p>² This module requires switch software version K.15.04 or greater on both the E5400 zl chassis and E8200 zl chassis. Contact your HP authorized networking products reseller or your HP networking representative for information on availability of other modules. You can also visit the HP networking products Web site http://www.hp.com/networking to get more information.</p>	

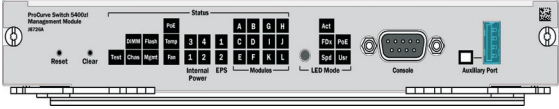
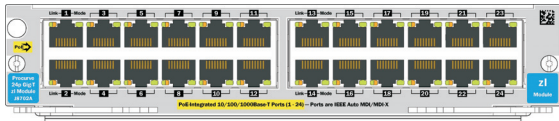
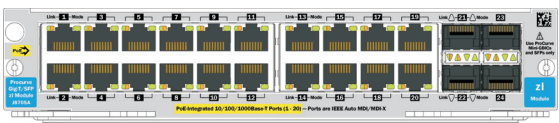
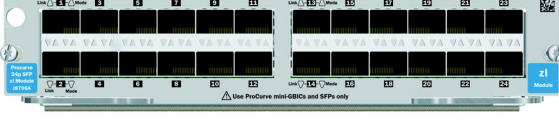

HP Switch zl Modules

For the HP E5400 zl and E8200 zl Switches

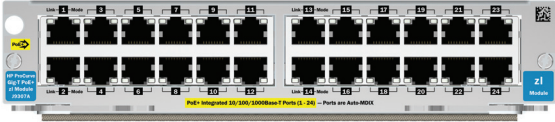
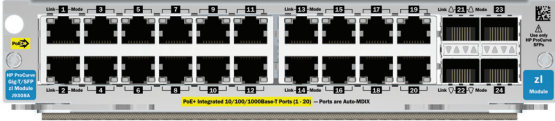
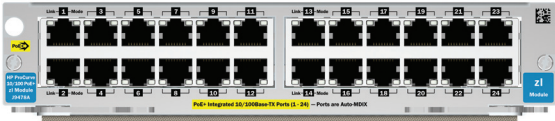
Descriptions. The HP Switch zl Modules are the first generation zl modules and provide a variety of network connectivity options for any of the HP E5400 zl or E8200 zl switches. The following modules are currently available.

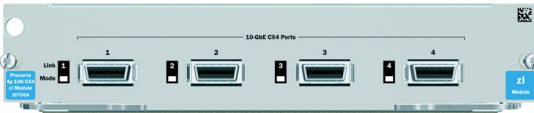
Module	Image	Description
<p>HP ProCurve Switch 5400zl Management Module¹</p>	 <p>The image shows the HP ProCurve Switch 5400zl Management Module. It features a control panel with a 'Reset' button, 'Clear' button, and a numeric keypad (0-9, *, #). There are also buttons for 'Power', 'Internal', 'LPS', and 'Module'. A status display shows 'Status' with indicators for 'Act', 'FDx', 'PbE', 'Sfx', and 'Lm'. A 'Cable' port and an 'Auxiliary Port' are also visible.</p>	<p>The E5400 zl switch requires a management module to operate. The management module maintains persistent images of all software that runs on the system. The primary non-volatile storage medium is a Compact Flash card located on the module.</p>
<p>HP ProCurve Switch zl 24 port Gig-T PoE Module (J8702A)¹</p>	 <p>The image shows the HP ProCurve Switch zl 24 port Gig-T PoE Module (J8702A). It features 24 RJ-45 ports arranged in two rows of 12. The ports are labeled 'Line 1' through 'Line 24'. A label at the bottom indicates 'Full integrated 24, 100, 1000Base-T Ports (1 - 24) - Ports are IEEE Auto MDI/MDI-X'.</p>	<p>24 twisted-pair ports with RJ-45 connectors for 10/100/1000Base-T operation over Category 5 or better 100-ohm UTP or STP cable (category 5e recommended for Gigabit). All ports have the IEEE 802.3ab Auto MDI/MDI-X (HP Auto-MDIX) feature and support IEEE 802.3af PoE.</p>
<p>HP ProCurve Switch zl 20 port Gig-T + 4 port mGBIC Module (J8705A)¹</p>	 <p>The image shows the HP ProCurve Switch zl 20 port Gig-T + 4 port mGBIC Module (J8705A). It features 20 RJ-45 ports in two rows of 10, and 4 mGBIC/SFP ports on the right side. A label at the bottom indicates 'Full integrated 20, 100, 1000Base-T Ports (1 - 20) - Ports are IEEE Auto MDI/MDI-X'.</p>	<p>20 twisted-pair ports with RJ-45 connectors for 10/100/1000Base-T ports that support PoE and 4 ports for installing any of the supported HP transceivers. All RJ-45 ports have the IEEE 802.3ab Auto MDI/MDI-X (HP Auto-MDIX) feature and support PoE. The mini-GBIC/SFP ports do not support IEEE 802.3af PoE.</p>
<p>HP ProCurve Switch zl 24 port mini-GBIC Module (J8706A)²</p>	 <p>The image shows the HP ProCurve Switch zl 24 port mini-GBIC Module (J8706A). It features 24 mini-GBIC/SFP ports arranged in two rows of 12. A label at the bottom indicates 'Use ProCurve mini-GBICs and SFPs only'.</p>	<p>24 mini-GBIC/SFP ports for connecting any of the supported HP transceivers. These ports do not support IEEE 802.3af PoE.</p>

Module	Description
<p>HP 24-Port 10/100/1000 PoE+ zl Module (J9307A)³</p> 	<p>24 twisted-pair ports with RJ-45 connectors for 10/100/1000Base-T operation over Category 5 or better 100-ohm UTP or STP cable (category 5e recommended for Gigabit). All ports have the IEEE 802.3ab Auto MDI/MDI-X (HP Auto-MDIX) feature and support IEEE 802.3at PoE+.</p>
<p>HP 20-Port 10/100/1000 PoE+ / 4-Port mini-GBIC zl Module (J9308A)³</p> 	<p>20 twisted-pair ports with RJ-45 connectors for 10/100/1000Base-T ports that support PoE and 4 ports for installing any of the supported HP transceivers. All RJ-45 ports have the IEEE 802.3ab Auto MDI/MDI-X (HP Auto-MDIX) feature and support PoE+. The mini-GBIC/SFP ports do not support IEEE 802.3at PoE+.</p>
<p>HP 24-Port 10/100 PoE+ zl Module (J9478A)³</p> 	<p>24 twisted-pair ports with RJ-45 connectors for 10/100 Base-TX integrated operation over Category 5 or better 100-ohm UTP or STP cable. All ports have the IEEE 802.3ab Auto MDI/MDI-X (HP Auto-MDIX) feature and support IEEE 802.3at PoE+.</p>
<p>HP Switch zl 4 port 10-GbE X2 Module (J8707A)¹</p> 	<p>4 ports for installing any of the supported HP 10-GbE X2 transceivers.</p>
<p>HP Switch zl 4 port 10-GbE CX4 Module (J8708A)²</p> 	<p>4 ports for connecting 10-GbE copper cable.</p>

Module	Description
<p>HP 4-Port 10-GbE SFP+ zl Module (J9309A)³</p> 	<p>4 ports for connecting 10-GbE SFP+ transceivers.</p>
<p>For supported transceivers, visit www.hp.com/networking/support.</p> <ul style="list-style-type: none"> – In the first textbox, type J4858 (for 100-Mb and Gigabit information), or J8436 (for 10-Gigabit information). – Select any of the products that display in the dropdown list. – Select Product support information. Then click on Manuals and find the Transceiver Support Matrix. <p>For technical details of cabling and technologies see "Cabling and Technology Information" on page 36.</p>	
<p>¹ These modules require switch software version K.11.00 or greater and installed on the E5400 zl chassis, or K.12.30 or greater to be installed on the E8212 zl chassis.</p> <p>² These modules require switch software version K.11.3x or greater and installed on the E5400 zl chassis, or K.12.30 or greater to be installed on the E8212 zl chassis.</p> <p>³ These modules require switch software version K.14.34 or greater and installed on the E5400 zl or E8200 zl chassis.</p> <p>Contact your HP authorized networking products reseller or your HP networking representative for information on availability of other modules and mini-GBICs. You can also visit the HP networking products Web site www.hp.com/networking/support to get more information.</p>	
<p>HP ONE Services zl Modules</p> 	<p>The module provides server resources as a platform to run HP certified applications within a zl switch slot.</p> <p>For configuration information see the <i>Getting Started Guide</i> for your ONE Services zl Module.</p>

For the HP E8200 zl Switches Only

The following modules are designed specifically for the E8200 zl switches only.

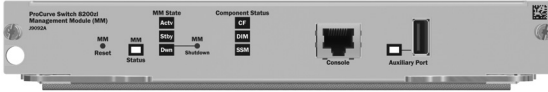
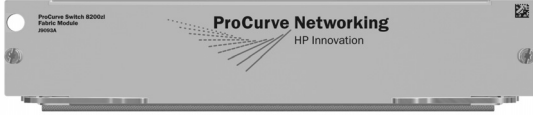
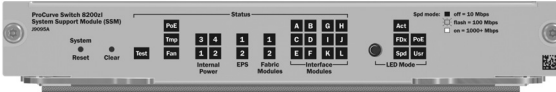
Module	Image	Description
<p>HP ProCurve Switch 8200zl Management Module (J9092A)</p>		<p>The switch requires at least one management module to operate. The management module maintains persistent images of all software that runs on the system. The primary non-volatile storage medium is a Compact Flash card located on the module. Two of these can be installed as a redundancy feature.</p>
<p>HP ProCurve Switch 8200zl Fabric Module (J9093A)</p>		<p>The switching fabric is provided by two fabric modules. These modules are load sharing, and should one fail the other one can run the system at half the total bandwidth.</p>
<p>HP ProCurve Switch 8200zl System Support Module (J9095A)</p>		<p>The SSM contains all the circuitry for monitoring the status of the different components of the switch.</p>

E8200 zl Management Module Dependencies

The HP E8206 zl and E8212 zl switches both use the same management module (J9092A). However, the E8206 zl switch Management Module requires software release K.14.34 or later, and the E8212 zl switch Management Module requires software release K.12.31 or later.

Using a spare or E8212 zl Management Module in an E8206 zl switch

Any J9092A management module will operate in both the E8206 zl and E8212 zl chassis when the correct minimum software version is loaded prior to installing the module. If you want to install a management module taken from an E8212 zl switch into an E8206 zl switch, you will first need to update the module's software to its minimum supported release, K.14.34 or greater.

Note

The management module must be updated in the E8212 zl switch prior to installing in the E8206 zl switch. This is because the E8206 zl switch does not recognize a management module running software prior to K.14.34.

Once a management module has been updated to the minimum supported E8206 zl software, all future software updates can be performed on either the E8206 zl or E8212 zl switches.

Updating Software and BootROMs to work in an E8206 zl Module

In order to update an E8212 zl management module to work in an E8206 zl switch, you must first update the module's software. Depending on the existing E8212 zl software version, the update requires either a one or two-step process. (See [“Software upgrade process”](#) on page 9.)

If the current software on the E8212 zl management module is K.12.31 through K.13.48, you must update the software twice. The first update is to version K.13.60, and the second update is to K.14.34 or greater.

If the current software on the E8212 zl management module is K.13.51 or newer K.13 version, you need only to update the software once to version 14.34 or greater.

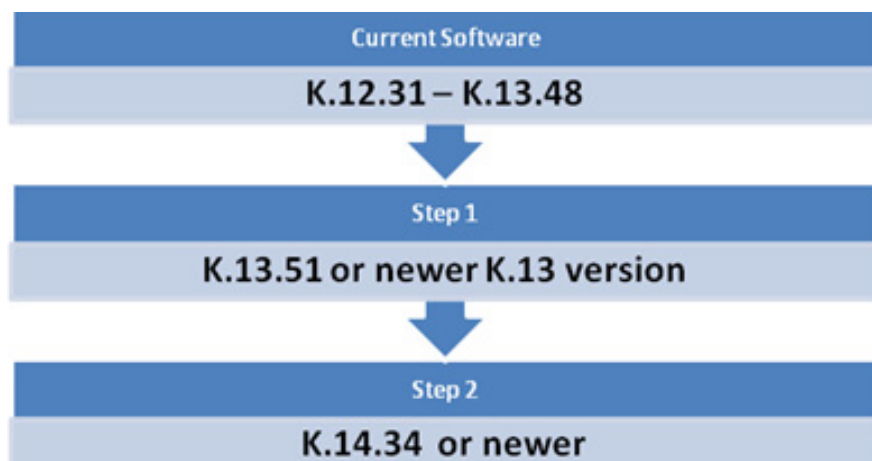

Figure 1. Software upgrade process

Steps to Update the E8212 zl Module Software

1. Copy new software to primary or secondary flash memory on active management module:

```

USB - E8200zl#copy usb flash K_13_60.swi pri
TFTP - E8200zl#copy tftp flash 192.168.248.10
      k_13_60.swi pri
  
```

After downloading a new software version to either the primary or secondary flash of the active management module, the software version is immediately copied to the corresponding flash (primary or secondary) of the standby module unless the standby module failed selftest or redundancy was disabled with the **no redundancy management-module** command.

2. Make sure boot setting is configured to boot to correct flash to which the software was copied.

```

E8200zl#boot set-default flash primary
E8200zl#write memory
  
```

This change will also be synchronized to standby management module.

3. Boot standby module

```

E8200zl#boot standby
  
```

This does not interrupt current switch operations yet. After the standby management module has rebooted and is back in standby mode. You can verify this by using the **showredundancy** command.

Example during reboot.

```
ProCurve Switch 8212z1# show redundancy

Settings
-----
Mgmt Redundancy : Enabled

Statistics
-----
Failovers           : 3
Last Failover      : Tue May 12 17:30:07 2009

Slot Module Description          Status   SW Version Boot Image
-----
MM1  ProCurve J9092A Management Module E8200z1 Unknown
MM2  ProCurve J9092A Management Module E8200z1 Active   K.13.60
Secondary

FM1  ProCurve J9093A,Fabric Module E8200z1      Enabled
FM2  ProCurve J9093A,Fabric Module E8200z1      Enabled
```

Example when standby management the module has rebooted.

```
ProCurve Switch E8212z1# show redundancy

Settings
-----
Mgmt Redundancy : Enabled

Statistics
-----
Failovers           : 3
Last Failover      : Tue May 12 17:30:07 2009

Slot Module Description          Status   SW Version Boot Image
-----
MM1  ProCurve J9092A Management Module E8200z1 Standby K.13.60
Secondary
MM2  ProCurve J9092A Management Module E8200z1 Active K.13.60 Secondary

FM1  ProCurve J9093A,Fabric Module E8200z1      Enabled
FM2  ProCurve J9093A,Fabric Module E8200z1      Enabled
```

4. Perform Switchover

```
E8200z1#redundancy switchover
```

This causes a switchover to the management module that received the new software version, which becomes the active management module. This method incurs the least amount of network downtime for booting. If downtime is not an issue, use the **boot system** command. Both management modules will then be running the new software version.

5. Both management modules are now updated to new software. If two step update is required repeat steps 1 through 4 again installing next step software.

Note:

When a bootROM is updated with software after the boot standby command is entered the switch will reboot twice, first to update the BootROM to new version, and then to load the updated system software. Following file copy to the switch flash and initiation of the boot standby command, no additional user intervention is needed. Do not interrupt power to the switch during this important update. See the release notes for additional information.

Network Interface Module LEDs

Network Connectivity Modules Port LEDs

There are two LEDs for each port:

- The Link LED lights green with a valid connection and orange if there is a fault or alert condition.
- The Mode LED lights according to the LED mode selected on the chassis.

The LED mode is selected on the Management Module for the E5400 zl switches, and on the System Support Module (SSM) on the Switch E8212 zl. The LED mode that is selected is indicated by the following five LEDs that are located near the LED mode selection button.

Network Ports Mode LED Display	Description	
Act	Activity	Transmit or receive traffic present
FDx	Full Duplex	Full duplex mode of operation
Spd	Indicates the Port LEDs are displaying the connection speed at which each port is operating.	<ul style="list-style-type: none"> • If the Port LED is on continuously, the port is operating at 1000 Mbps. • If the Port LED is flashing, the port is operating at 100 Mbps. • If the Port LED is off, the port is operating at 10 Mbps.
PoE	Power over Ethernet	<ul style="list-style-type: none"> • If the Mode LED is on, the port is providing PoE power. • If the Mode LED is off, the port is not providing PoE power. • If the Link LED is on, the port is enabled for PoE. • If the Link LED is off, the port is disabled for PoE. • If the Link LED is flashing, the port has an error or the port is denied power due to insufficient power.
Usr	For future development	

Features

zl v2 Module Features

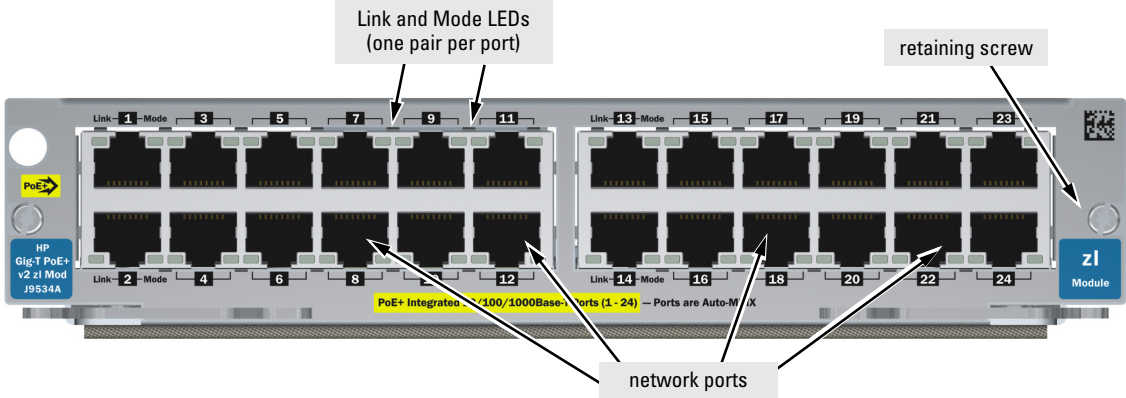

Figure 2. Example: HP 24-port Gig-T PoE+ v2 zl Module

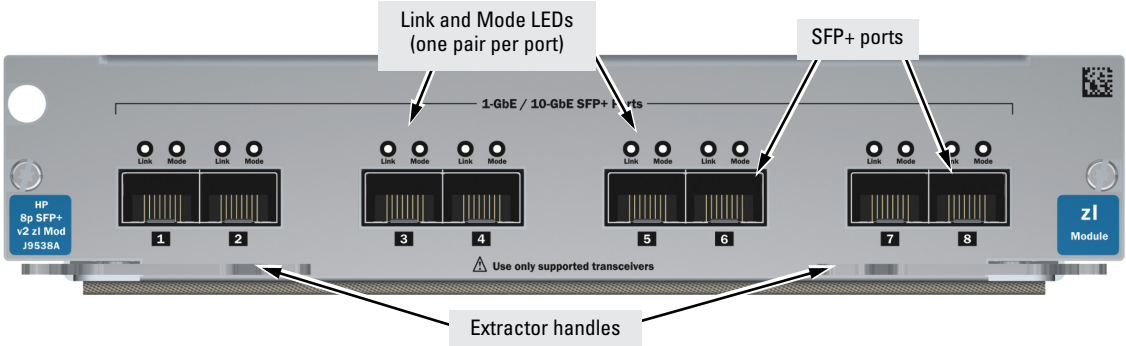

Figure 3. Example: HP 8-port 10-GbE SFP+ v2 zl Module

zl Module Features

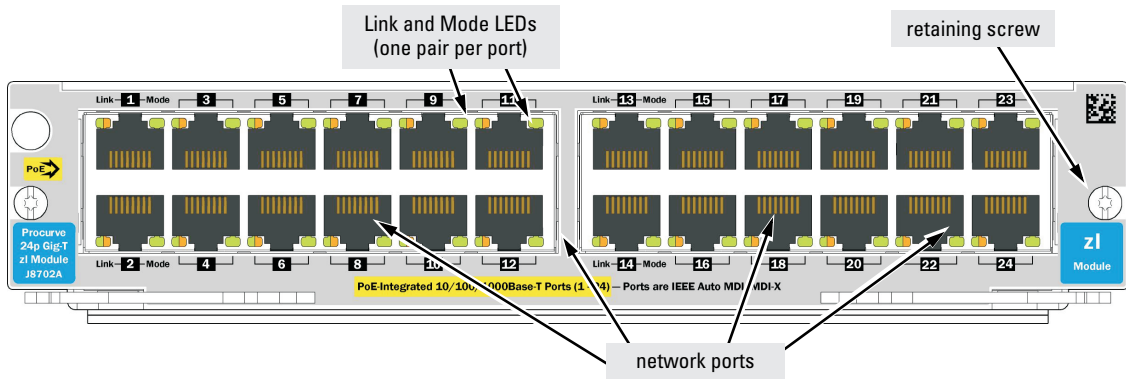

Figure 4. Example: HP ProCurve 24-Port 10/100/1000-T zl Module

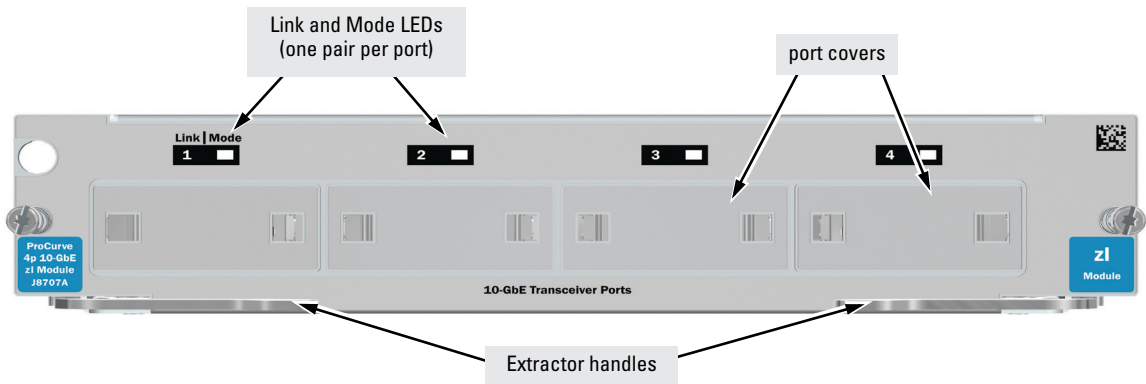

Figure 5. Example: HP ProCurve Switch 4-port 10 Gig-X2 zl Module

The zl Modules have the following features:

- All zl modules share the following features:
 - auto-enabled ports—the ports are all configured to be ready for network operation as soon as a viable network cable is connected
 - auto-configuration—a default configuration is applied to the module when the switch is powered on and the module passes self test; this default configuration works well for most network installations
 - LEDs that provide information for each port on the link status, network activity, connection bandwidth (speed), communication mode (half or full duplex)
 - “hot swap modules” operation—you can add a module or replace a module without having to shut down the switch (changing the module type in a given slot *does* require a switch reset)
 - “hot swap mini-GBICs” operation—you can add, replace, or change the type of any of the mini-GBICs that you use without having to first remove the module, and without having to shut down the switch
 - the RJ-45 ports on all modules have the **HP Auto-MDIX** and the IEEE 802.3ab **Auto MDI/MDI-X** feature. These features operate the same way and allow you to use either straight-through or crossover twisted-pair cables for all the twisted-pair network connections. (See the note on “Automatic Cable Sensing” on [page 25](#).)

Installing the Modules

Overview

Before installing any module, ensure you have loaded the most current software for that module onto your switch, see [page 3](#) for the V2 modules software version, and see [page 6](#) for the previous module software versions. You can install any of the modules into any of the HP networking chassis zl switches that have compatible module slots.

HP E5400 zl Switches:

- E5406 zl and all related bundles
- E5412 zl and all related bundles

HP E8200 zl Switches:

- E8206 zl and all related bundles
- E8212 zl and all related bundles

“Hot Swap” Notes

The mini-GBICs can be “hot swapped”. That is, they can be installed or removed after the Module is installed in the switch and the module is receiving power, see [page 19](#). You can “hot-swap” one module for another; that is, replace one module with another while the switch is still powered on, without interrupting the operation of the rest of the switch ports, see [page 28](#). You may have to reconfigure the switch if the modules are not the same type, check your configuration.

You can install the modules into the switch either with the switch powered on or off. The following procedures assume the switch is powered on.

1. Install the modules in a switch slot ([page 17](#)).
If you have installed any modules into slots that were previously occupied by a different type module, you need to reset the switch.
2. If you are using the zl Module that supports mini-GBICs, install the mini-GBICs in the module. You can install the mini-GBICs before or after installing that module into the switch ([page 19](#)).
3. Verify the modules are installed correctly ([page 22](#)).
4. Connect the network cabling ([page 24](#)).
5. Verify the network connections are working properly ([page 26](#)).
6. Optionally, customize the configuration for the modules’ ports (unless the default port configuration is satisfactory for your network application ([page 27](#))).

Installing the Module in an Unused Slot

Installation Precautions:

- Static electricity can severely damage the electronic components on the modules. When handling and installing the modules in your switch, follow these procedures to avoid damage from static electricity:
 - Handle the module by its bulkhead or edges and avoid touching the components and the circuitry on the board.
 - When installing the module, equalize any static charge difference between your body and the switch by wearing a grounding wrist strap and attaching it to the switch's metal body, or by frequently touching the switch's metal body.
- The HP Switch zl Modules have “low-force”, high-performance connectors. High insertion forces are not necessary to install the modules, and should not be used.
- **Ensure you fully insert the modules.** That is, press the module into the slot until the bulkhead on the module is contacting or is very close to contacting the front face of the switch chassis.
- Once the module is fully inserted, make sure you screw in the two retaining screws to secure the module in place.
- For safe operation, proper switch cooling, and reduction of electromagnetic emissions, ensure that a slot cover is installed on any unused module slot. For safety, no more than one slot should be uncovered at a time when the switch is powered on, except when installing a module that requires two slots.
- Ensure you check the temperature specifications for each module that will be installed into the chassis as different modules have different temperature requirements.

Installation Procedures:

1. Use a Torx T-10¹ or flat-bladed screwdriver to unscrew the screws in the cover plate over the slot you want to use, and remove the cover. Store the cover plate for possible future use.
2. Hold the module by its bulkhead—taking care not to touch the metal connectors or components on the board.
3. Open the extractor handles.
4. Insert the module aligning with the guides in the slot and slide it into the slot until it stops.
5. Once the contacts have engaged, use the extractor handles to seat the module completely.
6. Tighten the screws.

Installing the Modules

- ¹ The E8200 zl System Support Module (J9095A) uses Tamper-Resistant screws (TRS) Torx-20 with a center security pin and no flat blade slot. A TRS wrench is included with every separately purchased J9095A module.

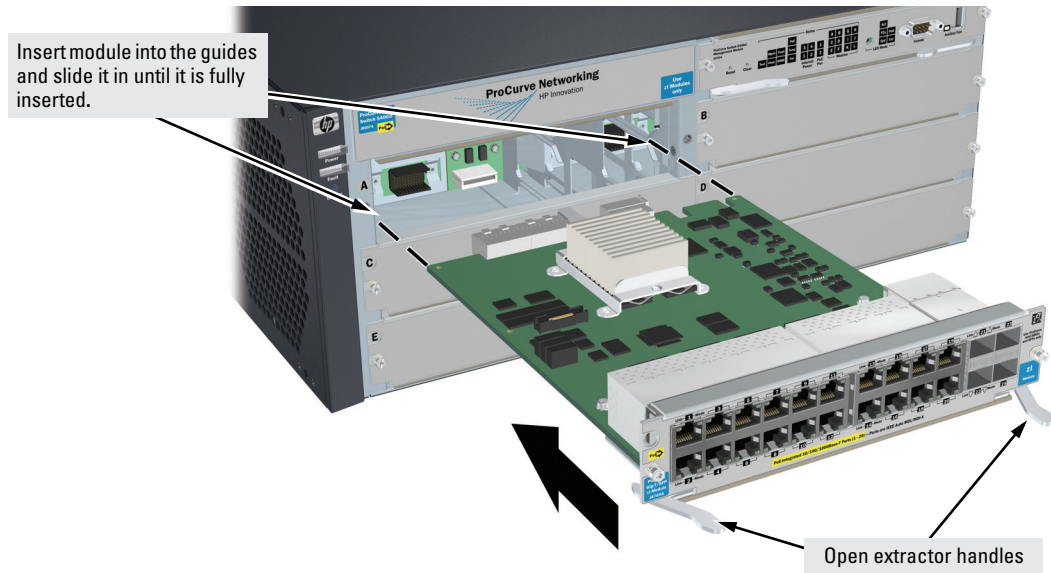

Figure 6. Example: Module being installed

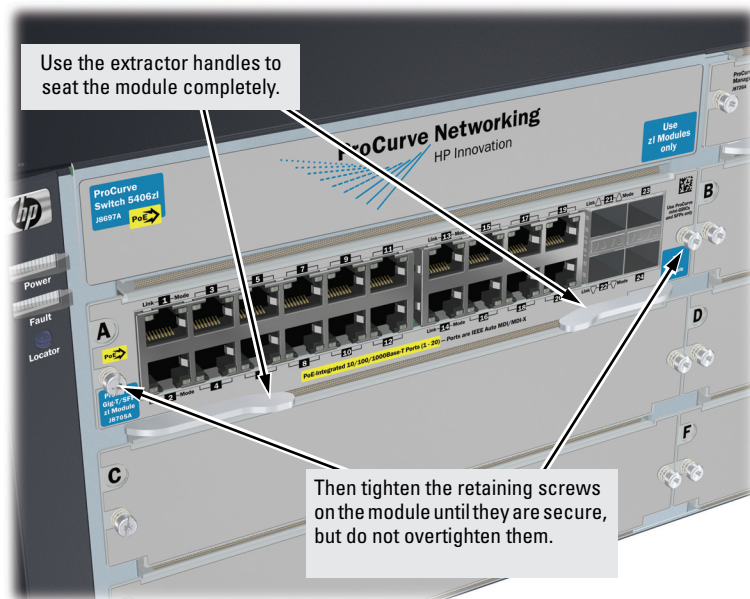

Figure 7. Module fully installed

Installing or Removing a mini-GBIC or SFP transceiver

You can install or remove a mini-GBIC or SFP transceiver from the mini-GBIC z1 Module without having to power off the switch. Use only HP mini-GBICs or SFP transceivers.

WARNING

The HP mini-GBICs and SFPs are Class 1 laser devices. Avoid direct eye exposure to the beam coming from the transmit port.

Caution

Use only supported genuine HP mini-GBICs or SFP transceivers with your switch. Non-HP mini-GBICs or SFP transceivers are not supported, and their use may result in product malfunction. Should you require additional HP mini-GBICs or SFP transceivers, contact your HP networking Sales and Service Office or authorized dealer.

Installing the mini-GBICs or SFP transceivers:

Hold the transceiver by its sides and gently insert it into any of the slots in the module until it clicks into place.

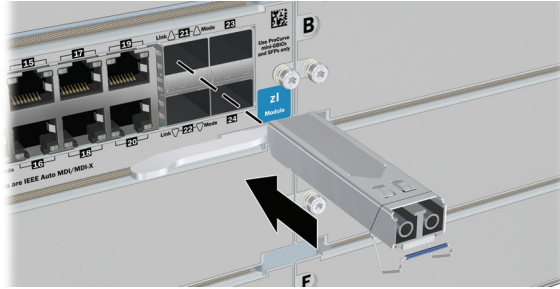

Figure 8. Example: Mini-GBIC or SFP transceiver being installed

Removing the mini-GBICs or SFP transceivers:

Disconnect the network cable from the transceiver before removing it from the module. Depending on when you purchased your transceiver, it may have either of three different release mechanisms: a plastic tab on the bottom, a wire bail, or a plastic collar.

To remove the transceivers that have the plastic tab or plastic collar, push in the plastic tab or collar toward the switch until you see the transceiver release from the switch (you can see it move outward slightly), and then pull it from the slot.

To remove the transceivers that have the wire bail, lower the bail until it is approximately horizontal, then using the bail, pull the transceiver from the slot.

Install or Remove an X2 Transceiver

Note

Hot swapping transceivers is supported. You can install or remove a transceiver with the switch powered on, a reset will not occur.

- a. Slide the transceiver in until it stops.

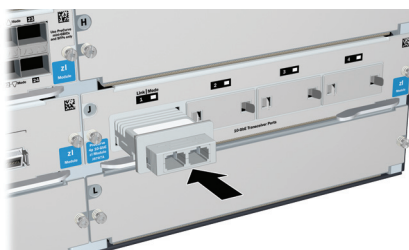

- b. Push firmly until the gasket seats against the bulkhead.

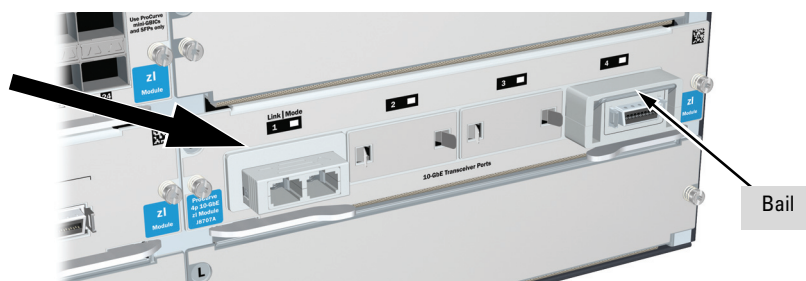

Note

When switch power is on, the Link and Mode LEDs will come on for approximately two seconds and then go off. This is confirmation the transceiver is completely seated.

- c. If your transceiver has a bail, move the bail up, if not your transceiver is now completely installed.

To remove the X2 transceiver:

If your transceiver has a bail, lower the bail until it is approximately horizontal, and then using the bail, pull the transceiver from the slot. If your transceiver does not have a bail, pull the transceiver straight out.

Verifying the Module is Installed Correctly

Observe the Module Status LED for the slot in which the module is being installed, and the Test and Fault LEDs on the switch to verify the module is installed properly.

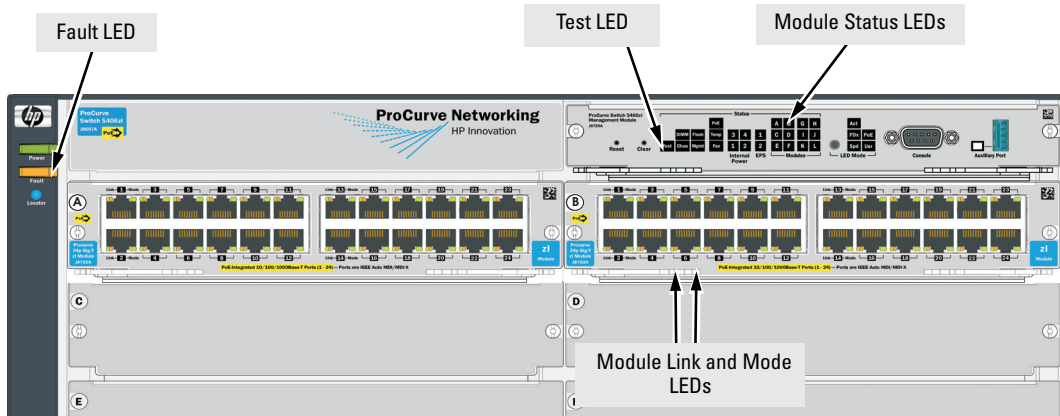

Figure 9. Module Status LEDs on an E5400 zl switch

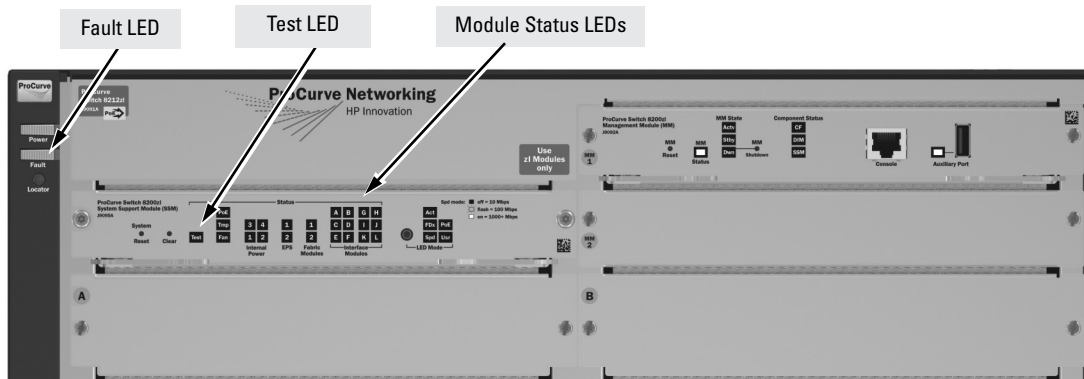

Figure 10. Module Status LEDs on an E8200 zl switch

When the module is installed properly and the switch is powered on, or the module is installed when the switch already has power, the module undergoes a self test that takes a few seconds. You can use the LEDs to determine that the module is installed properly and has passed the self test, as described in the “LED Behavior” table below.

LED Behavior

LED	Display for a Properly Installed Module
Module Status	(for the slot in which you are installing the module) The LED goes ON as soon as the module is installed and the switch is powered on, and stays ON steadily.
Test	ON briefly while the module is being tested, then OFF. Note: If the switch was powered off while the module was installed, when the switch is powered on, the Test LED will stay ON for the duration of the whole switch self test.
Fault	OFF
Link and Mode (on the modules)	For a module that is installed when the switch is already powered on (hot swap), all the Link and Mode LEDs on the module go ON for approximately 3 to 10 seconds, then OFF for 5 to 10 seconds depending on the module. Then, the Test LED on the switch goes OFF. If the module is already installed when the switch is powered on or reset, the process described above occurs approximately 30 seconds after the power on or reset, during which the switch is being tested.

Error Condition

If the Link LED on the module is flashing orange and the Fault LED on the switch is on, then there is a fault condition on the port with the flashing orange LED. The module letter, on the Management Module or System Support Module, corresponding to the module with the flashing orange LED will also be flashing simultaneously.

Connecting the Network Cables

Connect the appropriate network cables to the module's ports as shown in the table below. For more information on the cable specifications, see “Cabling and Technology Specifications” on [page 36](#).

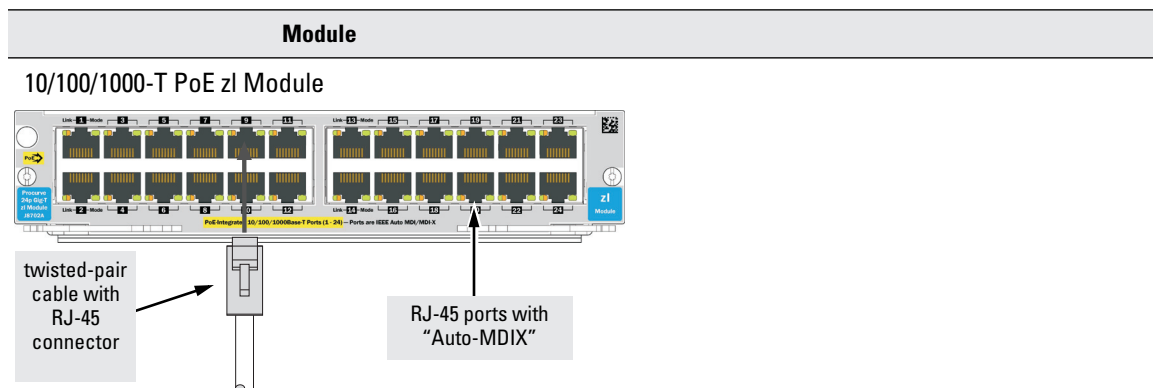

Notes:

- The RJ-45 ports on this module have the Auto-MDIX feature. In the module's default configuration, Auto, **either a straight-through or crossover cable can be used** to connect the module to any other 1000Base-T, 100Base-TX or 10Base-T device. See the Note on [page 25](#).
- Since the 10Base-T operation is through the 10/100Base-TX ports, if you ever want to upgrade the ports to 100Base-TX, it would be best to cable the ports initially with category 5 cable.

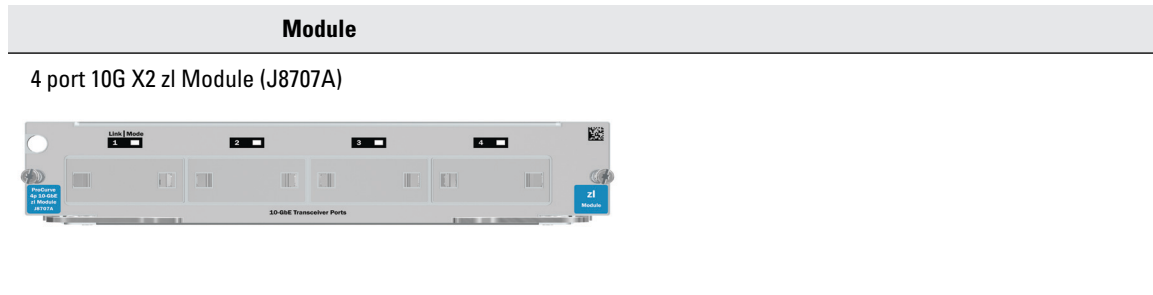
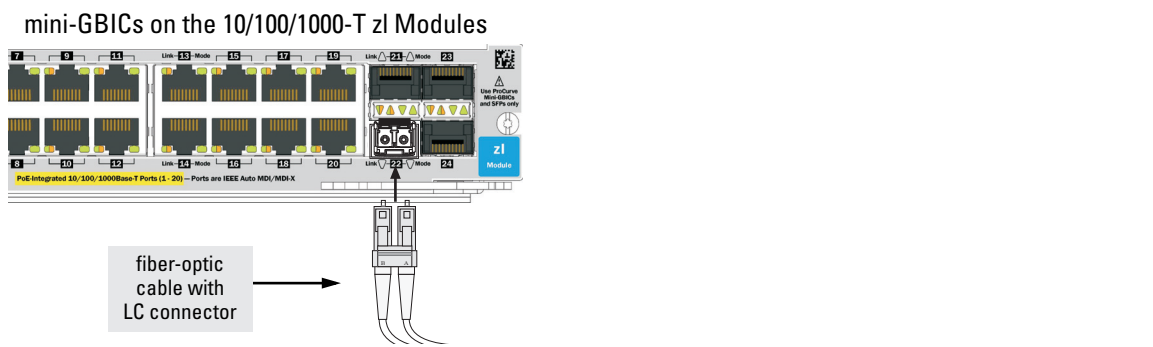

Connecting a fiber cable to an X2 transceiver

To connect:

1. Remove the dust covers from the cable connectors and the port.
2. Aligning the notches on the cable connectors with the slots of the port, press the cable connector into the port until it snaps into place.

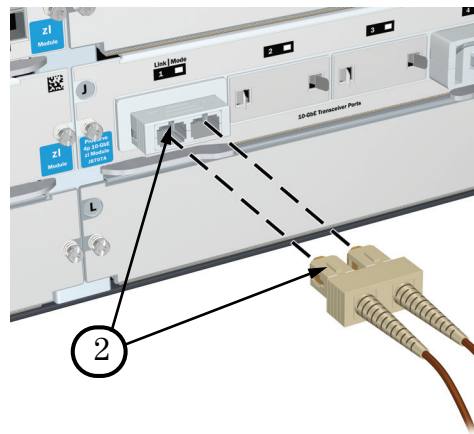

To disconnect:

Pull the cable connector straight out.

Connecting a copper cable to an X2 transceiver

To connect:

1. Push the copper cable connector into the copper port. Ensure the locking device locks the cable connector into place.

To disconnect:

Pull the cable connector straight out. When a network cable from an active network device is connected to the port, the port LED for that port should go on.

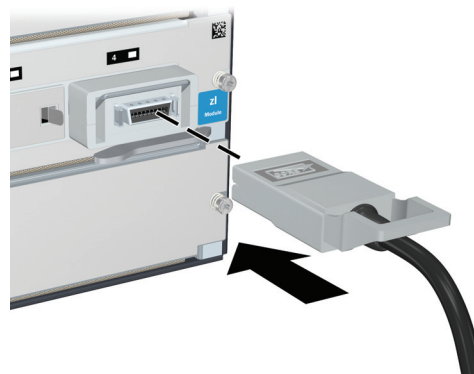

Note

Automatic Cable Sensing on Twisted-Pair Ports:

When the ports for these z1 Modules are in their default configuration, **Auto**, they automatically negotiate whether the ports operate as MDI or MDI-X, depending on the cable type and the connected device's operation. As a result, you can use either straight-through or crossover twisted-pair cable for all network connections to these modules.

Operation of these features depend on the port configurations being kept at **Auto**. If the configuration is changed to one of the available fixed options (for example, 100-Full Duplex), the port operates as an MDI-X port. In that case, to connect the module to another switch or hub, use a crossover cable; to connect to an end node, use a straight-through cable.

Verifying the Network Connections Are Working

Check the port LEDs for the newly-installed module to ensure the port(s) connected in the preceding step are operating correctly. Each port on the switch modules has Link and Mode LEDs near it as shown in the next illustration.

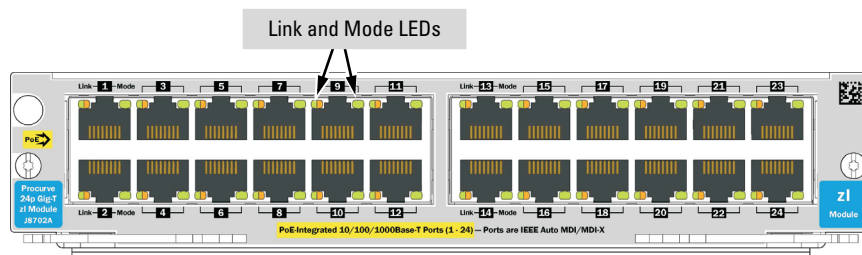

Figure 11. Example: Link and Mode LEDs

- The Link LED will be lit for each port that is connected properly to an active network device.

If the Link LED does not go on when an active network cable is connected to the port, there may be something wrong with the cable, the cable connectors, or the device at the other end of the cable. See the troubleshooting information on [page 29](#).
- If the switch Mode is set to display activity (the **Act** mode indicator LED is lit), then the Mode LED for each port that is transmitting and/or receiving packets will flicker when traffic is detected on the port.
- If the Mode is set to display full duplex (the **FDx** mode indicator LED is lit), then the Mode LED will be lit for each port that is operating in full duplex. If the port is in AUTO, the duplex mode LED will be off.
- If the Mode is set to display maximum link speed operation (the **Spd** mode indicator LED is lit), then the Mode LED will be lit for each port that is operating at its maximum possible link speed:
 - Off = 10 Mbps
 - Flashing = 100 Mbps (the flashing behavior is a repeated on/off cycle once every 0.5 sec.)
 - On = 1000 Mbps
 - If the port is in AUTO, the spd mode LED will be off.

Default Port Configuration

If the slot in which you installed the module was empty the last time the switch was either rebooted or reset (or the power to the switch was cycled), then the module will use preconfigured default parameter values that will work for most networks.

The default port configurations for connection parameters are:

- **Ports Enabled:** Yes
- **Mode:**
 - **10/100/1000-T zl Modules:** Auto — The port auto negotiates speed (10, 100 or 1000 Mbps), communication mode (half or full duplex), and MDI or MDI-X port operation.

Note

If you configure the port to one of the fixed 100 Mbps modes, the port will then operate only as an MDI-X port.

- **Dual Personality ports - (mini-GBIC ports using Gigabit-SX, Gigabit-LX, and Gigabit-LH ports):** Auto — The port always operates at 1000 Mbps and full duplex. The setting is Auto for best link establishment with other devices.
- **Gigabit-SX, Gigabit-LX, and Gigabit-LH ports in mini-GBIC zl Module:** Auto — The port always operates at 1000 Mbps and full duplex. The setting is Auto for best link establishment with other devices.
- **Flow Control:** Disabled
- **Advanced features** — Spanning Tree, Trunking, Meshing, VLANs, IGMP, LACP, Routing, Class of Service, Security, and so forth: all Disabled

If necessary, configure the port(s) in the module by using the switch console or the web browser interface. For more information, see the *Management and Configuration Guide* for your switch at www.hp.com/networking/support, and the online Help provided in the console and web browser interfaces. If the default port configuration listed above is acceptable for your network, then skip this process.

Note

By default, all ports on the J8702A and J8705A modules have PoE power enabled. Ports on the J9307A and J9308A modules provide PoE+ power. For information regarding customizing PoE and PoE+ ports refer to the *HP Power over Ethernet (PoE/PoE+) Planning and Implementation Guide* at www.hp.com/networking/support.

Replacing or Removing a Module

Follow these procedures to replace one module with another, or to remove a module without replacing it:

1. Remove any network cables from the ports on the module.
2. If the module you want to remove has a shutdown button, make sure to shut down the module before removing it either by using the CLI **shutdown** command or by using the shutdown button.
3. On the module you want to remove from the switch, unscrew the retaining screws enough to disconnect them from the threaded holes in the switch.

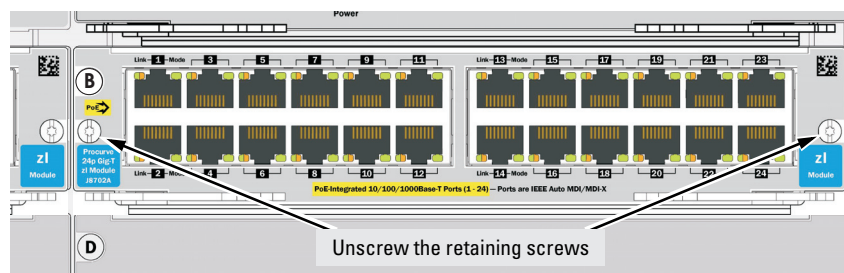

Figure 12. Removing a module

4. Using the extractor handles pull the module out from the slot.
5. Do one of the following:
 - If you will be installing another module in the slot, go to “Installing the Module in an Unused Slot” on [page 17](#) and begin with step 2.
 - If you will not install another module in the slot (that is, leave it empty), then re-install a slot cover plate over the empty slot opening.

Caution

For proper cooling and reduction of electromagnetic emissions, ensure a slot cover is installed on any unused slot.

6. Reset the switch, if you are exchanging one type of module with a different type of module in the same slot.

If you are replacing a module with another one of the *same* type in the same slot, it is not necessary to reset the switch. The current configuration for ports in that slot will apply to the new module.

Caution

When exchanging a Management Module between an E8206 zl switch and an E8212 zl switch, the switch software must be updated. See “[E8200 zl Management Module Dependencies](#)” on page 7 for more information.

Troubleshooting

One of the primary tools for troubleshooting the switch modules are the LEDs on the front of the switch and on the modules. Refer to “LED Behavior” on [page 23](#) for a description of the normal LED behavior. Also, refer to the switch *Installation and Getting Started Guide* for more detailed troubleshooting information for the switch.

Customer Support Services

If you are having any trouble with your module or switch, Hewlett-Packard offers support 24 hours a day, seven days a week through the use of a number of automated electronic services. For more information, visit www.hp.com/networking/support. Additionally, your HP-authorized network reseller can also provide you with assistance, both with services they offer and with services offered by HP.

Before Calling Support

Before calling your networking dealer or HP Support, to make the support process most efficient, retrieve the following information:

Information Item	Information Location
<ul style="list-style-type: none"> product identification, including the chassis, modules (for the J9154x module, see the <i>Getting Started Guide</i> that came with the Module), and transceivers 	the front of the switch, and on the modules and transceivers
<ul style="list-style-type: none"> details about the switch’s status including the OS (software) version, a copy of the switch configuration, a copy of the switch Event Log, and a copy of the switch status and counters information 	switch console: show tech command

Information Item	Information Location
<ul style="list-style-type: none">• copy of your network topology map, including network addresses assigned to the relevant devices	your network records

Specifications

Environmental

Modules Temperature		
Module	Operating	Non-Operating
J8702A	0°C to 55°C (32°F to 131°F)	-40°C to 70°C (-40°F to 158°F)
J8705A	0°C to 40°C (32°F to 104°F)	-40°C to 70°C (-40°F to 158°F)
J8706A	0°C to 40°C (32°F to 104°F)	-40°C to 70°C (-40°F to 158°F)
J8707A	0°C to 40°C (32°F to 104°F)	-40°C to 70°C (-40°F to 158°F)
J8708A	0°C to 55°C (32°F to 131°F)	-40°C to 70°C (-40°F to 158°F)
J8726A	0°C to 55°C (32°F to 131°F)	-40°C to 70°C (-40°F to 158°F)
J9051A	0°C to 40°C (32°F to 104°F)	-40°C to 70°C (-40°F to 158°F)
J9052A	0°C to 40°C (32°F to 104°F)	-40°C to 70°C (-40°F to 158°F)
J9092A	0°C to 45°C (32°F to 117°F)	-40°C to 70°C (-40°F to 158°F)
J9093A	0°C to 45°C (32°F to 117°F)	-40°C to 70°C (-40°F to 158°F)
J9095A	0°C to 45°C (32°F to 117°F)	-40°C to 70°C (-40°F to 158°F)
J9307A	0°C to 45°C (32°F to 117°F)	-40°C to 70°C (-40°F to 158°F)
J9308A	0°C to 40°C (32°F to 104°F)	-40°C to 70°C (-40°F to 158°F)
J9309A	0°C to 40°C (32°F to 104°F)	-40°C to 70°C (-40°F to 158°F)
J9478A	0°C to 40°C (32°F to 104°F)	-40°C to 70°C (-40°F to 158°F)
J9154A	0°C to 40°C (32°F to 104°F)	-10°C to 65°C (-10°F to 149°F)
J9534A	0°C to 55°C (32°F to 131°F)	-40°C to 70°C (-40°F to 158°F)
J9535A	0°C to 40°C (32°F to 104°F)	-40°C to 70°C (-40°F to 158°F)
J9536A	0°C to 40°C (32°F to 104°F)	-40°C to 70°C (-40°F to 158°F)
J9537A	0°C to 40°C (32°F to 104°F)	-40°C to 70°C (-40°F to 158°F)
J9538A	0°C to 40°C (32°F to 104°F)	-40°C to 70°C (-40°F to 158°F)
J9546A	0°C to 55°C (32°F to 131°F)	-40°C to 70°C (-40°F to 158°F)
J9547A	0°C to 55°C (32°F to 131°F)	-40°C to 70°C (-40°F to 158°F)
J9548A	0°C to 40°C (32°F to 104°F)	-40°C to 70°C (-40°F to 158°F)
J9549A	0°C to 40°C (32°F to 104°F)	-40°C to 70°C (-40°F to 158°F)
J9550A	0°C to 55°C (32°F to 131°F)	-40°C to 70°C (-40°F to 158°F)
J9637A	0°C to 40°C (32°F to 104°F)	-10°C to 65°C (-10°F to 149°F)
Relative humidity: (non-condensing)	15% to 95% at 40°C (104°F)	15% to 90% at 65°C (149°F)
J9154x only	15% to 90% at 40°C (104°F)	15% to 90% at 65°C (149°F)
Maximum altitude:	3.0 km (10,000 ft)	4.6 km (15,000 ft)

Network Connectivity Speeds and Technologies

Table 1. Optional Network Connectivity, Speeds and Technologies

			Transceiver Form-Factor and Connector ¹		
Speed	Technology	Cabling	SFP ("mini-GBIC") Connector	X2 Connector	SFP+ Connector
100 Mbps	100-FX	Fiber (multimode)	LC		
	100-BX	Fiber (single mode)	LC		
1 Gbps	1000-T	Copper (twisted-pair)	RJ-45		
	1000-SX	Fiber (multimode)	LC		
	1000-LX	Fiber (multimode or single mode)	LC		
	1000-LH	Fiber (single mode)	LC		
	1000-BX	Fiber (single mode)	LC		
10 Gbps	10-Gig CX4	Copper (twinaxial)		CX4	
	10-Gig Direct Attach	Copper (twinaxial)			Not Applicable
	10-Gig SR	Fiber (multimode)		SC	LC
	10-Gig LRM	Fiber (multimode)		SC	LC
	10-Gig LR	Fiber (single mode)		SC	LC
	10-Gig ER	Fiber (single mode)		SC	LC

¹ For supported transceivers, visit www.hp.com/networking/support.

- In the first textbox, type **J4858** (for 100-Mb and Gigabit information), or **J8436** (for 10-Gigabit information).
- Select any of the products that display in the dropdown list.
- Select **Product support information**. Then click on **Manuals** and find the **Transceiver Support Matrix**.

For technical details of cabling and technologies see "Cabling and Technology Specifications" on [page 36](#).

Technology Standards and Safety Compliance

Table 2. Technology Standards and Safety Compliance

		Laser safety information				
Technology	Compatible with these IEEE standards	EN/IEC standard compliance	SFP ("mini-GBIC") Lasers	X2 Lasers	SFP+ Lasers	Media Converter Lasers
10-T	IEEE 802.3 10BASE-T					
100-TX	IEEE 802.3u 100BASE-TX					
1000-T	IEEE 802.3ab 1000BASE-T					
10GBASE-T	IEEE 802.3an 10GBASE-T					
100-FX	IEEE 802.3u 100BASE-FX	EN/IEC 60825	Class 1 Laser Product Laser Klasse 1			
100-BX	IEEE 802.3ah 100BASE-BX10	EN/IEC 60825	Class 1 Laser Product Laser Klasse 1			
1000-SX	IEEE 802.3z 1000BASE-SX	EN/IEC 60825	Class 1 Laser Product Laser Klasse 1			
1000-LX	IEEE 802.3z 1000BASE-LX	EN/IEC 60825	Class 1 Laser Product Laser Klasse 1			
1000-LH	(not an IEEE standard)	EN/IEC 60825	Class 1 Laser Product Laser Klasse 1			
1000-BX	IEEE 802.3ah 1000BASE-BX10	EN/IEC 60825	Class 1 Laser Product Laser Klasse 1			
10-Gig CX4	IEEE 802.3ak 10GBASE-CX4					
10-Gig Direct Attach	(not an IEEE standard)					

Table 2. Technology Standards and Safety Compliance (Continued)

		Laser safety information				
Technology	Compatible with these IEEE standards	EN/IEC standard compliance	SFP ("mini-GBIC") Lasers	X2 Lasers	SFP+ Lasers	Media Converter Lasers
10-Gig SR	IEEE 802.3ae 10GBASE-SR	EN/IEC 60825		Class 1M Laser Product Laser Klasse 1M	Class 1 Laser Product Laser Klasse 1	
10-Gig LRM	IEEE 802.3aq 10GBASE-LRM	EN/IEC 60825		Class 1 Laser Product Laser Klasse 1	Class 1 Laser Product Laser Klasse 1	
10-Gig LR	IEEE 802.3ae 10GBASE-LR	EN/IEC 60825		Class 1 Laser Product Laser Klasse 1	Class 1 Laser Product Laser Klasse 1	
10-Gig ER	IEEE 802.3ae 10GBASE-ER	EN/IEC 60825		Class 1 Laser Product Laser Klasse 1	Class 1 Laser Product Laser Klasse 1	
CX4 Media Converter	(not an IEEE standard)	EN/IEC 60825				Class 1M Laser Product Laser Klasse 1M

Cabling and Technology Specifications

Table 3. Cabling Specifications

Twisted-pair copper	10 Mbps Operation	Category 3, 4 or 5, 100-ohm unshielded twisted-pair (UTP) or shielded twisted-pair (STP) cable, complying with IEEE 802.3 10BASE-T specifications.
	100 Mbps Operation	Category 5, 100-ohm UTP or STP cable, complying with IEEE 802.3u 100BASE-TX specifications.
	1000 Mbps Operation	Category 5, 100-ohm 4-pair UTP or STP cable, complying with IEEE 802.3ab 1000BASE-T specifications—Category 5e or better is recommended. See note on 1000BASE-T Cable Requirements below.
	10 Gbps Operation	Category 6 or 6A, 100-ohm 4-pair UTP cable, or Category 6A or 7, 100-ohm 4-pair STP cable, complying with IEEE 802.3an 10GBASE-T specifications. See note on 10GBASE-T Cable Requirements below, and see Table 4 for distances supported with each cable type.
Twinaxial copper	CX4 cables	Twinaxial cables complying with IEEE 802.3ak 10GBASE-CX4 specifications.
	Direct attach cables	One-piece devices consisting of a cable with SFP+ connectors permanently attached to each end, complying with SFF 8431 SFP+ specifications.
Multimode fiber		62.5/125 μm or 50/125 μm (core/cladding) diameter, low metal content, graded index fiber-optic cables, complying with the ITU-T G.651 and ISO/IEC 793-2 Type A1b or A1a standards respectively. ¹
Single mode fiber		9/125 μm (core/cladding) diameter, low metal content fiber-optic cables, complying with the ITU-T G.652 and ISO/IEC 793-2 Type B1 standards.
¹ A mode conditioning patch cord may be needed for some Gigabit-LX and 10-Gigabit LRM installations. See "Mode Conditioning Patch Cord" on page 39 for more information.		

Note on 1000BASE-T Cable Requirements. The Category 5 networking cables that work for 100BASE-TX connections should also work for 1000BASE-T, as long as all four-pairs are connected. But, for the most robust connections, you should use cabling that complies with the Category 5e specifications, as described in Addendum 5 to the TIA-568-A standard (ANSI/TIA/EIA-568-A-5).

Because of the increased speed provided by 1000BASE-T (Gigabit-T), network cable quality is more important than for either 10BASE-T or 100BASE-TX. Cabling plants being used to carry 1000BASE-T networking must comply with the IEEE 802.3ab standards. In particular, the cabling must pass tests for Attenuation, Near-End Crosstalk (NEXT), and Far-End Crosstalk (FEXT). Additionally, unlike the cables for 100BASE-TX, the 1000BASE-T cables must pass tests for Equal-Level Far-End Crosstalk (ELFEXT) and Return Loss.

When testing your cabling, be sure to include the patch cables that connect the switch and other end devices to the patch panels on your site. The patch cables are frequently overlooked when testing cable and they must also comply with the cabling standards.

Note on 10GBASE-T Cable Requirements. The Category 6 networking cables that work for 1000BASE-T connections may work for 10GBASE-T, as long as the distance is less than 55m and the cable installation has been tested for compliance to IEEE requirements. But, for the most robust connections, you should use cabling that complies with the Category 6A or Category 7 specifications, as described in the TIA-568-C (ANSI/TIA-568-C.2) and ISO/IEC 11801 standards.

10GBASE-T is a sophisticated technology that relies upon high quality cable installations. It is sensitive to Alien Near End Crosstalk (ANEXT) which can arrive upon the cable due to cables placed in close proximity to the data cables. It is recommended that cable dressing be done carefully and in compliance with recommendations in the TIA TSB-155A.

Like 1000BASE-T, 10GBASE-T requires testing of all the crosstalk and return loss parameters described above, and also ANEXT.

In addition to ANEXT, 10GBASE-T is more sensitive to external electrical noise in the environment. It is recommended that radio transmitters and other sources of high frequency continuous wave radio frequency be kept away from LAN cables.

When testing your cabling, be sure to include the patch cables that connect the switch and other end devices to the patch panels on your site. The patch cables are frequently overlooked when testing cable and they must also comply with the cabling standards. For 10GBASE-T, Category 6 patch cables are sensitive to movement once link has been established, and could cause link to drop if moved. Therefore HP recommends using Category 6A patch cables, or using cable management options to tie down (dress) the Category 6 patch cables so they cannot move.

Technology Distance Specifications

Table 4. Technology Distance Specifications

Technology	Supported cable type	Multimode fiber modal bandwidth	Supported distances
100-FX	multimode fiber	any	up to 2,000 meters
100-BX	single mode fiber	N/A	0.5 - 10,000 meters
1000-T	twisted-pair copper	N/A	up to 100 meters
10GBASE-T	twisted-pair copper	N/A	Cat 6 unshielded - up to 55 meters ¹ Cat 6 shielded - up to 100 meters ¹ Cat 6A unshielded - up to 100 meters Cat 6A shielded - up to 100 meters Cat 7 shielded - up to 100 meters
1000-SX	multimode fiber	160 MHz*km 200 MHz*km 400 MHz*km 500 MHz*km	2 - 220 meters 2 - 275 meters 2 - 500 meters 2 - 550 meters
1000-LX	multimode fiber single mode fiber	400 MHz*km 500 MHz*km N/A	2 - 550 meters 2 - 550 meters 2 - 10,000 meters
1000-LH	single mode fiber	N/A	10 - 70,000 meters ²
1000-BX	single mode fiber	N/A	0.5 - 10,000 meters
10-Gig CX4	twinaxial copper	N/A	up to 15 meters
10-Gig Direct Attach	twinaxial copper	N/A	(various lengths offered)
10-Gig SR	multimode fiber	160 MHz*km 200 MHz*km 400 MHz*km 500 MHz*km 2000 MHz*km	2 - 26 meters 2 - 33 meters 2 - 66 meters 2 - 82 meters 2 - 300 meters
10-Gig LRM	multimode fiber	400 MHz*km 500 MHz*km	0.5 - 100 meters 0.5 - 220 meters
10-Gig LR	single mode fiber	N/A	2 - 10,000 meters

Table 4. Technology Distance Specifications(Continued)

Technology	Supported cable type	Multimode fiber modal bandwidth	Supported distances
10-Gig ER	single mode fiber	N/A	2 - 40,000 meters
CX4 Media Converter	12-strand female-female multimode fiber MPO ribbon cable with MTP connectors, in a crossover (key up/key up) configuration	150 MHz*km 500 MHz*km 2000 MHz*km	1 - 50 meters 1 - 100 meters 1 - 300 meters
<p>¹ Cat 6 cabling requires TIA TSB-155A testing for 500 MHz operation and ANEXT.</p> <p>² For distances less than 20km, a 10dB attenuator must be used. For distances between 20km and 40km, a 5dB attenuator must be used. Attenuators can be purchased from most cable vendors.</p>			

Mode Conditioning Patch Cord

The following information applies to installations in which multimode fiber-optic cables are connected to a Gigabit-LX port or a 10-Gigabit LRM port. Multimode cable has a design characteristic called “Differential Mode Delay”, which requires the transmission signals be “conditioned” to compensate for the cable design and thus prevent resulting transmission errors.

Under certain circumstances, depending on the cable used and the lengths of the cable runs, an external Mode Conditioning Patch Cord may need to be installed between the Gigabit-LX or 10-Gigabit LRM transmitting device and the multimode network cable to provide the transmission conditioning. If you experience a high number of transmission errors on those ports, usually CRC or FCS errors, you may need to install one of these patch cords between the fiber-optic port in your switch and your multimode fiber-optic network cabling, at both ends of the network link.

The patch cord consists of a short length of single mode fiber cable coupled to graded-index multimode fiber cable on the transmit side, and only multimode cable on the receive side. The section of single mode fiber is connected in such a way that it minimizes the effects of the differential mode delay in the multimode cable.

Note

Most of the time, if you are using good quality graded-index multimode fiber cable that adheres to the standards listed on [page 36](#), there should not be a need to use mode conditioning patch cords in your network. This is especially true if the fiber runs in your network are relatively short.

For 10-Gigabit LRM using OM3 cable (50 μm multimode @ 1500/500 MHz*km), a mode conditioning patch cord is not required. Other multimode cables may require mode conditioning patch cords to achieve the LRM maximum distances.

Installing the Patch Cord

As shown in the illustration below, connect the patch cord to the transceiver with the section of single mode fiber plugged in to the Tx (transmit) port. Then, connect the other end of the patch cord to your network cabling patch panel, or directly to the network multimode fiber.

If you connect the patch cord directly to the network cabling, you may need to install a female-to-female adapter to allow the cables to be connected together.

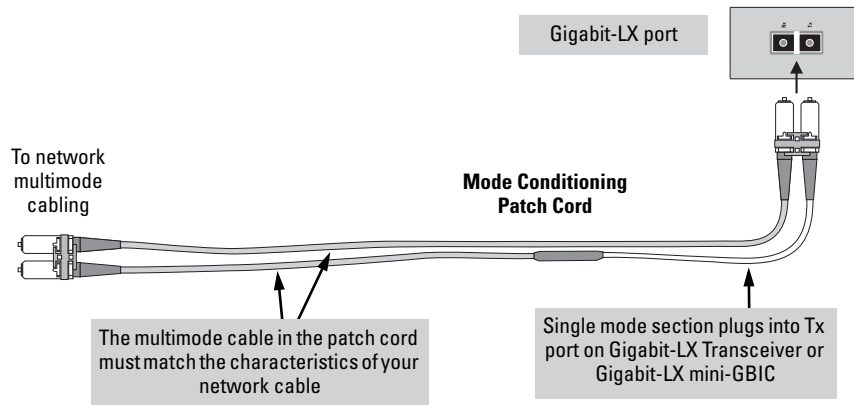

Figure 13. Example: Connecting a Mode Conditioning Patch Cord for Gigabit-LX

Make sure you purchase a patch cord that has appropriate connectors on each end, and has multimode fibers that match the characteristics of the multimode fiber in your network. Most important, the core diameter of the multimode patch cord must match the core diameter of the multimode cable infrastructure (either 50 or 62.5 microns).

EMC Regulatory Statements

U.S.A.

FCC Class A

This equipment has been tested and found to comply with the limits for a Class A digital device, pursuant to Part 15 of the FCC Rules. These limits are designed to provide reasonable protection against interference when the equipment is operated in a commercial environment. This equipment generates, uses, and can radiate radio frequency energy and, if not installed and used in accordance with the instruction manual, may cause interference to radio communications. Operation of this equipment in a residential area may cause interference in which case the user will be required to correct the interference at his own expense.

Canada

This product complies with Class A Canadian EMC requirements.

Australia/New Zealand



This product complies with Australia/New Zealand EMC Class A requirements.

Warning This is a Class A product. In a domestic environment this product may cause radio interference in which case the user may be required to take adequate measures.

Japan

VCCI Class A

<p>この装置は、クラスA情報技術装置です。この装置を家庭環境で使用すると電波妨害を引き起こすことがあります。この場合には使用者が適切な対策を講ずるよう要求されることがあります。</p> <p style="text-align: right;">VCCI-A</p>
--

Korea

A급 기기 (업무용 방송통신기기)	이 기기는 업무용(A급)으로 전자파적합등록을 한 기기이오니 판매자 또는 사용자는 이 점을 주의하시기 바라며, 가정 외의 지역에서 사용하는 것을 목적으로 합니다.
-----------------------	---

Taiwan

警告使用者：這是甲類的資訊產品，在居住的環境中使用時，可能會造成射頻干擾，在這種情況下，使用者會被要求採取某些適當的對策。

European Community Declaration of Conformity

These products are designed for operation with the HP switches that have zl module slots. Please see the Declarations of Conformity included in the Installation Guides for those products.

Note

For Conducted and Radiated Immunity in accordance with EN55024, the HP 8-port 10GBase-T v2 zl Module (J9546A) is limited to Performance Criteria A with shielded cable (Cat 6/6A).

Waste Electrical and Electronic Equipment (WEEE) Statements



Disposal of Waste Equipment by Users in Private Household in the European Union

This symbol on the product or on its packaging indicates that this product must not be disposed of with your other household waste. Instead, it is your responsibility to dispose of your waste equipment by handing it over to a designated collection point for the recycling of waste electrical and electronic equipment. The separate collection and recycling of your waste equipment at the time of disposal will help to conserve natural resources and ensure that it is recycled in a manner that protects human health and the environment. For more information about where you can drop off your waste equipment for recycling, please contact your local city office, your household waste disposal service or the shop where you purchased the product.



Likvidace zařízení soukromými domácími uživateli v Evropské unii

Tento symbol na produktu nebo balení označuje výrobek, který nesmí být vyhozen spolu s ostatním domácím odpadem. Povinností uživatele je předat takto označený odpad na předem určené sběrné místo pro recyklaci elektrických a elektronických zařízení. Okamžitě třídění a recyklace odpadu pomůže uchovat přírodní prostředí a zajistí takový způsob recyklace, který ochrání zdraví a životní prostředí člověka. Další informace o možnostech odevzdání odpadu k recyklaci získáte na příslušném obecním nebo městském úřadě, od firmy zabývající se sběrem a svozem odpadu nebo v obchodě, kde jste produkt zakoupili.



Bortskaffelse af affald fra husstande i den Europæiske Union

Hvis produktet eller dets emballage er forsynet med dette symbol, angiver det, at produktet ikke må bortskaffes med andet almindeligt husholdningsaffald. I stedet er det dit ansvar at bortskaffe kasseret udstyr ved at aflevere det på den kommunale genbrugsstation, der forestår genvinding af kasseret elektrisk og elektronisk udstyr. Den centrale modtagelse og genvinding af kasseret udstyr i forbindelse med bortskaffelsen bidrager til bevarelse af naturlige ressourcer og sikrer, at udstyret genvindes på en måde, der beskytter både mennesker og miljø. Yderligere oplysninger om, hvor du kan aflevere kasseret udstyr til genvinding, kan du få hos kommunen, den lokale genbrugsstation eller i den butik, hvor du købte produktet.



Seadmete jäätmete kõrvaldamine eramajapidamistes Euroopa Liidus

See tootel või selle pakendil olev sümbol näitab, et kõnealust toodet ei tohi koos teiste majapidamisjäätmetega kõrvaldada. Teie kohus on oma seadmete jäätmed kõrvaldada, viies need elektri- ja elektroonikaseadmete jäätmete ringlussevõtmiseks selleks ettenähtud kogumispunkti. Seadmete jäätmete eraldi kogumine ja ringlussevõtmine kõrvaldamise ajal aitab kaitsta loodusvarasid ning tagada, et ringlussevõtmine toimub viisil, mis kaitseb inimeste tervist ning keskkonda. Lisateabe saamiseks selle kohta, kuhu oma seadmete jäätmed ringlussevõtmiseks viia, võtke palun ühendust oma kohaliku linnakantselei, majapidamisjäätmete kõrvaldamise teenistuse või kauplusega, kust Te toote ostsite.



Laitteiden hävittäminen kotitalouksissa Euroopan unionin alueella

Jos tuotteessa tai sen pakkauksessa on tämä merkki, tuotetta ei saa hävittää kotitalousjätteiden mukana. Tällöin hävitettävä laite on toimitettava sähkölaitteiden ja elektronisten laitteiden kierrätyspisteeseen. Hävitettävien laitteiden erillinen käsittely ja kierrätys auttavat säästämään luonnonvaroja ja varmistamaan, että laite kierrätetään tavalla, joka estää terveyshaitat ja suojelee luontoa. Lisätietoja paikoista, joihin hävitettävät laitteet voi toimittaa kierrätettäväksi, saa ottamalla yhteyttä jätehuoltoon tai liikkeeseen, josta tuote on ostettu.



Élimination des appareils mis au rebut par les ménages dans l'Union européenne

Le symbole apposé sur ce produit ou sur son emballage indique que ce produit ne doit pas être jeté avec les déchets ménagers ordinaires. Il est de votre responsabilité de mettre au rebut vos appareils en les déposant dans les centres de collecte publique désignés pour le recyclage des équipements électriques et électroniques. La collecte et le recyclage de vos appareils mis au rebut indépendamment du reste des déchets contribue à la préservation des ressources naturelles et garantit que ces appareils seront recyclés dans le respect de la santé humaine et de l'environnement. Pour obtenir plus d'informations sur les centres de collecte et de recyclage des appareils mis au rebut, veuillez contacter les autorités locales de votre région, les services de collecte des ordures ménagères ou le magasin dans lequel vous avez acheté ce produit.



Entsorgung von Altgeräten aus privaten Haushalten in der EU

Das Symbol auf dem Produkt oder seiner Verpackung weist darauf hin, dass das Produkt nicht über den normalen Hausmüll entsorgt werden darf. Benutzer sind verpflichtet, die Altgeräte an einer Rücknahmestelle für Elektro- und Elektronik-Altgeräte abzugeben. Die getrennte Sammlung und ordnungsgemäße Entsorgung Ihrer Altgeräte trägt zur Erhaltung der natürlichen Ressourcen bei und garantiert eine Wiederverwertung, die die Gesundheit des Menschen und die Umwelt schützt. Informationen dazu, wo Sie Rücknahmestellen für Ihre Altgeräte finden, erhalten Sie bei Ihrer Stadtverwaltung, den örtlichen Müllentsorgungsbetrieben oder im Geschäft, in dem Sie das Gerät erworben haben



Απόρριψη άχρηστου εξοπλισμού από χρήστες σε ιδιωτικά νοικοκυριά στην Ευρωπαϊκή Ένωση

Το σύμβολο αυτό στο προϊόν ή τη συσκευασία του υποδεικνύει ότι το συγκεκριμένο προϊόν δεν πρέπει να διατίθεται μαζί με τα άλλα οικιακά σας απορρίμματα. Αντίθετα, είναι δική σας ευθύνη να απορρίψετε τον άχρηστο εξοπλισμό σας παραδίδοντάς τον σε καθορισμένο σημείο συλλογής για την ανακύκλωση άχρηστου ηλεκτρικού και ηλεκτρονικού εξοπλισμού. Η ξεχωριστή συλλογή και ανακύκλωση του άχρηστου εξοπλισμού σας κατά την απόρριψη θα συμβάλει στη διατήρηση των φυσικών πόρων και θα διασφαλίσει ότι η ανακύκλωση γίνεται με τρόπο που προστατεύει την ανθρώπινη υγεία και το περιβάλλον. Για περισσότερες πληροφορίες σχετικά με το πού μπορείτε να παραδώσετε τον άχρηστο εξοπλισμό σας για ανακύκλωση, επικοινωνήστε με το αρμόδιο τοπικό γραφείο, την τοπική υπηρεσία διάθεσης οικιακών απορριμμάτων ή το κατάστημα όπου αγοράσατε το προϊόν.



Készülékek magánháztartásban történő selejtezése az Európai Unió területén

A készüléken, illetve a készülék csomagolásán látható azonos szimbólum annak jelzésére szolgál, hogy a készülék a selejtezés során az egyéb háztartási hulladéktól eltérő módon kezelendő. A vásárló a hulladékká vált készüléket köteles a kijelölt gyűjtőhelyre szállítani az elektromos és elektronikai készülékek újrahasznosítása céljából. A hulladékká vált készülékek selejtezési begyűjtése és újrahasznosítása hozzájárul a természeti erőforrások megőrzéséhez, valamint biztosítja a selejtezett termékek környezetre és emberi egészségre nézve biztonságos feldolgozását. A begyűjtés pontos helyéről bővebb tájékoztatást a lakhelye szerint illetékes önkormányzattól, az illetékes személtakarító vállalattól, illetve a terméket eláruló helyen kaphat.



Smaltimento delle apparecchiature da parte di privati nel territorio dell'Unione Europea

Questo simbolo presente sul prodotto o sulla sua confezione indica che il prodotto non può essere smaltito insieme ai rifiuti domestici. È responsabilità dell'utente smaltire le apparecchiature consegnandole presso un punto di raccolta designato al riciclo e allo smaltimento di apparecchiature elettriche ed elettroniche. La raccolta differenziata e il corretto riciclo delle apparecchiature da smaltire permette di proteggere la salute degli individui e l'ecosistema. Per ulteriori informazioni relative ai punti di raccolta delle apparecchiature, contattare l'ente locale per lo smaltimento dei rifiuti, oppure il negozio presso il quale è stato acquistato il prodotto.



Nolietotu iekārtu iznīcināšanas noteikumi lietotājiem Eiropas Savienības privātajās mājāsaimniecībās

Šāds simbols uz izstrādājuma vai uz tā iesaiņojuma norāda, ka šo izstrādājumu nedrīkst izmest kopā ar citiem sadzīves atkritumiem. Jūs atbildat par to, lai nolietotās iekārtas tiktu nodotas speciāli iekārtotos punktos, kas paredzēti izmantoto elektrisko un elektronisko iekārtu savākšanai otrreizējai pārstrādei. Atsevišķa nolietoto iekārtu savākšana un otrreizējā pārstrāde palīdzēs saglabāt dabas resursus un garantēs, ka šīs iekārtas tiks otrreizēji pārstrādātas tādā veidā, lai pasargātu vidi un cilvēku veselību. Lai uzzinātu, kur nolietotās iekārtas var izmest otrreizējai pārstrādei, jāvērsas savas dzīves vietas pašvaldībā, sadzīves atkritumu savākšanas dienestā vai veikalā, kurā izstrādājums tika nopirkts.



Vartotojū iš privačių namų ūkių įrangos atliekų šalinimas Europos Sąjungoje

Šis simbols ant gaminio arba jo pakuotės rodo, kad šio gaminio šalinti kartu su kitomis namų ūkio atliekoms negalima. Šalintinas įrangos atliekas privalote pristatyti į specialią surinkimo vietą elektros ir elektroninės įrangos atliekoms perdirbti. Atskirai surenkamos ir perdirbamos šalintinos įrangos atliekos padės saugoti gamtinius išteklius ir užtikrinti, kad jos bus perdirbtos tokiu būdu, kuris nekenkia žmonių sveikatai ir aplinkai. Jeigu norite sužinoti daugiau apie tai, kur galima pristatyti perdirbtinas įrangos atliekas, kreipkitės į savo seniūniją, namų ūkio atliekų šalinimo tarnybą arba parduotuvę, kurioje įsigijote gaminį.



Verwijdering van afgedankte apparatuur door privé-gebruikers in de Europese Unie

Dit symbool op het product of de verpakking geeft aan dat dit product niet mag worden gedeponeerd bij het normale huishoudelijke afval. U bent zelf verantwoordelijk voor het inleveren van uw afgedankte apparatuur bij een inzamelingspunt voor het recyclen van oude elektrische en elektronische apparatuur. Door uw oude apparatuur apart aan te bieden en te recyclen, kunnen natuurlijke bronnen worden behouden en kan het materiaal worden hergebruikt op een manier waarmee de volksgezondheid en het milieu worden beschermd. Neem contact op met uw gemeente, het afvalinzamelingsbedrijf of de winkel waar u het product hebt gekocht voor meer informatie over inzamelingspunten waar u oude apparatuur kunt aanbieden voor recycling.



Pozbywanie się zużytego sprzętu przez użytkowników w prywatnych gospodarstwach domowych w Unii Europejskiej

Ten symbol na produkcie lub jego opakowaniu oznacza, że produktu nie wolno wyrzucać do zwykłych pojemników na śmieci. Obowiązkiem użytkownika jest przekazanie zużytego sprzętu do wyznaczonego punktu zbiórki w celu recyklingu odpadów powstałych ze sprzętu elektrycznego i elektronicznego. Osobna zbiórka oraz recykling zużytego sprzętu pomogą w ochronie zasobów naturalnych i zapewnią ponowne wprowadzenie go do obiegu w sposób chroniący zdrowie człowieka i środowisko. Aby uzyskać więcej informacji o tym, gdzie można przekazać zużyty sprzęt do recyklingu, należy się skontaktować z urzędem miasta, zakładem gospodarki odpadami lub sklepem, w którym zakupiono produkt.



Descarte de Lixo Elétrico na Comunidade Européia

Este símbolo encontrado no produto ou na embalagem indica que o produto não deve ser descartado no lixo doméstico comum. É responsabilidade do cliente descartar o material usado (lixo elétrico), encaminhando-o para um ponto de coleta para reciclagem. A coleta e a reciclagem seletivas desse tipo de lixo ajudarão a conservar as reservas naturais; sendo assim, a reciclagem será feita de uma forma segura, protegendo o ambiente e a saúde das pessoas. Para obter mais informações sobre locais que reciclam esse tipo de material, entre em contato com o escritório da HP em sua cidade, com o serviço de coleta de lixo ou com a loja em que o produto foi adquirido.



Likvidácia vyradených zariadení v domácnostiach v Európskej únii

Symbol na výrobku alebo jeho balení označuje, že daný výrobok sa nesmie likvidovať s domovým odpadom. Povinnosťou spotrebiteľa je odovzdať vyradené zariadenie v zberom mieste, ktoré je určené na recykláciu vyradených elektrických a elektronických zariadení. Separovaný zber a recyklácia vyradených zariadení prispieva k ochrane prírodných zdrojov a zabezpečuje, že recyklácia sa vykonáva spôsobom chrániacim ľudské zdravie a životné prostredie. Informácie o zberných miestach na recykláciu vyradených zariadení vám poskytne miestne zastupiteľstvo, spoločnosť zabezpečujúca odvoz domového odpadu alebo obchod, v ktorom ste si výrobok zakúpili.



Odstranjanje odslužene opreme uporabnikov v zasebnih gospodinjstvih v Evropski uniji

Ta znak na izdelku ali njegovi embalaži pomeni, da izdelka ne smete odvreči med gospodinjске odpadke. Nasprotno, odsluženo opremo morate predati na zbirališče, pooblaščeno za recikliranje odslužene električne in elektronske opreme. Ločeno zbiranje in recikliranje odslužene opreme prispeva k ohranjanju naravnih virov in zagotavlja recikliranje te opreme na zdravju in okolju neškodljiv način. Za podrobnejše informacije o tem, kam lahko odpeljete odsluženo opremo na recikliranje, se obrnite na pristojni organ, komunalno službo ali trgovino, kjer ste izdelek kupili.



Eliminación de residuos de equipos eléctricos y electrónicos por parte de usuarios particulares en la Unión Europea

Este símbolo en el producto o en su envase indica que no debe eliminarse junto con los desperdicios generales de la casa. Es responsabilidad del usuario eliminar los residuos de este tipo depositándolos en un "punto limpio" para el reciclado de residuos eléctricos y electrónicos. La recogida y el reciclado selectivos de los residuos de aparatos eléctricos en el momento de su eliminación contribuirá a conservar los recursos naturales y a garantizar el reciclado de estos residuos de forma que se proteja el medio ambiente y la salud. Para obtener más información sobre los puntos de recogida de residuos eléctricos y electrónicos para reciclado, póngase en contacto con su ayuntamiento, con el servicio de eliminación de residuos domésticos o con el establecimiento en el que adquirió el producto.



Bortskaffande av avfallsprodukter från användare i privathushåll inom Europeiska Unionen

Om den här symbolen visas på produkten eller förpackningen betyder det att produkten inte får slängas på samma ställe som hushållssopor. I stället är det ditt ansvar att bortskaffa avfallet genom att överlämna det till ett uppsamlingsställe avsett för återvinning av avfall från elektriska och elektroniska produkter. Separat insamling och återvinning av avfallet hjälper till att spara på våra naturresurser och gör att avfallet återvinns på ett sätt som skyddar människors hälsa och miljön. Kontakta ditt lokala kommunkontor, din närmsta återvinningsstation för hushållsavfall eller affären där du köpte produkten för att få mer information om var du kan lämna ditt avfall för återvinning.



Изхвърляне на отпадъчно оборудване от потребители в частни домакинства в Европейския съюз

Този символ върху продукта или опаковката му показва, че продуктът не трябва да се изхвърля заедно с другите битови отпадъци. Вместо това, трябва да предпазите човешкото здраве и околната среда, като предадете отпадъчното оборудване в предназначен за събирането му пункт за рециклиране на неизползваемо електрическо и електронно борудване. За допълнителна информация се свържете с фирмата по чистота, чиито услуги използвате.

Technology for better business outcomes

To learn more, visit www.hp.com/networking

© Copyright 2005, 2013 Hewlett-Packard Development Company, L.P. The information contained herein is subject to change without notice. The only warranties for HP products and services are set forth in the express warranty statements accompanying such products and services. Nothing herein should be construed as constituting an additional warranty. HP will not be liable for technical or editorial errors or omissions contained herein.



© Copyright 2005, 2013 Hewlett-Packard Development Company, L.P.
All rights reserved.

August 2013

Manual Part Number
5998-4703