

Graphic Panel, Logic Panel

GP, LP Series

USER MANUAL For COMMUNICATION



GP, LP Series

Preface

Thank you very much for selecting Autonics products.





Please familiarize yourself with the information contained in the **Safety Precautions** section before using this product.

This user manual contains information about the product and its proper use, and should be kept in a place where it will be easy to access.

User Manual Guide



- Please familiarize yourself with the information in this manual before using the product.
- This manual provides detailed information on the product's features. It does not offer any guarantee concerning matters beyond the scope of this manual.
- This manual may not be edited or reproduced in either part or whole without permission.
- A user manual is not provided as part of the product package. Please visit our home-page (www.autonics.com) to download a copy.
- The manual's content may vary depending on changes to the product's software and other unforeseen developments within Autonics, and is subject to change without prior notice. Upgrade notice is provided through our homepage.
- We contrived to describe this manual more easily and correctly. However, if there are any corrections or questions, please notify us these on our homepage.

User Manual Symbols

Symbol	Description
 Note	Supplementary information for a particular feature.
 Warning	Failure to follow instructions can result in serious injury or death.
 Caution	Failure to follow instructions can lead to a minor injury or product damage.
 Ex.	An example of the concerned feature's use.
※1	Annotation mark.

Safety Precautions

- Following these safety precautions will ensure the safe and proper use of the product and help prevent accidents and minimize hazards.
- Safety precautions are categorized as Warnings and Cautions, as defined below:

 Warning	Warning	Cases that may cause serious injury or fatal accident if instructions are not followed.
 Caution	Caution	Cases that may cause minor injury or product damage if instructions are not followed.

Warning

- In case of using this unit with machinery (Ex: nuclear power control, medical equipment, ship, vehicle, train, airplane, combustion apparatus, safety device, crime/disaster prevention equipment, etc) which may cause damages to human life or property, it is required to install fail-safe device.
It may cause a fire, human injury or property loss.
- In case using the GP, LP touch switch for controlling, do not use the switch as an emergency switches or those related to safety that may cause physical injury or property damage in the event of a malfunction.
It may cause a fire, human injury or property loss.
- In the event of defect or malfunction in GP, LP an alternative circuit must be constructed on the exterior.
It may cause a fire, human injury or property loss.
- Construct an emergency power-off circuit, safety circuit, or interlock circuit on the exterior of GP,LP.
It may cause a fire, human injury or property loss.
- If an error occurs on the watchdog timer of LP, the logic program will shut down automatically, so an alternative circuit must be constructed on the exterior.
It may cause a fire, human injury or property loss.
- The overall system operation may malfunction due to an input error resulting from a failure in input signal detection; so an alternative circuit must be constructed on the exterior.
It may cause a fire, human injury or property loss.
- For output signals that may cause a serious accident if the output section is damaged, a detection circuit and alternative circuit must be constructed on the exterior.
It may cause a fire, human injury or property loss.
- In case controlling other devices through GP, LP communication, and there is a possibility of malfunction due to communication error, an alternative circuit must be constructed.
It may cause a fire, human injury or property loss.
- When switching the mode to RUN mode please make sure that supply power to LP, I/O unit and load first. If not, output error or malfunction may be caused.
It may cause a fire, human injury or property loss.
- Before supplying power to LP, configure the circuit which is for supplying power to I/O unit and load at first. After starting LP program, if power is supplied to I/O unit and load, it may

cause malfunction and output error.

It may cause a fire, human injury or property loss.

- Do not use the product in an area or an environment not specified in the manual.
It may cause a fire, human injury or property loss.
- Do not connect, inspect or repair when power is on.
It may cause a fire or give an electric shock.
- Do not disassemble the product. Please contact us if it is required.
It may cause a fire or give an electric shock.
- Please use the rectified power with insulation trans.
It may cause a fire or give an electric shock.
- Do not use the power exceeded the rated voltage.
It may cause a fire or give an electric shock.
- This product uses lithium battery, do not disassemble or burn up.
It may cause an explosion or a fire.
- Wire properly after checking power terminal polarity.
It may cause a fire or a malfunction.



Caution

- Please read all notes and cautions related to installation and wiring in the manual.
If this is not observed, electrical shock or malfunction may occur.
- Make sure the ground wire of Graphic Panel is wired separately from the ground wires of other devices. Ground resistance must be less than 100Ω , and a lead wire of which sectional area is over 1.25mm^2 should be used.
If this is not observed, electrical shock or malfunction may occur.
- When connecting GP, LP ports and constructing input/output, check the pin number and terminal block before connecting.
It may cause a fire or a malfunction.
- Please tighten bolt on terminal block with specified tightening torque.
It may cause a short circuit, fire or a malfunction.
- Do not press the surface of the touch panel with sharp or hard objects.
The touch panel may be damaged.
- Keep GP, LP at the specified temperature.
If stored at a temperature beyond the specification, damage may occur.
- Do not inflow dust or wire dregs into the unit.
It may cause a fire or a malfunction.
- Do not use in an area with excessive humidity or temperature.
It may cause malfunction, or its useful life may be shortened.
- Do not close ventilating opening of this product.
Malfunction may occur due to temperature increase.
- Keep the product out of direct sunlight or excessive dust.
It may cause malfunction, or its useful life may be shortened.
- Do not use or store in a place with shock or vibration.
It may cause malfunction, or its useful life may be shortened.

- When liquid crystal from the broken LCD is smeared with skin, wash it for 15 minutes. If it is gotten in the eye, wash it for 15 minutes and contact with the medical specialist for more information.
- In cleaning unit, do not use water or an oil-based detergent and use dry towels. It may cause an electric shock or a fire.
- Please separate as an industrial waste when disuse this unit.
- To change the battery, contact the store or an authorized technician.
- The manufacturer is not liable for damages that occur due to causes for which the manufacturer is not responsible, damages that occur due to an extraordinary situation, secondary damages, compensation for accidents, damages occurring on other products, compensation for other processes, and damage and loss of opportunity to the user due a malfunction of the product, regardless of the predictability of the accident.

※The specifications and dimensions of this manual are subject to change without any notice.

※This inner device of user manual for communication is based on GP. If you use LP, refer to “LP user manual” for inner device of LP.

Table of Contents

Preface	iii
User Manual Guide	iv
User Manual Symbols	v
Safety Precautions	vi
Table of Contents	ix
1 Product Overview	1
1.1 Features	1
1.2 System organization	2
1.3 Communication	3
1.3.1 RS232C	3
1.3.2 RS422	4
1.3.3 Mono type	5
1.3.4 Color type	9
1.4 Link device	14
1.5 Connectable device	22
1.6 Applicable connection type	25
2 GP Editor Data Download.....	27
2.1 System organization	27
2.2 Communication configuration	28
2.2.1 GP Editor configuration	28
2.2.2 GP, LP configuration.....	31
3 PLC Communication.....	37
3.1 Communication configuration	37
3.1.1 GP Editor configuration	37
3.1.2 GP, LP configuration.....	38
3.2 1:1 communication.....	47
3.2.1 Communication configuration.....	47
3.2.2 GP Editor configuration	47
3.2.3 GP, LP configuration.....	48
3.3 1:N communication	54
3.3.1 System organization.....	54
3.3.2 Communication configuration.....	56
3.4 Heterogeneous communication.....	65
3.4.1 System organization.....	65
3.4.2 Communication configuration.....	66
3.4.3 GP, LP configuration	69
3.5 Other communication.....	76
3.5.1 System organization.....	76
3.5.2 Barcode reader communication configuration	76
3.5.3 PRINTER communication configuration	83

3.6	System signal	89
3.6.1	System signal 1 (GP/LP ← PLC)	89
3.6.2	System signal 2 (GP/LP → PLC)	90
3.6.3	System signal 3 (GP/LP ← PLC)	91
3.6.4	System signal 4 (GP/LP → PLC)	92
4	Communication Cable By Device	93
4.1	Ordering information.....	93
4.2	Cable wiring and dimensions.....	93
4.3	Communication cable by connectable device	97
5	Universal (General-purpose communication).....	103
5.1	System organization	103
5.2	Universal 1:1 communication	104
5.2.1	GP Editor configuration	104
5.2.2	GP, LP configuration.....	105
5.3	Universal 1:1:1 communication	111
5.3.1	GP Editor configuration	111
5.3.2	GP, LP configuration.....	112
5.4	Universal protocol.....	119
5.4.1	Available address	119
5.4.2	Available function code	119
5.4.3	Communication frame organization	120
5.5	Universal function example	123
5.5.1	03(Read holding register).....	123
5.5.2	16(Preset multiple register)	125
5.5.3	Exception response.....	127
6	Connectable PLC.....	129
6.1	Autonics product.....	131
6.1.1	System organization.....	131
6.1.2	Station configuration in GP/LP	132
6.1.3	Available device	133
6.1.4	Monitorable device in GP/LP.....	142
6.2	Autonics LP series PLC connection	145
6.2.1	System organization.....	145
6.2.2	Available device	146
6.2.3	Monitorable device in GP/LP.....	149
6.3	LS Master-K series PLC connection	150
6.3.1	System organization.....	150
6.3.2	Available device	151
6.3.3	Monitorable device in GP/LP.....	158
6.4	LS Glofa PLC connection	159
6.4.1	System organization.....	159
6.4.2	Available device	160
6.4.3	Monitorable device in GP/LP.....	162
6.5	LS Cnet communication connection.....	163
6.5.1	System organization.....	163

6.5.2	Communication configuration.....	165
6.5.3	Available device	166
6.6	OEMAX PLC(Samsung PLC) connection	167
6.6.1	System organization.....	167
6.6.2	Available device	168
6.6.3	Monitorable device in GP/LP.....	176
6.7	MITSUBISHI PLC	178
6.7.1	System organization.....	178
6.7.2	Available device	180
6.7.3	Monitorable device in GP/LP.....	187
6.8	MITSUBISHI Q series PLC connection	188
6.8.1	System organization.....	188
6.8.2	Available device	189
6.8.3	Monitorable device in GP/LP.....	191
6.8.4	MELSEC Q series PLC configuration	192
6.8.5	GP/PLC type configuration in GP Editor	195
6.9	Nais PLC connection	196
6.9.1	System organization.....	196
6.9.2	Available device	201
6.9.3	Monitorable device in GP/LP.....	210
6.10	OMRON SYSMAC C PLC connection	211
6.10.1	System organization.....	211
6.10.2	Available device	212
6.10.3	Monitorable device in GP/LP.....	214
6.11	OMRON temperature controller connection	215
6.11.1	System organization.....	215
6.11.2	Communication configuration.....	216
6.11.3	Available device	218
6.11.4	Monitorable device in GP/LP.....	219
6.12	SIEMENS S7 series connection.....	220
6.12.1	System organization.....	220
6.12.2	Available device	221
6.12.3	Monitorable device in GP/LP.....	227
6.13	Allen Bradley MicroLogix series connection.....	228
6.13.1	System organization.....	228
6.13.2	Available device	229
6.13.3	Monitorable device in GP/LP.....	232
6.14	KONICS Product connection	233
6.14.1	System organization.....	233
6.14.2	Available device	235
6.14.3	Monitorable device in GP/LP.....	249
6.15	DELTA temperature controller connection	250
6.15.1	System organization.....	250
6.15.2	Available device	252
6.15.3	Monitorable device in GP/LP.....	254
6.16	DANFOS FC Series.....	255

6.16.1	System organization.....	255
6.16.2	Available device	257
6.16.3	Monitorable device in GP/LP	257
6.17	Modbus Master	258
6.17.1	System organization.....	258
6.17.2	Available device	259
6.17.3	Monitorable device in GP/LP.....	260

1 Product Overview

GP and LP series which is connected with various controllers including PLC, temperature controller displays and monitors the operation of control variable by LCD screen visually as graphic interface device.

You can switch the screen and set or edit the variable value by touching LCD screen.

The variable value with various data type is displayed by graphic object(tag) drawn from GP Editor which is dedicated software for GP, LP screen. Connected with barcode reader and printer, etc. GP, LP realize numerous application by utilizing interface.

1.1 Features

- Responds to various connection type
 - It supports to connect with several PLCs and controllers.
 - It supports to connect with barcode reader for product lines or on-site that use barcodes.
 - It supports to print for alarm history.
- Friendly compatible with controller
 - High compatibility monitoring function with PLC including monitoring device, changing device value, multi monitoring function between heterogeneous controllers.
 - Easy to display the cause of PLC system alarm including alarm history, total number of alarm, history printing, detail indication of alarm.

1.2 System organization

GP, LP is able to communicate with various controllers including PLC, multi meter, pulse meter, temperature & humidity sensor and temperature controller.

GP,LP and controllers can execute RS-232C/RS-422(RS-485) communication, and please refer to the each controller section for more information about module or adapter to convert communication.

The following is the system organization for connecting with GP, LP.

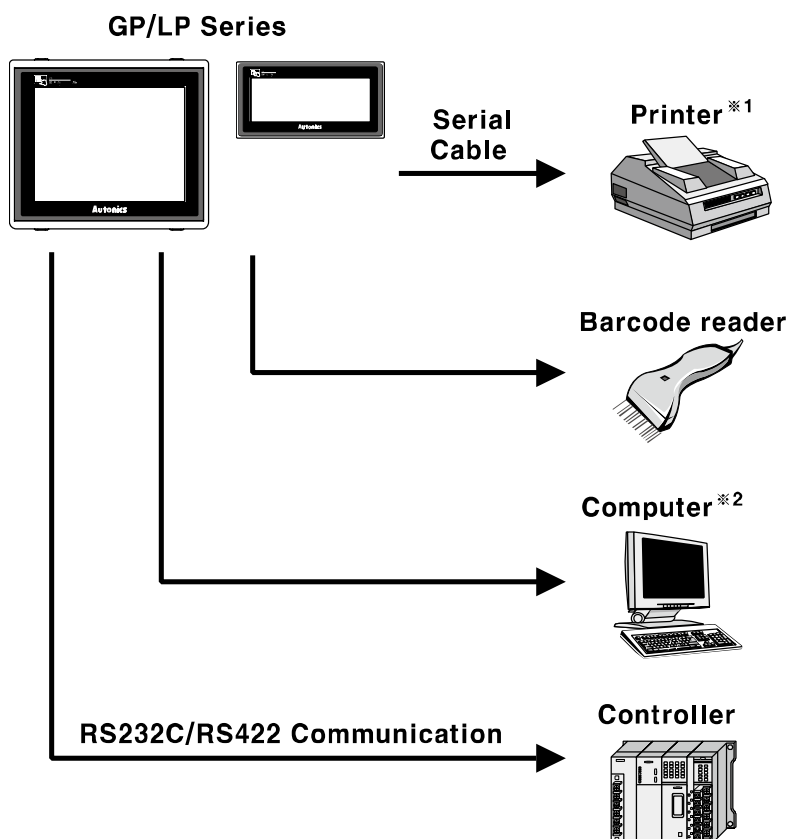

※1. Printer supports serial communication.

Printer is able to directly connect with GP/LP to be available serial communication both RS232C, RS422. You can print only alarm history by GP, LP. For more details, refer to '3.5 Other communication'.

※2. Personal Computer transmits written data to GP, LP.

It is required to use dedicated transmitting cable(sold separately) to transmit the data(User can create.).

GP Editor which is dedicated drawing software program creates data. Visit our homepage (www.autonics.com) to download GP Editor.

The below is computer specification required to use software.

Operating system: Windows98/NT/XP

Item	Minimum specifications	Recommended specification
CPU	Pentium 4 or above	Pentium Dual Core
Memory	512 MB	1GB
Hard disk	1 GB (Free space)	5GB (Free space)
Resolution	1024 × 768	1280 × 1024

1.3 Communication

1.3.1 RS232C

(1) Transmission standard

No.	Item	Description	
1	Communication method	Full Duplex	
2	Synchronous method	Asynchronous	
3	Communication distance	Approx. 15m	
4	Connection type	1:1	
5	Baud rate	300/600/1200/3200/4800/9600/19200/38400/57600bps	
6	Data format	Data length	7, 8 bit
		Parity	None, Odd, Even
		Stop bit	1, 2 bit

(2) Connector pin number and signal name

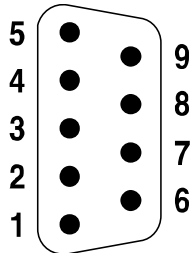

No	Signal name	No	Signal name
1	-	6	DSR
2	RXD	7	-
3	TXD	8	-
4	DTR	9	-
5	SG		

1.3.2 RS422

(1) Transmission standard

No.	Item	Description	
1	Communication method	Full Duplex	
2	Synchronous method	Asynchronous	
3	Communication distance	Approx. 15m	
4	Connection type	1:1	
5	Baud rate	300/600/1200/3200/4800/9600/19200/38400/57600bps	
6	Data format	Data length	7, 8 bit
		Parity	None, Odd, Even
		Stop bit	1, 2 bit

(2) Connector pin number and signal name

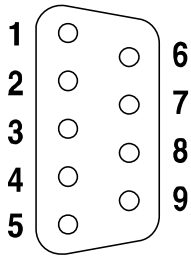

GP-2480				GP-S044, GP-S057, GP-S070 LP-S044, LP-S070			
No	Signal name	No	Signal name	No	Signal name	No	Signal name
1	TXD+	6	TXD-	1	TXD+	6	TXD-
2	RXD+	7	RXD-	2	RXD+	7	RXD-
3	RTS-	8	RTS+	3	-	8	-
4	CTS+	9	CTS-	4	-	9	-
5	SG			5	SG		

1.3.3 Mono type

This menu displays connected device to RS232C, RS422 port of GP/LP. You can designate station and connected port by each channel.

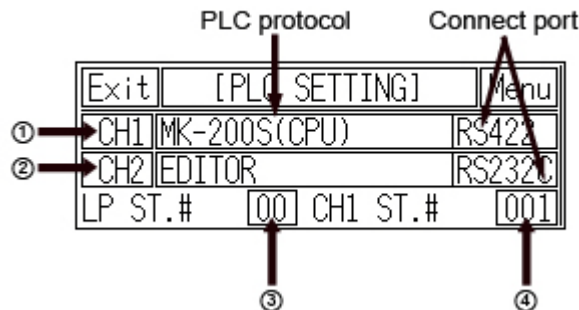

No	Function	Operation
①	CH1 configuration line	Displays connected device and connect port for CH1. Touch this to select one from downloaded protocol in GP Editor, EDITOR, PRINTER, BARCODE, UNIVERSAL, or DEFAULT protocol (MK-200S(CPU)) and designate connect port. (Select between RS232C/RS422 or RS232C-A / RS232C-B).
②	CH2 configuration line	Displays connected device and connect port for CH2. Touch this to select one from downloaded protocol in GP Editor, EDITOR, PRINTER, BARCODE, UNIVERSAL, or DEFAULT protocol and designate connect port. (Select between RS232C/RS422 or RS232C-A / RS232C-B). Depending on CH1 designation, CH2 is changed automatically as no use, and if CH1 is SLAVE, MONITOR does not appear.
③	GP station configuration touch key	Touch this and decimal (DEC) input key pad for station appears. Station set range: 0 to 31
④	CH1 station configuration touch key	Touch this and decimal (DEC) input key pad for station appears. Station set range: 0 to 255 Communication is available only when the station of CH1 is set as connected device station.

(1) In case of using only CH1 configured in GP Editor

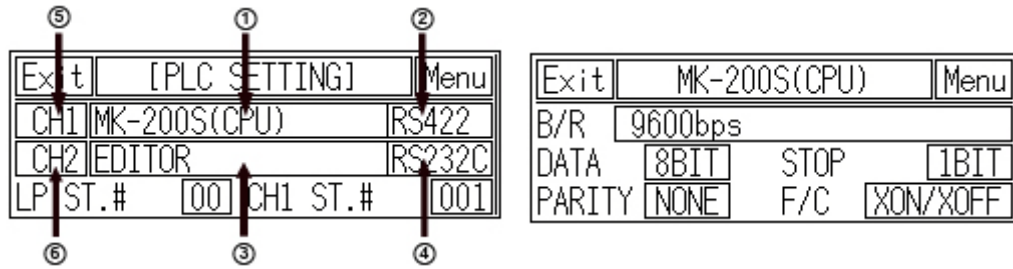

No	Item	Operation with touching
①	Displays CH1 protocol	Rotates in order as downloaded protocol in GP Editor → EDITOR → PRINTER → BARCODE → UNIVERSAL → DEFAULT protocol (MK-200S(CPU))
②	Displays CH1 connect port (Designates automatically as non-using port in ④)	Each of RS422 / RS232C interface type: RS422 PORT ↔ RS232C PORT Two ports of RS232C interface type: RS232C A PORT ↔ RS232C B PORT
③	Displays CH2 protocol (as EDITOR for default)	Rotates in order as No Use → EDITOR → PRINTER → BARCODE
④	Displays CH2 connect port (Designates automatically as non-using port in ②)	Each of RS422 / RS232C interface type: RS422 PORT ↔ RS232C PORT Two ports of RS232C interface type: RS232C A PORT ↔ RS232C B PORT
⑤⑥	Communication configuration by each channel	Moves communication configuration setting window for selected connected device. You can designate baudrate, data bit, parity, stop bit, and flow control for each channel. If CH2 is as NoUse, it is not able to communication configuration.

(2) In case of using only CH2 configured in GP Editor

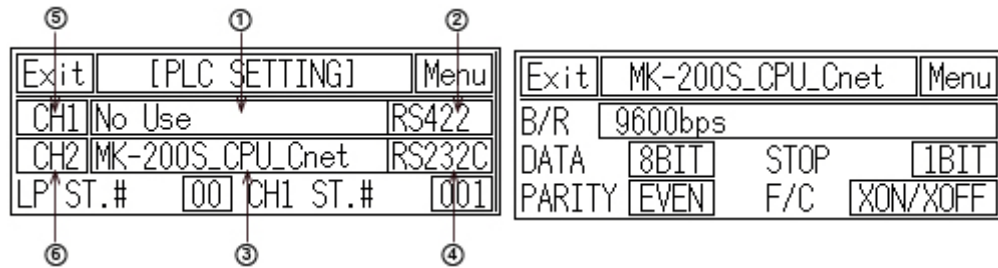

No	Item	Operation with touching
①	Displays CH1 protocol	Rotates in order as NoUse → EDITOR → PRINTER → BARCODE → UNIVERSAL → DEFAULT protocol (MK-200S(CPU))
②	Displays CH1 connect port (Designates automatically as non-using port in ④)	Each of RS422 / RS232C interface type: RS422 PORT ↔ RS232C PORT Two ports of RS232C interface type: RS232C A PORT ↔ RS232C B PORT
③	Displays CH2 protocol (as downloaded protocol for default)	Rotates in order as downloaded protocol in GP Editor → EDITOR → PRINTER → BARCODE
④	Displays CH2 connect port (Designates automatically as non-using port in ②)	Each of RS422 / RS232C interface type: RS422 PORT ↔ RS232C PORT Two ports of RS232C interface type: RS232C A PORT ↔ RS232C B PORT
⑤⑥	Communication configuration by each channel	Moves communication configuration setting window for selected connected device. You can designate baudrate, data bit, parity, stop bit, and flow control for each channel. If CH1 is as NoUse, it is not able to communication configuration.

(3) CH1/ CH2 details configuration

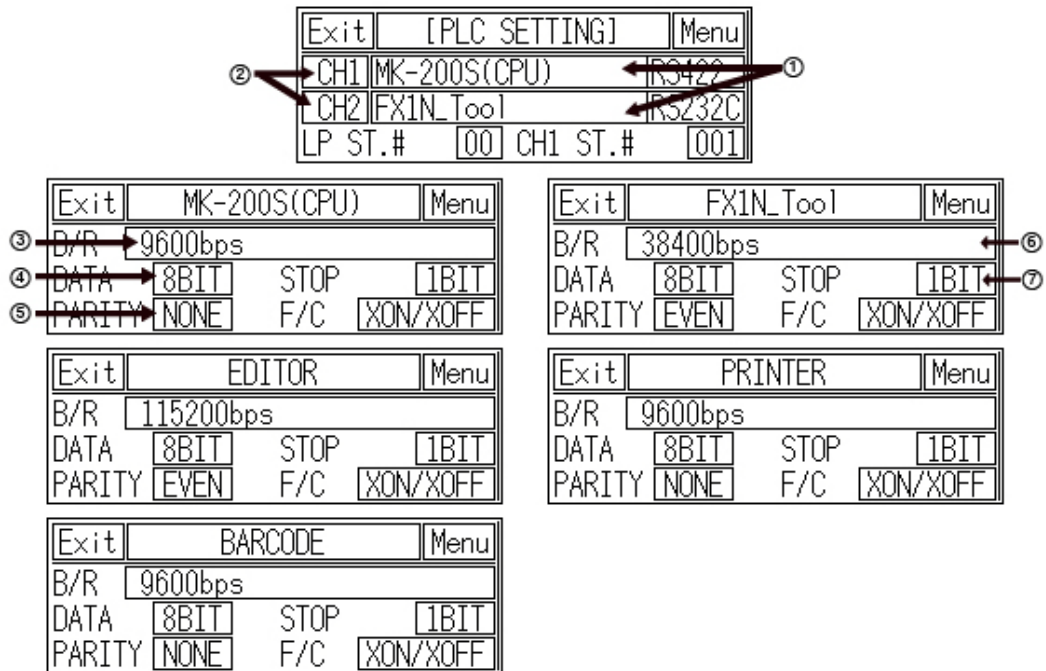

No	Function and operation
①	<p>Designate the device to be connected for CH1, CH2.</p> <ul style="list-style-type: none"> CH1, CH2 protocol: Communication mode for set PLC by GP and GP Editor by each port. EDITOR: I/O mode for downloading user-designed or PLC programming data from GP Editor or SmartStudio. PRINTER: Print mode for printing alarm history of GP. Refer to '3.5.3 PRINTER communication configuration'. BARCODE: Input mode for reading data from barcode. Refer to '3.5.2 Barcode reader communication configuration'. UNIVERSAL: It is general-purpose communication. GP/LP support Modbus slave communication. MK-200S(CPU): Default protocol of GP/LP. It is available to communication with LS MK-200S. MONITOR: Available only in CH2. Monitoring mode for PLC which is connected to GP/LP from PC directly. GP/LP is as transmitter by transmitting data from PC to PLC and data from PLC to PC. In case of MITSUBISHI FX-series, editor mode is available for monitoring. NoUse: Displayed only not using appropriate CH.
②	Touch this, detailed configuration screen for designated operation mode appears.
③ to ⑦	<p>Designate detailed configuration for designated operation mode.</p> <ul style="list-style-type: none"> Baudrate: Designate baud rate. Supports 300/600/1200/2400/4800/9600/19200/38400/57600/115200bps Data: Designate data bit. Supports 7 bit, or 8 bit. Stop bit: Designate stop bit. Supports 1 bit, or 2 bit. Parity: Designate parity type. Supports even, odd, or none parity. Flow control: Designate data flow control. Supports XON/ XOFF, or DSR/DTR.

1.3.4 Color type

This menu displays connected device to RS232C, RS422 port of GP/LP. You can designate station and connected port by each channel.

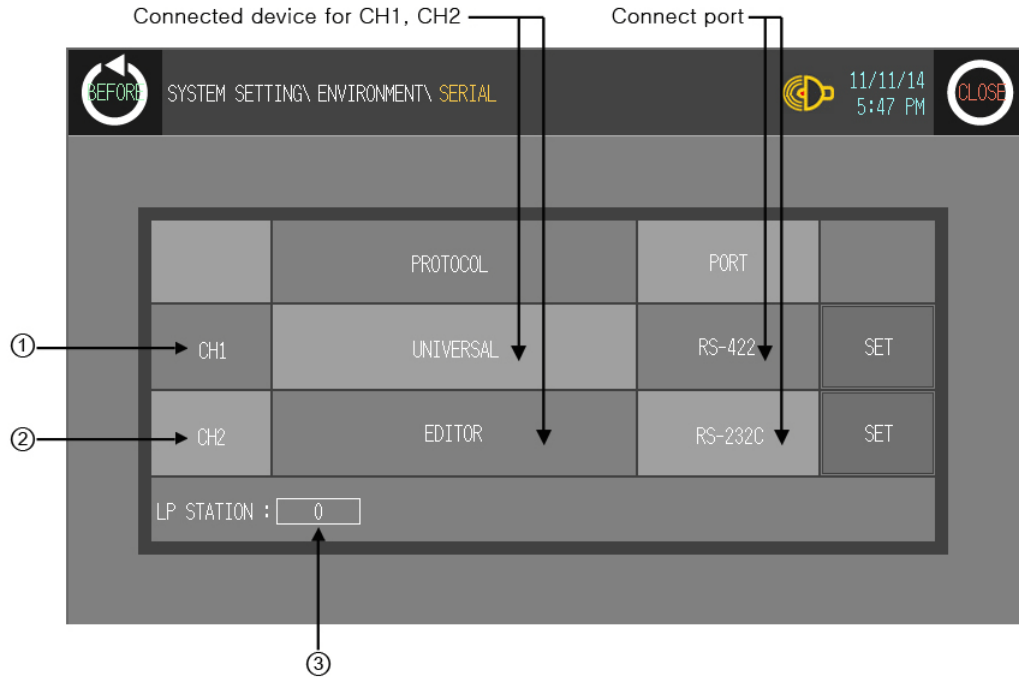

No	Function	Operation
①	CH1 configuration	Displays connected device and connect port for CH1. Touch this to select one from downloaded protocol in GP Editor, EDITOR, PRINTER, BARCODE, UNIVERSAL, or DEFAULT protocol and designate connect port. (Select between RS232C/RS422 or RS232C-A / RS232C-B). Depending on CH1 setting, CH2 may be changed as 'No Use'.
②	CH2 configuration	Displays connected device and connect port for CH2. Touch this to select one from downloaded protocol in GP Editor, EDITOR, PRINTER, BARCODE, UNIVERSAL, or DEFAULT protocol and designate connect port. (Select between RS232C/RS422 or RS232C-A / RS232C-B). If CH1 is SLAVE, MONITOR does not appear.
③	GP station configuration touch key	Touch this and input key pad for station appears. Station set range: 0 to 31

(1) In case of using only CH1 configured in GP Editor

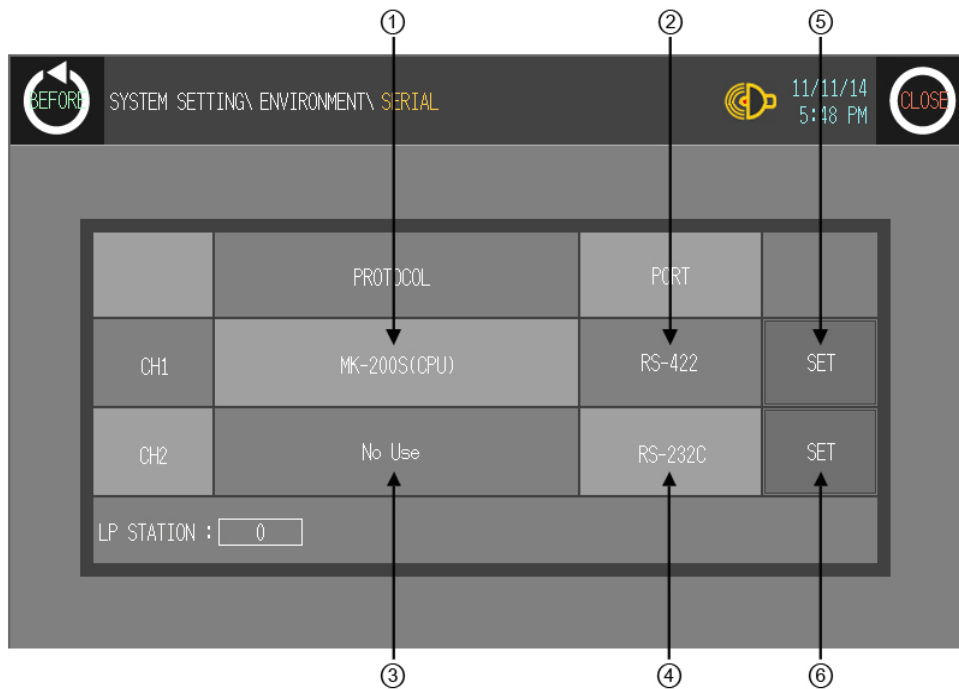

No	Item	Operation with touching
①	Displays CH1 protocol	Rotates in order as downloaded protocol in GP Editor → EDITOR → PRINTER → BARCODE → UNIVERSAL → DEFAULT protocol
②	Displays CH1 connect port (Designates automatically as non-using port in ④)	Each of RS422 / RS232C interface type: RS422 PORT ↔ RS232C PORT
		Two ports of RS232C interface type: RS232C A PORT ↔ RS232C B PORT
③	Displays CH2 protocol (as EDITOR for default)	Rotates in order as EDITOR → PRINTER → BARCODE → MONITOR → UNIVERSAL → No Use
④	Displays CH2 connect port (Designates automatically as non-using port in ②)	Each of RS422 / RS232C interface type: RS422 PORT ↔ RS232C PORT
		Two ports of RS232C interface type: RS232C A PORT ↔ RS232C B PORT
⑤⑥	Communication configuration by each channel	Moves communication configuration setting window for selected connected device. You can designate baudrate, data bit, parity, stop bit, and flow control for each channel. If CH1 is as NoUse, it is not able to communication configuration.

(2) In case of using only CH2 configured in GP Editor

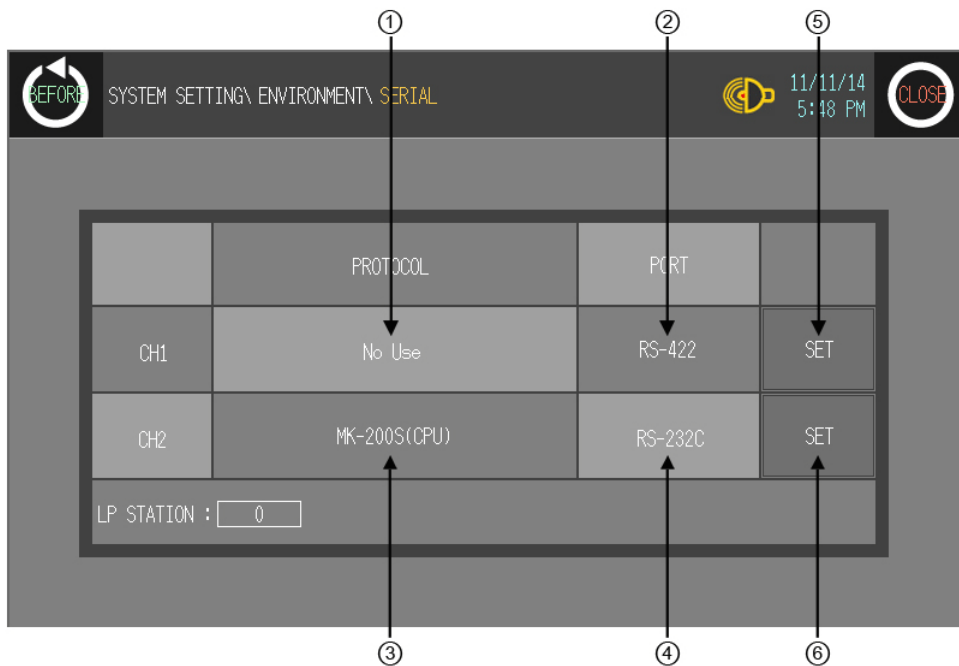

No	Item	Operation with touching
①	Displays CH1 protocol	Rotates in order as NoUse → EDITOR → PRINTER → BARCODE → UNIVERSAL → DEFAULT protocol.
②	Displays CH1 connect port (Designates automatically as non-using port in ④)	Each of RS422 / RS232C interface type: RS422 PORT ↔ RS232C PORT
		Two ports of RS232C interface type: RS232C A PORT ↔ RS232C B PORT
③	Displays CH2 protocol (as downloaded protocol for default)	Rotates in order as downloaded protocol in GP Editor → EDITOR → PRINTER → BARCODE
④	Displays CH2 connect port (Designates automatically as non-using port in ②)	Each of RS422 / RS232C interface type: RS422 PORT ↔ RS232C PORT
		Two ports of RS232C interface type: RS232C A PORT ↔ RS232C B PORT
⑤⑥	Communication configuration by each channel	Moves communication configuration setting window for selected connected device. You can designate baudrate, data bit, parity, stop bit, and flow control for each channel. If CH1 is as NoUse, it is not able to communication configuration.

(3) CH1/ CH2 details configuration

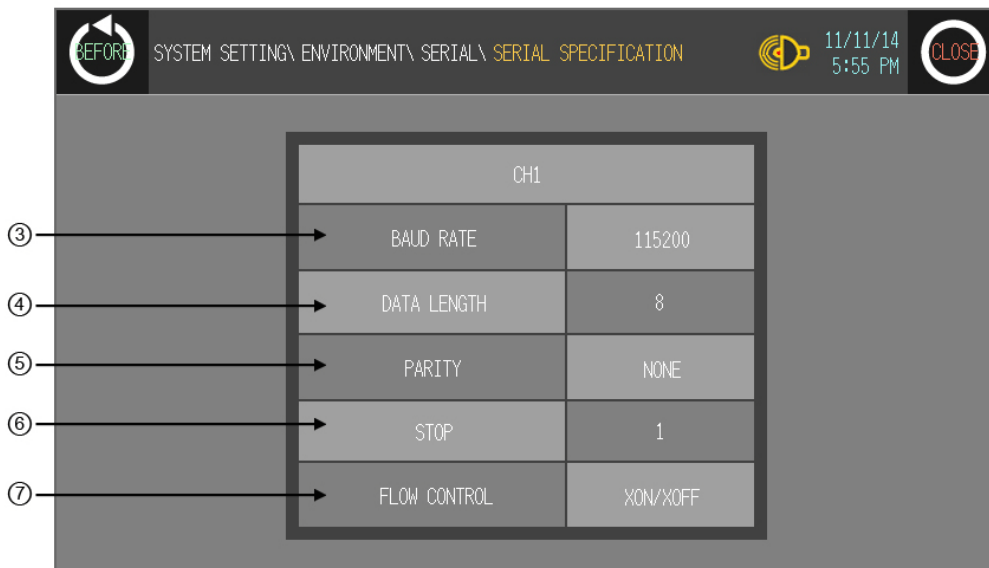
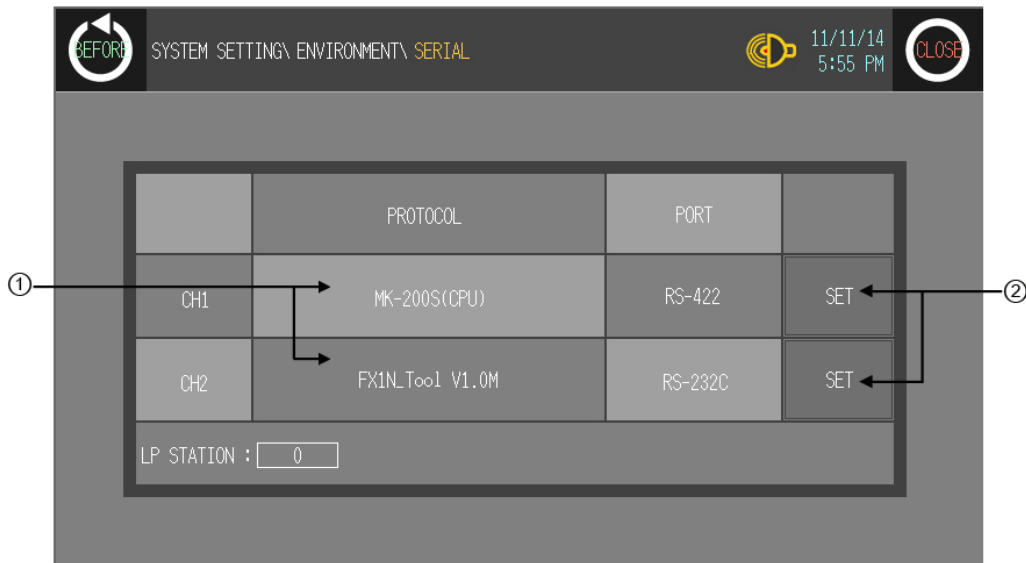

No	Function and operation
①	<p>Designate the device to be connected for CH1, CH2.</p> <ul style="list-style-type: none"> ▪ CH1, CH2 protocol: Communication mode for set PLC by GP and GP Editor by each port. ▪ EDITOR: I/O mode for downloading user-designed data from GP Editor ▪ PRINTER: Print mode for printing alarm history of GP Refer to '3.5.3 PRINTER communication configuration'. ▪ BARCODE: Input mode for reading data from barcode Refer to '3.5.2 Barcode reader communication configuration'. ▪ MONITOR: Available only in CH2. Monitoring mode for PLC which is connected to GP from PC directly. GP is as transmitter by transmitting data from PC to PLC and data from PLC to PC. In case of MITSUBISHI FX-series, editor mode is available for monitoring. ▪ NoUse: Displayed only not using appropriate CH.

No	Function and operation
②	Touch this, detailed configuration screen for designated operation mode appears.
③ to ⑦	Designate detailed configuration for designated operation mode. <ul style="list-style-type: none">▪ Baudrate: Designate baud rate. Supports 300/600/1200/2400/4800/9600/19200/38400/57600/115200bps▪ Data: Designate data bit. Supports 7 bit, or 8 bit.▪ Stop bit: Designate stop bit. Supports 1 bit, or 2 bit.Parity: Designate parity type. Supports even, odd, or none parity.▪ Flow control: Designate data flow control. Supports XON/ XOFF, or DSR/DTR.

1.4 Link device

Generally GP/LP monitors directly PLC device of CH1. To link PLC device of CH1 and GP/LP connect device (by saving monitored PLC device value to specified GP/LP connect device), link device menu is needed.

Mono type must use link device with CH2 to communicate 1:N.

Color type is able to monitor directly PLC device of each channel (CH1,CH2). Therefore, color type does not use link device and is able to communicate 1:N without CH1, CH2 division. However, PLC which supports station is only able to communicate 1:N.

Select [Common]-[Link Device] of GP Editor menu, 'Link Device Setting' dialog box appears.

No	Link Device	Description
①	GP/LP Type	Displays GP/LP model type.
②	CH1 Group	Displays CH1 group.
③	CH1 Type	Display PLC type of CH1 group.
④	CH1 Inner Link Device	Designate lead word address of GP/LP for communication with CH1
⑤	CH2 Group	Displays CH2 group.
⑥	CH2 Type	Displays PLC type of CH2 group.

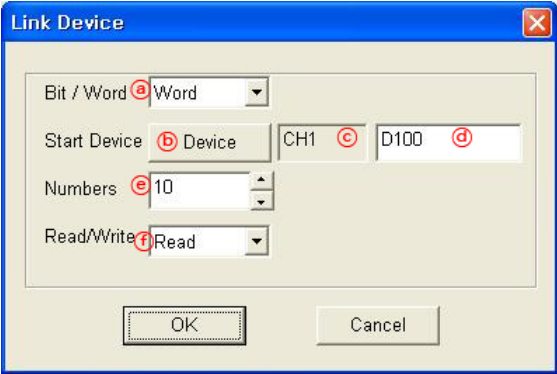
No	Link Device	Description
⑦	CH2 Inner Link Device	Designate lead word address of GP/LP for communication with CH2.
⑧	Link Device Setting Status	Displays bit/word, channel, station, start device, count, read/write of CH1/CH2 to communicate with GP/LP
⑨	Add	<p>Adds link device settings. 'Link Device' dialog box appears.</p>  <p> Ⓐ Bit/Word: Select bit/word device of PLC to communicate Ⓑ Start Device: Designate start device of PLC to communicate Ⓒ Start Device: Displays selected channel at Ⓑ Ⓓ Start Device: Displays selected device at Ⓑ Ⓔ Numbers: Designate the number of read/write device from start device at Ⓑ Ⓕ Read/Write: Set read/write operation for designated device </p> <p> ※For mono type, link device information by each channel is able to register up to 5. ※For color type, link device information by each channel is able to register to infinity. </p>
⑩	Edit	Edit the selected item on ⑧ among set link device
⑪	Delete	Delete the selected item on ⑧ among set link device
⑫	Delete All	Delete all of set link device
⑬	UP	Moves up all items of set link device.
⑭	DOWN	Moves down all items of set link device.

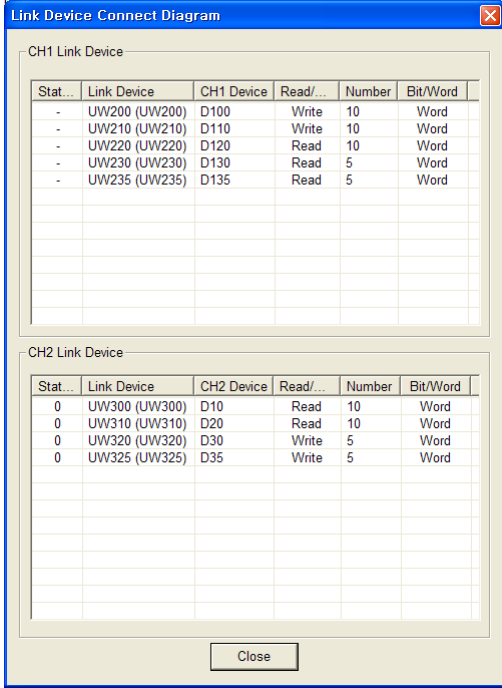
No	Link Device	Description
⑬	Linked Status	<p>Displays table for link device setting of set between GP/LP and CH1, GP/LP and CH2.</p>  <p>The screenshot shows a window titled 'Link Device Connect Diagram' with two tables. The first table, 'CH1 Link Device', lists settings for link devices UW200 to UW235. The second table, 'CH2 Link Device', lists settings for link devices UW300 to UW325. Both tables have columns for Stat..., Link Device, CH1/2 Device, Read/Write, Number, and Bit/Word.</p>

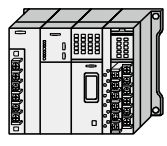
GP/LP	CH1 station	Communication direction	CH1 PLC
			
GP/LP series	※1		MK-200S
UW200 to UW209	-	(Write) →	D100 to D109
UW210 to UW219	-	(Write) →	D110 to D119
UW220 to UW229	-	(Write) →	D120 to D129
UW230 to UW234	-	(Read) ←	D130 to D134
UW235 to UW239	-	(Read) ←	D135 to D139

※1. Mono type(GP-S044, GP-S057, LP-S044) is able to communicate 1:1 for CH1, and does not support multi station selection. It is fixed as the station of GP/LP and displays '-'. Color type(GP-S070, LP-S070) is able to communicate 1:1, 1:N for without CH1, CH2 division, and supports multi station selection. It is able to designate station. If PLC of connected with CH2 does not support station, it displays '-' and 1:N communication does not execute.

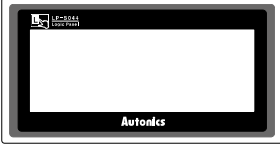
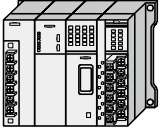
GP/LP	CH2 station	Communication direction	CH2 PLC
			
GP/LP series	※1		FX-2N
UW300 to UW309	-	(Read) ←	D0 to D9
UW310 to UW319	-	(Read) ←	D10 to D19
UW320 to UW329	-	(Read) ←	D20 to D29
UW330 to UW334	-	(Write) →	D30 to D34
UW335 to UW339	-	(Write) →	D35 to D39

※1. Mono type(GP-S044, GP-S057, LP-S044) is able to communicate 1:1, 1:N for CH2 and supports multi station selection. If PLC of connected with CH2 does not support station, it displays '-' and 1:N communication does not execute.

Color type(GP-S070, LP-S070) is able to communicate 1:1, 1:N for without CH1, CH2 division, and supports multi station selection. If PLC of connected with CH2 does not support station, it displays '-' and 1:N communication does not execute.

In this case, UW(i) is i_{st} GP device, Dk(i) is i_{st} CH1 device.

(1) CH1 inner link device: UW(i)

Link device setting

- Start Device: D1(i), Bit/Word: Word, Numbers: A, Read/Write: Write
- Start Device: D2(i), Bit/Word: Word, Numbers: B, Read/Write: Read
- Start Device: D3(i), Bit/Word: Word, Numbers: C, Read/Write: Read
- Start Device: D4(i), Bit/Word: Word, Numbers: D, Read/Write: Read
- Start Device: D5(i), Bit/Word: Word, Numbers: E, Read/Write: Write

Inner link device (Word)	Communication direction	CH1
		Device
First A units of device from UW (i)	(Write) →	D1(i) to D1(i+A-1)
B units of device from the next	(Read) ←	D2(i) to D2(i+B-1)
C units of device from the next	(Read) ←	D3(i) to D3(i+C-1)
D units of device from the next	(Read) ←	D4(i) to D4(i+D-1)
E units of device from the next	(Write) →	D5(i) to D5(i+E-1)

(2) CH1 inner link device: UW (i)

Link device setting

- Start Device: D1(i), Bit/Word: Word, Numbers: A, Read/Write: Write
- Start Device: D2(i), Bit/Word: Bit, Numbers: B, Read/Write: Read
- Start Device: D3(i), Bit/Word: Word, Numbers: C, Read/Write: Read
- Start Device: D4(i), Bit/Word: Bit, Numbers: D, Read/Write: Read
- Start Device: D5(i), Bit/Word: Word, Numbers: E, Read/Write: Write

Inner link device (Word)	Communication direction	CH1
		Device
First A units of device from UW (i)	(Write) →	D1(i) to D1(i+A-1)
[(B+16-1)/16] units of device from the next	(Read) ←	D2(i) to D2(i+[(B+16-1)/16]-1)
C units of device from the next	(Read) ←	D3(i) to D3(i+C-1)
[(D+16-1)/16] units of device from the next	(Read) ←	D4(i) to D4(i+[(D+16-1)/16]-1)
E units of device from the next	(Write) →	D5(i) to D5(i+E-1)

Inner link device is always word. When CH1 link device is set as bit, it is linked as below.

1 to 16 units of CH1 bit device ↔ 1 unit of GP word device

17 to 32 units of CH1 bit device ↔ 2 units of GP word device



Ex.

- CH1 inner link device: UW(30)
- Link device setting
 - Start Device: K(0), Bit/Word: Word, Numbers: 5, Read/Write: Write
 - Start Device: M(0), Bit/Word: Word, Numbers: 3, Read/Write: Write
 - Start Device: D(0), Bit/Word: Word, Numbers: 4, Read/Write: Read
 - Start Device: D(10), Bit/Word: Word, Numbers: 6, Read/Write: Write

GP/LP		Communication direction	CH1	
Inner link device (Word)	Numbers		Device	Numbers
UW(30) to UW(34)	5	(Write) →	K(0) to K(4)	Word 5
UW(35) to UW(37)	3	(Write) →	M(0) to M(2)	Word 3
UW(38) to UW(41)	4	(Read) ←	D(0) to D(3)	Word 4
UW(42) to UW(47)	6	(Write) →	D(10) to D(15)	Word 6



Ex.

- CH1 GP connect device: UW(30)
- Link device setting
 - Start Device: K(0), Bit/Word: Word, Numbers: 5, Read/Write: Write
 - Start Device: M(0), Bit/Word: Word, Numbers: 3, Read/Write: Read
 - Start Device: P(10), Bit/Word: Bit, Numbers: 20, Read/Write: Read
 - Device: D(10), Bit/Word: Word, Numbers: 6, Read/Write: Write

GP/LP		Communication direction	CH1	
Inner link device (Word)	Numbers		Device	Numbers
UW(30) to UW(34)	5	(Write) →	K(0) to K(4)	Word 5
UW(35) to UW(37)	3	(Write) →	M(0) to M(2)	Word 3
UW(38)	1	(Read) ←	P(10) to P(13)	Bit 4
UW(39) to UW(44)	6	(Write) →	D(10) to D(15)	Word 6

※ If numbers is set over than usable numbers, maximum range numbers is used.

CH2 device is monitored indirectly with linked GP device. CH2 link device setting is same as CH1 data link and is able to connect multi devices and to set several stations. In this case, UW(i) is GP i_{st} device, N_Dk(i) is that station is N, and i_{st} of D1 CH2 device.

- CH2 inner link device: D(i)
- Set for station and inner device

(3) Station N

- Start Device: N-D1(i), Bit/Word: Word, Numbers: A_N
- Start Device: N-D2(i), Bit/Word: Word, Numbers: B_N
- Start Device: N-D3(i), Bit/Word: Word, Numbers: C_N
- Start Device: N-D4(i), Bit/Word: Word, Numbers: D_N
- Start Device: N-D5(i), Bit/Word: Word, Numbers: E_N

GP/LP	Communication direction	CH2	
		Station	Device
Inner link device (Word)			
First A ₀ units of device from D(i)	Read/Write	0	0_D1(i) to 0_D1(i+A ₀ -1)
B ₀ units of device from the next	Read/Write		0_D2(i) to 0_D2(i+B ₀ -1)
C ₀ units of device from the next	Read/Write		0_D3(i) to 0_D3(i+C ₀ -1)
D ₀ units of device from the next	Read/Write		0_D4(i) to 0_D4(i+D ₀ -1)
E ₀ units of device from the next	Read/Write		0_D5(i) to 0_D5(i+E ₀ -1)
A ₁ units of device from the next	Read/Write	1	1_D1(i) to 1_D1(i+A ₁ -1)
B ₁ units of device from the next	Read/Write		1_D2(i) to 1_D2(i+B ₁ -1)
C ₁ units of device from the next	Read/Write		1_D3(i) to 1_D3(i+C ₁ -1)
D ₁ units of device from the next	Read/Write		1_D4(i) to 1_D4(i+D ₁ -1)
E ₁ units of device from the next	Read/Write		1_D5(i) to 1_D5(i+E ₁ -1)
...
A ₃₁ units of device from the next	Read/Write	31	31_D1(i) to 31_D1(i+A ₃₁ -1)
B ₃₁ units of device from the next	Read/Write		31_D2(i) to 31_D2(i+B ₃₁ -1)
C ₃₁ units of device from the next	Read/Write		31_D3(i) to 31_D3(i+C ₃₁ -1)
D ₃₁ units of device from the next	Read/Write		31_D4(i) to 31_D4(i+D ₃₁ -1)
E ₃₁ units of device from the next	Read/Write		31_D5(i) to 31_D5(i+E ₃₁ -1)

If Bit/Word setting is Bit, CH1 link device has same link structure as bit's and communicates with GP/LP.



Ex.

- CH2 inner link device: UW(30)
- Set for station and link device

(4) Station 1

- Start Device: K(0), Bit/Word: Word, Numbers:5, Read/Write: Write
- Start Device: M(0), Bit/Word: Bit, Numbers:3, Read/Write: Write
- Start Device: D(0), Bit/Word: Word, Numbers:4, Read/Write: Read
- Start Device: D(10), Bit/Word: Word, Numbers:6, Read/Write: Write

(5) Station 3

- Start Device: K(10), Bit/Word: Bit, Numbers:2, Read/Write: Read
- Start Device: M(16), Bit/Word: Word, Numbers:5, Read/Write: Write

(6) Station 11

- Start Device: D(20), Bit/Word: Word, Numbers:7, Read/Write: Read
- Start Device: D(30), Bit/Word: Word, Numbers:2, Read/Write: Write
- Start Device: M(32), Bit/Word: Bit, Numbers:4, Read/Write: Write

GP/LP		Communication direction	CH2		
Inner link device	Numbers		Station	Device	Numbers
UW(30) to UW(34)	5	(Write) →	1	K(0) to K(4)	Word 5
UW(35)	1	(Write) →		M(0) to M(3)	Bit 3
UW(36) to UW(39)	4	(Read) ←		D(0) to D(3)	Word 4
UW(40) to UW(45)	6	(Write) →		D(10) to D(15)	Word 6
UW(46)	1	(Read) ←	3	K(10) to K(11)	Bit 2
UW(47) to UW(51)	5	(Write) →		M(16) to M(20)	Word 5
UW(52) to UW(58)	7	(Read) ←	11	D(20) to D(26)	Word 7
UW(59) to UW(61)	2	(Write) →		D(30) to D(31)	Word 2
UW(62)	1	(Write) →		M(32) to M(35)	Bit 4

1.5 Connectable device

Connectable PLC with GP, LP is constantly being update.

Series	Connectable device	Communication connection type	GP-2480 (Below V2.70)	GP-2480 (Above V3.00)	GP-S057	GP/LP-S044	GP/LP-S070
LS Master-K	MK-10S1	CPU direct Loader	○	○	○	○	○
	MK-80S	CPU direct Loader	○	○	○	○	○
	MK-120S	CPU direct Loader	○	○	○	○	○
	MK-200S	CPU direct Loader	○	○	○	○	○
	MK-300S	CPU direct Loader	×	○	○	○	○
	MK-1000S	CPU direct Loader	×	○	○	○	○
LS Glofa	GM4	CPU direct Loader	○	○	○	○	○
	GM6	CPU direct Loader	○	○	○	○	○
	GM7U	CPU direct Loader	×	○	○	○	○
LS CNET (Built-in Cnet of CPU)	MK-80S	Cnet	○	○	○	○	○
	MK-120S	Cnet	○	○	○	○	○
	MK-200S	Cnet	○	○	○	○	○
LS CNET (with Cnet unit)	MK-80S	Cnet	○	○	○	○	○
	MK-120S	Cnet	○	○	○	○	○
	MK-200S	Cnet	○	○	○	○	○
	MK-300S	Cnet	×	○	○	○	○
	MK-1000S	Cnet	×	○	○	○	○
LS XGT (Cnet unit)	XGK-CPUS	Cnet	×	○	○	○	○
LS XGB	XBM	CPU direct Loader	×	○	○	○	○
	XBC	CPU direct Loader	×	○	○	○	○
OEMAX (Ex SAMSUNG)	N70	CPU direct Loader	○	○	○	○	○
	N70Plus	CPU direct Loader	○	○	○	○	○
OEMAX FARA	NX7	CPU direct Loader	×	○	○	○	○
	NX70	CPU direct Loader	×	○	○	○	○
MITSUBISHI FX	FX1S	CPU direct Loader	○	○	○	○	○
	FX1N	CPU direct Loader	○	○	○	○	○
	FX2N	CPU direct Loader	○	○	○	○	○
	FX2NC	CPU direct Loader	○	○	○	○	○
	FX3U	CPU direct Loader	×	○	○	○	○
MITSUBISHI Q(with Cnet unit)	Q00J	Cnet	×	○	○	○	○
	Q00	Cnet	×	○	○	○	○

Series	Connectable device	Communication connection type	GP-2480 (Below V2.70)	GP-2480 (Above V3.00)	GP-S057	GP/LP-S044	GP/LP-S070
	Q01	Cnet	x	○	○	○	○
	Q02	Cnet	x	○	○	○	○
	Q02H	Cnet	x	○	○	○	○
	Q06H	Cnet	x	○	○	○	○
	Q12H	Cnet	x	○	○	○	○
	Q25H	Cnet	x	○	○	○	○
NAIS FP	FP0-C10	CPU direct Loader	○	○	○	○	○
	FP0-C14	CPU direct Loader	○	○	○	○	○
	FP0-C16	CPU direct Loader	○	○	○	○	○
	FP0-C32	CPU direct Loader	○	○	○	○	○
	FPG-C24R2	CPU direct Loader	○	○	○	○	○
	FPG-C32T	CPU direct Loader	○	○	○	○	○
	FPG-C32T2	CPU direct Loader	○	○	○	○	○
	FP0R-C10	CPU direct Loader	x	○	○	○	○
	FP0R-C14	CPU direct Loader	x	○	○	○	○
	FP0R-C16	CPU direct Loader	x	○	○	○	○
	FP0R-C32	CPU direct Loader	x	○	○	○	○
	FP0R-T32	CPU direct Loader	x	○	○	○	○
FP0R-F32	CPU direct Loader	x	○	○	○	○	
SIEMENS SIMATIC S7-200	CPU221	CPU direct Loader	x	○	○	○	○
	CPU222	CPU direct Loader	x	○	○	○	○
	CPU224	CPU direct Loader	x	○	○	○	○
	CPU224XP	CPU direct Loader	x	○	○	○	○
	CPU224XPsi	CPU direct Loader	x	○	○	○	○
	CPU226	CPU direct Loader	x	○	○	○	○
SIEMENS SIMATIC S7-300	CPU312	CPU direct Loader	x	x	○	○	○
	CPU312C	CPU direct Loader	x	x	○	○	○
	CPU313C	CPU direct Loader	x	x	○	○	○
	CPU313C-2	CPU direct Loader	x	x	○	○	○
	CPU314	CPU direct Loader	x	x	○	○	○
	CPU314C-2	CPU direct Loader	x	x	○	○	○
	CPU315-2	CPU direct Loader	x	x	○	○	○
	CPU317-2	CPU direct Loader	x	x	○	○	○
	CPU319-3	CPU direct Loader	x	x	○	○	○

Series	Connectable device	Communication connection type	GP-2480 (Below V2.70)	GP-2480 (Above V3.00)	GP-S057	GP/LP-S044	GP/LP-S070
Allen-Bradley	MicroLogix 1000	CPU direct Loader	x	○	○	○	○
	MicroLogix 1200	CPU direct Loader	x	○	○	○	○
OMRON SYSMAC C	CPM1A	CPU direct Loader	○	○	○	○	○
OMRON temperature controller	E5AN	Modbus	○	○	○	○	○
	E5AR	Modbus	○	○	○	○	○
	E5CN	Modbus	○	○	○	○	○
	E5EN	Modbus	○	○	○	○	○
	E5ER	Modbus	○	○	○	○	○
AUTONICS	MT Series	Dedicated communication	○	○	○	○	○
		Modbus	x	○	○	○	x
		Modbus(TYPE A) ^{*1}	x	x	○	○	○
	MP Series	Dedicated communication	○	○	○	○	○
	THD Series	Modbus	○	○	○	○	x
		Modbus(TYPE A) ^{*1}	x	x	○	○	○
	TZ Series	Dedicated communication	○	○	○	○	○
	TK Series	Modbus	x	○	○	○	x
		Modbus(TYPE A) ^{*1}	x	x	○	○	○
	TM Series	Modbus	x	○	○	○	x
		Modbus(TYPE A) ^{*1}	x	x	○	○	○
	CT Series	Modbus	x	○	○	○	x
		Modbus(TYPE A) ^{*1}	x	x	○	○	○
	DS/DA Series	Modbus(TYPEA)	x	x	○	○	○
	ARM Series	Modbus(TYPEA)	x	x	○	○	○
LP-S044	CPU	x	○	○	○	○	
KONICS	DPU Series	Modbus	x	○	○	○	x
		Modbus(TYPE A) ^{*1}	x	x	○	○	○
	KRN50	Modbus	x	○	○	○	x
		Modbus(TYPE A) ^{*1}	x	x	○	○	○
DELTA	DTB Series	Modbus	○	○	○	○	x
		Modbus(TYPE A) ^{*1}	x	x	○	○	○
DANFOSS	FC Series	Modbus	x	x	x	x	x
		Modbus(TYPE A) ^{*1}	x	x	○	○	○
UNIVERSAL	UNIVERSAL	Modbus(Slave)	○	○	○	○	○
MODBUS MASTER	MODBUS MASTER	Modbus(Master) ^{*1}	x	x	○	○	○

※1. Modbus(TYPE A) supports every GP/LP series except GP-2480 series.

1.6 Applicable connection type

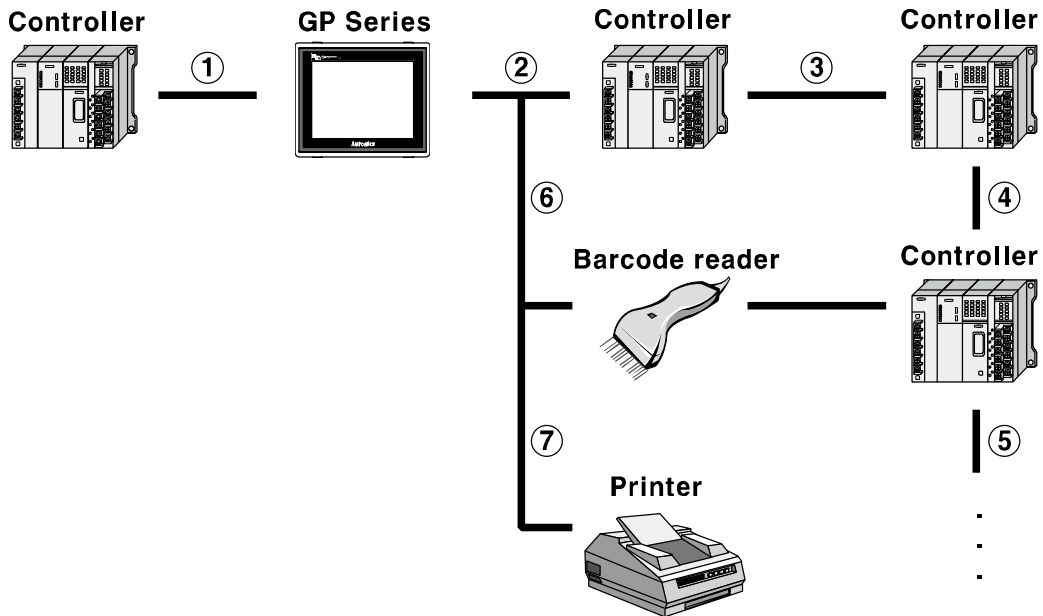

Communication	Description
① 1:1 communication	It is able to communicate between a GP/LP and a PLC or controller. For more details, refer to '3.2 1:1 communication'.
① ② Heterogeneous communication	It is able to communicate between GP or LP and PLC or controller by connecting heterogeneous PLC to each port of GP/LP. For more details, refer to '3.4 Heterogeneous communication'.
② ③ ④ ⑤ 1:N communication	It is able to communicate between a GP or LP and the number 'N' of PLCs or controllers. For more details, refer to '3.3 1:N communication'.
① ② ③ ④ ⑤ 1:1:N communication	
① ⑥ Communication with barcode reader	GP, LP is able to connect with barcode reader to read information from the barcode. For more details, refer to '3.5 Other communication'.
① ⑦ Communication with printer	GP, LP is able to connect with printer to print out alarm history list. For more details, refer to '3.5 Other communication'.

2 GP Editor Data Download

You can download created data from GP Editor which is drawing software in PC to GP, LP.

2.1 System organization

Computer

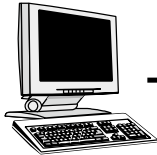

**RS232C
Cable**

GP/LP Series



GP, LP are basically supported by RS-232C communication and RS-422 communication is also available only with RS232/422 converter.

It is required to use dedicated transmitting cable(sold separately) to transmit the data. You can create the cable, refer to below.

The below is a diagram and pin arrangement for RS-232C cable to transmit data.

**D-Sub 9pin female
[Computer]**

**D-Sub 9pin female
[GP/LP Series]**

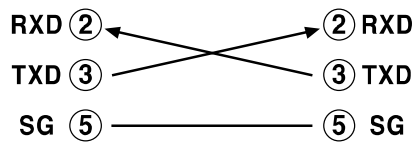
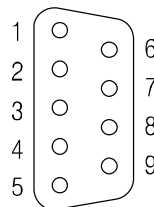
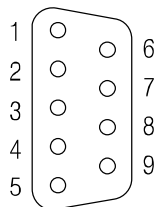

2.2 Communication configuration

There are two configurations to transmitting data. First is GP Editor configuration, and second is GP, LP configuration.

2.2.1 GP Editor configuration

This manual describes basic communication configuration of GP Editor and serial communication. For more details, refer to 'GP Editor user manual'.

Through GP Editor which is dedicated drawn software, you can download the data to GP/LP.

To download data editing in GP Editor to PLC, you should designate as following.

- 1st Install GP Editor and operate this program.
- 2nd 'Project Select' dialog appears. Select 'New' to create a new project.

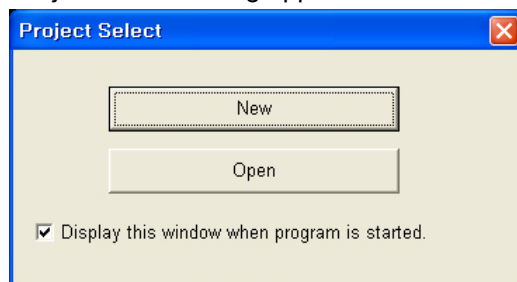

- 3rd 'GP/PLC Type' dialog box appears. Designate CH1 group and type, CH2 group and type and click 'OK'.

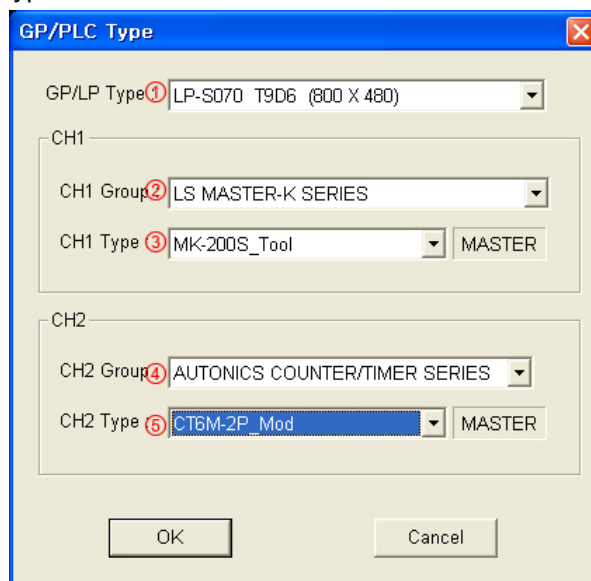

No	Item	Description
①	GP/LP Type	Designate GP/LP model type by pull-down menu.
②	CH1 Group	Designate PLC group of CH1 by pull-down menu.
③	CH1 Type	Designate PLC type of CH1 for ② by pull-down menu.
④	CH2 Group	Designate PLC group of CH2 by pull-down menu.
⑤	CH2 Type	Designate PLC type of CH2 for ④ by pull-down menu.

- 4th 'Project Auxiliary Property' dialog box appears. Designate the desired setting and click 'OK'.

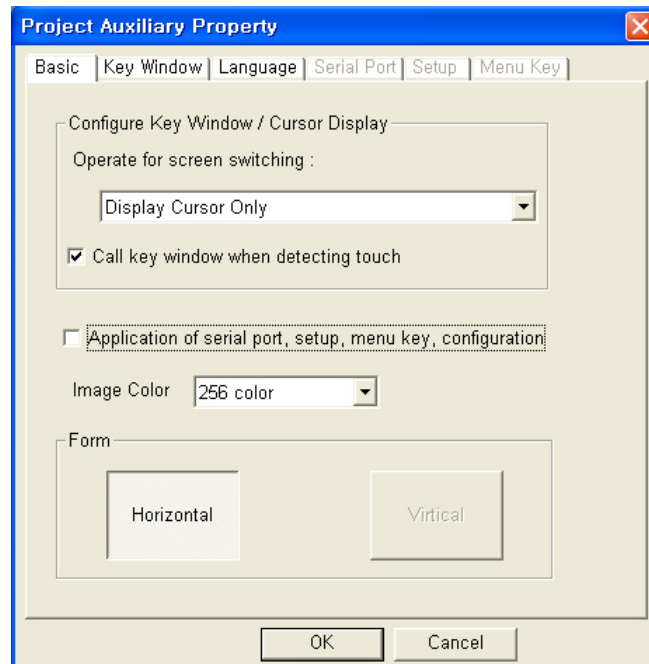

- 5th Draw the data to download for GP/LP.

For further details of drawing, refer to 'GP Editor user manual'.

- 6th After completing data input, select [Communication]-[Download] of menu. 'Monitor Data Download' dialog box appears.

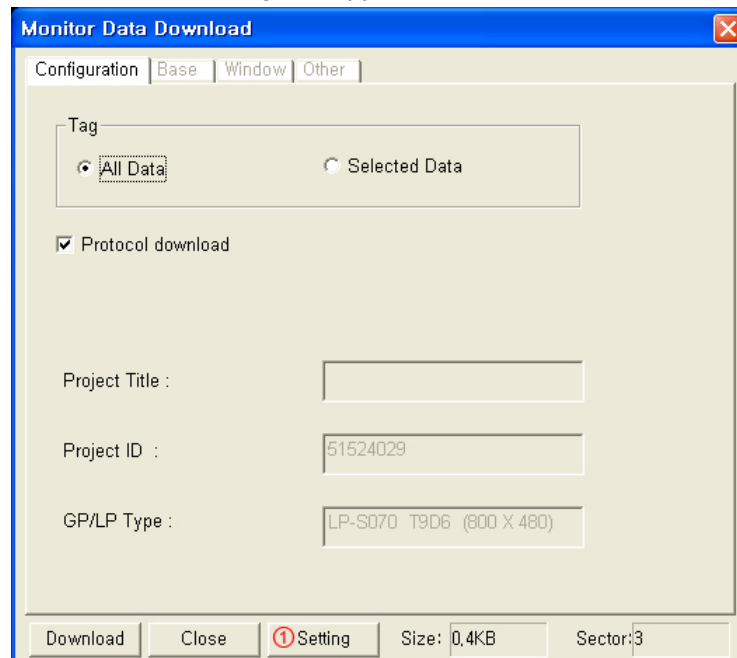

- 7th Click ① 'Setting' button and 'Option' dialog box appears.

- 8th Designate the connected communication port of PC to GP/LP and synchronize baud rate between GP/LP and GP Editor. Click 'OK'.

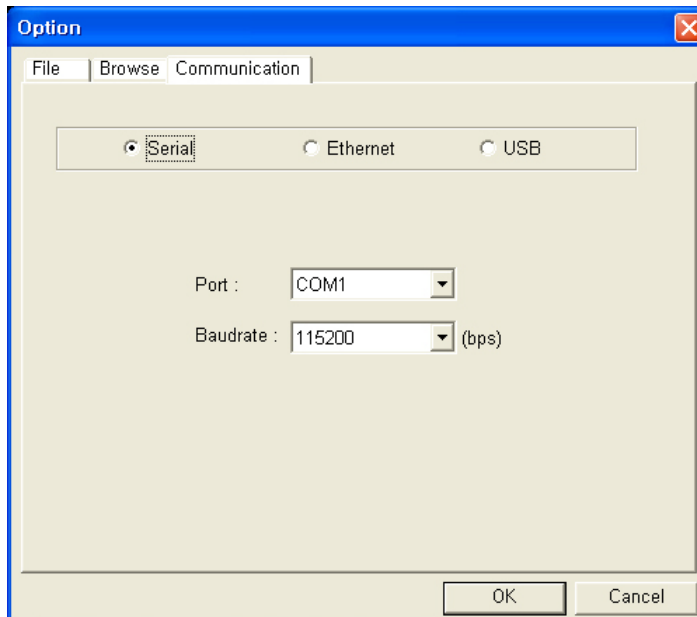

Baudrate default is 115200 bps at GP/LP and GP Editor.

- 9th Click 'Download' and 'Data Transmission' dialog box appears and displays download processing statuses when communication configuration is correctly synchronized.

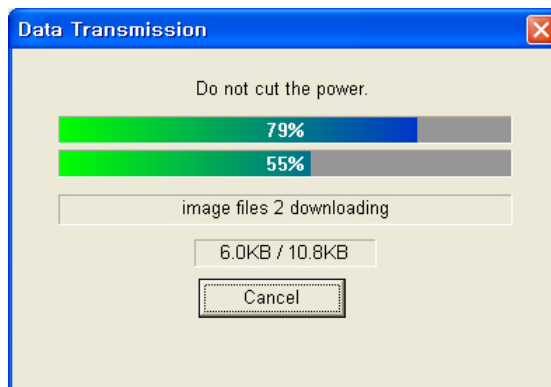

- 10th After completing download, 'Success to download' message appears.

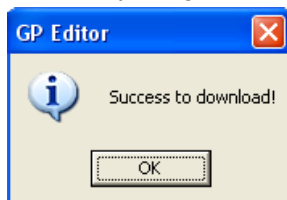

If there is communication setting error or other error, communication is not available.

After the time, GP Editor displays communication error message.

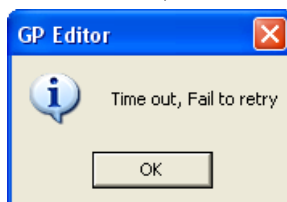

2.2.2 GP, LP configuration

This chapter is described by each of RS422/RS232C serial interface type.

For more details, refer to 'GP Editor user manual'.

2.2.2.1 Mono type

1st Enter system setting menu.

Touch left-upper point as default position of system setting menu.



2nd Select [SET ENVIRONMENT]-[PLC SETTING].

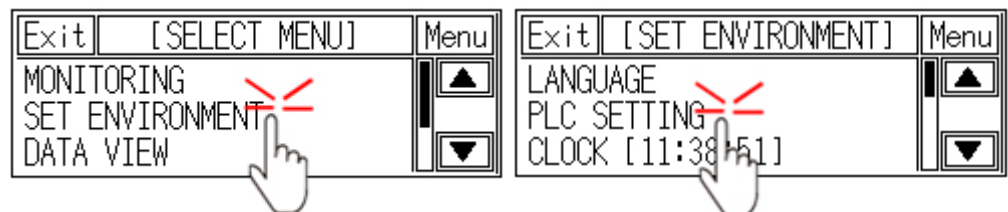

3rd CH2 protocol is set as 'EDITOR' and CH2 connection port is set as 'RS232C' as default. (For downloading drawn data of GP Editor to GP/LP, use 'RS232C' port. In case of using RS232/422 converter, you can download it with RS422 port.)

Exit	[PLC SETTING]	Menu
CH1	UNIVERSAL	RS422
CH2	EDITOR	RS232C
LP ST.#	[00]	CH1 ST.# [001]

4th If it is not configured as 'EDITOR' for CH2 protocol, touch protocol display item to set 'EDITOR' as following figure.

Protocol display rotates in order as No Use→EDITOR→PRINTER→BARCODE→MONITOR with touching.

Exit	[PLC SETTING]	Menu
CH1	MK-200S(CPU)	RS422
CH2	No Use	RS232C
LP ST.#	[00]	CH1 ST.# [001]

Exit	[PLC SETTING]	Menu
CH1	MK-200S(CPU)	RS422
CH2	EDITOR	RS232C
LP ST.#	[00]	CH1 ST.# [001]

5th If it is not configured as 'RS232C' for CH2 connect port even though 'EDITOR' for CH2 protocol is configured, touch connect port display item to set 'RS232C' as following figure.

Connect port display rotates in order as RS422↔RS232C with touching.

Exit	[PLC SETTING]	Menu	Exit	[PLC SETTING]	Menu
CH1	MK-200S(CPU)	RS232C	CH1	MK-200S(CPU)	RS422
CH2	EDITOR	RS422	CH2	EDITOR	RS232C
LP ST.#	[00]	CH1 ST.#	[00]	CH1 ST.#	[001]



6th After completing communication configuration, you should exit system setting menu and switch user screen to communicate GP Editor.

Touch 'Menu', current setting values are saved and it returns to previous menu.

Touch 'Exit', current setting values are saved and it returns to user screen.

2.2.2.2 Color type

1st Enter system setting menu.

Touch left-upper point as default position of system setting menu.



2nd Select [Environment]-[Serial Communication].

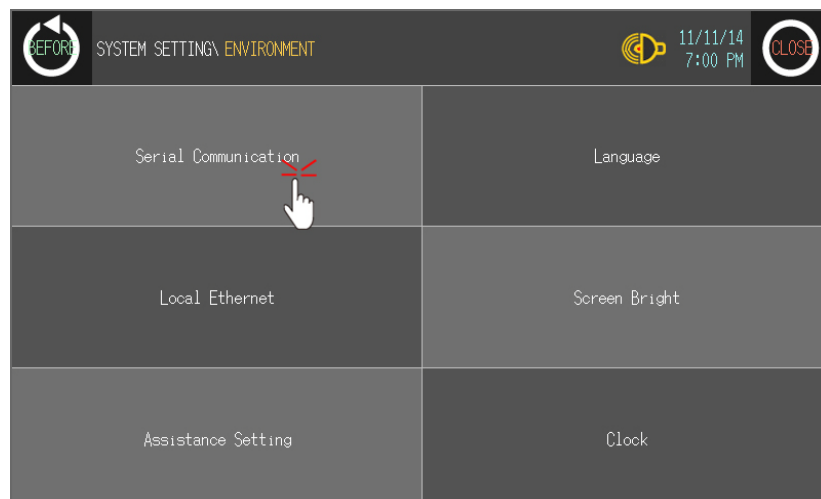
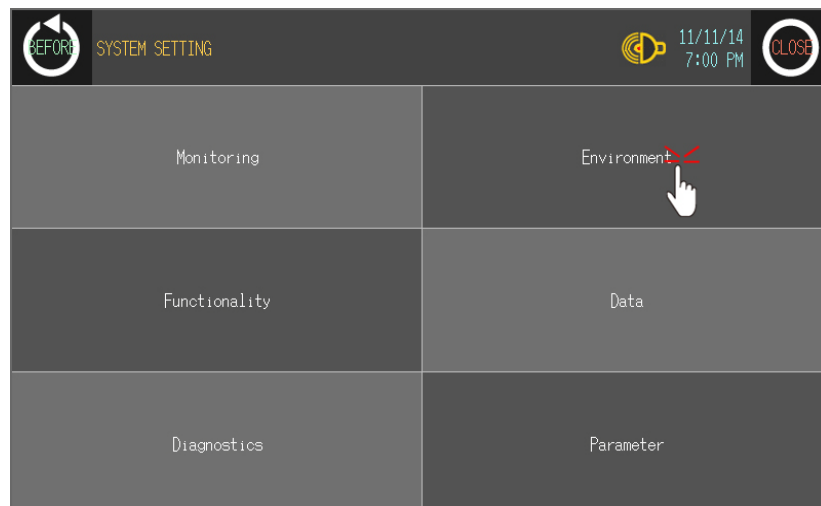

3rd CH2 protocol is set as 'EDITOR' and CH2 connection port is set as 'RS232C' as default. (For downloading drawn data of GP Editor to GP/LP, use 'RS232C' port. In case of using RS232/422 converter, you can download it with RS422 port.)

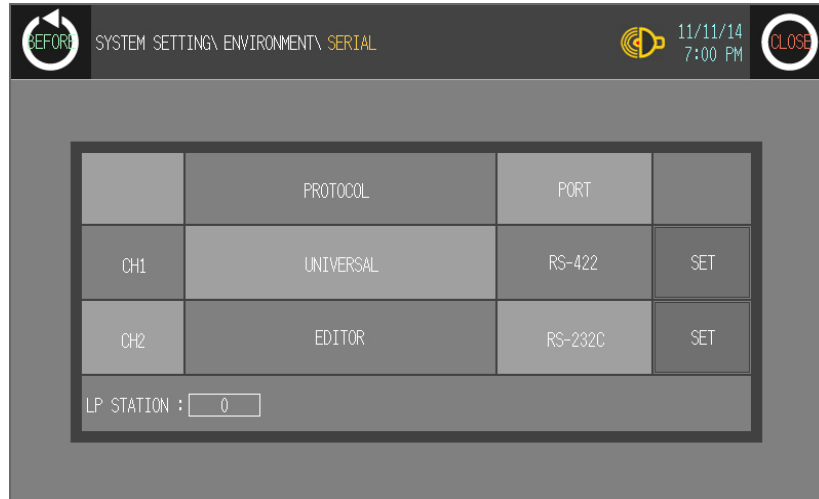

4th If it is not configured as 'EDITOR' for CH2 protocol, touch protocol display item to set 'EDITOR' as following figure. Protocol display rotates in order as No Use→EDITOR→PRINTER→BARCODE→MONITOR with touching.

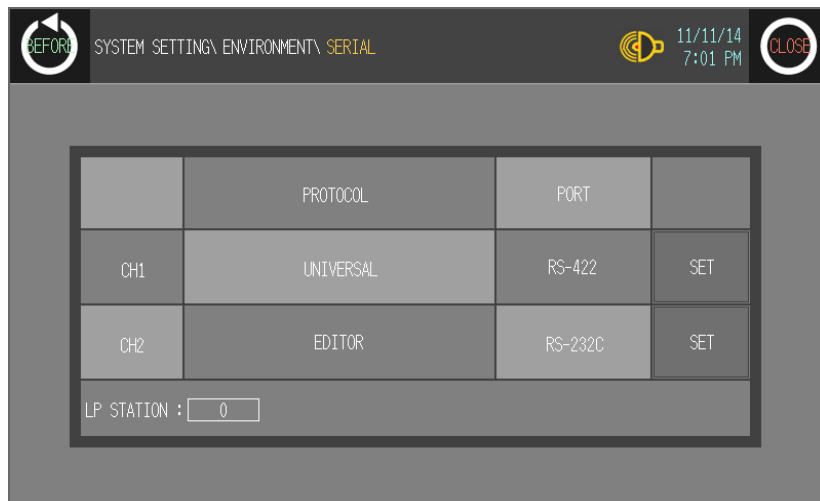
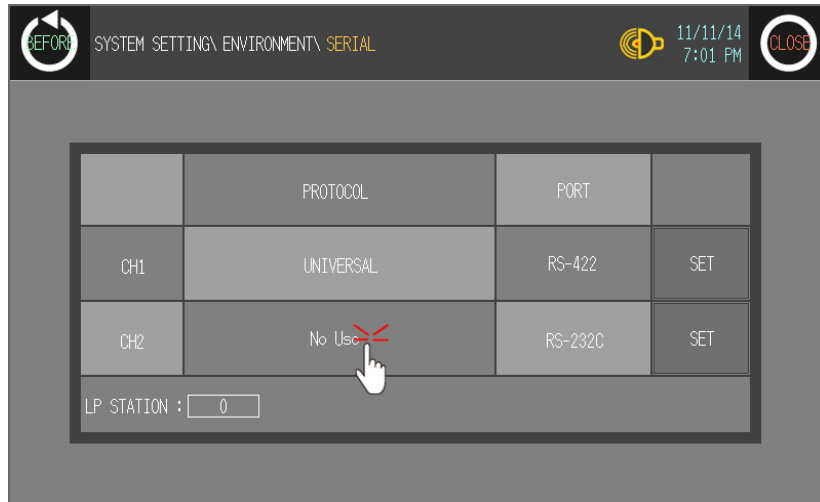

5th If it is not configured as 'RS232C' for CH2 connect port even though 'EDITOR' for CH2 protocol is configured, touch connect port display item to set 'RS232C' as following figure.

Connect port display rotates in order as RS422↔RS232C of two communication connector with touching.

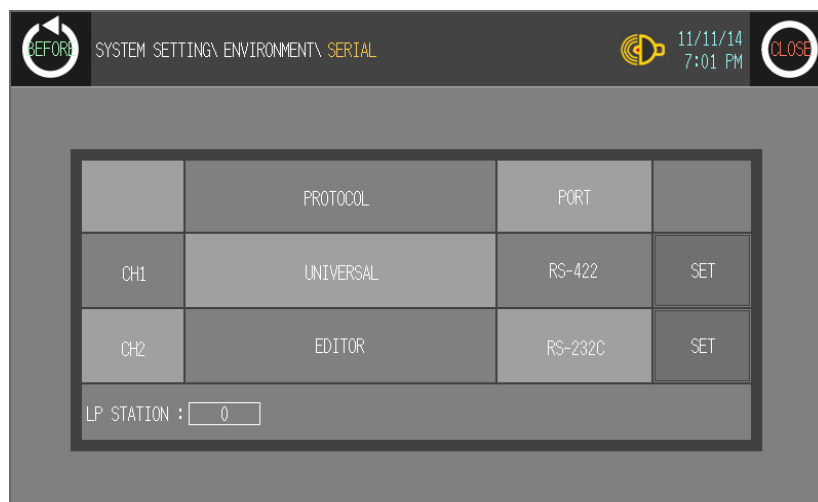
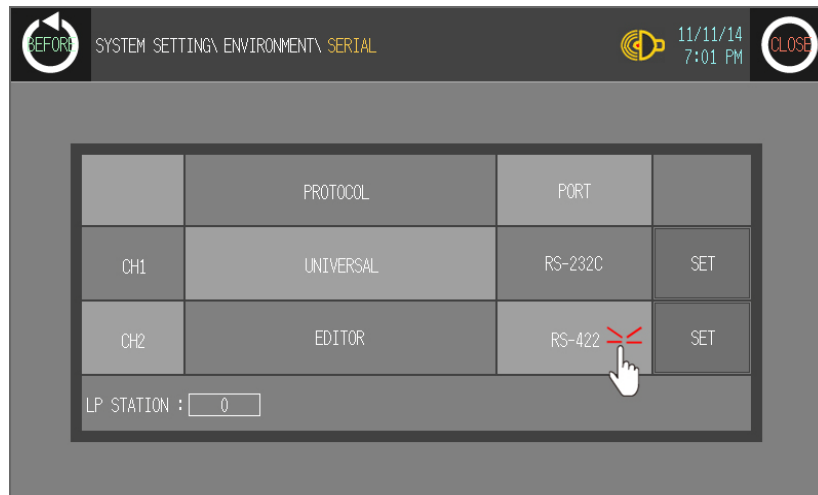

6th After completing communication configuration, you should exit system setting menu and switch user screen to communicate GP Editor.

Touch 'BEFORE', current setting values are saved and it returns to previous menu.

Touch 'CLOSE', current setting values are saved and it returns to user screen after exiting system setting menu.

3 PLC Communication

3.1 Communication configuration

For communicating GP/LP with PLC, you should designate detail configuration as following before communicating. This chapter is described by LS Master-K200 and Autonics CT6M-2P as example.

3.1.1 GP Editor configuration

Through GP Editor which is dedicated drawn software, you can download the data to GP/LP.

To download data editing in GP Editor to PLC, you should designate connected PLC group, type, and communication type.

(1) GP/PLC type configuration

No	Item	Description
①	GP/LP Type	Designate GP/LP model type by pull-down menu.
②	CH1 Group	Designate PLC group of CH1 by pull-down menu.
③	CH1 Type	Designate PLC type of CH1 for ② by pull-down menu.
④	CH2 Group	Designate PLC group of CH2 by pull-down menu.
⑤	CH2 Type	Designate PLC type of CH2 for ④ by pull-down menu.

(2) Data drawing by GP Editor

- Mono type: CH1 generally monitors directly PLC device of set CH1. (Supports 1:1 communication.) CH2 designates the set data register and communicated PLC by 'Link Device' (Supports 1:N communication for same type)
- Color type: Without CH1, CH2 division, it supports both 1:1 and 1:N communication. (For more details, refer to 'GP Editor user manual'.)

Download drawn data to GP/LP (Select [Communication]-[Download] of menu.).
 Drawn data, PLC protocol of CH1, CH2 are downloaded to GP/LP.

3.1.2 GP, LP configuration

3.1.2.1 Mono type

Before downloading drawn data from GP Editor: Synchronize communication configurations of between GP/LP and GP Editor.

After downloading drawn data from GP Editor: After downloading PLC protocol of CH1, CH2 which is designated from GP Editor to GP/LP, it starts communication between the specified PLC and GP/LP through communication configuration.

1st Enter system setting menu.

Touch left-upper point as default position of system setting menu.



2nd Select [SET ENVIRONMENT]-[PLC SETTING].

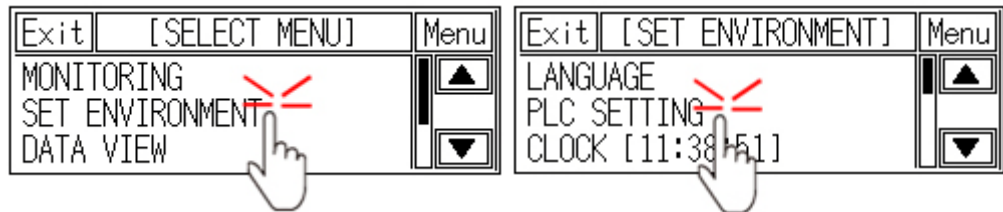

3rd CH1 protocol is set as following the designated PLC from GP Editor.

CH1 is designated as LS MASTER-K200 and CH2 is designated as AUTONICS CT6M-2P from GP Editor.

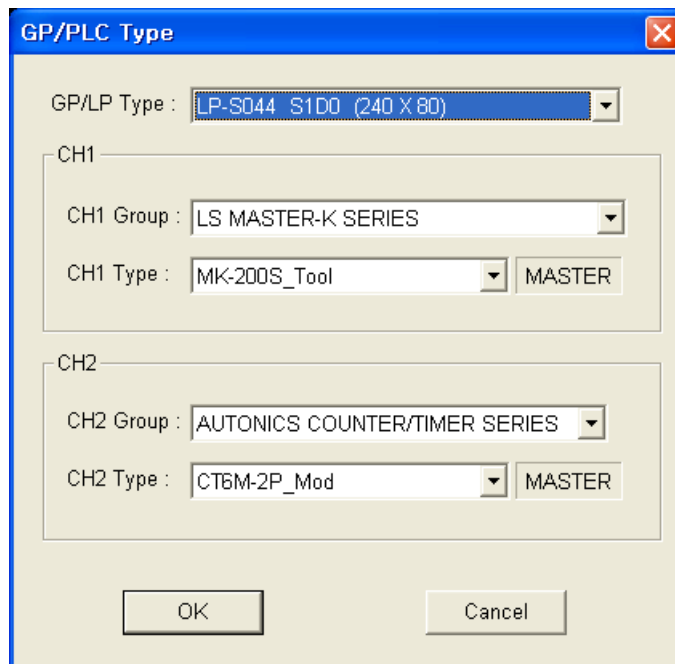

4th After downloading CH1 protocol is set as downloaded protocol 'LS MASTER K200' and CH2 protocol is set as 'EDITOR'.

Touch protocol display item of CH2 to set as downloaded protocol 'AUTONICS CT6M-2P'.

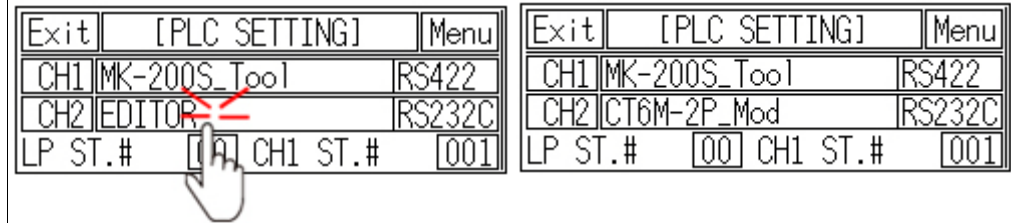

5th To communicate between GP/LP and LS Master-K200 for CH1, designate the connect port for the specific PLC and use the dedicated cable. (Refer to '4 Communication Cable By Device')

In case of LS Master-K200, it uses CPU module RS232C port. Set connect port item of CH1 as 'RS232C'. Connect port display rotates in order as RS422↔RS232C with touching.

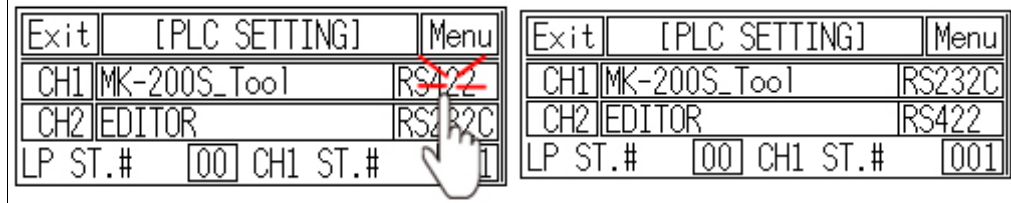

6th Synchronize the station of between GP/LP and LS Master-K200. Touch CH1 station item and input key pad appears. Enter the same station of LS Master-K200.

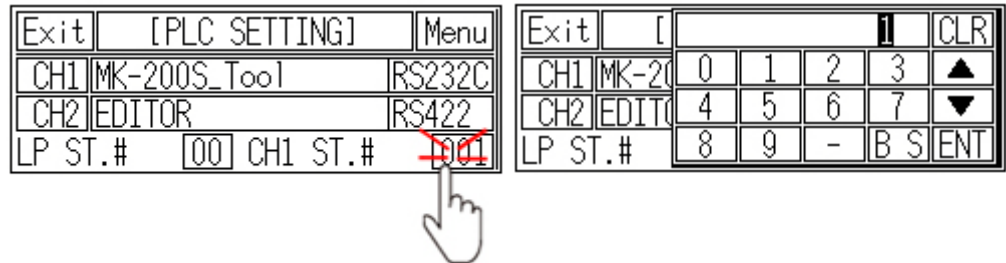

7th Synchronize communicate specifications (baudrate, data bit, stop bit, parity, flow control) of between GP/LP and LS Master-K200. The communicate specification of downloaded PLC to GP/LP is set as default of the connected PLC and communication is available directly. (Only when the communicate specification of connected PLC is set as default)

Touch 'CH1' and detailed configuration screen is switched. Designate detailed configuration.



8th To communicate between GP/LP and Autonics CT6M-2P for CH2, designate the connect port for the specific PLC and use the dedicated cable. (Refer to '4 Communication Cable By Device')

In case of Autonics CT6M-2P, it uses RS422 port. Set connect port item of CH2 as 'RS422'. Connect port display rotates in order as RS422↔RS232C with touching.

Exit	[PLC SETTING]	Menu
CH1	MK-200S_Tool	RS232C
CH2	CT6M-2P_Mod	RS422
LP ST.#	[00]	CH1 ST.# [001]

9th Synchronize the station of between GP/LP and Autonics CT6M-2P. The station of CH2 is set from link device of GP Editor. (Refer to '1.4 Link device'.)

Synchronize communicate specifications (baudrate, data bit, stop bit, parity, flow control) of between GP/LP and Autonics CT6M-2P.

The communicate specification of downloaded PLC to GP/LP is set as default of the connected PLC and communication is available directly. (Only when the communicate specification of connected PLC is set as default)

Touch 'CH2' and detailed configuration screen is switched. Designate detailed configuration.

Exit	[PLC SETTING]	Menu
CH1	MK-200S_Tool	RS232C
CH2	CT6M-2P_Mod	RS422
LP ST.#	[00]	CH1 ST.# [001]

Exit	CT6M-2P_Mod	Menu
B/R	38400bps	
DATA	[8BIT]	STOP [1BIT]
PARITY	[EVEN]	F/C [XON/XOFF]

10th After completing communication configuration, you should exit system setting menu and switch user screen to communicate GP Editor.

Touch 'Menu', current setting values are saved and it returns to previous menu.

Touch 'Exit', current setting values are saved and it returns to user screen.

3.1.2.2 Color type

Before downloading drawn data from GP Editor: Synchronize communication configurations of between GP/LP and GP Editor.

After downloading drawn data from GP Editor: After downloading PLC protocol of CH1, CH2 which is designated from GP Editor to GP/LP, it starts communication between the specified PLC and GP/LP through communication configuration.

1st Enter system setting menu.

Touch left-upper point as default position of system setting menu.



2nd Select [Environment]-[Serial Communication].



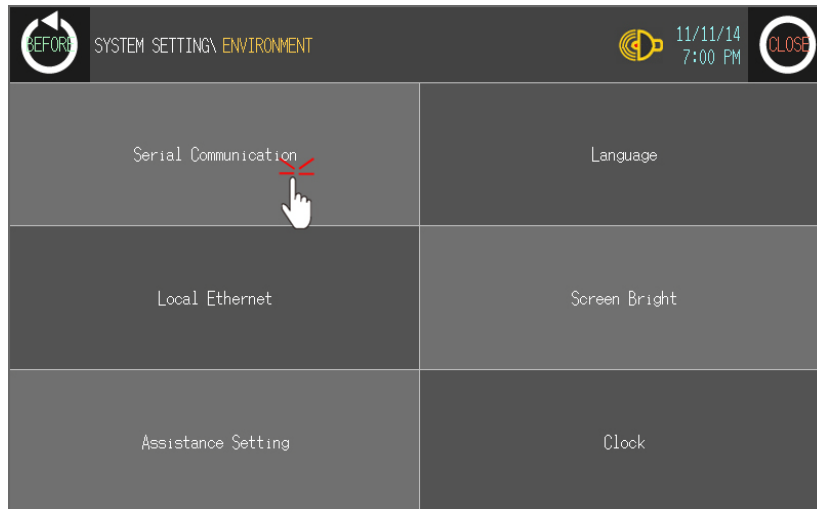

- 3rd CH1 protocol is set as following the designated PLC from GP Editor.
CH1 is designated as LS MASTER-K200 and CH2 is designated as AUTONICS CT6M-2P from GP Editor.

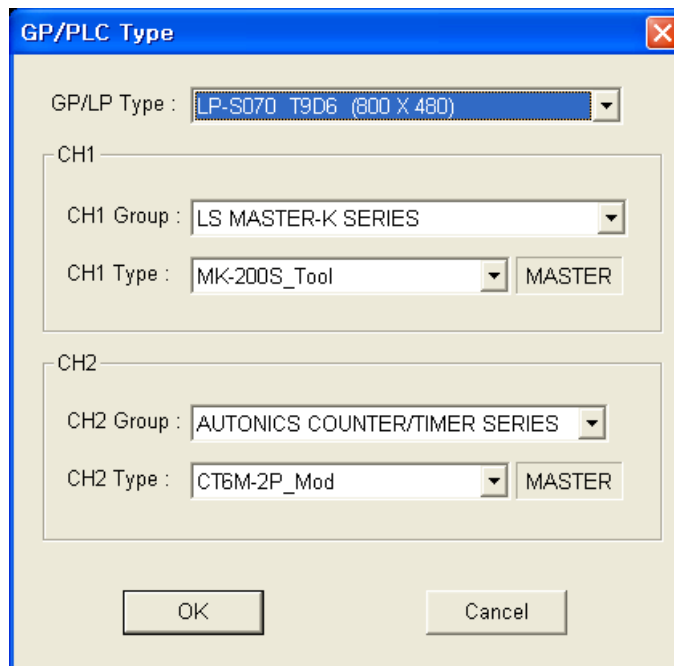

4th After downloading CH1 protocol is set as downloaded protocol 'LS MASTER K200' and CH2 protocol is set as 'EDITOR'.

Touch protocol display item of CH2 to set as downloaded protocol 'AUTONICS CT6M-2P'.

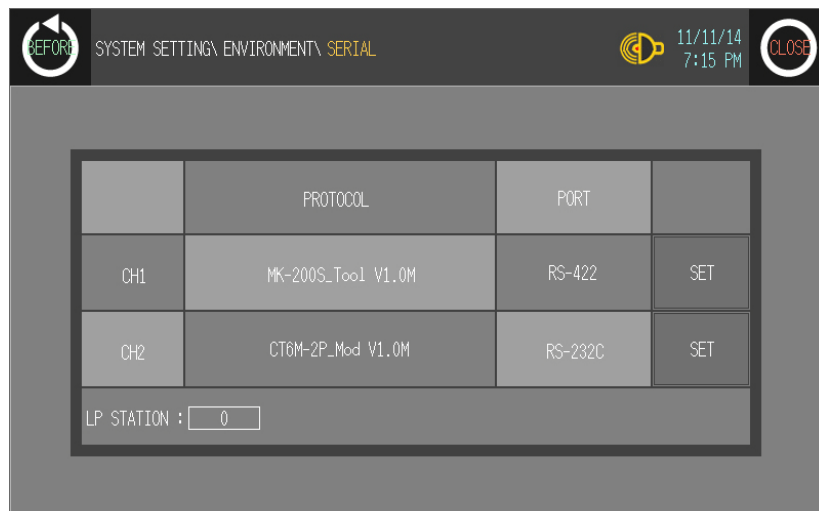
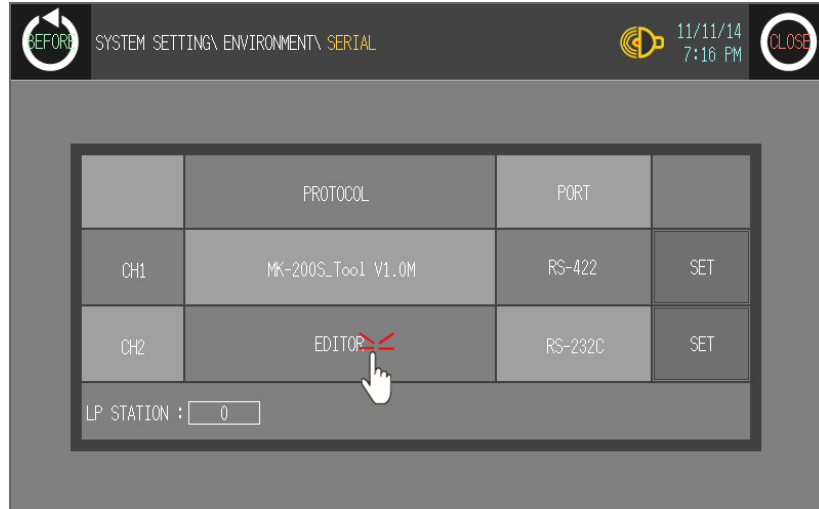

5th To communicate between GP/LP and LS Master-K200 for CH1, designate the connect port for the specific PLC and use the dedicated cable. (Refer to '4 Communication Cable By Device')

In case of LS Master-K200, it uses CPU module RS232C port. Set connect port item of CH1 as 'RS232C'. Connect port display rotates in order as RS422↔RS232C with touching.

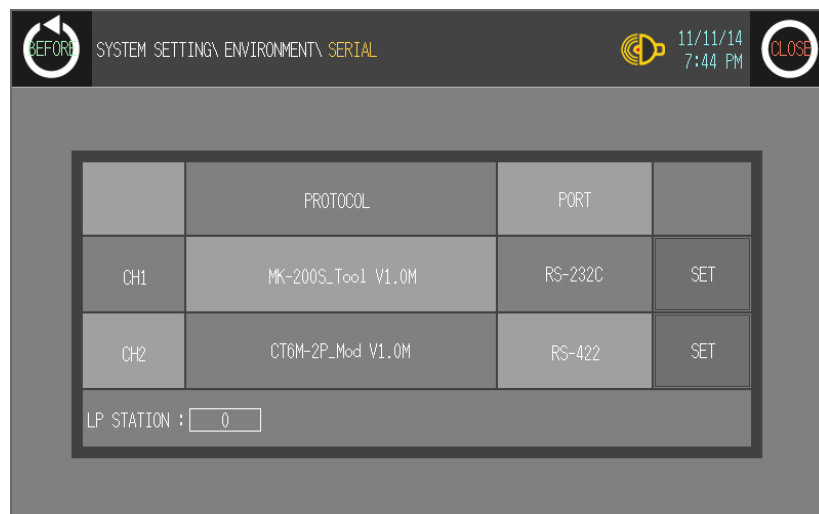
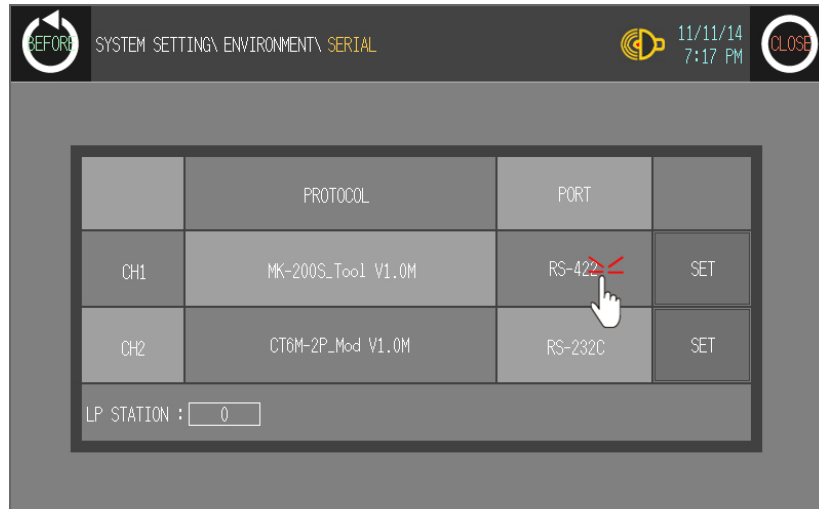

6th Synchronize communicate specifications (baudrate, data bit, stop bit, parity, flow control) of between GP/LP and LS Master-K200.

The communicate specification of downloaded PLC to GP/LP is set as default of the connected PLC and communication is available directly. (Only when the communicate specification of connected PLC is set as default)

Touch 'SET' and designate detailed configuration.

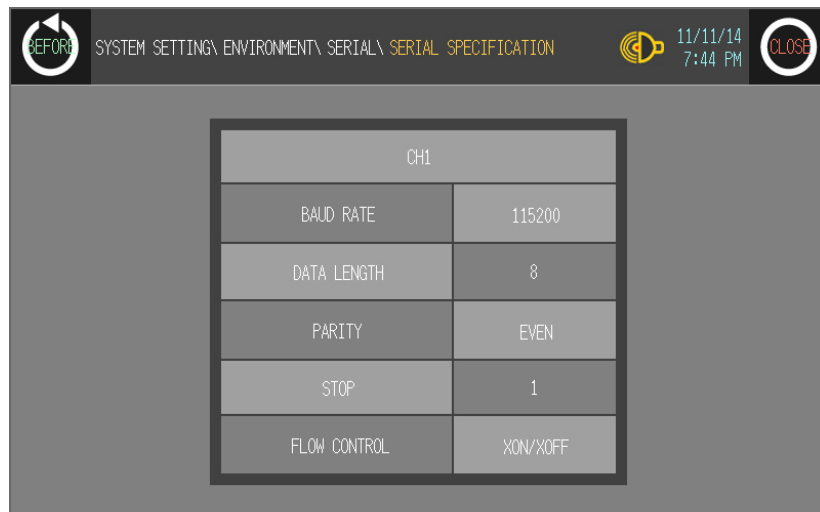
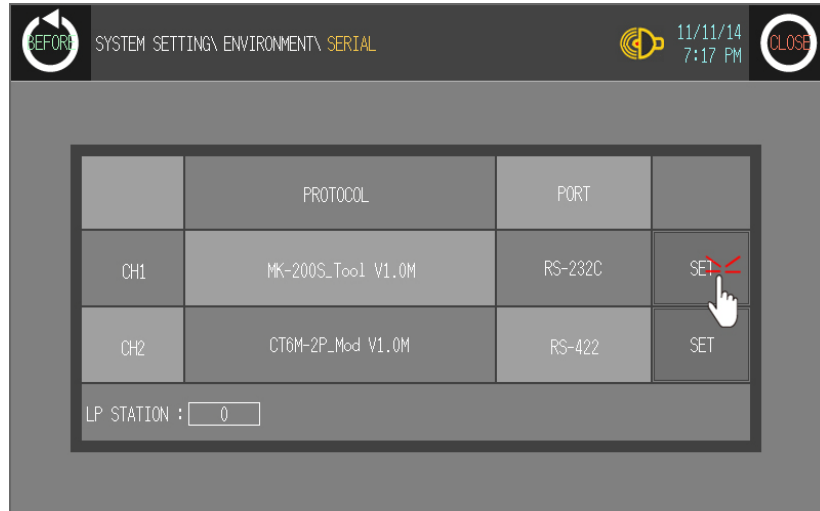

7th To communicate between GP/LP and Autonics CT6M-2P for CH2, designate the connect port for the specific PLC and use the dedicated cable. (Refer to '4 Communication Cable By Device')

In case of Autonics CT6M-2P, it uses RS422 port. Set connect port item of CH2 as 'RS422'. Connect port display rotates in order as RS422↔RS232C with touching.

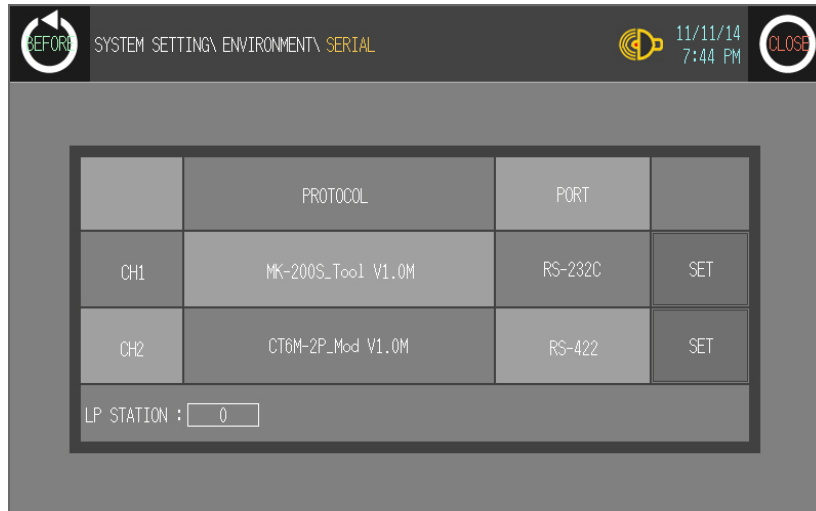

8th Synchronize communicate specifications (baudrate, data bit, stop bit, parity, flow control) of between GP/LP and Autonics CT6M-2P.

The communicate specification of downloaded PLC to GP/LP is set as default of the connected PLC and communication is available directly. (Only when the communicate specification of connected PLC is set as default)

Touch 'SET' and designate detailed configuration.

9th After completing communication configuration, you should exit system setting menu and switch user screen to communicate GP Editor.

Touch 'BEFORE', current setting values are saved and it returns to previous menu.

Touch 'CLOSE', current setting values are saved and it returns to user screen after exiting system setting menu.

3.2 1:1 communication

It is able to communicate between a GP/LP and a PLC or controller.

Mono type, 1:1 communication is available from both CH1, and CH2. Tags (numeral input/display, ASCII input/display) are available to communicate from only CH1, CH2 is available from link device. (Refer to 'GP Editor user manual' or '1.4 Link device' of this manual.)

Color type, 1:1 communication is available from both CH1, and CH2. Tags (numeral input/display, ASCII input/display) are available to communicate from both CH1 and CH2 as different from mono type.

This chapter is described 1:1 communication by LS Master-K200 as example.

3.2.1 Communication configuration

3.2.2 GP Editor configuration

1st Designate GP/LP and PLC type.

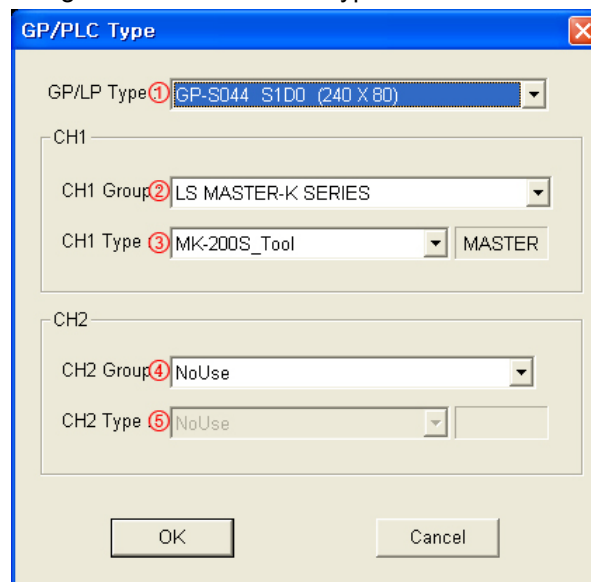

Item	Description	Note
① GP/LP Type	Designate GP/LP model type by pull-down menu.	
② CH1 Group	Designate PLC group of CH1 by pull-down menu.	This chapter is described by LS Master-K200 as example.
③ CH1 Type	Designate PLC type of CH1 for ② by pull-down menu.	
④ CH2 Group	Designate PLC group of CH2 by pull-down menu.	For mono type, 1:1 communication is not available from CH2. It does not matter which PLC is selected.
⑤ CH2 Type	Designate PLC type of CH2 for ④ by pull-down menu.	

2nd Draw the data for GP/LP from GP Editor.

(For more details, refer to 'GP Editor user manual'.)

3rd Download drawn data to GP/LP. (Select [Communication]-[Download] of menu.)

Drawn data, PLC protocol of CH1 are downloaded to GP/LP.

3.2.3 GP, LP configuration

3.2.3.1 Mono type

Before downloading drawn data from GP Editor: Synchronize communication configurations of between GP/LP and GP Editor.

After downloading drawn data from GP Editor: After downloading PLC protocol of CH1, CH2 which is designated from GP Editor to GP/LP, it starts communication between the specified PLC and GP/LP through communication configuration.

1st Enter system setting menu.

Touch left-upper point as default position of system setting menu.



2nd Select [SET ENVIRONMENT]-[PLC SETTING].

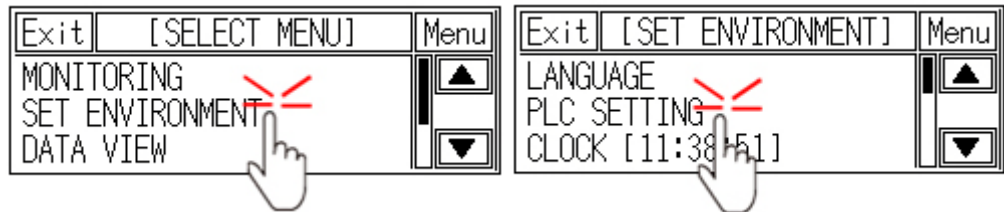

3rd CH1 protocol is set as following the designated PLC from GP Editor.

Exit	[SELECT MENU]	Menu
CH1	MK-200S_Tool	RS422
CH2	EDITOR	RS232C
LP ST.#	[00]	CH1 ST.# [001]

4th To communicate between GP/LP and LS Master-K200 for CH1, designate the connect port for the specific PLC and use the dedicated cable. (Refer to '4 Communication Cable By Device')

In case of LS Master-K200, it uses CPU module RS232C port. Set connect port item of CH1 as 'RS232C'. Connect port display rotates in order as RS422↔RS232C with touching.



5th Synchronize the station of between GP/LP and LS Master-K200. Touch CH1 station item and input key pad appears. Enter the same station of LS Master-K200.

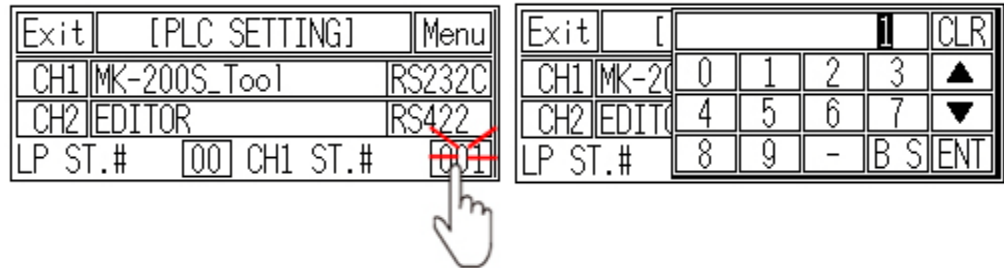

6th Synchronize communicate specifications (baudrate, data bit, stop bit, parity, flow control) of between GP/LP and LS Master-K200. The communicate specification of downloaded PLC to GP/LP is set as default of the connected PLC and communication is available directly. (Only when the communicate specification of connected PLC is set as default.)

Touch 'CH1' and detailed configuration screen is switched. Designate detailed configuration.



7th After completing communication configuration, you should exit system setting menu and switch user screen to communicate GP Editor to communicate with LS Master-K200.

Touch 'Menu', current setting values are saved and it returns to previous menu.

Touch 'Exit', current setting values are saved and it returns to user screen.

3.2.3.2 Color type

Before downloading drawn data from GP Editor: Synchronize communication configurations of between GP/LP and GP Editor.

After downloading drawn data from GP Editor: After downloading PLC protocol of CH1, CH2 which is designated from GP Editor to GP/LP, it starts communication between the specified PLC and GP/LP through communication configuration.

1st Enter system setting menu.

Touch left-upper point as default position of system setting menu.

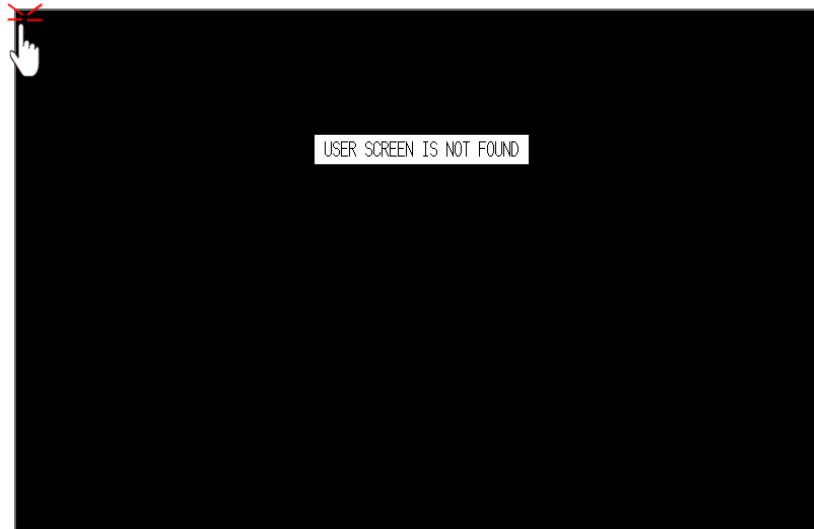

2nd Select [Environment]-[Serial Communication].



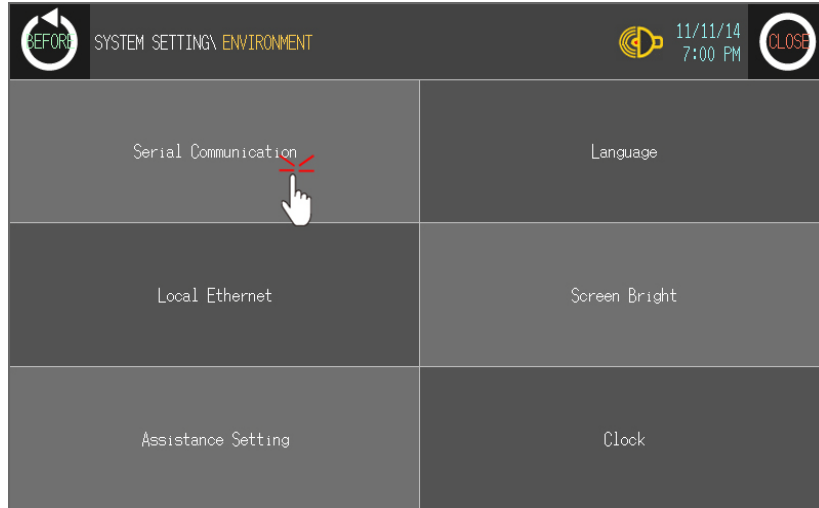

3rd CH1 protocol is set as following the designated PLC from GP Editor.

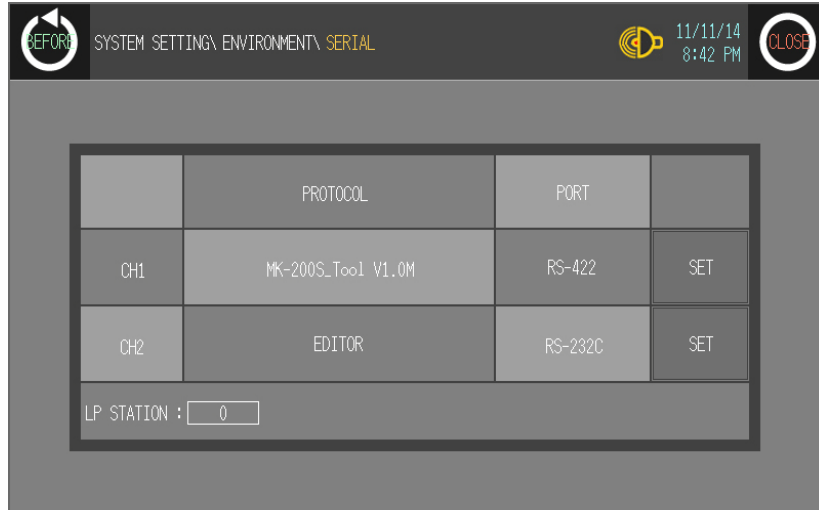

4th To communicate between GP/LP and LS Master-K200 for CH1, designate the connect port for the specific PLC and use the dedicated cable. (Refer to '4 Communication Cable By Device')

In case of LS Master-K200, it uses CPU module RS232C port. Set connect port item of CH1 as 'RS232C'. Connect port display rotates in order as RS422↔RS232C with touching.

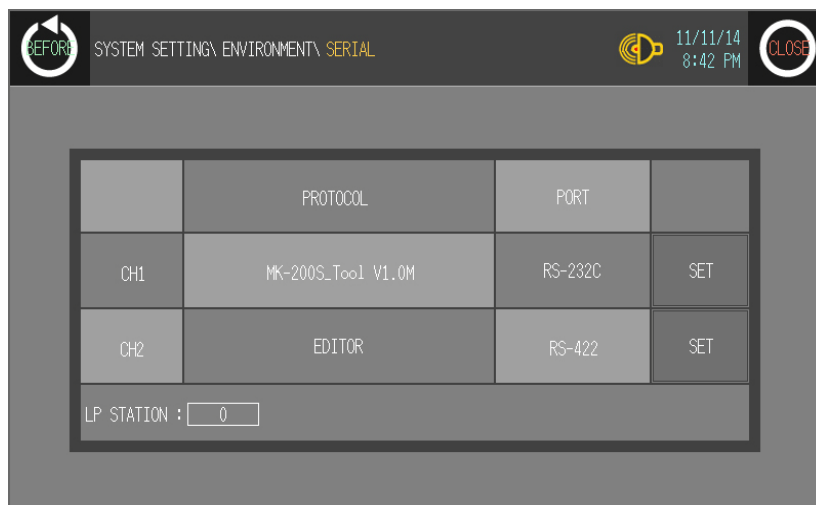
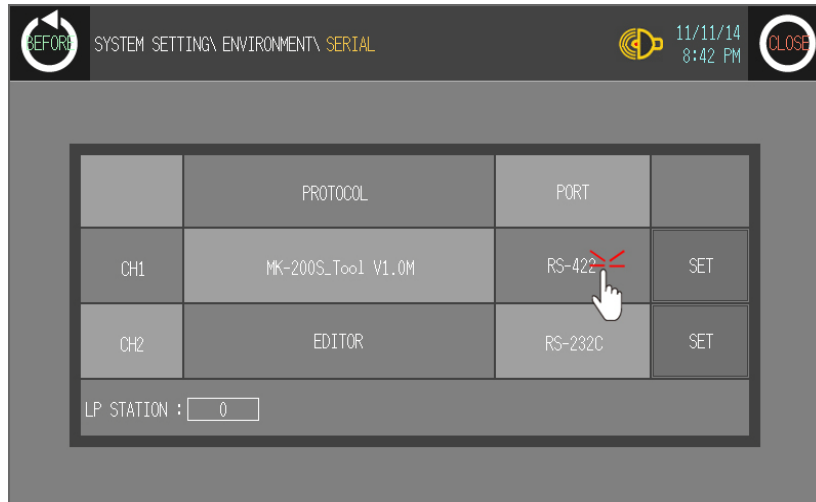

5th Synchronize communicate specifications (baudrate, data bit, stop bit, parity, flow control) of between GP/LP and LS Master-K200.

The communicate specification of downloaded PLC to GP/LP is set as default of the connected PLC and communication is available directly. (Only when the communicate specification of connected PLC is set as default)

Touch 'SET' and designate detailed configuration.

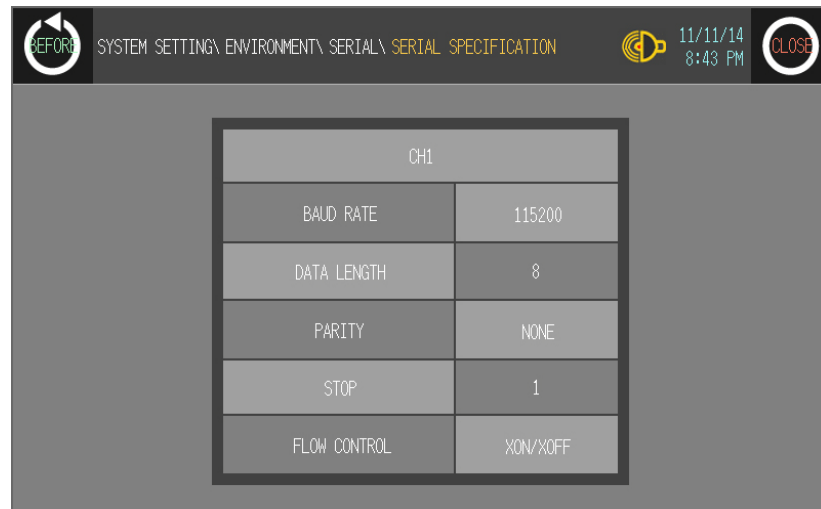
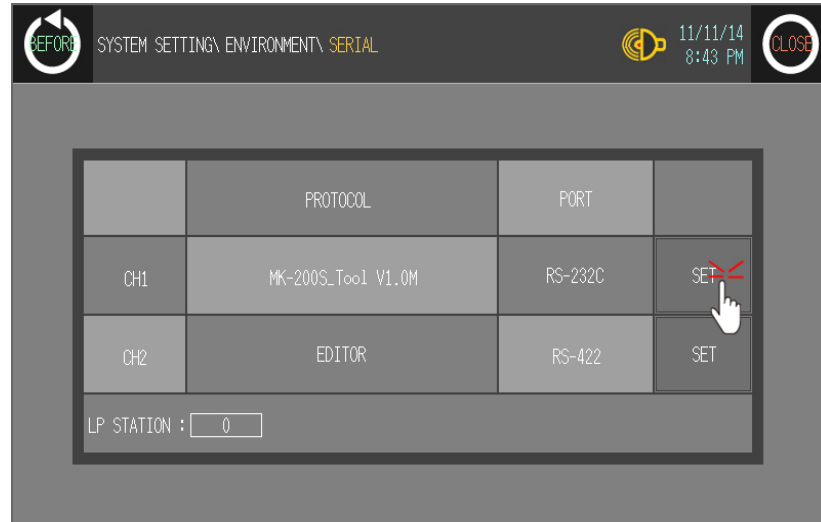

6th After completing communication configuration, you should exit system setting menu and switch user screen to communicate GP Editor to communicate with LS Master-K200.

Touch 'BEFORE', current setting values are saved and it returns to previous menu. Touch 'CLOSE', current setting values are saved and it returns to user screen after exiting system setting menu.

3.3 1:N communication

It is able to communicate between a GP or LP and the number 'N' of PLCs or controllers. All of connected PLCs for 1:N communication have to be same type, have RS422(or RS485) port and able to set the station for 1:N communication.

In case of mono type, 1:N communication is available by link device of CH2.

In case of color type, 1:N communication is available by setting PLC station and device directly from tag (numeral input/display, ASCII input/display) of CH1, CH2 and by link device.

3.3.1 System organization

The following figure displays 1:N communication organization for a GP/LP and the number 'N' of PLCs or controllers.

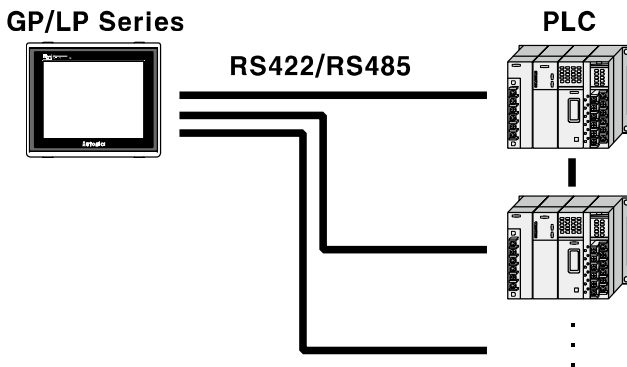

GP/LP communicates with PLC by RS422(or RS485) communication. (RS232C serial communication is not available for 1:N communication.).

For 1:N communication, the communication stations of connected PLC should not be overlapped.

The number 'N' of PLCs as one group is available only set one PLC type from GP Editor, you have to organize be same type PLC to communicate.



Note

The maximum number of connectable PLCs are the number of specified PLC station. For system stability, please set under 16 stations.

The below is RS422 communication connection diagram for 1:N communication.

D-Sub 9pin male

GP Series

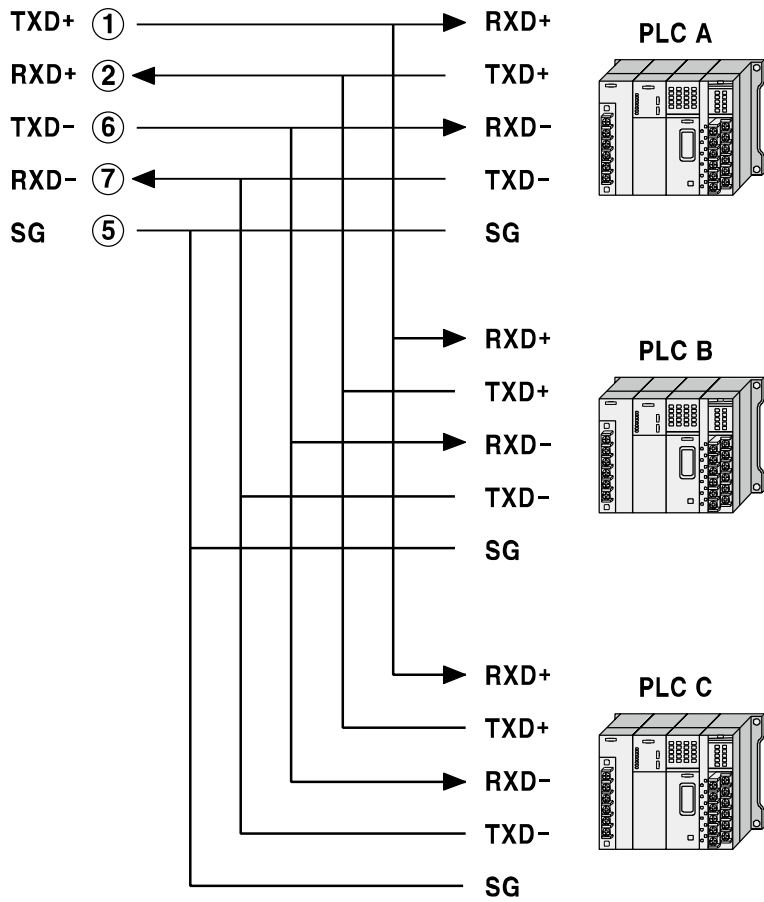
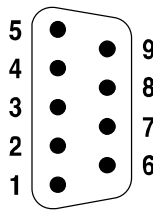

3.3.2 Communication configuration

This chapter is described 1:N communication by CT6M-2P of Autonics's counter/timer series as example.

3.3.2.1 GP Editor configuration

1st Designate GP/LP and PLC type.

Item	Description	Note
① GP/LP Type	Designate GP/LP model type by pull-down menu.	
② CH1 Group	Designate PLC group of CH1 by pull-down menu.	For mono type, 1:1 communication is not available from CH2. It does not matter which PLC is selected.
③ CH1 Type	Designate PLC type of CH1 for ② by pull-down menu.	
④ CH2 Group	Designate PLC group of CH2 by pull-down menu.	This chapter is described by CT6M-2P of Autonics's counter/timer series as example.
⑤ CH2 Type	Designate PLC type of CH2 for ④ by pull-down menu.	

2nd Select [Common]-[Link Device] and 'Link Device Setting' dialog box appears.
Designate the station of connected PLC to CH2 and connect device.

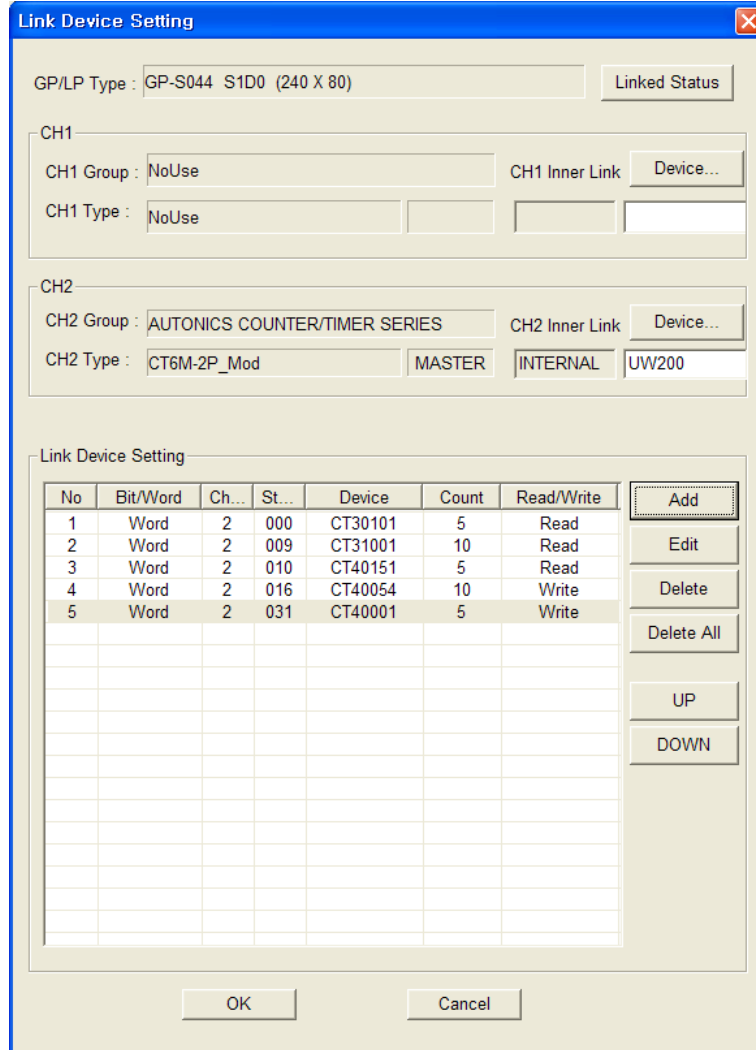

Communication operates as below table.

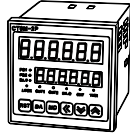
GP/LP	Communication direction	CH2 PLC station	CH2 PLC
			
GP/LP series			CT6M-2P
UW200 to UW209	(Read) ←	1	CT30105 to CT30114
UW210 to UW219	(Read) ←	9	CT31001 to CT31010
UW220 to UW224	(Read) ←	10	CT40151 to CT40156
UW225 to UW229	(Write) →	31	CT40001 to CT40010
UW230 to UW239	(Write) →	16	CT40054 to CT40063

In case of mono type, 1:N communication configuration is available only from link device. For more details, refer to '1.4 Link device'.

In case of color type, it is available by setting PLC station and device directly from tag (numeral input/display, ASCII input/display) of CH1, CH2 and by link device.

3rd Draw the data to download for GP/LP from GP Editor.

In case of mono type: Supports 1:N communication by CH2.

In case of color type: Supports 1:N communication by CH1, CH2 without division. (For more details, refer to 'GP Editor user manual'.)

4th Download drawn data to GP/LP (Select [Communication]-[Download] of menu.).

Drawn data, PLC protocol of CH1 are downloaded to GP/LP.

3.3.2.2 GP, LP configuration

(1) Mono type

Before downloading drawn data from GP Editor: Synchronize communication configurations of between GP/LP and GP Editor.

After downloading drawn data from GP Editor: After downloading PLC protocol (CT6M-2P) of CH2, it starts communication between the specified PLC and GP/LP through communication configuration.

1st Enter system setting menu.

Touch left-upper point as default position of system setting menu.



2nd Select [SET ENVIRONMENT]-[PLC SETTING].

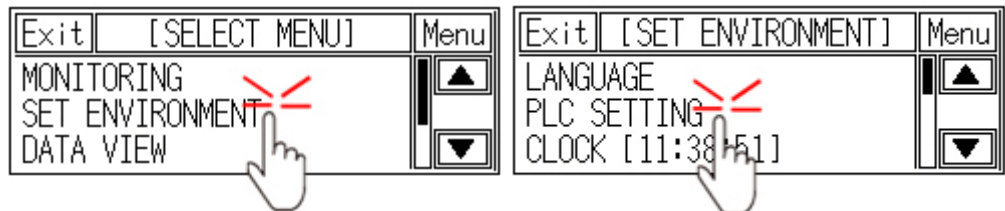

3rd CH2 protocol is set as CT6M-2P as PLC type from GP Editor but downloaded CT6M-2P protocol is not applied directly. (Communicates with EDITOR from CH2). Touch protocol display item of CH2 to set CT6M-2P.

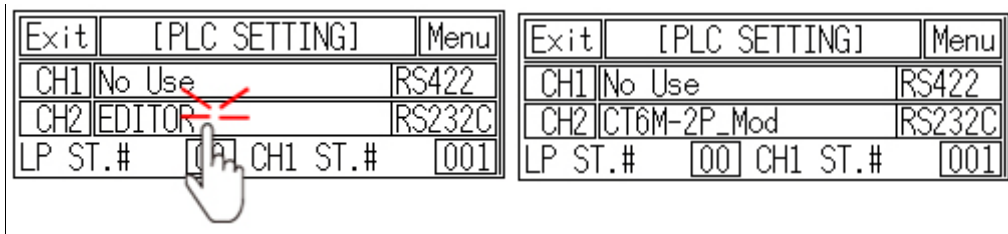

4th To communicate between GP/LP and CT6M-2P for CH2, designate the connect port for the specific PLC and use the dedicated cable. (Refer to '4 Communication Cable By Device'.)

In case of CT6M-2P, it uses Modbus RS485(RS422) port. Set connect port item of CH2 as 'RS422'. Connect port display rotates in order as RS422↔RS232C with touching.



5th Synchronize the station of between GP/LP and CT6M-2P. The station of CH1 is available to set from GP/LP. CH2 is set from link device of GP Editor. (Refer to '1.4 Link device'.) Enter the same station of CT6M-2P.

For more details, refer to 'GP Editor user manual'.

6th Synchronize communicate specifications (baudrate, data bit, stop bit, parity, flow control) of between GP/LP and CT6M-2P. The communicate specification of downloaded PLC to GP/LP is set as default of the connected PLC and communication is available directly. (Only when the communicate specification of connected PLC is set as default)

Touch 'CH2' and detailed configuration screen is switched. Designate detailed configuration.

Exit	[PLC SETTING]	Menu	Exit	CT6M-2P_Mod	Menu
CH1	No Use	RS232C	B/R	38400bps	
CH2	CT6M-2P_Mod	RS422	DATA	8BIT	STOP 1BIT
LP	ST.# [00]	CH1 ST.# [001]	PARITY	EVEN	F/C [XON/XOFF]



7th After completing communication configuration, you should exit system setting menu and switch user screen to communicate GP Editor with CT6M-2P.

Touch 'Menu', current setting values are saved and it returns to previous menu.

Touch 'Exit', current setting values are saved and it returns to user

(2) Color type

Before downloading drawn data from GP Editor: Synchronize communication configurations of between GP/LP and GP Editor. (Refer to '3.1.2.2 Color type'.)

After downloading drawn data from GP Editor: After downloading PLC protocol of CH1, CH2 which is designated from GP Editor to GP/LP, it starts communication between the specified PLC and GP/LP through communication configuration.

1st Enter system setting menu.

Touch left-upper point as default position of system setting menu.

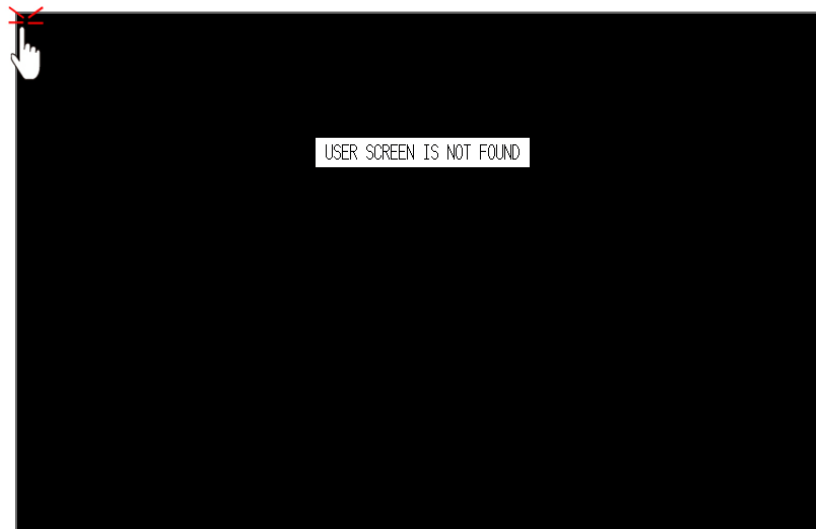

2nd Select [Environment]-[Serial Communication].



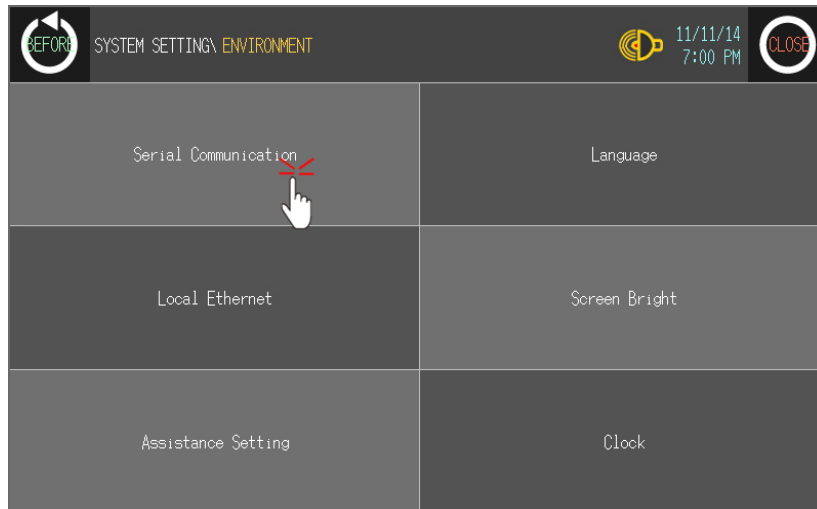

3rd CH2 protocol is set as CT6M-2P as PLC type from GP Editor but downloaded CT6M-2P protocol is not applied directly. (Communicates with EDITOR from CH2). Touch protocol display item of CH2 to set CT6M-2P.

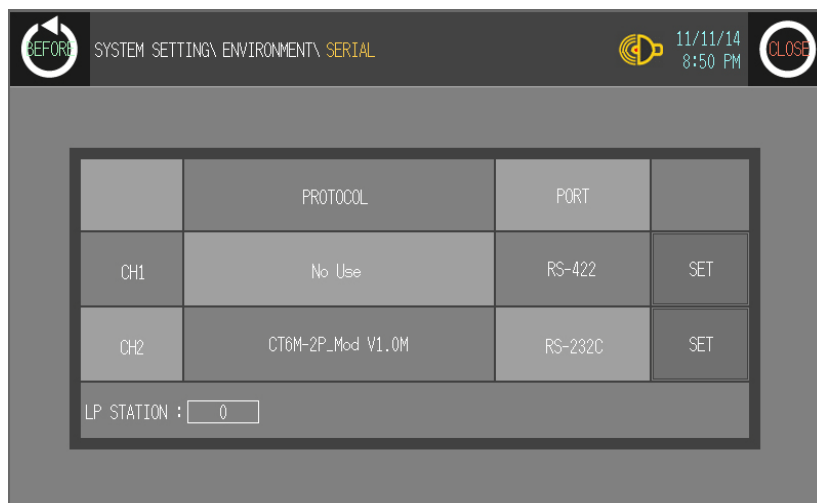
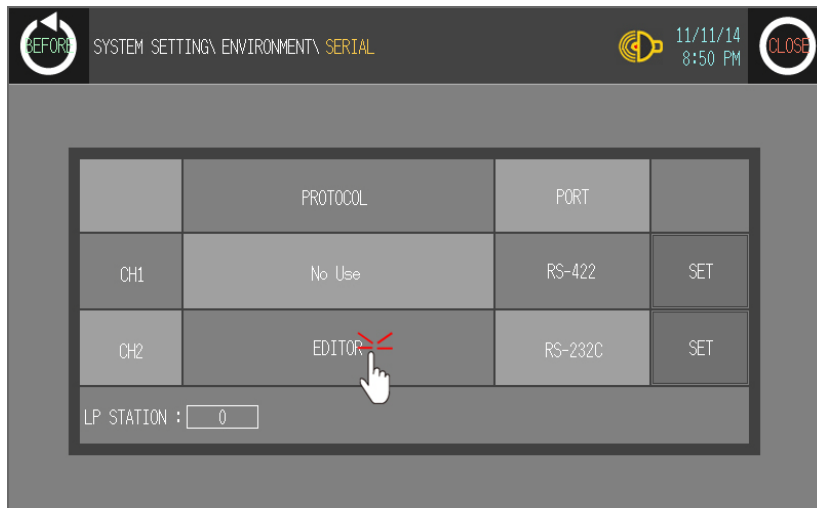

4th To communicate between GP/LP and CT6M-2P, designate the connect port for the specific PLC and use the dedicated cable.(Refer to '4 Communication Cable By Device'.) In case of CT6M-2P, it uses Modbus RS485(RS422) port. Set connect port item of CH2 as 'RS422'. Connect port display rotates in order as RS422↔RS232C with touching.

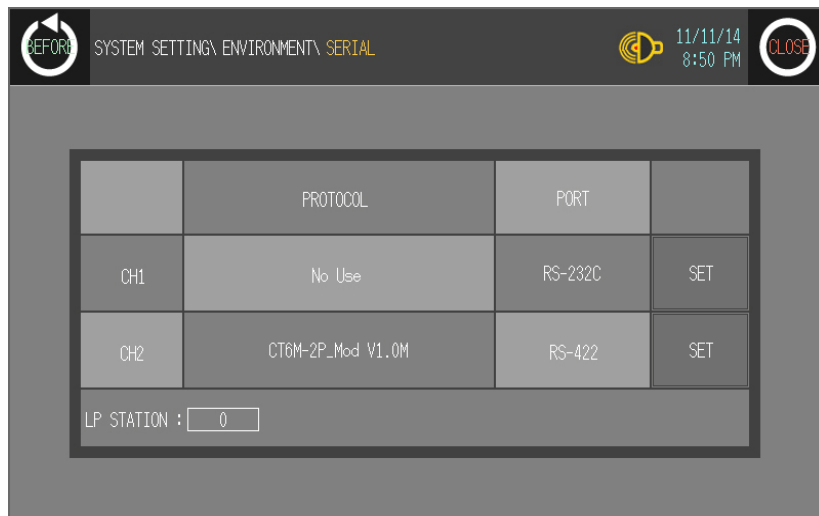
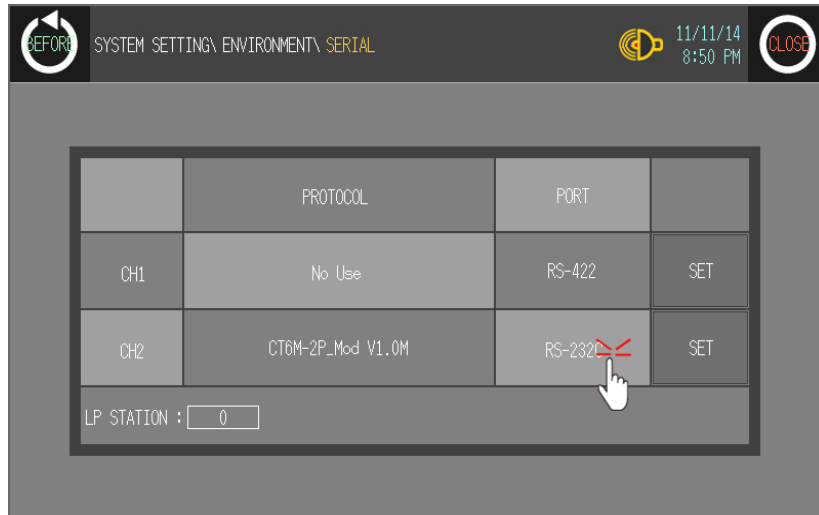

5th Synchronize communicate specifications (baudrate, data bit, stop bit, parity, flow control) of between GP/LP and CT6M-2P. The communicate specification of downloaded PLC to GP/LP is set as default of the connected PLC and communication is available directly. (Only when the communicate specification of connected PLC is set as default)

Touch 'SET' and detailed configuration screen is switched. Designate detailed configuration.

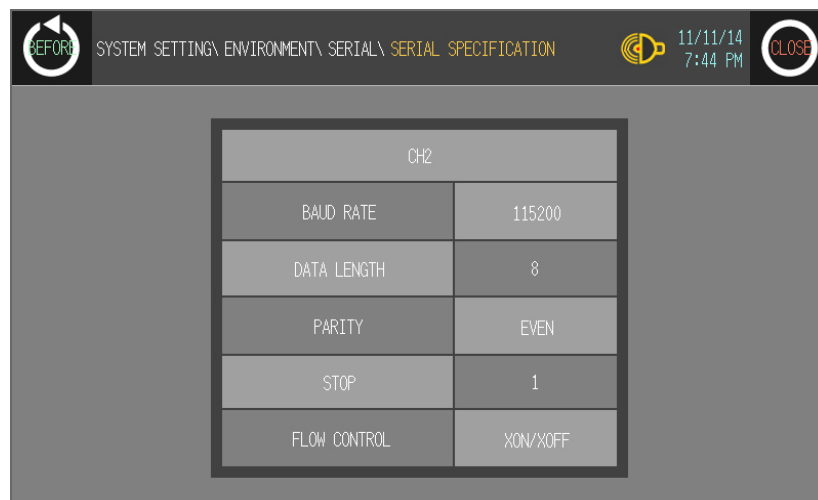
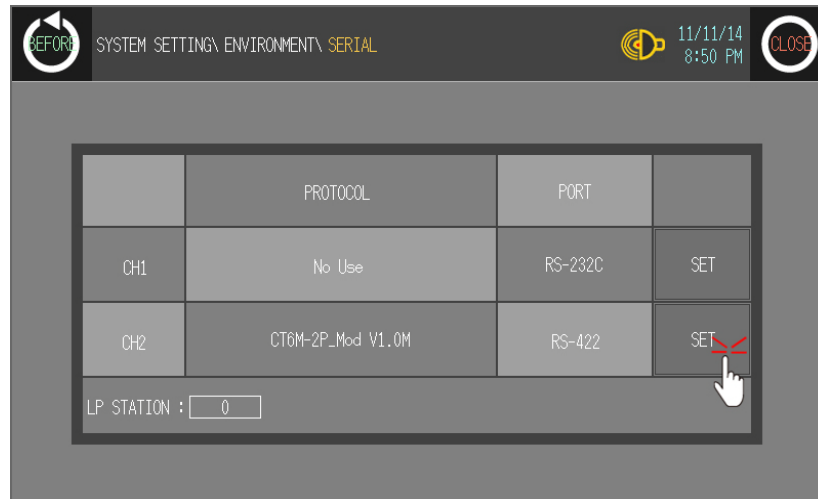

6th After completing communication configuration, you should exit system setting menu and switch user screen to communicate GP Editor with CT6M-2P.

Touch 'BEFORE', current setting values are saved and it returns to previous menu.

Touch 'CLOSE', current setting values are saved and it returns to user screen after exiting system setting menu.

3.4 Heterogeneous communication

3.4.1 System organization

It is able to communicate between GP or LP and PLC or controller by connecting heterogeneous PLC to each port RS232C and RS422 of GP/LP.

GP/LP transmits communication between CH1 and CH2 by the designated inner link device.

Heterogeneous communication is available by the following system organization such as CH1(1)↔GP(1)↔CH2(1) or CH1(1)↔GP(1)↔CH2(N).

[Heterogeneous 1:1:1 communication]

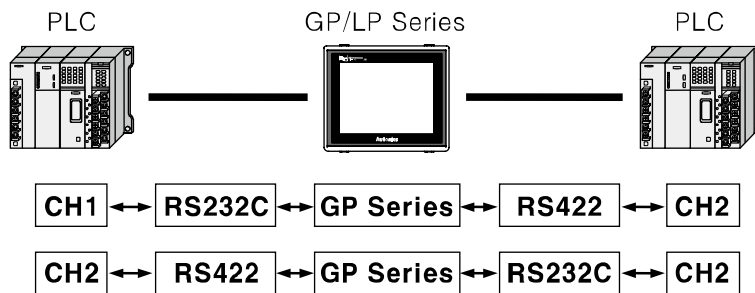

[Expanded 1:1:1 Heterogeneous communication(1:1:N communication)]

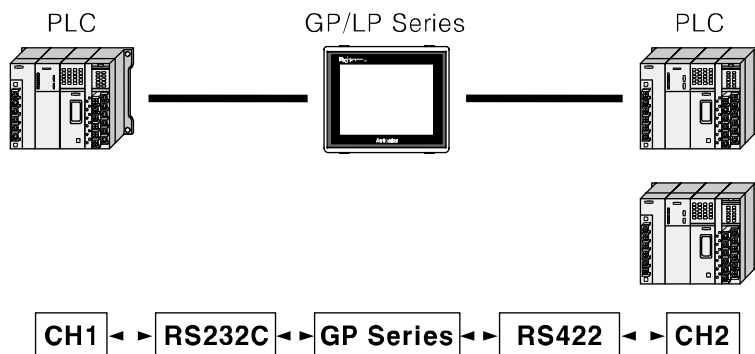

CH1 should be one device. If CH2 has one device, RS232C or RS422 communication is available as above figure. If CH2 has N devices, RS422 or RS485 communication is available.

If CH2 has N devices, PLCs are connected with GP through RS422(or RS485) port. Each connected PLC should have its station (individual ID) to avoid communication conflicts. PLCs have to be same type.



Note

The number 'N' of PLCs should be available to communicate with RS422 or RS485 port and they should be same type.

3.4.2 Communication configuration

This chapter is described by LS MASTER K200 and MITSUBISHI FX2N as example.

3.4.2.1 GP Editor configuration

1st Designate GP/LP and PLC type.

Item	Description
① GP/LP Type	Designate GP/LP model type by pull-down menu.
② CH1 Group	Designate PLC group of CH1 by pull-down menu.
③ CH1 Type	Designate PLC type of CH1 for ② by pull-down menu.
④ CH2 Group	Designate PLC group of CH2 by pull-down menu.
⑤ CH2 Type	Designate PLC type of CH2 for ④ by pull-down menu.

2nd Draw the data to download for GP/LP from GP Editor.



3rd Designate each link device of CH1, CH2.

For heterogeneous communication, you should designated ① CH1 inner link device and ② CH2 inner link device as same.

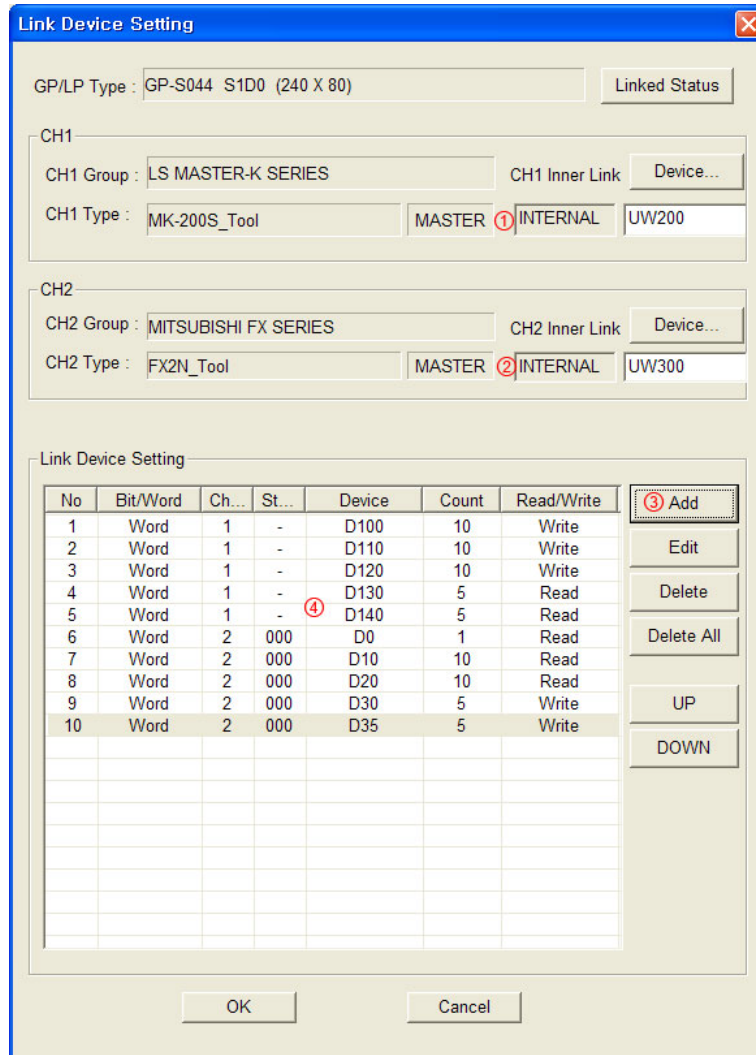
Click ③Add and designate CH1, CH2 connect device to communicate. Designated link devices are displayed on ④ as list.

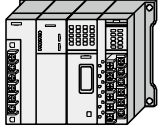

Communication operates as below table. (For more details, refer to '1.4 Link device')

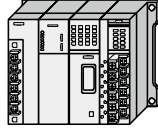
CH1 PLC	Communication direction	GP/LP	Communication direction	CH2 PLC
				
MK-200S		GP/LP series		FX2N
D100 to D109	(Write) ←	UW200 to UW209	(Read) ←	D0 to D9
D110 to D119	(Write) ←	UW210 to UW219	(Read) ←	D10 to D19
D120 to D129	(Write) ←	UW220 to UW229	(Read) ←	D20 to D29
D130 to D134	(Read) →	UW230 to UW234	(Write) →	D30 to D34
D135 to D139	(Read) →	UW235 to UW239	(Write) →	D35 to D39

4th Download drawn data to GP/LP (Select [Communication]-[Download] of menu.).

Drawn data, PLC protocol of CH1, CH2 are downloaded to GP/LP.

3.4.3 GP, LP configuration

3.4.3.1 Mono type

Before downloading drawn data from GP Editor: Synchronize communication configurations of between GP/LP and GP Editor. (Refer to '3.1.2.1 Mono type'.)

1st After downloading drawn data from GP Editor, enter system setting menu.

Touch left-upper point as default position of system setting menu.



2nd Select [SET ENVIRONMENT]-[PLC SETTING].

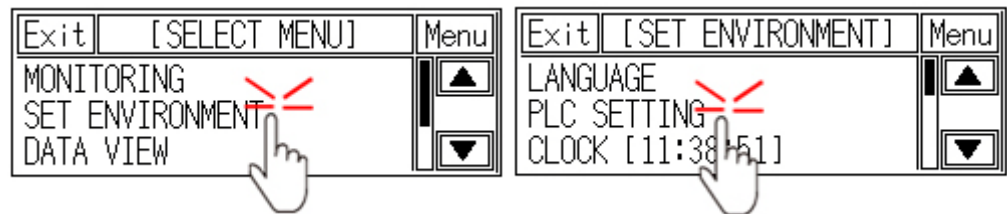

3rd CH1 protocol is set as LS MASTER K200 as PLC type from GP Editor. CH1 is designated as LS MASTER-K200 and CH2 is designated as MITSUBISHI FX2N from GP Editor.

Exit	[PLC SETTING]	Menu
CH1	MK-200S_Tool	RS422
CH2	EDITOR	RS232C
LP ST.#	[00]	CH1 ST.# [001]

4th CH2 protocol is set as MITSUBISHI FX2N as PLC type from GP Editor but downloaded MITSUBISHI FX2N protocol is not applied directly. (Communicates with EDITOR from CH2).

Touch protocol display item of CH2 to set MITSUBISHI FX2N.

Exit	[PLC SETTING]	Menu
CH1	MK-200S_Tool	RS422
CH2	EDITOR	RS232C
LP ST.#	[00]	CH1 ST.# [001]

Exit	[PLC SETTING]	Menu
CH1	MK-200S_Tool	RS422
CH2	FX2N_Tool	RS232C
LP ST.#	[00]	CH1 ST.# [001]

5th To communicate between GP/LP and LS MASTER K200 for CH1, MITSUBISHI FX2N for CH2, designate the connect port for the specific PLC and use the dedicated cable. (Refer to '4 Communication Cable By Device')

In case of LS MASTER K200 of CH1, it uses CPU module RS422 port. In case of MITSUBISHI FX2N for CH2, it uses CPU module RS232 and RS232/422 converter should be used. If two of RS232C serial interface type, connect RS232/422 converter at each RS232C A, or RS232C B port.

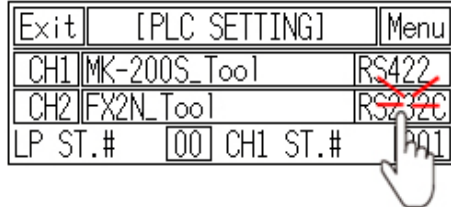

6th Synchronize the station of between GP/LP and connected devices.

The station of CH1 is available to set from GP/LP. CH2 is set from link device of GP Editor. (Refer to '1.4 Link device'.) For more details, refer to 'GP Editor user manual'.

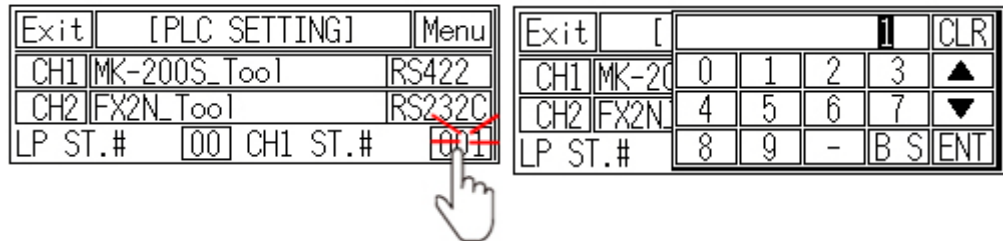

7th Synchronize communicate specifications (baudrate, data bit, stop bit, parity, flow control) of between GP/LP and connected devices by each CH1, CH2.

The communicate specification of downloaded PLC to GP/LP is set as default of the connected PLC and communication is available directly. (Only when the communicate specification of connected PLC is set as default)

Touch 'CH1' or 'CH2' and detailed configuration screen is switched. Designate detailed configuration by each channel.

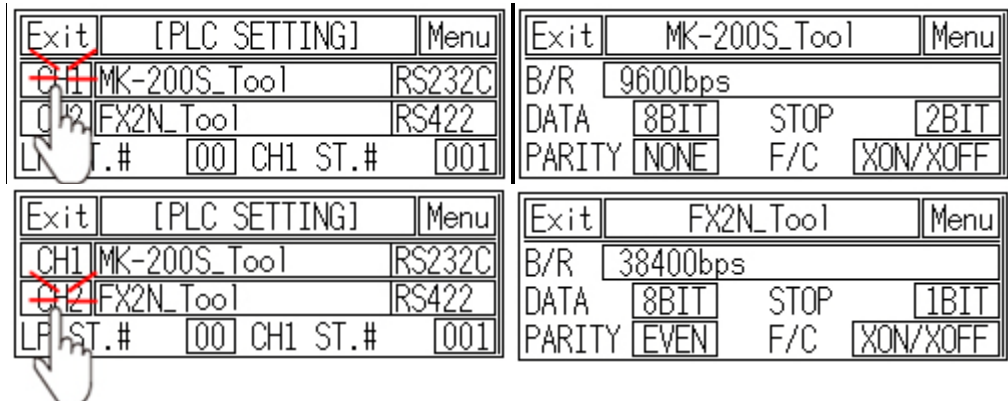

8th After completing communication configuration, you should exit system setting menu and switch user screen to communicate GP Editor with connected devices.

Touch 'Menu', current setting values are saved and it returns to previous menu.

Touch 'Exit', current setting values are saved and it returns to user

3.4.3.2 Color type

Before downloading drawn data from GP Editor: Synchronize communication configurations of between GP/LP and GP Editor.

1st After downloading drawn data from GP Editor, enter system setting menu.

Touch left-upper point as default position of system setting menu.

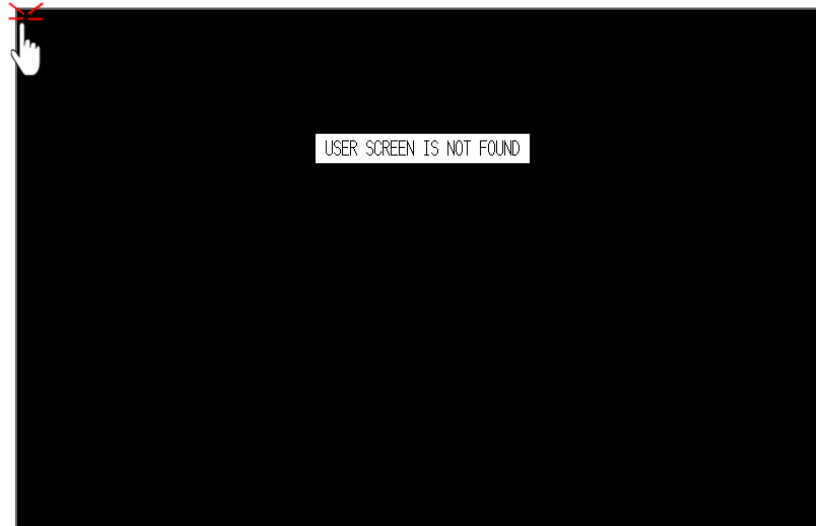

2nd Select [Environment]-[Serial Communication].



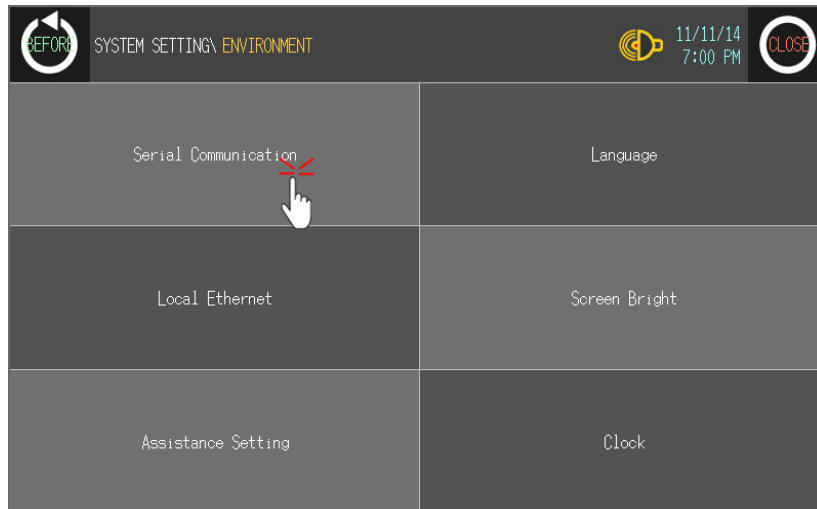

- 3rd CH1 protocol is set as LS MASTER K200 as PLC type from GP Editor. CH1 is designated as LS MASTER-K200 and CH2 is designated as MITSUBISHI FX2N from GP Editor.

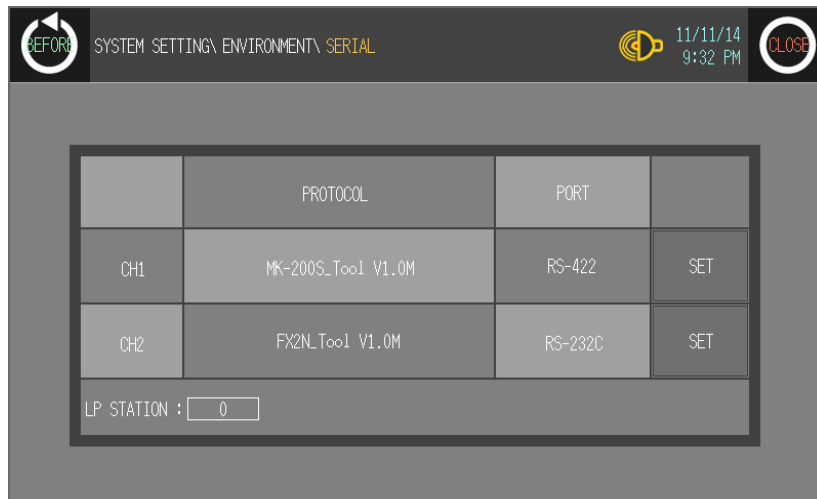

CH2 protocol is set as MITSUBISHI FX2N as PLC type from GP Editor but downloaded MITSUBISHI FX2N protocol is not applied directly. (Communicates with EDITOR from CH2).

Touch protocol display item of CH2 to set MITSUBISHI FX2N.

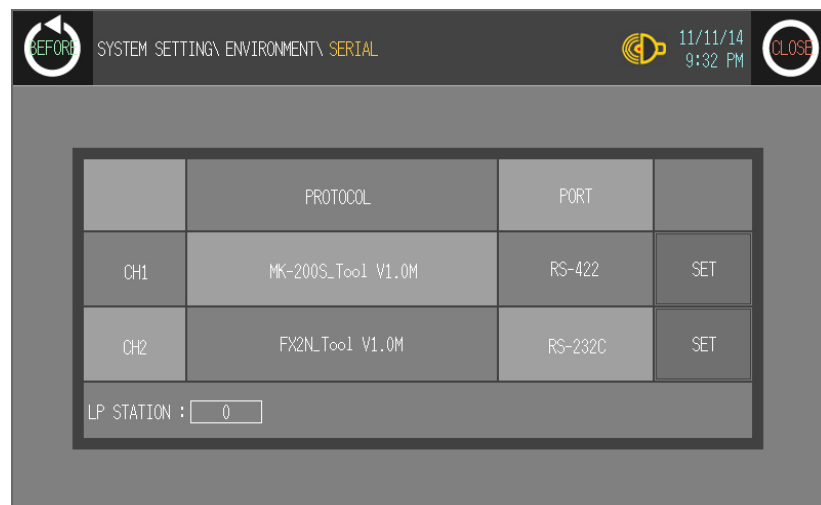
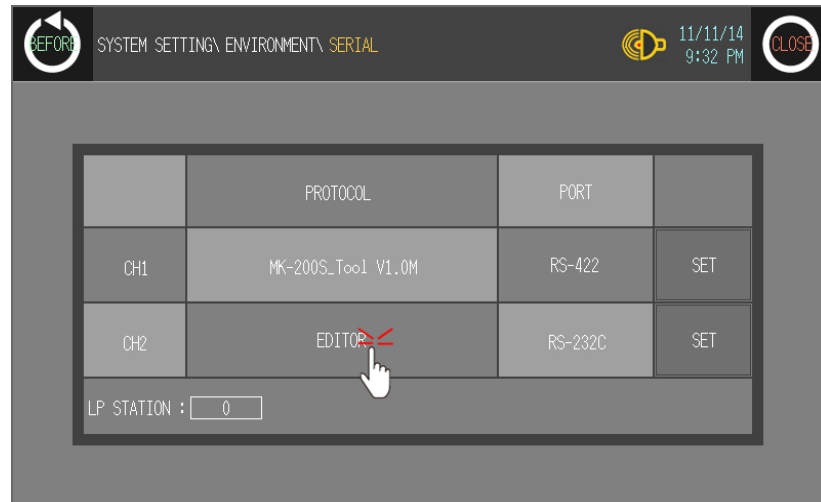

- 4th To communicate between GP/LP and LS MASTER K200 for CH1, MITSUBISHI FX2N for CH2, designate the connect port for the specific PLC and use the dedicated cable. (Refer to '4 Communication Cable By Device')

In case of LS MASTER K200 of CH1, it uses CPU module RS232 port. In case of MITSUBISHI FX2N for CH2, it uses CPU module RS232 and RS232/422 converter should be used. If two of RS232C serial interface type, connect each RS232C A, or RS232C B port.

5th Synchronize communicate specifications (baudrate, data bit, stop bit, parity, flow control) of between GP/LP and connected devices by each CH1, CH2.

The communicate specification of downloaded PLC to GP/LP is set as default of the connected PLC and communication is available directly. (Only when the communicate specification of connected PLC is set as default)

Touch 'SET' of CH1 or CH2 and detailed configuration screen is switched. Designate detailed configuration by each channel.

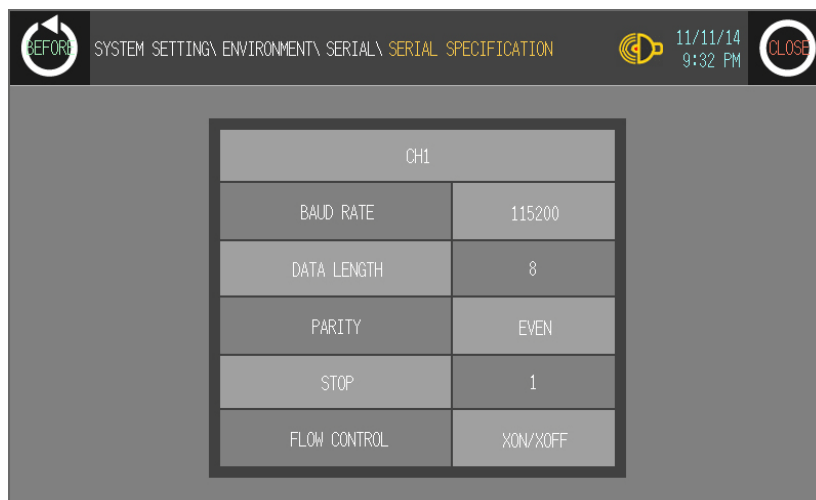
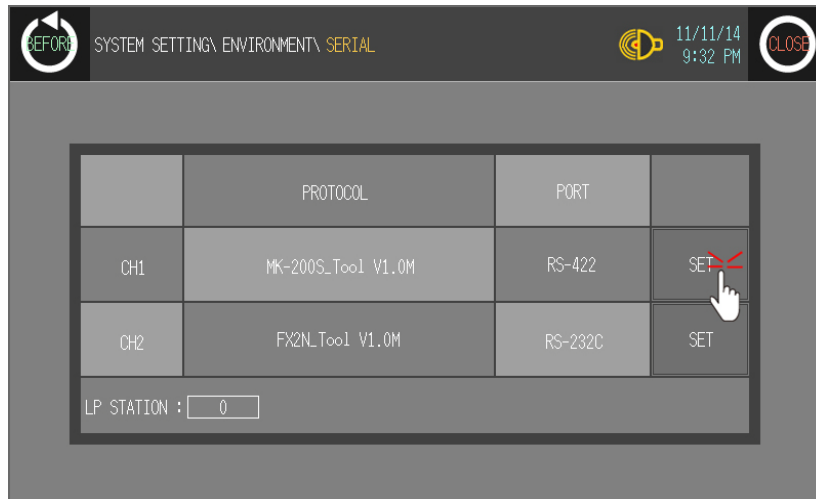

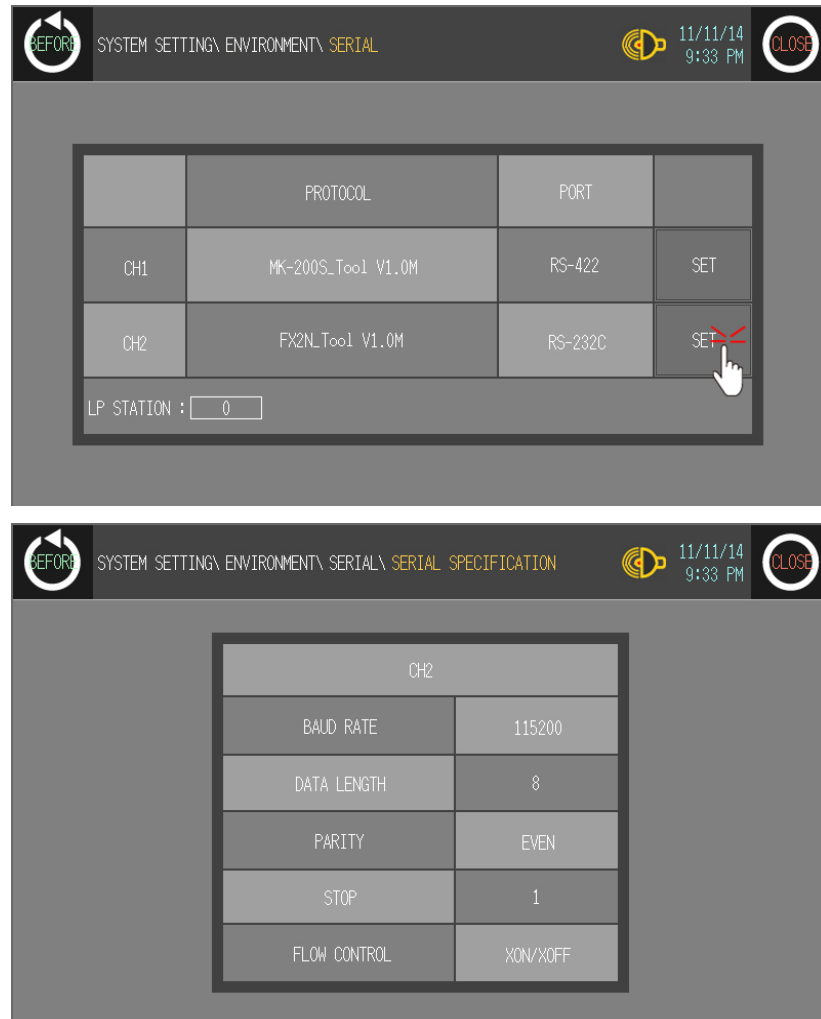

6th After completing communication configuration, you should exit system setting menu and switch user screen to communicate GP Editor with connected devices CH1(LS MASTER K200), CH2(MITSUBISHI FX2N).

Touch 'BEFORE', current setting values are saved and it returns to previous menu.

Touch 'CLOSE', current setting values are saved and it returns to user screen after exiting system setting menu.

3.5 Other communication

3.5.1 System organization

GP, LP is able to connect with barcode reader and printer to communicate, system organization is as following.

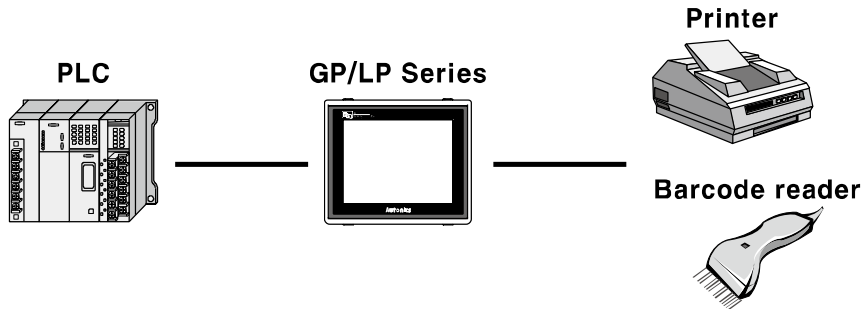

3.5.2 Barcode reader communication configuration

Basic communication for PLC↔GP/LP↔Barcode reader is by RS232C communication for barcode reader to GP/LP, by RS422 for PLC to GP/LP.

GP/LP is designed for any RS232C, RS422 communication. With RS232/422 converter, the opposite case is also available.

Download data after designating barcode setting (Select [Common]-[System Information] and [Common]-[Barcode] of menu) to GP/LP and designate barcode setting from GP/LP. For more details, refer to 'GP Editor user manual'.

The following table is for basic communication configuration of barcode.

No	Item	Description	
1	Baudrate	300,600,1200,3200,4800,9600,19200,38400,57600bps	
2	Data type	Data length	7, 8 bit
		Parity	None, Odd, Even
		Stop bit	1, 2 bit
3	Flow control	DSR/DTR, XON/XOFF	

3.5.2.1 GP Editor configuration

Download data after designating barcode setting (Select [Common]-[System Information] and [Common]-[Barcode] of menu) to GP/LP. For more details, refer to 'GP Editor user manual'.

3.5.2.2 GP, LP configuration

(1) Mono type

Before downloading drawn data from GP Editor: Synchronize communication configurations of between GP/LP and GP Editor.

1st After downloading drawn data from GP Editor, enter system setting menu.

Touch left-upper point as default position of system setting menu.



2nd Select [SET ENVIRONMENT]-[PLC SETTING].

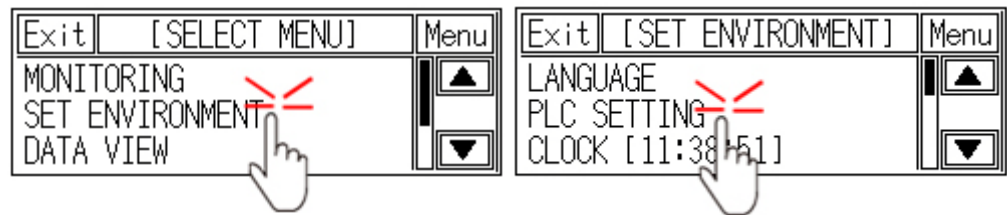

3rd CH2 protocol is set as 'EDITOR' as basic configuration.

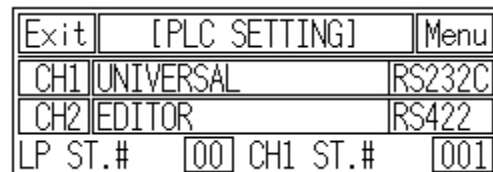

4th Touch protocol display item to set 'BARCODE' as following figure.

Protocol display rotates in order as EDITOR→PRINTER→BARCODE→MONITOR with touching.

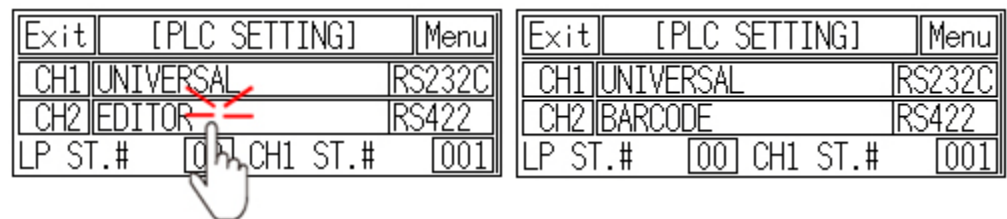

5th Designate connect port for communicating GP/LP and barcode reader. Connect port display rotates in order as RS422↔RS232C with touching.

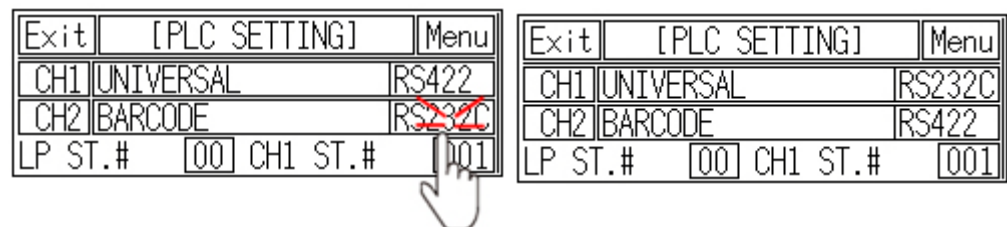

6th Synchronize communication specifications (baudrate, data bit, stop bit, parity, flow control) of between GP/LP and barcode reader.

Touch 'CH2' and detailed configuration screen is switched. Designate detailed configuration.

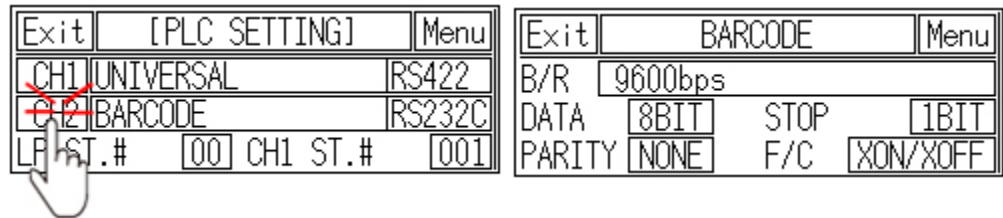

7th After completing communication configuration, you should exit system setting menu and switch user screen to communicate GP Editor with barcode reader.

Touch 'Menu', current setting values are saved and it returns to previous menu.

Touch 'Exit', current setting values are saved and it returns to user

(2) Color type

Before downloading drawn data from GP Editor: Synchronize communication configurations of between GP/LP and GP Editor.

1st After downloading drawn data from GP Editor, enter system setting menu.

Touch left-upper point as default position of system setting menu.



2nd Select [Environment]-[Serial Communication].

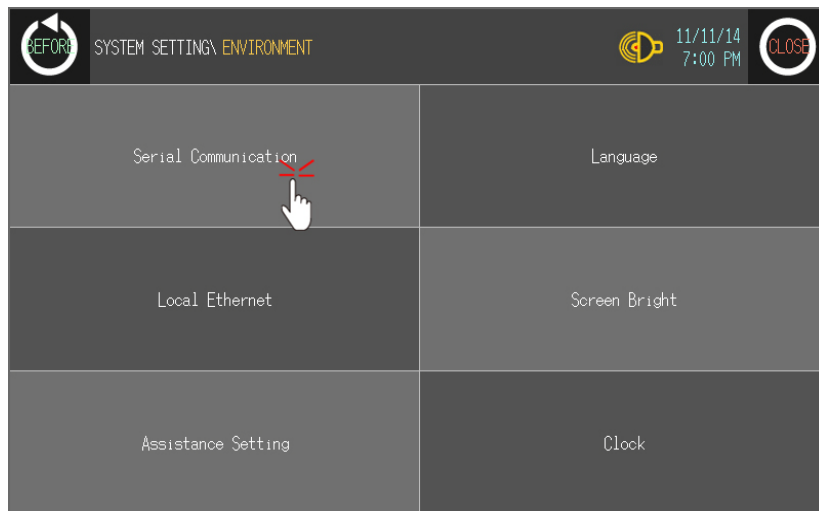

3rd CH2 protocol is set as 'EDITOR' as basic configuration.

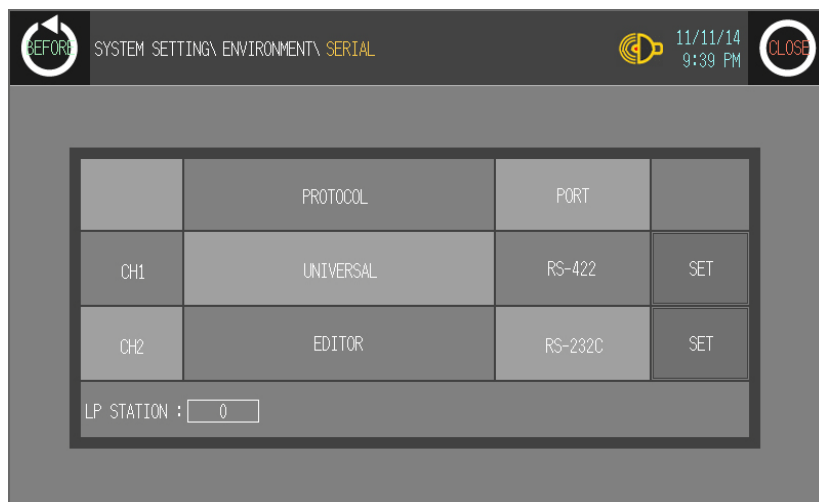

4th Touch protocol display item to set 'BARCODE' as following figure.

Protocol display rotates in order as EDITOR→PRINTER→BARCODE→MONITOR with touching.

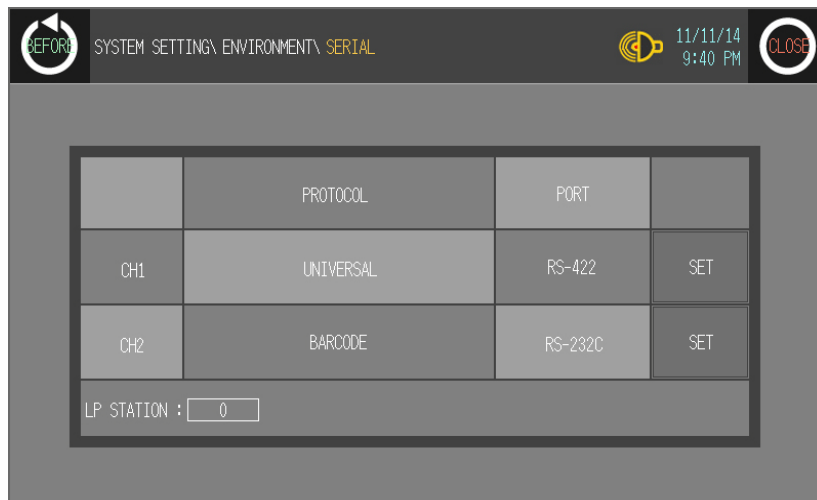
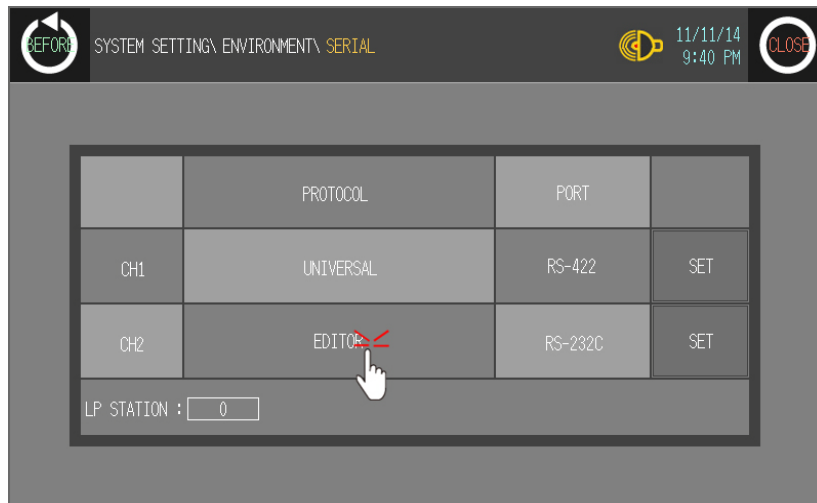

5th Designate connect port for communicating GP/LP and barcode reader. Connect port display rotates in order as RS422↔RS232C with touching.

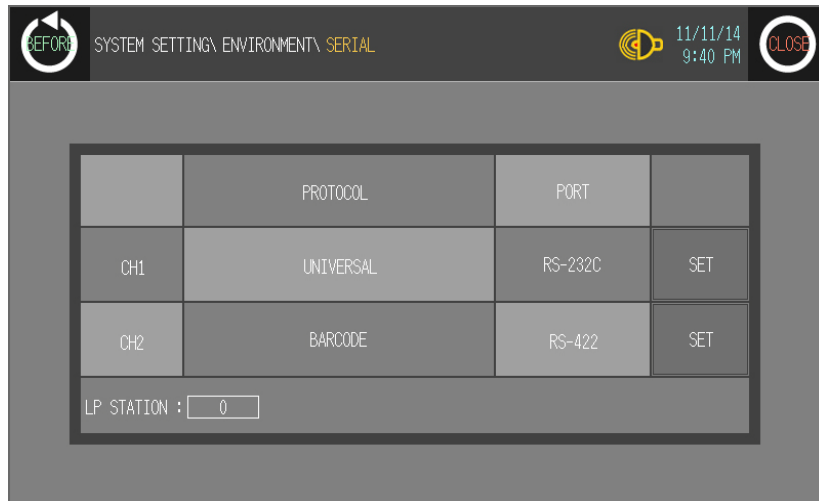
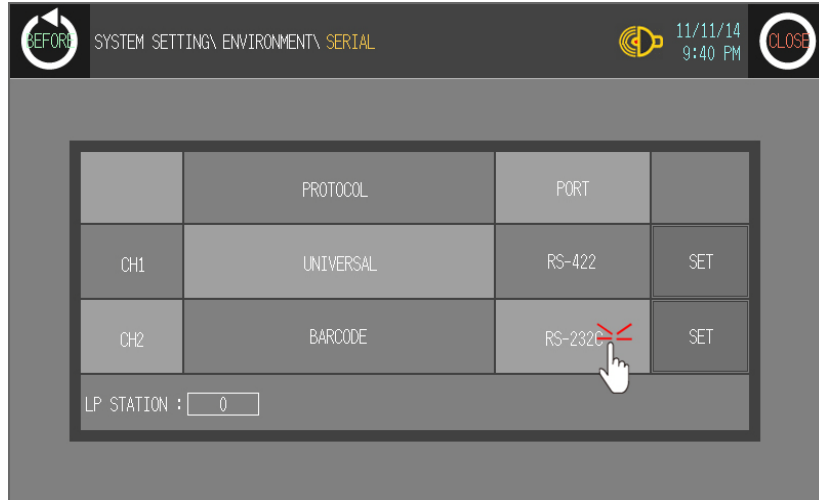

6th Synchronize communicate specifications (baudrate, data bit, stop bit, parity, flow control) of between GP/LP and barcode reader.

Touch 'SET' and detailed configuration screen is switched. Designate detailed configuration.

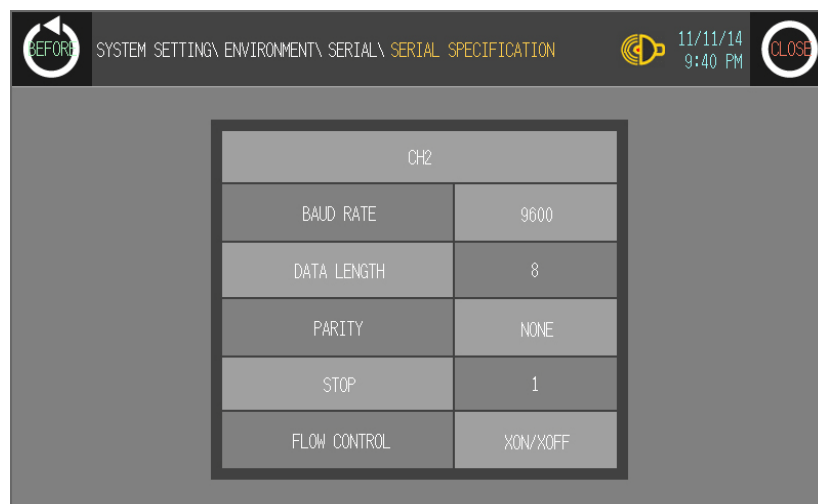
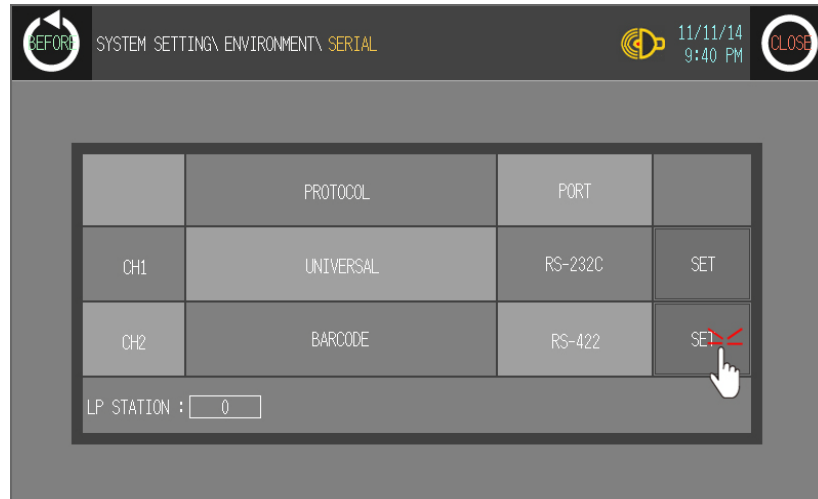

7th After completing communication configuration, you should exit system setting menu and switch user screen to communicate GP Editor with barcode reader.

Touch 'BEFORE', current setting values are saved and it returns to previous menu.

Touch 'CLOSE', current setting values are saved and it returns to user screen after exiting system setting menu.

3.5.3 PRINTER communication configuration

Basic communication for PLC ↔ GP/LP ↔ PRINTER is same as barcode reader communication's. PLC and PRINTER are available to both RS232C and RS422 communication and printer through GP/LP is able to print alarm history. The other words, if there are alarm history in downloaded data from GP Editor, and saved alarm history by communicating GP/LP and PLC, you can print out alarm history through GP/LP and printer.

3.5.3.1 GP, LP configuration for printer

Without printer configuration in GP Editor, download data and designate printer in GP/LP. The following table is for basic communication configuration of printer.

No	Item	Description	
1	Baudrate	300,600,1200,3200,4800,9600,19200,38400,57600 bps	
2	Data type	Data length	7, 8 bit
		Parity	None, Odd, Even
		Stop bit	1, 2 bit
3	Flow control	DSR/DTR, XON/XOFF	

3.5.3.2 GP, LP configuration

(1) Mono type

Before downloading drawn data from GP Editor: Synchronize communication configurations of between GP/LP and GP Editor.

1st After downloading drawn data from GP Editor, enter system setting menu.

Touch left-upper point as default position of system setting menu.



2nd Select [SET ENVIRONMENT]-[PLC SETTING].

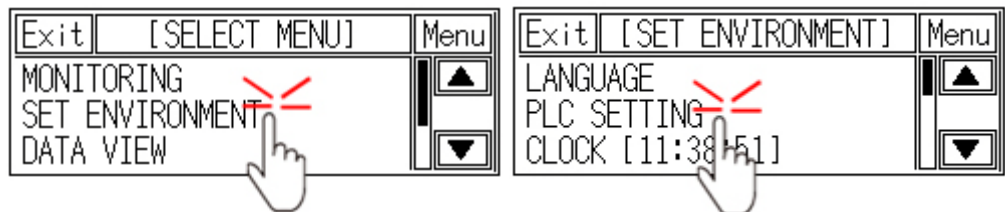

3rd CH2 protocol is set as 'EDITOR' as basic configuration.

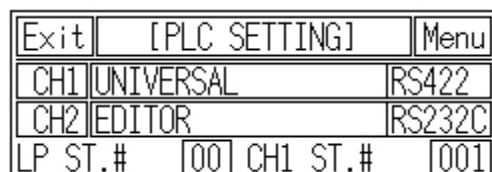

4th Touch protocol display item to set 'PRINTER' as following figure.

Protocol display rotates in order as EDITOR→PRINTER→BARCODE→MONITOR with touching.

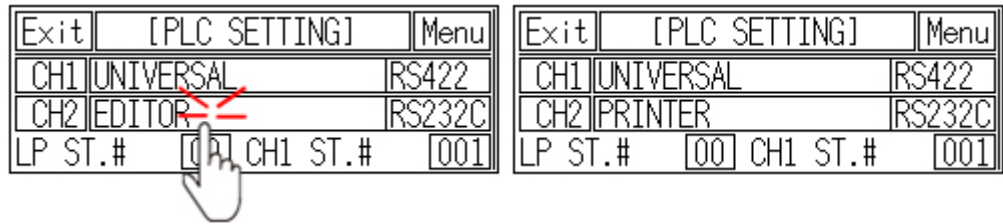

5th Designate connect port for communicating GP/LP and printer. Connect port display rotates in order as RS422↔RS232C with touching.

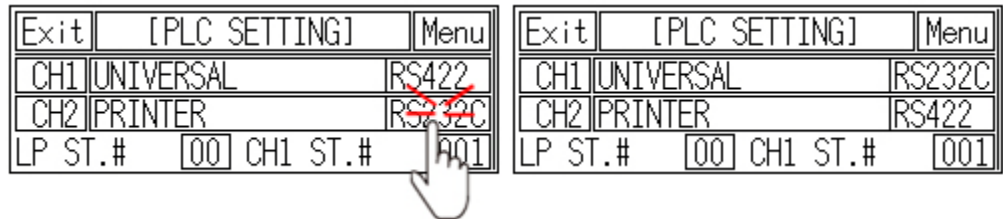

6th Synchronize communicate specifications (baudrate, data bit, stop bit, parity, flow control) of between GP/LP and printer.

Touch 'CH2' and detailed configuration screen is switched. Designate detailed configuration.

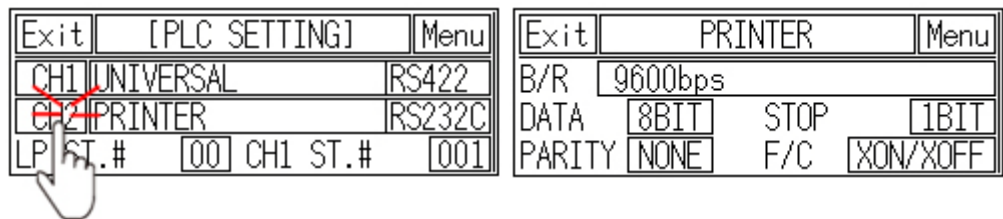

7th After completing communication configuration, you should exit system setting menu and switch user screen to communicate GP Editor.

Touch 'Menu', current setting values are saved and it returns to previous menu.

Touch 'Exit', current setting values are saved and it returns to user

(2) Color type

Before downloading drawn data from GP Editor: Synchronize communication configurations of between GP/LP and GP Editor.

1st After downloading drawn data from GP Editor, enter system setting menu.

Touch left-upper point as default position of system setting menu.

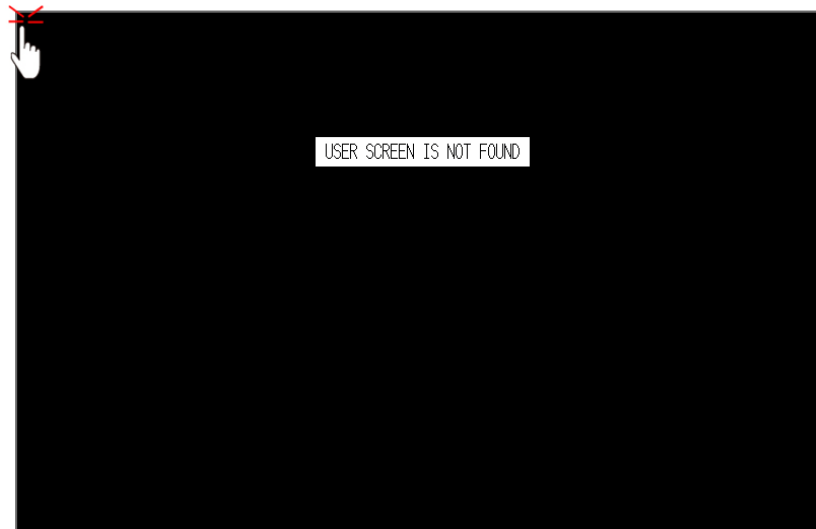

2nd Select [Environment]-[Serial Communication].

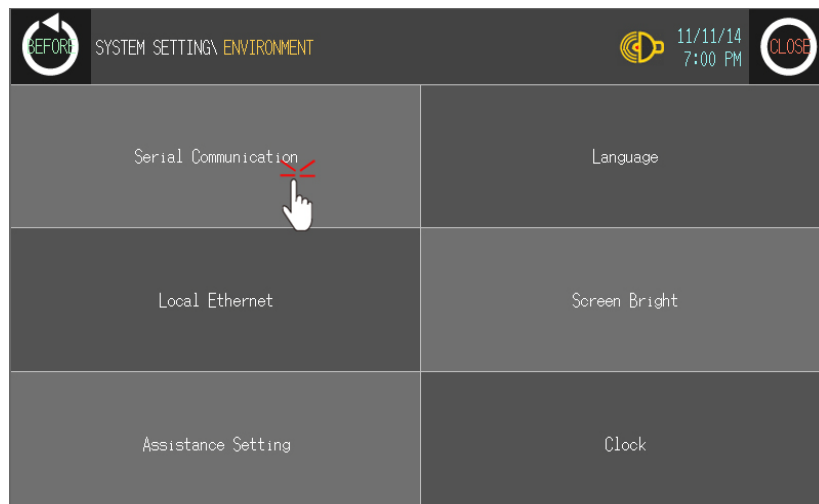

3rd CH2 protocol is set as 'EDITOR' as basic configuration.

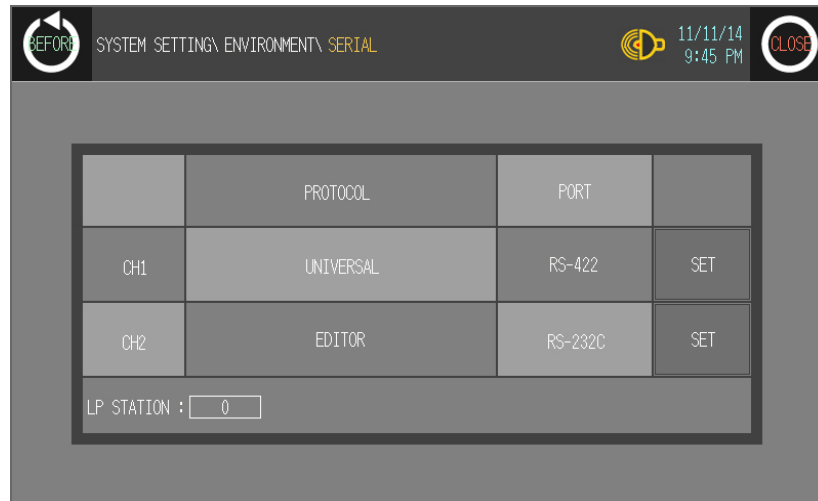

4th Touch protocol display item to set 'PRINTER' as following figure.

Protocol display rotates in order as EDITOR→PRINTER→BARCODE→MONITOR with touching.

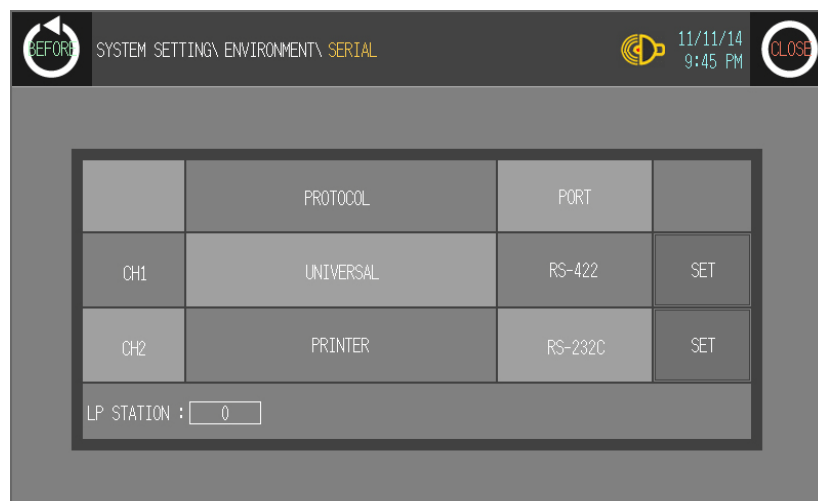
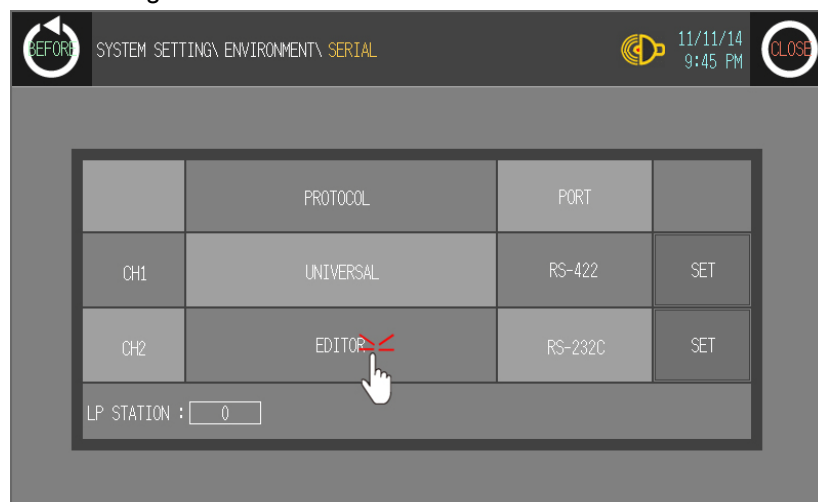

- 5th Designate connect port for communicating GP/LP and printer. Connect port display rotates in order as RS422↔RS232C with touching.

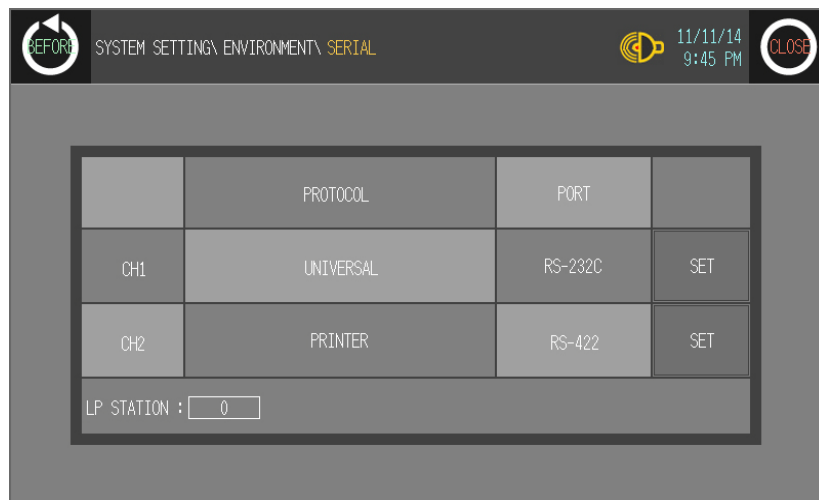
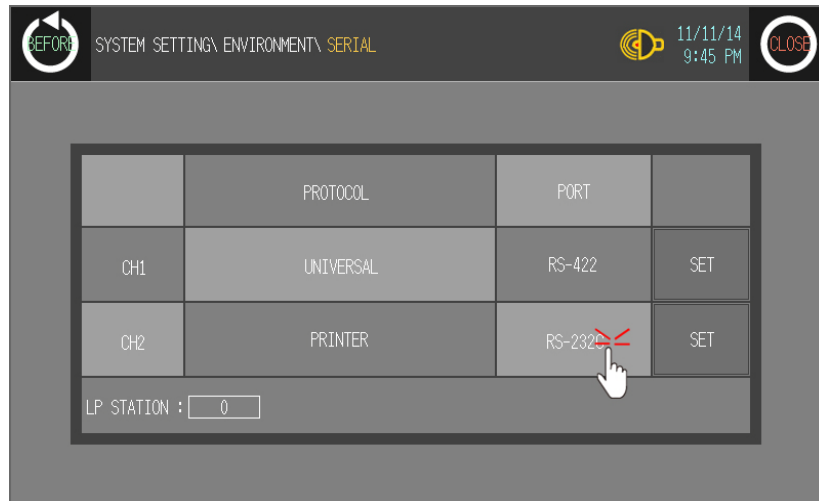

- 6th Synchronize communicate specifications (baudrate, data bit, stop bit, parity, flow control) of between GP/LP and printer.

Touch 'SET' and detailed configuration screen is switched. Designate detailed configuration.

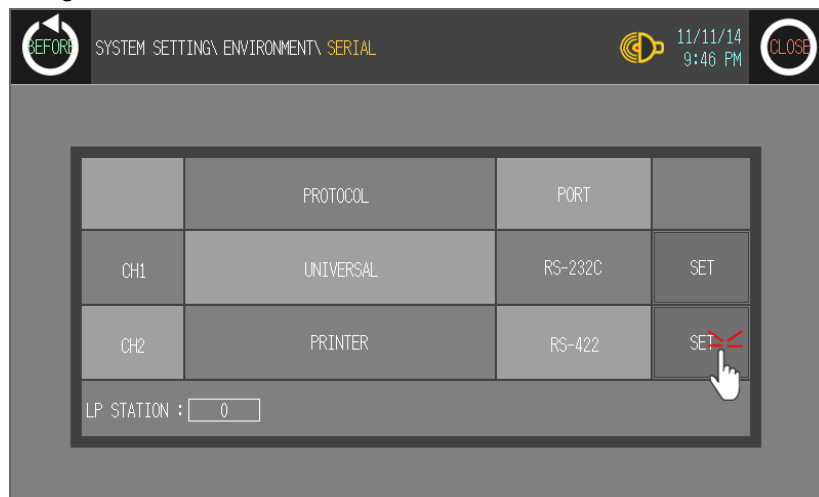

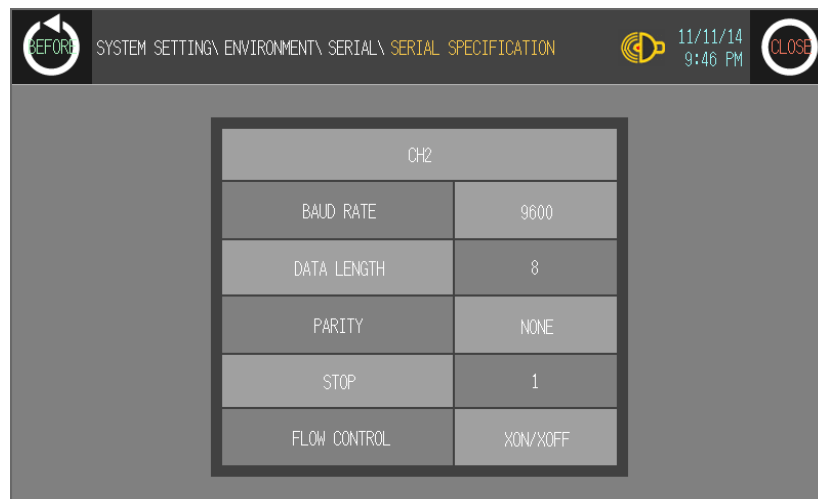

7th After completing communication configuration, you should exit system setting menu and switch user screen to communicate GP Editor.

Touch 'BEFORE', current setting values are saved and it returns to previous menu.

Touch 'CLOSE', current setting values are saved and it returns to user screen after exiting system setting menu.

3.6 System signal

3.6.1 System signal 1 (GP/LP ← PLC)

System signal 1 [UW15]															
F	E	D	C	B	A	9	8	7	6	5	4	3	2	1	0
1 Word															

It is allocated in GP/LP inner word device UW15(UB150 to UB15F).

- Bit 0 (UB150): It clears all alarm histories (history and the number of occurring time) when this bit is rising trigger of OFF→ON.
Alarm history clear function is available when the bit device of 'Erase History' in common setting of alarm history turns ON and it operated separately regardless of this bit.
- Bit 1 (UB151): After this bit is OFF→ON, backlight is turned off when set time in system environment settings is passed. When OFF this bit again or touch any part on GP/LP screen, backlight is turned ON. The setting of backlight is operated when this bit is ON, and it is not when this bit is OFF status.
- Bit 2 (UB152): This bit is able to select for user whether display error message for connection with CH1 on GP/LP screen or not. An error message is not displayed on GP/LP screen when this bit is OFF and an error message is displays when this bit is ON.
- Bit 3 (UB153): This bit is able to select for user whether display error message for connection with CH2 on GP/LP screen or not. It operates same as bit 2(UB152).
- Bit 4 (UB154): It processes data from barcode reader as invalid data when it is ON. Input is invalid.
- Bit 5 (UB155): When this bit is ON, barcode input reading is completed and barcode reader is ready to receive new data. It switches signal of barcode input data writing completion from GP, LP to PLC as OFF.
- Bit 6 (UB156)
- Bit 7 (UB157): Numeral input complete bit (bit4 of system signal2) is OFF when this bit is ON.
- Bit 8 (UB158)
- Bit 9 (UB159)
- Bit A (UB15A)
- Bit B (UB15B)
- Bit C (UB15C)
- Bit D (UB15D)
- Bit E (UB15E)
- Bit F (UB15F)

3.6.2 System signal 2 (GP/LP → PLC)

System signal 2 [UW4]															
F	E	D	C	B	A	9	8	7	6	5	4	3	2	1	0
1 Word															

It is allocated in GP, LP inner word device UW4(UB40 to UB4F).

- Bit 0 (UB40): This bit is ON while any of alarm monitor bit is ON.
- Bit 1 (UB41)
- Bit 2 (UB42)
- Bit 3 (UB43)
- Bit 4 (UB44): This bit turns ON when numeral input is completed. This bit is OFF when (bit7 of system signal 1) is ON.
- Bit 5 (UB45)
- Bit 6 (UB46)
- Bit 7 (UB47)
- Bit 8 (UB48): It turns ON when writing of barcode input data is completed from GP, LP to PLC.
- Bit 9 (UB49)
- Bit A (UB4A)
- Bit B (UB4B)
- Bit C (UB4C): It turns ON when battery voltage is low status.
- Bit D (UB4D)
- Bit E (UB4E)
- Bit F (UB4F)

3.6.3 System signal 3 (GP/LP ← PLC)

System signal 3 [UW17]															
F	E	D	C	B	A	9	8	7	6	5	4	3	2	1	0
1 Word															

It is allotted in GP, LP inner word device UW17(UB170 to UB17F).

- Bit 0 (UB170): Buzzer turns ON when this bit is changed from OFF to ON. Buzzer turns OFF when this bit is changed from ON to OFF. Buzzer turns OFF when user touches the screen, this bit maintains ON status.
- Bit 1 (UB171)
- Bit 2 (UB172)
- Bit 3 (UB173)
- Bit 4 (UB174): Backlight turns OFF when this bit is changed from OFF to ON. Backlight turns ON when this bit is changed from ON to OFF. Backlight turns ON when user touches the screen, this bit maintains ON status.
- Bit 5 (UB175): It prints alarm when this bit is changed from OFF to ON.
- Bit 6 (UB176)
- Bit 7 (UB177)
- Bit 8 (UB178)
- Bit 9 (UB179)
- Bit A (UB17A)
- Bit B (UB17B)
- Bit C (UB17C)
- Bit D (UB17D)
- Bit E (UB17E)
- Bit F (UB17F)

3.6.4 System signal 4 (GP/LP → PLC)

System signal 4 [UW5]															
F	E	D	C	B	A	9	8	7	6	5	4	3	2	1	0
1 Word															

It is allotted in GP, LP inner word device UW5 (UB50 to UB5F).

- Bit 0 (UB50): It turns ON during printing an alarm.
- Bit 1 (UB51)
- Bit 2 (UB52)
- Bit 3 (UB53)
- Bit 4 (UB54)
- Bit 5 (UB55): It turns ON when 0.5 sec of clock occurs. (Only for GP)
- Bit 6 (UB56): It turns ON when 1 sec of clock occurs. (Only for GP)
- Bit 7 (UB57): It turns ON when 2 sec of clock occurs. (Only for GP)
- Bit 8 (UB58): It turns ON when a frame error of communication port1 occurs.
- Bit 9 (UB59): It turns ON when a parity error of communication port1 occurs.
- Bit A (UB5A): It turns ON when an overrun error of communication port1 occurs.
- Bit B (UB5B)
- Bit C (UB5C): It is ON when a frame error of communication port2 occurs.
- Bit D (UB5D): It turns ON when a parity error of communication port2 occurs.
- Bit E (UB5E): It turns ON when an overrun error of communication port2 occurs.
- Bit F (UB5F)

4 Communication Cable By Device

4.1 Ordering information

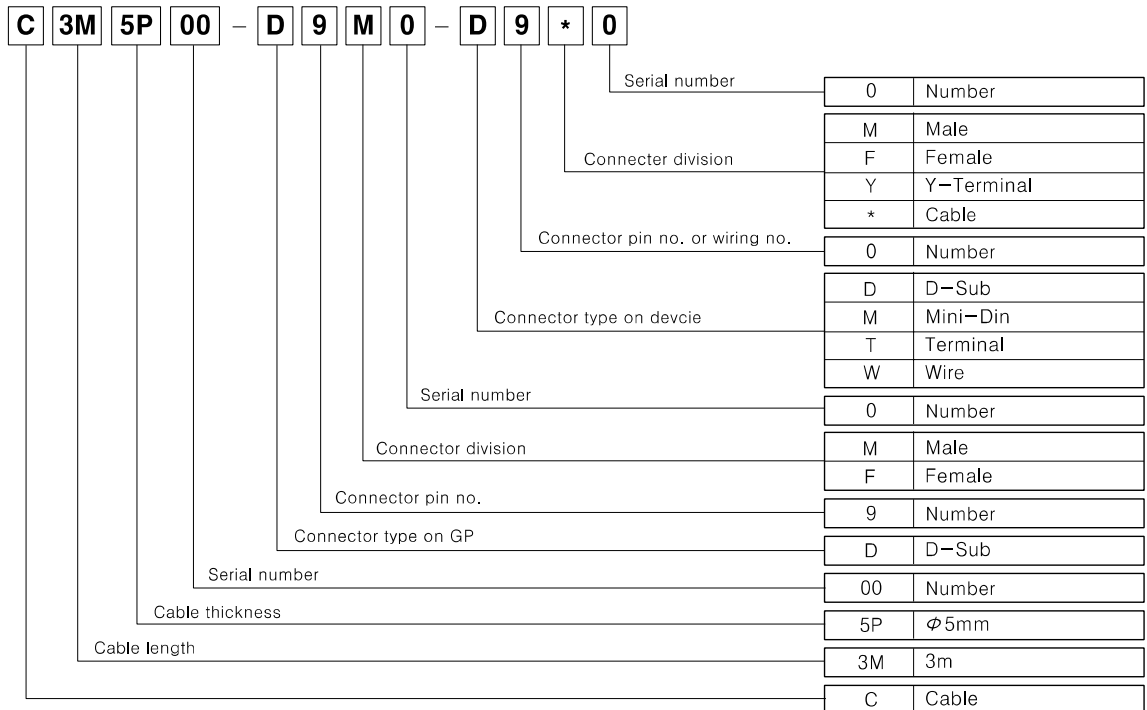

4.2 Cable wiring and dimensions

(1) C3M5P00-D9F0-M6MO

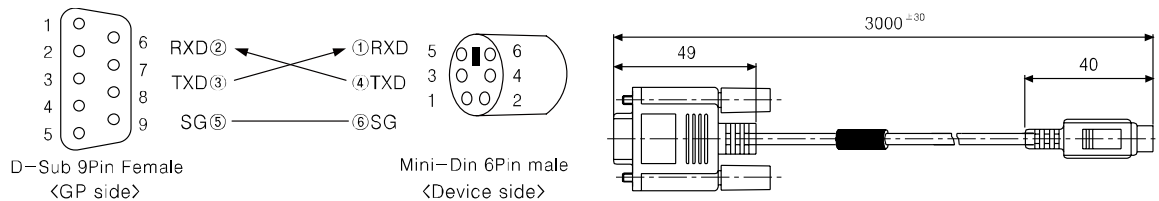

(2) C3M5P01-D9F0-D9M0

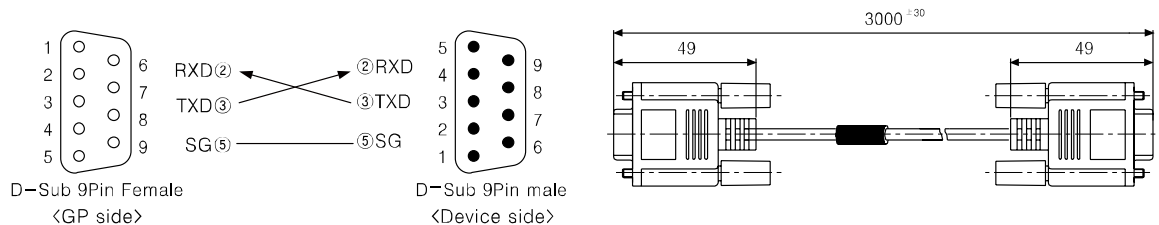

(3) C3M5P02-D9F0-D9M0

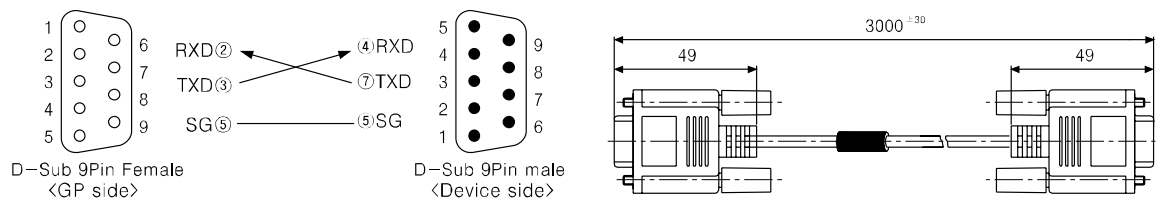

(4) C3M5P03-D9M0-W4*0

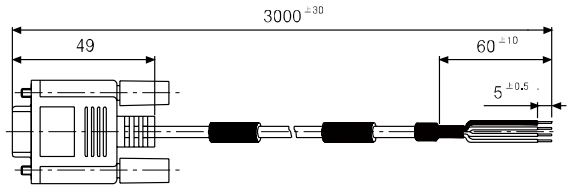
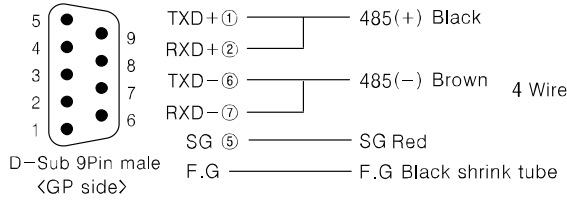

(5) C3M5P04-D9M0-W6*0

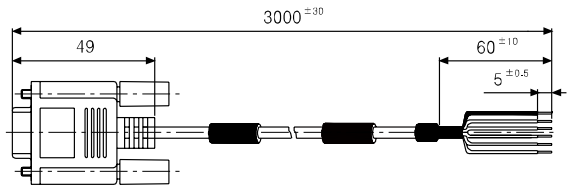
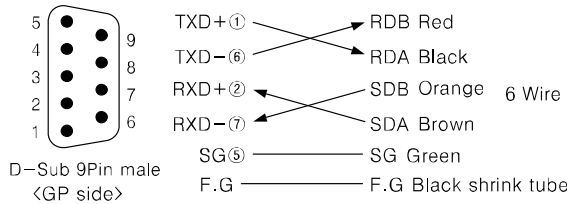

(6) C3M5P05-D9F0-D9M0

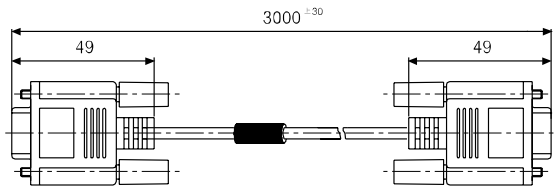
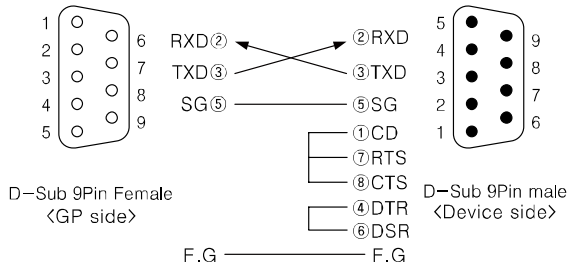

(7) C3M5P06-D9F0-D15M0

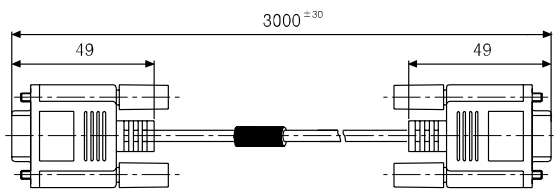
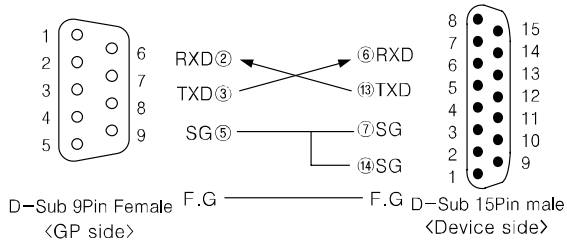

(8) C3M5P07-D9F0-D9M0

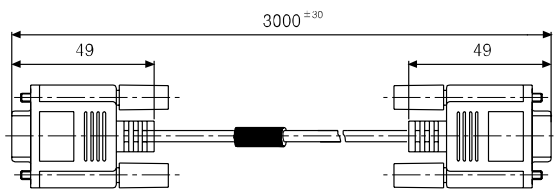

(9) C3M5P08-D9M0-M8M0

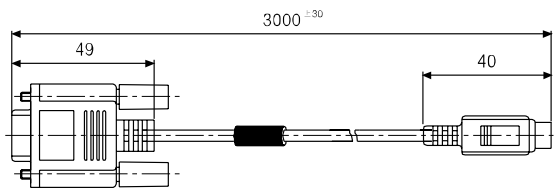
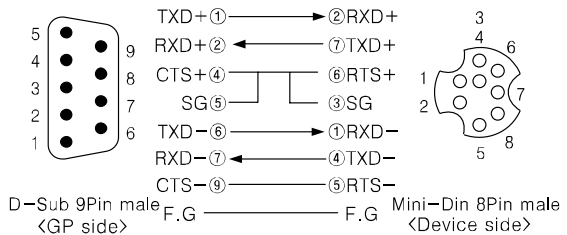

(10) C3M5P09-D9F0-D9F0

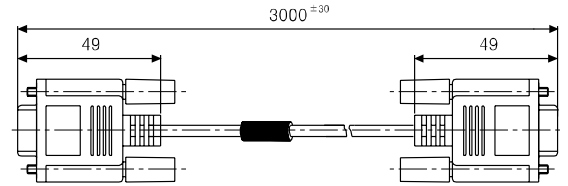
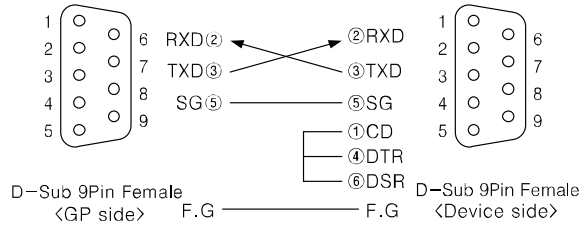

(11) C3M5P10-D9F0-M5M0

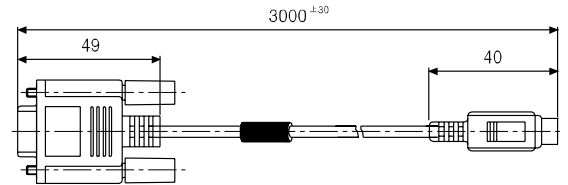
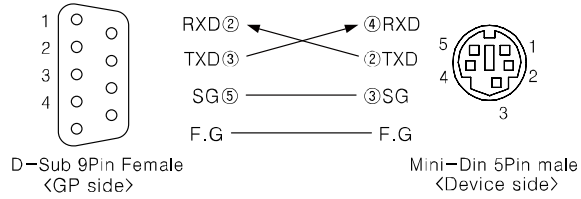

(12) C3M5P11-D9F0-W4*0

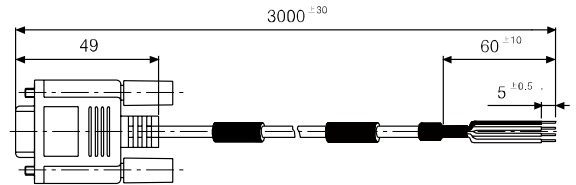
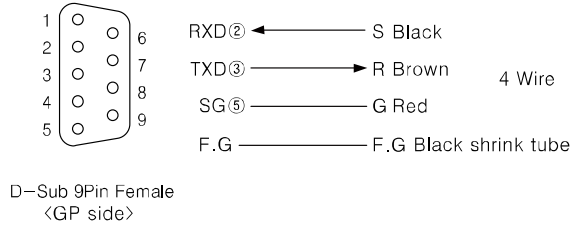

(13) C3M5P12-D9F0-D9M1

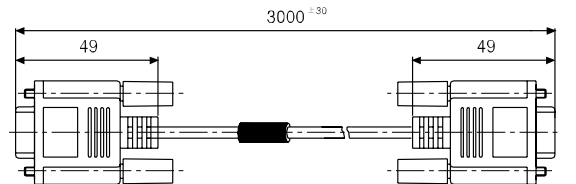
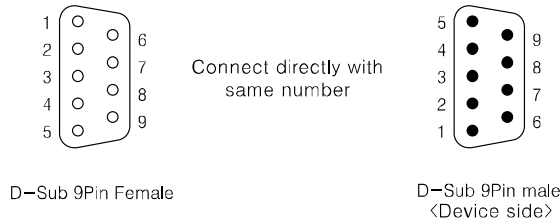

(14) C3M5P13-D9F0-T4Y0

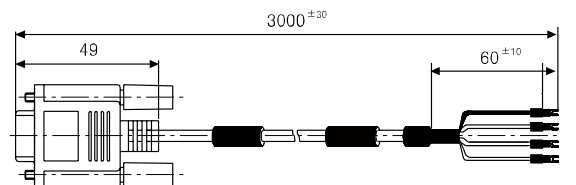
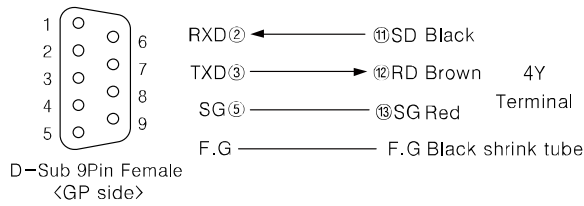

(15) C3M5P03-D9M0-T4Y0

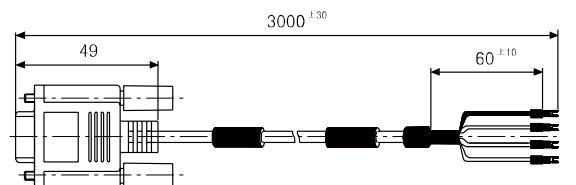
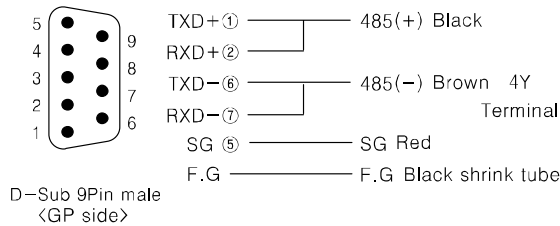

(16) C3M5P04-D9M0-T6Y0

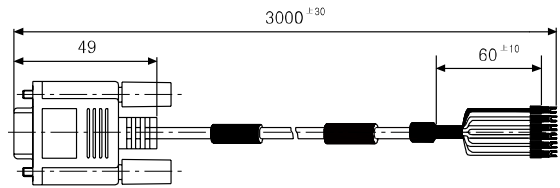
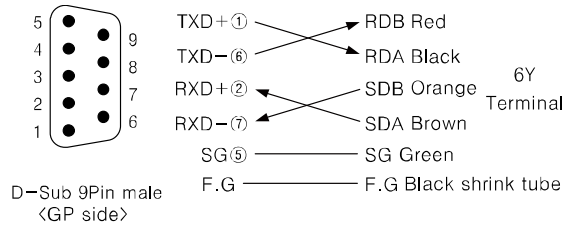

(17) C3M5P03-D9F0-D9F0

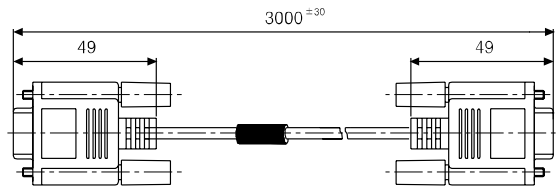
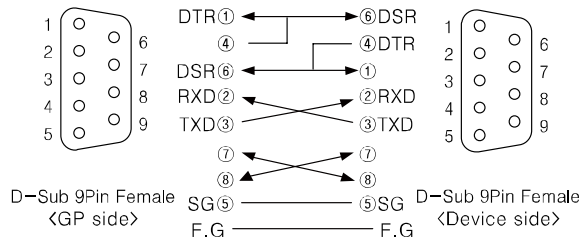

(18) C3M5P03-D9M0-D9M0

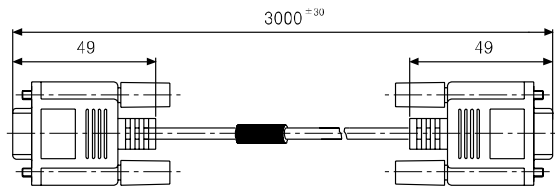
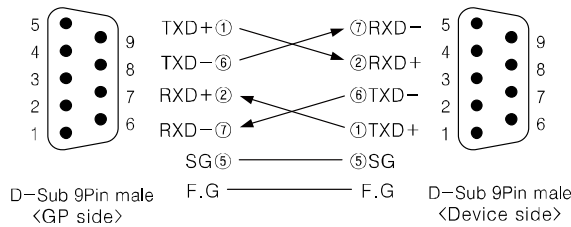

(19) C3M5P08-D9M0-M8M1

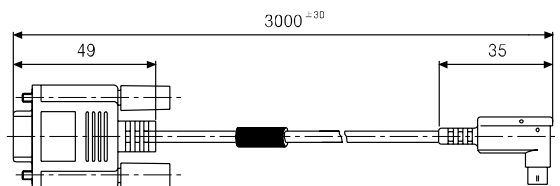
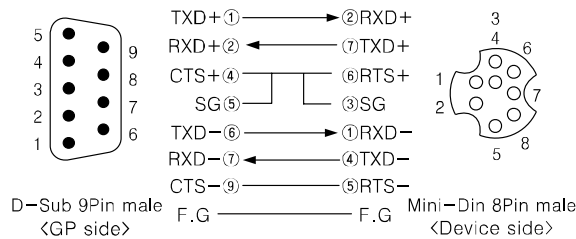

4.3 Communication cable by connectable device

Series	Connectable device	Connection module	Communication connection type	Communication cable model name	Communication cable wiring number
LS Master-K	MK-10S1	CPU	RS232C	C3M5P00-D9F0-M6M0	1
	MK-80S	CPU	RS232C	C3M5P01-D9F0-D9M0	2
	MK-120S	CPU	RS232C	C3M5P01-D9F0-D9M0	2
	MK-200S	CPU	RS232C	C3M5P01-D9F0-D9M0	2
	MK-300S	CPU	RS232C	C3M5P01-D9F0-D9M0	2
	MK-1000S	CPU	RS232C	C3M5P01-D9F0-D9M0	2
LS Glofa	GM4	CPU	RS232C	C3M5P01-D9F0-D9M0	2
	GM6	CPU	RS232C	C3M5P01-D9F0-D9M0	2
	GM7U	CPU	RS232C	C3M5P01-D9F0-D9M0	2
LS Master-K CNET	MK-80S	Cnet(G7L-CUEB)	RS232C	C3M5P05-D9F0-D9M0	6
		Cnet(G7L-CUEC)	RS422	C3M5P04-D9M0-T6Y0	16
	MK-120S	CPU	RS232C	C3M5P02-D9F0-D9M0	3
		CPU	RS485	C3M5P03-D9M0-W4*0	4
		Cnet(G7L-CUEB)	RS232C	C3M5P05-D9F0-D9M0	6
		Cnet(G7L-CUEC)	RS422	C3M5P04-D9M0-T6Y0	16
	MK-200S	CPU	RS232C	C3M5P02-D9F0-D9M0	3
		CPU	RS422	C3M5P04-D9M0-W6*0	5
		CPU	RS425	C3M5P03-D9M0-W4*0	4
		Cnet(G7L-CUEB)	RS232C	C3M5P05-D9F0-D9M0	6
		Cnet(G7L-CUEC)	RS422	C3M5P04-D9M0-T6Y0	16
	MK-300S	G4L-CUEA	RS232C	C3M5P05-D9F0-D9M0	6
			RS422	C3M5P04-D9M0-T6Y0	16
	MK-1000S	G3-CUEA	RS232C	C3M5P05-D9F0-D9M0	6
			RS422	C3M5P04-D9M0-T6Y0	16
	LS XGT CNET	XGK-CPUS	XGL-C22A	RS232C	C3M5P01-D9F0-D9M0
XGL-CH2A			RS232C	C3M5P01-D9F0-D9M0	2
			RS422	C3M5P04-D9M0-T6Y0	16
XGL-C42A			RS422	C3M5P04-D9M0-T6Y0	16
LS XGB CNET	XBM	CPU	RS232C	C3M5P11-D9F0-W4*0	12
			RS485	C3M5P03-D9M0-W4*0	4
	XBC	CPU	RS232C	C3M5P13-D9F0-T4Y0	14
			RS485	C3M5P03-D9M0-T4Y0	15

Series	Connectable device	Connection module	Communication connection type	Communication cable model name	Communication cable wiring number
OEMAX	N70	CPU	RS232C	C3M5P06-D9F0-D15M0	7
	N70Plus	CPU	RS232C	C3M5P07-D9F0-D9M0	8
OEMAX FARA	NX7	CPU	RS232C	C3M5P07-D9F0-D9M0	8
	NX70	CPU	RS232C	C3M5P07-D9F0-D9M0	8
MITSUBISHI FX	FX1S	CPU	RS422	C3M5P08-D9M0-M8M0	9
		RS232C (FX1S-232-BD)	RS232C	C3M5P09-D9F0-D9F0	10
	FX1N	CPU	RS422	C3M5P08-D9M0-M8M0	9
		RS232C (FX1N-232-BD)	RS232C	C3M5P09-D9F0-D9F0	10
	FX2NC	CPU	RS422	C3M5P08-D9M0-M8M0	9
	FX2N	CPU	RS422	C3M5P08-D9M0-M8M0	9
		RS232C module (FX2N-232-BD)	RS232C	C3M5P09-D9F0-D9F0	10
FX3U	CPU	RS422	C3M5P08-D9M0-M8M1	19	
MITSUBISHI Q	Q00J	Extension module QJ71C24N	RS232C	C3M5P05-D9F0-D9M0	6
			RS422	C3M5P04-D9M0-W6*0	5
		Extension module QJ71C24N-R2	RS232C	C3M5P05-D9F0-D9M0	6
		Extension module QJ71C24N-R4	RS422	C3M5P04-D9M0-W6*0	5
	Q00	Extension module QJ71C24N	RS232C	C3M5P05-D9F0-D9M0	6
			RS422	C3M5P04-D9M0-W6*0	5
		Extension module QJ71C24N-R2	RS232C	C3M5P05-D9F0-D9M0	6
		Extension module QJ71C24N-R4	RS422	C3M5P04-D9M0-W6*0	5
	Q01	Extension module QJ71C24N	RS232C	C3M5P05-D9F0-D9M0	6
			RS422	C3M5P04-D9M0-W6*0	5
		Extension module QJ71C24N-R2	RS232C	C3M5P05-D9F0-D9M0	6
		Extension module QJ71C24N-R4	RS422	C3M5P04-D9M0-W6*0	5
	Q02	Extension module QJ71C24N	RS232C	C3M5P05-D9F0-D9M0	6
			RS422	C3M5P04-D9M0-W6*0	5

Series	Connectable device	Connection module	Communication connection type	Communication cable model name	Communication cable wiring number
		Extension module QJ71C24N-R2	RS232C	C3M5P05-D9F0-D9M0	6
		QJ71C24N-R4	RS422	C3M5P04-D9M0-W6*0	5
	Q02H	Extension module QJ71C24N	RS232C	C3M5P05-D9F0-D9M0	6
			RS422	C3M5P04-D9M0-W6*0	5
		Extension module QJ71C24N-R2	RS232C	C3M5P05-D9F0-D9M0	6
			RS422	C3M5P04-D9M0-W6*0	5
	Q06H	Extension module QJ71C24N	RS232C	C3M5P05-D9F0-D9M0	6
			RS422	C3M5P04-D9M0-W6*0	5
		Extension module QJ71C24N-R2	RS232C	C3M5P05-D9F0-D9M0	6
			RS422	C3M5P04-D9M0-W6*0	5
	Q12H	Extension module QJ71C24N	RS232C	C3M5P05-D9F0-D9M0	6
			RS422	C3M5P04-D9M0-W6*0	5
		Extension module QJ71C24N-R2	RS232C	C3M5P05-D9F0-D9M0	6
			RS422	C3M5P04-D9M0-W6*0	5
	Q25H	Extension module QJ71C24N	RS232C	C3M5P05-D9F0-D9M0	6
			RS422	C3M5P04-D9M0-W6*0	5
Extension module QJ71C24N-R2		RS232C	C3M5P05-D9F0-D9M0	6	
		RS422	C3M5P04-D9M0-W6*0	5	
NAIS FP	FP0-C16	CPU(Tool port)	RS232C	C3M5P10-D9F0-M5M0	11
		CPU(COM port)	RS232C	C3M5P11-D9F0-W4*0	12
	FP0-C32	CPU(Tool port)	RS232C	C3M5P10-D9F0-M5M0	11
		CPU(COM port)	RS232C	C3M5P11-D9F0-W4*0	12
	FP0-T32C	CPU(Tool port)	RS232C	C3M5P10-D9F0-M5M0	11
		CPU(COM port)	RS232C	C3M5P11-D9F0-W4*0	12
	FPG-C24R2	CPU(Tool port)	RS232C	C3M5P10-D9F0-M5M0	11

Series	Connectable device	Connection module	Communication connection type	Communication cable model name	Communication cable wiring number
	FPG-C32T	CPU(COM port)	RS232C	C3M5P11-D9F0-W4*0	12
		CPU(Tool port)	RS232C	C3M5P10-D9F0-M5M0	11
	FPG-C32T2	CPU(COM port)	RS232C	C3M5P11-D9F0-W4*0	12
		CPU(Tool port)	RS232C	C3M5P10-D9F0-M5M0	11
	FP0R-C10	CPU(Tool port)	RS232C	C3M5P10-D9F0-M5M0	11
		CPU (COM port)	RS232C	C3M5P11-D9F0-W4*0	12
	FP0R-C14	CPU(Tool port)	RS232C	C3M5P10-D9F0-M5M0	11
		CPU (COM port)	RS232C	C3M5P11-D9F0-W4*0	12
	FP0R-C16	CPU(Tool port)	RS232C	C3M5P10-D9F0-M5M0	11
		CPU(COM port)	RS232C	C3M5P11-D9F0-W4*0	12
	FP0R-C32	CPU(Tool port)	RS232C	C3M5P10-D9F0-M5M0	11
		CPU(COM port)	RS232C	C3M5P11-D9F0-W4*0	12
	FP0R-T32	CPU(Tool port)	RS232C	C3M5P10-D9F0-M5M0	11
		CPU(COM port)	RS232C	C3M5P11-D9F0-W4*0	12
	FP0R-F32	CPU(Tool port)	RS232C	C3M5P10-D9F0-M5M0	11
		CPU(COM port)	RS232C	C3M5P11-D9F0-W4*0	12
SIEMENS SIMATIC S7-200	CPU221	CPU	PPI	Dedicated cable for SIEMENS	-
	CPU222	CPU	PPI	Dedicated cable for SIEMENS	-
	CPU224	CPU	PPI	Dedicated cable for SIEMENS	-
	CPU224XP	CPU	PPI	Dedicated cable for SIEMENS	-
	CPU224XPsi	CPU	PPI	Dedicated cable for SIEMENS	-
	CPU226	CPU	PPI	Dedicated cable for SIEMENS	-
SIEMENS SIMATIC S7-300	CPU312	CPU	MPI	Dedicated cable for SIEMENS	-
	CPU312C	CPU	MPI	Dedicated cable for SIEMENS	-
	CPU313C	CPU	MPI	Dedicated cable for SIEMENS	-
	CPU313C-2	CPU	MPI	Dedicated cable for SIEMENS	-
	CPU314	CPU	MPI	Dedicated cable for SIEMENS	-
	CPU314C-2	CPU	MPI	Dedicated cable for SIEMENS	-
	CPU315-2	CPU	MPI	Dedicated cable for SIEMENS	-
	CPU317-2	CPU	MPI	Dedicated cable for SIEMENS	-
	CPU319-3	CPU	MPI	Dedicated cable for SIEMENS	-
Allen-Bradley	MicroLogix 1000	CPU	RS232C	Dedicated cable for Allen-Bradley	-

Series	Connectable device	Connection module	Communication connection type	Communication cable model name	Communication cable wiring number
	MicroLogix 1200	CPU	RS232C	Dedicated cable for Allen-Bradley	-
OMRON SYSMAC C	CPM1A	CPU	RS232C	For communicating GP, CQM1-CIF02 of OMRON	-
				For extension cable, C3M5P12-D9F0-D9M1	13
OMRON temperature controller	E5AN	Modbus	RS232C	C3M5P13-D9F0-T4Y0	14
			RS485	C3M5P03-D9M0-T4Y0	15
	E5AR	Modbus	RS485	C3M5P03-D9M0-T4Y0	15
	E5CN	Modbus	RS485	C3M5P03-D9M0-T4Y0	15
	E5EN	Modbus	RS232C	C3M5P13-D9F0-T4Y0	14
			RS485	C3M5P03-D9M0-T4Y0	15
	E5ER	Modbus	RS485	C3M5P03-D9M0-T4Y0	15
AUTONICS	MT series	Dedicated communication, Modbus	RS485	C3M5P03-D9M0-W4*0	4
	MP seires	Dedicated communication	RS485	C3M5P03-D9M0-W4*0	4
	THD seires	Modbus	RS485	C3M5P03-D9M0-W4*0	4
	TZ series	Dedicated communication	RS485	C3M5P14-D9M0-T4Y0	15
	TK series	Modbus	RS485	C3M5P14-D9M0-T4Y0	15
	TM series	Modbus	RS485	C3M5P14-D9M0-T4Y0	15
	CT series	Modbus	RS485	C3M5P14-D9M0-T4Y0	15
	DS/DA Series	Modbus	RS485	C3M5P03-D9M0-W4*0	4
	Remote I/O ARM Series	Modbus	RS485	C3M5P03-D9M0-W4*0	4
	LP-S044	CPU	RS232C	C3M5P16-D9F0-D9F0	17
			RS422	C3M5P17-D9M0-D9M0	18
KONICS	DPU series	Modbus	RS485	C3M5P03-D9M0-W4*0	4
	KRN50	Modbus	RS485	C3M5P03-D9M0-W4*0	4
DELTA	DTB series	Modbus	RS-483	C3M5P03-D9M0-T4Y0	15
DANFOS	FC 200	Modbus	RS-485	C3M5P03-D9M0-T4Y0	15
GP firmware download cable	COMPUTER	-	RS232C	C3M5P14-D9F0-D9F0	17

5 Universal (General-purpose communication)

Universal indicates general purpose of communication, Modbus Slave communication is supported in GP/LP.

5.1 System organization

Microcomputer using as host unit is able to execute slave communicate with GP/LP through RS-232C or RS-422(RS-485) communication port. Host unit read and write inner register(UB, UW) of GP/LP as communication commander. Host unit as master transmits command to GP/LP and GP/LP as slave executes designated operation according to transmitted command and sends respond message.

The following is the system organization for connecting with GP/LP and host unit.

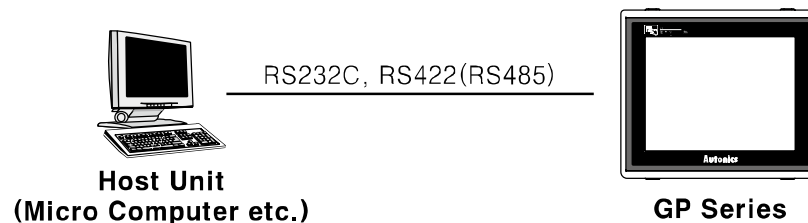

※For connect cable information, refer to '1.3 Communication'.

The following table is for basic communication configuration of host unit.

No	Item	Description	Note	
1	Communication mode	RTU	Not used	
2	Baudrate	38400 bps	Fixed	
3	Data type	Data length	8 bit	Fixed
		Parity	None	Fixed
		Stop bit	1 bit	Fixed
4	Station	0 to 31	Designate this in GP/LP	

5.2 Universal 1:1 communication

Universal 1:1 indicates communication between one host unit and one GP/LP to monitor GP/LP status.(It is able to extend.)

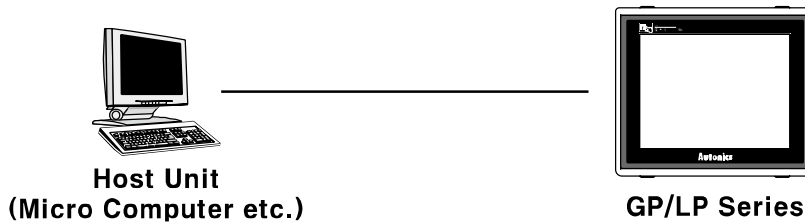

5.2.1 GP Editor configuration

Universal communication is available only by CH1.

1st Designate GP/LP and PLC type.

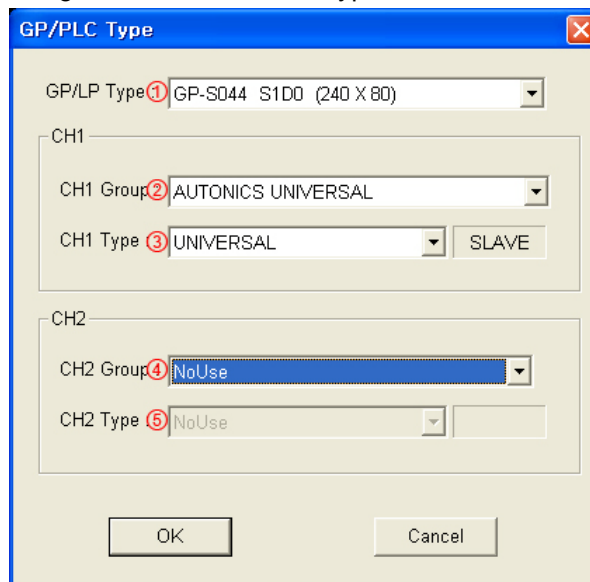

Item	Description
① GP/LP Type	Designate GP/LP model type by pull-down menu.
② CH1 Group	Designate PLC group of CH1 by pull-down menu.
③ CH1 Type	Designate PLC type of CH1 for ② by pull-down menu.
④ CH2 Group	Designate PLC group of CH2 by pull-down menu.
⑤ CH2 Type	Designate PLC type of CH2 for ④ by pull-down menu.

2nd Select [Communication]-[Download] of menu and download data.



Note

UNIVERSAL communication is executed by configuration of GP/LP download after additional configuration in EDITOR, because "UNIVERSAL" is saved in GP/LP.

5.2.2 GP, LP configuration

5.2.2.1 Mono type

You should designate CH1 protocol as 'UNIVERSAL' and set communication configuration for CH1 in GP/LP.

1st Enter system setting menu.

Touch left-upper point as default position of system setting menu.



2nd Select [SET ENVIRONMENT]-[PLC SETTING].

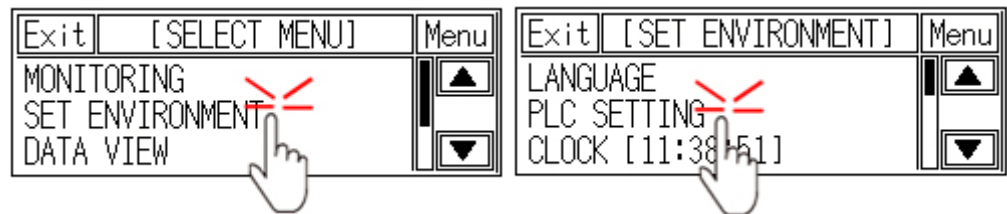

3rd CH1 protocol is set as 'UNIVERSAL' and CH1 connection port is set as 'RS422' as default.

Exit	[PLC SETTING]	Menu
CH1	UNIVERSAL	RS422
CH2	EDITOR	RS232C
LP ST.#	[00]	CH1 ST.# [001]

4th If it is not configured as 'UNIVERSAL' for CH1 protocol, touch protocol display item to set 'UNIVERSAL' as following figure.

Protocol display rotates in order as UNIVERSAL→MK-200S(CPU)→No Use→PRINTER→BARCODE with touching.

Exit	[PLC SETTING]	Menu
CH1	MK-200S(CPU)	RS422
CH2	EDITOR	RS232C
LP ST.#	[00]	CH1 ST.# [001]

Exit	[PLC SETTING]	Menu
CH1	UNIVERSAL	RS422
CH2	EDITOR	RS232C
LP ST.#	[00]	CH1 ST.# [001]

5th Synchronize CH1 connect port display item with touching.

Exit	[PLC SETTING]	Menu
CH1	UNIVERSAL	RS422
CH2	EDITOR	RS232C
LP ST.#	[00]	CH1 ST.# [001]

Exit	[PLC SETTING]	Menu
CH1	UNIVERSAL	RS232C
CH2	EDITOR	RS422
LP ST.#	[00]	CH1 ST.# [001]

6th Synchronize the station of between GP/LP and host unit.

Touch CH1 station item and input key pad appears. Enter the same station and setting range is 0 to 31.

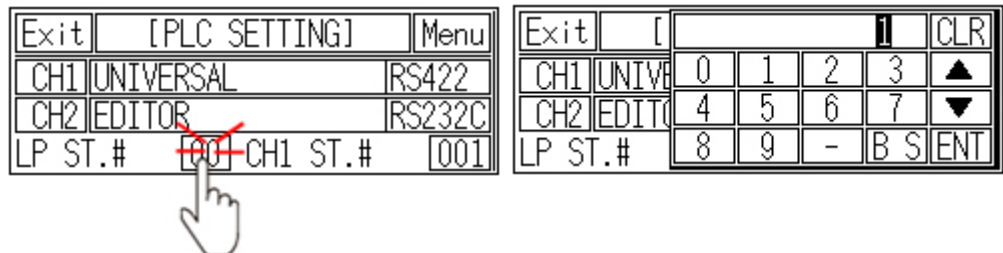

7th After completing communication configuration, you should exit system setting menu and switch user screen to communicate GP Editor with host unit.

Touch 'Menu', current setting values are saved and it returns to previous menu.

Touch 'Exit', current setting values are saved and it returns to user screen.

5.2.2.2 Color type

You should designate CH1 protocol as 'UNIVERSAL' and set communication configuration for CH1 in GP/LP.

1st Enter system setting menu.

Touch left-upper point as default position of system setting menu.



2nd Select [Environment]-[Serial Communication].

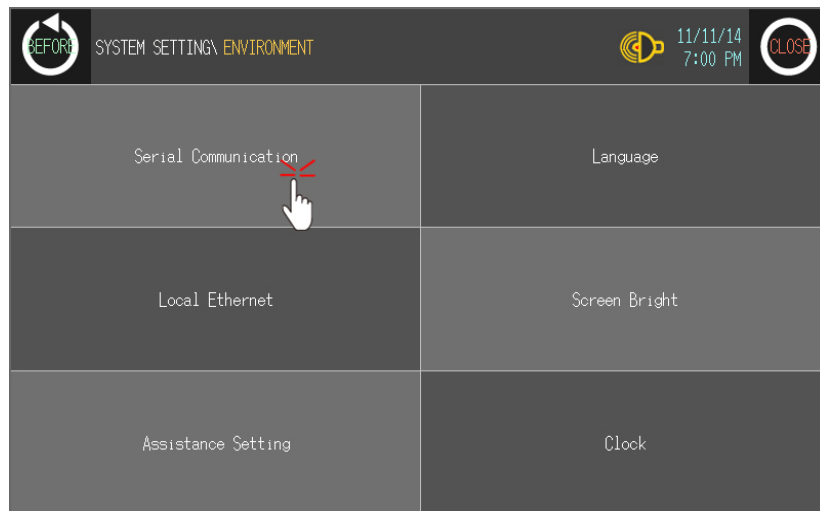

3rd CH1 protocol is set as 'UNIVERSAL' and CH1 connection port is set as 'RS422' as default.

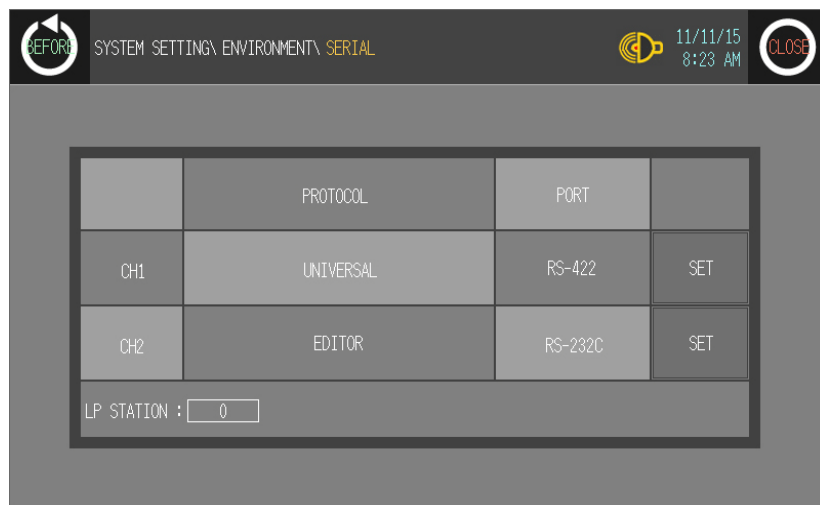

4th If it is not configured as 'UNIVERSAL' for CH1 protocol, touch protocol display item to set 'UNIVERSAL' as following figure.

Protocol display rotates in order as UNIVERSAL→MK-200S(CPU)→No Use→
PRINTER→BARCODE with touching.

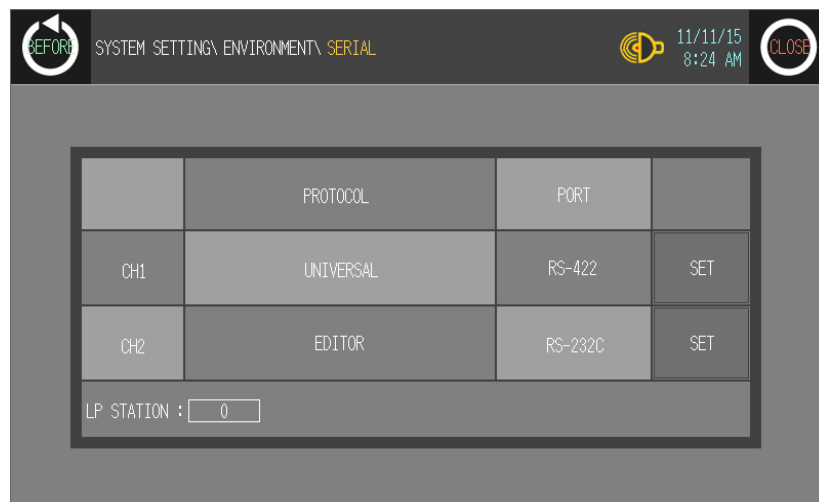
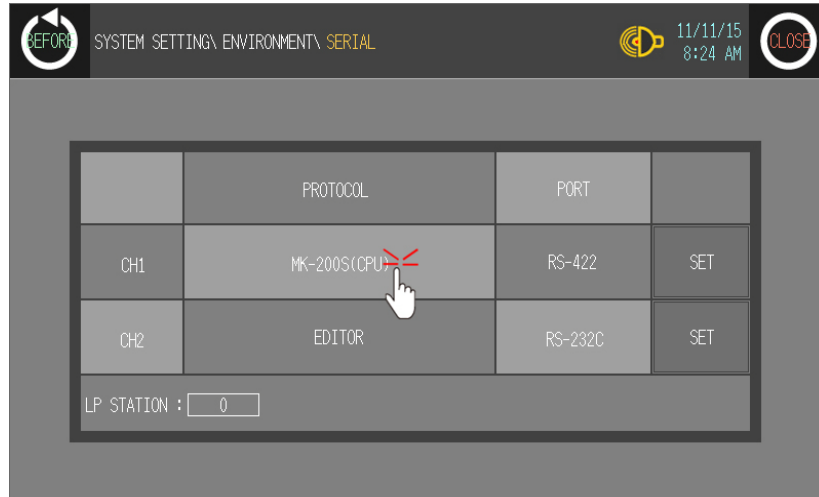

5th Synchronize CH1 connect port display item with touching.

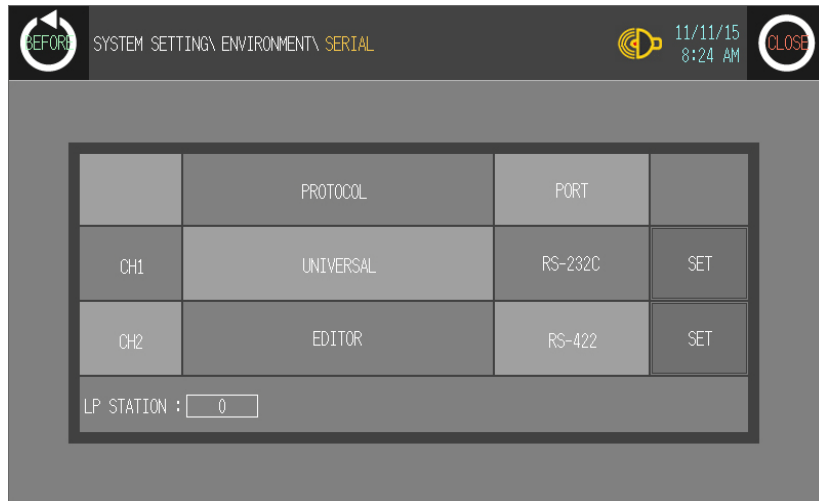
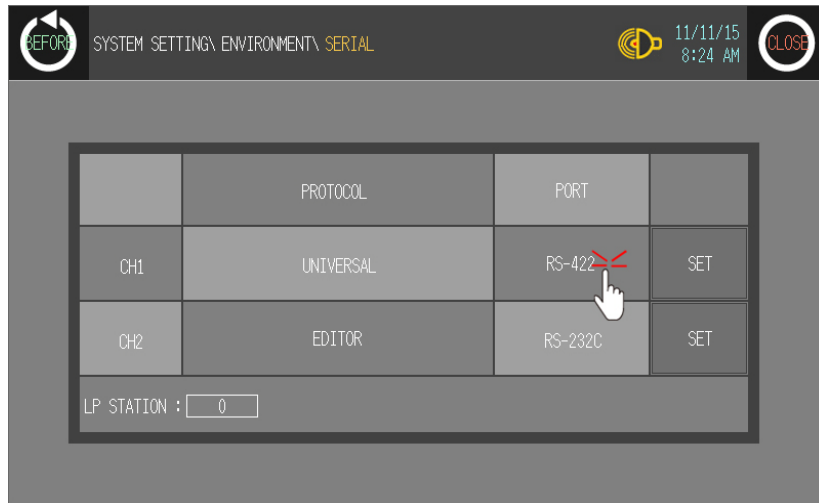

6th Synchronize the station of between GP/LP and host unit.

Touch the station item and input key pad appears. Enter the same station and setting range is 0 to 31.

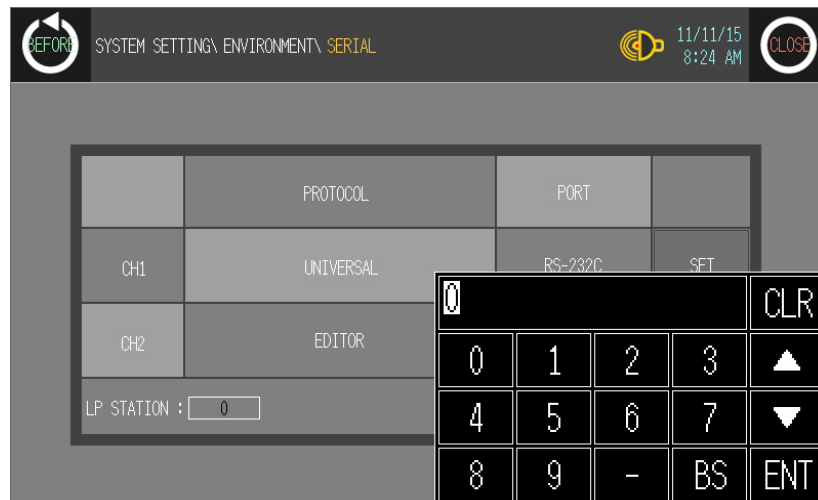
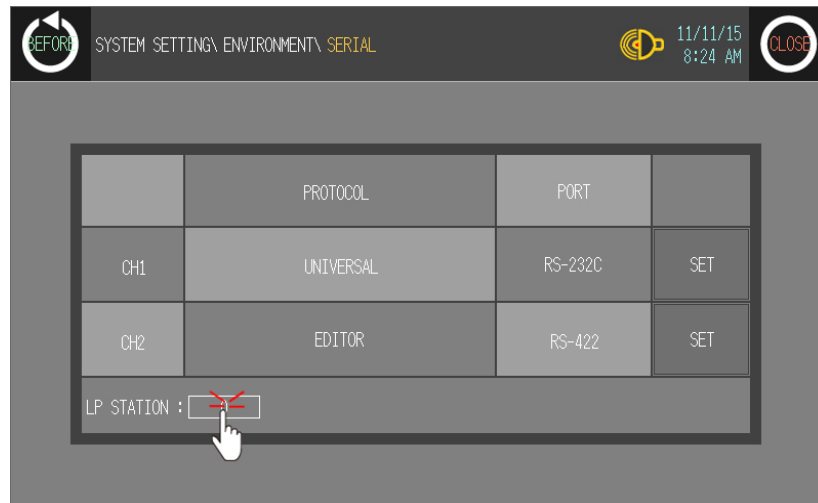

7th After completing communication configuration, you should exit system setting menu and switch user screen to communicate GP Editor with host unit.

Touch 'BEFORE', current setting values are saved and it returns to previous menu.

Touch 'CLOSE', current setting values are saved and it returns to user screen.

5.3 Universal 1:1:1 communication

Universal 1:1:1 indicates communication between one host unit, one GP/LP and one PLC which is connected to GP/LP.

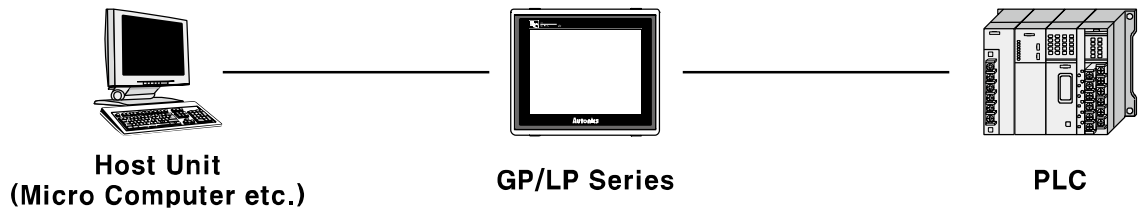

5.3.1 GP Editor configuration

When CH1 group is set as 'AUTONICS UNIVERSAL', CH1 type is set automatically as 'UNIVERSAL'. At CH2 configuration, designate PLC group and type to be connected to GP/LP.

1st Designate GP/LP and PLC type.

The screenshot shows the 'GP/PLC Type' dialog box. It contains the following fields and options:

- GP/LP Type: GP-S044 S1D0 (240 X 80)
- CH1 Group: AUTONICS UNIVERSAL
- CH1 Type: UNIVERSAL (with a 'SLAVE' button)
- CH2 Group: LS MASTER-K SERIES
- CH2 Type: MK-200S_Tool (with a 'MASTER' button)

Buttons for 'OK' and 'Cancel' are at the bottom.

Item	Description
① GP/LP Type	Designate GP/LP model type by pull-down menu.
② CH1 Group	Designate PLC group of CH1 by pull-down menu. In this chapter, it is set as 'AUTONICS UNIVERSAL'.
③ CH1 Type	Designate PLC type of CH1 for ② by pull-down menu. When ② CH1 Group is set as 'AUTONICS UNIVERSAL', it is set automatically as 'UNIVERSAL'.
④ CH2 Group	Designate PLC group of CH2 by pull-down menu.
⑤ CH2 Type	Designate PLC type of CH2 for ④ by pull-down menu.

2nd Draw PLC data to communicate with CH2.

CH2 designates communicating PLC with designated data register by link device.
(For more details, refer to 'GP Editor user manual'.)

3rd Select [Communication]-[Download] of menu and download drawn data to GP/LP.

 **Note**

Do not designate GP connect device and link device setting of CH1.
 In this communication, GP/LP is as master and host unit is as slave. Therefore it is not able to communicate between GP/LP and host unit.

5.3.2 GP, LP configuration

5.3.2.1 Mono type

1st Enter system setting menu.

Touch left-upper point as default position of system setting menu.



2nd Select [SET ENVIRONMENT]-[PLC SETTING].

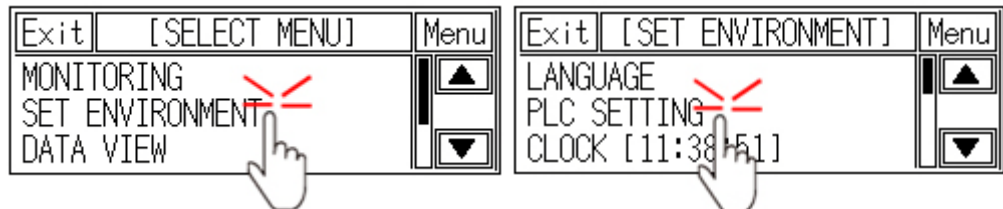

3rd CH1 protocol is set as 'UNIVERSAL' and CH1 connection port is set as 'RS422' as default.

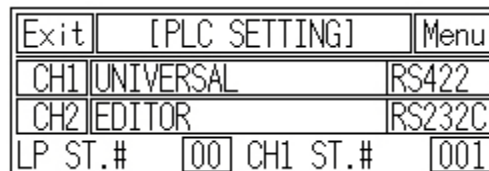

4th If it is not configured as 'UNIVERSAL' for CH1 protocol, touch protocol display item to set 'UNIVERSAL' as following figure.

Protocol display rotates in order as UNIVERSAL→MK-200S(CPU)→No Use→
 PRINTER→BARCODE with touching.

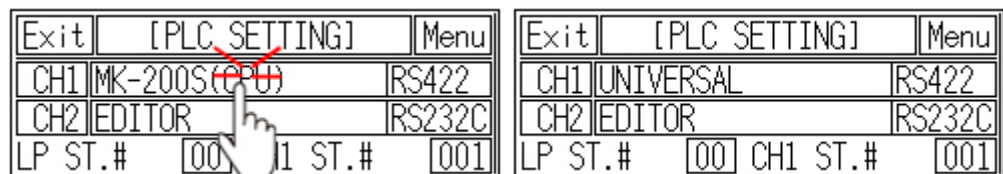

5th Touch protocol display item of CH2 to set 'MK-200S' as following figure.

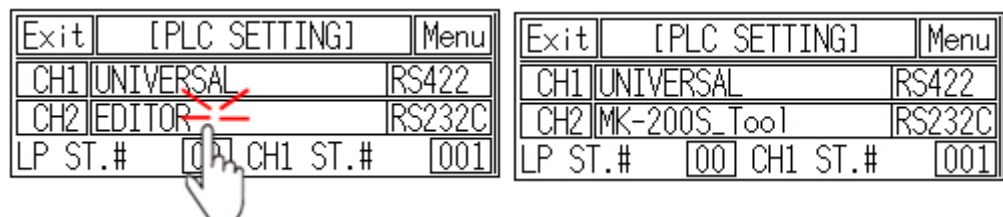

6th Synchronize CH1 and CH2 connect port display item with touching.

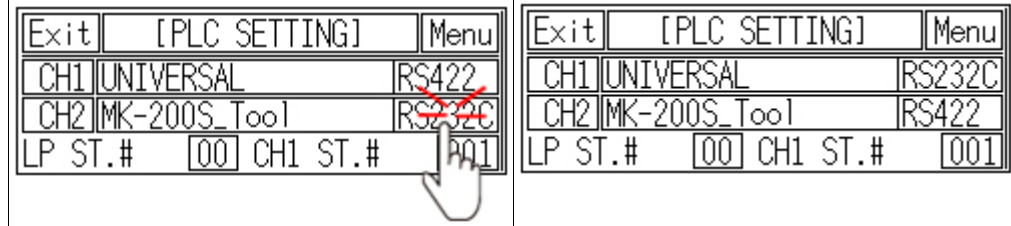

7th Synchronize the station of between GP/LP and host unit.

Touch the station item and input key pad appears. Enter the same station and setting range is 0 to 31.

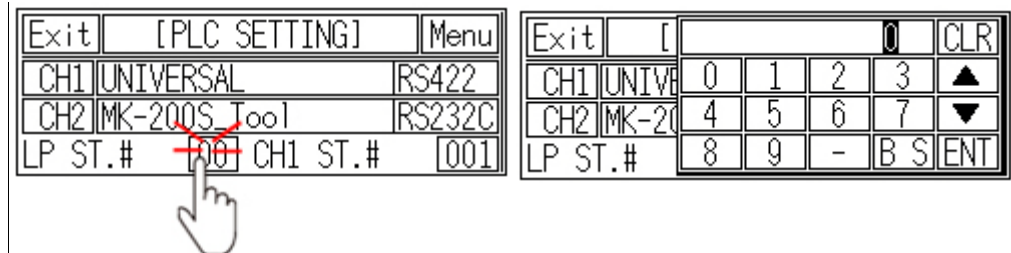

8th After completing communication configuration, you should exit system setting menu and switch user screen to 1:1:1 communication.

Touch 'Menu', current setting values are saved and it returns to previous menu.

Touch 'Exit', current setting values are saved and it returns to user screen.

5.3.2.2 Color type

1st Enter system setting menu.

Touch left-upper point as default position of system setting menu.



2nd Select [Environment]-[Serial Communication].

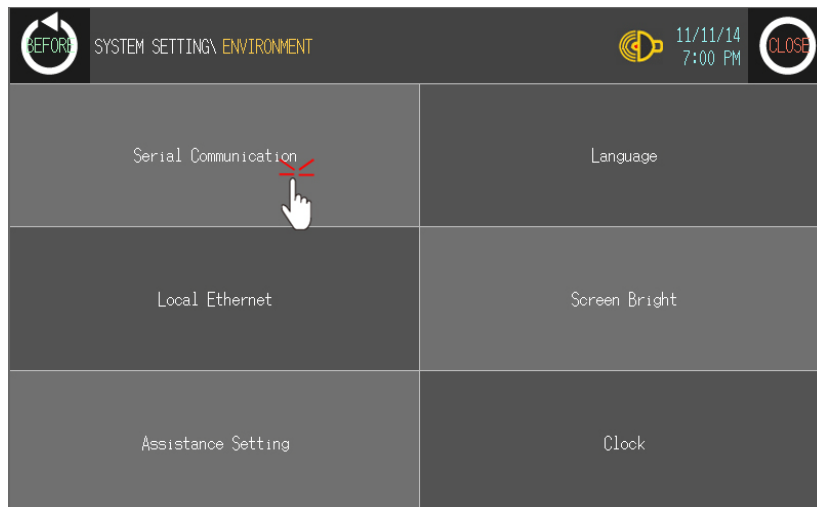

3rd CH1 protocol is set as 'UNIVERSAL' and CH1 connection port is set as 'RS422' as default.

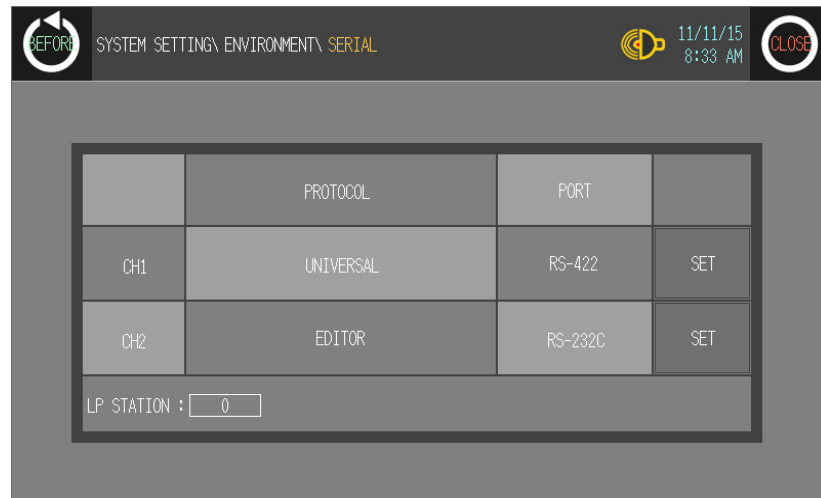

4th If it is not configured as 'UNIVERSAL' for CH1 protocol, touch protocol display item to set 'UNIVERSAL' as following figure.

Protocol display rotates in order as UNIVERSAL→MK-200S(CPU)→No Use→PRINTER→BARCODE with touching.

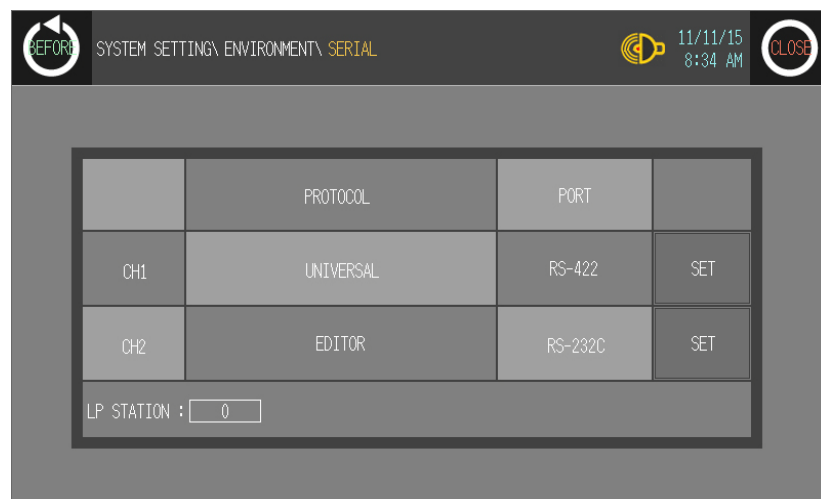
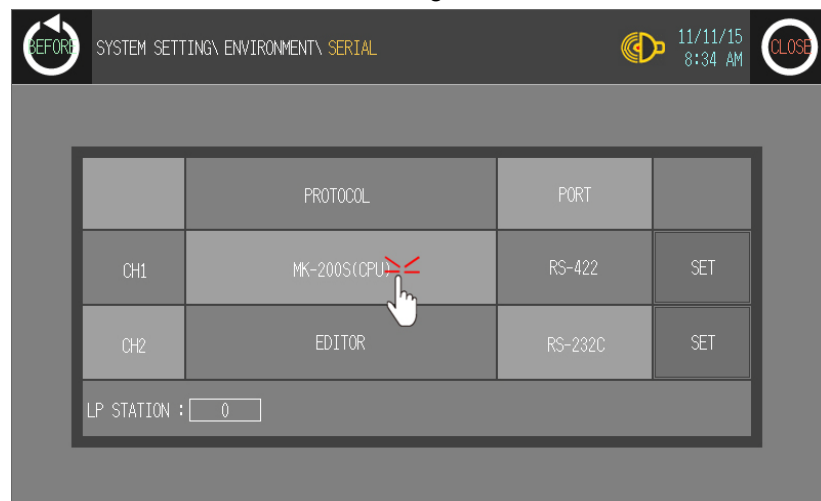

5th Touch protocol display item of CH2 to set 'MK-200S' as following figure.

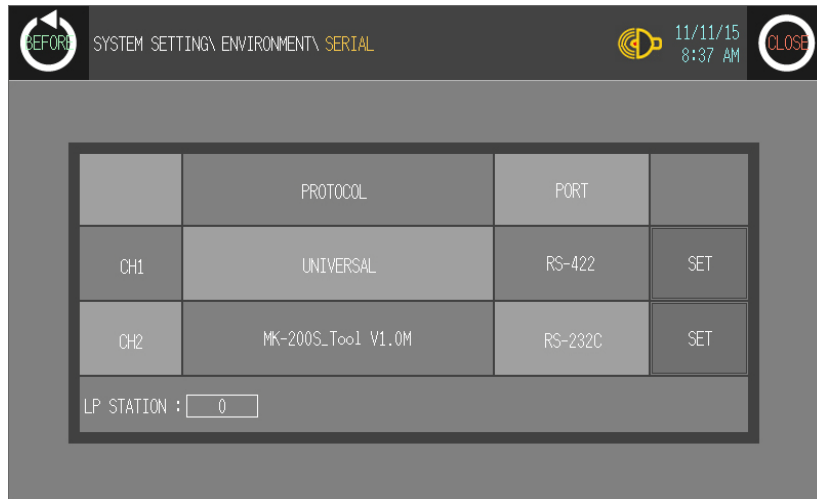
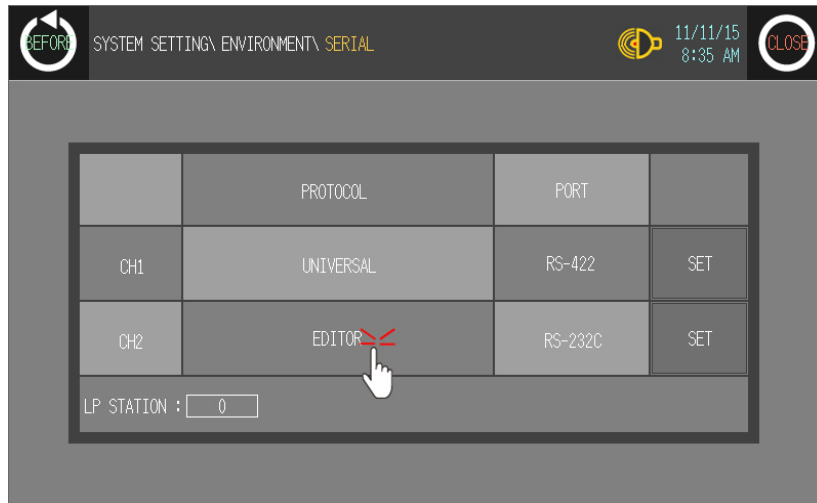

6th Synchronize CH1 and CH2 connect port display item with touching.

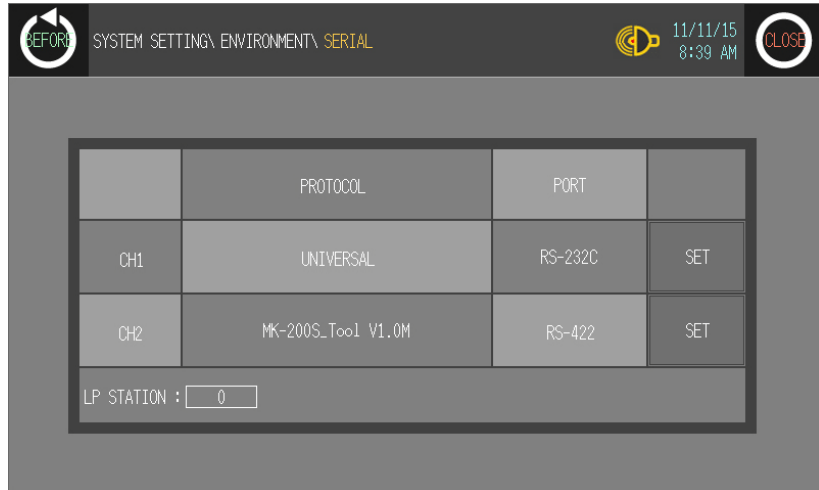
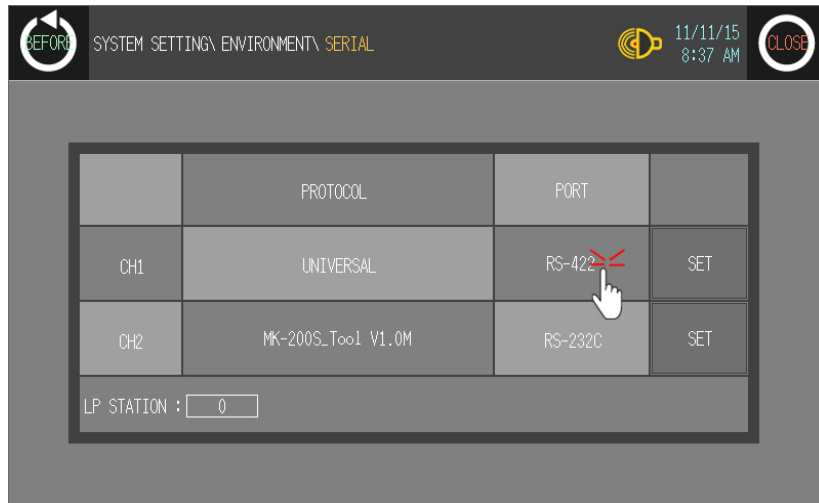

7th Synchronize the station of between GP/LP and host unit.

Touch the station item and input key pad appears. Enter the same station and setting range is 0 to 31.

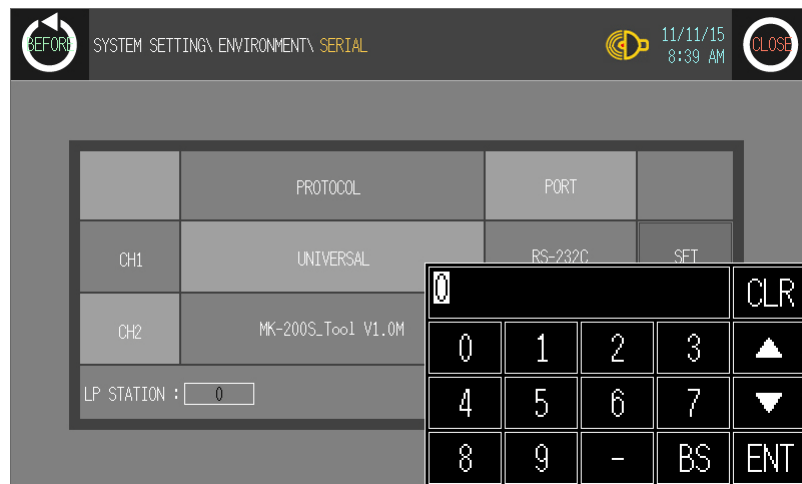
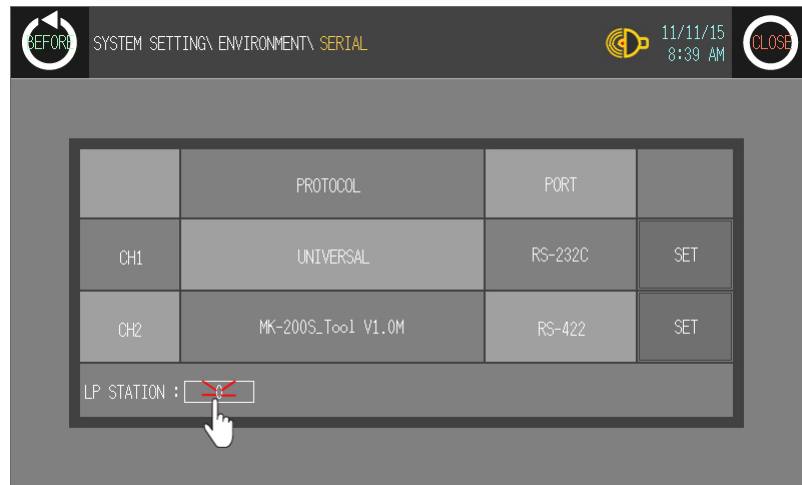

8th After completing communication configuration, you should exit system setting menu and switch user screen to 1:1:1 communication.

Touch 'BEFORE', current setting values are saved and it returns to previous menu.

Touch 'CLOSE', current setting values are saved and it returns to user screen.

5.4 Universal protocol

Modbus RTU is a standard. It communicates with host unit as master, GP/LP as slave. In host unit, it transmits Query to GP/LP, GP/LP executes designated operation according to received command and send response. When it receives Query of master and slave does not respond because of detection of error including parity, CRC or communication error, master re-transmits Query as timeout.

- Normal communication

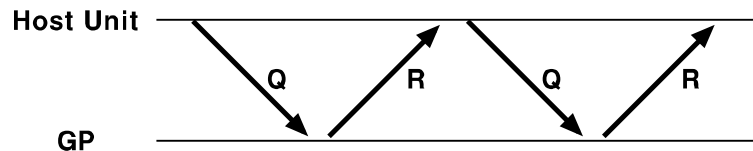

- When there is no response

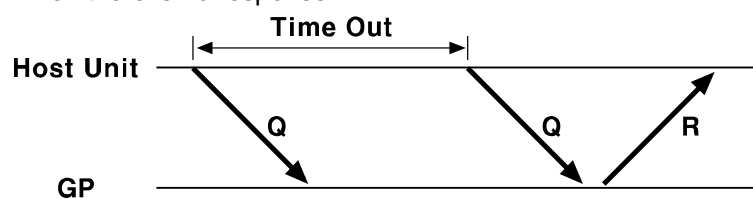

※ For more details, refer to general modbus protocol manual.

5.4.1 Available address

It uses UB, UW device as GP/LP inner memory.

Type	Device	Range		Enable read/write
		Start	End	
Bit	Coil	UB150	UB6047F	Write
	Input status	UB0	UB6047F	Read
Word	Input register	UW0	UW6047	Read
	Holding register	UW15	UW6047	Write

5.4.2 Available function code

There are several functions for using Modbus. Available functions in GP/LP general-purpose communication are two as below.

Code	Function	Read/Write	Description
03	Read Holding Register	Read	Read the appropriate address
16	Force Multiple Register	Write	Write the appropriate address

Additional function code will be upgraded.

5.4.3 Communication frame organization

5.4.3.1 Query master part

Station	Function code	Data area	CRC	
			L	H
①	②	③	④	

Item	Description
① Station	It is slave station (HEX) receiving a message from master. Setting range is 0 to 255. If it is 0, it is broadcast query which sends message to every slave.
② Function code (HEX)	Slave executes designated function according to function code. Available code is 03(Read Holding Register) and 16(Force Multiple Register).
③ Data area (HEX)	Transmit data related with function code. Data organization consists of (Upper 1byte) + (Lower 1byte) of the appropriate address. The length of area is variable and it is able to communicate without data.
④ CRC(HEX)	It is error check area. It calculates using CRC-16 code. It consists of 2byte. (Lower 1byte of CRC) + (Upper 1byte of CRC)

(1) Read Holding Registers(Func03-03H)

Slave Address (station)	Function (command)	Starting Address (starting address)		No. of Points (the number of data)		Error Check (CRC16)	
		Hi(upper)	Lo(lower)	Hi(upper)	Lo(lower)	Lo(lower)	Hi(upper)
1Byte	1Byte	1Byte	1Byte	1Byte	1Byte	1Byte	1Byte

(2) Preset Multiple Registers(Func16-10H)

Slave Address (station)	Function (command)	Starting Address (starting address)		No. of Points (the number of register)		Byte Count (the number of data byte)
		Hi(upper)	Lo(lower)	Hi(upper)	Lo(lower)	
1Byte	1Byte	1Byte	1Byte	1Byte	1Byte	1Byte

Data(data)		Data(data)		Error Check (CRC16)	
Hi(upper)	Lo(lower)	Hi(upper)	Lo(lower)	Lo(lower)	Hi(upper)
1Byte	1Byte	1Byte	1Byte	1Byte	1Byte

5.4.3.2 Response slave part

Station	Function code	Data area	CRC	
			L	H

① ② ③ ④

Item	Description
① Station	It is slave station (HEX) for confirmation about Query.
② Function code (HEX)	Transmits same function code sent by Master for confirmation about Query.
③ Data area (HEX)	Transmits data related with function code. The length is variable.
④ CRC(HEX)	It is error check area. It calculates using CRC-16 code. It consists of 2byte. (Lower 1byte of CRC) + (Upper 1byte of CRC).

(1) Read Holding Registers(Func03-03H)

Slave Address (station)	Function (command)	Byte Count (the number of data byte)	Data		Data		Data	
			Hi (upper)	Lo (lower)	Hi (upper)	Lo (lower)	Hi (upper)	Lo (lower)
1Byte	1Byte	1Byte	1Byte	1Byte	1Byte	1Byte	1Byte	1Byte

Error Check (CRC16)	
Lo(lower)	Hi(upper)
1Byte	1Byte

(2) Preset Multiple Registers(Func16-10H)

Slave Address (station)	Function (command)	Starting Address (starting address)		No. of Resigter (the number of register)		Error Check (CRC16)	
		Hi(upper)	Lo(lower)	Hi(upper)	Lo(lower)	Lo(lower)	Hi(upper)
1Byte	1Byte	1Byte	1Byte	1Byte	1Byte	1Byte	1Byte

5.4.3.3 Error

Station	Function code	Error code	CRC	
			L	H
①	②	③	④	

Item	Description
① Station	It is slave station (HEX) for confirmation about Query.
② Function code (HEX)	It is transmitted when Slave cannot process requirement of Master. It transmits after set the most upper bit of function code Master transmitted as 1.
③ Error code ^{※1} (HEX)	Transmits the specific error code.
④ CRC(HEX)	It is error check area. It calculates using CRC-16 code. It consists of 2byte. (Lower 1byte of CRC) + (Upper 1byte of CRC).

※Error code value

Code	Name	Description
01	Negative function	Operation function code not supported to slave
02	Negative function	Address not existing in slave
03	Negative data	Data which cannot be written in slave

5.5 Universal function example

5.5.1 03(Read holding register)

It reads contents of successive holding register. There is no Broadcast(Station designation of Slave as 0). Available address is 00000 to 06047, it accords slave UW0000 to UW6047 of GP/LP.



Ex.

When reading 5 register data from UW0000 to UW0004 of GP/LP with station no.31

GP/LP		
Station	Data(DEC)	Data(HEX)
UW0000	10	H000A
UW0001	20	H0014
UW0002	30	H001E
UW0003	40	H0028
UW0004	50	H0032

▪ Query

Station	Function code	Start address		The number of read register		CRC	
0x1F	0x03	0x00	0x00	0x00	0x05	0xE6	0x71
①	②	③	④	⑤	⑥	⑦	⑧

Item	Description
① Station	Slave station is 31, 31=(HEX)0X1F
② Function code	03
③ Start address upper byte	It conforms 0000
④ Start address lower byte	
⑤ the number of read register upper byte	Total 5.5=upper(HEX)0X00+lower(HEX)0X05
⑥ the number of read register lower byte	
⑦ CRC lower byte	
⑧ CRC upper byte	

▪ Response

Station	Function code	The number of data byte	Data 1		Data 2		Data 3	
0x1F	0x03	0x0A	0x00	0x0A	0x00	0x14	0x00	0x1E
①	②	③	④	⑤	⑥	⑦	⑧	⑨

Data 4		Data 5		CRC	
0x00	0x00	0x00	0x32	0x8F	0xD6
⑩	⑪	⑫	⑬	⑭	⑮

Item	Description
① Station	Slave station
② Function code	03
③ the number of data byte	The total number of byte of data area. Total 5Word=10byte
④, ⑥ Data1	Upper byte of UW0000
	Lower byte of UW0000
⑥, ⑦ Data2	Upper byte of UW0001
	Lower byte of UW0001
⑧, ⑨ Data3	Upper byte of UW0002
	Lower byte of UW0002
⑩, ⑪ Data4	Upper byte of UW0003
	Lower byte of UW0003
⑫, ⑬ Data5	Upper byte of UW0004
	Lower byte of UW0004
⑭, ⑮ CRC	Lower byte
	Upper byte

5.5.2 16(Preset multiple register)

It writes contents of successive holding register. When designating(Broadcast) slave station as 0, it writes in same address of slave.

Available address is 00015 to 06047, it accords slave UW0015 to UW6047 of GP/LP.



Ex.

In case of writing next data in UW100 to UW104 of GP/LP with station no.05.

Data(DEC)	Data(HEX)
123	H007B
234	H00EA
345	H0159
456	H01C8
567	H0237

▪ Query

Station	Function code	Start address		The number of register		The number of data byte	Alternation data 1	
0x05	0x10	0x00	0x64	0x00	0x05	0x0A	0x00	0x7B
①	②	③	④	⑤	⑥	⑦	⑧	⑨

Alternation data 2		Alternation data 3		Alternation data 4		Alternation data 5		CRC	
0x00	0xEA	0x01	0x59	0x01	0xC8	0x02	0x37	0xA6	0xC9
⑩	⑪	⑫	⑬	⑭	⑮	⑯	⑰	⑱	⑲

Item	Description
① Station	Slave station is 05, 05 = (Hex)0x05
② Function code	16. 16 = (Hex)0x10
③ Start address upper byte	Start address is UW100. 100 = upper (Hex)0x00 + lower (Hex)0x64
④ Start address lower byte	
⑤ The number of register upper byte	The total number of data to write. 5 = upper (Hex)0x00 + lower (Hex)0x05
⑥ The number of register lower byte	
⑦ The number of data byte	The total number of byte of data area. The total number of data to write: 5 Word = 10 byte. 10 = (Hex)0x0A
⑧ Alternation data 1 upper byte	Upper byte value of data to write in UW100
⑨ Alternation data 1 lower byte	Lower byte value of data to write in UW100
⑩ Alternation data 2 upper byte	Upper byte value of data to write in UW101
⑪ Alternation data 2 lower byte	Lower byte value of data to write in UW101
⑫ Alternation data 3 upper byte	Upper byte value of data to write in UW102
⑬ Alternation data 3 lower byte	Lower byte value of data to write in UW102

Item	Description
⑭ Alternation data 4 upper byte	Upper byte value of data to write in UW103
⑮ Alternation data 4 lower byte	Lower byte value of data to write in UW103
⑯ Alternation data 5 upper byte	Upper byte value of data to write in UW104
⑰ Alternation data 5 lower byte	Lower byte value of data to write in UW104
⑱ CRC lower byte	
⑲ CRC upper byte	

- Response

Station	Function code	Start address		The number of register		CRC	
0x05	0x10	0x00	0x64	0x00	0x05	0x40	0x51
①	②	③	④	⑤	⑥	⑦	⑧

Item	Description
① Station	Slave station is 05, 05 = (Hex)0x05
② Function code	16. 16 = (Hex)0x10
③ Start address upper byte	Start address is UW100. 100 = upper (Hex)0x00 + lower (Hex)0x64
④ Start address lower byte	
⑤ The number of register upper byte	The total number of data to write. 5 = upper (Hex)0x00 + lower (Hex)0x05
⑥ The number of register lower byte	
⑦ CRC lower byte	
⑧ CRC upper byte	

5.5.3 Exception response

It transmits function code response after set the most upper bit of function code master transmitted as 1.



Ex.

In case of reading 5 data of input register UW0000 to UW0004 with station no.5.

- Query

Station	Function code	Start address		The number of read register		CRC	
0x05	0x04	0x00	0x00	0x00	0x05	0x31	0x8D
①	②	③	④	⑤	⑥	⑦	⑧

Item	Description
① Station	Slave station is 05, 05 = (Hex)0x05
② Function code	04. It is not available code.
③ Start address upper byte	0000 is a real address for 30001.
④ Start address lower byte	
⑤ The number of read register upper byte	
⑥ The number of read register lower byte	
⑦ CRC lower byte	
⑧ CRC upper byte	

- Response

Station	Function code	Error code	CRC	
0x05	0x84	0x01	0x83	0x06
①	②	③	④	⑤

Item	Description
① Station	Slave station is 05, 05 = (Hex)0x05
② Function code	84. The top bit is 1 in function code 04 transmitted by master.
③ Error code	01. Operation function code error not supported to slave.
④ CRC lower byte	
⑤ CRC upper byte	

6 Connectable PLC

Series	Connect device	Connect module	Connect type	Communication cable model name	No.
LS Master-K	MK-10S1	CPU	RS-232C	C3M5P00-D9F0-M6M0	1
	MK-80S/120S/200S/300S/1000S	CPU	RS-232C	C3M5P01-D9F0-D9M0	2
LS Glofa	GM4, GM6, GM7U	CPU	RS-232C	C3M5P01-D9F0-D9M0	2
LS Master-K CNET	MK-80S	Cnet module(G7L-CUEB)	RS-232C	C3M5P05-D9F0-D9M0	6
		Cnet module (G7L-CUEC)	RS-422	C3M5P04-D9M0-T6Y0	16
	MK-120S	CPU	RS-232C	C3M5P02-D9F0-D9M0	3
		CPU	RS-485	C3M5P03-D9M0-W4*0	4
		Cnet module (G7L-CUEB)	RS-232C	C3M5P05-D9F0-D9M0	6
		Cnet module (G7L-CUEC)	RS-422	C3M5P04-D9M0-T6Y0	16
	MK-200S	CPU	RS-232C	C3M5P02-D9F0-D9M0	3
		CPU	RS-422	C3M5P04-D9M0-W6*0	5
		CPU	RS-422	C3M5P03-D9M0-W4*0	4
		Cnet module (G7L-CUEB)	RS-232C	C3M5P05-D9F0-D9M0	6
		Cnet module (G7L-CUEC)	RS-422	C3M5P04-D9M0-T6Y0	16
	MK-300S	G4L-CUEA	RS-232C	C3M5P05-D9F0-D9M0	6
			RS-422	C3M5P04-D9M0-T6Y0	16
	MK-1000S	G3-CUEA	RS-232C	C3M5P05-D9F0-D9M0	6
			RS-422	C3M5P04-D9M0-T6Y0	16
	LS XGT CNET	XGK-CPUS	XGL-C22A	RS-232C	C3M5P01-D9F0-D9M0
XGL-CH2A			RS-232C	C3M5P01-D9F0-D9M0	2
			RS-422	C3M5P04-D9M0-T6Y0	16
XGL-C42A			RS-422	C3M5P04-D9M0-T6Y0	16
LS XGB CNET	XBM	CNET	RS-232C	C3M5P11-D9F0-W4*0	12
			RS-485	C3M5P03-D9M0-W4*0	4
	XBC	CNET	RS-232C	C3M5P13-D9F0-T4Y0	14
			RS-485	C3M5P03-D9M0-T4Y0	15
OEMAX	N70	CPU	RS-232C	C3M5P06-D9F0-D15M	7
	N70Plus	CPU	RS-232C	C3M5P07-D9F0-D9M0	8
OEMAX FARA	NX7, NX70	CPU	RS-232C	C3M5P07-D9F0-D9M0	8
MITSUBUSHI FX	FX1S, FX1N, FX2N	CPU	RS-422	C3M5P08-D9M0-M8M0	9
		RS-232C module (FX1N-232-BD)	RS-232C	C3M5P09-D9F0-D9F0	10
	FX2NC	CPU	RS-422	C3M5P08-D9M0-M8M0	9
	FX3U	CPU	RS-422	C3M5P08-D9M0-M8M1	19
MITSUBUSHI Q	Q00J, Q00, Q01,	Extension module	RS-232C	C3M5P05-D9F0-D9M0	6

Series	Connect device	Connect module	Connect type	Communication cable model name	No .
	Q02, Q02H, Q06H Q12H, Q25H	QJ71C24N	RS-422	C3M5P04-D9M0-W6*0	5
		Extension module QJ71C24N-R2	RS-232C	C3M5P05-D9F0-D9M0	6
		Extension module QJ71C24N-R4	RS-422	C3M5P04-D9M0-W6*0	5
NAIS FP	FP0-C16/C32/T32C FPG-C24R2/C32T /C32T2 FP0R-C10/C14/C16/ C32/T32/F32	CPU(Tool port)	RS-232C	C3M5P10-D9F0-M5M0	11
		CPU(COM port)	RS-232C	C3M5P11-D9F0-W4*0	12
SIEMENS SIMATIC S7-200	CPU221, CPU222, CPU224, CPU224XP, CPU224XPsi, CPU226	CPU	PPI	Dedicated cable for SIEMENS	-
SIEMENS SIMATIC S7-300	CPU312, CPU312C, CPU313C, CPU313C- 2, CPU314, CPU314C- 2, CPU315-2, CPU317- 2, CPU319-3	CPU	MPI	Dedicated cable for SIEMENS	-
Allen-Bradley	MicroLogix 1000/1200	CPU	RS-232C	Dedicated cable for Allen-Bradley	-
OMRON SYSMAC C	CPM1A	CPU	RS-232C	For communicating GP CQM1-CIF0 of OMRON	-
				For extension cable, C3M5P12-D9F0-D9M1	13
OMRON temperature controller	E5AN, E5EN	Modbus	RS-232C	C3M5P13-D9F0-T4Y0	14
			RS-485	C3M5P03-D9M0-T4Y0	15
	E5AR, E5CN, E5ER	Modbus	RS-485	C3M5P03-D9M0-T4Y0	15
AUTONICS	MT series	Dedicated communication, Modbus	RS-485	C3M5P03-D9M0-W4*0	4
	MP seires	Dedicated communication	RS-485	C3M5P03-D9M0-W4*0	4
	THD seires	Modbus	RS-485	C3M5P03-D9M0-W4*0	4
	TZ series	Dedicated communication	RS-485	C3M5P03-D9M0-T4Y0	15
	TK , TM, CT series	Modbus	RS-485	C3M5P03-D9M0-T4Y0	15
	DS/DA Series	Modbus	RS-485	C3M5P03-D9M0-W4*0	4
	Remote I/O ARM Series	Modbus	RS-485	C3M5P03-D9M0-W4*0	4
	LP-S044	CPU	RS-232C	C3M5P03-D9F0-D9F0	17
RS-422			C3M5P03-D9M0-D9M0	18	
KONICS	DPU series, KRN50	Modbus	RS-485	C3M5P03-D9M0-W4*0	4
DELTA	DTB series	Modbus	RS-485	C3M5P03-D9M0-T4Y0	15
DANFOS	FC Series	Modbus	RS-485	C3M5P03-D9M0-T4Y0	15
GP firmware download cable	Computer	-	RS-232C	C3M5P14-D9F0-D9F0	17

Connectable device is upgraded cotinuously according GP Editor version and Patch.
Before using, please check version on our website(www.autonics.com) and it is recommended to use the latest version.

6.1 Autonics product

GP/LP is able to communicate with Autonics multi panel meter(MT series), pulse meter(MP series), temperature/humidity sensor(THD-RT series) and temperature controller(TZ), counter/timer(CT series), display unit (DS/DA series), and digital remote I/O (ARM series).

6.1.1 System organization

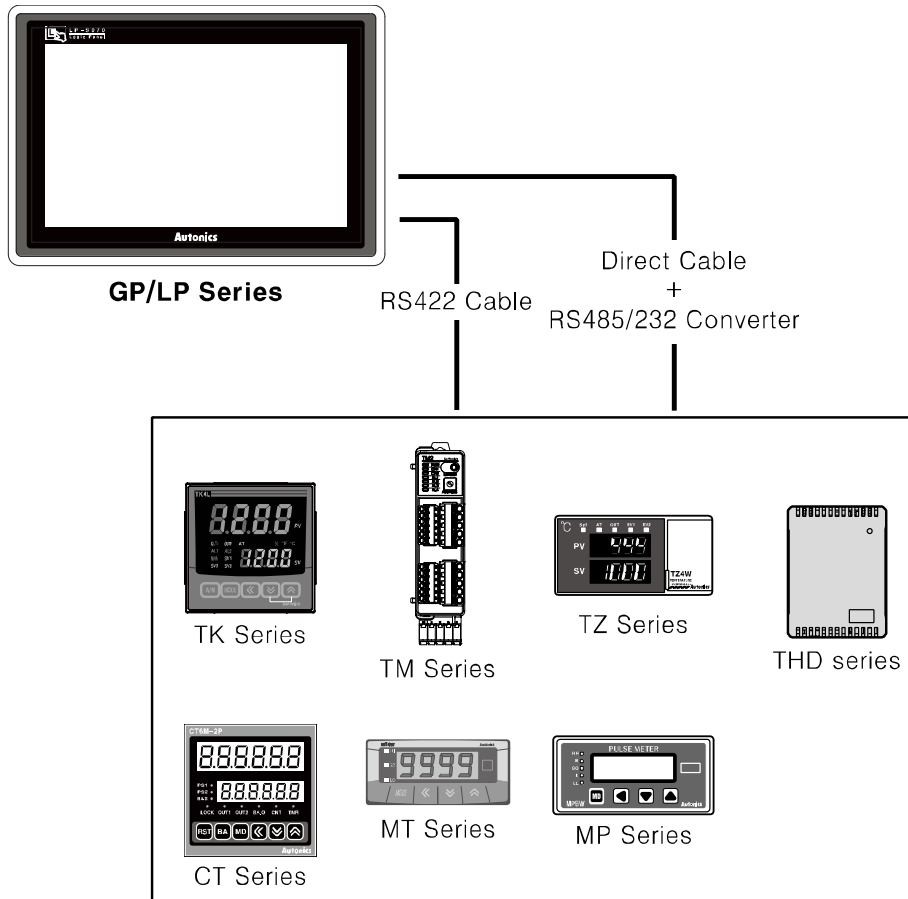

Autonics MT, MP, THD-RT, TZ, TM, TK, CT, DS/DA, ARM series execute RS485 communication and RS422 communication is available when connecting cable as below. It executes also RS232C communication with RS485/232 converter.

- Applied cable

(4)C3M5P03-D9M0-W4*0

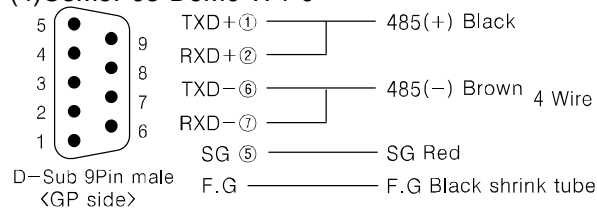

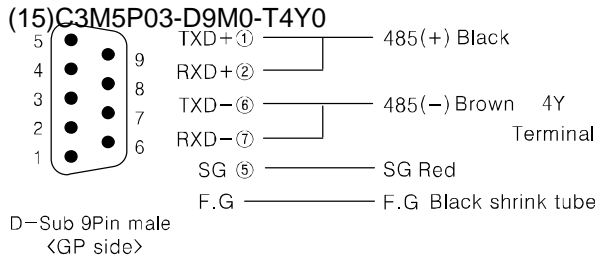

PLC type		Communication method	Default baudrate(bps)
Autonics	MT	RS485/422	9600
	MT(MODBUS)		
	MP		
	THD-RT(MODBUS)		
	TZ		
	TM(MODBUS)		
	TK(MODBUS)		
	CT(MODBUS)		
	DS/DA(MODBUS)		
	Remote I/O ARM(MODBUS)		

Note

It should be set same between baudrate, station of Autonics controllers and the baudrate, station of GP/LP. Refer to each product's user manual for communication configuration and station of each product.

Be sure that Autonics controller has devided read/write device for using device. Especially in the case of using CH2, refer to '3.3 1:N communication'.

6.1.2 Station configuration in GP/LP

1st Enter system setting menu.

Touch left-upper point as default position of system setting menu.

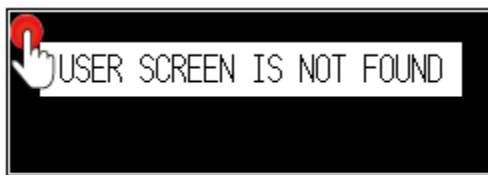

2nd Select [SET ENVIRONMENT]-[PLC SETTING].

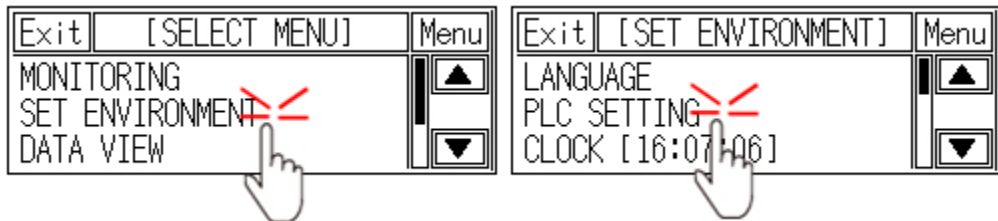

3rd Touch CH1 station, station input key pad appears. Enter the same station of the station which is set from MP(MT, THD, TZ, TM, TK, CT, DS/DA, ARM).

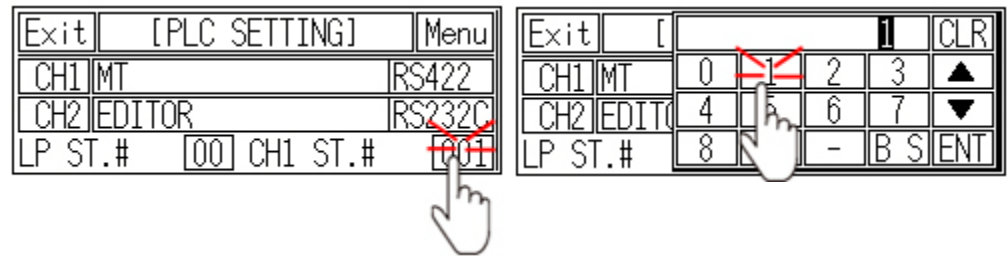

4th Touch 'ENT' to save the station and touch 'Menu' or 'Exit' to exit system setting meun.

6.1.3 Available device

6.1.3.1 MT series

Available device and displayed parameter of Autonics MT series are as following. Available device is only for MT series.

(1) Not Modbus communication type in MT series

Type	Device	Mark	Range	
			Start	End
Bit	GP/LP inner bit memory	UB	UB0	UB6047F
Word	Word device area	MT	MT0	MT0
	GP/LP inner word memory	UW	UW0	UW6047

Device	Description	Enable read/write
MT0	Present value	Read

(2) Modbus communication type in MT series (MT4N)

1) Modbus (MT4N_Mod)

Type	Device	Mark	Range	
			Start	End
Bit	Bit device area	MT	MT10001	MT10001
Bit	GP/LP inner bit memory	UB	UB0	UB6047F
Word	Word device area	MT	MT30001	MT30004
	Word device area	MT	MT30101	MT30109
	Word device area	MT	MT30118	MT30125
	GP/LP inner word memory	UW	UW0	UW6047

Device	Description	Enable Read/Write
MT30001	Present value	Read
MT30002	Dot setting value	Read
MT30003	Max. signal input	Read
MT30004	Min. signal input	Read
MT30101	Product number H	Read
MT30102	Product number L	Read
MT30103	Hardware version	Read
MT30104	Software version	Read
MT30105	Model name1	Read
MT30106	Model name2	Read

Device	Description	Enable Read/Write
MT30107	Model name3	Read
MT30108	Model name4	Read
MT30109	Model name5	Read
MT30118	Coil start address	Read
MT30119	Coil quantity	Read
MT30120	Input start address	Read
MT30121	Input quantity	Read
MT30122	Holding REG start address	Read
MT30123	Holding REG quantity	Read
MT30124	Input REG start address	Read
MT30125	Input REG quantity	Read

2) Modbus TYPE A (MT4N_Mod_A)

Type	Device	Mark	Range	
			Start	End
Bit	Bit device area	1	100001	100001
Bit	GP/LP inner bit memory	UB	UB0	UB6047F
Word	Word device area	3	300001	300004
	Word device area	3	300101	300109
	Word device area	3	300118	300125
	GP/LP inner word memory	UW	UW0	UW6047

Device	Description	Enable Read/Write
300001	Present value	Read
300002	Dot setting value	Read
300003	Max. signal input	Read
300004	Min. signal input	Read
300101	Product number H	Read
300102	Product number L	Read
300103	Hardware version	Read
300104	Software version	Read
300105	Model name1	Read
300106	Model name2	Read
300107	Model name3	Read
300108	Model name4	Read
300109	Model name5	Read
300118	Coil start address	Read
300119	Coil quantity	Read
300120	Input start address	Read
300121	Input quantity	Read

Device	Description	Enable Read/Write
300122	Holding REG start address	Read
300123	Holding REG quantity	Read
300124	Input REG start address	Read
300125	Input REG quantity	Read

(3) Modbus communication type in MT series (MT4W, MT4Y)

1) Modbus (MT4W_Mod, MT4Y_Mod)

Type	Device	Mark	Range	
			Start	End
Bit	Bit device area	MT	MT10001	MT10001
Bit	GP/LP inner bit memory	UB	UB0	UB6047F
Word	Word device area	MT	MT30001	MT30004
	GP/LP inner word memory	UW	UW0	UW6047

Device	Description	Enable read/write
MT30001	Present value	Read
MT30002	Dot setting value	Read
MT30003	Max. signal input	Read
MT30004	Min. signal input	Read

2) Modbus TYPE A (MT4W_Mod_A., MT4Y_Mod_A)

Type	Device	Mark	Range	
			Start	End
Bit	Bit device area	1	100001	100001
Bit	GP/LP inner bit memory	UB	UB0	UB6047F
Word	Word device area	3	300001	300004
	GP/LP inner word memory	UW	UW0	UW6047

Device	Description	Enable read/write
300001	Present value	Read
300002	Dot setting value	Read
300003	Max. signal input	Read
300004	Min. signal input	Read

6.1.3.2 MP

Available device and displayed parameter of Autonics MP series are as following. Available device is only for MP series.

Type	Device	Mark	Range	
			Start	End
Bit	GP/LP inner bit memory	UB	UB0	UB6047F
Word	Word device area (32bit)	MP	MP0	MP11
	GP/LP inner word memory	UW	UW0	UW6047

Device	Code	Description	Enable read/write
MP0	P0	Present value	Read
MP1	C0	Compare setting value(HH)	Read/Write
MP2	C1	Compare setting value(H)	Read/Write
MP3	C2	Compare setting value(L)	Read/Write
MP4	C3	Compare setting value(LL)	Read/Write
MP5	K0	Peak value (Max.)	Read
MP6	K1	Peak value (Min.)	Read
MP7	X0	Prescale value X.Ain	Read/Write
MP8	X1	Prescale value X.Bin	Read/Write
MP9	Y0	Prescale value Y.Ain	Read/Write
MP10	Y1	Prescale value Y.Bin	Read/Write
MP11	R0	Max./Min. value reset	Write

**Note**

In MP device, downloaded data type have to be set as 32 bit for numeral display/input, ASCII display/input of GP Editor to get accurate parameter value and to read/write right.

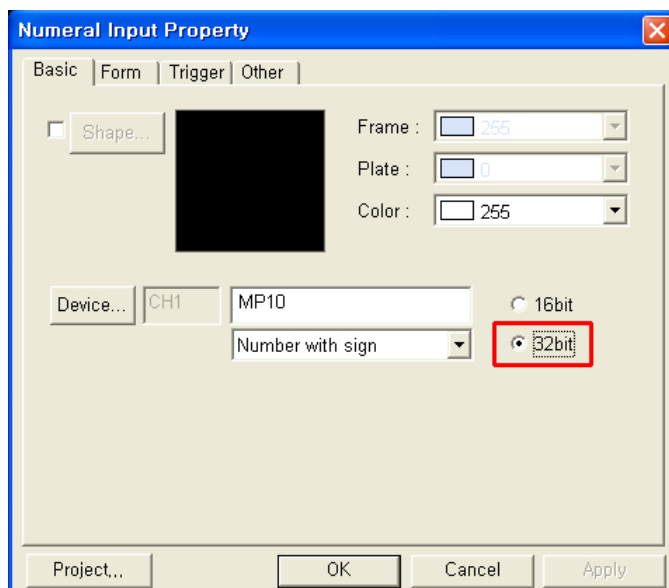

6.1.3.3 THD-RT(Modbus)

Available device and displayed parameter of Autonics THD-RT series are as following. Available device is only for TH series.

(1) Modbus (THD-RT_Mod)

Type	Device	Mark	Range	
			Start	End
Bit	GP/LP inner bit memory	UB	UB0	UB6047F
Word	Word device area	TH	TH30001	TH30002
	Word device area	TH	TH30101	TH30125
	GP/LP inner word memory	UW	UW0	UW6047

Device	Description	Enable read/write
TH30001	Temperature value	Read
TH30002	Humidity value	Read
...	Blank	-
TH30101	Product number H	Read
TH30102	Product number L	Read
TH30103	Hardware version	Read
TH30104	Software version	Read
TH30105	Model name 1	Read
TH30106	Model name 2	Read
TH30107	Model name 3	Read
TH30108	Model name 4	Read
TH30109	Model name 5	Read
TH30110	Model name 6	Read
TH30111	Model name 7	Read
TH30112	Model name 8	Read
TH30113	Model name 9	Read
TH30114	Model name 10	Read
TH30115	Reserved area	Read
TH30116	Reserved area	Read
TH30117	Reserved area	Read
TH30118	Coil start address	Read
TH30119	Coil quantity	Read
TH30120	Input start address	Read
TH30121	Input quantity	Read
TH30122	Holding REG start address	Read
TH30123	Holding REG quantity	Read
TH30124	Input REG start address	Read
TH30125	Input REG quantity	Read

(2) Modbus TYPE A(THD-RT_Mod_A)

Type	Device	Mark	Range	
			Start	End
Bit	GP/LP inner bit memory	UB	UB0	UB6047F
Word	Word device area	3	300001	300002
	Word device area	3	300101	300125
	GP/LP inner word memory	UW	UW0	UW6047

Device	Description	Enable read/write
300001	Temperature value	Read
300002	Humidity value	Read
...	Blank	-
300101	Product number H	Read
300102	Product number L	Read
300103	Hardware version	Read
300104	Software version	Read
300105	Model name 1	Read
300106	Model name 2	Read
300107	Model name 1	Read
300108	Model name 2	Read
300109	Model name 3	Read
300110	Model name 4	Read
300111	Model name 5	Read
300112	Model name 6	Read
300113	Model name 7	Read
300114	Model name 8	Read
300115	Model name 9	Read
300116	Model name 10	Read
300117	Reserved area	Read
300118	Coil start address	Read
300119	Coil quantity	Read
300120	Input start address	Read
300121	Input quantity	Read
300122	Holding REG start address	Read
300123	Holding REG quantity	Read
300124	Input REG start address	Read
300125	Input REG quantity	Read

6.1.3.4 TZ

Available device and displayed parameter of Autonics TZ series are as following. Available device is only for TZ series.

Type	Device	Mark	Range	
			Start	End
Bit	GP/LP inner bit memory	UB	UB0	UB6047F
Word	Word device area	TZ	TZ0	TZ1
	GP/LP inner word memory	UW	UW0	UW6047

Device	Description	Enable read/write
TZ0	Present value	Read
TZ1	Setting value	Read/Write

6.1.3.5 TM

For available device for Autonics TM, refer to 'TM user manual for communication'.

(1) Modbus (TM_Mod)

Type	Device	Mark	Range	
			Start	End
Bit	Bit device area	TM	Refer to TM device table	
	GP/LP inner bit memory	UB	UB0	UB6047F
Word	Word device area	TM	Refer to TM device table	
	GP/LP inner word memory	UW	UW0	UW6047

(2) Modbus TYPE A(TM_Mod_A)

Type	Device	Mark	Range	
			Start	End
Bit	Bit device area	0	Refer to TM device table	
	Bit device area	1	Refer to TM device table	
	GP/LP inner bit memory	UB	UB0	UB6047F
Word	Word device area	3	Refer to TM device table	
	Word device area	4	Refer to TM device table	
	GP/LP inner bit memory	UW	UW0	UW6047

6.1.3.6 TK

For available device for Autonics TK, refer to 'TK user manual for communication'.

(1) Modbus (TK_Mod)

Type	Device	Mark	Range	
			Start	End
Bit	Bit device area	TK	Refer to TK device table	
	GP/LP inner bit memory	UB	UB0	UB6047F
Word	Word device area	TK	Refer to TK device table	
	GP/LP inner word memory	UW	UW0	UW6047

(2) Modbus TYPE A (TK_Mod_A)

Type	Device	Mark	Range	
			Start	End
Bit	Bit device area	0	Refer to TK device table	
	Bit device area	1	Refer to TK device table	
	GP/LP inner bit memory	UB	UB0	UB6047F
Word	Word device area	3	Refer to TK device table	
	Word device area	4	Refer to TK device table	
	GP/LP inner word memory	UW	UW0	UW6047

6.1.3.7 CT

For available device for Autonics CT, refer to 'CT user manual for communication'.

(1) Modbus (CT_Mod)

Type	Device	Mark	Range	
			Start	End
Bit	Bit device area	CT	Refer to CT device table	
	GP/LP inner bit memory	UB	UB0	UB6047F
Word	Word device area	CT	Refer to CT device table	
	GP/LP inner word memory	UW	UW0	UW6047

(2) Modbus TYPE A(CT_Mod_A)

Type	Device	Mark	Range	
			Start	End
Bit	Bit device area	0	Refer to CT device table	
	Bit device area	1	Refer to CT device table	
	GP/LP inner bit memory	UB	UB0	UB6047F
Word	Word device area	3	Refer to CT device table	
	Word device area	4	Refer to CT device table	
	GP/LP inner word memory	UW	UW0	UW6047

6.1.3.8 DS/DA

For available device for Autonics display unit DS/DA series, refer to 'CT user manual for communication'.

Type	Device	Mark	Range	
			Start	End
Bit	GP/LP inner bit memory	UB	UB0	UB6047F
Word	Word device area	3	Refer to DS/DA device table	
	Word device area	4	Refer to DS/DA device table	
	GP/LP inner word memory	UW	UW0	UW6047

6.1.3.9 Remote I/O ARM

For available device for Autonics remote I/O ARM series, refer to 'CT user manual for communication'.

Type	Device	Mark	Range	
			Start	End
Bit	Bit device area	0	Refer to ARM device table	
	Bit device area	1	Refer to ARM device table	
	GP/LP inner bit memory	UB	UB0	UB6047F
Word	Word device area	3	Refer to ARM device table	
	Word device area	4	Refer to ARM device table	
	GP/LP inner word memory	UW	UW0	UW6047

6.1.4 Monitorable device in GP/LP

GP/LP is able to monitor PLC device and change the status.

Enter system setting menu of GP/LP and select [Monitoring]-[Device Monitor]-[DEV.]. Select to be monitored device and you can change the status.

The following is available device list of this menu, available range is same as '6.1.3 Available device'.

6.1.4.1 MT series

(1) Modbus

Type	Mark	Device	Note
Bit	UB	GP/LP inner bit memory	
Word	MT	Data register	
	UW	GP/LP inner word memory	

(2) Modbus TYPE A

Type	Mark	Device	Note
Bit	1	Bit device area	
	UB	GP/LP inner bit memory	
Word	3	Word device area	
	UW	GP/LP inner word memory	

6.1.4.2 MP series

Type	Mark	Device	Note
Bit	UB	GP/LP inner bit memory	
Word	MP16	Data register	16bit
	MP32	Data register	32bit
	UW	GP/LP inner word memory	

6.1.4.3 THD-RT(MOD)

(1) Modbus

Type	Mark	Device	Note
Bit	UB	GP/LP inner bit memory	
Word	TH	Word device area	
	UW	GP/LP inner word memory	

(2) Modbus TYPE A

Type	Mark	Device	Note
Bit	UB	GP/LP inner bit memory	
Word	3	Word device area	
	UW	GP/LP inner word memory	

6.1.4.4 TZ series

Type	Mark	Device	Note
Bit	UB	GP/LP inner bit memory	
Word	TZ	Data register	
	UW	GP/LP inner word memory	

6.1.4.5 TM series

(1) Modbus

Type	Mark	Device	Note
Bit	TM	Bit device area	
	UB	GP/LP inner bit memory	
Word	TM	Word device area	
	UW	GP/LP inner word memory	

(2) Modbus TYPE A

Type	Mark	Device	Note
Bit	0	Bit device area	
	1	Bit device area	
	UB	GP/LP inner bit memory	
Word	3	Word device area	
	4	Word device area	
	IR	Data register	
	UW	GP/LP inner word memory	

6.1.4.6 TK series

(1) Modbus

Type	Mark	Device	Note
Bit	TK	Bit device area	
	UB	GP/LP inner bit memory	
Word	TK	Word device area	
	UW	GP/LP inner word memory	

(2) Modbus TYPE A

Type	Mark	Device	Note
Bit	0	Bit device area	
	1	Bit device area	
	UB	GP/LP inner bit memory	
Word	3	Word device area	
	4	Word device area	
	UW	GP/LP inner word memory	

6.1.4.7 CT series

(1) Modbus

Type	Mark	Device	Note
Bit	CT	Bit device area	
	UB	GP/LP inner bit memory	
Word	CT	Word device area	
	UW	GP/LP inner word memory	

(2) Modbus TYPE A

Type	Mark	Device	Note
	0	Bit device area	
Bit	1	Bit device area	
	UB	GP/LP inner bit memory	
Word	3	Word device area	
	4	Word device area	
	UW	GP/LP inner word memory	

6.1.4.8 DS/DA Serise

Type	Mark	Device	Note
Bit	UB	GP inner bit memory	
Word	3	Word device area	
	4	Word device area	
	UW	GP/LP inner word memory	

6.1.4.9 Remote I/O ARM Serise

Type	Mark	Device	Note
Bit	0	Bit device area	
	1	Bit device area	
	UB	GP inner bit memory	
Word	3	Word device area	
	4	Word device area	
	UW	GP/LP inner word memory	

6.2 Autonics LP series PLC connection

GP/LP is able to connect with Autonics LP series.

6.2.1 System organization

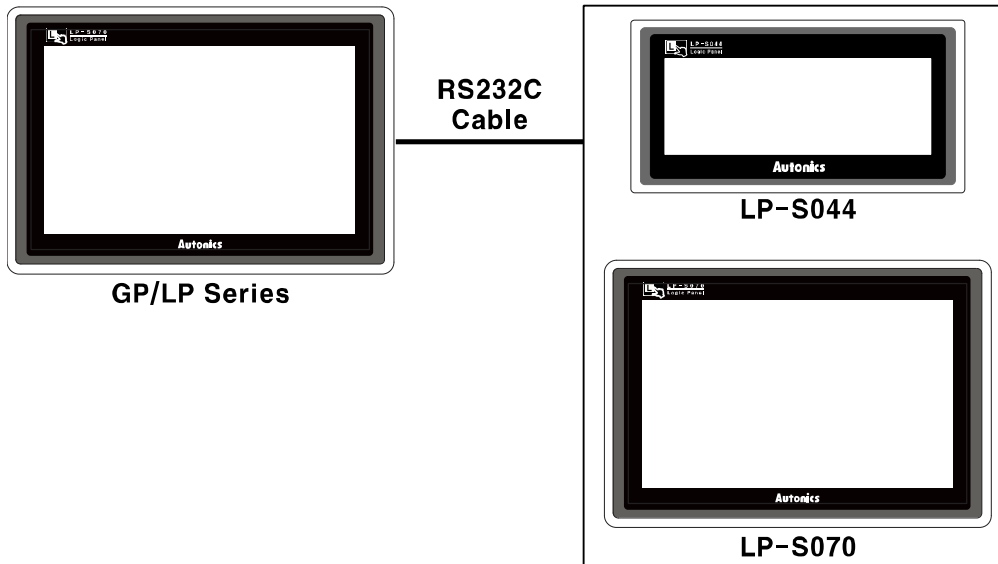

Autonics LP series executes RS-232C communication. It executes also RS-422 communication with RS-232/422 converter.

PLC type		Communication method	Communication type	Baudrate (bps)
Autonics LP series	LP-S044	RS-232C	CPU direct(Loader)	Selectable from 300 to 115200
	LP-S070	RS422		

(1) RS232C: Applied cable (17)C3M5P03-D9F0-D9F0

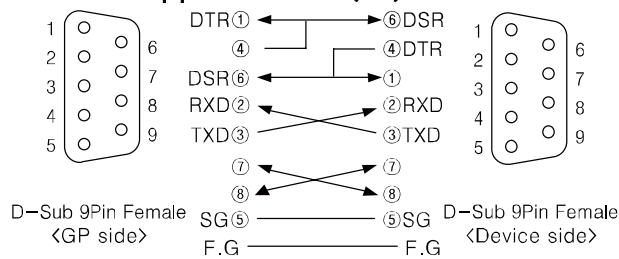

(2) RS422: Applied cable (18)C3M5P03-D9M0-D9M0

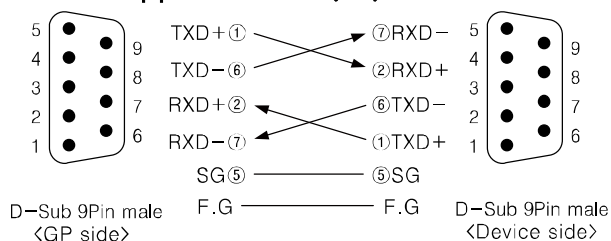

6.2.2 Available device

Device range is different depending on PLC model. Even though same type PLC, there is difference according to the number of I/O contact point.

UB device is as GP/LP inner bit memory, only in GP/LP it is able to use same as general inner device of PLC.

It is able to switch into word UW device binding 16 units. However it is related with functional area and it may cause serious error. Be sure to use only within user area UW30 to UW2047 (when not using recipe, UW30 to UW6047).

For further information of GP/LP inner memory, refer to '3.6 System signal'.

Refer to below bit/word available device organization and use the device.

X	00	0
----------	-----------	----------

① Device name ② Word address ③ Bit address

Type	①	②	③
Bit	X	Decimal	Hexadecimal
	Y	Decimal	Hexadecimal
	M	Decimal	Hexadecimal
	F	Decimal	Hexadecimal
	L	Decimal	Hexadecimal
	S	Bit address (Decimal)	
	T	Bit address (Decimal)	
	C	Bit address (Decimal)	
	UB	Decimal	Hexadecimal
Word	X	Word address (Decimal)	None
	Y	Word address (Decimal)	None
	M	Word address (Decimal)	None
	F	Word address (Decimal)	None
	L	Word address (Decimal)	None
	T	Word address (Decimal)	
	C	Word address (Decimal)	
	D	Word address (Decimal)	
	R	Word address (Decimal)	
	UW	Word address (Decimal)	None



Ex.

Word X1 = Bit X10 to X1F , Word UW10 = UB100 to UB10F

6.2.2.1 LP-S044

Type	Device	Mark	Range	
			Start	End
Bit	Input relay	X	X0	X255F
	Output relay	Y	Y0	Y255F
	Inner auxiliary relay	M	M0	M9999F
	Status relay	S	S0	S25599
	Special relay	F	F0	F255F
	Link relay	L	L0	L255F
	Timer contact [10ms]	T	T0	T127
	Timer contact [100ms]	T	T128	T255
	Counter contact [16bit]	C	C0	C255
	GP bit device	UB	UB0	UB6047F
Word	Input register	X	X0	X255
	Output register	Y	Y0	Y255
	Inner auxiliary register	M	M0	M9999
	File register	R	R0	R3999
	Special register	F	F0	F255
	Link register	L	L0	L255
	Timer present value [10ms]	T	T0	T127
	Timer present value [100ms]	T	T128	T255
	Counter present value [16bit]	C	C0	C255
	Data register	D	D0	D9999
	GP word device	UW	UW0	UW6047

6.2.2.2 LP-S070

Type	Device	Mark	Range	
			Start	End
Bit	Input relay	X	X0	X255F
	Output relay	Y	Y0	Y255F
	Inner auxiliary relay	M	M0	M9999F
	Status relay	S	S0	S25599
	Special relay	F	F0	F300F
	Link relay	L	L0	L255F
	Timer contact [10ms]	T	T0	T127
	Timer contact [100ms]	T	T128	T255
	Counter contact [16bit]	C	C0	C255
	GP bit device	UB	UB0	UB6047F
Word	Input register	X	X0	X255
	Output register	Y	Y0	Y255
	Inner auxiliary register	M	M0	M9999
	File register	R	R0	R3999
	Special register	F	F0	F300
	Link register	L	L0	L255
	Timer present value [10ms]	T	T0	T127
	Timer present value [100ms]	T	T128	T255
	Counter present value [16bit]	C	C0	C255
	Data register	D	D0	D9999
	GP word device	UW	UW0	UW6047

6.2.3 Monitorable device in GP/LP

GP/LP is able to monitor LP and change the status.

Enter system setting menu of GP/LP and select [Monitoring]-[Device Monitor]-[DEV.]. Select to be monitored device and you can change the status.

The following is available device list of this menu, available range is same as '6.2.2 Available device'.

Type	Mark	Device	Note
Bit	X	Input relay	
	Y	Output relay	
	M	Inner auxiliary relay	
	F	Special relay	
	S	Status relay	
	L	Link relay	
	T	Timer contact	
	C	Counter contact	
	UB	GP/LP inner bit memory	
Word	X	Input register	
	Y	Output register	
	M	Inner auxiliary register	
	F	Special register	
	L	Link register	
	T	Timer present value	
	C	Counter present value	
	D	Data register	16bit
	R	File register	
	UW	GP/LP inner word memory	

6.3 LS Master-K series PLC connection

GP/LP is able to communicate with LS Master-K series.

6.3.1 System organization

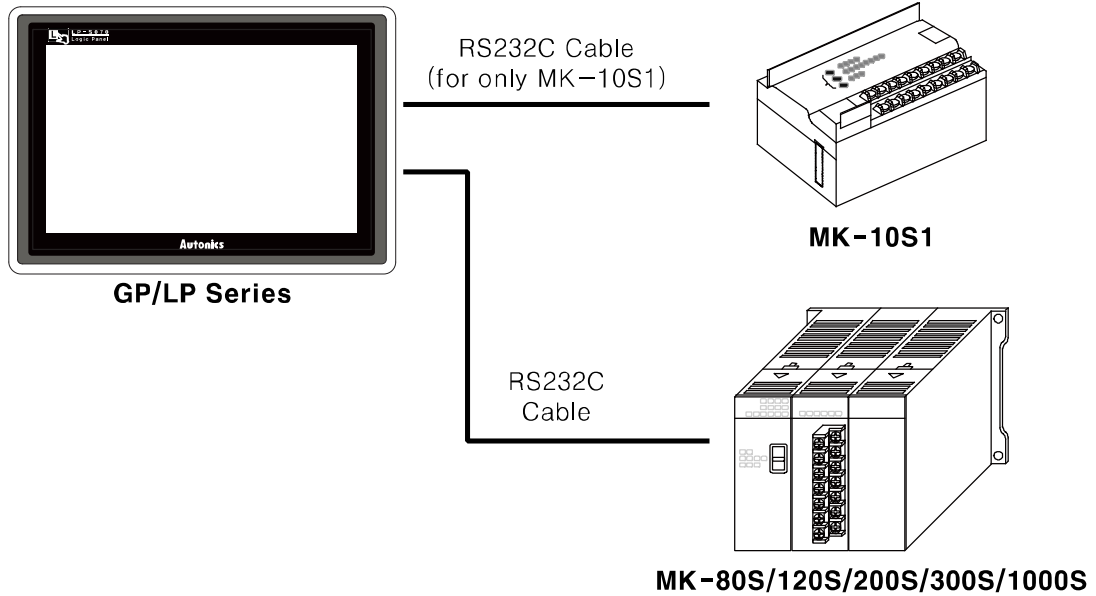

LS Master-K series executes RS232C communication. If PLC has imbedded RS422 loader port or you use RS232/422 converter, RS422 communication is also available.

PLC type		Communication method	Communication type	Baud rate (bps)
LS Master K	MK-10S1	RS232C	CPU direct(Loader)	9600
	MK-80S/120S/200S/300S/1000S			38400

RS232C cable is different by connected PLC type.

The following is RS232C cable diagram and pin arrangement by connected PLC type.

(1) K10S1 (Applied cable (1)C3M5P00-D9F0-M6M0)

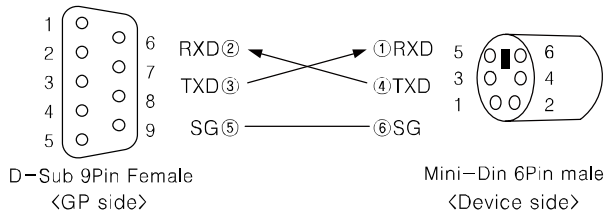

(2) MK-80S/ 120S/200S/300S/1000S (Applied cable (2)C3M5P01-D9F0-D9M0)

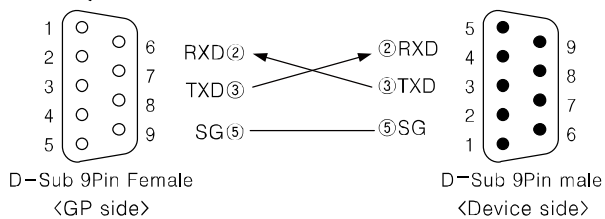

6.3.2 Available device

Device range is different depending on PLC model. Even though same type PLC, there is difference according to the number of I/O contact point.

Bit device; P, M, K, F, L are not used as general word at PLC. However, it is able to switch into word UW device binding 16 units in GP/LP.

UB device is as GP/LP inner bit memory, only in GP/LP it is able to use same as general inner device of PLC.

It is able to switch into word UW device binding 16 units. However it is related with functional area and it may cause serious error. Be sure to use only within user area UW30 to UW2047 (when not using recipe, UW30 to UW6047).

For further information of GP/LP inner memory, refer to '3.6 System signal'.

Refer to below bit/word available device organization and use the device.

P	00	0
----------	-----------	----------

① Device name ② Word address ③ Bit address

Type	①	②	③
Bit	P	Decimal	Hexadecimal
	M	Decimal	Hexadecimal
	K	Decimal	Hexadecimal
	F	Decimal	Hexadecimal
	L	Decimal	Hexadecimal
	T	Bit address(Decimal)	
	C	Bit address(Decimal)	
	UB	Decimal	Hexadecimal
Word	P	Word address (Decimal)	None
	M	Word address (Decimal)	None
	K	Word address (Decimal)	None
	L	Word address (Decimal)	None
	T	Word address (Decimal)	
	C	Word address (Decimal)	
	D	Word address (Decimal)	
	UW	Word address (Decimal)	None



Ex.

Word P1 = Bit P10 to P1F , Word UW10 = UB100 to UB10F

6.3.2.1 MK-10S1

Type	Device	Mark	Range	
			Start	End
Bit	Input relay	P	P0	P0F
	Output relay	P	P10	P1F
	Inner auxiliary relay	M	M0	M15F
	Memory protection relay	K	K0	K7F
	Special relay	F	F0	F15F
	Link relay	L	L0	L7F
	Timer contact[10ms]	T	T32	T47
	Timer contact[100ms]	T	T0	T31
	Counter contact[16bit]	C	C0	C15
	GP/LP inner bit memory	UB	UB0	UB6047F
Word	Input relay	P	P0	-
	Output relay	P	P1	-
	Inner auxiliary relay	M	M0	M15
	Memory protection relay	K	K0	K7
	Special relay	F	F0	F15
	Link relay	L	L0	L7
	Timer present value[10ms]	T	T32	T47
	Timer present value[100ms]	T	T0	T31
	Counter present value[16bit]	C	C0	C15
	Data register	D	D0	D63
	GP/LP inner word memory	UW	UW0	UW6047

6.3.2.2 MK-80S

Type	Device	Mark	Range	
			Start	End
Bit	Input relay	P	P0	P15F
	Output relay	P	P0	P15F
	Inner auxiliary relay	M	M0	M191F
	Memory protection relay	K	K0	K31F
	Special relay	F	F0	F63F
	Link relay	L	L0	L63F
	Timer contact[10ms]	T	T192	T255
	Timer contact[100ms]	T	T0	T191
	Counter contact[16bit]	C	C0	C255
	GP/LP inner bit memory	UB	UB0	UB6047F
Word	Input relay	P	P0	P15
	Output relay	P	P0	P15
	Inner auxiliary relay	M	M0	M191
	Memory protection relay	K	K0	K31
	Special relay	F	F0	F63
	Link relay	L	L0	L63
	Timer present value[10ms]	T	T192	T255
	Timer present value[100ms]	T	T0	T191
	Counter present value[16bit]	C	C0	C255
	Data register	D	D0	D4499
	Special register	D	D4500	D4999
	GP/LP inner word memory	UW	UW0	UW6047

6.3.2.3 MK-120S

Type	Device	Mark	Range	
			Start	End
Bit	Input relay	P	P0	P63F
	Output relay	P	P0	P63F
	Inner auxiliary relay	M	M0	M191F
	Memory protection relay	K	K0	K31F
	Special relay	F	F0	F63F
	Link relay	L	L0	L63F
	Timer contact[10ms]	T	T192	T255
	Timer contact[100ms]	T	T0	T191
	Counter contact[16bit]	C	C0	C255
	GP/LP inner bit memory	UB	UB0	UB6047F
Word	Input relay	P	P0	P63
	Output relay	P	P0	P63
	Inner auxiliary relay	M	M0	M191
	Memory protection relay	K	K0	K31
	Special relay	F	F0	F63
	Link relay	L	L0	L63
	Timer present value[10ms]	T	T192	T255
	Timer present value[100ms]	T	T0	T191
	Counter present value[16bit]	C	C0	C255
	Data register	D	D0	D4499
	Special register	D	D4500	D4999
	GP/LP inner word memory	UW	UW0	UW6047

6.3.2.4 MK-200S

Type	Device	Mark	Range	
			Start	End
Bit	Input relay	P	P0	P31F
	Output relay	P	P0	P31F
	Inner auxiliary relay	M	M0	M191F
	Memory protection relay	K	K0	K31F
	Special relay	F	F0	F63F
	Link relay	L	L0	L63F
	Timer contact[10ms]	T	T192	T255
	Timer contact[100ms]	T	T0	T191
	Counter contact[16bit]	C	C0	C255
	GP/LP inner bit memory	UB	UB0	UB6047F
Word	Input relay	P	P0	P31
	Output relay	P	P0	P31
	Inner auxiliary relay	M	M0	M191
	Memory protection relay	K	K0	K31
	Special relay	F	F0	F63
	Link relay	L	L0	L63
	Timer present value[10ms]	T	T192	T255
	Timer present value[100ms]	T	T0	T191
	Counter present value[16bit]	C	C0	C255
	Data register	D	D0	D4499
	Special register	D	D4500	D4999
	GP/LP inner word memory	UW	UW0	UW6047

6.3.2.5 MK-300S

Type	Device		Mark	Range	
				Start	End
Bit	Input relay	CPU OS version 3.X or above	P	P0	P63F
		CPU OS version 2.X or above	P	P0	P31F
	Output relay	CPU OS version 3.X or above	P	P0	P63F
		CPU OS version 2.X or above	P	P0	P31F
	Inner auxiliary relay		M	M0	M191F
	Memory protection relay		K	K0	K31F
	Special relay		F	F0	F63F
	Link relay		L	L0	L63F
	Timer contact[10ms]		T	T192	T255
	Timer contact[100ms]		T	T0	T191
	Counter contact[16bit]		C	C0	C255
	GP/LP inner bit memory		UB	UB0	UB6047F
	Word	Input relay	CPU OS version 3.X or above	P	P0
CPU OS version 2.X or above			P	P0	P31
Output relay		CPU OS version 3.X or above	P	P0	P63
		CPU OS version 2.X or above	P	P0	P31
Inner auxiliary relay		M	M0	M191	
Memory protection relay		K	K0	K31	
Special relay		F	F0	F63	
Link relay		L	L0	L63	
Timer present value[10ms]		T	T192	T255	
Timer present value[100ms]		T	T0	T191	
Counter present value[16bit]		C	C0	C255	
Data register		D	D0	D4499	
Special register		D	D4500	D4999	
GP/LP inner word memory		UW	UW0	UW6047	

6.3.2.6 MK-1000S

Type	Device	Mark	Range	
			Start	End
Bit	Input relay	P	P0	P63F
	Output relay	P	P0	P63F
	Inner auxiliary relay	M	M0	M191F
	Memory protection relay	K	K0	K31F
	Special relay	F	F0	F63F
	Link relay	L	L0	L63F
	Timer contact[10ms]	T	T192	T255
	Timer contact[100ms]	T	T0	T191
	Counter contact[16bit]	C	C0	C255
	GP/LP inner bit memory	UB	UB0	UB6047F
Word	Input relay	P	P0	P63
	Output relay	P	P0	P63
	Inner auxiliary relay	M	M0	M191
	Memory protection relay	K	K0	K31
	Special relay	F	F0	F63
	Link relay	L	L0	L63
	Timer present value[10ms]	T	T192	T255
	Timer present value[100ms]	T	T0	T191
	Counter present value[16bit]	C	C0	C255
	Data register	D	D0	D9499
	Special register	D	D9500	D9999
	GP/LP inner word memory	UW	UW0	UW6047

6.3.3 Monitorable device in GP/LP

GP/LP is able to monitor PLC device and change the status.

Enter system setting menu of GP/LP and select [Monitoring]-[Device Monitor]-[DEV.]. Select to be monitored device and you can change the status.

The following is available device list of this menu, available range is same as '6.3.2 Available device'.

Type	Mark	Device	Note
Bit	P	Input/Output relay	
	M	Inner auxiliary relay	
	K	Memory protection relay	
	F	Special relay	
	T	Timer contact	
	C	Counter contact	
	UB	GP/LP inner bit memory	
Word	P	Input/Output relay	
	M	Inner auxiliary relay	
	K	Memory protection relay	
	F	Special relay	
	T	Timer present value	
	C	Counter present value	
	D16	Data/File/Special register	16bit
	D32	Data/File/Special register	32bit type combining designated number of device and next number of device
	UW	GP/LP inner word memory	

6.4 LS Glofa PLC connection

GP/LP is able to communicate with LS Glofa series.

6.4.1 System organization

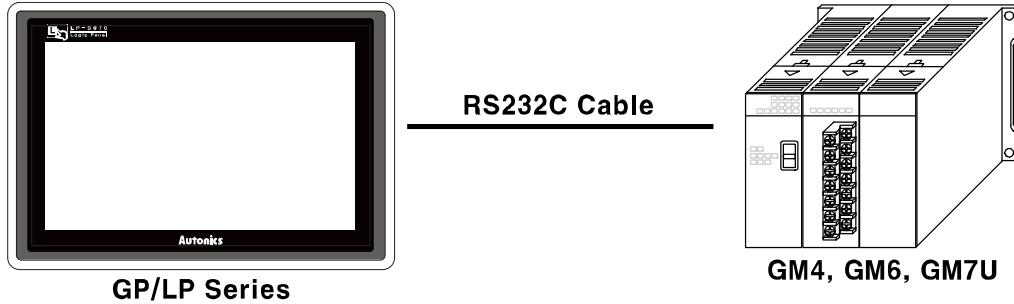

LS Glofa series executes RS232C communication. If PLC has imbedded RS422 loader port or you use RS232/422 converter, RS422 communication is also available.

PLC type		Communication method	Communication type	Baudrate (bps)
LS Glofa	GM4	RS232C	CPU direct(Loader)	38400
	GM6			
	GM7U			

The following is RS232C cable diagram and pin arrangement.

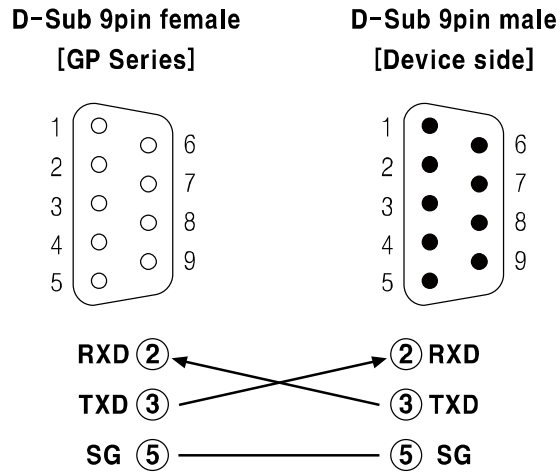

6.4.2 Available device

Display method for variable in GP/LP is used by direct display method for variable. Bit device uses IX, QX, MX only, word device uses IW, QW, MW only. Device range is different depending on PLC model.

UB device is as GP/LP inner bit memory, only in GP/LP it is able to use same as general inner device of PLC.

It is able to switch into word UW device binding 16 units. However it is related with functional area and it may cause serious error. Be sure to use only within user area UW30 to UW2047 (when not using recipe, UW30 to UW6047).

For further information of GP/LP inner memory, refer to '3.6 System signal'.

Refer to below bit/word available device organization and use the device.

IX	1	2	1	F
-----------	----------	----------	----------	----------

① ② ③ ④ ⑤

- ① Device name
- ② Base number
- ③ Slot number
- ④ The number of I/O card point
- ⑤ Bit address

MX	121	F
-----------	------------	----------

① ② ③

- ① Device name
- ② Quotient of base number(Device contact number/16)
- ③ Remainder of (Device contact number/16)

Type	①	②	③	④	⑤	Note
Bit	IX	Octonal	Octonal	Quaternary	Hexadecimal	Bit address 0 to F
	QX	Octonal	Octonal	Quaternary	Hexadecimal	Bit address 0 to F
	MX	Decimal			Hexadecimal	Bit address 0 to F
	UB	Decimal			Hexadecimal	Bit address 0 to F
Word	IW	Word address			None	
	QW	Word address			None	
	MW	Word address(Decimal)			None	
	UW	Word address(Decimal)			None	

6.4.2.1 Structure differences of use device for GP/LP and GMWIN

(1) Input/Output relay of bit device structure

- I/O bit device structure for GMWIN
%[Device name] [Base number] . [Slot number]. [(The number of I/O card point X 16)+Bit address]
- I/O bit device structure for GP
[Device name] [Base number] [Slot number] [The number of I/O card point] [Bit address (Hexadecimal)]



Ex.

Output device; Base number=2, Slot number=1, The number of I/O card point=2, Bit address=10
%QX 2.1.42 (GMWIN) ▶ QX 2 1 2 A (GP)

(2) Inner relay of bit device structure

- Inner relay of bit device structure for GMWIN
%[Device name] [Bit address (Decimal)]
- I/O bit device structure for GP
[Device name] [Quotient of base number(Bit address/16) (Decimal)] [Remainder of (Bit address/16) (Hexadecimal)]



Ex.

1000th inner relay

%MX 1002 (GMWIN) ▶ MX 6 2 A (GP)



Quotient of 1002/16 = 62 (Decimal)
Remainder of 1002/16 = 10 = A

6.4.2.2 GM4

Type	Device	Mark	Range	
			Start	End
Bit	Input relay	IX	IX0	IX773F*1
	Output relay	QX	QX0	QX773F*1
	inner auxiliary relay	MX	MX0	MX8191F
	GP/LP inner bit memory	UB	UB0	UB6047F
Word	Input relay	IW	IW0	IW773
	Output relay	QW	QW0	QW773
	Inner auxiliary relay	MW	MW0	MW8191
	GP/LP inner word memory	UW	UW0	UW6047

※1. Actual PLC supports from 0 to 31 bases, but GP/LP supports from 0 to 7 bases.

6.4.2.3 GM6

Type	Device	Mark	Range	
			Start	End
Bit	Input relay	IX	IX0	IX173F
	Output relay	QX	QX0	QX173F
	Inner auxiliary relay	MX	MX0	MX4095F
	GP/LP inner bit memory	UB	UB0	UB6047F
Word	Input relay	IW	IW0	IW173
	Output relay	QW	QW0	QW173
	Inner auxiliary relay	MW	MW0	MW4095
	GP/LP inner word memory	UW	UW0	UW6047

6.4.2.4 GM7U

Type	Device	Mark	Range	
			Start	End
Bit	Input relay	IX	IX0	IX173F
	Output relay	QX	QX0	QX173F
	Inner auxiliary relay	MX	MX0	MX4095F
	GP/LP inner bit memory	UB	UB0	UB6047F
Word	Input relay	IW	IW0	IW173
	Output relay	QW	QW0	QW173
	Inner auxiliary relay	MW	MW0	MW4095
	GP/LP inner word memory	UW	UW0	UW6047

6.4.3 Monitorable device in GP/LP

GP/LP is able to monitor PLC device and change the status.

Enter system setting menu of GP/LP and select [Monitoring]-[Device Monitor]-[DEV.]. Select to be monitored device and you can change the status.

The following is available device list of this menu, available range is same as '6.4.2 Available device'.

Type	Mark	Device
Bit	IX	Input relay
	QX	Output relay
	MX	Inner auxiliary relay
	UB	GP/LP inner bit memory
Word	IW	Input relay
	QW	Output relay
	MW	Inner auxiliary relay
	UW	GP/LP inner word memory

6.5 LS Cnet communication connection

GP/LP is able to communicate with LS Cnet.

6.5.1 System organization

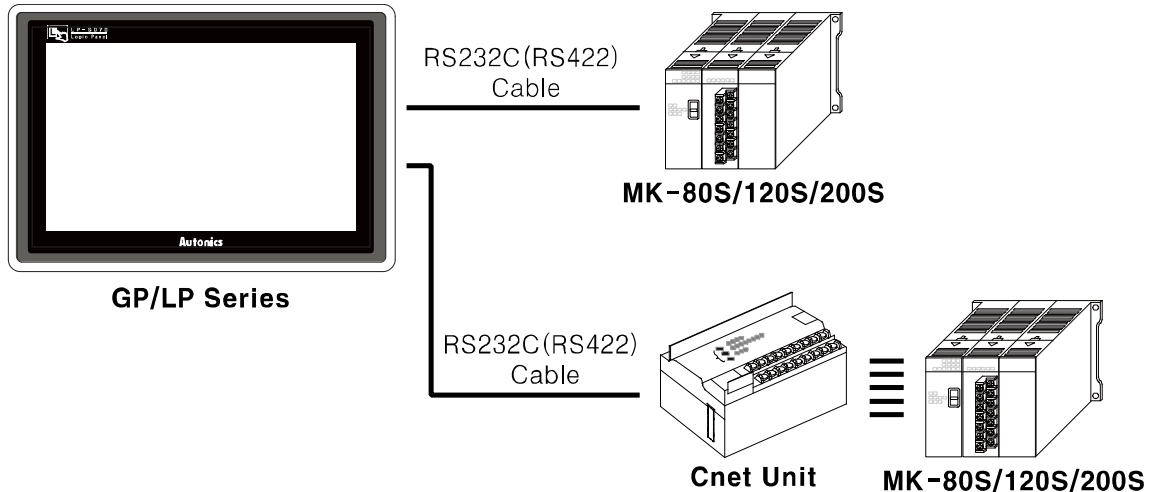

It executes Cnet communication with GP/LP connecting directly with PLC CPU or using Cnet Unit.

It is able to execute Cnet communication differing pin number of Loader port in CPU and connecting Cnet Unit.

6.5.1.1 When using built-in Cnet of CPU,

PLC type		CPU model name	Communication type	Communication method	Baudrate (bps)
LS Master-K	MK-80S	K7M-DR10S	CPU direct	RS232C	19200
		K7M-DR20S			
		K7M-DR30S			
		K7M-DR40S			
		K7M-DR60S			
	MK-120S	K7M-DR□□U		RS232C RS485	
		K7M-DT□□U			
		K7M-DRT□□U			
	MK-200S	K3P-07AS		RS232C	
		K3P-07BS		RS422	
		K3P-07CS		RS232C	

(1) RS-232C (Applied cable (3)C3M5P02-D9F0-D9M0)

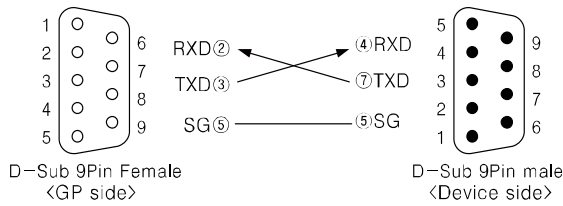

(2) RS-422(Applied cable (5)C3M5P04-D9M0-W6*0)

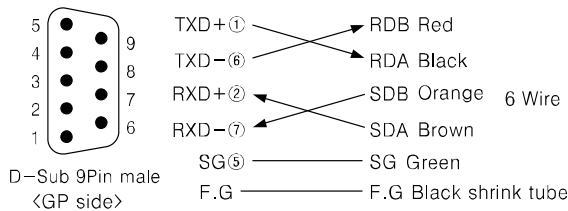

(3) RS-485 (Applied cable (4)C3M5P03-D9M0-W4*0)



6.5.1.2 When using Cnet Unit,

PLC type		UNIT model name	Communication method	Baudrate (bps)
LS Master-K	MK-80S	G7L-CUEB	RS232C	19200
		G7L-CUEC	RS422	
	MK-120S	G7L-CUEB	RS232C	
		G7L-CUEC	RS422	
	MK-200S	G6L-CUEB	RS232C	
		G6L-CUEC	RS422	
MK-300S	G4L-CUEA	RS232C, RS422		
MK-1000S	G3L-CUEA	RS232C, RS422		

In case of K7M-DR10S CPU of MK-80S, Cnet Unit cannot be connectable.

(1) Cnet Unit RS-232C(Applied cable (6)C3M5P05-D9F0-D9M0)

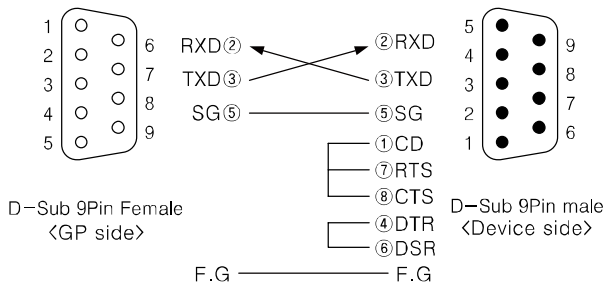

(2) Cnet Unit RS-422(Applied cable (16)C3M5P04-D9M0-T6Y0)

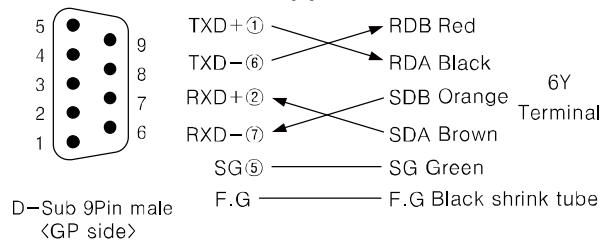

6.5.2 Communication configuration

6.5.2.1 Communication configuration when using built-in Cnet of CPU

Communication configuration for using built-in Cnet of CPU is set from the dedicated ladder program (KGL for Window) and communication configuration method is as following.

- 1st Connect the dedicated ladder program and set PLC as connectable status.
- 2nd From the workspace window of the ladder program, select [Parameter] and designate the items as below.

Item	Setting	Note
Station	User-defined	0 to 31(Current station is only 0)
Stop bit	1	Fixed
Data bit	8	Fixed
Parity	None	Fixed
Baudrate	19200	Fixed

6.5.2.2 Communication configuration when using Cnet Unit

Communication configuration for using Cnet Unit is set from Cnet Frame Editor and communication configuration method is as following. (You can download the program from LSIS website.)

- 1st Connect PC and ladder port in PLC CPU with RS232C cable.
- 2nd Execute Cnet Frame Editor.
- 3rd Select [Online]-[Connect] of menu and set the status to communication with PLC.
- 4th Select [Online]-[Read] of menu, 'Read' dialog box appears. Designate slot number and click 'Read'. From the right slot of CPU slot number starts with 1.
- 5th At 'Read' dialog box, click 'Close' and read data from Cnet Unit is displayed at communication channel and basic parameter of current frame editor.
- 6th When displayed data is same as following table, exit the program. If displayed data is not same as following table, set items as following table and select [Online]-[Write]. Designate slot number and click 'Write'. If there is no error, click 'Close'. Re-try 4th process and check the data is set correctly. If there is no error, exit the program.

Item	Description	Note
Station	User-defined	0 to 31(Current station is only 0)
Stop bit	1	Fixed
Data bit	8	Fixed
Parity	None	Fixed

Item	Description	Note
Baudrate	19200	Fixed

7th Turn OFF PLC power and turn ON again.

8th Connect GP and Cnet Unit with communication cable and start communication.

6.5.3 Available device

It is same as LS Master-K series's. For more details, refer to '6.3 LS Master-K series PLC connection'.

6.6 OEMAX PLC(Samsung PLC) connection

GP/LP is able to communicate with Samsung FARA N series and N plus series.

6.6.1 System organization

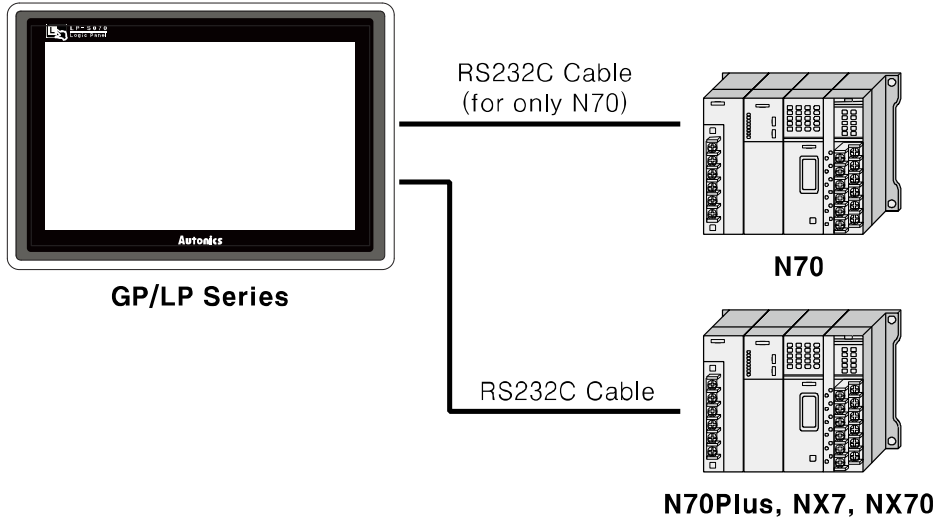

Samsung FARA series executes RS232C communication. If PLC has imbedded RS422 loader port or you use RS232/422 converter, RS422 communication is also available.

PLC type		Communication method	Communication type	Baudrate (bps)
Samsung FARA	N70	RS232C	CPU direct(Loader)	19200
	N70plus	RS232C	CPU direct(Loader)	38400
	NX7	RS232C	CPU direct(Loader)	38400
	NX70	RS232C	CPU direct(Loader)	38400



Note

Be sure that the baudrate of each PLC should be set same as above table. You can designate baudrate by dip switch of each PLC CPT module.

RS232C cable connection is different depending on PLC type.

The following is RS232C cable diagram and pin arrangement for N70 and N70plus.

(1) Connect PLC is N70 (Applied cable: (7)C3M5P06-D9F0-D15M0)

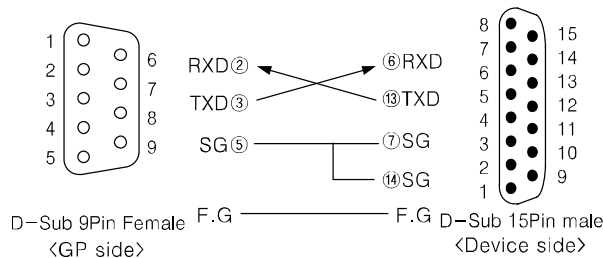

(2) Connect PLC is N70plus, NX7, NX70 (Applied cable (8)C3M5P07-D9F0-D9M0)

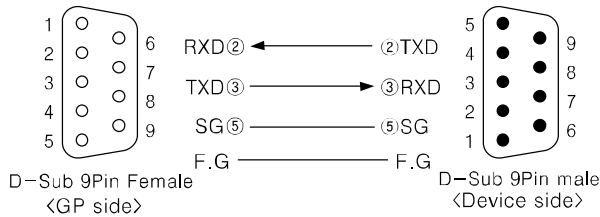

6.6.2 Available device

Be sure that device address of N70 and N70plus are different structure.

6.6.2.1 FARA N70

Device range is different depending on PLC model. Even though same type PLC, there is difference according to the number of I/O contact point.

UB device is as GP/LP inner bit memory, only in GP/LP it is able to use same as general inner device of PLC.

It is able to switch into word UW device binding 16 units. However it is related with functional area and it may cause serious error. Be sure to use only within user area UW30 to UW2047 (when not using recipe, UW30 to UW6047).

For further information of GP/LP inner memory, refer to '3.6 System signal'.

Refer to below bit/word available device organization and use the device.

X	00	0
---	----	---

① Device name ② Word address ③ Bit address

Type	①	②	③
Bit	X	Decimal	Hexadecimal
	Y	Decimal	Hexadecimal
	R	Decimal	Hexadecimal
	L	Decimal	Hexadecimal
	T	Bit address(Decimal)	
	C	Bit address(Decimal)	
	UB	Decimal	Hexadecimal
Word	WX	Word address(Decimal)	None
	WY	Word address(Decimal)	None
	WR	Word address(Decimal)	None
	WL	Word address(Decimal)	None
	EV	Word address(Decimal)	
	SV	Word address(Decimal)	
	DT	Word address(Decimal)	
	Ld	Word address(Decimal)	
	UW	Word address(Decimal)	None

Type	Device	Mark	Range	
			Start	End
Bit	Input relay	X	X0	X127F
	Output relay	Y	Y0	Y127F
	Inner auxiliary relay	R	R0	R97F
	Special relay	R	R9000	R910F
	Link relay	L	L0	L127F
	Timer contact[10ms]	T	T0	T199
	Timer contact[100ms]	T	T0	T199
	Timer contact[1000ms]	T	T0	T199
	Counter contact[16bit]	C	C200	C255
	GP/LP inner bit memory	UB	UB0	UB6047F
Word	Input relay	WX	WX0	WX127
	Output relay	WY	WY0	WY127
	Inner auxiliary relay	WR	WR0	WR97
	Link relay	WL	WL0	WL127
	Timer present value[10ms]	EV	EV0	EV199
	Timer present value[100ms]	EV	EV0	EV199
	Timer present value[1000ms]	EV	EV0	EV199
	Timer setting value[10ms]	SV	SV0	SV199
	Timer setting value[100ms]	SV	SV0	SV199
	Timer setting value[1000ms]	SV	SV0	SV199
	Counter present value[16bit]	EV	EV200	EV255
	Counter setting value[16bit]	SV	SV200	SV255
	Data register	DT	DT0	DT2047
	File register	FL	FL0	FL22524
	Special register	DT	DT9000	DT9255
Link register	Ld	Ld0	Ld255	
GP/LP inner word memory	UW	UW0	UW6047	

6.6.2.2 FARA N70 Plus

Device range is different depending on PLC model. Even though same type PLC, there is difference according to the number of I/O contact point.

Bit device; R, M, K, F, L are not used as general word at PLC. However, it is able to switch into word UW device binding 16 units in GP/LP.

UB device is as GP/LP inner bit memory, only in GP/LP it is able to use same as general inner device of PLC.

It is able to switch into word UW device binding 16 units. However it is related with functional area and it may cause serious error. Be sure to use only within user area UW30 to UW2047 (when not using recipe, UW30 to UW6047).

For further information of GP/LP inner memory, refer to '3.6 System signal'.

Refer to below bit/word available device organization and use the device.

R	00	0
---	----	---

① Device name ② Word address ③ Bit address

Type	①	②	③	Note
Bit	R	Decimal	Decimal(0 to 15)	R###.## of '.' is not used
	M	Decimal	Decimal(0 to 15)	M###.## of '.' is not used
	K	Decimal	Decimal(0 to 15)	K###.## of '.' is not used
	F	Decimal	Decimal(0 to 15)	F###.## of '.' is not used
	L	Decimal	Decimal(0 to 15)	L###.## of '.' is not used
	TC	Bit address(Decimal)		
	UB	Decimal	Hexadecimal	
Word	R	Word address(Decimal)	None	
	M	Word address(Decimal)	None	
	K	Word address(Decimal)	None	
	F	Word address(Decimal)	None	
	L	Word address(Decimal)	None	
	PV	Word address(Decimal)		
	SV	Word address(Decimal)		
	W	Word address(Decimal)		
	SR	Word address(Decimal)		
	UW	Word address(Decimal)	None	



Ex.

Word R1 = Bit R100 to R115 , Word UW10 = UB100 to UB10F

There is difference for mark of bit R, M, K, F, L between general mark and GP/LP mark. General mark is displayed as R##.##, GP/LP mark is displayed without middle of distinguisher. For example, R10.10 is displayed as 'R1010' in GP/LP.

Be sure that GP/LP does not use distinguisher, it uses virtual distinguisher cutting two digits from the backward of input bit R, M, K, F, L address.

(Ex) Bit R1 = R0.01 , Bit M10 = M0.10 , Bit K101 = K1.01

Type	Device	Mark	Range	
			Start	End
Bit	Input relay	R	R0	R12715
	Output relay	R	R0	R12715
	Inner auxiliary relay	M	M0	M12715
	Memory protection relay	K	K0	K12715
	Special relay	F	F0	F1515
	Link relay	L	L0	L6315
	Timer contact[10ms]	TC	TC0	TC63
	Timer contact[100ms]	TC	TC64	TC255
	Counter contact[16bit]	TC	TC0	TC255
	GP/LP inner bit memory	UB	UB0	UB6047F
Word	Input relay	R	R0	R127
	Output relay	R	R0	R127
	Inner auxiliary relay	M	M0	M127
	Memory protection relay	K	K0	K127
	Special relay	F	F0	F15
	Link relay	L	L0	L63
	Timer present value[10ms]	PV	PV0	PV63
	Timer present value[100ms]	PV	PV63	PV255
	Timer setting value[10ms]	SV	SV0	SV63
	Timer setting value[100ms]	SV	SV64	SV255
	Counter present value[16bit]	PV	PV0	PV255
	Counter setting value[16bit]	SV	SV0	SV255
	Data register ^{※1}	W	W0	W2047
	Special register	SR	SR0	SR511
	GP/LP inner word memory	UW	UW0	UW6047

※1. Depending on CPU type, that range is fluid.

In case of CPL9215A, the range is W0 to W2047. In case of CPL9216A, the range is W0 to W4095.

6.6.2.3 FARA NX7

Device range is different depending on PLC model. Even though same type PLC, there is difference according to the number of I/O contact point.

Bit device; R, M, K, F, L are not used as general word at PLC. However, it is able to switch into word UW device binding 16 units in GP/LP.

UB device is as GP/LP inner bit memory, only in GP/LP it is able to use same as general inner device of PLC.

It is able to switch into word UW device binding 16 units. However it is related with functional area and it may cause serious error. Be sure to use only within user area UW30 to UW2047 (when not using recipe, UW30 to UW6047).

For further information of GP/LP inner memory, refer to '3.6 System signal'.

Refer to below bit/word available device organization and use the device.

R	00	0
---	----	---

① Device name ② Word address ③ Bit address

Type	①	②	③	Note
Bit	R	Decimal	Decimal(0 to 15)	R##.## of '.' is not used
	M	Decimal	Decimal(0 to 15)	M##.## of '.' is not used
	K	Decimal	Decimal(0 to 15)	K##.## of '.' is not used
	F	Decimal	Decimal(0 to 15)	F##.## of '.' is not used
	L	Decimal	Decimal(0 to 15)	L##.## of '.' is not used
	TC	Bit address(Decimal)		
	UB	Decimal	Hexadecimal	
Word	R	Word address(Decimal)	None	
	M	Word address(Decimal)	None	
	K	Word address(Decimal)	None	
	F	Word address(Decimal)	None	
	L	Word address(Decimal)	None	
	PV	Word address(Decimal)		
	SV	Word address(Decimal)		
	W	Word address(Decimal)		
	SR	Word address(Decimal)		
	UW	Word address(Decimal)	None	



Ex.

Word R1 = Bit R100 to R115 , Word UW10 = UB100 to UB10F

There is difference for mark of bitR, M, K, F, L between general mark and GP/LP mark. General mark is displayed as R##.##, GP/LP mark is displayed without middle of distinguisher.

For example, R10.10 is displayed as 'R1010' in GP/LP.

Be sure that GP/LP does not use distinguisher, it uses virtual distinguisher cutting two digits from the backward of input bit R, M, K, F, L address.

(Ex) Bit R1 = R0.01 , Bit M10 = M0.10 , Bit K101 = K1.01

Type	Device	Mark	Range	
			Start	End
Bit	Input relay	R	R0	R3115
	Output relay	R	R0	R3115
	Inner auxiliary relay	M	M0	M12715
	Memory protection relay	K	K0	K12715
	Special relay	F	F0	F1515
	Link relay	L	L0	L6315
	Timer contact[10ms]	TC	TC0	TC63
	Timer contact[100ms]	TC	TC64	TC255
	Counter contact[16bit]	TC	TC0	TC255
GP/LP inner bit memory	UB	UB0	UB6047F	
Word	Input relay	R	R0	R127
	Output relay	R	R0	R127
	Inner auxiliary relay	M	M0	M127
	Memory protection relay	K	K0	K127
	Special relay	F	F0	F15
	Link relay	L	L0	L63
	Timer present value[10ms]	PV	PV0	PV63
	Timer present value[100ms]	PV	PV63	PV255
	Timer setting value[10ms]	SV	SV0	SV63
	Timer setting value[100ms]	SV	SV64	SV255
	Counter present value[16bit]	PV	PV0	PV255
	Counter setting value[16bit]	SV	SV0	SV255
	Data register ^{※1}	W	W0	W2047
Special register	SR	SR0	SR511	
GP/LP inner word memory	UW	UW0	UW6047	

※1. Depending on CPU type, that range is fluid.

In case of CPL9215A, the range is W0 to W2047. In case of CPL9216A, the range is W0 to W4095

6.6.2.4 FARA NX70 (CPU70)

Device range is different depending on PLC model. Even though same type PLC, there is difference according to the number of I/O contact point

Bit device; R, M, K, F, L are not used as general word at PLC. However, it is able to switch into word UW device binding 16 units in GP/LP.

UB device is as GP/LP inner bit memory, only in GP/LP it is able to use same as general inner device of PLC.

It is able to switch into word UW device binding 16 units. However it is related with functional area and it may cause serious error. Be sure to use only within user area UW30 to UW2047 (when not using recipe, UW30 to UW6047).

For further information of GP/LP inner memory, refer to '3.6 System signal'

Refer to below bit/word available device organization and use the device.

X	00	0
---	----	---

①Device name ②Word address ③Bit address

Type	①	②	③
Bit	X	Decimal	Hexadecimal
	Y	Decimal	Hexadecimal
	R	Decimal	Hexadecimal
	L	Decimal	Hexadecimal
	T	Bit address(Decimal)	
	C	Bit address(Decimal)	
	UB	Decimal	Hexadecimal
Word	WX	Word address(Decimal)	None
	WY	Word address(Decimal)	None
	WR	Word address(Decimal)	None
	WL	Word address(Decimal)	None
	EV	Word address(Decimal)	
	SV	Word address(Decimal)	
	DT	Word address(Decimal)	
	Ld	Word address(Decimal)	
	UW	Word address(Decimal)	None



Ex.

Word R1 = Bit R100 to R115 , Word UW10 = UB100 to UB10F

There is difference for mark of bit R, M, K, F, L between general mark and GP/LP mark. General mark is displayed as R##.##, GP/LP mark is displayed without middle of distinguisher.

For example, R10.10 is displayed as 'R1010' in GP/LP.

Be sure that GP/LP does not use distinguisher, it uses virtual distinguisher cutting two digits from the backward of input bit R, M, K, F, L address.

Bit R1 = R0.01 , Bit M10 = M0.10 , Bit K101 = K1.01

Type	Device	Mark	Range	
			Start	End
Bit	Input relay	X	X0	X127F
	Output relay	Y	Y0	Y127F
	Inner auxiliary relay	R	R0	R97F
	Special relay	R	R9000	R910F
	Link relay	L	L0	L127F
	Timer contact[10ms]	T	T0	T199
	Timer contact[100ms]	T	T0	T199
	Timer contact[1000ms]	T	T0	T199
	Counter contact[16bit]	C	C200	C255
	GP/LP inner bit memory	UB	UB0	UB6047F
Word	Input relay	WX	WX0	WX127
	Output relay	WY	WY0	WY127
	Inner auxiliary relay	WR	WR0	WR97
	Link relay	WL	WL0	WL127
	Timer present value[10ms]	EV	EV0	EV199
	Timer present value[100ms]	EV	EV0	EV199
	Timer present value[1000ms]	EV	EV0	EV199
	Timer setting value[10ms]	SV	SV0	SV199
	Timer setting value[100ms]	SV	SV0	SV199
	Timer setting value[1000ms]	SV	SV0	SV199
	Counter present value[16bit]	EV	EV200	EV255
	Counter setting value[16bit]	SV	SV200	SV255
	Data register	DT	DT0	DT2047
	File register	FL	FL0	FL22524
	Special register	DT	DT9000	DT9255
	Link register	Ld	Ld0	Ld255
GP/LP inner word memory	UW	UW0	UW6047	

※1. Depending on CPU type, that range is fluid.

In case of CPL9215A, the range is W0 to W2047. In case of CPL9216A, the range is W0 to W4095.

6.6.3 Monitorable device in GP/LP

GP/LP is able to monitor PLC device and change the status.

Enter system setting menu of GP/LP and select [Monitoring]-[Device Monitor]-[DEV.]. Select to be monitored device and you can change the status.

The following is available device list of this menu, available range is same as '6.6.2 Available device'.

6.6.3.1 FARA N70 / FARA NX70(CPU 70)

Type	Mark	Device	Note
Bit	X	Input relay	
	Y	Output relay	
	R	Inner auxiliary relay, Special relay	
	T	Timer contact	
	C	Counter contact	
	UB	GP/LP inner bit memory	
Word	WX	Input relay	
	WY	Output relay	
	WR	Inner auxiliary relay, Special relay	
	WL	Link relay	
	EV	Timer present value	
	SV	Counter setting value	
	DT16	Data/File/Special register	16bit
	DT32	Data/File/Special register	32bit type combining designated number of device and next number of device
	FL	File register	
	UW	GP/LP inner word memory	

6.6.3.2 FARA N70 Plus / FARA NX7

Type	Mark	Device	Note
Bit	R	Input/Output relay	
	M	Inner auxiliary relay	
	K	Memory protection relay	
	F	Special relay	
	TC	Counter/Counter contact	
	UB	GP/LP inner bit memory	
Word	R	Input/Output relay	
	M	Inner auxiliary relay	
	K	Memory protection relay	
	F	Special relay	
	PV	Timer/Counter present value	
	SV	Timer/Counter setting value	
	W16	Data/File/Special register	16bit
	W32	Data/File/Special register	32bit type combining designated number of device and next number of device
	SR	Special register	
UW	GP/LP inner word memory		

6.7 MITSUBISHI PLC

GP/LP is able to communicate with MITSUBISHI FX series.

6.7.1 System organization

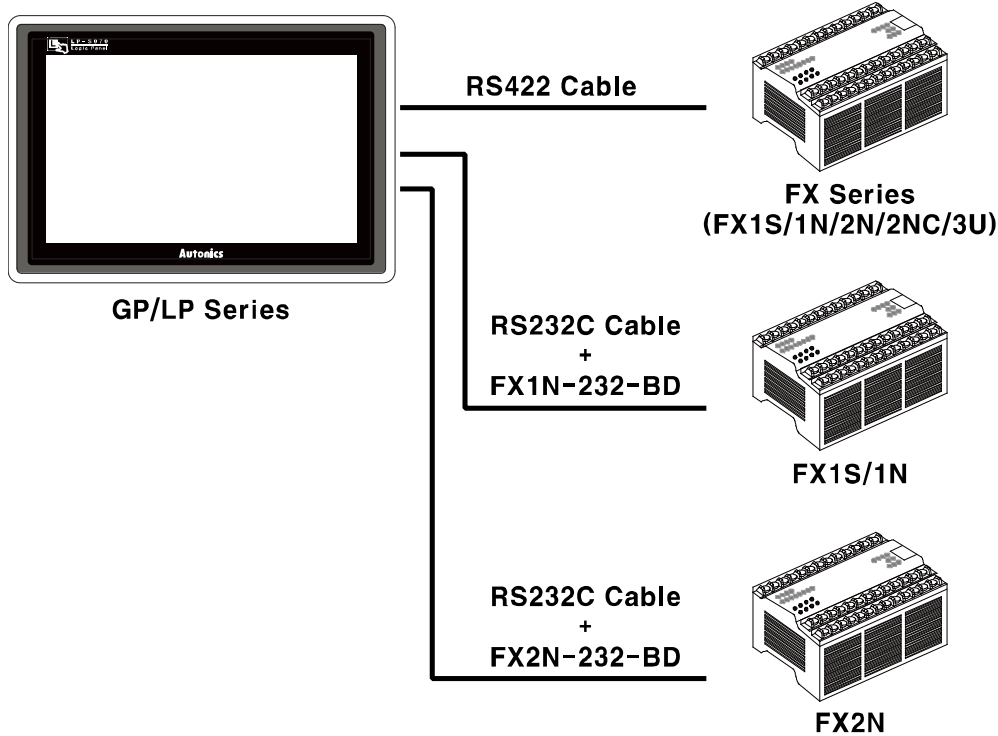

FX series executes RS422 communication and it also executes RS232C communication with RS232/422 converter or RS232C communication board (FX1N-232-BD, FX2N-232-BD).

PLC type		Communication method	Communication type
MITSUBISHI FX	FX1S	RS422	CPU direct(Loader)
		RS232C	Communication board(FX1N-232-BD)
	FX1N	RS422	CPU direct(Loader)
		RS232C	Communication board(FX1N-232-BD)
	FX2N	RS422	CPU direct(Loader)
		RS232C	Communication board(FX2N-232-BD)
FX2NC	RS422	CPU direct(Loader)	
FX3U	RS422	CPU direct(Loader)	

(1) RS-422: Applied cable (9)C3M5P08-D9M0-M8M0.

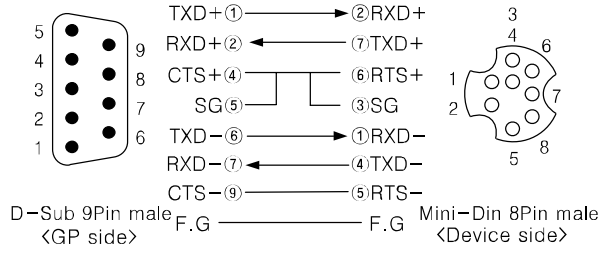

(2) RS-232C communication board(FX1N/FX2N-232-BD): Applied cable

(10)C3M5P09-D9F0-D9F0.

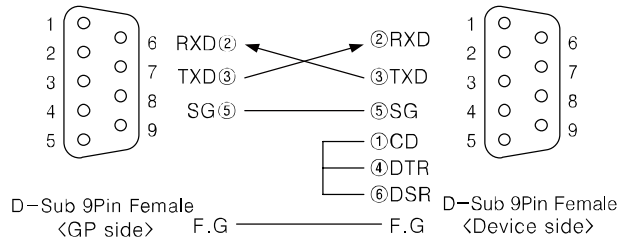

6.7.2 Available device

Device range is different depending on PLC model. Even though same type PLC, there is difference according to the number of I/O contact point.

Bit device; X, Y, M, S are not used as general word at PLC. However, it is able to use as word in GP/LP. M, S device are able to switch into word UW device binding 16 unit, X, Y device are able to switch into word UW device binding 8 unit.

UB device is as GP/LP inner bit memory, only in GP/LP it is able to use same as general inner device of PLC.

It is able to switch into word UW device binding 16 units. However it is related with functional area and it may cause serious error. Be sure to use only within user area UW30 to UW2047 (when not using recipe, UW30 to UW6047).

For further information of GP/LP inner memory, refer to '3.6 System signal'

Refer to below bit/word available device organization and use the device.

X	00	0
---	----	---

① Device name ② Word address ③ Bit address

Type	①	②	③	Note
Bit	X	Bit address(Octonal)		
	Y	Bit address(Octonal)		
	M	Bit address(Decimal)		
	S	Bit address(Decimal)		
	T	Bit address(Decimal)		
	C	Bit address(Decimal)		
	UB	Decimal	Hexadecimal	
Word	X	Word address(Octonal)	None	multiple 8 of bit
	Y	Word address(Octonal)	None	multiple 8 of bit
	M	Word address		multiple 16 of bit
	S	Word address		multiple 16 of bit
	T	Word address		
	C	Word address		
	D	Word address		
	UW	Word address(Decimal)	None	

※ The address of word M, S is multiple of 16, it is same with M0,M16,M32,...



Ex.

Example of Bit/Word usage

- Word X1 = Bit X10 to X17 , Word M0 = Bit M00 to M15 , UW10 = UB100 to UB10F

6.7.2.1 FX1S

Type	Device	Mark	Range	
			Start	End
Bit	Input relay	X	X0	X17
	Output relay	Y	Y0	Y15
	Inner auxiliary relay	M	M0	M383
	Memory protection relay	M	M384	M511
	Special relay	M	M8000	M8255
	Status relay	S	S0	S127
	Timer contact[1ms]	T	T63	-
	Timer contact[10ms]	T	T32	T62
	Timer contact[100ms]	T	T0	T31
	Counter contact[16bit]	C	C0	C31
	Counter contact[32b 1 phase 1count]	C	C235	C245
	Counter contact[32b 1 phase 2count]	C	C246	C250
	Counter contact[32b 2 phase 2count]	C	C251	C255
	GP/LP inner bit memory	UB	UB0	UB6047F
Word	Input relay	X	X0	X1
	Output relay	Y	Y0	Y1
	Inner auxiliary relay	M	M0	M368
	Memory protection relay	M	M384	M496
	Special relay	M	M8000	M8240
	Status relay	S	S0	S112
	Timer present value[1ms]	T	T63	-
	Timer present value[10ms]	T	T32	T62
	Timer present value[100ms]	T	T0	T31
	Counter present value[16bit]	C	C0	C31
	Counter present value[32b 1 phase 1count]	C	C235	C245
	Counter present value[32b 1 phase 2count]	C	C246	C250
	Counter present value[32b 2 phase 2count]	C	C251	C255
	Data register	D	D0	D255
File register	D	D1000	D2499	
Special register	D	D8000	D8255	
GP/LP inner word memory	UW	UW0	UW6047	

6.7.2.2 FX1N

Type	Device	Mark	Range	
			Start	End
Bit	Input relay	X	X0	X177
	Output relay	Y	Y0	Y177
	Inner auxiliary relay	M	M0	M383
	Memory protection relay	M	M384	M1535
	Special relay	M	M8000	M8255
	Status relay(Memory protection)	S	S0	S999
	Timer contact[1ms]	T	T246	T249
	Timer contact[10ms]	T	T200	T245
	Timer contact[100ms]	T	T0	T199
	Timer contact[100ms](Memory protection)	T	T250	T255
	Counter contact[16bit]	C	C0	C199
	Counter contact[32bit]	C	C200	C234
	Counter contact[32b 1 phase 1count]	C	C235	C245
	Counter contact[32b 1 phase 2count]	C	C246	C250
	Counter contact[32b 2 phase 2count]	C	C251	C255
	GP/LP inner bit memory	UB	UB0	UB6047F
Word	Input relay	X	X0	X17
	Output relay	Y	Y0	Y17
	Inner auxiliary relay	M	M0	M368
	Memory protection relay	M	M384	M1520
	Special relay	M	M8000	M8240
	Status relay	S	S0	S976
	Timer present value[1ms]	T	T246	T249
	Timer present value[10ms]	T	T200	T245
	Timer present value[100ms]	T	T0	T199
	Timer present value[100ms](Memory protection)	T	T250	T255
	Counter present value[16bit]	C	C0	C199
	Counter present value[32bit]	C	C200	C234
	Counter present value[32b 1 phase 1count]	C	C235	C245

Type	Device	Mark	Range	
			Start	End
	Counter present value[32b 1 phase 2count]	C	C246	C250
	Counter present value[32b 2 phase 2count]	C	C251	C255
	Data register	D	D0	D7999
	File register	D	D1000	D7999
	Special register	D	D8000	D8255
	GP/LP inner word memory	UW	UW0	UW6047

6.7.2.3 FX2N

Type	Device	Mark	Range	
			Start	End
Bit	Input relay	X	X0	X267
	Output relay	Y	Y0	Y267
	Inner auxiliary relay	M	M0	M3071
	Special relay	M	M8000	M8255
	Status relay	S	S0	S899
	Annunciator	S	S900	S999
	Timer contact[1ms]	T	T246	T249
	Timer contact[10ms]	T	T200	T245
	Timer contact[100ms]	T	T0	T199
	Timer contact[100ms](Memory protection)	T	T250	T255
	Counter contact[16bit]	C	C0	C199
	Counter contact[32bit]	C	C200	C234
	Counter contact[32b 1 phase 1count]	C	C235	C245
	Counter contact[32b 1 phase 2count]	C	C246	C250
	Counter contact[32b 2 phase 2count]	C	C251	C255
	GP/LP inner bit memory	UB	UB0	UB6047F
Word	Input relay	X	X0	X26
	Output relay	Y	Y0	Y26
	Inner auxiliary relay	M	M0	M3056
	Special relay	M	M8000	M8240
	Status relay	S	S0	S976
	Timer present value[1ms]	T	T246	T249
	Timer present value[10ms]	T	T200	T245
	Timer present value[100ms]	T	T0	T199

Type	Device	Mark	Range	
			Start	End
	Timer present value [100ms](Memory protection)	T	T250	T255
	Counter present value[16bit]	C	C0	C199
	Counter present value[32bit]	C	C200	C234
	Counter present value[32b 1 phase 1count]	C	C235	C245
	Counter present value[32b 1 phase 2count]	C	C246	C250
	Counter present value[32b 2 phase 2count]	C	C251	C255
	Data register	D	D0	D7999
	File register	D	D1000	D7999
	Special register	D	D8000	D8255
	GP/LP inner word memory	UW	UW0	UW6047

6.7.2.4 FX2NC

Type	Device	Mark	Range	
			Start	End
Bit	Input relay	X	X0	X267
	Output relay	Y	Y0	Y267
	Inner auxiliary relay	M	M0	M3071
	Special relay	M	M8000	M8255
	Status relay	S	S0	S899
	Annunciator	S	S900	S999
	Timer contact[1ms]	T	T246	T249
	Timer contact[10ms]	T	T200	T245
	Timer contact[100ms]	T	T0	T199
	Timer contact[100ms](Memory protection)	T	T250	T255
	Counter contact[16bit]	C	C0	C199
	Counter contact[32bit]	C	C200	C234
	Counter contact[32b 1 phase 1count]	C	C235	C245
	Counter contact[32b 1 phase 2count]	C	C246	C250
	Counter contact[32b 2 phase 2count]	C	C251	C255
GP/LP inner bit memory	UB	UB0	UB6047F	
Word	Input relay	X	X0	X26
	Output relay	Y	Y0	Y26

Type	Device	Mark	Range	
			Start	End
	Inner auxiliary relay	M	M0	M3056
	Special relay	M	M8000	M8240
	Status relay	S	S0	S976
	Timer present value[1ms]	T	T246	T249
	Timer present value[10ms]	T	T200	T245
	Timer present value[100ms]	T	T0	T199
	Timer present value [100ms](Memory protection)	T	T250	T255
	Counter present value[16bit]	C	C0	C199
	Counter present value[32bit]	C	C200	C234
	Counter present value[32b 1 phase 1count]	C	C235	C245
	Counter present value[32b 1 phase 2count]	C	C246	C250
	Counter present value[32b 2 phase 2count]	C	C251	C255
	Data register	D	D0	D7999
	File register	D	D1000	D7999
	Special register	D	D8000	D8255
GP/LP inner word memory	UW	UW0	UW6047	

6.7.2.5 FX3U

Type	Device	Mark	Range	
			Start	End
Bit	Input relay	X	X0	X367
	Output relay	Y	Y0	Y367
	Inner auxiliary relay	M	M0	M7679
	Special relay	M	M8000	M8511
	Status relay	S	S0	S899
	Annunciator	S	S900	S999
	Timer contact[1ms]	T	T256	T511
	Timer contact[1ms] Integration type	T	T246	T249
	Timer contact[10ms]	T	T200	T245
	Timer contact[100ms]	T	T0	T199
	Timer contact[100ms] Integration type	T	T250	T255
	Counter contact[16bit]	C	C0	C199
	Counter contact[32bit]	C	C200	C234

Type	Device	Mark	Range	
			Start	End
	Counter contact[32b 1 phase 1count]	C	C235	C245
	Counter contact[32b 1 phase 2count]	C	C246	C250
	Counter contact[32b 2 phase 2count]	C	C251	C255
	GP/LP inner bit memory	UB	UB0	UB6047F
Word	Input relay	X	X0	X36
	Output relay	Y	Y0	Y36
	Inner auxiliary relay	M	M0	M7648
	Special relay	M	M8000	M8496
	Status relay	S	S0	S976
	Timer present value[1ms]	T	T256	T511
	Timer present value[10ms]	T	T200	T245
	Timer present value[100ms]	T	T0	T199
	Timer present value [100ms](Memory protection)	T	T250	T255
	Counter present value[16bit]	C	C0	C199
	Counter present value[32bit]	C	C200	C234
	Counter present value[32b 1 phase 1count]	C	C235	C245
	Counter present value[32b 1 phase 2count]	C	C246	C250
	Counter present value[32b 2 phase 2count]	C	C251	C255
	Data register	D	D0	D7999
	File register	D	D1000	D7999
Special register	D	D8000	D8511	
GP/LP inner word memory	UW	UW0	UW6047	

6.7.3 Monitorable device in GP/LP

GP/LP is able to monitor PLC device and change the status.

Enter system setting menu of GP/LP and select [Monitoring]-[Device Monitor]-[DEV.]. Select to be monitored device and you can change the status.

The following is available device list of this menu, available range is same as '6.7.2 Available device'.



Type	Mark	Device	Note
Bit	X	Input relay	
	Y	Output relay	
	M	Inner auxiliary relay, Special relay	
	S	Status relay	
	T	Timer contact	
	C	Counter contact	
	UB	GP/LP inner bit memory	
Word	X	Input relay	
	Y	Output relay	
	M	Inner auxiliary relay, Special relay	Multiple of 16 (M0, M16, M32, ...)
	S	Status relay	Multiple of 16 (S0, S16, S32, ...)
	T	Timer present value	
	C	Counter present value	
	D16	Data/File/Special register	16bit
	D32	Data/File/Special register	32bit type combining designated number of device and next number of device
	UW	GP/LP inner word memory	

6.8 MITSUBISHI Q series PLC connection

GP/LP is able to communicate with MITSUBISHI Q series.

6.8.1 System organization

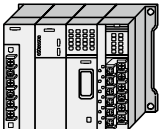
The following table is for system organization of this protocol.

PLC	Communication module	Cable	GP/LP
		↔	
Q00J/Q00/Q01 Q02/Q02H/Q06H /Q12H/Q25H	QJ71C24N QJ71C24N-R2 QJ71C24N-R4	RS-232C RS-422 / RS-485	GP/LP series

PLC type		Program capacity	The number of I/O point	
MITSUBISHI Q	Basic model	Q00J	8K	245 points
		Q00	8K	1024 points
		Q01	14K	1024 points
	High performance model	Q02	28K	4096 points
		Q02H	28K	4096 points
		Q06H	60K	4096 points
		Q12H	124K	4096 points
		Q25H	252K	4096 points

Serial communication module type	Communication channel
QJ71C24N	RS-232 1CH, RS-422/485 1CH
QJ71C24N-R2	RS-232 2CH
QJ71C24N-R4	RS-422/485 2CH

(1) RS-422: Applied cable (5)C3M5P04-D9M0-W6*0

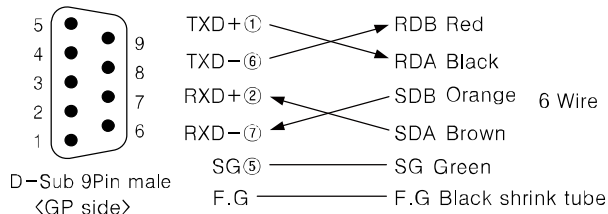

(2) RS-232C: Applied cable (6)C3M5P05-D9F0-D9M0

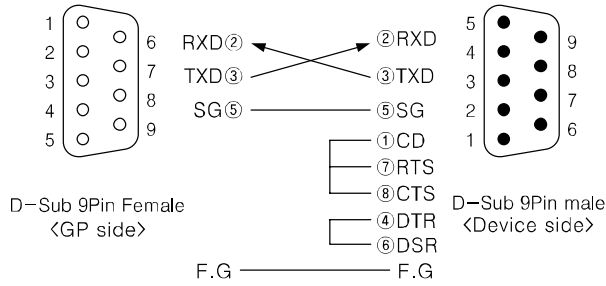

6.8.2 Available device

Device range is different depending on PLC model. Even though same type PLC, there is difference according to the number of I/O contact point.

UB device is as GP/LP inner bit memory, only in GP/LP it is able to use same as general inner device of PLC.

It is able to switch into word UW device binding 16 units. However it is related with functional area and it may cause serious error. Be sure to use only within user area UW30 to UW2047 (when not using recipe, UW30 to UW6047).

For further information of GP/LP inner memory, refer to '3.6 System signal'.

Refer to below bit/word available device organization and use the device.

X	00	0
---	----	---

① Device name ② Word address ③ Bit address

Type	①	②	③
Bit	X	Bit address(Hexadecimal)	
	Y	Bit address(Hexadecimal)	
	M	Bit address(Decimal)	
	L	Bit address(Decimal)	
	SM	Bit address(Decimal)	
	B	Bit address(Hexadecimal)	
	F	Bit address(Decimal)	
	TS	Bit address(Decimal)	
	CS	Bit address(Decimal)	
	UB	Decimal	Hexadecimal
Word	W	Word address	
	TN	Word address	
	CN	Word address	
	D	Word address	
	SD	Word address	
	UW	Word address(Decimal)	None



Ex.

UW10 = UB100 to UB10F

6.8.2.1 Q00J / Q00 / Q01

Type	Device	Mark	Range	
			Start	End
Bit	Input relay	X	X0	X7FF
	Output relay	Y	Y0	Y7FF
	Auxiliary relay	M	M0	M8191
	Special relay	SM	SM0	SM1023
	Latch relay	L	L0	L2047
	Facility error detecting relay	F	F0	F1023
	Link relay	B	B0	B07FF
	Timer contact	TS	TS0	TS511
	Counter contact	CS	CS0	CS511
	GP/LP inner bit memory	UB	UB0	UB6047F
Word	Data register	D	D0	D11135
	Special register	SD	SD0	SD1023
	Link register	W	W0	W7FF
	Timer present value	TN	TN0	TN511
	Counter present value	CN	CN0	CN511
	GP/LP inner word memory	UW	UW0	UW6047

6.8.2.2 Q02 / Q02H / Q06H / Q12H / Q25H

Type	Device	Mark	Range	
			Start	End
Bit	Input relay	X	X0	X1FFF
	Output relay	Y	Y0	Y1FFF
	Auxiliary relay	M	M0	M8191
	Special relay	SM	SM0	SM2047
	Latch relay	L	L0	L8191
	Facility error detecting relay	F	F0	F2047
	Link relay	B	B0	B01FFF
	Timer contact	TS	TS0	TS2047
	Counter contact	CS	CS0	CS2047
	GP/LP inner bit memory	UB	UB0	UB6047F
Word	Data register	D	D0	D12287
	Special register	SD	SD0	SD2047
	Link register	W	W0	W1FFF
	Timer present value	TN	TN0	TN2047
	Counter present value	CN	CN0	CN2047
	GP/LP inner word memory	UW	UW0	UW6047

6.8.3 Monitorable device in GP/LP

GP/LP is able to monitor PLC device and change the status.

Enter system setting menu of GP/LP and select [Monitoring]-[Device Monitor]-[DEV.]. Select to be monitored device and you can change the status.

The following is available device list of this menu, available range is same as '6.8.2 Available device'.

Type	Mark	Device
Bit	X	Input relay
	Y	Output relay
	M	Auxiliary relay
	SM	Special relay
	L	Latch relay
	F	Facility error detecting relay
	B	Link relay
	TS	Timer contact
	CS	Counter contact
	UB	GP/LP inner bit memory
Word	D	Data register
	SD	Special register
	W	Link register
	TN	Timer present value
	CN	Counter present value
	UW	GP/LP inner word memory

6.8.4 MELSEC Q series PLC configuration

6.8.4.1 DX-Developer parameter configuration

(1) I/O assignment

I/O assignment of parameter configuration is to set the type of various module mounted on base module, I/O signal range, and Q series switch.

Item		Description for setting
I/O assignment	Type	Set as 'Intelli'
	Model Name	Set the mounted module name (QJ71C24N/QJ71C24N-R2...)
	Points	Set as 32 points
	Start XY	Set the lead I/O signal of target module
	Switch Setting	Set baudrate, transmission specification, communication protocol
	Detailed setting	In case of multi CPU system, set the management CPU of Q series C24

The screenshot shows the 'Qn(H) Parameter' dialog box with the 'I/O assignment' tab selected. The dialog has several tabs: PLC name, PLC system, PLC file, PLC RAS, Device, Program, Boot file, SFC, and I/O assignment. The 'I/O Assignment(+)' section contains a table with columns for Slot, Type, Model name, Points, and StartXY. The table has 8 rows, with Slot 0 set to 'PLC' and others blank. To the right of the table are 'Switch setting' and 'Detailed setting' buttons. Below the table is a note: 'Assigning the I/O address is not necessary as the CPU does it automatically. Leaving this setting blank will not cause an error to occur.' The 'Base setting(+)' section contains a table with columns for Base model name, Power model name, Extension cable, and Slots. It has rows for Main, Ext.Base1, Ext.Base2, Ext.Base3, and Ext.Base4. To the right are 'Base mode' radio buttons for 'Auto' (selected) and 'Detail', and '8 Slot Default' and '12 Slot Default' buttons. At the bottom, there are buttons for 'Import Multiple CPU Parameter', 'Read PLC data', 'Acknowledge XY assignment', 'Multiple CPU settings', 'Default', 'Check', 'End', and 'Cancel'.

(2) Switch setting

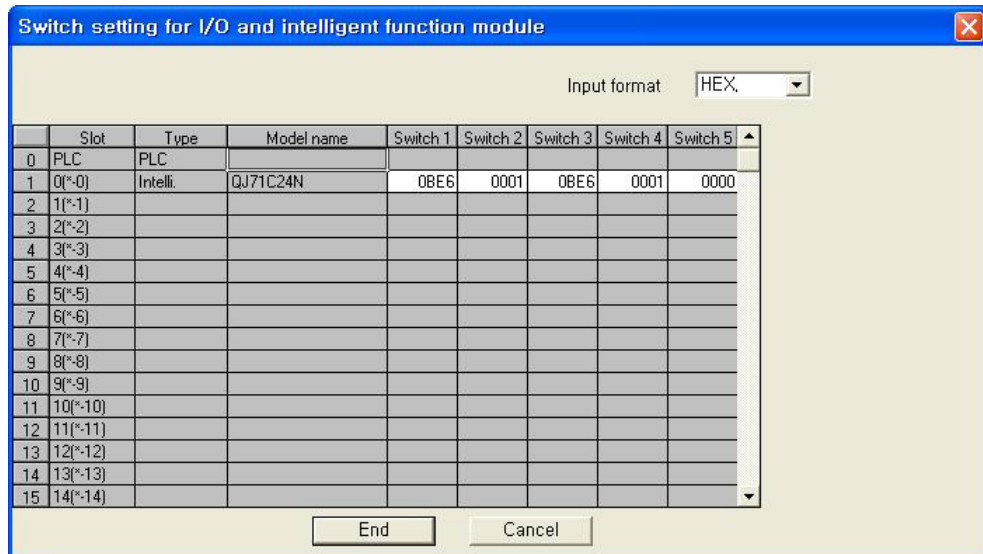

Switch setting description

Switch No.	Description	Note
Switch 1	B15 to b8	B7 to b0
	CH1 baudrate setting	CH1 transmission setting
Switch 2	CH1 communication protocol type setting	Should be set as 1
Switch 3	B15 to b8	B7 to b0
	CH2 baudrate setting	CH2 transmission setting
Switch 4	CH2 communication protocol type setting	Should be set as 1
Switch 5	Station setting	

Transmission setting - CH1(Switch 1), CH2(Switch 3)

Bit	Description	OFF(0)	ON(1)	Note
B0	Operation setting	Separate	Link	CH1 should be set as OFF
B1	Data bit	7	8	Set as 8
B2	Parity bit	No	Yes	Set as yes
B3	Odd/Even parity	Odd	Even	Set as odd
B4	Stop bit	1	2	Set as 1
B5	Checksum code	No	Yes	Set as yes
B6	RUN write	Restriction	Allowance	Set as allowance
B7	Setting change	Restriction	Allowance	Set as allowance

- Transmission speed setting

Baudrate(bps)	Bit unit	Baudrate (bps)	Bit unit
	B15 to B8		B15 to B8
50	0Fh	14400	06h
300	00h	19200	07h
600	01h	28800	08h
1200	02h	38400	09h
2400	03h	57600	0Ah
4800	04h	115200	0Bh
9600	05h	230400	0Ch

If two interfaces connect to correspondence device respectively, the sum of communication speed for both interfaces should be set 115,200bps or less(For QJ71C24N(-R2/R4), 230,400bps or less).

If only one interface connects to correspondence device, the communication speed for this interface can be set the maximum 115,200bps.(For QJ71C24N(-R2/R4), available to set maximum 230400bps).

In this case, please set the communication speed for the other interface to 300bps.

6.8.5 GP/PLC type configuration in GP Editor

6.8.5.1 Basic Model CPU

For using Q00J / Q00 / Q01 CPU, select [MITSUBISHI Q SERIES]-[QBasic_EXT_MC].

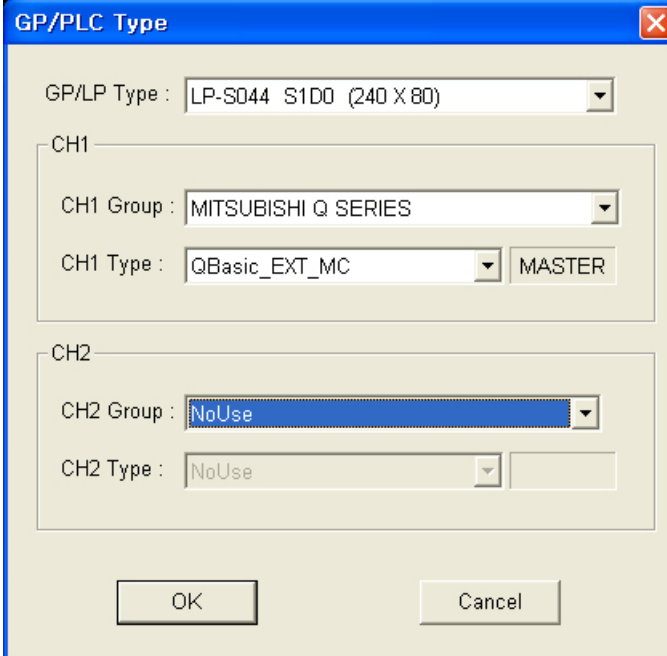

The screenshot shows the 'GP/PLC Type' dialog box. The 'GP/LP Type' is set to 'LP-S044 S1D0 (240 X 80)'. Under the 'CH1' section, 'CH1 Group' is 'MITSUBISHI Q SERIES' and 'CH1 Type' is 'QBasic_EXT_MC' with a 'MASTER' button. Under the 'CH2' section, 'CH2 Group' is 'NoUse' and 'CH2 Type' is 'NoUse'. 'OK' and 'Cancel' buttons are at the bottom.

6.8.5.2 High Performance Model CPU

For using Q02 / Q02H / Q06H / Q12H / Q25H CPU, select [MITSUBISHI Q SERIES]-[QHighP_EXT_MC].

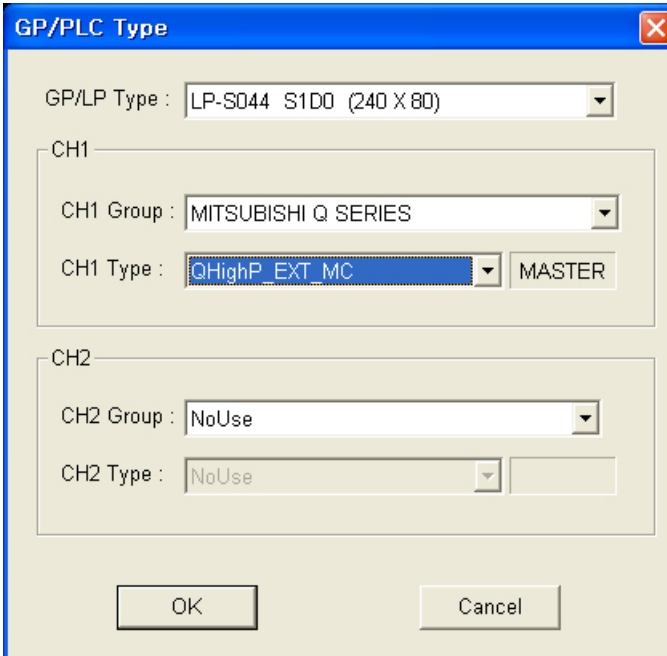

The screenshot shows the 'GP/PLC Type' dialog box. The 'GP/LP Type' is set to 'LP-S044 S1D0 (240 X 80)'. Under the 'CH1' section, 'CH1 Group' is 'MITSUBISHI Q SERIES' and 'CH1 Type' is 'QHighP_EXT_MC' with a 'MASTER' button. Under the 'CH2' section, 'CH2 Group' is 'NoUse' and 'CH2 Type' is 'NoUse'. 'OK' and 'Cancel' buttons are at the bottom.

6.9 Nais PLC connection

GP/LP is able to communicate with Nais FP series.

6.9.1 System organization

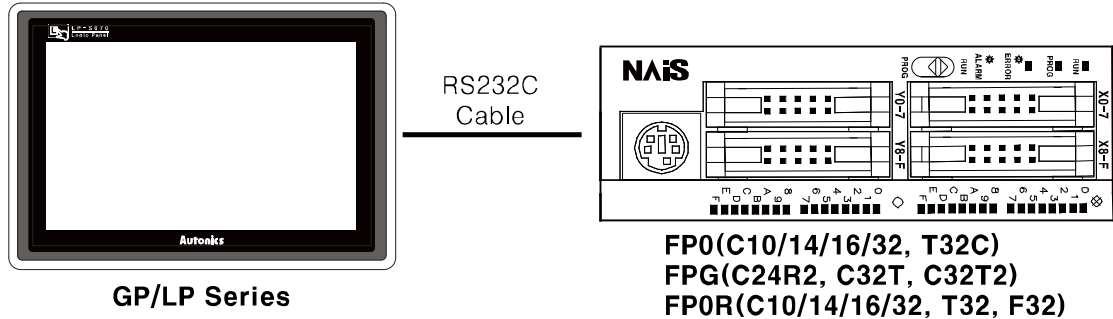

FP series executes RS232C communication. By Tool Port, it is connected with GP/LP. It executes also RS-422 communication with RS-232/422 converter.

PLC type		Communication method	Communication type	Baudrate (bps)	
Nais FP	FP0	RS232C	CPU direct(Loader)	9600	
					FP0-C10
					FP0-C14
					FP0-C16
					FP0-C32
	FP0-T32C				
	FP Sigma			FPG-C24R2	19200
				FPG-C32T	
				FPG-C32T2	
	FP0R			FP0R-C10	9600
				FP0R-C14	
				FP0R-C16	
				FP0R-C32	
				FP0R-T32	
				FP0R-F32	

※Select 'FP0-C16(CPU)' in GP Editor, you can use FP0-C10/C14/C16.

The below is a diagram and pin arrangement for RS-232C cable. It is able to connect with GP/LP with Tool Port or COM Port of PLC.

(1) When using Tool Port (Applied cable : (11)C3M5P10-D9F0-M5M0)

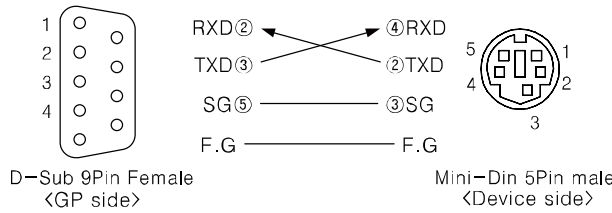

(2) When using COM Port (Applied cable : (12)C3M5P11-D9F0-W4*0)

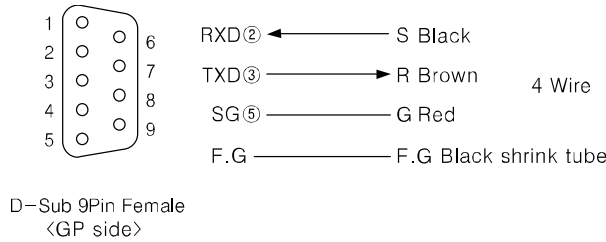

6.9.1.1 PLC communication configuration(When using Tool Port)

PLC communication configuration is available to set or edit from the dedicated ladder program (FPSOFT or FPWIN GR).

(1) When using FPSOFT

- 1st After connect the ladder program and PLC, maintain communication status.
- 2nd Select [Option]-[PLC Configuration] of menu in the ladder software.
- 3rd 'PLC Configuration' dialog box appears. Select 'Program port' in the left Topics box.
- 4th Select as below at the right 'No.414 RS232 Baudrate' item.
 In case PLC is FP0 series, select '1:9600bps'.
 In case PLC is FP Sigma series, select '1:19200bps'.
- 5th Click 'OK' and dialog box for downloading appears. Click 'OK' and baudrate is changed.

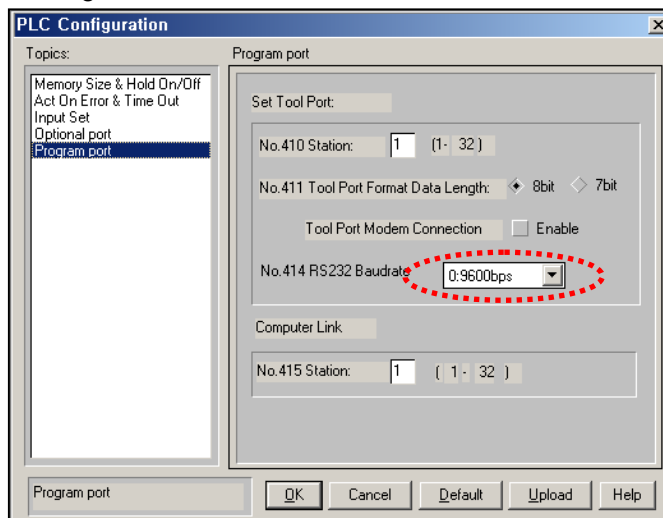

(2) When using FPWIN GR

- 1st After connect the ladder program and PLC, maintain communication status.
- 2nd Select [Option]-[PLC Configuration] of menu in the ladder software.
- 3rd 'PLC Configuration' dialog box appears. Select 'Tool Port' tab.
- 4th Select as below at the 'No.414 Baudrate Setting' item.
In case PLC is FP0 series, select '9600bps'.
In case PLC is FP Sigma series, select '19200bps'.
- 5th Click 'OK' and dialog box for downloading appears. Click 'OK' and baudrate is changed.

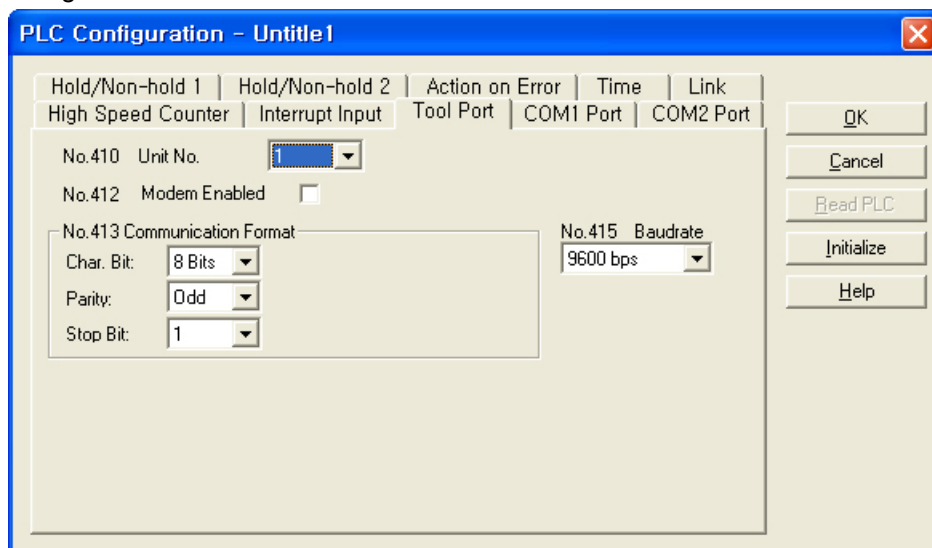

6.9.1.2 PLC communication configuration(When using COM Port)

PLC communication configuration is available to set or edit from the dedicated ladder program (FPSOFT or FPWIN GR).

(1) When using FPSOFT

- 1st After connect the ladder program and PLC, maintain communication status.
- 2nd Select [Option]-[PLC Configuration] of menu in the ladder software.
- 3rd 'PLC Configuration' dialog box appears. Select 'Optional port' in the left Topics box.

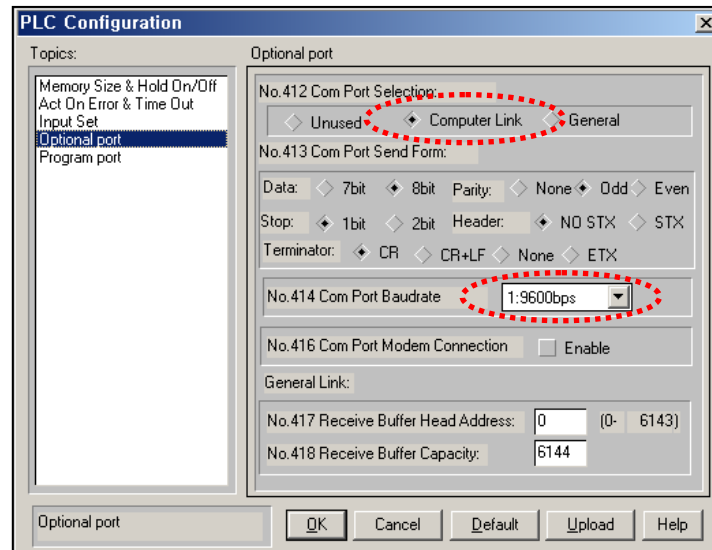

- 4th Select 'Computer Link' at the 'No.412 Com Port Selection' item.
- 5th Select as below at the 'No.414 Com Port Baudrate' item.
In case PLC is FP0 series, select '1:9600bps'.
In case PLC is FP Sigma series, select '0:19200bps'.
- 6th Click 'OK' and dialog box for downloading appears. Click 'OK' and baudrate is changed.
- 7th After completing configuration, PLC model should be RUN status once to use COM Port.

(2) When using FPWIN GR

- 1st After connect the ladder program and PLC, maintain communication status.
- 2nd Select [Option]-[PLC Configuration] of menu in the ladder software.
- 3rd 'PLC Configuration' dialog box appears. Select 'COM1 Port' tab.
- 4th Select 'Computer Link' at the 'No.412 Comm. Mode'.
- 5th Select as below at the 'No.414 Baudrate' item.
In case PLC is FP0 series, select '9600bps'.
In case PLC is FP Sigma series, select '19200bps'.
- 6th Click 'OK' and dialog box for downloading appears. Click 'OK' and baudrate is changed.
- 7th After completing configuration, PLC model should be RUN status once to use COM Port.

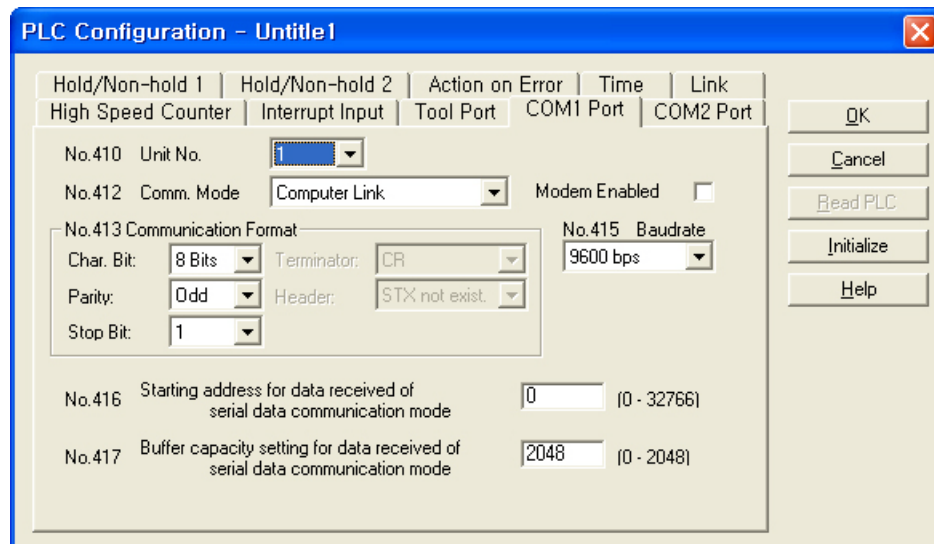

6.9.2 Available device

Device range is different depending on PLC model. Even though same type PLC, there is difference according to the number of I/O contact point.

UB device is as GP/LP inner bit memory, only in GP/LP it is able to use same as general inner device of PLC.

It is able to switch into word UW device binding 16 units. However it is related with functional area and it may cause serious error. Be sure to use only within user area UW30 to UW2047 (when not using recipe, UW30 to UW6047).

For further information of GP/LP inner memory, refer to '3.6 System signal'.

Refer to below bit/word available device organization and use the device.

X	00	0
---	----	---

① Device name ② Word address ③ Bit address

Type	①	②	③
Bit	X	Decimal	Hexadecimal
	Y	Decimal	Hexadecimal
	R	Decimal	Hexadecimal
	L	Decimal	Hexadecimal
	T	Bit address(Decimal)	
	C	Bit address(Decimal)	
	UB	Decimal	Hexadecimal
Word	WX	Word address(Decimal)	None
	WY	Word address(Decimal)	None
	WR	Word address(Decimal)	None
	WL	Word address(Decimal)	None
	EV	Word address(Decimal)	
	SV	Word address(Decimal)	
	DT	Word address(Decimal)	
	UW	Word address(Decimal)	None

6.9.2.1 FP0-C10/14/16

Type	Device	Mark	Range	
			Start	End
Bit	Input relay	X	X0	X12F
	Output relay	Y	Y0	Y12F
	Inner auxiliary relay	R	R0	R62F
	Special relay	R	R9000	R903F
	Timer contact[1ms]	T	T0	T99
	Timer contact[10ms]	T	T0	T99
	Timer contact[100ms]	T	T0	T99
	Timer contact[1000ms]	T	T0	T99
	Counter contact[16bit]	C	C100	C143
	GP/LP inner bit memory	UB	UB0	UB6047F
Word	Input relay	WX	WX0	WX12
	Output relay	WY	WY0	WY12
	Inner auxiliary relay	WR	WR0	WR62
	Special relay	WR	WR900	WR903
	Timer present value[1ms]	EV	EV0	EV99
	Timer present value[10ms]	EV	EV0	EV99
	Timer present value[100ms]	EV	EV0	EV99
	Timer present value[1000ms]	EV	EV0	EV99
	Timer setting value[1ms]	SV	SV0	SV99
	Timer setting value[10ms]	SV	SV0	SV99
	Timer setting value[100ms]	SV	SV0	SV99
	Timer setting value[1000ms]	SV	SV0	SV99
	Counter present value[16bit]	EV	EV100	EV143
	Counter setting value[16bit]	SV	SV100	SV143
	Data register	DT	DT0	DT1659
	Special register	DT	DT9000	DT9111
GP/LP inner word memory	UW	UW0	UW6047	

6.9.2.2 FPO-C32

Type	Device	Mark	Range	
			Start	End
Bit	Input relay	X	X0	X12F
	Output relay	Y	Y0	Y12F
	Inner auxiliary relay	R	R0	R62F
	Special relay	R	R9000	R903F
	Timer contact[1ms]	T	T0	T99
	Timer contact[10ms]	T	T0	T99
	Timer contact[100ms]	T	T0	T99
	Timer contact[1000ms]	T	T0	T99
	Counter contact[16bit]	C	C100	C143
	GP/LP inner bit memory	UB	UB0	UB6047F
Word	Input relay	WX	WX0	WX12
	Output relay	WY	WY0	WY12
	Inner auxiliary relay	WR	WR0	WR62
	Special relay	WR	WR900	WR903
	Timer present value[1ms]	EV	EV0	EV99
	Timer present value[10ms]	EV	EV0	EV99
	Timer present value[100ms]	EV	EV0	EV99
	Timer present value [1000ms]	EV	EV0	EV99
	Timer setting value[1ms]	SV	SV0	SV99
	Timer setting value[10ms]	SV	SV0	SV99
	Timer setting value[100ms]	SV	SV0	SV99
	Timer setting value[1000ms]	SV	SV0	SV99
	Counter present value [16bit]	EV	EV100	EV143
	Counter setting value[16bit]	SV	SV100	SV143
Data register	DT	DT0	DT6143	
Special register	DT	DT9000	DT9111	
GP/LP inner word memory	UW	UW0	UW6047	

6.9.2.3 FPO-T32C

Type	Device	Mark	Range	
			Start	End
Bit	Input relay	X	X0	X12F
	Output relay	Y	Y0	Y12F
	Inner auxiliary relay	R	R0	R62F
	Special relay	R	R9000	R903F
	Timer contact[1ms]	T	T0	T99
	Timer contact[10ms]	T	T0	T99
	Timer contact[100ms]	T	T0	T99
	Timer contact[1000ms]	T	T0	T99
	Counter contact[16bit]	C	C100	C143
	GP/LP inner bit memory	UB	UB0	UB6047F
Word	Input relay	WX	WX0	WX12
	Output relay	WY	WY0	WY12
	Inner auxiliary relay	WR	WR0	WR62
	Special relay	WR	WR900	WR903
	Timer present value[1ms]	EV	EV0	EV99
	Timer present value[10ms]	EV	EV0	EV99
	Timer present value[100ms]	EV	EV0	EV99
	Timer present value[1000ms]	EV	EV0	EV99
	Timer setting value[1ms]	SV	SV0	SV99
	Timer setting value[10ms]	SV	SV0	SV99
	Timer setting value[100ms]	SV	SV0	SV99
	Timer setting value[1000ms]	SV	SV0	SV99
	Counter present value[16bit]	EV	EV100	EV143
	Counter setting value[16bit]	SV	SV100	SV143
	Data register	DT	DT0	DT16382
	Special register	DT	DT90000	DT90111
	GP/LP inner word memory	UW	UW0	UW6047

6.9.2.4 FPG-C24R2

Type	Device	Mark	Range	
			Start	End
Bit	Input relay	X	X0	X73F
	Output relay	Y	Y0	Y73F
	Inner auxiliary relay	R	R0	R97F
	Special relay	R	R9000	R910F
	Link relay	L	L0	L63F
	Timer contact[1ms]	T	T0	T1007
	Timer contact[10ms]	T	T0	T1007
	Timer contact[100ms]	T	T0	T1007
	Timer contact[1000ms]	T	T0	T1007
	Counter contact[16bit]	C	C1008	C1023
	GP/LP inner bit memory	UB	UB0	UB6047F
Word	Input relay	WX	WX0	WX73
	Output relay	WY	WY0	WY73
	Inner auxiliary relay	WR	WR0	WR97
	Special relay	WR	WR900	WR910
	Link relay	WL	WL0	WL63
	Timer present value[1ms]	EV	EV0	EV1007
	Timer present value[10ms]	EV	EV0	EV1007
	Timer present value[100ms]	EV	EV0	EV1007
	Timer present value [1000ms]	EV	EV0	EV1007
	Timer setting value[1ms]	SV	SV0	SV1007
	Timer setting value[10ms]	SV	SV0	SV1007
	Timer setting value[100ms]	SV	SV0	SV1007
	Timer setting value[1000ms]	SV	SV0	SV1007
	Counter present value[16bit]	EV	EV1008	EV1023
	Counter setting value[16bit]	SV	SV1008	SV1023
	Data register	DT	DT0	DT32764
Special register	DT	DT90000	DT90259	
GP/LP inner word memory	UW	UW0	UW6047	

6.9.2.5 FPG-C32T

Type	Device	Mark	Range	
			Start	End
Bit	Input relay	X	X0	X31F
	Output relay,	Y	Y0	Y31F
	Inner auxiliary relay	R	R0	R97F
	Special relay	R	R9000	R910F
	Link relay	L	L0	L63F
	Timer contact[1ms]	T	T0	T1007
	Timer contact[10ms]	T	T0	T1007
	Timer contact[100ms]	T	T0	T1007
	Timer contact[1000ms]	T	T0	T1007
	Counter contact[16bit]	C	C1008	C1023
	GP/LP inner bit memory	UB	UB0	UB6047F
Word	Input relay	WX	WX0	WX31
	Output relay	WY	WY0	WY31
	Inner auxiliary relay	WR	WR0	WR97
	Special relay	WR	WR900	WR910
	Link relay	WL	WL0	WL63
	Timer present value[1ms]	EV	EV0	EV1007
	Timer present value[10ms]	EV	EV0	EV1007
	Timer present value[100ms]	EV	EV0	EV1007
	Timer present value [1000ms]	EV	EV0	EV1007
	Timer setting value[1ms]	SV	SV0	SV1007
	Timer setting value[10ms]	SV	SV0	SV1007
	Timer setting value[100ms]	SV	SV0	SV1007
	Timer setting value[1000ms]	SV	SV0	SV1007
	Counter present value[16bit]	EV	EV1008	EV1023
	Counter setting value[16bit]	SV	SV1008	SV1023
	Data register	DT	DT0	DT32764
	Special register	DT	DT90000	DT90259
GP/LP inner word memory	UW	UW0	UW6047	

6.9.2.6 FPG-C32T2

Type	Device	Mark	Range	
			Start	End
Bit	Input relay	X	X0	X73F
	Output relay	Y	Y0	Y73F
	Inner auxiliary relay	R	R0	R97F
	Special relay	R	R9000	R910F
	Link relay	L	L0	L63F
	Timer contact[1ms]	T	T0	T1007
	Timer contact[10ms]	T	T0	T1007
	Timer contact[100ms]	T	T0	T1007
	Timer contact[1000ms]	T	T0	T1007
	Counter contact[16bit]	C	C1008	C1023
	GP/LP inner bit memory	UB	UB0	UB6047F
Word	Input relay	WX	WX0	WX73
	Output relay	WY	WY0	WY73
	Inner auxiliary relay	WR	WR0	WR97
	Special relay	WR	WR900	WR910
	Link relay	WL	WL0	WL63
	Timer present value[1ms]	EV	EV0	EV1007
	Timer present value[10ms]	EV	EV0	EV1007
	Timer present value[100ms]	EV	EV0	EV1007
	Timer present value [1000ms]	EV	EV0	EV1007
	Timer setting value[1ms]	SV	SV0	SV1007
	Timer setting value[10ms]	SV	SV0	SV1007
	Timer setting value[100ms]	SV	SV0	SV1007
	Timer setting value[1000ms]	SV	SV0	SV1007
	Counter present value[16bit]	EV	EV1008	EV1023
	Counter setting value[16bit]	SV	SV1008	SV1023
	Data register	DT	DT0	DT32764
Special register	DT	DT90000	DT90259	
GP/LP inner word memory	UW	UW0	UW6047	

6.9.2.7 FP0R-C10/C14/C16

Type	Device	Mark	Range	
			Start	End
Bit	Input relay	X	X0	X109F
	Output relay	Y	Y0	Y109F
	Inner auxiliary relay	R	R0	R255F
	Special relay	R	R9000	R913F
	Timer contact[1ms]	T	T0	T1023
	Timer contact[10ms]	T	T0	T1023
	Timer contact[100ms]	T	T0	T1023
	Timer contact[1000ms]	T	T0	T1023
	Counter contact[16bit]	C	C100	C1023
	GP/LP inner bit memory	UB	UB0	UB6047F
Word	Input relay	WX	WX0	WX109
	Output relay	WY	WY0	WY109
	Inner auxiliary relay	WR	WR0	WR255
	Special relay	WR	WR900	WR913
	Timer present value[1ms]	EV	EV0	EV1024
	Timer present value[10ms]	EV	EV0	EV1024
	Timer present value[100ms]	EV	EV0	EV1024
	Timer present value [1000ms]	EV	EV0	EV1024
	Timer setting value[1ms]	SV	SV0	SV1024
	Timer setting value[10ms]	SV	SV0	SV1024
	Timer setting value[100ms]	SV	SV0	SV1024
	Timer setting value[1000ms]	SV	SV0	SV1024
	Counter present value[16bit]	EV	EV100	EV1024
	Counter setting value[16bit]	SV	SV100	SV1024
	Data register	DT	DT0	DT12315
Special register	DT	DT90000	DT90439	
GP/LP inner word memory	UW	UW0	UW6047	

6.9.2.8 FPOR-C32/F32/T32

Type	Device	Mark	Range	
			Start	End
Bit	Input relay	X	X0	X109F
	Output relay	Y	Y0	Y109F
	Inner auxiliary relay	R	R0	R255F
	Special relay	R	R9000	R913F
	Timer contact[1ms]	T	T0	T1023
	Timer contact[10ms]	T	T0	T1023
	Timer contact[100ms]	T	T0	T1023
	Timer contact[1000ms]	T	T0	T1023
	Counter contact[16bit]	C	C100	C1023
	GP/LP inner bit memory	UB	UB0	UB6047F
Word	Input relay	WX	WX0	WX109
	Output relay	WY	WY0	WY109
	Inner auxiliary relay	WR	WR0	WR255
	Special relay	WR	WR900	WR913
	Timer present value[1ms]	EV	EV0	EV1024
	Timer present value[10ms]	EV	EV0	EV1024
	Timer present value[100ms]	EV	EV0	EV1024
	Timer present value[1000ms]	EV	EV0	EV1024
	Timer setting value[1ms]	SV	SV0	SV1024
	Timer setting value[10ms]	SV	SV0	SV1024
	Timer setting value[100ms]	SV	SV0	SV1024
	Timer setting value[1000ms]	SV	SV0	SV1024
	Counter present value[16bit]	EV	EV100	EV1024
	Counter setting value[16bit]	SV	SV100	SV1024
	Data register	DT	DT0	DT32765
	Special register	DT	DT90000	DT90439
GP/LP inner word memory	UW	UW0	UW6047	

6.9.3 Monitorable device in GP/LP

GP/LP is able to monitor PLC device and change the status.

Enter system setting menu of GP/LP and select [Monitoring]-[Device Monitor]-[DEV.]. Select to be monitored device and you can change the status.

The following is available device list of this menu, available range is same as '6.9.2 Available device'.

Type	Mark	Device	Note
Bit	X	Input relay	
	Y	Output relay	
	R	Inner auxiliary relay, Special relay	
	L	Link relay	In case of FP Sigma series
	T	Timer contact	
	C	Counter contact	
	UB	GP/LP inner bit memory	
Word	WX	Input relay	
	WY	Output relay	
	WR	Inner auxiliary relay , Special relay	
	WL	Link relay	In case of FP Sigma series
	EV	Timer present value	
	SV	Counter setting value	
	DT16	Data/File/Special register	16bit
	DT32	Data/File/Special register	32bit type combining designated number of device and next number of device
	UW	GP/LP inner word memory	

6.10 OMRON SYSMAC C PLC connection

GP/LP is able to communicate with Omron SYSMAC C series.

6.10.1 System organization

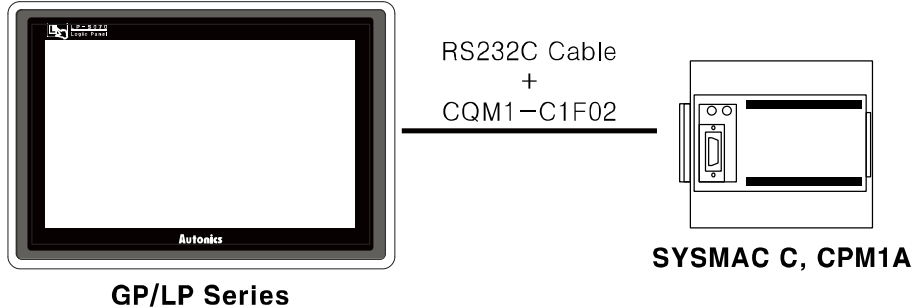

SYSMAC C series executes RS232C communication with GP/LP by Tool Port. It executes also RS-422 communication with RS-232/422 converter.

PLC type		Communication method	Communication type	Baudrate (bps)
SYSMAC C	CPM1A	RS232C	CPU direct(Loader)	9600

PLC communication configuration for baudrate is set from the dedicated ladder program (CX-Programmer).

Configuration is as below.

- 1st Connect the dedicated ladder program and set PLC as connectable status.
- 2nd From the workspace window of the ladder program, select 'Setting' item.
- 3rd 'PLC Settings' dialog box appears. Select 'Peripheral Port' tab. Click 'Standard (9600;1,7,2,E)' of 'Communication Settings' item.

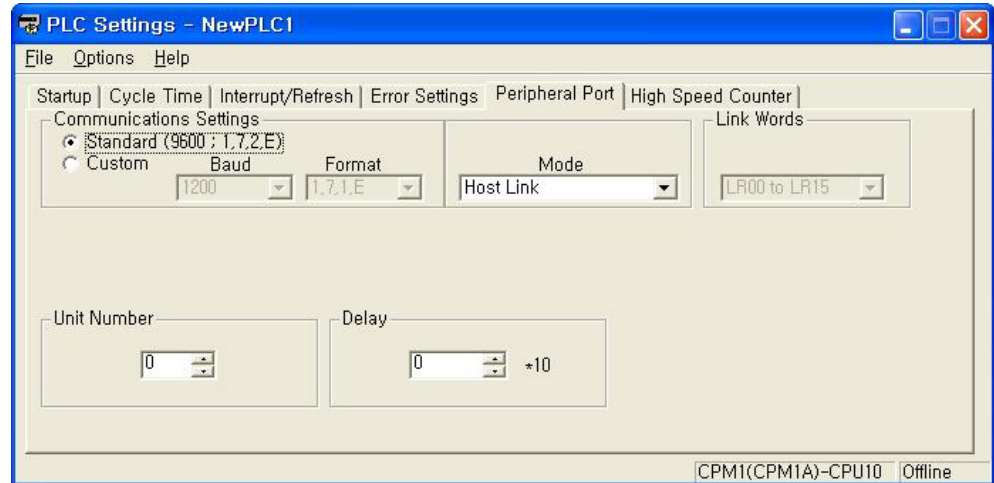

Communication cable connected with GP/LP is loader connection cable(CQM1-CIF02) of OMRON.

If PLC mode is Run, PLC device is available only monitor from GP/LP, and every device status is not able to change. (PLC specification) For changing PLC device status from GP/LP, set PLC mode to Program or Monitor.

6.10.2 Available device

Device range is different depending on PLC model. Even though same type PLC, there is difference according to the number of I/O contact point.

UB device is as GP/LP inner bit memory, only in GP/LP it is able to use same as general inner device of PLC.

It is able to switch into word UW device binding 16 units. However it is related with functional area and it may cause serious error. Be sure to use only within user area UW30 to UW2047 (when not using recipe, UW30 to UW6047).

For further information of GP/LP inner memory, refer to '3.6 System signal'.

Refer to below bit/word available device organization and use the device.

IR	00	0
----	----	---

① Device name ② Word address ③ Bit address

Type	①	②	③	Note
Bit	IR	Decimal	Decimal	Bit address 0 to 15
	HR	Decimal	Decimal	Bit address 0 to 15
	SR	Decimal	Decimal	Bit address 0 to 15
	AR	Decimal	Decimal	Bit address 0 to 15
	LR	Decimal	Decimal	Bit address 0 to 15
	TC	Bit address(Decimal)		
	UB	Decimal	Hexadecimal	
Word	IR	Word address(Decimal)	None	
	HR	Word address(Decimal)	None	
	SR	Word address(Decimal)	None	
	AR	Word address(Decimal)	None	
	LR	Word address(Decimal)	None	
	TC	Word address(Decimal)		
	DM	Word address(Decimal)		
	UW	Word address(Decimal)	None	

6.10.2.1 CPM1A

Type	Device	Mark	Range	
			Start	End
Bit	Input relay	IR	IR0	IR915
	Output relay	IR	IR1000	IR1915
	Inner auxiliary relay ^{※1}	IR	IR20000	IR23115
	Memory protection relay	HR	HR0	HR1915
	Special relay	SR	SR23200	SR25515
	Special relay 2	AR	AR0	AR1515
	Link relay	LR	LR0	LR1515
	Timer contact[10ms]	TC	TC0	TC127
	Timer contact[100ms]	TC	TC0	TC127
	Counter contact[16bit]	TC	TC0	TC127
	GP/LP inner bit memory	UB	UB0	UB6047F
Word	Input relay	IR	IR0	IR9
	Output relay	IR	IR10	IR19
	Inner auxiliary relay	IR	IR200	IR231
	Memory protection relay	HR	HR0	HR19
	Special relay	SR	SR232	SR255
	Special relay 2	AR	AR0	AR15
	Link relay	LR	LR0	LR15
	Timer present value[10ms]	TC	TC0	TC127
	Timer present value[100ms]	TC	TC0	TC127
	Counter present value	TC	TC0	TC127
	Data register ^{※2}	DM	DM0	DM6655
GP/LP inner word memory	UW	UW0	UW6047	

※1. The relay of PLC IR20000 to IR23115 range is work area. This range relay operate similar as inner auxiliary relay of other PLCs, GP/LP assigns these as inner auxiliary relay.

※2. Available data register range

No.	Range		Note
	Start	End	
1	DM0	DM999	Enable read, write
2	DM1000	DM1021	Save error code and time
3	DM1022	DM1023	Enable read, write
4	DM6144	DM6599	Enable only read
5	DM6600	DM6655	Enable only read

For further details of this function, refer to the specific PLC manual.

6.10.3 Monitorable device in GP/LP

GP/LP is able to monitor PLC device and change the status.

Enter system setting menu of GP/LP and select [Monitoring]-[Device Monitor]-[DEV.]. Select to be monitored device and you can change the status.

The following is available device list of this menu, available range is same as '6.10.2 Available device'.

Type	Mark	Device	Note
Bit	IR	Input relay, output relay, inner auxiliary relay	
	HR	Memory protection relay	
	SR	Special relay	
	AR	Special relay	
	LR	Link relay	
	TC	Timer/Counter contact	
	UB	GP/LP inner bit memory	
Word	IR	Input relay, output relay, inner auxiliary relay	
	HR	Memory protection relay	
	SR	Special relay	
	AR	Special relay	
	LR	Link relay	
	TC	Timer/Counter present value	
	DM16	Data register	16bit
	DM32	Data register	32bit type combining designated number of device and next number of device
	UW	GP/LP inner word memory	

6.11 OMRON temperature controller connection

GP/LP is able to communicate with Omron temperature controller E5XX series.

6.11.1 System organization

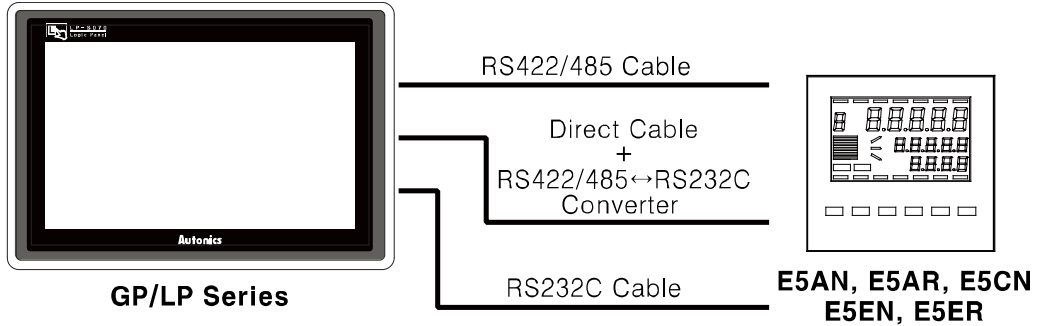

Omron E5XX series executes RS485 communication. It executes also RS232C communication with RS485/232 converter. E5AN and E5EN support RS232C communication without converter depending on the model.

Controller type	Communication method	Communication type
E5AN	RS485, RS232C	CPU direct(Loader)
E5AR	RS485	CPU direct(Loader)
E5CN	RS485	CPU direct(Loader)
E5EN	RS485, RS232C	CPU direct(Loader)
E5ER	RS485	CPU direct(Loader)

(1) RS-485 communication with GP/LP(E5AN, E5AR, E5CN): Applied cable (15) C3M5P03-D9M0-T4Y0

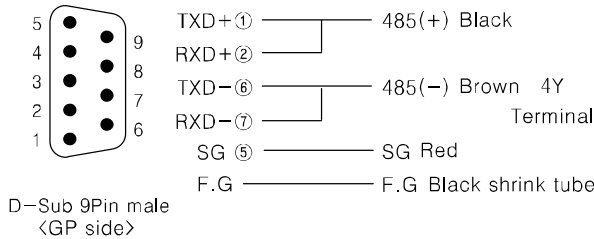

(2) RS-232C communication with GP/LP(E5AN, E5EN): Applied cable (14)C3M5P13-D9F0-T4Y0

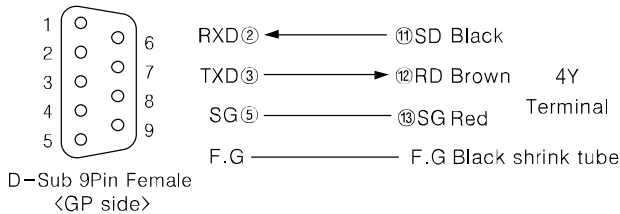

6.11.2 Communication configuration

The below table is for communication configuration of Omron E5XX series with GP/LP.



No.	Item	Description	Note
1	Communication mode	Modbus RTU	
2	Baudrate	9600 bps	Fixed
3	Data type	Data length	8 bit Fixed
		Parity	NONE Fixed
		Stop bit	1 bit Fixed
4	Station	0 to 31	Selectable



(1) Omron E5XX series communication configuration

Designate communication configuration for Omron E5XX series. For more details, refer to 'Omron E5XX series user manual'.

1st At operation level, press front button in 3 sec and it moves to input initial configuration level.

2nd At input initial configuraion level, press button, it moves to communication configuration level.

At each menu, press   keys to set.

3rd Press  key and it moves to other menus and press   also to set as same method.

Display status	Description	Setting value	Note
<i>PSEL</i>	Select protocol	<i>n̄ōd</i>	Modbus
<i>U-nō</i>	Communication station	0 to 99	Enable to set as user-defined
<i>bPS</i>	Baudrate	9.6	9.6 kbps
<i>LEn</i>	Communication data length	8	8bit
<i>Sb̄ct</i>	Stop bit	1	1bit
<i>Pr̄ty</i>	Parity	<i>n̄ōnĒ</i>	NONE
<i>Sb̄yt</i>	Waiting time of transmission	-	Display only when <i>PSEL</i> is <i>CUF</i>

(2) GP/LP communication configuration

As above configuration, GP/LP also should be set for the station as below.

- 1st Enter system setting menu. Touch left-upper point as default position of system setting menu.



- 2nd Select [SET ENVIRONMENT]-[PLC SETTING].

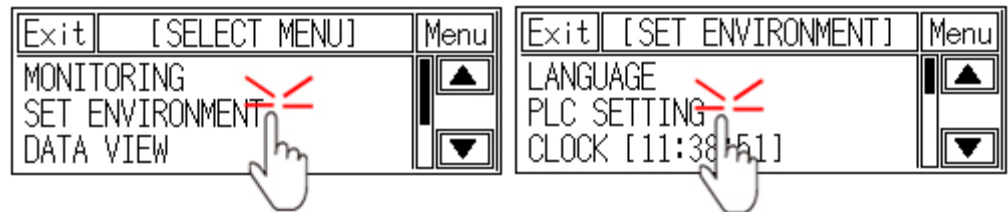

- 3rd Touch CH1 station, station input key pad appears. Enter the same station of the station which is set from E5XX series.

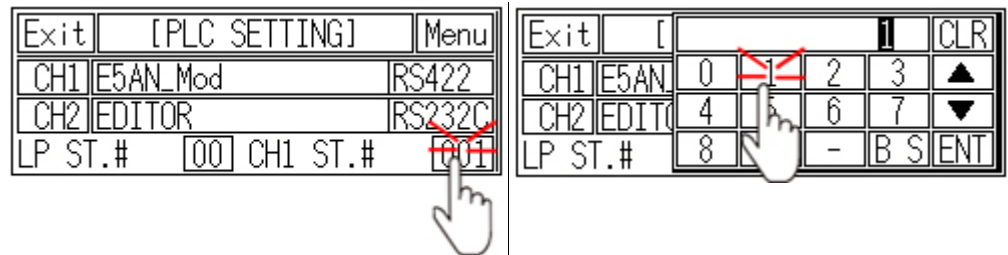

Touch 'ENT' to save the station and touch 'Menu' or 'Exit' to exit system setting meun.

6.11.3 Available device

UB device is as GP/LP inner bit memory, only in GP/LP it is able to use same as general inner device of PLC.

It is able to switch into word UW device binding 16 units. However it is related with functional area and it may cause serious error. Be sure to use only within user area UW30 to UW2047 (when not using recipe, UW30 to UW6047).

For further information of GP/LP inner memory, refer to '3.6 System signal'.

Refer to below bit/word available device organization and use the device.

UB	00	0
----	----	---

① Device name ② Word address ③ Bit address

Type	①	②	③
Bit	UB	Decimal	Hexadecimal
Word	M	Word address(Decimal)	
	D	Word address(Hexadecimal)	
	UW	Word address(Decimal)	None

6.11.3.1 E5AN, E5CN, E5EN

Type	Device	Mark	Range	
			Start	End
Bit	GP/LP inner bit memory	UB	UB0	UB6047F
Word	Operation command device ^{※1}	M	M0	M0
	Variable device ^{※2}	D	D0	D3FFF
	GP/LP inner word memory	UW	UW0	UW6047

6.11.3.2 E5AR, E5ER

Type	Device	Mark	Range	
			Start	End
Bit	GP/LP inner bit memory	UB	UB0	UB6047F
Word	Operation command device ^{※1}	M	M0	M0
	Variable device ^{※2}	D	D0	DFFFF
	GP/LP inner word memory	UW	UW0	UW6047

※1. It is used device when operating command. Enter the specific value, it executes the below table operation.

※2. Device address is same as each variable of temperature controller. For further details of each variable, refer to the each product manual.

Command value (DEC)	Command description	Executing operation	Note
00000	Communication Write	Stops communication write	
00001		Allows communication write	
00256	RUN/STOP	RUN	
00257		STOP	
00512	Multi SP	Target value 0	

Command value (DEC)	Command description	Executing operation	Note
00513		Target value 1	
00514		Target value 2	
00515		Target value 3	
00768		Stops AT	
00769	AT	Executes AT	Available when it is STOP
01024		Backup write mode	
01025	Write mode	Write mode RAM	
01280	Preserves RAM DATA	Preserves RAM DATA	
01536	Soft reset	Soft reset	
01792	Executes setting area 1	Executes setting area 1	
02048	Executes protect level	Executes protect level	
02304		AUTO mode	
02305	AUTO/ MANUAL	MANUAL mode	
02816		Initial default of setting value	
02817	Initializes setting value	Initial setting service value	
04352		Start reset program	
04353	Starts program	Starts program	

6.11.4 Monitorable device in GP/LP

GP/LP is able to monitor PLC device and change the status.

Enter system setting menu of GP/LP and select [Monitoring]-[Device Monitor]-[DEV.]. Select to be monitored device and you can change the status.

The following is available device list of this menu, available range is same as '6.11.3 Available device'.

Type	Mark	Device	Note
Bit	UB	GP/LP inner bit memory	
Word	M	Operation command device	
	DM16	Variable Device	16bit
	DM32	Variable Device	32bit type combining designated number of device and next number of device
	UW	GP/LP inner word memory	

6.12 SIEMENS S7 series connection

GP/LP is able to communicate with SIEMENS S7 series.

6.12.1 System organization

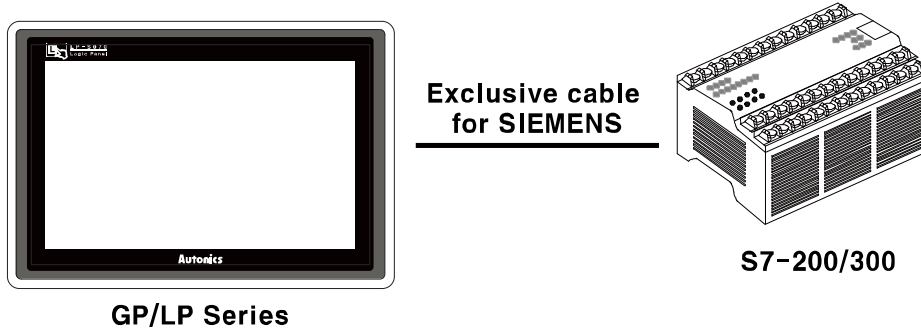

SIEMENS S7-200 uses PPI(Point to point interface) communication of SIEMENS and SIEMENS S7-300 uses MPI(Mutil point interface) communication of SIEMENS.

It executes RS232C communication with dedicated cable of SIEMENS. It executes also RS-422 communication with RS-232/422 converter.

PLC type		Communication method	Communication type	Baudrate (bps)
S7 series	200	PPI	CPU direct(Loader)	9600
	300	MPI	CPU direct(Loader)	38400

6.12.2 Available device

Device range is different depending on PLC model. Even though same type PLC, there is difference according to the number of I/O contact point.

UB device is as GP/LP inner bit memory, only in GP/LP it is able to use same as general inner device of PLC.

It is able to switch into word UW device binding 16 units. However it is related with functional area and it may cause serious error. Be sure to use only within user area UW30 to UW2047 (when not using recipe, UW30 to UW6047).

For further information of GP/LP inner memory, refer to '3.6 System signal'.

Refer to below bit/word available device organization and use the device.

I	00	0
---	----	---

① Device name ② Word address ③ Bit address

Type	①	②	③	Note
Bit	I	Decimal	Octonal	S7-200 / S7-300
	Q	Decimal	Octonal	S7-200 / S7-300
	V	Decimal	Octonal	S7-200
	M	Decimal	Octonal	S7-200 / S7-300
	SM	Decimal	Octonal	S7-200
	T	Bit address(Decimal)		
	C	Bit address(Decimal)		
	UB	Decimal	Hexadecimal	
Word	IW	Word address(Decimal)	None	S7-200 / S7-300
	QW	Word address(Decimal)	None	S7-200 / S7-300
	VW	Word address(Decimal)	None	S7-200
	MW	Word address(Decimal)	None	S7-200 / S7-300
	SM	Word address(Decimal)		S7-200(Special register)
	T	Word address(Decimal)		S7-200(Counter setting value)
	C	Word address(Decimal)		S7-200(Timer present value)
	UW	Word address(Decimal)	None	



Ex.

Word I0 = Bit I0 to I17 , Word UW10 = UB100 to UB10F

6.12.2.1 S7-200

(1) CPU 221 type

Type	Device	Mark	Range	
			Start	End
Bit	Input relay	I	I0	I157
	Output relay	Q	Q0	Q157
	Inner relay	V	V0	V20477
	Auxiliary relay	M	M0	M317
	Special relay	SM	SM0	SM1857
	Timer contact	T	T0	T255
	Counter contact	C	C0	C255
	GP/LP inner bit memory	UB	UB0	UB6047F
Word	Input register	IW	IW0	IW14
	Output register	QW	QW0	QW14
	Inner register	VW	VW0	VW2046
	Auxiliary register	MW	MW0	MW30
	Special register	SM	SM0	SM184
	Timer present value	T	T0	T255
	Counter present value	C	C0	C255
	GP/LP inner word memory	UW	UW0	UW6047

(2) CPU 222 type

Type	Device	Mark	Range	
			Start	End
Bit	Input relay	I	I0	I157
	Output relay	Q	Q0	Q157
	Inner relay	V	V0	V20477
	Auxiliary relay	M	M0	M317
	Special relay	SM	SM0	SM2997
	Timer contact	T	T0	T255
	Counter contact	C	C0	C255
	GP/LP inner bit memory	UB	UB0	UB6047F
Word	Input register	IW	IW0	IW14
	Output register	QW	QW0	QW14
	Inner register	VW	VW0	VW2046
	Auxiliary register	MW	MW0	MW30
	Special register	SM	SM0	SM298
	Timer present value	T	T0	T255
	Counter present value	C	C0	C255
	GP/LP inner word memory	UW	UW0	UW6047

(3) CPU 224 type

Type	Device	Mark	Range	
			Start	End
Bit	Input relay	I	I0	I157
	Output relay	Q	Q0	Q157
	Inner relay	V	V0	V81917
	Auxiliary relay	M	M0	M317
	Special relay	SM	SM0	SM5497
	Timer contact	T	T0	T255
	Counter contact	C	C0	C255
	GP/LP inner bit memory	UB	UB0	UB6047F
Word	Input register	IW	IW0	IW14
	Output register	QW	QW0	QW14
	Inner register	VW	VW0	VW8190
	Auxiliary register	MW	MW0	MW30
	Special register	SM	SM0	SM548
	Timer present value	T	T0	T255
	Counter present value	C	C0	C255
	GP/LP inner word memory	UW	UW0	UW6047

(4) CPU 224XP, 224XPsi, 226 type

Type	Device	Mark	Range	
			Start	End
Bit	Input relay	I	I0	I157
	Output relay	Q	Q0	Q157
	Inner relay	V	V0	V102397
	Auxiliary relay	M	M0	M317
	Special relay	SM	SM0	SM5497
	Timer contact	T	T0	T255
	Counter contact	C	C0	C255
	GP/LP inner bit memory	UB	UB0	UB6047F
Word	Input register	IW	IW0	IW14
	Output register	QW	QW0	QW14
	Inner register	VW	VW0	VW10238
	Auxiliary register	MW	MW0	MW30
	Special register	SM	SM0	SM548
	Timer present value	T	T0	T255
	Counter present value	C	C0	C255
	GP/LP inner word memory	UW	UW0	UW6047

6.12.2.2 S7-300

(1) CPU 312 type

Type	Device	Mark	Range	
			Start	End
Bit	Input relay	I	I0	I10237
	Output relay	Q	Q0	Q10237
	Auxiliary relay	M	M0	M2557
	GP/LP INNER BIT MEMORY	UB	UB0	UB6047F
Word	Input register	IW	IW0	IW1022
	Output register	QW	QW0	QW1022
	Auxiliary register	MW	MW0	MW254
	GP/LP INNER WORD MEMORY	UW	UW0	UW6047

(2) CPU 312C type

Type	Device	Mark	Range	
			Start	End
Bit	Input relay	I	I0	I10237
	Output relay	Q	Q0	Q10237
	Auxiliary relay	M	M0	M2557
	GP/LP INNER BIT MEMORY	UB	UB0	UB6047F
Word	Input register	IW	IW0	IW1022
	Output register	QW	QW0	QW1022
	Auxiliary register	MW	MW0	MW254
	GP/LP INNER WORD MEMORY	UW	UW0	UW6047

(3) CPU 313C type

Type	Device	Mark	Range	
			Start	End
Bit	Input relay	I	I0	I10237
	Output relay	Q	Q0	Q10237
	Auxiliary relay	M	M0	M2557
	GP/LP INNER BIT MEMORY	UB	UB0	UB6047F
Word	Input register	IW	IW0	IW1022
	Output register	QW	QW0	QW1022
	Auxiliary register	MW	MW0	MW254
	GP/LP INNER WORD MEMORY	UW	UW0	UW6047

(4) CPU 313C-2 type

Type	Device	Mark	Range	
			Start	End
Bit	Input relay	I	I0	I20477
	Output relay	Q	Q0	Q20477
	Auxiliary relay	M	M0	M2557
	GP/LP INNER BIT MEMORY	UB	UB0	UB6047F
Word	Input register	IW	IW0	IW2046
	Output register	QW	QW0	QW2046
	Auxiliary register	MW	MW0	MW254
	GP/LP INNER WORD MEMORY	UW	UW0	UW6047

(5) CPU 314 type

Type	Device	Mark	Range	
			Start	End
Bit	Input relay	I	I0	I10237
	Output relay	Q	Q0	Q10237
	Auxiliary relay	M	M0	M2557
	GP/LP INNER BIT MEMORY	UB	UB0	UB6047F
Word	Input register	IW	IW0	IW1022
	Output register	QW	QW0	QW1022
	Auxiliary register	MW	MW0	MW254
	GP/LP INNER WORD MEMORY	UW	UW0	UW6047

(6) CPU 314C-2 type

Type	Device	Mark	Range	
			Start	End
Bit	Input relay	I	I0	I20477
	Output relay	Q	Q0	Q20477
	Auxiliary relay	M	M0	M2557
	GP/LP INNER BIT MEMORY	UB	UB0	UB6047F
Word	Input register	IW	IW0	IW2046
	Output register	QW	QW0	QW2046
	Auxiliary register	MW	MW0	MW254
	GP/LP INNER WORD MEMORY	UW	UW0	UW6047

(7) CPU 315-2 type

Type	Device	Mark	Range	
			Start	End
Bit	Input relay	I	I0	I20477
	Output relay	Q	Q0	Q20477
	Auxiliary relay	M	M0	M20477
	GP/LP INNER BIT MEMORY	UB	UB0	UB6047F
Word	Input register	IW	IW0	IW2046
	Output register	QW	QW0	QW2046
	Auxiliary register	MW	MW0	MW2046
	GP/LP INNER WORD MEMORY	UW	UW0	UW6047

(8) CPU 317-2 type

Type	Device	Mark	Range	
			Start	End
Bit	Input relay	I	I0	I81917
	Output relay	Q	Q0	Q81917
	Auxiliary relay	M	M0	M40957
	GP/LP INNER BIT MEMORY	UB	UB0	UB6047F
Word	Input register	IW	IW0	IW8190
	Output register	QW	QW0	QW8190
	Auxiliary register	MW	MW0	MW4094
	GP/LP INNER WORD MEMORY	UW	UW0	UW6047

(9) CPU 319-3 type

Type	Device	Mark	Range	
			Start	End
Bit	Input relay	I	I0	I81917
	Output relay	Q	Q0	Q81917
	Auxiliary relay	M	M0	M81917
	GP/LP INNER BIT MEMORY	UB	UB0	UB6047F
Word	Input register	IW	IW0	IW8190
	Output register	QW	QW0	QW8190
	Auxiliary register	MW	MW0	MW8190
	GP/LP INNER WORD MEMORY	UW	UW0	UW6047

6.12.3 Monitorable device in GP/LP

GP/LP is able to monitor PLC device and change the status.

Enter system setting menu of GP/LP and select [Monitoring]-[Device Monitor]-[DEV.]. Select to be monitored device and you can change the status.

The following is available device list of this menu, available range is same as '6.12.2 Available device'.

Type	Mark	Device	Note
Bit	I	Input relay	Read only
	Q	Output relay	Write only
	V	Inner relay	Variable memory
	M	Auxiliary relay	Bit memory
	SM	Special relay	Special memory(Read only)
	T	Timer contact	
	C	Counter contact	
	UB	GP/LP inner bit memory	
Word	IW	Input register	Read only
	QW	Output register	Write only
	VW	Inner register	Variable memory
	MW	Auxiliary register	Bit memory
	SM	Special register	Special memory(Read only)
	T	Timer present value	
	C	Counter present value	
	UW	GP/LP inner word memory	

6.13 Allen Bradley MicroLogix series connection

GP/LP is able to communicate with Allen-Bradley MicroLogix series.

6.13.1 System organization

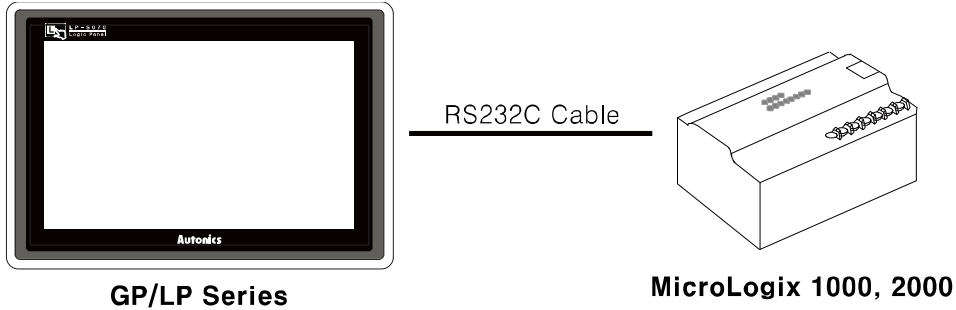

Allen-Bradley MicroLogix series executes RS232C communication. If PLC has imbedded RS422 loader port or you use RS232/422 converter, RS422 communication is also available.

PLC type		Communication method	Communication type	Baudrate (bps)
MicroLogix	1000	RS232C	CPU direct(Loader)	9600
	1200	RS232C	CPU direct(Loader)	19200

RS232C cable is different by connected PLC type.

The following is RS232C cable diagram and pin arrangement by connected PLC type.

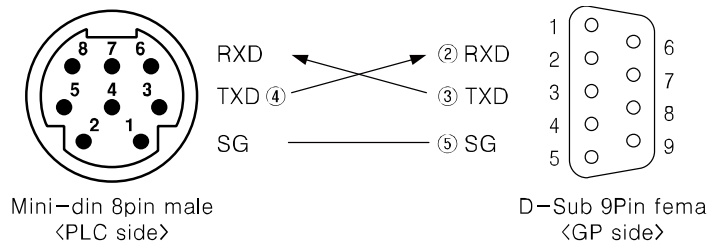

6.13.2 Available device

Device range is different depending on PLC model. Even though same type PLC, there is difference according to the number of I/O contact point.

UB device is as GP/LP inner bit memory, only in GP/LP it is able to use same as general inner device of PLC.

It is able to switch into word UW device binding 16 units. However it is related with functional area and it may cause serious error. Be sure to use only within user area UW30 to UW2047 (when not using recipe, UW30 to UW6047).

For further information of GP/LP inner memory, refer to '3.6 System signal'.

Refer to below bit/word available device organization and use the device.

I	00	0
---	----	---

① Device name ② Word address ③ Bit address

Type	①	②	③	Note
Bit	I	Decimal	Hexadecimal	
	O	Decimal	Hexadecimal	
	S2	Decimal	Hexadecimal	
	B3	Decimal	Hexadecimal	
	TD	Bit address(Decimal)		
	CD	Bit address(Decimal)		
	UB	Decimal	Hexadecimal	
Word	I	Word address(Decimal)	None	
	O	Word address(Decimal)	None	
	S2	Word address(Decimal)	None	
	B3	Word address(Decimal)	None	
	TS	Word address(Decimal)		Timer setting value
	CS	Word address(Decimal)		Counter setting value
	TP	Word address(Decimal)		Timer present value
	CP	Word address(Decimal)		Counter present value
	N7	Word address(Decimal)		
	UW	Word address(Decimal)	None	



Ex.

Word I1 = Bit I10 to I1F , Word UW10 = UB100 to UB10F

6.13.2.1 MicroLogix 1000

Type	Device	Mark	Range	
			Start	End
Bit	Input relay	I	I 0	I 1F
	Output relay	O	O 0	O F
	Status relay	S2	S2 0	S2 32F
	Inner relay	B3	B3 0	B3 31F
	Timer contact	TD	TD 0	TD 39
	Counter contact	CD	CD 0	CD 31
	GP/LP inner bit memory	UB	UB 0	UB 6047F
Word	Input register	I	I 0	I 1
	Output register	O	O 0	O 0
	Status register	S2	S2 0	S2 32
	Inner register	B3	B3 0	B3 31
	Timer setting value	TS	TS 0	TS 39
	Counter setting value	CS	CS 0	CS 31
	Timer present value	TP	TP 0	TP 39
	Counter present value	CP	CP 0	CP 31
	Data register	N7	N7 0	N7 104
GP/LP inner word memory	UW	UW 0	UW 6047	

6.13.2.2 MicroLogix 1200

Type	Device	Mark	Range	
			Start	End
Bit	Input relay	I	I 0	I 3F
	Output relay	O	O 0	O 3F
	Status relay	S2	S2 0	S2 65F
	Inner relay	B3	B3 0	B3 F
	Timer contact	TD	TD 0	TD 0
	Counter contact	CD	CD 0	CD 0
	GP/LP inner bit memory	UB	UB 0	UB 6047F
Word	Input register	I	I 0	I 3
	Output register	O	O 0	O 3
	Status register	S2	S2 0	S2 65
	Inner register	B3	B3 0	B3 0
	Timer setting value	TS	TS 0	TS 0
	Counter setting value	CS	CS 0	CS 0
	Timer present value	TP	TP 0	TP 0
	Counter present value	CP	CP 0	CP 0
	Data register	N7	N7 0	N7 0
	GP/LP inner word memory	UW	UW 0	UW 6047

6.13.3 Monitorable device in GP/LP

GP/LP is able to monitor PLC device and change the status.

Enter system setting menu of GP/LP and select [Monitoring]-[Device Monitor]-[DEV.]. Select to be monitored device and you can change the status.

The following is available device list of this menu, available range is same as '6.13.2 Available device'.

Type	Mark	Device
Bit	I	Input relay
	O	Output relay
	S2	Status relay
	B3	inner relay
	TD	Timer contact
	CD	Counter contact
	UB	GP/LP inner bit memory
Word	I	Input register
	O	Output register
	S2	Status register
	B3	Inner register
	TS	Timer setting value
	CS	Counter setting value
	TP	Timer present value
	CP	Counter present value
	N7	Data register
	UW	GP/LP inner word memory

6.14 KONICS Product connection

GP/LP is able to communicate with KONICS digital power thyristor unit DPU series and recorder KRN50.

6.14.1 System organization

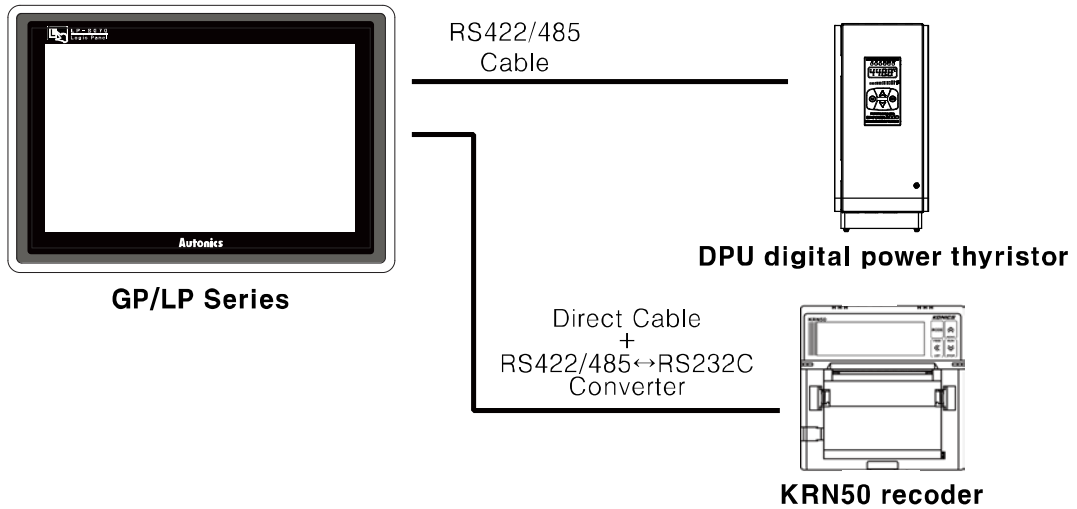

KONICS DPU series executes RS485 communication and it executes also RS232C communication with RS232/422 converter.

Controller type	Communication method	Communication type
DPU	RS485	CPU direct(Loader)
KRN50	RS485	CPU direct(Loader)

Wire as below for communicating GP/LP and RS485.

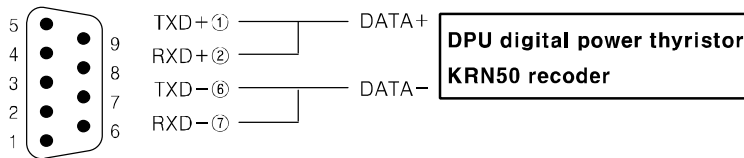

D-Sub 9Pin male
<GP side>

The below table is for communication configuration of digital power thyristor unit DPU series with GP/LP.

No	Item	Description	Note
1	Communication mode	Modbus RTU	
2	Baudrate	38400 bps(Default value of DPU)	Selectable
3	Data type	Data length	8bit Selectable
		Parity	EVEN Selectable
		Stop bit	1bit Selectable
4	Station	0 to 31	Selectable

The below table is for communication configuration of recorder KRN50 with GP/LP.

No	Item	Description	Note
1	Communication mode	Modbus RTU	
2	Baudrate	9600 bps (Default value of KRN50)	Selectable
3	Data type	Data length	8bit
		Parity	None
		Stop bit	2bit
4	Station	0 to 31	Selectable

As above configuration, GP/LP also should be set for the station as below.

(1) KONICS DPU series

1st Enter system setting menu. Touch left-upper point as default position of system setting menu.



2nd Select [SET ENVIRONMENT]-[PLC SETTING].

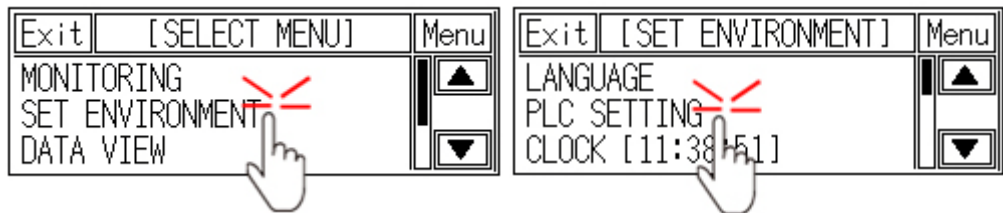

3rd Touch CH1 station, station input key pad appears. Enter the same station of the station which is set from DPU series.

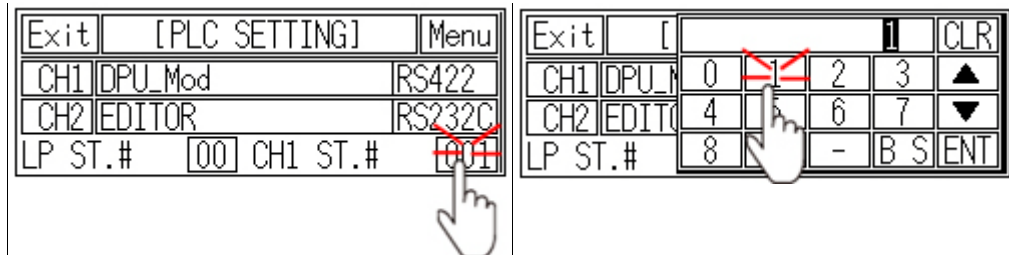

4th Touch 'ENT' to save the station and touch 'Menu' or 'Exit' to exit system setting menu.

5th For recorder KRN50, please designate the configuration as same method.

6.14.2 Available device

UB device is as GP/LP inner bit memory, only in GP/LP it is able to use same as general inner device of PLC.

It is able to switch into word UW device binding 16 units. However it is related with functional area and it may cause serious error. Be sure to use only within user area UW30 to UW2047 (when not using recipe, UW30 to UW6047).

For further information of GP/LP inner memory, refer to '3.6 System signal'.

Refer to below bit/word available device organization and use the device.

UB	00	0
----	----	---

① Device name ② Word address ③ Bit address

Type	①	②	③
Bit	UB	Decimal	Hexadecimal
Word	DP	Word address(Hexadecimal)	
	UW	Word address(Decimal)	None

6.14.2.1 DPU digital power thyristor unit

(1) Modbus (DPU_Mod)

Type	Device	Mark	Range	
			Start	End
Bit	GP/LP inner bit memory	UB	UB0	UB6047F
Word	Word device area	DP	DP30001	DP30005
	Word device area	DP	DP30101	DP30125
	Word device area	DP	DP40001	DP40043
	GP/LP inner word memory	UW	UW0	UW6047

Device	Description	Enable read/write
DP30001	Output voltage	Read
DP30002	Load current	Read
DP30003	Electric power	Read
DP30004	Load resistance	Read
DP30005	Power frequency	Read
DP30101	Product number H	Read
DP30102	Product number L	Read
DP30103	Hardware version	Read
DP30104	Software version	Read
DP30105	Model name1	Read
DP30106	Model name2	Read
DP30107	Model name3	Read
DP30108	Model name4	Read
DP30109	Model name5	Read
DP30110	Model name6	Read
DP30111	Model name7	Read

Device	Description	Enable read/write
DP30112	Model name8	Read
DP30113	Model name9	Read
DP30114	Model name10	Read
DP30115	Reserved	Read
DP30116	Reserved	Read
DP30117	Reserved	Read
DP30118	Reserved	Read
DP30118	Coil start address	Read
DP30119	Coil quantity	Read
DP30120	Input start address	Read
DP30121	Input quantity	Read
DP30122	Holding REG start address	Read
DP30123	Holding REG quantity	Read
DP30124	Input REG start address	Read
DP30125	Input REG quantity	Read

Device	Description	Enable read/write
DP40001	Reference value	Read/Write
DP40002	Start time	Read/Write
DP40003	Start limit	Read/Write
DP40004	Soft start time	Read/Write
DP40005	Output high limit	Read/Write
DP40006	Output low limit	Read/Write
DP40007	Remote Sp1 value	Read/Write
DP40008	Remote Sp2 value	Read/Write
DP40009	Remote Sp3 value	Read/Write
DP40010	Remote Sp4 value	Read/Write
DP40011	Remote Sp5 value	Read/Write
DP40012	Remote Sp6 value	Read/Write
DP40013	Slow up time	Read/Write
DP40014	Slow stop time	Read/Write
DP40015	CL value	Read/Write
DP40016	OC value	Read/Write
DP40017	OC time	Read/Write
DP40018	OV value	Read/Write
DP40019	OV time	Read/Write
DP40020	Load detector alarm value	Read/Write
DP40021	Select display regular value	Read/Write
DP40022	Bar display mode	Read/Write

Device	Description	Enable read/write
DP40023	Control integer KP value	Read/Write
DP40024	Control integer KI value	Read/Write
DP40025	Output control mode	Read/Write
DP40026	Event input 1 mode	Read/Write
DP40027	Event input 2 mode	Read/Write
DP40028	Event input 3 mode	Read/Write
DP40029	Auto ref input selector	Read/Write
DP40030	Select load resistance display direction	Read/Write
DP40031	Operation status 0x000	Read/Write
DP40032	Output gradient setting (%)	Read/Write
DP40033	When input is 0%, output quantity setting(%)	Read/Write
DP40034	Input correction	Read/Write
DP40035	Input gradient correction	Read/Write
DP40036	Overcurrent alarm output setting	Read/Write
DP40037	Current alarm output setting	Read/Write
DP40038	Overvoltage alarm output setting	Read/Write
DP40039	Fuse break alarm output setting	Read/Write
DP40040	Frequency error alarm output setting	Read/Write
DP40041	Heatsink overheating alarm output setting	Read/Write
DP40042	Element error alarm output setting	Read/Write
DP40043	Heater break alarm output setting	Read/Write

(2) Modbus TYPE A (DPU_Mod_A)

Type	Device	Mark	Range	
			Start	Start
Bit	GP/LP inner bit memory	UB	UB0	UB6047F
Word	Word device area	3	300001	300005
	Word device area	3	300101	300125
	Word device area	4	400001	400043
	GP/LP inner word memory	UW	UW0	UW6047

Device	Description	Enable read/write
300001	Output voltage	Read
300002	Load current	Read
300003	Electric power	Read
300004	Load resistance	Read
300005	Power frequency	Read
300101	Product number H	Read
300102	Product number L	Read
300103	Hardware version	Read
300104	Software version	Read
300105	Model name1	Read
300106	Model name2	Read
300107	Model name3	Read
300108	Model name4	Read
300109	Model name5	Read
300110	Model name6	Read
300111	Model name7	Read
300112	Model name8	Read
300113	Model name9	Read
300114	Model name10	Read
300115	Reserved	Read
300116	Reserved	Read
300117	Reserved	Read
300118	Reserved	Read
300118	Coil start address	Read
300119	Coil quantity	Read
300120	Input start address	Read
300121	Input quantity	Read
300122	Holding REG start address	Read
300123	Holding REG quantity	Read
300124	Input REG start address	Read

Device	Description	Enable read/write
300125	Input REG quantity	Read

Device	Description	Enable read/write
400001	Reference value	Read/Write
400002	Start time	Read/Write
400003	Start limit	Read/Write
400004	Soft start time	Read/Write
400005	Output high limit	Read/Write
400006	Output low limit	Read/Write
400007	Remote Sp1 value	Read/Write
400008	Remote Sp2 value	Read/Write
400009	Remote Sp3 value	Read/Write
400010	Remote Sp4 value	Read/Write
400011	Remote Sp5 value	Read/Write
400012	Remote Sp6 value	Read/Write
400013	Slow up time	Read/Write
400014	Slow stop time	Read/Write
400015	CL value	Read/Write
400016	OC value	Read/Write
400017	OC time	Read/Write
400018	OV value	Read/Write
400019	OV time	Read/Write
400020	Load detector alarm value	Read/Write
400021	Select display regular value	Read/Write
400022	Bar display mode	Read/Write
400023	Control integer KP value	Read/Write
400024	Control integer KI value	Read/Write
400025	Output control mode	Read/Write
400026	Event input 1 mode	Read/Write
400027	Event input 2 mode	Read/Write
400028	Event input 3 mode	Read/Write
400029	Auto ref input selector	Read/Write
400030	Select load resistance display direction	Read/Write
400031	Operation status 0x000	Read/Write
400032	Output gradient setting (%)	Read/Write
400033	When input is 0%, output quantity setting(%)	Read/Write
400034	Input correction	Read/Write
400035	Input gradient correction	Read/Write
400036	Overcurrent alarm output setting	Read/Write

Device	Description	Enable read/write
400037	Current alarm output setting	Read/Write
400038	Overvoltage alarm output setting	Read/Write
400039	Fuse break alarm output setting	Read/Write
400040	Frequency error alarm output setting	Read/Write
400041	Heatsink overheating alarm output setting	Read/Write
400042	Element error alarm output setting	Read/Write
400043	Heater break alarm output setting	Read/Write

6.14.2.2 KRN50 recorder

(1) Modbus (KRN50_Mod)

Device	Description	Enable read/write
KR1	Starts/Stops record	Read/Write
KR2	At power ON, starts/stops record	Read/Write
KR3	When recording, whether printing setting list or not	Read/Write
KR4	Initializes setting value (Parameter initialization) *1	Read/Write
KR5	Memo function(Memo)	Read/Write
KR11	DI-1 input terminal function	Read/Write
KR12	DI-2 input terminal function	Read/Write
KR51	Paper feed function	Read/Write
KR52	Paper list print function	Read/Write
KR101	CH 1 display mode	Read/Write
KR102	CH 2 display mode	Read/Write
KR103	Display standard mode*1	Read/Write

Device	Description	Enable read/write
KR10001	Paper status	Read
KR10101	CH1 AL1 status	Read
KR10102	CH1 AL2 status	Read
KR10103	CH2 AL1 status	Read
KR10104	CH2 AL2 status	Read
KR10301	Digital input 1 status(DI1-Status)	Read
KR10302	Digital input 2 status(DI2-Status)	Read

Device	Description	Enable read/write	
KR30001	CH1-present value (PV)	Read	
KR30002	CH1	Bit position	Read
	Unit	15 to 10	Read
	Unit group	9 to 4	Read
	Status	3 to 2	Read
	Decimal point position of display value	1 to 0	Read

Device	Description		Enable read/write
KR30003	CH2-present value(PV)		Read
KR30004	CH2	Bit position	Read
	Unit	15 to 10	Read
	Unit group	9 to 4	Read
	Status	3 to 2	Read
	Decimal point position of display value	1 to 0	Read
KR30101	Serial No H		Read
KR30102	Serial No L		Read
KR30103	Software version		Read
KR30104	Hardware version		Read
KR30105	Model name1		Read
KR30106	Model name2		Read
KR30107	Model name3		Read
KR30108	Model name4		Read
KR30109	Model name5		Read
KR30110	Model name6		Read
KR30111	Model name7		Read
KR30112	Model name8		Read
KR30113	Model name9		Read
KR30114	Model name10		Read
KR30118	Coil start address		Read
KR30119	Coil quantity		Read
KR30120	Input start address		Read
KR30121	Input quantity		Read
KR30122	Holding REG start address		Read
KR30123	Holding REG quantity		Read
KR30124	Input REG start address		Read
KR30125	Input REG quantity		Read

Device	Description	Enable read/write
KR40001	Communication station	Read/Write
KR40002	Baudrate	Read/Write
KR40003	Parity bit	Read/Write
KR40004	Stop bit	Read/Write
KR40005	Respond time	Read/Write
KR40006	Allows/Restricts communication write	Read/Write
KR40052	Year	Read/Write
KR40053	Month	Read/Write
KR40054	Day	Read/Write

Device	Description	Enable read/write
KR40055	Hour	Read/Write
KR40056	Minute	Read/Write
KR40057	Second	Read/Write
DP40013	Slow up time	Read/Write
DP40014	Slow stop time	Read/Write
DP40015	CL value	Read/Write
DP40016	OC value	Read/Write
DP40017	OC time	Read/Write
DP40018	OV value	Read/Write
DP40019	OV time	Read/Write
KR40066	Lock setting	Read/Write
KR40067	Backlight turn ON method	Read/Write
KR40070	Using reserved record function or not	Read/Write
KR40071	Record start hour	Read/Write
KR40072	Record start minute	Read/Write
KR40073	Record end hour	Read/Write
KR40074	Record end minute	Read/Write
KR40080	Record mode	Read/Write
KR40081	Record speed	Read/Write
KR40082	Digital memo cycle	Read/Write
KR40083	Record cycle	Read/Write
KR40084	Record font	Read/Write
KR40085	When alarming, record speed	Read/Write
KR40101	CH1 alarm output 1 operation mode	Read/Write
KR40102	CH1 alarm output 1 option	Read/Write
KR40103	CH1 alarm output 1 low limit setting value	Read/Write
KR40104	CH1 alarm output 1 high limit setting value	Read/Write
KR40105	CH1 alarm output 2 operation mode	Read/Write
KR40106	CH1 alarm output 2 option	Read/Write
KR40107	CH1 alarm output 2 low limit setting value	Read/Write
KR40108	CH1 alarm output 2 high limit setting value	Read/Write
KR40109	CH1 alarm output hysteresis	Read/Write
KR40110	CH2 alarm output 1 operation mode	Read/Write
KR40111	CH2 alarm output 1 option	Read/Write
KR40112	CH2 alarm output 1 low limit setting value	Read/Write
KR40113	CH2 alarm output 1 high limit setting value	Read/Write
KR40114	CH2 alarm output 2 operation mode	Read/Write
KR40115	CH2 alarm output 2 option	Read/Write
KR40116	CH2 alarm output 2 low limit setting value	Read/Write

Device	Description	Enable read/write
KR40117	CH2 alarm output 2 high limit setting value	Read/Write
KR40118	CH2 alarm output hysteresis	Read/Write
KR42001 to 16	User unit font0	Read/Write
KR42017 to 32	User unit font1	Read/Write
KR42033 to 48	User unit font2	Read/Write
KR42049 to 64	User unit font3	Read/Write
KR42065 to 80	User unit font4	Read/Write
KR42081 to 96	User unit font5	Read/Write
KR42097 to 112	User unit font6	Read/Write
KR420113 to 128	User unit font7	Read/Write
KR420129 to 144	User unit font8	Read/Write
KR420145 to 160	User unit font9	Read/Write
KR40301	CH1 use/recording or not	Read/Write
KR40302	CH1 input specification	Read/Write
KR40303	CH1 temperature unit	Read/Write
KR40304	CH1 graph low limit scale value	Read/Write
KR40305	CH1 graph high limit scale value	Read/Write
KR40306	CH1 low limit input value	Read/Write
KR40307	CH1 high limit input value	Read/Write
KR40308	None	Read/Write
KR40309	CH1 low limit scale display value	Read/Write
KR40310	CH1 high limit scale display value	Read/Write
KR40311	CH1 decimal point position of scale	Read/Write
KR40312	CH1 record display unit	Read/Write
KR40313	CH1 temperature unit	Read/Write
KR40314	CH1 CH name □□□□	Read/Write
KR40315		
KR40319	CH2 use/recording or not	Read/Write
KR40320	CH2 input specification	Read/Write
KR40321	CH2 temperature unit	Read/Write
KR40322	CH2 graph low limit scale value	Read/Write
KR40323	CH2 graph high limit scale value	Read/Write
KR40324	CH2 low limit input value	Read/Write
KR40325	CH2 high limit input value	Read/Write
KR40326	None	Read/Write
KR40327	CH2 low limit scale display value	Read/Write

Device	Description	Enable read/write
KR40328	CH2 high limit scale display value	Read/Write
KR40329	CH1 decimal point position of scale	Read/Write
KR40330	CH2 record display unit	Read/Write
KR40331	CH2 input correction	Read/Write
KR40332 to 40333	CH2 CH name	Read/Write
KR50001 to 52048	User logo	

(2) Modbus TYPE A (KRN50_Mod_A)

Device	Description	Enable read/write
000001	Starts/Stops record	Read/Write
000002	At power ON, starts/stops record	Read/Write
000003	When recording, whether printing setting list or not	Read/Write
000004	Initializes setting value (Parameter initialization) *1	Read/Write
000005	Memo function(Memo)	Read/Write
000011	DI-1 input terminal function	Read/Write
000012	DI-2 input terminal function	Read/Write
000051	Paper feed function	Read/Write
000052	Paper list print function	Read/Write
000101	CH 1 display mode	Read/Write
000102	CH 2 display mode	Read/Write
000103	Display standard mode*1	Read/Write

Device	Description	Enable read/write
100001	Paper status	Read/Write
100101	CH1 AL1 status	Read/Write
100102	CH1 AL2 status	Read/Write
100103	CH2 AL1 status	Read/Write
100104	CH2 AL2 status	Read/Write
100301	Digital input 1 status(DI1-Status)	Read/Write
100302	Digital input 2 status(DI2-Status)	Read/Write

Device	Description	Enable read/write	
300001	CH1- present value (PV)	Read	
300002	CH1	Bit position	Read
	Unit	15 to 10	Read
	Unit group	9 to 4	Read
	Status	3 to 2	Read
	Decimal point position of display value	1 to 0	Read
300003	CH2- present value (PV)	Read	

Device	Description		Enable read/write
300004	CH2	Bit position	Read
	Unit	15 to 10	Read
	Unit group	9 to 4	Read
	Status	3 to 2	Read
	Decimal point position of display value	1 to 0	Read
300101	Serial No H		Read
300102	Serial No L		Read
300103	Software Version		Read
300104	Hardware Version		Read
300105	Model Name1		Read
300106	Model Name2		Read
300107	Model Name3		Read
300108	Model Name4		Read
300109	Model Name5		Read
300110	Model Name6		Read
300111	Model Name7		Read
300112	Model Name8		Read
300113	Model Name9		Read
300114	Model Name10		Read
300118	Coil Start Address		Read
300119	Coil Quantity		Read
300120	Input Start Address		Read
300121	Input Quantity		Read
300122	Holding REG Start Address		Read
300123	Holding REG Quantity		Read
300124	Input REG Start Address		Read
300125	Input REG Quantity		Read

Device	Description	Enable read/write
400001	Communication station	Read/Write
400002	Baudrate	Read/Write
400003	Parity bit	Read/Write
400004	Stop bit	Read/Write
400005	Respond time	Read/Write
400006	Allows/Restricts communication write	Read/Write
400052	Year	Read/Write
400053	Month	Read/Write
400054	Day	Read/Write
400055	Hour	Read/Write

Device	Description	Enable read/write
400056	Minute	Read/Write
400057	Second	Read/Write
400066	Lock setting	Read/Write
400067	Backlight turn ON method	Read/Write
400070	Using reserved record function or not	Read/Write
400071	Record start hour	Read/Write
400072	Record start minute	Read/Write
400073	Record end hour	Read/Write
400074	Record end minute	Read/Write
400080	Record mode	Read/Write
400081	Record speed	Read/Write
400082	Digital memo cycle	Read/Write
400083	Record cycle	Read/Write
400084	Record font	Read/Write
400085	When alarming, record speed	Read/Write
400101	CH1 alarm output 1 operation mode	Read/Write
400102	CH1 alarm output 1 option	Read/Write
400103	CH1 alarm output 1 low limit setting value	Read/Write
400104	CH1 alarm output 1 high limit setting value	Read/Write
400105	CH1 alarm output 2 operation mode	Read/Write
400106	CH1 alarm output 2 option	Read/Write
400107	CH1 alarm output 2 low limit setting value	Read/Write
400108	CH1 alarm output 2 high limit setting value	Read/Write
400109	CH1 alarm output hysteresis	Read/Write
400110	CH2 alarm output 1 operation mode	Read/Write
400111	CH2 alarm output 1 option	Read/Write
400112	CH2 alarm output 1 low limit setting value	Read/Write
400113	CH2 alarm output 1 high limit setting value	Read/Write
400114	CH2 alarm output 2 operation mode	Read/Write
400115	CH2 alarm output 2 option	Read/Write
400116	CH2 alarm output 2 low limit setting value	Read/Write
400117	CH2 alarm output 2 high limit setting value	Read/Write
400118	CH2 alarm output hysteresis	Read/Write
402001 to 16	User unit font0	Read/Write
402017 to 32	User unit font1	Read/Write
402033 to 48	User unit font2	Read/Write

Device	Description	Enable read/write
402049 to 64	User unit font3	Read/Write
402065 to 80	User unit font4	Read/Write
402081 to 96	User unit font5	Read/Write
402097 to 112	User unit font6	Read/Write
402113 to 128	User unit font7	Read/Write
402129 to 144	User unit font8	Read/Write
402145 to 160	User unit font9	Read/Write
400301	CH1 use/recording or not	Read/Write
400302	CH1 input specification	Read/Write
400303	CH1 temperature unit	Read/Write
400304	CH1 graph low limit scale value	Read/Write
400305	CH1 graph high limit scale value	Read/Write
400306	CH1 low limit input value	Read/Write
400307	CH1 high limit input value	Read/Write
400308	None	Read/Write
400309	CH1 low limit scale display value	Read/Write
400310	CH1 high limit scale display value	Read/Write
400311	CH1 decimal point position of scale	Read/Write
400312	CH1 record display unit	Read/Write
400313	CH1 temperature unit	Read/Write
400314	CH1 CH name □□□□	Read/Write
400315		
400319	CH2 use/recording or not	Read/Write
400320	CH2 input specification	Read/Write
400321	CH2 temperature unit	Read/Write
400322	CH2 graph low limit scale value	Read/Write
400323	CH2 graph high limit scale value	Read/Write
400324	CH2 low limit input value	Read/Write
400325	CH2 high limit input value	Read/Write
400326	None	Read/Write
400327	CH2 low limit scale display value	Read/Write
400328	CH2 high limit scale display value	Read/Write

Device	Description	Enable read/write
400329	CH1 decimal point position of scale	Read/Write
400330	CH2 record display unit	Read/Write
400331	CH2 input correction	Read/Write
400332 to 400333	CH2 CH name	Read/Write
450001 to 452048	User Logo	

6.14.3 Monitorable device in GP/LP

GP/LP is able to monitor PLC device and change the status.

Enter system setting menu of GP/LP and select [Monitoring]-[Device Monitor]-[DEV.]. Select to be monitored device and you can change the status.

The following is available device list of this menu, available range is same as '6.14.2 Available device'.

6.14.3.1 DPU digital power thyristor unit

(1) Modbus

Type	Mark	Device
Bit	UB	GP/LP inner bit memory
Word	DP	Word device area
	UW	GP/LP inner word memory

(2) Modbus TYPE A

Type	Mark	Device
Bit	UB	GP/LP inner bit memory
Word	3	Word device area
	4	Word device area
	UW	GP/LP inner word memory

6.14.3.2 KRN50 recorder

(1) Modbus

Type	Mark	Device
Bit	KR	Bit device area
	UB	GP/LP inner bit memory
Word	KR	Word device area
	UW	GP/LP inner word memory

(2) Modbus TYPE A

Type	Mark	Device
Bit	0	Bit device area
	1	Bit device area
	UB	GP/LP inner bit memory
Word	3	Word device area
	4	Word device area
	UW	GP/LP inner word memory

6.15 DELTA temperature controller connection

GP/LP is able to communicate with DELTA temperature controller DTB series.

6.15.1 System organization

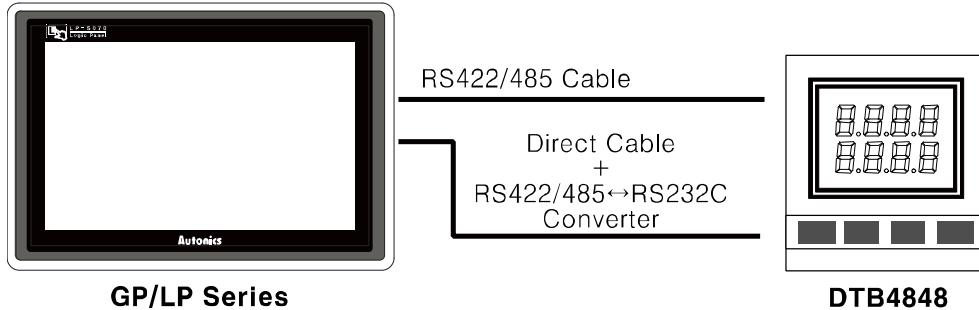

DELTA DTB series executes RS485 communication, and it also executes RS232C communication with an RS232/422 converter.

Controller type	Communication method	Communication type
DTB4848	RS485	CPU direct(Loader)

- RS-485 communication with GP/LP (Applied cable: (15) C3M5P03-D9M0-T4Y0)

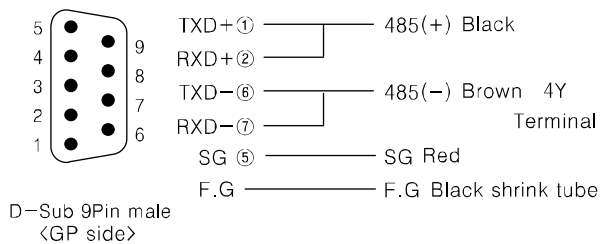

The below table is for communication configuration of DELTA DTB series with GP/LP.

No	Item	Description	Note
1	Communication mode	Modbus RTU	
2	Baudrate	9600 bps	Fixed
3	Data type	Data length	8bit Fixed
		Parity	NONE Fixed
		Stop bit	1bit Fixed
4	Station	CH1	1 to 247 Selectable
		CH2	0 to 31

As above configuration, GP/LP also should be set for the station as below.

1st Enter system setting menu.

Touch left-upper point as default position of system setting menu.



2nd Select [SET ENVIRONMENT]-[PLC SETTING].

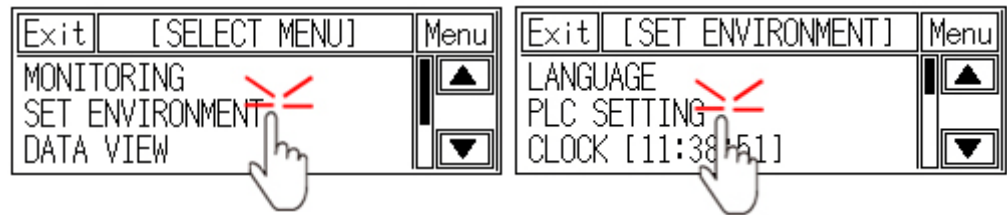

3rd Touch CH1 station, station input key pad appears. Enter the same station of the station which is set from DTB series.

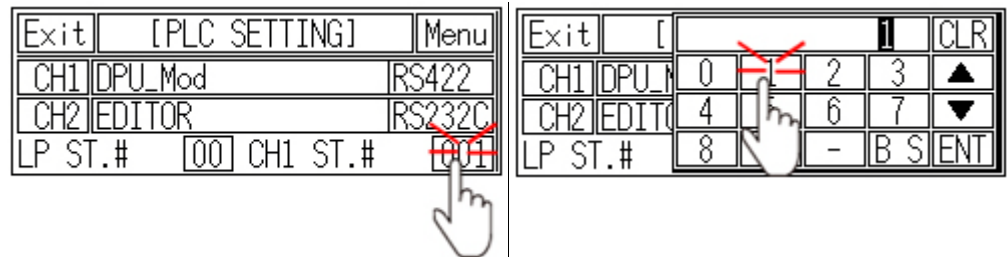

4th Touch 'ENT' to save the station and touch 'Menu' or 'Exit' to exit system setting meun.

6.15.2 Available device

UB device is as GP/LP inner bit memory, only in GP/LP it is able to use same as general inner device of PLC.

It is able to switch into word UW device binding 16 units. However it is related with functional area and it may cause serious error. Be sure to use only within user area UW30 to UW2047 (when not using recipe, UW30 to UW6047).

For further information of GP/LP inner memory, refer to '3.6 System signal'.

Refer to below bit/word available device organization and use the device.

UB	00	0
----	----	---

① Device name ② Word address ③ Bit address

Type	①	②	③
Bit	M	Hexadecimal	Hexadecimal
	UB	Decimal	Hexadecimal
Word	D	Word address(Hexadecimal)	
	UW	Word address(Decimal)	None

6.15.2.1 DTB4848

(1) Modbus (DTB_Mod)

Type	Device	Mark	Range	
			Start	End
Bit	Bit device area*1	M	M810	M818
	GP/LP inner bit memory	UB	UB0	UB6047F
Word	Word device area*2	D	D1000	D20BF
	GP/LP inner word memory	UW	UW0	UW6047

※1. It is used device when operating command. Enter the specific value, it executes the below table operation.

※2. Device address is same as each variable of temperature controller. For further details of each variable, refer to the each product manual.

Device	Command value	Command description	Executing operation	Note
M810	0	Communication Write	Stops communication write	Default
	1		Allows communication write	
M811	0	Select °C / °F	°F	Default
	1		°C	
M812	0	DECIMAL POINT	Refer to temperature controller manual	
	1	SELECTION		
M813	0	AT Setting	Stops AT	Default
	1		Executes AT	
M814	0	Control setting	Stops control	Default
	1		Executes control	
M815	0	STOP setting	RUN	Default
	1		STOP	

Device	Command value	Command description	Executing operation	Note
M816	0	Temporarily STOP Setting	RUN	Default
	1		STOP	
M817	0	Valve feedback	Feedback	Default
	1	Setting Status	Feedback Function	
M818	0	Auto-tuning Valve feedback	Stop AT	Default
	1	Status	Start AT	

(2) Modbus TYPE A(DTB_Mod_A)

Type	Device	Mark	Range	
			Start	Start
Bit	Bit device area	1	100810	100818
	GP/LP inner bit memory	UB	UB0	UB6047F
Word	Word device area	4	401000	4020BF
	GP/LP inner word memory	UW	UW0	UW6047

Device	Command value	Command description	Executing operation	Note
100810	0	Communication Write	Stops communication write	default
	1		Allows communication write	
100811	0	Select °C / °F	°F	
	1		°C	default
100812	0	Decimal point selection	Refer to temperature controller manual	
	1			
100813	0	AT Setting	Stops AT	
	1		Executes AT	default
100814	0	CONTROL Setting	Stops Control	
	1		Executes Control	default
100815	0	STOP setting	RUN	default
	1		STOP	
100816	0	Temporarily STOP Setting	RUN	default
	1		STOP	
100817	0	Valve feedback	Feedback	default
	1	Setting Status	Feedback Function	
100818	0	Auto-tuning Valve	Stop AT	default
	1	feedback Status	Start AT	

6.15.3 Monitorable device in GP/LP

GP/LP is able to monitor PLC device and change the status.

Enter system setting menu of GP/LP and select [Monitoring]-[Device Monitor]-[DEV.]. Select to be monitored device and you can change the status.

The following is available device list of this menu, available range is same as '6.15.2 Available device'.

(1) Modbus

Type	Mark	Device	Note
Bit	M	Bit device area	
	UB	GP/LP inner bit memory	
Word	D	Word device area	16bit
	UW	GP/LP inner word memory	

(2) Modbus TYPE A

Type	Mark	Device	Note
Bit	1	Bit device area	
	UB	GP/LP inner bit memory	
Word	4	Word device area	16bit
	UW	GP/LP inner word memory	

6.16 DANFOS FC Series

GP/LP is able to communicate with FC200 of DANFOS.

6.16.1 System organization

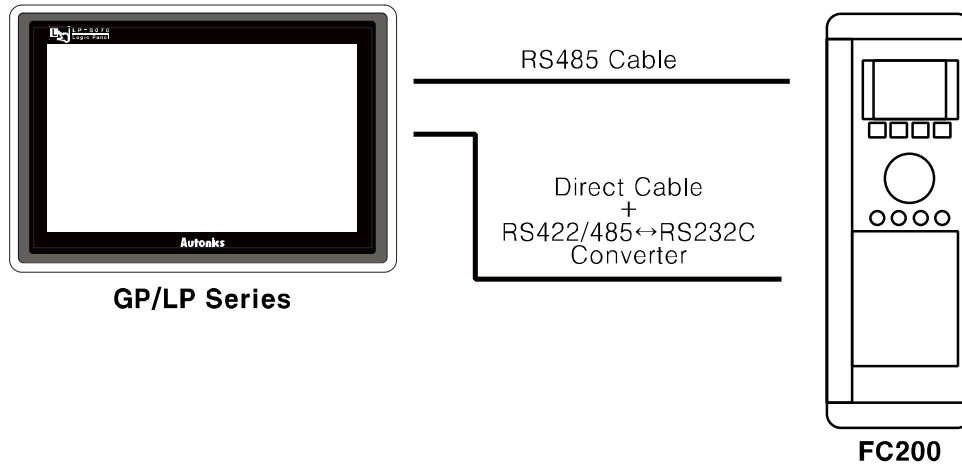

DANFOS FC200 executes RS485 communication and it executes also RS232C communication with RS485/232 converter.

Controller type	Communication method	Communication type
DANFOS FC200	RS485	CPU direct (Loader)

- RS-485 communication with GP/LP (Applied cable: (15) C3M5P03-D9M0-T4Y0)

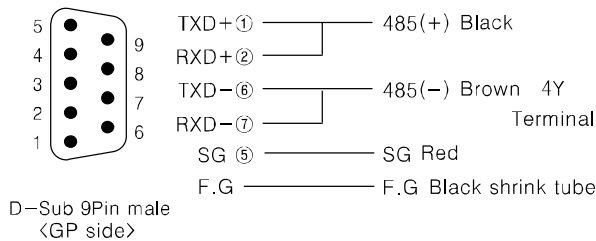

The below table is for communication configuration of DANFOS FC200 with GP/LP.

No	Item	Description	Note	
1	Communication mode	Modbus RTU		
2	Baudrate	9600 bps	Fixed	
3	Data type	Data length	8bit	Fixed
		Parity	NONE	Fixed
		Stop bit	1bit	Fixed
4	Station	CH1	1 to 247	Selectable
		CH2	0 to 31	

As above configuration, GP/LP also should be set for the station as below.

1st Enter system setting menu.

Touch left-upper point as default position of system setting menu.



2nd Select [Environment]-[Serial Communication] and check that the protocol is downloaded.

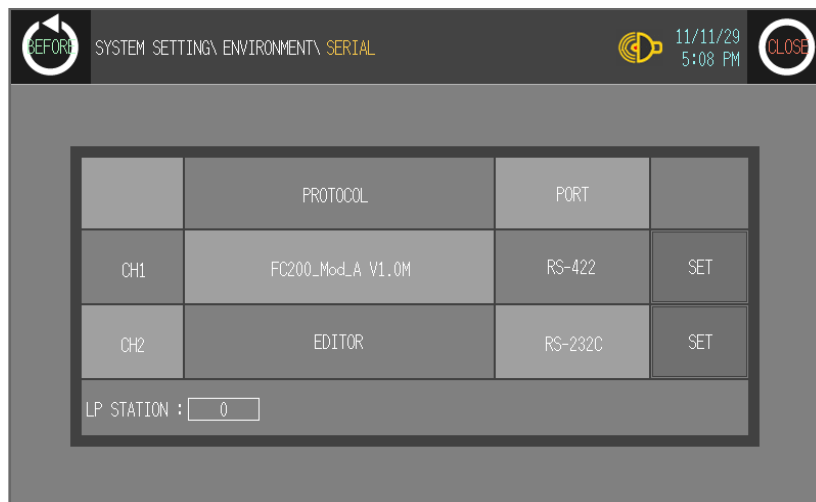

3rd Touch 'BEFORE' or 'CLOSE' to exit system setting menu.

6.16.2 Available device

Available device of DANFOS FC200 and displayable parameter are as below.

Type	Device	Mark	Range	
			Start	End
Bit	Bit device area	0	000001	000065
	GP/LP inner bit memory	UB	UB0	UB6047F
Word	Word device area	4	400001	400990
	Word device area	4	401000	401990
	Word device area	4	402000	402990
	Word device area	4	403000	403990
	Word device area	4	404000	404990
	Word device area	4	449000	449990
	Word device area	4	450000	450000
	Word device area	4	450010	450010
	Word device area	4	450210	450210
	GP/LP inner word memory	UW	UW0	UW6047

6.16.3 Monitorable device in GP/LP

GP/LP is able to monitor PLC device and change the status.

Enter system setting menu of GP/LP and select [Monitoring]-[Device Monitor]-[DEV.]. Select to be monitored device and you can change the status.

The following is available device list of this menu, available range is same as '6.16.2 Available device'.

Type	Mark	Device	Note
Bit	0	Bit device area	
	UB	GP/LP inner bit memory	
Word	4	Word device area	
	UW	GP/LP inner word memory	

6.17 Modbus Master

GP/LP supports Modbus Master function and is able to connect with other Modbus Slave devices.

6.17.1 System organization

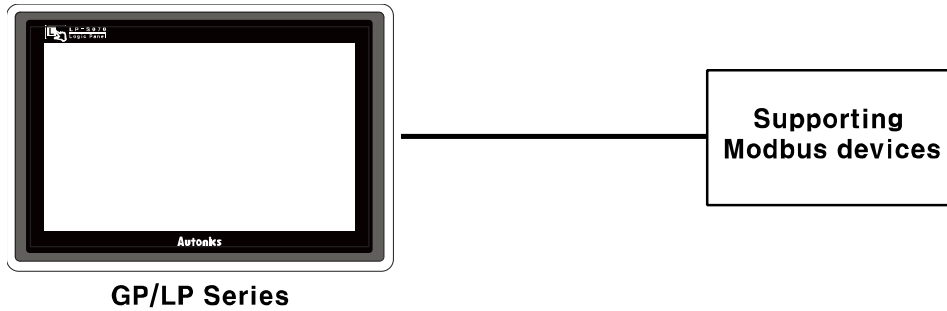

Modbus Master protocol is available to communicate with all product which supports Modbus.

Communication configuration of Modbus Master protocol should be synchronized with to be connected product's communication configuration.



Note

Modbus Master protocol supports Modbus Master01, Modbus Master02, Modbus Master03 type and each type has their own characteristics.

Type	Characteristics
Modbus Master01	Supports single write, multi write Supporting function: 1, 2, 3, 4, 5, 6, 15, 16
Modbus Master02	Supports only single write Supporting function: 1, 2, 3, 4, 5, 6
Modbus Master03	Supports only multi write Supporting function: 1, 2, 3, 4, 15, 16

6.17.2 Available device

Available devcie of Modbus Master and displayable parameter are as below.

Type	Device	Mark	Range	
			Start	End
Bit	Bit device area	0	000001	065536
	Bit device area	1	100001	165536
	GP/LP inner bit memory	UB	UB0	UB6047F
Word	Word device area	3	300001	365536
	Word device area	4	400001	465536
	GP/LP inner bit memory	UW	UW0	UW6047



Note

Device address is for Modbus Master protocol is 1 based protocol address(Start address: 1). The below example is for TM series of Autonics product. Following table is part of memory map(using 0 based protocol address) for TM series.

No (Address)				Parameter	Description
TM2		TM4			
31001	(03E8)	31001	(03E8)	CH1 Present Value	Present measured value
31002	(03E9)	31002	(03E9)	CH1 Dot	Decimal point position of sensor
31003	(03EA)	31003	(03EA)	CH1 Unit	Sensor temperature unit
31004	(03EB)	31004	(03EB)	CH1 Set Value	Present controlled temperature setting value
31005	(03EC)	31005	(03EC)	CH1 Heating_MV	Heating control value

Dot line area is for device address, solid line area is for protocol address.

To read CH1 PresentValue of TM2 from TM2_Mod protocol, it uses device address (31001). For Modbus Master protocol, it uses protocol address (03E8) plus 1. Device address of Modbus Master protocol is displayed with decimal. Therefore, protocol address value as 0x03E9 which is 0x03E8 plus 1 of CH1 PresentValue is converted decimal value as 1001 and it is used as device address. (Converting description is as below table.)

Use device address		Convert address (Hexadecimal→Decimal)				Use protocol address		
Protocol	TM2_Mod	→	Protocol address [Hexadeci mal]+1	→	Protocol address [Decimal]	→	Protocol	Modbus Master
Device	TM		Read word		Read word		Device	3
Address	31001		0x03E8+1		1000		Address	01000



Note

Used device address on Modbus Master protocol uses the value of protocol address (in case of 0 base) plus 1. Device address of Modbus Master protocol uses decimal value.

6.17.3 Monitorable device in GP/LP

GP/LP is able to monitor PLC device and change the status.

Enter system setting menu of GP/LP and select [Monitoring]-[Device Monitor]-[DEV.]. Select to be monitored device and you can change the status.

The following is available device list of this menu, available range is same as '6.17.2 Available device'.

Type	Mark	Device	Note
Bit	1	Read-only register	Modbus function 0x02
	0	Read, write register	Modbus function 0x01, 0x05, 0x0F
	UB	GP/LP inner bit memory	
Word	3	Read-only register	Modbus function 0x03
	4	Read, write register	Modbus function 0x06, 0x10
	UW	GP/LP inner word memory	



Caution

Device monitoring from GP/LP-S070 displays from input start data to 16 data at once. In case of Modbus Master protocol, if the number of devices from connected product is smaller than the number of displayed devices in monitoring, you cannot check the device status by device monitoring. In this case, you should draw data on the user screen and check the data status.

Autonics

Sensors & Controllers

www.autonics.com

Distributor



Major products

Proximity sensors • Photoelectric sensors • Area sensors • Fiber optic sensors • Door/Door Side sensors • Pressure sensors • Rotary encoders • Sensor controllers • Switching power supply • Temp. controllers • Temperature/Humidity transducers • Power controllers • Recorders • Tachometer/Pulse(Rate) meters • Panel meters • Indicators • Signal convertors • Counters • Timers • Display units • Graphic panel • Stepping Motors & Drivers & Motion controllers

Any proposal for a product improvement and development: Product@autonics.com

Headquarters

41-5, Yongdang-dong, Yangsan-si, Gyeongnam, 626-847, Korea

Overseas Business Dept.

Bldg. 402 3rd Fl., Bucheon Techno Park, 193, Yakdae-dong, Wonmi-gu, Bucheon-si, Gyeonggi-do, 420-734, Korea

Tel: 82-32-610-2730 / Fax: 82-32-329-0728 / E-mail: sales@autonics.com

Brazil

Autonics do Brasil Comercial Importadora Exportadora Ltda

Tel: 55-11-3055-1660 / Fax: 55-11-3055-1661 / E-mail: vendas@autonics.com.br

China

Autonics electronic(Jiaying) Corporation

Tel: 86-573-8216-1900 / Fax: 86-573-8216-1917 / E-mail: china@autonics.com

India

Autonics Corporation - India Liaison Office

Tel: 91-22-2781-4305 / Fax: 91-22-2781-0538 / E-mail: india@autonics.com

Indonesia

PT. Autonics Indonesia

Tel: 62-21-6586-6740 / Fax: 62-21-6586-6741 / E-mail: autonics@cbn.net.id

Japan

Autonics Japan Corporation

Tel: 81-3-5730-0568 / Fax: 81-3-5730-0569 / E-mail: ja@autonicsjp.co.jp

Malaysia

Mal-Autonics Sensor Sdn. Bhd.

Tel: 60-3-7805-7190(Hunting) / Fax: 60-3-7805-7193 / E-mail: malaysia@autonics.com

Mexico

Autonics Mexico Sales Office

Tel: 52-55-5207-0019 / Fax: 52-55-5207-0099 / E-mail: ventas@autonics.com

Russia

Autonics Corp. Russia Representative Office

Tel/Fax: 7-495-745-2343 E-mail: russia@autonics.com

Turkey

Autonics Otomasyon Ticaret Ltd. Sti.

Tel: 90-212-222-0117 (PBX) / Fax: 90-212-222-0108 / E-mail: info@autonics.com.tr

USA

Autonics USA, Inc.

Tel: 1-847-680-8160 / Fax: 1-847-680-8155 / E-mail: sales@autonicsusa.net

Vietnam

Autonics Vietnam Representative Office

Tel: 84-8-3925-6563 / Fax: 84-8-3925-6564 / E-mail: vietnam@autonics.com