



Buckeye

HARDWARE

DISTRIBUTING, LTD.

2022-2023

Catalog

Amerock

Amerock®



FULL LINE MASTER DISTRIBUTOR OF AMEROCK
THIS PAGE FOR COLOR REFERENCE ONLY

SILVER TONES



26, CH
POLISHED CHROME



PN
POLISHED NICKEL



G10, SN
SATIN NICKEL (MATTE)



SC
SILVER CHAMPAGNE



G9
STERLING NICKEL



S
SILVER



G10
SATIN NICKEL



14
NICKEL



SS
STAINLESS STEEL



AA
ANODIZED ALUMINUM



26D, SCH
BRUSHED CHROME



BBN
BLACK BRUSHED NICKEL



BCR
BLACK CHROME



AS
ANTIQUE SILVER



AP
AGED PEWTER



AN
ANTIQUE NICKEL



WN
WEATHERED NICKEL



WNC
WEATHERED NICKEL COPPER

GOLD TONES



CZ
CHAMPAGNE BRONZE



BBZ
BRUSHED BRONZE OR GOLDEN CHAMPAGNE



3, PB
POLISHED BRASS



GB
GILDED BRONZE



AE
ANTIQUE ENGLISH



EB
ELEGANT BRASS



O77, BB
BURNISHED BRASS



AB, ABS
ANTIQUE BRASS



DBS
DISTRESSED BRASS



R1
REGENCY BRASS



R2
WEATHERED BRASS



R3
RUSTIC BRASS



THIS PAGE FOR COLOR REFERENCE ONLY

BOLD TONES



AC
ANTIQUE COPPER



BC
BRUSHED COPPER



WC
WEATHERED
COPPER



RBZ
RUSTIC BRONZE



CBZ
CARMEL BRONZE



ART
ANTIQUE RUST



VS
VIRIDIAN SLATE



RB
ROMAN BRONZE



VB
VENETIAN
BRONZE



ORB
OIL-RUBBED
BRONZE



DOB
DARK OILED
BRONZE

BLACK TONES



WI, WID
WROUGHT IRON
OR WROUGHT
IRON DARK



PWT
PEWTER



GM
GUNMETAL



GPH
GRAPHITE



BN, BNB
BLACK NICKEL



BBR
BLACK BRONZE



FB
FLAT BLACK



CB
COLONIAL BLACK



MB
MATTE BLACK

WHITE TONES



30, W, 54, GW
WHITE



MW
MARBLE WHITE



1910-G10
 | 1/4" DIA
 | 1/8" PROJ



1387-26
 | 1/4" DIA
 | 1/16" PROJ



69151-G10
 | 1/2" DIA
 3/4" PROJ



3413-26
 | 1/2" DIA
 5/8" PROJ



53000-G10
 | 1/4" DIA
 7/8" PROJ



53002-G10
 | 3/16" DIA
 1" PROJ



53011-G10
 | 1/4" DIA
 | 1/8" PROJ



53015-G10
 | 1/4" DIA
 1" PROJ



53018-G10
 | 3/8" L
 | 1/2" PROJ



29112-CS
 | 3/16" DIA
 | 1/4" PROJ



29113-G10
 | 1/4" DIA
 3/4" PROJ



29115-G10
 | 1/2" DIA
 | 1/8" PROJ



4476-G10
 40MM L
 7/8" PROJ



594-AE
 | 1/2" DIA
 7/8" PROJ



3423-BB
 | 1/2" DIA
 1" PROJ



888-AE
 | 3/8" DIA
 5/8" PROJ



3401-CB
 3 1/4" C/C | 5 1/16" L



3403-CB
 | 1/4" DIA
 3/4" PROJ



53470-ORB
 3" C/C | 3 3/4" L



53471-ORB
 32MM DIA
 | 3 1/4" PROJ

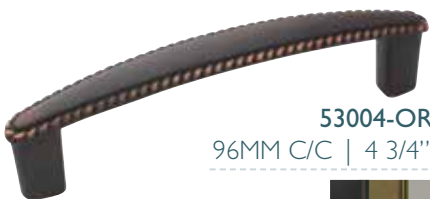

53004-ORB
 96MM C/C | 4 3/4" L



53001-ORB
 | 1/4" DIA
 7/8" PROJ



EVERYDAY HERITAGE



3441-3
3" C/C | 3 3/8" L



BB



29111-G10
128MM C/C | 6" L



G10



3424-BB
3" C/C/N | 5" L



BB

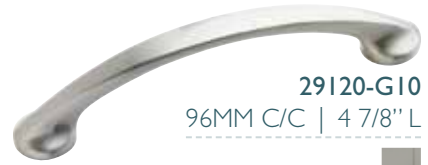

29120-G10
96MM C/C | 4 7/8" L



G10



735-AE
3" C/C | 4 3/4" L



AE

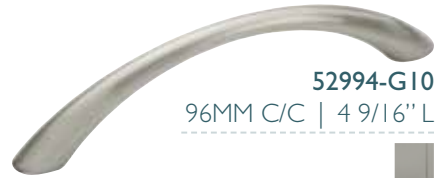

52994-G10
96MM C/C | 4 9/16" L



G10



766-AE
2 1/2" C/C
4 13/16" L



AE



52995-G10
96MM C/C | 5" L



G10



173-ORB
3" C/C | 4 5/8" L



ORB G10

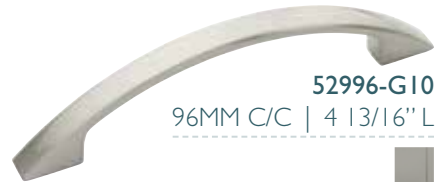

52996-G10
96MM C/C | 4 13/16" L



G10



174-ORB
3" C/C | 5 1/16" L



ORB



69153-G10
3" C/C | 4" L



G10



4478-G10
96MM C/C | 4" L



G10

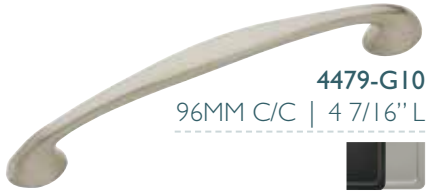

4479-G10
96MM C/C | 4 7/16" L



ORB G10



3415-26
2 3/4" C/C | 3 1/2" L



26



3416-26
3" C/C | 4" L



26



865-26D
3" C/C | 3 5/16" L



26



867-CS26D
3 1/2" C/C | 3 13/16" L



CS26D CSG10



53006-G10
3" C/C | 3 3/8" L



FB ORB G10 26



53007-G10
3" C/C | 5 1/8" L



G10



53008-G10
3" C/C | 4 7/8" L



G10



53009-G10
3" C/C | 3 3/8" L



G10



1908-G10
3" C/C | 5 1/2" L



G10



76312-G10
4" C/C | 4 1/4" L



G10



76313-26
4" C/C | 4 1/4" L



26



ABERNATHY



AVAILABLE FINISHES

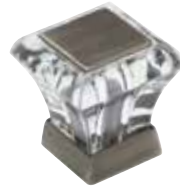

29460-CAS
1" L | 1" PROJ

ALOFT



AVAILABLE FINISHES



36743-BCR
4 13/16" C/C | 5 13/16" L



36744-BCR
4 9/16" C/C | 7 3/4" L



36745-BCR
6 9/16" C/C | 9 3/4" L



36746-BCR
8 9/16" C/C | 11 11/16" L

APPOINT



AVAILABLE FINISHES



36758-CZ
1 1/4" DIA
1" PROJ



36762-CZ
76MM C/C | 4 7/8" L



36764-CZ
76MM C/C | 3 3/4" L



36763-CZ
128MM C/C | 7 7/16" L



36759-CZ
96MM C/C | 4 9/16" L



36760-CZ
128MM C/C | 5 13/16" L



36761-CZ
192MM C/C | 8 5/16" L

AVAILABLE FINISHES



ASHBY



36640-GM
76MM C/C | 5 1/8" L

BAR PULLS



19010-SS
3" C/C | 5 3/8" L



CSG9 SS



19011-SS
96MM C/C | 6 1/8" L



CSG9 SS



19541-SS
128MM C/C | 7 3/8" L



CSG9 SS



19012-SS
192MM C/C | 9 15/16" L



CSG9 SS



19013-SS
256MM C/C | 13 1/4" L



CSG9 SS



BAR PULLS



 19009-ORB 2" L 1 3/8" PROJ  BBR ORB GM CZ BBZ CSG9 SS PN 26	 40515-CBZ 3" C/C 5 3/8" L  BBR ORB CBZ GM CZ BBZ PN 26	 40516-ORB 96MM C/C 6 1/8" L  BBR ORB GM CZ BBZ PN 26
 40517-ORB 128MM C/C 7 3/8" L  BBR ORB GM CZ BBZ PN 26	 40518-ORB 192MM C/C 9 7/8" L  BBR ORB GM CZ BBZ PN 26	 40519-ORB 256MM C/C 13 1/4" L  BBR ORB GM CZ BBZ PN 26
 54008-BBZ 12" C/C 14 5/8" L  BBR ORB GM BBZ CSG9 SS PN	 19014-ORB 320MM C/C 15 3/4" L  BBR ORB GM CZ BBZ CSG9 SS PN 26	
 19015-ORB 416MM C/C 19 1/2" L  ORB CSG9 SS	 54025-SS 18" C/C 20 5/8" L  BBR ORB BBZ SS PN	
 19016-ORB 480MM C/C 22" L  BBR ORB GM CZ BBZ CSG9 SS PN 26		
 19017-ORB 544MM C/C 24 9/16" L  ORB CSG9 SS		
 19018-ORB 640MM C/C 28 3/8" L  ORB CSG9 SS		
 19019-ORB 768MM C/C 33 3/8" L  ORB CSG9 SS		



AVAILABLE FINISHES



55274-BBZ
1 13/16" L | 3/4" PROJ



55270-BBZ
1 5/16" DIA | 1" PROJ



55275-BBZ
3" C/C | 3 3/4" L



55272-BBZ
1 5/8" DIA | 1 1/4" PROJ



55276-BBZ
96MM C/C | 4 5/8" L



55271-BBZ
1 3/16" L | 1 1/16" PROJ



55277-BBZ
128MM C/C | 6" L



55278-BBZ
160MM C/C | 7 1/4" L



55273-BBZ
1 1/2" L | 3/8" PROJ



55279-BBZ
8" C/C | 9 3/8" L



55280-BBZ
12" C/C | 13 3/8" L



55281-BBZ
18" C/C | 19 3/8" L



BLYPHE



55220-VB
2 5/8" L | 1 1/3" PROJ



55222-WN
3" C/C | 3 3/5" L



BRONX

AVAILABLE FINISHES



BBR ORB GM BBZ G10 PN



36557-GM
3" OR 3 3/4" C/C | 4 11/16" L



36558-GM
5 1/16" C/C | 5 15/16" L



36559-GM
6 5/16" C/C | 7 3/16" L



36562-GM
8" C/C | 8 7/8" L



36560-GM
10 1/16" C/C | 11" L



36561-GM
12 5/8" C/C | 13 1/2" L



36556-GM
2 5/8" C/C | 5/8" L

CALATHEA

AVAILABLE FINISHES



100396-BCR
3 3/4" C/C | 4 7/16" L



100312-BCR
5 1/16" C/C | 5 11/16" L



1003160-BCR
6 5/16" C/C | 7" L



10132-BCR
1 1/4" L | 1 1/8" PROJ



AVAILABLE FINISHES



CALIBER



36873-ORB
96MM C/C | 5 7/8" L



36874-ORB
128MM C/C | 7 1/8" L



36875-ORB
160MM C/C | 8 7/16" L



36876-ORB
192MM C/C | 9 11/16" L



36877-ORB
256MM C/C | 12 3/16" L



36872-ORB
1 1/4" DIA | 1 3/16" PROJ



CANDLER

AVAILABLE FINISHES



BBR ORB CBZ GM AS BBZ PN G10



29340-BBZ
1 1/4" L | 1 1/8" PROJ



29368-BBZ
1 1/2" L
1 1/4" PROJ



BBR ORB GM AS BBZ PN G10



29365-BBZ
8" C/C | 9 7/8" L



BBR ORB AS BBZ PN G10



29349-BBZ
3" C/C | 4 3/8" L



29355-BBZ
96MM C/C | 5 1/8" L



29363-BBZ
128MM C/C | 6 1/2" L



BBR ORB GM AS BBZ PN G10



29366-BBZ
12" C/C | 14 5/8" L



BBR ORB AS BBZ PN G10



29364-BBZ
160MM C/C | 8" L



BBR ORB GM AS BBZ PN G10



29367-BBZ
18" C/C | 20 3/4" L



BBR ORB AS BBZ PN G10

CARRIONE

AVAILABLE FINISHES



MW/BBZ MW/BBR MW/ORB MW/PN MW/G10



36648-MW/BBZ
3 3/4" C/C | 6 5/16" L



36649-MW/BBZ
5 1/16" C/C | 7 1/2" L



36650-MW/BBZ
6 5/16" C/C | 8 3/4" L



36647-MW/BBZ
2 1/2" L | 1 9/16" PROJ



CLASSICS

AVAILABLE FINISH



WI



771-WI
1 5/16" DIA | 1 1/4" PROJ



CONCENTRIC

AVAILABLE FINISHES



MB GM BBZ G10 PN



36830-GM
3 3/4" C/C | 4 1/2" L



36831-GM
5 1/16" C/C | 5 3/4" L



36832-GM
6 5/16" C/C | 7" L



36833-GM
7 9/16" C/C | 8 1/4" L



36834-GM
10 1/16" C/C | 10 3/4" L



36810-GM
1 9/16" DIA | 1 9/16" L



36812-PN
3 3/4" CC | 4 3/16" L



36813-PN
5 1/16" CC | 5 7/16" L



36814-PN
6 5/16" CC | 6 11/16" L



36815-PN
7 9/16" CC | 7 15/16" L



36816-PN
10 1/16" CC | 10 7/16" L



36811-PN
1 1/4" CC | 1 11/16" L



CONRAD

AVAILABLE FINISHES



29203-G10
39MM L | 1" PROJ

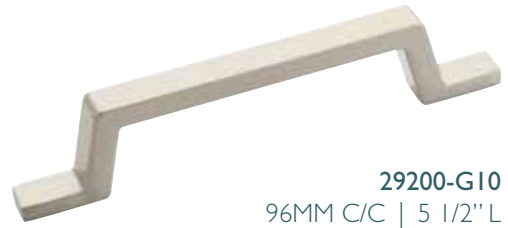

29200-G10
96MM C/C | 5 1/2" L



29202-G10
96MM C/C | 5 1/4" L



29201-G10
96MM C/C | 6 1/8" L

CRAWFORD

AVAILABLE FINISHES



36593-BBZ
3 3/4" C/C | 4 11/16" L



36594-BBZ
5 1/16" C/C | 6 1/16" L



36595-BBZ
6 5/16" C/C | 7 3/8" L



36613-BBZ
1 3/8" DIA | 1 3/16" PROJ

CREASED BOW

AVAILABLE FINISH



27017-AA
128MM C/C | 5 7/8" L

CUP PULLS



9365-ORB
64MM C/C | 4 1/8" L



ART ORB G10



53019-G10
2 1/2" C/C | 3 1/8" L



FB G10



53010-G10
3" C/C | 3 3/8" L



FB BN AS ORB BBZ G10 PN 26



CYPRUS

AVAILABLE FINISHES



26201-BBZ
3" C/C | 5 1/4" L

26203-BBZ
96MM C/C | 6 9/16" L

9362-BBZ
128MM C/C | 7 3/16" L

26204-BBZ
160MM C/C | 9 1/8" L

26205-BBZ
8" C/C | 12" L

26206-BBZ
12" C/C | 16" L

26207-BBZ
18" C/C | 22" L



AVAILABLE FINISHES



DAVENPORT



36600-ORB
3" C/C | 4 1/2" L

36605-ORB
3 3/4" C/C | 5 5/16" L

36606-ORB
5 1/16" C/C | 6 9/16" L

36607-ORB
6 5/16" C/C | 7 13/16" L

36601-ORB
1 1/4" L | 1 3/16" PROJ

36602-ORB
1 1/2" L | 1 3/8" PROJ



DESTINE

AVAILABLE FINISHES



36857-G10
1 3/8" L | 1" PROJ



36858-G10
96MM C/C | 4 15/16" L



36859-G10
128MM C/C | 6 3/16" L



36860-G10
160MM C/C | 7 7/16" L



36861-G10
224MM C/C | 9 15/16" L

DIVINITY

AVAILABLE FINISHES



19258-G10
3" C/C | 1 1/4" L

EDGE PULLS

AVAILABLE FINISHES

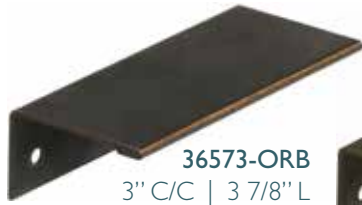

36573-ORB
3" C/C | 3 7/8" L

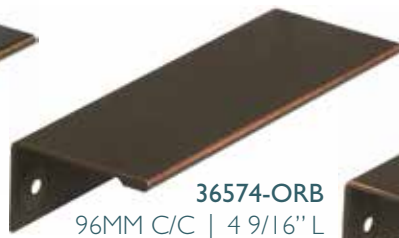

36574-ORB
96MM C/C | 4 9/16" L

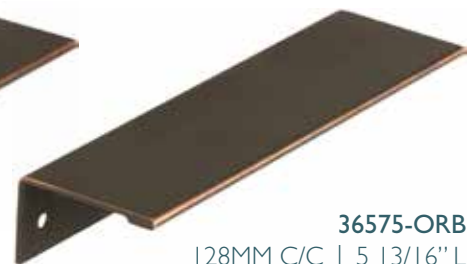

36575-ORB
128MM C/C | 5 13/16" L



EDONA

AVAILABLE FINISHES



53005-CZ
1 1/4" DIA | 1 1/8" PROJ

ERA

AVAILABLE FINISHES



36907-G10
1 1/4" DIA | 1 1/8" PROJ

ESQUIRE

AVAILABLE FINISHES



36556-G10ORB
2 5/8" L | 1 1/2" PROJ



36557-G10ORB
3" C/C | 4 11/16" L



36558-G10ORB
128MM C/C | 5 15/16" L



36559-G10ORB
160MM C/C | 7 3/16" L



36560-G10ORB
256 MM C/C | 11" L



36561-G10ORB
320MM C/C | 13 1/2" L

ESSENTIAL'Z



AVAILABLE FINISH



G10



24001-WNC
40MM DIA
1 1/8" PROJ



WNC



24002-AN
128MM C/C | 5 7/8" L



AN SN



19203-G10
128MM C/C | 6" L



19259-G10
3" C/C | 4 1/2" L



29409-G10
3" C/C | 4 3/8" L



29415-G10
96MM C/C | 5 1/8" L



29416-G10
128MM C/C | 6 3/8" L



29423-G10
160M C/C | 7 5/8" L



24017-SN
160MM C/C | 6 3/4" L



SN



24018-SN
96MM C/C | 4 1/8" L



SN



ESSENTIAL'Z STAINLESS STEEL

AVAILABLE FINISH



24015-SS
128MM C/C | 5 5/8" L



24013-SS
128MM C/C | 5 9/16" L



19008-SS
1 1/4" DIA
1 1/8" PROJ



19001-SS
3" C/C | 3 5/8" L



19002-SS
96MM C/C | 4 9/16" L



19003-SS
128MM C/C | 5 15/16" L



19004-SS
160MM C/C | 7 3/8" L



19005-SS
192MM C/C | 8 7/8" L



26200-SS
32MM DIA
1" PROJ



AVAILABLE FINISHES



36881-CZ
96MM C/C | 5 1/4" L



36880-CZ
1 1/2" DIA | 1 3/16" PROJ



36882-CZ
128MM C/C | 6" L



36883-CZ
160MM C/C | 7 1/4" L



36884-CZ
224MM C/C | 9 13/16" L

EXCEED



EXTENSITY

AVAILABLE FINISHES



29370-G10
1 3/16" L | 1 1/16" PROJ



29379-G10
3" C/C | 4 1/8" L



29385-G10
96MM C/C | 5" L



29393-G10
128MM C/C | 6 1/4" L



29394-G10
160MM C/C | 7 1/2" L



29398-G10
1 1/2" L | 1 1/8" PROJ

EXTENT

AVAILABLE FINISHES



36750-BCR
4 13/16" C/C | 5 13/16" L



36751-BCR
4 9/16" C/C | 7 3/4" L



36752-BCR
6 9/16" C/C | 9 3/4" L



36753-BCR
8 9/16" C/C | 11 11/16" L



AVAILABLE FINISHES

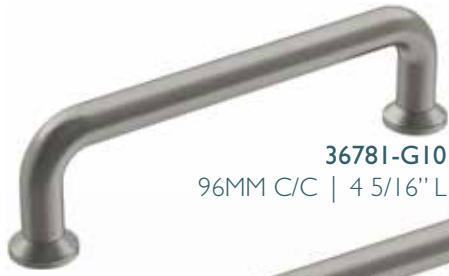

36781-G10
96MM C/C | 4 5/16" L



36782-G10
128MM C/C | 5 9/16" L



36782-G10
128MM C/C | 8 1/8" L



36780-G10
1 1/4" DIA | 1 1/16" PROJ

FACTOR



FORGINGS



4424-WI
3" C/C | 4 1/8" L



4425-WI
1 1/4" DIA
1 1/8" PROJ



4426-RBZ
3" C/C | 4" L



4428-WI
3" C/C | 4 1/8" L



4429-WI
1 1/8" L
1 1/8" PROJ



GLACIO

AVAILABLE FINISHES



36659-CGM
3" C/C | 4 9/16" L

36654-CGM
3 3/4" C/C | 5 5/16" L

36655-CGM
5 1/16" C/C | 6 9/16" L

36656-CGM
6 5/16" C/C | 7 7/8" L



36651-CGM
1 3/4" L | 1 3/16" PROJ



36652-CGM
1 3/8" L | 1" PROJ



36653-CGM
1 3/8" L | 5/16" PROJ

GRACE REVITALIZE

AVAILABLE FINISHES



36628-BBZ
1 3/8" DIA
1 3/16" PROJ



36629-BBZ
1 3/4" DIA
1 3/8" PROJ

GRANBY



53013-ORB
3" C/C | 3 3/8" L



55243-ORB
96MM C/C | 4 1/5" L



55244-ORB
128MM C/C | 5 1/2" L



55245-ORB
160MM C/C | 6 7/8" L



AVAILABLE FINISHES



55311-PN
35MM L | 1 1/7" PROJ



55312-PN
28MM DIA | 1 1/5" PROJ



55315-PN
1 3/8" L
1 5/16" PROJ

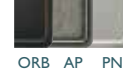

ORB AP PN



55316-PN
3" C/C | 4 1/3" L



55317-PN
96MM C/C | 5 1/6" L



55319-PN
128MM C/C | 6 2/3" L



55321-PN
160MM C/C | 8 4/7" L



55322-PN
8" C/C | 10 1/2" L



BBR ORB AP BBZ G10 PN



55323-PN
12" C/C | 15 1/3" L



BBR ORB AP BBZ G10 PN



55324-PN
18" C/C | 20 7/8" L



BBR ORB AP BBZ G10 PN



INSPIRATIONS



1584-ORB
3" C/C | 4 1/8" L



1585-ORB
1 1/4" DIA
1" PROJ



1784-ORB
96MM C/C | 4 7/8" L



1586-ORB
1 3/8" DIA
1" PROJ



1785-ORB
128MM C/C | 6 1/8" L



1586-2-ORB
1 3/4" DIA
1 1/4" PROJ



1590-ORB
3" C/C | 5 5/8" L



1593-ORB
1 7/8" L | 1 1/16" PROJ



1587-ORB
96MM C/C | 6 5/16" L



1592-ORB
3" C/C | 4 1/4" L



1588-ORB
128MM C/C | 7 1/2" L



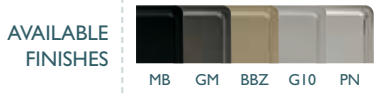

36820-MB
1 3/16" DIA | 1" PROJ



36821-MB
1 3/16" DIA | 1" PROJ



36822-MB
3 3/4" C/C | 4 15/16" L



36823-MB
5 1/16" C/C | 6 3/16" L



36824-MB
6 5/16" C/C | 7 7/16" L



36825-MB
7 9/16" C/C | 8 3/4" L



36826-MB
10 1/16" C/C | 11 1/4" L



KANE

AVAILABLE FINISHES



53700-PN
1 1/4" DIA | 1 1/4" PROJ



53807-2-PN
1 5/8" DIA | 1 1/2" PROJ



53701-PN
3" C/C | 3 5/8" L



53702-PN
96MM C/C | 4 1/2" L



53802-PN
128MM C/C | 5 3/4" L



53803-PN
160MM C/C | 7" L



53804-PN
8" C/C | 8 7/8" L

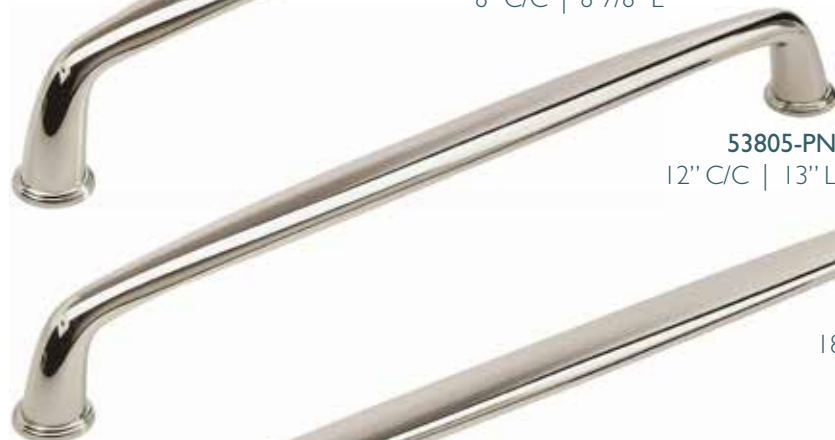

53805-PN
12" C/C | 13" L



53806-PN
18" C/C | 19 1/4" L

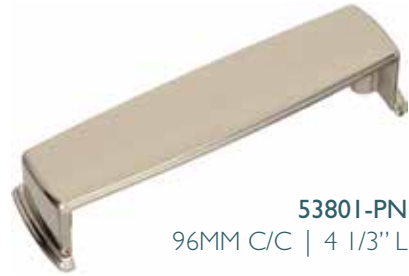

53801-PN
96MM C/C | 4 1/3" L



AVAILABLE FINISH



BBR/BBZ BBR/26 BBR/G10 BCR/BBZ BCR/26 BCR/G10 BBZ/BCR BBZ/26 PN/BBR PN/BCR G10/BCR G10/26



36648-PNBBR
3 3/4" C/C | 6 5/16" L



36647-PNBBR
1 1/2" L | 1 9/16" PROJ



36649-PNBBR
5 1/16" C/C | 7 1/2" L



36650-PNBBR
6 5/16" C/C | 8 3/4" L



36651-PNBBR
8" C/C | 10 7/16" L



36664-PNBBR
10 1/16" C/C | 12 1/2" L



26127-ORB
1 1/2" L
1 1/8" PROJ



ORB G10



MERGENCE

AVAILABLE FINISHES



36858-FBG10
96MM C/C | 4 15/16" L



36859-FBG10
128MM C/C | 6 3/16" L



36860-FBG10
160MM C/C | 7 7/16" L



36861-FBG10
224MM C/C | 9 15/16" L



36857-FBG10
1 3/8" DIA | 1" PROJ

MONUMENT

AVAILABLE FINISHES



36578-ORB
76MM C/C | 3 3/8" L



36570-ORB
96MM C/C | 4 1/8" L



36571-ORB
128MM C/C | 5 7/16" L



36572-ORB
160MM C/C | 6 11/16" L



36909-ORB
224MM C/C | 9 13/16" L



36905-ORB
1 3/16" DIA | 1" PROJ



AVAILABLE FINISHES



53030-BBZ
3" C/C | 3 3/4" L



53031-BBZ
96MM C/C | 4 9/16" L



53529-BBZ
128MM C/C | 5 7/8" L



53530-BBZ
160MM C/C | 7 1/6" L



53531-BBZ
8" C/C | 9 1/6" L



53532-BBZ
12" C/C | 13 1/4" L



53533-BBZ
18" C/C | 19 1/4" L



53029-BBZ
1 1/4" L | 1 1/8" PROJ



535342-BBZ
1 1/2" L | 1 1/8" PROJ



MULINO

AVAILABLE FINISHES



36724-SCBN
128MM C/C | 6 1/4" L

36725-SCBN
192MM C/C | 8 3/4" L

36726-SCBN
256MM C/C | 11 1/4" L

36720-SCBN
2 3/8" L | 1 9/16" PROJ

NATURE'S SPLENDOR

1581-ORB
1 1/4" DIA
1 1/8" PROJ

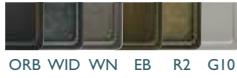

1583-WN
1 7/8" L
1 1/16" PROJ



1580-ORB
3" C/C | 5 5/8" L



1582-WN
3" C/C | 4 1/4" L



OBERON

36603-PN
1 3/8" DIA
1 3/16" PROJ



36604-PN
1 3/4" DIA
1 5/16" PROJ



36608-PNFA
1 3/8" DIA
1 3/16" PROJ



36609-PN
1 3/4" DIA
1 5/16" PROJ



OVERTON

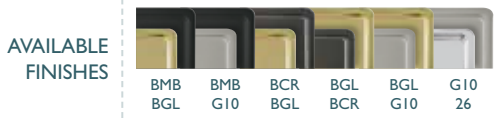

36681-G1026
3 3/4" C/C | 4 15/16" L

36682-G1026
5 1/16" C/C | 6 3/16" L

36683-G1026
6 5/16" C/C | 7 7/16" L

36684-G1026
8 13/16" C/C | 10" L

36685-G1026
11 5/16" C/C | 12 1/2" L



36680-G1026
2 5/8" L | 1 3/16" PROJ



36844-CZ
96MM C/C | 4 1/4" L

36845-CZ
128MM C/C | 5 9/16" L

36846-CZ
160MM C/C | 6 13/16" L



36843-CZ
1 1/4" DIA | 1 1/16" PROJ



RADIUS

AVAILABLE FINISHES



FB ORB CZ G10 26



36865-FB
96MM C/C | 5 3/4" L



36866-FB
128MM C/C | 7 1/16" L



36867-FB
160MM C/C | 8 5/16" L



36868-FB
7 9/16" C/C | 9 9/16" L



36869-FB
10 1/16" C/C | 12 1/16" L



36864-FB
1 1/4" DIA | 1 1/16" PROJ



RAVINO

AVAILABLE FINISHES



FB ORB G10



53012-G10
1 1/4" DIA | 1 1/8" PROJ



21935-G10
96MM C/C | 5" L



22094-G10
76MM C/C | 3 11/16" L



RENOWN

AVAILABLE FINISHES



FB ORB CZ G10 26



36794-ORB
96MM C/C | 4 7/16" L



36795-ORB
128MM C/C | 5 11/16" L



36796-ORB
160MM C/C | 7" L



36793-ORB
1 1/4" DIA | 1 1/8" PROJ



AVAILABLE FINISHES



55340-ORB
1 1/4" L | 7/8" PROJ



55342-ORB
1 1/4" DIA | 1 1/4" PROJ



55341-ORB
1 1/4" DIA
1 1/8" PROJ



ORB PN



55343-ORB
3" C/C | A3 11/16" L



BBR GM ORB GB CZ BBZ G10 PN 26



55344-ORB
96MM C/C | 4 5/16" L



BBR GM ORB GB CZ BBZ G10 PN 26



55346-ORB
128MM C/C | 5 5/8" L



BBR GM ORB GB CZ BBZ G10 PN 26



55347-ORB
160MM C/C | 6 7/8" L



BBR GM ORB GB CZ BBZ G10 PN 26



55348-ORB
8" C/C | 8 7/8" L



BBR ORB GB BBZ G10 PN



55349-ORB
12" C/C | 13" L



BBR ORB GB BBZ G10 PN



55350-CBZ
18" C/C | 18 7/8" L



BBR ORB GB BBZ G10 PN



REVOLVE

AVAILABLE FINISHES



RIFT

AVAILABLE FINISHES



RIVA



ROCHDALE

AVAILABLE FINISHES



53710-G10
1 1/4" DIA
1 1/8" PROJ



53711-G10
3" C/C | 4" L



53712-G10
96MM C/C | 4 3/4" L



53713-G10
128MM C/C | 6" L



53714-G10
160MM C/C | 7 1/4" L



53715-G10
3" C/C | 4 1/2" L



53716-G10
96MM C/C | 5 3/8" L



AVAILABLE FINISHES



36617-BBZ
1 3/4" L | 1 5/16" PROJ



36614-BBZ
1 1/2" L | 1 3/16" PROJ



36615-BBZ
3" C/C | 3 7/8" L



36621-BBZ
3 3/4" C/C | 5" L



36622-BBZ
5 1/16" C/C | 6 1/4" L



36623-BBZ
6 5/16" C/C | 7 1/2" L

SEA GRASS



SEPARA

AVAILABLE FINISHES



36735-BBN
160MM C/C | 8 13/16" L



36736-BBN
8" C/C | 10 1/2" L



36737-BBN
10 1/16" C/C | 12 5/8" L

ST. VINCENT

AVAILABLE FINISHES



36646-PN
3" C/C | 5 7/16" L



36642-PN
2 1/2" L | 1 7/16" PROJ



36643-PN
3 3/4" C/C | 6 5/16" L



36644-PN
5 1/16" C/C | 7 1/2" L



36645-PN
6 5/16" C/C | 8 3/4" L



STATURE

AVAILABLE FINISHES



36891-26
76MM C/C | 3 3/4" L



22439-26
128MM C/C | 6 3/8" L



36887-26
96MM C/C | 4 9/16" L



11287-26
1 1/4" L | 1 1/4" PROJ



36888-26
128MM C/C | 5 13/16" L



36889-26
160MM C/C | 7 1/16" L



36890-26
224MM C/C | 9 9/16" L

STATUS

AVAILABLE FINISHES



36837-MB
96MM C/C | 4 9/16" L



36836-MB
2" L | 1 1/16" PROJ



36838-MB
128MM C/C | 5 13/16" L



36839-MB
160MM C/C | 7 1/16" L



36840-MB
224MM C/C | 9 5/8" L



STERLING TRADITIONS



AVAILABLE FINISH



1307-ORB
1 1/4" DIA
15/16" PROJ



1300-ORB
3" C/C | 5 1/4" L



1302-ORB
3" C/C | 5" L

SURPASS



AVAILABLE FINISHES



36894-CZ
96MM C/C | 4 9/16" L



36895-CZ
128MM C/C | 5 13/16" L



36896-CZ
160MM C/C | 7 1/16" L



36893-CZ
1 1/4" L | 1 3/16" PROJ

THE ANNIVERSARY COLLECTION



853-G9
1 3/16" DIA
1 1/16" PROJ



874-G9
3" C/C | 5" L



TRADITIONAL CLASSICS



55268-CBBZ
1 1/4" DIA
1 1/2" PROJ



CORB CBBR CGB CBBZ CG10 CPN



55266-CG10
1" DIA
1 1/2" PROJ



CG10



14303-3G10
1 1/4" DIA
1 1/4" PROJ



CORB CBB CG10





741416-MBSC
5/8" C/C | 3 3/16" L



196732-MBSC
1 1/4" DIA | 7/8" PROJ



741496-MBSC
3 3/4" C/C | 6 15/16" L



7414128-MBSC
5 1/16" C/C | 8 3/16" L



7414160-MBSC
6 5/16" C/C | 9 7/16" L



7414192-MBSC
7 9/16" C/C | 10 11/16" L



7414256-MBSC
10 1/16" C/C | 13 3/16" L



7414320-MBSC
12 5/8" C/C | 15 3/4" L



UPRISE

AVAILABLE FINISHES



36917-G10
96MM C/C | 6 5/8" L



36918-G10
128MM C/C | 7 7/8" L



36919-G10
160MM C/C | 10 5/8" L



36920-G10
224MM C/C | 11 15/16" L

URBANITE

AVAILABLE FINISHES

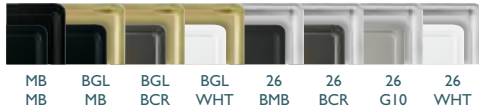

77896-BGLWHT
3 3/4" C/C | 6 1/2" L



778128-BGLWHT
5 1/16" C/C | 7 13/16" L



778160-BGLWHT
6 5/16" C/C | 9 1/16" L



778192-BGLWHT
7 9/16" C/C | 10 1/4" L



778256-BGLWHT
10 1/16" C/C | 12 3/4" L



67-BGLWHT
2 5/8" L | 1 3/16" PROJ



AVAILABLE FINISHES



VAILE

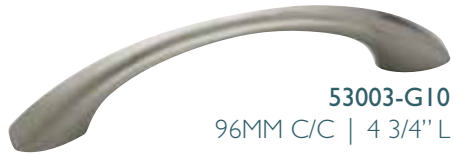

53003-G10
96MM C/C | 4 3/4" L



53014-G10
1 3/8" L | 1 1/2" PROJ

AVAILABLE FINISHES



VERSA



36912-FB
96MM C/C | 4 11/16" L

36913-FB
128MM C/C | 5 15/16" L

36914-FB
160MM C/C | 7 3/16" L

36912-FB
224MM C/C | 9 3/4" L



36904-FB
1 3/8" DIA | 1" PROJ

AVAILABLE FINISHES



VILLE



36775-26
96MM C/C | 4 5/8" L

36776-26
128MM C/C | 5 7/8" L

36777-26
160MM C/C | 7 1/8" L



36774-26
1 1/8" DIA | 1 1/16" PROJ

WESTERLY

AVAILABLE FINISHES

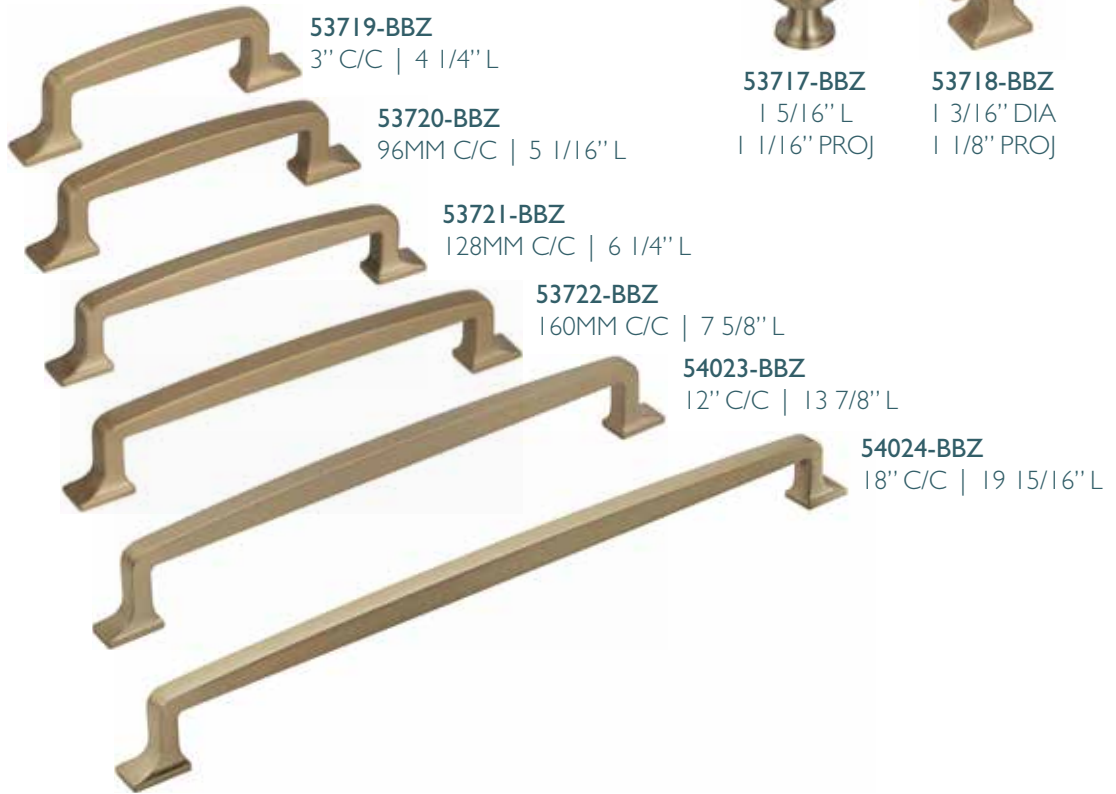

53719-BBZ
3" C/C | 4 1/4" L

53720-BBZ
96MM C/C | 5 1/16" L

53721-BBZ
128MM C/C | 6 1/4" L

53722-BBZ
160MM C/C | 7 5/8" L

54023-BBZ
12" C/C | 13 7/8" L

54024-BBZ
18" C/C | 19 15/16" L

53717-BBZ
1 5/16" L
1 1/16" PROJ

53718-BBZ
1 3/16" DIA
1 1/8" PROJ

WINSOME

AVAILABLE FINISHES

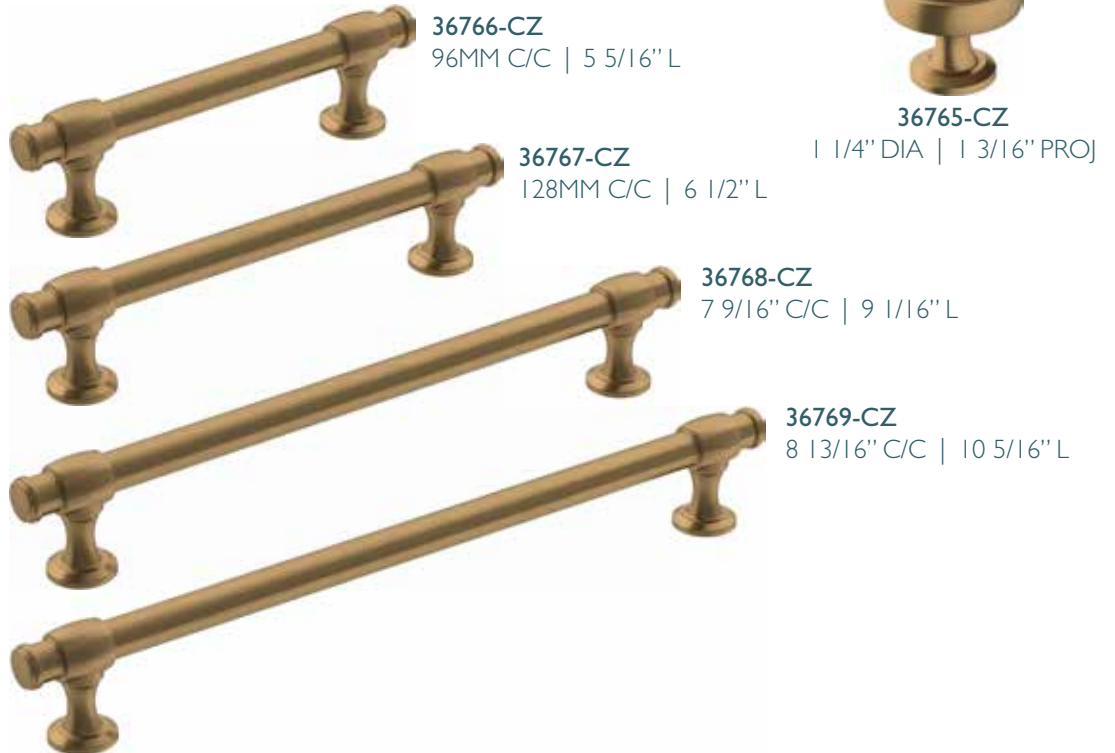

36766-CZ
96MM C/C | 5 5/16" L

36767-CZ
128MM C/C | 6 1/2" L

36768-CZ
7 9/16" C/C | 9 1/16" L

36769-CZ
8 13/16" C/C | 10 5/16" L

36765-CZ
1 1/4" DIA | 1 3/16" PROJ



APPOINT



36070-G10
1 7/8" L
2 1/2" PROJ



36071-G10
7 1/16" L
2 1/2" PROJ



36072-G10
7 1/16" L
2 1/16" PROJ



36073-G10
18" C/C | 19 1/4" L

36074-G10
24" C/C | 25 1/4" L



ARRONDI



26542-BBZ
2 1/16" L
2 1/16" PROJ



26540-BBZ
7 5/16" L
3 1/16" PROJ



26541-BBZ
6 3/8" L
2 1/16" PROJ



26546-BBZ
9" C/C | 11 5/8" L

26543-BBZ
18" C/C | 21" L

26544-BBZ
24" C/C | 27" L



BLACKROCK



36000-ORB
3 9/16" L
2 1/8" PROJ



36001-ORB
9 5/16" L
2 13/16" PROJ



36002-ORB
6 13/16" L
2 7/8" PROJ



36003-ORB
18" C/C | 19 7/8" L

36004-ORB
24" C/C | 25 7/8" L



DAVENPORT

AVAILABLE FINISHES



36050-MB
2 15/16" L
3" PROJ

36051-MB
8 13/16" L
3" PROJ

36052-MB
5 1/4" L
3" PROJ

36053-MB
18" C/C | 20 5/16" L

36054-MB
24" C/C | 26 5/16" L

ESQUIRE

AVAILABLE FINISHES



26613-PNGM
4 1/2" L
2 9/16" PROJ

26617-PNGM
5 7/8" L
3 3/16" PROJ

26612-PNGM
5 1/4" L
2 9/16" PROJ

26614-PNGM
18" C/C | 22 11/16" L

26615-PNGM
24" C/C | 28 5/8" L

GLACIO

AVAILABLE FINISHES



36060-CCZ
2 15/16" L
2 1/2" PROJ

36061-CCZ
7 1/16" L
3 1/16" PROJ

36062-CCZ
5 7/16" L
3 1/16" PROJ

36065-CCZ
8" C/C | 10 1/4" L

36063-CCZ
18" C/C | 20 1/4" L

36064-CCZ
24" C/C | 26 1/4" L



HIGHLAND RIDGE

AVAILABLE FINISHES



36010-26
2 5/8" L
2 1/2" PROJ



36011-26
10 5/8" L
2 13/16" PROJ



36012-26
7 7/16" L
3" PROJ

36013-26
18" C/C | 20 13/16" L



36014-26
24" C/C | 26 13/16" L



MONUMENT

AVAILABLE FINISHES



36080-MB
7/8" L
2 3/8" PROJ



36081-MB
5 7/8" L
2 3/4" PROJ



36082-MB
6 1/2" L
2 3/8" PROJ

36083-MB
18" C/C | 18 7/8" L



36084-MB
24" C/C | 24 7/8" L



MULHOLLAND

AVAILABLE FINISHES



36020-G10
4 1/4" L
3 5/8" PROJ



36021-G10
8 13/16" L
2 13/16" PROJ



36022-G10
5 3/4" L
2 5/16" PROJ

36023-G10
18" C/C | 19 13/16" L



36024-G10
24" C/C | 25 3/4" L



REVITALIZE

AVAILABLE FINISHES



36030-BBZ
2 1/8" L
2 3/8" PROJ



36031-BBZ
7 7/8" L
3 1/16" PROJ



36032-BBZ
6 3/8" L
2 13/16" PROJ



36033-BBZ
18" C/C | 19 3/4" L



36034-BBZ
24" C/C | 25 3/4" L

ST. VINCENT

AVAILABLE FINISHES



36040-CZ
2 1/16" L
2 1/16" PROJ



36041-CZ
7 5/16" L
3 1/16" PROJ



36042-CZ
6 3/8" L
2 1/16" PROJ



36043-CZ
18" C/C | 21" L



36044-CZ
24" C/C | 26 8/9" L

STATURE

AVAILABLE FINISHES



36090-G10
2 1/4" L
2 1/2" PROJ



36091-G10
7 1/16" L
2 5/8" PROJ



36092-G10
7 9/16" L
2 5/8" PROJ



36093-G10
18" C/C | 20 1/4" L



36094-G10
24" C/C | 26 1/4" L



H-Select

STOCKPORT - NEW!



K3219-96-ORB
OIL RUBBED BRONZE
4 5/8" L
96MM C/C



K3219-96-BYAB
BLACK YELLOW ANTIQUE BRASS
4 5/8" L
96MM C/C



K3219-96-BRN
BRUSHED NICKEL
4 5/8" L
96MM C/C



K3219-ORB
OIL RUBBED BRONZE
1 1/16" DIA
1" PROJ



K3219-BYAB
BLACK YELLOW ANTIQUE BRASS
1 1/16" DIA
1" PROJ



K3219-BRN
BRUSHED NICKEL
1 1/16" DIA
1" PROJ

H-SELECT

ROWVILLE - NEW!



K3235-96-BYAB
BLACK YELLOW ANTIQUE BRASS
5 1/8" L
96MM C/C



K3235-128-BYAB
BLACK YELLOW ANTIQUE BRASS
6 3/8" L
128MM C/C



K3235-96-ORB
OIL RUBBED BRONZE
5 1/8" L
96MM C/C



K3235-128-ORB
OIL RUBBED BRONZE
6 3/8" L
128MM C/C



K3235-96-BRN
BRUSHED NICKEL
5 1/8" L
96MM C/C



K3235-128-BRN
BRUSHED NICKEL
6 3/8" L
128MM C/C



K3235-96-BL
BLACK
5 1/8" L
96MM C/C



K3235-128-BL
BLACK
6 3/8" L
128MM C/C

H-Select

CHEYENNE - NEW!



K3417-ORB
OIL RUBBED BRONZE
1 1/4" DIA
1" PROJ



K3417-BB
BURNISHED BRASS
1 1/4" DIA
1" PROJ



K3417-WN
WEATHERED NICKEL
1 1/4" DIA
1" PROJ



K3417-GOLD
GOLD
1 1/4" DIA
1" PROJ

DENALI - NEW!



K4618-BN
BRUSHED NICKEL
1" DIA
1 3/16" PROJ



K4618-SAB
SABLE
1" DIA
1 3/16" PROJ

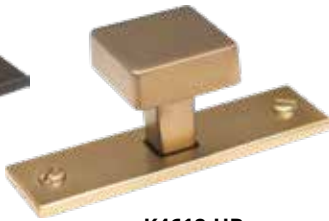

K4618-HB
HONEY BRONZED
1" DIA
1 3/16" PROJ



K773-SN
SATIN NICKEL
5 1/4" L
96MM C/C



K773-SAB
SABLE
5 1/4" L
96MM C/C



K773-HB
HONEY BRONZED
5 1/4" L
96MM C/C

INSPIRATION RING - NEW!



K4118-WN
WEATHERED NICKEL
2" DIA
1 1/2" PROJ



K4118-BB
BURNISHED BRASS
2" DIA
1 1/2" PROJ



K4118-ORB
OIL RUBBED BRONZE
2" DIA
1 1/2" PROJ

CLASSIC RING - NEW!



K4318-BRPW
BRUSHED PEWTER
2" DIA
1" PROJ



K4318-BN
BRUSHED NICKEL
2" DIA
1" PROJ



K4318-AE
ANTIQUENGLISH
2" DIA
1" PROJ



K4318-ORB
OIL RUBBED BRONZE
2" DIA
1" PROJ

LINCOLN - NEW!



K4218-BB
BURNISHED BRASS
7/8" DIA
3/4" PROJ



K4218-WN
WEATHERED NICKEL
7/8" DIA
3/4" PROJ



K4218-ORB
OIL RUBBED BRONZE
7/8" DIA
3/4" PROJ

MISC. KNOBS - NEW!



K2302-AS
ANTIQUENICKEL
1 1/2" DIA
1 1/8" PROJ



K4418-BN
BRUSHED NICKEL
3/4" DIA
15/16" PROJ



K3217-DACM
DARK ANTIQUE
COPPER MACHINED
1 1/4" DIA
1 1/8" PROJ



K4438-WI
WROUGHT IRON
1 1/2" DIA
1 1/4" PROJ

BOW



K2040-BL
BLACK
1 1/4" DIA
1 1/4" PROJ



K2040-OB
OIL BRONZE
1 1/4" DIA
1 1/4" PROJ



K2040-SN
SATIN NICKEL
1 1/4" DIA
1 1/4" PROJ



K2335-OB
OIL BRONZE
1 1/4" DIA
1" PROJ



K2335-WN
WEATHERED NICKEL
1" DIA
3/4" PROJ



K2029-BL
BLACK
6 1/8" L
128MM C/C



K2029-LAP
LIGHT ANTIQUE PEWTER
6 1/8" L
128MM C/C



K2029-OB
OIL BRONZE
6 1/8" L
128MM C/C



K2029-SN
SATIN NICKEL
6 1/8" L
128MM C/C



K2029-ABMD
ANTIQUENICKEL
6 1/8" L
128MM C/C

AMERICANA



K88
LANCASTER ANTIQUE
1 1/4" DIA
3/4" PROJ



K88-B
PEWTER
1 1/4" DIA
3/4" PROJ



K282-AN
ANTIQUÉ NICKEL
2 1/8" DIA
7/8" PROJ



K330-AN
ANTIQUÉ NICKEL
7/8" DIA
1 1/8" PROJ



K87
LANCASTER ANTIQUE
4 1/8" L
3" C/C



K87-B
PEWTER
4 1/8" L
3" C/C



K87-SN
SATIN NICKEL
4 1/8" L
3" C/C

BELL IRON 1



K117-ABMD
ANTIQUÉ BRASS
MACHINED DULL
1 1/4" DIA
15/16" PROJ



K117-DACM
DARK BRUSHED
COPPER MACHINED
1 1/4" DIA
15/16" PROJ



K527-ABMD
ANTIQUÉ BRASS MACHINED DULL
4 1/2" L
96MM C/C



K117-DBAC
DARK BRUSHED
ANTIQUÉ COPPER
1 1/4" DIA
15/16" PROJ



K117-SIM
PEWTER
1 1/4" DIA
15/16" PROJ



K527-DACM
DARK BRUSHED COPPER MACHINED
4 1/2" L
96MM C/C



K527-DBAC
DARK BRUSHED ANTIQUÉ COPPER
4 1/2" L
96MM C/C



K527-SIM
PEWTER
4 1/2" L
96MM C/C

BELL IRON 2



K6303-RG
ROSE GOLD
1 3/8" DIA
1" PROJ



K6303-ABMD
ANTIQUÉ BRASS
MACHINED DULL
1 3/8" DIA
1" PROJ



K6303-DMAC
DARK MACHINED
ANTIQUÉ COPPER
1 3/8" DIA
1" PROJ



K6373-ABMD
ANTIQUÉ BRASS MACHINED DULL
4 1/2" L • 96MM C/C



K6303-MB
MATTE BLACK
1 3/8" DIA
1" PROJ



K6303-DACM
DARK BRUSHED
COPPER MACHINED
1 3/8" DIA • 1" PROJ



K6303-SIM
PEWTER
1 3/8" DIA
1" PROJ



K6373-DMAC
DARK MACHINED ANTIQUÉ COPPER
4 1/2" L • 96MM C/C



K6373-DACM
DARK BRUSHED COPPER MACHINED
4 1/2" L • 96MM C/C



K6373-RG
ROSE GOLD
4 1/2" L • 96MM C/C



K6373-MB
MATTE BLACK
4 1/2" L • 96MM C/C



K6373-SIM
PEWTER
4 1/2" L • 96MM C/C



H-Select

ADVANTAGE

H-SELECT



K107-AEM
ANTIQUE ENGLISH
1 1/4" DIA
1" PROJ



K107-ASM
ANTIQUE SILVER
MACHINED
1 1/4" DIA
1" PROJ



K107-DBAC
DARK BRUSHED
ANTIQUE COPPER
1 1/4" DIA
1" PROJ



K107-SN
SATIN NICKEL
1 1/4" DIA
1" PROJ



K3898-DBAC
DARK BRUSHED
ANTIQUE COPPER
1 1/8" DIA
1 1/4" PROJ



K3898-DBN
BRIGHT NICKEL
BRUSHED DULL
1 1/8" DIA
1 1/4" PROJ



K3208-DBAC
DARK BRUSHED
ANTIQUE COPPER
4 1/4" L
3" C/C



K3208-SN
SATIN NICKEL
4 1/4" L
3" C/C



K3108-DBAC
DARK BRUSHED
ANTIQUE COPPER
5 1/4" L
3" C/C



K516-ASM
ANTIQUE SILVER
MACHINED
5 1/2" L
3" C/C



K3108-SN
SATIN NICKEL
5 1/4" L
3" C/C



K516-SN
SATIN NICKEL
5 1/2" L
3" C/C



K516-AEM
ANTIQUE ENGLISH
5 1/2" L
3" C/C



K516-DBAC
DARK BRUSHED
ANTIQUE COPPER
5 1/2" L
3" C/C



K3899-DBN
BRIGHT NICKEL
BRUSHED DULL
5 1/4" L
3" C/C



K3899-DBAC
DARK BRUSHED
ANTIQUE COPPER
5 1/4" L
3" C/C

BOUNTIFUL



K6102-ORB
OIL-RUBBED BRONZE
1 1/4" DIA
1 1/8" PROJ



K6102-SN
SATIN NICKEL
1 1/4" DIA
1 1/8" PROJ



K6765-ORB
OIL-RUBBED BRONZE
5" L
3" C/C



K6765-SN
SATIN NICKEL
5" L
3" C/C

H-Select

BASKET WEAVE



K3062-ORB
OIL-RUBBED BRONZE
1 1/4" DIA
1" PROJ



K3062-SN
SATIN NICKEL
1 1/4" DIA
1" PROJ



K3062-SI
PEWTER
1 1/4" DIA
1" PROJ



K3063-ORB
OIL-RUBBED BRONZE
4 3/4" L
3" C/C



K3063-SN
SATIN NICKEL
4 3/4" L
3" C/C



K3063-SI
PEWTER
4 3/4" L
3" C/C

COUNTRY TIME



K6060-DBAC
DARK BRUSHED
ANTIQUÉ COPPER
1 1/4" DIA
1 3/8" PROJ



K6060-DBN
BRIGHT NICKEL
BRUSHED DULL
1 1/4" DIA
1 3/8" PROJ



Z117-DACM
DARK BRUSHED
COPPER MACHINED
1 1/4" DIA
1" PROJ



Z117-DBN
BRIGHT NICKEL
BRUSHED DULL
1 1/4" DIA
1" PROJ



Z117-SIM
PEWTER
1 1/4" DIA
1" PROJ



K260-DBAC
DARK BRUSHED ANTIQUÉ COPPER
3 3/4" L
3" C/C



K260-DBN
BRIGHT NICKEL BRUSHED DULL
3 3/4" L
3" C/C

HARVEST



K6464-DBAC
DARK BRUSHED
ANTIQUÉ COPPER
1 1/4" DIA
1 1/8" PROJ



K6465-DBAC
DARK BRUSHED ANTIQUÉ
COPPER
5 5/8" L
3" C/C

H-SELECT

FLAIR



K196-ACM
ANTIQUE COPPER MACHINED
2 1/4" L
1 1/4" C/C



K196-DBAC
DARK BRUSHED ANTIQUE COPPER
2 1/4" L
1 1/4" C/C



K195-ACM
ANTIQUE COPPER MACHINED
4 7/8" L
96MM C/C



K195-DBAC
DARK BRUSHED ANTIQUE COPPER
4 7/8" L
96MM C/C

H-SELECT

DELGADO



K519-ABSB
ANTIQUE BRUSHED
SATIN BRASS
1 1/2" L
1 1/4" PROJ



K519-DBAC
DARK BRUSHED
ANTIQUE COPPER
1 1/2" L
1 1/4" PROJ



K519-DBN
BRIGHT NICKEL
BRUSHED DULL
1 1/2" L
1 1/4" PROJ



K519-96ABSB
ANTIQUE BRUSHED SATIN BRASS
4 1/4" L
96MM C/C



K519-96DBAC
DARK BRUSHED ANTIQUE COPPER
4 1/4" L
96MM C/C



K519-96DBN
BRIGHT NICKEL BRUSHED DULL
4 1/4" L
96MM C/C

ROCHESTER



K155-ABSB
ANTIQUE BRUSHED
SATIN BRASS
1 1/8" DIA
15/16" PROJ



K155-DBAC
DARK BRUSHED
ANTIQUE COPPER
1 1/8" DIA
15/16" PROJ



K155-DBN
BRIGHT NICKEL
BRUSHED DULL
1 1/8" DIA
15/16" PROJ



K155-96ABSB
ANTIQUE BRUSHED SATIN BRASS
4 1/4" L
96MM C/C



K155-96DBAC
DARK BRUSHED ANTIQUE
COPPER
4 1/4" L 96MM C/C



K155-96DBN
BRIGHT NICKEL BRUSHED
DULL
4 1/4" L
96MM C/C

H-Select

BALANCE



K2980-AB
ANTIQUE ENGLISH
1 1/4" DIA
1 1/8" PROJ



K2980-DACM
DARK BRUSHED
COPPER MACHINED
1 1/4" DIA
1 1/8" PROJ



K2980-SN
SATIN NICKEL
1 1/4" DIA
1 1/8" PROJ



K2980-DBAC
DARK BRUSHED
ANTIQUE COPPER
1 1/4" DIA
1 1/8" PROJ



K2980-ORB
OIL-RUBBED
BRONZE
1 1/4" DIA
1 1/8" PROJ



K2981-AB
ANTIQUE ENGLISH
3 3/4" L
3" C/C



K2981-DACM
DARK BRUSHED COPPER MACHINED
3 3/4" L
3" C/C



K2981-DBAC
DARK BRUSHED ANTIQUE COPPER
3 3/4" L
3" C/C



K2981-SN
SATIN NICKEL
3 3/4" L
3" C/C



K2981-ORB
OIL-RUBBED BRONZE
3 3/4" L
3" C/C

CLARK

ZINC DIE CAST



K801-B
PEWTER
1 1/8" DIA
1 1/8" PROJ



K800-SN
SATIN NICKEL
1 1/8" DIA
1 1/8" PROJ



K802-AE
ANTIQUE ENGLISH
1 1/8" DIA
1 1/8" PROJ



K803-BI
BLACK IRON
1 1/8" DIA
1 1/8" PROJ



K810-MB
MATTE BLACK
1 1/8" DIA
1 1/8" PROJ



K804-B
PEWTER
3 3/4" L
3" C/C



K805-SN
SATIN NICKEL
3 3/4" L
3" C/C



K806-AE
ANTIQUE ENGLISH
3 3/4" L
3" C/C



K807-BI
BLACK IRON
3 3/4" L
3" C/C



K811-MB
MATTE BLACK
3 3/4" L
3" C/C

H-SELECT

BAR PULLS

H-SELECT



K1001
BRUSHED NICKEL 1 9/16" L
1 3/8" PROJ



K1000
BRUSHED NICKEL
4 1/2" L
76MM C/C



K1002
BRUSHED NICKEL
5 5/16" L
96MM C/C



K1003
BRUSHED NICKEL
6 5/8" L
128MM C/C



K1004
BRUSHED NICKEL
7 7/8" L
160MM C/C



K1005
BRUSHED NICKEL
9 1/8" L
192MM C/C



K1006
BRUSHED NICKEL
10 3/8" L
224MM C/C



K1007
BRUSHED NICKEL
11 5/8" L
256MM C/C



K1008
BRUSHED NICKEL
12 7/8" L
288MM C/C



K1009
BRUSHED NICKEL
14 3/16" L
320MM C/C



K1010
BRUSHED NICKEL
15 7/16" L
352MM C/C

H-Select

SLEEK & MODERN



K1216-SN
SATIN NICKEL
7/8" DIA
1" PROJ



K426-SN
SATIN NICKEL
7/8" DIA
1" PROJ



K26-SN
SATIN NICKEL
1" DIA
15/16" PROJ



K8026-SN
SATIN NICKEL
1 3/4" L
3/4" PROJ



K515-SN
SATIN NICKEL
1 1/8" DIA
1" PROJ



D2753-SN
SATIN NICKEL
1 5/16" L
1 1/8" PROJ



K790-SN
SATIN NICKEL
1" DIA
1" PROJ



Z259-BL
BLACK
3 3/8" L
3" C/C



Z259-SN
SATIN NICKEL
3 3/8" L
3" C/C



K400-SN
SATIN NICKEL
4" L
3" C/C



K475-SN
SATIN NICKEL
4 3/4" L
96MM C/C



K3489-SN
SATIN NICKEL
4 1/2" L
3" C/C



K3489-MB
MATTE BLACK
4 1/2" L
3" C/C



K272-BL
BLACK
4 5/8" L
96MM C/C



K4690-SN
SATIN NICKEL
4 3/4" L
96MM C/C



K961-DSN
SATIN NICKEL
4 3/4" L
3" CC



K272-SN
SATIN NICKEL
4 5/8" L
96MM C/C



K2017-SN
SATIN NICKEL
5" L
96MM C/C



K4655-SN
SATIN NICKEL
6 1/4" L
5" C/C



K2017-BL
BLACK
5" L
96MM C/C



K4655-AB
ANTIQUE ENGLISH
6 1/4" L
5" C/C



K4655-BLK
BLACK
6 1/4" L
5" C/C



K5319-SN
SATIN NICKEL
14 1/8" L
12 1/2" C/C

H-SELECT



GLENDALE



K525-DBAC
DARK BRUSHED ANTIQUE
COPPER
1 1/16" SQ
1" PROJ



K525-DMAC
DARK MACHINED ANTIQUE
COPPER
1 1/16" SQ
1" PROJ



K525-SN
SATIN NICKEL
1 1/16" SQ
1" PROJ



K525-96DBAC
DARK BRUSHED
ANTIQUÉ COPPER
5" L
96MM C/C



K525-96DMAC
DARK MACHINED
ANTIQUÉ COPPER
5" L
96MM C/C



K525-96SN
SATIN NICKEL
5" L
96MM C/C

H-SELECT

KINGSPORT



K150-LP
LANCASTER ANTIQUE
2 7/8" X 4 1/4"
3" C/C

WHEAT



DRAWER BAIL PULL
K200-LP
LANCASTER ANTIQUE
2 5/8" X 4 1/2"
3" C/C



KNOB
K204-LP
LANCASTER ANTIQUE
1 1/4" DIA
1 1/4" PROJ



BAR HANDLE
K205-LP
LANCASTER ANTIQUE
4 1/4" L
3" C/C

OLD ENGLISH



K152-AE
ANTIQUÉ ENGLISH
4 3/4" L
3" C/C



K706-AE
ANTIQUÉ ENGLISH
4 7/8" L
3" C/C



K707-AE
ANTIQUÉ ENGLISH
4 1/4" L
2 1/2" C/C

CHIPPENDALE



K1461-AE
SOLID BRASS WITH ANTIQUE
ENGLISH FINISH
2 1/4" X 3 3/16"
2" C/C



K1461-PB
SOLID BRASS WITH POLISHED
BRASS FINISH
2 1/4" X 3 3/16"
2" C/C



K1462-AE
SOLID BRASS WITH ANTIQUE
ENGLISH FINISH
2 3/4" X 3 3/4"
2 1/2" C/C



K1462-PB
SOLID BRASS WITH POLISHED
BRASS FINISH
2 3/4" X 3 3/4"
2 1/2" C/C



K1464-AE
SOLID BRASS WITH ANTIQUE
ENGLISH FINISH
2 1/4" X 3 1/8"



K1463-AE
SOLID BRASS WITH ANTIQUE
ENGLISH FINISH
3 3/8" X 4 1/2"
3" C/C



K1463-PB
SOLID BRASS WITH POLISHED
BRASS FINISH
3 3/8" X 4 1/2"
3" C/C



K1464-PB
SOLID BRASS WITH POLISHED
BRASS FINISH
2 1/4" X 3 1/8"

H-SELECT

NEW IMPORTS ANTIQUE ENGLISH



80176-AE
PULL
81177-AE
BACKPLATE
3" C/C
4 1/4" L



80223-AE
3" C/C
5 1/4" L



80859-AE
ANTIQUE ENGLISH
5" L
3" C/C



80644-AE
3" C/C
5" L

RICHELIEU



KNOB
K147-AE
ANDOVER ANTIQUE
1 3/8" L
1 1/8" PROJ



BACKPLATE
K105-AE
ANDOVER ANTIQUE
1" X 4 1/8"

ANTIQUE ENGLISH



A76209-AE
ANTIQUENGLISH
1 1/8" DIA
1" PROJ



D89-AE
ANTIQUENGLISH
3/4" DIA
5/8" PROJ



D89-BL
BLACK
3/4" DIA
5/8" PROJ



K208-AE
ANTIQUENGLISH
1 1/8" DIA
3/4" PROJ



K157-AE
ANTIQUENGLISH
4 3/4" L
3" C/C



K703-AE
ANTIQUENGLISH
5 1/2" L



K3208-AE
ANTIQUENGLISH
4 1/4" L
3" C/C



K156-AE
ANTIQUENGLISH
4 1/2" L
3" C/C

RUSTIC



BHIM8900-5
BLACK
6 1/4" L
1 1/8" PROJ
5" C/C



BHIM5900-12
BLACK
13 1/8" L
1 1/4" PROJ
12" C/C

H-Select

STICKLEY MISSION II

ZINC DIE CAST



D924-AC
ANTIQUE COPPER
3 3/4" X 1"
3" C/C



D924-AE
ANTIQUE ENGLISH
3 3/4" X 1"
3" C/C



D924-BL
BLACK
3 3/4" X 1"
3" C/C



D925-AC
ANTIQUE COPPER
1 5/8" X 3 1/2"
3" C/C



D925-AE
ANTIQUE ENGLISH
1 5/8" X 3 1/2"
3" C/C



D925-BL
BLACK
1 5/8" X 3 1/2"
3" C/C



D942-AC
ANTIQUE COPPER
1 1/4" SQ
7/8" PROJ

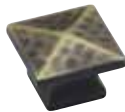

D942-AE
ANTIQUE ENGLISH
1 1/4" SQ
7/8" PROJ

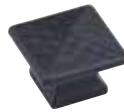

D942-BL
BLACK
1 1/4" SQ
7/8" PROJ

PERIOD MISSION



D552-AC
ANTIQUE COPPER
4 1/2" X 1 1/4"
3" C/C



D552-BL
BLACK
4 1/2" X 1 1/4"
3" C/C



D552-ORB
OIL-RUBBED BRONZE
4 1/2" X 1 1/4"
3" C/C



D553-AC
ANTIQUE COPPER
1 1/4" X 4 1/2"
3" C/C



D553-BL
BLACK
1 1/4" X 4 1/2"
3" C/C



D553-ORB
OIL-RUBBED BRONZE
1 1/4" X 4 1/2"
3" C/C

H-SELECT



TRADITIONAL MISSION

HEAVY DUTY BAILS



D527-A
BLACK
3 3/4" X 1"
2 1/4" C/C



D527-AE
ANTIQUE ENGLISH
3 3/4" X 1"
2 1/4" C/C



D527-B
PEWTER
3 3/4" X 1"
2 1/4" C/C



D528-A
BLACK
1 3/4" X 2 3/4"
1 1/8" C/C



D528-AE
ANTIQUE ENGLISH
1 3/4" X 2 3/4"
1 1/8" C/C



D528-B
PEWTER
1 3/4" X 2 3/4"
1 1/8" C/C



D529-A
BLACK
2" X 3 3/4"
3" C/C



D529-AE
ANTIQUE ENGLISH
2" X 3 3/4"
3" C/C



D529-B
PEWTER
2" X 3 3/4"
3" C/C

H-SELECT

REFINED MISSION



D523-BL
BLACK
1 1/8" DIA
1" PROJ



D521-BL
BLACK
4 1/16" L
3" C/C



D523-SN
SATIN NICKEL
1 1/8" DIA
1" PROJ



D521-SN
SATIN NICKEL
4 1/16" L
3" C/C



D523-W
WROUGHT IRON
1 1/8" DIA
1" PROJ



D521-W
WROUGHT IRON
4 1/16" L
3" C/C



HH4424-BL
BLACK
4" L
3" C/C



HH4425-BL
BLACK
1 1/4" DIA
1 1/8" PROJ

STICKLEY MISSION I

SOLID BRASS

PYRAMID HEAD SCREW (INCLUDED)



D526
BRASS
3 3/4" X 1 1/4"



D526-BL
BLACK IRON
3 3/4" X 1 1/4"



D526-AE
ANTIQUE ENGLISH
3 3/4" X 1 1/4"



D525
BRASS
1 1/2" X 3 1/8"



D525-BL
BLACK IRON
1 1/2" X 3 1/8"



D525-AE
ANTIQUE ENGLISH
1 1/2" X 3 1/8"



D542-AC
ANTIQUÉ COPPER
1 3/16" SQ
7/8" PROJ

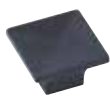

D522-BL
BLACK
1 1/4" SQ
7/8" PROJ



D524-BI
BLACK CAST IRON
1 1/8" SQ
7/8" PROJ

HAMMERED MISSION



D550
ANTIQUÉ COPPER
1 3/4" X 3 1/2"
3" C/C



D550-A
BLACK
1 3/4" X 3 1/2"
3" C/C



D550-B
PEWTER
1 3/4" X 3 1/2"
3" C/C



D551
ANTIQUÉ COPPER
3 1/2" X 1 3/4"



D551-B
PEWTER
3 1/2" X 1 3/4"

ELEGANT ART



D560-AP
ANTIQUÉ PEWTER
1 1/4" X 3 3/4"
2 1/8" C/C



D561-AP
ANTIQUÉ PEWTER
3 3/4" X 1 1/4"

LIBERTY MISSION



K8005
BLACK IRON
1 1/2" X 4 7/8"
4 1/4" C/C



K8006
BLACK IRON
4 7/8" X 1 1/2"
4 1/4" C/C

H-SELECT

BIRDCAGE



K1350-DACM
DARK BRUSHED
COPPER MACHINED
2 1/4" L
1 3/8" PROJ



K1350-SIM
PEWTER
2 1/4" L
1 3/8" PROJ

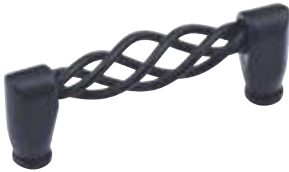

K1300-DACM
DARK BRUSHED
COPPER MACHINED
3 1/2" L
3" C/C



K1300-SIM
PEWTER
3 1/2" L
3" C/C

IRON FORGE



K58-BL
MATTE BLACK
1 1/2" L
1 1/4" PROJ



K558-BL
MATTE BLACK
6" L
96MM C/C



K58-SI
SWEDISH IRON
1 1/2" L
1 1/4" PROJ



K558-SI
SWEDISH IRON
6" L
96MM C/C



K462-BL
MATTE BLACK
4 5/8" L
96MM C/C



K462-SIM
PEWTER
4 5/8" L
96MM C/C

OLD WORLD



K530-W
WINDOVER ANTIQUE
1 3/4" X 1 1/4"
1 1/4" PROJ



K089-W
WROUGHT IRON
4 3/4" L
3 5/8" C/C



K570-W
WROUGHT IRON
1" DIA
3/4" PROJ



K3248-W
WROUGHT IRON
1" DIA
7/8" PROJ



K1814-W
WROUGHT IRON
3/4" DIA
3/4" PROJ



K3222-W
WROUGHT IRON
1 7/8" X 1 7/16"
5/8" PROJ

RUSTIC

H-Select



K3272-DACM
DARK BRUSHED
COPPER MACHINED
1 3/16" L
1 1/4" PROJ



K3273-DACM
DARK BRUSHED
COPPER MACHINED
4 1/2" L
96MM C/C



K3031-DACM
DARK BRUSHED COPPER MACHINED
2" DIA
1 1/8" PROJ

WILLOW



K329-LP
LANCASTER ANTIQUE
3" X 4"
3" C/C



K8018-LP
LANCASTER ANTIQUE
1 7/8" X 1 1/2"



K321-LP
LANCASTER ANTIQUE
1 1/8" L
1" PROJ



BACKPLATE
K326-LP
LANCASTER ANTIQUE
1" X 5 1/2"

SOLID BRASS



K6641-SN
SATIN NICKEL
3/4" DIA
3/4" PROJ



K6640
POLISHED BRASS
5/8" DIA
5/8" PROJ



K6641
POLISHED BRASS
3/4" DIA
3/4" PROJ



K6641-A
BLACK
3/4" DIA
3/4" PROJ



MOCK KEY
K1884
POLISHED BRASS
1 1/8" L
1" PROJ



K1908
POLISHED BRASS
4" X 4"
3" C/C



K15
POLISHED BRASS
4" L
3" C/C



K38
POLISHED BRASS
3/4" X 5 1/4"



BACKPLATE
K39
POLISHED BRASS
7/8" X 6 3/4"

MOCK KEY
K1884
POLISHED BRASS
1 1/8" L
1" PROJ

H-SELECT



TRANQUIL



K5302-AB
ANTIQUE BRASS/ WHITE
1 1/4" DIA
1" PROJ



K5302-AB-O
ANTIQUE BRASS/ OAK
1 1/4" DIA
1" PROJ



K5302-PB
POLISHED BRASS/ WHITE
1 1/4" DIA
1" PROJ



K5302-PB-O
POLISHED BRASS/ OAK
1 1/4" DIA
1" PROJ



P226
OATMEAL
1 1/4" DIA
7/8" PROJ



P220
WHITE
1" DIA
1" PROJ



P225
WHITE
1 1/4" DIA
7/8" PROJ

H-SELECT



K5312-AB
ANTIQUE BRASS/ WHITE
5" L
3" C/C



K5312-AB-O
ANTIQUE BRASS/ OAK
5" L
3" C/C



K5312-PB
POLISHED BRASS/ WHITE
5" L
3" C/C



K5312-PB-O
POLISHED BRASS/ OAK
5" L
3" C/C

PALISADE



K235
POLISHED BRASS PLATED
5" L
3" C/C



K3211-PB
BRASS PLATED
4 7/8" L
3" C/C



K3211-SN
SATIN NICKEL
4 7/8" L
3" C/C



K2910-SN
SATIN NICKEL
4 7/8" L
3" C/C

- COMES WITH INSERTS
- END GRAIN



KR15-OAK
OAK
KR15-C
CHERRY
KR15-M
MAPLE
KR15-W
WALNUT
1 1/16" DIA
1 1/16" PROJ



KR15-BL
BLACK PAINT
1 1/16" DIA
1 1/16" PROJ

MISSION

- COMES WITH INSERTS
- USE 8/32 BOLTS



K49-D
OAK
1 3/4" SQ

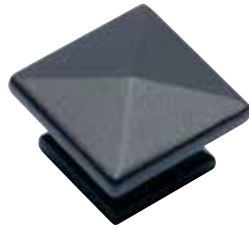

K49-B
OAK
1 1/4" SQ
K49-BC
CHERRY
1 1/4" SQ
K52-B
WALNUT
1 1/4" SQ
K53-BL
BLACK
1 1/4" SQ

PREMIUM MISSION

- COMES WITH INSERTS
- USE 8/32 BOLTS



K50-B
OAK
1 1/4" SQ
K51-B
CHERRY
1 1/4" SQ
K54-B
MAPLE
1 1/4" SQ



K50-C
OAK
1 1/2" SQ
K51-C
CHERRY
1 1/2" SQ
K54-C
MAPLE
1 1/2" SQ



K49-H
OAK
3" C/C

WOOD KNOBS I

- COMES WITH INSERTS
- FACE GRAIN
- USE 8/32 BOLTS



K40-A
OAK
1" DIA

K45-A
CHERRY
1" DIA

K47-A
OAK
1" DIA

K41-A
BEECH
1" DIA

K46-A
WALNUT
1" DIA



K40-B
OAK
1 1/4" DIA

K47-B
OAK
1 1/4" SQ

K40-C
OAK
1 1/2" DIA

K47-C
OAK
1 1/2" SQ

K41-B
BEECH
1 1/4" DIA

K48-B
CHERRY
1 1/4" SQ

K41-C
BEECH
1 1/2" DIA

K44-B
HICKORY
1 1/4" DIA

K45-C
CHERRY
1 1/2" DIA

K45-B
CHERRY
1 1/4" DIA

K46-C
WALNUT
1 1/2" DIA

K46-B
WALNUT
1 1/4" DIA

K55-C
MAPLE
1 1/2" DIA

K55-B
MAPLE
1 1/4" DIA

K56-C
QTR. SAWN W. OAK
1 1/2" DIA

K56-B
QTR. SAWN W. OAK
1 1/4" DIA

K57-B
GRAY ELM
1 1/4" DIA

H-SELECT

WOOD KNOBS II

- COMES WITH INSERTS
- FACE GRAIN



OVAL SHAPED WOOD KNOB

K114-M
MAPLE
1 7/8" X 1 1/2"
1 1/16" PROJ

K114-W
WALNUT
1 7/8" X 1 1/2"
1 1/16" PROJ

WOOD KNOBS IV



K4275
OAK
1 3/8" DIA



K4277
OAK
1 3/4" DIA



K4278
OAK
2" DIA

K4375
WALNUT
1 3/8" DIA

K4377
WALNUT
1 3/4" DIA

K4378
WALNUT
2" DIA



BBW1
OAK
5 1/2" C/C, 7" W X 1 3/8" H



BBW8
OAK
3 3/4" C/C, 4 1/2" W X 7/8" H



BBW2
OAK
3 1/2" C/C, 5" W X 1 3/8" H



BBW9
OAK
3 3/4" C/C, 4 1/4" W X 1 3/4" H
BBW9-A
CHERRY
3 3/4" C/C, 4 1/4" W X 1 3/4" H



BBW4
OAK
5 1/2" C/C, 7" W X 1 3/8" H



BBW12
OAK
3" C/C, 5 1/2" W



BBW5
OAK
3 3/4" C/C, 5" W X 1 3/8" H



BBW15
OAK
5" C/C, 7 1/4" W

BBW5-A
CHERRY
3 3/4" C/C, 5" W X 1 3/8" H

HOOKS



Q15
SOLID BRASS
5" H
BASE 2" X 1 1/8"

Q15-F
BLACK
5" H
BASE 2" X 1 1/8"

Q30
ANTIQUÉ BRASS
5" H
BASE 2 3/8" X 7/16"

Q34
BLACK
5 1/2" H
BASE 2" X 1 1/16"

Q4
SOLID BRASS
4 1/2" H
BASE 1 3/8" X 1 1/4"

Q4-F
BLACK
4 1/2" H
BASE 1 3/8" X 1 1/4"



CREST

AVAILABLE FINISHES



SN CH FUB



H076127-CH
Square Knob
1 1/4" Dia.



H076128-CH
Round Knob
1 1/4" Dia.



H076129-CH
3" C/C
3 1/2" L



H076130-CH
96MM C/C
4" L



H076131-CH
128MM C/C
5 9/16" L



H076132-CH
160MM C/C
6 13/16" L



H076133-CH
192MM C/C
8 1/16" L



H076134-CH
224MM C/C
9 5/16" L



H076135-CH
12" C/C
12 1/2" L

BELWITH

AMERICAN DINER

AVAILABLE FINISHES



CH SN BGB VB



P2140-SN
Small Knob
1" Dia.



P2142-SN
Large Knob
1 3/8" Dia.



P2143-SN
3" C/C



P2141-SN
96MM C/C



P2144-SN
3" & 96MM C/C

NOTE: P2144 is not available in VB Finish.

GREENWICH

AVAILABLE FINISHES

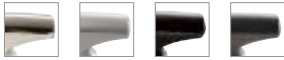

14 SS WOA 10B



P3372-SS
Knob
1 11/16" Dia.



P3370-SS
96MM C/C
4 1/4" L



P3371-SS
128MM C/C
6 3/8" L



P3041-SS
224MM C/C
10" L



P3374-SS
12" C/C
13 1/4" L



P3375-SS
18" C/C
19 1/4" L

BELWITH

PIPELINE

AVAILABLE FINISHES



VB BNV



HH075028
1 1/4" Dia.



HH076013-BNV
3" C/C, 3 3/4" L



HH076011-BNV
96mm C/C, 4 1/2" L



HH076012-BNV
128mm C/C, 5 3/4" L



HH075010-BNV
160mm C/C, 7" L

SKYLIGHT

AVAILABLE FINISHES



14 SS EGN BGB VB



HH075341-EGN
Square Knob
1 1/4" Dia.

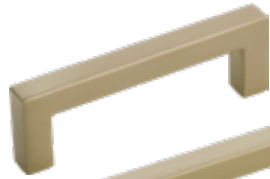

HH075326-EGN
3" C/C
3 3/8" L



HH075327-EGN
96MM C/C
4 3/16" L



HH075328-EGN
128MM C/C
5 7/16" L



HH075329-EGN
160MM C/C
6 3/4" L



HH075422-EGN
224MM C/C
9 1/4" L



HH075336-EGN
12" C/C
12 7/16" L



HH075337-EGN
18" C/C
18 1/2" L

BELWITH

EURO CONTEMPORARY

AVAILABLE FINISHES

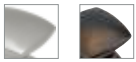

SN OBH

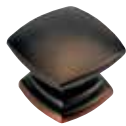

P2163-OBH
Square knob
1 1/2" SQ



P2164-OBH
4" C/C
7" L



P2165-OBH
128MM C/C
9" L

FORGE

AVAILABLE FINISHES

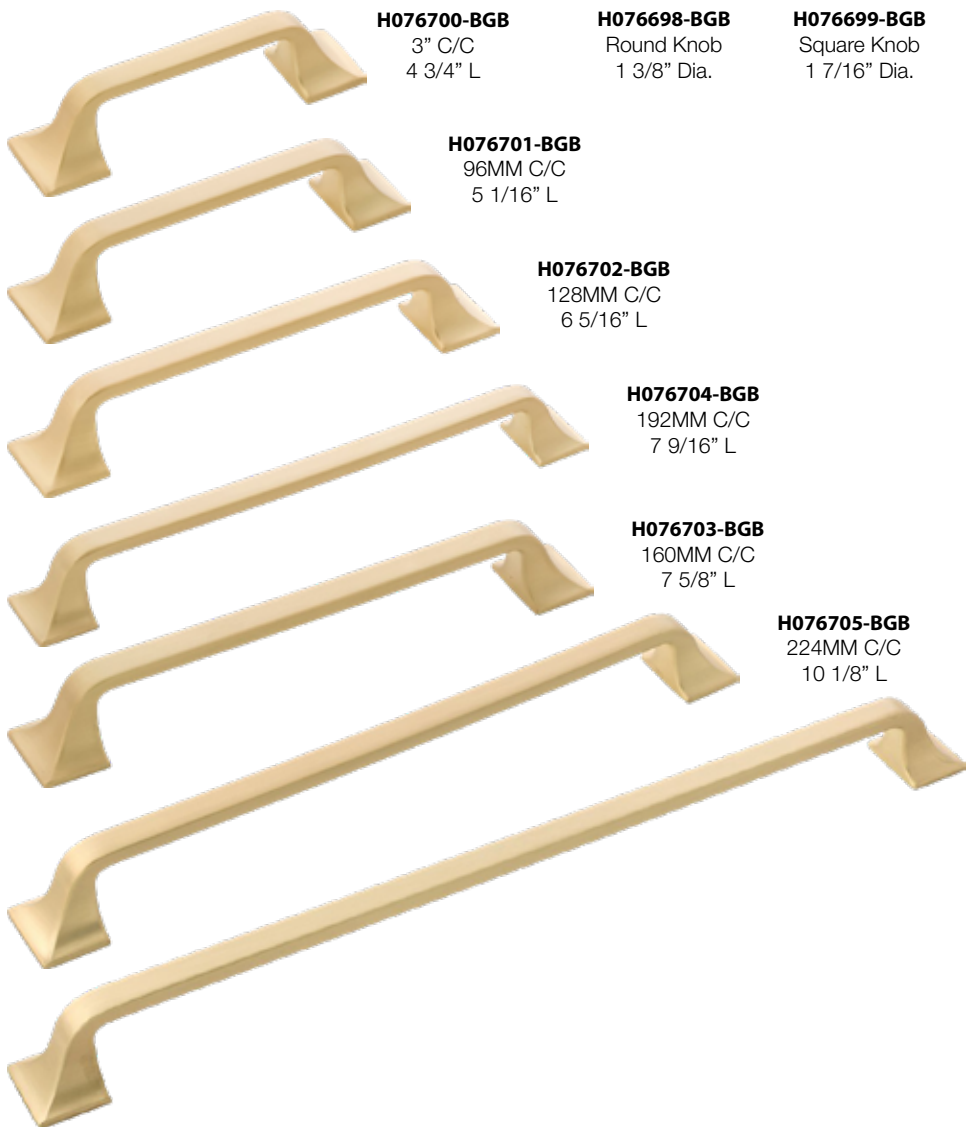

H076700-BGB
3" C/C
4 3/4" L

H076698-BGB
Round Knob
1 3/8" Dia.

H076699-BGB
Square Knob
1 7/16" Dia.

H076701-BGB
96MM C/C
5 1/16" L

H076702-BGB
128MM C/C
6 5/16" L

H076704-BGB
192MM C/C
7 9/16" L

H076703-BGB
160MM C/C
7 5/8" L

H076705-BGB
224MM C/C
10 1/8" L

H076706-BGB
12" C/C
13 3/8" L

BELWITH

MISC. KNOBS

AVAILABLE FINISHES



P2712-MB
Small Knob
1" Dia.



PA1218-MB
Large Knob
1 1/4" Dia.



P2623-MB
32MM C/C



PA1217-MB
Small Knob
1" Dia.

NOTE: P2712 is only available in MB Finish.

LUNA

AVAILABLE FINISHES



SN MB VB



P3448-VB
3" C/C
4 1/8" L

ZEPHYR

AVAILABLE FINISHES



SN OBH SS



P2286-SN
Small Knob
1" Dia.



P2283-SN
Large Knob
1 1/4" Dia.



P2280-SN
3" C/C



P2281-SN
96MM C/C



P2282-SN
128MM C/C

BELWITH

METROPOLIS

AVAILABLE FINISHES

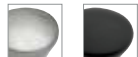

SN MB



P2922-SN
96MM C/C



P2921-SN
2 9/16" C/C



PA0221-SN
96MM C/C, 4 3/4" L



P3221-SN
128MM C/C, 6 3/8" L



PA0213-SN
Small Knob
1" Dia.



P7522-SN
96MM C/C, 5 1/2" L



P7523-SN
Oblong Knob
1 5/8" L

NOTE: PA0221, P3221, P7522 and P7523 are only available in SN Finish.

ROCHESTER

AVAILABLE FINISHES



PN SN OBH



P3112-SN
96 MM C/C, 4 1/4" L



P3114-SN
96 MM C/C, 4 1/8" L

DECO

AVAILABLE FINISHES



SN OBH



P3103-OBH
Knob
1 1/4" Dia.



P3100-OBH
3 1/2" C/C, 4 3/8" L



P3104-OBH
96MM C/C , 4 3/8" L

TWIST

AVAILABLE FINISHES



BI SN EGN PN CP



H076014-CP
1 1/4" Dia.



H076015-CP
3" C/C
3 5/8" L

H076016-CP
96mm C/C
4 7/16" L

H076017-CP
128mm C/C
5 11/16" L

H076018-CP
160mm C/C
6 15/16" L

H076019-CP
192mm C/C
8 1/4" L

H076020-CP
224mm C/C
9 9/16" L

H076021-CP
12" C/C
12 11/16" L

BELWITH

SOMERSET

AVAILABLE FINISHES



SN BNV DAC



74554-DAC
1 1/8" SQ

STUDIO

AVAILABLE FINISHES



P3010-OBH
3" C/C

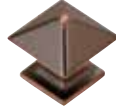

P3014-OBH
Small Knob
1" SQ

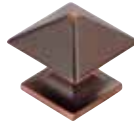

P3011-OBH
96MM C/C

P3015-OBH
Large Knob
1 1/4" SQ



P3013-OBH
3" & 96MM C/C

NOTE: P3014 is only available in PN, SN, and OBH Finishes.

BUNGALOW

AVAILABLE FINISHES



P2153-OBH
3" & 96MM C/C



P2150-OBH
Small Knob
1 1/4" L

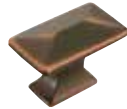

P2151-OBH
Medium Knob
1 3/4" L

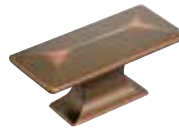

P2152-OBH
Large Knob
2 5/16" L

BELWITH

BEDROCK

AVAILABLE FINISH



DAC



P3565-DAC
3" C/C, 3 1/2" L



P3564-DAC
Round Knob
1 1/4" Dia.

CLOVER CREEK

AVAILABLE FINISH



DAC



P3563-DAC
3" C/C, 4 7/16" L



P3562-DAC
Round Knob
1 1/4" Dia.

CRAFTSMAN

AVAILABLE FINISHES



CH WOA OBH BI



P2174-WOA
96MM C/C



P2172-WOA
Square Knob
1 1/4" SQ



P2170-WOA
Round Knob
1 1/4" Dia.



P2171-WOA
3" C/C



P2173-WOA
96MM C/C

MOUNTAIN LODGE

AVAILABLE FINISHES



BI WOA



P3062-WOA
Square Knob
1 1/4" SQ



P3063-WOA
Round Knob
1 1/4" Dia.



P3061-WOA
Round Knob
1 1/4" Dia.



P3060-WOA
3" C/C



P3064-WOA
96MM C/C

CHARLESTON BLACKSMITH

AVAILABLE FINISHES



P1311-RI
Knob
1 1/2" Dia.



P1312-RI
Knob
1 1/4" Dia.



P1321-RI
3" C/C
3 3/4" L



PA1322-RI
3" C/C, 4 3/8" L



PA1323-RI
3" C/C, 4 1/2" L

MANCHESTER

AVAILABLE FINISHES



P2014-RI
2 1/8" L X 1 1/2" W



P2023-RI
96MM C/C
4 1/8" L

BELWITH

RALEIGH

AVAILABLE FINISHES



P3111-WOA
5" C/C, 5 3/4" L

REFINED RUSTIC

AVAILABLE FINISHES



P3002-BL
1 1/4" Dia.



P3003-BL
1 1/2" Dia.



P3001-BL
3" C/C, 4 3/4" L



P3000-BL
96MM C/C, 5 1/2" L



P3004-BL
3" & 96MM C/C, 5 1/2" L

BRIDGES

AVAILABLE FINISHES

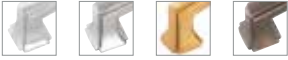

CH SN BGB OBH



P3230-SN
1 5/32" SQ
1" PROJ



P3231-SN
3" C/C, 3 5/8" L



P3232-SN
96MM C/C, 4 7/16" L

MANOR HOUSE

AVAILABLE FINISHES



DAC LP ST



MOCK KEY
P321-ST
1" PROJ



P329-ST
3" C/C



P8049-ST
3" C/C, 4" L

NOTE: P321, P326, and P329 are not available in DAC Finish.



BACKPLATE
P326-ST
5 1/2" L X 1" W

JEFFREY ALEXANDER[®]

by Hardware Resources

Aberdeen

AVAILABLE FINISHES

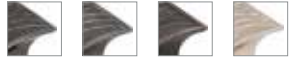

BNB BNBDL DBAC SN



535-BNB
Square Knob
1 1/4" Dia.



535L-BNB
Oblong Knob
1 1/2" Dia.



535-96-BNB
3 3/4" CC
5" Long



536-96-BNB
3 3/4" CC cup pull
5" Long



535-128-BNB
5" CC
6 1/4" Long



536-128-BNB
5" CC cup pull
6 1/4" Long



535-160-BNB
6 1/4" CC
5 5/8" Long

Alvar

AVAILABLE FINISHES



PC BNBDL DBAC SN NI SBZ



264-3-SBZ
3" CC
3 11/16" Long



264-96-SBZ
3 3/4" CC
5 7/16" Long



264-128-SBZ
5" CC
5 3/4" Long



264-160-SBZ
6 1/4" CC
7" Long



264-192-SBZ
7 9/16" CC
8 1/4" Long

Amsden

AVAILABLE FINISHES



DP DMAC DBAC SN NI



613-DMAC
Small Knob
1 7/16" Dia.



613L-DMAC
Large Knob
1 5/8" Dia.



613-96-DMAC
3 3/4" CC
4 3/8" Long



613-128-DMAC
5" CC
5 5/8" Long



613-160-DMAC
6 1/4" CC
6 7/8" Long

Annadale

AVAILABLE FINISHES



SN DBAC BNBDL DACM MB



435-DACM
Square knob
1 1/4" Dia.



435L-DACM
Oblong knob
1 1/2" Dia.



435-96-DACM
3 3/4" CC
5" Long



435-128-DACM
5" CC
6 1/4" Long



435-160-DACM
6 1/4" CC
7 5/8" Long



436-96-DACM
3 3/4" CC cup pull
5" Long



436-128-DACM
5" CC cup pull
6 1/4" Long

Anwick

AVAILABLE FINISHES



BNBDL DBAC NI SN



867-SN
Oblong Knob
1 3/8" Dia.



867L-SN
Square Knob
1 1/8" Dia.



867-3-SN
3" CC
4 5/16" Long



867-96-SN
3 3/4" CC
5 1/8" Long



867-128-SN
5" CC
6 3/8" Long



867-160-SN
6 1/4" CC
7 5/8" Long



867-228-SN
9" CC
10 5/16" Long



867-320-SN
12 5/8" CC
13 15/16" Long



Belcastel 1

AVAILABLE FINISHES



BNBDL DBAC NI PC SN SBZ

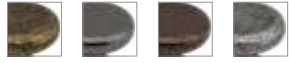

ABM-D DACM DMAC SIM-D



MO6303-BNBDL

Knob
1 3/8" Dia.



MO6373-BNBDL

3 3/4" CC
4 5/8" Long



MO6373-128-BNBDL

5" CC
5 7/8" Long



MO6373-160-BNBDL

6 1/4" CC
7 1/8" Long



MO6373-12-BNBDL

12" CC appliance pull
13 1/4" Long



MO6373-18-BNBDL

18" CC appliance pull
19 1/4" Long

Bella

AVAILABLE FINISHES



ABSB BNBDL DBAC NI SN



818-ABSB
Round Knob
1 3/8" Dia.



818L-ABSB
T Knob
2 1/4" Dia.



818-96-ABSB
3 3/4" CC
4 3/8" Long



818-128-ABSB
5" CC
5 11/16" Long



818-160-ABSB
6 1/4" CC
6 15/16" Long



818-12-ABSB
12" CC appliance pull
13 1/8" Long

Bienville

AVAILABLE FINISHES



ABSB BNBDL DBAC



959-BNBDL
Knob
1 5/16" Dia.



959-96-BNBDL
3 3/4" CC
5 13/16" Long

Bordeaux

AVAILABLE FINISHES

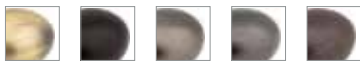

AB BLK BNBDL DACM DBAC



NI ORB PC SIM SN



3990-ORB
Egg Knob
1 3/16" Dia.



8236-ORB
3 3/4" CC
5" Long



Boswell

AVAILABLE FINISHES



MB BNBDL DBAC PC SN



177-96
96MM CC
4 1/4" Long



177-128
128MM CC
5 9/16" Long



177-160
160MM CC
6 13/16" Long



177-192
192MM CC
8 1/16" Long



177-224
224MM CC
9 5/16" Long

JEFFREY ALEXANDER

MO6373-18-PC
Belcastel

MO6373-160-PC
Belcastel



Bremen 1

AVAILABLE FINISHES



BNBDL DBAC NI PC SN SBZ



ABM-D ABSB DACM DMAC SIM



117-DACM
Knob
1 1/4" Dia.



527-DACM
3 3/4" CC
4 5/8" Long



527-128-DACM
5" CC
5 7/8" Long



527-160-DACM
6 1/4" CC
7 1/8" Long



527-12-DACM
12" CC appliance pull
13 1/16" Long



535L-BNBDL
Aberdeen

535-128-BNBDL
Aberdeen

Bremen 2

AVAILABLE FINISHES



ABSB DACM DBAC DMAC NI SN



127-NI
Knob (barrel)
1 3/16" Dia.



137-NI
Knob (stacked)
1 1/4" Dia.



537-NI
3 3/4" CC
4 3/16" Long



537-128-NI
5" CC
5 7/16" Long



537-160-NI
6 1/4" CC
6 9/16" Long



537-12-NI
12" CC appliance pull
12 11/16" Long

Cairo

AVAILABLE FINISHES



PC BNBDL DBAC SN



595-SN
Knob
1 1/4" Dia.



595-96-SN
3 3/4" CC
4 13/16" Long



595-128-SN
5" CC
6 1/16" Long

Callie

AVAILABLE FINISHES



BNBDL DBAC NI PC SN



839-3-PC
3" CC
4 3/16" Long



839-96-PC
3 3/4" CC
4 15/16" Long



839-128-PC
5" CC
6 1/4" Long



839-160-PC
60 1/4" CC
7 1/2" Long

Chesapeake

AVAILABLE FINISHES



ABSB BNBDL BNDL DACM DBAC SIM SN



737-96-BNBDL
3 3/4" CC
4 1/4" Long



737-128-BNBDL
5" CC
5 1/2" Long



737-160-BNBDL
6 1/4" CC
6 3/4" Long



737-12-BNBDL
12" CC appliance pull
12^{15/16}" Long



915-BNBDL
Knob
1 5/16" Dia.



Z110-BNBDL
Knob
1 3/16" Dia.

NOTE: BNDL Finish is only available on Z110.



Cordova

AVAILABLE FINISHES



ABSB BNBL DBAC SN



0251-SN
Knob
1 3/8" Dia.



Z110-SN
Knob
1 3/16" Dia.



Z111-SN
Knob
1 1/4" Dia.



Z281-SN
3" CC
3 3/8" Long



Z280-SN
3 3/4" CC
4 3/16" Long



Z281-128-SN
5" CC
5 7/16" Long



Z281-160-SN
6 1/4" CC
6 11/16" Long



Z281-12-SN
12" CC appliance pull
12 3/4" Long



Z281-18-SN
18" CC appliance pull
18 3/4" Long

NOTE: 0251 is also available in BNBL Finish. Z110 is also available in BNBL, DACM or SIN Finishes. 0251 is not available in BNBL.

Delgado

AVAILABLE FINISHES



BNBDL ABSB DBAC NI SN



519-NI
Knob
1 9/16" Dia.



519-96-NI
3 3/4" CC
4 1/4" Long



519-128-NI
5" CC
5 9/16" Long



519-160-NI
6 1/4" CC
6 13/16" Long



519-12-NI
12" CC appliance pull
12 1/2" Long



519-18-NI
18" CC appliance pull
18 1/2" Long



585-96-DP
Delmar

Delmar

AVAILABLE FINISHES



SN DBAC BNBDL DACM DP



585-96-DP
3 3/4" CC
4 1/2" Long

585-DP
Small knob
1" Dia.

585L-DP
Large knob
1 1/4" Dia.

585-128-DP
5" CC
5 13/16" Long

585-160-DP
6 1/4" CC
7 1/16" Long

585-12-DP
12" appliance pull
13 1/4" Long

Durham

AVAILABLE FINISHES

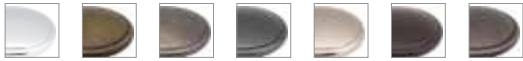

PC ABSB BNBDL DACM SN ORB DBAC



Z290-3-DBAC
3" CC
3 3/8" Long



3980-DBAC
Knob
1 1/4" Dia.

Z290-96-DBAC
3 3/4" CC
4 1/4" Long

Z290-128-DBAC
5" CC
5 1/2" Long

Z290-160-DBAC
6 1/4" CC
6 3/4" Long

Z290-12-DBAC
12" CC
13" Long

Dominique – NEW!

AVAILABLE FINISHES



MB DBAC BNBDL SBZ BG SN PC



845-SN
Knob
1 1/8" Dia.



845T-SN
Knob
2" Long



845TL-SN
Knob
2 1/4" Dia.



845-96-SN
3 3/4" or 96MM CC
5 3/4" Long



845-128-SN
5 1/16" or 128MM CC
7 1/16" Long



845-160-SN
6 5/16" or 160MM CC
8 5/16" Long



845-192-SN
7 9/16" or 192MM CC
9 9/16" Long



845-305-SN
12" or 305MM CC
14" Long



845-12-SN
12" CC appliance pull
15" Long



845-18-SN
18" CC appliance pull
21" Long



Duval

AVAILABLE FINISHES



BNBDL DACM DBAC NI SN



343-BNBDL
Knob
1 1/4" Dia.



343-96-BNBDL
3 3/4" CC
4 1/2" Long



343-128-BNBDL
5" CC
5 13/16" Long



343-160-BNBDL
6 1/4" CC
7 1/16" Long



343-12-BNBDL
12" CC appliance pull
13 1/8" Long

Elara

AVAILABLE FINISHES



BNBDL MB DBAC PC SN SBZ



484-SBZ
Knob
1 1/4" Dia.



484-32-SBZ
32MM CC
2 1/16" Long



484-396-SBZ
3" or 96MM CC
4 9/16" Long



484-128160-SBZ
128MM or 160MM CC
7 1/8" Long



484-192224-SBZ
192MM or 224MM CC
9 5/8" Long



484-305-SBZ
305MM CC
12 13/16" Long

Ella

AVAILABLE FINISHES



165-96-BNBDL
3 3/4" CC
4 1/2" Long

165-BNBDL
Knob
1 1/4" Dia.

165-128-BNBDL
5" CC
5 13/16" Long

165-160-BNBDL
6 1/4" CC
7 1/16" Long

165-12-BNBDL
12" CC
13" Long

Encada

AVAILABLE FINISHES



123-AEM
Knob
1 3/16" Dia.

125-AEM
Knob
1 3/16" Dia.

123-96-AEM
3 3/4" CC
4 13/16" Long

125-96-AEM
3 3/4" CC
4 13/16" Long

Evangeline

AVAILABLE FINISHES



925-DBAC
Knob
1 3/4" Dia.

925-96-DBAC
3 3/4" CC
6 1/2" Long



Glenmore

AVAILABLE FINISHES



ABSB BNMDL DACM DBAC



618-BNMDL
Small Knob
2 5/8" Dia.



618L-BNMDL
Large Knob
2 15/16" Dia.



718-BNMDL
5" CC
5 3/4" Long



718-128-BNMDL
5" CC bail pull
5 15/16" Long



Z718-12-BNMDL
5" CC appliance pull
13 5/16" Long

Harlow



G110-DBAC
Small egg
1 1/4" Dia.



G120-PC
Small button
1 7/16" Dia.



G130-DBAC
Small sphere
1 1/16" Dia.



G110L-BNBDL
Large egg
1 5/8" Dia.



G120L-SN
Large button
1 3/4" Dia.



G130L-BNBDL
Large sphere
1 3/8" Dia.



G140-BNBDL
Small square
1" Dia.



G140L-SN
Large square
1 3/8" Dia.



G150-DBAC
Small faceted
1" Dia.



G150L-PC
Large faceted
1 1/4" Dia.

Hayworth

AVAILABLE FINISHES



NI PC SN



885-PC
Knob
1 1/8" Dia.



885L-PC
T Knob
2" Dia.



885-96-PC
3 3/4" CC
4 3/4" Long



885-128-PC
5" CC
6" Long



885-160-PC
6 1/4" CC
7 1/4" Long



885-192-PC
7 9/16" CC
8 1/2" Long



885-224-PC
8 13/16" CC
9 3/4" Long



885-305-PC
12" CC appliance pull
4 3/4" Long

Hudson

AVAILABLE FINISHES

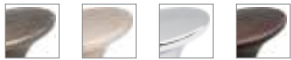

BNBDL SN PC DBAC



650-DBAC
Knob
1 7/8" Dia.



650-96-DBAC
3 3/4" CC
4 3/8" Long



650-128-DBAC
3 3/4" CC
5 5/8" Long



650-160-DBAC
6 1/4" CC
6 15/16" Long



650-12-DBAC
12" CC appliance pull
13" Long



Katharine

AVAILABLE FINISHES



BNBDL DBAC PC SN



188-SN
Small Knob
7/8" Dia.



188L-SN
Large Knob
1" Dia.



188-96-SN
3 3/4" CC
4 3/8" Long



188-128-SN
5" CC
5 11/16" Long



188-160-SN
6 1/4" CC
6 15/16" Long

Key Grande

AVAILABLE FINISHES



SN BG



596-SN
3 3/4" CC
5 3/8" Long



5128-SN
5" CC
6 5/8" Long



5192-SN
7 9/16" CC
9 1/8" Long



5224-SN
8 13/16" CC
10 3/8" Long



5319-SN
12 5/8" CC
14 1/8" Long

5480-SN
18 7/8" CC
20 1/2" Long

5673-SN
26 1/2" CC
28 1/16" Long

5900-SN
35 7/16" CC
37" Long



Key West & Key Largo

AVAILABLE FINISHES



48-SN
T Knob
1 7/8" Dia.



146-SN
3 3/4" CC
5 3/4" Long



152-SN
3 3/4" CC
6" Long



178-SN
5" CC
7" Long



242-SN
7 9/16" CC
9 1/2" Long



274-SN
8 13/16" CC
10 3/4" Long



370-SN
12 5/8" CC
14 9/16" Long

530-SN
18 7/8" CC
20 7/8" Long

722-SN
26 1/2" CC
28 7/16" Long

950-SN
35 1/2" CC
37 3/8" Long

NOTE: 242, 274, 370, 530, 722 and 950 are not available in ORB Finish.

JEFFREY ALEXANDER



Lafayette

AVAILABLE FINISHES



ABSB BNBDL DBAC SN



218-DBAC
Fleur-de-lis Knob
1 3/8" Dia.



317-DBAC
Circles Knob
1 3/8" Dia.



417-DBAC
Baroque Knob
1 3/8" Dia.



317-96-DBAC
3 3/4" CC
4 3/8" Long



317-128-DBAC
5" CC
5 5/8" Long



317-160-DBAC
6 1/4" CC
6 7/8" Long



317-12-DBAC
12" CC appliance pull
12 15/16" Long

JEFFREY ALEXANDER

Lenoir

AVAILABLE FINISHES



ABSB BNBDL DACM DBAC MB ORB SIM SN



Z117-ABSB
Knob
1 1/4" Dia.



8237-ABSB
3 3/4" CC
5" Long

Lexa

AVAILABLE FINISHES



BN BNBDL DBAC PC SN



259-BN
Knob
2" Dia.



259-96-BN
3 3/4" CC
4 3/16" Long



259-128-BN
5" CC
5 7/16" Long



259-160-BN
6 1/4" CC
6 11/16" Long



259-192-BN
7 9/16" CC
8" Long

Leyton

AVAILABLE FINISHES



BNBDL DBAC SN PC NI SBZ



286-96-SBZ
3 3/4" CC
5 1/8" Long



286-128-SBZ
5" CC
6 3/8" Long



286-160-SBZ
6 1/4" CC
7 11/16" Long



286-192-SBZ
7 9/16" CC
8 15/16" Long



286-224-SBZ
8 13/16" CC
10 3/16" Long



Lille

AVAILABLE FINISHES



ABSB BNBDL DACM DBAC SN



4155-DACM
Small Knob
1 1/4" Dia.



415-DACM
Large Knob
1 3/8" Dia.



415-96-DACM
3 3/4" CC
4 3/8" Long



415-96V-DACM
3 3/4" CC asymmetrical
4 3/4" Long



415-128-DACM
5" CC
5 5/8" Long



415-160-DACM
6 1/4" CC
6 7/8" Long



415-12-DACM
12" CC appliance pull
12 7/8" Long

JEFFREY ALEXANDER

Lyon

AVAILABLE FINISHES



AB BLK BNBDL DACM DBAC BG



NI ORB PC SIM SN SBZ



3991-PC
Egg Knob
1 9/16" Dia.



8233-PC
3" CC
4 15/16" Long

Marlo

AVAILABLE FINISHES



NI BNBDL DBAC PC SN



972S-SN
Small knob
7/8" Dia.



972-SN
Medium knob
1 1/8" Dia.



972L-SN
Large knob
1 1/4" Dia.



972-96-SN
3 3/4" CC
4 1/2" Long



972-128-SN
5" CC
5 13/16" Long



972-160-SN
6 1/4" CC
7 1/16" Long



972-224-SN
8 13/16" CC
9 3/4" Long



972-305-SN
12" CC
12 3/4" Long



972-12-SN
12" CC appliance pull
13" Long

JEFFREY ALEXANDER



Maybeck

AVAILABLE FINISHES



BN BNBDL DBAC PC SN



225-DBAC
Knob
1 11/16" Dia.



225-96-DBAC
3 3/4" CC
5 1/4" Long



225-128-DBAC
5" CC
6 3/8" Long



225-160-DBAC
6 1/4" CC
7 7/16" Long

Merrick

AVAILABLE FINISHES



PC BNBDL DBAC SN MB SBZ



549-96-SN
3 3/4" CC
4 3/16" Long



549-128-SN
5" CC
5 1/2" Long



549-160-SN
6 1/4" CC
6 3/4" Long



549-192-SN
7 9/16" CC
8" Long



549-320-SN
12 5/8" CC
13 1/16" Long

Milan 1

AVAILABLE FINISHES



1091-SN
Knob
1 3/16" Dia.



1092-SN
3 3/4" CC
4 1/4" Long



1092-128-SN
5" CC
5 9/16" Long



1092-160-SN
6 1/4" CC
6 13/16" Long



1092-12-SN
12" CC
12 13/16" Long

Milan 2

AVAILABLE FINISHES

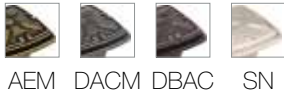

1093-AEM
Knob
1 3/16" Dia.



1094-AEM
3 3/4" CC
4 1/4" Long



1094-128-AEM
5" CC
5 9/16" Long



1094-160-AEM
6 1/4" CC
6 13/16" Long



1094-12-AEM
12" CC appliance pull
12 13/16" Long



Mirada

AVAILABLE FINISHES



ABSB BNBDL DBAC MB PC SN



81021-PC
5/8" CC Knob
1 9/16" Dia.



80152-96-PC
3 3/4" CC
5 9/16" Long



80152-128-PC
5" CC
6 13/16" Long



80152-160-PC
6 1/4" CC
8 1/16" Long

Modena

AVAILABLE FINISHES



PC SN SBN



910S-SBN
Small knob
1" Dia.



910-SBN
Large knob
1 3/16" Dia.



910-96-SBN
3 3/4" CC
5 1/4" Long



910-128-SBN
5" CC
5 9/16" Long



910-160-SBN
6 1/4" CC
6 13/16" Long



910-12-SBN
12" CC
12 13/16" Long

Montclair

AVAILABLE FINISHES



ABSB BNBDL DBAC SN



935-SN
Knob
2" Dia.



935-96-SN
3 3/4" CC
5 5/8" Long



935-128-SN
5" CC
7 1/2" Long



935-160-SN
6 1/4" CC
8 3/4" Long



935-12-SN
12" CC appliance pull
16" Long

Prestige

AVAILABLE FINISHES



AEM BNBDL DP NI SN



918-DP
Knob
1 3/8" Dia.



918L-DP
Knob
2 1/4" Dia.



918-96-DP
3 3/4" CC
4 3/8" Long



918-128-DP
5" CC
5 11/16" Long



918-160-DP
6 1/4" CC
6 15/16" Long



918-12-DP
12" CC appliance pull
13 1/8" Long



Rae

AVAILABLE FINISHES



BNBDL DBAC NI PC SN



667S-NI
Small Knob
1 1/16" Dia.



667-NI
Knob
1 1/4" Dia.



667L-NI
Large Knob
1 3/8" Dia.



667-3-NI
3" CC
3 7/16" Long



667-96-NI
3 3/4" CC
4 3/16" Long



667-128-NI
5" CC
5 1/2" Long



667-160-NI
6 1/4" CC
6 3/4" Long



667-224-NI
8 13/16" CC
9 1/4" Long



667-305-NI
12" CC
12 9/16" Long



667-12-NI
12" CC appliance pull
12 13/16" Long



667-18-NI
18" CC appliance pull
18 13/16" Long

Regan

AVAILABLE FINISHES



DBAC SN PC BNBDL



847-96-BNBDL
3 3/4" CC
5 9/16" Long



847-128-BNBDL
5" CC
6 13/16" Long



847-160-BNBDL
6 1/4" CC
8 1/16" Long

Rhodes

AVAILABLE FINISHES



BNB BNBDL DACM DBAC SN



Z260-3-DACM
3" CC
3 3/4" Long



Z261-96-DACM
3 3/4" CC
4 1/2" Long



B812-96R-DACM
3 3/4" CC
6" Long



Z261-128-DACM
5" CC
5 13/16" Long



Z260-12-DACM
12" CC appliance pull
13 1/4" Long



S6060-DACM
Knob & backplate
1 1/4" Dia.

Roman – NEW!

AVAILABLE FINISHES



MB DBAC BNBDL SBZ BG SN NI PC



944-SBZ
Knob
1 1/4" Dia.



944-96-SBZ
3 3/4" or 96MM CC
4 15/16" Long



944-128-SBZ
5 1/16" or 128MM CC
6 1/4" Long



944-160-SBZ
6 5/16" or 160MM CC
7 1/2" Long



944-192-SBZ
7 9/16" or 192MM CC
8 3/4" Long



944-224-SBZ
8 13/16" or 224MM CC
10" Long



944-305-SBZ
12" or 305MM CC
13 3/16" Long



944-12-SBZ
12" CC appliance pull
13 5/8" Long

Royce

AVAILABLE FINISHES



BNBDL DBAC PC SN



431-PC
Knob
1 3/16" Dia.



595-PC
Knob
1 1/4" Dia.



798-96-PC
3 3/4" CC
5 1/2" Long



798-128-PC
5" CC
6 3/4" Long



798-160-PC
6 3/4" CC
8 1/2" Long

Solana

AVAILABLE FINISHES



BN PC NI SN



457-BN
Knob
1 1/4" Dia.



457L-BN
Knob
2" Dia.



457-96-BN
3 3/4" CC
6" Long

Sonoma

AVAILABLE FINISHES



BNBDL DBAC MB PC SN



431-MB
Knob
1 3/16" Dia.



4128-MB
5" CC
6 5/16" Long



4160-MB
6 1/4" CC
8" Long



4192-MB
9 5/8" CC
6 5/16" Long



4288-MB
11 3/8" CC
14 7/16" Long



Sullivan

AVAILABLE FINISHES



SN BNBDL DBAC MB PC



752-96-DBAC
96MM CC
4 1/2" Long



752-128-DBAC
128MM CC
5 13/16" Long



752-160-DBAC
160MM CC
7 1/16" Long



752-192-DBAC
192MM CC
8 15/16" Long



752-224-DBAC
224MM CC
9 9/16" Long



752-19-DBAC
Knob
1 1/4" Dia.

Sutton

AVAILABLE FINISHES



BG BNBDL DBAC MB NI PC SBZ SN



635-32-PC
1 1/4" CC
2 1/4" Long



635-96-PC
3 3/4" CC
4 3/4" Long



635-128-PC
5" CC
5 7/8" Long



635-160-PC
6 1/4" CC
7 1/2" Long



635-256-PC
10 1/16" CC
11 7/16" Long

Symphony

AVAILABLE FINISHES



SN BNBDL DACM DBAC ABSB



1976-ABSB
Knob
2" Dia.



1977S-ABSB
Knob
1 3/8" Dia.



1977-ABSB
3 3/4" CC
4 9/16" Long

Tahoe

AVAILABLE FINISHES



BLK DMAC SIM



602S-SIM
Small knob
1 1/4" Dia.



602-SIM
Large knob
1 1/2" Dia.



602-96-SIM
3 3/4" CC
4 1/2" Long



602-128-SIM
5" CC
5 13/16" Long



602-12-SIM
12" CC
12 3/4" Long

Thatcher – NEW!

AVAILABLE FINISHES



MB DBAC BNBDL SBZ BG SN PC



859-3-BG
3" CC
5 5/16" Long



859-96-BG
3 3/4" or 96MM CC
6 1/8" Long



859-128-BG
5 1/16" or 128MM CC
7 1/2" Long



859-160-BG
6 5/16" or 160MM CC
8 9/16" Long



859T-BG
Knob
1 1/4" Dia.



Tiffany

AVAILABLE FINISHES



BG BNBDL DBAC NI PC SBZ SN



658-SBZ
Knob
1 1/4" Dia.



658-96-SBZ
3 3/4" CC
4 1/2" Long



658-128-SBZ
5" CC
5 3/16" Long



658-160-SBZ
6 1/4" CC
7 1/16" Long



658-192-SBZ
7 9/16" CC
8 3/8" Long



658-224-SBZ
8 13/16" CC
9 7/8" Long



658-12-SBZ
12" CC appliance pull
13" Long

JEFFREY ALEXANDER

Tuscany

AVAILABLE FINISHES



ABSB DACM DBAC SIM



749-96B-SIM
3 3/4" CC
4 1/16" Long



749-128B-SIM
5" CC
5 5/16" Long



749-128-SIM
5" CC bail pull
5 5/16" Long



749-160-SIM
6 1/4" CC bail pull
7 3/16" Long



749-224-SIM
8 3/16" CC bail pull
9 3/4" Long



749-SIM
Knob
2 5/16" Dia.



585-96-DP
Delmar

Zane

AVAILABLE FINISHES

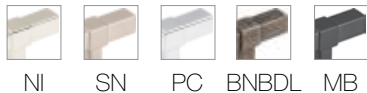

293-96-BNBDL
3 3/4" CC
5 1/16" Long

293T-BNBDL
Knob
2" Dia.

293-128-BNBDL
5" CC
6 7/16" Long

293-160-BNBDL
6 1/4" CC
7 9/16" Long

293-192-BNBDL
7 9/16" CC
8 13/16" Long

293-224-BNBDL
8 13/16" CC
10 1/16" Long

293-305-BNBDL
12" CC
13 3/4" Long

Zurich

AVAILABLE FINISHES



I300-ABSB
3" CC
3 9/16" Long

I350-ABSB
Knob
2" Dia.

I350-128-ABSB
5" CC bail pull
5 15/16" Long

I350-160-ABSB
6 1/4" CC
7 3/16" Long

E L E M E N T S[®]
by Hardware Resources

Aiden

AVAILABLE FINISHES



PC DBAC BNBDL SN



993-BNBDL
Knob
1 5/8" Proj.



993-3-BNBDL
3" CC
4 1/16" Long



993-96-BNBDL
3 3/4" CC
4 13/16" Long



993-128-BNBDL
5 1/16" CC
6 1/8" Long

Arcadia

AVAILABLE FINISHES

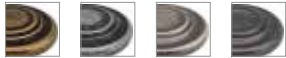

AEM ASM BNBDL DACM

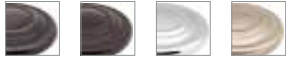

DBAC ORB PC SN



516-AEM
3" CC
5 1/2" Long



107-AEM
Knob
1 1/4" Dia.

Asher

AVAILABLE FINISHES



SN BNBDL DBAC PC BC



193-3-BC
3" CC
3 1/4" Long



193-96-BC
3 3/4" CC
4" Long



193-4-BC
4" CC
4 1/4" Long



193-128-BC
5" CC
5 1/4" Long



193-160-BC
6 1/4" CC
6 9/16" Long

Belfast

AVAILABLE FINISHES

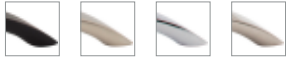

BLK DN PC SN



308-128-DN
5" CC
5 1/2" Long

406-128-DN
5" CC
6 1/2" Long

745-128-DN
5" CC
5 1/2" Long

776-128-DN
5" CC
5 1/2" Long

976-128-DN
5" CC
6" Long

Brenton

AVAILABLE FINISHES

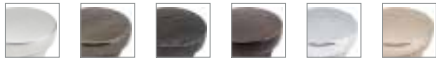

BC BNBDL DACM DBAC PC SN



239-BDBDL
Knob
1" Dia.

239-96-BNBDL
3 3/4" CC
4 5/16" Long

239-128-BNBDL
5" CC
5 9/16" Long

239-160-BNBDL
6 1/4" CC
6 13/16" Long

239-192-BNBDL
7 9/16" CC
8 1/16" Long

Calloway

AVAILABLE FINISHES

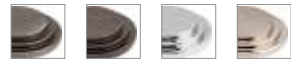

BNBDL DBAC PC SN



331-DBAC
Small Knob
1 1/8" Dia.

331L-DBAC
Large Knob
1 1/4" Dia.

351-DBAC
Small Knob
1 1/8" Dia.

351L-DBAC
Large Knob
1 1/4" Dia.



331-96-DBAC
3 3/4" CC
4 1/2" Long

351-96-DBAC
3 3/4" CC
4 7/16" Long

331-128-DBAC
5" CC
5 3/4" Long

351-128-DBAC
5" CC
5 11/16" Long



Capri

AVAILABLE FINISHES



412461-SN
Knob
1 1/8" Dia.



530142-SN
Knob
1" Dia.



530143-DN
Knob
1 1/4" Dia.



3211-SN
3" CC
4 7/8" Long



4656-SN
3" CC
3 3/8" Long



411689-DN
3 3/4" CC
4 3/8" Long



4690-SN
3 3/4" CC
4 1/2" Long



530144-DN
3 3/4" CC
5 1/8" Long



417572-DN
5" CC
4 1/2" Long



Z205-BB
5" CC
5 3/4" Long



Z500-128-SN
5" CC
5 5/8" Long

NOTE: 412461, 530142, 3211, 4656, 4690 and Z500-128 are only available in SN Finish. 531043, 411689, 530144 and 417572 are only available in DN Finish. Z205 is only available in BB or BC Finishes.

Cosgrove

AVAILABLE FINISHES



BNBDL DBAC PC SN



382-BNBDL
Knob
1 1/2" Dia.

382-96-BNBDL
3 3/4" CC
6 1/2" Long

382-128-BNBDL
5" CC
7 3/4" Long

382-160-BNBDL
6 1/4" CC
9" Long

Cypress

AVAILABLE FINISHES

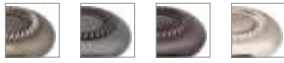

BNBDL DACM DBAC SN



Z118-DACM
Knob
1 1/4" Dia.



Z118-3-DACM
3" CC
3 3/8" Long



Z118-96-DACM
3 3/4" CC
4 1/8" Long

Drake

AVAILABLE FINISHES



BNBDL DACM DBAC PC SN



423-DBAC
Faceted Knob
1 1/4" Dia.



424-DBAC
Flat Top Knob
1 3/16" Dia.



423-3-DBAC
3" CC
4" Long



423-96-DBAC
3 3/4" CC
4 3/4" Long

Edgefield

AVAILABLE FINISHES

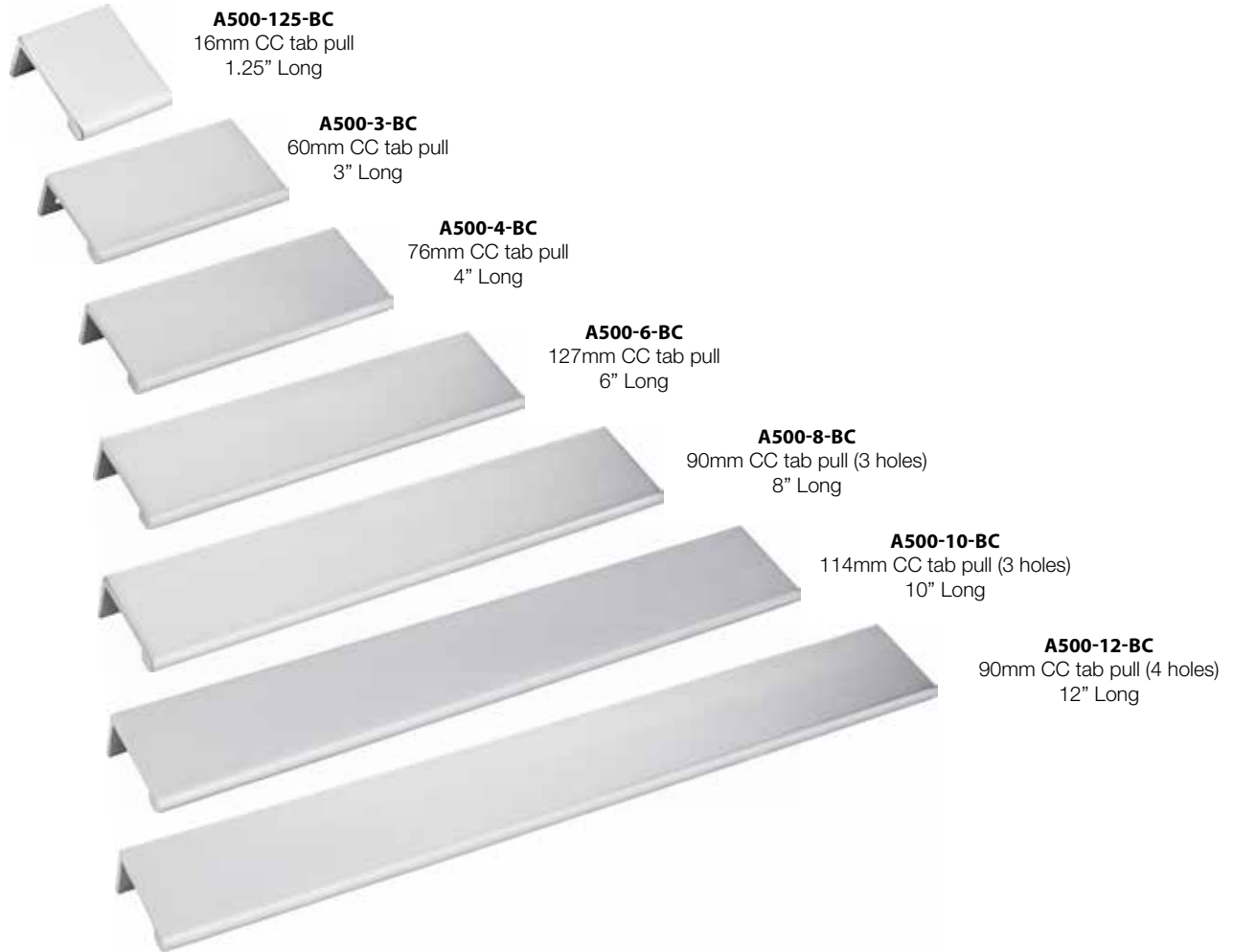
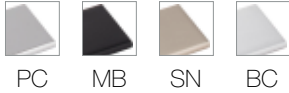

A500-125-BC
16mm CC tab pull
1.25" Long

A500-3-BC
60mm CC tab pull
3" Long

A500-4-BC
76mm CC tab pull
4" Long

A500-6-BC
127mm CC tab pull
6" Long

A500-8-BC
90mm CC tab pull (3 holes)
8" Long

A500-10-BC
114mm CC tab pull (3 holes)
10" Long

A500-12-BC
90mm CC tab pull (4 holes)
12" Long

Florence

AVAILABLE FINISHES

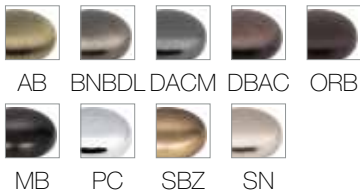

2980-SBZ
Knob
1 1/4" Dia.



2981-SBZ
3" CC cup pull
3 11/16" Long

Gatsby

AVAILABLE FINISHES



BNBDL DACM DBAC PC SN



3940-PC
Knob
1 1/4" Dia.



3950-PC
Knob
1 3/16" Dia.



3960-PC
Knob
1 1/4" Dia.



3970-PC
Knob
1 1/8" Dia.



3108-PC
3" CC
5 1/4" Long



3208-PC
3" CC
4 1/4" Long



3308-PC
3" CC
4 1/2" Long

Glendale

AVAILABLE FINISHES



ABM-DBNBDL DBAC DMAC

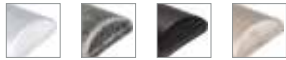

PC SIM MB SN



SBZ



525-SIM
Knob
1" Dia.



525-96-SIM
3 3/4" CC
5" Long



993-128-DBAC
Aiden

Hadly

AVAILABLE FINISHES



DBAC PC SN BNBDL



449-BNBDL
Knob
1" Dia.



449-3-BNBDL
3" CC
4" Long



449-96-BNBDL
96 mm CC
4 3/4" Long

Hammond

AVAILABLE FINISHES

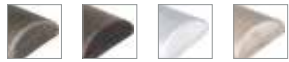

BNBDL DBAC PC SN



525-SN
Knob
1" Dia.



937-3-SN
3" CC
4 7/8" Long



937-96-SN
3 3/4" CC
5 11/16" Long

Kenner

AVAILABLE FINISHES



PC BNBDL DBAC SN



3970-SN
Knob
1 1/8" Dia.



254-3-BNBDL
3" CC
5" Long



254-96-SN
3 3/4" CC
5 3/4" Long

Lindos

AVAILABLE FINISHES



BNBDL DBAC PC SN



Z115-BNBDL
Knob
1 1/4" Dia.



Z115L-BNBDL
Knob
1 3/8" Dia.



Z115-96-BNBDL
3 3/4" CC
4 3/8" Long



Z115-128-BNBDL
5" CC
5 9/16" Long

Madison

AVAILABLE FINISHES



AB ALM BC BN BNBDL DACM WH SBZ



DBAC MB ORB PB SB SN PC



3910-AB
Knob
1 3/16" Dia.

NOTE: Z259-3 is not available in ALM or WH Finishes. Z259-12 is not available in ALM, BNBDL, MB, PB, SB or WH Finishes.



Z259-3-AB
3" CC
3 3/8" Long



Z259-12-AB
12" CC appliance pull
13" Long

Naples

AVAILABLE FINISHES

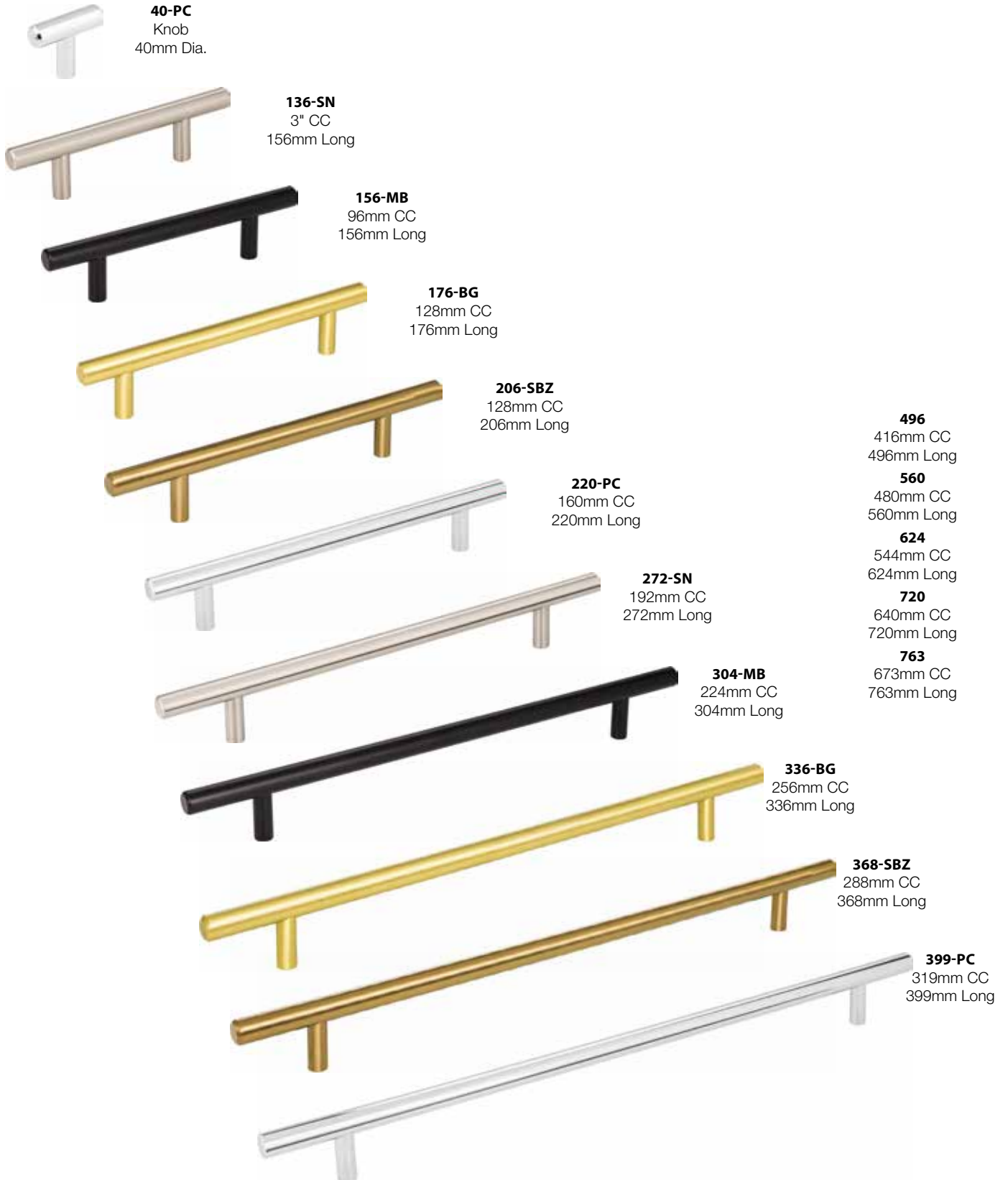

Naples

AVAILABLE FINISHES



SS



39-SS
Knob
39mm Dia.



154-SS
96mm CC
154mm Long



174-SS
128mm CC
174mm Long



204-SS
128mm CC
204mm Long



270-SS
192mm CC
270mm Long



302-SS
224mm CC
302mm Long



334-SS
256mm CC
334mm Long



366-SS
288mm CC
366mm Long



397-SS
319mm CC
397mm Long

494-SS
416mm CC
494mm Long

558-SS
480mm CC
558mm Long

622-SS
544mm CC
622mm Long

719-SS
640mm CC
719mm Long

761-SS
673mm CC
761mm Long



Merryville

AVAILABLE FINISHES



BNBDL DBAC PC SN



897-BNBDL
Knob
1 1/8" Dia.



897L-BNBDL
Knob
1 1/4" Dia.



897-3-BNBDL
3" CC
5 1/8" Long

Sedona

AVAILABLE FINISHES



SN MB SBZ



26-SN
Knob
1" Dia.



400-SN
3" CC
4" Long



475-SN
3 3/4" CC
4 3/4" Long



600-SN
5" CC
6" Long

193-96-BC
Asher



Slade

AVAILABLE FINISHES



PC BNBDL SN DBAC AB DACM PB



3915-DACM
Knob
1" Dia.



984-3-DACM
3" CC
3 1/2" Long



984-96-DACM
3 3/4" CC
4 1/4" Long



984-128-DACM
5" CC
5 1/2" Long



984-160-DACM
6 1/4" CC
6 3/4" Long



984-192-DACM
7 9/16" CC
8" Long

NOTE: 984-3, 984-96, 984-128, 984-160 and 984-192 are not available in AB or PB Finishes.

Somerset

AVAILABLE FINISHES



BNBDL DBAC PC SN MB SBZ



8004-DBAC
3 3/4" CC
4 7/8" Long



81065-DBAC
5" CC
6" Long



80814-DBAC
3 3/4" CC
5" Long



80815-DBAC
5" CC
6 1/4" Long



Stanton

AVAILABLE FINISHES

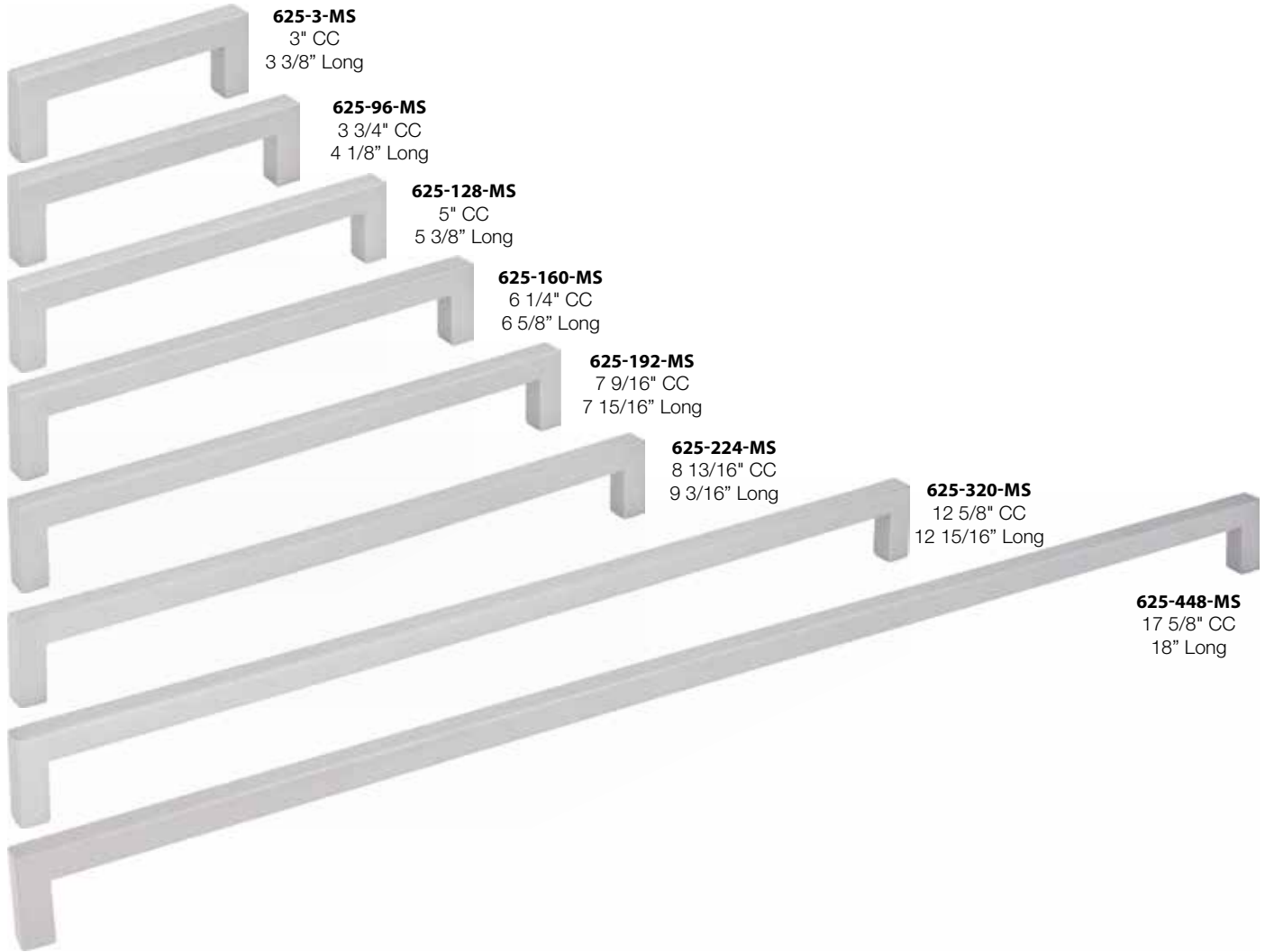

625-3-MS
3" CC
3 3/8" Long

625-96-MS
3 3/4" CC
4 1/8" Long

625-128-MS
5" CC
5 3/8" Long

625-160-MS
6 1/4" CC
6 5/8" Long

625-192-MS
7 9/16" CC
7 15/16" Long

625-224-MS
8 13/16" CC
9 3/16" Long

625-320-MS
12 5/8" CC
12 15/16" Long

625-448-MS
17 5/8" CC
18" Long

Strickland

AVAILABLE FINISHES



771-3-SN
3" CC
4 1/2" Long

771-128-SN
5" CC
6 5/16" Long

771-96-SN
3 3/4" CC
5 3/16" Long

771-160-SN
6 1/4" CC
7 11/16" Long



Syracuse

AVAILABLE FINISHES



BNBDL DBAC PC SN



575-96-BNBDL
3 3/4" CC
4 7/8" Long



575-BNBDL
Knob
1 3/16" Dia.

Torino

AVAILABLE FINISHES



AL SS WH ALM BC DBAC PB PC SN



A271-3AL
3" CC
3 3/8" Long



K271-3SS
3" CC
3 3/8" Long



S271-3-PB
3" CC
3 3/8" Long



A271-3.5AL
3 1/2" CC
3 13/16" Long



K271-3.5-SS
3 1/2" CC
3 13/16" Long



S271-3.5-PB
3 1/2" CC
3 13/16" Long



A271-96AL
3 3/4" CC
4 1/8" Long



K271-96-SS
3 3/4" CC
4 1/8" Long



S271-96-PB
3 3/4" CC
4 1/8" Long



A271-4AL
4" CC
4 5/16" Long



K271-4SS
4" CC
4 5/16" Long



S271-4-PB
4" CC
4 5/16" Long



S271-128-PB
5" CC
5 3/8" Long



Vienna

AVAILABLE FINISHES



DBAC SN AB



PBM PCM SB



110-DBAC
Knob
1 1/4" Dia.



202-DBAC
Knob
1 1/4" Dia.

NOTE: AB Finish is only available for 202. PBM, PCM or SB Finishes are only available for P106.



110-3-DBAC
3" CC
5 1/2" Long



P106-DBAC
3" CC
5" Long

Watervale

AVAILABLE FINISHES



SN BNBDL PC DBAC



647-DBAC
Knob
1 1/8" Dia.



647-3-DBAC
3" CC
4 5/8" Long



647-96-DBAC
3 3/4" CC
5 3/8" Long

Westbury

AVAILABLE FINISHES



BNBDL DBAC PC SN



3898-PC
Knob
1 1/4" Dia.



3899-PC
3" CC
5 1/8" Long

Zachary

AVAILABLE FINISHES

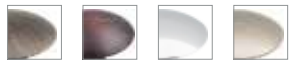

BNBDL DBAC PC SN

988-SN
Knob
1 1/6" Dia.



988-3-SN
3" CC
3 3/4" Long



988-96-SN
3 3/4" CC
4 1/2" Long



988-128-SN
5" CC
5 3/4" Long



988-160-SN
6 1/4" CC
7 1/16" Long

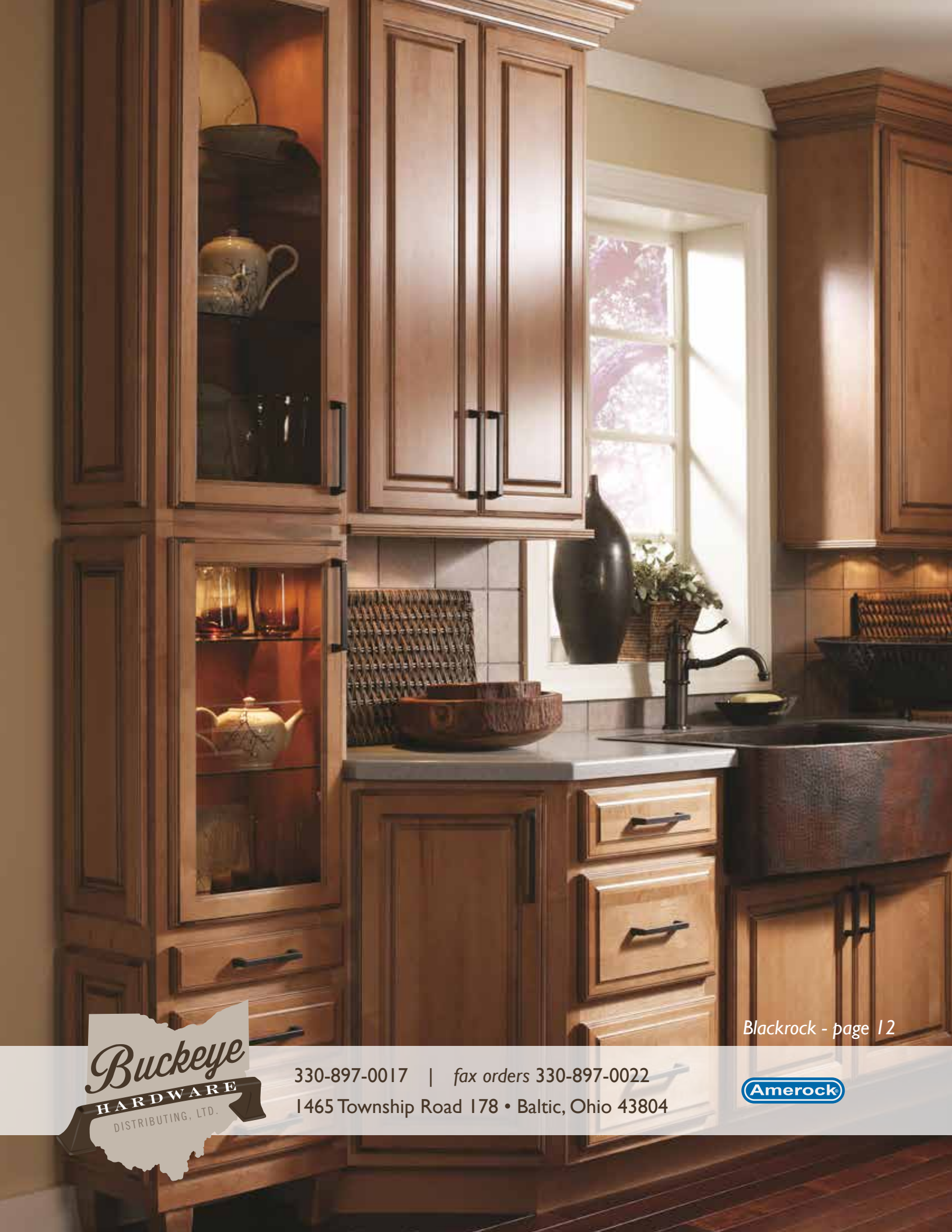

Blackrock - page 12

Buckeye

HARDWARE

DISTRIBUTING, LTD.

330-897-0017 | fax orders 330-897-0022

1465 Township Road 178 • Baltic, Ohio 43804

Amerock