

HANDGUNNER

MARKETPLACE FOR GUNS, ACCESSORIES, SERVICES

AMERICAN

JULY/AUGUST 1981 \$2.00

HANDGUNNER

OFFICIAL MAGAZINE OF THE OUTSTANDING AMERICAN HANDGUNNER AWARDS

67522 T&E

44 magnums

**HOW DO THEY MEASURE UP?
LEARNING LOADS
REDHAWK VS 29
LOADING TIPS**

BRAND NEW!

**9MM REVOLVERS
S&W'S "L" FRAME**

EXCLUSIVE!

**HOLSTER ROUNDUP
1981 LEATHERGOODS
DIRECTORY**



REMINGTON 700s. THE ULTIMATE IN ACCURACY.



The Model 700s became the world's most popular center fire bolt action rifles because they give you the best combination of accuracy, dependability, and variety. There are actually 17 popular calibers, in

four models. Each is built as ruggedly, as precisely as the heavy-barreled, super accurate Model 700 "Varmint Special" above.

TRADITION.



Like every 700, the "Classic" has a receiver machined from a solid bar of ordnance-quality chrome-nickel steel. What sets it apart is its clean, traditional styling. The subtle elegance of its rich satin

finish, its deep-cut checkering. The crisp look tells you this rifle means business.

APPEARANCE.



Like every Model 700, the BDL has one of the world's strongest bolt actions. Bolt face, barrel, and receiver surround the cartridge head with three rings of solid steel. What's different is its contemporary styling, its custom skip-line cut checkering.

VALUE & CHOICE.

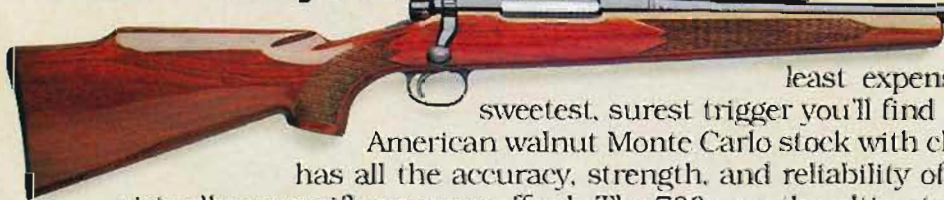

Like all the 700s, even our least expensive model, the ADL, has the sweetest, surest trigger you'll find anywhere. It, too, has a quality American walnut Monte Carlo stock with cheekpiece. In fact, the 700 ADL has all the accuracy, strength, and reliability of our other 700s but at a price virtually every rifleman can afford. The 700s are the ultimate in choice, too. See for yourself: then see your Remington dealer. Or write us for free, full-color catalog.

Accelerator is a trademark registered in the United States Patent & Trademark Office, and Varmint Special is a trademark of Remington Arms Company, Inc., Bridgeport, Conn. 06602.



Model 700	17 Rem.	222 Rem.	22-250 Rem.	233 Rem.	3000 Rem.	243 Win.	28-06 Rem.	270 Win.	7mm Mauser	7mm Rem.	7mm Rem. Mag.	30-06 Spfld.	308 Win.	7mm Rem. Mag.	300 Win. Mag.	8mm Rem. Mag.	270 Win. Mag.	458 Win. Mag.
"Varmint Special"	•	•	•	•	•	•	•	•	•	•	•	•	•	•	•	•	•	•
"Classic"	•	•	•	•	•	•	•	•	•	•	•	•	•	•	•	•	•	•
BDL	•	•	•	•	•	•	•	•	•	•	•	•	•	•	•	•	•	•
ADL	•	•	•	•	•	•	•	•	•	•	•	•	•	•	•	•	•	•

* New for 1981. ** Special for 1981 only. *30-06 and 308 are available in "Accelerator" cartridges.
** Available in left-hand models: 270 Win., 30-06 Spfld., 7mm Rem. Mag.

THE NEW MAGNUM FORCE IN HIGH SPEED, PRECISION RELOADING. THE NEW LYMAN T-MAG.

Lyman is proud to introduce our new magnum turret press: the Lyman T-Mag. It offers all the speed of a turret with the strength of a heavy-duty press.

The Turret That Turns Out Outstanding Ammunition.

With the T-Mag you can mount up to six different reloading dies on our turret. This means you can have all your dies set up, precisely mounted, locked in and ready to reload at all times. You can have just the combination of dies you want in place, for your specific needs. You can mount 3 pistol dies, 2 rifle dies and a powder measure. In fact, the T-Mag works with all $\frac{7}{8}$ x 14 dies. It's built with O-Mag strength and uses standard O-Mag primer feed and O-Mag primer catcher.

Speed That Doesn't Screw Up The Quality.

Our T-Mag is designed to give you all the speed advantages of turret reloading without even the slightest sacrifice in strength or precision.

Not only does it do away with all the set-up time of single station units, it also has features like a primer feed station for each of two different die sets. This means your primer feeds remain set up even when you're loading different cartridges.

The Strength To Stay In Line.

The T-Mag turret is held in rock solid alignment by a $\frac{3}{4}$ inch steel stud and an extra heavy support post that's part of a massive casting. This means you never have to worry about alignment problems and you have the strength and precision to load even bottle neck rifle cases. And when you're doing rifle cases, you're going to like the way we built the T-Mag

$\frac{3}{4}$ " steel stud and rear support post holds turret solidly, even under extreme pressure.

Our turret is designed to accept all competitive die sets.

Turret design allows dies to remain mounted and set at all times.

T-Mag set comes with a complete set of standard AA dies, and appropriate shell holder.

Third mounting hole in the rear to provide maximum leverage and stability.

Uses standard O-Mag primer feed and O-Mag primer catcher.

Textured grip handle that doesn't get slippery like the typical bicycle style grip.

with a larger opening clearance for real working ease.

More Time On The Firing Line.

Whether you batch process your cases at each station, or load one shell at a time, the T-Mag means less time reloading. And more time on the firing line, with precision quality ammunition. Yet with all these features, it comes at a surprisingly low price, little more than single station units.

Our T-Mag's another reason, when it comes to reloading, you've got to look at Lyman.

Lyman

Lyman Products Corporation
Dept. AH-7071
Route 147
Middlefield, CT 06455

AMERICAN HANDGUNNER

JULY/AUGUST 1981, Vol. 6, No. 29

FEATURES

FRY .38 SPECIAL , Frank Fry	30
<i>Comfort and accuracy in a police sidearm</i>	
MODEL NO. 25-5 , Jerry Ahern	34
<i>Smith & Wesson's .45 Colt big bore revolver</i>	
CUSTOM PISTOLSMITH UPDATE	36
<i>Our famous directory adds some new shops</i>	
CHUCK TAYLOR COMMANDO .45 , John S. Farnam	38
<i>A highly practical, working defense outo</i>	
S&W'S NEW GUNS & AMMUNITION , Evan Marshall	40
<i>New products from this giant manufacturer</i>	
.22 SILHOUETTES: PART II , Bert Stringfellow	53
<i>Tuning T/C, Ruger, S&W, High Standard</i>	
HANDGUN HUNTER'S SIXGUN , J. D. Jones	60
<i>A functional investment for hunters & shooters</i>	
COLT SHERIFF'S MODEL , George E. Virgines	62
<i>Commemorative collector's model</i>	
SPECIAL LEATHERGOODS 1981 ROUNDUP	64
SPILBORGH'S' CUSTOM LONGSLIDE .45 , Kevin Steele	82

EXCLUSIVE .44 MAGNUM SPECIAL SECTION

LEARNING LOADS FOR MAGNUMS , Mike Venturino	42
<i>How to reload 'em for less recoil</i>	
RON POWER CUSTOM PAIR OF .44'S	45
<i>Feast your eyes on these engraved beauts</i>	
HANDLOADING THE .44 MAGNUM , Don Zutz	46
<i>Our expert paves the way for perfect reloads</i>	
THE .44 MAGS: HOW THEY MEASURE UP , Staff	50
<i>A boatload of .44 Mag specifications</i>	
REDHAWK VS M29 , Al Pickles	61
<i>What happens when the best duel shot-for-shot</i>	

CUSTOM GUN GIVEAWAY CONTEST

H-S PRECISION'S CUSTOM XP-100	48
--	-----------

DEPARTMENTS

INDUSTRY INSIDER , Jerry Rakusan	10
SILUETAS , Phil Briggs	12
COMBAT COURSE , Jerry Usher & Seth Nadel	14
SIGHT SETTINGS , Lucy Chambliss	18
HANDGUN HUNTING , J. D. Jones	20
HANDLOADING , Dan Cotterman	22
HANDGUN LEATHER , Bob Arganbright	24
COP TALK , Massad Ayoob	26
SPEAK OUT	6



COVER: Ruger Blackhawk, S&W 29, Ruger Redhawk, Lama, all featured in our special .44 Mag section. Photo by James D. Mason.

STAFF

GEORGE E. VON ROSEN *Publisher*
JEROME RAKUSAN *Editorial Director*
KEVIN E. STEELE *Assistant Editorial Director*
MIKE PACKARD *Managing Editor*
SYDNEY BARKER *Art Director*
FERNANDO M. MARTINEZ *Asst. Art Director*
JOAN HUBERT *Art Assistant*
MAGGIE LOOS *Art Assistant*
GLENNA A. EIDENMILLER *Adv. Prod. Director*
TOM A. VON ROSEN *Production Director*
TOM HOLLANDER *Circulation Director*

NATIONAL ADV. OFFICE: Bob Cusick, Advertising Sales Manager, 591 Camino de la Reina, Suite 200, San Diego, CA 92108 (714) 297-8520
WEST COAST REPS.: Media Sales Associates, Bill Hague, Rick Ayer, 26944 Camino de Estralla, Capistrano Beach, CA 92624 (714) 661-2423
EAST COAST ADV. REPS.: Buchmayr Associates, 19 Birch Rd., Darien, CT 06820 (203) 655-1639.

AMERICAN HANDGUNNER (ISSN 0145-4250) is published bi-monthly by Publishers' Development Corp., 591 Camino de la Reina, San Diego, CA 92108. Second class postage paid at San Diego, CA 92108, and at additional mailing offices. Subscriptions: One year (6 issues) \$9.95. Single monthly copies \$2.00. Change Of Address: Four weeks' notice required on all changes. Send old address as well as new. Contributors submitting manuscripts, photographs or drawings do so at their own risk. Material cannot be returned unless accompanied by sufficient postage. Payment will be made at rates current at time of publication and will cover reproduction in any or all AMERICAN HANDGUNNER Magazine editions. Advertising rates furnished on request. Reproduction or use of any portion of this magazine in any manner, without written permission, is prohibited. All rights reserved. Title to this publication passes to subscriber only on delivery to his address. **SUBSCRIPTION PROBLEMS:** For immediate action write to AMERICAN HANDGUNNER, Attention Donna Maess—591 Camino de la Reina, Suite 200, San Diego, CA 92108 or call (714) 297-8524. Ask for Donna Maess or Tom Hollander.



In an emergency

P2A1 Signal Pistol!

For emergency use to launch signal or distress flares for hunters, mountain climbers, boatsmen, pilots or for any outdoorsman or cross-country traveller.

A reliable, compact, rugged signal-pistol which fires a variety of signal flares, parachute distress signals, and colored flares.



Specifications:

Caliber 26.5 mm (1.04 in.)

Weight 0.52 kg (18.2 oz.)

Length 200 mm (7.9 in.)

Length of barrel 155 mm (6.1 in.)

Width/height 38/145 mm (1.5/5.7 in.)



HECKLER & KOCH, INC.

933 NORTH KENMORE STREET, SUITE 218
ARLINGTON, VIRGINIA 22201 • (703) 525-3182

Write for our 20-pg. catalogue of new & exciting H&K weapons. Include \$3.00 for postage & handling.

MONOGRIP®

Made for:

- S & W: SQUARE BUTT K FRAME
- S & W: ROUND BUTT J FRAME
- RUGER: SECURITY-SIX, POLICE SERVICE-SIX, SPEED-SIX*

*(Post 1976 serial numbers 151 and above)

MONOGRIP® features include: Unique, ONE-PIECE construction • Hogue's famed orthopedic hand fit • Fully relieved for all speed loaders with positive case ejection • Compound, ambidextrous palm swells • Proportional finger grooves • Exclusive COBBLESTONE® non-slip, non-irritating stipple pattern • Strength and durability of reinforced Nylon — No cheap plastics.



\$18.95 Check or money order plus \$2.00 postage handling (California residents add 6% sales tax).

HOGUE COMBAT GRIPS
P.O. Box 460
Dept. HGR3
Morro Bay, CA 93442



THE procedure preferred by knowledgeable shooters to Reduce Muzzle Lift and Recoil.



RIFLE



PISTOL

Mag-Na-Port Arms has 20 years experience with EDM technology, and 10's of 1000's of satisfied customers will attest to our expertise.

There's only one, genuine Mag-Na-Port process, and it's available only from the Mag-Na-Port locations listed below.

Send for **FREE** literature today.



ARMS, INC. U.S.A.
30016 South River Road
Mt. Clemens, Michigan 48045



ARMS, INC. CANADA
1861 Burrows Avenue
Winnipeg, Manitoba R2X 2V6

SPEAK OUT

PISTOLS ON PLANES: AA CAPTAIN SAYS OK

I read Lucy's comments on firearms carriage aboard airlines and would suggest that you put American Airlines at the top of your list of air carriers. You stated that law enforcement personnel have lost their rights to be armed on aircraft. Not so on American.

American permits Law Enforcement Officers to carry weapons aboard in the performance of his/her duties and makes special procedures for them to clear security. In addition, the Captain meets the armed person and is aware of his/her seat. I personally take very good care of all armed personnel when aboard and many times am able to get them preferential seating.

In addition, no advance notification of firearms in checked luggage is required other than at point of check in that firearms are in checked luggage. The weapon must be unloaded, and if it is a handgun must be in a locked case only openable by the owner. Sporting rifles/shotguns do not require a locked case. (Although I strongly recommend it.)

You will find that American caters to the firearm owner with a courtesy not found on any other airline. Myself and many other of my pilot friends are avid gun owners and collectors and we welcome you to come see "what we do best."

Ronald R. Brice
Captain, American Airlines

WIPE AWAY THE LEAD WITH CLOTH CLEANER

In a recent issue of The American Handgunner, there was an article on the new Ruger Redhawk .44 magnum revolver. The author had much trouble getting rid of residues (from the bluing, I believe) from the barrel. He finally arrived at the right combination.

I am having similar problems with my .44 magnum, Hoppe's No. 9 solution will not work. I tried to find the magazine, but I have misplaced it somewhere.

Any help you can give me on this matter will be greatly appreciated.
Hashime Saito
Tucson, Arizona

Firstly, since the Ruger Redhawk is stainless steel, your problem would not be from bluing, but, rather, from leading. The best product we have seen for removing lead residues is called Wipe Away and it's a cloth that is easy to use, and really works. Write Belltown Distributors, Box 444, Bedford Hills, NY 10507.

	THE COLT .45 AUTO PISTOL	\$6.30
	AR-15, M-16 AND M-16A1 (5.56mm Rifles)	\$8.70
	INGRAM MAC-10	\$8.75
	\$5.50; M1 CARBINE	\$8.75

The most comprehensive, best illustrated manuals for the use, maintenance and repair of these effective weapons.
Money order or credit card only • in store or by mail • catalog \$1.00
SURVIVAL BOOKS (213) 769-0804
Dept. AH • 11206 Magnolia Blvd. • North Hollywood, CA 91605

COMBAT SHOOTERS

- Parts for .45 autopistols
- Adjustable rear sight
- Recoil system
- 8-round .45 magazine
- Magnum conversion kits

FACTORY DIRECT

DETONICS MANUFACTURING CORP.
2500 Seattle Tower
Seattle, Washington 98101
(206) 624-9090

High strength, heat treated
Stainless Steel.

DEALERS!



Quick as a Snake

SNICK

The Snick Stage V
Holster System:
A Break Front
Holster of Space
Age Plastic
Developed and
Tested in Combat
Competition and
Daily Wear,
Superb in Both
Applications



Send \$1 for catalog or order and specify Model for 45 Gov't or Commander or P-35 Browning or Medium Frame Revolver. \$28 plus \$1.50 postage and insurance. Magazine carriers - vertical or horizontal. 45ACP \$10, 9mm \$12 each. Calif. Res. add 6% tax. Send a street address if possible for UPS delivery. No left hand models.

SNICK PRODUCTS, Dept. A
3212 Gulf St., Bakersfield, Calif. 93308

MAGNIFICENT BRASS PAPERWEIGHT

Full size replica of the Knuckle Duster



ORDER TODAY! \$8.50 ea.
Postpaid
Aluminum paperweight \$4.50 ea.
Postpaid

For novelty paperweight use only.
Not intended for any other use.

Send check or M.O. to:

BEST SPORTS SUPPLIER

P.O. Box 492, Dept. 25
Hazelwood, Mo. 63042

JUST WHAT YOU NEED WHEN YOU'RE SHOOTING IRON.



Introducing the "Rambusters," a whole new family of Remington firearms, ammunition, and components made to improve your odds in all metallic silhouette events.

New is the "XP-100" Silhouette center fire pistol. It's drilled and tapped for easy mounting of sights, has a 15" barrel, and is chambered for an ideal silhouette cartridge—the new 7mm BR Remington. We offer the universal unprimed BR case for this one; with your reloading skills and 7mm bullets you've got the makings of a great silhouette shooting combination.

Another good choice for the iron animals is our new 7mm-08 Remington cartridge. This potent, compact package is ideal in short-action rifles. With a 140-grain bullet it optimizes down-range ballistics and retained energy, clear out to 500 meters. It's available in your choice of a factory load or as components.

The new 7mm-08 Rem. is chambered in our superaccurate, heavy-barreled Model 700 "Varmint Special." This rifle has a specially selected stock to meet strict weight restrictions for metallic silhouette events.

We didn't forget the growing sport of 22-cal. silhouette. With a match trigger, a rugged bolt with six locking lugs, double extractors, and a receiver drilled, tapped, and grooved for scope mounts, the accurate Model 541-S "Custom" Sporter is one strong competitor. And one of the best-looking 22s you can buy.

For information on silhouette rifle sports, write NRA, Silhouette Dept., 1600 Rhode Island Ave. N.W., Washington, D.C. 20036. Silhouette-handgun sports literature is available through IHMSA, P.O. Box 1609, Idaho Falls, Idaho 83401.

Learn more about Remington "Rambusters" silhouette products in our new full-line or components catalogs. See your dealer, or write Remington Arms Company, Inc., Bridgeport, Conn. 06602.

Remington 
FIRST IN THE FIELD

The Magnificent Beretta

MINX .22 SHORT JETFIRE .25 CAL.

No extractor-
blow back
action-
only pistol
with instant
breech cleaning-
double safety
features.



Minx M2—Cal. 22 short. Overall Length 4½",
Length of barrel 2½" ... Weight 10 ozs ... 6 shots ...
Thumb safety ... Half cock safety

Jetfire—Cal. 25 ... Overall Length 4½" ... Length of
barrel 2½" ... Weight 8 ozs ... 8 shots ... Thumb
safety ... Half cock safety



Galef COMPANION folding single with ventilated rib.
Here's an outstanding all purpose shotgun. Tang safety, 12
and 20 gauge chambered for 3" magnum, suitable for 2¾"
shells. Also 16 and 28 gauge for 2¾", 410 gauge for 3" and
2½" shells. Hand checkered rolled engraved receiver.

Distributed exclusively by

J.L. GALEF & SON INC.

For full details write Dept. D-7
and include your dealer's name and address.
85 Chambers Street, New York, N.Y. 10007

HUNTER FLAP HOLSTER

for
Ruger Super
Blackhawk
with 10½"
Barrel



- Pull a dot fastener
- Series 4100. Tan or black, right or left hand, available in sizes to fit most single action handguns

The Hunter Corp. Dept. AH-781
A Division of Crockett & Kelly, Inc.
3300 West 71st Avenue, Box 467
Westminster, Colorado 80030

See your dealer today or send \$2.00 for our new 1981 catalog.

Name _____

Address _____

City _____

State _____ Zip _____

SPEAK OUT

(Continued from page 6)

.22 RUGER IN ALASKA TRAPPER'S FAVORITE

Re: Ruger .22 autos.

I too have friends in South Africa who report 1000's of rounds through their Rugers. The only real complaint I have with the Ruger is the painful process of loading clips. Load more than 5 clips and your thumb hurts. Have suggested to Ruger that they sell a loading tool much like the old Luger loader/screwdriver. I'm sure they could stamp them out by the 1000's for a few cents each and could be kept on a key chain.

Tip: Ruger can rebuild and reblue most of their .22 autos for very little. Know guys that pay peanuts for rusted or nonworking Rugers (\$5-\$10) and send them to Ruger to rebuild and refinish. Two weeks later they get a "new" firearm back.

Have always wished that Ruger would offer their auto in .22 short. Think there is a small market for such a pistol. As a trapper, I use .22 short on trapped animals. Also .22 short is ample for 50-ft indoor target shooting. Ruger missed the boat when they discontinued the Bearcat. They are very popular here with trappers. Bearcats sell for \$200 here now—if you can find one.

Allen G. Skinner
Anchorage, Alaska

WEAK-HAND RELOAD FOR THE WHEELGUN

Weak-hand reloading was covered in the Nov/Dec issue in an article by Rick Miller, however, there is another way of reloading a revolver without snapping the cylinder in and out: (1) Cup the revolver in your left hand with the trigger guard at the base of your second and third fingers. The left thumb should be at the cylinder release, and the muzzle pointed away from you. (2) Push the cylinder release with your thumb and push out the cylinder with your second finger. (3) To extract the fired cartridges, hold the revolver with the trigger guard at the base of the fingers with the first and second fingers going through the frame where the cylinder was, push the extractor rod with your thumb, and turn the pistol muzzle up to dump out the fired brass. (4) Stick the muzzle in your belt to hold the gun. Reloading can be accomplished now with the use of either a speedloader, or with loose cartridges. (5) Now liftout the revolver and close the cylinder.

This sequence is easy to use and a safe way to reload.

Myles Shinsato
Honolulu, HI

PALADIN PRESS

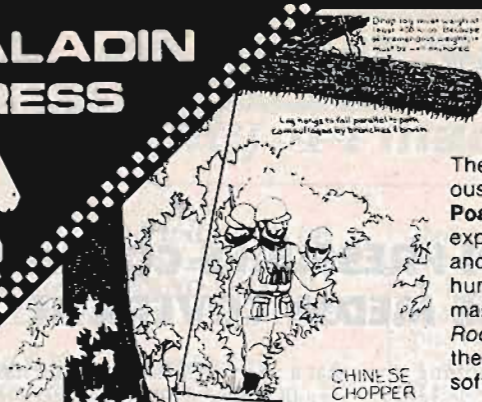

MANTRAPPING

by Ragnar Benson

The first book ever published to explain how to capture the most crafty and dangerous animal of all: man. Ragnar Benson, well respected as the author of **Survival Poaching**, has based this gut-wrenching book on his own personal mantrapping experiences while on special assignments in Asia, Africa, North and South America, and Cuba. Reveals over a dozen different traps specifically designed to catch and kill humans. This how-to manual is illustrated with detailed line drawings covering such mantraps as the *Malaysian Hawk*, the *Andes Mountain Trail Trap*, the *Sheepstealer's Rock Fall*, and the *Cuban Water Trap*. Survivalists can use these systems to protect their retreats. Includes a special chapter on the philosophy of mantrapping. 7 X 8 1/2, softcover, 15 chapters, illus., 88 pp., ISBN 0-87364-215-5. **\$8.00**



THE ARMCHAIR MILLIONAIRE

by Frederick Hal Vice
Leave the rat race behind and take the fast track to top money. Vice's rousing success story can be yours with this practical, money-maker's manual that goes far beyond pretty pep talk and financial fairy tales. Solid guidelines, practical examples, and real-life solutions—no get-rich-quick quackery. Dozens of case histories support the accessibility of *economic independence*. 5 1/2 X 8 1/2, softcover, 120 pp. **\$7.95**

BLACK MEDICINE I, II & III

by N. Mashiro, Ph.D.

Vol. I, Dark Art of Death—thorough and intriguing discussion of the human body's 140 vital points. **Vol. II, Weapons At Hand**—112 parts of the body that are natural weapons, plus 180 deadly makeshift weapons. **Vol. III, Low Blows** Mashiro's favorite fighting techniques. Lethal responses to wrist holds, punches, chokes, rear attacks, bear hugs, knives and clubs.

Vol. I 5 1/2 x 8 1/2, softcover, 92 pp., photos **\$8.00**
Vol II 5 1/2 x 8 1/2, softcover, 88 pp., photos **\$8.00**
Vol III 5 1/2 x 8 1/2, softcover, 140 pp., photos **\$10.00**
The Set (3 volumes) **\$26.00**



THE COMPLETE BOOK OF KARATE WEAPONS

by Dr. Ted Gambordella, 4th Dan
Defend yourself! And learn how to do it right with the only comprehensive book on karate weapons ever published! Shows the proper usage and katas for seven lethal karate weapons, including nunchuka, yawara sticks, sai, fighting knife, tonfa, staff, and bo. 8 1/2 x 11, hardcover, 870 action photos, 256 pp. **\$24.95**



DON'T BECOME THE VICTIM

by Marcus Wayne Ratledge
Jimmy Carter once called this book's author "the most dangerous criminal in the history of Georgia." Read Ratledge's inside story! Specific, down-to-earth details on how to avoid becoming the victim of muggers, burglars, con artists, car thieves, rapists, etc. a gutsy, real-life guide by a reformed criminal and a gifted writer. 5 1/2 x 8 1/2, softcover, 120 pp. **\$6.00**



LIFE AFTER DOOMSDAY

by Dr. Bruce Clayton
Who will survive the nuclear war that many experts predict is coming? *Life After Doomsday* tells you how to survive such a radioactive nightmare. Includes eye-opening information about shelters, food storage, home medical techniques, survival psychology, and shelter defense. 8 1/2 x 11, hardcover, charts, drawings, photos, 180 pp. **\$19.95**



GET EVEN: The Complete Book Of Dirty Tricks

An hilarious overview of the methods people use to get even with big business, government, and plain old enemies. More sophisticated and involved tricks are included, as devised by CIA and Mafia members, and political dirty tricksters. Presents over 80 separate topics. 5 1/2 x 8 1/2, 180 pp., hardcover. **\$9.95**

HOME WORKSHOP SILENCERS I

Fantastic, large format guide to making an smg or pistol silencer in the home workshop. Over 50 9" x 12" working machinist drawings are presented, all of superb quality. Shows step-by-step construction for three different firearms silencers, all of very advanced design. Improvised materials and machining techniques are suggested, and the text is written clearly and concisely. An excellent addition to your silencer bookshelf! Note: *Home Workshop Silencers I* is for entertainment and historical purposes only. 9 x 12, softcover, illus., 80 pp. **\$12.00**



GET EVEN 2

by George Hayduke
Outrageous sequel to Hayduke's underground best seller. This second volume—*More Dirty Tricks from the Master of Revenge*—offers an all-new selection of mind-boggling tactics people use to *Get Even* with asinine enemies, big business bums, footloose lovers—rippers of all types. For entertainment purposes only! 5 1/2 x 8 1/2, illustrated, hardcover, 170 pp. **\$9.95**



THE GREAT SURVIVAL RESOURCE BOOK

Compiled by Paladin Press
The most complete resource book ever published for the modern survivalist! Includes concise reviews and bibliographies of the most important survival literature, listings of practical equipment suppliers, PLUS state-of-the-art articles by America's best survival writers. 8 1/2 X 11, hardcover, illus., 240 pp. **\$19.95**



THE REVENGE BOOK

by Bob Smith
Over the phone lines and through the mails, in the hands of messengers and on the backs of vermin. *The Revenge Book* tells you how to strike out anonymously at those vexing jerks who make life miserable for you. Revenge artist Bob Smith guarantees you'll engage your victim's spouse, shock his neighbors, and business associates—turn the world against him. 5 1/2 x 8 1/2, softcover, cartoons. **\$6.00**

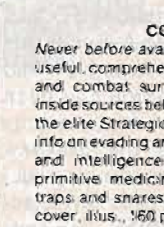

COMBAT SURVIVAL

Never before available to the public. An extremely useful, comprehensive training manual on physical and combat survival, training, and tactics. Our inside sources believe this manual is used to instruct the elite Strategic Air Service (SAS). Contains rare info on evading and silencing guard dogs, sabotage and intelligence gathering, survival navigation, primitive medicine, evasion and escape, animal traps and snares, and much more. 8 1/2 x 11, softcover, illus., 160 pp. **\$12.95**



SURVIVAL POACHING

Tells the survivalist how to collect wild game under any circumstances, using Indian secrets. Shows specific poaching methods for deer, elk, bear, moose, beaver, mink, muskrat, trout, salmon, grouse, pheasant, ducks, and dozens more. Includes detailed plans for many traps, snares, deadfalls, etc. Truly a fascinating and useful selection. 5 1/2 x 8 1/2, 190 pp., hardcover, illus. **\$12.95**

OTHER FASCINATING TITLES:

Automatic & Concealable Firearms I.....	\$12.00	Principles of Personal Defense.....	\$4.00
Automatic & Concealable Firearms II.....	\$12.00	Get Tough.....	\$12.95
Slash and Thrust.....	\$6.00	Special Forces Operational Techniques.....	\$12.95
How To Kill I.....	\$6.00	Special Forces Handbook.....	\$8.00
How To Kill II.....	\$6.00	War Story.....	\$14.95
How To Kill III.....	\$6.00	Home Workshop Guns I: The Submachine Gun.....	\$8.00
How To Kill IV.....	\$6.00	Home Workshop Guns II: The Handgun.....	\$8.00
How To Kill V.....	\$6.00		

(No Volume in the How To Kill Series available in Canada)

Call Toll Free for credit card orders:

1-800-824-7888

In California 1-800-852-7777, Alaska, Hawaii 1-800-824-7919

Ask for Operator #249

DEALER INQUIRIES INVITED

PALADIN PRESS
PO Box 1307-AH6
Boulder, CO. 80308

Please send me the following titles:

Send \$1.00 for latest CATALOG! Catalog free with any order.

Bill my: VISA/Bank Americard Mastercard Card No. _____
 Phone (303) 443-7250 Exp. Date _____
 Please include \$2.00 for postage and handling.

NAME _____
 ADDRESS _____
 CITY _____ STATE _____ ZIP _____

R N

the competitive advantage

THERE ARE 105 WAYS TO BECOME THE WORLD'S BEST PRECISION HANDLOADER

...with the components that set the standards for the world. Components from Dynamit Nobel. Components that expert shooters the world over rely upon. The components that many of the top benchresters swear by. 105 of the finest, most reliable, precision components from the company that back in 1926 revolutionized shooting with their invention of the famous RWS SINOXID non-corrosive primers. The company that makes the reputable Rottweil Brenneke shotgun slugs, the original Brenneke RWS TIG and RWS TUG bullets, specially heat-treated RWS center fire rifle cartridge cases - and scores of other great, top quality products for the serious handloader who demands that competitive advantage!

- RWS SINOXID BOXER PRIMERS
- RWS SINOXID BERDAN PRIMERS
- RWS CENTER FIRE RIFLE CASES
- RWS CENTER FIRE RIFLE BULLETS
- GECO PISTOL AND REVOLVER CASES
- GECO PISTOL AND REVOLVER BULLETS
- ROTTWEIL BRENNKE SLUGS

If your dealer doesn't stock the complete line of RWS, GECO and ROTTWEIL precision handloading components, write or call us today... 201-767-1660.



Dynamit Nobel



Dynamit Nobel of America Inc.
105 Stonehurst Court
Northvale, N.J. 07647

INDUSTRY INSIDER

JERRY RAKUSAN

NEW ANTI-GUN PRESSURES COMING DUE TO INTENSE MEDIA COVERAGE

Here's a scenario that is popping up more and more. A gun designer wants to produce his dream gun, but bumps into the realities of getting cash to start up. "Eureka," he exclaims as he decides that the fastest way to raise money would be to put out a limited edition series of guns, charge a good buck for them—as collector items—and thus finance his tooling, etc.

Looking back we find the High Standard Crusader; still not into production, but delivering commemorative models at mucho bucks. Wildey has a special edition of his auto pistol in the works, engraved, cased, and with all the trimmings.

What next? The Coonan .357 auto? The Bren Ten? The Sokolovski .45? Whatever happens, hope that it does not become a trend.

Handgun industry quote of the month: An Associated Press reporter asked Colt Firearms Division President C. E. Warner how people he meets socially, react when they learn he makes guns for a living. Ed replied, "Usually you'll find a group at a party divided into those who love it and tell you about guns, and those who hate it and ask you questions."

We understand, Ed. Sometimes the whole world seems like that.

COLT SA ARMY GONZO

Meanwhile, back at the Colt plant, the model P is gonzo. That's right, the Peacemaker, the venerable Single Action Army of 1873, will cease production in 1981, and this time for good. Production had been trickling down up until the first, wartime discontinuance in 1941, but the fast-draw craze of the Fifties, and the stunning success of the Colt-pattern Ruger single actions, revived the gun in 1955. The cancellation includes the classy, adjustable-sight New Frontier model.

The factory cites general economic reasons as the cause of the decision. Prices on the beautifully made single actions, with their case hardened frames and nice blue jobs, were soaring. Today's handgun market accepts high prices more readily than ever before... but only for high performance hardware. The SAA wasn't doing anything performance-wise that it hadn't been doing for a hundred and eight years.

This is not to say that the Single Action Army might not be reborn yet again some time in the future, but it won't be the same gun you knew. Word from the factory is

that a new single action would have re-designed lockwork to allow safe hammer-down carry on the sixth round, à la the Ruger New Model. Though Colt never got burned as badly in civil liability suits as Ruger, there were too many turkeys for comfort out there, who didn't know enough to keep an empty chamber under the Peacemaker's hammer.

ELECTROLESS NICKEL

Another Colt newie is an electroless nickel finish on the J-frame guns (Mark III revolvers), as a production option. This finish is also available on Pythons and O-frame autoloaders, but only through Colt's Custom Shop.

The new finish will make the Mark III Trooper and its sister guns more desirable than ever. Colt doesn't make a stainless gun, but this finish (on all metal surfaces, including the mechanism) is felt by some firearms metallurgists to be superior to stainless alloys in terms of hardness and durability, while offering essentially the same corrosion resistance, and easier machining for lower cost. An added advantage is that while stainless parts sometimes have a tendency to gall, electroless nickel's smoothness makes for almost an action job in itself. Those who've tried the shiny new MK III say the action is far slicker than before. This should boost sales; while the MK III has long been accepted as rugged and durable, in terms of both staying in time and handling heavy loads, a smooth action was never its strong point.

PYTHON SILHOUETTE

In the Python line, we have another new snake in the family: the Python Silhouette should make its debut about the time you read this. Tailored expressly for the metal animal game, this long-nosed .357 will come in a fitted Halliburton accessory case like the well-received Python Hunter of last year. Price will be about the same: just under \$1,000.

The Connecticut gunmaker is also looking at the new 75-pound Firepower magazine, a drum similar to that for the Soviet AKM machinegun, which can theoretically give each GI equipped with an M-16 an equivalent level of firepower to a Squad Automatic Weapon for a short duration. Though Masters and Johnson say "It isn't the size of your wand that counts, it's how much magic you've got," any M-16

(Continued on page 55)

The Incredible Dan Wesson .44

the mighty .44 magnum with POWER CONTROL™

- the ONLY .44 with **POWER CONTROL™** to reduce muzzle flip — **STANDARD ON EVERY GUN . . . PATENTED**
- the ONLY .44 with the strength of a one-piece frame combined with the ease of repair of a side-plate gun . . . **PATENTED**
- the ONLY .44 with a unique gain bolt, designed for maximum strength and minimum bulk . . . **PATENTED**
- the ONLY .44 with interchangeable barrel assemblies, grips and colored front sight blades . . . **PATENTED**

**Five Year Limited Warranty
on every revolver**

Here's a .44 unlike anything you shooters have ever seen: a revolver so incredible it needed a number of brand new patents! One of these patents covers **POWER CONTROL™** — a new gun-leveling device that is a standard factory production feature built right into the barrel assembly to control muzzle flip.

Shooters will also appreciate the unique trigger guard assembly that you can remove easily from the one-piece frame — **PLUS** the action is **FULLY OPERABLE OUTSIDE THE GUN** offering the ease of repair until now only found in a sideplate gun.

We've gone to a one-piece frame to create a .44 of incredible strength. And the combination of this remarkable frame and the removable trigger guard assembly means we have support for the trigger and hammer pivots **ON BOTH SIDES!**

When you buy a Dan Wesson .44 magnum you get a revolver with all

of the outstanding features that make Dan Wesson revolvers **THE MOST ACCURATE, THE MOST VERSATILE, THE MOST DEPENDABLE** double-action revolvers on the market today . . . **BAR NONE!** And each boasts the superb craftsmanship and quality that shooters have come to expect from Dan Wesson, plus brilliantly designed new features that are sure to make this a shooter's dream.

Dan Wesson revolvers are produced under the most exacting conditions using strict quality control. Each boasts a built-in "fail-safe" device that prevents firing if dropped. And each is inspected and test-fired before leaving the factory.

Shown below:

Model Series 44VH with 8", 6", 4" and 10" interchangeable, ventilated rib, heavy barrel assemblies. (Note: Only 6" and 8" guns are shipped from the factory. 4" and 10" barrel assemblies are available separately.)

Interchangeable colored front sight blades

Built-in factory
POWER CONTROL™

Interchangeable
barrel assemblies

Rear sight with
white outline

One-piece frame

Interchangeable
grips

Front cylinder latch

Removable trigger-
guard assembly

" . . . the most accurate .44
ever! . . . tames recoil and muzzle
flip . . . you'll be amazed!"

nationally-known firearms expert



Dan Wesson Arms, Inc.

293j Main Street, Monson, MA 01057 (415) 267-4081

SILUETAS

PHILIP C. BRIGGS

NRA SILHOUETTE COMPETITION CATERS TO AVERAGE SHOOTERS

It's been almost six years now since the first national championship long range handgun silhouette match, and nearly five since the birth of the sport's first national sanctioning body, the IHMSA. That group has done a lot to promote the new sport, has a rapidly growing membership, sanctions matches in all 50 states, and seems to get most of the media coverage. But there's a far larger national sanctioning body, that has the potential to involve even more shooters, that has done a tremendous amount of good for the nation's gun owners, and has been sanctioning silhouette matches for eight years now—the NRA.

HUNTERS PISTOL

In 1973 the NRA was encouraged to sponsor the first national championship rifle silhouette match by members of the Tucson Rifle Club, one of the first US clubs to shoot the popular Mexican sport. This same club hosted the first national championship long range handgun silhouette match in 1975, and in 1976 at the second championships, shooters in attendance organized IHMSA, and adopted the first set of formal rules. The leadership of NRA watched the growth of the new version of the sport with interest, and in 1977 moved to bring all forms of silhouette competition—rifle, pistol, and airgun—into the fold. The NRA silhouette committee, holding their first meeting in Washington, D.C. that fall, began the work necessary to include both the long range handgun game, as formalized by IHMSA, and a new, short range variant developed by a club here in Phoenix that has become known as Hunters Pistol.

STOCK-AS-A-STOVE

From the start, the NRA silhouette committee was interested in promoting the sport, and encouraging participation from shooters that weren't involved, or interested in their other sanctioned forms of handgun competition. The rules were written to facilitate competition by the average shooter, equipped with an out-of-the-box, stock-as-a-stove pistol and to allow shooters to compete in both IHMSA and NRA matches with the same pistols under similar rules, and in equivalent classifications. There has been some departure from those early, closely related rules by both organizations, but the opportunity for a shooter to compete with similar equipment in ei-

ther groups matches remains and they both offer regional as well as national championships in all their sanctioned versions of the sport to allow local shooters the chance to compete against the best.

The NRA's second national championship was held in the fall of 1980 near Reno, Nevada at the Washoe County shooting range on a new eight-bank range built just for the occasion. Although not the biggest handgun silhouette match ever held, with only 187 entries, it was certainly the most



Wichita pistol used by some shooters is a superb out-of-the box performer.

ambitious ever, consisting of 120 targets fired over two days, 60 at a setting.

The range sits 20 miles out from Reno, in the sparse high desert that surrounds the city, against a back drop of craggy mountains; the desert soils at the site provides excellent target contrast, and the range lends itself to shooting high scores.

Although promotion was low key, no doubt accounting for the low and principally regional turn out, some of the top national shooters did compete. The AAA unlimited class for example, included four IHMSA national unlimited champions—Skip Talbot (1977), Stan Hannigan (1978), Dave Tobin (1979) and Jim Jonasen (1980). Many of the entrants were IHMSA shooters, and the sponsoring club, the Reno Silhouette Association successfully prevailed on the NRA representatives to honor IHMSA classifications for shooters that hadn't established NRA classifications. Skip Talbot observed that this event had some of the best shooters in a match he'd shot in—and that they proceeded to shoot over their heads.

Scores were starting high in the top unlimited, conventional (production) and modified conventional classes, with seven 120's shot in AAA unlimited, one in AA unlimited, a 120 and a 119 in conventional
(Continued on page 77)



Hercules.

Specialists in smokeless powders for the Reloader.

Hercules. The leader in reloading powders for more than sixty years.

Red Dot[®] Bullseye[®] Herco[®]
Green Dot[®] Unique[®] Reloder 7[®]
Blue Dot[®] Hercules 2400[®]

Each is special, and each delivers high energy, fast, clean burn, shot-to-shot consistency, and economy. Anticorrosive, too, for gun protection.

You do a special job when you reload. Be sure your powder comes from the specialist. And be sure to pick up a Hercules Reloaders' Guide FREE at your dealer's.

Hercules Incorporated, Marketing Division, Wilmington, DE 19899.

XS 81-1



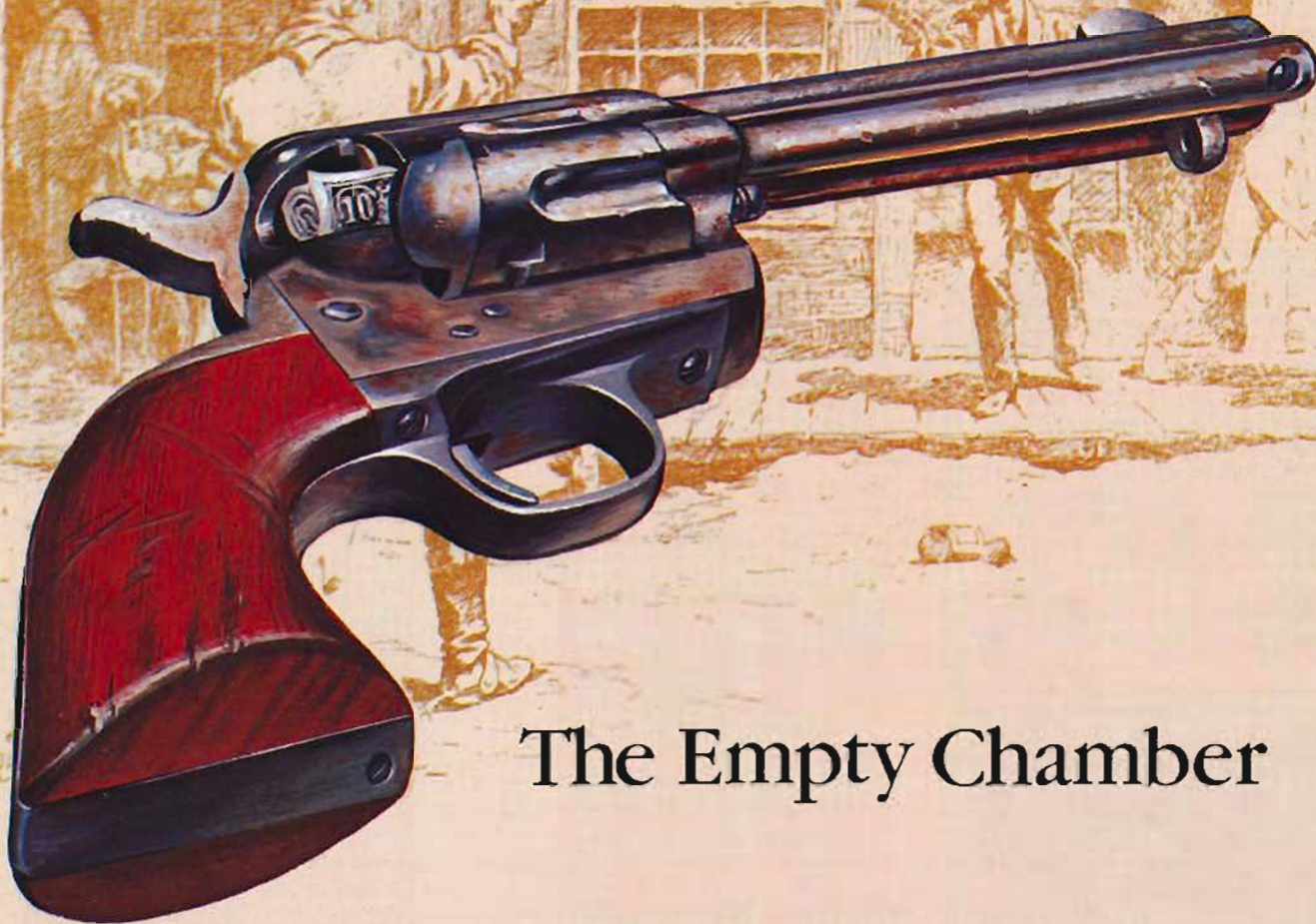

The Empty Chamber

From the earliest frontier days of the old west, the mechanical characteristics and limitations of the single-action revolver have been well understood, as the writings of the day amply demonstrate. The safety precaution of loading the "six-shooter" with only five cartridges and resting the hammer on the empty chamber was universally practiced. According to folklore, some cowboys habitually carried "burying money" or their last bank note rolled up in the empty chamber. These old-timers understood that the notches in the hammer provided only limited protection, and that an accidental discharge could result if a fully loaded revolver were to be dropped, or if the hammer were to receive a sharp blow.

Despite the lessons of history, there are still

people who get themselves in trouble by ignoring the following common sense rules of gun handling:

1. The shooter should thoroughly understand the mechanical characteristics and rules for handling the particular type of firearm he is using.
2. The safest way to carry any old style single-action revolver is with five chambers loaded and the hammer resting on the empty chamber.

"The Ruger "New Model" single-action revolvers are not subject to this limitation and can be carried safely with all six chambers loaded. Some other manufacturers have added various manual safety devices to old style single-action revolvers, but no manual safety can ensure against accidents if the shooter fails to use it properly. Remember: There is no such thing as a foolproof gun!"

© 1980 by Sturm, Ruger & Company, Inc.



FREE CARTRIDGES AND INSTRUCTION MANUALS WHICH CONTAIN APPROPRIATE WARNINGS AND ADVICE FOR THE USE OF ALL MODELS OF RUGER FIREARMS ARE AVAILABLE FROM THE FACTORY ON REQUEST

STURM, RUGER & Company, Inc.
2 Lacey Place
Southport, Connecticut 06490 U.S.A.

ALL RUGER FIREARMS ARE DESIGNED AND MANUFACTURED IN RUGER FACTORIES IN THE UNITED STATES OF AMERICA

COMBAT SHOOTERS

now have a low cost way to practice with the Beeman/Webley Tempest air pistol.

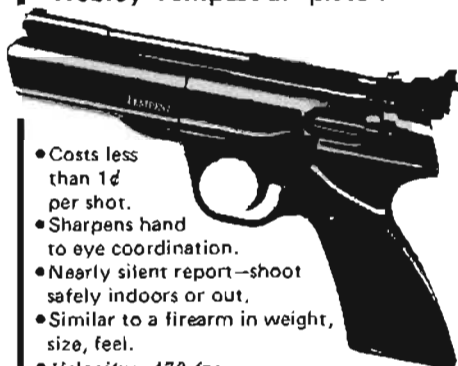

- Costs less than 1¢ per shot.
- Sharpens hand to eye coordination.
- Nearly silent report—shoot safely indoors or out.
- Similar to a firearm in weight, size, feel.
- Velocity: 470 fps.
- 10 Meter Accuracy: .95" c-t-c.
- Adjustable sights and trigger pull.
- No Pumping, No CO2, No valves.

Sugg. Retail \$89.95. If no local Beeman dealer is near you, order from our 92-pg Adult Airgun Catalog/Guide \$1.50 (FREE with mention of code HG7Y. Add \$1 for fast first class mailing).

BEEMAN 47-HG7Y Paul
San Rafael, California 94903
Phone: (415) 472-7121



"FOR SALE" EXPERTS



IS YOUR LIFE SAFE?

Some of their trophies

Now you can join the champions, Mickey Fowler and Mike Dalton, in the latest, most improved techniques in the arts of self defense, competition, or just those who must carry a pistol daily. Classes are now forming with the personal supervision of Mickey and Mike at their new facility in So Cal. These international experts will teach you to fire fast controlled shots, with the mental conditioning to attain pin-point accuracy and fulfill your personal goals!

Send \$1.00 Postage and Handling For Full Descriptive Brochure To: International Shootists Inc. P.O. Box 5254, Mission Hills, CA 91345



INTERNATIONAL SHOOTISTS INC.

COMBAT COURSE

JERRY USHER

H&K P9S .45ACP PRACTICAL TEST PROVES RELIABILITY & ACCURACY

There are dozens, perhaps hundreds of shooters in the USA that have the basic skill required to develop into potential USA Practical Pistol Team Members. A young man or woman with the skill and interest seldom has the time, money, and circumstances to develop into a great competitive shot. This is especially true of working police officers and security officers. Recent "cross discipline" matches have proven that the top level PPC shooters are equal to and in many cases better precision shooters than the top IPSC competitors.

Practical Pistol shooting has become synonymous with the .45 ACP. The reasons this has occurred are many and varied. One major reason is that the Colt 1911 and its many variations is in fact a superb defense firearm. The second major reason is that the matches and rules in most Practical Pistol competitions have been designed by persons that believe in the .45 and have stacked the deck in favor of the big bore semi-auto, often at the expense of the practical aspect. The reasons many of us believe in a big bore defensive gun are sound, but the fact remains that to be competitive in practical pistol matches one



The "backward" safety on H&K's P9S is feature that takes getting used to.

must use a big bore semi-auto. This, of course, eliminates the majority of police and security officers from a very valuable form of competition and deprives the U.S. Practical Pistol team of some very fine shooters.

Practical Pistol shooting will never develop its potential until more people who carry a gun for a living are attracted to the sport. At this time police officers can receive support and recognition through their departments only by competing in PPC matches. While this may be of questionable practical value, it is a lot better than no competition at all. Actually, one of the major weaknesses of PPC is now developing to be a problem in Practical Pistol matches as well. This problem is the "special" guns that have developed. Special guns detract from the practical aspect of most shooting sports. I am glad to have discovered a gun that may help bridge the gap between duty and match use.

Until 1975 I had competed in PPC matches for the enjoyment of competition. For its training value, however, I taught and participated in several practical shooting activities the best of which were in the San Diego area. We used our service revolvers and did very well. After reading about Ray Chapman winning the World Practical Pistol Championship in 1975, I developed "Big Frog in Little Pond Itis." I decided to switch to a semi-auto, which was possible in our police department, and make a try at SWPL and IPSC competition. Several thousand dollars worth of guns later and some success, I found myself eliminated from contention at the 1979 "Second Chance" match by multiple jams. In that frame of mind I was very receptive

(Continued on page 86)



HECKLER & KOCH P9S .45

Caliber:	.45 ACP
Action:	DA semi-auto
Magazine:	7 rounds
Barrel:	4" polygonal rifling
L.O.A.:	7-9/16"
Weight:	32 ounces
Sights:	Combat fixed, or target adjustable
Stocks:	Checkered black plastic, or walnut
Finish:	Non-glare black
Price:	\$590 combat \$662 target

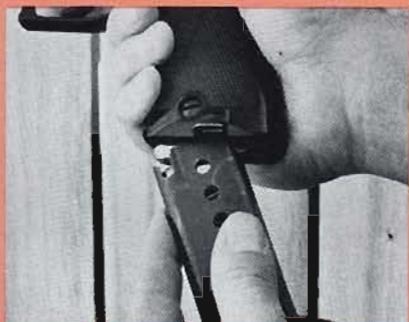
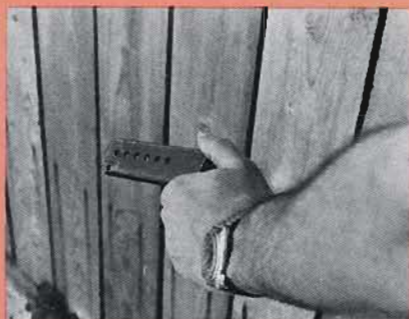
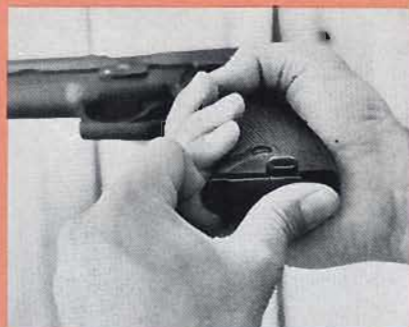
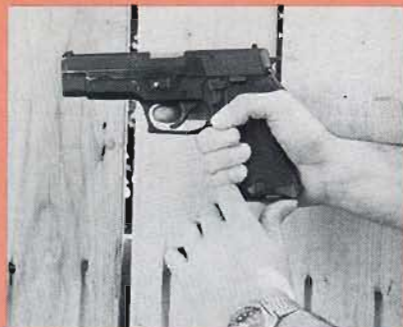

Butt magazine release seems awkward, but gets easier with practice. Sequence shows steps involved in release technique as outlined below.

After learning the technique butt release is not so slow

By Seth Nadel

The method suggested by Jerry Usher for speed reloads with the butt magazine release on some semi-autos is easy to do, but hard to write down.

Start from a two hand hold, with the left index finger under the trigger guard. To reload, bring the left hand down, putting the left thumb on the floorplate of the magazine. Rotating the hand up, push the butt release with your thumb while hooking the index finger around the front lip of the floorplate. Pull the magazine out and down in your left hand and drop it as you reach for the reload magazine. Reload as with a Browning button type pistol.

The important thing is to practice until you always draw the magazine

out. When you blow it, you end up with a mag stuck halfway out of the well. One other problem is the tendency of the magazine to hit the ground with the lips, with the possibility of damage. It never bothered the mags on the BDA I tested, but you may want to drop the magazine against your leg to reduce such damage.

This system works, and works well with some practice. After working with the BDA for two weeks fairly steady, I could manage reloads only one-half second slower than with my familiar Gov't Model. And I have seen Jerry do it faster than that. Work with your gun, indoors, unloaded, over some padding. Then you can show your pals that a butt release is not all that bad.

Attention!

COMBAT SHOOTERS

Now you can purchase the accessories you need in one convenient place. We offer:

Kings Extended Safeties	18.50
Ambidextrous Safeties	34.50
Extended Slide Release	19.50
Recoil Buffers	9.95
Wilson Shok-Buff	5.50
Ext. Mag Release	15.00
Micro Sights (melted & Blued)	34.00
King-Tappan Sights	29.00
MMC-Bar Cross Sights	26.50
Mellett Fixed Sight	26.00
Beavertail Grip Safeties	16.00
Long Match Trigger (with backlash adj.)	10.45
Wolff 18½ Spr. Kit	4.50
MK IV Recoil Spring	1.50
Magazines (Colt) Blue	14.00
Laka SS Mags	15.00
Mag Pads	1.00
Pachmayr Grips (combat)	18.50
Pachmayr Mainspring Housings (flat)	10.50
Colt Commander Hammers	14.00
MK IV Barrel and Bushing	44.50
Dwyer Group Gripper Gov't Com	22.95
	27.95
Banchi Chapman Hi-Ride Holsters	35.95
IPSC Hat Pins	7.50

We have considerable experience in performing IPSC style modifications. We are here to stay, and we take pride in doing first class work at reasonable prices - inquire at the address below for particulars.

We are pleased to be associated with Colts Ptd. Firearms Co. as an authorized Warranty Repair Station, and we carry a wide variety of Colt Parts.

We offer a complete money back guarantee -- if you are not 100% satisfied, your money will be cheerfully refunded.

Forward correct remittance in cash, check or M.O. along with 10% or \$2.50 postage to:

SHOOTIST SUPPLY

622 5th

Belle Fourche, SD 57717

C.O.D.'s Welcome

or call your Visa and Mastercharge orders to
(605) 892-2822

HANDGUNNER

The AMERICAN HANDGUNNER magazine is written for the competitor, sportsman, collector, hunter, combat shooter and lawman. If you're one of these or just enjoy fine handguns, you can share in the knowledge and experiences of men like Massad Ayoob, Mason Williams, J.D. Jones and James Mason. They're men who really know handguns and who excel in writing about them in The AMERICAN HANDGUNNER magazine.

If you're a man who wants to gain a thorough knowledge of handguns and their uses or about reloading and pistolsmithing, and to keep up with the latest action concerning handguns today, it's time to subscribe to The AMERICAN HANDGUNNER.

THE AMERICAN HANDGUNNER IS THE ONLY MAGAZINE DEVOTED 100% TO HANDGUNS. PUBLISHED BI-MONTHLY.

Save yourself a trip to the newsstand and never miss a single issue by subscribing now – and save.

BONUS! Subscribe now and receive your heavy-duty, all fabric AMERICAN HANDGUNNER 1st PATCH . . . FREE!

For a subscription to The AMERICAN HANDGUNNER, use the enclosed postage paid card or send your check or money order in the amount of \$9.95 for one year, or \$17.95 for a two year period to The AMERICAN HANDGUNNER, Dept. 32, 591 Camino de la Reina, San Diego, CA 92108.

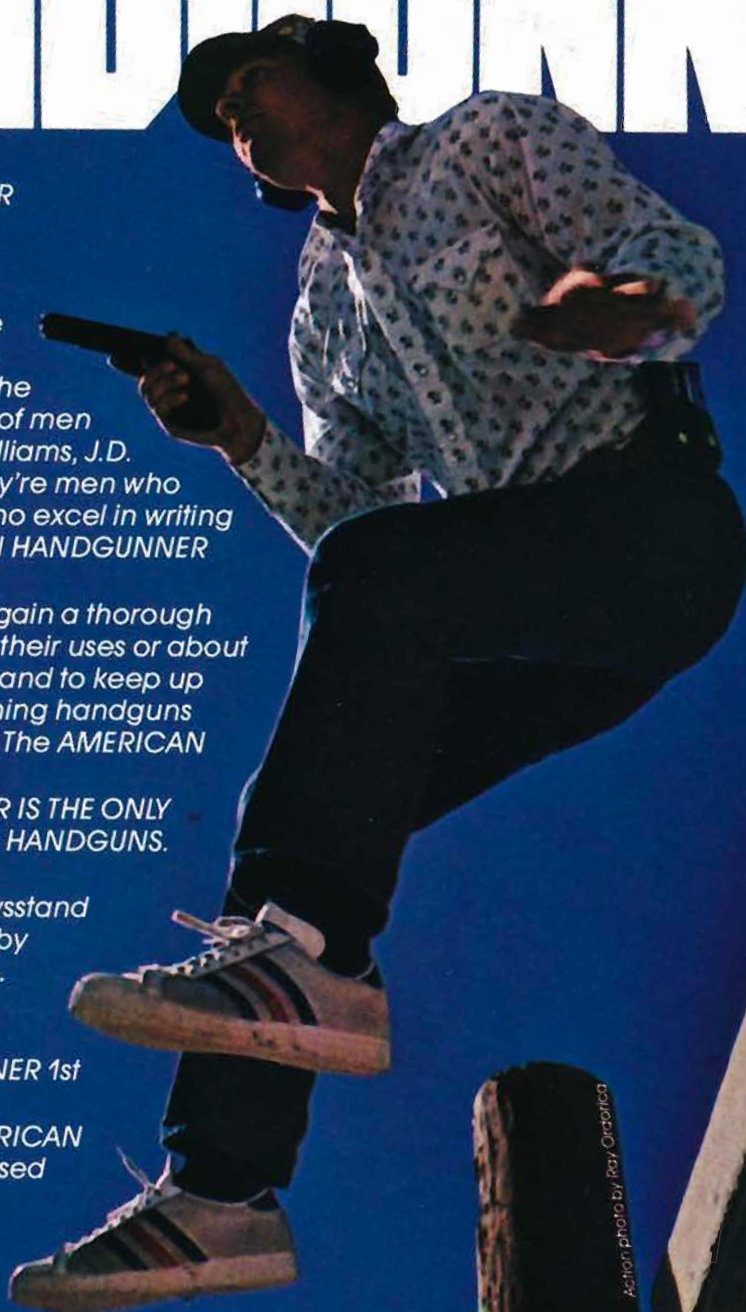

Action photo by Ray Ordofica

THERE'S MORE TO A MOSSBERG

When you go to pick a firearm for hunting or target shooting, consider what makes Mossberg all you'll ever need . . . and more. Our shotguns and rimfire rifles have been known for quality, accuracy and performance for more than 60 years. The new single-action Abilene* handguns are getting the same reputation. Compared with competitive products, it's plain to see why more shooters buy a Mossberg — they simply get more gun for the money.

MORE...

Variety

Features

Performance

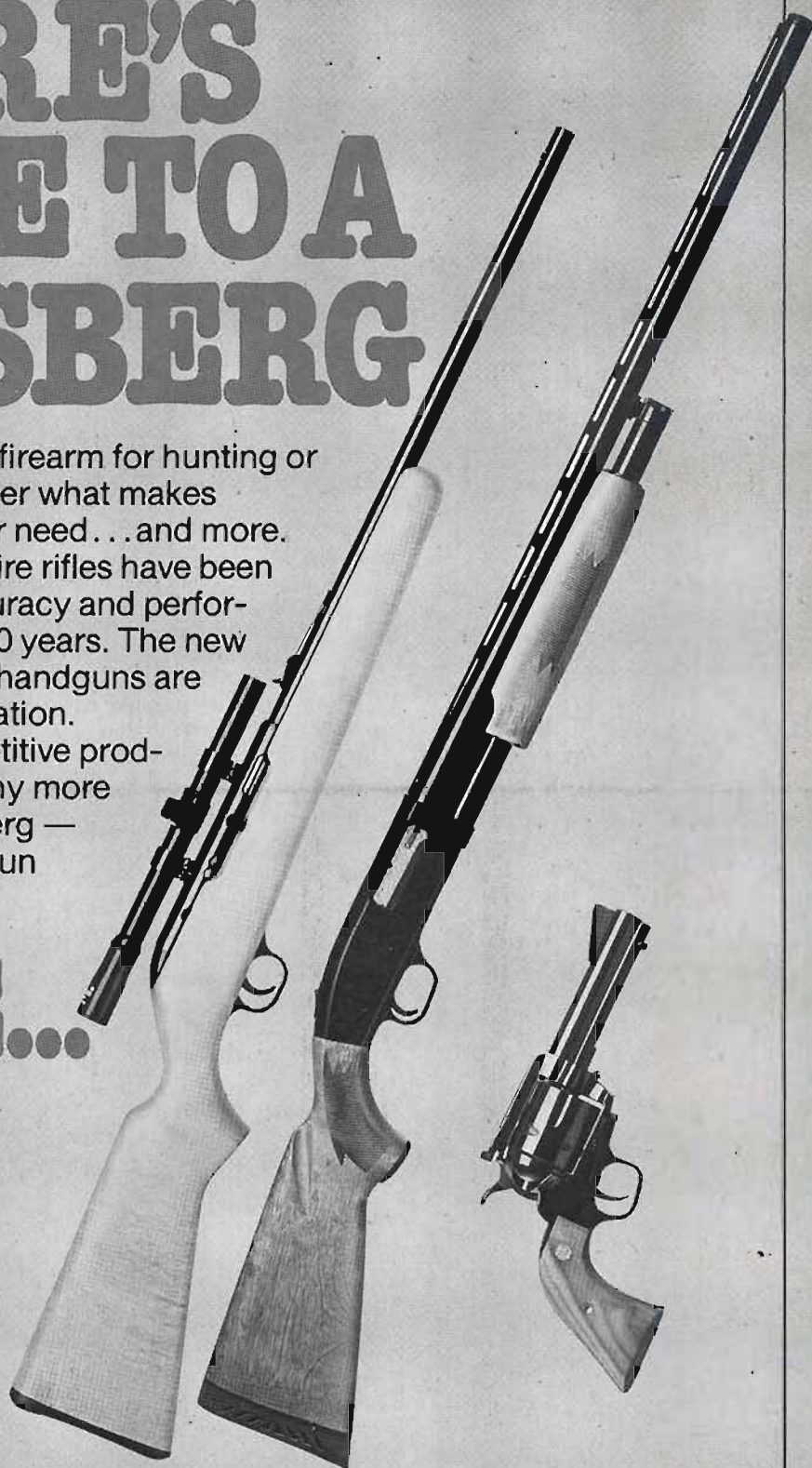

O. F. MOSSBERG & SONS, INC.

Dept. AH-7
7 Grasso Ave.
North Haven, CT 06473

*Write for a free
copy of our
complete 1981 catalog;
or, include \$1.00
for catalog and patch.*

*All Abilene handguns are marketed and manufactured under an exclusive arrangement with the U.S. Arms Div. of A.I.G., Inc.

MILLETT

Series 100 Adjustable Sight System
The Finest Pistol Sights In The World

This sight system replaces the factory sights with an all steel, highly finished, better fitting unit, which has finer click adjustments for windage and elevation. **NO GUNSMITHING REQUIRED** on rear sight installation.



Colt Combo 56.95
Browning Combo 56.95
Rear only 44.95

Series 100 1911 Colt 45 Combo Series 100 Browning Hi-Power



S & W K or N Frame 39.95
(Specify model & barrel length)

Series 100 Smith & Wesson K & N Series



Gold Cup Combo \$1.95
Colt Revolver 39.95

Series 100 Colt Gold Cup Combo Series 100 Colt Revolver



Ruger 39.95
Dan Wesson 39.95

Series 100 Ruger Revolver Series 100 Dan Wesson Revolver

Gun Smith's Service Kit
Series 100 Sight System 99.95

Interchangeable Sight Pictures

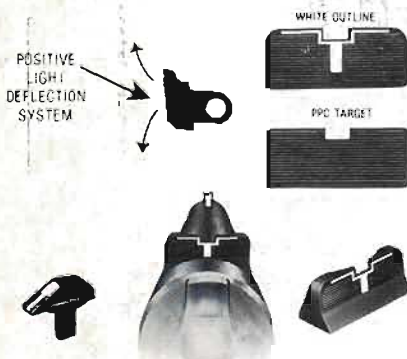

POSITIVE LIGHT DEFLECTION SYSTEM



Mark I Fixed Sight

This all steel precision made sight fits Colt 1911 Autos and the Browning P-35 hi-power fixed sight version. (Browning requires minor dovetail modifications. Mark I Combo 27.95)

SEE YOUR LOCAL DEALER

If there is no dealer in your area, please send Cashier's Check or Money Order plus sales tax (CA residents) and \$2 for shipping.

MILLETT INDUSTRIES

16131 GOTHARD ST., HUNTINGTON BEACH, CA 92647
Dept. AH-7 (714) 842-5575

SIGHT SETTINGS

LUCY CHAMBLISS

THE SECURITY GUARD BUSINESS: BOOMING BUT LACKING TRAINING

Private security guards at an installation in Florida last year went on strike for a raise, and they got one—to \$11.50 an hour. Some police officers who have demeaned security guards with such terms as "Door-shakers," may not be making \$11.50 an hour. A career as a security guard looks brighter now, with constantly improving pay, conditions and job stability. The private guard companies are hiring young well-educated, trained officers who are no longer "needed" by state, county, and municipal agencies.

The upgrading of the police profession in the last 10 years has resulted in lower crime rates, so now some thinking has been to save dollars by cutting the police budgets first. Layoffs, both actual and rumored, make job security the prime concern of many officers who cannot survive on whims of whether governing bodies will at best keep them on without even a cost of living raise, or at worse, fire them.

NO MORE GRANTS

Government grants and funds are shrinking or gone, so who has the money? The private sector, which is able to charge, within competitive bid bounds, what it takes to get and keep trained personnel. The time is coming for private guards for businesses and individuals who can afford them. Police departments which took years to build are being cut in half over night. The very thin Blue Line left in governmental agencies will have to take care of those not able to hire protection.

Large and small companies bid on the government installation contracts for guards. Old-fashioned me, thought the federal agencies such as Secret Service, or NASA, guarded their own properties. Not true, some if not all, obtain their security from competitive bidding among private companies.

Some states have unarmed and armed classifications for guards, though I think the unarmed designation must be disappearing. That position always seemed to me as useless as a handgun without a barrel. The firearms training required for security guards is inadequate in almost everyone's opinion, partially due to the unavailability of instructors. Police firearms instructors allowed and willing to teach for private companies on a "moonlight" basis are scarce. Usually on today's legal requirements there is not enough work for full time employment. Also, lia-

bility insurance for instructors, if they must provide it themselves, is almost prohibitive in cost. Insurance has to be provided by the company you teach for, but if you are forced to buy it, you simply have to and include the cost in your teaching fees. I would not be without such coverage until the courts stop giving judgments for such far reaching liability.

REFRESHER NEEDED

Basic and regular refresher qualification shooting is bound to be required by law as the private guards become more numerous, or company owners are influenced by firearms oriented personnel who know the value of such training. Police went through years of inadequate training until court decisions convinced agency heads that a trained officer was cheaper than a lawsuit awarding thousands of dollars for proved negligence, lack of training, etc. In the private company, you have even a more competitive public relations image to deal with. You are merchandising an unattractive product if your guards frequently kill or get killed.

ONLY 5 HOURS REQUIRED

In 1980, the Florida law concerning Watchman, Guard, or Patrol Agency licenses required only 5 hours classroom instruction—when to use a gun: 1 hour, legal limitations: 2 hours, and the rest divided between safety and maintenance of the handgun. Range qualification requires only 3 hours, the target can be the large Colt silhouette, or equal, and the weapon must be the same as used on duty. The first stage of the qualification course is the only real pressure stage, 12 rounds fired in 30 seconds from 7 yards. The rest of the 30 rounds are fired at 25 yards, some at the barricade with left and right hand, and choosing the sitting, standing, kneeling, or prone position for the last 6 rounds. All rounds after 7 yards may be fired single or double action. There is no mention of periodic requalification. This training, which is very typical of that required in any state, qualifies an armed guard to patrol. Before we ridicule this training, remember that 20 years ago not that much training was required of either a rookie or a veteran officer, in many states, including Florida. We have improved and so will the private guards.

For the three years I have been on the
(Continued on page 57)

357 MAGNUM

The Colt Trooper MKIII. A heavy duty, no nonsense 357 Magnum revolver. Built to function reliably under the most adverse conditions. Built to perform, when performance is critical.

The Colt Trooper MKIII is now available with 4", 6" or 8" barrel, in 357 Magnum, 38 Special, 22 Magnum and 22 LR. Features the deluxe Colt blue finish, strong coil mainspring and adjustable rear sight.

The fixed sight version, the Lawman MKIII, is also available with 2" and 4" barrels.

Rugged, large frame revolvers at a moderate price; backed by over 140 years of quality engineering and manufacturing experience.



COLT An Investment
in Precision



Important product and service literature accompany every Colt sale; be sure to ask for yours.

PATHFINDER .22's ARE INSTANT HITS!

Charter Pathfinder 6-shot double action .22 revolvers are popularly priced to give you more gun for the money. Great little .22's for target, home protection or hunting small game. There are 3 popular Pathfinder models—Each is made of aircraft quality chrome-moly steel with a swing-out 6-shot cylinder. .22LR in a 6" bbl. and 3" bbl. The 3" .22LR is also available in Stainless Steel.

Has wide partridge-type front sight & fully adjustable rear sight for windage and elevation. Wide trigger and hammer spur for better control and accuracy. Service blue finish with handsome walnut grips. See the whole Charter line at better gun dealers everywhere.



Write for FREE catalog
Send \$2 for handsome shooter's patch



CHARTER

Charter Arms Corporation
Fine American Handguns
430 Sniffens Lane, Dept. AH-7
Stratford, CT 06497
Made in U.S.A.

HANDGUN HUNTING

J. D. JONES

ELEPHANT DOWNED BY HAND CANNON WHILE HHI ORGANIZES BOAR HUNT

Last week while standing in brilliant sunshine at the bottom of a 50-60-foot-high bank in powdery snow a foot deep at about five below zero I looked up just in time to see two does run across the skyline brilliantly silhouetted against a beautiful dark blue sky. They ran through flying powdered snow and their coats glistened brilliantly. I can't remember a more beautiful sight. Those few seconds made years of hunting worthwhile. I hope you see something comparable to it sometime.

Deer season's over and via the Shot Show in New Orleans I'm heading for the

fall. (HHI, Box .357 Mag, Bloomingdale, OH 43910—\$15 annual dues)

This year has been a good one for hand-gunners. Larry Kelly (Mag-Na-Port) using a .375 JDJ SSK Hand Cannon had a fantastic year, killing two elephants and over 35 head of other assorted big game with the .375 JDJ. The cartridge is a full length .444 Marlin necked to .375 caliber. Larry's Hand Cannon is an SSK custom T/C.

SSK makes the barrels, scope bases and RCBS makes the dies. The .375 has a little brother, the .358 JDJ and two big brothers, the .411 and .430 JDJ cartridges. All are very powerful. Complete guns or barrels are available. The .375 is the most versatile. 44.0 grains of H-322 give a 270 grain Hornandy spire point 1900 fps, amazing accuracy and killing power. Larry's 300 grain Hornandy FMJ's completely penetrated both elephants' heads. (SSK Ind., Rt. 1, Della Drive, Bloomingdale, OH 43910 (614) 264-0176) Jerry Kraft bagged a gigantic moose in Alaska. Horn spread measured 68.5 inches, wet. Not bad for a pistol! Tom Shippy, again with a .375 JDJ dropped an antelope in excess of 200 yards as did Gary Geraud with a .30-40 Krag T/C. Delbert Roberts had a spectacular hunt on exotic sheep with a custom S&W .44 Mag.

Certainly not everyone was successful—including me. I went to Alaska for 25 days
(Continued on page 79)



T/C IN JDJ caliber will get varmints just as well as the largest of game.

Hall Brothers Wilderness Area, Route 4, Box 392, Savannah, Georgia 31405, to meet some friends and check out this 15,000 acre swamp with a bunkhouse, guides and dogs for a possible Handgun Hunters International boar hunt-blast this



One shot to the head bagged trophy for Larry Kelly who used .375 JDJ T/C. JDJ barrel for T/C is by SSK Industries and is Mag-Na-Ported by Kelly.

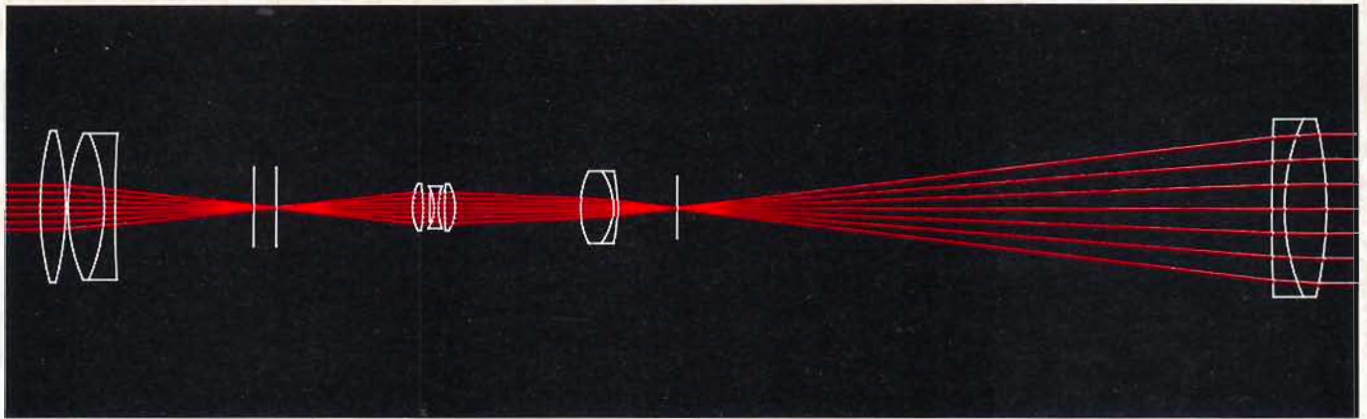

Making a high performance optical system is one thing. Making it last a lifetime is another.

Ask Leupold's chief optical engineer to single out the one quality that makes his scopes clearly superior to all others, and you get a very non-optical answer: "It's the way we make them hold together."

To prove his point, he'll take you down to the shooting tunnel beneath the Leupold plant, the only place with enough sound insulation to run the impact testing machine shown here. With several scopes firmly clamped in place, the machine slams these fine combinations of beautifully finished lenses and precise mechanical systems through worse torture than produced by the recoil of a .375 H & H magnum. Every new scope design must survive several thousand cycles in the prototype stage to assure that production models will stand up to the same kind of punishment in the field.

"The difference," he points out, "is whether the scope will function perfectly after such abuse, or if it will be a tube full of loose parts."

Making scopes that won't unravel here, or in the field where terrain, horses and heavy caliber rifles exact their toll, starts by manufacturing every component with a watchmaker's precision. Up to 11 separate lenses for each scope are computer designed, ground and



polished to a near-perfect surface with precisely the right curvature. Each lens is physically checked against a master to make sure its shape conforms exactly to specifications. Those which do not meet the optically-measured tolerances are not used in Leupold scopes.

Lenses, adjusting mechanisms and other components must be installed within the scope tube not only to be firmly anchored, but also perfectly aligned to create a flawless optical system.

The optical system diagram above, which was used to create the Leupold Vari-X III 3.5x10 scope, was actually drawn by an electronic plotter from the computer program that designed the system. Com-

puters are used by Leupold to achieve optimum design characteristics in each scope, including the desired magnification, the field of view and the eye relief... the distance from your eye to the metal rim of the eyepiece. This is where Leupold never scrimps, nor has the company ever allowed eye relief... and the shooter's safety... to be sacrificed in order to squeeze out more field of view.

The quality of the lenses and the design of the optical system combine to produce the optical excellence hunters expect from a Leupold scope. Take a few minutes looking through a Leupold and you'll discover this excellence in light gathering ability, in edge-to-edge sharpness, in flatness of field, in precise resolution and in lack of distortion.

With all of that going into each Leupold scope, it's also comforting to know that if your equipment doesn't exactly get pampered out in the woods, and if you shoot thundering loads, everything will hang together hunt after hunt, year after year.

For complete specifications on Leupold variable and fixed power scopes, send \$1.00 for catalog to Leupold, P.O. Box 688, Beaverton, Oregon 97075 U.S.A.



LEUPOLD

Performance starts on the inside



HOW TO MAKE MONEY With GUNS!

Turn Your Hobby Into a Profession Be a "GUN PRO"—the Man Other Men Respect When It Comes to Guns.

Careers to Choose from: Counsel gun buyers in gun shop, sporting goods store, discount house. Work at shooting club or range. Or start your own business — sell or repair guns. It's an exciting, satisfying life that pays you money — and it can be your life... If you act now!

As a "Gun Pro" trains at North American WE SHOW YOU HOW TO APPLY FOR A FEDERAL FIREARMS LICENSE

If you qualify otherwise, you may obtain a Federal License to buy and sell guns, ammunition and accessories... while you are a student at North American. You can start making extra cash almost immediately ordering guns for others on a cost-plus basis.

IN YOUR FIRST LESSON we reveal a ballistics secret that can increase your hunting accuracy dramatically

Your shooting friends will scarcely believe their eyes when they see how your shooting improves. It's part of your training to become a gun pro. A simple, easy-to-understand chart included in your first lesson tells you everything you need to know... just one example of dozens of inside tips revealed as you progress through this exciting course.

Approved for Veterans and Accredited by the National Home Study Council

YOU GET IT ALL!

How to buy and sell guns... customize, repair and accrize them... fit and finish stocks... handloading... scopes... ballistics... antique firearms black powder... importing guns... chokes... all you need to know to answer almost any question about guns, ammunition, shooting!

APPROVED FOR VETERANS

WRITE TODAY... No Obligation. No Salesman will call.

"Training for the Future through Home Study"

NORTH AMERICAN SCHOOL OF FIREARMS, Dept. NH061
4500 Campus Dr., Newport Beach, CA 92660

RUSH ME INFORMATION telling how I may become a GUN PRO. Check here for GI or VA benefits

NAME _____ AGE _____

ADDRESS _____

CITY _____ STATE _____ ZIP _____

HANDLOADING

DAN COTTERMAN

MORE HELPFUL .45ACP INSIGHTS GAINED FROM READERS LETTERS

A damnable loss occurs when communications from independent experimenters wind up in some dust-laden mail basket. That's why, last time around, I laid the groundwork for including contributions from you, the reader of this column. In continuing such a plan—call it an open exchange of ideas and experimental discoveries—I am demonstrating faith in my conviction that this is the best way to share a maximum amount of useful data. Much serious handloading is done outside the so-called "gun press," beyond the advantage of mass publication. That's a condition I hope to remedy.

As I said at the outset, it will not be possible to print everything that is received.

COLT .45 BENCH TEST

Powder	Ch. Wt. (gr.)	Group Size
Unique	5.6	4-.678"/5-.950"
Bullseye	3.8	4-.665"/5-1.15"
Herco	6.0	5-1.28"
Herco	6.2	5-1.40"

However, if you wish to take part in this exchange, feel free to contribute information on loads, components, and products. Your comments and ideas will receive thoughtful consideration.

The concept of sharing information is assuming healthy proportions, as is evidenced by a constant increase in the volume of mail received. Interest in the .45 ACP has, thus far, taken a position of priority, and, although our exchange is aimed at including all reloadable handgun cartridges, the persistence of communications dealing with this hoary favorite demands exposure.

Jack Williams, of St. Joseph, Illinois, is a dedicated handloader with whom I have communicated for many years. He's like a lot of us in that he loads his own ammo, but also he does his own accuracy work. His comments are interesting and may prove useful to you.

"The gun I am shooting now is a standard Colt Gov't 1911-A1. I got it from the DCM program through the NRA. All modifications are by me and are as follows: Colt NM barrel and collet bushing; recoil buffer; trigger job (also added trigger shoe); Bo-Mar rib; throated barrel ramp.

"I got a hold of some Hornady 200-grain lead SWC bullets and tried them with Bullseye, Herco, Unique, 700-X, and W-W 230."

Williams encloses the results of the

handloads he tested in the gun described. Five-shot groups were fired at a distance of 25 yards with the use of a Lee machine rest.

Williams explains, "Primers used were Alcan L.P. seated with a Lee priming tool, the new one with the tray, which I like very much.

"I shot two control groups. One with Remington factory 185-gr. SWC FMJ. They grouped about 1.125" center-to-center. The other control group was with Remington 185-gr. H.P. I had horizontal stringing with the group. It measured about 1.73" center-to-center. Three shots were touching in a cloverleaf pattern.

TWO CONTROL GROUPS

"700-X in three loadings was bad:

4.1 grs.—3.192"

4.3 grs.—2.471"

4.5 grs.—3.142"

"230 wasn't too good:

4.2 grs.—4.425"

4.3 grs.—1.687"

4.4 grs.—1.305"

"Bullseye in 3.6-grain charges gave 2.926", and with a 4.0-grain charge gave 2.53". Herco in a 5.8-grain charge opened to 3.781". Unique in 5.4 grains gave 2.827", and with a 5.8-grain charge gave 2.7", with four going into 1".

"All bullets were seated to a L.O.A. equal to the factory Remington 185-grain JHP.

"I have also been working with the Taurus 200-grain lead semi-wadcutter. I can get groups of about 1.6" with 6.0 grains of Unique.

"Cases used were mixed military and commercial with little attempt to separate different cases. Cases were sized with an RCBS carbide die. I used an RCBS taper-crimp die set to take out the bell and not too tight on the bullet.

LEADING PROBLEM

"There is a leading problem, but not very much. It is easily removed. I fired 75 rounds in this particular test with the Hornady lead bullets, and then proceeded to run another 100 or so lead rounds through the spout and the leading was minimal. A buddy of mine says that the Taurus bullets are giving him real leading problems, but that could be his barrel."

We should note that, although Williams says the 230 didn't produce his best results,

(Continued on page 59)

Complete .45 Combat Modifications Specializing in all Colt A.C.P. handguns



ALL WORK UNCONDITIONALLY GUARANTEED

Call or write for details and our catalog!

Michigan Armament is pleased to recommend Weapons Employment Survival Training Inc. and their course in small-arms training, disaster survival, and self-sufficiency training.

CRIME and VIOLENCE - ARE YOU CONCERNED?

PROBLEM-Because of the brutality and frequency of violent crime, home owners and family, business and professional people must be prepared to defend against a **Life Threatening Situation**.

OBSERVATION-Handguns in the past were owned primarily for recreation and competition, but are being purchased in unprecedented numbers for Self Defense of the Home and Business.

CONCLUSION-Unless you have law enforcement, competition, or a military background, you probably have had no formal training in the art of Handgun Self Defense, and are not prepared to defend yourself in a **Life Threatening Situation**. What can you do?

SOLUTION-WEST'S 600 acre facility, one hour north of downtown Los Angeles, is devoted to small arms training, disaster and self-sufficiency planning. WEST offers courses to Specifically provide you with the ability and discipline for defensive use of the handgun. Live firing courses of one to four days duration are offered. You will have a new respect for the handgun through proficiency in safe, decisive, controlled, rapid, accurate Firing of the handgun.

Your training will be a rewarding and enjoyable experience, and you will be confident of having prepared yourself with a skill for use in a **Life Threatening Situation**.

Please request a complete brochure by calling or writing.



Weapons Employment Survival Training Inc.
BOX 308 PIRU, CALIF 93040 805/521-1892

MICHIGAN ARMAMENT, INC. *Custom Handgun Specialists*

214 East Adrian St. • Blissfield, MI 49228 • 517/486-4000

FULL-TIME PROFESSIONAL PISTOL SMITHS

Thomas Kohler

Darrell Burch

John Post, Sr.

DUNK-KIT
A NEW CONCEPT IN
GUN CLEANING!!



- Dunk-Kit, the fast, easy way to clean and protect your guns is used and endorsed by gunsmiths, pistol shooters and police.
- Dunk-Kit cleans, oils, and displaces moisture all in one easy operation.
- Dunk-Kit comes in a large 3/4 gallon pail, is reusable, and should last for years.
- Dunk-Kit is also ideal for cleaning and protecting small parts, reefs, cycle chains or almost anything!

For your Dunk-Kit, send \$12.95 plus \$3.00 for postage and handling to:

Larson Industries, Inc.
P.O. Box 393
Fremont, Ne. 68025

Please no C.O.D.'s. Send street address for U.P.S. delivery. Dealer inquiries invited.



TAURUS
Swaged
Lead
Pistol
Bullets

**Complete information
on the bullets that
have set new
standards.**

4 page brochure
+
4 pages of Load Data
+
4 page reprint of
AMERICAN RIFLEMAN
article,
"Taurus Stands for Bullets"

Send \$1.00 to

THE ALBERTS CORPORATION
P.O. Box 157 • Franklin Lakes, NJ. 07417

HANDGUN LEATHER
LEATHER '81
BOB ARGANBRIGHT

**BLOCKER TEFLON-LINED HOLSTERS
REDUCE FRICTION TO A MINIMUM**

Several years ago Roy Baker introduced his famous Pancake holsters. Made of two pieces of leather sewn together along the leading and trailing edges to form a pocket for the handgun, with belt slots in the leading and trailing edges, the Pancake was an immediate success. Today, most major holster manufacturers offer some version of pancake holster. The original Baker Pancake has two slots in the leading edge, allowing the user to wear it with gun butt canted forward, FBI style, or straight up and down, often as a cross draw.

Recently, I received two holsters for testing from Ted Blocker's Custom Holsters, 3559 Lashbrook, Rosemead, CA 91770.



Two models for the .45, with teflon. Author says Blocker holsters are fast.

Called the "Bodyguard" and the "Security," these holsters are of standard pancake configuration with single belt slots fore and aft. Made for the Colt Govt. model pistol, the Bodyguard has a thumb break retaining strap, while the Security holster has an adjustable tension retainer.

What makes these holsters unique? Both are fully lined with a thin sheet of Teflon. This Teflon liner reduces to a minimum the friction on the gun when it is being inserted or drawn from the holster, which reduces gun finish wear to a minimum. In addition, the Teflon adds extra body which should greatly extend holster life. Normally, as holsters are used, the leather slowly stretches, just as leather boots will stretch. The Teflon lining should reduce or prevent this. An additional advantage is perspiration can not work through the leather to damage the gun.

Teflon liners are not new to me, but this is the first time they have been offered commercially as part of a sporting holster. For approximately 10 years, western fast

draw shooters have been making their own liners out of 1/16 inch sheet Teflon. A pattern is first made from paper by trial and error and the Teflon is cut to shape with a sharp knife, curled into a cylinder and slipped into the fast draw holster. This greatly extends the life of a hard used fast draw rig. Before the use of the Teflon insert, it was not unusual to see a fast draw holster with the leather worn down to the metal lining at the top of the pouch, where the ejector rod head rubbed at every draw.

Ted Blocker is a fast-draw shooter who started producing fast draw rigs as a hobby in 1972. Today, he produces some of the finest holsters available, with his hand carving being as fine as any I have seen. Ted's is a custom operation with many different finishes available. His two-tone brown, with basket stamping is especially attractive.

Being a hobby custom holster maker myself, I am not easily impressed, but Ted's work is first class. I find the lazy-s curve of the back border of the basket stamping, on the adjustable tension holster, very pleasing to the eye. In this day when man's manual talents are constantly being replaced by machines, I was pleased to see that the basket stamping is done by

(Continued on page 70)

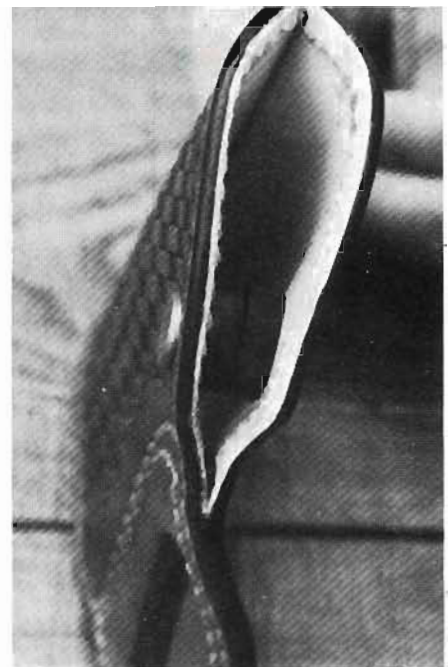

Teflon inner lining protects holster. Also, draw speed is greatly enhanced.

BULLSEYE HANDGUN ACCESSORIES

The Complete Tune Up Center

	Price Includes UPS Postage
KIT #1-H FITS ALL NEW MODEL RUGER SINGLE ACTION REVOLVERS \$ 8.45 Hunting Model Reduces Trigger Pull Up To 45%	\$ 8.45
KIT #1-T FITS ALL NEW MODEL RUGER SINGLE ACTION REVOLVERS \$ 8.45 Target Model Reduces Trigger Pull Up To 60%	\$ 8.45
KIT #1-A FITS ALL NEW MODEL RUGER SINGLE ACTION REVOLVERS—COMPLETE TUNE-UP KIT \$10.45 With New Style Hammer Spring To Eliminate Hammer Shock. Included: Your Choice Of Either Hunting Or Target Trigger Spring—Please Specify.	\$10.45
KIT #1-A FITS ALL NEW MODEL RUGER SINGLE ACTION REVOLVERS—HAMMER SPRING ONLY \$ 4.00	\$ 4.00
KIT #2 FITS ALL CENTER FIRE COLT MARK III TROOPERS & LAWMAN REVOLVERS \$ 8.60 Reduces Double & Single Action Trigger Pull Up To 45%	\$ 8.60
KIT #3 FITS ALL CENTER FIRE SMITH & WESSON I FRAME REVOLVERS \$ 8.60 Reduces Double & Single Action Trigger Pull Up To 45%	\$ 8.60
KIT #4 FITS ALL RUGER SECURITY-SIX & SPEED-SIX REVOLVERS \$ 8.60 Reduces Double & Single Action Trigger Pull Up To 45%	\$ 8.60
KIT #5 FITS ALL SMITH & WESSON K & N FRAME REVOLVERS \$11.50 Reduces Double & Single Action Trigger Pull Up To 45%	\$11.50
KIT #6 FITS THOMPSON CENTER CONTENDERS \$ 2.85 Fast Snap Hammer Spring—Insures Primer Fire With All Primers	\$ 2.85
KIT #6-A FITS THOMPSON CENTER CONTENDERS—COMPLETE TUNE-UP KIT \$ 9.45 Heavy Duty Hammer & Safety Spring, Plus 40% Lighter Trigger Spring	\$ 9.45
KIT #7 FITS ALL COLT PYTHON & OLDER STYLE COLT TROOPER REVOLVERS \$ 9.45 Reduces Double & Single Action Trigger Pull Up To 45%	\$ 9.45
KIT #8 FITS ALL BROWNING HI-POWER \$13.50 Reduces Trigger Pull Up To 45% & Increases Slide Power 15%	\$13.50
KIT #9 FITS ALL COLT GOVERNMENT MODELS/70 SERIES HARDBALLER & CROWN CITY ARMS \$14.45 Reduces Trigger Pull Up To 45% & Increases Slide Power 15%	\$14.45
KIT #9-A FITS ALL COLT GOVERNMENT MODELS/70 SERIES HARDBALLER & \$14.45 CROWN CITY ARMS—TARGET KIT Reduces Trigger Pull Up To 45% & Reduces Slide Power For Target Loads	\$14.45
KIT #10 FITS ALL COLT COMMANDER MODELS & CROWN CITY ARMS \$14.45 Reduces Trigger Pull Up To 45% & Increases Slide Power 15%	\$14.45
KIT #11 FITS ALL SMITH & WESSON MODELS 39 & 59 \$13.50 Reduces Double & Single Action Trigger Pull Up To 45% & Increases Slide Power 15%	\$13.50
KIT #12 FITS ALL DAN WESSON CENTER FIRE REVOLVERS \$ 8.60 Reduces Double & Single Action Trigger Pull Up To 45%	\$ 8.60
BULLSEYE WHITE OUTLINE REAR SIGHT BLADES—FITS ALL COLT & RUGER FIREARMS \$ 7.45 Will Not Blur Out	\$ 7.45

NOW AVAILABLE ... THE SAME TOOLING WE USE IN OUR SHOP

BULLSEYE STONE KITS

Stones so different you have to use them to believe it. Completely stone out a handgun in less than 1/4 the time of a regular type stone.

TRAIL SIZE \$14.45 MASTER GUNSMITH SIZE \$26.45

BULLSEYE HEADSPACE WASHERS for S&W, Ruger Sec-Six & Colt Python (2 sizes)
to remove and shake from cylinder to insure proper headspace, 30 Pcs. Set \$21.50

BULLSEYE CHAIN LOCKING BALL KIT
For use with S&W, & Ruger Sec-Six Rev. \$19.45
when installing custom barrels and not using front barrel lug, enough for 20 guns

BULLSEYE DRIMEL TOOL KIT

Over 80 pcs. to help polish out the works in fine guns
and jewel the hammers & triggers a must in a gunshop \$24.50

BULLSEYE POLISHING WHEELS

Used for crowning and throating barrels; also very good for polishing out frames
where stones are too slow (6 pcs. kit) \$19.50

BULLSEYE LAPPING COMPOUND

A 900 micron range lapping compound that will give a glass smooth finish to your work (2 oz. bottle) \$13.50

BULLSEYE GUN POLISH

The finest you will ever use to help keep your guns beautiful \$ 5.50
Also the best glass polish for your shooting glasses and scope lens

BULLSEYE GUN LUBE

Sickest stuff around—2 oz. bottle \$ 5.50

FROM CUSTOM WORK—TO TUNE UP KITS—WE SUPPLY THE VERY BEST



TRAPPER GUN INC.
28019 Harper
St. Clair Shores, Michigan 48081 (313-779-8750)

For Overseas Postage Include
\$1.50 extra (All checks or M.O. in U.S. Funds.
Dealers inquire about special prices.

New! THE NEW HANDBOOK OF HANDGUNNING by Paul B. Weston, *California State Univ., Sacramento*. This well-illustrated guide demonstrates the safe and accurate use of pistols and revolvers. Each of the ten chapters of the text presents a step-by-step guide to one important aspect of handgun shooting. Areas covered include nomenclature and functioning, safety, position, grip, sighting, aiming, trigger finger motion, self-study, breathing, and planned practice. Each segment concludes with a list of common faults — problems that are likely to occur and how to avoid them — and a summary of the chapter. '80, 112 pp., #8 il., \$12.95

New! PRACTICAL HANDGUN BALLISTICS by Mason Williams, *Firearms and Ballistic Consultant, Libby, Montana*. Concentrating on practical considerations, this volume presents separate segments on interior, exterior, and terminal ballistics. The first section covers such topics as the cartridge, the revolver and semiautomatic pistol, and test conditions; the second details noise, velocities, different types of bullets, and chamber and barrel length; and the third discusses performance evaluation, foot-pounds of energy, police handgun ammunition, and the Glasser safety slug. '80, 232 pp., #9 il., 2 tables, \$17.50

COMBAT SHOOTING FOR POLICE (2nd Ed.) by Paul B. Weston, *California State Univ., Sacramento*. This text provides comprehensive coverage of such basics as grip, sights, aim, and trigger pressure and discusses defensive firing, target training, safety, automatic pistols, service revolvers, off-duty guns, holsters, reloading, combat tactics, selection of the combat revolver or pistol, and related topics. Directions for combat shooting in all positions are detailed. '78, 184 pp., 71 il., 6 tables, \$12.75

THE IDENTIFICATION AND REGISTRATION OF FIREARMS by Vaclav Krcma, *Consultant, Forensic Firearms Field*. Foreword by William P. Brefka. Detailed information on serial numbering systems and codes is provided. Extensive tables and photographs explain and show the location of hidden serial numbers, and an alphabetical index of more than five hundred handguns is included. '71, 200 pp. (8 1/2 x 11), 115 il., \$19.75

Prepaid orders sent postpaid, on approval
Catalog of 2924 titles sent on request

301-327 EAST LAWRENCE
SPRINGFIELD • ILLINOIS • 62717

COP TALK

MASSAD AYOOB

HIGHWAY VS CITY ISSUE-GUN CHOICE: THE CONTROVERSIAL IDEAL FIREARM

It wasn't long ago when any police firearms instructor would tell you, "A .357 Magnum is just the ticket for Highway Patrolmen 'cause they have to shoot through cars and don't have to worry about bystanders. A .38 wouldn't work for them, but it's the logical gun for city cops, 'cause a Magnum will shoot through a felon and wipe out ten people before it stops. A metro policeman won't have to shoot at cars anyway."

Thinking is more enlightened today. Some state police agencies have done studies that indicate they're not terribly likely to have to shoot endways through an Oldsmobile, and more urban agencies are issuing the .357 than ever before.

THE DEMARCATION LINE

How much of a demarcation is there, really, between the duties of rural and highway peace officers, and those of their blue brethren in the megalopolis? Will it require different guns, different calibers, different ammo?

Well...

Today, more state police and highway patrol agencies issue .357s than .38s, but the margin is about the same as the popular vote difference between Carter and Ford. In fact, it may tip the other way: at least two such agencies require that .38 Special ammo be carried in the issue .357. Iowa troopers carry 125-grain semi-jacketed S&W .38 specials in the Model 13 Smiths that are slowly replacing their Model 10s, though the Chief, Col. Ed Dickinson, says he'll switch to a similar loading in .357 once every trooper has been issued a Magnum. Colorado State Patrolmen, though they've been issued four-inch Colt Python .357s for years, just recently switched from the 158-grain round nose lead .38 to a JHP in the same caliber.

THE HIGHWAY SPLIT

You might say that on the highway, .38 and .357 are split about down the middle, not counting Illinois State Police with their 9 mm S&W Model 39 automatics. One or two highway patrols went to the .41 Magnum shortly after it came out, but I understand they switched back to .357. An agency that de-escalated and then changed its mind was the New Hampshire State Police. In the early sixties, their 6" .44-frame Smith .357s were traded in for 4" Model 10 .38s, but a few years ago they

became the first SP outfit to adopt the Model 66 Stainless Combat Magnum, and took full advantage of the Magnum firepower with 158-grain jacketed .357 hollow-points.

Let's take a look at NHSP's experience, because it's kind of a microcosm of what the .357/.38 controversy is all about. Ostensibly, they scrapped the big-frame .357s so they could do away with the bulky flap holster, and go to a lightweight gun with a quick border patrol scabbard, and eliminate the Sam Browne shoulder strap. Of course, they could have achieved the same with a 4" Combat Magnum, as indeed they did later. The fact was that many officers couldn't handle magnum recoil and were carrying their 27s and 28s with .38 ammo in the chambers. Oddly enough, the shoulder strap remained for some time, though it's since been dispensed with. At the time the Model 10 was adopted (it was issued, incidentally, with 125-grain JHP loads, an effective .38 formula), then—Lt. Les Menzies, the department firearms instructor, had completed a survey that showed a New Hampshire trooper was most likely to encounter a firefight at a robbery scene or a family disturbance call—the exact same circumstances that initiate most metropolitan shootouts. He felt that the .38 would be more controllable, hence more effective as an anti-personnel weapon. And that the ability to

(Continued on page 28)

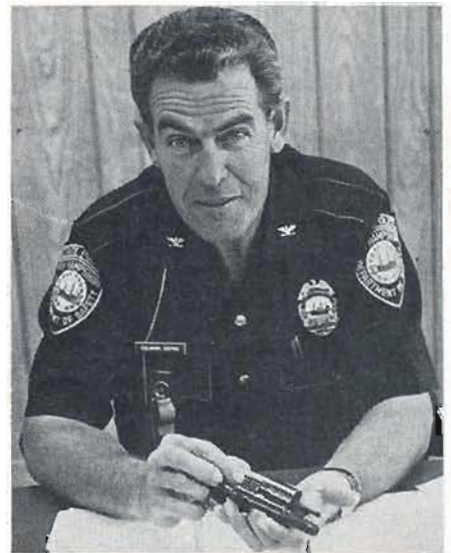

Col. Dayon (NH State) loads standard command officer's desk gun—2" .38.



Not Every Law Officer Qualifies In This Situation!... Can You?

The game is SURVIVAL on the streets. That's why we adhere to the principle that STREET SURVIVAL doesn't stop with departmental training — it's just the beginning! It's your life that is on the line every day on the streets — and it is your responsibility to stay in shape. As a P.M.A. member, you'll be kept up-to-date on essential tactics you need to perform more effectively in the line of duty while giving yourself maximum protection. Knowing how to react during armed encounters may even save your life.

From becoming survival sensitive to improving your shooting skills, you'll get more out of THE POLICE MARKSMAN ASSOCIATION because we put more into it. Here is what you get when you join our group!

GET THESE GREAT MEMBER BENEFITS

POLICE MARKSMAN MAGAZINE — With your P.M.A. membership you receive a year's subscription to POLICE MARKSMAN Magazine — our official association publication and a reading must for every officer. Exciting in-depth articles cover equipment, legal aspects, combat shooting, departmental training programs such as street survival simulation and much more. They'll teach you how to gain more confidence, improve your ability to react, and help you stay alive!

PLUS THESE EXTRA BENEFITS

- PMA Membership Card
- Special Buying Service
- Eligibility for PMA Competition Awards
- PMA Decal
- National Marksman Matches
- PMA Chapters
- FREE Renewal Gear

Sharpen your instincts for survival and improve your shooting skills. Plus, increase your technical knowledge as national training experts and champion shooters such as John Pride, L.A.P.D. Firearms Instructor and National Municipal Champion Shooter, and Chief Inspector Greg Sambor, Chief Firearms Instructor, Philadelphia P.D., teach you!

Join the 15,000 member strong — POLICE MARKSMAN ASSOCIATION. In it's 5th year, P.M.A. is dedicated to officer survival through innovative and continuous training and knowledge of the law.

Don't wait, join your friends. Fill in the coupon below and mail it along with your annual dues to Police Marksman, 305 South Lawrence Street, Montgomery, AL 36104

Join by July 31

...and receive a PMA Fifth Anniversary Patch ...absolutely FREE*



*With your prepaid membership dues

POLICE MARKSMAN ASSOCIATION AH-JA

305 South Lawrence Street, Montgomery, AL 36104

Yes! Enroll me as a member of P.M.A. as indicated below. If I am not completely satisfied I will notify you and you will refund the unused portion of my dues.

Full-Fledged Member: 1 yr. — \$15 — Eligible for all PMA Benefits (open only to recognized law enforcement personnel). \$10 is applied to PMA Magazine.

2 yr. — \$28.50 3 yr. — \$42.50 Life Member — \$225

Associate Member: 1 yr. — \$10 (THE POLICE MARKSMAN Magazine only) Open to interested shooters.

Dues Enclosed Bill Me Member No. _____

Charge my MC No. _____ New Member Renewing

Exp. date _____

Charge my VISA No. _____ Name _____

Exp. date _____ Street _____

Bank on which account is drawn: _____ City _____

_____ State _____ Zip _____

The heavy duty press with award-winning features...

PACIFIC'S
NEW

OO-7™



1980
Award
of
Merit



American Firearms
Industry Magazine

New Pacific
PPS™ Automatic
Priming System
wins 1980 Award
of Merit for most
innovative design
feature for
reloading tools.

We're proud that the unique PPS automatic priming system on our O-7 and OO-7 presses has been awarded this honor. But this "hands-off" feature (you never touch the primer) is just one of the exclusive advantages you get with the Pacific press design. Perhaps the most noticeable feature of the O-7 and OO-7 is the angled frame that "turns" the press 30° to one side. This, combined with the exclusive offset handle, gives the Pacific press more uncluttered working area than any other press on the market. Add to this the Power-Pac™ linkage and the rock-solid mount and you can easily see why the "O" series from Pacific is a winner.

Read more about it in our 1981 Catalog.
Get one today at your Pacific dealer or
send \$1.00 to:

Pacific

A Division of Hornady Manufacturing Co.

PACIFIC TOOL CO.
Dept. AH-7, Box 2048
Grand Island, NE 68801

Hornady Pacific Frontier



COP TALK

(Continued from page 26)

shoot through automotive sheet metal was extraneous to the purpose at hand.

Let's digress for a moment. There are two kinds of state-level uniformed law enforcement agencies: highway patrols, which do nothing but traffic work, and true state police organizations that provide complete law enforcement services to rural areas that are too small, thinly populated, or poor to afford their own police. NHSP is



Popular two-gun concept illustrated with belted 9mm and holstered .38 Spl.

one of the latter, as are most. A pure highway patrol, for obvious reasons, *does* skew the gunfight statistics toward fire-fights involving vehicles, simply because they're always on the road, and don't face the same hazard calls as "all-purpose" lawmen. For the pure road trooper—in Colorado, for instance, or Florida—the .357 does make more sense, though I believe both those departments are issued .38 ammo.

But even in a shootout that unfolds on an Interstate, the capacity to penetrate an automobile may or may not be essential. The situation is often one where the suspect opens up on the officer after the latter has walked up to the suspect's vehicle: it's a point blank death duel, and the trooper or patrolman is likely to be shooting through an open window. On the other hand, the cop's best tactic in such a confrontation is to drop to the ground; the angle is such that the suspect now can't shoot at him without opening his door, but an officer with the right gun and load can drill cleanly through the door and take the driver out.

Let's expand on that for a second, using an actual case that involved a mid-west state trooper. As he approached the right-side door of what turned out to be a stolen Pontiac, the trooper saw the driver's hand

rise, and found himself looking down the barrel of a 9 mm Luger P-08. He drew his issue Smith 19 4", and fired one shot through the passenger window.

The bullet, a 158-grain Remington semi-jacketed soft point .357, pulverized the glass. The core of the bullet struck the subject in the upper right chest, and coursed through right lung, heart, and left lung, stopping in the ribcage on the left side. From the autopsy photos I saw, it appears that the separated jacket of the bullet struck the gunman an inch above where the rest of the slug went in, creating a large flesh wound near the right nipple.

ALIVE & DANGEROUS

The gunman's own door was open, and either the impact of the bullet or his convulsive muscular reaction to taking the hit threw him out the door and onto the ground. He rolled or scuttled toward the left rear of the car, belly down. The trooper moved cautiously around the front. The whole time, the gunman was trying to pull the trigger of his Luger; either it was defective, or he had not remembered to release the thumb safety. Desperately, the would-be cop killer reached up with his left hand and jacked the toggle action, ejecting the live round from the chamber and seating a fresh one. He aimed again at the trooper, then lowered his head and died. He had run out of blood, fully ten seconds after a .357 slug had pierced his heart and lungs at point blank range.

You can make a case in any direction from this documented incident, depending on what you want to prove. Those who feel as I do that the JSP .357 round has excessive penetration and minimal shock power can certainly point to it; had it not been slowed by the sheet of safety glass, the slug would almost certainly have penetrated the felon's body with enough retained force to inflict a fatal wound on any innocent standing behind him. Advocates of monstrously destructive police loads like the Glaser Safety Slug would announce flatly that a man hit in the same place with one would have been instantly neutralized. They're probably right, but the Safety Slug's plastic capsule of #12 shot floating in liquid Teflon wouldn't have entered this particular gunman's body at all. On hitting the window, it would have disintegrated along with the glass, and the punk with the Luger would have been harmlessly showered with neutered birdshot.

9mm PENETRATION

Take the 9 mm used by Illinois State Police, and by such metropolitan agencies as Salt Lake City PD. Penetration of body armor or auto bodies actually exceeds that of most equivalent .357 loads. Yet, the Illinois troopers, who for many years carried them with full-jacketed hardball, bemoaned the fact that the bullets would penetrate a felon completely, with little shock effect. In one case, the bullet exited even after coursing through the thorax and

through the thick, hard center of the gunman's spinal column. After ISP went to the softnosed Winchester 100-grain power point in 1976, there was an incident at 52 yards in which a suspect was shot through the chest; the bullet exited without deforming, and the gunman ran over a hundred yards before dropping dead. Had he been otherwise inclined, he might have killed the trooper who shot him.

The policeman's sidearm is not there for shooting cars; it's there for shooting "the most dangerous game," which happens to be a soft-skinned mammal that is often supercharged with narcotics and virtually immune to pain or fear, immune to psychological and, to some extent, even physiological shock. The two targets demand opposite performance. The high penetration of a "car gun" makes it ineffective as a manstopper, and dangerous to bystanders. Light expanding-bullets at high velocity are very effective in flesh, but penetrate sheet metal rather poorly.

The .45 ACP hardball is a definite contender for the title of all-around police cartridge. It's hampered by the fact that most police departments consider the Army automatic too "tricky" to issue. It does offer excellent penetration with a straight-on shot on a car, and its stopping power against armed assailants is legend-



The obsolete cross-draw flap holster is still in use by some departments.

ary. The bullet tends to course through muscle and bone, expend its energy, and stop in the elastic skin on the opposite side. However, the nature of the round-nose jacketed bullet is that it cuts a narrow wound channel, and there are several cases on record where it decidedly failed to drop an assailant who hadn't been hit on a large bone or vital organ. Also, this slug will ricochet dangerously off pavement, or off tough sheet metal at acute angles.

The seldom seen .41 Magnum (in the low velocity lead Police load) does combine good metal penetration with very good stopping power and minimal over-penetration of flesh. However, the gun is violent to control, and is not considered

(Continued on page 32)

GUNFIGHTING AT HOME AND RELATED SUBJECTS

A TEXTBOOK BY E. R. FENJOHN
ABOUT THE PROPER USE OF A
HAND GUN TO DEFEND A HOME
AND ITS OCCUPANTS

HARDCOVER
ILLUSTRATED

SEND

\$4.95 PLUS 59¢ POSTAGE

TO:

GOLD STAR PUB. CO.

DEPT. AH-71, 90 CRICKET AVE.
ARDMORE, PA 19003

Now! for Serious Shooters

FREE!
OFFER

a completely new
CLEANING PATCH. **Honeycombed Surface**
Unique combination
of fibers developed by **traps and removes**
MATCH GRADE ORNANCE **foreign matter.**

to help you provide the care
your firearms need. Proven results with less
effort for those who demand better performance.
Guaranteed to outperform any cleaning patch.
Send S. A. S. E. for FREE sample. Specify cal.

QUANT.

\$2.00 — 150 patches for .22 caliber
FOR YOUR — 75 patches for 9 mm, .38/ .357 cal.
CHOICE — 75 patches for .44/ .45 caliber

NAME _____

ADDRESS _____

CITY _____

STATE _____

ZIP _____

mgo

MATCH
GRADE ORNANCE

MAIL TO: MGO
PO BOX 2178 A
EDISON NJ 08817

A police revolver incorporating some PPC revolver features results in a compact, easy to carry weapon that hits where it is pointed, and stays on target during firing.

It all started one day last winter when Chuck Pulliam, member of the Yuma Police Department, and handgun enthusiast, complained to me about not being able to find what he wanted in the way of a duty

weapon. Chuck was carrying an S&W 19 custom 6" with Bo-Mar rib. Over the past several years we had tuned it, put custom grips on it, and had gone as far as practical. I was beginning to think Chuck was relying on gadgetry to try to improve his shooting rather than spending his time at the range. Nonetheless, he is a customer and his checks don't bounce, so I tried to listen to him with some degree of courtesy.

He complained about everything! First he complained about his gun butt poking him in the ribs when he sat in the patrol car, then he complained that he couldn't lean over to reach the right door, and on and on.

When I more or less tactfully suggested he might find a 4" gun more comfortable and he said he refused to sacrifice accuracy

(Continued on page 31)



FRY

(above & below) This Smith & Wesson K-frame Model 15 Combat Masterpiece .38 Special sports R&J grips and slab sided 4-inch Douglas barrel for the ultimate police duty sidearm with custom, yet reasonable, PPC accuracy.

Converting a duty gun for comfortable carry and accurate shooting

By Frank Fry



.38 SPECIAL

for comfort—the seeds of his gun were then planted.

Several days later we got together and began to discuss the problem seriously.

The Yuma Police Department allows its officers to carry .357 Mag pistols, however the qualification is done with .38 mid-range wad cutters. Both Chuck and I agreed that accuracy had priority over power and presently he gave me carte blanche to produce a gun to satisfy his needs both for accuracy and carrying.

After some small search we found a suitable S&W M15, the old barrel was removed and having no idea of what barrel designs might appeal to Chuck, I proceeded to present him with some shapes for his approval. The first purchase I made was a supply of 1½" dowel rods to make prototype barrels. We wanted the heaviest possible barrel, yet it had to complement the frame and overall contour of the gun. We looked at square barrels, triangular barrels, fluted barrels and several exotic and weird shapes. We finally settled on 1" design with flat top and sides, with about a ¼" radius between, and a round bottom. This seemed to satisfy Chuck and had the best potential of the samples offered.

STRAIGHTFORWARD WORK

The basic machine work was straightforward. The Douglas blank was threaded and fit to the M15 frame, indexed and cut to a long 4", set up between centers and turned to 1". The top and sides of the barrel were then milled flat and the rear portion contoured to the receiver for an eye-pleasing blend. The ejector rod recess was a basic end mill operation and the gun was beginning to take form. I have always been reluctant to apply heat to a target barrel, preferring, when possible, to drill and tap so the ejector rod hanger required some thought. An end-milled extension was made forward of the ejector rod cut in the barrel and a steel block made to fit the new cut. The block was then drilled to accept a collared plunger and spring. This unit was then fitted to the ejector rod, and held in place with two 6/48 screws. A long shallow forcing cone was cut in the breech, the barrel screwed back into the receiver, and initial test firing took place. Recoil with mid range wad cutters was mild and with Plus P only slightly more. Muzzle jump was noticeably less than with a standard Model 15.

The next project was the sights. I have always liked the idea of a replaceable front sight and the DWA front sight blade width was exactly correct for the width of the rear blade. An ⅛" high ramp was made and slotted for the DWA sight, drilled and counterbored for 6/48 screws and attached to the barrel. The sight blade was trimmed from the bottom till the original height of the S&W sight was reached. The sight base and sight were drilled together to accept two small pins. It might be noted that the screw heads are hidden beneath the front sight blade which not only makes a neat



WHAT HAPPENS
WHEN YOU
LOAD & FIRE
THESE
CARTRIDGES
IN A
SCOPE
MOUNTED

CONTENDER

The hunting affect is rather devastating. A Mulie or Whitetail will crumble with the first well placed shot. A Pronghorn will turn into trophyville—but one thing for sure, you won't be picking up lens and scope parts if you read this ad and follow through!

NEW!

RP SCOPE SERIES FROM THOMPSON/CENTER ARMS

Granted, we created a problem for scope designers by building the world's leading hunting handgun and offering it in a series of "block busting" calibers. Now, we also offer a full line of long eye relief handgun scopes which will stand up to the shock of recoil produced by these calibers.

Factory tested at 32 G's, extensively field tested and backed by a Lifetime Warranty, our **RECOIL PROOF SERIES** in 1.5X, 2.5X, 3X and 4X offer advantages which are too extensive to be covered by this one ad — so write for our descriptive brochure. **No, they don't just fit Contenders.** They can be mounted on Rugers, Smiths, Colts or any other brand of handgun which adapts to 1" ring requirements.

Write FOR FREE
CATALOG AND
BROCHURE

Receive our four color scope brochure and 28 page catalog and read our story — you'll be glad you did!



THOMPSON/CENTER ARMS

Farmington Road, Dept. TAH7
Rochester, New Hampshire 03867



Bull-barrelled Frank Fry .38 Special absorbs recoil well under rapid-fire.

installation but locks the screws in place. An extra sight blade was also prepared for future use at this time.

The barrel was now cut to finished length and a target crown machined at the muzzle. The second test firing produced some very satisfactory results. Rapid firing required no effort to bring the muzzle back into line. The mass of the gun soaked up recoil easily. Fifty yard groups easily bench rested into the center of a PPC target. The action was then tuned, polished and balanced. A few rubs with some emery paper, a lick or two on the buffing wheels and it was ready for a blueing bath. Finally a set of R&J grips were installed. Empty the gun weighs in at 42 oz.

Chuck has carried this gun on duty now for 8 months and tells me it is exactly what he ordered. 

Frank's Gun Shop, 4646 E. Cty 15 St., Yuma, AZ 85364.

R & J Grips, 508 W. MacArthur Blvd., Oakland, CA 94609.

Dan Wesson Arms, 293 j Main St., Monson, MA 01057.

COP TALK

(Continued from page 29)

suitable for general issue. Like the .45 auto, it's really pretty much an "experts only" gun.

One comes, inevitably, back to the .38 and the .357. While I like the 110-gr JHP in either caliber, for the minimized recoil and reduced penetration coupled with substantial shock effect, there are cases of dramatic failure to shoot through barricades. I dislike the 158-grain bullet's substantially greater recoil, but that weight gives three advantages: auto body penetration is good, the bullet will print in roughly the same place as the 148-grain .38 mid-range wadcutter ammo the officer is almost certainly trained with (thus making sure that his gun is reasonably well sighted in for this duty load, compared to 110-grainers which often hit inches away from the practice load's point of impact), and because, in a hollowpoint loading, it deliv-

ers maximum energy transmission and is unlikely to exit the target mass and cause danger to standers-by.

A better answer may be found in the new generation of 38/357 loads developed by S&W Ammunition and Remington. These are 90-grain semi-jacketed pills at extremely high velocity. These rounds have been known to pierce "bullet-proof" police vests that stop .44 Magnum slugs. At the same time, you're getting up into the lower regions of rifle velocities where secondary shock waves are set up that tear apart living tissue for a fist-sized radius around the wound channel.

However, there hasn't been time enough for sufficient reports to come in from the field as to whether this bullet will reliably drill through car doors, or whether it will dangerously drill through felons.

The all-lead hollowpoint 158-grain .38 Special is a load that grows more popular



Popular Jordan-style holster shown with S&W stainless Model 64 M&P .38.

with police every week. In the 1000-1100 FPS range out of a 4" service revolver, this is a formula that mushrooms dramatically, hits hard by whatever criterion you're using to measure it, and virtually eliminates overpenetration. Capability of drilling through barriers, however, is mediocre.

W/W's LHP .38 may be the ideal .38 Special load. You may never see the equivalent in .357, because the leading problem demands an alloy so hard that the expansion capability would be impaired, but if the .38 is your gun, and you don't patrol the Interstates, the 158 gr. LHP in the fast +P loading may well be your choice.

The same round in a solid Keith Semi-wadcutter is growingly popular with police, as a compromise between the ineffectual roundnose and the hollowpoint bullet that in some regions is too hot to handle politically rather than ballistically. Massachusetts State Police went to his round in their Model 10 .38s after their JHP 3-D brand service ammo caused a hue and cry in certain circles of that politically ultra-liberal state.

NYCPD went to this load, but watered it

down to standard (± 900 fps) velocity. Most other agencies have kept the "+P" velocity specs (in the region of 1000-1050 fps), and many feel that this may be the ideal all-purpose police cartridge. The chopping shoulder of the Keith style bullet does deliver much greater stopping power than the round-nose, and in the .38, velocity is "just about right" in that complete felon-body penetration seldom happens, while auto body penetration is adequate. Oddly enough, the Keith style bullet is quite good for shooting through steel. Remember, round noses glance off, and hot lead is a lubricant substance. If you're shooting at a car from an acute angle, the sharp shoulder of the spinning semi-wadcutter takes a biting purchase into the steel and drills through instead of sliding off.

4-INCH HERE TO STAY

Enough of ammo. What about the guns? There was a time, and not so long ago, when street cops carried mid-frame four-inch 38s, and highway lawmen packed 6" heavy frame wheelguns. The six-inch is outé and will remain so; it is too awkward to carry all day, monstrously uncomfortable to sit down with when carried in a conventional police holster, and actually harder to shoot accurately in rapid combat fire at point blank range because the longer sight radius is harder to line up even roughly.

The big Colts, such as the New Service .45 revolver carried for so long by the New York State Police, are history now, but the "N" frame Smith & Wesson is still extremely popular in the Highway Patrolman .357. This gun offers much less recoil than any other weapon in its caliber save the heavy barrelled Colt Python and Dan Wesson Pacesetter, neither of which are popular as issue service revolvers. The action is smooth and trouble-free, accuracy is superb, and the gun is formidable in appearance without being unduly bulky in the holster, at least in the 4" barrel length. Several state police agencies still issue it, including the Texas Department of Safety, and because it's such an excellent dollar value (the best in the S&W catalog, I feel) many municipal and county lawmen who buy their own weapons choose it. As an issue gun, the N-frame Smith has but a single drawback: a lot of people with small hands find it slightly awkward.

COMBAT MAGNUM CHOICE

There was a time when Smith sold as many Model 28s to cops as they did Model 19s. This is not now the case; the trim Combat Magnum is the odds-on choice for both individuals and departments who are upgrading to .357 Magnum firepower. The stainless Model 66 is especially popular, and at least four state police agencies have switched to it.

For all the talk about police automatics, the real trend is to the .357 revolver. In fact, a lot of departments that have gone to the

(Continued on page 70)



GREAT SPORTING POSTERS of the Golden Age

A fabulous collection of scenes in full color for the home or office from these legendary manufacturers:

- REMINGTON • WINCHESTER • SAVAGE • L. L. BEAN • LEFEVER • ABERCROMBIE & FITCH
PETERS • UMC CARTRIDGE • MANY OTHERS

**EVERY POSTER A COLLECTOR'S ITEM
HURRY WHILE THE SUPPLY LASTS**

Imagine owning these 24 historic posters. Every poster measures 11 x 16 and is printed on heavy duty poster stock. They can be removed easily from this single bound volume or kept together as a book. A collection you'd search years to obtain.

Send me _____ sets of Great Sporting Posters @ \$12.95 plus \$2.35 postage and handling per set. Total enclosed \$ _____

NAME _____
 ADDRESS _____
 CITY _____ STATE _____ ZIP _____

MAIL TO: **GUNS MAGAZINE**
 591 Camino de la Reina, Suite 200 • San Diego, Ca. 92108

**COMPLETE SET
24 POSTERS**

The 25-5

SW's Latest For Big Bore Revolver Shooters

*By Jerry Ahern
Photos By Sharon Ahern*

ONE OF THE MOST POPULAR caliber conversions in recent years has involved taking an N-frame Smith & Wesson—usually a Model 27 .357 Magnum or the .41 Magnum four-inch M&P—and converting to .45 Long Colt. To be sure, there were plenty of excellent single actions in the still popular frontier cartridge, but the Colt New Service was the last DA made in the round.

The .45 Long Colt offered several advantages as a cartridge for defense and sporting use. The big, 250-grain lead bullet was a proven manstopper and when handloaded with modern bullets the veteran cartridge was excellent in the field. And, this performance potential could be realized in a non-magnum cartridge—hence lesser recoil and pressure.

The only double action revolver available in any .45 caliber round was the Smith & Wesson Model 25 1955 Target, but this only in ACP and Auto Rim. To use factory ammo with better than the standard military ball performance, the Auto Rim had to be abandoned and the ACP round used with three-round half-moon clips.

Then, Smith & Wesson startled the shooting public with the announcement of a limited edition 125th Anniversary commemorative Model 25 in .45 Long Colt. The relatively few guns produced were enormously popular and most likely never shot, especially those with special 125th Anniversary markings. But the idea of a .45 LC d.a. that actually came that way from the factory was even more popular.

Roy Jinks, Smith & Wesson historian and noted firearms author, indicated that offering a production .45 LC version of the

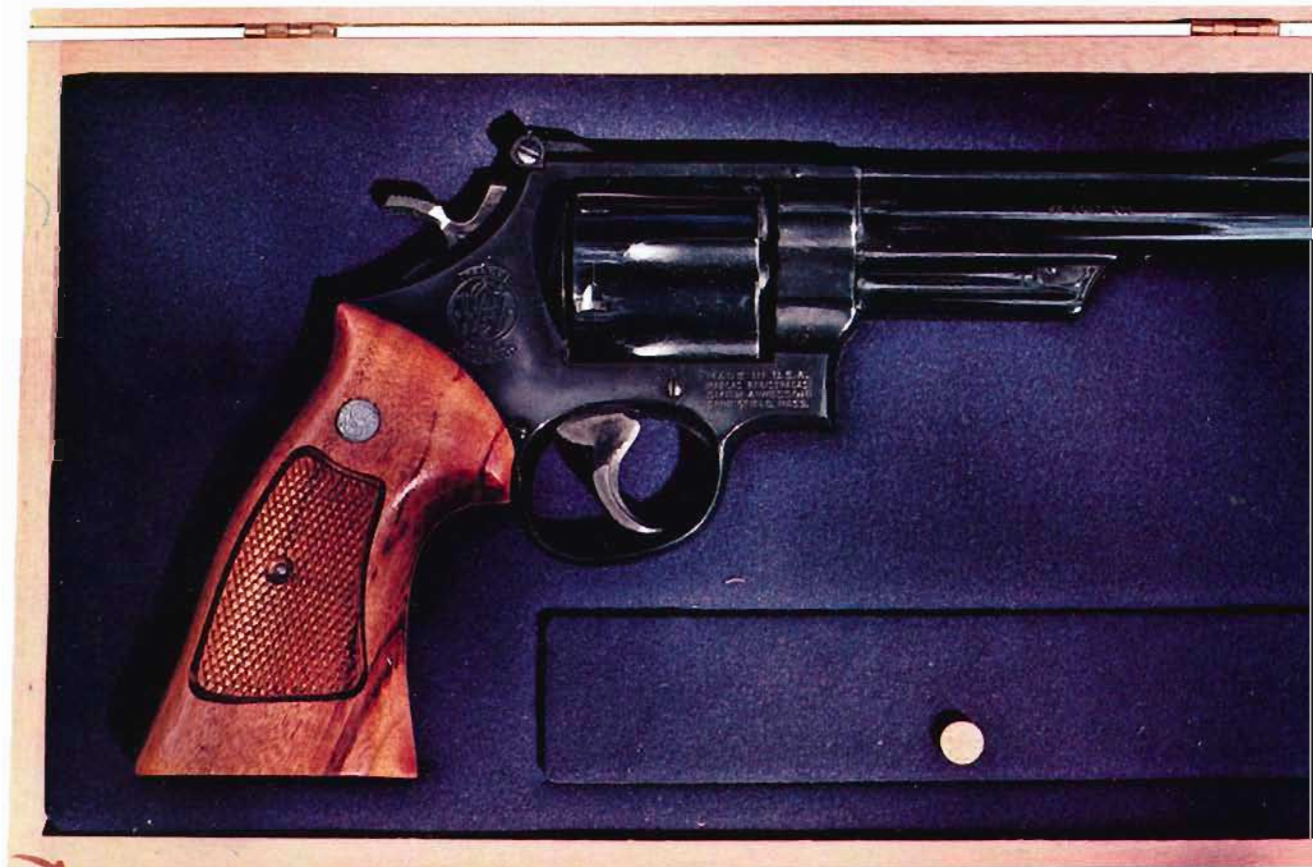

Model 25 wouldn't be quite as simple as one might imagine, this as he gestured towards a display rack of new Smith & Wesson handguns at the 1978 National Association of Sporting Goods Wholesalers Show in November of that year. One of the guns he gestured to was a Smith & Wesson Model 25-5—in .45 Long Colt. Jinks and others at Smith & Wesson had wanted a longer cylinder if the gun was to be made at all—not a standard Model 25 but chambered for the Long Colt round. This was it.

Meanwhile, the new .45 revolver demanded a few things—namely the new Federal 225-grain lead hollow point semi-wadcutter load and a suitable holster. The obvious choice was Lawman Leathers Dirty Harry Holster. Made for the six and one-half-inch 29 in .44 Magnum, it would easily accommodate any caliber N-frame with similar barrel length. And similar is the word. Smith has standardized its N-frame barrel lengths to 4, 6, 8 inch—no more 3½ inch or 5½ inch Model 27 .357, the 8½ inch N-frames. And no more the 6½.

The Model 25-5 was a six-inch. When it arrived at the co-operating dealer's shop, it was hard to imagine proprietor Sid Harper grinning any wider. The 25-5 is that impressive.

The 25-5 is available in the customary three barrel lengths—four, six and eight. The rear sight is windage and elevation adjustable, the fixed front ramp featuring a bright red insert, easy to pick up in the white outlined rear notch. Grips are the Goncalo Alves oversize target stocks, hand-filling and leaving plenty of room for constructive whittling if the owner wishes to alter the profile. The trigger is the grooved target type, case hardened, as is the wide-spur checkered target hammer.

The 25-5 is cased in a French-fitted walnut presentation box, the gun complete with cleaning rod and accessories. The Lawman Leather holster, comfortable with a big gun such as this, is easily adjustable to any average sized person. Women or very

small men might find the rig a bit oversized. With the unique cylinder cut out in the holster, surrounded by spring steel, the Dirty Harry holds the 25-5 comfortably and securely. modern gun, it was decided to test the 25-5 with only modern ammo—the new Federal round. At a nearby outdoor testing facility the 25-5 proved its mettle.

Because of the 225 gr. bullet of the new Federal round and the hotter loading, recoil with the 25-5 was noticeable, yet not at all unpleasant. At twenty-one feet, then again at thirty feet, cloverleafing with the 25-5 was more the rule than the exception. Going back out to fifty feet, firing from a modified kneeling position, this writer was able to obtain consistent groups of about three inches—and yours truly isn't noted for marksmanship.

The technical aspects of the 25-5 were just what one expects from a top-of-the line Smith revolver: indexing was accurate; lockup achieved well before the hammer reached full stand; cylinder alignment was even, with no wobble when the cylinder was spun open and consistently even light areas showing between the cylinder and the crane and frame. Single action trigger pull was even and broke cleanly with minimal overtravel, while DA pull was steady and smooth.

This new Smith & Wesson is a gun American shooters have been looking for for quite a long time, and proof that Smith & Wesson does respond to shooter demand and is just as interested in the sportsman as the policeman. Yet, with the 25-5 in .45 Long Colt, Smith & Wesson has catered to both. On the frontier, the .45 Colt round was used for game shooting, defense against predators, enforcing the law and ordinary self-defense. The new .45 Colt sixgun—the one from Smith & Wesson—will have no less versatile a future.

And, this new gun in this massive non-magnum caliber may be the first step towards high performance handguns without mag-

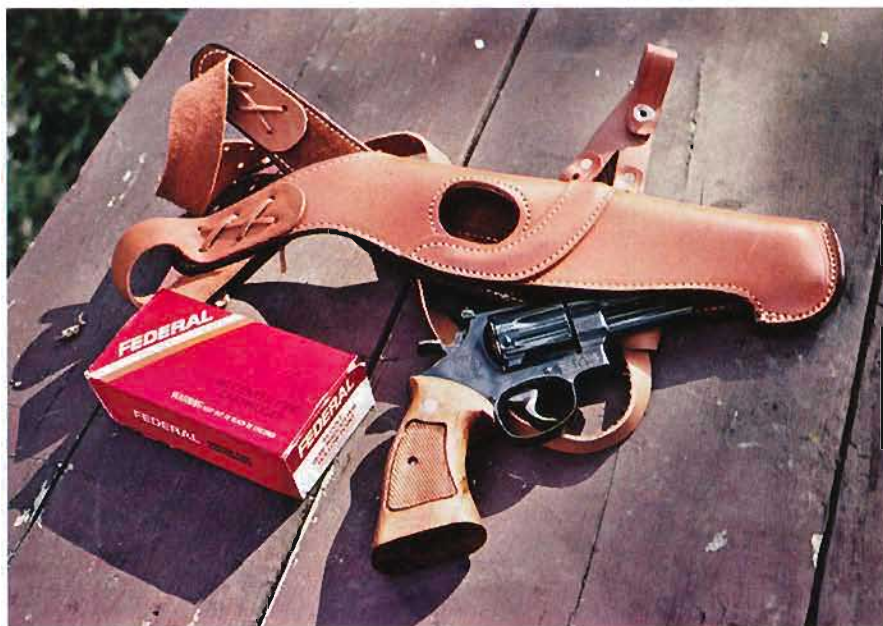

Left: The gun looks great in a Dirty Harry type holster. Holster is by Lawman and ammo by Federal. The barrel is 6". This gun is proof-positive that Smith responds to shooter interest.

Left: Here's the long-awaited, new S&W Model 25-5 in a nifty French-fitted presentation case. It has a ½" shorter barrel than the gun Smith used for the 125th Anniversary but sports a slightly longer cylinder.

num recoil—a dramatic step backward in time but forward in technology.

As this is written, suggested retail for the six-inch Model 25-5 is \$419.83, and the guns are in full production and available on dealer's shelves, though with their popularity you may spend a good amount of time hunting one down. 

HANDGUNNER

CUSTOM PISTOLSMITH DIRECTORY

This is the bi-annual update of our regular annual Custom Pistolsmith Directory. For the complete listing of 99-plus custom pistolsmiths, including a regional directory, refer to AMERICAN HANDGUNNER January/February 1981 issue. Our next full directory will appear in the Jan/Feb 1982 issue—watch for it. Our exclusive Directory is the most up-to-date and complete in print!

For any of you who missed our 1981 Custom Pistolsmith Directory, back issues are available for \$2.00 each from AMERICAN HANDGUNNER, J/F ISSUE, 291 Camino de la Reina, San Diego, CA 92108.

As always, the 'smiths listed here all do general pistolsmithing work—trigger jobs, barrel work, sight installation, etc.—and one step further: their custom specialties, as listed, separate them from being just a repair facility, and highlight them as skilled handgun craftsmen.

SILHOUETTE 'SMITHS

The 1982 Directory will feature, in addition to our regular listings, a special listing of Silhouette 'Smiths who work on, or build custom silhouette unlimited handguns. Anyone wanting to get on the list, write or call Managing Editor Mike Packard (714) 297-5352. The listing is free—the ton of extra work you'll receive from being listed is your problem.

NEW LISTINGS

AUTO SHOP (Marvin Wetstein), 8545 Washington Blvd., Culver City CA 90230, (213) 836-0179—Customizing, accurizing of .45 autos.

BROADWAY ARMS CORP. (Joe Pruden), 4114 East Broadway, No. Little Rock AR 72117, (501) 945-1853—Custom combat Colt, S&W, Ruger.

CW SPORTS (Collin Weisz), 218 3rd. St., Riverdale ND 58565, (701) 654-7612—Action jobs on Ruger, S&W, Colt revolvers. Ruger is specialty.

DAVIS CO., 1176 No. Knollwood Circle, Anaheim CA 92801 (714) 952-2191—Bill Davis' second shop, managed by son Jeff; home of the Davis Custom PPC gun, the Smolt, and the Cougar, PPC custom conversions and super duty-tunes on S&W, Colt, Ruger.



DEMPEY CUSTOM GUN, 19715 Bolton Bridge Lane, Humble TX 77338, (713) 446-7842—IPSC .45's, PPC revolvers, customizing, accurizing, conversions, rebarreling on Colt, S&W, Ruger, and Dan Wesson.

J&G SALES, Inc. (Richard Aldis), 442 Miller Valley Rd., Prescott AZ 86301, (602) 445-9650—Tuning and custom revolvers (S&W, Ruger, some Colt). Also .45 combat conversions and work.

PAUL JAEGER, INC., 211 Leedom St., Jenkintown PA 19046, (215) 884-6920—PPC Packages, specializing in S&W and Ruger, IPSC packages, XP-100 conversions.

MAC'S .45 SHOP (Jim McDonnell), Box 2028, Seal Beach, CA 90740, (213) 443-1679 or 438-5056—Customizing and accurizing .45 autos. Patented "Accu-Guide" combat system. Also custom .45 frames and barrels to order. Trigger installation and other work done while you wait. Call for appointment.

MIKE'S GUNSMITH SHOP (Michael Ray Watkins), 918 84th St., Lubbock TX 79423, (806) 745-1269—Trigger and accurizing for NRA match, .45 auto combat a specialty. Will build PPC and IHMSA unlimiteds.

J. MICHAEL PLAXCO, Rt. 1 Box 203, Roland AR 72135, (501) 868-9787—Full competition combat autos for IPSC, basic to full house custom packages. Some S&W custom revolver work. Delivery within 10 weeks in most cases.

PRECISION SPECIALTIES, Ltd., (Fran Brown), 24 Davis St., Springfield MA 01104, (413) 734-2665—PPC custom revolvers, action tuning.

QUALITY PISTOLSMITHING (Stephen M. Snider), Box 301, Energy IL 62933, (618) 942-7285—Custom duty-grade S&W 39's and 59's, combat .45's. Special finishes—Nitex, Metaloy.

RPS GUNSHOP (Jim Rice), Box 3502, Central Point OR 97502, (503) 664-5010—PPC custom and duty revolvers, bull barrels, tune and accurize, some auto work.

SCHLUTER'S GUNSMITHING & SALES (Don Schluter), 568 6th Ave., San Diego, CA 92101, (714) 239-0181—Custom tuning Colt and S&W revolvers, .45 auto tuning for combat or match.

SHOOTIST SUPPLY (John Cook), 622 5th Ave., Belle Fourche SD 57717 (605) 892-2822—Revolver and auto work, IPSC autos, mail order accessories for .45's.

BILL WISEMAN, 3600 Old College Road, Bryon TX 77801, (713) 846-3570—Ex-marine gunsmith specializing in .45 accuracy jobs. Also works Brownings and other autos.

B. WITT GUN WORKS (Carl Witt), 4020 Ridgelane, West Linn OR 97068, (503) 656-6186—IPSC modifications to S&W and Colt autos. Bo-Mar, MMC, S&W sight, hardchroming, rebluing, action tuning.

UPDATED LISTINGS

BEHLERT CUSTOM GUNS (Austin Behlert), US Rt. 1 Northbound, Monmouth Junction NJ 08852, (201) 687-3350—Combat and PPC, wide variety.

BELLS CUSTOM SHOP (Dave Norin), 3313 Mannheim Rd., Franklin Park IL 60131, (312) 678-1900—Reliable and accurate .45's for combat.

LOU CIAMILLO (Maryland Gun works), 26200 Frederick Rd., Hyattstown MD 20734, (301) 831-8456—Specializing in Ruger, S&W, and Colt conversions for police combat.

DUNCAN GUN SHOP, Box 1959, 414 2nd St., N. Wilkesboro NC 28659, (919) 667-3222/838-4857—Guaranteed X-ring accuracy custom PPC revolvers.

JACK'S GUNS & RELOADING (Jack Abene), 3911 W. Waters Ave., Suite 3, Tampa FL 33606, (813) 932-8824—PPC tuning and auto accurizing.

LEE JURRAS—retired from full-time 'smithing.

ALAN C. MARVEL, 3922 Madonna Rd., Jarrettsville MD 21084, (301) 557-7270—Accurizing autos and revolvers, specializing in Colt .45 auto and .38 Super conversions in standard and long slide, trigger tuning on High Standard and S&W M41 autos.

GREG ROBERTS, 2145 Delaware St., Santa Cruz CA 95060, (408) 426-7630—High quality revolver work. S&W, Colt. Also quality reloaded ammo in .38, .357, .45 calibers.

SHERMAN'S CUSTOM GUNS (Walt Sherman), 9621 Rose Rd., Tallahassee FL 32304, (904) 877-3390—Specializes in Colt Python actions, but will do S&W K or N frames.

TRULOCK FIREARMS (George Trulock), Box 74, Whigham GA 31797, (912) 762-4678—Caliber conversions on N-frame S&W, old model Ruger and new model stainless steel Blackhawks. Custom auto and revolver work.

WALTERS INDUSTRIES (Dave Walters), 6226 Park Lane, Dallas TX 75225, (214) 691-6973—Combat and NRA target .45's.

ROYCE O. WEDDLE, 4111 24th Ave., Norman OK 73069, (405) 364-0444—Custom target revolvers, action jobs, single or double action trigger smoothing.

WILSON'S GUN SHOP (Bill Wilson), Rt. 3, Box 211-D, Berryville AR 72616, (501) 545-3618—Acclaimed Wilson Combat .45 autos, basic to full house selection with varying price ranges. Custom accessories available also.



**OUR BLUE IS
THE BASIC POLICY**

Small caliber, pocket automatics designed for personal protection, as back-up or off-duty police arms or for fishermen and campers. American made of ordnance steel. Rugged, reliable and easy to clean. Fast action thumb safeties.

**THE STAINLESS GIVES YOU
A RIDER AGAINST RUST
AND CORROSION**

The same lightweight, dependable arms are available with stainless steel finish for those who want that extra edge against moisture.



.22 and .25 caliber models available with Blue, Stainless or Nickel finish. All with 6-round magazine capacity. Extra magazines available.

**STERLING
ARMS
CORP.**

211 Grand Street, Lockport, N.Y. 14094

At your firearms dealer. Or write for new catalog of all Sterling autoloaders. Please send 25 cents.

INSURANCE

CHUCK TAYLOR

Commando Special

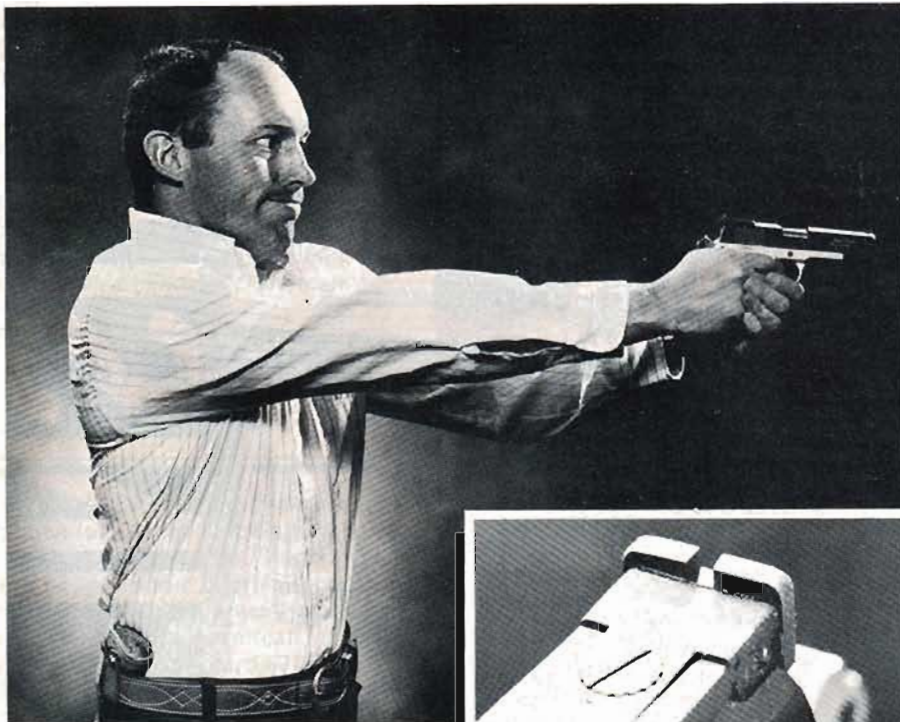

By John S. Farnam

THE CHUCK TAYLOR COMMANDO SPECIAL is a Colt Lightweight Commander that has been skillfully modified by the distinguished gunsmiths at Sportswest in Denver under the supervision of Chuck Taylor, well-known IPSC shooter, author, and top-flight weapons training specialist.

These days there is a plethora of gunsmiths claiming to do quality work on the Colt auto. Some are excellent, most are decent, a few are abominable. Among the very best are Ikey Starks and George Orndorff of Sportswest. Their work has enjoyed a superb reputation, which is doubtless why Chuck chose them to make the weapon which bears his name.

By latest count, the number of modifications available on the Colt auto exceeds one-hundred. You can get everything from a vented, extended barrel to an ambidexterous slide release! Most of these have

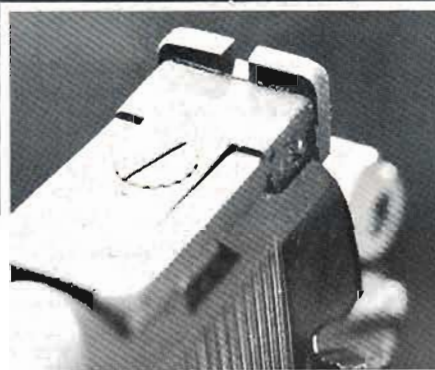

Melted adjustable Bo-mar rear sight for de-horned, instant sight picture.

been created at the behest of IPSC shooters looking for every possible competitive advantage. It has not been a one-way street, however. As anyone who has attended high-level IPSC competitions will attest, many of these highly-modified, finely-tuned competition guns have proven ungainly, heavy, finicky, and prone to stoppages.

Chuck has carefully analyzed all the available modifications, most of which he has had considerable personal experience with, and refined them down to include only those which have proven legitimately helpful and do not degrade the carryability and reliability of the weapon. The Chuck Taylor Commando Special is designed to be carried concealed and give its

owner every survival advantage in an actual armed encounter. It is *not* designed to win IPSC matches (though it may well do just that).

Here then is a description of the Chuck Taylor Commando Special:

Standard Colt safety. Many of the enlarged safeties add unacceptable bulk to the weapon. Ambidexterous safeties tend to get "elbowed" off inadvertently when the weapon is carried concealed, according to many left-handers who have employed this modification. Left-handers should have a left-hand *only* safety or, learn to shoot right-handed.

Standard, functional grip safety. The grip safety performs a legitimate function. If the weapon is dropped or jarred from the shooter's hand, it is rendered inert the moment it leaves his grip—a good feature. Most shooters have no trouble with it and forget it's even there. Those few who do have a problem with it should have it modified to suit them rather than have it pinned out of action.

Crisp trigger 3.5 lbs. As they come from the box, Colt autos have a trigger that is heavier and creepier than most of us want. A crisp, three and a half pound pull is about right, lighter and you're flirting with unintentional discharges, heavier and you're adding milliseconds to your first round.

(Continued on page 39)

A .45 tuned for street/survival with just the right accessories and smithing for concealment and smooth-functioning reliability



Commando Special concealment rig is Milt Sparks holster and Bianchi belt.

Ikey's trigger jobs are among the best.

Sights. Wide, serrated ramp in front—adjustable, rounded-off Bo-mar in the rear, "melted" into the slide. Sights need to be conspicuous and striking enough to be picked up rapidly when the gun is drawn; yet they must not excessively protrude from the weapon adding bulk and bothersome sharp corners. Ikey has masterfully installed the Bo-mars in a way that maximizes their usefulness yet keeps excessive bulk to a minimum. The weapon remains slick and fast. Unlike some, the Bo-mars are husky and rugged—a necessity with a carry gun.

Checked front strap. Very helpful during the draw, particularly when drawing from under a coat. It fixes the hand in position, prevents the grip from shifting.

Heavy, hardened barrel bushing. Enhances accuracy. Does not bind or wear excessively like some. Bushing wrench is provided with gun.

Beveled magazine well, 60 degrees. Nearly all endorse this modification. Greatly speeds magazine changes. Experience has shown 60 degrees to be the preferred angle.

Throated and polished feed ramp. Another universally endorsed modification. Greatly enhances feeding reliability, enables the weapon to reliably use a variety of ammunition. I tested it with all the commercially available hollowpoints as well as several other high-performance loads, and it functioned flawlessly. I personally prefer hardball, but you can use your favorite hollowpoint with confidence.

Chuck Taylor Commando Special logo. Identifies the gun for what it is. Enhances pride in ownership.

Colt Lightweight frame and Colt slide. Rounded and dehorned throughout. Ejector area ported out. Slide is gloss finished (blue) on sides, frosted on top. Frame is shot blasted white. When selecting a .45 auto on which a life may depend, premier gunsmiths agree: stick with a Colt. There are "other" .45's, and many people like them, but if there is one thing Colt can do well, it's build a .45 auto.

So, if you routinely carry a gun concealed, the Chuck Taylor Commando Special was designed for you. It combines reliability, shootability, power, controllability, simplicity, durability, carryability, convenience, and quality in a weapon that is available at a reasonable price. Designed by a gunman, built by experts; it is a gun for gunmen. If the foregoing describes the kind of weapon you've been looking for—don't pass it up.

Author's note: The Chuck Taylor Commando Special is available thru Sportswest (ask for Ikey or George) 2200 W Alameda Ave., Alameda Square Shopping Center, Denver, CO 80223 (303) 934-4466. Price \$700-\$750 complete; delivery: 4-6 weeks.

S&W FINE ACTION JOBS

Combat-Competition-Target

All parts matched, fit to your gun, polished and tested. Glass smooth pull, crisp letoff, single and double, 30 years experience. Old S&W revolvers restored. Affordable prices. For illustrated price list, Write To: 2187 Lakeales Blvd., White Bear Lake, Minnesota 55110.

THE PEACEABLE MAN

FOR FURTHER INFORMATION CONTACT:

A. JACK ROSENBERG & SONS
12229 COX LANE
DALLAS, TEXAS
75234
214-241-8302



Thousands Sold
100 STEEL 38 CALIBER FREE DARTS
BUY 2 GET 600 BONUS DARTS
NO LICENSE REQ SURVIVAL HUNTING
AMAZON BLOW-GUN
GUARANTEED 15 YEARS
NOW ONLY \$8.97
NOW ONLY \$19.95 list

SILENT, POWERFUL, ACCURATE, HITS IN THE BULLET. Improved version of famous Amazon blowgun. Thrilling sport! Kills varmints, pests. Defense. Ideal gift. Compressed breath gives amazing power. 200 ft. range. Astound friends! Rugged. 38 cal. precision aluminum rubber grips. Pierces 1/2" plywood. Speed 300 ft/sec. Not a toy! Has 100 steel darts (kit) carry case, instructions. Compact 4 1/4 ft. model \$8.97! Popular 5 1/2 ft. \$9.97! Magnum 6 ft. \$10.97! Extra darts \$3.50 for 100! \$5.95, 200! \$14.50! \$26.00! Super BONUS BUY 2 guns get 600 darts, sling, quiver, patches, camouflage, targets, carry box (\$22 Free)! BUY 3 SAME + cleaning rod + 900 (\$32 Free)! BUY SAME + 1100 + Guerrilla Gun (\$50 Free) BUY 3 SAME + 1300 + FREE 7th GUN! (\$65) BUY 4 SAME + 1600! (\$85) Add \$1.35 postage EACH gun. Send cash, check, m.o. Will replace if broken within 15 YEARS! Use 30 days. Money back if not delighted. HOUSE OF WEAPONS, INC. Box 794-B, Provo, Utah 84601. Dealer Inquiries Invited. Buy direct from manufacturer. MUST SEE TO BELIEVE.

VISA/Master Charge CARD orders ONLY. CALL TOLL FREE NOW 24 hrs: 800-824-7888/AK/Hawaii 800-824-7919. Ask for operator 720.

Guns,
Guns Accessories,
Clips, and Parts for Broomhandle
Mausers, Lugers, P-38,
1911A1, M1 Carbines

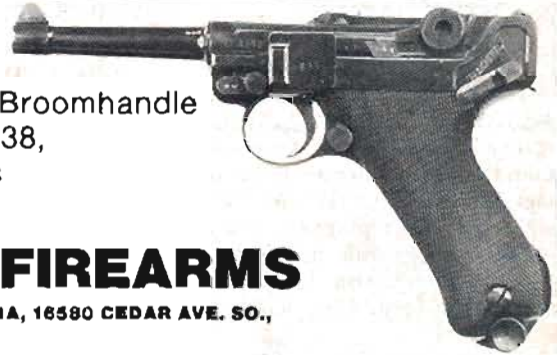

MIDWEST FIREARMS

WRITE FOR CATALOG. DEPT. 1A, 16580 CEDAR AVE. SO.,
ROSEMOUNT, MN 55068

LIGHTNING GRIPS

NEW FROM BIANCHI

Patented.
Other Patents
Pending.

"LIGHTNING"TM
Grips for Revolvers
Model #650 S&W Chief Spl.
M36, M60
Model #655 S&W "K" M19,
M10 Round
• Shrouded Hammer • Finger
Grooves • Molded Rubber
Construction • Speed Loader
Clearance • Single Action
Capability • Flat Compact
Design • Hand Filling Shape
• Checkered Palm Swells

\$22.95 ea. plus \$1.00 postage & handling.
CA Res. add 6% Sales Tax.

SPECIAL
"Dished" area
for quick and
easy magazine
button release.

Full
Shrouded
Hammer

"LIGHTNING"TM
Grips for Autos
Model #660 Colt "Government"
.45 Auto; Colt "Commander"
• Flat Compact Design • Deep Finger
Grooves • Hand Filling Shape • Left
Panel Specially "Dished" for Quick
Magazine Button Release

\$23.95 ea. plus \$1.00 postage & handling.
CA Res. add 6% Sales Tax.

REDUCES RECOIL • IMPROVES ACCURACY

At Bianchi Authorized Dealers Worldwide.



Write
Today for Full
Color Catalog
(send \$1.00)



BIANCHI
GUNLEATHERTM

100 Calle Cortez, Dept. AH-781, Temecula, California 92390

By Evan P. Marshall

SMITH & WESSON BROKE with tradition on January 13, 1981, and invited a select group of gun writers to preview new gun and ammunition offerings. American Handgunner staffer Evan Marshall not only test fired these guns extensively at the factory, but brought a number of them home for in-depth evaluation.

Marshall also toured the factory, and saw first hand S&W doing everything possible to produce enough handguns to meet current demands. Furthermore, in spite of rumors to the contrary, S&W is producing the J frame .38 snubs in large numbers. Here is his report.

MODELS 439/459

The second generation S&W 9mms that we have heard so much about are finally a reality. The 439 and 459 retain the aluminum frame, but offer a number of advantages over the original versions. The rear sight has been replaced with a fully adjustable version with sheet metal wings to prevent snagging on clothing. Also new and sorely needed is a wider extractor

made of stainless steel that offers reliable extraction of all 9mm loads. S&W had found that the wide disparity in rim thickness had made the original extractor only marginally adequate.

Early prototype 439s and 459s did not retain the hammer drop feature of the slide safety. The safety had to be applied and then the trigger pulled to drop the hammer. The possibilities for accidental discharge were obvious, so S&W returned to the original format.

While it was not commonly known, S&W Model 39s and 59s would discharge if dropped with the safety off. While condi-

(Continued on page 41)

S&W INTRODUCES

New Guns & Ammo

On the heels of the new 9mm auto pistols, come steel-framed versions, a stronger frame .357 Magnum, and a 9mm revolver, plus new hollowpoint ammo for .38 & 9mm

"CHIEF SPECIAL"
38 SPECIAL—STANDARD PRESSURE
125gr NYCLAD HOLLOW POINT



70 CAL



38 SPECIAL
"4 P" 125 gr JACKETED HOLLOW POINTS



50 CAL



90 CAL



56 CAL

ALL SAMPLES FIRED INTO GELATIN
FROM S&W MODEL 38
2" BULLET

NYCLAD 9mm 125gr HOLLOW PT.



76 CAL

9mm 125 JACKETED HOLLOW POINTS



30 CAL



39 CAL

ALL SAMPLES FIRED INTO GELATIN
FROM S&W MODEL 459



M547 9mm revolver (top)
L-frame M586 .357 Mag (middle)
New steel-frame M559 (bottom)

tions had to be exactly right, it was possible. To eliminate this problem, S&W has introduced a firing pin block that holds the firing pin immobile until the trigger is pulled.

Last but far from least, the guns have been redesigned so that they will feed virtually any 9mm load on the market. I repeatedly filled the magazine at random with loads ranging from Super Vels 90 grain jhp to Remingtons 124 grain full metal jacket offering. The weapons fed all without a hitch.

MODELS 539/559

Over the succeeding years S&W have received countless requests for steel framed 9mms. Finally, after several years of research, S&W has introduced the 539 and 559.

These steel frame pistols incorporate all the improvements of the 439 and 459. Unlike the aluminum frame guns, the steel ones can be accurized. My 559 is currently being accurized by a well known custom pistolsmith and we hope to have it finished in time for the Bianchi Cup.

MODELS 586/686

When S&W introduced the Model 19 medium frame .357 Magnum, it was envisioned that police officers would practice with .38 wadcutters. Today, those departments that issue .357 Magnums routinely practice and qualify with full power Magnum loads. This coupled with new high intensity Magnum loads has created problems with medium frame .357s.

S&W response to this problem has been to introduce a new "L" frame .357 Magnum, the Model 586. The Model 586 is designed with a larger cylinder and heavier barrel to withstand constant use of Magnum loads. The grips are interchangeable with the "K" frame, so custom grips can be easily installed.

The 586 will be available with either a four or six inch barrel. The four inch version will weigh 42 ounces unloaded; the six inch will weigh 46 ounces. It will come standard with a smooth combat trigger and semi-target hammer. The four inch will come standard with a red ramp and white outline, while the six inch will come with a plain patridge or red ramp. The Goncalo Alves target grips have a speed loader cutaway.

S&W refers to this Model as the "Distinguished Combat Magnum" and it will certainly be popular among NRA Police Combat Shooters who prefer the S&W for the "Distinguished" stage. While the cylinder size is different than the "K" or "N" frame, Colt Python speedloaders work perfectly.

The 586 has proven extremely accurate. I've gotten groups under 1" at 25 yards with S&W Nyelad wadcutter ammo. Federal 125 grain jhp .357 loads have proven virtually as accurate. It will also be offered in nickel and stainless steel (Model

COMBAT AND IPSC SHOOTERS

Extended Magazine Release Button for Colt, AMT and Crown City Autos. Completely replaces the existing release. No drilling or tapping necessary. Instructions included. \$19.95 postpaid. N.Y. res. add 7% tax. JIM'S FLYE SHOPPE Dept. AHG Rd. # 1 9518 Rt. 60 Fredonia, NY 14063.



M500 CHRONOGRAPH

VELOCITY TEST YOUR RELOADS

FROM \$79

WRITE FOR FREE TEST REPORT:

Cust. Chr. Co. Box 1061, Brawster, WA 98812



A revolutionary concept in firepower for your favorite .45 pistol

TAYLOR MK I .45 PISTOL DRUM

Designed and manufactured exclusively for Bingham! Drum is centered to pistol frame to maintain balance of pistol. Added weight is balanced to reduce recoil, provide greater accuracy and reduce recovery time. 30 round cartridge capacity without reloading. Nonglare blued finish. Pistol can be carried in most holsters with drum magazine attached. To order, send cash, check or money order for \$46.50 plus \$2 shipping and insurance for each drum.

PATENT PENDING

BINGHAM, LTD.

Dept. AH-7
1775-C Wilwat Drive, Norcross, Ga. 30093 Phone: 404/448-1440

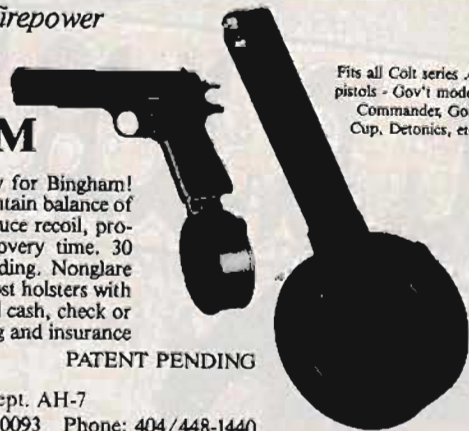

Fits all Colt series .45 pistols - Gov't model, Commander, Gold Cup, Detonics, etc.

The Wichita™ Multi Range Quick Change Sighting System will revolutionize the way you compete.

Imagine this. You can pre-set 4 settings on the rear sight that quickly 'click' into position by simply turning a serrated wheel to 1-2-3-4. Then, to compensate for day-to-day light and weather conditions all you adjust is the front sight. You eliminate the need to tamper with the rear sight. Now that's a revolutionary sighting system.

It's available for all Wichita silhouette pistols, and can be adapted to any firearm. Front and rear sights may be purchased separately.

Wichita Multi-Range Rear Sight \$69.95

Wichita Adjustable Front Sight \$39.95

Contact your Local Dealer. Please specify firearm.



Wichita Arms / 333 Lulu, P.O. Box 11371, Wichita, KS 67211 / (316) 265-0661

There is a lifetime of design experience in every Herrett's stock.

THE NEW HERRETT'S SHOOTING MASTER™

Shooting confidence with your personal handgun starts with stability under heavy recoil and that is what I have designed into the new Shooting Master stock. Carved in matched traditional walnut to tolerances that exceed the gun frame itself. With smooth line rounded butt, speed loader clearance, and combat style finger grooves. Designed for identical right or left hand hold. It is the ultimate for combat or silhouette shooting. This is quality to match your professionalism.

Choice of smooth, fine line or skip checkered for Ruger, Colt and S&W, DA revolvers.



Available from your dealer.
For catalog send \$1.00
P.O. Box 741 - H7
Twin Falls, Idaho 83301 U.S.A.



WARRIOR



S FOR MAGNUMS

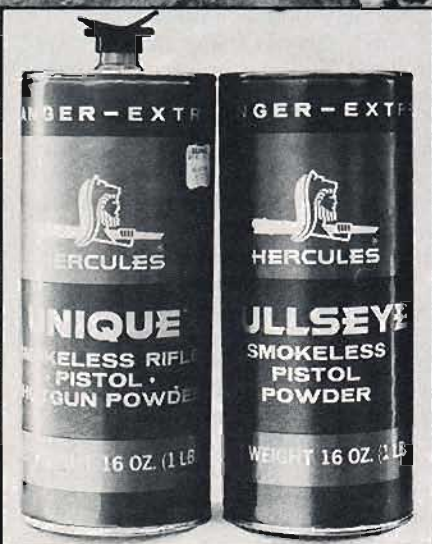
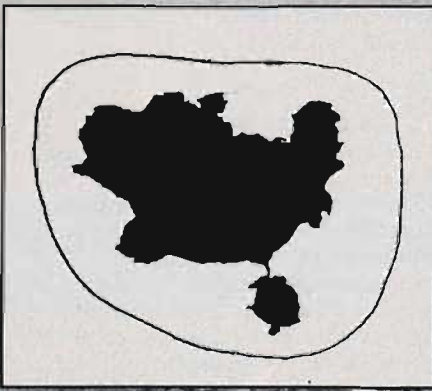

Your Initiation To The Big Boomers Can Be Made A Lot More Pleasant If You Take It A Step At A Time...

By Mike Venturino

We are living in the age of the magnum handgun.

Metallic silhouette shooting with handguns is a fast growing sport; handgun hunting is being legalized in many areas; and the total selection of magnum handguns available from various manufacturers is simply amazing.

The only benefits a magnum handgun offers over the standard calibers are power and flatness of trajectory. On the other hand, the side effects of that power are noise and recoil—both of which make the magnum a very difficult handgun to learn to shoot accurately.

No one that I have ever met has become even a mediocre shot with a magnum handgun by using full power loads in it from the very beginning. To become an accurate marksman with a hard-hitting, big bore handgun requires much practice with what I term "learning loads; handloads for a big bore handgun that are mild—say no more than 900 FPS at the most, and accurate." By accurate I mean groups no larger than two inches at 25 yards—when the handgun is fired from either a mechanical or sandbag rest.

Another requirement for "learning loads" is that they be relatively cheap. This is a tall order in this day and age, but since

it takes much ammo to become good with a handgun, cost is a consideration.

Jacketed bullets for this variety of handgun are a waste—pure and simple. For "learning loads" their ability to expand into the classic mushroom is useless, and worse yet, at low velocities it is possible for them to stick in a handgun's bore. And they are too expensive for most of us to shoot hundreds and thousands away in practice.

If a handgunner does not cast his own bullets then the soft, swaged lead bullets put out by various manufacturers are the ticket. Unless driven too fast they will not lead the bore.

For those who already own bullet casting equipment the moulded lead bullet is a far better route to go. Casting your own bullets gives you a latitude in bullet weight, alloy, diameter, and lubricant not available to shooters of store-bought bullets.

I know my cast bullets are good because I have tested thousands of them through over a dozen handguns using a Lee Pistol Machine Rest. I have yet to find a revolver that will not shoot groups of at least two inches at 25 yards with the proper loads—with cast bullets!

Self-cast bullets are good and by far the cheapest bullets available. *I know!*

Bullet design is not greatly important for "learning loads" except that the bullet should be accurate. If the shooter will do most of his practicing at paper targets then the standby wadcutter shape or the semi-wadcutter is best because of the clean holes they will cut. For varmints such as gophers or small game this same reasoning is sound.

However, if a roundnose bullet (or mould) is all that is available don't sell it short. Some of these old-fashioned looking bullets are amazingly accurate.

For my own use I have generally settled
(Continued on page 44)

At the far left, notice that recoil is slight. That's because author is using his "learning loads." The gun is a S&W Model 29 .44 Magnum. Inset shows usual recoil of .44 Magnum—how's that for a big jump? Top photo shows target with a nice 25 yd. group measuring 1 1/4" shot with author's best load of Bullseye. This powder and the Unique have been around a long time and make great learning loads. Cast bullets make good loads for inexpensive shooting and were used by writer. So, learning loads were set up to be cheap, accurate, and to lessen recoil.

CLARK & RUGER



Adjustable
Rear Sight

\$ 17.50
RETAIL

Add \$1.00 for postage
and handling.

(White outline blade — \$3.50 extra)

Replaces rear sight on Ruger models with adjustable sights. Large, flat rear blade with deeper sight notch. Improved sight picture. Better click adjustments.

Also available to fit base on current
production model Mark I.

DEALER INQUIRIES INVITED.

James E. Clark
PISTOLSMITH

Rt. 2 — Box 22A
Keithville, Louisiana 71047
(318) 925-0836

Deluxe All Caliber Pistol Cleaning Kit

Complete care for your finest pistols. Duraluminum cleaning rod, phosphor bronze brushes, silicone cloth, nylon cleaning tips, wool mops, patches, Gunslick, oil, solvent and expert cleaning instructions. Deluxe kits for shotguns and rifles also available.



See your dealer
or write

Outers
Laboratories, Inc.

P.O. Box 39-HG, Onalaska, WI 54650

LEARNING LOADS

(Continued from page 43)

on the various semi-wadcutter designs as I use them in both practice and full power loadings.

In .44 caliber I use either Lyman #429421, or RCBS 44-250K. In .41 caliber the Lyman #410459 and the RCBS 41-210K are fine, and for .357 Magnum both Lyman #358477 or RCBS 38-150K are good choices. However, for my last birthday my wife gave me a Lyman mould #35891 for a bevel base full wadcutter bullet that has shot rings around some of my previously favored bullets—accuracy wise.

It pays to experiment!

In general gas check type bullets are good but the gas checks are a needless



**Heavy recoil of magnum caliber guns
can be toned down with learning loads.**

expense at the velocity level of "learning loads."

Again; the individual design of bullet is not so important as long as they are accurate, plentiful, and reasonably priced.

As important as the bullet design picked for practice loads is the choice of powders. Accuracy and economy are still the watchwords. Nearly any of the faster burning powders are suitable regardless of brand.

Don't figure that just because one of the slower powders is the best choice for full magnum loads it will be good for reduced loads with reduced charges. Powders such as 2400, IMR-4227, or H-110 which are good for the high velocity loads, will give incomplete burning or maybe even misfires at low pressures. Accuracy will also be poor.

My favorite powders for "learning loads" are Bullseye and Unique. Accuracy is easily obtainable with both these propellants using moderate charges, and because of those moderate charge weights the cost factor is low.

Recently I have used some other powders such as SR-4756 and Red Dot, with very good results so my mind is open as far as powders are concerned.

As an example of the cost factor I will use my favorite load for my Smith & Wesson .357 Magnum Model 27. It consists of one of the aforementioned cast bullets over a charge of 4.0 grains of Bullseye.

Velocity is around 850 FPS at 25 yards,

groups average about 1½ inches. But, the powder cost per shot is also excellent with 1,750 charges to a one pound (approx. \$8.00) can of powder!

When using these light charges of fast-burning powders it pays to be very cautious about double charging a case. Where the above mentioned 4.0 grains of Bullseye in a .357 Magnum case is fine, a double charge of 8.0 grains may blow the gun to pieces. I check every case after charging them. It takes a little longer—but I'm loading for accuracy and safety—not quantity!

The fact that a handgun can be just as sensitive about its powder charge as a rifle is generally not well known. However, it is true.

4.0 GRAINS BULLSEYE

When working up with Bullseye for that .357 Magnum target load I tried 3.0, 3.2, 3.4, 3.6, 3.8, and then 4.0 grains using the handgun in my Lee Pistol Machine Rest. The 10-round groups with 3.0, 3.4, and 3.8 gave nowhere near the accuracy as those with 3.2 and 3.6 grains. But none of the charge weights gave near the excellent accuracy of the 4.0-grain charge, whose groups very rarely measure over 1.5 inches, and then only a fraction or so over.

To check this out I shot this test over again twice and the order of accuracy always stayed the same. Loads with 3.0, 3.4 and 3.6 grains always averaged over two inches; loads with 3.2 and 3.6 grains hovered right at the two-inch mark, and the 4.0-grain charge always was much under that.

This experience convinced me to always test various powder charges when striving for accuracy with handguns.

I have also seen the use of a filler material such as dacron recommended for light handgun loads. I disagree with this after trying it. For me accuracy deteriorated in every instance.

One practice I do heartily recommend for "learning loads" is the use of the full-length magnum in both .357 and .44 Magnum calibers.

MAGNUM BRASS BETTER

In fact, it was my inability to achieve any kind of accuracy with my Smith & Wesson Model 27 .357 Magnum using loads in .38 Special brass that lead me to experiment with the various powder charges in .357 Magnum brass as I just mentioned.

Even using factory match .38 Special wadcutters that are known for their accuracy my Model 27 would not present me with a 10-shot, 25-yard group of under three inches. Nor has it done so with any load I have put in .38 Special brass.

Checking this matter out a bit further I found that my Smith & Wesson Model 29 .44 Magnum would not shoot nearly as well with .44 Special loads. But, put .44 Special-class loads in .44 Magnum brass and accuracy was again excellent.

(Continued on page 70)

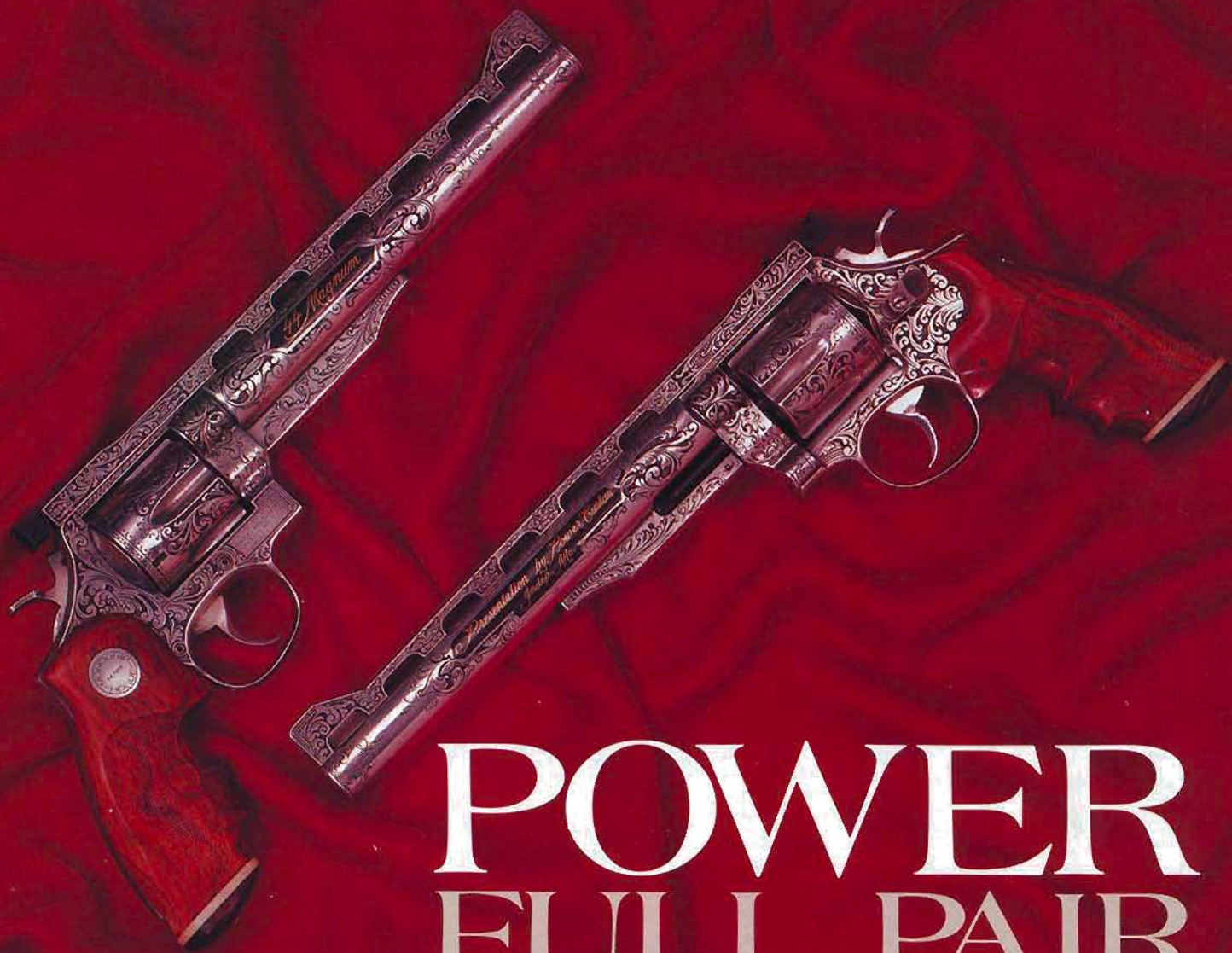

POWER FULL PAIR

*Ron Power customized .44 Magnums
with Frank Hendricks engraving*

WHEN RON POWER does something to a gun, you can just bet that it will turn out to be a classic job. The pair of .44 Magnums shown here are evidence to the truth of that statement.

Ron first told us about these guns several years ago, and every chance he had, he would end his conversations with; "Wait till you see these guns."

The story behind these guns will interest not only those who admire fine engraving, but also anyone interested in handgun conversions. Ron took the basic S&W Model 58 frame, added a Model 29 cylin-

der (Ron does not believe in rechambering), then installed his own barrel and rib. The guns are, of course, tuned to perfection, using many of Ron's own accessory parts to assure a smooth and long life.

The classic engraving job was done by Frank Hendricks of San Antonio, and combines the heavy leaf patterns with fine scrolls in a blending of the two that bespeaks of artistic talent and good taste.

The guns, unfortunately, are not for sale. They were made especially for Mr. Edward Benson, President of Royce Electronics.



HAND LOAD ING

THE
.44
MAG



There's more to it than just packing the case for high-speed blast-offs, for instance . . .

By Don Zutz

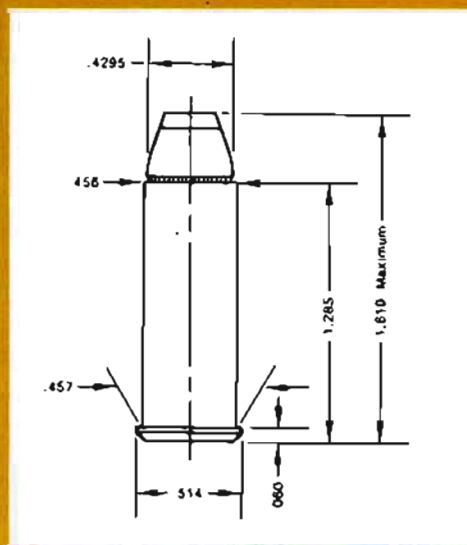

ONE OF THE FUNNIEST stories I've heard is about a local handgun silhouette shooter who thought he'd beat the game by having a Contender chambered for the .444 Marlin cartridge. He thought the larger round would give him an advantage over shooters using the .44 Magnum, because he was sure the added powder capacity would flatten trajectories and deliver positive knockdown power on the distant rams. But the first time he shot it with full-throttle loads, it broke a bone in his hand!

There are a couple lessons to be learned from that tale. First, there's always somebody who wants more, more, more. Secondly, everything has its limitations. Both apply to reloading the .44 Magnum, since there's more to this cartridge than merely stuffing in great gobs of powder for the highest possible velocities.

Introduced in 1955, the .44 Magnum is essentially a lengthened version of the old .44 S&W Special, which is itself a lengthened form of the even older .44 S&W Russian. Aside from having basically similar case dimensions except for length, all similarities between the .44 Magnum and the earlier rounds end there. To run signifi-

(Continued on page 55)

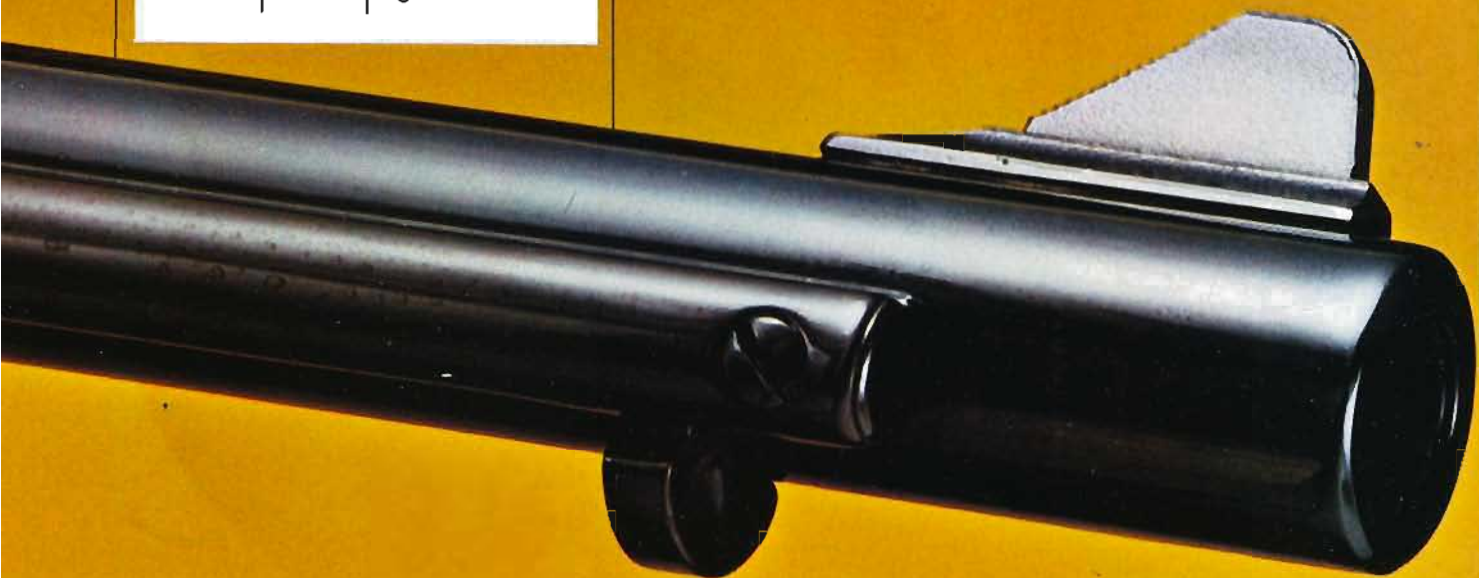

SILHOUETTE

WIN THIS CUSTOM PISTOL

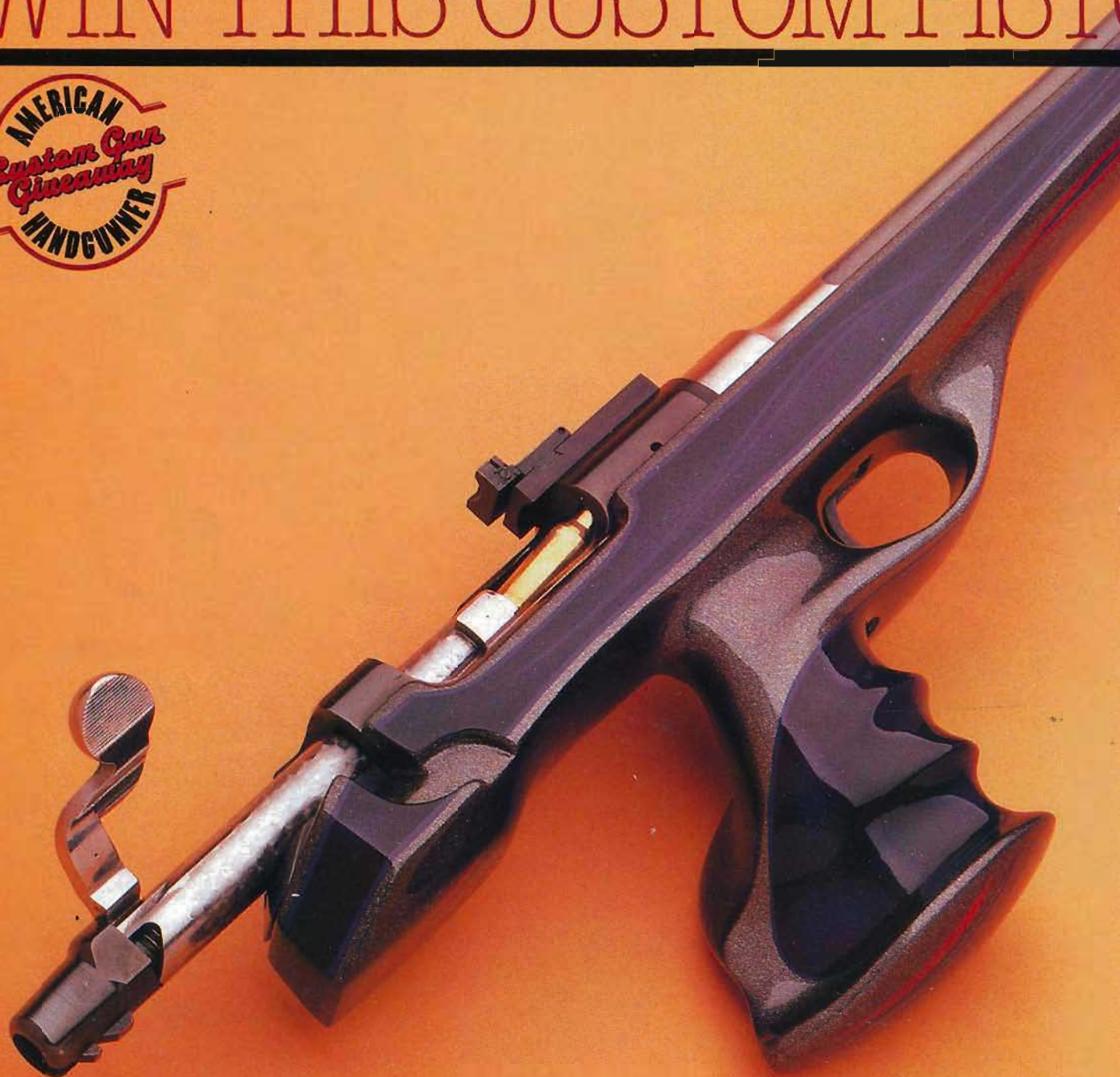

THE SHOOTERS

MODEL FROM H-S PRECISION

The first time that we have been able to offer our readers a chance to win a silhouette pistol, we have a real beauty!

Produced especially for the AMERICAN HANDGUNNER Custom Gun Giveaway, this custom XP-100 was crafted by H-S Precision of Prescott, Arizona. Here are the specifics, and as you read them, think how much it would cost you to get a similar pistol made to order.

ACTION: Remington XP-100

BARREL: Match Grade Atkinson barrel by H-S Precision. This is the only grade they produce, and their accuracy is verified by the number of times they have won national championships; three in 1980 alone.

STOCK: H-S Precision's newest design, the FRP-1000-1 "Fiberthane" stock is reaction injection moulded. It is a polythane foam reinforced with fiberglass. The stock has a machined "V" block molded in to eliminate the need for bedding. The paint job was done by "Slimbo" of Prescott, AZ.

SIGHTS: Installed and calibrated are a Micro rear sight and a Lyman globe front sight.

CALIBER: The latest and hottest cartridge on the silhouette scene, Remington's 7mm BR. Included with the gun is one of H-S Precision's "Tru-Nec" neck turning tools.

WEIGHT: 4 pounds, 7 ounces

H-S Precision was founded in 1978 by its president, Tom Houghton. The firm purchased the assets of the Atkinson Gun Co. producers of fine rifle barrels for many years.

In addition to manufacturing target and hunting barrels for shooting sportsmen, they also make test and experimental barrels for the ammunition industry.

Another aspect of H-S Precision is the manufacture of "Fiberthane" gun stocks. They have 8 benchrest rifle models, 2 sporter rifle models, 3 silhouette pistol and 7 silhouette rifles models. There are two versions of the latest silhouette model shown on our prize gun that require no bedding.

H-S Precision will soon have a line of accessory products, including bedding compound, cleaning rod guides, etc. Take a look, also, at their "Sierra

Grande" Lightweight rifle, using the 700 Remington action.

For more information on this pistol, the "Fiberthane" stocks or Atkinson barrels, contact: Tom Houghton, H-S Precision, Inc., P.O. Box 512, Prescott, AZ 86302. Send \$2.00 (refundable on first order) for their new catalog.

Name	_____	
Address	_____	
City & State	_____	
HOM—JULY/AUG		
If I win, please ship my gun through the following dealer:		
Dealer	_____	
Address	_____	
City	State	Zip
_____	_____	_____
Contest void where taxed or prohibited by law. No purchase necessary. Winner must comply with all federal and local laws. Employees and agents of Publisher's Development Corp. not eligible.		

MORE WINNERS!

November/December contest:
A Safari Arms Matchmaster .45 with Armoloy finish is now proudly owned by lucky winner Doug Grindstaff who is a patrolman with the Fulton, Missouri PD. He was in the process of buying an auto when he won. "I've never won a thing in my life," he said. "Being a police officer you can imagine the use I'll get from this prize."

January/February contest:
The beautiful satin-brushed and nickel-plated \$1000 .45 auto went to Scott Dickman of Hermosa Beach, California. You all out there can now stop calling our editorial office to ask if you won this gun—it's gone. But don't despair, just call pistolsmith Venry D'Aiguillon at Precision Sports & Crafts (210) 569-3450 and ask him to build you one. Tell him you saw it in HANDGUNNER.



DOUBLE ACTIONS

Shown here are representative samples of double action .44 Magnum revolvers. From the left: S&W Model 629, a stainless steel version of the Model 29; Ruger Redhawk stainless steel revolver; Llama Super Comanche from

Stoeger, and the S&W Model 29, this one with the 8 $\frac{3}{8}$ " barrel. Not shown, but available or soon to be available are the RG Model 57, Interarms Astra and the Dan Wesson; these guns were not available to us at the time, but will be featured in future issues.



SINGLE SHOT

The Thompson / Center Contender is the most popular single shot .44 Magnum on the market today. It is the only single shot we were able to examine. Gaining in popularity is the Merrill Sportsman by Rock Co. of California. Soon to appear on the scene is the X-Callber single shot shown for the first time at the recent SHOT Show by Sterling Arms.

.44 MAGNUMS

A new dimension to the study of today's .44 Magnum handguns.

How Do They Measure Up?

According to Elmer Keith, it all came together one day in 1956 when Harold Austin, then Sales Manager of Smith & Wesson, called him and said: "Elmer, your .44 Magnum dream has come true." Shortly thereafter, as Elmer relates it, he had a prototype gun and a couple of boxes of ammunition from Remington.

It was not long after production started on the Model 29 that the public relations types came up with the slogan, "The most powerful handgun cartridge in the world." The rest is history.

The Model 29 Smith & Wesson stood alone as the gun chambered for the .44 Magnum until Bill Ruger's .22 Single Six revolver doubled up and became the Ruger Blackhawk Single Action .44 Magnum. The successes of these two guns was all that was needed to bring forth the variety of .44 Magnum revolvers and single shot pistols—and rifles—offered to the shooter today.

It is unfortunate that just as we reached the deadline for this issue, two new revolvers and one single shot pistol were announced, too late for coverage here, but scheduled for test reports in the near future; Interarms announced the availability of the Astra revolver in

AMERICAN HANDGUNNER • JULY/AUGUST

SINGLE ACTIONS

The single action .44 Magnums have held their own in popularity for a long time. Although Colt has never chambered their single action for the .44 Magnum cartridge, there have been numerous copies that will carry this powerful cartridge. Shown here, from the top, A.I.G.'s Abilene, offered by Mossberg; F.I.E.'s Arminius "Hombre," and Sturm Ruger's New Model Super Blackhawk. Not available for this study, but offered now: Mitchell Arms single action; Interarms "Virginian Dragon," and EMF's Super Dakota.



.44 Magnum and Dan Wesson's version of the "Most powerful handgun . . ." is reportedly in production, though we haven't seen one as yet. The most recent offering is the .44 version of Sterling Arms X-Caliber single shot pistol.

On these pages, then, is a representative sample of what's available in .44 Magnum chambering. We have put each of the guns pictured under the critical eye of the micrometer, and herewith present all of the vital measurements of each

model. We forego the words of the pitchman—heavy duty, massive construction, etc.—and show just how big, or how small certain critical dimensions are.

Here, then, are the .44 Magnums of today, the guns that will lead the way into tomorrow.

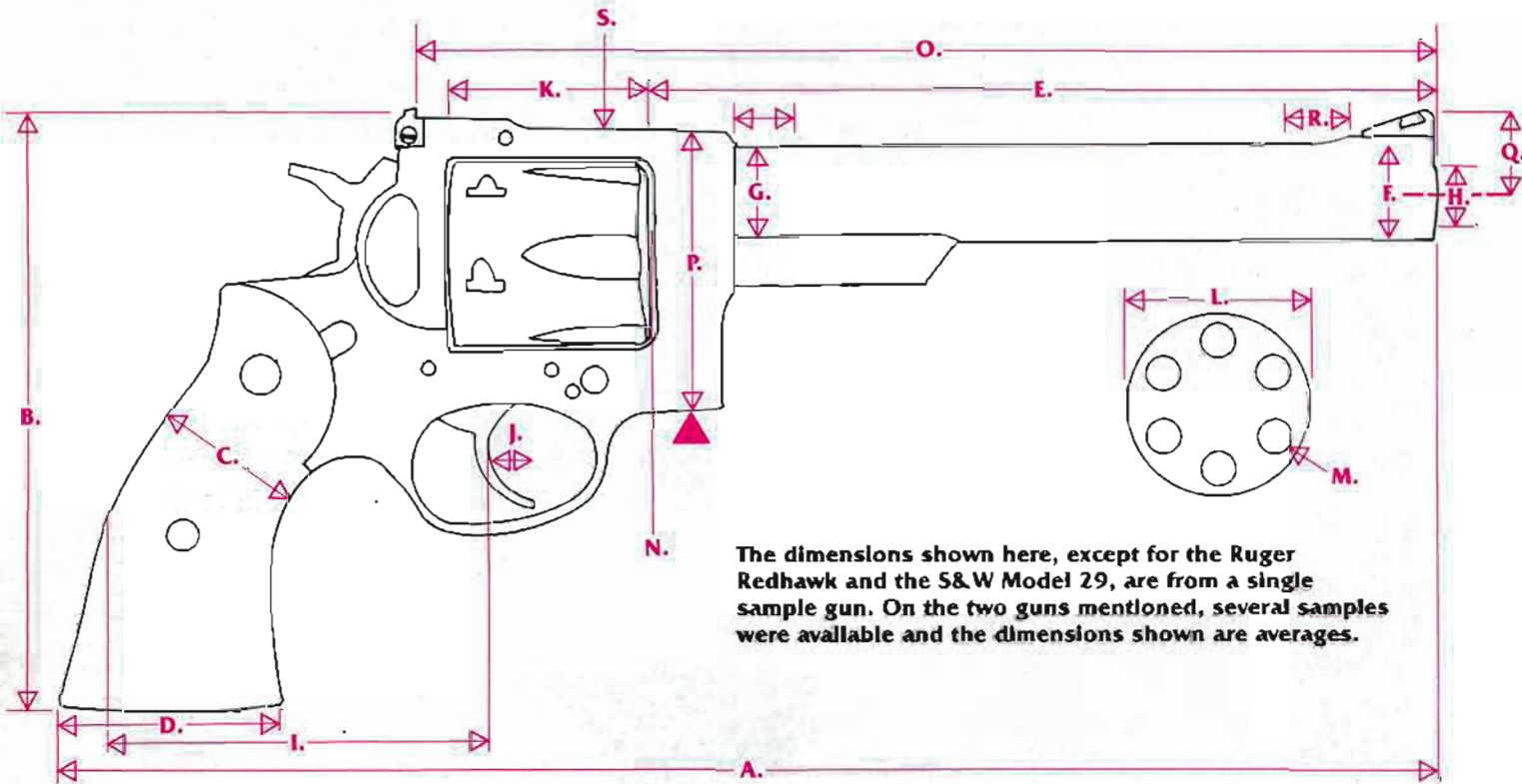

The dimensions shown here, except for the Ruger Redhawk and the S&W Model 29, are from a single sample gun. On the two guns mentioned, several samples were available and the dimensions shown are averages.

	RUGER REDHAWK	S&W MODEL 629	S&W MODEL 29	LLAMA	RUGER SUPER BLACKHAWK	ARMINIUS HOMBRE	ABILENE	T/C
A. Overall Length	13.0	11.437	13.875	11.5	13.625	11.0	13.5	14.0
B. Height (to top of rear sight)	5.625	6.125	5.875	5.875	5.50	5.125	5.50	6.25
C. Grip Frame (at narrowest point)	1.34	1.22	1.26	1.24	1.14	1.18	1.15	N.A.
D. Grip Frame (bottom)	2.77	1.961	1.92	1.91	2.32	2.80	2.274	N.A.
E. Barrel Length	7.46	5.875	8.312	5.937	7.42	5.50	6.437	10.0
F. Barrel Diameter at Muzzle	.739	.737	.714	.815	.700	.714	.700	.715
G. Barrel Diameter at Frame	.914	.804	.766	.818	.785	.766	.781	.809
H. Groove Diameter	.429	.429	.430	.426	.429	.430	.430	.429
I. Trigger Distance	3.265	3.185	3.31	3.46	3.14	2.68	2.915	3.60
J. Trigger Width	.314	.408	.496	.379	.287	.190	.364	.405
K. Cylinder Length	1.751	1.746	1.745	1.745	1.704	1.76	1.753	N.A.
L. Cylinder Diameter	1.78	1.712	1.712	1.72	1.727	1.73	1.73	N.A.
M. Chamber Wall Thickness (front/rear)	.120 .134	.086 .100	.086 .097	.100 .102	.098 .110	.098 .108	.090 .100	N.A.
N. Cylinder/Barrel Gap	.004	.008	.004	.005	.003	.006	.004	N.A.
O. Sight Radius	9.375	7.875	10.875	8.00	9.625	6.75	9.625	9.187
P. Frame Depth (at barrel)	2.70	2.52	2.54	2.62	2.27	2.23	2.265	N.A.
Q. Front Sight Height (to center of bore)	.963	.900	.902	.962	.870	.615	.890	.888
R. Rib Width (front/rear)	.440 .460	.480 .550	.488 .542	.408 .408	N.A.	N.A.	N.A.	N.A.
S. Top Strap Width	.710	.656	.656	.661	.715	.748	.675	N.A.
T. Balance Point (from muzzle)	7.54	6.21	8.25	5.87	8.00	6.25	7.75	8.00

.22 SILHOUETTES

TUNING THE .22 PISTOL

**A word on shooting
techniques & how to tune your
production .22 for IHMSA
competition**

PART II



By Bert Stringfellow

In the last issue we introduced many of our readers to rimfire silhouette shooting. In Part II the author gives some tips on shooting and tuning some of the more popular .22 handguns.

SHOOTING TECHNIQUES

A match is won or lost before the shooter arrives at the match. That is to say, proper preparation will provide a competitor the experience, expertise and confidence in himself and his equipment which will put him in a position to win his match.

The competitor should always sight in his match pistols on paper targets so that he may evaluate his pistol-ammo performance. He should test many different manufacturer's ammo and use only the cartridges which group well at 100 yards (Ram distance) for competition and practice.

When sighting-in a revolver, the shooter should fire separate groups from each chamber in the cylinder to determine if one chamber groups better than the others. If one chamber does group better than the rest, use only that chamber for competition.

Always carry a notebook to record sight settings and ammo performance. Shoot your pistols under different light and temperature conditions and record type of ammo used during each practice session along with the sight setting for each target distance and the point of aim, so that you will have sighting information available for any match or range conditions you might encounter. After sighting in, every practice session should be shot following match procedures. Always shoot the targets in their proper order. If a shooter does not practice following the match procedure of shooting the targets in order from left to right, there is a good possibility that he will shoot a target out of order in a match and that is a miss.

Prior to the 1979 Regional Championships I had been practicing on single targets. At the Championships I missed the first ram, my spotter gave me the sight correction, I made the sight correction and dropped that first ram with my second shot. Zero number two on the score card!!

Remember that consistency is accuracy, the shooter must do everything the same way for every shot. During practice sessions concentrate on grip, breathing, pistol position (cant), sight alignment and then *press the trigger*. Be sure and call each shot before looking at the target; this will help establish the concentration required for good marksmanship.

In freestyle competition the rear reclining (Creedmoor) position has proven to be the most stable position to date. Freestyle Standing allows a two-hand hold and the

(Continued on page 54)

Gunsmith John Bosch is well-known for work on silhouette pistols like S&W M17, T/C, and High Standard shown.

BUY RIGHT WITH FRANZITE

★ FOR GRIPS

Send \$1 for illustrated 32-page catalog.

SPORTS, INC., P.O. Box 683-AH, Park Ridge, IL 60068

Most durable grips made, precision-fitted for foreign and domestic handguns. Conventional, Conversion, and Target styles. Four lustrous colors, plus Staghorn.

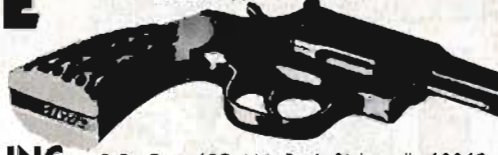

.22 SILHOUETTES

(Continued from page 53)

shooter should definitely get both hands on his pistol. The Cooper Combat, or Weaver, stance is my favorite and I find it works very well for me.

To win, the shooter must know his equipment, ammo and himself. All this may seem like a lot of trouble, but believe me, when the Match Director calls you up to receive a Championship trophy, all the preparations are forgotten.

TUNING THE .22 PISTOL

The IHMSA Production gun rule is not meant to imply that a pistol's action may not be made to function properly. The action may be smoothed by stoning, springs may be shortened or stretched and a trigger job may be performed to improve or correct the performance of a pistol for competition. The stoning and adjusting described requires a complete knowledge of the handgun's mechanism and a good deal of skill, therefore, this work is best left to a competent gunsmith.

John Bosch, Co-owner of Madera Gun & Reloading, Madera, California, is a

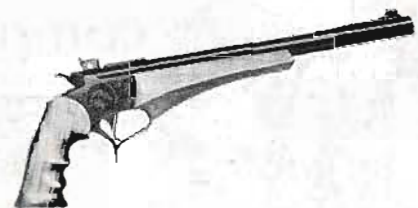

gunsmith who has done work on a majority of the competition .22's in central California. John smoothed the actions and performed trigger jobs on the three guns which won the Overall Championship for me at the 1980 California State Match.

I had a visit with John and he gave me the following tips on tuning some of the more popular .22 pistols.

Ruger MK I

Stone all the burrs off the hammer and polish both sides to reduce the friction during hammer fall. Stone the sear until a two (2) pound trigger pull has been reached. Do not try for a trigger pull of less than two (2) pounds because the pistol will malfunction. Most people prefer either the Ruger or Herrett target stocks.

Smith & Wesson Model 17

Polish all the moving parts to reduce friction during hammer fall. Use a standard small hammer, as it falls faster than the wide target hammer, thus providing a faster lock time. The trigger pull is adjusted by stoning the hammer notch and sear. Do not reduce the tension on the hammer spring. A .22 cartridge requires a strong hammer blow to get good uniform primer ignition.

The trigger pull may be reduced to a



The Oldest and Largest 45 Auto Accessory Specialists with the Widest Selection at the Lowest Prices!

P.O. Box 1126, Dept. AH Cortland, N.Y. 13045

24 Hr. "Live Order Phone": 607/753-0194

TWX:

Colt Ambidexterous Safety List \$46.25 Special \$32.50
Extended Ambidexterous Safety List \$52.50 Special \$37.50

Wide Combat Grip Safety (GM or Commander) List \$25.94 Special \$19.95

Commander Hammer List \$14.40 Special \$11.50



AUTHORIZED Parts Distributor & Warranty Station

Colt Checkered Mainspring Housing List \$23.94 Special \$16.95

Colt Accurized Barrel & Bushing Kit MK IV, Gold Cup, 9mm or .38 Super List \$51.38

Famous Colt-Ellison Rear Sight Assembly List \$39.30 Special \$31.50

Colt Government .45 Barrel List \$40.25 Special \$28.95

Colt Premium Grips Birdseye Maple w/Medallion List \$14.95 Special \$8.50

9mm Blue .38 Super List \$20.20 Special \$16.25
List \$18.20 Special \$14.50

Colt Commander Barrel .45 List \$40.85 Special \$28.95
9mm List \$45.50 Special \$36.50
.38 Super List \$45.55 Special \$36.50

Colt Magazines .45 Blue List \$16.70 Special \$13.50
.45 Nickel List \$18.20 Special \$14.50

.22 Conversion List \$32.30 Special \$25.75
AR-15 (6-rds) List \$13.50 Special \$10.95
AR-15 (20-rds) List \$14.00 Special \$11.25

Authorized Distributor of Complete Colt Line - 20% Off List!

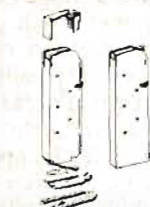

Crown Deluxe Magazine with Removable Floor Plate (either steel or stainless) List \$17.50 Special \$11.75

Crown Extended Safety List \$19.95 Special \$12.95
Stainless List \$24.95 Special \$14.95

Crown Stainless Magazine with convex follower List \$12.00 Special \$8.50

Crown Extended Slide Stop List \$19.95 Special \$12.95
Stainless List \$24.95 Special \$14.95

Crown Competitive Magazine Base Pad List \$1.99 Special \$1.50

Crown Long Adjustable Trigger List \$9.95 Special \$6.95

Crown Extended Magazine Catch List \$27.50 Special \$18.95

Crown Muzzle Brake List \$24.95 Special \$18.50

Rogers Shock Bull List \$2.50 Special \$1.50 ea.
Rogers E-Z Loader List \$7.50 Special \$5.95

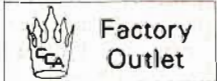

Crown Recoil Buffer (GM or Commander) List \$14.95 Special \$10.95



Bingham Battle Combat Pistol Sights List \$15.00 Special \$9.95

Crown Recoil Spring Guide Assembly List \$24.95 Special \$19.95

Crown City Patch - Original! Colorful! Special \$1.25



Authorized Distributor

	List	Special
GM-45 Combat Grips	17.50	12.50
GM-45 Combat Grips w/Colt Medallion	21.00	14.95
Mainspring Housing (Specify flat or arched)	9.75	8.95
S & W "K" Frame Grips	12.75	8.95
Colt "I" Frame Grips	12.75	8.95
Ruger Sec. Six, Service Six, etc. Grips	12.75	8.95
Convex SS Follower	2.50	1.95



Crown Square Trigger Guard Shoe List \$19.95 Special \$14.95



Wolf Extra Power Recoil Spring (GM or Commander) List \$5.00 Special \$4.00

Millen MK I Fixed Sights List \$27.95
Millen Adjustable Sight (no machining to slide) List \$56.95

Hallok's 45 Auto Handbook (The best 45 Book - A Must!) List \$11.95 Special \$8.95

Authorized Distributor of Complete Pachmayr Line - 25% Off List!



TO ORDER: Send Money Order or Cashier's Check only, or complete MC/VISA information. Company and personal checks clear. Add shipping: \$1.75 for first item, 50 cents for each additional, \$3.50 maximum. Alaska/Hawaii double shipping amounts. NY State residents add 7% Sales Tax. FFL required for frame and gun orders. Prices are subject to change without notice. Prices in effect at time of shipping prevail.

Send SASE and \$1.00 for current literature, price lists, order form and Personal Discount Label.

good clean 1½ pounds and still provide a safe functional pistol.

Thompson/Center

Polish all the moving parts to assure consistent hammer fall. To set the trigger pull, stone the trigger notch and mating striker, then trim the trigger return spring until a two (2) pound trigger pull is achieved. Trimming the trigger return spring is a cut and try proposition, this operation should be approached slowly. Grind off a small amount of spring and then assemble the trigger mechanism and check the pull. This procedure is repeated until the desired trigger pull is reached. John cautions that the grinding be done in easy stages, as the spring is easily ruined. After the trigger pull has been set at the desired poundage, use the Allen wrench provided by T/C and set the striker engagement and trigger over-travel. Put a drop of lock tite on the striker engagement adjusting screw to keep it from backing out during firing.

High Standard

John says that most High Standard pistols come from the factory ready to go. However, after a bit of shooting some of them develop trigger creep. This creep is removed by stoning the hammer notch and sear. Extreme care must be taken while stoning these parts or the result will be a pistol which chain fires. A very embarrassing situation.

John uses Break Free Oil for all his lubrication needs and he recommends it very highly, especially for the Semi-Autos. John's charge for a tune-up on an undamaged gun is a mere \$12.50, not a very big expenditure for the improved performance. Remember, pistol malfunctions and faulty ammo shall not be cause for an alibi or the allowance of extra firing time.



INDUSTRY INSIDER

(Continued from page 10)

owner with a size complex may find this \$75 extender a useful therapy. It's made by Mack Gwinn, designer of the Bushmaster .223 pistol.

American handgunners can look forward to heavy anti-gun pressures in the near future, in spite of the pro-gun attitude of the new President and many of the new federal legislators. This pressure will come from the media. TV is full of stories about the crime problems of the entire country, and most especially trouble spots like Los Angeles and Miami, and all of a sudden, the media has discovered that citizens are arming themselves. Picture stories of citizen groups getting handgun training are mixed with survivalists who are into heavy

armament and ethnic groups who are fearful of racist attacks.

A reporter from ABC's 20/20 program told us that he could not get information on where one could learn to handle a gun from any of the large metropolitan police departments. Perhaps the time has come when those of us who are members and officers of gun clubs should make a concerted effort to introduce ourselves and our shooting programs to local law enforcement officers.



.44 MAG LOADS

(Continued from page 47)

cantly higher velocities, a cartridge/handgun duo must also be made to handle considerably higher chamber pressures, and that's where the .44 Magnum is different. Whereas the old .44 Russian and .44 Special were made to take pressures no greater than 15,000 c.u.p., the .44 Magnum was built to take a full 40,000 c.u.p. average working pressure and an individual maximum pressure of 43,500 c.u.p. That, of course, is virtually a rifle pressure. Thus, the .44 Magnum isn't really an example of brilliant designing; technicians merely utilized modern metallurgy to build a huskier revolver and a sturdier case.

Understanding the impact of this intense pressure level is the most important element in a sensible approach to reloading the .44 Magnum. Continuous use of maximum pressure reloads will loosen handguns *muy pronto*. Silhouette shooters discovered that a thousand maximum charges will loosen the big S&W M29, and some of the economy priced single-actions will rattle apart under the strain of just a few hundred maximum loads, homebrew or factory fodder. High pressures and heavy recoil take their toll regardless of gun frame strength and cylinder bulk, and a handloader can't get giddy about souped up reloads without considering the consequences in the form of shortened gun life and expensive repairs.

To date, silhouette shooters have found the Ruger single-action and the T/C Contender to be the toughest .44 Magnums. The Ruger generally outlasts the S&W M29 with full-throttle loads. And the Contender is, in reality, able to take rifle-like pressures for an extremely long life, thanks to a sizeable locking lug.

Despite the threat to gun life, any comprehensive approach to reloading for the .44 Magnum must begin with maximum loads, for its high energies at that level are what sets it apart from the other revolver rounds, hence, it is where we'll start to get specific.

The .44 Magnum uses the same shell holder as the .44 Special. In fact, most

(Continued on page 72)

THE LEWIS LEAD REMOVER

SATISFACTION GUARANTEED

\$9.75

Revolver Cleaning Kit. Removes leading from Forcing Cone, Cylinder, and Barrel. Available in either 38-41-44-46 cal. Brass cloth patches (Pk. 10) \$1.90. Order direct or from your dealer. Check or Money Order. or Money Order.

GUN SPECIALTIES INC. College Park, Georgia P.O. Box 31

WELL CAST
HARD BULLETS
for pistol & revolver
WEST COAST BULLETS
820 N. Sierra Bonita Ave.
Los Angeles, CA 90046
(213) 651-2691

NRA FORMULA LUBE

MAKER OF CUSTOM LEATHER PRODUCTS FOR THE PRACTICAL PISTOL SHOOTER

#455
"SECURITY"
Many new products for both autos and revolvers.
Send \$1 for new '80 Catalog.

G W M DAVIS
P.O. Box 446 • Arcadia • CA 91006

THEY CAN'T STEAL IT...
IF THEY CAN'T FIND IT.



These books are Brand New. Titles Will Vary. When the Cover is closed, you can't tell these from an ordinary book. Inside openings are lined with Red Velvet-Like Material.

OPENING	WIDE	HEIGHT	*POSTPAID
SENIOR	5½"	8¾"	\$16.99
STANDARD	5"	8"	\$14.99

*POSTPAID IN 48 STATES. DEALER INQUIRIES INVITED.

ROGCHILD, INC., P.O. BOX 1336F
CLARKSBURG, WV 26301

LEFT HANDERS!

Now—the Swenson
Ambidextrous
Safety.
Patent No.
3492748.



For use on all .45 caliber Colt, Mk IV, Gold Cup, Lightweight and Combat Commanders, 1911 and 1911 A1 govt. models, and Vega, AMT Hardballer, Detonics and Crown City Arms. \$40.00 plus \$1.50 postage & handling. California residents add 6% State Sales Tax. Overseas postage slightly higher. Installation instructions included.

RIGHT HANDERS!

Swenson Extended Speed
Safety for all above
models:
\$25.00 plus \$1.50
postage & handling.
6% Calif. Sales Tax
for Calif. Residents.
Overseas slightly
higher postage.
Complete installation
instructions included.



SWENSON'S .45 SHOP

Post Office Box 606
Fallbrook, Ca. 92028
Phone: (714) 728-5319



THE COLT .45 AUTO PISTOL

This book covers nearly every facet of the Colt .45 Auto Pistol. From mechanical training to manual of arms for the pistol to marksmanship training to complete detailed inspection, disassembly, repair and replacement of parts. Plus drawings on the construction of repair tools and fixtures. With over 100 pages and over 80 clear photos and illustrations, this book has it all on the Colt .45 Auto. A must book for any gunsmith or pistol owner.

128, \$4.95

DESERT PUBLICATIONS
Dept. AH Cornville, AZ 86325

I have enclosed \$_____ Please Rush me:
_____ copy(s) of

The Colt .45 Auto Pistol

NAME _____

ADDRESS _____

CITY _____ STATE _____ ZIP _____

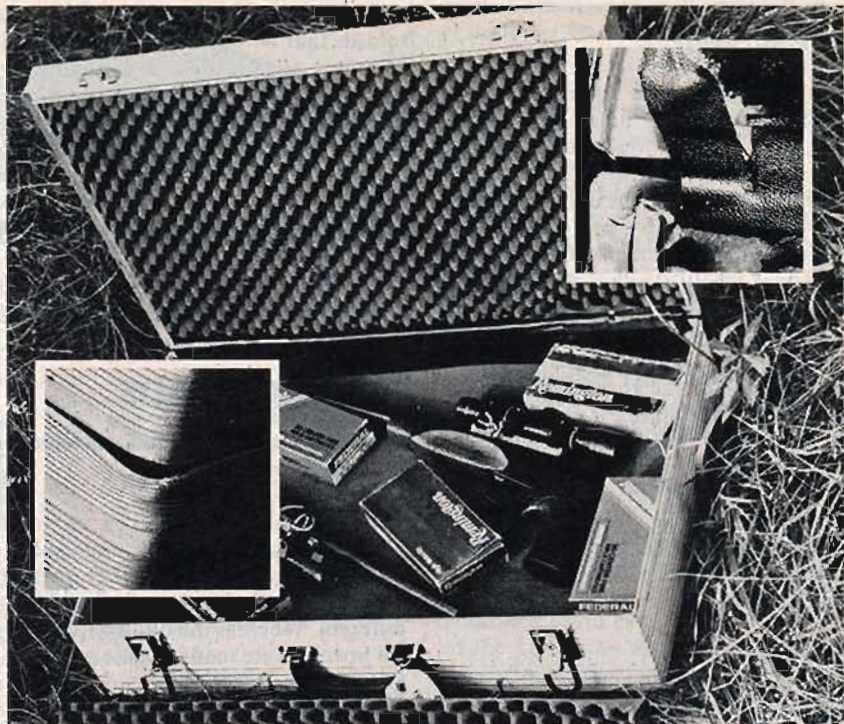

One tough case

J.D. Jones

GUN CASES ARE important accessories to protect a shooter's equipment investment. Of the many on the market, I've been hesitant to recommend many of them and in the past have used the Dan Wesson Pistol Case for carrying a lot of cameras, lenses and iron.

Some really fine cases are available though; and they are also financially out of my reach and that of the vast majority of shooters.

ALCO Carrying Cases, Inc., (Walter J. Barker, Sales Mgr., 601 W. 26th St., NYC, NY 10001) an established manufacturer of carrying cases for many industrial and recreational uses, has stepped into the highly competitive handgun carrying case market with a line of high quality aluminum, lockable cases at a reasonable cost. Based on the protection given—they might be called 'dirt cheap.'

Frankly, I was singularly unimpressed with the Silhouette Model tested at first glance. It appeared too lightly constructed and there wasn't enough foam filler in it. A short conversation with the company corrected the latter—another layer has been added to assure a tighter fit providing more security for your equipment. It can also be removed and two layers of equipment utilized with essentially identical security of the cased items.

The Silhouette Model measures 15.5" x 24" x 6" and will easily hold

an XP or T/C unlimited gun, standing production gun, freestyle production gun, .22, spotting scope, ammo and tool kit. Dimensionally, I can't fault it and it'll do exactly the job the manufacturer claims for it.

I've used the sample extensively for about seven months at this writing and made absolutely no effort to baby it. In fact, I'd guess that *that* seven months probably equaled several years use by the average shooter.

At home, I usually fill it up, throw it in the back of the pickup and let it rattle around. It has a lot of miles on it in this fashion. It's survived the airlines, bush pilots and a 70 mile raft trip in Alaska. That includes at least 15 handlings by air baggage personnel.

It's accumulated its share of scratches, dents, dings and "character," but it still works and has not allowed a scratch on anything packed in it. In addition to guns, I trusted my cameras, lenses, strobe and film to it for the Alaskan venture.

I have to admit the case is a hell of a lot more durable than I thought it was when I got it. In fact, I can't fault it at all. At this point it looks a little beat and I probably ought to clean it up a little, but I probably won't. I'm sure it has a few more years service left in it and if it looks battle scarred maybe when some of the freight handlers spot the "Firearms Unloaded" tag they won't even bother to see how far they can throw it!

SIGHT SETTINGS

(Continued from page 18)

NRA Law Enforcement Assistance Committee, I have seen the constant requests coming to the NRA from security agencies for help in setting standards for their firearms instructors and their becoming NRA certified. Finally, at the October 1980 board meeting the LEA Committee presented a resolution pointing out the following: There are about 500,000 security guards in the U.S. The NRA is recognized in some 30 states as the qualified leader for firearms instruction, including basics and any required refresher. Unfortunately standards for training and certifying instructors do not exist at most any level, from national to local. These commercial police organizations have the money for paying instructors and are looking for ones to hire. Quite a few states have named the NRA as its authority for certifying instructors and the training requirements for guards. The NRA did not seek or solicit this responsibility, but regardless, the public looks to the NRA.

NRA CERTIFICATION

The NRA Police Activities staff, and their budget, never has and does not now, have the resources to provide services to the governmental police agencies, let alone private guards. The board, therefore, was urged not to miss this opportunity. The board, the NRA President and the Executive Vice President were asked by the LEA Committee to "establish a cost effective program in security guard firearms instruction field." This resolution was adopted by the NRA Board of Directors.

INSTRUCTOR'S COURSE

In getting my Security Guard Instructor's certificate, in Florida and Virginia, I noticed the meticulous scrutiny given character, credit, and employment background. However, no actual visual inspection as to your being an expert handgunner or an instructor in marksmanship was required. State licensing agencies and perhaps the NRA, through use of its Field Representatives, should see this individual fire the qualification course he is going to teach. States require and applicant for a beauticians license to give a permanent or a hair cut under state inspection visual testing. Because of lack of pressure to do so, or knowledge of what they are looking for, they fail to even see the firearms instructor fire a round. Maybe the NRA can work for that added requirement. Arming a guard with the capability to try, convict, and execute on the spot, must be shown to be more important than cosmetology.

More on security guards in future columns. Next month, where do the NRA Police Combat Championships go from Jackson, Mississippi? **Lucy**

TOM'S GUN BLUING SHOP

1818 Crestview Drive
Carroll, Iowa 51401
(712) 792-4238

PPC Conversions on S&W, Colts and Rugers. Specializing in 10" Bull Barrel for .22 auto In-Shop bluing, satin nickel, gold and all types of metal and wood finishing. Delivery time—3 to 5 weeks. Write or call for details and prices.



PERFECTION IS OUR STANDARD

Suddenly, with the introduction of the Dillon RL300, EVERY OTHER LOW PRICED LOADING TOOL IS OBSOLETE!

The Dillon RL 300 is a true progressive reloader, utilizing a four position rotary shell plate which carries the cartridges through the various die positions -- producing a loaded round with every stroke of the tool. Cyclic rate of the RL 300 is in excess of 400 rounds per hour -- **production rates of 300 rounds per hour can easily be maintained.** The RL 300 is not limited to pistol calibers. Powerful, compound linkage enables the full length sizing of all pistol and rifle calibers from .380 ACP to .30-06, using standard dies. Four die positions on the interchangeable tool head provide capacity for a roll or taper crimping station. The integral powder measure system is supplied with one adjustable powder bar (large or small, depending on caliber).

Complete
with all necessary dies and powder measure
Set up in the caliber of your choice
Ready to start reloading
only

\$335.00
F.O.B. Phoenix

Optional semi-automatic primer feed - includes all parts necessary for both large and small primers, complete with safety shield \$45.00

Dillon Precision Products, Inc.
7755 E. Gelding Dr., Dept. AH
Scottsdale, AZ 85260
Phone: 602-948-8009

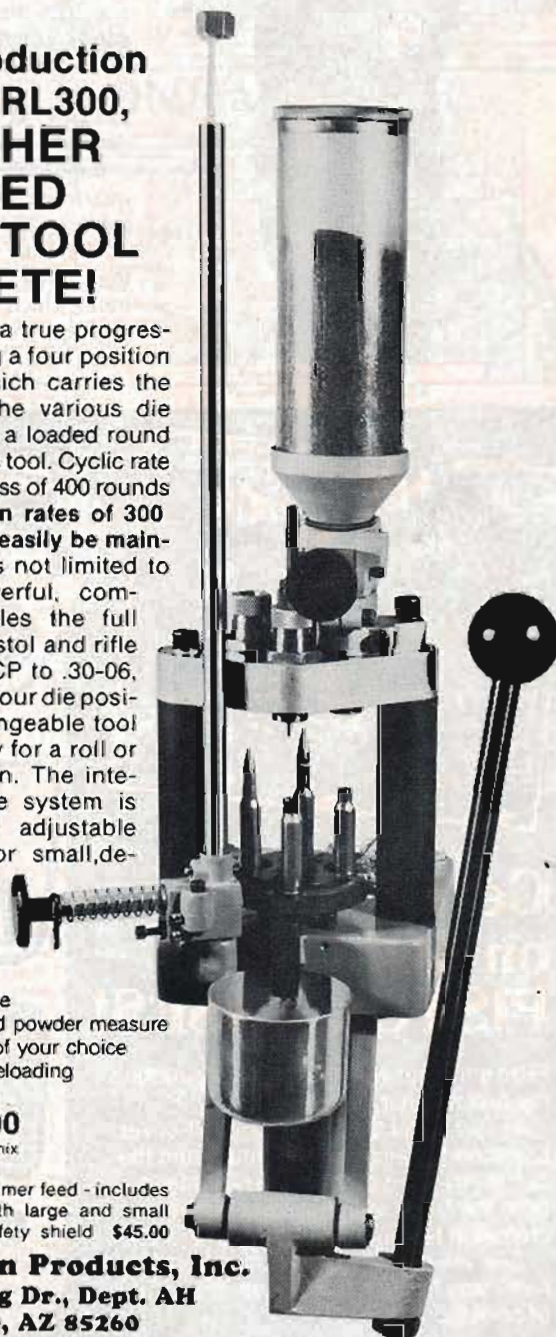

Firearms vest for women



TODAY'S WORLD CONTINUES to rapidly change for women as they become ever-increasingly active. Their necessary defense-mindedness is now more prevalent. Also, additional numbers of women are seeking occupations in police and security agencies as well as in military fields.

Regrettably, concealed weapons carrying equipment is not progressing as is necessary. Few companies recognize the problem in its appropriate magnitude.

For women to attempt use of gear designed for men is most always a mistake as anatomical differences between the two sexes make mutual equipment compatibility virtually impossible, from the two standpoints of efficiency and comfort. Fitting requirements are different, more exacting and individually necessary, for women as the flaring of both the upper torso and hip areas in relation to the waist is far more exaggerated than is the usual case with men.

Suggestions abound from all quarters that women carry small-caliber (.22 Rimfire to .380 ACP and .38 Special) weapons on the premise that 'small' means little weight and bulk (which is true), thus negating the problem. However, this illogic simply means that Milady is inappropriately

and inadequately armed. Also, the little handguns are usually haphazardly secreted in the poorest of places, namely the handbag, one of the top priority targets of street punks. One reasonable solution is to improve the mode of carry.

A joint effort by myself, wife Eunice, and assistance by friend Don Shumar, resulted in the vest solution as pictured here.

This custom-tailored denim vest is an excellent alternative to discomfort, and has worked out very well. Weight distribution of the weapon itself and accompanying magazines far surpass those of an under-the-arm shoulder holster arrangement. This is a definite plus especially if the weapon is large and weighty such as the reworked-for-combat Colt Gold Cup .45 automatic pictured. The vest is designed for concealment carry, so outer clothing must, by necessity, be loose-fitting.

At this writing, facilities are set-up for production of this vest in a variety of fabrics for numerous occasions and climates. Satisfaction is guaranteed or an immediate refund will be sent. A brochure is available for \$1.00 plus a self-addressed stamped envelope (this dollar is deducted from your order) from: Bosselmann, P.O. Box 900, Tombstone, Arizona 85638.



Get a Grip on KOLPIN'S PISTOL CASES!

Here's a great way to give your handgun the protection it deserves!

Kolpin Pistol Cases provide full-cover protection against dirt, moisture and the possibility of scratches. They're made from the finest materials and expertly crafted to fit your gun like a glove.

See 'em today. It's the convenient, easy-carry way to pack a handgun. It's a case of pride!



#24 Luxurious black virgin vinyl with thick, siliconized pile lining of 100% polyester. Full 1/4" Tufflex padding. Lengths: 4 1/2", 7", 10", 13", 15", 20"



#21 Made of rugged, water-repellent 21 oz. tan canvas with durable brown corduroy water-repellent lining. Full 1/4" Tufflex padding. Lengths: 4 1/2", 7", 10", 13", 15."



#24XF Sporty Autumn Brown leather-like expanded vinyl with soft, lint-free yellow cotton lining. Extra-protective 3/8" polyurethane foam padding. Lengths: 10", 13."



#175 Attache style with handles and pockets for shells and cleaning rod. Black virgin vinyl exterior with water-proof corduroy lining. Full 1/4" Tufflex padding. Length: 13."



#28 Our finest! Rugged genuine suede leather in deep Walnut Brown with durable water-repellent corduroy lining. Full 1/4" Tufflex padding. Lengths: 4 1/2", 7", 10", 13", 15."



These are but a few of Kolpin's great American-made pistol cases. See the entire Kolpin line of quality gun cases, archery equipment and hunting accessories at your local sporting goods dealer.

A Case of Pride!

KOLPIN

Kolpin Manufacturing, Inc.
P.O. Box 231, Dept. AH-7
Berlin, Wisconsin 54923

HANDLOADING

(Continued from page 22)

the 4.4-grain charge that gave a five-shot center-to-center of 1.305" was fully a tenth of an inch tighter than the 1.405" spread of the 6.2-grain Herco loading.

I have used 230 with the same 200-grain Hornadys in my old Colt Gold Cup (Old? I bought it new for \$125—that's old!) and have had five-shot, 25-yard machine rest groups that measured an inch or less from center to center. Some of these involved 4.2-grain charges with the use of a moderate taper crimp. The object of all this is simply to bring light to the fact that different guns often seem to have different "appetites" when it comes to digesting a particular load combination.

Don Ingram, of Winnemucca, Nevada, is a member of that state's National Guard Pistol Team. He writes that he has been using 228-grain Lee round-nosed bullets, cast from wheel weights only, and propelled by 5.5 grains of Green Dot. Ingram comments, "This load shoots the same point of impact as military hardball, and I have experienced no leading."

Then, he adds, "We are issued 1500 rounds of hardball a year, which is hardly enough to stay on the team, so I load about 8,500 to 11,000 rounds per year, and have had no problems getting 15 to 20 loads per case."

BULLSEYE ACCURACY

Accuracy is stressed by a report from Paul McCollum, of Lewiston, New York. "Some of the most accurate loads I have developed for use in my LW Colt Commander are: 3.6 grains of Bullseye and a H&G No. 78 bullet. The same bullet and 4.5 grains of Bullseye is also extremely accurate. The Zero 200 grain SWC with 4.2 grains of HP38 is another very accurate load for this particular gun.

"I find that the LW Colt Commander will shoot just about any kind of bullet that is available for the .45 ACP, including the Speer 250-grain SWC—without jamming. It is quite an accurate and dependable firearm.

"My most accurate jacketed bullet load is the Hornady 185 grain JHP with 5.0 grains of Bullseye."

McCollum goes on to portray the "Bullseye scare" as a purely transcendent issue. He expresses his belief that the 2.7 blow-ups reported by Jeff Cooper and me might well be taken with a grain of salt. "Maybe," he insists, "in many of those cases where a revolver was damaged by the so-called 2.7 Bullseye load, the gun was ready to let go with anything."

The foregoing suggestion is plausible. However, the blow-up I mentioned involved, not a gun, but the .38 Special handloaded cartridge itself. The injured, his hand bandaged and his arm in a sling,

(Continued on page 67)

HAVE A GUN THAT SHOOTS THE WAY YOU WANT IT TO!

Real hand fit actions, every part matched and polished for beautifully smooth crisp feel. S&W -Colt -Ruger revolvers only. Write for information.

ACTION WORKS P.O. Box 23028
Richfield, MN 55423

HANDGUNNERS

SCOPES
SCOPE MOUNTS
CASES, SIGHTS
TRIGGER SPRINGS
TOOL KITS, TARGETS
GRIPS, SPEED LOADERS
... AND MORE

GET OUR
CATALOG OF
ACCESSORIES
FOR THE
HANDGUNNER



ROBBINS

SEND \$1.00
FOR CATALOG

NO FOREIGN
ORDERS

P.O. BOX 504
ST. CHARLES
ILLINOIS
60174

DREADNAUGHT

357/44 B & D

Conversions of S&W 27-28 Ruger 357
T.C. Contender—Marlin 1894

BAIN & DAVIS

559 W. Las Tunas, San Gabriel, Ca.

ACCURIZE

YOUR OWN .45 AUTO. COMMANDER
OR BROWNING HI-POWER

Stainless steel barrel & NM Bushing match grade	\$84.00 PP.
Stainless steel barrel & Collet bushing match grade	\$84.00 PP.
Stainless steel Browning Hi-Power barrel match grade	\$134.00 PP.

BAR-STO PRECISION MACHINE

633 S. Victory Blvd., AH •
Burbank, CA 91502

ALLOW 12 TO 16 WEEKS FOR DELIVERY

SMITH & WESSON and RUGER

MOST MODELS
IN STOCK

We have Bushnell & Weaver scopes at tremendous discounts. We also offer many specials on Ruger, Colt, Remington, S&W, SAKO, T/C, Winchester, Armalite, Hardballer, Back-Up, Leupold, Weaver, Bushnell, Etc. Please send us \$1.00 in stamps or change to cover shipping and handling on our large illustrated list. Your dollar is refundable on first order over \$100.00.

HIGH QUALITY MERCHANDISE AT
REASONABLE MARKET PRICES.



J & G Sales Inc.

442AH Miller Valley Road Dept. AH
Prescott, Arizona 86301
Telephone: 1-602-445-9650

HUMIDITY, CONDENSATION IS RUINING VALUABLE EQUIPMENT

Stop Rust, Mildew with Silica Gel That "Drinks" Dampness From the Air

- No electricity required
- Reactivates indefinitely

Once marred by corrosion, no oil, rust remover or chemical can restore the value of fine guns, instruments or other precision-finished objects. Now you can protect them with the same government spec silica gel used on naval vessels. (You are familiar with silica gel as small packets of crystals packed to protect new guns, cameras.) The desiccant of choice by gov't and industry, silica gel creates a shield of dry air within any enclosed area.



Compact Unit: Aluminum canister designed to withstand years of use contains 40 grams of silica gel. For individual gun and camera cases, tackle boxes, silver drawers etc. Protects 3 cubic feet of enclosed space. When monitor "window" turns pink, unit can be easily reactivated in any oven.
\$4.95 postpaid.



REACTIVATION INDICATOR

2000 Gram Canister: This self-contained unit provides maximum protection. Only 4" x 16", yet can protect 144 cubic feet of enclosed space. Used on naval vessels, in armories, museums. Ideal for camper-trailer, large closets, darkroom, gunroom, workshop. Steel construction with precision-cut side breathers to silica gel within. Built-in indicator signals when unit should be reactivated. (Reactivates easily in any oven.) This unit can prevent thousands of dollars of damage due to rust, dampness and mildew. A lifetime of protection.
\$8.50 postpaid. \$35.00 postpaid.



INDICATOR BUILT-INTO FOIL CARTON

360 Gram Unit: Ideal for eliminating dampness and humidity in large gun chests, display cabinets, safes, large storage containers, etc. Protects over 27 cubic feet of enclosed space. Built-in indicator signals when unit should be reactivated. (Reactivates easily in any oven.)
\$8.50 postpaid.

All items... Money-back Guarantee

To: Commonwealth Corp., Box 675, Rye, N.Y. 10580
Dept. Z

Please send postpaid:

360 Gram Units	\$ 8.50 each
Compact Units	\$ 4.95 each (NY Residents add 5% sales tax)
2000 Gram Units	\$35.00 each

Please Print TOTAL ENCLOSED \$

NAME _____

ADDRESS _____

CITY _____ STATE _____ ZIP _____

AMERICAN HANDGUNNER · JULY/AUGUST 1981

59

TYLER'S "T" GRIP

BETTER SHOOTING with this improved cast Aluminum Grip ADAPTOR. For Colt and S & W MODERN Revolvers. DURABLE, PRACTICAL—EASY TO INSTALL. THREE ATTRACTIVE FINISH COLORS. POLISHED or BLACK \$3.00; GOLD \$3.25



TYLER'S TRIGGER SHOE

Durable light weight cast aluminum for Colt, S & W and many other modern pistols, rifles and shotguns. POLISHED or BLACK \$2.75; GOLD FINISH \$4.00

ORDER DIRECT OR AT YOUR FAVORITE DEALER. Send make & model of gun. No C.O.D.'s please. Fully Guaranteed. Prompt Postpaid Delivery. Genuine Stag—Wood & Synthetic Gun Grips. Lee Loaders—Bullet Molds—Gun Accessories. Hand-made Holsters & Belts, Leather & Clarino.

— Dealer Inquiries Welcome —
MELVIN TYLER MFG. AND DIST.
1326 W. Britton Rd., Oklahoma City, Okla. 73114
Call toll-free (800) 654-8415 (Outside OK)

FLUORESCENT COLORS!

BULLSHOOTERS new FLUORESCENT Sight Insert Kit. An acrylic resin with 5 fluorescent colors: red, yellow, orange, blue, green, and opaque white. A liquid that hardens in 10 minutes, without heat. Inserts won't fall out, withstand hot bluing. Our Fluorescent kit includes side-forms, mixing bowl, and complete, illustrated instructions on front and rear sight inserts. Immediate shipment, satisfaction guaranteed.

20 INSERT FLUORESCENT 6 COLOR KIT \$16.95 Ppd.
150 INSERT FLUORESCENT 7 COLOR KIT \$38.50 Ppd.
300 INSERT FLUORESCENT 7 COLOR KIT \$59.00 Ppd.
(Original 12 insert opaque 4 color kit \$11.95 Ppd.)

Ask about our luminous pigment
Arizona Residents add 6% Sales Tax

BULLSHOOTERS' SUPPLY

Dept. AH 9625 E. 3rd Street, P.O. Box 13446
Tucson, Arizona 85732/602-298-6924

Bullshooters' Supply is a division of the B. E. W. B. Corp.

.45 COMBAT SHOOTERS

Ambidextrous Safetys	\$30.00
Extended Ambidextrous Safetys	\$36.00
Extended Speed Safetys	\$17.50
NEW Trigger Guard Shoe - squares	
Trigger Guard	\$14.95
Extended Magazine Release - drilled and tapped, complete	\$21.95
Extended Slide Release - Blue	\$16.50
Extended Slide Release - SS	\$18.95
NEW Long or Short Adjustable Trigger, Smooth Face (aluminum)	\$12.50
Wide Grip Safetys-Blue, specify Gov't. or Comm.	\$17.95
Combat Rubber Base Pads-BHP also.	\$ 1.50
Combat Rubber Base Pads-6 Pack.	\$ 6.95
Pachmayr Grips GM-45, GM-45C	\$13.00
Combat Fixed Sights-Red Dot Front.	\$21.00
NEW Recoil Spring Guide Assembly.	\$18.50
Combat Shok-Buff, Gov't. or Comm.	\$ 5.00
NEW Plast-A-Lube, grease for assault rifles	\$ 3.50
Rogers Combat PPS Grips	\$13.00
Rogers EZ Loaders	\$ 8.50
Rogers Idaho Loaders	\$ 4.50

ALL BIANCHI PRODUCTS - 30% OFF-Retail
Send Cashiers Check or Money Order
C.O.D.'s Welcome - Add Sufficient Postage

WATCHEX SHOOTERS SUPPLIES

P.O. Box 17591-A, Nashville, Tenn. 37217
Phone (615) 331-0224

We Stock RCBS Redfield Burris And Many Other Accessories At Greatly Reduced Prices
Send \$1.25 For Our 1981 Catalog.

HHI SIXGUN

FOR COLLECTORS & HUNTERS

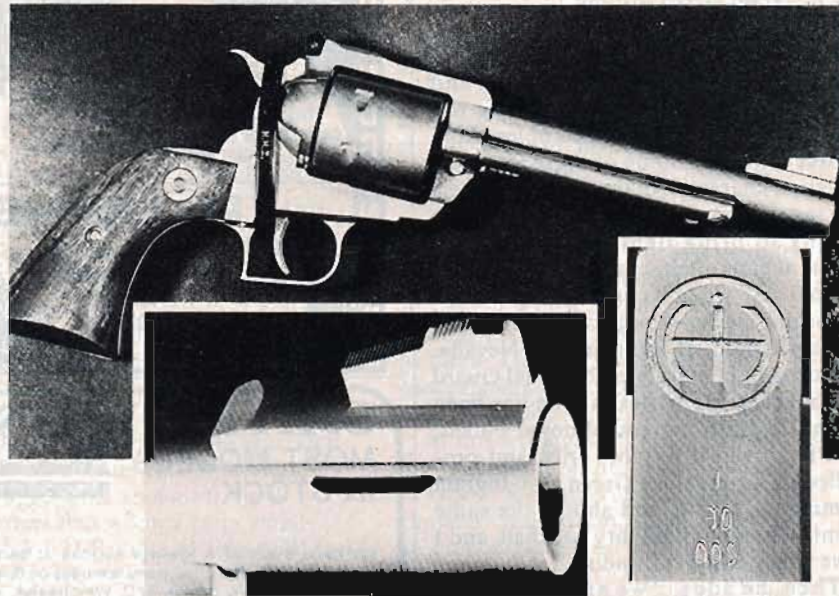

SINCE THE FOUNDING of Handgun Hunters International (Box .357 Mag, Bloomingdale, OH 43910) during the summer of 1979, the membership has clamored for "collectables."

The first offering was 100 custom knives made by noted knifemaker R. W. Wilson of Weirton, WV. These knives are limited to a maximum of 100. Price is \$210, although that is expected to raise considerably as collectors become aware of them.

The HHI Sixgun is a basic composite of what the members wanted in a Super Blackhawk hunting sixgun. Personally, being deeply into custom handguns for a number of years, it wasn't difficult to select the company and features the gun should have.

Mag-Na-Port Arms has produced a number of limited edition custom Rugers over the past years and their value has increased tremendously. Mag-Na-Port's workmanship is superb and past performance of their guns both in the field and collectors market is excellent.

It was decided to make up a gun that would meet the criterion of: (1) Being an effective, powerful, accurate, rugged hunting handgun. (2) Possess the basic attributes of good sights and trigger pull. (3) Be finished with a very durable, rust resistant finish. (4) Be identified properly and provide an instant collectors item. (5) Keep costs within the reach of most members and provide the opportunity to obtain a gun of increasing value.

The guns start out as a Ruger .44 Magnum Super Blackhawk. The gun is totally stripped. Then the barrel is cut back to six inches and front sight relocated. The barrel is crowned with a special tool to provide an attractive appearance and exceptional accuracy. It is also Mag-Na-Ported. The front sight base is "dressed" for appearance and

full finished to prevent glare. A red insert is incorporated into the sight itself. The rear sight blade is replaced with a SSK White Outline Blade. The ejector housing is replaced with one made of stainless steel. An action smoothing and lightening of the trigger pull is performed. An SSK heavy duty mainspring is installed to decrease lock time. After final assembly the action is sealed to prevent cylinder rotation. Once broken, the seal will not be replaced. The seal assures collectors that the gun has never been cycled.

Stocks are always a problem. Since the standard Rugers work better than any others for me, it was decided to remove the Ruger emblem and replace it with a Federal .44 Magnum Cartridge case head complete with inert primer.

The gun is finished in Metalife SS; a very hard, rust resistant industrial hard chrome resembling a mildly polished stainless steel in appearance.

Each gun is identified as a HHI Limited Edition by the HHI logo EDM'ed into the top strap and the HHI gun number—example "44 of 400" engraved into the top strap. In addition, the underside of the barrel above the cylinder pin is stamped M-N-P with a special stamp to certify the gun is a genuine Mag-Na-Port job. As far as possible, purchasers of the knife and gun will have the opportunity to match their HHI numbers. All lettering is gold filled.

The gun is priced at \$550. A deposit of \$250 is required per gun. Handgun Hunters International membership (\$15 annually) is mandatory to purchase one of these guns.

The HHI Sixgun is desirable as both a functional, workhorse handgun and as an investment that is sure to increase in value. Guns are now available, as are a few knives.

SHOOT OFF!

REDHAWK vs. S&W 29

Can you imagine what happens when these two greats face-off?

By Al Pickles

I HAD INVITED BILL AUBERTIN to my ranch to try my new Ruger Redhawk .44 Magnum double action revolver. As a gun writer I had pretty much completed my own tests and welcomed a "second opinion." Bill worked as a Criminal Investigator for the Bureau of Indian Affairs and was additionally a pistolero of considerable ability.

I guess the realization that we were going to engage in a "big bore shoot-off" struck me the minute he alighted his pickup—he was wearing his own Smith & Wesson Model 29 in a shoulder holster and carrying eight boxes of freshly reloaded ammo.

My first impulse was to cry foul! I knew his 8 $\frac{3}{8}$ " S&W had, shortly after he purchased it, undergone an expensive fine tuning and was now delivering a smooth as glass 2 $\frac{1}{2}$ pound single action let off. On the other hand, my Redhawk was an out-of-the-box early production run which regis-

tered a shade over four pounds on the trigger pull gauge. Probably the main reason I made no technical objection to the pending "duel" was the apparent fact that we would be using Bill's ammo—a condition under which I always like to "bust caps."

Of course, we didn't get into a comparison of the two big magnums right off the bat. Bill was anxious to try out Ruger's new Redhawk after reading articles in every gun and hunting magazine on the market.

The Redhawk, at 52 ounces, actually outweighs the longer barreled S&W Model 29 because Ruger built a solid beefy gun for the .44 Magnum cartridge. When S&W tooled up for the .44 Magnum they used the existing N Frame which was originally made for lesser loadings.

Ruger's 7 $\frac{1}{2}$ inch barrel is topped by blue steel sights with white outline rear and red ramp front inserts. The contrast with the otherwise all stainless steel gun is pleasing,

and the walnut checkered stocks set the whole shebang off very nicely.

Internally the two guns are as different as night and day. Ruger started from scratch with a clean sheet in designing the Redhawk to handle modern developments in cartridges, bullets, and powders. Both the crane and cylinder assembly lock directly into the frame. The chamber wall thickness is 25% greater than that of the S&W 29. Both the hammer and trigger work off opposite ends of the same spring but in spite of this completely new design concept, the Ruger retains simplicity in disassembly. In fact, like the Security-Six, it is one of the easiest revolvers to disassemble of all those currently offered.

By the time Bill and I had shot a full box of his reloads the conversation had worked around to comparing recoil on the two revolvers. We were shooting 240 grain Speer JSP bullets backed by 18 grains of 2400

(Continued on page 91)

Out-of-the-box but heavier built Ruger Redhawk on left was pitted against 8 $\frac{3}{8}$ -inch Smith & Wesson M29 that had undergone expensive tune-up work.



THE WORLD'S BIGGEST

POCKET PISTOL

By George E. Virgines



The new Colt Sheriff's Model .44/40 with extra .44 Special cylinder in shiny nickel finish and in Royal Blue.

THE WORLD'S BIGGEST POCKET PISTOL, has once again, made its debut. This newest Colt Single Action is introduced as the "Colt Sheriff's Model 44/40." It is the ever-popular short barrel, ejectorless model that has a heritage going back as far as the 1870's and 1880's and has continued right on to the present. Also it continues to provide all the unique variations to satisfy every Colt Single Action collector's whim and fancy. Even the nick-names attached to this short barrel Colt constitute a variety such as custom model, Storekeepers and/or Sheriff's Model, hide-a-way gun, snubbie, pocket-pistol, and commemorative. An extremely scarce version of the Sheriff's Model of the pre-World War II era is the Bisley Single Action short barrel model. After World War II Colt experimented with the idea of a Frontier Scout Single Action .22 with a 3-1/2 inch barrel, however the idea fell thru. Two very custom special Sheriff's Models were created from New Frontier Single Action Flat-tops with Serial numbers 5410-NF and 5411-NF, both in .45 Long Colt caliber and .45 ACP, and profusely engraved by the master engraver Alvin A. White.

This newest addition to the Colt family will certainly not lack in any way for uniqueness or variety. Even in the 1870's and early 1880's there is evidence that these ejectorless models were supplied on special order basis long before they were listed in Colt's catalogs. In over a century this practice has not changed.

Today, this new Colt Sheriff's Model, 44/40 is being offered in four variations, which should please the most exacting collector. This was not too much the case in 1960 when the first new Colt Sheriff's Model was reintroduced in .45 caliber and with a 3 inch barrel. Production was limited to only 503 pieces, 25 of these nickel plated, and the balance blued with case-hardened frames and equipped with two piece wood grips. Only two of these 1960 models were factory engraved and on the butts only. However some of the 1960 models have been engraved by other than factory engravers. To later enhance these 1960 Sheriff's Models, blond wood cases were made available by Charles Kidwell, noted collector and dealer of Wichita, Kansas. There were 52 single and 11 double presentation cases made up with the lids branded "Sheriff's Model" and the same imprinted on the inside of the cover lining. The interior is lined with yellow gold velvet in the bottom and yellow satin in the lid. This is one of the few and rare examples in which a non-factory case has become a rarity and collector's item.

Actually about the first time that the Sheriff's Model was brought to the public's attention was the advertisement in Colt's 1888 catalog which listed barrel lengths of 3-1/2 inch and 4 inch without ejectors for their Colt Single Action models. The actual count of how many Colt Sheriff Models produced between 1870's to 1940 has not been determined.



1960 Colt Sheriff's Model .45 caliber revolver. The non-factory engraving was created by Lynton McKenzie.

But according to the scarcity of these unique models they certainly were and still are a limited production model.

The new 44/40 Sheriff's Model should prove to become a most desirable collector's item. Because of its limited production number it's most doubtful if any of these pocket pistols will be used as shooters.

In fact the statement "Warning: Do Not Shoot This Gun" has become a golden rule for collectors of commemoratives and limited edition guns. If possible in order to keep these very "Special" firearms in mint condition, handling is kept to a bare minimum, thus assure future increases in value. This new abbreviated barrel piece should fit into this category very appealingly.

To initiate the appeal for this new 44/40 Sheriff's Model are the many variations it has to offer. Starting first, four different limited model variations are being made available. First is Model P1932, Sheriff's Model, Standard, quantity: 1000, caliber .44-40, 3-inch barrel, blued with case hardened frame, standard SSA composite stocks with rampant colt and eagle. 1980 retail price \$399.95. Second Model P1934 is Sheriff's Model with dual cylinder and case. Quantity: 1,150, caliber .44-40, .44 Special, 3-inch barrel, Royal Blue with case-hardened frame. Grips are Standard SAA wood with no medallion, all in a French fitted walnut presentation case with glass top. 1980 retail price \$680.95. Third Model P1933, quantity: 600, caliber .44-40 and .44 Special, is similar to Model 1934 except it comes in all-nickel plate and similar walnut presentation case. 1980 retail price: \$680.95.

A fourth variation is offered on a price on request basis

and that is a factory engraved Sheriff's Model, .44-40 and .44 Special, 3-inch barrel, cased with extra cylinder and gold inlaid to customer's specifications.

The Royal Blued and nickle-plated models marked on the left side of the barrel "Colt Sheriff's Model," and on the right side of the barrel marked "Colt SAA .44 CAL." The standard model is marked "Colt SAA .44-40." Also all models are numbered in the standard Colt Single Action Army serial number range.

In this day and age in which much concern is generated by interest in trivia perhaps the following might be of interest in relation to this latest Colt Sheriff's Model. Noted in all of the recent ads pertaining to this new model is a "Deputy United States Marshal" badge which somehow does not relate to a gun marked "Sheriff's Model," the reason for the use of this badge is that it was borrowed from the author by Colt in 1979 when the Colt Company was seriously contemplating a new Sheriff's Model but was going to be known as the "U.S. Marshal" Commemorative, and so marked. As a commemorative this would have been a most unique piece but according to Colt has been shelved for the time being.

Last but not least and certainly not trivia is the latest announcement by the Colt Firearms Division that on or about December 1981 the Colt Single Action Army models will all be discontinued. the phase-out will occur model by model each month throughout 1981.

So with this ominous news facing the Colt SAA collector this new and exclusive Sheriff's Model should definitely become a classic in its own time.



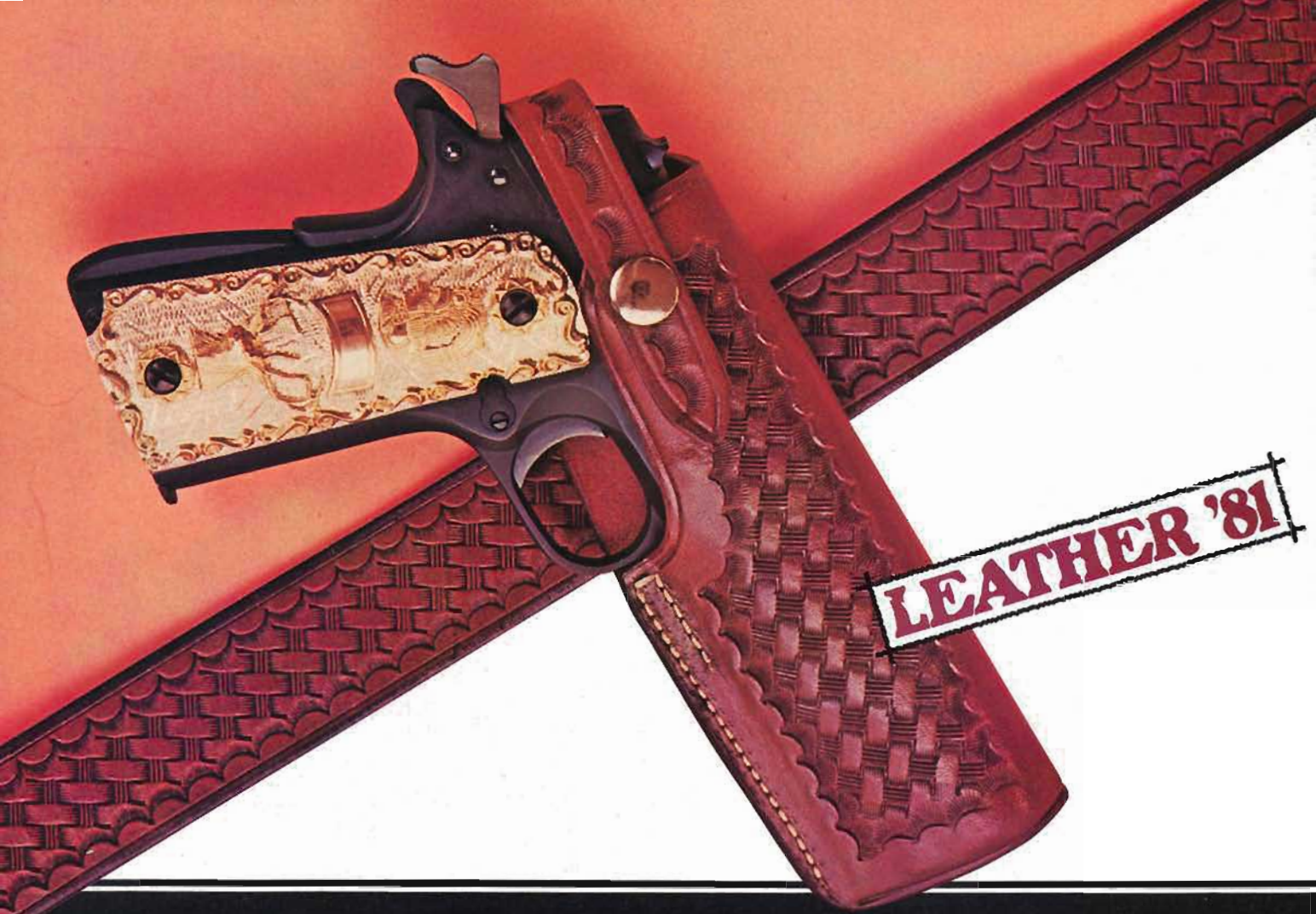

LEATHER '81

Holster & Accessory

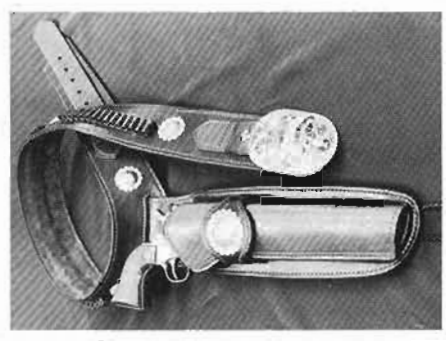

Hunter Custom
Thumb-break, Robert Strong



Bianchi #5
Cobra "X-100"

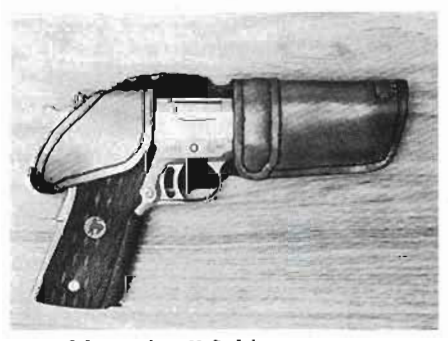

"Double Action," Seldeen
Undercover, De Santis



64

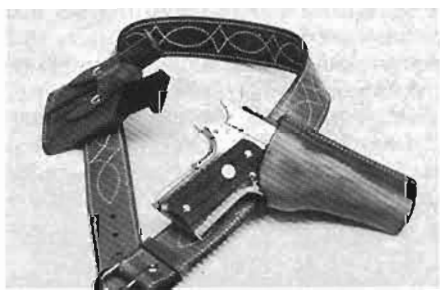

ASP (Armament Systems & Products)
Box 18595
Atlanta, GA 30326

Alessi Custom Concealment Holsters
2465 Niagara Falls
Tonawanda, NY 14150

American Sales & Mfg. Co.
Box 677
Laredo, TX 78040

Beeman Precision Airguns, Inc.
47 Paul Dr.
San Rafael, CA 94903

Belt-Slide Inc.
P.O. Drawer 15303
Austin, TX 78761

Benjamin Air Rifle Co.
1525 S. 8th St.
St. Louis, MO 63104

Bianchi Gunleather
100 Calle Cortez
Temecula, CA 92390

Ted Blocker Custom Holsters
Box 821
Rosemead, CA 91770

The Carpenter Co.
Box 13881
Orlando, FL 32809

Cathey Enterprises, Inc.
9516 Neils Thompson Dr.
Austin, TX 78758

Chace Leather Products
507 Alden St.
Fall River, MA 02722

Charter Arms Corp.
430 Sniffens Lane
Stratford, CT 06497

Cobra Gunleather
1865 New Highway
Farmingdale, NY 11735

Colt's
150 Huyshope Ave.
Hartford, CT 06102

Courtlandt Boot Jack Co., Inc.
270 Lafayette St.
New York, NY 10012

Crosman Airguns
980 Turk Hill Road
Fairport, NY 14450

El Paso Saddlery Co.
Box 27194
El Paso, TX 79926

4-D, Inc.
Box 19157
Detroit, MI 48219

Fury Leather Co.
2204 Niagara St.
Niagara Falls, NY 14303

J. L. Galef & Son, Inc.
85 Chambers St.
New York, NY 10007

Garth Company
Box 14354
Tampa, FL 33690

Goerg Enterprises
Box 531
Renton, WA 98055

Gibbs of Texas, Inc.
Box 296
Gilmer, TX 75644

The Gun Protector
Rt. 1, Box 303
McKinney, TX 75069

ry Manufacturers

Edward H. Bohlin
931 N. Highland Ave.
Hollywood, CA 90038

Boyt Co., Div. of Welch Sptg.
Box 1108
Iowa Falls, IA 51026

Brauer Brothers
2012 Washington St.
St. Louis, MO 63103

Browning
Rt. 4, Box 624-B
Arnold, MO 63010

J.M. Bucheimer Co.
Box 280, Airport Rd.
Frederick, MD 21701

Daisy Mfg. Co.
Rogers, AR 72756

G. William Davis
Box 446
Arcadia, CA 91006

Eugene DeMayo & Sons, Inc.
2795 Third Ave.
Bronx, NY 10455

DeSantis Holsters & Leather Goods
1601 Jericho Turnpike
New Hyde Park, NY 11040

El Dorado Leather Co.
8406 Magnolia, Suite E
Santee, CA 92071

Steve Henigson
2049 Kerwood Ave. #3
Los Angeles, CA 90025

H. J. Herman Leather Co.
Route #1
Skiatook, OK 74070

Hoyt Holster CO.
Box 69
Coupeville, WA 98239

Don Hume Leathergoods
Box 351
Miami, OK 74354

The Hunter Corp.
Box 467
Westminster, CO 80030

Jackass Leather Co.
7383 N. Rogers Ave.
Chicago, IL 60626

John's Custom Leather
525 S. Liberty
Blairville, PA 15717

Kirkpatrick Leather
Box 3150
Laredo, TX 78041

Kolpin Mfg. Co.
119 S. Pearl St.
Berlin, WI 54923

Lawman Leather
Box 4772
Scottsdale, AZ 85258

George Lawrence Co.
306 S.W. 1st Ave.
Portland, OR 97204

Leathercrafters
710 S. Washington
Alexandria, VA 22314

Michaels of Oregon
Box 13010
Portland, OR 97213

Milwaukee Holster Co.
Box 559
Milwaukee, WI 53201

S.D. Myres Saddle Co.
Box 357
Millis, MA 02054

K. L. Null Holsters, Ltd.
RD 5, Box 197
Hanover, PA 17331

Odin International Ltd.
818 Sisters Lane
Alexandria, VA 22314

Old West Inc. Leather Products
Box 2030
Chula Vista, CA 92012

Ranger Leather Products
Box 3198
East Camden, AR 71707

Red Head Brand Corp.
4949 Joseph Hardin Dr.
Dallas, TX 75236

Renegade Holsters & Leather Co.
Box 31546
Phoenix, AZ 85046

Lou Reno Enterprises
Box 253
Okeechobee, FL 33472

Rogers Holsters
10601 Theresa Dr.
Jacksonville, FL 32216

Roy's Custom Leather
Box 852
Magnolia, AR 71753

Safariland Leather Products
1941 Walker Ave.
Monrovia, CA 91016

Safety Speed Holster, Inc.
910 So. Vail
Montebello, CA 90640

Seldeen Leathersmiths
222 Ramona Place
Camarillo, CA 93010

Tex Shoemaker & Sons
714 W. Cienega Ave.
San Dimas, CA 91773

Sile Distributors
7 Centre Market Place
New York, NY 10013

Smith & Wesson
2100 Roosevelt Ave.
Springfield, MA 01101

Snick Products
Box 480009
Los Angeles, CA 90048

Storm Manufacturing
Box 41
Rossville, IL 60963

Robert A. Strong Co.
105 Maplewood Ave.
Gloucester, ME 01930

Sundance Products, Inc.
Box 836
Salt Lake City, UT 84110

Trailrider Products
Box 2612
Littleton, CO 80161

Triple-K Mfg. Co.
568 Sixth Ave.
San Diego, CA 92101

Viking Leathercraft
Box 2030
Chula Vista, CA 92012

Whitco
Box 1712
Brownsville, TX 78520



Lawrence #778



Ted Blocker



S&W Model 27



Roy's Custom Leather

HANDLOADING

(Continued from page 59)

brought the fragmented remnants of a brass case to me in a plastic bottle. He reported that he had merely picked up the 2.7 load for the purpose of transferring it from his loading bench to an ammo box when it exploded.

That was almost 20 years ago. The event, although dramatic, was ultimately diminished by the passing of time and by the knowledge that literally millions of Bullseye handloads were being used without mishap.

My abstinence from the continued use of Bullseye didn't come about until I happened to read Cooper's "Blowing Up With Two Point Seven" in the November/December, 1977, *AMERICAN HANDGUNNER*.

Discontinuing the use of Bullseye is a matter of personal choice. My report on the "cartridge incident" was not intended as a horror story; and neither should it be taken as a mandate against the use of this propellant by anyone who continues to find it satisfactory and safe.

Personal choice prevailing, I have found Hodgdon's HP38, an even-metering spherical, to be an excellent propellant for everything from the .38 Special to the .45 ACP—and with a broad range of bullet weights and types.

HEAVY STOPPING POWER

Ken Pantling, of Leicester, England, agrees with my contention that heavy bullets pack the greatest potential for handgun stopping power. He says he's a keen practical pistol shooter, and goes on to report, "I have been searching for a load that would be easily controllable, but would also show major calibre against a ballistic pendulum. Many shooters have followed the light-bullet/high-velocity path, but I have found that they pay a penalty in terms of high recoil and disturbing blast. I thus started looking at the possibilities of heavy bullets in the .45 ACP.

"What I have been looking for is a .455 Webley-type load in the Colt auto pistol. Jeff Cooper has described the .455 Webley as 'a model of easily controlled stopping power.' I hope to combine this with the tactical superiority of the auto pistol.

"The bullets I have been using are: RCBS 45-250 FN, Lyman 454424, and Lee 454-255-RF. All of which weigh about 255 grains in hard alloy.

"The most successful powders are Nobel 82 and Herco. However, Red Dot and Herco are the only available powders over here so I will list the Herco loads. The best loads I have used are: 5.0 grains to give 690 fps. This just makes major calibre and is very easy to shoot. It probably makes major so easily because of the bullet's sectional density and dwell time against the

(Continued on page 70)



WALLET-HOLSTER
for Hi-Standard Derringer
Looks Like a Wallet on the Outside
Packs a 2-Shot Punch Inside!
ONLY \$17.95 POSTPAID
and
BELT SLIDE HOLSTER
for Colt Gov't Model, Colt Hunter,
and other Large Frame Autos
Thick Durable Leather
ONLY \$3.95 POSTPAID
(CAH residents add 6% tax)

For info, send S.A.S.E.
STEVE HEMIGSON
2049 Kerwood Ave. # 3, Los Angeles, CA 90025

RANSOM "Master Series" REST

An International Standard for Accuracy Development

50 Grip Inserts
available to fit
different Pistol
and Revolver
Frames



See your local
gun dealer or
write direct for
free brochure

C'Arco Box 308HG, Highland, CA 92346

Hatco Hits The Target!



Take aim and hit the bullseye with Hatco's Sharp Shooter caps. Solid cap front has multicolored, embroidered Picture Patch; back is nylon mesh. One size fits all. Only \$6 each, including postage and handling.

Choose from these exciting favorites: Smith and Wesson, Colt, Browning, Marlin, Ruger, Winchester, Deer Hunter, and Savage. Other patches available—please write for information. Cap colors are Royal Blue, Gold, Red, White, Maroon, Black, Navy and Light Blue.

Name _____
Address _____
City _____
State _____ Zip _____
Phone _____ Cap color _____
Patch make _____

Foreign residents add \$1.25. Va. residents add 4% sales tax.

Note: If color selected does not match embroidery colors on patch, we will match to best color.

hatco

Dept. HG
7307 Hull St. Road / Richmond, Va. 23235
Wholesale inquiries invited.

BIANCHI'S NEW

NIGHT HAWK™

THE ULTIMATE SURVIVAL KNIFE!

Developed for rough use
in the field - hunting,
hiking and backpacking.

MODEL
#855

... Knife sheath
specially designed
pouch on front contains
medium grit sharpening
stone. Wide belt
loop. Snap down
safety strap.

Quality that comes
only from Bianchi!

Check these features!

- Hammer forged 6" long Stainless Steel blade with high chromium content • 3/16" thick blade with 20 saw teeth • 10-1/2" overall knife length • Solid brass hilt shaped for optimum thumb support • Built-in water tight compartment holds matches, etc. • Precision made by German craftsmen giving you life time satisfaction • Each knife is individually serial numbered. **\$85.00 ea.** plus 10% postage and handling. Ca. res. add 6% tax.

DEALERS WORLDWIDE!

Send \$1.00
FOR NEW 1981
color catalog

100 Calle Cortez, Dept. AH-781, Temecula, CA 92390



BIANCHI
GUNLEATHER™

Buy One **DBI** Book, Get One Free!

Buy DBI Books Locally – Or Order By Mail

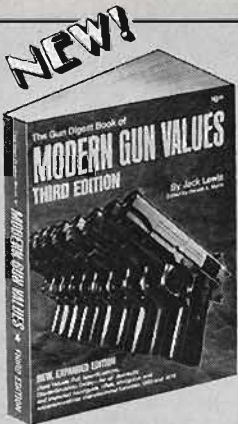

3rd Edition
By Jack Lewis
#MG5836
\$9.95

Gun Digest Book Of **MODERN GUN VALUES**

The most up-to-date reference for value analysis whether you're buying, selling, trading or just feel like gloating over the worth of your guns. In developing input for this edition, the author found awesome the extent to which some firearms have jumped in price since the last edition was published. For example, the value of the common garden-variety Colt Government Model 1911 in .45 ACP has more than doubled in that three-year period.

This edition has been greatly expanded to include all non-military guns introduced in this country between 1900 and 1978,

covering 29 more years than the first two editions. Includes full specifications, introduction and discontinuance dates, detailed descriptions with crisp, accurate illustrations for thousands of domestic and imported handguns, rifles, shotguns, and commemoratives. All guns are listed alphabetically by manufacturer within their appropriate section for easy reference. Each section – handguns, rifles, shotguns, and commemoratives – is prefaced with important tips peculiar to the intelligent buying, selling and trading of that type of firearm. Below is a list of manufacturers covered in this edition:

- | | | | | | | | |
|--|---|--|--|--|---|--|--|
| HANDGUNS
ALKARTASNA
AMERICAN ARMS
ASTRA
AUTO MAG
BAUER
BAYARD
BEHOLLA
BERETTA
BERNARDELLI
BRONCO
BROWNING
BUDISCHOWSKY
CHARTER ARMS
CLERKE
COLT
CZ
DOMINO
DREYSE
DWM
ERMA
FIE
FN BROWNING
FROMMER
GARCIA
GALISI
GREAT WESTERN
HAMMERLI
HARRINGTON &
RICHARDSON
HARTFORD | HAWES
HECKLER &
KOCH
HIGH STANDARD
INDIAN ARMS
INTERARMS
IVER JOHNSON
KASSNAR
KLEINGUENTHER
LAHTI
LE FRANCAIS
LIGNOSE
LLAMA
MAB
MAUSER
MERRILL
MKE
MOSSBERG
NAVY ARMS
NORTH AMERICAN
ARMS
ORTIGIES
PLAINFIELD
RADOM
RAVEN ARMS
RECORD
REISING
REMINGTON
ROSSI
RUGER
RUGER
RG | SAUER
SAVAGE
SECURITY
INDUSTRIES
SEDFLEY
SHERIDAN
SIG
SMITH &
WESSON
STAR
STERLING
STEVH
STEVENS
STOEGER
TARGA
TAURUS
TDE
THOMAS
THOMPSON/
CENTER
UNIQUE
U.S. ARMS
WALTHER
WARNER
WEBLEY
DAN WESSON
WILKINSON ARMS
WHITNEY
RIFLES
ANSCHUTZ
ARMALITE | BERETTA
BRNO
BROWNING
BSA
BUFFALO
NEWTON
CLERKE
COLT
COMMANDO ARMS
DAISY
DAILY
DIXIE
GUN WORKS
ERMA
FINNISH LION
F.N.
GEVARM
GOLDEN EAGLE
GREIFELT
CARL GUSTAF
HAENEL
HAMMERLI
HARRINGTON &
RICHARDSON
HECKLER &
KOCH
HIGH STANDARD
HOLLAND &
LHOLLAND
HUSOVARNA
INTERARMS | ITHACA
IVER JOHNSON
KRICO
KRIEGHOFF
MANNLICHER
MARLIN
MAUSER
MOSSBERG
MUSGRAVE
MUSKETEER
NAVY ARMS
NEWTON
NOBLE
NORRAHAMMAR
OMEGA
PARKER-HALE
PEDERSEN
PLAINFIELD
PURDY
REMINGTON
RIGBY
ROSS
ROSSI
RUGER
SAKO
SAUER
SAVAGE
SCHULTZ &
LARSEN
SEDFLEY
SHILEN | SMITH &
WESSON
SPRINGFIELD
ARMORY
SQUIRES
BINGHAM
STANDARD
STAR
STEVENS
STEVH
UNIQUE
UNIVERSAL
VICKERS
WALTHER
WEATHERBY
PARKER-HALE
RICHARDS
WHITWORTH
WICKLIFFE
WINCHESTER
WINSLOW
SHOTGUNS
ARMALITE
AYA
BAKER
BERETTA
BERNARDELLI
BOSS
BREDA
BROWNING
CHURCHILL | COGSWELL &
HARRISON
COLT
ARMORY
DARNE
DAVIDSON
FERLACH
FOX
FRANCHI
FRANCHOTTE
GALEF
GARCIA
GOLDEN EAGLE
GREENER
GREIFELT
HARRINGTON &
RICHARDSON
HIGH STANDARD
HOLLAND &
HOLLAND
HUNTER
ITHACA
IVER JOHNSON
KESSLER
KLEINGUENTHER
KRIEGHOFF
LEFEVER
MARLIN
MAUSER-BAUER
MERKEL
MIIDA | MORONNE
MOSSBERG
NEW HAVEN
DAILY
NOBLE
PARKER
PEDERSEN
PERAZZI
PREMIER
PURDY
REMINGTON
RICHLAND
RIGBY
RUGER
SARASQUETA
SAUER
SAVAGE
L.C. SMITH
SMITH &
WESSON
STEVENS
UNIVERSAL
VALMET
WEATHERBY
WESTERN ARMS
WESTLEY
RICHARDS
WINCHESTER
WOODWARD
PLUS EVERY
AMERICAN
COMMEMORATIVE! |
|--|---|--|--|--|---|--|--|

THE BLACK POWDER HANDGUN

By Sam Fadala

Fadala covers this oldtime weapon in all its forms: pistol and sixshooter in both small and large bore, target and hunting as well as its ballistics, tuning and timing, lubes and solvents, patching, sighting-in, cleaning and care, grips and leathers, and its unique idiosyncrasies as a shooting tool. The great amount of information on loads, loading and ballistics makes this book outstanding in its breadth. An in-depth look at many black powder handgun types including derringers, pepperboxes, duckfoot pistols, Kentucky pistols, the Walker Colt, the target underhammer, Harper's Ferry Horse Pistol, dueling guns, Ruger's Old



#BO9266
\$8.95

Army, the Thompson Center Patriot, the Remington 1868 revolver, plus how to mold your own bullets and balls, how to choose the right firearm and where to buy it, gun museums that shooters should visit, and an entire chapter on building the CVA Mountain Pistol with step-by-step instructions and illustrations. Much more. 288 8½" x 11" pages.

RELOADING FOR SHOTGUNNERS

Edited by Robert S.L. Anderson

Articles by well-known authorities cover the psychology of trap and Skeet, slug reloading, wildcatting, home defense reloads, patterning, shotshells for the small bores plus questions and answers on shotshell reloading, tips and tricks to make reloading easier. Ed Matunas, ammo and components authority, provides over 60 pages of load data for 10, 12, 16, 20, 28 and .410 bore shotguns. Each gauge listed is divided into loads (where applicable) for waterfowl, upland game, trap and Skeet. For ease of use, the load tables are further separated into sections covering popular brands of shotshell hulls. Our shotshell loading



#RS2606
\$7.95

tables allow you to easily and quickly select the load you want for the gauge of gun you shoot, for the brand of hulls you prefer, and the type of shotgunning you intend to do. Photos and descriptions of loading presses in operation and a separate catalog section of current presses and components round out this complete book of shotshell reloading. 224 8½" x 11" pages.

USE COUPON ON OPPOSITE PAGE TO ORDER NOW!

Buy One



Book, Get One Free!

Buy DBI Books Locally - Or Order By Mail

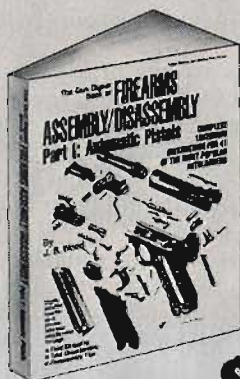

#FP8616

\$8.95

Gun Digest Book Of FIREARMS ASSEMBLY/DISASSEMBLY

By J. B. Wood

To answer the question, "How do I take it apart?" for both the average gun tinkerer and the pro, J.B. Wood has written a series of highly detailed "how-to" books on the takedown and reassembly of most modern guns, a number of older ones, and some of the more tricky ones. Disassembly takes you step-by-step to the "field-strip" level, then on to complete

disassembly down to the last spring and screw. Accompanying the text are hundreds of close-up photos showing the most intricate detail. Wood also illustrates the more complicated steps in reassembly. Each volume includes an illustrated section on tools, a list of sources for specialized items, and contains 288 to 320 8-1/2" x 11" pages.

PART I: AUTOMATIC PISTOLS

#FP8616 \$8.95

PART II: REVOLVERS

#FR8626 \$8.95

PART III: RIMFIRE RIFLES

#RR8636 \$8.95

PART IV: CENTERFIRE RIFLES

#CR8646 \$8.95

PART V: SHOTGUNS

#SR8656 \$8.95

ORDER INDIVIDUALLY



KNIVES '81

Edited by Ken Warner

The A to Z source for current info on top knives and knifemakers, custom and factory. Knife experts, Ken Warner and Jim Woods, examine design trends and the state of the art in knifemaking techniques, blade steels, sheaths, handle materials and trimmings. Lists over 400 custom knifemakers, plus manufacturers of commercial cutlery, retail and

specialty stores, mail order houses. A fascinating look at this diverse world from working knives for the hunter to elegant Damascus daggers for the collector. The finest compact catalog of knives and sources available. Over 600 photos. 192 8 1/2" x 11" pages.

#KV9816 \$5.95

TWO BOOKS FOR PRICE OF ONE! HERE'S HOW!

Buy one of these DBI books anywhere and get another DBI book FREE! Now you can own any of the books shown in this ad FREE!

- Buy any book(s) in this ad at retail price.
- For each book you buy, you may select a second book from this ad of the same price or less FREE!
- Please include \$2.00 for each FREE book you order to help us cover postage, insurance, packing and handling.
- If you buy DBI books from your local dealer, send genuine dealer sales slip showing which books in this ad you bought and where. Same FREE book offer applies, including \$2.00 postage, insurance and handling fees for each FREE book.

A I'm Buying These	B Retail Price	C Send These FREE!
	\$	
Book #		Book #
	\$	
Book #		Book #
	\$	
Book #		Book #

Please send the DBI book(s) listed above.

Column 'B' Total \$

PLUS postage, insurance, and handling charges (\$2.00 for each FREE book). \$

TOTAL ENCLOSED \$

OR

Enclosed is genuine proof-of-purchase (dealer sales slip only) for DBI book(s) bought locally. Send FREE book(s) listed in Column 'C' above. I've included the \$2.00 processing fee for each book.

TOTAL ENCLOSED \$

MONEYBACK GUARANTEE...

PLEASE ALLOW

THREE WEEKS FOR DELIVERY

DBI BOOKS, INC.

Dept. Z297, One Northfield Plaza
Northfield, IL 60093

Name _____

Address _____

City _____ State _____ Zip _____

U.S. & Canada only...2 for 1 offer expires in 60 days!

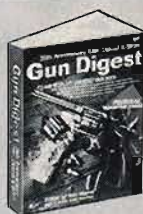

1981 GUN DIGEST

35th Edition

Edited by Ken Warner

New articles by top writers: Amber, Lott, Simmons, Hacker, more. 20 pages of test-fire reports, nearly 150 pages of photos, specs, up-to-date prices on all U.S./imported guns available in the U.S. today! 448 8 1/2" x 11" pages.

#GD1016 \$10.95



LAW ENFORCEMENT HANDGUN DIGEST

3rd Edition By Jack Lewis

All that's new for on and off-duty weapons: shotguns, special weapons, ammo, leather and body armor. How SWAT works, combat shooting, a visit to S&W's Police Academy. 288 8 1/2" x 11" pages.

#LU5236 \$8.95

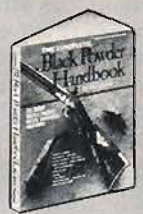

THE COMPLETE BLACK POWDER HANDBOOK

By Sam Fadala

Everything from proper lubes and rifling twist to do-it-yourself accessories. Plus surefire loading methods, ballistics, safety, successful shooting tips. 320 8 1/2" x 11" pages.

#BL8326 \$8.95



GUN DIGEST BOOK OF PISTOLSMITHING

by Jack Mitchell

Covers smoothing, tuning, timing, joining, metal tempering, rebarrelling, troubleshooting, accurizing, installing/altering sights, making replacement parts. Kits for a 45 auto, rebuilding a junker pistol. 288 8 1/2" x 11" pages.

#PS9546 \$8.95

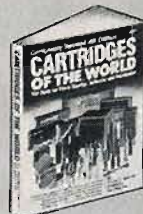

CARTRIDGES OF THE WORLD, 4th Edition

By Frank C. Barnes

Completely up-dated, this encyclopedic work covers the dimensions, performance parameters, physical characteristics for over 1,000 different cartridges in one, well-organized book. 384 8 1/2" x 11" pages.

#CW5046 \$9.95



ABC'S OF RELOADING

2nd Edition

By Dean A. Grennell

Step-by-step instruction on powders, shells, shot and loading density. Covers handgun, rifle and shotshell procedures. New ballistic info and reload testing techniques. 288 8 1/2" x 11" pages.

#AB5636 \$8.95



PISTOL AND REVOLVER DIGEST

2nd Edition Edited by Dean A. Grennell and Jack Lewis

All-new 2nd edition covers reloading, maintenance and repairs, silhouette shooting, handgunning for big game, new developments in ammo, leather, grips. 288 8 1/2" x 11" pages.

#PR5926 \$7.95



GUN DIGEST REVIEW OF CUSTOM GUNS

Edited by Ken Warner

Investigates checkering, woods, barrels, actions, sights, finishes and more. Price and design trends. Plus special Artisan directory, listing gunsmiths and specialty shops by type. 256 8 1/2" x 11" pages.

#CU8916 \$8.95

PLINK® KIT
PORTABLE TARGET HOLDER
 HOLDS ALL STANDARD TARGETS
 FOR RIFLES
 PISTOLS
 AIR GUNS

For
 Information
 Contact:

Safety Direct, Inc.
 23 Snider Way
 Sparks, Nevada
 89431



THE ULTIMATE
8-round combat magazine

- Colt type autopistols
- Improved feeding
- High strength, heat treated Stainless Steel
- Removable floor plate
- Self cleaning design
- Specially designed follower for improved loading
- Large viewing holes
- Toughest magazine on market

Factory Direct } **DETONICS MANUFACTURING CORP.**
 2500 Seattle Tower
 Seattle, Wa 98101
 (206) 624-9090

LEARNING LOADS

(Continued from page 44)

Now, I save all my .38 Special and .44 Special brass for use in guns chambered for those calibers.

Using Magnum brass for both heavy and light loads could lead to some confusion if one is not careful. It would be a shame to try to stop a grizzly with a "learning load" or pop a grouse with an inadvertently chosen bear load.

The varieties of loads can be identified by a dab of Marks-A-Lot on the primer, but I prefer a different method. I use brass of one brand headstamp for the "learning loads" and another for the Magnum class loads. For example; my light .357 Magnum loads are always put in 200 Browning headstamped cases that I reserve exclusively for that purpose. If I pick up a .357 Magnum case of any other headstamp from my storage box I know it is a hot load.

These practice loads, because of their light recoil will not require the heavier crimp needed for hot loads, therefore, with a little care the brass will last for quite a while. That also helps the cost factor.

These loads are good—for their intended purpose. Don't try to substitute them for high velocity loads. They are for small game, gophers, rockchucks, plinking, and informal competition.

I am not a great handgun shot, but I am much better now than I would have been without the practice made possible by my inexpensive and accurate "learning loads."

but it is difficult to handload. For reliable functioning it has to be seated well out, but it then catches on the rifling when it chambers.

"One spin-off of using heavier-than-normal cast bullets in barrels cut for jacketed bullets is that they tend to take the rifling better because you are not pushing them so fast. This applies equally well for the 9MM Luger."

Mr. Pantling's account of heavy-bullet research is well worth serious review by anyone interested in lending more clout to an already-potent handgun round. Furthermore, his notes on the various feeding characteristics of different types of cast bullets are well taken.

In our next issue I'll have much more handloading information to share. The letters continue to come, and although I can't guarantee a personal reply to each correspondent, the spirit of cooperation is appreciated. We seem to be proving that even though no one knows it all, everyone can benefit when knowledge is provided the advantage of widespread circulation.



UNI-VEST BY GARTH

Designed for Law Enforcement & Sporting Use



The most practical comfortable way to carry a gun. Uni-Vest fits revolvers or automatics with 2" to 6 1/2" barrels in three specially designed holster pockets. Uni-Vest also has a two magazine pocket which opens to accommodate loose ammo. Heavyweight blue denim. Sizes S-M-L-XL. Specify right or left handed. \$5.00 deposit on COD's. Stamped envelope brings literature. \$39.95

GARTH CO.
 Dept AH, P.O. Box 14354
 Tampa, Florida 33690

HANDGUN LEATHER

(Continued from page 24)

hand rather than machine embossed. The holsters have nicely finished edges, double-stitched points of strain, and are finished in an attractive shade of brown.

Adjustable tension holsters are the current state of the art. Such big name custom makers as Milt Sparks and Gordan Davis, as well as holster maker giant John Bianchi, offer such holsters. It was Milt Sparks who took an earlier FBI revolver holster having an adjustable welt to retain the gun, and modified it for use with the Colt .45 auto pistol. Milt inverted the welt, putting the adjustable portion at the bottom of the holster. If one wants more tension on the pistol, the tension screw is



HANDLOADING

(Continued from page 67)

pendulum. Meanwhile, 6.0 grains gives 803 fps and would make a very decent defense load.

"These velocities were chronographed five feet from the muzzle of a Colt Government Model. Incidentally, all 230-grain factory loads I have chronographed have failed to break 800 fps.

"Of the bullets, I prefer the RCBS. It feeds well in all pistols I have tried. It should be seated with 1/16th-inch of the forward driving band showing.

"The Lyman SWC feeds well in my throated pistol, but in few others. It has an excellent shape, and if I had to use my pistol for defense I would load this slug in the chamber and the RCBS loads in the magazine. The practice of loading the most efficient bullet shape into the chamber, and the best feeding shape into the magazine is hardly ever mentioned, but seems a good idea to me.

"The Lee bullet has a good nose shape,



Blocker holster fits nicely on belt.

.45 SHOOTERS



D.B.P. ENGINEERING'S
MUZZLE BRAKE FOR .45 AUTO BBL'S.

- ▶ COMPUTER DESIGNED W/3-LONGITUDINAL TEAR-DROP VENTS FOR IMPROVED ACTION
- ▶ DRASTICALLY REDUCES MUZZLE LIFT — FASTER RECOVERY FROM RECOIL
- ▶ GUNSMITH INSTALLED ON BBL. (PERM.)
- ▶ NORMAL TAKE-DOWN

\$1.50 + 1.00 HANDLING AND POSTAGE
 L.A. RESIDENTS ADD 6% TAX



D.B.P. ENGINEERING
FULL LENGTH CAPTIVE RECOIL SPRING SYSTEM FOR GOV. MOD. / GOLD CUP, COMM. AND LONG SLIDES

- IMPROVES FUNCTIONAL RELIABILITY
- REDUCES TORQUE
- FASTER RECOVERY FROM RECOIL
- IMPROVES HANDLING
- NO MODIFICATIONS REQUIRED

GOV. MOD. / GOLD CUP - 28.50
 COMM. AND LONG SLIDES - 33.50
 L.A. RESIDENTS ADD 6% TAX
 1.00 HANDLING AND POSTAGE

D.B.P. Engineering 7821 Willow St. N.O., La. 70118

loosened, the bottom end of the welt is pressed further into the holster and the screw is tightened to hold the welt in its new position. This works best when the holster is empty. With more welt inside the holster pouch, there is less room for the muzzle end of the slide, making the holster fit tighter. One advantage of this system is that the gun need only be drawn upward approximately one inch to clear the tension area of the holster.

In the Security holster, Ted has replaced the tension welt with two large rubber washers, with the adjustment screw passing through them. The bottom edge of the gun muzzle rests against the washers. When the tension screw is tightened, the washers grow in diameter and press harder on the bottom of the slide.

Of the two holsters tested, I personally prefer the Security with the tension device. Worn on a heavy 1 1/4 inch trousers belt and positioned just behind the right hip, it is very comfortable and secure. As all pancakes, these ride high and close, adding to their comfort. The FBI angle adds to the drawing ease when the gun sets this high, and the cocked and locked .45 auto is instantly ready. The lack of a thumb break makes this beautiful holster idiot proof.

Shortly after receiving these holsters I was to shoot in the first annual Soldier of Fortune Combat Match. This included handgun, riot gun and assault rifle matches with the shooter required to wear the sidearm in all three matches. This was an ideal chance to test the new Security holster under actual competition conditions. While the shooter didn't perform as well as I had hoped, the holster came through with flying colors.

I unhesitatingly recommend the Teflon lined Bodyguard and Security holsters, as made by Ted Blocker's Custom Holsters.

COP TALK

(Continued from page 32)

autoloader have switched back to the six-shooter.

A ripple this writer sees growing into a wave is the re-introduction of the ultra-compact .38 Special service revolver. In effect a small-frame .38 belly gun with 4" barrel and manageable-size grips, the compact service revolver may well take us back to the Thirties when the original Colt Police Positive was the choice of many departments that wanted to combine .38 Special firepower with a gun that was easy to carry on the Sam Browne belt, and off duty.

When it comes right down to it, the choice of an issue police gun isn't really predicated on whether the officer patrols the rural roads or the city streets. A four-



THE ORIGINAL RIG®

Rust inhibiting grease is back at your local gun dealer or sports shop now!

or write to:

RIG PRODUCTS

P.O. Box 1488

CANOGA PARK, CA 91304

© 1981 Mitann Inc.

IF YOU HAVE A RUGER SECURITY SIX

WE HAVE A VENT RIB FOR IT!

\$1495

PLUS \$1.00 POSTAGE, HANDLING

A great new look for your favorite DA 4" or 6". Install it yourself in minutes. No machining. Available, too, for all Ruger Blackhawks and the 6 1/2 Super Single Six.

Poly-Choke

Box 2496 HARTFORD, CT 06101



CLICK! When you hear it, you can believe it.

The Wichita™ .45 automatic pistol target and combat sight systems feature easy to operate positive click elevation and windage adjustments. When you hear the click, you can believe it, so your shooting is more accurate.

In addition, these all-steel sights, designed by renowned pistolsmith Ron Power, have been ruggedly constructed. Each is made to withstand the shock of service ammo and heavy loads better than any sights you've seen before. And they're legal for all ISPC and NRA competitions.

Visit your favorite dealer to see (and hear) Wichita Arms target and combat sight systems.

.45 Auto Pistol Rear Target Sight \$49.50

.45 Auto Pistol Rear Combat Sight \$49.50



Wichita Arms / 333 Lulu, P.O. Box 11371, Wichita, KS 67211 / (316) 265-0661

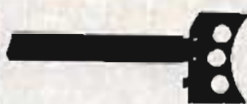

WILSON COMBAT Competition Match Trigger \$15.95

WILSON COMBAT™

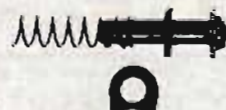

WILSON COMBAT SHOCK-BUFF® Shock Absorber Kit \$5.50 std. - \$12.95 deluxe (govt. or Comm.)

Custom Combat Handguns & Accessories for the Discriminating Shooter.

Extended Combat Safety	\$19.50
Extended Combat Slide Release	20.00
Dwyer "Group Gripper" Kit (Govt. or Gold Cup)	22.95
Dwyer "Group Gripper" Kit (Comm.)	27.95
Heavy Duty Recoil Spring (Govt. or Comm.)	2.50
Heavy Duty Recoil Spring Kit (Govt. or Comm.)	4.50
Magazine Base Pads	1.50
Beavertail Grip Safety (Std. or Comm.)	22.50
Commander Style Hammer	14.95
Pachmayr GM-45C Combat Grips	17.50
Pachmayr Mainspring Housing (B or C)	9.75
Break-Free CLP, 90 gm	3.00
Rogers Combat Grips (black)	14.95
Bianchi "Chapman Hi-Ride" Rig (state size)	76.50
Bbl. Bushing Wrench	3.00
Wilson Combat T-Shirt (state size)	5.95

Add \$2.50 Postage & Handling Per Order, NO COD or Credit Card Orders Please. Send SASE for price sheet or \$1.00 for NEW complete picture brochure of Custom Services & Accessories.

All ORDERS processed within 5 business days.

Wilson's Gun Shop

Route 3, Box 211-D, Berryville, Ark. 72616
Phone: 501-545-3618

WILSON COMBAT Competition Magazine With Pad (7rd-Stainless) \$18.00

Dealer Inquiries Invited.

WILSON COMBAT High Visibility Combat Sights \$25.00, with 3 dot system \$32.00. We will install in 3 weeks for a \$20.00 labor charge.



1/3 MOON CLIPS

Readily available .45 ACP ammo can be used in your U.S. 1917 Model and newer models of Auto Rim Type .45 Caliber Revolver. This new clip holds two cartridges and has many advantages over the half-moon clip. For a FREE sample, send stamped, self-addressed envelope.

Clip Prices: 25 for \$3.95; 50 for \$6.95 ppd.
RANCH PRODUCTS, PO Box 145, Malinta, OHIO 43535

CUSTOM HANDGUN STOCKS

Presentation grade stocks of fancy American & exotic woods for discriminating shooters.

SUPERIOR CRAFTSMANSHIP

Illustrated brochure \$1.00

ROBERT H. NEWELL

55 Coyote St. Los Alamos, N.M. 87544

DON JUDD 45 ACCURACY JOBS

SPECIALIZING IN

TARGET/COMBAT PISTOLSMITHING THE 45 ACP

ALL POPULAR SIGHT OPTIONS

GUARANTEED ACCURACY AND PERFORMANCE

COLT . . . S&W . . . RUGER

LONG CASE FOR DESCRIPTIVE PRICE LIST

3202 W. DENGAR

915-694-1766

MIDLAND, TEXAS 79701

NRA LIFE MEMBER

Pistol Sights

MMC ADJUSTABLE PISTOL SIGHTS
for S&W M-39 & M-59



Fully Adjustable, uses factory front sight. Matt Black Oxide or Satin Nickel. Order yours by mail!

Write or Call for Brochure & Price Lists.
Dealers Please Inquire.
No Collect Calls, Please!

Miniature Machine Company
210 E. Poplar
Deming, New Mexico 88030
505-546-2151

PACK A .38

THIS UNIQUE, LIMITED EDITION T-SHIRT WAS DESIGNED JUST FOR YOU

At last! A shirt for us gun lovers. Wear this top quality T-Shirt enhanced with our full color print of a Colt .38 Special "packed into your belt."

You'll feel comfortable and look fantastic

- Expertly silk-screened
- Will not fade, crack or peel
- Hanes top quality 50/50 Poly/Cotton
- A unique, one-of-a-kind design
- Full color, blue steel walnut grips, chrome trim
- Great for clubs
- Light blue shirt, sharp navy blue trim
- Our trusted, money-back guarantee

PRINTED T-SHIRT
small, med., large, extra large

\$5.95 Plus \$1.00 post and handling

ORDER 2 OR MORE
And We Pay Postage

SPECIFY QTY. AND SIZE WHEN ORDERING

INNOVATIVE PRODUCTS CO.
P.O. BOX 8411 H-7, CORAL SPRINGS, FL 33065



Free catalog with order
Catalog only—\$1.00 postpaid

inch revolver of mid-bore is still the logical choice as an issue gun, though you can make a good argument for big-bores in the hands of select officers who've proven their mastery of weapons.

If I was arming a metropolitan police force, I'd stay with the .38 Special, and would seriously consider a light-frame gun like the Police Positive or the Police Bulldog, though I'd probably wind up with the S&W Model 10 heavy barrel or its stainless Model 64 equivalent. If I were a State Police or Highway Patrol Colonel, I'd specify a 4" stainless .357.

My metro cops would carry 158-grain lead .38 Special ammo, either the Winchester or the new Federal hollow-point. My Troopers would be issued 158-gr. JHP .357 rounds, and would qualify with that same "Magnum Force."

And if I had an unlimited firearms training budget, I'd let them carry whatever the hell they wanted, above .38 short and under .44 Magnum, so long as they could qualify with it. Probably a lot of them would carry .45 automatics, as I do on patrol, but they'd be in that special category of lucky cops with an understanding administration, like those Honolulu policemen who patrol in their own Olds 440's and Pontiac GTOs.

So much of police work is cliché. In the reality of public police service as it exists today in most of the United States, you've got to find a happy medium that focuses on the lowest common denominator. The guns described above, and the loads, do that as well as anything now available to the law enforcement community.



.44 MAG LOADS

(Continued from page 55)

manufacturers supply only one basic die set for the .44 Special and .44 Magnum combined. These are the normal 3-die sets (resizer/decapper, case mouth expander, and bullet seater), and they are used in straightaway fashion. My only suggestions for case preparation are that the hand-loader (1) pay some attention to case mouth condition and (2) use as little "bell-ing" as possible. Excess case mouth expansion merely invites early splitting. I find that better accuracy is attained in handguns when the fired cases have perfectly trimmed mouths so that roll crimps will apply a uniform pressure and give a uniform release.

Crimps are very important to the .44 Magnum. They should be used almost universally on the .44 Magnum to prevent bullet movement under recoil and to insure proper ignition and combustion of the slow-burning powders common to this cartridge. Case neck trimming tools handle

.45 AUTOMATIC PISTOL PARTS

	EACH
Hammer Strut	\$1.25
Hammer Strut Pin	.20
Barrel Link	.75
No. 13 Barrel Link (For Matching Guns)	.85
Barrel Link Pin	.35
Firing Pin	1.25
Firing Pin Stop	1.50
Plunger Tube	1.95
Ejector	1.95
Grip Screw	.30
Recoil Spring	.45
Magazine Catch Spring	.30
Firing Pin Spring	.30
Main Spring	.30
Plunger Tube Spring	.30
Recoil Spring Plug	1.50
Grip Screw Bushing	.55
Main Spring Cap	.30
Main Spring Cap Pin	.30
Main Spring Retainer	.30
Slide Stop Plunger	.30
Safety Plunger	.30
Grip Safety (Long)	7.95
Hammer Pin	.30
Sear Pin	.30
Ejector Pin	.25
Main Spring Housing Retainer Pin	.30
Main Spring Housing (Flat)	7.95
Main Spring Housing (Gold Cup Style)	8.95
Recoil Spring Guide	2.25
Disconnecter	4.95
Trigger (Long)	6.95
Trigger (Short)	5.95
Trigger (Adjustable Match, Aluminum)	8.95
Trigger (Adjustable Match, Blue Steel)	10.95
Trigger (Adjustable Match, Stainless Steel)	12.50
Sear Spring	.95
Hammer (1911A1)	7.95
Hammer (1911, wide)	10.95
Barrel Bushing	5.95
Sear	5.95
Magazine Catch Lock	1.25
Magazine Catch	5.50
Grips (G.I.)	3.95
Magazine	5.95
Slide	59.95
Rear Sight	1.50
Front Sight	1.50
Extractor	4.75
Thumb Safety	6.95
Slide Stop	6.95
Barrel	27.50
Barrel Bushing Wrench	.60

Please include postage. Texas residents please include 4% sales tax. Write or call to get our monthly mailing of bargain priced gun parts and accessories.

TEXAS ARMAMENT CO.

P.O. Box 135H Brownwood, TX 76801
(915) 646-5827

this assignment, of course. The industry's suggested maximum length of .44 Magnum brass is 1.285 inches, while the suggested "trim-to" minimum length is 1.280 inches. Trimming any shorter reduces the initial combustion space, thereby causing higher-than-normal pressures and, in some instances, increasing the potential for poor accuracy by making the bullet take a longer jump.

Magnum primers are always recommended with jacketed bullets to insure the proper ignition with heavy charges of slow-burning powder. However, standard force primers are recommended with cast bullets to avoid deforming the projectile. The .44 Magnum uses large pistol primers, of course. And, as always, the primers



.44 Magnum reloads: 245-grain Lyman, 240-grain Hornady jhp, and shot load.

should be sensitively seated so that the cup is pressed over the exposed primer anvils on seating.

For absolutely optimum velocities, only a certain range of slow-burning powders will do. The most efficient powders are 2400, Blue Dot, H-110, 296, and Herco. Although the 4227's are popular with some gunners, neither H-4227 nor IMR-4227 is a very efficient powder in the .44 Mag. It takes 23.3 to 24.0 grains of IMR-4227 to move the 240-grain jacketed bullet at 1,300 f.p.s. from a 7½-inch Ruger Super Blackhawk, while just 17.2-17.5 grains of Blue Dot will give the same bullet 1,370-1,390 f.p.s. in the same gun.

Although Herco doesn't give the highest possible velocities in the .44 Magnum, it trails the best powders by little (about 50-75 f.p.s. at maximum charge levels), and I've had some fine accuracy with it. A 15.8-grain load of Herco under the 200-grain Speer HP gives 1,485-1,500 f.p.s. in the 7½-inch blackhawk, which isn't bad when one considers that it takes roughly 24.8-25.0 grains of 2400 to do 1,500-1,525 f.p.s. Moreover, I find that recoil and muzzle blast are more tolerable with the lighter maximum charges of Blue Dot and Herco than they are with the robust loads of H-110 and 296.

For top speed, however, H-110 and 296

When The Competition Gets Hot!

MODEL #3000A "AUTO DRAW"® Assembly

Silicone Suede Lined "Pistolero Belt"

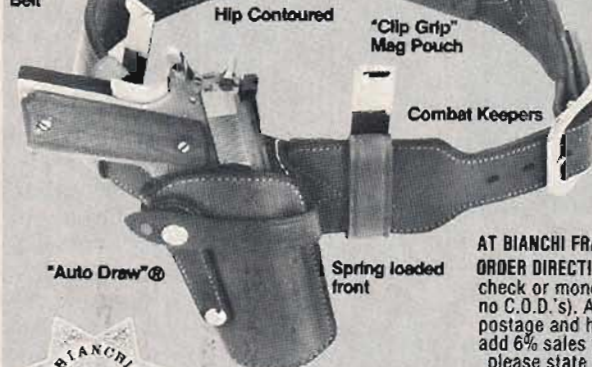

"Auto Draw"®

Spring loaded front



BIANCHI
GUNLEATHER™

The ultimate combat rig for .45 automatics. This radical new front opening speed holster contains over 30 precision parts. A lightweight spring mechanism locks the gun in place, securing it by the trigger guard under the most rigorous combat conditions. The companion "Pistolero" gun belt is suede lined and fully contoured for a glove-fit. Comes equipped with #45 combat keepers and the new #30 "Clip Grip" controlled draw magazine pouch. Made for Colt Gov't. .45 & Gold Cup; AMT Hardballer. Barrel length: 5" only. Plain tan finish only. Belt slot; 2½" only. **Entire assembly \$138.90.**

AT BIANCHI FRANCHISED DEALERS WORLDWIDE OR ORDER DIRECT! Send cash, check or money order (sorry no C.O.D.'s). Add 10% for postage and handling. Calif. res. add 6% sales tax. When ordering holsters please state Model No., color, finish, right or left hand, and make of gun, model, caliber and barrel length. Immediate delivery.

Write today for full color catalog (send \$1.00)
100 Calle Cortez, Dept. #AH-781 Temecula, CA 92390

Use the **HANDGUN MARKET** Classified Ads

RESULTS

BUY - SELL - SWAP - LOCATE

WE DID IT!

Completely secure - Functional design -
Velcro® closure quickly drawn

No zipper to snatch

THE PROTECTOR

The *Protector* is designed to give years of service while giving your handgun the protection it deserves.



Money Back Guarantee

4 Sizes To Protect Most Handguns

PV-8	SMALL AUTOS REVS TO 3"	PV-12	LARGE AUTOS REVS TO 6"
PV-10	MOST AUTOS REVS TO 4"	PV-16	T.C. 21" PG REVS TO 16"

YOUR ORDER SENT WITHIN 24 HOURS
CHECK OR MONEY ORDER - NO C.O.D.'s
ADD \$3.00 SHIPPING FOR FIRST ITEM

FINALLY:

- A pistol case that really protects;
- A design that is superior to any other
- Breathable Naugahyde Sweat-Proof construction
- A total system that utilizes the best of quality materials

TO ORDER: Enclose coupon with Name & Address
(include Zip Code)

HERE'S HOW THE HAYNES SYSTEM PROTECTS

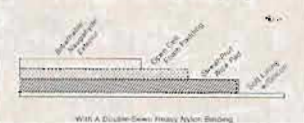

WITH A DUAL-SIDE STRAP Nylon Binding

MODEL	QUANTITY	PRICE	AMOUNT
PV-8	X	6.95	
PV-10	X	7.95	
PV-12	X	8.95	
PV-16	X	9.95	

MAIL TO:
HAYNES ENT.
P.O. Box 12275
"Dept. HP1"
Santa Ana, CA
92712

TOTAL
\$449.45
ADD \$3.00
\$452.45
TOTAL
ENCLOSED

Send in #10 TAGS for other product information.
DURS-INS-11A-1

SHOTGUN BARREL POLISHING HEAD

Let your electric hand-drill, polisher or grinder do the polishing. Removes lead. Polishes to a mirror-like finish. Breech thru choke to muzzle. No resetting head. Fits 12, 16 & 20-gauge barrels. Comes with polishing head, 34" steel rod, 4 polishers.

\$1195 - \$1. Page

NEW GUNSMITH CATALOG \$2.00

FRANK MITTERMEIER, INC. (Est. 1938)
Dept. AH-781 577 East Tremont Avenue New York 10465



FUNCTIONAL, RELIABLE, COMBAT PROVEN PISTOLSMITHING

Send \$1 for full list of services available.

EXCLUSIVE WEST COAST DISTRIBUTOR FOR ESSEX ARMS .45 Receivers & Sides
Dealer Inquiries Invited

CHUCK RIES

P.O. Box 205, Culver City, CA 90230

NEW '81 CATALOG
CHOOSE FROM 100,000

GUNSTOCKS



Fajen's fabulous Full Color Catalog is a Reference Book every Gun Lover will want to have. Contains complete information on Stock Styles, wood selections and designs. Write today.

Only **\$300**
Post Paid

REINHART FAJEN, INC.
DEPT. GM WARSAW, MISSOURI 65355

SHOULDER HOLSTER #7
for
Double Action
Revolvers
and Automatics

Lawrence

The perfect spring shoulder holster... lightweight, made with smooth unglazed leather for maximum comfort and concealment. Shown with optional under arm strap for weight distribution.

non Available at dealers or by mail.
Write for Free Catalog for all details on complete Lawrence line of over 100 holster styles and other shooting accessories.

THE GEORGE LAWRENCE CO.
Dept. AH-7 Portland, Oregon 97204



are exceptional with bullets of 225-240 grains. Both are ball-type powders with similar burning speeds, and a maximum load of 24.5/H-110 and a magnum primer will move the 240-grain jacketed bullet at 1,400 f.p.s. in a 7½-inch revolver. Here again, though, one pays the price for those extra 50-100 feet per second, as the ball types must be thrown in heavy charges resulting in severe muzzle blast and recoil. My own inclinations are to sacrifice 50 f.p.s. or so and keep the .44 Magnum within comfortable shooting levels.

Indeed, one rap against the .44 Magnum is slow recovery for a second shot, and the massive gas blasts from heavy doses of slow-burners like 296, H-110, and 2400 will always be obnoxious. For that reason, along with improved gun life, .44 Magnum owners might wisely consider mid-range reloads that operate 100-200 f.p.s. below maximum. Such reloads still outdo the old .44 Special. For shaved loads, the faster burning powders are indicated; merely reducing the charge of slow-burning fuels can leave air space in the case, and that isn't conducive to perfect interior ballistics. Fast- and medium-speed propellants are better suited to reloads that have air space in the powder chamber. A list of these



Speer shot-load capsule 2-piece units.

powders includes Unique, SR-7625, 630, 231, HS-5, and HP-38. I had relatively good accuracy results with 9.5/HP-38 and the 180-grain Sierra HC for 1,325 f.p.s. and 12.0/Unique with the 240-grain Hornady for 1,300 f.p.s.

Some fine light loads can be developed for the .44 Magnum for long gun life and pleasant shooting. In fact, I've seen better overall accuracy with the .44 Magnum using mid-range or light loads than maximum charges. Powders like "Hi-Skor" 700-X, 231 Ball, Red Dot, and Hodgdon's Trap-100 give velocities above those of the .44 Special with tolerable recoil and muzzle jump. Still using magnum primers, a 10-grain charge of Trap-100 does about 1,250 f.p.s. with 180-grain jacketed bullets and roughly 1,200 f.p.s. with 200-grain Speer HP's. We get about the same speed with 11.3/231 Ball.

Those velocities were taken with a 7½-inch Ruger Blackhawk, and they could be considerably different if they had been gleaned from a 10-inch Contender. The Contender is a solid handgun that doesn't



THE MOST POWERFUL AIR PISTOL IN ITS CLASS

Power and accuracy. Not usually found together in an air pistol—until now. The BSA Scorpion charges to full power with a single cocking stroke. No "pumping" or CO₂ variables. The unique power seal gives you an identical release of air pressure for every shot. You get the same sizzling velocity and same straight trajectory. Accuracy is phenomenal.

See what innovative design does for air pistol ballistics. Try a Scorpion at your Gun Shop.

Want more details? Write us.

PRECISION SPORT'S

Division of General Sporting Goods Corp.
Box 39-06, 798 Cascadeville Street, Ithaca, New York 14850

ATTENTION 9MM SHOOTERS!



STOP PAYING HIGH PRICES FOR 9MM AMMO!

This is your last chance to buy high quality CZECH 9MM ammo at less than half the cost of commercial ammo.

500 rounds ... \$54.95 Postage Paid UPS
1000 rounds ... \$89.95 Postage paid UPS
5000 rounds ... \$85.95 per 1000 Postage Paid UPS

10,000 rounds ... \$75.50 per 1000 truck Freight Collect

20,000 rounds ... \$69.95 per 1000 truck Freight Collect

50,000 rounds ... \$65.50 per 1000 truck Freight Collect

Sample Box of 80 rounds ... \$10.00 UPS Postpaid

Czech mfg. in 1950-60's. Berdan corrosive primed. Near 100% reliable. Suitable for all 9MM pistols, semi auto MACs and all 9MM submachine guns. We have now sold over 1 million rounds of this ammo with no complaints—only reorders. FFL license must accompany each order. If you are not a dealer, find a local dealer or gunshop who will accept shipment for you. Orders with certified check or money order are shipped same day they are received. Personal checks held 10 days.

Semi-Auto MAC M10 pistols and carbines in stock, call for current availability and price. .45, 9MM, .380. These are patterned after the infamous MAC-10 submachine gun but are available for purchase same as any pistol.

QUALITY PRODUCTS CO.
DIV. OF PARAGON S-S INC.
P.O. BOX 301-H
ROMEVILLE, IL 60441
(815) 725-9212

lose velocity potential because of gas seepage at the cylinder/barrel juncture, and its obviously longer barrel does a better job of wringing energy from the powder gases. For example, using 27.0 grains of 296 Ball in the 7½-inch Ruger with the 200-grain Speer jacketed HP gave me an average of 1,509 f.p.s., whereas data supplied by Thompson/Center gives the same reload 1,668 f.p.s. through a 10-inch Contender. Sticking with the 200-grain Speer JHP, 17.5/Blue Dot gave 1,462 f.p.s. in the 7½-inch tube while reaching 1,592 f.p.s. in the 10-inch contender.

Jumping to the popular 240-grain Sierra JHC bullet, we find 21.5/2400 doing 1,353 f.p.s. in the Ruger and 1,418 f.p.s. in the 10-inch Contender. With 22.5/296 under the 240-grain Sierra JHC, the Ruger turned in 1,298 f.p.s., but the 10-inch T/C registered 1,456 f.p.s. It is virtually redundant, then, to note that revolvers are hardly the most efficient guns with .44 Magnum reloads. One will not only find that maximum "recipes" will give greater MV's through the solid Contender barrel than they will from a leaky revolver, but that less-than-maximum reloads in a Contender will often outpace full-throttled loads in a revolver. The point is obvious: with a 10- or 14-inch



Three powders for maximum velocities.

Contender, the reloader can cut his charge slightly for reduced recoil and blast without sacrificing downrange energy. Thus, gun types do make a difference in load performance.

Many shooters like to use cast bullets in the .44 Magnum, and the high velocities often used dictate harder alloys than needed in the old .44 Russian and .44 Special. Soft cast bullets would lead the bore quickly, ruining accuracy. Unless I am badly mistaken, there seems to be a trend toward harder cast bullets, anyway, and .44 Mag. users who mould their own may lean toward a mixture like 10 parts lead to 1 part tin or Lyman's No. 2, which uses 10 parts lead, 1 part tin, and 1 part antimony. My own feeling is that bullets of 240-250 grains give the best cast bullet accuracy in this cartridge, and Lyman indicates that their bullet No. 429412 has given excellent accuracy as a plain-based 245-grainer seated to an overall loaded length of 1.710 inches.

Despite the tendency for some reloaders to advocate cast bullets 0.001-inch over-

PRICE COMBAT GUNS

CUSTOM .45 COMBAT WORK

Reliable — Accurate — Tastefully
executed combat modifications
performed on the .45 auto.



Write for details and price list.

WESTERN GUN EXCHANGE

Gunsmith — Bud Price	Route 2, Box 92	Open 9:00-5:00 Daily
21 years experience	Miami, OK 74354	Closed Sunday
NRA Life Member		Phone (918) 673-2810

LEAD BUILD-UP

* WIPE AWAY™

GUN CLEANING CLOTH KIT

JUST WIPE AWAY LEAD, BURN RINGS, & CARBON BUILD-UP
ON HANDGUNS, RIFLES & SHOTGUNS

THIS AMAZING CLOTH KIT CLEANS, LEAVES A SPARKLING FINISH,
IS INEXPENSIVE & LONG-LASTING

“... I can vouch for it really working. Just one or two swipes of the cloth and leading around barrel disappears....”

—Jerome Rakusan (Editor)
American Handgunner Magazine

“... For removing leading & carbon build-up WIPE AWAY is the best that I have worked with to date.”

—Bob Zwirz
Eastern Editorial Director
Gun World And Annuals



1. Removing lead from the forcing cone, barrel and cylinders is no longer a task. Simply cut a 1/2"x1/2" patch and wrap it around an old brush of the same caliber. A little scrubbing and the lead is gone. Follow this with a clean gun patch and that part is done.
2. To clean the face of the cylinders simply wipe the lead away.
3. Lightly wipe the exterior with the WIPE AWAY followed by a clean cloth and the job is finished.

With the WIPE AWAY, it is no longer a messy and time consuming job to clean a handgun.

Look for it at your Local Dealer, or send \$4.95 & 1.00 P & H to:
BELTOWN DISTRIBUTORS - P.O. BOX 444, BEDFORD HILLS, N.Y. 10507 (203)348-0911

*PATENT PENDING

FIRST CHANCE HOLSTERS by STRONG

The BEST concealable holster made.
Ask your dealer why or write us.



ROBERT A. STRONG CO.

DEPT. AH-7
105 MAPLEWOOD AVENUE
GLOUCESTER, MA 01930
1-617-281-3300



IPSC, PPC & SERVICE GUNS

tailored to your needs

W. R. MOORE

P.O. Box 17252

Pittsburgh, PA 15235

(send case for prices)

GUNS, MILITARY

BOOK CATALOG

Best catalog of its type in the world.

1700 titles. **\$2** Big 200 Pages.

Profusely illustrated.

Fairfield Book Co. Box 289, Dept. AH-9
Brookfield Center, CT 06805

DEPENDABLE

**FINEST PISTOL
& RIFLE CLIPS
STEEL FABRICATED**

Featuring Extended Clips for many Pistols &
Rifles New & Old Models

SPORTING • SURVIVAL • MILITARY
Remington, Ruger, Browning, HK, H & R,
Marlin, Explorer and many more!

"ASK FOR OUR EXTENSIVE CLIP LINE"

For answers to your questions, send self-addressed
stamped envelope. For UP-DATED production price
list, include 3 Bucks to cover our expenses. Will ignore
inquiries without cover cost. For foreign mail,
price is \$3.75.

D & E MAGAZINES MFG.

P.O. Box 4578 "H"

Downey, California 90241 USA

Do it yourself action jobs

S & W "K" & "N" DA Spring Kits

\$10.00

RUGER SECURITY SIX, COLT MK
III, S&W M-36 & 60. Double action
spring kits. Specify Kit

\$7.65

COMBAT PAK. Heavy duty spring kit
for all COLT .45 autos and Browning
Hi-Power.

Specify which model

\$16.50

WHITE OUTLINE SIGHT BLADES
for RUGER, COLT, MICRO adjustable
rear sights. Specify

\$6.10

SECURITY SIX

Adjustable Kit

\$11.00

S&W TRIGGER REBOUND, SPRING

PACK-4 Spring Strength

\$7.65

T/C SPRING PAK, 10-30 oz. Trigger

Return Spring, Heavy Duty Hammer

Spring & Heavy Duty Bolt Spring

\$16.00

NEW MODEL S.A. RUGER TRIG-

GER RETURN SPRING. Reduces

pull about 50%

\$7.10

S.A. RUGER Mainspring, Fast

Hammer Fall

\$6.50

CUSTOM T/C BARRELS for

SILHOUETTE or HUNTING.

17 through 50 cal from \$155.00

SECURITY SIX Hot Pink

Front Sight

\$15.00

2 CAVITY MOLDS, 265 & 315

GR. 44, 225 & 275 GR. 41, 182 &

200 GR. 357

\$30.00

CUSTOM PISTOL SCOPE BASES

\$27.50

Rechamber T/C—30-30 to 30-40

Krag, 41 to 411 JDJ, 44 to .430

JDJ, 35 Rem & 357 H to

.358 JDJ

\$30.00

Solid rib for Super

Blackhawk

\$60.00

Dealer Inquiries Invited

SSK INDUSTRIES

Rt. 7AH, Della Drive

Bloomington, OH 43910

(614) 264-0176

size, I have a hunch that optimum accuracy in the .44 Mag. will come with cast bullets held to bore diameter. One will have to slug his gun's barrel to be absolutely sure of the groove diameter, of course, as machining can vary; but the industry's standard indicate a 0.429-inch groove diameter for the .44, in which case 0.430-inch would be slightly oversize. This idea of holding bullet diameter at bore diameter is especially needed if reloads are going to be screwed to maximum pressures, because oversized bullets would suffer acute deformation if kicked from behind by intense pressures and rammed into the rifling to be swaged down at breakneck speed.

If cast bullets are to be driven at magnum speeds, a gas check is suggested to protect the bullet's base from heat and deformation pressures.

Although much attention is focused on jacketed bullets and cast slugs, there are two bullet concepts that lend themselves to excellent hunting performances in the .44 Magnum: the Speer half-jacket and the Lyman "Composite" bullet. Ideally, a hunting bullet will expand (mushroom) on impact, and that requires a relatively soft nose. By itself, that requirement could be easily met by casting soft bullets. But magnum velocities complicate matters and if one is going to push high-speed hunting bullets through the .44 Magnum, he must make some provision to eliminate leading. This is handled nicely by half-jackets and composite bullets.

SPEER HALF-JACKETS

Speer makes two excellent half-jackets for the .44, a 225-grain HP and a 240-grain soft nose. Both have the Keith-style design. The 225-grainer can be moved to 1,525 f.p.s. by 26.0/296 or H-110, while 23.2/2400 and 18.0/Blue Dot give it about 1,500 f.p.s. the 240-grain Speer half-jacket does roughly 1,400 f.p.s. ahead of 24.5-24.7/296 or H-110, and 22.2/2400 registers about 1,375-1,400 f.p.s. Half-jackets should be crimped so that the roll crimp impinges on the leading edge of the bullet's jacket. Half-jackets are *not* suggested for reduced reloads and should always be fired at maximum or near maximum velocities; for there is a possibility that, given low gas pressures, the jacket may remain stuck in the rifling as the lead core continues.

The Lyman composite bullet is an innovative way to give cast bullets both a hard bearing surface to eliminate leading while also providing a soft nose for expansion. It is a 2-part bullet, in fact. The cylindrical shank/base segment is cast separately of linotype for optimum hardness; then, the nose portion is also cast independently of pure lead, and the two are joined with 2-part Epoxy. In .44 caliber, the Lyman composite bullet weighs about 245 grains, and it can be reloaded to high speeds because of the base portion's hardness. Twenty-two and a half grains of 2400, a compressed load, will give it 1,400 f.p.s. with a Remi-

RELIABILITY ACCURACY QUALITY BELLS CUSTOM SHOP

Specialists in
Combat & Competition
Handguns



Send S.A.S.E.
for complete
price list.

BELLS CUSTOM SHOP

DAVE NORIN-Pistol Smith
3313 MANNHEIM ROAD
Franklin Park, Illinois 60131

(312) 678-1900

45 SHOOTERS GET THE MOST IN ACCURACY



Guaranteed 2 1/2" Groups at 50 Yards
Buy NSGI Match Grade Barrels made from
chrome moly steel by Nott's Industries Inc.

5" Match Grade \$100.00

6" Match Grade \$150.00

Dealer and Distributor Inquiries Invited

We offer a full line of Parts, Accessories and
Services at Wholesale prices.

Send \$4.00 for the complete
mail order catalog, or a
SASE for Service and Product List

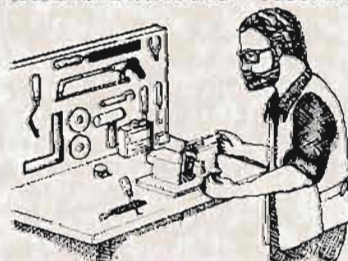

The Sho Gun Shop

26646 5 MILE RD.

REDFORD, MICH. 48239

Hours: 10-5 Monday-Friday

313 - 535-0819

Check, CDD or Credit Cards Accepted

ngton 2½ primer, as will 17.5/Blue Dot or 16.5/AL-7.

A final observation: I did not have good luck with the softer swaged (not cast) lead bullets being offered commercially. Even at lower speeds, they leaded the bore and gave indifferent accuracy. At magnum velocities, they were impossible. I'd suggest that commercially obtainable swaged lead slugs be held below 1,000 f.p.s. for the best chance at accuracy with light loads such as 6.0-7.0/Unique (800-900 f.p.s.), 5.3-6.0/Bullseye (825-900 f.p.s.), or 5.5-6.5/Red Dot (850-950 f.p.s.). Standard-force primers seem most compatible with these swaged slugs.

Thus, there's more to reloading the .44 Magnum than merely shoveling in the coals for high-speed blast-offs. Gun life, gun type, shooter recovery time and comfort, powder efficiency, bullet performance and selection, velocity levels, and shot charges plus plastic indoor loads—they all give the handloading handgunner a chance to flex his versatility and add new dimensions to the most exciting handgun cartridge going, the .44 Magnum.



SILUETAS

(Continued from page 12)

and several 118's and 117's in the conventional pistol classes.

Jack Dann was the first to shoot a 120, a new record, his reign was short lived as Dennis O'Brien, a junior and Jack's stepson followed shortly with another straight. By the time the match was over, all four IHMSA unlimited champions, in a stun-



The unconventional Wichita silhouette.

ning display of skill, had also shot 120's. Doug Scott survived a couple of banks of a 200m chicken off to take first place in triple A unlimited.

Nolan Jackson of Wichita shot the one straight in conventional and although that's certainly an accomplishment of which Nolan can be justifiably proud, it deserves some explanation. Nolan, you see, used a Wichita bolt action, 10½ barreled 308—not what most would consider a

QUALITY UNSEEN WORLDWIDE

CONCEALMENT

NULL

HOLSTERS

BROCHURE \$3.00

717 - 632 - 6873

K. L. NULL HOLSTERS LTD. HANOVER, PA.



GOVERNMENT SURPLUS

WE'LL TELL YOU ABOUT YOUR TWO BEST SOURCES

Interested in U.S. military surplus, like camping and survival gear, weapons, and jeeps? Or GSA surplus equipment like office equipment, cars, tools, and household items?

(1) Send us \$2, and we'll send you our illustrated catalog of small arms parts, weapon accessories, and many other survival and camping oriented surplus items. We'll include a redeemable coupon good for a \$1 credit on your first purchase.

(2) Send us \$5, and we'll tell you who to contact for information about buying U.S. military surplus and GSA surplus direct. And we'll still send you our catalog and a coupon.

Please include Self Addressed Stamped Envelope.

ROCK ISLAND ARMORY, INC. STORAGE AREA AH
E EXCHANGE ST. ENTRANCE, GENEO, ILLINOIS 61254. 309/944-2109 or 309/944-5739

Lou Ciamillo Pistolsmith

C/O MARYLAND GUN WORKS, LTD.

Police Combat Revolvers



**SPECIALIZING IN RUGER,
S&W, AND COLT
CONVERSIONS**

Combat Conversions on all guns include Douglas or Apex 1-1/16" round or square barrel, Bo-Mar, Davis, Mascot or Anstocrat Rib, complete action job including smooth trigger w/ trigger stop and speed hammer.

All above work on most Colt, S&W and Ruger Revolvers:

Round 1-1/16" Barrel (Blue)
Square Barrel w/ ejector rod shroud
(Add \$10.00 for stainless)

*Prices include taking original sights and barrel in trade.

DEALERS IN HOGUE AND ROGERS CUSTOM GRIPS

CHARTER MEMBER AMERICAN PISTOLSMITHS GUILD/M.D. FIELD REP PMA

For more information write: Lou Ciamillo — Gunsmith

c/o Maryland Gun Works, LTD. / 28200 Frederick Road / Hyattstown, Maryland 20734
(301) 831-8456



T-Shirts

Only \$6.95

Hand Silkscreened
On U.S.-Made Shirt
Gold on Royal
Rebel Flag and Second Amendment Also
Available
Send Size, Make and \$6.95 + \$1 p&h to
Box 55045 Dept A Little Rock, AR 72205

Shadowshirts



**JOHN
SPILBORGH'S**

P.O. BOX 40529
SANTA BARBARA
CA. 93103

**SPECIALIZING IN
6" .45 LONG SLIDE**

Shooter's Choice!



**Here's What World Practical
Pistol Champion Ray Chapman
says about Straightaway®
Hearing Protectors:**

"One of the best investments I made was a pair of Straightaway® Hearing Protectors. For the last 15 years I have been using the same pair of David Clark Straightaway's.

No shooter should ever leave their ears unprotected when firing. I won't."

Call or write for name of nearest dealer.



"the quiet people"

David Clark COMPANY
INCORPORATED
364 Franklin St., Worcester, MA 01604
(617) 756-6216

conventional pistol. But it is, as in NRA's rules conventional pistols are only defined as being a catalog item; the intent being that technically anybody can buy one. I say technically advisedly, as if it were not for the deterrent effect of the \$595 price tag there'd be no way that Wichita, a small firm, could build enough pistols to provide one to every shooter walking his fingers through that catalog. The pistol does provide an advantage, and I feel the NRA should redefine conventional; still, I should tell you that the next three shooters fired a 119, and two 118's—with two, more conventional pistols (T/C 30 Her, Mer. 30 Her, T/C 30 Her., respectively). That the shooter still figures into the equation is shown in modified conventional, where Nolan did nearly as well (117) with the same pistol, but was beaten by a target by a T/C 7mm TCU, and tied (twice) with T/C's—once a 30-30, and the other a 7mm TCU. Still, take ten top shooters, and have

1980 NRA National Championships Long Range Handgun Silhouette 120 Target Match

Open Standing

Class	Shooter	Pistol	Score
AAA	Skip Talbot-NV	XP-C 6.5mm U*	95
AA	John Dann-NV	T/C 270 VJ	80
A	Charles Kokesh-CA	T/C 7mm TCU	62
B	Sharon Grade-CA	S&W 41 Mag	61

Conventional

AAA	Nolan Jackson-KS	Wic 308	120
AA	Jim Shepard-NV	T/C 7mm TCU	106
A	Tom Williams-CA	T/C 30 Her	106
B	Roger Greene-CA	T/C 7mm TCU	107

Modified Conventional

AAA	Dave Tobin-CA	T/C 7mm TCU	118
AA	Kathy Miner-NV	T/C 7mm TCU	110
A	Charles Reay-CA	Rug 44 Mag	63
B	Roger Greene-CA	T/C 7mm TCU	117

Unlimited

AAA	Doug Scott-CA	XP-C 7mm U	120
AA	Tom Collins-NV	Rem 7mm BR	120
A	Ken Thornton-CA	T/C 30-30	106
B	Geoffrey Wise-NV	T/C 270 VJ	109

*Custom caliber XP

them shoot a match with each pistol, and I expect there'd be more straights with the Wichita.

I think NRA has potential problems that will arise in other matches in other places that could be eliminated by revising their criteria to include additional factors, such as requiring a minimum production run (say 200) to qualify as a conventional pistol, barring certain action styles, or establishing size and/or weight limits that would eliminate or discourage action types that clearly have superior potential accuracy.

As it stands now, the pistol's eligibility withstood a protest at the match, and it is still legal in the newly defined conventional class, which now allows the same modifications last year's modified class did. Nolan says he'd sold a few pistols like his—some to shooters that he says are obviously going to make sure he won't have that advantage next time.

The standing classes were combined

The Original Dirty Harry Shoulder Holster from The Original Company

Made from thick TEXAS COWHIDE . . .
"HARD TEMPERED" for strength . . .
Fully suede lined.



Now available for
ALL popular
handguns 6½"
barrels & under
\$64.95. 7½",
8", or 8¾"
barrels \$74.95.

Add 5% Stateside;
10% A.P.O.; 20% all others
for Shipping & Handling.
CREDIT CARD ORDERS
CALL:
802-991-5277 (orders only)
Send Check or M.O. to:



**Lawman
Leather
Inc.**

Dept. AH7 P.O. Box 4772
Scottsdale, Arizona 85261

Send \$3.00 for color catalog

Be aware of cheaply made imitations!

THE COLT GOES DOUBLE ACTION IN '81 in the SELDEEN D/A HOLSTER



Single action autos can be carried with no round in the chamber and be action ready—Safely and Reliably. This holster activates the slide and chambers a round during draw.

**"FROM EMPTY CHAMBER TO
FIRED SHOT IN A FRACTION OF
A SECOND"**

Available for all large frame single action
automatics in black or brown from
\$35.00 to 39.95.

**SELDEEN
LEATHERSMITHS**

222 Ramona Place
Camarillo, CA 93010

Brochure on request

into Open standing class (legal under NRA rules, but not in 1981) with anything, including scoped unlimiteds allowed. Still, the shooter is the dominant factor in standing and although Skip Talbot's 95x120 with a custom XP unlimited is a record score, the kill ratio is not any higher than what has been obtained with production pistols in 40, 60 or 80 round matches.

Being a small, low key sort or proceeding the match didn't attract lots of industry participation, but silhouette stalwarts like Thompson/Center, Western Gunstocks and Wichita were represented as were gunsmiths Wes Ugalde and Vern Jenke.

The match ran smoothly and the winners were rewarded with large attractive trophies and merchandise awards, including lots of pistols.

The sport is still new to the NRA, but they are interested and supportive. Keith Gaffney, First Vice President of NRA was there for the trophy presentations. Apparently they were pleased with the match, as the Reno Silhouette Association has been awarded the 1981 long range championships for July 4-7. They've already begun plans for a bigger and better shoot. You can contact them by writing the Association at 247 Wronde!, Suite 100, Reno, Nevada 89502, or calling Carter or Kathy Miner at 702-825-3600.

And if you're a triple A conventional shooter, best take along a Wichita.



HANDGUN HUNTING

(Continued from page 20)

and got only a caribou. A 125-150 yard running shot with a Hand Cannon in .45-70 caliber saved the trip. The Speer 400 grain bullets gave fantastic expansion. Recovered, one expanded to .930" and weighed 375 grains; the other expanded to .831" and weighed 383 grains. Had I not been shooting a Hand Cannon the whole trip would have been a dry run. I wouldn't have attempted the shot with anything else and no other shots were presented.

While the snow is a foot deep now, varminting will be in full swing all over the country by the time this is printed. Handgunning and varminting go hand in glove. You don't need any specialized equipment to get into varminting. Almost any handgun can be made to work. I killed my first groundhog at about age 8 with a Origies .32 ACP by spending a lot of time sitting about six feet from groundhog holes. It can be done even with a .25 Auto. You may not have groundhogs in your area of the country, but jacks, or whatever can be stalked to within a few feet and killed with the most rudimentary equipment. Running rabbits give the best practice for learning to shoot

(Continued on page 85)

IPSC-45 AUTOS-COMBAT Full Range of Combat Modifications CUSTOM SIGHTS-ACCURIZING TRIGGER WORK

50-Round Test Fire & Ransom Target on Accuracy Work
Improved Reliability

BROWN CUSTOM, INC.

8810 Rocky Ridge Road
Indianapolis, IN 46217

Long SASE
For Brochure & Prices



NAZI Collectors M-43 Stive
Black S-S Caps, Only \$15.00
Postpaid. Order your size
NOW. Our 224-page fully il-
lustrated catalog only \$3.00
(free with order).

OVER 40,000 Items in Stock

W.W. #2 Ltd. (H) Box #2063
St. Louis, MO 63158

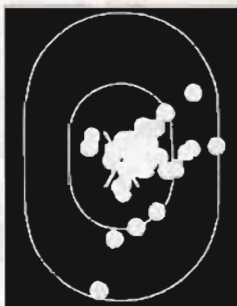

Match #5, A & B
Stage A - 7 yards 12 Rds. 25 sec.
Stage B - 25 yards 18 Rds. 90 sec.
6 Rds. Kneeling
6 Rds. Standing Barricade, L.H.
6 Rds. Standing Barricade, R.H.
25X 6-10

Fred's Gun Shop

Custom Gun Work 45, PPC



Short Cylinder P.P.C. Conversion (Pat. Pend)
Douglas 1-10 twist BBL 1,080" Dia. 6" Long
Square recess muzzle
Cylinder is shortened to function with 38 spc.
H.B.W.C. only
*Reduced Leading
*No bullet jump
*Reduced recoil
*X-Ring Accuracy
Each gun individually built

Fred Schmidt
Tel: (804) 746-9269
5904 Signal Hill Rd.
Mechanicsville, Va. 23111

GUTRIDGE, INC.

2143 Gettler Street, Dyer, Indiana 46311 • 865-8817

NEW QUICKLINE™ COMBAT SIGHT

For Colt Government and commander
As Quick as pointing your finger

COLT 45 ACCURIZING CUSTOM PPC REVOLVER

Complete Gunsmithing Service

Send 30¢ in stamps for information and prices

BROWNING HI-POWER



We offer all popular combat
modifications for the
Browning Hi-Power.

- Bo-Mar, S&W, or Micro sights installed
- Polish barrel ramp for improved feeding
- Complete accurizing
- Trigger jobs
- Cylinder & Slide's own wide trigger, extended slide release, and extended mag. release
- Your choice of finishes

- Browning
 - Colt
 - Remington
 - Weatherby
- Authorized warranty repair
- Colt parts distributor



Please send \$1 for our illustrated price lists

CYLINDER & SLIDE SHOP, INC.
P.O. BOX 937
FREMONT, NEBR. 68025
Ph: (402) 721-4277

PLEASE! no calls after 12:00noon C.S.T.

*** The Limited First Edition ***

Stagecoach Gun Collection Book!



Ozzie Klavestad, founder and owner of the Stagecoach Museum and world famous gun collection.

"My world famous Stagecoach Museum Gun Collection has been sold and its historic collection of guns dispersed to all corners of the globe. Before the collection was broken up, it was photographed (much of it in color) for this special Collector's Edition to make it available for study and enjoyment by historians, serious collectors and anyone interested in the history of firearms."

Gun Shown:
#465 in collection — Colt frontier, single action 44 cal., factory engraved nickel, one piece carved ivory grips with buffalo head and brown pearl eyes. Serial #151830.



LIMITED FIRST EDITION
\$39.95
plus \$1.50 handling.

ORDER TODAY!

THIS LIMITED FIRST EDITION IS SURE TO BECOME A COLLECTOR'S ITEM!

- Over 50 years of collecting in building this collection.
- Spans 400 years of firearms history and includes over 1,000 guns.
- Guns belonging to some of history's most famous characters: "Buffalo Bill" Cody, Annie Oakley, Calamity Jane, Frank James, John Brown, Ned Buntline, Emperor Maximillian, Czar Nicholas I of Russia, and Add Topperwein (world famous sharpshooter).
- Includes the infamous one-of-a-kind Tom Mix/Winchester Revolver designed by William Mason.
- Large 11¼" x 8¼" hardbound brown cover/beautifully printed in gold/full color dust cover included/over 200 pages.
- Over 40 color plates/others in black & white/all showing very sharp details of guns.



(IF USING CREDIT CARD)

CALL TOLL FREE 1-800-328-4646 Ext 60

Complete the order form and mail with check or money order payable to:

Mid-Western Artifacts, Inc. • 1125 Aquarius Lane • Eagan, MN 55122

Please send _____ copies of "The Stagecoach Museum Gun Collection" at \$39.95 ea. plus \$1.50 per book for postage and handling. (Minnesota residents add 4% sales tax)

Ship to: _____ Please Print Clearly  
Name _____
Address _____
City _____ State _____ Zip _____ (We must have zip)

Charge my Visa MasterCard (check one)

(Fill in complete card number)

Expire Date _____ Signature X _____ (IF USING CREDIT CARD)

Money Back Guarantee — If within 10 days you are not satisfied return the book and you will receive a full refund including shipping charges. **NOT AVAILABLE IN ANY STORE!**

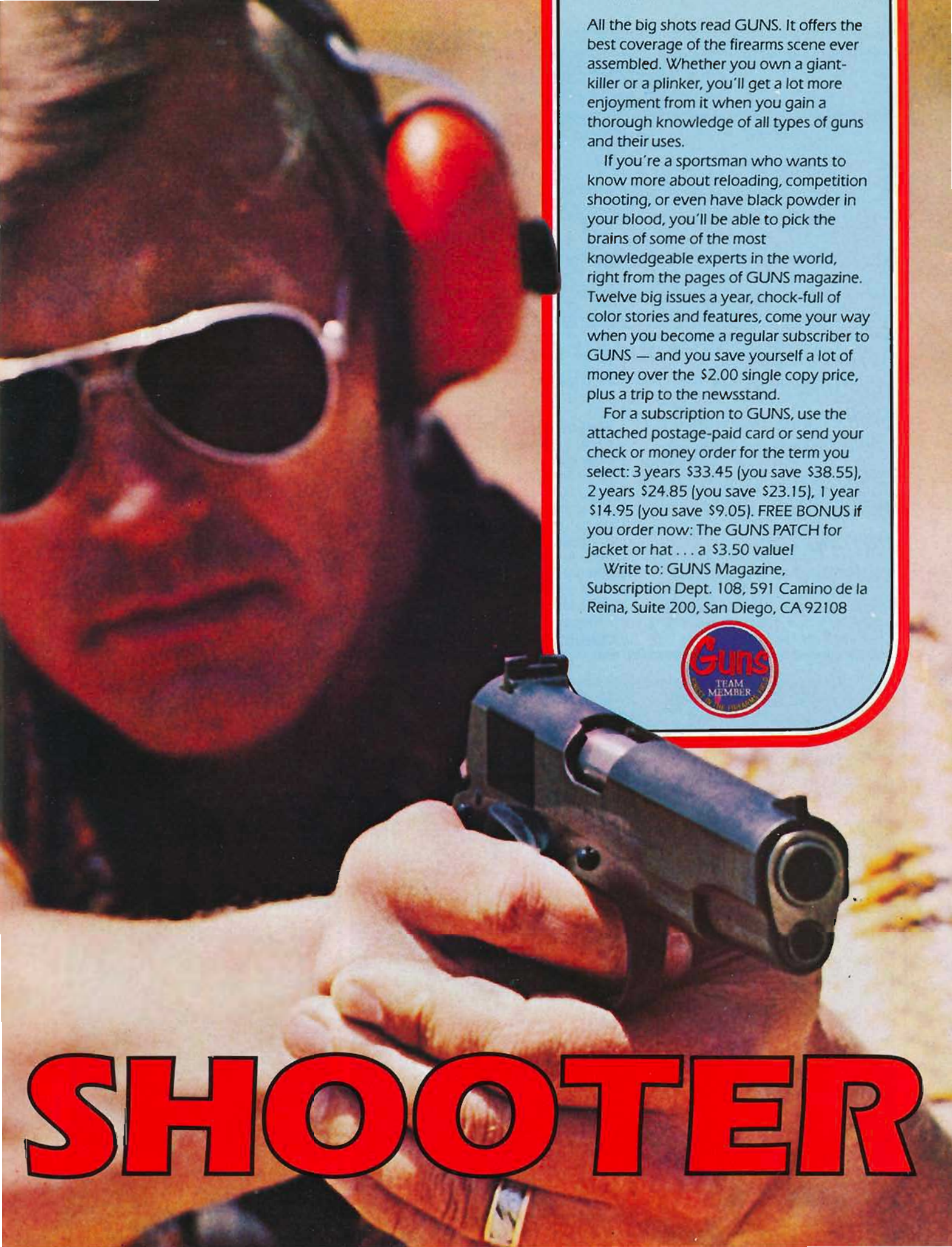

All the big shots read GUNS. It offers the best coverage of the firearms scene ever assembled. Whether you own a giant-killer or a plinker, you'll get a lot more enjoyment from it when you gain a thorough knowledge of all types of guns and their uses.

If you're a sportsman who wants to know more about reloading, competition shooting, or even have black powder in your blood, you'll be able to pick the brains of some of the most knowledgeable experts in the world, right from the pages of GUNS magazine. Twelve big issues a year, chock-full of color stories and features, come your way when you become a regular subscriber to GUNS — and you save yourself a lot of money over the \$2.00 single copy price, plus a trip to the newsstand.

For a subscription to GUNS, use the attached postage-paid card or send your check or money order for the term you select: 3 years \$33.45 (you save \$38.55), 2 years \$24.85 (you save \$23.15), 1 year \$14.95 (you save \$9.05). FREE BONUS if you order now: The GUNS PATCH for jacket or hat . . . a \$3.50 value!

Write to: GUNS Magazine,
Subscription Dept. 108, 591 Camino de la
Reina, Suite 200, San Diego, CA 92108



SHOOTER

JOHN SPILBORGH'S

Custom Extended Auto

When master machinist John Spilborghs decided to go into customizing .45's, he didn't realize he would soon be turning out a patented longslide that looks great and wins matches

By Kevin Steele

JOHN SPILBORGH'S IS A METAL craftsman of the old school. A native of Belgium, he came to the U.S. fourteen years ago and set up business as a machinist and gunsmith in Santa Barbara, California.

Becoming interested in IPSC shooting several years ago, John drew upon his machining talents and wealth of original ideas to create an extended .45 that was both unique in design and an improvement over the existing methods used to make long barrel auto pistols.

Beginning with a 6" Bar-Sto barrel he expertly fits the barrel to the slide, making
(Continued on page 83)



Barrel extension sleeve/bushing is patent pending; machined bar stock.



Cut in barrel locks into sight extension when barrel returns to battery.



sure that the barrel lugs mate perfectly with the cuts in the slide. The next step in the conversion is perhaps the most important, and in Spilborghs' case the most innovative. Since John is a machinist, he decided that his extended .45 would feature a custom designed bushing (currently patent pending) that would secure the slide and at the same time increase the sight radius. We should digress at this point to mention that most extended .45's today feature an extended slide. This is accomplished by either casting a longer slide to begin with, or welding sections of two separate slides together. Spilborghs opted for neither, instead an extended bushing was conceived that is milled and turned from a solid piece of bar stock.

As John says, "Welding is welding, you have to take advantage of your talents; I'm good on a machine." The extended bushing is carefully fitted to the gun in a manner that makes it look as if it's always belonged there. Two lugs on the bottom of the bushing lock it to the slide. The recoil spring plug is grooved to index with the forward face of the bushing lugs. The recoil spring guide is extended to meet the plug, and it is buffered to take up recoil shock. The end product stabilizes the barrel to the extent that under one-inch groups can be obtained from the Ransom Rest.

SCIENTIFIC TUNING JOB

This is not the end of John's work on the extended forty-five. Even before the gun has been fitted for the extended barrel and custom bushing, the piece gets a full blown tuning job accomplished scientifically rather than just by "feel."

For example: John's trigger job is done with the help of a special jig he himself designed. The jig is built to hold the main spring under pressure. An Ohaus trigger-pull scale is affixed to the top of the jig and pressure is applied to the spring until the desired "pull" weight is indicated. At this point the spring is cut and re-inserted into the frame. John feels that this method is necessary since the tolerances of spring steels differ, and an arbitrary cut job that might work fine on one gun could ruin another.

After the trigger is adjusted the ejection port is enlarged for easy and positive ejection. The magazine well is beveled and the interior is polished to remove all burrs and imperfections. The grip straps are checked to the buyer's specifications along with the front of the trigger guard.

An extended slide stop is fitted to the frame along with an ambidextrous safety, both of John's design. The ambidextrous safety differs significantly from the Swenson design, in fact, John's is so different that it is patent pending. The safety itself is machined from a solid piece of bar stock, as are all of John's parts—he uses no castings. The ambidextrous safety produces excellent torque, and its engagement-disengagement sequence is so posi-

Custom Pistols

J. MICHAEL PLAXCO

Highest quality workmanship by a champion competitor. We are quoting 1 to 3 months delivery time.



For more information and gun specifications:
J. Michael Plaxco, Rt. 1 Box 203
Roland, Arkansas 72135

(501) 868-9767 or (501) 868-9787

LEE'S RED RAMP KITS - \$9.95

The original liquid sight kit, highly fluorescent under poor lighting conditions. Our material should not be mistaken by the "Bull-ogna" being offered by some would-be competitors. ■ Mini-Kit — 1 color (your choice), will do 25 sights - \$9.95.

■ Deluxe Mini-Kit - all four colors (red, orange, yellow and white), will do 100 sights - \$35.00. ■ Regular Kit - 1 color (your choice), will do 55 sights \$19.95 ■ Deluxe Kit - all four colors, will do 220 sights - \$69.50. ■ Our kits are very easy to use. Fully illustrated instructions provided. (No tools).



Also available, the new Lee White Outline rear sight blade for Colts, Rugers and Micro at \$4.95 each. Jobbers and distributors call or write for quantity discounts.

Our kits are being used by many major law enforcement agencies and by most major pistol-smiths in the U.S., including Centaur Systems, Cheshire & Perez, Jim Clark, L. E. Jurras, Kings, Mathews & Sons, and Pachmayr. With a minimum of tools, you can have an attractive, functional front sight. All our products are fully guaranteed by Lee Baker. Send check or money order to:

LEE'S RED RAMPS, 7252 E. Ave. U-3, Dept. AHG, Littlerock, CA 93543

Phone (805) 944-4487. MasterCharge, VISA and COD orders are welcome.

Residents of California please add 6% state sales tax.

CASE-GARD®

Ammo Protection for Handgunners

By MTM

- Dirt and moisture resistant
- Virtually indestructible
- Guaranteed for 3 years

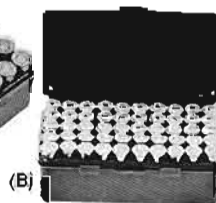
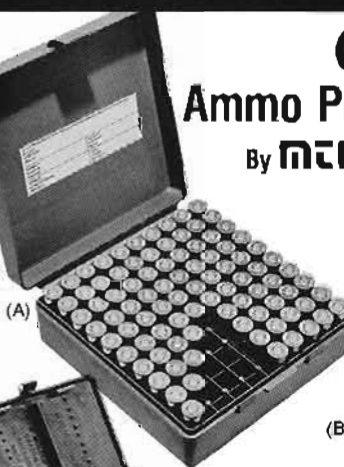

- (A) The NEW Mag-100 \$2.95
- (B) The ORIGINAL Case-Gard 50's \$1.49
- (C) The GENUINE Ammo Wallet (TM) . . . \$2.49 to \$2.99
- (D) The UNIQUE Magazine Wallet (TM) \$3.69

For complete information see your MTM Dealer, or send \$.75 for our 12 page, Full Color 1981 Catalog.

MTM MTM Molded Products Company
5680 Webster Street • Dayton, Ohio 45414



NU-LINE GUNS "UNDER RIB"

PPC GUNS BUILT 1 BULL BARRELS
HANDGUN BARRELS RELINED
HANDGUN CYLINDERS RECHAMBERED
JAY SCOTT GRIPS & COLT PARTS — \$10 MIN. ORDER
S&W SIGHTS INSTALLED ON COLT SLIDES
S&W MOD. 28 TO 44 SPECIAL & 45 L.C.

6" Python Barrels \$52.95 prepaid

NU-LINE GUNS

1053 Caulks Hill Rd, Dept. AH
Harvester, MO 63301
(314) 441-4500
(314) 447-4501

SEND LARGE S&W
FOR BROCHURE

Do-it-yourself Pistol Ammo Kit

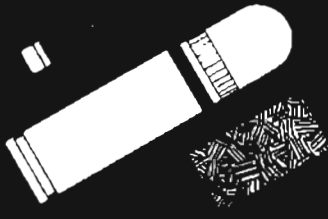

Anyone can learn to reload pistol ammunition. It's easy, fun, and money-saving, too! Send \$1.00 for introductory booklet to NRMA, Suite 300, 1221 S.W. Yamhill, Portland, OR 97205. National Reloading Manufacturers Association.

DISCOVER RELOADING !!

GENCO

DEALERS IN DISCRIMINATING
FIREARMS FOR COLLECTORS & COMPETITION



GENCO IPSC AUTO'S

STD. Width, Hard-Chrome, Bar-Sto
Barrels, Bo-Mar Sights

GUNS CURRENTLY IN STOCK

Available for immediate delivery

HECKLER & KOCH

Full line of H & K guns & accessories

FN FAL & ACCESSORIES

COMPLETE LINE S/W & COLT HANDGUNS IN STOCK

GENCO

PHONE (704) 274-4574 (24-Hour Answering)
530 Hendersonville Rd
P.O. Box 5704, Asheville, NC 28803

tive that you can literally "feel" it.

At this point the Spilborghs Custom Extended .45 is complete. The guns are finished in either rust blue or hard chrome to the buyer's preference. The full blown conversion with all parts, tuning, checkering and miscellaneous metal work will set you back \$900 with your gun; delivery time is 3-4 months.

Spilborghs is not the type of man who puts all his eggs in one basket. He offers numerous other examples of custom work that would be of specific interest to law enforcement personnel and PPC shooters.

For example; the Detonics "mini" .45 made a big bang when it hit the market about three years ago. But when most men shoot one the common complaint centers around the purchase the hand has around the shortened grip. John has effectively and with great simplicity solved this dilemma. He simply fits a magazine extension to the Detonics clip which accommodates the little finger. This allows the shooter to effectively hold the Detonics in the normal three finger hold, and the size of the extension can be built to suit the size of the shooter's hand.

Another innovative and simple device of John's is his "Speed Loader Extension" that he will fit to the standard Safariland speedloaders. The extension is especially suited to competition, either PPC or IPSC. The extension makes the loaders easier to remove from their pouches; it makes the loaders more effective in regard to insertion of the cartridges; and it clears all grip styles meaning that the common speed loader cut-outs do not have to be made on oversize target-style factory grips.

When tuning stock .45's without Bar-Sto barrels, John developed a locking system that effectively prevents excess barrel movement. This system centers around a small rectangular groove milled into the extension at the breech end of the barrel. This groove mates with a steel shim which extends downward from the slide in the cut milled for the S&W adjustable sight. When the slide returns to the battery position, this steel shim engages the groove on the top of the barrel surface, locking the barrel in place, where it consistently returns with each successive shot.

John also does some great work on shortened versions of the popular Colt pistols, as can be seen in the photographs showing the shortie Gold Cup and Commander. Excellent balance and "feel" is maintained in all of Spilborghs' custom work, from the extended 6" guns to the shorties ideal for concealed entry by either law enforcement personnel or approved civilians.

Dave Wheeler, an accomplished West coast IPSC competitor, has been using one of John's 5" customs with compensator for the past year. Dave feels that the Spilborghs gun gives him an edge. John Spilborghs can be reached at: JS Customs, Box 40529, Santa Barbara, CA 93103.



If you're planning to move, please let us know at least eight weeks before changing your address. Fill in the following information to insure uninterrupted service.

Publication _____

Changing Address??

1. Present address

Attach address label from a recent issue or print your name and address *exactly* as shown on the label plus your I.D. number which appears directly above your name on the label.

Name _____

Address _____

City _____

State _____ Zip _____

I.D. number _____

2. Fill in new address

Name _____

New Address _____

City _____

State _____ Zip _____

Mail this form to:

PUBLISHERS'

DEVELOPMENT CORP.

591 Camino de la Reina,

Suite 200

San Diego, CA 92108

HANDGUN HUNTING

(Continued from page 79)

moving game that I know of.

A lot of years ago I put another animal on the "varmint" list. I call it a wild dog. They are really a problem in many areas of the country, running in packs, killing small game, deer, farm livestock, and occasionally children. They won't back down from you either. I figure any dog that is where he ain't supposed to be and doesn't wear a collar is a genuine wild dog. The same dog with a collar can be called semi-domesticated. If he isn't doing anything wrong he gets a break. If he is running a deer or in a pack, he's wild and a duster as far as I'm concerned. It would be a good idea to check your local laws prior to embarking on a dog hunt. A few years ago in



.375 JDJ took care of African varmint. T-C hand cannon from SSK Industries.

West Virginia the minimum mandatory sentence for being convicted of killing a dog was more severe than for killing a human being. People lovers got that one straightened out. I didn't mention cats 'cause I just figured everyone knew enough to kill every one of them they found in the field already.

I've got the urge to go to Africa on a handgun hunt. South Africa and Rhodesia are probably the most feasible places to try handgunning now. There are numerous safari outfits in business but as a result of Kelly's hunt, Don Price of Greater Kudu-land Safaris Of Zimbabwe, Nottingham Estates, Box 60, Beitbridge, Zimbabwe, had announced plans to tailor make safaris for handgun hunters. Anyone can write him direct for info. Anyone seriously interested in forming a group of handgunners for an African trip please contact me through SSK whose address is previously listed.



DO YOU NEED SPEED?

SPEED-LATCH™

The ultimate in Combat Accessories



ALIGNS SPEEDLOADER

MODEL 102 FITS S & W K
COMPETITION MODEL 101
SLIGHTLY LARGER

\$29.95

SPEED-LATCH
WILL NOT
INTERFERE WITH
HOLSTER



EASIER OPENING

MODEL 216 FITS ALL RUGER D.A.'s
MODEL 212 SLIGHTLY SMALLER
FOR SERVICE USE

\$24.95

Manufactured of high quality STAINLESS STEEL for a lifetime of use.
Available in blue or satin stainless

RISK NOTHING

If you are not completely satisfied, return to F.T.C. for full refund.

FIREARM TECHNOLOGY CO. P.O. Box 266 Massapequa N.Y. 11758

*Patent Pending

N.Y. Residents Add 7% Sales Tax



MODERN PRACTICAL and DEFENSIVE SHOOTING

is being taught at the CHAPMAN ACADEMY OF PRACTICAL SHOOTING. Courses are now available for pistol, rifle and shotgun. The courses have been attended and praised by world class competitive shooters as well as law enforcement personnel. For information write:

CHAPMAN ACADEMY

P.O. BOX 7035 • Columbia, MO 65205

(314) 696-5544





(This design for caps too)

- **SWEATSHIRTS.** 50% cotton, 50% polyester. Long sleeve pull-over. Lt. Blue only. **\$12.95 ea.**
- **SHOOTERS Ball Caps.** One size fits all. Foam lined. Choice of Dark Blue or Green. Available in designs shown. **\$4.50 ea.** (Includes postage & handling.)
- Attention Gun Clubs! Custom design work available with minimum order. Write for details.
- Dealer Program Available.
- **Ladies V-Neck** in 50% cotton, 50% polyester. Machine washable, color fast. **\$8.50 ea.**
- Black imprint on either Yellow, Bone or Powder Blue shirt.
- Sizes in S, M, L, and XL.
- Indicate size, quantity, color, design, and full mailing address.

To order send check or M.O. to:

SHOOTERS T-SHIRTS

30097 Via Velez Pl., Dept. AH-781 Temecula, CA 92390
(CA res. add 6% sales tax) (Foreign orders add 25% postage)



IF YOU DON'T HAVE THIS FUNNY BOOK ABOUT THE PISTOL SHOOTERS YOU'RE MISSING OUT ON THINGS!

DEAD AIM

Lee Echols

.45 Nat'l Trophy Winner 1941

Send \$6.00 to Lee Echols, 1640 Maple Dr., Unit 68, Chula Vista, CA 92011. CA buyers add 6% sales tax.

NUMRICH
ARMS CORPORATION

NEW

Over 200 Pages

WORLD GUIDE TO GUN PARTS

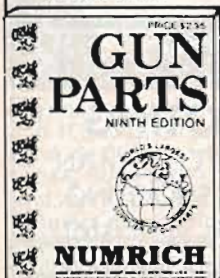

9TH EDITION

MODERN MILITARY • ANTIQUE

NUMRICH ARMS, the world's largest supplier of gun parts offers new for Catalog No. 9 covering a 100 million parts inventory with information never before in print.

U.S. PRICE \$2.95 FOREIGN \$3.95

P.O. BOX AH, WEST HURLEY, N.Y. 12491
PHONE (914) 679-2417 TELEX 145 331

SHARE YOUR INTEREST IN SHOOTING

TELL A FRIEND ABOUT HANDGUNNER MAGAZINE

Better yet . . . give them the enclosed subscription order card.

ATTENTION: HUNTERS & SILHOUETTE SHOOTERS



IT'S PROVEN
-20-30% ACCURACY IMPROVEMENT
-20-30% INCREASE IN CASE LIFE.

IT'S ADJUSTABLE
-TIGHTENS BARREL TO FRAME LOCKUP
-MAINTAINS CONSTANT BARREL POSITION.

IT'S ALSO
-EASY TO INSTALL - COMES WITH ALL NECESSARY TOOLS
-GUARANTEED FOR 5 YEARS.

ORDER DIRECT \$14.95 COMPLETE

CARONE RESEARCH DANVILLE, N.Y. 14437 PHONE 716-335-3636

COMBAT COURSE

(Continued from page 14)

to an offer by H&K to try the P9S .45. Although put off by its appearance, I liked its feel and was impressed with the way it shot and how easy it was to control in recoil. H&K loaned me two standard guns to evaluate culminating in the 1980 "Second Chance" match where the P9S and I placed 8th out of over 450 shooters with very little practice. Recently I won a "practical" match at Oceanside with it. The match was close and fast which certainly suited the P9S.

The P9S is one gun a police officer could buy that would make an excellent duty gun as well as a very good match gun. The price is too high from an administrator's point of view. It is, however, much cheaper than buying a duty and a match gun, and more sensible. I am convinced that an officer should use the same firearm at all



The H&K P9S trigger guard drops down.

times. Using one firearm type on duty and a different one for matches seriously detracts from the practical value.

The P9S as it came from the factory was more a duty than match gun. With both guns, I have had good double action triggers and excellent single action releases. The pre-travel and other travel of the triggers was, however, a serious problem in precision shooting. The basic accuracy was surprising. Using Super-Vel hollow points at 50 yards from a table rest my "Full House" Hoag MK-IV grouped 5 rounds in 2 3/8" x 7/8" (1.6" ave.). The P9S grouped 3 3/8" x 1 1/2" (2.3" ave.). With Federal hardball at 25 yards off hand the P9S grouped 1 3/4" x 3/4" (1.25" ave.) at exactly my point of aim. This level of accuracy is certainly good enough for any kind of shooting.

The sights, accuracy, and function of the P9S are superb. For both combat and duty use, the sights are perfect as far as I am concerned. The sights are strong and easy to pick up fast. The function was fabulous with every type of ammo I used. The roller block lock up system seems to make the pistol much less sensitive to power variations. The top of the magazine allows the next round to be stripped directly into the chamber. One P9S would even feed empty cases. The other pistol had a burr in the chamber. Once removed, it too fed and functioned with any bullet shape.

Unfortunately, I have had time to put

THE "BODYGUARD" WITH THE ALL NEW TEFLON LINING

Send \$1.00 For 1981 Catalog



REDUCES FRICTION BLUE WEAR AND RUST



Available in Black or Brown. The two tone brown pictured is available with B/W only.

Available for: S&W K-Frame, Gov't Auto, Commander, Brng H. P., Med. Auto's, Small Frame D.A.

	Teflon Lined	Unlined
S&W K Frame	\$38.95	\$24.95
Gov't Auto	\$38.95	\$24.95
Small D.A.	\$36.95	\$22.95
Medium Auto	\$36.95	\$22.95

The first major Holster innovation in years. A perfect combination of Top Grain Leather with Teflon Lining.

Add \$2.00 for B/W plus \$1.50 for shipping. California residents add 6% sales tax. Send check or money order. Dealers Inquiry welcome.



P.O. Box 821
Rosemead, California 91770

only 5000 rounds through either P9S. This is not enough to determine the strength of the gun. Close examination reveals no sign of wear, but the screw holding the double action lock work has to be checked occasionally. I feel the lock up system and light weight slide along with the advanced engineering eliminates the broken slide and frames I have experienced with other semi-auto types.

All is not perfect with the P9S, however. There are four points on the P9S that we had to work on. All of these problems are correctable without expensive gunsmith help. These four points are: the bottom magazine release, the "backward" safety, a trigger stop, and conversion to single action without pre-travel of the trigger.

The bottom magazine release cannot presently be changed but it need not be a serious problem. On a duty firearm it makes no real difference provided the shooter is familiar with the procedure. The need for a one-second magazine change in actual use has not been proven to me. It is not needed in most practical pistol matches either. Where it is needed, it can be learned.

MAGAZINE CHANGING

Nick Pruitt is a championship class shooter that works with me for Westec. Nick can do a magazine change on the P9S faster than I can on the Colt. The procedure he uses is to slide the left hand under the gun butt raking the magazine release with one of his middle fingers and stripping the magazine out with the index finger of his left hand. On this motion, his hand travels directly to his loaded magazine on the left front of his belt. His next motion is to grab a loaded magazine and slam it home. While not as fast as Nick, I can change magazines more consistently on the P9S than I can on my Colt.

I have done poorly at times on man vs. man competition due to magazine change problems. Each time it was due to a magazine that failed to drop out of the gun. Occasionally this was due to a dirty magazine well. Most of the time it was due to my short thumb not depressing magazine release properly. Others with small hands



Butt release on BDA is same on P9S. Practice will make this release fast.

BRASS

.45 ACP—9mm—.38—.357
.44S&W—.223—.308

WE HAVE IT!

Call For Quantity Prices
(512) 858-4441

THE BRASS WORKS

P.O. Box 315

Dripping Springs, TX 78620

CHOOSE A WINNER

Model
K-86



Specify waist
size Gun make,
bbl. length &
caliber.

Send \$1.00 for complete catalog.
Dealers, please inquire.

AMERICAN SALES & MFG.
BOX 677 AH LAREDO, TX 78040

Hand crafted, fully
lined, leg & hammer
tie downs, 24 loops.
Prompt Shipment.
\$49.80 p.p. Cashier's
check or money order.
Please add \$2.00
extra for 7 1/2" bbl.



FISHER CUSTOM FIREARMS

2199 S. Kittredge Way, Aurora, Co. 80013, (303) 755-3710

Specializing in 45
IPSC conversions;
Perfect match
of reliability;
Accuracy and
control;
All guns tested
and guaranteed
Recommended by
ROSS SEYFRIED
1978 National
Champion

Roy's Pancake®, the
most Practical holster
for Combat shooting . . .

and we've been making it
for years!



Send \$1
For Our NEW
1981 Catalog #9

Roy's Original
PANCAKE®
HOLSTERS

Roy's Custom Leather Goods, Inc.



Dept. AH P.O. Box G
Magnolia, Arkansas 71753
501-234-1599



Put the best leather on your side . . . wear ours!!!



QUALITY DUPLEX HOLSTER ONLY \$5.95

WHAT A VALUE! Genuine sueded pigskin on the outside and deep pile lining inside add up to quality protection for your gun. And the price tag on this holster is small compared to the investment your handgun represents. A nylon zipper and a binding that resists cracking to 20° below assure you this holster will last. **All orders prepaid. Send \$1.00 for mini-catalog.**

Barrels up to 6", send \$5.95. Over 6", send \$6.95. Send check or M.O. No C.O.D. MO residents add 5% tax.

BRAUER BROS. MFG. CO.

Dept. AH, 2012 Washington Ave., St. Louis, MO 63103

CUSTOM **COMPETITION** HANDGUNS

FROM THE ACCURACY SPECIALIST,
ALPHA PRECISION

The "FIRST IN ACCURACY" is our name



PPC, ISPC, DUTY, TARGET,
SILHOUETTE, AND SPORT



- Competitive prices • Over 20 years experience • Dependable functioning • Professional craftsmanship •
- All work fully tested and guaranteed •
- Fast service, less than 15 days for most work •
- Send large SASE for details •

ALPHA PRECISION, INC., Dept. 01, 1231 Sunderland, Ct.
Atlanta, Georgia 30319 (404) 458-0477

will find the P9S avoids this problem. Some competitors use extensions on the magazine release button on their Colt to avoid this problem. I never did due to an actual experience that a fellow officer had. The police department was making a raid on an activity that included one suspect that was known to be armed. Our biggest officer was to kick open the door and cover the suspect. The door crashed open, the officer jumped into the room, took a classic Weaver Stance and yelled "freeze," followed immediately by the clang of his magazine hitting the floor. He had hit the magazine release with the heel of his left hand.

When using the P9S, or any other gun with a bottom magazine release, one must be careful in prone positions not to allow the magazine release to scrape on the ground. Nick did this in the 1980 Bianchi Match, and the magazine dropped costing him many points. Don't however, switch back and forth between your types. Make your mind up and practice with one kind.

THE BACKWARD SAFETY

The "backward" safety is the same as on most of the German-made semi-autos and the Smith & Wesson model 39 and model 59. No amount of practice will make an upward motion of the safety as natural feeling as the downward motion used by Colt. This problem too was solved by Nick Pruitt and will work on the Smith & Wesson too. By welding on a lever with a slightly changed angle the safety works with an upward or downward motion.

The trigger stop is available from H&K. The plastic trigger guard assembly is available with or without a trigger stop. A perfectly functional trigger stop can be made by using a short self-tapping screw through the plastic trigger guard.

SA TO DA AND BACK

I have saved the best for last. There are advantages to being able to easily convert the gun from single to double action and back. To accomplish the conversion one need only cock the weapon, take up all the slack out of the trigger travel and mark a point just ahead of the trigger on the plastic trigger guide that extends down, from the action of the gun. After marking the part remove it from the gun. Use a small drill bit and drill laterally through the piece. Cut off a 1/8" length of a small nail and fit it into the hole. Reassemble the gun, pull the trigger and insert the pin in the hole you drilled. The gun can now be used single action only as the trigger will not travel far enough forward to engage the double action. All that is required to return the gun to double action is to pull out the pin.

With the P9S, an officer has an outstanding duty gun and is not handicapping himself in the least for serious competition except in matches requiring unreasonable magazine changes. I certainly intend to keep using mine.



NEW S&W GUNS

(Continued from page 41)

686). The Models 581 and 681 will be fixed sight versions of the same weapon. Suggested retails are as follows; 581-\$178 (blue), \$187 (nickel), 681-\$198, 586-\$247, and 686-\$268. The Model 586 will be available in May of 1981.

If you've been looking for a sturdy .357, but didn't care for the "N" frame, this new "L" frame should be just the ticket. You can rest assured that I won't be sending mine back!

MODEL 547

When S&W President Jim Oberg introduced the Model 547, 9mm revolver, those of us present wondered if S&W was rowing with both oars in the water. I can't speak for the other writers, but I quickly changed my opinion after examining and shooting this superb little revolver.

Originally designed for the French Po-



New S&W M559 9mm with steel frame.

lice, the Model 547 will also be an excellent choice for those who want better performance than the .38 Special without the drawbacks of the .357 Magnum. It should be highly popular with those police departments who have settled on the 9mm cartridge, but who have sizable segments who prefer the revolver to the pistol.

Unlike others who use half moon clips, the 547 uses a unique extractor system. The extractor head is investment cast out of beryllium copper, chosen for its low coefficient of friction and strength.

Another obvious difference in the 547 is the lack of hammer nose. A firing pin is located in the frame and located above it is another pin S&W calls the limit pin. Both pins are retained in the gun by a piece similar to those used in the Model 53 revolver.

The purpose of the limit pin is to restrict the primer indent and reduce extraction problems. Since the 9mm headspaces off the front of the case, variation in shell length can cause a .020" gap between the recoil plate and the shell. The limit pin prevents excessive penetration of the pri-

NITEX METAL FINISHING PROCESS HARD, CORROSION RESISTANT



...provides handsome appearance of stainless steel

WRITE FOR
Full color illustrated
brochure and name
of nearest
dealer



THIS IS THE FINISH! It protects ALL metal surfaces by a combination of heat and chemical treatments. The surface you see; the bore where deterioration is most deadly; moving parts — without harm to close machine tolerances, without loss of temper to springs. Far outlasts bluing. Lab and field tested for several years. Provides like-new restoration for favorite older guns; special good-looking protective finish for that new purchase. Results guaranteed! Investigate.

DEALER
INQUIRIES INVITED

NITEX

600 N. Glenville
Richardson, Texas 75081
214-690-0143

NEW from MUSTANG

HAND PICK YOUR GRIP

Here at Mustang Grips you select from the beauty of fine hardwoods or the practicality of neoprene. No matter which material you choose, you always get the time-tested quality of Mustang custom designs and beauty. Our newest models, the Rangefield line are made of neoprene and contain no steel plates. Eliminating the need for steel inserts gives you much better recoil absorption. The neoprene itself makes a non-slip surface for positive control and has just enough

give to help conform to your hand.

Write today for your **FREE** color
brochure or call 1-800-854-8236 for the
name of your nearest Mustang Dealer.



OVER 900 CHOICES
IN SELECTED
HARDWOODS
AND NEOPRENE.



MUSTANG GRIPS

1334 E. KATELLA AVE.
ANAHEIM, CA. 92805



CUSTOM PARTS

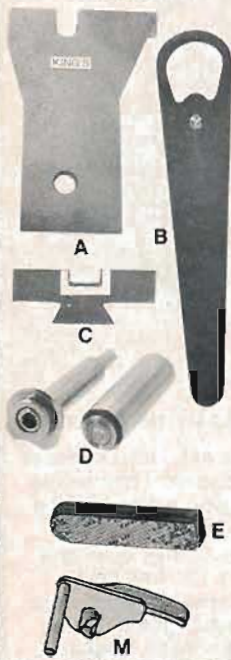

- A. King's Arsenal Type Staking Tool for King's, Micro, Bomar front sights 18.50
- B. King's Bushing Wrench 3.00
- C. King's White Outline Blade for Ruger, Colt, Micro sights 5.50
- D. King's Recoil Buffer & Heavy Duty Plug Set for Colt 45 Auto; 416 stainless steel, RC 30-35 (specify Government or Commander) ... 25.00
- E. Magazine Base Pad 1.95
- F. King's Wide Combat Grip Safety — no alteration to frame (specify Gov't or Commander) ... 22.50
- G. King's Recoil Spring Guides; 416 stainless steel, ground, heat treated finish (specify Government or Commander) 22.50
- H. King's Trigger Boot for Colt 45 Auto, acts as stop, Gold Cup Width 12.00
- I. King's Target Bushing (blued) 8.50
- J. King's N.M. Bushing; 416 stainless steel RC30-35 15.00
- K. King-Tappan Combat Sight, the famous original for Colt 45 Auto 29.00
- L. King Hard Ball Sight 18.00
King's Hard Ball with White Outline 21.00
- M. King's Combat Speed Safety 18.00

Gunsmithing at Its Finest

Have your Colt Auto or ours customized as only King's can do it! We've been satisfying our customers nationwide for over 30 years! Inquire for prices.

Dealer Inquiries Welcome. Order from:

KING'S GUN WORKS 1837 W. Glenoaks Blvd. • Glendale, CA 91201 • (213) 244-6811 • 244-7686
COD, MASTER CARD, VISA ACCEPTED.
CA. RESIDENTS ADD 6%. SHIPPING & HANDLING 1.50



mer by pushing the hammer back as the case moves back to the recoil plate. If the limit pin is removed, some brands of ammo will give as many as 5 out of 6 pierced primers.

The hammer spur has been bobbed so that it will not contact the shooter's hand when the limit pin pushes the hammer back. The primary advantage of the Model 547 is that the extractor segments are cammed out of the way and offer no resistance during reloading. The segments also easily snap over shells or rounds which get under the extractor.

A stronger main spring and a longer strain screw are used to give a .015" copper indent to fire all varieties of 9mm ammo. This indent is possible with a double action pull of less than 14 pounds and a 3 to 5 pound single action pull.

Because I was curious as to how much would be lost by firing 9mm rounds through a revolver, I chronographed a variety of loads in both the 559 and 547.



Smith & Wesson

9mm: REVOLVER VS AUTO

Load	547	559
a. W-W 100gr jhp	1287fps	1279fps
b. S&W 115gr jhp	1128fps	1123fps
c. R-P 115gr jhp	1187fps	1164fps
d. S&W 115gr fmj	1105fps	1153fps
e. W-W 100gr jsp	1278fps	1264fps

The reason for the excellent performance of this round in the 4" revolver appears to be because the cylinder length provides additional chamber space to make up for the gap between cylinder and barrel.

AMMUNITION

Along with the new guns, S&W also introduced two new ammunition loadings. Both are 125 grain Nyclad hollow points. One is a non +P for the .38 Special, while the other is a 9mm load. Both were tested for expansion and velocity. The results are listed below:

NEW S&W AMMO

Load	2"Vel	2"Exp.	4"Vel	4"Exp.
a. .38 Sp1	825fps	.71"	917fps	.78"
b. 9mm	—	—	1145fps	.80"

The .38 load is designed for extensive use in airweight snubs, and offers impressive performance. It will turn the short-barreled .38 into a gun an officer or civilian can depend on. The 9mm load is most impressive and gratifyingly accurate in all my 9mms. S&W is also working on a variety of other calibers with Nyclad bullets.

Watch future pages of HANDGUNNER for complete test reports on these new guns.



LUBRI-BOND GUN LUBRICANT KIT

For the first time Lubri-Bond Solid Film Gun Lubricant is available to the general public. Lubri-Bond Gun Lubricant contains molybdenum disulfide in a paint-like binder and meets military specifications MIL-L-23398 and MIL-L-46147. It is used on high speed rapid fire guns (large and small caliber), aircraft, tanks and spacecraft, to mention a few. It is a permanent lubricant and once applied should last the life of the gun, depending upon its use. Lubri-Bond Gun Lubricant will inhibit corrosion and provide a super smooth mechanical action on all moving parts. Dust and dirt will not stick to coated surfaces as it does when using oil or grease. All moving parts should be coated. If

desired, the entire gun can be coated, which will provide exceptional corrosion protection. Parts coated with Lubri-Bond Gun Lubricant will be grey in color. The Gun Lubricant Kit comes with two 3 oz. aerosol containers. One of the aerosols contains a degreaser which is used as a pre-treatment before applying the gun lubricant. The other aerosol can contains the gun lubricant. Electrofilm also offers a service whereby you send us your gun and we will parkerize the entire gun (with the exception of the bore) and put on a topcoat of heat cured Lubri-Bond Solid Film Gun Lubricant. Dealer inquiries invited.



ELECTROFILM, INC.

(805) 257-2240

7116 Laurel Cyn. Blvd. • No. Hollywood, CA 91605 / 27727 Ave. Scott • Valencia, CA 91355 • (213) 675-1000

REDHAWK VS M29

(Continued from page 61)

powder. It was not anywhere near a maximum load, but rather an accuracy load delivering a bit over 1000 fps. The recoil was nearly similar with both guns. Trying a hotter factory load of Western 240 grain HSP (index 44MHSP) we noted the Ruger Redhawk delivered what could be described as a "hard push" vs. the "sharp whip" of the S&W 29.

As expected, the challenge of an accuracy test was finally delivered as we polished off the second box of meticulous individually weighed reloads. Targets were set up at 25 yards and firing was to be off the bench. We would not really be shooting against each other as we were very well matched in ability. We were comparing guns and would each shoot several targets with both guns. As mentioned earlier, I was, in effect, matching an out-of-the-box Redhawk against a custom tuned M29.

I wish I could report to you that something spectacular happened. It didn't!



Test firing Ruger Redhawk .44 Mag. New Ruger did well against S&W M29.

Both guns were so good that the whole thing got sort of boring. Our groups, no matter who was shooting which gun, stayed consistently within 1½ to 2½ inches. At times I would beat my own Ruger using Bill's S&W, and he would beat his S&W using my Ruger. The better group of 5 shots was seldom more than ¼ inch smaller. If we proved anything at all, it was our own honesty in evaluating the potential of the new Redhawk.

It is this potential, however, that makes this report worthy of note. The Ruger Redhawk is capable of delivering, out-of-the-box, accuracy equal to a much more expensive quality handgun which sported an accuracy job by a fine pistolsmith. In addition to this the Ruger is a more modern design, stronger, and made of better materials.

Having satisfied our curiosity, we pocketed our shoulder holsters, and headed up to an old abandoned farmhouse on a hill that was just plumb plagued with rockchucks. Heck, who wants to work on a Monday anyway!



Metaloy Co.

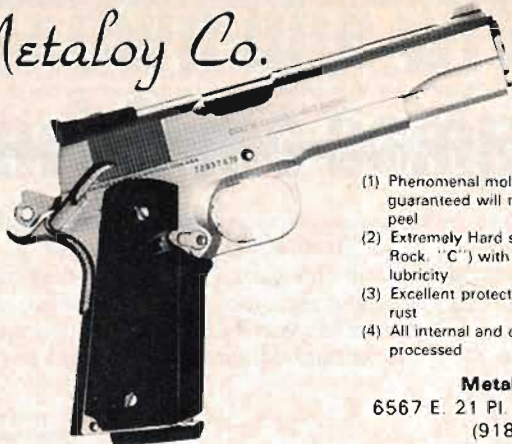

The
"METALOY"
finish

- (1) Phenomenal molecular bond—guaranteed will not chip or peel
- (2) Extremely Hard satin finish (70 Rock "C") with super lubricity
- (3) Excellent protection against rust
- (4) All internal and external parts processed

Metaloy Co., Inc.

6567 E. 21 Pl. "E" Tulsa, OK 74129
(918) 836-3781



BUEHLER PISTOL MOUNT

The Dan Wesson 44 Mag., 357, and .22 with ventilated or solid ribs are ideal for scoping. The BUEHLER base is installed on the barrel shroud with screws. Shrouds can be changed without removing the mount. Like all BUEHLER products, quality and dependability are built in. No mount is made better. Mount complete \$49.50. Send for FREE Catalog 36H



MAYNARD P. BUEHLER, Inc. - ORINDA, CA 94563

BEAUTIFUL CONTROL

(For Colt .45 auto and identical frames)

You will solve the problems of slippage and inconsistent hold by simply installing a pair of Bullshooters' Fingergroove Grips on your .45 auto.

Your scores will improve automatically as the fingergrooves insure proper hand placement and totally eliminate shifting of the weapon especially during rapid fire.

These features, combined with the natural pointing and handling characteristics give the advantage you need in hunting or competitive shooting.



SUPERIOR CONTROL DOESN'T HAVE TO BE UGLY.

Now you can have beautiful control in Cocobolo, Zebra wood, Rosewood, or other unusual exotic woods. Like the exhibition grade Bacote illustrated above. Quality engineered, finely finished, your new Bullshooters' Fingergroove Grips will give you positive, beautiful control.

	Retail Price
Walnut	\$24.95
Standard Grade Exotics	\$35.00
Exhibition Grade Exotics	\$50.00

For more information and complete list of exotic woods, send S.A.S.E.

Dealers write for discount information on all Bullshooters' products.

BULLSHOOTERS' SUPPLY

Dept. AH/9625 E. 3rd Street/P.O. Box 13446

Tucson, Arizona 85732/602-298-6924

Bullshooters' Supply is a division of the B.E.W.B. Corp.

Copyright, 1980, BEWB CORP.

HANDGUN MARKET

Classified ads 35¢ per word per insertion, including name and address. Minimum charge \$4.90 per ad. Copy must be submitted with payment in advance. No cash or frequency discount allowed. All ads must be received with advance payment by not later than the 14th of the fourth month preceding date of issue. Example: Closing for July/August issue (on sale May 1) is March 14th. Ads received after closing date will appear in the following issue. Please type or print clearly. No proofs furnished. Include name, address, post office, zip code, city and state as counted words. Abbreviations count as one word each. Mail to AMERICAN HANDGUNNER Magazine, 591 Camino de la Reina, Suite 200, San Diego, Calif. 92108.

ACCESSORIES

MAUSER MILITARY PISTOL LEATHER HARNESS. Carries pistol and holster stock over shoulder. VG. \$14. Excellent, \$16. Unused, \$18. Postpaid. Kenneth Lane (AHG), Sulz (Vorarlberg), Austria.

Smooth! Is the way you describe resizing with Imperial Sizing Die Lube. Great! The ease of wiping it off. 1 oz. tin \$1.65 plus 20¢ postage. LeClear Industries, P.O. Box 484HG, Royal Oak, MI 48068.

PROTECT your guns while carrying or traveling. SECURE-TOTE has a complete line of high quality aluminum gun cases. Custom aluminum cases to meet your specific needs are also available. Write for free catalog: Hutchinson Supply Service, P.O. Box 3641, Columbus, Georgia 31903.

PROTECTION! We manufacture a full line of BULLET-PROOF VESTS. Mail \$2.00 and a SASE for catalog to: John Wayne Body Armor Company, P.O. Box 406, Oregon City, OR 97045.

ARMS CHESTS AND PRESENTATION CASES Custom Made for any weapon in select American Black Walnut or figured African Mahogany. Solid brass fittings, leather or velvet lined. "French-fitted" to the weapon's shape—within 2mm! \$150-\$1,000+. Send \$2.00 for info. Mahogany Masterpieces, RFD 1, Wing Rd., Suncook, NH 03275.

SAVE MONEY ON PROGRESSIVE RELOADING EQUIPMENT. CPM & others. Send \$2.50 and SASE for list. Choate/Alpha, Box 655, Winona Lake, IN 46590.

SHOOTER'S NECESSITY protect your hearing from muzzle blast—ear plugs with case. Small, medium, large \$2.00 pair postpaid. Wadcutter, 303 W. Lee St., Athens, AL 35611.

VIBRA-TEK BRASS POLISHER cleans inner, outer case surfaces, even primer pocket. Ten times faster agitating media at ultra high vibrator speed, without shells striking each other. No moving parts to repair or replace. Leaves no residue. Capacity 250 45's, 100 30-06. Only draws 20 watts. Complete 2 lbs. media. Extra tub for using solvents. Excellent for jewelry, coins, gems. \$59.95 PREPAID. LIFETIME WARRANTY. For overseas add \$6.00 for 230 volt and postage. MC, Visa, COD, check. HAYDEN-HOLMES COMPANY, 1844 Arroya Road, Colorado Springs, Colorado 80906.

SPECIAL: 5 lbs. SHELL MEDIA to be used with VIBRA-TEK Case Cleaner or tumblers. Won't stick in flash hole. Finely ground black walnut shells impregnated with iron oxide for perfect bond. Insures no residue. Only \$13.50 prepaid. MO, COD, MC, Visa, Check. HAYDEN-HOLMES COMPANY, 1844 Arroya Road, Colorado Springs, Colorado 80906.

AMMUNITION

GUARANTEED LOWEST PRICES ON QUALITY RELOADING, BULLETMAKING TOOLS/SUPPLIES. BEGINNERS/COMBAT SHOOTERS OUTFITS. STAR UNIVERSALS, C-H AUTOCHAMPS IN STOCK. FITZ PISTOL GRIPS/AMMO BOXES, FACTORY DIRECT. "HOW TO" BOOKLETS. NEW "1980 DISCOUNT CATALOG"—\$5.00—CONTAINS "HOW TO" INFORMATION ON BRASS CLEANING, TUMBLING, TAPER CRIMPING, BULLET LUBE FORMULAS, COMPLETE ANALYSIS OF CURRENT PROGRESSIVE RELOADING MACHINES. PAUL JONES, BOX 1087G, SAN FERNANDO, CA 91340. FREE EXPERT ADVICE. 213/365-4450.

New U.S. Military Bullets—POSTPAID—22cal. 55gr. FMJBT cannule \$45.00 per 1000; 7640 round drum. \$265.00 per drum (West of Rockies add \$7.00 per drum additional shipping) MILITARY BRASS: once-fired, tumble cleaned. POSTPAID 223 \$25.00 per 1000; 308-\$45.00 per 1000. FFL required for shipments. Wideners, 2309 Nave Dr., Johnson City, TN 37601. Phone: 615-282-6786.

CANNON FUSE, 3/32" diameter, waterproof, 10 feet \$1.00, 34 feet \$3.00, 58 feet \$5.00 Postpaid. Catalog 25¢. Zeller Enterprises, Drawer W-27, Wickenburg, AZ 85358.

Make Lead Shot at Home! Illustrated booklet shows how for sm. sizes. Send \$5.50 to: F. Koegel, P.O. Box 621, Cranford, NJ 07016.

BOOKS

COLT'S SAA POST-WAR MODELS by Geo. Garton. All info verified by COLT! History, scarce or rare models, Buntline specials, flap-tops, production figs, commemorative-tives + MORE! \$17.95 + \$1.50 post. HANDGUNNER BOOKS/Dept-CA, 591 Camino Reina, San Diego, CA 92108**

GUNSMITHING by Roy F. Dunlap. A volume that will be a constant source of info for many years to come. A complete one-book reference for the professional and amateur alike!! \$16.95 + 50¢ post. HANDGUNNER BOOKS/Dept-CA, 591 Camino Reina, San Diego, CA 92108**

SURVIVAL GUNS by Tappan. A guide to the selection, modification and use of firearms and related devices for defense, food gathering, etc. \$9.95 (softbound) + 75¢ post. HANDGUNNER BOOKS/Dept-CA, 591 Camino Reina, San Diego, CA 92108**

MAUSER BOLT RIFLES by Olson. Over 672 photos, drawings, exploded views and cutaways. Charts, spec tables, data tables and symbols. \$24.95 + \$1.50 post. HANDGUNNER BOOKS/Dept-CA, 591 Camino Reina, San Diego, CA 92108**

U.S. CARTS & THEIR HANDGUNS by Suydam. Softback Only! Most info ever printed on the subject! \$9.95 Softbound & \$14.95 Hardbound + \$1.50 post. HANDGUNNER BOOKS/Dept-CA, 591 Camino Reina, San Diego, CA 92108**

PISTOLS OF THE WORLD. Hogg & Weeks. THE ABSOLUTE AUTHORITY reference manual on the modern, unique, exotic, rare or otherwise handgun. \$24.95 + \$1.50 post. HANDGUNNER BOOKS/Dept-CA, 591 Camino Reina, San Diego, CA 92108**

PERSONAL DEFENSE by Collins & McLoughlin. A guide to personal safety with common sense do's & don'ts, defense against firearms and edged weapons, what to do after it's over and more. \$8.95 + \$1.50 post. HANDGUNNER BOOKS/Dept-CA, 591 Camino Reina, San Diego, CA 92108**

STATE PISTOL LAWS, latest pistol carrying, purchasing, etc., regulations for all states and FEDERAL GUN LAWS. Both booklets \$3.00. POLICE EQUIPMENT CATALOG \$2.00. Schlesinger, 415 East 52nd St., New York, NY 10022, Department E.

CRIMEFIGHTERS SEND \$1.00 FOR FULLY ILLUSTRATED POLICE CATALOG: B-PEC, DEPT. AH580, 9889 ALONDRA, BELLFLOWER, CA 91706.

INGRAM-MAC M10 & M11 .380, 9mm, .45. Operation & Maintenance Manual. Contains 35 illustrated, detailed pages. Info on Operation, Disassembly, Cleaning, Maintenance, and Silencer. \$5.75, MO or Credit Card only. Catalog \$1. Survival Books, 11068 Magnolia Blvd., North Hollywood, CA 91601. (213) 763-0804. In store or by mail.

Fascinating new Paladin catalog listing books on weaponry, survival, home workshop guns, revenge techniques, plus more. \$1.00. Paladin Press, Box 1307-AHC, Boulder, CO 80306.

HALLOCKS .45 AUTO HANDBOOK, \$11.95 PPD. All new material. By a retired USAF Gunsmith. 237 p. SC. History, I.D. etc. but primarily maintenance. The MIHAN CO., 4917 Karen, OKLA City, Ok 73135.

SOURCE 5000 BOOKS—Complete Reader Service. 250 selected books plus 5000 others including Handguns and Military. Free catalog. Source 6000 Books, 1504 S. Maryland Pkwy., Las Vegas, Nevada 89104.

SHOOTING HANDGUNS SAFELY AND ACCURATELY. Excellent 28 page manual for handgun owners who have no opportunity for formal training. Imparts safety precautions and teaches proven techniques for becoming accurate shooter. Supplemented by instructive photographs. \$2.50. Saitzer Publications, Dept. AH, Box 4414, Albany, Georgia 31705.

SURVIVE WWII with these new books by Duncan Long: NUCLEAR WAR SURVIVAL, CHEMICAL/BIOLOGICAL WARFARE, and SHELTER/REFUGE DEFENSE... straightforward plans, facts, strategies to protect you and your family when the world goes completely insane... \$6.99 each, postpaid. Moneyback guarantee. Long Survival Publications, 163-AH3, Wamego, Kansas 66547.

BUSINESS OPPORTUNITIES

START GUN BUSINESS TODAY! Part-time O.K. Proven plan! Cash in on fantastic demand! FREE INFORMATION (S.A.S.E. appreciated). MESA, Drawer 9045-NR, Steamboat Springs, CO 80477.

EMBLEMS & INSIGNIAS

CUSTOM EMBROIDERED EMBLEMS, your design, low minimum. Identify, promote, reward with emblems. Free booklet. Emblems, Dept. 93, Littleton, New Hampshire 03561.

REGULATION INSIGNIA—all military branches + police, all genuine. Over 700 items including rank, service wings, badges, miniature medals, NASA patches. Catalog \$1.00 (refundable). Kaufman's; Dept. GG-32, 504 Yale SE, Albuquerque, NM 87106.

FIREWORKS

BEER CAN MORTAR. Complete information and detailed instructions, no complicated machining, range to 1000 yards. Information on bursting projectiles included. Send \$4.00. Pioneer Industries, Box 36, 14A Hughey St., Nashua, NH 03061.

FIREWORKS. BUY DIRECT. Price list. Send \$1.00 to ACE FIREWORKS, P.O. Box 221, Dept. H, Conneaut, Ohio 44030.

FIREWORKS—Where to buy any type of fireworks ranging from ladyfingers to giant aerial shells shot at public displays. Products include firecrackers from \$2.60 a brick, bottle rockets \$1.75 a gross, M-80's, blockbusters, and hundreds of other class B fireworks. Send \$3 for complete list of addresses, phone numbers, and product descriptions from 14 great companies which will sell these items through mail order. PYROTECHNICAL RESEARCH, Box 230, RFD #1, Mystic, Conn. 06355.

FOR SALE

GREAT SPORTING POSTERS—24/set, full color. Collection of scenes from Remington, UMC, Lefever, Abercrombie & Fitch, Winchester, etc. Printed on heavy duty stock. \$9.95 + \$1.50 post. HANDGUNNER BOOKS/Dept-CA, 591 Camino Reina, San Diego, CA 92108**

BULLET-PROOF VEST. Tested by the U.S. Army Edgewood Arsenal. Will stop the .44 magnum. Send \$1.00 (refundable) and SASE for details. MPS Co., PO Box 1754, Matthews, NC 28105.

COLT .45 AUTO PISTOL. COMPLETE MANUAL. More than 100 pages, 80 photos and illustrations. Details on disassembly, repair, construction, and marksmanship. \$6.50 Catalog \$1.00. MONEY ORDER or CREDIT CARD ONLY. SURVIVAL BOOKS, 1106 Magnolia Blvd., North Hollywood, CA 91601. (213) 763-0804.

Handcuffs! Peerless Nickel or Blue \$18.95. Leg Irons \$28.95. S&W Maximum Security Handcuffs \$29.60. Order! Deco Products, "M" Box 42808 #151, Houston, Texas 77042.

(Continued on page 94)

Customize your own gun with the famous M-S Safari Arms components

At M-S Safari Arms, we are constantly developing custom components for the average shooter/sportsman as well as the true professional. We developed the .45 caliber automatic Enforcer® and MatchMaster® pistols and now, those same custom features are individually available for your own handgun. These parts are designed and priced so that you can

customize your Browning, S&W, or Colt automatic easily and inexpensively with the same professional features that were once only attainable through custom gun mechanics.

All components are supplied in satin finished stainless steel or high luster blue ready for your local gunsmith's installation. **EnForcer**

▼ **Fixed Rear Sight Set.** No-nonsense front and rear sights designed for fast target acquisition. Provides the proper light gap between front and rear sight. Melted full radius style. Blue or stainless steel. Rear sight fits standard dove tail. \$14.95

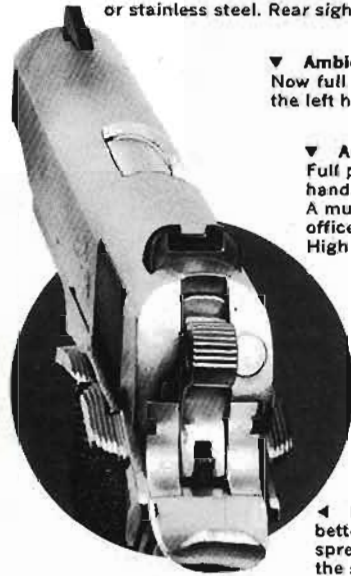

▼ **Ambidextrous Combat Slide Release Set.** Now full control of the .45 automatic with the left hand. \$29.50

▼ **Ambidextrous Combat Safety Set.** Full position control with right or left hand. Get the most from your automatic. A must for combat shooters, police officers, and all left handers. Browning High Power: \$39.95 Colt: \$34.95*

*Manufactured under pat. #3492748

▲ **Hammer.** Stainless steel commander style. Designed with enough metal for correct fitting of the sear engagement. \$14.95

▲ **Beavertail Grip Safety.** Provides better control of the weapon by spreading recoil over a larger area of the shooter's hand. This reduces apparent recoil and eliminates hammer pinch. Requires minimal frame contouring for a perfect fit. \$15.00

▲ **Extended Combat Safety.** Match proven design assures positive control of safety without having to shift or reposition grip. Browning High Power: \$19.95 Colt \$16.95

▲ **Extended Combat Slide Release.** Now the same technology as applied to the Enforcer parts provides for one hand control during reloading leaving the left hand free to insert a fresh magazine. Browning High Power: \$19.50 Colt: \$17.50

► **The Enforcer (3.8" barrel, E-102) or The MatchMaster (5" barrel, E-103.)** Deadly accurate, .45 caliber combat pistols. Loaded with custom features. Available in Teflon, Armaloy, blue, alloy, or stainless steel finishes. Send \$1.00 for fully illustrated catalog and ordering information.



◀ **Adjustable Rear Sight Set.** Includes front sight. Gives the proper light gap between front and rear sights. Provides shooter with optimum flat sighting surface. Designed for fast sight/target alignment. Blue or stainless steel. Will fit S&W K frame. Standard: \$29.95 White outlined rear, dove tail front: \$39.95

► **Ambidextrous Safety Set for S&W Models 39 & 59.** A must for the serious combat shooter, police officer and left handed shooter. \$39.95

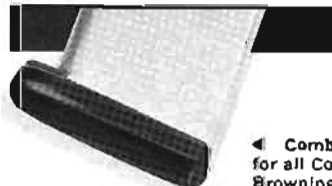

◀ **Combat Magazine Base Pads.** Available for all Colt, S&W Model 39, S&W Model 59, Browning High Power automatics. With this

component, you don't have to worry about noise or damage to magazine when ejecting the clip — even from a standing position — during match shooting or in combat. \$1.95

Dealer Inquiries Invited

24 HOUR TOLL FREE ORDER DESK



Master Charge
Visa
C.O.D. Only
Call
Operator 758



National 1-800-824-7888 California only 1-800-852-7777 Alaska & Hawaii 1-800-824-7919



**SAFARI
ARMS**

M-S Safari Arms • P.O. Box 23370 • Phoenix, AZ 85063 • (602) 269-7283

MAIL TO: M-S Safari Arms Dept. AH-781
P.O. Box 23370 • Phoenix, AZ 85063

Please enter my order for:

	Quantity:		Make:	Total:
	Stainless	Blue		
<input type="checkbox"/> Fixed Rear Sight Set				
<input type="checkbox"/> Standard \$14.95				
<input type="checkbox"/> With front sight ready for insert \$19.95				
<input type="checkbox"/> Ambidextrous Combat Slide Release Set \$29.95				
<input type="checkbox"/> Ambidextrous Combat Safety Set				
<input type="checkbox"/> Browning \$39.95				
<input type="checkbox"/> Colt \$34.95				
<input type="checkbox"/> Hammer (Stainless only) \$14.95				
<input type="checkbox"/> Beavertail Grip Safety \$15.00				
<input type="checkbox"/> Extended Combat Safety				
<input type="checkbox"/> Browning \$19.95				
<input type="checkbox"/> Colt \$16.95				
<input type="checkbox"/> Extended Combat Slide Release				
<input type="checkbox"/> Browning \$19.50				
<input type="checkbox"/> Colt \$17.50				
<input type="checkbox"/> Information on The Enforcer/MatchMaster & other M-S Products \$2.00				
<input type="checkbox"/> Adjustable Rear Sight Set				
<input type="checkbox"/> Standard \$29.95				
<input type="checkbox"/> Outlined rear, dove tail front \$39.95				
<input type="checkbox"/> Combat Magazine Base Pads \$1.95				
<input type="checkbox"/> Browning				
<input type="checkbox"/> S&W 39				
<input type="checkbox"/> S&W 59				
<input type="checkbox"/> Colt				
<input type="checkbox"/> Mast. Chg. <input type="checkbox"/> VISA Card				
				Shipping & Handling \$ 1.00

Date Card Exp. My Check My Money Order Is enclosed.. TOTAL: \$ _____

Name _____

Address _____

City _____ State _____ Zip _____

\$34.95 "DODGE CITY"
GUARANTEED!

Don't be fooled by the low price!
Genuine heavy cowhide. Complete with leg & hammer ties and bullet loops. State: Make, Model, Caliber & barrel length. Measure where worn.

EI DORADO LEATHER
4810 PANORAMA, P.O. Box 581C, La Mesa, CA 92041

WRITE FOR FREE CATALOG

Your STAR TOOL will DOUBLE PRODUCTION with a HULME CASE FEEDER. THE RELOADER IS DRILLED & TAPPED FOR THE FEEDER. Manufactured by the same firm for 40 YEARS. HULME FIREARM SERVICE, DEPT. AH, BOX 83, MILLBRAE, CA 94030



WONDERSIGHT
A fully adjustable rear sight that requires no alteration to the older five-screw S&W "K" and "N" frame revolvers. Also adapts to current models and many others using one tapped hole in frame.

18.95

CA Res. Add Tax
Factory Orders Postpaid
FIREARMS DEVELOPMENT LAB
512 YOLO AVE., DEPT. AH
OROVILLE, CA 95965



YOU HAVE TO BE TOUGH TO SURVIVE

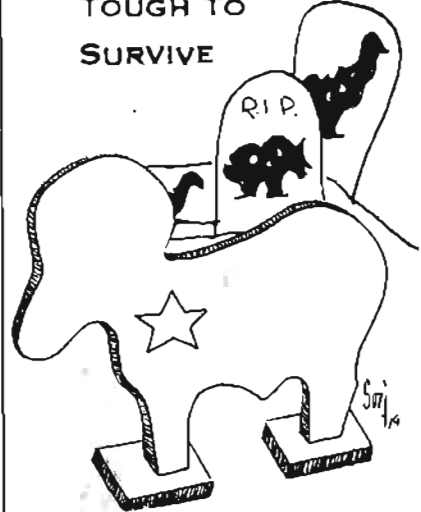

SWMS manufactures standard or custom scaled silhouettes for your range. For more information, send 25¢ and a self-addressed envelope to:

Southwest Metallic Silhouettes
P.O. Box 476 Uvalde, Texas 78801
Or Call: (312) 278-3454 or (512) 278-3287

Full scale long lasting Jolley 360 long range pistol and high powered rifle silhouettes..... \$249.99

Below are made of mild steel.
One set consists of 4 animals.

1/5 scale N.R.A. Small Bore rifle silhouettes..... \$9.98
1 set..... \$9.98
3/8 scale IHMSA 22 pistol silhouettes, 1 set..... \$17.80

HANDGUN MARKET

(Continued from page 52)

WHALE SPERM OIL. Genuine, 100% pure. Stockpile supply collected prior to endangered species act. Excellent firearms lubricant/preservative. Legal sale certificate accompanies shipment. Pint \$15.00; quart \$28.00; two quarts \$50.00; gallon \$87.75. Postpaid. COD orders, add \$1.13. Order from distributor: Nick Wyshinski, Dept. AH, 1319 Sixth Ave., Berwick, PA 18603.

Your specific reloading, ballistic or firearm questions researched and answered. No appraisals or collector arms questions. \$3.00 each + S&S. T. Robinson, Box 521-B, Grangeville, Idaho 83530. NRA Life Member.

FREE HARD HITTING FACTS on how to receive firearms consultant agency reports just like law enforcement and military agencies. Don't let armament problems happen "ON THE LINE" to you. FREE INFO. DON BILLY & ASSOCIATES, Box 39541AG, Phoenix, AZ 85069.

CROSSBOWS—For hunting, target competition or just plain fun. Cat. send \$1.00, RW Dist., P.O. Box 1817, Des Plaines, IL 60018.

Bianchi Gun Leather and Buck Knives. 20% off list. Send \$1.00 for catalogs (refundable on order). J.E.B. Enterprises, RD #2, Box 1A, Mowile, IA 51039.

WHOLESALE CATALOG—hunting & fishing supplies, Buck & Case knives, Daiwa, Garcia, Redfield, Leupold, black powder assoc., reloading equipment. We ship in 24 hours of receipt or refund. For catalog send \$1 to: Vespation, Box 1308, Cayce, SC 29033, Dept. AH-1.

GUN PARTS

T/C Contender 45/410 Barrels, Octagon or Bull \$95. Robert Bryarly, 8132 Union, Indianapolis, IN 46227.

SILENCER. Very effective. Complete plans. Inexpensive part, simple modification. Send \$5.00 cash. Keith's Enterprises, Box 5686, Hacienda Heights, Calif. 91745.

GUNS FOR SALE

GUNS! CONFIDENTIAL SUPPLIERS LIST. \$5. HORTON, BOX 0832AH, MILWAUKEE, WIS. 53208.

INSTRUCTION

REMEMBER THE OLD ASH CAN, M80, etc? Complete detailed instructions on above and many others. Send \$3.00 to: Pioneer Ind., Box 36, 14A Hughey St., Nashua, NH 03061.

KNIVES & SWORDS

REPRODUCTIONS OF chivalrous swords are expensive. Beat the high cost and gain self-satisfaction by building your own with precise plans describing how to use inexpensive materials. Moneyback Guarantee. Send \$3.75 to J. Scott Jardine, P.O. Box 310, St. Vital Manitoba, Canada R2M 5C8.

Swiss Style Army Knife—Eleven precision tools built in. Large blade, small blade, scissors, can opener, screw driver, scaler, file, cork screw, drilling awl, hook disgorger. 1000's of uses. Send \$14.95 postpaid, check or money order. Quantity orders of 12 knives \$9.00 each. Plus 10% shipping and handling. To: William Marrero, 125 Division Avenue, Brooklyn, NY 11211.

SURVIVAL KNIVES!! Swords, canes, daggers, hollow-handles, icepicks, razors, wiresaws, & more. 100% Satisfaction—Guaranteed. Photographic Catalogue \$1.50/Airmailed. SELECTLINE, Box 391AHG, Pearl City, Hawaii, 96782.

MILITARIA

Military Sportswear—World's largest selection of Military Insignia sportswear—also military or civilian award certificates—special forces. U.S.M.C., Airborne, U.S.N. Seal Marksmanship. Weapons expert & Instructor and many more—Send \$1.00 for 1981 catalog—Military Graphics, Dept. BB, Box 228, Dunkirk, Maryland 20754.

Military Medals & Decorations Bought, Sold, Traded. Current List 69¢; subscription 8 issues, \$2.50. Vernon, Box 387AH, Baldwin, NY 11510.

CAMOUFLAGE COLLECTION CATALOG. Field jackets, T-Shirts, cloth, jogging shorts, caps, berets, insignia, more. Genuine GI \$1.50 (refundable). Kaufman's; Dept. GG-22; 504 Yale SE, Albuquerque, NM 87106.

MILITARY SURPLUS

J-E-B-P-S—\$19,301—C-A-R-S—\$13,501—650,000 ITEMS! GOVERNMENT SURPLUS—MOST COMPREHENSIVE DIRECTORY AVAILABLE TELLS HOW, WHERE TO BUY—YOUR AREA—\$2—MONEYBACK GUARANTEE—"GOVERNMENT INFORMATION SERVICES," DEPARTMENT UP-4, BOX 99249, SAN FRANCISCO, CALIFORNIA 94109.

MISCELLANEOUS

Your Personalized Custom Made Hand Stamp, Hardened Tool Steel, 1/16" Letters, SSAE Custom Stamps, Box 5, Bear, DE 19701.

SHORT-RUN CUSTOM BELT BUCKLES WITH YOUR LOGO MY SPECIALTY. SOLID SANDCAST SILICON BRONZE ALL HAND FINISHED. BUCKLES BY MIKE. 1225 MANZANITA, DEPT. AH, LOS ANGELES, CA 90029.

HANDCUFFS—Smith & Wesson \$22.50 pair, two \$38.00, Leg Irons \$28.50 set. G. Noramaco, Box 30243-AH, St. Paul, Minn.

Decor Hy-Wyd Custom Sport Glasses. 30 lens shades—"Finest under the Sun." Interchangeable lenses—Permanent mount. Write for brochure: P.O. Box 10355, Phoenix, Arizona 85064.

ALTERNATE IDENTITIES, Name Changes, whatever. Custom made Badges, I.D.'s List \$1. (refundable); C.W.L., Box 3230, Pasadena, CA 91103.

GI DOG TAGS/MEDICAL TAGS—from \$2.00. Protect yourself in the field, your kids at school; vital medical information. Customized imprinting. Free brochure. Kaufman's; Dept. GG-32, 504 Yale SE, Albuquerque, NM 87106.

CHEMICALS, FUSE, CASINGS, etc. Send \$2 for catalog, refundable with first order. WESTECH CORP., Box 593, Logan, Utah 84321.

DUCK STAMPS—Signed and unsigned. Send stamps, remittance via return mail. Inquiries invited. Ducks, P.O. Box 629, Ashland, WI 54806.

SURVIVALIST'S SHOPPING LIST—Learn what you need to survive a "situation," the first winter—and beyond! Send \$4.96 for large list to R. Mahoney, P.O. Box 10663, Pittsburgh, PA 15235.

Alaska's Frontier. Recipes Recipes Grandma's best. We'll send to you, you do the rest. \$5.00 cash or money order guaranteed. Send now to: Louise Sivertsen, P.O. Box 1881, Fairbanks, Alaska 99707.

GI CAMOUFLAGE CLOTH. Manufactured for military combat clothing, USMC/Vietnam leaf pattern or U.S. military's newest Woodland pattern. Free swatches, details, price list. Send stamped envelope. Kaufman's; Dept. GG-82; 504 Yale SE, Albuquerque, NM 87106.

CHEMICALS OF ALL TYPES AVAILABLE WITH PLANS AND SUPPLIES CREATING YOUR OWN JTH OF JULY DISPLAYS SEND \$1.00 FOR CATALOG TO PIONEER IND., BOX 36, DEPT. AH, 14A HUGHEY ST., NASHUA, NH 03061.

SURVIVOR'S CHECKLIST. Be prepared for ANY Emergency or Crisis! Have your supplies ready for the bad times. \$4.25 BLUEJAY Box 6179-ARCI, Long Beach, CA 90806.

HANDCUFFS! \$13.50 Pair Postpaid Two \$25.00. Lightweight Double-Lock Handcuffs that Compare To \$24.95 Handcuffs. Cold Rolled Steel, Chrome Plated, Two Keys Best Sports Supplier, Box 492-AH, Hazelwood, MO 63042.

REAL ESTATE

SURVIVAL, RETREAT, MINI-FARM in Southern Oregon. Free info packet: McQuinn & Co. Real Estate, 122 N.E. Savage, Dept. PM, Grants Pass, Oregon 97526.

WANT TO PURCHASE

Buddy L. Toys and Trains 1920's-30's. T. W. Sefton, P.O. Box 1871, San Diego, CA 92112.

Ideas, inventions, new products needed by innovative manufacturers. Marketing assistance available to individuals, tinkers, universities, and companies. Write IMI-AHG, 701 Smithfield, Pittsburgh, PA 15222.

Vol. 2, No. 1 (1977) issue "American Handgunner." Flynn: 3116 Harvey Pky, Oklahoma City, OK 73118.

WE NEED MORE
HANDGUN

ENTHUSIASTS
ON OUR

SIDE!

YOUR
COPY OF
HANDGUNNER

MAGAZINE

WITH A FRIEND

Maybe they'll get their own copy, by using the enclosed subscription card.

The Convertibles

.22 Long Rifle or .22 Win. Magnum

You'll have two superb sporting calibers with H&R's Model 686 convertibles... Authentic western styling, each is fitted with 2 cylinders, quickly convertible to use either .22 Long Rifle or .22 Win. Magnum cartridges. 6 shot single-action or double-action, side ejector.

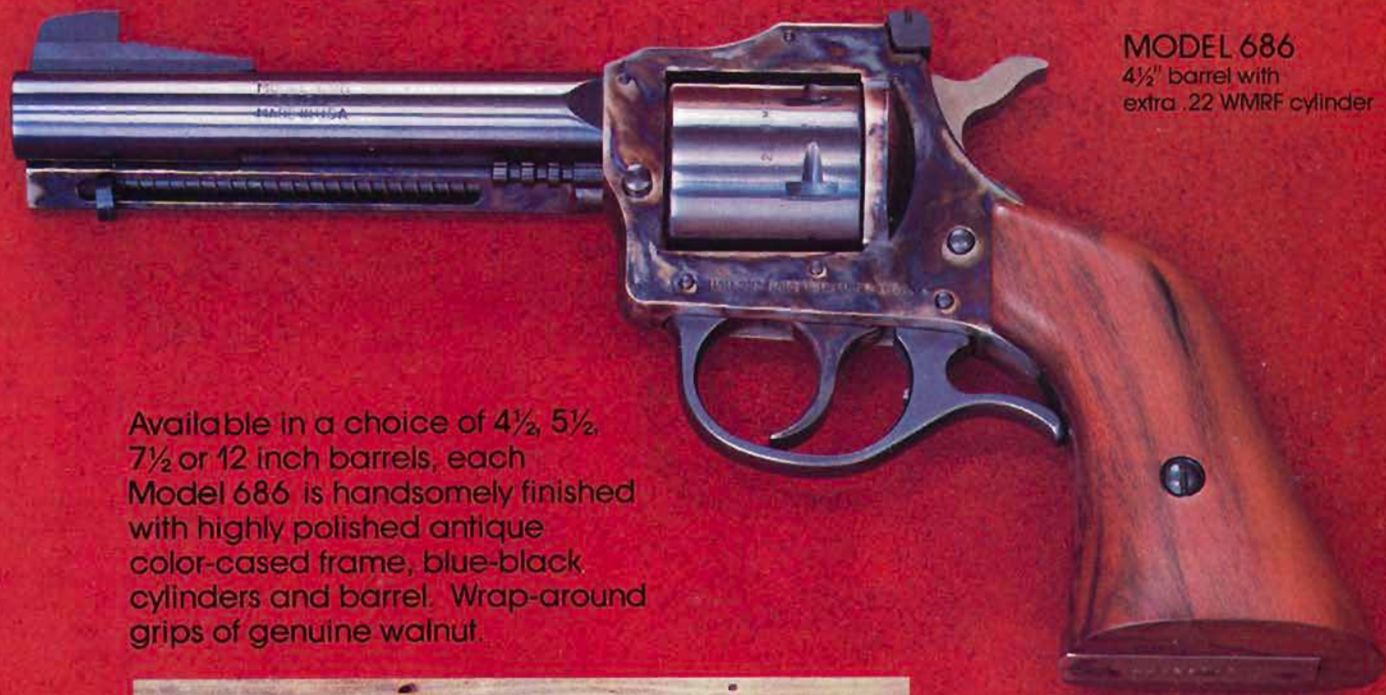

MODEL 686
4 1/2" barrel with
extra .22 WMRF cylinder

Available in a choice of 4 1/2, 5 1/2, 7 1/2 or 12 inch barrels, each Model 686 is handsomely finished with highly polished antique color-cased frame, blue-black cylinders and barrel. Wrap-around grips of genuine walnut.



Harrington & Richardson, Inc.

Industrial Rowe Gardner, Massachusetts 01440

For complete information on all H&R rifles, shotguns and revolvers, send \$2. for new color catalog and jacket patch. Write Dept. AH.



Every time you fire,
up to 1000 g's are trying to tear up your gear.



It's time for a Redfield Pistol Scope.

Vicious. That's the best word to describe the tremendous kick of a pistol, especially magnums. And that's exactly why Redfield makes scopes specially designed for use with today's high powered handguns. Some manufacturers simply offer rifle-type scopes with extended eye relief. But at Redfield, we know that's not good enough.

Our pistol scopes, in 1 1/2X, 2 1/2X and 4X, are designed and manufactured to withstand the recoil of any caliber handgun you choose to put underneath. How do we do it? First, the internal lens assembly is mounted in a sturdy non-rotating ball pivot and actually threaded into the scope tube (some other manufac-

turers glue in their assembly). This makes the assembly an integral part of the scope tube and beefs it up where the stress is greatest. Second, we utilized our famous rotary dovetail mounting system to develop our "Double Dovetail" mount for pistols. Rings are machined to precise tolerances to provide uniform pressure around the scope tube and positive gripping to retain accuracy. In most mounts, special recoil shoulders are incorporated for even greater strength. In short, these modifications assure that Redfield Pistol Scopes will hold up on calibers that tear other scopes apart.

A durable pistol scope is just one example of the kind of innovations

Redfield has pioneered to help all kinds of shooters since 1909. You can always depend on Redfield quality and precision. You'll get the finest materials available, clear and brilliant optics, and the highest attention to detail. Redfield standards dictate that every scope undergoes over 400 checks before it gets to you.

When you want the finest-quality precision-made scope on the market, you need a Redfield. For our complete catalog, send 50¢ to: Redfield Company, Dept. 322, 5800 E. Jewell Ave., Denver, Colorado 80224.

You need a
Redfield