



Orbitrade Marine är en avdelning inom Swenautic-Tedo AB

Orbitrade Marine är specialist på ersättningsdelar till de vanligaste marinmotorerna. Vi har tillverkat och marknadsfört delar av absolut högsta kvalitet i mer än 20 år. Vår specialitet är bland annat servicesatser, impellrar, filter, zinkanoder, avgaskrökar, drivremmar och knutbälgsatser.

NYHET

Sortimentet har nu utökats med packningssatser till Volvo Penta D-serie och Yanmar marinmotorer. Vi erbjuder även ett brett sortiment med impellersatser och bränslefilter till de populäraste marinmotorerna. För mer information, se www.orbitrademarine.com eller begär katalog.

High Quality Spare Parts for the most popular marine engines

Orbitrade Marine is a specialist in spare parts for marine engines. Engineering and manufacturing of high quality spare parts for more than 20 years. We supply complete service kits, impellers, filter zinkanodes, exhaust manifolds, drive belts plus drive and exhaust bellow kits. Swenautic is also manufacturing waterheaters for boats.

The Orbitrade Marine range is growing. In 2011 you will find parts and accessories for a wide range of marine engines. Our distributors are located in over 30 countries worldwide. As the business is growing we are looking for new customers in selected countries.

If you are interesting in becoming a distributor for Orbitrade Marine, please get in touch with us at info@swenautic.se. You can also use our website www.orbitrademarine.com.

NEWS

The range is now including gasket sets for Volvo Penta D Series and Yanmar. We also offer a wide range of impeller kits and fuel filters for the most popular marine engines.

REPLACEMENT SPARE PARTS

All original part numbers of engine or vehicle manufacturers in this catalogue are mentioned for comparison reasons only and should not be used in contacts with vehicle owners.

*We do not accept any responsibility for errors in this catalogue.
Reproduction in whole or in parts is not permitted.*

ERSÄTTNINGSDELAR

Alla originalnummer från motortillverkare i denna katalog är endast upptagna för jämförelse och får ej användas i kontakt med fordonsägare.

*Vi ansvarar ej för eventuella felaktigheter i denna katalog.
Kopiering av hela eller delar av katalogen är förbjuden.*

Sakregister

| A | Avsnitt |
|---|---------|
| Avgasbälgsatser | 11 |
| Avgaskrökar | 6 |
| Avgaskrökar YANMAR, rostfria/syrafria | 15 |
| Avgasrör | 6 |
| Avgasslangar för avgaskrök | 6 |
| Avtappningskranar för kylvatten | 5 |
| Avtappningsplugg för CAV filter | 7 |
| Avtappningspropp för kylvatten | 5 |
| Axiallager för vertikalaxel i underhus..... | 14 |
| B | |
| Brickor för oljeavtappningsplugg | 4 |
| Bricksatser för bränslesystem | 7 |
| Brytarspetsar | 8 |
| Brytpinnesats | 11 |
| Bränslefilter..... | 7 |
| Bränslefilter YANMAR | 15 |
| Bränslepumpar | 7 |
| Bult för CAV bränslefilter | 7 |
| Bultsats för dubbellagerbox | 14 |
| Bultsatser för avgasrör | 6 |
| Bussningssats för upphängning av AQ-drev .. | 11 |
| C | |
| CAV filter komplett | 7 |
| Cirkulationspump | 5 |
| Cylinderfodersatser (komplett med kolv och ringar) .. | 1 |
| Cylinderlocksultsatser | 3 |
| Cylinderlocksmutter | 3 |
| D | |
| Delar för Bosch tändfördelare | 8 |
| Delar för V-6 och V-8 fördelare | 8 |
| Distansbricka (plast) | 11 |
| Distansbricka för bränslepump | 7 |
| Distansbricka för propeller | 11 |
| Drevlyftsmotor | 10 |
| Drivknutkors | 14 |
| Drivremmar | 8 |
| E | |
| Elektrisk universal bränslepump | 7 |
| Elpumpar för MARTEC sötvattenkylning | 5 |
| Expansionsbrickor (galvaniserade) | 1 |
| Expansionspluggar (galvaniserade) | 5 |
| F | |
| Fisklinebricka | 11 |
| Fjädersats för backhake | 11 |
| Fördelarlock | 8 |
| Förgasarmembran | 7 |

Index

| A | Section |
|--|---------|
| Adjusting shims cylinder - cylinder block..... | 3 |
| Air filter inserts..... | 7 |
| Axial bearing for vertical shaft in lower gear unit ... | 14 |
| B | |
| Ball bearing for double bearing unit | 14 |
| Ball bearing for vertical shaft in upper gear unit ... | 14 |
| Bearing kit for interm. shaft | 2 |
| Bolt for CAV fuel filter | 7 |
| Bolt kits for double bearing unit..... | 14 |
| Bolt kits for exhaust manifold | 6 |
| Break pin kit..... | 11 |
| Breaker points | 8 |
| Bushing kits for hook up fork..... | 11 |
| C | |
| Camshaft bearing kits..... | 2 |
| Camshaft grease | 2 |
| Camshaft kits..... | 2 |
| Camshafts | 2 |
| Carburettor diaphragm | 7 |
| CAV fuel filter complete..... | 7 |
| Circulating pump | 5 |
| Con rod bearing kits | 1 |
| Condensers | 8 |
| Connecting plug for zinc anode..... | 5 |
| Connecting rod bushings..... | 1 |
| Connector kit for CAV filter..... | 7 |
| Conversion gasket set..... | 9 |
| Cotter pin for folding propeller lock nut | 11 |
| Cover plate for exhaust manifold | 6 |
| Crankcase filter | 4 |
| Cross piece for water pump | 5 |
| Cross reference for V-6 and V-8 distributors | 8 |
| Cylinder head gaskets..... | 3 |
| Cylinder head screw kits | 3 |
| Cylinder liner kits (complete with piston and rings) ... | 1 |
| D | |
| Damper (vibration damper) | 10 |
| Decarb. gasket set | 9 |
| Distributor caps | 8 |
| Drain plug for CAV fuel filter..... | 7 |
| Drain prop for cooling water | 5 |
| Drain taps for cooling water..... | 5 |
| Drive bellow kits | 11 |
| Drive belts | 8 |

G

| | |
|--|----|
| Gavellock för avgasrör | 6 |
| Glasskål för CAV bränslefilter | 7 |
| Glid tapp (växelförare) | 14 |
| Gummidämpare för ventiler | 2 |
| Gummikudde för motorupphängning | 10 |
| Gummikudde för propelleraxelkoppling | 10 |
| Gummipackning för ventilkåpsbultar | 3 |
| Gummiring för klämring i sköld | 10 |

H

| | |
|---------------------------|----|
| Hydraulpump | 10 |
| Hållare för zinkanod..... | 5 |

I

| | |
|----------------------------|----|
| Impellersatser | 5 |
| Impellersatser YANMAR..... | 15 |

J

| | |
|---|---|
| Justershims mellan cylinderfot och block..... | 3 |
|---|---|

K

| | |
|---|----|
| Kamaxelbricka | 2 |
| Kamaxelfett | 2 |
| Kamaxellagersatser | 2 |
| Kamaxelremmar | 2 |
| Kamaxelsatser | 2 |
| Kamaxlar | 2 |
| Kamdrevsats (stål) | 2 |
| Kamremmar | 8 |
| Knutbälgsatser | 11 |
| Kolvar (komplett med kolvbult och ringar) | 1 |
| Kolvringssatser | 1 |
| Kondensatorer | 8 |
| Kullager för ingående axel i överhus | 14 |
| Kullager för vertikalaxel i överhus | 14 |

L

| | |
|--|----|
| Laddningsregulator | 8 |
| Lagersats mellanaxel | 2 |
| Luftfilterinsatser | 7 |
| Låsbricka för propeller | 11 |
| Låsring för vertikalaxel..... | 14 |
| Låsskruv för propellerkona | 11 |
| Låsskruv för styrarm | 10 |
| Låsskruv och bricka för upphängningslagertapp | 11 |
| Låsskruvar för folding propellerblad | 11 |

M

| | |
|---|---|
| Medbringare (korsstycke) för vattenpumpar | 5 |
| Monteringsklack för sjövattpump..... | 5 |
| Monteringsatser för avgaskrök | 6 |

E

| | |
|--|----|
| Electric pumps for MARTEC fresh water cooling | 5 |
| Electric universal fuel pump | 7 |
| Exhaust bellow kits..... | 11 |
| Exhaust bends..... | 6 |
| Exhaust elbows YANMAR..... | 15 |
| Exhaust hoses for exhaust bend..... | 6 |
| Exhaust manifolds | 6 |
| Expansion plugs (galvanized) | 1 |
| Expansion plugs (galvanized) | 5 |
| Expansion plugs (stainless)..... | 5 |

F

| | |
|---|----|
| Flange kit for crankshaft sealing (rear)..... | 1 |
| Fuel filter YANMAR | 15 |
| Fuel filters | 7 |
| Fuel pumps..... | 7 |

G

| | |
|---|----|
| Gasket kit for cylinder liner | 1 |
| Gasket kits for connect. with turbo | 6 |
| Gasket kits for connecting fuel injector | 7 |
| Gasket kits for exhaust manifold | 6 |
| Gasket kits for sea water pumps..... | 5 |
| Gasket set for CAV fuel filter | 7 |
| Gasket set for cylinder liner..... | 9 |
| Gasket set for intern. housing - lower gear unit..... | 13 |
| Gasket set for upper gear unit - intern. housing.... | 13 |
| Gasket sets for after cooler | 5 |
| Gasket sets for carburettor..... | 7 |
| Gasket sets for complete AQ-drive units..... | 13 |
| Gasket sets for fuel pump | 7 |
| Gasket sets for gear mechanism | 13 |
| Gasket sets for heat exchanger | 5 |
| Gasket sets for inlet pipe..... | 6 |
| Gasket sets for lower gear unit | 13 |
| Gasket sets for oil cooler | 5 |
| Gasket sets for oil plugs..... | 13 |
| Gasket sets for propeller shaft | 13 |
| Gasket sets for universal joint | 14 |
| Gasket sets for upper gear unit..... | 13 |
| Gasket sets for vacuum valve | 5 |
| Gasket sets for water circulating pumps | 5 |
| Gasket sets for water pipe..... | 5 |
| Gasket sets YANMAR | 15 |
| Gaskets for exhaust bend | 6 |
| Gaskets for exhaust manifold..... | 6 |
| Glass bowl for CAV fuel filter..... | 7 |

H

| | |
|----------------------|----|
| Hose kits..... | 11 |
| Hydraulic pump | 10 |

N

| | |
|--|----|
| Nedre lager för vertikalaxel i underhus..... | 14 |
| Nippelsats för CAV-filter | 7 |
| Nållager för upphängningsgaffel | 14 |
| Nållager för vertikalaxel i överhus | 14 |

O

| | |
|---|---|
| Oljeavtappningsplugg | 4 |
| Oljefilter | 4 |
| Oljepumpar | 4 |
| Oljetryckskontakater | 8 |
| Oljetrågspackningar | 4 |
| Ombyggnadssats CAV-filter | 7 |
| Ombyggnadssats för bakre vevaxeltätning | 1 |

P

| | |
|---|----|
| Packningar för avgaskrök | 6 |
| Packningar för avgasrör | 6 |
| Packningsklister | 9 |
| Packningssats för bränslepump | 7 |
| Packningssats för byte av knutkors..... | 14 |
| Packningssats för CAV bränslefilter | 7 |
| Packningssats för cylinderfoder | 9 |
| Packningssats för propelleraxel | 13 |
| Packningssats för vakuumventil | 5 |
| Packningssats för växelmekanism | 13 |
| Packningssats mellan mellanhus - underhus .. | 13 |
| Packningssats mellan överhus - mellanhus ... | 13 |
| Packningssatser för avgaskrök - turbo | 6 |
| Packningssatser för avgasrör | 6 |
| Packningssatser för cirkulationspumpar..... | 5 |
| Packningssatser för cylinderfoder | 1 |
| Packningssatser för insugsrör | 6 |
| Packningssatser för kompletta AQ-drev | 13 |
| Packningssatser för mellankylare | 5 |
| Packningssatser för montering av spridare | 7 |
| Packningssatser för oljekylare..... | 5 |
| Packningssatser för oljepluggar | 13 |
| Packningssatser för sjövattpumpar | 5 |
| Packningssatser för underhus | 13 |
| Packningssatser för vattenrör | 5 |
| Packningssatser för värmeväxlare | 5 |
| Packningssatser för överhus | 13 |
| Packningssatser YANMAR | 15 |
| Packningssats för gasare | 7 |
| PINWING - skruvsatser för impellerlock | 5 |
| Propelleraxel | 14 |
| Propellerkona | 11 |

R

| | |
|--|----|
| Ramlagersatser | 1 |
| Reparationssats för förgasare | 7 |
| Reparationssats för svänghjulskåpa | 10 |
| Reparationssatser för sjövattpump | 5 |
| Rotorer | 8 |

I

| | |
|---|----|
| Ignition cable sets | 8 |
| Ignition coils | 8 |
| Impeller kits | 5 |
| Impeller kits YANMAR..... | 15 |
| Injector sleeve kit..... | 3 |
| Inner bearing for propeller shaft..... | 14 |
| Installation kits for exhaust bend..... | 6 |

L

| | |
|--|----|
| Lock ring for vertical shaft | 14 |
| Lock screw for propeller cone | 11 |
| Lock screw for steering fork | 10 |
| Lock screws for folding propeller blades..... | 11 |
| Lower bearing for vertical shaft in lower gear unit... | 14 |

M

| | |
|---|---|
| Main bearing kits | 1 |
| Mounting clamp for sea water pump | 5 |

N

| | |
|---|----|
| Needle bearing for hook up fork..... | 14 |
| Needle bearing for vertical shaft in upper gear unit | 14 |
| Nozzles..... | 7 |

O

| | |
|---|----|
| Oil drain plug | 4 |
| Oil filters..... | 4 |
| Oil pan gaskets..... | 4 |
| Oil pressure sensors | 8 |
| Oil pumps | 4 |
| Outer bearing for propeller shaft | 14 |

P

| | |
|---|----|
| Parts for Bosch distributor | 8 |
| Pins and washer for control cable cube | 11 |
| PINWING - screw kits for impeller cover | 5 |
| Piston ring kits | 1 |
| Pistons (complete with piston pin and rings)..... | 1 |
| Propeller cone | 11 |
| Propeller shaft | 14 |
| Protecting cover for gearshift mechanism..... | 11 |

R

| | |
|---|----|
| Rebuilding kit for CAV filter | 7 |
| Repair kits for carburettor | 7 |
| Repair kits for flywheel casing | 10 |
| Repair kits for sea water pump | 5 |
| Rotors | 8 |
| Rubber block for engine suspension | 10 |
| Rubber block for propeller shaft coupling | 10 |
| Rubber rings for clamp ring in shield | 10 |
| Rubber seal for shield | 10 |
| Rubber washer for camshaft | 2 |

S

| | |
|---|----|
| Saxpinnar och bricka för reglage | 11 |
| Saxpinne för foldingpropellermutter | 11 |
| Sjövattenpumpar komplett | 5 |
| Skruv till klämring | 10 |
| Slangfäste | 11 |
| Slangsatser | 11 |
| Slitbricka för dubbellagerbox | 14 |
| Sotningsatser | 9 |
| Spridarhyllsats | 3 |
| Spridarspets | 7 |
| Spännrullar för kamrem | 2 |
| Ställpinne | 11 |
| Stödlager i vevaxel | 1 |
| Svängningsdämpare | 10 |

T

| | |
|-------------------------------------|----|
| Termostatsatser | 5 |
| Tilläggsatser | 9 |
| Topplöckspackningar | 3 |
| Tryckbrickssatser för vevaxel | 1 |
| Täckkåpa för växelmekanism | 11 |
| Tändkabelsats | 8 |
| Tändspolar | 8 |
| Tätbricka för kamaxel | 2 |
| Tätlist för sköld | 10 |
| Tättringar för styrarm | 10 |

V

| | |
|---|---|
| Vattenfilter för sötvattenkylning | 5 |
| Ventiler | 2 |
| Ventilfjädrar | 2 |
| Ventiljusterbrickor | 2 |
| Ventilkåpspackningar | 3 |
| Ventillyftare | 2 |
| Ventilstyrningar | 2 |
| Vevhusfilter | 4 |
| Vevlagersatser | 1 |

Y

| | |
|-------------------------------------|----|
| Yanmar-delar | 15 |
| Yttre lager för propelleraxel | 14 |

Z

| | |
|---------------------------------------|----|
| Zinkanod för foldingpropeller | 12 |
| Zinkanod för sköld | 12 |
| Zinkanod för upphängningsgaffel | 12 |
| Zinkanoder | 12 |
| Zinkanoder för kylsystem | 5 |
| Zinkring för segelbåtdrev | 12 |
| Zinkringar för AQ-drev | 12 |

Ö

| | |
|--|----|
| Övre lager för vertikalaxel i underhus | 14 |
|--|----|

S

| | |
|---|----|
| Screw and washer for bearing pin..... | 11 |
| Screw for clamp ring in shield | 10 |
| Sea water pumps complete..... | 5 |
| Seal ring for steering fork | 10 |
| Sealing compound | 9 |
| Sealing washer kits for fuel system..... | 7 |
| Sensor (Pick-Up coil)..... | 8 |
| Setting pin | 11 |
| Sliding pin | 14 |
| Spacer for fuel pump | 7 |
| Spacer washer (plastic)..... | 11 |
| Spacer washer for propeller cone | 11 |
| Spring sets for reverse tilt inhibitor..... | 11 |
| Support bearing in crankshaft | 1 |

T

| | |
|--|----|
| Tab washer for propeller (stainless)..... | 11 |
| Thermostat kits..... | 5 |
| Thrust flange | 2 |
| Thrust washers (fishing line protectors) | 11 |
| Thrust washer kits for crankshaft | 1 |
| Timing belt tensioner | 2 |
| Timing belts | 2 |
| Timing belts | 8 |
| Timing gear kit (steel)..... | 2 |
| Trim and tilt motor | 10 |

U

| | |
|--|----|
| Universal joint..... | 14 |
| Upper bearing for vertical shaft in lower gear unit | 14 |

V

| | |
|----------------------------|---|
| Valve adjusting shims..... | 2 |
| Valve cover gaskets | 3 |
| Valve guides..... | 2 |
| Valve lifters..... | 2 |
| Valve springs..... | 2 |
| Valves..... | 2 |
| Voltage regulator | 8 |

W

| | |
|---|----|
| Washer for oil sealer in double bearing unit..... | 14 |
| Water filter for fresh water cooling | 5 |
| Water hose connection..... | 11 |

Y

| | |
|--------------------|----|
| Yanmar Parts | 15 |
|--------------------|----|

Z

| | |
|--|----|
| Zinc anode for shield | 12 |
| Zinc anode for suspension yoke | 12 |
| Zinc anode kit for folding propeller | 12 |
| Zinc anodes | 12 |
| Zinc anodes for cooling system..... | 5 |
| Zinc ring kits for AQ drives | 12 |
| Zinc ring kits for sailing boat drives | 12 |

TILLBEHÖR

| | Sida |
|--------------------------------|-----------------------------|
| | med början efter avsnitt 15 |
| Ljuddämpare..... | 1 |
| Bordsgenomföring – Avgas | 2 |
| Avgaskrökar..... | 2 |
| Fläns – Packningar..... | 3 |
| Impellrar..... | 3 |
| Bränslefilter Yanmar | 3 |
| Varmvattenberedare | 4 |
| Reglagekablar | 5 |
| Oljesug..... | 6 |

ACCESSORIES

| | Page |
|--------------------------|---------------------------|
| | starting after section 15 |
| Exhaust silencer | 1 |
| Exhaust – Outlet | 2 |
| Wet exhaust elbows..... | 2 |
| Flange – gaskets | 3 |
| Impellers | 3 |
| Fuel filter Yanmar | 3 |
| Water heater | 4 |
| Control cables..... | 5 |
| Oil draining kit | 6 |

Kolvar (komplett med kolvbult och ringar) / Pistons (complete with piston pin and rings)

| Motor typ Engine type | Ref.nr Ref. No. | Best.nr Part No. | |
|--|-------------------------------------|---|---|
| <p>B18</p> <p>AQ90, AQ95, AQ95A, AQ100, AQ110, AQ120 BB100, BB100A MB18B</p> <p>Std ,030" ö.d./o.s. ,040" ö.d./o.s.</p> | <p>275193 275195</p> | <p>11193 11195 11196</p> |  |
| <p>B20, B30, MB10</p> <p>AQ115A, AQ115B AQ130A, AQ130B, AQ130C, AQ130D BB115A, BB115B, BB115C MB20A, MB20B, MB20C</p> <p>AQ165A, AQ170A, AQ170B, AQ170C BB165A, BB170A, BB170B, BB170C</p> <p>MB10A</p> <p>Std ,015" ö.d./o.s. ,030" ö.d./o.s.</p> <p>Kolvbult / Piston pin 22 mm</p> | <p>272002 272012 272004</p> | <p>11202 11203 11200</p> |  |
| <p>B20, B30, MB10</p> <p>AQ115A, AQ115B AQ130A, AQ130B, AQ130C, AQ130D BB115A, BB115B, BB115C MB20A, MB20B, MB20C</p> <p>AQ165A, AQ170A, AQ170B, AQ170C BB165A, BB170A, BB170B, BB170C</p> <p>MB10A</p> <p>,030" ö.d./o.s.</p> <p>Kolvbult / Piston pin 24 mm</p> | <p>272059</p> | <p>11059</p> |  |
| <p>B21</p> <p>AQ120B, AQ125A, AQ140A BB140A</p> <p>Std 0.50 mm ö.d./o.s. 1.00 mm ö.d./o.s.</p> <p>Ringbredd / Ring width 1.75x2.0x4.0mm</p> | <p>272040 272042 272043</p> | <p>11040 11042 11043</p> |  |



Kolvar (komplett med kolvbult och ringar) forts. / Pistons (complete with piston pin and rings cont.)

| Motor typ Engine type | Ref.nr Ref. No. | Best.nr Part No. | |
|--|--------------------|---------------------|---|
| D1, D2, D3, D11, D17 MD1B, MD2B, MD3B AQD2B MD11C, MD11D MD17C, MD17D Std | 875551 | 11551 |  |
| MD 1B, MD2B, MD3B 0.75 mm ö.d./o.s. | 875579 | 11579 | |
| Kolv diameter / Piston diam. 89 mm | | | |





Cylinderfodersatser (komplett med kolv och ringar) Cylinder liner kits (complete with piston and rings)

| Motor typ Engine type | Ref.nr Ref. No. | Best.nr Part No. | |
|---|--------------------|---------------------|--|
| D30, D40 AD30A, AQAD30A, MD30A, TAMD30A TMD30A, AD30, AQAD30, MD30, TAMD30 TMD30 MD40, TMD40, AQD40, TAMD40 AQAD40 | 875722 | 30722 | <p style="text-align: center;">NEW</p>  |





Kolvringsatser / Piston ring kits

| | | | |
|--|-------------------------------------|---|---|
| <p>B18</p> <p>AQ60F, AQ90, AQ95, AQ95A AQ110, AQ120 BB100</p> <p>Std .020" ö.d./o.s.</p> <p>Ringbredd / Ring width 2.0x2.0x4.0mm</p> | <p>275282 275283</p> | <p>11082 11083</p> |  |
| <p>B20, B30, MB10</p> <p>AQ105A, AQ115A, AQ115B AQ130A, AQ130B, AQ130C, AQ130D BB115A, BB115B, BB115C MB20A, MB20B, MB20C</p> <p>AQ165A, AQ170A, AQ170B, AQ170C BB165A, BB170A, BB170B, BB170C</p> <p>MB 10A</p> <p>Std .015" ö.d./o.s. .030" ö.d./o.s.</p> <p>Ringbredd / Ring width 2,0x2.0x4.7mm</p> | <p>275334 275335 275336</p> | <p>11534 11535 11536</p> |  |
| <p>B20, B30, MB10</p> <p>AQ115A, AQ115B AQ130A, AQ130B, AQ130C, AQ130D BB115B, BB115B, BB115C MB20A, MB20B, MB20C</p> <p>AQ165A, AQ170A, AQ170B, AQ170C BB170A, BB170A, BB170B, BB170C</p> <p>MB 10A</p> <p>Std .015" ö.d./o.s. .030" ö.d./o.s.</p> <p>Ringbredd / Ring width 1.75x2.0x4.0mm</p> | <p>275344 275345 275346</p> | <p>11344 11345 11346</p> |  |



Kolvringssetter forts. / Piston ring kits cont.

| Motor typ Engine type | Ref.nr Ref. No. | Best.nr Part No. | |
|--|----------------------------|-------------------------|---|
| B21 AQ 120B, AQ125A, AQ140A BB 140A Std 0.50 mm ö.d./o.s. 1.00 mm ö.d./o.s. Ringbredd / Ring width 1,75x2,0x4,0mm | 275340 275341 275342 | 11340 11341 11342 |  |
| B21 AQ120B, AQ125A, AQ140A BB 125A, BB140A Std 0.50 mm ö.d./o.s. 1.00 mm ö.d./o.s. Ringbredd / Ring width 2.0x2.0x4.0mm | 275337 275338 275339 | 11337 11338 11339 |  |
| B23 AQ145A BB145A Std 0.30 mm ö.d./o.s. 1.00 mm ö.d./o.s. Ringbredd / Ring width 1.75x2.0x4.0mm | 275331 275332 275333 | 11531 11533 11532 |  |
| B23, B25 230A, 230B AQ125B AQ131A, AQ131B, AQ131C, AQ131D AQ145B 250A, 251A AQ151A, AQ151B AQ171A, AQ171C Std 0.30 mm ö.d./o.s. 0.60 mm ö.d./o.s. Ringbredd / Ring width 1.75x1.75x3.5mm | 275369 275370 275371 | 11369 11370 11371 |  |
| D1, D2 MD1A MD2A Std MD1 = 1 st åtgår / 1 piece required MD2 = 2 st åtgår / 2 pcs required Diameter 79 mm | 875271 | 11271 |  |

Kolvringsatser forts. / Piston ring kits cont.

| Motor typ Engine type | Ref.nr Ref. No. | Best.nr Part No. | |
|---|--------------------|------------------------------|---|
| D1, D2, D3, D11, D17 MD1B, MD2B, MD3B MD11C, MD11D MD17C, MD17D Std 0,75 mm ö.d./o.s. | 875498 875499 | 11498 11499 | <p style="text-align: center;">NEW</p>  |
| D21, D32 AQD21A, AQD21B MD 21A AQD32A MD 32 Std MD21 = 4 st åtgår / 4 pcs required MD32 = 6 st åtgår / 6 pcs required | 876161 | 11161 |  |
| D30, D40, D31, D41 AD30A, AQAD30A, MD30A, TAMD30A TMD30A, AD30, AQAD30, MD30 TAMD30, TMD30 MD40, TMD40, AQD40, TAMD40, AQAD40 TMD41, D41A, TAMD41, AQAD41A AD41A, AD41B, DP-A, DP-B, DP-A1 DP-B1, SP-A, SP-A1 AD31D, AD31XD, TAMD31D, TMD31D AD41D, D41D, TAMD41D, TMD41D DP-D1, DP-E, DP-S, DPX, SP-C1, HSIA Std | 275350 | 30350 | <p style="text-align: center;">NEW</p>  |
| D42, D43, D44, D300, D31, D41 KAD42P-A, KAD42, KAMD42 KAMD42P-A, DPX, HS1A, DP-D1 DP-E, DP-G KAD32P, TAMD42WJ-A KAD43P, KAMD43P, KAD44P KAMD44P, KAD300, KAMD300 TMD31L, TAMD31P/L/M/S AD31P/L, TMD41L, TAMD41P/L/M/H KAD42A, KAMD42A, DP-D, HS1A, MS5B AD31D, AD31XD, TAMD31D, TMD31D AD41D, D41D, TAMD41D, TMD41D DP-D1, DP-E, DP-S, DPX, SP-C1, HS1A KAD42B, KAMD42B, TAMD42B Std | 3817033 | 30033 | <p style="text-align: center;">NEW</p>  |



Ramlagersatser / Main bearing kits

| Motor typ Engine type | Ref.nr Ref. No. | Best.nr Part No. | |
|---|-------------------------------------|---|---|
| <p>B18, B20, B21, B23</p> <p>AQ60F, AQ90, AQ95, AQ95A, AQ110, AQ120 BB30, BB100 MB18</p> <p>AQ105, AQ115A, AQ115B AQ130A, AQ130B, AQ130C, AQ130D BB115A, BB115B, BB115C MB20A, MB20B, MB20C</p> <p>AQ120B, AQ125A, AQ140A BB140A</p> <p>AQ145A BB145A</p> <p>Std .010" u.d./u.s. .020" u.d./u.s.</p> | <p>271214 271215 271216</p> | <p>11214 11215 11216</p> |  |
| <p>B30</p> <p>AQ 165A, AQ170A, AQ170B, AQ170C BB 165A, BB170A, BB170B, BB170C</p> <p>Std .010" u.d./u.s. .020" u.d./u.s.</p> | <p>271217 271218 271219</p> | <p>11019 11020 11021</p> |  |
| <p>B23, B25</p> <p>AQ125B AQ131A, AQ131B AQ145B</p> <p>AQ151A, AQ151B AQ171A</p> <p>Std 0.25 mm u.d./u.s. 0.50 mm u.d./u.s.</p> <p>Tryckbricksats 11471 ingår ej / Thust washer kit 11471 not included.</p> | <p>271236 271237 271238</p> | <p>11236 11237 11238</p> |  |



Ramlagersatser forts. / Main bearing kits cont.

| | | | |
|--|-------------------------------------|---|--|
| <p>B23, B25</p> <p>230A, 230B AQ131C, AQ131D</p> <p>250A, 250B, 251A AQ151C, AQ171C</p> <p>Std 0.25 mm u.d./u.s. 0.50 mm u.d./u.s.</p> | <p>270906 270907 270908</p> | <p>11906 11907 11908</p> |  |
| <p>D21</p> <p>AQD21A, AQD21B MD21A</p> <p>Std 0.30 mm u.d./u.s. 0.50 mm u.d./u.s.</p> <p>Tryckbricksats 11262 ingår ej / Thrust washer kit 11262 not included.</p> | <p>875306 875307 875308</p> | <p>11306 11307 11308</p> |  |
| <p>D29, D32</p> <p>AQD29, AQD29A MD 29, MD29A</p> <p>AQD32A MD32A</p> <p>Std 0.30 mm u.d./u.s. 0.50 mm u.d./u.s.</p> <p>Tryckbricksats 11262 ingår ej / Thrust washer kit 11262 not included.</p> | <p>875334 875335 875336</p> | <p>11334 11335 11336</p> |  |



Tryckbricksatser för vevaxel / Thrust washer kits for crankshaft

| Motor typ Engine type | Ref.nr Ref. No. | Best.nr Part No. | |
|---|--------------------|---------------------|---|
| B23, B25 AQ125B, AQ131A, AQ131 AQ145B AQ151A, AQ151B AQ171A Std | 270471 | 11471 |  |
| D21, D29, D32 AQD21A, AQD21B, MD21A, MD21B AQD29, AQD29A MD29, MD29A AQD32A MD32A Std | 818262 | 11262 |  |

Vevlagersatser / Con rod bearing kits

| | | | |
|---|--|-------------------------|---|
| MB10 MB 10A MO -2778 Std ,010" u.d /u.s. ,020" u.d /u.s. Lagerbredd / Bearing width 27 mm | 2 x 270015 2 x 875478 2 x 875479 | 11477 11478 11479 |  |
| MB10 MB 10A MO 2779- Std ,010" u.d /u.s. ,020" u.d /u.s. Lagerbredd / Bearing width 24 mm | 2 x 875538 2 x 875539 2 x 875540 | 11538 11539 11540 |  |

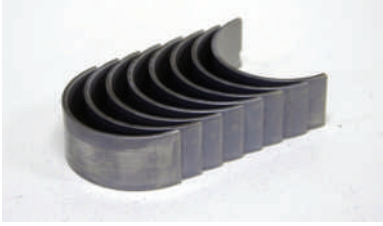

Vevlagersatser forts. / Con rod bearing kits cont.

| Motor typ Engine type | Ref.nr Ref. No. | Best.nr Part No. | |
|---|-------------------------------------|---|---|
| <p>B18, B20</p> <p>AQ60F, AQ90, AQ95, AQ95A, AQ110, AQ120 BB30, BB100 MB18</p> <p>AQ105, AQ115A, AQ115B AQ130A, AQ130B, AQ130C, AQ130D BB115A, BB115B, BB115C MB20A, MB20B, MB20C</p> <p>Std .010" u.d./u.s. .020" u.d./u.s.</p> <p>Lagerbredd / Bearing width 27 mm</p> | <p>271051 271052 271053</p> | <p>11051 11105 11053</p> |  |
| <p>B20, B21, B23</p> <p>AQ105A, AQ115A, AQ115B AQ130A, AQ130B, AQ130C, AQ130D BB115A, BB115B, BB115C MB20A, MB20B, MB20C</p> <p>AQ120B, AQ125A, AQ140A, BB140A</p> <p>AQ145A BB145A</p> <p>Std .010" u.d./u.s. .020" u.d./u.s.</p> <p>Lagerbredd / Bearing width 24 mm</p> | <p>271063 271064 271065</p> | <p>11063 11064 11106</p> |  |
| <p>B30</p> <p>AQ165A AQ170A, AQ170B, AQ170C BB165A BB170A, BB170B, BB170C</p> <p>Std .010" u.d./u.s. .020" u.d./u.s.</p> <p>Lagerbredd / Bearing width 27 mm</p> | <p>271054 271055 271056</p> | <p>11022 11023 11024</p> |  |
| <p>B30</p> <p>AQ165A AQ170A, AQ170B, AQ170C BB165A BB170A, BB170B, BB170C</p> <p>Std .010" u.d./u.s. .020" u.d./u.s.</p> <p>Lagerbredd / Bearing width 24 mm</p> | <p>271066 271067 271068</p> | <p>11025 11026 11027</p> |  |

Vevlagersatser forts. / Con rod bearing kits cont.

| Motor typ Engine type | Ref.nr Ref. No. | Best.nr Part No. | |
|--|--|--|---|
| <p>B23, B25</p> <p>230A, 230B AQ125B AQ131A, AQ131B, AQ131C, AQ131D AQ145B</p> <p>250A, 251A AQ151A, AQ151B, AQ151C AQ171A, AQ171C</p> <p>Std 0.25 mm u.d./u.s. 0.50 mm u.d./u.s.</p> | <p>270136 270137 270138</p> | <p>11136 11137 11138</p> |  |
| <p>D21</p> <p>AQD21A, AQD21B MD21A, MD21B</p> <p>Std 0.30 mm u.d./u.s. 0.50 mm u.d./u.s. 0.80 mm u.d./u.s.</p> | <p>875302 875303 875304 875305</p> | <p>11302 11303 11304 11305</p> |  |
| <p>D29, D32</p> <p>AQD29, AQD29A MD29, MD29A</p> <p>AQD32A MD32A</p> <p>Std 0.30 mm u.d./u.s. 0.50 mm u.d./u.s. 0.80 mm u.d./u.s.</p> | <p>875330 875331 875332 875333</p> | <p>11330 11331 11332 11333</p> |  |

Packningssatser för cylinderfoder / Gasket kits for cylinder liner

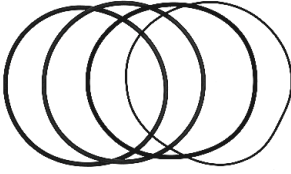
| Motor typ Engine type | Ref.nr. Ref. No: | Best.nr. Part No. | |
|--|------------------------------|----------------------|---|
| D5 MD5, MD5B, MD5C | 875560 | 11560 |  |
| D11, D17 MD11C, MD11D MD17C, MD17D D11 = 2 st åtgår / 2 pcs required D17 = 3 st åtgår / 3 pcs required | 875550 | 11550 |  |
| D30, D31, D32 D40, D41, D42, D43, D44 D300 Samtliga utföranden / All version D30, 31, 32 = 4 st åtgår / 4 pcs required D40, 41, 42, 43, 44, 300 = 6 st åtgår / 6 pcs required | 275751 875651 (275595) | 11651 |  |

Stödlager i vevaxel / Support bearing in crankshaft

| | | | |
|---|--------|-------|---|
| B18, B20, B21, B23, B25, B30 AQ60F, AQ90, AQ95, AQ95A, AQ110 AQ120 BB30, BB100 MB18 AQ115A, AQ115B AQ130A, AQ130B, AQ130C, AQ130D BB115A, BB115B, BB115C MB20A, MB20B, MB20C AQ120B, AQ125A, AQ140A BB140A 230A, 230B AQ125B AQ131A, AQ131B, AQ131C, AQ131D AQ145A BB145A 250A, 250B, 251A AQ151A, AQ151B, AQ151C AQ171A, AQ171C AQ165A AQ170A, AQ170B, AQ170C BB165A BB170A, BB170B, BB170C Kapslat lager / Sealed bearing | 181799 | 11799 |  |
|---|--------|-------|---|





Ombyggnadssats för bakre vevaxeltätning / Flange kit for crankshaft sealing (Rear)

| Motor typ Engine type | Ref.nr. Ref. No: | Best.nr. Part No. | |
|--|---------------------|----------------------|---|
| <p>B18, B20</p> <p>AQ60F, AQ90, AQ95, AQ95A, AQ110 AQ120 BB30, BB100 MB18</p> <p>AQ115A, AQ115B AQ130A, AQ130B, AQ130C, AQ130D BB115A, BB115B, BB115C MB20A, MB20B, MB20C</p> <p>Satsen innehåller / Contents: Bakre gavel / Rear flange 1218634 Packbox / Oil seal 430118 Packning / Gasket 430134</p> | | 11014 |  |



Expansionsbrickor (galvaniserade) / Expansion plugs (galvanized)

| | | | |
|----------------|---------|-------|--|
| Diameter 35 mm | 463903 | 11903 |  |
| Diameter 42 mm | 463902 | 11902 | |
| Diameter 40 mm | 968955 | 11955 | |
| Diameter 45 mm | 463904 | 11904 | |
| Diameter 52 mm | 4639053 | 11905 | |

Kamaxlar / Camshafts

| Motor typ Engine type | Ref.nr Ref. No. | Best.nr Part No. | |
|--|------------------------------|---------------------|---|
| <p>B18, B20</p> <p>AQ60F, AQ90, AQ95, AQ95A, AQ110 AQ120 BB30, BB100 MB18</p> <p>AQ105, AQ115A, AQ115B, AQ130A, AQ130B, AQ130C, AQ130D BB115A, BB115B, BB115C MB20A, MB20B, MB20C</p> <p>Profil / Profile P</p> | <p>1218674 (418707)</p> | <p>12003</p> |  |
| <p>B30</p> <p>AQ165A AQ170A, AQ170B, AQ170C BB165A BB170A, BB170B, BB170C</p> <p>Profil / Profile P</p> | <p>461511</p> | <p>12004</p> |  |
| <p>B21, B23</p> <p>AQ120B, AQ125A</p> <p>230A, 230B AQ125B AQ131A, AQ131B, AQ131C, AQ131D</p> <p>Märkt / Marked A</p> | <p>1336767 (1219706)</p> | <p>12767</p> |  |
| <p>B21, B25</p> <p>AQ140A BB140A</p> <p>250A, 250B AQ151A, AQ151B, AQ151C</p> <p>Märkt / Marked V</p> | <p>1346442 (1219032)</p> | <p>12442</p> |  |

Kamaxelsatser / Camshaft kits

| Motor typ Engine type | Ref.nr Ref. No. | Best.nr Part No. | |
|---|--------------------|---------------------|--|
| <p>B18, B20</p> <p>AQ60F, AQ90, AQ95, AQ95A, AQ110 AQ120 BB30, BB100 MB18</p> <p>AQ105, AQ115A, AQ115B, AQ130A, AQ130B, AQ130C, AQ130D BB115A, BB115B, BB115C MB20A, MB20B, MB20C</p> <p>Innehåll / Contents: 1 Kamaxel / Camshaft 1218674 8 Lyftare / Lifters 1218630 1 Kamaxelfett / Camshaft grease</p> | | 12010 |  |
| <p>B30</p> <p>AQ165A AQ170A, AQ170B, AQ170C BB165A BB170A, BB170B, BB170C</p> <p>Innehåll / Contents: 1 Kamaxel / Camshaft 461511 12 Lyftare / Lifters 1218630 1 kamaxelfett / Camshaft grease</p> | | 12011 |  |



Kamaxelbricka / Thrust flange

| | | | |
|---|--|--------------|---|
| <p>B18, B20, B30</p> <p>AQ60F, AQ90, AQ95, AQ95A, AQ110 AQ120 BB30, BB100 MB18</p> <p>AQ105, AQ115A, AQ115B, AQ130A, AQ130B, AQ130C, AQ130D BB115A, BB115B, BB115C MB20A, MB20B, MB20C</p> <p>AQ165A AQ170A, AQ170B, AQ170C BB165A BB170A, BB170B, BB170C</p> <p>Skruvar ingår / Screws included</p> | | 22142 |  |
|---|--|--------------|---|

Ventillyftare / Valve lifters

| Motor typ Engine type | Ref.nr Ref. No. | Best.nr Part No. | |
|--|-----------------------------|---------------------|---|
| <p>B18, B20, B30</p> <p>AQ60F, AQ90, AQ95, AQ95A, AQ110 AQ120 BB30, BB100 MB18</p> <p>AQ105, AQ115A, AQ115B, AQ130A, AQ130B, AQ130C, AQ130D BB115A, BB115B, BB115C MB20A, MB20B, MB20C</p> <p>AQ165A AQ170A, AQ170B, AQ170C BB165A BB170A, BB170B, BB170C</p> | <p>1218630 (418423)</p> | <p>12513</p> |  |

Kamaxellagersatser / Camshaft bearing kits

| | | | |
|--|--|---------------------|---|
| <p>B18, B20</p> <p>AQ60F, AQ90, AQ95, AQ95A, AQ110 AQ120 BB30, BB100 MB18</p> <p>AQ105, AQ115A, AQ115B, AQ130A, AQ130B, AQ130C, AQ130D BB115A, BB115B, BB115C MB20A, MB20B, MB20C</p> <p style="text-align: right;">Std</p> | | <p>12101</p> |  |
| <p>B30</p> <p>AQ165A AQ170A, AQ170B, AQ170C BB165A BB170A, BB170B, BB170C</p> <p style="text-align: right;">Std</p> | | <p>12102</p> |  |

Lagersats mellanaxel / Bearing kit for interm. shaft

| Motor typ Engine type | Ref.nr. Ref. No. | Best.nr. Part No. | |
|--|---------------------|----------------------|---|
| <p>B21, B23, B25</p> <p>AQ120B, 125A, AQ140A BB140A</p> <p>230A, 230B AQ125B AQ131A, AQ131B, AQ131C, AQ131D AQ145A, AQ145B BB145A</p> <p>250A, 250B, 251A AQ151A, AQ151B, AQ151C AQ171A, AQ171C</p> <p style="text-align: right;">Std</p> | | 12100 |  |

Tätbricka för kamaxel / Rubber washer for camshaft

| | | | |
|---|---------|--------------|--|
| <p>B23, B25</p> <p>230B AQ125B AQ131A, AQ131B, AQ131C, AQ131D AQ145B 250A, 250B AQ151A, AQ151B, AQ151C</p> <p style="text-align: right;">Std</p> | 1336763 | 12006 |  |
|---|---------|--------------|--|

Kamaxelfett / Camshaft grease

| | | | |
|---|--|--------------|---|
| <p>Installationsfett av molybdendisulfidtyp / Installation and running-in paste on MoS base</p> | | 12311 |  |
|---|--|--------------|---|



Kamdrevsats (stål) / Timing gear kit (steel)

| Motor typ Engine type | Ref.nr Ref. No. | Best.nr Part No. | |
|--|--|---------------------|---|
| <p>B18, B20, B30</p> <p>AQ60F, AQ90, AQ95, AQ95A, AQ110 AQ120 BB30, BB100 MB18</p> <p>AQ105, AQ115A, AQ115B, AQ130A, AQ130B, AQ130C, AQ130D BB115A, BB115B, BB115C MB20A, MB20B, MB20C</p> <p>AQ165A AQ170A, AQ170B, AQ170C BB165A BB170A, BB170B, BB170C</p> | <p>271944 (270691) (875375) (418678)</p> | <p>12944</p> |  |

Kamaxelremmar / Timing belts

| | | | |
|--|---------------|---------------------|---|
| <p>B21, B23, B25</p> <p>AQ120B, AQ125A, 140A BB140A</p> <p>230A, 230B AQ125B, AQ131A, AQ131B, AQ131C, AQ131D AQ145A, AQ145B BB145A</p> <p>250A, 250B AQ151A, AQ151B, AQ151C</p> | <p>463377</p> | <p>12377</p> |  |
| <p>B25</p> <p>AQ171A,C 251A</p> | <p>855506</p> | <p>12506</p> | |





Spännrullar för kamrem / Timing belt tensioner

| Motor typ Engine type | Ref.nr Ref. No. | Best.nr Part No. | |
|--|--------------------|---------------------|---|
| <p>B21, B23, B25</p> <p>AQ120B, AQ125A, AQ140A BB140A</p> <p>230A, 230B AQ125B, AQ131A, AQ131B, AQ131C, AQ131D AQ145A, AQ145B, BB145A</p> <p>250A, 250B AQ151A, AQ151B, AQ151C</p> <p>Rostfri och galvaniserad / Stainless and galvanized</p> | 831986 | 12986 |  |
| <p>B25</p> <p>251A AQ171A, AQ171C</p> | 855507 | 12507 |  |

Ventiler / Valves

| | | | |
|--|---|---------------------------|---|
| <p>B18</p> <p>AQ60F, AQ90, AQ95, AQ95A, AQ110 BB30, BB100</p> <p>AQ 95A, 120A Endast avgas / Only outlet</p> <p>Insgsventil / Inlet valve 40x8,6 mm</p> <p>Avgasventil / Outlet valve 35x8,6 mm</p> | <p>419368 (418290)</p> <p>419292 (415268)</p> | <p>12368</p> <p>12292</p> |  |
| <p>B20, B30</p> <p>AQ105A AQ115A, AQ115B AQ130A, AQ130B, AQ130C, AQ130D BB115A, BB115B, BB115C MB20A, MB20B, MB20C</p> <p>AQ165A, AQ170A, AQ170B, AQ170C BB170165A BB170A, BB170B, BB170C8</p> <p>Insgsventil / Inlet valve 42 mm</p> <p>Avgasventil / Outlet valve 35 mm</p> | <p>419734</p> <p>419735</p> | <p>12734</p> <p>12005</p> |  |

Ventiler forts. / Valves cont.

| Motortyp Engine type | Ref.nr. Ref. No. | Best.nr. Part No. | |
|---|----------------------------|--|---|
| <p>B21, B23, B25</p> <p>AQ120B, AQ125A, AQ140A BB140A</p> <p>230A, 230B AQ125B, AQ131A, AQ131B, AQ131C, AQ131D AQ145A, AQ145B BB145A</p> <p>250A, 250B AQ151A, AQ151B, AQ151C</p> <p>Insgsventil / Inlet valve 44 mm Avgasventil / Outlet valve 35 mm</p> | <p>463395 463526</p> | <p>12395 12526</p> |  |
| <p>B25</p> <p>251A AQ171A, AQ171C</p> <p>Insgsventil / Inlet valve 34,5 mm Avgasventil / Outlet valve 31,5 mm</p> | <p>1317793 1317792</p> | <p>12793 12792</p> |  |
| <p>D1, D2, D3, D11, D17</p> <p>AQD2B MD1B, MD2B, MD3B MD11C, MD11D MD17C, MD17D</p> <p>Insgsventil / Inlet valve 38 mm Avgasventil / Outlet valve 34 mm</p> | <p>833188 829620</p> | <p>12188 12020</p> |  |
| <p>D31, D32, D41, D42, D43</p> <p>AD31L-A, AD31P-A TAMD31L-A, TAMD31M-A, TAMD31P-A TMD31L-A KAD32PA AD41L-A, AD41P-A D41L-A TAMD41H-A, TAMDS41L-A, TAMD41P-A TMD41A, TMD41L-A KAD42A, KAD42P-A KAMD42A, KAMD42B, KAMD42P-A TAMD42B TAMD42WJ-A KAD43P-A KAMD43P-A</p> <p>Insgsventil / Inlet valve 39 mm Avgasventil / Outlet valve 37 mm</p> | <p>838637 838638</p> | <p>12637 <i>NEW</i> 12638 <i>NEW</i></p> |  |

Ventiler forts. / Valves cont.

| Motortyp Engine type | Ref.nr. Ref. No. | Best.nr. Part No. | |
|---|-------------------------------|---|---|
| <p>D40</p> <p>AD40B AQAD40A, AQAD40B AQD40A MD40A TAMD40A, TAMD40B TMD40A, TMD40B, TMD40C</p> <p>Insgsventil / Inlet valve 42 mm</p> <p>Avgasventil / Outlet valve 36 mm</p> | <p>1542472</p> <p>1542389</p> | <p>12472 <i>NEW</i></p> <p>12389 <i>NEW</i></p> |  |

Ventilstyrningar / Valve guides

| Motor typ Engine type | Ref.nr. Ref. No. | Best.nr. Part No. | |
|--|---|--|---|
| <p>B18</p> <p>AQ60F, AQ90, AQ95, AQ95A AQ110, AQ120 BB30, BB100 MB18 Insug och avgas / Inlet and outlet</p> <p>AQ95A, AQ120 Endast avgas / Only outlet 63,5x 15,0x8,7 mm</p> | 415266 (418495) | 12266 |  |
| <p>B18, B20, B30, MB10</p> <p>MB 10 A Insug och Avgas / Inlet and outlet</p> <p>AQ 105, 115, 130, 165, 170</p> <p>Insug / Inlet std 52x13,5x8 mm</p> <p>Avgas / Outlet std 59x13,5x8 mm</p> | 419652 419652 3582561 (419653) | 12652 12652 12653 |  |
| <p>B21, B23, B25</p> <p>AQ 120B, 125, 131, 140, 145, 151 230A, 250A</p> <p>Insug / Inlet 52x13,5x8 mm</p> <p>Avgas / Outlet 52x13,5x8 mm</p> | 419652 3547603 (436771) | 12652 12603 |  |
| <p>B25</p> <p>251A AQ171A, AQ171C</p> <p>Insug och Avgas / Inlet and outlet 55x12,0x7 mm</p> | 1378960 | 12960 |  |
| <p>D1, D2, D3, D11, D17 D30, D31, D40, D41, D42</p> <p>MD 1B, 2B, 3B, 11C,D, 17C,D Insug / Inlet</p> <p>MD 30, 31, 40, 41 KAD/ KAMD 42P-A Insug och avgas / Inlet and outlet 59x13,5x8 mm</p> | 3582561 (419653) | 12653 |  |

Ventilfjädrar / Valve springs





| Motor typ Engine type | Ref.nr. Ref. No. | Best.nr. Part No. | |
|--|---------------------|----------------------|--|
| <p>B18, B20, B30, MB10</p> <p>AQ60F, AQ90, AQ95, AQ95A, AQ110 AQ120 BB30, BB100 MB18</p> <p>AQ115A, AQ115B AQ130A, AQ130B, AQ130C, AQ130D BB115A, AQ115B, BB115C MB20A, MB20B, MB20C</p> <p>AQ165A, AQ170A, AQ170B, AQ170C BB165A BB170A, BB170B, BB170C</p> <p>MB10A</p> | 418737 | 12737 |  |
| <p>B21, B23, B25</p> <p>AQ120B, AQ125A, AQ140A BB140A</p> <p>230A, 250A AQ125B AQ131A, AQ131B, AQ131C, AQ131D AQ145A, AQ145B BB145A</p> <p>250A, 250B AQ151A, AQ151B, AQ151C</p> | 463739 | 12739 |  |

Ventiljusterbrickor / Valve adjusting shims

| Motor typ Engine type | Tjocklek Thickness | Ref.nr. Ref. No. | Best.nr. Part No. |
|--|-----------------------|---------------------|----------------------|
| B21, B23, B25 AQ120B, AQ125A, AQ140A BB140A 230A, 230B AQ125B AQ131D AQ145A, AQ145B BB145A 250A, 250B AQ151A, AQ151B, AQ151C | 3,30 | 463546 | 12546 |
| | 3,35 | 463547 | 12547 |
| | 3,40 | 463548 | 12548 |
| | 3,45 | 463549 | 12549 |
| | 3,50 | 463550 | 12550 |
| | 3,55 | 463551 | 12551 |
| | 3,60 | 463552 | 12552 |
| | 3,65 | 463553 | 12553 |
| | 3,70 | 463554 | 12554 |
| | 3,75 | 463555 | 12555 |
| | 3,80 | 463556 | 12556 |
| | 3,85 | 463557 | 12557 |
| | 3,90 | 463558 | 12558 |
| | 3,95 | 463559 | 12559 |
| | 4,00 | 463560 | 12560 |
| | 4,05 | 463561 | 12561 |
| | 4,10 | 463562 | 12562 |
| | 4,15 | 463563 | 12563 |
| | 4,20 | 463564 | 12564 |
| | 4,25 | 463565 | 12565 |
| | 4,30 | 463566 | 12566 |
| | 4,35 | 463567 | 12567 |
| | 4,40 | 463568 | 12568 |
| | 4,45 | 463569 | 12569 |
| | 4,50 | 463570 | 12570 |
| | 4,55 | | 12045 |
| | 4,60 | | 12460 |
| | 4,65 | | 12046 |
| | 4,70 | | 12470 |
| | 4,75 | | 12475 |
| 4,80 | | 12480 | |
| 4,85 | | 12485 | |
| 4,90 | | 12490 | |
| 4,95 | | 12495 | |
| 5,00 | | 12500 | |





Topplöckspackningar / Cylinder head gaskets

| Motor typ Engine type | Ref.nr. Ref. No. | Best.nr. Part No. | |
|--|---|----------------------|---|
| <p>B18</p> <p>AQ95, AQ110 BB100</p> <p>Ej för fotogenmotor / Not for paraffin engine</p> <p>Runda hål / Round holes Ingår i sotn. sats 21357 / Incl. in decarb. gasket set 21357</p> | <p>9139283 (418990)</p> | <p>13990</p> |  |
| <p>B20</p> <p>AQ115A, AQ130A, AQ130C MB 20B</p> <p>Tjocklek 0,8 mm ovala hål / Thickness 0,8 mm oval holes Ingår i sotn. sats 21401 / Incl. in decarb. gasket set 21401</p> | <p>419310</p> | <p>13009</p> |  |
| <p>B20</p> <p>AQ115A, AQ130B BB115A, BB115B MB20A,</p> <p>Tjocklek 2,0 mm runda hål / Thickness 2,0 mm round holes Ingår i sotn. sats 21418 / Incl. in decarb. gasket set 21418</p> | <p>857621 (876783) (875543) (419628)</p> | <p>13783</p> |  |
| <p>B20</p> <p>AQ115B, AQ130D BB115C MB20C</p> <p>Tjocklek 1,2 mm ovala hål / Thickness 1,2 mm oval holes Ingår i sotn. sats 21569 / Incl. in decarb. gasket set 21569</p> | <p>9139282 (462623)</p> | <p>13623</p> |  |
| <p>B30</p> <p>AQ165A AQ170A, AQ170B, AQ170C BB165A BB170A, BB170B, BB170C</p> <p>Tjocklek 0,8 mm ovala hål / Thickness 0,8 mm oval holes Ingår i sotn. sats 21335, 21359 / Incl. in decarb. gasket set 21335, 21359</p> | <p>9139284 (3855409) (461056) (430107) (461618)</p> | <p>13008</p> |  |





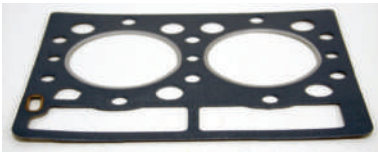
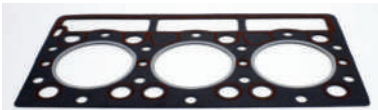

Topplöckspackningar forts. / Cylinder head gaskets cont.

| Motor typ Engine type | Ref.nr. Ref. No. | Best.nr. Part No. | |
|--|-----------------------------------|----------------------|---|
| B21 AQ120B, AQ125A, AQ140A BB140A | 1378645 (463412) | 13645 |  |
| B23, B25 230A, 230B AQ 125B AQ131A, AQ131B, AQ131C, AQ131D AQ145A, AQ145B BB145A 250A, 250B, 251A AQ151A, AQ151B, AQ151C AQ171A, AQ171C | 1378646 (1326785) (1332644) | 13646 |  |
| D1, D2 MD1A MD2A Ingår i sotn. sats 21422 Incl. in decarb.gasket set 21422 Kolv / Piston 79 mm | 833274 | 13274 |  |
| D1, D2, D3 MD1B AQD2A MD2B, MD3B Ingår i sotn. sats 21500 Incl. in decarb.gasket set 21500 Kolv / Piston 89 mm | 859151 (833070) | 13070 |  |
| D11, D17 MD11C, MD11D MD17C, MD17D Ingår i sotn. sats 21553, 21572 Incl. in decarb.gasket set 21553, 21572 | 859137 (833453) | 13453 |  |
| D5 MD5A, MD5B, MD5C Ingår i sotn. sats 21561 Incl. in decarb.gasket set 21561 | 859134 (838127) | 13127 |  |

Topplöckspackningar forts. / Cylinder head gaskets cont.

| Motor typ Engine type | Ref.nr. Ref. No. | Best.nr. Part No. | |
|---|---|----------------------|---|
| D6 MD6A, MD6B Ingår i sotn. sats 21379 Incl. in decarb.gasket set 21379 | 859135 (3875376) | 13376 |  |
| D7 MD7A MO - 35144 MD7B MO - 35144 Tjocklek 1,3 mm Thickness 1,3 mm Ingår i sotn. sats 21430 Incl. in decarb.gasket set 21430 | 3809167 (859136) (840270) | 13136 |  |
| D7 MD7A MO 35145 - MD7B MO 35145 - Tjocklek 0,8 mm Thickness 0,8 mm Ingår i sotn. sats 21431 Incl. in decarb. gasket set 21431 | 3809167 (860749) (840910) (840270) | 13749 |  |
| 2001 2001, 2001AG, 2001B, 2001BG Ingår i sotn. sats 21307 Incl. in decarb.gasket set 21307 | 840569 | 13569 |  |
| 2002 2002, 2002AG, 2002B, 2002BG Ingår i sotn. sats 21308 Incl. in decarb.gasket set 21308 | 859094 (840328) | 13094 |  |
| 2003 2003, 2003AG, 2003B, 2003BG 2003T, 2003TB Ingår i sotn. sats 21309, 21310 Incl. in decarb.gasket set 21309, 21310 | 859093 (840405) | 13093 |  |



Topplöckspackningar forts. / Cylinder head gaskets cont.

| Motor typ Engine type | Ref.nr. Ref. No. | Best.nr. Part No. | |
|--|--------------------------------|----------------------|---|
| 2030 MD2030A, MD2030B | 3580309 | 13309 |  |
| 2040 MD2040A, MD2040B | 3584202 (3580482) | 13202 |  |
| 22 MD22A, MD22L-A, MD22L-B, MD22P-B TAMD22P-B TMD22A, TMD22B | 859647 | 13647 |  |
| D21 AQD21A, AQD21B MD21A, MD21B Ingår i sotn. sats 21417 Incl. in decarb.gasket set 21417 | 859152 (829531) (829214) | 13531 |  |
| D30 AD30A, AQAD30A MD30A TAMD30A, TMD30A Ingår i sotn. sats 21453 Incl. in decarb.gasket set 21453 | 859150 | 13150 |  |
| D31, D32 AD31A, AD31B, AD31L-A, AD31P-A AD31XD AQAD31A MD31A TAMD31A, TAMD31B, TAMD31D TAMD31L-A, TAMD31M-A, TAMDP-A TMD31A, TMD31B, TMD31D TMD31L-A, KAD32P-A Ingår i sotn. sats 21103 Incl. in decarb.gasket set 21103 | 3582432 (858993) | 13993 |  |



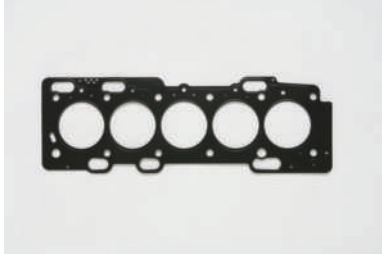

Topplöckspackningar forts. / Cylinder head gaskets cont.

| Motor typ Engine type | Ref.nr. Ref. No. | Best.nr. Part No. | |
|---|---|----------------------|---|
| <p>D40</p> <p>AD40B AQAD40A, AQAD40B AQD40A MD40A TAMD40A, TAMD40B TMD40B, TMD40C</p> <p>Ingår i sotn. sats 21395 Incl. in decarb.gasket set 21395</p> | 859155 | 13155 |  |
| <p>D41, D42, D43, D44</p> <p>AD41A, AD41B, AD41D AD41L-A, AD41P-A AQAD41A D41A, D41B, D41D, D41L-A TAMD41A, TAMD41B, TAMD41D TAMD41H-A, TAMD41L-A, TAMD41M-A TAMD41P-A TMD41A, TMD41B, TMD41D, TMD41LA</p> <p>KAD42A, KAD42B, KAD42P-A KAMD42A, KAMD42B, KAMD42P-A TAMD42B, TAMD42WJ-A</p> <p>KAD43P-A KAMD43P-A</p> <p>KAD44P-A, KAD44P-B, KAD44P-C KAMD44P-A, KAMD44P-B KAMD44P-C</p> <p>Ingår i sotn. sats 21104 Incl. in decarb.gasket set 21104</p> | 3583786 (3582433) (3580742) (858992) (876853) | 13742 |  |
| <p>D2</p> <p>D2-55A, D2-55B, D2-55C D2-55D, D2-55E</p> <p>D2-75A, D2-75B, D2-75C</p> <p>Ingår i sotn.sats 21801 Incl in decarb.gasket set 21801</p> | 21228429 | 90051 | <p>NEW</p>  |

Topplöckspackningar forts. / Cylinder head gaskets cont.

| Motor typ Engine type | Ref.nr. Ref. No. | Best.nr. Part No. | |
|--|--|---|---|
| <p>D3</p> <p>D3-110I-A, D3-130A-A, D3-130I-A D3-160A-A, D3-160I-A D3-110I-B, D3-110I-C, D3-130A-B D3-130I-B, D3-130A-C, D3-130I-C D3-160A-B, D3-160I-B, D3-160A-C D3-160I-C, D3-190A-B, D3-190I-B D3-190A-C, D3-190I-C</p> <p>Packning med 1 hål, klass A Gasket with 1 hole, class A</p> <p>Packning med 2 hål, klass B Gasket with 2 holes, class B</p> <p>Packning med 3 hål, klass C Gasket with 3 holes, class C</p> <p>Packning med 4 hål, klass D Gasket with 4 holes, class D</p> <p>Packning med 5 hål, klass E Gasket with 5 holes, class E</p> | <p>30731261</p> <p>30731262</p> <p>30731263</p> <p>30731264 (30650524)</p> <p>30650525</p> | <p>90261</p> <p>90262</p> <p>90263</p> <p>90524</p> <p>90525</p> | <p>NEW</p>  |
| <p>D4</p> <p>D4-180I-B, D4-210A-A, D4-210A-B D4-210I-A, D4-210I-B, D4-225A-B D4-225I-B, D4-260A-A, D4-260A-B D4-260I-A, D4-260I-B</p> <p>Ingår i sotn.sats 21804 Incl in decarb.gasket set 21804</p> | <p>21165389 (3581868)</p> | <p>90028</p> | <p>NEW</p>  |
| <p>D6</p> <p>D6-280I-A, D6-280I-B, D6-280A-A D6-280A-B, D6-310I-A, D6310I-B D6-310A-A, D6-310A-B, D6-310D-B D6-350A-A, D6-350A-B, D6-370I-A D6-370I-B, D6-370D-B</p> <p>Ingår i sotn.sats 21805 Incl in decarb.gasket set 21805</p> | <p>21165390 (3581869)</p> | <p>90029</p> | <p>NEW</p>  |





Ventilkåpspackningar / Valve cover gaskets

| Motor typ Engine type | Ref.nr. Ref. No. | Best.nr. Part No. | |
|---|----------------------|----------------------|---|
| B18, B20 AQ60F, AQ90, AQ95, AQ95A, AQ110 AQ120 BB30, BB100 MB18 AQ115A, AQ115B AQ130A, AQ130B, AQ130C, AQ130D BB115A, BB115B, BB115C MB20A, MB20B, MB20C | 419678 | 13100 |  |
| B30 AQ165A AQ170A, AQ170B, AQ170C BB165A BB170A, BB170B, BB170C | 430039 | 13039 |  |
| B21, B23 AQ120B, AQ125A, AQ140A BB140A AQ145A BB145A | 1378909 | 13909 |  |
| B23, B25 230A, 230B AQ125B AQ131A, AQ131B, AQ131C, AQ131D AQ145B 250A, 250B AQ151A, AQ151B, AQ151C | 1378870 (1336753) | 12870 |  |
| B25 251A AQ171A, AQ171C Innehåll / Contents: 1 Packning / Gasket 1378853 1 Packning / Gasket 1378851 2 Gummitätning / Rubber seal 463416 | | 13393 |  |



Ventilkåpspackningar forts. / Valve cover gaskets cont.

| Motor typ Engine type | Ref.nr. Ref. No. | Best.nr. Part No. | |
|---|---------------------|----------------------|---|
| <p>B21, B23, B25</p> <p>AQ120B, AQ125A, AQ140A BB140A</p> <p>AQ125B, AQ145A BB145A</p> <p>251A AQ171A, AQ171C</p> <p>2 st åtgår för 171A, C, 251A 2 pcs required for 171A, C, 251A Gummitätning för ventilkåpa / Rubber seal for valve cover</p> | 463416 | 11416 |  |
| <p>D1, D2, D3, D11, D17</p> <p>MD1A, MD1B</p> <p>AQD2B MD2, MD2B MD3B MD11C, MD11D MD17C, MD17D</p> | 859120 (802399) | 13399 |  |
| <p>D5</p> <p>MD5A, MD5B, MD5C</p> | 838066 | 13066 |  |
| <p>D6, D7</p> <p>MD6A, MD6B MD7A</p> <p>2 st åtgår / 2 pcs required</p> <p>MD7B</p> <p>1 st åtgår / 1 piece required</p> | 840115 (3875384) | 13115 |  |
| <p>2001</p> <p>2001 2001AG 2001B, 2001BG</p> | 859042 (840572) | 13042 |  |
| <p>2002</p> <p>2002 2002AG 2002B, 2002BG</p> | 859043 (840440) | 13043 |  |

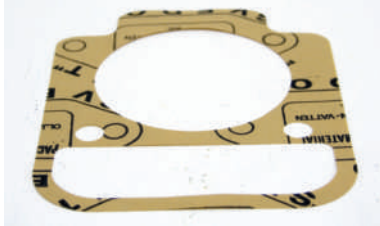
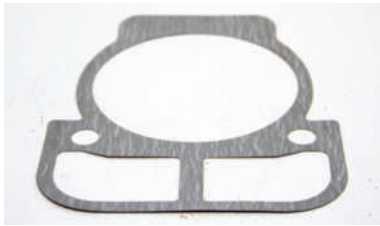

Ventilkåpspackningar forts. / Valve cover gaskets cont.

| Motor typ Engine type | Ref.nr. Ref. No. | Best.nr. Part No. | |
|--|---------------------|----------------------|---|
| 2003 2003 2003AG 2003B, 2003BG 2003T, 2003TB | 859044 (840461) | 13044 |  |
| D30 AD30A AQAD30A MD30A TAMD30A TMD30A | 1544119 | 13119 |  |
| D31, D32 AD31A, AD31B AD31L-A, AD31PA AQAD31A MD31A TAMD31A, TAMD31B TAMD31L-A, TAMD31M-A, TAMD31P-A TMD31A, TMD31B, TMD31L-A KAD32P-A | 838652 | 13652 |  |
| D40 AD40B AQAD40A, AQAD40B AQD40A MD40A TAMD40A, TAMD40B TMD40A, TMD40B, TMD40C | 1542287 | 13287 |  |
| D41, D42, D43 AD41A, AD41B AD41L-A, AD41P-A AQAD41A D41A, D41B, D41L-A TAMD41A, TAMD41B TAMD41H-A, TAMD41L-A TAMD41M-A, TAMD41P-A TMD41A, TMD41B, TMD41L-A KAD42A, KAD42B, KAD42P-A KAMD42A, KAMD42B, KAMD42P-A TAMD42B, TAMD42WJ-A KAD43P-A KAMD43P-A | 838653 | 13653 |  |

Justershims mellan cylinderfot och block / Adjusting shims cylinder - cylinder block

| Motor typ Engine type | Ref.nr. Ref. No. | Best.nr. Part No. | |
|--|--|--------------------------|---|
| D1, D2 MD1A MD2A 0,2 mm 0,3 mm | 859224 (807294) 859225 (807298) | 13 024 13 025 |  |
| D1, D2, D3 MD1B AQD2B MD2B MD3B 0,2 mm 0,3 mm | 859138 (833497) 859148 (833498) | 13 497 13 498 |  |
| D11, D17 MD11C, MD11D MD17C, MD17D 0,2 mm 0,3 mm | 833780 833781 | 13 780 13 781 |  |

Cylinderlocksbulsets / Cylinder head screw kits

| Motor typ Engine type | Ref.nr. Ref. No. | Best.nr. Part No. | |
|--|----------------------------|----------------------|---|
| <p>B21, B23, B25</p> <p>AQ120B, AQ125A, AQ140A BB140A</p> <p>230A, 230B AQ125B AQ131A, AQ131B, AQ131C, AQ131D AQ145A, AQ145B BB145A</p> <p>250A, 250B AQ151A, AQ151B, AQ151C</p> <p>1 sats åtgår / 1 set required</p> | 10 x 1306341 | 13341 |  |
| <p>B25</p> <p>251A AQ171A, AQ171C</p> <p>1 sats åtgår / 1 set required</p> | 3 x 1326239 7 x 1317761 | 13416 |  |

Spridarhylssats / Injector sleeve kit

| | | | |
|---|--------------------|--------------|---|
| <p>D31, D41, D42, D43</p> <p>AD31A, AD31B, AD31L-A, AD31P-A AD31XD AQAD31A MD31A TAMD31A, TAMD31B, TAMD31D TAMD31L-A, TAMD31M-A, TAMD31P-A TMD31A, TMD31B, TMD31D, TMD31L-A</p> <p>AD41A, AD41B, AD41D AD41L-A, AD41P-A AQAD41A D41A, D41B, D41D, D41L-A TAMD41A, TAMD41B, TAMD41D TAMD41H-A, TAMD41L-A TAMD41M-A, TAMD41P-A TMD41A, TMD41B, TMD41D, TMD41L-A</p> <p>KAD42A, KAD42B, KAD42P-A KAMD42A, KAMD42B, KAMD42P-A TAMD42B, TAMD42WJ-A</p> <p>KAD43P-A* KAMD43P-A</p> <p>* Tidigare utförande / Earlier version Packningar ingår / Gaskets included</p> | 861255 (838609) | 11609 |  |
|---|--------------------|--------------|---|

Oljefilter / Oil filters

| Motor typ Engine type | Ref.nr Ref. No. | Best.nr Part No. | |
|---|---|---------------------|---|
| 2001, 2002, 2003 D1, D2, D3, D5, D6, D7, D11, D17 MB10 2001, 2001AG, 2001B, 2001BG 2002, 2002AG, 2002B, 2002BG 2003, 2003AG, 2003B, 2003BG 2003T, 2003TB MD1B AQD2B D2A, MD2, MD2A, MD2B MD3B MD5A, MD5B, MD5C MD6A, MD6B MD7A, MD7B MD11C, MD11D MD17C, MD17D MB10A | 834337 (897321) | 14337 |  |
| 2010 MD2010A MD2010B | 861473 | 14473 |  |
| 2010, 2020, 2030, 2040 D2 MD2010C, MD2010D MD2020A, MD2020B, MD2020C MD2020D MD2030A, MD2030B, MD2030C MD2030D MD2040A, MD2040B, MD2040C MD2040D D2-55 | 3581621 (861475) (861474) (3580228) (3580454) | 14621 |  |
| D22 MD22A MD22L-A TMD22A | 861476 | 14476 |  |

Oljefilter forts. / Oil filters cont.

| Motor typ Engine type | Ref.nr Ref. No. | Best.nr Part No. | |
|--|--|---------------------|--|
| <p>B18, B20, B21, B23, B25, B30 D22, D30, D31, D32, D300</p> <p>AQ60F, AQ90, AQ95, AQ105, AQ110 AQ120 BB30, BB100</p> <p>AQ115A, AQ115B AQ130A, AQ130B, AQ130C, AQ130D BB115A, BB115B, BB115C MB20A, MB20C, MB20C</p> <p>AQ120B, AQ125A, AQ140A BB140A</p> <p>230A, 230B AQ125B AQ131A, AQ131B, AQ131C, AQ131D AQ145A, AQ145B BB145A</p> <p>250A, 250B, 251A AQ151A, AQ151B, AQ151C AQ171A, AQ171C</p> <p>AQ165A, AQ170A, AQ170B, AQ170C</p> <p>BB165A, BB170A, BB170B, BB170C</p> <p>AQD21A*, AQD21B* MD21A, MD21B</p> <p>MD22L-B, MD22P-B TAMD22P-B TMD22B</p> <p>AD30A AQAD30A MD30A TAMD30A TMD30A</p> <p>AD31A, AD31B, AD31D AD31L-A, AD31P-A AD31XD AQAD31A MD31A TAMD31A, TAMD31B, TAMD31D TAMD31L-A, TAMD31M-A, TAMD31P-A TMD31A, TMD31B, TMD31D</p> <p>KAD32P-A</p> <p>KAD300A KAMD300A</p> <p>* Tidigare utförande / Earlier version Upp till / Up to MO - 103386</p> | <p>3517857 (1266286) (418432) (430143)</p> | <p>14057</p> |  |

Oljefilter forts. / Oil filters cont.

| Motor typ Engine type | Ref.nr Ref. No. | Best.nr Part No. | |
|--|--------------------|---------------------|--|
| 4,3, V 6 4,3GL, 4,3GS, 4,3LK 430A, 430B 431A, 431B 432A, 434A AQ175A AQ205A | 841750 | 14750 |  |
| V-8 5,0FL, Fi 5,8FL, Fi AQ190A AQ240A | 835779 | 14779 |  |
| V-8 5,0GL,Gi 5,7GS,GSi,GXi 7,4GL,Gi,GSi BY,WT,EF 8,1 Gi,GSi 8,2GL 8,2GSi BY,WT,EF | 3850559 | 14559 |  |

Oljefilter forts. / Oil filters cont.

| Motor typ Engine type | Ref.nr Ref. No. | Best.nr Part No. | |
|---|--------------------|---------------------|--|
| <p>V-6, V-8</p> <p>3,0GS</p> <p>5,7GL, 5,7GLi, 5,7GSi</p> <p>7,4GL, 7,4GSi, 7,4Gi</p> <p>BB231A</p> <p>500A, 500B</p> <p>501A, 501B</p> <p>570A</p> <p>571A</p> <p>572A</p> <p>740A,740B</p> <p>AQ200A, AQ200C, AQ200D, AQ200F</p> <p>AQ211A</p> <p>AQ225A, AQ225B, AQ225C, AQ225D AQ225E, AQ225F</p> <p>AQ231A, AQ231B</p> <p>AQ255A, AQ255B</p> <p>AQ260A, AQ260B</p> <p>AQ271A, AQ271B, AQ271C, AQ271D</p> <p>AQ280A</p> <p>AQ290A</p> <p>AQ311A, AQ311B</p> <p>BB225A, BB225AV, BB225B, BB225C</p> <p>BB260A, BB260AV, BB260B, BB260C</p> <p>BB261A</p> | <p>835440</p> | <p>14440</p> |  |

Oljefilter forts. / Oil filters cont.

| Motor typ Engine type | Ref.nr Ref. No. | Best.nr Part No. | |
|---|--|---------------------|---|
| <p>D21, D32, D61, D63 D71, D72, D73, D74, D75</p> <p>AQD21A*, AQD21B* MD21A*, MD21B*</p> <p>AQD32A MD32</p> <p>TAMD61A</p> <p>TAMD63P-A</p> <p>TAMD71A</p> <p>TAMD72A, TAMD72P-A, TAMD72WJ-A</p> <p>TAMD73P-A, TAMD73WJ-A</p> <p>TAMD74A-A, TAMD74A-B, TAMD74C-A TAMD74C-B, TAMD74L-A, TAMD74L-B TAMD74P-A, TAMD74P-B</p> <p>TAMD75P-A</p> <p>61, 63, 71, 72, 73, 74, 75 for by-pass</p> <p>* Senare utförande / Later version Från / From MO 103387 -</p> | <p>3827069 (829390) (829161)</p> | <p>14390</p> |  |
| <p>D40, D41, D42, D70</p> <p>AD40B AQAD40A, AQAD40B AQD40A MD40A TAMD40A, TAMD40B TMD40A, TMD40B, TMD40C</p> <p>AD41A, AD41B, AD41D AD41L-A, AD41PA AQAD41A AQD41A D41A, D41B, D41D, D41L-A TAMD41A, TAMD41B, TAMD41D TAMD41H-A, TAMD41L-A, TAMD41M-A TAMD41P-A TMD41A, TMD41B, TMD41D, TMD41L-A</p> <p>TAMD42WJ-A</p> <p>AQD70BL, AQD70CL, AQD70D TAMD70D, TAMD70E THAMD70B, THAMD70C</p> | <p>471034</p> | <p>14034</p> |  |

Oljefilter forts. / Oil filters cont.

| Motor typ Engine type | Ref.nr Ref. No. | Best.nr Part No. | |
|--|--|---------------------|--|
| <p>D42, D43, D44, D50, D60, D70 D100, D120</p> <p>KAD42A, KAD42B, KAD42P-A KAMD42A, KAMD42B, KAMD42P-A TAMD42B</p> <p>KAD43P-A KAMD43P-A</p> <p>KAD44P-A KAMD44P-A KAD44P-A, KAD44P-C KAMD44P-B, KAMD44P-C</p> <p>MD50A, MD50AK TMD50A, TMD50AK</p> <p>TAMD60A, TAMD60B, TAMD60C TD60A, TD60B, TD60BG, TD60BPP TD60D, TD60D-83, TD60DG-83 TD60DPP-83 TID60D, TID60DG</p> <p>AQD70B, AQD70C D70B, D70BK, D70CHC, D70CRC MD70A, MD70B, MD70BK, MD70C TAMD70B, TAMD70C TD70B, TD70CHC, TD70CRC TMD70A, TMD70AB, TMD70B, TMD70C</p> <p>D100A, D100AK, D100B, D100BHC D100BK, D100BRC MD100A, MD100B, MD100BCC MD100BK TD100A, TD100AG, TD100AHC TD100AK, TD100ARC TMD100A, TMD100ACC, TMD100AK</p> <p>D120A, D120AK MD120A, MD120AK TAD120AHC TAMD120A, TAMD120AK TD120A, TD120AG, TD120AGPP TD120AHC, TD120AK, TD120ARC TMD120A, TMD120ACC, TMD120AK</p> | <p>423135 (4785974) (423135)</p> | <p>14974</p> |  |

Oljefilter forts. / Oil filters cont.

| Motor typ Engine type | Ref.nr Ref. No. | Best.nr Part No. | |
|---|--------------------|---------------------|--|
| <p>D12, D61, D62, D70, D71, D73 D100, D102, D103, D120, D121, D122 D610, D630, D640 D710, D730, D731 D740, D741 D1210, D1211, D1230, D1231</p> <p>D12-AMP</p> <p>TAMD61A TD61A, TD61ACE, TD61AG, TD61AGP TD61AP, TD61APB, TD61AW TID61AG, TID61AGP</p> <p>TAMD62A</p> <p>TD70G, TD70G-83, TD70GG TD70GG-83, TD70GPP, TD70PP-83 TID70G, TID70GG, TID70GPP</p> <p>TAMD71A TD71A, TD71ACE, TD71AG, TD71AGP TD71AP, TD71APB, TD71AW, TD71FSQ TID71A, TID71AG, TID71AGP, TID71AP TID71APB</p> <p>TD73E, TD73ES</p> <p>TD100CHC, TD100CRC, TD100G TD100G-85, TD100G-87, TD100GG TD100GG-85, TD100GG-87 TD100GPP-87, TD100GP, TD100GP-85 TD100HP-87, TD100HPB-87 TID100K, TID100K-87, TID100KG TID100KG-87, TID100KGP-87 TID100KP, TID100KP-87, TID100KPG-87 TMD100C</p> <p>TMD102A</p> <p>TAMD103A-A</p> <p>TAD120BHC, TAD120CHC TAMD120B, TAMD120BCC TD120BHC, TD120BRC, TD120C TD120G, TD120GG, TD120H TD120HP-86, TD120HPP TID120FG, TID120FPP, TID120HPP TMD120B</p> <p>TAD121CHC TAMD121C, TAMD121D TD121CHC, TD121CRC, TD121G TD121G-87, TD121GG, TD121GG-86 TD121GG-87, TD121GPP-87 TD121GP-87, TD121GPB-87 TID121K, TID121K-87, TID121KG TID121KG-87, TID121KGP-87 TID121KP, TID121KP-87, TID121KPB-87 TID121L-87, TID121LG, TID121LG-87 TID121LGP-87, TID121LGU-87 TID121LPTID121LP-87, TID121LPB-87 TMD121C</p> <p>Fortsättning på nästa sida / Continue on next page.</p> | <p>466634</p> | <p>14634</p> |  |

Oljefilter forts. / Oil filters cont.

| Motor typ Engine type | Ref.nr Ref. No. | Best.nr Part No. | |
|---|--------------------|---------------------|--|
| <p><i>Fortsättning från föregående sida / Continue from prev. page.</i></p> <p>D12, D61, D62, D70, D71, D73 D100, D102, D103, D120, D121, D122 D610, D630, D640 D710, D730, D731 D740, D741 D1210, D1211, D1230, D1231</p> <p>TAMD122A, TAMD122C, TAMD122P-A TMD122A</p> <p>TD610G, TD610M, TD610V TWD610G, TWD610V</p> <p>TD630ME, TD630VE TWD630ME, TWD630VE</p> <p>TD640VE</p> <p>TD710G TWD710G, TWD710V</p> <p>TD730ME, TD730VE TAD730G, TAD730V TWD730ME</p> <p>TWD731ME, TWD731VE</p> <p>TAD740GE TWD740GE, TWD740VE</p> <p>TAD741GE</p> <p>TWD1210V</p> <p>TWD1211V</p> <p>TAD1230V</p> <p>TWD1230VE</p> <p>TWD1231VE</p> | <p>466634</p> | <p>14634</p> |  |





Vevhusfilter / Crankcase filter

| Motor typ Engine type | Ref.nr Ref. No. | Best.nr Part No. | |
|--|----------------------------|---------------------|--|
| <p>D30, D31, D32, D40, D41</p> <p>AD30A AQAD30A MD30A TAMD30A TMD30A</p> <p>AD31A, AD31B AQAD31A MD31A TAMD31A, TAMD31B TAMD31L-A, TAMD31M-A TMD31A, TMD31B</p> <p>KAD32P-A</p> <p>AD40B AQAD40A, AQAD40B AQD40A MD40A TAMD40A, TAMD40B TMD40A, TMD40B, TMD40C</p> <p>AD41A, AD41B AQAD41A D41A, D41B TAMD41A, TAMD41B, TAMD41P-A TMD41A, TMD41B</p> <p>Filtret förekommer även på följande grundmotorer. / To be used also for the following base engines:</p> <p>D12, D60, D61, D62, D63 D70, D71, D72, D73, D74 D100, D102, D103 D120, D121, D122, D162, D163 D610, D630 D710, D730, D731, D740, D741</p> | <p>876069 (875850)</p> | <p>14069</p> |  |

Oljepumpar / Oil pumps

| Motor typ Engine type | Ref.nr Ref. No. | Best.nr Part No. | |
|--|---------------------------------|---------------------|---|
| B18, B20 AQ60F, AQ90, AQ95, AQ110, AQ120 BB30, BB100 AQ105 AQ115A, AQ115B AQ130A, AQ130B, AQ130C, AQ130D BB115A, BB115B, BB115C MB20A, MB20B, MB20C | 1218706 (418280) (149542) | 14706 |  |
| B30 AQ165A AQ170A, AQ170B, AQ170C BB165A BB170A, BB170B, BB170C | 461677 (430190) | 14677 |  |
| B21, B23 AQ120B* AQ125A* AQ140A* BB140A* * Tid. utförande / Earlier version AQ125B AQ145A BB145A | 1219946 | 14946 |  |
| B21, B23, B25 AQ120B* AQ125AB* AQ140A* BB140A* * Senare utf. / Later version 230A, 230B AQ125B AQ131A, AQ131B, AQ131C, AQ131D AQ145A, AQ145B BB145A 250A, 250B, 251A AQ151A, AQ151B, AQ151C AQ171A, AQ171C | 1346144 (1276336) | 14144 |  |

Oljetrågspackningar / Oil pan gaskets

| Motor typ Engine type | Ref.nr Ref. No. | Best.nr Part No. | |
|--|--|---------------------|---|
| <p>B18, B20, B21, B23, B25</p> <p>AQ60F, AQ90, AQ95, AQ95A, AQ110 AQ120 BB30, BB100 MB18</p> <p>AQ105, AQ115A, AQ115B AQ130A, AQ130B, AQ130C, AQ130D BB115A, BB115B, BB115C MB20A, MB20B, MB20C</p> <p>AQ120B, AQ125A, AQ140A BB140A</p> <p>230A, 230B AQ125B, AQ131A, AQ131B, AQ131C, AQ131D AQ145A, AQ145B BB145A</p> <p>250A, 250B, 251A AQ151A, AQ151B, AQ151C AQ171A, AQ171C</p> | <p>1378864 (463587) (418262)</p> | <p>14864</p> |  |
| <p>B30</p> <p>AQ165A AQ170A, AQ170B, AQ170C BB165A BB170A, BB170B, BB170C</p> | <p>1378914 (461113)</p> | <p>14914</p> |  |
| <p>D1, D2, D11</p> <p>D1A, MD1A, MD1B D2A, MD2A, MD2B MD11C, MD11D</p> | <p>859159 (833792)</p> | <p>11159</p> |  |
| <p>D3, D17</p> <p>MD3B MD17C, MD17D</p> | <p>859189 (833047)</p> | <p>14189</p> |  |
| <p>D5</p> <p>MD5A MD5B MD5C</p> | <p>859031 (838235)</p> | <p>14031</p> |  |

Oljetrågspackningar forts. / Oil pan gaskets cont.

| Motor typ Engine type | Ref.nr Ref. No. | Best.nr Part No. | |
|---|---------------------------------|---------------------|---|
| D6, D7 MD6A, MD6B MD7A, MD7B | 859036 (3875377) | 14036 |  |
| D22 MD22A, MD22L-A, MD22L-B, MD22P-B TAMD22P-B TMD22A, TMD22B | 861603 (833792) | 14603 NEW |  |
| 2001, 2002, 2003 2001, 2001AG, 2001B, 2001BG 2002, 2002AG, 2002B, 2002BG 2003, 2003AG, 2003B, 2003BG 2003T, 2003TB Tätmassa i tub till oljetråg / Sealant for oil pan. | 840879 | 14879 |  |
| D21 AQD21A, AQD21B MD21A, MD21B | 840648 (818035) | 14005 |  |
| D30, D31, D32 AD30A AQAD30A MD30A TAMD30A TMD30A AD31A, AD31B, AD31D AD31L-A, AD31P-A AD31XD AQAD31A MD31A TAMD31A, TAMD31B, TAMD31D TAMD31L-A, TAMD31M-A, TAMD31P-A TMD31A, TMD31B, TMD31D TMD31L-A KAD32P-A | 861250 (860684) (1544124) | 14250 |  |



Oljetrågspackningar forts. / Oil pan gaskets cont.

| Motor typ Engine type | Ref.nr Ref. No. | Best.nr Part No. | |
|---|--|---------------------|---|
| <p>D40, D41, D42, D43, D44 D300</p> <p>AD40A AQAD40A, AQAD40B AQD40A MD40A MD40A TAMD40A, TAMD40B TMD40A, TMD40B, TMD40C</p> <p>AD41A, AD41B, AD41D AD41L-A, AD41P-A AQAD41A D41A, D41B, D41D, D41L-A TAMD41A, TAMD41B, TAMD41D TAMD41H-A, TAMD41L-A TAMD41L-A, TAMD41M-A TAMD41P-A TMD41A, TMD41B, TMD41D TMD41L-A</p> <p>KAD42A, KAD42B, KAD42P-A KAMD42A, KAMD42B, KAMD42P-A TAMD42B, TAMD42WJ-A</p> <p>KAD43P-A KAMD43P-A</p> <p>KAD44P-A, KAD44P-B, KAD44P-C KAMD44P-A, KAMD44P-B KAMD44P-C</p> <p>KAD300A KAMD300A</p> | <p>861251 (860685) (1542247)</p> | <p>14251</p> |  |

Oljeavtappingsplugg / Oil drain plug

| Motor typ Engine type | Ref.nr Ref. No. | Best.nr Part No. | |
|---|--------------------|---------------------|---|
| <p>B18, B20, B21, B23, B25, B30 D30, D31, D32 D40, D41, D42, D43, D44 D300</p> <p>AQ60F, AQ90, AQ95, AQ110, AQ120 BB30, BB100 AQ105 AQ115A, AQ115B AQ130A, AQ130B, AQ130C, AQ130D BB115A, BB115B, BB115C MB20A, MB20B, MB20C AQ120B, AQ125A, AQ140A BB140A 230A, 230B AQ125B, AQ131A, AQ131B, AQ131C, AQ131D AQ145A, AQ145B BB145A 250A, 250B, 251A AQ151A, AQ151B, AQ151C AQ171A, AQ171C AD30A AQAD30A MD30A TAMD30A TMD30A AD31A, AD31B, AD31D AD31L-A, AD31P-A AD31XD AQAD31A MD31A TAMD31A, TAMD31B, TAMD31D TAMD31L-A, TAMD31M-A, TAMD31P-A TMD31A, TMD31B, TMD31D TMD31L-A KAD32P-A AD40A AQAD40A, AQAD40B AQD40A MD40A MD40A TAMD40A, TAMD40B TMD40A, TMD40B, TMD40C AD41A, AD41B, AD41D AD41L-A, AD41P-A AQAD41A D41A, D41B, D41D, D41L-A TAMD41A, TAMD41B, TAMD41D TAMD41H-A, TAMD41L-A TAMD41L-A, TAMD41M-A TAMD41P-A TMD41A, TMD41B, TMD41D TMD41L-A KAD42A, KAD42B, KAD42P-A KAMD42A, KAMD42B, KAMD42P-A TAMD42B, TAMD42WJ-A KAD43P-A KAMD43P-A KAD44P-A, KAD44P-B, KAD44P-C KAMD44P-A, KAMD44P-B KAMD44P-C KAD300A KAMD300A</p> | <p>948187</p> | <p>14001</p> |  |

Impellersatser / Impeller kits

| Motor typ Engine type | Ref.nr Ref. No. | Best.nr Part No. | |
|--|--|---------------------|---|
| <p>MB10 D1, D2, D6, 2010, 2020</p> <p>MB10A</p> <p>D1A MD1A, MD1B</p> <p>AQD2B D2A, MD2, MD2A, MD2B</p> <p>MD6A</p> <p>MD2010A, MD2010B*</p> <p>MD2020A, MD2020B*</p> <p>* Upp till / Up to Mo. - 5101203007 Tidigare utförande med glidlager / Earlier version with plain bearing Impeller : Ø 39 mm H = 19 mm, shaft Ø 9,5 mm</p> | <p>3586494 (875807) (876689)</p> | <p>15807</p> |  |
| <p>B16, B18, B20 D3, D17 2010, 2020, 2030</p> <p>AQ80 BB25, BB70 MB16</p> <p>AQ60F, AQ90, AQ95, AQ95A, AQ110 AQ120 BB30, BB100 MB18</p> <p>AQ105A AQ115A, AQ115B AQ130A, AQ130B, AQ130C, AQ130D BB115, BB115B, BB115C MB20A, MB20B, MB20C</p> <p>MD3B</p> <p>MD17C, MD17D</p> <p>MD2010B* MD2020B* MD2030, MD2030B MD2040, MD2040B</p> <p>* Från / From Mo. 5101203008 - Impeller Ø 50 mm H = 22 mm</p> | <p>3593659 (875808) (3580066) (897055) (804696) (876690)</p> | <p>15808</p> |  |



Impellersatser forts. / Impeller kits cont.

| Motor typ Engine type | Ref.nr Ref. No. | Best.nr Part No. | |
|---|-----------------------------|---------------------|---|
| <p>MB10 D1, D2, D5, D6, D7, D11 2001, 2002, 2003</p> <p>MB10A*</p> <p>D1A, MD1A D2A, MD2A</p> <p>MD5A, MD5B, MD5C</p> <p>MD6B</p> <p>MD7A, MD7B</p> <p>MD11C, MD11D</p> <p>2001, 2001AG, 2001B, 2001BG 2002, 2002AG, 2002B, 2002BG 2003, 2003AG, 2003B, 2003BG</p> <p>*..För kullagrad pump / * For ball bearing pump Impeller: Ø 39 mm H = 19 mm, shaft Ø 12 mm</p> | <p>3586496 (875583)</p> | <p>15583</p> |  |
| <p>B21, B23, B25, B30 D21, D32</p> <p>AQ120B, AQ125A BB140A</p> <p>230A, 230B AQ125B AQ131A, AQ131B, AQ131C, AQ131D AQ145A, AQ145B BB145A</p> <p>250A, 250B, 251A AQ151A, AQ151B, AQ151C AQ171A, AQ171C</p> <p>AQ165A, AQ170A, AQ170B, AQ170C BB165A, BB170A, BB170B, BB170C</p> <p>AQD21A*, AQD21B MD 21A *, MD 21B</p> <p>* Från / From MO 103387 -</p> <p>Impeller Ø 57 mm H = 31 mm Med kilspår / With key groove</p> | <p>875575 (831182)</p> | <p>15575</p> |  |

Impellersatser forts. / Impeller kits cont.

| Motor typ Engine type | Ref.nr Ref. No. | Best.nr Part No. | |
|---|---|---------------------|---|
| <p>3,0, 4,3, 5,7, 7,4, 8,1 430, 431, 432, 434 500, 501, 570, 571, 572 V-6, V-8</p> <p>D21, D22, 2003 D375, D420</p> <p>3,0GS LK</p> <p>4,3GL LK, 4,3GS LK, 4,3Gi LK 430A, 430B, 431A, 431B, 432A, 434A, AQ175A</p> <p>5,7GL LK, 5,7GLi LK, 5,7GSi LK 7,4GL LK, 7,4GSi LK, 7,4Gi LK 8,1GSi-A, 8,1GSiL-A, 8,1GXi-A 8,1GXi-AF, 8,1GXi-B, 8,1GXi-BF 8,1GXi-C, 8,1GXi-CF, 8,1GXiL-A 8,1GXiL-B, 8,1GXiL-C, 8,1Gi-A 8,1Gi-B, 8,1Gi-BF, 8,1Gi-C 8,1Gi-CF, 8,1Gi-D, 8,1Gi-DF 8,1GiL-B, 8,1GiL-C, 8,1GiL-D</p> <p>500A, 501A, 570A, 571A, 572A</p> <p>AQ150A, AQ150B AQ231A, AQ231B</p> <p>AQ200D, AQ200F AQ211A AQ225D, AQ225F AQ255B AQ260A AQ271A, AQ271B, AQ271C, AQ271D AQ290A BB225A, BB225AV, BB225B, BB225C BB260A, BB260AV</p> <p>DPX375-A, DPX375-B, DPX375BF DPX375-CF DPX420-A, DPX420B, DPX420-BF DPX420-CF</p> <p>2003T, 2003TB</p> <p>AQD21A* MD21A*</p> <p>MD22A, MD22L-A, MD22L-B, MD22P-B TAMD22P-B TMD22A, TMD22B</p> <p>V8-För pump monterad på vevaxeln med fyra skruvar i impellerlocket / V8 - For pump mounted on the crankshaft with four screws in impeller cover</p> <p>* Upp till / Up to MO -103386</p> <p>Impeller Ø 57 mm H = 31 mm Med splines / With splines</p> | <p>21213660 (3862567) (38622811) (3858256) (875811) (829940) (876243) (3855546) (3856039)</p> | <p>15811</p> |  |

Impellersatser forts. / Impeller kits cont.

| Motor typ Engine type | Ref.nr Ref. No. | Best.nr Part No. | |
|--|-----------------------------|---------------------|---|
| <p>V-8</p> <p>AQ200C AQ225A, AQ225B, AQ225C AQ255A</p> <p>För pump med remdrift / For pump with belt drive Impeller Ø 61 mm H = 31,5 mm</p> | <p>3854286 (835512)</p> | <p>15512</p> |  |
| <p>V-8</p> <p>AQ190A, AQ240A</p> <p>För pump med remdrift / For pump with belt drive Impeller Ø 64 mm H = 41 mm</p> | <p>835874</p> | <p>15874</p> |  |
| <p>V-6, V-8</p> <p>431A BB231A</p> <p>570A, 571A, 572A, 740A, 740B</p> <p>AQ200D, AQ205A AQ225D AQ255B AQ260A, AQ260B AQ271A, AQ271B, AQ271C, AQ271D AQ280A, AQ290A AQ311A, AQ311B, BB225A, BB225AV, BB225B BB260A, BB260AV BB261A</p> <p>V8-För pump monterad på vevaxeln med sex skruvar i impellerlocket / V8-Pump mounted on crankshaft with six screws in impeller cover Impeller Ø 57 mm H = 50 mm Med splines / With splines</p> | <p>876120 (834794)</p> | <p>15120</p> |  |

Impellersatser forts. / Impeller kits cont.

| Motor typ Engine type | Ref.nr Ref. No. | Best.nr Part No. | |
|---|---|---------------------|--|
| <p>D29, D30, D31, D32 D40, D41, D42, D43, D44 D60, D70 D100, D102, D120, D121 D300</p> <p>AQD29, AQD29A MD29, MD29A</p> <p>AD30A AQAD30A MD30A TAMD30A TMD30A</p> <p>AD31A, AD31B, AD31D AD31L-A, AD31P-A, AD31XD AQAD31A MD31A TAMD31A, TAMD31B, TAMD31D TAMD31L-A, TAMD31M-A, TAMD31P-A TMD31A, TMD31B, TMD31D TMD31L-A</p> <p>AQD32A KAD32P-A MD32A</p> <p>AQD40A MD40A TMD40A, TMD40B, TMD40C</p> <p>AD41A, AD41B, AD41D AD41L-A, AD41P-A, AQAD41A D41A, D41B, D41D, D41L-A TAMD41A, TAMD41B, TAMD41D TAMD41H-A, TAMD41L-A TAMD41M-A, TAMD41P-A TMD41A, TMD41B, TMD41D, TMD41L-A</p> <p>KAD42B, KAD42P-A KAMD42B, KAMD42P-A TAMD42B, TAMD42WJ-A</p> <p>KAD43P-A KAMD43P-A</p> <p>KAD44P-A, KAD44P-C KAMD44P-A, KAMD44P-B, KAMD44P-C</p> <p>För pump med sex skruvar i locket / For pump with six screws in cover Impeller Ø 65 mm H = 50 mm</p> <p>Forts. nästa sida. / Cont. next page.</p> | <p>3841697 (877061) (875593) (807904)</p> | <p>15593</p> |  |

Impellersatser forts. / Impeller kits cont.

| Motor typ Engine type | Ref.nr Ref. No. | Best.nr Part No. | |
|--|---|---------------------|---|
| <p>Forts. / Cont.</p> <p>D29, D30, D31, D32 D40, D41, D42, D43, D44 D60, D70 D100, D102, D120, D121 D300</p> <p>TMD60A, TMD60B, TMD60C</p> <p>AQD70B, AQD70BL, AQD70C AQD70CL, AQD70D D70CHC MD70B, MD70BK, MD70C, TAMD70B, TAMD70C, TAMD70D TAMD70E TD70CHC THAMD70B, THAMD70C TMD70B, TMD70C</p> <p>MD100A, MD100B, MD100BCC MD100BK TMD100A, TMD100ACC, TMD100AK</p> <p>TAMD102A</p> <p>MD120A, MD120AK TAMD120A, TAMD120AK TAMD120B, TAMD120BCC TMD120A, TMD120ACC, TMD120AK TMD120B</p> <p>TAMD121D, TMD121C</p> <p>KAD300A, KAMD300A</p> <p>För pump med sex skruvar i locket / For pump with six screws in cover Impeller Ø 65 mm H = 50 mm</p> | <p>3841697 (877061) (875593) (807904)</p> | <p>15593</p> |  |

Impellersatser forts. / Impeller kits cont.

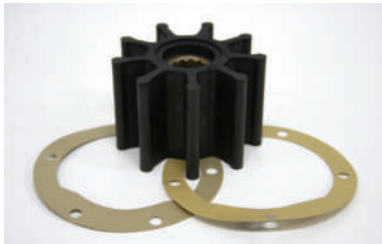
| Motor typ Engine type | Ref.nr Ref. No. | Best.nr Part No. | |
|--|--|---------------------|---|
| <p>D40, D61, D62, D70, D71 D100, D102, D120, D121, D122</p> <p>AD40B AQAD40A, AQAD40B TAMD40A, TAMD40B</p> <p>TAMD61A</p> <p>TAMD62A</p> <p>TD70CHC</p> <p>TAMD71A, TAMD71B</p> <p>D100BHC MD100A MD100B, MD100BCC, MD100BK TD100AHC, TD100CHC TMD100A, TMD100ACC, TMD100AK TMD100C</p> <p>TAMD102A TMD102A</p> <p>MD120A, MD120AK TAD120AHC TAMD120A, TAMD120AK TAMD120B, TAMD120BCC TD120AHC, TD120BHC TMD120A, TMD120ACC, TMD120AK TMD120B</p> <p>TAMD121D TD121CHC TMD121C</p> <p>TAMD122C, TAMD122D TMD122A</p> <p>För pump med fem skruvar i locket / For pump with five screws in cover Impeller \varnothing 95 mm H = 63 mm</p> | <p>21430184 (875736) (875660) (825942)</p> | <p>15660</p> |  |

Impelleravdragare / Impeller puller

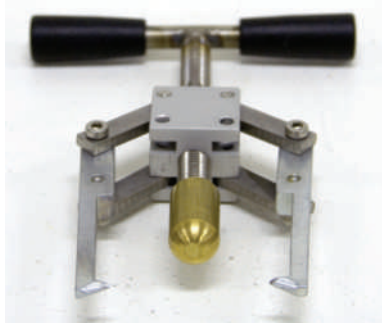
| | | | |
|--|--|---------------------|---|
| <p>Impuller</p> <p>För alla utförande / For all versions</p> | | <p>15999</p> |  |
|--|--|---------------------|---|

Vattenfilter för sötvattenkyllning / Water filter for fresh water cooling

| Motor typ Engine type | Ref.nr Ref. No. | Best.nr Part No. | |
|---|--------------------|---------------------|---|
| <p>Vattenfiltret monteras i motorns kylsystem för att eventuella rostflagor inte skall sätta igen slangar eller skada cirkulationspumpen / Water filter to be mounted in connection with cooling system to avoid stops in pipes and hoses</p> | | 15637 |  |

Pinwing - skruvsatser för impellerlock / Pinwing - screw kits for impeller cover

| | | | |
|---|--|-------|---|
| <p>B18*, B20*, B30, MB10, V-8 D1, D2, D3*, D6, D17*, D21, D22 2010, 2020, 2030, 2040</p> <p>MB10A</p> <p>AQ60, AQ90, AQ110, AQ120A BB30, BB100 MB18</p> <p>AQ105A AQ115A, AQ115B AQ130A, AQ130B, AQ130C, AQ130D BB115A, BB115B, BB115C MB20A, MB20B, MB20C</p> <p>AQ165A, AQ170A, AQ170B, AQ170C BB165A, BB170A, BB170B, BB170C</p> <p>AQ200D, AQ225D, AQ255B, AQ260A AQ280A, AQ290A BB225A, BB225AV, BB225B, BB260A BB260AV, BB260B</p> <p>MD1A, MD1B</p> <p>MD2A, MD2B</p> <p>MD3B</p> <p>MD6A, MD6B</p> <p>MD17C, MD17D</p> <p>MD21A, MD21B</p> <p>MD22A, TMD22A</p> <p>MD2010A</p> <p>MD2020A</p> <p>MD2030A</p> <p>MD2040A</p> <p>Med sex skruvar i locket / With six screws in cover * Ej för kullagrad pump / * Not for ball bearing pump</p> | | 15350 |  |
|---|--|-------|---|

Pinwing - skruvsatser för impellerlock forts / Pinwing - screw kits for impeller cover cont.

| Motor typ Engine type | Ref.nr Ref. No. | Best.nr Part No. | |
|--|--------------------|---------------------|---|
| <p>D5, D7, D11 2001, 2002, 2003</p> <p>MD5A, MD5B, MD5C</p> <p>MD7A, MD7B</p> <p>MD11C, MD11D</p> <p>2001, 2002, 2003</p> <p>Med fyra skruvar i locket / With four screws in cover</p> | | <p>15351</p> | |
| <p>B18, B20 D3, D17 2003</p> <p>AQ60, AQ90, AQ100, AQ110, AQ120A BB30, BB100 MB18</p> <p>AQ105A, AQ115A, AQ115B AQ130A, AQ130B, AQ130C, AQ130D MB20A, MB20B, MB20C</p> <p>MD3B</p> <p>MD17C, MD17D</p> <p>2003T</p> <p>För kullagrad pump med sex skruvar i locket / For ball bearing pump with six screws in cover</p> | | <p>15932</p> |  |

Pinwing - skruvsatser för impellerlock forts / Pinwing - screw kits for impeller cover cont.

| Motor typ Engine type | Ref.nr Ref. No. | Best.nr Part No. | |
|---|--------------------|---------------------|---|
| <p>D30, D40, D41, D42</p> <p>AD30A AQAD30A MD30A TAMD30A TMD30A</p> <p>AD31A, AD31B, AD31D AD31L-A, AD31P-A, AD31XD AQAD31A MD31A TAMD31A, TAMD31B, TAMD31D TAMD31L-A, TAMD31M-A, TAMD31P-A TMD31A, TMD31B, TMD31D TMD31L-A</p> <p>KAD32P-A</p> <p>AQD40A MD40A TMD40A, TMD40B, TMD40C</p> <p>AD41A, AD41B, AD41D AD41L-A, AD41P-A, AQAD41A D41A, D41B, D41D, D41L-A TAMD41A, TAMD41B, TAMD41D TAMD41H-A, TAMD41L-A TAMD41M-A, TAMD41P-A TMD41A, TMD41B, TMD41D, TMD41L-A</p> <p>KAD42A, KAMD 42A KAD42B, KAD42P-A KAMD42B, KAMD42P-A TAMD42B, TAMD42WJ-A</p> <p>KAD43P-A KAMD43P-A</p> <p>KAD44P-A, KAD44P-C KAMD44P-A, KAMDP-B, KAMD44P-C</p> <p>Med sex skruvar i locket / With six screws in cover</p> | | <p>15934</p> |  |
| <p>V6, V8</p> <p>430A, 430B, 431A, 431B AQ175A</p> <p>500A, 500B, 501A, 570A, 571A, 572A</p> <p>AQ200D, AQ211A, AQ225B, AQ225D AQ225F AQ231A, AQ231B AQ260A, AQ271A, AQ271C, AQ290A AQ311A, AQ311B BB225A, BB225AV, BB225B, BB225C BB231B BB260A, BB260AV, BB260B, BB260C BB261B</p> <p>Med fyra skruvar i locket / With four screws in cover</p> | | <p>15935</p> | |

Pinwing - skruvsatser för impellerlock forts / Pinwing - screw kits for impeller cover cont.

| Motor typ Engine type | Ref.nr Ref. No. | Best.nr Part No. | |
|---|--------------------|---------------------|---|
| <p>D27, D29, D32</p> <p>AQD27 MD27</p> <p>AQD29, AQD29A MD29, MD29A</p> <p>AQD32A MD32A</p> <p>Med sex skruvar i locket / With six screws in cover</p> | | <p>15356</p> |  |
| <p>D40</p> <p>AQAD40A, AQAD40B TAMD40A, TAMD40B</p> <p>Med sex skruvar i locket / With six screws in cover</p> | | <p>15357</p> | |

Reparationsatser för sjövattenpump / Repair kits for sea water pump

| Motor typ Engine type | Ref.nr Ref. No. | Best.nr Part No. | |
|--|--------------------|---------------------|---|
| <p>B18, B20 D3, D17</p> <p>AQ60F, AQ90, AQ95, AQ95A, AQ110 AQ120 BB30, BB100 MB18</p> <p>AQ105A AQ115A, AQ115B AQ130A, AQ130B, AQ130C, AQ130D BB115, BB115B, BB115C MB20A, MB20B, MB20C</p> <p>MD3B</p> <p>MD17C, MD17D</p> <p>Impeller 15808 För pump utan kullager For pump without ball bearing</p> | | 22073 |  |
| <p>B18, B20 D3, D17</p> <p>AQ60F, AQ90, AQ95, AQ95A, AQ110 AQ120 BB30, BB100 MB18</p> <p>AQ105A AQ115A, AQ115B AQ130A, AQ130B, AQ130C, AQ130D BB115, BB115B, BB115C MB20A, MB20B, MB20C</p> <p>MD3B</p> <p>MD17C, MD17D</p> <p>Impeller 15808 För kullagrad pump / For pump with ball bearing Kam ingår ej / Cam not include</p> | (875698) | 15698 |  |
| <p>B30 D21</p> <p>AQ165A AQ170A, AQ170B, AQ170C BB165 BB170A, BB170B, BB170C</p> <p>AQD21A*, AQD21B MD21A*, MD21B</p> <p>* Från / From MO 103387 -</p> <p>Axel med kilspår / Shaft with key groove Kam ingår ej / Cam not include Impeller 15575</p> | 875383 | 15383 |  |



Reparationssatser för sjövattpump forts. / Repair kits for sea water pump cont.

| Motor typ Engine type | Ref.nr Ref. No. | Best.nr Part No. | |
|---|--|--|---|
| <p>B21, B23, B25</p> <p>AQ120B, AQ125A, AQ125B BB140A</p> <p>230A, 230B AQ125B AQ131A, AQ131B, AQ131C, AQ131D AQ145A, AQ145B BB145A</p> <p>250A, 250B, 251A AQ151A, AQ151B, AQ151C AQ171A, AQ171C</p> <p>Impeller 15575 Kam ingår ej / Cam not include</p> | <p>876081 (875574)</p> | <p>15574</p> |  |
| <p>V-6, V-8</p> <p>För pump / For pump 841640</p> <p>AQ175</p> <p>500A, 500B, 501A, 501B 570A, 572A AQ200D, AQ200F AQ211A AQ225D, AQ225F AQ231A, AQ231B AQ255B, AQ260A AQ290A BB225A, BB225AV, BB225B BB225C, BB260A, BB260AV BB260B, BB260C</p> <p>Skruv / Screw (m) 841893 Trycktätning / Seal 841642 Låsring / Lock washer 809444 Kullager / Ball bearing Ø 62 mm 183861</p> <p>Impeller 15811 För pump på vevaxeln med fyra skruvar i impellerlocket / For pump on crankshaft with four screws in impeller cover</p> | <p>841893 841642 809444 183861</p> | <p>15093 15642 15444 15861</p> |  |

Reparationsatser för sjövattpump forts. / Repair kits for sea water pump cont.

| Motor typ Engine type | Ref.nr Ref. No. | Best.nr Part No. | |
|---|-------------------------------------|---|---|
| <p>V-6, V-8</p> <p>För pump / For pump 856952, 857451</p> <p>430A, 430B, 431A, 431B 432A, 434A AQ175A AQ205A</p> <p>500A, 500B, 501A, 501B 570A, 572A AQ200D, AQ200F AQ211A AQ225D, AQ225E, AQ225F AQ231A, AQ231B AQ255B AQ260A, AQ260B AQ271A, AQ271B, AQ271C, AQ271D AQ280A AQ290A AQ311A, AQ311B BB225A, BB225AV, BB225B, BB225C BB231A BB260A, BB260AV BB260B, BB260C BB261A</p> <p>Skruv / Screw (m) Tätning / Seals Ø 12 mm Kullager / Ball bearing Ø 62 mm</p> <p>För pump på vevaxeln med fyra skruvar i impellerlocket / For pump on crankshaft with four screws in impeller cover Impeller 15811</p> | <p>841693 827247 183861</p> | <p>15093 15247 15861</p> |  |

Reparationssatser för sjövattpump forts. / Repair kits for sea water pump cont.

| Motor typ Engine type | Ref.nr Ref. No. | Best.nr Part No. | |
|---|-------------------------------------|---|---|
| <p>V-6, V-8</p> <p>För pump / For pump 826456, 855722, 856513</p> <p>430A, 430B, 431A, 431B AQ205A</p> <p>500A, 500B, 501A, 501B 570A, 571A, 572A 740A, 740B</p> <p>AQ200D, AQ200F AQ225D, AQ225E, AQ225F AQ231A, AQ231B AQ255B AQ260A, AQ260B AQ271A, AQ271B, AQ271C, AQ271D AQ280A AQ290A AQ311A, AQ311B BB225A, BB225AV BB225B, BB225C BB231A BB260A, BB260AV, BB260B BB261A</p> <p>Skruv / Screw (unc) Tätning / Seal \varnothing 12,5 mm Kullager / Ball bearing \varnothing 72 mm</p> <p>För pump på vevaxeln med sex skruvar i impellerlocket / For pump on crankshaft with six screws in impeller cover Impeller 15120</p> | <p>855728 809441 181355</p> | <p>15693 15864 15355</p> |  |
| <p>MB10 D1, D2, D6</p> <p>MB10A</p> <p>D1A MD1B</p> <p>AQD2B D2A MD2, MD2A, MD2B</p> <p>MD6A</p> <p>Impeller 15807 Tidigare utförande med glidlager / Ealier version with plain bearing</p> | | <p>22076</p> |  |

Reparationssatser för sjövattpump forts. / Repair kits for sea water pump cont.

| Motor typ Engine type | Ref.nr Ref. No. | Best.nr Part No. | |
|--|--|---------------------|---|
| <p>D5, D6, D7, D11</p> <p>MD5A, MD5B, MD5C</p> <p>MD6B</p> <p>MD7A, MD7B</p> <p>MD11C, MD11D</p> <p>Lock och kam ingår ej / Cover and cam not included Impeller 15583</p> | 875584 | 15 584 |  |
| <p>2001, 2002, 2003</p> <p>2001, 2001AG, 2001B, 2001BG</p> <p>2002, 2002AG, 2002B, 2002BG</p> <p>2003, 2003AG, 2003B, 2003BG</p> <p>Impeller 15583 Ej för turbo. Lock och kam ingår ej / Not for turbo. Cover and cam not included</p> | 875756 | 15 756 |  |
| <p>D30, D31, D32 D40, D41, D42, D43, D44</p> <p>AD30A AQAD30A MD30A TAMD30A TMD30A</p> <p>AD31A, AD31B, AD31D, AD31XD AQAD31A MD31A TAMD31A, TAMD31B, TAMD31D TMD31A, TMD31B, TMD31D</p> <p>KAD32P-A</p> <p>AQD40A MD40A TMD40A, TMD40B, TMD40C</p> <p>AD41A, AD41B, AD41D AQAD41A</p> <p>D14A, D14B, D14D TAMD41A, TAMD41B, TAMD41D TMD41A, TMD41AB, TMD41D</p> <p>KAD42A, KAD42B, KAD42P-A KAMD42A, KAMD42B, KAMD42P-A TAMD42B, TAMD42WJ-A</p> <p>KAD43P-A KAMD43P-A</p> <p>KAD44P-A KAMD44P-A</p> <p>Impeller \varnothing 65 mm 15593 För pump med sex skruvar i locket / For pump with six screws in cover</p> | 877373 (876088) (876529) (875759) | 22 136 |  |

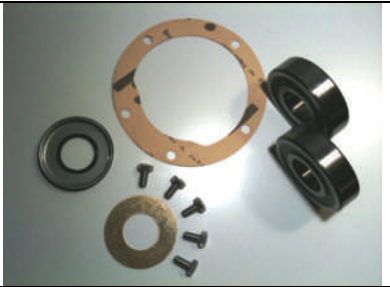

Reparationssatser för sjövattpump forts. / Repair kits for sea water pump cont.

| Motor typ Engine type | Ref.nr Ref. No. | Best.nr Part No. | |
|--|----------------------------|---------------------|---|
| <p>D40</p> <p>AD40B AQAD40A, AQAD40B TAMD40A, TAMD40B</p> <p>För pump med fem skruvar i locket / For pump with five screws in cover Impeller \varnothing 95 mm 15660</p> | <p>875769 (875712)</p> | <p>22137</p> |  |

Packningsatser för sjövattpumpar / Gasket kits for sea water pumps

| | | | |
|--|--|--------------|---|
| <p>B18, B20 D3, D17</p> <p>AQ60F, AQ90, AQ95, AQ95A, AQ110 AQ120 BB30, BB100 MB18</p> <p>AQ105A AQ115A, AQ115B AQ130A, AQ130B, AQ130C, AQ130D BB115, BB115B, BB115C MB20A, MB20B, MB20C</p> <p>MD3B</p> <p>MD17C, MD17D</p> <p>För pump utan kullager For pump without ball bearing Impeller 15808</p> | | <p>22042</p> |  |
| <p>B18, B20 D3, D17</p> <p>AQ60F, AQ90, AQ95, AQ95A, AQ110 AQ120 BB30, BB100 MB18</p> <p>AQ105A AQ115A, AQ115B AQ130A, AQ130B, AQ130C, AQ130D BB115, BB115B, BB115C MB20A, MB20B, MB20C</p> <p>MD3B</p> <p>MD17C, MD17D</p> <p>För kullagrad pump / For pump with ball bearing Impeller 15808</p> | | <p>22009</p> |  |

Packningsatser för sjövattenpump forts. / Gasket kits for sea water pump cont.

| Motor typ Engine type | Ref.nr Ref. No. | Best.nr Part No. | |
|--|--------------------|---------------------|---|
| <p>B30 D21</p> <p>AQ165A, AQ170A, AQ170B, AQ170C BB165A, BB170A, BB170B, BB170C</p> <p>AQD21A*, AQD21B MD21A*, MD21B</p> <p>* Från / From MO 103387 - Impeller 15575</p> | | <p>22047</p> |  |
| <p>B21, B23, B25</p> <p>AQ120B, AQ125A, AQ140A BB140A</p> <p>230A, 230B AQ125B AQ131A, AQ131B, AQ131C, AQ131D AQ145A, AQ145B BB145A</p> <p>250A, 250B, 251A AQ151A, AQ151B, AQ151C AQ171A, AQ171C</p> <p>Impeller 15575</p> | | <p>22072</p> |  |
| <p>MB10 D1, D2, D6</p> <p>MB10A</p> <p>D1A MD1A, MD1B</p> <p>AQD2B D2A MD2, MD2A, MD2B</p> <p>MD6A</p> <p>Tidigare utförande med glidlager / Ealier version with plain bearing Impeller 15807</p> | | <p>22053</p> |  |

Packningsatser för sjövattpump forts. / Gasket kits for sea water pump cont.

| Motor typ Engine type | Ref.nr Ref. No. | Best.nr Part No. | |
|--|--------------------|---------------------|--|
| <p>2001, 2002, 2003 D5, D6, D7, D11</p> <p>2001, 2001AG, 2001B, 2001BG 2002, 2002AG, 2002B, 2002BG 2003*, 2003AG, 2003B, 2003BG MD5A, MD5B, MD5C MD6B MD7A, MD7B MD11C, MD11D</p> <p>* Ej för turbo / Not for turbo Impeller 15583</p> | | <p>22054</p> |  |
| <p>2003</p> <p>2003T 2003TB</p> <p>Endast för turbo / Only for turbo Impeller 15811</p> | | <p>22040</p> |  |

Packningsssatser för sjövattpump forts. / Gasket kits for sea water pump cont.

| Motor typ Engine type | Ref.nr Ref. No. | Best.nr Part No. | |
|---|--------------------|---------------------|---|
| <p>D30, D31, D32 D40, D41, D42, D43, D44</p> <p>AD30A AQAD30A MD30A TAMD30A TMD30A</p> <p>AD31A, AD31B, AD31D, AD31XD AQAD31A MD31A TAMD31A, TAMD31B, TAMD31D TMD31A, TMD31B, TMD31D</p> <p>KAD32P-A</p> <p>AQD40A MD40A TMD40A, TMD40B, TMD40C</p> <p>AD41A, AD41B, AD41D AQAD41A D41A, D41B, D41D TAMD41A, TAMD41B, TAMD41D TMD41A, TMD41B, TMD41D</p> <p>KAD42A, KAD42B, KAD42P-A KAMD42A, KAMD42B, KAMD42P-A TAMD42B, TAMD42WJ-A</p> <p>KAD43P-A KAMD43P-A</p> <p>KAD44P-A KAMD44P-A</p> <p>För pump med sex skruvar i locket / For pump with six screws in cover</p> <p>Impeller Ø 65 mm 15593</p> | | <p>22016</p> |  |
| <p>D40</p> <p>AD40B AQAD 40A, AQAD40B TAMD 40A, TAMD40B</p> <p>För pump med fem skruvar i locket / For pump with five screws in cover</p> <p>Impeller Ø 95 mm 15660</p> | | <p>22089</p> |  |



Monteringsklack för sjövattpump / Mouting clamp for sea water pump

| Motor typ Engine type | Ref.nr Ref. No. | Best.nr Part No. | |
|--|--------------------|---------------------|---|
| <p>B18, B20, MB10 D1, D2, D3, D6, D7, D11, D17</p> <p>AQ60, AQ90, AQ95, AQ95A, AQ110 AQ120 BB30, BB100 MB18</p> <p>AQ105A, AQ115A, AQ115B AQ130A, AQ130B, AQ130C, AQ130D BB115A, BB115B, BB115C MB20A, MB20B, MB20C</p> <p>MB10A</p> <p>D1A, MD1A, MD1B</p> <p>AQD2B D2A, MD2, MD2A, MD2B</p> <p>MD3B</p> <p>MD6A, MD6B</p> <p>MD7A, MD7B</p> <p>MD11C, MD11D</p> <p>MD17C, MD17D</p> <p>För kullagrad pump / For ball bearing pump.</p> | 833878 | 15878 |  |

Sjövattpumpar komplett / Sea water pumps complete

| | | | |
|---|---|--------------|---|
| <p>MB10 D1, D2, D5, D6, D7, D11</p> <p>MB10A</p> <p>D1A, MD1A, MD1B</p> <p>AQD2B D2A, MD2, MD2A, MD2B</p> <p>MD5A, MD5B, MD5C</p> <p>MD6A, MD6B</p> <p>MD7A, MD7B</p> <p>MD11C, MD11D</p> <p>Monteringssats ingår. Kullagrad pump. Ersätter tidigare utförande med glidlager / Installation kit included Ball bearing pump. Replacement for ealier version with plain bearing</p> | <p>833883 (833415) (833522) (858065) (840076)</p> | 15883 |  |
|---|---|--------------|---|

Sjövattenpumpar komplett forts./ Sea water pumps complete cont.

| Motor typ Engine type | Ref.nr Ref. No. | Best.nr Part No. | |
|---|----------------------------|---------------------|---|
| <p>B18, B20 D3, D17</p> <p>AQ60F, AQ90, AQ95, AQ95A, AQ110 AQ120 BB30, BB100 MB18</p> <p>AQ105A AQ115A, AQ115B AQ130A, AQ130B, AQ130C, AQ130D BB115A, BB115B, BB115C MB20A, MB20B, MB20C</p> <p>MD3B</p> <p>MD17C, MD17D</p> <p>Monteringssats ingår. Kullagrad pump. Ersätter tidigare utförande med glidlager / Installation kit included Ball bearing pump. Replacement for ealier version with plain bearing</p> | <p>829895 (825916)</p> | <p>15895</p> |  |
| <p>B21, B23, B25</p> <p>AQ120B, AQ125A, AQ140A BB140A</p> <p>230A, 230B AQ125B AQ131A, AQ131B, AQ131C, AQ131D AQ145A, AQ145B BB145A</p> <p>250A, 250B, 251A AQ151A, AQ151B, AQ151C AQ171A, AQ171C</p> | <p>855578 (828026)</p> | <p>15578</p> |  |
| <p>B30 D21</p> <p>AQ165A, AQ170A, AQ170B, AQ170C BB165A, BB170A, BB170B, BB170C</p> <p>AQD21A*, AQD21B MD21A *, MD21B</p> <p>* Från / From MO 103387 -</p> | <p>831178</p> | <p>15178</p> |  |

Sjövattenpumpar komplett forts./ Sea water pumps complete cont.

| Motor typ Engine type | Ref.nr Ref. No. | Best.nr Part No. | |
|--|--------------------|---------------------|---|
| <p>V-6, V-8</p> <p>430A, 430B, 431A, 431B BB231A</p> <p>500A, 500B, 501A, 501B, 570A, 571A 572A, 740A, 740B</p> <p>AQ200C, AQ200D, AQ200F AQ211A AQ225D, AQ225E, AQ225F AQ230B AQ231A, AQ231B AQ255A, AQ255B AQ271A, AQ271B, AQ271C, AQ271D AQ290A AQ311A BB225A, BB225AV, BB225B, BB225C BB231B BB255AV BB260A, BB260AV, BB260B BB261A</p> <p>V6 - V8 - För pump monterad på vevaxel med fyra skruvar i impellerlocket / V6 - V8 - For pump mounted on the crankshaft with four screws in impeller cover High speed pump</p> | <p>856513</p> | <p>15952</p> |  |

Medbringare (korsstycke) för vattenpumpar / Cross piece for water pumps

| Motor typ Engine type | Ref.nr Ref. No. | Best.nr Part No. | |
|--|----------------------------|---------------------|--|
| <p>B18, B20, B21, B23, B25, B30 D3. D17, D21</p> <p>AQ60F, AQ90, AQ95, AQ95A, AQ110 AQ120 BB30, BB100 MB18</p> <p>AQ105A AQ115A, AQ115B AQ130A, AQ130B, AQ130C, AQ130D BB115A, BB115B, BB115C MB20A, MB20B, MB20C</p> <p>AQ120B, AQ125A, AQ140A BB140A</p> <p>230A, 230B AQ125B AQ131A, AQ131B, AQ131C, AQ131D AQ145A, AQ145B BB145A</p> <p>250A, 250B, 251A AQ151A, AQ151B, AQ151C AQ171A, AQ171C</p> <p>AQ165A, AQ170A, AQ170B, AQ170C BB165A, BB170A, BB170B, BB170C</p> <p>MD3B</p> <p>MD17C, MD17D</p> <p>AQD21A*, AQD21B MD21A*, MD21B</p> <p>* Från / From MO 103387 - *.För impeller med kil / * For impeller with key</p> | <p>831009 (806256)</p> | <p>15109</p> |  |
| <p>D30, D40</p> <p>AD30A AQAD30A MD30A TAMD30A TMD30A</p> <p>AQD40A MD40A TMD40A, TMD40B, TMD40C</p> <p>För pump med sex skruvar i locket / For pump with six screws in cover</p> | <p>829433</p> | <p>15433</p> | |

Medbringare (korsstycke) för vattenpumpar forts. / Cross piece for water pumps cont.

| Motor typ Engine type | Ref.nr Ref. No. | Best.nr Part No. | |
|---|--------------------|---------------------|---|
| <p>D31, D32, D41, D42, D43, D44 D300</p> <p>AD31A, AD31B, AD31D AD31L-A, AD31P-A, AD31XD AQAD31A MD31A TAMD31A, TAMD31B, TAMD31D TAMD31L-A, TAMD31M-A, TAMD31P-A TMD31A, TMD31B, TMD31D, TMDL-A</p> <p>KAD32P-A</p> <p>AD41A, AD41B, AD41D AD41L-A, AD41P-A AQAD41A D41A, D41B, D41D, D41L-A TAMD41A, TAMD41B, TAMD41D TAMD41H-A, TAMD41L-A TAMD41M-A, TAMD41P-A TMD41A, TMD41B, TMD41D, TMD41L-A</p> <p>KAD42A, KAD42B, KAD42P-A KAMD42A, KAMD42B, KAMD42P-A TAMD42B, TAMD42WJ-A</p> <p>KAD43P-A KAMD43P-A</p> <p>KAD44P-A, KAD44P-B, KAD44P-C KAMD44P-A, KAMD44P-B KAMD44P-C</p> <p>KAD300A KAMD300A</p> <p>För pump med fem skruvar i locket / For pump with five screws in cover</p> | <p>858467</p> | <p>15467</p> |  |





Termostatsatser / Thermostat kits

| Motor typ Engine type | Ref.nr Ref. No. | Best.nr Part No. | |
|---|--|---------------------|---|
| <p>60C</p> <p>MB10 D6, D7</p> <p>MB10A MD6A, MD6B MD7A, MD7B</p> | <p>875796 (833366)</p> | <p>15796</p> |  |
| <p>60C</p> <p>B18, B20 D2, D3, D11, D17</p> <p>AQ60, AQ90, AQ95, AQ95A, AQ110 AQ120 BB30, BB100 MB18</p> <p>AQ105A AQ115A, AQ115B AQ130A, AQ130B, AQ130C, AQ130D BB115A, BB115B, BB115C MB20A, MB20B, MB20C</p> <p>För B18-B20 bensin / For B18-B20 gasoline</p> <p>AQD2B MD2B</p> <p>MD3B</p> <p>MD11C, MD11D</p> <p>MD17C, MD17D</p> <p>Utan sötvattenkyllning / Without fresh-water cooling</p> | <p>876097 876080 (875781) (875790) (824912) (829812)</p> | <p>15097</p> |  |
| <p>55C</p> <p>B30</p> <p>AQ165A AQ170A, AQ170B, AQ170C BB165A BB170A, BB170B, BB170C</p> | <p>875791 (831040)</p> | <p>15791</p> |  |
| <p>82C</p> <p>B21, B23, B25</p> <p>AQ120B, AQ125A, AQ140A BB140A</p> <p>230A, 230B AQ125B AQ131A, AQ130B, AQ130C, AQ130D AQ145A, AQ145B BB145A</p> <p>250A, 250B, 251A AQ151A, AQ151B, AQ151C AQ171A, AQ171C</p> | <p>875580</p> | <p>15580</p> |  |

Termostatsatser forts. / Thermostat kits cont.

| Motor typ Engine type | Ref.nr Ref. No. | Best.nr Part No. | |
|---|--|---------------------|---|
| <p>62C</p> <p>V6, V8</p> <p>430A, 430B, 431A, 431B 432A, 434A AQ175A AQ205A</p> <p>500A, 501A, 501B, 570A, 571A, 572A 740A, 740B AQ190A AQ200A, AQ200C, AQ200D AQ200F AQ211A AQ225A, AQ225B, AQ225C, AQ225D AQ225E, AQ225F AQ231A, AQ231B AQ240A AQ255A, AQ255B AQ260A, AQ260B AQ271A, AQ271B, AQ271C, AQ271D AQ280A AQ290A AQ311A, AQ311B BB225A, BB225AV, BB225B, BB225C BB231A BB260A, BB260AV, BB260B, BB260C BB261A</p> | <p>876305 (875794) (424299) (835177)</p> | <p>15305</p> |  |
| <p>60C</p> <p>D5</p> <p>MD5A, MD5B, MD5C</p> | <p>875783</p> | <p>15783</p> | <p>NEW</p>  |
| <p>75C</p> <p>D1</p> <p>MD1B</p> | <p>875780</p> | <p>15780</p> |  |
| <p>74C</p> <p>D11, D17</p> <p>MD11C, MD11D MD17C, MD17D</p> <p>Med Volvo-Penta sötvattenkyllning / With Volvo-Penta fresh-water cooling</p> | <p>877349 (875784) (838501)</p> | <p>15784</p> |  |
| <p>60C</p> <p>2001, 2002, 2003</p> <p>2001, 2001AG, 2001B, 2001BG 2002, 2002AG, 2002B, 2002BG 2003, 2003AG, 2003B, 2003BG 2003T</p> <p>Ej för Volvo-Penta sötvattenkyllning / Not for Volvo-Penta fresh-water cooling</p> | <p>877355 (875779)</p> | <p>15779</p> |  |

Termostatsatser forts. / Thermostat kits cont.

| Motor typ Engine type | Ref.nr Ref. No. | Best.nr Part No. | |
|--|--|---------------------|---|
| <p>71C</p> <p>D19, D21, D27, D29, D32</p> <p>AQD19 MD19</p> <p>AQD21A, AQD21B MD21A, MD21B</p> <p>AQD27 MD27</p> <p>AQD29, AQD29A MD29, MD29A</p> <p>AQD32A MD32A</p> | <p>875785 (833826)</p> | <p>15785</p> |  |
| <p>76C</p> <p>D30, D40</p> <p>AD30A* AQAD30A* MD30A* TAMD30A* TMD30A*</p> <p>AD40B** AQAD40A**, AQAD40B** AQD40A** MD40A** TAMD40A**, TAMD40B** TMD40A**, TMD40B**, TMD40C**</p> <p>* 2 st åtgår / 2 pcs required ** 1 st åtgår / 1 piece required</p> | <p>3831425 (875787) (824200) (1544297)</p> | <p>15787</p> |  |
| <p>80C</p> <p>D3</p> <p>D3-110I-A, D3-130A-A, D3-130I-A D3-160A-A, D3-160I-A D3-110I-B, D3-110I-C, D3-130A-B D3-130I-B, D3-130A-C, D3-130I-C D3-160A-B, D3-160I-B, D3-160A-C D3-160I-C, D3-190A-B, D3-190I-B D3-190A-C, D3-190I-C</p> | <p>3840816 (3584474)</p> | <p>15261</p> | <p>NEW</p>  |
| <p>D2010, D2020, D2030, D2040, D2</p> <p>MD2010C, MD2010D, MD2020C MD2020D, MD2030C, MD2030D MD2040C, MD2040D, 120S-D, 120S-E</p> <p>D2-55A, D2-55B, D2-55C, D2-55D, D2-55E</p> <p>MD2010B, MD2020B, MD2030B, MD2040B, MS2L-D, MS2A-D 120S-D, MS2-R, MS2A.E, MS2L-E</p> <p>MD2010A, MD2020A, MD2030A, MD2040A</p> | <p>3580365</p> | <p>15263</p> | <p>NEW</p>  |



Termostatsatser forts. / Thermostat kits cont.

| Motor typ Engine type | Ref.nr Ref. No. | Best.nr Part No. | |
|---|--------------------|---------------------|---|
| <p>D4, D6, D63, D122</p> <p>D4-180I-B, D4-210A-A, D4-210A-B D4-210I-A, D4-210I-B, D4-225A-B D4-225I-B, D4-260A-A, D4-260A-B D4-260I-A, D4-260I-B</p> <p>D6-280I-A, D6-280I-B, D6-280A-A D6-280A-B, D6-310I-A, D6310I-B D6-310A-A, D6-310A-B, D6-310D-B D6-350A-A, D6-350A-B, D6-370I-A D6-370I-B, D6-370D-B</p> <p>TAMD63L-A, TAMD63P-A</p> <p>TMD122A, TAMD122A, TAMD122P</p> | 8149182 | 15266 | <p>NEW</p>  |
| <p style="text-align: right;">81C</p> <p>D31, D41, D32, D42, D43 D44, D300, D100, D121</p> <p>TMD31L, TAMD31P/L/M/S AD31P/L, TMD41L, TAMD41P/L/M/H</p> <p>MD31A, TMD31B, TAMD31B, AD31B</p> <p>AD31D, AD31XD, TAMD31D, TMD31D</p> <p>TMD41, D41A, TAMD41, AQAD41A AD41A, AD41B, 290A, DP-A, DP-B DP-A1, DP-B1, SP-A, SP-A1</p> <p>TMD41B, D41B, TAMD41B, AD41B</p> <p>AD41D, D41D, TAMD41D, TMD41D DP-D1, DP-E, DP-S, DPX, SP-C1, HS1A</p> <p>KAD32P, TAMD42WJ-A, KAD43P KAMD43P, KAD44P, KAMD44P KAD300, KAMD300</p> <p>KAD42P-A, KAD42, KAMD42 KAMD42P-A, DPX, HS1A, DP-D1 DP-E, DP-G</p> <p>KAD42A, KAMD42A, DP-D, HS1A, MS5B</p> <p>KAD42B, KAMD42B, TAMD42B</p> <p>TD100CHC, TD100CRC, TD121CHC TD121CRC, TAD121CHC</p> <p>TMD100C, TMD121C, TAMD121C TAMD121D, TAMD122C, TAMD122D</p> <p>TMD102A, TAMD102A, TAMD102D</p> <p>TAMD103A-A, TAMD103A-A AUX</p> <p>TMD122A, TAMD122A, TAMD122P</p> | 3831424 | 15269 | <p>NEW</p>  |







Termostatsatser forts. / Thermostat kits cont.

| Motor typ Engine type | Ref.nr Ref. No. | Best.nr Part No. | |
|---|--|---------------------|---|
| <p>70C</p> <p>V8 D40</p> <p>5,0GXi-EF, 5,0OSi-EF</p> <p>8,1GSi-A, 8,1GSi-L-A 8,1GXi-A, 8,1GXi-AF 8,1GXi-B, 8,1GXi-BF 8,1GXi-C, 8,1GXi-CF 8,1GXiL-A, 8,1GXiL-B, 8,1GXiL-C 8,1Gi-A 8,1Gi-B, 8,1Gi-BF 8,1Gi-C, 8,1Gi-CF 8,1Gi-D, 8,1Gi-DF 8,1GiL-A, 8,1GiL-B 8,1GiL-C, 8,1GiL-D</p> <p>740B**</p> <p>DPX375-A DPX375-B, DPX375-BF DPX375-CF</p> <p>DPX420-A DPX420-B, DPX420-BF DPX420-CF</p> <p>AD40B* AQAD40A*, AQAD40B* AQD40A* MD40A* TAMD40A*, TAMD40B* TMD40A*, TMD40B*, TMD40C*</p> <p>* 1 st åtgång / 1 piece required ** Med Volvo-Penta sötvattenkyllning / ** With Volvo-Penta fresh-water cooling</p> | <p>3831426 (875788) (824200) (1544389)</p> | <p>15788</p> |  |







Packningsatser för vattenrör / Gasket sets for water pipe

| | | | |
|--|--|---------------------|---|
| <p>MB10</p> <p>MB10A</p> | | <p>22036</p> |  |
| <p>B18, B20</p> <p>AQ60F, AQ90, AQ95, AQ95A, AQ110 AQ120 BB30, BB100 MB18</p> <p>AQ105A MB20A, MB20B, MB20C</p> | | <p>22049</p> |  |



Packningssatser för vattenrör forts. / Gasket sets for water pipe cont.

| Motor typ Engine type | Ref.nr Ref. No. | Best.nr Part No. | |
|---|--------------------|---------------------|---|
| B20 AQ115A, AQ115B AQ130A, AQ130B, AQ130C, AQ130D BB115A, BB115B, BB115C | | 22061 |  |
| B21, B23 AQ120B, AQ125A, AQ140A BB140A AQ125B, AQ145A, AQ145B BB145A | | 22051 |  |
| B23, B25 230A, 230B AQ131A, AQ131B, AQ131C, AQ131D 250A, 250B, 251A AQ151A, AQ151B, AQ151C AQ171A, AQ171C | | 22037 |  |
| B30 AQ165A AQ170A, AQ170B, AQ170C BB165A BB170A, BB170B, BB170C | | 22012 |  |
| D1, D2 MD1B AQD2B D2A MD2, MD2A, MD2B | | 22035 |  |
| D5 MD5A, MD5B, MD5C | | 22019 |  |
| D6, D7 MD6A, MD6B MD7A, MD7B | | 22024 |  |







Packningsseter för vattenrör forts. / Gasket sets for water pipe cont.

| Motor typ Engine type | Ref.nr Ref. No. | Best.nr Part No. | |
|--|--------------------|---------------------|---|
| D11 MD11C, MD11D | | 22021 |  |
| D11, D17 MD11C, MD11D MD17C, MD17D Med Volvo-Penta sötvattenkyllning / With Volvo-Penta fresh-water cooling | | 22023 |  |
| D17 MD17C, MD17D | | 22025 |  |
| 2001, 2002, 2003 2001, 2001AG, 2001B, 2001BG 2002, 2002AG, 2002B, 2002BG 2003, 2003AG, 2003B, 2003BG | 876224 | 22011 |  |
| 2002, 2003 2002, 2002AG, 2002B, 2002BG 2003, 2003AG, 2003B, 2003BG Med Volvo-Penta sötvattenkyllning / With Volvo-Penta Fresh-water cooling | | 22017 |  |
| 2003 2003T 2003TB Med Volvo-Penta sötvattenkyllning / With Volvo-Penta Fresh-water cooling | | 22008 |  |
| D30 MD30A TMD30A | | 22114 |  |

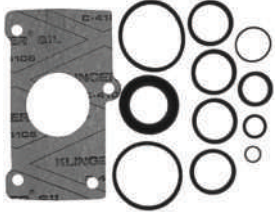

Packningssatser för vattenrör forts. / Gasket sets for water pipe cont.

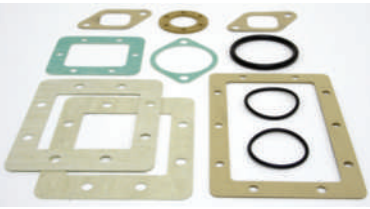
| Motor typ Engine type | Ref.nr Ref. No. | Best.nr Part No. | |
|---|--------------------|---------------------|--|
| <p>D30</p> <p>AD30A AQAD30A TAMD30A</p> | | 22115 |  |
| <p>D40</p> <p>AD40B AQAD40A, AQAD40B AQD40A MD40A TAMD40A, TAMD40B TMD40A, TMD40B, TMD40C</p> | | 22116 |  |
| <p>D31, D32, D41, D42, D43, D44</p> <p>AD31A, AD31B, AD31D, AD31XD AQAD31A MD31A TAMD31A, TAMD31B, TAMD31D TMD31A, TMD31B, TMD31D</p> <p>KAD32P-A</p> <p>AD41A, AD41B, AD41D AQAD41A D41A, D41B, D41D TAMD41A, TAMD41B, TAMD41D TMD41A, TMD41B, TMD41D</p> <p>KAD42A, KAD42B, KAD42P-A KAMD42A, KAMD42B, KAMD42P-A TAMD42B, TAMD42WJ-A</p> <p>KAD43P-A KAMD43P-A</p> <p>KAD44P-A KAMD44P-A</p> | | 22113 |  |

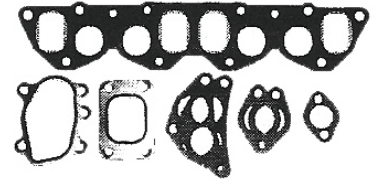

Packningsseter för värmeväxlare / Gasket sets for heat exchanger

| Motor typ Engine type | Ref.nr Ref. No. | Best.nr Part No. | |
|--|--------------------|---------------------|---|
| <p>B21, B23</p> <p>AQ120B, AQ125A, AQ140A BB140A</p> <p>AQ125B, AQ145A, AQ145B BB145A</p> | | <p>22103</p> |  |
| <p>B23, B25</p> <p>230A, 230B AQ131A, AQ131B, AQ131C, AQ131D</p> <p>250A, 250B, 251A AQ151A, AQ151B, AQ151C AQ171A, AQ171C</p> | | <p>22015</p> |  |
| <p>2002, 2003</p> <p>2002, 2002AG, 2002B, 2002BG 2003, 2003AG, 2003B, 2003BG</p> <p>Med Volvo-Penta sötvattenkyllning / With Volvo-Penta fresh-water cooler</p> | | <p>22032</p> |  |
| <p>2003, 2003</p> <p>2003T 2003TB</p> <p>Med Volvo-Penta sötvattenkyllning / With Volvo-Penta fresh-water cooler</p> | | <p>22033</p> |  |
| <p>D21</p> <p>MD21A</p> | | <p>22122</p> |  |
| <p>D21</p> <p>AQD21A MD21B</p> | | <p>22123</p> |  |
| <p>D22</p> <p>MD22A MD22L-A</p> | | <p>22155</p> |  |

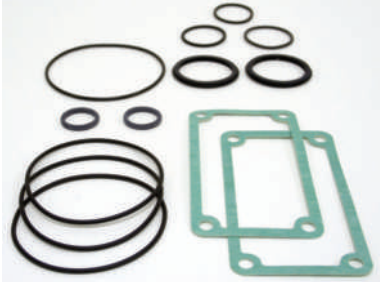
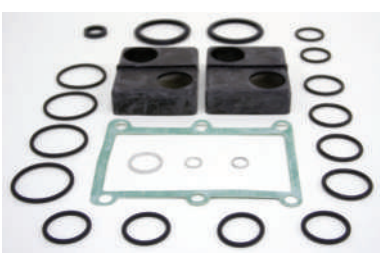
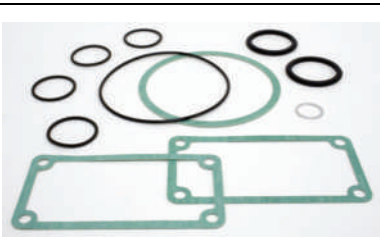

Packningsatser för värmeväxlare forts. / Gasket sets for heat exchanger cont.

| Motor typ Engine type | Ref.nr Ref. No. | Best.nr Part No. | |
|---|--------------------|---------------------|---|
| D22 MD22L-B MD22P-B | | 22077 |  |
| D22 TMD22A | | 22156 |  |
| D22 TMD22B TAMD22P-B | | 22148 |  |
| D32 AQD29, AQD29A MD29, MD29A AQD32A MD32A | | 22124 |  |
| D30 AD30A AQAD30A MD30A TAMD30A TMD30A | | 22105 |  |
| D40 AQD40A MD40A TMD40A | | 22106 |  |
| D40 AD40B AQAD40A, AQAD40B TAMD40A, TAMD40B TMD40B, TMD40C | | 22107 |  |

Packningsseter för värmeväxlare forts. / Gasket sets for heat exchanger cont.

| Motor typ Engine type | Ref.nr Ref. No. | Best.nr Part No. | |
|--|--------------------|---------------------|--|
| <p>D31, D41</p> <p>AD31A, AD31B AQAD31A TAMD31A, TAMD31B TMD31A, TMD31B</p> <p>AD41A, AD41B AQAD41A D41A, D41B TAMD41A, TAMD41B TMD41A, TMD41B</p> | | 22108 |  |
| <p>D31, D32 D41, D42, D43, D44 D300</p> <p>AD31D, AD31L-A, AD31P-A, AD31XD TAMD31D TAMD31L-A, TAMD31M-A, TAMD31P-A TMD31D, TMD31L-A</p> <p>KAD32P-A</p> <p>AD41D, AD41L-A, AD41P-A D41D, D41L-A TAMD41D, TAMD41H-A, TAMD41L-A TAMD41M-A, TAMD41P-A TMD41D, TMD41L-A</p> <p>KAD42A, KAD42B, KAD42P-A KAMD42A, KAMD42B, KAMD42P-A TAMD42B, TAMD42WJ-A</p> <p>KAD43P-A KAMD43P-A</p> <p>KAD44P-A, KAD44P-B, KAD44P-C KAMD44P-A, KAMD44P-B, KAMD44P-C</p> <p>KAD300A KAMD300A</p> | | 22109 |  |





Packningsseter för mellankylare / Gasket sets for after cooler

| | | | |
|--|--|-------|---|
| <p>D22</p> <p>TAMD22P-B</p> | | 22154 |  |
| <p>D30</p> <p>AQAD30A TAMD30A</p> | | 22110 |  |



Packningsatser för mellankylare forts. / Gasket sets for after cooler cont.

| Motor typ Engine type | Ref.nr Ref. No. | Best.nr Part No. | |
|--|--------------------|---------------------|---|
| D40 AQAD40A, AQAD40B TAMD40A, TAMD40B | | 22111 |  |

Packningsatser för oljekylare / Gasket sets for oil cooler

| | | | |
|--|--|-------|---|
| B18 AQ60F, AQ90, AQ95, AQ95A, AQ110 AQ120 BB30, BB100 MB18 | | 22068 |  |
| B20, B21, B23, B25, B30 AQ105A AQ115A, AQ115B AQ130A, AQ130B, AQ130C, AQ130D BB115A, BB115B, BB115C MB20A, MB20B, MB20C AQ120B, AQ125A, AQ140A BB140A 230A, 230B AQ145A, AQ145B BB145A 250A, 250B, 251A AQ151A, AQ151B, AQ151C AQ171A, AQ17C AQ165A AQ170A, AQ170B, AQ170C BB165A BB170A, BB170B, BB170C | | 22070 |  |
| 2003 2003T 2003TB Med Volvo-penta sötvattenkylare / With Volvo-Penta fresh-water cooling | | 22022 |  |
| D21 AQD21A, AQD21B MD21A, MD21B | | 22127 |  |

Packningsssatser för oljekylare forts. / Gasket sets for oil cooler cont.

| Motor typ Engine type | Ref.nr Ref. No. | Best.nr Part No. | |
|--|--------------------|---------------------|---|
| D22 MD22L-B MD22P-B TAMD22P-B TMD22B | | 22153 |  |
| D29, D32 AQD29A MD29, MD29A AQD32A MD32A | | 22128 |  |
| D30, D31, D32, D40, D41, D42, D43 För oljekylarhus / For oil cooler housing AD30A AQAD30A MD30A TAMD30A TMD30A AD31A, AD31B, AD31D AD31L-A, AD31P-A, AD31XD AQAD31A MD31A TAMD31A, TAMD31B, TAMD31D TAMD31L-A, TAMD31M-A, TAMD31P-A TMD31A, TMD31B, TMD31D, TMD31L-A KAD32P-A AD40B AQAD40A, AQAD40B AQD40A MD40A TAMD40A, TAMD40B TMD40A, TMD40B, TMD40C AD41A, AD41B, AD41D AD41L-A, AD41P-A AQAD41A D41A, D41B, D41D, D41L-A TAMD41A, TAMD41B, TAMD41D TAMD41H-A, TAMD41L-A TAMD41M-A, TAMD41P-A TMD41A, TMD41B, TMD41D, TMD41L-A KAD42A, KAD42B, KAD42P-A KAMD42A, KAMD42B, KAMD42P-A TAMD42B, TAMD42WJ-A KAD43P-A KAMD43P-A KAD44P-A, KAD44P-B, KAD44P-C KAMD44P-A, KAMD44P-B, KAMD44P-C KAD300A KAMD300A | | 22149 |  |



Packningssatser för oljekylare forts. / Gasket sets for oil cooler cont.

| Motor typ Engine type | Ref.nr Ref. No. | Best.nr Part No. | |
|--|--------------------|---------------------|--|
| <p>D22 D30, D31, D32 D40, D41, D42, D43</p> <p>MD22L-B, MD22P-B TAMD22P-B TMD22B</p> <p>AD30A AQAD30A MD30A TAMD30A TMD30A</p> <p>AD31A, AD31B, AD31D AD31L-A, AD31P-A, AD31XD AQAD31A MD31A TAMD31A, TAMD31B, TAMD31D TAMD31L-A, TAMD31M-A, TAMD31P-A TMD31A, TMD31B, TMD31D, TMD31L-A</p> <p>KAD32P-A</p> <p>AD40B AQAD40A, AQAD40B AQD40A MD40A TAMD40A, TAMD40B TMD40A, TMD40B, TMD40C</p> <p>AD41A, AD41B, AD41D AD41L-A, AD41P-A AQAD41A D41A, D41B, D41D, D41L-A TAMD41A, TAMD41B, TAMD41D TAMD41H-A, TAMD41L-A TAMD41M-A, TAMD41P-A TMD41A, TMD41B, TMD41D, TMD41L-A</p> <p>KAD42A, KAD42B, KAD42P-A KAMD42A, KAMD42B, KAMD42P-A TAMD42B, TAMD42WJ-A</p> <p>För oljekylare med fyra skruvar / For oil cooler cover with four bolts</p> | | <p>22152</p> |  |



Packningssatser för oljekylare forts. / Gasket sets for oil cooler cont.

| Motor typ Engine type | Ref.nr Ref. No. | Best.nr Part No. | |
|--|--------------------|---------------------|---|
| <p>D31, D32 D41, D42, D43, D44 D300</p> <p>AD31L-A, AD31P-A TAMD31L-A, TAMD31M-A, TAMD31P-A TMD31L-A</p> <p>KAD32P-A</p> <p>AD41L-A, AD41P-A D41L-A TAMD41H-A, TAMD41L-A TAMD41M-A, TAMD41P-A TMD41L-A</p> <p>KAD42P-A KAMD42P-A TAMD42WJ-A</p> <p>KAD43P-A KAMD43P-A</p> <p>KAD44P-A, KAD44P-B, KAD44P-C KAMD44P-A, KAMD44P-B, KAMD44P-C</p> <p>KAD300A KAMD300A</p> <p>För oljekylare med tre skruvar / For oil cooler cover with three bolts</p> | | 22143 |  |





Cirkulationspump komplett / Circulating pump complete

| | | | |
|--|------------------------------|---------------|---|
| <p>B21, B23</p> <p>AQ120B, AQ125A, AQ140A BB140A</p> <p>AQ145A BB145A</p> | <p>3587508 (828023)</p> | 15509 |  |
| <p>3,0</p> <p>3,0</p> | <p>3858340 (3854017)</p> | 15 340 |  |

Cirkulationspump komplett forts. / Circulating pump complete cont.

| Motor typ Engine type | Ref.nr Ref. No. | Best.nr Part No. | |
|---|---|----------------------|---|
| <p>4,3, 5,7, 7,4, 8,2 V6, V8</p> <p>4,3GL, 4,3GS, 4,3Gi</p> <p>5,0GXi, 5,0OSi</p> <p>5,7GL, 5,7GLi, 5,7GSi</p> <p>430A, 430B 431A, 431B 432A 434A</p> <p>500A, 500B 501A, 501B 570A 571A 572A</p> <p>AQ175A AQ205A</p> <p>AQ200A, AQ200C, AQ200D, AQ200F AQ211A AQ225A, AQ225B, AQ225C, AQ225D AQ225E, AQ225F AQ231A, AQ231B AQ255A, AQ255B AQ260A, AQ260B AQ271A, AQ271B, AQ271C, AQ271D AQ280A AQ290A AQ311A, AQ311B</p> <p>BB225A, BB225AV BB225B, BB225C BB231A BB260A, BB260AV, BB260B, BB260C BB261A</p> | <p>3853850 (856364) (835390)</p> | <p>15 850</p> |  |
| <p>5,0, 5,8</p> <p>5,0Fi, 5,0FL</p> <p>5,8Fi, 5,8FL</p> | <p>3853796</p> | <p>15 853</p> |  |
| <p>740</p> <p>740A, 740B</p> | <p>3855991 (856609) (3854118)</p> | <p>15 991</p> |  |

Packningsatser för cirkulationspumpar / Gasket sets for water circulating pumps

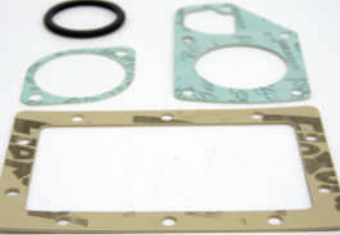
| | | | |
|---|--|---------------------|---|
| <p>B21, B23</p> <p>AQ120B, AQ125A, AQ140A BB140A</p> <p>AQ145A BB145A</p> | | <p>22014</p> |  |
| <p>B23</p> <p>AQ125B AQ145B</p> | | <p>22038</p> |  |
| <p>B23, B25</p> <p>230A, 230B AQ131A, AQ131B, AQ131C, AQ131D</p> <p>250A, 250B, 251A AQ151A, AQ151B, AQ151C AQ171A, AQ171C</p> | | <p>22039</p> |  |
| <p>B30</p> <p>AQ165A AQ170A, AQ170B, AQ170C BB165A BB170A, BB170B, BB170C</p> | | <p>22013</p> |  |
| <p>D21</p> <p>AQD21A, AQD21B* MD21A, MD21B*</p> <p>* Tidigare utförande / Ealier version</p> | | <p>22125</p> |  |



Packningsseter för cirkulationspumpar forts. / Gasket sets for water circulating pumps cont.

| Motor typ Engine type | Ref.nr Ref. No. | Best.nr Part No. | |
|--|--------------------|---------------------|---|
| D21 AQD21B MD21B Senare utförande med rörkylare / Late version with pipe cooler | | 22126 |  |

Avtappningskranar för kylvatten / Drain taps for cooling water

| | | | |
|---|--------|-------|---|
| B18, B20, B21, B23, B25, B30 MB10 D19, D21, D22, D27, D29, D32 Gänga / Thread 1/8" | 82744 | 15744 |  |
| B18, B20, B21, B23, B25, B30 MB10 D19, D21, D22, D27, D29, D32 Gänga / Thread 1/8" | 966871 | 15871 |  |
| B18, B20, B21, B23, B25, B30 D40 Gänga / Thread 1/4" | 82745 | 15745 |  |
| D1, D2, D3, D5, D6 MD 1, 2, 3 MD 5A,B MD 6A, MD 6B* * Earlier version Gänga / Thread 1/4" | 807036 | 15036 |  |
| V8 D5, D11, D17 | 829592 | 15592 |  |

Avtappningskranar för kylvatten forts. / Drain taps for cooling water cont.

| Motor typ Engine type | Ref.nr Ref. No. | Best.nr Part No. | |
|---|--------------------|---------------------|---|
| V6 B23, B25 D30, D31, D40, D41 Gänga / Thread 1/4" | 949918 | 15918 |  |
| B18, B20, B21, B23, B25, B30 D31, D40 2001, 2002, 2003 Gänga / Thread 1/4" | 947893 | 15893 |  |
| B23, B25 Gänga / Thread 3/8" | 947894 | 15894 |  |

Avtappningspropp för kylvatten / Drain prop for cooling water

| | | | |
|---|--------------------|-------|---|
| V-6, V8 D30, D31, D40, D41, D42 Gänga / Thread 1/4" | 861551 (192134) | 15134 |  |
|---|--------------------|-------|---|

Hållare för zinkanod / Connecting plug for zinc anode

| | | | |
|---|--------------------|-------|---|
| D19, D21, D27, D29, D30, D31, D32 D40, D41, D42 2001, 2002, 2003 Gänga / Thread 1/2" | 838928 (800475) | 15928 |  |
|---|--------------------|-------|---|

Zinkanoder för kylsystem / Zinc anodes for cooling system

| Motor typ Engine type | Ref.nr Ref. No. | Best.nr Part No. | |
|---|--|---|--|
| <p>D19, D21, D27, D29, D30, D31, D32 D40, D41, D42 2001, 2002, 2003</p> | <p>838929 (804107) (800476) (858501)</p> | <p>19929</p> |  |
| <p>D60, D70, D100, D120 60, 70, 100, 120 - motorer / engines Zink anod / Zinc anod Packning / Gasket</p> | <p>823661 836169</p> | <p>15661 15169</p> |  |
| <p>D2, D3, D5, D6, D7, D11, D17 2001, 2002, 2003</p> <p>MD2A, MD2B, MD3B MD5A, MD5B, MD5C MD6A, MD6B, MD7A, MD7B MD11C, MD11D, MD17C, MD17D 2001, 2002, 2003</p> <p>Med Martec och Sendure sötvattenkyllning With Martec and Sendure fresh-water cooling</p> <p>1/4" x 19 mm</p> | <p>43957300</p> | <p>15300</p> |  |

Zinkanoder för kylsystem forts./ Zinc anodes for cooling system cont.

| Motor typ Engine type | Ref.nr Ref. No. | Best.nr Part No. | |
|---|--------------------|---------------------|---|
| <p>B18, B20, B30</p> <p>AQ60F, AQ90, AQ95, AQ95A, AQ110 AQ120 BB30, BB100 MB18</p> <p>AQ105A AQ115A, AQ115B AQ130A, AQ130B, AQ130C, AQ130D BB115, BB115B, BB115C MB20A, MB20B, MB20C</p> <p>AQ165A AQ170A, AQ170B, AQ170C BB165A BB170A, BB170B, BB170C</p> <p>Med Martec sötvattenkylning With Martec fresh-water cooling</p> <p>1/4" x 27 mm</p> | 43957301 | 15301 |  |
| <p>V-6, V-8</p> <p>Med Martec sötvattenkylning With Martec fresh-water cooling</p> <p>1/4" x 44 mm</p> | 43957302 | 15302 |  |
| <p>V-6, V-8</p> <p>Med Volvo-Penta sötvattenkylning / With Volvo-Penta fresh-water cooling</p> <p>3/8" x 38 mm</p> | 841063 | 15304 |  |

Packningsssats för vakuumentil / Gasket set for vacuum valve

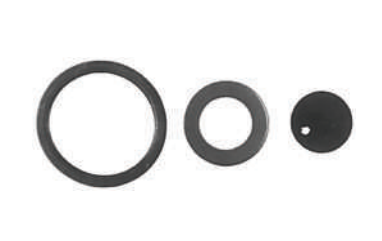
| | | | |
|---|---------------------|-------|---|
| <p>För alla motorer med vakuumentil / For all engines with vacuum valve</p> | 3818424 (875738) | 15738 |  |
|---|---------------------|-------|---|

Expansionspluggar (rostfri) / Expansion plugs (stainless)

| Motor typ Engine type | Ref.nr Ref. No. | Best.nr Part No. | |
|--|--------------------|---------------------|---|
| B18, B20 V-8 D30, D31, D32, D40, D41, D42 Diameter 26 mm rostfri / stainless | 477026 (192426) | 11031 |  |
| B18, B20, B30 V-8 2001, 2002, 2003 Diameter 35 mm rostfri / stainless | 477024 (192211) | 11032 | |
| B-18, B-20, B-30 D 21, D 29 Diameter 45 mm rostfri / stainless | 192212 | 11033 | |

Expansionspluggar (galvaniserad) / Expansion plugs (galvanized)

| | | | |
|---|--------------------|--------------|---|
| Diameter 35 mm | 463903 | 11903 |  |
| B18, B20 B-18, B-20 Kamaxelbricka Diameter 42 mm | 463902 (955103) | 11902 | |
| B21 AQ120B, 125A, 140A, 145A Diameter 45 mm | 463904 | 11904 | |

Expansionspluggar (galvaniserad) forts. / Expansion plugs (galvanized) cont.

| Motor typ Engine type | Ref.nr Ref. No. | Best.nr Part No. | |
|---|---------------------|---------------------|---|
| D42 KAD / KAMD 42A Diameter 40 mm | 968955 (1542263) | 11955 |  |
| B21, B23, B25, B30 D42 B-30 Kamaxelbricka Diameter 52 mm | 463905 | 11905 | |





Elpumpar för Martec sötvattnenkyllning / Electric pumps for Martec fresh water cooling

| | | | |
|---|----------|--------------|---|
| D2, D3, D5, D6, D7, D11, D17 2001, 2002, 2003 MD2A, MD2B, MD3B MD5A, MD5B, MD5C MD6A, MD6B MD7A, MD7B MD11C, MD11D 2001, 2002 16 mm anslutning / hose connection 14 liter / min. 12 volt | 43213002 | 15102 |  |
| D3, D17 MD3B MD17C, MD17D 19 mm anslutning / hose connection 23 liter / min. 12 volt | 43213003 | 15108 | |

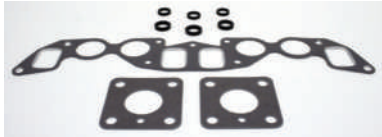

Avgasrör / Exhaust manifolds

| Motor typ Engine type | Ref.nr Ref. No. | Best.nr Part No. | |
|---|--------------------------------|---------------------|---|
| <p>B20</p> <p>AQ115A, AQ115B AQ130A, AQ130B, AQ130C, AQ130D BB 115A, BB115B, BB115C</p> <p>Passar ej / Not for: AQ60F, AQ105A, BB30, MB18F MB20A, MB20B, MB20C</p> | 824532 | 16532 |  |
| <p>B21, B23, B25</p> <p>AQ120B, AQ125A, AQ140A BB140A</p> <p>230A, 230B AQ125B AQ131A, AQ131B, AQ131C, AQ131D AQ145A, AQ145B BB145A</p> <p>250A, 250B AQ151A, AQ151B, AQ151C, AQ151D</p> | 855387 | 16387 |  |
| <p>V6</p> <p>430A, 430B, 431A, 431B, 432A, 434A AQ175A, AQ205A</p> | 856894 (841676) (856137) | 16894 |  |
| <p>V8</p> <p>500A, 500B, 501A, 501B 570A, 571A, 572A AQ200D, AQ200F, AQ211A AQ225D, AQ225E, AQ225F AQ231A, AQ231B AQ255B AQ260A, AQ260B, AQ271A, AQ271B, AQ271C, AQ271D AQ280A AQ290A AQ311A, AQ311B BB225A, BB225AV BB225B, BB225C BB231A BB260A, BB260AV BB260B, BB260C BB261A</p> | 856883 (855926) (835804) | 16804 |  |

Packningsatser för avgasrör / Gasket kits for exhaust manifold

| Motor typ Engine type | Ref.nr Ref. No. | Best.nr Part No. | |
|---|--------------------|---------------------|---|
| <p>B18, B20</p> <p>AQ60F, AQ90, AQ95, AQ95A, AQ110 AQ120 BB30, BB100 MB18</p> <p>AQ105 MB20A, MB20B, MB20C</p> <p>För avgasrör V-P 806333 / For exhaust manifold V-P 806333</p> | | 22003 |  |
| <p>B20</p> <p>AQ115A, AQ115B AQ130A, AQ130B, AQ130C, AQ130D BB115A, BB115B, BB115C</p> <p>För avgasrör 16532 / For exhaust manifold 16532</p> | | 22002 |  |
| <p>B21, B23, B25</p> <p>AQ120B, AQ125A, AQ140A BB140A</p> <p>230A, 230B AQ125B AQ131A, AQ131B, AQ131C, AQ131D AQ145A, AQ145B BB145A</p> <p>250A, 250B AQ151A, AQ151B, AQ151C</p> | | 22004 |  |
| <p>B30</p> <p>AQ 165A AQ170A, AQ170B, AQ170C BB 165A BB170A, BB170B, BB170C</p> | | 22041 |  |
| <p>V6</p> <p>430A, 430B, 431A, 431B, 432A, 434A AQ175A AQ205A</p> <p>P-sats för 1 sida / Gasket kit for one side 2 st åtgär / 2 pcs required</p> | | 22147 |  |





Packningsatser för avgasrör forts. / Gasket kits for exhaust manifold cont.

| Motor typ Engine type | Ref.nr Ref. No. | Best.nr Part No. | |
|--|--------------------|---------------------|---|
| V8 500A, 500B, 501A, 501B 570A, 571A, 572A AQ200D, AQ200F, AQ211A AQ225D, AQ225E, AQ225F AQ231A, AQ231B AQ255B AQ260A, AQ260B, AQ271A, AQ271B, AQ271C, AQ271D AQ280A AQ290A AQ311A, AQ311B BB225A, BB225AV BB225B, BB225C BB231A BB260A, BB260AV BB260B, BB260C BB261A P-sats för 1 sida / Gasket kit for one side 2 st åtgär / 2 pcs required | | 22001 |  |
| D21 AQD21A, AQD21B MD21A, MD21B | | 22129 |  |
| D29, D32 AQD29, AQD29A MD29, MD29A AQD32A MD32A | | 22130 |  |

Packningar för avgasrör / Gaskets for exhaust manifold

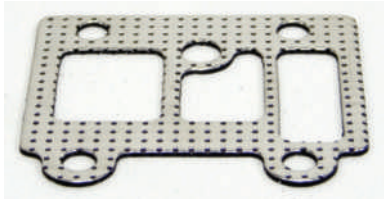
| | | | |
|--|--------|-------|---|
| B25 251A AQ171A, AQ171C | 855513 | 16513 |  |
|--|--------|-------|---|

Packningar för avgasrör forts. / Gaskets for exhaust manifold cont.

| Motor typ Engine type | Ref.nr Ref. No. | Best.nr Part No. | |
|--|---|-------------------------|---|
| <p>D1, D2, D3, D11, D17</p> <p>D1A MD1A, MD1B</p> <p>AQD2B D2A MD2A, MD2B</p> <p>MD3B</p> <p>MD11C, MD11D</p> <p>MD17C, MD17D</p> <p>Mellan avgasrör och topplock / Exhaust manifold gasket</p> | <p>859145 (833598) (897322)</p> | <p>16098</p> |  |
| <p>D6, D7</p> <p>MD6A, MD6B</p> <p>MD7A, MD7B</p> <p>Mellan avgasrör och topplock / Exhaust manifold gasket</p> | <p>859194 (3875382)</p> | <p>16194</p> |  |
| <p>D22</p> <p>MD22A, MD22L-A MD22L-B, MD22P-B TMD22A, TMD22B TAMD22P-B</p> | <p>859785</p> | <p>16785 NEW</p> |  |
| <p>D30, D40</p> <p>AD30A AQAD30A MD30A TAMD30A TMD30A</p> <p>AD40A AQAD40A, AQAD40B AQD40A MD40A TAMD40A, TAMD40B TMD40A, TMD40B, TMD40C</p> <p>30 = 4 st åtgår / 4 pcs required 40 = 6 st åtgår / 6 pcs required</p> | <p>1542123</p> | <p>16123</p> |  |

Packningar för avgasrör forts. / Gaskets for exhaust manifold cont.

| Motor typ Engine type | Ref.nr Ref. No. | Best.nr Part No. | |
|---|---|---------------------|---|
| <p>D31, D41</p> <p>AD31A, AD31B, AD31D AD31L-A, AD31P-A AD31XD AQAD31A MD31A TAMD31A, TAMD31B, TAMD31D TAMD31L-A, TAMD31M-A, TAMD31P-A TMD31A, TMD31B, TMD31D TMD31L-A</p> <p>KAD32P-A</p> <p>AD41A, AD41B, AD41D AD41L-A, AD41P-A AQAD41A D41A, D41B, D41D, D41L-A TAMD41A, TAMD41B, TAMD41D TAMD41H-A, TAMD41L-A TAMD41M-A, TAMD41P-A TMD41A, TMD41B, TMD41D, TMD41L-A</p> <p>KAD42A, KAD42B, KAD42P-A KAMD42A, KAMD42B, KAMD42P-A TAMD42B TAMD42WJ-A</p> <p>KAD43P-A KAMD43P-A</p> <p>KAD44P-A, KAD44P-B, KAD44P-C KAMD44P-A, KAMD44P-B, KAMD44P-C</p> <p>KAD300A KAMD300A</p> <p>31 = 4 st åtgår / 4 pcs required 41 = 6 st åtgår / 6 pcs required</p> | <p>876144 (838673) (876144)</p> | <p>16673</p> |  |

Bultsatser för avgasrör / Bolt kits for exhaust manifolds

| | | | |
|--|--|---------------------|---|
| <p>B18, B20</p> <p>AQ60F, AQ90, AQ95, AQ95A, AQ110 AQ120 BB30, BB100 MB18</p> <p>AQ105A AQ115A, AQ115B AQ130A, AQ130B, AQ130C, AQ130D BB115A, BB115B, BB115C MB20A, MB20B, MB20C</p> <p>För avgasrör 806333, 824532 For exhaust manifold 806333, 824532</p> | | <p>22005</p> |  |
|--|--|---------------------|---|

Bultsatser för avgasrör forts. / Bolt kits for exhaust manifolds cont.

| Motor typ Engine type | Ref.nr Ref. No. | Best.nr Part No. | |
|--|--------------------|---------------------|---|
| <p>B21, B23, B25</p> <p>AQ120B, AQ125A, AQ140A BB140A</p> <p>230A, 230B AQ125B AQ131A, AQ131B, AQ131C, AQ131D AQ145A, AQ145B BB145A</p> <p>250A, 250B AQ151A, AQ151B, AQ151C</p> | | 22007 |  |
| <p>B30</p> <p>AQ165A AQ170A, AQ170B, AQ170C BB165A BB170A, BB170B, BB170C</p> | | 22045 |  |
| <p>V6</p> <p>430A, 430B, 431A, 431B, 432A, 434A AQ175A AQ205A</p> <p>2 satser åtgår för komplett motor / 2 sets required for compl. engine</p> | | 22145 |  |
| <p>V8</p> <p>500A, 500B, 501A, 501B 570A, 571A, 572A AQ200D, AQ200F, AQ211A AQ225D, AQ225E, AQ225F AQ231A, AQ231B AQ255B AQ260A, AQ260B, AQ271A, AQ271B, AQ271C, AQ271D AQ280A AQ290A AQ311A, AQ311B BB225A, BB225AV BB225B, BB225C BB231A BB260A, BB260AV BB260B, BB260C BB261A</p> <p>2 satser åtgår för komplett motor / 2 sets required for compl. engine</p> | | 22006 |  |

Avgaskrökar / Exhaust bends

| Motor typ Engine type | Ref.nr Ref. No. | Best.nr Part No. | |
|---|--|---------------------|---|
| <p>B18, B20</p> <p>BB30, BB100 MB18</p> <p>BB115A, BB115B, BB115C MB20A, MB20B, MB20C</p> <p>För motorer med backslag / For engines with reverse gear</p> | 825600 | 16600 |  |
| <p>B18, B20</p> <p>AQ115A, AQ115B</p> <p>, AQ115C MB20A, MB20B, MB20C</p> <p>För motorer med backslag / For engines with reverse gear</p> | 825599 | 16599 |  |
| <p>V6</p> <p>430A, 430B, 431A, 431B, 432A, 434A AQ175A AQ205A</p> | 857037 (841847) (855380) (856895) | 16037 |  |
| <p>V8</p> <p>500A, 500B, 501A, 501B 570A, 571A, 572A AQ200D, AQ200F, AQ211A AQ225D, AQ225E, AQ225F AQ231A, AQ231B AQ255B AQ260A, AQ260B, AQ271A, AQ271B, AQ271C, AQ271D AQ280A AQ290A AQ311A, AQ311B BB225A, BB225AV BB225B, BB225C BB231A BB260A, BB260AV BB260B, BB260C BB261A</p> | 856891 (855384) | 16384 |  |

Avgaskrökar forts./ Exhaust bends cont.

| Motor typ Engine type | Ref.nr Ref. No. | Best.nr Part No. | |
|--|--------------------|---------------------|--|
| <p>D30, D40</p> <p>AD30A AQAD30A TAMD30A TMD30A</p> <p>AD40B AQAD40A, AQAD40B AQD40A TAMD40A, TAMD40B TMD40A, TMD40B, TMD40C</p> | 845261 | 16261 NEW |  |
| <p>D31, D41</p> <p>AD31A AQAD31A TAMD31A TMD31A</p> <p>AD41A AQAD41A D41A TAMD41A TMD41A</p> <p>Ersätter avgaskrök med spjäll / Replaces exhaust bend with throttle</p> | 877415 (858481) | 16415 NEW | <p>NEW</p>  |
| <p>D31, D41</p> <p>AD31D, AD31L-A, AD31P-A, AD31XD</p> <p>KAD32P-A</p> <p>AD41D, AD41L-A, AD41P-A D41D, D41L-A</p> <p>KAD42A, KAD42B, KAD42P-A KAMD42A, KAMD42B, KAMD42P-A TAMD42B, TAMD42WJ-A</p> <p>KAD43P-A KAMD43P-A</p> <p>KAD44P-A, KAD44P-B, KAD44P-C KAMD44P-A, KAMD44P-B, KAMD44P-C</p> <p>KAD300A KAMD300A</p> <p>Med 38 mm slangfäste / With 38 mm hose connection</p> | 861289 | 16289 NEW |  |

Avgaskrökar forts./ Exhaust bends cont.

| Motor typ Engine type | Ref.nr Ref. No. | Best.nr Part No. | |
|--|--------------------|-------------------------|---|
| <p>D31, D41</p> <p>AD31B TAMD31B, TAMD31D TAMD31L-A, TAMD31M-A, TAMD31P-A TMD31B, TMD31D, TMD31L-A</p> <p>AD41B, AD41D D41B TAMD41B, TAMD41D TAMD41H-A, TAMD41L-A TAMD41M-A, TAMD41P-A TMD41B, TMD41D, TMD41L-A</p> | 859963 | 16963 <i>NEW</i> |  |



Gavellock för avgasrör / Cover plate for exhaust manifold

| | | | |
|---|--------|--------------|--|
| <p>B18, B20</p> <p>AQ60F, AQ90, AQ95, AQ95A, AQ110 AQ120 BB30, BB100 MB18</p> <p>AQ105A AQ115A, AQ115B AQ130A, AQ130B, AQ130C, AQ130D BB115A, BB115B, BB115C MB20A, MB20B, MB20C</p> | 806341 | 16341 |  |
|---|--------|--------------|--|

Monteringskit för avgaskrök / Installation kits for exhaust bend

| | | | |
|---|--|--------------|---|
| <p>B18, B20</p> <p>AQ60F, AQ90, AQ95, AQ95A, AQ110 AQ120 BB30, BB100 MB18</p> <p>AQ105A AQ115A, AQ115B AQ130A, AQ130B, AQ130C, AQ130D BB115A, BB115B, BB115C MB20A, MB20B, MB20C</p> | | 16001 |  |
| <p>B30</p> <p>AQ165A AQ170A, AQ170B, AQ170C BB165A BB170A, BB170B, BB170C</p> | | 22102 |  |

Monteringssatser för avgaskrök forts./ Installation kits for exhaust bend cont.

| Motor typ Engine type | Ref.nr Ref. No. | Best.nr Part No. | |
|--|--------------------|---------------------|---|
| <p>V6</p> <p>430A, 430B, 431A, 431B, 432A, 434A AQ175A AQ205A</p> <p>2 satser åtgår för komplett motor / 2 sets required for compl. engine</p> | | <p>22146</p> |  |
| <p>V8</p> <p>500A, 500B, 501A, 501B 570A, 571A, 572A AQ200D, AQ200F AQ211A AQ225D, AQ225E, AQ225F AQ231A, AQ231B AQ255B AQ260A, AQ260B, AQ271A, AQ271B, AQ271C, AQ271D AQ280A AQ290A AQ311A, AQ311B BB225A, BB225AV BB225B, BB225C BB231A BB260A, BB260AV BB260B, BB260C BB261A</p> <p>För avgaskrök 16384 / For exhaust bend 16384</p> | | <p>16008</p> |  |



Packningar för avgaskrök / Gaskets for exhaust bend

| Motor typ Engine type | Ref.nr Ref. No. | Best.nr Part No. | |
|--|-----------------------------|-------------------------|---|
| <p>2001, 2002, 2003 D6, D7</p> <p>2001, 2001AG, 2001B, 2001BG 2002, 2002AG, 2002B, 2002BG 2003, 2003AG, 2003B, 2003BG 2003T, 2003TB</p> <p>MD6A, MD6B</p> <p>MD7A, MD7B</p> | <p>840902 (3875050)</p> | <p>16902</p> |  |
| <p>MB10 D1, D2, D3, D5, D6, D7, D11, D17</p> <p>MB10A</p> <p>MD1A, MD1B</p> <p>AQD2B D2, MD2, MD2A, MD2B</p> <p>MD3B</p> <p>MD5A, MD5B, MD5C</p> <p>MD6A, MD6B</p> <p>MD7A, MD7B</p> <p>MD11C, MD11D</p> <p>MD17C, MD17D</p> | <p>859015 (803374)</p> | <p>16374</p> |  |
| <p>D22</p> <p>MD22A, MD22L-A MD22L-B, MD22P-B TMD22A, TMD22B TAMD22P-B</p> | <p>859834</p> | <p>16834 NEW</p> |  |
| <p>D19, D21, D27, D29, D32</p> <p>AQD19 MD19</p> <p>AQD21A, AQD21B MD21A, MD21B</p> <p>AQD27 MD27</p> <p>AQD29, AQD29A MD29 MD29A</p> <p>AQD32A MD32A</p> | <p>859140 (819720)</p> | <p>16140</p> |  |

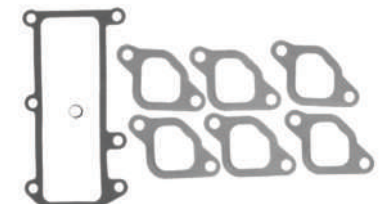

Avgasslangar för avgaskrök / Exhaust hoses for exhaust bend

| Motor typ Engine type | Ref.nr Ref. No. | Best.nr Part No. | |
|---|--------------------|---------------------|---|
| <p>B16, B18, B20, V8 D19, D21, D29, D32</p> <p>AQ80, AQ80S, AQ60F, AQ90, AQ95, AQ95A, AQ100 AQ110, AQ120</p> <p>AQ105A AQ115A, AQ115B AQ130A, AQ130B, AQ130C, AQ130D</p> <p>AQ210A</p> <p>AQD19 AQD21A, AQD21B AQD27 AQD29 AQD29A AQD32A</p> <p>Längd 200 mm. Innerdiameter \varnothing 57 mm / Length 200 mm. Inside \varnothing 57 mm</p> | | <p>16007</p> |  |
| <p>B30, V8</p> <p>AQ165A AQ170A, AQ170B, AQ170C</p> <p>AQ190A AQ240A</p> <p>Längd 130 mm. Innerdiameter \varnothing 75 mm / Length 130 mm inside \varnothing 75 mm</p> | | <p>16010</p> |  |
| <p>V6, V8</p> <p>430A, 430B, 431A, 431B, 432A, 434A AQ175A, AQ205A</p> <p>500A, 500B, 501A, 501B 570A, 571A, 572A AQ200D, AQ200F, AQ211A AQ225D, AQ225E, AQ225F AQ231A, AQ231B AQ255B AQ260A, AQ260B, AQ271A, AQ271B, AQ271C, AQ271D AQ280A AQ290A AQ311A, AQ311B BB225A, BB225AV BB225B, BB225C BB231A BB260A, BB260AV BB260B, BB260C BB261A</p> <p>För avgaskrök 16384 Längd 160 mm. Innerdiameter \varnothing 95 mm 4 slangklammer 19012 åtgår / For exhaust bend 16384. Length 160 mm. Inside \varnothing 95 mm 4 hose clamps 19012 required</p> | <p>834751</p> | <p>16751</p> |  |

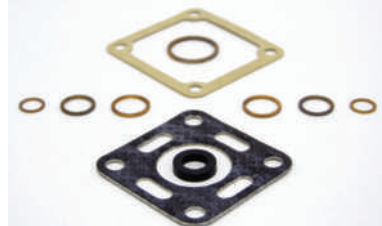
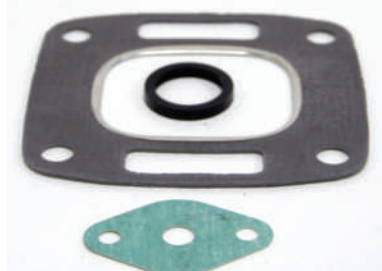

Packningsatser för insugsrör / Gasket sets for inlet pipe

| Motor typ Engine type | Ref.nr Ref. No. | Best.nr Part No. | |
|---|--------------------|---------------------|---|
| D30 AD30A AQAD30A MD30A TAMD30A TMD 30A | | 22119 |  |
| D40 AQAD40A, AQAD40B MD40A TAMD40A, TAMD40B | | 22120 |  |
| D40 AD40B AQD40A TMD40A, TMD40B, TMD40C | | 22121 |  |



Packningsatser för avgaskrök - turbo / Gasket kits for connect. with turbo

| | | | |
|---|--------------------|-------|---|
| 2003 2003T 2003TB | | 22034 |  |
| D30, D31, D40 MD30A MD31A MD40A | | 22134 |  |
| D30 AD30A AQAD30A TAMD30A TMD30A | 876313 (875734) | 22135 |  |

Packningssatser för avgaskrök - turbo forts./ Gasket kits for connect. with turbo cont.

| Motor typ Engine type | Ref.nr Ref. No. | Best.nr Part No. | |
|---|--|---------------------|--|
| <p>D40</p> <p>AD40B AQAD40A, AQAD40B AQD40A TAMD40A, TAMD40B TMD40A, TMD40B, TMD40C</p> | <p>876398 (875646)</p> | <p>22139</p> |  |
| <p>D31, D32 D41, D42, D43, D44 D300</p> <p>AD31A, AD31B, AD31D AD31L-A, AD31P-A, AD31XD AQAD31A TAMD31A, TAMD31B, TAMD31D TAMD31L-A, TAMD31M-A, TAMD31P-A TMD31A, TMD31B, TMD31D, TMD31L-A</p> <p>KAD32P-A</p> <p>AD41A, AD41B, AD41D AD41L-A, AD41P-A AQAD41A D41A, D41B, D41D, D41L-A TAMD41A, TAMD41B, TAMD41D TAMD41H-A, TAMD41L-A TAMD41M-A, TAMD41P-A TMD41A, TMD41B, TMD41D, TMD41L-A</p> <p>KAD42A, KAD42B, KAD42P-A KAMD42A, KAMD42B, KAMD42P-A TAMD42B, TAMD42WJ-A</p> <p>KAD43P-A KAMD43P-A</p> <p>KAD44P-A, KAD44P-B, KAD44P-C KAMD44P-A, KAMD44P-B, KAMD44P-C</p> <p>KAD300A KAMD300A</p> | <p>3582563 (876312) (876108)</p> | <p>22138</p> |  |

Bränslefilter / Fuel filters

| Motor typ Engine type | Ref.nr Ref. No. | Best.nr Part No. | |
|--|--|---------------------|---|
| <p>B21, B23, B25 V6, V8</p> <p>AQ120B, AQ125A, AQ140A BB140A</p> <p>230A, 230B AQ125B AQ131A, AQ131B, AQ131C, AQ131D AQ145B</p> <p>250A, 250B, 251A AQ151A, AQ151B, AQ151C AQ171A, AQ171C</p> <p>AQ175A</p> <p>AQ200C, AQ200D AQ225B, AQ225C, AQ225D, AQ225E AQ225F AQ255A, AQ255B AQ260A, AQ260B AQ280A AQ290A BB225A, BB225AV, BB225B, BB225C BB260A, BB260AV, BB260B, BB260C</p> <p>Packning ingår / Gasket included</p> | <p>877765 (855952) (841162) (835860)</p> | <p>17162</p> |  |
| <p>V6, V8</p> <p>430A, 430B, 431A, 431B, 432A, 434A AQ205A</p> <p>500A, 500B, 501A, 501B 570A, 571A, 572A 740A, 740B AQ200F AQ211A AQ225F AQ231A, AQ231B AQ271A, AQ271B, AQ271C, AQ275D AQ311A, AQ311B BB225C BB231A BB260C BB261A</p> | <p>855686</p> | <p>17686</p> |  |



Bränslefilter forts. / Fuel filters cont.

| Motor typ Engine type | Ref.nr Ref. No. | Best.nr Part No. | |
|--|----------------------------|---------------------|---|
| <p>D1, D2, D3, D5, D11, D17</p> <p>D1A MD1A, MD1B</p> <p>D2A MD2A, MD2B</p> <p>MD3B</p> <p>MD5A, MD5B*</p> <p>MD11C*, MD11D*</p> <p>MD17C*, MD17D*</p> <p>* Tidigare utförande / Earlier version Packning ingår / Gasket included</p> | <p>876554 (870065)</p> | <p>17065</p> |  |
| <p>D5, D7, D11, D17 2001, 2002, 2003</p> <p>MD5B, MD5C*</p> <p>MD7B*</p> <p>MD11C*, MD11D*</p> <p>MD17C*, MD17D*</p> <p>2001, 2001AG, 2001B, 21001BG 2002, 2002AG, 2002B, 21002BG 2003, 2003AG, 2003B, 21003BG 2003T, 2003TB</p> <p>* Senare utförande / Later version</p> | <p>829913</p> | <p>17913</p> |  |
| <p>MD2010, MD2020, MD2030, MD2040 D2-55</p> <p>MD2010A, MD2010B MD2020A, MD2020B MD2030A, MD2030B MD2040A, MD2040B</p> <p>D2-55</p> | <p>861477</p> | <p>17477</p> |  |



Bränslefilter forts. / Fuel filters cont.

| Motor typ Engine type | Ref.nr Ref. No. | Best.nr Part No. | |
|---|--|---------------------|---|
| <p>D5, D7, D30, D31, D32</p> <p>D5A-AT, D5A-ATA</p> <p>D7A-AT, D7A-ATA, D7C-ATA</p> <p>MD7A*, MD7B**</p> <p>AD30A AQAD30A MD30A TAMD30A TMD30A</p> <p>AD31A, AD31B, AD31D AD31L-A, AD31P-A, AD31XD AQAD31A MD31A TAMD31A, TAMD31B, TAMD31D TAMD31L-A, TAMD31M-A, TAMD31P-A TMD31A, TMD31B, TMD31D, TMD31L-A</p> <p>KAD32P-A</p> <p>D50 D60, D61, D62, D63 D70, D71, D72, D73, D74 D100, D103 D120, D121, D122 D162 D610, D630, D640 D710, D730, D731 D740, D741</p> <p>* Senare utförande / Later version ** Tidigare utförande / Earlier version</p> | <p>21492771 (3825133) (829993) (466987) (243004)</p> | <p>17987</p> |  |

Bränslefilter forts. / Fuel filters cont.

| Motor typ Engine type | Ref.nr Ref. No. | Best.nr Part No. | |
|---|---|---------------------|---|
| <p>D6, D7, D22 D40, D41, D42, D43, D44 D300</p> <p>MD6A, MD6B</p> <p>MD 7A*</p> <p>MD22A, MD22L-A, MD22L-B, MD22P-B TAMD22P-B TMD22A, TMD22B</p> <p>AD40B AQAD40A, AQAD40B AQD40A MD40A TAMD40A, TAMD40B TMD40A, TMD40B, TMD40C</p> <p>AD41A, AD41B, AD41D AD41L-A, AD41P-A AQAD41A D41A, D41B, D41D, D41L-A TAMD41A, TAMD41B, TAMD41D TAMD41L-A, TAMD41M-A, TAMD41P-A TMD41A, TMD41B, TMD41D, TMD41L-A</p> <p>KAD42A, KAD42B, KAD42P-A KAMD42A, KAMD42B, KAMD42P-A TAMD42B, TAMD42WJ-A</p> <p>KAD43P-A KAMD43P-A</p> <p>KAD44P-A, KAD44P-B, KAD44PC KAMD44P-A, KAMD44P-B, KAMD44P-C</p> <p>KAD300A KAMD300A</p> <p>* Tidigare utförande / Earlier version</p> | <p>3840335 (860874) (838593) (243464)</p> | <p>17874</p> |  |
| <p>D21, D32</p> <p>AQD21A, AQD21B MD21A, MD21B</p> <p>AQD32A MD32A</p> <p>Kort filter för Cav vattenavskiljare (typ 296) Short filters insert for CAV water separator (type 296)</p> | <p>3581078 (858201) (236628)</p> | <p>17201</p> |  |
| <p>Lång filterinsats för Cav filter Long filter insert for Cav filter</p> | <p>858202 (858306)</p> | <p>17306</p> |  |

Bränslefilter forts. / Fuel filters cont.

| Motor typ Engine type | Ref.nr Ref. No. | Best.nr Part No. | |
|--|----------------------------------|---------------------|---|
| Filter insats för RACOR & SEPAR filter / Filter insert for RACOR & SEPAR filter 861143 and 861144 Ø 80 mm 10 micron Packningar ingår / Rubber seals included | 861014 (828897) | 17101 |  |
| Filter insats för RACOR & SEPAR filter / Filter insert for RACOR & SEPAR filter 3825020 and 3825021 Ø 110 mm 10 micron Packningar ingår / Rubber seals included | 3838852 (3825027) (846734) | 17027 |  |

Cav filter komplett / Cav fuel filter complete

| | | | |
|---|---|--------------|--|
| Med 1/2" x 20 UNF invändig gänga / With 1/2" x 20 UNF inner thread | 877767 (1140639) (875542) (821094) | 17109 |  |
|---|---|--------------|--|

Nippelsats för Cav-filter / Connector kit for Cav filter

| | | | |
|--|---------------|---------------------|--|
| <p>Slangfäste för 8 mm slang med 1/2" x 20 UNF gänga /</p> <p>Hose connectors for 8 mm hose with 1/2" x 20 UNF thread</p> | | <p>22140</p> |  |
| <p>Slangfäste för 10 mm slang</p> <p>Hose connector for 10 mm hose</p> | | <p>17005</p> |  |
| <p>Nippel för Cav-filter för 5/16" rör med 1/2" x 20 UNF gänga</p> <p>Nipple for Cav filter for 5/16" pipe with 1/2" x 20 UNF thread</p> | <p>191394</p> | <p>17023</p> |  |
| <p>Nippel för Cav-filter för 3/8" rör med 1/2" x 20 UNF gänga</p> <p>Nipple for Cav filter for 3/8" pipe with 1/2" x 20 UNF thread</p> | <p>941438</p> | <p>17024</p> |  |

Ombyggnadsats Cav-filter / Rebuilding kit for Cav filter

| Motor typ Engine type | Ref.nr Ref. No. | Best.nr Part No. | |
|--------------------------|--------------------|---------------------|---|
| | | 17002 |  |

Packningsset för Cav bränslefilter / Gasket set for Cav fuel filter

| | | | |
|--|--|-------|---|
| Packningsset komplett för filter / Complete set of gaskets for filter | | 22046 |  |
|--|--|-------|---|

Glasskål för Cav bränslefilter / Glass bowl for Cav fuel filter

| | | | |
|-----------------------|--------|-------|---|
| Glasskål / Glass bowl | 818407 | 17407 |  |
|-----------------------|--------|-------|---|

Bult för Cav bränslefilter / Bolt for Cav fuel filter

| | | | |
|--|--|-------|---|
| Bult för ombyggnad av Cav vattenavskiljare till längre modell / Long centre bolt to convert Cav filter to longer type | | 17307 |  |
|--|--|-------|---|

Avtappningsplugg för Cav filter / Drain plug for Cav fuel filter

| | | | |
|---|--------------------|-------|---|
| Packning 17249 ingår / Gasket 17249 included | 862293 (826648) | 17648 |  |
|---|--------------------|-------|---|

Luftfilterinsatser / Air filter inserts

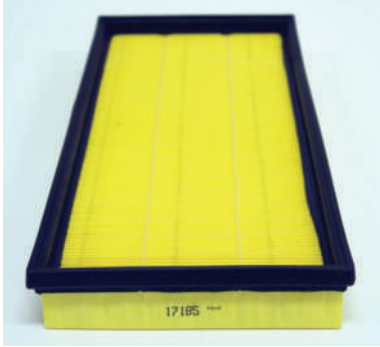
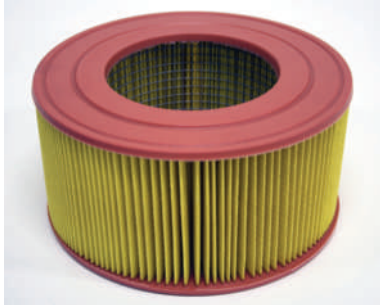
| Motor typ Engine type | Ref.nr Ref. No. | Best.nr Part No. | |
|---|----------------------------|---------------------|---|
| <p>D30, D32, D40, D42, D43, D44 D61, D62, D71, D72, D300</p> <p>AD30A AQAD30A MD30A TAMD30A TMD30A</p> <p>KAD32P-A</p> <p>AD40B AQAD40A, AQAD40B AQD40A MD40A TAMD40A, TAMD40B TMD40A, TMD40B, TMD40C KAD42A, KAD42B, KAD42P-A KAMD42A, KAMD42B, KAMD42P-A</p> <p>KAD43P-A KAMD43P-A</p> <p>KAD44P-A, KAD44P-B, KAD44P-C KAMD44P-A, KAMD44P-B, KAMD44P-C</p> <p>TAMD61A TAMD62A TAMD72A, TAMD72P-A, TAMD72WJ-A</p> <p>KAD300A KAMD300A</p> | <p>876185 (463505)</p> | <p>17185</p> |  |
| <p>D31, D41, D42</p> <p>AD31A, AD31B, AD31D AD31L-A, AD31P-A, AD31XD AQAD31A MD31A TAMD31A, TAMD31B, TAMD31D TAMD31L-A, TAMD31M-A, TAMD31P-A TMD31A, TMD31B, TMD31D, TMD31L-A</p> <p>AD41A, AD41B, AD41D AD41L-A, AD41P-A AQAD41A D41A, D41B, D41D, D41L-A TAMD41A, TAMD41B, TAMD41D TAMD41H-A, TAMD41L-A TAMD41M-A, TAMD41P-A TMD41A, TMD41B, TMD41D, TMD41L-A</p> <p>TAMD42B, TAMD42WJ-A</p> <p>Ø 200 mm Tidigare utförande / Earlier version</p> | <p>858488</p> | <p>17488</p> |  |

Luftfilterinsatser forts. / Air filter inserts cont.

| Motor typ Engine type | Ref.nr Ref. No. | Best.nr Part No. | |
|---|--------------------|-------------------------|---|
| <p>D31, D41</p> <p>AD31A, AD31B, AD31D AD31L-A, AD31P-A, AD31XD AQAD31A TAMD31A, TAMD31B, TAMD31D TAMD31L-A, TAMD31M-A, TAMD31P-A TMD31A, TMD31B, TMD31D, TMD31L-A AD41D, AD41L-A, AD41P-A AQAD41A AQD41A D41A, D41B, D41D, D41L-A TAMD41A, TAMD41B, TAMD41D TAMD41H-A, TAMD41L-A TAMD41M-A, TAMD41P-A TMD41A, TMD41B, TMD41D, TMD41L-A</p> <p>Ø 155 mm Senare utförande / Later version</p> | 3582358 | 17535 <i>NEW</i> |  |

Packningsatts för bränslepump / Gasket sets for fuel pump

| | | | |
|---|--|--------------|---|
| <p>MB10 2001, 2002, 2003 D1, D2, D3, D5, D6, D7, D11, D17</p> <p>MB10A</p> <p>2001*, 2001AG*, 2001B*, 2001BG* 2002*, 2002AG*, 2002B*, 2002BG* 2003*, 2003AG*, 2003B*, 2003BG* 2003T*, 2003TB*</p> <p>MD1B</p> <p>MD2A, MD2B</p> <p>MD3B</p> <p>MD5A, MD5B, MD5C</p> <p>MD6A, MD6B</p> <p>MD7A, MD7B</p> <p>MD11C, MD11D</p> <p>MD17C, MD17D</p> <p>* Tidigare utförande med lock / * Earlier version with cover.</p> | | 17003 |  |
|---|--|--------------|---|



Packningsssats för bränslepump forts. / Gasket sets for fuel pump cont.

| Motor typ Engine type | Ref.nr Ref. No. | Best.nr Part No. | |
|---|--------------------|---------------------|--|
| <p>D30, D31, D32 D40, D41, D42, D43, D44</p> <p>AD30A AQAD30A TAMD30A TMD30A</p> <p>AD31A, AD31B, AD31D, AD31XD AQAD31A MD31A TAMD31A, TAMD31B, TAMD31D TMD31A, TMD31B, TMD31D</p> <p>KAD32P-A</p> <p>AD40B AQAD40A, AQAD40B, AQD40A MD40A TAMD40A, TAMD40B TMD40A, TMD40B, TMD40C</p> <p>AD41A, AD41B, AD41D AQAD41A D41A, D41B, D41D TAMD41A, TAMD41B, TAMD41D TMD41A, TMD41B, TMD41D</p> <p>KAD42A, KAD42B, KAD42P-A KAMD42A, KAMD42B, KAMD42P-A TAMD42B, TAMD42WJ-A</p> <p>KAD43P-A KAMD43P-A</p> <p>KAD44P-A KAMD44P-A</p> | <p>273663</p> | <p>17663</p> |  |

Packningsssats förgasare / Gasket sets for carburettor

| Motor typ Engine type | Ref.nr Ref. No. | Best.nr Part No. | |
|---|--------------------|---------------------|---|
| <p>B20, B21, B23, B25, B30</p> <p>AQ115A, AQ115B AQ130A, AQ130B, AQ130C, AQ130D BB115A, BB115B, BB115C MB20B</p> <p>AQ125A</p> <p>230A, 230B AQ125B AQ131A, AQ131B, AQ131C, AQ131D AQ145A, AQ145B BB145A</p> <p>250A, 250B, 251A AQ151A, AQ151B, AQ151C AQ171A, AQ171C</p> <p>AQ170A, AQ170B, AQ170C BB170A, BB170B, BB170C</p> <p>För solex förgasare / For solex carburettor</p> | 856470 (824803) | 17803 |  |

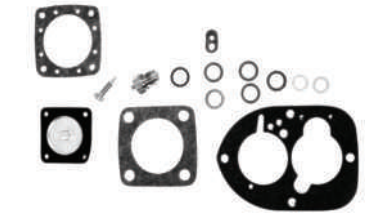
Rep. sats förgasare / Repair kits for carburettor

| | | | |
|---|--------|------------------|---|
| <p>B20, B21, B23, B25, B30</p> <p>AQ115A, AQ115B AQ130A, AQ130B, AQ130C, AQ130D BB115A, BB115B, BB115C MB20B</p> <p>AQ125A</p> <p>230A, 230B AQ125B AQ131A, AQ131B, AQ131C, AQ131D AQ145A, AQ145B BB145A</p> <p>250A, 250B 251A AQ151A, AQ151B, AQ151C AQ171A, AQ171C</p> <p>AQ170A, AQ170B, AQ170C BB170A, BB170B, BB170C</p> | 841293 | 17292 NEW |  |
| <p>B21</p> <p>AQ120B AQ140A BB140A</p> | 841293 | 17293 NEW |  |



Bränslepumpar / Fuel pumps

| Motor typ Engine type | Ref.nr Ref. No. | Best.nr Part No. | |
|---|--------------------|---------------------|---|
| <p>B21, B23, B25</p> <p>AQ120B* AQ140A* BB140A*</p> <p>230A, 230B AQ125B AQ131A, AQ131B, AQ131C, AQ131D AQ145A, AQ145B BB145A</p> <p>250A, 250B, 251A AQ151A, AQ151B, AQ151C AQ171A, AQ171C</p> <p>* Senare utförande / Later version</p> | 841161 | 17161 |  |
| <p>2001, 2002, 2003 D1, D2, D3, D5, D6, D7, D11, D17</p> <p>2001*, 2001AG*, 2001B*, 2001BG* 2002*, 2002AG*, 2002B*, 2002BG* 2003*, 2003AG*, 2003B*, 2003BG* 2003T*, 2003TB*</p> <p>MD1B</p> <p>AQD2B D2A MD2, MD2A, MD2B</p> <p>MD3B</p> <p>MD5A, MD5B, MD5C</p> <p>MD6A, MD6B</p> <p>MD7A, MD7B</p> <p>MD11C, MD11D</p> <p>MD17C, MD17D</p> <p>* Tidigare utförande med lock / * Earlier version with cover.</p> | 833323 | 17323 |  |
| <p>D2, D2010, D2020, D2030, D2040</p> <p>D2-55A, D2-55B, D2-55C, D2-55D, D255E</p> <p>MD2010A/B/C/D, 2020A/B/C/D MD2030A/B/C/D, 2040A/B/C/D</p> | 3580100 | 80100 | <p>NEW</p>  |

Bränslepumpar forts. / Fuel pumps cont.

| Motor typ Engine type | Ref.nr Ref. No. | Best.nr Part No. | |
|---|--------------------|---------------------|---|
| V8 500A, 500B 501A, 501B 570A 571A 572A AQ200D, AQ200F AQ211A AQ225D, AQ225E, AQ225F AQ231A, AQ231B AQ255B AQ260A, AQ260B AQ271A, AQ271B, AQ271C, AQ271D AQ280A AQ290A AQ311A, AQ311B BB225A, BB225AV BB225B BB225C BB231A BB260A, BB260AV BB260B BB260C BB261A | 826493 | 17493 |  |

Elektrisk bränslepump / Electric fuel pump

| | | | |
|---|-------------------|-------|---|
| V6, V8 430B 431B 432A 434A 740B | 3858261 856955 | 17261 |  |
| V6, V8 4,3Gi 5,7GLi 5,7GSi 5,7Gi | 3857650 | 17650 |  |
| V8 Ford 5,0 5,8 | 3850810 | 17810 |  |



Elektrisk universal bränslepump / Electric universal fuel pump

| Motor typ Engine type | Ref.nr Ref. No. | Best.nr Part No. | |
|--|--------------------|---------------------|---|
| <p>För bensin och dieselmotorer / For gasolin and diesel engines 12 volt/ 132 liter / tim. sughöjd 300 mm med inbyggd övertrycksventil 0,3-0,5 kg</p> <p>132 l/ hour selfpriming 12 inches fuel lift. Built in pressure relief valve 6,5-7,5 psi</p> | | 17017 |  |

Distansbricka för bränslepump / Spacer for fuel pump

| | | | |
|--|--------|-------|--|
| <p>B21, B23, B25</p> <p>AQ120B* AQ125A AQ140A* BB140A</p> <p>230A, 230B AQ125B AQ131A, AQ131B, AQ131C, AQ131D AQ145A, AQ145B BB145A</p> <p>250A, 250B, 251A AQ151A, AQ151B, AQ151C AQ171A, AQ171C</p> <p>* Senare utförande / Later version</p> | 463391 | 17391 |  |
|--|--------|-------|--|

Förgasarmembran / Carburettor diaphragm

| | | | |
|--|--------------------|-------|---|
| <p>B18, B20</p> <p>AQ95 AQ110 AQ105A</p> <p>För Zenith/Stromberg förgasare CD 150 For Zenith/Stromberg carburettor CD 150</p> | 825973 (820366) | 17973 |  |
| <p>B18, B20, B30</p> <p>AQ120 AQ130A, AQ130B BB115B</p> <p>AQ165A BB165A</p> <p>För Zenith/Stromberg förgasare CD 175 For Zenith/Stromberg carburettor CD 175</p> | 237666 (237299) | 17666 |  |

Spridarspets / Nozzles

| Motor typ Engine type | Ref.nr Ref. No. | Best.nr Part No. | |
|---|--------------------|---------------------|---|
| D1, D2, D3, D11, D17 MD1B AQD2B MD2B MD3B MD11C MO -50988 MD17C MO -16621 | 233179 | 17179 | |
| D5, D7 MD5A, MD5B, MD5C MD7A, MD7B (DLLA 150 P33) | 838287 | 17287 | |
| D6 MD6A, MD6B (DLLA 150 P1) | 3875400 | 17400 | |
| D11, D17 MD11C MO 50989- MD11D MD17C MO 16622- MD17D (DLLA 150 S 828) | 829909 | 17909 |  |
| 2001, 2002, 2003 2001, 2001AG, 2001B, 2001BG 2002, 2002AG, 2002B, 2002BG 2003, 2003AG, 2003B, 2003BG 2003T, 2003TB (OLL 140 P 10746-N8) | 860340 (859461) | 17461 | |
| 2001, 2002, 2003 2001, 2001AG, 2001B, 2001BG 2002, 2002AG 2003 (DLLA 150 P65) | 840597 | 17597 | |



Spridarspets forts. / Nozzles cont.

| Motor typ Engine type | Ref.nr Ref. No. | Best.nr Part No. | |
|--|--------------------|---------------------|--|
| 2001, 2002, 2003 2001B, 2001BG 2002B, 2002BG 2003B, 2003BG (DLLA 150 P47) | 860791 | 17791 | |
| 2003 2003, 2003AG (OLL 150 P 11157 ON) | 860177 | 17177 | |
| 2003 2003T (DLLA 150 P 117) | 858068 | 17068 |  |
| D30, D40 AD30A AQAD30A MD30A TMD30A AD40A AQAD40A, AQAD40B AQD40A MD40A TAMD40A, TAMD40B TMD40A, TMD40B, TMD40C (DNO SD 193) | 1542303 | 17303 | |
| D31 MD31A (DLLA 144 P 138) | 858205 | 17205 | |







Spridarspets forts. / Nozzles cont.

| Motor typ Engine type | Ref.nr Ref. No. | Best.nr Part No. | |
|---|--------------------|---------------------|---|
| D31, D41 AD31A AQAD31A TAMD31A TMD31A AD41A AQAD41A D41A TAMD41A TMD41A (DLLA 144 P 118) | 858358 | 17358 |  |
| D31, D41 AD31B, AD31D, AD31L-A, AD31XD TAMD31B, TAMD31D TAMD31L-A, TAMD31M-A TMD31B, TMD31D, TMD31L-A AD41B, AD41P-A D41B TAMD41B, TAMD41D TAMD41H-A, TAMD41L-A, TAMD41P-A TMD41B (DLLA 140 P 196) | 859782 | 17782 | |







Packningssatser för montering av spridare / Gasket kits for connecting fuel injector

| | | | |
|--|--|-------|---|
| D30 AQAD30A MD30A TAMD30A TMD30A | | 22018 |  |
| D40 AD40B AQAD40A, AQAD40B AQD40A MD40A TAMD40A, TAMD40B TMD40A, TMD40B, TMD40C | | 22010 |  |

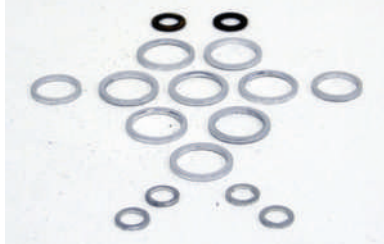
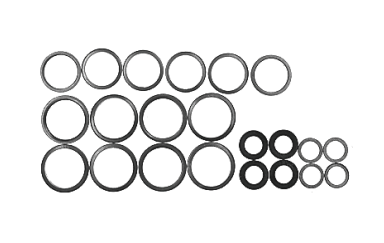





Bricksatser för bränslesystem / Sealing washer kits for fuel system

| Motor typ Engine type | Ref.nr Ref. No. | Best.nr Part No. | |
|---|--------------------|---------------------|---|
| D1, D2, D11 D1A MD1A, MD1B AQD2B D2A MD2, MD2A, MD2B MD11C | | 22088 |  |
| D3, D17 MD3B MD17C | | 22043 |  |
| D5 MD5A, MD5B | | 22048 |  |
| D5 MD5C | | 22063 |  |
| D6, D7 MD6A, MD6B MD7A, MD7B | | 22044 |  |
| D11 MD11D | | 22064 |  |
| D17 MD17D | | 22065 |  |

Bricksatser för bränslesystem forts. / Sealing washer kits for fuel system cont.

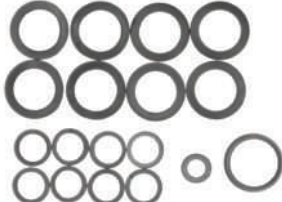
| Motor typ Engine type | Ref.nr Ref. No. | Best.nr Part No. | |
|---|--------------------|---------------------|---|
| 2001 2001, 2001AG, 2001B, 2001BG | | 22029 |  |
| 2002 2002, 2002AG, 2002B, 2002BG | | 22030 |  |
| 2003 2003, 2003AG, 2003B, 2003BG 2003T, 2003TB | | 22031 |  |
| D21 AQD21A MD21A | | 22131 |  |
| D21 AQD21B MD21B | | 22132 |  |
| D29, D32 AQD29, AQD29A MD29, MD29A AQD32A MD32 | | 22133 |  |
| D30 AD30A AQAD30A MD30A TAMD30A TMD30A | | 22020 |  |



Bricksatser för bränslesystem forts. / Sealing washer kits for fuel system cont.

| Motor typ Engine type | Ref.nr Ref. No. | Best.nr Part No. | |
|--|--------------------|---------------------|---|
| D31, D32 AD31A, AD31D AD31L-A, AD31P-A, AD31XD AQAD31A MD31A TAMD31A, TAMD31D TAMD31L-A, TAMD31M-A, TAMD31P-A TMD31A, TMD31D, TMD31L-A KAD32P-A | | 22027 |  |
| D31 AD31B TAMD31B TMD31B | | 22026 |  |
| D31, D32 AD31L-A, AD31P-A TAMD31L-A, TAMD31M-A, TAMD31P-A TMD31L-A KAD32P-A | | 22117 |  |
| D40 AD40B AQAD40A, AQAD40B AQD40A MD40A TAMD40A, TAMD40B TMD40A, TMD40B, TMD40C | | 22052 |  |
| D41 AD41A AQAD41A D41A TAMD41A TMD41A | 876227 | 22069 |  |
| D41, D42, D43 AD41B, AD41D, AD41L-A, AD41P-A D41B, D41D, D41L-A TAMD41B, TAMD41D TAMD41H-A, TAMD41L-A TAMD41M-A, TAMD41P-A TMD41B, TMD41D, TMD41L-A KAD42P-A KAMD42P-A TAMD42WJ-A KAD43P-A KAMD43P-A | | 22028 |  |



Fördelarlock / Distributor caps

| Motor typ Engine type | Ref.nr Ref. No. | Best.nr Part No. | |
|---|---|---------------------|---|
| <p>B18, B20</p> <p>AQ60F, AQ90, AQ95, AQ95A, AQ110 AQ120 BB30, BB100 MB18</p> <p>AQ105A AQ115A, AQ115B AQ130A, AQ130B, AQ130C, AQ130D BB115A, BB115B, BB115C MB20A, MB20B, MB20C</p> | <p>870690 (870422) (239598) (233260) (243632)</p> | <p>18690</p> |  |
| <p>B20, B21</p> <p>AQ115A, AQ115B AQ130A, AQ130B, AQ130C, AQ130D BB115A, BB115B, BB115C MB20A, MB20B, MB20C</p> <p>AQ120B*, AQ125A*, AQ140A* BB140A*</p> <p>* Lock med clippsfastsättning / * Cap to be fitted with spring clips</p> | <p>243797</p> | <p>18797</p> |  |
| <p>B30</p> <p>AQ165A AQ170A, AQ170B, AQ170C BB 165A BB170A, BB170B, BB170C</p> <p>Diameter 73 mm</p> | <p>241669</p> | <p>18669</p> |  |
| <p>B30</p> <p>AQ170A, AQ170B, AQ170C BB170A, BB170B, BB170C</p> <p>Diameter 90 mm</p> | <p>243658 (243803)</p> | <p>18658</p> |  |
| <p>B21, B23, B25</p> <p>AQ120B, AQ125A, AQ140A BB140A</p> <p>230A, 230B AQ125B AQ131A, AQ131B, AQ131C, AQ131D AQ145A, AQ145B</p> <p>250A, 250B AQ151A, AQ151B, AQ151C</p> <p>Lock med skruvfastsättning / Cap to be fitted with screws</p> | <p>841263</p> | <p>18263</p> |  |



Fördelarlock forts. / Distributor caps cont.

| Motor typ Engine type | Ref.nr Ref. No. | Best.nr Part No. | |
|---|--------------------|---------------------|---|
| 3,0 3,0 | 3854260 | 18260 |  |
| V6 4,3 | 3854331 | 18331 |  |
| V6 430A, 430B, 431A, 431B AQ175A AQ205A | 841926 | 18926 |  |
| V8 AQ200A, AQ200C AQ210A AQ225A, AQ225B, AQ225C AQ255A Platt lock / Flat cap | 841244 (835310) | 18244 |  |
| V8 5,7GL LK, 5,7GS LK 7,4GL LK 500A, 500B 501A, 501B 571A, 572A 740A, 740B AQ200D, AQ200F AQ211A AQ225D, AQ225E, AQ225F AQ231A, AQ231B AQ255B AQ260A, AQ260B AQ271A, AQ271B, AQ271C, AQ271D AQ290A AQ311A, AQ311B BB225A, BB225AV, BB225B, BB225C BB231A BB260A, BB260AV, BB260B, BB260C BB261A Lock med skruvfastsättning / Cap to be fitted with screws | 841070 | 18070 |  |

Fördelarlock forts. / Distributor caps cont.

| Motor typ Engine type | Ref.nr Ref. No. | Best.nr Part No. | |
|---|--------------------|---------------------|---|
| V8 AQ190A AQ200D AQ225D AQ240A AQ255B AQ260A AQ280A AQ290A Lock med clippfsfastsättning / Cap to be fitted with spring clips | 835702 | 18702 |  |
| V8 5,7 7,4 8,2 | 3854548 | 18454 |  |

Tändkabelsats / Ignition cable sets

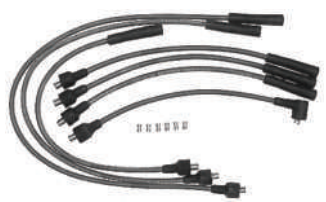
| | | | |
|---|--------|-------|---|
| B18, B20 AQ60F, AQ90, AQ95, AQ95A, AQ110 AQ120 BB30, BB100 MB18 AQ105A AQ115A, AQ115B AQ130A, AQ130B, AQ130C, AQ130D BB115A, BB115B, BB115C MB20A, MB20B, MB20C | 875363 | 18363 |  |
| B21, B23, B25 AQ120B, AQ125A, AQ140A BB140A 230A, 230B AQ125B AQ131A, AQ131B, AQ131C, AQ131D AQ145A, AQ145B 250A, 250B AQ151A, AQ151B, AQ151C | 875571 | 18571 |  |
| B30 AQ165A AQ170A, AQ170B, AQ170C BB 165A BB170A, BB170B, BB170C | 875404 | 18404 |  |



Tändkabelsats forts. / Ignition cable sets cont.

| Motor typ Engine type | Ref.nr Ref. No. | Best.nr Part No. | |
|---|----------------------|---------------------|---|
| V6 AQ175A AQ205A | 875532 | 18532 | |
| V8 500B, 501B AQ200C, AQ200D, AQ200F AQ211A AQ225C, AQ225D, AQ225E, AQ225F AQ231A, AQ231B AQ255A, AQ255B AQ260A, AQ260B AQ271A, AQ271B, AQ271C, AQ271D AQ280A AQ290A BB225A, BB225AV, BB225B, BB225C BB231A BB260A, BB260B, BB260C BB261A Värmetåliga siliconkablar / Heat resistant silicone cables | 3857166 (3851819) | 18001 |  |

Tändspolar / Ignition coils

| | | | |
|---|-------|--------------|---|
| B18, B20, MB10A MB10A AQ60F, AQ90, AQ95, AQ95A, AQ110 AQ120 BB30, BB100 MB18 AQ105A AQ115A, AQ115B AQ130A, AQ130B, AQ130C, AQ130D BB115A, BB115B, BB115C MB20A, MB20B, MB20C AQ120B, AQ125A, AQ140A BB140A 230A, 230B AQ125B AQ131A, AQ131B, AQ131C, AQ131D AQ145A, AQ145B BB145B 250A, 250B AQ151A, AQ151B, AQ151C | 35254 | 18254 |  |
|---|-------|--------------|---|





Tändspolar forts. / Ignition coils cont.

| Motor typ Engine type | Ref.nr Ref. No. | Best.nr Part No. | |
|---|--------------------|---------------------|---|
| V6, V8 AQ175A AQ200D, AQ200F AQ211A AQ225D, AQ225E, AQ225F AQ231A, AQ231B AQ255B AQ260A, AQ260B AQ280A, AQ290A BB225A, BB225AV, BB225B BB231A BB260A, BB260AV, BB260B, BB260C BB261A | 835998 | 18998 |  |
| V8 5,0 5,8L For 1993 - 95 | 3854161 | 18161 |  |

Rotorer / Rotors

| Motor typ Engine type | Ref.nr Ref. No. | Best.nr Part No. | |
|---|---|---------------------|---|
| <p>B18, B20</p> <p>AQ60F, AQ90, AQ95, AQ95A, AQ110 AQ120 BB30, BB100 MB18</p> <p>AQ105A AQ115A, AQ115B AQ130A, AQ130B, AQ130C, AQ130D BB115A, BB115B, BB115C MB20A, MB20B, MB20C</p> | <p>238258 (233678)</p> | <p>18258</p> |  |
| <p>B18, B20, B21, B23, B25, B30, MB10</p> <p>MB 10A</p> <p>AQ60F, AQ90, AQ95, AQ95A, AQ110 AQ120 BB30, BB100 MB18</p> <p>AQ105A AQ115A, AQ115B AQ130A, AQ130B, AQ130C, AQ130D BB115A, BB115B, BB115C MB20A, MB20B, MB20C</p> <p>AQ120B, AQ125A, AQ140A BB140A</p> <p>230A, 230B AQ125B AQ131A, AQ131B, AQ131C, AQ131D AQ145A, AQ145B BB145A</p> <p>250A, 250B AQ151A, AQ151B, AQ151C</p> <p>AQ165A* AQ170A*, AQ170B*, AQ170C* BB 165*A BB170A*, BB170B*, BB170C*</p> <p>* Tidigare utförande / Earlier version</p> | <p>243903 (240305) (243796)</p> | <p>18903</p> |  |
| <p>B30</p> <p>AQ165A AQ170A, AQ170B, AQ170C BB 165A BB170A, BB170B, BB170C</p> <p>Senare utförande / Later version</p> | <p>243657</p> | <p>18657</p> |  |
| <p>V8</p> <p>AQ200A AQ210A AQ225A, AQ225B</p> | <p>841243</p> | <p>18243</p> |  |





Rotorer forts. / Rotors cont.

| Motor typ Engine type | Ref.nr Ref. No. | Best.nr Part No. | |
|--|---------------------------------|---------------------|---|
| V6 4,3 | 3854311 | 18431 |  |
| V6, V8 430A, 430B, 431A, 431B AQ157A AQ205A 5,7GL LK, 5,7GS LK 7,4GL LK 500A, 500B, 501A, 501B 570A, 571A, 572A 740A, 740B AQ200D, AQ200F AQ211A AQ225D, AQ225E, AQ225F AQ231A, AQ231B AQ255B AQ260A, AQ260B AQ271A, AQ271B, AQ271C, AQ271D AQ290A AQ311A, AQ311B BB225A, BB225AV, BB225B, BB225C BB231A BB260A, BB260AV, BB260B, BB260C BB261A | 3853801 (855845) (841907) | 18845 |  |
| V8 AQ190A AQ200C, AQ200D AQ225C, AQ225D AQ240A AQ255A, AQ255B AQ260A AQ280A | 834975 | 18975 |  |
| V8 5,7 7,4 8,2 | 3854549 | 18549 |  |





Brytarspetsar / Breaker points

| Motor typ Engine type | Ref.nr Ref. No. | Best.nr Part No. | |
|---|--------------------|---------------------|---|
| <p>B18, B20</p> <p>AQ60F, AQ90, AQ95, AQ95A, AQ110 AQ120 BB30, BB100 MB18</p> <p>AQ105A AQ115A, AQ115B AQ130A, AQ130B, AQ130C, AQ130D BB115A, BB115B, BB115C MB20A, MB20B, MB20C</p> | 240149 | 18149 |  |
| <p>B18, B20</p> <p>AQ60F, AQ90, AQ95, AQ95A, AQ110 AQ120 BB30, BB100 MB18</p> <p>AQ105A AQ115A, AQ115B AQ130A, AQ130B, AQ130C, AQ130D BB115A, BB115B, BB115C MB20A, MB20B, MB20C</p> | 1306169 | 18169 |  |
| <p>B18, B20, B21, MB10</p> <p>MB 10A*</p> <p>AQ60F, AQ90, AQ95, AQ95A, AQ110 AQ120 BB30, BB100 MB18</p> <p>AQ105A AQ115A, AQ115B AQ130A, AQ130B, AQ130C, AQ130D BB115A, BB115B, BB115C MB20A, MB20B, MB20C</p> <p>AQ120B, AQ125A, AQ140A BB140A</p> <p>230A, 230B AQ125B AQ131A, AQ131B, AQ131C, AQ131D AQ145A, AQ145B BB145A</p> <p>250A, 250B AQ151A, AQ151B, AQ151C</p> <p>AQ165A AQ170A, AQ170B, AQ170C BB 165A BB170A, BB170B, BB170C</p> <p>* Fördelare / Distributor 0231 109 017</p> | 243799 | 18799 |  |



Brytarspetsar forts. / Breaker points cont.

| Motor typ Engine type | Ref.nr Ref. No. | Best.nr Part No. | |
|--|--------------------------------|---------------------|---|
| <p>B30</p> <p>AQ165A AQ170A, AQ170B, AQ170C BB165A BB170A, BB170B, BB170C</p> <p>Tidigare utförande / Earlier version</p> | 241652 | 18652 |  |
| <p>B30</p> <p>AQ165A AQ170A, AQ170B, AQ170C BB165A BB170A, BB170B, BB170C</p> <p>Senare utförande / Late version</p> | 243801 | 18801 |  |
| <p>V8</p> <p>AQ200A, AQ200C AQ210A AQ225A, AQ225B, AQ225C AQ255A</p> <p>För fördelare med platt lock / For distributor with flat cap</p> | 835304 | 18304 |  |
| <p>V6, V8</p> <p>AQ175A</p> <p>AQ190A AQ200D, AQ200F AQ211A AQ225D, AQ225E, AQ225F AQ231A, AQ231B AQ240A AQ255B AQ260A, AQ260B AQ280A, AQ290A BB225A, BB225AV, BB225B, BB225C BB231A BB260A, BB260AV, BB260B, BB260C BB261A</p> | 835705 (855846) (841287) | 18705 |  |

Kondensatorer / Condensers

| Motor typ Engine type | Ref.nr Ref. No. | Best.nr Part No. | |
|--|--------------------|---------------------|---|
| <p>B18, B20</p> <p>AQ60F, AQ90, AQ95, AQ95A, AQ110 AQ120 BB30, BB100 MB18</p> <p>AQ105A AQ115A, AQ115B AQ130A, AQ130B, AQ130C, AQ130D BB115A, BB115B, BB115C MB20A, MB20B, MB20C</p> | 233842 | 18842 |  |
| <p>B18, B20, MB10A</p> <p>MB10A*</p> <p>AQ60F, AQ90, AQ95, AQ95A BB30, BB100 MB18</p> <p>AQ105A AQ130A BB115A, BB115B, BB115C MB20A, MB20B, MB20C</p> <p>* Fördelare / Distributor 0231 109 017</p> | 834545 | 18545 |  |
| <p>B18, B20</p> <p>AQ60F, AQ90, AQ95, AQ95A, AQ110 AQ120 BB30, BB100 MB18</p> <p>AQ105A AQ115A, AQ115B AQ130A, AQ130B, AQ130C, AQ130D BB115A, BB115B, BB115C MB20A, MB20B, MB20C</p> | 241710 | 18710 |  |
| <p>B30</p> <p>AQ165A AQ170A, AQ170B, AQ170C BB165A BB170A, BB170B, BB170C</p> <p>Tidigare utförande / Earlier version</p> | 243653 | 18653 |  |
| <p>B30</p> <p>AQ165A AQ170A, AQ170B, AQ170C BB165A BB170A, BB170B, BB170C</p> <p>Fördelare / Distributor 0231 311 002</p> | 834546 | 18546 |  |

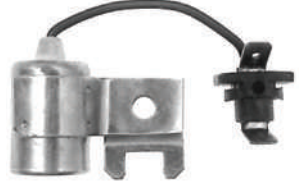
Kondensatorer forts. / Condensers cont.

| Motor typ Engine type | Ref.nr Ref. No. | Best.nr Part No. | |
|--|--------------------|---------------------|---|
| <p>B21, B23, B25</p> <p>AQ120B, AQ125A, AQ140A BB140A</p> <p>230A, 230B AQ125B AQ131A, AQ131B, AQ131C, AQ131D AQ145A, AQ145B BB145A</p> <p>250A, 250B AQ151A, AQ151B, AQ151C</p> <p>Rund genomföring / Round hole</p> | 841262 | 18262 |  |
| <p>B21, B23</p> <p>AQ120B, AQ125A, AQ140A BB140A</p> <p>Fyrkantig genomföring / Square hole Lock med clippsfästning / Cap to be fitted with spring clips</p> | 841262 (834560) | 18560 |  |
| <p>V8</p> <p>AQ200A, AQ200C AQ210A AQ225A, AQ225B, AQ225C AQ255A</p> | 835308 | 18308 |  |
| <p>V8</p> <p>AQ175A</p> <p>AQ190A AQ200D, AQ200F AQ211A AQ225D, AQ225E, AQ225F AQ231A, AQ231B AQ240A AQ255B AQ260A, AQ260B AQ280A BB225A, BB225AV, BB225B, BB225C BB231A BB260A, BB260AV, BB260B, BB260C BB261A</p> | 835704 | 18704 |  |

Sensor

Sensor (Pick-Up Coil)

| Motor typ Engine type | Ref.nr Ref. No. | Best.nr Part No. | |
|--|--------------------|---------------------|---|
| 3,0, V6, V8 3,0 4,3 5,7 7,4 8,2 | 3854001 | 18400 <i>NEW</i> |  The image shows a pick-up coil sensor assembly. It consists of a circular coil of wire on the left, connected by a thin wire to a black plastic housing on the right. The housing has a rectangular connector. Below the main assembly is a small, square black component with a white circular mark in the center. |

DELAR FÖR BOSCH TÄNDFÖRDELARE / PARTS FOR BOSCH DISTRIBUTORS

| BOSCH beteckning på fördelarhus./ BOSCH distributor Part No. | Äldre BOSCH beteckningar./ Earlier BOSCH part No. | Fördelare Ref.nr./ Distributors Ref.No. | Lock Best.nr./ Cap Part No. | Rotor Best.nr./ Rotors Part No. | Brytare Best.nr./ Breaker p. Part No. | Kondens. Best.nr./ Condensor Part No. |
|---|--|--|--------------------------------------|--|--|--|
| 0231 109 015 | | 234240 | -- | 18903 | -- | -- |
| 0231 109 017 | | 834695 | -- | 18903 | 18799 | 18545 |
| 0231 110 036 | VJU 4 BR 30 | 238724 | 18690 | 18258 | -- | 18842 |
| 0231 110 038 | VJ4 BL 32 (tmk) | 238903 | 18690 | 18258 | 18149 | 18842 |
| 0231 110 043 | VJ4 BL 37 t | 239771 | 18690 | 18258 | 18149 | 18842 |
| 0231 112 007 | VJU 4 BR 9 | 76853 | 18690 | 18258 | -- | -- |
| 0231 112 031 | VJU 4 BR 20 | 233347 | 18690 | 18258 | -- | -- |
| 0231 116 054 | | 241533 | 18669 | 18903 | 18652 | 18653 |
| 0231 116 060 | | 241533 | 18669 | 18903 | 18652 | 18653 |
| 0231 121 008 | | 831786 | 18669 | 18903 | 18169 | 18653 |
| 0231 153 003 | | 240208 | 18690 | 18903 | 18149 | 18842 |
| 0231 153 007 | | 241261 | 18690 | 18903 | 18149 | 18842 |
| 0231 153 010 | | -- | 18690 | 18903 | 18169 | 18710 |
| 0231 153 012 | | 241531 | 18690 | 18903 | 18169 | 18710 |
| 0231 153 038 | | -- | 18690 | 18258 | 18149 | 18842 |
| 0231 178 005 | | 831785 | 18797 | 18903 | 18799 | 18545 |
| 0231 178 010 | | 831663 | 18797 | 18903 | 18799 | 18560 |
| 0231 178 011 | | 834465 | 18797 | 18903 | 18799 | 18545 |
| 0231 178 016 | | 834960 | 18263 | 18903 | 18799 | 18262 |
| 0231 178 017 | | 834961 | 18263 | 18903 | 18799 | 18262 |
| 0231 178 018 | | 841053 | 18797 | 18903 | 18799 | 18560 |
| 0231 178 019 | | 855712 | 18263 | 18903 | 18799 | 18262 |
| 0231 311 002 | | 834466 | 18658 | 18657 | 18801 | 18546 |

Delar för V-6 och V-8 fördelare / Cross reference for V-6 and V-8 distributors

| Lock typ / Cap type | Motor typ / Engine type | Fördelare Ref.nr./ Distributors Ref.No. | Lock Best.nr./ Caps Part No. | Rotor Best.nr./ Rotors Part No. | Brytare Best.nr./ Breaker p. Part No. | Kondens Best.nr./ Condensor Part No. |
|---|---|--|---------------------------------------|--|--|---|
| 18926 | AQ 175A | 841760 855599 | 18926 | 18845 | 18705 | 18704 |
| | AQ 205A 431A,B | 856143 | 18926 | 18845 | -- | -- |
| | 430A,B | 856846 | 18926 | 18845 | -- | -- |
| Platt lock / Flat cap | AQ 210A | 835152 | 18244 | 18243 | 18304 | 18308 |
| 18244 | AQ 200B 225A, B 255B | 835309 | 18244 | 18243 | 18304 | 18308 |
| | AQ 200C 225C 255A | 826430 | 18244 | 18975 | 18304 | 18308 |
| Lock med fjäderclips / Cap to be fitted with spring clips | AQ 200D, 225D 255B, 260A, 280A | 834855 | 18702 | 18975 | 18705 | 18704 |
| 18702 | AQ 190A 240A | 835689 | 18702 | 18975 | 18705 | 18704 |
| | AQ 290A | 841288 | 18702 | 18975 | 18705 | 18704 |
| Lock med skruv / Cap to be fitted with screws | AQ 200B, D 225B, C, D, E, F 255B, 260A, B BB 225A, AV, B, C 260A,B, AV, C 261A | 841069 | 18070 | 18845 | 18705 | 18704 |
| 18070 | AQ 211A, 231A,B BB 231A | 855929 | 18070 | 18845 | 18705 | 18704 |
| | AQ 290A | 841729 | 18070 | 18845 | 18705 | 18704 |
| | AQ271A,B, 311A | 855705 | 18070 | 18845 | -- | -- |
| | 500A, 501A | 856794 | 18070 | 18845 | -- | -- |
| | 500B | 856840 | 18070 | 18845 | -- | -- |
| | 501B | 856975 | 18070 | 18845 | -- | -- |

Delar för V-6 och V-8 fördelare forts. /

Cross reference for V-6 and V-8 distributors. cont.

| Lock typ/ Cap type | Motor typ/ Engine type | Fördelare Ref.nr/ Distributor Ref.No. | Lock Best.nr/ Caps Part No. | Rotor Best.nr/ Rotors Part No. | Brytare Best.nr/ Breaker Part No. | Kondens. Best.nr/ Condensor Part No. |
|-----------------------|--------------------------------------|--|--------------------------------------|---|--|---|
| 18070 | 271C,D, 311B 570A, 571A 740A,B | 855932 | 18070 | 18845 | -- | -- |
| | 572A | 857151 | 18070 | 18845 | -- | -- |

Oljetryckskontakter / Oil pressure sensors

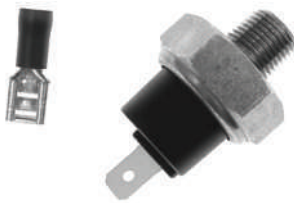
| | | | |
|--|--|---------------------|---|
| <p>B18, B20, B21, B23, B30, MB10 V8 2001, 2002, 2003, D21, D29, D32</p> <p>AQ60F, AQ90, AQ95, AQ95A, AQ110 AQ120 BB30, BB100 MB18</p> <p>AQ105A AQ115A, AQ115B AQ130A, AQ130B, AQ130C, AQ130D BB115A, BB115B, BB115C MB20A, MB20B, MB20C</p> <p>AQ120B*, AQ125A*, AQ140A*</p> <p>AQ145A BB145A</p> <p>AQ165A AQ170A, AQ170B, AQ170C BB165A BB170A, BB170B, BB170C</p> <p>AQ200A AQ225A, AQ225B</p> <p>MB10A</p> <p>2001, 2001AG, 2001B, 2001BG</p> <p>2002, 2002AG, 2002B, 2002BG</p> <p>2003, 2003AG, 2002B, 2002BG</p> <p>2003T, 2003TB</p> <p>AQD21A, AQD21B MD21A</p> <p>AQD29, AQD29A MD29, MD29A</p> <p>AQD32A MD32A</p> | <p>1324750 (653874) (672910) (1266085) (1606877)</p> | <p>18750</p> |  |
|--|--|---------------------|---|

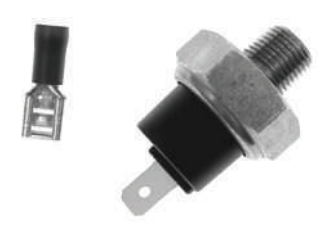
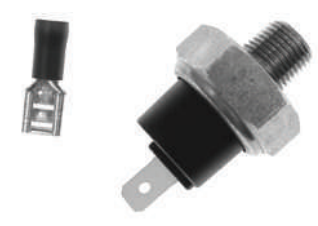

Oljetryckskontakter / Oil pressure sensors

| Motor typ Engine type | Ref.nr Ref. No. | Best.nr Part No. | |
|--|--------------------|---------------------|---|
| D1, D2, D3, D5, D6 D1A MD1A, MD1B AQD2B D2A MD2A, MD2B MD3B MD5A, MD5B MD6A, MD6B | 807078 | 18078 |  |
| D5, D7, D11, D17 MD5C MD7A, MD7B MD11C, MD11D MD17C, MD17D | 829587 | 18587 |  |



Drivremmar / Drive belts

| | | | |
|--|--------|--------------|---|
| B18, B20 AQ60F, AQ90, AQ95, AQ95A, AQ110 AQ120 BB30, BB100 MB18 AQ105A AQ115A, AQ115B AQ130A, AQ130B, AQ130C, AQ130D BB115A, BB115B, BB115C MB20A, MB20B, MB20C Längd / Length 711 mm | 966891 | 18805 |  |
|--|--------|--------------|---|



Drivremmar forts. / Drive belts cont.

| Motor typ Engine type | Ref.nr Ref. No. | Best.nr Part No. | |
|--|---|---------------------|---|
| <p>D2, D30, D40</p> <p>MD2A Upp till / Up to MO -6274</p> <p>AD30A AQAD30A MD30A TAMD30A TMD30A</p> <p>AD40B AQAD40A, AQAD40B AQD40A MD40A TAMD40A, TAMD40B TMD40A, TMD40B, TMD40C</p> <p>Med extra vx-generator / With additional alternator</p> <p>Längd / Length 1000 mm</p> | <p>978510 (966914) (958310)</p> | <p>18310</p> |  |
| <p>D1, D2</p> <p>MD1B*</p> <p>AQD2B D2A MD2 MD2A Från / From MO 6275 - MD2B*</p> <p>* För vevaxelremskiva diam. 210 mm / * For crankshaft pulley diam. 210 mm</p> <p>Längd / Length 1025 mm</p> | <p>978515 (966916) (958311)</p> | <p>18311</p> |  |
| <p>D29</p> <p>AQD29*, AQD29A* MD29*, MD29A* V-8 **</p> <p>* Med vx-generator / With alternator ** För servopump / For servo pump</p> <p>Längd / Length 1050 mm</p> | <p>966387</p> | <p>18387</p> |  |





Drivremmar forts. / Drive belts cont.

| Motor typ Engine type | Ref.nr Ref. No. | Best.nr Part No. | |
|---|----------------------------|---------------------|---|
| <p>B21, B23, B25, B30, MB10</p> <p>AQ120B, AQ125A, AQ140A BB140A</p> <p>230A, 230B AQ125B AQ145A, BB145A</p> <p>250A, 250B, 251A</p> <p>AQ165A AQ170A, AQ170B, AQ170C BB165A BB170A, BB170B, BB170C</p> <p>MB 10A*</p> <p>För 35 amp. generator / For 35 amps alternator</p> <p>* För Bosch startgenerator / * With Bosch dynamo 2 st åtgår / 2 pcs required</p> <p>Längd / Length 1075 mm</p> | <p>966694 (834548)</p> | <p>18548</p> |  |
| <p>B21, B23, B25 D22</p> <p>AQ120B, AQ125A, AQ140A BB140A</p> <p>AQ125B AQ131A, AQ131B, AQ131C, AQ131D AQ145A, AQ145B BB145A</p> <p>AQ151A, AQ151B, AQ151C AQ171A, AQ171C</p> <p>MD22A, MD22L-A, TMD22A</p> <p>För 50 amp. generator / For 50 amps alternator</p> <p>Längd / Length 1092 mm</p> | <p>966382 (841821)</p> | <p>18382</p> |  |







Drivremmar forts. / Drive belts cont.

| Motor typ Engine type | Ref.nr Ref. No. | Best.nr Part No. | |
|--|--------------------|---------------------|---|
| <p>D30, D31, D40, D41, D42</p> <p>AD30A AQAD30A MD30A TAMD30A TMD30A</p> <p>AD31A, AD31B, AD31D AD31L-A, AD31P-A, AD31XD AQAD31A MD31A TAMD31A, TAMD31B, TAMD31D TAMD31L-A, TAMD31M-A, TAMD31P-A TMD31A, TMD31B, TMD31D, TMD31L-A</p> <p>AD40B AQAD40A, AQAD40B AQD40A MD40A TAMD40A, TAMD40B TMD40A, TMD40B, TMD40C</p> <p>AD41A, AD41B, AD41D AD41L-A, AD41P-A AQAD41A D41A, D41B, D41D, D41L-A TAMD41A, TAMD41B, TAMD41D TAMD41H-A, TAMD41L-A TAMD41M-A, TAMD41P-A TMD41A, TMD41B, TMD41D, TMD41L-A</p> <p>KAD42B* KAMD42B* TAMD42B*</p> <p>* Med extra generator / * With additional alternator</p> <p>Sats om 2 remmar / Kit of 2 belts Längd / Length 1100 mm</p> | 966978 | 18978 |  |
| <p>D6</p> <p>MD6A From MO 1235-</p> <p>För startgenerator, sats om 2 remmar / For dynamo, kit of 2 belts</p> <p>Längd / Length 1140 mm</p> | 966981 | 18981 |  |
| <p>D21, D32</p> <p>AQD21A, AQD21B MD21A</p> <p>AQD32A MD32A</p> <p>Med vx-generator / With alternator</p> <p>Längd / Length 1168 mm</p> | 829207 | 18207 |  |





Drivremmar forts. / Drive belts cont.

| Motor typ Engine type | Ref.nr Ref. No. | Best.nr Part No. | |
|---|--------------------|---------------------|---|
| D3, D17 MD3B MD17C Längd / Length 1175 mm | 976489 (966383) | 18383 |  |
| D6 MD6A Up to MO -1234 För startgenerator, sats om 2 remmar / For dynamo, kit of 2 belts Längd / Length 1175 mm | 966700 | 18700 |  |
| V6, V8 430A, 430B, 431A, 431B AQ175A AQ205A 500A, 500B, 501A, 501B 570A, 571A, 572A AQ200A, AQ200C, AQ200D, AQ200F AQ211A AQ225B, AQ225C, AQ225D AQ225E, AQ225F AQ231A, AQ231B AQ255A, AQ255B AQ260A, AQ260B AQ271A, AQ271B, AQ271C, AQ271D AQ280A AQ290A AQ311A, AQ311B BB225B, BB225C BB231A BB260B, BB260C BB261A Längd / Length 1200 mm | 978750 (966857) | 18498 |  |
| D17 MD17D Längd / Length 1250 mm | 966385 | 18385 |  |

Drivremmar forts. / Drive belts cont.

| Motor typ Engine type | Ref.nr Ref. No. | Best.nr Part No. | |
|---|--------------------|---------------------|---|
| <p>D1, D2</p> <p>D1A MD1A Från / From MO 11132 - MD1B</p> <p>AQD2B D2A MD2 MD2A MD2B</p> <p>För startgenerator sats om 2 remmar / For dynamo. Kit of 2 belts</p> <p>Längd / Length 1300 mm</p> | 966990 | 18990 |  |
| <p>D5, D11</p> <p>MD5 Upp till / Up to MO -30016</p> <p>MD11C</p> <p>Längd / Length 1300 mm</p> | 966698 | 18698 |  |
| <p>D5</p> <p>MD5 Från / From MO 30017 -</p> <p>Längd / Length 1325 mm</p> | 976492 (966843) | 18843 |  |
| <p>D6, D11</p> <p>MD6A MD11C</p> <p>Längd / Length 1400 mm</p> | 966931 | 18931 |  |
| <p>D6, D7</p> <p>MD6B MD7A</p> <p>Längd / Length 1425 mm</p> | 966933 (958327) | 18327 |  |
| <p>D7</p> <p>MD7B</p> <p>Längd / Length 1450 mm</p> | 966707 | 18707 |  |

Drivremmar forts. / Drive belts cont.

| Motor typ Engine type | Ref.nr Ref. No. | Best.nr Part No. | |
|---|--------------------|---------------------|---|
| D17 MD17D Längd / Length 1500 mm | 966938 | 18330 |  |
| D11 MD11C, MD11D Med V-P sötvattnenkyllning / With V-P fresh water cooling Längd / Length 1550 mm | 966942 | 18942 |  |
| 2002, 2003 2002, 2002AG, 2002B, 2002BG 2003, 2003AG, 2003B, 2003BG 2003T, 2003TB Längd / Length 825 mm | 966900 | 18900 |  |
| 2001 2001, 2001AG, 2001B, 2001BG Längd / Length 863 mm | 966903 | 18003 |  |
| 2002, 2003 D2, D11 2002**, 2002AG**, 2002B**, 2002BG** 2003**, 2003AG**, 2003B**, 2003BG** 2003T**, 2003TB** AQD2B* MD2B* MD11C * För vevaxelremskiva diam. 150 mm / * For crankshaft pulley diam. 150 mm ** Med V-P sötvattnenkyllning ** With V-P fresh water cooling Längd / Length 900 mm | 966906 | 18906 |  |

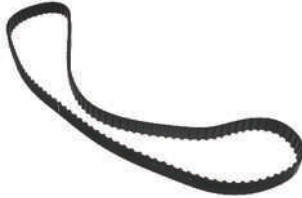

Kamremmar / Timing belts

| Motor typ Engine type | Ref.nr Ref. No. | Best.nr Part No. | |
|--|--------------------|---------------------|---|
| D11 MD11D Längd / Length 913 mm | 966907 | 18283 |  |
| B21, B23, B25 AQ120B, AQ125A, AQ140A BB140A 230A, 230B AQ125B AQ131A, AQ131B, AQ131C, AQ131D AQ145A, AQ145B BB145A 250A, 250B AQ151A, AQ151B, AQ151C Spännrulle / Tension pulley 12 986 | 463377 | 12377 |  |
| B25 251A AQ171A, AQ171C Spännrulle / Tension pulley 12 507 | 855506 | 12506 | |

Laddningsregulator / Voltage regulator

| | | | |
|---|--------|-------|---|
| För alla Volvo Penta marinmotorer med SEW-Marchal 35 amp generator Komplett med långa kablar For all Volvo Penta marine engines with SEV-Marchal 35 amps alternator. Complete with long cables | 847605 | 18605 |  |
|---|--------|-------|---|

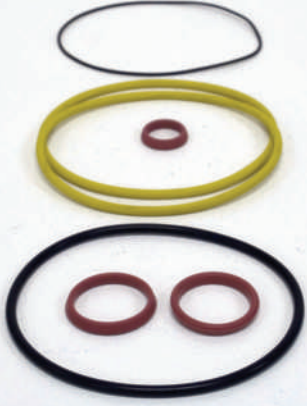

Packningsatts för cylinderfoder / Gasket set for cylinder liner

| Motor typ Engine type | Ref.nr Ref. No. | Best.nr Part No. | |
|---|--------------------|---------------------|---|
| <p>D11, D17</p> <p>MD11C, MD11D</p> <p>MD17C, MD17D</p> <p>MD 11 = 2 st åtgår / 2 pcs required MD 17 = 3 st åtgår / 3 pcs required</p> | 875550 | 11550 |  <p>The image shows a gasket set for D11 and D17 engines. It includes a thin black O-ring at the top, a yellow O-ring in the middle, and a large black O-ring at the bottom. Inside the large black O-ring, there are two smaller red O-rings.</p> |
| <p>D5</p> <p>MD5A, MD5B, MD5C</p> <p>1 st åtgår / 1 piece required</p> | 875560 | 11560 |  <p>The image shows a gasket set for D5 engines. It consists of three O-rings stacked vertically: a thin black O-ring at the top, a medium-sized black O-ring in the middle, and a large red O-ring at the bottom.</p> |

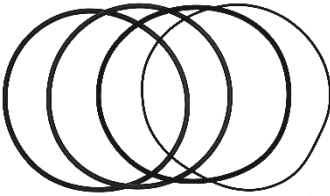

Packningsssats för cylinderfoder forts. / Gasket set for cylinder liner cont.

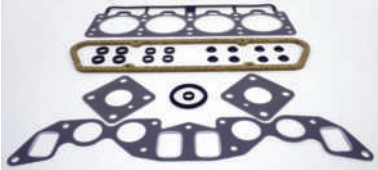
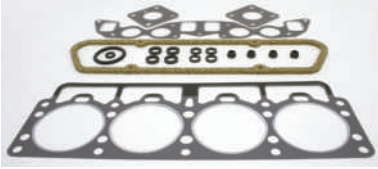
| Motor typ Engine type | Ref.nr Ref. No. | Best.nr Part No. | |
|--|---|---------------------|--|
| <p>D30, D31, D32 D40, D41, D42, D43, D44 D300</p> <p>AD30A AQAD30A MD30A TAMD30A TMD30A</p> <p>AD31A, AD31B AD31L-A, AD31P-A, AD31XD AQAD31A MD31A TAMD31A, TAMD31B, TAMD31D TAMD31L-A, TAMD31M-A, TAMD31P-A TMD31A, TMD31D, TMD31L-A</p> <p>KAD32P-A</p> <p>AD40B AQAD40A, AQAD40B AQD40A, MD40A TAMD40A, TAMD40B TMD40A, TMD40B, TMD40C</p> <p>AD41A, AD41B, AD41D AD41L-A, AD41P-A AQAD41A D41A, D41B, D41D, D41L-A TAMD41A, TAMD41B, TAMD41D TAMD41H-A, TAMD41L-A TAMD41M-A, TAMD41P-A TMD41A, TAMD41B, TMD41D TMD41L-A</p> <p>KAD42A, KAD42B, KAD42P-A KAMD42A, KAMD42B, KAMD42P-A TAMD42B, TAMD42WJ-A</p> <p>KAD43P-A KAMD43P-A</p> <p>KAD44P-A, KAD44P-B, KAD44P-C KAMD44P-A, KAMD44P-B, KAMD44P-C</p> <p>KAD300A KAMD300A</p> <p>30, 31 = 4 st åtgår / 4 pcs required</p> <p>40, 41, 42, 43, 44, 300 = 6 st åtgår / 6 pcs required</p> | <p>275751 (875651) (275595)</p> | <p>11651</p> |  |

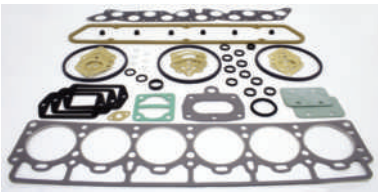
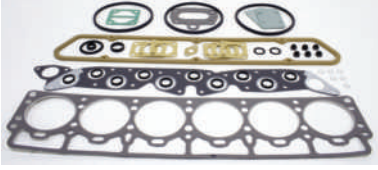

Sotningssetter / Decarb. gasket sets

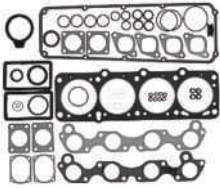
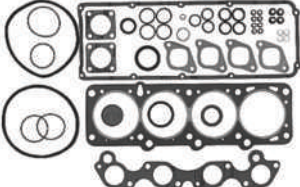
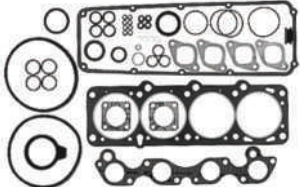
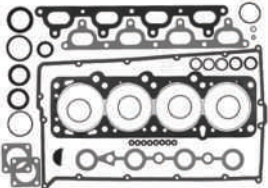
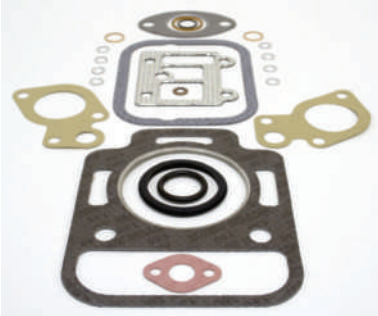
| Motor typ Engine type | Ref.nr Ref. No. | Best.nr Part No. | |
|--|--|---------------------|---|
| B18 AQ60F AQ90, AQ95 AQ110 BB30, BB100, MB 18 | 876357 (875077) | 21357 |  |
| B18 AQ60F AQ90, AQ95 AQ110 BB30, BB100, MB 18 För motorer med B-20 topp / For engines with B-20 cylinder head | | 21358 |  |
| B20 AQ115A AQ130A, AQ130C MB20B | 876356 (875401) | 21401 |  |
| B20 AQ130B BB115A, BB115B MB20A | 876348 (875418) | 21418 | |
| B20 AQ115B AQ130D BB115C MB20C | 876358 (875569) | 21569 |  |
| B30 AQ165A AQ170A, AQ170B BB165A BB170A, BB170B | 876335 876337 (875402) (875533) | 21335 |  |
| B30 AQ170C BB170C | 876359 (875570) | 21359 |  |





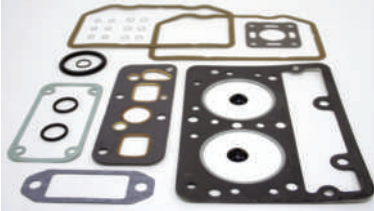
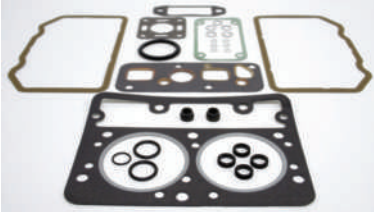

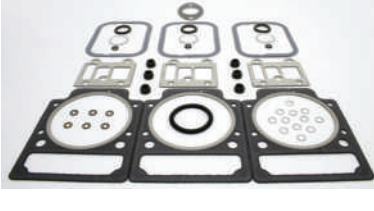
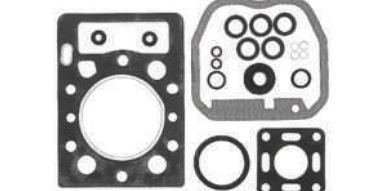
Sotningssetter forts. / Decarb. gasket sets cont.

| Motor typ Engine type | Ref.nr Ref. No. | Best.nr Part No. | |
|---|--------------------|---------------------|---|
| B21 AQ120B, AQ125A, AQ140A BB140A | 876300 (875587) | 21300 |  |
| B23, B25 230A, 230A AQ125B AQ131A, AQ131B, AQ131C, AQ131D AQ145B 250A, 250B AQ151A, AQ151B, AQ151C | 876302 (876022) | 21302 |  |
| B23 AQ145A BB145A | 876301 (875678) | 21301 |  |
| B25 251A AQ171A, AQ171C | 876303 (876071) | 21303 |  |
| D1, D2 D1A MD1A D2A MD2, MD2A Kolv / Piston \varnothing 79 mm MD1A = 1 st åtgår / 1 piece required MD2A = 2 st åtgår / 2 pcs required | 875422 (876415) | 21422 |  |
| D1, D2, D3 MD1B AQD2B MD2B MD3B Kolv / Piston \varnothing 89 mm MD1B = 1 st åtgår / 1 piece required MD2B = 2 st åtgår / 2 pcs required MD3B = 3 st åtgår / 3 pcs required | 876377 (875500) | 21500 |  |

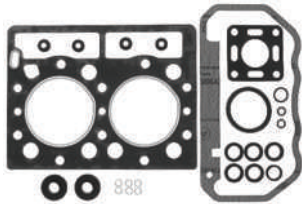
Sotningssatser forts. / Decarb. gasket sets cont.

| Motor typ Engine type | Ref.nr Ref. No. | Best.nr Part No. | |
|--|--------------------|---------------------|---|
| D5 MD5A, MD5B, MD5C | 876341 (875561) | 21561 |  |
| D6 MD6A, MD6B | 876379 (875508) | 21379 |  |
| D7 MD7A Upp till / Up to MO -35144 | 876430 (875613) | 21430 |  |
| D7 MD7A* MD7B * Från / From MO 35145- | 876431 (875613) | 21431 |  |
| D11 MD11C, MD11D Foderpackningssats 11550 ingår ej i denna packningsats / Cylinder liner gasket kit 11550 not included. 2 st 11550 åtgår / 2 pcs 11550 required | 876376 (875553) | 21553 |  |
| D17 MD17C, MD17D Foderpackningssats 11550 ingår ej i denna packningsats / Cylinder liner gasket kit 11550 not included. 3 st 11550 åtgår / 3 pcs 11550 required | 876380 (875572) | 21572 |  |
| 2001 2001 2001AG 2001B 2001BG | 876307 | 21307 |  |

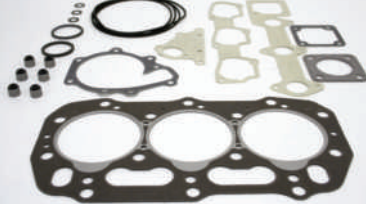
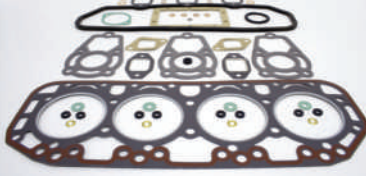
Sotningsatser forts. / Decarb. gasket sets cont.

| Motor typ Engine type | Ref.nr Ref. No. | Best.nr Part No. | |
|--|--------------------------------|---------------------|---|
| 2002 2002 2002AG 2002B 2002BG | 876308 | 21308 |  |
| 2003 2003 2003AG 2003B 2003BG | 876309 | 21309 |  |
| 2003 2003T 2003TB | 876310 | 21310 |  |
| 2030 2030A 2030B | | 21760 <i>NEW</i> |  |
| 2040 2040A 2040B | | 21761 <i>NEW</i> |  |
| D21 AQD21A, AQD21B MD21A, MD21B | 876417 (875388) (875567) | 21417 |  |
| D22 MD22A MD22L-A | | 21762 <i>NEW</i> |  |

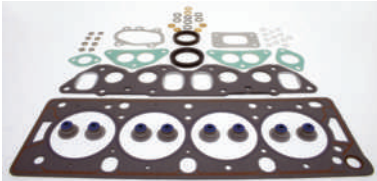
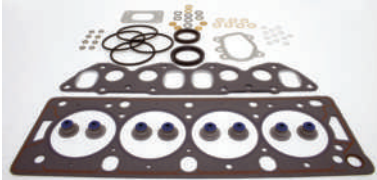
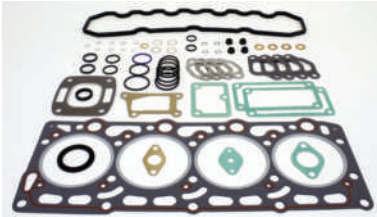
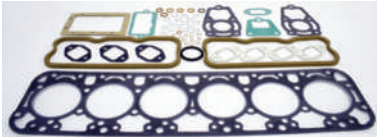
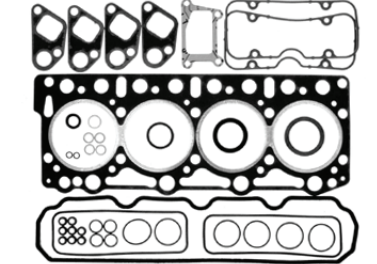

Sotningssetter forts. / Decarb. gasket sets cont.

| Motor typ Engine type | Ref.nr Ref. No. | Best.nr Part No. | |
|--|---------------------------------|---------------------|---|
| D22 MD22L-B MD22P-B | | 21763 <i>NEW</i> |  |
| D22 TMD22A | | 21764 <i>NEW</i> |  |
| D22 TAMD22P-B TMD22B | | 21765 <i>NEW</i> |  |
| D30 AD30A AQAD30A MD30A TAMD30A TMD30A | 3582597 (876453) (875031) | 21453 |  |
| D32 AQD32A MD32A | 875416 (875438) | 21416 |  |
| D31, D32 AD31A, AD31B, AD31D AD31L-A, AD31P-A, AD31XD AQAD31A MD31A TAMD31A, TAMD31B, TAMD31D TAMD31L-A, TAMD31M-A, TAMD31P-A TMD31A, TMD31B, TMD31D TMD31L-A KAD32P-A | 3582435 (876103) | 21103 |  |

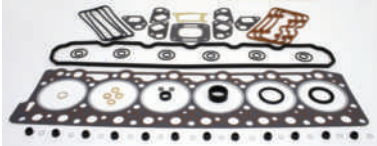
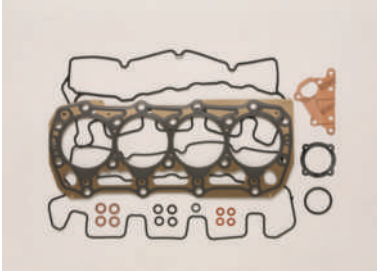
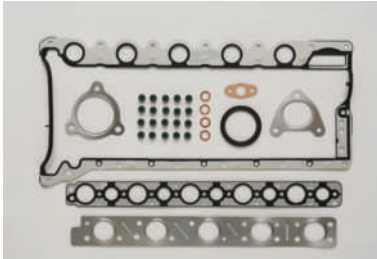

Sotningssetter forts. / Decarb. gasket sets cont.

| Motor typ Engine type | Ref.nr Ref. No. | Best.nr Part No. | |
|--|---|---------------------|---|
| D40 AD40B AQAD40A, AQAD40B AQD40A MD40A TAMD40A, TAMD40B TMD40A, TMD40B, TMD40C | 3582596 (876395) (875633) (875662) | 21395 |  |
| D41, D42, D43 AD41A, AD41B, AD41D AD41L-A, AD41P-A AQAD41A AQD 41A D41A, D41B,, D41D, D41L-A TAMD41A, TAMD41B, TAMD41D TAMD41H-A, TAMD41L-A TAMD41MA, TAMD41P-A TMD41A, TMD41B, TMD41D TMD41L-A KAD42A, KAD42B, KAD42P-A KAMD42A, KAMD42B, KAMD42P-A TAMD42B, TAMD42WJ-A KAD43P-A2 KAMD43P-A | 3583787 (876104) (876530) | 21104 |  |
| D2 D2-55A, D2-55B, D2-55C D2-55D, D2-55E D2-75A, D2-75B, D2-75C | 3589322 | 21801 | NEW  |
| D3 D3-110I-A, D3-130A-A, D3-130I-A D3-160A-A, D3-160I-A D3-110I-B, D3-110I-C, D3-130A-B D3-130I-B, D3-130A-C, D3-130I-C D3-160A-B, D3-160I-B, D3-160A-C D3-160I-C, D3-190A-B, D3-190I-B D3-190A-C, D3-190I-C Toppløckspackning ingår inte. Se sid 3.6 Cylinder head gasket not included. See page 3.6 | 3883845 | 21802 | NEW  |



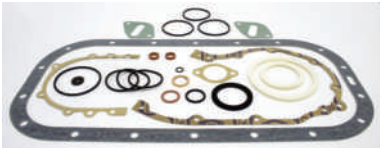

Sotningssetter forts. / Decarb. gasket sets cont.

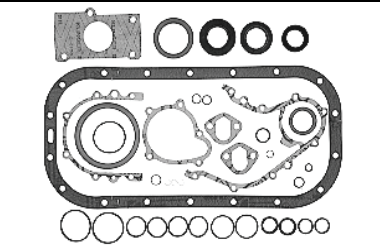
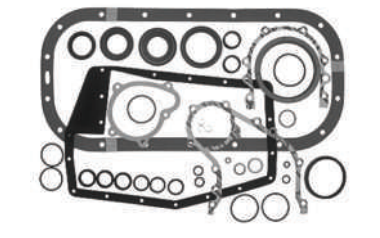
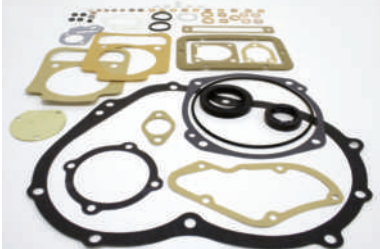
| Motor typ Engine type | Ref.nr Ref. No. | Best.nr Part No. | |
|--|-------------------------------|---------------------|---|
| <p>D4</p> <p>D4-180I-B, D4-210A-A, D4-210A-B D4-210I-A, D4-210I-B, D4-225A-B D4-225I-B, D4-260A-A, D4-260A-B D4-260I-A, D4-260I-B</p> | <p>21371112 (3588432)</p> | <p>21803</p> | <p>NEW</p>  |
| <p>D6</p> <p>D6-280I-A, D6-280I-B, D6-280A-A D6-280A-B, D6-310I-A, D6-310I-B D6-310A-A, D6-310A-B, D6-310D-B D6-350A-A, D6-350A-B, D6-370I-A D6-370I-B, D6-370D-B</p> | <p>21370000 (3588433)</p> | <p>21805</p> | <p>NEW</p>  |





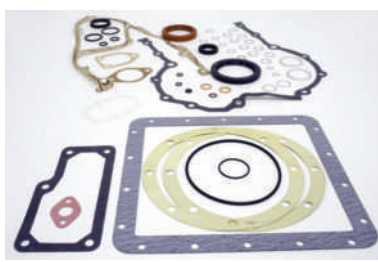
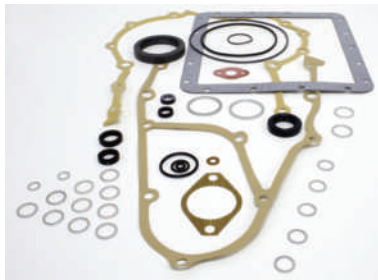

Tilläggsatser / Conversion gasket sets

| Motor typ Engine type | Ref.nr Ref. No. | Best.nr Part No. | |
|---|--------------------------------|---------------------|---|
| <p>B18, B20</p> <p>AQ60F AQ90, AQ95, AQ95A AQ110, AQ120 BB30, BB100, MB18</p> <p>AQ105 AQ115A, AQ115B AQ130A, AQ130B, AQ130C, AQ130D BB115A, BB115B, BB115C MB20A, MB20B, MB20C</p> <p>Satsen är kompletterad att passa både för B-18 och B-20 motorer / Gaskets added to fit both B18 and B20 engines</p> | 876342 (875400) | 21400 |  |
| <p>B30</p> <p>AQ165A AQ170A, AQ170B, AQ170C BB165A BB170A, BB170B, BB170C</p> | 876306 (875403) | 21306 |  |
| <p>B21, B23</p> <p>AQ120B, AQ125A, AQ140A BB140A</p> <p>AQ145A BB145A</p> | 876393 (876433) (875588) | 21433 |  |
| <p>B23</p> <p>AQ125B AQ145B</p> | 876448 (876023) | 21023 |  |
| <p>B23, B25</p> <p>230A, 230B AQ131A, AQ131B, AQ131C, AQ131D</p> <p>250A, 250B, 251A AQ151A, AQ151B, AQ151C AQ171A, AQ171C</p> | 876304 | 21304 |  |
| <p>D1</p> <p>D1A MD1A</p> | 876393 (875423) | 21423 |  |

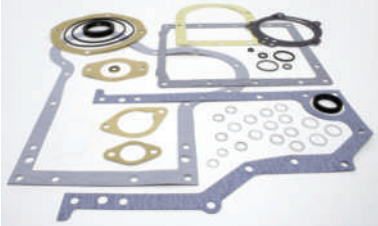

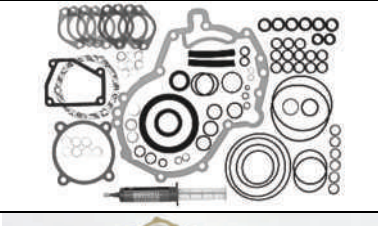

Tilläggsatser forts. / Conversion gasket sets cont.

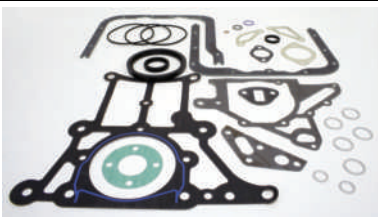
| Motor typ Engine type | Ref.nr Ref. No. | Best.nr Part No. | |
|---|--------------------|---------------------|---|
| D1 MD1B | 876378 (875501) | 21378 |  |
| D2 D2A MD2 MD2A | 876394 (875424) | 21394 |  |
| D2 AQD2B MD2B | 876389 (875503) | 21389 |  |
| D3 MD3B | 876388 (875505) | 21388 |  |
| MD5 MD5A, MD5B Foderpackningssats 11560 ingår ej i denna packningsats / Cylinder liner gasket kit 11560 not included. 1 st 11560 åtgår / 1 piece 11560 required | 876381 (875562) | 21381 |  |
| D5 MD5C Foderpackningssats 11560 ingår ej i denna packningsats / Cylinder liner gasket kit 11560 not included. 1 st 11560 åtgår / 1 piece 11560 required | 876382 (875715) | 21382 |  |

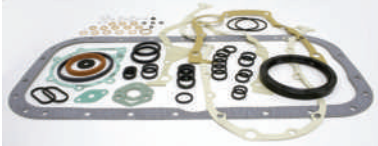

Tilläggsatser forts. / Conversion gasket sets cont.

| Motor typ Engine type | Ref.nr Ref. No. | Best.nr Part No. | |
|--|--------------------|---------------------|---|
| D6, D7 MD6A, MD6B MD7A, MD7B | 876314 (875509) | 21314 |  |
| D11 MD11C, MD11D Foderpackningsatts 11550 ingår ej i denna packningsatts / Cylinder liner gasket kit 11550 not included. 2 st 11550 åtgår / 2 pcs 11550 required | 876384 (875554) | 21384 |  |
| D17 MD17C, MD17D Foderpackningsatts 11550 ingår ej i denna packningsatts / Cylinder liner gasket kit 11550 not included. 2 st 11550 åtgår / 2 pcs 11550 required | 876383 (875573) | 21383 |  |
| 2001, 2002, 2003 2001, 2001AG, 2001B, 2001BG 2002, 2002AG, 2002B, 2002BG 2003, 2002AG, 2002B, 2002BG | 875757 | 21757 |  |
| 2003 2003T 2003TB | 876054 | 21054 |  |
| D21 AQD21A, AQD21B MD21A, MD21B | 875387 | 21387 |  |
| D22 MD22A MD22L-A, MD22L-B MD22P-B TAMD22P-B TMD22A, TMD22B | | 21766 NEW |  |

Tilläggsatser forts. / Conversion gasket sets cont.

| Motor typ Engine type | Ref.nr Ref. No. | Best.nr Part No. | |
|--|----------------------------|---------------------|---|
| <p>D32</p> <p>AQD32A MD32A</p> | <p>875439</p> | <p>21439</p> |  |
| <p>D30</p> <p>AD30A AQAD30A MD30A TAMD30A TMD30A</p> <p>Foderpackningssats 11651 ingår ej i denna packningsats / Cylinder liner gasket kit 11651 not included. 4 st 11651 åtgår / 4 pcs 11651 required</p> | <p>876427 (876032)</p> | <p>21427</p> |  |
| <p>D31, D32</p> <p>AD31A, AD31B, AD31D AD31L-A, AD31P-A, AD31XD AQAD31A MD31A TAMD31A, TAMD31B, TAMD31D TAMD31L-A, TAMD31M-A, TAMD31P-A TMD31A, TMD31B, TMD31D TMD31L-A</p> <p>KAD32P-A</p> <p>Foderpackningssats 11651 ingår ej i denna packningsats / Cylinder liner gasket kit 11651 not included. 4 st 11651 åtgår / 4 pcs 11651 required</p> | <p>876361 (876105)</p> | <p>21361</p> |  |
| <p>D40</p> <p>AD40B AQAD40A, AQAD40B AQD40A MD40A TAMD40A, TAMD40B TMD40A, TMD40B, TMD40C</p> <p>Foderpackningssats 11651 ingår ej i denna packningsats / Cylinder liner gasket kit 11651 not included. 6 st 11651 åtgår / 6 pcs 11651 required</p> | <p>876349 (875634)</p> | <p>21349</p> |  |

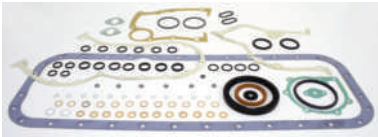
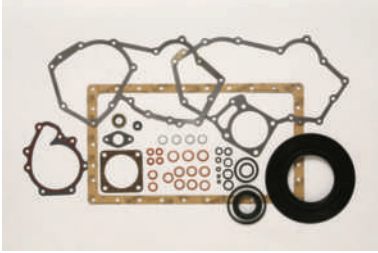
Tilläggsatser forts. / Conversion gasket sets cont.

| Motor typ Engine type | Ref.nr Ref. No. | Best.nr Part No. | |
|---|--|---------------------|---|
| <p>D41, D42, D43, D44 D300</p> <p>AD41A, AD41B, AD41D AD41L-A, AD41P-A AQAD41A D41A, D41B, D41D, D41L-A TAMD41A, TAMD41B, TAMD41D TAMD41H-A, TAMD41L-A TAMD41M-A, TAMD41P-A TMD41A, TMD41B, TMD41D TMD41L-A KAD42A, KAD42B, KAD42P-A KAMD42A, KAMD42B, KAMD42P-A TAMD42B, TAMD42WJ-A</p> <p>KAD43P-A KAMD43P-A</p> <p>KAD44P-A, KAD44P-B, KAD44P-C KAMD44P-A, KAMD44P-B, KAMD44P-C</p> <p>KAD300A KAMD300A</p> <p>Foderpackningssats 11651 ingår ej i denna packningsats / Cylinder liner gasket kit 11651 not included. 6 st 11651 åtgår / 6 pcs 11651 required</p> | <p>876774 (876362) (876106) (876531)</p> | <p>21362</p> |  |
| <p>D2</p> <p>D2-55A, D2-55B, D2-55C D2-55D, D2-55E</p> <p>D2-75A, D2-75B, D2-75C</p> | <p>877419</p> | <p>21800</p> | <p>NEW</p>  |
| <p>D4, D6</p> <p>D4-180I-B, D4-210A-A, D4-210A-B D4-210I-A, D4-210I-B, D4-225A-B D4-225I-B, D4-260A-A, D4-260A-B D4-260I-A, D4-260I-B</p> <p>Ingår i sotn.sats 21804 Incl in decarb.gasket set 21804</p> <p>D6-280I-A, D6-280I-B, D6-280A-A D6-280A-B, D6-310I-A, D6310I-B D6-310A-A, D6-310A-B, D6-310D-B D6-350A-A, D6-350A-B, D6-370I-A D6-370I-B, D6-370D-B</p> | <p>3588434</p> | <p>21804</p> | <p>NEW</p>  |

Tilläggsatser forts. / Conversion gasket sets cont.

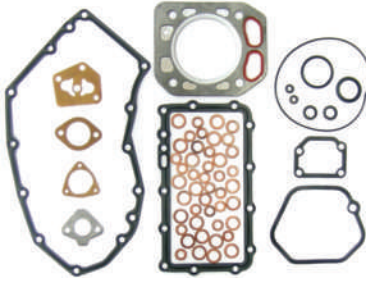
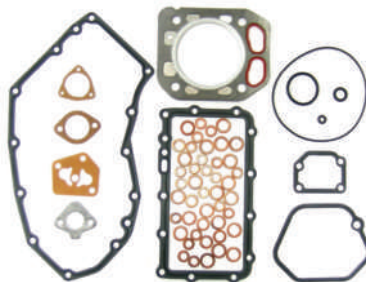
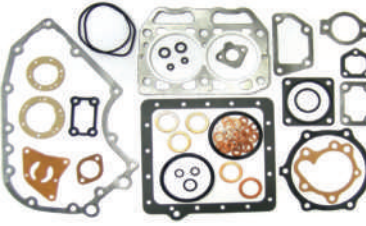
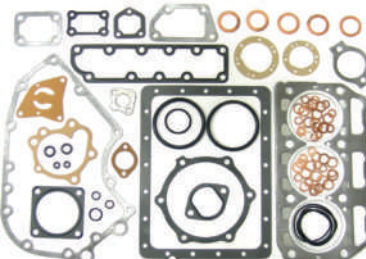
| Motor typ Engine type | Ref.nr Ref. No. | Best.nr Part No. | |
|---|--------------------|---------------------|---|
| YANMAR 1GM 7 hästkrafter 7 Horse power | 728170-92600 | 60000 | NEW  |
| YANMAR 1GM10 9 hästkrafter 9 Horse power | 728171-92601 | 60001 | NEW  |
| YANMAR 2GM2D, 2GM20F 18 hästkrafter 18 Horse power | 728271-92605 | 60002 | NEW  |
| YANMAR 3GM30, 3GM30(EU) 3GM30F, 3GM30F(EU) 27 hästkrafter 27 Horse power | 728374-92605 | 60003 | NEW  |



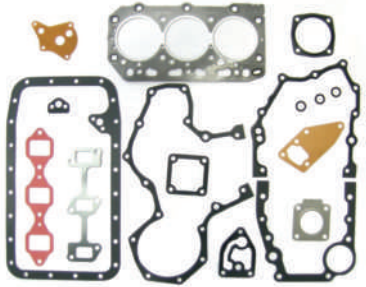
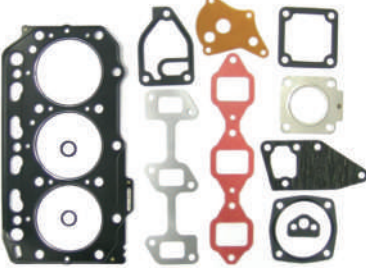
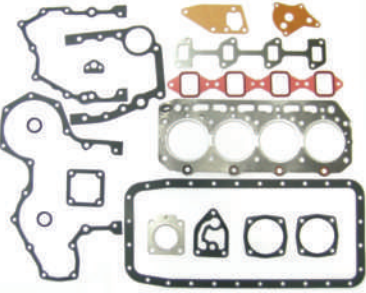

Tilläggsatser forts. / Conversion gasket sets cont.

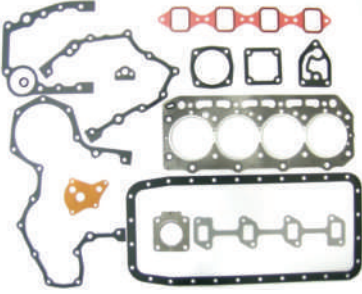
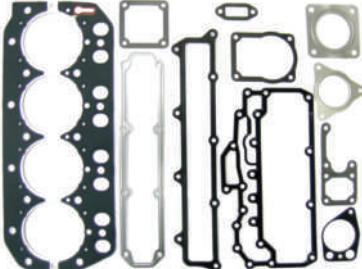
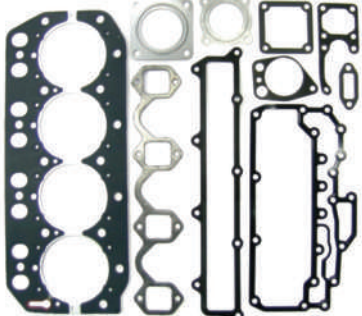
| Motor typ Engine type | Ref.nr Ref. No. | Best.nr Part No. | |
|--|--------------------|---------------------|---|
| <p>YANMAR</p> <p>3JH2E</p> <p>38 hästkrafter 38 Horse power</p> <p>3JH2TE</p> <p>55 hästkrafter 55 Horse power</p> | 729171-92600 | 60004 | <p>NEW</p>  |
| <p>YANMAR</p> <p>3JH3EYEU</p> <p>40 hästkrafter 40 Horse power</p> | 729270-92601 | 60005 | <p>NEW</p>  |
| <p>YANMAR</p> <p>4JHE</p> <p>44 hästkrafter 44 Horse power</p> <p>4JHTE</p> <p>55 hästkrafter 55 Horse power</p> <p>4JHDTE</p> <p>77 hästkrafter 77 Horse power</p> | 729470-92605 | 60006 | <p>NEW</p>  |

Tilläggsatser forts. / Conversion gasket sets cont.

| Motor typ Engine type | Ref.nr Ref. No. | Best.nr Part No. | |
|--|--------------------|---------------------|---|
| <p>YANMAR</p> <p>4JH2E 62 hästkrafter 62 Horse power</p> <p>4JH2TE 72 hästkrafter 72 Horse power</p> <p>4JM2HTE 83 hästkrafter 83 Horse power</p> <p>4JH2DTE 95 hästkrafter 95 Horse power</p> <p>4JH2UTE 106 hästkrafter 106 Horse power</p> | 729573-92605 | 60007 | <p style="text-align: center;">NEW</p>  |
| <p>YANMAR</p> <p>4LHTE 125 hästkrafter 125 Horse power</p> <p>4LHHTE 142 hästkrafter 142 Horse power</p> <p>4LHDTE 182 hästkrafter 182 Horse power</p> <p>4LHSTE 238 hästkrafter 238 Horse power</p> | 719171-92602 | 60008 | <p style="text-align: center;">NEW</p>  |
| <p>YANMAR</p> <p>4LHAHTE 150 hästkrafter 150 Horse power</p> <p>4LHADTE 190 hästkrafter 190 Horse power</p> <p>4LHASTE 238 hästkrafter 238 Horse power</p> | 719173-92600 | 60009 | <p style="text-align: center;">NEW</p>  |

Packningsklister / Sealing Compound

| | | | |
|---|---------------|----------------------|---|
| <p>Silicone</p> <p>Form A Gasket Nr. 6 BR</p> <p>Permatex 40 ml</p> | | <p>13750</p> |  |
| <p>Packningsspray / Gasket spray</p> <p>Loctite 3020</p> <p>För topplockspackningar mm. For cylinder head gaskets etc.</p> <p>400 ml</p> | | <p>13751</p> |  |
| <p>Packningsklister / Sealing compound</p> <p>Loctite 5972</p> <p>För höga temperaturer / For high temperature -40° - +315° C</p> <p>200 ml</p> | | <p>13 752</p> |  |
| <p>Universalpackning / Universal gasket</p> <p>Loctite 574</p> <p>25 g</p> | <p>840879</p> | <p>14879</p> |  |

Gummikudde för motorupphängning / Rubber block for engine suspension

| Motor typ Engine type | Ref.nr Ref. No. | Best.nr Part No. | |
|--|--|---------------------|---|
| <p>B18, B20</p> <p>AQ60F, AQ90, AQ95, AQ95A, AQ100 AQ110, AQ120</p> <p>AQ105A AQ115A, AQ115B AQ130A, AQ130B, AQ130C, AQ130D</p> <p>För motorer med främre stödbalk / For engine with forward suport</p> | 653190 | 19106 |  |
| <p>B30</p> <p>AQ165A AQ170A, AQ170B, AQ170C</p> <p>För främre stödbalk / For forward suport</p> | 682694 | 19107 |  |
| <p>MB10, D5, D6, D7, D11, D17</p> <p>MB10A MD5A, MD5B, MD5C MD6A, MD6B MD7A, MD7B MD11C, MD11D MD17C, MD17D</p> <p>35 mm lång pinnbult på ovansidan. Invändigt hål på undersidan med UNC 3/8" gänga. Övre diameter 64 mm, höjd 40mm.</p> <p>1 st mutter 19850 ingår / 1 nut 19850 included</p> | 833950 | 22050 |  |
| <p>D1, D2, D3, D6, D7, D11, D17</p> <p>MB10A D1A* MD1A*, MD1B AQD2B D2A* MD2*, MD2A*, MD2B MD3B MD6A, MD6B MD7A, MD7B MD11C, MD11D MD17C, MD17D</p> <p>* Endast bakre fäste / Only rear rubber block</p> <p>35 mm lång pinnbult på ovansidan och 23 mm på undersidan. Övre diameter 64 mm, höjd 40mm.</p> <p>2 st muttrar 19850 ingår 2 nuts 19850 included</p> | 849170 (833315) (833625) (807464) (833720) | 22144 |  |

Gummikudde för propelleraxelkoppling / Rubber block for propeller shaft coupling

| Motor typ Engine type | Ref.nr Ref. No. | Best.nr Part No. | |
|---|--------------------|---------------------|---|
| <p>B18, B20, B30, MB10 2001, 2002, 2003, 2010, 2020, 2030, 2040 D1, D2, D3, D5, D6, D7, D11, D17 D21, D22, D29, D32</p> <p>BB30, BB100, BB115, BB165, BB170 MB10A, MB18, MB20</p> <p>2001, 2002, 2003, 2010, 2020, 2030, 2040</p> <p>D1, MD1</p> <p>AQD2 D2, MD2</p> <p>MD3</p> <p>MD5</p> <p>MD6</p> <p>MD7</p> <p>MD11</p> <p>MD17</p> <p>MD21</p> <p>MD22</p> <p>MD29</p> <p>MD32</p> <p>4 eller 6 st åtgår / 4 or 6 pcs required 2 st muttrar ingår / 2 nuts included</p> | <p>803762</p> | <p>22062</p> |  |

Svängningsdämpare / Damper (vibration damper)

| Motor typ Engine type | Svängningsdämpare typ Damper type | Ref.nr Ref. No. | Best.nr Part No. |
|--------------------------|--------------------------------------|--------------------|---------------------|
| 230A | Hål / Hole 34 mm 26 splines | 855389 | 19389 |
| 230B | Hål / Hole 34 mm 26 splines | 855389 | 19389 |
| 250A | Hål / Hole 34 mm 26 splines | 855389 | 19389 |
| 250B | Hål / Hole 34 mm 26 splines | 855389 | 19389 |
| 251A | Hål / Hole 34 mm 26 splines | 855389 | 19389 |
| AQ60F | Hål / Hole 25 mm 10 splines | 841896 | 19896 |
| AQ90 | Hål / Hole 25 mm 10 splines | 841896 | 19896 |
| AQ95 | Hål / Hole 25 mm 10 splines | 841896 | 19896 |
| AQ95A | Hål / Hole 25 mm 10 splines | 841896 | 19896 |
| AQ100 | Hål / Hole 25 mm 10 splines | 841896 | 19896 |
| AQ105A | Hål / Hole 25 mm 10 splines | 841896 | 19896 |
| | Hål / Hole 34 mm 26 splines | 855389 | 19389 |
| AQ110 | Hål / Hole 25 mm 10 splines | 841896 | 19896 |
| AQ115A | Hål / Hole 25 mm 10 splines | 841896 | 19896 |
| | Hål / Hole 34 mm 26 splines | 855389 | 19389 |
| AQ115B | Hål / Hole 25 mm 10 splines | 841896 | 19896 |
| AQ120 | Hål / Hole 25 mm 10 splines | 841896 | 19896 |
| AQ120B | Hål / Hole 34 mm 26 splines | 855389 | 19389 |
| AQ125A | Hål / Hole 34 mm 26 splines | 855389 | 19389 |
| AQ125B | Hål / Hole 34 mm 26 splines | 855389 | 19389 |
| AQ130A | Hål / Hole 25 mm 10 splines | 841896 | 19896 |
| | Hål / Hole 34 mm 26 splines | 855389 | 19389 |
| AQ130B | Hål / Hole 25 mm 10 splines | 841896 | 19896 |
| | Hål / Hole 34 mm 26 splines | 855389 | 19389 |
| AQ130C | Hål / Hole 25 mm 10 splines | 841896 | 19896 |
| | Hål / Hole 34 mm 26 splines | 855389 | 19389 |
| AQ130D | Hål / Hole 25 mm 10 splines | 841896 | 19896 |
| | Hål / Hole 34 mm 26 splines | 855389 | 19389 |
| AQ131A | Hål / Hole 34 mm 26 splines | 855389 | 19389 |
| AQ131B | Hål / Hole 34 mm 26 splines | 855389 | 19389 |
| AQ131C | Hål / Hole 34 mm 26 splines | 855389 | 19389 |
| AQ131D | Hål / Hole 34 mm 26 splines | 855389 | 19389 |
| AQ140A | Hål / Hole 34 mm 26 splines | 855389 | 19389 |
| AQ145A | Hål / Hole 34 mm 26 splines | 855389 | 19389 |
| AQ145B | Hål / Hole 34 mm 26 splines | 855389 | 19389 |
| AQ151A | Hål / Hole 34 mm 26 splines | 855389 | 19389 |
| AQ151B | Hål / Hole 34 mm 26 splines | 855389 | 19389 |
| AQ151C | Hål / Hole 34 mm 26 splines | 855389 | 19389 |
| AQ165A | Hål / Hole 34 mm 26 splines | (841893) | 19389 |
| AQ170A | Hål / Hole 34 mm 26 splines | (841893) | 19389 |
| AQ170B | Hål / Hole 34 mm 26 splines | (841893) | 19389 |
| AQ170C | Hål / Hole 34 mm 26 splines | (841893) | 19389 |
| AQ171A | Hål / Hole 34 mm 26 splines | 855389 | 19389 |
| AQ171C | Hål / Hole 34 mm 26 splines | 855389 | 19389 |
| AQ130D | Hål / Hole 25 mm 10 splines | 841896 | 19896 |
| BB30 | Hål / Hole 25 mm 10 splines | 841896 | 19896 |
| BB100 | Hål / Hole 25 mm 10 splines | 841896 | 19896 |
| BB115A | Hål / Hole 25 mm 10 splines | 841896 | 19896 |
| | Hål / Hole 34 mm 26 splines | 855389 | 19389 |
| BB115B | Hål / Hole 25 mm 10 splines | 841896 | 19896 |
| | Hål / Hole 34 mm 26 splines | 855389 | 19389 |
| BB115C | Hål / Hole 25 mm 10 splines | 841896 | 19896 |
| | Hål / Hole 34 mm 26 splines | 855389 | 19389 |
| BB140A | Hål / Hole 34 mm 26 splines | 855389 | 19389 |
| BB145A | Hål / Hole 34 mm 26 splines | 855389 | 19389 |
| BB165A | Hål / Hole 34 mm 26 splines | (841893) | 19389 |
| BB170A | Hål / Hole 34 mm 26 splines | (841893) | 19389 |
| BB170B | Hål / Hole 34 mm 26 splines | (841893) | 19389 |
| BB170C | Hål / Hole 34 mm 26 splines | (841893) | 19389 |
| MB18 | Hål / Hole 25 mm 10 splines | 841896 | 19896 |

Svängningsdämpare forts. / Damper (vibration damper) cont.



| Motor typ Engine type | Svängningsdämpare typ Damper type | Ref.nr Ref. No. | Best.nr Part No. |
|--------------------------|--------------------------------------|--------------------|---------------------|
| MB20A | Hål / Hole 25 mm 10 splines | 841896 | 19896 |
| | Hål / Hole 34 mm 26 splines | 855389 | 19389 |
| MB20B | Hål / Hole 25 mm 10 splines | 841896 | 19896 |
| | Hål / Hole 34 mm 26 splines | 855389 | 19389 |
| MB20C | Hål / Hole 25 mm 10 splines | 841896 | 19896 |
| | Hål / Hole 34 mm 26 splines | 855389 | 19389 |
| | DIESEL | | |
| AD30A | Hål / Hole 34 mm 26 splines | 855389 | 19389 |
| AD31A | Hål / Hole 34 mm 26 splines | 855389 | 19389 |
| AD31B | Hål / Hole 34 mm 26 splines | 855389 | 19389 |
| AD31D | Hål / Hole 34 mm 26 splines | 855389 | 19389 |
| AD31L-A | Hål / Hole 34 mm 26 splines | 855389 | 19389 |
| AD31P-A | Hål / Hole 34 mm 26 splines | 855389 | 19389 |
| AD31XD | Hål / Hole 34 mm 26 splines | 855389 | 19389 |
| AD40B | Hål / Hole 34 mm 26 splines | 855389 | 19389 |
| | | 841893 | * |
| AD41A | Hål / Hole 34 mm 26 splines | 855617 | 19617 |
| AD41B | Hål / Hole 34 mm 26 splines | 855617 | 19617 |
| AD41D | Hål / Hole 34 mm 26 splines | 855617 | 19617 |
| AD41L-A | Hål / Hole 34 mm 26 splines | 855617 | 19617 |
| AD41P-A | Hål / Hole 34 mm 26 splines | 855617 | 19617 |
| AQAD30A | Hål / Hole 34 mm 26 splines | 855389 | 19389 |
| | | 846755 | * |
| AQAD31A | Hål / Hole 34 mm 26 splines | 855389 | 19389 |
| AQAD40A | Hål / Hole 34 mm 26 splines | 855389 | 19389 |
| AQAD40B | | 841893 | * |
| | Hål / Hole 34 mm 26 splines | 855389 | 19389 |
| AQAD41A | Hål / Hole 34 mm 26 splines | 855617 | 19617 |
| AQD19 | | | |
| AQD21A | Hål / Hole 25 mm 10 splines | 841892 | 19092 |
| | Hål / Hole 34 mm 26 splines | 841894 | 19189 |
| | | 841893 | * |
| AQD21B | | 841893 | * |
| | Hål / Hole 34 mm 26 splines | 841894 | 19189 |
| AQD27 | | | ? |
| AQD29 | Hål / Hole 25 mm 10 splines | 841896 | 19896 |
| AQD29A | Hål / Hole 25 mm 10 splines | 841896 | 19896 |
| AQD32A | Hål / Hole 25 mm 10 splines | 841896 | 19896 |
| | | 841893 | * |
| AQD40A | Hål / Hole 34 mm 26 splines | 855389 | 19389 |
| | | 841893 | * |
| D41A | Hål / Hole 34 mm 26 splines | 855617 | 19617 |
| D41B | Hål / Hole 34 mm 26 splines | 855617 | 19617 |
| D41D | Hål / Hole 34 mm 26 splines | 855617 | 19617 |
| D41L-A | Hål / Hole 34 mm 26 splines | 855617 | 19617 |
| KAD32P-A | Hål / Hole 34 mm 26 splines | 855389 | 19389 |
| KAD42A | Hål / Hole 34 mm 26 splines | 855617 | 19617 |
| KAD42B | Hål / Hole 34 mm 26 splines | 855617 | 19617 |
| KAD42P-A | Hål / Hole 34 mm 26 splines | 855617 | 19617 |
| KAD43P-A | Hål / Hole 34 mm 26 splines | 855617 | 19617 |
| KAD44P-A | Hål / Hole 34 mm 26 splines | 855617 | 19617 |
| KAD44P-B | Hål / Hole 34 mm 26 splines | 855617 | 19617 |
| KAD44P-C | Hål / Hole 34 mm 26 splines | 855617 | 19617 |
| KAD300A | Hål / Hole 34 mm 26 splines | 855617 | 19617 |
| KAMD42A | Hål / Hole 34 mm 26 splines | 855617 | 19617 |
| | | 3582751 | * |
| MD21A | Hål / Hole 25 mm 10 splines | 841892 | 19092 |
| | Hål / Hole 34 mm 26 splines | 841894 | 19189 |

Svängningsdämpare forts. / Damper (vibration damper) cont.

| Motor typ Engine type | Svängningsdämpare typ Damper type | Ref.nr Ref. No. | Best.nr Part No. |
|--------------------------|--------------------------------------|--------------------|---------------------|
| MD21B | Hål / Hole 25 mm 10 splines | 841892 | 19092 |
| | Hål / Hole 34 mm 26 splines | 841894 | 19189 |
| MD29 | Hål / Hole 25 mm 10 splines | 841896 | 19896 |
| | Hål / Hole 34 mm 26 splines | 841894 | 19189 |
| MD29A | Hål / Hole 25 mm 10 splines | 841896 | 19896 |
| | Hål / Hole 34 mm 26 splines | 841894 | 19189 |
| MD30A | Hål / Hole 34 mm 26 splines | 855389 | 19389 |
| | | 846755 | * |
| MD31A | Hål / Hole 34 mm 26 splines | 855389 | 19389 |
| | | 846755 | * |
| MD32A | Hål / Hole 34 mm 26 splines | 841894 | 19189 |
| MD40A | Hål / Hole 34 mm 26 splines | 855389 | 19389 |
| | | 841893 | * |
| TAMD30A | Hål / Hole 34 mm 26 splines | 855389 | 19389 |
| | | 846755 | * |
| TAMD31A | Hål / Hole 34 mm 26 splines | 855389 | 19389 |
| | | 846755 | * |
| | | 854573 | * |
| | | 854506 | * |
| TAMD31B | Hål / Hole 34 mm 26 splines | 855389 | 19389 |
| TAMD31D | Hål / Hole 34 mm 26 splines | 855389 | 19389 |
| | | 3582751 | * |
| | | 872987 | * |
| | | 854321 | * |
| TAMD40A | Hål / Hole 34 mm 26 splines | 855389 | 19389 |
| | | 841893 | * |
| TAMD40B | Hål / Hole 34 mm 26 splines | 855389 | 19389 |
| | | 841893 | * |
| TAMD41A | Hål / Hole 34 mm 26 splines | 855617 | 19617 |
| | | 854321 | * |
| | | 854506 | * |
| | | 854573 | * |
| TAMD41B | Hål / Hole 34 mm 26 splines | 855617 | 19617 |
| | | 3582751 | * |
| TMD30A | Hål / Hole 34 mm 26 splines | 855389 | 19389 |
| | | 846755 | * |
| TMD31A | Hål / Hole 34 mm 26 splines | 855389 | 19389 |
| | | 846755 | * |
| TMD31B | Hål / Hole 34 mm 26 splines | 855389 | 19389 |
| TMD31D | Hål / Hole 34 mm 26 splines | 855389 | 19389 |
| | | 3582751 | * |
| TMD40A | | 841893 | * |
| | Hål / Hole 34 mm 26 splines | 855389 | 19389 |
| TMD40B | Hål / Hole 34 mm 26 splines | 855389 | 19389 |
| | | 841893 | * |
| TMD40C | Hål / Hole 34 mm 26 splines | 855389 | 19389 |
| | | 841893 | * |
| TMD41A | Hål / Hole 34 mm 26 splines | 855617 | 19617 |
| TMD41B | Hål / Hole 34 mm 26 splines | 855617 | 19617 |
| | | 3582751 | * |

* ingår ej in vårt sortiment / not in our program



Svängningsdämpare forts. / Damper cont.

| Motor typ Engine type | AQ-drev / backslags typ Sterndrive type | Ref.nr Ref. No. | Best.nr Part No. | |
|--|--|------------------------------|---------------------|---|
| AQD21A AQD21B MD21A MD21B | 250 250 RB RB | 841892 (829476) | 19092 |  |
| AQD21A AQD21B MD21A MD21B MD29 MD29A MD32A | 110S 110S Borg Warner Borg Warner, MS3 Borg Warner Borg Warner Borg Warner | 841894 (829132) 818405 | 19189 |  |

Svängningsdämpare forts. / Damper cont.

| Motor typ Engine type | AQ-drev / backslags typ Sterndrive type | Ref.nr Ref. No. | Best.nr Part No. | |
|---|---|--------------------------------|---------------------|---|
| AQ115A AQ115B AQ130A AQ130B AQ130C AQ130D BB115A BB115B BB115C MB20A MB20B MB20C 230A 230B AQ125B AQ145A AQ145B BB145A 250A 250B 251A AQ151A AQ151A AQ151C AQ171A AQ171C | 100B 100B | | | |
| AQ165A AQ170A AQ170B AQ170C BB165A BB170A BB170B BB170C AD30A AQAD30A MD30A TAMD30A TMD30A AD31A AD31B AD31D AD31XD AQAD31A MD31A TAMD31A TAMD31B TAMD31D TMD31A TMD31B TMD31D KAD32P-A AD40B AQAD40B AQD40A AQD40A MD40A TAMD40A TAMD40B TMD40A TMD40B TMD40C | MS4 MS4 MS4 MS4 MS4 MS4 MS4 MS4B | 855389 (831778) (841895) | 19389 |  |

Svängningsdämpare forts. / Damper cont.

| Motor typ Engine type | AQ-drev / backslags typ Sterndrive type | Ref.nr Ref. No. | Best.nr Part No. | |
|--|--|--|--|---|
| AQ60F AQ90 AQ95 AQ95A AQ110 AQ120 BB30 BB100 MB18 AQ115A AQ115B AQ130A AQ130B AQ130C AQ130D BB115A BB115B BB115C MB20A MB20B MB20C AQD29 AQD29A MD29 MD29A AQD32A | RB RB 250 | 841896 (806270) (831777) | 19896 |  |
| AD41A AD41B AD41D AQAD41A D41A D41B D41D TAMD41A TAMD41B TMD41A TMD41B | 6-fjädrar 6-springs | 855617 | 19617 |  |
| KAD42A KAD42B KAD42P-A KAMD42A KAD43P-A KAD44P-A KAD44P-B KAD44P-C KAD300A KAMD300A | 8-fjädrar 8-springs Parameter 287/159NGS Diameter: 287 mm Hub profile: 31,8 x 34,3_26 N Number of teeth: 26 Max transmittable engine torque: 820 NM | 855617 | 19618 | NEW  |

Rep-sats för svänghjulskåpa

Repair kits for flywheel casing

| Motor typ Engine type | AQ-drev typ Sterndrive type | Best.nr Part No. | |
|--------------------------|--|---------------------|--|
| 230A | SP-A, SP-A/MT, SP-A1 | 22074 | |
| 230B | SP-A, SP-A1 | 22074 | |
| 250A | SP-A, SP-A1 | 22074 | |
| 250B | SP-C | 22074 | |
| 251A | SP-A, SP-A1 | 22074 | |
| 430A | DP-A1, DP-A2, DP-C SP-A1, SP-C | 22075 | |
| 430B | DP-C SP-C | 22075 | |
| 431A | DP-A, DP-A1, DP-A2, DP-C SP-A, SP-A1, SP-A2, SP-C | 22075 | |
| 431B | DP-C SP-C | 22075 | |
| 432A | DP-C1 SP-C1 | 22055 | |
| 434A | DP-C1 SP-C1 | 22055 | |
| 500A | 290A, 290DP DP-A SP-A | 22075 | |
| 500B | DP-A1, DP-A2, DP-C SP-A1, SP-A2, SP-C, SP-C1* | 22075 | * tid.utf. med 2 lager / earl. version 2 bearing |
| | DP-C1, DP-D1 SP-C1* | 22055 | * sen.utf. med 1 lager / later version 1 bearing |
| 501A | 290A, 290DP DP-A, DP-A1, DPA2 SP-A, SP-A1, SP-A2 | 22075 | |
| 501B | DP-A2, DP-C, DP-C1* SP-A2, SP-C, SP-C1* | 22075 | * tid.utf. med 2 lager / earl. version 2 bearing |
| | DP-C1* DP-D1 SP-C1* | 22055 | * sen.utf. med 1 lager / later version 1 bearing |
| 570 | 290A, 290DP | 22075 | |
| 570A | DP-A, DP-A1, DP-A2, DP-C, DP-C1* SP-A, SP-A1, SP-A2, SP-C, SP-C1* | 22075 | * tid.utf. med 2 lager / earl. version 2 bearing |
| | DP-C1*, DP-D1 SP-C1* | 22055 | * sen.utf. med 1 lager / later version 1 bearing |
| 571A | 290A SP-A, SP-A1, SP-A2 | 22075 | |
| 572 | 290A, 290DP | 22075 | |
| 572A | DP-C, DP-C1* SP-C, SP-C1* | 22075 | * tid.utf. med 2 lager / earl. version 2 bearing |
| | DP-C1*, DP-D1 SP-C1* | 22055 | * sen.utf. med 1 lager / later version 1 bearing |
| 740A | DP-B, DP-B1, DP-C, DP-D, DP-D1 | 22075 | |
| 740B | DP-C, DP-D, DP-D1 | 22055 | |
| AQ60F | 100A | 22057 | |
| AQ80 | 80 | 22057 | |
| AQ80S | 80 | 22057 | |
| AQ90 | 100A | 22057 | |
| AQ95 | 100A | 22057 | |
| AQ95A | 100A | 22057 | |
| AQ100 | 80, 100A | 22057 | |
| AQ105A | 100A | 22057 | |
| AQ110 | 100A | 22057 | |
| | 200 | 22059 | |
| AQ115A | 100A | 22057 | |
| | 100B | 22058 | |
| AQ115B | 100B | 22058 | |
| AQ120 | 200 | 22059 | |
| AQ120B | 270 | 22074 | |
| AQ125A | 270, 275A | 22074 | |
| AQ125B | 270 | 22074 | |

Rep-sats för svänghjulskåpa forts. / Repair kits for flywheel casing cont.

| Motor typ Engine type | AQ-drev typ Sterndrive type | Best.nr Part No. | |
|--------------------------|----------------------------------|---------------------|--|
| AQ130A | 100A | 22057 | |
| | 250 | 22059 | |
| AQ130B | 100A | 22057 | |
| | 250 | 22059 | |
| AQ130C | 250 | 22059 | |
| | 270, 270T | 22074 | |
| AQ130D | 280 | 22074 | |
| AQ131A | 275, 275A, 290 SP-A, SP-A/MT | 22074 | |
| AQ131B | 275, 275A, 290 SP-A, SP-A/MT | 22074 | |
| AQ131C | 275, 275A, 290A SP-A, SP-A/MT | 22074 | |
| AQ131D | 275, 275A, 290 SP-A, SP-A/MT | 22074 | |
| AQ140A | 280, 280PT | 22074 | |
| AQ145A | 280, 280PT, 290 | 22074 | |
| AQ145B | 290 | 22074 | |
| AQ151A | 290, 290A SP-A1 | 22074 | |
| AQ151B | 290, 290A SP-A | 22074 | |
| AQ151C | 290, 290A SP-A | 22074 | |
| AQ165A | 250* | 22074 | * med 62 mm lager / with 62 mm bearing |
| | 250* | 22060 | * med 55 mm lager / with 55 mm bearing |
| AQ170A | 250, 270*270T* | 22074 | * med 62 mm lager / with 62 mm bearing |
| | 270*, 270T* | 22060 | * med 55 mm lager / with 55 mm bearing |
| AQ170B | 270*, 270T* | 22060 | * med 55 mm lager / with 55 mm bearing |
| | 270*, 270T*, 280, 280T | 22074 | * med 62 mm lager / with 62 mm bearing |
| AQ170C | 280 | 22074 | |
| AQ171A | 290A SP-A | 22074 | |
| AQ171C | 290A SP-A | 22074 | |
| AQ175A | 280, 280PT, 290 | 22075 | |
| AQ190A | 280B | 22075 | |
| AQ200A | 280B | 22075 | |
| AQ200B | 280, 280PT, 290 | 22075 | |
| AQ200C | 280, 280PT, 290 | 22075 | |
| AQ200D | 280, 280PT, 290 | 22075 | |
| AQ200F | 290A, DP290A | 22075 | |
| AQ205A | DP-A SP-A | 22075 | |
| AQ210A | 270 | 22160 | |
| AQ211A | 290A, 290DP DP-A SP-A | 22075 | |
| AQ225A | 280B | 22075 | |
| AQ225B | 280B | 22075 | |
| AQ225C | 280B | 22075 | |
| AQ225D | 280, 280L, 280PT, 290, 290A | 22075 | |
| AQ225E | 275 | 22075 | |
| AQ225F | 290A, DP290A | 22075 | |
| AQ231A | 275, 285, 290A DP-A, DP290A | 22075 | |
| AQ231B | 275A, 285A | 22075 | |
| AQ240A | 280B | 22075 | |
| AQ255A | 280 | 22075 | |
| AQ255B | 280 | 22075 | |
| AQ260A | 280B, 280PT, 290 | 22075 | |
| AQ260B | 275 | 22075 | |

Rep-sats för svänghjulskåpa forts. / Repair kits for flywheel casing cont.

| Motor typ Engine type | AQ-drev typ Sterndrive type | Best.nr Part No. |
|--------------------------|--------------------------------|---------------------|
| AQ271A | 290 DP290A | 22075 |
| AQ271B | 275A | 22075 |
| AQ271C | 290A DP-A, DP290A SP-A | 22075 |
| AQ271D | 275A | 22075 |
| AQ280A | 280B | 22075 |
| AQ290A | 280B, 280L, 280PT, 290 | 22075 |
| AQ311A | 275A, 290A | 22075 |
| AQ311B | 290A DP-A SP-A | 22075 |

DISELMOTORER

| | | |
|---------|--|----------------|
| AD30A | DP290 | 22075 |
| AD31A | 290A DP-A, DP290A SP-A | 22075 |
| AD31B | DP-A, DP-A2, DP-D SP-A, SP-A2, SP-C | 22075 |
| AD31D | DP-D1 SP-C1 | 22161 |
| AD31L-A | DP-D1 SX | 22161 |
| AD31P-A | DP-D1 SX | 22161 |
| AD31XD | DP-D1 SP-C1 | 22161 22163 |
| AD40B | 280, 290 DP290 | 22075 |
| AD41A | 290A DP-A, DP290A SP-A | 22075 |
| AD41B | DP-A, DP-A2, DP-B, DP-B1, DP-D SP-A, SP-A1, SP-A2, SP-C | 22075 |
| AD41D | DP-D1 SP-C1 | 22161 |
| AD41L-A | DP-D1 | 22161 |
| AD41P-A | DP-D1 | 22161 |
| AQAD30A | DP280 V-drive cardan 2 ätgår / required | 22075 |
| AQAD31A | DP290A | 22075 |
| AQAD40A | 280 | 22075 |
| AQAD40B | 280, 290 DP280, DP290 | 22075 |
| AQAD41A | 290A DP-A, DP290A SP-A | 22075 |
| AQD19 | 100A | 22057 |
| AQD21A | 250, 270, 280 | 22074 |
| AQD21B | 270, 280 | 22074 |
| AQD27 | 200 | 22059 |
| AQD29 | 200 | 22059 |
| AQD29A | 250 | 22059 |
| AQD32A | 250 270, 280 | 22059 22074 |
| AQD40A | 280 | 22075 |
| AQD41A | 290A DP-A, DP290A SP-A | 22075 |



Rep-sats för svänghjulskåpa forts. / Repair kits for flywheel casing cont.

| Motor typ Engine type | AQ-drev typ Sterndrive type | Best.nr Part No. |
|--------------------------|--|---------------------|
| D41A | 290A DP-A, DP290A SP-A | 22075 |
| D41B | DP-A, DP-A2, DP-D SP-A, SP-A2, SP-C | 22075 |
| D41D | DP-D1 SP-C1 | 22161 |
| D41L-A | DP-D1 | 22161 |
| KAD32P-A | DP-E, DP-G, DPX | 22161 |
| KAD42A | DP-D | 22075 |
| KAD42B | DP-D1 DPX | 22161 |
| KAD42P-A | DP-D1 DPX | 22161 |
| KAD43P-A | DP-D, DP-E, DP-G DPX | 22161 |
| KAD44P-A | DP-D, DP-E, DP-G DPX | 22161 |
| KAD44P-B | DP-D | 22161 |
| KAD44P-C | DP-E, DP-G DPX | 22161 |
| KAD300A | DP-G, DP-E DPX | 22161 |
| KAMD42A | DP-D | 22075 |
| KAMD42P-A | DP-D1 DPX | 22161 |
| KAMD44P-B | V-drive | 22075 |
| KAMD44P-C | DP-E | 22161 |
| KAMD300A | DP-G, DP-E DPX | 22161 |
| TAMD31A | 290A DP-A, DP290A SP-A | 22075 |
| TAMD31B | DP-A, DP-A2, DP-D SP-A, SP-A2, SP-C | 22075 |
| TAMD31D | DP-D1 SP-C1 | 22163 |
| TAMD41A | 290A DP-A, DP290A SP-A | 22075 |
| TAMD41B | DP-A, DP-B, DP-B1, DP-D SP-A, SP-A2, SP-C | 22075 |
| TAMD41L-A | DP-D1 | 22161 |
| TMD31D | DP-D1 SP-C1 | 22163 |

Rep-sats för svänghjulskåpa forts. / Repair kits for flywheel casing cont.

| Motor typ Engine type | AQ-drev typ Sterndrive type | Innehåll Contents | Best.nr Part No. | |
|---|---|-------------------------------------|---------------------|---|
| 432A 434A 500B 501B 570A 572A 740B | SP-C1, DP-C1 SP-C1, DP-C1 SP-C1, DP-C1, DP-D1 SP-C1, DP-C1, DP-D1 SP-C1, DP-C1, DP-D1 SP-C1, DP-C1, DP-D1 SP-C1, DP-C1, DP-D1 | 11013 856917 958859 958866 | 22055 |  |
| B16 AQ60 AQ80S AQ90 AQ95 AQ100 AQ105 AQ110 AQ115 AQ130 AQD19 | 80 100 80 100 100 100 100 100 100 100 100 100 | 11012 958973 | 22057 |  |
| AQ115A,B | 100B | 181105 958859 958866 | 22058 |  |
| AQ110 AQ120A AQ115A AQ115B AQ115C AQ130A AQ130B AQ130C AQD21A AQD21B AQD27 AQD29 AQD32A | 200 200 250 250 250 250 250 250 200 200, 250 250 | 11012 958973 946242 | 22059 |  |
| AQ165A AQ170A AQ170B | 250 270, 270 270 Lager / Bearing \varnothing 55 mm | 19058 2X946242 | 22060 |  |

Rep-sats för svänghjulskåpa forts. / Repair kits for flywheel casing cont.

| Motor typ Engine type | AQ-drev typ Sterndrive type | Innehåll Contents | Best.nr Part No. | |
|---|---|------------------------------|---------------------|---|
| AQ 120B AQ 125A,B AQ 130 AQ 131A,B,C,D AQ 140A AQ 145A,B AQ 151A,B,C AQ 165A AQ 170 AQ 171A,C 230 250 251 AQD 21A,B AQD 32A | 270 270, 275A 270, 270T, 280 275, 290, SP-A 280, 280PT 280, 280PT, 290 290, 290A, SP-A 250 250, 270, 270T, 280, 280T 290A, SP-A 275, SP-A, SP-A1 SP-A, SP-A1 SP-A, SP-A1 270, 280 270, 280 | 11013 946242 958860 | 22074 |  |
| AQ 175 AQ 200B,C,D AQ 205A AQ 211A AQ 225A,B,C,D,E,F AQ 231A,B AQ 255A,B AQ 260A AQ 271A,B,C,D AQ 290A AQ 311A,B 430 430A 430A 430B 431A 431A 431B 500B 500B 501B 570A 570A 572A 740A AQAD 30A AQAD 30A AD 30A AD 31A,B AQAD 31A TAMD 31B AQD 40A AQAD 40A,B AQAD 40B AD 40B AD 41A AQAD 41A AQD 41A AD 41B D 41B TAMD 41B KAD 42 | 280,PT, 290 280,PT, 290 SP-A, DP-A 290A,DP, SP-A, DP-A 275, 280,PT, 280L, 290,A,DP 275, 285, 290A,DP 280 280,PT, 290 275, 290A 280PT, 290 290A, SP-A SP-A, DP-A SP-A1, SP-A2, SP-C, DP-A, DP-A1 DP-A2, DP-C SP-C, DP-C SP-A, SP-A1, SP-A2, SP-C, DP-A DP-A1, DP-A2, DP-C SP-C, DP-C SP-A1, SP-A2, SP-C, DP-A1 DP-A2, DP-C SP-A2, SP-C, DP-A2, DP-C SP-A, SP-A1, SP-A2, SP-C DP-A, DP-A1, DP-A2 SP-C, DP-C DP-B, DP-B1, DP-C Cardan shaft 2 pcs required 280DP,PT, 290A,DP 290A,DP 290A,DP, SP-C, DP-C, DP-D 290A,DP SP-A2, DP-A2 280,DP,PT 280,DP,PT, 290,DP Cardan shaft 2 pcs required 280,DP, 290,DP 290,DP 290A,DP 290A,DP SP-A2, SP-C, DP-C, DP-D, DP-B1 SP-A2, DP-A2 SP-A2, SP-C, DP-B1, DP-D SP-D | 11013 181105 2x 958860 | 22075 |  |

Rep-sats för svänghjulskåpa forts. / Repair kits for flywheel casing cont.

| Motor typ Engine type | AQ-drev typ Sterndrive type | Innehåll Contents | Best.nr Part No. | |
|---|--|--|---------------------|---|
| AQ210A | 270 | 19258 181105 946242 958860 | 22160 |  |
| AD31D AD31L-A AD31P-A AD31XD AD41D AD41L-A AD41P-A D14D D41L-A KAD32P-A KAD42B KAD42P-A KAD43P-A KAD44P-A KAD44P-B KAD44P-C KAD300A KAMD42P-A KAMD44P-C KAMD300A | DP-D1, SP-C1 DP-D1, SX DP-D1, SX DP-D1 DP-D1, SP-C1 DP-D1 DP-D1 DP-D1, SP-C1 DP-D1 DP-E, DP-G, DPX DP-D1, DPX DP-D1, DPX DP-D, DP-E, DP-G, DPX DP-D, DP-E, DP-G, DPX DP-D DP-E, DP-G, DPX DP-G, DP-E, DPX DP-D1, DPX DP-E DP-G, DP-E, DPX | 184841 958860 | 22161 |  |
| AD31XD TAMD31D TMD31D | SP-C1 DP-D1, SP-C1 DP-D1, SP-C1 | 3851019 3860697 958859 958860 | 22163 |  |

Dim. för lager och tätningar för svänghjulskåpa / Dim. for ballbearing and seals for flywheel casing

| Benämning Description | Ref.nr Ref. No. | Ref.nr Ref. No. | Dimension |
|--------------------------|--------------------|--------------------|------------|
| Kullager / Ballbearing | 11012 | 19112 | 52 x 25 mm |
| Kullager / Ballbearing | 11013 | 19101 | 62 x 30 mm |
| Kullager / Ballbearing | 19258 | 19058 | 55 x 30 mm |
| Kullager / Ballbearing | 181105 | 19105 | 62 x 35 mm |
| Kullager / Ballbearing | 184841 | 19841 | 62 x 30 mm |
| Kullager / Ballbearing | 3851019 | 19101 | 62 x 30 mm |
| Bussning / Bushing | 856917 | 19917 | |
| Bussning / Bushing | 3860697 | 19917 | |
| Tätning / Seal | 946242 | 19242 | 55 x 35 mm |
| Tätning / Seal | 958859 | 19014 | 52 x 35 mm |
| Tätning / Seal | 958860 | 19860 | 62 x 35 mm |
| Tätning / Seal | 958866 | 19866 | 62 x 40 mm |
| Tätning / Seal | 958973 | 19973 | 35 x 25 mm |

Gummiring för klämring i sköld / Rubber rings for clamp ring in shield

| Motor typ Engine type | Ref.nr Ref. No. | Ref.nr Ref. No. | |
|--|--------------------|---------------------|--|
| <p>Hård / Hard</p> <p>Ytter / Outer 200 mm 2 st åtgår / 2pcs required</p> <p>230A / SP-A/MT 250A / SP-A/MT 500A 501A 571A 740A AQ 100* AQ 105* AQ 110* AQ 115A*,B* AQ 120A* AQ 120B AQ 125A,B AQ 130A*,B* AQ 131A,D AQ 175A AQ 190A AQ 200A,C,D,F AQ 210A AQ 211A AQ 225A,B,C,D,E,F AQ 231A,B AQ 240A AQ 255A,B AQ 260A,B AQ 271A,B,C,D AQ 280A AQ 290A AQ 311A,B AQ 60F* AQ 80* AQ 90* AQ 95* AQD 19* AQD 29,A AQD 32A</p> <p>* Utan främre motorbalk / * Without forward suport</p> | <p>804190</p> | <p>19190</p> |  |

Gummiring för klämring i sköld forts. / Rubber rings for clamp ring in shield cont.

| Motor typ Engine type | Ref.nr Ref. No. | Ref.nr Ref. No. | |
|--|--------------------|--------------------|--|
| <p>Mjuk / Soft</p> <p>Ytter / Outer 200 mm 2 st åtgår / 2pcs required</p> <p>230A / SP-A, SP-A1 230B 250A,B 251A 430A,B 431A,B 432A 434A 500B 501B 570A 572A 740B AD 31A,B,D,XD AD 40B AD 41A,B,D AQ 100* AQ 105* AQ 110* AQ 115A*,B* AQ 130A*,B* AQ 131B,C AQ 140A AQ 145A,B AQ 151A,B,C AQ 171A,C AQ 205A AQ 60F* AQ 90* AQ 95* AQAD 30A AQAD 31A AQAD 40A,B AQAD 41A AQD 19* AQD 21A,B AQD 40A D 41A,B,D KAD 32 KAD 42A,B,P KAD 43P KAD 44P KAMD42A TAMD41A</p> <p>* Med främre motorbalk / * For forward suport</p> | <p>813967</p> | <p>19967</p> |  |



Skruv till klämring / Screw for clamp ring in shield

| Motor typ Engine type | Ref.nr Ref. No. | Ref.nr Ref. No. | |
|--|--------------------|--------------------|---|
| För alla modeller / For all versions. 6 st åtgår / 6 pcs required | 191844 | 19844 |  |

Tätlist för sköld / Rubber seal for shield

| | | | |
|--|--------|-------|---|
| AQ 200, 250, 270,T, 275,A 280,T,DP SP-A/MT | 897726 | 19726 |  |
| AQ290, AQ290A, AQ290DP SP-A, SP-A1, SP-A2, SP-C DP-A1, DP-A2, DP-B1, DP-C, DP-C1 DP-D, DP-D1 DPX | 852868 | 19015 | |

Tätringar för styrarm / Seal ring for steering fork

| | | | |
|--|--------|-------|---|
| V-ring Inre Ø 28 mm tidigare utförande / Inner Ø 28 mm earlier version | 814359 | 19359 |  |
| V-ring see catalouge Inre Ø 36 mm senare utförande / Inner Ø 36 mm later version | 839195 | 19195 |  |
| SP-C DP-C, DP-C1 DP-D, DP-D1 DPX Packbox iner Ø 40 mm / Seal ring inner Ø 40 mm | 977313 | 19313 |  |

Låsskruv för styrarm / Lock screw for steering fork

| Motor typ Engine type | Ref.nr Ref. No. | Ref.nr Ref. No. | |
|--|--------------------|--------------------|---|
| SP-C, SP-C1 DP-C, DP-C1 DP-D1 Rostfri / Stainless | 947904 | 19904 |  |

Drevlyftsmotor / Trim and tilt motor

| | | | |
|--|--------|-------|---|
| | 850834 | 19834 |  |
|--|--------|-------|---|

Hydraulpump / Hydraulic pump

| | | | |
|--|--|-------|---|
| | 3586765 (852928) (853084) (854346) (872449) (873051) (3857006) (3857243) (3857265) | 19985 |  |
|--|--|-------|---|

Knutbälgsatser / Drive bellow kits

| AQ-drev typ Sterndrive type | Ref.nr. Ref. No. | Best.nr. Part No. | |
|---|---|----------------------|---|
| <p>AQ 80, 100, 100B AQ 100 S*</p> <p>* Segelbåtsdrev / Sailing boat drive</p> <p>Slangklammar ingår / Hose clamps included</p> | <p>875827 (804186) (875512)</p> | <p>19827</p> |  |
| <p>AQ 200, 250, 270, 270T, 275, 275A 280, 280T, 280PT, 280DP, 280L, 285A 290, 290A, 290DP SP-A, SP-A/MT, SP-A1, SP-A2 SP-C, SP-C1 DP-A, DP-A1, DP-A2 DP-B, DP-B1 DP-C, DP-C1 DP-D, DP-D1 DPX</p> <p>Slangklammar ingår / Hose clamps included</p> | <p>876294 (875826) (897889)</p> | <p>19294</p> |  |
| <p>SX-drev</p> <p>Slangklamma ingår ej / Hose clamp not included</p> | <p>3841481 (3854127)</p> | <p>19127</p> |  |
| <p>Slangklamma för knutbälg 19127 / Hose clamp for drive bellow 19127</p> | <p>853012</p> | <p>19012</p> |  |



Avgasbälgsatser / Exhaust bellow kits

| | | | |
|---|----------------------------|---------------------|---|
| <p>AQ 200, 250, 270, 275, 280, 280DP 290, 290DP SP-A, SP-A/MT, SP-A1, SP-A2 SP-C, DP-A, DP-A1, DP-A2 DP-B, DP-B1 DP-C, DP-C1 DP-D, DP-D1 DPX</p> <p>Utan klaffar / Without flaps</p> <p>Slangklammor ingår / Hose clamps included</p> | <p>876631 (875848)</p> | <p>19848</p> |  |
|---|----------------------------|---------------------|---|



Avgasbälgsatser forts. / Exhaust bellow kits cont.

| AQ-drev typ Sterndrive type | Ref.nr. Ref. No. | Best.nr. Part No. | |
|--|--|----------------------|---|
| <p>AQ 280, 280T, 280PT, 280DP 290,A,DP SP-A, SP-A/MT, SP-A1, SP-A2 SP-C1 DP-A, DP-A1, DP-A2 DP-B, DP-B1 DP-C, DP-C1 DP-D, DP-D1 DPX</p> <p>För V-8 och 40 motorer For V-8 and type 40-engines</p> <p>Med klaffar / With flaps</p> <p>Slangklammor ingår / Hose clamps included</p> | <p>876633 (875828) (875829) (850004)</p> | 19828 |  |
| <p>SX-drev SX-drive</p> | 3850426 | 19069 |  |
| <p>Slangklamma för avgasbälg 19069 / Hose clamp for exhaust bellow 19069</p> | | 19603 |  |



Slangsatser / Hose kits

| | | | |
|---|---|--------------------------|---|
| <p>AQ 200, 250, 270, 275, 280, 280DP 280PT, 285, 285A, 290DP SP-A/MT</p> <p>Slangklammor ingår / Hose clamps included</p> | <p>875822 (897599)</p> | 19822 |  |
| <p>AQ 290, 290A, 290DP SP-A, SP-A1, SP-A2, SP-C, SP-C1 DP-A, DP-A1, DP-A2 DP-B, DP-B1, DP-C, DP-C1 DP-D, DP-D1 DPX</p> <p>Slangklamma och o-ring ingår / Hose clamp and o-ring included</p> | <p>876632 (875847) (854555)</p> | 19630 (19847) |  |



Slangsatser forts. / Hose kits cont.

| AQ-drev typ Sterndrive type | Ref.nr. Ref. No. | Best.nr. Part No. | |
|---|-----------------------|----------------------|--|
| AQ 270T, 280T Slangklammor ingår / Hose clamps included | 832831 | 19831 |  |
| SX, DP-S Slangklammor ingår ej / Hose clamps not included | 3852352 | 19097 |  |
| SX, DP-S Slangklammer för 19097 Clamps for 19097 Klamma motorsida / Clamp engine side Klamma drevsida / Clamp sterndrive side | 3852602 948616 | 19602 19616 |  |

Slangfäste / Water hose connection

| | | | |
|---|--------------------------------|-------|---|
| AQ 200, 250, 270, 275, 280, 280DP, 285A, 290, 290A, 290DP SP-A, SP-A/MT, SP-A1, SP-A2 SP-C, SPC1 DP-A, DP-A1, DP-A2 DP-B, DP-B1 DP-C DP-D Packning 19356 ingår / Gasket 19356 included | 854031 (851766) (897600) | 19766 |  |
| AQ 270T, 280T, 280PT Packning 19356 ingår / Gasket 19356 included | 832846 | 19846 |  |

Bussningsatts för upphängning av AQ-drev / Bushing kits for hook up fork

| AQ-drev typ Sterndrive type | Ref.nr. Ref. No. | Best.nr. Part No. | |
|---|--------------------------------|----------------------|---|
| AQ 80, 100, 100B, 200, 250, 270, 275,A 280, 280L, 280DP, 280PT, 285A SP-A/MT Sats om 2 bussningar / Set of 2 bushings | 826341 (876278) (826341) | 19278 |  |
| 290, 290A, 290DP SP-A, SP-A1, SP-A2 DP-A, DP-A1, DP-A2 DP-B, DP-B1 Sats om 2 bussningar / Set of 2 bushings | 853223 (876279) (853223) | 19279 |  |
| AQ 270T, 280T Sats om 2 bussningar / Set of 2 bushings | (2x832820) | 22080 |  |



Saxpinnar och bricka för reglage / Pins and washer for control cable cube

| | | | |
|--|--------|-------|---|
| För länkarmer och växelmekanism / For control rod gear shift mechanism | 17253 | 19053 |  |
| För reglagetärning / For control cable cube | 17276 | 19276 | |
| Rostfri bricka för reglagetärning / Stainless washer for control cable cube | 940191 | 19091 | |

Låsskruv och bricka för upphängningslagertapp / Screw and washer for bearing pin

| | | | |
|---|--------------------------|-------|---|
| 200, 250, 270, 275, 280, 285 SP-A, SP-A/MT Gänga / Thread 5/16" UNC | 2 x 941873 2 x 941670 | 22092 |  |
| 290, 290A, 290DP SP-A, SP-A1, SP-A2 SP-C, SP-C1 DP-A, DP-A1, DP-A2 DP-B, DP-B1 DP-C, DP-C1 DP-D, DP-D1 DPX Gänga / Thread M 8 | 2 x 963699 2 x 941670 | 22093 | |



Täckåpa för växelmekanism / Protecting cover for gearshift mechanism

| AQ-drev typ Sterndrive type | Ref.nr. Ref. No. | Best.nr. Part No. | |
|--|---------------------|----------------------|---|
| AQ 200, 250, 270,T, 275,A 280 L,T,DP, 285A, 290,A,DP Övre och undre skruvarna ingår Lower and upper screws included | 832570 | 19570 |  |
| AQ 200, 250, 270,T, 275,A 280 L,T,DP, 285A, 290,A,DP Nedre skruv i täckåpa / Lower screw for protecting cover | 941816 | 19816 |  |

Ställpinne / Setting pin

| | | | |
|--|--------|-------|--|
| AQ 200, 250, 270,T, 275,A 280 L,T,DP, 285A, 290,A,DP 2 rostfria muttrar och brickor ingår / 2 stainless nuts and washers included | 814301 | 19301 |  |
|--|--------|-------|--|



Fisklinebricka / Thrust washers (fishing line protectors)

| | | | |
|---|--------|-------|---|
| AQ 110S, 200 | 832965 | 19965 |  |
| AQ 250, 270, 275 | 839534 | 19534 |  |
| AQ 280, 285, 290 Ej för DP-drev / Not for DP drive | 839423 | 19423 |  |

Brytpinnesats / Break pin kit

| AQ-drev typ Sterndrive type | Ref.nr. Ref. No. | Best.nr. Part No. | |
|--------------------------------|---------------------|----------------------|---|
| AQ 100, 100B, 100S | 1x806661 1x17268 | 22094 |  |

Låsskruvar för folding propellerblad / Lock screws for folding propeller blades

| | | | |
|--|--------|-------|--|
| För 14" och 15" propeller For 14" and 15" propellers Rostfri / Stainless Längd / Length 20 mm | 947904 | 19904 |  |
| För 16" och 17" propeller For 16" and 17" propellers Rostfri / Stainless Längd / Length 12 mm | 946847 | 19047 |  |

Saxpinne för foldingpropellermutter / Cotter pin for folding propeller lock nut

| | | | |
|--|--------|-------|---|
| För alla propellrar utom 100S For all propellers except 100S Rostfri / Stainless | 949807 | 19007 |  |
|--|--------|-------|---|

Propellerkona / Propeller cone

| | | | |
|--|--------------------|-------|---|
| AQ 200, 250, 270, 275, 280, 285 290, SP-A, SP-A/MT, SP-A1, SP-A2 SP-C, SP-C1 Ej för DP-drev / Not for DP-drive För propeller med kort nav behövs distansbricka 19261 / For propeller with short hub spacer washer 19261 is required | 854045 (850785) | 19785 |  |
|--|--------------------|-------|---|

Distansbricka för propeller / Spacer washer for propeller cone

| AQ-drev typ Sterndrive type | Ref.nr. Ref. No. | Best.nr. Part No. | |
|---|---------------------|----------------------|---|
| AQ 200, 250, 270, 275, 280, 285, 290 SP-A, SP-A/MT, SP-A1, SP-A2 SP-C, SP-C1 Ej för DP-drev. För drev med kort nav / Not for DP-drive Required for propeller with short hub | 854047 (851261) | 19261 |  |

Distansbricka (plast) Spacer washer (plastic)

| | | | |
|--|--------|-------|---|
| AQ 200, 250, 270, 275, 280, 285 290, SP-A, SP-A/MT, SP-A1, SP-A2 SP-C, SP-C1 För propellerkona med låsskruv / For propeller cone with lock screw | 850888 | 19888 |  |
|--|--------|-------|---|

Låsbricka för propeller / Tab washer for propeller (stainless)

| | | | |
|--|--------|-------|---|
| AQ 200, 250, 270, 275, 280, 285 290, SP-A, SP-A/MT, SP-A1, SP-A2 SP-C, SP-C1 För propellerkona utan låsskruv / For propeller cone without lock screw | 897367 | 19367 |  |
|--|--------|-------|---|



Låsskruv för propellerkona / Lock screw for propeller cone

| | | | |
|---|--------|-------|---|
| AQ200, 250, 270, 275, 280, 285 290, SP-A, SP-A/MT, SP-A1, SP-A2 SP-C, SP-C1 För propellerkona med låsskruv / For propeller cone with lock screw | 850889 | 19889 |  |
|---|--------|-------|---|

Fjädersats för backhake / Spring sets for rev. tilt inhibitor

| | | | |
|--|--|-------|---|
| AQ250, 270, 275, 275A, 280, 280DP, 280L, 285A, 290, 290A, 290DP SP-A, SP-A/MT, SP-A1, SP-A2 DP-A, DP-A1, DP-A2 DP-B, DP-B1 | | 22056 |  |
|--|--|-------|---|



Zinkanod för sköld / Zinc anode for shield

| AQ-drev typ Sterndrive type | Ref.nr. Ref. No. | Best.nr. Part No. | |
|--|---------------------|----------------------|---|
| 200 250* För sköld /For shield *Tidigare utförande / Earlier version | 838929 | 19929 |  |
| 250* 270, 275, 280, 280DP, 280PT, 285 SP-A/MT Cardan shaft * Senare utförande / Later version Passar ej 270T, 280T -drev Not for 270T, 280T drives | 832598 | 19598 |  |
| 290, 290A, 290DP SP-A, SP-A1, SP-A2 SP-C, SP-C1 DP-A, DP-A1, DP-A2 DP-B, DP-B1 DP-C, DP-C1 DP-D, DP-D1 | 852835 | 19835 |  |

Zinkringar för AQ-drev / Zinc ring kits for AQ drives

| | | | |
|---|--------|-------|---|
| 80, 100, 100B Skruvar ingår / Screws included | 875810 | 19810 |  |
| 200 Skruvar ingår / Screws included | 875809 | 19809 |  |
| 250, 270, 270T, 275, 275A SP-A/MT SP-A1, SP-A2, SP-C Skruvar ingår / Screws included | 875805 | 19805 |  |



Zinkringar för AQ-drev forts. / Zinc ring kits for AQ drives forts.

| AQ-drev typ Sterndrive type | Ref.nr. Ref. No. | Best.nr. Part No. | |
|--|---------------------|----------------------|---|
| 280, 280L, 280T, 280PT, 285A 290, 290A SP-A, SP-A/MT, SPA1, SP-A2 SP-C, SP-C1 Skruvar ingår / Screws included | 875815 | 19815 |  |
| 280DP, 290DP DP-A, DP-A1, DP-A2 DP-B, DP-B1 DP-C, DP-C1 DP-D, DP-D1 DP-E Skruvar ingår / Screws included | 875821 | 19821 |  |

Zinkanod för upphängningsgaffel / Zinc anode for suspension yoke

| | | | |
|---|--------|-------|--|
| För SP och DP - drev For SP and DP -drive 1 eller två åtgår / 1 or 2 required Instalationsanvisning och skruv ingår / Installation instructions and screw included | 872793 | 19793 |  |
|---|--------|-------|--|

Zinkring för segelbåtdrev / Zinc ring kits for sailing boat drives

| | | | |
|---|--------------------|-------|---|
| 100S Ej för 100S med foldingpropeller / Not for 100S with folding propeller Skruvar ingår /Screws included | 875810 | 19810 |  |
| 110S Skruvar och O-ring ingår / Screws and O-ring included | 875812 | 19812 |  |
| 120S, 120SB, 120C-D, 120S-D S120C Skruvar ingår / Screws included | 876286 (851983) | 19983 |  |





Zinkanod för foldingpropeller / Zinc anode kit for folding propeller

| AQ-drev typ Sterndrive type | Ref.nr. Ref. No. | Best.nr. Part No. | |
|---|---------------------|----------------------|--|
| 110S 120S, 120SB, 120S-D S120C För 2-bladig folding tid. utförande / For 2-blade folding earlier version Skrubar ingår / Screws included | 852018 | 19018 |  A photograph showing two curved metal anodes with circular holes, and two screws with washers, arranged on a white background. |

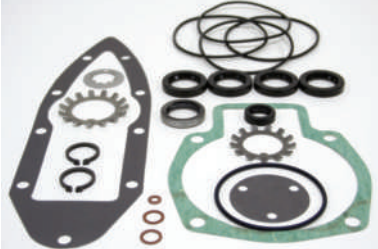
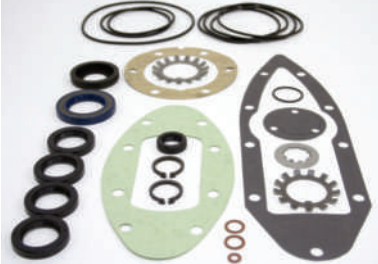

Zinkanoder / Zink anodes

| | Ref.nr. Ref. No. | Best.nr. Part No. | NEW |
|--|----------------------------|--|---|
| Axelanod / Shaft nuts 25/30 3/4" 35 7/8" 40 1" | 833913 833915 828140 | 19913 19915 19140 |  |
| DP-S, SX | 3854130 | 19130 |  |
| DPX | 873395 | 19395 |  |
| DPX | 876638 | 19638 |  |
| DPX | 872139 | 19139 |  |
| DPX-S, SX | 3855411 | 19411 |  |
| DPH | 3588746 | 19746 |  |
| DPH | 3588745 | 19745 |  |
| Zinkanod VP Bronsprop set om 3 st Anode for sail drive foot propeller kit of three pieces | 3858399 | 19499 |  |



Packningsssatser för kompletta AQ-drev / Gasket sets for complete AQ-drive units

| AQ-drev typ Sterndrive type | Ref.nr. Ref. No. | Best.nr. Part No. | |
|--|---------------------|----------------------|---|
| 100A | | 19399 |  |
| 100B 100S* * Segelbåtsdrev / * Sailing boat drive | 876392 (875389) | 19392 |  |
| 110S Segelbåtsdrev / Sailing boat drive | 876397 (875591) | 19591 |  |
| 120C-D 120S 120S-B S120C Segelbåtsdrev / Sailing boat drive | 876391 (875720) | 19720 |  |
| 200 250 270, 270T 275, 275A 280, 280T 285A 290, 290A SP-A, SP-A/MT, SP-A1, SP-A2 SP-C Passar alla drevtyper utom DP-drev / Fits all types except DP-drives | | 19037 |  |
| 250, 270, 275, 280, 285, 290 För drev med DP-underhus / For drive units with DP lower housing 280DP 290DP DP-A, DP-A1, DP-A2 DP-B DP-C DP-D | 875741 | 19741 |  |

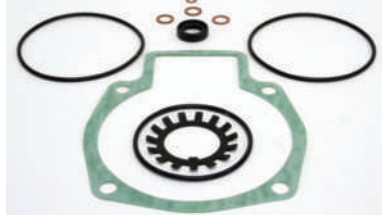

Packningsatser för kompletta AQ-drev forts. / Gasket sets for complete AQ-drive units cont.

| AQ-drev typ Sterndrive type | Ref.nr. Ref. No. | Best.nr. Part No. | |
|---|---------------------|----------------------|---|
| DP-C1 DP-D1 DP-E DPX-S, DPX-S1 | | 19035 |  |
| 285, 290A SP-A, SP-A/MT Passar alla drevtyper utom DP-drev / Fits all types except DP-drives | | 19031 |  |
| SP-A1, SP-A2 SP-C, SP-C1 | | 19033 |  |





Packningsatser för överhus / Gasket sets for upper gear unit

| | | | |
|--------------|--|-------|---|
| 100A | | 22090 |  |
| 100B 100S | | 22091 |  |
| 110S | | 22096 |  |

Packningsatser för överhus forts. / Gasket sets for upper gear unit cont.

| AQ-drev typ Sterndrive type | Ref.nr. Ref. No. | Best.nr. Part No. | |
|--|---------------------|----------------------|---|
| 120C-D 120S 120S-B S120C | | 22097 |  |
| 200 250 270, 270T 275, 275A 280, 280DP, 280T 285A 290, 290A, 290DP SP-A, SP-A/MT, SP-A1, SP-A2 SP-C DP-A, DP-A1, DP-A2 DP-B, DP-B1 DP-C DP-D | 876266 | 19036 |  |
| SP-C1 DP-C1 DP-D1 DP-E DP-S1 DPX DPX-S DPX-S1 | | 19029 |  |

Packningsatser för underhus / Gasket sets for lower gear unit

| AQ-drev typ Sterndrive type | Ref.nr. Ref. No. | Best.nr. Part No. | |
|--|---------------------|----------------------|---|
| 200 250 270, 270T 275, 275A 280, 280T 285A 290, 290A SP-A, SP-A/MT Passar alla drevtyper utom DP-drev / Fits all types except DP-drives | 876268 | 19010 |  |
| SP-A1, SP-A2 SP-C, SP-C1 | | 19011 |  |
| 280DP 290DP DP-A, DP-A1, DP-A2 DP-B, DP-B1 DP-C DP-D För alla drev med DP-underhus / For all drive units with DP lower housing | 876267 | 19267 |  |
| DP-C1 DP-D1 DP-E DPX-S, DPX-S1 | | 19026 |  |

Packningsatts mellan överhus - mellanhus / Gasket set for upper gear unit - interm. housing

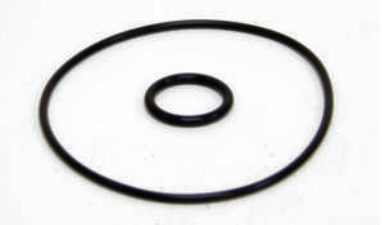
| AQ-drev typ Sterndrive type | Ref.nr. Ref. No. | Best.nr. Part No. | |
|---|---------------------|----------------------|---|
| 200 250 270, 270T 275, 275A 280, 280DP, 280T 285A 290, 290A, 290DP SP-A, SP-A/MT, SP-A1, SP-A2 SP-C, SP-C1 DP-A, DP-A1, DP-A2 DP-B, DP-B1 DP-C, DP-C1 DP-D, DP-D1 DP-E DP-G DPX DPX-S, DPX-S1 | | 22079 |  |



Packningsatts mellan mellanhus - underhus / Gasket set for interm. housing - lower gear unit

| | | | |
|--|--|-------|---|
| 200 250 270, 270T 275, 275A 280, 280DP, 280T 285A 290, 290A, 290DP SP-A, SP-A/MT, SP-A1, SP-A2 SP-C, SP-C1 DP-A, DP-A1, DP-A2 DP-B, DP-B1 DP-C, DP-C1 DP-D | | 22081 |  |
|--|--|-------|---|

Packningsatts för propelleraxel / Gasket sets for propeller shaft

| AQ-drev typ Sterndrive type | Ref.nr. Ref. No. | Best.nr. Part No. | |
|--|---------------------|----------------------|---|
| 100A 100B 100S | | 22082 |  |
| 110S | | 22083 |  |
| 120C-D 120S 120S-B S120C | | 22085 |  |
| 200 | | 22084 |  |
| 250 270, 270T 275, 275A 280, 280T 285A 290, 290A SP-A, SP-A/MT, SP-A1, SP-A2 SP-C, SP-C1 Ej för DP-drev / Not for DP-drives | | 22086 |  |
| 280DP 290DP DP-A, DP-A1, DP-A2 DP-B, DP-B1 DP-C, DP-C1 DP-D, DP-D1 DPX-S, DPX-S1 För alla med DP-drev / For all with DP-drives | | 22087 |  |

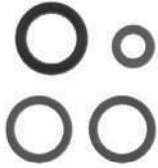

Packningsatser för oljepluggar / Gasket sets for oil plugs

| AQ-drev typ Sterndrive type | Ref.nr. Ref. No. | Best.nr. Part No. | |
|--|---------------------|----------------------|--|
| 80 100A 100B 100S | | 22066 |  |
| 120C-D 120S 120S-B S120C | | 22071 |  |
| 200 250 270, 270T 275, 275A 280, 280DP, 280T 285A 290, 290DP SP-A, SP-A/MT, SP-A1, SP-A2 SP-C, SP-C1 DP-A, DP-A1, DP-A2 DP-B DP-C, DP-C1 DP-D, DP-D1 DP-E DPX DPX-S, DPX-S1 | | 22067 |  |

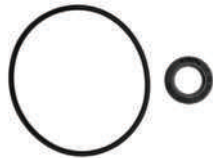
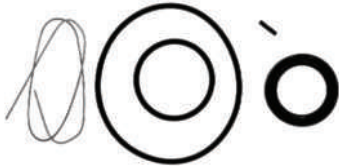
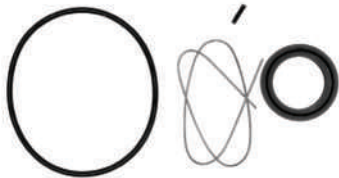
Packningsssats för växelmekanism / Gasket sets for gearshift mechanism

| AQ-drev typ Sterndrive type | Ref.nr. Ref. No. | Best.nr. Part No. | |
|---|---------------------|----------------------|---|
| 100A 100B 100S | | 22095 |  |
| 110S 120C-D 120S 120S-B S120C 200 250 270, 270T 275 Packbox med enkel tätyta / Oil seal with single sealing lips | | 22098 |  |
| 275A 280, 280DP, 280T 285A 290, 290A, 290DP SP-A, SP-A/MT, SP-A1, SP-A2 SP-C, SP-C1 DP-A, DP-A1, DP-A2 DP-B, DP-B1 DP-C, DP-C1 DP-D, DP-D1 DP-E DP-G DPX DPX-S XDP-B Packbox med dubbla tätytor / Oil seal with double sealing lips | | 22101 |  |



Drivknutkors / Universal joint

| AQ-drev typ Sterndrive type | Ref.nr. Ref. No. | Best.nr. Part No. | |
|--|---------------------|----------------------|---|
| 200 250 270, 270T 275, 275A 280, 280DP, 280T 285A 290, 290A, 290DP SP-A, SP-A/MT DP-A DP-B | 853255 (897707) | 19255 |  |
| SP-A1, SP-A2 SP-C, SP-C1 DP-A1, DP-A2 DP-B1 DP-C, DP-C1 DP-D, DP-D1 DP-E DP-G DPX DPX-S, DPX-S1 | 3860232 (854619) | 19619 |  |

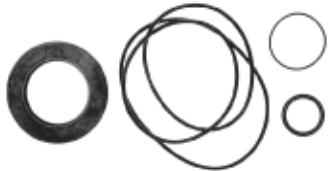
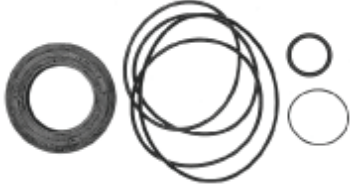

Packningsssats för byte av knutkors / Gasket sets for universal joint

| | | | |
|---|--|-------|---|
| 200 250 | | 22150 |  |
| 270, 270T 275, 275A 280, 280DP, 280T 285A 290, 290A, 290DP SP-A, SP-A/MT, SP-A1, SP-A2 SP-C, SP-C1 DP-A, DP-A1, DP-A2 DP-B, DP-B1 DP-C, DP-C1 DP-D, DP-D1 DP-E DPX, DPX-S | | 22151 |  |

Bultsats för dubbellagerbox / Bolt kits for double bearing unit

| AQ-drev typ Sterndrive type | Ref.nr. Ref. No. | Best.nr. Part No. | |
|--|----------------------|----------------------|---|
| 200 250 270, 270T 275 280, 280DP, 280T 290 Samtliga utföranden / All versions Längd / Length 63 mm | 4x956590 4x942598 | 22099 |  |
| 275A 285A 290A, 290DP SP-A, SP-A/MT, SP-A1, SP-A2 SP-C, SP-C1 DP-A, DP-A1, DP-A2 DP-B, DP-B1 DP-C, DP-C1 DP-D, DP-D1 DP-E DP-G DPX DPX-S, DPX-S1 Samtliga utföranden / All versions Längd / Length 70 mm | 4x956591 4x942598 | 22100 |  |

Slitbricka för dubbellagerbox / Washer for oil sealer in double bearing unit

| | | | |
|---|--------|--------------|---|
| 200 250 Alla versioner / All versions | 897315 | 19315 |  |
| 270, 270T 275, 275A 280, 280DP, 280T 285A 290, 290A, 290DP SP-A, SP-A/MT, SP-A1, SP-A2 SP-C, SP-C1 DP-A, DP-A1, DP-A2 DP-B, DP-B1 DP-C, DP-C1 DP-D, DP-D1 DP-E DP-G DPX DPX-S, DP-S1 Alla versioner / All versions | 832675 | 19075 |  |



Kullager för ingående axel i överhus / Ball bearing for double bearing unit

| AQ-drev typ Sterndrive type | Ref.nr. Ref. No. | Best.nr. Part No. | |
|--|--------------------------------|----------------------|---|
| 80 100 100B 100S 110S 2 st åtgår / 2 pcs required | 181290 | 19290 |  |
| 120C-D 120S 120SB S120C Koniskt rulllager / Roller bearing Yttering / Outer ring Yttre lager i dubbellagerbox / Outer bearing for double bearing unit | 183834 (183752) (183750) | 19700 |  |
| 120C-D 120S 120S-B S120C Koniskt rulllager / Roller bearing Yttering / Outer ring Inre lager i dubbellagerbox / Inner bearing for double bearing unit | 181301 181302 | 19006 19302 |  |
| 200 250 270, 270T 275, 275A 280, 280DP, 280T 285A 290, 290A, 290DP SP-A, SP-A/MT, SP-A1, SP-A2 SP-C, SP-C1 DP-A, DP-A1, DP-A2 DP-B, DP-B1 DP-C, DP-C1 DP-D, DP-D1 DP-E DP-G DPX DPX-S, DPX-S1 Yttre lager i dubbellagerbox / Outer bearing for double bearing unit | 183247 | 19247 |  |

Kullager för ingående axel i överhus forts. / Ball bearing for double bearing unit cont.



| AQ-drev typ Sterndrive type | Ref.nr. Ref. No. | Best.nr. Part No. | |
|---|---|----------------------|---|
| 200 250 270, 270T 275, 275A 280, 280DP, 280T 285A 290, 290A, 290DP SP-A, SP-A/MT, SP-A1, SP-A2 SP-C, SP-C1 DP-A, DP-A1, DP-A2 DP-B, DP-B1 DP-C, DP-C1 DP-D, DP-D1 DP-E DP-G DPX DPX-S, DPX-S1 Inre lager i dubbellagerbox / Inner bearing for double bearing unit | 3850852 (853949) (183247) (183668) | 19949 |  |

Kullager för vertikalaxel i överhus / Ball bearing for vertical shaft in upper gear unit

| | | | |
|--|--------|--------------|---|
| 80 100 100B 100S 110S 2 st åtgår / 2 pcs required | 181287 | 19087 |  |
| 120C-D 120S 120SB S120C 2 st åtgår / 2 pcs required | 851756 | 19756 |  |



Kullager för vertikalaxel i överhus forts. /

Ball bearing for vertical shaft in upper gear unit cont.

| AQ-drev typ Sterndrive type | Ref.nr. Ref. No. | Best.nr. Part No. | |
|---|----------------------------------|----------------------|---|
| 270, 270T 275, 275A 280, 280DP, 280T 285A 290, 290A, 290DP SP-A, SP-A/MT DP-A DP-B 2 st åtgår / 2 pcs required | 853542 | 19542 |  |
| SP-A1, SP-A2 SP-C, SP-C1 DP-A1, DP-A2 DP-B1 DP-C, DP-C1 DP-D, DP-D1 DP-E DP-G DPX DPX-S, DPX-S1 SX 2 st åtgår / 2 pcs required | 3857176 (854670) (3852389) | 19019 |  |

Nållager för vertikalaxel i överhus /

Needle bearing for vertical shaft in upper gear unit

| | | | |
|---|---------------------|-------|---|
| 100A 100B 100S 110S 4 st åtgår / 4 pcs required | 181268 | 19068 |  |
| 200 250 270, 270T 275, 275A 280, 280DP, 280T 4 st åtgår / 4 pcs required | 3852390 (181359) | 19059 |  |

Nållager för vertikalaxel i överhus forts. /

Needle bearing for vertical shaft in upper gear unit cont.

| AQ-drev typ Sterndrive type | Ref.nr. Ref. No. | Best.nr. Part No. | |
|---|---------------------|----------------------|---|
| 285A 290, 290A, 290DP SP-A, SPA/MT, SP-A1, SP-A2 SP-C, SP-C1 DP-A, DP-A1, DP-A2 DP-B, DP-B1 DP-C, DP-C1 DP-D, DP-D1 DP-E DP-G DP-S, DP-S1 DPX DPX-S, DPX-S1 SX SX-C1, SX-C1AC SX-CT1, SX-CT2 SX-CLT SX-RT1 XDP-B 2 st åtgår / 2 pcs required | 3852390 (853819) | 19819 |  |

Låsring för vertikalaxel /

Lock ring for vertical shaft



| | | | |
|--|--------|--------------|---|
| 100 100B 100S 2 st åtgår / 2 pcs required | 814030 | 19030 |  |
|--|--------|--------------|---|

Glidtapp (växelförare) /



Sliding pin

| | | | |
|---------------------|--------|--------------|---|
| 100 100B 100S | 813934 | 19934 |  |
|---------------------|--------|--------------|---|

Nållager för upphängningsgaffel / Needle bearing for hook up fork

| AQ-drev typ Sterndrive type | Ref.nr. Ref. No. | Best.nr. Part No. | |
|---|---------------------|----------------------|---|
| 80 100 100B 2 st åtgår / 2 pcs required | 181289 | 19289 |  |
| 200 250 270, 270T 275, 275A 280, 280DP, 280T 285A 290, 290A, 290DP SP-A, SP-A/MT, SP-A1, SP-A2 SP-C, SP-C1 DP-A, DP-A1, DP-A2 DP-B, DP-B1 DP-C | 183391 | 19391 |  |

Övre lager för vertikalaxel i underhus / Upper bearing for vertical shaft in lower gear unit

| | | | |
|---|--------------------------------|-------|---|
| 80 100 100B 110S | 18559 | 19559 |  |
| 120C-D 120S 120SB S120C Koniskt rullager / Roller bearing Yttering / Outer ring Lagersats / Bearing kit | 183834 (183752) (183750) | 19700 |  |



Övre lager för vertikalaxel i underhus / Upper bearing for vertical shaft in lower gear unit

| AQ-drev typ Sterndrive type | Ref.nr. Ref. No. | Best.nr. Part No. | |
|---|---------------------|----------------------|---|
| 200 250 270, 270T 275 280, 280DP, 280T 285A 290, 290A, 290DP SP-A, SP-A/MT, SP-A1, SP-A2 SP-C, SP-C1 DP-A, DP-A1, DP-A2 DP-B, DP-B1 DP-C, DP-C1 DP-D, DP-D1 DP-G DP-S1 DPX DPX-S, DPX-S1 Koniskt lager / Roller bearing | 11072 | 19072 |  |
| 270, 270T 275, 275A 280, 280DP, 280T 285A 290, 290A SP-A, SP-A/MT, SP-A1, SP-A2 SP-C, SP-C1 DP-A, DP-A1, DP-A2 DP-B, DP-B1 DP-C, DP-C1 DP-D, DP-D1 DP-E DP-G DP-S1 DPX DPX-S, DPX-S1 Kullager under koniska lagret / Ball bearing under roller bearing | 183374 | 19374 |  |



Axiallager för vertikalaxel i underhus / Axial bearing for vertical shaft in lower gear unit

| | | | |
|------------------------------------|--------|-------|---|
| 80 100A 100B 100S 110S | 806620 | 19004 |  |
|------------------------------------|--------|-------|---|

Nedre lager för vertikalaxel i underhus / Lower bearing for vertical shaft in lower gear unit

| AQ-drev typ Sterndrive type | Ref.nr. Ref. No. | Best.nr. Part No. | |
|--|--|--|---|
| 80 100A 100B 100S 110S | 181288 | 19288 |  |
| 280DP 290DP DP-A, DP-A1, DP-A2 DP-B, DP-B1 DP-C, DP-C1 DP-D, DP-D1 DP-E DP-G DP-S, DP-S1 DPX DPX-S, DP-S1 Nållager / Needle bearing Innerring / Inner ring | 184654 184682 | 19654 19008 |  |

Inre lager för propelleraxel / Inner bearing for propeller shaft

| | | | |
|---|--------|--------------|---|
| 100A 100B 100S 110S* * För utväxling 1,66:1 / * Ratio 1,66:1 | 181413 | 19413 |  |
| 110S För utväxling 2,15:1 / Ratio 2,15:1 | 183390 | 19390 |  |

Inre lager för propelleraxel forts. / Inner bearing for propeller shaft cont.

| AQ-drev typ Sterndrive type | Ref.nr. Ref. No. | Best.nr. Part No. | |
|---|--|----------------------|---|
| <p>120C-D 120S 120SB S120C</p> <p>Koniskt rullager / Roller bearing Yttering / Outer ring</p> <p>Lagersats / Bearing kit</p> | <p>3854249 (181588) (181587)</p> | <p>19500</p> |  |
| <p>200 250, 270, 270T 275, 275A 280, 280T 285A 290, 290A</p> <p>SP-A, SP-A/MT, SP-A1, SP-A2 SP-C, SP-C1</p> | <p>183390</p> | <p>19390</p> |  |
| <p>280DP 290DP</p> <p>DP-A, DP-A1, DP-A2 DP-B, DP-B1 DP-C, DP-C1 DP-D, DP-D1 DP-E DP-S, DP-S1 DPX DPX-S, DPX-S1</p> <p>Inre lager på inre propelleraxel / Inner bearing on inner propeller shaft</p> | <p>11044</p> | <p>19044</p> |  |
| <p>280DP 290DP</p> <p>DP-A, DP-A1, DP-A2 DP-B, DP-B1 DP-C, DP-C1 DP-D, DP-D1 DP-E DP-G DP-S, DP-S1 DPX DPX-S, DPX-S1</p> <p>Inre lager på yttre propelleraxel / Inner bearing on outer propeller shaft Röraxel / Pipe shaft</p> | <p>184691</p> | <p>19691</p> |  |

Yttre lager för propelleraxel / Outer bearing for propeller shaft

| AQ-drev typ Sterndrive type | Ref.nr. Ref. No. | Best.nr. Part No. | |
|--|---------------------------------|----------------------|---|
| 80 100A 100B 100S 110S* * För utväxling 1,66:1 / * Ratio 1,66:1 | 181286 | 19286 |  |
| 110S* 200, 250 * För utväxling 2,15:1 / * Ratio 2,15:1 | 181287 | 19087 |  |
| 120S, 120S-B, 120S-D S120C Koniskt rulllager / Roller bearing Ytterring / Outer ring Lagersats / Bearing kit | 3854249 (181588) (181587) | 19500 |  |
| 270, 270T 275, 275A 280, 280T 285A 290, 290A SP-A, SP-A/MT, SP-A1, SP-A2 SP-C, SP-C1 | 854541 | 19541 |  |
| 280DP 290DP DP-A, DP-A1, DP-A2 DP-B, DP-B1 DP-C, DP-C1 DP-D, DP-D1 DP-S, DP-S1 DPX DPX-S, DP-S1 XDP-B Yttre nållager på inre propelleraxel / Outer bearing on inner propeller shaft | 183272 | 19272 |  |

Yttre lager för propelleraxel forts. / Outer bearing for propeller shaft cont.

| AQ-drev typ Sterndrive type | Ref.nr. Ref. No. | Best.nr. Part No. | |
|--|--|--|---|
| 280DP 290DP DP-A, DP-A1, DP-A2 DP-B, DP-B1 DP-C, DP-C1 DP-D, DP-D1 DP-E DP-G DP-S, DP-S1 DPX DPX-S, DPX-S1 XDP-B Nållager / Needle bearing / Innerring / Inner ring Yttre lager på yttre propelleraxel / Outer bearing on outer propeller shaft | 183859 184683 | 19859 19683 |  |

Propelleraxel / Propeller shaft

| | | | |
|--|--|---|---|
| 100A 100B 100S Inre nållager ingår / Inner needle bearing included | 875177 | 19177 |  |
|--|--|---|---|

YANMAR PARTS

Packningsatser / Gasket sets

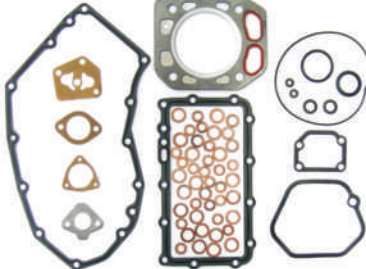
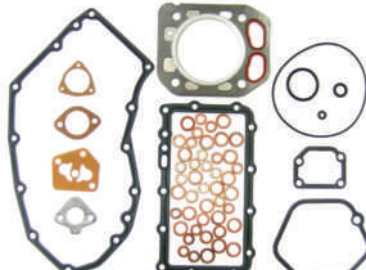
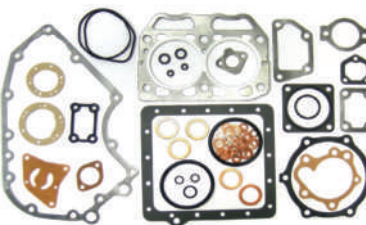
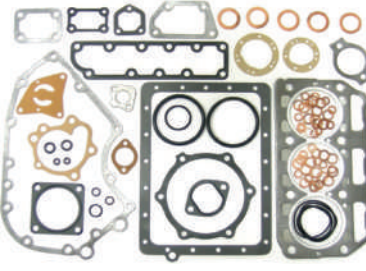
| Motor typ Engine type | Ref.nr Ref. No. | Best.nr Part No. | |
|---|--------------------|---------------------|---|
| YANMAR 1GM 7 hästkrafter 7 Horse power | 728170-92600 | 60000 | NEW  |
| YANMAR 1GM10 9 hästkrafter 9 Horse power | 728171-92601 | 60001 | NEW  |
| YANMAR 2GM2D, 2GM20F 18 hästkrafter 18 Horse power | 728271-92605 | 60002 | NEW  |
| YANMAR 3GM30, 3GM30(EU) 3GM30F, 3GM30F(EU) 27 hästkrafter 27 Horse power | 728374-92605 | 60003 | NEW  |

YANMAR PARTS

Packningsatser forts. / Gasket sets cont.

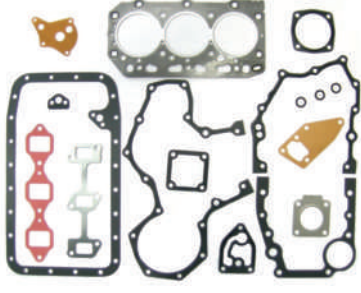
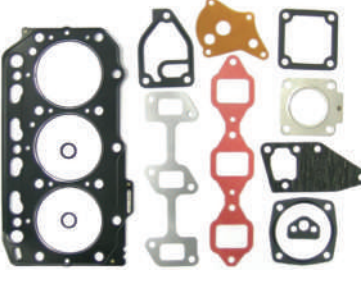
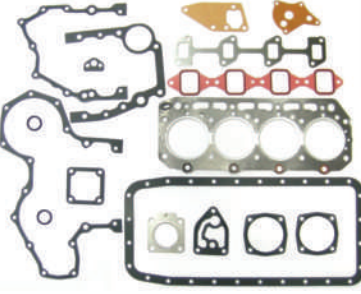
| Motor typ Engine type | Ref.nr Ref. No. | Best.nr Part No. | |
|--|--------------------|---------------------|---|
| YANMAR 3JH2E 38 hästkrafter 38 Horse power 3JH2TE 55 hästkrafter 55 Horse power | 729171-92600 | 60004 | NEW  |
| YANMAR 3JH3EYEU 40 hästkrafter 40 Horse power | 729270-92601 | 60005 | NEW  |
| YANMAR 4JHE 44 hästkrafter 44 Horse power 4JHTE 55 hästkrafter 55 Horse power 4JHDTE 77 hästkrafter 77 Horse power | 729470-92605 | 60006 | NEW  |

YANMAR PARTS

Packningsatser forts. / Gasket sets cont.

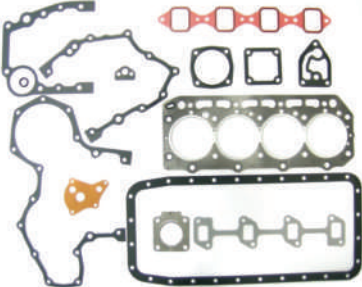
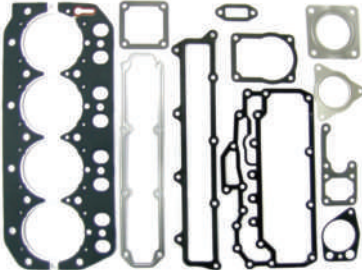
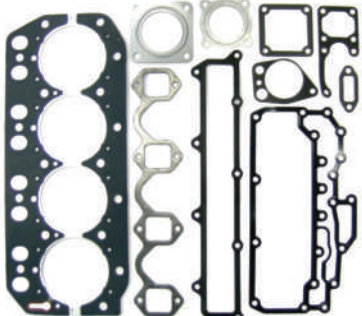
| Motor typ Engine type | Ref.nr Ref. No. | Best.nr Part No. | |
|--|--------------------|---------------------|---|
| <p>YANMAR</p> <p>4JH2E 62 hästkrafter 62 Horse power</p> <p>4JH2TE 72 hästkrafter 72 Horse power</p> <p>4JM2HTE 83 hästkrafter 83 Horse power</p> <p>4JH2DTE 95 hästkrafter 95 Horse power</p> <p>4JH2UTE 106 hästkrafter 106 Horse power</p> | 729573-92605 | 60007 | <p>NEW</p>  |
| <p>YANMAR</p> <p>4LHTE 125 hästkrafter 125 Horse power</p> <p>4LHTE 142 hästkrafter 142 Horse power</p> <p>4LHDTE 182 hästkrafter 182 Horse power</p> <p>4LHSTE 238 hästkrafter 238 Horse power</p> | 719171-92602 | 60008 | <p>NEW</p>  |
| <p>YANMAR</p> <p>4LHAHTE 150 hästkrafter 150 Horse power</p> <p>4LHADTE 190 hästkrafter 190 Horse power</p> <p>4LHASTE 238 hästkrafter 238 Horse power</p> | 719173-92600 | 60009 | <p>NEW</p>  |





YANMAR PARTS

Bränslefilter / Fuel filter

| Motor typ Engine type | Ref.nr Ref. No. | Best.nr Part No. | |
|--------------------------------|--------------------|---------------------|---|
| YANMAR SB, YSB, YSM, QM, GM | 104500-55710 | 2241 |  |

YANMAR PARTS

Impellersatser / Impeller kits

| Motor typ Engine type | Ref.nr Ref. No. | Best.nr Part No. | |
|--|--------------------|---------------------|---|
| <p>YANMAR</p> <p>3HM, 2QM20, 3QM20, YM42091</p> | | <p>2044/Y</p> |  |
| <p>YANMAR</p> <p>SDB8-12, YSE8-12, YSDB8-12, YSMDB8-12, 2QM15, 2GM, 3GM, YM42070</p> | | <p>2043/Y</p> |  |
| <p>YANMAR</p> <p>3HM, 2QM20, 3QM20, YM42091</p> | | <p>2051/Y</p> |  |
| <p>YANMAR</p> <p>3JHT, 3JHTBE, 4JH, 4JHDTE, 4JHHTE, 4JHTE, 4JHTUE, 4JH2DTE, 4JH2E, 4JH2TE, 4JMTE, YM42590</p> | | <p>2040/Y</p> |  |

YANMAR PARTS

Rostfria syrafria avgaskrökar / Stainless steel and acid proof wet exhaust elbows

| Motor typ Engine type | Ref.nr Ref. No. | Best.nr Part No. | |
|--------------------------|--------------------|---------------------|--|
| YANMAR QM Serie | | 16800 |  |
| YANMAR 6 YL Serie | | 16810 |  |
| YANMAR 4 JHT | | 16820 |  |

TILLBEHÖR
~
ACCESSORIES

LJUDDÄMPARE

DPC ljudämpare har visat sig vara en av de bästa på marknaden. Systemet passar både segel- och motorbåtar. Vattenlåset/ljudämparen är konstruerad med två ändrar av rostfritt stål, monterade i en gummibälga. Tillsammans med vatten ger det en exceptionell ljudämpande effekt och ett minimum av baktryck. Gummibälgen är godkänd av VERITAS.

EXHAUST SILENCER

The DPC exhaust silencer has proven to be one of the best at the market. The system is suitable for both sail and motor yachts. The waterlock/silencer is constructed with two stainless steel ends mounted in a rubber bellow. With water it gives an exceptional silencing effect and a minimum of back pressure. The rubber bellow is approved by VERITAS.

| Max hp | Ø1 mm | Ø2 mm | L1 mm | L2 mm | H mm | LTR | Typ A Art. nr. | Typ B Art. nr. |
|--------|-------|-------|-------|-------|------|------|----------------|----------------|
| 50 | 40 | 160 | 200 | 310 | 155 | 4,0 | 16703 | |
| 50 | 45 | 160 | 200 | 310 | 155 | 4,0 | 16704 | |
| 50 | 45 | 160 | 300 | 410 | 150 | 6,0 | 167041 | |
| 50 | 51 | 160 | 200 | 320 | 150 | 4,0 | 16705 | |
| 50 | 51 | 160 | 300 | 410 | 150 | 6,0 | 167051 | |
| 100 | 51 | 160 | 400 | 510 | 150 | 8,0 | 16706 | |
| 100 | 57 | 160 | 300 | 420 | 150 | 6,0 | 16707 | |
| 100 | 60 | 160 | 300 | 420 | 150 | 6,0 | 16708 | |
| 100 | 63 | 160 | 300 | 420 | 150 | 6,0 | 16709 | |
| 100 | 76 | 160 | 400 | 560 | 140 | 8,0 | 16711 | |
| 200 | 89 | 215 | 450 | 640 | 190 | 15,0 | 16716 | |
| 200 | 100 | 217 | 500 | 680 | 190 | 17,0 | 16717 | |
| 300 | 125 | 265 | 550 | 750 | 230 | 28,0 | 16720 | |
| 50 | 45 | 160 | 200 | 320 | 150 | 4,0 | | 16725 |
| 50 | 51 | 160 | 200 | 330 | 150 | 4,0 | | 16726 |
| 100 | 51 | 160 | 300 | 430 | 150 | 6,0 | | 16727 |

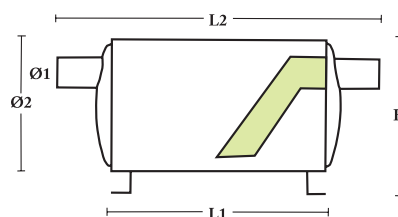

Typ A / Type A
Rak anslutning in/ut
Straight in/out

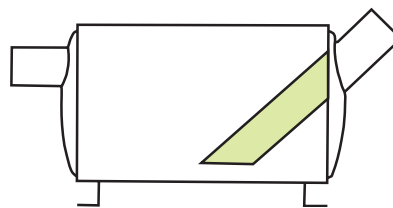

Typ B / Type B
Rak in / 45° ut
Straight in/ 45° out



BORDSGENOMFÖRING-AVGAS



Tillverkade i rostfritt syrafast stål. Samliga med droppkant.

EXHAUST OUTLET

Made of stainless steel. With trumpet shaped outlet.

| Art. nr. Part No | Ø 1 mm | Ø 2 mm | L mm |
|---------------------|--------|--------|------|
| 16920 | 38 | 78 | 130 |
| 16921 | 45 | 85 | 130 |
| 16922 | 51 | 91 | 130 |
| 16923 | 57 | 97 | 130 |
| 16924 | 60 | 100 | 130 |
| 16925 | 63 | 103 | 130 |
| 16926 | 76 | 126 | 130 |
| 16927 | 89 | 139 | 130 |
| 16928 | 101 | 151 | 130 |
| 16929 | 124 | 174 | 150 |

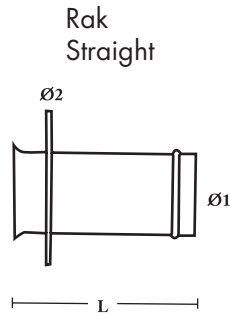

| Art. nr. Part No | Ø 1 mm | Ø 2 mm | L mm |
|---------------------|--------|--------|------|
| 16930 | 38 | 88 | 125 |
| 16931 | 45 | 95 | 125 |
| 16932 | 51 | 101 | 125 |
| 16933 | 57 | 107 | 125 |
| 16934 | 60 | 110 | 125 |
| 16935 | 63 | 113 | 125 |
| 16936 | 76 | 126 | 140 |
| 16937 | 89 | 139 | 170 |
| 16938 | 101 | 151 | 190 |
| 16939 | 124 | 174 | 190 |

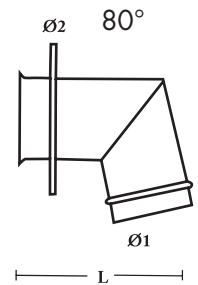
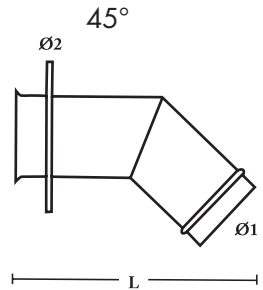

Art. nr PS11661 80° Ø 60 mm



16920



16930

AVGASKRÖKAR



Rostfria syrafasta avgaskrökar till Volvo Penta och Yanmar.

WET EXHAUST ELBOWS

Made of stainless steel for Volvo Penta and Yanmar.

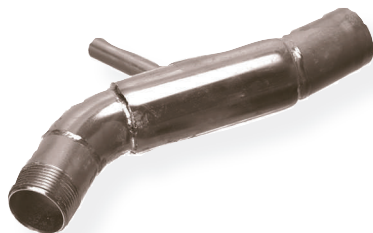

Art. nr 16100 (Volvo MD 1-3, 6, 7, 11, 17) ex. fläns / excl. flange



Art. nr 16500 (Volvo MD 22)



Art. nr 16300 (Volvo MD 5)

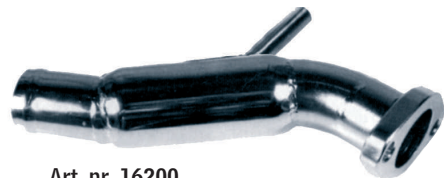

Art. nr 16200 (Volvo MD 2-3, 11, 17) med fläns / with flange



Art. nr 16750 (Volvo 2010, 2020, 2030, 2040)

AVGASKRÖKAR



WET EXHAUST ELBOWS



Art. nr 16800 (Yanmar QM Serie)

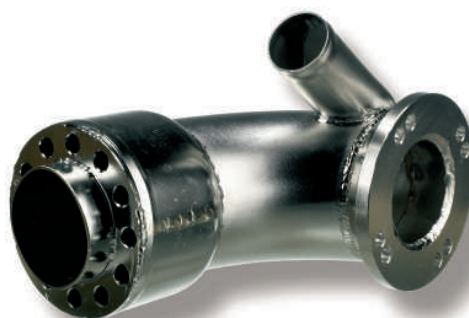

Art. nr 16810 (Yanmar 6 YL Serie)

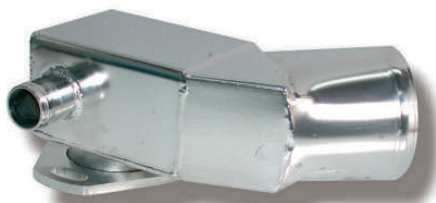

Art. nr 16820 Yanmar 4 JHT



Art. nr 16400 (Volvo MD21)

Fläns/Packningar Flange/Gaskets

Art. nr / Part No 75051000 Fläns MD 6-7/gjutjärn
 Art. nr / Part No 75050000 Packning MD 6-7
 Art. nr / Part No 75050001 MD



Art. nr 75050000



Art. nr 75051000



Art. nr 75050001

IMPELLER IMPELLERS

| Tillverkare Manufacturer | Modell Type | Impeller |
|-----------------------------|---------------------|----------|
| BUKH | DV8-DV10-DV20 | 2048 |
| | DV36-DV48 | 2040 |
| CUMMINS | V 504 M | 2039 |
| | NH220M-NH250M-V555M | 2038 |
| | A30-A40-L30 | 2048 |
| FARYMANN | R30-S30-P30 | 2049 |
| | K34-18W | 2048 |
| | 12MDJC-15MDJF-30MDE | 2037 |
| ONAN | 50MDEG | 2047 |
| | | 2043 |
| | 4.99M-4.107M-4.236M | 2040 |
| PERKINS | 4.108M | 2040 |
| | 6.305M-6354M | 2039 |
| | V8.510-TV8.510 | 2038 |
| | | |
| YANMAR | IGM10, 1GM | 2044/Y |
| | 2GM20-GM30 | 2043/Y |
| | QM-HM-3GM | 2051/Y |
| | JHE-JHTE-JHHTE | 2040/Y |

Bränslefilter Yanmar
 SB, YSB, YSM, QM, GM
 Art. nr 2241

Fuel filter Yanmar
 SB, YSB, YSM, QM, GM
 Part No 2241



Art. nr / Part No 2241

VARMVATTENBEREDARE



TROPIC

Tropic varmvattenberedare är isolerade med polyuretan, har 230V elpatron, säkerhetsventil och slangkopplingar som standard. Uppvärmning med cirkulerande vatten från motorns kylsystem-, alternativt värmare med vattenburen värme eller elpatron 230V/750–1000W. Vattnet i beredaren uppnår efter ca 25 minuters motorgång samma temperatur som motorns kylvatten – ca 74°. Effektiv isolering gör att värmeförlusten blir mindre än 1°C per timma. Rostfritt syrafast stål SIS 2343 i beredare/slinga och rör. Värmeslingan är placerad för att ge så bra självluftning som möjligt. Ger även bästa värmeeffekt för beredare som installeras horisontellt. Kan även monteras vertikalt.

TILLBEHÖR:

Blandningsventil. Art.nr. 100280.

WATER HEATER



TROPIC

Hot water onboard is not a luxury any more. It's heated up free of charge by letting your engines cooling water pass through the coil of the insulated water heater. The water will be heated to the same temperature as the engine within 25 min. It is also supplied with an immersion heater of 230V and 1000W. The water heater is well insulated with a hard surface of polyethene. The heat-loss is approximately 0.5–1° per hour.

Tropic water heater is made of stainless steel 316 with global shaped flanges according to the rules for pressure tanks. The heating coil is positioned to give the best heating effect for horizontal installation, but can also be mounted vertically. A complete mounting kit with a one way valve and a safety valve of 4 bar is included.

Easy to install – complete mounting kit.

Individually tested – for your safety.

ACCESSORIES:

Water mixing valves. Part No 100280.

Tropic

| Art. nr Part No | Volym Volume | Ø Ø | Längd Length | Max tryck (säkerhetsventil) Safety valves | Elpatron Immersion heater |
|--------------------|-----------------|--------|-----------------|---|---------------------------------|
| 100224 | 24l | 405 | 331 | 4,0 bar | 220V/1000W |



Val av reglagekabel
Selection of control cables

| | | |
|---------------------------------|--|----------------------|
| UTOMBORDARE OUTBOARD | Mercury/Gen II ® | C36/MACH36 |
| | Mercury Mariner ® (över 50hk) | C5/MACH5 |
| | Mariner ® (upp till 50 hk) | C16 |
| | Force/Selva/Yamaha ®/Suzuki/Tohatsu/ Honda/Nissan | C2/C8/MACHZero |
| | Johnson/Evinrude ® | C14/MACH14 efter -79 |
| INUDREV STERN DRIVE | Mercury/Gen. II ® | C36/MACH36 |
| | Mercruiser ® | C5/MACH5 |
| | OMC ® | C14/MACH14 efter -79 |
| | Volvo Penta ® | C2/C8/MACHZero/C22 |
| INOMBORDARE INBOARD | | C2/C8/MACHZero/C22 |

Mach Zero lågfriktionskablar gör att man med mindre kraft kan manövrera reglaget. Kabeln är mycket flexibel och underhållsfri. Höljet är resistent mot UV-ljus och kemikalier. Rostfria ändanslutningar.

Mach Zero high performance cables. The core design maximizes efficiency and minimizes lost motion. Extremely high level of flexibility. High resistance outer jacket against abrasion, UV and chemicals.

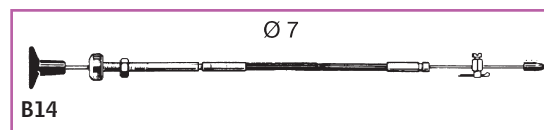
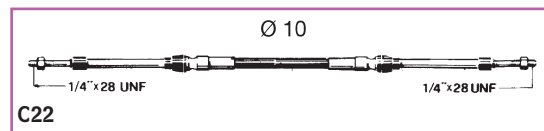
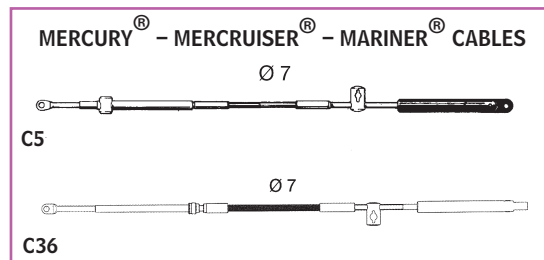
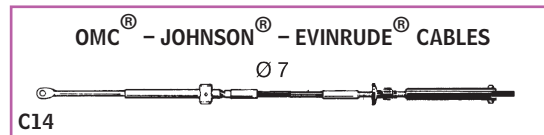
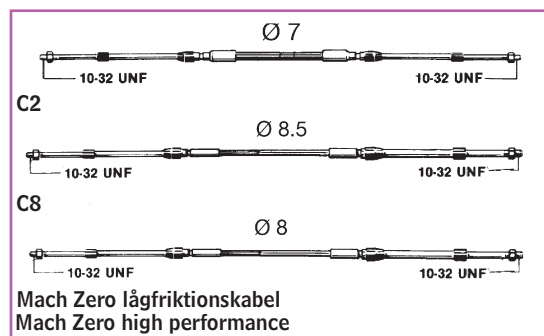

SWN OLJESUG / OIL DRAINING KIT

Speciellt för varv, båtklubbar, marin service och industri. Pump av kugghjulstyp monterad på en 15 liters plasttank. Handtag i aluminium. Levereras med sugslang för tömning av oljeträget, komplett med krokodilklämmor.

Designed for boat yards, boatclubs, marine service and industry. Gear pump mounted on a 15L plastic tank with handle, easy to carry. Including suction hose for draining the oil and el.clamps.

Art.nr / Part No **OS6122** (12V/4L/Min)

Art.nr / Part No **OS6132** (12V/6L/Min)

Art.nr / Part No **OS6133** (24V/6L/ Min)



Art.nr / Part No **OS6122**

KORSREFERENSTABELL
~
CROSS REFERENCE CHART

OBT Part No. – Ref. No.

| Best. nr. Part. No. | Ref. nr. Ref. No. |
|------------------------|----------------------|
| 11005 | 859115 |
| 11014 | |
| 11019 | 271217 |
| 11020 | 271218 |
| 11021 | 271219 |
| 11022 | 271054 |
| 11023 | 271055 |
| 11024 | 271056 |
| 11025 | 271066 |
| 11026 | 271067 |
| 11027 | 271068 |
| 11038 | 860921 |
| 11039 | 859039 |
| 11040 | 272040 |
| 11042 | 272042 |
| 11043 | 272043 |
| 11051 | 271051 |
| 11052 | 1542052 |
| 11053 | 271053 |
| 11059 | 272059 |
| 11063 | 271063 |
| 11064 | 271064 |
| 11065 | 925065 |
| 11075 | 840075 |
| 11082 | 275282 |
| 11083 | 275283 |
| 11088 | 859088 |
| 11092 | 463092 |
| 11096 | 1275379 |
| 11105 | 271052 |
| 11106 | 271065 |
| 11134 | 430134 |
| 11136 | 270136 |
| 11137 | 270137 |
| 11138 | 270138 |
| 11159 | 859159 |
| 11160 | 6842160 |
| 11161 | 876161 |

| Best. nr. Part. No. | Ref. nr. Ref. No. |
|------------------------|----------------------|
| 11177 | 943177 |
| 11181 | 944181 |
| 11183 | 957183 |
| 11193 | 275193 |
| 11195 | 275195 |
| 11196 | 275196 |
| 11200 | 272004 |
| 11202 | 272002 |
| 11203 | 272012 |
| 11214 | 271214 |
| 11215 | 271215 |
| 11216 | 271216 |
| 11236 | 271236 |
| 11237 | 271237 |
| 11238 | 271238 |
| 11254 | 829254 |
| 11262 | 818262 |
| 11271 | 875271 |
| 11282 | 946282 |
| 11295 | 418295 |
| 11302 | 875302 |
| 11303 | 875303 |
| 11304 | 875304 |
| 11305 | 875305 |
| 11306 | 875306 |
| 11307 | 875307 |
| 11308 | 875308 |
| 11318 | 1542318 |
| 11329 | 949329 |
| 11330 | 875330 |
| 11331 | 875331 |
| 11332 | 875332 |
| 11333 | 875333 |
| 11334 | 875334 |
| 11335 | 875335 |
| 11336 | 875336 |
| 11337 | 275337 |
| 11338 | 275338 |

| Best. nr. Part. No. | Ref. nr. Ref. No. |
|------------------------|----------------------|
| 11339 | 275339 |
| 11340 | 275340 |
| 11341 | 275341 |
| 11342 | 275342 |
| 11344 | 275344 |
| 11345 | 275345 |
| 11346 | 275346 |
| 11356 | 803356 |
| 11359 | 803359 |
| 11369 | 275369 |
| 11370 | 275370 |
| 11371 | 275371 |
| 11385 | 471956 |
| 11385 | 980936 |
| 11416 | 463416 |
| 11471 | 270471 |
| 11472 | 864723 |
| 11477 | 270015 |
| 11478 | 875478 |
| 11479 | 875479 |
| 11487 | 829487 |
| 11492 | 1378492 |
| 11498 | 875498 |
| 11499 | 875499 |
| 11531 | 275331 |
| 11532 | 275333 |
| 11533 | 275332 |
| 11534 | 275334 |
| 11535 | 275335 |
| 11536 | 275336 |
| 11538 | 875538 |
| 11539 | 875539 |
| 11540 | 875540 |
| 11550 | 875550 |
| 11551 | 875551 |
| 11560 | 875560 |
| 11579 | 875579 |
| 11590 | 967590 |

OBT Part No. – Ref. No.

| Best. nr. Part. No. | Ref. nr. Ref. No. |
|------------------------|----------------------|
| 11592 | 967592 |
| 11609 | |
| 11621 | 418621 |
| 11622 | 418622 |
| 11646 | 948646 |
| 11651 | 275751 |
| 11651 | 875651 |
| 11671 | 859671 |
| 11677 | 18677 |
| 11684 | 859684 |
| 11718 | 859718 |
| 11742 | 946742 |
| 11742 | 955982 |
| 11743 | 946743 |
| 11747 | 191747 |
| 11789 | 947789 |
| 11799 | 11009 |
| 11799 | 181799 |
| 11821 | 943821 |
| 11846 | 469846 |
| 11882 | 948882 |
| 11902 | 463902 |
| 11903 | 463903 |
| 11904 | 463904 |
| 11905 | 463905 |
| 11906 | 270906 |
| 11907 | 270907 |
| 11908 | 270908 |
| 11919 | 861211 |
| 11955 | 968955 |
| 11971 | 3852851 |
| 11980 | 955980 |
| 11998 | 11998 |
| 12002 | 838062 |
| 12003 | 1218674 |
| 12004 | 461511 |
| 12005 | 419735 |
| 12006 | 1336763 |

| Best. nr. Part. No. | Ref. nr. Ref. No. |
|------------------------|----------------------|
| 12009 | 859089 |
| 12010 | |
| 12011 | |
| 12020 | 829620 |
| 12044 | 833044 |
| 12045 | |
| 12046 | |
| 12048 | 859048 |
| 12053 | 859053 |
| 12059 | 838059 |
| 12062 | 859062 |
| 12066 | 859066 |
| 12067 | 859067 |
| 12075 | 3877075 |
| 12084 | 947084 |
| 12090 | 955990 |
| 12100 | |
| 12101 | |
| 12102 | |
| 12122 | 859122 |
| 12141 | 859141 |
| 12171 | 859171 |
| 12173 | 960173 |
| 12181 | 859181 |
| 12186 | 859186 |
| 12187 | 859187 |
| 12188 | 833188 |
| 12198 | 969198 |
| 12251 | 3582513 |
| 12252 | 190252 |
| 12266 | 415266 |
| 12273 | 6842273 |
| 12278 | 859147 |
| 12292 | 419292 |
| 12305 | 3580305 |
| 12306 | 3580306 |
| 12307 | 463075 |
| 12311 | |

| Best. nr. Part. No. | Ref. nr. Ref. No. |
|------------------------|----------------------|
| 12327 | 897327 |
| 12357 | 405357 |
| 12360 | 803360 |
| 12368 | 419368 |
| 12371 | 803371 |
| 12377 | 463377 |
| 12389 | 1542389 |
| 12395 | 463395 |
| 12425 | 1276425 |
| 12432 | 3514432 |
| 12441 | 944441 |
| 12442 | 1346442 |
| 12446 | 840446 |
| 12455 | 943455 |
| 12460 | |
| 12465 | 3853159 |
| 12470 | |
| 12472 | 1542472 |
| 12475 | |
| 12480 | |
| 12485 | |
| 12490 | |
| 12493 | 1378493 |
| 12495 | |
| 12500 | |
| 12506 | 855506 |
| 12507 | 855507 |
| 12513 | 1218630 |
| 12526 | 463526 |
| 12546 | 463546 |
| 12547 | 463547 |
| 12548 | 463548 |
| 12549 | 463549 |
| 12550 | 463550 |
| 12551 | 463551 |
| 12552 | 463552 |
| 12553 | 463553 |
| 12554 | 463554 |

OBT Part No. – Ref. No.

| Best. nr. Part. No. | Ref. nr. Ref. No. |
|------------------------|----------------------|
| 12555 | 463555 |
| 12556 | 463556 |
| 12557 | 463557 |
| 12558 | 463558 |
| 12559 | 463559 |
| 12560 | 463560 |
| 12561 | 463561 |
| 12562 | 463562 |
| 12563 | 463563 |
| 12564 | 463564 |
| 12565 | 463565 |
| 12566 | 463566 |
| 12567 | 463567 |
| 12568 | 463568 |
| 12569 | 463569 |
| 12570 | 463570 |
| 12603 | 3582609 |
| 12630 | 1306630 |
| 12637 | 838637 |
| 12638 | 838638 |
| 12643 | 419643 |
| 12652 | 419652 |
| 12653 | 419653 |
| 12659 | 859659 |
| 12660 | 859660 |
| 12734 | 419734 |
| 12737 | 418737 |
| 12739 | 463739 |
| 12759 | 833759 |
| 12760 | 833760 |
| 12767 | 1336767 |
| 12792 | 1317792 |
| 12793 | 1317793 |
| 12860 | 861860 |
| 12870 | 1378870 |
| 12893 | 3517893 |
| 12944 | 271944 |
| 12960 | 1378960 |

| Best. nr. Part. No. | Ref. nr. Ref. No. |
|------------------------|----------------------|
| 12979 | 1378979 |
| 12986 | 831986 |
| 13008 | 9139284 |
| 13009 | 419310 |
| 13010 | 3855409 |
| 13024 | 807294 |
| 13025 | 859225 |
| 13039 | 430039 |
| 13042 | 859042 |
| 13043 | 859043 |
| 13044 | 859044 |
| 13051 | 1378851 |
| 13052 | 1378853 |
| 13053 | 925053 |
| 13066 | 838066 |
| 13068 | 803068 |
| 13070 | 859151 |
| 13090 | 859090 |
| 13093 | 859093 |
| 13094 | 859094 |
| 13100 | 419678 |
| 13115 | 840115 |
| 13119 | 1544119 |
| 13127 | 859134 |
| 13136 | 3809167 |
| 13150 | 859150 |
| 13155 | 859155 |
| 13181 | 957161 |
| 13191 | 957191 |
| 13202 | 3584202 |
| 13221 | 945221 |
| 13238 | 859154 |
| 13274 | 833274 |
| 13287 | 1542287 |
| 13296 | 3514296 |
| 13309 | 3580309 |
| 13317 | 3580317 |
| 13341 | 1306341 |

| Best. nr. Part. No. | Ref. nr. Ref. No. |
|------------------------|----------------------|
| 13376 | 859135 |
| 13393 | |
| 13399 | 859120 |
| 13414 | 943414 |
| 13416 | 1317761 |
| 13416 | 1326239 |
| 13442 | 840442 |
| 13453 | 859137 |
| 13495 | 3580495 |
| 13496 | 3580496 |
| 13497 | 859138 |
| 13498 | 859148 |
| 13531 | 859152 |
| 13569 | 840569 |
| 13623 | 9139282 |
| 13645 | 1378645 |
| 13646 | 1378646 |
| 13647 | 859647 |
| 13652 | 838652 |
| 13653 | 838653 |
| 13654 | 838654 |
| 13742 | 3583786 |
| 13749 | 3809167 |
| 13750 | |
| 13751 | |
| 13752 | |
| 13763 | 419763 |
| 13780 | 833780 |
| 13781 | 833781 |
| 13783 | 857621 |
| 13897 | 861897 |
| 13909 | 1378909 |
| 13986 | 955986 |
| 13990 | 418990 |
| 13993 | 3582432 |
| 14001 | 948187 |
| 14005 | 840648 |
| 14031 | 859031 |

OBT Part No. – Ref. No.

| Best. nr. Part. No. | Ref. nr. Ref. No. |
|------------------------|----------------------|
| 14034 | 471034 |
| 14035 | 859035 |
| 14036 | 859036 |
| 14057 | 3517857 |
| 14061 | 947061 |
| 14069 | 876069 |
| 14074 | 838074 |
| 14081 | 3580818 |
| 14086 | 859086 |
| 14087 | 949187 |
| 14114 | 947114 |
| 14132 | 907132 |
| 14144 | 1346144 |
| 14157 | 859157 |
| 14158 | 421158 |
| 14184 | 957184 |
| 14189 | 859189 |
| 14193 | 957193 |
| 14222 | 3848222 |
| 14250 | 861250 |
| 14251 | 861251 |
| 14337 | 834337 |
| 14360 | 829714 |
| 14390 | 3827069 |
| 14440 | 835440 |
| 14473 | 861473 |
| 14476 | 861476 |
| 14482 | 469482 |
| 14483 | 469483 |
| 14559 | 3850559 |
| 14568 | 833568 |
| 14570 | 858570 |
| 14591 | 967591 |
| 14621 | 3581621 |
| 14626 | 907135 |
| 14626 | 947626 |
| 14627 | 947627 |
| 14634 | 466634 |

| Best. nr. Part. No. | Ref. nr. Ref. No. |
|------------------------|----------------------|
| 14641 | 420641 |
| 14653 | 945653 |
| 14677 | 461677 |
| 14685 | 859685 |
| 14706 | 1218706 |
| 14711 | 862711 |
| 14730 | 859081 |
| 14731 | 859082 |
| 14732 | 859732 |
| 14735 | 859735 |
| 14747 | 859747 |
| 14750 | 841750 |
| 14779 | 835779 |
| 14805 | 419805 |
| 14806 | 18806 |
| 14807 | 838807 |
| 14811 | 18811 |
| 14818 | 18818 |
| 14840 | 18840 |
| 14840 | 947624 |
| 14855 | 833855 |
| 14864 | 1378864 |
| 14879 | 840879 |
| 14914 | 1378914 |
| 14946 | 1219946 |
| 14974 | 423135 |
| 14975 | 955975 |
| 14977 | 955977 |
| 14992 | 11992 |
| 15001 | 833991 |
| 15003 | 826013 |
| 15004 | 856004 |
| 15005 | 18669 |
| 15006 | 835417 |
| 15007 | 808007 |
| 15007 | 835511 |
| 15009 | 826241 |
| 15010 | 11010 |

| Best. nr. Part. No. | Ref. nr. Ref. No. |
|------------------------|----------------------|
| 15013 | 838013 |
| 15014 | 827014 |
| 15017 | 430017 |
| 15018 | 430018 |
| 15020 | 430020 |
| 15027 | 859027 |
| 15028 | 855728 |
| 15033 | 416033 |
| 15036 | 807036 |
| 15037 | 856037 |
| 15044 | 955244 |
| 15045 | 1378491 |
| 15047 | 859047 |
| 15055 | 859104 |
| 15057 | 925057 |
| 15059 | 951959 |
| 15061 | 859061 |
| 15066 | 949722 |
| 15067 | 968927 |
| 15068 | 925068 |
| 15069 | 925069 |
| 15091 | 975672 |
| 15092 | 925092 |
| 15093 | 841693 |
| 15094 | 812994 |
| 15095 | 842695 |
| 15096 | 925096 |
| 15097 | 876097 |
| 15102 | 43213002 |
| 15106 | 964106 |
| 15108 | 43213003 |
| 15109 | 831009 |
| 15111 | 846111 |
| 15120 | 876120 |
| 15127 | 860127 |
| 15130 | 422130 |
| 15131 | 859131 |
| 15133 | 838942 |

OBT Part No. – Ref. No.

| Best. nr. Part. No. | Ref. nr. Ref. No. |
|------------------------|----------------------|
| 15134 | 861551 |
| 15149 | 841149 |
| 15158 | 861582 |
| 15168 | 411168 |
| 15169 | 836169 |
| 15172 | 430172 |
| 15178 | 831178 |
| 15179 | 859216 |
| 15181 | 831181 |
| 15183 | 960183 |
| 15189 | 1526189 |
| 15196 | 859196 |
| 15198 | 1542198 |
| 15215 | 806215 |
| 15227 | 958227 |
| 15244 | 826244 |
| 15247 | 827247 |
| 15250 | 827250 |
| 15255 | 925255 |
| 15261 | 3840816 |
| 15263 | 3580365 |
| 15266 | 8149182 |
| 15269 | 3831424 |
| 15275 | 808275 |
| 15282 | 947282 |
| 15300 | 43957300 |
| 15301 | 43957301 |
| 15302 | 43957302 |
| 15304 | 841063 |
| 15305 | 876305 |
| 15330 | 969330 |
| 15331 | 969331 |
| 13340 | 3858340 |
| 15350 | |
| 15351 | |
| 15352 | 859103 |
| 15353 | |
| 15354 | 845354 |

| Best. nr. Part. No. | Ref. nr. Ref. No. |
|------------------------|----------------------|
| 15355 | 181355 |
| 15356 | |
| 15357 | |
| 15358 | 3581093 |
| 15383 | 875383 |
| 15385 | 840385 |
| 15387 | 840387 |
| 15405 | 855405 |
| 15408 | 859105 |
| 15411 | 418411 |
| 15412 | 418412 |
| 15417 | 833417 |
| 15423 | 855423 |
| 15424 | 828424 |
| 15433 | 829433 |
| 15444 | 809444 |
| 15445 | 418445 |
| 15446 | 914446 |
| 15467 | 858467 |
| 15476 | 834476 |
| 15502 | 925027 |
| 15504 | 3580316 |
| 15508 | 835508 |
| 15508 | 3854293 |
| 15509 | 3587508 |
| 15512 | 3854286 |
| 15551 | 802551 |
| 15554 | 963554 |
| 15555 | 968555 |
| 15574 | 875574 |
| 15574 | 876081 |
| 15575 | 875575 |
| 15578 | 855578 |
| 15580 | 875580 |
| 15581 | 835581 |
| 15582 | 855582 |
| 15583 | 875583 |
| 15584 | 875584 |

| Best. nr. Part. No. | Ref. nr. Ref. No. |
|------------------------|----------------------|
| 15590 | 859010 |
| 15592 | 829592 |
| 15593 | 3841697 |
| 15597 | 842597 |
| 15598 | 859811 |
| 15601 | 826601 |
| 15608 | 946608 |
| 15610 | 841610 |
| 15615 | 845615 |
| 15617 | 831617 |
| 15622 | 831622 |
| 15625 | 1336255 |
| 15629 | 817629 |
| 15637 | |
| 15642 | 841642 |
| 15656 | 949656 |
| 15657 | 949657 |
| 15658 | 949658 |
| 15659 | 949659 |
| 15660 | 21430184 |
| 15661 | 823661 |
| 15689 | 859084 |
| 15693 | 804693 |
| 15693 | 840785 |
| 15695 | 804695 |
| 15697 | 804697 |
| 15698 | 875698 |
| 15699 | 330699 |
| 15714 | 829714 |
| 15717 | 181717 |
| 15721 | 949721 |
| 15728 | 825728 |
| 15730 | 803730 |
| 15738 | 875738 |
| 15744 | 82744 |
| 15745 | 82745 |
| 15756 | 875756 |
| 15766 | 838766 |

OBT Part No. – Ref. No.

| Best. nr. Part. No. | Ref. nr. Ref. No. |
|------------------------|----------------------|
| 15769 | 875769 |
| 15771 | 418771 |
| 15773 | 840773 |
| 15779 | 877355 |
| 15780 | 875780 |
| 15783 | 875783 |
| 15784 | 877349 |
| 15785 | 875785 |
| 15787 | 3831425 |
| 15788 | 3831426 |
| 15791 | 875791 |
| 15795 | 840795 |
| 15796 | 875796 |
| 15804 | 859119 |
| 15807 | 3586494 |
| 15808 | 3593659 |
| 15811 | 21213660 |
| 15811 | 3862567 |
| 15825 | 817825 |
| 15836 | 18836 |
| 15849 | 3580849 |
| 15850 | 3853850 |
| 15853 | 3853796 |
| 18855 | 838855 |
| 15857 | 3857794 |
| 15861 | 183861 |
| 15864 | 818684 |
| 15871 | 966871 |
| 15874 | 835874 |
| 15878 | 833878 |
| 15880 | 859215 |
| 15883 | 858065 |
| 15891 | 831891 |
| 15892 | 831892 |
| 15893 | 947893 |
| 15894 | 947894 |
| 15895 | 829895 |
| 15901 | 855901 |

| Best. nr. Part. No. | Ref. nr. Ref. No. |
|------------------------|----------------------|
| 15906 | 1378906 |
| 15912 | 804912 |
| 15913 | 842913 |
| 15918 | 949918 |
| 15928 | 838928 |
| 15932 | |
| 15934 | |
| 15935 | |
| 15938 | 817938 |
| 15952 | 856513 |
| 15952 | 3860703 |
| 15957 | 951957 |
| 15959 | 819959 |
| 15960 | 831960 |
| 15971 | 968971 |
| 15972 | 829972 |
| 15974 | 829974 |
| 15976 | 955976 |
| 15978 | 859780 |
| 15979 | 838979 |
| 15981 | 948981 |
| 15982 | 859825 |
| 15983 | 955983 |
| 15986 | 858986 |
| 15989 | 829989 |
| 15991 | 3855991 |
| 15994 | 833994 |
| 15995 | 955995 |
| 15996 | 833996 |
| 15997 | 840384 |
| 15998 | 955998 |
| 15999 | |
| 16001 | |
| 16007 | |
| 16008 | |
| 16010 | |
| 16011 | |
| 16027 | 859114 |

| Best. nr. Part. No. | Ref. nr. Ref. No. |
|------------------------|----------------------|
| 16028 | 856028 |
| 16034 | 856034 |
| 16036 | 856036 |
| 16037 | 857037 |
| 16039 | 857618 |
| 160441 | 856041 |
| 16042 | 856042 |
| 16046 | 950046 |
| 16047 | 942547 |
| 16086 | 842986 |
| 16091 | 859091 |
| 16098 | 859145 |
| 16105 | 860105 |
| 16107 | 859107 |
| 16111 | 3582676 |
| 16112 | 859112 |
| 16116 | 940116 |
| 16123 | 1542123 |
| 16140 | 859140 |
| 16186 | 940186 |
| 16194 | 859194 |
| 16261 | 845261 |
| 16268 | 942268 |
| 16271 | 955271 |
| 16281 | 947281 |
| 16289 | 861289 |
| 16293 | 955293 |
| 16308 | 973080 |
| 16310 | 955310 |
| 16336 | 942336 |
| 16341 | 806341 |
| 16374 | 859015 |
| 16384 | 856891 |
| 16387 | 855387 |
| 16414 | 861414 |
| 16415 | 877415 |
| 16481 | 858481 |
| 16513 | 855513 |

OBT Part No. – Ref. No.

| Best. nr. Part. No. | Ref. nr. Ref. No. |
|------------------------|----------------------|
| 16532 | 824532 |
| 16535 | 955535 |
| 16542 | 947542 |
| 16547 | 955547 |
| 16600 | 825600 |
| 16622 | 947622 |
| 16633 | 856044 |
| 16673 | 876144 |
| 16679 | 967944 |
| 16690 | 859085 |
| 16751 | 834751 |
| 16785 | 859785 |
| 16793 | 959793 |
| 16794 | 959794 |
| 16804 | 856883 |
| 16826 | 955826 |
| 16829 | 859829 |
| 16834 | 859834 |
| 16835 | 859835 |
| 16844 | 859144 |
| 16854 | 1378854 |
| 16864 | 838864 |
| 16879 | 1378879 |
| 16894 | 856894 |
| 16900 | 859002 |
| 16901 | 859801 |
| 16901 | 859011 |
| 16902 | 840902 |
| 16906 | 941906 |
| 16907 | 941907 |
| 16911 | 1378911 |
| 16913 | 1378913 |
| 16943 | 859004 |
| 16944 | 840944 |
| 16963 | 859963 |
| 16967 | 855967 |
| 16980 | 952980 |
| 16986 | 952986 |

| Best. nr. Part. No. | Ref. nr. Ref. No. |
|------------------------|----------------------|
| 17000 | 1695000 |
| 17001 | 1695001 |
| 17002 | |
| 17003 | |
| 17004 | |
| 17005 | |
| 17017 | |
| 17020 | 828020 |
| 17023 | 191397 |
| 17024 | 941438 |
| 17027 | 3825027 |
| 17034 | 859034 |
| 17040 | 856040 |
| 17045 | 859045 |
| 17052 | 925052 |
| 17056 | 925056 |
| 17065 | 876554 |
| 17068 | 858068 |
| 17101 | 861014 |
| 17109 | 1140639 |
| 17129 | 831129 |
| 17130 | 859130 |
| 17138 | 978961 |
| 17139 | 859139 |
| 17142 | 859142 |
| 17143 | 859143 |
| 17146 | 859146 |
| 17149 | 859149 |
| 17157 | 1542157 |
| 17158 | 1542158 |
| 17159 | 1542159 |
| 17161 | 841161 |
| 17162 | 877765 |
| 17170 | 957170 |
| 17171 | 957171 |
| 17173 | 834452 |
| 17175 | 957175 |
| 17176 | 957177 |

| Best. nr. Part. No. | Ref. nr. Ref. No. |
|------------------------|----------------------|
| 17176 | 957177 |
| 17177 | 860177 |
| 17179 | 233179 |
| 17185 | 876185 |
| 17201 | 3581078 |
| 17205 | 858205 |
| 17249 | 6643249 |
| 17255 | 861255 |
| 17261 | 3858261 |
| 17287 | 838287 |
| 17292 | 841293 |
| 17293 | 841293 |
| 17303 | 1542303 |
| 17306 | 858202 |
| 17307 | |
| 17323 | 833323 |
| 17358 | 858358 |
| 17391 | 463391 |
| 17400 | 3875400 |
| 17407 | 818407 |
| 17461 | 860340 |
| 17477 | 861477 |
| 17488 | 858488 |
| 17493 | 826493 |
| 17530 | 3501530 |
| 17535 | 3582358 |
| 17597 | 840597 |
| 17648 | 862293 |
| 17650 | 3857650 |
| 17663 | 273663 |
| 17666 | 237666 |
| 17686 | 855686 |
| 17698 | 859698 |
| 17782 | 859782 |
| 17791 | 860791 |
| 17803 | 856470 |
| 17810 | 3850810 |
| 17843 | 859843 |

OBT Part No. – Ref. No.

| Best. nr. Part. No. | Ref. nr. Ref. No. |
|------------------------|----------------------|
| 17874 | 3840335 |
| 17905 | 1378905 |
| 17909 | 829909 |
| 17913 | 829913 |
| 17973 | 825973 |
| 17981 | 955981 |
| 17987 | 21492771 |
| 18001 | 3857166 |
| 18003 | 966903 |
| 18070 | 3853815 |
| 18078 | 807078 |
| 18149 | 240149 |
| 18161 | 3854161 |
| 18169 | 1306169 |
| 18207 | 829207 |
| 18243 | 841243 |
| 18244 | 841244 |
| 18254 | 35254 |
| 18258 | 238258 |
| 18260 | 3854260 |
| 18262 | 841262 |
| 18263 | 841263 |
| 18283 | 966907 |
| 18304 | 835304 |
| 18308 | 835308 |
| 18310 | 978510 |
| 18311 | 978515 |
| 18327 | 966933 |
| 18330 | 966938 |
| 18331 | 3854331 |
| 18363 | 875363 |
| 18382 | 966382 |
| 18383 | 976489 |
| 18385 | 966385 |
| 18387 | 966387 |
| 18400 | 3854001 |
| 18404 | 875404 |
| 18431 | 3854311 |

| Best. nr. Part. No. | Ref. nr. Ref. No. |
|------------------------|----------------------|
| 18454 | 3854548 |
| 18498 | 978750 |
| 18532 | 875532 |
| 18545 | 834545 |
| 18546 | 834546 |
| 18548 | 966694 |
| 18549 | 3854549 |
| 18560 | 841262 |
| 18571 | 875571 |
| 18587 | 829587 |
| 18605 | 847605 |
| 18652 | 241652 |
| 18653 | 243653 |
| 18657 | 243657 |
| 18658 | 243658 |
| 18669 | 241669 |
| 18690 | 870690 |
| 18698 | 966698 |
| 18700 | 966700 |
| 18702 | 835702 |
| 18704 | 835704 |
| 18705 | 835705 |
| 18707 | 966707 |
| 18710 | 241710 |
| 18750 | 1324750 |
| 18797 | 243797 |
| 18799 | 243799 |
| 18801 | 243801 |
| 18805 | 966891 |
| 18821 | 840821 |
| 18842 | 233842 |
| 18843 | 976492 |
| 18845 | 3853801 |
| 18889 | 241889 |
| 18900 | 966900 |
| 18903 | 243903 |
| 18906 | 966906 |
| 18926 | 841926 |

| Best. nr. Part. No. | Ref. nr. Ref. No. |
|------------------------|----------------------|
| 18931 | 966931 |
| 18942 | 966942 |
| 18975 | 834975 |
| 18978 | 966978 |
| 18981 | 966981 |
| 18990 | 966990 |
| 18998 | 835998 |
| 19014 | 958859 |
| 19015 | 852868 |
| 19017 | 125017 |
| 19018 | 852018 |
| 19019 | 3857176 |
| 19020 | 941820 |
| 19021 | 956591 |
| 19022 | 969073 |
| 19023 | 907023 |
| 19024 | 907024 |
| 19025 | 907025 |
| 19026 | |
| 19029 | |
| 19030 | 814030 |
| 19031 | |
| 19033 | |
| 19034 | 832534 |
| 19035 | |
| 19036 | 876266 |
| 19037 | |
| 19044 | 11044 |
| 19047 | 946847 |
| 19053 | 17253 |
| 19054 | 925054 |
| 19055 | 925055 |
| 19058 | 19258 |
| 19059 | 3852390 |
| 19061 | 804261 |
| 19062 | 804262 |
| 19063 | 925063 |
| 19065 | 826765 |

OBT Part No. – Ref. No.

| Best. nr. Part. No. | Ref. nr. Ref. No. |
|------------------------|----------------------|
| 19068 | 181268 |
| 19069 | 3850426 |
| 19071 | 969071 |
| 19072 | 11072 |
| 19073 | 941873 |
| 19075 | 832675 |
| 19087 | 181287 |
| 19090 | 979254 |
| 19091 | 940191 |
| 19092 | 841892 |
| 19093 | 925093 |
| 19094 | 925094 |
| 19095 | 925095 |
| 19096 | 872755 |
| 19097 | 3852352 |
| 19098 | 942598 |
| 19101 | 11013 |
| 19105 | 181105 |
| 19106 | 653190 |
| 19107 | 682694 |
| 19112 | 11012 |
| 19127 | 3841481 |
| 19130 | 3854130 |
| 19139 | 872139 |
| 19140 | 828140 |
| 19165 | 814165 |
| 19168 | 814168 |
| 19175 | 831075 |
| 19177 | 875177 |
| 19188 | 948188 |
| 19189 | 841894 |
| 19190 | 804190 |
| 19191 | 832191 |
| 19195 | 839195 |
| 19195 | 872290 |
| 19201 | 925261 |
| 19203 | 940203 |
| 19209 | 804209 |

| Best. nr. Part. No. | Ref. nr. Ref. No. |
|------------------------|----------------------|
| 19211 | 834211 |
| 19218 | 943218 |
| 19238 | 960238 |
| 19242 | 946242 |
| 19247 | 183247 |
| 19253 | 839253 |
| 19253 | 853670 |
| 19254 | 1664473 |
| 19255 | 853255 |
| 19256 | 925256 |
| 19257 | 925257 |
| 19258 | 925258 |
| 19259 | 925259 |
| 19260 | 925260 |
| 19261 | 854047 |
| 19262 | 925262 |
| 19263 | 925263 |
| 19266 | 876266 |
| 19267 | 876267 |
| 19268 | 907881 |
| 19272 | 183272 |
| 19276 | 17276 |
| 19278 | 876278 |
| 19286 | 181286 |
| 19287 | 851287 |
| 19288 | 181288 |
| 19289 | 181289 |
| 19290 | 181290 |
| 19294 | 876294 |
| 19300 | 854300 |
| 19301 | 814301 |
| 19302 | 181302 |
| 19313 | 977313 |
| 19315 | 897315 |
| 19332 | 814332 |
| 19338 | 941338 |
| 19344 | 804344 |
| 19352 | 945352 |

| Best. nr. Part. No. | Ref. nr. Ref. No. |
|------------------------|----------------------|
| 19356 | 814356 |
| 19359 | 814359 |
| 19374 | 183374 |
| 19389 | 855389 |
| 19390 | 183390 |
| 19391 | 183391 |
| 19392 | 875129 |
| 19392 | 876392 |
| 19395 | 873395 |
| 19396 | 814396 |
| 19399 | 876392 |
| 19407 | 851407 |
| 19411 | 3855411 |
| 19413 | 181413 |
| 19419 | 814419 |
| 19423 | 839423 |
| 19426 | 897426 |
| 19458 | 183458 |
| 19483 | 830483 |
| 19499 | 3858399 |
| 19500 | 3854249 |
| 19500 | 181588 |
| 19522 | 181522 |
| 19534 | 839534 |
| 19541 | 854541 |
| 19542 | 853542 |
| 19548 | 853548 |
| 19548 | 3852602 |
| 19559 | 18559 |
| 19570 | 832570 |
| 19573 | 191573 |
| 19590 | 956590 |
| 19591 | 876397 |
| 19598 | 832598 |
| 19603 | 3852603 |
| 19615 | 942615 |
| 19616 | 948616 |
| 19617 | 855617 |

OBT Part No. – Ref. No.

| Best. nr. Part. No. | Ref. nr. Ref. No. |
|------------------------|----------------------|
| 19619 | 3860232 |
| 19620 | 181620 |
| 19621 | 181621 |
| 19632 | 852632 |
| 19638 | 876638 |
| 19654 | 184654 |
| 19661 | 806661 |
| 19669 | 832669 |
| 19670 | 941670 |
| 19673 | 961673 |
| 19675 | 872531 |
| 19677 | 963677 |
| 19682 | 897682 |
| 19683 | 184683 |
| 19691 | 184691 |
| 19695 | 963695 |
| 19699 | 963699 |
| 19700 | 183750 |
| 19700 | 183834 |
| 19720 | 876391 |
| 19726 | 897726 |
| 19741 | 875741 |
| 19745 | 3855745 |
| 19746 | 3588746 |
| 19755 | 873094 |
| 19756 | 851756 |
| 19757 | 851757 |
| 19766 | 854031 |
| 19785 | 854045 |
| 19805 | 875805 |
| 19807 | 958807 |
| 19808 | 966808 |
| 19809 | 875809 |
| 19810 | 875810 |
| 19812 | 875812 |
| 19815 | 875815 |
| 19816 | 941816 |
| 19819 | 3852390 |

| Best. nr. Part. No. | Ref. nr. Ref. No. |
|------------------------|----------------------|
| 19821 | 875821 |
| 19822 | 875822 |
| 19823 | 949823 |
| 19827 | 875827 |
| 19828 | 876633 |
| 19831 | 832831 |
| 19835 | 852835 |
| 19838 | 958838 |
| 19844 | 191844 |
| 19846 | 832846 |
| 19848 | 897631 |
| 19850 | 955850 |
| 19856 | 958856 |
| 19859 | 183859 |
| 19860 | 958860 |
| 19866 | 958866 |
| 19868 | 853868 |
| 19871 | 853871 |
| 19873 | 897873 |
| 19885 | 853885 |
| 19886 | 853886 |
| 19888 | 850888 |
| 19889 | 850889 |
| 19892 | 3856834 |
| 19894 | 853894 |
| 19896 | 841896 |
| 19898 | 853898 |
| 19904 | 947904 |
| 19913 | 833913 |
| 19915 | 833915 |
| 19917 | 3860697 |
| 19929 | 838929 |
| 19934 | 813934 |
| 19941 | 853941 |
| 19945 | 853945 |
| 19949 | 3850852 |
| 19962 | 949962 |
| 19965 | 832965 |

| Best. nr. Part. No. | Ref. nr. Ref. No. |
|------------------------|----------------------|
| 19967 | 813967 |
| 19973 | 958973 |
| 19974 | 955974 |
| 19979 | 873108 |
| 19983 | 876286 |
| 19985 | 3586765 |
| 19989 | 955989 |
| 20935 | 853935 |
| 21023 | 876448 |
| 21054 | 876054 |
| 21103 | 876103 |
| 21104 | 3583787 |
| 21300 | 876300 |
| 21301 | 876301 |
| 21302 | 876302 |
| 21303 | 876303 |
| 21304 | 876304 |
| 21306 | 876306 |
| 21307 | 876307 |
| 21308 | 876308 |
| 21309 | 876309 |
| 21310 | 876310 |
| 21314 | 876314 |
| 21335 | 876335 |
| 21349 | 876349 |
| 21357 | 876357 |
| 21358 | |
| 21359 | 876359 |
| 21361 | 876361 |
| 21362 | 876774 |
| 21378 | 876378 |
| 21379 | 876379 |
| 21381 | 876381 |
| 21382 | 876382 |
| 21383 | 876383 |
| 21384 | 876384 |
| 21387 | 875387 |
| 21388 | 876388 |

OBT Part No. – Ref. No.

| Best. nr. Part. No. | Ref. nr. Ref. No. |
|------------------------|----------------------|
| 21389 | 876389 |
| 21394 | 876394 |
| 21395 | 3582596 |
| 21400 | 876342 |
| 21401 | 876356 |
| 21416 | 876416 |
| 21417 | 876417 |
| 21418 | 876348 |
| 21422 | 875422 |
| 21423 | 876393 |
| 21427 | 876427 |
| 21430 | 876430 |
| 21431 | 876431 |
| 21433 | 876433 |
| 21439 | 875439 |
| 21453 | 3582587 |
| 21500 | 876377 |
| 21553 | 876376 |
| 21561 | 876341 |
| 21569 | 876358 |
| 21572 | 876380 |
| 21757 | 875757 |
| 21760 | |
| 21761 | |
| 21762 | |
| 21763 | |
| 21764 | |
| 21765 | |
| 21766 | |
| 21800 | 877419 |
| 21801 | 3589322 |
| 21802 | 3883845 |
| 21803 | 21371112 |
| 21804 | 3588434 |
| 21805 | 21371111 |
| 22001 | |
| 22002 | |
| 22003 | |

| Best. nr. Part. No. | Ref. nr. Ref. No. |
|------------------------|----------------------|
| 22004 | |
| 22005 | |
| 22006 | |
| 22007 | |
| 22008 | |
| 22009 | |
| 22010 | |
| 22011 | 876224 |
| 22012 | |
| 22013 | |
| 22014 | |
| 22015 | |
| 22016 | |
| 22017 | |
| 22018 | |
| 22019 | |
| 22020 | |
| 22021 | |
| 22022 | |
| 22023 | |
| 22024 | |
| 22025 | |
| 22026 | |
| 22027 | |
| 22028 | |
| 22029 | |
| 22030 | |
| 22031 | |
| 22032 | |
| 22033 | |
| 22034 | |
| 22035 | |
| 22036 | |
| 22037 | |
| 22038 | |
| 22039 | |
| 22040 | |
| 22041 | |

| Best. nr. Part. No. | Ref. nr. Ref. No. |
|------------------------|----------------------|
| 22042 | |
| 22043 | |
| 22044 | |
| 22045 | |
| 22046 | |
| 22047 | |
| 22048 | |
| 22049 | |
| 22050 | 833950 |
| 22051 | |
| 22052 | |
| 22053 | |
| 22054 | |
| 22055 | |
| 22056 | |
| 22057 | |
| 22058 | |
| 22059 | |
| 22060 | |
| 22061 | |
| 22062 | 803762 |
| 22063 | |
| 22064 | |
| 22065 | |
| 22066 | |
| 22067 | |
| 22068 | |
| 22069 | 876227 |
| 22070 | |
| 22071 | |
| 22072 | |
| 22073 | |
| 22074 | |
| 22075 | |
| 22076 | |
| 22077 | |
| 22079 | |
| 22080 | 832820 |

OBT Part No. – Ref. No.

| Best. nr. Part. No. | Ref. nr. Ref. No. |
|------------------------|----------------------|
| 22081 | |
| 22082 | |
| 22083 | |
| 22084 | |
| 22085 | |
| 22086 | |
| 22087 | |
| 22088 | |
| 22089 | |
| 22090 | |
| 22091 | |
| 22094 | |
| 22095 | |
| 22096 | |
| 22097 | |
| 22098 | |
| 22099 | |
| 22100 | |
| 22101 | |
| 22102 | |
| 22103 | |
| 22104 | |
| 22105 | |
| 22106 | |
| 22107 | |
| 22108 | |
| 22109 | |
| 22110 | |
| 22111 | |
| 22113 | |
| 22114 | |
| 22115 | |
| 22116 | |
| 22117 | |
| 22118 | |
| 22119 | |
| 22120 | |
| 22121 | |

| Best. nr. Part. No. | Ref. nr. Ref. No. |
|------------------------|----------------------|
| 22122 | |
| 22123 | |
| 22124 | |
| 22125 | |
| 22126 | |
| 22127 | |
| 22128 | |
| 22129 | |
| 22130 | |
| 22131 | |
| 22132 | |
| 22133 | |
| 22134 | |
| 22135 | 3582595 |
| 22136 | 875759 |
| 22137 | 875769 |
| 22138 | 3582563 |
| 22139 | 876398 |
| 22140 | |
| 22141 | 271473 |
| 22142 | |
| 22143 | |
| 22144 | 849170 |
| 22145 | |
| 22146 | |
| 22147 | |
| 22148 | |
| 22149 | |
| 22150 | |
| 22151 | |
| 22152 | |
| 22154 | |
| 22155 | |
| 22156 | |
| 2241 | 104500-55710 |
| 30033 | 3817033 |
| 30350 | 275350 |
| 30722 | 875722 |

| Best. nr. Part. No. | Ref. nr. Ref. No. |
|------------------------|----------------------|
| 60000 | 728170-92600 |
| 60001 | 728171-92601 |
| 60002 | 728271-92605 |
| 60003 | 728374-92605 |
| 60004 | 729171-92600 |
| 60005 | 729270-92601 |
| 60006 | 729470-92605 |
| 60007 | 729573-92605 |
| 60008 | 719171-92602 |
| 60009 | 719173-92600 |
| 80100 | 3580100 |
| 90028 | 21165389 |
| 90029 | 21165390 |
| 90051 | 21228429 |
| 90261 | 30731261 |
| 90262 | 30731262 |
| 90263 | 30731263 |
| 90524 | 30731264 |
| 90525 | 30650525 |

Ref. No. – OBT Part No.

| Ref. nr. Ref. No. | Best. nr. Part. No |
|----------------------|-----------------------|
| 11009 | 11799 |
| 11010 | 15010 |
| 11012 | 19112 |
| 11013 | 19101 |
| 11044 | 19044 |
| 11072 | 19072 |
| 11992 | 14992 |
| 11998 | 11998 |
| 17253 | 19053 |
| 17276 | 19276 |
| 18559 | 19559 |
| 18669 | 15005 |
| 18677 | 11677 |
| 18806 | 14806 |
| 18811 | 14811 |
| 18818 | 14818 |
| 18836 | 15836 |
| 18840 | 14840 |
| 19258 | 19058 |
| 35254 | 18254 |
| 82744 | 15744 |
| 82745 | 15745 |
| 125017 | 19017 |
| 181105 | 19105 |
| 181268 | 19068 |
| 181286 | 19286 |
| 181287 | 19087 |
| 181288 | 19288 |
| 181289 | 19289 |
| 181290 | 19290 |
| 181302 | 19302 |
| 181355 | 15355 |
| 181413 | 19413 |
| 181522 | 19522 |
| 181588 | 19500 |
| 181620 | 19620 |
| 181621 | 19621 |
| 181717 | 15717 |

| Ref. nr. Ref. No. | Best. nr. Part. No |
|----------------------|-----------------------|
| 181799 | 11799 |
| 183247 | 19247 |
| 183272 | 19272 |
| 183374 | 19374 |
| 183390 | 19390 |
| 183391 | 19391 |
| 183458 | 19458 |
| 183750 | 19700 |
| 183834 | 19700 |
| 183859 | 19859 |
| 183861 | 15861 |
| 184654 | 19654 |
| 184683 | 19683 |
| 184691 | 19691 |
| 190252 | 12252 |
| 191397 | 17023 |
| 191573 | 19573 |
| 191747 | 11747 |
| 191844 | 19844 |
| 233179 | 17179 |
| 233842 | 18842 |
| 237666 | 17666 |
| 238258 | 18258 |
| 240149 | 18149 |
| 241652 | 18652 |
| 241669 | 18669 |
| 241710 | 18710 |
| 241889 | 18889 |
| 243653 | 18653 |
| 243657 | 18657 |
| 243658 | 18658 |
| 243797 | 18797 |
| 243799 | 18799 |
| 243801 | 18801 |
| 243903 | 18903 |
| 270015 | 11477 |
| 270136 | 11136 |
| 270137 | 11137 |

| Ref. nr. Ref. No. | Best. nr. Part. No |
|----------------------|-----------------------|
| 270138 | 11138 |
| 270471 | 11471 |
| 270906 | 11906 |
| 270907 | 11907 |
| 270908 | 11908 |
| 271051 | 11051 |
| 271052 | 11105 |
| 271053 | 11053 |
| 271054 | 11022 |
| 271055 | 11023 |
| 271056 | 11024 |
| 271063 | 11063 |
| 271064 | 11064 |
| 271065 | 11106 |
| 271066 | 11025 |
| 271067 | 11026 |
| 271068 | 11027 |
| 271214 | 11214 |
| 271215 | 11215 |
| 271216 | 11216 |
| 271217 | 11019 |
| 271218 | 11020 |
| 271219 | 11021 |
| 271236 | 11236 |
| 271237 | 11237 |
| 271238 | 11238 |
| 271473 | 22141 |
| 271944 | 12944 |
| 272002 | 11202 |
| 272004 | 11200 |
| 272012 | 11203 |
| 272040 | 11040 |
| 272042 | 11042 |
| 272043 | 11043 |
| 272059 | 11059 |
| 273663 | 17663 |
| 275193 | 11193 |
| 275195 | 11195 |

Ref. No. – OBT Part No.

| Ref. nr. Ref. No. | Best. nr. Part. No |
|----------------------|-----------------------|
| 275196 | 11196 |
| 275282 | 11082 |
| 275283 | 11083 |
| 275331 | 11531 |
| 275332 | 11533 |
| 275333 | 11532 |
| 275334 | 11534 |
| 275335 | 11535 |
| 275336 | 11536 |
| 275337 | 11337 |
| 275338 | 11338 |
| 275339 | 11339 |
| 275340 | 11340 |
| 275341 | 11341 |
| 275342 | 11342 |
| 275344 | 11344 |
| 275345 | 11345 |
| 275346 | 11346 |
| 275350 | 30350 |
| 275369 | 11369 |
| 275370 | 11370 |
| 275371 | 11371 |
| 275751 | 11651 |
| 330699 | 15699 |
| 405357 | 12357 |
| 411168 | 15168 |
| 415266 | 12266 |
| 416033 | 15033 |
| 418295 | 11295 |
| 418411 | 15411 |
| 418412 | 15412 |
| 418445 | 15445 |
| 418621 | 11621 |
| 418622 | 11622 |
| 418737 | 12737 |
| 418771 | 15771 |
| 418990 | 13990 |
| 419292 | 12292 |

| Ref. nr. Ref. No. | Best. nr. Part. No |
|----------------------|-----------------------|
| 419310 | 13009 |
| 419368 | 12368 |
| 419643 | 12643 |
| 419652 | 12652 |
| 419653 | 12653 |
| 419678 | 13100 |
| 419734 | 12734 |
| 419735 | 12005 |
| 419763 | 13763 |
| 419805 | 14805 |
| 420641 | 14641 |
| 421158 | 14158 |
| 422130 | 15130 |
| 423135 | 14974 |
| 430017 | 15017 |
| 430018 | 15018 |
| 430020 | 15020 |
| 430039 | 13039 |
| 430134 | 11134 |
| 430172 | 15172 |
| 461511 | 12004 |
| 461677 | 14677 |
| 463075 | 12307 |
| 463092 | 11092 |
| 463377 | 12377 |
| 463391 | 17391 |
| 463395 | 12395 |
| 463416 | 11416 |
| 463526 | 12526 |
| 463546 | 12546 |
| 463547 | 12547 |
| 463548 | 12548 |
| 463549 | 12549 |
| 463550 | 12550 |
| 463551 | 12551 |
| 463552 | 12552 |
| 463553 | 12553 |
| 463554 | 12554 |

| Ref. nr. Ref. No. | Best. nr. Part. No |
|----------------------|-----------------------|
| 463555 | 12555 |
| 463556 | 12556 |
| 463557 | 12557 |
| 463558 | 12558 |
| 463559 | 12559 |
| 463560 | 12560 |
| 463561 | 12561 |
| 463562 | 12562 |
| 463563 | 12563 |
| 463564 | 12564 |
| 463565 | 12565 |
| 463566 | 12566 |
| 463567 | 12567 |
| 463568 | 12568 |
| 463569 | 12569 |
| 463570 | 12570 |
| 463739 | 12739 |
| 463902 | 11902 |
| 463903 | 11903 |
| 463904 | 11904 |
| 463905 | 11905 |
| 466634 | 14634 |
| 469482 | 14482 |
| 469483 | 14483 |
| 469846 | 11846 |
| 471034 | 14034 |
| 471956 | 11385 |
| 653190 | 19106 |
| 682694 | 19107 |
| 802551 | 15551 |
| 803068 | 13068 |
| 803356 | 11356 |
| 803359 | 11359 |
| 803360 | 12360 |
| 803371 | 12371 |
| 803730 | 15730 |
| 803762 | 22062 |
| 804190 | 19190 |

Ref. No. – OBT Part No.

| Ref. nr. Ref. No. | Best. nr. Part. No |
|----------------------|-----------------------|
| 804209 | 19209 |
| 804261 | 19061 |
| 804262 | 19062 |
| 804344 | 19344 |
| 804693 | 15693 |
| 804695 | 15695 |
| 804697 | 15697 |
| 804912 | 15912 |
| 806215 | 15215 |
| 806341 | 16341 |
| 806661 | 19661 |
| 807036 | 15036 |
| 807078 | 18078 |
| 807294 | 13024 |
| 808007 | 15007 |
| 808275 | 15275 |
| 809444 | 15444 |
| 812994 | 15094 |
| 813934 | 19934 |
| 813967 | 19967 |
| 814030 | 19030 |
| 814165 | 19165 |
| 814168 | 19168 |
| 814301 | 19301 |
| 814332 | 19332 |
| 814356 | 19356 |
| 814359 | 19359 |
| 814396 | 19396 |
| 814419 | 19419 |
| 817629 | 15629 |
| 817825 | 15825 |
| 817938 | 15938 |
| 818262 | 11262 |
| 818407 | 17407 |
| 818684 | 15864 |
| 819959 | 15959 |
| 823661 | 15661 |
| 824532 | 16532 |

| Ref. nr. Ref. No. | Best. nr. Part. No |
|----------------------|-----------------------|
| 825600 | 16600 |
| 825728 | 15728 |
| 825973 | 17973 |
| 826013 | 15003 |
| 826241 | 15009 |
| 826244 | 15244 |
| 826493 | 17493 |
| 826601 | 15601 |
| 826765 | 19065 |
| 827014 | 15014 |
| 827247 | 15247 |
| 827250 | 15250 |
| 828020 | 17020 |
| 828140 | 19140 |
| 828424 | 15424 |
| 829207 | 18207 |
| 829254 | 11254 |
| 829433 | 15433 |
| 829487 | 11487 |
| 829587 | 18587 |
| 829592 | 15592 |
| 829620 | 12020 |
| 829714 | 14360 |
| 829714 | 15714 |
| 829895 | 15895 |
| 829909 | 17909 |
| 829913 | 17913 |
| 829972 | 15972 |
| 829974 | 15974 |
| 829989 | 15989 |
| 830483 | 19483 |
| 831009 | 15109 |
| 831075 | 19175 |
| 831129 | 17129 |
| 831178 | 15178 |
| 831181 | 15181 |
| 831617 | 15617 |
| 831622 | 15622 |

| Ref. nr. Ref. No. | Best. nr. Part. No |
|----------------------|-----------------------|
| 831891 | 15891 |
| 831892 | 15892 |
| 831960 | 15960 |
| 831986 | 12986 |
| 832191 | 19191 |
| 832534 | 19034 |
| 832570 | 19570 |
| 832598 | 19598 |
| 832669 | 19669 |
| 832675 | 19075 |
| 832820 | 22080 |
| 832831 | 19831 |
| 832846 | 19846 |
| 832965 | 19965 |
| 833044 | 12044 |
| 833188 | 12188 |
| 833274 | 13274 |
| 833323 | 17323 |
| 833417 | 15417 |
| 833568 | 14568 |
| 833759 | 12759 |
| 833760 | 12760 |
| 833780 | 13780 |
| 833781 | 13781 |
| 833855 | 14855 |
| 833878 | 15878 |
| 833913 | 19913 |
| 833915 | 19915 |
| 833950 | 22050 |
| 833991 | 15001 |
| 833994 | 15994 |
| 833996 | 15996 |
| 834211 | 19211 |
| 834337 | 14337 |
| 834452 | 17173 |
| 834476 | 15476 |
| 834545 | 18545 |
| 834546 | 18546 |

Ref. No. – OBT Part No.

| Ref. nr. Ref. No. | Best. nr. Part. No |
|----------------------|-----------------------|
| 834751 | 16751 |
| 834975 | 18975 |
| 835304 | 18304 |
| 835308 | 18308 |
| 835417 | 15006 |
| 835440 | 14440 |
| 835508 | 15508 |
| 835511 | 15007 |
| 835581 | 15581 |
| 835702 | 18702 |
| 835704 | 18704 |
| 835705 | 18705 |
| 835779 | 14779 |
| 835874 | 15874 |
| 835998 | 18998 |
| 836169 | 15169 |
| 838013 | 15013 |
| 838059 | 12059 |
| 838062 | 12002 |
| 838066 | 13066 |
| 838074 | 14074 |
| 838287 | 17287 |
| 838637 | 12637 |
| 838638 | 12638 |
| 838652 | 13652 |
| 838653 | 13653 |
| 838654 | 13654 |
| 838766 | 15766 |
| 838807 | 14807 |
| 838855 | 18855 |
| 838864 | 16864 |
| 838928 | 15928 |
| 838929 | 19929 |
| 838942 | 15133 |
| 838979 | 15979 |
| 839195 | 19195 |
| 839253 | 19253 |
| 839423 | 19423 |

| Ref. nr. Ref. No. | Best. nr. Part. No |
|----------------------|-----------------------|
| 839534 | 19534 |
| 840075 | 11075 |
| 840115 | 13115 |
| 840384 | 15997 |
| 840385 | 15385 |
| 840387 | 15387 |
| 840442 | 13442 |
| 840446 | 12446 |
| 840569 | 13569 |
| 840597 | 17597 |
| 840648 | 14005 |
| 840773 | 15773 |
| 840785 | 15693 |
| 840795 | 15795 |
| 840821 | 18821 |
| 840879 | 14879 |
| 840902 | 16902 |
| 840944 | 16944 |
| 841063 | 15304 |
| 841149 | 15149 |
| 841161 | 17161 |
| 841243 | 18243 |
| 841244 | 18244 |
| 841262 | 18262 |
| 841262 | 18560 |
| 841263 | 18263 |
| 841293 | 17292 |
| 841293 | 17293 |
| 841610 | 15610 |
| 841642 | 15642 |
| 841693 | 15093 |
| 841750 | 14750 |
| 841892 | 19092 |
| 841894 | 19189 |
| 841896 | 19896 |
| 841926 | 18926 |
| 842597 | 15597 |
| 842695 | 15095 |

| Ref. nr. Ref. No. | Best. nr. Part. No |
|----------------------|-----------------------|
| 842913 | 15913 |
| 842986 | 16086 |
| 845261 | 16261 |
| 845354 | 15354 |
| 845615 | 15615 |
| 846111 | 15111 |
| 847605 | 18605 |
| 849170 | 22144 |
| 850888 | 19888 |
| 850889 | 19889 |
| 851287 | 19287 |
| 851407 | 19407 |
| 851756 | 19756 |
| 851757 | 19757 |
| 852018 | 19018 |
| 852632 | 19632 |
| 852835 | 19835 |
| 852868 | 19015 |
| 853255 | 19255 |
| 853542 | 19542 |
| 853548 | 19548 |
| 853670 | 19253 |
| 853868 | 19868 |
| 853871 | 19871 |
| 853885 | 19885 |
| 853886 | 19886 |
| 853894 | 19894 |
| 853898 | 19898 |
| 853935 | 20935 |
| 853941 | 19941 |
| 853945 | 19945 |
| 854031 | 19766 |
| 854045 | 19785 |
| 854047 | 19261 |
| 854300 | 19300 |
| 854541 | 19541 |
| 855387 | 16387 |
| 855389 | 19389 |

Ref. No. – OBT Part No.

| Ref. nr. Ref. No. | Best. nr. Part. No |
|----------------------|-----------------------|
| 855405 | 15405 |
| 855423 | 15423 |
| 855506 | 12506 |
| 855507 | 12507 |
| 855513 | 16513 |
| 855578 | 15578 |
| 855582 | 15582 |
| 855617 | 19617 |
| 855686 | 17686 |
| 855728 | 15028 |
| 855901 | 15901 |
| 855967 | 16967 |
| 856004 | 15004 |
| 856028 | 16028 |
| 856034 | 16034 |
| 856036 | 16036 |
| 856037 | 15037 |
| 856040 | 17040 |
| 856041 | 160441 |
| 856042 | 16042 |
| 856044 | 16633 |
| 856470 | 17803 |
| 856513 | 15952 |
| 856883 | 16804 |
| 856891 | 16384 |
| 856894 | 16894 |
| 857037 | 16037 |
| 857618 | 16039 |
| 857621 | 13783 |
| 858065 | 15883 |
| 858068 | 17068 |
| 858202 | 17306 |
| 858205 | 17205 |
| 858358 | 17358 |
| 858467 | 15467 |
| 858481 | 16481 |
| 858488 | 17488 |
| 858570 | 14570 |

| Ref. nr. Ref. No. | Best. nr. Part. No |
|----------------------|-----------------------|
| 858986 | 15986 |
| 859002 | 16900 |
| 859004 | 16943 |
| 859010 | 15590 |
| 859011 | 16901 |
| 859015 | 16374 |
| 859027 | 15027 |
| 859031 | 14031 |
| 859034 | 17034 |
| 859035 | 14035 |
| 859036 | 14036 |
| 859039 | 11039 |
| 859042 | 13042 |
| 859043 | 13043 |
| 859044 | 13044 |
| 859045 | 17045 |
| 859047 | 15047 |
| 859048 | 12048 |
| 859053 | 12053 |
| 859061 | 15061 |
| 859062 | 12062 |
| 859066 | 12066 |
| 859067 | 12067 |
| 859081 | 14730 |
| 859082 | 14731 |
| 859084 | 15689 |
| 859085 | 16690 |
| 859086 | 14086 |
| 859088 | 11088 |
| 859089 | 12009 |
| 859090 | 13090 |
| 859091 | 16091 |
| 859093 | 13093 |
| 859094 | 13094 |
| 859103 | 15352 |
| 859104 | 15055 |
| 859105 | 15408 |
| 859107 | 16107 |

| Ref. nr. Ref. No. | Best. nr. Part. No |
|----------------------|-----------------------|
| 859112 | 16112 |
| 859114 | 16027 |
| 859115 | 11005 |
| 859119 | 15804 |
| 859120 | 13399 |
| 859122 | 12122 |
| 859130 | 17130 |
| 859131 | 15131 |
| 859134 | 13127 |
| 859135 | 13376 |
| 859137 | 13453 |
| 859138 | 13497 |
| 859139 | 17139 |
| 859140 | 16140 |
| 859141 | 12141 |
| 859142 | 17142 |
| 859143 | 17143 |
| 859144 | 16844 |
| 859145 | 16098 |
| 859146 | 17146 |
| 859147 | 12278 |
| 859148 | 13498 |
| 859149 | 17149 |
| 859150 | 13150 |
| 859151 | 13070 |
| 859152 | 13531 |
| 859154 | 13238 |
| 859155 | 13155 |
| 859157 | 14157 |
| 859159 | 11159 |
| 859171 | 12171 |
| 859181 | 12181 |
| 859186 | 12186 |
| 859187 | 12187 |
| 859189 | 14189 |
| 859194 | 16194 |
| 859196 | 15196 |
| 859215 | 15880 |

Ref. No. – OBT Part No.

| Ref. nr. Ref. No. | Best. nr. Part. No |
|----------------------|-----------------------|
| 859216 | 15179 |
| 859225 | 13025 |
| 859647 | 13647 |
| 859659 | 12659 |
| 859660 | 12660 |
| 859671 | 11671 |
| 859684 | 11684 |
| 859685 | 14685 |
| 859698 | 17698 |
| 859718 | 11718 |
| 859732 | 14732 |
| 859735 | 14735 |
| 859747 | 14747 |
| 859780 | 15978 |
| 859782 | 17782 |
| 859785 | 16785 |
| 859801 | 16901 |
| 859811 | 15598 |
| 859825 | 15982 |
| 859829 | 16829 |
| 859834 | 16834 |
| 859835 | 16835 |
| 859843 | 17843 |
| 859963 | 16963 |
| 860105 | 16105 |
| 860127 | 15127 |
| 860177 | 17177 |
| 860340 | 17461 |
| 860791 | 17791 |
| 860921 | 11038 |
| 861014 | 17101 |
| 861211 | 11919 |
| 861250 | 14250 |
| 861251 | 14251 |
| 861255 | 17255 |
| 861289 | 16289 |
| 861414 | 16414 |
| 861473 | 14473 |

| Ref. nr. Ref. No. | Best. nr. Part. No |
|----------------------|-----------------------|
| 861476 | 14476 |
| 861477 | 17477 |
| 861551 | 15134 |
| 861582 | 15158 |
| 861860 | 12860 |
| 861897 | 13897 |
| 862293 | 17648 |
| 862711 | 14711 |
| 864723 | 11472 |
| 870690 | 18690 |
| 872139 | 19139 |
| 872290 | 19195 |
| 872531 | 19675 |
| 872755 | 19096 |
| 873094 | 19755 |
| 873108 | 19979 |
| 873395 | 19395 |
| 875129 | 19392 |
| 875177 | 19177 |
| 875271 | 11271 |
| 875302 | 11302 |
| 875303 | 11303 |
| 875304 | 11304 |
| 875305 | 11305 |
| 875306 | 11306 |
| 875307 | 11307 |
| 875308 | 11308 |
| 875330 | 11330 |
| 875331 | 11331 |
| 875332 | 11332 |
| 875333 | 11333 |
| 875334 | 11334 |
| 875335 | 11335 |
| 875336 | 11336 |
| 875363 | 18363 |
| 875383 | 15383 |
| 875387 | 21387 |
| 875404 | 18404 |

| Ref. nr. Ref. No. | Best. nr. Part. No |
|----------------------|-----------------------|
| 875422 | 21422 |
| 875439 | 21439 |
| 875478 | 11478 |
| 875479 | 11479 |
| 875498 | 11498 |
| 875499 | 11499 |
| 875532 | 18532 |
| 875538 | 11538 |
| 875539 | 11539 |
| 875540 | 11540 |
| 875550 | 11550 |
| 875551 | 11551 |
| 875560 | 11560 |
| 875571 | 18571 |
| 875574 | 15574 |
| 875575 | 15575 |
| 875579 | 11579 |
| 875580 | 15580 |
| 875583 | 15583 |
| 875584 | 15584 |
| 875651 | 11651 |
| 875698 | 15698 |
| 875722 | 30722 |
| 875738 | 15738 |
| 875741 | 19741 |
| 875756 | 15756 |
| 875757 | 21757 |
| 875759 | 22136 |
| 875769 | 15769 |
| 875769 | 22137 |
| 875780 | 15780 |
| 875783 | 15783 |
| 875785 | 15785 |
| 875791 | 15791 |
| 875796 | 15796 |
| 875805 | 19805 |
| 875809 | 19809 |
| 875810 | 19810 |

Ref. No. – OBT Part No.

| Ref. nr. Ref. No. | Best. nr. Part. No |
|----------------------|-----------------------|
| 875812 | 19812 |
| 875815 | 19815 |
| 875821 | 19821 |
| 875822 | 19822 |
| 875827 | 19827 |
| 876054 | 21054 |
| 876069 | 14069 |
| 876081 | 15574 |
| 876097 | 15097 |
| 876103 | 21103 |
| 876120 | 15120 |
| 876144 | 16673 |
| 876161 | 11161 |
| 876185 | 17185 |
| 876224 | 22011 |
| 876227 | 22069 |
| 876266 | 19036 |
| 876266 | 19266 |
| 876267 | 19267 |
| 876278 | 19278 |
| 876286 | 19983 |
| 876294 | 19294 |
| 876300 | 21300 |
| 876301 | 21301 |
| 876302 | 21302 |
| 876303 | 21303 |
| 876304 | 21304 |
| 876305 | 15305 |
| 876306 | 21306 |
| 876307 | 21307 |
| 876308 | 21308 |
| 876309 | 21309 |
| 876310 | 21310 |
| 876314 | 21314 |
| 876335 | 21335 |
| 876341 | 21561 |
| 876342 | 21400 |
| 876348 | 21418 |

| Ref. nr. Ref. No. | Best. nr. Part. No |
|----------------------|-----------------------|
| 876349 | 21349 |
| 876356 | 21401 |
| 876357 | 21357 |
| 876358 | 21569 |
| 876359 | 21359 |
| 876361 | 21361 |
| 876376 | 21553 |
| 876377 | 21500 |
| 876378 | 21378 |
| 876379 | 21379 |
| 876380 | 21572 |
| 876381 | 21381 |
| 876382 | 21382 |
| 876383 | 21383 |
| 876384 | 21384 |
| 876388 | 21388 |
| 876389 | 21389 |
| 876391 | 19720 |
| 876392 | 19392 |
| 876392 | 19399 |
| 876393 | 21423 |
| 876394 | 21394 |
| 876397 | 19591 |
| 876398 | 22139 |
| 876416 | 21416 |
| 876417 | 21417 |
| 876427 | 21427 |
| 876430 | 21430 |
| 876431 | 21431 |
| 876433 | 21433 |
| 876448 | 21023 |
| 876554 | 17065 |
| 876633 | 19828 |
| 876638 | 19638 |
| 876774 | 21362 |
| 877349 | 15784 |
| 877355 | 15779 |
| 877415 | 16415 |

| Ref. nr. Ref. No. | Best. nr. Part. No |
|----------------------|-----------------------|
| 877419 | 21800 |
| 877765 | 17162 |
| 897315 | 19315 |
| 897327 | 12327 |
| 897426 | 19426 |
| 897631 | 19848 |
| 897682 | 19682 |
| 897726 | 19726 |
| 897873 | 19873 |
| 907023 | 19023 |
| 907024 | 19024 |
| 907025 | 19025 |
| 907132 | 14132 |
| 907135 | 14626 |
| 907881 | 19268 |
| 914446 | 15446 |
| 925027 | 15502 |
| 925052 | 17052 |
| 925053 | 13053 |
| 925054 | 19054 |
| 925055 | 19055 |
| 925056 | 17056 |
| 925057 | 15057 |
| 925063 | 19063 |
| 925065 | 11065 |
| 925068 | 15068 |
| 925069 | 15069 |
| 925092 | 15092 |
| 925093 | 19093 |
| 925094 | 19094 |
| 925095 | 19095 |
| 925096 | 15096 |
| 925255 | 15255 |
| 925256 | 19256 |
| 925257 | 19257 |
| 925258 | 19258 |
| 925259 | 19259 |
| 925260 | 19260 |

Ref. No. – OBT Part No.

| Ref. nr. Ref. No. | Best. nr. Part. No |
|----------------------|-----------------------|
| 925261 | 19201 |
| 925262 | 19262 |
| 925263 | 19263 |
| 940116 | 16116 |
| 940186 | 16186 |
| 940191 | 19091 |
| 940203 | 19203 |
| 941338 | 19338 |
| 941438 | 17024 |
| 941670 | 19670 |
| 941816 | 19816 |
| 941820 | 19020 |
| 941873 | 19073 |
| 941906 | 16906 |
| 941907 | 16907 |
| 942268 | 16268 |
| 942336 | 16336 |
| 942547 | 16047 |
| 942598 | 19098 |
| 942615 | 19615 |
| 943177 | 11177 |
| 943218 | 19218 |
| 943414 | 13414 |
| 943455 | 12455 |
| 943821 | 11821 |
| 944181 | 11181 |
| 944441 | 12441 |
| 945221 | 13221 |
| 945352 | 19352 |
| 945653 | 14653 |
| 946242 | 19242 |
| 946282 | 11282 |
| 946608 | 15608 |
| 946742 | 11742 |
| 946743 | 11743 |
| 946847 | 19047 |
| 947061 | 14061 |
| 947084 | 12084 |

| Ref. nr. Ref. No. | Best. nr. Part. No |
|----------------------|-----------------------|
| 947114 | 14114 |
| 947281 | 16281 |
| 947282 | 15282 |
| 947542 | 16542 |
| 947622 | 16622 |
| 947624 | 14840 |
| 947626 | 14626 |
| 947627 | 14627 |
| 947789 | 11789 |
| 947893 | 15893 |
| 947894 | 15894 |
| 947904 | 19904 |
| 948187 | 14001 |
| 948188 | 19188 |
| 948616 | 19616 |
| 948646 | 11646 |
| 948882 | 11882 |
| 948981 | 15981 |
| 949187 | 14087 |
| 949329 | 11329 |
| 949656 | 15656 |
| 949657 | 15657 |
| 949658 | 15658 |
| 949659 | 15659 |
| 949721 | 15721 |
| 949722 | 15066 |
| 949823 | 19823 |
| 949918 | 15918 |
| 949962 | 19962 |
| 950046 | 16046 |
| 951957 | 15957 |
| 951959 | 15059 |
| 952980 | 16980 |
| 952986 | 16986 |
| 955244 | 15044 |
| 955271 | 16271 |
| 955293 | 16293 |
| 955310 | 16310 |

| Ref. nr. Ref. No. | Best. nr. Part. No |
|----------------------|-----------------------|
| 955535 | 16535 |
| 955547 | 16547 |
| 955826 | 16826 |
| 955850 | 19850 |
| 955974 | 19974 |
| 955975 | 14975 |
| 955976 | 15976 |
| 955977 | 14977 |
| 955980 | 11980 |
| 955981 | 17981 |
| 955982 | 11742 |
| 955983 | 15983 |
| 955986 | 13986 |
| 955989 | 19989 |
| 955990 | 12090 |
| 955995 | 15995 |
| 955998 | 15998 |
| 956590 | 19590 |
| 956591 | 19021 |
| 957161 | 13181 |
| 957170 | 17170 |
| 957171 | 17171 |
| 957175 | 17175 |
| 957177 | 17176 |
| 957177 | 17176 |
| 957183 | 11183 |
| 957184 | 14184 |
| 957191 | 13191 |
| 957193 | 14193 |
| 958227 | 15227 |
| 958807 | 19807 |
| 958838 | 19838 |
| 958856 | 19856 |
| 958859 | 19014 |
| 958860 | 19860 |
| 958866 | 19866 |
| 958973 | 19973 |
| 959793 | 16793 |

Ref. No. – OBT Part No.

| Ref. nr. Ref. No. | Best. nr. Part. No |
|----------------------|-----------------------|
| 959794 | 16794 |
| 960173 | 12173 |
| 960183 | 15183 |
| 960238 | 19238 |
| 961673 | 19673 |
| 963554 | 15554 |
| 963677 | 19677 |
| 963695 | 19695 |
| 963699 | 19699 |
| 964106 | 15106 |
| 966382 | 18382 |
| 966385 | 18385 |
| 966387 | 18387 |
| 966694 | 18548 |
| 966698 | 18698 |
| 966700 | 18700 |
| 966707 | 18707 |
| 966808 | 19808 |
| 966871 | 15871 |
| 966891 | 18805 |
| 966900 | 18900 |
| 966903 | 18003 |
| 966906 | 18906 |
| 966907 | 18283 |
| 966931 | 18931 |
| 966933 | 18327 |
| 966938 | 18330 |
| 966942 | 18942 |
| 966978 | 18978 |
| 966981 | 18981 |
| 966990 | 18990 |
| 967590 | 11590 |
| 967591 | 14591 |
| 967592 | 11592 |
| 967944 | 16679 |
| 968555 | 15555 |
| 968927 | 15067 |
| 968955 | 11955 |

| Ref. nr. Ref. No. | Best. nr. Part. No |
|----------------------|-----------------------|
| 968971 | 15971 |
| 969071 | 19071 |
| 969073 | 19022 |
| 969198 | 12198 |
| 969330 | 15330 |
| 969331 | 15331 |
| 973080 | 16308 |
| 975672 | 15091 |
| 976489 | 18383 |
| 976492 | 18843 |
| 977313 | 19313 |
| 978510 | 18310 |
| 978515 | 18311 |
| 978750 | 18498 |
| 978961 | 17138 |
| 979254 | 19090 |
| 980936 | 11385 |
| 1140639 | 17109 |
| 1218630 | 12513 |
| 1218674 | 12003 |
| 1218706 | 14706 |
| 1219946 | 14946 |
| 1275379 | 11096 |
| 1276425 | 12425 |
| 1306169 | 18169 |
| 1306341 | 13341 |
| 1306630 | 12630 |
| 1317761 | 13416 |
| 1317792 | 12792 |
| 1317793 | 12793 |
| 1324750 | 18750 |
| 1326239 | 13416 |
| 1336255 | 15625 |
| 1336763 | 12006 |
| 1336767 | 12767 |
| 1346144 | 14144 |
| 1346442 | 12442 |
| 1378491 | 15045 |

| Ref. nr. Ref. No. | Best. nr. Part. No |
|----------------------|-----------------------|
| 1378492 | 11492 |
| 1378493 | 12493 |
| 1378645 | 13645 |
| 1378646 | 13646 |
| 1378851 | 13051 |
| 1378853 | 13052 |
| 1378854 | 16854 |
| 1378864 | 14864 |
| 1378870 | 12870 |
| 1378879 | 16879 |
| 1378905 | 17905 |
| 1378906 | 15906 |
| 1378909 | 13909 |
| 1378911 | 16911 |
| 1378913 | 16913 |
| 1378914 | 14914 |
| 1378960 | 12960 |
| 1378979 | 12979 |
| 1526189 | 15189 |
| 1542052 | 11052 |
| 1542123 | 16123 |
| 1542157 | 17157 |
| 1542158 | 17158 |
| 1542159 | 17159 |
| 1542198 | 15198 |
| 1542287 | 13287 |
| 1542303 | 17303 |
| 1542318 | 11318 |
| 1542389 | 12389 |
| 1542472 | 12472 |
| 1544119 | 13119 |
| 1664473 | 19254 |
| 1695000 | 17000 |
| 1695001 | 17001 |
| 3501530 | 17530 |
| 3514296 | 13296 |
| 3514432 | 12432 |
| 3517857 | 14057 |

Ref. No. – OBT Part No.

| Ref. nr. Ref. No. | Best. nr. Part. No |
|----------------------|-----------------------|
| 3517893 | 12893 |
| 3580100 | 80100 |
| 3580305 | 12305 |
| 3580306 | 12306 |
| 3580309 | 13309 |
| 3580316 | 15504 |
| 3580317 | 13317 |
| 3580365 | 15263 |
| 3580495 | 13495 |
| 3580496 | 13496 |
| 3580818 | 14081 |
| 3580849 | 15849 |
| 3581078 | 17201 |
| 3581093 | 15358 |
| 3581621 | 14621 |
| 3582358 | 17535 |
| 3582432 | 13993 |
| 3582513 | 12251 |
| 3582563 | 22138 |
| 3582587 | 21453 |
| 3582595 | 22135 |
| 3582596 | 21395 |
| 3582609 | 12603 |
| 3582676 | 16111 |
| 3583786 | 13742 |
| 3583787 | 21104 |
| 3584202 | 13202 |
| 3586494 | 15807 |
| 3586765 | 19985 |
| 3587508 | 15509 |
| 3588434 | 21804 |
| 3588746 | 19746 |
| 3589322 | 21801 |
| 3593659 | 15808 |
| 3809167 | 13136 |
| 3809167 | 13749 |
| 3817033 | 30033 |
| 3825027 | 17027 |

| Ref. nr. Ref. No. | Best. nr. Part. No |
|----------------------|-----------------------|
| 3827069 | 14390 |
| 3831424 | 15269 |
| 3831425 | 15787 |
| 3831426 | 15788 |
| 3840335 | 17874 |
| 3840816 | 15261 |
| 3841481 | 19127 |
| 3841697 | 15593 |
| 3848222 | 14222 |
| 3850426 | 19069 |
| 3850559 | 14559 |
| 3850810 | 17810 |
| 3850852 | 19949 |
| 3852352 | 19097 |
| 3852390 | 19059 |
| 3852390 | 19819 |
| 3852602 | 19548 |
| 3852603 | 19603 |
| 3852851 | 11971 |
| 3853159 | 12465 |
| 3853796 | 15853 |
| 3853801 | 18845 |
| 3853815 | 18070 |
| 3853850 | 15850 |
| 3854001 | 18400 |
| 3854130 | 19130 |
| 3854161 | 18161 |
| 3854249 | 19500 |
| 3854260 | 18260 |
| 3854286 | 15512 |
| 3854293 | 15508 |
| 3854311 | 18431 |
| 3854331 | 18331 |
| 3854548 | 18454 |
| 3854549 | 18549 |
| 3855409 | 13010 |
| 3855411 | 19411 |
| 3855745 | 19745 |

| Ref. nr. Ref. No. | Best. nr. Part. No |
|----------------------|-----------------------|
| 3855991 | 15991 |
| 3856834 | 19892 |
| 3857166 | 18001 |
| 3857176 | 19019 |
| 3857650 | 17650 |
| 3857794 | 15857 |
| 3858261 | 17261 |
| 3858340 | 13340 |
| 3858399 | 19499 |
| 3860232 | 19619 |
| 3860697 | 19917 |
| 3860703 | 15952 |
| 3862567 | 15811 |
| 3875400 | 17400 |
| 3877075 | 12075 |
| 3883845 | 21802 |
| 6643249 | 17249 |
| 6842160 | 11160 |
| 6842273 | 12273 |
| 8149182 | 15266 |
| 9139282 | 13623 |
| 9139284 | 13008 |
| 21165389 | 90028 |
| 21165390 | 90029 |
| 21213660 | 15811 |
| 21228429 | 90051 |
| 21371111 | 21805 |
| 21371112 | 21803 |
| 21430184 | 15660 |
| 21492771 | 17987 |
| 30650525 | 90525 |
| 30731261 | 90261 |
| 30731262 | 90262 |
| 30731263 | 90263 |
| 30731264 | 90524 |
| 43213002 | 15102 |
| 43213003 | 15108 |
| 43957300 | 15300 |

Ref. No. – OBT Part No.

| Ref. nr. Ref. No. | Best. nr. Part. No |
|----------------------|-----------------------|
| 43957301 | 15301 |
| 43957302 | 15302 |
| 104500-55710 | 2241 |
| 719171-92602 | 60008 |
| 719173-92600 | 60009 |
| 728170-92600 | 60000 |
| 728171-92601 | 60001 |
| 728271-92605 | 60002 |
| 728374-92605 | 60003 |
| 729171-92600 | 60004 |
| 729270-92601 | 60005 |
| 729470-92605 | 60006 |
| 729573-92605 | 60007 |
| | 11014 |
| | 11609 |
| | 12010 |
| | 12011 |
| | 12045 |
| | 12046 |
| | 12100 |
| | 12101 |
| | 12102 |
| | 12311 |
| | 12460 |
| | 12470 |
| | 12475 |
| | 12480 |
| | 12485 |
| | 12490 |
| | 12495 |
| | 12500 |
| | 13393 |
| | 13750 |
| | 13751 |
| | 13752 |
| | 15350 |
| | 15351 |
| | 15353 |

| Ref. nr. Ref. No. | Best. nr. Part. No |
|----------------------|-----------------------|
| | 15356 |
| | 15357 |
| | 15637 |
| | 15932 |
| | 15934 |
| | 15935 |
| | 15999 |
| | 16001 |
| | 16007 |
| | 16008 |
| | 16010 |
| | 16011 |
| | 17002 |
| | 17003 |
| | 17004 |
| | 17005 |
| | 17017 |
| | 17307 |
| | 19026 |
| | 19029 |
| | 19031 |
| | 19033 |
| | 19035 |
| | 19037 |
| | 21358 |
| | 21760 |
| | 21761 |
| | 21762 |
| | 21763 |
| | 21764 |
| | 21765 |
| | 21766 |
| | 22001 |
| | 22002 |
| | 22003 |
| | 22004 |
| | 22005 |
| | 22006 |

| Ref. nr. Ref. No. | Best. nr. Part. No |
|----------------------|-----------------------|
| | 22007 |
| | 22008 |
| | 22009 |
| | 22010 |
| | 22012 |
| | 22013 |
| | 22014 |
| | 22015 |
| | 22016 |
| | 22017 |
| | 22018 |
| | 22019 |
| | 22020 |
| | 22021 |
| | 22022 |
| | 22023 |
| | 22024 |
| | 22025 |
| | 22026 |
| | 22027 |
| | 22028 |
| | 22029 |
| | 22030 |
| | 22031 |
| | 22032 |
| | 22033 |
| | 22034 |
| | 22035 |
| | 22036 |
| | 22037 |
| | 22038 |
| | 22039 |
| | 22040 |
| | 22041 |
| | 22042 |
| | 22043 |
| | 22044 |
| | 22045 |

Ref. No. – OBT Part No.

| Ref. nr. Ref. No. | Best. nr. Part. No |
|----------------------|-----------------------|
| | 22046 |
| | 22047 |
| | 22048 |
| | 22049 |
| | 22051 |
| | 22052 |
| | 22053 |
| | 22054 |
| | 22055 |
| | 22056 |
| | 22057 |
| | 22058 |
| | 22059 |
| | 22060 |
| | 22061 |
| | 22063 |
| | 22064 |
| | 22065 |
| | 22066 |
| | 22067 |
| | 22068 |
| | 22070 |
| | 22071 |
| | 22072 |
| | 22073 |
| | 22074 |
| | 22075 |
| | 22076 |
| | 22077 |
| | 22079 |
| | 22081 |
| | 22082 |
| | 22083 |
| | 22084 |
| | 22085 |
| | 22086 |
| | 22087 |
| | 22088 |

| Ref. nr. Ref. No. | Best. nr. Part. No |
|----------------------|-----------------------|
| | 22089 |
| | 22090 |
| | 22091 |
| | 22094 |
| | 22095 |
| | 22096 |
| | 22097 |
| | 22098 |
| | 22099 |
| | 22100 |
| | 22101 |
| | 22102 |
| | 22103 |
| | 22104 |
| | 22105 |
| | 22106 |
| | 22107 |
| | 22108 |
| | 22109 |
| | 22110 |
| | 22111 |
| | 22113 |
| | 22114 |
| | 22115 |
| | 22116 |
| | 22117 |
| | 22118 |
| | 22119 |
| | 22120 |
| | 22121 |
| | 22122 |
| | 22123 |
| | 22124 |
| | 22125 |
| | 22126 |
| | 22127 |
| | 22128 |
| | 22129 |

| Ref. nr. Ref. No. | Best. nr. Part. No |
|----------------------|-----------------------|
| | 22130 |
| | 22131 |
| | 22132 |
| | 22133 |
| | 22134 |
| | 22140 |
| | 22142 |
| | 22143 |
| | 22145 |
| | 22146 |
| | 22147 |
| | 22148 |
| | 22149 |
| | 22150 |
| | 22151 |
| | 22152 |
| | 22154 |
| | 22155 |
| | 22156 |