

**TWO  
STUNNING DISCS**

The best-selling Acorn magazine in the world

# ACORN USER

Essential for all users of 32-bit RISC OS computers

## FAST PHOTO FUN FOUR DIGITAL CAMERAS COMPARED



**JUNE 1997 ACORN USER Cover Disc 1**  
**Apocalypse**  
 Play the first 3D arcade game for RISC OS machines  
 CHECKED • VIRUS CHECKED • VIRUS CHECKED • VIRUS CHECKED • VIRUS CHE

**JUNE 1997 ACORN USER Cover Disc 2**  
**Digital Landscapes**  
 • Hard disc backup to ZIP drives  
 • Year 2000 correction for BBC Master  
 • Latest 3D software from our series  
 • Plotting sprites in windows, Run the Risc on frequency analysis and all the 'INFO' programs  
 • Plus more extras for you to use  
 CHECKED • VIRUS CHECKED • VIRUS CHECKED • VIRUS CHECKED • VIRUS CHE

Plus reviews of:

- StrongARM + ARM600/700 = ARMSwitcher
- Game creation with GAMES SUITE
- SPECIAL FEATURES & all the regulars

June 1997 Issue 182 £3.75  
 IDG MEDIA  
 9 770263 745093  
 06

F A S T E R . . .  
F A S T E R  
&  
F A S T E R



£99 + VAT (£116.32 inc.)  
Site Licence  
£440 + VAT (£517 inc.)

IMPRESSION



£129 + VAT (£151.57 inc.)  
Site Licence  
£440 + VAT (£517 inc.)

IMPRESSION



£229 + VAT (£269.07 inc.)  
Impression Publisher Plus  
for Publisher owners  
£99 + VAT (£116.32 inc.)

IMPRESSION



£79 + VAT (£92.82 inc.)  
Site Licence  
£350 + VAT (£411.25 inc.)

# StrongARM™

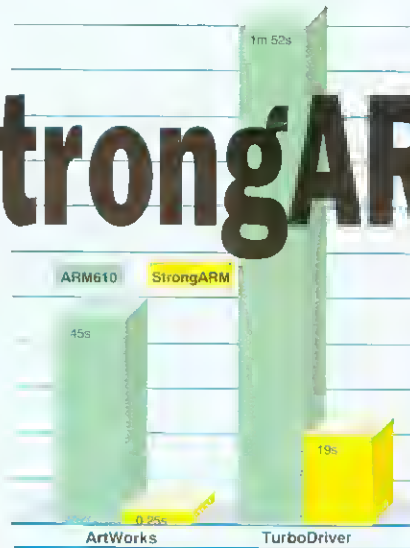

Computer Concepts has produced 'go-fast' StrongARM upgrades for all of their major software and hardware products.

#### Upgrades:

from ArtWorks no dongle £22.32 inc  
from ArtWorks with dongle £27.02 inc

from Publisher no dongle £22.32 inc  
from Publisher with dongle £27.02 inc

Publisher Plus £27.02 inc  
Style £22.32 inc

TurboDrivers, LaserDirect, Spoolers, MacFS, MacFS Light, Compression, Movie Magic, Wacom drivers: £11.75 inc each

Some upgrades are available for free download from our www site <http://www.cconcepts.co.uk>

For information on other CC software and hardware call sales and ask for our Product Guide or check out our web site.



## Computer Concepts Ltd

Gaddesden Place  
Hemel Hempstead, Herts HP2 6EX  
Tel 01442 351000 • Fax 01442 351010  
<http://www.cconcepts.co.uk>



£49 + VAT (£57.57 inc.)



## NETWORK SPOOLER

FOR TURBODRIVERS & LASERDIRECT  
£149 + VAT (£175.07 inc.)



FOR ACORN RISC COMPUTERS

MacFS  
£99 + VAT (£116.32 inc.)  
MacFS Light  
£49 + VAT (£57.57 inc.)



£29 + VAT (£34.07 inc.)

E&OE  
StrongARM is a trademark of Acorn Risc Technologies.

**StrongARM Graph above shows:**  
Speed comparisons between a 166MHz StrongARM and a 33MHz ARM610 Risc PC.  
On the left: Time taken for ArtWorks to redraw the well known mini illustration.  
On the right: Time taken for TurboDriver to print a 2.2Mb file



### • regulars

- 5 News**  
All the latest happenings in the Acorn world
- 13 Graphics**  
New Acorn driver imminent
- 15 Comms**  
Hands-on at Bansyeo BBS
- 16 Public Domain**  
Special feature on PD programming tools
- 19 PC page**  
Software for young learners

**Managing Editor** Pam Turnbull  
**Editor** Steve Turnbull  
**Assistant Editor** Karen Peach  
**Art Editor** Stuart Cripps  
**Sub Editor** Alan McLachlan

#### Contributors

Dave Acton, Ian Burley, Mike Buckingham, Mike Cook, David Dade, Jack Kreindler, Dave Lawrence, Rob Miller, Steve Mumford, Graham Nelson, Geoff Preston, Jill Regan, Colin Rouse, Greg Scott, Stephen Scott, Mike Tomkinson, Stuart Tyrrell, Paul Wheatley

**Group Advertisement Manager**  
Elaine Prescott

**Account Manager** Ian Antrobus  
**Account Executive** Carl Jackson  
**Ad Production** Barbara Newall  
**Ad Typesetting** Eddie Burke

**Marketing Manager** Steve Tagger  
**Marketing Assistant** Jane Comber  
**Database Development Manager**  
Victoria Quinn-Harkin

**Production Manager** Alan Capper  
**Circulation Director** David Wren  
**Distribution** COMAG (01895) 444055  
**Subscriptions & Back Issues**  
Database Direct 0151-357 1275

**Email:** database@dbdirect.demon.co.uk  
**Managing Director** Ian Bloomfield  
**Cover** Stuart Cripps

Member of the Audit Bureau of Circulation  
 Acorn User is an independent publication and Acorn is not responsible for any of the articles in this issue or for any of the opinions expressed



Published by IDG Media Ltd,  
 Media House, Adlington Park, Macclesfield SK10 4NP  
 e-mail: aueditor@idg.co.uk  
<http://www.idg.co.uk/acornuser/>  
 Tel: (01625) 878888 Fax: (01625) 850652  
 Printed by Apple Web Offset, Warrington

13 issue subscription rate: £39.99 (UK),  
 £53.99 (EU), £68.99 (World)

©1997 IDG Media Ltd.

No material may be reproduced in whole or in part without written permission. While every care is taken, the publishers cannot be held legally responsible for any errors in articles, listings or advertisements and the views of contributors do not necessarily reflect the views of the publishers

**21 Music & Audio**  
Our new bi-monthly page

**23 Cover disc**  
Play Apocalypse, the 3D arcade game. There's also lots of exciting extras on disc two

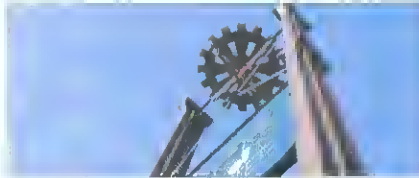

**55 Game Show**  
Quake on the Acorn? Find out more

**72 Back issues**  
A chance to buy any copies of AU that you've missed

**72 Free ads**  
Our free service to help you buy and sell your Acorn goodies

**80 Letters**  
Air your views on the pages of AU

**82 The Regan Files**  
AU talks to Rachele Smith of Spacetech

### • hands on

**62 Rambles through Acorn Wood**  
Your technical questions answered

**65 \*INFO**  
More programs, hints, tips and graphical offerings

**73 Follow the humming**  
Plotting an audio frequency response

**77 C for yourself**  
Introducing the ColourTrans module

### • education

**47 Editorial**  
A page of educational snippets

**49 Type it right**  
Two ways to help the young with keyboard skills

**49 Switch to HotSpots**  
Software access for switch users

**50 A varied time-table**  
Take a look at a variety of educational software

## Advertisers index

See page 45 for details

### Subscribe now

Fantastic new subscription offers  
 See page 78 for more details

**53 Breakaway with fun**  
Inspiration for the reluctant mathematician

### • reviews

**38 Snap happy**  
Photo fun – four digital cameras compared



**43 Multiple personalities**  
How to switch between StrongARM and earlier processors

**59 Amnesia and Grasshopper**  
Two suites for writing action games reviewed

### • features

**27 Pitfalls on platforms**  
An Acorn users experiences in a multi-format environment

**30 Reverse pressure**  
A case study of a business that uses Acorn computers

**33 Acorn virtuality part 3**  
The graphics pick up pace in the next stage of creating a 3D game

### Free ads

To pick up a bargain  
 look on this month's cover disc

The Acorn User **website**

Check it out at:

<http://www.idg.co.uk/acornuser/>

Next month in **Acorn User**

We test out the new A7000 plus review the awaited TopModel 2 package. There's all the regulars and much, much more

**Next issue** on sale 12 June 1997

# spring sale!

WHILE STOCKS LAST

## bargain games

Herndat	Amiga	14.10	£12
HeroQuest	Amiga	10.55	£9
Quest for Gold	Amiga	5.95	£5
Speedball II	Amiga	10.55	£9
<b>ALL FOUR AS ABOVE</b>		<b>23.50</b>	<b>£20</b>
<b>ANY THREE OF THE ABOVE</b>		<b>17.65</b>	<b>£15</b>
Alone in the Dark	Amiga	17.65	£15
Birds of War (not Risc PC)	Amiga	23.50	£20
Break 147 & Superpool (not Risc PC)	Amiga	19.25	£17
Burn 'Out	Amiga	17.65	£15
Champions Compilation	Amiga	10.55	£9
Crystal Maze FD, age 7+	Amiga	12.55	£11
Cyber Chess	Amiga	19.25	£17
Dune II FD	Amiga	29.10	£20
Fire & Ice	Amiga	14.10	£12
Knsalis Collection	Amiga	10.55	£9
Oh Not More Lemmings	Amiga	4.75	£4
Real McCoy 4	Amiga	19.25	£17
Real McCoy 5	Amiga	19.25	£17
Revelation	Amiga	4.75	£4
Saloon Cars Deluxe	Amiga	19.25	£17
Sim City 2000 for A5000	Amiga	19.25	£17
Simon the Sorcerer CD	Amiga	30.25	£30
Simon the Sorcerer FD	Amiga	30.55	£26
Star Fighter 3000	Amiga	17.65	£15
Stunt Racer 2000 (not Risc PC)	Amiga	19.25	£17
Tanks	Amiga	18.50	£16

## network computer

NC Ethernet (10baseT)	Amiga	32.55	£449
NC Modem (28.8 kbps)	Amiga	32.55	£449

## strongarm risc pc

4Mb 1.0Gb SA 14" Monitor	Amiga	1250.08	£1149
4Mb 1.0Gb SA 17" Monitor	Amiga	1292.58	£1149
4Mb 1.0Gb 8x CD SA 14" Monitor	Amiga	1409.83	£1199
4Mb 1.0Gb 8x CD SA 17" Monitor	Amiga	1791.30	£1499
10Mb 1.0Gb SA 14" Monitor	Amiga	1543.83	£1399
10Mb 1.0Gb SA 17" Monitor	Amiga	1586.33	£1699
10Mb 1.0Gb 8x CD SA 14" Monitor	Amiga	1697.83	£1445
10Mb 1.0Gb 8x CD SA 17" Monitor	Amiga	2055.08	£1749

## now you can trade in your old Beeb!

PRICES WITH TRADE-IN ALLOWANCE (CALL US FOR FULL DETAILS)

4Mb 1.0Gb SA	Amiga	219.82	£799
4Mb 1.0Gb SA 14" Monitor	Amiga	1175.83	£999
4Mb 1.0Gb SA 17" Monitor	Amiga	1326.35	£1299
4Mb 1.0Gb 8x CD SA	Amiga	297.56	£849
4Mb 1.0Gb 8x CD SA 14" Monitor	Amiga	1292.58	£1049
4Mb 1.0Gb 8x CD SA 17" Monitor	Amiga	1585.08	£1349
10Mb 1.0Gb SA	Amiga	1232.58	£1049
10Mb 1.0Gb SA 14" Monitor	Amiga	1487.58	£1249
10Mb 1.0Gb SA 17" Monitor	Amiga	1820.08	£1549
10Mb 1.0Gb 8x CD SA	Amiga	1291.33	£1099
10Mb 1.0Gb 8x CD SA 14" Monitor	Amiga	1525.33	£1299
10Mb 1.0Gb 8x CD SA 17" Monitor	Amiga	1878.33	£1599

## education

10 Out of 10, various titles	Amiga	17.75	£10
Amazing Maths, KS 4	Amiga	22.33	£19
Arctecture I - The Romans, age 10+	Amiga	27.03	£23
Arctecture II - The Egyptians, age 10+	Amiga	27.03	£23
Arctecture III - The Vikings, age 10+	Amiga	27.03	£23
Arctecture IV - The Anglo Saxons, age 10+	Amiga	27.03	£23
Batsr, KS 2	Amiga	27.03	£23
Bodywise FD, age 10+	Amiga	34.08	£29
Breakaway Maths, age 10+	Amiga	17.58	£14
Castle of Dreams, age 10+	Amiga	19.98	£17
Crystal Rain Forest FD, KS 4	Amiga	35.43	£31
Eureka (Angla), KS 4	Amiga	35.43	£31
Guardians of the Greenwood, KS 1	Amiga	44.18	£38
Kingfisher Childrens Micromedia, KS 1	Amiga	44.18	£38
Mission Control - Crystal Rain Forest 2 FD, age 10+	Amiga	41.18	£35
Science Series 3: Electricity and Magnetism, Primary, age 7+	Amiga	35.03	£47
Talking Textease	Amiga	64.93	£55
Tizzy's Toybox FD, age 4	Amiga	36.43	£31

## ide products

IDE HD 170 Mb Kit for A3000 Series	Amiga	161.59	£129
IDE HD 170 Mb Kit + User Port for A3000 Series	Amiga	167.45	£134
IDE HD 400 Mb Kit for A3000 Series	Amiga	182.12	£155
IDE HD 540 Mb Kit for A3000 Series	Amiga	188.89	£169

## huge reductions!

IDE HD 170 Mb + CD 8-speed Kit for A3000 Series	Amiga	381.33	£329
IDE HD 400 Mb + CD 8-speed Kit for A3000 Series	Amiga	391.89	£325
IDE HD 540 Mb + CD 8-speed Kit for A3000 Series	Amiga	401.85	£342
IDE HD 1.2 Gb Kit for Archimedes	Amiga	252.63	£215
IDE HD 1.6 Gb Kit for Archimedes	Amiga	264.39	£225
IDE HD 2.0 Gb Kit for Archimedes	Amiga	280.83	£239
IDE 2 1/2" Hard Disc, 170 Mb	Amiga	89.15	£75
IDE 2 1/2" Hard Disc, 400 Mb	Amiga	116.33	£99
IDE 2 1/2" Hard Disc, 540 Mb	Amiga	139.83	£119
IDE 3 1/2" Hard Disc, 1.2 Gb	Amiga	166.83	£159
IDE 3 1/2" Hard Disc, 1.6 Gb	Amiga	198.88	£169
IDE 3 1/2" Hard Disc, 2.0 Gb	Amiga	217.38	£185
IDE CD 8-speed Kit for A3000 Series	Amiga	303.80	£199
IDE CD 8-speed Kit for Archimedes	Amiga	243.70	£207
IDE CD 8-speed Kit for Risc PC	Amiga	155.10	£132
IDE CD 8-speed Kit + HDFS for A3000 Series	Amiga	249.75	£210
IDE CD 8-speed Kit + HDFS for Risc PC	Amiga	160.03	£143
IDE CD 8-speed Upgrade for A3000 Series with ICS IDE	Amiga	199.50	£169
IDE CD Drive 8-speed	Amiga	104.56	£89
IDE CD Interface for A3000 Series	Amiga	80.43	£71
IDE CD Interface for Archimedes	Amiga	69.75	£58
IDE CD Interface for Risc PC	Amiga	64.63	£55
IDE CD + HD Interface for Risc PC	Amiga	77.55	£66
IDE HD Interface for A3000 Series	Amiga	88.13	£75
IDE HD Interface for Archimedes	Amiga	64.83	£55
IDE HD Interface for Risc PC	Amiga	64.63	£55
IDE HD Interface + User Port for A3000 Series	Amiga	92.83	£79
CD External Case with PSU	Amiga	85.79	£73
CD or Second Hard Disc Fitting Kit for Risc PC	Amiga	11.75	£10
Hard Disc Filling Kit for Risc PC 5 1/4" bay	Amiga	30.50	£20

## give-aways

Advantage, KS 2	Amiga	34.08	£29
Albert's House	Amiga	34.08	£29
Anagram Genius	Amiga	9.40	£8
Animator	Amiga	11.63	£11
Apollonius PDT	Amiga	11.63	£9
Arcturus	Amiga	18.60	£16
AudioWorks	Amiga	26.20	£24
Axis	Amiga	14.10	£12
Atlets, age 8+	Amiga	29.38	£25
Big Bang	Amiga	6.23	£7
Billiole Old Art Collections	Amiga	15.28	£13
CardShop	Amiga	14.10	£12
Casio Camera QV-10A with Connection Kit	Amiga	340.63	£295
CDTracker	Amiga	6.23	£7
Celebration	Amiga	22.39	£19
Christmas Allsorts	Amiga	10.58	£9
Classcardz for Risc	Amiga	14.10	£12
Classcardz for Wordz	Amiga	14.10	£12
Craftshop 1	Amiga	10.58	£9
Craftshop 2	Amiga	10.58	£9
DataGraph, KS 1	Amiga	19.08	£17
DeskEdit 4	Amiga	27.53	£19
Desktop Folio, KS 4	Amiga	29.38	£25
Digital Symphony	Amiga	45.83	£39
DMI 3D	Amiga	92.83	£79
Earthwarp, KS 2	Amiga	22.39	£19
Eldoscope, KS 2	Amiga	116.33	£99
Eye for Spelling, KS 2	Amiga	22.39	£19
Find It!	Amiga	29.38	£25
Fun School 4 - 7-11 Years, KS 2	Amiga	15.28	£13
Hard Disc Companion 2	Amiga	38.79	£33
Help 3, age 7+	Amiga	4.70	£4
Home Accounts	Amiga	22.39	£19
Hutchinson Encyclopedia 1996 CD for PC	Amiga	29.38	£25
Illusionist	Amiga	31.73	£27
InterTalk	Amiga	57.58	£49
Landmarks - Elizabeth I, KS 1	Amiga	14.10	£12
Landmarks - The Aztecs, KS 1	Amiga	22.39	£19
Landmarks - The Civil War, KS 1	Amiga	17.63	£15
Logic Mania	Amiga	22.39	£19
Magc Maths	Amiga	24.69	£21
Monotype Fonts (Pack 1)	Amiga	69.33	£59
Number Tiles, KS 1	Amiga	18.45	£14
Numbertime, KS 1	Amiga	22.39	£19
Oxford Reading Tree Stage 2 Talking Stories FD, age 5+	Amiga	29.38	£25
Oxford Reading Tree Stage 3 Story Books, age 5+	Amiga	6.00	£6
Oxford Talking Infant Atlas CD, KS 1	Amiga	17.63	£15
Oxford Talking Infant Atlas FD, KS 1	Amiga	17.63	£15
Photobase Decades, The Victorians	Amiga	45.83	£39
Photobase: Science	Amiga	45.83	£39
PhotoTouch	Amiga	64.63	£55
PhotoView	Amiga	34.08	£29
Plantwise FD, age 10+	Amiga	34.08	£29
PrimeMover, KS 2	Amiga	22.39	£19
PublishArt Release 2, Artworks format	Amiga	22.39	£19
PublishArt Release 2, Draw format	Amiga	22.39	£19
SolidsRENDER	Amiga	41.13	£35
Spooler (Clare) for Amiga	Amiga	9.40	£8
Studio24 - Studio24Pro	Amiga	116.33	£99
Temite Internet	Amiga	176.83	£165
ThinkSheet	Amiga	34.08	£29
Time Traveller - Tudor and Stuart Times	Amiga	14.10	£12
Resource Pack, KS 2	Amiga	21.13	£18
Time Traveller - The Victorians, KS 1	Amiga	64.63	£55
Tiler	Amiga	11.63	£9
TV Tuner with Teletext	Amiga	34.08	£29
Viewpoints, KS 2	Amiga	29.38	£25
Zig Zag - The Anglo Saxons, KS 1	Amiga	29.38	£25
Zig Zag - The Romans, KS 1	Amiga	29.38	£25

## dabs guides

1st Word Plus	Amiga	4.00	£4
ArtWorks Made Easy	Amiga	4.00	£4
Budget DTP	Amiga	4.00	£4
C Guide	Amiga	4.00	£4
Graphics on the ARM Machines	Amiga	4.00	£4
Impression	Amiga	4.00	£4



## other lines

Acorn Companion	Amiga	11.00	£11
ANT Internet Suite Release II	Amiga	104.59	£89
ArcFax 1.2b 11	Amiga	32.90	£28
ArcFS 2	Amiga	21.15	£18
ArtWorks CD	Amiga	88.13	£75
ArtWorks FD	Amiga	88.13	£75
Big Picture	Amiga	64.63	£55
Bitolio 7 CD	Amiga	48.18	£41
CADEt, KS 1	Amiga	41.13	£35
Composition, KS 1	Amiga	69.33	£59
Dazzle!	Amiga	47.50	£36
Drifter	Amiga	32.90	£28
EasyClip	Amiga	28.20	£24
Eureka 3, KS 2	Amiga	81.08	£69
Font Directory 2	Amiga	41.13	£35
Hutchinson Multimedia Encyclopedia (shrink-wrapped)	Amiga	24.88	£21
ImageMaster, age 10+	Amiga	26.20	£22
Impression Style	Amiga	81.38	£69
Junior Sibelius, KS 2	Amiga	32.69	£45
Music Studio 32	Amiga	32.69	£65
Ovation Pro	Amiga	103.30	£139
PC Pro	Amiga	44.65	£38
Personal Accounts V3	Amiga	34.08	£29
Photodesk v2	Amiga	243.83	£199
Photodesk v2 Light	Amiga	176.33	£99
Prophet 3	Amiga	139.83	£119
Sibelius 6, KS 2	Amiga	163.33	£139
Sound Byte Recorder	Amiga	48.18	£41
Textease Version 2	Amiga	50.55	£43
Topographer	Amiga	57.58	£49
TurboDriver Canon	Amiga	45.83	£39
TurboDriver Epson Stylus 800	Amiga	45.83	£39
TurboDriver HP	Amiga	45.83	£39
Understanding Energy, KS 1	Amiga	45.83	£39
Understanding the Body, KS 1	Amiga	36.43	£31

## how to order

Carriage is free within mainland UK if you pay on ordering. Cheques should be made payable to Ian Copestake Limited. You may also pay by credit card or debit card. We make no charge for this on most products and take no payment until goods are despatched. We need your address as known to the card issuer, the card number and expiry date, and the valid from date and issue number if any.

If you leave an order on our answering machine please include your telephone number, your card details as above and your indication of the total payment due.

Official orders are welcome from UK educational and government institutions (invoices are due for payment within 14 days and are subject to damage and late payment charges).

Prices including VAT are shown in italics, followed by the price excluding VAT eg £175.00/£150.00. Zero-rated items are marked V0. Please pay the amount including VAT unless you are a VAT-registered EC customer outside the UK, in which case please quote your international VAT number. Ours is GB 995 7245 84.

Overseas carriage: If you are paying by credit card we will add airmail and insurance at cost. Otherwise please add £6 (Europe) or at least £12 (elsewhere) to cover software item and send a pounds sterling bank draft payable at a London clearing bank or Eurocheques for not more than £100 each.

All products, prices and specifications are offered in good faith and are subject to availability and change without notice. Spec art offers apply only while stocks last. Goods are guaranteed but we do not supply them on approval. Returns (in original packaging) and cancellations can only be accepted by prior agreement and there may be a charge to cover the costs involved.

## ICS THIS WAY

for 3000 Acorn products and prices now with SHORT LIST SECTIONS for FAST DOWNLOAD! Visit the ICS web site for up-to-the-minute prices and special offers not shown here: <http://www.ianco.co.uk>



Authorised Acorn Dealer and Developer  
Cheques payable to Ian Copestake Limited please

Dept U704, 1 Kington road  
WIRRAL, Merseyside, England  
L48 5ET

Tel: 0151-625 1006 Fax: 0151-625 1007

sales@ianco.co.uk

<http://www.ianco.co.uk>





## Acorn reveals new A7000

The two-year-old Acorn A7000 entry-level RISC OS computer is to be replaced at the end of May by a considerably updated model, called the A7000+.

Externally similar to the old A7000, the new version has a completely new processor, the ARM 7500E and more efficient EDO memory. The processor alone should deliver an approximate 50 per cent performance improvement as it is clocked 50 per cent faster than the old machine at 48MHz.

The E1 version of the 7500 chip includes hardware floating point, so programs dependent on intensive floating point

calculations like ray tracers and some CAD applications, among others, will show a large gain in performance. Among applications of this type which benefit will be Java applications, so Acorn's new *RISCafé* Java virtual machine should run well on the A7000+.

RISC OS 3.71 ships with the A7000+ in 4 megabytes of page mode ROM and there is 8 megabytes of EDO RAM on the motherboard as standard, which can be expanded to a maximum of 128 megabytes via a single on-board expansion socket. The faster 7500 processor and more efficient EDO

RAM enables higher bandwidth video performance, which means bigger and more colourful screen modes. 1024x768 pixels in 256 colours is now available or 800x600 in 32,000 colours. 1280x1024 is also possible using 16 colours.

Other specification changes include a 1.2Gb hard disc instead of the old model's 540Mb model and the optional CD-ROM is now an 8x performer instead of 4x.

At press time Acorn had not yet finalised prices, but the hint is that the new A7000+ will be priced similarly to the outgoing A7000.

## Down at the RISCafé

Comdex Japan last month was the venue for Acorn to unveil two major enhancements to its Network Computer product strategy; a Java virtual machine called *RISCafé* and X Windows compatibility through an enhancement to the RISC OS-based NCOS operating system called eXtend.

*RISCafé* is an important development because it confirms Acorn's commitment to fully supporting Java, something it has not been able to demonstrate practically until now. The eXtend feature is important because it enables users of Acorn NCs to run Microsoft Windows applications hosted by suitably configured Windows NT servers. It's thought that eXtend, which is ROM-based, makes the Acorn NC the first Oracle-compliant Network Computer (NC) to feature integral X Windows compatibility.

Acorn's implementation of eXtend X Windows compatibility on its NC answers one criticism that it is not able to run Windows applications. Granted, you need a fairly powerful Windows NT server to run these applications, but it's now perfectly possible. The ability to run X-compliant Unix applications is an added bonus.

*RISCafé* is a much-needed development, signalling that the Acorn NC will be fully Java compliant. Although a Java interpreter was present in earlier Acorn NC versions it was a relatively simple affair and Acorn NC demos largely involved running familiar RISC OS applications. *RISCafé* changes all that. Acorn's *RISCafé* Java Virtual Machine is based

on the Java 1.0.2 JDK (Java Developers Kit). This release of *RISCafé* does not yet feature a JIT (just in time) compiler, but Acorn has already begun work on its Java 1.1 JDK implementation and intends to release a JIT compiler which will further improve Java performance.

Commenting on the new technologies Mark Phillips, marketing manager for Acorn Risc Technologies, a division of the Acorn Computer Group said: "Devices which are able to offer high functionality at a low cost are always likely to be popular. Using these new technologies, Acorn is able to offer a high performance operating system together with access to Java and Microsoft Windows separately or in the same device. These devices will consume little power and will require a very low memory footprint. Several manufacturers have already declared an intention to use this technology."

He added: "We have always said that PCs and NCs would co-exist - it is clear that there are many applications that do not require a PC and we are demonstrating that customers can buy NCs with confidence that they can continue to run and manage familiar applications. The benefits of Network Computers and support for established applications need not be mutually exclusive".

There are grounds for optimism that *RISCafé* and even eXtend will eventually be made available by Acorn for general use by non-NC Acorn users.

## Acorn@heart

We've had 'Intel Inside' and 'Arm Powered' and now Acorn is getting in on the act with "Acorn@heart". Kevin Coleman, head of corporate affairs at Acorn, commented, "Acorn is working on a new logo and strap line to be used by third parties who license our technology. Acorn have come up with a concept that third

parties have agreed to use on their products." This is likely to be the slogan Acorn@heart. There are indications that Acorn partners in the UK, USA and Japan will be using this slogan in logo form on products and packaging in the next few months. We will bring you the logo design once it is finalised.

## The death of the Pocket Book?

The signs are that Acorn will not continue its long association with Psion, through the badge-engineering of the Psion Series 3 as the Acorn Pocket Book. Nobody is suggesting the Pocket Book has been unsuccessful, but now that Xemplar is handling Acorn's education business, there is less incentive to promote the Psion as an Acorn branded product. The new Series 3c model will not now be branded as a Pocket Book, either. Instead it's likely Xemplar will choose to sell Psion-branded Series 3s.

## WimpBasic version 1.03

Clares *WimpBasic*, the easy-to-use WIMP programming environment, has been updated slightly. The new version 1.03 includes bug fixes, corrections to the manual and extra tutorials. Registered users can claim a free upgrade which can be downloaded from the *WimpBasic* Web site at [www.treknet.is/wb/](http://www.treknet.is/wb/)

Clares Micro Supplies

Tel: (01606) 48511

Fax: (01606) 48512

e-mail [sales@clares.demon.co.uk](mailto:sales@clares.demon.co.uk)

or check out [www.stcoll.ac.uk/clares/](http://www.stcoll.ac.uk/clares/)

## ARM buys into mass storage company

ARM Ltd has taken a 45 per cent stake in Palmchip, a US company specialising in mass storage device design consultancy. Palmchip uses ARM CPU cores in its highly integrated electronic controllers for a variety of storage peripherals. Through the use of ARM technology, Palmchip controllers need only a single processor compared with more expensive dual-processor designs from competitors.

"We believe ARM-based mass storage solutions are ultimately the most cost-effective and offer the quickest path to market, and our investment in Palmchip will enable ARM, through its partnership, to prove this," said Robin Saxby, president and CEO of ARM.



## Chris Curry resurfaces

Chris Curry, a co-founder of Acorn, has been associated with a company developing NoCs or Network-Orientated Computers. Alas, the company, DOT Matrix Limited, has no apparent relation with Acorn and its products will use Motorola PowerPC processors. Since leaving Acorn in the mid-1980s, Chris Curry has dabbled in computer networking using mains electricity wiring and an ambitious tele-shopping venture called Keyline, unfortunately without much success.

## Election results

Last month in our election feature we mentioned that students and teachers at 250 schools around the country were being balloted using an automated data capture system from DRS Data & Research Services plc. The overall result returned: Labour 42 per cent, Conservative 21 per cent, Liberal Democrat, 9 per cent, Don't know 24 per cent. The poll was much more extensive than just party choice and if you would like to see the full set of results, check out the DRS Web site at [www.drs.co.uk/election.htm](http://www.drs.co.uk/election.htm)

## HardBack now StrongARM compatible

The Shareware utility, *HardBack*, is now StrongARM compliant according to its creator, Theo Marketto. *HardBack* is a backup system capable of archiving hard discs, optical discs, networks drives etc, to fixed and removable media, including floppies and Zip discs. Features include compression, incremental backups, automatic backups, virtual Filer display for restoring etc.

Registered users can upgrade by filling in the form at: [www.marketto.demon.co.uk/hard-back/html/register/newvvers.htm](http://www.marketto.demon.co.uk/hard-back/html/register/newvvers.htm) *HardBack's* full registration fee is just a tenner, for which you get an enhanced version of the software, complete with a printed manual. Theo can be contacted via e-mail at: [theo@marketto.demon.co.uk](mailto:theo@marketto.demon.co.uk)

# Acorn portable to be shown at Wakefield Spring Show

A surprise attraction at the Wakefield Acorn Spring show, Saturday 17 and Sunday 18 May, will be the much debated new Acorn portable. A prototype of the new portable, which will eventually replace the old Acorn A4, will be demonstrated by Acorn at the show. Chris Cox, Acorn's product sales and marketing manager, confirmed to *Acorn User* that the new machine would be in prototype form but wasn't able to reveal much else.

Our research does suggest, however, that the machine to be unveiled is not the Stork sub-notebook portable developed over a year ago and housed in an Olivetti Echos shell. Acorn appears to be relying far less than it used to on the Olivetti parts bin.

Brendan O'Sullivan, managing director of Xemplar – the education outlet for Acorn computers – has poured cold water on any prospects of Xemplar taking on a new Acorn portable, preferring instead to concentrate on selling Apple PowerBooks. However, it is early days and we believe that Xemplar has not yet been fully

briefed on the new Acorn portable. Xemplar is committed to selling Acorn products if it determines there is an adequate demand from education customers.

The Wakefield show, which was widely praised last year by both organisers and the 2,000 visitors, will also see some other Acorn goodies. The new A7000+ will debut at the show – it will be the first chance to see the new Network Computer RISCafé Java virtual machine plus, eXtend client/server technology. Acorn will also be showing RISC OS applications running on NCs, the latest version of the Acorn Web browser – now supporting frames and tables – will be there, plus a multi-tasking version of Replay.

The Wakefield Acorn Spring show takes place at the Thornes Park Athletics Stadium, Horbury Road, Wakefield. For more information on the show, e-mail [show97@cumbrian.demon.co.uk](mailto:show97@cumbrian.demon.co.uk) or [show97@barc.demon.co.uk](mailto:show97@barc.demon.co.uk). The show Web site is at [www.cyberivillage.co.uk/acorn/wakefield/](http://www.cyberivillage.co.uk/acorn/wakefield/) Alternatively, call Chris Hughes on (01924) 379778 or Mike Wilson on 0113-253 3722.

## Reference design for StrongARM network appliances

Last month we reported that Oracle had demonstrated an Intel-based NC. Oracle's subsidiary tasked with developing and licensing Oracle's NC technologies, NCI (Network Computer Inc.) followed this up by announcing a partnership with a manufacturer planning to make Intel-based NCs. In some quarters this was seen as a damning rejection by Oracle of RISC-based NCs and there was even a report on the Internet which suggested NCI was going to start making Intel-based NCs itself. In fact NCI doesn't make NCs of any description – it licenses NC technology to partner companies, one of whom is our very own Acorn.

'Intel Inside' panic was suitably neutralised by several subsequent announcements, including Acorn's launch of RISCafé and eXtend, plus the announcement that Digital and NCI have jointly developed a Network Appliance Reference Design based around StrongARM. Digital says the StrongARM reference design is aimed at creating a standard for the most powerful, low-cost network computing platform. NCI is contributing its NCI Access software, which provides access to the Web, electronic mail, scheduling, news services and multimedia services.

Peter Kastner, an industry analyst with Aberdeen Group, said, "The reference platform answers four market concerns about network computers: price, performance, power and productivity. The synergy of Digital's StrongARM and NCI's NC system software will be attractive to the many organisations now evaluating network computing."

## Sub-£100 12x CD-ROM drive

Clares Micro Supplies has started supplying Samsung's 12x Hi-Speed CD-ROM drive for Acorn customers. Clares notes that the drive has a sprung suspension system to support the CD, which is essential with CDs spinning at such high speeds and there is a 256K buffer. Dave Clare commented, "Clares' aim is to provide quality products, extensively tested on Acorn equipment by ourselves, with easy-to-follow, Acorn specific fitting instructions, complete with all necessary cables and drivers."

Clares' own tests show that the new drive loads a 3.5Mb file in three seconds, which is slightly more than four times faster than a Cumana 2X drive. Eesox CD Speed check software returns a transfer rate of 1745KB/s against 307KB/s on the double speed drive. Clares ask that you check with them to determine if an optional cable and RISC OS 3.6 is required for your installation before ordering.

Clares Micro Supplies, tel: (01606) 48511, fax: (01606) 48512, e-mail [sales@clares.demon.co.uk](mailto:sales@clares.demon.co.uk) or check out [www.stcoll.ac.uk/clares/](http://www.stcoll.ac.uk/clares/)







## Acorn integrated modular designs finally adopted by PC world

When the Risc PC was launched by Acorn three years ago, its modular stacking expansion design was unique in the personal computer world. Two years before that, Acorn introduced the A3010, A3020 and A4000 series which used ARM's highly integrated 3500 CPU. Only now has the PC industry recognised the value of such advanced designs.

PC clone chip maker, Cyrix, has just introduced the MediaGX processor, an integrated chip which contains the circuitry normally found in separate chips, plus audio functionality and a 586 processor. In fact the GX chip arguably offers less functionality than, say, the new ARM7500FE, but it's a step in the right direction.

NeoSystems, meanwhile, has patented modular hardware architecture, called MDA or Modular Digital Architecture, which completely does away with the conventional system board, integral expansion card slots and matching case. Similarity with the Risc PC's stacking design is in NeoSystems PCs resemblance to micro hi-fi stacking units. A small footprint base unit contains the power supply unit, graphics interface, audio system and basic peripheral interfaces, like

keyboard, mouse and joystick ports. The same base unit could also contain a floppy disc drive, modem, network interface and a hard disc.

On to the top of the base unit are attached so-called FUMs or functional upgrade modules and these are connected together by a Modular Bus system. Modules clip and un-clip in seconds and each module can contain either a conventional PCI expansion card or plug and play ISA card, or a peripheral unit which would normally fit in a 5.25 inch expansion bay, like a CD-ROM or tape backup unit, for example.

Sounds vaguely familiar? In fact, this time the NeoSystems design is a generation or two ahead of the Risc PC, but so it should be since the Risc PC is a three year old product. In fact when we spoke to NeoSystems, they were familiar with the Risc PC, but denied that it influenced their own design. Instead, the NeoSystems PC owes its inspiration to stackable networking hubs. NeoSystems has some good animated demos of its modular PC on its Web site at [www.neosystems.com](http://www.neosystems.com)

## SuperTFT monitor from Microvitec

Your Risc PC looks great, so why not mate it to a great looking space-age monitor as well? Microvitec is the latest monitor manufacturer to introduce a flat-panel active matrix monitor. The Proteus 34X (not to be confused with a Cinnamon CD-ROM drive!) uses a 13.3 inch SuperTFT screen which boasts an extra wide viewing angle of 140 degrees. Unusually, the viewing angle is preserved equally in both vertical and horizontal planes. The 13.3 inch diagonal

dimension of the viewable area on the screen makes its display as large as some 15 inch monitors. The Proteus 34X has an analogue interface, which means it can be connected to any standard VGA port, which Acorn has standardised on for some time now. Sounds like a great product, so what's the catch? £2,595, the recommended price. Ah well, it's bound to get cheaper!

**Microvitec**  
Tel: (01274) 390011



## Argo shares and NCs

At press time, Ian Goodall, Argo Interactive's sales and marketing director informed *AU* that Argo Interactive Group plc's second share offer was going very well, though there was still an opportunity for further new investors to join the Argo club. Argo Interactive Group plc is raising a further £600,000 through the issue of one million shares at 60p each. Last September's initial share offer was quickly subscribed, much of it in response to contact made via the Internet. Part of the Argo group runs the Argonet Internet service which specialises in Internet provision for Acorn platform users.

National press interest saw articles about the company in *The Times*, *Financial Times* and the *Daily Mail*. This generated useful investor interest from outside the Acorn community for the first time, which Goodall described as particularly encouraging.

Part of the interest in Argo is its growing participation in Network Computer developments, which will be helped by funds generated by the share offer. Outside of Acorn, the only public Internet service provider you can yet use an Acorn NC with is Argonet. This is because the service provider needs to be set up to

recognise the NC's smart card identification system. Work done by Argo in this area could eventually be licensed to other service providers.

Goodall also revealed that Argo would be supplying Acorn NCs for use via Argonet imminently, probably priced at £399 + VAT (without monitor). This will make Argo the first supplier of Acorn NCs at the retail level. Meanwhile, Argo Interactive has announced it is participating in the Socrates project, which links five Cambridge schools, plus teachers and parents, over the Internet. The project aims to explore the use of the Internet for extended learning, not just at school but in the home and elsewhere in the community.

**Argo Interactive Ltd**  
Tel: 01243 815 815  
Fax: 01243 815 805  
E-mail: [info@argonet.co.uk](mailto:info@argonet.co.uk)  
WWW: [www.argonet.co.uk](http://www.argonet.co.uk)

### Contacting me

You can contact the news page by writing to me, Ian Burley, at Acorn User, Adlington Park, Macclesfield, Cheshire, SK10 4NP, or by e-mail to [aunews@idg.co.uk](mailto:aunews@idg.co.uk)



## Cable file transfer utility

John Kortink, the prolific producer of Acorn freeware and shareware programs in Holland, has released *ZeriLink 2.20*, a file transfer utility for linking a Risc PC or other RISC OS machine with a ECP parallel port (most recent Acorn models) to another Risc PC or standard PC. 400K/second transfers are possible using *ZeriLink* over a suitably wired parallel port cable. *ZeriLink* is ShareWare and costs 30 guilders.

## ...plus EarthMap update

John Kortink has also updated his freeware *EarthMap* program. *EarthMap* is a computerised globe which works with a huge database containing 5,719,617 line segments, co-ordinates and shapes describing both natural and man-made features on the planet, including coastlines, country borders, rivers, lakes, canals, glaciers, etc.

The revised program now supports all Risc PC screen modes, there is a world wrap display mode, the database files may be cached in memory to speed things up and detail colours can be edited and saved if you have RISC OS 3.50 or later. The *EarthMap* data is available from the Internet or from the CD-ROM supplied with StrongARM cards.

John Kortink can be reached on the Web at: [www.inter.nl.net/users/J.Kortink](http://www.inter.nl.net/users/J.Kortink), or via e-mail: [kortink@inter.nl.net](mailto:kortink@inter.nl.net)

## NC Trivia

NCOS, as we all know, is a version of RISC OS designed specifically for Acorn's NC designs. But did you know that 'Oracle NCOS' is a trademark of the Oracle Corp?

## Xemplar celebrates first birthday

Xemplar Education is one year old. The equal partnership joint venture between Acorn and Apple UK has successfully completed its first year, showing a small profit for the second half of its financial year. Over 50 per cent of students in the UK now use computers sold and supported by Xemplar. Coinciding with its anniversary, Xemplar announced it is to commence a trial of Acorn network computers (NCs) in a number of UK schools, underlining the company's commitment to exploring the boundaries of education IT.



## Acorn World to be research-based

Plans for the 1997 Acorn World exhibition at Wembley will be more influenced by research than any of the previous events. Organisers EPS Limited commissioned extensive questionnaires among visitors and exhibitors at the 1996 show, in order to ascertain the extent to which the show met the expectations of its audience and the developers, manufacturers and service providers who exhibit at Acorn World.

The research revealed that show visitors spent well in excess of £300 each. Many exhibitors regard the show as the high point of their marketing year, transacting a significant part of their annual business during the three days of the event. For many visitors too, the exhibition is their established route to update existing equipment and software. This is particularly true for schools, and a number of respondents said that they visit BEIT in January to try out new systems and programs, persuade their purchasing authorities or increasingly, PTA's, of the need for the purchase during the year, then buy in Autumn at Acorn World, when they can take advantage of promotional discounts and deals.

All who were interviewed confirmed that the event was of strategic interest to them for their personal, educational or



business needs, as well as an entertaining occasion in its own right. This is born out by the total spend at the 1996 show, estimated at nearly £2 million. Such a high level of purchase at computer shows, and certainly compares well

with anything in the Mac or PC world.

Other trends indicate increasing interest among older individuals - average visitor age was 35, and the total child attendance was only 774, regarded by all with previous experience of the show to be considerably less than in previous years. Over 45 per cent of the visitors were mainly interested in education, while home users accounted for 65 per cent, business 31 per cent, publishing 20 per cent and games 17 per cent (the overlap is obviously accounted for by respondents having split areas of interest). The biggest single group (31.5 per cent) of visitors were teachers and lecturers specialising in IT in schools and universities.



- High a con
- 24 h
- Opti man
- Con
- Bui and
- Sell
- 37m
- Sta res (64
- Opti allo
- Tri
- 24 Co
- Ad wil
- Ca fro vid mo
- 1M im
- Re im ar
- So
- Ha tir
- Pac Incl com



# NEW! - Epson Digital Camera

High resolution, 24 bit colour digital camera

- High quality colour digital camera - as easy to use as a conventional 35mm compact.
- 24 bit colour sensor providing 16.7 million colours.
- Optical resolution of 640 x 480 pixels - twice that of many other comparably priced digital cameras.
- Connects to RS232 port - no interface to fit.
- Built-in four way flash - automatic, always, never, and red-eye reduction modes.
- Self-timer, erase last/every picture functions.
- 37mm thread accepts camcorder lenses and filters.
- Standard 2Mb memory stores up to 60 standard resolution (320 x 240) pictures, or 30 high resolution (640 x 480) pictures, or any combination.
- Optional 2Mb and 4Mb memory upgrades, which allow up to 200 pictures to be stored.
- Tripod mounting boss.



Package includes our *Snapshot* application software, allowing you to quickly download pictures and view them as thumbnails. Selected pictures can then be easily saved as either Sprite or JPEG files.

**Introductory price £499**, including carriage and VAT. Includes camera, a set of batteries, serial lead, all necessary software, and manual.

## 24i16 Multimedia Card

Combined 24 bit digitiser and 16 bit sampler

- Advanced 24 bit video digitiser with stereo 16 bit sound sampler.
- Captures brilliant still images from any S-VHS or composite video source, plus superb Replay movies, and hi-fi audio.
- 1Mb framestore captures still images at full PAL resolution, 768 pixels x 576 lines.
- Replay movies (including sound) can be recorded, image size and frame rate are fully adjustable and are limited only by hard disc and system bandwidth.
- Sound sampler records at sample rates up to 48kHz.
- Hardware video scaling and anti-aliasing, plus real-time control of brightness, contrast & saturation.



**Package price £472.94**, including carriage and VAT. Includes expansion card, all necessary software, and comprehensive manual.

## ColourMobile

Motorised 24 bit colour hand scanner

- 24 bit colour scan head providing 16.7 million colours.
- Resolutions from 100 to 400 dpi (interpolated).
- Connects directly to bidirectional parallel port - no interface to fit.
- Works with printers, dongles, and parallel CD-ROM drives.



*"Intuitive and remarkably easy to use... scans are outstandingly sharp with excellent colour accuracy... What more can I say!"* - Archimedes World.

*"Operation is extremely easy... the results were excellent..."* - Acorn Publisher.

*"The detail is impressive... this is a good scanner for schools and home DTP users."* - Acorn User.

**Special price £199**, including carriage and VAT. Includes scanner, interface, all necessary software, and manual.

For the Complete Picture...



**Irlam Instruments Ltd**, Brunel Institute for Bioengineering, Brunel University, Uxbridge, Middlesex, UB8 3PH. Tel/Fax 01895 811401. Email: sales@irlam.co.uk

Please note: All products require RISC OS 3.1 or later, a hard disc, 2Mb RAM minimum (4Mb recommended). Check suitability for your computer before ordering. All hardware products come with a full 1 years guarantee E & OE.

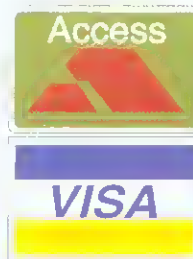



## Art & Mental Health Exhibition dates

Here's an updated list of dates and venues of the exhibition organised by NCET and sponsored by Inclusive Technology. For more details contact Sally McKeon of NCET on (01203) 416994.

- *The Link Cafe, Glasgow*  
19 - 31 May 1997
- *Croydon Central Library*  
2 - 9 June 1997
- *Newcastle Discovery Museum*  
2 - 30 June 1997
- *Coventry Central Library*  
28 July - 2 August 1997
- *St Mary's Hospital, Isle of Wight*  
4 - 15 August
- *Cafe Surf, Birmingham*  
1 - 12 September 1997
- *Education Northern Ireland Kings Hall, Belfast*  
30 Sept - 1 Oct 1997

## Web site dedicated to special needs

Inclusive Technology, supplier of educational IT products for all learners including those with special needs has launched an extensive on-line information service.

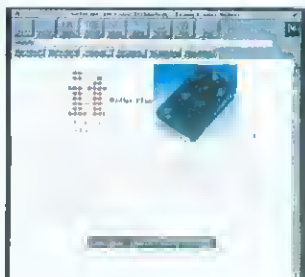

The Web site contains 700 pages of advice and information concerning products and services available for students with learning difficulties and disabilities. Roger Bates, Information Director for Inclusive Technology said, 'We plan to make our site the first place to which people go for Special Educational Needs information'. Check it out at <http://www.inclusive.co.uk>

## My World Resource packs

Inclusive Technology has released new *My World Resource packs* featuring *Story Book 1*. This is a collection of pictures illustrating popular childhood stories, the texts of which are also included. The resource can be used to re-tell traditional stories or create new ones using parts of the originals. The new resource packs are priced from between £19 and £25 (ex VAT).

**Inclusive Technology**  
Tel: 0161-835 3677  
Fax: 0161-835 3688  
E-mail: [trish@inclusive.co](mailto:trish@inclusive.co)



## Exodus - a new Acorn game

*Exodus* is a simulation featuring the conquest and colonisation of a galaxy. Your aim - to fulfil missions, satisfy the Space Guild and become Guild Master - leader of the galaxy. It's the first commercial production by Arlex Software, a new group that intend to specialise in Acorn games.

E-mail: [Duvls@lusect.demon.co.uk](mailto:Duvls@lusect.demon.co.uk)

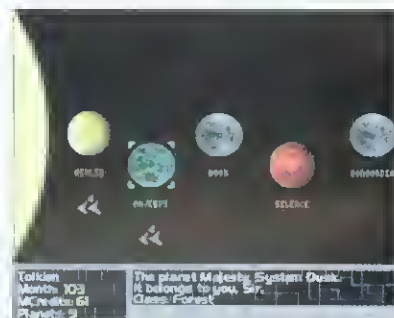

## Acorn NABS the limelight

Acorn's new state-of-the-art set-top box (STB), the STB22, was recently demonstrated at the NAB broadcast technology show in the US. Acorn and partner company Optivision, Inc. demonstrated the STB22 as a solution for cost-effective delivery of high-quality, interactive MPEG video for intranet applications - or local area networks running Internet protocols. Optivision's contribution was its LiveStation MPEG video networking system for intranets, which was demonstrated working with an Oracle Video Server.

"We see video as potentially the most valuable tool for intranets," said Reed Majors, Optivision product line manager. He added, "Our partnership with Acorn opens the door to a whole new range of intranet applications that have important ramifications for the way we

communicate. Businesses for example will see tremendous cost savings as a result of being able to standardise and automate the delivery of training or organisational news in the form of video over intranets."

"Acorn and Optivision are both highly committed to the advancement of interactive television," said Simon Wyatt, Director of Acorn Online Media. He continued: "The pairing of our revolutionary new STB22 with Optivision's cutting-edge image and compression technology will result in delivery of high-quality video for intranets."

This is a unique solution that will be imperative for the advancement of communications in everything from home entertainment to mission critical functions in the corporate market."

## Sing along with Sherston

*Nursery Rhyme Time* is the latest multimedia title from Sherston Software for youngsters to learn well-known nursery rhymes. The collection of animated nursery rhymes is available on a triple format CD-ROM for PC, Mac and Acorn machines. A cut-down version is also available on floppy discs.

Research has indicated that nursery rhymes are a valuable early-learning tool, helping children develop phonological awareness which can aid learning to read later. Sherston says its has designed *Nursery Rhyme Time* to foster this phonological awareness. Full-screen animations have been produced by Bevanfield Films in London and the narrator is Jacqueline Tong. Specially arranged music is courtesy of Rob Kirkwood. *Nursery Rhyme Time* is priced £40+ VAT for a single user copy. Site licences are available.

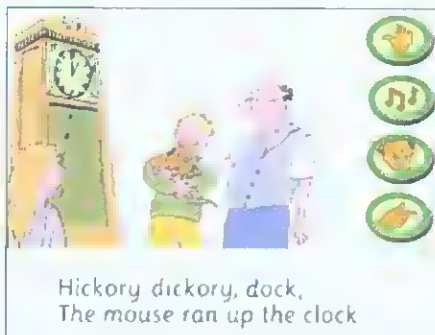

**Sherston Software, tel: (01666) 840433**  
fax: (01666) 840048  
e-mail: [Info@sherston.co.uk](mailto:Info@sherston.co.uk)  
WWW: [www.sherston.com/](http://www.sherston.com/)





## New products upgrades

PRODUCT	NEW FEATURES/PRODUCT DETAILS	PRICE	CONTACT
WebSpider	<ul style="list-style-type: none"> <li>• First interactive, visual editor of HTML on the Acorn RISC OS platform</li> </ul>	Introductory offer price £40 (full price £50)	Dalriada Data Technology Tel: (01926) 492459
EasyPage	<ul style="list-style-type: none"> <li>• Simple 'desktop publisher' for children from the age of five upwards</li> </ul>	£49.95 for three computer licence, £79.95 for full site licence	Porters Primary Software Tel: 0114-258 2878
Eureka - An Encyclopaedia of Discoveries & Inventions CD-ROM	<ul style="list-style-type: none"> <li>• Contains over 600 discoveries and inventions that changed our world</li> <li>• Text and images can be transferred to students' own presentations</li> <li>• Range of activity sheets</li> </ul>	£40 ex VAT	Anglia Multimedia Tel: (01603) 615151
PublishArt Release 3	<ul style="list-style-type: none"> <li>• New designs and categories</li> <li>• A total of 2790 line art designs</li> <li>• Available on CD-ROM</li> </ul>	£39.95. Upgrade from earlier releases costs £19.95. Prices are fully inclusive	Smart DTP Tel: (01332) 842803
Mr Clippy	<ul style="list-style-type: none"> <li>• Clip-art manager for RISC OS</li> <li>• Handles vectors and hitmap</li> <li>• Exports files as JPEGs</li> <li>• Supports many standard file formats</li> </ul>	£20 plus £1.50 p&p	iSV Products Tel: (01344) 55769
King Arthur - Legends of Saxon Conquest & Medieval Chivalry CD-ROM	<ul style="list-style-type: none"> <li>• Quests to discover Arthurian tales and ideals</li> <li>• Section on the Saxons</li> <li>• Over 200 places are covered with pictorial, text and literary resources attached</li> </ul>	£49.95 (excl. carriage & VAT)	CSH Tel: (01487) 741223 E-mail: cshsoft@compuserve.com
Recycler	<ul style="list-style-type: none"> <li>• Captures deleted files and stores them in the 'bin' • Manually empty or set to auto empty • Prevents deletion of files/directories • Compacts deleted files</li> </ul>	£29.95 (+£1.50 p&p)	Fabis Computing Tel: (01283) 552761 E-mail: info@fabis.demon.co.uk
FontNamer	<ul style="list-style-type: none"> <li>• Rename an entire font family</li> <li>• Doesn't affect kerning data</li> <li>• Works with RISC OS 2 &amp; RISC OS 3 fonts</li> </ul>	£14.95 (+£1.50 p&p)	Fabis Computing Tel: (01283) 552761 E-mail: info@fabis.demon.co.uk
New extras for Local Studies package	<ul style="list-style-type: none"> <li>• Extended Keys - map symbols arranged as three loadable keys</li> <li>• Symbol Draw - add symbols to existing Keys or draw new keys with specialist symbols</li> </ul>	Extended Keys - £15 (site licence), Symbol Draw (site licence) - Junior/Middle £20, Secondary £30	SoftTeach Tel: (01985) 840329 Fax: (01985) 840334
VirtuaCD	<ul style="list-style-type: none"> <li>• Alternative to multiple CD-ROM drives</li> <li>• Store compressed images off CD-ROMs on HD which can be accessed as if from original</li> </ul>	Basic product costs £44.95 for two virtual CD-ROM drives. Additional drives £14.95 (block of five). Max of 27 drives. A free 30-day evaluation of the product from Web site	PEP Associates 34 Tiverton Way, Cambridge, CB1 3TU WWW: <a href="http://www.pep-assoc.co.uk/virtuacd/">http://www.pep-assoc.co.uk/virtuacd/</a>
Tutorial guide to Impression (updated & republished)	<ul style="list-style-type: none"> <li>• 64 page (A4) tutorial guide</li> <li>• Exercises and examples</li> <li>• Learn to design on the desktop step by step</li> </ul>	£9.95	Order from any bookshop using ISBN number: 1-899820-04-3 or directly from Paragon Publishing, tel: (01604) 83214
Fresco v1.46	<ul style="list-style-type: none"> <li>• Many new features including HTML parser</li> <li>• Many bug fixes</li> <li>• Most crashing problems cured</li> <li>N.B. This version does not include frames support</li> </ul>	Available for download from ANT Internet Suite upgrades page	ANT Ltd Tel: (01223) 567808 E-mail: sales@ant.co.uk WWW: <a href="http://www.ant.co.uk">http://www.ant.co.uk</a>



PHONE ORDERS:  
01728 621222

CASTLE TECHNOLOGY

FAX ORDERS (24HR):  
01728 621179

**NEW**  
**SINGLE-PASS**  
versions

FROM  
**£249**

**SCANFLAT II**  
SCSI Flatbed scanner  
plus SCSI II Interface



Scanflat II 600 & 800

The single pass high quality Scanflat II range of A4 flatbed scanners is a new and improved version of the highly successful Scanflat series. With a new compact footprint to save space, improved scanning speeds and quiet operation, the Scanflat II provides both quality and ease of use for the busy office or classroom. Available now in 600dpi and 800dpi versions.

- ◆ New versions with 400x290mm footprint
- ◆ High resolution Scanflat 1200 still available
- ◆ Line art, grey or 24-bit colour modes
- ◆ Pre-scan colour/brightness control
- ◆ Free ImageMaster Software & TWAIN driver
- ◆ PC SCSI interface & software kit £45 extra
- ◆ 25 way SCSI cable included
- ◆ Full 1 year guarantee

Scanflat 1200



Scanflat II with Transparency adaptor

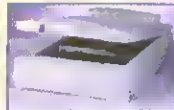

Price in brackets includes VAT	Scanner Price	Trans. Adaptor
Scanflat II 600 (600dpi)	£249 (£292.58)	£149 (£175.08)
Scanflat II 800 (800dpi)	£299 (£351.33)	£149 (£175.08)
Scanflat 1200 (1200dpi)	£349 (£410.08)	£199 (£233.83)

Use the Scanflat to scan great photos like this!

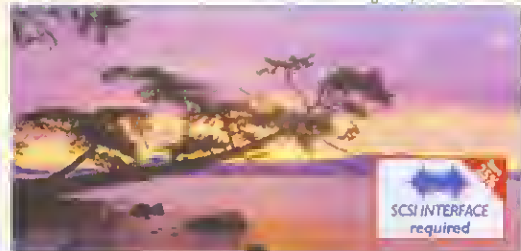

SCSI INTERFACE required

**HARD DRIVES**  
from 100Mb

FROM  
**£39**



- ◆ Internal drives are suitable for A300/A400/A540/R140/A5000/RiscPC/A7000
- ◆ External drives are suitable for all Acorns except A4

- ◆ Fast access times
- ◆ Easy to fit
- ◆ Full 1 year guarantee
- ◆ AV drives also available
- ◆ Larger drives available - please call
- ◆ All drives formatted and soak tested



**FITTING KITS AVAILABLE.**  
Please specify computer when ordering.

	100Mb		500Mb		1Gb		2Gb	
	ex VAT	inc VAT	ex VAT	inc VAT	ex VAT	inc VAT	ex VAT	inc VAT
Internal	£39	£45.83	£99	£116.33	£179	£210.33	£329	£386.58
External (Combo Case)	£99	£116.33	£159	£186.83	£239	£280.83	£389	£457.08

**CD-ROM drives**

FROM  
**£39**

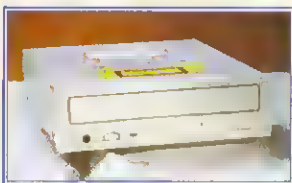

Castle Technology's range of CD ROM drives are chosen for their reliability, ease of use and robustness. All are suitable for multimedia applications.

- Fast access times
- Free headphones
- Driver software included
- Full 1 year warranty
- Compatibility: CD-ROM Mode I, Photo CD, MPEG Movie, CD-DA, CD-i, Video CD, CD-ROM XA mode 2

	2-speed*	4-speed*	8-speed*	12-speed*
Access time	320ms	170ms	145ms	100ms
Data transfer rate	306kb/s	600kb/s	1200kb/s	1800kb/s
Data Buffer	256k	256k	256k	128k

PRICES:	£39	£69	£129	£199
Bare / RiscPC (inc VAT)	(£45.83)	(£81.08)	(£151.58)	(£233.83)
Combo cased (inc VAT)	£99 (£116.33)	£129 (£151.58)	£189 (£222.08)	£259 (£304.33)

\* typical specifications



**FREE!**  
**HEADPHONES**

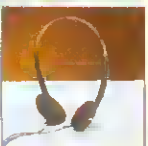

**COMBO CASE**  
FOR SCSI DEVICES

**£60**



The unique expandability of SCSI makes it so easy to install extra SCSI hardware, and Castle Technology is delighted to be able to make this product available to the Acorn user. The Combo Case's two standard 5.25" size bays and robust construction provide a flexible and long-lasting carrier for your SCSI peripherals.

**FREE INSTALLATION!**  
When Combo Case is purchased we will install SCSI devices absolutely FREE!

Combo Case £60 (70.50 inc VAT)

Slot 1

Slot 2

- SCSI terminator
- 25/50 way SCSI cable
- Own internal PSU
- SCSI in & expansion
- SCSI ID selectors
- Daisychain power
- Whisper-quiet fan
- Phono output (to hi-fi etc)

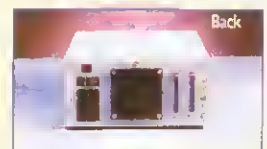

Illustration shows Combo Case with CD-ROM



Suitable SCSI devices include: hard drives, CD-ROM, MaxiIT, SyQuest, Panasonic PD, Zip etc

CASTLE TECHNOLOGY  
01728 621222

Delivery £10 (£11.75 inc VAT) per order.  
VAT inclusive prices are in red.  
Cheques (allow 5 working days to clear), debit cards (Switch & Delta), credit cards (2% charge may apply), and educational orders accepted.  
All trademarks acknowledged. E&OE



CASTLE TECHNOLOGY  
Ore Trading Estate Woodbridge Road  
Framlingham Suffolk IP13 9LL  
e-mail: sales@castle-technology.co.uk  
Web: http://www.castle-technology.co.uk



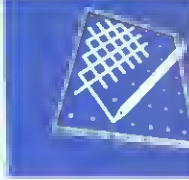

## New Acorn driver imminent

Good news for those impressed by the Canon 4200 (A4) and 4550 (A3) PhotoRealism printers as versions of a fully functional Acorn driver reaches beta stage. Xemplar has kept its promise to deliver a driver that takes full advantage of the Canon's photorealism technology, but it is not Acorn who has developed the product. It emerges that Spacotech was asked to design the software but Xemplar was responsible for supplying the development hardware, dithering algorithms and non-disclosure agreements with Canon.

This kind of interaction between Acorn and Acorn developers is very encouraging. In my opinion it ought to be the norm rather than the exception with such developments: Acorn, simply because of its size and name, has considerably greater influence with large hardware manufacturers than smaller third parties who may not have enough of a standing or the resources to deal with the likes of the leading printing, scanning and digitising manufacturers. It can be nothing but beneficial to Acorn if the same approach is taken in future projects as with the Canon driver.

Luco Leonardi at Xemplar explained that all the information needed to emulate perfectly the performance and quality achieved by the PC and Mac drivers had been delivered to Spacotech. This includes the code for the extremely powerful dithering algorithm used by

Canon to achieve their remarkable photorealistic output. Spacotech may decide to use this technology or opt for an advanced, variable tone dithering system of their own such as the Floyd Steinberg based system used in *Photodesk*. The latter could take advantage of the Canons' variable ink intensities to print antialiased fonts and graphics.

Only when the results match the manufacturers' will the Acorn driver be released and at the time of writing, that stage has already been reached. Spacotech, however, is intent on tweaking the driver to produce results that may look different under the microscope but are arguably more appealing. Certainly, Spacotech's driver for the Primera dye-sublimation printer was transformed by its dithering technology. The important factors of ink usage, speed and accurate colour reproduction will have to be scrutinised alongside the dithering when the driver is released in the coming weeks.

The driver, at the Beta stage, is a stand-alone application like *Laser Direct*, *Turbo Drivers* and Spacotech's *Primera* application, though it could take the guise of a standard Acorn Printer Driver in its final release. But whichever way Xemplar decide to market the product itself, the driver will be sold independently by Spacotech. More information can be found on this and all the latest graphics developments from Spacotech from its Web site: <http://www.spacotech.co.uk>

### ANSI drivers

Having put the finishing touches to its SCSI 3 card, which now supports a sustained data transfer of the same rate as the RiscPC's 8Mb/sec maximum bus bandwidth, Alsystems is now busy completing its anticipated ANSI driver. This will allow the Powertec SCSI cards to be exploited by Windows and PC software. Among many possible uses, a PC second processor upgrade could then talk to SCSI-based scanners and digitisers via the Acorn bus. This is welcome news to graphics users as some manufacturers' PC software is unbeatable in areas like colour calibration and pre-scan image manipulation within specially tailored preview applications.

Alsystems

Tel: (01420) 561111

### Linking cameras

Spacotech has recently finished its other major driver project, for inputting imagery. The new *Photolink* drivers are set to become the Twain Drivers for digital cameras and most promising is the interest that Spacotech has generated from the camera manufacturer Olympus.

Olympus' digital camera technology does not have a significant foothold in the IT or education marketplace and so has a vested interest in helping Acorn developers write drivers for their higher end products. A driver for the high resolution, 1024x768 800L Olympus is only one of many cameras that are ready to plug into the new driver application.

Soon, the new 6000 dpi Olympus 35mm negative/transparency scanner will have a *Photolink* driver, an interesting option for those who need higher resolutions than what current £500 digital camera technology can offer. What's more, Spacotech will be offering regular street price for the hardware itself when buying the driver. Hopefully many more cameras like the acclaimed 1600x1200 Polaroid PDC2000 will be one of the additions to the *Photolink* range.

Spacotech

Tel: (01395) 822753

## Pic of the month

This month's winner is Simon Fraser from Italy. This image is actually a promotional illustration for his comic character, Nicolai Dante, soon to appear on the contents page of the renowned *2000AD* magazine (in issue #1035). The image was created on Simon's "poor Arm610" RiscPC. The hardware specification is quite impressive; 32Mb RAM, 2Mb VRAM, SCSI II card and EZ 135 removable hard disc, 1Gb Micropolis internal drive and an Eesox A4 graphics tablet.

The original line work was scanned into his computer using a fax machine, plugged directly into his modem and received with *Archfax* - an ingenious and fast way to scan low-quality line art. *Studio24 Pro*, though a little buggy in Simon's experience, is used in all his artwork to colour his images which can be up to 80Mb in size. This file fitted onto a single floppy but required a PC: public domain utility to convert it into a compressed TIF used by the magazine publishers. *ImageFS* and *Photodesk* can read compressed TIFFs but cannot write the LZW compressed format.

Already employed by *2000AD* and *Judge Dredd* magazines for his comic illustrations Simon has kindly donated the £20 prize to a charity of *Acorn User's* choice. Congratulations on this impressive example of Acorn graphics and may the Adventures of Nicolai Dante live long.



### Contacting me

You can contact the graphics and DTP page by writing to me, Jack Kreindler at *Acorn User*, Media House, Adlington Park, Macclesfield SK10 4NP, or by e-mail to [augrafix@idg.co.uk](mailto:augrafix@idg.co.uk).



### CD-ROM Drives

Multi-Session, Photo-CD, CD-DA, White & Green Book compatible. SCSI drives require SCSI card with CDFS v2.20  
Carriage: a=£2, b=£6, c=£8  
**Internal ATAPI CD-ROM Drives**  
Panasonic 8xCD ATAPI (Tray) £75c  
Cable & Fitting Kit £5a  
Above drives are compatible with RiscPC/A7000 only.  
**Internal SCSI Drives (Tray)**  
Sony 2x CD SCSI £275ms £80c  
Pioneer 12x CD SCSI 130ms £200c  
**External SCSI CD-ROM Drives**  
Sony 2x CD SCSI £275ms £135c  
Pioneer 12x CD SCSI 130ms £280c

### Hard Discs

**IDE 3 1/2" Bare Hard Drives**  
Quantum 1Gb £150b  
Quantum 2.1Gb £180b  
Quantum 4Gb £245b  
**SCSI 3 1/2" Bare Hard Drives**  
IBM 540Mb £150b  
Fujitsu 1Gb £210b  
Quantum 2Gb £260b  
**Syquest Removable SCSI Drives**  
All following Syquest Drives include a Cartridge.  
105Mb Internal £90b 105Mb Cartridge £29a  
EZ230 External £242c EZ135Mb Cartr. £20a  
270Mb Internal £165b EZ230Mb Cartr. £21a  
270Mb External £235c 270Mb Cartridge £40a

### zip/jaz Drives

• zip & jaz Drives work just like hard drives except they are removable, letting you instantly access files and applications.  
• zip drives use 100Mb capacity discs & jaz drives use 540Mb/1Gb discs allowing any number of discs giving unlimited capacity  
• The drives are fast. Data transfer speeds around 1Mb/s for zip drives & >2.3Mb/s for jaz drives - ideal to backup your hard drive.  
• Each drive comes with 1 year warranty and a starter disc.  
• These drives require a SCSI card that is suitable for removable devices.  
**Internal zip drive (5 1/4")** £145c  
**External zip drive** £145c  
**Single 100Mb zip Cartridge** £14a  
**Pack of 6 zip Cartridges** £65b  
**Internal 1Gb jaz drive (3 1/2")** £340c  
**External 1Gb jaz drive** £430c  
**Single 1Gb jaz cartridge** £73a

### TopicArt

**TopicArtCD1 £20a**  
This CD-ROM Contains over 2000 ClipArt files, each in Draw, ArtWorks & EPS formats + Replay Movies & demos

### Floppy discs £8a each

Single disc (blank) containing approx. 50 high quality draw format clip art images on each disc, on a single subject. Comes with mono reference sheet. 20 subjects are available now. Please specify when ordering. Site licence is included.

1 General	11 Tools
2 Transport	12 Chemicals GB
3 Costumes	13 Chemical Hazard Signs
4 Entertainment	14 Fire/Emergency Signs
5 Bugs & Slugs	15 Hazard Signs
6 Road Signs	16 Safety Signs
7 Sports Equipment	17 Xmas1
8 Sports Figures	18 Xmas2
9 Dinosaurs	19 Xmas3
10 Symbols	20 Xmas4

### StrongARM Card Limited Offer £250 (Carr.£6)

**Hard Disc Interfaces/Accessories**  
IDE Interface £85b 50-50C SCSI Cbte £12a  
Morley Uncached £113b 25D-50C SCSI Cbf £12a  
Morley Cached £165b SCSI2 50C Cbf £18a  
Cumana SCSI II £175b SCSI2-25D cable £18a  
50IDD 4-way SCSI £12a  
50C Terminator £12a  
2nd IDE Drive Kit £15a 50HPC Terminator £15a

### RiscOS Computer Systems

All include 1yr on-site maintenance (except SA RiscPCs). 3yr On-site available. Carriage is included on computers. For PC Cards see section below. All machines are single elice & have backplane fitted except the 4Mb machines.  
**Special Offer - Trade-in your old BBC Micro, BBC Master, RiscOS, PC, Amiga or Atari computer for a £200 discount!**  
**Computer Model with 14" Monitor (AKF60) 17" Monitor No Monitor (AKF91)**

NetStation (28k modem QR 10baseT Ether)	£725	£1100	£460
RiscPC StrongARM 4MHD1.2Gb	£1390	£1765	£1125
RiscPC StrongARM 4MHD1.2Gb+8xCD	£1440	£1815	£1175
RiscPC700 5MHD540	£1400	£1780	£1140
RiscPC700 5MHD540+8xCD	£1450	£1830	£1190
RiscPC StrongARM 10MHD1Gb	£1690	£2065	£1425
RiscPC StrongARM 10MHD1Gb+8xCD	£1740	£2115	£1475

**Deduct £115 for iiyama MF-8617E or £95 for iiyama MT-9017E from 17" system prices.**  
**StrongARM (when purchased with a RiscPC700) £115**  
**20/20 Finance on Acorn computers - ~20% deposit & 20 interest free monthly payments. Loans from £700(min) - £3000. Subject to status.**

### QuickLynk (v1.04) £32a

**With 5m Local Cable £39a**  
**With 10m Local Cable £45a**  
**With 20m Local Cable £52a**  
QuickLynk allows you to access another unattended RiscOS computer remotely using the serial port via modems or locally using a cable to connect the 2 computers. Each computer can be configured to allow access to any attached filing system device eg ADFS, IDE, SCSI, CDFS, etc. Once connected, files can be transferred to/from the remote computer. Other features include password access, auto dialler with phone book and chat mode to send messages to remote computer/user. Transfer rates up to 1.9 kbytes/s can be achieved with older computers, eg. A410, A3000, rising to 11.4 kbytes/s on the RiscPC range. The transfer rate is limited by the speed of the serial port. QuickLynk cannot at present be used directly from programs/command line. Requires RiscOS 3.10 or greater, ring for details.

### QuickTile (v1.03) £29a

QuickTile allows you to create posters from ANY RiscOS application, including Impression. Simply enter the size of poster required & select PRINT from the application! QuickTile does the rest, printing each tile with crop marks and tile references. New features include the facility to print inverted crop marks or no crop marks. QuickTile can only be used with the RiscOS printer Driver or TurboDrivers. Requires RISCOS 3.10 or later. Return disc to upgrade for £4. Upgrade from Tiler for £18.

## Mail Order - 0161-474 0778 (All prices INCLUDE VAT) See us at the Wakefield Show, Stand 10

### RiscPC PC Cards

PC Card A B  
5x86-100 £350 £460  
486DX4-100 £230 £350  
486DX2-66 £175 £290  
PC Pro (without PCExchange) £40a  
Window '95 CD (Full) £90a  
The above can be installed directly from CD without previously installing PCDO5/MS-DOS

### RiscPC Upgrades

Carriage: £3 for Sound Cards  
**StrongARM Upgrade\* £250b**  
**2nd Slice with PSU £116c**  
**2nd Slice without PSU £90c**  
**YES 16 bit Mozart Card £70a**

### Memory

The current price trend is up as at 03/03/97. Following prices include full silicones last.  
**RiscPC/A7000 SIMMS**  
4Mb £25a 8Mb £33a  
16Mb £70a 32Mb £149b  
**RiscPC VRAM**  
1Mb 2nd user £45 2Mb £100  
1-2Mb u/g (exchange) £80  
Call for details of memory for other models.

### Monitors (Carriage £10)

Order computers will require an adaptor £12  
AKF50 14" 0.28dp £245  
Iiyama MF-8617E 17" £525  
High spec FST Tube with 0.25" dot pitch  
Iiyama MT-9017E 17" £550  
Very High spec Diamondtron tube, 0.25" slope

### Printers (Carriage £8)

Canon BJC-240 £175  
Canon BJC-4100 £200  
Canon BJC-4200 £225  
Canon BJC-4550 (A3) £360  
Canon BJC-620 (720dpi) £295  
HP LaserJets Printers £Call  
Add £47 to above printers for TurboDriver  
**P Networking (Carr. £6)**  
A30X0 EtherLan 102 £140  
Archi EtherLan 514 £140  
RPC/A7k EtherLan 602 £120  
Add £17 to above prices for Access+

### Portable Computers

Carriage: £3 for Sound Cards  
**Pocket Book II (1Mb) £305b**  
**Psion 3c**  
1Mb RAM £320c  
2Mb RAM £385c  
AutoRoute Express UK/Eire £60a  
\*one of the best packages for the PB3a  
A Link £59e PC Serial Link £60a  
Parallel Link £34a Mains Adaptor £18a  
128k RAM SSD £48e 512k RAM SSD £135a  
256k Flash SSD £53e 512k Flash SSD £89a  
PB/Pa3 Games £Call PBII/Pa3a Games £65a

### Hardware Upgrades

**17" Monitor Dust Cover £14a**  
**24i16 Card (1Mb) £450b**  
**Dual Serial Card £104b**  
**FPA for 25MHz ARM3 £67a**  
**iTV TVTuner+TT (1 only) £100b**  
**Joystick I/F (Not RiscPC) £30a**  
**Logitech Mouse (Acorn) £226a**  
**Midi Max Card (CC) £79b**  
**Movie Magic (1 only) £210b**  
**RiscTV Card (Irlam) £285b**  
**RiscTV Teletext option £45a**  
**Scart Cable (9 or 15 pin) £12a**  
**Serial Upgrade (A3000) £27a**  
**2 x 25W Speakers £30b**  
**2 x 80W Speakers £35c**  
**Videocards (Irlam) £1165b**

### Hard Cards/Multi-Pods

See top for other hard discs. Carriage £8  
**A3000/A3010 Hard Cards**  
340Mb £Call  
420Mb £Call

### Scanners (Carriage £8)

**ScanLight Video 256 £215**  
Epson Colour Scanners, include iTWAIN & ImageMaster for RiscOS. Bundles include ComiPami & OCR software for PCs/PC Cards  
**GTx-5000 Para bundle £389**  
**GTx-5000 SCSI bundle £499**  
**GT-5000 SCSI (bare) £369**  
**GTx-8500 Para bundle £630**  
**GT-8500 (bare) £529**  
**GTx-9500 Para bundle £760**  
**GT-9500 (bare) £679**

### Modems (Carriage £8)

**14.4 Voice Sportster £115**  
**33.6 Voice Sportster £180**  
Modems come with a 9-25 PC wired cable. A3000/Archi require an Archi wired cable.  
**ANT Internet Suite II £115a**  
**ArchiFax £32a**  
**Dual Serial Card £104b**  
9-25 Archi or PC Wired Modem Cable £12ea  
3-way Serial T-Switch (incl. comm. cable) £32b

### Printer Consumables

Carriage: £2 for Cartridges, £8 for Toner  
B.J.10 (BC-01) £18 B.J.200 (BC-02) £19  
B.J.210 (BC-05) £28 B.J.240 (BC-06) £Call  
B.J.C-600 Series B.J.C-300 (B.J.642) £16  
B.J.201H Cbk Black £10 B.CI-21 Ck Colour £17  
B.J.201C M/Y £8 ea B.CI-21C Colour £17  
**B.J.800** B.CI-20 Fast Black £23  
B.J.643 Black £18 B.CI-22 Photo Card £34  
HP DeskJets 500 ser. HP DeskJets 600 ser.  
Mono £23 Mono £25  
Colour £25 Colour £27  
Epson Stylus Colour Bk £16 C/Colour £26  
Epson Stylus Colour II Bk £20/Colour £26  
C9993A Toner (LJ5F) £64  
E.P.L. Toner (LBP-4HP LJ11) £84  
HP 82274A Toner (HP LJ4L) £60  
SW1124 Mono/Colour Ribbon £8/£16

### Terms & Carriage

Carriage: To benefit personal callers to our showroom carriage is itemised separately. The carriage indicated is for single items. Please call us for total carriage when ordering more than one item since it is not cumulative.  
**Terms:** All prices include VAT except books. Carriage is not included unless otherwise stated. Carriage charges apply to mainland UK (excluding remote areas, Scottish Highlands, Channel Isles, IOM), elsewhere at cost. Orders MUST be accompanied by a phone number. Prices and specs subject to change without notification. Goods subject to availability. Goods not offered on final basis. Restocking fee on non-faulty returns. Educ Inst official orders accepted £/OE

### Where to Find Us



### Books (No VAT)

Carriage: a=£2, b=£6, c=£8  
Acorn RISCOS3 PRM's £99.95c  
Acorn Volume 5a PBM £29.75b  
Acorn BBC Basic VJ Guide £19.95b  
Acorn RiscPC Tech Ref Manual £49.95c  
ArtWorks Made Easy (Dabs) £5.00a  
Budget DTP (Dabs) £5.00a  
C 'A Dabhand Guide (Dabs) £5.00b  
RiscOS 3 File Seps (Dabs) £5.00a  
Wimp Picatutorial for All (Beebug) £10.95a

### CD-ROM's (Carriage £2)

**CD software for RISCOS**  
ArtWorks on CD (CC) (Carriage £6) £109  
ClipArt CD 12 (CC) £21 each  
Dinosaurs (Microsoft) £44  
Dune II (Eclipse) £41  
Granny's Garden CD £32  
Guardians of the Greenwood £51  
Hutchinsons Encyclopedia £20  
Kiyeko £Calla  
Musical Instruments (MS) £44  
My 1st Incred. Anagram Dictionary (DK) £37  
P5 Bears Birthday Party £37  
RiscDisc Vol 1 / 2 CD £17 / £20  
Simon the Sorcerer CD £41  
The Way Things Work (DK/IMS) £44  
Ultimate Human Body (DK/IMS) £44

### Applications

Carriage: a=£2, b=£6, c=£8  
Acorn C/C++ (Acorn) £230c  
Advantage (Longman) £52a  
ANT Internet Suite (ANT) £115a  
ArchiFax (David Pilling) £32a  
ArtWorks (CC) Limited Offer £100b  
Card Shop (Clares) £39a  
Chameleon 2 (4Mailton) £39a  
Compression (CC) £36a  
DataPower (OTA) £105b  
DaVinci (Spex) £12a  
Disc Rescue 2 (Look) £43a  
Easy C++ (Beebug) £102b  
Eureka v3 (Longman) £100b  
FileWorkz Pic (Colton) £155b  
Font Director 2 (Look) £12a  
Font FX (DataStore) £42a  
Hatchback (4Mailton) £43a  
HTML Edit 1 (R-Comp) £42a  
ImageFS2 (All Pub) £43a  
Image Outliner (OTA) £52a  
Impression Style / Publisher £80b / £125b  
Impression Graphics Loaders (CC) £40a  
Impression Text Loaders (CC) £30a  
MacFS / MacFS Lite (CC) £89a / £50a  
Ovalton Pro £175c  
PC Pro (without PCExchange) £38a  
PC Pic (with PCExchange) £47a  
PC Sound Professional (R-Comp) £27a  
Personal Accounts (API) £40a  
PhotoDesk Light (Spacetech) £120b  
PhotoDesk 2 (Spacetech) £245b  
Propheet (Apicote) £154b  
Resultz (Colton) £95b  
Rhapsody (Clares) v3 £24a  
S-Base2 Personal / Developer £54c / £100c  
ShapeFX (Datastore) £12e  
Sibelius Junior £50e

### Games (Carriage £2)

Alone in the Dark (Krisalis) £27  
Birds of War (4D) 2Mb £100a  
Break 147/Superpool £24  
Carriage Inc (4D) £19  
Chicks Compendium £24  
Crystal Maze (Isher) £24  
Cyber Chess (4D) £26  
Darkwood (Eclipse) £23  
Drifter (4D) £24  
Dune II ( floppy) (Eclipse) £30  
Empire Soccer (Magim) £24  
E-Type Compend (4D) £19  
E-Type 2 (4D) £22  
Fire & Ice (Times Warner) £22  
Global Elite (Eclipse) £30  
GODS (Krisalis) £10  
Hawked House (4D) 2Mb £19  
Holed Out Compendium £10  
James Pond (Krisalis) £25  
Krisalis Collection £25  
Lolus Turbo Chalk (Kris) £22  
Magic Pockets (Reneg) £23  
Play It Again Sam 2:3 £22 each  
Pogues (Krisalis) £25  
Real McCoy 2/3/4/5 £24 each  
Repton 3/4 (Supervisor) £22 each  
Selly & Wally (Oregon) £21  
Saloon Cars Deluxe (4D) £24  
Scratch (US Gold) £24  
Sim City 2000 (RPF/ACS) £31  
Simon the Sorcerer 2Mb £31  
Sprobbled Fantasy (4D) £24  
Starlighter 3000 (Fednel) £24  
Suntl Rampart 2000 (4D) £24  
Tanks (Weswork) £23  
Time Machine (4D) £19  
Virtual Golf (4D) 2Mb £24

### Wolfenstein 3D £20

### Educational (Carr. £2)

10/10 Series £14 each  
Early Essentials (over 7), English (6-16yrs), French (8-16yrs), Junior Essentials (5-11), Maths (Number) (6-15), Maths Algebra (8-16), Maths Statistics (6-18), Maths Geometry (5-18), Spelling (over 9), Essential IT, Geog. Fun School 2 (under 5, 5-7, or over 7) £20  
Fun School 4 (under 5, 5-7, or over 7) £20  
Gianny's Garden (Floppy) (4M) £25  
Mains Circus (4Mailton) £27  
Naughty Stories Volumes 1 or 2 £45 each  
Playdays (Gamesave) £22  
Ridiculous Rhymes £45  
Rose & Jim - Jack loses his Quack £10  
Rose & Jim - Jim gets the sneezes £10

# Desktop Projects Ltd Tel: 0161-474 0778

Authorised Acorn Dealer, Fax: 0161 474 0781, Email: info@desktop.demon.co.uk

Unit 2A, Heapriding Business Park, Ford St, STOCKPORT, Cheshire. SK3 0BT





# comms

## Hands-on at Bransyeo BBS

It all started for Richard Branson at Hazelgrove House School in Sparkford, Somerset. Unlike his ballooning namesake, this younger Richard Branson won the school's computing cup for his World Wide Web page designs and, encouraged by his head of Information Technology teacher Alistair Telfer, Richard has never looked back.

Now attending Kings School Bruton, Richard intends to continue computing studies but has a hankering to study Art as well. Both are subjects that will stand him in good stead not only for future BBS and Web page design, but for building a career in either computing or in design.

Richard operates Bransyeo BBS from his home in Yeovil, Somerset. He explains that the BBS name came about when he was given an Argonet Internet account for Christ-mas two years ago by his father who chose the Argonet domain name *bransyeo* for him.

*Bransyeo BBS* runs on a Risc PC 700 which was bought to complement Richard's learning experience in the school computing department where

there were several Risc PCs. A deciding factor on the choice of computer was the Risc PC's ability to run PC software using the PC card. For BBS use, the machine runs ArinBBS BBS software driving a Sportster 28800bps modem which has its own dedicated phone line.

The filebase stands at 150Mb at the time of writing, and Richard has plans for tutorial areas on the BBS for building WWW pages, writing PD software, football and so on. The BBS has the usual file, games and message areas and a nice set of ANSI menus designed mainly by David Hart. Richard is keen on ANSI graphic art and design and programming dynamic effects, as can be seen all around the BBS.



Up, up and away with Bransyeo BBS

in due course, and in the mean time, he and his brothers share the desktop and BBS with the PC card. When I asked him what happens to the BBS if they are running a PC program, he said, 'When the phone rings, I press the middle mouse button pretty quickly!'. Definitely a hands-on BBS.

### Breaking Windows

*Convergence* is a user group dedicated to bringing together users of 'non-Wintel' computers – those not running Windows software on Intel processors – to highlight the strengths and successes of these competing technologies – which include RISC OS and ARM RISC processors – and to promote compatibility between these platforms so as to present a united front against Wintel. To find out more about the *Convergence International* user and development group, visit their new Web site.

*Convergence International*  
<http://convergence.int.eu.org/>  
E-mail: [enquiries@convergence.eu.org](mailto:enquiries@convergence.eu.org)

### ARM Pit movement

Matthew Page's ARM Pit BBS has moved with him from Yorkshire down to Cambridgeshire at Longthorpe, Peterborough. There's a new 24-hour number for the 2Bk8 line, and the Fidonet node has become 2:2504/112.0. Matthew is a prolific writer of add-on games and utilities for BBS operators, and recent examples popping up on many systems are *Pac-man*, *Downhill Pro-Ski* and his real-time display *World Time* feature.

ARM pit BBS  
(01733) 445800

### Ringo stars in ANT suite

Alisdair McDiarmid has released an excellent program called *Ringo* on his Demon Web site that calculates how much money you have spent on phone time while using the *ANT@ Internet Suite*. You can set up the cost for the various charge rates, although other currencies and discount schemes such as BT's *Friends and Family* or *Premier Line* are yet to be incorporated. Alisdair describes it as *Emailware*, which requires that you E-mail him to tell him you're using it – not too much to ask.

*!Ringo Call Costs Utility*  
<http://www.verisimilitude.demon.co.uk/alisdair>

### Contacting me

Keep sending me interesting URLs for the next yoUR List by e-mail to [david@arcade.demon.co.uk](mailto:david@arcade.demon.co.uk), or mail #2 on Arcade BBS 01B1 654 2212.

## Who is poppy?

URL of this month is the Acorn Computer Users WWW Server created and maintained by [poppy@poppyfields.net](mailto:poppy@poppyfields.net) and hosted by Oaktree Internet Solutions. This is a carefully crafted and attractive Web site full of useful information and links to every kind of resource Acorn users could wish for.

If you are persistent you can find out that the enigmatic *poppy* is a music graduate and contract HTML programmer, and owner of an Acorn A3010 computer. Poppy's Acorn site has a light and airy feel, mostly containing Web links to other sites but arranged in a useful and logical way that makes browsing a pleasure.

The index page features an image-mapped Acorn logo by Mark O'Mahony that leads to listings of forthcoming events, product information about Acorn Computers, the Acorn ftp site and links to other Acorn users' sites. There are links to documents such as the Acorn FAQ by Philip Banks, press reports on Oracle and the Network Computer, Robin Watts' technical documents, E-Format discs information, and to Freeware and Shareware software such as *ArcWeb*, *IRCCClient* and *Zup*.

Links to News, technical info and a route to the Acorn Web site complete poppy's Acorn index. You can visit Cantaloop, Web site of The Unbroken Circle, a Derbyshire team of programmers for RISC OS computers, and find out about *Chockcino*, the independent Java implementation for RISC OS by New Zealander Peter Naulls.

So who is poppy? It's well-hidden and I'll leave it to you to discover her real name, but suffice to say she really is a young lady living in Surrey. There's so much on this site that it deserves to be high on everyone's hotlist.

The Acorn Computer Users WWW Server  
<http://www.poppyfields.net/acorn/>

## Q The Music news

The first stage of the long awaited QTM editor is almost complete and QTM Turbo, the follow up to Acorn User's QTM music player, should be previewed in July at the Revelation demo party. QTM author, Stephen Harrison, has produced the new editor module to work with the player, allowing a protracker mod to be edited.

All the low-level code will be provided as SWI calls, contained in the editor module. Programmers can then create their own front end interfaces (as has happened with QTM player front ends like QTMplay and RiscTracker).

Interested parties should contact Stephen at sah195@soton.ac.uk

## APDL Web site

APDL, one of the top PD libraries, has just opened its own Web site. It's early days yet but proprietor David Holden says, 'I'll be adding various other things in the near future so I hope it's going to be worth visiting.

As it's still very new, suggestions and comments will be welcomed. The site can be found at <http://www.apdl.co.uk>

## InterGif

The superb Sprite to Gif conversion software, *InterGif*, has now reached version 5.

InterGif is essential for anyone creating graphics for their Web pages and comes highly recommended. It can be obtained from the InterGif Web site at <http://www.ant.co.uk/~peter/software/intergif.htm>

# Programming

Many people are quick to criticise the Acorn for its lack of support for programmers. High profile problems like Acorn's use of a makeshift C.Front program instead of proper C++ compiler have created this false idea that programming on the Acorn isn't easy. Some problems do exist but the answers can usually be found in the public domain. This special feature on programming tools covers everything you need to code anything from desktop applications to graphical demos.

## Languages

As if it wasn't enough to have BBC BASIC and an excellent ARM Assembler built into your machine, the PD scene spoils you for choice with a big range of other programming languages. Of particular note is the excellent GNU C/C++ compiler which has recently reached version 2.72. Other languages available include: Forth 83, GNU Fortran 77, Icon 9, SML 4, CLisp, GNU Smalltalk, XLIsp, Python, Narcroft or GNU Pascal, SB-Prolog, GNU Ada, Hope and Perl 5. HENSA is a good place to start if you're looking for a particular language.

## Editors

So you've got a language to code in but what do you type the source code into? Several editors are available for RISC OS, but the top two to consider are *Zap* and *StrongEd*. Regular PD column readers will know that I'm a big fan of Dominic Symes' Zap. The program's ease of use makes file editing very fast. A massive range of patches (some third party) allow you to edit and instantly compile and run programs written in different languages. Special colouring modes make the code easier to

view. As an example, you can setup a C compiler to work entirely from Zap, with the throwback appearing in another Zap window.

PD old hand, Guttorm Vik has constantly been updating his StrongEd software which is well worth checking out. Most people tend to prefer the editing style of either Zap or StrongEd, while disliking the other. Although I usually use Zap, StrongEd does have some very tempting features.

If there's anyone still uses Edit to do anything, get hold of the editors described above and I guarantee you'll find everyday editing a lot easier.

## Libraries

A large number of libraries for programming the WIMP can be found in almost all sources of PD, starting with a range of BASIC, C and C++ libraries like Libstore2 and OSLib, and progressing all the way to complete programming shells. The best of these is the comprehensive *EventShell* application which has received much praise in previous months of the PD column. Writing the code for a desktop application is often

only half the work. A large number of tools exist to help debug your code and understand what's going on. *Tracker* and *VDUstream* are just a couple of the examples available.

The interface to any desktop program has to be one of the most important design aspects, in an age where usability is paramount. As a result, a good template editor is essential. Several well developed programs are available but *TempEd* is a good start.

Many programmers can't afford the Programmers Reference Manuals and hence find it very difficult to get anywhere without any SWI details. Help is at hand in the form of the extra files available for use with *StrongHelp*. A 160k hypertext document details all the SWIs you can use.

## Games/Graphics

Several tools are currently available that make demo or games coding a little easier for novice programmers. *GameSuite* is ideal for arcade type games and has just reached version 3. Michael Grimmincks *ADutils* (now in version 1.08) contains everything you need to produce

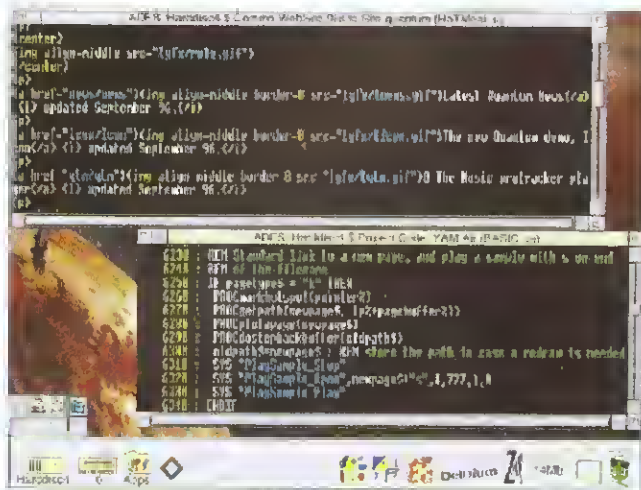



# ij special

3D graphics. As mentioned in last month's column, several other 3D graphics libraries, targeted at the Risc PC level, are also under development and interested parties may find it worthwhile to wait a little longer.

Expect more news in this area in future issues.

## Sound

Sound and music playback is covered by a good range of utilities freely available as PD, making it easy for the prospective programmer to plug in extra modules, saving the need for extra coding work.

A wide range of music players is available with the latest version of *QFM* incorporating a lot of very handy sound effects SWIs and comes highly recommended.

For sample playback direct from disc, a range of modules is available. David Radford's *CompUtils* offers specialised compression and sound playback.

Alternatively Rick Hudson's *SoundCon* and *PlaySample* programs provide everything you need while maintaining a very easy-to-use interface. *SoundCon* will convert between all the common sound formats.

## Compression

As with the use of sound in programs, file compression can also be provided by existing code. A large number of compaction programs are available in the public domain, including everything from command line modules to sets of SWIs with desktop front ends to go with them.

Kai Schiebting's misleadingly titled *GZip*, is a front end to John Kortink's excellent *LZW* compaction modules which can be found in a wide range of other software.

Other compression utilities include *Condense*, *LZH* and a number of ports of *Zip*. It's well worth getting hold of a range of these programs and trialling them on the data you want to compress. You can then select the best compression versus time taken ratios. The main bulletin boards seem to be a good place to locate these tools, but many can also be found on the Net.

As well as data file compressors, several utilities aim at compressing the source code of a program. *BasCompress* squashes BASIC programs down to size by replacing variable names with single letters and removing comments. *Crunch* uses conventional compression

routines but builds the decompression code into the output file, creating a self-extracting archive. Very handy to save disc space but make sure you use version 1.21 - previous versions produce archives that are not StrongARM compatible.

## Conclusion

That's just a sample of the many programming aids available in the Public Domain from a wide range of sources. The best place to browse for these utilities are in the comprehensive catalogues of the bigger PD libraries or on the Internet. Try any of these:

- The DataFile, Willoughby House, 89 Woodville Road, Boston, PE21 8BB
- Five Star Marketing, 4 Shepherds Walk, Bushey, Herts, WD2 1LZ
- APDL, 39 Knighton Park Road, Sydenham, London, SE26 5RN
- Arcade BBS - 0181 654 2212
- Digital Databank BBS - 01707 323531

Last month's *PD on the Net* feature details more Internet sites than I have room to repeat here, but as a quick guide, HENSA (<http://micro.hensa.ac.uk/>) is a good place to start for programming tools.

## Pdf

I've recently had enquiries about the conversion and viewing of Adobe PDF files. The best program to use is an Acorn conversion of *xpdf*, helpfully called *Pdf*. Most features are already supported and the author, Leo Smiers, is continuing development and welcomes bug reports for any problems encountered. *Pdf* can be obtained from Digital Databank or the HENSA ftp site.

## UUCoder

*UUCoder* is the best program for dealing with uuencoded e-mails and split files and has recently been updated with several bug fixes, to version 1.23. This can be found on the UUCoder Web site at <http://www.bramber.demon.co.uk/john/soft.html>

## Icebird demo

The latest news from Mr Hill is that the next Icebird demo is almost complete, and will be released at the *Siliconvention* demo party. Mr Hill, formerly a coder for the renowned group Archilogics, is now writing for Icebird. Check the Icebird Web site for more info at <http://www.germany.net/teilnehmer/100,160485/>

## Contacting me

You can contact the PD page by writing to me, Paul Wheatley, at Acorn User, IDG Media, Media House, Adlington Park, Macclesfield, SK10 4NP. Or preferably, by e-mail to [aupdp@idg.co.uk](mailto:aupdp@idg.co.uk).

## Atlanta

Several low-cost font managers have appeared recently and *Atlanta*, by David McCormack, is one of the most outstanding. It allows easy management of large numbers of fonts, making regular DTP work much easier. After a simple installation process, the program allows you to control which fonts are accessible to other applications.

Fonts can be turned on and off at the click of a mouse but there is a range of precautions in place to prevent clashes with applications in use that require fonts that have been turned off. Installing new fonts is very easy and the usual range of han-

dling features like re-naming and deletion are supported. Previewing is accompanied by a sorting feature, making it easy to manage a font collection. The application is fully configurable without making things too complicated, and the associated text manual is well written and informative.

*Atlanta* is one of the new breed of programs with a commercial feel and a shareware price. Registration is £5 and it can be found on the author's Web site at: <http://www.atlantic.oak-tree.co.uk/>

Buy with confidence from

# BEEBUG

As a Specialist for over 15 years

## New StrongARM Risc PC's from £1150.95

Includes Free RISC User Magazine Subscription & Free Ovation DTP  
Plus £200 Trade-in Offer for Clan Members  
Plus 0% Finance (Phone for details)

All Acorn Products

Books & Manuals

Mouse from £16  
Mouse Mats from £3

Wide range of leads & cables

Printers  
Dot Matrix  
Inkjet  
Laser



Network Computers  
£468



Storage Solutions



Computer Spares



Software  
Business  
Home  
Entertainment  
Educational

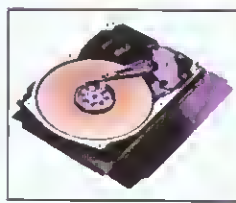

CD-ROM Drives  
from £99

Monitors  
from  
£309

RISC User Magazine  
Subscribe for  
£24



Joysticks  
Gamepads  
Trackballs

Flatbed  
Scanners  
from £470

Pocket Book & Accessories



Memory & Expansion Cards

Networking Products & Installations

Chargeable  
hotline support  
0897 556000

Modems & Internet Packs

Printer Ribbons Cartridges & Toner

BEEBUG Ltd., 117 Hatfield Road, St Albans, Herts AL1 4JS  
Tel: 01727 840303 Fax: 01727 860263 Email: sales@beebug.co.uk  
All prices inc VAT Courier delivery £11.75





# Live and learn

I'VE heard that the average age of Acorn Clan members is just over 40. If that's representative of Acorn users as a whole that means that many of you, like me, who use Trusty Acorns at home will also have families and will be on the lookout for software to help them get through the dubious delights of school, SATs and so on.

It would be nice if every piece of software on the planet worked in RISC OS, but sadly we have to accept that most titles never will. But that, of course, is why we have PC cards. So this issue I'm going to run through a few software titles that don't exist on the Acorn which are aimed at young children learning at home.

## PC Genius

*PC Genius* was one of the reasons I started to look into this – my son saw the adverts and thought he'd like it. The question is: would you want it? The software comes with a magazine – two or three discs stuck to an issue that arrives (or should arrive) every fortnight. The magazines are bright and cheerful providing some written work and giving all the necessary instructions on how to set up the games. It's not difficult and thus far everything has functioned perfectly on my system save for the set of discs that were corrupted and wouldn't load on a PC either.

Unlike many educational PC titles, these games were written for the UK market. Thus they are well targeted to key stages one two and three (ages 7-11) and don't botch the job with US spellings or focus. As the games arrive on floppy (and aren't

expensive) the designers could not go in for the highly complex animated graphics you might find on today's CDs.

These games are simple by comparison. But they are colourful, they are fun and they cover a wide range of subject matter – maths, English, French and more besides. A few years ago, teachers would have despaired of them: drill and practice dressed up. But these days, such learning is back in fashion. This isn't riveting software, but it's not really meant to be. It's disposable, fun for a while, use it and forget it stuff. But at £2.99 per issue, with nine new games each time, that's not a bad deal.

## 7th Level

7th Level have produced several titles aimed at this age group (Key stage 1 & 2). My first experience of their software was with their *Great Word Adventure*. It has been lauded in the press and quite rightly. It's brilliant. The CD-ROM makes full use of cartoon style graphics and music. Presentation is by a bear (I think) called Little Howie, assisted by a robot and a skunk (with a peg on his tail). You are taken on an adventure through various games most of which are both pretty and funny enough to be played many times over.

The child logs in each time and the levels are adjusted according to performance. And at the end, there's a certificate of progress too.

The Great Math adventure follows the same format and is equally good. There are several other titles in the series including science.

Despite reference to the National Curriculum on the box, there are a few transatlantic problems – in the English software I haven't noticed any US spellings but the rhymes aren't anglicised and in the maths software the \$ signs haven't been altered to £s. That aside, these titles certainly won't disappoint. My only technical concern is with speed. The programs run well but though a StrongARM isn't necessary, a reasonably quick PC card is probably advisable.

## 10 out of 10

10 out of 10 is a familiar name to Acorn users. Having built its reputation on simple educational titles for the Acorn market it is now writing software that is only available for PCs. Among its titles are test programs for Maths and English. Now that the National Curriculum sets defined standards it is actually possible to check out how well your child is doing against these markers. And that's exactly what *Test Your Child* (available for Maths and English at Key stage 1) does.

So, are they any use? The software allows for the tracking of children, logging progress and printing out results. What it doesn't do, to my mind, is give nearly enough support for the parent. For example, how much help do you give a six or seven year old? Children sit such tests with a teacher who is allowed to ensure the question is understood, but no more. But that is open to interpretation and it's hard as a parent to know what is reasonable and what is not.

Having said that, the tests do

cover the whole range of tasks required of children and using them does show up gaps in knowledge very clearly. They probably also help the child to understand what is required of them in the test. SATs, like the old 11 plus, are in part understanding how to pass the test as well as knowing the underlying skill. So a little practice may be no bad thing.

These programs are basic but with some care are pretty good at their job. They are very tightly targeted to the National Curriculum and have been designed by specialists although the target levels do seem to be on the high side, (which 10 out of 10 admitted) though I fail to understand why the standards should be anything but right. So, they are useful, but use it with care to find out what your child is missing out on. Don't panic too much at apparently poor results.

Technically these programs should not present any problems.

## EuroPress

I'd also like to mention the software from EuroPress. Not because I want to recommend it but because I think it is better avoided – and it is still being pushed as an International Bestseller and looks attractive as a bundled cheap offer.

This claims to be Win95 compatible but isn't really. It's old DOS software with a front end that in my experience doesn't always work even on a real PC. It's low quality graphics with poor quality games. Cheap, but not cheerful.

From what I've tried, PC Genius is better in just about every respect.

## Play the ACE

Having reported last time around that CJE have released their 133MHz board with a 512K cache I can also tell you that ACE in Germany are offering a similar card. In fact ACE can add a 512K cache to any card, DX4/100 or faster.

Both boards offer a 900 per cent improvement in on-board

processing speed which translates to a more sedate 25 per cent (approx) improvement in overall performance. So far as I know, CJE can't as yet offer an upgrade service, but ACE of Dortmund in Germany does. The downside is it costs £149. Check them out at <http://www.acebase.de>. Tel: 00 49 231 727 4260.

## Contact

You can contact me, Mike Buckingham, by post at: *Acorn User, Media House, Adlington Park, Macclesfield SK10 4NP* or by dropping me an e-mail at: [aupcpage@idg.co.uk](mailto:aupcpage@idg.co.uk)

## Aleph card improves

Aleph One cards now feature a 512K cache. Prices are unchanged. Increased speeds are detailed on their Web site at [www.aleph1.co.uk](http://www.aleph1.co.uk) or tel: (01223) 811679.



**Computers**

StrongArm Risc-PC 200MHz	
4/HD1 2Gig base only	£1150.00e
4/HD1 2Gig 8xCD base only	£1200.00e
10/HD1 0.0Gig base only	£1450.00e
10/HD1 8Gig 8xCD base only	£1500.00e

**£200.00 Trade-In on most old computers against Any Risc-PC**

**A7000**  
(1.6 Floppy 4 Mb expandable to 130Mb ram, Am 7500 540MHz HD, 1 year oil sale warranty)

4M/HD540	base only	£834.00d
4M/HD540/8xCD	base only	£834.00d

*Single disk 1.44mb floppy computer base. All disk systems tested before leaving factory. All Computers are built and tested by hand. Dispatch with printed software package unless you request additional cost.*

**Monitors**

Acorn AKF60	£264.00d
Acorn AKF91	£640.00d
Acorn AKF93	£423.00d
iyama 17"MF8617E 256dot	£599.00d
iyama 17"MT9017E 256dot	£639.00d
Microv 14"1438 (AKF50)	£289.00d
Microv 14"1450 (AKF60)	£219.00d
Microv 15"1565 28dot	£299.00d

**Risc-PC Upgrades**

486 DX2-66 PC Upgrade	£175.00d
486 DX4-100 PC Upgrade	£230.00d
586-100 PC Upgrade	£350.00d
PC Exchange	£29.00a
Access+ Card	£139.00d
Strong Arm Upgrade	£292.00d
Audio Mixer	£40.00a
Movie Magic	£279.00d
Second Slice no PSU	£90.00d
Sound Card	£69.00b
RiscPC 4Mb RAM	£20.00b
RiscPC 8Mb RAM	£45.00b
RiscPC 16Mb RAM	£94.00b
RiscPC 32Mb RAM	£179.00b
RiscPC 1Mb VRAMsmtec	£81.00c
RiscPC 2Mb VRAMsmtec	£116.00c

**Portable Computers**

A4 Portable (Lasi 2)	£1350.00d
Pocket Book 2(256k)	£239.00c
Pocket Book 2(1MB)	£319.00c
A-Link	£59.00b
M-Link	£59.00b
PC Link +	£59.00b
Parallel Link	£29.00a
Power Supply	£14.50b
Flash SSD 1MB	£119.00c

**Hardware Upgrades**

Casio QV-10a inc Software & Ink	£375.00d
Casio QV-100 inc Software & Ink	£525.00d
Casio QV-Mains Adaptor	£15.00a
Casio QV-10a/100 Con.Kit	£116.00c
Hawk V9 MkII	£194.00c
Lark Midi Sound-So.	£172.00c
Midi Max	£78.00c
Risc OS Upgrade Chips	£36.00a
RiscTV (Irlam)	£295.00c
Teletext module for above	£45.00a
SCSI 16bit	£95.00c
SCSI 2 32bit	£205.00c
TV Tuner	£99.00c
TV Tuner + Teletext	£159.00c

**Data Storage**

A30x0 CD Atapi interface	£84.00b
Quad External Atapi CD	£176.00c
A30x0 IDE Interface	£88.00b
A30x0 IDE/CD interface	£104.00b

*All above include HD fixing kit*

IDE 2.5"	
60mb	£69.00c
350mb	£129.00c
540mb	£169.00c

EIDE 3.5"		
1.2 gb	1yr Warranty	£169.00c
1.7 gb	2yr Warranty	£199.00c
2.1 gb	3yr Warranty	£219.00c
2.5 gb	5yr Warranty	£239.00c
3.2 gb	5yr Warranty	£289.00c

SCSI 2 3.5"		
544 Meg Fujitsu	£119.00c	
1.0 gb	1yr Warranty	£209.00c
2.0 gb	2yr Warranty	£239.00c
3.2 gb	3yr Warranty	£359.00c
4.3 gb	5yr Warranty	£649.00c

IDE CD Tray Internal	
4 speed	£69.00c
8 speed	£89.00c
12 speed	£119.00c

**PD SYSTEMS**

4X speed CD-ROM Drive	
650 MB Optical Disc Drive	
Internal or External	
Including 1 Cartridge	£539.00d
Extra 650MB Cartridge	£45.00a

Parallel Port	
Zip Drives 100mb	£175.00a
Zip Drives 100mb	£135.00a

**Archived Memory**

A3000 1-2mb	£64.00b
A3000 1-4mb	£139.00b
A3010 1-2mb	£47.00b
A3010 2-4mb	£89.00b
A3020/A4000 2-4mb	£89.00b
A5000 2-4mb	£99.00b

*All Upgrades fitted free if ordered with Computer else £18.00*

**Scanners**

Epson GT5000 parallel	£359.00d
Epson GT5000 scsi	£429.00d
Epson GT8500 para/scsi	£499.00d
Epson GT9500 para/scsi	£659.00d
Scanlight 256 8bit	£164.00c
Scanlight 256 16bit	£151.00c
Scanlight 256 Video	£222.00c
Image Master/Twain Driver	£35.00a

**Printers**

Canon			
EJ-30	(black)	£169.00d	
BJC-70	(colour)	£199.00d	
BJC-240	(colour)	£179.00d	
BJC-4200	(colour)	£229.00d	
BJC-4550	(A3 colour)	£389.00d	
BJC-620	(colour)	£339.00d	

Canon			
Stylus 400	(colour)	£239.00d	
Stylus 600	(colour)	£299.00d	
Stylus 800	(colour)	£449.00d	
Stylus Pro	(colour)	£419.00d	
Stylus ProXL+A3colour		£1119.00d	

**Printer Inks/Refills**

HP 1200 Laser	(black)	£1150.00d
---------------	---------	-----------

Inkjet Refills are an economical way of re-charging your existing cartridge. All inks come complete with gloves, syringe and easy to use instructions. Single 20ml Any Colour £6.70a  
Twin 2x20ml Black £10.00a  
Bulk 125ml Any Colour £21.00b

**'CartridgeMate'**

A new and easy to use cartridge refill system for HP 51626A high cap. cartridges. A refill system with no mess. Comprises: CartridgeMate & 2 x 40ml Ink Tanks  
Cartridge not included £30.00b  
Ink Tank 2 x 40ml £20.00a  
HP51626A Tri-Colour Cartridge refill kit 3 x 3 colour refills. Comprises: C/M & Y Inks, Cap Retaining Clip, Cartridge Cap Remover £30.00a  
*We also carry a large stock of inkjet cartridges and ribbons.*

EP-L Toner for LBP-4	£69.00c
EP-E Toner for LBP-8	£79.00c
HP Lserjet5L Toner	£59.00c

**Printable Items**

Colour'n Wear (2 white Baseball Caps + 3 transfer papers)	£10.50b
Colour'n Wear (2 white T Shirts + 4 transfer papers)	£13.50b
Colour'n Wear (4 transfer papers only)	£7.50a
(30 transfer papers only)	£41.00a
Design & Print Mouse Mat	£4.00a
Design & Print Business Cards	
10x8 A4 150g Perforated	£5.00a
Col Inkjet mail photo white paper	
25 sheets x 120gms	£5.50b
Monochrome Inkjet brilliant white paper	
100 sheets x 90gms	£3.00b

**CD Software**

100 Classic Cars (Photo CD)	£16.00b
Artistic Landscapes (M/S)	£44.00b
ArtWorks (M/S)	£99.00c
ArtWorks Clipart I (CC)	£20.00a
ArtWorks Clipart II (CC)	£20.00a
Being a Scientist (Anglia)	£44.00b
Biffoho Ed7 (M/S)	£50.00c
Breakaway Maths (NYTA)	£70.00b
Britain from the Air	£44.00b
Britain Since 1930	£28.00a
British Birds rev 5-72	£109.00c
Care Maths in Motion (Camber)	£105.00c
Democritus (M/S)	£44.00b
Diadex (Anglia)	£44.00b
Guardians of the Greenway	£54.00a
Grimm's Garden (M/S)	£35.00a
Garden Wildlife (Anglia)	£44.00b
Humorous M/Media	£45.00a
Industrial Revolution (Anglia)	£44.00b
Intenetic/Chivvenhoe (Anglia)	£164.00c
Kingfisher Childrens Maths 1996	£65.00b
Kingfisher and the last night (M/S)	£34.00b
Landscape (CCS)	£104.00c
Medieval Realism 1000-1500	£104.00c
Musical Instruments (M/S)	£44.00b
Mysteries of Nature (Anglia)	TBA
My 1st memorable amazing day (M/S)	£36.00b
Nagely Birdies V1&2 (M/S)	£93.00c
PB Bear's Birthday Party (M/S)	£36.00b
PhotoBase 1920x300x300 (M/S)	
Victorians and a spec. Each 1.1	£54.00a
RiscDisc 1 (M/S)	£15.00a
RiscDisc 2 (M/S)	£18.00a
RiscDisc 3 (M/S)	£23.00a
Sensure Laid 17-11	£44.00b
The Way Things Work (M/S)	£44.00b
Ultimate Human Body (M/S)	£44.00b
Understanding Energy	£53.00a
Undermining the Book	£44.00b
World War 2	£28.00a

**DAVYN**  
MART  
Acorn  
Awards of Excellence

**Finance**  
Clearly the Best Choice

based on 20% deposit and 0% finance over 24 month period (Acorn items only)

**20.0%**

Personal finance is available in qualifying purchases. Credit subject to status. Written quotation on request.

**APR 0%**

**Acorn Net Station**  
New  
www.davyn.com

**Application Software**

Airance	(Acorn)	£116.00c
Advantage	(LL)	£54.00c
Ancestry II	(M/Amstr)	£87.00b
ANT internet	(ANT)	£109.00c
Apple FS	(M/Amstr)	£30.00a
Artex	(David P)	£33.00a
Armadex	(Clare)	£29.00c
ArtWorks	(CC)	£99.00c
Card	(Acorn)	£249.00c
Card Shop	(Clare)	£22.00a
Celebration	(Clare)	£32.00a
The Comp. Animatn	(Irlam)	£93.00c
Computation	(Clare)	£150.00c
Computation	(CC)	£31.00a
DataPower	(Irlam)	£135.00c
Desktop Theatrics	(R Der)	£19.00a

**Davyn Software**

**Draw to DXF Converter**  
NEW Only £23.00a

Dance Works 2	(M/S)	£19.00a
Easy Clip	(Falcon)	£31.00a
Easy Print 3	(Falcon)	£31.00a
EdiSource (Risc PC only)	(CC)	£170.00b
Eureka 3	(LL)	£99.00c
Formally	(CC)	£70.00a
Font FX	(Dunmore)	£12.00a
Frame It 1 to 2	(Darcy)	£6.00a
Graphics Loaders	(CC)	£44.00b
Illustrator	(Clare)	£45.00a
Image FS 2	(Alternative P)	£44.00b
Image Outliner	(Irlam)	£54.00b
Impression Publisher	(CC)	£139.00c
Impression Style	(CC)	£79.00c
Intenak	(Acorn)	£29.00a
Investigator III	(Vivi)	£45.00a
Knowledge Organizer 2	(Clare)	£72.00a
Notat	(LL)	£62.00b
PC PRO (M/S)	(ANT)	£45.00a
PC Sound Print	(RC/Imp)	£29.00b
Pendulum DTP	(LL)	£59.00b
Pendulum Editor	(LL)	£58.00c
Pennwin Plus	(LL)	£83.00c
Personal Accounts	(Apricot)	£40.00b
PhotoDeck 2	(Space Tech)	£259.00c
Pinpoint	(Lingua)	£104.00c
Pin Artium 2	(Clare)	£135.00c
Pin Artium 24	(Clare)	£99.00c
Printer 3 Accounts	(Apricot)	£163.00c
Render Bender v2	(Clare)	£45.00a
Replay Starter Kit	(Acorn)	£30.00b
Revelation ImagePrint	(LL)	£163.00c
Rhapsody 3	(Clare)	£93.00a
Rhythm Bed	(Clare)	£45.00a

**Games Software**

Alderbaron (M/S)	(Erin)	£10.00a
Alone in the Dark	(Kraut)	£29.00a
Arise 3 Games (GameWare)		£25.00a
Arise 3 Games (GameWare)	(4D)	£27.00a
Axe	(TBA)	£22.00a
Big Bang	(Psycore)	£14.00a
Birds of War	(4D)	£20.00a
Black Angel	(4D)	£28.00a
Boxing Manager	(Kraut)	£5.00a
Burn Out	(Gagan)	£22.00a
Chuck Rock	(Kraut)	£10.00a
Cobalt Seed	(TBA)	£21.00a
Corruption (M/S)	(Zeller)	£5.00a
Crytal Maze	(Sher)	£27.00a
Cyber Ace	(TBA)	£17.00a
Cyber Chess	(4D)	£28.00a
Darkwood	(Echpe)	£22.00a
Dune 2	(Echpe)	£32.00a
Dune 2 CD	(Echpe)	£40.00a
Dungeon 2	(4D)	£20.00a
Empire Soccer	(Apricot)	£23.00a
Emet The Realm	(4D)	£21.00a
E-Type Compendium	(4D)	£22.00a
E-Type Jaguar 2	(4D)	£29.00a

SmArt Art File Manager	(4Matron)	£21.00a
Snipper	(4Matron)	£38.00a
Sound FX Maker	(CC)	£39.00a
Strongaid	(Am)	£25.00a
Strong Internet (DoggySoft)		£89.00c
TextFace	(SoftFace)	£54.00a
TextFace Talking	(SoftFace)	£74.00b
TextFace Talking Multimedia		£94.00c
TimeCode	(ART)	£29.00a
Titles	(Clare)	£44.00a
Typographer	(Clare)	£74.00a
Touch Type	(Irlam)	£45.00b
Turbo Driver	(CC)	£51.00b
Twain Drivers	(DP)	£19.00a

**Education Software**

1000 of 10 Full Range	(Each)	£1.00a
1000s (for use on Early Essential)		
ESsentials	(M/S)	£31.00a
ESsentials Multi Algebra		
ESsentials Multi Geometry		
ESsentials Multi Statistics		
ESsentials Multi Spelling		
Adaptive Playground (Storm)		£21.00a
Amazing Maths	(CSH)	£23.00a
Amazing Office	(Storm)	£15.00a
Arithmetic I Roman	(Sher)	£38.00a
Arithmetic II Egyptian	(Sher)	£38.00a
Arithmetic III Viking	(Sher)	£38.00a
Arithmetic IV A Sumer	(Sher)	£38.00a
Annual World 80 Days	(Sher)	£40.00a
Azters	(Sher)	£48.00a





# music & audio

## Welcome

First off, let me welcome you all to the new, singing and dancing *Acorn User Music and Audio* page. Ever since the BBC Micro was launched back at the start of the '80s, music and sound have played an important part in the Acorn world.

Even though it has never been the computer for making music, the BBC Micro and the Archimedes have both had their obligatory 15 minutes of fame.

More recently with the development of the Risc PC and in particular the StrongARM Risc PC, the Acorn name might soon be as common in the studio as Atari and Apple Mac. Sibelius has already proved to the world that Acorn machines can take on the best and win. Couple this with the emergence of powerful new software from the likes of Oregon and ESP and it looks like the Acorn platform could and will compete

well in this new and exciting marketplace. It's been a long time convincing the Editor that the interest and support for such a page is out there. I would therefore be pleased to hear from anyone who has any comments (good or bad) about what they think of it. I would be especially pleased to hear from anyone out there who is using Acorn hardware and software in any professional or semi-professional situation.

## MIDIWorks and AudioPort

One of the main uses, if not the main use, for using a computer in a recording studio is for running a sequencer. Ask anyone involved in the technical side of music making and you'll hear the names *Cubase* and *Cakewalk*; two of the leading MIDI sequencers for the PC and Apple Mac. Oregon, makers of *CineWorks* and *ProSound* hope to add another name to that list with the impending release of its *MIDIWorks* sequencer package.

There have of course been other sequencers on the Acorn platform, but none has had the advanced features that *MIDIWorks* boasts. As well as the usual piano roll editor, the program includes full editing for controllers, plus Groove quantisation and non-linear timestretching.

SMPT/MTS (Society of Motion Picture and Television Engineers/Midi Time Code) synchronisation allows *MIDIWorks* to sync to external hardware including synthesisers and DAT recorders, emphasising its aim at being a serious program.

While I have yet to see the finished program working in full, the author's track record to date has been exemplary with *ProSound* and *Studio Sound* already under his belt, so I expect great things of this flagship product. *MIDIWorks* will be making its public debut at the Wakefield show on 17th/18th May so get along if you can and see (and hear) just what Acorn machines can really do.

Good software is only part of the solution in making the Acorn

platform a musical force to be reckoned with. Perhaps the only real expansion hardware aimed at the professional musician has been the *Armadillo A616* 16-bit sampler, but this is now incompatible with current versions of RISC OS.

Oregon's soon to be released *AudioPort* aims to provide full SPDIF (Sony/Philips Digital Interface Format) input and output of audio data, with the option of an add-on external unit to give analogue in and out.

Two designs exist for these – one providing two channels in and six channels out in a half-sized rack mount unit, and one with eight channels in and eight channels out in a full-size 19 inch rack mount unit.

In addition to the digital I/O, the *AudioPort* motherboard contains dual buffered MIDI ports, plus onboard DSP (Digital Signal Processor). By combining the *AudioPort* and the

8in/8out CODEC, plus *ProSound* and *StudioSound*, you effectively have an 8-track hard disc digital recording unit – something which is only available on top-end PCs. Macs and dedicated systems costing thousands of pounds.

If Oregon can deliver the goods, I can see no reason why Acorn machines should not be a viable alternative to the usual suspects in a recording studio.

A fuller specification for *MIDIWorks* and *AudioPort* can be found at Oregon's web site: <http://www.oregan.demon.co.uk>

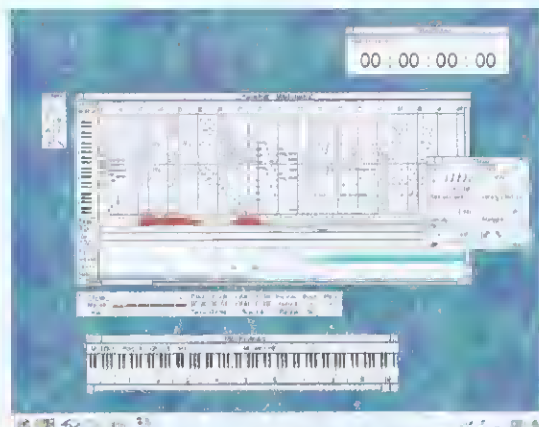

## MelIDI

Just like buses, good RISC OS programs seem to be a bit thin on the ground and then suddenly a load of similar ones all appear at once. *MelIDI* is another MIDI sequencer currently in development, which aims to provide Acorn users with features until now only available on other platforms. The current version – marketed by Liquid Silicon – is only a beta release, but a full version is

promised soon and users will be able to upgrade from one to the other for a nominal charge.

Features include tempo, controller and aftertouch maps, as well as definable note mapping. A professional version of the program, cunningly named *MelIDI Pro*, adds support for SMPT/MTS synchronisation, unlimited tracks, plus rather interestingly,

lyrics. Whether *MelIDI Pro* will be able to sing your compositions remains to be seen (or heard).

Further details on both products, plus a demo version of *MelIDI*, can be found at: <http://www.shf.ac.uk/~av1dpm/melidi/> Anyone interested in technical details can contact the author Stephen Borrill at [sjb42@cam.ac.uk](mailto:sjb42@cam.ac.uk)

### Contact:

You can contact me, Rob Miller, by post at: *Acorn User*, Media House, Adlington Park, Macclesfield SK10 4NP or by dropping me an e-mail at: [aumusic@idg.co.uk](mailto:aumusic@idg.co.uk)

# CUMANA

And

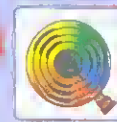

**SyQuest®**

**LATEST NEWS**



bring you  
the....

**OFFER PRICE**  
**£219**  
**PLUS CARRIAGE + VAT**



Cumana are pleased to announce the availability of Acorn drivers for the SyQuest EZFlyer 230MB parallel-port removable cartridge hard drive.

We are the Sole Authorised Development Partner and distributor for SyQuest Technology for the Acorn market.

These high capacity, high performance drives have an excellent media cost - a fraction over 10p/MB when bought as part of this offer. They use a well-proven drive technology giving 13.5ms access time and the media is widely available. The ezflyer is an ideal solution for those wishing to add further drive space or take essential regular backups of important data and applications.

The Cumana drivers are compatible with a wide range of Acorn computers from the A3010 to the StrongARM-powered RiscPC. A bi-directional parallel port is required so unfortunately this drive is not suitable for A300/A400/A3000 or A540 computers - but please do give us a call for a quote on a SCSI version of the drive. The drive also features a through port for attaching a printer and is supplied with PC/MAC drivers PLUS one free 230MB media disc.

**The offer price of £219** (normally £239 plus carriage & VAT) is only available until May 31st 1997. For further details or a full specification please call the Cumana team on: Tel: 01483 503121.

## SCSI II interface card for Risc PC

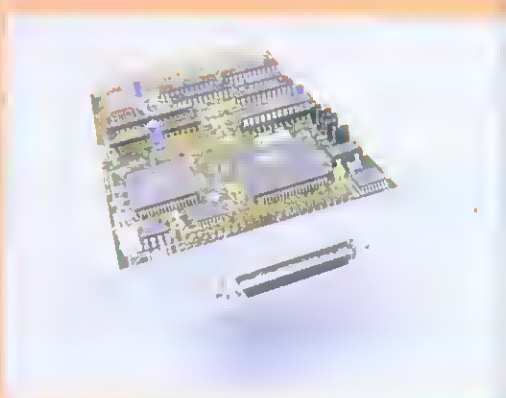

### Features:

- \* The SCSI driver is fully Risc OS compliant to support the Risc PC 600, 700 and StrongARM
- \* Supports up to 256kB of on-board Flash EPROM along with FREE technical support and upgrades from floppy disc or can be downloaded from the Cumana Website
- \* 32 bit DMA transfers supported on the Risc PC giving 7Mb/sec
- \* Built-in security for CMOS RAM and EEPROM
- \* Supports 8 logical drives on the icon bar
- \* New icon bar management features include the ability to "stack" multiple drives to save icon bar space
- \* Support for DOS format media (e.g. proTeus, SyQuest and Jazz)
- \* Drive mapping and configuring from the icon bar plus support for user defined user icons

SCSI II interface £149.00 + VAT  
(Order code: 3-1040-A)  
SCSI II cable £15.00 + VAT  
(Order code: SCSI2-50)

### Special Offer Price Oscar CD-ROM Package

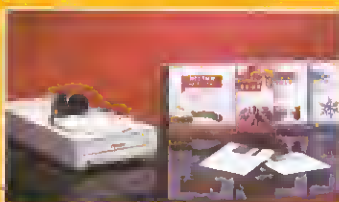

**Oscar CD-ROM Drive**  
(Includes headphones and PC/Acorn driver software)  
+ Free Choice of 4 from 14 Anglia Multimedia CD-ROM titles for just....

**£299.00**  
(Inc. Carriage-Excluding VAT)

### Indigo

The Indigo ATAPI internal fit CD-ROM drives offer 8 speed performance and are ideal for the Acorn Risc PC and A7000. StrongARM compatible.

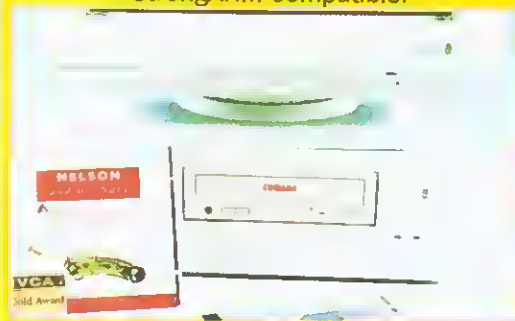

Indigo CAA380i (as detailed) £99.00+ VAT  
(Order code: 3-1518-A)  
Indigo CAA380iA (as detailed plus audio mixer and Clares ProArtisan 2CD)  
£149.00 + VAT (Order code: 4-1519-A)

Call the Cumana team for further details and a copy of our 1997 Catalogue.

Tel: (01483) 503121 Fax: (01483) 451371 E-mail: sales@cumana.co.uk  
www.cumana.demon.co.uk

The Cumana product range is also available through your local dealer

Cumana, Boundary House, The Pines,  
Broad Street, Guildford, Surrey, GU3 3BH



# cover disc

## Apocalypse

Gordon Key/The Fourth Dimension



The time is the future. Computers have evolved so that they are mobile, can think for themselves and can even reproduce. They have become the Rakonians and no longer need humans, establishing their own colonies.

They took over the first planet some time ago and are now well-established. Their first action was to ruthlessly destroy all carbon-based life-forms and then mine all the silicon for their own reproductive purposes. This leaves planets flat and barren, the Rakonians are not green.

Once this has been achieved the Rakonians multiply and swarms are despatched to take over other planets. They have been very successful.

All human defences have proved powerless against them so the Royal Guild of Spacing has diverted all resources into the development of the Ilanerk, a highly advanced combat machine even more powerful than the Rakonians. You have been chosen as the pilot.

Your task is to sterilise all colonised planets, which means you must destroy enough installations so that the Rakonians can no longer develop. The Guild will then re-colonise the planet with human and other carbon-based life-forms.



At the end of each mission you will be assessed. You must perform well as the Guild will not tolerate anything but the best.

### Controls

Mouse or joystick controls:

Left Accelerate forwards

Middle Accelerate backwards

Right Fire photon cannon

Pull back on the mouse or joystick to point up, push forward to point down, left/right to change direction. The *spacebar* also fires the photon cannon. Height can be adjusted with the

up/down cursor keys, see also section on auto-levelling.

F8 Fire energy bomb

F9 Volume up

F10 Volume down

F11 Pause, any key to restart

F12 Escape from surface (press delete to abort the escape)

Control+Q To abort the current game

### Playing guidelines



At the start you will be given information about the planet to visit and then lowered to the surface from the mothership via a tractor beam. At the main screen press Q to return to the desktop.

The best plan, on reaching the surface, is to destroy everything in sight before it destroys you. As a rule, buildings and objects that shoot are more important than those which don't - they are also harder to destroy.

Certain objects *must* be destroyed before the planet will be sterilised - the computer will inform you when one of them has been demolished. Note what they look like - you will need to destroy them all to sterilise the planet.

When you fly backwards your height will rise to



maximum to avoid crashing into buildings.

The mushroom-shaped objects on the planets contain a special radiation which can increase your firepower for 1 to 10 shots.

### Radar and map

The radar has four levels of magnification controlled by F1, F2, F3 and F4. Your ship is in the centre and the coloured dots are the enemy - those to the top are in front, the ones below are behind. The different colours represent different types of building or other objects - learn them or die.

Pressing F5 toggles between the play area and the main map. Use F1 to F4 to change magnification.

If you leave the battle zone you will experience severe radiation which will drain energy very fast. You will be warned as soon as you leave the area. Immediately select the map option and return as fast as possible.

### Energy and shields

Your energy bank is drained more quickly while flying. If you stay still it may restore slowly but keeping still is dangerous. When energy is getting low the indicator will flash - be ready to escape because when the energy level reaches zero the Ilanerk will self-destruct to avoid capture.

Different planets have different gravities and will drain energy at a different rate.

Shields are depleted whenever the Rakonians score a hit on your ship. The shields do recharge quite quickly if you stay away from trouble but if they are totally depleted by a single hit you will be destroyed. When shield energy is low there is a beep and the indicator will flash. Be prepared to escape if you cannot avoid taking hits.



# cover disc

## Console controls



## Flight aids

F6 toggles the auto-stabilisers which makes the ship return to horizontal if under 75 per cent of maximum height. If over that, auto-stabilisers only work if you are moving.

Pressing F7 toggles the auto-levelling feature. You can only land with it on. When it's off you climb and dive depending on whether the nose is pointing up or down.

## Loading instructions

**Warning:** You must have ArcFS loaded to run this game as some files have been compressed to save space on the cover disc.

Double-click on the Apocalypse icon, if you are using a Risc PC or A7000 you will be asked to click on the button for the monitor you are using. If an AKF60 or AKF85 the program uses a mode definition file to display the game correctly, otherwise you will have the game in letterbox mode.

There is no problem with the playing speed on the newest machines, even StrongARM. The seven-year-old game code required no modification whatsoever to run correctly and playably.

If a new mode definition file was used you will find the desktop being displayed in Mode 13 when you return to it. Run the !Configure program (double-click on !Boot), select Screen and click the Set button to reset your screen to normal.



## Extras

- Demo of Simple Control by Camboard Technology
- Millenium bug fix test for BBC Master
- RiscUtils, PD utilities for RISC OS
- WimpUtils, PD utilities for the WIMP
- One photo produced by the Olympus C800L

## Regular items

- Move around our 3D world
- More on plotting sprites in windows
- Free Ads — all our Free Ads on disc
- Bucketloads of \*INFO from graphics to games
- Mike Cook's frequency response package

## Disc information

The software on these discs has been compressed using ArcFS 2 from VTi, and are opened by running a copy of ArcFS then double-clicking on the archive to open it. There is a copy of ArcFS on each disc.

Most software will run straight from the archive, but some programs may need to be copied out of the archive before being run, uncompressing them in the process. Any program that saves a file to disc, for instance, will be unable to do so into the archives on the disc.

## Faulty disc?

If your disc is faulty, test whether it will verify by clicking with Menu on the floppy drive icon and choosing Verify.

If it fails to verify or is physically damaged you should return it to TIB, TIB House, 11 Edward Street, Bradford, Yorkshire BD4 7BH. If it verifies successfully return it to the Acorn User editorial office at the usual address.

The Acorn User cover discs have been checked for viruses using Killer version 2.500 from Pineapple Software.



NE  
'colour Sup



his fully inte  
s profession  
ace output  
nercial litho  
colour an  
ations are  
ns to view  
n and to co  
n angles, fra  
Included is a  
essing facilit  
ness, cont  
s of images  
g slider co  
ast settings  
he colour r  
be converted

tion Pro  
plement

(that all reg  
bought Ov  
1st 1997  
ar suppleme

For more in  
vation Pro,  
date news,  
atest applet  
visit our  
http://www





# OVATION

## Pro

### THE PROFESSIONAL DESKTOP PUBLISHER

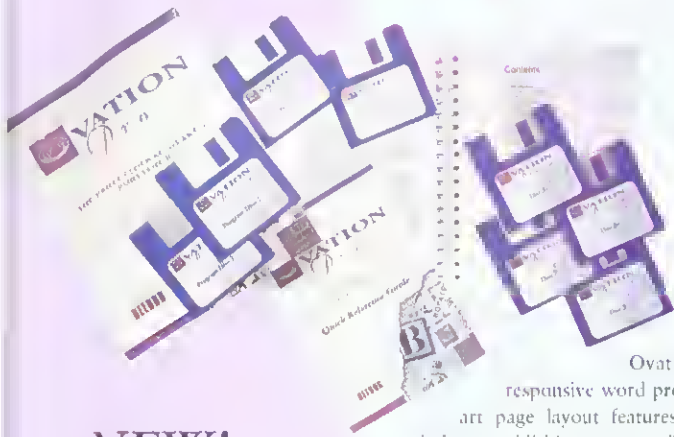

#### New features!!!

- Colour palette
- Definable multi-row button bar
- Style palette
- Instant highlight of misspelt words

#### Package includes:

- 300 page reference guide
- Step-by-step tutorial
- Quick reference card
- 50 high-quality fonts
- Selection of clipart
- Desktop Thesaurus
- Bubble help

## NEW!

### Colour Supplement



This fully integrated extension allows professional designers to produce output for high quality commercial litho printing. Both full colour and spot colour separations are supported, with options to view separations on-screen and to control PostScript screen angles, frequency etc.

Also included is a powerful image processing facility which allows brightness, contrast and gamma levels of images to be adjusted using slider controls. Custom contrast settings may be defined on the colour map, and images can be converted to dithered.

### Ovation Pro Colour Supplement costs £57.58

Note that all registered users who have bought Ovation Pro before May 1st 1997 will be sent the colour supplement free-of-charge.

Ovation Pro combines fast, responsive word processing with state-of-the-art page layout features to deliver the ultimate desktop publishing system. Packed with a staggering range of features – many available on the Acorn platform for the first time – Ovation Pro opens up a whole new world of document design. At last you can flow text inside and outside irregular frames or rotate them to any angle – in both cases the text remaining fully editable. Even with such a vast range of features Ovation Pro is still easy-to-use, thanks to its superb user interface.

- Definable Button Bar
- Irregular frames with Bézier curves
- Rotated text frames with editable text
- Multi-step Undo & Redo
- Drag & Drop for text and objects
- Drag & Drop between documents
- Named colours & definable colour charts
- Automatic drop caps
- Justification with letter spacing
- Multi-column frames
- Frames with skew & rounded corners
- Vertical justification
- Frame borders and drop shadows
- Straight and curved line drawing
- Auto flow around irregular graphics
- Easy-to-use master pages
- Context sensitive info palette
- Reads Ovation, RTE, DDF, Artworks files
- Macro handling and script language

Ovation Pro is fully expandable using extension modules called Applets. Over 30 of these are supplied, including applets to automatically insert ligatures, generate fractions and expand abbreviations.

### Ovation Pro costs £193.88

### Upgrade from Ovation £116.33

### Upgrade from another desktop publisher or word processor\* £139.83

\*includes Style, Publisher, FastWriter, TechWriter, PenDown+ and Advance. Site licences and upgrades are available – please phone for details. To upgrade you must return your original program disc with payment (discs will be returned).

## BEEBUG

Beebug Ltd. 117 Hatfield Road,  
St. Albans, Herts. AL1 4JS  
Tel: +44 (0) 1727 840303  
Fax: +44 (0) 1727 860263  
Email: sales@beebug.co.uk

All prices include VAT, but please add £3.50 carriage. Airmail will be charged at cost to overseas customers.

For more information on Ovation Pro, including up-to-date news, specifications, latest applets etc., why not visit our web site at: <http://www.beebug.com>

...ation has so ...  
powerful frame attributes that ...  
... anywhere ... and creating ...  
... features anywhere ... and creating ...  
... elements there ... a grid and ...

name | address

Text Editing  
Text may be typed directly  
... into the page ... like a ...

... traditional ...  
... frames or ...  
... hold the t ...  
When a ...  
text a ...

32 BIT  
ACORN  
SOFTWARE

# Yet another VAT Return!



We can't guarantee that your paperwork will decrease, but we can assure you that you will spend far less time looking in old ledgers!

Your accounts may even become enjoyable with **Prophet 3**, the award winning business accounting application from Apricote Studios.

From simple book-keeping to invoicing, stock control, VAT and final accounts, **Prophet 3** does it.

Whether you are doing your accounts by hand or with a spreadsheet, database and DTP software, changing to **Prophet 3** will make the whole job that much simpler - no more manual adding up, entering formulas, incrementing invoice numbers etc., just open the relevant ledger and type in your data - everything else is automatically done for you.

It is no wonder that we have won the **Acorn User Best Business Software Award** two years running.

Why not give **Prophet 3** a test drive today - telephone or fax us on **01354 680432** or visit our WWW site: <http://homepages.enterprise.net/apricote> and ask for our free brochure and demonstration disc.



EXPRESS

**APRICOTE Studios**  
2 Puris Bridge Farm • Manea • Cambs • PE15 0ND



# Pitfalls on platforms

Experiences of an intrepid Acorn user in a multi-format environment.

**Stephen Scott** tells all

I am a student at Staffordshire University undertaking a three-year design course in electronic media. Similar courses have been added to other university prospectuses due to the upsurge in recent years of multimedia and the Internet – a rapidly growing industry.

## Compatibility complaints

All multimedia courses use the Apple Macintosh or Wintel PC as the basis for project work. I am unique in that I am the only person on my course to own an Acorn which gives rise to all sorts of compatibility problems.

This article expands on my original letter published in the January 1997 issue of *Acorn User* and covers in more depth, the trials and tribulations of using my machine – a Risc PC 600 – in a multi-format environment.

While reading this article, you may recognise some of the pitfalls and experiences I have encountered and may be interested in how I came to solve them. As Acorn users we are used to a standard envi-



Subtle merging of the knife with the head of the fish to produce a 'swordfish'

ronment, just as PC or Mac users are used to theirs. We also have relatively bug-free, high-quality software and an enjoyable hassle-free existence. Problems can arise, however, when trying to access Acorn work on another machine.

It can be a tedious and frustrating experience when you go down to the local print bureau with a PC disc containing an Acorn Postscript file, hoping to get a

result, only to find that the file cannot be understood by the typesetting machines. This is just one example. In multimedia, there are major gaps in the compatibility stakes.

## Learning the hard way?

First, a little background information. I received my Risc PC in 1994 while I was at college studying graphic design. Although Macs were also used, I never needed to produce any work on them as my trusty Acorn could do the job far quicker and easier. But this was merely DTP and vector graphics, not movies, sounds and interactive systems. At the time I applied for university, I was well aware of the bias towards Macs, utilising software such as Adobe *Photoshop*, the Macromedia *Director* authoring package and the *Infini-D 3D* modeller packages.

Acorns did not get a look in as, at the time, there was nothing to compete with this software. I was tempted to buy a Mac but the cost of the required high-end machines plus the standard software was prohibitive for my student budget and, anyway, I found the Acorn environment easier to use for work purposes. I managed to survive almost all the first year of the course, relying solely on my copy of *MacFS Lite* and my army of worn out flo-



Composed entirely using an old edition of ProArtisan 2 for the student rag

## Acorn compatibility

pies. Of course, there were the inevitable corrupted files (coat pockets in place of disc boxes!), which resulted in my having to walk back to my hall of residence to rewrite the file and then back to the design block.

At least I kept fit. It was only at the end of the year, when the final project demanded a long *Quicktime* movie as a final piece, that I had to migrate from using floppies. And I was thus introduced to the Syquest EZ135 by a colleague who generously lent me some cartridge space until I could get my own drive. After the presentation, I was able to fit the *Quicktime* and soundtrack on two discs, albeit at a postage stamp size!

### The price of portability

Right now I am coming towards the end of my second year, which has changed tack dramatically from the previous year. No more pretty pictures but full-blown movies and multimedia presentations, hence leading to an emphasis on more Mac-based work. Despite continuing to produce images and graphics on the Acorn, I was still facing the problem of portability. I eventually purchased a second-hand EZ drive with three cartridges to save Mac work on. But to use the drive on the Acorn, I had yet to buy a SCSI card. I knew little about these cards, except that the recommended specification was SCSI 2, with a cost in excess of £200. I had already spent £120 on the EZ and my finances were getting severely strained.

From trawling through various magazine articles, letters, e-mails and newsgroup postings, I discovered there was a lot of conflicting information about which SCSI cards worked with the Syquest. I wanted to get the right solution immediately as I needed to be able to work on the Acorn at home. In desperation, I e-mailed the aforementioned letter to this very magazine to see what help I would get from fellow readers.

At this point, I should thank those of you who took the trouble to contact me. But before the letter was published, I managed to find a very good solution, which was extremely cost effective. I purchased an old Morley SCSI 1 card from AlSystems (cool – what a plug!), along with its PowerROM which, when connected to the Morley, gave me SCSI 2 capability at half the price. I also bought a SCSI 1 cable, as the Syquest cable was Mac-only. This cost me a total of £130 (£110 for the card and ROM, £20 for the cable). That plus the £120 for the EZ drive cost £250 saving me at least £100.

The solution was still not complete. I could not read Mac formatted cartridges using the SCSI software or my copy of MacFS Lite. A generous parental contribution of £50 led to my possession of the full version of MacFS, giving a total cost of £300 – still a saving of £50, which is five good weeks of shopping to a student. The solution works quite well, although MacFS has quite a few bugs and my CD drive ejects on shutdown. My cure is to use the \*Lock command under CD's, to stop the drive shelf accidentally winding me in the stomach.

### In the pipeline

I still have problems getting files to work, particularly my own movie files. My latest copy of MovieFS still cannot provide enough support for my work, so I'm more careful in the compression methods when creating them on the Mac. And there is still nothing on the Acorn (bar *HyperStudio* which is more suitable for use in schools) to match or interpret Director, although I read recently that an Acorn version of Director is in the pipeline.

I now have *Photodesk 2* in my possession which, with the addition of file loader plugins, can interpret *Photoshop* files, getting me one step closer to harmony. I had found on my course that Acorn is still regarded as a has-been, not up with the times and used solely in schools. I have convinced them, through my work, that this is most definitely not the case and platform bias is one of the most crippling aspects of the computing industry.

Just look at some of the Internet newsgroup postings as an example. Hopefully this year, cross-platform compatibility will improve markedly for everyone in the Acorn world, whatever field of work they

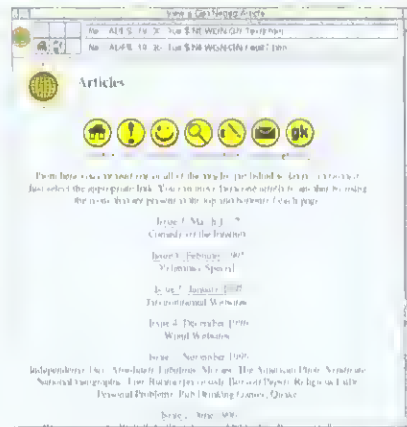

The Get Netted web site at Staffordshire University produced using ArtWorks and Zap

are in, due to the release of the NetStation and accompanying network computers plus the release of the so-called 'XMPIC' – the fabled Acorn/Apple computer in one – which was mentioned last year in various articles and exhibitions.

I am still annoyed that these problems were not at the forefront of Nemplar's strategy last year. Multimedia is a constantly evolving market and Acorn does have the power and the technology at its fingertips to become a major competitor alongside the so-called industry standards. I would rather suffer a few months of incompatibility problems than defect to either of the other two platforms.

My experience at university is not a unique one. There will be many more young people out there, brought up on Acorn technology at school, who will be introduced to the working practices of other machines, discovering that they are not as good as they are cracked up to be. It is really a matter of finding the best uses for each platform and doing the best you can, something I have mostly been successful in achieving.

It is conceivable, with the advances expected to take place in 1997, that problems Acorn users have had to cope with when using PCs and Macs will be just a distant memory in a few years. I look forward to that prospect with anticipation.

If you wish to contact me about the subject matter of this article, you can e-mail me at dc5bass@cr47c.staffs.ac.uk. The screenshots and project work shown here can be found on my Web page at <http://www.geocities.com/SiliconValley/Pines/2760>



Part exchange  
:W Strong:  
:PC 4M SRP  
:PC 10M SRP  
ongArm proce  
: Digital 14" Mo  
na Digital 17" M  
: Speed CDR  
: DX4-100 PC  
: 1MB VRAM up  
: 17GB HD upgr  
erest free fina  
these coi

Minimum  
ide-in allowen  
puter (most  
for Clan n  
(Clan member

Typical Trade  
BBC Master  
A310  
A3000  
A440/A  
A4000  
A5000  
RiscPC600

JS Co

Millstone H  
1/53 Heath  
Chelmsf  
Essex CM  
tel 01245 3  
fax 01245 3  
all sales@aj  
all prices ph

COPI  
this  
TU  
E  
H  
SC  
ed

ir reader  
that Ac  
blisher i  
st read  
orn mar  
rail us n  
mple co  
spira  
forma  
corn



# Once Again!



Aleph One Limited

## Improvements!

Aleph One has once again improved the performance of Second Processor PC Cards without increasing the price!

## Bigger and Better!

This time the gain comes from providing 512 KB of Secondary Cache on the Card, in place of the 128KB we previously used as standard, and still used by some suppliers.

## To Prove It!

Careful benchmark testing shows that the greatest benefits in performance of Second Processors come from providing plenty of RAM from the host Risc PC. When 16MB is allocated, there are larger benefits from larger cache, amounting to 9% using ARM 610 and 14% using StrongARM.

## Results!

We used the Winstone 96 Benchmark to run a large set of practical PC applications, in many different system configurations. As well as the effect of cache size, these results show that the AMD/133 MHz CPU runs from 1% slower to 5% faster than the Cyrix 5x86 at 100 MHz. These and many other details are available on our Web site at <http://www.aleph1.co.uk/benchmark.html>

## Simply The Best!

And of course !PCPro comes as standard with our Second Processor Cards at no extra charge. It is also available to other users at £49 including VAT and postage and a copy of PC Exchange.

We have 5x86 Cards in stock at £339 + VAT = £398.33, including 512 KB cache and !PCPro and postage in Britain. Also from good dealers. We take Visa and MasterCard.

Ask us to send you a copy of the full report by fax or Email.

Aleph One Limited The Old Courthouse Bottisham  
CAMBRIDGE CB5 9BA Tel +44 (0)1223 811 679  
Fax 812 713 EMail [sales@aleph1.co.uk](mailto:sales@aleph1.co.uk)  
[www.aleph1.co.uk/](http://www.aleph1.co.uk/)

### Part exchange to a

### NEW Strongarm RiscPC

RiscPC 4M SRP10 £979.00  
RiscPC 10M SRP05 £1234.00

StrongArm processor included  
AOC Digital 14" Monitor £155.00  
Iiyama Digital 17" Monitor £475.00  
Eight Speed CDROM £42.00  
486 DX4-100 PC Card £199.00  
1 - 2MB VRAM upgrade £59.00  
1.0 - 1.7GB HD upgrade £79.00

Interest free finance available on these computers.

### Minimum £200

trade-in allowance on your old computer (most types accepted) for Clan members.  
(Clan membership - £15.00)

### Typical Trade in Allowances

BBC Master	£ 200
A310	£ 200
A3000	£ 200
A440/1	£ 200
A4000	£ 300
A5000	£ 350
RiscPC600	£ 550

### Second Hand Items

Acorn A3000 - £125.00  
Acorn A5000 4MB - £345.00  
CC Colour Card - £55.00  
CC Laser Direct LBPA - £375.00  
BBC Master 128 - £40.00  
Microvtec CUB Monitor - £40.00  
486SX25 computers systems with monitors - £295.00  
3 month warranty on all S/H Items

### Clearance sale (all new)

EESOX PD system - £325.00  
Epson Stylus Colour II - £150.00  
HP Deskjet 340 + SF - £125.00  
Epson LQ300 - £60.00  
Sportsster V114.4 - £60.00  
Acorn RiscPC700 5M - £895.00

### SIMMs for RiscPC

additional 4Mb - £15.00  
additional 8Mb - £30.00  
additional 16Mb - £60.00  
additional 32Mb - £120.00

## AJS Computers

Millstone Houses  
51/53 Heath Drive  
Chelmsford  
Essex CM2 9HE  
tel 01245 345263  
fax 01245 345233

email [sales@ajscomps.demon.co.uk](mailto:sales@ajscomps.demon.co.uk)  
all prices plus vat and carriage



### A7000 Special Package

- ↳ 8Mb RAM
- ↳ 540Mb Hard Drive
- ↳ Eight Speed CDROM
- ↳ AOC Digital Monitor
- ↳ Stereo speakers

£825.00

# Acorn publisher

The magazine for all interested in publishing using Acorn computer systems

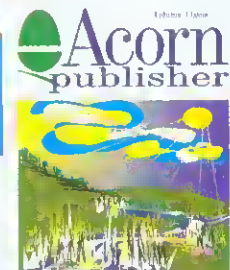

EXACT QVID DIGITAL CAMERA PRINTERS AND PRINTING - NEW SERIES CARTOGRAPHY ON ACORN COMPUTERS

Our readers tell us that Acorn Publisher is the best looking, most readable magazine in the Acorn market. Write, phone or email us now for your free sample copy. Acorn Publisher - something to look into.

Inspiration  
Information  
Acorn Publisher

## AKALAT Publishing

P.O. Box 231, Barton, Bedford MK45 4HQ.  
Tel. 01582 881614  
Email: [akalat@kbnet.co.uk](mailto:akalat@kbnet.co.uk)  
<http://www.nms.co.uk/acornpub>

# Reverse pres

## Mike Tomkinson reveals Risc PCs managing waste

It is a well established fact that computers are capable of assisting in the creation of rubbish. It only seems fair, therefore, that they are also capable of playing a significant part in cleaning up some of the mess made by their creators.

Waste disposal is big business and anyone with a large hole in the ground can make equally large amounts of money by having others fill it for them. However, this really only works well with the disposal of solid waste — liquids create other problems altogether.

Water and effluent treatment is highly specialised and can be very expensive. By law it has to be cleaned to certain standards before discharge into sewer and river



Part of the aerobic biological purification process



Chris Crewdson uses Schema 2 to produce assessment reports

systems — and quite rightly so. We do not want to get too deeply into the technical aspects of Chemical Oxygen Demand and Suspended Solids in this article so I will try to concentrate on the computing.

However, most of the food industry, for example, produces dirty water as a side effect. If this is discharged into a sewer it results in very high bills from the water companies. If it is pre-treated before discharge the bills reduce. They can even reduce to nothing if the water is cleaned to the correct standards. It is a fine dividing line between cleaning the water/effluent to the required standards yourself and paying a water company to treat it.

Obviously the privatised water companies charge for this service and literally have the customer over a barrel (no pun intended) in deciding their charges. So how do you make the decision as to whether to do it yourself or pay someone else to clean the water to the required standard?

The answer, not surprisingly, is to use a computer — more specifically, an Acorn computer. This is where Crewdson and Company enters the picture. It's a company situated in an area famous for its clean water — the Lake District. The service it provides, on a consulting basis, is to

examine a customer's water treatment needs and assess the benefits which they would gain from cleaning their own effluent before discharge to the sewer system.

Thus it is able to answer all the clients important questions. These are likely to include the cost/ benefits of on-site water treatment, the capital costs, the running costs and the payback period. So how is this all done?

Crewdson and Company has devised a complex spreadsheet based on Schema 2 from Clares. Into this spreadsheet go the various client parameters and data to enable the spreadsheet to answer the above questions. The program then enables various 'What if.....?' scenarios to be modelled to allow the client to make the best decision based on the inputs.

These are set against the charges made by various water companies for treatment. An obvious job for a spreadsheet. Schema 2 is ideal as a number of spreadsheets can be open but hidden behind the main sheet and it is particularly strong at conditional logic. Another very big plus is the always excellent support from Clares when the company has got stuck. Support in such a situation is vital and is generally very good in the Acorn world.

Interestingly, Schema 2 came out tops



# pressure

in our spreadsheet shootout in the February 97 Issue. Crewdson obviously agrees with us on this one.

The spreadsheet program is called *Effluensis* and can allow such factors as any relevant depreciation and tax allowances to be entered. It eventually produces a comprehensive four-page printed analysis of the options with an Executive Summary.

Crewdson does not sell the program but runs it on behalf of its clients in a client/consultant relationship. This involves site visits and data collection before the actual running of the program. For this mobile phase of the operation it uses an A4, while back at the office in Kendal sits an A420, an A5000 and a Risc PC 600.

The mobility is important as clients can be anywhere in the UK and the company can work in real time with a customer's data. If Acorn is listening, here is yet another potential customer for a new portable, preferably colour, computer.

From a business point of view using Acorns has many advantages. The A4 may only be monochrome but as Managing Director Chris Crewdson points out it is a very good monochrome. The A4 can drive a customer's colour monitor or projector for presentations which is important as the message may require delivery to an audience greater than one.

As he also points out, running software on an Acorn gives a degree of security as it is not as easy for a customer to make his own copies for use on PCs. This protects, to a certain extent, the time and money invested in setting up the spreadsheet.

The A4 is not the only Acorn equipment the company uses and since its start up in 1991 it has used a venerable A420 (still in

daily use), an A5000 and a Risc PC 600. Printing is via a mix of HP and Canon BJs.

Obviously the Schema 2 spreadsheet is at the centre of the operation but use is also made of *Impression* and *Advance* (mainly for its database). Once again we have living proof of the viability of the Arc and its software in terms of being able to run a business and not simply being a machine for education or enthusiasts.

Once the program has been run and the various scenarios have been examined, or more correctly modelled by the spreadsheet, sensible cost/benefit projections are available. The basis for any sound business

The basis for any sound business decision must be reliable information from good data. Hence the part played by the Acorn computers and Schema 2

decision must be reliable information from good data. Hence the part played by the Acorn computers and Schema 2.

Crewdson acts as agent for a range of water treatment equipment produced by Meyn Water Treatment BV, a company based in the Netherlands. This makes Crewdson a true international company



Rapid separation of the pollutants by flotation

flying the Acorn flag. As a result of running *Effluensis*, Crewdson has 18 water treatment plants running in the UK.

I asked Chris Crewdson if using Acorn equipment had ever posed any problems. He replied, "They are wonderful to use and we have suffered no limitations on our activities. With good word processing (*Impression Style*), a good spreadsheet (*Schema 2*) and the excellent *!Draw* we do not feel the need for much more".

Given the potential savings possible for a company in deciding to treat on-site water before discharge Crewdson makes the service available for only £250 plus VAT. The service can prevent costly mistakes being made in installing the wrong plant or simply deciding that it is cheaper in the long run to tender the treatment out to water companies. At least any decisions are made based upon recent, relevant facts and not upon long established custom and practice. **AU**

## Company information

Crewdson and Company Limited  
 Address: Beck Mills, Kendal, Cumbria LA9 6NY  
 Tel: (01539) 730990  
 Fax: (01539) 725316

## Product details

Product: Schema 2  
 Price: £114 plus VAT  
 Supplier: Clares Micro Supplies, 98 Middlewich Road, Northwich, Cheshire, CW9 7DA  
 Tel: (01606) 48511  
 Fax: (01606) 48512  
 E-mail: sales@clares.demon.co.uk  
 WWW: <http://www.stcoll.ac.uk/clares/>

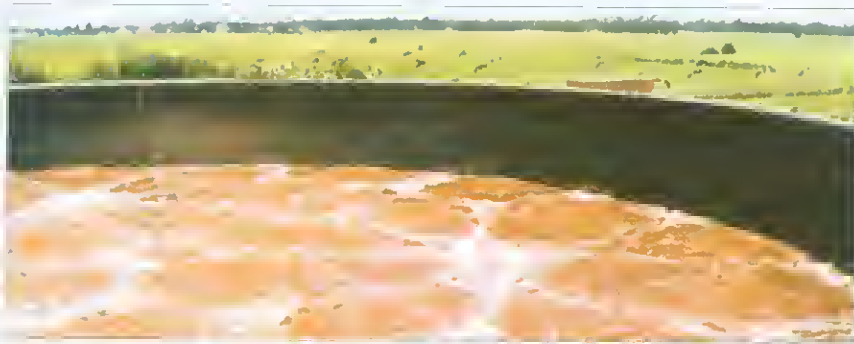

An oxidisation tank that treats polluted waste water

The Fastest RiscPC PC Card just got faster!  
The 'CJE 133MHz 5x86' with **512K Cache!**

Now Available £ 390 inc VAT Please phone for details.

## RiscPC CD Rom Systems

<b>IDE:</b>		<b>SCSI:</b>	
Eight Speed Drive	£ 85	Double Speed Drive - tray	£ 95
Twelve Speed Drive	£ 110	6.7 Speed Drive - tray	£ 170
6Speed 4Disk Autochange	£ 222	Eight Speed Drive - tray	£ 200

For details on drives for other systems, please call

**Job Vacancy: Trade Sales**  
**send CV to Mr C Evans**

(Please add £ 15 for IDE CD Drivers if using RiscOS 3.5 computer).

*Combined Quad Speed SCSI CD Rom Drive AND 650MB Optical Read/Write Drive £ 360\**

SCSI I Mini Podule Int. (e.g. A3020)	£ 115
SCSI I Podule Int. (e.g. RiscPC)	£ 90
SCSI II Podule Int. Cumana	£ 180
SCSI II Podule Int. PowerTec	£ 195
Cases for External CD Rom Drives from	£ 47
*Optical Discs for PD Drive	£ 46

**0%**

RiscPC's from £ 48 p.m.  
20% deposit.  
20 Months to pay.  
Call for further details.



All prices include VAT @ 17.5%

Call for prices on:

- Interfaces
- Scanners
- Speakers
- Printer Ribbons & Cartridges
- Digital Cameras
- Modems
- Arch. Hardware

and much much more...

... A new WWW site is coming to you soon ... <http://www.cje.co.uk/> ...

## RiscPC RAM

4MB	£ 18	128MB <b>NEW</b>	P.O.A.
8MB	£ 35	1MB V-RAM	£ 70
16MB	£ 72	2MB V-RAM	£ 120
32MB	£ 140	1-2MB V-RAM	£ 90
64MB <b>NEW</b>	£ 525	For DRAM Part Exchange prices please Call.	

## Monitors

14" SVGA (AKF 60 equiv.)	£ 225
15" Link (0.28mm FST MPC 1280 x 1024)	£ 280
15" Idek (0.28mm FST MPC 1280 x 1024)	£ 300
17" Idek 8617e (0.26mm FST MPC 1600 x 1200)	£ 580
17" Idek 9017e Pro (0.25mm FST MPC 1600 x 1200)	£ 625

## Hard Disc Drives

420MB Conner 3.5" IDE	**Special price**	£ 85
1.2GB Quantum Fireball TM 3.5" IDE		£ 170
1.7GB Quantum 3.5" IDE		£ 200
2.5GB Quantum Scirrocco 3.5" IDE		£ 260
3.2GB Quantum Fireball 3.5" IDE <b>NEW</b>		£ 280
3.8GB Quantum Fireball 3.5" IDE		£ 310
2.0GB 3.5" SCSI		£ 325
3.2GB 3.5" SCSI <b>NEW</b>		£ 475
4.3GB 3.5" SCSI		£ 725
Hard Disc Kits for A3000 from (A3020 from £ 90)		£ 175
Syquest EZ230MB 3.5" Drive	Price reduced	£ 220
Xyratex 540MB Drive (removable cartridge)	external	£ 320
Iomega 1GB JAZ Drive (removable cartridge)	from	£ 350

## Printers

BJ30 Black	£ 155	BJC620 Colour	£ 320
BJC210 Colour	£ 190	Stylus Colour 500	£ 230
BJC4100 Colour	£ 230	HP5L 4ppm	£ 380

## Risc PC's

### 15" Monitors at 14" Prices

with SRP5/6 RiscPC systems, £20 with SRP10/11.

OR

### £ 20 Eight Speed CD Drive

£40 with SRP10/11 (£ 35/£ 55 Extra for TWELVE Speed.)

OR

### £ 50 for 15" & 8 Speed CD

£70 with SRP10/11

RiscPC Systems Prices Reduced!

RiscPC's Built to your specification.

Example : RiscPC 200MHz StrongARM, RISC OS 3.7, 1.7GB H/D, 16MB RAM, 2MB V-RAM, 15" FST Monitor

**£ 1700 inc. VAT & Delivery.**  
**For 8 Speed CD Add £50**

All Prices include VAT @ 17.5%

Post from £ 2.50 Courier from £ 7.00  
Credit Cards & Official Orders Welcome.

Acorn  **CJE**micro's  Acorn

78 Brighton Road, Worthing, West Sussex, BN11 2EN Telephone : 01903 523666 Fax : 01903 523679

Email : sales@cje.co.uk or info@cje.co.uk Web : <http://www.cje.co.uk/>

D428/05g



The graphics pick up  
pace as **Greg Scott**  
explains further

# Acorn virtua lity

part 3

Now that we have a simple ray casting engine to work with, it's time to make some optimisations — in terms of speed of rendering, movement of the viewpoint and engine capabilities.

There is a worrying abundance of floating point variables in the source code of last month's engine. To a PC programmer this probably wouldn't cause as much of a worry — all machines after the 486 DX2-66 have dedicated floating point co-processors on board to handle the operations.

Acorn owners aren't so well off, floating point hardware is rare and instead we have the Floating Point Emulator (FPE) — a software module written by Acorn to emulate the function of a co-processor. Although this allows us to use floating point instructions, they all take far too long to be used in real-time graphics applications. For Acorn games

programmers it means that floats should be avoided at all costs.

Simply to replace all the floats in our program with integers would be far from the correct solution — this would cause great inaccuracies in the calculations. Somehow we need to keep the decimal portion of numbers rather than discarding them as we do with integers. Fixed Point Maths, the technique employed by programmers when using floats, is out of the question.

By using a combination of conversions, multiplications and binary shifting (described last month), we can perform operations as accurate as floats but at the speed of normal integer instructions. Figure 1 shows most of the floating point operations and their fixed point equivalents.

Fixed Point Maths works by splitting a traditional 32-bit integer into two parts.

The right-hand portion holds the decimal part of the number while the left-hand bits store the whole part of the number. Depending on the type of number to be represented, we assign a different number of bits to each section — we will use 16 bits apiece.

To convert an integer to fixed point number we shift it 16 places to the left (making it 65536 times bigger). For a floating point conversion, we multiply the variable by 65536 — remember that you can't shift floating point numbers because of the way they are stored in memory. In both these cases we are moving the bits of numbers to fit into our fixed point system.

An integer should occupy the 16 left-hand bits of the number only. For a floating point variable we aim to preserve the decimal fraction of the number, so we multiply the number by

# Acorn

## Virtuality

65536 rather than discarding the decimal portion as we would do with normal integer assignment.

Once converted, operations on fixed point numbers are no more complex than traditional integer maths. Addition and subtraction are identical, however multiplication and division of fixed point numbers require more understanding.

### Bigger than big

Overflow can occur when two fixed point numbers are multiplied together. The numbers are so large that the product is too large to be represented by the fixed point system — there simply aren't enough bits. Therefore we must take care to avoid overflow, by shifting the two factors to the right before the multiplication, so that bits don't overflow to the left.

```
fixed var=fixed var2*fixed var3 ;
```

In this case, if *fixed\_var2* and *fixed\_var3* held large enough numbers such that all 16 left-hand bits were used, to multiply them together would produce a result too large to store in a 32-bit memory location. To avoid this situation we shift the bits of each factor to the right, so that after the calculation we haven't lost any bits to the left. The only disadvantage in using this method is that part of the decimal portion of each factor is lost. This is, however, a small price to pay for preventing a potentially disastrous error. The total number of shifts to the right we make should equal 16, so:

```
(fixed var>>10)*(fixed var2>>6);
(fixed var>>8) *(fixed var2>>8);
(fixed var>>12)*(fixed var2>>4);
```

are all valid expressions. We weight the shifts on the number which is

least accurate — the fewer places we shift to the right the less accuracy is lost. So in the following code:

```
(fixed var>>2)*(fixed var2>>14);
```

the variable *fixed\_var* maintains all but two bits of accuracy, whereas *fixed\_var2* loses most of its decimal portion. If we know that one variable is really an integer (without a decimal ending) all shifts can be applied to that variable alone:

```
fixed var=int var<<16;
fixed var>>16)*(fixed var2);
```

Fixed point division is, unfortunately, still a division. The absence of a division function in the ARM instruction set means that they are painfully slow to perform. Thankfully there are ways around using a division — multiplying by the reciprocal is the most common. This leads me on to the next area of improvement...

### Look-up tables

The ray casting process involves a fair amount of trigonometric functions — all of which take a great deal of time to

execute. To do them *on the fly* is certainly out of the question, no matter how many StrongARMs present, so we must somehow precalculate the functions and store them for retrieval later in the program.

The function *aaa\_tables()* does this for us — storing the sines, cosines and tangents of all possible angles. Figure 11 lists all of the look-up tables we use in the engine. Notice that floating point variables need not be used anymore — fixed point does the trick, and a lot quicker.

To allocate the memory for each table we use the ANSI C dynamic allocation function *malloc()*. Once memory has been reserved we loop through all possible angles (0-360 degrees), and store the result of each trigonometric function in the appropriate array. As an example, the tangential function is precalculated as follows:

```
tan table =(int*)malloc(sizeof(int)
*(ANGLE 360+1)); /* assign memory */

for(ang=ANGLE 0;ang<=ANGLE 360;ang++)
{ /* start at 0 degrees and loop up */
rad angle=(float)((3.272e-4) + ang *
```

Instruction	Floating point	Fixed point
Integer Assignment	float_var=(float)int_var;	int_var=int_var<<16;
Float Assignment	float_var=float_var2;	int_var=(int)(float_var*65536);
Addition	float_var+float_var2;	int_var+int_var2;
Subtraction	float_var=float_var2;	int_var-int_var2;
Multiplication	float_var*float_var2;	(int_var>>8)*(int_var2>>8);
Division	float_var/float_var2;	(not used in the engine)
Integer De-Assignment	int_var=(int)float_var;	int_var=int_var>>16;
Float De-Assignment	float_var=float_var2;	float_var=(float)(int_var/65536.0);

Figure 1: Floating Point and Fixed Point expressions



Open Sunday 11am to 4pm  
Late Night Opening Wednesday & Thursday till 7.30pm

**FIRST COMPUTER CENTRE**

**LOW COST DELIVERY**  
Tel: 013 231-9444

- 2-4 Week Days £3.99
- Next Week Day £5.99
- Saturday Delivery £14.99

Delivery subject to stock availability

**SHOWROOM ADDRESS:**  
FIRST COMPUTER CENTRE,  
DEPT. 40 UNIT 1, WILTON FLETT,  
STANNINGLEY RD, LEEDS, LS12 2AE.

EASY ACCESS FROM M62, M1 and A1

From M1 follow signs for A1. Take A614 East Road (M1 Junction 27) and Armitley gateway from the A1 to the unit for A14. The merge with the A1 (by-passing town centre) which meets Armitley gateway.

From M62 follow signs for A1. Take A614 East Road (M62 Junction 17) and Armitley gateway from the A1 to the unit for A14. The merge with the A1 (by-passing town centre) which meets Armitley gateway.

From M62 follow signs for A1. Take A614 East Road (M62 Junction 17) and Armitley gateway from the A1 to the unit for A14. The merge with the A1 (by-passing town centre) which meets Armitley gateway.

**LARGE SHOWROOM WITH FREE PARKING**

**AUTHORISED REPAIR CENTRE**

We offer a FREE quotation on your Acorn or any peripheral (monitors, printers etc.). A delivery tariff of just £5.00 is charged or alternatively you can visit our showroom. We can also arrange a courier pickup at an additional cost of £11.00.

**OPEN 7 DAYS A WEEK**

Delivery £1.50 per title or £3.99 for 4+

**Hardware**

**Acorn Risc PC's**

**StrongARM Risc PC (200Mhz)**

- 4Mb HD1.2Gb & AKF60 £1399.99
- 4Mb HD1.2Gb/CD & AKF60 £1449.99
- 4Mb HD1.2Gb & AKF91 £1769.99
- 4Mb HD1.2Gb/CD & AKF91 £1819.99
- 10Mb HD1.0Gb & AKF60 £1689.99
- 10Mb HD1.0Gb/CD & AKF60 £1739.99
- 10Mb HD1.0Gb & AKF91 £2059.99
- 10Mb HD1.0Gb/CD & AKF91 £2109.99

**Acorn A7000 Systems**

- A7000 4Mb HD540 & AKF60 £1061.99
- A7000 4Mb HD540CD & AKF60 £1161.99

Backplane A7000 £39.99  
Backplane A600/A700 £34.99  
Extra Slice Case £115.99  
Extra Slice Case no PSU £89.99

**0% Finance Acorn 20/20**  
Interest Free Credit Finance  
20% Deposit 20 Monthly Payments

**PC Cards With Risc PC Separately**

- SX-33 £115.99 £233.99
- DX2-66 £174.99 £292.99
- DX4-100 £233.99 £350.99
- 5x86 £350.99 £468.99

**Microvitec Branded Multi-Scan Monitors**

- 1438, 14" .28dp Only £259.99
- 1701, 17" .28dp Only £396.99

**Software**

**Entertainment Software**

- Alone in the Dark £25.99
- Anagram Genius £17.99
- Black Angel £26.99
- Burn Out £23.99
- Cannon Fodder £22.99
- Cobalt Seed £22.99
- Cyber Chess £26.99
- Darkwood £26.99
- Fist Lore £21.99
- FTT Formula 2000 £23.99
- Global Effect £29.99
- High Rise Racing £21.99
- Logie Mania £26.99
- Rick Dangerous £14.99
- Saloon Cars Deluxe £26.99
- Shuggy £22.99
- SimCity 2000 (A5000) £32.99
- SimCity 2000 (RiscPC) £32.99
- Simon the Sorcerer £24.99
- Star Fighter 2000 £26.99
- Spooified Fantasy £23.99
- The Real McCoy 2,3,4 or 5 £26.99
- Tanks £22.99
- Virtual Golf £24.99
- Wargame Length £19.99

**Application Software**

- Arc Comm 2 £53.99
- Arc Fax 1.12 £37.99
- Arcterm 7 £65.99
- Artworks 1.54 £115.99
- Hearsay II £75.99
- Home Accounts £31.99
- Copernicus Astronomy £117.99
- Impression Publisher £117.99

**Sibelius 6 Version 3 £174.99**

- Sibelius 7 Student ver3 £544.99
- Sibelius 7 Version 3 £999.99
- Termitte Internet £84.99
- Titler £83.99
- Touch Typing £34.99
- Turbo Driver/B/Eps/HP £46.99

**Educational Software**

- Badger Trails £42.99
- Chrystal Rain Forest £42.99
- French Learning Series £19.99
- Oxford R/Tree Stage2 £39.99
- Oxford R/Tree More £39.99
- Oxford R/Tree Stage3 £39.99
- Rosie & Jim (Sneezes) £11.99
- 10/10 Dinosaurs £11.99
- 10/10 Driving Test £13.99
- 10/10 Early Essentials £13.99
- 10/10 Essential Maths £13.99
- 10/10 Essential Science £13.99
- 10/10 English £13.99
- 10/10 French £13.99
- 10/10 German £13.99
- 10/10 Junior Essentials £13.99
- 10/10 Maths Algebra £13.99
- 10/10 Maths Geometry £13.99
- 10/10 Maths Numbers £13.99
- 10/10 Maths Statistics £13.99
- 10/10 Spelling £13.99

**10/10 Education Series Any 2 for £25.99**

**PC CD ROM Software**

- Schubert £37.99
- Strauss £26.99
- Stravinsky £37.99
- Ancient Lands £26.99
- Dinosaurs £26.99
- MSDOS 6.22 & Windows Works V3 for Windows £26.99

**Reference**

- Chambers Dictionary £35.99
- Grolier Encyclopedia £15.99
- Red Shift Astronomy II £37.99
- Dorling Kindesley Titles
- Encyclopedia of Science £27.99
- Encyclopedia of Nature £27.99
- History of the World £27.99
- My 1st Incred. Dictionary £21.99
- PB Birthday Party £23.99
- Stowaway £24.99
- The Way Things Work £27.99
- The Ult. Human Body £27.99
- Virtual Reality Bird £23.99
- Virtual Reality Cat £23.99

**Top sellers on CD-ROM**

- Comm. & Conquer OEM £9.99
- C & C Red Alert £23.99
- Duke Nukem Atomic Pack £29.99
- Flight Sim 6 £39.99
- MDK Special Edition £29.99
- Ordnance Survey OEM £9.99
- Quake Mission Pack I £19.99
- Red Alert Counterstrike £6.49
- Settlers 2 OEM £9.99

**Strong-ARM Processor Upgrade**  
£284.99

Limited Offer  
Part exchange your ARM710 Processor for £25.00 or RiscOS 3.6 For £10.00

**Acorn Spares**

- Acorn Mouse (Original) £29.99
- PC Serial Mouse (Risc PC) £4.99
- RiscOS 3.11 ROMs only £89.99
- \*2nd User RiscOS 3.6 £29.99
- \*2nd User ARM710 £59.99
- \*Both Together £74.99
- MIDIMax (Risc PC & A5000) £80.99
- MIDIUser (A30x0 & A4000) £67.99
- MIDI Cables (2x3m) £9.99

Available

**2.5" H/Drives**

CONNER FUJITSU Seagate

- 120Mb 2.5" IDE £80.99
- 170Mb 2.5" IDE £85.99
- 210Mb 2.5" IDE £104.99
- 250Mb 2.5" IDE £119.99
- 420Mb 2.5" IDE £129.99
- 540Mb 2.5" IDE £139.99

When Bought With Drive

**3.5" H/Drives**

Quantum TOSHIBA Seagate

- 1.2Gig 3.5" IDE £146.99
- 1.7Gig 3.5" IDE £161.99
- 840Mb 3.5" SCSI £199.99
- 1.2Gig 3.5" SCSI £231.99
- 3.2Gig 3.5" SCSI £309.99
- A3/A400 IDE Card £80.99
- A5000 2nd H/Drive Kit £19.99

**Memory Modules**

- Risc PC/A7000 4Mb £20.99
- Risc PC/A7000 8Mb £41.99
- Risc PC/A7000 16Mb £89.99
- Risc PC/A7000 32Mb £183.99
- Risc PC VRAM 2Mb £119.99
- With 1Mb Trade In £122.99
- A30 1Mb to 2Mb £44.99
- A30 1Mb to 4Mb £94.99
- A3020/A4000 2-4Mb £74.99

Part X. your old Memory Call...

**Printers**

**Canon**

- Canon B330 £159.99
- Canon BJC70 Colour £185.99
- Canon BJC240 Colour £150.99
- Canon BJC4200 Colour £199.99
- Canon BJC4550 Colour £369.99
- Canon BJC620 Colour £290.99

**EPSON**

- Epson Stylus 400 colour £211.99
- Epson Stylus 600 colour £284.99
- Epson Stylus 800 colour £397.99
- Epson Stylus Pro £349.99
- Epson GT-5000 Scanner £269.99
- Epson GT-8500 Scanner £450.99

**HEWLETT PACKARD**

- HP Deskjet 400 Colour £134.99
- HP Deskjet 690 Colour £249.99
- HP Deskjet 820 £279.99
- HP Deskjet 870CXI £389.99
- HP SLLaserjet £279.99
- HP 6P Laserjet £564.99

**CITIZEN**

- ABC Colour Printer £129.99
- Citizen Project IIC £129.99
- Citizen Printiva 600C £371.99
- Citizen Printiva 1700C £529.99

**ACCESSORIES**

- Printer Switch Box 2 way inc. cable £14.99
- Printer Switch Box 3 way inc. cable £19.99
- Printer Switch Box 4 way inc. cable £23.99
- 1.8 metre printer cable £6.99
- 3 Metre printer cable £8.99
- 5 Metre printer cable £8.99
- 10 Metre printer cable £12.99
- Inkjet Printer Cleaning Kit £9.99
- Personal Computer Cleaning Kit £9.99

**Canon T-Shirt Transfer Pack £12.99**

- Canon BC-04 Photography Carts. £24.99
- Canon BC-06 Photography Kit £34.99
- Canon BC-09 Fluorescent Cartridge £24.99
- Canon BC-22 Photography Carts. £32.99
- Canon BC-22 Photography Kit £32.99
- Canon BC-39 Fluorescent Cartridge £29.99
- Canon HR-101 Inkjet Paper (200) £33.99

**HP D1690/694 Photography Cart. £29.99**

- HP D1690/694 Photo Image Kit £43.99
- HP D1690/694 Photography Paper £9.99
- HP D1690/694 Banner Paper £9.99
- HP Deskjet Bright White Paper (500) £10.99
- HP Premium Glossy Paper (10) £9.99

**Multi Media/CD ROM**

**RISCPC's (RISCDS 3.6 & 3.7)**

- 8x Goldstar R580B £79.99
- 6x Goldstar R560B £69.99
- 4x Goldstar R542B £49.99

**RISCPC's (RISCDS 3.5 only)**

- 8x Dptics Stingray £89.99
- 6x BTC CD drive £54.99
- Oscar (Parallel) 4 Speed CD Drive £287.99

**Acorn CD Software**

- APDL Clipart DTP1 £18.99
- APDL Clipart DTP2 £18.99
- APDL Clipart DTP3 £18.99
- Arrows Clipart 1 £20.99
- Care Maths in Motion £58.99
- Childrens Micropedia £87.99
- Dune II £41.99
- Goldlocks £45.99
- Grannys Garden £34.99
- Hutchinsons Encyclopedia £31.99
- Oxford Reading Tree £39.99
- PCDC 1 (Datafile) £24.99
- PCDC 2 (Datafile) £24.99
- PCDC 3 (Datafile) £24.99
- PCDC 1 (APDL) £14.99
- PCDC 2 (APDL) £14.99
- Simon the Sorcerer £41.99
- Photobase Landscaps £55.99
- Understanding the Body £50.49

**Modems**

**PRIMA V34+ Fax Modem**

Superb Price/Performance  
33,600 bps, BAPT Approved

Also available:  
Arc Comm 2 £53.99  
Arcterm 7 £65.99  
Hearsay II £75.99

**Sportster Vi**

- Call Discrimination
- Personal Voice Mail
- Fax on Demand
- 14,400 Data/14,400 Fax £79.99
- 33,600 Data/14,400 Fax £161.99

The UK's Best Selling Modems

**Cables**

Cables and Adaptors... Lots more in stock

- Phone Line Ext. 5M/10M/15M £6.99/£8.99/£10.99
- Dual Socket Adaptor £6.99
- Telephone Socket adaptor BT-US/US-BT £4.99
- Printer Cables 1.8M/5M/10M £4.99/£11.99/£19.99
- Modem Cable/Null Modem £9.99/£9.99
- 2x3M MIDI Cables £9.99, Dual IDE cable £9.99

**CLEARANCE SALE**  
Limited Stocks Available

- SupraFax Modem 2400 £19.99
- SupraFax Modem 14.4 £49.99
- SupraFax Modem 28.8 £79.99
- Sportster 14.4 Vi Ext. £79.99
- Sportster 28.8 Vi Int. £79.99
- GVC 14.4 Voice Internal £29.99

**Consumables**

**Ribbons**

- Citizen Swift/ABC mono £3.99
- Citizen Swift/ABC colour £12.99
- Star LC90 mono ribbon £4.99
- Star LC100/100 colour £7.99
- Star LC240c colour £13.99
- Star LC240c mono £8.99
- Star LC240 mono £5.99
- Star LC240-100/200/300 Colour £13.99
- Re-Ink Spray for mono ribbons £9.99

**Ink Cartridges**

- Canon B110/Star S148 £12.99
- Canon B1200/230 £18.99
- Canon B330 (3 pack) £12.99
- Canon BJC70 mono (3 pack) £10.99
- Canon BJC70 colour (3 pack) £17.99
- Canon BJC 4000 colour (single) £16.99
- Canon BJC 4000 mono (single) £16.99
- Canon BJC 4000 mono high cap. £26.99
- Canon BJC 600e mono high cap. £8.49
- Canon BJC 600e colour high cap. £7.99
- Citizen Printiva Std. colours £6.49
- Citizen Printiva Metallic colours £16.49
- HP Deskjet 500/550 Mono £22.99
- HP Deskjet 500/550 Colour £24.99
- HP Deskjet 640 double mono £25.99
- HP Deskjet 640 colour £25.99
- Epson Stylus mono £13.99
- Epson Stylus colour £27.99
- Epson Stylus Col. II/S/820 Mono £17.99
- Epson Stylus Col. II/S/820 Colour £24.99
- Star S1144 mono/colour (single) £8.99

**Disks**

- 10x £3.49
- 100x £26.99
- 200x £49.99
- 500x £114.99

**Branded DSSD**

- 10x £4.99
- 100x £41.99
- 200x £76.99
- 500x £175.99

**Branded DSHD**

- 10x £3.99
- 100x £29.99
- 200x £55.99
- 500x £129.99

**Branded DSHD**

- 10x £5.99
- 100x £44.99
- 200x £82.99
- 500x £233.99

**Disk Labels**

- 500x £6.99
- 1000x £9.99

Printer repair specialists call for quote



# Acorn Virtuality

int	*tan_table,*inv_tan_table;	/* pointers to tangent look_ups */
int	*y_step,*x_step;	/* pointers to more complex look_ups */
int	*inv_cos_table,	/* inverse sin/cos tables (look_ups) */
	*inv_sin_table;	
int	*cos_table;	/* cosine look_up table */

Figure II: The look-up tables used in the engine

```
2*3.141592654/ANGLE 360);
/* convert degrees into radians */

tan_table[ang]=(int)(tan(rad_angle!*
65536);
/* perform tan() math.h function
and convert to fixed point integer */
```

The one disadvantage of look-up tables is the large amount of memory occupied by the values. We can easily work out how much space our tables will take up:

2000 values for each array x 4 bytes = 8000 bytes  
 8000 bytes x 8 tables = 64000 bytes  
 64000 bytes / 1024 bytes = 62.5 kilo bytes

63K is a fraction of the memory available for use by our program. I would

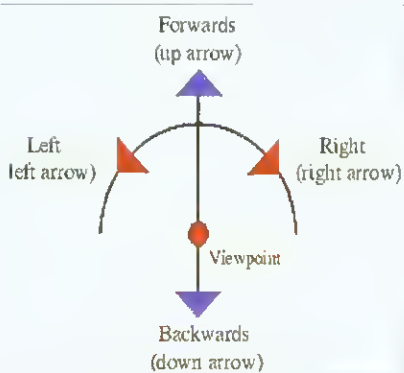

Figure III: Movements of the viewpoint

only start to worry if more than 100K was occupied by look-up tables.

### Moving the viewpoint

Last month's engine generated a static, single frame view by taking specific coordinate values and passing these to the ray casting function. Moving the viewpoint requires a set of functions to input key presses and update the viewing coordinates. For now we'll use the cursor keys to move the viewpoint around the maze, and the "Q" key to quit the program (see Figure III).

Rotating the viewpoint left and right is simply a matter of adding and subtracting a specific amount to the viewing angle:

```
if(ourlib_keydown(121)==255)
/* ourlib_keydown function to test
for specific key-press (left arrow),
returns 255 if so */
{
if((player view angle-
=ANGLE 6)<ANGLE 0)
player view angle=ANGLE 360;
}
```

In the above example, each press on the left arrow key causes the viewing angle to decrease by six degrees. Notice the additional *if()* structure to ensure the viewing angle does not venture below zero.

Moving the viewpoint forwards and backwards is a more complex operation involving the use of the cosine and sine functions:

```
if(ourlib_keydown(57)==255)
{
/* ourlib_keydown function to test
for specific key-press (up arrow),
returns 255 if so */
dx=(float)cos(6.28*player view angl
e/ANGLE 360)*STEP_LENGTH);
dy=(float)sin(6.28*player view angl
e/ANGLE 360)*STEP_LENGTH);
}
player x+=dx;
player y+=dy;
```

The use of both floating point instructions and trigonometry in the above code might come as some surprise. Fortunately we can use look-up tables to replace the complex mathematics, and converting it all to fixed point will cause a further decrease in execution time:

```
dx=dx_table[player view angle];
/* look-up tables holding fixed
point numbers */
dy=dy_table[player view angle];

player x+=dx; /* no shifting
required for fixed point addition */
player y+=dy;
```

To move the viewpoint backwards we subtract the *dx* and *dy* values from the

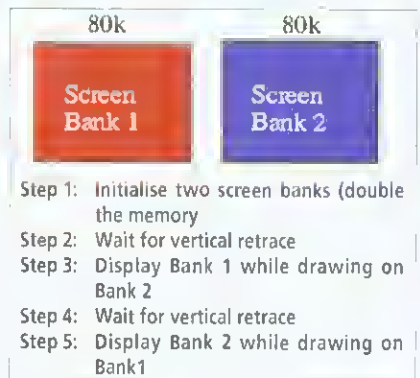

Figure IV: Using screen banks allows smooth and fluid animation





Figure V: The new graphics file

viewing coordinates rather than add them as in the above example.

### Screen banks

Achieving effective animation in a computer game involves avoiding screen flicker caused by altering pixels at the same time the picture is redrawn. To gen-

erate a smooth and fluid animation we need to pay special attention to when we update the image. This is achieved by the use of screen banks (see Figure IV). In addition to this we need to use the *ourlib\_waitvsync()* function, which will halt all screen rendering until the vertical retrace is underway.

The vertical retrace is the small time period during which no screen update is taking place — when the monitor's light guns are moving to the top of the screen after drawing the picture. We use this time to make any changes to the image we need, in the knowledge that the resultant view will be smooth and flicker-free.

### Shading, floors and ceilings

The last update we shall make to the engine involves colouring the floors and ceilings. For now we'll adopt the same approach as *Wolfenstein 3D* — plain

colouring of the upper and lower halves of the screen.

The floor and ceiling function shall also serve as a screen clearing process — *ourlih\_fastclg()*. This function is passed the colours for the floor and ceiling through the function *ourlih\_setup\_background()*. The colouring function is written in assembler for speed, though all it really involves is a repeated STM (multiple store) instruction to the screen memory.

Another feature we can add to the engine is an element of shading — of sorts. Again it is a technique found in *Wolfenstein* (I believe). All we need do is alter our graphics file so that instead of having twenty different tiles, we have ten pairs of tiles — one tile in each pair being a darker version of the other (Figure V).

Then all we have to do is use each darker tile occasionally in the ray caster, by making all vertical boundary intersections use the lighter tile and all horizontal intersections use the darker graphic.

Though this is far from realistic shading, it does add some variation to the world, and at little expense.

### Next month

We'll be adding objects to the world, and a few other features. The !AUA\_Ray application on this month's cover disc contains all of the updates discussed this month.

Try out any graphics or levels you may have put together — it's interesting to see them in full motion. Remember that any files received through my e-mail account will be uploaded to my Web site for all to enjoy.

• Send by mail to Acorn User 3D, IDG Media, Media House, Adlington Park, Macclesfield SK10 4NP

Or e-mail: [AUThreeD@aol.com](mailto:AUThreeD@aol.com)

[WWW.http://members.aol.com/AUThreeD/](http://WWW.http://members.aol.com/AUThreeD/)

AU



Figure VI: A view generated by the new engine

**Stuart Tyrrell** puts a range of digital cameras through their paces

Developments in the Acorn world are like buses — you wait for ages and then four come along at once. Only a few months ago using a camera required a PC card or a video-in card. Now, several native RISC OS applications are available, working with affordable cameras from different manufacturers.

Digital cameras have always been expensive products, used almost exclusively by professional photographers — very wealthy ones. Over recent years there has been a lot of development in the field of CCD (Charge Coupled Device) technology — the element which responds to the light that forms the picture and converts it into an electrical form.

This work, much of which was pioneered at the University of Edinburgh, has led to methods which allow CCD elements to be made cheaply. These are now used in video cameras and, of course, digital cameras for computers.

Although the quality of the pictures produced by the new low-cost cameras is often dramatic, the specifications of professional cameras has increased correspondingly: one of the high-specification Kodak models boasts a resolution of 6144 x 4096, nearly 600dpi in full colour on an A4 page costs nearly £25,000.

**Acorn PhotoQV/Casio QV-10A**

The QV-10A is a strange-looking camera, similar in construction to some of the new video cameras. It has a rotatable section to the lefthand side of the body, which houses the lens, and a colour LCD screen on the body itself. To compose a picture, you point the lens in the appropriate direction and press the shutter button when you are happy with what's visible in the screen.

The rotating section works well and the camera automatically inverts the image when it is turned beyond 90 degrees, so you can easily take self portraits by turning the lens while viewing yourself in the LCD screen. The arrangement puts the lens very close to the corner of the camera, and it's easy for a stray finger to appear in the middle of the photograph, but once I learned how to hold it correctly I had few problems.

In use, the QV-10A is fairly intuitive. To take a photograph, you switch the camera into record mode, turn it on, point and shoot. There is a macro facility which may be used to photograph objects close to the camera. There is also a self-timer, although when it's operational the LCD display blanks and shows the number of seconds

# Snap

# Happy

to go. Surely it would be more sensible to overlay the time over the picture, so that you can arrange the view in the 10 seconds allowed?

Notably missing from the QV-10A is a flash — the camera relies on ambient light only. This is not as disabling as it may at first seem, as the CCD in the QV-10A is much more sensitive than the others reviewed. In fact, a switch is fitted which reduces the light falling on the CCD, to enable the full range of shutter speeds to be used in outdoor and indoor lighting.

The lack of flash does have certain drawbacks, namely that the camera cannot be used unless there is fair ambient light, and that photographs taken under tungsten lighting suffer from discolouration. While the second problem can be addressed to some extent with image manipulation in a graphic package, I can't help feeling that cutting back on a flash facility on this camera and its more capable sibling — the QV-100 — was not a good idea.

Reviewing pictures involves switching the camera into play mode where each of the 96 pictures can be displayed on the screen either in groups of four or nine. In addition to viewing pictures full-size, there is a surprisingly useful zoom feature, as the LCD displays on all the cameras cannot show any appreciable level of detail. Pictures may be deleted at will or protected from deletion.

The QV-10A has a cable to provide a link with Acorn machines, which plugs in under a flip-up section on the top of the

camera and feeds into the serial port.

The software used to download photographs, *PhotoQV*, will work across the range of newer Acorn machines, with a serial port speed maximum of 19200 baud on machines such as the A5000, and 57600 baud on the Risc PC and A7000.

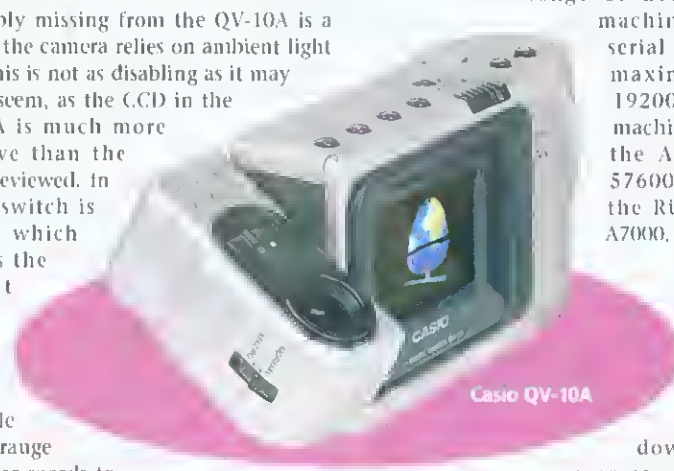

Casio QV-10A

Clicking on PhotoQV's iconbar icon produces a small window showing progress while the thumbnails are generated as a set of numbered slides in a window.

From this window, selected slides can be grouped and saved as an album. Alternatively they may be printed, deleted, protected from deletion or re-ordered. Double-clicking on a slide opens up a dialogue box which enables the slide to be rotated through multiples of 90 degrees or mirrored, before opening a full-size image.

It is at this point that the limitations of the QV-10A show. These pictures are only 320x240 pixels and often suffer from false colouration, especially if they were taken in low-level or tungsten lighting. The quality is approximately that which could be achieved with a video camera and digitiser, although such an arrangement would certainly be more expensive and cumbersome.

A dialogue box is available which allows time-lapse photography — a number of pictures can be taken at regular intervals, for example every minute or every hour. I was surprised that this facility only allowed for the camera memory to be filled, without allowing a download to the

compute  
96 pictu  
which w

Irlam S

If the C  
PhotoPC  
sturdy.  
camera l  
was a sr  
film" pr  
a hidden  
card to e

The ca  
a viewf  
moves t  
turns o  
lens ha  
ing ring  
can  
s t a n  
37mm-  
camco  
lenses.

Th  
PhotoP  
d o e s  
n o t  
h a v e  
an LC  
screen  
picture  
be rev  
camera  
able  
arrang  
down  
very co

A sr  
camera  
first of  
standa  
camera  
picture  
tion p  
comb  
shows  
numb  
battery

And  
the fla  
set to  
disabl  
every  
serves  
before

The  
timed  
the L  
not tu  
you c  
handy  
ture i  
the c  
on th  
ture t  
clean

Th  
in or  
itself.  
(hrar



computer. This results in a maximum of 96 pictures for every time-lapse session, which will be adequate for most needs.

### Irlam Snapshot/Epson PhotoPC 500

If the QV-10A is strange looking, the PhotoPC should probably be described as sturdy. A first glance it reminded me of a camera I was bought at the seaside when I was a small child which had "takes real film" printed on the box. The PhotoPC has a hidden flap which will take a Flash RAM card to expand the memory instead.

The camera is traditional in design, with a viewfinder, flash and a switch which moves the lens cover out of the way and turns on the camera. The lens has a mounting ring which can accept standard 37mm-thread camcorder lenses.

The PhotoPC does not have an LCD screen, so pictures may not be reviewed on the camera — a screen is available as an optional extra. This arrangement helps to keep the basic price down but carrying an extra screen isn't very convenient.

A small LCD panel on the top of the camera is surrounded by four buttons. The first of these allows you to choose between standard and high-resolution pictures. The camera can store 60 standard resolution pictures of 320x200 pixels, 30 high-resolution pictures of 640x480 pixels, or a combination of both. The panel also shows the number of pictures taken, the number of free spaces remaining and the battery status.

Another button enables you to change the flash action. Normally this would be set to auto but there is also the option of disabling the flash, forcing it to flash on every picture, or a red-eye setting which serves temporarily to blind the subject before taking the photograph.

The camera may also be set for a self-timed exposure. The picture does stay on the LCD screen if it is filled, but you cannot turn the screen through 180 degrees as you can with the QV10 — although it is handy to have a quick check that the picture is framed before you run in front of the camera. An erase button is mounted on the camera which enables the last picture to be deleted or the memory wiped clean.

The optional LCD screen must be fitted in order to review pictures on the camera itself. I ran into some problems here using (brand new) alkaline batteries. It seems

that the screen uses a fair amount of power and this causes the built-in battery management software to think that the batteries have run down and the camera turns itself off.

Waiting a few moments and then turning the camera on again showed the battery level to be full. Substituting the alkaline batteries for rechargeable ones solved the problem completely.

The LCD screen has two modes, similar to the QV-10A. In view mode you can see the view through the camera's lens rather than the viewfinder. The LCD module also has a button called macro, which allows

close-up shots to be taken. These require the camera to be close to the subject, which means that the view through the viewfinder often does not correspond with the one through the lens (and therefore the LCD screen is required).

Reviewing pictures on the PhotoPC is a little more simple than the QV-10A. There are only two levels: one picture filling the frame or nine pictures, but you cannot zoom in on one picture to see details. Individual pictures can be deleted freeing up space.

The PhotoPC is linked to the Acorn by means of a lead to the serial port. Irlam's *Snapshot* program works on all later Acorn machines. Clicking on the iconbar icon opens a window which gradually fills with thumbnails.

The save mechanism is a little strange as you drag with Select to save as sprites (either 8, 16 or 24-bit sprites are generated), or with Adjust to save as JPEG. There is no facility for bringing up a standard save window, although pictures can be saved or deleted from the menu.

The software

has a preview mode where pictures are taken by the camera and displayed in a small window in the desktop.

The update rate is a bit slow, but it's a fun option to play with, and is handy for lining up still-life shots if the camera is attached to the computer.

Snapshot allows comprehensive control

over the camera via the Acorn — all aspects can be controlled, such as the flash setting, shutter speed, quality setting and so on.

Although Snapshot lacks a viewer built in to the program for full-sized pictures, loading the images generated by the camera into Change\$! or similar shows the quality to be remarkably good.

The latest version of Irlam's software is able to support multiple camera types — all Olympus, Sanyo Image PCs and others. Image processing is now built into the software and it can output several different filetypes.

### Spacotech Photolink/Olympus CaMedia C-800L

Olympus has released a set of three new digital cameras. The C-400 and C-400L resolve to 640x480 pixels, the latter having a built-in LCD screen and more memory. The C-800L is the most expensive in the range with a resolution of 1024x768 pixels.

The C-800L, and indeed the rest of the range, looks like an expensive compact camera, although the case has obviously been designed especially — it has an LCD screen mounted in the back. The camera is turned on by moving back the lens cover. As you do so, the camera emits a meaningful clunk, indicating that it is fitted with an auto-focus lens.

Although the overall build quality of the C-800L is very good, I was surprised that the serial and power connectors were covered by a fairly flimsy rubberised section, rather than the plastic flap arrangement seen on the QV-10A and PhotoPC. I wouldn't expect the flap to last more than a few months in service, and the design seems uncharacteristic compared with the rest of the camera.

Like the PhotoPC, the C-800L has a small LCD panel which indicates the number of pictures remaining, battery level, flash status and so on, which are controlled with a number of buttons on the top of the camera, although the C-800L has an extra button providing a macro

facility (macro is available as standard as the camera has an LCD screen).

The camera can store 30 pictures in high-quality mode (1024x768 pixels), or 120 in standard quality (512x384 pixels). Again, using it is

just a case of selecting the correct flash mode if necessary then point and shoot. There is a delay of half a second or so as the autofocus works, but as with



Epson Photo PC 500



Olympus CaMedia C-800L





# Snap Happy

in a school environment where ease of use may be important

- The PhotoPC camera produces reasonable quality pictures, and does not suffer from the QV-10A's lack of flash. In terms of a quality/price ratio, this system performs very well, although the addition of an LCD screen can push up the price
- Of course the top of the range Olympus camera is fantastic in terms of features and quality and unfortunately, price.

Each software package works adequately with its camera, although Spacotech's offering is by far the most comprehensive — their drivers are modular, so perhaps we will see support for other cameras in the future? **AU**

## Picture perfect ?

Casio QV-10A

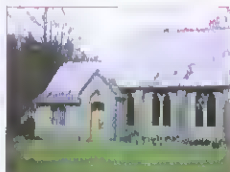

Epson PhotoPC 500



Olympus CaMedia C-800L

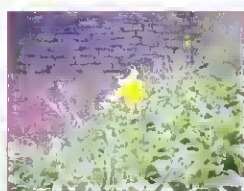

### Product details

**Product:** Epson PhotoPC500 including Snapshot

**Price:** Introductory price £499 inc carriage and VAT. Includes camera, a set of batteries, serial lead, all necessary software and manual

**Supplier:** Irlam Instruments Ltd

**Address:** Brunel Institute for Bioengineering, Brunel University, Uxbridge, Middlesex. U88 3BH

**Tel/fax:** (01895) 811401

**E-mail:** sales@irlam.co.uk

**Product:** PhotoLink

**Price:** £69 (inc VAT)

**Bundles:** (include PhotoLink)  
Epson PhotoPC 500 £499  
Sanyo ImagePC £434.75  
Olympus C400 £299, C410L £587.49, C800L £949.99

**Supplier:** Spacotech

**Address:** 21 West Woods, Portland, Dorset, DT5 2EA

**Tel:** (01305) 822753

**Fax:** (01305) 860483

**E-mail:** sales@spacotech.co.uk

**WWW:** http://www.spacotech.co.uk

**Product:** Connectix Colour QuickCam

**Price:** Includes Acorn software £199.95 fully inclusive

**Supplier:** Oregon Developments

**Address:** 36 Grosvenor Avenue, Streetly, Sutton Coldfield, B74 3PE

**Tel:** 0121-353 6044

**Fax:** 0121-353 6472

**E-mail:** sales@oregon.demon.co.uk

**Product:** Acorn PhotoQV/Casio QV-10A

**Prices (ex VAT):** QV-10a £320, QV-100 £450  
Mains adaptor £12.75  
Connection kit £99

**Supplier:** Acorn Computers

**Address:** Acorn House, 645 Newmarket Road, Cambridge, CB5 8P8

**Tel:** (01223) 725000

**Fax:** (01223) 725100

**E-mail:** info@acorn.co.uk



# Wakefield Acorn Spring Show

Sponsored by Acorn User Supported by Acorn and Xemplar  
**Saturday & Sunday 17/18 May 1997**

At Thornes Park Athletics Stadium, Horbury Road, Wakefield  
 (Follow the AA Road Signs from M1 Junctions 39 & 40)

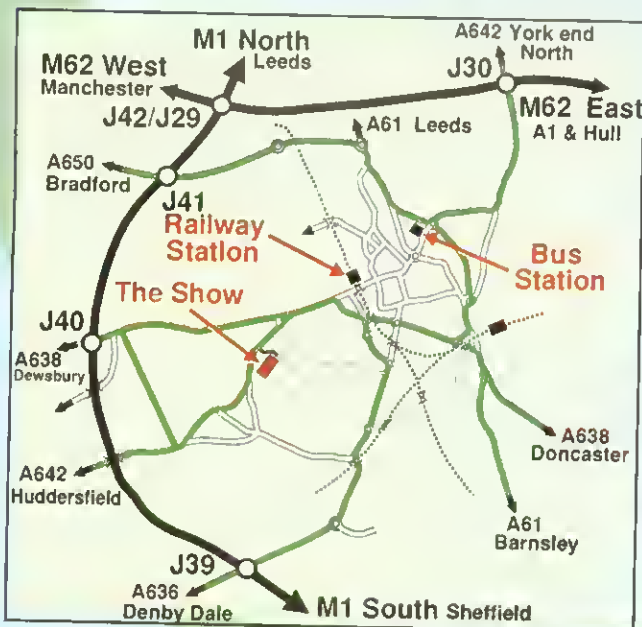

**SEE ALL THE LATEST PRODUCTS AND DEVELOPMENTS  
 FROM THE EXCITING WORLD OF ACORN COMPUTING**

Show Theatre sponsored by Acorn User with continuous demonstrations and celebrity speakers

**Opening Times: Saturday 10:30 to 6:00  
 Sunday 10:00 to 5:00**

Tickets on day £3 Adults, £2 Juniors (age 5 to 16)  
 Or save and avoid queues by pre-booking at £2.50 Adult and  
 £1.50 Junior before 9th May 1997

Pre-booking ticket holders will be admitted 30 minutes early on both days

Booking to WACG Show, 95 Cumbrian Way, Lupset Park, Wakefield, WF2 8JT  
 Further information from the co-organisers:

Chris Hughes Tel: 01924 379 778 email: show97@cumbrian.demon.co.uk  
 Mike Wilson Tel: 0113 253 3722 email: show97@barc.demon.co.uk

Or see our Website: <http://www.cyberwillodge.co.uk/acorn/wakefield/> for the latest information

FREE CAR PARKING • CATERING • CHILDREN'S PLAYGROUND • MINIATURE STEAM RAILWAY  
 Less than 3/4 mile from City Centre with frequent bus service passing park entrance



Mike Buckingham discovers a way to switch between StrongARM and earlier processors

# Multiple personalities

The process of upgrading from ARM610 or 710 to SA110 has taken up many centimetres of column space in recent Acorn magazines. And the two most common themes have been the hike in speed and the problem of older software that no longer functions on the SA110 thanks to its different internal architecture.

Of course, many of the more important software titles have now been upgraded to be SA compliant which leaves us with two problems: the added expense of upgrading all those non-SA compliant titles and the fact that many items will probably never be altered to run on the new chip.

I've just fitted my StrongARM and have these problems. This article is, for compatibility reasons, being written on a piece of software I don't want the expense of upgrading but requires my 710 to run. So I'm running it on the 710 and no, it's not in a second machine. It's the same machine now equipped with both 710 and SA110 by virtue of the *ArmSwitcher* from ACE (Acorn Computer Enterprises) in Germany, distributed in the UK by Qtec.

The *ArmSwitcher* is in theory quite simple. It's an expansion card that has a plug on one side that fits into the rear processor slot of the motherboard. On the other side is a small complement of chips and three sockets, one of which is currently covered with a warning label – DO NOT USE. I'll come back to that later but first the simple stuff.

## Fitting ArmSwitcher

Fitting is a doddle. Turn off the machine, lift the lid and extract the processor card or cards. Screw the legs onto the *ArmSwitcher* board, then place it in the rear processor slot that was either empty or which held the PC card if you have one. Now the only tricky bit. The board comes with a small switch which needs fitting into the case somewhere.

Bear in mind that first you won't want to be knocking this accidentally, and secondly that in time it will be redundant and can be disposed of. Having done that, clip the cable into the board and you are ready to refit both the old ARM board and the SA. These go in the two empty slots on the board. Their order is important but the instructions are perfectly clear.

At first sight this arrangement may not seem as secure as the original, as the ARM boards now no longer have their guide slots in the case to keep them in vertical alignment. Fortunately the PC card still does. I say that because a PC card with a heavyweight chip plus heatsink and fan

needs some support. By comparison the ARM boards are physical featherweights and unless you are going to put your Rise PC in something mobile, I can't see the boards working loose.

This process is very simple but there is one more proviso. My PC card only just fits in this orientation. It's fan is very close to touching the new hardware. Apparently some cards are too wide and require a special adapter to lift them clear. Ask Q-Tec or ACE if you are worried.

Assuming all is well, switch on and the machine will boot up as normal. The only difference is that it will use whichever processor is currently selected – which naturally the boot sequence will report on-screen as per normal.

## The choice is yours

So now you have a machine with multiple personalities – an ARM 610/710, an ArmSA110 or with either running your PC card as well.

Like anything else it's not without its problems. The major hassle is that at present there is no facility to switch processors while 'live'. Flicking the switch with software up and running will lose whatever it is you are doing, whether the application is compliant with both processors or not. In fact the whole machine will hang up and a reset will be required. The set of instructions with the device warn that switching on boot-up should never be done and may have dire consequences. I can't vouch for those consequences – I

don't want to prove them right!

That's the down-side. The up-side is that you will not be stuck trying to run a piece of software that reports some kind of stack error with no alternative options open. Now you can reboot and use the older chip. Having that facility, especially during the process of upgrading to StrongARM, has already proved invaluable. Not the least benefit has been in tracking down the source of problems – a software that reports as faulty under both chips is clearly missing something related to the resources or system files. Software that works under 710 is obviously failing for reasons of incompatibility.

The cost of the purchase has been justified for me. As I test software it will be a great help to know whether it runs adequately fast on 710 configuration. More to the point, I know I still have access to many programs I use from time to time that I don't want to spend time and effort upgrading; some which will never be upgraded anyway. But, naturally, for those activities that will really benefit from the SA, it's there too.

## Under development

At present the lack of live switching is a pain and somewhat frustrating. All apps need to be shut down in order to restart with the other processor. What is needed is a software switch that allocates particular tasks to particular processors.

However, it is under development and Mike Saxton of ACE explained to me that

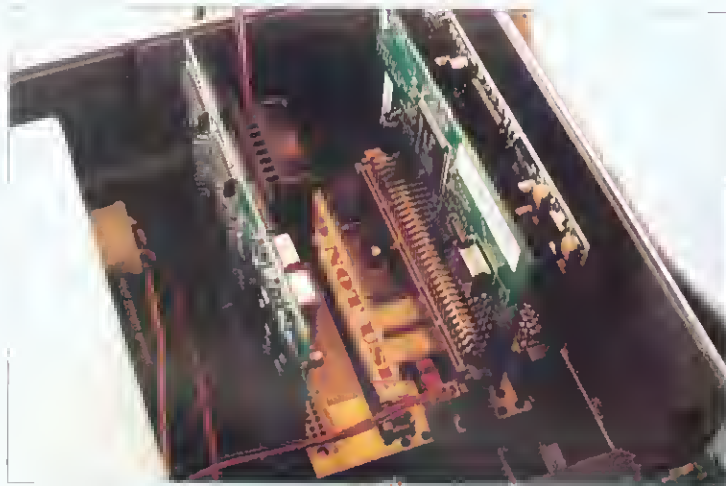

# Multiple personalities



the software has been delayed because although the basic switching software has been completed and works correctly, there are several packages (including some major ones) that crash. The problem according to Mike is the illegal use of memory. Acorn publishes strict guidelines to which writers should adhere when allocating blocks of memory for particular applications but apparently not everyone follows the rules.

For the ArmSwitcher this a real headache. Any live control software will need to be able to track memory locations in use and cache their contents when the user selects a window that requires the activation of the other processor. If the memory isn't properly cached, the software being put into cold storage, as it were, will be missing something crucial when it is restarted with the inevitable disastrous consequences.

## Code to cope

To make the best of a difficult situation, ACE has used the services of a local ARM powered University to run software while having a second computer analysing calls to memory. In this way it's been able to patch the code to cope with some popular software titles such as *Impression*, that otherwise crash.

But there is a limit to how much can be done without increasing the price beyond a sensible level, not to mention delaying the software indefinitely. As I write, Mike Saxton is considering releasing the software anyway with a listing of all titles that break the rules – and so won't work. Clearly this problem could scupper the purchase for people who frequently use software that won't run. I'd therefore advise anyone interested in the ArmSwitcher to find out whether their favourite titles are OK or not. And bear in mind that we're not just talking about titles that need the older chip. All titles will have to comply for the software switcher to work reliably.

Because of this problem I haven't yet

seen the software front end. The general idea is to use a sort of dual launcher bar system that allows the allocation of particular applications to particular 'sides' of the machine. In use, this should be more fluid than having to shut down and start again.

That is the present. But before making up your mind about whether the card is worthwhile, also consider the future. Will it pay off long-term? As time goes by, fewer applications will need to be switched back to older ARM chips so the use for the switcher will fade.

It's also possible that *StrongGuard*, the Arm Club's software patch for the StrongARM, will gradually expand its scope and encompass more of the older titles that fall foul of the SA's split registers.

## Slotting in

Before you write off ArmSwitcher, there's still the question of that extra slot with the ominous warning stuck over it.

Although physically identical to the other processor slots, the fact that it is covered and mustn't be confused with the others suggests it isn't quite the same. Earlier versions of ArmSwitcher had just the two slots; this third has been added to give the card some extra long-term prospects.

Mike Saxton said that the first priority for this slot is a graphics accelerator card. They aren't building one themselves but are working on a small PCI adapter to allow a Matrox Mystique card to be plugged into the slot. Mike says this would provide more than simple graphics speed improvements for PC cards. The Matrox card is a hang up-to-date PC graphics card boasting 3D rendering for games and supporting up to 4Mb of Video RAM.

When not in use by the PC, this Video RAM could be made available for use by the RPC's own video system. Also on the cards is an extra video output so the PC could output to a separate screen, and the possibility that the VRAM could also be used under some circumstances as high speed RAM for general processing without having to access main RAM via the RPC's bus. That

could provide a welcome speed boost for RPC operations that need to shuttle large amounts of data in and out of memory.

If you are into PC cards and high speed graphics, the Matrox may sound intriguing but if you aren't it may be of no interest at all. In which case, consider this: the development of a PCI adapter means that in principle, any PCI card could be plugged in. Given the host of cards available to the PC market, this opens up interesting options.

And finally, I shall indulge in a little rumour mongering. Nothing has been said officially but for a while there have been suggestions that Xemplar should/would be making an Apple card. If it does happen and when your Arm710 or 610 ceases to be of any real value, you will have a spare slot to tuck in that extra piece of hardware if you want it.

## Conclusions

It would be rash of me to make hard and fast conclusions about this product, especially over whether you should go out and buy one. There are too many variables and too many individual needs and considerations to make such recommendations even remotely useful.

Costwise it may pay for itself simply on the basis that you will be able to avoid some expensive upgrades. But you have to be sure that the device will switch all the software you want to run. As an ArmSwitcher, its lifetime is almost certainly limited, but further developments could well give it a new lease of life – always assuming you decide not to upgrade the Acorn motherboard when the new design becomes available later this year (we hope – and who knows what will be on it?).

Certainly my ArmSwitcher is going to stay put. And I look forward to the launcher software. When it appears, I'll report back.

AU

## Product details

Product:	ArmSwitcher
Manufacturer:	ACE
Address:	8aroper Bahnhof Str55, 4425 Dortmund, Germany
E-mail:	acesales@knipp.de
WWW:	www.acebase.de
Tel:	00 49 231 727 4260
UK distributor:	QTec
Address:	Unit 22, Brougham Enterprise Centre, Brougham Terrace, Hartlepool TS24 8EY
Tel:	(01429) 890800
Fax:	(01429) 890700
Price:	£119 inc VAT plus £3 P&P



# ACORN USER

## ADVERTISERS INDEX

10 out of 10 .....	64	HS Software .....	75
1st Computer Centre .....	35	I.C.S. (Ian Copestake Ltd) .....	4
4 Mation .....	75	IFEL .....	68
4th Dimension .....	61	Innovative Media .....	71
A P D L .....	58	Irlam Instruments .....	9
AJS Computers Ltd .....	29	Kudlian Software .....	52
Akalat Publishing .....	29	Liquid Silicon .....	57
Aleph One .....	29	Mauden Sales .....	76
ANT Ltd .....	OBC	Micro Laser Design .....	54
Apricote Studios .....	26	Misen Electronics .....	75
Arnold Comp Supplies .....	76	Pineapple Software .....	IBC
Beebug .....	18, 25	Quantum Software .....	75
Birdtech .....	75, 76	Really Good Software .....	45
C.S.S. .....	75	Room 20 Software .....	75
Casile Technology .....	12, 51	SoftEase .....	48
CJE Micros .....	32	Spacetech .....	51
Computer Concepts .....	IFC	Technology Matrix .....	57
Cumana .....	22	The Datastore .....	48
Curriculum Training Ass .....	48	Todd Education Supp .....	76
D S L Supplies .....	75	Topologika .....	75
Daco Systems .....	76	Uniqueway .....	76
Dalriada Data Tech .....	52	Wardlaw Surveys .....	76
Davyn Computer Services .....	20, 76	Werewolf .....	52
Desktop Projects .....	14	West Devon Electronics .....	76
Dixon & Dixon .....	75	Xavier Educational .....	75
Eesox .....	58	Zenta .....	58
Electronic Font Foundry .....	71		
Generation Design .....	75		
GeneSys .....	76		
GLC Electronics .....	77		

## RECRUITMENT

### Micro Librarian Systems

We are a small, well-established software company specialising in library automation for the education market, working with both Acorn and PC systems.

### WANTED:

**Computer programmer**

**Essential requirements:**  
**Proficiency in the Acorn Rise OS environment**

**Salary: Negotiable**

Please telephone **0161 449 9357** for further details

*(Smokers need not apply)*

## picture book 2

**6** high-quality programs specially designed to help pre-school, primary school and special needs children with Reading, Spelling and Counting - enjoyably and very effectively!

• **AlphaBook** • **Snap** • **WordMatch**  
 • **Count'em** • **Spell It** • **FlashCard**



Each program uses Alphabet files with professionally drawn graphics, sound effects and spoken words and offers many setting choices to suit each child's ability. For RISC OS 3.1 or later. **£35.00**  
 Site licence: £105.

### Draggie The Professional Application Launcher

For easy on-screen access to your most frequently used files and applications **Draggie** is the professional answer. Cut out constant clicking with these easy to install pull-down menus. The best way yet to organise your computer screen, your files and your time. **£12.00**

### Notice Board

"..for rolling presentations Notice Board excels."

*Acorn User*

Using Draw and Artworks files **Notice Board** enables you to create multi-page, poster-like presentations to run unattended in any location. Widely used in schools, **Notice Board** provides a colourful, constantly changing information point that is also ideal for information/sales messages at conferences and exhibitions, libraries, reception areas, etc. **£35.00**

*For use with RISC OS 3.1 or later.*

### Montage Creative Fractal Art

"...decidedly the most original and unusual package I have seen for a very long time.....once you've digested what the instructions say, Montage is a fascinating and enthralling program." *RISC User*

Create your own stunning fractal art pictures quickly and easily with Montage. Working in interactive mode Montage builds the images as you work. Requires RISC OS 3.1 minimum 2mb, 4mb for hi-res pictures. **£45.00**

**MultiLink** Transfers data effortlessly between 8-bit BBC and all RISC OS 32-bit computers. Easy to use click and drag operation. *With serial cable* **£29.95**

### The Really Good Software Company

39 Carisbrooke Road, Harpenden, Herts. UK AL5 5QS

Tel/Fax: 01582 761 395 Email: rgsc@turnbull.compulink.co.uk

No VAT or post/packing. Cheques, with order please, made payable to the company. Official orders welcomed.

# Acorn WORLD

31 October - 2 November 1997

Wembley Conference and Exhibition Centre

HALL 3



**A WORLD  
OF OPPORTUNITIES**

FOR INFORMATION ABOUT EXHIBITING

**CALL 0701 0709 901**

Web Site: <http://www.eps-events.com/acorn-world>

Sponsored by

Acorn 

  
XEMPLAR  
CORPORATION

Supported by

ACORNUSER

 **Archimedes**  
WORLD

*The* **Guardian**





# Interactive History Day

THE CRISIS that led up to the First World War is to be re-examined by students across the globe in the first ever Interactive History Day. It's supported by YITM (Yorkshire International Thompson Multimedia) and Teeside Tertiary College and users will experience the events of July 1914, over a period of 24 hours. A news service containing contemporary press reports and other historical materials from the period will go live on-line on Monday 30 June at 10am. As the day progresses, bulletins relating to different aspects of the July crises will be released as news items.

Using YITM's WWI Web site and specially prepared materials from historical sources, the Interactive History Day will offer students the opportunity to use their historical skills to interpret

documents from that era. They will be able to contribute to an on-line discussion, ask questions of one another or of guest contributors and, as class groups, create electronically a contemporary news item or newspaper. The best of these will receive prizes and will be built into the YITM WWI Web site.

Designed as a global experience, the news service will operate in English although contributions can be received in French, German and Spanish. All participating schools and colleges will be required to pre-register and will receive an electronic starter pack. This will include ideas for making the best use of the day, free software and software vouchers. For further information and to register, see the YITM WWI Web page: <http://www.yitm.com/yitm/ww1>

## Anglia's Atlasfiles

ANGLIA MULTIMEDIA has recently released two CD-ROMs for Geography. *World Atlasfiles* and *Japan Atlasfiles* enable students to draw distribution maps using data contained on the discs.

Each CD-ROM contains about 100 activity sheets aimed at different levels ensuring students of all ages and abilities get the most from the resource. Both discs contain

data files in a variety of formats including Anglia's own *Key Plus*, Iota's *DataPower* as well as CSV (comma separated value) files which can be used with most data handling programs on Acorn, Mac and PC computers.

The discs also contain over 80 photographs categorised into geographical topics together with text and audio com-

mentary. The quality of this software is outstanding and yet the programs cost just £35 each.

Anglia: Tel: (01268) 755811

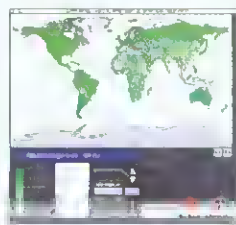

## Sherston's Talking Books

THE OXFORD READING TREE is one of the most popular reading schemes in use in primary schools across the country. For several years, Sherston has been supporting this scheme with its excellent talking book software. Its latest, *Wrens 2*, now makes a total of six packs, each containing six stories covering three levels of the Oxford Reading Tree.

Sherston: Tel: (01666) 840433

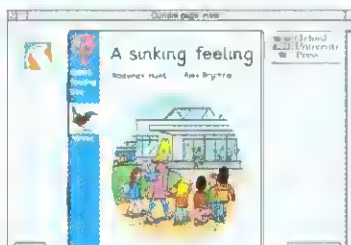

## Talking Jigsaws

PROGRAMS for the very young seem to be quite popular at present with software coming from several well-known sources. Topologika's latest is a set of eight talking puzzles based on popular nursery rhymes. The puzzle is displayed with the lines of the rhyme printed over the picture. The rows, columns or squares are then arranged into the correct sequence using

the text and/or the picture for clues. At any point the text on a line or square can be read out.

There are two packs each containing four rhymes and a printing utility. Also included are the pictures on paper which may be photocopied and used for colouring in and/or making into a jigsaw puzzle.

Each *Talking Rhymes* pack costs £24+VAT.

Topologika: Tel: (01326) 377771  
or fax: (01326) 376755

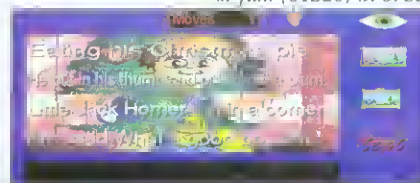

## Mathematics for A Level Physics

So much of the software I receive for review is aimed at Key Stage 1 or 2. Occasionally I receive something for Key Stage 3 but it is very rare to see anything aimed much higher. As the name implies, *Mathematics for A level Physics* is a complete course intended to prepare A Level Physics students with the required mathematics.

There are five lesson packs which together cover the mathematics required by all UK Examination Boards. Each pack contains about three hours of audio visual tuition, the audio part being recorded on two cassette tapes while the disc contains the visual part of the lessons and the exercises.

Not only is the material pitched at the right level, but the 'self-help' style is also appropriate for A level students. Each course costs £42.51 + VAT.

Caves Ltd (Computer Audio-Visual Education System). Tel: (01438) 832695

## Contacting me

You can contact the Education page by writing to me, Geoff Preston at Acorn User, IDG Media, Media House, Adlington Park, Macclesfield SK10 4NP or by e-mail to: [aueduc@idg.co.uk](mailto:aueduc@idg.co.uk)

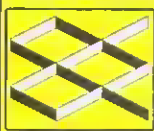

# CTA DIRECT

Mail Order Specialists



Curriculum Training Associates  
Dept. AU06, 34a Coach Road  
Astley, Tyldesley  
Gtr Manchester  
M29 7ER

EMAIL: sales@cta.u-net.com

http://www.cta.u-net.com

Tel - 01942 511000

Fax - 01942 749325

### RiscPC/A7000 System Offers

£200.00 OFF\* Exchange deal  
**FREE 5% off Scheme**  
i.e. RiscPC SA 2M+16M/2.1G/8A/D  
17" monitor for only £2500 inc VAT  
base models from £999.00 inc VAT  
**Or we will match and beat your best offer!**

### RiscPC PC Cards

	With RiscPC	or Separately
5X-33	£115.99	inc VAT
DN2-66	£174.99	inc VAT
DN4-100	£243.99	inc VAT
58b-100	£350.99	inc VAT

### RiscPC Ergo Keyboard

£29.79 +VAT (£35 inc VAT)

### RiscOS 3.1 upgrades from £29.00

	Ex VAT	VAT	Inc VAT
33000 Voice CE approved	£85.00		£99.88
33000 Voice BAPT approved	£90.00		£116.33
33000 Voice U.S. Robotics	£160.00		£193.88

### COLOUR MONITORS

	Ex VAT	VAT	Inc VAT
14" SVGA 0.28 Colour	£139.00		£163.33
14" SVGA 0.28 MPR2 Colour	£165.00		£193.88
15" SVGA 0.28 MPR2 Colour	£189.00		£222.08
17" SVGA 0.28 5yr Wty	£349.57		£399.00
17" Multisync II 280 any Acorn	£360.00		£423.00
21" SVGA 0.25 Iiyama	£960.00		£1128.00
22" SVGA Colour w/spkts	£849.00		£997.58
1AKP50 Multisync 0.28 Col	£239.00		£280.83
1AKF60 SVGA III Rev Colour	£165.00		£193.88
Multisync A300/3000 cable	£8.50		£9.99

### 6.4 Gb 3.5" IDE Hard drives

£365 +VAT (+£28.88 inc VAT)

A3000/A3010 Hard Drive & Interface	
Internal 60 Mb	Ex. VAT Inc. VAT £299.00 £116.33
Internal 250 Mb	£129.00 £151.58
Internal 340 Mb	£144.00 £169.20
Internal 512 Mb	£169.00 £198.58

### ACORN Joystick adapters

only £29.95 inc Vat (please state model 1)

### HARD DRIVES

Bare drives	Ex VAT	VAT	Inc. VAT
85Mb 2.5" IDE	£59.00		£69.33
170Mb 2.5" IDE	£79.00		£92.83
340Mb 2.5" IDE	£89.00		£104.58
540Mb 2.5" IDE	£115.00		£135.13
700Mb 2.5" IDE	£135.00		£158.63
1Gb 2.5" IDE	£189.00		£217.38
540Mb 3.5" IDE	£85.00		£99.88
1.2Gb 3.5" IDE/Qua/Sea	£124.00		£145.70
1.7Gb 3.5" IDE/Qua/Enj	£135.00		£158.63
2.1Gb 3.5" IDE/Qua F/B	£149.00		£175.08
3.2Gb 3.5" IDE/Qua F/B	£185.00		£217.38
3.8Gb 3.5" IDE/Qua F/B	£215.00		£252.63
5.1Gb 3.5" IDE	£309.00		£363.08
6.4Gb 3.5" IDE	£365.00		£428.88
6.4Gb 5.25" IDE	£279.00		£327.83
1.2Gb 3.5" SCSI Qua	£119.00		£139.58
2Gb 3.5" SCSI Qua	£229.00		£269.08
3.2Gb 3.5" SCSI Qua	£249.00		£292.58
4.4Gb 3.5" SCSI from	£400.00		£475.75
9.1Gb 3.5" SCSI from	£934.00		£1097.45
Removable IDE or SCSI int	£20.00		£23.50
SCSI External Case	£38.00		£44.65

All drives are pre-formatted for use with Acorn Machines

### CD-ROM DRIVES

IDE	SCSI
16x max £99.00 (£116.33inc)	P.O.A.
12x max £89.00 (£104.58inc)	£119.00 (£139.83inc)
8x max £69.00 (£81.08inc)	£99.00 (£116.33inc)
4x max £49.00 (£57.57inc)	£59.00 (£69.33inc)
4x4 Autochanger for 3.5" 4x	See cases £38 +vat
3.5 8x driver £8.51 + vat (£10)	
IDE fitting kit £5 +vat	Kit from £10 +vat

### COLOUR SCSI SCANNERS

	Ex. VAT	Inc. VAT
SCSI Scanner 600dpi	£170.00	£199.75
SCSI Scanner 800dpi	£249.00	£292.57
SCSI Scanner 1200dpi	£299.00	£351.32
Imagemaster & Twin for above	£49.00	£57.58

### Removable Drives

	Ex. VAT	Inc. VAT
Zip 100 Acorn parallel	£139.00	£163.33
Zip 100 Int or Ext SCSI	£129.00	£151.58
EZIIyer ext 230 SCSI	£199.00	£233.83
Jazz 1Gb Int SCSI	£297.00	£348.98
Jazz 1Gb Ext SCSI	£339.00	£398.33
SyJet 1.5G Int SCSI/IDE	£279.00	£327.83
SyJet 1.5G Ext SCSI	£339.00	£398.33
100mb Zip Drive Disk	£11.00	£12.93
1Gb Jazz Drive Disk	£68.00	£79.90
EZIIyer 230 Cartridge	£19.00	£23.38

### Casio QV10 Camera

	Ex VAT	Inc VAT
With Acorn Software	£349	£410.08
With PC Software	£299	£351.33
Acorn Software only	£99	£116.33

For postage charges and more products please see AW advert or please ring.

### StrongARM Special Offer

£269.00 inc VAT (with any RisePC Memory purchase)

### RISC PC MEMORY

	Ex VAT	Inc. VAT
Also FOR A7000	£14.45	£16.98
4Mb SIMM	£29.50	£34.66
8Mb SIMM	£55.00	£64.63
16Mb SIMM	£108.00	£126.90
32Mb SIMM	£159.00	£181.08
1Mb VRAM upgradeable	£89.00	£106.33

### NEW LOW MEMORY Prices

	Ex VAT	Inc VAT
4-8 MB 1-p 1A310/410/3000*1	£159.00	£186.83
4-8 MB 1-p 1A5000*1	£159.00	£186.83
*rework for A3000/5000/25mbz	£25.00	£29.18
A3010 1-2 MB Upgrade	£37.00	£43.48
A3010 2-4 MB Upgrade	£62.00	£72.85
A3010 1-4 MB Upgrade	£79.00	£92.83
A3020/4000 2-4 MB Upgrade	£65.00	£76.38
A5000 2-4 MB Upgrade	£68.00	£79.90
A3000 1-2 MB Non-Upgrade	£20.00	£23.50
A3000 1-2 MB Upgradeable	£45.00	£52.88
A3000 2-1 upgrade for above	£60.00	£70.50
A3000 1-4 MB Upgrade	£69.00	£81.08
A3000 Serial Port Upgrade	£23.00	£27.03
A310 4Mb Upgrade	£89.00	£104.58
A4000 1Mb Upgrade per mem	£35.00	£41.13
Risc OS Carrier Board 1A310	£20.00	£23.50
MEMC 1A upgrade (short supply)	£45.00	£52.88

### KEYBOARDS & MICE

	Ex VAT	Inc. VAT
RiscPC Original Keyboard	£29.00	£34.07
Arch High quality Keyboard	£99.00	£116.33
Acorn Original Mouse	£25.00	£29.38
Acorn Replacement Mouse	£12.00	£14.10

## NEW EFF Font Poster '97

New poster, (size B1, glossy paper) displays samples of our complete font library, including all the latest collections (over 1,200 samples). It provides reference at glance and looks great on the wall, too. The poster costs just £1 (refundable and free with every font order).

## FREE 4000 PD Fonts CD

The largest collection of Public Domain Risc OS fonts - of the higher quality than any other Acorn Fonts CD released so far, is still available just for the handling charge of £2.35 (and free with every high quality font order). If you still haven't got it, contact us before it's too late.

## FREE EFF Font Book '95

A5 booklet which shows samples of our high quality fonts. There are also separate leaflets displaying our ranges of Educational (primary, easy reading, dotted and joint-writing) and Indic (Bengali, Gujarati, Devanagari, Punjabi and Tamil) fonts. Contact us for your copy.

The Electronic Font Foundry  
11 Silwood Road, Ascot, SL5 0PY,  
tel 01344 875 201, fax 01344 875 202,  
e-mail sales@effonts.demon.co.uk



## Quality Statement

All EFF fonts have been designed especially for Acorn, rather than merely translated from PostScript™, and all are carefully hand-hinted by skilled typographers - we are unique in that all fonts in our library have properly made hints and skeletons. We have never compromised on quality in our 14 year long reputation, and we are dedicated to provide only the highest quality products and services in the future.

## EFF Font Collections

You can order any single standard font from us for just £7. Some larger collections are also available, such as EFF Typographer Pack - a complete set of EFF LondonA fonts including full Expert Sets, Small Caps and Title versions, or EFF Basic Pack of 35 fonts, each costing £49. And all our fonts can be provided for the same price for

✂ Please send me:

- EFF Font Book and Price List  FREE
- Educational Fonts Leaflet  FREE
- Indic Fonts Catalogue  FREE
- NEW Font Poster  £1.00
- 4,000 PD Fonts CD (address label enclosed)  £2.35
- I enclose a cheque/PO order for the total of  £.....

Name ..... Address .....

..... Postcode .....

Please tick here if you are a previous EFF customer

The Electronic Font Foundry, 11 Silwood Road, Ascot, SL5 0PY  
tel 01344 875 201, fax 01344 875 202, e-mail sales@effonts.demon.co.uk



# Type it right

Geoff Preston looks at a couple of programs to help the young with their keyboard skills

It's well documented that the good old qwerty keyboard dates back to the time when the only chips you'd be likely to find are those produced by a carpenter. It's still as unfriendly as it always was so we have to learn to live with it – at least for entering text. It follows therefore that we should become familiar with this as early as possible.

CSH's imaginatively named *Keyboard* is aimed at just that: it's a program to help the very young become familiar with this age-old device.

In use, the program displays a series of words which are typed in on the keyboard. Incorrect entries are greeted with a growling key and you're timed. When the exercise is finished, it is scored and if you've really done well a certificate is presented which can be printed out.

The software also keeps a record of each pupil's work in a password protected log. This gives the name of the pupil, the name of the test, the percentage of correct entries and the time taken.

*Keyboard* is supplied with 50 files providing tests on a variety of subject-based words (food, flowers, animals) and 12

graded files to help pupils learn to touch-type. The great strength with this program is that you can easily create further files. All you need is a text file (created with *Edit*). The first line must begin with the word *Title* followed by a colon then the name of the file as you want it to appear in *Keyboard*'s menu. Then follows as many lines as you wish.

As a spin-off, this is also an excellent way of learning spellings. CSH has once again come up with just the right program for a specific need.

*Keyboard* costs £17.50 for a single user and £35 for five copies.

Cambridgeshire Software House  
Tel: (01487) 741223

## Look whose alphabet is talking again!

Sherston Software has launched an enhanced and revised CD-ROM version of its best-selling *Talking Animated Alphabet*.

The new, triple-format abc-CD features a welcome return for *Alphabod*, the lovable character from the original BBC



Micro version of the program, but with some significant improvements. The new *Alphabod* jumps back-flips, star-jumps, spins on the spot and performs all sorts of other antics to make learning the alphabet fun for young children.

The CD-ROM version also features the unique morphing graphics that made its predecessor so successful. Using clever illustrations and animations, the program lets children watch each letter of the alphabet magically morph into something that will really help them remember its shape and sound.

Three carefully graded activities teach children to discriminate visually between the different letter shapes, to recognise the various letter sounds and finally to match together the shapes and sounds.

The *Talking Animated Alphabet* is compatible with Acorn, PC (Windows) and Apple Macintosh computers and costs £29.95 + VAT for a single user copy. Site licences are available.

Sherston Software  
Tel: (01666) 840433

# Switch on to Hotspots

Geoff Preston discovers how some existing software can be accessed by switch users

Computers can provide the physically impaired with the means to communicate but, sadly, not a great deal of suitable software is available. Some programs have been designed to allow users to operate with a simple on/off switch. This may be a foot-operated switch, a tilt switch or even a vacuum switch which can be operated with the mouth. This facility means that almost anyone can use a computer regardless of physical impairment simply by moving a switch at the right time.

*HotSpots* by The ACE Centre is a program to enable switch users easy access to certain programs. At first glance, the list of programs with which it will work might seem rather limited, but there are a number of important types of application for which *HotSpots* will provide a very simple but effective means of control. The most likely use is in multimedia software where the screen displays 'buttons' to change

pages. However there are others such as some *My World* screens, although not all.

*HotSpots* allows users to operate programs in five possible switching techniques:

- Single Switch Auto Scan – hot spots are scanned automatically and the current hot spot is selected when the switch is operated
- Single Switch User Scan – hot spots are scanned while the switch is operated, the current hot spot being selected when the switch is released
- Single Switch Toggle – similar to the first scanning technique except that scanning stops when a selection is made and a further switch operation is required to restart scanning
- Two Switch User Scan – one switch is used to scan the hot spots while the second selects the current hot spot
- Two Switch Step – similar to the previous type except that scanning is not automatic and occurs each time the switch is pressed.

*HotSpots* also allows users to set four parameters which control the scan:

- Scan time – the period of the scanning
- Pre-Acceptance Delay – how long the switch

must be held before the action is registered

- Post-Acceptance Delay – how long the switch must be released for before a switch action may be repeated
- Mouse Speed – the speed between moving the mouse pointer between one hot spot and the next.

Once a program has had its hotspots defined, the data can be saved as a *HotSpots* file. The file can then be reloaded for use with the appropriate program or edited. *HotSpots* is not a general-purpose mouse or keyboard emulator. It cannot be used where mouse dragging or double clicking is required or where the mouse needs to be moved under the control of the user.

It runs on all Acorn RISC OS computers, needs 100K of disc space, 128K of free memory and costs £15 inc VAT. The disc only is available as shareware and both versions can be obtained from:

SEMERC (Tel: 0161-627 4469) or The ACE Centre (Tel: 01865-63508)

• The shareware version can also be found on their Web site: <http://www.rmplc.co.uk/eduweb/sites/acccent>

# A varied time-table

Geoff Preston take a look at a variety of education packages

## Sherston in a Tizz

Sherston's latest offering, *Tizzy's Toybox*, is essentially 10 activities for the very young. The activities practise simple spelling, number work, colours, comprehension and several other tasks which we all do without thinking, but children find quite challenging.



As with all Sherston's software, high quality graphics, clever animations and most importantly sound education are the hallmarks of this program. Child motivation is also included at no extra cost.

£40 + VAT single user  
£65 + VAT site licence  
Sherston  
Tel: (01666) 840433

## Evacuation

Nobody can really know what it was like to have been one of the 1.5 million children who were evacuated during the war, apart from the children themselves. What is certain is that for some, it was no holiday.



4Mation's *The Evacuees* is a multimedia production which opens on Friday 1 September 1939, the day the German troops invaded neighbouring Poland. The program follows the experiences of two children, Vera aged 11 and her younger

brother Davy, who were caught up in Britain's preparations for war as the country waited to learn how Hitler would respond to Chamberlain's ultimatum.

Vera and Davy were evacuated in an operation that became known as the week-end of 'The Great Evacuation'. The program has been designed to provide older Key Stage 2 pupils who are studying the history unit 'Britain Since 1930' with factual information about the evacuation and the ways it affected the lives of ordinary people. The software could also be used by younger Key Stage 3 students studying World War II.

In addition to material about the evacuation itself, there is a wealth of information about life in Britain in the late 1930s.

Education, the blackout and rationing are all covered in this thought-provoking story. The manual contains additional background material for the teacher on these and other issues.

The Evacuees is yet another excellent program developed with 4Mation's in-house authoring system. The 50 locations are beautifully illustrated with each screen having several hot-spots which, when clicked upon, display additional information.

£27.50 + VAT single user  
£55 + VAT site licence  
4Mation  
Tel: (01271) 25353

## Tanzanian Village

Compared to some of the larger software houses, CCS does not produce a great deal of software but when it does it's a gem. This active learning resource package comprises a CD-ROM, a video cassette and an A4 book containing teachers notes and worksheets with additional activities.

The 50-minute video is not intended to be run in one go but in small self-contained parts of about five minutes each. The programme introduces Elizabeth Mchaki and her family who live in a small house in Arusha in Tanzania, East Africa. Elizabeth Mchaki is a teacher but also farms a small piece of land and has a few animals. Other parts of the video show how water is collected, how home-grown maize is ground into flour for cooking, going to market and cooking and eating.

The CD-ROM contains a multimedia document created using *Genesis* which is

used for additional research.

Although the documentation claims to cover Key Stages 1 to 3, the presentation seems to be most suitable for younger children. At the back of the handbook is a table listing all of the National Curriculum links, of which there are several. I tend to view tables like this with some scepticism, but having spent a considerable time with the software, I can confirm that it can address many areas, although attainment targets in Geography, English and Technology will probably be the most likely.

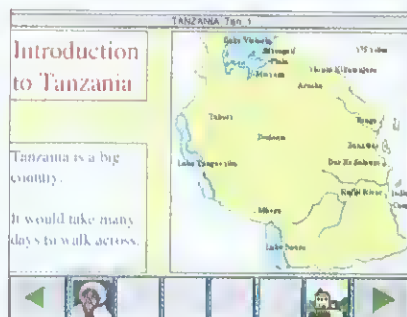

This is a very well-conceived and executed resource. It certainly focuses the mind that while we live in our hi-tech, micro-processor controlled environment with modern labour-saving devices, others don't even have running water or fuel to cook. Anything that increases awareness of life in developing countries should be seen as valuable experience.

£49 ex VAT single user CD-ROM  
£69 ex VAT single user whole package  
£99 ex VAT site licence  
Creative Curriculum Software  
Tel: (01422) 340524

## Key French

Users of Anglia's Key data handling programs may be interested to know about *Key Français* - two discs containing a total of 11 datafiles to aid the teaching and learning of French.

The discs contain numerous other resources including drawfiles of worksheets which may be used on screen or printed out and completed by hand. *DataPower* users will also be able to make use of much of this material.

£22 + VAT (+ £2.50 p&p)  
Anglia Multimedia  
Tel: (01268) 755811





**NEW! PhotoLink** is an Acorn multi-driver for the most popular makes of Digital camera. Cameras currently supported are the **Olympus 400, 400L & 800L, the Sanyo Image PC** and the **Epson PhotoPC 500**. Other cameras are in the pipeline. PhotoLink has many features including some not available from the camera itself. The camera may be "hot-linked" directly to your favourite application. PhotoLink is available on its own or bundled with a camera.

Prices (inc VAT):

**PhotoLink £69.00.**

Camera + PhotoLink:

**Sanyo ImagePC £434.75, Olympus C400 £299.00, C410L £587.49, C800L £949.99, Epson PhotoPC 500 £499.00.**



**PHOTODESK (v.2)** is the package which defines studio quality image editing and artwork on RISC OS machines. It is easy to use but has many powerful features, including a sophisticated colour management system (CMS) for the full-time graphics professional. Most of the extensive programming effort invested in this project has been concentrated upon ensuring a predictable user interface with an integrated design and most importantly, all operations have been engineered to the **highest quality** possible. **£269.50 (£229.36 ex VAT)**

**PHOTODESK LIGHT**, an economic alternative to PHOTODESK2 retains most of its creative features apart from the CMS and the possibility to add LAYERS. **£269.50 (£229.36 ex VAT).**

**Plug-in Effects Packs** are available for both packages. A pack containing 10 special effects, or 5 extra loader/savers is available at **£19.95**

*all prices include UK VAT and UK P&P*

**2Mb A3020 computer  
with Acorn 14" monitor  
+£200 worth of 1st class  
Acorn software for only  
£399** (~~£468.83~~  
inc VAT)

**SOFTWARE:**

**StartWrite** (Wordprocessor),  
**Application Suite**, **Mouse Mat**,  
**PLUS** choice of Options 1 or 2 below  
(£39 extra for both together):

**OPTION 1 - EARLY TIMES BUNDLE.**

**Artisan 2.** Art package from Clares.  
**Doris the Dotty Dog.** Naughty story from Sherston.  
**Daryl the Dragon.** Adventure story from 4Mation.  
**Amazing Maths.** Mental arithmetic from Cambridgeshire Software House.  
**Gemini.** Matching pair game from Cambridgeshire Software House.  
**Maths Gen.** Maths worksheet creator from Creative Curriculum Software.

**OPTION 2 - HOME BUNDLE.**

**Resultz.** Spreadsheet from Colton Software.  
**Desktop Database.** Database from Iota.  
**Revelation.** Art package from Longman Logotron.  
**Zool.** Fantasy arcade game from Gremlin.

**A SPECIAL SUMMER OFFER FROM**



**CASTLE TECHNOLOGY**



**Available now while stocks last!**

**Call 01728 621222**

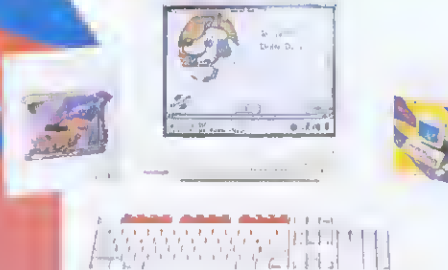

Colour Monitor included

**HARDWARE UPGRADE OPTIONS:**

- 4Mb RAM - £50 (£58.75 inc VAT)
- Hard Drive - £50 (£58.75 inc VAT) for 80Mb (170Mb & 400Mb also available)
- SCSI Interface for CD-ROM drive, Scanners etc
- MIDI Interface
- Econet / Ethernet interface
- 386 PC card

**PHONE FOR FULL DETAILS**

**THE SPECIAL OFFER A3020 COMPUTER**

This A3020 system comes complete with 2Mb of RAM, mouse, AKF53 colour monitor and choice of software bundles. Features include ARM 250 processor, serial port, printer port, network expansion slot, and one internal expansion socket for a wide range of hardware upgrades.

**COLOUR  
PRINTER  
JUST £69!**

Buy an A3020 and get this superb Acorn JP 360 printer for just £69 (£81.08 inc VAT). Price includes printer cable and colour kit.

*Also available separately (call for details)*



**ORDER NOW!** Order by telephone on 01728 621222 or Fax on 01728 621179.

Delivery £10 per computer (£11.75 inc VAT)  
Cheques\*, debit cards (Switch & Delta), credit cards (2% charge may apply), and educational orders accepted. All trademarks acknowledged.  
\*Cheques: allow 5 working days in clear. E&OE



## WebSpider

WebSpider is an easy-to-use editor for creating pages for the World Wide Web, which works just like a traditional DTP or wordprocessing package.

The complexities of maintaining links between your website files, converting graphics etc are performed automatically, and there is no need to learn web jargon, freeing you to focus on the design of a really attractive and effective website.

Due to Dalriada's long experience in DTP, WebSpider comes to you at an extremely competitive price, and with all the interactive design expertise only an established DTP software house can bring.

- Links are automatically update as files are renamed, moved, etc
- Graphics converted automatically to Internet formats
- Complete with website management, sub-directories etc
- Easy-to-use drag-and-drop linking and point-and-click editing
- Tabling, imagemap etc tools included
- Comprehensive professionally printed manual with design hints

Web5pider is only £40 until 31st August 1997, then just £60.

## TableMate Designer

TableMate Designer is the latest generation of Dalriada's flagship DTP utility - offering extensive features to create stunning tables instantly!

- Variable fonts inside cells
- Super- & sub-scripts, bold, italic effects
- Export/Import HTML tables
- Global cut-and-paste
- Named styles and colours

Only £60 (£45 for Impression Style & Publisher users).

Also available:

**DiagramIt**  
Diagrams of all sorts - in a flash!

**GraphMate**  
Presentation graphics without tears.

Dalriada Data Technology, 74 Greville Road, Warwick, CV34 5PJ Phone/Fax: 01926 492459 www.dalriad.demon.co.uk

**werewolf**  
presents  
**shuggy**

A brand new graphical-adventure game for your Acorn computer

**TANKS**  
(Tactical Armoured Nuclear Kombat Stations)

"...buy this game now!" - Acorn User, February 1997  
"Its certainly a game that gets played time and time again" - Archimedes World, Volume 14 Issue 2 1997

Please contact us for more details Shuggy and T.A.N.K.S. retail for £25.95 Add £1.50 for carriage in the UK

Werewolf Software, 23 The Spinneys, Bromley, Kent, BR1 2NT • Tel: 0181-467 1138  
Email: info@werewolf.demon.co.uk • WWW: http://www.werewolf.demon.co.uk/

**NEW**

**Data Sweet 3**

Easy Data Handling For Education

**DataPlot** - an easy to use graph drawing program. Produces Bar and Line graphs, Bar-line graphs and Pie charts immediately and quickly.

**DataPick** - an introductory database using key pictures to describe features of data items. A graphic file can be associated with each card.

**DataCard** - uses keywords to describe features of data items instead of pictures.

**DataFind** - Introduces the concept of fields within records, and has full search and sort capability.

**DataCalc** - an easy introduction to spreadsheets. Clear and easy to use buttons allow access to the functions. Recognises money values.

1-5 Machine licence £70.73  
Primary Site licence £105.98  
Secondary Site licence £177.66  
All prices include V.A.T. and carriage

**Kudlian Soft**

8 Barrow Road, Kenilworth  
Warwickshire CV8 1EH  
Tel: 01926 842544  
Fax: 01926 843537

email: sales@kudlian.demon.co.uk



# Breakaway with FUN

**Colin Rouse** visits the new CD-ROM theme park which will inspire reluctant mathematicians to explore

**B**reakaway Maths on CD-ROM is a fully interactive learning package from YITM, aimed at Key Stage 2 pupils who are experiencing difficulties in making progress in mathematics.

The software offers the pupil the opportunity to develop mathematical skills in real-life situations. The setting is the Breakaway Theme Park, a fictitious park based on the real-life excitement of Alton Towers. This background provides a stimulating environment for learning, providing fascinating images, video and enjoyable activities to interest even the most reluctant pupil.

## Finding your way around

Children embarking on the adventure find themselves at the entrance. Here they are introduced to the park, and a simple on-screen assessment is undertaken to determine the level of the questions they will encounter.

Once inside, the children receive an on-screen map to help navigate themselves around. Basic skills in navigation – left, right, up and down – are used to visit the various attractions, 12 in all, in the Breakaway theme park. Explorers are accompanied by four friends, Rupa, Lisa, Nicky and Dave, who provide help, guidance and encouragement. As each of the 12 locations is visited, the children will encounter either a mathematical activity or an investigation area.

There are six activity areas located at various rides. Each area has two sets of questions, tailored to meet the needs of individual pupils. When the children arrive in an activity area, they can see a visual image of it on screen and hear an audio commentary told by their friends. Then, having completed the first set of questions, they can see the first part of the video of the ride. To see the rest, the children must successfully complete the second series of questions. On finishing

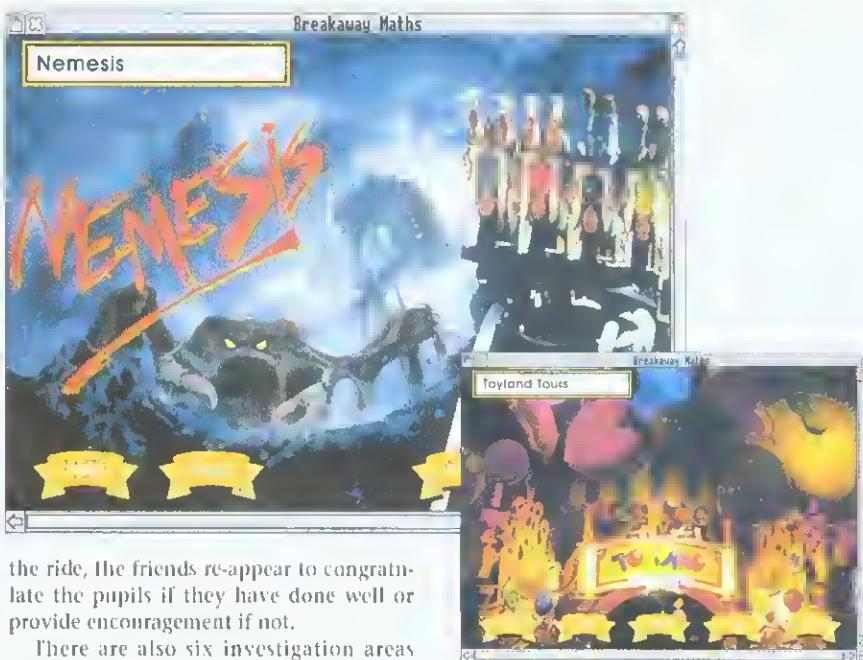

the ride, the friends re-appear to congratulate the pupils if they have done well or provide encouragement if not.

There are also six investigation areas within the park, located at different attractions. Each presents mathematics in a problem-solving context, set at one of three levels. Investigations encountered include work on place, value and digits in numbers at the Skyride; food combinations at the Explorer restaurant; triangular numbers in the Courtyard; squares at Old MacDonald's farm; 3D shapes in the Kiddies Kingdom and combinations of coins in the fabulous Toyshop.

The investigations involve work both with and away from the computer. Pupils are asked an initial question which they must attempt to answer. Following the on-screen instructions, they attempt a sequence of questions. At an appropriate point, they are prompted to continue their work away from the computer.

## Optional extras

Within the program is a fully configurable teachers' section that allows a variety of options to be exercised. One very useful option is that of audio instructions, which can be used by children who have reading difficulties – often a crucial point in developing mathematical skills. Another useful part is that the children's progress is assessed and reported as they move around the park. Depending on their responses, the computer will move pupils onto a higher or lower level of questions as they explore further.

The children can leave the park whenever they want, but when they return they will automatically find themselves at the

point they left, using the built-in password facility. An assessment option, for parents and teachers, is also available to monitor pupil's progress, both in the short and the long term. The level of difficulty can be changed to suit individual situations, learning outcomes or pupils. Pupils can also be directed to selected tasks, as appropriate.

## In conclusion

Breakaway Maths is an excellent resource for any school. Presented in a stimulating and original way, this software package and its accompanying Teachers' Guide can go a long way towards helping pupils with learning difficulties in mathematics acquire some of the basic skills needed to survive in the big, wide world outside the school gates. Breakaway Maths is a piece of software I would wholeheartedly recommend for any school wishing to cater for the needs of their less able mathematicians. It's also cheaper than a visit to Alton Towers!

## Product details

Product:	Breakaway Maths
Price:	£65 single user. Available for PC and Acorn
Supplier:	YITM
Tel:	(01264) 342992



## Micro Laser Designs

105 Midford Road  
Combe Down  
BATH BA2 5RX

Tel : (01225) 833266  
Fax : (01225) 833266

Micro Laser Designs is an Acorn Centre of Technology and supplies the complete range of Acorn Hardware and Software. We also offer scanning, printing and imagesetting services and specialise in litho printing from Acorn files - Letterheads, School Magazines, Brochures, etc

**ALL PRICES SHOWN IN THIS ADVERT INCLUDE VAT.**

### Carriage Charges:

For orders of £250 or more, carriage is FREE. Small orders will have a delivery charge of £2.50, or £5 for heavier items.

### E&OE.

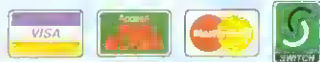

## IMAGESETTING

Check our FILM prices! (P & P may apply). Prices are per page

Don't forget prices INCLUDE VAT.

Pages	A4, A4+	A3/A3+
1	11.75	14.10
2-9	8.45	11.10
10-24	5.85	9.40
25-49	5.00	8.20
50+	4.10	7.00

Bromide prices on request.

Further discounts available - please call. Email: bureau@microlas.demon.co.uk

## PC Corner :

We build PC's to your specifications.

eg: AMD 150 Multimedia System, Mini Tower, 8 x CD, 14" Monitor, 16Mb RAM, Sound Card, Speakers, 1.2Gb Hard Disc, Windows 95, Encarta '97, MS Golf 3, MS Works, MS Money

**£999.00**

We stock PC motherboards, disc drives, keyboards, memory, sound / graphics cards etc.

# MICRO LASER DESIGNS

All prices listed were correct at the time of going to press. We reserve the right to change them if the need arises - you will be notified of any changes upon ordering. Please allow time for clearance of cheques. Credit / debit cards will be charged on day of despatch.

## 20/20 Finance

We operate the Acorn 20/20 Finance Interest Free Credit Scheme - Please call for details.

## NEW STRONGARM RISC PC's!

	Memory	Hard Disc	Price
Risc PC StrongARM 4M	4Mb	1Gb	£1105.00
Risc PC StrongARM 4M, 8 x CD	4Mb	1Gb	£1155.00
Risc PC StrongARM 10M	10Mb	1Gb	£1390.00
Risc PC StrongARM 10M, 8 x CD	10Mb	1Gb	£1440.00

A7000	Memory	Hard Disc	Price
A7000 4MB NET	4Mb	NONE	£655.00
A7000 4MB HD540	4Mb	540Mb	£799.00

**WE BUILD COMPUTERS TO YOUR EXACT SPECIFICATION - PLEASE CALL ALL PRICES LISTED ABOVE EXCLUDE MONITORS, PLEASE SEE LIST BELOW**

Acorn 14" AKF60	£255.00	Acorn 17" AKF91	£610.00
Iiyama 8617E	£585.00	Iiyama Pro 9017E	£650.00
CTX 14"	£199.00	CTX 15"	£265.00
CTX 17"	£430.00	CTX 20"	£920.00
CTX 21"	£1199.00	Sony 15" Trinitron	£350.00
ADI 15"	£299.00	ADI 17"	£495.00

Prices marked \* only available when purchased with Computer.

## Acorn Network Computer (CALL IN AND SEE ONE FOR YOURSELF!)

NC with 28.8 modem	8Mb	£450.00
NC with 10BaseT Ethernet	8Mb	£450.00

### Pocket Book

Pocket Book II 256K	256K	£230.00
Pocket Book II 1MB	1MB	£305.00

### PC CARDS FOR RISC PC

ordered alone with RISC PC

OX2-66	£285	£165
DX4-100	£345	£220
5x86-100	£470	£350

### CD ROM DRIVES

4 X 4 Auto Changer	£125
8 spd IDE	£105
12 spd IDE	£139
12 spd SCSI	£170
Parallel Port 8 spd	£220

### CD ROM WRITERS / PO Drives

(Needs SCSI)	
Internal CD ROM Writer	£655
External CD ROM Writer	£699
10 x DISCS for above	£68
Panasonic PD Drive	£399
650Mb PD Cartridge	£36

## INK JET CARTRIDGES / TONER CARTRIDGES / CONSUMABLES

Acorn JP150	£23.00	Canon LBP8	£65.21	REFILLS / COMPATIBLE	
Canon BJ10etc	£18.75	Canon LBP4	£67.55	Canon BC01	£43.45
Canon BJ200/230	£21.14	BJC600 Black	£10.92	BJC600 Black	£5.39
Canon BJ130E	£15.26	BJC600 Col	£7.63	BJC600 Col	£6.45
HP 51626A	£19.90	BJC800 Black	£18.20	BJC800 Black	£5.86
HP 51649A	£23.50	BJC800 Col	£21.14	BJC800 Col	£6.45
HP 51625A	£23.50	Can BC20	£29.36	Canon LBP8	£46.94
Epson SO20047	£16.39	Can BC21	£45.81	Canon LBP4	£42.29
Epson SO20025	£11.15	Can BC1-21BK	£7.04	10xHD Discs	£4.47

Listed are just a few of the consumables we supply - please call for our full colour 28 page Computer Supplies Catalogue which contains hundreds of products! Mouse Mats, Ribbons, Ink Jet Toner, Discs, Cleaning Products, Labels, Disc Boxes, CD towers, Furniture, Workstations, Screen Filters, Notebook Carry Cases, and much more!

## PRINTERS / MOEMS etc

Canon BJC70	£199
Canon BJC240	£199
Canon BJC620	£365
Canon BJC4200 (limited offer)	£229
HP DeskJet 400C	£156
HP DeskJet 690C	£254
HP DeskJet 820C	£305
HP DeskJet 870CXI	£413
HP LaserJet 5L	£392
HP LaserJet 5P	£585
HP OfficeJet LX	£559
33.6K Sportster Flash (56K U/G)	£199
33.6K Sportster VI	£179
ANT Internet Suite	£115

## CABLES CONNECTORS SPARES

Parallel Printer Cable	£5
Parallel 36 way to Parallel 36 way	£5
25 way D to 25 way D	£5
SCSI 50 way IDC to 50 way IDC	£12
SCSI 25 way D to 50 way Centronics	£12
SCSI 50 way Cent. to 50 way Cent.	£12
SCSI II Hi Density to 50 Way Cent.	£20
9 way D type to SCART	£12
5 1/4" Drive Power Splitter	£4
5 1/4" - 3 1/2" Power Adaptor	£4
Two way Printer Sharer (Cent. 36 way)	£13
Two way Printer Sharer (D type 25 way)	£13
BBC Printer Cable	£7
D type Male 9 way	95p
D type Male 15 way	95p
D type Female 9 way	95p
D type Female 15 way	95p
Covers for above	80p
IDC Connector 34 Way	£2
Centronics Plug 36 way	£2
Centronics Plug 50 way	£3
50 way IDC Cable, per metre	£2
9 way to 15 way Monitor Adaptor	£7
Original Acorn mouse	£27.50
Microsoft serial mouse	£22.50
Standard PC serial mouse	£15.00
RISC PC Case Slice kit (PSU)	£110
RISC PC Case Slice kit (no PSU)	£85

## MEMORY etc

A305 / A310 4Mb	£110
A305 / A310 4 - 8Mb	£185
RISC OS 3 Carrier Board	£22
MEMC1A Upgrade	£49
A400/1 1Mb Pack	£38
A400/1 4 - 8Mb	£185
A3000 1 - 2Mb (expandable to 4Mb)	£46
A3000 1 - 4Mb	£83
A3000 4 - 8Mb	£185
A3010 1 - 2Mb	£42
A3010 2 - 4Mb	£73
A3010 1 - 4Mb	£87
A3020 / A4000 2 - 4Mb	£76
A5000 2 - 4Mb	£80
A5000 4 - 8Mb	£185
RISC PC 1Mb VRAM	£70
RISC PC 2Mb VRAM	£110
RISC PC / A7000	
4Mb SIMM	£20
8Mb SIMM	£35
16Mb SIMM	£75
32Mb SIMM	£135

Memory prices are currently fluctuating daily - please call for our latest price

We supply a full range of hardware and software please telephone for more details and a quote.

## BITS 'N' PIECES

25 Watt Powered Speakers	£29.00
50 Watt Powered Speakers	£39.00
PowerTec SCSI II Card	£200.00
Cumana SCSI II Card	£175.00
1Gb IDE Hard Disc	£150.00
1Gb SCSI Hard Disc	£210.00
2Gb IDE Hard Disc	£215.00
2Gb SCSI Hard Disc	£295.00
3Gb IDE Hard Disc	£285.00
4Gb SCSI Hard Disc	£665.00
5Gb IDE Hard Disc	£395.00
EPSON GT9500 Scanner with ImageMaster TWAIN	£655.00
IRLAM COLOUR MOBILE SCANNER	£199.00
EESOX GRAPHICS TABLETS	
ArtPad	£210
A5	£300
A4	£445
A3	£560
A2	£1820
Impression Style	£89
Impression Publisher	£139
Impression Publisher Plus	£250
ArtWorks	£105
TurboDrivers	£49

Telephone : (01225) 833266

Facsimile : (01225) 833266

email : sales@microlas.demon.co.uk

www : http://www.microlas.demon.co.uk

- Acorn & PC Computer Systems
- Printing / Stationery
- Desktop Publishing
- Graphic Design
- Imagesetting
- Scanning

THE RIGHT CHOICE



**STRONGARM PROCESSOR UPGRADE FOR RISC PC £275.00**

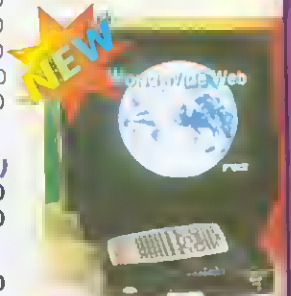



# GAME SHOW

## Will we see Quake on the Acorn? Steve Mumford investigates

I'm not one to spread idle rumours, but once in a while a morsel of information floats my way and the only decent thing I can do is pass it on. You might remember that, many moons ago, a talented programmer named Eddie Edwards converted *Wolfenstein 3D*, originally written by Id software. The licence fee for this product wasn't set particularly high because by that stage the majority of the PC world had discovered a game called *Doom*, and were merrily chasing each other round dark, oppressive levels in this updated 'sequel'. Once the Acorn version of *Wolfenstein* hit the shelves people began to ask the same inevitable question - "When is someone going to convert *Doom*?"

Known only to a few, work was indeed progressing on this task, and I was particularly excited to receive regular news bulletins from Mr Edwards. However, shortly after Eddie had told me of the existence of a wire-frame version of *Doom*, and just before I could announce the project to the world at large, things went horribly quiet and the message slipped out that due to the excessive price of the licence, *ArcDoom* would never see the light of day.

Time has moved on and *Doom* itself has grown old, although a whole host of clones pop up in one form or another on the PC and games console. The big name of the moment, if you didn't already know, is a game called *Quake* - essentially *Doom* set in a real 3D environment, so the chronic pixelation that used to be a hallmark of its earlier cousins has been banished for good. The setting and the gameplay are fairly similar to its predecessors - indeed, *Quake*'s one-player game has been criticised for being predictable and uninspiring. However, the atmosphere is superb and the levels are carefully designed, and if you've been able to enjoy a game in multiplayer network mode, you'll understand when I say that it's amazing

how time disappears when you're being ambushed.

So, what bearing does this have on the Acorn games scene - the licence fee for *Quake* will be astronomical, won't it? Well, not necessarily. I've been playing *Quake* for some time on a Silicon Graphics workstation, and I was able to download the converted game engine for free over the Internet - Id software have given permission for Silicon Graphics to convert the game code and distribute it free of charge, but have placed the restriction that they can't distribute any of *Quake*'s level files - even the shareware ones - with the executable. In order to make the game complete, the user simply buys a full copy of the PC game and extracts the relevant PAK files. Id software sell an extra copy of *Quake*, so they get their money, and the user gets a fully-functional version of the game - everybody's happy.

Two questions spring to mind. The first is whether Id software will agree to a similar arrangement for the Acorn, and secondly, whether *Quake* will be able to run at a reasonable speed, assuming someone did sit down and convert the engine. I can't answer the first question, but I can say this - I'm sure that the game engine has already been converted to some extent and is running on StrongARM Risc PCs. However, there's a small problem in that the PC original was designed to run exclusively on machines with floating point co-processors, and that's the one thing the Acorn doesn't have.

I won't say any more until I have further details but, if all goes well, there might be a surprise appearance at the Spring show. I honestly hope this venture succeeds; a game of this calibre would brighten Acorn's gaming future considerably. If the programmers put

some effort into optimising the code for our integer-based machines, we might have a conversion to show the power of our flagships. I'm sure several people at Acorn would like to see that happen.

## Son of Moonquake

*Marsquake* is rapidly nearing a playable state, and Paul Taylor has spent some time adding the little touches that go to make a game look more professional. For instance, once you pick up the relevant token, you can heft bombs up into the air and lob them all over the place. In order to convey the feeling of the bombs flying through the air, Paul had to alter the graphics so that the object appears to leave the 2D playing area. A simple technique that's quite effective is to draw an image of the bomb diagonally down and to the left, similar to a shadow. Once it's in the air, the bomb continues to bounce along until it reaches an empty floor tile, at which stage it comes to rest. Bombs can also be thrown over the edge of the arena to land on the other side.

In *Moonquake*, if an uncovered bonus was engulfed by flame it was destroyed. This time round, Paul's decided not to let that happen, and if any tokens lie in the path of an explosion they're blown out of the way to land nearby. Again, a shadow is plotted underneath the tokens as they spin through the air, and it's indescribably satisfying watching that 'mega-bomb' bonus fly over a wall away from your opponent to land just in front of your feet.

One of the nicest features I've seen so far



# GAME SHOW



is the fact that you can be crushed by falling bombs – if you are unlucky enough to be at the end of a bomb's trajectory, there's a particularly juicy squelch and you will be incapacitated for a few moments while you scrape yourself off the floor.

I've been privileged enough to play an alpha-test version of Mersquake, and things are beginning to take shape. Although the game's not complete as yet (more levels need to be designed and quite a few bits and pieces need tweaking) the difference between it and its predecessor are already apparent.



Multiplayer games are particularly fun, and the new bonuses and hazards open up a whole new range of playing tactics.

The pipe networks are particularly powerful, and once you begin to drop supercharged bombs, it's not an unusual occurrence to see the screen fill with fire. When designing a game of this type, it's important to make sure the bonuses are well-balanced, and a good rule of thumb is that every bonus added should have some small drawback – flower bombs are great at clearing a large area of the map in one go, but they're also rather good at shortening your lifespan.

Testing is still in progress, but things are going well. So with a little luck you should be able to lay your hands on the complete version of Mersquake in the not too distant future – more news as it happens.

## Back to Decerto

Andrew and Claire Tidmarsh have written in to ask for a few more bits of advice in the classic 3D arcade adventure game *Alone in*

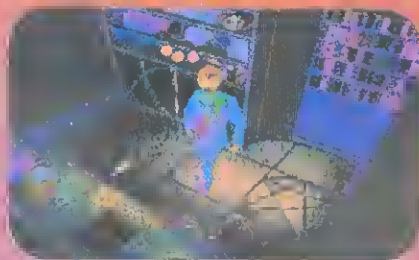

*the Dark*. I covered the initial sections in Merch last year, but here are some extra pointers for those suffering at the claws of the evil inhabitants of the Decerto mansion.

Vital information is held in Jeremy's bedroom at the end of the picture gallery – however, there are forces at work which would prefer you never make it to the room.



Hanging the rug over the first picture and shooting the one at the far end of the hall with the bow and arrow will allow you to get

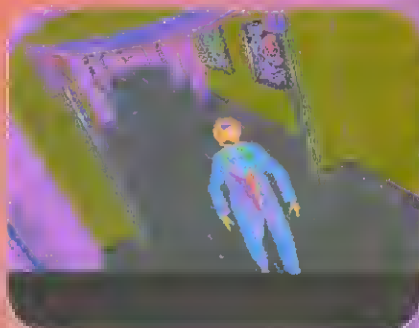

through the gallery safely – you're then free to push aside the grandfather clock and look in the compartment that's revealed. Once you've found the false book, you should be able to open the secret room in the library – find the section of the bookcase with the hidden mechanism and place the false book there. Watch out for the ghostly figure known as the Vegabond – his touch is definitely fatal.

The ghosts in the dance hall have very specific tastes in music, and you'll have to hunt around for a particular record before they'll start moving. Jeremy's study might hold the key – the 'Dance of Death' sounds ideal. While you're there, try placing the old sabre on the shield, next to its partner – that should open up a new area to explore. Finally, if you've popped down to the cellar and attempted to get through the hole behind the barrels, you're out of luck. That passageway is well guarded and is intended to be used as an exit from the labyrinth beyond later in the game.



Hard

3300 400 4000 5000 470

SCSI DRIVES (INTERN

SCSI DRIVES (EXTERN

Syque

Equipment that make the pref

Tech

39a Str

32

Liquor

Co

For Call

Rec

Rec



# Technology Matrix

Mail Order Specialists

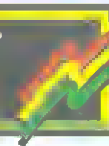

## Hard Drives

	Exc. VAT	Inc. VAT
4.0Mb IDE	£42	£50
8.0Mb IDE	£48	£58
16.0Mb IDE	£54	£65
32.0Mb IDE	£60	£72
64.0Mb IDE	£66	£79
128.0Mb IDE	£72	£87
256.0Mb IDE	£78	£94
512.0Mb IDE	£84	£101
1.0Gb IDE	£90	£108
2.0Gb IDE	£100	£120
4.0Gb IDE	£110	£132
8.0Gb IDE	£120	£144
16.0Gb IDE	£130	£156
32.0Gb IDE	£140	£168
64.0Gb IDE	£150	£180
128.0Gb IDE	£160	£192
256.0Gb IDE	£170	£204
512.0Gb IDE	£180	£216
1.0Tb IDE	£190	£228
2.0Tb IDE	£200	£240
4.0Tb IDE	£210	£252
8.0Tb IDE	£220	£264
16.0Tb IDE	£230	£276
32.0Tb IDE	£240	£288
64.0Tb IDE	£250	£300
128.0Tb IDE	£260	£312
256.0Tb IDE	£270	£324
512.0Tb IDE	£280	£336
1.0Pb IDE	£290	£348
2.0Pb IDE	£300	£360
4.0Pb IDE	£310	£372
8.0Pb IDE	£320	£384
16.0Pb IDE	£330	£396
32.0Pb IDE	£340	£408
64.0Pb IDE	£350	£420
128.0Pb IDE	£360	£432
256.0Pb IDE	£370	£444
512.0Pb IDE	£380	£456
1.0Pb IDE	£390	£468
2.0Pb IDE	£400	£480
4.0Pb IDE	£410	£492
8.0Pb IDE	£420	£504
16.0Pb IDE	£430	£516
32.0Pb IDE	£440	£528
64.0Pb IDE	£450	£540
128.0Pb IDE	£460	£552
256.0Pb IDE	£470	£564
512.0Pb IDE	£480	£576
1.0Pb IDE	£490	£588
2.0Pb IDE	£500	£600
4.0Pb IDE	£510	£612
8.0Pb IDE	£520	£624
16.0Pb IDE	£530	£636
32.0Pb IDE	£540	£648
64.0Pb IDE	£550	£660
128.0Pb IDE	£560	£672
256.0Pb IDE	£570	£684
512.0Pb IDE	£580	£696
1.0Pb IDE	£590	£708
2.0Pb IDE	£600	£720
4.0Pb IDE	£610	£732
8.0Pb IDE	£620	£744
16.0Pb IDE	£630	£756
32.0Pb IDE	£640	£768
64.0Pb IDE	£650	£780
128.0Pb IDE	£660	£792
256.0Pb IDE	£670	£804
512.0Pb IDE	£680	£816
1.0Pb IDE	£690	£828
2.0Pb IDE	£700	£840
4.0Pb IDE	£710	£852
8.0Pb IDE	£720	£864
16.0Pb IDE	£730	£876
32.0Pb IDE	£740	£888
64.0Pb IDE	£750	£900
128.0Pb IDE	£760	£912
256.0Pb IDE	£770	£924
512.0Pb IDE	£780	£936
1.0Pb IDE	£790	£948
2.0Pb IDE	£800	£960
4.0Pb IDE	£810	£972
8.0Pb IDE	£820	£984
16.0Pb IDE	£830	£996
32.0Pb IDE	£840	£1008
64.0Pb IDE	£850	£1020
128.0Pb IDE	£860	£1032
256.0Pb IDE	£870	£1044
512.0Pb IDE	£880	£1056
1.0Pb IDE	£890	£1068
2.0Pb IDE	£900	£1080
4.0Pb IDE	£910	£1092
8.0Pb IDE	£920	£1104
16.0Pb IDE	£930	£1116
32.0Pb IDE	£940	£1128
64.0Pb IDE	£950	£1140
128.0Pb IDE	£960	£1152
256.0Pb IDE	£970	£1164
512.0Pb IDE	£980	£1176
1.0Pb IDE	£990	£1188
2.0Pb IDE	£1000	£1200
4.0Pb IDE	£1010	£1212
8.0Pb IDE	£1020	£1224
16.0Pb IDE	£1030	£1236
32.0Pb IDE	£1040	£1248
64.0Pb IDE	£1050	£1260
128.0Pb IDE	£1060	£1272
256.0Pb IDE	£1070	£1284
512.0Pb IDE	£1080	£1296
1.0Pb IDE	£1090	£1308
2.0Pb IDE	£1100	£1320
4.0Pb IDE	£1110	£1332
8.0Pb IDE	£1120	£1344
16.0Pb IDE	£1130	£1356
32.0Pb IDE	£1140	£1368
64.0Pb IDE	£1150	£1380
128.0Pb IDE	£1160	£1392
256.0Pb IDE	£1170	£1404
512.0Pb IDE	£1180	£1416
1.0Pb IDE	£1190	£1428
2.0Pb IDE	£1200	£1440
4.0Pb IDE	£1210	£1452
8.0Pb IDE	£1220	£1464
16.0Pb IDE	£1230	£1476
32.0Pb IDE	£1240	£1488
64.0Pb IDE	£1250	£1500
128.0Pb IDE	£1260	£1512
256.0Pb IDE	£1270	£1524
512.0Pb IDE	£1280	£1536
1.0Pb IDE	£1290	£1548
2.0Pb IDE	£1300	£1560
4.0Pb IDE	£1310	£1572
8.0Pb IDE	£1320	£1584
16.0Pb IDE	£1330	£1596
32.0Pb IDE	£1340	£1608
64.0Pb IDE	£1350	£1620
128.0Pb IDE	£1360	£1632
256.0Pb IDE	£1370	£1644
512.0Pb IDE	£1380	£1656
1.0Pb IDE	£1390	£1668
2.0Pb IDE	£1400	£1680
4.0Pb IDE	£1410	£1692
8.0Pb IDE	£1420	£1704
16.0Pb IDE	£1430	£1716
32.0Pb IDE	£1440	£1728
64.0Pb IDE	£1450	£1740
128.0Pb IDE	£1460	£1752
256.0Pb IDE	£1470	£1764
512.0Pb IDE	£1480	£1776
1.0Pb IDE	£1490	£1788
2.0Pb IDE	£1500	£1800
4.0Pb IDE	£1510	£1812
8.0Pb IDE	£1520	£1824
16.0Pb IDE	£1530	£1836
32.0Pb IDE	£1540	£1848
64.0Pb IDE	£1550	£1860
128.0Pb IDE	£1560	£1872
256.0Pb IDE	£1570	£1884
512.0Pb IDE	£1580	£1896
1.0Pb IDE	£1590	£1908
2.0Pb IDE	£1600	£1920
4.0Pb IDE	£1610	£1932
8.0Pb IDE	£1620	£1944
16.0Pb IDE	£1630	£1956
32.0Pb IDE	£1640	£1968
64.0Pb IDE	£1650	£1980
128.0Pb IDE	£1660	£1992
256.0Pb IDE	£1670	£2004
512.0Pb IDE	£1680	£2016
1.0Pb IDE	£1690	£2028
2.0Pb IDE	£1700	£2040
4.0Pb IDE	£1710	£2052
8.0Pb IDE	£1720	£2064
16.0Pb IDE	£1730	£2076
32.0Pb IDE	£1740	£2088
64.0Pb IDE	£1750	£2100
128.0Pb IDE	£1760	£2112
256.0Pb IDE	£1770	£2124
512.0Pb IDE	£1780	£2136
1.0Pb IDE	£1790	£2148
2.0Pb IDE	£1800	£2160
4.0Pb IDE	£1810	£2172
8.0Pb IDE	£1820	£2184
16.0Pb IDE	£1830	£2196
32.0Pb IDE	£1840	£2208
64.0Pb IDE	£1850	£2220
128.0Pb IDE	£1860	£2232
256.0Pb IDE	£1870	£2244
512.0Pb IDE	£1880	£2256
1.0Pb IDE	£1890	£2268
2.0Pb IDE	£1900	£2280
4.0Pb IDE	£1910	£2292
8.0Pb IDE	£1920	£2304
16.0Pb IDE	£1930	£2316
32.0Pb IDE	£1940	£2328
64.0Pb IDE	£1950	£2340
128.0Pb IDE	£1960	£2352
256.0Pb IDE	£1970	£2364
512.0Pb IDE	£1980	£2376
1.0Pb IDE	£1990	£2388
2.0Pb IDE	£2000	£2400
4.0Pb IDE	£2010	£2412
8.0Pb IDE	£2020	£2424
16.0Pb IDE	£2030	£2436
32.0Pb IDE	£2040	£2448
64.0Pb IDE	£2050	£2460
128.0Pb IDE	£2060	£2472
256.0Pb IDE	£2070	£2484
512.0Pb IDE	£2080	£2496
1.0Pb IDE	£2090	£2508
2.0Pb IDE	£2100	£2520
4.0Pb IDE	£2110	£2532
8.0Pb IDE	£2120	£2544
16.0Pb IDE	£2130	£2556
32.0Pb IDE	£2140	£2568
64.0Pb IDE	£2150	£2580
128.0Pb IDE	£2160	£2592
256.0Pb IDE	£2170	£2604
512.0Pb IDE	£2180	£2616
1.0Pb IDE	£2190	£2628
2.0Pb IDE	£2200	£2640
4.0Pb IDE	£2210	£2652
8.0Pb IDE	£2220	£2664
16.0Pb IDE	£2230	£2676
32.0Pb IDE	£2240	£2688
64.0Pb IDE	£2250	£2700
128.0Pb IDE	£2260	£2712
256.0Pb IDE	£2270	£2724
512.0Pb IDE	£2280	£2736
1.0Pb IDE	£2290	£2748
2.0Pb IDE	£2300	£2760
4.0Pb IDE	£2310	£2772
8.0Pb IDE	£2320	£2784
16.0Pb IDE	£2330	£2796
32.0Pb IDE	£2340	£2808
64.0Pb IDE	£2350	£2820
128.0Pb IDE	£2360	£2832
256.0Pb IDE	£2370	£2844
512.0Pb IDE	£2380	£2856
1.0Pb IDE	£2390	£2868
2.0Pb IDE	£2400	£2880
4.0Pb IDE	£2410	£2892
8.0Pb IDE	£2420	£2904
16.0Pb IDE	£2430	£2916
32.0Pb IDE	£2440	£2928
64.0Pb IDE	£2450	£2940
128.0Pb IDE	£2460	£2952
256.0Pb IDE	£2470	£2964
512.0Pb IDE	£2480	£2976
1.0Pb IDE	£2490	£2988
2.0Pb IDE	£2500	£3000
4.0Pb IDE	£2510	£3012
8.0Pb IDE	£2520	£3024
16.0Pb IDE	£2530	£3036
32.0Pb IDE	£2540	£3048
64.0Pb IDE	£2550	£3060
128.0Pb IDE	£2560	£3072
256.0Pb IDE	£2570	£3084
512.0Pb IDE	£2580	£3096
1.0Pb IDE	£2590	£3108
2.0Pb IDE	£2600	£3120
4.0Pb IDE	£2610	£3132
8.0Pb IDE	£2620	£3144
16.0Pb IDE	£2630	£3156
32.0Pb IDE	£2640	£3168
64.0Pb IDE	£2650	£3180
128.0Pb IDE	£2660	£3192
256.0Pb IDE	£2670	£3204
512.0Pb IDE	£2680	£3216
1.0Pb IDE	£2690	£3228
2.0Pb IDE	£2700	£3240
4.0Pb IDE	£2710	£3252
8.0Pb IDE	£2720	£3264
16.0Pb IDE	£2730	£3276
32.0Pb IDE	£2740	£3288
64.0Pb IDE	£2750	£3300
128.0Pb IDE	£2760	£3312
256.0Pb IDE	£2770	£3324
512.0Pb IDE	£2780	£3336
1.0Pb IDE	£2790	£3348
2.0Pb IDE	£2800	£3360
4.0Pb IDE	£2810	£3372
8.0Pb IDE	£2820	£3384
16.0Pb IDE	£2830	£3396
32.0Pb IDE	£2840	£3408
64.0Pb IDE	£2850	£3420
128.0Pb IDE	£2860	£3432
256.0Pb IDE	£2870	£3444
512.0Pb IDE	£2880	£3456
1.0Pb IDE	£2890	£3468
2.0Pb IDE	£2900	£3480
4.0Pb IDE	£2910	£3492
8.0Pb IDE	£2920	£3504
16.0Pb IDE	£2930	£3516
32.0Pb IDE	£2940	£3528



# excellent value CD ROMS

## THE CLIP ART COLLECTION CD

The ClipArt Collection CD is the most comprehensive internet clipart CD yet produced. All of its 10,000 files are all in pure draw format. Supplied with a thumbnail viewer which makes finding the clip you want easy. Clips are split into 88 categories, just ten are shown here. The clipart can be used with all DTP applications including Impression, Ovation and Draw.

Ten thousand illustrations for DTP work

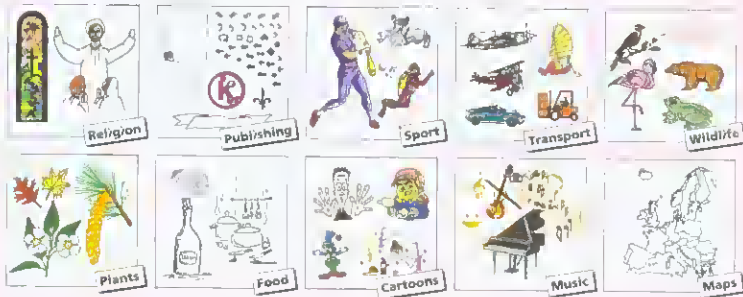

## The FONT Emporium CD

Featuring over 550 different font families, this CD ROM is supplied with a comprehensive font selection application, which splits the fonts into fifteen handy reference groups for easy typeface selection. Our fonts will work with all software that supports fonts, including Impression and Ovation. A full set of poster files are supplied to print out for reference.

Over one thousand unique typefaces

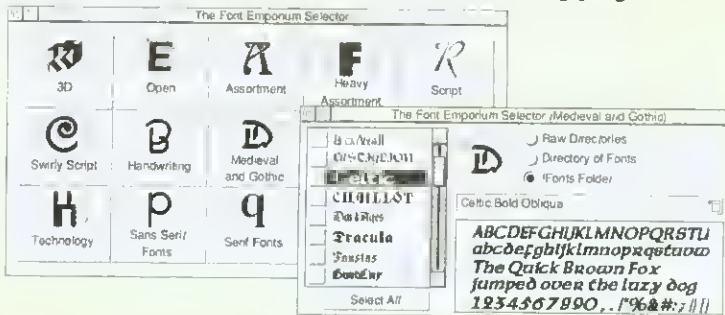

## Masterpieces Collection CD

If you've ever started tapping your feet while playing a game with great music, then you'll love this CD. Well over 3000 music tracks are included on the disc, enough to satisfy even the most arid devotee. Includes Classic, Plain, Rave, Blues and Jazz.

Three thousand stunning compositions



EACH CD ROM COSTS £29.95  
BUT ALL THREE COST £69.95 Offer  
A SAVING OF OVER £19  
PRICES INCLUDE VAT & POSTAGE

Zenta Multimedia  
10 Ravenhurst Drive / Birmingham / B-13 7RS  
Tel 0121 358 3054 Fax 0121 358 5969



ZENTA

WWW.ZENTA.DEMON.CO.UK

## Archimedes Public Domain Library



Public Domain, Shareware and low cost software for Acorn computers



APDL PD CD-1 and PD CD-2 £14.50 each  
A huge collection of P.D. and Shareware at a realistic price.  
PD-1 contains serious and educational, PD-2 games and novelties.

Issue 2, both PD CDs for just £27.50  
Upgrades from Issue 1 £6 each or £11 for both

### APDL Clip Art CDs

DTP-1 and DTP-2 - £17.50 each, DTP-3 - £19.50  
DTP1 + DTP 2 £33, all three for just £50

All in Acorn format, Sprite, Drawfile and Artworks. Ideal for schools.  
DTP-1 and DTP-2 have around 500 Mb, DTP-3 more than 720 Mb

### Hard discs

A310/A400 IDE including interface	A3010/A3000 IDE including interface	Drives only
210 Mb - £129	120 Mb - £134	2.5 Gb IDE - £208
330 Mb - £139	170 Mb - £154	3.2 Gb IDE - £239
420 Mb - £149	250 Mb - £172	1 Gb SCSI - £198
850 Mb - £192	340 Mb - £187	2 Gb SCSI - £287
1.6 Gb - £232	420 Mb - £199	3.2 Gb SCSI - £345
	512 Mb - £219	Others available

Syquest 105, 230 & 270Mb removable, SCSI or IDE, internal or external  
Solve your backup and security problems - from £99, discs from £17

**PLUS** RISC PC RAM upgrades, the famous APDL part-exchange scheme if you need a bigger hard disc (eg. 420Mb to 1.6Mb for only £145) and more!

For a catalogue please send 50p or two 1st class stamps to  
APDL, 39 Knighton Park Road, Sydenham, London SE26 5RN

Phone: 0181 778 2659 Fax: 0181 488 0487 www.apdl.co.uk



All prices include VAT and carriage





# Amnesia and Grasshopper

## Graham Nelson reviews two suites designed to make writing action games easier

So you want to write an action game, full of sound and fury. Where to begin? You'll need some ARM-coded routines to plot sprites a good bit faster than RISC OS can. Then some administration to keep track of where to plot them: a typical object in a game, like a bullet or a spaceship, will have a position, a given appearance, a pattern of movement and so on. This bookkeeping had better be rapid too, especially when it comes to detecting collisions, when one object has run into another. Then it will be time to provide a background, which might need to slide around in play, and a way of playing sound effects or music.

All this is painstaking labour, so most programmers start a new game by cannibalising the nuts and bolts out of the previous one. If you haven't got an earlier game to plunder, the easiest alternative is to get hold of a core of ready-written routines.

This is a review of two such cores: *Games Suite V2.05* by Grasshopper Software, on the commercial market, and *GameSuite* by Andy Southgate, which is freeware available from most of the main Acorn archive sites on the Internet. Mr Southgate's is a three-piece suite: *Amnesia* (in charge), *FastSpr* (for plotting) and *Staze* (sound effects), but for now I'll call the whole thing *Amnesia*.

### Two suites, one aim

At first eight the similarities go much further than the names. Both provide routines for plotting and moving sprites across a Mode 13 screen, taking action when they collide and so on. Both read pictures in ordinary Acorn sprite file format. (*Amnesia* compiles these to a better format, enabling it to plot around four times faster than the normal RISC OS routines would.) Both suites are intended for two-dimensional games, with solid shapes which can't easily be scaled in proportion, rather than wireframe drawings which can easily be zoomed in or out. *Snepper* or *Rocket Raid*, yes: *Elite* or *Zarch*, no.

Both suites provide a relocatable module of machine-coded procedures which can be called from BASIC programs using the SYS statement. Both are StrongARM-compatible. Both come with simple examples, though without impressively finished games. As a fine spooky coincidence, one author has an address at St John's College, Cambridge, the other at St John's College, Oxford.

Both suites suggest that you might use them to make and sell a game of your own. Not only is *Amnesia* free, but there are no charges made for selling derivative works, either. In contrast using the *Games Suite* for a shareware game will cost you a further £10, and Grasshopper Software reserves the right to charge royalties on more commercial projects.

The other key difference – except, as we shall see, in terms of quality – is that *Games Suite* provides a desktop interface which can in theory allow entire games to be written without any programming at all. In contrast *Amnesia* has no presence in the desktop and is in effect a library of procedures to use from a BASIC program.

### Grasshopper's Games Suite

This suite consists of two discs, one given over to examples and a 54-page A5 manual. On the whole this explains the desktop interface fairly well but is disorganised just where organisation is most needed. Chapter 5, a tutorial for newcomers, begins with 'hint and tips' which includes essential instructions, and goes on to be vague on how to make the first completion; it is further marred by misprints. Something created with the name 'Me' is later referred to as 'plane0'; in another name, an underscore comes and goes. If

these are not spotted and corrected, *Games Suite* will silently compile something that crashes out: it is extremely bad at reporting errors in the game design.

The manual also omits installation instructions – but there's an *installer* application which did all the work for me. Serious problems then ensued. The notes on getting *Vector*, the only example game, to work are incorrect: it must be edited before being played because it contains settings from the author's own hard disc. (These produce illegal file handle errors, suggesting that the Suite doesn't bother to check whether files opened correctly before trying to use them.)

The editor itself allows a database of sprites and movement patterns, and so on, to be created with reasonable ease. This seems to work although as mentioned there is far too little consistency checking. After the details are entered, one saves a hopefully working copy of the game to some chosen directory. This sometimes, and mysteriously, does nothing: a window appears which might reveal why, but it vanishes too quickly to read.

With *Vector* built and saved, there was yet another crash to overcome: the scrolling introductory text produces a bogus 'subscript error'. I edited this text to just 'Press Space'

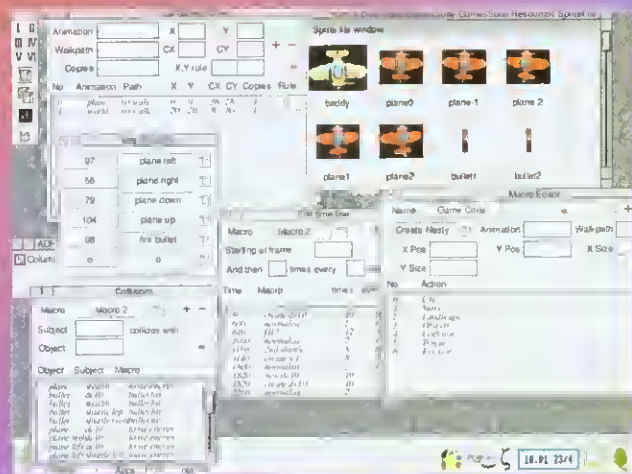

The Games Suite from the desktop

Writing games

and the bug disappeared, though so did the instructions, of course.

Vector is amateurish, despite some rather nice, though unimaged, pictures of planes. This would not matter if it were just a simple example. Unfortunately, Vector makes maximum use of a system which is severely limited. There are no sound effects, because GameSuits can only provide a musical soundtrack. Collision detection is very crude, so that a shot clearly passing between fuselage and wing will bring down a jet. When the player's energy runs out, the game snaps back to the desktop - no explosion, no noise, no high-score table, indeed no score.

The GameSuits is a shabby piece of work and not yet fit for commercial release: it needs testing, debugging and extensive rewriting, but even then its basic design would be inadequate. As this issue was about to go to press an upgrade to v2.09 arrived, fixing some of the bugs and allowing up to six sampled sound effects.

**Amnesia, FastSpr, Stasis**

Exactly the opposite applies to Andy Southgate's suite, a thoroughly professional work which deserves to be better known. Release 3, the most recent, is two years old: Mr Southgate has given up maintaining it, and has instead produced a 'final version' with full source code. But everything seems in good working order.

To use the suite, a little programming experience is needed: it's essential to feel comfortable with BASIC and to be able to use the SYS statement, at least in simple ways. It would help to be familiar with hexadecimal and binary numbers and to know what's meant by remarks like 'bit 2 is a flag which, if set...'. But no very technical knowledge, or

ability to write ARM code, is needed.

The suite comes in a 900K archive file which expands to about 1.7M with the aid of *Spark Plug*.

Documentation is provided with a hypertext manual, and is detailed and well organised. (Full software to generate such manuals is included as a bonus - the system is similar to *StrongHelp*, though in my view easier on the eyes.)

The examples directory gives four short ones - a diverting bouncing-ball demo, with a few dozen red balls colliding and merging; a crude shoot-em-up game; a demo of scrolling and jumbling text; a speed test - and a more substantial platform and ladders game, with landscape scrolling in all directions.

The bouncing-ball demo consists of about 70 statements of BASIC plus a sprite tile containing five differently-coloured balls. What the program does is to tell Amnesia to create a 'table' of objects and then to go into a loop, repeatedly 'processing' the table until something happens which needs special attention. The objects, of course, are the bouncing balls, and Amnesia automatically moves and plots these using its assistant *FastSpr*: it could also have animated them, run timed events connected with them, and automatically accelerated them under gravity. Amnesia only reports back to the program when one of the balls hits the edge of the screen, or one of the other balls. This really cuts down on program size: the shoot-em-up example has aliens, bullets, bombs, bonus tokens and a player, all in all about 300 statements.

Amnesia is not a very reassuring name for a memory manager but I found it efficient and well-specified. *FastSpr* can be used directly should this be necessary. *Stasis* is a simple system holding up to 64 sound samples and allowing them to be played on



A Dalak-infested corner of one of the Amnesia examples

any of the sound channels using, for instance, the ordinary BASIC SOUND command. All in all the suite is free, well written and well worth trying out.

**Product details**

Product: Games Suite  
 Supplier: Grasshopper Software  
 Tel: (01509) 853166  
 E-mail: benjamin.ollivere@st-johns.ox.ac.uk  
 Price: £25 fees payable for commercially distributing any games produced  
 Pros: Desktop front-end • Upgrades apparently planned  
 Cons: Poor quality • Limited scope • Needs mending before use

Product: GameSuite 3.00 (Amnesia, FastSpr, Stasis)  
 Author: Andy Southgate  
 Available: e.g. as archive c130 at 'Hensa' (URL <http://micros.hensa.ac.uk/micros/arch/riscos/arch-riscos.html>)  
 Price: Free  
 Pros: Flexible • Efficient and well-written • On-line manual  
 Cons: Programming experience needed • Suite no longer actively maintained

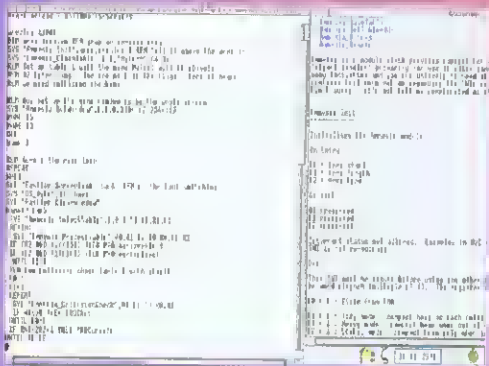

Good online help but no front end



The Fourth Dimension Presents...

TM

# DRIFTER

- 9 thrilling tracks with numerous powerups, obstacles, trackside graphics, soundFX and music.
- 3 different racing vehicles, each with unique handling characteristics.
- Compete against intelligent computer players in tournament and practice modes.
- Visuals rendered with a revolutionary new 3D graphics engine (Perpetual Motion), featuring awesome high-speed texture mapped graphics.
- Fantastic Risc PC only features.

"The playability of Drifter is also amazing...it makes me ask myself, 'Has anyone else designed a game like this?' What are you standing there for? Buy it!" - Archimedes World, 1997

"Amazingly fast...Really does the burn for Risc OS machines" - Acorn User, Jan '97

£34.95

For all Acorn 32bit Computers  
Including Risc PCs with StrongARM  
Minimum 2Mb RAM

## FOURTH DIMENSION

Available from all good stockists or from "4D" direct on 0114 276 9950.  
Come and try Drifter at the Wakefield Acorn Spring Show on stand 48.

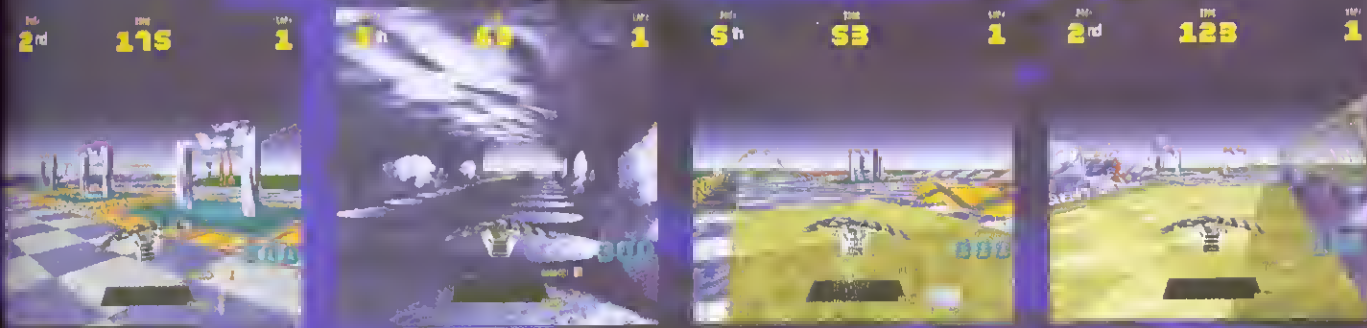

Design, Code and Graphics by Andrew Docking.

© The Fourth Dimension 1997. 1 Percy Street, Sheffield S3 8AU.

Tel: 0114 276 9950 Fax: 0114 278 1091 Web site: [www.rsenter.demon.co.uk](http://www.rsenter.demon.co.uk)





# Rambles through Acorn Wood

Mike Cook explores nooks and crannies

Steve Turnbull's article about threads in the January issue of *Acorn User* took me back to 1979 when I had to put on an exhibit about micro-processors. I constructed a model train layout which was basically two circles with a common section of track. I buried reed switches under various parts of the track so I could sense where the train was by the magnets fixed to the underside.

I also had points controlling access to the common section of track. When I wrote the program all I wanted to do was to see if the common section was in use, if it was to halt the train and, if not, let it go. In effect the program had to do the same thing for each train so I wrote what now would be called a pre-emptive, multitasking, multi-threaded program.

All that happened was that I generated a hardware interrupt at 20ms so that the interrupt service routine swapped the stack pointer between one of two values. Therefore the same program looked after two different trains, each controlled by its own thread through the same code.

As I had thought of the technique myself I invented a name: *multitasking the same program* – not as elegant as *threads* but it served its purpose. For those interested in history I wrote it in machine code on a Smith West Products 6800 machine which had a massive 4K of RAM.

I was called out to a friend last month whose hard drive had just disappeared from the desktop – it was his extra SCSI hard drive. After much testing and swapping of boards I concluded that both the SCSI hard drive and SCSI CD drive had gone down. He was very puzzled as to why this had happened after a year of use. He also had a flat bed scanner on the bus and I discovered that it had terminating resistors – as had the hard drive and the SCSI board.

So there were three terminators on the line instead of two. I have heard in the past that this could cause damage eventually but it's the first time I'd come across it.

The moral is clear, look out for those little resistor packs when you upgrade. It was fine before the external scanner was fitted but once it had been, the resistors on the SCSI board should have been removed.

Even though the scanner was not switched on all the time, the termination was still in effect. Incidentally this friend runs an antiques business that got started by money made trading in Acorn shares. He was going to call his business Acorn Antiques but then thought better of it.

*Richard Sage of Flintshire is having problems getting his designs on to paper, he writes:*

I have just recently completed a design in *Draw* using the A4 paper format for a full-scale drawing; the trouble is that I only have access to an A4 BJI0x printer. Is there a way to split my drawing up into A4 pages so I can print them and then tape

them together? The Applications guide says that by holding down Ctrl and clicking Select you can print part of a drawing, but I have tried this and Draw seems only to print the bottom corner of the page, even though the A4 border is somewhere else.

I must admit I hadn't come across the feature of printing out part of a drawing before so I tried it. Despite your experiences I found it to work every time on a variety of printers. However, I could not try it out on your specific model.

I can only conclude that the driver you are using is not up to scratch. Have you tried contacting the dealer to see if there is a more up-to-date version? Alternatively, programs like *Paster* and *ArtWorks* will allow you to print a large drawing in parts.

*Mr Rolfe from Southampton is having some problems running games, he writes:*

I have started having problems with some software on my RISC PC 600 (2Mb VRAM, 24Mb DRAM, 8x1 D-ROM). The major problem is *Blots of War* software not running properly – the screen goes blank and then displays this message:

```
Illegal address (e.g. wildly outside
array bounds)
Post-mortem requested
Arg1: 0x0003d6bc 251580 -> [0x74736f52
0x00007265 0x6e696e70 0x20726574]
$9b94 in function load_packedscreen
3d650 in function roster
32528 in function corridor
e6e8 in function main
39fac78 in unknown procedure
```

I have returned the discs to Fourth Dimension explaining the fault but the ones sent back still give the same fault. The program has been working fine until recently. Also with my version of *Jurassic Impression* every time a document is loaded the pages are black with white letters. Even starting a new document it has a black page. Both problems started at the same time but I do not know what caused them.

With a little detective work I think I have worked out what is happening. If something used to work and now doesn't, something has changed. It's tempting to think that you have developed some sort of hardware fault but in this case I don't think you have.

The clue lies in the error message. I know a bit of it just sounds like gobbledygook but what it is reporting is where it was in the C program when it crashed. C uses procedures similar to BASIC and it is reporting not only the procedure in which it crashed but also the procedure that called it, and

what called that and so on. This allows the developer to pinpoint exactly where the program failed.

We are fortunate here that the programmer used vaguely descriptive names for his procedure as the error is reported in a procedure called *load\_packedscreen* which at a guess would suggest that the program is trying to load a graphic to the screen. Looking at the specification of your computer I see you have 2Mb of VRAM so I guess you will be running the computer with a large number of bits per pixel.

Maybe the thing that has changed is the default screen pixel depth. This would tie in with the other problem concerning the display. Therefore I would suggest you try changing the screen mode to 256 colours before launching any of these programs.

*Mr Rolfe has a supplementary question:*

I also have a PC 486 SX 33 Card and when installing PC games a bit of them either crash or will not run. Will PC Pro help?

A lot of PC stuff crashes on PCs, so you could think that Acorn introduced a procedure that randomly crashed the PC card just to make it more realistic. As PC Pro is a more complex system I would suspect that it might help a little, but I would not hold out much hope of any specific title working.

*Mr W A Jeffs has been savouring the delights of the PC side of the Risc PC:*

I am having a problem with intertacting the Maplin PC programmer with my Risc PC and am hoping you might be able to suggest a solution or advise me on a method to try and identify the problem. The PC is the Microchip version of a programmable microcontroller.

The basic problem is that the PC software does not appear to activate the parallel port when run on the Risc PC. The program reports a hardware fault and automatically goes into debug mode. This steps through a sequence which toggles each control line in turn. There is no indication of any change to the port lines. It has been tested on a second Risc PC which gave identical results.

I have carried out the following checks so far. Using your parallel port monitor program and with the programmer plugged into the parallel port, I managed to switch the two indicator LEDs and two other lines to the programmer on and off. So the hardware appeared to be working.

I have access to a Centrex-hadged PC so I was able to test the programmer and software on a standard machine. No problems were encountered and the final proof of correct operation was obtained when a programmed PC ran OK. Therefore I suspected incompatibility in the software.

I did a QONFIG which reported the parallel port as LPT1: 03BC. The PC program reports the



hardware setup as P13 at 038C. So there was no clue there. The PC prints OK when running OLYSIC (vnhk), flies when running N1601D and also when running Radio Amateur packet program callbf paket. So the general indication is that everything is satisfactory when running the Risc PC as a PC. I phoned Maplin but it was unable to offer a solution.

It does not surprise me that Maplin is unable to offer a solution – it seems to know little about Acorn products. Congratulations on the tests – they all point to one conclusion, the PC software is written in such a way as to be incompatible with the Risc PC's 486 card. This arises because the software on the 486 card expects to see itself surrounded by the standard PC hardware and it is not.

What the Acorn side does is to emulate the hardware by transferring hardware requests to the real hardware in the computer. It does a reasonable job of this but it looks like the programmer responsible for the PIC programming software has been a little too clever in accessing the printer port.

You can access the port through the Windows interface, the DOS or the BIOS, all of which the Acorn system will pick up. The other way to access the hardware is by memory access – that is using operations that read and write to memory locations where the hardware is assumed to sit. This can sometimes fail on the Acorn PC system, depending on what hardware is being addressed.

Incidentally, this technique can also fail on true PCs as well so it is generally discouraged. There are several solutions to this but they are not very cheap, practical or convenient. The first is to buy a real PC but make sure it is one that will run this program – that probably rules out most laptops. The second is to try to contact the author and persuade him to rewrite the program using a more sensible form of accessing the hardware. However, he probably doesn't know the proper way. Finally you could wait a little. I have the PCB for this Maplin project and it is on my list to write some Acorn software to drive it.

*Mr G Clark from Essex has been upgrading his system:*

I have recently bought an upgrade to RISC OS 3.6 for my old Risc PC – I say old because I have had it for three years. Unfortunately the supplier did not send me any instructions with the upgrade which I presume was taken from a model which has now been turned into a Strong ARM machine.

I titled the upgrade following the guidance which I found in December's issue on titling the StrongARM upgrade. Everything went swimmingly until I tried to install my Comuna Internal IDE CD drive. Each time I attempted to run the installation software I was met with the error message "Unrecognised version of ADIS".

I turned to my back issues of Acorn User to see whether anyone had had a similar problem and was pleasantly surprised to find that in March '96 Dave Walker had answered my problem on page 85.

His solution was to issue "UNPLUG CDISSoft:ADIS" at the command line and then comment out (prefix with a #) the line in the !Run file of the installation application which reads ADISPatch. He went on to say that the installation could then be performed as per instructions. I am pleased to say that as predicted all went well and the drive works.

I am sorry to say that I do not, however, know what I have done to my machine which reports that CDISSoft:ADIS remains Unplugged. It also refuses to allow me to tick the configuration and

start up as "second wish" to. Instead it reverts to mode 27.

When I try to alter this using the Display options, from configure to my desired set up, the message "Using system ADIS" must be given a name\* is displayed. (If I have configuration unlocked, i.e. remove the password, the machine starts up as I want it to). If I ignore the error message and click on "Set" a second time the desired settings are reflected in the Drsktop.

I have tried to reset my computer believing that the problem was simply due to the fact that CDISSoft:ADIS was still unplugged. This resulted in a period of sheer terror when the system refused to load the desktop and asked to be loaded by floppy. I am pleased to say that I have it running once more but would like to know what this module CDISSoft:ADIS is and why it has to be unplugged.

Can I get a better, more RISC OS 3.6 friendly IDE CD and driver, and is there a way of getting my configure options to work properly? By properly I mean being able to keep them locked to prevent my young son accidentally deleting files and not having to wrestle with the computer each time I start it up to get it to appear as I would like it to.

I think your dealer has been a bit naughty here. As far as I know RISC OS 3.6 has not been released as an upgrade to earlier models and was only supplied with the A7000 and later Risc PC models. There are several features in RISC OS 3.6 which makes it not the upgrade of choice, some of which you seem to have found.

However, for the many users who do not want to protect their system configuration or have third-party add-ons of this type, this system offers some marginal improvement over the lower ones. I would suggest that you refit RISC OS 3.5 and wait until RISC OS 3.7 is available. However, with the increase in the numbers of redundant RISC OS 3.6's chips I suspect my postbag will be filled with these sorts of problems.

*Darren Armitage, being only 16, has his computing on a tight budget. He writes:*

I have a dated A3000 with 4Mb RAM, IDEIS version 3.13, an SCSI or other interfaces with a printer connected to the parallel port. My A3000 has an 82Mb hard drive which occupies my one and only internal expansion slot. Taking all these factors into consideration, would it still be possible for me to purchase a grey-scale hand-held scanner within my budget of £100 to £170? And if so please could you point me in the right direction?

On the A3000 you have an external expansion slot as well as an internal one. This means you could fit a £151 Computer Concepts Scanlight 256 and plug the card into the external expansion port. The only addition you would need is a housing for this card that bolts on the back – these are about £25. You can do without this box but it is not a very robust setup. Thanks to Davyn Computers for this information.

*Finally Edward Waugh from Forster is also looking to expand his ageing computer:*

I am currently the proud owner of an old A3000 with RISC OS 3.1, 4Mb of RAM with a 120Mb hard disc in the middle slot. However, recently I have begun to feel that my tread with his new P133+Win95 has been getting close to the performance I am used to, so I am looking to upgrade my machine as I cannot afford a Risc PC.

I don't feel I need more RAM as I rarely fill my 4Mb so what about the processor? Can I still get

the 33MHz ARM – could I stick the 33MHz PPA 11 with it? If not what performance benefit could I expect from a normal ARM 3 and what areas of speed would an optional TPA affect (text rendering, *Star flight = 3000* etc)? What is a PRTS housing and where could I get one? Could I put a HD floppy drive in it and another hard disc (CD drive)? What is a profile expansion case and what could I put in it?

And generally how much Acorn is doing so little to the front end of the OS, such as long libraries, virtual memory, a much more extensive help system and improving the system applications which as far as I can tell are not much different from the ones I have?

Acorn is trying to discourage users of older machines from upgrading and instead is trying to persuade them to consider buying a newer computer. That's why it is currently offering £200 trade in for your model along with the 20/20 deal that gives 20 months interest free credit with only 20 per cent deposit.

Advertised, it is getting increasingly difficult to upgrade old machines. The only place you can get an ARM3 chip is CJE Micro at a cost of £160. However, before you can do that you need to have the processor card socketed by someone like Simtec or IFEL.

The same goes for high density floppies. The only seller of upgrades went out of business last year and with second-hand A3010s going for under £200 it's just not worth making an upgrade. A PRES housing allows you to add an external expansion card – ring around the advertisers to get a supplier. You can get long filename support from various PD libraries.

The lack of extensive change is a good thing in many respects and the system applications have had many changes but they're not visible on the outside. However Acorn is now in the business of producing hardware and software for other companies and we get the benefits in the technology of new machines. **AU**



# FREE SOFTWARE PACKS

## FOR EVERY READER - Worth £29.98!

**Award Winning Educational Software**

**TABLES**  
REINFORCEMENT AND PRACTICE OF MULTIPLICATION TABLES MADE FUN

- ✓ Practice
- ✓ Assessment
- ✓ Motivation
- ✓ Fun Games
- ✓ Reinforcement
- ✓ Recording
- ✓ Certificates
- ✓ Accuracy
- ✓ Speed
- ✓ Customisation

**R.R.P. £14.99**

**WORDS**  
THE FUN WAY TO BOOST VOCABULARY AND IMPROVE SPELLING

- ✓ Vocabulary
- ✓ Spelling
- ✓ Plurals
- ✓ Proper Nouns
- ✓ Compound Nouns
- ✓ Collective Nouns
- ✓ Gender
- ✓ Verbs
- ✓ Adjectives
- ✓ Meanings

**R.R.P. £14.99**

10 out of 10 Tables lets children practise all the tables from 1 to 12 in a motivating, fun way.



Floppy disk versions also available!

10 out of 10 Words will help all 5 to 12 year olds boost their vocabulary & improve spelling.

### USED AND RECOMMENDED BY THE PROFESSIONALS!

*'It's fun and easy to load. The lively games offer competition and progressively challenging problem solving. It's a recipe for successful learning!'*

**Yvonne Daly, Headteacher, Lark Hill Primary School, Stockport.**

*'We recommend all 10 out of 10 titles. The educational content and ease of use make them a great hit. Parents are always saying that their children do not even realise they are learning!'*

**Eileen Kilvington, Whizzkidz™ Multimedia Learning Centres. Tel: 01788 833233**

*'The 10 out of 10 Series is highly recommended, offering fun and exciting learning based on sound educational principals.'*

**Phil Martin, Editor, Educational Computing and Technology.**

*'If the national council for education and technology's researchers ever got around to assessing the impact of a daily fifteen minutes with 10 out of 10 they would surely discover real improvements in maths and spelling.'*

**The Times Educational Supplement.**

*'10 out of 10 are the best educational packages I've used. My children love them.'*

**Janet Pennington, Parent and School Governor.**

### HOW TO SECURE YOUR FREE COPIES!

To secure your **FREE SOFTWARE PACKS** all you have to do is cover the cost of P.&P. (£1.95 for one package or £3.90 both).

You will be sent the full latest versions complete with documentation and boxes.

**ORDER BY 'PHONE - 0113 2394627**

**ORDER BY FAX - 0113 2394629**

**ORDER BY POST - Use The Coupon Below**

**ORDER BY E-mail - sales@10outof10.com**

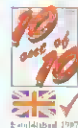

Why not visit our Web Site?  
<http://www.10outof10.com>



To secure your FREE copy or copies simply fill in the form below and post it to: Tables/Words Offer - Troydale Mills, Troydale Lane, Leeds LS28 9LD

#### IMPORTANT

Please tick to select title & version required:

- Tables  Words
- PC CD ROM
- PC 3 1/2" disk
- AMIGA 3 1/2" disk
- ACORN 3 1/2" disk

Please send me the packages I have ticked. I understand that in order to receive my pack(s) I have to cover the £1.95 cost of P.&P. for one package or £3.90 for both.

Name \_\_\_\_\_ Tel: \_\_\_\_\_

Address \_\_\_\_\_

Postcode: \_\_\_\_\_

Cheque/P.O. enclosed for £1.95/£3.90, made payable to 10 out of 10 or please debit my Access/Visa card

\_\_\_\_\_

Card expiry date \_\_\_\_\_

Signature \_\_\_\_\_

**TABLES/WORDS OFFER**  
Troydale Mills, Troydale Lane, Leeds LS28 9LD

Please tick here if you do not wish to receive mailings on other products



**Dave Acton** and  
**Dave Lawrence**  
are joined by another five  
Davids in this month's  
exciting instalment

# star info

## Slate of hand

Author: David Thomas

The first offering from **David Thomas** (# 1) is a particularly realistic granite plotting demo, *Rock'nRoll*. The clever thing is that the rock pattern is generated entirely from code – no sprites involved. And the unusual thing is that you can 'paint' with the rock design. The program was based

on a one-liner we carried some time ago.

Simply paint the area you want to fill with Select and then click Adjust to start the fill. You can clear the screen with C and use + and - to alter the brush size.

There is also some control over the way the rock pattern is generated. Use Z and X to alter the 'factor' – powers of two work best and many values don't work at all. Try 12 for a lighter effect and remember that you need to press A to reassemble the plotting code for the new factor. You can save the current screen as *Rock* with S.



## Bonsai!

Author: Matthew Hammond

In our continuing search for the smallest programs, we have received a fine offering from **Matthew Hammond** which generates a 'info classie' – the recursive fractal tree. The reason it has found its way into our micro hall of fame is that it is only 256 bytes long, that's only 64 ARM instructions!

When you run it nothing appears to happen at first as it is expecting two numbers, the first is an angular step (in the range 1 to 5) and second is the screen mode, press 2 for VGA or any other key for TV resolution. Both numbers should be entered without pressing RETURN.

Due to considerable memory limitations there is not enough space for any nice prompts or error trapping, so if you type 'W', say, instead of 2 for the first parameter you'll get some completely unintentional effects although more often than not the result will be pleasing.

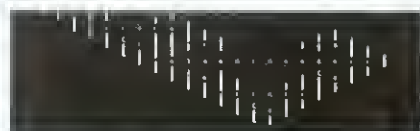

# Gamma Radiation

Author: David Radford

Last November we featured a short piece by Fred Williams on the new gamma-correction facilities built into the Risc PC. It seems that this article has caused a minor sensation as David Radford (David # 2) has sent an e-mail outlining a number of points:

"Quoting from the November 1996 issue:

'One of the new features of the Risc PC that seems to have been ignored for an awfully long time is the hardware gamma-correction.'

"This is half true, in the sense that the mapping between the colour you write to the display and the one actually sent to the monitor is performed in hardware. However, a quick glance at the VIDC20 datasheet will show that there is no special gamma correction hardware built into it.

'The video circuitry gets a pixel's worth of screen data. It converts that into RGB values using the palette. Unless of course, you're in a 16 or 24-bit mode, in which case, the pixel defines the colour.'

"The palette is actually used in every mode, including 16 and 32 bpp ones - try switching to a 16M colour mode in the desktop, press F12 (not a task window - vdu is filtered), enter Basic and try the following to see everything rose-tinted:

```
FOR T%=0 TO 255:COLOUR
T%,T%,T%/1.25,T%/1.25:NEXT
```

"The diagram illustrates how the palette works. The only difference between one mode and another is how the decoder generates the index to each LUT from the pixel data. Note that the input to each DAC is solely from the corresponding LUT - there is no way of passing pixel data directly to the DAC and bypassing the LUTs.

"To perform gamma-correction RISC OS copies the gamma tables away into its private

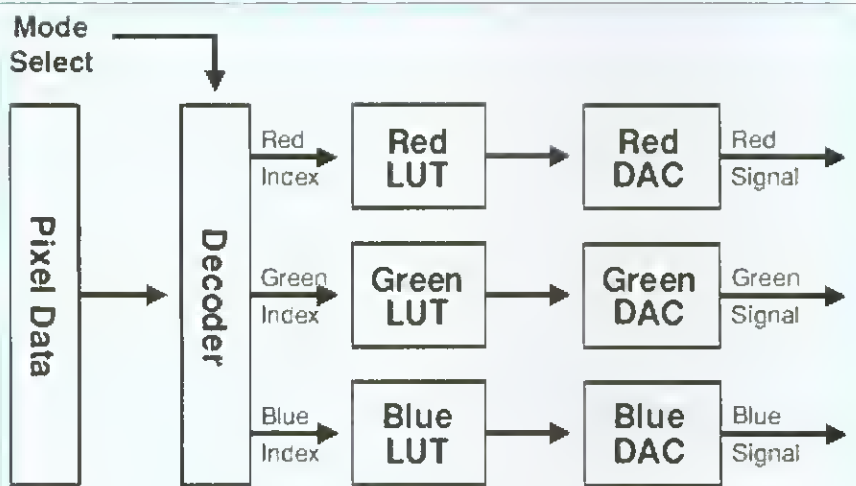

The Ext LUT (Look Up Table) is omitted here for simplicity

workspace. Then, whenever it is about to update the VIDC's palette registers it first modifies the data to be written by running each colour component through its gamma tables.

"If you'd like to see more details on how the decoder works in 16 and 32bpp modes, crank out your internet software and point your browser at:

<http://www.argonet.co.uk/users/radford/VIDCdoc.html>

David also addresses Fred's question about R4 being returned with a value of 0 if the video drivers support the given function - does this mean that there are Risc PCs, or other future Acorns, that don't support this? David replies:

"First: it is meant for backward compatibility rather than forward. If you call PaletteV with an unrecognised reason code in R4, the call will eventually be passed

back to you with R4 unchanged, indicating that no claimant knew what to do with it. If the call was understood, you get R4=0 back (like a service call). Since RISC OS 2 and RISC OS 3 don't recognise R4=9 you will get R4<>0 back and you'll know that the tables aren't supported.

"Second: there are circumstances under which attempting to perform gamma correction would impair the display. VIDC1 didn't have the range of intensities necessary for proper 'automatic' gamma-correction, nor could it work in 8bpp modes. I hope RISC OS 3.5 on a VIDC1 machine would return R4<>0 rather than try to use the tables.

"Third: Acorn has sensibly switched to a policy of allowing all calls that rely on specific features of the hardware to report that the hardware doesn't provide such a facility, and lets the program fail gracefully or take alternative action in such cases."

## Dance groove bezier party

Author: David Thomas

We've carried a few little graphical ditties that dance along with Tracker modules in interesting ways. *Groover* by David Thomas is one of the simplest and nicest ideas. *Groover* is just one of a trio of delights from David # 1 this month.

"Groover came out of an experimental program which mixed a Lissajoux pattern with QTMTracker's VU bars. Instead of plotting lines, with their end-points controlled by the VU bars I decided to try it with a Draw module bézier curve path, and continuously

update the start, end and control-points. The VU readings 'propel' the indices into the sine and cosine tables, which are read and used as the co-ordinates of the curve.

"Its behaviour is quite strange. It uses the Draw module's calls to plot the path, so it needs a Risc PC to run at a decent speed with the default parameters.

"It should run okay on previous machines if you tweak the parameters. It runs in mode 4 which will appear squashed on some users' monitors."

## It's a sine

Author: David Thomas

David Thomas continues to show an unhealthy interest in trigonometric functions with this conversion of his friend's PC plasma program, *Plasmoid*.

As with all such demos, there'll be a bit of looking up, down, left and right somewhere along the line, but the use of sinusoidal patterns produces a relaxing effect. A custom 256-colour palette is used so you will need a Risc PC or similar.

You can increase the size of the plasmic area by changing the values of fx% and fy% - there are some restrictions on what these values may be, but setting both to 252 works quite well on fast machines.



## Electric fire craters

Author: Philip Mellor

It would be hard to deny that Jan Vibe is one of the biggest influences on this column over the years. Even in the periods when we have no programs from The Man Himself there is inevitably someone waiting in the wings raring to produce a *Vibism*. **Philip Mellor** is this month's pre-tender to the throne with three excursions into the graphical zone.

*Electric* is an attempt to simulate one of those plasma spheres that always used to be advertised in those wonderful innovation catalogues. It has a tendency to run a tad too fast, but does produce a surprisingly convincing display.

It would be interesting to see the program's obvious speed to produce a higher resolution version, but with smoother arcs – the current ones are drawn with simple DRAW commands which make quite 'steppy' lines.

With this and Nigel Stoner's lava lamp version 0.01 in the March issue, we seem to be startling a trend for simulators of animated

ornaments. Can anyone come up with one of those fibre optic afro things? A wave tank? One of those lovely clocks with ball bearings running down little ramps?

*Fire* is a one line program. Well, okay, apart from the four lines of comments. It generates a static screen of coloured wibbly lines which are then colour cycled to simulate flames.

*Craters* is our favourite and will be entered into the \*info gallery of unpleasant images along side such classics as *Guts*, *Writhe* and *Tentacles*.

On the surface of it (ha ha) *Craters* generates a number of textured craters made up from many spheres, however the final result always seems to end up

looking like something very unsavoury viewed through an electron microscope.

Something very unsavoury indeed, probably insect in origin with far too many legs.

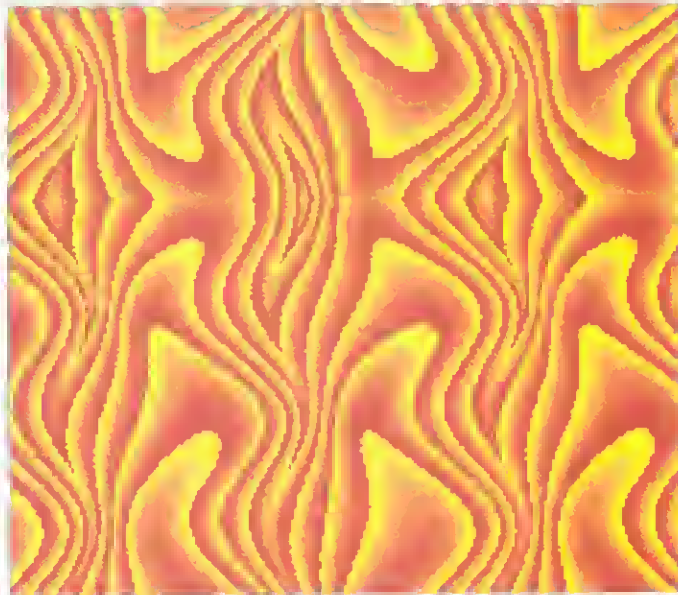
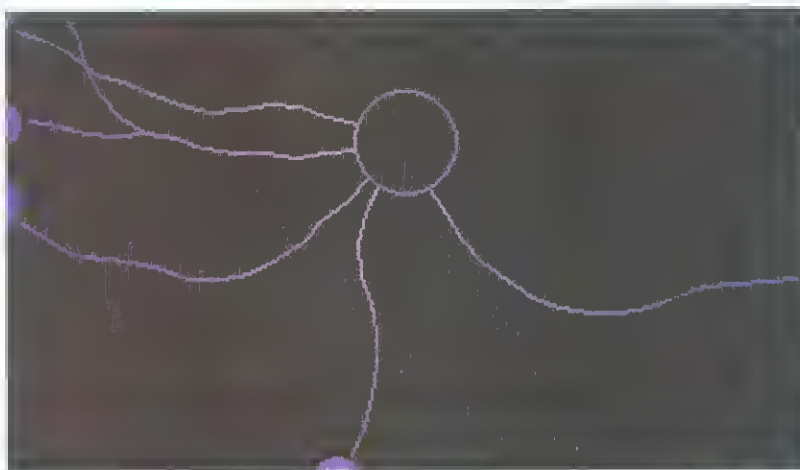

## Splemage

Author: Clem Edwards

This sounds like the name of an exotic vegetable, and who knows, **Clem Edmonds** may have been munching on some when the inspiration for his tune came about. It is in his usual 'happy hardcore' style – possibly even happier and less hardcore than usual, if that can be possible.

As always, the format is Digital Symphony – *Flux* will play it happily and provide suitably jolly graphical accompaniment.

## The (not very) big Ying

Author: David Gamble



**David Gamble's** (#3) aim is to restore a little cosmic balance in your life with a desktop doodle called *!Ying*.

Simply double-click on the application and a spinning yin/yang thing/thang will delight you with its multi-tasking presence. Use

Select to drag the motif to the position where it will have the greatest restorative effects and then click Menu to fix it.

If you feel yourself too much in harmony with the world, simply quit the application from the Task Manager window.

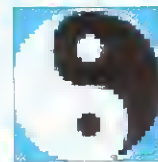

## A3000 upgrades

### Memory

1-4Mb	£68 (79.90)
(See also the "2nd user" section)	
2-4Mb upgrade pack	£45 (52.87)
4-8Mb	£149 (175.07)

The above upgrades are all constructed on four-layer boards, as recommended by Acorn. Gold plated connectors are used for reliable contact with the A3000 main board. There are no clips or wires, and no soldering is required (except 8Mb). Full instructions supplied. Some older types of 2Mb board cannot be upgraded to 4Mb, but we offer a trade-in allowance. Please phone for details.

### Hard drives

A range of internal hard disc upgrades is available. The upgrades simply plug into the internal expansion slot. Also suitable for the A3010.

170Mb	£135 (158.62)
250Mb	£149 (175.07)
420Mb	£169 (198.57)

RISC OS 3	£39 (45.82)
ARM3 (25MHz)	£129 (151.57)

(Dealer fitting recommended for the ARM3)

## A3010 upgrades

### Memory

1-4Mb	£79 (92.82)
1-2Mb	£35 (41.12)
2-4Mb	£61 (71.67)

The 4Mb upgrade is constructed on a compact four-layer board. No soldering is required. Full instructions supplied.

### Hard drives

A range of internal hard disc upgrades is available. The upgrades simply plug into the internal expansion slot. For prices, refer to the A3000 section.

## RISC PC

### SIMMs...(please phone for latest prices)

4Mb	£18 (21.15)
8Mb	£35 (41.12)
16Mb	£65 (76.37)
<b>32Mb</b>	<b>£109 (128.07)</b>

### 16Mb SIMM to 32Mb upgrade £63 (74.02)

(By upgrading your 16Mb SIMM to 32Mb you don't lose a SIMM socket. original 16Mb SIMM must be returned to IFEL and the type must be suitable - most are. Please phone to check first or ask for our free leaflet.)

### RAM packs for upgradable SIMMs

4Mb-8Mb	£24 (28.20)
16Mb-32Mb	£65 (76.37)

Each pack consists of 8 chips which simply plug into empty sockets. Instructions supplied, no soldering needed.

### VRAM modules...

1Mb	£49 (57.57)
<b>2Mb</b>	<b>£88 (103.40)</b>
1Mb-2Mb upgrade	£59 (69.32)

**A3000 4Mb RAM £68 (79.90)**

**RISC PC 16Mb SIMM £65 (76.37)**

### A5000

#### Memory

2-4Mb	£67 (78.72)
4-8Mb	£149 (175.07)

Dealer fitting for the 8Mb upgrade is recommended for the 25MHz A5000.

### A3020/A4000

#### Memory

2-4Mb	£64 (75.20)
-------	-------------

#### Hard drives

170Mb	£82 (96.35)
250Mb	£95 (111.62)
420Mb	£115 (135.12)

### A400/1

#### Memory

Per Mb (up to 4Mb)	£30 (35.25)
4-8Mb	£149 (175.07)
RISC OS 3	£39 (45.82)
ARM3 (25MHz)	£129 (151.57)

Hard drives. For prices, refer to the A310 section.

### Various

Alsystems SCSI 2	£170 (199.75)
ARM3	£129 (151.57)
RISC OS 3	£39 (45.82)
MEMC1a	£39 (45.82)
MEMC1a (2nd User)	£20 (23.50)
Hard disc cradle	£6 (7.05)
Fan filters (pack of 5)	£3 (3.52)
RISC OS manuals, no vat	£22
Dongle dangle	£6 (7.05)
Clip extractor tool	£4 (4.70)
(for eg. MEMC, ARM2)	
CDFS upgrade for Oak SCSI card	£25 (29.37)

The following item is reduced to clear. Please phone to check availability.

Wordworks	£23 (27.02)
-----------	-------------

### A310

#### Memory

4Mb	£85 (99.87)
4-8Mb	£149 (175.07)

#### Backplane (4-slot, four-layer)

	£49 (57.57)
--	-------------

#### Fan for above

	£8 (9.40)
--	-----------

#### RISC OS 3

	£39 (45.82)
--	-------------

#### RISC OS carrier board

	£17 (19.97)
--	-------------

#### ARM3 25MHz

	£129 (151.57)
--	---------------

#### MEMC1a

	£39 (45.82)
--	-------------

#### Hard drives

850Mb IDE	£125 (146.87)
1Gb IDE	£135 (158.62)
IDE controller	£65 (76.37)
1Gb SCSI	£199 (233.82)

### 2nd User

Please phone to check availability.

A3000 1-2Mb	£15 (17.62)
-------------	-------------

A3000 RAM board	£5 (5.87)
-----------------	-----------

(ie bare board, no chips)

A5000 2-4Mb	£38 (44.65)
-------------	-------------

### Spares/Repairs

We carry stocks of most replacement chips for the Acorn range. (MEMC, VIDC, IOC and most memory devices). We can also fit any upgrades and offer a computer repair service.

**How to order:** The VAT inclusive amount is shown in brackets. Cheques made payable to IFEL. Most Credit cards accepted, and Switch. Official orders welcome.

Educational and quantity discount available.  
Dealer enquiries welcome.

**IFEL**

21, Glenfield Road, Glenholt, Plymouth PL6 7LL. Tel (01752) 777106. Fax (01752) 777830

All products (except some marked "2nd User") are fully guaranteed for 12 months. All items normally carried in stock have a 14-day money-back guarantee. Please note that the cost of memory products varies - please phone for the latest pricing.





## On the beaten track Author: Jan Vlietinck

Our other influential Jan, Mr Vlietinck, returns to the pages of \*info with a bang this month with the fastest Mandelbrot plotter we've ever seen.

This is not entirely surprising as it has been optimised for the StrongARM and uses the new 64-bit UMULL (unsigned multiply) instruction to attain hitherto unreachable levels of accuracy in Mandelplotting – magnification of up to 10e18 is possible. On non-StrongARM machines these UMULLs are emulated in

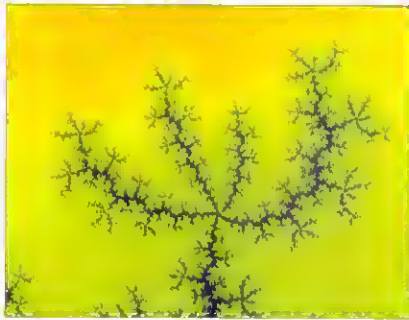

software so this accuracy can still be reached – just not quite as quickly! The set is plotted using the super-fast edge tracking algorithm we've seen before, hence the name *Trackman*.

To zoom, use the left and right mouse buttons to adjust the size of the zoom box and press the middle button to start the new plot. If you get lost (which is remark-

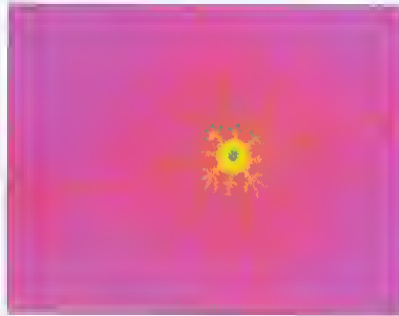
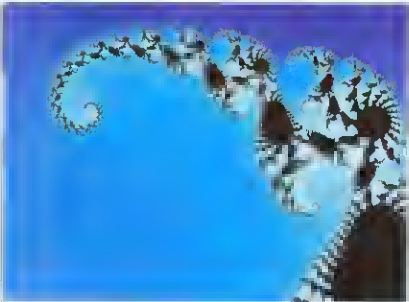

able easy to do) press 'R' to return to the start. By default the program uses 200 iterations to determine the colour of each pixel. At very high magnifications this is unlikely to be enough and you'll start to notice the image breaking up into large areas of solid colour. (this doesn't seem to be exactly the right turn of phrase here, but you'll know what we mean when it does it). Press 't' to change the number of iterations.

Jan has used a programmed 256-colour

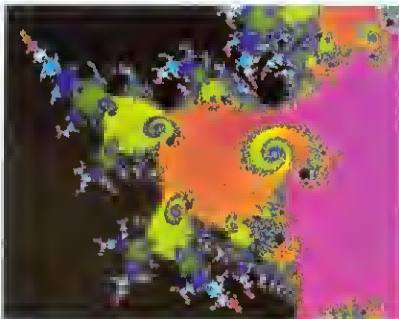

palette which can be cycled to great effect with the 'C' and 'D' keys. The blue/white set is particularly striking.

We've asked Jan if it would be possible to add real-time zooming and panning and he's certainly interested in the idea although when he gets the time to try some things out is another matter.

## RTGHAW

Author: David Glover

At first we thought this was all about that blond bloke who used to do the Guinness ads. Not so – the program's name stands for *Red Tanks, Green Hills And Water*. The author, David Glover of Oxford, hereafter referred to as David # 4, may have been inspired by the popular game *Worms* or the even more popular mode 7 *Catacastles* by Thomas Evans which we just had to dig out of the archives for just one game for old times sake...

Select the number of players required – anything from two to twenty-five, and name them appropriately. Tank drivers then alternate in taking pot-shots at their adversaries.

To fire, select the direction and strength of shot using the mouse – the line indicates these. Click Select to launch. The author offers the advice "aim for the other tanks".

Your energy level is displayed at the start of your turn. You can boost your next shot (at the expense of some energy) by pressing Space. You may also teleport but this will use 15 per cent of energy too and you will not be able to re-materialise too close to the other tanks.

Upon death you too will explode and this will cause damage to any other tanks nearby.

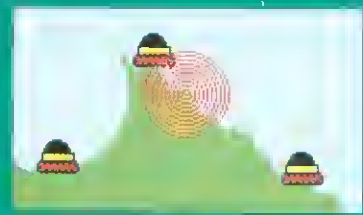

## AddApp Author: David Walker

David Walker of Wakefield's, David # 5', first modular utility makes light work of adding new applications to the Resource Filing System. We've covered the theory behind adding files before, but this module, *AddApp*, wraps up a lot of the initial fiddling about by providing a single \* command, used thus:

```
*AddApp <application name>
```

The name provide should be that of an application on disc somewhere. In fact, the whole application isn't copied into

Resources:\$Apps – small obeys files *!Boot*, *!Run* and *!Help* are created and these point to their real counterparts on disc.

It would not be beyond the wit of man to enclose this module in a filter which could intercept drags on the resource filer icon on the icon bar and automatically add the files using the star command.

If you use Director, you can easily do this with one \*command. In many Director configurations, the actual resource filing system icon is removed and a Director icon used in its place.

This behaves in exactly the same way as

the original – opening Apps etc, but has been extended with various -menu and -select's (and so on) to provide other useful menus.

It is a simple matter to add:

```
-dragto "Dynamic:AddApp  
|<Director$CurrentPath>"
```

to the line that creates this icon and you will then be able to drag applications to it and they will be added to the resource filing system. If you do not wish to do this, you could easily add a further icon with a



# Stretching the point

Author: Andrew Bolt

In the words of the author:

'Since Acorn seem to be keen to revamp the desktop look and feel for a future version of RISC OS, here's my proposal for what the mouse pointer should look like. It should also have the added benefit of being

able to soak up those extra CPU cycles that the next generation of StrongARM machines will have going spare...

We particularly like the way the pointer turns before moving although we think that the wobble may be a little too wibbly. Can

anyone think of a way to integrate Andrew's pointer into the desktop?



# Software with alt-itude

Author: David Walker

The second module from David # 5 provides a solution to the age-old problem of how to bring the window you're interested in to the top of the stack when its title bar and resize icon are buried under all the

usual desktop debris.

Just double-click on *AltClick* to install (or more usefully, load in your boot sequence).

Thereafter clicking anywhere on a window while holding down the Alt key will

pop it to the surface.

The module doesn't use a filter apparently - in fact it is a Wimp task and as such can be quit from the Task Manager window in the usual way.

# Area manager

Author: Tom Tanner

Tom Tanner of Corsley has come up with a friendlier way of deleting RISC OS dynamic areas. As with all programs that have 'delete' in their name, use *DelDynArea* with care.

Once installed on the icon bar, a menu provides lists of system and user dynamic areas. The former includes things like the font cache and free pool. Deleting most of these might be rather unwise, although you may wish to delete the RAM disc.

Deleting user area is of slightly more practical value, particularly if an application has died unexpectedly and left its dynamic areas intact, using up all your memory. It is for this purpose that Tom's program was really written.

For the record, the SWI call used to do the dirty work is *OS\_DynamicArea*. This takes in R0 a reason code as follows:

### Create area

- R0 = 0
- R1 = area number: use -1 to force RISC OS to choose one
- R2 = initial size of area
- R3 = base address: use -1 so RISC OS allocates it
- R4 = flags: bits 0-3: access privileges:
  - bit 0 = readable/writable by all
  - bit 1 = read-only in user mode
  - bit 2 or 3 = inaccessible in user mode
- bit 4: set if area not bufferable
- bit 5: set if area not cacheable
- bit 6: 0 singly mapped, 1 doubly mapped
- bit 7: set if area may not be 'dragged'

- R5 = maximum size of area (-1 means no limit)
- R6 -> handler routine, 0 for none
- R7 = workspace pointer passed in R12 to handler. If -1, the base address of the area will be passed.
- R8 -> null-terminated area description string, for display in the Task Manager window.

On exit, r1 contains the allocated area number, r3 contains the allocated base address and r5 the allocated maximum size. Other registers are preserved.

### Delete area

r0 = 1, r1 = area number

### Return info

r0 = 2, r1 = area number

On exit, r2 to r8 are set as for the Create area call.

### Enumerate areas

r0 = 3, r1 = area number, or -1 to start

On exit, r1 = next area number or -1

*DelDynArea* uses this call to find the number of all currently defined dynamic areas.

Tasks	
Applications (used)	4984K
System workspace	32K
<b>total</b>	<b>22528K</b>
Dynamic areas	
Director Menus	48K
InetSuite workspace	56K
Zap bitmaps	24K
Zap files	8K
SparkFS	412K
Fresco pages	184K
InverseTable	32K
ROM patches 3.78/1	36K
LineEditor Buffers	12K
Wimp sprite pool	528K

## \*QUIT

All submissions be they large, small or that in-between kind of size some call medium, to our usual haunt please:

\*INFO, *Acorn User*, IDG Media, Media House, Adlington Park, Macclesfield SK10 4NP

or, if your submission is about 100K or less, e-mail us (including your real address please) at: [austarinfo@idg.co.uk](mailto:austarinfo@idg.co.uk)

You needn't include a letter but please put your name, address and program title on every disc and include a text file containing your name, address, disc contents and program details. Diagrams, examples and background info are always welcome as extras. We like to carry source code wherever possible and any notes about particularly clever pieces of programming will be of great interest to the readership. An SAE will ensure your discs are returned. \*info submissions only please.

## Compatibility table

Program	RISC OS 2	RISC OS 3.1	RISC OS 3.5+
AddApp	No	Yes	Yes
AltClick	Yes	Yes	Yes
Trackman	No	No	Yes
Groover	No	Yes	Yes
Plasmoid	No	No	Yes
Rock'nRoll	No	Yes	Yes
DelDynArc	No	No	Yes
IL-Fire	Yes	Yes	Yes
Craters	No	Yes	Yes
Electric	Yes	Yes	Yes
Bonsai	Yes	Yes	Yes
RTGHAW	No	Yes	Yes
Ying	Yes	Yes	Yes
MouseP	Yes	Yes	Yes



# textease

Simply the Best  
Word Processor and  
Desktop Publisher

Just click anywhere  
and start to type

**BETT 97  
Gold Award**

Talking *textease*

**Best Primary  
Software**

Softease Limited,  
The Old Courthouse,  
St Peters Church Yard,  
Derby, DE1 1NN  
Tel 01332 204911 Fax 01332 609224  
Email sales@softease.co.uk

For Windows 3.11 and '95 or Acorn RISC OS3.1



Produced on RISC OS

Creating and maintaining your  
website has never been so easy ...

WebMaster™

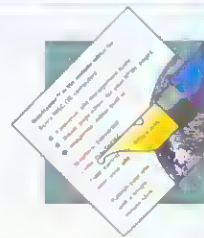

The website editor for Acorn RISC OS computers

Extensive site management...



- Keep your site together in one 'site file'.
- Hyperlinks updated when resources moved / renamed.
- Upload your site with a single mouse click.
- Named colours & a master page for consistency.
- Browse your site locally with the browser of your choice.
- Subdirectories for a properly structured site.
- Converts from Sprite and Draw files into network formats.
- Integrated visual imagemap editor (works like !Draw)

Visual page editor...

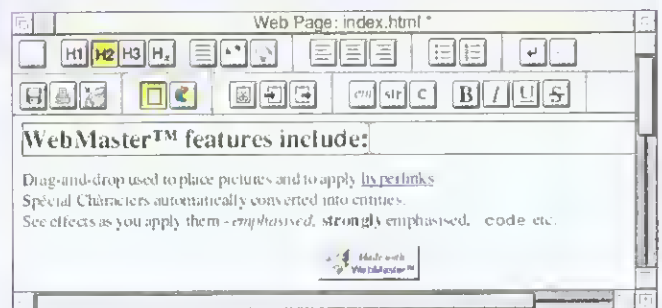

- Operates in a wordprocessor-like way.
- Generates HTML 3.2 (the latest standard).
- See your page change instantly as you apply effects.
- Fully integrated with the site management tools.
- Impressive control over the page, within HTML rules.

...all this for just £99 +VAT

Clan members price £89 -VAT (quote your clan number when ordering)

Upgrade from HTML Edit 2 for only £69+VAT (send your disc and manual with your order)

Customers buying direct from IMS will qualify for a free Photogallery CD (subject to availability)

**Available June. See the preview at the Wakefield  
Spring Show (stand 70) on May 17th & 18th**

Innovative Media Solutions Ltd., Box Bush Farm,  
West Wick, Weston-super-Mare BS24 7TF  
Tel (01934) 522 880. Fax (01934) 522 881.  
<http://www.ims-cdc.demon.co.uk/>

**NEW Acorn & RISC PC  
Net Station**

Please call for latest details and prices

**CASIO®**  
DIGITAL CAMERAS  
QV10A, QV100  
and QV300

**zip**  
DRIVES

**Robotics®**  
SPORTSTER FLASH

**S S =? SIBELIUS  
SOFTWARE  
SPECIALISTS!**

The best music processing software in the world, and the  
best place for a demonstration? The Data Store. Ring first  
for an appointment - you'll need at least an hour!

DON'T DEAL IN THE DARK! COME AND SEE THE LIGHT AT

**THE DATA STORE**

Microcomputers

6 CHATTERTON ROAD BROMLEY KENT BR2 9QN

Tel 0181-460 8991 Fax 0181-313 0400

Email info@datstore.demon.co.uk

CLOSED ALL DAY WEDNESDAY

<http://www.datstore.demon.co.uk/>



# BACK ISSUES

Missed out on one of our previous issues? Now's your opportunity to bring your collection up to date. But hurry: stocks are limited

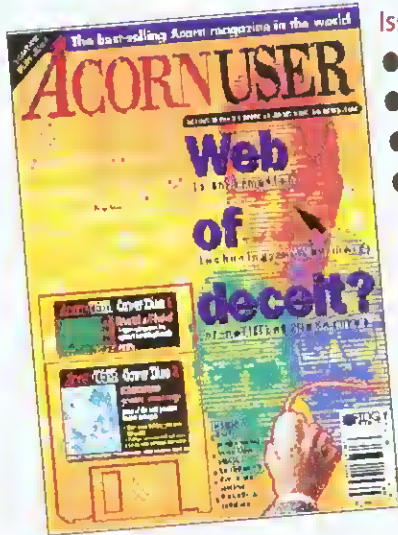

## Issue 181-May 1997

- Politics & I.T.
- Real programming
- Acorn User survey
- Quick time VR

## Issue 180 - April 1997

- Creating your own 3D games
- The new Zip drives
  - Public Domain software CDs
  - C++ books reviewed



## Issue 179 - March 1997

- Flatbed scanners reviewed
- Oregon's SoundStudio
- Control your business payroll
- HTML oddments examined

## Issue 171 - August 1996

- Unlocking the Internet ● Writing HTML ● The Lindis Technology bus ● Set-top boxes ● Ridiculous Rhymes demo

## Issue 172 - September 1996

- Ovation Pro ● Printer survey results ● Acorn in Holland ● Images in HTML ● Customising your desktop

## Issue 173 - October 1996

- Top-level Acorn interviews ● NChannel & the NetStation ● Presentation software ● Highlighter package ● Save the Gweeks

## Issue 174 - November 1996

- StrongARM ● Hi-res online video editing ● MIDI explained and explored ● Rainbow CD from RESOURCE ● Inferno

## Issue 175 - December 1996

- TopModel ● ActiveX and the NetStation ● Fitting the StrongARM ● Creating images for the Web ● Shanghai and Shogi

## Issue 176 - Christmas 1996

- AU awards ● StrongARM compatibility table ● SCSI vs IDE ● Nstore for the pocketbook

## Issue 177 - January 1997

- Acorn in New Zealand ● Risc TV ● New Psions ● HTML creation tools ● Bett'97 Show

## Issue 178 - February 1997

- Acorn Internet Relay ● Spreadsheets compared ● Upgrading to Hard Drive or CD ● Acorn Portables

## Order form

<input type="checkbox"/>	Issue 171, August 1996.....£3.25	Name .....
<input type="checkbox"/>	Issue 172, September 1996 .....£3.25	Address.....
<input type="checkbox"/>	Issue 173, October 1996 .....£3.75	.....
<input type="checkbox"/>	Issue 174, November 1996 .....£3.25	.....
<input type="checkbox"/>	Issue 175, December 1996.....£3.75	.....
<input type="checkbox"/>	Issue 176, Christmas 1996 .....£3.25	.....
<input type="checkbox"/>	Issue 177, January 1997.....£3.75	.....
<input type="checkbox"/>	Issue 178, February 1997.....£3.75	.....Tel No.....
<input type="checkbox"/>	Issue 179, March 1997 .....£3.75	.....
<input type="checkbox"/>	Issue 180, April 1997.....£3.75	.....
<input type="checkbox"/>	Issue 181, May 1997 .....£3.75	.....

Please allow 14 days for delivery. Send cheques payable to IDG Media to: Acorn User Back Issues, Database Direct, FREEPOST, South Wirral L65 3EB or phone 0151 357 1275 Fax: 0151 357 2813 E-mail: database@dbdirect.demon.co.uk

Please tick if you do NOT wish to receive further information or special offers

**Free ads  
are on  
this  
month's  
cover  
disc**

## Acorn User Free Ads Service

Why not take advantage of our free reader ad service? Fill in your details on this coupon (25 words maximum, one word per box below) and send it to Free Ads, Acorn User, IDG Media Ltd, Media House, Adlington Park, Macclesfield SK10 4NP or by e-mail to: aufreeads@idg.co.uk. Only one ad per reader, please. Although we try to publish every ad we receive, we can make no guarantees; publication is entirely dependent on space and time constraints. We may also publish free ads on the cover disc if magazine space is short. Please fill in your name and telephone number below: these will not be published, but they enable us to contact you in case of any queries.

Your name:..... Telephone no: .....



# Follow the humming

Mike Cook plots an audio frequency response

Last month I looked at how to measure an IAC signal using a peak detector and a programmable gain amplifier. Now, I am going to see how we can take that hardware and make an automatic frequency response plotter – a project I have wanted to do for a long time, as far back as the BBC Model B days.

The problem has always been the audio frequency generator which had to be programmable from the computer. So occasionally I would pore over data sheets of frequency synthesisers seeing what I could do. As most of these are designed to control radio receivers I didn't get too far. Then inspiration struck – the computer itself is source of programmable audio. No hardware is needed. I could have kicked myself as the answer was there all the time. Mind you it's not a perfect solution as the frequency range is limited and the total harmonic distortion of the wave is not too brilliant but it will do what I want.

The basic idea is shown in Figure 1. The computer generates a sequence of audio frequency notes which are applied to the circuit to test and the output is measured with last month's peak detector. Looks simple enough. Well this is a case of Cook's law, if something looks simple you might just be able to do it, if it looks in any way complex, forget it.

The first problem is generating the audio signals. I did look at a module called DataVox, which plays the contents of a memory location as a sound using a number of different formats. However, after some initial experiments and problems, I abandoned this in favour of writing my own routines. Well, all right, not exactly my own, but modifying the one on

page 74 of Volume 4 of the Programmers Reference Manual.

I have always found the sound system a little overbearing and so have not ventured into that part of the manual before. However, I found the sample program printed there to be almost what I wanted, namely a simple sine wave generator.

So I did something I haven't done for many years and typed in the listing – it's on the cover disc for you to play with. Basically this is a voice generator and its function is to respond to a request, by the channel handler, to fill up a buffer with sound samples. This is done in short bursts and other system software ensures these samples are delivered to the D/A converter of the computer's sound hardware at regular intervals.

However, in experimenting with this program I found that it would not produce the full frequency range due to aliasing – an effect that occurs when you sample a signal at too slow a rate. The minimum theoretical rate is to sample twice per output waveform cycle, although that does not always hold up in practice. This minimum rate is known as the Nyquist Rate, named after the mathematician John Rate, I suppose. The alias is an artificial signal created with a much lower frequency than the original.

To get round this problem I had to generate two wave tables, one with twice as many samples as the other. Then when a certain pitch was reached I had to switch over to the second table and halve the requested frequency. This seemed to work and is on the cover disc as a separate program.

The computer's sound system has an unusual way of specifying the frequency of a note. Instead of using Hertz it uses an octave system. In hex format it can be expressed as &NXXX where N is the octave number from 0 to 8 and XXX is

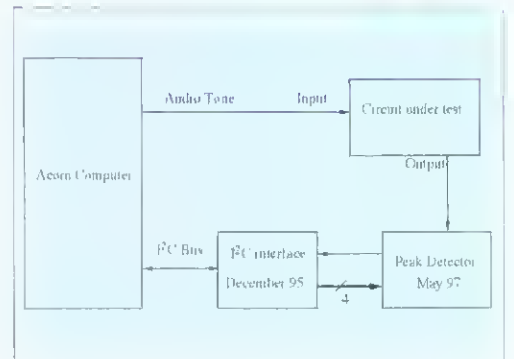

Figure 1: The Frequency Response plotter set up

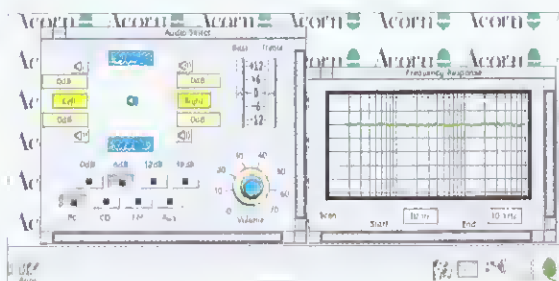

Figure 2: A flat response with tone controls at zero

the fractional part of the octave. A note of middle C has an octave number of &4000 corresponding to a frequency of 261.63Hz.

I wanted to take a frequency and work out its octave number, so with a bit of maths I produced the formula, but there was a snag. It turned out that I needed a LOG2 (Log to the base 2) function and there isn't one in BASIC.

So I asked a mathematical colleague at the university and he produced this handy formula for producing the log to any base:

$$\text{Log}_X(N) = \text{Log}_e(N) / \text{Log}_e(X)$$

The Log to the base e is the natural log or LN function in Basic. If you want the full details of the conversion from a frequency to an octave number the short program *FtoO* is on the cover disc.

Now that we can generate any frequency of tone, we have to decide what frequencies to generate. I wanted the display to be like most frequency plots you see in the literature and so went for a logarithmic frequency sweep. That is, instead of the frequency changing by the same amount in the X direction of the plot, it changes by the Log10 of the X distance. This produces a most useful display as it compresses higher frequencies and produces a display that matches the way the ear perceives the sound.

For example, we perceive a much greater difference between notes of 100Hz and 200Hz than between ones of 800Hz and 900Hz, despite the difference being only 100Hz in both cases. In a logarithmic plot these last two notes are much closer together than the first two, matching our perceptions.

I wanted the frequency range plotted to be user-definable so I made it a variable number of decades. A decade, by the way, is the range 1 to 10 or 10 to 100 or 100 to 1000. I wanted the Y axis to show the response, again logarithmically as it matches the ear's amplitude response. This time I used decibels or dBs which is:

$$20 * \text{Log}_{10}(V_{\text{out}}/V_{\text{in}})$$

only instead of  $V_{\text{in}}$  I used the maximum reading for the peak detector. For attenuation this results in a negative number.

We say so many dBs down, so a bit of mathematical jiggling is required to scale it to the display. The vertical grid is drawn in divisions of 5dBs, which is quite handy. You can change this to a linear function through a menu option.

Finally, as the frequency sweep can take quite some time if you measure the circuit's response to all the possible points on the X axis, I have included a choice of resolutions to use.

For the coarser resolutions bigger blocks are plotted whereas for the finest resolution, single pixels are plotted and joined up.

The result of these labours are on the cover

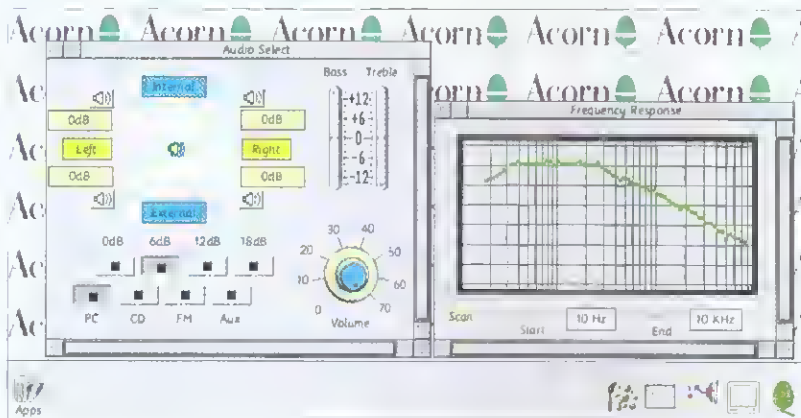

Figure III: With a bass boost and a treble cut there's a falling response

disc as the application *!Freq* and it is quite straightforward to drive. It takes over the whole computer while it is scanning so multi-tasking comes to a stop – don't try to break out of this with an Alt+Break as you will hang the sound drivers in the computer and have to restart it to restore the sound. There are some frequencies in the first and last decade that the computer can't produce. These are simply ignored and no tone is generated, which explains why on a full three decade scan the trace does not go fully to the ends of the graph.

As a test, I used the tone controls on my Audio Switcher unit described in November 96 *Acorn User* and simply connected the sound output to the peak detector input. As you can see from the screen dumps, when the tone controls were set to zero there was a flat

response (Figure II); with a bass boost and a treble cut you get a falling response (Figure III), although there is a slight dip at the low end. Finally, with bass cut and treble boost (Figure IV) there is a dip in the response at 100 Hz before it climbs up again.

I did get the odd drop out or spurious reading. This was normally at the low frequency end and improved when I increased the time delay between generating the note and taking the reading.

As this was only needed for low frequencies I made it automatically switch out above 100Hz. However, there is still the occasionally bad reading suggesting I should take a bit more care with power supply decoupling on the peak detector.

Now, where is all this leading? Well, now with an automatic frequency response plotter I have the tools to make and test a graphics equaliser which is what I will try to do for next month.

AU

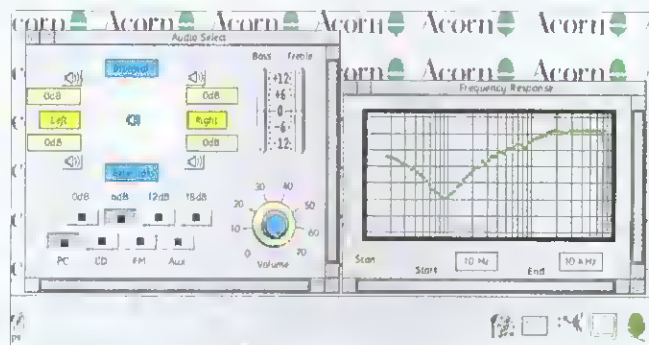

Figure IV: With a bass cut and a treble boost there's a dip in the response at 100 Hz before it climbs



# SOFTWARE SHOWCASE

Help your child or student to become a SuperSpeller.

For: PC,  
MAC  
and  
ACORN

## SUPERSPELL

FREE  
CATALOGUE  
AVAILABLE

SuperSpell is a new spelling program for all ages. It has a strong educational basis and was designed by teachers. Four non-threatening activities access 3200 pre-programmed words grouped in 160 word lists, of which 138 lists highlight particular spelling patterns or rules, 5 lists cover the most commonly misspelt words and 17 lists deal with the most frequently used words. Many other useful features are included.

Educational  
software  
specialists

### 4MATION

Established  
1983

14, Castle Park Road, Barnstaple, Devon EX32 8PA  
Phone: 01271 25353 Fax: 01271 22974



## TEACHERS

Are you worrying about:  
▷ impending inspection?  
▷ end of year reports?  
Then YOU need Nstore 5!

Our National Curriculum Record Keeping & Reporting Package for Acorn RISC machines has lots of new time saving features for only £44.95, including:



- ▷ Level Descriptions for all subjects + 750 teacher comments
- ▷ automatic target printing and search for related topics
- ▷ easy transfer of pupil data between subject teachers

For full details including our low cost upgrades and our special £5 demo disc, telephone us on: (01792) 204319 write to us at: H.S. Software, Freeport, Swansea SA2 9ZZ or get a FREE demo from: <http://www.argonet.co.uk/h.s.soft>

## DISKS+ from BIRDTECH

Disks+ is a exciting range of software for the expanding range of available disk formats. We write some excellent educational software which can be used by the home user or in schools.

- Disks+A Nearly 2000 PC font
- Disks+B Copy Video Animation
- Disks+C Multimedia Keyboard
- Disks+D Spelling example text
- Disks+E Art digital painting
- Disks+F Bird Tagging video

Available on **zip** £14.95  
SyQuest £21.95

Fully inclusive price  
Tel/Fax/Email: WWW.BIRDTECH.CO.UK

33 Blackbird Close, Bradwell,  
Great Yarmouth, Norfolk  
NR31 8RT  
Fax: 01493 442445

Acorn Authorised Dealer

Acorn RISC OS 3.0, 4.0, 5.0  
Acorn RISC OS 4.0, 5.0  
Acorn RISC OS 6.0, 7.0

Acorn RISC OS 8.0, 9.0

Tel: 01493 600966



## Undelete

At last the program everyone has been waiting for!

Undelete does just what it says, it allows you to recover any file, application or directory you may have deleted on a Floppy Disc or Hard Drive.

This program is incredibly *totally* non-technical in use! Once you've installed it any files then deleted can be quickly and simply recovered by selecting the file from a list and clicking on it! You don't have to know anything about Disc Maps, Tracks or Sectors, etc.

Undelete works with any of the popular Acorn Filing Systems such as ADFS, SCSIFS, ATAFS, IDEFS, etc, and runs from RISCOS 3.1 to StrongARM 3.7.

Undelete is available for only £18.95 + £1 UK P&P (£3 overseas). No VAT from Quantum Software, 35 Pinewood Park, Livingston, EH54 8NN, Scotland.

Email: [Sales@quantumsoft.co.uk](mailto:Sales@quantumsoft.co.uk)  
Tel: 01506 411162 or order via the Acorn CyberVillage Shop at <http://www.cybervillage.co.uk/acorn/>

### MATHSBOOK

Save up to £10 on the TALKING version of MATHSBOOK!

Sums can be hard work for some children. What you need is a way to get them done on the screen - and MathsBook does just that. What they see looks just like an exercise book, right down to square d paper and 'teacher's' red 'helpful comments'. Fully configurable from tens and units to thousands and decimals, MathsBook tracks progress, automatically moving lemmings up and down difficulty levels. It even keeps (and prints) records, so that you find out what they can really do. By Marshol Anderson, author of ScreenTurtle and whose Music Box won the BETTS '95 Gold Award. For home and school.

Pack 1 (+ and -) RISC OS 3 only) normally £35 + VAT. Site Lic. an extra £35 + VAT. Special Reader Offer: £5 m EACH price - send this ad. Pack 2 (+ and div) & PC versions. January '97.

Topologika Software, FREEPOST, Islandton Wharf, PENRYN, Cornwall TR10 8BR  
Tel (24hrs): 01326 377771 Fax: 01326 376755 e-mail: [sales@topologika.demon.co.uk](mailto:sales@topologika.demon.co.uk)  
FREE DEMOS from our WEB site: [www.topologika.demon.co.uk](http://www.topologika.demon.co.uk)  
Educational software publishers since 1987 - GOLD Award Winners 1991, 96 SILVER 1992, 94

### Dixon & Dixon

35 Rokeby Drive, Kempton  
Newcastle upon Tyne NE13 4JY  
0191 2853 042 North East Acorn Dealer

## Textile Transfer Paper

Truly Remarkable and Revolutionary  
Print it - Iron it - Wear it

4 Sheets A4 £8	30 Sheets A4 £44	100 Sheets £140
-------------------	---------------------	--------------------

Hobby Kit - includes 2 T-Shirts and 4 Transfer sheets 12.99  
MouseMat Kit - Your favourite Pin-Up to stare at 5.99

Refill your inkjet with UVLR ink  
No Fade Ultra Violet Light Resistant ALL COLOURS  
3 Refills (60 ml) for 18.80 inc VAT & postage  
FLASH SOLUTION (why not change your cartridge colour)  
Flush out the old refill with new £5.00 inc VAT & postage

TWIN REFILLS FOR ALL INKJETS FROM 11.99  
Cartridges for JP150's £19.96

FLYPRINT	£ 19.97
DEAD CERT	£ 19.00
KEYBOARD EMULATOR	£ 9.99

Prices Inc VAT £1 postage UK mainland

### EDUCATION

## Xavier Software for Dyslexia / Literacy skills

Wide range of specialist programs, available on 28 day approval. Digitised speech throughout. See review in Acorn User Dec. 95 or CDROM January 96. Illustrated catalogue from:

**Xavier Educational Software Ltd.**  
Psychology Dept, University College of Wales, Bangor, Gwynedd  
LL57 2DG Tel: 01248-382616 Fax: 01248-382599  
<http://www.psych.bangor.ac.uk/deptpsych/xavier/>  
email: [pss005@bangor.ac.uk](mailto:pss005@bangor.ac.uk)

### BUSINESS SOFTWARE

## DSL SUPPLIES

### Squirrel StrongARM upgrade £32.50 inc. P&P

ST MARGARET'S LANE  
FAREHAM  
HANTS PO14 4BO  
TEL/FAX 01329 841600

### NETWORKING

## Room 20

Report  
A sophisticated software solution which allows the teacher to compile reports for groups of pupils.  
£59.99 (single user)

Network + Pupils + Printer = Waste paper!  
Solve this equation with 'Quota'  
The paper saving printer management software for ALN networks \*  
Only £49.99  
\* Requires Level 4 fileriver unit Spooler

ROOM 20 SOFTWARE  
47 Henry Street, Grassmoor, Chesterfield, Derbyshire, S42 5AT  
Tel: 01246 866684

<http://www.rmtwenty.demon.co.uk/>  
email: [sales@rmtwenty.demon.co.uk](mailto:sales@rmtwenty.demon.co.uk)

### ELECTRONICS

## PRINTER SWITCHES

GET TWO PORTS FROM ONE!

Colour-PC Bone OR Etc.  
Only £19.95 (inc. postage) (Cheque with order)

Eliminate connector wear. 25pin D plug switches to two 25 way D sockets. Works with any parallel peripheral such as printers or game consoles. Long life, compact and ergonomic. Bi-directional.

No software to install. Mean Electronics, The Street, Farley, Salisbury, SP5 1AA operating systems. Tel/TAM/FAX 01722 712556



# ACORN USER GUIDE TO LOCAL DEALERS

**NOTTINGHAMSHIRE** - Arnold Computer Supplies. Home enquiries welcome. Repairs & Service. Tel: 0115 9264973

**ESSEX** - GeneSys for all your Acorn needs, serving Education, Business & Home. Contact Richard Brown 01702 462385. E-mail: genesys@argonet.co.uk

**HIGHLANDS** - Wardlaw Surveys, Authorised Acorn Dealer, for all your needs from supply, service, repair & full after sales. Tel/Fax: 01463 831214

**DEVON** - West Devon Electronics covers Devon and Cornwall, supplies and repairs Acorn computers. Tel: 01822 853434. Fax: 01822 855542

**GLASGOW** - Todd Education Supplies, covers the central Scotland area. Welcomes educational & private enquiries. Tel: 0141 644 4952

**NORFOLK** - Birdtech, Acorn Authorised Dealer, Services for Acorn users since 1990. Tel: 01493 600966. Fax: 01493 442445. Email: roy@birdtech.demon.co.uk

## ESSEX & LONDON

**FAST, FRIENDLY SERVICE FROM REPUTABLE ACORN DEALER**

ESTABLISHED 9 YEARS

- ★ Education Discounts
- ★ Network Design and Installation
- ★ Teacher and Concerned Parents' Scheme
- ★ Leasing

For all your Acorn needs call  
**GLC ELECTRONICS**  
PO Box 5754  
Basildon, Essex SS16 6XU  
Tel: 01268 540040  
Fax: 01268 548008

## GAMES

**14 DAY HOME TRIAL**

What we will do is send you our latest five quality budget games for you to try in the comfort of your own home.

**Any Risc OS including StrongARM**

**GENERATION DESIGN**  
2 Whitecliff Gardens, Blandford Forum, Dorset DT11 7BU  
Tel: 01258 452507  
Email: genden@argonet.co.uk

## CUMBRIA



**Cumbria Software Systems**  
Specialist Acorn Dealer

Risc PC700, A7000  
Sales, Repairs, Software, Peripherals

*Network design and installation  
Ethernet, Nexus ATM, Multi-platform networks*

Semerc Authorised Dealer

CSS Ltd., Unit 3A, Townfoot Industrial Estate  
Brampton, Cumbria, CA8 1SW  
Tel: 016977 3779

## WEST YORKSHIRE

THE CHOICE OF EXPERIENCE



**Davyn Computer Services**  
Printers, Ribbons, Ink Cartridges, Refills  
Expert Advice & After Sales Service  
Mail Order Master Card, Visa, Switch  
Ring for Prices  
Service & Repair to all Equipment  
Full Range of Acorn Hardware & Software  
(We operate the Acorn Finance Schemes)  
Full Range of Educational Software  
Tel: 01924 254800 Fax: 01924 258036  
e-mail sales@davyn.demon.co.uk

For the best service in Yorkshire (we think)  
CALL US! for A7000 RiscPC & Pocket Book II  
Visit our Showroom  
Open 9.30 to 5.30  
Mon, Tues, Weds, Sat.  
9.30 to 7.30  
Thurs & Fri.



**How to find us**

WE ARE HERE  
The Workshop  
off Princess Street  
Sande/  
Wakefield  
WF1 5NY

Acorn Risc PC hp HEWLETT PACKARD  
Pocket Book II

## SOUTH WALES

**UNIQUEway**

SOUTH WALES' ONLY DEDICATED ACORN DEALER AND ACORN CENTRE OF TECHNOLOGY

Technical Support - Repairs - Hire - Internet Connections  
Low cost finance available on all systems.

3 Clarendon Road, Cyncoed, Cardiff CF3 7JD  
Tel 01222-464020 Fax 01222-440071  
<http://www.uniqueway.co.uk>

## MIDLANDS AND OXFORD

**DACO**

459-465 Warwick Road, Tyseley, Birmingham B11 2JP  
**XEMPLAR EDUCATION AGENT**  
Tel: 0121 706 8933 Fax: 0121 706 4306

- Home use
- Business
- Education
- Special Needs
- Software Training
- Acorn approved network installers
- Complete range of Acorn equipment
- Consultancy



For expert advice & friendly service come and see us.  
We are open  
Monday - Friday  
9.00am - 5.30pm

## WEST MIDLANDS

**MAUDENS**  
Established 1980

"Millside", 133 High Street,  
Wollaston, Stourbridge,  
West Midlands, DY8 4NZ.

- Full Acorn Authorised Service Centre
- Authorised Microsoft re-seller
- PC Developers and Category 5 Networking Specialists
- New Showrooms with complete range of Acorn machines
- MAIL ORDER - It is our policy to match most prices on offer
- Come to our showrooms and view the Internet

0% Finance on PC and Acorn Machines  
With 16 years of service you can't go wrong with Maudens  
Tel: (01384) 444433 / 833300. Fax: (01384) 441655

## SURREY

**Calancraft Ltd.**  
THE COMPLETE ACORN DEALER

- Showroom open 9.00 - 5.30 six days and to 8.00 on Thursday.
- Acorn range on display, and full demonstrations given.
- Lots of programs, games and education software for you to try.
- Full service and repair facilities.
- Network Dealer and Training Centre for Education and Home.
- Printers, Upgrades, Internet, CD ROM, etc. etc.

"Very helpful people"  
with a 13 year long reputation for exceptional service and support.  
Easy parking.  
96 High Road, Byfleet,  
Surrey KT14 7QT  
Tel: (01932) 342137 Fax: (01932) 336435





**Amazing free gifts and special offers!!!**  
**Over £100 worth of magazines**  
**and software for just £39.99**

# ACORN USER

the world's number 1 Acorn magazine

**Y**ou already know what a great magazine ACORN USER is. It is the only Acorn magazine with up-to-the-minute Acorn news, in-depth hardware and software reviews, and without doubt the best cover discs available.

What you might not know is that by taking out a subscription today, not only are you guaranteed never to miss an issue of the biggest and best Acorn magazine in the world, but you can also claim an excellent free gift or special offer, available exclusively to all new ACORN USER subscribers.

\*All our software offers are StrongARM compatible.

## TEXTEASE



**Only £20**  
**rrp £49**

The most flexible, straightforward and comprehensive wordprocessor and desktop publisher ever. Use it to make letters, invitations, cards, banners, notices, posters, overhead foils, in fact any kind of text and graphics. It is designed to be ideal for children and is invaluable for older children and adults.

**CURRENT SUBSCRIBERS**  
 - you can take advantage of these offers by renewing your subscription at any time

## RHAPSODY



Your chance to compose your own musical score. Rhapsody allows you to modify and manipulate music as a wordprocessor does text. You can enter score by hand, note by note, or, if a MIDI Interface is fitted to your computer, you can play a tune using a MIDI keyboard and capture the music in Rhapsody. The music can then be transcribed ready for editing, replaying, etc.

In the shops £59.99 as an Acorn User subscriber you can claim it for free!

### SUBSCRIBING HAS NEVER BEEN EASIER

**DIRECT Debit**  
 Why not make your subscription even easier and subscribe by direct debit, spreading the cost of your subscription over quarterly hassle-free payments. What's more, you need never worry about missing an issue again, as the subscription continues until you decide to cancel.



**CRYSTAL MAZE**

**New offer**  
rrp £16.95

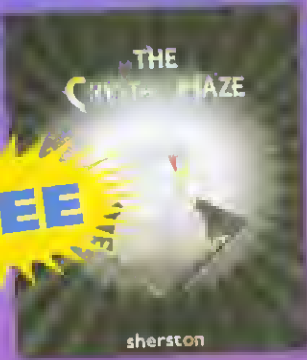

Pit your wits against TV's most famous maze! Discover the secrets of the maze as you take up the challenges of the Aztec, Medieval, Futuristic and Ocean zones. Solve the ingenious games and fiendish puzzles to win precious seconds in the ultimate challenge - the Crystal Dome.

**FREE**

**PERSONAL ACCOUNTS 3**

**Just £10**  
rrp £49.95

The most popular home and club accounts package. Multiple accounts, standing orders and forecasting are just some of its features. We gave it top marks in the Jan '95 issue. See the demo on the AU CD-ROM 2.

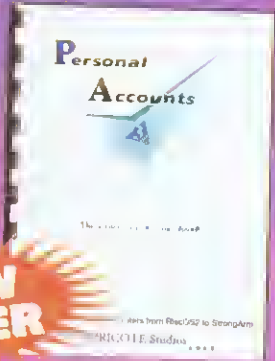

**NEW OFFER**

**HIGH RISC RACING**



**PLUS A £10 OFF VOUCHER FOR LAST OFFENCE.** Fast, furious and fatal, the ultimate racing game. You'll need nerves of steel and lightning fast reflexes to win. Runs on any 32 bit Acorn Risc Machine with 2Mb of memory and RISC OS 2+

**FREE**  
rrp £30

**BINDER & TWO FREE MAGAZINES**

Choose your favourite Acorn User magazine binder with hold your favourite magazine PLUS receive an extra two magazines absolutely FREE



**FREE**

**Subscription Hotline numbers**

**Tel: 0151-357 1275**  
**Fax: 0151-357 2813**  
**Email: database@dbdirect.demon.co.uk**

**Yes! I will subscribe...**

**1a** There's never been a better time to subscribe so take advantage of one of these offers TODAY. See section 2

4234  UK £39.99    4202  EU £53.99    4203  World £68.99\*

To renew subscription please tick:

4235  UK £39.99    4224  EU £53.99    4225  World £68.99\*

\*Unfortunately World subscribers are not eligible to receive the free gift/special offer

I wish to pay by:  Cheque/postal order made payable to IDG Media  
 Credit card (Visa/Access/Barclaycard/Mastercard/Eurocard/Connect)

Expiry date  /

Card No.

**1b** Please enrol me as a subscriber to Acorn User.

4210  with payments of £9.49 by continuous quarterly direct debit See section 2. Your subscription will continue until you cancel. Over a year you will receive 13 issues.

Name of Bank/Building Society .....

Address .....

Name of Account .....

Your Account No. .... Sort Code .....

Date ..... Signature(s) .....

Your instructions to the bank/building society: **Originator's ID No. 851412**

I instruct you to pay direct debits from my account at the request of IDG Media. The amounts are variable and may be debited on various dates. No acknowledgement required. I understand that IDG Media may change the amounts and dates only after giving me prior notice. I will inform the bank/building society in writing if I wish to cancel this instruction. I understand that if any direct debit is paid which breaks the terms of the instruction, the bank/ building society will make a refund. Bank/building society may decline to accept instructions to pay direct debit from some types of accounts.

**2** Please send me the following FREE Gift/Special Offer (tick one):

- 4247  Rhapsody **FREE**    4705  Binder & 2 magazines **FREE**
- 4249  Crystal Maze **FREE**    4770  High Risc Racing **FREE**
- 4248  TextEase **£20**    4250  Personal Accounts 3 **£10**

**3** Name (Mr/Mrs/Ms/Miss) .....

Address .....

Postcode ..... Tel .....

**4** Now send your completed form and payment to Acorn User, Database Direct, FREEPOST, South Wirral L65 3EB. Tel: 0151-357 1275. Please state if credit card billing address is different from the delivery address. Photocopies or handwritten versions of the above information are acceptable.

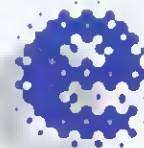
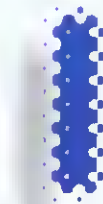

cise details covering a whole range of topics, from the basics of scanning and printing (professional – not hobby or school), to painting, producing text and graphics realistically carved into stone, or text that looks as if cast from clear Perspex and laid to rest on a sandy beach. The big difference is in the little details that the professionals include to give their work that competent, polished and believable look.

The book even comes with a CD-ROM car-

## Data'll be the day

I have followed the development of the Internet over the last couple of years with a fair degree of scepticism, but having had some hands-on experience recently, I have found a use for it.

As an electronics engineer I can download datasheets from manufacturers' Web sites and get a copy quicker – although at times it seems only *marginally* quicker – than waiting for it to be sent by post and better quality than a fax. The only problem is I have to use a PC! All datasheets are downloaded in .pdf format and require the Adobe Acrobat reader to display them. As far as I know there is no such reader for the Acorn.

So hurry up all you Internet providers and software writers, I am ready to sign up and buy my Web browser software, but not if I can't read my datasheets.

Ian Benton  
Ilkeston, Derbyshire

*There most certainly is an Acrobat format reader for Acorn machines – admittedly a recent addition – available on the Web at <http://utopia.knoware.nl/users/lsmiers/>*

## Top book marks

Having spent the last few months playing with Spacotech's *PhotoDesk*, I have again become aware of the dearth of good quality books to assist in exploring the potential of the quality software available for Acorn computers. Software such as *PhotoDesk* does need and deserve good books to point the way to getting professional quality results.

In the case of *PhotoDesk* I have found such a book – published for *PhotoShop 3 Wow!* book. Despite the awful title, the American authors and a moderately high price of £34, the book really is excellent as an adjunct to *PhotoDesk* on RISC OS machines. It gives complete, clear and con-

rying a copy of *PhotoShop* (save and Print disabled) and lots of, pardon my use of the expression again, *professional* quality pictures to play with.

Provided that one has first become familiar with *PhotoDesk*, transferring the instructions for the PC program to the Acorn one is not a problem – particularly as the Acorn is often a little simpler to work with. The techniques are generally identical – just substitute *PhotoDesk* terms for *PhotoShop* ones, wherever there is a difference. I did load *PhotoShop* onto my PC in case I needed to sort out the differences, but in fact I have not had to switch it on.

*PhotoShop 3* in 1996 introduced image layers to the PC which are very handy for montage work – I understand Spacotech is working on this. But given the supreme ease with which we can drag and drop pieces of images from canvas to canvas, modify them and drag them back on the Acorn, I have



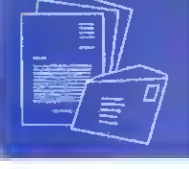

not found the lack of layers as such in PhotoDesk to be a real problem,

Although you are unlikely to do a review of this book I would like to recommend it to your readers. The publisher is Peachpit Press, Berkeley, CA, USA. ISBN 0-201-88370-8, published 1996. (Disclaimer - no, I am not involved with the publisher or authors, except as a satisfied customer).

**M E Hodgson**  
Camberley, Surrey

(FireWorkz Pro) running from a single floppy in a mere 2Mb of memory on my 12MHz A3010 - well, OK, I would like another 2Mb of RAM and FireWorkz Pro does find 2Mb a little tight. Not having to deal with huge multi-disc packages is one of the main reasons I didn't follow the herd and get a PC.

How am I affected by the compatibility argument? I found that the problem of transferring data between my A3010 at

## Survey problems

I have tried to answer the later, long questions in your survey but the program forgets my first few answers.

**Robert Caldwell**  
Welwyn Garden City, Herts

*It's true that the program appears to forget. The buttons show as unclicked but, in fact, the answers are still recorded so you can send in your answers without any trouble.*

## Millenium bug for Acorn

In the March issue, Mike Tomkinson, the Business Editor, was asking if anyone knew of any year 2000 problems on the Acorn range. Well there is one: The BBC Master series of computers stop counting and cycle back round to 1900 at midnight on the 31st of December 1999.

Fortunately I have already addressed this problem by writing a 'Doomsday' ROM for the BBC series of microcomputer. It will not only work with Masters but also with 8-bit Acorns that have suitable hardware added.

To test whether the ROM will work your readers can run the OSWordDetect program on the cover disc and available from my Web page ([www.york.ac.uk/~rps102/bbc/bbc.htm](http://www.york.ac.uk/~rps102/bbc/bbc.htm)) as of the week commencing 21st April.

It has also been tested and is working in Warm Silence Software's emulator ('BBCEm') in BBC, Master 128, and Master Compact modes. The ROM costs just £4 (plus 52p postage) and comes with comprehensive fitting manual and user guide.

Enquiries should be sent to R P Sprowson, 6 Bullinbrook road, Macclesfield, Cheshire SK10 3DJ. Or by e-mail: [rps102@york.ac.uk](mailto:rps102@york.ac.uk)

**Robert Sprowson**  
Macclesfield, Cheshire



*Thanks for that interesting information. If any other reader has found a non-RISC OS book to be particularly useful in helping with a RISC OS product, we'd like to hear about it.*

## Worldly wise

My job here in Nauru has included helping to set up and run two small networks (14 machines in all) of PCs running Windows 95, Microsoft Office and MSWorks. On a couple of occasions we experienced some very severe problems which required us to re-install the software on some of the machines. This involved well over 50 discs multiplied by several computers - not a very enjoyable experience.

What I really found interesting about all this was that all the PC owners here regarded this as one of the normal features of using a computer. They found it difficult to believe that I use a word processor/spreadsheet/database package

home and the PC at work no more difficult than between different programs on the PC. I have run courses on using the various formats like RTE, CSV, text etc to allow people to continue using what they are used to (be it Lotus, Microsoft or whatever) while still being able to transfer information. In my own case, I can of course use FireWorkz for Windows.

I'll finish this letter with a query. I have heard of a software package (for RISC OS) called *Alexander*. This was produced by the International Institute for Aerospace Survey and Earth Sciences. Is this package still available?

**Gary Hughes**  
Republic of Nauru, Central Pacific

*While we do vaguely recall this package we have to admit you've got us stumped. We had a good long rummage around the Web and still came up with nothing. Perhaps some kind reader can put us out of our misery?*

## Atlas error

In the QuickTime VR article last month, the method of map projection referred to as Mxxxx should have been Mercator. Sorry for any confusion.



# the Regan files



Rachelle Smith photographed by Jill Regan

Portland is renowned for its mist. Prisoners used to dread being sent to jail here because the weather made it twice as miserable. I am driving around Portland in late March and the weather is ... well, guess.

'I wonder where they got that from, we haven't got ours yet,' exclaims my passenger on spying a Labour party poster. She is Rachelle Smith, the general manager of Spacotech and active member of the local Labour party.

'The most important thing to me is my kids, so I want a society which is structured, where everybody has opportunity and everybody has clean water. To me the chances of getting the kind of society I would like, and the kind of world I would like my kids to live in are greater with a Labour government.'

Rachelle is a familiar sight at shows as the helpful woman on the Spacotech stand. Spacotech is these days renowned for two key Acorn graphics products - *Photodesk* and *Top Model*, but it had unusual origins.

Spacotech was originally started by Chris Hornby, almost as a hobby. Chris was into the BBC Micro and weather satellites. He was on a course at the South Bank Poly - his project was writing software to receive weather satellite information.

When it came to the assessment, the guy teaching the course said: 'Yes, it's OK, but look at this one which is much more professional and can do much more.' Chris gleefully pointed out that the 'professional' one was his program, the other being the one which the college had just spent thousands of pounds on.

He then found a fantastic software writer to follow on with his ideas and write a

decoder which won gold straight away at BETT and has become the educational standard.

'It is a bit difficult to say really what I do,' Rachelle says unassumingly, when I ask where she fits in. 'I do anything I can in running the business. I am not technical, I cannot program, I didn't really know much about computers - it's something I have just picked up.'

'Originally I did French at Sussex University. I had a job in a secondary school which was a complete disaster. I was off sick - sometimes the doctor wrote anxiety and sometimes he wrote depression. Basically I

... men like to maintain a big mystique about computers

was having a complete nervous breakdown.

'Chris and his wife Lucy lived right next door to the primary school and our children were best friends. I used to drag myself to the school and then I was fit for nothing except a cup of tea and a bit of sympathy. As I was sitting there weeping into my cup of tea, Lucy would say: "just stuff that into an envelope, address this for me or come down to the post office" and things like that.'

Chris went home to Zimbabwe for a holiday, leaving Rachelle in charge. By the time he came home Rachelle had decided it was about time she got herself a proper job with a pension; Chris suggested she work for them. That was when letters and

invoices were done by hand, although eventually the DTP package arrived.

'To be honest, men like to maintain a big mystique about computers,' Rachelle smiles with a wicked glint in her eye. 'They suggest that computers are complicated and horrendously difficult, but they're just like driving a car. To use them, you don't need to know what is in the engine or understand them. If anything more than oil or water goes wrong with the computer I am stuck.'

'I like the Acorn market a lot, but one thing I do not like is going to meetings which you know are going to be 99 per cent male and technical. There is always going to be someone who will put you down - the young male who does not bother even to tell you his name because by definition you are the older female and so cannot know anything. Fortunately they do not seem to last very long.'

Rachelle is used to young males, as she teaches life skills to young offenders in prison. This is a very demanding job which most people would not even consider.

'You would be amazed that a lot of people have had no chance in life and it is inevitable they end up in prison. What they needed early on in life was a bit of love. I was talking to some lads in my class the other day and they thought that if you earned £15,000 you were comfortably off. They even thought I wore expensive clothes.'

It is rare to find people who are not too caught up in their own problems to find the time unselfishly to help others. When you read this we will know if the rest of the country has thought along the same political lines as Rachelle.

Portland ... not a sentence but a breath of fresh air.

AU



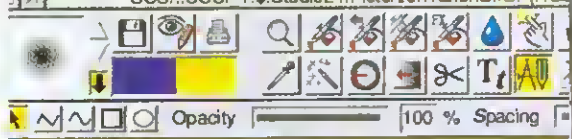

Studio24 was hailed as one of the best 24 bit painting programs. A completely new program Studio24Pro is now set to lead the field in painting & photo-retouching

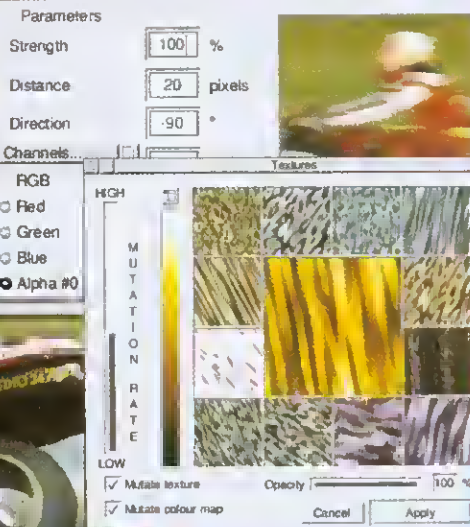

created from scratch using this program alone, concrete proof of the power of this creative tool! - Acorn User March 96

**Studio24Pro**  
£146.87 inc vat  
**Special Offer!**  
**Studio24 v1 £35.00**



The Casio QV100a and the high resolution QV100 Digital Cameras are now available for Acorn Computers. They are supplied complete with all cables and software. Store up to 96 images. Software and cables only price- £116.33

**Removable Harddrive System**  
**Total Data Security & Harddisc Backup**



The removable harddrive system fits into a 5 1/4" drive slot in the RiscPC and harddrives are available in many sizes which can simply plug in and out of the slot as required. The drive may be locked in place to prevent unauthorized removal. For total security the drive may be removed and stored in a safe place to prevent unauthorized access to your data. Because the removable drives are available in any size (up to

at least 4Gb) they are also ideal for use as backups for existing drives, and may be transported between different computers.

**PAL TV Coders**



The PLC/3 PAL TV Coder works in any of the 'Standard' Modes, e.g. mode 12 and 15 on all Acorn computer models. The PLC/3 has a 15 pin RGB output for the monitor, a BNC for video and an S-VHS connector for S-Video. The PLC/3 will work with RiscPC computers although the AKF60 and AKF91 will not work at the same time.

PLC/3 £104.57



The AVK/3 will work with all computer models in all screen modes up to 800 x 600 resolution in 16 million colours. It has a remote control with facilities for zooming, freezing & panning the TV picture. The AVK/3 includes all connecting cables including a SCART which gives TV frequency RGB O/P for large screen TV's, a phono socket for composite video and an S-VHS socket for S-Video.

AVK/3 £325.00

**!NEW!** A new model, the AVK/5 is similar to the AVK/3 but has the added feature of remote mouse operation using the infra red hand held remote control. This enables lectures and demonstrations to be done without having to sit at the computer keyboard.

AVK/5 £425.00

**ArtWorks Video Tutorial**



Walter Briggs is the tutor for this 1 hour video which shows how to use all the ArtWorks tools and then goes on to show how Walter produced his famous Tiger head picture. Walter also draws an impressive landscape picture which can be copied by those with no artistic talent at all!

ArtWorks Video Tutorial £19.99

**24 Bit Colour Scanners**



**!NEW!** NEW Scanners now available! We can now offer the popular Umax Vista S6E colour scanner at just £269.00 including vat and Acorn software. Drivers are also now available for the Microtek Scanmaker and AGFA Snapscan scanners.

These new scanners do require a SCSI card though, so the faithful Epson GT5000 parallel port yet! Imagemaster and Twain software are included in the price of all scanners, but we also offer our Studio24Pro Photo re-touching software at just £80.00 inc vat with every scanner purchase.

**Internet & World Wide Web** Jet Media Labs 33,600 ext £ 89.00  
US Robotics Voice Modem £189.00  
of new products try our Web Site:- ANT Internet Suite Software £116.32

<http://www.pineapple.demon.co.uk>

**20 : 20 Finance available on all RiscPC's**  
Studio24 v1 FREE with any RiscPC purchase

FREE membership of the Virus Protection Scheme with any RiscPC Studio24Pro at just £49.00 with any RiscPC purchase

Try our 'Choose your own RiscPC' deal and save money

**Pineapple Software have moved!**  
Come and visit us in our new showroom  
Easy Parking

352 Green Lane, Ilford  
Essex IG3 9JS

Tel 0181 599 1476 Fax 0181 598 2343  
email:- sales@pineapple.demon.co.uk

**Terms:-** All prices include 17.5% vat. Carriage £15.00 on computer systems. £5.88 on all other hardware. Other items free. Phone for quote outside U.K. Official orders, cheques and all major credit cards accepted at no extra charge.

'Pineapple offer some of the finest and friendliest after-sales support you will find' - Acorn User Mar 96  
Why not come and visit us (easy parking) where you can see most of the Acorn range of computers and other hardware in action.  
Monday - Saturday 0900 - 1730



**Virus Protection**

The Pineapple Virus Protection Scheme will allow you to detect and remove over 100 viruses from your Acorn computer.

£28.20 one year subscription  
**'If you're interested in virus protection, join the Pineapple virus protection scheme and buy Killer. Accept no alternatives.'** - Acorn User Feb 96



**Multimedia Speakers**

Yamaha 10 Watt YST-M15 £63.00

**A4 Colour Scanners**

Primax Flatbed A4 (1 only)	£199
Epson GT5000 (parallel)	£399
Epson GT5000 (SCSI)	£469
Epson GT8500	£529
Epson GT9500	£679
Microtek E3 (SCSI)	£325
Microtek E6 (SCSI)	£365
Agfa Snapscan (SCSI)	£359
Umax Vista S6E (SCSI)	£269

All scanners include Imagemaster & Twain. Studio24Pro at just £80.00

**A7000 Computers**

4Mb HD540 14" Mon	£1099
4Mb HD540 CD 14" Mon	£1199

**StrongARM RiscPC**

4Mb HD1Gb No Mon	£1139
4Mb HD1Gb x8CD No Mon	£1189
10Mb HD1Gb No Mon	£1439
10Mb HD1Gb x8CD No Mon	£1489

**RiscPC monitors**

Acorn 14" SVGA monitor	£ 264
Acorn 17" SVGA monitor (.25)	£ 640
Acorn 17" SVGA monitor (.28)	£ 423

**PC Cards/StrongARM**

DX2-66 Card	Separately	with RiscPC
	£289.00	£169.00
DX4-100 Card	£349.00	£229.00
586-100 Card	£468.83	£351.33
StrongARM	£279.00	£116.32

**RiscPC upgrades**

x8 CDROM (RiscOS 3.6/3.7)	£ 89.00
Second Slice (largePSU)	£116.33
Second Slice - no PSU	£ 89.00
RiscOS 3.6 upgrade	£ 49.95

**Memory Upgrades**

1Mb Vram (Simtec)	£ 80.00
2Mb Vram (Simtec)	£115.00
4Mb SIMM Ram	£ 19.00
8Mb SIMM Ram	£ 39.00
18Mb SIMM Ram	£ 69.00
32Mb SIMM Ram	£135.00

Phone for latest SIMM prices !!

**All our prices INCLUDE 17.5% vat**

**Printers**

<b>Hewlett Packard</b>		
Laserjet 5L 4ppm		£399.00
Deskjet 690 colour		£269.00
Deskjet 870 colour		£399.00
<b>Canon</b>		
BJC620 col 720dpi		£315.00
BJC4200 col 720dpi		£249.00
BJC240 colour		£199.00
BJC4550 A3 Colour		£399.00
<b>Epson</b>		
Stylus Colour 600		£299.00
Stylus Colour IIS		£199.00
Stylus Pro XL+ (A3)		£999.00

**3.5" Bare Harddrives**

540Mb IDE	£ 99.00
850Mb IDE	£119.00
1.2Gb IDE	£155.00
2.0Gb IDE	£229.00
3.2Gb IDE	£285.00
1.2Gb SCSI	£195.00
2.0Gb SCSI	£295.00
3.2Gb SCSI	£329.00
4.2Gb SCSI	£635.00

**Removable Harddrives**

IDE Mounting Kit	£ 15.00
IDE Removable Case	£ 10.00
SCSI Mounting Kit	£ 19.00
SCSI Removable Case	£ 10.00
External Mounting Box	£ 89.00

**SCSI Systems**

SCSI Card	£116.32
SCSI Internal Cable	£ 9.99
SCSI External Cable	£ 19.99
SCSI II Card	£189.00
SCSI II Internal Cable	£ 9.99
SCSI II External Cable	£ 22.32

**Monitors**

14" CTX 1024x768	£189.00
15" CTX 1280x1024	£279.00
17" CTX 1280x1024	£449.00
17" CTX 1600x1200	£579.00
20" 82Khz SVGA	£1115.00
<b>Ilyama Visionmaster</b>	
17" 0.26mm MF8617E	£599.00
17" 0.25mm MF9017E	£669.00
<b>Acorn</b>	
14" AKF53 Multiscan	£265.00

**!NEW Computer Trade in deals!**

**!! £200 trade-in when you buy any new computer!!**

This offer is open to any Clan members when purchasing any RiscPC. (You can join the clan for just £15). Trade-in a PC compatible, Atari, Amiga or Acorn computer (including BBC), and deduct £200 from the prices shown above.

# There are two ways to get on the Internet:

## Manual



## Automatic



**TCP/IP, PPP, SLIP, SMTP, POP2, POP3, IMAP, MIME, UUencode, FTP, HTTP, HTML 3.2, NNTP, GIF, JPEG, Telnet, Gopher and more.**

If the Internet is a superhighway, the directions can be pretty confusing.

When you use the ANT Internet Suite Release II, you don't need to worry about all the technical jargon. Our software takes care of setup and configuration. All that most users need do is put our disc in the floppy drive, type in name and serial number, and choose their Internet provider and access point from pop up lists.

The new version includes some of the most powerful and up-to-date Internet software available for Acorn computers such as our Web

browser **Fresco**® (also used in Network Computers), so you won't be left in the slow lane as new Internet technologies emerge.

So you can sit back and enjoy the ride. And if you do experience any difficulties, our dedicated customer support team won't leave you stranded on the roadside.

For further details, get motoring and contact ANT at PO Box 300, Cambridge, CB1 2EG, or visit our Web site at <http://www.ant.co.uk>



The ANT Internet Suite is £99 + VAT. If you use another commercial Internet product for RISC OS we'd like you to try the Suite for £49 (inclusive) plus proof of ownership. Upgrades from release I are £10 (inclusive).

ANT Ltd, PO Box 300, Cambridge, CB1 2EG. Tel: 01223 567808. Fax: 01223 567801. Email: [sales@ant.co.uk](mailto:sales@ant.co.uk)

Fresco is a registered trademark of ANT Ltd. September 1996. E&OE.