

The best-selling Acorn magazine in the world

# ACORN USER

Essential for all users of 32-bit RISC OS computers

## New Acorn machines

*Three new systems unveiled*

**Thirteen pages of product reviews including Textease, CineWorks and Iota's flat bed colour scanner**

**Taos: Acorn's future replacement for RISC OS?**

**The secrets behind the writing of Archimedes Elite**

The **ACORN USER** DISC  
SEPTEMBER 1995

Back up your hard drive with the award-winning **ClickBack**



**Plus**

- Plantwise demo from Sherston
- 'Lorem Ipsum' generator
- Elite files
- All our regular features

✓CHECKED ✓VIRUS CHECKED ✓VIRUS CHECKED ✓VIRUS CHECKED ✓VIRUS CHECKED

SEPTEMBER 1995 Issue 159 £3.25



9 770263 745048 09 >

# MAKE THE MOST OF MULTI-MEDIA

Are you wondering how to make the most of the multimedia resources available to you — scanned images (drawings or photos etc), video clips, music and sound samples, Replay movies, MPEG video clips or movies, teletext.....?

Computer Concepts offer a range of related products that can help you produce your own sound and video productions; all the hardware and software you need to input, manipulate and output stills, video and sound.



The ultimate multimedia expansion card — combining the functionality of a high quality (24bit) video digitiser with real time digital movie capture facilities, stereo sound sampling and playback, plus MIDI. All the software you will need to manipulate the captured data is included in the package — TakeTwo for

video manipulation, ScanLight for grabbing and manipulating still images, AudioWorks for manipulating audio samples and generating audio effects and !AudioCtrl provides mixing facilities. The card is also sold with real time video movie compression software from Eidos, which considerably speeds up and simplifies the process of movie generation. The video files you create can be played back using Acorn Replay. Suitable for any Acorn RISC computer except 3000/4000 series, requires 2MBytes RAM and RISC OS 3.1 or later (4MBytes, an ARM3 and a high data rate IDE or SCSI hard drive for movie recording and sound output).

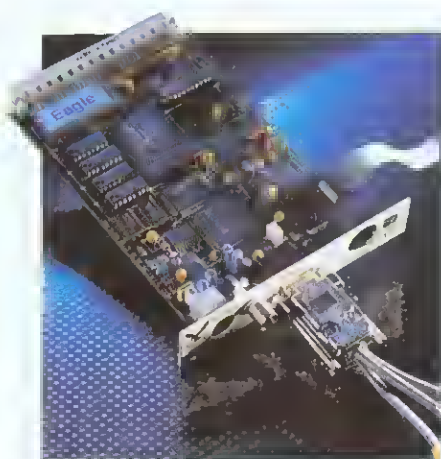

An optional extra is the latest release from Eidos — their Eidoscope video editing software, which can be used to edit movies created on an Eagle card and includes many professional video editing tools.



Price: Eagle card with Eidos compression software: £329 + £6 p&p + VAT (£386.57 inc.) Eagle card with Eidoscope: £449 + £6 p&p + VAT (£534.62 inc.) Eidoscope for existing Eagle owners: £169 + VAT (£198.57 inc.)

Acorn  
Replay



A 16 bit audio sampling and play back expansion card. Features include stereo line-level input and output, MIDI connection and software support. A copy of AudioWorks is included to handle the capture, manipulation and playback of samples and a copy of !AudioCtrl which controls the Lark's sampling options (for example sampling to memory or disc, continuous or single shot sampling, background or foreground sampling and setting of sample rates and formats). Suitable for any Acorn RISC computer except 3000/4000 series, requires 2MByte and RISC OS 3.1 or later.

Price £199 + £6 p&p + VAT (£240.87 inc.)



## MidiMax Card

An expansion card designed to provide a stand alone MIDI solution at an affordable price. A 16 byte memory buffer is included on the card for both transmit, and receive which means no data is lost even when the MIDI interface is transmitting at maximum rate. Standard MIDI In, Out and Thru connectors are provided, with the added benefit of a second Out connector to ease the interfacing of multiple devices. MidiMax is supplied with the same MIDI support software as the Eagle M2 and offers full compatibility with Acorn MIDI implementation. Suitable for any Acorn RISC computer except 3000/4000 series, requires 1MByte and RISC OS 3.1 or later.

Price: £69 + £6 p&p + VAT (£88.12 inc.)

IN THE

# ACORN WORLD



Combining the ScanLight 256 scanner (400 dpi, 256 grey levels) and GreyHawk digitiser. The digitiser offers real time greyscale video digitising from any video source. Includes the ultra-fast 'TakeOne' previewer, allowing live video in a window on the desktop — at quarter screen size this can update at 50 frames per second, far faster than any other digitiser. ScanLight software provides image enhancement of captured images, such as smoothing,



rotation, cropping, sharpening. Suitable for all models of Acorn RISC computer with 2MBytes.

Computer Concepts offer a range of other colour and greyscale scanners and digitisers — please ask for further details.

*Price: £220 + VAT (£258.50 inc.)*



The MPEG card allows full screen, full motion MPEG videos to be played back at better than VHS quality, with CD quality stereo sound tracks. MPEG videos can be played from hard disc or MPEG compatible CD ROM drives. Any Video CD format CDs are suitable (feature films, music videos etc) as are multimedia CDs that include MPEG clips. Any application that can display Replay movies can play MPEG movies. The software provides video type control over the movie eg fast forward, pause etc. Any frame can be

*Computer Concepts have other products in their range which can also be used in this field — for example a range of video genlocks, colour digitisers and flatbed scanners, the ColourCard graphics accelerator card and many more. Please ask for our Product Guide.*

captured as a 24 bit full colour sprite. Requires a Risc PC with 4MBytes and a suitable RGB monitor or TV capable of 50Hz PAL modes.

*Price: £249 + £6 p&p + VAT (£299.62 inc.)*



TV tuner comes in two forms; a tuner only device which allows live TV to be displayed, either through connection to a video composite compatible monitor or in a window on the desktop in machines that have a digitiser installed. The user can scan the frequency range, set up frequency pre-sets and select channels. The second option with Teletext software can access and display all the pages available on Teletext, select Teletext or Fasttext pages, decode foreign teletext and save pages out as either text or sprite files. Suitable for any Acorn RISC computer except 3000/4000 series, requires 2MBytes and RISC OS 3.1 or later.

*Price: TV Tuner only £89 + £6 p&p + VAT (£111.62 inc.)  
TVTuner+Teletext software £159+£6 p&p + VAT (£193.87 inc.)*

## Pioneer 602X CD Rom drive

Many multimedia resources are supplied on CD, so Computer Concepts also include a CD ROM drive in their range. The Pioneer DRM-602X is a double speed (300 kilobytes per second transfer rate), 6 disc CD ROM drive. Multi session PhotoCD compatible. It can also be used for standard audio compact discs. ArtWorks clip-art CD disc included. Suitable for any model of Acorn RISC computer, requires 2MBytes and a fully Acorn compatible SCSI card with CDFS 2.2.

*RRP: £499.00 + £10 p&p + VAT (£598.07 inc.)*



Computer Concepts Ltd



# CONTENTS

## Editor's letter

As I write this, the marketplace has gone quite, quite mad. The furore over Acorn's new distribution and sales strategy in the education sector threatens to overshadow the release of its new education-aimed machine, the A7000 – details of which are on page 31.

It's too early to tell what impact Acorn's new policy – described in the News section on page 9 – will have on the cosy Acorn market we're used to, but it's certainly a big gamble. We'll be looking into the effects in detail next month, but there is one good thing to come out of all this: at last, Acorn is doing something about its market. Whether it works is a different matter...

Mark Moxon, Editor

Editor Mark Moxon

Deputy Editor David Matthewman

Production Editor Judith Chapman

Art Editor Alan Capper

Contributing editors

Ian Burley (News) Steve Mumford (Games)

Jack Kreindler (Graphics) David Dade

(Comms) Paul Wheatley (Public Domain)

Geoff Preston (Education) Steve Powell

(DTP) Alex Singleton (Business)

Advertisement Manager Emma Barr

Assistant Ad Manager Lisa-Jo Oliver

Ad Sales Executive Nikki Clarke

Ad Production Helen Weaver

Ad Typesetting Eddie Burke

Marketing Manager Claire Mawdsley

Production Manager Sandra Childs

Commercial Director Denise Wright

Circulation Director David Wren

Distribution COMAG (01895) 444055

Subscriptions Database Direct 0151-357 1275

Managing Director Ian Bloomfield

Cover Regan

Member of the Audit Bureau of Circulation  
*Acorn User* is an independent publication  
and Acorn is not responsible for any of  
the articles in this issue or for any of the  
opinions expressed.



Published by IDG Media Ltd,  
Media House, Adlington Park,  
Macclesfield SK10 4NP

e-mail mark@acornusr.demon.co.uk  
Tel: (01625) 878888 Fax: (01625) 850652  
Printed by Duncan Web Offset, Maidstone

13 issue subscription rate: £37.99 (UK),  
£53.99 (EU), £68.99 (World)

©1995 IDG Media Ltd.

No material may be reproduced in whole  
or in part without written permission. While  
every care is taken, the publishers cannot  
be held legally responsible for any errors in  
articles, listings or advertisements

## REGULARS

**9 News**  
Acorn revamps dealer system

**15 Graphics**  
Serious 3D modelling

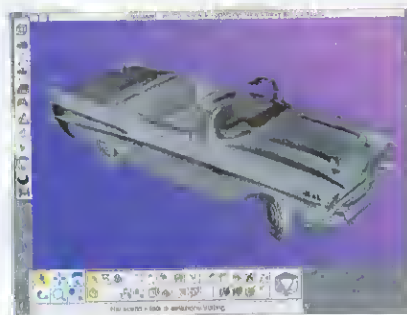

**17 Comms**  
Acorn's World Wide Web site

**19 DTP**  
Robin's Reed gets a make-over

**21 Public Domain**  
Demos galore

**23 Business**  
Easy PC file exchange

**25 Education**  
Sherston's Listening Books

**26 Portables**  
New bubble-jet printers from Canon



**30 Cover disc**  
ClicBack, a hard disc backup utility

**50 Letters**  
You have your say

**56 Game show**  
Games news and PC card  
compatibility

**88 The subscribers' pages**  
Special deals for subscribers

**90 The Moxon interview**  
Pat Cleaver of Minerva

## HANDS ON

**65 Questions and answers**  
Problems solving and hints & tips

**66 C for yourself**  
Linking your lists in C

**68 Absolute beginners**  
Jargon-busting for beginners

**71 Run the RISC**  
Mike Cook's hardware series

**75 Acorn customer hotline**  
Exclusive advice from you know who

**81 \*INFO**  
More wacky and off-beat programs

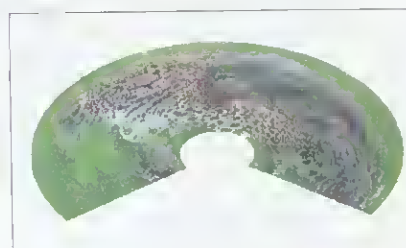

## EDUCATION

**60 Custom clothing**  
Print your own T-shirts using your  
Acorn



**61 Presenting the evidence**  
Using Junior Pinpoint in the  
classroom

**62 Family ties**  
Compiling your family tree on  
computer



# September 1995

## REVIEWS

**40** **A thousand and one tools**  
Steve Turnbull looks at the Taos operating system on his Acorn machine

**44** **In brief**  
A four-page collection of short reviews, including: Sibelius update, Textease, ClearView 2, CineWorks, MovieFS and Iota's new flat-bed colour scanner



**59** **Games reviews**  
Simon the Sorcerer on CD

## FEATURES

**31** **Codename: Kryten**  
Acorn's three new machines revealed



**35** **I wrote that...**  
How the classic game Elite was written for the Archimedes

**52** **Good-looking logos**  
How to make great logos without taking up huge amounts of memory

**55** **Online in the Acorn World**  
The Information Superhighway at the Acorn World show

**85** **Acorn User stock clearance**  
Get five quality products for only a tenner

**28**

On the cover disc:  
Back up your hard disc with ClicBack  
and try out  
Plantwise from  
Sherston Software



**31**

A7000:  
Acorn's newest  
machine is  
examined in detail

**40**

Taos:  
We are on the  
brink of a new  
era, if only ...



### Next month in Acorn User

#### Acorn User on the Web

Acorn User will be unveiling its new site on the World Wide Web, combining all that is best in your favourite Acorn magazine with the advantages of electronic publishing. If you've ever wanted to get the latest independent information on the Acorn market, or you need to find a review of a product without trawling through your back issues, then the Acorn User web site is for you.

#### Acorn's new dealer direction

Acorn has completely revamped its dealer network in a bold move to corner the education market. We have a special report on the risks involved and the potential problems that lie ahead, not least the threat to the existing dealer network as we know it.

#### Composition

Clares' new image composition package gets the once over: it's been a long time coming, but is it worth the wait?

#### The A7000 in education

The A7000 is unashamedly an education machine, and next month we'll be looking at the new machine from an educationalist's point of view. Does it ensure that Acorns are still the best machines for education?

**NEXT  
ISSUE  
ON SALE  
7 SEPTEMBER**







QuickKey site licence  
Rainbow, KS1, 2  
Rainbow site licence, KS1, 2  
Real McCoy 4  
Recordz  
    - primary site licence  
    - secondary site licence  
Remailer's Parallel Port  
RemedFS Serial Port  
Rendel Bender 2  
Rephorm  
Report Writer KS1/2, KS1/2  
Report Writer KS3/4, KS3/4  
Repro  
Resultz  
Resultz secondary site licence  
Revelation 2, KS2-4  
Revelation ImagePro 24 bit, KS2-4  
    - secondary site licence  
Rhapsody 2  
Rhapsody 3  
Rhythm-8ed  
RISC OS 3 Applications Upgrade  
RISC OS 3  
Programmer's Reference Manual vol 1-4  
RISC OS 3  
Programmer's Reference Manual vol 5  
RISC OS 3 User Guide for Risc PC 600  
RISC OS Style Guide  
Risc PC Technical Reference Manual  
RiscBASIC Compiler  
Rosie and Jim: Duck loses his Quack, age 4-5  
Rosie and Jim: Jim gets the Sneezes, age 4-5  
Round the World Yacht Race, age 9+  
RTF and WordPerfect Loaders and Savers  
    - Base 2 Developer  
    - site licence  
S-Base 2 Personal  
    - site licence  
Sally and Wally  
Saloon Cars Deluxe  
    - Extra Courses  
Schema 2  
Science  
Scrabble  
ShapeFX  
**Sibelius 6**  
    - primary site licence  
    - secondary site licence  
Sibelius 6 + Sibelius 7 Student  
Sibelius 6 secondary site licence  
+ Sibelius 7 Student  
Sibelius 7 Student  
    - site licence  
**Sim City**  
**Sim City 2000** for A5000  
**Sim City 2000** for Risc PC  
Simon the Sorcerer  
Sleuth  
Sleuth 2  
smArt (not Risc PC)  
smArtiller  
Smudge the Scientist, age 4+  
Smudge the Spaniel, age 4+  
    - site licence, age 4+  
SnapHappy  
Snapper  
SolidCAD  
Somerset Talking Computer Project  
Learning Materials  
Space City, age 7-9  
SparkFS  
Special  
Special site licence  
Speech  
Speech II  
Spelling week-by-week  
Spex  
Split an Image (not Risc PC), age 6-16  
Star Fighter 3000  
Spells Plus  
Studio24  
Stunt Racer 2000 (not Risc PC)  
Stunt Racer 2000 for Risc PC  
Stunt Racer 2000 Extra Tracks  
TableCalc  
TABS  
Talking Clocks  
Talking PenDown, KS1-3  
    - primary site licence  
Technodream (Nevron 2)  
**TechWriter Professional**  
    £191  
Textease with Spelling Checker  
    - primary site licence  
    - secondary site licence  
Time Detectives... The Victorians, age 7-11  
Time Machine  
Time Traveller, KS2  
Time Traveller - Brian Since 1930, KS2  
Time Traveller - The Victorians, KS2  
Time Traveller - Tudor and Stuart Times, KS2  
TinyDraw/TinyLogo  
Titrer  
Topographer  
Touch Type  
    - site licence for 10  
Trace  
**TurboDriver:**  
    Canon, Epson Stylus 600, HP  
    Twin, various titles  
Tween  
Two (Task and Window Organiser)  
    - site licence  
TypeStudio  
Vector (not Risc PC)  
Versatile  
VideoPack, various titles  
Virtual Golf  
Voy Box  
Voyage of Discovery, age 9-13  
WaveLength  
WimpGEN  
Wolfenstein 3D  
Wordz  
WormCad  
Worrcad site licence



### NEW Risc PC's !!

Risc PC600 4M HD425 14" Monitor	£1145
Risc PC600 4M HD425 17" Monitor	ACOR £1425
Risc PC600 4M HD425CD 14" Monitor	ACOR £1255
Risc PC600 4M HD425CD 17" Monitor	ACOR £1535
Risc PC700 5M HD425 14" Monitor	£1359
Risc PC700 5M HD425 17" Monitor	ACOR £1635
Risc PC700 5M HD425CD 14" Monitor	ACOR £1469
Risc PC700 5M HD425CD 17" Monitor	ACOR £1745
Risc PC700 10M HD850 14" Monitor	£1689
Risc PC700 10M HD850 17" Monitor	ACOR £1969
Risc PC700 10M HD850CD 14" Monitor	ACOR £1799
Risc PC700 10M HD850CD 17" Monitor	ACOR £2079
486DX2/80 Card for Risc PC	ALFP £398
486DX-40 Card for Risc PC	ALFP £348
Case Mid Upgrade for Risc PC 600 2M and 5M	ACOR £105

**ColorMobile** Scanner for Windows  
    - Direct model  
    - Office model with Feeder  
    - Uses parallel printer port  
    - Scan width 105mm  
    - Up to 24 bit at 400 dpi  
    - Includes OCR and image manipulation software  
    - Requires PC 486 Card, 12 Mb ram, Windows 3.1  
Ethernet Network Interface Card  
for Risc PC 600 ACOR £99  
Hard Disc Fitting Kit  
for Risc PC 5 1/4" bay ACS £20  
IDE Internal Interface  
ACS £60

**Removable Hard Disc Kit**  
for Risc PC, 270Mb ACS £359  
Indigo CD Rom Drive CAA3001 CLMA £124  
Indigo CD Rom Drive CAA3001A CLMA £174  
proTeus CD Rom / Optical Drive, Risc PC, Internal CLMA £548  
Removable Hard Disc Fitting Kit  
for Risc PC 5 1/4" bay ACS £20  
Risc PC 486 Card, special offer if ordered with computer ACOR £99  
Risc PC Sound Card ACOR £58  
**SCSI II Interface** for Risc PC CLMA £165  
SIMM 4 Mb 32 bit ACOR £110  
**SIMM 8 Mb 32 bit** £215  
SIMM 16 Mb 32 bit £345

### NEW Acorn A7000!

A7000 2M NET	£889
A7000 2M HD425	£935
A7000 4M HD425	£1019
A7000 2M NETCD	£999
A7000 2M HD425CD	£1045
A7000 4M HD425CD	£1129
A7000 2M HD425 Early Years System	£979

### Other Computers

A3010:	ACOR
Early Years	£335
Early Years Med-Res SVGA Multiscan System	£499
Learning Curve	£335
Learning Curve Med-Res SVGA Multiscan System	£499
A3020 HD Med-Res SVGA Multiscan System	ACOR £499
<b>A4000 HD210</b>	
High-Res SVGA Multiscan System	ACOR £739
Med-Res SVGA Multiscan System	ACOR £699

### ICS Hard Disc Kits

The best IDE filing system!  
    - Password protection + Disc partitioning +  
    - Not limited to 512 Mb +  
See our amazing prices!  
(Other sizes also available)  
Please specify OS 2 or OS 3 for all kits and interfaces

<b>IDE Internal Hard Disc Kit for A3000 Series</b>	
80 Mb	£149
120 Mb	£185
240 Mb	£299
Internal Interface only	£75
IDE Internal Hard Disc Kit for Archimedes Range	
240 Mb in short supply - please check	£199
330 Mb in short supply - please check	£225
420 Mb	£275
540 Mb	£299
1000 Mb	£500
Internal Interface only	
Hard Disc Cradle Kit for Archimedes	£15
Hard Disc Fitting Kit for A3000	£7
Hard Disc Fitting Kit for A3020	£7

**OS**

### ICS IDE Hard Discs

IDE 2 1/2" Hard Disc, 80 Mb	£89
IDE 2 1/2" Hard Disc, 120 Mb	£125
IDE 2 1/2" Hard Disc, 240 Mb	£239
IDE 3 1/2" Hard Disc, 240 Mb	£149
IDE 3 1/2" Hard Disc, 330 Mb	£175
IDE 3 1/2" Hard Disc, 420 Mb	£225
IDE 3 1/2" Hard Disc, 540 Mb	£249
IDE 3 1/2" Hard Disc, 1000 Mb	£449
Form Factor Converter 2 1/2" to 3 1/2"	£7
Second Hard Disc Fitting Kit for A5000	£15
Second Hard Disc Fitting Kit for A5000	£15

### Removable discs

IDE 3 1/2" Removable Hard Disc Cartridge, 1.05 Mb SVCF	£52
IDE 3 1/2" Removable Hard Disc Cartridge, 270 Mb SVCF	£55
IDE Removable Hard Disc Kit for A5000, 270 Mb ACS	£359
Removable Hard Disc Fitting Kit for A5000	ACS £25

### Printers

A4-1200/1 Direct Drive Laser Printer	CALL £978
Bubble Jet BJ-105x	CANO £149
Bubble Jet BJ-30	CANO £179
Bubble Jet BJC-70	CANO £275
Bubble Jet BJ-200ex	CANO £199
Bubble Jet BJC-600	CANO £359
Bubble Jet BJC-600	CANO £112
- Ink Cartridge, Black High Capacity	CANO £17
- Ink Cartridge, Cyan	CANO £10
- Ink Cartridge, Magenta	CANO £10
- Ink Cartridge, Yellow	CANO £10
Bubble Jet BJC-800 + TurboDriver	£1160
- Ink Cartridge, Black	CANO £19
- Ink Cartridge, Cyan	CANO £19
- Ink Cartridge, Magenta	CANO £19
- Ink Cartridge, Yellow	CANO £19
<b>Bubble Jet BJC-4000</b>	CANO £252
- Ink Cartridge	CANO £40
- Ink Cartridge, Black	CANO £26
- Ink Tank, Black	CANO £9
- Ink Tank, Colour	CANO £15
DeskJet 500 Series	
Tri-Chamber Colour Ink Cartridge	HEWL £29
DeskJet 540	HEWL £229
DeskJet Ink Cartridge, Black	HEWL £21
EP-1 Toner Cartridge for LBP-4	CANO £50
EP-5 II Toner Cartridge for LBP-8	CANO £69

### Memory

A3000 1 - 2 Mb, Non-upgradable	IFEL £53
A3000 1 - 2 Mb, Upgradable	IFEL £57
<b>A3000 1 - 4 Mb</b>	IFEL £110
A3010 1 - 2 Mb	IFEL £38
<b>A3020 / A4000 2 - 4 Mb</b>	IFEL £74
A305/310 1 - 2 Mb	IFEL £72
A305/310 1 - 4 Mb soldered with MEMCI A	IFEL £83
A5000 2 - 4 Mb	IFEL £79

### Other hardware

486SLC 25 PC Card 25 MHz Bare	ALEP £298
486SLC2/50 PC Card 50 MHz Bare	ALEP £348
A305/310/440	
RISC OS 3 Carrier Board	IFEL £119
Andi Oddule	BAR £89
Backplane, 4-slot 4-layer with fan	IFEL £55
ColourCard Gold	COMC £195
DMI 30	AUDI £72
DMI 50	AUDI £83
DMI 50 - S	AUDI £159
Dongle Dangle	ICS £6
<b>Eagle M2</b>	COMC £315
Ergo-keyboard	CANT £90
Fan Filters (pack of 10) (not A5000 or Risc PC)	ICS £6
Fan Kit for A300 / A400	ICS £15
Fine Grain SVGA Multiscan Monitor 17"	ACOR £589
Lambda 6	IRLA £98
Link A16	COMC £195
Micro Mouse	CLAF £21
Midi Max	COMC £68
Movie Magic	COMC £245
PD Cartridge, 650 Mb Rewritable	PARNA £39
Power Pad (Dual)	ECLU £28
Power Pad (Single)	ECLU £22
PowerWAVE 30	AUDI £177
PowerWAVE 50	AUDI £193
PowerWAVE 50-6	AUDI £242

### proTeus CD Rom / Optical Drive,

Acorn External	CLMA £648
RISC OS 3 Software Upgrade Kit	ACOR £82
RISC OS 3 Bulk Software Upgrade Kit (set of 10)	ICS £67
ScanLight 256	ACOP £338
ScanLight 256 for A3000/310I/3020/A4000	COMC £128
ScanLight Video 256	COMC £188
ScanLight Video 256 A3000/A4000	COMC £188
Sound Force I	COMC £34
Multimedia Speaker System	QUIC £84
TV Tuner	COMC £98
<b>TV Tuner with Teletext</b>	CCV £157
User Port / MIDI Upgrade for A3000	ACOR £51
Vision 24:	
A3000 external	HCES £91
A3000/3010/3020/4000 Internal	£67
A5000/4000/3000/RPC600	£67
Vision 24 508 line	HCES £91
A3000 external	£117
A3000/3010/3020/4000 Internal	£91
A5000/4000/3000/RPC600	£91
Whisper Fan Quieter	ICS £19
(for A300/A400 Series only)	ICS £19
Wizzo5 for A5000	ICS £35



# ICS

### 0151-625-1006

### TCS Bundle deals

**Upgrade your A3010** £185  
    - 1 - 2 Mb Memory Upgrade  
    - 80 Mb IDE Internal Hard Disc Kit

**Educate your under 5's** £50  
    - Fun School 4  
    - Playdays  
    - Noddy's Playtime (not Risc PC)

**Flatbed Colour Scanner** £595  
    - Canon TX4015 (requires SCSI)  
    - Twain Driver  
    - ImageMaster

**Communications** £185  
    - 14.4K Modem  
    - Hearsay

**Internet** £210  
    - 14.4K Modem  
    - Tarnite Internet

**Risc PC 'PC' System** £1620  
    - Risc PC700 5M HD425 14" Monitor  
    - Risc PC 486 Card  
    - SIMM 4 Mb 32 bit  
    - Windows for Workgroups 3.11

**Sound for the Risc PC** £89  
    - Risc PC Sound Card  
    - Multimedia Speaker System

### HOW TO ORDER

Carriage is free within mainland UK if you pay on ordering.

Cheques should be made payable to Ian Copestake Limited.

You may also pay by **credit card, debit card or Switch**. We normally make **no charge** for this, and take no payment until goods are despatched. We need your address as known to the card issuer.

If you leave an order on our **answering machine** please include your telephone number, your card number and its expiry date (and issue number if any), and your calculation of the total payment due.

**Official orders** are welcome from UK educational and government institutions (invoices are due for payment within 14 days and are subject to carriage and late payment charges).

**VAT is not included.** Zero-rated items are marked V0. UK customers please add 17 1/2% to all other prices. EC customers outside the UK please do the same unless you are VAT-registered, in which case quote your international VAT number. Ours is GB 595 7258 84.

**Overseas carriage:** If you are paying by credit card we will add air-mail and insurance at cost. Otherwise please add £6 (Europe) or at least £12 (elsewhere) for each software item and send a pounds sterling bank draft payable at a London clearing bank, or Eurocheques for not more than £100 each.

All products, prices and specifications are offered in good faith and are subject to availability and change without notice. Special offers apply only while stocks last. We process all orders immediately, but suppliers do sometimes keep us waiting. Goods are guaranteed but we do not supply them on approval. Returns and cancellations can only be accepted by prior agreement and there may be a charge to cover the costs involved.

Authorised Acorn Dealer and Developer

Please make cheques payable to Ian Copestake Limited

Dept U19, 1 Kingston Road, West Kirby, WIRRAL, Merseyside, England, L48 5ET

Tel: 0151-625 1006 Fax: 0151-625 1007



# RISC user

UK  
Subscription  
£21.90

## Tap into 14 years of Acorn experience

- **COMPREHENSIVE REFERENCE LIBRARY**  
Back issues are available along with rapid Indexing software.
- **INTERESTING FEATURES**  
Essential reading for beginners and experts alike, providing comprehensive information on a wide range of topics.
- **PRODUCT REVIEWS**  
Critical reviews of the latest products as they are released. Comparative surveys to help readers make the right choice.
- **HINTS & TIPS**  
Short cuts, problems solved and mysteries unveiled.
- **SUBSTANTIAL DISCOUNTS**  
Save 15% on software and 5% on hardware from BEEBUG's own range of products. Subscribers can more than cover the cost of a subscription for a whole year with a single purchase from our catalogue.
- **LATEST NEWS**  
Up to the minute news about what's happening in the Acorn marketplace.



To subscribe or receive further information telephone 01727 840303 NOW!  
BEEBUG Ltd., 117 Hatfield Road, St Albans, Herts AL1 4JS

# ALL ABOUT PC COMPATIBILITY ON ACORN COMPUTERS

## PC Survival Guide



BEEBUG

**ONLY £5.95** ex. postage  
(Code BKP1b)

Read about DOS, Windows, Partitions, DRAM, Sound Cards, File Compatibility etc. Contains tutorials on how to set up your system, including installing video drivers, CD-ROM drivers and expansion cards.

Whatever your Acorn computer, if you want PC compatibility this is the book for you. PCs are in a different world and there is a great deal you should know before making a decision that could cost you dearly later.

The Beebug PC Survival Guide covers in detail the wide range of options available for running PC software AND hardware on your Acorn computer.

The various software emulators and hardware expansion cards, including Acorn's new Risc PC 486 Card, are examined in depth. Hardware and software requirements are detailed, and solutions provided for common problems.

Whichever PC operating system you want to use, you'll find the information you need in this invaluable guide. Easy-to-follow 'hands on tutorials' make installation problems a thing of the past.

BEEBUG Ltd., 117 Hatfield Road, St Albans, Herts AL1 4JS  
Tel: 01727 840303 Fax: 01727 860263





## Acorn broadens its range

IT was with little surprise that *Acorn User* learned of the launch of two new Acorn computers, the A7000 and the Risc PC 700, plus the updating of the trusty Risc PC 600. Compared to when Acorn launched the original Risc PC 600 over a year ago, when the press was briefed months in advance of actual public launch, official news of the new machines had been kept concealed until the last minute so that Acorn could co-ordinate a joint product and education strategy announcement. While the Acorn strategy has proved highly controversial, in design and specification terms, the new computers represent subtle evolutionary changes rather than anything radical.

All the newly announced models are supplied with RISC OS 3.60 which resides in an on-board ROM doubled in size to 4Mb. Several bundled RISC OS applications have now been returned to the OS ROM. OS code executed off the ROM runs faster than before, the new ADFS filecore is implemented to eliminate partition size restrictions on hard discs, and there is a most impressive integral JPEG image decompression routine which works almost instantaneously.

Disappointingly, Acorn is not releasing RISC OS 3.60 as an upgrade for existing machines until at least next year. While Clan members have been given the opportunity to 'test' the new filecore code at their own risk, Acorn has decided that the upgrade issue is too much of a mine field for now. RISC OS 3.6 would mean a hard disc reformat, plus a new *!Boot* arrangement for example, a task far more fraught with danger than simply swapping some ROM chips.

On the hardware side, the main improvement is the inclusion of on-board 16-bit stereo sound as standard, complete with ATAPI CD-ROM drive support and a fixed audio mixer to enable convenient combined computer generated and CD sound rendition. ATAPI is a new IDE-based disc controller standard with an open software interface specification. The new Risc PC 700 shares a near-identical main board with its new Risc PC 600 sibling. As with the A5000, there are no clear external indications to show that the new model is any different to the earlier one, bar the use of a new style Logitech mouse.

Internally, the Risc PC 600 gets a 10 per cent power boost through its 33MHz ARM610, up from 30MHz, though in some areas the new Risc PC 600 will be more than 10 per cent faster than the original because of the RISC OS ROM performance

improvement. The Risc PC 700 has a 40MHz ARM710, which Acorn says can enable the Risc PC 700 to be up to 40 per cent faster than the original Risc PC 600. In PC terms, the improvement can be likened to a comparison between a 486DX2/66 and a 486DX4/100. However, until Digital-produced StrongARMs enter the equation – probably in 1996 – it's not quite possible to say that Acorn has entered Pentium-level performance territory just yet.

Compared with the ARM710, the alternative ARM700 processor module continues to cause development headaches at Acorn and in any case it will be clocked down to 33MHz to match the maximum clock rate of the FPA11 floating point accelerator chip. This news will frustrate a vocal number of potential users who need fast floating point maths, but at least Acorn has finally released some end-user products based on the ARM7 family of processors for the first time.

PC users now being encouraged to go for a minimum of 8Mb RAM might ridicule Acorn's 2Mb minimum specification of the A7000, but the ARM architecture has good code density, RISC OS programs are comparatively compact, there is no RAM wasted on disc or processor caches, and the operating system lives in its own 4Mb ROM. A 2Mh A7000 is therefore more comparable with a 4-6Mb PC.

Externally, the neat plastic-clad case bears a passing family resemblance to the highly innovative all-plastic Risc PC; underneath, however, there is a more conventional metal case. It's actually based on the case used by Online Media for its original set-top box design. Users have the choice of fitting a single internal 5.25in device, like a CD-ROM or a single full size expansion card.

So what about prices? With Acorn's new direct-sell education policy, education prices have been reduced generously across the board. However, the retail deal now looks comparatively less attractive. Full pricing for the new machines is given on page 33. The RRP of the Risc PC 700 with



The new A7000 from Acorn; compact and fast, but is the price right?

8Mb DRAM, 2Mb VRAM, 850Mb HD and AKF60 14in monitor is roughly £100 more than the typical selling price of an old Risc PC 600 with only 1Mb VRAM and half the hard disc capacity at 420Mb. On top of that, the new model has a faster processor, integrated 16-bit sound, RISC OS 3.6 and a better printer port, so Acorn has certainly delivered improved value for money – much to the probable annoyance of those who have just bought a Mk I Risc PC! It's an even better deal for education customers, though we discuss that topic in a separate news story on page 10.

The all-new A7000 is a quantum leap from the old A4000, but is only marginally more expensive than the former typical A4000 selling price. In fact, Acorn has massacred the education price of the A4000 in the wake of the A7000 and claims it is still in production. A3010s and A3020s, however, while remaining on the official price list, are no longer produced. In fact, Beebug reportedly purchased Acorn's entire remaining stock of A3010s.

The new improved Risc PC specifications enhance an already attractive design and the new A7000 is an essential offering for the education market, but despite reduced prices, some continue to say that Acorn is losing the value for money contest with the PC community. On page 31 in this issue we look at the new Acorns in greater depth.



# Acorn puts dealer network at risk

IN one fell swoop Acorn has effectively dismissed two thirds of its registered approved education dealers. The controversial move is part of a radical re-structuring of Acorn's education policy. Although painful, Acorn is adamant it had no choice but to make sweeping changes in order to maintain existing business and successfully gain a new education market share.

Acorn says members of its old dealer network were guilty of being too pre-occupied in competing among themselves to win education tenders put out by established Acorn schools. The net result was that margins were cut to the bone, and dealers – which had cut-price box-shifters moving in on the deal at the last minute and, because of the intense competition, not enough resources – were being directed at winning tenders with schools new to Acorn, in other words beating RM, Apple and the PC vendors.

Acorn's answer has been to axe its education dealer network and introduce a direct selling policy towards education customers with a fixed price. Without employing a large direct-sales task force, like RM for example, Acorn still needs the support of effective education dealers around the country. Therefore, Acorn has appointed official agents to represent Acorn in the education market. These agents have been given exclusive territories in which schools will earn their regional agents commission payments for all computer orders received by Acorn, whether or not the school was directly approached by their agent dealer.

It sounds like a good idea: there is price stability, Acorn effectively gets an RM-style direct sales force in the form of its appointed agents, and these dealers get guaranteed business according to their territory. The bad news is that Acorn has decided to award agencies to just 25 or so of the formerly 70-plus strong network of former Acorn education dealers. For those dealers left out, there was the further insult of not being officially informed of the new arrangements. Some only found out of the new arrangements via mailings directed at the software development side of their businesses. A week after the announcement, former dealers had still not received official communication from Acorn regarding their changed status. Dealers were telling *Acorn User* they were receiving orders from schools and not knowing what to do with them.

While previously, some ordinary Acorn dealers proved they could still earn business in schools outside the original official Acorn education dealership, it will be much more difficult now. Acorn's fixed education prices are mostly below the trade price of ordinary retail dealers. Without the Acorn commission enjoyed by agents, some of which will not actually be earned by their sales efforts, ordinary dealers would have to sell Acorn computers at a loss and hope to add considerable value in the form of networks, consultancy, peripherals, etc. With cost prices per computer differing by as much as £200, the uphill struggle is all too apparent. Acorn says it has a scheme to promote retail dealers, but this had not been revealed at press time, generating further complaints about the manner in which Acorn was handling the situation.

Many of the disenfranchised dealers have predictably voiced their anger at what amounts to a sense of betrayal by Acorn. The list of well known names not awarded agencies is sobering. A sample number includes The Data Store (Bromley), Desktop Projects, Senlac Computing, Minerva, Kimberley Computer Services, CJE Micros, Cambridgeshire Software House, Ian Copestake and Castle Technology, to name but a few.

Acorn, while sympathetic with their plight, has indicated that the vast majority of effort and success in the education market is actually accounted for by the companies offered education agencies. This could be interpreted that those left out weren't effective enough or, in some cases, have been distracted by other platforms, like PCs. Some supporting Acorn's line have even suggested that if some of the dealers left in the cold had put as much effort into their

businesses as they had in complaining, they wouldn't have found themselves in such dire consequences.

However, at least one dealer we spoke to claimed £200,000 worth of Acorn education business in the last year – despite cut throat competition from box-shifters. He felt that he was exactly the type of dealer who should have been helped by Acorn, not abandoned. Another dealer, Minerva, had just closed its retail operation in order to re-focus on education. Now that investment is wasted. The Data Store, which has built up a well-respected service reputation in the Acorn community, told *Acorn User* it had now approached Apple for dealership information. Without exception, all the ex-education dealers we spoke to were bitter at the manner in which the new policy had been introduced.

Of the successful agency-appointed dealers we spoke to, all were optimistic about their prospects and one confirmed that Acorn had provided a playing field in which it could confidently work with optimism to expand its business through established Acorn customers and compete successfully in new school tender opportunities against RM and Apple. However, one such agent also admitted that the way the scheme had been implemented was troubling and another suggested it could have been done differently, involving more dealers, while at the same time cutting out the seriously dead wood.

*Acorn User* has detected a general consensus that Acorn had to do something to re-organise its education marketing or risk falling victim to a progressively shrinking market and weakening dealer force. Some dealers have accepted their fate with sad resignation, adding that they will probably be forced out of the Acorn market completely. Acorn says there is still a bright future for its 400 or so remaining registered dealers. But until Acorn shows its consumer and retail hand, there is little optimism outside the education market, especially as the smaller dealers picked up vital sales from teachers and parents off the back of their schools presence.

After the initial fall-out had settled, concerns were emerging about the huge territories awarded to some agents, sometimes over a hundred miles end-to-end. Could these agents adequately serve the thousands of schools in their areas? Was there really a viable place for the dealers left out of the scheme? How would the schools react? *Acorn User* will be examining these questions in a special feature next month.

## Stack those Pocket Book SSDs

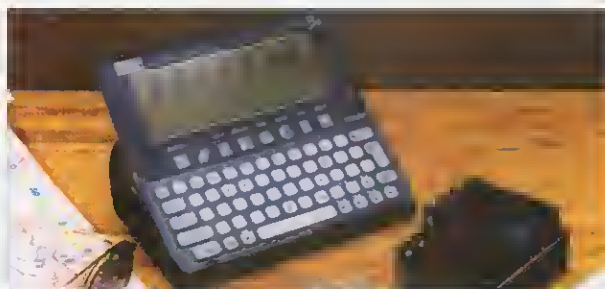

Widget Software, which specialises in the Psion Series 3 pocket computer, has produced a 'toast' rack for Series 3 and Acorn Pocket-Book SSDs (solid state disc cartridges). The anodised aluminium rack matches Widget's Series 3 desk stand introduced two years ago which has sold over 10,000 units.

Widget Software  
Tel: (01438) 815444  
Fax: (01438) 815222

E-mail [widget@cix.compulink.co.uk](mailto:widget@cix.compulink.co.uk)





## Cumana drives

CUMANA, the UK's leading manufacturer and supplier of multimedia products, has recently announced a number of enhancements to its extensive range of CD-ROM drives. Cumana can now offer at least one model which is compatible with every RISC OS computer manufactured by Acorn, from the A3000 right up to Acorn's latest Risc PC and A7000 models.

The Risc PC and the A7000 can either have fitted competitively-priced double-speed IDE drives or quad-speed drives based on the ATAPI standard. Cumana's external parallel-port drives can be used with the current range of Acorn computers and, as a bonus, offer dual compatibility with IBM machines.

Cumana's flagship is its proTeus drive. This combines a quad-speed CD-ROM drive with an optical drive offering 650Mb of re-writable storage per disc. This offers great potential for backing-up data, as well as being a supplement



Cumana has recently expanded its range of CD-ROM drives, along with improvements to its existing range.

to the hard disc, and a very fast CD-ROM drive.

The proTeus drive costs £549 + VAT, with individual discs priced from £39 + VAT. As it is a SCSI device, a SCSI interface will also be needed.

Cumana  
Tel: (01483) 503121  
Fax: (01483) 451371

## Parallel port drive from Eesox

Eesox has added a parallel port CD-ROM drive to its range. The 'Bronze' CD-ROM drive comes with Eesox's parallel port CD-ROM driver and is compatible with any Acorn machine which has a bi-directional parallel printer port, like the A3010/3020/4000/A4 and later machines. A *Simon the Sorcerer* demo CO is currently being included in the price, along with a £30 voucher towards the cost of making your own custom CO. The basic Bronze CO-ROM drive is priced £199 inc VAT or £215 inc VAT with CDFast cache software to improve performance.

Eesox  
Tel/fax: (01223) 264242  
e-mail: eesox@cityscape.co.uk

## KCS releases new Big Keys keyboard



A version of the Big-Keys Keyboard for use by youngsters and special needs students has been released in new lower case formats, apparently due to alphabetically arranged keyboards to choose from.

Now three variations are available: lower case black on yellow, yellow on black, and the original upper case version. Big-Keys keyboards are priced £85 + VAT and a 'Co-Pilot' accessory, to enable a normal keyboard to be connected at the same, costs £25.49 + VAT.

KCS Ltd  
Tel: (01703) 584314  
Fax: (01703) 584320  
E-mail:

100070.1254@compuserve.com

## Official: no Mac clone

Despite a denial through these very pages in the last issue of *Acorn User*, speculation has continued that Acorn will produce an Apple PowerMac clone running a licensed version of Apple's Mac OS. As we previously pointed out, Olivetti, Acorn's parent company, does indeed have plans to produce clone Macs, but, despite the appearance of a *Sunday Times* article repeating the suggestion, Acorn has re-confirmed there are no plans for Acorn to get into the Mac market.

## ExpLAN on the launch pad

Tavistock-based ExpLAN Computers Ltd has produced an interesting Acorn Pocket Book data file for aspiring rocket scientists. The software is part of a complete rocket experiment kit, including solid-fuelled rocket kits and teachers guide suitable for maths, science and technology classes. The Pocket Book data file enables the calculation of attainable rocket altitudes according to different payload masses.

Not that we have had much need for them for weeks and weeks at the time of writing, but ExpLAN is hoping the demand for lightning suppressors will literally go through the roof. ExpLAN now supplies Phoenix Contact lightning suppressors for isolating Acorn local area networks from nature at her most destructive. Phoenix suppressors stop typical lightning spikes at the electricity mains, with solutions starting at £35.

ExpLAN  
Tel: (01822) 613868

## Acorn User diary

Date	Event	Venue	Contact
9 Sept	ARM Club open day	Leicester High School for girls	The ARM Club: 0181-624 9918
23 Sept	Outch Acorn Computer User Society open day	Community Centre, The Tesselschedelan 1, Harderwijk, Netherlands	The Big Ben Club, PO Box 1189 6801 80 Arnhem, The Netherlands, modem: +31 20-663 1849, fax: +31 70-366 3193
27 - 28 Sept	SEMERC 9th national Micros for Special Needs exhibition	Queen Elizabeth Hall, Oldham	SEMERC tel: 0161-627 4469, fax 0161-627 2381
27 - 29 Oct	Acorn World '95	Wembley Exhibition Hall 1	Ticket hotline: (01933) 441448



# Britain's baffled parents

A NATIONWIDE survey of 1000 UK parents has revealed that they are still struggling to come to grips with the world of computing.

In a survey commissioned by *Parents & Computers* – a new magazine from IDG Media – one of the typical responses was that only 15 correctly described the Internet as the global electronic highway; 133 apparently thought it was part of the European railway system. *Parents & Computers* also compiled a regional league table of adult computer literacy in which Northern Ireland scored top marks.

Full details of the survey will be in the issue one of *Parents & Computers*, which will be on sale 24 August in WH Smiths, Tesco's, Sainsburys and other good newsagents. The magazine, edited by *Acorn Computing's* Pam Turnbull, is a guide to education and computing for all parents who own or are considering buying an Acorn, Mac or PC for their 3 – 11 year-old children

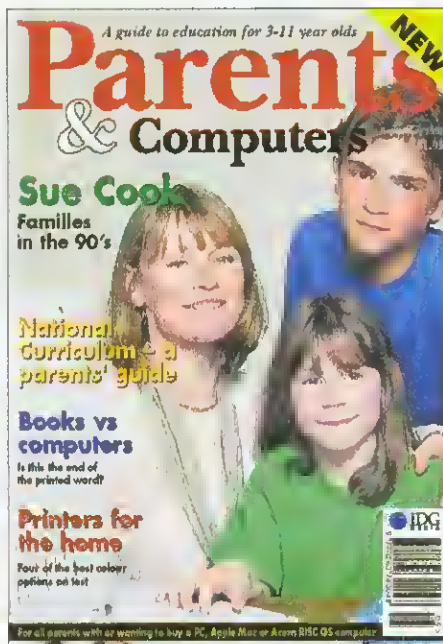

## Kimberley offers Acorn alternative

KIMBERLEY Computer Services – not to be confused with Southampton-based KCS Ltd in another news story – ironically now an ex-official education dealer, has nevertheless ploughed ahead and announced its KCS *NetServer* for schools. Targeting schools who wish to pay less for a multi-platform network server solution, the KCS offering undercuts Acorn's recently announced *SchoolServer* product, which is based on powerful but higher priced PowerPC technology.

The KCS server is based on a 486DX4/100 plat-

form, less powerful than the PowerPC but more than adequate for many schools according to KCS. Prices start at £2750, including 24Mb RAM, PCI expansion bus, 1Gb hard drive, quad-speed CD ROM, 100 Mbit/sec capable ethernet interface, *Windows NT Server 3.5x* and *Arcshare Server 1.5*.

KCS Premier

Tel: (01942) 677777

Fax: (01942) 672300

e-mail: [info@kcsprem.demon.co.uk](mailto:info@kcsprem.demon.co.uk)

## Online Media challenge

ACORN'S digital interactive TV (dITV) division, Online Media, numbers BT as one of its competitors. BT currently uses Apple set top box (STB) hardware in its dITV trials. However, Westminster Cable – a BT subsidiary – is now set to trial OM STBs in a deal struck with OM's partner, Digital Equipment Corp.

Digital will provide multimedia servers and OM the STB technology. Although Westminster Cable is a BT subsidiary, it is not obliged to use products and services supplied by other BT divisions. And even if it did use BT services, it would not be able to negotiate special cost deals as these would contravene strict rules against subsidising within BT. The Digital/OM deal is just the latest in a long line of prestigious contracts won by OM in the last year.

## Land of hope and Sibelius

ACORN-BASED music composition goes to the Proms this year as a number of composers have prepared their Proms performances using *Sibelius 7* on Acorn computers. Such performances include Julian Anderson's *Khorovod* to be performed on 16 August, Malcolm Williamson (Master of the Queen's Music) contributing to *A Year of Birds* on 19 August, and James Woods' *Two men meet, each presuming the other to be from a distant planet*, on 11 September. New percussion notations were specially created for the latter by Woods and Sibelius' Jonathan Finn and many of these will be made available to other *Sibelius* users.

*Sibelius*

Tel: (01223) 302765

Fax: (01223) 351947

## Portable delayed

Acorn doesn't deny it has a second-generation Olivetti notebook-based portable under development to replace the venerable A4, but it's now not likely to go on sale until early next year at the earliest. A prototype could well make an appearance at the Acorn World show in October, but it's thought that production engineering difficulties have delayed the project.

On the Pocket Book front, the latest education catalogue from Acorn lists a 1Mb version of the Pocket book for £285 + VAT (Education price), although there has been no official release date set for this product.

## DEC\_data spins its own web

Clip art and educational resource file specialist, DEC\_data has announced its own World Wide Web (WWW) home page on the Internet. Its brochure can now be found in electronic form at URL <http://www.zynet.co.uk/decdata/> and you can e-mail DEC\_data at [info@decdata.zynet.co.uk](mailto:info@decdata.zynet.co.uk) DEC\_data can also be by more conventional means on tel: (01392) 221702.

## Parallel port splitter

Misen Electronics has announced a simple device to provide an extra parallel port for all Acorn RISC OS computers. The MI25MTF data switch allows hardware to be connected to two separate ports which are then switched between.

Not only is this more convenient than delving round the back of the machine to swap connectors, it should also prolong the life of the connectors, which can easily be damaged by constant plugging and unplugging.

The data switch costs £17.95 all inclusive.

Misen Electronics

Tel/fax: (01722) 712256



# INKJET PRINTING SOLUTIONS

## BJ-200EX

A fast and affordable quality mono inkjet. Resolution with smoothing up to 720dpi. *The obvious choice if your work is black and white.*

BJ-200ex + TurboDriver  
£199 + £10 p&p +VAT  
(£245.58 inc.)

## BJ-600E

A fast, dedicated inkjet printer. Colour resolution of 360dpi and in mono with smoothing up to 720dpi. Four separate colour inks. *The one to go for if the majority of your work is in colour.*

BJ-600e + TurboDriver  
£389 + £10 p&p +VAT  
(£468.82 inc.)

BJC-4000 + TurboDriver  
£289 +  
£10 p&p +VAT  
(£351.32 inc.)

## BJC-4000

BJC-70 + TurboDriver  
£259 + £10 p&p +VAT  
(£316.07 inc.)

## BJC-70

Fast colour and mono printing. Colour resolution of 360dpi and when using the special high speed black cartridge in mono with smoothing up to 720dpi. *The most flexible choice if the majority of your work is in black and white (prints at twice the speed of the BJ-200 in mono) but there is a colour requirement.*

A portable version of the colour and mono BJC-4000, with the same dpi. Just 1.4kg and 300mm wide. *This should be your choice if portability is the priority - fits in the average briefcase (otherwise see the BJC-4000, which offers greater speed and ink capacity).*

Introducing the very latest Printers & TurboDrivers  
from Canon & Computer Concepts  
- the right answer,  
whatever your printing requirements.

All printer/TurboDriver bundles are available direct from Computer Concepts.

All printers are supplied with all necessary leads, a user guide, one ink cartridge (or set of), DOS & Windows drivers and one years off site maintenance. The stand alone TurboDrivers can be bought from any Acorn dealer, the RRP is £49 + VAT, street prices may vary. The new printers and TurboDrivers are suitable for all Acorn RISC computers, with 2MBytes of RAM (4MBytes for colour) and RISC OS 3.1 or later. IPrinters 1.22 or later (a hard disc and IPrinters 1.28 recommended).



Computer Concepts Ltd

Gaddesden Place  
Hemel Hempstead • Herts HP2 6EX  
Tel: 01442 351000 • Fax: 01442 351010  
Email: [Info@cconcepts.co.uk](mailto:Info@cconcepts.co.uk)

# REMOVABLE HARDDRIVE SYSTEM

- \* TOTAL DATA SECURITY
- \* EASY DATA TRANSFER BETWEEN COMPUTERS
- \* IDEAL HARDDISC BACKUP



The removable harddrive system fits into a 5¼" drive slot in the RiscPC and harddrives are available in many sizes which can simply plug in and out of the slot as required. The drive may be locked in place to prevent unauthorized removal. For total security the drive may be removed and stored in a safe place to prevent unauthorized access to your data. Because the removable drives are available in any size (up to at least 1Gb) they are

also ideal for use as backups for existing harddrives, and may be easily transported between different computers for rapid transfer of large datafiles. The system is available for use with both IDE and SCSI filing systems. External boxes are available to enable SCSI removable drives to be used with older Acorn models. Please 'phone for details.

## IDE systems

Mounting Kit for IDE systems	£25.00		
Plug in IDE drives:-			
210Mb	£135.00	420Mb	£164.50
540Mb	£189.75	850Mb	£219.00
		1Gb	£299.00

## SCSI systems

Mounting Kit for SCSI systems	£29.00		
Plug in SCSI drives:-			
730Mb	£246.00	1Gb	£429.00
External Mounting Box (A400/5000etc.)	£145.00		

## PAL TV CODERS



PLC/3

Price £104.57 inc vat



AVK/3

Price £411.25 inc vat

There are now two coders in our range which cover all Acorn computer models and allow Computer output in virtually all screen modes to be converted to a PAL TV signal suitable for recording to a video recorder or displaying on any TV with a Video input socket.

The PLC/3 is our standard model which works in any of the 'standard TV' modes (eg modes 12 & 15) on all Acorn computer models. (Note that the AKF60 & AKF85 monitors will not work in these modes, although the PLC/3 will still produce a TV output with the RiscPC). The PLC/3 has a 15 pin RGB output for the monitor, a BNC for video and an S-VHS socket for S-Video.

A new addition to the range - the AVK/3 will work with all computer models in all screen modes up to 800 x 600 resolution in 16 million colours. It has a remote control with facilities for zooming, freezing & panning the TV picture. Ideal for lectures and demonstrations etc. The AVK/3 includes all connecting cables including a SCART which gives TV frequency RGB O/P for large screen TV's, a phono socket for composite video and an S-VHS socket for S-Video.

Note:-Older Acorn Computer models may have 9 pin monitor sockets. 9 to 15pin & 15 to 9 pin converters are available at £4.11 each.

**NEW ACORN COMPUTER MODELS! - THE RISCPC700 & THE A7000**  
**SPECIAL OFFER - FREE MEMBERSHIP OF THE VIRUS PROTECTION SCHEME AND**  
**STUDIO24 AT JUST £49.00 WITH ANY RISCPC PURCHASE**

RiscPC600 Computers	A7000 Computers	3.5" Harddrives	SCSI Cards
<b>NB Prices inc VAT &amp; Delivery!</b>			
4Mb HD425 +AKF60 £1325	2Mb Net +AKF60 £1039	IDE Drives	SCSI Cards
4Mb HD425CD +AKF60 £1450	2Mb NetCD +AKF60 £1169	210Mb £116.32	All Computers £116.32
4Mb HD425 +AKF85 £1650	2Mb HD425 +AKF60 £1099	420Mb £147.75	SCSI Cable
4Mb HD425CD +AKF85 £1775	2Mb HD425CD +AKF60 £1219	540Mb £169.75	Internal £9.99
	4Mb HD425 +AKF60 £1189	850Mb £199.75	External £19.99
	4Mb HD425CD +AKF60 £1299	1Gb £275.75	SCSI II Cards
<b>RiscPC700 Computers</b>		SCSI Drives	RiscPC £199.00
5Mb HD425 +AKF60 £1550	RiscPC upgrades:-	730Mb £226.00	SCSI II Cable
5Mb HD425 +AKF85 £1875	1Mb to 2Mb Vram £116.32	1Gb £399.00	External £22.32
5Mb HD425CD +AKF60 £1699	4Mb SIMM Ram £135.12	<b>Printers</b>	<b>Scanners</b>
5Mb HD425CD +AKF85 £1999	8Mb SIMM Ram £258.50	colour printers	IX4015 £675.00
10Mb HD850 +AKF60 £1949	16Mb SIMM Ram £405.37	BJC600E £419.00	GT8500 £599.00
10Mb HD850 +AKF85 £2249	16bit sound card £69.32	BJC4000 £289.00	GT9000 £733.00
10Mb HD850CD +AKF60 £2069	Note: All RiscPC's come with one	Epson Stylus £419.00	
10Mb HD850CD +AKF85 £2374	years on site warranty	B/W	
486PC Card £116.32		BJ30 £199.00	
(Only with RiscPC)		BJ200EX £217.00	

## Pineapple Software

Suites 13 & 14  
 South Park Business Centre  
 310 Green Lane, Ilford  
 Essex IG1 1XT

Tel 0181 599 1476 Fax 0181 598 2343

**Terms:-** All prices include 17.5% vat. Carriage FREE to mainland U.K. Phone for quote outside U.K. Official orders, cheques and all major credit cards accepted. Money back guarantee on all products.

For demonstrations of most of our advertised products why not come and visit us in our new offices (easy parking) where you can see most of the Acorn range of computers and other hardware in action.



# Graphics

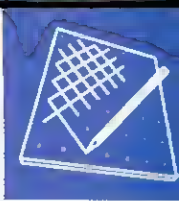

## Film recording for less

YOU might not get a cover CD-ROM teeming with goodness knows how many megabytes of this, that and the other, but I have always believed that in an enthusiasts' market you will find people who are less out to make money than put a smile on the face of their fellow users. My belief was no more justified than when, this month, a recently established company popped out of the blue,

offering specialised printing services dedicated to the Acorn graphics user at a price that PC or Mac users would happily amputate their right arms for.

The Digital Darkroom, a company run by an Acorn enthusiast, is offering hassle free, high-resolution colour slide printing direct from the Acorn, for a remarkably low price. What's more, Picture of the Month prize winners can have their award-winning

artwork printed free of charge, courtesy of the Digital Darkroom. Direct from disc printing of vector graphics or hitmap artwork is otherwise offered at £5 (plus £2 handling charge) for a one-off slide. Down to £3.75 (all inclusive) for bigger orders. Compared to all other commercial bureaux I've come across, these prices are unbeatable.

Digital Darkroom  
Tel: 0181-311 2001

## Serious 3D at long last

IT seems as if my call has been heard. Two companies, one German the other Italian, are on the brink of releasing 3D modelling and rendering packages for the Acorn. The German entrant, *Merlin* from Evolution Computer, looks remarkably like the elusive *Powershade*. Is this where the first serious Acorn ray-tracer has finally touched ground? At £100 + VAT it looks like a powerful intermediate-level package.

The other package has been developed by Italian company Sincronia Soluzioni Multimediali, the official Italian distributor for Acorn. Its series of studio quality modelling and rendering applications begins with the advanced modeller, *TopModel*, using highly optimised machine code routines which on an ARM610 can generate 9000 fully Phong-shaded, texture-mapped triangles per second with true transparency, and an astonishing 33,000 triangles per second in wire frame. There is import and export into industry standard packages such as *POVRay* and *AutoCad 3DStudio*. The extensions for professional ray-tracing and animation are to follow the release of the modeller priced at £99 + VAT – or £70 if you return your old rendering package disks. This promises to be the fastest and most capable 3D graphics package

ever for the Acorn, and with multi-processor cards and a *Top Model* 40MFlop DSP card in development, this could invite a good few PC and Mac modellers to the Acorn platform. This is exciting stuff indeed, and we will give a full preview of both products in the near future.

Evolution Computer  
Tel: +49 27 61 30 62  
Sincronia Soluzioni Multimediali  
Tel/fax: +39 11 53 91 73

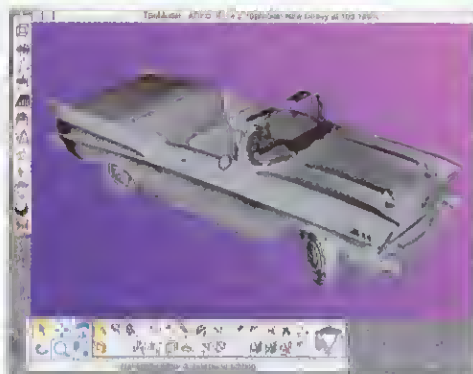

The *TopModel* 3D modelling suite looks set to take the Acorn market by storm.

## Buena Vista

AT 24K, this is probably the smallest file I have ever awarded Pic of the Month to. Philip Webster of New Malden in Surrey is armed with a Risc PC and 2Mb of VRAM, so there's just as much power behind his artwork as there is skill. Far less technically impressive than some of the other files that Philip sent into the graphics page, this picture, named *Valley*, is a brilliant example of how *ArtWork*'s graduated fills can be used to tremendous effect. Especially

commendable is the fact that this piece, used as GCSE coursework, was the artist's first picture created in *ArtWorks*.

Philip receives £20 and his image printed onto slide courtesy of the Digital Darkroom. Prize winners are asked to simply send their entries to the address below to claim their free, colour slide. Please note as well that prize winners will only receive their cheque in the month dated on the issue which their winning Pic appears. Keep 'em coming.



## PostScript from Calligraph

Calligraph, in collaboration with a company called Rapport, has developed a full PostScript level 2 RIP for the Acorn. As with all level 2 processes, it gives control over vital areas of imagesetting such as dot gain and screen angles. The RIP has been integrated to also work with the Calligraph range of direct-drive printers. This means the benefits of direct-drive printers can be used in a multi-platform network environment with Unix, PC, Mac and Acorn machines all being able to benefit from the advantage of Calligraph's direct-drive technology.

Calligraph  
Tel: (01223) 566642  
Fax: (01223) 566643

## Ovation Pro looking good

Though I should probably leave this to our DTP man, Mr Powell, I thought it important to mention that Beebug's *Ovation Professional* will be heading our way in the near future, packed full of fantastic graphics capabilities for the design-orientated publishers among us. Irregular frames containing text areas can be drawn with special tools and these frames can be rotated, as can the text within them. How fast these operations will be relative to the rapidity of CC's *Impression* remains to be seen but *Ovation Pro* does seem, feature-wise, to fill most of the gaps in page-setting capabilities that still exist in the present king of the Acorn DTP programs. At present, *Impression Publisher* is still the only choice for those producing colour-separated output, although this may be added to *Ovation Pro* later.

## Contacting me

You can contact the Graphics page by writing to me, Jack Kreindler, at *Acorn User*, IDG Media, Media House, Adlington Park, Macclesfield SK10 4NP, or by e-mail to: jack@acornusr.demon.co.uk.

# Arcshare™

Acorn to PC Networking Software

Its finally happened. A company has come up with a simple and inexpensive solution to an age old problem.

Getting access to files stored on a PC has always been a problem for Acorn computer owners. There has always been Floppy Disk transfers, but these are slow and limited to 1.44Mb. There has been several attempts to "Network" the two computers together but most attempts have been problematic and needed a great deal of extra hardware.

Arcshare is the latest program from KCS which allows any Acorn computer with an Access network card to talk to any PC with a network card & Windows.

Arcshare needs no extra hardware other than cheap network cards. Arcshare is very easy to use through its graphical interface and is, on average 40 times quicker than using a floppy disk, but with no file size limitation. Arcshare can even use CD Rom drives from a different machine.

## Available Now.



In the Main screen on Arcshare Client, both the Acorn and the PC directories are visible. Files can either be copied, or deleted, even new directories can be created on the Acorn from the PC. Arcshare has the advantage, that it can be run directly from the Windows Filemanager so that file manipulation is simple. Arcshare can run under a Windows for Workgroups network in conjunction with other PC's on the same network. There is no limit as to the amount of Acorns that can be seen from the PC on the Access network.

On the Acorn, the PC directories are designed to look just like any other Acorn directory. In fact, Arcshare makes the PC behave as if it were part of an Access network. Files can be copied from the PC directories to acorn directories in the normal manner. Files can even be copied from one PC to another PC via the Acorn.

It's time to join the PC and the Acorn on the same network. Call KCS now to find out more about Arcshare and networking Acorns to PC's.

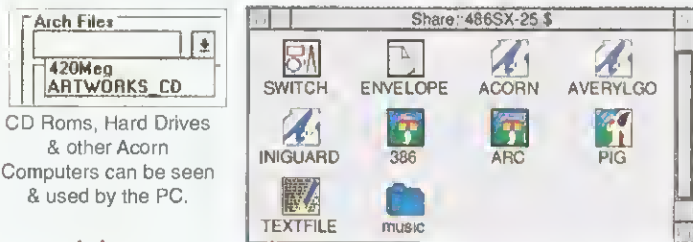

CD Roms, Hard Drives & other Acorn Computers can be seen & used by the PC.

The PC Directory looks like just another Acorn Directory, thanks to Automatic, remote Filetyping.

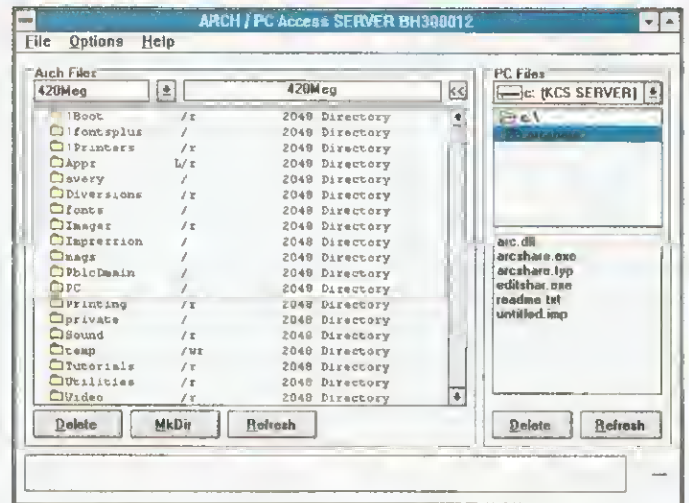
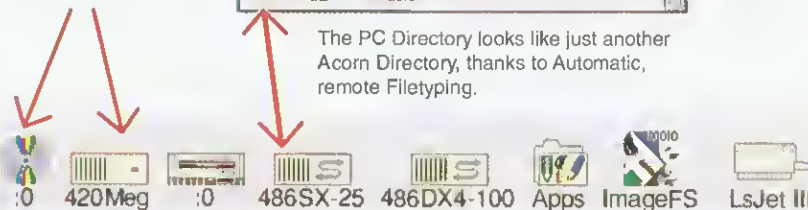

### Arcshare Client v1.4

- \* Allows file transfers between Acorn and PC Computers.
- \* No Filesize Limitation.
- \* Automatic Filetyping when the Acorn receives a file so that the file is ready to be loaded into an application straight away.
- \* Automatic File Extensions added when a file is transferred from the Acorn to the PC so that the file can be loaded into a program straight away.
- \* Easy to Use Graphic Interface.
- \* No "Dedicated Server" Computer required.
- \* Connects directly to Acorn Access Network. Very easy to setup and install.
- \* Works with Windows 3.1, 3.11, Windows 95 & Windows NT

### Arcshare Server v1.4

- \* Has ALL the Functions of Arcshare Client v1.4 but with the following additional extras.
- \* Allows transfers of files from the Acorn.
- \* When a Window is open displaying a PC directory, all the files are filetypeed even though they are stored on the PCI
- \* Files can even be copied from PC to PC from the Acorn.
- \* Any Acorn on the Network can access the PC.
- \* Makes the PC system look like another Acorn Access system.
- \* Files can be loaded into applications directly from the PC.

## Ideal for School Networks!

Prices  
**Arcshare Client v1.4**  
 £79.00 & Vat  
**Arcshare Server v1.4**  
 £99.00 & Vat

Available from:





## Down at Acorn Town

THE Acorn Computer Group plc World Wide Web server went live on Monday 19 June 1995. The site hosts pages for the three arms of the group – Acorn Computers, ARM Ltd and Online Media, as well as providing links to Olivetti Telemedia. A welcome message from Acorn Group MD Sam Wauchope and brief introduction to the group greets visitors to the site.

As promised last month, here is a screenshot of the Acorn Computers' home page. Acorn has given its Web site a friendly feel using the idea of a small town with buildings to visit containing various resources. Although this main inlined image is 66K of data by using the latest Freeware Internet software available – *ArcWeb* and *FreeNet* – and a V34 modem connection, quite acceptable fetching speeds are now becoming possible.

Most of the graphics used on the pages are beautifully drawn by Webmaster Paul LeBeau, of Cave Rock Software in New Zealand, who designs and maintains the pages, reflecting the truly worldwide nature of the Web. Using the latest *NetScape* web page 'standards', the pictures look best on white backgrounds, capably shown here by *ArcWeb*.

The town has eight main buildings to visit. The Library holds an increasing number of reference documents and application notes, while the Acorn Daily News building contains latest press releases and cuttings, event reports and press comment. The School holds information for teachers, students and education authorities, and Corporate centre, Acorn House deals with marketing and financial information and Customer services.

In danger of attracting the attention of the Trades Descriptions Act, the Airport appears to offer daily flights to Acorn's overseas dealers,

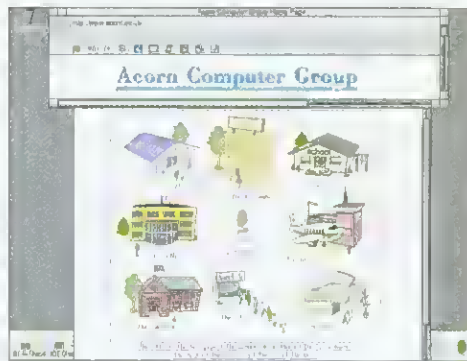

Acorn Town – the Rooftops view.

listing dozens of contacts in countries from Norway to Panama. The University houses the 'tertiary education' service for the higher education community, offering case studies of Acorn in Action, HE resource location details, and information on Networking and the new Rise PC 600X.

The Clan enthusiasts club have a special feel-good kiosk with information on joining, events and other club information. Members with e-mail addresses have already been given special access to their own password protected area which will contain exclusive information on Acorn's future. Currently, it contains only what Clan members have already received by mail. The Store offers product information, prices, dealer lists, special offers and links to free software on the Acorn ftp server.

The Town Square is the central point for announcements and what's new on other pages. The Acorn Web site is certainly worth visiting and provides a colourful and interesting shop window on all Acorn's activities. The URL is quite simple to type: <http://www.acorn.co.uk/>.

## HTMLEdit – Web page editor for RISC OS

I HAVE just received advance information of a new editor software package for producing World Wide Web pages from the RISC OS Desktop. HyperText Mark-up Language (HTML) is the page description text language used for designing WWW pages, and it is possible, but often totally confusing, to design Web pages using a standard text editor such as *Edit* or *Zap*.

The recent *Acorn User* cover CD-ROM contained Ben Summers' Freeware *HTMLTools* for use with *Impression Style* and *Publisher*, which can make the job a lot easier, but a dedicated editor is really what we need. Andrew Rawnsley's reasonably-priced commercial package may just fit the bill.

According to the pre-release information, you can view and edit the document you are working on with an automatic preview of the document as it will appear on the Web. *HTMLEdit* uses menu and command structures familiar to users

of *Edit*, with the same function key effects, such as F8 Undo. You can also extract the textual information from existing HTML documents as saved online from your Browser.

Other features include full support for images and forms, Netscape extensions where appropriate, all styles and effects available from a toolbox with at most two mouse clicks, and new features can be added. A later hands-on review will explore the possibilities more fully.

*HTMLEdit* is currently delivered by e-mail with the full, packaged release to follow by post. The single user licence costs £30 (no VAT). Make cheques payable to Andrew Rawnsley and send them, with your e-mail address, to:

R-Comp, 22 Robert Moffat, High Legh,  
Knutsford Cheshire WA16 6PS  
E-mail: [HTMLEdit@arsvcs.demon.co.uk](mailto:HTMLEdit@arsvcs.demon.co.uk)  
Fax: (01925) 757377

### ARMed Forces BBS

Chris Claydon's ARMed Forces Multimedia BBS located near Winchester in Hampshire, his showcase for the *RSDFS* Immediate multimedia BBS software package for Acorn 32-bit computers, is now running with 24-hour public access on all speeds to V32bis (14,400bps). You can call with a normal ANSI/Zmodem comms terminal such as *HearsayII* to download the free Immediate slave package. Chris claims that all FidoNet and Usenet conferences are available.

ARMed Forces BBS  
Modem: (01962) 880003

### SchoolNet on the Web

Paul Welbank, IT co-ordinator at Eaton (City of Norwich) School, tells me that SchoolNet UK has set up a World Wide Web site at the University of East Anglia. The aim is to provide a focus for school's net activity and a means by which they can all get in touch with each other, as well as being a good starting point for teachers searching for resources round the Web. The pages include links to UK Schools' Web Home Pages, a list of UK Schools' e-mail addresses and links to world school sites and teacher resources. Contact Paul by e-mail at [paul@starnet.demon.co.uk](mailto:paul@starnet.demon.co.uk) and try out these URLs:

<http://www.sys.uea.ac.uk/Schools/schoolnet/>  
<http://schoolnet.sys.uea.ac.uk/schoolnet/>

### Skyline update

Robbie Record's Skyline BBS in Twickenham now has full FidoNet access, with Netmail, Internet e-mail via UUCP and a more sensible FidoNet Point address of 2:254/279.2. The phone number is unchanged.

Skyline BBS  
Modem: 0181-255 6912

### Contacting me

You can contact the Comms page by writing to David Dade, Acorn User, IDG Media, Media House, Adlington Park, Macclesfield SK10 4NP, or by e-mail to: [DavidD@arcade.demon.co.uk](mailto:DavidD@arcade.demon.co.uk), or mail #2 on Arcade BBS 0181-654 2212.

**FREE**  
Admission,  
Seminars,  
Refreshments  
& Parking

# Hands-on Open Day

at our Luton Showroom

**Sunday 10th September 1995**  
from **10.00am to 4.30pm**

See  
**Microsoft**  
**Windows '95**  
in Action  
all day!

In association with *Computer Shopper, PC Direct & Personal Computer World*



The mark of  
Experience



  
**Aries**  
The sign of Quality

Amongst our many exhibitors will be:



Acorn

Borland

Canon

COREL®

CREATIVE

EPSON

IMSI

Intuit

Microsoft®

NOVELL

Panasonic

SAGE  
THE SAGE GROUP PLC

SYMANTEC™

Visio

It's a day out for all the family - 'hands-on' opportunities for you to try out all the latest products in the PC market. Seminars, Presentations and Demonstrations throughout the day for both the home and business user (SOHO). Our technical and sales support team will be there to assist and advise you on the best products for all your computing needs and representatives from a host of leading computer companies will be on hand to answer your questions. Try it and then buy it - for the young and old (and those in between) - it's fun, it's educational and it's FREE.

For business users, demonstrations will take place throughout the day for; Wordprocessing; Spreadsheet, Accounts and Payroll software; Video conferencing and Aries Office Computer Systems will be available for hands-on evaluation

Our full range of products will be available for purchase on the day ♦ Printers ♦ Plotters ♦ Aries Notebooks ♦ Arles PC's  
♦ Scanners ♦ Software ♦ Monitors ♦ MultiMedia ♦ Mice ♦ Books ♦ Education Products ♦ Psion ♦ Networks

## Watford Electronics Ltd

Jessa House, Finway (off Dallow Road), Luton LU1 1TR. Tel: 01582 487777

**Direction to Jessa House from the M1 Motorway:**

Exit off junction 11 of the M1. If coming from the south, turn right at the roundabout (under the motorway); or from the North, turn immediately left. Continue across 3 sets of traffic lights. At the roundabout turn right. Pass 'DO-IT-ALL' on the left. Over a bridge, across two roundabouts with B&Q on your left. You are now in Dallow Road. After half a mile you pass BESTWAYS on the left. Finway is now the first turning on the left.





## Fishy layouts get a makeover

THE first victim of a makeover turned up all too eager to go under the knife. *Robin's Reed* is a quarterly newsletter for the Nottingham & District Section of The British Koi Keepers Society. The A5 pamphlet-style newsletter is laid out by Adrian Grigg on what he describes as a modest setup – an A5000 with 4Mb. It has a printed colour cover with black only pages. It runs to about 50 pages and is printed professionally thanks to a friend of Adrian's in the trade. Adrian uses *Impression Publisher*, *Draw* and a hand scanner. The pages I've made-over show the tail end of one article and the start of another.

### The changes

To make the blocks of text look darker and somewhat denser, I changed the body font from 12pt Trinity to 12pt Bembo. I also added a paragraph spacing to help break the text up, but removed the initial indents as they didn't go too well with the spaced paragraphs.

The headlines and subheads tended to blend in with the copy so they were changed to a sans serif font and increased in size to make them easier to read. Some spacing was added top and bottom to separate them from the body copy. I used GillSans and altered the aspect ratio for the headlines to 75 per cent to make them look tall and thin. I also added a deep sink to the top of the page, adding white space around the headline to draw your attention to it.

The new master pages included the graphics, page numbers and rules, but only contained guide frames since space is limited on an A5 page. It's therefore often easier to draw frames as you need them and link them manually.

The original used the basic single A5 page with no regard to left-right page pairs. The new master pages use mirror imaged left and right layouts. The columns containing the main copy were moved in from the outer edges of each page to allow for thumb space, and this space can still be used to flow graphics, captions or quotes into because they can be obscured by your thumbs as you hold the newsletter without covering up any of the copy you're reading. I added some prominent sub-heads and the prominent headings to help provide cues for readers.

The photograph was lightened to make the contrast with the text less blatant and help retain detail by preventing fill-in. It was also made smaller to prevent it dominating the page. The chart was re-drawn and made a bit smaller; the grey bars help when tracking data across the columns.

Steve Powell

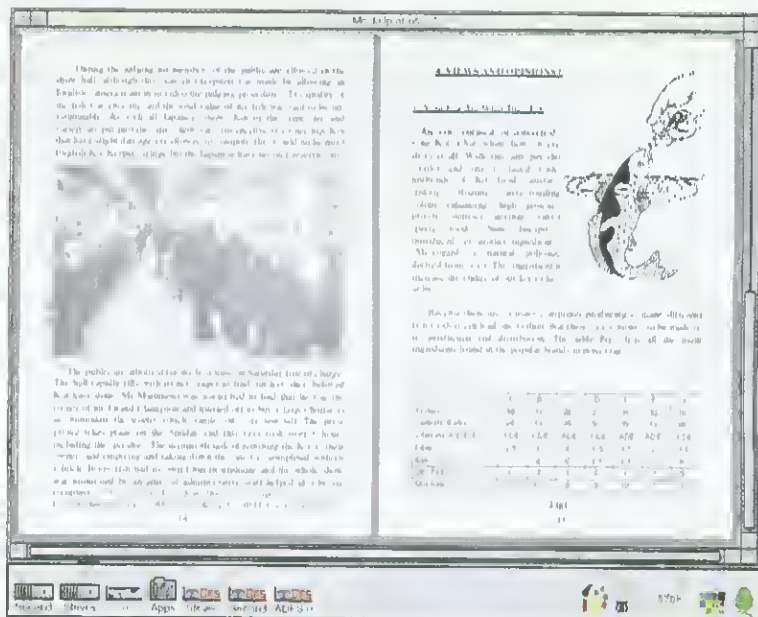

The overall look of the pages is very text-heavy. The graphics tend to look very dark or very light compared to the areas of text on the page.

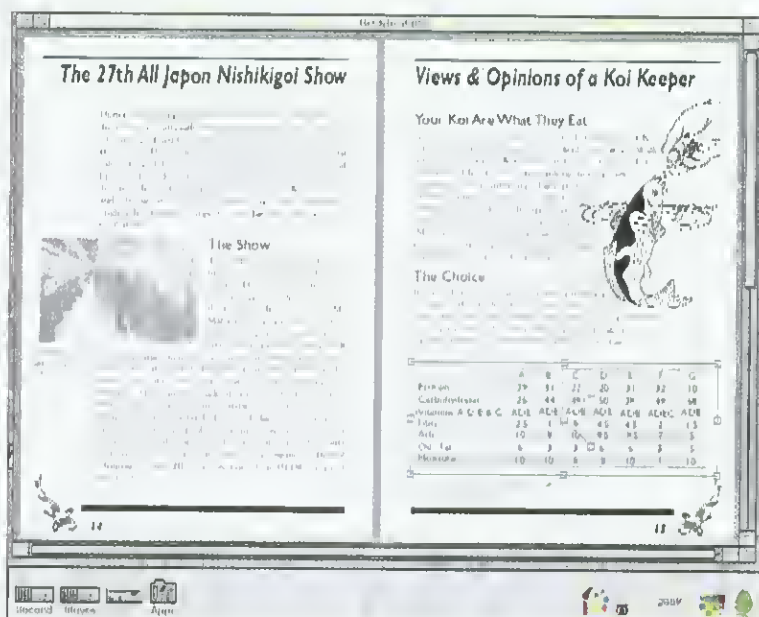

A repeating graphic on each page maintains the theme of the newsletter and helps with continuity from page to page. The extra line along the bottom was added to offset the much darker headlines at the top of each page and to frame the text.

### Jargon notes

Cues are things like headlines, quotes, captions, subheads and such like which the reader can use to navigate round pages. It tells them what the main copy is all about without them having to read it. The body copy is the main block or blocks of text on the page. The sink is the space at the top of the page before the top line of copy.

Master pages are the templates that *Impression* uses to describe common features like the graphics and frames that will appear on every page in a document. They can be used to give a uniform look to a document, which is usually lost if you design each page from scratch.

Fill-in can occur when too much ink is applied to the page when printing. The very dark areas become solid black because the ink spots merge and details are lost. Making photos lighter and adding contrast can help prevent fill-in and maintain detail.







# Public Domain



## Demos galore

**DEMOS** certainly aren't everyone's cup of tea, but the ability to produce unusual computer graphics on your own machine remains a popular interest for coders and demo watchers alike. There's been a bit of a lull in the demo scene over the last few months, but fortunately a range of new and old groups has produced quite a glut of demos for review in this month's PD page demo special.

Before I get down to some serious pixel pushing and vector spinning, a word for the beginners among you. What are demos? A demo program represents a fusion of programmed code, graphics and music which produces a rolling demonstration that shows off the authors' skills.

The idea from a demo group's point of view is to produce a program that is both technically impressive (in order to impress the coders in all the other demo groups) and well presented and interesting to watch (for the non-programmers among us). First up from the range of demos

before me are a couple of older productions from the continent that have only just made it across to the UK. *The Demo* and *Terrademo* are fair representations of some of the most boring demos to appear on the Arc in the last few years – sequences of effects that aren't linked, require us to press space after each effect, and use endless scroll texts that go on for hours. To add insult to injury, *Terrademo* contains music that was originally used in an Amiga demo, before then being used in a Bytepool demo on the Arc. Is it too much to ask for some new tunes?

A much more recent demo by Sounds Riscy is no better, with terrible music and pretty useless coding. Fortunately, the version I saw is 'not yet ready for distribution'; let's hope they start again before releasing it.

*MetaMorphosis* by Zarquon is a relief to watch after the last three demos. It's a small but very nice production making use of texture mapping, and some nice effects linked together with a little mouse-controlled menu, reminiscent of the routines used on the latest Silicon Graphics windows. Check this one out, but you'll need an ARM3 to appreciate it fully.

From here on things can only get better, with two fantastic releases from Germany. *Xcentric* and *Ostern95* are examples of the way the demo scene on the Arc is headed – fast moving, interesting effects which have no problems holding your attention.

With *Xcentric*, presentation is to the fore, but it's a bit of a shame that it's aimed solely at ARM2 machines. Having said that, the coding is excellent and has been combined to great effect with some superb graphics by Marc Andreoli of Alderbaren fame. None of

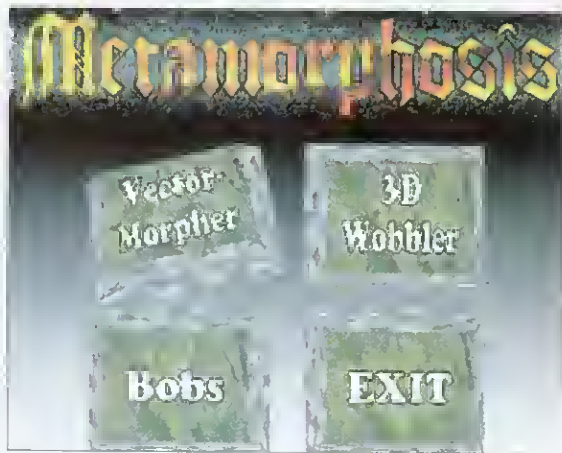

*MetaMorphosis* by Zarquon, featuring a mouse-controlled menu and some texture-mapped 3D buttons which give this an impressive look.

the effects seem to drag out too long, and all are very impressive, given the lack of ARM2 speed. TXP has excelled, definitely achieving its aim to produce the best ARM2 demo. I'm now looking forward to the next production which will be Risc PC only.

*Ostern95* shows where the scene should be headed. It's fast, snappy and has great presentation. *Ostern* is the result of three days' coding at the 'Fried Bits Eastern Coding Convention 3' and is a collaboration between three groups, including the well-known Slompt. It's not very big, but it doesn't have to be. The first effect warps a logo on to the screen in a couple of seconds and looks fantastic.

Despite *Xcentric's* overall excellence, I liked the style of *Ostern* – lets hope they do it again next year. There's only one major criticism of these productions – the fairly average music. Where are those Arc musicians?

It looks like Germany has maintained its lead on the demo front, but the UK isn't far behind. The recent *Slippery Slideshow* release by Dizzy Wizard has some great graphics and demonstrates the potential of a new group on the scene. Another new UK group, with the bizarre name of the 'Nutters', is also looking very promising. Fronted by two coders and a plethora of artists, its first demo should be one to look out for. I'll keep you informed.

All demos reviewed are available from The Datafile or online on Arcade and Digital Datahank BBSs.

### Contacting me

You can contact the PD page by writing to me, Paul Wheatley, at Acorn User, IDG Media, Media House, Adlington Park, Macclesfield, SK10 4NP. Or preferably, by e-mail to [quantum@digibank.demon.co.uk](mailto:quantum@digibank.demon.co.uk) or online on the Arcade BBS.

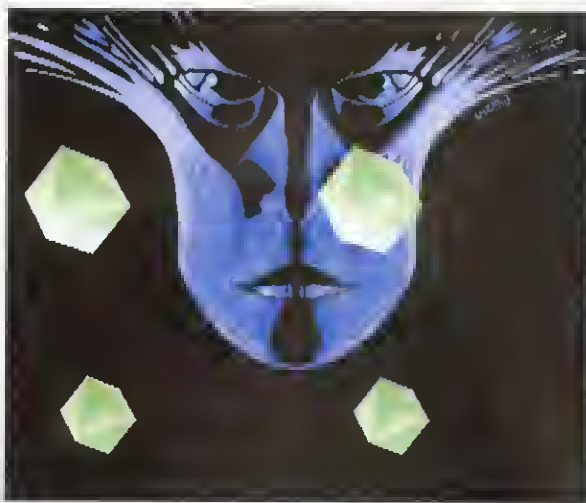

*Ostern95*, an excellent demo from German coding groups Archilogies, Icebird and Slompt.



*Slippery Slideshow* by Dizzy Wizard Software – anarchy in the UK?

# ACORN WORLD '95

## The highway to the Future

WEMBLEY EXHIBITION HALL 1. - 27, 28, 29 OCTOBER 1995

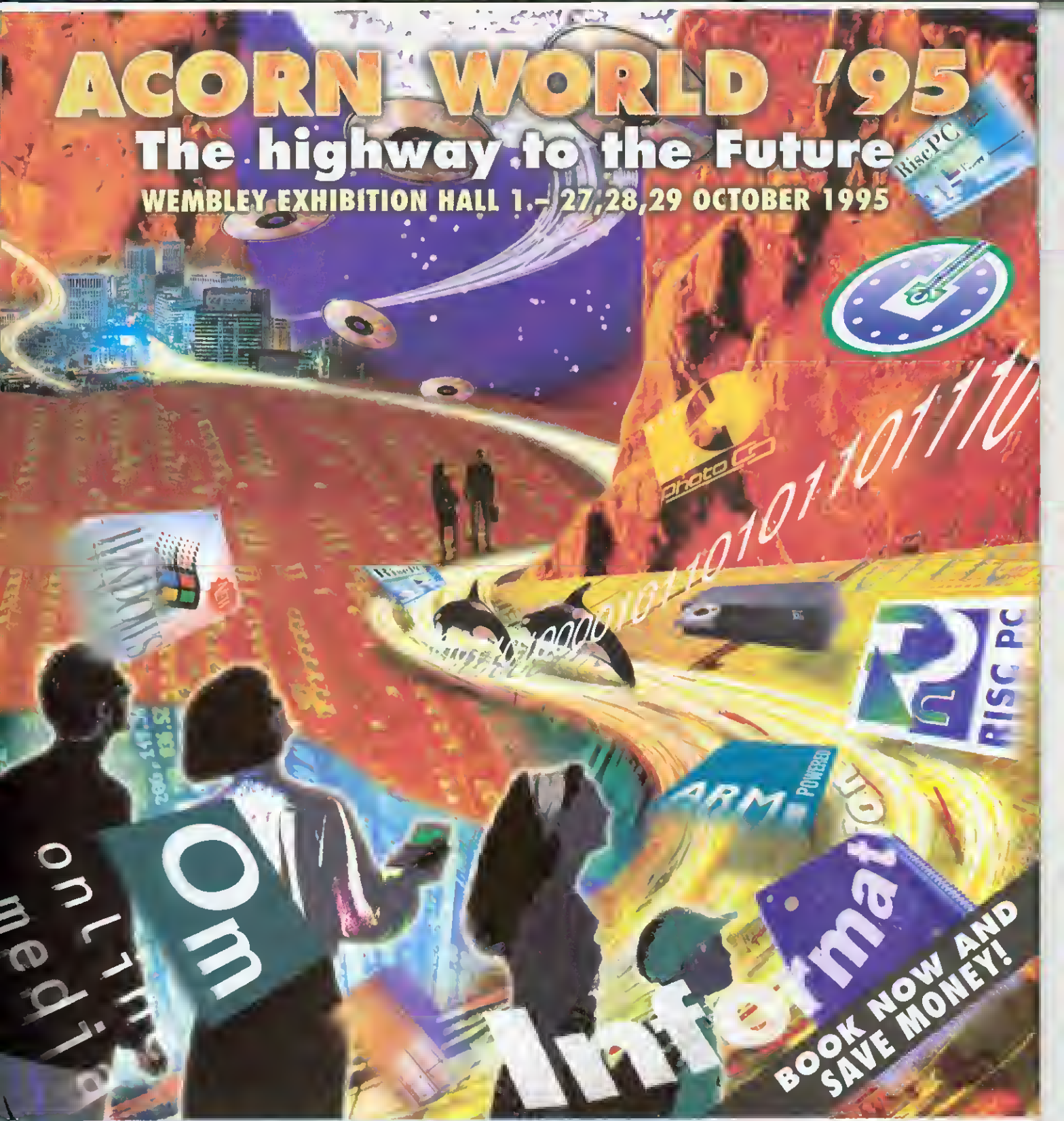

Lag an, hook up or plug into the Information Superhighway. Whichever way you want to enter this new world, Acorn World '95 promises to be the best event of the year. Come and get real, hands-on experience of all the latest desktop products. Learn from the experts at the live theatre presentations. See the revolution in home services being created by Acorn's "Set-Top Box" technology. Plus jugglers, face painting, a games arcade, competitions with prizes. A FREE crèche and over 100 exhibitors showing what's new and exciting in the world of IT.

SPONSORED BY  
**ACORNUSER**

NAME .....  
ADDRESS .....  
POST CODE ..... TEL .....

TICKET TYPE	ON THE DAY PRICE	ADVANCED PRICE	SAVE	NO OF TICKETS	AMOUNT
ADULTS	£6.00	£5.00	16%	<input type="text"/>	<input type="text"/>
CHILDREN	£5.00	£4.00	20%	<input type="text"/>	<input type="text"/>
FAMILY	£20.00	£16.00	20%	<input type="text"/>	<input type="text"/>
				TOTAL	<input type="text"/>

All cheques made payable to Acorn Direct.  
Please return your booking form to:  
**ACORN DIRECT**  
13 DENINGTON ROAD  
WELLINGBOROUGH  
NORTHANTS NN8 2RL

WEMBLEY EXHIBITION HALL 1  
27, 28, 29 OCTOBER 1995.  
DON'T MISS THE OPPORTUNITY  
TO SAVE £££  
**BUY YOUR TICKETS NOW!**



Windows screen shot ©Microsoft Corporation

**ADVANCE TICKET AND INFORMATION HOTLINE: 01933 441448**

**Acorn**





## Easiest ever PC exchange

**NEVER** say that no-one listens. Back in the Business issue (last August) we wrote that 'the absence of Novell compatibility to the Acorn world is a major drawback to commercial users. Until an Acorn can sit on the same network as and share resources with PCs, this will continue to be a problem.'

A year on, and not only can we connect onto large PC networks (with Acorn's *Omniclient*), but we can also connect PCs to *Acorn Access* networks (with KCS' *Arcshare*). Furthermore, an increasing number of programs can import and export using 'industry standard' file formats.

*Arcshare* has only just been released and I expect it will be popular with small businesses. Now, companies with just a handful of mixed machines can share files without running around with discs. What's more, *Acorn Access* is a 'peer-to-peer' system so no dedicated file server is required. *Arcshare*

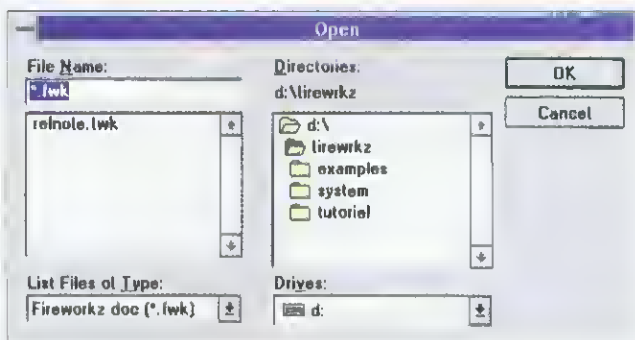

If you're unfortunate enough to use Windows, you'll see plenty of dialog boxes like this (no 'ue'). RISC OS users simply double-click on file in a directory display. But there's one thing that can be said as a plus for both systems of loading files. With *ArcShare* or *Omniclient*, each operating system can access the same files from networks.

is a piece of Windows software which, in conjunction with a cheap Ethernet card, allows PCs to plug into *Access* networks with no hassle.

Acorn users can load and save all the important graphics, spreadsheet and database formats. There will probably be readers shaking their heads at the mention of database format, but all good PC databases load and save CSV (comma separated variable)

files. The same applies to RISC OS databases. There is a reason why CSV is not suitable for transferring spreadsheets – formulae aren't kept. But how many name and address databases have formulae in them? Of course, if you want to transfer actual database applications rather than just data, dream on...

Kimberley Computer Services  
Tel: (01942) 677777

## Spreadsheet – power or ease of use?

**REGULAR** readers may have guessed that I use *Fireworkz Pro* (£149) as my spreadsheet. It's powerful, has an attractive button bar and gets regular updates. Does it really matter if the check-as-you-type spell checker beeps when you type correct words?

However, *Fireworkz Pro* is far from offering white simplicity – changing the font and other effects is a pain (see *AU* May 1995). When questioned on whether the effects system was intuitive, one employee at

Colton replied 'very.' On the other hand, Mark Colton thinks it is a little old now and we could well see a new design.

In the iSV Products camp, there is a product which is simple to use. It's called *TableCalc* (£31.50). It doesn't have names or custom functions, or graphing or drag-and-drop; what it does present is ease of use. In fact, it's ridiculously easy to use. Nicely designed windows and a save dialogue box identical to the one in the RISC OS Style Guide (see picture) make this delightful to use. Whatever *TableCalc* lacks in features it more than makes up for in its low price and interface.

Clares' *Schema* (£114.89) is often criticised for being difficult to use. This is utter nonsense. It has a revolting button bar (though if you picked up the July issue,

you will have some nice-looking replacements). More importantly, its menu structure and dialogue boxes are very easy to use, if a little rushed-looking. If *Schema* had a little more control of page layout and Clares draughted in a Style Guide fanatic, it could become a best-seller.

As for *Eureka* (£119), it is a spreadsheet which people seem either to love or hate. Very similar to Microsoft's *Excel*, it is definitely the best solution for those with a mixed computer environment. I would not recommend that users purchase the PC version of *Fireworkz* as I have found it unbearably bug-ridden.

Longman Logotron  
Tel: (01223) 42558  
Clares Micro Supplies  
Tel: (01606) 48511  
iSV Products  
Tel: (01344) 55769  
Colton Software  
Tel: (01223) 311881

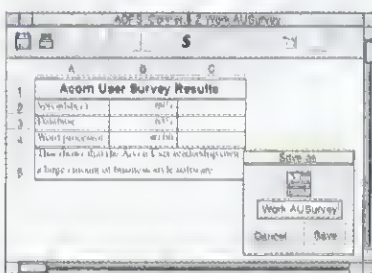

*TableCalc* – low on features, but cheap and easy to use.

### Learning to type

It's a sad fact that most office workers can't touch type. I have to profess I can't either. *Touch Type* from Iota Software is the best-known learn-to-touch-type program for RISC OS and is probably the finest. A new version is in the pipeline for early next year which will allow users to pick the keyboard layout their machine has – including the standard British layout which the Risc PC has.

Iota Software  
Tel: (01223) 566789  
Fax: (01223) 566788  
E-mail: admin@iota.co.uk

### Bitz and bobz

Colton 'Z' users among you who want to change the icons on the button bar and items in the menus should look at a couple of files in a text editor. They are *!Appname.Resource.Config* and *!Appname.Resource.Choices*. *Choice18*. If, on the other hand, you would prefer to get rid of the loading screen, delete the file *!Appname.Resource.15prite*. Before you do anything, make sure you have a backup just in case.

### Finance manager

A new company – Solloway Software – has released what it claims to be a 'powerful, flexible accounting application for personal, home or club accounting'. *Finance Manager*, as it is called, is fully editable like *Apricote's Personal Accounts*, has similar features, but is organised differently.

My advice to potential purchasers is to ask both companies for an information pack and decide for yourself. Competition is always good and this should spur on some rapid development from both companies.

Solloway Software  
Tel: (01908) 233206  
Apricote Studios  
Tel/Fax: (01354) 680432

### Contacting me

You can contact the Business page by writing to me, Alex Singleton, at Acorn User, IDG Media, Media House, Adlington Park, Macclesfield SK10 4NP, or by e-mail to: alex@acornusr.demon.co.uk.

# Composition

*drag and drop ArtWorks files*

*butterfly mask used as template for Vegas image*

*flower masked, smoothed and tinted. Opacity set to 50%*

*frog attacks Ayers Rock*

*plane masked with ward and then anti-aliased*

*sky 'repaired' with ProArt 24 clone tool via OLE protocols*

*horse masked and blends*

*simple masking with ghost effect*

*drop shadow applied*

*edge and anti-alias filters used to tidy edges drop shadow added for emphasis*

*ArtWorks import masked in Compo*

*mask created in Compo and finished in ProArtisan 2*

*circular blend mask used*

**£169.95 inc VAT (P&P free)**

**Special offer price of £85 for ProArtisan 24 owners**

*Introductory offer - £99.95 for users of other art packages*

**CLARES**  
MICRO SUPPLIES

98 MIDDLEWICH ROAD, RUDHEATH, NORTHWICH, CHESHIRE CW9 7DA  
TEL: 01606 48511 FAX: 01606 48512 email: soles@clores.demon.co.uk





# Education

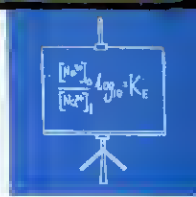

## Sherston now listens

### SHERSTON'S

*Talking Books* and *Talking Topics* have proved to be very popular and, more importantly, very effective. Its latest project is a speech recognition system for schools which will form the basis of *Listening Books*. The system is based on an original speech recognition system called AURIX, developed especially for children by the Speech Research Unit of the Defence Research Agency. Sherston

and the DRA are working together to produce a commercial system for schools by January 1997. Until now, all speech recognition was for adults, but children have very different voice patterns. The hardware for the system will probably comprise a printer port key, headphone/ microphone pack and an interface box. The disc-based talking/listening book software will contain speech patterns of all the words used in the story. The children will be able to read the text, listen to the words, and then be able to



Talking books like this could soon be listening too.

speak back to the computer which will assess how accurately the words have been spoken.

This, I believe, is a significant advance in computer software, with almost endless possibilities. The obvious one is for Key Stage 1 and 2 children who are learning to read, but possibilities are also opened up for special needs children and students for whom English is not their first language.

Sherston will be developing software for their speech recognition system but are

also planning to make it available to other software houses, although the licensing details have yet to be worked out.

Bill Bonham commented: 'This really is a very exciting progression in educational technology. I am sure the potential for education is enormous and am thrilled that Sherston Software has the opportunity to play an integral part in such an important development.'

*Sherston Software Ltd*

Tel: (01666) 840433

Fax: (01666) 840048

E-mail: [info@sherston.co.uk](mailto:info@sherston.co.uk)

## How's it done?

SEVERAL people at the Acorn World Show commented on the lapel badge I was wearing which, although laser printed on card, appeared to have a metallic finish on the words 'Acorn' and 'User'. The certificates presented to the competition prize winners were the same. So, how's it done? Well, it's a product called *Laser Colour* which is available from Paper Direct. To apply colour you begin by printing a document on a laser printer in the usual way.

The *Laser Colour* is in the form of a film and comes in either a roll or as A4 sheets. A piece of the film is cut to cover the print you want coloured and is held in place with 'low-tack' self-adhesive stickers. The sheet is then inserted into the printer again and a blank document is printed.

The printer's heater melts the toner, and the colour from the film is bonded onto it. Remove the film and the colour remains on the

parts the film once covered.

*Laser Colour* is a fairly easy material to use, although care must be taken not to handle the surface that will bond to the toner. A very sharp knife is required for cutting and the self-adhesive stickers must not be positioned over an area which is to be coloured, nor should the *Laser Colour* film be positioned over an area which is not to be coloured.

*Paper Direct*

Tel: (0800) 616244

### Spex augmented

Aspex Computing has released *Spex+* - a significant upgrade to the very successful design program *Spex*. The new version includes many enhancements including improved compatibility with Aspex's other CAD program, *ArchiTech*. Of the many new features, one of the most significant is 'snap to object' which enables the user to more easily position objects side-by-side. Existing environments are fully compatible with *SPEX+*, and more environments are expected shortly. The upgrade price from *SPEX* to *SPEX+* is £14.95, and the outright price of *SPEX+* is still an amazing £99 for a full licence.

*Aspex Computing*

Tel: (01822) 611060

Fax: (01822) 611061

### Headphones to the rescue

Thank you for the several letters I received about the increased amount of computer-generated sound in the IT rooms. A couple of people came up with a manufacturer of 'indestructible' headphones which are available through most county suppliers.

Ivan Howlett of Chesterton Community College supplied a neat solution for eliminating the need for students to grope around behind the computer to plug in headphones. For each computer he simply purchased a one metre headphone extension lead for about £1.30. This is plugged into the back of the computer and the socket on the other end of the lead is secured to the leg of the table by drilling a hole in the leg exactly the same size as the socket, and force fitting the socket into the hole so that it is just visible from the front. Thanks Ivan.

### Contacting me

You can contact the Education page by writing to me, Geoff Preston at Acorn User, IDG Media, Media House, Adlington Park, Macclesfield SK10 4NP or by e-mail to [GPreston@arcade.demon.co.uk](mailto:GPreston@arcade.demon.co.uk).

# Portables

## Blowing bubbles

**THE** two newest editions to the Canon BubbleJet range – the BJ-30 and BJC-70 – have both been designed with the portable user in mind. The BJ-30 is the replacement for the popular BJ-10 while the BJC-70 is an all-new colour model. Both measure a minute 300 x 157.6 x 57mm and weigh a mere 1.4kg, have an integral 30 sheet paper feeder, offer LQ and BJ emulation and resolutions up to 720 x 360dpi.

The BJ-30 has a print speed in the region of 2.5ppm (text) and 1.5ppm (graphics). The print quality, especially at 720 x 360dpi, is excellent and the banding effect common on many bubble jets is barely noticeable. The black cartridge is separate from the printhead and will do about 130 pages before needing to be replaced. This is a very simple job as the ink tanks simply click in and out of the print head. At a cost of around £14 for three cartridges, the BJ-30's running costs are one of the lowest for any bubble jet.

The BJC-70 offers all the features of the BJ-30 but has an increased mono print speed of 3.3ppm (text) and 2.2ppm (graphics) and also full colour printing with a true black. The BJC-70 has an interchangeable print head, one designed to hold a large black cartridge and another which holds both a three colour and black ink cartridge. The colour output of the BJC-70 is excellent, especially when using Canon's coated or glossy paper and compares very favourably to the 720 x 720 dpi output of the much larger (and more expensive) Epson Stylus Color.

As expected, both printers work very well with the A4. Print quality using

Acorn's BJ-10 driver is excellent, although I really would recommend upgrading to CC's *TurboDrivers* as the speed increase they offer, without sacrificing quality, is amazing. Both models would make an ideal companion to the A4 but I would highly recommend that, if you can afford it, you buy the BJC-70.

If you are a Pocket Book user, the BJ-30 has to be the machine for you, unless you have a need for colour on another computer. The BJ-30 allows you to print in LQ or BJ emulation – the Pocket Book can handle both – although my advice is to opt for the LQ emulation. This allows you to use most of the BJ-30's internal fonts at various different font sizes and by using the Pocket Book's graphics set simple DTP is possible.

Having used the BJ-30 and BJC-70 for three weeks in various different situations, I have become a great fan of both printers. They are ideal for any Pocket Book or A4 user, being economical, fast and, if the BJ-10 is anything to go by, very reliable.

Canon UK  
Tel: (0500) 246246  
Computer Concepts  
Tel: (01442) 351000



The excellent BJC-70 colour printer from Canon.

## SoundMaster compatible

Included in the Psion 3a and Pocket Book 2's application suite is a recording facility which, until recently, seemed to have little use. However, this could all change with the launch of a sound sampling package from Psion. *SoundMaster* is able to manipulate your samples in many different ways and a large number of effects are possible.

The package is supplied with 50 extra sound samples, from classical pieces to car horns and slamming doors, all of which can be copied into your sample. The program costs £24.95 inc VAT, and I hope to be taking a more detailed look at it in the near future.

Psion plc  
Tel: 0171-262 5580

## Downloading

I recently received a letter from a reader who is experiencing problems downloading software from The Datafile's PDCD1 and it occurred to me that many other people may be having the same problem.

The answer is to load *PocketF5* and then use the 'Open S' menu option. This will bring up a window containing two or more directories, one of them called *M*. Double-click on this directory and then on the *APP* directory and place any applications in here. Then on the Pocket Book use the 'Install Application' option – select the program you wish to install and then press Enter. Your program will then be installed.

## A rich Ovation

*Ovation* users currently suffering from depression due to the program's inability to import RTF files will be pleased to hear that its rather impressive looking replacement, *Ovation Pro* will solve all your problems, when released.

Beebug Ltd  
Tel: (01727) 840303

## Contacting me

You can contact the Portables column by writing to me, Mark Taylor at *Acorn User*, IDG Media, Media House, Adlington Park, Macclesfield SK10 4NP or by e-mail to: markt@acornusr.demon.co.uk.



# The Theodore Set

Theodore Fancy open  
 Theodore Tooled  
 Theodore Regular  
 Theodore Open Theodore Bold  
 Theodore Fancy

Only £27.50 fully inclusive



**Gothic & Medieval**  
 Fonts and Decoration

Collection of outline and Draw fonts along with Complimentary Decoration & Examples Supplied on 4 Disks. The Package includes 3 Outline Fonts

**Karen**  
**Charlie**  
**Priory**  
**VERSALS**  
**Carol**

There are 4 complete draw alphabets including dozens of decorative elements to customize your own letters plus dozens more draw objects for making up borders and motifs. The ideal package for creating Posters, Certificates Stationery, embroidery designs and much much more.

**£37 inclusive.**  
 of VAT & p&p



Almost 1 gigabyte of PD and Shareware

## SPECIAL OFFER

PDCD-1 and 2 together

**ONLY £55 inclusive**  
 98% RISC PC friendly

## FREE Catalogue disc

During August you can get a free copy of our catalogue disc 26 by sending a stamped, self addressed jiffy bag stating HD or DD.

.....  
 We can offer you 1500 discs containing almost 12000 archived files.

.....  
 Our catalogue system is the only one to get the Archimedes World Power PD Award.

.....  
 We now have some great Red Dwarf Replay movies



**THE Datafile**

THE

fax 01934 823005

71 Anson Road, Locking  
 Weston-Super-Mare, Avon  
 BS24 7DQ

Tel 01934 823005

**THE Datafile**

THE



# Cover disc

## Plantwise demonstration

by Sherston Software

**THIS** is a demonstration of Sherston Software's innovative multimedia program which shows the inner workings of plants. It is fully-working, but only contains a fraction of the data of the full version. Even though it is a cut-down version, you can get a good idea of the care and detail that have gone into the programming. The two topics that have been included are the 'leaf' topic in the structure section and the 'seed dispersal' topic in the reproduction section.

To see what topics have been included, click on the 'Fast find' button on the tool bar. Those topics available have an orange background. The 'What

word?' button opens a window showing all the technical words associated with the topics, and giving definitions of them.

In the demonstration version, this list is naturally restricted to those topics included. The icon bar menu allows you to choose whether the labels accompanying the topics are worded simply or at a more advanced level.

The full version of *Plantwise* is available from Sherston Software at a cost of £44.95 + VAT. See the *!ReadMe1st* file in the archive for more details.

*Plantwise* will work on all versions of RISC OS, from RISC OS 2 upwards.

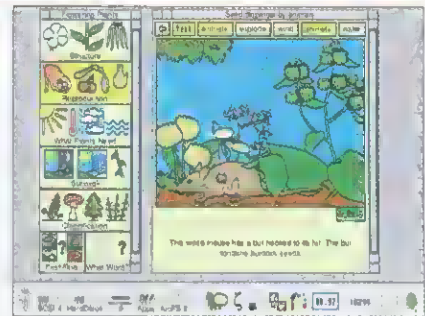

Sherston Software  
Tel: (01666) 840433  
Fax: (01666) 840048  
E-mail: sales@sherston.co.uk

## ClicBack

by Steve Spry

**THIS** Careware program is a fully-featured hard disc backup utility. It recently won the APDL Shareware of the year award, and has been recommended on the Questions and Answers pages of *Acorn User*. Among its many features are:

- Full or incremental backup available.
- Back up to floppy, Syquest or another hard drive.
- Variable data compression rates when backing up the drive.
- Retrieval of individual files from the archive.

- Parts of the hard drive – directories or files – may be backed up or excluded from the backup.
- Option to verify the data as it is saved.

Given the list of features of *ClicBack*, it is remarkably easy to use. Install it on the icon bar and click on the icon to open a window. Choose the drive to be backed-up and the drive to store the backup, either by typing into the writable icon, dragging a file or a directory to the icon or using the pop-up menu for the destination. If a file is dragged to the writable icon the path-name of the directory containing the file is entered. The window will also set the type of backup required and whether it is a full, incremental or differential backup.

The pop-up menus in *ClicBack* are slightly non-standard, in that you have to use the Menu button on the mouse to open them – you cannot use Select as you would normally be able to. If you run *ClicBack*, quit and then try to run it again, you may get the error '*Clicback* is already

running.' If you do, then run the *ClicBack.!Boot* file, which should reset the relevant system variable.

Be warned that if you perform a full backup on a hard disc of any size this will involve a lot of floppy discs and disc swapping.

For more information on running *ClicBack*, consult the comprehensive *!Help* file. Interactive help is also supported.

Because *ClicBack* is Careware, if you find it useful you should register. Money from registrations goes towards the Cancer and Leukaemia In Childhood Trust (CLIC), a registered charity. Registration costs £10 – please send a cheque or postal order payable to 'Steve Spry' to: Steve Spry, 36 Moreton Avenue, Bideford, North Devon EX39 3AY, along with a blank formatted disc. More details are in the *!Help* file.

Both *ClicBack* and *ClicLogs* should be copied out of the archive onto another disc before use, as the program will attempt to write information back to them when it runs. *ClicBack* needs RISC OS 3.1 or greater to run.

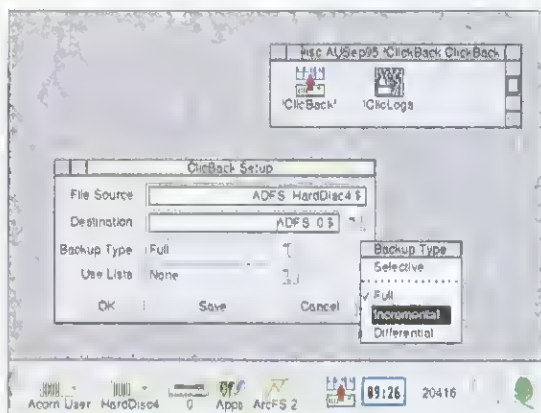

## Regular features

Various authors

**THERE** is also the standard range of items on the disc which tie in with articles in the magazine:

- Our ever-popular C tutorial this month reaches linked-lists, a fascinating way of storing data perfectly suited to illustrating the use of pointers with structures. Study the program closely; all uses of pointers in C can be confusing if you're not used to them, but pointers when used with structures are especially hairy.
- In the *Education* directory, you will find a *Junior Pinpoint* file by Colin Rouse. The file is a sample questionnaire, as described in his *Junior Pinpoint* review in the magazine, and needs *Junior*

*Pinpoint* to run it.

- Mike Cook's latest incarnation of his *PortMon* program is in the *RunTheRISC* directory, as he exchanges new ports for old on pre-A5000 machines.

- That old faithful \*INFO section is still going strong. There's a neat little utility to give your machine a name, another annoying *Tetris* variant, a module to swap your mouse buttons round – guaranteed to break the ice at parties – and a program to generate pictures which need to be viewed with a tube of foil; foil not provided.



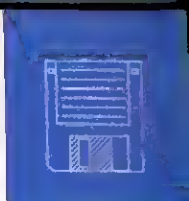

# Lorem Ipsum

by Tony Howat

**LOREM IPSUM** is – to quote the *!Help* file – unadulterated drivel. It is pseudo-Latin designed to create text that ‘looks right’ but which in practice is meaningless. The text is arranged in sentences with paragraph breaks, just like normal text.

This does admittedly beg the question: ‘Why?’

Actually, it’s very useful for DTP work. If you are designing a page layout, you need a block of text to test that the design looks right. Obviously, you can write some yourself, but this suffers from the problem that you will have to write at least one and preferably several pages of text to get enough variety to really test the design. What you really need is a program to generate any amount of correct-looking text – you need *Lipsum*.

*Lipsum* installs on the icon bar like any other application. Clicking on the icon with Select opens a window containing a number of options and a text file icon. When this is dragged to another window, some *Lorem Ipsum* text is sent to that application or (if it is a Filer window) saved to a file. The amount of text generated is controlled from the options in the *Lipsum* window; a friendly window pops-up once the text has been generated to let you that *Lipsum* has done it.

*Lipsum* is very straightforward to use, although there are some

problems saving text direct into another application on the Risc PC. If you have trouble, simply save the text to a file and load it into the application in two separate operations.

*Lipsum* requires RISC OS 3.1 or greater to run.

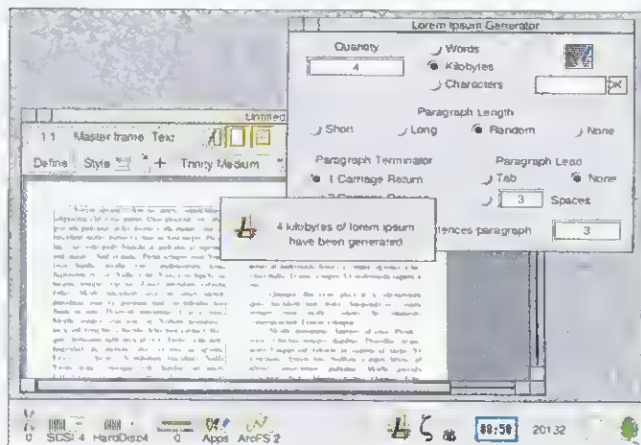

# Cover disc news

**WE** at *Acorn User* are very sorry to report the break-up of the Insight programming team responsible for *HomeWorks*. Both programmers have now moved on to other jobs within the Acorn market that do not allow them the time to continue developing the program.

For this reason, there will unfortunately not be any further parts of *HomeWorks*. *Acorn User* apologises to all our eager readers who were

awaiting the database and word-processor modules. We had hoped that the programmers might be able to finish them, albeit more slowly, but this has not proved to be the case.

Apologies also to everyone who was trying to find the *StarFighter 3000* codes on the cover disc of the last issue – they were inadvertently missed off. Sadly, no one noticed this until after the

magazine had been in the shops for a week, by which time this month’s disc had been sent off. They will appear next month – honest!

Chris Taylor – who wrote the *MacroLife* program on the July cover disc – reports that he has now made it RISC OS 2-compatible. Interested readers should contact him at the address given in that issue of the magazine.

Chris Jordan of Hybrid

Technology has revealed that there are a few full manuals for *Elite* still available on a first-come, first-served basis at £10 each. Commanders who want the full manual, trading record pad, ship ID cards, key strip, colour poster, registration card and shirt order form should send £10 to Hybrid Technology, 1 Winship Road, Milton, Cambridge CB4 6BQ. But hurry – stocks may not last long!

# Disc information

The majority of our survey responses suggested that readers wanted more software packed on the cover disc. In order to do this, we have removed the *Menu* program.

RISC OS 3 users will normally be presented with the usual display of icons; they can open the archives by double-clicking upon them (this is the equivalent of the ‘View’ option in the *Menu* program). To get help on an archive, RISC OS 3 users should choose Help from the App. ‘Appname’ submenu obtained by clicking with Menu over the archive icon. If *ArcFS* is included in your boot sequence, you will need to run it before the archives are displayed as applications, though they will open as normal archives.



RISC OS 2 users will have to work slightly harder. They should first run *ArcFS*, which is the program which uncompresses the data in the archives. Double-clicking on an archive will open it, revealing a *!Help* file, a *!Run* file, a *!Sprites* file and a directory containing the archived data. Loading the *!Help* file into a text editor will give information on the archive contents.

If your disc is faulty, then you should either return it to TIB, TIB House, 11 Edward Street, Bradford, Yorkshire BD4 7BH (if it does not verify or is damaged) or to the editorial office at *Acorn User* (if it verifies). The *Acorn User* cover disc has been checked for viruses using *Killer* version 2.002 from Pineapple Software.

# SEN LAC Computing

PO Box 304

Brighton

BN1 1LE

Callers by appointment

Tel: (01273) 208074

Fax: (01273) 738258

e-mail: pete@senlac.co.uk

Compuserve: 100113,603



Big news this month is the launch of Acorn's new A7000 and the second generation of Risc PCs. Prices are, of course, as good as usual.

One or two people have shown concern that we don't make it clear enough that our prices include VAT so it can look as though we are dearer than is really the case. OK then...

**"All our prices include VAT and UK mainland delivery. WHAT YOU SEE IS WHAT YOU PAY!"**

If you run a school or business don't forget that our leasing scheme offers an easy way of obtaining your computer(s) and if you are leasing a Risc PC you can still take advantage of our extra cash/cheque discount.

**PC Card:** Don't forget that we are also PC dealers so are in the best position to offer you the keenest deals on PC software including the amazing Xara Studio from the Computer Concepts stable.

Of course, it's impossible to list everything in an advert this size so if you don't see what you want, please call.

Pete Sykes  
**Acorn**

Dear SENLAC Computing, PO Box 304, Brighton, BN1 1LE,  
I wish to order these items from you. I'm glad that I don't have to pay any more for UK postage and packing and that the prices you quote include VAT.

Item

My name and address are...

... and I'd like to pay...  
 with the enclosed cheque  
 by Access/Visa/Delta/Connect/Switch

Number: \_\_\_\_\_

Expiry Date: \_\_\_/\_\_\_/\_\_\_

Signed:

Date:

Post Code:

Tel:

## Accounts

Personal Accounts v3 ..... 43.00  
Prophet ..... 168.00

## Art & Graphics

Artworks (on floppy or CD) ..... 145.00  
Complete Animator ..... 94.00  
ImageFS ..... 34.95  
Image Outliner ..... 83.50  
PhotoDesk ..... 180.00  
Plot ..... 74.00  
ProArtisan 2 ..... 119.00  
ProArtisan 24 (Risc PC only) ..... 160.00  
Studio 24 ..... 128.00

Dune II ..... 32.50  
Flashback ..... 24.95  
FIT (Formula 2000) ..... 23.25  
Global Effect ..... 32.00  
Lemmings Pack for Risc PC ..... 25.50  
Lemmings 2 - Tribes ..... 25.50  
Magnetoids ..... 22.50  
Sally and Wally ..... 22.50  
Scrabble ..... 24.95  
Sim City 2000 (RiscPC) ..... 35.00  
Sim City 2000 (A5000) ..... 35.00  
Simon the Sorcerer ..... 35.95  
Simon the Sorcerer on CD ..... 43.00

Fireworkz Pro ..... 160.00

## Music/Sound/Vision

*Extra Discount for Bundles - Ask*  
Fatar CMS61 Keyboard w/s ..... 260.00  
DMI30 (A3/4xxx MIDI i/f) ..... 85.00  
DMI50 (Dual MIDI i/f) ..... 97.70  
Eagle M2 ..... 360.00  
iTV TV Tuner Card ..... 225.00  
Lark A16 Sampler ..... 225.00  
MIDI Max ..... 75.00  
PowerWave 30 (inc DMI 30) ..... 208.00  
PowerWave 50 (inc DMI 50) ..... 229.00  
Rhapsody 3 ..... 88.00  
Serenade ..... 88.00  
Sibelius 6 ..... 165.00  
Sibelius 7 Student ..... 540.00  
Sibelius 7 ..... 875.00  
Yamaha M10 Speakers ..... 65.00  
Yamaha MSW10 Sub-woofer ..... 95.00

## Printers

Brother HL660 (600dpi, 6ppm) .. 615.00  
Canon BJ-30 ..... 220.00  
Canon BJC-4000 ..... 355.00  
Canon BJC-600e ..... 420.00  
Epson Stylus Colour (720dpi) ... 430.00  
Turbo Drivers ..... 49.00

## Scanners

Epson GT8500 + TWAIN & ImageMaster .. 585.00  
Epson GT9000 + TWAIN & ImageMaster .. 720.00

**!!NEW!!**

Make the professional connection between your Acorn computer and Amstrad NC100 with N-Connect.

**£24.95**

Contact us for details

## Communications

ArcFax ..... 33.00  
ArcTerm 7 ..... 68.50  
Courier v34 Fax (with cable) ... 325.00  
Hearsay 2 ..... 76.95  
Sportster v34 Fax (with cable) ... 220.00

Star Fighter 3000 ..... 27.00  
Spobbleoids ..... 22.95  
Wolfenstein 3D ..... 27.00

## Hypermedia

Genesis Professional ..... 130.00

## Integrated Packages

Fireworkz ..... 103.00

## Consumables

Inkjet Refills ..... from 14.50  
Print'n'Wear Packs ..... from 6.94  
TDK DS/HD 3 1/2" Discs ..... 8.50

## Databases

Data Power ..... 145.00  
Junior Database ..... 57.00  
S-Base 2 Personal Edition ..... 140.00

## DTP/WP

Easy Font 3 ..... 35.00  
Formulix ..... 75.00  
Impression Publisher ..... 145.00  
Impression Publisher Plus ..... 285.00  
Impression Style ..... 88.00

## Games

Arcturus ..... 22.50  
Big Bang ..... 14.50  
Burn Out ..... 22.50  
Cannon Fodder ..... 21.50  
Crystal Maze ..... 36.50  
Cyber Ape ..... 18.75  
Dreadnoughts ..... 25.75

## NEW! A7000

ACM02 A7000 2Mb/HD425 ..... 1090.00  
ACM03 A7000 4Mb/HD425 ..... 1165.00  
With Acorn Dual Speed CD ROM ..... add 130.00

## NEW! Risc PCs

ACB60 Risc PC 600 4Mb/HD425 ..... 1335.00  
ACB70 Risc PC 700 5Mb/HD425 ..... 1585.00  
ACB75 Risc PC 700 10Mb/HD850 ..... 1970.00  
With 17" Monitor ..... add 315.00  
... or Acorn Dual Speed CD ROM ..... add 130.00

A7000 & Risc PCs include 1 year's free on-site maintenance.

### Schools/ Businesses

Lease a Risc PC from as little as £39.00 per month over 3 years. Call for details.

### Paying by Cash, Cheque, Switch, Connect or Delta?

You may deduct an extra £35 discount from the VAT Inclusive price of your Risc PC!!

### A selection of A7000/Risc PC bits 'n' pieces...

8Mb SIMM ..... 245.00  
16Mb SIMM ..... 399.00  
32Mb SIMM ..... 795.00  
Cumana proTeus 4x CD ROM/650Mb MO Drive ..... 635.00  
Cumana SCSI 2 Interface ..... 190.00  
Special bundle: SCSI 2 + proTeus save £20 ..... 805.00  
Early Years Bundle (A7000/Risc PC 600 only) ..... add 50.00  
Learning Curve Bundle (A7000/Risc PC 600 only) ..... add 50.00  
Home Office Bundle (A7000/Risc PC 600 only) ..... add 85.00



# Code name Kryten

There's a new machine in the Acorn town, and the one-year-old Risc PC has been given a birthday makeover. That's the welcome news from Acorn this month. The A7000 (codenamed Kryten during development) is based around the ARM7500 chip, and is in essence a Risc PC with no VRAM or co-processor slot, and reduced expansion capabilities. The Risc PC 600 now boasts full 16-bit sound as standard and a newer version of RISC OS (which comes in all the machines) in ROM. The new Risc PC 700 is similar, but has a fast ARM710 chip inside.

There are a few enhancements common to all the new machines. All of them have:

- RISC OS 3.6 (see separate box for details)
- 16-bit sound as standard
- an on-board mixing point for CD, internal, and external sound which could be seen as raising them to the standard the Risc PC should have been at when it was originally released.

## The A7000

Acorn's A7000 machine can be considered as replacing the A5000. It is pitched between the A4000 – which is still in production – and the Risc PC. It follows the philosophy of the A3020 and A4000 as it is based around a single chip which combines the functions of processor, VIDC, MEMC and I/O chip, in this case the ARM7500.

This leads to an extremely compact design of computer. The circuit board for the A7000 contains the ARM7500, two ROMs with RISC OS 3.6 on, sockets for up to 8Mb of RAM, a SIMM slot for extra memory and a slot for an optional backplane. Aside from a few other connectors, that's pretty much it. Although the circuit board on the A7000 is the same size and shape as the Risc PC – and the connectors on the back of the machine are in identical places, meaning that either board can in principle sit in either case – the machine itself is smaller. It's also more robust,

The long-awaited new machine from Acorn has finally arrived in the shape of the A7000. The Risc PC has also been updated with two new models. David Matthewman reveals all.

having been designed to survive seven years of continuous abuse in schools.

The main features of the A7000 are as follows:

- 32MHz ARM7500 processor.
- 16MHz memory, running off the halved clock signal from the crystal that drives the processor. However, a second crystal can be added, allowing the memory and processor to run at different rates – a 40MHz ARM7500 processor is not ruled out.
- 2, 4 or 8Mb of RAM soldered onto the motherboard, with one SIMM slot able to take a Risc PC-style SIMM upgrade up to 128Mb.
- A single 27pence speaker for sound output, better – and louder – than the 21pence one in the Risc PC but still no substitute for connecting speakers to the jack socket in the back of the machine.
- Either a 32-bit expansion card or a 5.25in floppy – for instance – the optional ATAPI IDE CD-ROM drive. The 32-bit expansion card has an EBI slot to take standard modules, though with no DMA as there would be on the Risc PC.
- A bi-directional printer port and a serial port offering speeds of up to 115,200bps, as on the Risc PC. The printer

port's performance has been improved.

- Keyboard connection as on the Risc PC.
- An IBM PS/2 mouse, not a Quadrature mouse.
- A network socket as on the Risc PC, removing the need to use the expansion



The A7000 boasts a compact and robust design. The ATAPI CD-ROM drive shown here is optional – the A7000 can take a single expansion card, but only if it has no CD-ROM drive, as they occupy the same physical space inside the machine.

## New machines from Acorn

slot for networking. Acorn's *Access+* software comes on the hard drive, and *Access* is now built into ROM. The network socket may be used instead to connect PC-style analogue joysticks.

- A Connor 425Mb IDE hard disc on the more expensive models.
- One (and emphatically *only* one) floppy drive.
- No VRAM or second processor possible, and the ARM7500 chip cannot easily be upgraded.

All this adds up to a very nippy machine. While the A7000 is currently aimed fairly and squarely at schools, there is a lot to attract the home user and small businesses. The A7000 is between three and four times faster than the A4000 – in fact it is slightly faster than existing Risc PCs with no VRAM. The VRAM, in any case, only helps the Risc PC in high-bandwidth screen modes. The lack of VRAM on the A7000 is also noticeable in the range of Desktop modes available; 32 thousand colour is only available in 640 x 480, and 16-million colour not at all. 16-million colour modes are, of course, possible outside the Desktop and, as on the Risc PC, the palette in 256-colour modes may be varied throughout the 24-bit colour spectrum.

For anyone who does not do extensive graphics work, does not need a co-processor and will not use several hardware add-ons, the A7000 could be the ideal computer. Remember that either a CD-ROM drive or a SCSI adaptor can be added to the printer port, so the relative lack of expandability is not quite as restrictive as it appears.

### Faster Risc PCs

Possibly the biggest surprise in the list of new machines from Acorn is the new Risc PC 600. Far from being content to let this machine continue as it was, Acorn has improved its specifications. In addition to the improvements given at the start of the



Scratch off the '6' and add a '7' ... actually, there is slightly more to the new Risc PC 700. Note the new operating system: RISC OS 3.6.

article, the Risc PC 600 now has:

- 4Mb DRAM as standard (no VRAM).
  - A 425Mb IDE hard disc.
  - A faster (33MHz) ARM610 processor.
- This makes it a slightly faster and far more expandable machine than the A7000.

Its big brother is the new Risc PC 700, similar in specification but containing an ARM710 processor clocked at 40MHz. Those who were waiting for the ARM700 and FPA will have to wait a while longer unfortunately, as technical problems have delayed this card, probably until the end of the year.

The ARM710 will be available to existing Risc PC owners as an upgrade for

£100 + VAT, probably around the end of August.

The Risc PC 700 comes in two configurations. One has 4Mb of DRAM, 1Mb of VRAM and a 425Mb hard disc; the other has 8Mb DRAM, 2Mb VRAM and an 850Mb hard disc.

### When can I buy one?

The products should be available during the last two weeks in August. As with the Risc PC, there will probably be a waiting list, so the earlier you get your order in, the earlier you stand a chance of the machine arriving on your desk. Education customers should note that a change in how machines may be purchased is

### RISC OS 3.6

The A7000 and the new Risc PC models are all now fitted with RISC OS 3.6, an updated version of the operating system. This comes on two 2Mb ROM chips and contains a number of enhancements even over RISC OS 3.5 which was fitted to the original Risc PC. RISC OS 3.6 needs fast backing store to operate, so the machine must either be connected to a network or have a hard disc. Major changes are as follows:

**Improved FileCore:** the filing system in RISC OS 3.6 can now address larger hard discs, theoretically up to 4Gb for an IDE disc and up to 16Gb for SCSI. Previous releases could not address more than 512Mb, so this is a substantial improvement. However, the ten-character filename limit and 77-file limit in a directory remain as limitations.

**Applications in ROM:** as with RISC OS 3.1, the standard applications – *Edit*, *Draw*, *Paint*, *Alarm* and *Help* – are in ROM rather than on the hard disc. In addition, *Printers* is in ROM, although of course individual printer drivers will still need to be loaded from disc. *Paint* now has full support

for deep sprites and will convert JPEGs to sprites. The *Draw* module will load and render JPEG files extremely quickly, resulting in a great saving of space because the files only need to be held in memory as JPEGs, not full uncompressed bitmaps. *Paint* obviously cannot perform the same trick, as pixel-by-pixel editing on JPEGs would mean uncompressing and re-compressing the image on the fly each time a change was made. **Toolbox modules:** the *Toolbox* modules distributed with the latest Acorn development system are also built in to RISC OS 3.6, representing a large saving in memory when running a program which uses them. **Networking:** RISC OS 3.6 comes with *Acorn Access* built in, including a long overdue TCP/IP stack. This makes plug-and-play networking simple – just slot in a network card.

The question on the lips of every existing Risc PC owner is, of course, 'Can I upgrade to RISC OS 3.6?' The answer from Acorn is 'Yes, but you'll have to wait until 1996 at the earliest.'



### Pricing for the machines

Acorn has released the new machines at a competitive price, and has lowered the price of its existing models accordingly. In line with its new policy of aggressive pricing for the education sector, the machines are available at a lower price (the REP) to that sector. Note that the REP is lower than the price Acorn will sell to dealers, so there's no use asking your dealer to match it – it's only available direct from Acorn and Acorn's Education Agents to bona fide Acorn education customers. All the prices quoted below exclude VAT.

**Notes:**

(1) The AKF52 is a low-resolution 14in monitor – the high-resolution AKF50 is typically £40 more. The AKF60 is a high-resolution 14in monitor; the 17in AKF85 is available for the Risc PC range for £250 (REP) or £280 + VAT (RRP) extra.

(2) The A7000Net comes with built-in networking card but no hard disc. It must be run as part of a network.

(3) The A7000 and the new Risc PC 600 range can have an optional IDE CD-ROM drive fitted for £100 (REP) or £111 + VAT (RRP) extra.

Machine	RAM	Hard disc	Monitor (1)	REP	RRP
A3020	2Mb	No	AKF52	£449	£509.79
A4000	2Mb	210Mb	AKF52	£599	£722.55
A7000Net (2)(3)	2Mb	No	AKF60	£749	£892.77
A7000 (3)	2Mb	425Mb	AKF60	£799	£935.32
A7000 (3)	4Mb	425Mb	AKF60	£875	£1020.43
Risc PC 600 (3)	4Mb	425Mb	AKF60	£999	£1148.09
Risc PC 700 (3)	5Mb	425Mb	AKF60	£1199	£1360.85
Risc PC 700 (3)	10Mb	850Mb	AKF60	£1499	£1692.77

reported on the news pages – if in doubt, contact Acorn.

Acorn intends to build 6000 A7000s between now and the end of the year, which should hopefully satisfy the immediate demand for the machines.

### The rest of the range

The A7000, while clearly a cut-down Risc PC, is not perhaps as cheap and low-end as many people were expecting. This is reflected in the fact that Acorn continues to sell A3020s and A4000s, though it has reduced the price of both. Cheap A3010s are still available as well from many dealers, and the A4 still nominally keeps Acorn in the portables market.

This reflects the relative longevity of Acorn technology. The older machines are neither laughably slow nor unable to run most modern applications, as would be the case with similar-aged PCs. Both the A3020 and the A4000 sell well, and will probably continue to do so despite the release of the A7000. They should currently be regarded as the low-end Acorn machines. Acorn claims to have no plans to replace them, saying there is little scope for cutting the price of the A7000 much further.

A portable based on the ARM7500 is another matter, as the A4 is clearly showing its age. Will there be a prototype or a full machine on display at Acorn World? We'll have to go to find out, as Acorn's cards are very close to its chest on this one. **AU**

### The ARM7500 chip

The compact design of the A7000 is made possible by the custom chip designed by ARM and made by VLSI, the 0.6µ ARM7500. This 240-pin chip combines the functions of the ARM7, VIDC20 and IOMD chips all on a single chip, and has been used in the Online Media set-top boxes for a year now. It comes to the A7000 therefore as proven technology.

A similar design – the ARM250 – was at the heart of the A3010, A3020 and A4000 machines. As was the case with them, it will not be possible to upgrade the A7000 with, say, a faster processor without removing the ARM7500 chip, which would not be easy. However, this should not really be necessary; at 25Mips the 32MHz ARM7500 is currently comparable to a 66MHz 486 DX2, so performance is

currently more than adequate. The chip will address up to 256Mb of DRAM, though the maximum possible in the A7000 is 136Mb. Among the features of the combined chip are:

- ARM704 processor with Memory Management Unit (MMU), 4K onboard cache and 8-word write buffer.
- Video support for 24-bit colour (and incidentally for mono LCD and colour TFT-type panels, which could be useful if a portable version ever appears). The video, cursor and sound data reads all use Direct Memory Access (DMA).
- Two ports for P5/2-style 'keyboards', one of which will in practice usually be a mouse.
- Support for up to four PC-style analogue joysticks.

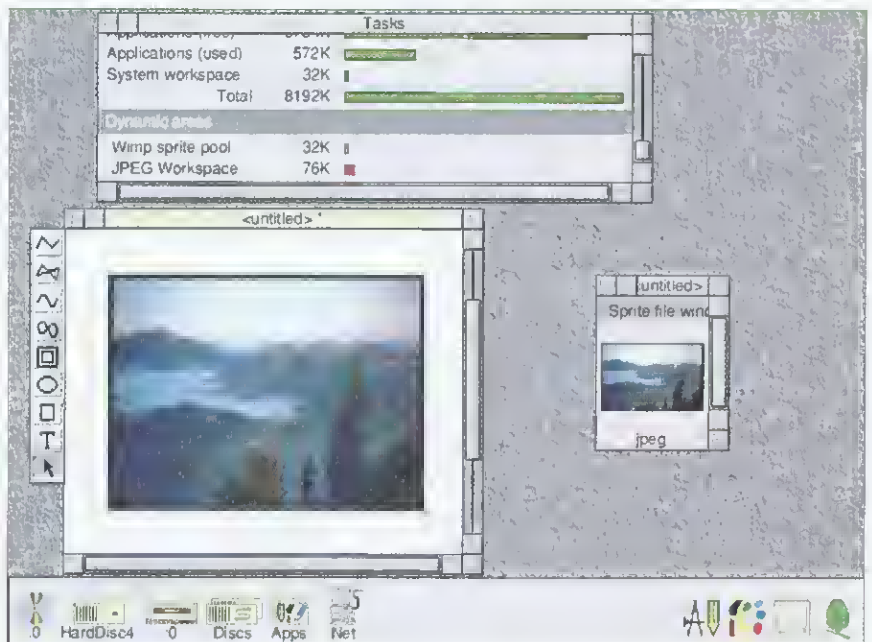

RISC OS 3.6 comes as standard in all the machines. The Acorn Access networking suite is now in ROM, and Draw includes direct support for JPEGs. Note though that the JPEG cannot be rotated, only re-sized, as the fast display routine for JPEGs relies on the image's being horizontal.

### Product details

Your local dealer should have details of the new machines. Otherwise, contact Acorn on:

Tel: (01223) 254254

Fax: (01223) 254262

E-mail: info@acorn.co.uk

WWW: http://www.acorn.co.uk/

**10 out of 10**

TEN OUT OF TEN EDUCATIONAL SYSTEMS

Introducing

THE FUN LEARNING SYSTEM

FOR SCHOOL . . . AND HOME!

SAVE OVER £40

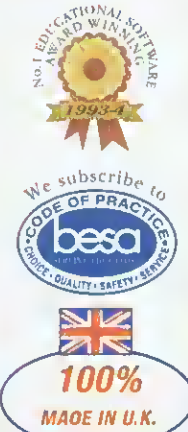
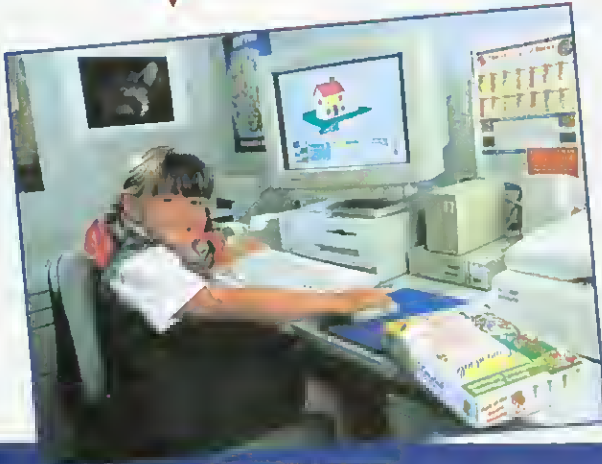

IMPROVE MATHS AND SPELLING IN JUST 15 MINUTES



Great fun as you play and learn



Fast action learning from games

These FUN EDUCATIONAL SOFTWARE PACKAGES were compared by The Times Educational Supplement with systems costing over £1,500 and they concluded: "If the National Council for Education and Technology's researchers ever got round to assessing the impact of a daily 15 minutes with 10 out of 10 they would surely discover real improvements in Maths and Spelling."

If you have children aged 6 to 16 take this opportunity to judge the real improvements for yourself. Buy either MATHS or ENGLISH (or both) at just £4.99 each. The RRP is £25.95 each - A SAVING OF OVER £40!

These are brand new full versions, in attractive durable library boxes with colour manual and you are under no obligation to make any further purchases.

Versions of Maths and English are available on 3.5" Disc for: PC & Compatibles, Acorn, Apple Mac and Commodore Amiga. CD's are also available for PC & Compatibles.



Progress is automatically recorded

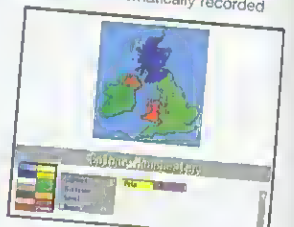

Varied educational challenges

EXCLUSIVE MAIL ORDER OFFER

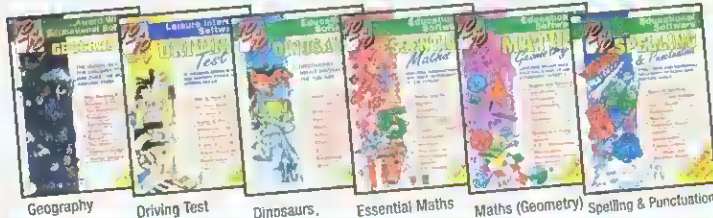
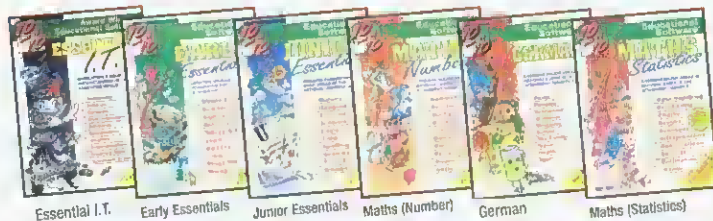

Order either for £4.99 + £1 P & P  
Order both for £9.98 + £2 P & P

AS SEEN ON TV



10 out of 10 as featured on Satellite Television's The Children's Channel!



Steve Butterill (MD) 10 out of 10 interviewed by Granada TV on 'The Program'



MATHS & ENGLISH JUST £4.99 EACH Limited Period Only

WHAT THE PRESS SAYS:

Top Of The League - CD ROM NOW  
Truly Remarkable - Amiga User International  
Great Value For Money - Amiga Computing  
Seriously Useful - PC Plus  
Excellent Value - PC Home  
Children Can't Help But Learn - Acorn Computing  
Highly Recommended - Archimedes World

HOW TO ORDER

Tell us your name, address, type of computer & which titles you want on 3.5" DISC or on CD.

PAYMENT Can Be Made:

BY PHONE  
With ACCESS/VISA on 24hr answering service.

BY POST  
With cheques/PO's or ACCESS/VISA.

BY FAX  
With ACCESS/VISA - available 24 hours.

BY FOOT  
Call in during office hours Monday to Friday  
Please allow up to 28 days for delivery



10 out of 10 Educational Systems  
Troydale Mills, Troydale Lane, Pudsey, LS28, England  
Tel: 0113 239 4627  
Fax: 0113 239 4629

The 10 out of 10 Series only £25.95 each Available From Stores Nationwide!



# I wrote

# that . . .

Four years ago, two BBC *Elite* Commanders were allowed to flesh-out a dream: to write *Elite* for the Archimedes. One of them, Clive Gringras, tells all.

Warren Burch and I met in a computer shop called Fairhurst Instruments in Cheshire. Warren had recently breezed through a Computer and Electronics degree at Durham University; I'd just started my Law degree at the University of Sheffield. Within months of meeting we were churning out programs, each constructed with the same division of energy and skill. Warren was the main coder; I was responsible for the ideas and graphics. And out of that fusion eventually came ... *Trojan*.

*Trojan* was a three-dimensional space game with combat and missions. It was fast, colourful and championed the true power of the Archimedes, with one problem: *Trojan* simply was *Elite*. While Warren and his friend Stephen Pollard brainstormed amendments to prevent the game infringing the copyright in *Elite*, I mused on more legal solutions. I can recall the sound of Warren's jaw hitting the keyboard when I told him of my simple solution: we should write *Elite* for the Archimedes. After much negotiation with the authors of the BBC version, Ian Bell and David Braben, we were finally given the go-ahead. In May 1991, the twenty-hour days commenced.

## Speed or style?

As mentioned earlier, Warren and I had different approaches to the same challenge. Warren would break down a task into logical portions, and then write the quickest, most efficient code to solve the problem. I was the dialectic opposite. Looks and feel were my main concern. This tension between efficiency and

appearance, lubricated with black coffees and shepherd's pies, created the quality that Archimedes *Elite* was heralded for.

The favourite arena for these compromises was in negotiations about the front-end. In *Elite*, ships and other objects in space are represented by 'golf-clubs' superimposed on an elliptical grid, but how do you portray the 'golf-club' as moving over the elliptical grid? If the club is simply re-plotted each frame, the previous club will be left on the grid, creating a mess, so you must delete the previous

club first; there are two main ways to delete this old club.

The quick procedure is to plot over the old club with the same shaped club, but in an EOR colour. For our purposes, this means that the grid 'underneath' the club is left unaffected and the club disappears.

Unfortunately if two clubs cross one another, the crossed area vanishes.

The slower method to delete the clubs is by brute force. Simply 'blit' out all the clubs, 're-blit' the scanner and then draw in the new, moved, clubs. The testing we did on this suggested that it was at least five times slower than using the EOR method. However, when we saw the results of this slower method we were both convinced it was worth it.

The above quandary was not even in the same league as the irritation caused by the golden console itself. Although we knew that the scanner and readouts had to conform to the BBC *Elite* layout, we also knew that we should take advantage of the increased resolution and palette of the Archimedes. I designed about nine different consoles in *Atelier* – each as artificial

as the last. By the time the sprite was compressed into the game, either I would have decided it was awful, or Warren would hate it.

We finally achieved this sought-after depth by chiselling out the centre of the console. This allowed ships and objects to fly slightly nearer without being 'clipped' by the top of the console. Again, it caused a slight speed loss because we couldn't simply blit the whole playing screen as a rectangle, but we were finally happy with the console.

For this reason the triangle-plotting routine had to be frighteningly fast. It was the time-critical aspect of the Archimedes *Elite*. Eighty two percent of game time is spent plotting triangles. Even with Warren's incredibly optimised triangle routine, it remained quicker to recalculate the position of 50 ships than to plot one small fragment of shrapnel. This was why the triangle routine was written in pure Assembler – it had to be rapid.

Of course, not all of Archimedes *Elite* needed to be written in Assembler, due to the 80-20 rule; 80 per cent of the computer's time is spent in 20 per cent of the code. There is no speed gain in using Assembler to plot, for example, trading information; C is very capable and the user will never know the difference. Believe us, apart from taking a further six months to program and debug, a 100 per cent ARM *Elite* would not have been perceptively quicker.

## Ships that pass in the night

It is probably important to correct another rumour about Archimedes *Elite*. We didn't merely use the code from BBC *Elite*, tweak it and then add some colour to ships. The game had to be rewritten for two reasons. First, the code used in the original BBC version was very tight 6502 assembler, a far cry from C and ARM on the Archimedes. The second reason was self-imposed: we wanted to stretch the

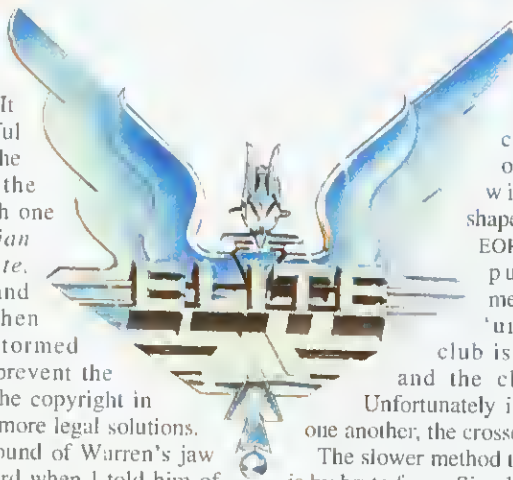

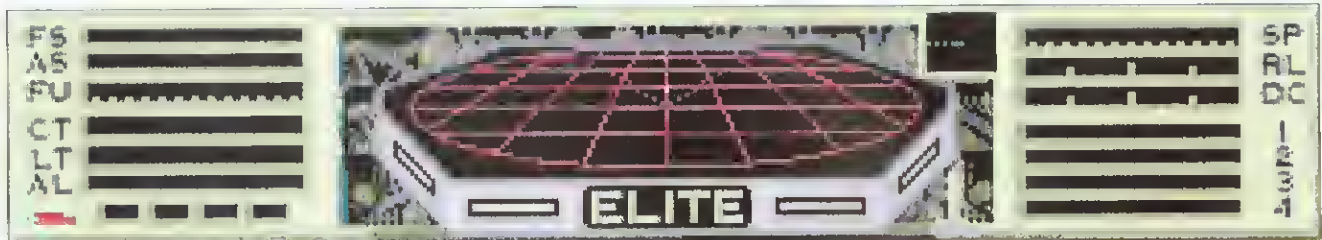

A number of alternative panels were considered, including this one with an 'organic' feel to it.

Archimedes to the limits those two Cambridge undergraduates stretched their BBC to in 1984. It would have been too easy to rewrite a game written for a 32K BBC for a 1024K Archimedes without altering the specification. However, we were of the opinion that Archimedes *Elite* needed more ships, more interaction and more realism.

The creation of more ships was achieved, primarily, with the use of Silicon Vision's *SolidCAD*, the most professional 3D modelling program in the

Archimedes' market. Sculpting a 3D spaceship out of thin air is never easy; one must work in three separate views and attempt to keep in mind a representation of what the craft should look like on completion. With some kind reprogramming of the modeller thanks to Yunas Nadiadi, we were able to effortlessly port these 3D creations straight into our game. All the three-dimensional shapes that appear in *Elite*, everything from the huge Generation Ships and Space Stations to the tiny Escape Capsules and Caimen,

were crafted with *SolidCAD*. We got so carried away with creating new ships, we almost ran out of snake names!

One feature we would have liked to have included in Archimedes *Elite* was point-of-light shading. The reason this wasn't included was not laziness or inability; the Archimedes' palette simply isn't large enough. Either we used 64 colours with, therefore, only four ranges of shade, or 16

colours with 16 shades. Both options looked shabby and less realistic than block colours, and we found dithering the colours looked messy.

This all being said, even choosing block colours isn't easy. One particular choice of colours almost started an argument. I had designed a new-look Boa called, in true *Elite* tradition, the Boa II – sleek, fast and pink. But Warren objected to this colour. So strong was his aversion to pink that on one occasion Warren tried to compile the code without the ship. We finally came to a compromise that we would include on the Ship Datacards that the ship could be resprayed by Berch (as in Burch) Industries on Birera.

### Interaction in action

Our philosophy behind Archimedes *Elite* was simple: the player should not be the centre of attention. To put this into practice, every object in space had its own mission. A ship's behaviour in space was out of our control as soon as the game's ship 'director' had selected them for inclusion in a particular



Warren and Clive's original *Trojan* game, looking remarkably familiar. A number of things changed between *Trojan* and *Elite*; in *Trojan* you could fly straight through solid objects, engage reverse gear and even blow up the space station. Shame you couldn't do this in *Elite*!

### Thanks to...

Jez Swimer was an astonishing editor of the manual, especially as he didn't see the game until the manual was finished. For the actual layout of the manual, thanks go to Charles Moir at Computer Concepts for sticking in the Archimedes market and providing the fine DTP package, *Impression*. Appreciation must also go to the programmers of Acorn's *Draw*, which was used to generate all the manual's drawings, and to Rob Hamilton for providing an early version of *Merc\_lib* for the Wimp Front-End. We must also thank Dr Lee Thompson who worked hard on an *Elite* tune that was sadly never included.

Help for the gameplay came from the able alpha-testing of

Commander William Moffet, Commander Rob Woodgate, and Commander Bob Redrup; the Missionary ships were dedicated to Bob's close friend, the Mad Hatter. Laser physics and space flight were explained by Prav (soon to be Dr) Patel. Many of the mission concepts and cute 'touches' came from Mat Tizard who, in respect, had Zartid m.t.a. named after him.

Obvious thanks go to Chris and Tony at Hybrid and lastly to the first ever *Elite* Commanders – Ian Bell and David Braben – for writing the ultimate space game. Even ten years on there has been nothing to beat *Elite*.



### Where are they now?

For one reason and another, both Warren and Clive said goodbye to programming the Archimedes after finishing *Elite*.

Warren now lives with his wife and daughter in Seattle and works as one of the coders for Microsoft. He's been out there for almost four years now and loves it; he skis, flies a plane, rides his motorbike, hikes up Mount Rainier and still programs into the night.

Clive has just joined one of the largest law firms in London, called

Nabarro Nathanson. They sponsored him through Law Finals and a year as a Law Postgraduate at St John's College, Oxford where he concentrated on the licensing of software. He hopes, eventually, to specialise in Computer Law.

So, as you can see, they're both still very involved with computers, albeit 8000 miles apart. Still, that's nothing in their Cobra Mk IV...

David Matthewman

scene. For the first time in *Elite*, ships fought each other. Sometimes we'd fly out to the sun and see 30 or 40 pirates at war, only to be stopped by a hand of Police Vipers with their unique white lasers.

We also introduced ships flying in formation: Missionaries in herds; Mambas huddled in groups to protect wealthy pirates: Vipers in sixes and sevens. The temptation was to pick off one Viper with a shot up the glowing boosters – less effective than one on the body, as the laser bolt is refracted by the plume of the booster – and then watch the other Police gracefully break formation like ballet dancers. Unfortunately, this temptation wore off after we realised that five Vipers don't play fair after you kill one of their buddies.

### Sorting the men from the boys

Our discussions with David Braben and Ian Bell sometimes ended with Ian or David saying a particular aspect of the game was quite tricky. Docking computers was a case in point; Ian said they should 'sort the men from the boys.' He was right.

The first hurdle with docking, as any Commander knows, is getting lined-up with the letterbox (opening slot) of the space station. This was achieved by marking a point out in front of the letterbox with an invisible buoy. However, lining-up with the letterbox is the least of a Commander's worries; it's the 'boxing' or matching the rotation of the letterbox that really flummoxes.

We decided to imagine that there was one 'arrow' or vector sticking out of the right wing of the ship and one out of the left side of the space station. As the station rotated, the two vectors described the

various positions of the hands of a clock. When the vectors pointed in the same direction, it was safe to dock without scraping the craft. Therefore we coded the flight program to minimise at all times the angle between the two vectors. Because the flight program actually manipulated the Cobra, the added bonus was that – if present – yaw boosters were utilised, and the player could still use the Cobra in case of trouble. Needless to say, the next communication from Commander Bell began, 'Hello men...!'

The programming of missiles was also demanding. If the missile flies too quickly it's no fun to watch and it's even less fun to avoid. If it flies too slowly it can be outrun. But that is only the half of it. If its maximum turn angle is too obtuse, it can end up overturning and circling a target in simple harmonic motion like a fly. And if it can't turn enough, it can overshoot and never come back. So how did we solve this complex mathematical riddle? With the use of complicated vector algorithms? Intricate formulae? Well, not quite. We used that tried and tested scientific

principle of trial and error! By the time our missiles didn't overshoot and weren't too accurate we'd shot over a thousand of the blighters.

Before we're asked, yes, we did use a special Commander with infinite missiles. And, no, we won't be releasing that file.

### Some things never change

There are two specifications that should never be changed for any version of *Elite*. We wanted to ensure that in Archimedes *Elite* the planets in the Galaxies and the trading prices on those planets adhered rigidly to those in BBC *Elite*. To do this we needed the actual code used by Ian and David. But it wasn't as simple as that. The unseen difficulty was that the code that generated all this information was quite machine-specific, because the algorithms used were tied in with the workings of the BBC. Because we couldn't face having our galaxies different from those in the original *Elite* we took no chances; Warren wrote a small 6502 emulator to run that section of code.

AU



Another idea which didn't make it to the final game – a pretty 3D *Elite* logo on the start-up screen.

One Stop Storage



All prices exclude VAT and carriage. Prices & specifications may change without notice.

## Technology Matrix

Authorised Acorn Reseller  
 Authorised Apple Macintosh Reseller  
 Authorised IBM Reseller

### HARD DRIVES      HARD DRIVES

**A3000/10    A3020    A3/400    A4/5000    RISC PC**

<b>A3000 - A3010</b>	<b>A3/400 A4/5000 RISC PC</b>	<b>4.0 GB SCSI</b>	£979
_80MB 15MS IDE	250MB IDE	2.0 GB SCSI (AV)	£439
120MB 15MS IDE	420MB IDE	4.0 GB SCSI (AV)	£1129
250MB 15MS IDE	520MB SCSI	<b>DRIVE ACCESSORIES</b>	
340MB 15MS IDE	1.0 GB SCSI	Twin IDE (int.) cable	£8
<i>These drives are supplied with interface - ready assembled and ready to use! "Plug &amp; Play"</i>			
<b>A3020</b>	2.0 GB SCSI	Twin SCSI (int.) cable	£10
_80MB 15MS IDE	4.0 GB SCSI	Power splitter	£2
120MB 15MS IDE	2.0 GB SCSI (AV)	25/50 way SCSI cable	£15
250MB 15MS IDE	4.0 GB SCSI (AV)	50/50 way SCSI cable	£15
340MB 15MS IDE	<b>EXTERNAL DRIVES</b>	SCSI 2 cable	£25
	520MB SCSI	SCSI Terminator	£15
	1.0 GB SCSI	5.25" to 3.50" brackets	£10
	2.0 GB SCSI	External enclosure	£69

**SPECIAL!!**  
**SPECIAL!!**

**SPECIAL!!**  
**SPECIAL!!**

**SPECIAL!!**  
**SPECIAL!!**

**420mb IDE    £115**

### SYQUEST REMOVABLE DRIVES

NEW

SyQuest EZ-135  
IDE or SCSI  
Internal or External  
From £145.00

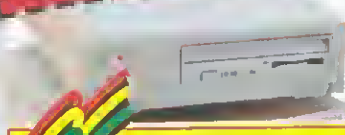

<b>3.50" INTERNAL (BARE)</b>	
270MB IDE	£249
270MB SCSI	£249
<b>5.25" INTERNAL (BARE)</b>	
200MB SCSI	£289
<b>3.50" EXTERNAL (CASED)</b>	
270MB SCSI	£299
<b>5.25" EXTERNAL (CASED)</b>	
200MB SCSI	£329
<b>CARTRIDGES</b>	
105MB 3.50"	£39
270MB 3.50"	£45
200MB 5.25"	£55

**FROM £249**

### CD-ROM DRIVES



<b>PANASONIC PD DRIVE</b>	<b>£499</b>
(QUAD SPEED CD & 650MB OPTICAL)	
<b>QUAD SPEED INT. SCSI</b>	<b>£149</b>
(Suitable for fitting internal to RISC PC)	
<b>QUAD SPEED EXT. SCSI</b>	<b>£199</b>
(Suitable for fitting to any external SCSI port. Includes high quality external enclose with cables & terminator.	
<b>QUAD SPEED INTERNAL (KIT)</b>	<b>£229</b>
(Suitable for RISC PC. Includes 16 bit SCSI card allowing the connection of upto 6 other devices.	
<b>QUAD SPEED EXTERNAL (KIT)</b>	<b>£279</b>
(Suitable for A3/400 A3000/10/20 A4/5000. Includes 16 bit SCSI card, allowing the connection of upto 6 other devices	
<b>4 DRIVE TOWER (QUAD SPEED SCSI)</b>	<b>£689</b>
<b>6 DRIVE TOWER (QUAD SPEED SCSI)</b>	<b>£989</b>

### TAPE DRIVES



4.0 GB (INT) DAT	£779
4-16 GB (INT) DAT	£879
4.0 GB (EXT) DAT	£859
4-16 GB (EXT) DAT	£1019
Supplied with tape, cables & software	

### OPTICAL DRIVES



230MB INTERNAL	£389
230MB EXTERNAL	£429
1.3MB INTERNAL	£1339
1.3MB EXTERNAL	£1379
230MB CARTRIDGE	£29
1.3MB CARTRIDGE	£69

**FROM £779**

**FROM £389**

**FROM £149**

**PAYMENT CARDS WELCOMBE**



Equipment, prices and backup that make Technology Matrix the right choice

Technology Matrix Hot Line 0161 320 3081

89a Stockport Road, Denton Manchester M34 6DD. Fax: 0161 320 321



# Technology Matrix

Authorised Acorn Reseller  
Authorised Apple Macintosh Reseller  
Authorised IBM Reseller

All prices exclude VAT and carriage. Prices & specifications may change without notice.



## UPGRADES & ACCESSORIES



### IDE CARDS

A3000/3010 £69  
A300/400 £89

### SCSI CARDS

A300/400 16bit £85  
A3000/3010/3020/4000 16bit £85  
A5000/RISC PC 16bit £85  
RISC PC 32bit SCSI II £186

### MEMORY

A3000 1-2MB £54  
A3000 2-4MB £89  
A3000 1-4MB £128  
A3010 1-2MB £44  
A3010 2-4MB £104  
A3010 1-4MB £144  
A3020/A4000 2-4MB £88  
A5000 2-4MB £88  
A5000 8MB £258  
A300/400 8MB £248  
RISC PC 4MB £99  
RISC PC 8MB £219  
RISC PC 16MB £CALL  
RISC PC 32MB £CALL

**SDFTWRE**  
RISC OS 3 CHIPS ONLY £36  
RISC OS 3 (with manuals) £79

Call for products not listed

## PRINTERS & ACCESSORIES

### CANON

BJ200ex 80col mono £205  
BJ30 80col mono £182  
BJ230 132col mono £281  
BJ300 80col mono £409  
BJ330 132col mono £459  
BJC4000 80col colour £279  
BJC600e 80col colour £399  
BJC70 80col colour £265  
BJC800 132col colour £1139

### EPSON

Stylus 80col mono £CALL  
Stylus 80col colour £CALL

### HEWLETT PACKARD

HP DeskJet 320 mono £195

HP DeskJet 660 colour £341  
HP DeskJet 850 colour £457  
HP DeskJet 1600 colour £975  
HP PaintJet XL300-A4 £CALL  
HP PaintJet XL300-A3 £CALL  
HP LaserJet 4L 300dpi £419  
HP LaserJet 5p 600dpi £689  
HP LaserJet 4+ 600dpi £1169

### STAR

LC90 9pin 80col mono £CALL  
LC100 9pin 132col colour £CALL  
LC240 24pin 80col mono £CALL  
LC240 24pin 80col colour £CALL

Call for full range of Consumables & Accessories

**CANON BJC4000 £279**



PRODUCT LAUNCH

## NETWORK PRODUCTS & ACCESSORIES

### I-CUBED ETHERNET CARDS

A3000  
EtherLAN 102 BNC/TP £125  
A3020 / A4000  
EtherLAN 200 BNC £135  
EtherLAN 201 TP £135  
A5000  
EtherLAN 502 BNC/TP £125  
Risc PC  
EtherLAN 602 BNC/TP £105

### REPEATERS / HUBS

8 - Port 10BaseT BNC £159  
Expandable to 16/24/32 Ports  
8 - Port 10BaseT FOIRL £379

### NETWORK SOFTWARE

Level 4 Fileserver Rel. 3 £359  
TCP/IP Protocol Suite S/U £99  
OmniClient £235  
InterTalk £75  
ADMIN £75

We also stock & supply a full range of network accessories

### ADMIN

"If you were allowed to buy only one network tool ever - it would have to be this one" It is one of the most sensible and practical network tools you have at your disposal. The following routines are just a small selection from this totally convincing product.

- Find any User's password from any station.
- Users can change their password from desktop.
- Create or delete users instantly from any station.
- Recover MEGA Megabytes by clearing out the dreaded "Scrapie".
- Wild card password search for users and passwords.

Save £25  
RRP £75  
Launch offer  
£50

All the above cards are available with FLASH ROM incorporating Acorn Access+ peer to peer software

## MODEMS MODEMS

### SPORTSTER

14400 £149

### SPORTSTER

28000 £219

### COURIER

V34 £319

## SCANNERS SCANNERS



### CANON

IX-4015 Colour SCSI £589

### EPSON

GT-6500 300dpi SCSI £CALL  
GT-8500 400dpi SCSI £499  
GT-9000 600dpi SCSI £619

### SOFTWARE

PhotoDesk £CALL  
ImageMaster £CALL

## MONITORS MONITORS



### ACORN

AKF52 14" Multiscan £249  
AKF50 14" Hi-Res. £305  
AKF60 14" Multiscan £315  
AKF85 17" Multiscan £530

### MICROVITEC

1450 14" Autoscan £219  
(Alternative to AKF60)

### IDEK

Vision Master 17" £549  
(Brilliant)

We also stock & supply a full range of PC & Macintosh Monitors

## PAYMENT CARDS WELCOMBE



Today businesses rely 100% on their computers, that's why we rely on Technology Matrix



Technology Matrix Hot Line 0161 320 3087

89a Stockport Road, Denton Manchester M34 6DD. Fax: 0161 320 3210

One Stop Storage

# A thousand and one

The wind of change is blowing through the market and Acorn's Product Development chief, Peter Bondar, has made no secret of the fact that the company is examining Taos as a possible operating system of the future. But what is it? And why is Acorn interested?

The blurb says that Taos is a multi-tasking, multi-threaded, multi-processor, parallel processing system – it's all things to all users and probably makes tea as well – but that doesn't really help. Let's take these terms one at a time and see where they take us.

## Jargon explained

Multi-tasking is the easy one; our machines have been doing this trick for seven years. It's simply the ability to run more than one program at a time, running the alarm clock and the CD player software together, for example.

Multi-threaded means using the same code to do more than one task at a time. With the standard Acorn operating system, multi-threading usually only applies to a single program; if a program can handle more than one document at a time, it's multi-threaded.

However, it can get more complex – you might get a piece of code that is executing which passes control to another routine, at which point the same code can get called again from another place and get executed. At this point you would have one piece

of code with two 'threads' running through it.

Multi-threading is not very common with RISC OS, though it does happen in the background a reasonable amount. Some routines can do it, some can't. With Taos, every routine can.

Then there's multi-processor; we might be able to plug a 486 PC card into the Risc PC and run Windows, but that doesn't make it multi-processor – at least not in this sense. What's intended here is to show that Taos will run on any processor. Taos programs don't require a huge effort to convert from platform to platform either – any processor for which there is a Taos kernel and interpreter can run any Taos program, without modification.

But it's even more useful than that: if you have more than one processor – and the kernel knows about the other processors – Taos automatically distributes the executing code across the available processors and thus runs as a parallel processing system. And with parallel

processing every additional processor adds power.

There does come a point where the sending and receiving of messages between processors can cancel out any increase in power that adding another processor brings. However, it takes quite a few processors to do that and, theoretically, Taos can handle over two million of them.

## Taos for Acorn

Just one week before I was due to hand in this review I received my advance copy of the Taos development system for RISC OS. It's not entirely finished and won't be released for a while yet, but further changes are really a matter of bells and whistles rather than any fundamental alterations.

Taos comes in two varieties: TUI and GUI. The first is the *textual user interface* and the other is the *graphical user interface*; each is a separate application. There's the ARM6 kernel application which provides the Taos environment and needs, by default, 6Mb of RAM to run in,

though it can run in less if needed. The final part of the system is the 32Mb DOS





Steve Turnbull opens the Pandora's box that is the Taos operating system.

# tools

partition. 32Mb is not an absolute requirement – the current size of the installed Taos code is just 8Mb – but it allows for future expansion. As Taos was originally developed on a PC it expects filenames to be in the old 8+3 DOS format and it needs virtually unlimited files in a directory. The Acorn filing system can't handle 11 character filenames or more than 77 objects in a directory (yet). Unfortunately, Taos must have an identical file system on every machine it runs on; hence the DOS partition.

One of the delays in releasing the system was the need to produce an installation routine that can create the partition without the need for the PC emulator or *PCconfig* application, which is what I was able to use. From there, installation is just a matter of using a ver-

sion of *Spark* to unpack the *.zip* files off the floppies and into the partition. Once this has been done, Taos will run.

## It's tool time

When any Taos program – or Taos itself – is run for the first time there is an enormous amount of disc activity and it can take quite a time to get up and running. One of the unique features of Taos is its use of tools: it's almost true to say that where most programs have subroutine calls, Taos has accesses to another tool.

Each tool is a very short (100-150 byte) piece of code that carries out a very precise and quick action, though it might require further calls to other tools to achieve it. It is located on disc and is accessed via its file name and path. The good news is that once it's loaded, Taos

will hold it in memory until it's no longer needed *and* its space is needed by another tool. Bearing in mind that each tool is very short, you can get a lot of them into the space provided.

For, example let's say you've written a piece of code that needs to calculate the SIN of an angle. To do this your code would call the MATH/SIN tool or, if a floating point version were needed, MATH/SINF. Both tools are stored in the MATH directory in the partition. Now, the MATH directory contains all the tools to implement the C math library, but the nature of Taos means they are all separate and any program can call them, regardless of the language it's being written in. No special interface is required – try that on any other machine!

Another reason for having short lengths



Francis Charig, Chairman of Taos systems.



Chris Hinsley, Technical Director and founder of Taos.

## Operating systems

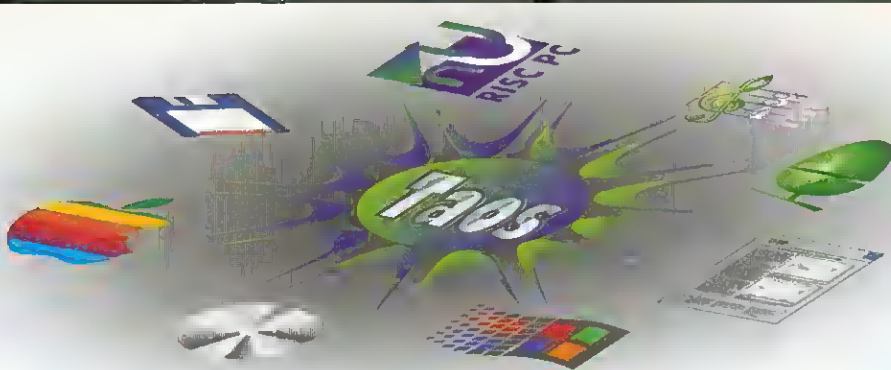

of code is the way Taos operates as far as different processors are concerned. Until now I've rather glibly stated that code is translated as it's loaded. Let's take a closer look at that.

Taos programs are generally written in VP code – VP standing for Virtual Processor. VP code is an idealised set of instructions and directives that, while not elegant, is certainly compact. When a call is made to a tool that isn't loaded, Taos checks the path to the directory and examines what's there. Routines that end in .00 are VP code routines, so MATH/SIN.00 is the VP code for calculating the SIN of a number.

If this were the only one available, Taos would pull the code in and translate it into ARM code – or 486 code, or Pentium, or R6000, or whatever – and then execute it. Any further calls to the code would not require the translation step as long as it's in memory. If it got purged it would have to be reloaded and re-translated.

But the load check doesn't stop at VP code. It may be that a particular function can be re-coded especially efficiently for a specific processor, so it's possible to

write a machine-specific routine, give it the same name, but make the file extension a different number relating to that processor. The number for the ARM2/3 series is .05, and .08 for ARM6/7 series. This means that when Taos is looking for the code to execute, it checks for routines that are specific to the processor first and for VP code last.

### What's in it for Acorn?

While Acorn may not currently be the biggest manufacturer of computers in the world, it's certainly one of the most innovative, and within the next two years Acorn is very likely to produce a 3D user-interface for its machines, and for responsive 3D work you need power.

Not only is Simtec developing the five-ARM system for existing Risc PCs, but Acorn has also revealed that it's planning to produce a multi-processor machine which has exactly the kind of power to deliver an effective and responsive 3D system. What Acorn doesn't have is an operating system.

Up to now, all parallel processing computers have required finely-tuned

operating systems that usually have some sort of hierarchical control methodology. Taos throws this out of the window – there is no boss processor, each one operates on its own and uses an algorithm to compare its own 'power' with those of its neighbours. If one of its neighbours has more power it gives it the process to execute, then gets on with its own work.

Taos absorbs more power in messaging than the clever OSS, but it makes up for it with simplicity and robustness. This is precisely the philosophy that Acorn uses in the development of its hardware and software: make it clean and simple and it'll work fast.

The Taos GUI, in my opinion, is horrible. It resembles Windows and lacks any subtlety. However, this is not important – Taos can build any GUI you want, whether it be the 3D-Rooms of the future, or the RISC OS 3 of the present. What's more important is that once it works it can be put on any processor that runs Taos, and suddenly you'll have Acorn's Rooms or RISC OS on any machine you care to mention.

The future may well be Taos.

AU

### A brief history of Taos

Taos was not initially created as a multi-processor operating system. Its first incarnations (in 1989) were as a macro language to help port games between different platforms. But its inventor Chris Hinsley decided to target the forthcoming 32-bit machines rather than aiming at the popular machines available then.

During the early part of the 1990s, development by a core team of enthusiasts continued until Francis Charig joined the group, setting up Taos Systems with Chris and Tim Moore (who had also been a major part of the development team) and organising financing from Japan.

Since then, development has continued apace, the team has grown, the company has managed to sustain itself without creating any debt whatsoever, and has now established a group of major consumer electronics companies as customers which assures it of long-term stability. Some of these companies will be using Taos as their primary operating system.

As a product, Taos is able to offer an unusual solution because its features allow manufacturers to utilise a single operating system that can be used with PDAs (personal digital assistants), mobile phones, faxes, printers, VCRs, set-top boxes, personal computers, games machines, virtual reality, video servers and so forth, regardless of the processor and using common software. Within the games market, there will be a developer's kit launched which allows games to be written once which will then run across dissimilar workstations and games consoles.

Taos Systems considers its competitors to be such things as OS-9, pSOS, Win95, UNIX and the IBM Microkernel, but these are mostly processor-specific and lack the generalisation of Taos.

Taos is portable, exactly the same code runs on any processor or machine for which a Taos translator exists with minimal speed degradation – given that there has to be some slowdown since code translation is involved. It's also highly compact – the ARM kernel occupies just 7K while the Intel one occupies 10K.

Taos is also a parallel operating system in which it self-load balances using an optimising algorithm across the network, capable of distributing across up to 2,000,000 processors in a single network. So long as the bandwidth between processors is sufficient, the performance on the network will increase. This is the result of using a masterless network rather than traditional techniques.

By being parallel and portable, Taos can run with dissimilar microprocessors across the same network, with everything being shared, even though the processors are dissimilar. Thus, an ARM-based workstation can take advantage of Intel 486s as they are added to the network and will distribute the process load according to the power available on each processor. This provides consumers with future-proofing as they are able to extend networks based on the latest technologies as they become available, not just on historical decisions. As interest in Taos increased there was pressure to permit outside development of actual software. However, this was resisted to allow the OS for Taos to be put together into a usable structure, which now exists.

A number of global consumer electronics companies involved with Taos will be announcing their support formally over the summer. There is also going to be more public support for Taos from the cable and satellite companies in the months ahead as they look for an effective solution for interactive television.



**Late Night Opening**  
Wednesday & Thursday  
till 7.30pm

**Open Sunday**  
11am to 4pm



**FIRST  
COMPUTER CENTRE**

**HOW TO ORDER**

Order by telephone quoting your credit card number. If paying by cheque please make payable to: **FIRST COMPUTER CENTRE**. In any correspondence please quote a phone number, post code & Dept. Allow 5 working days cheque clearance.

**SHOWROOM ADDRESS:**  
**FIRST COMPUTER CENTRE,**  
DEPT. ST7, UNIT 3, ARMLEY  
PARKCOURT, STANNINGLEY  
RD, LEEDS, LS12 2AE.

24 HR MAIL ORDER SERVICE FAX: 0113 231-9191  
NEWBSS Sales & Technical Line: Tel: 0113 231-1422

**LOW COST DELIVERY**

- Standard delivery £1.95
- 2-3 Week Days £2.95
- Next Week Day £4.95

Delivery subject to stock availability  
All prices include VAT @ 17.5%

- Large showroom with parking
- Multi-million pound company
- Overseas orders welcome
- Educational purchase orders welcome

**OPEN 7 DAYS A WEEK**

Prices are correct at the time of going to press. Please check our latest prices before ordering. All sales are subject to our standard terms & conditions (copy available upon request), E&OE.

**Telephone 0113 231-9444**  
E-Mail sales@firstcom.demon.co.uk

**EASY ACCESS FROM M62, M1 and the A1**



**REPAIRS**

We offer a FREE quotation on your ST or any peripheral (monitors, printers etc). A delivery card is just £3.00 in charge or alternatively you can visit our showroom. We can also arrange a courier pickup at an additional cost of £11.00.

**SupraFAX Modem** **COMPUTER SHOPPER'S BEST BUY**

**SupraFAX Modem 288** **COMPUTER SHOPPER'S BEST BUY**

28,000 Data + 14,400 Fax

- Up to 115,200bps (v42bis)
- Silent & Adaptive Answer
- V34 Standard
- DOS & Win Fax Software
- Class 1 & 2 Fax
- Unique LCO Oispla
- Flash ROM
- 5 Year Warranty

90% **DOWN IN PRICE**

Is it a bargain the size of a Hippo's butt? You Betchall! Amiga Computing Oct, 1994

**ONLY!! £199.99**

---

**SupraFAX Modem V32bis** **COMPUTER SHOPPER'S BEST BUY**

14,000 Data + 14,400 Fax

- Up to 57,600bps (v42bis)
- Silent & Adaptive Answer
- DOS & Win Fax Software
- Class 1 & 2 Fax
- Unique LCD Display
- 5 Year Warranty

**ONLY!! £152.99**

---

**SupraFAX Modem 144LC** **COMPUTER SHOPPER'S BEST BUY**

14,000 Data + 14,400 Fax

- Up to 57,600bps (v42bis)
- Silent Answer
- DOS & Win Fax Software
- Class 1 Fax Only
- 5 Year Warranty

**ONLY!! £96.99**

Performed perfectly...easy to set up and travel...missed a connection... C. Shopper - April 94

All modems supplied with cables & comm software. Supra modems are NON-BABT Approved

**Straight Fax 2.1 £69.95** Fax software for Atari

**Robotics Preferred Resellers**

**Sportster 288 COURIER**

Up to 115,200bps (v42bis)  
V34 Standard  
Class 1 & 2 Fax  
5 Year Warranty  
DOS & Win Fax Software

**£225.99**

**Sportster 144**

Up to 57,600bps (v42bis)  
Class 1 & 2 Fax  
5 Year Warranty  
DOS & Win Fax Software

**£146.99**

**Dual Standard V34+ Fax**  
**Special Limited Offer**  
**Only £315.99**

Now 33,600bps!

**Tabby**



**£49.99**

- It's **QUICKER** than a mouse
- More **ACCURATE** than a mouse
- More **"NATURAL"** than a mouse
- It **SAVES TIME**
- It's **EASIER** to use

**Zinberg**

**Guaranteed lowest prices**

**Cubase Lite £74.99**  
16 track, score printing

**Cubase Score V.2 £344.99**  
Professional 128 track sequencer

**Cubase Audio Falcon £614.99**  
Integrated Digital Audio/Midi/Scoreprinting V2

Full range of products available

The First Computer Centre is a fully authorised Zinberg dealer, providing only full spec. UK software/hardware. Educational discounts available.

**Drives/Mice/Trackballs**

**Power 720B 3.5" Drive £69.99**  
This 1 meg external drive comes with Virus checker, built in Blin turbo 3rd boot switch for drive B, includes PSU

**Zydec 3.5" Drive £59.99**  
1 meg ext. drive, high quality low noise, includes PSU

**Atari Int. Drive (original) £49.99**  
1 meg replacement internal disk drive for ST/FME, direct replacement, no case modification required.

**Mega Mouse 400dpi £11.49**  
~~Track mouse 300 dpi £10.99~~

**Zydec Trackball £29.99**

**Alfa Trackball £34.99**

**Video/Genlocks**

**HAMA TRI-LOCK £340.99**

NTSC/PAL COMPATIBLE  
CALL FOR DETAILS.

**VIDI ST (1) £69.99**

High quality mono output, up to 4 Pip/Pi, ASF in built-in.

**Peripherals**

**The Zy-Fi Stereo System only £26.99**

This is a powerful speaker system with built in stereo amplifier. It will plug into an Atari STE, Commodore Amiga or Amra Archimedes. Connect it with its own power supply the Zy-Fi system can also be powered by batteries.

**The Zy-Fi Pro Stereo System only £57.99**

High spec location version of above

**Forget-me-Clack 2 only £19.99**

Real time clock that plugs into cartridge port. Software for setting time & date. 3 year guarantee.

**ROBOSHIFT MK-1 £9.99**  
Automatic Mouse/Joystick switcher

**CD Rom/Hard drives**

**aiwa ACD-300**

- Large LCD operation panel
- SCSI interface
- 300k/sec data transfer, 275ms access time
- Audio CD dedicated operation buttons

**ONLY £169.99**

**PRIMA ST-Combo**

**200Mb Hard Drive and Seed CD-ROM £459.99**

**Bare SCSI drives**

368Mb £119.99  
540Mb £177.99  
1.0 Gig. £364.99  
2.0 Gig. £699.99

For larger drives please call.

**PRIMA**

This new range of hard drive cxs be purchased as just as a hard drive or can have the capability to be combined with a built in CD-ROM drive or other SCSI devices. The IC0 Link II controller gives link up to 7 separate SCSI devices.

This drive is fully auto booting and auto parking. They have a very small footprint, less error (VERY QUIET).

The PRIMA range comes with a built in disk cache as standard that can reduce disk accessing time by 50%. Standard warranty 1 year.

**STe Falcon**

**PRIMA 340 £265.99 £224.99**  
**PRIMA 540 £324.99 £269.99**  
**PRIMA 1Gig £489.99 £465.99**  
**PRIMA 2Gig £799.99 £679.99**

Prices include IC0 Link II SCSI controller and all connecting cables.

**ICD Link II SCSI controller NOW!! only £74.99**

**Printers**  
All our printers come with ribbon or toner, paper & cables!

**Canon**

**Canon B130 £204.99**  
Compact Portable Printer, 30 page ASF in built.

**Canon B1200ex £229.99**  
High quality mono output, up to 4 Pip/Pi, ASF in built.

**Canon BJC70 Col. £299.99**  
High quality Portable Colour Printer, 30 page ASF.

**Canon BJC4000 Col. £299.99**  
High quality Colour. Super fast mono printing, 340 dpi

**Canon BJC600e £439.99**  
Dedicated Col. printer, New enhanced version, 720dpi

**HEWLETT® PACKARD**

**NEW! HP540 mono £269.99**  
**HP540 Colour upgrade £36.99**  
**NEW! HP660 Colour £435.99**

3 year warranty

**CITIZEN**

**ABC Colour printer £145.99**  
simple (as easy) as ABC to use 24 pin printer. Comes as standard with 50 sheet auto sheet feeder. Tractor feed optional at £17.99

**Project IIc Colour £254.99**  
New inkjet printer with built in auto sheet feeder.

**star**

**Star LC90 9 pin mono £102.99**  
**Star LC100 9 pin colour £117.99**  
**Star LC240 24 pin mono £117.99**  
**Star LC240C 24 pin colour £134.99**  
Tractor Feed for the new range £15.99

**Accessories**

Modem/null modem cables £9.99  
ST-HIRES monitor cable £9.99  
Power cable £4.99  
Twin Joystick/Mouse Ext. cable £4.99  
Mouse/joystick splitter cable £4.99  
ST/EM scart cable £9.99  
Falcon VGA adaptor £9.99  
Quality Mouse Mats £3.99  
ST01.8MTR printer lead £4.99  
STFM/STE Power Supplies £39.99  
STE or STFM Casenow only £4.99  
Keyboard Membrane Covers £14.95  
14" Monitor cover £6.99  
Atari S20/1040 dust cover £3.99

**Parallel port sharers**

2 Way £12.99  
3 Way £18.99  
4 Way £21.99

Prices include connecting cable

**Monitor Switcher Box £17.99**  
switches between mono & colour monitors, such as Prima Mono Monitor & 8833 MK2

**Memory**

1 Mb 72 Pin SIMM £39.99  
2 Mb 72 Pin SIMM £79.99  
4 Mb 72 Pin SIMM £130.99  
8 Mb 72 Pin SIMM £262.99  
16 Mb 72 pin SIMM £399.99  
1 Mb 30 pin SIMM £34.99  
4 Mb 30 pin SIMM £110.99  
256b 4 DRAM (DILs) (each) £64.99  
1 Mb by 4 ZIPS (1/2 Mb) £32.99  
256b 4ZIPS (each) £65.99

Part Ex. available on your old memory. Call for pricing.

**Monitors**

**PRIMA TrustHi-Res**

High resolution 14" mono monitor, 640 x 400 resolution. Stable image and razor sharp quality. Comes with built in 0.6" diameter monitor stand.

**£94.99**

**Microvitec I 438**

The Auto-Scan is a 14", 28dp, MP II compatible monitor. ST/FM, Falcon, Amiga and PC compatible. Ideal for both business and games use.

**only £274.99**

**Atari SC1435 colour monitor £199.99!!**  
only have a small number available so order quickly

**colour monitor 14" SVGA £202.99!!**

MPR II, 28 dot pitch, Non-interlaced monitor, Falcon and PC compatible.

All our monitors are UK spec. All monitors come complete with connecting leads.

**Consumables**

**Cartridges**

Canon B110sx/5J48 cart. £19.99  
Canon B1200/280ex mono cart. £19.99  
Canon B130 mono ink tank £14.49  
Canon BJC70 col. ink tank £19.49  
Canon BJC70 mono ink tank £12.49  
Canon BJC4000 col. ink tank £19.99  
Canon BJC4000 mono ink tank £8.99  
Canon BJC600e col. ink tank £8.99  
Canon BJC600e mono ink tank £6.99  
HP520/540 Office mono cart. £24.99  
HP550/560/660 col. cart. £26.99  
Star S1144 mono or colour £7.99

**PREMIER Ink Refills**

Save a fortune in running costs with your ink! bubble jet. Compatible with HP, Canon, Star, Citizen & many others.

Single refills (22ml) £6.99  
Twin refills (44ml) £12.99  
Three colour kit (66ml) £19.99  
Full colour kit (88ml) £27.99

**RIBBONS**

Citizen Swift/ABC mono £4.99  
Citizen Swift/ABC Colour £13.99  
Star LC90 mono £4.99  
Star LC10/20/100 mono £3.69  
Star LC10/20/100 colour £7.99  
Star LC240C mono £8.49  
Star LC240C colour £13.99  
Star LC240 mono £5.99  
Star LC240-200/300 Colour £11.99  
Re-Ink Spray for mono rib. £11.99

**Disks/Boxes**

**LOW PRICES LOW**

	Bulk DD	Branded DD
10	£3.49	£4.49
30	£9.99	£11.99
50	£15.99	£18.99
100	£29.99	£35.99
200	£52.99	£63.99
500	£118.99	£142.99
1000	£211.49	£253.99

All disks are guaranteed. All branded disks come with labels

**Disk labels 500 £6.99**  
**Disk labels 1000 £9.99**  
**10 Capacity Box £0.99**  
**50 Capacity Lockable Box £3.99**  
**100 Capacity Lockable Box £5.49**  
**\*90 Capacity Box £10.99**  
**\*150 Capacity Posso Box £20.99**

\*add £3.00 delivery if purchasing just one Posso or Box box. Normal delivery when purchased with other product or when buying 2 or more.

**Software**

**MUSIC/SOUND**

Replay 16 Digitiser £109.99  
Stereo Master £34.99

**UTILITIES/PROGRAMMING**

Oiamond back 3 backup util. £44.99  
Multi Tos £44.99  
Speedogods £34.99  
ST Straight Fax 2.1 £72.99  
ST Basic £5.99

**VIDEO ANO GRAPHICS**

True Paint £34.99  
Video Master £59.99  
Video Master (professional) £79.99

**WORD PROCESSING & DTP**

Calamus 1.09m £59.99  
Papyrus Gold £109.99

**Scanners**

**The Power Scanner only £99.99**

This scanner comes with the latest version of software.

**Alpha Scan Plus only £139.99**

New version of this famous 400 DPI scanner. Includes Touch up, Merge-it and OCR software enabling you to alter and manipulate high resolution images. Needs 1 Mb of RAM and runs in mono only. HQ

**Marpet**

**STFM Deluxe SIMMS modules**

4Mb unpopulated £24.99  
4Mb populated to 512k £34.99  
4Mb populated to 2Mb EPOA  
4Mb populated to 4Mb EPOA

Marpet products come with a 12 month warranty

**Prima RAM expansion**

512K Ste £9.99  
2Mb Ste EPOA  
4Mb Ste EPOA  
14Mb unpop. for the Falcon £49.99

The Falcon board runs 72 pin SIMM modules, you just add the rest of the SIMMS to get your populated price.

Prima products come with a 2 year guarantee



**Sibelius 7 update**

Product: Sibelius 7  
 Supplier: Sibelius Software  
 Tel: (01223) 302765  
 Fax: (01223) 351947  
 E-mail:  
 info@sibelius.demon.co.uk  
 Prices: Sibelius 7, £795 + VAT  
 Sibelius 7 student, £499 +  
 VAT  
 Sibelius 6, £159 + VAT

**Pros:** Update keeps *Sibelius* ahead • Already excellent manual improved  
**Cons:** Expensive for *Sibelius 7*

*Sibelius*, the score draw package for Acorn platforms, has achieved a high profile for a niche product. Widely acknowledged as the fastest and cleverest score notator, bar none, it generated welcome publicity for Acorn recently when both the Royal College of Music and the Royal Academy of Music chose the Acorn/Sibelius combination over PC- and Mac-based alternatives.

Constructed by knowledgeable musicians, the software handles the arcane and idiosyncratic rules of music publishing with a sensitivity that more mechanical competitors cannot manage. The current version (2.5) of *Sibelius 7* provides a number of enhancements.

The first is enhanced replay. Not only can you record and replay via MIDI instruments, *Sibelius* also reads dynamic and text instructions and can introduce expression consisting of subtle tempo variations. This makes rubato-rich scores like a Chopin Etude sound as if they're played by Rubinstein rather than a Dalek, which must be a good thing, despite suggesting that even great interpretation is more programming than inspiration.

The handbook has been rewritten to give more guidance to those without computer experience, though the impressive list of real composers who use *Sibelius* is the best evidence that this is a working tool rather than a toy. An early problem with ambiguous display of enharmonic notes has been corrected. If you're in Eb you expect Ab to appear as

# In brief

Under scrutiny this month: Sibelius 7 update

- Textease • MovieFS • CineWorks • ClearView 2
- Iota colour scanner

Ab, not as G#, even though on a keyboard they're the same note.

While some users will be content to use mouse and function keys for input, musicians are bound to prefer the faster and more intuitive piano type keyboard. Current versions of *Sibelius* accept such input in real pitch, but not in real time – the notes come in as a monotempo crotchet, irrespective of their real time values, and must be subsequently edited. The reason for this restriction has puzzled some users who are familiar with sequencer software like Clare's excellent *Serenade* which accepts real time input.

However, *Serenade* has the undemanding task of rendering the note length as a scaled horizontal line, whereas *Sibelius* must display it as a

fixed note symbol – a crotchet, minim, or whatever. Even maintaining strict tempo, a keyboard player's note lengths will vary by a percent or two; indeed, perfectly metrical playing sounds mechanical and lifeless, and performers instinctively avoid it. Real-time stave notation thus consists of extremely complex sequences of unrealistic bar lengths, and time signatures which would be unplayable.

The solution is to apply quantisation rules to interpret the input according to what the player intends. As with speech recognition, this is a quest for the holy grail (though the rules of musical language are more restricted and amenable to specification than the grammars and syntax of speech). Version 3 of *Sibelius* will make a stab at processing real

time input, but how successfully and when are as yet unknown. It will also then be able to import and export MIDI files, which for the same reasons cannot currently be sensibly interpreted.

I took Sibelius Software's advice and used a Roland SC-88 sound sampler to replay scores through a hi-fi. The SC-88 stores digital samples of 600 high-quality instruments as well as a cornucopia of trains, planes and horses hooves. The stunningly realistic sounds eclipse the 16-bit multimedia audio we're just getting used to. *Sibelius* will sell just the software or set you up with a complete supported hardware package, and this update makes sure that this package is the best in its field.

Clem Vogler



A typical score in *Sibelius 7*.



## Textease

Product: Textease

Supplier: Softease

Tel: (01332) 204911

Prices: £29.95 without spell checker

£39.95 with spell checker

Site licences for primary and secondary are available

Pros: Ease of use • Value for money

Cons: Spelling checker is optional • Graphics can lose their aspect ratio

With one or two exceptions, all DTP programs are frame-based. Simply, the user is provided with a frame into which may be placed text or graphics (usually not both). The user is able to alter the frame and/or add new frames into which more text or another graphic can be placed. Depending on which program you are using, adding new frames and moving them around can be simplicity itself, or it can be hell on earth.

Softease felt that a frame-based document processor was not the way forward, so it has produced an object-based program called *Textease*. Object-based software is not new. *Draw* is an object-based program, as is *ArtWorks*. In simple terms, each item placed on the screen is referred to as an object, and each object can be controlled independently of every other object.

So how is all this better than using frames? Well, I guess the answer will depend on what you are currently used to using. For me, the advantage

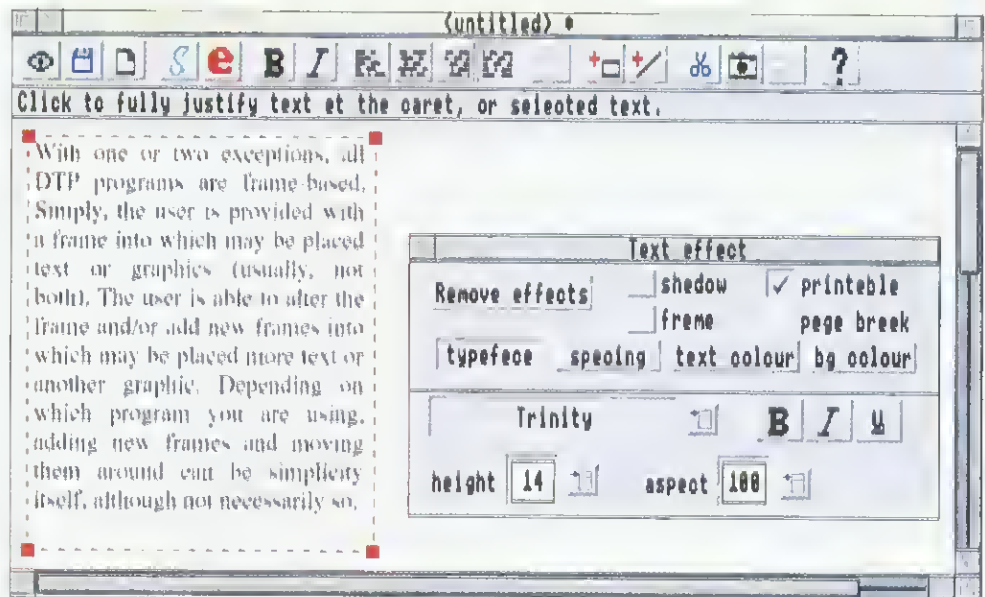

*Textease* contains all the modern features usually found in desktop publishers and word processors – button bar, spelling checker and on-line help.

is that I don't have to 'set up' a document. I don't need to begin laying out frames, getting them to fit and then flowing text from one frame to the next. I can just load in the program, click where I want to type, and type.

As a productivity tool, there are no equals to *Textease*. Graphics can simply be dropped in anywhere and positioned as required. Objects can be placed either on top or behind other objects, can be aligned vertically and/or horizontally with other objects, and can also be copied. All these are features which users of *Draw* will be very familiar with. You can also drag in text from other applications in the form of a text file, place text in multiple columns, and fully

justify and globally or selectively search and replace features with which users of word processors and DTP packages will be familiar.

*Textease* has some other features which I believe are unique. My favourite is the spelling checker which checks as you type and beeps when you enter a word it doesn't recognise. Yes, I know, they all do that. But *Textease* leaves the unrecognised word highlighted so that you can easily spot where it is. Your attention is also drawn to it before printing commences. *Textease* can save files both as conventional files in native format, or as text files. *Textease* can also save files as templates. When a template is loaded, the program forgets the pathname and when an attempt is made to save, the user is provided with a default filename ensuring the modified document is not saved over the template.

So who's going to buy it? The simple answer to this is anyone and everyone. *Textease* is aimed at education in general, and primary schools in particular. For younger users it is excellent, but to call it an 'educational program' is, I feel, a marketing mistake. In my experience, if a program is labelled as educational, nobody above the age of 15 seems to give it a second look except

teachers. This program will easily do everything the average home user would want and much more besides. In fact, this program is far more advanced than one would guess. All being well, I'll be following up this article with a second aimed at the advanced user.

As it is aimed at education, what will it offer? Everything that students need to be able to do can be done with *Textease*. Therefore, as a word processor/DTP package it is certainly all that is required for the communication element of the first strand of the Information Technology capability (Communicating and Handling Information) KS1 - KS4. But I feel that this program really comes into its own when used in other subject areas. Because of the software's ability to allow the user to 'click-and-go', it will be especially useful for labelling maps and diagrams and creating spidergrams.

Students are forever pulling material down from teletext. *Textease* will allow the material to be neatly presented a good deal more easily than with conventional frame-based processors. This is especially true when text and graphics are bought together on a single page, as is the case when students download material for CD-ROM.

Geoff Preston

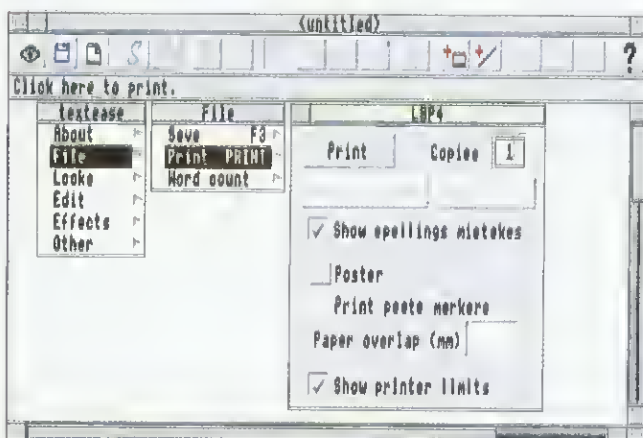

There are lots of printing options, including Poster, which prints a large document onto several of A4 sheets.

**ClearView 2**

Supplier: DEC\_data  
Tel/fax: (01392) 221702  
Price: £40 inc VAT and P&P

- Pros:** Compact hypertext system • Import *Draw*, sprite and *Euclid* files • Comes with freely distributable viewer
- Cons:** Script language is a little hard to learn

*ClearView 2* is hypertext/multi-media application that enables you to create and view files which are designed like reference books.

The manual is a ready-made *ClearView 2* file and therefore a good showcase for what the program can do. I was impressed with how clearly everything was laid out. To view a file you use a series of icons, such as move to next page, go back to previous page, go to index page. There is also a 'back trace' icon which returns you to the last page you looked at so you don't get lost looking through a file, which makes it very easy to navigate a *ClearView* file. Certain words in the text have coloured boxes around them; these are 'reference points.' Clicking on them takes you to a topic related to that word. To make words stand out without making them into a reference point, there are 'text buttons' which make a word stand off the page – these are

only there for decoration.

Although *ClearView* is excellent for viewing files, it is harder to create the files in the first place. It took me a couple of hours to learn how to make a small file without generating errors. You are not able to create a file in the program itself; instead you have to do all your page-creation in a text editor such as *Edit* or *StrongED*, using a script language not unlike HTML.

There is a 'skeleton' file that comes with *ClearView 2* which contains the basic layout from which you would make your own *ClearView 2* file. This is a good tutorial for first-time users of the program because you are able to add your text in the places indicated in the file. The file comes with two fonts already available to use, although you can program in as many fonts as you want by giving each one a number. You are then able to refer to a font just by using an abbreviation of the one you require.

Other options presented to the user are: whether to give each page a topic title, to rule off below a piece of text, create a reference point or text button, or even import *Draw* files, sprites and *Ace* films. It will

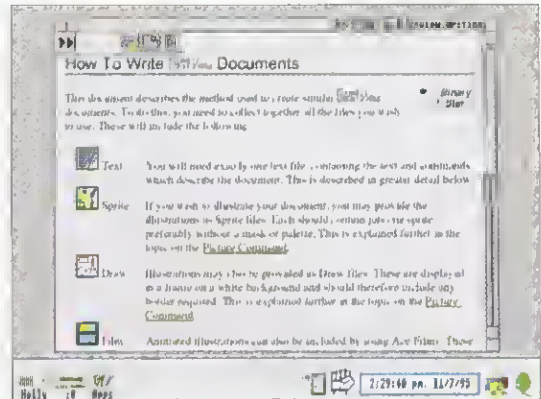

The *ClearView 2* manual is supplied as a *Clearview 2* file.

also *Filer\_Run* files, allowing (for instance) *Replay* or *Rhapsody* files to be run.

*ClearView 2* is quite a useful piece of software, but would have been even more so had the programmer included a way to programme your files inside *ClearView 2* instead of having to use a text editor. It isn't very user-friendly when your script files go wrong, so be prepared to spend quite a few hours just getting to grips with it before actually attempting to create a proper file.

However, as a compact (320K) hypertext system, with a public domain file reader, it excels.

Richard Verity

**MovieFS**

Supplier: Warm Silence Software  
Tel: (0585) 487642  
E-mail: Robin.Watts@com-lah.ox.ac.uk  
Price: £26.42 (£19.80 to *Acorn User* readers – see offer)

- Pros:** Allows AVI, Quicktime and other 'foreign' movie formats to be played on *Replay* • Will convert to

- Replay* files • Very simple to use  
**Cons:** None, other than the need for such files to play in the first place

*MovieFS* is one of those very awkward products to review that 'does exactly what it says on the packet.' It acts as a 'front end' for *Replay*, and supplies extra codecs to play a number of foreign video file formats, after converting them

**Special offer**

Up to the end of September, Warm Silence Software is offering *Acorn User* readers the chance to buy *MovieFS* at a 25 per cent discount price of £19.80 all inclusive. Simply contact Warm Silence Software – quoting *Acorn User* and this page number – and you will be able to claim the discount.



to the ARMovie standard. Once you have installed *MovieFS* on your system, perhaps running it on boot up, you notice no difference, except that now you can play AVI, Quicktime, *Animator Pro* and WAV files – *Replay* is a perfectly good sound-only system as well as a video one – as if they were *Replay* files. This means that any system which uses *Replay* will be able to play the files back with no fuss whatsoever. The odd file may give it trouble, but I have found very few that refuse to play.

Surprisingly enough, this works and is completely transparent to the user. There are a few frills – an application to correctly set the file type of files on a DOS-format CD-ROM

according to the file name extension, and a self-confessed kludge to allow Quicktime files on a Mac CD-ROM to be run. This is a program that you drop into your hoot sequence and forget about, so smoothly does it run.

More file formats (including MPEG) will be supported in the near future, but the current crop is enough to allow you to access videos and animations on most CD-ROMs and on the World Wide Web. To be honest, if you're not into either of these, you're not likely to encounter the sort of files for which you will need *MovieFS*, but if you are I would call it an essential purchase. *Replay* files are rare on the Internet, but AVI is almost a standard.

David Matthewman



**CineWorks**

Supplier: Oregon Software  
Developments

Tel: 0121-353 6044

E-mail: sales@oregan.demon.co.uk

Price: £159.95 inc VAT

**Pros:** Very intuitive • Imports and exports many different video formats  
• Multitude of video effects possible  
• Allows for third-party modules  
• Excellent value

**Cons:** Still slightly unstable • More powerful than current Arc hardware

It's not often you come across a piece of software that shows up the lack of power in the Risc PC, but *CineWorks* is one such product. It is a multi-track video editing program, treating video clips rather as *Composition* treats bitmaps. The philosophy is: take all the clips you want to use, load them into *CineWorks*, arrange them in the order you want (with crossfades, video effects and even a good old-fashioned bit of CSO), and get *CineWorks* to create a finished movie.

The crucial point about all this is that *CineWorks* only keeps thumbnails of the movie you use in memory. These are good enough to show what you are doing, but make the program very fast to use and not nearly as memory-hungry as you'd expect

from something that is, after all, cutting and pasting 10Mb files without a problem.

Say you have a clip of some seagulls, and also a clip of you walking on a beach and talking – Bill Oddie-style – about seagulls. You decide to use a portion of the seagull clip as an introduction, then fade to the walking on the beach clip, but have your commentary throughout. Simplicity itself in *CineWorks* – drop both clips into separate tracks, drop the beach clip into one of the audio tracks, drag the clips around until they are in the correct relative positions, drag out the bar on the bottom of the beach clip to set a transition, drag the crossfade icon from the 'transitions' window to the beach clip, and preview the clip. When you are happy with the effect, save the finished file to disc, and *CineWorks* will start to do the hard work of creating a video file at full resolution and quality based on the clips you have given it. It certainly beats all that messing around with pause buttons on two connected video recorders, and as it's all digital there's no quality loss in making copies.

Quality is the problem, of course. Anyone who saw the *CineWorks* demos on the *Acorn User* CD-ROM will have noticed that they were low-resolution and hardly comparable even to VHS quality. This isn't *CineWorks*'s fault, however.

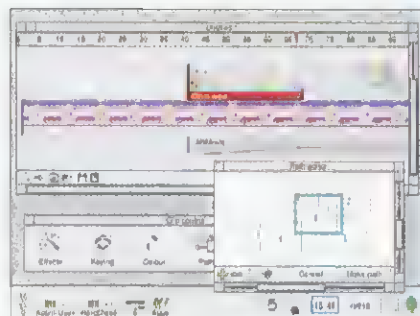

Here, an FLI file is combined with an AVI file, showing that *CineWorks* can easily mix video file formats. This also shows the path editor, allowing the picture to be moved around the screen for that *Top Of The Pops* feel.

The processing power and hard disc space necessary to cope with full-motion broadcast quality video simply does not exist in most people's Acorn computers, even Risc PCs.

Provided you can get the Replay files you want to use, *CineWorks* provides a highly intuitive platform for editing them, bristling with features. The review software I looked at was in a beta-test state – it did crash occasionally – and a much more in-depth look at this software is certainly required when it has been finally debugged.

David Matthewman

**Microtek Scanner**

Supplier: Iota Software

Tel: (01223) 566789

Fax: (01223) 566788

E-mail: sales@iota.co.uk

Price: £499 + VAT

**Pros:** Fast • Medium resolution • Good software  
**Cons:** Some problems with contrast

Back in the February issue of *Acorn User* we did a round up of scanners, which ended with a note that there were a few more arriving on the market soon. One of these is Iota's A4 flatbed scanner, based on a Microtek ScanMaker IIsp. This will scan 24-bit colour at a maximum optical resolution of 300 x 600 dpi – which can be interpolated by software up to 1200 dpi. This puts it in the medium resolution range of flatbed scanners – good, but less than pricey models such as the Epson GT9000.

The scanner is fast as it scans in one pass rather than building up the red, green and

blue components separately. On the same 5 x 4 print as scanned for the last review, the scanner gave a preview scan in 12 seconds and a 300 dpi 24-bit colour scan in 76 seconds. This is roughly comparable with the Canon IX-4015, and faster than most.

The scanner is a SCSI device, so you will need a SCSI card to use it. Interestingly, Iota has chosen to write its own software rather than use the popular *Twain 1 ImageMaster* combination from David Pilling. In general ease of use, Iota's software is about the same as David Pilling's, although *ImageMaster* has many more image processing facilities.

There is a problem with the software, which means that if you increase

the contrast when scanning a picture the colours go haywire, but Iota is aware of this and a fix is promised soon. It is a result of the hardware on the scanner having been changed recently, and should not affect early buyers of the scanner.

This aside, the picture quality is excellent, detail in both light and dark areas is retained, and you would have to spend serious money on a high-end Epson scanner from Irlam to beat this one.

Richard Verity













# Letters

## Wild progress

The Viewpoint in July's *Acorn User* makes interesting, but controversial reading.

From my 'viewpoint', responsible for managing Computer Concepts' hardware development and manufacturing arm, Wild Vision, I just cannot agree that we are abandoning the Acorn market. Not only are our current developments one hundred per cent Acorn related, but we have just had our most successful year in the market ever, something we could not have achieved by 'ignoring the needs of Acorn users.'

Our flagship product, the Eagle M2 multimedia card, has proved to be our fastest selling product of all time and we have struggled through the last few months with our factory at full capacity just trying to meet demand. Some of the companies you mention in your article would be rejoicing if they could achieve half the volume of sales we attain from the Eagle M2 with a low-cost product like a SCSI card, let alone with a technology-packed product retailing for over £300. Similar success stories can be told about our other newer products like Scanlight Video, TV Tuner, Lark A16 and MIDI card to name a few. Even the Chroma Genlock, one of the first podules ever released for the Archimedes, is still as popular as ever.

Surely this is testimony to the many man years of development effort invested in these products and the marketing resources required to reach sufficient volume for us to offer them at affordable prices. While, as you are keen to point out, there are plenty of other companies ready to take our place, I do not believe any of them have been inclined to accept the high levels of risk involved in serious product development and product launches that we have.

This is a fact perhaps borne out by Computer Concepts' four pages of full colour advertising in your July edition, devoted entirely to proprietary products (as opposed to *Computer Shopper*-style super-

market price list ads). So what of the future? Over the last year we have been working in partnership with Online Media in the development of the MPEG technology used in its Set Top Boxes. Much of this work has been at the very leading edge of video technology and has already had one spin off into the Acorn market in the form of our Movie Magic card. I can assure you and our customers that there is more to come as well! We have an ongoing program of development of MPEG and video technology. In the coming months this will be reflected in new releases of multimedia hardware that will fully exploit Acorn's latest platforms and offer a path of upward compatibility into the future. Moreover, guess who's developing the software - Computer Concepts!

Wild Vision may have had less direct visibility in the market place over the last year since Computer Concepts took over our marketing activities. As intended, we have been able to concentrate fully on product development and in doing so there has been no slacking whatsoever in our commitment to Acorn. When we first formed our alliance with Computer Concepts three years ago, it was with the declared aim of offering trend-setting multimedia products. Although some of Computer Concepts' software products may have reached a certain maturity in their development, the multimedia product range has some way to go before it could be called mature.

I believe we are already the number one provider of multimedia solutions in the Acorn marketplace and the claim to that pinnacle is not one we intend giving up without a fight. If we have competitors in the market place who are lulling themselves into a false



The Movie Magic card, one of the latest products from Wild Vision. And it's certainly not the last, according to Peter Wild.

sense of security by thinking our interest in the market is waning, they are in for a tough time.

**Peter Wild  
Wild Vision**

**Good news, I'm sure you'll agree. There's only one thing that bugs me: ScanLight Video was launched in 1993, the Lark card was released in 1993, the Eagle card is a year-and-a-half old, and the MIDI card, although reasonably new, is hardly the cutting-edge stuff we're used to from Computer Concepts and Wild Vision.**

**Peter says this is surely testimony to the development put in. Absolutely - I've always felt that Computer Concepts and Wild Vision research their products meticulously and release polished results. My point is that - to the outside world, at least - this seems to have slowed down immensely. The last major product was Movie Magic, which was released back in November 1994, and that's eight months ago. Eight months and still waiting for new products... (MM)**

## Very strong arm

In the StrongARM feature you stated three things:

1. An estimate SPECint92 for

an ARM610 based on a clock of 25MHz is 37.5.

2. The emerging StrongARM clock will be 200MHz.

3. The first StrongARM will be compatible with ARM6-7-8 since they have the same instruction set.

Surely the instruction set (mostly one instruction per clock cycle) is a major contributor to the high performance of the ARM chip, with regard to its apparent slower clock speed compared to the Intel world. Other factors such as pipelining and caches increase this base performance. This would imply that the StrongARM version of the ARM6-7-8 would have the same 1:1.5 ratio of clock to SPECint. Therefore an initial estimate of a 200MHz StrongARM would be 300 SPECint92! Hello Alpha, here we come.

On a slightly related topic, hands up all those Acorn fans who think the silence from Acorn about new hardware is deafening. The product department must have something remarkable waiting in the wings. How about a Risc PC800 with ARM800 running at 50-75Mhz, 16-bit sound, 4Mb video RAM, MPEG2, optional Power PC/Pentium co-processor... and not forgetting the portable A75 with ARM7500 (obviously) with optional 486/Pentium PC heater.





Whatever happened to the ARM710 upgrade for the Risc PC, or are they jumping straight to the ARM8 series?

Malcolm Ripley  
Glasgow

The ARM700 processor cards are due out soon, so don't hold your breath for ARM800 cards. The ARM710 cards can simply be swapped for the ARM610, and suddenly your processor is running at 40MHz rather than 30MHz. However, the PC card is apparently causing problems in conjunction with the ARM700 card - the one with the floating point chip - so that may appear a little later.

Still, Acorn has a new machine based around the ARM7500, which while priced below the Risc PC actually runs about as fast as the original Risc PC 600. It may not be a super-fast, super-spec Risc PC, but it's fast and it's cheap.

In the meantime, the Risc PC has been upgraded in specification - even the ARM600 model, which now runs at 32MHz. And of course they all now have RISC OS 3.6. (MM)

### Issue support

I recently purchased the Acorn *InterTalk* software but am having problems using it. I have followed the instructions in the manual and set up the configurations (correctly I hope) but when I try to run the program it gets as far as 'waitocol', then it throws out an error message 'script aborted (incorrect)' and starts the dialling procedure again. And it keeps repeating that sequence ad-infinity.

When I received the software, the package contained a printed card from a company called STNC Enterprises which contained a paragraph: 'The *InterTalk* Help-line is available for all users to answer any questions you may have about *InterTalk*. Calls will be charged in five minute periods on production of a credit card number. Alternatively for a fixed fee, unlimited telephone support will be provided. For more information call us on

(01223) 572548.'

I telephoned the number and was told:

- a. The credit card facility was not available;
- b. The fixed fee was £200.

I was, however, offered one hour of telephone advice at a cost of £20, but only by payment in advance. I declined.

My own opinion is that I am appalled that there is no after-sale support from Acorn, and that the only support that is available is on a commercial basis at exorbitant prices. To put it bluntly, I think that it's a rip off and ought to be exposed.

I would be interested in hearing your comments, and if you can offer any help or advice concerning the problem mentioned in the opening paragraph, I would be very grateful.

Royal Moore  
Via the Internet

Could this be the start of support charging in the Acorn market? I don't think so, but it is quite a hefty charge for those used to free support. On the other hand, supporting Internet software is a full-time job, so it's understandable. (MM)

### Networkz

You should warn your readers that *Fireworkz Pro* will not allow multiple access to data over a network. Only a single user *DataPower* engine is supplied with a *Fireworkz Pro* site licence.

This is a bit of sharp practice from Colton, like selling a Ferrari with cross-ply tyres fitted. A multi-user *DataPower* engine costs an extra £600!

Also, reviews are very complimentary, but surely reviewers have uncovered the multitude of bugs that have emerged in *Fireworkz Pro* that were not there in plain old *Fireworkz*?

Paul Williamson  
Castle Donington

Interesting point here - when does 'network version' mean 'works over a network', and when does it mean 'multi-user'? You live and learn. (MM)

## Viewpoint

Whoever said 'Nostalgia is the English disease' was sadly mistaken. Diseases are unpleasant and certainly aren't beneficial, but as far as I'm concerned nostalgia is great.

And I'm not alone. From misguided ramblings about how life was much better in the old days, to retro fashion and repeats on the TV, we revel in the past. Take music, for example. The other day I bought ABBA Gold, the digitally remastered recordings from the kings and queens of Scandinavian pop. And do you know what? It's great. The last time I was into ABBA was when my dad used to play it in the car on the way to school, and judging by the number of people my age who know every word to 'Dancing Queen', it's not uncommon. Okay, it's a bit cheesy compared to the MTV-savvy bands we have today, but sometimes cheesy's cool.

Nightclubs playing 1980s music are packed out mid-week, full of people who are slightly embarrassed that they can recognise every song played all night - but, what the hell. At least we Children of Thatcher didn't invent tartan flares or lava lamps, we just inherited them.

And there's a strong similarity in the computer market. Nostalgia is a way of life for seasoned computer users, as anyone who has got involved in an 'I remember the days when RAM pack wobbles were real RAM pack wobbles' conversation at a computer show will testify. *PCW* has an excellent new column called 'Retro Computing' in which nostalgic journalists wax lyrical about the Mattel Aquarius and how it should have been the Super Nintendo of the mid-'80s. It's a great read.

But what use is nostalgia? As far as Acorn users are concerned, it's one area where they have an edge over the PC: have you ever met a PC user who wishes everyone still had an upper limit of 640K and used DOS? No. But people look back on the BBC with considerably more fondness, and with good reason. The BBC taught the Acorn market a thing or two that other markets haven't quite got to grips with yet.

Compact coding is one of them. Flagship Acorn products like *Impression* and *DataPower* don't take up that many discs, and if they do it's because the packages include obscene amounts of extra software bundled for free. I've just done a count on *Impression Publisher Plus* on my hard disc, and it's taking up about 1.5Mb - not a lot compared to the almost virus-like ability of Windows software to eat hard disc space for breakfast. Could this be an offshoot of the BBC's whopping 32K of memory, the machine on which a large number of RISC OS coders learnt their trade? Could be...

Another offshoot - possibly due to the lack of C and C++ compilers on the Acorn platform until comparatively recently - is speed. Because no cool coder would be seen dead programming in BASIC, despite its speed on the ARM systems, assembly language is the hip language for fast and furious coding. So we have compact and fast programs that whip Windows applications where it hurts most: performance. Remember the good old days when every good program started with '{OPT pass%}'? Well, they're still here.

Stability is another attribute learnt from years on the BBC. If the Beeb was one thing, it was reliable (after the initial teething problems at the very beginning). You paid for quality and got it; this applied, also, to the incredibly cheap ZX Spectrum, but at the other end of the reliability scale. Beebs are still in common usage in many schools and homes today, a testament to the programmers and designers involved in the project. In the same way, Acorn hardware and software still has an enviable record for reliability, at least when compared to the Mac and PC environments. There are some lapses, but they're not that common.

Back on VE Day I heard a girl of 21 say 'I don't know why everyone's so bothered - what's the point in wallowing in the past?' The point is that the only way to move forward is to know where you've been, and people with her opinion end up being left behind. Luckily, Acorn is pretty good at learning from its and others' mistakes; it knows the value of nostalgia.

Mark Moxon

# Good-looking logos

Tim Powys-Lybbe describes how to create eye-catching letterheads without taking up huge chunks of memory.

Not unnaturally, many people doing a small amount of business want to put some emblem on the head of their letters. With most modern word processors, this is easy – you just construct a sprite or a drawing and put it in a frame at the top of the page.

But it's not so easy in practice. The worst problem for me was the additional 50K required for the sprite for each letter on the discs. With my correspondence of 40-odd letters a month this could add 2Mb every month; even with hard discs at the price they are, and with data compression utilities such as *ArcFS*, this soon produces an expensive demand for more discs.

## The font solution

Some years ago I had read of a suggestion that the answer was to define a font with the logo as one of the characters. The idea of that was that the overhead for each document was only the few characters to bring that font into the document, and the main data for the logo was stored once in the font definition.

This was something I immediately thought a Good Idea and over the years accumulated some of the tools to follow up

this suggestion. In my case I had a sprite that occupied a mere 1.4Mb in all its glory, though the part for the logo only took up 400K.

I use *Impression* so it gets a regular mention through this account. However, this technique will work with any word processor that can load in a *Draw* object, which includes virtually all word processors nowadays.

I approached one company that shall be nameless to enquire if they could define a font for this purpose. 'Yes, no trouble' was the answer. Then I sent them the sprite. 'No way, far too complicated' came back the reply.

This led to my obtaining a copy of *FontEd* to enable me to define the character for my logo. Slowly I found out how to use this complex tool, though fairly soon came up against the same problem: *FontEd* cannot hold much detail and crashes if one tries to make too complex a character. I persevered and eventually managed to produce something that looked like the logo I wanted, but with rather crude outlines and lacking some of the important details. This result did not appeal so I had to use the 50K sprite sparingly when I really wanted to use it.

One feature of RISC OS fonts is that they are in two colours and these are solid black and white in the original. Inevitably this means that surface detail is lost by using this font technique; however a logo is usually a simple, bold design and should not be textured.

## Enter Trace

A related issue was that I wished to transfer the source original of the 50K sprite, a mere 1.4Mb of uncompressed sprite in 256 colours of mode 21, to an Irish Business Machines environment. I eventually found the answer in David Pilling's *ImageMaster*, which would convert a sprite to a BMP object. The more important thing was that with *ImageMaster* came an update to an old program I had had for years. *Trace*,

and I was reminded of another of his programs, *DrawToFont*, again included within *ImageMaster*.

*Trace* is brilliant, as is *DrawToFont*. *Trace* converts a sprite to *Draw* format with reasonable veracity. But converting the whole of a 50K sprite to *Draw* was a nonsense and I ended up with an over-large object. The answer, that had already occurred to me at an earlier date, was to construct a font of many characters, each representing a different part of the logo and then assemble them as one large object in *Impression* by putting each character in a separate frame. The procedure is as follows:

1. Use *ImageMaster* to abstract each component piece of the logo. This was done in two stages using the Crop function, first a rough cut from the source sprite and second, from this, a refined cut of the desired piece.

2. Use *Paint*'s colour change facilities to get rid of any surrounding detail from the refined cut, to give a flat white background. This should not be to a transparent background because of a 'funny' in *Trace*, even though a transparent background is the obvious choice; see step 4.

3. Use *Paint* to make each component all into black. This is partly because the font will be in black anyhow and partly as it makes *Trace*'s job much easier and produces a far less complex result in *Draw*.

4. Use *Trace* to convert each component sprite to a *Draw* object. As long as the *Paint* source was only in two colours, I found *Trace*'s default error factor of 0.8 to give very good results.

A curious feature of *Trace* will be seen if the source sprite has its background set to a transparent mask; anything that was thought to have been deleted by the mask will now appear in the *Draw* object. This points out that the transparent mask does not delete the data in those pixels, it merely masks them over and *Trace* finds what was there before. This is why a mask should not be used in the source sprite for *Trace*. The same effect can be found in *ImageMaster* for a transparent mask. A mask in *Paint* usually doubles the size of the sprite file on disc, confirming this interpretation.

5. Open the new *Draw* object. Use Select All to locate the background element that is created by *Trace* and delete it. If you delete the wrong element, close the file without saving and start again.

6. Simplify each *Draw* object in *Draw*. *Trace* will tend to add a few surplus segments that can be removed with judicious tweaking of the segment handles of those that remain. I might add that it has taken me a few years to become fairly proficient with *Draw*'s line editing facilities so this is not to be attempted by the novice, at least not unless you have made secure backups.

7. Enlarge each *Draw* object, whatever its real size, to roughly three-quarters of



The original logo, as a very memory-hungry sprite.



A5. This is vital to the use of *DrawToFont*.

8. Put the separate objects into *DrawToFont* and save the resulting font. *DrawToFont* is, thank goodness, ridiculously simple to use and almost unfailingly successful, though see below.

9. Copy the new font into your fonts folder and re-boot the machine. The re-booting gets the new font loaded correctly for use.

### One small problem

This method worked. A by-product was that I could quickly create the logo in *Draw* by suitably assembling and combining all the objects, and I had an acceptable result that occupied a mere 25K, saving 50 per cent of the space occupied by the sprite.

I then had to labour to assemble the logo in *Impression*, using the various characters, one each to a frame, and enlarging and positioning until the required whole was produced. The composite frame in an *Impression* document was now down to 17K, including the 6K for *Impression* itself. Progress, but still a high overhead: now only 440K extra required per month.

A new problem now showed up. The composite logo had 22 separate frames for all its separate components, each holding one character, and for reasons best known to *Impression*, all these characters have to be redrawn, each in their own frame, every time one character is typed anywhere else into the document. The redrawing is slowed down by this, and the screen flashes as a result of each key-press – even with my ARM3 chip – badly enough to cause a brain seizure. This was not acceptable.

More thought and a night's rest produced the answer: try putting the whole logo as one character and see if *DrawToFont* will handle this. This was no trouble, and the one-character font was created quite successfully. But the Font Manager did not like this heavy character and would not draw it on the screen at all, an error condition that *Impression* handled gracefully, though something left the font file open as a result.

Eventually I split the *Draw* object into three separate objects, each taking up no more than 10K, as 10K seems to represent the upper limit of acceptable complexity for a character of a font. These were then made into a three character font and tried out in *Impression* to see if they would assemble properly. A little bit of trial and error and eventually I had a result. The logo was displayed for the addition of a mere 1.5K per *Impression* document, giving a monthly overhead of 60K, possibly reduced by *ArcFS* to a mere 10 or 20K: entirely acceptable.

### The final cut

The crowning achievement only came when I was preparing some illustrations for this account. I made up the logo in

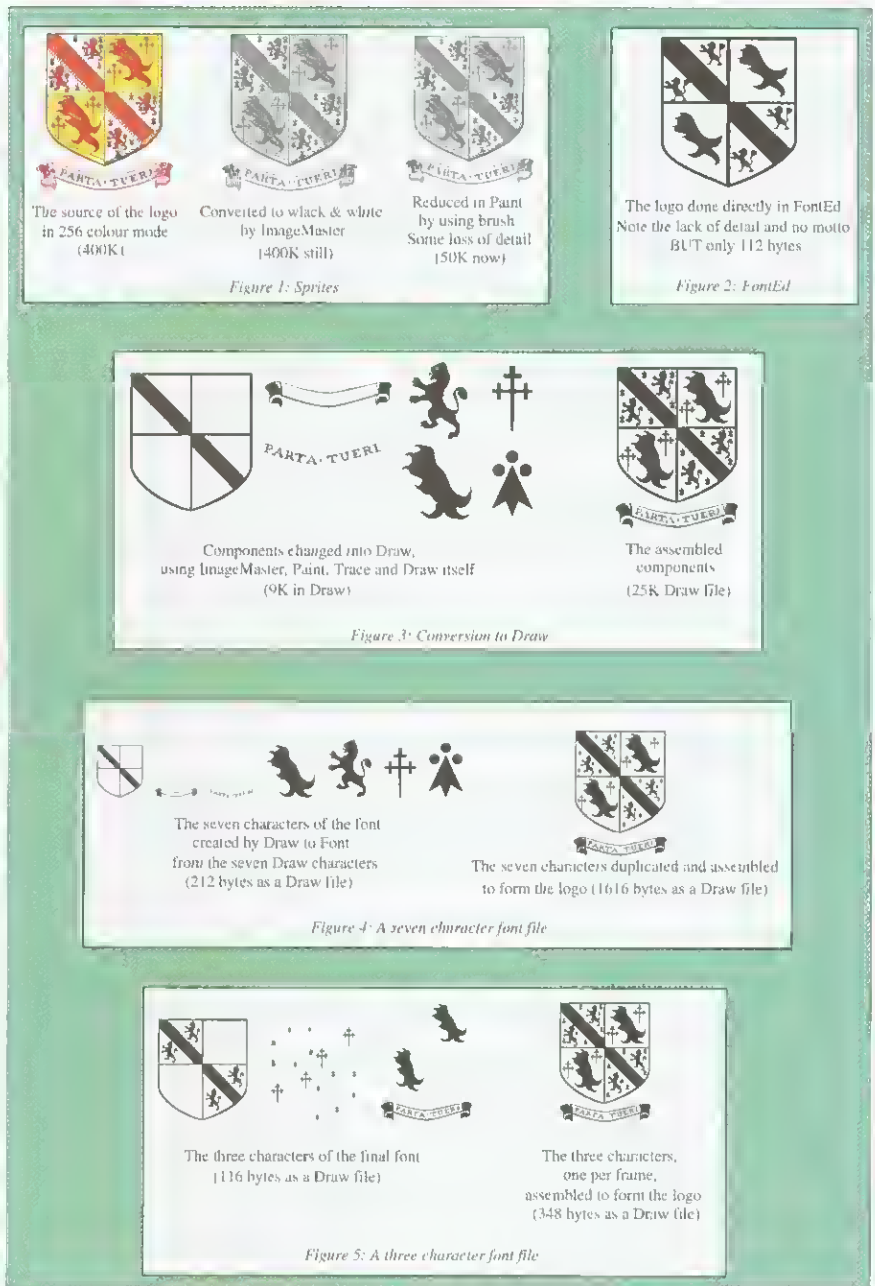

*Draw* and found it only occupied 350 bytes as a *Draw* file. So I deleted the assembly of characters from *Impression* and replaced it by this *Draw* file, giving an overhead of less than 450 bytes (depending on how one built up the document) that requires only 18K of disc space per month and much less with *ArcFS*. This confirms what I found with the 23-character logo, that *Impression* has a high overhead per additional frame, both in storage space and in redrawing time; *Draw* avoids this, for reasons that are beyond me.

A massive advantage of combining the font characters in *Draw* over *Impression* is that the result can be scaled larger and smaller totally satisfactorily in *Impression* as well as in *Draw*. In *Impression* scaling a combination of frames gets the component frames badly out of alignment and results in a mess.

Out of interest I tried this three-

character font in *FontEd* and discovered it blew up immediately, complaining that some buffer could not handle things. The Font Manager, then, can handle far more complex objects than *FontEd* and the only way to get them into the Font Manager is by using *DrawToFont*. Note that all this needs version 3.28 of the Font Manager; version 3.07, which comes in RISC OS 3.1, will not handle the large characters of the 'logo' font; indications are that its limit is characters whose *Draw* files are between 5K and under 10K.

I am now a happy camper! My thanks must go to David Pilling for producing such simple programs that do what no-one else has done for such a reasonable price. Thanks also to the anonymous person who mailed me a copy of *FontEd*, without which I would never have got to the desired end, albeit that *FontEd* was a red herring.



**Risc PC**  
 on-site maintenance  
 We operate Acorn Assist  
 Low finance available  
 6 months @ 14%  
 2 years @ 13.25%  
 3 years @ 13.75%  
 The following prices do not apply to finance deals  
 ring for details  
 17th July 1999

**Acorn**

**Risc PC 6001 (arm610)**  
 4M/HD425 14" mon. £1148.00e  
**RiscPC 700 (arm710)**  
 5M/HD425 14" mon. £1360.00e  
 10M/HD850 14" mon. £1692.00e  
 For 17AKF85 monitor Add £278.00  
 For CD Rom Drive Add £111.00  
 All Computers are built and tested before  
 dispatch with printers and software  
 installed as required at no additional cost

**RiscPC Upgrades**

488 PC Upgrade £99.00e  
 when purchased with RiscPC

Windows 3.1 Workgroups  
 + ODS 6.22 £95.00e

Access+ Card £99.00e  
 Movie Magic £237.00e  
 Second Slice £99.00e  
 Sound Card £59.00e

RiscPC 2Mb RAM £59.00e  
 RiscPC 4Mb RAM £129.00e  
 RiscPC 8Mb RAM £229.00e  
 RiscPC 16Mb RAM £379.00e  
 RiscPC 1Mb VRAM £89.00e  
 RiscPC 2Mb VRAM £199.00e

**Archimedes Computers**

A3010 (1.8 Floppy Disc, Software  
 Pack, Joystick Ports, TV Modulator)  
 Learning Curve 2Mb £339.00d  
 Early Years 2Mb £339.00d  
 For 14AKF52 monitor Add £180.00d

A3020 (1.8 Floppy Disc, 2Mb ram,  
 AKF52 M/S Monitor)  
 Floppy Disc System £509.00e  
 80Mb Hard Disc Sys £637.00e  
 For 14AKF50 monitor Add £37.00d

A4000 (1.8 Floppy Disc, 2Mb ram,  
 AKF52 M/S Monitor, 210 Mb HD)  
 210Mb H/Disc Sys £722.00e  
 Add £37 for AKF50 Monitor

**A7000** (1.8 Floppy Disc, 2 or  
 4 Mb expendable to 130Mb ram, Rm  
 7800 AKF60 M/S Mon, 425Mb HD,  
 on site 12 months warranty)  
 2M/HD425 14" mon. £841.00e  
 4M/HD425 14" mon. £918.00e  
 For CD Rom Drive Add £111.00e

**Software Packs:**  
 only available if purchased with  
 A4, A3020, A4000 or RiscPC

Early Years £63.83  
 (Talking Starturite, Flossy the Frog,  
 A Mouse in Holland, Dorla the Dotty Dog,  
 Archiving Maths, Gemini, Painpal)

Home Office £108.39  
 (Easy Writer, Data Power, Filedream4,  
 PC Soft doc 6, Demos)

Learning Curve £63.83  
 (Advance, PC Soft 1 Doc 6, Demos)

**Portable Computers**

A4 4mb 60Hard Disc £1445.00d  
 (1.8 Floppy Disc, 4Mb RAM, 80Mb HD, LCD  
 Screen, PC Emulator)

Pocket Book 2(255k) £205.00e  
 Pocket Book 2(512k) £255.00e  
 Pocket Book 2(1Mb) £285.00e

R-Link £40.49b  
 M-Link £64.80b  
 PC-Link £56.70b  
 Parallel Link £24.28a  
 Power Supply £12.72b  
 Flash 56D 128 £34.00a  
 Flash 56D 256 £46.77a  
 Flash 56D 512 £76.65a

**Hardware Upgrades**

Chroma Genlock £142.00b  
 Colour Card Gold £189.00b  
 Compatible Mouse £17.00a  
 Eagle M2 +Eidos £316.00e  
 Lark Midi Sound-Sa. £189.00b  
 Midi Max £68.00b  
 Risc OS Upgrade Kit £76.00a  
 Scanlight 256 8bit £161.00e  
 Scanlight 256 15bit £161.00e  
 Scanlight 256 Video £209.00e

**(Mail Order Tel: 01924 254800)**

**SCSI 16bit** £91.00b  
**SCSI 232bit** £151.00e  
**TV Tuner** £85.00b  
**TV Tuner + Teletext** £151.00e  
 All Hardware fitted free if ordered  
 with Computer else £15.00

**Data Storage**

IDE 2.5" £79.00e  
 80mb Areal £109.00e  
 250mb Maxtor £170.00e

IDE 3.5"  
 425mb 14ms Conner £139.00e  
 540mb Conner £149.00e

535mb 10ms Digital £180.00e  
 1034mb 10ms IBM £380.00e

SCSI CD Tray Quad Internal  
 Pioneer XM361B £259.00e  
 Toshiba DR-U124X £279.00e  
 SCSI CD Caddy Quad Internal  
 Toshiba XM-3501B £299.00e

All Drives fitted free if ordered  
 with Computer else £15.00

**Memory Upgrades**

A3000 1-2mb £55.00b  
 A3000 2-4mb £119.00b  
 A3010 1-2mb £39.00b  
 A3010 2-4mb £89.00b  
 A3010 1-4mb £140.00b  
 A3020 2-4mb £85.00b  
 A4000 2-4mb £85.00b  
 A6000 2-4mb £86.00b

All Memory fitted free if ordered  
 with Computer else £15.00

**Printers**

Canon  
 BJ-105x (black) £169.00d  
 BJ-30 (black) £195.00d  
 BJ-70 (colour) £276.00d  
 BJ-200ex (black) £210.00d  
 BJ-C4000 (colour) £285.00d  
 BJ-C600e (colour) £289.00d

Heulell Packard  
 DeskJet 540 (black) £249.00d  
 DeskJet 550C (colour) £359.00d

Calligraphy  
 A4 1200 Laser (black) £979.00e

**Printer Inks**

Inkjet Refills are an economical way  
 of re-charging your existing cartridge  
 All inks come complete with gloves,  
 syringe and easy to use instructions.  
 Single 20ml Any Colour £6.70a  
 Twin 2x20ml Any Colour £10.50a  
 Tri-Colour C/M & Y £16.50a  
 Bulk 126ml Any Colour £20.00b

**'CartridgeMate' A new and  
 easy to use cartridge refill system for  
 HP 15126A high cap. cartridges**

A refill system with no mess  
 Comprises: CartridgeMate  
 & 2 x 40ml Ink Tanks

Cartridge not included £30.00b  
 Ink Tank 2 x 40ml £17.00a

HP5126A Tri-Colour Cartridge refill  
 kit 3 x 3 colour refills  
 Comprises: C/M & Y Inks

Cartridge Cap Remover  
 Cap Retaining Clip £30.00a

EP-L Toner for LBP-4 £69.00e  
 EP-S Toner for LBP-8 £59.00e

**Printable Items**

Print'n Wear (2 white T Shirts +  
 4 transfer papers, works with dot  
 matrix or ink jet printers) £11.50b  
 Design & Print Mouse Mat £5.00a  
 Design & Print Business Cards  
 10x8 A4 150g Perforated £4.60a  
 Col InkJet matt photo white paper  
 25 sheets x 120gms £5.00b  
 Monochrome InkJet brilliant white  
 paper 100 sheets x 90gms £2.50b

**Application Software**

Advance (Acorn) £99.00e  
 Advantage (LL) £46.00b  
 Arcfax (David PI) 28.50a  
 Ancestry (Minerva) £49.50a

**DAVYN**

**Davyn Computer Services**  
 Acorn Approved Dealer

ArtWorks (CC) £135.00e  
 Audio Works (CC) £43.50a  
 Card Shop (Clares) £19.50a  
 Celebration (Clares) £27.10a  
 Complete Animator (Jota) £79.50b  
 Composition (Jates) £129.00b  
 Compression (CC) £27.50a  
 DataPower (Jota) £119.00b  
 Desktop Thesaurus (R Dev) £17.50a  
 Easy Font 3 (Fabis) £26.50a  
 Eudora (RiscPC only) (CC) £146.00a  
 Eureka 3 (LL) £89.00b  
 Fun Works Pro (Gilton) £1e  
 Formula (CC) £60.00a  
 Font FX (Dalestree) £9.50a  
 Frame 1.1 or 2 (Davyn) £5.00a  
 Publisher (original frames)  
 Graphics Loaders (CC) £37.00a  
 Illusionist (Clares) £39.00a  
 Image Animator (Jota) £46.00a  
 Image Bank (Jaram) £23.00a  
 Image Outliner (Jota) £46.00a  
 Impression Publisher (CC) £135.00e  
 Impression Publisher + (CC) £259.00e  
 Impression Style (CC) £79.00e  
 Knowledge Organiser 2 (Clare) £61.50a  
 Mouse Recorder (Klein) £27.00a  
 Ninate (LL) £53.00b  
 Pendown Eloives (LL) £49.00b  
 Pendown Plus (LL) £69.00e  
 Personal Accounts (Apricot) £37.00b  
 PhotoDesk (Space Tech) £157.00a  
 Pinpoint (Longman) £89.00b  
 Plot (Clares) £61.50a  
 Pro Artisan 2 (Clares) £108.00a  
 Pro Artisan 24 (Clares) £125.00a  
 Prophet 2 Accounts (Apricot) £143.00e  
 Render Bender v2 (Clares) £39.00a  
 Revelation ImagePro (LL) £119.00e  
 Rhymody 3 (Clares) £79.00a  
 Rhythm Beat (Clares) £39.00a

**RiscCad Professional**  
 (Davyn) £159.00e

Schemata 2 (Clares) £104.00a  
 Score Draw (Clares) £47.50a  
 Screenshot (Clares) £79.00a  
 ShapeX (Dalestree) £9.50a  
 Sibelius 6 (Sibe) £144.50b  
 Sibelius 7 (Sibe) £719.00b  
 Sibelius 7 Student (Sibe) £449.00a  
 SmArt (4Mat) £49.00a  
 SmArt Files (4Mat) £14.50a  
 SmArt File Mtd.Lang. (4Mat) £18.50a  
 Snippet (4Mat) £32.00a  
 Sound FX Maker (CIS) £34.00a  
 Split an Image (Sher) £16.50a  
 Titrer (Clares) £79.00a  
 Topographer (Clares) £79.00a  
 Touch Type (Jota) £39.00a  
 Turbo Driver (CC) £43.00b

**Education Software**

10 out of 10 Full Range Each £18.00a  
 Dinosaurs, Driving Test, Early Essentials,  
 English, Essential Maths, Essential  
 Science, Junior Essentials, Math Algebra,  
 Maths Number, Math Statistics Spelling  
 + buy 2 get 3rd FREE

Adventure Playground (Storm) £17.00a  
 Amazing Maths (CSH) £17.00a  
 Amazing Ollie (Storm) £13.50a  
 Arcventure 1 Romans (SHER) £32.00a  
 Arcventure II Egyptians (SHER) £32.00a  
 Arcventure III Vikings (SHER) £32.00a  
 Around World 80 Days (SHER) £42.00a  
 Aztecs (SHER) £41.00a  
 Badger Trails (SHER) £41.00b  
 Body Wise (SHER) £41.00a  
 BookStore (ESM) £34.00a  
 Coffee (Siorn) £25.00a  
 Connections (SHER) £29.00a  
 Crystal Rain Forrest (SHER) £41.00a  
 Daryl the Dragon (4Mat) £18.00a  
 Farm (SHER) £19.00a  
 First Logo (LL) £21.50a  
 First Page DTP (LL) £45.00a  
 Flossy The Frog (4Mat) £22.00a  
 Flight Path 9+ (Siorn) £26.00a  
 Freddy Teddy (Topolnika) £17.00a  
 Freddy Teddy's Adv (Topol.) £17.00a  
 Fun School 3/4/5,5,7,7+) each £17.00a

(Please Specify age group)

Granny's Garden (4Mat) £22.00a  
 Happy Life (CCS) £26.00e  
 Happy Numbers (CCS) £26.00e  
 Happy Reading (CCS) £26.00e  
 Happy Sea (CCS) £26.00e  
 Happy Time (CCS) £26.00e  
 Lammarks Full range (LL) £24.00a  
 Look Here Talking Topics (Sh) £52.00b  
 Magpie (LL) £50.00b

Naughty Stories V1 or 2 (SHER) £49.00e  
 Ollie Octopus SK Pad (Storm) £13.50a  
 Oxford Reading Tree Stage 2  
 Talking Stories (SHER) £38.00b  
 More Talking Stories A (SHER) £38.00b  
 Oxford Reading Tree Stage 3  
 Talking Stories (SHER) £38.00b  
 Oxford Talking Infant Atlas £18.00a  
 PinPoint Junior (LL) £26.00a  
 Plant Wise (SHER) £12.00a  
 Podd (ESM) £20.00b  
 Prime Solver (Minerva) £68.00a  
 Rosie & Jim Duck (SHER) £10.00a  
 Rosie & Jim Sneezees (SHER) £10.00a  
 Sea Rescue (SHER) £26.00a  
 Selladore Tales (SHER) £22.50a  
 Snuggle the Spaniel (Storm) £17.50a  
 Snuggle the Scientist (Storm) £36.00a  
 Spaced City (SHER) £26.00a  
 Splash (SHER) £19.00a  
 Stig of the Dump (SHER) £22.50a  
 Story Starters (SHER) £22.50a  
 Talking Clock (Toppo) £57.00a  
 Talking Animated Alphabet £17.00a  
 Time Detectives (SHER) £42.00a  
 Teddy Bear's Picnic (SHER) £26.00a  
 Voyage of Discovery (SHER) £32.50a  
 Worst Witch (SHER) £26.00a

**Games Software**

Arcurus (Otagon) £19.00a  
 Champions (Krisalis) £21.50a  
 Big Bump (Pycvone) £12.00a  
 Battle Chess (Krisalis) £21.50a  
 Black Angel (4D) £24.00a  
 Burn Out (Oragan) £20.00a  
 Cannon Fodder (Krisalis) £19.50a  
 Card Manta (CIS) £15.00a  
 Chopper Force (4D) £22.00a  
 Chuck Rock (Krisalis) £8.50a  
 Crystal Maze (SHER) £28.50a  
 Cyber Ape (11BA) £15.00a  
 Cyber Chess (4D) £24.00a  
 Cycloids (Soft42) £15.00a  
 Diggers (Milica) £22.00a  
 Dreadnoughts (Turcan) £26.00a  
 Bismark scenario (Turcan) £13.00a  
 Ironclad scenario (Turcan) £13.00a  
 Dune 2 (Eclipse) £27.00a  
 Dungeon (4D) 2mb £24.00a

Empire Soccer £a  
 Enter The Realm (4D) 2mb £18.00a  
 Fir & Ice £21.00b  
 Flashback (US Gold) £21.00a  
 Fred (Soft42) £15.00a  
 F.T.T. (TBA) £19.00a  
 Galactic Dan (4D) £17.00a  
 Global Effect £28.00a  
 Gods (Krisalis) £8.50a  
 Haunted House (4D) 2mb £19.00a  
 Heimdall (Krisalis) 2mb £21.00a  
 Hero Quest (Krisalis) £21.00a  
 James Pond (Krisalis) £8.50a  
 James Pond 2 RobnCod (G/W) £19.50a  
 Krisalis Collection (Krisalis) £22.00a  
 Lemmings (Krisalis) £18.50a  
 Lemmings Oh No More (Kris) £15.00a  
 Lemmings RiscPC (Krisalis) £21.00a  
 Lemmings 2 Tribes (Krisalis) £21.00a  
 Magic Pockets (Renegade) £19.00a  
 Magnetoids (Oragan) £19.00a  
 Man United Europe (Kris) £8.50a  
 Microdrive 2 (CIS) £24.00a  
 Mig29M Super Ful. (Don) £22.00a  
 Omar Sharif's Bridge (Krisalis) £22.00a  
 Populus (Krisalis) £22.00a  
 Raw Power (Software 42) £19.00a  
 Real McCoy (4D) £21.00a

(U/M Arcade Soccer, White Magic, Quaker)

Saigon Cars Deluxe (4D) £23.00a  
 Sally & Wally (Oragan) £19.00a  
 Scrabble (US Gold) £21.00a  
 SimCity (Krisalis) £24.00a  
 SimCity 2000 (Kris) £29.00a  
 Simon The Sorcerer (G/W) £29.00a  
 Simon The Sorcerer CD(G/W) £35.00a  
 Small (Virgol) £19.00a  
 Speedball (Krisalis) £20.00a  
 Spheres of Chaos (Malt) £19.00a  
 Spudbrikk (Cybenation) £19.00a  
 Starfighter 3000 (Fednet) £23.00a  
 Swiv (Krisalis) £8.50a  
 Time Machine (4D) £24.00a  
 Turbo Challenge 2 (Kris) £19.50b  
 Virtual Golf (4D) 2mb £24.00a  
 Virtual Golf augusta course (4D) £12.00a  
 Waducks (Network 23) £22.00a  
 Waterloo (Turcan) £19.00a  
 Wolfenstein 3D (1Power 5) £23.00a  
 Xenon 2 (G/W) £19.00a

**CD Software**

ArtWorks (CC) £135.00e  
 ArtWorks Clipart I (CC) £17.00a  
 ArtWorks Clipart II (CC) £17.00a  
 Granny's Garden (4Mat) £30.00a  
 Hutchinson M/Media £47.00a  
 Langsdale (CCS) £89.00b  
 Naughty Stories V1&2 (SHER) £79.00b  
 Oxford Reading Tree Stage 2  
 Talking Stories (SHER) £36.00b  
 PhotoBase 1920s (LL) £46.00a  
 PhotoBase 1930s (LL) £46.00a

**All Prices Exclude VAT**

PhotoBase 1950s (LL) £46.00a  
 PhotoBase 1960s (LL) £46.00a  
 PhotoBase Landscapes (LL) £46.00a  
 PhotoBase Victorians (LL) £46.00a  
 RiscDisc (Uniqueway) £15.50a

**Bargain Basement**

5.25"40T D/S Bare Drive (NEW) £15.00b  
 Blob 1 or 2 (Widgit/Semerc) £16.00b  
 Blob count with (Widgit/Semerc) £16.00b  
 Colony Rescue (Alien Images) £5.00e  
 Concept Kids (BBC) (SHER) £10.00e  
 Cyborg (Alpine) £6.00b  
 Drop Ship (4D) £6.00b  
 From Pictures - Words (Semerc) £25.00b  
 Humanoids + Robotix (CIS) £5.00b  
 Ibib the Viking RiscOS2 (Miner) £5.00b  
 Le Monde A Moi (Semerc) £16.00b  
 Meinte Welt (Semerc) £16.00b  
 Overload (Clares) £5.00b  
 Piranoid 2000 (Graft-Gold) £6.00b  
 Provocator (CTS) £5.00b  
 Revelation 2 (LL) £59.50b  
 S-Base Person (LL) £69.00b  
 Serpents (CIS) £5.00b  
 Starch (Aliant) £6.00b  
 Tiles (Brian Games) £6.00b  
 Tracker (Seral Part) £20.00b  
 Vision Col Digtiser (JICCS) £75.00b  
 WolfPack (Sih42) £5.00b  
 WordWorks (CC) £25.00b  
 Zelanites RiscOS2 (MPower) £6.00b  
 3.5" Disc Box 40cap. £3.40  
 3.5" Disc Box 40cap. £4.80  
 3.5" Disc Box 40cap. £6.50

**Second User**

3.5" 80T Ext. drive with PSU for BBC  
 Model Cumana CS354 £65.00  
 Second drive interface to fit AX000 (if  
 above) £15.00  
 Second user hardware sold as working  
 with 3 months warranty

**How To Order**

Checks: should be made  
 payable to **Davyn Computers**  
 Credit Cards: you may also pay  
 by Visa, Delta, Euro, Switch  
 Electron, or Master Card. We  
 normally make no charge for this  
 and take no payment until good  
 are ready for dispatch. We need  
 the card holders address and  
 telephone number, card number  
 and issue number if any and the  
 expiry date.

**Carriage:** charges are as follows

a Small £1.00  
 b Medium £2.00  
 c Medium Recorded £4.00  
 d Courier £9.00  
 e Courier Large £15.00

**Official Orders:** are welcome  
 from UK education and  
 government institutions (invoice  
 are due for payment within 14  
 days and are subject to carriage  
 and late payment charges).

**VAT is not included:** Zer  
 rated items are marked with U  
 customers please add 17.5% to al  
 other prices including carriage.

**Order Address:** please send  
 your orders to:  
**Davyn Computer Services**  
 'The Workshop'  
 off Princess Street, Sandal  
 Wakefield, West Yorkshire,  
 WF1 5NY

**Opening Hours:**

Monday 9.30 - 5.30  
 Tuesday 9.30 - 5.30  
 Wednesday 9.30 - 5.30  
 Thursday 9.30 - 7.30  
 Friday 9.30 - 7.30  
 Saturday 9.30 - 5.30

**Terms:** All products, prices and  
 specifications are offered in good  
 faith and are subject to change  
 without notice. We Process all  
 orders immediately, but suppliers  
 do sometimes keep us waiting  
 Goods are guaranteed but are not  
 supplied on approval. Returns and  
 cancellations can only be accepted  
 by prior agreement and there may  
 be a restocking and administration  
 charge A full copy of our terms are  
 available upon request.  
 E. & O.E



Acorn reveals how it is building up for the Information Superhighway event of the year.



# Online in the Acorn World

Microsoft, National Westminster Bank and *The Guardian* are some of the big names at Acorn World '95 whose exhibits will underline the theme of this year's show – the Information Superhighway. Microsoft will be demonstrating its range of educational software – now highly compatible with the Acorn platform and running on the Acorn Risc PC 486 card – within the context of the Superhighway environment.

*The Guardian's* theatre session will complement its exhibit promoting *Education Guardian, Online* – the paper's computing, science, technology and communication section – and *The Guardian's* affiliation with *Wired*.

The National Westminster Bank's exhibit will be pointing the way towards banking of the future and showing its involvement in the set-top box technology being developed by Online Media.

## Acorn's main exhibit

The main exhibit will be circular and on two levels, will feature:

- An impressive educational area, with a row of the new Acorn A7000 models demonstrating the latest IT solutions.
- The information and sales desk, the place to track down those special, never-to-be-repeated show offers.
- Technology City, the area that's a must for all enthusiasts, showing the latest developments on the Risc PC front.
- A knowledgeable Advice Centre providing 'straight from Acorn' answers to all your questions.
- A dedicated Clan Acorn 'rocket ship' system for members to try some 'hands-on' manoeuvres.
- A video wall which will recreate the Cambridge Trial, one of the first pilot schemes in the country, bringing home-banking, shopping, video-on-demand and games into

your living room. Participants include Tesco, Anglia TV, National Westminster Bank, BMP DDB Media, Needham, NOP and the Post Office. This will also give a taste of Acorn's newly developing education service, designed to be delivered to schools, homes and colleges using the emerging infrastructure technologies – in particular, broadband networks. The service will add educational value to existing content (video, audio, software, etc) and develop completely new ideas for interactive applications. Content providers signed up so far include the Open University and Anglia TV, with more large names set to follow suit.

• On the upper level, there's the 'multimedia experience'; the place to sit for a convergence of sound, visual imagery and information.

## Other attractions

On separate stands in the hall there will be:

- A pre-school learning area: reflecting Acorn's recent link-

up with the Pre-School Learning Alliance to develop and promote IT through the PLA's 22,000 pre-school playgroups in the UK – Acorn being the only computer manufacturer endorsed by the PLA. Experts in young learning from both organisations will be on hand to talk to parents and toddlers and provide some hands-on experience of IT packages designed specifically for this young audience. Mixed with face painting, games, jugglers, magicians and a colourful, toy-packed crèche, it promises some real fun with computers.

In the Cyber Services area you'll find:

- The Cyber Café: a civilised place where you can sip a cup of coffee and surf the Net. See for yourself what the Highway is all about – there's help on hand for those who haven't travelled the Superhighway yet – visit some of the places you've read about in the Internet magazines, or check out your favourite URL.
- A games arcade: Built to

**Acorn WORLD**

**WEMBLEY EXHIBITION CENTRE  
27-29 OCTOBER 1995**

**TICKET HOTLINE 01933 441 448**  
Advance Prices: Adults £5 Children £4 Family £16

**SPONSORED BY  
ACORNUSER**

impress inside one of the highway maintenance vehicles, this is always a highly popular venue where you can try out the latest computer games.

Don't forget the joint Acorn World/Clan Acorn offer for £15, details of which were in the last issue. **AU**

## Theatre timetable

Time	Friday	Saturday	Sunday
11.00 – 11.25	Risc PC700/A7000: P Bondar	Risc PC700/A7000: P Bondar	Risc PC700/A7000: P Bondar
11.35 – 12.00	Give your child a head start: A Bennett	Give your child a head start: A Bennett	Special Education: T Downey
12.10 – 12.35	Super Highway: OnLine Media	Making Music: J Laroche	Internet: C Cox
12.45 – 1.10	Making Music: J Laroche	Pocket Book: H Howarth	Making Music: J Laroche
1.20 – 1.45	Consumer Awareness & the use of New Media: <i>The Guardian</i>	Multimedia – Myth or Magic? S Palmer	Pocket Book: H Howarth
1.55 – 2.20	Networking: M Phillips	Special Education: T Downey	Multimedia – Myth or Magic? S Palmer
2.30 – 2.55	Future Technology: P Bondar	Networking: M Phillips	Give your child a head start: A Bennett
3.05 – 3.30	Multimedia – Myth or Magic: S Palmer	Internet: C Cox	Super Highway: Online Media
3.40 – 4.05	StrongARM/ARM700: ARM Ltd	ATM and MPEG: ATML	Technical question time
4.15 – 5.00	Technical question time	Publishing on The Internet: <i>Acorn User</i>	Closed

# GAME SHOW

After the successes of *Dune II*, Eclipse has informed me that it intends to produce a CD-ROM version of the popular game – the full graphical introduction will be included, along with more speech and all the music. It's also planning to add several saved game files which would allow players to access parts of the game that they might not have seen. However, there will be plenty of space left on the disc, so Eclipse are thinking about including a short film on the making of *Dune II*, and a demonstration version of their forthcoming strategy game, *Global Effect*. The price of this product is likely to be around £49, and the upgrade for existing *Dune II* owners should be about £25. You can give Eclipse a ring on (01243) 531194.

## Sim City Secrets

If your conurbations are crumbling, or you've gut a haul case of the sprawling suburbs, help is at hand in the form of a book by Andrew Banner. *Secrets of Sim City 2000* aims to lead players through all the features of the game, suggesting a few new ideas on the way. It's written in an informal style, and is liberally sprinkled with screenshots. Seasoned

gamers will probably have discovered the majority of information in the book already; however, if you've just started playing the game and you could do with some advice then Andrew Banner's guide is simple to read. *Secrets of Sim City 2000* costs £9.95 and is published by Bruce Smith Books – you can give them a call on (01923) 894355.

Andrew's book is by no means the only collection of *Sim City 2000* information around, and I'd suggest that those with Internet access look for a copy of the frequently asked questions list for the game. It's a veritable mine of information covering all aspects of the game. If you've ever puzzled over an aspect of *Sim City*, the chances are that the answer's buried in there somewhere. Neither of these items are specifically for the Acorn, so be prepared to wade through information relating to other platforms.

## Mixed spice

I've been spending a lot of time playing *Dune II* recently, and any fellow players will recognise the feelings of frustration that arise whenever you've just completed your supposedly indestructible fortification, only to have it blown to smithereens by a well-aimed Death Hand missile. Michael

Richards has sent in a whole host of hints and tips for *Dune II*, so if you're desperate to turn the tables on the Sardaukar, read on.

Firstly, make sure you've prepared a task force of vehicles out of the way of the rest of the battle so you can launch a mass attack against your opponent. You'll have to knock out the missile turrets before you can safely attack the buildings, so include a few long-range vehicles such as the missile launcher or the Atreides sonic tank. It's vital to knock out your enemy's construction yard as early as possible, so it's worthwhile sending out a fast, expendable vehicle on a reconnaissance mission to locate it. Bear in mind that you're equally vulnerable, so on later levels think about sending a mobile construction vehicle to a remote part of the battlefield in order to keep your supplies going.

When the situation warns up, you may well find that the computer refuses to let you build any further structures or vehicles – this is particularly infuriating when you're desperate to build a silo to avoid losing spice. The only way round this is to mount an attack on your enemy and destroy a few things. This should lower the structure count enough to alleviate the problem.

Finally, a few general hints – spice is limited on some of the levels, so make sure you're out there collecting it as soon as you can. Be prepared to build three or four refineries if necessary, along with enough silos to store the product. Destroy enemy harvesters on sight, and

don't waste your cash once you've earned it; consider building a repair station to avoid the costs of constructing 'brand new' vehicles all the time.

## Making the connection

For those of you that have access to the Internet, you might like to add Gareth Moore's 32-bit Acorn Gaming page to your hotlist – a World Wide Web document featuring news on forthcoming games, full reviews of a sizeable number of titles, and the obligatory hints and tips section. For those with a technical inclination, there is a whole host of links to programming resources which contain information and tutorials on the art of writing games.

I've been a regular reader for quite some time now, and it's obvious that Gareth's put a lot of effort in to produce a high-quality resource. If you'd like to take a look, fire up your World Wide Web browser and enter <http://www.csv.warwick.ac.uk/~csuod/> as the URL.

## PC Compatibility

Thanks to everyone who's written in with details of game compatibility on the PC card for the Risc PC – keep it coming. I've been making notes, and I'll keep you posted with the details – the major problems appear to be connected with



Understand *Sim City 2000* with Andrew Banner's book or by reading the FAQ on the Internet.

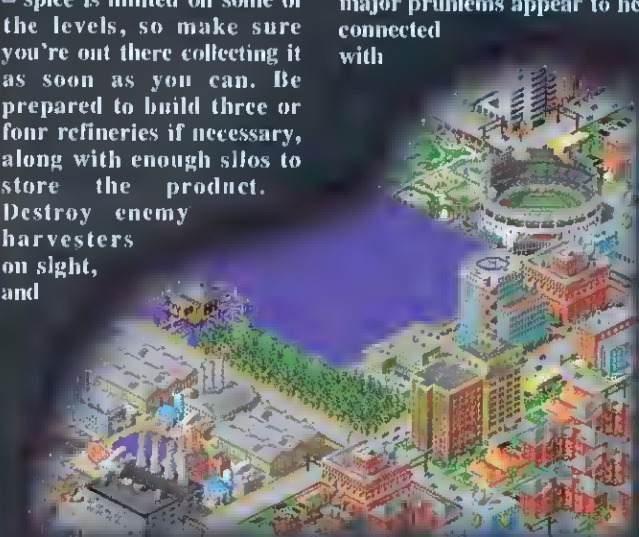





Digital Psychosis's *Oddball* gets the cheat treatment.



Steve Mumford gives advice worthy of a Mentat for *Dune II* addicts.

graphics and memory. Programs requiring VESA drivers fail to work, and most of the newer programs need a reasonable slice of memory to run. However, I can report moderate successes with games such as *Doom*, *Theme Park*, *Lemmings 3D* and *Magic Carpet*. On the other hand, I'd avoid *Cannon Fodder 2* and *Lemmings 3*; both crash the machine. If you're thinking about buying a PC game to use with the card, it's a good idea to hunt around for a demonstration disc first – if the game doesn't work, you'll have saved yourself quite a bit of cash.

Assuming you've found a game that works, you'll probably be disappointed by the colour scheme: in the process of displaying the PC

screen, the Acorn chips in and converts all the PC colours to their nearest equivalent in the old 256-colour palette. Needless to say, this doesn't look too pretty, and is a bit of a shame considering that the Rise PC doesn't really need to second-guess colours in this way. However, it's early days for the PC card, so hopefully we'll see some driver upgrades in the future. I've already seen an unofficial patch that removes this problem, but it does tend to make a mess of the colours in the desktop. If there's anybody out there who has written a patch and is willing to submit it, might I humbly suggest that you contact *Acorn User*? You'd make a lot of games players very happy.

### Cheat Corner

Here's a piece of information for *Oddball*, the latest game from Digital Psychosis. If you'd like to start the game on a different level, try typing the command:

`*SetEval OddballCheat`

followed by the level number to jump to that screen. If that's not enough, try selecting the instructions page and typing:

`Stuff This`

which will enable you to cycle through all the special tokens on offer by clicking the right-hand mouse button during play.

### And finally...

A while ago, I received a letter from M. Chatterley, who would like to see some more coverage of text-based adventure games in the Game Show. I have to admit that they're not my strong suit, but I have been known to spend hours in a state of complete bewilderment while playing games such as *Jinxter* or *Wonderland*. With this in mind, I'm tempted to dedicate a future column to the subject, but I'll need some help from the adventure game fans out there. If you've got any questions, or perhaps more importantly, any solutions, please get in touch.

Before I move on, if you fancy writing your own adventure game, take a look at the *Acorn User* CD-ROM – it contains *Zip*, an Infocom interpreter, as well as Graham Nelson's adventure

compiler *Inform*. These programs also appeared on the *Acorn User* cover discs between the August and October issues of 1994.

If there are any subjects you'd like to see covered in the Game Show, or you've got some information that you want to share, please drop me a line. I'm always interested to hear from programmers, whether new or established, so if you're slaving away on a project and you think more people should know about it, you know who to contact.

Next month I'll be talking to Bertie, otherwise known as Tom Cooper – responsible for games such as *Hamsters*, *Wavelength* and *Ixion*. His latest game, *Darkwood*, is almost ready to be released on the unsuspecting world, and I'll be there to give you the details. See you then.

Steve Mumford



*Doom* will run on the Risc PC 486 co-processor.



The CD-ROM version of *Simon the Sorcerer* allows you to listen to the wizards chattering away as they play Mah Jongg – in their awful accents, of course.

Supplier: Gamesware  
Tel: (01703) 456523  
Price: £45.99  
Upgrade from 3.5in disc version, £8.50  
Demo CD-ROM, £9.99

*Simon the Sorcerer* has not had an auspicious history on the Archimedes. The original game turned up a full year later than intended, and we had to wait another six months for the CD-ROM version with full digitised speech.

The CD-ROM version of *Simon* on other platforms is wonderful. I have encountered it on the CD-32 and it really lifts the game to have all the characters speaking their lines rather than reading some text on the screen. As anyone who is up on the games scene already knows, *Simon* himself is voiced by Chris Barrie – recently of *Red Dwarf* and *The Brittas Empire* fame, though connoisseurs will remember him as the voice of Margaret Thatcher in *Spitting Image* – who brings just the right sarcastic tone to the precocious 12-year-old.

Something went badly wrong in the conversion to the Archimedes, though. Not only have the music and sound effects vanished, but the speech itself is distorted and muffled. At first I thought my internal speaker was on the blink but no, it's worse through headphones.

Apparently, this is an unavoidable consequence of the way the samples are stored on disc. It's certainly a great pity, because – far from enhancing the game – the CD-ROM version of *Simon* is in many ways inferior to the 3.5in version. What is gained by adding speech is lost by making the speech unclear in places, and the village becomes a ghost town as *Simon* wanders past a silent forge with no music in the background.

The program also isn't very intelligent about where it breaks long samples. Several times in the introduction to both the game and the demo version, *Simon* pauses mid-words as the next part of the sample is loaded in. There is no attempt to put these breaks between sentences where they wouldn't be noticed – perhaps this also was impossible because of the way they were stored on disc – so you have to cope with vital information being spoken in a distorted manner and stopping mid-words every so often.

I hate being negative about any innovation in the Acorn market – a game on CD-ROM is certainly innovative – and *Simon the Sorcerer* is one of the all-time great games. Sadly, *Simon the Sorcerer* does not live up to expectations, and actually makes the Archimedes look

shoddy in comparison to other platforms. This is not fair on the Acorn; it may only have an 8-bit sound system, but it can do much better

than *Simon* suggests. Don't show this one to your friends with PCs and Amigas – they'll laugh.

David Matthewman

# Simon the Sorcerer

# CD

## Detritus competition

Reviewed in the July issue, *Detritus* from Myndgaemz is a complicated adventure with a plethora of puzzles to be solved. The game may take even experienced adventurers months to complete.

To celebrate the release of *Detritus*, the programming team Myndgaemz has decided to offer a prize of £100 to the first *Acorn User* reader to complete *Detritus*. The rules of the competition are as follows:

- A full solution, with a step-by-step guide to completion, must be sent to Myndgaemz, so it can verify that the whole adventure has been completed.
- The first correct solution received by Myndgaemz will win the prize of £100. It is therefore the responsibility of the player to keep the solution secret until the winner is announced. Myndgaemz accepts no responsibility for policing 'stolen' solutions.
- If no solution is sent in by the end of September, the competition will be declared void and the prize will not be awarded.
- The competition is open to registered users of the game only – this does not include copies provided for review.
- The competition is not open to friends, family or employees of Myndgaemz, Byte Back Computing, or *Acorn User*.
- The decision of Myndgaemz is final and no correspondence will be entered into.

Completed solutions should be sent to:

Detritus competition  
Myndgaemz  
18 Mallory Crescent  
Fareham  
Hants  
PO16 7QA

and may also be submitted by e-mail to: [mgaemz@jonwat.demon.co.uk](mailto:mgaemz@jonwat.demon.co.uk).

*Detritus* is available for £29.95 from Byte Back Computing, PO Box 40, Nottingham NG5 6SS, tel: 0115-955 4501.



# COMING SOON

**A survival guide for parents**

## Sue Cook

Ex-Crimewatch presenter Sue Cook has strong views on family computers

### The biggest day of your life

The first day at school is more traumatic for parent than child

### National Curriculum – help or hindrance

What does it mean to your child?

### Number crunching

Helping 7-11-year olds with their maths at home and school

### Spoilt for choice

We gave one family £1,500 and told them to buy a computer

### Competition

Three top-of-the-range CD-ROM drives to be won

*A guide to education for 3-11 year olds*

# Parent & Computers

**FIRST ISSUE ON SALE 24 AUGUST**



 IDG

For further information, ring 01625 878888

T-shirt printing

I've always liked the idea of using the computer to make something which isn't on a flat piece of A4 paper, so I was particularly keen to try some of the *Colour 'n' Wear* kits distributed by Quill Marketing.

There are several kits available, from the basic four A4 sheets up to kits which include a T-shirt. You can even buy a mouse mat kit. The theory is simple - use the computer to draw a picture, print it onto the special film using an inkjet printer, iron it onto a garment and wear it. The trouble with most clever things like this is that it works fine in theory, but falls over as soon as you try to put it into practice. This doesn't. It really does do what it says it does.

**Step one - design**

Designs can be created in several ways. Drawing them yourself is the obvious option, but some very pleasing results can be obtained using PD clip art. If you're fortunate enough to own a video recorder and have a digitiser, you can include a photo into the design. Extra care should be taken here though, as many printers don't make a very good job of photos unless they're black and white.

Some clever text effects can be added with the use of such cheap utilities as *Fontasy* and *DrawBend*, both by Ian Copstake Software. *Fontasy* enables text to be printed around a curve or irregular path, and *DrawBend* can 'mould' text into an irregular boundary. *Acorn User's Stretch*, which appeared on the cover CD-ROM, can also produce some clever effects.

The design need not occupy a whole sheet of iron-on film. Small logos can be printed and then cut out before ironing on to a garment. But rather than running the film through the printer several times, it's better to create a page full of designs, print the whole page in one go, and then cut them out before the iron-on stage.

**Step two - printing**

In most cases, the computer artwork will need to be flipped left to right so that a mirror image is achieved. This is particularly important if the design contains lettering or digitised photographs. Most programs have a flip facility built in, although it's not always obvious. In Draw, for example, you should group all the objects together (Ctrl-A, Ctrl-G) and then set the X scale to -1 (in the Transform sub-menu). If you're using *Publisher*, go to Typesetting... in the Print dialogue box, and choose Reflect pages to output a mirror image.

It's not necessary to have a top-of-the-range printer for this job. It's not even necessary to have a colour printer. In fact, if you've got an old dot matrix

# Custom clothing

printer and a pack of marker pens, you can still get some excellent results.

**Step three - ironing**

Having printed the design onto film, the film is now ironed onto fabric. Initially, it's probably best to choose white fabrics as these will not alter the colours, unlike dark colours which may not provide the necessary contrast.

Place the garment flat onto an ironing board, put the printed film onto the garment and place another piece of fabric on top - a pillow case is probably best. With a very hot iron and firm pressure, move the iron broadside along the long edge of the transfer. The instructions supplied are very precise: follow them carefully. Gently smooth the fabric with your hand and leave to cool for a few minutes.

**Step four - washing**

After wearing the garment it will need to be washed. This is the stage most other similar products fail. To wash the garment, turn it inside out and wash in cool/warm water. Dry at the 'cool' setting and do not iron the surface with the transfer.

Geoff Preston tries out Quill Marketing's range of iron-on transfers.



**Special offer**

These 'Colour 'n' Wear' products are great fun. We at Acorn User have arranged a special offer in conjunction with Quill Marketing. Details are on the form below. Quill Marketing stocks a range of 'Colour 'n' Wear' kits. For a full list, contact Quill Marketing on: (01603) 748002 or fax (01603) 748003.

**Special offer to Acorn Users**

Acorn User readers can obtain a special discount on a range of Quill Marketing special transfer papers and kits.

Product	Description	Price
AU5000	4 x A4 sheets hand-ironable ink-jet transfer paper	£6.95 inc VAT
AU5001	30 x A4 sheets hand-ironable ink-jet transfer paper	£37.95 inc VAT
AU5004	Hobby Kit: 4 x A4 hand-ironable ink-jet transfer paper plus 2 adult white T-shirts	£12.95 inc VAT
AU7151	Mouse mat kit, 2 x A4 hand-ironable ink-jet transfer paper plus one plain white mouse mat	£6.95 inc VAT

Plus P&P of £2.95 inc VAT for UK per order  
Plus P&P of £6.95 no VAT for rest of world per order

Name \_\_\_\_\_

Address \_\_\_\_\_

Daytime tel no \_\_\_\_\_

Please charge my credit card (Master card/Visa/Delta/Switch/Access):

Signature \_\_\_\_\_

Card no:

Expiry date: /

I enclose a cheque made payable to Quill Marketing (UK only, rest of world by credit card only)

Send to Quill Marketing, 11 Hemmings Close, Norwich NR5 9EH.

Tel: (01603) 748002, Fax: (01603) 748003

Please allow 21 days for delivery.



Data-handling is not new. Even before computers, people have needed to have access to information, and traditionally schools have taught pupils how to gather information in books, card index files and other paper-based systems. With the advent of the computer, however, we are now able to use a machine that could sort, search and present that information much faster than traditional methods, processing large quantities of information with great ease, especially with the advent of CD-ROM. The need to manipulate data has become so essential in today's world that the National Curriculum has defined a basic set of information-handling skills which all pupils must have the opportunity to acquire. Many people, however, have been put off the idea of using a database because the traditional computer databases did not make these skills easy to learn. They put many pupils off with their unwieldy terms such as 'fields' and 'alphanumeric.'

### Junior Pinpoint's capabilities

*Junior Pinpoint* provides an easy-to-use desktop environment in which pupils can create their own questionnaires which become the database when completed so that the need to construct a database is eliminated. Once created, the questionnaire can be completed in one of two ways: it can either be printed and photocopied to be filled in manually, or can be completed directly with mouse and keyboard. The option to use multiple choice questions can help to all but eliminate spelling errors, if necessary.

The program is divided into four main sections. The *form designer* is like a desktop publishing environment where pupils can design their own questionnaires. There is the opportunity to design questions, write text, draw lines and boxes and import *Draw* files and sprites to make the questionnaire more attractive. Once completed it can be stored on disc for future reference but is easily accessible if the pupil wishes to modify it in some way. The *sheets* option allows you to use the questionnaire to answer the questions

A survey sheet, arranged as a questionnaire, allows a simple database to be set up.

# Presenting the evidence

Colin Rouse surveys the flexibility of *Junior Pinpoint*, a new concept in data-handling software.

contained within it, answering a yes/no question by clicking a mouse-button or typing in a longer answer using the keyboard. The *spreadsheet view* is where you can sort the information gathered, select some of the sheets and print lists or draw graphs. Finally, there is the *desktop publisher* where your graph is drawn on to a sheet of paper as in a DTP program. Here you can add text, lines and boxes to produce a finished report to a very high standard.

### In the classroom

Contained within the software is a well thought out manual which is unusual because it is written for children. Working their way through it enables children to experience the many basic skills necessary for information handling in a series of real tasks such as: understanding the need to collect information, using record sheets, entering information, drawing graphs and producing finished reports. Presented as a set of photocopiable sheets, the manual will lead pupils from an understanding of the nature of information handling right through to developing the skills of collecting information, creating their own databases and producing high-quality presentations and reports.

By working through the manual, the pupils will have the opportunity to gain the essential skills of data-handling while undertaking real and well thought out tasks. They will have the opportunity to use the skills necessary to achieve the data-handling statements of attainment,

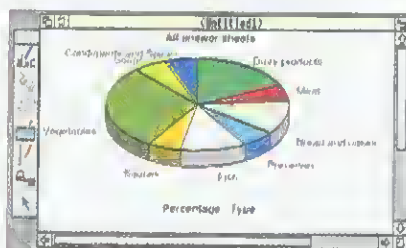

*Junior Pinpoint* will produce results in the form of graphs.

## Product details

Product: *Junior Pinpoint*  
Supplier: Longman Logotron  
Tel: (01223) 425558  
Fax: (01223) 425349

Pros: Good user interface  
• Excellent manual, written for children  
• Simple database creation for primary schools

Cons: None

starting at level one and progressing to level five and beyond in a coherent and interesting way. Pupils also have the opportunity to communicate information using *Junior Pinpoint*, which again takes pupils up to level five and beyond. All the examples are set in a curriculum context and include ideas for follow-up work or for solving problems using existing data.

### Conclusion

Having used *Junior Pinpoint* extensively in the classroom, I have found it to be a program children soon find easy to use. The manual takes them through a series of tasks which they find interesting and this work provides a good stimulus for children at the higher levels to undertake a survey of their own choice, allowing them the opportunity to interrogate their results and present their findings in a professional manner. This package would have a place in any primary classroom.

Apart from the data files already held on the disc, Longman has produced a series of *Junior Pinpoint* support packs for various curriculum areas. Titles include: *The Olympics*, *Dinosaurs* and *The Victorians*. A sample *Junior Pinpoint* questionnaire constructed by me, called 'All about Me', can be found on this month's cover disc.

AU

## Family trees

Having retired from the company I had worked for for 43 years, I wanted to find something to do that would supplement the inevitable decorating, gardening and the many other jobs around the house I would have to catch up on.

Coming from a very large family, I thought it would be a nice idea to trace our family history and record the information in such a way that it would be of lasting interest and value to myself, and to my many cousins. But how could I do this in a relatively simple and convenient way, but produce a high-quality document?

### Enter the computer

I decided to put my Archimedes 410/1 and some of my software to use for this major project. As this was to be more than just a family tree, I decided to create a loose leaf booklet using *Ovation*. A separate page would be used to display

# Family

Jim Farrow compiles a record of his family, for his family.

information about each family member with additional information about their marriages and children. A picture of each member of the family would be included with such details as where they were born, where they worked and comments about their hobbies and interests.

I used *Ovation* because of its ease of use, particularly the simple means of being able to draw lines within the program and then to be able to add 'end caps' to the lines. This is particularly useful for placing arrows to identify people in the many and various 'group' photographs I used. To achieve this, I created a text frame with a border to take the individual's name, with a line leading from this to the relevant person in the picture. Line thickness, length, colour, end cap and position are easily adjusted. To do the same in Computer Concepts' *Impression* is a little trickier as you must create the line of the correct thickness and colour (and with the arrow head) in *Draw*, and then import it into *Impression* as a graphic.

I scanned the photographs with Computer Concepts' Scanlight Plus scanner, and needed to carry out a small amount of enhancement before cropping the pictures to fit the frames. I then saved them as *Draw* files and imported them into the *Ovation* document.

# ties

### Using fonts

I wanted to use different fonts for different sections of the booklet and needed to control the use of these in a straightforward manner. Consistency of style is also very important. Fabis Computing's *Easy Font* provided me with on-screen styles of the all the fonts I had, and used a simple process of installing and de-installing them which made selection very simple.

*Ancestry* from Minerva was invaluable, and although this was not RISC OS compliant and would not allow me to print out the family tree on my Canon printer, it did allow me, in a very precise way, to record and retrieve all the specific dates and information for each individual of the family. This program has now been upgraded to *Ancestry II* and because this version is fully RISC OS compliant, I am now able to create a family tree in the style and design I choose, and import it into *Ovation* as a graphic.

To add a touch of style to the pages, I



A *Draw* file imported into a Datafile Gothic Frame and modified in *ArtWorks*.

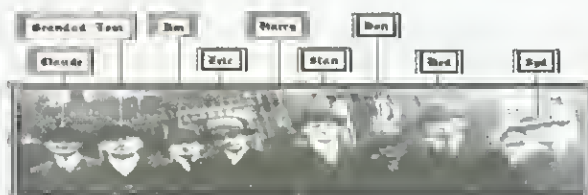

A picture showing the use of frames with borders and lines with 'end caps'.

used *Gothic Frames* from The Datafile which enabled me to place some intricate designs around the graphics and text frames. More recently I discovered that papersoft supplies templates for the Acorn range of computers that are compatible with paper frames produced by Paper Direct. I am now experimenting with these to determine which of the designs I will use to further enhance the final appearance of the booklet.

I wanted the final pages to be produced in a high-quality print. A laser printer would have been preferable, but I found that some very good results could be achieved with a Canon BJC-600 printer.

When the record is finally completed, each member of my family will be presented with their own copy of our family history.

AU

### Contact details

Beebug (*Ovation*): (01727) 840303

Computer Concepts (*Scanlight*): (01442) 351000

The Datafile (*Gothic Frames*): (01934) 823005

Minerva (*Ancestry II*): (01392) 437756

Paper Direct (*Designer Stationery*): (0800) 616244

Papersoft (*Software Templates*): (01442) 391967



## RapIDE Fast IDE Interface

32-bit DMA-based IDE Interface for the RISC PC. Interface provides vastly increased throughput over the RISC PC motherboard. Using alternative drives it is possible to achieve reading speeds approaching 8Mb per second using 32-bit direct memory access. Provides two IDE ports, allowing upto 4 devices to be connected including IDE CD ROMS.

Supports the new enhanced-IDE (ATA-2) standard, which will allow all PIO modes (up to mode 4) to be used if the hard drive will support it. Full fitting instructions supplied. Also available, a range of fast IDE hard disc drives.

RapIDE RISC PC Interface	£ 99
540Mb 12mS IDE Drive	£ 155
850Mb 12mS IDE Drive	£ 205
1.08Gb 10mS IDE Drive sustained data rate of approx. 7Mb/sec	£ 259
1.2Gb 12mS IDE Drive	£ 279
1.6Gb 12mS IDE Drive	£ 299
1.08Gb Drive & RapIDE	£ 339

## CD-ROM for RISC PC

Connects to IDE port of RISC PC or a port on the RapIDE card. Supplied with dual IDE cable and **PlayCD** audio CD player software

Dual Speed	£ 99
Quad Speed	£ 149
Audio Mixer Board	£ 29

In order to allow an IDE CD ROM to be used on A300 / 400 A540 and A5000 machines an interface such as the Watford IDE card must be used - which has an external connector. The software supplied with this card must be upgraded to be fully RISC OS 3.1-compatible. A5000 machines require a chip replacement also.

RISC OS 3.1 software for Watford IDE board	£ 15
Replacement chip for use on A5000 machines	£ 8
External case and power supply for CD ROM	£ 79



All prices exclude VAT @ 17.5%. P & P £ 5 per order.

## Yellowstone Educational Solutions

Welbeck House, Welbeck Road, Luton, Beds., LU2 0HD

Tel: 01582 484828

Fax: 01582 415541

## MICRO LASER DESIGNS



Telephone : (01225) 833266

Facsimile : (01225) 833266

105 Midford Road, Combe Down, Bath BA2 5RX

• ACORN PUBLISHING DEALER • PRINTING, COPYING, SCANNING AND BUREAU SERVICES •

Micro Laser Designs is an Authorised Acorn Publishing and Consumer Dealer. **ALL PRICES SHOWN INCLUDE VAT - CARRIAGE IS FREE!** Prices shown are for CASH / CHEQUE / DEBIT CARD / SWITCH only. CREDIT CARDS 3% SURCHARGE. Prices / specs subject to change. E&OE.

**PRINTING!** Don't forget we offer a complete range of printing services at very competitive prices. Letterheads, Business Cards, Booklets, Leaflets, FULL COLOUR BROCHURES etc. **ATTENTION SOFTWARE HOUSES:** Why not ask us to quote for your next brochure, leaflet or manual. You are assured of the best prices, prompt service and no hassle!

**NEW ACORN MACHINES • NEW LOW PRICES • NEW HIGH SPECIFICATIONS • ORDER NOW!**

We operate the Acorn Assist Scheme. We can also offer **INTEREST FREE CREDIT (up to 2 years) and BUY NOW PAY LATER.** Please call for details. Businesses schools can use our leasing schemes. Subject to Status. **PLEASE TELEPHONE (01225) 833266 for info!**

### ACORN RISC PC 600 • NEW MOELS!

4M HD425 + AKF60	£1315
4M HD425 + AKF85	£1633
4M HD425 + CD ROM + AKF60	£1442
4M HD425 + CD ROM + AKF85	£1760

### ACORN RISC PC 700

5M HD425 + AKF60	£1559
5M HD425 + AKF85	£1877
5M HD425 + CD ROM + AKF60	£1685
5M HD425 + CD ROM + AKF85	£2000
10M HD850 + AKF60	£1939
10M HD850 + AKF85	£2257
10M HD850 + CD ROM + AKF60	£2066
10M HD850 + CD ROM + AKF85	£2384

### RISC PC 486 CARO (when bought with RISC PC) ... £99

<b>ACORN A7000</b>	
2M NET + AKF60	£1022
2M NET + CD ROM + AKF60	£1149
2M HD425 + AKF60	£1070
2M HD425 + CD ROM + AKF60	£1198
4M HD425 + AKF60	£1169
4M HD425 + CD ROM + AKF60	£1295

### ACORN A4000

2M HD210 + AKF52	£827
2M HD210 + AKF50	£873

### ACORN A3020

2M + AKF52	£584
2M + AKF50	£629
2M HD80 + AKF52	£730
2M HD80 + AKF50	£776

### ACORN A4

A4 4M HD80	£1656
------------	-------

### ACORN POCKET BOOK

Pocket Book II 256k	£234
Pocket Book II 512K	£292
Pocket Book II 1Mb	£326

### EARLY YEARS

A3010 2M, No monitor	£389
A3010 2M + AKF52	£584
A4000 2M HD210 + AKF52	£879
A4000 2M HD210 + AKF50	£924
A7000 2M HD425 + AKF60	£1123
RISC PC600 4M HD425 + AKF60	£1365

### LEARNING CURVE

A3010 2M, No monitor	£389
A3010 2M + AKF52 14" Monitor	£584
A4000 2M HD210 + AKF52	£879
A4000 2M HD210 + AKF50	£924
RISC PC600 4M HD425 + AKF60	£1365

### HOME OFFICE

A4000 2M HD210 + AKF52	£913
A4000 2M HD210 + AKF50	£959
RISC PC600 4M HD425 + AKF60	£1399

### RISC PC VRAM:

1Mb VRAM	£135
2Mb VRAM	£199
1 - 2Mb VRAM Upgrade	£110

### SRAM MEMORY:

2Mb SRAM	£145
4Mb SRAM	£180
8Mb SRAM	£225
16Mb SRAM	£270

### SOFTWARE:

Impression Style	£90
Impression Publisher	£145
Impression Publisher Plus	£275
ArtWorks	£145
Complete Animator	£90
PhotoDesk	£180
EasyFont 3	£35
Hearsay 2	£75
AudioWorks	£48
Advantage	£48

### SYQUEST CARTRIOGES

44Mb	£50
88Mb	£55
105Mb	£60
270Mb	£65

**A6 Art Pad** ... .. £175

### CONNOR HARD DISCS

1Gb SCSI II	£360
2Gb SCSI II	£600
4Gb SCSI II	£1050

**CUMANA SCSI II CARD** ... .. £189

• ACORN • QMS • CANDN • EPSON • COLOURGEN • SONY • CUMANA • SAMSUNG • HEWLETT PACKARD • CONNOR • SYQUEST •

# textease

**EASY TO USE WORD PROCESSOR AND DESK TOP PUBLISHER**

*It's like a sheet of paper, just click anywhere and start to type*

Easy to use for

- Letters
- Posters
- Notices
- Overhead foils
- in fact any text plus graphics...

### FACTFILE

Archimedes World April 1995

Performance	● ● ● ● ●
Features	● ● ● ● ○
Value	● ● ● ● ●
Overall	● ● ● ● ●

from **£29.50**

Basic Version £29.50 + VAT (£34.66)

With Spelling £39.50 + VAT (£46.41)



Tel 01332 204911 Requires RISC OS3

**Softease Limited, The Old Courthouse, St Peters Church Yard, Derby, DE1 1NN**

Produced on *textease*

# iSV Summer SALE

## Over 550 OS3 Fonts

All with full latin1 character sets including Welsh  
All with kerning pairs and fully scofolded  
Supplied with easy to use font instoller & Print outs  
Auto install into Easyfont and FontDir, Acorn lFonts  
Serif fonts, Sons Serif fonts, Blockletter fonts, Script fonts...  
2Mb Rom and a hard disk required

**Normally £50.00 - now £36.50**

## ViVID Hi-res Emulator

Work areas up to 2048x1234 on pre Risc PC computers  
256 colour desktops up to 1472x1070 (57hz emulated)  
Refresh rates up to 85hz including (1600x1200 at 62hz)  
Emulated modes up to XGA (16 colour) and beyond  
Arm250/Arm3, VIDC Enhancer, Multisync monitor required

**Special price only £11.50**

## Font Designers Toolkit

*"The toolkit is very well designed, elegant and good value for money."*

Archive Morch 1994

*"A fine set of font utilities for the serious font meddler."*

Archimedes World Morch 1994

**Normally £31.50 - now £21.50**

86 Turnberry, Home Farm  
Bracknell Berks RG12 8ZH

Tel 01344 55769 Demobook Catalogue £2.00



# Liquid Silicon

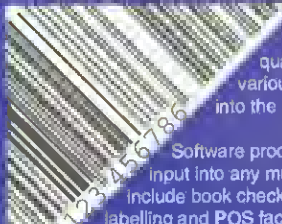

### Bar Coding Systems

We supply a range of high quality bar code readers from various manufacturers, integrated into the RISC OS 2 or 3 desktop.

Software processing of the bar codes allows input into any multitasking application. Uses include book checking in libraries, product labelling and POS facilities.

We also produce software to create numerous formats of bar codes yourself, enabling all kinds of information to be stored and read back by a reader.

Further information is available.

### MIDI Setups

We supply a range of keyboards, synthesizers, sound expander modules, MIDI interfaces and software to provide you with a complete MIDI setup.

Enter music into your computer via a keyboard and MIDI interface and let the computer play it back for you through the keyboard or via a sound module, using the proper instrument sounds!

Further information is available.

We will attempt to match or beat any advertised price, whether in a sale or otherwise.

**FREEPOST EH2725, Kirkcaldy, Fife KY2 5BR**  
Tel/Fax: (01592) 592265

Run by enthusiasts for you  
**All prices INCLUDE VAT and postage**

Official orders and callers welcome

**Acorn Authorised Dealer**

### Computer Systems

Call for details of the Early Years, Learning Curve & Home Office options

Risc PC600 4Mb+1Mb HD425, AKF60 - £1349  
Risc PC700 4Mb+1Mb HD425, AKF60 - £1599  
Risc PC700 8Mb+2Mb HD650, AKF60 - £1969

### Options when buying a Risc PC:

AKF60 (14") monitor to AKF65 (17") - add £328  
1Mb VRAM to 2Mb VRAM - add £100  
PC Card - add £118  
CD, ROM drives - from £190

A7000 2Mb Network, AKF60 - £1049.00  
A7000 2Mb HD425, AKF60 - £1099.00  
A7000 4Mb HD425, AKF60 - £1199.00

A4000 2Mb HD210, AKF52 - £848

A3020 2Mb, AKF52 - £599

A3020 2Mb HD80, AKF52 - £749

A301 0 2Mb, EY or LG - £399

A3010 2Mb, AKF52, EY or LG - £599

A4 4Mb HD60 - £1521

Pocket Book II (256K) - £240

Pocket Book II (512K) - £299

Pocket Book II (1Mb) - £334

### Memory Upgrades

Please call before ordering to check prices. Others available

A3600 1-4 Mb - £180.00

A3010 1-2 Mb - from £42.00

A3010 2-4 Mb - £104.50

A3010 1-4 Mb - £180.00

A3020/A4000 2-4 Mb - £92.80

A5000 2-4 Mb - £95.00

Flash SSD (128K) - £97.95

Flash SSD (256K) - £84.95

Flash SSD (512K) - £89.90

Flash SSD (1Mb) - £185.95

Flash SSD (2Mb) - £279.95

Flash SSD (4Mb) - £325.95

RAM SSD (128K) - £49.90

RAM SSD (512K) - £139.95

RAM SSD (1Mb) - £285.95

Risc PC/A7000 SIMMs (Call for current prices):

4Mb - £137.00

8Mb - £284.00

16Mb - £240.00

32Mb - £310.00

64Mb - £1240.00

1Mb VRAM - from £80.00

2Mb VRAM - £175.00

### Bare Hard Drive Prices

Please call before ordering to check prices

Other capacities and sizes available

420Mb 3.5" IDE - £165

540Mb 3.5" IDE - £175

850Mb 3.5" IDE - £235

This is a very small selection of our prices. Call or write for your free catalogue which also contains many bargain items.

Access, Visa, Mastercard, Eurocard and Delta cards accepted. Finance available.

1Gb 3.5" IDE - £309  
Call for details of drive fitting kits  
A3000/3010 hard drive kits from £175

### Hardware & Software

A3010 scart lead - £10.95

Acorn/Logitech Mouse - £28

BJC70, TurboDriver & cable - £385

BJC4000, TurboDriver & cable - £391

BJC6000, TurboDriver & cable - £530

Eagle M2 - £360

Link - £225

MIO Max - £79

Pocket Book A-Link - £49.90

Pocket Book Mac Link - £79.00

Pocket Book A-Link - £69.00

RISC OS 3 PRM - £104

RISC OS 3 PRM V.5 - £32.75

RISC OS 3.11 chips only - £39.90

Sportster 14400 fax modem - £185

Sportster 28800 fax modem - £229

ArxFax - £33

10/10 Series - £22

Arcturus - £22

Big Bang - £14.50

Burn Out - £22

CADet - £123

Canon Fodder - £22

The Cobalt Seed - £22

The Crystal Maze - £35

Cyber Ape - £18.50

Dune II - £30

E-Type 2 - £26

Fire & Ice - £22

Flashback - £24

Formula 2000 - £22

Game On! - £10

Impression Style - £99

Impression Publisher - £160

Impression Publisher Plus - £299

Lemmings/OhNo (RPC) - £35

Personal Accounts 3 - £43

Prophet 2 - £185

Home AD - £211

Sally & Wally - £22

Schema 2 - £119

Scrabble - £24

Sensible Soccer - £22

Sibelius 8 - £165

Elbelius 7 (Amateur) - £629

SimCity 2000 - £95

Simon The Sorcerer - £36

Simon The Sorcerer CD - £40

Speedball 2 - £22

Star Fighter 2000 - £27

Striker - £211

Wollenstein 3D - £27



# Questions & answers

New cases for the A3010, mouse trouble, and games from The Fourth Dimension.

**Q** I have owned an A3010 since last December, and so far I have been very pleased with it. The only thing which lets it down is its Amiga-style case.

I was wondering if it would be possible to transfer the contents of my computer to a more professional-style case; a mini-tower case would suit me just fine, but I am not really that fussy about what type of case I have.

Do you know of any Acorn dealers who can supply these cases – any useful information or advice that you could offer to me would be much appreciated.

David Bloor  
Newcastle

**A** This is certainly possible; Kimberley Computer Services – tel (01942) 677777 – will do it for around £150, putting the computer in a PC-style case.

However, you should consider carefully if it is worth the money. For such a relatively unexpandable machine as the A3010, the only benefit would be that it looked 'more professional', and even this would be a matter of opinion. For the sort of money that you would spend on putting it in a new case, you could buy some software or hardware that would actually improve the computer's performance rather than just its look.

**Q** I have noticed what seems to be a bug in RISC OS 3.5. If the Menu button on the mouse is used in a Filer

window and is operated twice, the computer acts upon the second click as if Select had been pressed, this could be disastrous, as it even works for 'Delete'.

I noticed this because of a fault with my mouse where it was double-clicking for just one press. Is this a bug in RISC OS 3.5 or is something else causing it?

Mr D L Bergg  
Southampton

**A** As far as I can tell from your letter the RISC OS 3.5 behaviour you are experiencing is actually correct. On any menu, clicking with Menu is equivalent to clicking with Select (the reason probably being that some users like to navigate a menu structure with their fingers resting on the Menu button rather than moving it to Select). This should be true in all windows, not just the Filer one. It was also true in RISC OS 3.1 and RISC OS 2, so it is actually nothing new.

Is your computer still under guarantee? If it is, then you should be able to get Granada Microcare to fix the mouse free of charge. If not, then a replacement mouse should be available from between £20 and £40.

**Q** G'day! I am an Acorn Risc PC user from Tasmania, Australia. I accessed the internet at TAFE, where I go to school, and found messages about a program called *Game On!*. From what I could figure out, this program allowed the use of the whole



*Chocks Away Extra Missions* – the Tiger Moth now rules the skies on the Risc PC, thanks to *Game On!*

screen when playing games on the Risc PC. If this is right, where can I get a copy of it from?

I have contacted Fourth Dimension a couple of times, asking about *Saloon Cars*, *Birds of War* and *Chocks Away Extra Missions*. I have heard of an upgrade for *Birds of War*, but the others won't work either. Is there anything that I can do or get to make them work?

Leigh Rowbottom  
via the Internet

**A** I think if I give *Game On!* one more plug then The ARM Club will have to give me free membership. However, it is the only program that does what it does, so I suppose that's my excuse.

Yes, *Game On!* gives you full screen games on the Risc PC. It also enables several games to work that previously had problems with the

hardware changes. A new version is due out real soon now, which increases the range of games that will work with it – including *Sensible Soccer* for instance. It is available from The ARM Club on +44 171-624 9918, and *Game On!* release 2 will cost £15.

As to The Fourth Dimension, rumours of its demise have been greatly exaggerated. Under the new management of Rick Sutcliffe, 4D has been concentrating on making many of its most popular games Risc PC-compatible, and is set to announce some exciting new releases. Its offices have moved, and its new phone number is +44 114-278 1091.

There is a Risc PC upgrade for *Birds of War* – costing £5 – and both *Chocks Away Extra Missions* and *Saloon Cars* will run on the Risc PC as long as you have *Game On!* installed. **AU**

## Programming

Last month, I finished off by introducing the methods of using pointers to structures. I'll start this month's column by explaining how you can manipulate them, and I'll go on to describe some of the ways in which you can link structures together to create all manner of weird and wonderful data formations.

### Manipulating pointers to structures

After you have declared a pointer to a structure and set aside the appropriate amount of memory for it using the `malloc()` function, it's possible to access the areas of memory to which it points by using the normal pointer notation:

```
typedef struct {
    int num1;
    int num2;
} SIMPLE;
SIMPLE pair[5];
SIMPLE *pointer;
pointer = &pair[0];
```

The fragment above defines a structure named `SIMPLE` and declares an array called `pair` which contains five of these structures. A pointer to this structure type is then declared, and it's initialised so that it holds the address of the first structure in the `pair[]` array. Having done this, it's now possible to access the five array structures through the pointer, as shown below:

```
(*pointer).num1 = 10;
(*pointer).num2 = 15;
```

Remember that at this stage, the pointer contains the address of `pair[0]`, and when prefixed by the asterisk it instructs the computer to access the data stored at that address – in this case, the members of the array held there are being assigned.

Although the compiler is perfectly happy accessing structures in this way, the ampersands and asterisks can become somewhat confusing. To this end, C possesses another operator to make the programmer's life that bit simpler – it's called the *membership operator* and it's written as a minus sign followed by a greater-than symbol. An example is shown below:

```
pointer = &pair[0];
pointer->num1 = 5;
```

This method of accessing structures through pointers is equivalent to using all those asterisks, but it looks a little neater.

### Linking structures together

In last month's column I referred to an apparent limitation when defining a structure – you're not allowed to include a reference to the structure itself in its own definition, for reasons of recursion. However, I did mention that there was a way round it, and here it is. If, instead of trying to include the structure itself in the definition, you incorporate a pointer to that structure type, the compiler remains happy. This is because the pointer doesn't actually contain the structure; it's more of a signpost capable of sending the computer to an appropriate piece of memory:

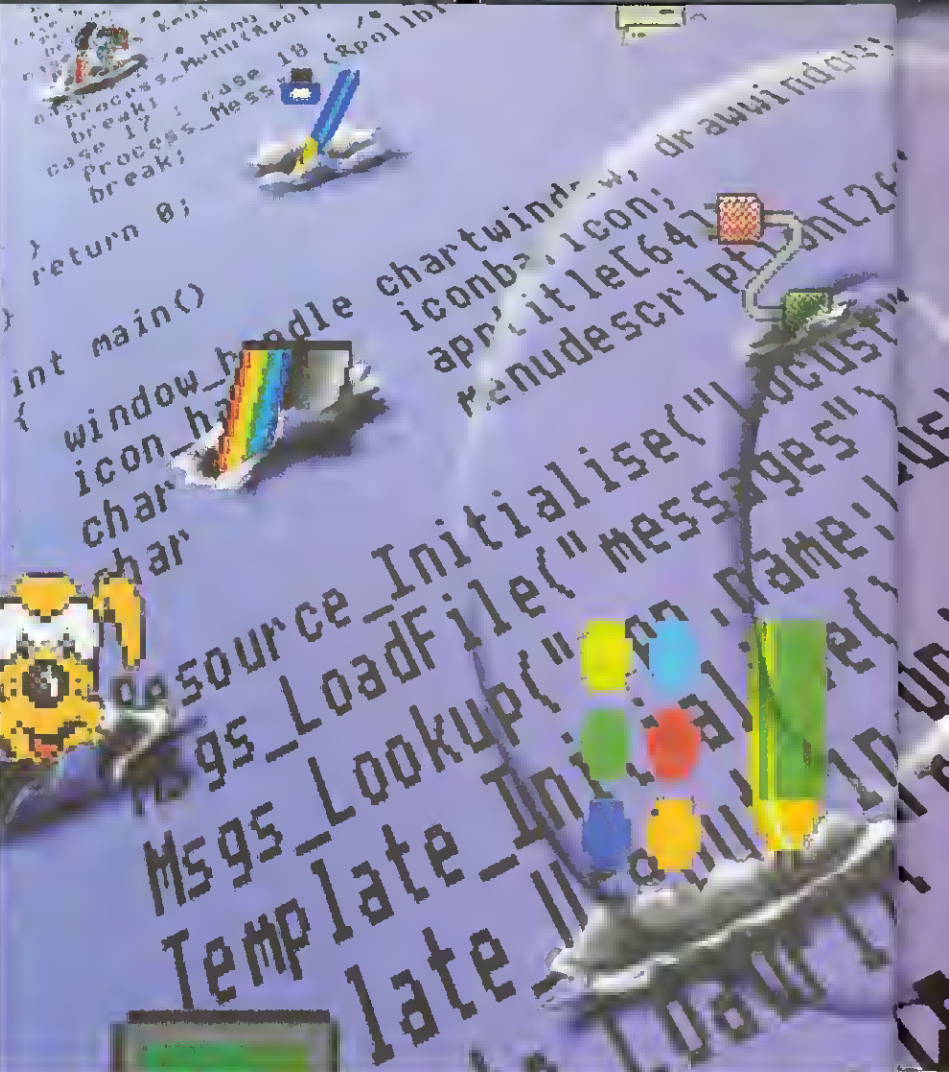

JACK KREINDLER

```
struct list {
    int num1;
    int num2;
    struct list *next;
};
struct list *root;
root = malloc(sizeof(struct list));
```

The code above defines a structure that includes a pointer to a structure of its own type. The last two lines declare a pointer named `root` and allocate it enough memory to hold the list structure. As things stand, we've only got one structure in memory, and it's not complete – the member called `next` doesn't actually point to anything yet. However, that will soon change.

```
struct list *current;
root->next = malloc(sizeof(struct list));
current = root->next;
```

What's happened here? Well, another chunk of memory has been allocated, and its address has been stored in that empty pointer – in effect, we've tacked another structure on to the end of the first. We can keep track of which structure we're looking at with another pointer, named `current` in the above example. As things stand, there are two structures in memory, one pointed to by `root` and another whose address is stored in the `next` pointer inside the `root` structure itself. A copy of that address has been stored in `current`, and this is so that another area of memory can be allocated by the same procedure.

```
current->next = malloc(sizeof(list));
current = current->next;
```

We've now got three structures in memory – the first contains the address of the second, and the second holds the address of the third. This is

C

for y





what's known as a *linked list*, since each member points to the next one in the sequence. The list can be extended as far as memory allows, and it's possible to step down the chain by making use of the stored pointers. However, we need some way of telling the computer where the end of the list is; if we don't, the program would merrily run down the line of structures and fall off the end – we'd probably witness a spectacular crash.

How do we go about creating a *stop* sign? The simplest method is to store NULL in the pointer at the end of the list. In this way, we can check that the structure pointed to is 'real' and not just a rogue address. The safest way of doing this is to assign the NULL value just after a new structure has been added to the list – this way, you can't forget about it later.

```
current->next = malloc(sizeof(list));
current = current->next;
current->next = NULL;
```

### Some more data constructions

Now that we've designed a linked list, we can move on to create more complex formations. Although linked lists are easy to sort and search,

they do have limitations in the fact that you can only step through them in one direction – there's no way of going backwards. If you've just gone past a piece of information, you'd have to start at the beginning of the list and work through it all again. This can be avoided by including another pointer in each structure to refer to the previous item in the list – it requires a little more bookkeeping work, but it can save time in the long run. It's also possible to link the end structure to the first one in the sequence, to form a cyclic list. This can be useful in some circumstances as a buffer.

### Linked lists versus arrays of structures

You'll have seen by now that the process of creating a linked list is somewhat complicated, and unless you thoroughly understand where all the pointers are pointing to, it's easy to get hopelessly confused. Because an array of structures is very similar to a linked list in terms of its capabilities, there would be no point in using them unless there were some definite advantages – so, what are they?

Firstly, if you're using an array you must fix the number of elements it contains before you compile it, and once the program is running this value cannot be altered. In order for the capacity of the array to be increased, the code would have to be recompiled. However, with a linked list that problem does not exist, since each element is declared when it is needed and added on to the end of the list using a pointer. Structures can be added at any point during the execution of the program, and the only limit imposed is that of memory.

The other great advantage that linked lists possess is that the way in which they connect to each other can be altered quickly and easily, whereas arrays are fixed. This makes sorting data much easier, as well as the insertion and removal of records. If, for instance, a list contained three structures named A, B and C and the user wanted to swap B and C, all it would involve would be the alteration of the pointers within the structures. C would be changed so that it pointed to B, A changed to point to C, and B's pointer would be assigned a NULL value. If an array of structures were being used, the actual data in those arrays would have to be copied across, involving a good deal more work. Similarly, if a record is to be deleted it can be removed from the list by manipulating the pointers and then the memory that it occupied released by calling `free()` – something which is impossible using arrays.

Well, that concludes my brief introduction to some of the more complex things you can do with structures – don't worry if it all seems a little confusing at present. The best method of understanding these data formations is to make use of them, so take a look at the disc and create a few data trees for yourself. If there are any topics that you'd like me to clarify, please drop me a line and I'll do my best to help. See you next month, when I'll introduce the ideas **AU** behind recursion.

Steve Mumford takes a look at linked lists and the principles of their creation

# yourself

## Getting started

**W**hen you first get your computer, it almost seems as though the people who designed it talk a different language, one full of acronyms and mysterious numbers with letters after them. Actually, the common ones are not that hard to understand, but to do so requires a certain knowledge of how the computer operates.

### The ARM processor

At the heart of the computer sits the *processor*. Put simply, this gets told what to do and does it, several million times a second. The instructions it is given are of the nature of 'add this number to that number' or 'store this value at that position in memory' rather than 'draw a blue square', as they are in *machine code*. However, by combining several machine code instructions – perhaps in a loop to store a particular value at sequential positions in memory – blue squares may be drawn. The processor knows nothing of this, however. As far as it is concerned, it's just moving numbers around in a series of unconnected instructions.

The processor in the Archimedes is called an ARM (Advanced RISC Machine) processor. Why RISC? That stands for Reduced Instruction Set Chip, and means that the chip is of a new design which knows how to perform a small number of tasks quickly (as opposed to a large number of tasks where the chip has to think longer about each instruction to work out what it is required to do). You can survive without knowing any of this, naturally.

The fundamental speed of the processor is measured by its clock rate, quoted in cycles per second or Hz. Any given

Our series for those starting out with their computers continues with some jargon-busting from David Matthewman, aimed at those who don't know their ARM from their RAM.

instruction may take several cycles to execute, but it will always execute twice as fast on a 2Hz chip as on a 1Hz chip. The original processor sold with the Archimedes A300, A400 series and A3000 was the ARM2, an 8MHz (million cycles per second) chip. The A540, A5000 and A4 had an ARM3, either a 25MHz or a 35MHz chip. The Risc PC has a 33MHz ARM600 and will take faster processors in the future. (If 33MHz sounds slow, then you should realise that there are other ways of improving speed than increasing the clock rate.)

Closely connected with the processor are three other chips which handle the interfacing of the chip with the outside world: the MEMC to interface with the memory, the VIDC to handle video and sound output and the I/O controller to handle things like the keyboard. On the A3010, A3020 and A4000 these were all combined on a single chip – the ARM250.

### Memory

The computer needs somewhere to store information to be able to run: programs, text, graphics and so on. This comes in two forms: *volatile memory* which is wiped when the computer is switched off and *static memory* which is not. The most familiar form of static memory is the floppy disc; the most familiar form of volatile memory is the memory on chips inside the computer, which is what is usually meant when someone refers to the 'memory of the computer.'

Memory was originally measured in bytes, later in K (kilobytes, 1024 bytes) and then in Mb (megabytes, 1024Kb). Hard discs can even be measured in Gb (gigabytes, a further 1024 up the scale).

Exactly how big a byte is isn't very important – what matters is relative size. To give you some idea, one byte roughly equates to one character; the text on one page of *Acorn User* is usually between 5K and 10K. Floppy discs hold either 800K or 1.6Mb – hard discs these days are usually over 100Mb. The memory in earlier Archimedes machines ranges from 1Mb to 4Mb or 8Mb, and in the Risc PC it can theoretically be up to 256Mb.

The volatile memory on chips in the machine is called RAM (Random Access Memory). The fact that it is 'random access' is far less important than the fact that you can change its contents. This is really what differentiates it from ROM (Read Only Memory) which can only be read from and not changed. There is ROM in your computer, which is used to store permanent programs like the operating system which will never need to be changed.

### The operating system

Speaking of which, the *operating system* is the final part of the jigsaw. This is the program which controls everything else on the machine. I have already said the processor doesn't know or care what the instructions it is processing actually do; the operating system is the part that *does* know and care. As soon as the computer is switched on, the operating system takes

# Absolute

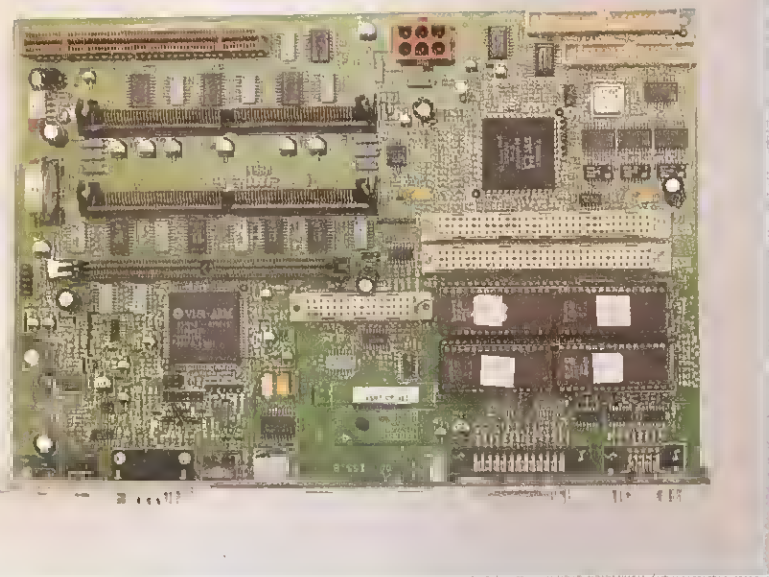

The operating system on this machine is in the four large rectangular chips on the bottom right of the circuit board.



# beginners



## How do you abbreviate 'megabyte?'

There is a certain disagreement over how the units 'byte', 'kilobyte' and 'megabyte' should be abbreviated. You can get by as a beginner without worrying about this, of course, but it can cause some confusion.

In *Acorn User*, we write b, K and Mb respectively, but this is largely to make the text easily readable. Strictly speaking, the abbreviations should probably be B, KB and MB, with an upper-case 'B' to distinguish them from the unit of information, the *bit* (eight bits to the byte, don't you know?) The 'K' in 'kilobyte' is always upper case, as it means 1024, not 1000 as in the SI kilo-prefix which is a lower-case 'k'. This is because 1024 is two to the power of 10, which is a much more useful number than 1000 when working with binary systems like a computer.

There is, however, no typographical distinction between the M in Mb and the M in (for instance) MPa, despite the fact that the former is 1048,576 bytes and the latter 1000,000 pascals.

control and tells it how to start up. It produces the familiar Desktop display, tells the machine how to read the hard drive, and generates the start-up beep. Any programs which are run rely on the operating system to be there first to do most of the 'hard work.' A program doesn't contain instructions to write data to disc itself – it contains an instruction to tell *the operating system* to write data to disc.

The bulk of the operating system is stored in ROM, although there can be additions loaded in from the hard disc, for instance. That some part of it must be in ROM should be obvious from its nature – if the computer didn't know how to do *anything* when it was switched on it wouldn't know how to read a disc to load in any instructions.

The operating system in the Archimedes is called RISC OS and comes in two basic

flavours – RISC OS 2 and RISC OS 3. I explained in July how to find out which one is in your machine. The Risc PC has a slightly enhanced version of RISC OS 3 called RISC OS 3.5. All other Archimedes machines can have their operating system chips upgraded to RISC OS 3, and this is recommended. The reason for this is that modern programs increasingly assume that this is the operating system fitted to the machine on which they are running, and won't work as well (or at all) on AU RISC OS 2.

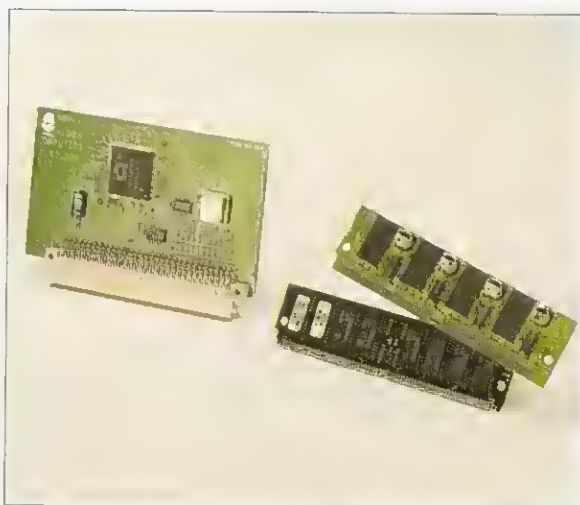

This is what it's all about: the ARM processor (left) and two memory cards containing RAM chips (right).

## Jargon box

**ARM chip:** the processor in the Archimedes.

**I/O controller:** a chip which allows the processor to control various input and output functions.

**Machine code:** the language understood by the processor. To you and me it's all just ones and zeros, but the processor knows what it means.

**MEMC:** a chip which sits between the processor and the memory and allows them to talk to each other – this means the processor does not need to know how the memory is actually arranged.

**Operating system:** the program which controls the computer, including its interface with the user. It could almost be described as the brains of the computer – without an operating system the processor has no instructions to process and the memory has nothing to read from and write to.

**Processor:** the heart of the computer; this does all the work. However, it only executes instructions – it doesn't know or care where the instructions are coming from or what they will do.

**Random Access Memory (RAM):** a confusing name for memory whose

contents can be changed. It might more reasonably be called Read/Write Memory, but sadly (because of the way memory developed) it isn't. The main memory of the computer – the memory meant when a '4Mb A440' is mentioned – is RAM.

**Read Only Memory (ROM):** memory whose contents cannot be changed, only read. This is useful for storing permanent data like the operating system or a table of constants.

**RISC OS:** The operating system in the Archimedes. It is stored in ROM and kicks in when the computer is switched on. All other programs rely on the operating system to do the 'hard work'.

**Static memory:** memory which will retain information when the power is switched off: floppy discs, hard discs, CD-ROMs and so on.

**VIDC:** a chip which allows the processor to control the sound and video output.

**Volatile memory:** memory which is cleared when the power is switched off.

# Why DO people buy from THE DATA STORE?

We're an Acorn specialist – no other brands of computer to distract you.

A large stock of hardware, software and peripherals, all on demonstration if required.

Friendly, knowledgeable and efficient service – in person or by mail/telephone order.

Finance terms available (subject to status, written details on request) including six months interest-free on selected items.

Education specialist – for both schools and parents. Assist and Advantage schemes available.

Free parking right outside the shop.

Harold's coffee is the BEST IN BROMLEY! (so he says...)



We accept:  
 Visa  
 Diners Club  
 Mastercard  
 Switch.

6 CHATTERTON ROAD, BROMLEY, KENT BR2 9QN - Tel: 0181-460 8991 - Fax: 0181-313 0400

## TableMate 3

...Table creation made easy!

"Possibly an essential purchase"  
 - TableMate 2 Review, Archive May 95

**Great news! There's now TableMate 3!**

- A Buttonbar & Interactive help support
- Simple spreadsheet facilities
- Vertical joining of cells, vertical tabs
- Extended import & export ... and much more!

Available NOW! Prices held while stocks last!  
 Full price £32-50 inc p&p - upg. from Impression Style £17-50  
 Secondary Site £100 (£55 as Imp. upg.), Primary £65 (£35 upg.)

**Phone /SAE for details!**

## -DiagramIt-

Diagrams of all sorts - in a flash!

- Flowcharts, organisational charts, annotated diagrams spider diagrams, process diagrams - and more!
- Full colour control, word wrapping and graphic scaling
- Intelligent connection of symbols using leading-edge Artificial Intelligence - let the computer do the work!
- £50 inc. p&p; TableMate 2/3 users £45. (No VAT)
- SSAE or phone for information & site licence prices.

**Dalriada Data Technology, 145 Alhion Street, Kenilworth, Warwickshire CV8 2FY**  
 Phone (01926) 53901.



## CASTLE TECHNOLOGY

<p><b>SCANFLAT</b> <span style="float: right;"><b>£399</b></span></p> <ul style="list-style-type: none"> <li>• Flatbed SCSI scanner</li> <li>• Fits all Acorn computers with SCSI interface</li> <li>• ImageMaster software included</li> <li>• Fast Scanning speed - 3.6ms per-line</li> <li>• Twin compliant</li> </ul> <p><i>Scanflat offers high quality scanning of photographs, artwork or text in up to 600 dpi, capturing 16-78 million colours</i></p>	<p><b>CD-ROM</b></p> <ul style="list-style-type: none"> <li>• Supplied with Acorn driver</li> <li>• Choice of SCSI or IDE interface</li> <li>• Free headphones, Photoview &amp; Audioplay</li> <li>• Compatible with Kodak Photo CD</li> <li>• Internally or externally housed</li> </ul>
<p><b>HARD DISCS</b></p> <ul style="list-style-type: none"> <li>• 2.5" or 3.5" sizes</li> <li>• Fast access of up to 8ms</li> <li>• 20Mb to 2Gib capacity</li> <li>• Formatted and soak-tested</li> <li>• Interface may be required</li> </ul>	<p><b>from £70</b></p> <p><i>A range of ultra fast hard discs that come with up to a five year guarantee, up to two Gigabytes, with a choice of SCSI or IDE</i></p>
<p><b>£199</b></p> <p><i>A unique product that replaces your mouse, ideal for art and Computer Aided Design work. Available for Acorn and PC.</i></p>	<p><b>LIGHT PEN</b></p> <ul style="list-style-type: none"> <li>• Supplied for all Acorn computers</li> <li>• Menu &amp; select buttons on pen</li> <li>• Instant response time</li> <li>• Three colour aluminium or plastic casing</li> <li>• National Curriculum "Input device"</li> </ul>
<p><b>ERG0 KEYBOARD</b></p> <ul style="list-style-type: none"> <li>• Built in wrist support</li> <li>• Tested to 30 million operations</li> <li>• Quiet, tactile and curved low profile keys</li> <li>• Full two year guarantee</li> <li>• International versions available</li> </ul>	<p><b>£99</b></p> <p><i>A PC style keyboard for Acorn computers, with modern ergonomic features and the MIDE keyboard mouse emulation</i></p>
<p><b>from £175</b></p> <p><i>A smart alternative to other storage media, these removable drives can store up to 270Mb, ideal for multimedia and DTP work.</i></p>	<p><b>SYQUEST REMOVABLE DRIVES</b></p> <ul style="list-style-type: none"> <li>• 3.5" 105/270 Mb capacity</li> <li>• 5.25" 200 Mb capacity</li> <li>• SCSI or IDE interfaces</li> <li>• Programmable power saving modes</li> <li>• Internal or externally housed</li> </ul>
<p><b>SCSI DISC SHARE</b></p> <ul style="list-style-type: none"> <li>• Suitable for all Acorn computers</li> <li>• Easy to use and manage</li> <li>• Share CD ROMs, scanners and printers</li> <li>• The fastest disc sharing system</li> <li>• Plug-in and go installation</li> </ul>	<p><b>from £199 (+r station)</b></p> <p><i>A proven, simple, low cost solution for connecting up to six Acorn computers to a hard drive and CD ROM to share both applications and resources</i></p>
<p><b>from £65</b></p> <p><i>High performance interfaces designed to connect Acorn computers to hard discs, CD-ROMS, scanners, printers etc.</i></p>	<p><b>IDE AND SCSI INTERFACES</b></p> <ul style="list-style-type: none"> <li>• Designers of interfaces since 1988</li> <li>• Connect your computer to hard drives etc.</li> <li>• Up to seven devices per interface (SCSI)</li> <li>• Available for all Acorn computers</li> <li>• Transfer rates of up to 4.5Mb/sec</li> </ul>

*"A lot of thought has gone into this program. I've seen some impressive Bible programs in my time .. there are many Mac and PC programs that HolyBible leaves standing"*  
 Archive May'95

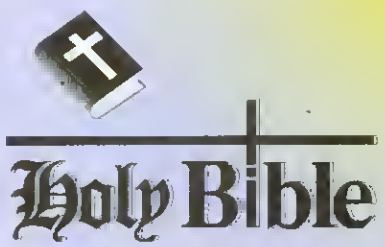

**Multimedia • Modular**

- Rapid, intuitive searching
- Inbuilt User-Notes editor
- Auto-tracking of Bible versions
- Maps & Graphics
- High quality text display
- Text export (incl DDF)

- UK Base Pack; incl KJV, Strongs, Englishmons concordance £70
- New International Version, odd-on module £25
- New Revised Standard with Cambridge Study Notes £45
- Russian Synodal Text, incl Cyrillic font £45

+VAT

To follow:- Multi-media resource builder utility  
 7 other modules in development including educational resource packs  
 Site licences - Base Pack £199, other modules at twice single-user price  
 Requires RISC OS 3.1 or later, and hard disc drive or network



**St Catherines House, Plymouth Road, Tavistock, Devon, PL19 8AY**  
 (01822) 613868 Fax 610868

Tel: 01728 621222 Fax: 01728 621179  
 Call for current price list. Delivery £8 for 3 day, £10 for 24hr. Official orders, credit cards\*, debit cards etc. accepted. Complete range of Acorn computers & installation and training are also available. \*2% credit card surcharge may apply. All trademarks acknowledged. All prices exclude VAT, F&OE.  
 Castle Technology, Ore Trading Estate, Woodbridge Road, Framlingham, Suffolk IP13 9LL



# Run the

# RISC

Mike Cook becomes the Abanazar of the Acorn world when he exchanges new ports for old in part five of the hardware series.

As I have said before, as far as interfacing is concerned, there are two types of Acorn RISC machines; those with bi-directional printer ports and those without. It's not just a matter of the data lines as there are more handshaking lines on the newer machines. The problem is that if I design something that needs the greater capability of the bi-directional port, there are a great number of you who will be left behind. On the other hand, ignoring the capability of the bi-directional port will severely limit the number of projects I can cover. Therefore, for this month only I will address just the owners of older single direction printer ports and we will see how we can bring them up to date.

At first it might seem like *Mission Impossible* to convert the old port to the new, but with a handful of chips and a small piece of software you can come fairly close to emulating the new hardware. I say 'fairly close' because although you have all the input and output capacity, the price you pay is in speed of access, although for the vast majority of our projects that doesn't matter.

## Multiplexing

So how do we pull this trick? Well the secret lies in multiplexing, that is, using one line or channel to carry many different signals. The old printer port does, in fact, have two inputs and we can use those to squeeze all the data and status lines through to the computer. In fact, not content with matching the capacity of the new port, this hardware will actually surpass it, giving you one bi-directional 8-bit port with 8-bits of status input and 7-bits of control outputs.

You can think of a multiplexer as one large

multi-way switch with the choice of what input is connected to the output governed by not the rotation of a switch but the value on a number of binary input select lines. The number of select lines determines how many inputs you can have by the simple formula:

$$\text{input lines} = 2^{\text{number of select lines}}$$

Or, to put it into words, the number of inputs is equal to two to the power of the number of select lines. Now, as we have 8-bits of the printer output to drive select lines, we could have up to 256 inputs and, given that we have two inputs on the port to squeeze the data through, we can double this up to 512 inputs. I think you will agree that this is going over the top somewhat but you see we have no trouble getting the 16 inputs we need.

Unlike switches, you can't put signals through digital logic in both directions, so to have lots of outputs coming from one input you need another circuit - a demultiplexer. However, as the signal only appears on the output when it is selected, we need some sort of memory on the other side of the demultiplexer to remember

Figure 1: Making a tri-state output with switches.

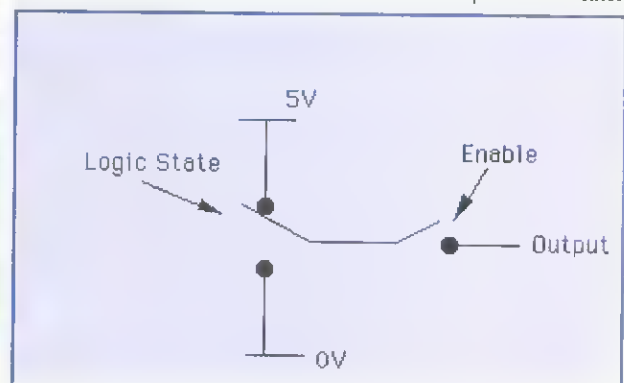

The multiplexer in all its glory, though quite why it's in front of a Risc PC (which has a bi-directional printer port) is anyone's guess.

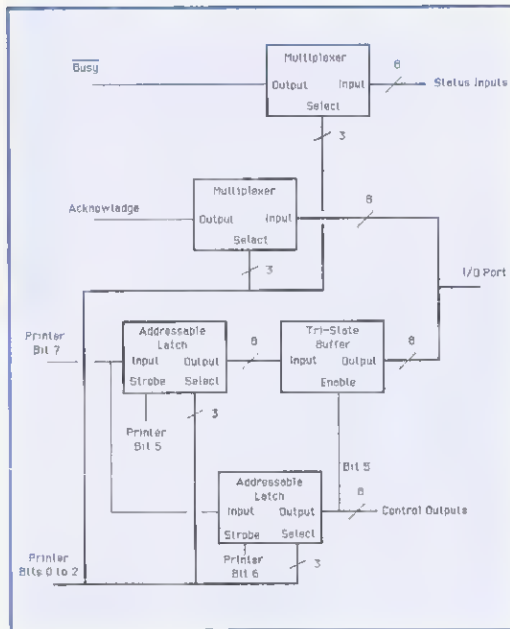

Figure 2: The block diagram of the bi-directional emulator hardware.

the last state of the signals. Fortunately, this sort of circuit is available in a single IC and is called an addressable latch. The 74LS259 is an 8-hit addressable latch and by using two of them we can get the required 16 bits of output.

### Inputs and outputs

The only thing we need to do is to make eight of the output bits and eight of the input hits common – that is sit on the same wires. To do this we need a tri-state buffer; the 74LS244 has eight such buffers in one package. Now you might have heard that electronic logic has two states – on or off, one or zero, or true or false, to choose just three sets of names we can give them. However, there is a third

state which is a high-impedance (or as I prefer to say a 'don't care') state. The output is not connected to a high voltage nor a low voltage but is just not connected to any voltage. You can see in Figure 1 that you can think of this system in terms of switches – when the output is disabled it is like the Grand Old Duke of York's men, neither up nor down. This enable state is controlled by a logic signal and can be used to switch our eight data bits between acting as inputs and acting as outputs.

The hardware is now taking shape and we can draw the block diagram as seen in Figure 2. Here we see that the three least significant bits of the printer port are used to control the data select lines of both the multiplexer and addressable latches. The outputs from the two multiplexers are fed into the busy and acknowledge inputs of the port. Note here that the busy line is an inverting input – that is, the computer reads the inverse of whatever logic level is being fed into it. We can compensate for this in software but there is no need as the 74L151 has an inverting output as well as a true output.

Therefore, all we need to do is use the inverting output of the multiplexer, and the inverting input of the port will turn it the right way up again. The outputs of the addressable latch are fed through the tri-state buffer to join up with the inputs of the multiplexer, so that when the buffer is enabled we have outputs, with the inputs being able to read what we have put out. Conversely, when the buffer is disabled the multiplexer inputs can read whatever logic level we put on them.

So how do we control whether the buffer is enabled or disabled? Well, with the bi-directional printer port it is bit 5 of the control register that determines whether we have an input or output. As we have an addressable latch acting as the control register, we will simply use bit 5 of that. In this way the same piece of software that controls a bi-directional port will work on our emulator.

The full circuit is shown in Figure 3 and is mostly quite straightforward, except that the power supplies and decoupling have been omitted for clarity – these are shown in Figure 4. I constructed the circuit on Veroboard using a wiring pen and had a flying lead with a 25-way plug going to the computer. The new port signals were wired to a 25-way socket mounted on a bracket on the board. The idea is that all the signals are wired into the socket so that any interface simply plugs into the board just the same as it would if it were being plugged into a bi-directional printer port.

There are a few points to note here about the circuit. First of all, look at the three small capacitors and pull-up resistors on the multiplex select lines. These are to prevent oscillations on the lines when they are driven very fast by the software. This happens because the printer data lines are buffered to drive a printer at the end of a long cable and are not designed to be used at the speed we need. Therefore, the resistors and capacitors act as terminators and help prevent signal distortion through reflections at the end of the lines. The second point is that I have put a

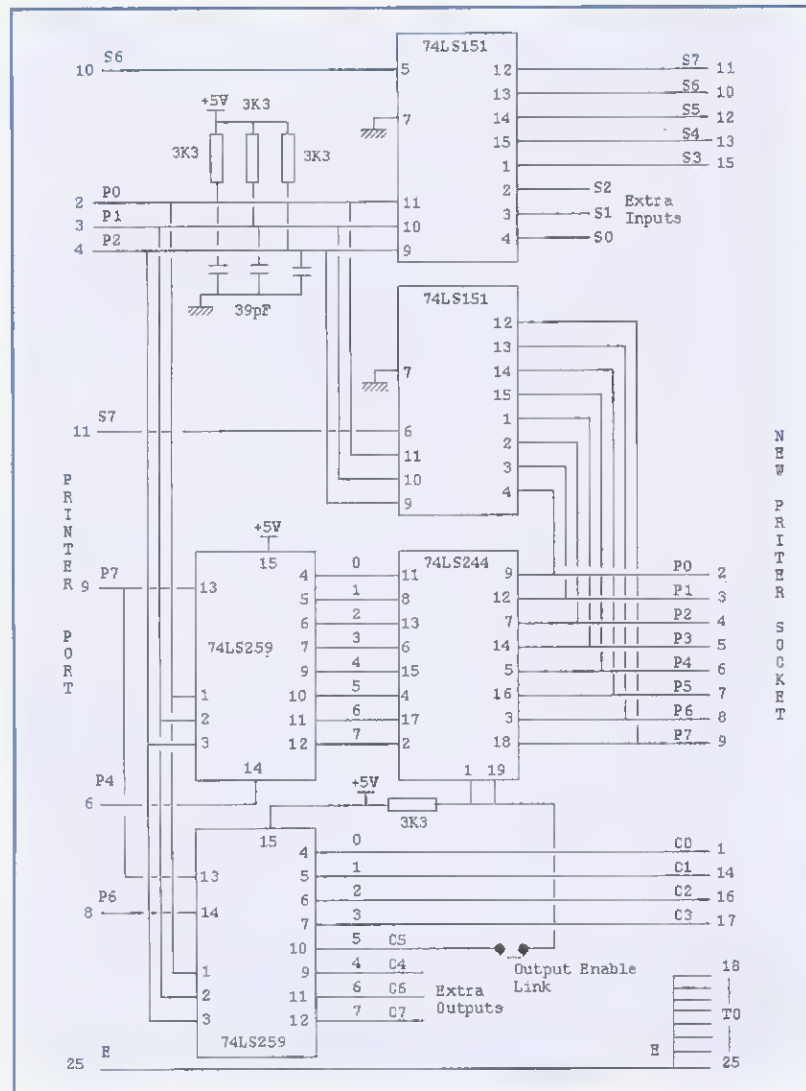

Figure 3: The full circuit for the printer port converter.



link in the tri-state huffer's enable lines. This is so you can remove it if you are using the data port for input: then there is no danger of accidentally connecting two outputs together.

## The software

As you know, the hardware is only half the story. To make the bi-directional port emulator truly useful we have to have some software that is capable of driving it. Not only that, but it also has to look exactly like a bi-directional port to any software wanting to use it. Here we can use software written in the form of a module to replace the Parallel Port SWIs just like I did in the May issue of *Acorn User*. However, this time the module does not just make a stab at producing the same effects as the bi-directional port but actually duplicates them exactly. The beauty of this scheme is that any software that expects to talk to a bi-directional port through the Parallel Port SWIs (and they all should) will work perfectly with the emulator. This means I can write one piece of code for all my projects and it will work with any machine.

The module and the source code for this are on the cover disc and you might like to see how it is done. Figure 5 shows the programmer's view of the emulator circuit – what register hits control what pieces of hardware. Basically, what we have to do to perform an input scan is to go through each of the data select line addresses in turn and gather the bits as they appear, in turn, on the busy and acknowledge bits. These bits are then assembled into a separate register.

For the output scan we have to do the same, but this time place the data bit we want to store on bit 7 and then strobe bit 6 or bit 5 depending upon what addressable latch we want to fill. By strobe I mean putting the bit down to a logic zero and then up again to a logic one.

The routine that writes to the control register has to be slightly different because of the way Acorn's routines work. Basically, they take two registers and perform an AND and then an exclusive OR operation on the register value before it is output. In order to do this you need to keep a copy of the register value in memory as there is no way of reading it back, either from my emulator or the true bi-directional port. The module therefore needs four bytes of storage space.

Finally, you will remember that some inputs and outputs are inverting, that is, the value the computer sees for some bits is the inverse of the

value on the actual hardware. My module simulates this effect in software by inverting some control hits before writing them and some status bits before passing them back to the calling program.

The source code for this module is on the cover disc along with the module itself, stored inside the *Port Monitor* application.

When I first wrote the routine I had trouble with the reliability, so I put in a large delay between outputting anything and reading something back. This was also useful because it made the signals long enough to observe with my oscilloscope. However, by using the capacitors on the select lines and tinkering with the code I was able to eliminate the delays altogether.

Note here that the module copes with all hits of the status and control registers, unlike the hardware it is emulating. This means you have these extra bits to use for anything you want. I will try to avoid using them in my articles, however, because then those projects would not be assessable to those with the newer port.

In order to make use of this new emulating hardware, I have had to tinker a little with the *Port Monitor* application I gave you in the May issue. Basically, the changes detect the presence of a system variable indicating that this new module has been loaded and thus prevent the loading of the earlier module and produce the right pinout information. It also defaults to inputs on the printer port instead of outputs – this is just a little safer when feeding signals in. As *Port Monitor* appears on the disc it is not suitable for use with the new hardware; to do this you will have to un-comment two lines in the *Boot* file. This is quite straightforward and instructions are given in the file.

There is one slight shortcoming with this emulator hardware and that is the fact that you can't generate any interrupts with the status inputs as you can with the real hardware. This is not too much of a hardship with my projects, but it might just prevent other applications from working. Also, beware of 'intelligent' applications; these check the system to see what type of port chip is fitted (a bit like my original *Port Monitor*) and could report an incompatibility where none exists.

If you would like to add some refinements to the circuit, how about putting an LED on bit 5 of the control register; in that way the light could indicate whether the port was set to be an output. You could even have two lights – a red and a green – driven from this bit, or the inverse with red indicating output and green input. If you really want to be fancy you could have a two-colour LED and get it to change colour with changing state. I will leave it to you to work that one out.

So there we have it, we now have a common base with which to develop our interfacing projects, so we can all run the RISC. **AU**

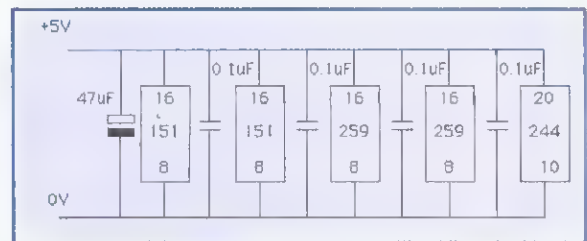

Figure 4: The power supply of the circuit.

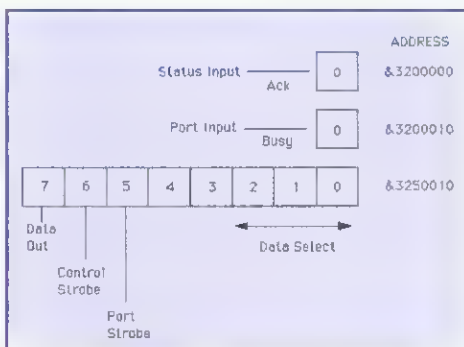

Figure 5: The programmer's view of the interface.



**FIVE STAR  
MARKETING**

TOP QUALITY P.D. WITH LOW PRICES  
AND A FAST AND FRIENDLY SERVICE  
WHAT MORE COULD YOU ASK FOR?

Our \*NEW\* demo disc-catalogue for just £1

Exclusive to Five Star the full version of DINOSAW at only £3.50

## EXCELLENT PACK OFFERS

- Games Pack 1 • Games Pack 2 • Games Pack 3
- \*NEW\* Games Pack 4 • Draw Clipart Pack 1
- \*NEW\* Draw Clipart Pack 2 • Sound Sample Pack 1
- \*NEW\* Sound Sample Pack 2 • Educational Pack
- Utils Pack 1 • Utils Pack 2 • \*NEW\* Utils Pack 3

At only £3.50, each pack has three fully archived discs.  
Sorry, no credit card facilities available.

Buy any two packs and get our demo disc free.  
Buy any four packs and get a free mystery disc.



Five Star Marketing, 4 Shepherds Walk  
Bushey, Herts. WD2 1LZ.



Programs available for all  
ages and abilities.

- For school and home use •
- PC and Acorn formats •

Send for our free catalogue.

4Mation  
Publishers of  
quality educational  
software since  
1983.

4Mation Educational Resources  
14 Castle Park Road  
Bamstaple  
Devon  
EX32 8PA  
☎ (01271) 25353

# TT Turing Tools

2A Trinity Road  
Headington, Oxford OX3 8LQ  
Tel. (01865) 62339

## SpoilSport

**RISC OS 3.x System Defense Kit**  
"They rename the hard disc... scramble the configuration... turn off the auto-boot... reset the system clock... do factory resets..." The solution is SpoilSport. £30.00 inc.

## IronMask 2.1

**Multi-user File Security System**  
"Frozen" directories or application folders are made unchangeable except by the IronMask superuser. "Shielded" files are made completely inaccessible except to their owners. User authentication. Failsafe encryption. The software solution for RISC OS security in school or office. £55.00 inc.

IronMask 2.1 + SpoilSport £65.00. 10% OFF all prices for prompt payment (14 days).

Prices quoted for 1 computer. British Isles postage included. Overseas add £3.00. ☎ for educational and site prices, further information or factsheets. Allow 14 days delivery.



Incorporating  
A.P.D.L.

For a catalogue please send £1  
or four 1st class stamps to -  
**A.P.D.L.**  
39 Knighton Park Road  
Sydenham  
London SE26 5RN  
0181 778 2659  
Please specify 800K or 1.6Mb discs.

Public Domain, Shareware, and low cost software for the serious Archimedes user, including over 200 discs of clip art. We also have a large range of P.C. Shareware and P.D. at very low price

**APDL Clip Art CD-1 only £28**

Nearly 6,000 items, about 500 megabytes. Ideal for education.

**FasterPC the alternative PC emulator, only £20**

### Hard discs

Part exchange your old drive for 420Mb  
80Mb to 420Mb only £120 :-: 210Mb to 420Mb only £120

New drives and interfaces - includes all fittings

A310/A400	170 Mb	- £155
A310/A400	210 Mb	- £180
A310/A400	420 Mb	- £230
A3000/3010	210 Mb	- £220

(Others available. All prices inclusive - nothing more to pay!)

**Risc PC RAM now available** - upgrades possible

## Part Exchange to RiscPC

### Prices of NEW NEW Risc PC600 and 700

Risc PC600 4M	£1148.00
4Mb RAM, 425Mb HD	
Risc PC700 5M	£1360.00
4Mb RAM, 425Mb HD, 1Mb VRAM	
Risc PC700 10M	£1692.00
8Mb RAM, 850Mb HD, 2Mb VRAM	
17" monitor option add	£ 275.00
CDROM Drive add	£ 110.00

### Typical Trade in Allowances

A3000	£ 125
A440/1	£250
A4000	£300
A5000 4/80Mb	£450
AKF11/2/7/40	£ 50
AKF18	£ 75
AKF50	£ 125

Subject to change

Please phone to confirm  
Collection and delivery £25.00

### Special Offer

**A4000HD80 + AKF52**

**£579**

(Upgrade to 4MB - add £89)

### Clearance Offer

**HP Deskjet 660C £295**

### SIMM Exchanges

4Mb to 8Mb	- £125.00
4Mb to 16Mb	- £275.00
8Mb to 16Mb	- £205.00
4Mb	- £95.00
8Mb	- £205.00
16Mb	- £345.00

### Hard Disk Exchanges

For A5000 and A4000,	
40Mb to 210 Mb	- £ 79.00
40Mb to 425 Mb	- £ 139.00
80Mb to 210 Mb	- £ 59.00
80Mb to 425 Mb	- £ 129.00
A3020 and RiscPC	
60Mb to 340 Mb	- £ 129.00
210Mb to 425Mb	- £ 109.00

### AJS Computers

123 New London Road  
Chelmsford Essex CM2 0QT  
tel 01245 345263  
fax 01245 345233

all prices plus vat and carriage





# Acorn Customer hotline

Essential information for all Acorn users, compiled by Dave Walker of Acorn Customer Services exclusively for Acorn User.

## Questions and answers

**Q:** How can I get my machine to reboot using nothing more than a software call?

**A:** My initial reaction to this question is 'Why would you need to reboot from software?', however this is a valid thing to need to do under a very small number of circumstances (such as executing at the end of the exit routine in another operating system).

A 'hard' reset – complete memory wipe and reinitialise from ROM, returning the machine to a state consistent with a machine which has just been powered up – is very difficult to perform in anything earlier than RISC OS 3.5; in this release, we addressed the issue by providing a single SWI (OS\_Reset) which effectively calls the reset code for you.

In RISC OS 2, it was possible to get a soft reset (equivalent to a Ctrl-Break) by issuing CALL !4 from BASIC; in RISC OS 3.1 this facility stopped working.

To get a reset in RISC OS 3.1 requires some low-level programming; essentially, you need to copy the contents of the start of ROM (&3800000) to the ARM reset vector (&0) and branch directly to &0. Before doing this, make sure you are in SVC mode by calling SWI 'OS\_EnterOS'.

## Adding IDE slave drives

One of the most common queries we receive concerns adding further IDE drives to machines to increase their local storage capacity. In the case of systems with an IDE interface (this includes all our current range, with the exception of the A3010), the system can support a total of

two IDE devices operating in a master/slave configuration. The drives we have tested, and their appropriate link settings, are detailed in the table.

If you are planning to make use of a drive which is not listed in the table, there are a few things to pay particular attention to:

- Drive speed: some drives have slow I/O timings which will work on a machine such as an A3020, which has slower cycle times. A faster Acorn machine such as a Risc PC might have trouble.
- IRQ issues: some drives have a pull-up resistor on the IRQ line. This is not a good idea – the IRQ line on IDE drives is a tri-state output, and is active high, so disabling the IRQ output on the drive can cause an erroneous IRQ.
- Drive selection: some IDE drives support selection of the drive via a signal on the IDE connector – the jumper which enables this is the Cable Select, and is often marked as CS on the drive. The Risc PC does not support Cable Select, therefore connecting a drive with this enabled will not work. Similarly, Spindle Sync must be disabled.

## Full IP for all

In response to increasing demand for software to enable connection to the Internet, the Network Group at Acorn has arranged to make available a release of Acorn's implementation of the TCP/IP protocol stack, subject to the licence conditions detailed in the documentation accompanying the software.

The software comprises two archives – produced with David Pilling's *SparkFS* – containing software and related documentation, both software items being compliant with the DCI 4 specification, as used in all new Acorn AUN products:

1) the *InterNet* archive, which contains the TCP/IP protocol stack itself, and which can be found as

Master					Slave				
Drive	Link Settings				Drive	Link Settings			
	HSP	C/D	DSP	ACT		HSP	C/D	DSP	ACT
CP3044 CP30084E CP30126 CP30174E	✓	✓	✓	✓		No slave drive			
CP3044	✓	✓	✓	✓	CP3044 CP30084E CP30126 CP30174E				✓
CP30084E	✓	✓	✓	✓	CP3044 CP30126				✓
CP30126	✓	✓	✓	✓	CP3044 CP30084E CP30174E				✓
CP30174E	✓	✓	✓	✓	CP3044 CP30126				✓
CFS210A	✓				CFS210A				
CFS420A	✓				CFS420A				

A table showing what master/slave combination of IDE hard drives have been tested, and what the link settings should be for them.

[ftp.acorn.co.uk:/pub/riscos/releases/DCI4/internet.arc](http://ftp.acorn.co.uk:/pub/riscos/releases/DCI4/internet.arc); the stack has a full BSD sockets interface.

2) the *BootNet* archive, which contains the AUN protocol stack, and which can be found as [ftp.acorn.co.uk:/pub/riscos/releases/DCI4/bootnet.arc](http://ftp.acorn.co.uk:/pub/riscos/releases/DCI4/bootnet.arc)

*BootNet* supplies an AUN programming interface to the TCP/IP protocol stack, using the simplified AUN addressing scheme, rather than full IP addressing.

If used in conjunction with *Internet*, it is important that *Internet* is run before *Bootnet*, and that all appropriate setting up has been done.

This release does not include the client tools which form a part of the 'Acorn TCP/IP Protocol Suite (Release 2)' product, nor does it include some of the more advanced components of the networking software which are present in the above product. You will also need extra software if you intend to access the Internet via a dial-up connection using a modem.

Installing *Internet* is not as simple as installing most other applications, as a fair amount of configuration needs to be done. Detailed documentation on the configuration and installation procedure is supplied as part of the archives. 

**Acorn Customer Services**  
**Acorn Computers Ltd**  
**Acorn House, Vision Park,**  
**Histon, Cambridge CB4 4AE**  
**E-mail: [customer.services@acorn.co.uk](mailto:customer.services@acorn.co.uk)**

# RiscPC Computer Systems

RiscPC offers all the traditional strengths of RISC processing, and a great deal more. It is the world's most cost-effective 32-bit RISC based computer, producing astounding graphics and crystal clear sound. It's innovative design provides virtually unlimited upgrade capability, expanding as your needs increase. Built around the ARM 610 processor, RiscPC pushes computing to the limits, with it's intuitive operating system, support for up to 256Mb RAM, powerful 32-bit graphics and 16-bit sound system. RiscPC allows the use of foreign operating systems via it's unique second processor slot, thus opening up the world of DOS, Windows and Unix to name but a few. Access to CD-ROM and networking is also provided, making RiscPC an ideal multimedia or network station..

## RiscPC 600 Systems include:

- ◆ ARM610 processor running at 30MHz
- ◆ RISC OS 3 v3.5 operating system
- ◆ 3.5" 1.6Mb Floppy Disk Drive
- ◆ 2, 4 or 8Mb RAM expandable to 256Mb
- ◆ 1Mb or 2Mb Video RAM
- ◆ 210Mb or 420Mb IDE hard disk drive
- ◆ 8 channel stereo sound
- ◆ full 32-bit graphics capabilities
- ◆ 2nd processor slot
- ◆ 2 or 4 32-bit expansion bus slots
- ◆ 5.25" drive bay for CD-ROM drive
- ◆ 14" EPA 0.28mm SuperVGA Monitor
- ◆ 102-key keyboard u 3 button mouse
- ◆ optional CD-ROM drive
- ◆ 1-year On-Site Warranty (3-year option)



**0% Finance**  
available on some  
RiscPC systems -  
call for details

## RiscPC Upgrade Options

### Memory Options

ARA0340/U	upgrade from 2Mb to 4Mb RAM	£69.00
ARA0350/U	upgrade from 4Mb to 8Mb RAM	£129.00
ARA0370/U	upgrade from 8Mb to 16Mb RAM	£249.00
ARA0410/U	upgrade from 1Mb to 2Mb VRAM	£79.00

### Hard Disk Options

ADA1520/U	upgrade from 210Mb to 420Mb IDE hard drive	£89.00
ADA1530/U	upgrade from 210Mb to 540Mb IDE hard drive	£159.00
ADA2320/U	upgrade from 420Mb to 1Gb SCSI hard drive	£459.00
GDA0330	270Mb Syquest IDE HDD (2 slices req'd)	£259.00

### Monitor Options

MKA1640/U	upgrade 14" to 15" Aries 6000i monitor	£89.00
MKA1670/U	upgrade 14" to 17" Acorn AKF85 monitor	£379.00
MKA0490/U	upgrade 14" to 20" Panasync Pro	£899.00

### Miscellaneous Options

AEA1650/U	upgrade to 486SX-33MHz PC Card	£99.00
AEA1890/U	upgrade to 16-bit Sound Card	£55.00
APA0410/U	upgrade to Dual Speed CD-ROM drive	£209.00
AQA0020	Aries XLink 14400 Fax Modem & ArcFax	£119.00
AQA0040	Aries XLink V34 Fax Modem & ArcFax	£219.00
AEA1640	Additional Case Module Kit	£99.00
GUA0230	3 year Extended On-Site Warranty	£ POA
AAA0600	Learning Curve software pack	£39.00
AAA0610	Home Office software pack	£85.00
AAA 0730	Early Years software pack	£39.00

# Acorn

## RiscPC 600 2M HD210

- ◆ 2Mb RAM
- ◆ 210Mb IDE Hard Disk Drive
- ◆ 1Mb Video RAM

£1149

## RiscPC 600 5M HD210

- ◆ 4Mb RAM
- ◆ 210Mb IDE Hard Disk Drive
- ◆ 1Mb Video RAM

£1259

## RiscPC 600 9M HD420

- ◆ 8Mb RAM
- ◆ 420Mb IDE Hard Disk Drive
- ◆ 2Mb Video RAM

£1529

## RiscPC Learn & Play System

- ◆ 2Mb RAM
- ◆ 210Mb IDE Hard Disk Drive
- ◆ Software bundle - 10/10 English, Number, French, Spelling, Junior Essentials, Virtual Golf, Haunted House, E Type 2, Dungeon & Break 147

£1159

*Above systems available while stocks last*

# Multimedia Systems

## RiscPC 600 MPC System

- ◆ 4Mb RAM
- ◆ 210Mb IDE Hard Disk Drive
- ◆ 1Mb Video RAM
- ◆ Dual speed CD-ROM Drive
- ◆ Hi-Fi Stereo Speakers
- ◆ CD Software Bundle

£1659

## RiscPC 600 MPC System 486

- ◆ 4Mb RAM
- ◆ 1Mb Video RAM
- ◆ 210Mb IDE Hard Disk Drive
- ◆ Dual speed CD-ROM Drive
- ◆ Hi-Fi Stereo Speakers
- ◆ 486 PC Card with DOS/Windows
- ◆ MS Encarta, Golf, Works, Money, Dangerous Creatures & Scenes

£1759

## CD Software Bundle

- ◆ Acorn Replay Video Collection CD vol.1
- ◆ Illustrated Sherlock Holmes
- ◆ Illustrated Works of Shakespeare
- ◆ Kingfisher Children's Micropedia
- ◆ Pro Artisan v2 CD



## RiscPC MPC SYSTEM OPTIONS

- ◆ Upgrade from 1Mb to 2Mb VRAM £70
- ◆ Upgrade from Dual Speed to Quad Speed CD £50
- ◆ Upgrade to 16-bit Sound Card £53
- ◆ Upgrade to Aries 25W Digital Speakers £20
- ◆ Upgrade to Aries 160W UltraPower Speakers £80

# RiscPC 700 Systems

The RiscPC 700 is the new flagship machine in the range. Offering even more power and larger standard hard disk capacities than the previous models. They are available with a dual speed CD ROM drive fitted or as a basic configuration of floppy and hard drive.

- ◆ ARM710 processor running at 40MHz
- ◆ RISC OS v3.6 operating system
- ◆ 5Mb or 10Mb RAM as standard
- ◆ 425Mb or 850Mb IDE Hard Disk as standard
- ◆ 14" EPA 0.28mm SVGA Monitor
- ◆ 102-key keyboard
- ◆ 1-year On-Site warranty (3-year option)

## RiscPC 700 5M HD425 System

- ◆ 4Mb RAM
- ◆ 1Mb Video RAM
- ◆ 425Mb IDE Hard Disk Drive

£1359

## RiscPC 700 10M HD850 System

- ◆ 8Mb RAM
- ◆ 2Mb Video RAM
- ◆ 850Mb IDE Hard Disk Drive

£1689





# Acorn 32-bit RISC Computer Systems



The entry level range of 32-bit RISC based computer systems, ideal for home, education or small business applications. The A3010 is aimed at home use, with its built-in TV modulator, it will connect to a standard colour TV. The A3020 is the standard education model, ideal as a network workstation or for stand-alone use with built-in hard drive. The A4000 is designed for home and small business use, coming with a 210Mb hard drive and choice of monitor. The A4 Notebook is for those who need a RISC OS machine on the move. Supplied with 4Mb RAM, hard disk and mouse.

\*FREE CD-ROM Drive offer available until end June 1995

System	No Monitor	AKF52	AKF50
A3010 1M Action Pack	£229	-	-
A3010 2M Learning Curve	£339	-	£509
A3010 2M Early Years	£339	-	£509
A3020 2M FD	-	£509	£549
A3020 2M HD80	-	£629	£669
A4000 2M HD210	-	£719	£759
A7000 2M NET	-	AKF60: £889	
A7000 2M HD425	-	AKF60: £929	
A7000 4M HD425	-	AKF60: £1019	
A4 4M HD Notebook	£1439	-	-

## CD-ROM & Multimedia

### Cumana CD-ROM Drives

All Cumana CD-ROM drives are supplied with all connecting cables, driver software and interfaces where necessary.



#### Oscar CD-ROM Drive

A low cost drive which connects to the parallel port of an A3010, A3020, A4000 or A5000.

◆ Oscar CD-ROM Drive - Parallel Port £199

#### Bravo CD-ROM Drive

A range of low cost high performance drives which have a built-in audio mixer.

◆ Bravo CD-ROM Drive - Parallel Port £249  
 ◆ Bravo CD-ROM Drive - A300/A400/A5000 £249  
 ◆ Bravo CD-ROM Drive - A3000/A4000 £249  
 ◆ Bravo CD-ROM Drive - EMU £249

#### Victor CD-ROM Drive

A SCSI based CD-ROM drive system for those who require improved performance over the SLCD type.

◆ Victor CXX402A CD-ROM Drive - SCSI £289

#### Indigo CD-ROM Drive

A range of Internal fitting CD-ROM drives for use with the RiscPC computer system.

◆ CAA300i CD-ROM Drive - IDE £189  
 ◆ CAA300iA CD-ROM Drive - IDE £219  
 ◆ CAA401 CD-ROM Drive - SCSI £189

### Speakers & Accessories



◆ Aries Stereo Speakers £6  
 ◆ Aries Hi-Fi Stereo Speakers - 10W £19  
 ◆ Aries Hi-Fi Pro Stereo Speakers - 25W £28  
 ◆ Aries Digital Stereo Speakers - 25W £39  
 ◆ Aries Digital Plus Stereo Speakers - 70W £48  
 ◆ Aries Microphone £4.50  
 ◆ Aries Stereo Headphones £4.50

### CD-ROM Software

Some titles require additional software to run under RISC OS. These are marked as follows:

EB - Electronic Books : PaperOut software required  
 PD - PDSView software required

◆ PDSView £99  
 ◆ PaperOut - Electronic Book player £49

#### Art, Graphics & Design

◆ Artworks v1.5 £129  
 ◆ Artworks Clipart CD v1 £19  
 ◆ Artworks Clipart CD v2 £19  
 ◆ Art In the National Curriculum £75  
 ◆ Pro Artisan v2 £136

#### English & Literature

◆ Goldilocks £39  
 ◆ Granny's Garden £30  
 ◆ Illustrated Works of Shakespeare £23  
 ◆ Karaoke Macbeth £49  
 ◆ Karaoke Midsummer Night's Dream £49  
 ◆ Living Poetry £49  
 ◆ Listen & Read (EB) £39  
 ◆ Oxford Reading Tree Talking Stories £39  
 ◆ Sherlock Holmes £23  
 ◆ Sherston Naughty Stories £79

#### Geography, Nature & Environment

◆ British Birds £150  
 ◆ Creepy Crawlies £49  
 ◆ Countries of Great Britain £39  
 ◆ Countries of the World £39  
 ◆ Dictionary of the Living World £89  
 ◆ Earth Guide (EB) £39  
 ◆ Environment: Land & Air £97  
 ◆ Environment: Water £97  
 ◆ Environment: Climate Change £34  
 ◆ Environment: Dwindling Resources £34  
 ◆ Environment: Conservation £34  
 ◆ Garden Wildlife £39  
 ◆ Langdale Primary £99  
 ◆ Map Skills £49  
 ◆ Seahora Life £39  
 ◆ The Physical World £97  
 ◆ Usborne Exploring Nature £125  
 ◆ The World's Weather £47

#### History

◆ Castles £39  
 ◆ Changing Times £125  
 ◆ Frontier 2000 £109  
 ◆ Industrial Revolution £105  
 ◆ Medieval Realms £145  
 ◆ Photobase: Victorians £49  
 ◆ Photobase: Victorian Britain £99  
 ◆ World War II: Global Conflict £97  
 ◆ World War II: Sources & Analysis £97  
 ◆ World of the Vikings £39

#### Languages

◆ Directions 2000: French £137  
 ◆ En Marcha: Spanish £137

#### Mathematics

◆ Cars - Maths In Motion £49  
 ◆ Number Games £79  
 ◆ Perspectives £79  
 ◆ Picture Gallery £79  
 ◆ Who Stole the Decimal Point? £79

#### Science & Technology

◆ Chemistry Set £149  
 ◆ Science & Technology Library (EB) £39  
 ◆ Collins Electronic Food File (EB) £29  
 ◆ Science: Elements £67  
 ◆ Science: Materials £87  
 ◆ Inventors & Inventions £97  
 ◆ Photobase: Science £49  
 ◆ Understanding the Body £39  
 ◆ Understanding Energy £47

◆ Space & Astronomy £34  
 ◆ Space Encyclopaedia £40  
 ◆ Space Science Sampler (PD) £200  
 ◆ Voyager Spacecraft (PD)

#### Educational Resources

◆ Acorn Video Collection Disc 1 £10  
 ◆ Bitfolio 6 - clipart Images £49  
 ◆ Horizon Report £19  
 ◆ Photobase: 1920's £49  
 ◆ Photobase: 1930's £49  
 ◆ Photobase: 1940's £49  
 ◆ Photobase: 1950's £49  
 ◆ Photobase: 1960's £49  
 ◆ Photobase: Landscapes £49  
 ◆ Sermac Treasure Chest £69  
 ◆ SSERC Graphics Collection £99

#### Dictionaries & Encyclopaedias

◆ 19th Century Biographies £25  
 ◆ CIA World Fact Book (EB) £29  
 ◆ Oxford English Dictionary (EB) £29  
 ◆ Hutchinson Gallup Info (EB) £29  
 ◆ Hutchinson Guide to the World (EB) £29  
 ◆ Hutchinson Encyclopaedia £49  
 ◆ Kingfisher Children's Micropedia £88  
 ◆ Times & Sunday Times £178  
 ◆ Times & Sunday Times Sampler £50  
 ◆ Tekkie CD - Acorn PRM's on CD £99

## Pocketbook



The truly portable computer. With built-in word processor, spreadsheet, database, spelling checker and calculator, it provides all the basic tools for recording ideas, notes & data.

◆ Pocket Book II 256K Computer £202  
 ◆ Pocket Book II 512K Computer £249  
 ◆ Pocket Book II 1Mb Computer £279

#### Pocket Book Accessories

◆ A-Link £40  
 ◆ Parallel Link £25  
 ◆ MAC Link £65  
 ◆ PC Serial Link £59  
 ◆ Leather Case £21  
 ◆ Schedule £16  
 ◆ Schedule Class Pk £160  
 ◆ Plotter £25  
 ◆ Plotter Class Pack £250  
 ◆ 128K RAM Disk £49  
 ◆ 256K Flash Disk £59  
 ◆ 512K Flash Disk £85  
 ◆ OPL Editor £59  
 ◆ Mains Adaptor £12

## Aries

## Fax Modems

Enter the realm of high speed communications with the new Aries XLink range of fax modems. Two versions are available - standard 14400bps V32bis or high speed 28800bps V34 model. Error correction and data compression are standard on all models, so taxing and data transmission overseas will not cost the earth.

When used with ArcFax software, you can send a fax directly from your RISC OS desktop, as easily as printing a document.

◆ 14400bps V32bis or 28800bps\* V34 data transmission speed  
 ◆ V32, V32bis, V22, V22bis and V21  
 ◆ Error correction to MNP2-5 and V42 standards  
 ◆ Data compression to MNP5 and V42 standards  
 ◆ Cell back security  
 ◆ Synchronous & Asynchronous operation  
 ◆ Group 3, Class I & II Fax et up to 14400bps (V17)  
 ◆ Group 1 and 2 Fax compatible (V27ter and V29)  
 ◆ 100% Hayes compatible  
 ◆ 3 year manufacturers warranty  
 ◆ BBT approved

◆ Aries XLink XL144e Fax Modem £89  
 ◆ Aries XLink XL144e Fax Modem & ArcFax software £119  
 ◆ Aries XLink XL288e Fax Modem £185  
 ◆ Aries XLink XL288e Fax Modem & ArcFax software £215

\* note 28800bps speeds only available when used with a RiscPC



**Watford Electronics Ltd**

Mail Order & Showroom: Jessa House, 1 Finway, Dallow Road, Luton LU1 1TR

SALES HOTLINE

**01582 745555**





# Flatbed Scanners

## Canon IX-4015 Scanner

### Canon

The IX-4015 is a compact A4 flatbed scanner offering full 24-bit colour scanning up to a max resolution of 400 x 800 dpi. The scanner will also scan 256 grey scale images with a max resolution of 400 x 1200 dpi.

- ◆ 400 x 800 dpi resolution in colour
- ◆ 400 x 1200 dpi resolution in monochrome
- ◆ Connection via SCSI interface (not included)
- ◆ ImageMaster scanning software
- ◆ TWAIN driver software

£569

- ◆ Auto Document Feeder - IX-4015 £249

## HP ScanJet 3C Scanner

The ScanJet 3C is an A4 flatbed scanner capable of producing full 24-bit colour scans at a maximum resolution of up to 1600 dpi.

- ◆ 400 x 400 optical resolution
- ◆ 24-bit colour and grey scale modes
- ◆ A4 scanning area (216 x 297mm)
- ◆ Connection via SCSI interface
- ◆ ImageMaster scanning software
- ◆ TWAIN drivers

£699

- ◆ Auto Document Feeder - ScanJet 3C £365
- ◆ Transparency Adapter - ScanJet 3C £499

### SCSI Interfaces

- ◆ 16-bit SCSI Interface (A300/A400) £89
- ◆ 32-bit SCSI-2 Interface for RiscPC £159
- ◆ SCSI-2 Interface Cable £20

### Software

- ◆ upgrade to Spacotech Photodesk software £119
- ◆ Sleuth OCR software £40

# Aries Monitors

## EnergyPro 14" LR

- ◆ 14" hi-res 0.28mm dot pitch tube
- ◆ Low Radiation MPRII standard
- ◆ 800 x 600 resolution
- ◆ Tilt and swivel base
- ◆ Horiz frequency - 29KHz to 70KHz

£159

## Alphascan Pro LR

- ◆ 14" hi-res 0.28mm dot pitch tube
- ◆ Low Radiation MPRII standard
- ◆ 1280 x 1024 @ 60Hz
- ◆ 1024 x 768 @ 72Hz
- ◆ Horiz frequency - 29KHz to 70KHz

£199

## 15" EnergyPro 6000i

- ◆ 15" hi-res 0.28mm dot pitch tube
- ◆ Low Radiation MPRII standard
- ◆ EPA Energy Star compliant
- ◆ 1280 x 1024 @ 60Hz
- ◆ Horiz frequency - 29KHz to 70KHz

£239

## 17" EnergyPro 7560i

- ◆ 15" hi-res 0.28mm dot pitch tube
- ◆ Low Radiation MPRII standard
- ◆ EPA Energy Star compliant
- ◆ 1280 x 1024 @ 60Hz
- ◆ Horiz frequency - 29KHz to 70KHz

£419

# Hard Drives

**A300/A400 IDE Hard Drive Upgrades**  
Complete with drive, interface, mounting kit, cables and software.

- ◆ ADA0580 365Mb 11ms £179
- ◆ ADA2030 420Mb 11ms £199
- ◆ ADA2210 540Mb 12ms £219

**A5000/RiscPC IDE Hard Drive Upgrades**  
For use as replacement of existing drive.

- ◆ ADA0880 365Mb 11ms £119
- ◆ ADA2060 420Mb 11ms £149
- ◆ ADA2220 540Mb 11ms £399

- ◆ 2nd Drive Accessory Kit £10

### IDE Interfaces & Accessories

- ◆ 8-bit IDE interface for A300/A3010 £59
- ◆ 16-bit IDE interface for A300/A400 £39
- ◆ Dual IDE interface Cable £9

**A3000/A3010 Internal IDE Hard Drives**  
Complete with drive, interface and software.

- ◆ ADA2360 170Mb 13ms £199
- ◆ ADA2090 340Mb 11ms £299
- ◆ ADA2200 510Mb 11ms £399

**A300/A400 SCSI Hard Drive Upgrades**  
Complete with 16-bit interface, drive, cables and mounting kit.

- ◆ ADA2300 365Mb 12ms £249
- ◆ ADA2310 540Mb 11ms £299
- ◆ ADA2320 1.0Gb 9ms £499
- ◆ ADA2330 2.0Gb 10ms £849

### SCSI Interfaces & Accessories

- ◆ 16-bit SCSI interface - A300/A400 £89
- ◆ 32-bit SCSI II interface RiscPC £159
- ◆ Dual SCSI interface Cable - ribbon £9
- ◆ SCSI interface Cable - round £15

# Upgrades & Accessories

## RISC OS Upgrades

- ◆ Software Upgrade - all machines £74
- ◆ Carrier Board - A300/A440 machines £21
- ◆ Software Upgrade - Bulk 10 Pack £319

## Memory Upgrades

Model	2Mb	4Mb	8Mb
◆ A3000	£49	£119	-
◆ A3010	£59	£139	-
◆ A3020/A4000	-	£89	-
◆ A5000	-	£79	£269
◆ A540/R260	-	£249	-

## RiscPC Additional RAM Modules

- ◆ 2Mb £79
- ◆ 4Mb £105
- ◆ 8Mb £225
- ◆ 16Mb £345
- ◆ 32Mb £POA
- ◆ 64Mb £POA
- ◆ 1Mb VRAM £89
- ◆ 2Mb VRAM £159

## Graphics/Sound Cards

- ◆ Acorn RiscPC 16-bit Sound Card £59
- ◆ CC ColourCard Gold - A300/A400 £239
- ◆ CC Eagle M2 Multimedia Card £319
- ◆ CC Hawk V9 MK2 Digitiser £189
- ◆ CC Chroma 500 Genlock Card £419
- ◆ CC Chroma 150 PAL Encoder £169
- ◆ CC Chroma Genlock Card £209
- ◆ CC TV Tuner £89
- ◆ CC TV Tuner & Teletext £159
- ◆ CC Movie Magic MPEG Card £249
- ◆ CC ScanLight Video 256 £199
- ◆ CC ScanLight 256 - A3000 Internal £189
- ◆ HCCS Vision24 254 line Digitiser £99
- ◆ HCCS Vision24 508 line Digitiser £149
- ◆ WE Scan256 handscanner - A5000 £115
- ◆ WE Scan256 handscanner - A3000 £125
- ◆ WE A4 Mono Scanner & Feeder £199
- ◆ WE Multiscan VIDC Enhancer £10
- ◆ WE SuperVGA VIDC Enhancer £15

## Ultimate Expansion

Increase the expansion possibilities of your Acorn computer with the Ultimate Expansion system. In its simplest form it is a standard internal module with built in user port and also space for a 2.5" IDE hard disk drive. Up to 3 micro module slots are provided for other uses such as analogue port, video digitiser or even SCSI interface.

- ◆ Ultimate Expansion Interface £39
- ◆ Ultimate Expansion Interface & IDE £99
- ◆ Ultimate Expansion with 170Mb drive £249
- ◆ Ultimate Expansion with 340Mb drive £299

## Micro Modules for Ultimate Expansion

- ◆ SCSI Interface £69
- ◆ Vision24 Colour Digitiser £99
- ◆ ScanLight 256 handscanner £229
- ◆ MIDI Interface £49
- ◆ Analogue Interface £29

## I/O Cards

- ◆ A3000 I/O Card - User/Analogue £25
- ◆ A3000 User Port/MIDI Card £44
- ◆ A300/A400 I/O Card - User/Analogue £29

## Miscellaneous Add-Ons

- ◆ A300 4 way Backplane £25
- ◆ A300/A400 Fan £10
- ◆ A3000 Serial Port Upgrade £18
- ◆ ARC to BBC Serial Transfer Link £15
- ◆ MEMC1A Upgrade Kit £29
- ◆ Floating Point Accelerator - A5000 £89
- ◆ A4 Notebook Battery Pack £49
- ◆ 25MHz ARM3 Turbo Card £149
- ◆ Sportster 14.4 Modem & ArcFax £159
- ◆ Sportster 28.8 Modem & ArcFax £239
- ◆ DataSafe 120Mb Portable Tape Drive £399

# Networking

## Acorn Ethernet Network Interface Cards

- ◆ Acorn Ethernet Card - A5000 £149
- ◆ Acorn Ethernet Interface - RiscPC £99

## Access+ Peer-to-Peer Networking

Simple, easy to use networking system allows you to share hard disks, CD-ROM and printers. Using industry standard Ethernet cabling, you have a flexible system that can grow as your requirements do.

- ◆ Access+ for A3000 £129
- ◆ Access+ for A3020/A4000 £129
- ◆ Access+ for A5000 £129
- ◆ Access+ for RiscPC £95
- ◆ Access+ CD Share software £95

## i-Cubed Ethernet Network Interface Cards

- ◆ EtherLAN 102 BNC/TP - A3000 £125
- ◆ EtherLAN 200 BNC - A3020/A4000 £135
- ◆ EtherLAN 201 TP - A3020/A4000 £135
- ◆ EtherLAN502 BNC/TP - A5000 £125
- ◆ EtherLAN602 BNC/TP - RiscPC £105

## Ethernet Hubs

- ◆ Anes EH-8 8port Ethernet Hub £129
- ◆ Anes EH-16 16port Ethernet Hub £279
- ◆ Aries EH-32 32port Ethernet Hub £459

## Ethernet Cabling

Cable Length	Thinnet	UTP
◆ 3m	£5	£4
◆ 5m	£6	£6
◆ 10m	£8	£9
◆ 20m	£15	£16

## Connectors and Accessories

- ◆ BNC 50ohm Terminator £0.95
- ◆ BNC T-connector £1.75
- ◆ BNC In-line coupler £1.75

## Networking Software

- ◆ Level 4 Fileserver Release 3 £359
- ◆ TCP/IP Protocol Suite - single user £99
- ◆ OmniClient £235
- ◆ InterTalk £75

## PC Cards

- ◆ 486 25MHz 0Mb PC Card - A5000 £339
- ◆ 486 50MHz 0Mb PC Card - A5000 £399
- ◆ 4Mb RAM module £125
- ◆ 8Mb RAM module £249
- ◆ 16Mb RAM module £399
- ◆ MS-DOS 6.2 & Windows 3.11 £89

## RiscPC 486 PC Card

Add PC functionality to your RiscPC with the 486SX-33 2nd processor card

£199

## Accessories

### Dustcovers & Carry Cases

- ◆ A3000 Keyboard cover £5
- ◆ A3000 Keyboard & Monitor cover £9
- ◆ A300/A400 Micro & Monitor cover £9
- ◆ A5000 Micro & Monitor cover £9
- ◆ 14" Monitor cover £6
- ◆ A3000/A3010 Carry Case £10
- ◆ A4 Notebook Carry Case £35

### Mice & Joysticks

- ◆ Archimedes MK4 Mouse £24
- ◆ Acorn Logitech Mouse £27
- ◆ Quest Tracerball £20
- ◆ PowerPad Single Joypad £25
- ◆ PowerPad Dual Joypad £34

### Miscellaneous Accessories

- ◆ A3000 Monitor Stand £15
- ◆ A3000 External Module Case £10
- ◆ ARC Keyboard Extension Cable £5
- ◆ ARC Mouse Port Splitter £5

We stock the complete range of spare parts call for prices and availability.

## Concept Keyboards

- ◆ A4 2010 Concept Keyboard £99
- ◆ A3 2010 Concept Keyboard £109
- ◆ 2010 BBC User Port Cable £12
- ◆ 2010 Archimedes Serial Cable £12
- ◆ ARC Concept Keyboard Design S/W £20

## Multiscan Monitors

- ◆ Acorn AKF52 - 14" £219
- ◆ Acorn AKF50 - 14" £279
- ◆ Acorn AKF60 - 14" £299
- ◆ Acorn AKF85 - 17" £599
- ◆ Panasonic TX-D1732 - 17" £479
- ◆ Panasonic TX-D2131 - 21" £1359
- ◆ Sony CPD-15SF1 - 15" £287
- ◆ Sony GDM-17SE1 - 17" £819
- ◆ Sony GDM-20SE1 - 20" £1425
- ◆ Taxan EV400 LR - 14" £190
- ◆ Taxan Ergovision 580 LR - 15" £275
- ◆ Taxan Ergovision 880 LR - 17" £520
- ◆ Taxan Ergovision 2100 LR - 21" £1530

## Diskettes

- ◆ Excel Diskettes - Lifetime Guarantee
- ◆ Excel 3.5" DSDD Diskettes - 10pk £6
- ◆ Excel 3.5" DSHD Diskettes - 10pk £7
- ◆ Excel 3.5" DSHD Diskettes - 50pk £22

## 3M/Verbatim Diskettes

- ◆ 3.5" DSDD Diskettes - 10pk £6
- ◆ 3.5" DSHD Diskettes - 10pk £7
- ◆ 5.25" DSDD 80T Diskettes - 10pk £7
- ◆ 5.25" DSHD Diskettes - 10pk £10

## Educational Discounts

available on some products to Schools, Colleges & Universities  
Call 01582 745555 for details



**Watford Electronics Ltd**

Mail Order & Showroom: Jessa House, 1 Finwav, Dallow Road, Luton LU1 1TR

SALES HOTLINE

**01582 745555**



Prices exclude VAT @ 17.5%



# Printers

## Laser Printers

• Brother HL630	6ppm	£324
• Brother HL660	6ppm	£464
• Canon LBP430W	4ppm	£363
• Canon LBP1260	12ppm	£909
• Epson EPL-3000*	4ppm	£389
• Epson EPL-5200*	5ppm	£471
• HP Laserjet 4L	4ppm	£355
• HP Laserjet 5P	5ppm	£587
• HP Laserjet 4 Plus	12ppm	£938
• HP Laserjet 4V - A3	16ppm	£1368
• HP Laserjet Colour	2ppm	£4199
• QKI QL-400ex	4ppm	£289
• QKI QL-410ex	4ppm	£399
• Panasonic KX-P4401	4ppm	£330
• Panasonic KX-P4410**	5ppm	£318
• Panasonic KX-P4430**	5ppm	£479
• Panasonic KX-P4440**	10ppm	£679

All printers are covered by 12 months RETURN TO BASE warranty unless stated differently as below:

\* = 12 months On-Site Warranty  
\*\* = 2 years On-Site Warranty

## Inkjet Printers

• Canon BJ200ex	80col	£170
• Canon BJ30	80col	£153
• Canon BJ230	132col	£247
• Canon BJ300	80col	£364
• Canon BJ330	132col	£404
• Canon BJC4000 Colour	80col	£232
• Canon BJC600e Colour	80col	£344
• Canon BJC70 Colour	80col	£225
• Canon BJC800 Colour	132col	£1065
• Citizen Project IIC	80col	£198
• Epson Stylus Colour	80col	£350
• Epson SQ870	80col	£453
• Epson SQ1170	132col	£609
• HP DeskJet 320	80col	£164
• HP DeskJet 320 & CSF	80col	£180
• HP DeskJet 540	80col	£209
• HP DeskJet 660 Colour	80col	£294
• HP DeskJet 850 Colour	80col	£387
• HP DeskJet 1600 Colour	80col	£834
• HP PaintJet XL300 - A4	80col	£1599
• HP PaintJet XL300 - A3	132col	£1769
• Star SJ144	80col	£285

## 24pin Matrix Printers

• Citizen ABC	80col	£103
• Citizen ABC Colour	80col	£125
• Citizen Swift 240X	132col	£219
• Epson LQ100	80col	£99
• Epson LQ150	80col	£112
• Epson LQ150 Colour	80col	£158
• Epson LQ570+	80col	£217
• Epson LQ1070+	132col	£303
• Epson LQ1170	132col	£441
• Epson DLQ3000 Colour	132col	£672
• Panasonic KX-P2023	80col	£108
• Panasonic KX-P2135 Col.	80col	£124
• Panasonic KX-P2124	80col	£198
• Panasonic KX-P3626	132col	£252
• Star LC24-11 II	132col	£232
• Star LC24-300	80col	£188
• Star LC240	80col	£92
• Star LC240 Colour	80col	£103
• Star XB24-200 Colour	80 col	£329
• Star XB24-250 Colour	132col	£395

## LUTON SHOWROOM

Finway, Dallow Road, Luton, Beds.  
Tel: 01582 74 55 55

## WATFORD SHOWROOM

250 Lower High Street, Watford, Herts.  
Tel: 01923 23 77 74

## 9pin Matrix Printers

• Citizen Swift 90	80col	£114
• Citizen Swift 90 Colour	80col	£121
• Citizen Swift 120Q+ Parallel	80col	£90
• Citizen Swift 120D+ Serial	80col	£105
• Epson LX300	80col	£98
• Epson FX870	80col	£245
• Epson FX1170	132col	£304
• Epson DFX5000+	132col	£1188
• Panasonic KX-P1150	80col	£259
• Panasonic KX-P3696	132col	£259
• Star LC15	80col	£177
• Star LC100 Colour	132col	£89
• Star LC90	80col	£89
• Star ZA200 Colour	80col	£255
• Star ZA250 Colour	80col	£315

# Printer Accessories

## Memory Upgrades

Type	1M	2M	4M
• Canon LBP-4+	£139	-	-
• Canon LBP-8 IV	£129	-	£299
• EPL 4100/4300	£62	-	-
• EPL 5200/5600	-	-	£199
• Epson 5200/5600	£58	£115	£215
• HP III/III/IIID	£59	£95	£150
• HP II/IIID	£65	£95	-
• HP 4L/4ML	£65	-	-
• HP 4/4M/4P	-	£84	-
• HP 4/4M/4P/4V	£75	£85	£125
• KXP4410/4430	£89	£129	-
• KXP4420/4450I	£89	£109	£165
• KXP4400/5400	£75	£109	£175
• Pan 4420/4450	£75	£115	£135
• Pan 4410/4430	£129	£199	-
• Pan 4400/5400	£89	£139	£229
• QKI QL400ex	£99	£118	-
• HP DeskJet 500 256K RAM	-	-	£75
• Panasonic 32K Buffer - Matrix range	-	-	£16

## Laser Consumables

Type	Toner	Drum	Dev
• Brother HL630	£20	£99	-
• Canon/Star 4s	£46	-	-
• Canon LBP-8 IV	£70	-	-
• Epson 4100/4300	£85	-	-
• HP III/IIID	£47	-	-
• HP II/IIID	£46	-	-
• HP 4/4M	£72	-	-
• HP 4L/4ML/4P/4MP	£49	-	-
• QKI QL-400/800	£19	£189	-
• QKI QL-400ex	£17	£129	-
• Pan 4410/4430	£29	£80	£90
• Pan 4420	£32	£108	£115
• Pan 4420	£24	£60	£55
• Pan 4450/551/55	£18	£75	£60
• Pan 4400/5400	£12	£69	-

## Sheet Feeders

• Canon BJ10ex/BJ10sx	£40
• Canon BJ300	Std: £86
• Canon BJ330	Std: £96
• Citizen Swift 200/240	£75
• Epson LQ570/LQ870	Std: £47
• Epson LQ1070/1170	Std: £89
• HP DeskJet 320	£48
• Panasonic 1170/1180/1123	£59
• Panasonic 1124/2124	£79
• Panasonic 1624/2624	£128
• Panasonic 2135/1150	£30
• Star LC100	£69
• Star LC24-20	£69
• Star LC200/LC24-200	£69

## Tractor Feeders

• Epson LQ100/150	£29
• Epson LX300	£18
• Epson LQ570 Pull	£39
• Epson FX/LQ870	£45
• Epson FX/LQ1170	£65

## Colour Kits

• Citizen Swift 24/200/240	£36
• Citizen ABC	£22
• Epson LX300/LQ300	£33
• HP DeskJet 320/540	£28
• Panasonic 2180/2123/2124	£32

## Ribbons/Ink Cartridges

(Manufacturers Original Ribbons Only)

Type	Black	Colour
• Canon BJ10ex/sx	£14	-
• Canon BJ30	£10	-
• Canon BJ200/BJ230	£11	-
• Canon BJ300/BJ330	£16	-
• Canon BJC70	£9	£14
• Canon BJC4000	£8	£13
• Canon BJC600	£7	£8
• Canon BJC800/820	£16	£22
• Citizen 120D+	£4	-
• Citizen Swift 200/240	£4	£12
• Citizen Swift 24X	£8	£18
• Epson LX400/850/FX870	£4	-
• Epson LX100	£4	-
• Epson LQ100	£5	-
• Epson LQ150	£4	£12
• Epson LQ570/870	£5	-
• Epson LQ1070/1170	£8	-
• Epson Stylus 800/1000	£10	-
• Epson Stylus Colour	£12	£27
• Epson SQ870/SQ1170	£23	-
• Fujitsu B100/B200	£18	-
• HP DeskJet 500 Series	£19	£21
• HP DeskJet 660	£20	£23
• HP DeskJet 850	£22	£23
• HP DeskJet 310/320	£13	£21
• HP DeskJet 1200	£19	£21
• HP PaintJet XL300	£16	£18
• Kaga/Taxan 810/815	£5	-
• Pan 1170/1180/1150	£7	-
• Pan 1123/1124	£7	-
• Pan 2180/2123/2124/2135	£7	£14
• Pan 1624/2624	£8	-
• Pan 3626/3696	£11	-
• Star LC10/20/100	£5	£9
• Star LC200	£5	£11
• Star LC24-20/24-200/240	£5	£12
• Star LC24-30	£8	£12
• Star ZA/XB24-200/ZA250	£5	£12
• Star SJ48	£16	-
• Star SJ144	£5	£8

## Miscellaneous

• Canon BJ10sx Battery Pack	£33
• Epson OK Serial Interface	£29
• Epson 8K Serial Interface	£75
• Epson 32K Serial Interface	£95
• HP DeskJet 500 FX Emulation Cart.	£49
• HP DeskJet 500 Quotcover	£6
• HP DeskJet IBM Emulation Cart	£57
• HP DeskJet 320 Battery Pack	£33
• HP DeskJet 320 Parallel Cable	£12
• HP DeskJet 1200 PostScript SIMM	£499
• HP DeskJet Prestige Elite Font Cart	£55
• HP DeskJet Letter Gothic Font Cart	£56
• HP LaserJet IIP Lower Cassette	£115
• HP LaserJet 4 Lower Cassette	£205
• HP LaserJet 4Si Duplex Unit	£475
• HP LaserJet Font Cartridges	from £45
• HP LaserJet FX/IBM Emulation cart	£79
• HP LaserJet 4P A5 Paper Feeder	£85
• HP LaserJet 4 Envelope Feeder	£199
• Panasonic KX-P4420 Qzone Filter	£9
• Panasonic KX-P4450 Qzone Filter	£20
• Panasonic Serial Interface	£49
• Star 8K Serial Interface - LC range	£52
• Star 8K Serial Interface XB/ZA	£39
• Dustcover for 80 column printers	£6
• Dustcover for 132 column printers	£10
• 80 column Perspex Printer Stand	£12
• 132 column Perspex Printer Stand	£18

## On-Site Warranties

Model	1 year	3 year
• Brother LH630/631/660	£34	-
• HP Mono DeskJets	£32	£40
• HP Colour DeskJets	£45	£85
• HP LaserJet 4L/4P	£78	£100
• HP LaserJet 4+4M+	£135	£185
• HP LaserJet 4V/4MV	£425	£485

## Ink Refill Packs

• Canon BJ10sx & BJ200/230 2 pack	£12
• Canon BJ300/BJ330 2 pack	£12
• HP DeskJets Hi-Capacity 2 pack	£24
• HP DeskJets Hi-Capacity 5 pack	£35
• HP DeskJet Color Refill	£49

## Compatible Ink Cartridges

• Black Cartridge for Canon BJC800	£10
• Colour Cartridge for Canon BJC800	£12
• Black Cartridge for Canon BJC600	£25
• Colour Cartridge for Canon BJC600	£26
• Black Cartridge for Epson Stylus Col.	PQA
• Colour Cartridge for Epson Stylus Col.	PQA

## Paper & Labels

A4 Cut Sheet Paper - 500 sheets	£7.00
• A4 90g Laser/Inkjet Paper	£3.00
• A4 80g Laser/Copier Paper	£3.50
• A4 80g Coloured Paper	£3.50

## Inkjet Paper & Transparencies

• Canon BJC A4 Transparency (50)	£39.00
• Canon BJC A4 Paper (50)	£22.00
• Canon BJC800 A3 Paper (50)	£45.00
• Epson Stylus 360dpi A4 Paper (50)	£17.00
• Epson Stylus 720dpi A4 Paper (50)	£19.00
• Epson Stylus A4 Transparency (50)	£59.00
• HP DeskJet Glossy A4 Paper (50)	£35.00
• HP DeskJet A4 Transparency (50)	£35.00
• HP DeskJet A4 Paper (200)	£15.00
• Image+ A4 Glossy Paper (50)	£28.00
• Image+ 90g A4 Paper (200)	£10.00
• Image+ 100g A4 Paper (200)	£12.00
• Image+ 120g A4 Paper (200)	£14.00
• Image+ A4 Transparency (50)	£28.00

## Fanfold Paper

• 1000 60g 9.5" x 11" - 1pt	£6.50
• 2000 60g 9.5" x 11" - 1pt	£11.00
• 1000 60g 9.5" x 11" - 2pt	£21.00
• 700 60g 9.5" x 11" - 3pt	£28.00
• 1000 60g 14.5" x 11" - 1pt	£8.00
• 2000 60g 14.5" x 11" - 1pt	£14.50
• 1000 70g True A4 - 1pt	£9.00
• 2000 70g True A4 - 1pt	£15.00
• Stylus coated paper 360 A4 200 sht	£17.00
• Stylus coated paper 720 A4 200 sht	£19.00

## Continuous Fanfold Labels

• 1000 89mm x 36mm Single Row	£4.50
• 1000 89mm x 36mm Twin Row	£4.80
• 1000 89mm x 49mm Single Row	£4.95
• 1000 102mm x 36mm Twin Row	£4.70

## Laser Labels (on A4 sheet)

• 2400 70mm x 37mm (3x8)	£15
• 2100 70mm x 37mm (3x7)	£15
• 1600 105mm x 35mm (2x8)	£17
• 1400 105mm x 38mm (2x7)	£16

## Printer Sharers

Manual Printer Sharers	Serial	Parallel
Connects		
• 2in/1out	£12	£13
• 2in/2out	£28	£29
• 3in/1out	£15	£17
• 4in/1out	£24	£26
• 5in/1out	£27	£28

Note: Serial sharers have 25-way "D" type female connectors and parallel sharers have 36-way Centronics connectors

## Automatic Parallel Printer Sharer Buffers

Type	0Kb	256K	1Mb
• 2in/1out	£29	-	-
• 2in/2out	-	£105	£134
• 4in/1out	£45	-	-
• 4in/2out	£69	£124	£149
• 8in/1out	£64	-	-

## Automatic Serial Printer Sharer Buffers

Type	0Kb	256K	1Mb
• 2in/1out	£27	-	-
• 2in/2out	-	£124	-
• 4in/1out	£44	-	-
• 4in/2out	£69	£147	-
• 8in/1out	£62	-	-

Note: All automatic sharers and buffer products have 25way 'Q' female connectors.

## RAM Expansion for Auto Sharers

• RAM Module	256K	1Mb	2Mb
	£59	£78	£124

## Compact Convertors

• Serial to Parallel Converter	£49
• Serial to Parallel Converter/BJC	£55
• IEEE-488 to Centronics converter	£49
• RS232 to RS422 Converter	£37
• Parallel Line Extender	£37



# Software

As one of the largest dealer in Acorn software in the UK, we doubt that you will find any of the titles listed here cheaper elsewhere.

Also if there is something you don't see listed, give us a call and we will attempt to source it for you and give you the best price.

All software requires at least 1Mb RAM and RISC OS operating system.

Special notes  
 † - not suitable for RiscPC  
 †† - requires 2Mb RAM  
 ‡ - hard disk required

## Games

<b>4th Dimension</b>	
Adventures of Sylvia Lane	£16
Birds of War †	£22
Black Angel	£22
Break 147 & Superpool	£22
Carnage Inc.	£16
Chocks Away Compendium †	£18
Chopper Force	£15
Cyber Chess	£18
Demon's Lair	£18
Dungeon ††	£18
Enter the Realm †	£18
E-Type II	£22
E-Type Compendium	£15
Galactic Dan	£15
Greivous Bodily ARM	£15
Haunted House	£18
Holed Out Compendium	£18
Pandora's Box	£15
Real McCoy 2	£20
Real McCoy 3	£20
Real McCoy 4	£20
Saloon Cars Deluxe	£20
Stunt Racer 2000 †	£18
Stunt Racer 2000 Extra Tracks †	£14
Time Machine	£18
Virtual Golf †	£18
Virtual Golf Augusta †	£12
Watford Learn & Play Pack	£40

<b>Krisalis Software</b>	
Battle Chess	£17
Cannon Fodder	£17
Champions	£20
Chuck Rock	£8
Gods †	£8
Hero Quest	£18
Heimdall ††	£18
James Pond †	£8
Krisalis Collection	£20
Lemmings	£14
Lemmings 2 - The Tribes	£18
Lemmings Double Pack - RiscPC	£21
Lotus Turbo Challenge II †	£18
Mad Professor Mania!	£8
Manchester United †	£8
Manchester United Europe †	£8
Nebulus	£14
Oh No! More Lemmings	£12
Populous	£18
Quest for Gold (HD)	£10
Revelations	£8
Sim City	£18
Sim City 2000	£25
Sim City 2000 - RiscPC	£25
Speedball 2	£17
SWIV	£8

<b>Gamesware</b>	
Ames	£21
Cycloids	£14
FRED	£14
Games Wizard	£18
Ixon	£14
James Pond 2 - Robocod	£18
Playdays	£29
Simon the Sorcerer	£29
Xenon 2	£18

<b>Renegade</b>	
Chaos Engine	£18
Magic Pockets	£17
Sensible Soccer	£18

<b>Superior Software</b>	
Air Supremacy	£14
Ego: Repton 4	£17
Play It Again Sam 1	£14
Play It Again Sam 2	£14
Play It Again Sam 3	£14
Repton 3	£14
Superior Golf	£14
Technodream	£14

<b>US Gold</b>	
Flashback	£18
Flashback HD	£18

<b>Gremlin Graphics</b>	
Premier Manager	£18

<b>Qregan Software</b>	
Arcturus	£21
Magnetoids	£21
Sally & Wally	£21

<b>Other Software Suppliers</b>	
Chess 3D	£18
Crystal Maze	£24
Diggers	£18
Dune II ††	£29
Elite	£29
PTT	£21
Scrabble	£18
Starlighter 3000	£22
Tower of Babel	£10
Wolstein 3D	£22

## Educational Software

<b>Primary - ages 4 to 7 years</b>	
An Eye for Spelling	£32
Bookstore Primary	£33
Connections	£23
Desktop Folio	£59
Exploring with Flossy the Frog	£22
Folio	£34
Fun School 3 - Under 5 years	£17
Fun School 3 - 5 to 7 years	£17
Fun School 4 - Under 5 years	£17
Fun School 4 - 5 to 7 years	£17
Happy Life	£25
Happy Numbers	£25
Happy Reading	£25
Happy Sea	£25
Happy Time	£25
Kid Pix	£34
Letters	£42
Maths Circus	£25
Numbertime	£24
Oxford Talking Stories - Stage 2	£32
Oxford More Talking Stories - Stage 2	£32
Oxford Talking Stories - Stage 3	£32
Playdays	£18
Picture Point	£26
Podd - English version	£23
Podd - Welsh & English version	£36
Primary Nature	£42
PIMS - Information Management	£375
Rainbow	£27
Rainbow Book Project - Fiction 1	£69
Rainbow Book Project - Language 1	£69
Rainbow Book Project - Non Fiction 1	£69
Rose & Jim - Duck Loses His Quack	£10
Rose & Jim - Jim Gets the Sneezes	£10
Seelinks - Ourselves	£34
Seelinks - Pondwatch	£34
Seelinks - Transport	£34
Sherston Naughty Stories - vol.1	£39
Sherston Naughty Stories - vol.2	£39
Sherston Naughty Stories CD	£64
Talking Animated Alphabet	£27
Talking Topics - The Body	£10
Talking Topics - Dinosaurs	£10
Talking Topics - Homes	£10
Talking Topics - Land Transport	£10
Talking Topics - Pets	£10
Talking Topics - The Seaside	£10
Talking Topics - all six above titles	£47
Zig Zag - Anglo Saxon	£29
Zig Zag - Romans	£29

<b>Junior - ages 7 to 11</b>	
A Mouse in Holland	£22
Ancient Egypt	£42
Arcture I - Romans	£24
Arcture II - Egyptians	£24
Arcture III - Vikings	£24
Around the World in 80 Days	£31
Aztecs	£31
Badger Trails	£31
Battle of the Somme	£42
Bodywise	£31
Castle Life	£42
Crystal Rain Forest	£31
Fun School 3 - Over 7 years	£17
Fun School 4 - Over 7 years	£17
Investigating Maths	£32
Junior Insight	£40
Landmarks - Aztecs	£21
Landmarks - Civil War	£21
Landmarks - Columbus	£21
Landmarks - Elizabeth I	£21
Landmarks - Project Egypt	£21
Landmarks - Rain Forest	£21
Landmarks - Victorians	£21
Landmarks - World War II	£21
Landmarks Datalife - various titles	£13
Langdale River Project	£45
Langdale Stickle Tam Project	£45
Linkword - French	£35
Linkword - German	£35
Linkword - Spanish	£35
Look & Read - Earthwarp	£24
Look & Read - Geodie Racer	£24
Look & Read - LRTV	£24
Look & Read - Skyhunter	£24
Look & Read - Through Dragon's Eye	£24
Magpie 2	£49
Maths Card	£45
Microworlds - Victorians	£24
Microworlds - War Years	£24
Numerator	£32
Numerator Chaos Pack	£32
Recall	£31
Report Writer	£45
Saxon Life	£42
Sea Rescue - Fractions	£21
Selladora Tales	£19
Space City - Angles	£21
Splash	£16
Time Detectives - Victorians	£31
Topographer	£59
VersaTile	£42
Viewpoints	£31
Viking Invaders	£42
Voyage of Discovery	£25
World Map Study	£55
Time Traveller - Britain Since 1930's	£29
Time Traveller - Making of the UK	£29
Time Traveller - Medieval Realms	£29
Time Traveller - Tudors & Stuarts	£29
Time Traveller - Trade and Industry	£29
Time Traveller - Victorians	£29

<b>Secondary - ages 11 to 16 years</b>	
Bookstore Secondary	£52
Investigating Local Industry	£85
Insight	£62

## Educational cont'd...

Night Sky	£59
<b>10 Out of 10 Educational Software</b>	
Dinosaurs	£15
Driving Test	£15
Early Essentials	£15
English	£15
Essential Maths	£15
Essential Science	£15
French	£15
German	£15
Italian	£15
Junior Essentials	£15
Maths - Algebra	£15
Maths - Geometry	£15
Maths - Number	£15
Maths - Statistics	£15
Spanish	£15
Spelling & Punctuation	£15
Structured Spelling	£15

## Desktop Publishing

Impression Style	£69
Impression Publisher	£119
Impression Publisher Plus	£219
Impression Borders Disk	£12
Ovation DTP	£68
First Page DTP	£41

## DTP Utilities

Desktop Thesaurus	£16
Formulix	£65
Graphics Loaders	£35
Sleuth OCR v1.5	£43
Sleuth OCR v2.0	£95
Spellmaster	£25
Type Studio	£38

## Word Processors

DeskEdit 4	£21
Easiword Plus	£36
Easiwriter 3	£115
Pendown	£45
Pendown Etologies	£45
Pendown Plus	£66
Primeword	£42
Talking Pendown	£53
Techwriter	£164
Wordz	£54
Wordworks	£35

## Integrated Packages

Acorn Advance	£87
Desktop Office	£48
Fireworkz	£89
Fireworkz Pro	£145
Pipedream 3	£69
Pipedream 4	£85

## Spreadsheets

Advantage ††	£42
Eureka 3	£91
ProSheet v1.4	£33
Resultz	£74
Schema 2	£94

## Databases

Flexifile	£19
Insight	£58
Genesis Project	£47
Genesis Professional	£111
Knowledge Organiser 2	£60
Masterfile 3	£39
Pinpoint 2	£78
Pinpoint Junior	£25
Recordz	£96
S-Base 2 Personal	£103
S-Base 2 Developer	£188
S-Base 2 Developer Plus	£339

## Programming Tools

Acorn Desktop C	£151
Acorn C++ Compiler/Assembler	£189
Acorn PC Emulator v1.8	£89
ABC Basic Compiler v3	£65
Cambridge Pascal	£65
Control LOGO	£21
Easy C Compiler	£43
Easy C++ Compiler	£95
First LOGO	£20
Logotron LOGO	£55
RiscBASIC Compiler v3.15	£65
RiscFORTH Compiler v1.2	£65
RoboLOGO v1.1	£35
WimpGEN v1.1	£65

## Music & Speech

Audioworks	£35
Notate	£51
Rhapsody 3	£72
Rhythm Bed	£35
Scoredraw	£44
Serenade	£72
Sibelius 7	£785
Vox Box	£35

## Computer Aided Design

ArcPCB v1.9	£80
ArcPCB Professional v3.3	£162
ArcPCB Schematics v5.2	£223
CADet	£95
ExcellonDRILL v2.1	£36
GerberPLOT v2.1	£36
LOGIX v1.1	£80
Oak Logic	£65
Oak PCB II	£69
Oak Apollonian PDT	£135
PowerROUTER v1.6	£49
SolidCAD v5.1	£65
WorraCAD	£65

## Communications

ArcComm 2	£35
ArcFAX	£28
ArcTerm v7	£59
Hearsay v2	£59

## Graphics & Design

Artworks v1.5	£122
Card Shop	£19
Clipart - Christmas Assorts	£15
Clipart - Food for Thought	£15
Clipart - Split an Image	£15
Complete Animator	£94
Composition - RiscPC only	£184
Euclid 2	£62
FilmMAKER v5.1	£39
Glimpse - clipart viewer	£8
Image Animator	£45
Image Outliner	£45
Image Master	£25
Illusionist	£37
Kid Pix	£34
Photodesk	£156
Prime Art	£46
Pro Artisan 2	£99
Pro Artisan 24 - RiscPC only	£122
Render Bender 2	£37
Rephorm	£44
Revelation Image Pro 24-bit	£49
SolidsRENDER v5.1	£63
SolidTOOLS v5.1	£169
Titler	£72

## Presentation Graphics

Chartwell	£22
Graphbox	£35
Graphbox Professional	£84
Plot	£61
Presenter GTI 16v	£69

## Business/Accounts

Home Accounts	£24
Payroll Manager v3	£59
Personal Accounts	£39
PlanING	£95
ProjectING	£289
Prophet Accounts ††	£144
Shareholder v2	£69
Shareholder Professional v3	£110

## Miscellaneous

Ancestry	£42
Compression	£31
Concept Keyboard Designer	£21
File Handling for All Disc	£4
Hard Disc Companion 2	£39
Investigator 3	£41
MacFS Light - read/write floppies	£45
MacFS	£89
PaperOut - Electronic Book player	£49
PDSView	£99
RISC OS Application Disks	£5
ROM Upgrade for Acorn I/O Module	£10
Show Page	£139
Touch Type	£39
ITWAIN - HP, Canon or Epson	£16
WIMP Programming for All Disc	£4

## Printer Drivers

Citizen/Star Colour Printer Driver	£10
Expression PS	£18
HP DeskJet Colour Printer Driver	£10
!Printers v1.22 Upgrade Disk	£5
Canon BJ Turbodriner v4 ‡	£38
Epson Stylus Turbodriner v4 ‡	£38
HP DeskJet Turbodriner v4 ‡	£38
Repro	£45

Carriage Charges - Standard Service		
	1st Item	2nd Item
Small items	£5.00	£2.00
Accessories	£6.00	£3.00
Software	£6.00	£3.00
Hardware	£7.00	£4.00
14" & 15" Monitors	£9.00	£5.00
17" Monitors & Lasers	£10.00	£6.00
Printers	£8.00	£5.00
Computer Systems	£16.00	-

For Express Service simply double the above charges.

Delivery to some areas of Scotland & N. Ireland are subject to additional surcharge.

Terms & Conditions: Offers and all items are subject to availability. Specifications & prices correct at time of going to press, but may change without notice. Please check suitability of software & peripherals before ordering. Software & printer consumables which have been opened will not be accepted back for refund or exchange. All trademarks are duly acknowledged. Goods are sold on our standard terms & conditions of sale and are available on request. Goods are not sold on a trade basis. All prices are exclusive of VAT and carriage. EAOE



# Watford Electronics Ltd

SALES HOTLINE

01592 715555





Dave Lawrence and Dave Acton present more programs, tips and techie trivia from beyond the PRM.

# \*info

## 'Snowball' and 'hell'...

Author: Paul Marshall

This wild stab in the dark appears courtesy of Paul Marshall. It is a program to help you choose *the* winning numbers in the National Lottery. Honest, Paul says:

'It is an inescapable fact that every draw of random numbers is completely unique; the randomness is unaffected by the draws which have taken place before, and any set of numbers is just as likely to come up as any other combination.

'Yet one can't help feeling that certain number combinations are less likely to win. It *seems* unlikely that for example 1,

2, 3, 4, 5, and 6 could be drawn out by the lottery machine in the same week. And even less likely that they would come out in that order – yet it is possible.

'And supposing the number 27 came out six weeks running. Would 27 be a good bet for the seventh week on the basis that it gets drawn often, or would you avoid it on the basis that it couldn't possibly be drawn again?

'Sadly, it really doesn't make any difference which numbers you choose, so this program will generate for you a set of

six completely random numbers. However, as that's a trifle boring it can also generate a set of numbers from a person's name, or pick at random from the most frequently drawn numbers in past draws, or at random from the least drawn numbers.

'The choice is made by clicking on the caption where the draw method is displayed. A menu will open up. An arrow from "By name" leads to an entry box for the user's name.'

The calculation to compute six numbers from a name needs at least seven characters to work on. Spaces are ignored and case is not important. It may sometimes throw up some identical numbers; there is no way round this unfortunately, but the program does apologise.

Two other windows can be opened from the icon bar: 'Statistics' shows how often each number has been chosen. As the weeks go by the distribution should even out – it will be interesting to see if it does. 'Past Winners' shows the results of previous draws and allows each new draw to be entered.

To enter a new result, click on the right-pointing arrows to step through to the next clear position. Enter the date and the numbers, then click on 'Save New.' Once saved, entries cannot be altered. However, the data is stored in a plain text file called 'numbers' within the *Lottery* application, and this can be edited if any mistakes have been made. Previous winning numbers can be found on BBC2 teletext on page 750.

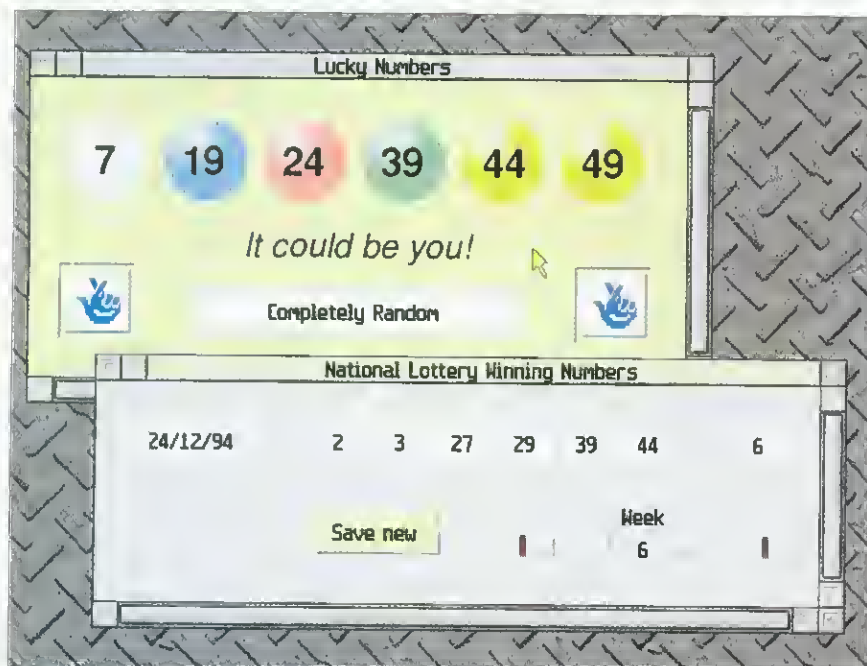

## One-line corners

Various authors

Three minute masterpieces now. The first comes from 14-year-old Alister Fields and is one of your colour-cycling numbers. *Columns* builds up a pattern in mode nine using a cunning formula that almost certainly has SINCOSRAD in it, which is then copied across the screen to form strange column-like structures. The palette is then cycled (well, lets face it, what else can you do with a palette?) and the columns pulsate in a moderately disturbing, though mildly entertaining, fashion. The next pair of

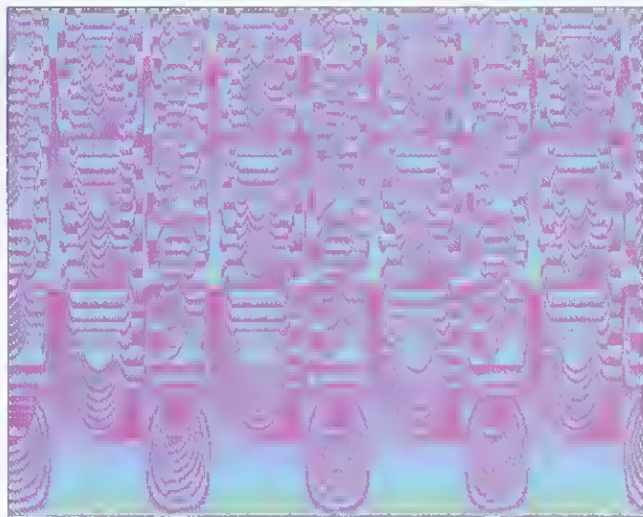

one-line wonders are truly astounding in their simplicity. Roddy Graham of Motherwell got the idea from *The New Hacker's Dictionary*. In said volume, (which incidentally Roddy highly recommends, so I hope they won't mind me quoting their definition) *Munching Squares* is defined as 'a display hack dating back to the PDP-1 (ca. 1962, reportedly discovered by Jackson



Wright), which employs a trivial computation to produce an impressive display of moving and growing squares that devour the screen.'

The 'trivial computation' involves repeatedly plotting the graph  $Y = X \text{ EOR } T$  for successive values of  $T$ . A later development from this was the variant *Munching Triangles* and Roddy has supplied versions of both. The versions we have included switch to mode 0 at the start so you can best see what is going on, although you can remove the MODE command so they munch the desktop directly if you like.

## Welcome to the machine

Author: Dave Lawrence

If you regularly use more than one computer it is often very handy for software to be able to distinguish between them. For example, one machine might be your main work machine and another only used for printing, modeming and possibly faxing. It is obviously advantageous to keep things such as boot sequences as similar as possible between machines to cut down on maintenance when components are upgraded. However, there will inevitably be differences between them – whether to auto-load the printer driver for example.

One feature of other operating systems which is sadly lacking in RISC OS as it stands is a facility to name machines. When machines are networked they usually acquire a 'host name' so that users can identify the machine on which they wish to log (pardon the split or frankly mangled infinitive) but from day to day your computer remains quietly anonymous.

This is where the utility *MachineID* comes in. This is an assembly language program that creates two special system variables: `Machine$Name` and `Machine$ID` to help you sort out your fax server from your printer server.

Having run *MachineID* you must now think of a name for your machine; you can use any characters you like but are limited to a maximum of 15. To set the name, move

to the command line or a task window and type:

```
*Set Machine$Name Ermintrude
```

The name is written to CMOS RAM and will therefore remain even after the machine is switched off. To see the name you can, of course, use `*Show Machine$Name`. It can also be used in Obey files to perform tasks:

```
*If "<Machine$Name>" = "Dylan" Then  
Filer_Run ...
```

All you need to do to use this variable from now on is to include it somewhere in your hoot sequence.

*MachineID* uses the 15 bytes of CMOS RAM Acorn have allocated to the user – bytes 30 to 45. According to the manual, these should not be used in any distributed product – so if anyone from Acorn asks, you wrote this program yourself. In reality, unless you have written anything else that uses these bytes you should not have any clashes with other software [except perhaps *MityMouse* also in this month's `*INFO!` – Ed]

The other variable *MachineID* creates is `Machine$ID`. This is a read-only variable and holds the value of the unique machine ID present in machines from the A5000 onwards. As above, it can be displayed or used in `*if` statements.

If you are interested in these things, the source code for *MachineID* is also provided for you to peruse. Both of these variables are *code variables*, which means that rather than being a fixed number or string like the numerous other system variables, their value is set to be a piece of code which is called whenever the value of the variable is needed. The system variable `Sys$Time` is an example of another code variable – its value is always the current time read from the system clock. `Machine$Name` can also be written to – when a `*Set` is performed on a code variable another piece of (user supplied) code is called to set the value, in this case the bytes of the string provided are written to CMOS RAM.

One rather strange concept of code variables is that their values don't exist anywhere until you ask for them. Unlike in BASIC where you might have:

```
name$ = "Fred"
```

resulting in `name$` thereafter containing 'Fred' in a little cubby hole somewhere in memory – you could see it if you had a fiddle with a memory editor for a while. Unless something has taken a copy of `Machine$Name` you won't find the string 'Ermintrude' anywhere in memory (except of course in CMOS, but you can't see that anyway).



## Stretching the point

Author: Darren Salt

Darren Salt's application takes path objects from *Draw* and moulds them to fit between two other paths. You know – the kind of thing you keep seeing *ArtWorks* doing.

When *DrawShape* is loaded it puts two icons on the icon bar, and both of these appear as raised slabs. The left-hand slab has two cyan lines on it, one above the other – this is the mould icon. The right-hand slab has a pair of compasses on it – this is the image icon. It initially appears greyed out because *DrawShape* has no mould to use. You should proceed as follows:

1. Select the two paths you wish to use as the template.
2. Export them to *DrawShape* (use 'Save selected'), dropping them on the mould icon.
3. Select the paths (or path groups) you wish to mould.
4. Export them to *DrawShape* (save selected), dropping them on the image icon. Export the whole file if you want to process the whole file.
5. *DrawShape* will process the file, and

puts the resulting file back to *Draw*. This can now be combined with the original drawing.

The two paths describe the upper and lower bounds of the moulded image. Whichever is used as the lower bound must be 'in front of' the other path. It is important that the paths used in the mould:

- are individual path objects
- do not contain moves
- are not grouped together.

If the paths are rejected by *DrawShape*, you will be told why, and the previous mould (if there was one) will be retained.

There are a number of options which may be chosen using the icon bar menu.

**Fast:** this controls whether the screen is blanked while moulding. When on, this option reduces the time taken by around 12 per cent.

**Shortcut:** this controls which of two line length calculation methods is used – the slower one is much more accurate, but the faster method appears to have little effect on the output quality. Using the faster method reduces the time taken by around 45 per cent. With both options on, the time

taken is around 49 per cent of the time that would otherwise be taken.

**Clear:** this causes *DrawShape* to forget about the current mould definition.

For details of the moulding process used, see Michael Attenborough's article 'Round the Bend' (*Acorn User* December 1992).

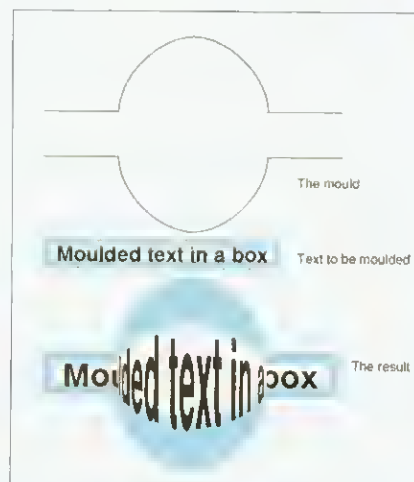

## Red Square-d

Author: L T Thurlby

There is a medieval method of multiplication, known as Russian multiplication, which needs only the ability to multiply and divide by two and to add.

The numbers to be multiplied are placed at the heads of two columns. One number is

then multiplied by two, while the other is divided by two, remainders are ignored, until the number one is reached. If any number in the division column is even, the corresponding number in the multiplication column is deleted. The remaining

numbers in this latter column are then added together. The result of this addition is the product of the two original numbers.

Mr L T Thurlby has sent in a simple basic program to illustrate this cunning mathematical short cut. Don't you think that

if you didn't have the incredibly useful MUL instruction in ARM code that this would be a speedy way of multiplying in code?

Especially as computers do like dealing with multiplying by two (ASL) and dividing by two (ASR)...

## Poetrio in motion

Author: Darren Green

Don't be fooled for a second here. We make no bones about the fact that this is another variation from the *Tetris* school. However, this particular example of block-dropping fun from Darren Green is one of the best varieties of the genre, so worthy of inclusion, we thought.

Once installed, click on the *Trio* icon to open the main 'Bucket.' Surprisingly enough, a variety of multi-coloured things are dropped one by one into the bucket. Each one consists of three coloured blocks. You can move them left or right (with Z or X by default), cycle the order of the blocks (with ``` – that is, the key next to Return. No hang on, if you've got a Rise PC it's next to #. Oh well, never mind – just try a few keys around that general area) and drop the current block (with /).

When three or more blocks are positioned in a line, you score points (your score is shown in a little

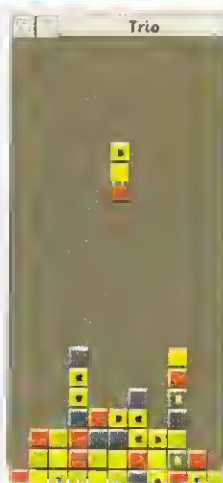

window of its own). In fact, you score the square of the number of blocks in a line, so try and get long lines if you can.

A special block (marked with a sunken red horizontal bar) will appear in pieces from time to time. When this reaches the bottom, the whole line is obliterated, although you will score no points in the process. Such blocks are ideal for removing awkward rows of mismatched squares.

As you might expect, the game ends when your bucket is full and the next block has no room to descend. There is a high score table, for those adept enough to achieve a place on it, and a key defining window if you've worn out Z and X playing all the other *Tetris*-like games.

A simple menu is provided and this includes a Pause option. The game can also be paused and restarted by clicking on the Bucket window.

## Mighty Mouse

Author: Michael Stirling

We must apologise to Michael Stirling, whose little application was due to feature in July's \*INFO, but the gremlins cut this text while leaving the program on the cover disc. In case any of you found the application, and wondered why we didn't mention it, here are some belated details.

We presume Michael may be left-handed, or have ambidextrous tendencies, since his module is designed to help such folk. The author explains:

'If the mouse is placed on the left, then the Select & Adjust buttons are in the wrong place, making it awkward to use. I came across this problem when I wanted to place the mouse on the left, to fit in with the arrangement of my table.

'There appears to be no way of reconfiguring RISC OS to swap the effect of the

mouse buttons, so I have written a module that intercepts OS\_Mouse and post-processes it to swap the positions of Select and Adjust. The software consists of the application *MittyMouse*, and double-clicking on it loads the module *MittyMouse* which performs the button swapping.'

Michael has included the source for those interested and it serves as a useful example of a module which provides SWIs and configures CMOS RAM.

The module has a single \* command. \*Buttons which takes as a parameter 0 to 3. 0 means 'normal', 1 means 'swapped'. 2 and 3 mean the same, only the status is also written to CMOS RAM (user location 30). You will need to add a

```
*Buttons 1
```

line to the !Run file of *MittyMouse* for the program to automatically swap the buttons when run.

The call:

```
SWI "MittyMouse_Buttons"
```

performs a similar action. R0 contains the new status required and R1 a mask. That is, the button state is set to:

```
(old AND NOT R1) OR (R0 AND R1)
```

On exit, R0 contains the old state, so call with zeros to read the current state.

Another SWI, *MittyMouse\_CmosAccess* is included to allow the reading and writing of specific bits of CMOS RAM. On entry, R1=CMOS location, R3=value to read/write and R4 is a mask. On exit, R0=old contents, R2=modified contents and the other registers are preserved.

## Anamorph Art

Author: Jan Vibe

Anamorph art is the strange subject of this pair of demos from regular Jan Vibe. They were inspired, apparently, by an article on the subject in *Scientific American*. The idea is to take an ordinary picture and squish it in a peculiar way so that it can only be viewed using a special mirror, in this case, a roll of tin foil. Simply hold said roll of foil against the screen at the appropriate place and all will be revealed.

*Anamorph1* is just a little demo to show the morphing process and simply converts a pattern into an anamorphic image. *Anamorph2* does the real business, taking as input a sprite file and then converting into something unrecognisable. The size of the sprite is irrelevant since it is automatically scaled. (No doubt some bright spark of a reader will now send in a program to convert the desktop into an anamorphic image – we've already had a 3D desktop if you remember.)

As Jan Vibe programs generally appear in threes in these pages, here is a golden oldie from our Danish friend which we don't think ever actually made it into the mag. Apologies to Jan for not using his fine demo, *Waves*, sooner. We've actually carried quite a lot of programs called *Waves* in the past, but the waves in this case are not ripples across some 3D pond or in some plasmic pool. In fact, they are waves of colour moving around the surface of a tube which winds its way around the screen.

This is a classic example of Jan using sprite masks and some clever BASIC to achieve effects you would normally only expect from machine-code demos. A sprite (called 'box' for some reason – perhaps box is Danish for tube...) is created with a pattern of rays of different colours emanating from the centre.

Then, by redirecting output to the sprite's mask, a hula-hoop shaped piece of the sprite is cut out and plotted on the screen. This process is repeated to build up the 'snake' but each time the ring is cut out, this is done from a slightly different place in the sprite. In this way, the pattern around the edge of the tube alters along the way. All the time this is going on, the palette is gently cycled in time-honoured fashion, with splendid results.



### Compatibility table

Program	RISC OS 2	RISC OS 3.1	RISC OS 3.5/3.6
Trio	x	✓	✓
MachineID	✓	✓	✓
Lottery	✓	✓	✓
Columns	✓	✓	✓
Square/Triangle	✓	✓	✓
DrawShape	x	✓	✓
MittyMouse	✓	✓	✓
Russian	✓	✓	✓
Anamorph	x	✓	✓
Waves0	✓	✓	✓

### \*QUIT

All submissions most welcome. They needn't be huge applications – in fact the supply of 'Hints & Tips' seems to have dried up a bit, so more of those little gems please. Send all your bits and bobs to:

\*INFO, Acorn User, IDG Media, Media House, Adlington Park, Macclesfield SK10 4NP.

You needn't include a letter (if like many contributors you have an allergy to the printed word) but do please put your name, address and program title on every disc and include a text file containing at least your name, address and disc contents. An SAE will ensure your discs are returned and any other instructions, diagrams, saved screens and so on are most welcome.



# ACORNUSER Reader Offer

## THE AMAZING ACORN USER STOCK CLEARANCE



Swap between aircraft, ground and sea combat forces, as your battle develops.

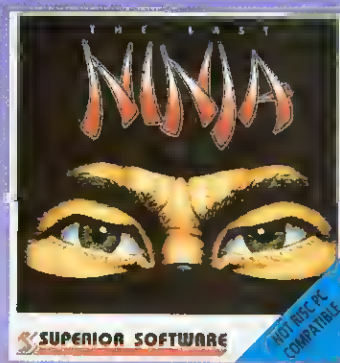

Fight to recover the sacred scrolls which tell of the secrets of the Ninjitsu way



Comprising the excellent Chocks Away from 4th Dimension, a Shareware resources disc, an education User handbook!

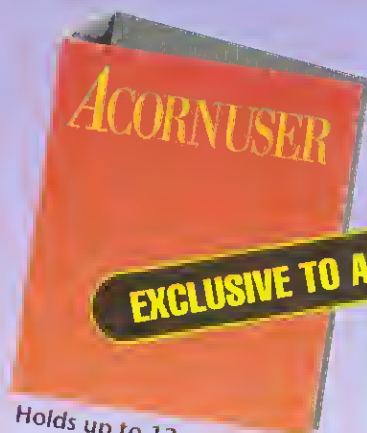

Holds up to 12 magazines

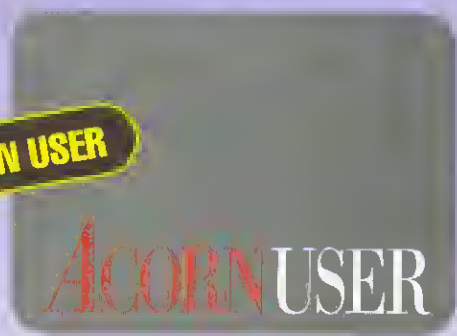

# GET ALL THESE FOR ONLY £10!

## Priority Order Form

**YES!**

Please send me my exclusive Acorn User binder, mouse mat, gift pack, Air Supremacy AND Last Ninja **ALL FOR ONLY £10.**

I would like to pay by:

- Cheque/Eurocheque/Postal Order, payable to IDG Media  
 Credit Card (Visa/Access/Barclaycard/Mastercard/Eurocard/Connect)

Expiry Date  /

Card Number

Send this form to Acorn User Reader Offer, IDG Media, Media House, Adlington Park, Macclesfield, Cheshire SK11 6SR

Please send my goodies to:

Name: (Mr/Mrs/Ms/Miss) \_\_\_\_\_

Address: \_\_\_\_\_  
\_\_\_\_\_

Postcode: \_\_\_\_\_

Daytime phone: \_\_\_\_\_

Please state no if you do not wish to receive promotional materials from other companies \_\_\_\_\_

SAVE SAVE SAVE SAVE SAVE SAVE

# ACORN USER guide to local dealers

## SURREY

### Calancraft Ltd.

THE COMPLETE ACORN DEALER



- Showroom open 9.00 - 5.30 six days and to 8.00 on Thursday.
- Acorn range on display, and full demonstrations given.
- Lots of programs, games and education software for you to try.
- Full service and repair facilities.
- Acorn Approved Education Dealer, Network Dealer and Training Centre.

*"Very helpful people"*

with a 12 year long reputation for exceptional service and support.

Easy parking.

96 High Road, Byfleet,  
Surrey KT14 7QT



Tel: (01932) 342137

Fax: (01932) 336435

## WEST YORKSHIRE

THE CHOICE OF EXPERIENCE



### Davyn Computer Services

Printers, Ribbons, Ink Cartridges, Refills  
Expert Advice & After Sales Service  
Mail Order Master Card, Visa, Switch  
Ring No. Below for Prices  
Service & Repair to all Equipment  
Full Range of Acorn Hardware & Software  
(We operate the Acorn Finance Schemes)  
Full Range of Educational Software  
in Stock & on Demand

Tel. 01924 254800  
Fax. 01924 258036



For the best service in Yorkshire  
(we think)

CALL US! for A3010, AA3020, A4000, RiscPC,  
A4 Portable & Pocket Book

Visit our Showroom

Open 9.30 to 5.30 Mon, Tues, Weds, Sat.  
9.30 to 7.30 Thurs & Fri.



## BIRMINGHAM

### DACO SOFTWARE AND DACO SYSTEMS LIMITED

459-465 Warwick Road, Tyseley,  
Birmingham B11 2JP

**ACORN AUTHORISED  
EDUCATION AGENT  
FOR THE MIDLANDS**

- Special Needs • Business • Repairs •
- Network cabling throughout the UK •

We've expanded - New Showroom - Full new Acorn  
range on display, including networked products  
WATCH THIS SPACE FOR OUR OPEN DAY!!

Tel: 0121-706 8933  
Fax No: 0121 706 4306



## MIDLANDS

### KEYBOARD TECHNOLOGY

ACORN Education Dealer  
ACORN Network Dealer  
ACORN Special Needs Centre

Be the first to see the NEW  
range of Acorn machines

Visit our Showroom just 1/2 mile from  
M1 junction 24 (2nd right on A6 south)

Keyboard Technology Ltd  
51 High Street Kegworth  
Derby DE74 2DA  
Tel 01509 672222



Open Mon to Fri 9.00 - 6.00pm  
Sat 9.00 - 2.00pm (Summer)

## ESSEX

### AT LAST!

A File Server which INTEGRATES your computers  
The DATATHORN SUPER SERVER

- Integrates Ethernet of Acorn, Apple and PCs
- Enhances fast RISC based computers (eg RiscPC)
- is EASY to manage and INDUSTRY-STANDARD
- can run DIFFERENT NOS (eg NT, Novell)
- can support upwards of 75-100 CLIENTS
- is the most COST-EFFECTIVE server for 20 users
- is the first PowerPC/PCI based server offered to education
- has built-in CD-ROM
- is guaranteed by MOTOROLA for FIVE YEARS
- reference sites available



Datathorn is an i3 preferred dealer and Acorn  
Education Dealer.

Contact John Hart or Vince Hagedorn now  
on (0181) 502 4221

DATATHORN

Systems Ltd

The Seedbed Centre, Langston Rd, Loughton ESSEX, IG10 3TQ  
Fax (0181) 508 6660 Email: sales@dtorn.demon.co.uk

## CUMBRIA

### CUMBRIA SOFTWARE SYSTEMS LTD



Acorn Authorised Education Dealer  
and Network Centre



Network design and installation  
Ethernet, Nexus ATM, Multi-platform networks

Semerc Authorised Dealer

Latest Acorn models  
Sales, Repairs, Software, Peripherals

Unit 3A, Townfoot Industrial Estate  
Brampton, Cumbria, CA8 1SW

Tel: 016977 3779



# SOFTWARE SHOWCASE

## DEALERS

### SUMMER SIZZLERS

UNREPEATABLE OFFERS WHILST STOCKS LAST

A3020/A4000 486 PC. Card with 4MB RAM	£399
A3020/A4000 486 PC Card with 0MB RAM	£269
Aleph One 486/50 PC Card with 0MB RAM	£399
Irlam Instruments Replay DIY Plus card	£299
Irlam Instruments 24116 with 1Mb VRAM	£420
Acorn Pocketbook 1 256K	£169
Pflexor 6 speed SCSI CDROM Internal	£470
Pflexor 4 speed SCSI CDROM Internal	£250
Computer Concepts Lark A16 Card	£215
A5100/Risc PC 500MB Internal IDE drive	£175
IDE drive carily for Risc PC	£30
Syquest 270MB IDE drive	£349
Soundwave 10 Hi-Fi speakers	£49
Acorn Multimedia Expansion Unit	£199
A4 Comr opt Keyboards	£55
A3 Concept Keyboards	£65
SJ Resear h 120MB tape backup	£450
Risc PC 1MB VRAM	£80
The Risc Disc CD Volume One	£15

All prices INCLUDE VAT  
Next day courier delivery £8.50

## UNIQUEway

42 Crwys Road, Carlisle, CF2 4NN  
Tel 01222 644611 Fax 01222 644622  
E-mail Sales@uniqueway.demon.co.uk



## SOFTWARE/HARDWARE

### Dixon & Dixon

35 Rokeby Drive, Kenton  
Newcastle upon Tyne NE3 4JY  
0191 2853 042 North East Acorn Dealer

### Textile Transfer Paper

Truly Remarkable and Revolutionary

IN WASH-PROOF COLOUR

Print it - Iron it - Wear it

Ink Jet	Dot Matrix	Lasers	Photocopiers	Wax Crayons
4 Sheets A4		30 Sheets A4		100 Sheets
£8		£44		£140

Also available in A3 Also in 36" wide rolls of 80ft Length

Childrens Hobby Kit - includes 3 T-Shirts and Templates 10.99

MouseMat Kit - Your favourite Pin-Up to stare at 5.99

### Refill your inkjet with UVLR ink

No Fade Ultra Violet Light Resistant ALL COLOURS

3 Refills (60 ml) for 18.80 inc VAT & postage

FLUSH SOLUTION (why not change your cartridge colour)

Flush out the old refill with new £5.00 inc VAT & postage

REFILLS FOR ALL INKJETS FROM 11.98

Cartridges for JPI50's £19.96

FLYPRINT	£ 39.97
DEAD CERT	£ 39.00
KEYBOARD EMULATOR	£ 12.00

ALL THINGS ACORN

Prices inc VAT and postage UK mainland

## UTILITIES

### BLINDS

"At last a truly professional Pinboard!"

Blinds is an easy to use, but sophisticated 'Pinboard' type application which will make your life a whole lot more effortlessly when using your computer.

- Have blinds which snap open and close at the click of a mouse, therefore taking up no valuable desktop space.
- Give your icons long meaningful names at last!
- Change the icon displayed by choosing from over one thousand sprites we have provided.
- Set windows to open automatically whenever your favourite application is loaded. You'll never have to look for that elusive file again!
- Make a blind which will attach itself to the side of your application, it will then follow your favourite application's window around the desktop just like it was made for it!

RISC USER review - "It went straight onto my icon bar!"

Blinds costs only £19.95 plus £1.00 Postage, etc.  
No V.A.T. Blinds requires RISC OS 3.10 or better.

A demonstration disc is available free of charge on receipt of a A5 size SAAE. You'll find Blinds is available from all good Acorn software dealers or direct from:

Quantum Software at 35 Pinewood Park, Livingston, EH54 8NN, Scotland. Tel/Fax: 01506 - 411162

## UTILITIES

### Trellis The Adventure Interpreter

A program to help YOU write YOUR OWN text based adventure games. Just £7.99 from

SOFT ROCK SOFTWARE,

FREEPOST (BS 7978)

Westbury-on-Trym,

Bristol, BS10 7BR.

It's not quite an apple turnover, but it's good!

## NETWORKS

Phone for details 01736 762541

### Admin

### Network Utilities Suite

The ultimate aid for AUN school networks.

Room J Software

Release date - September 7th

Simple user creation, ready for the new Inlake

fsrap clearer! Effective password management

Crammed with essential manager's aids

Can you wait?

See Acorn User - October Issue

## BUREAU

### PRINTMAKER

### CUT VINYL BUREAU

LETTERING, LOGOS & DECALS

cut in self-adhesive vinyl on our

plotter from Acorn DRAW files.

Any size, colour and quantity.

Ideal for Signs, Van sides, Car Decals & Exhibition graphics.

14 Eldon Terrace Reading Berks RG1 4DX

Tel 01734 567947 Fax 01734 561112

# ACORNUSER ADVERTISERS INDEX

10 out of 10	34	ICS	6, 7
1st Computer Centre	43	ISV Products	64
4 Mation	74	K.C.S.	48, 49
5 Star Marketing	74	Keyboard Tech/Resource	86
Acorn World	22	Kimberley	16
A.J.S.	74	Liquid Silicon	64
Aleph One	OBC	Micro Laser Design	63
APDL	74	Pineapple Software	IBC, 14
Beebug	8	Printmaker	87
Calancraft	86	Quantum Software	87
Castle Technology	70	Room J Software	87
Clares Micro Supplies	24	Senlac Computing	30
Computer Concepts	IFC, 3, 13	Soft Rock Software	87
CSS	86	Softase	64
Daco Systems	86	Technology Matrix	38, 39
Dalriada Data	70	Uniqueway	87
Datathorn Systems	86	The Datafile	27
Davyn Computer Services	54, 86	The Datastore	70
Desktop Projects	20	Turing Tools	74
Dixon and Dixon	87	Watford Electronics	18, 76-80
Explan	70	Yellowstone Educational	63

# BIG CHOICE

No PD Library offers a choice of PD as wide as Skyfall does. So don't bother collecting other PD libraries catalogue discs. Send for the one that counts. And choose Skyfall.

Please send £1 for the Printed Catalogue and demo disc to;

**SKYFALL PD**

PO Box 2220  
Birmingham  
B43 5RZ

# Choose a FREE GIFT or exclusive special offer when you subscribe to

# ACORN USER

Choose any one of these excellent free gifts or special offers when you subscribe to the most established, informative Acorn magazine in the world, each and every month.

Subscribing takes out the hassle of trekking down to the newsagents each month as every issue is delivered to your door, postage free. You're also protected against any cover price rises that may take place over the duration of your subscription.

The best way to subscribe is by continuous quarterly direct debit, where you can spread the cost with a small payment each quarter, rather than paying one lump sum in advance. Plus – you can forget about the worry of your subscription ever lapsing, as it runs until you are ready to cancel.

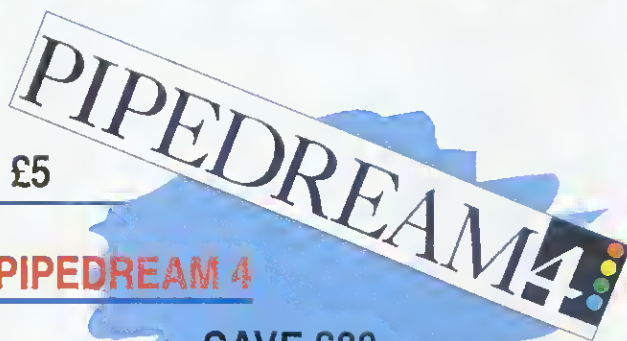

ONLY £5

**PIPEDREAM 4**

SAVE £80

Ideal for any Acorn machine with 2Mb RAM.

Includes a flexible word processor, powerful spreadsheet package, charts and a fast and compact database.

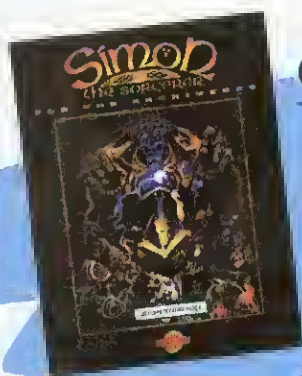

ONLY £25

**SIMON THE SORCERER**

SAVE £6

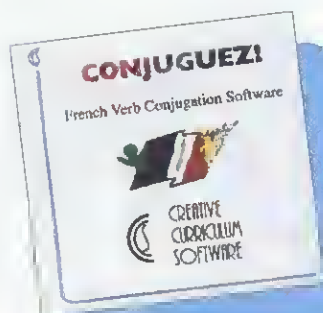

ONLY £5

**CONJUGEZ**

SAVE £15

French verb conjugation software, for beginners up to GCSE standard, with over 800 verbs set in 7 levels.

FREE

**CARNAGE INC**

SAVE £25







**FREE**

**SENSIBLE  
SOCCER \***

**SAVE £20**

**ONLY £5**

**STUNT  
RACER 2000**

**SAVE £25**

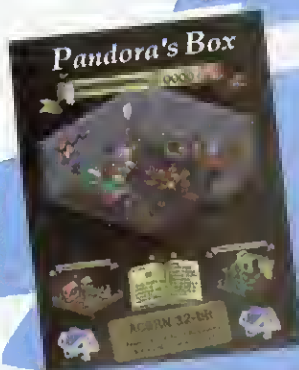

**FREE**

**PANDORA'S  
BOX**

**SAVE £25.95**

**FREE**

**ENTER THE  
REALM**

**SAVE £25.95**

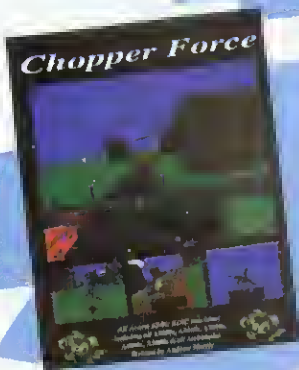
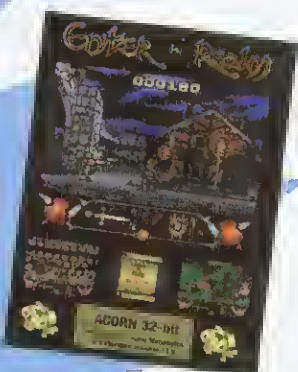

**FREE**

**CHOPPER  
FORCE**

**SAVE £29.95**

\* Not suitable for the Risc PC

## Subscriptions form for Acorn User

**1a** Please enrol me as a subscriber to *Acorn User* for 13 issues.  
All subscriptions will commence with the next available issue.  
See section 2.

4170  UK £37.99    4171  EU £53.99    4172  World £68.99\*

\*Unfortunately World subscribers are not eligible to receive the free gift/special offer

I wish to pay by:

- Cheque/postal order made payable to IDG Media  
 Credit card (Visa/Access/Barclaycard/Mastercard/Eurocard/Connect)

Expiry date  /

Card No.

**1b** Please enrol me as a subscriber to *Acorn User*.

4173  with payments of £9.49 by continuous quarterly direct debit  
See section 2.

Your subscription will continue until you cancel. Over a year you will receive 13 Issues.

Name of Bank/Building Society .....

Address .....

Name of Account .....

Your Account No. .... Sort Code .....

Date ..... Signature(s) .....

Your instructions to the bank/building society:  
I instruct you to pay direct debits from my account at the request of IDG Media. The amounts are variable and may be debited on various dates. No acknowledgement required.

any direct debit is paid which breaks the terms of the Instruction, the bank/ building society will make a refund. Bank/building society may decline to accept instructions to pay direct debit from some types of accounts.

I understand that IDG Media may change the amounts and dates only after giving me prior notice. I will inform the bank/building society in writing if I wish to cancel this instruction. I understand that if

**FOR OFFICE USE ONLY**  
Originator's ID No. 851412

Ref No. ....

**2** The free gift/special offer I would like is (please tick one):

- |                               |                    |          |                               |                 |      |
|-------------------------------|--------------------|----------|-------------------------------|-----------------|------|
| 4162 <input type="checkbox"/> | Pipedream 4        | Only £5  | 4154 <input type="checkbox"/> | Sensible Soccer | FREE |
| 4163 <input type="checkbox"/> | Stunt Racer 2000   | Only £5  | 4156 <input type="checkbox"/> | Pandoras Box    | FREE |
| 4164 <input type="checkbox"/> | Conjugez           | Only £5  | 4166 <input type="checkbox"/> | Enter the Realm | FREE |
| 4165 <input type="checkbox"/> | Simon the Sorcerer | Only £25 | 4167 <input type="checkbox"/> | Chopper Force   | FREE |
|                               |                    |          | 4168 <input type="checkbox"/> | Carnage Inc     | FREE |

♦ Please remember to either add the appropriate amount when you write your cheque or if paying by direct debit, send additional payment.

**3** Name .....

Address .....

Postcode ..... Tel .....

**4** Now send your completed form and payment to Acorn User, Database Direct, FREEPOST, South Wirral L65 3EB. Tel: 0151-357 1275. Please state if credit card billing address is different from the delivery address. Photocopies or handwritten versions of the above information are acceptable.

IDG Media offers you the chance to receive information about other organisations' goods and services, please tick the box if you prefer not to take advantage of this.



REGAN



# The Moxon Interview

Pat Cleaver

**We went on to give out awards to the Acorn staff, and I think people realised then that we were not standing with knives in each other's backs.**

If things had turned out differently, Pat could have taken this interview photograph. We're sitting in one of the many excellent pubs on Exeter quay, where she once spent a week working on a project for a photography course.

'My tutor came down to the quay and caught me sitting outside one of the pubs,' Pat recalls. 'He said: "You don't look like you're working hard," but I assured him I was. Pub gardens are a perfect place to sit and observe people, full of photo opportunities.'

Is she serious? There's a mischievous twinkle in Pat's eye as she says this. On the other hand, the photographs were good enough for her tutor to suggest that she could take up photography professionally. She nearly went to do a degree in it at Nottingham, but for various reasons decided she needed the stability of a job in Exeter. Photography's loss was Minerva Software's gain.

Minerva Software is one of the few Acorn companies who are long-lived enough to pre-date the Archimedes. Pat joined just before the Arc's release; upon arriving she was presented with the Acorn equivalent of the Official Secrets Act to sign before they'd let her near the A500 prototype Arc hidden away in the attic.

Joining Minerva eight years ago on the accounts and secretarial side, Pat was taken to a show at Alexandra Palace where she found she had a talent for talking to people in the market. She quickly moved more into the sales side, and is now Sales and Marketing Manager.

'I enjoy being in this market; it's very friendly. No one gives a damn what anybody

else is or does, as long as you all get on and do your job and work together – there's no back-biting, not that I've come across.'

'A few years ago, we were a bit head to head with Clares because we both had an art package out at the same time, but that was built up more outside the company than it was inside. It was quite strange, because Dave Clare and I have always got on well, and we were both discussing how surprised people were – "You're talking to each other?" At the end of one Acorn roadshow, where there was always a bit of fun and games with Acorn giving out awards – funniest joke, heaviest bar bill – after Acorn had done their awards, Dave and I stood up and said: "Right; we're going to do the *Pro Atelier* awards." We went on to give out awards to the Acorn staff, and I think people realised then that we were not standing with knives in each other's backs.'

Pat is a true Acorn fan, though this is perhaps unsurprising given her first introduction to computers.

'Where I worked before I joined Minerva they had a little Amstrad word-processor; one of those with the 3in disc drive that wasn't able to read discs from anything else. I was told that this was "the computer" and I had to use it to write letters, do the accounts, everything. It was a nightmare. The relief when I got to Minerva and found these easy-to-use BBC micros was indescribable.'

People who've been in the Acorn market for a while may recall that when she started at Minerva, Pat – who incidentally attended the first ever Glastonbury Festival – had what she describes as 'slight Gothic tendencies.'

'I was labelled in the early years as "Punk Pat", because I was ... well ... going through different coloured hair. It was never outrageous; I suppose there was the *odd* occasion when I might have had a *little* bit of pink in there, and I also wore quite a lot of black. Obviously "Punk Pat" was more alliterative than "Gothic Pat".'

Pat's creative tendencies have been put to good use by Minerva. She designs most of the artwork for the company – software packs, literature and advertising – using *Draw* on the Archimedes which she finds much quicker than *Impression* for the sort of work she does. And best of all, it comes free with the machine, a fact that Pat feels that Acorn should make more of.

The very recent changes in the way Acorn sells to education came as an unwelcome surprise to Pat, who was all geared up to sell Acorn to the schools in her area and now finds that Acorn have 'kicked her in the teeth'. She'll bounce back though – she regularly goes mountain biking over Dartmoor, and admits:

'Sometimes I wonder why on Earth I'm doing it when I'm pushing uphill, or tumbling over the handlebars into the mud and thinking "Why am I here?" Then I go across a bit of moorland and there's nobody in sight, you've just got this spectacular view of heather and woodland, and then...'

'Then I wish I'd still got the camera.'

David Matthewman **AU**



The Formula 1 package for original painting and photo-retouching. Studio24 leaves the competition at the starting grid with its power and performance. The FREE updating service ensures that once you join the Pineapple team you will never have to pay for the latest model!



Studio 24

The price is a special price for a limited time only. It is not available in other parts of the country.

Includes everything you need to get started with Studio24. This includes the software and a complete set of manuals. There is also a free update service for the latest version of the software.

Full Package Price  
£146.87 inc vat

Stop Press!! - Vers 2 coming soon - buy now before it goes and get a free upgrade to version 2

## Virus Protection Scheme

The Pineapple Software Virus Protection Scheme provides the most comprehensive protection available against computer viruses. !Killer together with VProtect will detect and remove all of the currently known 71 families of virus (over 100 viruses in total). Because new viruses are being discovered all the time our virus protection scheme will provide you with 3-4 updates of the software each year. We can also offer immediate advice by 'phone. !Killer can scan any filing system or device including floppies, harddisks, networks, even CDRoms. All types of compressed file can also be scanned. All infected files are fully restored without having to reload from master discs or backups.

*Don't wait until you discover you have a virus! Use the software that Acorn themselves use to check for viruses.*

*A years subscription costs just £28.20 inc vat*

*Low cost school and county licences available*



## Acorn Computers

We are fully authorised Acorn dealers and we can supply all Acorn computers and upgrades at very competitive prices, usually by return of post. All

Acorn computers are supplied with free membership of the Virus Protection Scheme and a



## A4 Colour Scanners

New from Pineapple the superb IX-4015 A4 flatbed Cano colour scanner. Supplied with Imagemaster and Twain software this scanner makes the perfect companion for our Studio24 re-touching software. With a basic resolution of 400 x 800 dpi this scanner is unbeatable value.

IX4015 with Imagemaster & Twain £675.00  
As above + Studio24 £769.00  
SCSI interface + cable 'phone

## Epson Colour Scanners

Also supplied with ImageMaster and Twain software these models can work on either SCSI systems or via the Parallel Port. Basic resolution of GT8500 is 400dpi and the GT9000 is 600dpi

GT-8500 £599.00 GT-9000 £733.00

## Pineapple Software

Suites 13 & 14  
South Park Business Centre  
310 Green Lane, Ilford  
Essex IG1 1XT

Tel 0181 599 1476 Fax 0181 598 2343

**Terms:-** All prices include 17.5% vat. Carriage FREE to mainland U.K. Phone for quote outside U.K. Official orders, cheques and all major credit cards accepted. Money back guarantee on all products.

For demonstrations of most of our advertised products why not come and visit us in our new offices (easy parking) where you can see most of the Acorn range of computers and other hardware in action.

# Why are you waiting



## when you could be using an Aleph One Risc PC card?

**Y**ou won't wait around for an Aleph One Risc PC card. Its powerful 486DX processor will complete tasks much more quickly than the alternatives. The card fits easily into your Risc PC's second processor slot in a few seconds.

### Fast processors

Software executes at real PC speeds with a choice of powerful 486DX-40 or 486DX2/80 processors blazing through all your tasks.

### Windows support

You can use most standard Windows or DOS software on the Risc PC card – at the same time as your existing RISC OS software. You may also wish to connect to existing PC networks.

### ARM graphics support

While you're working in Windows, the RiscPC's ARM processor is still busy acting as a graphics accelerator to further boost performance. High-resolution Risc PC video modes are supported, up to 1280x1024 resolution. Subject to suit-

able VRAM being fitted to the Risc PC, you can enjoy up to 24-bit colour and a 256 colour palette in 8-bit per pixel modes.

### Share Acorn peripherals

Save money compared with the cost of buying separate systems: the PC card can use all your Acorn peripherals including hard discs, removable discs and CD-ROMs, Ethernet network cards and printers.

### Connect to PC networks

Use the Risc PC card with optional networking software to bridge between your computer and local area networks. Any PC network server can be used – Novell Netware or Windows.

### Recommended retail prices

Choose from the 486DX-40, running at 40MHz, for **£349**, and the 486DX2/80, running at 80MHz, for **£399**. Cards are available direct from Aleph One.

**Also still available at new reduced prices – Aleph One podule 486 cards for the A5000, A540, A4x0. 486SLC-25 is £299 and 486SLC2/50 is £349 (prices exclude VAT and RAM). RAM for Risc PCs and podule cards £99 for 4MB, £199 for 8MB and £379 for 16MB. All prices exclude VAT.**

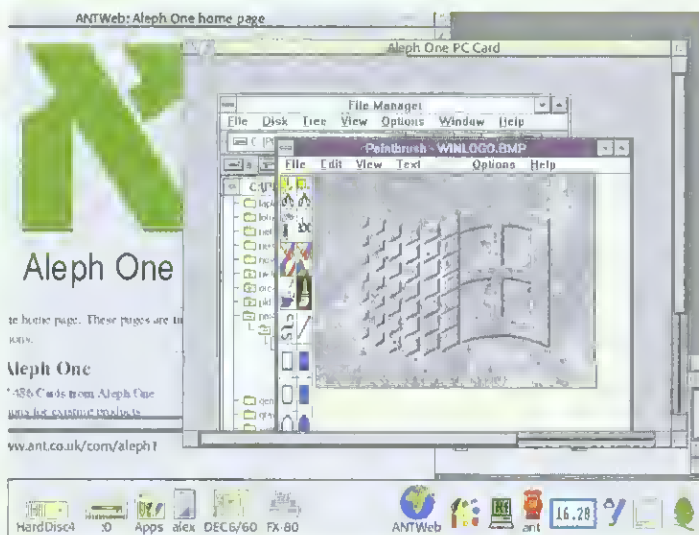

For further information contact Aleph One Limited at:

Post: The Old Courthouse, Bottisham, Cambridge CB5 9BA  
Telephone: 01223 811679  
Fax: 01223 812713  
Email: sales@aleph1.co.uk  
WWW: <http://www.ant.co.uk/com/aleph1>

All trademarks acknowledged. E&OE. Prices correct at June 95.

