

Ty-Rap®

Ty-Rap® High-Performance Cable Ties, Tools & Accessories

In this section...



Ty-Rap® High-Performance Cable Ties, Tools & Accessories

Ty-Rap® High-Performance Nylon Cable Ties	C-2-C-4
Engineered-Performance Material Cable Ties.....	C-5-C-11
Color Coding Cable Ties	C-12
Identification Tags, Cable Ties and Accessories	C-13-C-14
Mounting Bases, Cable Ties and Accessories.....	C-15-C-24
Safety, Reusable and Double-Loop Cable Ties	C-25
Messenger and Lashing Ties and Straps.....	C-26-C-27
Deltec® Cable Tie and Support System	C-28-C-29
Ty-Rap® High-Performance Stainless Steel Cable Ties ...	C-30-C-43
Hook-and-Loop Fasteners.....	C-44-C-45
Ty-Rap® Installation Tools.....	C-46-C-50
Ty-Rap® Wire Management Clips, Clamps, Spiral Wrap and More.....	C-51-C-60

Thomas&Betts

www.tnb.com

Choose Genuine Ty-Rap® High-Performance Cable Ties for Quality, Performance and Innovation.

Oval, Low-Profile Head

gives a professional, quality look to wire bundling projects. The classic-shaped head is designed to prevent snags on uneven surfaces and is easier to pull through bulkheads. There are no sharp edges, so these ties are also easier on the installer's hands.



The **Turned-up Tail** makes the tie easier to pick up off a flat surface and provides the ability to orient the cable tie for easy assembly without looking down — perfect for blind or repetitive applications.

No-Slip Tail provides extra grip during tensioning.

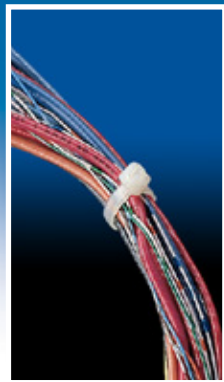

For a whole bundle of reasons, trust only Genuine **Ty-Rap® High-Performance Cable Ties** by Thomas & Betts in your next wiring installation.

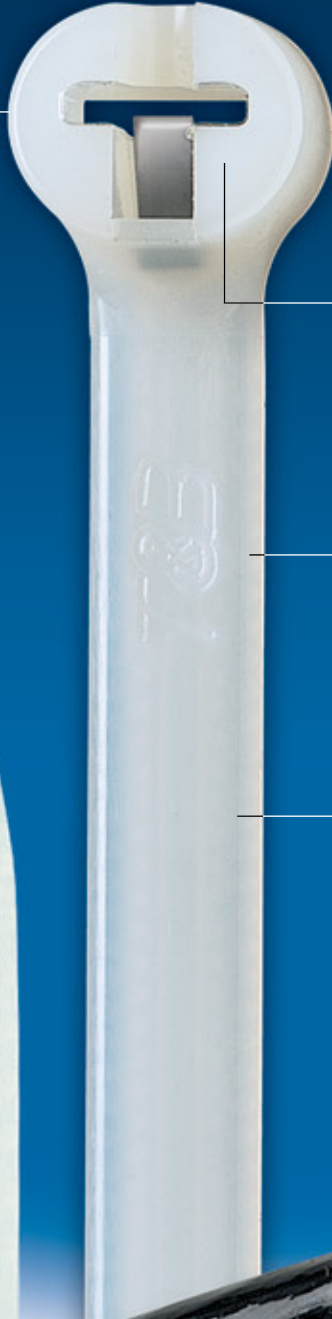

The Original Cable Tie®
Invented in 1958

“The Grip of Steel®” Non-Hydroscopic Stainless Steel Locking Device ensures maximum performance, strength and life.

Versatile Nylon 6.6 Material provides high strength and a wide temperature range. Ty-Rap® High-Performance Cable Ties are also available in a wide range of other materials for a variety of extreme environments.

Smooth, Notchless Body reduces stress concentration points under tension, making the tie stronger and increasing life expectancy, especially in changing environments.

Ribbed and Stippled Body grips the bundle and prevents slippage.

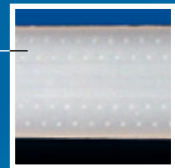

Ty-Rap® High-Performance Nylon Cable Ties



Ty-Rap® 6.6 Nylon Cable Ties — Natural

- Suitable for air handling (plenum) applications



Select the best material for your application.
See pages C-9-C-11 for a Material Selection Guide.

STD. PKG. CAT. NO.	BULK PKG. CAT. NO.	BODY WIDTH IN./MM	LENGTH IN./MM	MAX. WIRE BUNDLE DIA. IN./MM	MILITARY STANDARD PART NO.	TENSILE STRENGTH LBS./N	STD. PKG. QTY.	BULK PKG. QTY.
TY523M	TY23M	.09/2.29	3.62/91.95	.63/16.00	MS3367-4	18/80.07	100	1,000
TY52315M	TYB2315M	.09/2.29	7.00/177.80	1.50/38.10	—	18/80.07	100	1,000
TY5232M	TY232M	.09/2.29	8.00/203.20	2.00/50.80	—	18/80.07	100	1,000
TY5234M	TY234M	.09/2.29	14.00/355.60	4.00/101.60	—	18/80.07	100	1,000
TY524M	TY24M	.14/3.56	5.50/139.70	1.13/28.70	MS3367-5	40/177.90	100	1,000
TY5242M	TY242M	.14/3.56	8.19/208.03	2.00/50.80	—	40/177.90	100	1,000
TY526M	TY26M	.14/3.56	11.10/281.94	3.00/76.20	—	30/133.40	100	1,000
TY5244M	TY244M	.14/3.56	14.50/368.30	4.00/101.60	—	30/133.40	100	1,000
TY525M	TY25M	.19/4.83	7.31/185.67	1.75/44.45	MS3367-1	50/222.40	100	1,000
TY5253M	TY253M	.19/4.83	11.60/294.64	3.00/76.20	MS3367-7	50/222.40	100	1,000
TY528M	TY28M	.19/4.83	14.20/360.68	4.00/101.60	MS3367-2	50/222.40	100	1,000
TY5272M†	TY272M†	.27/6.86	8.75/222.250	2.00/50.80	—	120/533.80	50	500
TY527M†	TY27M†	.27/6.86	13.40/340.36	3.50/88.90	MS3367-3	120/533.80	50	500
TY5275M	TY275M	.27/6.86	18.00/457.20	5.00/127.00	—	120/533.80	50	500
TY5277M	TY277M	.27/6.86	24.30/617.22	7.00/177.80	—	120/533.80	50	500
TY529M	TY29M	.27/6.86	30.00/762.00	9.00/228.60	MS3367-6	120/533.80	50	500
TY53510M†	—	.32/8.13	35.00/889.00	10.00/254.00	—	175/778.40	50	—
TY54513M†	—	.32/8.13	45.00/1,143.00	13.00/330.20	—	175/778.40	50	—

Cable ties made from natural nylon 6.6 are excellent performers in most applications.

For use in temperatures ranging from -40° F to 185° F (-40° C to 85° C).

† UL Recognized Models

• UL® Listed Natural 6.6 Nylon Cable Ties are suitable for use in air handling spaces (plenums) in accordance with Section 300.22 (C) & (D) of the National Electrical Code®.

• UL File No. E49405

• Installation tools available on pp. C-46-C-48.

Air handling (plenum) and UV colors!

Ty-Rap® UV-Resistant 6.6 Nylon Cable Ties — Color Assortment

- Suitable for air handling (plenum) applications



STD. PKG. CAT. NO.	BULK PKG. CAT. NO.	DESCRIPTION	LENGTH IN./MM	TENSILE STRENGTH LBS./N	STD. PKG. QTY.	BULK PKG. QTY.
TY525M-35	TY25M-35	Air Handling (plenum) Maroon	7.31/185.67	50/222.40	100	1,000
TY525M-CLRS	—	Multi-Colored, UV-Stabilized Nylon, (10 each of standard 10 colors)*	7.31/185.67	50/222.40	100	—
—	TY25M-X	Black, UV-Stabilized Nylon	7.31/185.67	50/222.40	—	1,000
—	TY25M-1	Brown, UV-Stabilized Nylon	7.31/185.67	50/222.40	—	1,000
TY525M-2	TY25M-2	Red, UV-Stabilized Nylon	7.31/185.67	50/222.40	100	1,000
—	TY25M-3	Orange, UV-Stabilized Nylon	7.31/185.67	50/222.40	—	1,000
—	TY25M-4	Yellow, UV-Stabilized Nylon	7.31/185.67	50/222.40	—	1,000
TY525M-5	TY25M-5	Green, UV-Stabilized Nylon	7.31/185.67	50/222.40	100	1,000
TY525M-6	TY25M-6	Blue, UV-Stabilized Nylon	7.31/185.67	50/222.40	100	1,000
—	TY25M-7	Purple, UV-Stabilized Nylon	7.31/185.67	50/222.40	—	1,000
—	TY25M-8	Gray, UV-Stabilized Nylon	7.31/185.67	50/222.40	—	1,000
—	TY25M-9	White, UV-Stabilized Nylon	7.31/185.67	50/222.40	—	1,000
—	TY25M-22	Beige, UV-Stabilized Nylon	7.31/185.67	50/222.40	—	1,000

For use in temperatures ranging from -40° F to 185° F (-40° C to 85° C).

Suitable for use in air handling spaces in accordance with Section 300.22 (C) & (D) of the National Electrical Code®, except for TY25M-X (black).

* 100 standard ties in black, brown, red, orange, yellow, green, blue, purple, gray and white (10 each)

Recommended tooling — ERG-50, WT1-TB

How to Order Colored Ty-Rap® Cable Ties and Accessories

COLOR	SUFFIX NO.	COLOR	SUFFIX NO.	COLOR	SUFFIX NO.	COLOR	SUFFIX NO.	COLOR	SUFFIX NO.
Black	X	Orange	3	Blue	6	White	9	Fluor. Orange	53
Brown	1	Yellow	4	Purple	7	Beige	22	Fluor. Yellow	54
Red	2	Green	5	Gray	8	Maroon	35	Fluor. Green	55
								Fluor. Pink	59

Note: The base catalog number for Ty-Rap® cable ties is for natural (non-colored) nylon without the UV-stabilizing additive, which is not suitable for outdoor use. For colored UV-stabilized nylon Ty-Rap® cable ties, add the following suffix numbers to the base catalog numbers. For example, TY25M is natural (non-colored) nylon for indoor use only, while TY25M-2 is red UV-stabilized nylon for indoor or outdoor use. Consult customer service for ordering information.

NEC and National Electrical Code are registered trademarks of the National Fire Protection Association, Inc.

Ty-Rap® High-Performance Nylon Cable Ties

Ty-Rap® 6.6 Nylon Cable Ties — Weather-Resistant Black

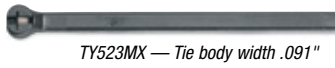

STD. PKG. CAT. NO.	BULK PKG. CAT. NO.	BODY WIDTH IN./MM	LENGTH IN./MM	MAX. WIRE BUNDLE DIA. IN./MM	MILITARY STANDARD PART NO.	TENSILE STRENGTH LBS./N	STD. PKG. QTY.	BULK PKG. QTY.
TY523MX	TY23MX	.09/2.29	3.62/91.95	.63/16.00	MS3367-4	18/80.07	100	1,000
TY52315MX	TYB2315MX	.09/2.29	7.00/177.80	1.50/38.10	—	18/80.07	100	1,000
TY5232MX	TY232MX	.09/2.29	8.00/203.20	2.00/50.80	—	18/80.07	100	1,000
TY5234MX	TY234MX	.09/2.29	14.00/355.60	4.00/101.60	—	18/80.07	100	1,000
TY524MX	TY24MX	.14/3.56	5.50/139.70	1.13/28.70	MS3367-5	40/177.90	100	1,000
TY5242MX	TY242MX	.14/3.56	8.19/208.03	2.00/50.80	—	40/177.90	100	1,000
TY526MX	TY26MX	.14/3.56	11.10/281.94	3.00/76.20	—	30/133.40	100	1,000
TY5244MX	TY244MX	.14/3.56	14.50/368.30	4.00/101.60	—	30/133.40	100	1,000
TY525MX	TY25MX	.19/4.83	7.31/185.67	1.75/44.45	MS3367-1	50/222.40	100	1,000
TY5253MX	TY253MX	.19/4.83	11.60/294.64	3.00/76.20	MS3367-7	50/222.40	100	1,000
TY528MX	TY28MX	.19/4.83	14.20/360.68	4.00/101.60	MS3367-2	50/222.40	100	1,000
TY5272MX†	TY272MX†	.27/6.86	8.75/222.250	2.00/50.80	—	120/533.80	50	500
TY527MX†	TY27MX†	.27/6.86	13.40/340.36	3.50/88.90	MS3367-3	120/533.80	50	500
TY5275MX	TY275MX	.27/6.86	18.00/457.20	5.00/127.00	—	120/533.80	50	500
TY5277MX	TY277MX	.27/6.86	24.30/617.22	7.00/177.80	—	120/533.80	50	500
TY529MX*	TY29MX*	.27/6.86	30.00/762.00	9.00/228.60	MS3367-6	120/533.80	50	500
TY53510MX†	—	.32/8.13	35.00/889.00	10.00/254.00	—	175/778.40	50	—
TY54513MX†	—	.32/8.13	45.00/1,143.00	13.00/330.20	—	175/778.40	50	—

For use in temperatures ranging from -40° F to 185° F (-40° C to 85° C).

* For military compliance of weather-resistant black 120-lb. ties, replace suffix X with O (i.e., TY27M-O).

† Not Listed or Recognized Models.

- UL® File No. E49405
- Installation tools available on pp. C-46-C-48.

Increase efficiency! Ty-Rap Tote® Cable Tie Dispensers

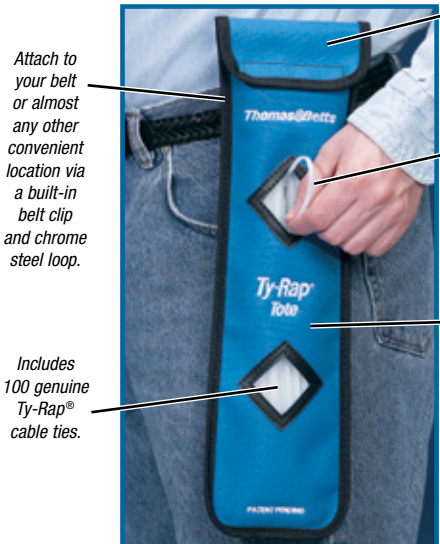

Attach to your belt or almost any other convenient location via a built-in belt clip and chrome steel loop.

Includes 100 genuine Ty-Rap® cable ties.

Quickly refill your Ty-Rap Tote® through the hook-and-loop-secured flap.

Easily remove the tie you need through the reinforced, diamond-shaped cut-out while the Ty-Rap Tote® securely holds the rest.

Keep cable ties clean and organized inside the durable, lightweight polyester exterior and tough vinyl interior.



STD. PKG. CAT. NO.	DESCRIPTION	STD. PKG. QTY.
TY-TOTE-25	Ty-Rap Tote® 8" Cable Tie Dispenser (includes 1 pkg. TY525M)	1
TY-TOTE-23	Ty-Rap Tote® 4" Cable Tie Dispenser (includes 1 pkg. TY523M)	1
TY-TOTE-28	Ty-Rap Tote® 11"-14" Cable Tie Dispenser (includes 1 pkg. TY528M)	1

Order only genuine Ty-Rap® Cable Ties to refill your dispenser!

Engineered-Performance Material Cable Ties

Safety and decontamination.

Ty-Rap® Detectable Ties

Ty-Rap® Detectable Cable Ties are made from standard nylon or polypropylene, and incorporate a unique compound detectable by metal detectors and x-ray equipment. Their bright blue color makes them easy to spot. The polypropylene version is buoyant, making it ideal for use in liquid-processing areas.

With Ty-Rap® Detectable Cable Ties, you have all of the advantages of the original Ty-Rap® Cable Tie, including a smooth body with an infinitely adjustable design, high-performance stainless steel locking device for a perfect fit and superior holding power — plus the peace of mind of knowing the integrity of your product is uncompromised.

Ty-Rap® Detectable Cable Ties are a contamination solution for food and beverage processing plants and may aid companies in meeting the US Food and Drug Administration (FDA) Hazard Analysis of Critical Control Points (HACCP) safety standards and the European Union (EU) hygiene monitoring regulations.



See p. C-46–C-48 for cable tie installation tools.

Features

- Detectable by metal detectors set at minimum 1.5mm ferrous sphere
- Detectable by x-ray equipment
- Bright blue color allows easy visual detection, especially on white conveyor systems
- Buoyant Polypropylene version available for use in liquid-processing applications

Typical Applications

- Food and beverage processing
- Pharmaceutical production
- Chemical and compounds manufacturing
- Tobacco processing
- Tire and airbag manufacturing
- Any other industry sensitive to contamination and using detection equipment

Material — Polyamide (Nylon 6.6) or Polypropylene, for use in temperatures ranging from -40° F to 185° F (-40° C to 85° C)

Color — Blue (for easy visual detection)

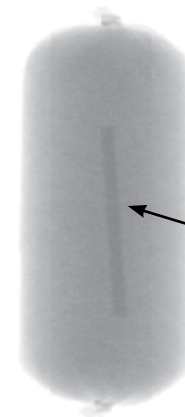

A piece of Ty-Rap® Detectable Cable Tie

STD. PKG. CAT. NO.	TIE LENGTH IN./MM	BODY WIDTH IN./MM	MAX. WIRE BUNDLE IN./MM	TENSILE STRENGTH LBS./N	BASE MATERIAL	STD. PKG. QTY.
Nylon 6.6						
TY523M-NDT	3.62/91.90	.09/2.36	.63/15.90	18/80	Nylon	100
TY524M-NDT	5.50/139.70	.14/3.56	1.13/28.70	40/178	Nylon	100
TY525M-NDT	7.31/186.00	.19/4.70	1.75/44.40	50/220	Nylon	100
TY527M-NDT	13.40/340.00	.27/6.86	3.50/89.00	120/540	Nylon	50
TY528M-NDT	14.20/361.00	.19/4.70	4.00/102.00	50/220	Nylon	100
Polypropylene						
TY523M-PDT	3.62/91.90	.09/2.36	.63/15.90	18/80	Polypropylene	100
TY525M-PDT	7.31/186.00	.19/4.70	1.75/44.40	30/135	Polypropylene	100
TY527M-PDT	13.40/340.00	.27/6.86	3.50/89.00	60/267	Polypropylene	50
TY528M-PDT	14.20/361.00	.19/4.75	4.00/102.00	30/135	Polypropylene	100

Engineered-Performance Material Cable Ties

Extra high temperatures!

Ty-Rap® Extra High-Temperature 4.6 Nylon Ties



For use in temperatures ranging from -40° F to 302° F (-40° to 150° C).

Color — Natural (Olive)

- Non-hydroscopic stainless steel barb will not weaken or wear out after years of environmental stress
- Smooth, notchless body reduces stress, increasing life expectancy over standard notched, one-piece cable ties
- Quicker to install and less expensive than metallic fasteners, lacing cord or tape
- Ideal for Industrial applications including metal processing, paper mills, lighting and commercial construction markets with high temperature environments up to 302° F (150° C)
- Provides a smooth, low-profile look and unlimited tensioning range for a perfect fit
- Features an oval head on every original Ty-Rap® Cable Tie



BULK PKG. CAT. NO.	LENGTH IN./MM	TENSILE STRENGTH LBS./N	BULK PKG. QTY.
TYHT23M	3.62/91.95	18/80.07	1,000
TYHT25M	7.31/185.67	50/222.40	1,000
TYHT27M	13.40/340.36	120/533.80	500
TYHT28M	14.20/360.68	50/222.40	1,000

Engineered to withstand high temperatures!

Ty-Rap® Heat-Stabilized Natural 6.6 Nylon Ties



For use in temperatures ranging from -40° F to 221° F (-40° C to 105° C).

Material meets ASTM D4066 PA121.

Color — Green Tint

BULK PKG. CAT. NO.	WIDTH IN./MM	BODY LENGTH IN./MM	MAX. WIRE BUNDLE DIA. IN./MM	TENSILE STRENGTH LBS./N	BULK PKG. QTY.
TYH23M	.09/2.29	3.62/91.95	.63/16.00	18/80.07	1,000
TYH232M	.09/2.29	8.00/203.20	2.00/50.80	18/80.07	1,000
TYH24M	.14/3.56	5.50/139.70	1.13/28.70	40/177.90	1,000
TYH242M	.14/3.56	8.19/208.03	2.00/50.80	40/177.90	1,000
TYH26M	.14/3.56	11.10/281.94	3.00/76.20	30/135	1,000
TYH25M	.18/4.57	7.31/185.67	1.75/44.45	50/222.40	1,000
TYH253M	.18/4.57	11.40/289.56	3.00/76.20	50/222.40	1,000
TYH28M	.18/4.57	14.20/360.68	4.00/101.60	50/222.40	1,000
TYH27M	.27/6.86	13.20/335.28	3.50/88.90	120/533.80	500
TYH272M	.27/6.86	8.75/222.25	2.00/50.80	120/533.80	500
TYH29M	.30/7.62	30.00/762.00	9.00/228.60	120/533.80	500

Perfect for outdoor applications!

Ty-Rap® Heat-Stabilized/UV-Resistant Black 6.6 Nylon Ties



For use in temperatures ranging from -40° F to 221° F (-40° C to 105° C)

Color — Black



- Non-hydroscopic stainless steel barb will not weaken or wear out after years of environmental stress
- Smooth, notchless body reduces stress, increasing life expectancy over standard notched, one-piece cable ties
- Ideal for Industrial applications including lawn/garden/farming equipment, recreation vehicles and heavy equipment
- Can be placed in environments requiring heat stabilization and UV resistance
- Provides a smooth, low-profile look and unlimited tensioning range for a perfect fit
- Features an oval head on every original Ty-Rap® Cable Tie
- Quicker to install and less expensive than metallic fasteners, lacing cord or tape



BULK PKG. CAT. NO.	LENGTH IN./MM	TENSILE STRENGTH LBS./N	BULK PKG. QTY.
TY23MX-A	3.62/91.95	18/80.07	1,000
TY24MX-A	5.50/139.70	40/177.90	1,000
TY25MX-A	7.31/185.67	50/222.40	1,000
TY28MX-A	14.20/360.68	50/222.40	1,000
TY27MX-A	13.40/340.36	120/533.80	500

Engineered-Performance Material Cable Ties

Resists acids, salts and bases.

Ty-Rap® Weather-Resistant Polypropylene Ties

- Excellent resistance to chemical exposure
- Greater UV resistance
- Buoyant – will float to the surface of most liquids

Color — Black

For use in temperatures ranging from -40° F to 185° F (-40° C to 85° C)



BULK PKG. CAT. NO.	WIDTH IN./MM	BODY LENGTH IN./MM	MAX. WIRE BUNDLE DIA. IN./MM	TENSILE STR. LBS./N	BULK PKG. QTY.
TYP23MX	.09/2.29	3.62/91.95	.63/16.00	18/80.07	1,000
TYP25MX	.18/4.57	7.31/185.67	1.75/44.45	30/133.40	1,000
TYP28MX	.18/4.57	14.20/360.68	4.00/101.60	30/133.40	1,000
TYP27MX	.27/6.86	13.20/335.28	3.50/88.90	60266.90	500

Long life in UV and chemical environments.

Ty-Rap® Weather-Resistant Nylon 12 Ties

This material provides very good resistance to ultraviolet light and chemical exposure. Nylon 12 is a lower, moisture-absorbing material than 6.6 nylon, and the effect of water on properties is much less.

For use in temperatures ranging from -40° F to 185° F (-40° C to 85° C).

Color — Black



STD. CAT. NO.	BULK CAT. NO.	BODY WIDTH IN./MM	LENGTH IN./MM	MAX. WIRE BUNDLE DIA. IN./MM	TENSILE STRENGTH LBS./N	STD. PKG. QTY.	BULK PKG. QTY.
TYC525MX	TYC25MX	.18/4.57	7.31/185.67	1.75/44.45	35/155.70	100	1,000
—	TYC28MX	.18/4.57	14.20/360.68	4.00/101.60	35/155.70	—	1,000
—	TYC272MX	.27/6.86	8.00/203.20	2.00/50.80	85/378.10	—	500
TYC527MX	TYC27MX	.27/6.86	13.20/335.28	3.50/88.90	85/378.10	50	500
—	TYC29MX	.30/7.62	30.00/762.00	9.00/228.60	85/378.10	—	500

Engineered-Performance Material Cable Ties

Perfect for passenger areas!

Ty-Rap® Flame-Retardant 6.6 Nylon Ties

- Meets the UL94V-0 flammability rating
- Low smoke

Color — White

For use in temperatures ranging from -40° F to 185° F (-40° C to 85° C).



BULK CAT. NO.	BODY WIDTH IN./MM	LENGTH IN./MM	MAX WIRE BUNDLE DIA. IN./MM	MARKING PAD SIZE IN./MM W X H	TENSILE STRENGTH LBS./N	BULK PKG. QTY.
TY23MFR	.09/2.29	3.62/91.95	.63/16.00	N/A	18/80.07	1,000
TY232MFR	.09/2.29	8.00/203.20	2.00/50.80	N/A	18/80.07	1,000
TY24MFR	.14/3.56	5.50/139.70	1.13/28.70	N/A	40/177.90	1,000
TY25MFR	.18/4.57	7.31/185.67	1.75/44.45	N/A	50/222.40	1,000
TY28MFR	.18/4.57	14.20/360.68	4.00/101.60	N/A	50/222.40	1,000
TY272MFR†	.27/6.86	8.00/203.20	2.00/50.80	N/A	120/533.80	500
TY27MFR	.27/6.86	13.20/335.28	3.50/88.90	N/A	120/533.80	500
TY53MFR	.09/2.29	4.00/101.60	.63/16.00	.81 x .36/20.57 x 9.1	18/80.07	500
TY153MFR	.10/2.54	4.35/110.49	.63/16.00	.78 x 1/19.81 x 14.00	18/80.07	500

† Not UL® Recognized Model.

Withstand even the toughest environments!

Ty-Rap® Radiation-Resistant Fluoropolymer Ties

- High radiation resistance — 2 x 10⁸ Rads
- Extremely chemical resistant
- Meets flammability rating UL94V-0
- Long application life expectancy

Color — Aqua

For use in temperatures ranging from -76° F to 338° F (-60° C to 170° C)



STD. CAT. NO.	BULK CAT. NO.	BODY WIDTH IN./MM	LENGTH IN./MM	MAX. WIRE BUNDLE DIA. IN./MM	TENSILE STRENGTH LBS./N	STD. PKG. QTY.	BULK PKG. QTY.
TYZ523M*	TYZ23M*	.09/2.29	3.62/91.95	.63/16.00	18/80.07	100	1,000
TYZ525M	TYZ25M	.18/4.57	7.31/185.67	1.75/44.45	50/222.40	100	1,000
TYZ528M	TYZ28M	.18/4.57	14.19/360.43	4.00/101.60	50/222.40	100	1,000
TYZ527M	TYZ27M	.27/6.86	13.38/339.85	3.50/88.90	120/533.80	50	100

*UL Listed

Perfect for low smoke-generation applications.

Ty-Rap® Low-Smoke Fluoropolymer Ties

- Made of tough fluoropolymer material
- Use in air-handling spaces
- UL94V-0 flammability rating
- Low-smoke density

Color — Maroon

For use in temperatures ranging from -50° F to 284° F (-45° C to 140° C)



STD. CAT. NO.	BULK CAT. NO.	BODY WIDTH IN./MM	LENGTH IN./MM	MAX. WIRE BUNDLE DIA. IN./MM	TENSILE STRENGTH LBS./N	STD. PKG. QTY.	BULK PKG. QTY.
TYV523M	TYV23M	.09/2.29	3.62/91.95	.63/16.00	18/80.07	100	1,000
TYV525M	TYV25M	.18/4.57	7.31/185.67	1.75/44.45	50/222.40	100	1,000

Engineered-Performance Material Cable Ties

Select the cable ties you need for special environments!

Thomas & Betts offers Ty-Rap® cable ties and accessories in a wide variety of materials, each suited for specific environments. The purpose of this document is to assist you in choosing the best material for your particular application. The effects of weathering, flame, chemicals, extreme temperatures, and radiation on the different materials are clearly presented in the following tables to simplify this process. Once you have determined the most suitable material, you can choose from the wide variety of Ty-Rap® cable ties, identification ties, mounting bases, lashing ties, etc., offered by Thomas & Betts.

General — How to use Table 1:

Table 1 simplifies the material selection process by giving the relative performance ratings of the materials offered by Thomas & Betts. For example, if your application is in an extremely cold environment, four materials will answer your need: 1. Radiation-resistant fluoropolymer, 2. Low-smoke fluoropolymer, 3. Nylon 12, 4. Stainless steel. Then, cost may be your next most important criteria, so out of those four options, nylon 12 would be the most cost effective. However, if tensile strength is important, then stainless steel would be the better choice.

Refer to Tables 2 and 3 for more detailed information regarding physical properties of the materials and chemical resistance of the materials respectively.

It is extremely difficult to provide data on all the possible combinations or conditions that can occur. This information is based on data provided by the manufacturers of the specific materials listed and is provided only as a general guide. No specific recommendation is intended. As each application may differ, cable tie samples should be tested in the intended application by the user to determine suitability.

Table 1 — Available Materials 5 = Most Suitable 1 = Least Suitable

	NATURAL 6.6 NYLON*	WEATHER- RESISTANT 6.6 NYLON	HEAT- STABILIZED NATURAL 6.6 NYLON	HEAT- STABILIZED UV 6.6 NYLON	EXTRA HIGH TEMP 4.6 NYLON	FLAME- RETARDANT 6.6 NYLON	WEATHER- RESISTANT NYLON 12	WEATHER- RESISTANT POLY- PROPYLENE	LOW- SMOKE FLUORO- POLYMER	RADIATION- RESISTANT FLUORO- POLYMER	DELTEC® WEATHERABLE ACETEL	DETECTABLE NYLON*	STAINLESS STEEL
Ultraviolet Resistance	1	4	1	4	1	1	4	4	5	5	4	1	5
Radiation Resistance	1	1	1	1	1	1	1	1	4	4	1	1	5
Low Temperature	3	3	3	4	3	2	4	3	4	4	4	2	5
High Temperature	3	3	4	3	4	3	2	2	4	4	2	2	5
Flammability	3	3	3	3	3	4	1	1	4	4	1	3	5
Tensile Strength	3	3	3	3	3	3	2	1	3	3	2	3	5
Relative Cost	Low	Low	Low	Low	Med	Med	Med	Low	High	High	High	Med	High

SEE TABLE 3 (PAGES C-10-C-11)

* Fungus inert

Flammability ratings for selecting Ty-Rap® cable ties

Flammability ratings of Ty-Rap® cable tie materials are shown in Table 2 on the following page. These tests for flammability of plastic material are intended to serve as a preliminary indication of acceptability with respect to flammability for particular applications.

UL 94 vertical burn test procedures

Test specimens of the material, with dimensions 5" x 1/2", with the thickness intended for use in the end product, are tested in both the manufactured condition and in the aged state. The test requires that the specimen be supported in a vertical fixture and a precisely controlled flame applied for a 10-second period.

The flame is removed and the duration of flaming is noted. If the flame extinguishes, a second exposure to flame for 10 seconds is applied and duration of flaming is again noted. It is observed and recorded whether or not test specimens drip flaming particles that ignite a cotton swatch.

Materials classed UL94V-0:

A material classed V-0 shall:

- A.** Not have any specimens that burn with flaming combustion for more than 10 seconds after either application of the test flame.
- B.** Not have a total flaming combustion time exceeding 50 seconds for the 10 flame applications for each set of five specimens.
- C.** Not have any specimens that burn with flaming or glowing combustion up to the holding fixture.
- D.** Not have any specimens that drip flaming particles that ignite the dry absorbent surgical cotton located 12" below the test specimen.
- E.** Not have any specimens with glowing combustion that persists for more than 30 seconds after the second removal of the test flame.

Materials classed UL94V-1:

A material classed V-1 shall:

- A.** Not have any specimens that burn with flaming combustion for more than 30 seconds after either application of the test flame.
- B.** Not have a total flaming combustion time exceeding 250 seconds for the 10 flame applications for each set of five specimens.
- C.** Not have any specimens that burn with flaming or glowing combustion up to the holding fixture.
- D.** Not have any specimens that drip flaming particles that ignite the dry absorbent surgical cotton located 12" below the test specimen.

- E.** Not have any specimens with glowing combustion that persists for more than 60 seconds after the second removal of the test flame.

Materials classed UL94V-2:

A material classed V-2 shall:

- A.** Not have any specimens that burn with flaming combustion for more than 30 seconds after either application of the test flame.
- B.** Not have a total flaming combustion time exceeding 250 seconds for the 10 flame applications for each set of five specimens.
- C.** Not have any specimens that burn with flaming or glowing combustion up to the holding fixture.
- D.** Be permitted to have specimens that drip flaming particles that burn only briefly, some of which ignite the dry absorbent surgical cotton placed 12" below the test specimen.
- E.** Not have any specimens with glowing combustion that persists for more than 60 seconds after the second removal of the test flame.

Engineered-Performance Material Cable Ties

Table 2 — Physical Properties of Ty-Rap® Cable Tie Materials

	NATURAL 6.6 NYLON	WEATHER- RESISTANT 6.6 NYLON	HEAT- STABILIZED NATURAL 6.6 NYLON	HEAT- STABILIZED UV 6.6 NYLON	EXTRA HIGH TEMP 4.6 NYLON	FLAME- RETARDANT 6.6 NYLON	WEATHER- RESISTANT NYLON 12	WEATHER- RESISTANT POLY- PROPYLENE	LOW-SMOKE FLUORO- POLYMER	RADIATION- RESISTANT FLUORO- POLYMER	DELTEC® WEATHERABLE ACETAL	STAINLESS STEEL
Tensile Strength (Yield) @ 73° F (Dry-As-Molded) ¹ [psi]	12,000	12,000	12,000	11,500	14,500	11,000	7,500	4,600	6,600	6,700	10,000	90,000
Flammability Rating	UL94V-2	UL94V-2	UL94V-2	UL94V-2	UL94V-2	UL94V-0	—	—	UL94V-0	UL94V-0	UL94HB	—
Radiation Resistance [rads]	1 x 10 ⁵	1 x 10 ⁵	1 x 10 ⁵	1 x 10 ⁵	1 x 10 ⁵	1 x 10 ⁵	1 x 10 ⁵	1 x 10 ⁵	2 x 10 ⁶	2 x 10 ⁶	1 x 10 ⁶	2 x 10 ⁶
Ultraviolet Light Resistance	Poor	Good	Poor	Good	Poor	Poor	Good	Good	Excellent	Excellent	Very Good	Excellent
Water Absorption (24 hrs.) [%]	1.3	1.2	1.4	.25	2.3	1.4	.25	.1	<.1	<.01	.25	None
Oxygen Index	28	28	31	26	27	34	—	—	52	30	21	—
Max. Continuous Use Temperature [F°/C°]	185/85	185/85	221/105	221/105	302/150	185/85	176/80	194/90	284/140	302/150	194/90	1000/537
Min. Continuous Use Temperature [F°/C°]	-40/-40	-40/-40	-40/-40	-40/-40	-40/-40	-40/-40	-40/-40	-65/-65	-50/-46	-50/-46	-85/-65	-112/-80
Color	Natural	Black	Green Tint	Black	Light Green	White	Black	Black	Maroon	Aqua	Black	Stainless

¹ ASTM D638-87B except stainless steel, which is ASTM E8

Chemical Resistance

Table 3 shows the resistance of Ty-Rap® cable tie materials to various chemicals. The table is designed to help you determine the cable tie material best suited for a particular chemical environment.

Table 3 — Resistance of Available Materials to Various Chemicals Temp 70° F

REAGENTS	CONCENTRATION	STANDARD 6.6 NYLON AS USED IN TY SERIES	WEATHER- RESISTANT 6.6 NYLON AS USED IN TY X SERIES	HEAT- STABILIZED 6.6 NYLON AS USED IN TYH SERIES	FLAME- RETARDANT 6.6 NYLON AS USED IN TY FR SERIES	WEATHER- RESISTANT NYLON 12 AS USED IN TYC X SERIES	WEATHER- RESISTANT POLY- PROPYLENE AS USED IN TYV X SERIES	LOW-SMOKE FLUOROPOLYMER AS USED IN TYV SERIES	RADIATION- RESISTANT FLUOROPOLYMER AS USED IN TYZ SERIES	DELTEC® WEATHERABLE ACETAL AS USED IN TYD SERIES	STAINLESS STEEL AS USED IN TYS SERIES
Arsenic Acid	40%	—	—	—	—	—	E	—	—	—	E
Acetaldehyde	50%	S	S	S	S	—	—	—	—	—	—
Acetone	100%	E	E	E	E	E	E	E	E	F	E
Aluminum Hydroxide	AQ	—	—	—	—	—	E	E	E	—	E
Ammonia	All	—	—	—	—	E	E	E	E	—	—
Ammonium Carbonate	5%	S	S	S	S	E	E	E	E	—	E
Ammonium Hydroxide	10%	E	E	E	E	—	E	E	E	F	E
Ammonium Nitrate	—	—	—	—	—	E	E	E	E	—	E
Ammonium Sulfate	10%	—	—	—	—	S	S	E	S	—	S
Barium Carbonate	All	—	—	—	—	E	E	E	E	—	E
Barium Chloride	5%	NR	NR	NR	NR	E	E	E	E	—	E
Barium Sulfate	10%	E	E	E	E	E	E	E	E	—	E
Barium Sulfide	10%	S	S	S	S	E	E	E	E	—	E
Benzene	100%	E	E	E	E	E	S	E	E	F	E
Benzoic Acid	100%	NR	NR	NR	NR	E	E	E	E	—	E
Butyric Acid	50%	NR	NR	NR	NR	—	E	E	E	—	E
Calcium Carbonate	AQ	—	—	—	—	—	E	E	E	—	E
Calcium Hydroxide	20%	—	—	—	—	—	E	F	E	E	E
Calcium Hydrochlorite	2	NR	NR	NR	NR	—	F	—	F	—	F
Calcium Sulfate	2%	—	—	—	—	—	E	E	E	—	E
Carbon Tetrachloride	100%	E	E	E	E	E	F	E	E	E	E
Chlorine (WET)	—	NR	NR	NR	NR	—	F	—	F	—	F
Chlorine (DRY)	—	NR	NR	NR	NR	—	NR	—	F	—	F
Chloroacetic Acid	30%	NR	NR	NR	NR	—	—	—	F	—	F
Chloroform	100%	—	—	—	—	F	F	E	E	—	E
Chromic Acid	50%	NR	NR	NR	NR	—	F	S	F	—	F
Citric Acid	50%	S	S	S	S	E	E	E	E	E	E
Copper Cyanide	10%	—	—	—	—	—	E	E	E	—	E
Copper Nitrate	50%	—	—	—	—	—	E	E	E	—	E
Cider	—	—	—	—	—	—	E	E	E	—	E
Dichloroethane	100%	—	—	—	—	—	—	E	E	—	E
Diethyl Ether	100%	—	—	—	—	E	E	E	E	S	E
Ethyl Alcohol	100%	S	S	S	S	E	E	E	E	—	E
Ethyl Chloride	100%	—	—	—	—	F	F	S	E	E	E
Ethylene Glycol	100%	E	E	E	E	—	E	E	E	S	E
Ferric Hydroxide	All	—	—	—	—	—	E	E	E	—	E
Ferric Nitrate	10%	—	—	—	—	—	E	E	E	—	E
Ferrous Sulfate	10%	—	—	—	—	—	E	E	E	—	E
Fuel Oil	100%	—	—	—	—	—	E	—	E	—	E
Furfural	100%	—	—	—	—	—	F	E	E	—	E
Gallic Acid	AQ	—	—	—	—	—	—	E	E	—	E
Gasoline	100%	E	E	E	E	—	S	E	E	—	E
Glycerine	100%	—	—	—	—	E	E	E	—	—	E
Hydrocyanic Acid	All	—	—	—	—	—	E	E	E	—	E
Hydrogen Peroxide	30%	NR	NR	NR	NR	S	E	E	E	F	E
Hydrogen Sulfide	Dry	NR	NR	NR	NR	E	E	E	E	—	E

Engineered-Performance Material Cable Ties

Table 3 (continued)

REAGENTS	CONCENTRATION	STANDARD 6.6 NYLON AS USED IN TY SERIES	WEATHER- RESISTANT 6.6 NYLON AS USED IN TY X SERIES	HEAT- STABILIZED 6.6 NYLON AS USED IN TYH SERIES	FLAME- RETARDANT 6.6 NYLON AS USED IN TY FR SERIES	WEATHER- RESISTANT NYLON 12 AS USED IN TYC X SERIES	WEATHER- RESISTANT POLY- PROPYLENE AS USED IN TYP X SERIES	LOW-SMOKE FLUOROPOLYMER AS USED IN TYV SERIES	RADIATION- RESISTANT FLUOROPOLYMER AS USED IN TYZ SERIES	DELTEC® WEATHERABLE ACETAL AS USED IN TYD SERIES	STAINLESS STEEL AS USED IN TYS SERIES
Iodoform	100%	—	—	—	—	—	—	E	E	—	E
Isopropyl Alcohol	100%	S	S	S	S	E	E	E	E	—	E
Jet Fuel	100%	E	E	E	E	—	S	E	E	—	E
Lactic Acid	10%	E	E	E	E	S	E	E	E	—	E
Lanolin	10%	E	E	E	E	E	E	E	E	—	E
Lead Acetate	5%	—	—	—	—	—	E	E	E	—	E
Linseed Oil	10%	E	E	E	E	E	E	E	E	E	E
Magnesium Carbonate	All	—	—	—	—	E	E	E	E	—	E
Magnesium Chloride	10%	F	F	F	F	F	F	—	F	—	F
Magnesium Nitrate	All	—	—	—	—	E	E	E	E	—	E
Malic Acid	AQ	—	—	—	—	—	E	E	E	—	E
Mercury	100%	—	—	—	—	E	E	E	E	—	E
Methyl Alcohol	100%	S	S	S	S	E	E	E	E	—	E
Methyl Chloride	100%	—	—	—	—	—	S	S	E	—	E
Methyl Ethyl Ketone	100%	—	—	—	—	E	E	E	E	F	E
Naptha	100%	—	—	—	—	—	E	E	E	—	E
Nitric Acid	30%	NR	NR	NR	NR	—	E	E	E	NR	E
Nitric Acid	30-70%	NR	NR	NR	NR	—	F	S	S	NR	E
Nitrous Acid	5%	—	—	—	—	—	F	E	E	—	E
Oleic Acid	100%	—	—	—	—	—	E	E	E	S	E
Oxalic Acid	10%	—	—	—	—	S	E	E	E	—	E
Paraffin	100%	E	E	E	E	E	E	E	E	—	E
Petroleum Ether	100%	—	—	—	—	E	F	E	E	—	E
Phenol	90%	NR	NR	NR	NR	—	E	E	E	NR	E
Phosphoric Acid	10%	NR	NR	NR	NR	—	E	E	E	—	E
Picric Acid	1%	—	—	—	—	—	E	E	E	—	E
Potassium Bromide	AQ	—	—	—	—	—	S	—	S	—	S
Potassium Carbonate 1%	—	—	—	E	E	E	E	—	E	—	E
Potassium Chlorate	AQ	—	—	—	—	S	E	E	E	—	E
Potassium Dichromate	40%	NR	NR	NR	NR	F	E	E	E	—	E
Potassium Ferrocyanide	25%	—	—	—	—	—	E	E	E	—	E
Potassium Hydroxide	5%	S	S	S	S	—	E	E	E	—	E
Potassium Iodide	All	—	—	—	—	E	E	E	E	—	E
Potassium Nitrate	50%	F	F	F	F	E	E	E	E	—	E
Potassium Permanganate	5%	NR	NR	NR	NR	NR	E	E	E	S	E
Potassium Sulfate	5%	—	—	—	—	E	E	E	E	—	E
Potassium Sulfide	AQ	—	—	—	—	—	E	E	E	—	E
Propyl Alcohol	100%	E	E	E	E	—	E	E	E	—	E
Silver Nitrate	10%	—	—	—	—	E	E	E	E	—	E
Sodium Acetate	60%	E	E	E	E	—	E	E	E	—	E
Sodium Bicarbonate	All	E	E	E	E	E	E	E	E	—	E
Sodium Bisulfate	10%	—	—	—	—	E	E	E	E	E	E
Sodium Borate	All	—	—	—	—	—	E	E	E	—	E
Sodium Carbonate	5%	E	E	E	E	E	E	E	E	S	E
Sodium Chlorate	25%	—	—	—	—	S	E	E	E	E	E
Sodium Chloride	2%	E	E	E	E	E	E	E	E	S	E
Sodium Fluoride	5%	—	—	—	—	—	F	—	F	—	F
Sodium Hydroxide	10%	E	E	E	E	E	E	E	E	S	E
Sodium Hyposulfite	AQ	—	—	—	—	—	—	E	E	—	E
Sodium Nitrate	5%	E	E	E	E	E	E	E	E	—	E
Sodium Nitrite	AQ	—	—	—	—	S	E	E	E	—	E
Sodium Perchlorate	10%	—	—	—	—	—	—	E	E	—	E
Sodium Phosphate	5%	—	—	—	—	E	E	E	E	—	E
Sodium Sulfate	5%	S	E	S	E	E	E	E	E	—	E
Sodium Thiosulfate	5%	—	—	—	—	S	S	—	S	S	S
Stearic Acid	100%	—	—	—	—	F	E	E	E	—	E
Sulfur	100%	—	—	—	—	E	E	E	E	—	E
Sulfur Dioxide	All	NR	NR	NR	NR	E	E	E	E	—	E
Sulfuric Acid	Conc.	NR	NR	NR	NR	—	S	E	E	NR	E
Sulfuric Acid	5%	NR	NR	NR	NR	F	F	F	F	F	F
Tannic Acid	10%	—	—	—	—	—	E	E	E	—	E
Tartaric Acid	50%	—	—	—	—	E	E	E	E	E	E
Tetrahydrofuran	100%	—	—	—	—	S	F	F	E	E	E
Toluene	100%	E	E	E	E	E	F	E	E	F	F
Xylene	100%	E	E	E	E	E	F	E	E	—	E
Zinc Chloride	70%	F	F	F	F	E	E	E	E	NR	E
Zinc Nitrate	AQ	—	—	—	—	E	E	E	E	—	E
Zinc Sulfate	AQ	—	—	—	—	E	E	E	E	—	E

Ratings: E=Excellent S=Satisfactory F=Fair NR=Not Recommended (AQ=Aqueous)

Color Coding Cable Ties

Ty-Rap® Striped-Colored Cable Ties for Identification Telephone Cable Binder

Designed primarily for P.I.C. and station cable binder marking, these self-locking ties install without tools in less than 10 seconds. Compared to an installation time of 30–60 seconds using the twisted-wire method, the time saving is substantial. High-contrast color stripes extend to end of tail for instant, permanent identification of binder.



STD. PKG. CAT. NO.	BULK. PKG. CAT. NO.	TIE COLOR	COLOR STRIPE	BODY WIDTH IN./MM	LENGTH IN./MM	TENSILE STRENGTH LBS./N	STD. PKG. QTY.	BULK PKG. QTY.
696-40527-0C	696-40527-0	Black	—	.09/2.29	3.62/91.95	18/80.07	50	1,000
696-40527-1-0C	696-40527-1-0	Brown	Black	.09/2.29	3.62/91.95	18/80.07	50	1,000
696-40527-1-2C	696-40527-1-2	Brown	Red	.09/2.29	3.62/91.95	18/80.07	50	1,000
696-40527-1-4C	696-40527-1-4	Brown	Yellow	.09/2.29	3.62/91.95	18/80.07	50	1,000
696-40527-1-7C	696-40527-1-7	Brown	Violet	.09/2.29	3.62/91.95	18/80.07	50	1,000
696-40527-1-9C	696-40527-1-9	Brown	White	.09/2.29	3.62/91.95	18/80.07	50	1,000
696-40527-2C	696-40527-2	Red	—	.09/2.29	3.62/91.95	18/80.07	50	1,000
696-40527-3-0C	696-40527-3-0	Orange	Black	.09/2.29	3.62/91.95	18/80.07	50	1,000
696-40527-3-2C	696-40527-3-2	Orange	Red	.09/2.29	3.62/91.95	18/80.07	50	1,000
696-40527-3-4C	696-40527-3-4	Orange	Yellow	.09/2.29	3.62/91.95	18/80.07	50	1,000
696-40527-3-7C	696-40527-3-7	Orange	Violet	.09/2.29	3.62/91.95	18/80.07	50	1,000
696-40527-3-9C	696-40527-3-9	Orange	White	.09/2.29	3.62/91.95	18/80.07	50	1,000
696-40527-4C	696-40527-4	Yellow	—	.09/2.29	3.62/91.95	18/80.07	50	1,000
696-40527-5-0C	696-40527-5-0	Green	Black	.09/2.29	3.62/91.95	18/80.07	50	1,000
696-40527-5-2C	696-40527-5-2	Green	Red	.09/2.29	3.62/91.95	18/80.07	50	1,000
696-40527-5-4C	696-40527-5-4	Green	Yellow	.09/2.29	3.62/91.95	18/80.07	50	1,000
696-40527-5-7C	696-40527-5-7	Green	Violet	.09/2.29	3.62/91.95	18/80.07	50	1,000
696-40527-5-9C	696-40527-5-9	Green	White	.09/2.29	3.62/91.95	18/80.07	50	1,000
696-40527-6-0C	696-40527-6-0	Blue	Black	.09/2.29	3.62/91.95	18/80.07	50	1,000
696-40527-6-2C	696-40527-6-2	Blue	Red	.09/2.29	3.62/91.95	18/80.07	50	1,000
696-40527-6-4C	696-40527-6-4	Blue	Yellow	.09/2.29	3.62/91.95	18/80.07	50	1,000
696-40527-6-7C	696-40527-6-7	Blue	Violet	.09/2.29	3.62/91.95	18/80.07	50	1,000
696-40527-6-9C	696-40527-6-9	Blue	White	.09/2.29	3.62/91.95	18/80.07	50	1,000
696-40527-8-0C	696-40527-8-0	Slate	Black	.09/2.29	3.62/91.95	18/80.07	50	1,000
696-40527-8-2C	696-40527-8-2	Slate	Red	.09/2.29	3.62/91.95	18/80.07	50	1,000
696-40527-8-4C	696-40527-8-4	Slate	Yellow	.09/2.29	3.62/91.95	18/80.07	50	1,000
696-40527-8-9C	696-40527-8-9	Slate	White	.09/2.29	3.62/91.95	18/80.07	50	1,000

For use in temperatures ranging from -40° F to 185° F (-40° C to 85° C).

Ty-Rap® Striped-Colored Cable Tie Kits



STD. PKG. CAT. NO.	DESCRIPTION	STD. PKG. QTY.
650-40587	Pouch only	1
650-40587-1	Pouch with Ty-Rap® cable tie assortment 1 bag each of 50 each (1,250 total)	1
650-40587C	Cloth pouch only	1
650-40587CF	Cloth pouch with 1 bag of 50 each Ty-Rap® cable ties (1,250 total)	1
650-40587M	Mini pouch only	1
650-40587MF	Mini pouch filled with assortment of Ty-Rap® cable ties (50 each)	1

Identification Tags, Cable Ties and Accessories

Keep your cables clearly identified!

Ty-Rap® 6.6 Nylon Identification Ties

Self-locking Ty-Rap® identification ties are available in both single and multiple configurations. They can be marked with the special Thomas & Betts marking pen (see **page C-14**) that immediately produces a permanent legend, or they can be heat stamped. Because the ties serve the dual purpose of tying and identifying, you will achieve extra economies. They can be applied with the standard Ty-Rap® tying tools used for regular ties.

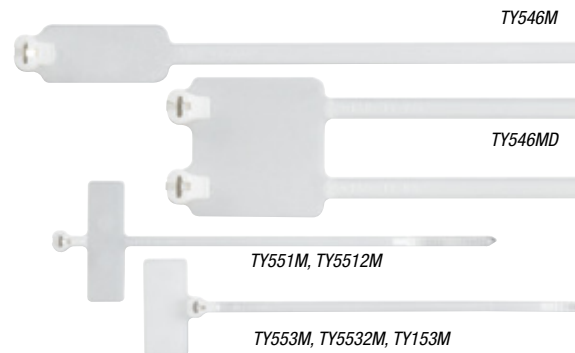

STD CAT. NO.	BULK CAT. NO.	BODY WIDTH IN./MM	TOTAL LENGTH IN./MM	MAX. WIRE BUNDLE IN./MM	MILITARY STANDARD PART NO.	MARKING PAD SIZE IN./MM. W X H	TENSILE STRENGTH LBS./N	STD. PKG. QTY.	BULK PKG. QTY.
TY551M	TY51M	.09/2.29	3.60/91.44	.63/16.00	MS3368-5	1 x .313	18/80.07	100	500
TY5512M	TY512M*	.09/2.29	8.30/210.82	2.00/50.80	—	1 x .313	18/80.07	100	1,000
TY553M	TY53M	.09/2.29	4.00/101.6	.63/16.00	—	.813 x .359	18/80.07	100	500
TY5532M	TY532M	.09/2.29	8.40/213.36	2.00/50.80	—	.813 x .359	18/80.07	100	1,000
—	TY153M	.10/2.54	4.35/110.49	.63/16.00	—	.781 x 1	18/80.07	—	500
TY546M	TY46M	.18/4.57	7.10/180.34	1.75/44.45	MS3368-1	.5 x .875	50/222.40	100	1,000
TY548M	TY48M*	.19/4.83	14.20/360.68	4.00/101.6	MS3368-2	.5 x 2.125	50/222.40	100	1,000
TY546MD	TY46MD*	.19/4.83	7.25/184.15	1.75/44.45	MS3368-3	1.172 x 1	50/222.40	50	500
TY546MT	TY46MT*	.19/4.83	7.25/184.15	1.75/44.45	MS3368-4	1.210 x 1	50/222.40	100	500
TY546MF	TY46MF	.19/4.83	7.25/184.15	1.75/44.45	—	2.48 x 1	50/222.40	50	250

*Nylon 6.6 UV weather-resistant version available (add suffix X).

For use in temperatures ranging from -40° F to 185° F (-40° C to 85° C).

• Natural nylon color

Custom Heat Stamping

Thomas & Betts Custom Heat Stamping provides an economical way to fasten and identify cable bundles. Mark nylon cable ties, identification cable ties, and identification plates to suit your application.

- 1/16", 1/8", 3/16" characters available
- Standard type — Gothic Capitol
- Character sizes can be mixed from line to line on Identification cable ties
- Alphanumeric and sequential numbering available
- Six-digit sequential numbering available in 1/8" characters
- Eight-digit sequential numbering available in 1/16" and 3/16" characters
- Special logos and different type styles can be accommodated when camera-ready artwork is provided



For heat stamping quotations, contact Technical Services at 888.862.3289.

- Minimum order quantity is 3,000 pieces per part number and message
- Lead time is 8–10 weeks

Identification Tags, Cable Ties and Accessories

Stay organized!

Identification Tags

Ranging in length from 1.25" to 2.5", the identification plates are secured to the cable with Ty-Rap® ties. They are composed of .010"- and .015"-thick nylon 6.6, and have a surface that can be marked easily. Thomas & Betts offers custom heat stamping of your plates at the factory.

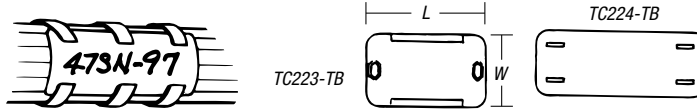

TC123-TB

BULK CAT. NO.	WIDTH IN./MM	LENGTH IN./MM	THICKNESS IN./MM	MAX. CABLE BUNDLE DIA. IN./MM	# TIE SLOTS	BULK PKG. QTY.
TC123-TB	.75/19.05	1.25/31.75	.01/.25	.19/4.83	3	1,000
TC124-TB	.75/19.05	1.50/38.10	.01/.25	.19/4.83	3	1,000
TC125-TB	.75/19.05	1.75/44.45	.01/.25	.19/4.83	3	1,000
TC126-TB	.75/19.05	2.00/50.80	.01/.25	.19/4.83	3	1,000
TC128-TB	.75/19.05	2.50/63.50	.01/.25	.19/4.83	3	1,000
TC223-TB	.75/19.05	1.28/32.51	.02/.51	.19/4.83	2	1,000
TC224-TB	.75/19.05	1.50/38.10	.02/.51	.19/4.83	2	1,000
TC225-TB	.75/19.05	1.75/44.45	.02/.51	.19/4.83	2	1,000
TC226-TB	.75/19.05	2.00/50.80	.02/.51	.19/4.83	2	1,000
TC228-TB	.75/19.05	2.50/63.50	.02/.51	.19/4.83	2	1,000

For use in temperatures ranging from -40° F to 185° F (-40° C to 85° C).

• Natural nylon color

Mark and bundle simultaneously!

Snap-On Identification Marker Tag



Snaps onto the head of a conventional cable tie to convert it to an identification tie.

- When snapped onto the tie head, the tag is conveniently held in place until it is permanently fastened
- Offers maximized inventory control because the I.D. tag will accommodate different tie lengths and materials

- Enables marking and bundling to be done in one operation
- The marking can be made with a Thomas & Betts permanent marking pen, Cat. No. WT163M-1
- The identification tags are sold separately and can be conveniently snapped on the cable ties at the assembly location just before being installed on the bundle
- Made of natural nylon 6.6

STD. CAT. NO.	BULK CAT. NO.	DESCRIPTION	MARKING PAD SIZE W X H (IN./MM)	PKG. QTY.	PKG. QTY.
TC523	TC23	Snaps onto the heads of all miniature 18 lbs. (80.07 N) series cable ties	1 x .35/25.40 x 889.00	100	1,000
TC524	TC24	Snaps onto the heads of all intermediate 30 (133.40N) & 40 (177.90N) lbs. series cable ties	1 x .50/25.40 x 500.00	100	1,000
TC525	TC25	Snaps onto the heads of all standard 50 lbs. series cable ties	1 x .50/25.40 x 500.00	100	1,000

• Natural nylon color

Ty-Rap® Marking Pen



- Permanent ink for long life on nylon cable ties and tags
- Fine-point tip for easy cable tie and tag marking

CAT. NO.	COLOR INK	STD. PKG. QTY.
WT163M-1	Black	1

Mounting Bases, Cable Ties and Accessories

Great for use with screws, nuts and bolts for secure fastening to surfaces.

Ty-Rap® 6.6 Nylon Mounting Head Ties — Natural



STD. CAT. NO.	BULK CAT. NO.	BODY WIDTH IN./MM	LENGTH IN./MM	MAX. WIRE BUNDLE DIA. IN./MM	MOUNTING HOLE	TENSILE STRENGTH LBS./N	STD. PKG. QTY.	BULK PKG. QTY.
TY533M	TY33M	.09/2.29	4.00/101.60	.63/16.00	#4	18/80.07	100	1,000
TY534M	TY34M	.14/3.56	6.00/152.40	1.13/28.70	#8	40/177.90	100	1,000
TY535M	TY35M	.18/4.57	7.80/198.12	1.75/44.45	#10	50/222.40	100	1,000
TY5354M	TY354M	.18/4.57	14.60/370.84	4.00/101.60	#10	50/222.40	100	1,000
—	TY635M	.19/4.83	7.80/198.12	1.77/44.96	#6	50/222.40	—	1,000
TYF535M	TYF35M	.19/4.83	7.24/183.90	1.77/44.96	#6	50/222.40	100	1,000
TY537M	TY37M	.30/7.62	13.90/353.06	3.50/88.90	¼"	120/533.80	50	500

For use in temperatures ranging from -40° F to 185° F (-40° C to 85° C).

• Natural nylon color

Ty-Rap® 6.6 Nylon Mounting Head Ties — Weather Resistant

The MX series cable ties are recommended for outdoor use. The addition of carbon black provides good ultraviolet resistance and prolongs the useful life of the cable tie.



STD. CAT. NO.	BULK CAT. NO.	BODY WIDTH IN./MM	LENGTH IN./MM	MAX. WIRE BUNDLE DIA. IN./MM	MOUNTING HOLE	TENSILE STRENGTH LBS./N	STD. PKG. QTY.	BULK PKG. QTY.
TY533MX	TY33MX	.09/2.29	4.00/101.60	.63/16.00	#4	18/80.07	100	1,000
TY534MX	TY34MX	.14/3.56	6.00/152.40	1.13/28.70	#8	40/177.90	100	1,000
TY535MX	TY35MX	.18/4.57	7.80/198.12	1.75/44.45	#10	50/222.40	100	1,000
TY5354MX	TY354MX	.18/4.57	14.60/370.84	4.00/101.60	#10	50/222.40	100	1,000
TY537MX	TY37MX	.30/7.62	13.90/353.06	3.50/88.90	¼"	120/533.80	50	500

For use in temperatures ranging from -40° F to 185° F (-40° C to 85° C).

• Black color

Ty-Rap® 6.6 Nylon Push-Mount Ties

For use in ⅜" and ¼" pre-drilled holes. Panel thickness .09" max. (TY554M)
Range .04-.156" (TY538M)

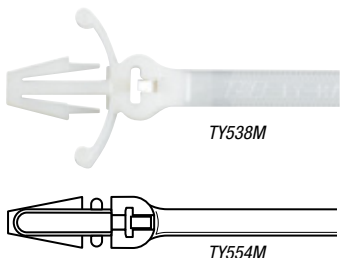

STD. CAT. NO.	BULK CAT. NO.	BODY WIDTH IN./MM	LENGTH IN./MM	MAX. WIRE BUNDLE DIA. IN./MM	MOUNTING HOLE	TENSILE STRENGTH LBS./N	STD. PKG. QTY.	BULK PKG. QTY.
TY554M	TY33MX	.14/3.56	5.96/151.38	1.13/28.70	⅜"	40/177.90	100	1,000
TY538M	TY38M*	.18/4.57	7.80/198.12	1.75/44.45	¼"	50/222.40	100	1,000

*Nylon 6.6 UV weather-resistant version available (TY38MX).

For use in temperatures ranging from -40° F to 185° F (-40° C to 85° C).

• Natural nylon color

Mounting Bases, Cable Ties and Accessories

Convenient one-piece design!

Ty-Rap® Tie for Panel and Chassis Mounting



- One-piece design, fast and convenient to use
- Clamping range of 1/16 to 2 3/8 inches reduces your inventory — one clamp replaces many
- Visually attractive — head resembles rivet
- Locking grooves maintain tight grip
- Lowers your installed cost

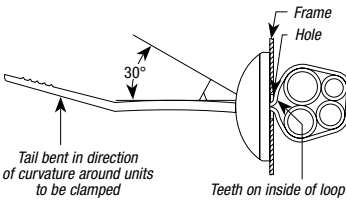

STD. CAT. NO.	BULK CAT. NO.	BODY WIDTH IN./MM	LENGTH IN./MM	MAX. WIRE BUNDLE DIA. IN./MM	HOLE SIZE IN./MM	STRENGTH LBS./N	STD. PKG. QTY.	BULK PKG. QTY.
TY541M	TY41M	.23/5.84	9.60/243.84	2.37/60.20	.32-.68/8.13-17.27	65/289.10	50	1,000
650-41600	—	.23/5.84	10.25/260.35	2.50/63.50	.32-.68/8.13-17.27	65/289.10	500	1,000
696-41848	—	.23/5.84	12.50/317.50	3.00/76.20	.32-.68/8.13-17.27	65/289.10	500	1,000

Note: Loop tie through hole in frame, around electrical, hydraulic, or air hoses to be clamped, and through head. Tighten and cut off with Ty-Rap tool. Visually looks like a rivet.

- For use in temperatures ranging from -40° F to 185° F (-40° C to 85° C).
- Black color

Choose from adhesive-backed, epoxy or screw mounting bases!

Two-Way Adhesive Mounting Bases

- Available in a variety of materials for both indoor and outdoor use
- One-piece molding — no lost parts
- Adhesive-backed with pressure-sensitive adhesive tape (where applicable)

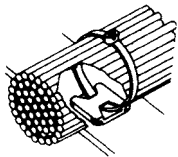

STD. PKG. CAT. NO.	BULK PKG. CAT. NO.	MOUNTING METHOD	MAX. TIE WIDTH ACCOM. IN./MM	LENGTH IN./MM	WIDTH IN./MM	MATERIAL	STD. PKG. QTY.	BULK PKG. QTY.
TC5342A	TC342A	SRA* Adhesive	.19	1.13/28.58	1.13/28.58	Nylon 6.6	100	1,000
—	TC342A-X	SRA* Adhesive	.19	1.13/28.58	1.13/28.58	UV Black	—	1,000
—	TC342	TC2PA [†]	.19	1.13/28.58	1.13/28.58	Nylon 6.6	—	1,000
—	TC342X	TC2PA [†]	.19	1.13/28.58	1.13/28.58	UV Black	—	1,000
—	TC342A-FR	SRA* Adhesive	.19	1.13/28.58	1.13/28.58	Flame-Retardant Nylon	—	1,000
—	TC342AH-TFR	Acrylic Adhesive	.19	1.13/28.58	1.13/28.58	Black High-Temp Flame-Retardant Nylon	—	1,000

Temperature Rating: 32° F to 120° F (0° C to 48° C) *Synthetic Rubber Adhesive [†]TC2PA Adhesive sold separately

Note: See product expiration date on package. Periodically check product for adhesion and replace as needed. Product is for wire management only and is not intended for use as a primary support of wire, cable, etc.

Mounting Bases, Cable Ties and Accessories

Select the four-way configuration you need! Four-Way Adhesive Mounting Base

- Eliminates errors in premounting the base with respect to its orientation to wire bundle direction
- For synthetic rubber adhesive (SRA), allow 15-minute setting time for maximum adhesion performance
- For acrylic adhesive, allow 24- to 72-hour setting time for maximum adhesion performance (acrylic-adhesive mounting bases may be re-positioned initially before the adhesive has set)

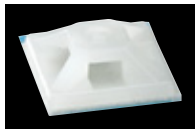

Four-Way Mini Base



Large Four-Way Base

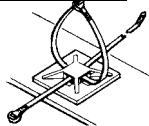
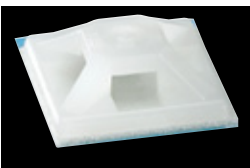

STD. PKG. CAT. NO.	BULK PKG. CAT. NO.	MOUNTING METHOD	MAX. TIE WIDTH ACCOM.	LENGTH IN./MM	WIDTH IN./MM	MATERIAL	STD. PKG. QTY.	BULK PKG. QTY.
4-Way Adhesive Mounting Base								
TC5345A	TC345A	SRA* Adhesive	.19	1.13/28.58	1.13/28.58	Nylon 6.6	100	1,000
—	TC345AFR	SRA* Adhesive	.19	1.13/28.58	1.13/28.58	Flame-Retardant Nylon	—	1,000
TC5345AX	TC345AX	SRA* Adhesive	.19	1.13/28.58	1.13/28.58	UV Black	100	1,000
TC5345AHTFR	—	Acrylic Adhesive	.19	1.13/28.58	1.13/28.58	Black High-Temp Flame-Retardant Nylon	100	1,000
—	TC345	TC2PA/Screws	.19	1.13/28.58	1.13/28.58	Nylon 6.6	—	1,000
4-Way Mini Base								
TC050X050A-C	TC050X050A	SRA* Adhesive	.10	.5/12.70	.5/12.70	Nylon 6.6	100	1,000
TC5344A	TC344A	SRA* Adhesive	.14	.75/19.05	.75/19.05	Nylon 6.6	100	1,000
TC5344AX	TC344AX	SRA* Adhesive	.14	.75/19.05	.75/19.05	UV Black	100	1,000
TC5344	TC344	Screw Mount	.14	.75/19.05	.75/19.05	Nylon 6.6	100	1,000
Large 4-Way Base								
TC150X150A-L	TC150150A	SRA* Adhesive	.19	1.5/38.10	.50/38.10	Nylon 6.6	50	500
TC150X150AX-L	TC150X150AX	SRA* Adhesive	.19	1.5/38.10	.50/38.10	UV Black	50	500
—	TC200X200	Screw Mount	.30	2.0/50.80	2.0/50.80	Nylon 6.6	50	500
TC200X200A-L	TC200X200A	SRA* Adhesive	.30	2.0/50.80	2.0/50.80	Nylon 6.6	50	500
—	TC368	Screw Mount	.75	2.0/50.80	2.0/50.80	Nylon 6.6	—	500
—	TC368A	SRA* Adhesive	.75	2.0/50.80	2.0/50.80	Nylon 6.6	—	500

• Storage/Service Temperature: 32° F to 120° F (0° C to 48° C)

• Application Temperature: 65° F to 100° F (18° C to 37° C)

• Surface Preparation: Surface should be cleaned with alcohol-based (IPA) cleaner before application

*Synthetic Rubber Adhesive

Note: See product expiration date on packages with adhesive. Periodically check product for adhesion and replace as needed.

Product is for wire management only and is not intended for use as a primary support of wire, cable, etc.

Two-and Four-Way Adhesive Mounting Base



- 4-way base for cable ties up to .184" maximum width and a two-way base for ties up to .301" maximum width
- May also be mounted with #8 size screw (2 holes)

STD. PKG. CAT. NO.	BULK PKG. CAT. NO.	MOUNTING METHOD	MAX. TIE WIDTH ACCOM.	LENGTH IN./MM	WIDTH IN./MM	MATERIAL	STD. PKG. QTY.	BULK PKG. QTY.
TC5347A	TC347A	SRA* Adhesive	.30	1.13/28.58	1.13/28.58	Nylon 6.6	100	1,000
TC5347AX	—	SRA* Adhesive	.30	1.13/28.58	1.13/28.58	UV Black	100	—
—	TC347	TC2PA/Screws	.30	1.13/28.58	1.13/28.58	Nylon 6.6	—	1,000
—	TC347FR	TC2PA/Screws	.30	1.13/28.58	1.13/28.58	Flame-Retardant	—	1,000
—	TC347X	TC2PA/Screws	.30	1.13/28.58	1.13/28.58	UV Black	—	1,000

Temperature Rating: 32° F to 120° F (0° C to 48° C) *Synthetic Rubber Adhesive

Note: See product expiration date on packages with adhesive. Periodically check product for adhesion and replace as needed.

Product is for wire management only and is not intended for use as a primary support of wire, cable, etc.

Mounting Bases, Cable Ties and Accessories

Great for securing cables!

One-Piece Mounting Clamp



- Provides a fast and convenient method of securing bundles
- Single-piece design offers reduced installation time and maximized inventory control
- Integral top cover incorporates a unique ratchet design that is fully adjustable and releasable
- Available in a pressure-sensitive adhesive or screw mount design

STD. PKG. CAT. NO.	BULK PKG. CAT. NO.	BASE STYLE	MAXIMUM HEIGHT (IN.)	CLAMPING AREA		STD. PKG. QTY.	BULK PKG. QTY.
				MINIMUM IN./MM	MAXIMUM IN./MM		
TC5349A-TB	TC349A-TB	SRA* Adhesive	.57	.18 x .24/4.57 x 6.10	.035 x .24/.89 x 6.10	100	1,000
TC5350A-TB	TC350A-TB	SRA* Adhesive	.89	.20 x .59/5.08 x 14.99	.45 x .59/11.43 x 14.99	100	1,000
TC5350-TB	—	Screw Mount (#8)	.89	.20 x .59/5.08 x 14.99	.45 x .59/11.43 x 14.99	100	1,000

• Natural nylon color. *Synthetic Rubber Adhesive Product Base is .94" x .94" (23.88 x 23.88 mm)

For adhesive-back bases, temperature rating is 32° F to 120° F (0° C to 48° C) For non-adhesive-back bases, temperature rating is -40° F to 185° F (-40° C to 85° C)

Note: See product expiration date on packages with adhesive. Periodically check product for adhesion and replace as needed. Product is for wire management only and is not intended for use as a primary support of wire, cable, etc.

Simple to install!

Snap-In Mounting Base for Preassembled Ties



Hole for #6 screw

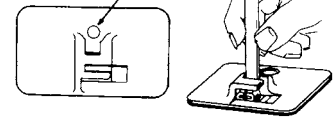

STD. PKG. CAT. NO.	BULK PKG. CAT. NO.	MOUNTING METHOD	MAX. TIE WIDTH ACCOM.	LENGTH IN./MM	WIDTH IN./MM	MATERIAL	STD. PKG. QTY.	BULK PKG. QTY.
TC5353A	TC353A	SRA* Adhesive	.190	2.00/50.80	1.00/25.40	Nylon 6/6	25	500

• Natural nylon color.
Temperature Rating: 32° F to 120° F (0° C to 48° C).
*Synthetic Rubber Adhesive.

Note: See product expiration date on package. Periodically check product for adhesion and replace as needed. Product is for wire management only and is not intended for use as a primary support of wire, cable, etc.

Great for securing cables!

Aluminum Mounting Plates

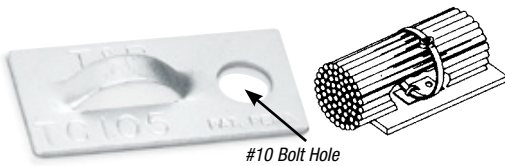

#10 Bolt Hole

STD. PKG. CAT. NO.	MOUNTING METHOD	WIDTH ACCOM.	MAX. TIE LENGTH ACCOM.	WIDTH IN./MM	MATERIAL	BULK PKG. QTY.
TC105	TC2PA/Screws	.190	1.00/25.40	.50/12.70	Aluminum	1,000
TC824-TB	TC2PA	.190	1.38/34.93	.38/.38	Aluminum	1,000
650-41349*	TC2PA/Screws	.190	1.38/34.93	.38/.38	Aluminum	1,000
650-41863	Adhesive	.190	1.38/34.93	.38/.38	Aluminum	1,000

Temperature Rating: 32° F to 150° F (0° C to 66° C). *650-41349 has two holes for mounting.

Note: See product expiration date on package. Periodically check product for adhesion and replace as needed. Product is for wire management only and is not intended for use as a primary support of wire, cable, etc.

Super strong adhesive!

Mounting Base Adhesive



STD. PKG. CAT. NO.	DESCRIPTION	STD. PKG. QTY.
TC2PA	Consists of one tube of adhesive and activator	1

Note: See product expiration date on package. Periodically check product for adhesion and replace as needed. Product is for wire management only and is not intended for use as a primary support of wire, cable, etc.

Mounting Bases, Cable Ties and Accessories

Saddle Support Base

This mounting base provides a saddle for the wire run. Ty-Rap® tie is threaded under bundle and tied in usual manner.
Note: For additional materials, see Technical Services.



TC5141



TC5142

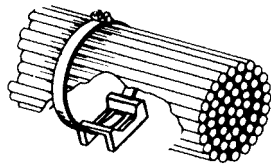

STD. PKG. CAT. NO.	BULK PKG. CAT. NO.	MOUNTING METHOD	MAXIMUM TIE WIDTH ACCOM.	WIDTH IN./MM	LENGTH IN./MM	STD. PKG. QTY.	BULK PKG. QTY.
—	TC140	#4 Pan Head	.091	.344/8.74	.563/14.30	—	500
TC5141	TC141**	#6 Pan Head	.190	.439/11.15	.672/17.07	100	500
TC5142	TC142*	#10 Pan Head	.301	.563/14.30	.922/23.42	100	500

* Add suffix FR for flame-retardant material (TC141 only).

* Add suffix X for UV Black material.

• Natural nylon color.

For use in temperatures ranging from -40° F to 185° F (-40° C to 85° C).

Multiple-Bundle Mounting Strips

These nylon mounting strips for parallel installation of wire bundles can accommodate up to six closely spaced bundles.

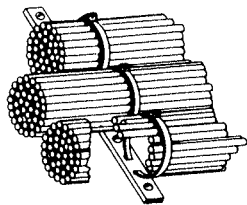

STD. PKG. CAT. NO.	MAXIMUM MOUNTING METHOD	TIE WIDTH ACCOM.	WIDTH IN./MM	LENGTH IN./MM	CAPACITY (BUNDLES)	MIL. STD. PART NO.	BULK PKG. QTY.
TC1101	#6 Screws	.190	.50/12.70	1.75/44.45	1	MS3339-1	100
TC1102	#6 Screws	.190	.50/12.70	3.00/76.20	2	MS3339-2	100
TC1103	#6 Screws	.190	.50/12.70	4.25/107.95	3	MS3339-3	100
TC1104	#6 Screws	.190	.50/12.70	5.50/139.70	4	MS3339-4	100
TC1105	#6 Screws	.190	.50/12.70	6.75/171.45	5	MS3339-5	100
TC1112	#6 Screws	.301	.63/15.88	9.60/243.84	6	MS3339-11	100
TC1113	#6 Screws	.301	.63/15.88	2.10/53.34	1	MS3339-6	100
TC1114	#6 Screws	.301	.63/15.88	3.60/91.44	2	MS3339-7	100
TC1115	#6 Screws	.301	.63/15.88	5.10/129.54	3	MS3339-8	100
TC1116	#6 Screws	.301	.63/15.88	6.60/167.64	4	MS3339-9	100
TC1117	#6 Screws	.301	.63/15.88	8.10/205.74	5	MS3339-10	100

• Natural nylon color.

For use in temperatures ranging from -40° F to 185° F (-40° C to 85° C).

Provides a mounting range for bundles from 1/4" through 4" in diameter!

Single-Bundle Mounting Base

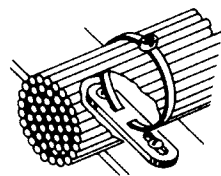

STD. PKG. CAT. NO.	BULK PKG. CAT. NO.	MOUNTING METHOD	MAXIMUM TIE WIDTH ACCOM. IN./MM	WIDTH IN./MM	LENGTH IN./MM	STD. PKG. QTY.	BULK PKG. QTY.
—	TC101	#10 Screws	.190/4.83	.500/12.7	2.00/50.80	—	1,000
TC503	TC103	1/4" Screws	.301/7.65	.625/15.88	3.08/78.23	100	500

The TC101 and TC103 nylon bases provide a mounting range for bundles from 1/4" through 4" in diameter.

One mounting hole is slotted to permit adjustment of the bundle position up to the time of actual bundle installation.

• Natural nylon color.

For use in temperatures ranging from -40° F to 185° F (-40° C to 85° C).

Mounting Bases, Cable Ties and Accessories

Permits vertical stacking!

Ty-Rap® Mounting Blocks

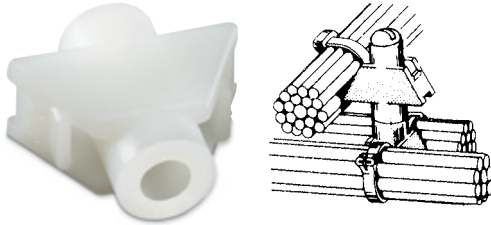

BULK PKG. CAT. NO.	MOUNTING HOLE SIZE	TIE WIDTH ACCOM.	MAXIMUM WIDTH IN./MM	LENGTH IN./MM	BULK PKG. QTY.
TC115-TB	#10	.190/4.83	.47/11.91	1.00/25.40	1,000

Mounting blocks permit vertical stacking and can be used in any direction.
 • Natural nylon color.
 For use in temperatures ranging from -40° F to 185° F (-40° C to 85° C).

Meets military specs as a support in bulkheads and walls!

Right-Angle Bundle Support

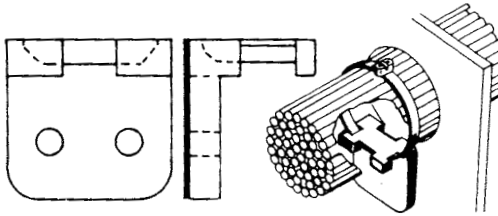

BULK PKG. CAT. NO.	TIE WIDTH ACCOM.	MAXIMUM WIDTH IN./MM	LENGTH IN./MM	BULK PKG. QTY.
TC109	.19/4.83	.56/14.30	.44/11.13	200
TC106	.30/7.62	1.00/25.40	1.00/25.40	1,000

This style meets Military Specification requirements as a support at holes in bulkheads and walls. (MS3341)
 • Natural nylon color.
 For use in temperatures ranging from -40° F to 185° F (-40° C to 85° C).

Mount bundles on either side!

Ty-Rap® Stand-Off Brackets

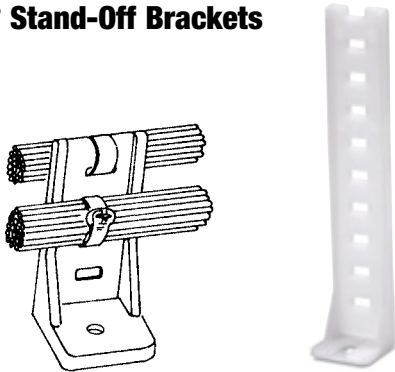

STD. PKG. CAT. NO.	MAXIMUM TIE WIDTH ACCOM.	WIDTH IN./MM	LENGTH IN./MM	STD. PKG. QTY.
TC375	.19/4.83	.75/19.05	3.65/92.71	100
TC375X (WEATHERABLE)	.19/4.83	.75/19.05	3.65/92.71	100
TC376	.19/4.83	.67/17.01	1.75/44.45	100

These brackets permit bundles to be mounted on either side. They also serve as means to raise bundles off the surface.
 • Natural nylon color.
 For use in temperatures ranging from -40° F to 185° F (-40° C to 85° C).
 Weatherable nylon is black.

Ideal for high-density packaging!

Low-Profile Two-Way Miniature Mounting Bases

- Simply slip Ty-Rap® cable tie under slot in fastened mount, and attach bundle

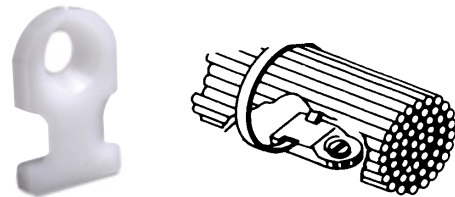

STD. PKG. CAT. NO.	BULK PKG. CAT. NO.	MOUNTING METHOD	MAXIMUM TIE WIDTH ACCOM.	WIDTH IN./MM	LENGTH IN./MM	STD. PKG. QTY.	BULK PKG. QTY.
TC502	TC102	#8 screw	.19	.50/12.70	.75/19.05	100	1,000
—	TC104	#5 screw	.09	.32/8.03	.41/10.31	—	1,000
—	TC804-TB	#2 screw	.09	.32/8.03	.40/10.31	—	1,000
—	TC112-TB	#8 screw	.19	.38/9.53	.75/19.05	—	1,000
—	TC812-TB	#10 screw	.19	.38/9.53	.75/19.05	—	1,000
—	TC814-TB	#5 screw	.19	.38/9.53	.75/19.05	—	1,000

Threaded insert permits screw to come from outside of mounting surface.
 • Natural nylon color.
 For use in temperatures ranging from -40° F to 185° F (-40° C to 85° C).

Mounting Bases, Cable Ties and Accessories

Installs in-line with the wire bundle!

In-Line Mounting Base

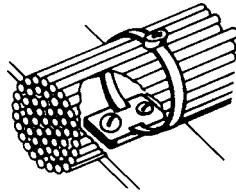

BULK CAT. NO.	MOUNTING METHOD	WIDTH ACCOM. IN./MM	MAX. TIE WIDTH IN./MM	LENGTH IN./MM	BULK PKG. QTY.
TC815-TB	#10 screws	.30/7.62	.75/19.05	1.13/28.58	500

A standard 2-hole base that installs in-line with the wire bundle that conceals it.
 • Natural nylon color.
 For use in temperatures ranging from -40° F to 185° F (-40° C to 85° C).

Miniature Base

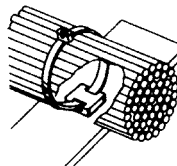

BULK PKG. CAT. NO.	MOUNTING METHOD	MAX. TIE WIDTH ACCOM. IN./MM	LENGTH IN./MM	WIDTH IN./MM	MATERIAL	BULK PKG. QTY.
TC817-TB	TC2PA	.19	.44/11.10	.44/11.10	Nylon 6/6	1,000

• Natural nylon color.
 For use in temperatures ranging from -40° F to 185° F (-40° C to 85° C).

Handles ties installed in either direction!

Low-Profile Four-Way Mounting Base

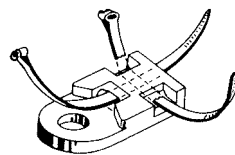

STD. PKG. CAT. NO.	BULK PKG. CAT. NO.	MOUNTING METHOD	MAXIMUM TIE WIDTH ACCOM. IN./MM	WIDTH IN./MM	LENGTH IN.	STD. PKG.	BULK PKG.
—	TC826-TB*	#8 screw	.19	.50/12.70	1/25.40	—	1,000
TC5828	TC828-TB*	#8 screw	.19	.39/9.91	.88/22.23	100	1,000

The TC826-TB mounting base can be used to tie bundles running parallel or perpendicular to length of base.
 The TC828-TB mounting plate also handles ties installed in either direction and is somewhat smaller than TC826.
 *Natural nylon color is standard. Replace TB with O suffix for black color.
 For use in temperatures ranging from -40° F to 185° F (-40° C to 85° C).

Firmly locks into position when projecting pin is pushed into the mounting hole.

Self-Riveting Base

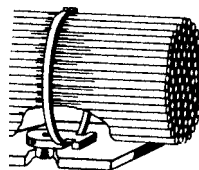

BULK CAT. NO.	MOUNTING HOLE PKG. SIZE	MAX. TIE WIDTH ACCOM. IN./MM	WIDTH IN./MM	LENGTH IN./MM	MATERIAL	BULK PKG. QTY.
TC116-TB	.146	.190	.5/12.7	.75/19.05	Nylon 6.6 (Red)	1,000
TC116-0	.146	.190	.5/12.7	.75/19.05	Nylon 6.6 (Black)	1,000
TC118-TB	.169	.190	.5/12.7	.75/19.05	Nylon 6.6 (Blue)	1,000
TC120	.196	.190	.5/12.7	.75/19.05	Nylon 6.6 (Yellow)	1,000

Slip tie under base to attach bundle.
 For use in temperatures ranging from -40° F to 185° F (-40° C to 85° C).

Mounting Bases, Cable Ties and Accessories

Push-In and Bolted Bases

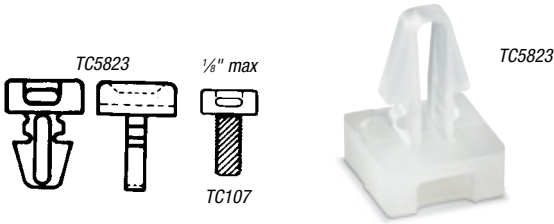

STD. PKG. CAT. NO.	STD. PKG. CAT. NO.	MOUNTING HOLE SIZE	MAXIMUM TIE WIDTH ACCOM.	WIDTH IN./MM	LENGTH IN./MM	STD. PKG. QTY	BULK PKG. QTY
TC5823	TC823-TB	1/4	.190	.44/11.13	.63/15.88	100	1,000
—	TC107†	#10-32 thd	.190	.44/11.13	.69/15.88	—	1,000

† Not UL Recognized.
 • Natural nylon color.
 For use in temperatures ranging from -40° F to 185° F (-40° C to 85° C).

Snap-In Mounting Base Cap

Snap-in, premountable base for securing wire bundles in cabinets maintains the attractive external appearance of the equipment housing — TC121 Snap-Cap.

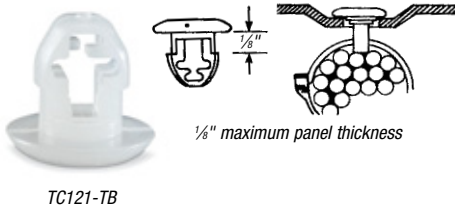

BULK PKG. CAT. NO.	MOUNTING HOLE PKG. SIZE	MAX. TIE WIDTH ACCOM.	WIDTH IN./MM	LENGTH IN./MM	MATERIAL	BULK PKG. QTY.
TC121-TB	.250	.190	.445/11.30	.415/10.54	Nylon 6.6	1,000
TCH121†	.250	.190	.445/11.30	.415/10.54	Nylon 6.6 Heat Stabilized	1,000
TCH121-0†	.250	.190	.445/11.30	.415/10.54	Nylon 6.6 Black Heat Stabilized	1,000

† Not UL Recognized.
 • Natural nylon color.
 Nylon 6.6 for use in temperatures ranging from -40° F to 185° F (-40° C to 85° C).
 Heat stabilized for use in temperatures ranging from -40° F to 221° F (-40° C to 105° C).

Weather resistant and transparent!

Aluminum Siding Clip

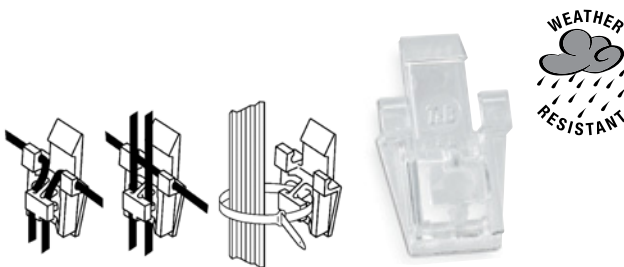

STD. PKG. CAT. NO.	WIRE ACCOMMODATION	STD. PKG. QTY.
TC201	1/8" Diameter Wire (2-pair station wire)	50

Material:
 • Transparent — Color and texture of siding shows through.
 • Material — Weather-resistant grade polycarbonate.
 • Designed to accommodate PITTSBURG INTERLOCK metal siding.
 • Accommodates wires both vertically and/or horizontally.
 • Provision for utilizing Ty-Rap® cable ties to secure large diameter bundles.

Mounting Bases, Cable Ties and Accessories

Designed for indoor or outdoor use and heavy-duty applications.

Framing Channel Clamp

- Quick and easy to install on existing metal framing channel
- Installs with a push and twist
- Smooth design protects cable insulation
- Takes range of cable diameters

When fastening wire bundles, cables or hoses to framing channels, you can cut costs considerably by using the Ty-Rap® cable clamp. It's made of smooth, weather-resistant nylon and designed to protect cable insulation and hoses from wear or damage, which can occur with metal clamps. The clamp may be used for both indoor or outdoor applications. It quickly installs in the framing channel with a simple push and twist. It requires no screws, nuts or tools. The clamp fits all 1½" and 1¾" channels regardless of channel depth.



STD. PKG. CAT. NO.	CHANNEL SIZE (IN.)	MAXIMUM TIE WIDTH ACCOM.	STD. PKG. QTY.
TC5363X	1½ & 1¾	.301/7.65	50

• Made from high-impact weather-resistant black nylon
For use in temperatures ranging from -40° F to 185° F (-40° C to 85° C).

Specially designed head is range-taking.

Ty-Rap® Mounting Base for Masonry and Brick Surfaces

- Quick, easy installation without cumbersome adhesives or epoxies
- Provides a quick, easy and dependable means of attaching cable and wires to masonry surfaces
- Installs by tapping it into a drilled hole
- It's immediately ready to accept a cable tie and wire bundle — no tedious surface preparation; no waiting for adhesives to set
- Replaces a variety of anchors, clamps, screws and adhesives
- Designed for both indoor and outdoor applications
- Only two sizes to stock — reduces inventory

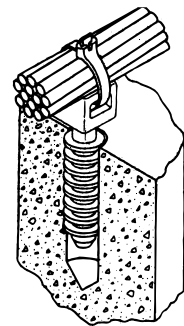

STD. PKG. CAT. NO.	HOLE SIZE IN MASONRY	MAXIMUM TIE WIDTH ACCOM.	STD. PKG. QTY.
TC5358	¼	.190/4.83	100
TC5359	⅜	.500/12.70	50

• Made of a special impact and ultraviolet-resistant black nylon
For use in temperatures ranging from -40° F to 185° F (-40° C to 85° C).

Weather resistant!

Ty-Rap® Mounting Base for Lashing Tie



- For use with lashing ties up to .500" width (i.e. TY5409)
- High impact

STD. PKG. CAT. NO.	MOUNTING METHOD	TIE WIDTH ACCOM.	MAXIMUM WIDTH IN./MM	LENGTH IN./MM	STD. PKG. QTY.
TC5355	#8 screw	.500/12.70	.750/19.05	1.750/44.45	25
TC5356	#10 screw	.500/12.70	.750/19.05	1.750/44.45	25
TC5357	¼" screw	.500/12.70	.750/19.05	1.750/44.45	25

• Black nylon construction
For use in temperatures ranging from -40° F to 185° F (-40° C to 85° C).

Mounting Bases, Cable Ties and Accessories

A fast and simple harnessing method for neat, versatile wire management.

Stud Mounting System

- Great for harnessing wires, cables and hoses to truck and trailer chassis
- Fast, easy installation, using standard 3/8" power drill and application tool or simply hammer on
- Unlimited harnessing flexibility using conventional T&B cable ties
- Custom drill bit quickly installs base to proper torque — won't crack or break mounting base due to being overtightened
- Unique 4-way multi-directional design
- 10-position harness capability
- Available for 3/8", 1/2", 5/8", and 3/4" stud/bolt sizes
- Self-tapping thread design for reliable installation onto stud
- High pull-out strength of 500+ lbs.

Thomas & Betts Stud Mount Fastening System is a fast and simple harnessing method for neat, versatile, cord, cable, hose, and wire management. Using a custom drill bit for your 3/8" power drill, the Stud Mount base is quickly attached onto a threaded stud or bolt to the proper torque—every time. The innovative "X" design of the base reliably supports many types of cable or hose assemblies using a wide range of conventional T&B cable ties. Designed with 10 separate lashing positions, the Stud Mount offers unlimited wire harnessing arrangements. T&B's Stud Mount is available in four convenient stud bolt sizes.



The Stud Mount Cable Fastening System includes a range of bases and the custom drill bit that mounts all sizes.



During installation, the custom Stud Mount drill bit application tool ejects itself from mounting base, ensuring proper torque and preventing cracking or breaking of the mount from being overtightened.



Virtually unlimited harnessing flexibility is provided in the unique 10-position harness design of the Stud Mount base.

BULK PKG. CAT. NO.	DESCRIPTION	STUD SIZE	MATERIAL	COLOR	BULK PKG.
XMNY-375-0-D	Mount Fastener	3/8"	Nylon, UV Stabilized	Black	500
XMNY-500-0-D	Mount Fastener	1/2"	Nylon, UV Stabilized	Black	500
XMNY-625-0-D	Mount Fastener	5/8"	Nylon, UV Stabilized	Black	500
XMNY-750-0-D	Mount Fastener	3/4"	Nylon, UV Stabilized	Black	500
WTXM	Application Tool	—	Tool Steel	—	1

• Material: Impact-resistant weatherable black nylon
For use in temperatures ranging from -40° F to 185° F (-40° C to 85° C).

Safety, Reusable and Double-Loop Cable Ties

Ideal for precision bundling!

Low-Profile All-Nylon 6.6 Ties

This fastener design from Thomas & Betts is ideal for use where clearance is a necessity and allows for easy pull-through in bulkheads and other tight spaces. Our contoured head eliminates snagging, and sharp edges are reduced by our safeguard walls.

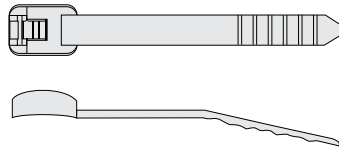

Low-profile contoured head compared with the profile of a common cable tie.

- Low-profile, contoured head reduces clearance required for the bundle and enhances the appearance of your harness
- The safeguard wall eliminates exposure to sharp edges
- The saddleback fits snug against the contour of the wiring harness
- Sizes and colors available to accommodate varying requirements

STD. PKG. CAT. NO.	BULK PKG. CAT. NO.	MATERIAL	BUNDLE RANGE DIA. IN./MM	TENSILE STRENGTH LBS./N	TIE LENGTH IN./MM	STRAP WIDTH IN./MM	STRAP THICK IN./MM	STD. PKG. QTY.	BULK. PKG. QTY.
—	SF100-18	Natural	.13/3.3–1.00/25.4	18/80.07	4.65/118.11	.095/2.41	.04/1.09	—	1,000
SF100-18X-100	SF100-18X	UV Black	.13/3.3–1.00/25.4	18/80.07	4.65/118.11	.095/2.41	.04/1.09	100	1,000
—	SF200-18	Natural	.13/3.3–2.00/50.8	18/80.07	8.10/205.74	.1/2.41	.04/1.09	—	1,000
—	SF200-18X	UV Black	.13/3.3–2.00/50.8	18/80.07	8.10/205.74	.1/2.41	.04/1.09	—	1,000
—	SF175-50	Natural	.19/4.8–1.75/44.45	50/222.4	7.70/195.58	.19/4.75	.05/1.22	—	1,000
—	SF175-50X	UV Black	.19/4.8–1.75/44.45	50/222.4	7.70/195.58	.19/4.75	.05/1.22	—	1,000
—	SF175-50FR	Flame Retardant	.19/4.8–1.75/44.45	50/222.4	7.70/195.58	.19/4.75	.05/1.22	—	1,000
—	SF300-50X	UV Black	.19/4.8–3.00/76.2	50/222.4	11.33/287.78	.19/4.75	.05/1.22	—	1,000
—	SF400-50	Natural	.19/4.8–4.00/101.6	50/222.4	14.53/369.06	.19/4.75	.05/1.22	—	1,000
—	SF400-120X	UV Black	.38/9.6–4.00/101.6	120/533.8	14.58/370.33	.30/7.62	.07/1.78	—	500

Use these ties again and again!

Ty-Rap® Reusable Ties

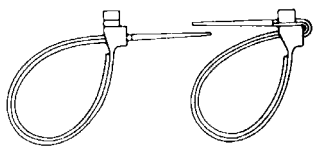

STD. PKG. CAT. NO.	BODY WIDTH IN./MM	LENGTH IN./MM	BUNDLE DIA. IN./MM	TENSILE STRENGTH LBS./N	STD. PKG. QTY.
TYR505	.18/4.57	7.50/190.50	1.75/1.75	50/222.40	100
TYR508	.18/4.57	14.30/363.22	4.00/101.60	50/222.40	100

For use in temperatures ranging from -40° F to 185° F (-40° C to 85° C).

- Natural nylon color

Double Loop 6.6 Nylon Tie

Advantages:

- Enables parallel routing of two cable bundles with one single cable tie!
- Halogen- and silicone-free to meet your application needs
- Quick and easy pull-through increases productivity, reduces operator fatigue

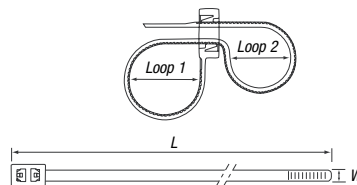

BULK PKG. CAT. NO.	LENGTH IN./MM	WIDTH IN./MM	BUNDLE DIAMETER RANGE		TENSILE STRENGTH (LB/N)	INSTALLATION TOOLING FOR ALL SIZES	BULK PKG.
			LOOP 1 IN./MM	LOOP 2 IN./MM			
TB-12-50RLDH	11.8/299.72	.19/4.83	.1/2.54–2.8/71.12	.1/2.54–2.7/68.58	50/222.4	ERG50	1,000

- Natural nylon color

For use in temperatures ranging from -40° F to 185° F (-40° C to 85° C).

Messenger and Lashing Ties and Straps

Resistant to UV light, chemicals, and lower in moisture absorption.

Weather-Resistant Nylon 12 Messenger Hanger and Hanger Straps (Releasable)

Nylon 12 is a lower moisture-absorbing material than 6.6 nylon — making the effect of water on properties much less.



STD. PKG. CAT. NO.	BODY WIDTH IN./MM	LENGTH IN./MM	MAX. WIRE BUNDLE DIA. IN./MM	HOOK MATERIAL	TENSILE STRENGTH LBS./N	STD. PKG. QTY.
Weather-Resistant Nylon 12 Messenger Hanger Straps (Releasable)						
TYM5412X	.5/12.7	12/304.8	3/76.2	Bronze	200/889.6	50
TYM5418X	.5/12.7	18/457.2	5/127	Bronze	200/889.6	25
TYM5423X	.5/12.7	24/609.6	7/177.8	Bronze	200/889.6	25
TYM5430X	.5/12.7	30/762.0	9/228.6	Bronze	200/889.6	25
TYM5412X-S	.5/12.7	12/304.8	3/76.2	304 Stainless Steel	200/889.6	50
TYM5418X-S	.5/12.7	18/457.2	5/127	304 Stainless Steel	200/889.6	25
TYM5423X-S	.5/12.7	24/609.6	7/177.8	304 Stainless Steel	200/889.6	25
TYM5430X-S	.5/12.7	30/762.0	9/228.6	304 Stainless Steel	200/889.6	25
TYM5436X-S	.5/12.7	36/914.4	11/279	304 Stainless Steel	200/889.6	25

STD. PKG. CAT. NO.	BODY WIDTH IN./MM	LENGTH IN./MM	MAX. WIRE BUNDLE DIA. IN./MM	HOOK MATERIAL	TENSILE STRENGTH LBS./N	STD. PKG. QTY.
Weather-Resistant Nylon 12 Hanger Strap (Releasable)						
TY54407X	.5/12.7	6.36/151.54	2/50.8	Steel	200/889.6	50
TY54413X	.5/12.7	13.75/349.25	4/101.6	Steel	200/889.6	25

The recommended maximum continuous static loading for the nylon 12 straps is 25 lbs. per strap. For best results, suggested spacing is 15". It's the responsibility of the user to determine whether or not their application meets our recommendation. Hook will accommodate 1/8" dia. messenger wire.

• Color – Black For use in temperatures ranging from -40° F to 176° F (-40° C to 80° C).

Heavy-Duty Lashing Tie (Releasable)



- Heavy-duty and made of weather-resistant nylon
- For use in temperatures ranging from -40° F to 176° F (-40° C to 80° C)

STD. PKG. CAT. NO.	BULK PKG. CAT. NO.	BODY WIDTH IN./MM	LENGTH IN./MM	MAX. WIRE BUNDLE DIA. IN./MM	TENSILE STRENGTH LBS./N	STD. PKG. QTY.	BULK PKG. QTY.
TY5409	TY409	.5/12.7	19/482.6	4.75/120.65	200/889.6	25	100



1-800-453-1692

www.aboveboardelectronics.com

Messenger and Lashing Ties and Straps

An absolute in chemical environments — and it floats!

Weather-Resistant Polypropylene Lashing Ties with Releasable Heads

- Excellent chemical resistance
- Buoyant — will float on most surfaces
- Made of black weather-resistant polypropylene for outdoor use
- Locking heads made of UV-resistant nylon
- For use in temperatures ranging from -40° F to 176° F (-40° C to 80° C)



STD. PKG. CAT. NO.	BODY WIDTH IN./MM	LENGTH IN./MM	MAX. WIRE BUNDLE DIA. IN./MM	TENSILE STRENGTH LBS./N	STD. PKG. QTY.
Weather-Resistant Polypropylene Lashing Tie (Releasable)					
TY5418PX	.5/12.7	18/457.2	5/127.0	150/667.2	25
TY5424PX	.5/12.7	24/609.6	7/177.8	150/667.2	25
TY5442PX	.5/12.7	42/1066.8	12/304.8	150/667.2	10
TY5460PX	.5/12.7	60/1524	18/457.2	150/667.2	10
Weather-Resistant Polypropylene Hanger Lashing Tie (Releasable)					
TY53418PX	.5/12.7	18/457.2		5	25

Weather-Resistant Polypropylene Strapping and Accessories

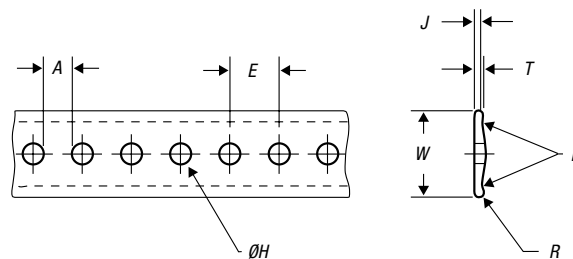

STRAPPING CAT. NO.	MATERIAL	DIMENSIONS (IN.)								STRAP-TITE BUCKLE	MOUNTING TAB	MACHINE SCREW
		A	B	E	H	J	R	T	W			
S2NY-096-0-C	Black Nylon	.091 ± .010	.189	.187	.096 ± .003	.023 ± .003	.016	.031 ± .003	.284 ± .012	—	—	#2
S4NY-167-0-C	Black Nylon	.145 ± .020	.189	.312	.167 ± .005	.033 ± .003	.022	.045 ± .003	.375 ± .010	—	—	#8
S6NY-203-0-C	Black Nylon	.187 ± .020	.189	.390	.203 ± .005	.045 ± .005	.030	.060 ± .005	.490 ± .015	B6NY-203-0-D	M6NY-265-0-D	#10



Request Info

1-800-453-1692

www.aboveboardelectronics.com

Deltec® Cable Tie and Support System

Designed to perform a minimum of 20 years outdoors down to -65° C.
The Deltec® Cable Tie and Support System

Lost-time accidents and downtime are often the result of using traditional metal bundling and support systems for high strength and harsh environment applications. Metal support systems can be both difficult and dangerous to install. They can also nick or cut through cable insulation. Insulation failures lead to dangerous and costly situations. There are few options outside of traditional metal for bundling and supporting cable that will withstand the harshest of environments and offer extended outdoor life.

In response to the demand for a better solution, Thomas & Betts engineers developed the Deltec® Cable Support System. The Deltec® System is safe and easy to install with a guaranteed weatherable life, even at temperatures as low as -85° F.

A three-piece, three-material engineered design provides the ideal solution for bundling in harsh outdoor environments. The Deltec® System combines the strength and rigidity of an injection-molded head with marine-grade copper barbs and a soft and pliable, stress-resistant, extruded body. The unique multi-piece design with separate head and strapping also allows installers to select and customize the strap length for any application. The Deltec® System provides the ultimate in cable support and management for your most demanding applications.



Advantages of the Deltec® System Include:

- Designed to perform a minimum of 20 years outdoors
- Continuous use temperature: -85° F to 194° F (-65° C to 90° C)
- No sharp edges
- Perfect for coaxial, fiber optic and all other communication and electrical conducting cables
- Total flexibility in length when using reel
- Extruded body provides total flexibility in length from 10" to 5,000 feet
- Made in the USA
- Rodents and other pests won't eat it
- Strap and Body: Weatherable acetal; offers superior resistance to sunlight, moisture and salt environments
- Locking Device: Marine-grade corrosion-resistant copper alloy
- Installation Temperature Range: -30° F to 150° F (-34° C to 66° C)
- Minimum Tensile Strength: 250 lbs. (1,211 N)
- Continuous Load: 20 lbs. (9.07 kg)

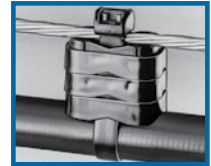

Extra security!

Deltec® Cable Tie with Double-Locking Head

The recommended maximum continuous static loading for the Deltec® straps is 20 lbs. per strap. For best results, suggested spacing is 15". It's the responsibility of the user to determine whether or not their application meets our recommendation.

Note: Use WT3D Tool for tensioning and cutoff.

Specifications

- Strap and Body: Weatherable acetal; offers superior resistance to sunlight, moisture and salt environments
- Locking Device: Marine-grade corrosion-resistant copper alloy
- Installation Temperature Range: -30° F to 150° F (-34° C to 66° C)
- Continuous Use Temperature: -85° F to 194° F (-65° C to 90° C)
- Minimum Tensile Strength: 250 lbs. minimum (1,211 N)
- Service Life: Designed to last a minimum of 20 years outdoors
- Continuous Load: 20 lbs. (9.07 kg)
- Color: Black



STD. PKG. CAT. NO.	BODY WIDTH IN./MM	LENGTH IN./MM	MAX BUNDLE DIA. IN./MM	TENSILE STRENGTH LBS./N	STD. PKG. QTY.
CSS-100	.5/12.70	10/254.00	3/76.20	250/1,112	50
CSS-135	.5/12.70	13.5/342.90	3.5/88.90	250/1,112	50
CSS-160	.5/12.70	16/406.40	4/101.60	250/1,112	50
CSS-270	.5/12.70	27/685.80	8/203.20	250/1,112	25

Deltec® Cable Tie and Support System

Cut to the length you need!

Deltec® Strap Dispenser on Reels



STD PKG. CAT. NO.	DESCRIPTION	TENSILE STRENGTH LBS./N	BODY WIDTH IN./MM	STD. PKG. QTY.
CSS-50R	50' Reel of Strap	250/1,112	.50/12.70	1
696-41794	1,000' Reel of Strap	250/1,112	.50/12.70	1
696-41952	3,500' Reel of Strap	250/1,112	.50/12.70	1

One spacer for any cable size!

Modular Stackable Cable Spacers

- Stackable for any desired spacing
- Less inventory — one catalog number
- ½" high



STD PKG. CAT. NO.	DESCRIPTION	STD. PKG. QTY.
TCP5255	Modular Stackable Spacer for Deltec® Straps	25
TCP360	For Coaxial Cable	100

- Made of weather-resistant polypropylene
- Color — Black

Heads for Deltec® strap!

Locking Heads



STD PKG. CAT. NO.	DESCRIPTION	STD. PKG. QTY.
CSS-LH	Heads only for Deltec® Strap	25
696-41795	Heads only for Deltec® Strap	1,000

- Made of weatherable acetal
- Color — Black

Secures cables to all types of surfaces.

Deltec® Base and Hanger



STD PKG. CAT. NO.	DESCRIPTION	STD. PKG. QTY.
CSS-B	Base for Deltec® Strap	50
CSS-H	Hanger for Deltec® Strap	50

- Made of zinc-plated steel

Install ties easily!

Installation/Cutting Tool

STD PKG. CAT. NO.	DESCRIPTION	RANGE	WT. EACH	STD. PKG. QTY.
WT3D	Installs self-locking Ty-Rap® cable ties, lashing ties and Deltec® System	.184 thru .500	8 oz.	1

Twist tool handle one-half turn to cut strapping.



Ty-Rap® High-Performance Stainless Steel Cable Ties

Engineered Ty-Rap® Tough to Withstand the World's Harshest Environments!



Ty-Rap®

Stainless Steel Cable Ties

Ball-Lock Ties

- Polyester-coated 316 grade (marine-grade) stainless steel
- Uncoated 302/304 grade stainless steel
- Uncoated 316 grade (marine-grade) stainless steel

Roller-Locking Ties

- Uncoated 302/304 grade stainless steel
- Uncoated 316 grade (marine-grade) stainless steel

Dual-Lock Ties

- Uncoated 304 grade stainless steel
- Also available in uncoated 316 grade stainless steel

Re-Usable Ties

- Nylon 11-coated 200/300 series stainless steel
- Also available in nylon 11-coated 316 grade stainless steel

Free-End Clamps

- Uncoated 201 grade stainless steel

Multi-Lok Stainless Steel Self-Locking Ties

- Nylon-coated 316 grade stainless steel
- Uncoated 316 grade stainless steel

Stainless Steel Strap Ties

- Uncoated 316 grade stainless steel

Ty-Rap® High-Performance Stainless Steel Cable Ties

Safe and easy to install! Designed for continuous exposure to salt spray, sunlight, petroleum and chemicals!

Ty-Rap® Polyester-Coated Stainless Steel Ball-Lock Cable Ties

Stainless steel offers excellent strength, durability and corrosion-resistance properties. But to stand up to the harshest environments in the world, such as those found on offshore drilling rigs, petroleum refineries, shipyards and chemical processing plants, even stainless steel needs an added layer of protection. That's why Ty-Rap® has added coated ties to its line of stainless steel cable ties. These new ties offer the same easy-to-install, low-profile, secure ball-lock mechanism as standard Ty-Rap® stainless steel ball-lock ties, but they're fully coated with a layer of rugged polyester to seal out salt, moisture, chemicals and UV radiation. Put these Ty-Rap® tough ties to the test against the elements in your harshest applications!

- 316 grade (marine-grade) stainless steel construction for strength and durability
- Fully coated with polyester to resist corrosion, UV radiation, temperature extremes, chemicals, impact, abrasion and cracking
- Rolled wire versus traditional slot steel to ensure no sharp edges
- Low-smoke, halogen-free polyester coating offers added personnel safety
- Pointed tail enables fast, easy insertion
- Low-profile ball in wedge-shaped head locks tie securely in place
- Wide operating temperature range of -40° F to 302° F (-40° C to 150° C)
- Certifications/Standards: Lloyds Register, DNV, GL, CE, RoHS



Fastening Systems — Ty-Rap® High-Performance Cable Ties, Tools & Accessories

CAT. NO.	LENTH (IN/MM)	WIDTH (IN/MM)	MAX. BUNDLE DIA. (IN/MM)	TENSILE STRENGTH (IN/MM)	STD. PKG. QTY.
316 Grade Stainless Steel — Fully Polyester Coated					
LS-4.6-200-C	7.9/201	.18/4.6	2/51	100/444.8	100
LS-4.6-260-C	10.2/259	.18/4.6	27/69	100/444.8	100
LS-4.6-360-C	14.3/362	.18/4.6	4/102	100/444.8	100
LS-4.6-520-C	20.5/521	.18/4.6	6/152	100/444.8	100
LS-4.6-680-C	26.8/679	.18/4.6	8/203	100/444.8	100
LS-7.9-200-C	7.9/201	.31/7.9	2/51	250/1112	50
LS-7.9-360-C	14.3/362	.31/7.9	4/102	250/1112	50
LS-7.9-520-C	20.5/521	.31/7.9	6/152	250/1112	50
LS-7.9-680-C	26.8/679	.31/7.9	8/203	250/1112	50

Ty-Rap® High-Performance Stainless Steel Cable Ties

Safe and easy to install!

Ty-Rap® Ball-Lock Stainless Steel Ties

These one-piece, self-locking stainless steel cable ties offer quick and easy installation — no crimping or folding required — and a strong, reliable lock. Choose among a variety of sizes and materials to meet all of your wire and cable bundling needs, even in the most extreme environments.

Fast, easy installation

- Self-locking — no time-consuming crimping or folding
- Stainless steel ball in low-profile, wedge-shaped head locks tie securely in place
- Angled tail enables fast, easy insertion
- Rounded edges and smooth surfaces protect installer's hands

Two materials suit a variety of environments

- 302/304 grade stainless steel for standard applications
- 316 grade (marine-grade) stainless steel for extra corrosion resistance

Typical Applications

- Offshore drilling
- Petrochemical processing
- Shipbuilding
- Food and beverage processing
- Pharmaceutical processing

Specifications

- Operating Temp. Range:
-112° F to 1,000° F (-80° C to 538° C)



Application Tool

DAS250 HAND TOOL

(Adjustable tension, automatic cut-off)



CAT. NO.	LENTH (IN/MM)	WIDTH (IN/MM)	MAX. BUNDLE DIA. (IN/MM)	TENSILE STRENGTH (IN/MM)	STD. PKG. QTY.
302/304 Grade Stainless Steel — Uncoated					
LS-4.6-200A	7.9/201	.18/4.6	2/51	100/444.8	100
LS-4.6-260A	10.2/259	.18/4.6	2.9/69	100/444.8	100
LS-4.6-360A	14.2/360	.18/4.6	4 /102	100/444.8	100
LS-4.6-520A	20.5/520	.18/4.6	6/152	100/444.8	100
LS-4.6-680A	26.7/679	.18/4.6	8/203	100/444.8	100
LS-4.6-840A	33.0/838	.18/4.6	10/254	100/444.8	100
LS-7.9-200A	7.9/201	.31/7.9	2/51	250/1112	50
LS-7.9-360A	14.2/360	.31/7.9	4/102	250/1112	50
LS-7.9-520A	20.5/520	.31/7.9	6/152	250/1112	50
LS-7.9-680A	26.7/679	.31/7.9	8/203	250/1112	50
LS-7.9-840A	33.0/838	.31/7.9	10/254	250/1112	50
LS-7.9-1010A	41.3/1050	.31/7.9	12.5/318	250/1112	50
316 Grade Stainless Steel — Uncoated					
LS-4.6-200B	7.9/201	.18/4.6	2/51	100/444.8	100
LS-4.6-260B	10.2/259	.18/4.6	2.7/69	100/444.8	100
LS-4.6-360B	14.2/360	.18/4.6	4 /102	100/444.8	100
LS-4.6-520B	20.5/520	.18/4.6	6/152	100/444.8	100
LS-4.6-680B	26.7/679	.18/4.6	8/203	100/444.8	100
LS-4.6-840B	33.0/838	.18/4.6	10/254	100/444.8	100
LS-7.9-200B	7.9/201	.31/7.9	2/51	250/1112	50
LS-7.9-360B	14.2/360	.31/7.9	4/102	250/1112	50
LS-7.9-520B	20.5/520	.31/7.9	6/152	250/1112	50
LS-7.9-680B	26.7/679	.31/7.9	8/203	250/1112	50
LS-7.9-840B	33.0/838	.31/7.9	10/254	250/1112	50
LS-7.9-1010B	41.3/1050	.31/7.9	12.5/318	250/1112	50

Ty-Rap® High-Performance Stainless Steel Cable Ties

Multiple barb lock design!

Ty-Rap® Multi-Lok Stainless Steel Self-Locking Cable Ties

Fire hazards — corrosive environments — temperature extremes — for many cable bundling applications, plastic ties are simply inadequate—or even dangerous.

That's why we developed stainless steel Multi-Lok Ties. Unaffected by fire, UV or extreme temperatures, corrosion-resistant Multi-Lok Ties provide a safe, strong, worry-free hold.

Quickly and easily applied by hand or with the Thomas & Betts Cable Tie Tensioner or Tensioning Hook, Multi-Lok Ties feature a unique, self-locking, multiple-locking system that holds in excess of 200 lbs.

Nylon II coating is halogen-free and non-toxic black. This weather-resistant coating is unaffected by UV sunlight. This adds resistance to corrosion, chemicals and weathering. Preferred stainless steel strap eliminates sharp edges.

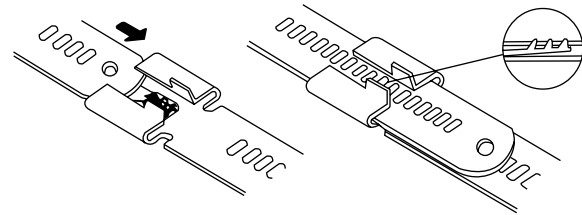
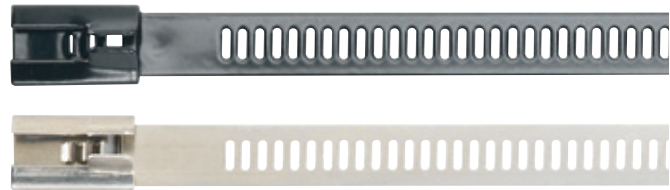

As the free end of the Multi-Lok tie passes through the buckle, three separate teeth (four teeth in the 12mm Multi-Lok) mesh with corresponding slots in the band automatically locking the tie as it is being tensioned. Self-locking Multi-Lok Ties feature an extremely strong, unique multiple locking system.

Type 316 Stainless Steel — Nylon 11 Halogen-Free Coated



CAT. NO.	TENSILE STRENGTH		WIDTH		LENGTH		WEIGHT	
	LBS		IN	MM	IN	MM	LBS	KG
TYS6-280C	250		.276	7	6	150	.66	.30
TYS9-280C	250		.276	7	9	225	.99	.45
TYS12-280C	250		.276	7	12	300	1.32	.60
TYS18-280C	250		.276	7	18	450	1.76	.80
TYS24-280C	250		.276	7	24	610	2.64	1.20
TYS6-470C	250		.472	12	6	150	1.10	.50
TYS9-470C	250		.472	12	9	225	1.65	.75
TYS12-470C	250		.472	12	12	300	2.20	1.00
TYS18-470C	250		.472	12	18	450	2.97	1.35
TYS24-470C	250		.472	12	24	610	4.29	1.95

Packaging Quantity: 100/bag
.010" (.245mm) Thickness

Type 316 Stainless Steel — Uncoated

CAT. NO.	TENSILE STRENGTH		WIDTH		LENGTH		WEIGHT	
	LBS		IN	MM	IN	MM	LBS	KG
TYS6-280	250		.276	7	6	150	.66	.30
TYS9-280	250		.276	7	9	225	.88	.40
TYS12-280	250		.276	7	12	300	1.21	.55
TYS18-280	250		.276	7	18	450	1.98	.90
TYS24-280	250		.276	7	24	610	2.64	1.20
TYS6-470	250		.472	12	6	150	1.10	.50
TYS9-470	250		.472	12	9	225	1.65	.75
TYS12-470	250		.472	12	12	300	2.20	1.00
TYS18-470	250		.472	12	18	450	3.19	1.45
TYS24-470	250		.472	12	24	610	4.29	1.95

Packaging Quantity: 100/bag
.010" (.245mm) Thickness

Ty-Rap® High-Performance Stainless Steel Cable Ties

Strong and slip-free with a unique dual lock.

Ty-Rap® Dual-Lock Stainless Steel Cable Ties

- 304 grade stainless steel construction
- Two-piece design
- Fast, easy installation
- Mini ties (.18" wide) offer 100 lbs. tensile strength
- Standard ties (.25" wide) offer 200 lbs. tensile strength
- Also available in 316 grade stainless steel (to order, add -316 suffix to catalog number)

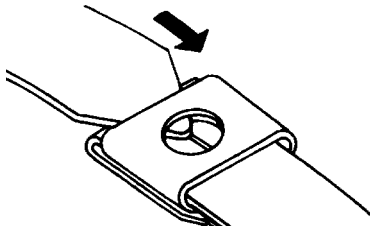

After wrapping the object to be tied, insert the free end of the tie through the buckle and into the tool.

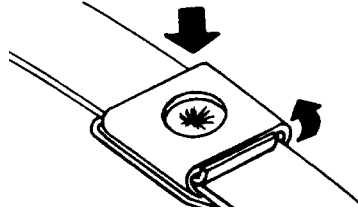

Squeeze the handle of the tool to create the dual lock and cut off the tail. The cable tie forms a low-profile dual lock.



The tail is formed into a fold lock behind the buckle. The tool forces a dimple in the band into a hole in the buckle.

CAT. NO.	FOR BUNDLE DIAMETER OF IN/MM	TENSILE STRENGTH LBS/N	WIDTH IN/MM	LENGTH IN/MM	WEIGHT LBS/KG	STD. PKG. QTY.
Mini Stainless Steel Cable Ties						
SS7-180	1/25	100/444.8	.18/4.5	6.5/165	.70/.32	100
SS10-180	2/51	100/444.8	.18/4.5	10.0/254	.90/.41	100
SS16-180	4/102	100/444.8	.18/4.5	16.0/406	1.40/.64	100
SS23-180	6/152	100/444.8	.18/4.5	22.5/572	1.85/.84	100
SS29-180	8/203	100/444.8	.18/4.5	29.0/737	2.35/1.07	100
Standard Stainless Steel Cable Ties						
SS10-250	2/51	200/890	.25/6.35	10.0/254	1.10/.50	100
SS17-250	4/101	200/890	.25/6.35	16.5/419	1.80/.82	100
SS23-250	6/152	200/890	.25/6.35	22.5/572	2.50/1.13	100
SS29-250	8/203	200/890	.25/6.35	29.0/737	3.20/1.45	100
SS35-250	10/254	200/890	.25/6.35	35.0/ 889	3.80/1.72	100

304 Stainless Steel

.015" (.38mm) Thickness

Note: Other lengths available on special request.

Add suffix -316 for 316 Stainless Steel.

Ty-Rap® High-Performance Stainless Steel Cable Ties

Ties to use and re-use with quickness and ease!

Ty-Rap® Re-Usable Stainless Steel Cable Ties

- 200/300 series stainless steel construction
- Fully coated in non-toxic, halogen-free low-smoke Nylon 11 for extra corrosion resistance
- Unique buckle design for easy application and re-use
- May be double-wrapped for additional tensile strength
- Also available in 316 grade stainless steel (to order, add -316 suffix to catalog number)

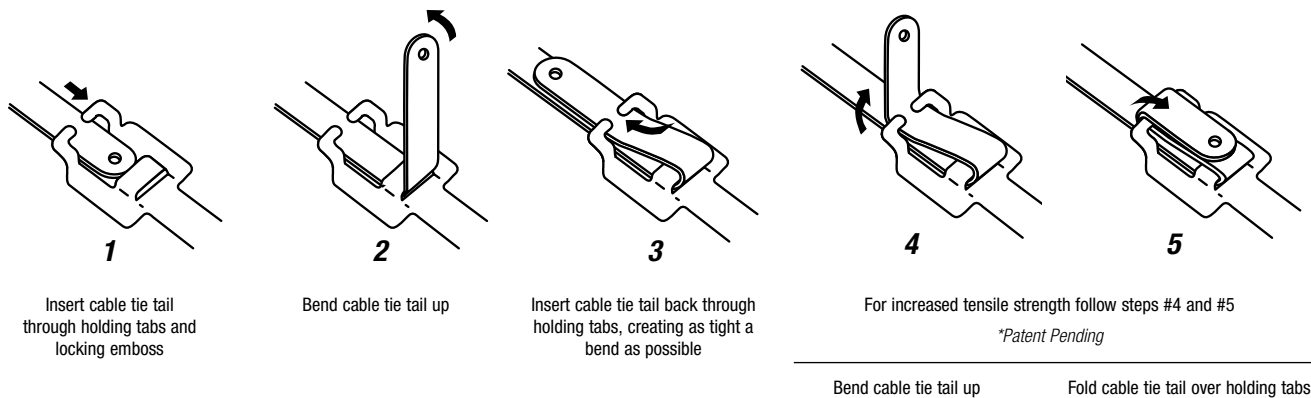

CAT. NO.	TENSILE STRENGTH (LBS/N)	WIDTH (IN/MM)	LENGTH (IN/MM)	WEIGHT (LBS/KG)	STD. PKG. QTY.
SSR6-250C	75/333.60	.25/6.35	6/152	1.4/ .64	100
SSR9-250C	75/333.60	.25/6.35	9/229	1.8/ .82	100
SSR12-250C	75/333.60	.25/6.35	12/305	2.1/ .95	100
SSR18-250C	75/333.60	.25/6.35	18/457	3.0/ 1.36	100
SSR24-250C	75/333.60	.25/6.35	24/610	3.7/ 1.68	100
SSR6-375C	100/444.80	.38/9.53	6/152	1.8/ .82	100
SSR9-375C	100/444.80	.38/9.53	9/229	2.0/ .91	100
SSR12-375C	100/444.80	.38/9.53	12/305	3.1/ 1.41	100
SSR18-375C	100/444.80	.38/9.53	18/457	4.4/ 2.00	100
SSR24-375C	100/444.80	.38/9.53	24/610	6.6/ 2.99	100
SSR30-375C	100/444.80	.38/9.53	30/762	7.0/ 3.18	100
SSR36-375C	100/444.80	.38/9.53	36/914	8.3/ 3.76	100

Material: 200/300 Series Stainless Steel

.015" (.38mm) metal thickness; .045" (1.1mm) coated thickness

Note: This product may be double-wrapped for additional tensile strength. For additional colors and uncoated ties, consult Thomas & Betts Customer Service for pricing and availability. For 316 Stainless Steel, add suffix -316 after catalog number. Consult Customer Service for availability.

Ty-Rap® High-Performance Stainless Steel Cable Ties

Pre-assembled for single or double wrapping.

Ty-Rap® Free-End Stainless Steel Clamps

- 201 grade stainless steel construction
- Double-wrapped clamps provide extra strength
- Available in various lengths, widths and thicknesses

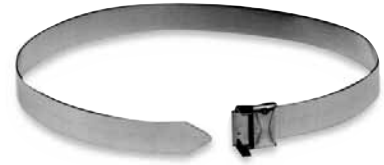

CAT. NO.	MAX. DIA. ONCE AROUND IN/MM	MAX. DIA. TWICE AROUND IN/MM	LENGTH IN/MM	TENSILE STRENGTH SINGLE WRAP LBS/N	BAND WIDTH IN/MM	BAND THICKNESS IN/MM	WEIGHT LBS/KG	STD. PKG. QTY.
SSH10-250	2/50	—	10/25	450/2002	.25/6.35	.02/.51	2.2/1.00	100
SSH16-250	3.5/88	1.5/38	16/40	450/2002	.25/6.35	.02/.51	3.1/1.41	100
SSH16-375	3.5/88	1.5/38	16/40	900/4003	.38/9.53	.03/.63	6.2/2.81	100
SSH18-500	4/101	2/50	18/45	1,400/6228	.5/12.70	.03/.76	10.5/4.76	100
SSH19-250	5/127	2.5/63	19/48	450/2002	.25/6.35	.02/.51	3.5/1.59	100
SSH21-625	5/127	2.5/63	21/53	1,700/7562	.63/15.88	.03/.76	15.1/6.85	100
SSH24-750	6/152	3/76	24/60	2,000/8896	.75/19.05	.03/.76	10.9/4.94	50
SSH27-250	7/177	3.5/88	27/68	450/2002	.25/6.35	.02/.51	4.6/2.09	100
SSH31-500	8/203	4/101	31/78	1,400/6228	.5/12.70	.03/.76	4.7/2.13	25
SSH34-250	9/228	4.5/114	34/86	450/2002	.25/6.35	.02/.51	5.6/2.54	100
SSH37-750	10/254	5/127	37/93	2,000/8896	.75/19.05	.03/.76	7.6/3.45	25
SSH44-375	12/304	6/152	44/112	900/4003	.38/9.53	.03/.76	3.6/1.69	25
SSH50-750	14/355	7/177	50/127	2,000/8896	.75/19.05	.03/.76	9.7/4.40	25
SSH56-625	16/406	8/203	56/142	1,700/7562	.63/15.88	.03/.76	9.0/4.08	25
SSH62-750	18/457	9/228	62/157	2,000/8896	.75/19.05	.03/.76	11.6/5.26	25
SSH69-625	20/508	10/254	69/175	1,700/7562	.63/15.88	.00/.76	10.7/4.86	25

Type 201 Stainless Steel

Other Free-End Clamp sizes and metals are available on special order.

Boiler rooms, shipyards, or off-shore oil platforms — a match for any severe environment!

Ty-Rap® Stainless Steel Strap Cable Ties

- Stainless steel strap cable ties have been designed for high-temperature applications and for use in areas of harsh, corrosive environments
- Rated at 200-lb. tensile strength
- Smooth edges protect both the cable insulation and the installer



CAT. NO.	BODY WIDTH IN/MM	LENGTH IN/MM	MAX. WIRE BUNDLE DIA. IN/MM	TENSILE STRENGTH LBS/N	STD. PKG. QTY.
TYS8	.31/7.87	10.65/270.51	2/50.80	200/889.60	100
TYS14	.31/7.87	14.65/372.11	4/101.60	200/889.60	50
TYS22	.31/7.87	22.65/575.31	6/152.40	200/889.60	50
TYS28	.31/7.87	28.65/727.71	8/203.20	200/889.60	50

Note: Use WT3S Tool for tensioning

Cannot be coated with any covering material

Made of 316 stainless steel

Ty-Rap® High-Performance Stainless Steel Cable Ties

1,000-ft. reel to cut your desired length!

Stainless Steel Strapping on a Reel



CAT. NO.	DESCRIPTION	WIDTH IN/MM	STRENGTH LBS/N	STD. PKG. QTY.
TYS1000	1,000 ft. of strap, 2 reels of 500 ft. each	.31/7.87	200/889.60	1

Stainless steel ties of virtually any length can be produced from the 1,000-ft. reel in combination with the matching head.

Note: Use WT3S tool for tensioning

Lockable heads for stainless steel strapping.

Stainless Steel Strapping Locking Heads

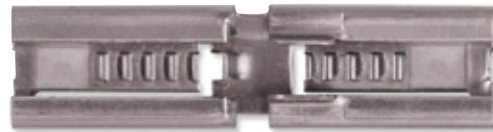

CAT. NO.	DESCRIPTION	STD. PKG. QTY.
TYS5200H	Heads only for stainless strapping	50

Long-lasting anchor hold.

Stainless Steel Mounting Base



CAT. NO.	DESCRIPTION	STD. PKG. QTY.
TCS25	Mounting base for stainless steel ties	50

Ty-Rap® High-Performance Stainless Steel Cable Ties

Identify cable bundles with permanent, stainless steel imprintable tags.

ID Tagging System

- Apply Type 304 stainless steel tags with stainless steel cable ties
- Easy-to-use — slip a tie through the slots in the tag and fasten with the installation tool
- Works with ¼" wide ties
- .015" thickness



CAT. NO.	WIDTH IN/MM	LENGTH IN/MM	WEIGHT PER 100 LBS/N	STD. PKG. QTY.
SSID100	.75/	2.0/	.5/	100
	19.05	50.80	2.22	
SSID101	1.50/	2.5/	1.2/	100
	38.10	63.50	5.34	
SSID102	.75/	3.5/	.8/	100
	19.05	88.90	3.56	

Packaging Quantity: 100/box

Note: Customized pre-embossed tags are available. Please consult Technical Service for details.

Add suffix (316) for 316 Stainless Steel.

No second guessing — quickly and accurately position ID tags!

ID Tag Imprinter

- Imprint Thomas & Betts stainless steel ID tags
- Includes special tag holder for secure positioning and a ⅜" character imprinting wheel, standard (no substitutions allowed)

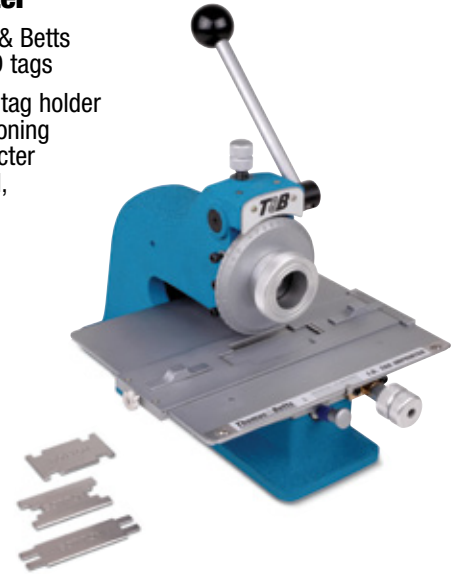

CAT. NO.	DESCRIPTION	WEIGHT LBS/N
WTID200	I.D. Tag Imprinter	29.5/131.2
WTID290	⅜" Character Imprinting Wheel	—
	⅜" Character Imprinting Wheel	—
WTID281	⅜" Character Imprinting Wheel	—
	⅜" Character Imprinting Wheel	—
WTID283	⅜" Character Imprinting Wheel	—
	⅜" Character Imprinting Wheel	—
WTID204	(Kit) WTID200 and WTID 283	—

Packaging Quantity: 1/box

Stainless Steel ID Tag Strips/Carriers



CAT. NO.	DESCRIPTION	LENGTH IN/MM	WIDTH IN/MM	WT. PER 100 LBS	STD. PKG. QTY.
ER043	6-Character Carrier	3.64/92.46	.38/9.65	.73	100
ER044	10-Character Carrier	5.14/130.56	.38/9.65	1.25	100
ER045	16-Character Carrier	7.39/187.71	.38/9.65	1.47	100
ER050	Short Strip	4.25/107.95	.38/9.65	.98	100
ER051	Medium Strip	5.75/146.05	.38/9.65	1.33	100
ER052	Long Strip	8.00/203.20	.38/9.65	1.85	100
ER060	I.D. Tag Kit	—	—	—	1

ID Tag Kit contains 50 of each letter, number, symbol, carrier, and strip in a handy carrying case.

Thomas & Betts

United States
Tel: 901.252.8000
800.816.7809
Fax: 901.252.1354

Technical Services
Tel: 888.862.3289

www.tnb.com

Ty-Rap® High-Performance Stainless Steel Cable Ties

Letters, numbers, and symbols — create easy-to-use custom identifications!

Stainless Steel ID Tags

- Slip tags over carriers or strips (see **previous page**) and attach to your cable or hose with a variety of Thomas & Betts Stainless Steel Cable Ties

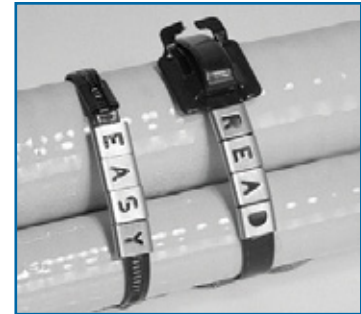

CAT. NO.	DESCRIPTION	LENGTH IN/MM	WIDTH IN/MM	WT. PER 100	STD. PKG. QTY.
ER010	A	.45/2.00	.38/1.69	.31	100
ER011	B	.45/2.00	.38/1.69	.31	100
ER012	C	.45/2.00	.38/1.69	.31	100
ER013	D	.45/2.00	.38/1.69	.31	100
ER014	E	.45/2.00	.38/1.69	.31	100
ER015	F	.45/2.00	.38/1.69	.31	100
ER016	G	.45/2.00	.38/1.69	.31	100
ER017	H	.45/2.00	.38/1.69	.31	100
ER018	I	.45/2.00	.38/1.69	.31	100
ER019	J	.45/2.00	.38/1.69	.31	100
ER020	K	.45/2.00	.38/1.69	.31	100
ER021	L	.45/2.00	.38/1.69	.31	100
ER022	M+W	.45/2.00	.38/1.69	.31	100
ER023	N	.45/2.00	.38/1.69	.31	100
ER024	O	.45/2.00	.38/1.69	.31	100
ER025	P	.45/2.00	.38/1.69	.31	100
ER026	Q	.45/2.00	.38/1.69	.31	100
ER027	R	.45/2.00	.38/1.69	.31	100
ER028	S	.45/2.00	.38/1.69	.31	100
ER029	T	.45/2.00	.38/1.69	.31	100
ER030	U	.45/2.00	.38/1.69	.31	100
ER031	V	.45/2.00	.38/1.69	.31	100
ER032	X	.45/2.00	.38/1.69	.31	100
ER033	Y	.45/2.00	.38/1.69	.31	100
ER034	Z	.45/2.00	.38/1.69	.31	100
ER018	1	.45/2.00	.38/1.69	.31	100
ER037	2	.45/2.00	.38/1.69	.31	100
ER038	3	.45/2.00	.38/1.69	.31	100
ER039	4	.45/2.00	.38/1.69	.31	100
ER040	5	.45/2.00	.38/1.69	.31	100
ER041	6	.45/2.00	.38/1.69	.31	100
ER021	7	.45/2.00	.38/1.69	.31	100
ER042	8	.45/2.00	.38/1.69	.31	100
ER041	9	.45/2.00	.38/1.69	.31	100
ER024	0	.45/2.00	.38/1.69	.31	100
ER035	Minus/Hyphen (-)	.45/2.00	.38/1.69	.31	100
ER036	Blank ()	.45/2.00	.38/1.69	.31	100
ER046	Plus (+)	.45/2.00	.38/1.69	.31	100
ER047	Earth (≈)	.45/2.00	.38/1.69	.31	100
ER048	Sine (~)	.45/2.00	.38/1.69	.31	100
ER049	Slash (/)	.45/2.00	.38/1.69	.31	100

Character size: .218"

Material: .025" 316 stainless steel



1-800-453-1692

www.aboveboardelectronics.com

Ty-Rap® High-Performance Stainless Steel Cable Ties

Stainless Steel Cable Tie Specifications

Fastening Systems — Ty-Rap® High-Performance Cable Ties, Tools & Accessories



Type LS
Heavy-Duty Stainless Steel
Ball-Lock Cable Ties — Uncoated



Type LS
Heavy-Duty Stainless Steel
Ball-Lock Cable Ties — Coated



Type TYS
Multi-Lok Stainless Steel Ties — Uncoated



Type TYS
Multi-Lok Stainless Steel Ties — Coated



Type SS
Mini Stainless Steel Cable Ties



Type SS
Standard Stainless Steel Cable Ties

CAT. NO.	WIDTH IN./MM	LENGTH IN./MM	THICKNESS IN./MM	MAX. DIA. SINGLE WRAP IN./MM	MAX. DIA. DOUBLE WRAP IN./MM
Type LS Heavy-Duty Stainless Steel Ball-Lock Cable Ties					
Uncoated					
LS-4.6-200A	.18/4.6	7.9/201	—	2/51	(single
LS-4.6-360A	.18/4.6	14.2/360	—	4/102	wrap
LS-4.6-520A	.18/4.6	20.5/520	—	6/152	only)
LS-4.6-680A	.18/4.6	26.7/679	—	8/203	
LS-4.6-840A	.18/4.6	33.0/838	—	10/254	
LS-7.9-200A	.31/7.9	7.9/201	—	2/51	(single
LS-7.9-360A	.31/7.9	14.2/360	—	4/102	wrap
LS-7.9-520A	.31/7.9	20.5/520	—	6/152	only)
LS-7.9-680A	.31/7.9	26.7/679	—	8/203	
LS-7.9-840A	.31/7.9	33.0/838	—	10/254	
LS-7.9-1010A	.31/7.9	41.3/1050	—	12.5/318	
Fully Polyester					
Uncoated					
LS-4.6-200B	.18/4.6	7.9/201	—	2/51	(single
LS-4.6-360B	.18/4.6	14.2/360	—	4/102	wrap
LS-4.6-520B	.18/4.6	20.5/520	—	6/152	only)
LS-4.6-680B	.18/4.6	26.7/679	—	8/203	
LS-4.6-840B	.18/4.6	33.0/838	—	10/254	
LS-7.9-200B	.31/7.9	7.9/201	—	2/51	(single
LS-7.9-360B	.31/7.9	14.2/360	—	4/102	wrap
LS-7.9-520B	.31/7.9	20.5/520	—	6/152	only)
LS-7.9-680B	.31/7.9	26.7/679	—	8/203	
LS-7.9-840B	.31/7.9	33.0/838	—	10/254	
LS-7.9-1010B	.31/7.9	41.3/1050	—	12.5/318	
Type TYS Multi-Lok Stainless Steel Cable Ties					
Uncoated					
TYS6-280	.28/7.00	6/152	.01/.25	1.9/48	(single
TYS9-280	.28/7.00	9/229	.01/.25	2.8/71	wrap
TYS12-280	.28/7.00	12/305	.01/.25	3.8/96	only)
TYS18-280	.28/7.00	18/457	.01/.25	5.7/144	
TYS24-280	.28/7.00	24/610	.01/.25	7.6/193	
TYS6-470	.47/12.00	6/152	.01/.25	1.9/48	
TYS9-470	.47/12.00	9/229	.01/.25	2.8/71	
TYS12-470	.47/12.00	12/305	.01/.25	3.8/96	
TYS18-470	.47/12.00	18/457	.01/.25	5.7/144	
TYS24-470	.47/12.00	24/610	.01/.25	7.6/193	
Nylon 11 Coated					
TYS6-280C	.28/7.00	6/152	.01/.25	1.9/48	(single
TYS9-280C	.28/7.00	9/229	.01/.25	2.8/71	wrap
TYS12-280C	.28/7.00	12/305	.01/.25	3.8/96	only)
TYS18-280C	.28/7.00	18/457	.01/.25	5.7/144	
TYS24-280C	.28/7.00	24/610	.01/.25	7.6/193	
TYS6-470C	.47/12.00	6/152	.01/.25	1.9/48	
TYS9-470C	.47/12.00	9/229	.01/.25	2.8/71	
TYS12-470C	.47/12.00	12/305	.01/.25	3.8/96	
TYS18-470C	.47/12.00	18/457	.01/.25	5.7/144	
TYS24-470C	.47/12.00	24/610	.01/.25	7.6/193	
Type SS Mini Stainless Steel Cable Ties					
SS7-180	.18/4.50	6.5/165	.02/.51	1.7/43	(single
SS10-180	.18/4.50	10/254	.02/.51	2.8/71	wrap
SS16-180	.18/4.50	16/406	.02/.51	4.7/119	only)
SS23-180	.18/4.50	22.5/572	.02/.51	6/152	
SS29-180	.18/4.50	29.0/737	.02/.51	8/203	
Type SS Standard Stainless Steel Cable Ties					
SS10-250	.25/6.35	10/254	.02/.51	2.1/53	
SS17-250	.25/6.35	16.5/419	.02/.51	4.3/109	(single
SS23-250	.25/6.35	22.5/572	.02/.51	6.5/165	wrap
SS29-250	.25/6.35	29/737	.02/.51	8.5/215	only)
SS35-250	.25/6.35	35/889	.02/.51	10.5/265	

Ty-Rap® High-Performance Stainless Steel Cable Ties

STAINLESS STEEL TYPE	COATING OR FINISH	MIN. LOOP TENSILE STRENGTH SINGLE WRAP LBS./N	MIN. LOOP TENSILE STRENGTH DOUBLE WRAP LBS./N	APPLICATION TOOLS USED	GENERAL APPLICATION
302/304	Dull	100/445	(single wrap only)	DAS250	<ul style="list-style-type: none"> Offshore drilling Petrochemical processing Shipbuilding Food & Beverage processing Pharmaceutical processing
302/304		100/445		DAS250	
302/304		100/445		DAS250	
302/304		100/445		DAS250	
302/304		100/445		DAS250	
302/304		250/1,112	DAS250		
302/304		250/1,112	DAS250		
302/304		250/1,112	DAS250		
302/304		250/1,112	DAS250		
302/304		250/1,112	DAS250		
316	Uncoated or Fully Polyester Coated Black	100/445	(single wrap only)	DAS250	
316		100/445		DAS250	
316		100/445		DAS250	
316		100/445		DAS250	
316		100/445		DAS250	
316		250/1,112	DAS250		
316		250/1,112	DAS250		
316		250/1,112	DAS250		
316		250/1,112	DAS250		
316		250/1,112	DAS250		
316	Uncoated or Nylon 11 Coated Black	250/1,112	(single wrap only)	WTAE200	<ul style="list-style-type: none"> Self-locking Cable bundling Hazardous and corrosive environments
316		250/1,112		WTAE200	
316		250/1,112		WTAE200	
316		250/1,112	WTAE200		
316		250/1,112	WTAE201		
316		400/1,779	WTC075		
316		400/1,779	WTC075		
316		400/1,779	WTC075		
316		400/1,779	WTC075		
316		400/1,779	WTC075		
304*	Dull to Bright	100/445	(single wrap only)	WTA290	<ul style="list-style-type: none"> Wire/cable bundling I.D. tagging
304*		100/445		WTA290	
304*		100/445		WTA290	
304*		100/445	WTA290		
304*		100/445	WTA290		
304*	Dull to Bright	200/890	(single wrap only)	WTA250	<ul style="list-style-type: none"> Wire/cable bundling I.D. tagging
304*		200/890		WTA250	
304*		200/890		WTA250	
304*		200/890	WTA250		
304*		200/890	WTA250		

* SS series also available in Type 316 stainless.

Ty-Rap® High-Performance Stainless Steel Cable Ties



Type SSR
Reusable Stainless Steel Cable Ties



Type SSH
Free-End Clamps

Stainless Steel Cable Tie Specifications (continued)

CAT. NO.	WIDTH IN./MM	LENGTH IN./MM	THICKNESS IN./MM	MAX. DIA. SINGLE WRAP IN./MM	MAX. DIA. DOUBLE WRAP IN./MM
Type SSR Reusable Stainless Steel Cable Ties					
SSR6-250C	.25/6.35	6/152	.02/.51	1.5/38	N/A
SSR9-250C	.25/6.35	9/229	.02/.51	2.5/63	1.1/28
SSR12-250C	.25/6.35	12/305	.02/.51	3.4/86	1.5/38
SSR18-250C	.25/6.35	18/457	.02/.51	5.4/137	2.5/64
SSR24-250C	.25/6.35	24/610	.02/.51	7.3/185	3.5/89
SSR6-375C	.38/9.53	6/152	.02/.51	1.5/38	N/A
SSR9-375C	.38/9.53	9/229	.02/.51	2.5/63	1.1/28
SSR12-375C	.38/9.53	12/305	.02/.51	3.4/86	1.5/38
SSR18-375C	.38/9.53	18/457	.02/.51	5.4/137	2.5/64
SSR24-375C	.38/9.53	24/610	.02/.51	7.3/185	3.5/89
SSR30-375C	.38/9.53	30/762	.02/.51	9.1/231	4.4/112
SSR36-375C	.38/9.53	36/914	.02/.51	11.0/280	5.3/135
Type SSH Free-End Clamps					
SSH10-250	.25/6.35	10/250	.02/.51	2.0/50	—
SSH16-250	.25/6.35	16/400	.02/.51	3.5/88	1.5/38
SSH19-250	.25/6.35	19/480	.02/.51	5.0/127	2.5/63
SSH27-250	.25/6.35	27/680	.02/.51	7.0/177	3.5/88
SSH34-250	.25/6.35	34/860	.02/.51	9.0/228	4.5/114
SSH16-375	.38/9.53	16/400	.03/.76	3.5/88	1.5/38
SSH44-375	.38/9.53	44/1,120	.03/.76	12.0/304	6.0/152
SSH18-500	.5/12.70	18/460	.03/.76	4.0/101	2.0/50
SSH31-500	.5/12.70	31/780	.03/.76	8.0/203	4.0/101
SSH21-625	.63/15.88	21/530	.03/.76	5.0/127	2.5/63
SSH56-625	.63/15.88	56/1,420	.03/.76	16.0/406	8.0/203
SSH69-625	.63/15.88	69/1,750	.03/.76	20.0/508	10.0/254
SSH24-750	.75/19.05	24/600	.03/.76	6.0/152	3.0/76
SSH37-750	.75/19.05	37/940	.03/.76	10.0/254	5.0/127
SSH50-750	.75/19.05	50/1,270	.03/.76	14.0/355	7.0/177
SSH62-750	.75/19.05	62/1,570	.03/.76	18.0/457	9.0/228



Request Info



1-800-453-1692

www.aboveboardelectronics.com

Ty-Rap® High-Performance Stainless Steel Cable Ties

STAINLESS STEEL TYPE	COATING OR FINISH	MIN. LOOP TENSILE STRENGTH SINGLE WRAP LBS./N	MIN. LOOP TENSILE STRENGTH DOUBLE WRAP LBS./N	APPLICATION TOOL USED	GENERAL APPLICATION
200/300	Nylon 11 Coated	75/334	300/1,334	WTAE200	<ul style="list-style-type: none"> • Reusable • Cable bundling • Oil rigs • Telecommunications towers • Hazardous and corrosive environments • Cable trays
200/300	(Uncoated or other)	75/334	300/1,334	WTAE200	
200/300	colors available on	75/334	300/1,334	WTAE200	
200/300	special order)	75/334	300/1,334	WTAE200	
200/300		75/334	300/1,334	WTAE200	
200/300		100/445	500/2,224	WTAE200	
200/300		100/445	500/2,224	WTAE200	
200/300		100/445	500/2,224	WTC075	
200/300		100/445	500/2,224	WTC075	
200/300		100/445	500/2,224	WTC075	
200/300		100/445	500/2,224	WTC075	
200/300		100/445	500/2,224	WTC075	
200/300		100/445	500/2,224	WTC075	
200/300		100/445	500/2,224	WTC075	
201	Bright	450/2,002	1,200/5,338	WTJ020/WTC075/WTC001	
201		450/2,002	1,200/5,338	WTJ020/WTC075/WTC001	
201		450/2,002	1,200/5,338	WTJ020/WTC075/WTC001	
201		450/2,002	1,200/5,338	WTJ020/WTC075/WTC001	
201		450/2,002	1,200/5,338	WTJ020/WTC075/WTC001	
201		900/4,003	2,400/10,675	WTJ020/WTC075/WTC001	
201		900/4,003	2,400/10,675	WTJ075/WTC001	
201		1,400/6,227	3,300/14,678	WTJ075/WTC001	
201		1,400/6,227	3,300/14,678	WTJ075/WTC001	
201		1,700/7,562	4,000/17,792	WTJ075/WTC001	
201		1,700/7,562	4,000/17,792	WTJ075/WTC001	
201		1,700/7,562	4,000/17,792	WTC001	
201		2,000/8,896	5,000/22,240	WTC001	
201		2,000/8,896	5,000/22,240	WTC001	
201		2,000/8,896	5,000/22,240	WTC001	
201		2,000/8,896	5,000/22,240	WTC001	

Ty-Rap® Stainless Steel Cable Ties have passed a variety of mechanical, environmental, and electrical tests. Other data can be made available upon request.



Request Info

1-800-453-1692



www.aboveboardelectronics.com

Hook-and-Loop Fasteners

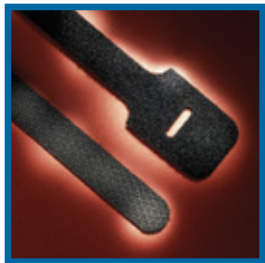

Slotted Loop Ties
(FO Series)

Never lose your strap. Use the slotted head hook-and-loop tie to install on one wire while using the body of the strap to bundle.

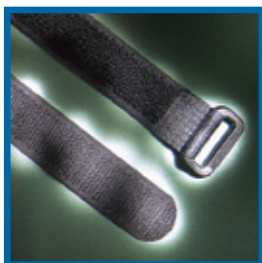

Buckle Ties (FOL Series)

Polymer buckles provide added strength and stability.

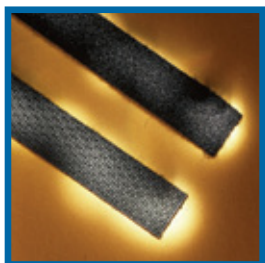

Strip Ties (FOS Series)

Pre-cut lengths make bundling a cinch!

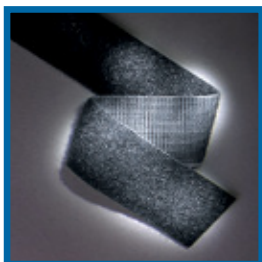

Rolls (FOR Series)

Rolled hook-and-loop material enables custom cut lengths, avoiding waste.

Fasteners available in these colors: Black, Brown, Red, Orange, Yellow, Green, Blue, Gray, and White. Please consult Customer Service for pricing and availability.

Hook-and-Loop Fasteners

Available in UL94V-2 rated material.

F0, FOL, FOS and FOR Series Hook-and-Loop Fasteners

- High-quality Hook-and-Loop Fasteners
- Reusable — great for frequently changed bundles
- Wide bearing surface — ideal for data and fiber optic cable
- Sizes available to accommodate varying bundle diameters
- Flame-retardant and colored material available

STD. PKG. CAT. NO.	MIN. TENSILE STRENGTH LBS./N	MAX. BUNDLE DIA. IN./MM	LENGTH IN./MM	WIDTH IN./MM	STD. PKG. QTY.
F0 Series Slotted Loop Ties*					
F0200-40-0	40/177.9	2.0/50.80	9/228.6	.50/12.7	10
F0200-50-0	50/222.4	2.0/50.80	9/228.6	.75/19.05	10
F0350-40-0	50/222.4	3.5/88.90	13/330.2	.50/12.7	10
F0350-50-0	50/222.4	3.5/88.90	13/330.2	.75/19.05	10
FOL Series Buckle Ties					
FOL300-50-0	50/222.4	3.0/76.20	12/304.8	.75	10
FOL500-50-0	50/222.4	5.0/127.0	18/457.2	.75	10
FOS Series Strip Ties					
FOS150-50-0	50/222.4	1.5/38.10	6/152.4	.75	10
FOS320-50-0	50/222.4	3.2/81.28	12/304.8	.75	10
FOS500-50-0	50/222.4	5.0/127.00	18/457.2	.75	10
FOR Series Rolled Hook and Loop					
FOR180-50-0	50/222.4	Various	180/4572	.75	1

- $\frac{1}{16}$ " strap thickness
 - Black is standard color.
 - Multiple colors available for identifying specific bundles
- *Add suffix "FR" for UL94V-2 rated flame-retardant material, after color choice.
Contact Customer Service for availability and delivery.

Mounting bases for use with hook-and-loop fasteners.

Nylon 6.6 Mounting Bases

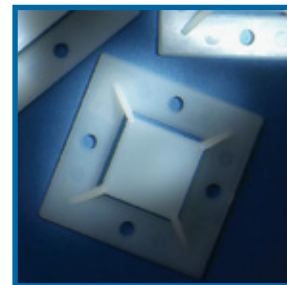

BULK PKG. CAT. NO.	DESCRIPTION	SCREW SIZE	MAXIMUM TIE WIDTH ACCOM.	BULK PKG. QTY.
TC368	2" x 2" Screw Mounted	#8	.75/19.05	500
TC368A	2" x 2" Adhesive Mounted	#8	.75/19.05	500

-40° F to 176° F (-40° C to 80° C)

- Natural nylon color.

Note: See expiration date on TC368A package. Periodically check product for adhesion and replace as needed. Product is for wire management only and is not intended for use as a primary support of wire, cable, etc.

Ty-Rap® Installation Tools

Boost productivity and reduce user fatigue in demanding, high-volume cable tie installations!

Ty-Rap® Pneumatic Cable Tie Installation Tool

For fast, consistent installation of cable ties in high-volume applications, you can't beat the new Ty-Rap® Pneumatic Cable Tie Installation Tool. Pneumatic power combined with a balanced, ergonomic design enables you to tension and trim large quantities of Ty-Rap® cable ties in rapid succession with accuracy and one-button ease.

- Easy, one-step tensioning and cut-off of cable ties
- Narrow nose rotates 360° to maneuver in tight spaces
- Easy-access tension-adjustment wheel at nose with locking mechanism for repetitive-tension work
- Spare cutting blade storage in handle
- Cuts tail off flush — no sharp ends to injure installers or damage cables
- Holds tails captive until ejected by operator — no mess to clean up
- Soft, over-molded grip with over-sized trigger
- Wide cable-tie insertion gap — no fumbling to insert tie

Specifications

- Dimensions: 10"L x 6¼"H x 1⅞"D
- Weight: 14 oz.
- Operating Pressure: 85–100 psi (non-lubricated air)
- Cable Tie Tensile-Strength Range: 18–50 lbs.



CAT. NO.	DESCRIPTION	STD. PKG. QTY.
ERG50P	Pneumatic Cable Tie Installation Tool for 18–50 lb. Ties (includes 9-ft. air hose)	1



Tightens cable tie and cuts flush in one step



360° rotating nose for maximum flexibility



Narrow-shaped nose for easy reach in tight spaces

Ty-Rap® Installation Tools

The most comfortable and efficient hand tool available for installing cable ties!

Ty-Rap® Cable Tie Installation Tool

Thomas & Betts set out to develop a reliable, high-performance hand-operated cable tie installation tool. It's ergonomic with more features than any competing tool on the market. This new and improved Ty-Rap® Cable Tie Installation Tool is the result, and it fits the bill in every aspect.

Our engineers carefully considered user comfort and designed this rugged yet lightweight, well-balanced tool to reduce stress, fatigue and the risk of cumulative trauma injury to the hand and wrist. They didn't stop with ergonomics, however. This new tool offers a flush cable tie tail-to-head trim, a longer handle stroke requiring less handle force, higher tension capabilities and much, much more!



Fastening Systems — Ty-Rap® High-Performance Cable Ties, Tools & Accessories



Eliminate sharp cable tie ends with flush tail-to-head cut-off

Specifications

- Dimensions: 7" (177mm) L x 5" (127mm) H x 1 1/8" (41.3mm) W
- Weight: 9 oz. (255g)

STD. PKG CAT. NO.	DESCRIPTION	STD. PKG. QTY.
ERG50	Tool for 18–50 lb. (80–222N) Cable Ties	1
ERG120	Tool for 50–120 lb. (222–534N) Cable Ties	1



Most flexible with a 360° rotating nose for use at any angle and in tight spaces



Adjustable grip perfectly fits any hand size



Tension-adjustment wheel on nose for easy access and setting

www.tnb.com

United States
Tel: 901.252.8000
800.816.7809
Fax: 901.252.1354

Technical Services
Tel: 888.862.3289

ABE
Above Board Electronics, Inc.

Request Info
⚙️ 🛒 🔄

Thomas & Betts

1-800-453-1692
www.aboveboardelectronics.com

Ty-Rap® Installation Tools

Lightweight. Economical. Durable.
Perfect for spot-tying!

Ty-Rap® Cable Tie Installation Tool — Light Duty

- Installs Ty-Rap cable ties up to .301" wide by .080" thick
- Designed for use by both left- and right-handed operators
- Lightweight, high-impact polymer and steel components

They cinch up the tie with a squeeze action, and cut away the excess tail when twisted 180°. A specially designed pawl cuts away the tail if the tension limit is exceeded, thereby preventing the cable tie from being over-tightened.



STD. PKG. CAT. NO.	DESCRIPTION	TIE BODY WIDTH IN./MM	STD. PKG. QTY.
WT1-TB	Cable Tie Installation Tool, 18–50 lbs. (80–222.4N)	.09–.18/2.39–4.67	1
WT2-TB	Cable Tie Installation Tool, 50–120 lbs. (222.4–533.8N)	.18–.301/4.67–7.65	1

Cuts tail off — flush.

Ty-Rap® Cable Ties Installation Tool — Metallic

- Installs Ty-Rap® cable ties
- Rugged metallic construction
- Pistol-grip installation tool
- Easy tension adjustment
- Tensions and cuts tie tail off flush



STD. PKG. CAT. NO.	DESCRIPTION	TIE BODY WIDTH IN./MM	STD. PKG. QTY.
WT193A	Cable Tie Installation Tool, 18–50 lbs. (80–222.4N)	.09–.18/2.39–4.67	1

Easy tension adjustment!

Ty-Rap® Heavy-Duty Installation Tool — Mil Spec Approved

- Installs Ty-Rap® cable ties
- Rugged metallic construction
- Pistol-grip installation tool
- Tensions and cut cable tie tail off flush



STD. PKG. CAT. NO.	DESCRIPTION	TIE BODY WIDTH IN./MM	STD. PKG. QTY.
WT199	Installation Tool, 18–50 lbs. (80–222.4N)	.09–.18/2.39–4.67	1
WT197	Installation Tool, 50–120 lbs. (222.4–533.8N)	.18–.30/4.67–7.65	1

* Mil Spec Approved (WT199 — MS90387-1, WT197 — MS90387-2)

Makes tie installation easy!

Ty-Rap® Installation Tool — Deltec® & Stainless Steel

WT3D

- Installs both self-locking Ty-Rap® cable ties and lashing ties

WT3S

- Installs stainless steel ties



WT3D

STD. PKG. CAT. NO.	DESCRIPTION	TIE BODY WIDTH IN./MM	STD. PKG. QTY.
WT3D	Deltec Installation Tool	.18–.50/4.67–12.70	1
WT3S	Stainless Steel Installation Tool	Up to .50/12.70	1

Ty-Rap® Installation Tools

Get the job done right!

Ty-Rap® Heavy-Duty Installation Tool — Stainless Steel

- Installs Ty-Rap® Ball-Lock and Multi-Lok Stainless Steel Cable Ties
- Rugged stainless steel construction
- Pistol-type installation tool
- Adjustable tension settings



STD. PKG. CAT. NO.	DESCRIPTION	TIE BODY WIDTH IN./MM	STD. PKG. QTY.
DAS250	Stainless Steel Installation Tool	Up to .31/7.87	1



The right tools make installing Ty-Rap® Stainless Steel Cable Ties a cinch!

Installation Tools for Dual-Lock Stainless Steel Ties

- Lightweight
- Easy-to-use tool applies tension, locks tie with the dual lock, and cuts off band flush with top surface of buckle

CAT. NO.	DESCRIPTION	WEIGHT LBS/KG	STD. PKG. QTY.
WTA290	Hand tool to apply mini stainless steel cable ties	1.17/.53	1
WTA250	Hand tool to apply standard stainless steel cable ties	1.17/.53	1

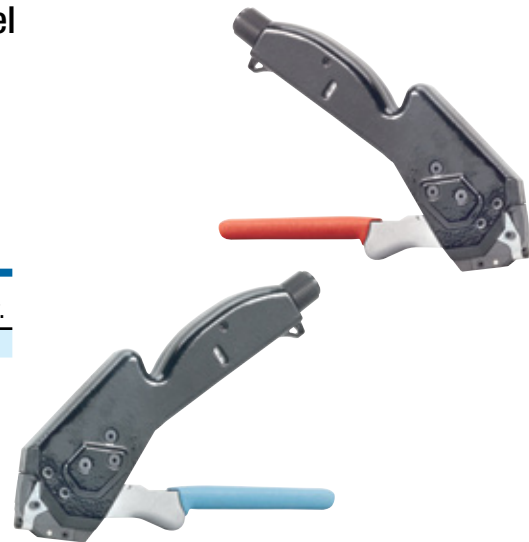

Quality tools for tensioning.

Tensioning Tools



WTAE200
Cable Tie Tensioner



WTAE201
Tensioning Hook

CAT. NO.	DESCRIPTION	WEIGHT LBS/KG	STD. PKG. QTY.
WTAE200	Cable Tie Tensioner, for tensioning Re-Usable Ties and Multi-Lok Ties	.6/.27	1
WTAE201	Tensioning Hook, for tensioning Re-Usable Ties and Multi-Lok Ties	.1/.05	1

Ty-Rap® Installation Tools

Apply tension, cut and secure with confidence!

Installation Tools for Free-End Stainless Steel Ties



WTC001
A drop-forged tool with tensioning capability to do all ¼" to ¾" Free-End Clamp sizes.



WTC075
Designed to install ¼" to ¾" wide Free-End Clamps. The lightweight, ratchet-action tool tension cuts and secures the buckle tab.



WTJ020
Lightweight pocket-sized toll to install ¼" and ¾" wide Free-End Clamps. This tool also applies tension and has a built-in cutter.

CAT. NO.	DESCRIPTION	WEIGHT LBS/KG	STD. PKG. QTY.
WTJ020	Compact Free-End Stainless Steel Cable Tie Installation Tool for ¼" to ¾" sizes	1.1/1.50	1
WTC075	Pistol-Grip Free-End Stainless Steel Cable Tie Installation Tool for ¼" to ¾" sizes	2.6/1.18	1
WTC001	Free-End Stainless Steel Cable Tie Installation Tool for All Sizes	4.4/2.00	1

Makes tie installation easy!

Ty-Rap® Installation Tool

- Installs stainless steel ties



CAT. NO.	DESCRIPTION	TIE BODY WIDTH IN./MM.	STD. PKG. QTY.
WT3S	Installation Tool for Stainless Steel Ties	Up to .50/12.70	1

Note: Tensions only

Ty-Rap® Wire Management Clips, Clamps, Spiral Wrap and More

Versatile adhesive clips keep cable paths organized.

Round Adhesive Clips

- Diverse cable clamps for bundle diameters from .160" to .620"
- Mounted on a rubber-based closed cell foam adhesive
- Flexible center tang for removal or addition of cables

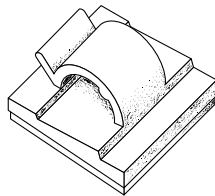
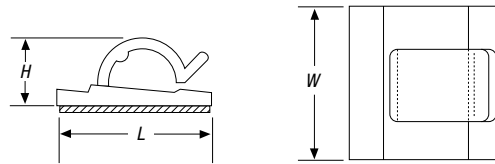

BULK PKG. CAT. NO.	MATERIAL	HEIGHT IN./MM	H LENGTH IN./MM	L WIDTH IN./MM	W MAXIMUM BUNDLE	MOUNTING METHOD	BULK PKG. QTY.
RANY-280-9-D	Nylon	.410/10.41	1.000/25.40	1.000/25.40	.280/7.11	Rubber-based adhesive	500
RANY-530-9-D	Nylon	15.75/.620	1.000/25.40	1.000/25.40	.530/13.46	Rubber-based adhesive	500
RANY-620-9-D	Nylon	14.22/.560	1.250/31.75	28.45	.620/15.75	Rubber-based adhesive	500

Natural nylon color.

Adhesive for use in temperatures ranging from 32° F to 150° F (0° C to 66° C).

Note: See product expiration date on package. Periodically check product for adhesion and replace as needed. Product is for wire management only and is not intended for use as a primary support of wire, cable, etc.

Release and refasten with ease — in three adjustable sizes!

Adjustable Cable Clamps

- Three sizes for bundles from .118" to .984"
- Ladder-style fastener is easily released and refastened
- Supplied on a rubber-based closed cell foam adhesive
- Optional screw hole for #4 or #5 flat head screw

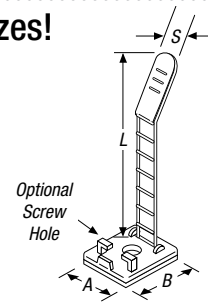

STD. PKG CAT. NO.	MATERIAL	A HEIGHT IN./MM	B LENGTH IN./MM	S WIDTH IN./MM	L MAXIMUM BUNDLE IN./MM	APPLIED WIRE RANGE IN./MM	SCREW HOLE DIAMETER IN./MM	STD. PKG. QTY.
ULNY-013-8-C	Gray Nylon	.709/18.00	.984/24.99	.314/7.98	2.340/59.44	.118 – .500/3.0 – 12.7	.110/2.79	100
ULNY-018-8-C	Gray Nylon	.827/21.00	1.180/29.97	.472/11.99	3.120/79.25	.197 – .827/5.0 – 21.0	.110/2.79	100
ULNY-023-8-C	Gray Nylon	.984/24.99	1.380/35.05	.551/14.00	3.370/79.25	.275 – .984/7.0 – 25.0	.135/3.43	100

Adhesive for use in temperatures ranging from 32° F to 150° F (0° C to 66° C).

Choose from four sizes to accommodate bundles up to 1/2".

Press Clips

- Clips are provided on a rubber-based closed cell foam adhesive
- Stocked in 6.6 natural nylon color. Contact factory for availability in special materials

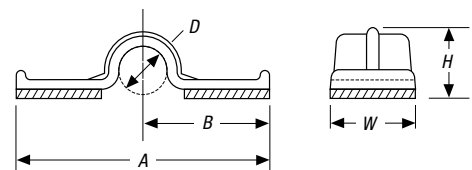
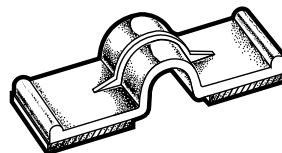

BULK PKG. CAT. NO.	MATERIAL	D DIAMETER IN./MM	A IN./MM	B IN./MM	H IN./MM	W IN./MM	PKG. QTY.
PCNY-125-9-D	Nylon	.13/3.30	.76/19.30	.38/9.65	.21/5.33	.38/9.65	500
PCNY-250-9-D	Nylon	.25/6.35	1.38/35.05	.69/17.53	.32/8.13	.50/12.70	500
PCNY-375-9-D	Nylon	.38/9.65	1.47/37.34	.74/18.80	.44/11.176	.63/16.00	500
PCNY-500-9-D	Nylon	.50/12.70	1.59/40.39	.80/20.32	.59/15.00	.75/19.05	500

For use in temperatures ranging from 32° F to 150° F (0° C to 66° C).

Ty-Rap® Wire Management Clips, Clamps, Spiral Wrap and More

Flat design provides an attractive, yet discreet look.

Flat Cable Screw Clip

- Flat ribbon cable clamp with mounting hole for #8 screw
- Stocked in 6.6 natural nylon color
- Flexible center tang enables easy removal and replacement of desired cable

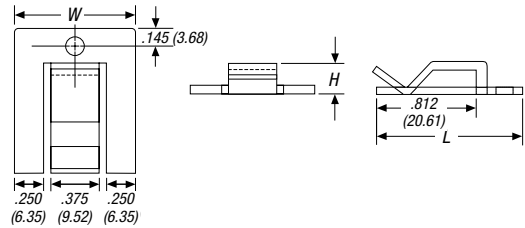
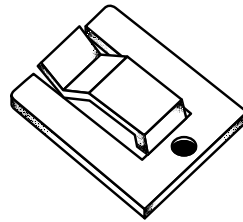

STD. PKG. CAT. NO.	MATERIAL	HEIGHT IN./MM	H LENGTH IN./MM	L WIDTH IN./MM	W MOUNTING METHOD	STD. PKG.
FSNY-812-9-C	Nylon	.25/6.35	1.19/30.23	1.00/25.40	#8 Screw	100

For use in temperatures ranging from 32° F to 150° F (0° C to 66° C).

Adhesive eliminates need for tools when mounting clips.

Flat PVC Clips

- Low-profile clip for single or multiple layers of flat ribbon cable.
- “Single-Cut” on a rubber-based closed cell foam adhesive
- Gray PVC
- UL Flammability 94 V-0 (clip)

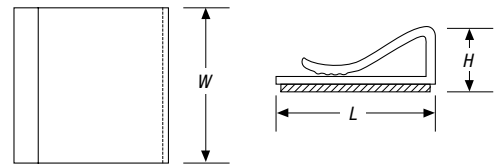

STD. PKG. CAT. NO.	BULK PKG. CAT. NO.	MATERIAL	H HEIGHT IN./MM	L LENGTH IN./MM	W WIDTH IN./MM	MOUNTING METHOD	STD. PKG. QTY.	BULK PKG. QTY.
FRPV-1000-8-C	FRPV-1000-8-D	Gray PVC	.42/10.67	1.06/26.92	1.00/25.40	Adhesive	100	500

For use in temperatures ranging from 32° F to 150° F (0° C to 66° C).

Note: See product expiration date on package. Periodically check product for adhesion and replace as needed. Product is for wire management only and is not intended for use as a primary support of wire, cable, etc.

Ty-Rap® Wire Management Clips, Clamps, Spiral Wrap and More

Choose the diameter you need to clamp a specific-sized cable.

Plain Edge Cable Clamps

- Fully radiused inside edges with size markings in inches and millimeters for easy identification
- Stocked in natural and black nylon 6.6
- Plain edge cable clamps are designed to perform to NAS-1397P
- 18 diameters and 2 widths with mounting holes for #8 and #10 screws
- Replace “-M” or “-D” with “-C” for 100 pack

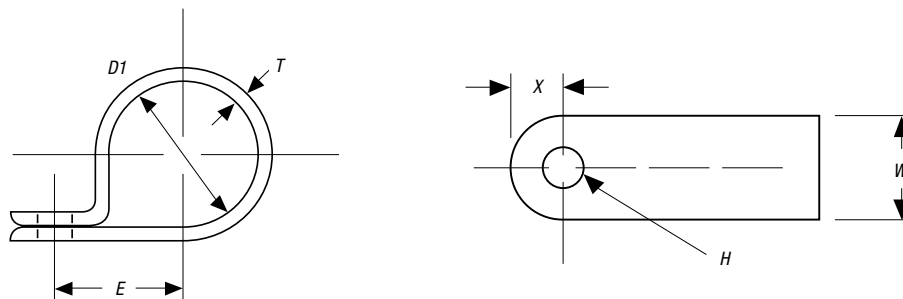

For use in temperatures ranging from -40° F to 185° F (-40° C to 85° C).

WHITE CAT. NO.	BLACK CAT. NO.	D1 CLOSED DIA. IN./MM	E IN./MM	T THICKNESS IN./MM	W WIDTH IN./MM	H MOUNTING HOLE SIZE	X IN./MM	BULK PKG. QTY.
N4NY-002-9-M	N4NY-002-0-M	.13/3.18	.34/8.71	.05/1.27	.38/9.53	#8	.22/5.54	1,000
N4NY-003-9-M	N4NY-003-0-M	.19/4.475	.38/9.60	.05/1.27	.38/9.53	#8	.22/5.54	1,000
N4NY-004-9-M	N4NY-004-0-M	.25/6.35	.42/10.70	.05/1.27	.38/9.53	#8	.22/5.54	1,000
N4NY-005-9-M	N4NY-005-0-M	.31/7.92	.44/11.20	.05/1.27	.38/9.53	#8	.22/5.54	1,000
N4NY-006-9-M	N4NY-006-0-M	.38/9.53	.46/11.79	.05/1.27	.38/9.53	#8	.22/5.54	1,000
N4NY-007-9-M	N4NY-007-0-M	.44/11.10	.50/12.70	.05/1.27	.38/9.53	#8	.22/5.54	1,000
N4NY-008-9-M	N4NY-008-0-M	.50/12.70	.53/13.46	.05/1.27	.38/9.53	#8	.22/5.54	1,000
N6NY-004C-9-M	N6NY-004C-0-M	.25/6.35	.44/11.10	.06/1.52	.50/12.70	#10	.22/5.54	1,000
N6NY-005C-9-M	N6NY-005C-0-M	.31/7.92	.47/12.04	.06/1.52	.50/12.70	#10	.22/5.54	1,000
N6NY-006C-9-M	N6NY-006C-0-M	.38/9.53	.50/12.70	.06/1.52	.50/12.70	#10	.22/5.54	1,000
N6NY-007C-9-M	N6NY-007C-0-M	.44/11.10	.53/13.54	.06/1.52	.50/12.70	#10	.22/5.54	1,000
N6NY-008C-9-M	N6NY-008C-0-M	.50/12.70	.55/14.05	.06/1.52	.50/12.70	#10	.22/5.54	1,000
N6NY-009-9-M	N6NY-009-0-M	.56/14.27	.60/15.32	.06/1.52	.50/12.70	#10	.22/5.54	1,000
N6NY-010-9-M	N6NY-010-0-M	.63/15.88	.63/15.88	.06/1.52	.50/12.70	#10	.22/5.54	1,000
N6NY-011-9-M	N6NY-011-0-M	.69/17.45	.67/16.89	.06/1.52	.50/12.70	#10	.22/5.54	1,000
N6NY-012-9-M	N6NY-012-0-M	.75/19.05	.67/17.75	.06/1.52	.50/12.70	#10	.22/5.54	1,000
N6NY-013-9-M	N6NY-013-0-M	.81/20.62	.77/19.43	.06/1.52	.50/12.70	#10	.22/5.54	1,000
N6NY-014-9-M	N6NY-014-0-M	.88/22.23	.80/20.19	.06/1.52	.50/12.70	#10	.22/5.54	1,000
N6NY-016-9-M	N6NY-016-0-M	1.00/25.40	.83/21.00	.06/1.52	.50/12.70	#10	.22/5.54	1,000
N6NY-018-9-D	N6NY-018-0-D	1.13/28.58	.94/23.88	.06/1.52	.50/12.70	#10	.22/5.54	500
N6NY-019-9-D	N6NY-019-0-D	1.19/30.15	.96/24.46	.06/1.52	.50/12.70	#10	.22/5.54	500
N6NY-020-9-D	N6NY-020-0-D	1.25/31.75	.98/24.90	.06/1.52	.50/12.70	#10	.22/5.54	500
N6NY-022-9-D	N6NY-022-0-D	1.38/34.93	1.05/26.54	.06/1.52	.50/12.70	#10	.22/5.54	500
N6NY-024-9-D	N6NY-024-0-D	1.50/38.10	1.11/28.30	.06/1.52	.50/12.70	#10	.22/5.54	500

Ty-Rap® Wire Management Clips, Clamps, Spiral Wrap and More

Several mounting styles available.

Mechanical-Locking Routing Clamps

- Clamp acts as a retainer during wire routing, and as a permanent clamp when desired

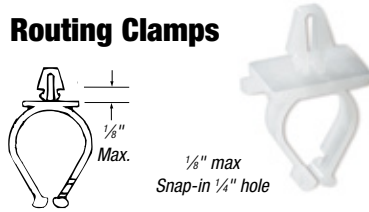

STD. CAT. NO.	MOUNTING HOLE SIZE		MAX. WIRE BUNDLE DIA.		LENGTH IN./MM	STD. PKG. QTY.
	IN./MM	IN./MM	IN./MM	IN./MM		
TC88	.250/6.35	.500/12.7	.250/6.35	.891/22.63	100	1,000
TC95	.250/6.35	1.000/25.4	.500/12.7	1.590/40.39	100	1,000

• Natural nylon color.
For use in temperatures ranging from -40° F to 185° F (-40° C to 85° C).

Ty-Rap® Saddle Mounting Plate

- For use with round bundles

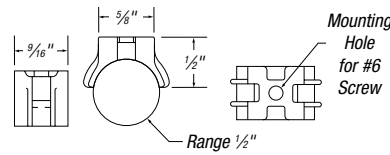

STD. PKG. CAT. NO.	MAX TIE WIDTH IN./MM	SIZE IN./MM	BUNDLE HOLE SIZE IN./MM	MOUNTING STD. PKG. QTY.
TC92	.190/4.83	1/2-1 1/4/12.7-31.75	#6 Screw	100

• Natural nylon color.
For use in temperatures ranging from -40° F to 185° F (-40° C to 85° C).

Wires are held 1/2" above work surface for easy tying.

Wire-Bundle Retainers

- Consist of a spring-loaded clip and an elastic bundle support
- Wires are inserted by snapping them through spring-loaded clips



STD. PKG. CAT. NO.	FASTENER	MAX. WIRE BUNDLE DIA.	WIDTH IN./MM	LENGTH IN./MM	HEIGHT IN./MM	STD. PKG. QTY.
TC86	#6 screws	.750/19.05	1.750/44.45	1.813/46.05	25	1,000
TC87	#6 screws	1.250/31.75	2.469/62.71	2.281/57.94	10	1,000

Hardened, nickel-plated, steel construction.

Harness-Board Nails

- For wire harness board manufacturing



STD. PKG. CAT. NO.	DIMENSIONS			STD. PKG. QTY.
	A	B	C	
HBP112	1.500/38.10	.625/15.88	.082/2.08	100
HBP2	2.000/50.80	.625/15.88	.092/2.34	100
HBP212	2.500/63.50	.625/15.88	.105/2.67	100
HBP3	3.000/76.20	.625/15.88	.120/3.05	100

Keep wire bundles apart.

Wire-Bundle Spacer



STD. PKG. CAT. NO.	MAXIMUM TIE WIDTH ACCOM.	WIDTH IN./MM	LENGTH IN./MM	STD. PKG. QTY.
TC5339	.190/4.83	.266/6.76	.500/12.70	100

• Natural nylon color.
For use in temperatures ranging from -40° F to 185° F (-40° C to 85° C).

Ty-Rap® Wire Management Clips, Clamps, Spiral Wrap and More

Install with gaps for greater flexibility or butted together for maximum abrasion resistance, insulation and rigidity!

Spiral Wrap

- Packaged in 100 foot reels
- Protects bundles from .063" to 7" (1.6 mm to 177.8 mm) diameters
- Available in three material types
- Also commonly known as reverse cut, left-handed cut or counter-clockwise cut
- Use cutting tool CC120B (see **page C-57**)
- UL94HB Flammability Rating

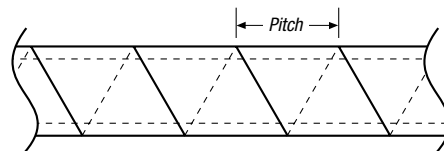
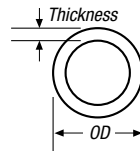

STD. PKG. CAT. NO.	MATERIAL	OUTSIDE DIAMETER IN./MM	PITCH IN./MM	NOMINAL WALL THICKNESS IN./MM	MINIMUM/MAXIMUM BUNDLE RANGE		REEL QTY.
					IN./MM	IN./MM	
SRPE-125-9-C	Natural Polyethylene	.13/3.18	.21/5.33	.04/.89	.06/1.60	.50/12.70	1 (100 ft.)
SRPE-187-9-C	Natural Polyethylene	.19/4.75	.24/6.10	.04/1.02	.13/3.18	1.50/38.10	1 (100 ft.)
SRPE-250-9-C	Natural Polyethylene	.25/6.35	.38/9.53	.05/1.14	.19/4.78	2.00/50.80	1 (100 ft.)
SRPE-375-9-C	Natural Polyethylene	.38/9.53	.44/11.13	.05/1.32	.31/7.95	3.00/76.20	1 (100 ft.)
SRPE-500-9-C	Natural Polyethylene	.50/12.70	.56/14.30	.06/1.57	.38/9.53	4.00/101.60	1 (100 ft.)
SRPE-625-9-C	Natural Polyethylene	.63/15.88	.63/15.88	.06/1.57	.63/15.88	4.50/114.30	1 (100 ft.)
SRPE-750-9-C	Natural Polyethylene	.63/15.88	.75/19.05	.07/1.65	.75/19.05	5.00/127.00	1 (100 ft.)
SRPE-1000-9-C	Natural Polyethylene	1.00/25.40	1.11/28.19	.70/17.78	1.0/25.40	7.00/177.80	1 (100 ft.)
SRPE-125-0-C	Weatherable Black Polyethylene	.13/3.18	.21/5.33	.04/.89	.06/1.60	.50/12.70	1 (100 ft.)
SRPE-187-0-C	Weatherable Black Polyethylene	.19/4.75	.24/6.10	.04/1.02	.13/3.18	1.50/38.10	1 (100 ft.)
SRPE-250-0-C	Weatherable Black Polyethylene	.25/6.35	.38/9.53	.05/1.14	.19/4.78	2.00/50.80	1 (100 ft.)
SRPE-375-0-C	Weatherable Black Polyethylene	.38/9.53	.44/11.13	.05/1.32	.31/7.95	3.00/76.20	1 (100 ft.)
SRPE-500-0-C	Weatherable Black Polyethylene	.50/12.70	.56/14.30	.06/1.57	.38/9.53	4.00/101.60	1 (100 ft.)
SRPE-625-0-C	Weatherable Black Polyethylene	.63/15.88	.63/15.88	.06/1.57	.63/15.88	4.50/114.30	1 (100 ft.)
SRPE-750-0-C	Weatherable Black Polyethylene	.63/15.88	.75/19.05	.07/1.65	.75/19.05	5.00/127.00	1 (100 ft.)
SRPE-1000-0-C	Weatherable Black Polyethylene	1.00/25.40	1.11/28.19	.70/17.78	1.0/25.40	7.00/177.80	1 (100 ft.)
SRNY-187-9-C	Natural Nylon 6.6	.19/4.75	.24/6.10	.03/.64	.13/3.18	1.50/38.10	1 (100 ft.)

Sold in 100-ft. rolls.

Polyethylene

Available in natural and weatherable black.

For general indoor use to 122° F (50° C). Material is flexible and easy to work with.

Weatherable Polyethylene

Available in black only. Designed to resist ultraviolet light in outdoor applications.

Nylon 6.6

Available in natural only.

Offers highest abrasion resistance and rigidity. Self-extinguishing to UL94HB and a UL® Recognized Component.

Ty-Rap® Wire Management Clips, Clamps, Spiral Wrap and More

Perfect for protection of bundles from .063" to 7" diameters.

Forward Cut Spiral Wrap

- Install with gaps for greater flexibility or butted together for maximum abrasion resistance, insulation, and rigidity
- Available in three materials
- Also known as right-hand cut or clockwise cut
- Use cutting tool CC120B (page C-57)

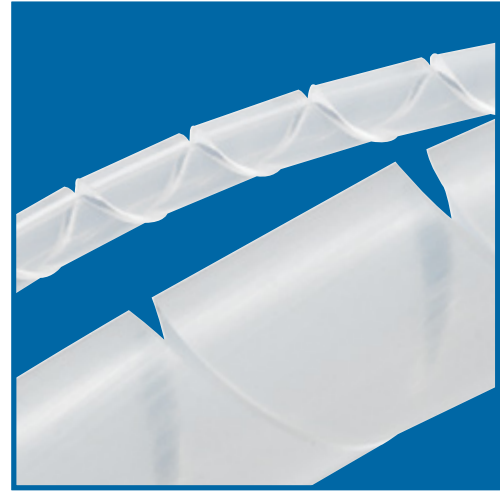
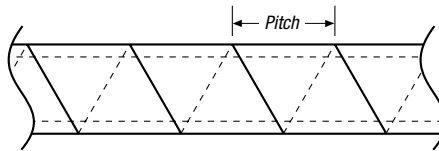
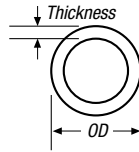

STD. PKG. CAT. NO.	MATERIAL	OUTSIDE DIAMETER IN./MM	PITCH IN./MM	NOMINAL WALL THICKNESS IN./MM	MIN./MAX. BUNDLE RANGE IN./MM	UL FLAMMABILITY	REEL QTY.
SRPE-125F-9-C	Natural Polyethylene	.19/4.75	.24/6.10	.04/1.02	.13-1.50/3.18-80.77	94 HB	1 (100 ft.)
SRPE-187F-9-C	Natural Polyethylene	.19/4.75	.24/6.10	.04/1.02	.13-1.50/3.18-80.77	94 HB	1 (100 ft.)
SRPE-250F-9-C	Natural Polyethylene	.25/6.35	.38/9.53	.05/1.14	.19-2.0/4.78-50.80	94 HB	1 (100 ft.)
SRPE-375F-9-C	Natural Polyethylene	.38/9.53	.44/11.13	.05/1.32	.31-3.0/7.95-76.20	94 HB	1 (100 ft.)
SRPE-500F-9-C	Natural Polyethylene	.50/12.70	.56/14.30	.06/1.57	.38-4.0/9.53-101.60	94 HB	1 (100 ft.)
SRPE-625F-9-C	Natural Polyethylene	.63/15.88	.63/15.88	.06/1.57	.63-4.5/15.88-114.30	94 HB	1 (100 ft.)
SRPE-750F-9-C	Natural Polyethylene	.75/19.05	.75/19.05	.07/1.65	.75-5.0/19.05-127.00	94 HB	1 (100 ft.)
SRPE-1000F-9-C	Natural Polyethylene	1.0/25.40	1.11/28.19	.07/1.78	1.0-7.0/25.40-177.80	94 HB	1 (100 ft.)
SRPE-125F-0-C	Weatherable Black Polyethylene	.19/4.75	.24/6.10	.04/1.02	.13-1.50/3.18-80.77	94 HB	1 (100 ft.)
SRPE-187F-0-C	Weatherable Black Polyethylene	.19/4.75	.24/6.10	.04/1.02	.13-1.50/3.18-80.77	94 HB	1 (100 ft.)
SRPE-250F-0-C	Weatherable Black Polyethylene	.25/6.35	.38/9.53	.05/1.14	.19-2.0/4.78-50.80	94 HB	1 (100 ft.)
SRPE-375F-0-C	Weatherable Black Polyethylene	.38/9.53	.44/11.13	.05/1.32	.31-3.0/7.95-76.20	94 HB	1 (100 ft.)
SRPE-500F-0-C	Weatherable Black Polyethylene	.50/12.70	.56/14.30	.06/1.57	.38-4.0/9.53-101.60	94 HB	1 (100 ft.)
SRPE-625F-0-C	Weatherable Black Polyethylene	.63/15.88	.63/15.88	.06/1.57	.63-4.5/15.88-114.30	94 HB	1 (100 ft.)
SRPE-750F-0-C	Weatherable Black Polyethylene	.75/19.05	.75/19.05	.07/1.65	.75-5.0/19.05-127.00	94 HB	1 (100 ft.)
SRPE-1000F-0-C	Weatherable Black Polyethylene	1.0/25.40	1.11/28.19	.07/1.78	1.0-7.0/25.40-177.80	94 HB	1 (100 ft.)

Sold in 100-ft. rolls.

Polyethylene

Available in natural and weatherable black.

For general indoor use to 122° F (50° C). Material is flexible and easy to work with.

Weatherable Polyethylene

Available in black only. Designed to resist ultraviolet light in outdoor applications.

Nylon 6.6

Available in natural only.

Offers highest abrasion resistance and rigidity. Self-extinguishing to UL94HB and a UL® Recognized Component.

Ty-Rap® Wire Management Clips, Clamps, Spiral Wrap and More

Suitable for round hole or odd-shape applications!

Molded Grommeting

- Used to protect panel edges and knockouts where the chafing of passing wires is a concern
- Strip length — 12¾"

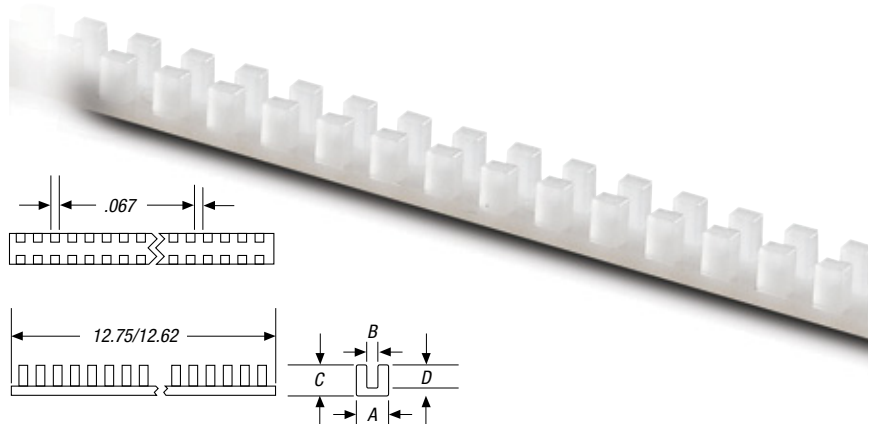

STD. PKG. CAT. NO.	MATERIAL	A IN./MM	B IN./MM	C IN./MM	D IN./MM	FOR PANEL THICKNESS IN./MM	STD. PKG.
GSNY-052-9-C	Natural Nylon 6.6	.15/3.81	.06/1.42	.16/3.94	.10/2.54	.02-.052/1.38-1.32	100
GSNY-085-9-C	Natural Nylon 6.6	.18/4.45	.09/2.29	.16/3.94	.10/2.54	.05-.085/1.35-2.16	100
GSNY-128-9-C	Natural Nylon 6.6	.22/5.59	.13/3.33	.16/3.94	.10/2.54	.09-.128/2.18-3.25	100
GSNY-192-9-C	Natural Nylon 6.6	.36/8.26	.20/4.95	.23/5.84	.16/4.06	.19-.192/3.25-4.88	100

High-carbon, Teflon® coated steel blade!

Cutting Tool

Use our cutting tool for all your spiral wrap, plastic pipe, raceway, PVC conduit and tubing cutting needs up to 1¼" I.D.

- Contoured handle resists tube crushing
- Produces no "sawdust" — no need to debur
- Lightweight, low-profile and no exposed blade when stored
- Can be used to cut Carlon® Electrical Non-Metallic Tubing (ENT)



CAT. NO.	DESCRIPTION
CC120B	Cutting Tool

Teflon® is a trademark of the DuPont Corporation.

Ty-Rap® Wire Management Clips, Clamps, Spiral Wrap and More

Line panel edges and knockouts! Extruded Grommeting

- Used to line panel edges and knockouts where the chafing of passing wires is a concern
- Available in 8 stock sizes in 100-ft. lengths for panels from .040" (1.02mm) to .250" (6.35mm) thick
- A variety of stocked materials to cover a wide range of applications

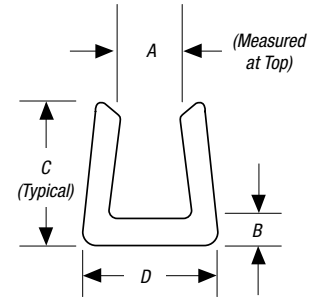

Note: Min. bend radius is 1¼".

Fastening Systems — Ty-Rap® High-Performance Cable Ties, Tools & Accessories

STD. PKG. CAT. NO.	MATERIAL	A MAX. PANEL THICKNESS IN./MM	B GROMMETING THICKNESS IN./MM	C GROMMETING HEIGHT IN./MM	D GROMMETING WIDTH IN./MM	UL FLAMMABILITY	REEL QTY.
GRNY-040-9-C	Natural Nylon	.04/1.02	.04/1.02	.19/4.83	.13/3.18	94 V-2	1 (100 ft.)
GRNY-052-9-C	Natural Nylon	.05/1.32	.04/1.02	.19/4.83	.13/3.18	94 V-2	1 (100 ft.)
GRNY-062-9-C	Natural Nylon	.06/1.57	.05/1.14	.20/5.08	.17/4.32	94 V-2	1 (100 ft.)
GRNY-085-9-C	Natural Nylon	.09/2.16	.05/1.14	.20/5.08	.17/4.32	94 V-2	1 (100 ft.)
GRNY-100-9-C	Natural Nylon	.10/2.54	.05/1.14	.22/5.89	.21/5.33	94 V-2	1 (100 ft.)
GRNY-125-9-C	Natural Nylon	.13/3.18	.05/1.27	.22/5.89	.21/5.21	94 V-2	1 (100 ft.)
GRNY-187-9-C	Natural Nylon	.19/4.75	.05/1.27	.27/6.86	.28/6.99	94 V-2	1 (100 ft.)
GRNY-250-9-C	Natural Nylon	.25/6.35	.05/1.27	.28/7.11	.379/4.0	94 V-2	1 (100 ft.)
GRNY-040-0-C	Black Nylon	.04/1.02	.04/1.02	.19/4.83	.13/3.18	94 V-2	1 (100 ft.)
GRNY-052-0-C	Black Nylon	.05/1.32	.04/1.02	.19/4.83	.13/3.18	94 V-2	1 (100 ft.)
GRNY-062-0-C	Black Nylon	.06/1.57	.05/1.14	.20/5.08	.17/4.32	94 V-2	1 (100 ft.)
GRNY-085-0-C	Black Nylon	.09/2.16	.05/1.14	.20/5.08	.17/4.32	94 V-2	1 (100 ft.)
GRNY-100-0-C	Black Nylon	.10/2.54	.05/1.14	.22/5.89	.21/5.33	94 V-2	1 (100 ft.)
GRNY-125-0-C	Black Nylon	.13/3.18	.05/1.27	.22/5.89	.21/5.21	94 V-2	1 (100 ft.)
GRNY-187-0-C	Black Nylon	.19/4.75	.05/1.27	.27/6.86	.28/6.99	94 V-2	1 (100 ft.)
GRNY-250-0-C	Black Nylon	.25/6.35	.05/1.27	.28/7.11	.379/4.0	94 V-2	1 (100 ft.)
GRPE-040-9-C	Natural Polyethylene	.04/1.02	.04/1.02	.19/4.83	.13/3.18	94 HB	1 (100 ft.)
GRPE-052-9-C	Natural Polyethylene	.05/1.32	.04/1.02	.19/4.83	.13/3.18	94 HB	1 (100 ft.)
GRPE-062-9-C	Natural Polyethylene	.06/1.57	.05/1.14	.20/5.08	.17/4.32	94 HB	1 (100 ft.)
GRPE-085-9-C	Natural Polyethylene	.09/2.16	.05/1.14	.20/5.08	.17/4.32	94 HB	1 (100 ft.)
GRPE-100-9-C	Natural Polyethylene	.10/2.54	.05/1.14	.22/5.89	.21/5.33	94 HB	1 (100 ft.)
GRPE-125-9-C	Natural Polyethylene	.13/3.18	.05/1.27	.22/5.89	.21/5.21	94 HB	1 (100 ft.)
GRPE-187-9-C	Natural Polyethylene	.19/4.75	.05/1.27	.27/6.86	.28/6.99	94 HB	1 (100 ft.)
GRPE-250-9-C	Natural Polyethylene	.25/6.35	.05/1.27	.28/7.11	.379/4.0	94 HB	1 (100 ft.)



Request Info
⚙️ 📄 🕒

1-800-453-1692

www.aboveboardelectronics.com

Ty-Rap® Wire Management Clips, Clamps, Spiral Wrap and More

Available in handy mini spools or bulk reels!

Braided Expandable Wire Protection Sleeving

Thomas & Betts braided wire protection sleeving is used to bundle and protect wires and cables from abrasion and excessive wear. Its flexible, lightweight, open weave construction installs easily over a variety of bundle diameters and shapes. The sleeving is resistant to chemicals, fungus, fuels, UV sunlight, and has an indefinite shelf life. It's easily cut with a hot knife, which seals the end, preventing fraying. Ends can be secured using Ty-Rap® cable ties.

Available in:

- Handy mini spools or bulk reels
- Eight sizes from 1/8" (3.18mm) to 2 1/2" (63.5mm) nominal I.D. size
- Solid or wraparound hook and loop braided expandable wire sleeving
- Meets UL94V-1
- Meets Federal Motor Vehicle Standard No. FMV SS 302

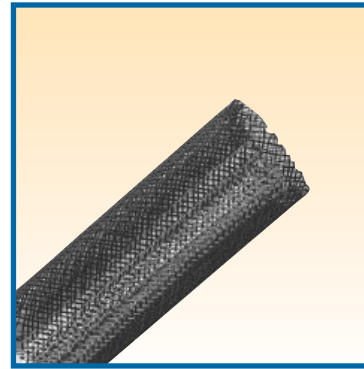

Polyethylene Terephthalate (P.E.T.)

A black 0.010" (.25mm) polyester monofilament material designed for indoor and outdoor applications. It's rated for continuous operating temp. -103° F to 257° F (-75° C to 125° C).

Catalog Number System

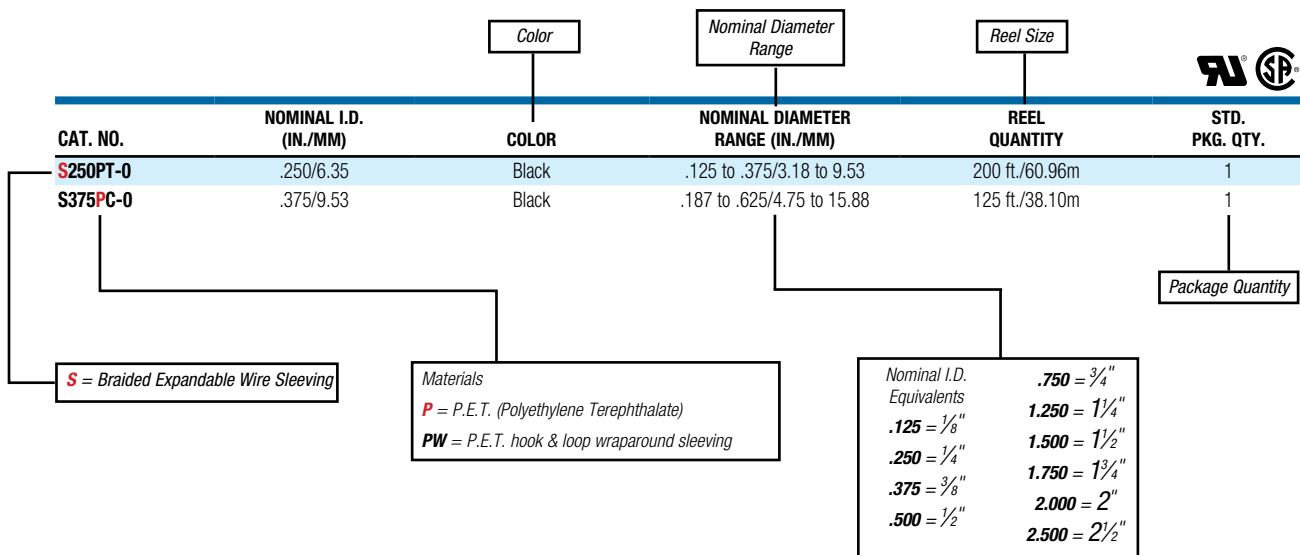

Ty-Rap® Wire Management Clips, Clamps, Spiral Wrap and More

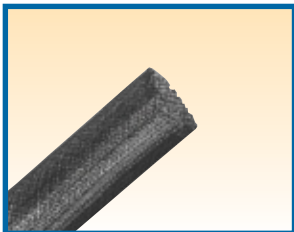

Portable convenience!

PET Braided Expandable Wire Sleeveing — Mini Spool



STD PKG. CAT. NO.	NOMINAL I.D. IN./MM	COLOR	NOMINAL DIAMETER RANGE IN./MM	SPOOL QUANTITY	STD. PKG. QTY.
S250PT-0	.25/6.35	Black	.13 to .38/3.18 to 9.53	200 ft./60.96m	1
S375PC-0	.38/9.53	Black	.19 to .63/4.75 to 15.88	125 ft./38.10m	1
S500PC-0	.50/12.70	Black	.25 to .75/6.35 to 19.05	100 ft./30.48m	1
S750PC-0	.75/19.05	Black	.50 to 1.25/12.70 to 31.75	100 ft./30.48m	1
S1250PL-0	1.25/31.75	Black	.75 to 1.75/19.05 to 44.45	50 ft./15.24m	1

Note: Order by spool, not per foot.

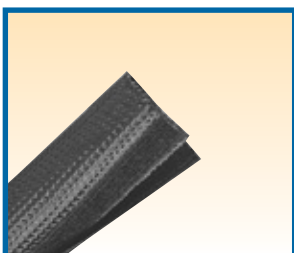

Enables for easy wrapping of existing wire harnesses and cables!

PET Hook and Loop, Wraparound Sleeveing — Mini Spool



STD PKG. CAT. NO.	NOMINAL I.D. IN./MM	COLOR	NOMINAL DIAMETER RANGE IN./MM	SPOOL QUANTITY	STD. PKG. QTY.
S500PWL-0	.50/12.70	Black	.25 to .75/6.35 to 19.05	50 ft./15.24m	1
S750PWL-0	.75/19.05	Black	.50 to 1.25/12.70 to 31.75	50 ft./15.24m	1
S1250PWL-0	1.25/31.75	Black	.75 to 1.75/19.05 to 44.45	50 ft./15.24m	1
S2000PWL-0	2.00/50.80	Black	1.50 to 3.50/38.10 to 88.90	50 ft./15.24m	1

Note: Order by spool, not per foot.

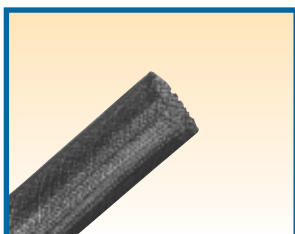

Buy in bulk and save!

PET Braided Expandable Wire Sleeveing — Bulk Reel



BULK PKG. CAT. NO.	NOMINAL I.D. IN./MM	COLOR	NOMINAL DIAMETER RANGE IN./MM	REEL QUANTITY	BULK PKG. QTY.
S125PM-0	.125/3.18	Black	.09 to .250/2.39 to 6.35	1,000 ft./304.80m	1
S250PM-0	.25/6.35	Black	.125 to .375/3.18 to 9.53	1,000 ft./304.80m	1
S500PD-0	.50/12.70	Black	.25 to .75/6.35 to 19.05	500 ft./152.40m	1
S750PK-0	.75/19.05	Black	.50 to 1.25/12.70 to 31.75	250 ft./76.20m	1
S1250PK-0	1.25/31.75	Black	.75 to 1.75/19.05 to 44.45	250 ft./76.20m	1
S1500PT-0	1.50/38.10	Black	1.00 to 2.50/25.40 to 63.50	200 ft./60.96m	1
S1750PT-0	1.75/44.45	Black	1.25 to 2.75/31.75 to 59.85	200 ft./60.96m	1
S2000PT-0	2.00/50.80	Black	1.50 to 3.50/38.10 to 88.90	200 ft./60.96m	1
S2500PT-0	2.50/63.50	Black	1.75 to 4.50/44.45 to 114.30	200 ft./60.96m	1

Note: Order by reel, not per foot.



The right tool for the job!

Sleevings End Cutter/Sealer Tool

It's recommended that the sleeveing be cut with a hot knife for a straight cut and to seal the ends, which prevents fraying.



STD. PKG. CAT. NO.	DESCRIPTION	STD. PKG.
WTBM	Benchmark End Cutter/Sealer Tool, 110 VAC	1