

Overview

HP ProLiant DL80 Generation9 (Gen9)

The HP ProLiant DL80 Gen9 Server is designed with affordable storage, networking and processor scalability, and manageability in a 2U server for cost conscious service provider and SMBs. Apart from basic IT infrastructure workloads this server is ideal for running storage capacity intensive applications like cold storage, back-up due to compelling cost/GB that it offers.

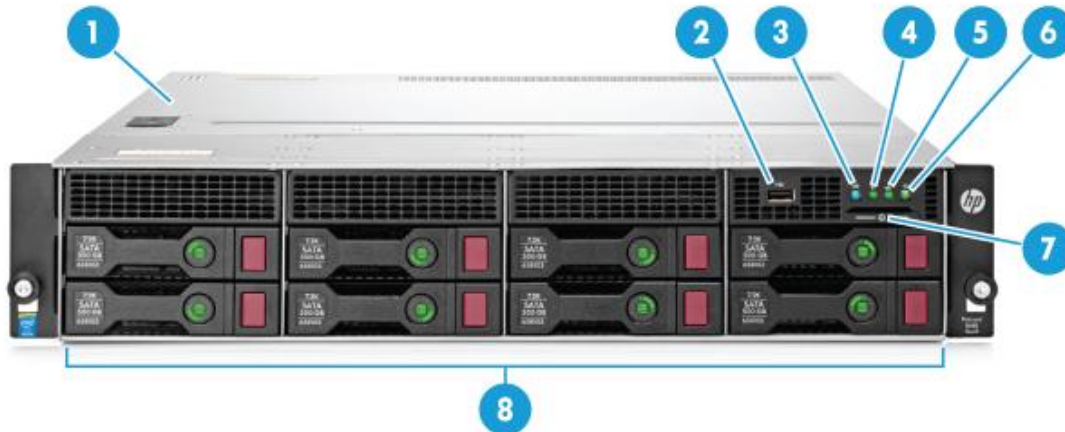

Front View

1. Access Panel (Top Cover)
2. USB 2.0 connector
3. UID button/LED
4. Health LED
5. NIC status LED
6. Power On/Standby button and system power LED
7. Serial label pull tab
8. 8-bay LFF drive cage bay

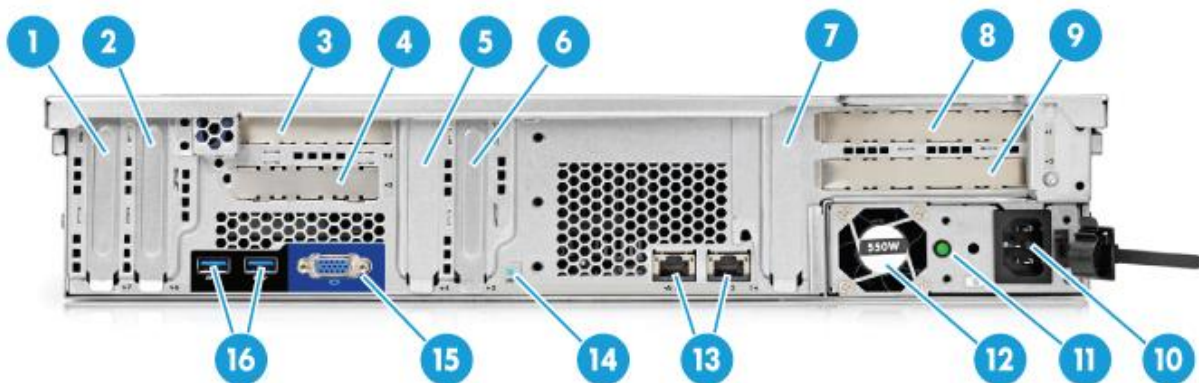

Rear view

1. Slot 7 PCIe3 x16 low-profile, standup
2. Slot 6 PCIe3 x8 low-profile, standup
3. Slot 4 PCIe3 x8 low-profile, riser (optional)
4. Slot 5 PCIe3 x8 FlexibleLOM riser (optional)
5. Slot 4 PCIe3 x16 low-profile, standup
6. Slot 3 PCIe3 x8 low-profile, standup

Overview

7. Slot 1 PCIe3 x16 low-profile, standup
8. Slot 1 PCIe3 x16 full-height, full-length GPU riser (optional) or Slot 1 PCIe3 x8 (8, 4, 1) full-height, half-length riser (optional)
9. Slot 2 PCIe3 x8 full-height half-length riser (optional)
10. Power supply power connection
11. Power supply status LED
12. Non-hot-plug power supply
13. Embedded 2x1 GbE network adapter
14. UID LED
15. Video connector
16. USB 3.0 connectors

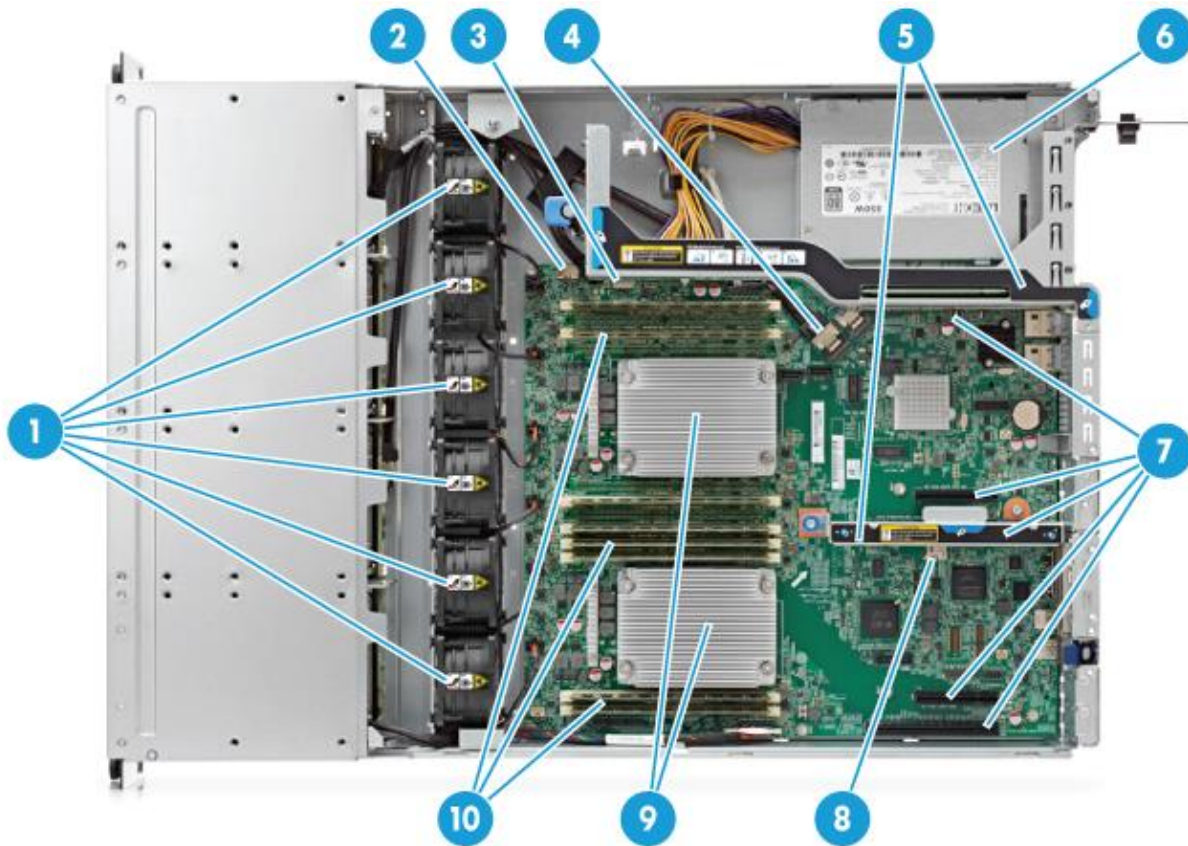

Internal View

1. Fans shown with 6 Hot-swap fans
2. HP Smart Storage Battery connector (optional)
3. Internal USB 3.0 connector
4. Embedded HP Smart Array B140i Controller
5. PCIe riser kits
6. (Under) Non-Hot Plug HP Power supply
7. PCIe 3.0 slots
8. MicroSD card slot
9. 2 Processors, heatsink showing, with HP Smart Socket Guide
10. HP DDR4 SmartMemory DIMM slots. Shown fully populated in 8 slots (4 per processor)

Standard Features

NOTE: For more information regarding Intel Xeon processors, please see the following <http://www.intel.com/xeon>.

Processor	Model	CPU frequency	Cores	L3 Cache	Power	QPI	DDR4 Hz
One of the following depending on model	E5-2660v3	2.6GHz	10	25MB	105W	9.6GT/s	2133
	E5-2650v3	2.3GHz	10	25MB	105W	9.6GT/s	2133
	E5-2650Lv3	1.8GHz	12	30MB	65W	9.6GT/s	2133
	E5-2640v3	2.6GHz	8	20MB	90W	8.0GT/s	1866
	E5-2630v3	2.4Ghz	8	20MB	85W	8.0GT/s	1866
	E5-2630Lv3	1.8GHz	8	20MB	55W	8.0GT/s	1866
	E5-2623v3	3.0GHz	4	10MB	105W	8.0GT/s	1866
	E5-2620v3	2.4GHz	6	15MB	85W	8.0GT/s	1866
	E5-2609v3	1.9GHz	6	15MB	85W	6.4GT/s	1600
	E5-2603v3	1.6GHz	6	15MB	85W	6.4GT/s	1600

Chipset	Chipset
One of the following depending on model	Intel® C610 Series Chipset
	Intel® E5-2600v3 Processor Family

NOTE: For more information regarding Intel chipsets, please see the following URL: <http://www.intel.com/products/server/chipsets/>.

On System Management Chipset	Management Chipset
One of the following depending on model	HP iLO (Firmware HP iLO4 2.0) 2GB NAND
	NOTE: For more information, visit: http://www.hp.com/go/ilo .

Memory	Type:	
One of the following depending on model	HP SmartMemory	
	DDR4 Registered (RDIMM) or Load Reduced (LRDIMM)	
	DIMM Slots Available	8 (4 DIMM slots per processor, 4 channels per processor, 1 DIMMs per channel)
	Maximum Capacity (LRDIMM)	256GB (8 x 32GB LRDIMM @2133MHz)
Maximum Capacity (RDIMM)	256GB (8 x 32GB RDIMM @2133MHz)	

Memory Protection	Memory Protection	Description
One of the following depending on model	Advanced ECC	Advanced ECC uses single device data correction to detect and correct single and all multibit error that occurs within a single DRAM chip.
	Online spare	Memory online spare mode detects a rank that is degrading and switches operation to the spare rank.

Expansion Slots	Expansion Slots #	Technology	Bus Width	Connector Width	Bus Number	Form Factor	Notes
Motherboard slots (Standard)	1	PCIe 3.0	x16	x16		Low Profile	CPU 1 slots
	3	PCIe 3.0	x8	x8		Low Profile	CPU 1 slots
	4	PCIe 3.0	x16	x16		Low Profile	CPU 1 slots
	6	PCIe 3.0	x8	x8		Low Profile	CPU 2 slots
	7	PCIe 3.0	x16	x16		Low Profile	CPU 2 slots

NOTE: Bus Width data indicates the number of physical electrical lanes running to the connector.

Expansion Slots	Expansion Slots #	Technology	Bus Width	Connector Width	Bus Number	Form Factor	Notes
Primary Riser (Optional)	1	PCIe 3.0	x8	x8		Full-height, half-length slot	CPU 1 slots
	2	PCIe 3.0	x8	x8		Full-height, half-length slot	CPU 1 slots

Standard Features

Flexible LOM Riser (Optional)	Expansion Slots #	Technology	Bus Width	Connector Width	Bus Number	Form Factor	Notes
	4	PCIe 3.0	x8	x8		Low profile	CPU 1 slots
	5	PCIe 3.0	x8	x8		Flexible LOM	CPU 1 slots

NOTE: This riser is mandatory for installing Flexible LOMs.

GPU riser (Optional)	Expansion Slots #	Technology	Bus Width	Connector Width	Bus Number	Device Number	Form Factor	Notes
	1	PCIe 3.0	x16	x16			Full height, full length slot	CPU 1 slots

NOTE: When populating slots on second riser, a second processor must be installed.

Storage Controller	Entry Models	HP Dynamic Smart Array B140i Controller
One of the following depending on model	NOTE: Provides support for up to 10 SATA drives and data transmission speeds up to 6Gb/s and supports RAID 0, 1 & 5.	
Storage Controller	Base Models	HP H240 FIO Smart Host Bus Adapter
One of the following depending on model	NOTE: H240 Provides support for up to 8 SAS/SATA drives, data transmission speeds up to 12Gb/s and supports RAID 0, 1 & 5.	

Internal Storage Devices	Optical Drives	Via USB only
One of the following depending on model	Hard Drives	None ship standard
	Hard Drive Bays	12 LFF drive bays total without Optical Bay 8 LFF drive bays total without Optical Bay

Maximum Internal Storage	CAPACITY	CONFIGURATION
One of the following depending on model	Hot Plug LFF SAS	12 x 8TB (with 12LFF drive cage)
	Hot Plug LFF SATA	12 x 8TB (with 12LFF drive cage)
	Hot Plug LFF SATA SSD	12 x 1.6TB (with 12LFF drive cage)
	Non-Hot Plug LFF SATA	8 x 4TB (with 8LFF drive cage)

Power Supply	HP 550W FIO Power Supply
One of the following depending on model	HP 800W/900W Gold AC Power Input Module
	HP Entry-Level Power Supplies provide lower-cost options for customers trying to balance their need for enterprise class efficiency and reliability while maintaining lowest possible hardware costs. All Entry-Level power supply options have been designed specifically for HP ProLiant Gen9 Essential Series servers.

The HP 550W FIO Power Supply is the standard, non-redundant AC power supply option for most HP ProLiant Gen9 Essential servers. It features Silver-level (89%) certified power efficiency with a set of features optimized for the Gen9 Essential-series rack and tower servers.

The HP 800W Gold (Redundant)/900W (Non-Redundant) AC Power Input Module with Power Backplane can be configured to support power redundancy in ProLiant servers that offer only a single power supply bay, providing additional protection against power loss. With an 80 Plus Gold power efficiency rating (up to 92%), this power option helps to reduce operating expenses while protecting against trapped power capacity in the data center. Each power backplane option can support up to two (2) hot-plug AC power input modules.

All pre-configured servers ship with a standard 6-foot IEC C-13/C-14 jumper cord (A0K02A). This jumper cord is also included with each standard AC power supply option kit. If a different power cord is required, please check the [ProLiant Power Cables](#) web page.

To review the power requirements for your selected system, please use the HP Power Advisor Tool located at <http://www.hp.com/go/hppoweradvisor>.

System Fans	Non-redundant	Redundant
One of the following depending on model	2 fans	4 fans
	NOTE: Redundant and non-redundant fan counts vary with riser selection. 1P configurations either one of primary and secondary risers need 3 fans in non-redundant configuration and	

Standard Features

	Non-redundant	Redundant
2P model	4 fans	5 fans
	<p>NOTE: Customers may separately purchase redundant fans with the 765516-B21 option kit. Additional fans (two) are also included in -B21 processor option kits when upgrading from one processor to two processors.</p> <p>NOTE: All the riser option kits ship with necessary fan option kits.</p>	
Interfaces	Video	1 (Vaux Support)
	LOM Network Ports	2 x 1GbE ports
	SD Slot	1 Micro SD
	<p>NOTE: The SD slot is not a hot-pluggable device. Customers should not attempt to plug an SD card into the SD slot while the server is powered.</p>	
	USB	Up to 4 USB ports (standard); Front: 1xUSB 2.0 std; (1xUSB2.0 optional upgrade with quick release ears) Rear: 2xUSB 3.0 Internal: 1x USB 3.0
	<p>NOTE: 12LFF drive cage models with Quick release latch rack ears supports front USB 2.0.</p>	
Operating Systems and Virtualization Software Support for ProLiant Servers	<p>Microsoft Windows Server</p> <p>Red Hat Enterprise Linux (RHEL)</p> <p>SUSE Linux Enterprise Server (SLES)</p> <p>Oracle Solaris</p> <p>VMware</p> <p>NOTE: For more information on HP's Certified and Supported ProLiant Servers for OS and Virtualization Software and latest listing of software drivers available for your server, please visit our Support Matrix at: http://www.hp.com/go/ossupport and our driver download page http://www.hp.com/support/DL80Gen9.</p>	
Upgradeability One of the following depending on model	<p>Upgradeable to two processors (24 cores)</p> <p>Up to 8 DIMM slots</p> <p>NOTE: To take advantage of DIMMs 5-8, a second processor must be installed.</p> <p>FlexibleLOM slot for 1Gigabit or 10 Gigabit Ethernet or QDR/FDR InfiniBand networking options</p> <p>NOTE: To take advantage of the additional 2 PCI slot upgrade, a second processor must be installed.</p> <p>Redundant Power Supply</p> <p>Redundant Fan</p>	
Industry Standard Compliance	<p>ACPI 2.0b Compliant</p> <p>PCIe 3.0 Compliant</p> <p>PXE Support</p> <p>WOL Support</p> <p>Microsoft® Logo certifications</p> <p>USB 3.0 Support</p> <p>ASHRAE A3</p> <p>NOTE: Supports A3 extended ambience.</p> <p>NOTE: Refer to technical specifications section for more details.</p>	
Graphics	<p>Integrated Matrox G200eH2 video standard</p> <ul style="list-style-type: none"> 1280 x 1024 (32 bpp) 1920 x 1200 (16 bpp) 	
HP Server UEFI/Legacy ROM	<p>HP Server UEFI /Legacy ROM</p> <p>Unified Extensible Firmware Interface (UEFI) is an industry standard that provides better manageability and more secured configuration while interacting with your server at boot time. HP ProLiant Gen9 platform defaults to UEFI and can be factory or field configured for Legacy BIOS Boot Mode.</p>	

Standard Features

NOTE: The UEFI System Utilities function is analogous to the HP ROM-Based Setup Utility (RBSU) of legacy BIOS. For more information, please visit <http://www.hp.com/go/proliantuefi/docs>.

UEFI enables numerous new capabilities specific to HP ProLiant servers such as:

- Secure Boot
- Operating system specific functionality
- Support for > 2.2 TB (using GPT) boot drives
- USB 3.0 Stack
- Embedded UEFI Shell
- Mass Configuration Deployment Tool using HP RESTful API.
- PXE boot support for IPv6 networks
- Boot support for option cards that only support a UEFI option ROM

For more information please visit <http://www.hp.com/go/proliant/uefi>.

NOTE: For UEFI Boot Mode, boot environment and OS image installations should be configured properly to support UEFI.

NOTE: HP UEFI FIO Setting (758959-B22) can be selected to configure the system in Legacy mode in the factory.

Form Factor

One of the following depending on model

2U Rack form factor
 All models ship with Easy Install rails (Cable management arm optional).
 8 LFF Drive Bay Version:
 3.44 (8.75cm) Height x 17.54" (44.55 cm) Width x 23.9" (60.70 cm) Length
 12 LFF Drive Bay Version:
 3.44 (8.75cm) Height x 17.54" (44.55 cm) Width x 23.9" (60.70 cm) Length

Embedded Management

HP Integrated Lights-Out (HP iLO)	Monitor your servers for ongoing management, service alerting, reporting and remote management with HP iLO. Learn more at http://www.hp.com/go/ilo .
UEFI	Configure and boot your servers securely with industry standard Unified Extensible Firmware Interface (UEFI). Learn more at http://www.hp.com/go/ProLiant/uefi .
HP RESTful API	RESTful API is an application programming interface. RESTful Web Service API served by iLO's web server: Learn more at http://www.hp.com/go/restfulapi .
Intelligent Provisioning	Provision servers by discovering and deploying 1 to few servers with Intelligent Provisioning. Learn more at http://www.hp.com/go/intelligentprovisioning .
Embedded Remote Support	HP's embedded remote support, when used with Insight Online direct connect or HP Insight Remote Support, allows HP ProLiant servers to transmit hardware events directly to HP or an HP Authorized Partner for automated phone home support. Learn more at http://www.hp.com/go/insightonline/info .

Server utilities

HP Smart Update	Optimize firmware and driver updates with HP Smart Update solutions. Learn more at http://www.hp.com/go/smartupdate .
HP Systems Insight Manager (HP SIM)	HP SIM allows you to monitor the health of your HP ProLiant Servers and HP Integrity Servers, and also provides you with basic support for non-HP servers. HP SIM also integrates with HP SUM to provide quick and seamless firmware updates. Learn more at http://www.hp.com/go/sim .
HP OneView Standard	HP OneView Standard can inventory, monitor, alert, and report on your G6, G7, Gen8, and Gen9 servers, while using the HP OneView user interface. Annual support is optionally available. Learn more at http://www.hp.com/go/oneview .

Standard Features

Scripting Tool Kit and Windows PowerShell	Provision 1 to many servers using your own scripts to discover and deploy them with HP Scripting Tool Kit for Windows and Linux or HP Scripting Tools for Windows PowerShell. Learn more at http://www.hp.com/go/ProLiantSTK or http://www.hp.com/go/powershell .
HP RESTful Interface Tool	HP RESTful Interface tool is a scripting tool to provision servers using RESTful API Interface to discover and deploy servers at scale. Learn more at http://www.hp.com/go/restfulapi .
HP iLO Mobile Application	Enables the ability to access, deploy, and manage your server anytime from anywhere from select smartphones and mobile devices. For additional information please visit: http://www.hp.com/go/ilo/mobileapp .
HP Insight Online	HP Insight Online, available at no additional cost as part of your HP warranty, Care Pack or contractual support agreement with HP, is a personalized dashboard for simplified tracking of IT operations and support information from anywhere, anytime. Learn more at http://www.hp.com/go/insightonline/info .

Security

Power-on password
Serial interface control
Administrator's password
TPM 1.2
UEFI

Warranty

This product is covered by a global limited warranty and supported by HP Services and a worldwide network of HP Authorized Channel Partners resellers. Hardware diagnostic support and repair is available for three years from date of purchase. Support for software and initial setup is available for 90 days from date of purchase. Enhancements to warranty services are available through HP Care Pack services or customized service agreements. Hard drives have either a one year or three year warranty; refer to the specific hard drive QuickSpecs for details.

NOTE: Server Warranty includes 1-Year Parts, 1-Year Labor, 1-Year Onsite support with next business day response. Warranty repairs may be accomplished through the use of Customer Self Repair (CSR) parts. These parts fall into two categories: 1) Mandatory CSR parts are designed for easy replacement. A travel and labor charge will result when customers decline to replace a Mandatory CSR part; 2) Optional CSR parts are also designed for easy replacement but may involve added complexity. Customers may choose to have HP replace Optional CSR parts at no charge. Additional information regarding worldwide limited warranty and technical support is available at: <http://h18004.www1.hp.com/products/servers/platforms/warranty/index.html>.

Optional Features

Embedded Management

- iLO Essentials** HP iLO Essentials is the preferred license for small and medium business that offers full remote server management capabilities for small and medium business via the Integrated Remote Console (IRC), virtual media, and e-mail based alerts. Learn more about HP iLO Essentials at <http://www.hp.com/go/iLO/essentials>.
- iLO Scale-Out** HP iLO Scale-Out is the preferred license built for web hosting, cloud service providers, and high performance computing data centers, managing massive scale out environments. This license offers sophisticated scripting tools that provides remote access through Text Console via SSH, Dynamic power capping, Email-based Alerting and proactive notifications. For more information, visit <http://www.hp.com/go/iLO/scale-out>.
- iLO Advanced** HP iLO Advanced licenses offer smart remote functionality without compromise, for all HP ProLiant servers. The license includes the full integrated remote console, virtual keyboard, video, and mouse (KVM), multi-user collaboration, console record and replay, and GUI-based and scripted virtual media and virtual folders. You can also activate the enhanced security and power management functionality. Learn more about HP iLO Advanced at <http://www.hp.com/go/iloadvanced>.

Server Management

- HP Insight Control** HP Insight Control, lets you deploy, migrate, monitor, remote control, and optimize your IT infrastructure through a single, simple management console. For more information, see <http://www.hp.com/go/insightcontrol>.
- HP OneView Advanced** HP OneView Advanced is converged management that eliminates infrastructure complexity with automation simplicity. This modern architecture is designed to accelerate your IT operations across servers, storage, and network resources using software-defined approaches and automation, see <http://www.hp.com/go/oneview>.

Rack and Power Infrastructure

HP Rack and Power Infrastructure products and services create highly efficient and intelligent solutions for existing or new IT data centers. HP Rack and Power infrastructure solutions – rack infrastructure, power protection and management, performance optimized data centers (PODs) – are the foundation you are looking for to help secure your long-term IT success. These products are designed to help you react to changes in the industry. They deliver efficient, easy-to-use capabilities to manage, monitor, deploy and provision infrastructure from entry to enterprise. As an industry leader, HP is uniquely positioned to address the key concerns of power, cooling, cable management and system access.

Learn more at [HP Rack and Power Infrastructure](#).

High Performance Clusters

HP Cluster Platforms are specifically engineered, factory-integrated large-scale ProLiant clusters optimized for High Performance Computing, with a choice of servers, networks and software. Operating system options include specially priced offerings for Red Hat Enterprise Linux and SUSE Linux Enterprise Server, as well as Microsoft Windows HPC Server. A Cluster Platform Configurator simplifies ordering. <http://www.hp.com/go/clusters>.

HPC Interconnects

NOTE: High Performance Computing (HPC) interconnect technologies are available for this server under the HP Cluster Platform product portfolio. These high-speed interconnects are fully supported by HP when they are part of these configure to order clusters. Solutions can be defined with a lot of flexibility with the help of configuration tools. Please visit the following URL to configure HPC Clusters with InfiniBand Interconnects: <http://www.hp.com/techservers/clusters/ucp/index.html>.

Storage Software

Whether you need to solve a specific data protection, archiving, or storage command and control challenge, or deliver on strategic consolidation, compliance, or continuity initiatives, look no further than HP storage software. Our storage software helps you reduce costs, simplify storage infrastructure, protect vital assets and respond faster to business opportunities.

Storage software that gets the job done:

- Data Protection and Recovery Software** Whether you're a large enterprise or a smaller business, HP data protection and recovery software will cost-effectively protect you against disaster and ensure business continuity.
- Data Archive and Migration Software** HP's storage software enables you to comply with data retention and retrieval requirements, improve

Optional Features

application performance, and reduce costs by efficiently migrating infrequently accessed or less valuable data to lower cost storage.

- **Storage Resource Management Software (SRM)**
HP's storage resource management software reduces operational costs and provides the command and control foundation you need to efficiently manage and visualize your physical and virtual environments.
- **Data Replication Software**
HP offers array-based and host-based replication software for use in disaster recovery, testing, application development and reporting.
- **Storage Device Management Software**
Maximize your investment in HP storage and networking with software that enables hardware-specific configuration, performance tuning and connectivity management.
- **HP StoreVirtual VSA**
With HP StoreVirtual VSA you can use the power of virtualization to create a virtual array within your host server. Manage it as a single pool of shared storage capacity, and scale it to match your evolving needs. HP ProLiant Gen9 servers include a 3-year limited license for HP StoreVirtual VSA software with 1 TB of capacity at no extra cost. Simply select to install HP StoreVirtual VSA software during server setup within Intelligent Provisioning. More information, instructional videos, and free console management software are available at <http://www.hp.com/go/vsa1TB>.

NOTE: For more information about Storage Software including QuickSpecs, please see: <http://www.hp.com/go/storage/software>.

One Config Simple (SCE)

SCE is a guided self-service tool to help sales and non-technical people provide customers with initial configurations in 3 to 5 minutes. You may then send the configuration on for configuration help, or use in your existing ordering processes. If you require "custom" rack configuration or configuration for products not available in SCE, please contact HP's Customer Business Center or an Authorized Partner for assistance. <http://www.hp.com/products/configurator>.

Service and Support

Service and Support **HP Technology Services for Industry Standard Servers**

HP Technology Services delivers confidence, reduces risk and helps customers realize agility and stability. Connect to HP to help prevent problems and solve issues faster. Our support technology lets you tap into the knowledge of millions of devices and thousands of experts to stay informed and in control, anywhere, any time.

Protect your business beyond warranty with HP Care Pack Services

HP Care Pack Services enable you to order the right service level, length of coverage and response time as you purchase your new server, giving you full entitlement for the term you select.

Optimized Care**Supports maintaining servers at optimum performance availability****HP Proactive Care with 24x7 coverage, three year Care Pack Service**

HP Proactive Care helps prevent problems and stabilize IT by utilizing secure, real-time, predictive analytics and proactive consultations when your products are connected to HP. This Care Pack Service combines three years' proactive reporting and advice with our 24x7 coverage and enhanced escalation management, four hour hardware response time and two hour call back for software questions on leading industry standard software running on your HP ProLiant server. <http://h20195.www2.hp.com/v2/GetPDF.aspx/4AA3-8855ENW.pdf>

Standard Care Package**Supports maintaining high level of server availability****Foundation Care 24x7, three-year Care Pack Service**

HP Foundation Care 24x7 connects you to HP 24 hours a day, seven days a week for assistance on resolving issues. Hardware onsite response within four hours if needed; collaborative software included in this Care Pack service provides troubleshooting assistance on industry leading software running on your HP server. Simplify your support experience and make HP your first call for hardware or software questions.

<http://h20195.www2.hp.com/V2/GetDocument.aspx?docname=4AA4-8876ENW&cc=us&lc=en>

Basic Care**Foundation Care NBD, three-year Care Pack Service**

HP Foundation Care Next Business Day connects you to HP during business hours for assistance on resolving issues – features next business day hardware onsite response if needed and software call back within two hours. Collaborative software support is included and provides troubleshooting assistance on industry leading software running on your server. Simplify your support experience and make HP your first call for hardware or software questions.

<http://h20195.www2.hp.com/V2/GetDocument.aspx?docname=4AA4-8876ENW&cc=us&lc=en>

Related Services**HP ProLiant Server Hardware Installation**

Provides for the basic hardware installation of HP branded servers, storage devices and networking options to assist you in bringing your new hardware into operation in a timely and professional manner.

<http://h20195.www2.hp.com/V2/GetPDF.aspx/5981-9356EN.pdf>

Factory Express for Servers and storage

HP Factory Express offers configuration, customization, integration and deployment services for HP servers and storage products. Customers can choose how their factory solutions are built, tested, integrated, shipped and deployed. For more information on Factory Express services for your specific server model please contact your sales representative or go to: <http://www.hp.com/go/factory-express>.

Data Privacy Services

Protect your data through better media management. HP Data privacy services help manage and protect sensitive data to reduce the risk of unauthorized access to private information and help meet compliance requirements. Our retention services allow you to keep drives and other devices upon failure, our removal services provide convenient data sanitization and our recovery services allow you to safely retire IT assets and capture any remaining value from the hardware. <http://www.hp.com/services/dataprivacy>

Additional HP Care Pack services can be found at: <http://www.hp.com/go/cpc>

Get connected to HP to improve your support experience

Prevent problems with innovative, automated monitoring tools and proactive services. Combining Proactive Care Services with our remote support technology such as Insight Online provides you with expert advice and personalized, cloud-based automated IT support, helping to prevent unplanned down time and solve problems quickly. For more information, visit: <http://www.hp.com/go/proactiveinsightexperience>

Service and Support

HP Support Center Personalized online support portal with access to information, tools and experts to support HP business products. Submit support cases online, chat with HP experts, access support resources or collaborate with peers. Learn more <http://www.hp.com/go/hpsc>.

HP's Support Center Mobile App** allows you to resolve issues yourself or quickly connect to an agent for live support. Now, you can get access to personalized IT support anywhere, anytime.

HP Insight Remote Support and HP Support Center are available at no additional cost with a HP warranty, HP Care Pack or HP contractual support agreement.

** HP Support Center Mobile App is subject to local availability

Parts and Materials HP will provide HP-supported replacement parts and materials necessary to maintain the covered hardware product in operating condition, including parts and materials for available and recommended engineering improvements. Parts and components that have reached their maximum supported lifetime and/or the maximum usage limitations as set forth in the manufacturer's operating manual, product quick-specs, or the technical product data sheet will not be provided, repaired, or replaced as part of these services. The defective media retention service feature option applies only to Disk or eligible SSD/Flash Drives replaced by HP due to malfunction.

Pre-configured Models

For the Standard Features shipped in the "Factory Integrated Models", please see the "Configuration Information - Factory Integrated Models" section.

1. Pre-configured models ship with the configurations below. Options can be selected from the Core or Additional options section of this QuickSpecs.
2. HP does not allow factory integration of options into pre-configured models. Any additional options purchased will be shipped separately.
3. If you desire a custom configuration please see "Configuration Information - Factory Integrated Models" section of this QuickSpecs.
4. Not all models are available in all regions. Check with your local country HP offices for availability.

NOTE: All Pre-configured Models come populated with some hard drive blanks installed. Should the customer need additional hard drive blanks, they can order more using either P/N 666987-B21: HP SFF Hard Drive Blank Kit or P/N 666986-B21: HP LFF Hard Drive Blank Kit.

NOTE: All pre-configured servers ship with a standard 6-foot IEC C-13/C-14 jumper cord (AOK02A). This jumper cord is also included with each standard AC power supply option kit. If a different power cord is required, please check the [ProLiant Power Cables](#) web page.

Caution: HP recommends that a minimum of two people are required for all Rack Server installations. Please refer to your installation instructions for proper tools and number of people to use for any installation.

	Entry Models	Base Models
[SKU Number]	778640-B21	778641-B21
Model Name	HP ProLiant DL80 Gen9 E5-2603v3 4GB-R B140i 4LFF 550W PS Entry Server	HP ProLiant DL80 Gen9 E5-2609v3 8GB-R H240 8LFF 550W PS Entry Server
Processor	Intel® Xeon® E5-2603v3	Intel® Xeon® E5-2609v3
Number of Processors	One	
Memory	4GB (1x4GB Registered DIMMs, 2133 MHz) NOTE: Due to processor limitation, these DDR4 DIMMs will operate at 1600 MHz in this model.	8GB (1x8GB Registered DIMMs, 2133 MHz) NOTE: Due to processor limitation, these DDR4 DIMMs will operate at 1600 MHz in this model.
Network Controller	HP Embedded Dual Port 361i Adapter Network Interface	
Storage Controller	HP Dynamic Smart Array B140i	HP H240 FIO Smart Host Bus Adapter
Hard Drive	None ship standard	
Internal Storage	4 LFF HDD Bays (Non Hot Plug)	8 LFF HDD Bays
Optical Drive Bay	Not Available	
Optical Drive	Optional via HP Mobile USB DVDRW Drive (701498-B21)	
PCI-Express Slots	5 PCIe 3.0 slots (without risers)	
Power Supply	(1) HP 550W FIO Power Supply	
Fans	2 hot swap fans, non-redundant	4 hot swap fans, redundant
Management	iLO Management (standard), Intelligent Provisioning (standard), iLO Essentials (optional)	
Form Factor	Rack (2U), HP Easy Install Rails	

Country Code Key

xx1 = B21

Worldwide

Note: The -B21 WW SKU is to be ordered in all countries other than Japan or PRC.

xx1 = 291

Japan

xx1 = AA1

PRC

Configuration Information - Factory Integrated Models

This section lists some of the steps required to configure a Factory Integrated Model. To ensure only valid configurations are ordered, HP recommends the use of an HP approved configurator. Contact your local sales representative for information on configurable product offerings and requirements.

1. Factory Integrated Models must start with a CTO Server.
2. FIO indicates that this option is only available as a factory installable option.
3. All Factory Integrated Models will be populated with sufficient hard drive blanks based on the number of initial hard drives ordered with the server.
4. Some options may not be integrated at the factory. Contact your local sales representative for additional information.

Step 1: Base Configuration (choose one of the following configurable models)

[Chassis]	HP ProLiant DL80 Gen9 Non-hot Plug 4LFF Configure-to-order Server	HP ProLiant DL80 Gen9 8LFF Configure-to-order Server	HP ProLiant DL80 Gen9 12LFF Configure-to-order Server
SKU Number	778686-B21	778685-B21	787217-B21
Processor	2 (optional) x HP Smart Socket Guides		
DIMM Slots	8 DIMM slots for RDIMM, LRDIMM DDR4 Memory		
Storage Controller	HP Dynamic Smart Array B140i		
PCIe	5 Low Profile PCIe 3.0 slots		
Drive Cage	4LFF Non Hot Plug	8LFF Hot Plug	12LFF Hot Plug
Network Controller	HP Embedded Dual Port 361i Adapter Network Interface		
Fans	2 hot swap fans, non-redundant		
Management	iLO Management (standard), Intelligent Provisioning (standard), iLO Essentials (optional)		
USB	1 front, 1 internal, 2 rear		

Step 2: Choose Required Options (only one of the following from each list unless otherwise noted)

HP Processors

Select one or two processors from Core options-Processor section below,

- If one processor is desired, select one xxxxxx-L21
- If two processors are desired, select one xxxxxx-L21 and one xxxxxx-B21.
- Up to 2 processors supported. Mixing different processor models is not supported.
- DDR4 speed is the maximum memory speed of the processor. Actual memory speed may depend on the quantity and type of DIMMs installed.

For the Intel® C600 Chipset E5-2600 Series, the letter preceding the model number indicates the Product Line (E3, E5, E7); 2600x v#, 2 = number of CPUs in a Node, 6 is socket/segment designation, 00 = Processor SKU, x = L for low power SKUs and v# (not yet designated) = version number.

HP Memory

Select one or more memory from Core options-Memory section below,

- LRDIMM, RDIMM are all distinct memory technologies and cannot be mixed within a server. The majority of ProLiant Gen9 servers support LRDIMM and RDIMM.
- HP memory from previous generation servers are not qualified or warranted with this HP ProLiant Server. HP SmartMemory is required to realize the memory performance improvements and enhanced functionality listed in this document for Gen9.
- If only one processor is installed, only half of the total DIMM slots are available. When populating with two processors all DIMM slots are available.
- Kits described as LP include Low Power DIMMs. For more information on ProLiant Energy Efficient Features, see: <http://www.hp.com/go/proliant-energy-efficient>.
- Depending on the memory configuration and processor model, the memory speed may run at 2133MHz, 1866MHz, 1600MHz or 1333MHz. Please see Memory Population Table or the Online Memory Configuration Tool at: <http://www.hp.com/go/ddr4config>.

HP Power Supplies

Select one or more power supplies from Core Options-Power Supplies section below:

Configuration Information - Factory Integrated Models

- Prior to selecting a power supply option, it is highly recommended that you review your server configuration in the HP Power Advisor tool to determine the right size power supply for your server configuration. The HP Power Advisor is located at: <http://www.hp.com/go/hppoweradvisor>.
- Mixing of power supplies in the same server is not supported. All power supplies must be of the same input voltage, output rating, and efficiency rating. If non-matching power supplies are installed, you may receive an error message and/or experience operational issues with your server.

Step 3: Choose Additional Factory Integratable Options

HP Unique Options

Select one or more Unique options from Core options section below.

- This section may contain FIO options, please see the Unique options section below.
- FIO indicates that this option is only available as a factory installable option.

HP Drives

Select one or more drives from Core options-HP Drives section below:

- The components of a storage subsystem (e.g. the drive, the HBA/controller, firmware, and the server backplane) should operate at the same data transfer rate or the system bandwidth will be negotiated down to an acceptable level for all components.
- Hard drives have either a one year or three year warranty; refer to the specific hard drive QuickSpecs for details.
- The HP ProLiant Gen9 Smart Storage solutions are equipped with re-designed Small Form Factor (SFF 2.5 in) and Large Form Factor (LFF 3.5 in) hot plug carriers for HP Qualified Hard Drives and Solid State Drives. These new carriers provide status and activity indicators as well as caution indicators for "Do Not Remove".

HP Flexible LOM

Select a FlexibleLOM from Core options-Networking section below,

- Only one FlexibleLOM can be added to the server. These options are upgradeable and can be changed from the original configuration after the server is shipped.
- For 10Gb adapters, a minimum of two Gigabytes (2 GB) of server memory is required per each adapter.
- Please see the QuickSpecs for Technical Specifications and additional information: <http://www.hp.com/go/ProLiantNICs>.

HP Networking

Select a standup NIC adapter from Core options-Networking section below,

- Please see the QuickSpecs for Technical Specifications and additional information: <http://www.hp.com/go/ProLiantNICs>.
- These options are upgradeable and can be changed from the original configuration after the server is shipped.
- For 10Gb adapters, a minimum of two Gigabytes (2 GB) of server memory is required per each adapter.

HP Graphics Options

Select one or more graphics adapter from Additional options section below.

- Please see the HP Power Advisor for estimated power consumption of your individual system configuration prior to installing GPUs. The HP Power Advisor is located at: <http://www.hp.com/go/hppoweradvisor>.
- This section may contain FIO options, please see HP Computation & Graphics Accelerators section below.

HP Cooling Options

Select one or more Fan Kits from Core options section below.

- This section may contain FIO options, please see HP Cooling Options section below.
- FIO indicates that this option is only available as a factory installable option.

HP Storage Controllers

Select one or more Storage options from Additional options section below.

Configuration Information - Factory Integrated Models

- The embedded B140i controller will operate in UEFI only mode. For legacy support an additional controller will be needed, and for CTO orders please also select the Legacy mode settings part, 758959-B22
- This section may contain FIO options, please see HP Storage Controllers section below.
- FIO indicates that this option is only available as a factory installable option.

HP I/O Expansion Options

Select one or more Riser Kit options from Core options section below.

- To take advantage of the additional PCI slot upgrade, the second processor must be installed.
- This section may contain FIO options, please see HP I/O Expansion Options section below.
- FIO indicates that this option is only available as a factory installable option.

HP Rail Kits

Select one type of rail kit from Additional options section below.

- Please take a moment to review the installation documentation that comes with the server to help you with the installation of your Gen9 server.
- To assist in the installation of the server into the rack, an optional installation tool is available by contacting your local services representative (p/n 695539-001).
- See HP Rack Options in Additional Options section of this QuickSpecs for more rack kit choices.

Caution: HP recommends that a minimum of two people are required for all Rack Server installations. Please refer to your installation instructions for proper tools and number of people to use for any installation.

Core Options

NOTE: Some options may not be integrated at the factory. To ensure only valid configurations are ordered, HP recommends the use of an HP approved configurator. Contact your local sales representative for additional information.

HP Unique Options	HP DL80 Gen9 8LFF Non-hot Plug Enablement Kit NOTE: Required to upgrade from 4LFF NHP to 8LFF NHP models.	788355-B21
	HP DL80 Gen9 Full Height Half Length Riser Kit NOTE: Includes two FHHL PCIe 3.0 slots and one fan.	765515-B21
	HP DL80 Gen9 GPU Enablement Kit NOTE: Includes 1 FHFL slot, one fan and power cable required to enable GPU support. Either one of FHHL or FlexibleLOM riser or GPU riser can be selected.	765518-B21
	HP DL80 Gen9 FlexibleLOM Riser Kit NOTE: Includes one FlexibleLOM slot, one Low Profile slot and one fan.	765514-B21
	HP AHCI-Enable FIO Setting NOTE: This needs to be selected when Advanced Host Controller Interface mode is required on B140i controller.	801845-B21

HP Processors

Entry Processors - E5-2600v3 series Processors

HP DL80 Gen9 Intel® Xeon® E5-2603v3 (1.6GHz/6-core/15MB/85W) Processor Kit	765521-B21
HP DL80 Gen9 Intel® Xeon® E5-2603v3 (1.6GHz/6-core/15MB/85W) FIO Processor Kit	765521-L21
HP DL80 Gen9 Intel® Xeon® E5-2609v3 (1.9GHz/6-core/15MB/85W) Processor Kit	765523-B21
HP DL80 Gen9 Intel® Xeon® E5-2609v3 (1.9GHz/6-core/15MB/85W) FIO Processor Kit	765523-L21

Base Processors - E5-2600v3 series Processors

HP DL80 Gen9 Intel® Xeon® E5-2620v3 (2.4GHz/6-core/15MB/85W) Processor Kit	765525-B21
HP DL80 Gen9 Intel® Xeon® E5-2620v3 (2.4GHz/6-core/15MB/85W) FIO Processor Kit	765525-L21
HP DL80 Gen9 Intel® Xeon® E5-2630v3 (2.4GHz/8-core/20MB/85W) Processor Kit	765526-B21
HP DL80 Gen9 Intel® Xeon® E5-2630v3 (2.4GHz/8-core/20MB/85W) FIO Processor Kit	765526-L21
HP DL80 Gen9 Intel® Xeon® E5-2640v3 (2.6GHz/8-core/20MB/90W) Processor Kit	765531-B21
HP DL80 Gen9 Intel® Xeon® E5-2640v3 (2.6GHz/8-core/20MB/90W) FIO Processor Kit	765531-L21
HP DL80 Gen9 Intel® Xeon® E5-2623v3 (3GHz/4-core/10MB/105W) Processor Kit	780100-B21
HP DL80 Gen9 Intel® Xeon® E5-2623v3 (3GHz/4-core/10MB/105W) FIO Processor Kit	780100-L21
HP DL80 Gen9 Intel® Xeon® E5-2630Lv3 (1.8GHz/8-core/20MB/55W) Processor Kit	765530-B21
HP DL80 Gen9 Intel® Xeon® E5-2630Lv3 (1.8GHz/8-core/20MB/55W) FIO Processor Kit	765530-L21

Performance Processors - E5-2600v3 series Processors

HP DL80 Gen9 Intel® Xeon® E5-2650v3 (2.3GHz/10-core/25MB/105W) Processor Kit	765528-B21
HP DL80 Gen9 Intel® Xeon® E5-2650v3 (2.3GHz/10-core/25MB/105W) FIO Processor Kit	765528-L21
HP DL80 Gen9 Intel® Xeon® E5-2650Lv3 (1.8GHz/12-core/30MB/65W) Processor Kit	765532-B21
HP DL80 Gen9 Intel® Xeon® E5-2650Lv3 (1.8GHz/12-core/30MB/65W) FIO Processor Kit	765532-L21
HP DL80 Gen9 Intel® Xeon® E5-2660v3 (2.6GHz/10-core/25MB/105W) Processor Kit	765529-B21
HP DL80 Gen9 Intel® Xeon® E5-2660v3 (2.6GHz/10-core/25MB/105W) FIO Processor Kit	765529-L21

HP Memory

Registered DIMMs (RDIMMs) for E5-2600v3 Series

HP 4GB (1x4GB) Single Rank x8 DDR4-2133 CAS-15-15-15 Registered Memory Kit	726717-B21
HP 8GB (1x8GB) Single Rank x4 DDR4-2133 CAS-15-15-15 Registered Memory Kit	726718-B21
HP 8GB (1x8GB) Dual Rank x8 DDR4-2133 CAS-15-15-15 Registered Memory Kit	759934-B21
HP 16GB (1x16GB) Dual Rank x4 DDR4-2133 CAS-15-15-15 Registered Memory Kit	726719-B21
HP 32GB (1x32GB) Dual Rank x4 DDR4-2133 CAS-15-15-15 Registered Memory Kit	728629-B21

Load Reduced DIMMs (LRDIMMs) for E5-2600v3 Series

HP 16GB (1x16GB) Dual Rank x4 DDR4-2133 CAS-15-15-15 Load Reduced Memory Kit	726720-B21
HP 32GB (1x32GB) Quad Rank x4 DDR4-2133 CAS-15-15-15 Load Reduced Memory Kit	726722-B21

HP Standard Memory

HP 4GB (1x4GB) Single Rank x8 DDR4-2133 CAS-15-15-15 Registered Standard Memory Kit	803026-B21
HP 8GB (1x8GB) Single Rank x4 DDR4-2133 CAS-15-15-15 Registered Standard Memory Kit	803028-B21

Core Options

NOTE: These memory options are available as standalone only and cannot be configured in the factory. These are standard memory DIMMs with no Smart Memory features.

HP Optical Drives	HP Mobile USB Non Ledged System DVD RW Drive	701498-B21
HP Drives	SAS Hot Plug LFF (3.5-inch) Enterprise (ENT) Drives	
	HP 600GB 12G SAS 15K rpm LFF (3.5-inch) SC Converter Enterprise 3yr Warranty Hard Drive	765424-B21
	HP 450GB 12G SAS 15K rpm LFF (3.5-inch) SC Converter Enterprise 3yr Warranty Hard Drive	737394-B21
	HP 300GB 12G SAS 15K rpm LFF (3.5-inch) SC Converter Enterprise 3yr Warranty Hard Drive	737261-B21
	SAS Hot Plug LFF (3.5-inch) Midline (MDL) Drives	
	HP 8TB 12G SAS 7.2K rpm LFF (3.5-inch) SC 512e Helium 1yr Warranty Hard Drive	793703-B21
	HP 6TB 12G SAS 7.2K rpm LFF (3.5-inch) SC 512e Helium 1yr Warranty Hard Drive	793699-B21
	HP 6TB 6G SAS 7.2K rpm LFF (3.5-inch) SC Midline 1yr Warranty Hard Drive	761477-B21
	HP 6TB 12G SAS 7.2K rpm LFF (3.5-inch) SC Midline 512e 1yr Warranty Hard Drive	765259-B21
	HP 6TB 12G SAS 7.2K rpm LFF (3.5-inch) SC 512e Performance 1yr Warranty Hard Drive	793671-B21
	HP 4TB 6G SAS 7.2K rpm LFF (3.5-inch) SC Midline 1yr Warranty Hard Drive	695510-B21
	HP 4TB 12G SAS 7.2K rpm LFF (3.5-inch) SC Midline 512e 1yr Warranty Hard Drive	765257-B21
	HP 4TB 12G SAS 7.2K rpm LFF (3.5-inch) SC 512e Performance 1yr Warranty Hard Drive	793669-B21
	HP 3TB 6G SAS 7.2K rpm LFF (3.5-inch) SC Midline 1yr Warranty Hard Drive	652766-B21
	HP 2TB 6G SAS 7.2K rpm LFF (3.5-inch) SC Midline 1yr Warranty Hard Drive	652757-B21
	HP 1TB 6G SAS 7.2K rpm LFF (3.5-inch) SC Midline 1yr Warranty Hard Drive	652753-B21
	12G SAS Hot Plug LFF (3.5-inch) Enterprise Value Solid State Drives	
	HP 800GB 12G SAS Value Endurance LFF 3.5-in SC Enterprise Value 3yr Wty Solid State Drive	762270-B21
	HP 1.6TB 12G SAS Value Endurance LFF 3.5-in SC Enterprise Value 3yr Wty Solid State Drive	762272-B21
	SATA Hot Plug LFF (3.5-inch) Midline (MDL) Drives	
	HP 8TB 6G SATA 7.2K rpm LFF (3.5-inch) SC 512e Helium 1yr Warranty Hard Drive	793695-B21
	HP 6TB 6G SATA 7.2K rpm LFF (3.5-inch) SC 512e Helium 1yr Warranty Hard Drive	793683-B21
	HP 6TB 6G SATA 7.2K rpm LFF (3.5-inch) SC Midline 1yr Warranty Hard Drive	753874-B21
	HP 6TB 6G SATA 7.2K rpm LFF (3.5-inch) SC Midline 512e 1yr Warranty Hard Drive	765255-B21
	HP 6TB 6G SATA 7.2K rpm LFF (3.5-inch) SC 512e Performance 1yr Warranty Hard Drive	793667-B21
	HP 4TB 6G SATA 7.2k rpm LFF (3.5-inch) SC Midline 1yr Warranty Hard Drive	693687-B21
	HP 4TB 6G SATA 7.2K rpm LFF (3.5-inch) SC Midline 512e 1yr Warranty Hard Drive	765253-B21
	HP 4TB 6G SATA 7.2K rpm LFF (3.5-inch) SC 512e Performance 1yr Warranty Hard Drives	793665-B21
	HP 3TB 6G SATA 7.2K rpm LFF (3.5-inch) SC Midline 1yr Warranty Hard Drive	628061-B21
	HP 2TB 6G SATA 7.2K rpm LFF (3.5-inch) SC Midline 1yr Warranty Hard Drive	658079-B21
	HP 1TB 6G SATA 7.2K rpm LFF (3.5-inch) SC Midline 1yr Warranty Hard Drive	657750-B21
	HP 500GB 6G SATA 7.2K rpm LFF (3.5-inch) SC Midline 1yr Warranty Hard Drive	658071-B21
	SATA Non-Hot Plug LFF (3.5-inch) Midline (MDL) Drives	
	HP 4TB 6G SATA 7.2K rpm LFF (3.5in) Non-hot Plug Standard 1yr Warranty Hard Drive	801888-B21
	HP 3TB 6G SATA 7.2K rpm LFF (3.5-inch) Non-hot plug Midline 1yr Warranty Hard Drive	628065-B21
	HP 3TB 6G SATA 7.2K rpm LFF (3.5in) Non-hot Plug Standard 1yr Warranty Hard Drive	801886-B21
	HP 2TB 6G SATA 7.2K rpm LFF (3.5-inch) Non-hot plug Midline 1yr Warranty Hard Drive	659339-B21
	HP 2TB 6G SATA 7.2K rpm LFF (3.5in) Non-hot Plug Standard 1yr Warranty Hard Drive	801884-B21
	HP 1TB 6G SATA 7.2K rpm LFF (3.5-inch) Non-hot plug Midline 1yr Warranty Hard Drive	659337-B21
	HP 1TB 6G SATA 7.2K rpm LFF (3.5in) Non-hot Plug Standard 1yr Warranty Hard Drive	801882-B21
	HP 500GB 6G SATA 7.2K rpm LFF (3.5-inch) Non-hot plug Midline 1yr Warranty Hard Drive	659341-B21
	6G SATA Hot Plug LFF (3.5-inch) Enterprise Mainstream Solid State Drives	
	HP 800GB 6G SATA Mainstream Endurance LFF 3.5-in SC Enterprise Mainstream 3yr Wty Solid State Drive	691860-B21

Core Options

HP 400GB 6G SATA Mainstream Endurance LFF 3.5-in SC Enterprise Mainstream 3yr Wty Solid State Drive	691856-B21
HP 200GB 6G SATA Mainstream Endurance LFF 3.5-in SC Enterprise Mainstream 3yr Wty Solid State Drive	691854-B21
HP 100GB 6G SATA Mainstream Endurance LFF 3.5-in SC Enterprise Mainstream 3yr Wty Solid State Drive	691852-B21
HP 240GB 6G SATA Read Intensive LFF 3.5-in SC Converter 3yr Wty Solid State Drive	789137-B21
HP 480GB 6G SATA Read Intensive LFF 3.5-in SC Converter 3yr Wty Solid State Drive	789147-B21
HP 960GB 6G SATA Read Intensive LFF 3.5-in SC Converter 3yr Wty Solid State Drive	789157-B21
6G SATA Hot Plug LFF Value Endurance (3.5-inch) Converter Enterprise Value M1 Solid State Drives	
HP 800GB 6G SATA Value Endurance LFF 3.5-in SC Converter ENT Value 3yr Wty M1 Solid State Drive	764945-B21
HP 480GB 6G SATA Value Endurance LFF 3.5-in SC Converter ENT Value 3yr Wty M1 Solid State Drive	764943-B21
HP 240GB 6G SATA Value Endurance LFF 3.5-in SC Converter ENT Value 3yr Wty M1 Solid State Drive	764941-B21
HP 120GB 6G SATA Value Endurance LFF 3.5-in SC Converter ENT Value 3yr Wty M1 Solid State Drive	764939-B21
6G SATA Hot Plug LFF (3.5-inch) Enterprise Value Solid State Drives	
HP 1.6TB 6G SATA Value Endurance LFF 3.5-in SC Converter Enterprise Value 3yr Wty Solid State Drive	757342-B21
HP 800GB 6G SATA Value Endurance LFF 3.5-in SC Enterprise Value 3yr Wty Solid State Drive	718189-B21
HP 600GB 6G SATA Value Endurance LFF 3.5-in SC Converter Enterprise Value 3yr Wty Solid State Drive	739900-B21
HP 480GB 6G SATA Value Endurance LFF 3.5-in SC Enterprise Value 3yr Wty Solid State Drive	718183-B21
HP 300GB 6G SATA Value Endurance LFF 3.5-in SC Converter Enterprise Value 3yr Wty Solid State Drive	739890-B21
HP 240GB 6G SATA Value Endurance LFF 3.5-in SC Enterprise Value 3yr Wty Solid State Drive	718177-B21
HP 960GB 6G SATA Light Endurance LFF 3.5-in SC Converter ENT Light 3yr Wty G1 Solid State Drive	756604-B21
HP 120GB 6G SATA Value Endurance LFF 3.5-in SC Converter ENT Value 3yr Wty G1 Solid State Drive	756624-B21
HP 240GB 6G SATA Value Endurance LFF 3.5-in SC Converter ENT Value 3yr Wty G1 Solid State Drive	756639-B21
HP 480GB 6G SATA Value Endurance LFF 3.5-in SC Converter ENT Value 3yr Wty G1 Solid State Drive	756660-B21
6G SATA Hot Plug LFF (3.5-inch) Enterprise Boot Solid State Drives	
HP 120GB 6G SATA Value Endurance LFF 3.5-in SC Enterprise Boot 3yr Wty Solid State Drive	718171-B21
HP 80GB 6G SATA Value Endurance LFF 3.5-in SC Enterprise Boot 3yr Wty Solid State Drive	734362-B21
M.2 SSD	
HP Dual 120GB Value Endurance Solid State M.2 Enablement Kit for ProLiant ML/DL Servers	777894-B21
HP 120GB Value Endurance Solid State M.2 Enablement Kit for ProLiant ML/DL Servers	788028-B21
NOTE: M.2 drives go in PCIe slot and use B140i SATA controller only.	
6G SATA Hot Plug with SmartDrive LFF (3.5-inch) Midline 512e Helium Drives	
HP 8TB 6G SATA 7.2K rpm LFF (3.5-inch) SC 512e Helium 1yr Warranty Hard Drive	793695-B21
HP 6TB 6G SATA 7.2K rpm LFF (3.5-inch) SC 512e Helium 1yr Warranty Hard Drive	793683-B21
Hard Drive Blank Kits	
HP Large Form Factor Hard Drive Blank Kit	666986-B21
Hard Drive Kits	
HP DL80 Gen9 8LFF Non-hot Plug Enablement Kit	788355-B21

Core Options

NOTE: Required to move from 4LFF NHP model to 8 LFF NHP model.

HP Networking

1 Gigabit Ethernet adapters

HP Ethernet 1Gb 4-port 331T Adapter	647594-B21
HP Ethernet 1Gb 4-port 366T Adapter	811546-B21
HP Ethernet 1Gb 2-port 332T Adapter	615732-B21
HP Ethernet 1Gb 2-port 361T Adapter	652497-B21

10 Gigabit Ethernet adapters

HP Ethernet 10Gb 2-port 530SFP Adapter	652503-B21
HP Ethernet 10Gb 2-port 530T Adapter	656596-B21
HP Ethernet 10Gb 2-port 561T Adapter	716591-B21
HP Ethernet 10Gb 2-port 560SFP+ Adapter	665249-B21
HP Ethernet 10Gb 2-port 546SFP+ Adapter	779793-B21

FlexibleLOM Adapters

HP Ethernet 1Gb 4-port 331FLR Adapter	629135-B22
HP Ethernet 1Gb 4-port 366FLR Adapter	665240-B21
HP Ethernet 10Gb 2-port 561FLR-T Adapter	700699-B21
HP FlexFabric 10Gb 2-port 534FLR-SFP+ Adapter	700751-B21
HP FlexFabric 10Gb 2-port 533FLR-T Adapter	700759-B21
HP Ethernet 10Gb 2-port 546FLR-SFP+ Adapter	779799-B21

HP InfiniBand

HP InfiniBand FDR 2-port 545QSFP Adapter	702211-B21
HP InfiniBand FDR/Ethernet 10Gb/40Gb 2-port 544+QSFP Adapter	764284-B21

HP I/O Expansion Options

HP DL80 Gen9 FlexibleLOM Riser Kit NOTE: Includes one FlexibleLOM slot, one Low Profile slot and one fan.	765514-B21
HP DL80 Gen9 Full Height Half Length Riser Kit NOTE: Includes two FLFH PCIe 3.0 slots and one fan.	765515-B21
HP DL80 Gen9 GPU Enablement Kit NOTE: Includes 1 FHFL slot, one fan and power cable required to enable GPU support. Either one of FHHL or FlexibleLOM riser or GPU riser can be selected.	765518-B21

HP Power Supplies

HP Entry-Level Power Supplies

HP 550W FIO Power Supply Kit	730941-B21
HP 800W Gold (Redundant)/900W (Non-Redundant) AC Power Input FIO Module NOTE: HP Server RPS FIO Backplane Kit (P/N: 813535-B21) is required for this power supply. NOTE: Up to two of these option kits can be installed in one system. NOTE: This FIO kit only be bought integrated in the server. It cannot be ordered as standalone option after server purchase. NOTE: With just one power supply module installed, up to 900W wattage is supported while with both power supply modules installed in RPS mode, up to 800W is supported.	813534-B21
HP Server Redundant Power Supply Backplane FIO Kit NOTE: Required for RPS capability. NOTE: This FIO kit only be bought integrated in the server. It cannot be ordered as standalone option after server purchase. NOTE: The above power supply option is 80Plus Gold-certified with an efficiency rating of up to 92%. Each power backplane kit (813535-B21) can support up to two (2) AC power input modules (813534-B21). Power specifications and technical content for all HP Server power supplies can be found at http://www.hp.com/go/proliant/powersupply .	813535-B21
HP 800W Gold (Redundant)/900W (Non-Redundant) AC Power Input Module NOTE: HP Server RPS Backplane Kit (P/N: 745813-B21) is required for this power supply. NOTE: Up to two of these option kits can be selected in one system.	744689-B21

Core Options

NOTE: This kit is only available as option kit and cannot be factory installed in the server.
NOTE: With just one power supply module installed, up to 900W wattage is supported while with both power supply modules installed in RPS mode, up to 800W is supported.

HP Server Redundant Power Supply Backplane Kit

745813-B21

NOTE: This kit is only available as option kit and cannot be factory installed in the server.
NOTE: The above power supply option is 80Plus Gold-certified with an efficiency rating of up to 92%. Each power backplane kit (745813-B21) can support up to two (2) AC power input modules (744689-B21). Power specifications and technical content for all HP Server power supplies can be found at <http://www.hp.com/go/proliant/powersupply>.

HP Computation and Graphics Accelerators

HP NVIDIA Quadro K2200 Graphics Accelerator

J0G89A

NOTE: GPU enablement kit (P/N: 765518-B21) is required with this option.

HP NVIDIA Quadro K4200 Graphics Accelerator

J0G90A

NOTE: GPU enablement kit (P/N: 765518-B21) is required with this option.

NOTE: 1 GPU supported per Server, attached to the Primary CPU.

NOTE: Only the above listed Graphics cards are HP standard supported options in this server.

NOTE: The NVIDIA Quadro modules are supported only on 64-bit versions of Linux and Windows operating systems as well as on Virtual Machine client operating systems. The supported bare metal operating systems are RHEL6, SLES 11 and Windows Server 2012 R2.

NOTE: Please see the HP Power Advisor for estimated power consumption of your individual system configuration prior to installing GPUs. The HP Power Advisor is located at: <http://www.hp.com/go/hppoweradvisor>.

HP Cooling Options

HP DL80 Gen9 Redundant Fan Kit

765516-B21

NOTE: Includes two fans and is required to move from non-redundant to redundant fan configurations. Since each riser includes a fan as well, please refer to user-guide for exact fan requirements to enable fan redundancy

Additional Options

NOTE: Some options may not be integrated at the factory. To ensure only valid configurations are ordered, HP recommends the use of an HP approved configurator. Contact your local sales representative for additional information.

HP Insight Software	HP Insight Control	
	HP Insight Control including 1yr 24x7 Technical Support and Updates Single Server License	C6N27A
	HP Insight Control including 1yr 24x7 Technical Support and Updates Electronic License	C6N28ABE
	HP Insight Control including 1yr 24x7 Support ProLiant ML/DL/BL-bundle Single Server FIO License	C6N36A
	HP Insight Control including 1yr 24x7 Support ProLiant ML/DL/BL-bundle FIO Electronic License	C6N36ABE
	HP Insight Control Server Provisioning Media Kit	BD883A
	HP Insight Management Media Kit	C6N31A
	NOTE: Electronic and Flexible-Quantity licenses can be used to purchase multiple licenses with a single activation key.	
	NOTE: Customer will receive a license entitlement certificate. The license entitlement certificate must be redeemed online or via fax in order to obtain the license activation key(s). Includes one year of 24x7 HP Software Technical Support and Update Service.	
	NOTE: Licenses ship without media. The HP Insight Control Media Kit can be ordered separately, or can be downloaded at: http://www.hp.com/go/insightupdates .	
	NOTE: For additional license options please see the QuickSpecs at: http://h18000.www1.hp.com/products/quickspecs/12631_div/12631_div.html .	

Embedded Management	HP iLO Advanced	
	HP iLO Advanced including 1yr 24x7 Technical Support and Updates Single Server License	512485-B21
	HP iLO Advanced 1 Server License with 3yr 24x7 Tech Support and Updates	BD505A
	HP iLO Advanced including 1yr 24x7 Technical Support and Updates E-LTU	E6U59ABE
	HP iLO Advanced including 3yr 24x7 Technical Support and Updates E-LTU	E6U64ABE
	HP iLO Essentials	
	HP Integrated Lights-Out Essentials including 3yr 24x7 Tech Support and Updates Single Svr License	BD774A
	HP Integrated Lights-Out Essentials including 1yr 24x7 Tech Support and Updates Single Svr License	BD775A
	HP Integrated Lights-Out Essentials including 3yr 24x7 Technical Support and Updates E-LTU	E6U61ABE
	HP Integrated Lights-Out Essentials including 1yr 24x7 Technical Support and Updates E-LTU	E6U62ABE
	HP iLO Scale-out	
	HP Integrated Lights-Out Scale-Out 3yr 24x7 Tech Support and Updates Flex Quantity License	BD776A
	HP Integrated Lights-Out Scale-Out including 3yr 24x7 Tech Support and Updates Flex Qty E-LTU	BD776AAE
	HP Integrated Lights-Out Scale-Out including 3yr 24x7 Tech Support and Updates Tracking License	BD777A
	HP Integrated Lights-Out Scale-Out 1yr 24x7 Tech Support and Updates Flex Quantity License	BD778A
	HP Integrated Lights-Out Scale-Out including 1yr 24x7 Tech Support and Updates Flex Qty E-LTU	BD778AAE
	HP Integrated Lights-Out Scale-Out including 1yr 24x7 Tech Support and Updates Tracking License	BD779A

HP Converged Infrastructure Management Software	HP OneView	
	HP OneView incl 3yr 24x7 Supp Phys 1 Svr Lic	E5Y34A
	HP OneView incl 3yr 24x7 Supp Flex Qty E-LTU	E5Y35AAE
	HP OneView Media Kit Phys No Lic	E5Y37A
	HP OneView for ProLiant DL Server incl 3yr 24x7 Supp FIO Bundle Physical 1 Svr Lic	E5Y43A
	HP OneView without iLO Advanced	
HP OneView w/o iLO Adv incl 3yr 24x7 Supp Phys 1 Svr Lic	E5Y38A	

Additional Options

HP OneView w/o iLO Adv inc 3yr 24x7 Supp Flex Qty E-LTU	E5Y39AAE
HP Operations Analytics for HP OneView LTU	K8G29A
HP Operations Analytics for HP OneView E-LTU	K8G29AAE

NOTE: Full licenses of HP OneView Advanced also provide the right-to-use HP Insight Control without additional charge.

NOTE: Server provisioning (via 'HP Insight Control server provisioning') is licensed as part of HP OneView Advanced and provides multi-server OS and driver provisioning. Media kit #BD883A can be ordered for a physical copy of this software (USB flash drive).

NOTE: Licenses ship without media. The HP OneView Media Kit can be ordered separately, or can be downloaded at: <http://www.hp.com/go/oneview>.

NOTE: Electronic and Flexible-Quantity licenses can be used to purchase multiple licenses with a single activation key.

HP Security

HP Trusted Platform Module Option	488069-B21
HP 2U Security Bezel Kit	666988-B21
NOTE: Quick release EAR FIO kit (P/N: 778109-B21) is required for installing security bezel.	
HP DL80 Gen9 Quick Release Ear FIO Kit	778109-B21
NOTE: Quick Release Ears are mandatory for 12LFF models.	
HP DL80 Gen9 Thumbscrew Ear FIO Kit	787211-B21
NOTE: The TPM (Trusted Platform Module) is a microcontroller chip that can securely store artifacts used to authenticate the server platform. These artifacts can include passwords, certificates and encryption keys. Windows® BitLocker™ Drive Encryption (BitLocker) is a data protection feature available in Windows Server® 2008. BitLocker leverages the enhanced security capabilities of a Trusted Platform Module (TPM) version 1.2. The TPM works with BitLocker to help protect user data and to ensure that a server running Windows Server 2008 has not been tampered with while the system was offline. For more information about TPM, including a white paper, go to: http://www.hp.com/go/TPM .	
NOTE: ProLiant OS pre-installed units will come with the partition required for TPM deployment.	
NOTE: The TPM key is unique to every TPM deployed server and must be retained. Misplacing or losing the key could result in data loss.	

HP Storage Controllers

SAS Controllers

HP Smart Array Controllers

HP Smart Array P440/4GB FBWC 12Gb 1-port Int SAS Controller	726821-B21
HP Smart Array P840/4GB FBWC 12Gb 2-ports Int SAS Controller	726897-B21
HP Smart Array P441/4GB FBWC 12Gb 2-ports Ext SAS Controller	726825-B21
HP Smart Array P440/4GB FBWC 12Gb 1-port Int FIO SAS Controller	761872-B21

NOTE: Includes the HP Smart Storage Battery.

HP Smart Array P840/4GB FBWC 12Gb 2-ports Int FIO SAS Controller	761874-B21
--	------------

NOTE: Includes the HP Smart Storage Battery.

HP Smart Array P841/4GB FBWC 12Gb 4-ports Ext SAS Controller	726903-B21
--	------------

HP Smart Host Bus Adapters

HP H240 12Gb 2-ports Int Smart Host Bus Adapter	726907-B21
HP H240 12Gb 2-ports Int FIO Smart Host Bus Adapter	761873-B21
HP H241 12Gb 2-ports Ext Smart Host Bus Adapter	726911-B21

HP Cable Options

HP DL60/80/120 Gen9 4LFF Cable FIO Kit	777331-B21
HP DL80 Gen9 LFF Smart Array P440/P840 SAS Cable Kit	779619-B21

NOTE: One cable kit must be selected with P440 controller.

NOTE: Two of these cable kits must be selected with P840 controller.

HP DL80 Gen9 LFF Smart Array H240 SAS Cable Kit	779622-B21
---	------------

NOTE: Two cable Kits must be selected with H240.

NOTE: One of the above cables is required to be selected depending on the combination of chassis and storage controller. Cable option kit descriptions include the right chassis and storage controllers names.

NOTE: FIO indicates that this option is only available as a factory installable option. Please select FIO option if you want the option to be factory installed.

Additional Options

NOTE: NHP server chassis (Mod-x) includes SATA cables required to connect drives to embedded B140i SATA controller.

Optional Software

HP Secure Encryption No Media Flexible License per Drive D8S84A
 HP Secure Encryption No Media E-LTU per Drive D8S85AAE

NOTE: HP Secure Encryption is supported when one of the supported Smart Array Controllers or the supported Smart SAS HBA (configured in a RAID mode) is installed in the server.

HP Secure Encryption licensing is based on the number of physical drives requiring encryption.

NOTE: For more information about HP Secure Encryption, go to <http://www.hp.com/go/hpsecureencryption>.

HP SmartCache No Media 24x7 Technical Support 1 Svr License D7S26A
 HP SmartCache No Media 24x7 Technical Support Flexible License D7S27A
 HP SmartCache No Media 24x7 Technical Support Electronic License D7S27AAE

NOTE: HP SmartCache is supported when one of the supported Smart Array Controllers is installed in the server.

NOTE: HP SmartCache comes standard (no licensing is required) if the HP Smart Array P840 Controller is installed in the server.

Optional Upgrades

HP 96W Smart Storage Battery with 145mm Cable for DL/ML/SL Servers 727258-B21

NOTE: This option is mandatorily required with HP Smart Array controllers. One server can accommodate only 1 Smart Storage Battery that would suffice the requirement of all HP Smart Array controllers.

HP Tape Backup

NOTE: For the complete range of tape drives, autoloaders, libraries and media see: <http://www.hp.com/go/tape>. For hardware and software compatibility of HP tape backup products see: <http://www.hp.com/storage/SPOCK> and <http://www.hp.com/go/ebs>.

NOTE: For Internal drives to be connected to DL servers please make sure that you order rack mount kit as well.

Tape Drives

HP StoreEver LTO-6 Ultrium 6650 SAS External Tape Drive EH964A
 HP StoreEver LTO-6 Ultrium 6250 External Tape Drive EH970A
 HP StoreEver LTO-5 Ultrium 3000 SAS External Tape Drive EH958B
 HP StoreEver LTO-5 Ultrium 3280 SAS External Tape Drive EH900B
 HP StoreEver LTO-4 Ultrium 1760 SCSI External Tape Drive EH922B
 HP StoreEver LTO-4 Ultrium 1760 SAS External Tape Drive EH920B
 HP StoreEver LTO-3 Ultrium 920 SAS External Tape Drive EH848B
 HP Mini SAS High Density to 4-lane Mini SAS External Fanout 2 Meter Cable K2R09A
 HP Mini SAS High Density to 4-lane Mini SAS External Fanout 4 Meter Cable K2R10A

Tape Libraries

HP MSL2024 0-Drive Tape Library AK379A
 HP MSL4048 0-Drive Tape Library AK381A

HP Tape Storage Systems

HP StoreEver 1U SAS Rack-mount Kit AE459B
 HP StoreEver LTO-4 Ultrium 1760 SAS (1) in 1U Rack-mount Kit EH946C
 HP StoreEver LTO-5 Ultrium 3280 SAS Tape Drive in 3U Rack-mount EJ013B
 HP StoreEver LTO-5 Ultrium 3000 SAS Tape Drive in 1U Rack-mount EJ014B
 HP StoreEver LTO-6 Ultrium 6250 Tape Drive in 1U Rack-mount Kit COL99A
 HP StoreEver 1/8 G2 LTO-6 Ultrium 6250 FC Tape Autoloader COH19A

HP StoreEver MSL6480

HP StoreEver MSL6480 Scalable Base Module QU625A
 HP StoreEver MSL6480 Scaleable Expansion Module QU626A

HP Disk Backup

HP RDX Removable Disk Backup System

HP RDX320 USB3.0 External Disk Backup System B7B63A
 HP RDX500 USB 3.0 External Disk Backup System B7B66A

Additional Options

HP RDX1000 USB 3.0 External Disk Backup System	B7B69A
HP RDX 2TB USB3.0 External Disk Backup System	E7X53A
HP RDX 2TB USB3.0 External Disk Backup System	E7X53B
HP D3700 Enclosure	QW967A
HP D3600 Enclosure	QW968A
HP RDX+ 500GB External Backup System	B7B66B
HP RDX+ 1TB External Backup System	B7B69B
HP RDX+ External Docking System	C8S07B

HP Storage Options

Emulex Fibre Channel HBAs

HP 81E 8Gb 1-port PCIe Fibre Channel Host Bus Adapter	AJ762B
HP 82E 8Gb 2-port PCIe Fibre Channel Host Bus Adapter	AJ763B
HP StoreFabric SN1100E 16Gb Single Port Fibre Channel Host Bus Adapter	C8R38A
HP StoreFabric SN1100E 16Gb Dual Port Fibre Channel Host Bus Adapter	C8R39A

QLogic Fibre Channel HBAs

HP 82Q 8Gb 2-port PCIe Fibre Channel Host Bus Adapter	AJ764A
HP 81Q 8Gb 1-port PCIe Fibre Channel Host Bus Adapter	AK344A
HP StoreFabric SN1000Q 16GB 1-port PCIe Fibre Channel Host Bus Adapter	QW971A
HP StoreFabric SN1000Q 16GB 2-port PCIe Fibre Channel Host Bus Adapter	QW972A

Converged Network Adapter

HP StoreFabric CN1200E 10Gb Converged Network Adapter	E7Y06A
---	--------

HP Disk Storage Systems

Disk Enclosures

HP D6000 Dual I/O Module Disk Enclosure	QQ695A
HP D6000 w/35 4TB 6G SAS 7.2K LFF Dual Port MDL HDD 140TB Bundle	E7W30A
HP D6000 w/70 4TB 6G SAS 7.2K LFF Dual Port MDL HDD 280TB Bundle	E7W31A
HP D6000 w/70 3TB 6G SAS 7.2K LFF Dual port MDL HDD 210TB Bundle	QQ700A
HP D6000 w/70 2TB 6G SAS 7.2K LFF Dual port MDL HDD 140TB Bundle	QQ698A
HP D6000 w/35 3TB 6G SAS 7.2K LFF Dual port MDL HDD 105TB Bundle	QQ699A
HP D6000 w/35 2TB 6G SAS 7.2K LFF Dual port MDL HDD 70TB Bundle	QQ697A
HP D2600 w/12 4TB 6G SAS 7.2K LFF Dual Port MDL HDD 48TB Bundle	E7W32A

HP Data Center Racks

HP 11000 G2 Series Racks

HP 11648 1075mm Pallet Universal Rack	H6J87A
HP 11648 1075mm Shock Universal Rack	H6J88A
HP 11642 1075mm Pallet Universal Rack	H6J65A
HP 11642 1075mm Shock Universal Rack	H6J66A
HP 11642 1200mm Pallet Universal Rack	H6J67A
HP 11642 1200mm Shock Universal Rack	H6J68A
HP 11636 1075mm Pallet Universal Rack	H6J77A
HP 11636 1075mm Shock Universal Rack	H6J78A
HP 11622 G2 1075mm Pallet Universal Rack	H6J83A
HP 11622 G2 1075mm Shock Universal Rack	H6J84A
HP 11614 1075mm Shock Universal Rack	H6J82A

NOTE: Please see the [HP 11000 G2 Series Racks QuickSpecs](#) for information on additional racks options and rack specifications.

HP Intelligent Series Rack

HP 647 1075mm Pallet Intelligent Series Rack	BW911A
HP 647 1075mm Shock Intelligent Series Rack	BW912A
HP 647 1200mm Pallet Intelligent Series Rack	BW913A
HP 647 1200mm Shock Intelligent Series Rack	BW914A
HP 642 1075mm Pallet Intelligent Series Rack	BW903A
HP 642 1075mm Shock Intelligent Series Rack	BW904A
HP 642 1200mm Pallet Intelligent Series Rack	BW907A

Additional Options

HP 642 1200mm Shock Intelligent Series Rack	BW908A
HP 636 1075mm Pallet Intelligent Series Rack	BW895A
HP 636 1075mm Shock Intelligent Series Rack	BW896A
HP 842 1075mm Pallet Intelligent Series Rack	BW917A
HP 842 1075mm Shock Intelligent Series Rack	BW918A

NOTE: Please see the [HP Intelligent Series Racks QuickSpecs](#) for information on additional racks options and rack specifications.

HP Value Series Rack

HP V142 1075mm deep Pallet 100 series Rack	AF046A
--	--------

NOTE: Please see the [HP Value Series Rack QuickSpecs](#) for information on additional racks options and rack specifications.

HP Power Distribution Units (PDUs)

HP Basic Power Distribution Unit (bPDU)

HP 1.9kVA 120 Volt L5-20 Input (12xNEMA 5-20R) NA/JP Basic PDU	H5M54A
HP 3.6kVA 200-240 Volt Detachable C20 Input (12xC13) WW Basic PDU	H5M56A
HP 2.8kVA 120 Volt L5-30 Input (18xNEMA 5-20R) NA/JP Basic PDU	H5M55A
HP 3.6kVA 200-240 Volt Detachable C20 Input (18xC13) WW Basic PDU	H5M57A
HP 4.9kVA 208 Volt L6-30 Input (20xC13) NA/JP Basic PDU	H5M58A
HP 7.3kVA 230 Volt IEC309 32A Input (20xC13) INTL Basic PDU	H5M68A
HP 8.6kVA 208 Volt L15-30 3-Phase Input (18xC13) NA/JP Basic PDU	H5M61A
HP 4.9kVA 208 Volt L6-30 Input (24xC13/6xC19) NA/JP Basic PDU	H5M59A
HP 7.3kVA 230 Volt IEC309 32A Input (24xC13/6xC19) INTL Basic PDU	H5M70A
HP 8.3kVA 208 Volt CS8265C Input (30xC13/6xC19) NA/JP Basic PDU	H5M60A
HP 11kVA 230 Volt IEC309 63A Input (30xC13/6xC19) INTL Basic PDU	H5M71A
HP Hardwired 200-240 Volt Input (30xC13/6xC19) WW Basic PDU	H5M75A
HP 5.7kVA 208 Volt L21-20 3-Phase Input (24xC13/3xNEMA 5-20R) NA/JP Basic PDU	H5M63A
HP 8.6kVA 208 Volt L21-30 3-Phase Input (24xC13/3xC19/3xNEMA 5-20R) NA/JP Basic PDU	H5M64A
HP 8.6kVA 208 Volt L15-30 3-Phase Input (24xC13/6xC19) NA/JP Basic PDU	H5M62A
HP 11kVA 400 Volt IEC309 16A 3-Phase Input (30xC13/6xC19) INTL Basic PDU	H5M72A
HP 11kVA 400 Volt IEC309 16A 3-Phase Input (36xC13/6xC19) INTL Basic PDU	H5M73A
HP 11kVA 400 Volt IEC309 30A 3-Phase Input (36xC13/6xC19) NA Basic PDU	H5M67A
HP 19.9kVA 480 Volt IEC309 30A 3-Phase Input (30 Outlet) NA Basic PDU	H3X08A
HP 800VA - 277V Input / 230V Output NA Rack Mount Transformer	H3X09A
HP 2.8kVA 24A Low Voltage NA/JP Modular Power Distribution Unit	252663-D71
HP 4.9kVA 24A High Voltage NA/JP Core Modular Power Distribution Unit	252663-D74
HP 8.3kVA 40A High Voltage NA/JP Core Modular Power Distribution Unit	252663-D75
HP 7.3kVA 32A High Voltage INTL Core Modular Power Distribution Unit	252663-B33
HP 9.2kVA 40A High Voltage INTL Core Modular Power Distribution Unit	252663-B34
HP 8.6kVA 24A Three Phase NA/JP Modular Power Distribution Unit	AF512A
HP 11kVA 16A Three Phase INTL Modular Power Distribution Unit	AF513A
HP 14.4kVA 40A Three Phase NA/JP Modular Power Distribution Unit	AF519A
HP 17.3kVA 48A Three Phase NA/JP Modular Power Distribution Unit	AF511A
HP 22kVA 32A Three Phase INTL Core Modular Power Distribution Unit	AF518A

NOTE: To learn more about HP Basic Power Distribution Units (bPDU), please visit the [HP website at http://www.hp.com/go/pdu](http://www.hp.com/go/pdu).

HP Monitored Power Distribution Units (mPDU)

HP 2.8kVA 120 Volt L5-30 Input (12xNEMA 5-20R)NA/JP Monitored PDU	D9N43A
HP 3.6kVA 200-240 Volt Detachable C20 Input (12xC13) WW Monitored PDU	D9N46A
HP 4.9kVA 208 Volt L6-30 Input (12xC13) NA/JP Monitored PDU	D9N44A
HP 3.6kVA 200-240 Volt Detachable C20 Input (16xC13) WW Monitored PDU	D9N45A
HP 4.9kVA 208 Volt L6-30 Input (12xC13) NA/JP Monitored PDU	G9Z05A
HP 7.3kVA 230 Volt IEC309 32A Input (12xC13) INTL Monitored PDU	G9Z06A
HP 4.9kVA 208 Volt L6-30 Input (20xC13/4xC19) NA/JP Monitored PDU	D9N47A
HP 7.3kVA 230 Volt IEC309 32A Input (20xC13/4xC19) INTL Monitored PDU	D9N48A
HP 8.6kVA 208 Volt L15-30 3-Phase Input (18xC13/3xC19) NA/JP Monitored PDU	D9N51A

Additional Options

HP 5.7kVA 208 Volt L21-20 3-Phase Input (18xC13/3xNEMA 5-20R) NA/JP Monitored PDU	D9N52A
HP 8.6kVA 208 Volt L21-30 3-Phase Input (20xC13/3xC19/3xNEMA 5-20R) NA/JP Monitored PDU	D9N53A
HP 11kVA 400 Volt IEC309 16A 3-Phase Input (18xC13/3xC19) INTL Monitored PDU	D9N55A
HP 8.3kVA 208 Volt CS8265C Input (30xC13/3xC19) NA Monitored PDU	D9N49A
HP 7.3kVA 230 Volt IEC309 32A Input (32xC13/4xC19) INTL Monitored PDU	D9N50A
HP 11kVA 400 Volt IEC309 16A 3-Phase Input (30xC13/3xC19) INTL Monitored PDU	D9N57A
HP 14.4kVA 208 Volt CS8365C 3-Phase Input (12xC13/12xC19)NA Monitored PDU	D9N58A
HP 16.6kVA 400 Volt IEC309 30A 3-Phase Input (30xC13/3xC19) NA Monitored PDU	D9N61A
HP 16.6kVA 400 Volt IEC309 30A 3-Phase Input (12xC13/12xC19) NA Monitored PDU	D9N62A
HP 17.3kVA 208 Volt IEC309 60A 3-Phase Input (24xC13/3xC19) NA/JP Monitored PDU	D9N54A
HP 17.3kVA 208 Volt IEC309 60A 3-Phase Input (12xC13/12xC19) NA/JP Monitored PDU	D9N59A
HP 17.3kVA 208 Volt IEC309 60A 3-Phase Watertight Input (12xC13/12xC19) NA/JP Monitored PDU	G9Z07A
HP 19.9kVA 480 Volt 3-Phase (30 Outlet) NA Monitored PDU	D9N63A
HP 22kVA 400 Volt IEC309 32A 3-Phase Input (30xC13/3xC19) INTL Monitored PDU	D9N56A
HP 22kVA 400 Volt IEC309 32A 3-Phase Input (12xC13/12xC19) INTL Monitored PDU	D9N60A
HP 22kVA 400 Volt IEC309 32A 3-Phase Watertight Input (12xC13/12xC19) INTL Monitored PDU	G9Z08A
HP Environmental Sensor for Remote Monitored and Managed PDUs	E2D53A

NOTE: Please see the [HP Monitored Power Distribution Units QuickSpecs](#) for information on additional options and product specifications.

HP Intelligent Power Distribution Units (iPDU)

HP 4.9kVA 24A Single Phase NA/JP Core Intelligent Modular Power Distribution Unit	AF520A
HP 8.3kVA 40A Single Phase NA/JP Core Intelligent Modular Power Distribution Unit	AF521A
HP 8.6kVA 24A Three Phase NA/JP Core Intelligent Modular Power Distribution Unit	AF522A
HP 17.3kVA 48A Three Phase NA/JP Core Intelligent Modular Power Distribution Unit	AF523A
HP 11.4kVA 16A 415V Three Phase L22-20 NA Core Intelligent Power Distribution Unit	AF900A
HP 17.3kVA 24A 415V Three Phase IEC309 NA Core Intelligent Power Distribution Unit	AF901A
HP 7.3kVA 32A Single Phase INTL Core Intelligent Modular Power Distribution Unit	AF525A
HP 11kVA 16A Three Phase INTL Core Intelligent Modular Power Distribution Unit	AF526A
HP 22kVA 32A Three Phase INTL Core Intelligent Modular Power Distribution Unit	AF527A
HP 17.3kVA 48A 208V Three Phase 12 Outlet Core NA/JP Intelligent Power Distribution Unit	AF535A
HP 17.3kVA 24A 415V Three Phase 12 Outlet Core NA/JP Intelligent Power Distribution Unit	AF537A
HP 22kVA 32A 400V Three Phase 12 Outlet Core INTL Intelligent Power Distribution Unit	AF538A
HP 4.9kVA 24A Single Phase NA/JP Intelligent Modular Power Distribution Kit	AF531A
HP 8.6kVA 24A Three Phase NA/JP Intelligent Modular Power Distribution Kit	AF532A
HP 14.4kVA 40A Three Phase NA/JP Intelligent Modular Power Distribution Unit	AF533A
HP 7.3kVA 32A Single Phase INTL Intelligent Modular Power Distribution Kit	AF534A
HP 5xC13 Intelligent PDU Extension Bar G2 Kit	AF547A
HP 5xC13 Outlets Power and UID LEDs Pair Standard Extension Bar	AF528A

NOTE: Please see the [HP Intelligent Power Distribution Units QuickSpecs](#) for information on additional options and product specifications.

HP Managed Power Distribution Units (maPDU)

HP 2.8kVA 120 Volt L5-30 Input (24x NEMA 5-20) NA/JP Managed PDU	H8B48A
HP 3.6kVA 200-240 Volt Detachable C20 Input (7xC13/1xC19) WW Managed PDU	H8B49A
HP 4.9kVA 208 Volt L6-30 Input (20xC13/4xC19) NA/JP Managed PDU	H8B50A
HP 7.3kVA 200-240 Volt IEC309 32A Input (20xC13/4xC19) INTL Managed PDU	H8B51A
HP 8.6kVA 208 Volt L15-30 3 Phase Input (18xC13/6xC19) NA/JP Managed PDU	H8B52A
HP 8.6kVA 208 Volt L21-30 3 Phase Input (20xC13/3xC19/1x NEMA 5-20) NA/JP Managed PDU	H8B53A
HP 11kVA 400 Volt IEC309 16A 3 Phase Input (21xC13/3xC19) INTL Managed PDU	H8B54A
HP 14.4kVA 208V CS8365C 3 Phase Input (12xC13/12xC19) NA/JP Managed PDU	H8B55A
HP 17.3kVA 208V IEC309 60A 3 Phase Input (12xC13/12xC19) NA/JP Managed PDU	H8B56A

NOTE: Please see the [QuickSpecs for Technical Specifications and additional information:](#)

Additional Options

<http://www8.hp.com/h20195/v2/GetHtml.aspx?docname=c04376673>

(Worldwide)

NOTE: To learn more, please visit the [HP Uninterruptible Power Systems \(UPS\) web page](#).

HP Rack Mount Consoles, KVM Switches, and Keyboards

HP Location Discovery Services

HP Location Discovery Services LCD8500 Kit TL052A

NOTE: Please see the QuickSpecs for Technical Specifications and additional information:

http://h18000.www1.hp.com/products/quickspecs/14429_div/14429_div.html

(Worldwide)

HP Rack Mount Consoles

HP LCD8500 1U US Rackmount Console Kit AF630A

HP LCD8500 1U UK Rackmount Console Kit AF631A

HP LCD8500 1U DE Rackmount Console Kit AF632A

HP LCD8500 1U FR Rackmount Console Kit AF633A

HP LCD8500 1U JP Rackmount Console Kit AF642A

HP LCD8500 1U RU Rackmount Console Kit AF643A

HP LCD8500 1U INTL Rackmount Console Kit AF644A

HP LCD8500 1U US TAA Rackmount Console Kit AF645A

HP TFT7600 G2 KVM Console Rackmount Keyboard JP Monitor AZ882A

HP KVM Switches

HP 0x1x8 G3 KVM Console Switch AF651A

HP 0x2x16 G3 KVM Console Switch AF652A

HP TAA 0x2x16 G3 KVM Console Switch AF653A

HP USB Remote Access Key for G3 KVM Console Switches AF650A

HP KVM Console USB Interface Adapter AF628A

HP 0x2x16 KVM Server Console Switch G2 with Virtual Media CAC Software AF618A

HP 0x2x32 KVM Server Console Switch G2 with Virtual Media CAC Software AF619A

HP KVM Console USB 2.0 Virtual Media CAC Interface Adapter AF629A

HP 1x4 USB/PS2 KVM Console Switch AF611A

HP 1x1Ex8 KVM IP Console Switch G2 with Virtual Media CAC Software AF620A

HP 2x1Ex16 KVM IP Console Switch G2 with Virtual Media CAC Software AF621A

HP 4x1Ex32 KVM IP Console Switch G2 with Virtual Media CAC Software AF622A

NOTE: To learn more, please visit the [HP KVM Switches web page](#).

HP USB Keyboard and Mouse

HP USB BFR with PVC Free US Keyboard/Mouse Kit 631341-B21

HP USB BFR with PVC Free UK Keyboard/Mouse Kit 631344-B21

HP USB BFR with PVC Free FR Keyboard/Mouse Kit 631346-B21

HP USB BFR with PVC Free ES Keyboard/Mouse Kit 631348-B21

HP USB BFR with PVC Free DE Keyboard/Mouse Kit 631358-B21

HP USB BFR with PVC Free JP Keyboard/Mouse Kit 631360-B21

HP USB BFR with PVC Free IT Keyboard/Mouse Kit 631362-B21

HP USB BFR with PVC Free CN Keyboard/Mouse Kit 631364-B21

HP USB BFR with PVC Free AE Keyboard/Mouse Kit 638212-B21

HP USB BFR with PVC Free RU Keyboard/Mouse Kit 638214-B21

HP USB BFR with PVC Free IN Keyboard/Mouse Kit 672097-D63

HP USB BFR with PVC Free AP-Intl Keyboard/Mouse Kit 672097-373

HP USB BFR with PVC Free Intl Keyboard/Mouse Kit 672097-B33

HP USB BFR with PVC Free PT Keyboard/Mouse Kit 672097-133

HP USB BFR with PVC Free TR Keyboard/Mouse Kit 672097-143

HP USB BFR with PVC Free CZ Keyboard/Mouse Kit 672097-223

HP USB BFR with PVC Free FI Keyboard/Mouse Kit 672097-353

HP USB BFR with PVC Free SE Keyboard/Mouse Kit 672097-103

HP USB BFR with PVC Free CH Keyboard/Mouse Kit 672097-113

HP USB BFR with PVC Free KR Keyboard/Mouse Kit 672097-KD3

HP 1U INT Rackmount Keyboard with USB AG086A

Additional Options

HP 1U US Rackmount Keyboard with USB	AG072A
NOTE: Please see the HP USB Keyboard and Mouse QuickSpecs for information on additional options and product specifications.	
Rail Kits	
HP 2U Small Form Factor Easy Install Rail Kit	733660-B21
HP 2U Cable Management Arm for Easy Install Rail Kit	733664-B21
HP Other Options	
HP Rack LED Light Kit	BW939A
HP Kit LCD 1.83m Latch Display Port Cable	G7T29A

HP Uninterruptible Power Systems (UPS)

HP DirectFlow Three Phase UPS Power Unit (1U UPS)

HP R12000 DirectFlow - 1U Rackmount Uninterruptible Power System	G9Y75A
HP R12000 DirectFlow - POD 1U Rackmount Uninterruptible Power System	AF478A

Input/Output Module Options for 1U UPS

HP 32A 400-415 Volt Three Phase INTL R12000 DirectFlow UPS IEC309 Input/Output Module	AF488A
HP 30A 400-415 Volt Three Phase NA R10000 DirectFlow UPS IEC309 Input/Output Module	AF489A
HP 32A 380 Volt Three Phase China R12000 DirectFlow UPS Unterminated Input/Output Module	AF490A
HP 30A 480 Volt Three Phase NA R12000 DirectFlow UPS L22-30 Input/Output Module	AF491A
HP 30A 480 Volt Three Phase NA R12000 DirectFlow UPS IEC309 Input/Output Module	AF492A
HP 30A 400-415 Volt Three Phase NA R12000 DirectFlow UPS IEC309 Input/Output Module	G9Y76A

Power Unit (2U UPS)

HP R18000 DirectFlow - 2U Rackmount Uninterruptible Power System	AF479A
--	--------

Input/Output Module Options for 2U UPS

HP 32A 400-415 Volt Three Phase INTL R18000 DirectFlow UPS IEC309 Input/Output Module	AF483A
HP 30A 380 Volt Three Phase China R18000 DirectFlow UPS Unterminated Input/Output Module	AF485A
HP 30A 480 Volt Three Phase NA R18000 DirectFlow UPS IEC309 Input/Output Module	AF486A
HP 30A 480 Volt Three Phase NA R18000 DirectFlow UPS IEC309 Input/Output Module	AF487A
HP 30A 400 Volt Three Phase NA R18000 DirectFlow UPS IEC309 Input/Output Module	D9Q02A
HP 30A 400-415V Three Phase NA R18000 DirectFlow UPS 1:1 IEC309 Input/Output Module	AF484A

NOTE: All Input/Output Modules support dual output outlets except the AF484A.

Battery Pack Options

HP DirectFlow UPS - 1U Rackmount Lithium-ion Battery Pack	AF480A
HP DirectFlow UPS - 3U Rackmount VRLA Battery Pack	AF482A
HP WW DirectFlow Secondary Battery Cable	AF497A

NOTE: Please see the [HP DirectFlow Three Phase Uninterruptible Power System QuickSpecs](#) for information on additional options and product specifications.

HP Tower UPS

HP T750 G4 UPS Models

HP T750 G4 NA/JP Uninterruptible Power System	J2P85A
HP T750 G4 INTL Uninterruptible Power System	J2P88A

HP T1000 G4 UPS Models

HP T1000 G4 NA/JP Uninterruptible Power System	J2P86A
HP T1000 G4 INTL Uninterruptible Power System	J2P89A

HP T1500 G4 UPS Models

HP T1500 G4 NA/JP Uninterruptible Power System	J2P87A
HP T1500 G4 INTL Uninterruptible Power System	J2P90A

HP Rack/Tower UPS

HP R/T2200 G4 UPS Models

HP R/T2200 G4 NA/JP Uninterruptible Power System	J2R00A
--	--------

HP R/T3000 G4 UPS Models

Additional Options

HP R/T3000 G4 Low Voltage NA/JP Uninterruptible Power System	J2R01A
HP R/T3000 G4 High Voltage NA/JP Uninterruptible Power System	J2R02A
HP R/T3000 G4 High Voltage INTL Uninterruptible Power System	J2R04A
HP R/T3000 G2 Uninterruptible Power System (UPS)	
HP R/T3000 G2 2U L530 Low Voltage NA/JP Uninterruptible Power System	AF466A
HP R/T3000 G2 2U L620 High Voltage NA/JP Uninterruptible Power System	AF467A
R1500 G4 Models	
HP R1500 G4 NA Uninterruptible Power System	J2Q99A
HP R1500 G4 JP/TWN Uninterruptible Power System	J2R05A
HP R1500 G4 INTL Uninterruptible Power System	J2R03A
R7000 Uninterruptible Power System (UPS)	
HP R7000 4U 50A High Voltage NA/JP Uninterruptible Power System	AF462A
HP R7000 4U IEC-32A High Voltage INTL Uninterruptible Power System	AF463A
R5000 Uninterruptible Power System (UPS)	
HP R5000 3U L630 High Voltage NA/JP Uninterruptible Power System	AF460A
HP R5000 3U IEC309-32A High Voltage INTL Uninterruptible Power System	AF461A
NOTE: Please see the HP Line Interactive Single Phase UPS QuickSpecs for information on additional options and product specifications.	
HP UPS Options	
HP R/T2200 G4 Extended Runtime Module	J2R09A
HP R/T3000 G4 Extended Runtime Module	J2R10A
HP 2U Rack/Tower UPS Shipping Kit	L4Q11A
NOTE: To learn more, please visit the HP Uninterruptible Power Systems (UPS) web page .	

HP USB and SD Options

HP Enterprise Mainstream Flash Media Kits for Memory Cards

HP 32GB microSD Enterprise Mainstream Flash Media Kit	700139-B21
HP 8GB microSD Enterprise Mainstream Flash Media Kit	726116-B21
HP 8GB USB Enterprise Mainstream Flash Media Drive Key Kit	737953-B21
HP Dual 8GB microSD Enterprise Midline USB Kit	741279-B21

HP Care Pack Services

Installation & Start-up Services

HP Installation DL60/DL80 Service	U7WZ5E
HP Startup DL60/DL80 Service	U7WZ7E

Foundation Care

HP 3 year Next business day DL80 Gen9 Foundation Care Service	U7WG1E
HP 3 year Next business day with Defective Media Retention DL80 Gen9 Foundation Care Service	U7WG2E
HP 3 year Next business day w/ComprehensiveDefectiveMaterialRetention DL80 Gen9 Foundation Care SVC	U7WG3E
HP 3 year 24x7 DL80 Gen9 Foundation Care Service	U7WG4E
HP 3 year 24x7 with Defective Media Retention DL80 Gen9 Foundation Care Service	U7WG5E
HP 3 year 24x7 w/Comprehensive Defective Material Retention DL80 Gen9 Foundation Care Service	U7WG6E

Proactive Care

HP 3 year 24x7 DL80 Gen9 Proactive Care Service	U7WK1E
HP 3 year 24x7 with Defective Media Retention DL80 Gen9 Proactive Care Service	U7WK2E
HP 3 year 24x7 w/ComprehensiveDefectiveMaterialRetention DL80 Gen9 Proactive Care SVC	U7WK3E

Memory

Memory Subsystem Architecture Each Intel® Xeon® E5-2600v3 family processor socket contains four memory channels per installed processor with one DIMM per channel for a total of four (4) DIMMs or a grand total of eight (8) DIMMs for the server.

Memory Population guidelines

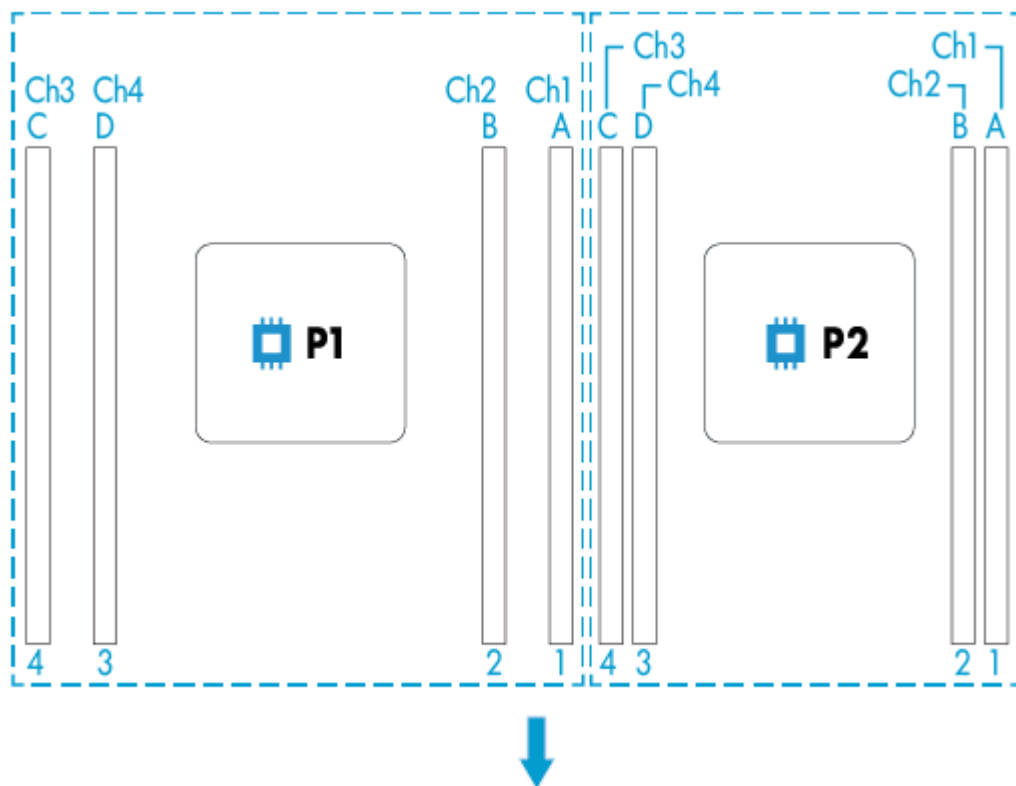

General Memory Population Rules and Guidelines:

- Install DIMMs only if the corresponding processor is installed.
- If only one processor is installed in a two processor system, only half of the DIMM slots are available.
- To maximize performance, it is recommended to balance the total memory capacity between all installed processors and load the channels similarly whenever possible.
- When two processors are installed, balance the DIMMs across the two processors.
- White DIMM slots denote the first slot to be populated in a channel.
- Do not mix RDIMMs or LRDIMMs.
- Quad rank RDIMMs are not supported in HP ProLiant DL80 Gen9 servers.
- DIMMs of different speeds may be mixed in any order; the server will select a common optimal speed.
- The maximum memory speed is a function of the memory type, memory configuration, and processor model.
- The maximum memory capacity is a function of the memory type and number of installed processors.
- To realize the performance memory capabilities listed in this document, HP SmartMemory is required.

Intel Gen9 Supported Memory Bandwidth for HP ProLiant Gen9 Intel® Xeon®E5-2600v3 Series Processor Family

Memory Bandwidth and Capacity					
[DIMM Type]	Registered Dimms (RDIMMs)			Load Reduced (LRDIMMs)	Unbuffered with ECC DIMMs (UDIMMs)
DIMM Rank	Single Rank		Dual Rank		Quad Rank
DIMM Capacity	4GB	8GB	16GB		32GB
Voltage	Std Voltage 1.2V				

Memory

SLOTS THAT CAN BE POPULATED						
8 slot servers	8	8	8	8	8	8
MAXIMUM CAPACITY (GB)	32	64	64	128	128	256
1 DIMM Per Channel	2133					

DIMM slot and configuration diagram

DIMM slot and configuration diagrams

Basic memory slot & population diagram

- Population order; start with "A" first, "B" second, "C" third, etc.
- When one processor is installed, install DIMMs in sequential alphabetic order: A, B, C, D, E, F ...
- When two processors are installed, install DIMMs in sequential alphabetic order: CPU1-A, CPU2-A, CPU1-B, CPU2-B, CPU1-C, CPU2-C

CPU #1 IS PROCESSOR ON LEFT - LOOKING FROM FRONT OF SERVER

	CPU 1		CPU 2	
	Slot #	population order	Slot #	population order
Chnl 1	1	A1	1	A1
Chnl 2	2	B2	2	B2
Chnl 4	3	D3	3	D3
Chnl 3	4	C4	4	C4

Memory Speed by Processor Model

Processor Models	Supported Memory Speeds
E5-2603v3, E5-2609v3,	1600MHz
E5-2620v3, E5-2630v3, E5-2640v3, E5-2623v3, E5-2630Lv3,	1866MHz
E5-2650v3, E5-2650Lv3, E5-2660v3,	2133MHz

Standard and Maximum Memory Capacity (Pre-configured Models)

Pre-Configured Models	Standard Memory	Maximum Memory Plus Optional Memory	Standard Memory Replaced with Optional Memory
E5-2603v3,	4GB (1x4GB)	228GB (7x32GB, 1x4GB)	256GB (8x32GB)
E5-2609v3,	8GB (1x8GB)	232GB (7x32GB, 1x8GB)	256GB (8x32GB)

Memory

DDR4 memory options part number decoder

NOTE: Capacity references are rounded to the common gigabyte (GB) values.

- 2GB = 2,048MB
- 4GB = 4,096MB
- 8GB = 8,192MB
- 16GB = 16,384MB
- 32GB = 32,768MB
- 64GB = 65,536MB

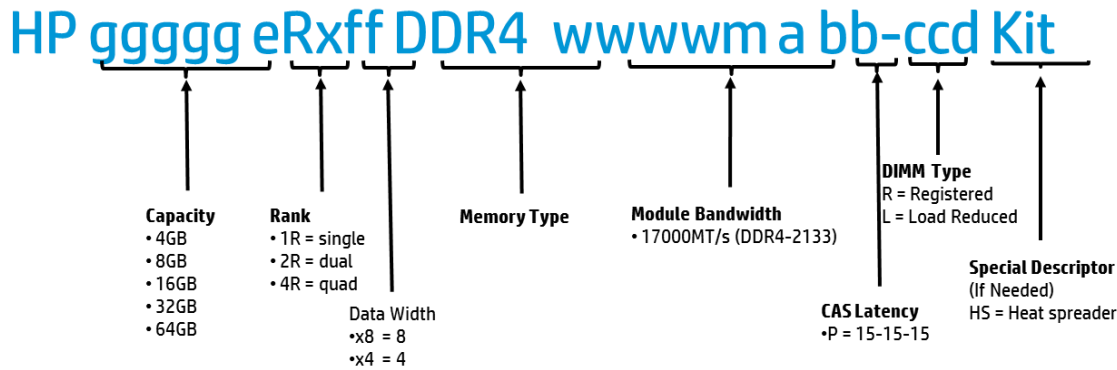

Storage

4-bay LFF non-hot-plug drive model

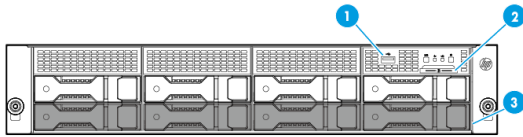

1-4

4 x LFF SATA Non-Hot Pluggable Hard Drive Bays

8-bay LFF non-hot plug drive model

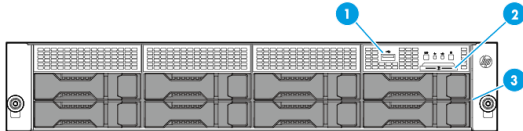

1-8

8 x LFF SATA Non- Hot Pluggable Hard Drive Bays

8-bay LFF hot-plug drive model

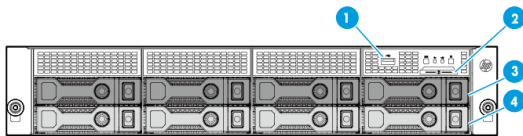

1-8

8 x LFF SATA/SAS/SDD Hot Pluggable Hard Drive Bays

12-bay LFF hot-plug drive model

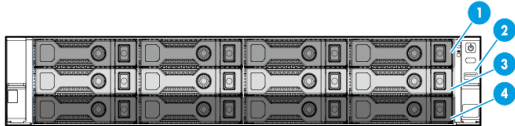

1-12

12 x LFF SATA/SAS/SDD Hot Pluggable Hard drive bays

Technical Specifications

System Unit	Dimensions (with bezel)	3.45 x 18.98 x 24.97 in (8.75 x 44.55 x 60.7 cm)
	Weight (approximate)	Maximum: 47/6 lb (21.59 kg) Minimum: 36.58 lb (16.59 kg)
Input Requirements	Rated Line Voltage	100 to 240 VAC
	Rated Input Current	For 550W Power Supply: 6.7 A (at 100 VAC) 3.3 A (at 200 VAC)
	Rated Input Frequency	47 to 63 Hz
	Rated Input Power	For 550 W Power Supply: < 670 W (at 100 VAC), < 660 W (at 200 VAC),
BTU Rating	Maximum	For 550 W Power Supply: 2201 BTU/hr (at 100 VAC), 2153 BTU/hr (at 200 VAC)
Power Specifications		To review typical system power ratings use the Power Advisor which is available via the online tool located at URL: www.hp.com/go/proliant-energy-efficient or www.hp.com/go/hppoweradvisor - Click on the system of interest. Example: DL80 Gen9- Follow the instructions of the next screens.
Power Supply Output	Rated Steady-State Power	For 550 W Power Supply: 550 W (at 100 VAC), 550 W (at 200 VAC),
	Maximum Peak Power	For 550 W Power Supply: 550 W (at 100 VAC), 550 W (at 200 VAC),
System Inlet Temperature	Standard Operating Support	10° to 35°C (50° to 95°F) at sea level with an altitude derating of 1.0°C per every 305 m (1,000 ft) above sea level to a maximum of 3050 m (10,000 ft), no direct sustained sunlight. Maximum rate of change is 20°C/hr (36°F/hr). The upper limit and rate of change may be limited by the type and number of options installed. System performance during standard operating support may be reduced if operating with a fan fault or above 30°C (86°F).
	Extended Ambient Operating Support	For approved hardware configurations, the supported system inlet range is extended to be: 5° to 10°C (41° to 50°F) and 35° to 40°C (95° to 104°F) at sea level with an altitude derating of 1.0°C per every 175 m (574 ft) above 900 m (2953 ft) to a maximum of 3050 m (10,000 ft). The approved hardware configurations for this system are listed at the URL: http://www.hp.com/servers/ashrae
		System performance may be reduced if operating in the extended ambient operating range or with a fan fault.
		NOTE: Supports A3 extended ambient.
Relative Humidity (non-condensing)	Non-operating	-30° to 60°C (-22° to 140°F). Maximum rate of change is 20°C/hr (36°F/hr).
	Operating	Minimum to be the higher (more moisture) of -12°C (10.4°F) dew point or 8% relative humidity. Maximum to be the lower (less moisture) of 24°C (75.2°F) dew point or 90% relative humidity.
	Non-operating	5% to 95% relative humidity (Rh), 38.7°C (101.7°F) maximum wet bulb temperature, non-condensing.
Altitude	Operating	3048 m (10,000 ft). This value may be limited by the type and number of options installed. Maximum allowable altitude change rate is 457 m/min (1500 ft/min).

Technical Specifications

	Non-operating	9144 m (30,000 ft). Maximum allowable altitude change rate is 457 m/min (1500 ft/min).
Acoustic Noise		Listed are the declared A-Weighted sound power levels (LWAd) and declared average bystander position A-Weighted sound pressure levels (LpAm) when the product is operating in a 23°C ambient environment. Noise emissions were measured in accordance with ISO 7779 (ECMA 74) and declared in accordance with ISO 9296 (ECMA 109).
	Idle	
	L WAd	Entry: 4.8 B Base: 4.7 B
	L pAm	Entry: 34 dBA Base: 33 dBA
	Operating	
	L WAd	Entry: 4.9 B Base: 4.9 B
	L pAm	Entry: 34 dBA Base: 36 dBA
Emissions Classification (EMC)	FCC Rating	Class A
	Normative Standards	CISPR 22; EN55022; EN55024; FCC CFR 47, Pt 15; ICES-003; CNS14336-1; CNS13438; GB4943; GB9254; EN 61000-3-2; EN 61000-3-3; EN 60950-1; IEC 60950-1
		NOTE: The listed sound levels apply to standard shipping configurations. Additional options may result in increased sound levels.
		NOTE: Product conformance to cited product specifications is based on sample (type) testing, evaluation, or assessment. This product or family of products is eligible to bear the appropriate compliance logos and statements.
		NOTE: The listed sound levels apply to standard shipping configurations. Additional options may result in increased sound levels.

HP Dynamic Smart Array B140i Controller	Number of PCI links	Four
	PCI link rate	4 Gb/s
	Storage protocol support	SATA
	SAS/SATA peak data transfer rate	6 Gb/s
	Number of SAS/SATA links	10 links
	SAS/SATA connectivity	2x4 connectors; 2x1 connectors
	Expander support	No
	Drives supported (max)	Up to 10 Internal Drives
	RAID support	0, 1, 10, 5 SATA
	Software management	HP SSA, SMH, SIM
	Warranty	Server warranty
	HP Secure Encryption license	Not Supported
	HP SmartCache License	Not Supported
HP Smart Storage Administrator	Supported	

HP Embedded Dual Port 361i Adapter	Network Interface	10Base-T/100Base-TX/1000Base-TX
	Compatibility	IEEE 802.3 10Base-T
		IEEE 802.3ab 1000Base-T
		IEEE 802.3u 100Base-TX

Technical Specifications

	IEEE 1588, IEEE 802.1AS
	IEEE 802.3az - Energy Efficient Ethernet (EEE)
Data Transfer Method	PCI Express v 2.0, 5.0 GT/s, two lanes (x2)
Controller	Intel I350 Powerville
Network Transfer Rate	10Base-T (Half-Duplex) 10 Mb/s per port, 40 Mb/s combined
	10Base-T (Full-Duplex) 20 Mb/s per port, 80 Mb/s combined
	100Base-TX (Half-Duplex) 100 Mb/s per port, 400 Mb/s combined
	100Base-TX (Full-Duplex) 200 Mb/s per port, 800 Mb/s combined
	1000Base-TX (Half and Full-Duplex) 1000Mb/s per port, 4000 Mb/s combined
Connector	Two RJ-45
Cable Support	10 Base-T Categories 3, 4 or 5 UTP; up to 328 ft (100 m)
	10/100/1000 Base-TX Category 5 or higher UTP; up to 328 ft (100 m)

Environment-friendly Products and Approach

End-of-life Management and Recycling

Hewlett-Packard offers end-of-life HP product return, trade-in, and recycling programs in many geographic areas. For trade-in information, please go to: <http://www.hp.com/go/green>. To recycle your product, please go to: <http://www.hp.com/go/green> or contact your nearest HP sales office. Products returned to HP will be recycled, recovered or disposed of in a responsible manner.

The EU WEEE directive (2002/95/EC) requires manufacturers to provide treatment information for each product type for use by treatment facilities. This information (product disassembly instructions) is posted on the Hewlett Packard web site at: <http://www.hp.com/go/green>. These instructions may be used by recyclers and other WEEE treatment facilities as well as HP OEM customers who integrate and re-sell HP equipment.

Summary of Changes

Date	Version History	Action	Description of Change
06/10/2015	From Version 5 to 6	Added	Added new HP Drives: HP 8TB 12G SAS 7.2K rpm LFF (3.5-inch) SC 512e Helium 1yr Warranty Hard Drive HP 6TB 12G SAS 7.2K rpm LFF (3.5-inch) SC 512e Helium 1yr Warranty Hard Drive HP 8TB 6G SATA 7.2K rpm LFF (3.5-inch) SC 512e Helium 1yr Warranty Hard Drive HP 6TB 6G SATA 7.2K rpm LFF (3.5-inch) SC 512e Helium 1yr Warranty Hard Drive
		Changed	Maximum Internal Storage was revised.
06/01/2015	From Version 4 to 5	Added	New Hard Drives were added to Core Options. Added new HP Power Supplies options. Added new HP OneView LTUs to HP Converged Infrastructure Management Software. New RDX+ backup external backup options added to HP Disk Backup.
		Changed	Core Options and Additional Options were revised.
		Removed	Obsolete SKUs were removed from QuickSpecs.
04/24/2015	From Version 3 to 4	Added	Added 813534-B21 and 813535-B21 to HP Power Supplies.
03/30/2015	From Version 2 to 3	Added	New Hard Drives offering. Optional Software added to HP Storage Controllers.
		Changed	HP Memory, HP Disk Storage Systems, HP USB and SD Options, HP Storage Controllers, and HP Disk Storage Systems were updated.
02/09/2015	From Version 1 to 2	Added	Added HP Insight Software. Added new G4 UPS models.
		Changed	HP Memory, HP Tape Backup, HP Disk Backup, HP Rack Mount Consoles, KVM Switches, and Keyboards, and HP Uninterruptible Power Systems (UPS) sections were revised.



© Copyright 2015 Hewlett-Packard Development Company, L.P.

The information contained herein is subject to change without notice. The only warranties for HP products and services are set forth in the express warranty statements accompanying such products and services. Nothing herein should be construed as constituting an additional warranty. HP shall not be liable for technical or editorial errors or omissions contained herein.

Intel® and Xeon® are registered trademarks of Intel Corporation in the U.S. and other countries.

Summary of Changes

Microsoft®, Windows®, and Windows Server® are U.S. registered trademarks of the Microsoft group of companies.

For hard drives, 1GB = 1 billion bytes. Actual formatted capacity is less