

YU-AS19

BEST VALUE IN THE WORLD OF CUTTING TOOLS



A E R O S P A C E S O L U T I O N S

*Helping Aerospace Manufacturers
Reach New Heights in Productivity*

**HIGH-PERFORMANCE TOOLS
for Milling, Holemaking and Threading**

V7 PLUS A



ALU-POWER HPC



MINICUT



TITANOX



TANK-POWER



DREAM DRILLS



The YG-1 Global Aerospace Capabilities

High-performance solutions from takeoff to touchdown and everywhere in-between

In the world of aerospace, lighter and more durable components are driving manufacturers to use higher-performance materials and tools. That's where YG-1 has been raising the bar by rising to the challenges of working with today's innovate materials. From milling titanium structural components to machining inconel for the engine hot zones, YG-1 is developing best-in-class tools to meet the growing demand for innovation in this category. Whether you need tools for roughing, for aluminum or titanium, for stainless steel or for Inconel, YG-1 offers a cost-effective solution for all your applications and materials.

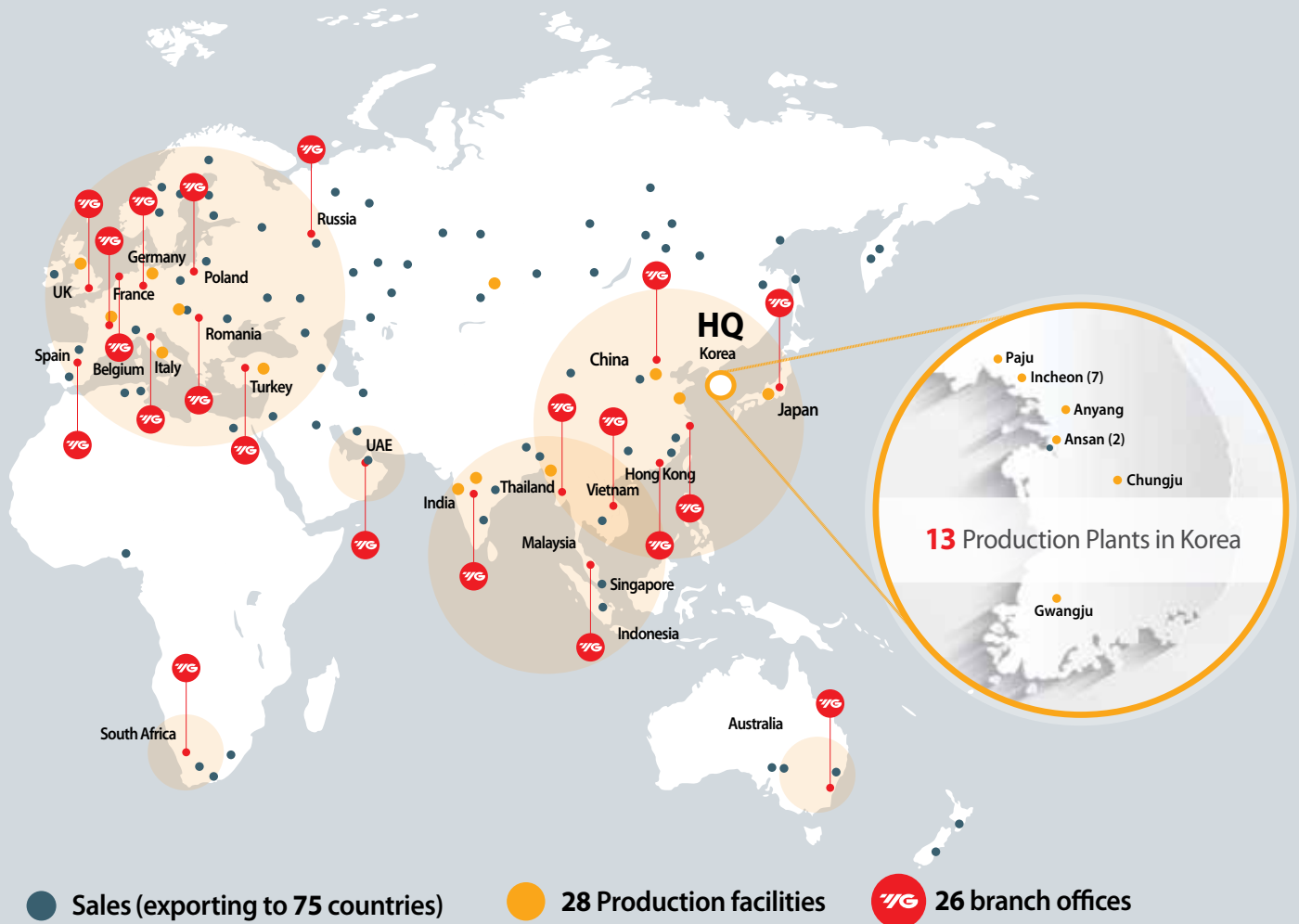

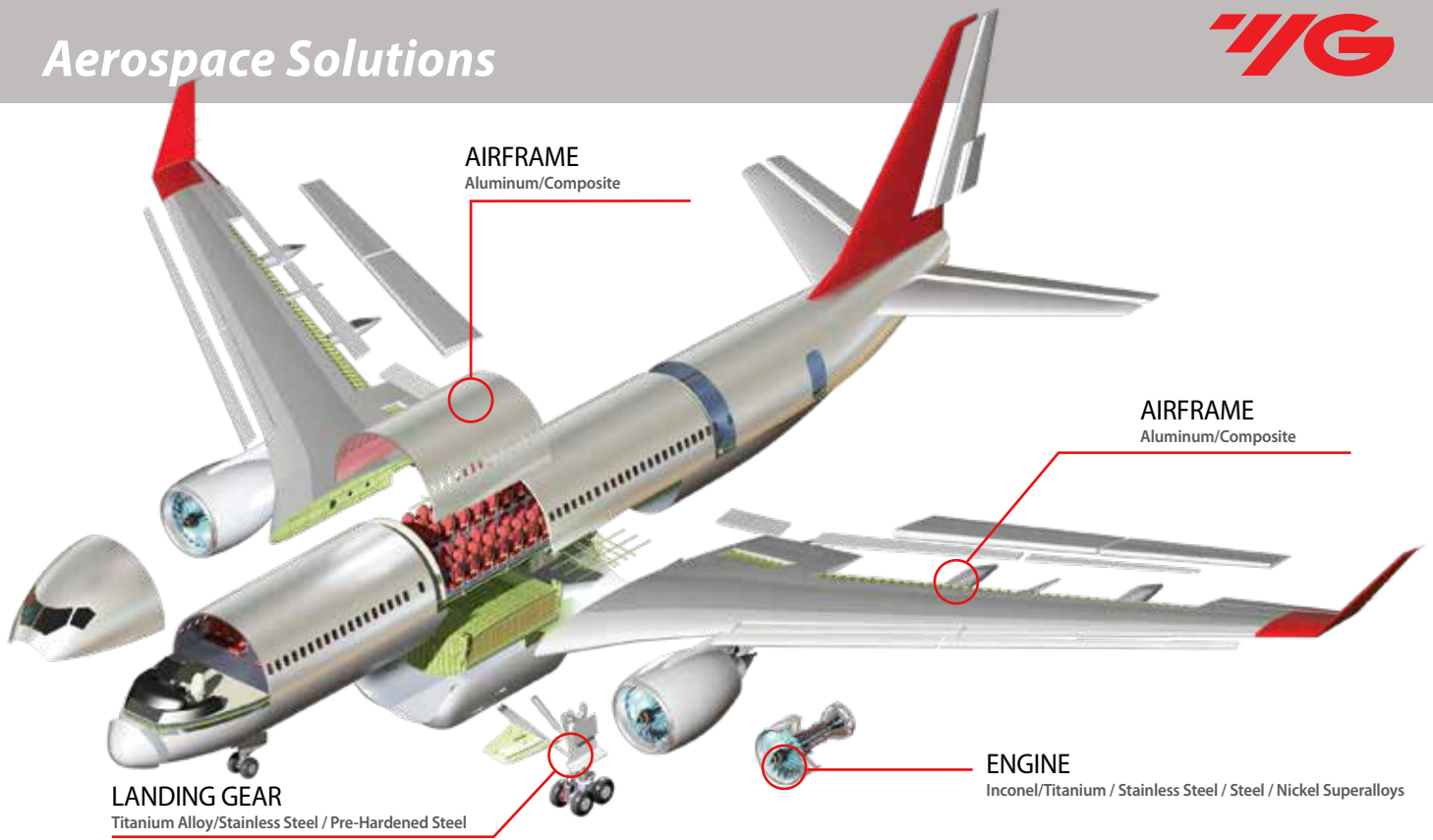

Global Leader. Local Partner.

As a global leader in the manufacturing and application of cutting tools, YG-1 offers you superior tooling backed by professional support and world-class delivery. In fact, with 28 production facilities and 26 branch offices, you're never far from getting the support you need, no matter where you are in the world. And since YG-1 tools are available 24/7 from its vast network of high-quality local distributors, you're only a phone call away from finding the tools you need.

And if you need expert advise or help building specialized tools, we have the expertise and facilities to give you world-class service, fast.



PRODUCT LINE INDEX

⊙ Excellent ○ Good

ISO Code	Material	Type of Cut	V7 Plus A		TitaNox		ALU-POWER HPC		Minicut Cobalt	
			Carbide		Carbide		Carbide		M-42	
			4 flutes	6 flutes	4 flutes	5 flutes	HPC 3 flutes	2 & 3 flutes	993/865/836	930 3 flutes
P	≤ 275 ALLOY STEELS 4140, 4150, 4320, 5120, 5150, 8630, 86L20, 50100	Roughing	⊙							
		Finishing	○	⊙		⊙				
		High-Speed Machining		⊙		○				
		Side Milling	⊙	⊙		⊙				
		Slotting	⊙							
		Drilling								
		Threading								
M	≤ 185 STAINLESS STEELS (FREE MACHINING) 303, 416, 420F, 430F 440F	Roughing	⊙							
		Finishing		⊙		⊙				
		High-Speed Machining		⊙		○				
		Side Milling	⊙	⊙		⊙				
		Slotting	⊙							
		Drilling								
	Threading									
	≤ 185 STAINLESS STEELS (DIFFICULT) 304, 304L, 316, 316L	Roughing	⊙							
		Finishing		⊙		⊙				
		High-Speed Machining		⊙		○				
		Side Milling	⊙	⊙		⊙				
		Slotting	⊙							
		Drilling								
	Threading									
	≤ 325 STAINLESS STEELS (PH) 13-8 PH, 15-5PH, 17-4 PH, Custom 450	Roughing	⊙		⊙				⊙	
		Finishing		⊙	○	⊙			○	
		High-Speed Machining		⊙		○				
		Side Milling	⊙	⊙	⊙	⊙			⊙	
Slotting		⊙		⊙				⊙		
Drilling										
Threading										
S	≤ 300 SUPERALLOYS: NICKEL-, COBALT-, IRON-BASED Inconel 601, 617, 625, Incoly 800, Monel 400	Roughing	○							
		Finishing	○	⊙						
		High-Speed Machining		⊙						
		Side Milling	○	⊙						
		Slotting	○							
		Drilling								
	Threading									
	> 300 SUPERALLOYS: NICKEL-, COBALT-, IRON-BASED (DIFFICULT) Inconel 718, 750X, Incoly 925, Waspaloy, Hastelloy, Rene	Roughing	○							
		Finishing	○	⊙						
		High-Speed Machining		⊙						
		Side Milling	○	⊙						
		Slotting	○							
Drilling										
Threading										

⊙ Excellent ○ Good

TANK-POWER - PM		DREAM DRILL•INOX		DREAM DRILL•ALU	DREAM DRILL•FLAT BOTTOM	TiNi Spiral Flute/ Spiral Point Taps	SS Spiral Flute/ Spiral Point Taps	STI Taps	Thread Mills
HSS		Carbide		Carbide	Carbide				
2/3/4 flutes	Rougher 3/4/5/6/8 flutes	2 flutes	3 flutes high feed	2 flutes	2 flutes				
⊙	⊙								
⊙	⊙								
⊙	⊙								
		⊙	⊙						
							⊙	⊙	⊙
⊙	⊙								
⊙	⊙								
⊙	⊙								
		⊙							
							⊙		○
⊙	⊙								
⊙	⊙								
⊙	⊙								
		⊙							○
⊙	⊙								
⊙	⊙								
⊙	⊙								
		⊙							○
⊙	⊙								
⊙	⊙								
⊙	⊙								
		⊙							○
						⊙			○

PRODUCT LINE INDEX



⊙ Excellent ○ Good

ISO Code	Material	Type of Cut	V7 Plus A		TitaNox		ALU-POWER HPC		Minicut Cobalt	
			Carbide		Carbide		Carbide		M-42	
			4 flutes	6 flutes	4 flutes	5 flutes	HPC 3 flutes	2 & 3 flutes	993/865/836	930 3 flutes
S	≤ 350 TITANIUM ALLOYS Pure Titanium, Ti6Al4V, Ti6Al2Sn4Zr2Mo, Ti4Al4Mo2Sn0.5Si	Roughing	○		⊙				⊙	
		Finishing	○	⊙	○	⊙			○	
		High-Speed Machining		⊙		○				
		Side Milling	○	⊙	⊙	⊙			⊙	
		Slotting	○		⊙				⊙	
		Drilling								
		Threading								
	> 350 ≤ 450 TITANIUM ALLOYS (DIFFICULT) Ti10Al2Fe3Al, Ti5Al5V5Mo3Cr, Ti7Al4Mo, Ti3Al8V6Cr4Zr4Mo, Ti6Al6V6Sn, Ti15V3	Roughing	○		⊙				⊙	
		Finishing	○	⊙	○	⊙			○	
		High-Speed Machining		⊙		○				
		Side Milling	○	⊙	⊙	⊙			⊙	
		Slotting	○		⊙				⊙	
		Drilling								
		Threading								
N	ALUMINUM ALLOYS 2024, 5052, 5086, 6061, 6073, 7075	Roughing					⊙	○		⊙
		Finishing					⊙	⊙		○
		High-Speed Machining					⊙			
		Side Milling					⊙	⊙		⊙
		Slotting					⊙	○		⊙
		Drilling								
		Threading								
	ALUMINUM DIE CAST ALLOYS A-390, A392, B-390	Roughing					⊙	○		⊙
		Finishing					⊙	⊙		○
		High-Speed Machining					⊙			
		Side Milling					⊙	⊙		⊙
		Slotting					⊙	○		⊙
		Drilling								
		Threading								
	PLASTICS Materials description here	Roughing						○		
		Finishing						○		
		High-Speed Machining								
		Side Milling						○		
		Slotting						○		
		Drilling								
		Threading								

☉ Excellent ○ Good

TANK-POWER - PM		DREAM DRILL•INOX		DREAM DRILL•ALU	DREAM DRILL•FLAT BOTTOM	TiNi Spiral Flute/ Spiral Point Taps	SS Spiral Flute/ Spiral Point Taps	STI Taps	Thread Mills
HSS		Carbide		Carbide	Carbide				
2/3/4 flutes	Rougher 3/4/5/6/8 flutes	2 flutes	3 flutes high feed	2 flutes	2 flutes				
☉	☉								
☉	☉								
☉	☉								
		☉			☉				
						☉			○
☉	☉								
☉	☉								
☉	☉								
		☉			☉				
						☉			○
○	○								
○	○								
○	○								
				☉	☉				
							○	○	☉
				☉	☉				
								○	☉
									○
							○		○

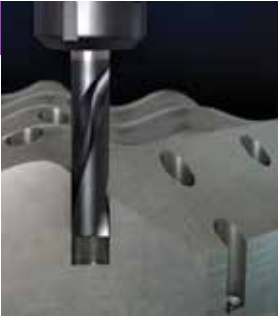
Contents

MILLING		PAGE 9	
		V7 Plus A	10
		TitaNox Power	42
		ALU-POWER HPC	58
		Minicut Cobalt	68
		TANK-POWER	78
HOLEMAKING		PAGE 93	
		DREAM DRILL INOX	98
		DREAM DRILL ALU	114
		DREAM DRILL FLAT BOTTOM	120
THREADING		PAGE 125	
		TiNi Spiral Flute/Spiral Point Taps	130
		Stainless Steel Spiral Flute/Spiral Point Taps	132
		STI Taps	144
		Thread Mills	152
TOOLING SYSTEMS		PAGE 157	
		Hydraulic Chuck	160
		Shrink-Fit Holder	191
		End Mill Holder (Side Lock)	204
		Collet Chuck	218
		Power Milling Chuck	236

MILLING



From concept to completion, milling is the first step for what takes shape.

Milling complex materials for aerospace applications takes sophistication and know-how to bring your ideas to life. And on all of these counts, YG-1 has the right solution and the right tool for the job. No other company has invested in developing end mills that perform on titanium, aluminum, stainless steels, superalloys and more, like YG-1 — and no other company designs and manufactures more end mills than YG-1. So if we don't have the tools you need, let us know — and we'll make them for you.

V7 Plus A: NOTHING CUTS AEROSPACE MATERIALS BETTER.

FOR TOUGH STEEL, STAINLESS STEEL, TITANIUM AND EXOTICS

Got an aerospace machining challenge? We have the solution.

- ▶ 4-flute and 6-flute standard-stocked or custom-designed solutions
- ▶ Square, radius and chamfered end geometries
- ▶ Standard and extended lengths
- ▶ Plain and Weldon flat shanks
- ▶ Inch and metric sizes
- ▶ Ball nose available



V7 Plus A: Top gun for performance in aerospace materials.

Aerospace materials are demanding. So we engineered the V7 Plus A line from the tip of the flutes to the end of the shank to meet those demands and more, with:

- ▶ Excellent material removal rates and surface finishes
- ▶ Reduced chatter (harmonics), greater stability with variable indexing; noticeably smooth operation in high-speed machining and peel-milling
- ▶ Superior performance, longer tool life with premium-grade carbide substrate and advanced heat-resistant coating
- ▶ Impressive chip formation and evacuation due to optimized flute geometry
- ▶ More flexible use: superior slotting, ramping and profiling in most ferrous materials
- ▶ Greater accuracy, less vibration, better heat displacement in high-speed trochoidal milling

V7 Plus A

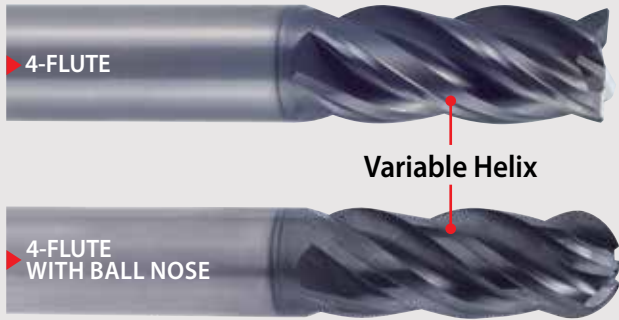

V7 Plus A 4-FLUTE END MILLS: A higher standard in 4-flute design for anything that flies.

State-of-the-art geometry provides cutting stability in a 4-flute design:

- ▶ Excellent performance in aerospace materials
- ▶ Reduced vibration, optimal chip formation and evacuation created by special flute and variable helix designs
- ▶ Longer tool life in heavy cutting conditions; advanced coating shields cutting edges against wear



V7 Plus A 6-FLUTE END MILLS: Better by every measure.

Solid carbide end mills with unique cutting geometry for greater stability with higher cutting-edge engagement, smoother running and higher productivity in the most challenging materials on the planet.

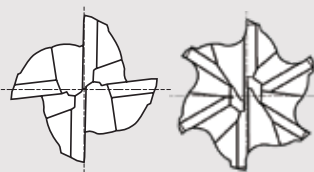

VARIABLE INDEX WITH HIGH-PERFORMANCE CORNER GEOMETRIES INCLUDING CORNER RADIUS

Better trochoidal milling/high-speed machining.

The V7 Plus A 6-flute's 45-degree helix is ideal for applying a small radial width of cut with a long length of cut (up to 4xD, depending on material) with higher cutting speeds and feed rates. Here's why:

- ▶ Smaller arc of engagement reduces cutting forces, improves heat displacement
- ▶ More flutes, allowing for a longer length of cut, equals more productivity and less wear
- ▶ Stability-inducing geometry (larger core diameter) cuts vibration for greater accuracy, longer tool life
- ▶ Excellent evacuation permits prolonged aggressive feed rates

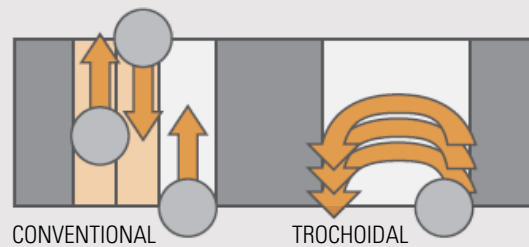

GUIDE TO ICONS

The tool is made of premium micrograin carbide

MG
HM

Tolerance of Ball Radius

R ±0.008 in. R ±0.02 mm

No. of Flutes

4 6

Cutting Conditions



Helix Angle

35°/37° 45°

Tool Ends

Square Chamfer 45°

Type of Shank

PLAIN FLAT

Plain shank

Weldon flat





Radius Ball

R

Radius

Ball

SELECTION GUIDE – INCH

SERIES	MODEL	DESCRIPTION	DIAMETER (in.)		PAGE	
			Min.	Max.		
UGMF68		4-FLUTE (Plain Shank) STANDARD LENGTH	SQUARE END	1/8	1	16-17
UGMF76			CHAMFER	1/4	1	16-17
UGMF70			CORNER RADIUS	1/8	1	16-17
UGMG53			BALL NOSE	1/8	1	16-17
UGMF69		4-FLUTE (Weldon Flat Shank) STANDARD LENGTH	SQUARE END	11/32	1	18
UGMF77			CHAMFER	3/8	1	18
UGMF71			CORNER RADIUS	3/8	1	18
UGMG54			BALL NOSE	11/32	1	18
UGMF72		4-FLUTE (Plain Shank) EXTENDED LENGTH	SQUARE END	1/8	1	19
UGMF74			CORNER RADIUS	1/8	1	19
UGMH10			BALL NOSE	1/8	1	19
UGMF73		4-FLUTE (Weldon Flat Shank) EXTENDED LENGTH	SQUARE END	3/8	1	20
UGMF75			CORNER RADIUS	3/8	1	20
UGMG20		6-FLUTE (Plain Shank) STANDARD LENGTH	SQUARE END	1/4	1	27
UGMG22			CORNER RADIUS	1/4	1	27
UGMG21		6-FLUTE (Weldon Flat Shank) STANDARD LENGTH	SQUARE END	3/8	1	28
UGMG23			CORNER RADIUS	3/8	1	28
UGMH08		6-FLUTE (Plain Shank) EXTENDED LENGTH	SQUARE END	1/4	1	29
UGMH09			CORNER RADIUS	1/4	1	29
RECOMMENDED CUTTING CONDITIONS					32-37	

V7 Plus A



◎ Excellent ○ Good

P					M	K	S	
Carbon Steels	Alloy Steels	Prehardened Steels	Hardened Steels		Stainless Steels	Cast Iron	High-Temperature Alloy	Titanium
~HB225	HB225~352	HRC30~40	HRC40~55	HRC55~				
◎	◎	◎	○		◎	◎	○	○
◎	◎	◎	○		◎	◎	○	○
◎	◎	◎	○		◎	◎	○	○
◎	◎	◎	○		◎	◎	○	○
◎	◎	◎	○		◎	◎	○	○
◎	◎	◎	○		◎	◎	○	○
◎	◎	◎	○		◎	◎	○	○
◎	◎	◎	○		◎	◎	○	○
◎	◎	◎	○		◎	◎	○	○
◎	◎	◎	○		◎	◎	○	○
◎	◎	◎	○		◎	◎	○	○
◎	◎	◎	○		◎	◎	○	○
◎	◎	◎	○		◎	◎	○	○
◎	◎	◎	○		◎	◎	○	○
◎	◎	◎	○		◎	◎	○	○
◎	◎	◎	○		◎	◎	○	○
◎	◎	◎	○		◎	◎	○	○
◎	◎	◎	○		◎	◎	○	○
◎	◎	◎	○		◎	◎	○	○
◎	◎	◎	○		◎	◎	○	○
◎	◎	◎	○		◎	◎	○	○

SELECTION GUIDE – METRIC

SERIES	MODEL	DESCRIPTION	DIAMETER (mm)		PAGE	
			Min.	Max.		
GMF52 GMF56		4-FLUTE (Plain Shank) STANDARD LENGTH	CHAMFER	3.0	25.0	21
GMF54 GMF58			CORNER RADIUS	3.0	25.0	21
GMG55			BALL NOSE	3.0	25.0	21
GMF53 GMF57		4-FLUTE (Weldon Flat Shank) STANDARD LENGTH	CHAMFER	3.0	25.0	22
GMF55 GMF59			CORNER RADIUS	3.0	25.0	22
GMG56			BALL NOSE	3.0	25.0	22
GMF60		4-FLUTE (Plain Shank) EXTENDED LENGTH	CHAMFER	3.0	20.0	23
GMF62			CORNER RADIUS	3.0	20.0	24
GMF61		4-FLUTE (Weldon Flat Shank) EXTENDED LENGTH	CHAMFER	3.0	20.0	25
GMF63			CORNER RADIUS	3.0	20.0	26
GMG12 GMG14		6-FLUTE (Plain Shank) STANDARD LENGTH	SQUARE END	6.0	25.0	30
GMG16 GMG18			CORNER RADIUS	6.0	25.0	30
GMG13 GMG15		6-FLUTE (Weldon Flat Shank) STANDARD LENGTH	SQUARE END	6.0	25.0	30
GMG17 GMG19			CORNER RADIUS	6.0	25.0	30
RECOMMENDED CUTTING CONDITIONS					38-41	



⊙ Excellent ○ Good

P					M	K	S	
Carbon Steels	Alloy Steels	Prehardened Steels	Hardened Steels		Stainless Steels	Cast Iron	High-Temperature Alloy	Titanium
~HB225	HB225~352	HRC30~40	HRC40~55	HRC55~				
⊙	⊙	⊙	○		⊙	⊙	○	○
⊙	⊙	⊙	○		⊙	⊙	○	○
⊙	⊙	⊙	○		⊙	⊙	○	○
⊙	⊙	⊙	○		⊙	⊙	○	○
⊙	⊙	⊙	○		⊙	⊙	○	○
⊙	⊙	⊙	○		⊙	⊙	○	○
⊙	⊙	⊙	○		⊙	⊙	○	○
⊙	⊙	⊙	○		⊙	⊙	○	○
⊙	⊙	⊙	○		⊙	⊙	○	○
⊙	⊙	⊙	○		⊙	⊙	○	○
⊙	⊙	⊙	○		⊙	⊙	○	○
⊙	⊙	⊙	○		⊙	⊙	○	○
⊙	⊙	⊙	○		⊙	⊙	○	○
⊙	⊙	⊙	○		⊙	⊙	○	○
⊙	⊙	⊙	○		⊙	⊙	○	○

4-FLUTE STANDARD LENGTH (PLAIN SHANK)

UGMF68 | UGMF76 | UGMF70 | UGMG53 SERIES



Pages 32-35

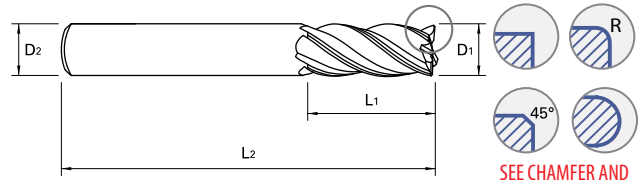

SEE CHAMFER AND BALL KEYS ON PAGE 18

Unit: INCH

OD (D1)	SD (D2)	LOC (L1)	OAL (L2)	Square End	Chamfer	Corner Radius									Ball Nose
						.010	.015	.030	.060	.090	.125	.190	.250		
						EDP No.	EDP No.	EDP No.	EDP No.	EDP No.	EDP No.	EDP No.	EDP No.		
1/8	1/8	1/8	1-1/2	UGMF68008		UGMF70008		UGMF70955						UGMG53901	
		3/8	1-1/2	UGMF68901		UGMF70901		UGMF70902						UGMG53008	
		1/2	2-1/2	UGMF68S915		UGMF70S956		UGMF70S957						UGMG53S902	
5/32	3/16	3/16	2	UGMF68010		UGMF70010								UGMG53903	
		7/16	2	UGMF68902		UGMF70958								UGMG53010	
3/16	3/16	3/16	2	UGMF68012		UGMF70012								UGMG53904	
		5/16	2	UGMF68916		UGMF70959		UGMF70960						UGMG53905	
		7/16	2	UGMF68903		UGMF70903		UGMF70904						UGMG53012	
		5/8	2-1/2	UGMF68S917		UGMF70S961		UGMF70S962						UGMG53S906	
7/32	1/4	1/4	2	UGMF68014		UGMF70014								UGMG53907	
		7/16	2-1/2	UGMF68904		UGMF70963								UGMG53014	
1/4	1/4	3/8	2	UGMF68016	UGMF76016	UGMF70016		UGMF70905	UGMF70906					UGMG53908	
		1/2	2-1/2	UGMF68918			UGMF70964	UGMF70965	UGMF70966					UGMG53016	
		3/4	2-1/2	UGMF68905	UGMF76902	UGMF70907	UGMF70908	UGMF70909	UGMF70967					UGMG53909	
		1	3	UGMF68S919			UGMF70S968	UGMF70S969	UGMF70S970					UGMG53S910	
9/32	5/16	5/8	2-1/2	UGMF68018			UGMF70018	UGMF70971	UGMF70972					UGMG53018	
		1	3	UGMF68S920			UGMF70S973	UGMF70S974						UGMG53S911	
5/16	5/16	7/16	2	UGMF68020				UGMF70020						UGMG53912	
		13/16	2-1/2	UGMF68906	UGMF76020	UGMF70910		UGMF70911	UGMF70912					UGMG53020	
		1-1/4	3	UGMF68S921			UGMF70S975	UGMF70S976	UGMF70S977					UGMG53S913	
11/32	3/8	1/2	2-1/2	UGMF68022				UGMF70022						UGMG53914	
		13/16	2-1/2	UGMF68922				UGMF70978						UGMG53022	
3/8	3/8	1/2	2-1/2	UGMF68024	UGMF76903	UGMF70024		UGMF70913	UGMF70914	UGMF70979				UGMG53915	
		7/8	2-1/2	UGMF68907	UGMF76024	UGMF70915		UGMF70916	UGMF70917	UGMF70980				UGMG53024	
		1	3	UGMF68923		UGMF70981		UGMF70982	UGMF70983	UGMF70984				UGMG53916	
		1-1/4	3	UGMF68S924		UGMF70S985		UGMF70S986	UGMF70S987	UGMF70S988				UGMG53S917	
13/32	7/16	1/2	2-3/4	UGMF68026				UGMF70026						UGMG53026	
		15/16	2-3/4	UGMF68925				UGMF70989						UGMG53918	
7/16	7/16	5/8	2-1/2	UGMF68028			UGMF70028	UGMF70918	UGMF70990	UGMF70991				UGMG53919	
		7/8	2-3/4	UGMF68926	UGMF76028		UGMF70992	UGMF70993	UGMF70994	UGMF70995				UGMG53920	
		1	2-3/4	UGMF68908		UGMF70919		UGMF70920	UGMF70921					UGMG53028	
15/32	1/2	5/8	2-1/2	UGMF68030				UGMF70030						UGMG53030	
		1	3	UGMF68927				UGMF70996						UGMG53921	
		1-1/4	3-1/2	UGMF68928				UGMF70997						UGMG53922	

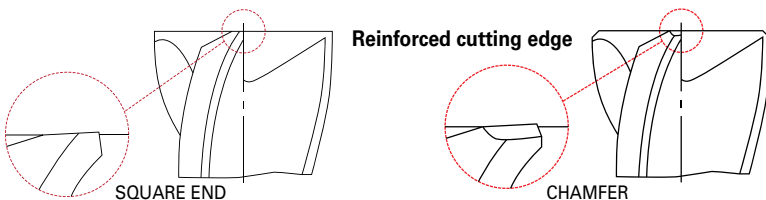

NEXT PAGE ▶

NOTE: ▶ Length of cut in excess of 3xD on 37° single-helix requires feed reduction of approximately 50%.

OD (D ₁)	SD (D ₂)	LOC (L ₁)	OAL (L ₂)	Square End EDP No.	Chamfer EDP No.	Corner Radius								Ball Nose EDP No.
						.010	.015	.030	.060	.090	.125	.190	.250	
						EDP No.	EDP No.	EDP No.	EDP No.	EDP No.	EDP No.	EDP No.	EDP No.	
1/2	1/2	5/8	2-1/2	UGMF68032	UGMF76032	UGMF70032	UGMF70922	UGMF70923	UGMF70924	UGMF70998	UGMF70999			UGMG53923
		1	3	UGMF68909	UGMF76904	UGMF70925	UGMF70801	UGMF70926	UGMF70927	UGMF70802	UGMF70928			UGMG53032
		1-1/4	3-1/2	UGMF68910	UGMF76901	UGMF70929	UGMF70930	UGMF70931	UGMF70932	UGMF70803	UGMF70933			UGMG53924
		1-5/8	4	UGMF685929	UGMF765905		UGMF70S804	UGMF70S805	UGMF70S806	UGMF70S807	UGMF70S808			UGMG535925
		2	4	UGMF685939			UGMF70S889	UGMF70S890	UGMF70S891	UGMF70S892	UGMF70S893			UGMG535939
		2-1/2	4-1/2	UGMF685940	UGMF765906		UGMF70S894	UGMF70S895	UGMF70S896	UGMF70S897	UGMF70S898			UGMG535940
5/8	5/8	3/4	3	UGMF68040		UGMF70040	UGMF70809	UGMF70934	UGMF70935	UGMF70810	UGMF70811			UGMG53926
		1-1/4	3-1/2	UGMF68911	UGMF76040	UGMF70936	UGMF70937	UGMF70938	UGMF70939	UGMF70812	UGMF70940			UGMG53040
		1-5/8	4	UGMF68930	UGMF76907		UGMF70813	UGMF70814	UGMF70815	UGMF70816	UGMF70817			UGMG53927
		2	4	UGMF685931			UGMF70S818	UGMF70S819	UGMF70S820	UGMF70S821	UGMF70S822			UGMG535928
		3-1/4	6	UGMF685932			UGMF70S823	UGMF70S824	UGMF70S825	UGMF70S826	UGMF70S827			UGMG535929
3/4	3/4	3/4	3	UGMF68048	UGMF76908		UGMF70828	UGMF70048	UGMF70941	UGMF70829	UGMF70830	UGMF70831	UGMF70832	UGMG53930
		1-1/2	4	UGMF68912	UGMF76048		UGMF70942	UGMF70943	UGMF70944	UGMF70833	UGMF70945	UGMF70834	UGMF70835	UGMG53048
		1-7/8	4	UGMF68933			UGMF70836	UGMF70837	UGMF70838	UGMF70839	UGMF70840	UGMF70841	UGMF70842	UGMG53931
		2-1/4	5	UGMF68934	UGMF76909		UGMF70843	UGMF70844	UGMF70845	UGMF70846	UGMF70847	UGMF70848	UGMF70849	UGMG53932
		3-1/4	6	UGMF685935			UGMF70S850	UGMF70S851	UGMF70S852	UGMF70S853	UGMF70S854	UGMF70S855	UGMF70S856	UGMG535933
1	1	1	4	UGMF68064	UGMF76910		UGMF70064	UGMF70946	UGMF70947	UGMF70857	UGMF70858	UGMF70859	UGMF70860	UGMG53934
		1-1/2	4	UGMF68913	UGMF76064		UGMF70948	UGMF70949	UGMF70950	UGMF70861	UGMF70951	UGMF70862	UGMF70863	UGMG53064
		2	5	UGMF68914	UGMF76911		UGMF70952	UGMF70953	UGMF70954	UGMF70864	UGMF70865	UGMF70866	UGMF70867	UGMG53935
		2-5/8	5	UGMF68936	UGMF76912		UGMF70868	UGMF70869	UGMF70870	UGMF70871	UGMF70872	UGMF70873	UGMF70874	UGMG53936
		3	6	UGMF68937			UGMF70875	UGMF70876	UGMF70877	UGMF70878	UGMF70879	UGMF70880	UGMF70881	UGMG53937
		4-1/4	7	UGMF685938			UGMF70S882	UGMF70S883	UGMF70S884	UGMF70S885	UGMF70S886	UGMF70S887	UGMF70S888	UGMG535938

Can't find what you're looking for?

Specialty products are not a problem. With over 30 years of tooling experience for some of the world's most successful companies, YG-1 can handle your most demanding design, testing and manufacturing needs. And now with our state-of-the-art Charlotte Technical Center, you have a place that can do it all (see more about our Technical Center on pages 38 and 39).

When you're looking for the best solution at the most efficient cost, come to YG-1. **Call us at 800-765-8665 or contact our distributor partners** to discuss your machining solution needs.



4-FLUTE STANDARD LENGTH (WELDON FLAT SHANK)

UGMF69 | UGMF77 | UGMF71 | UGMG54 SERIES



Pages 32-35

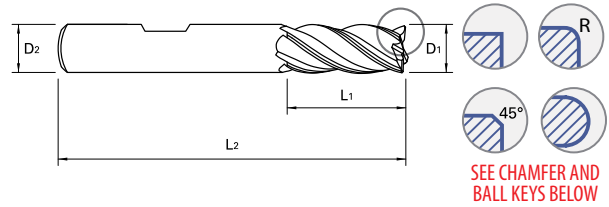

Unit: INCH

OD (D ₁)	SD (D ₂)	LOC (L ₁)	OAL (L ₂)	Square End EDP No.	Chamfer EDP No.	Corner Radius						Ball Nose EDP No.
						.010	.015	.030	.060	.090	.125	
						EDP No.	EDP No.	EDP No.	EDP No.	EDP No.	EDP No.	
11/32	3/8	1/2	2-1/2	UGMF69022								
		13/16	2-1/2									UGMG54022
3/8	3/8	1/2	2-1/2	UGMF69024	UGMF77902	UGMF71024		UGMF71913	UGMF71914			
		7/8	2-1/2	UGMF69907	UGMF77024	UGMF71915		UGMF71916	UGMF71917			UGMG54024
7/16	7/16	5/8	2-1/2	UGMF69028			UGMF71028	UGMF71918				
		1	2-3/4	UGMF69908		UGMF71919		UGMF71920	UGMF71921			UGMG54028
1/2	1/2	5/8	2-1/2	UGMF69032	UGMF77032	UGMF71032	UGMF71922	UGMF71923	UGMF71924			
		1	3	UGMF69909	UGMF77903	UGMF71925		UGMF71926	UGMF70927		UGMF71928	UGMG54032
		1-1/4	3-1/2	UGMF69910	UGMF77901	UGMF71929	UGMF71930	UGMF71931	UGMF71932		UGMF71933	
		2	4	UGMF695915			UGMF71S955	UGMF71S956	UGMF71S957	UGMF71S958	UGMF71S959	UGMG54S901
		2-1/2	4-1/2	UGMF695916			UGMF71S960	UGMF71S961	UGMF71S962	UGMF71S963	UGMF71S964	UGMG54S902
5/8	5/8	3/4	3	UGMF69040	UGMF77904	UGMF71040		UGMF71934	UGMF71935			
		1-1/4	3-1/2	UGMF69911	UGMF77040	UGMF71936	UGMF71937	UGMF71938	UGMF71939		UGMF71940	UGMG54040
3/4	3/4	3/4	3	UGMF69048	UGMF77905			UGMF71048	UGMF71941			
		1-1/2	4	UGMF69912	UGMF77048		UGMF71942	UGMF71943	UGMF71944		UGMF71945	UGMG54048
1	1	1	4	UGMF69064	UGMF77906		UGMF71064	UGMF71946	UGMF71947			
		1-1/2	4	UGMF69913	UGMF77064		UGMF71948	UGMF71949	UGMF71950		UGMF71951	UGMG54064
		2	5	UGMF69914	UGMF77907		UGMF71952	UGMF71953	UGMF71954			

KEYS:

CHAMFER KEY	
Mill Diameter	Chamfer Size
1/4	.007
5/16	.007
3/8	.011
7/16	.013
1/2	.013
5/8	.015
3/4	.019
1	.019

BALL NOSE KEY	
Mill Diameter	Radius of Ball
1/8	1/16
5/32	5/64
3/16	3/32
7/32	7/64
1/4	1/8
9/32	9/64
5/16	5/32
11/32	11/64
3/8	3/16
7/16	7/32
1/2	1/4
5/8	5/16
3/4	3/8
1	1/2

NOTE: ▶ Length of cut in excess of 3xD on 37° single-helix requires feed reduction of approximately 50%.

Reinforced cutting edge

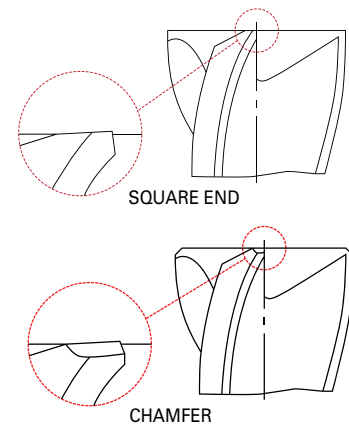

4-FLUTE EXTENDED LENGTH (PLAIN SHANK)

UGMF72 | UGMF74 | UGMH10 SERIES



Pages 32-35

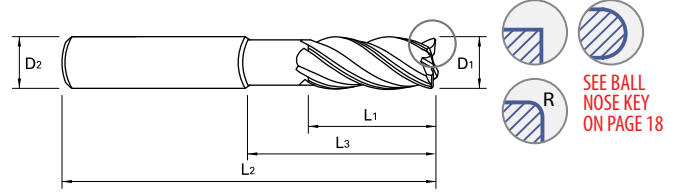

Unit: INCH

OD (D ₁)	SD (D ₂)	LOC (L ₁)	LBS (L ₃)	OAL (L ₂)	Square End EDP No.	Corner Radius									Ball Nose Mill EDP No.
						.010	.015	.030	.060	.090	.125	.190	.250		
						EDP No.	EDP No.	EDP No.	EDP No.	EDP No.	EDP No.	EDP No.	EDP No.		
1/8	1/8	5/32	3/8	3	UGMF72008	UGMF74008		UGMF74913							UGMH10008
		5/32	1/2	3	UGMF72913	UGMF74914		UGMF74915							UGMH10901
		5/32	5/8	3	UGMF72914	UGMF74916		UGMF74917							UGMH10902
3/16	3/16	7/32	1/2	3	UGMF72012	UGMF74012		UGMF74918							UGMH10012
		7/32	3/4	3	UGMF72915	UGMF74919		UGMF74920							UGMH10903
		7/32	1	3	UGMF72916	UGMF74921		UGMF74922							UGMH10904
1/4	1/4	3/8	3/4	4	UGMF72016		UGMF74016	UGMF74923	UGMF74924						UGMH10016
		3/8	1-1/8	4	UGMF72901		UGMF74901	UGMF74925	UGMF74926						UGMH10905
		3/8	2-1/8	4	UGMF72902		UGMF74902	UGMF74927	UGMF74928						UGMH10906
3/8	3/8	1/2	1-1/8	4	UGMF72024		UGMF74929	UGMF74024	UGMF74930	UGMF74931					UGMH10024
		1/2	2-1/8	4	UGMF72903		UGMF74932	UGMF74903	UGMF74933	UGMF74934					UGMH10907
		1/2	3-1/8	5	UGMF72922		UGMF74815	UGMF74816	UGMF74817	UGMF74818					UGMH10922
		1/2	3-1/8	6	UGMF72904		UGMF74935	UGMF74904	UGMF74936	UGMF74937					UGMH10908
		1/2	4-1/8	6	UGMF72917		UGMF74938	UGMF74939	UGMF74940	UGMF74941					UGMH10909
1/2	1/2	5/8	1-1/2	4	UGMF72032		UGMF74942	UGMF74032	UGMF74943	UGMF74944	UGMF74945				UGMH10032
		5/8	2-1/4	4	UGMF72905		UGMF74946	UGMF74905	UGMF74947	UGMF74948	UGMF74949				UGMH10910
		5/8	3-3/8	5	UGMF72923		UGMF74819	UGMF74820	UGMF74821	UGMF74822	UGMF74823				UGMH10923
		5/8	3-3/8	6	UGMF72906		UGMF74950	UGMF74906	UGMF74951	UGMF74952	UGMF74953				UGMH10911
		5/8	4-1/8	6	UGMF72918		UGMF74954	UGMF74955	UGMF74956	UGMF74957	UGMF74958				UGMH10912
5/8	5/8	3/4	1-5/8	4	UGMF72040			UGMF74040	UGMF74959	UGMF74960	UGMF74961				UGMH10040
		3/4	2-3/8	5	UGMF72924			UGMF74824	UGMF74825	UGMF74826	UGMF74827				UGMH10924
		3/4	3-3/8	5	UGMF72925			UGMF74828	UGMF74829	UGMF74830	UGMF74831				UGMH10925
		3/4	2-3/8	6	UGMF72907			UGMF74907	UGMF74962	UGMF74963	UGMF74964				UGMH10913
		3/4	3-3/8	6	UGMF72908			UGMF74908	UGMF74965	UGMF74966	UGMF74967				UGMH10914
		3/4	4-1/8	6	UGMF72919			UGMF74968	UGMF74969	UGMF74970	UGMF74971				UGMH10915
3/4	3/4	1	2	4	UGMF72048			UGMF74048	UGMF74972	UGMF74973	UGMF74974	UGMF74975	UGMF74976	UGMF74977	UGMH10048
		1	3	5	UGMF72926			UGMF74832	UGMF74833	UGMF74834	UGMF74835	UGMF74836	UGMF74837	UGMH10926	
		1	2-1/2	6	UGMF72920			UGMF74977	UGMF74978	UGMF74979	UGMF74980	UGMF74981	UGMF74982	UGMH10916	
		1	3	6	UGMF72909			UGMF74909	UGMF74983	UGMF74984	UGMF74985	UGMF74986	UGMF74987	UGMH10917	
		1	4	6	UGMF72910			UGMF74910	UGMF74988	UGMF74989	UGMF74990	UGMF74991	UGMF74992	UGMH10918	
1	1	1-1/8	2	4	UGMF72064			UGMF74064	UGMF74993	UGMF74994	UGMF74995	UGMF74996	UGMF74997	UGMH10064	
		1-1/8	2-5/8	5	UGMF72927			UGMF74838	UGMF74839	UGMF74840	UGMF74841	UGMF74842	UGMF74843	UGMH10927	
		1-1/8	3	5	UGMF72928			UGMF74844	UGMF74845	UGMF74846	UGMF74847	UGMF74848	UGMF74849	UGMH10928	
		1-1/8	2-5/8	6	UGMF72921			UGMF74998	UGMF74999	UGMF74801	UGMF74802	UGMF74803	UGMF74804	UGMH10919	
		1-1/8	3	6	UGMF72911			UGMF74911	UGMF74805	UGMF74806	UGMF74807	UGMF74808	UGMF74809	UGMH10920	
		1-1/8	4	6	UGMF72912			UGMF74912	UGMF74810	UGMF74811	UGMF74812	UGMF74813	UGMF74814	UGMH10921	

Reinforced cutting edge

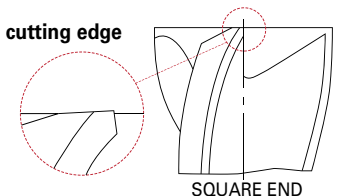

SQUARE END

4-FLUTE EXTENDED LENGTH (WELDON FLAT SHANK)

UGMF73 | UGMF75 SERIES



Pages 32-35

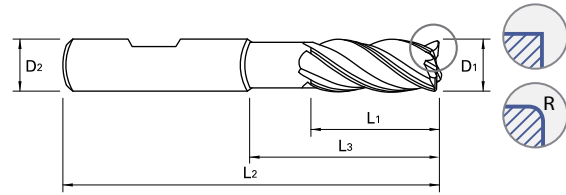

Unit: INCH

OD (D ₁)	SD (D ₂)	LOC (L ₁)	LBS (L ₃)	OAL (L ₂)	Square End	Corner Radius
					EDP No.	.030 EDP No.
3/8	3/8	1/2	1-1/8	4	UGMF73024	UGMF75024
		1/2	2-1/8	4	UGMF73903	UGMF75903
		1/2	3-1/8	5	UGMF73913	UGMF75913
		1/2	3-1/8	6	UGMF73904	UGMF75904
1/2	1/2	5/8	1-1/2	4	UGMF73032	UGMF75032
		5/8	2-1/4	4	UGMF73905	UGMF75905
		5/8	3-3/8	5	UGMF73914	UGMF75914
		5/8	3-3/8	6	UGMF73906	UGMF75906
5/8	5/8	3/4	1-5/8	4	UGMF73040	UGMF75040
		3/4	2-3/8	5	UGMF73915	UGMF75915
		3/4	3-3/8	5	UGMF73916	UGMF75916
		3/4	2-3/8	6	UGMF73907	UGMF75907
		3/4	3-3/8	6	UGMF73908	UGMF75908
3/4	3/4	1	2	4	UGMF73048	UGMF75048
		1	3	5	UGMF73917	UGMF75917
		1	3	6	UGMF73909	UGMF75909
		1	4	6	UGMF73910	UGMF75910
1	1	1-1/8	2	4	UGMF73064	UGMF75064
		1-1/8	2-5/8	5	UGMF73918	UGMF75918
		1-1/8	3	5	UGMF73919	UGMF75919
		1-1/8	3	6	UGMF73911	UGMF75911
		1-1/8	4	6	UGMF73912	UGMF75912

Reinforced cutting edge

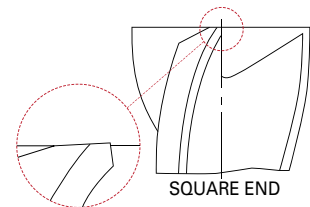

Need something you don't see?

Bring us your special orders. The YG-1 Technical Center is your one-stop center for all your tool-making needs. With state-of-the-art manufacturing assets, including a full assortment of top-of-the-line CNC stations, multiple high-performance grinding and milling machines, plus flexible programming testing modules, the YG-1 Technical Center gives you a turnkey solution for tool design, testing and manufacturing. **Call us at 800-765-8665 or contact our distributor partners** to discuss your machining solution needs.



V7 Plus A

4-FLUTE STANDARD LENGTH (PLAIN SHANK)

GMF52 | GMF56 | GMF54 | GMF58 | GMG55 SERIES



Pages 38-40

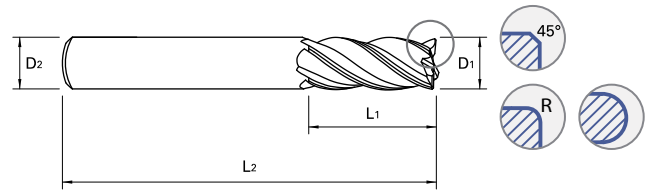

Unit: METRIC

OD (D1)		SD (D2)	LOC (L1)	OAL (L2)	Chamfer		Ball Nose	
Metric	Inch				EDP No.	EDP No.	EDP No.	EDP No.
3.0	.1181	6	7	54	GMF52030			
		6	8	57	GMF56030	GMG55030		
4.0	.1575	6	8	54	GMF52040			
		6	11	57	GMF56040	GMG55040		
5.0	.1969	6	10	54	GMF52050			
		6	13	57	GMF56050	GMG55050		
6.0	.2362	6	10	54	GMF52060			
		6	13	57	GMF56060	GMG55060		
8.0	.3150	8	12	58	GMF52080			
		8	19	63	GMF56080	GMG55080		
10.0	.3937	10	14	66	GMF52100			
		10	22	72	GMF56100	GMG55100		
12.0	.4724	12	16	73	GMF52120			
		12	26	83	GMF56120	GMG55120		
14.0	.5512	14	18	75	GMF52140			
		14	26	83	GMF56140			
16.0	.6299	16	22	82	GMF52160			
		16	32	92	GMF56160	GMG55160		
18.0	.7087	18	24	84	GMF52180			
		18	32	92	GMF56180			
20.0	.7874	20	26	92	GMF52200			
		20	38	104	GMF56200	GMG55200		
25.0	.9843	25	38	104	GMF56250	GMG55250		

CHAMFER KEY		
Mill Diameter		Chamfer Size (mm)
Metric	Inch	
3.0	.1181	0.10
4.0	.1575	0.15
5.0	.1969	0.15
6.0	.2362	0.20
8.0	.3150	0.20
10.0	.3937	0.30
12.0	.4724	0.35
14.0	.5512	0.40
16.0	.6299	0.40
18.0	.7087	0.50
20.0	.7874	0.50
25.0	.9843	0.50

BALL NOSE KEY		
Mill Diameter		Radius of Ball
Metric	Inch	
3.0	.1181	1.5
4.0	.1575	2.0
5.0	.1969	2.5
6.0	.2362	3.0
8.0	.3150	4.0
10.0	.3937	5.0
12.0	.4724	6.0
16.0	.6299	8.0
20.0	.7874	10.0
25.0	.9843	12.5

OD (D1)		SD (D2)	LOC (L1)	OAL (L2)	Corner Radius				
Metric	Inch				0.30	0.50	1.00	2.00	3.00
				EDP No.		EDP No.	EDP No.	EDP No.	EDP No.
3.0	.1181	6	7	54	GMF54030	GMF54901			
		6	8	57	GMF58030	GMF58901			
4.0	.1575	6	8	54	GMF54040	GMF54902			
		6	11	57	GMF58040	GMF58902			
5.0	.1969	6	10	54	GMF54050	GMF54903			
		6	13	57	GMF58050	GMF58903			
6.0	.2362	6	10	54	GMF54060	GMF54904	GMF54905		
		6	13	57	GMF58060	GMF58904	GMF58905		
8.0	.3150	8	12	58		GMF54080	GMF54906		
		8	19	63		GMF58080	GMF58906		
10.0	.3937	10	14	66		GMF54100	GMF54907		
		10	22	72		GMF58100	GMF58907		
12.0	.4724	12	16	73		GMF54120	GMF54908	GMF54909	
		12	26	83		GMF58120	GMF58908	GMF58909	
14.0	.5512	14	18	75		GMF54140			
		14	26	83		GMF58140			
16.0	.6299	16	22	82			GMF54160	GMF54912	GMF54913
		16	32	92			GMF58160	GMF58912	GMF58913
18.0	.7087	18	24	84			GMF54180		
		18	32	92			GMF58180		
20.0	.7874	20	26	92			GMF54200	GMF54916	GMF54917
		20	38	104			GMF58200	GMF58916	GMF58917
25.0	.9843	25	38	104			GMF58250		

Reinforced cutting edge

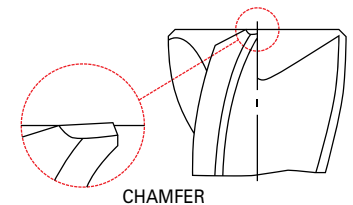

4-FLUTE STANDARD LENGTH (WELDON FLAT SHANK)

GMF53 | GMF57 | GMF55 | GMF59 | GMG56 SERIES



Pages 38-40

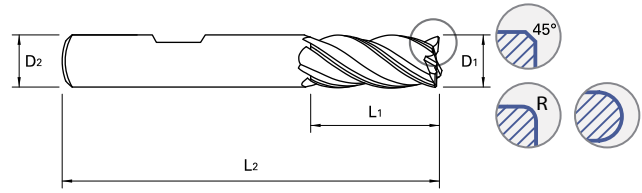

Unit: METRIC

OD (D ₁)		SD (D ₂)	LOC (L ₁)	OAL (L ₂)	Chamfer		Ball Nose	
Metric	Inch				EDP No.	EDP No.	EDP No.	EDP No.
3.0	.1181	6	7	54	GMF53030			
		6	8	57	GMF57030		GMG56030	
4.0	.1575	6	8	54	GMF53040			
		6	11	57	GMF57040		GMG56040	
5.0	.1969	6	10	54	GMF53050			
		6	13	57	GMF57050		GMG56050	
6.0	.2362	6	10	54	GMF53060			
		6	13	57	GMF57060		GMG56060	
8.0	.3150	8	12	58	GMF53080			
		8	19	63	GMF57080		GMG56080	
10.0	.3937	10	14	66	GMF53100			
		10	22	72	GMF57100		GMG56100	
12.0	.4724	12	16	73	GMF53120			
		12	26	83	GMF57120		GMG56120	
14.0	.5512	14	18	75	GMF53140			
		14	26	83	GMF57140			
16.0	.6299	16	22	82	GMF53160			
		16	32	92	GMF57160		GMG56160	
18.0	.7087	18	24	84	GMF53180			
		18	32	92	GMF57180			
20.0	.7874	20	26	92	GMF53200			
		20	38	104	GMF57200		GMG56200	
25.0	.9843	25	38	104	GMF57250		GMG56250	

CHAMFER KEY		
Mill Diameter		Chamfer Size (mm)
Metric	Inch	
3.0	.1181	0.10
4.0	.1575	0.15
5.0	.1969	0.15
6.0	.2362	0.20
8.0	.3150	0.20
10.0	.3937	0.30
12.0	.4724	0.35
14.0	.5512	0.40
16.0	.6299	0.40
18.0	.7087	0.50
20.0	.7874	0.50
25.0	.9843	0.50

BALL NOSE KEY		
Mill Diameter		Radius of Ball
Metric	Inch	
3.0	.1181	1.5
4.0	.1575	2.0
5.0	.1969	2.5
6.0	.2362	3.0
8.0	.3150	4.0
10.0	.3937	5.0
12.0	.4724	6.0
16.0	.6299	8.0
20.0	.7874	10.0
25.0	.9843	12.5

OD (D ₁)		SD (D ₂)	LOC (L ₁)	OAL (L ₂)	Corner Radius					
Metric	Inch				0.30	0.50	1.00	2.00	3.00	
						EDP No.	EDP No.	EDP No.	EDP No.	EDP No.
3.0	.1181	6	7	54	GMF55030	GMF55901				
		6	8	57	GMF59030	GMF59901				
4.0	.1575	6	8	54	GMF55040	GMF55902				
		6	11	57	GMF59040	GMF59902				
5.0	.1969	6	10	54	GMF55050	GMF55903				
		6	13	57	GMF59050	GMF59903				
6.0	.2362	6	10	54	GMF55060	GMF55904	GMF55905			
		6	13	57	GMF59060	GMF59904	GMF59905			
8.0	.3150	8	12	58		GMF55080	GMF55906			
		8	19	63		GMF59080	GMF59906			
10.0	.3937	10	14	66		GMF55100	GMF55907			
		10	22	72		GMF59100	GMF59907			
12.0	.4724	12	16	73		GMF55120	GMF55908	GMF55909		
		12	26	83		GMF59120	GMF59908	GMF59909		
14.0	.5512	14	18	75		GMF55140				
		14	26	83		GMF59140				
16.0	.6299	16	22	82			GMF55160	GMF55912	GMF55913	
		16	32	92			GMF59160	GMF59912	GMF59913	
18.0	.7087	18	24	84			GMF55180			
		18	32	92			GMF59180			
20.0	.7874	20	26	92			GMF55200	GMF55916	GMF55917	
		20	38	104			GMF59200	GMF59916	GMF59917	
25.0	.9843	25	38	104			GMF59250			

Reinforced cutting edge

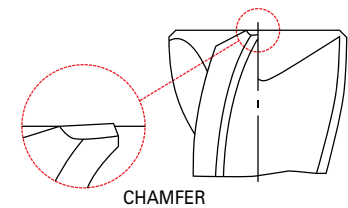

4-FLUTE EXTENDED LENGTH (PLAIN SHANK)

GMF60 SERIES

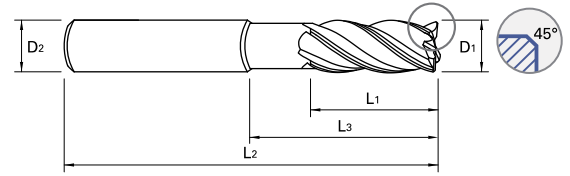

Pages 38–39

Unit: **METRIC**

OD (D ₁)		SD (D ₂)	LOC (L ₁)	LBS (L ₃)	OAL (L ₂)	Chamfer
Metric	Inch					EDP No.
3.0	.1181	6	7	12	54	GMF60030
		6	7	17	57	GMF60901
		6	8	14	57	GMF60902
4.0	.1575	6	8	15	57	GMF60040
		6	8	22	63	GMF60903
		6	11	16	57	GMF60904
5.0	.1969	6	10	17	57	GMF60050
		6	10	27	67	GMF60905
		6	13	18	57	GMF60906
6.0	.2362	6	10	15	57	GMF60060
		6	10	20	62	GMF60907
		6	10	32	74	GMF60908
		6	13	21	57	GMF60909
8.0	.3150	8	12	20	63	GMF60080
		8	12	30	73	GMF60910
		8	12	46	90	GMF60911
		8	19	27	63	GMF60912
10.0	.3937	10	14	25	72	GMF60100
		10	14	35	82	GMF60913
		10	14	55	102	GMF60914
		10	22	32	72	GMF60915
12.0	.4724	12	16	30	83	GMF60120
		12	16	40	93	GMF60916
		12	16	64	117	GMF60917
		12	26	38	83	GMF60918
16.0	.6299	16	22	38	92	GMF60160
		16	22	55	109	GMF60919
		16	22	87	141	GMF60920
		16	32	44	92	GMF60921
20.0	.7874	20	26	50	104	GMF60200
		20	26	70	124	GMF60922
		20	26	110	164	GMF60923
		20	38	54	104	GMF60924

CHAMFER KEY		
Mill Diameter		Chamfer Size (mm)
Metric	Inch	
3.0	.1181	0.10
4.0	.1575	0.15
5.0	.1969	0.15
6.0	.2362	0.20
8.0	.3150	0.20
10.0	.3937	0.30
12.0	.4724	0.35
16.0	.6299	0.40
20.0	.7874	0.50

Reinforced cutting edge

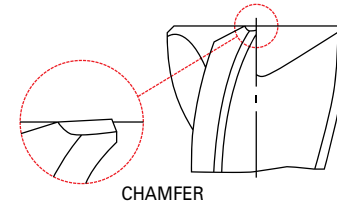

CHAMFER

4-FLUTE EXTENDED LENGTH (PLAIN SHANK)

GMF62 SERIES

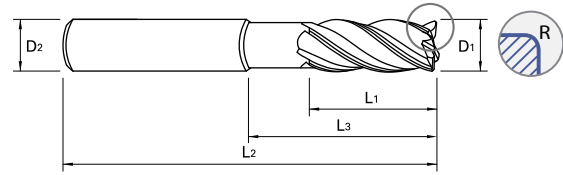

Pages 38–39

Unit: **METRIC**

OD (D ₁)		SD (D ₂)	LOC (L ₁)	LBS (L ₃)	OAL (L ₂)	Corner Radius				
Metric	Inch					0.30	0.50	1.00	2.00	3.00
						EDP No.	EDP No.	EDP No.	EDP No.	EDP No.
3.0	.1181	6	7	12	54	GMF62030	GMF62901			
		6	7	17	57	GMF62902	GMF62903			
		6	8	14	57					
4.0	.1575	6	8	15	57	GMF62040	GMF62904			
		6	8	22	63	GMF62905	GMF62906			
		6	11	16	57					
5.0	.1969	6	10	17	57	GMF62050	GMF62907			
		6	10	27	67	GMF62908	GMF62909			
		6	13	18	57					
6.0	.2362	6	10	15	57	GMF62060	GMF62910	GMF62911		
		6	10	20	62	GMF62912	GMF62913	GMF62914		
		6	10	32	74	GMF62915	GMF62916	GMF62917		
		6	13	21	57					
8.0	.3150	8	12	20	63		GMF62080	GMF62918		
		8	12	30	73		GMF62919	GMF62920		
		8	12	46	90		GMF62921	GMF62922		
		8	19	27	63					
10.0	.3937	10	14	25	72		GMF62100	GMF62923		
		10	14	35	82		GMF62924	GMF62925		
		10	14	55	102		GMF62926	GMF62927		
		10	22	32	72					
12.0	.4724	12	16	30	83		GMF62120	GMF62928	GMF62929	
		12	16	40	93		GMF62930	GMF62931	GMF62932	
		12	16	64	117		GMF62933	GMF62934	GMF62935	
		12	26	38	83					
16.0	.6299	16	22	38	92			GMF62160	GMF62936	GMF62937
		16	22	55	109			GMF62938	GMF62939	GMF62940
		16	22	87	141			GMF62941	GMF62942	GMF62943
		16	32	44	92					
20.0	.7874	20	26	50	104			GMF62200	GMF62944	GMF62945
		20	26	70	124			GMF62946	GMF62947	GMF62948
		20	26	110	164			GMF62949	GMF62950	GMF62951
		20	38	54	104					

4-FLUTE EXTENDED LENGTH (WELDON FLAT SHANK)

GMF61 SERIES



Pages 38–39

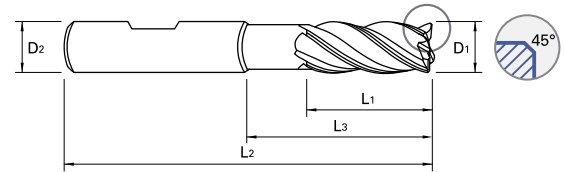

Unit: METRIC

OD (D ₁)		SD (D ₂)	LOC (L ₁)	LBS (L ₃)	OAL (L ₂)	Chamfer
Metric	Inch					0.10
						EDP No.
3.0	.1181	6	7	12	54	GMF61030
		6	7	17	57	GMF61901
		6	8	14	57	GMF61902
4.0	.1575	6	8	15	57	GMF61040
		6	8	22	63	GMF61903
		6	11	16	57	GMF61904
5.0	.1969	6	10	17	57	GMF61050
		6	10	27	67	GMF61905
		6	13	18	57	GMF61906
6.0	.2362	6	10	15	57	GMF61060
		6	10	20	62	GMF61907
		6	10	32	74	GMF61908
		6	13	21	57	GMF61909
8.0	.3150	8	12	20	63	GMF61080
		8	12	30	73	GMF61910
		8	12	46	90	GMF61911
		8	19	27	63	GMF61912
10.0	.3937	10	14	25	72	GMF61100
		10	14	35	82	GMF61913
		10	14	55	102	GMF61914
		10	22	32	72	GMF61915
12.0	.4724	12	16	30	83	GMF61120
		12	16	40	93	GMF61916
		12	16	64	117	GMF61917
		12	26	38	83	GMF61918
16.0	.6299	16	22	38	92	GMF61160
		16	22	55	109	GMF61919
		16	22	87	141	GMF61920
		16	32	44	92	GMF61921
20.0	.7874	20	26	50	104	GMF61200
		20	26	70	124	GMF61922
		20	26	110	164	GMF61923
		20	38	54	104	GMF61924

CHAMFER KEY

Mill Diameter		Chamfer Size (mm)
Metric	Inch	
3.0	.1181	0.10
4.0	.1575	0.15
5.0	.1969	0.15
6.0	.2362	0.20
8.0	.3150	0.20
10.0	.3937	0.30
12.0	.4724	0.35
16.0	.6299	0.40
20.0	.7874	0.50

Reinforced cutting edge

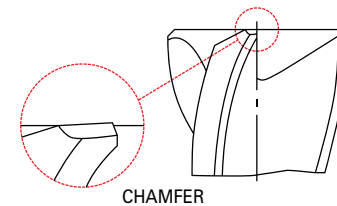

4-FLUTE EXTENDED LENGTH (WELDON FLAT SHANK)

GMF63 SERIES



Pages 38-39

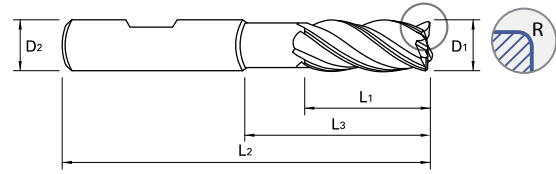

Unit : METRIC

OD (D ₁)		SD (D ₂)	LOC (L ₁)	LBS (L ₃)	OAL (L ₂)	Corner Radius				
Metric	Inch					0.30	0.50	1.00	2.00	3.00
						EDP No.	EDP No.	EDP No.	EDP No.	EDP No.
3.0	.1181	6	7	12	54	GMF63030	GMF63901			
		6	7	17	57	GMF63902	GMF63903			
		6	8	14	57					
4.0	.1575	6	8	15	57	GMF63040	GMF63904			
		6	8	22	63	GMF63905	GMF63906			
		6	11	16	57					
5.0	.1969	6	10	17	57	GMF63050	GMF63907			
		6	10	27	67	GMF63908	GMF63909			
		6	13	18	57					
6.0	.2362	6	10	15	57	GMF63060	GMF63910	GMF63911		
		6	10	20	62	GMF63912	GMF63913	GMF63914		
		6	10	32	74	GMF63915	GMF63916	GMF63917		
		6	13	21	57					
8.0	.3150	8	12	20	63		GMF63080	GMF63918		
		8	12	30	73		GMF63919	GMF63920		
		8	12	46	90		GMF63921	GMF63922		
		8	19	27	63					
10.0	.3937	10	14	25	72		GMF63100	GMF63923		
		10	14	35	82		GMF63924	GMF63925		
		10	14	55	102		GMF63926	GMF63927		
		10	22	32	72					
12.0	.4724	12	16	30	83		GMF63120	GMF63928	GMF63929	
		12	16	40	93		GMF63930	GMF63931	GMF63932	
		12	16	64	117		GMF63933	GMF63934	GMF63935	
		12	26	38	83					
16.0	.6299	16	22	38	92			GMF63160	GMF63936	GMF63937
		16	22	55	109			GMF63938	GMF63939	GMF63940
		16	22	87	141			GMF63941	GMF63942	GMF63943
		16	32	44	92					
20.0	.7874	20	26	50	104			GMF63200	GMF63944	GMF63945
		20	26	70	124			GMF63946	GMF63947	GMF63948
		20	26	110	164			GMF63949	GMF63950	GMF63951
		20	38	54	104					

6-FLUTE STANDARD LENGTH (PLAIN SHANK)

UGMG20 | UGMG22 SERIES



Page 37

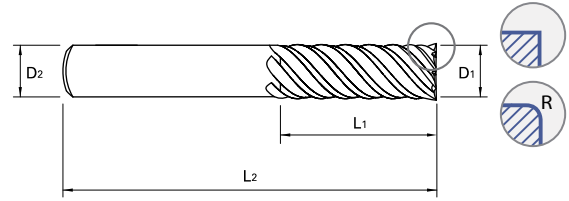

Unit: INCH

OD (D ₁)	SD (D ₂)	LOC (L ₁)	OAL (L ₂)	Square End	Corner Radius									
					.015	.030	.060	.090	.120	.125	.190	.250		
					EDP No.	EDP No.	EDP No.	EDP No.	EDP No.	EDP No.	EDP No.	EDP No.		
1/4	1/4	1/2	2-1/2	UGMG20914	UGMG22956	UGMG22957	UGMG22958							
		3/4	2-1/2	UGMG20016	UGMG22016	UGMG22959	UGMG22960							
		1-1/8	3	UGMG20901	UGMG22901	UGMG22902	UGMG22961							
		1-1/2	4	UGMG20902	UGMG22903	UGMG22904	UGMG22962							
5/16	5/16	3/4	2-1/2	UGMG20020	UGMG22020									
		1-1/4	3	UGMG20903	UGMG22905	UGMG22906								
		1-5/8	4	UGMG20904	UGMG22907	UGMG22908								
3/8	3/8	5/8	2-1/2	UGMG20915	UGMG22963	UGMG22964	UGMG22965	UGMG22966						
		1	3	UGMG20024	UGMG22024	UGMG22909	UGMG22910	UGMG22967						
		1-1/2	4	UGMG20905	UGMG22911	UGMG22912	UGMG22913	UGMG22968						
		2	4	UGMG20906	UGMG22914	UGMG22915	UGMG22916	UGMG22969						
1/2	1/2	5/8	3	UGMG20916	UGMG22970	UGMG22971	UGMG22972	UGMG22973		UGMG22974				
		1	3	UGMG20917	UGMG22032	UGMG22917	UGMG22918	UGMG22975		UGMG22976				
		1	3-1/4	UGMG20032										
		1-1/4	3-1/2	UGMG20907	UGMG22977	UGMG22919	UGMG22920	UGMG22921	UGMG22922	UGMG22978				
		1-5/8	4	UGMG20918	UGMG22979	UGMG22980	UGMG22981	UGMG22982		UGMG22983				
		2	4	UGMG20908	UGMG22984	UGMG22923	UGMG22924	UGMG22925	UGMG22926	UGMG22985				
		2-5/8	5	UGMG20919	UGMG22986	UGMG22987	UGMG22988	UGMG22989		UGMG22990				
5/8	5/8	3/4	3	UGMG20920	UGMG22993	UGMG22994	UGMG22995	UGMG22996		UGMG22997				
		1-1/4	3-1/2	UGMG20040	UGMG22998	UGMG22040	UGMG22931	UGMG22932	UGMG22933	UGMG22999				
		1-7/8	4	UGMG20921	UGMG22801	UGMG22802	UGMG22803	UGMG22804		UGMG22805				
		2	4	UGMG20910	UGMG22806	UGMG22934	UGMG22935	UGMG22936	UGMG22937	UGMG22807				
		2-5/8	5	UGMG20922	UGMG22808	UGMG22809	UGMG22810	UGMG22811		UGMG22812				
		3	5	UGMG20911	UGMG22813	UGMG22938	UGMG22939	UGMG22940	UGMG22941	UGMG22814				
3/4	3/4	1	3-1/2	UGMG20923	UGMG22815	UGMG22816	UGMG22817	UGMG22818		UGMG22819	UGMG22820	UGMG22821		
		1-1/2	4	UGMG20048	UGMG22822	UGMG22048	UGMG22942	UGMG22943	UGMG22944	UGMG22823	UGMG22824	UGMG22825		
		1-7/8	5	UGMG20924	UGMG22826	UGMG22827	UGMG22828	UGMG22829		UGMG22830	UGMG22831	UGMG22832		
		2-1/4	5	UGMG20925	UGMG22833	UGMG22834	UGMG22835	UGMG22836		UGMG22837	UGMG22838	UGMG22839		
		2-3/4	5	UGMG20926	UGMG22840	UGMG22841	UGMG22842	UGMG22843		UGMG22844	UGMG22845	UGMG22846		
		3	5-1/2	UGMG20912	UGMG22847	UGMG22945	UGMG22946	UGMG22947	UGMG22948	UGMG22848	UGMG22849	UGMG22850		
1	1	1-1/2	4	UGMG20064	UGMG22851	UGMG22064	UGMG22949	UGMG22950	UGMG22951	UGMG22852	UGMG22853	UGMG22854		
		2	5	UGMG20927	UGMG22855	UGMG22856	UGMG22857	UGMG22858		UGMG22859	UGMG22860	UGMG22861		
		2-5/8	5	UGMG20928	UGMG22862	UGMG22863	UGMG22864	UGMG22865		UGMG22866	UGMG22867	UGMG22868		
		3-1/4	6	UGMG20929	UGMG22869	UGMG22870	UGMG22871	UGMG22872		UGMG22873	UGMG22874	UGMG22875		
		4	7	UGMG20913	UGMG22876	UGMG22952	UGMG22953	UGMG22954	UGMG22955	UGMG22877	UGMG22878	UGMG22879		

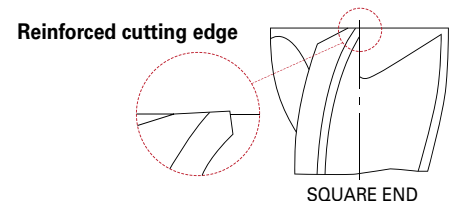

6-FLUTE STANDARD LENGTH (WELDON FLAT SHANK)

UGMG21 | UGMG23 SERIES



Page 37

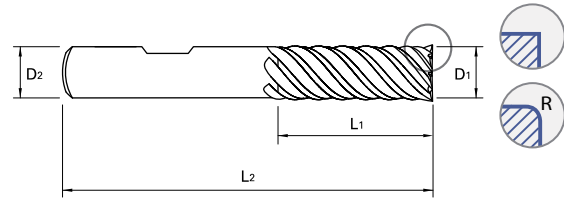

Unit: INCH

OD (D ₁)	SD (D ₂)	LOC (L ₁)	OAL (L ₂)	Square End EDP No.	Corner Radius				
					.015 EDP No.	.030 EDP No.	.060 EDP No.	.090 EDP No.	.120 EDP No.
3/8	3/8	1	3	UGMG21024	UGMG23024	UGMG23909	UGMG23910		
		1-1/2	4	UGMG21905	UGMG23911	UGMG23912	UGMG23913		
		2	4	UGMG21906	UGMG23914	UGMG23915	UGMG23916		
1/2	1/2	1	3	UGMG21914	UGMG23032	UGMG23917	UGMG23918		
		1	3-1/4	UGMG21032					
		1-1/4	3-1/2	UGMG21907		UGMG23919	UGMG23920	UGMG23921	UGMG23922
		2	4	UGMG21908		UGMG23923	UGMG23924	UGMG23925	UGMG23926
		3	5	UGMG21909		UGMG23927	UGMG23928	UGMG23929	UGMG23930
5/8	5/8	1-1/4	3-1/2	UGMG21040		UGMG23040	UGMG23931	UGMG23932	UGMG23933
		2	4	UGMG21910		UGMG23934	UGMG23935	UGMG23936	UGMG23937
		3	5	UGMG21911		UGMG23938	UGMG23939	UGMG23940	UGMG23941
3/4	3/4	1-1/2	4	UGMG21048		UGMG23048	UGMG23942	UGMG23943	UGMG23944
		3	5-1/2	UGMG21912		UGMG23945	UGMG23946	UGMG23947	UGMG23948
1	1	1-1/2	4	UGMG21064		UGMG23064	UGMG23949	UGMG23950	UGMG23951
		4	7	UGMG21913		UGMG23952	UGMG23953	UGMG23954	UGMG23955

Reinforced cutting edge

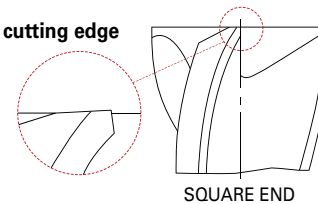

SQUARE END

Every custom job starts with a blank.

Give us your specifications and **we will build the tools you need** – on time and guaranteed to meet your needs. It's how YG-1 has built a reputation for reliable service for the most demanding applications – and customers. So, the next time you need a special order, **call us at 800-765-8665 or contact our distributor partners.** We're here to meet all your tooling needs.



6-FLUTE EXTENDED LENGTH (PLAIN SHANK)

UGMH08 | UGMH09 SERIES



Page 37

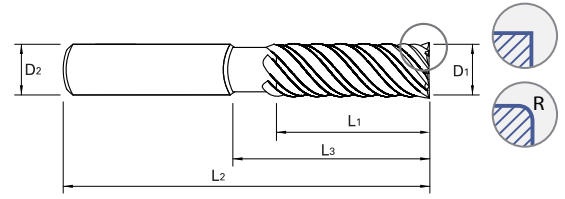

Unit : INCH

OD (D ₁)	SD (D ₂)	LOC (L ₁)	LBS (L ₃)	OAL (L ₂)	Square End	Corner Radius					
						.030	.060	.090	.125	.190	.250
						EDP No.	EDP No.	EDP No.	EDP No.	EDP No.	EDP No.
1/4	1/4	3/8	3/4	4	UGMH08016	UGMH09016	UGMH09901				
		3/8	1-1/8	4	UGMH08901	UGMH09902	UGMH09903				
		3/8	2-1/8	4	UGMH08902	UGMH09904	UGMH09905				
3/8	3/8	1/2	1-1/8	4	UGMH08024	UGMH09024	UGMH09906	UGMH09907			
		1/2	2-1/8	4	UGMH08903	UGMH09908	UGMH09909	UGMH09910			
		1/2	3-1/8	5	UGMH08919	UGMH09999	UGMH09801	UGMH09802			
		1/2	3-1/8	6	UGMH08904	UGMH09911	UGMH09912	UGMH09913			
		1/2	4-1/8	6	UGMH08905	UGMH09914	UGMH09915	UGMH09916			
1/2	1/2	5/8	1-1/2	4	UGMH08032	UGMH09032	UGMH09917	UGMH09918	UGMH09919		
		5/8	2-1/4	4	UGMH08906	UGMH09920	UGMH09921	UGMH09922	UGMH09923		
		5/8	3-3/8	5	UGMH08920	UGMH09803	UGMH09804	UGMH09805	UGMH09806		
		5/8	3-3/8	6	UGMH08907	UGMH09924	UGMH09925	UGMH09926	UGMH09927		
		5/8	4-1/8	6	UGMH08908	UGMH09928	UGMH09929	UGMH09930	UGMH09931		
5/8	5/8	3/4	1-5/8	4	UGMH08040	UGMH09040	UGMH09932	UGMH09933	UGMH09934		
		3/4	2-3/8	5	UGMH08921	UGMH09807	UGMH09808	UGMH09809	UGMH09810		
		3/4	3-3/8	5	UGMH08922	UGMH09811	UGMH09812	UGMH09813	UGMH09814		
		3/4	2-3/8	6	UGMH08909	UGMH09935	UGMH09936	UGMH09937	UGMH09938		
		3/4	3-3/8	6	UGMH08910	UGMH09939	UGMH09940	UGMH09941	UGMH09942		
		3/4	4-1/8	6	UGMH08911	UGMH09943	UGMH09944	UGMH09945	UGMH09946		
3/4	3/4	1-1/8	2	4	UGMH08048	UGMH09048	UGMH09947	UGMH09948	UGMH09949	UGMH09950	UGMH09951
		1-1/8	2-5/8	5	UGMH08912	UGMH09952	UGMH09953	UGMH09954	UGMH09955	UGMH09956	UGMH09957
		1-1/8	3-1/4	6	UGMH08913	UGMH09958	UGMH09959	UGMH09960	UGMH09961	UGMH09962	UGMH09963
		1-1/8	4-1/4	7	UGMH08914	UGMH09964	UGMH09965	UGMH09966	UGMH09967	UGMH09968	UGMH09969
1	1	1-1/4	2-1/4	4	UGMH08064	UGMH09064	UGMH09970	UGMH09971	UGMH09972	UGMH09973	UGMH09974
		1-1/4	2-5/8	5	UGMH08915	UGMH09975	UGMH09976	UGMH09977	UGMH09978	UGMH09979	UGMH09980
		1-1/4	3-1/4	6	UGMH08916	UGMH09981	UGMH09982	UGMH09983	UGMH09984	UGMH09985	UGMH09986
		1-1/4	4-1/4	7	UGMH08917	UGMH09987	UGMH09988	UGMH09989	UGMH09990	UGMH09991	UGMH09992
		1-1/4	5-1/4	8	UGMH08918	UGMH09993	UGMH09994	UGMH09995	UGMH09996	UGMH09997	UGMH09998

Designed to accommodate your needs.

- ▶ Capabilities for small batch production
- ▶ Ready access to world-class engineering
- ▶ Fast turnaround for one-of-a-kind tools and solutions

Our promise:

The best cost-effective solution in less time with less expense.



Reinforced cutting edge

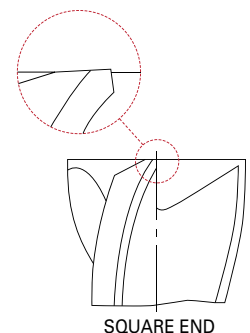

SQUARE END

6-FLUTE STANDARD LENGTH (PLAIN SHANK)

GMG12 | GMG14 | GMG16 | GMG18 SERIES



Page 41

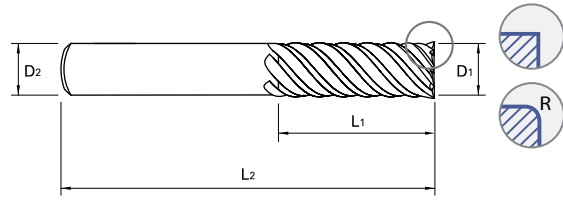

Unit: METRIC

OD (D ₁)		SD (D ₂)	LOC (L ₁)	OAL (L ₂)	Square End	Corner Radius					
Metric	Inch					0.50	1.00	1.50	2.00	3.00	4.00
				EDP No.		EDP No.	EDP No.	EDP No.	EDP No.	EDP No.	EDP No.
6.0	0.2362	6	13	57	GMG12060	GMG16060	GMG16901				
		6	24	75	GMG14060	GMG18060	GMG18901				
8.0	0.3150	8	19	63	GMG12080	GMG16080	GMG16902				
		8	32	75	GMG14080	GMG18080	GMG18902		GMG18903		
10.0	0.3937	10	22	72	GMG12100	GMG16100	GMG16903	GMG16904	GMG16905		
		10	40	100	GMG14100	GMG18100	GMG18904	GMG18905	GMG18906		
12.0	0.4724	12	26	83	GMG12120	GMG16120	GMG16906	GMG16907	GMG16908	GMG16909	
		12	48	120	GMG14120	GMG18120	GMG18907	GMG18908	GMG18909	GMG18910	
16.0	0.6299	16	32	92	GMG12160		GMG16160	GMG16910	GMG16911	GMG16912	
		16	64	140	GMG14160		GMG18160	GMG18911	GMG18912	GMG18913	
20.0	0.7874	20	38	104	GMG12200		GMG16200	GMG16913	GMG16914	GMG16915	
		20	80	150	GMG14200		GMG18200	GMG18914	GMG18915	GMG18916	GMG18917
25.0	0.9843	25	44	104	GMG12250		GMG16250	GMG16916	GMG16917	GMG16918	
		25	100	170	GMG14250		GMG18250	GMG18919	GMG18920	GMG18921	GMG18922

6-FLUTE STANDARD LENGTH (WELDON FLAT SHANK)

GMG13 | GMG15 | GMG17 | GMG19 SERIES



Page 41

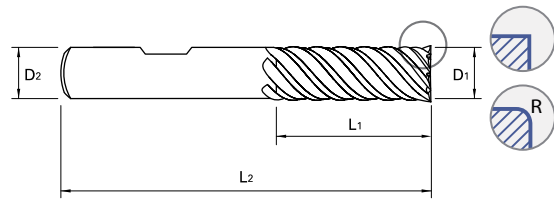

Unit: METRIC

OD (D ₁)		SD (D ₂)	LOC (L ₁)	OAL (L ₂)	Square End	Corner Radius					
Metric	Inch					0.50	1.00	1.50	2.00	3.00	4.00
				EDP No.		EDP No.	EDP No.	EDP No.	EDP No.	EDP No.	EDP No.
6.0	0.2362	6	13	57	GMG13060	GMG17060	GMG17901				
		6	24	75	GMG15060	GMG19060	GMG19901				
8.0	0.3150	8	19	63	GMG13080	GMG17080	GMG17902				
		8	32	75	GMG15080	GMG19080	GMG19902		GMG19903		
10.0	0.3937	10	22	72	GMG13100	GMG17100	GMG17903	GMG17904	GMG17905		
		10	40	100	GMG15100	GMG19100	GMG19904	GMG19905	GMG19906		
12.0	0.4724	12	26	83	GMG13120	GMG17120	GMG17906	GMG17907	GMG17908	GMG17909	
		12	48	120	GMG15120	GMG19120	GMG19907	GMG19908	GMG19909	GMG19910	
16.0	0.6299	16	32	92	GMG13160		GMG17160	GMG17910	GMG17911	GMG17912	
		16	64	140	GMG15160		GMG19160	GMG19911	GMG19912	GMG19913	
20.0	0.7874	20	38	104	GMG13200		GMG17200	GMG17913	GMG17914	GMG17915	
		20	80	150	GMG15200		GMG19200	GMG19914	GMG19915	GMG19916	GMG19917
25.0	0.9843	25	44	104	GMG13250		GMG17250	GMG17916	GMG17917	GMG17918	
		25	100	170	GMG15250		GMG19250	GMG19919	GMG19920	GMG19921	GMG19922



CASE STUDY

V7 Plus A 6-Flute vs Competitor

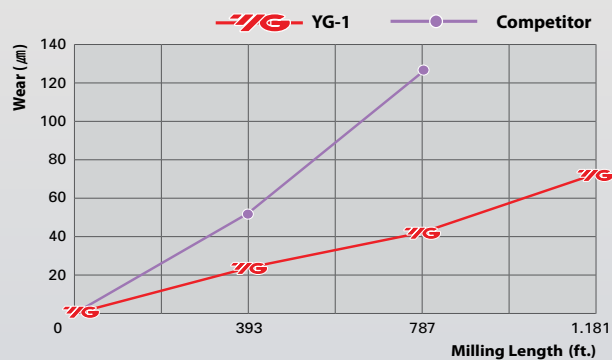

	V7 Plus A	Competitor
Wear (µm)	70.855	123.776
Milling Length (ft.)	1,181	787
Size (mm)	Ø12(R1) x Ø12 x 26 x 83	
Work Material	- JIS : S45C(HRc30) - DIN : C45	- WR : 1.0503 - AISI : 1405
Cutting Speed/RPM	914 ft./min. / 7,392 rev./min.	
Feed/Feed per tooth	295.08 in./min. / .007 in./tooth	
Milling Method	Trochoidal Cutting	
Milling Depth	Axial : .945 in., Radial : .024 in.	
Coolant	Wet Cut	
Overhang	1.417 in.	
Machine	Machining Center	

4-FLUTE RECOMMENDED CUTTING CONDITIONS – INCH

UGMF68 | UGMF69 | UGMF70 | UGMF71 | UGMF72 | UGMF73 |
UGMF74 | UGMF75 | UGMF76 | UGMF77 SERIES

RPM = rev./min.
SFM = ft./min.

FEED = in./min.
Fz = in./tooth

ISO Hardness (BHN)	Work Materials	Speed and Feed Recommendations				Diameter (in.)			
		Type of Cut	Ap x D1	Ae x D1	Parameters	1/8	5/32	3/16	7/32
P <300	CARBON STEELS 10**, 11**, 12**, 12L**, 15**	Side Cutting 	1.5 (1.2)	0.5	SFM (Vc)	499 (400-599)			499 (400-598)
					RPM	15249	12200	10166	8714
					Fz	.0002	.0003	.0004	.0005
		Slotting 	1 (0.8)	1	SFM (Vc)	499 (400-599)			499 (400-598)
					RPM	15249	12200	10166	8714
					FEED	12.01	15.37	17.61	18.53
P >300 P <380	ALLOY STEELS 41**, 43**, 51**, 86**	Side Cutting 	1.5 (1.2)	0.5	SFM (Vc)	351 (281-422)			351 (281-421)
					RPM	10727	8581	7151	6129
					Fz	.0002	.0003	.0004	.0005
		Slotting 	1 (0.8)	1	SFM (Vc)	351 (281-422)			351 (281-421)
					RPM	10727	8581	7151	6129
					FEED	8.45	10.81	12.39	13.03
P <380	TOOL STEELS A2, D2, H13, P20, T15	Side Cutting 	1.5 (1.2)	0.5	SFM (Vc)	210 (168-252)			
					RPM	6418	5134	4278	3667
					Fz	.0001	.0002	.0003	.0004
		Slotting 	1 (0.8)	1	SFM (Vc)	210 (168-252)			
					RPM	6418	5134	4278	3667
					FEED	3.03	4.85	5.39	5.49
K <260	CAST IRON GRAY, MALLEABLE, DUCTILE	Side Cutting 	1.5 (1.2)	0.5	SFM (Vc)	367 (294-440)			
					RPM	11216	8972	7477	6409
					Fz	.0002	.0004	.0006	.0007
		Slotting 	1 (0.8)	1	SFM (Vc)	367 (294-440)			
					RPM	11216	8972	7477	6409
					FEED	10.60	14.13	16.48	17.16

Side Cutting

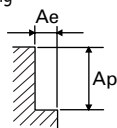

Slotting

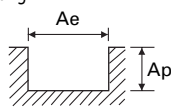

NOTES: ▶ Feed to be reduced by approximately 50% if L.O.C. (length of cut) is over 3xD

▶ The above recommendations are based on ideal conditions; for smaller taper machining centers or less rigid conditions, please adjust parameters accordingly on diameters greater than 1/2"

▶ In profile operations engaging more than 2xD reduce the radial depth of cut by 50%-60%.

▶ Finish cuts typically require reduced cutting feeds and speeds; also, it is recommended the radial width of cut (AE) should not exceed 2%xD1.

RPM = rev./min. FEED = in./min.
SFM = ft./min. Fz = in./tooth

Diameter (in.)									
1/4	9/32	5/16	11/32	3/8	7/16	1/2	5/8	3/4	1
499 (400-599)	499 (400-598)	499 (400-599)	525 (420-630)	551 (441-662)	551 (441-661)	551 (441-662)			
7625	6778	6100	5834	5613	4811	4210	3368	2806	2105
.0006	.0008	.0011	.0013	.0015	.0017	.0019	.0021	.0026	.0025
19.21	22.95	25.94	29.86	33.59	32.20	31.16	28.11	28.73	21.21
499 (400-599)	499 (400-598)	499 (400-599)	525 (420-630)	551 (441-662)	551 (441-661)	551 (441-662)			
7625	6778	6100	5834	5613	4811	4210	3368	2806	2105
.0006	.0008	.0011	.0013	.0015	.0017	.0019	.0021	.0026	.0025
19.21	22.95	25.94	29.86	33.59	32.20	31.16	28.11	28.73	21.21
351 (281-422)	351 (281-421)	351 (281-422)	368 (295-441)	384 (308-461)	384 (308-460)	384 (308-461)			
5363	4767	4291	4089	3912	3353	2934	2347	1956	1467
.0006	.0008	.0011	.0013	.0015	.0017	.0019	.0021	.0026	.0025
13.51	16.14	18.24	20.93	23.41	22.44	21.71	19.59	20.02	14.78
351 (281-422)	351 (281-421)	351 (281-422)	368 (295-441)	384 (308-461)	384 (308-460)	384 (308-461)			
5363	4767	4291	4089	3912	3353	2934	2347	1956	1467
.0006	.0008	.0011	.0013	.0015	.0017	.0019	.0021	.0023	.0025
13.51	16.14	18.24	20.93	23.41	22.44	21.71	19.59	18.17	14.78
210 (168-252)			220 (176-264)		230 (184-276)				
3209	2852	2567	2445	2343	2008	1757	1406	1171	879
.0004	.0006	.0007	.0009	.0011	.0012	.0013	.0015	.0018	.0018
5.56	6.74	7.68	8.86	9.96	9.33	8.86	8.19	8.30	6.23
210 (168-252)			220 (176-264)		230 (184-276)				
3209	2852	2567	2445	2343	2008	1757	1406	1171	879
.0004	.0006	.0007	.0009	.0011	.0012	.0013	.0015	.0018	.0018
5.56	6.74	7.68	8.86	9.96	9.33	8.86	8.19	8.30	6.23
367 (294-440)			386 (309-463)		404 (324-484)				
5608	4985	4486	4290	4115	3527	3087	2469	2058	1543
.0008	.0011	.0013	.0016	.0019	.0021	.0023	.0026	.0032	.0031
17.66	21.19	24.02	27.70	31.11	29.44	28.19	25.28	26.25	19.20
367 (294-440)			386 (309-463)		404 (324-484)				
5608	4985	4486	4290	4115	3527	3087	2469	2058	1543
.0008	.0011	.0013	.0016	.0019	.0021	.0023	.0026	.0032	.0031
17.66	21.19	24.02	27.70	31.11	29.44	28.19	25.28	26.25	19.20

NEXT PAGE ►

* Axial Cutting Depth			
	D	0.5D	
Length of Cut	<1.5xD	0.8xD	1.2xD
	≥1.5xD	1xD	1.5xD

4-FLUTE RECOMMENDED CUTTING CONDITIONS – INCH

UGMF68 | UGMF69 | UGMF70 | UGMF71 | UGMF72 | UGMF73 |
UGMF74 | UGMF75 | UGMF76 | UGMF77 SERIES

RPM = rev./min. FEED = in./min.
SFM = ft./min. Fz = in./tooth

ISO Hardness (BHN)	Work Materials	Speed and Feed Recommendations				Diameter (in.)			
		Type of Cut	Ap x D1	Ae x D1	Parameters	1/8	5/32	3/16	7/32
M	STAINLESS STEELS 300 304, 316, 304L, 316LSUS316	Side Cutting 	1.5 (1.2)	0.5	SFM (Vc)	348 (279-417)			
					RPM	10635	8508	7090	6077
					Fz	.0002	.0003	.0005	.0006
					FEED	8.37	10.72	14.51	14.83
		Slotting 	1 (0.8)	1	SFM (Vc)	348 (279-417)			
					RPM	10635	8508	7090	6077
					Fz	.0002	.0003	.0005	.0006
					FEED	8.37	10.72	14.51	14.83
M	STAINLESS STEELS 400 416, 420F, 430F, 440F	Side Cutting 	1.5 (1.2)	0.5	SFM (Vc)	486 (389-583)			
					RPM	14852	11882	9901	8487
					Fz	.0002	.0002	.0004	.0004
					FEED	9.36	11.23	14.03	14.70
		Slotting 	1 (0.8)	1	SFM (Vc)	486 (389-583)			
					RPM	14852	11882	9901	8487
					Fz	.0002	.0002	.0004	.0004
					FEED	9.36	11.23	14.03	14.70
M	STAINLESS STEELS (PH) 17-4PH, 15-5PH, 13-8PH	Side Cutting 	1.5 (1.2)	0.5	SFM (Vc)	312 (250-374)			
					RPM	9535	7628	6356	5448
					Fz	.0002	.0003	.0005	.0006
					FEED	7.51	9.61	13.01	13.30
		Slotting 	1 (0.8)	1	SFM (Vc)	312 (250-374)			
					RPM	9535	7628	6356	5448
					Fz	.0002	.0003	.0005	.0006
					FEED	7.51	9.61	13.01	13.30
S	TITANIUM Ti6Al4V, Ti5Al5V5Mo, Ti7Al4Mo	Side Cutting 	1	0.35	SFM (Vc)	190 (152-228)			
					RPM	5806	4645	3871	3318
					Fz	.0002	.0003	.0004	.0005
					FEED	3.66	5.12	6.71	7.05
		Slotting 	0.5	1	SFM (Vc)	190 (152-228)			
					RPM	5806	4645	3871	3318
					Fz	.0002	.0003	.0004	.0005
					FEED	3.66	5.12	6.71	7.05
S	HIGH-TEMPERATURE ALLOYS INCONEL, HASTELLOY, RENE	Side Cutting 	1	0.25	SFM (Vc)	85 (68-102)			
					RPM	2598	2078	1732	1484
					Fz	.0002	.0003	.0003	.0004
					FEED	2.05	2.29	2.18	2.34
		Slotting 	0.5	1	SFM (Vc)	85 (68-102)			
					RPM	2598	2078	1732	1484
					Fz	.0002	.0003	.0003	.0004
					FEED	2.05	2.29	2.18	2.34

Side Cutting

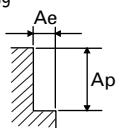

Slotting

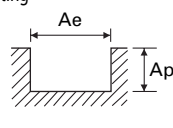

NOTES: ▶ Feed to be reduced by approximately 50% if L.O.C. (length of cut) is over 3xD

▶ The above recommendations are based on ideal conditions; for smaller taper machining centers or less rigid conditions, please adjust parameters accordingly on diameters greater than 1/2."

▶ In profile operations engaging more than 2xD reduce the radial depth of cut by 50%-60%.

▶ Finish cuts typically require reduced cutting feeds and speeds; also, it is recommended the radial width of cut (AE) should not exceed 2%xD1.

RPM = rev./min. FEED = in./min.
SFM = ft./min. Fz = in./tooth

Diameter (in.)									
1/4	9/32	5/16	11/32	3/8	7/16	1/2	5/8	3/4	1
348 (279-417)									
5317	4727	4254	3867	3545	3039	2659	2127	1772	1329
.0007	.0009	.0011	.0015	.0019	.0020	.0022	.0024	.0030	.0030
15.07	17.12	18.76	23.14	26.80	24.64	23.03	20.77	21.49	16.12
348 (279-417)									
5317	4727	4254	3867	3545	3039	2659	2127	1772	1329
.0007	.0009	.0011	.0015	.0019	.0020	.0022	.0024	.0030	.0030
15.07	17.12	18.76	23.14	26.80	24.64	23.03	20.77	21.49	16.12
486 (389-583)									
7426	6601	5941	5401	4951	4243	3713	2970	2475	1857
.0005	.0007	.0009	.0011	.0013	.0014	.0015	.0018	.0022	.0022
15.20	18.48	20.58	23.81	26.51	24.39	22.80	21.05	21.44	16.08
486 (389-583)									
7426	6601	5941	5401	4951	4243	3713	2970	2475	1857
.0005	.0007	.0009	.0011	.0013	.0014	.0015	.0018	.0022	.0022
15.20	18.19	20.58	23.81	26.51	24.39	22.80	21.05	21.44	16.08
312 (250-374)									
4767	4238	3814	3467	3178	2724	2384	1907	1589	1192
.0007	.0009	.0011	.0015	.0019	.0020	.0022	.0024	.0030	.0030
13.51	15.35	16.82	20.75	24.02	22.09	20.65	18.62	19.02	14.26
312 (250-374)									
4767	4238	3814	3467	3178	2724	2384	1907	1589	1192
.0007	.0009	.0011	.0015	.0019	.0020	.0022	.0024	.0030	.0030
13.51	15.35	16.82	20.75	24.02	22.09	20.65	18.62	19.02	14.26
190 (152-228)									
2903	2581	2323	2111	1935	1659	1452	1161	968	726
.0006	.0008	.0010	.0013	.0017	.0018	.0020	.0022	.0027	.0027
7.32	8.33	9.14	11.14	12.80	12.02	11.43	10.06	10.36	7.89
190 (152-228)									
2903	2581	2323	2111	1935	1659	1452	1161	968	726
.0006	.0008	.0010	.0013	.0017	.0018	.0020	.0022	.0027	.0027
7.32	8.33	9.14	11.14	12.80	12.02	11.43	10.06	10.36	7.89
85 (68-102)									
1299	1154	1039	945	866	742	649	520	433	325
.0005	.0006	.0007	.0010	.0013	.0014	.0015	.0017	.0021	.0020
2.45	2.82	3.11	3.87	4.50	4.15	3.89	3.52	3.68	2.66
85 (68-102)									
1299	1154	1039	945	866	742	649	520	433	325
.0005	.0006	.0007	.0010	.0013	.0014	.0015	.0017	.0021	.0020
2.45	2.82	3.11	3.87	4.50	4.15	3.89	3.52	3.68	2.66

* Axial Cutting Depth

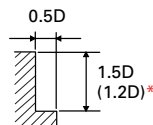
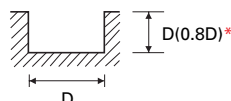

Length of Cut	<1.5xD	0.8xD	1.2xD
	≥1.5xD	1xD	1.5xD

4-FLUTE RECOMMENDED CUTTING CONDITIONS – INCH

UGMG53 | UGMG54 | UGMH10 SERIES

RPM = rev./min. FEED = in./min.
SFM = ft./min. Fz = in./tooth

ISO Hardness (BHN)	Work Materials	Speed and Feed Recommendations				Diameter (in.)										
		Type of Cut	Ap x D1	Ae x D1	Parameters	1/8	3/16	13/64	1/4	5/16	3/8	1/2	5/8	11/16	3/4	1
P < 300	CARBON STEELS 10**, 11**, 12**, 12L**, 15**		1	0.5	SFM (Vc)	531 (425-637)										
					RPM	16227	10818	9986	8114	6491	5409	4057	3245	2950	2705	2028
					Fz	.0010	.0011	.0012	.0016	.0024	.0026	.0028	.0030	.0031	.0035	.0039
					FEED	63.89	46.00	47.18	51.11	61.33	55.37	44.72	38.33	37.17	38.33	31.62
P > 300 P < 380	ALLOY STEELS 41**, 43**, 51**, 86**		1	0.5	SFM (Vc)	371 (297-445)										
					RPM	11338	7559	6977	5669	4535	3779	2834	2268	2061	1890	1417
					Fz	.0010	.0011	.0012	.0016	.0024	.0026	.0028	.0029	.0031	.0035	.0039
					FEED	44.64	32.14	32.96	35.71	42.85	38.69	31.25	26.43	25.65	26.78	22.10
P < 380	TOOL STEELS A2, D2, H13, P20, T15		1	0.5	SFM (Vc)	223 (178-268)										
					RPM	6815	4543	4194	3407	2726	2272	1704	1363	1239	1136	852
					Fz	.0007	.0007	.0008	.0011	.0017	.0018	.0019	.0020	.0022	.0025	.0028
					FEED	18.24	13.59	13.87	15.02	18.03	16.10	13.15	11.16	10.93	11.27	9.39
K < 260	CAST IRON Gray, Malleable, Ductile		1	0.5	SFM (Vc)	390 (312-468)										
					RPM	11918	7946	7334	5959	4767	3973	2980	2384	2167	1986	1490
					Fz	.0012	.0013	.0015	.0020	.0029	.0032	.0034	.0037	.0039	.0044	.0049
					FEED	58.18	41.29	42.74	46.92	55.56	50.68	40.82	34.91	33.78	35.04	29.09
M	STAINLESS STEELS 300 304, 316, 304L, 316LSUS316		1	0.5	SFM (Vc)	279 (223-335)										
					RPM	8526	5684	5247	4263	3410	2842	2132	1705	1550	1421	1066
					Fz	.0008	.0008	.0010	.0016	.0018	.0020	.0022	.0024	.0025	.0026	.0027
					FEED	26.85	17.90	20.66	27.53	24.17	22.38	18.46	16.11	15.62	14.55	11.41
M	STAINLESS STEELS 400 416, 420F, 430F, 440F		1	0.5	SFM (Vc)	253 (202-304)										
					RPM	7732	5154	4758	3866	3093	2577	1933	1546	1406	1289	966
					Fz	.0006	.0006	.0010	.0012	.0016	.0018	.0020	.0021	.0023	.0023	.0023
					FEED	18.26	12.18	18.73	18.26	19.48	18.26	15.22	13.15	13.06	11.77	8.98
M	STAINLESS STEELS (PH) 17-4PH, 15-5PH, 13-8PH		1	0.5	SFM (Vc)	253 (202-304)										
					RPM	7732	5154	4758	3866	3093	2577	1933	1546	1406	1289	966
					Fz	.0008	.0008	.0010	.0016	.0018	.0020	.0022	.0024	.0025	.0026	.0027
					FEED	24.35	16.23	18.73	24.96	21.92	20.29	16.74	14.61	14.17	13.19	10.35
S	TITANIUM Ti6Al4V, Ti5Al5V5Mo, Ti7Al4Mo		0.3	0.5	SFM (Vc)	154 (123-185)										
					RPM	4706	3137	2896	2353	1882	1569	1177	941	856	784	588
					Fz	.0007	.0007	.0009	.0015	.0016	.0018	.0019	.0021	.0023	.0023	.0024
					FEED	13.34	8.89	10.03	13.71	11.86	11.12	9.08	8.00	7.82	7.16	5.65
S	HIGH-TEMPERATURE ALLOYS INCONEL, HASTELLOY, RENE		0.3	0.2	SFM (Vc)	69 (55-83)										
					RPM	2109	1406	1298	1054	843	703	527	422	383	351	264
					Fz	.0006	.0006	.0007	.0011	.0012	.0014	.0015	.0017	.0018	.0018	.0019
					FEED	4.65	3.10	3.47	4.65	4.12	3.87	3.15	2.79	2.72	2.49	1.99

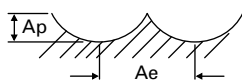

See notes on next page

6-FLUTE RECOMMENDED CUTTING CONDITIONS – INCH

UGMG20 | UGMG21 | UGMG22 | UGMG23 | UGMH08 | UGMH09 SERIES

RPM = rev./min.
SFM = ft./min.

FEED = in./min.
Fz = in./tooth

ISO Hardness (BHN)	Work Materials	Speed and Feed Recommendations			Diameter (in.)							
		Type of Cut	Ap x D1	Ae x D1	Parameters	1/4	5/16	3/8	1/2	5/8	3/4	1
P <300	CARBON STEELS 10**, 11**, 12**, 12L**, 15**	Side Cutting 	2 (*)	0.05	SFM (Vc)	984 (787-1181)						
					RPM	15036	12028	10024	7518	6014	5012	3759
					Fz	.0027	.0046	.0057	.0068	.0080	.0089	.0091
					FEED	241.52	329.60	340.96	307.22	286.98	266.38	206.00
P >300 P <380	ALLOY STEELS 41**, 43**, 51**, 86**	Side Cutting 	2 (*)	0.05	SFM (Vc)	666 (533-799)						
					RPM	10176	8141	6784	5088	4071	3392	2544
					Fz	.0020	.0033	.0042	.0050	.0059	.0066	.0069
					FEED	120.19	163.46	169.88	153.85	143.27	133.82	104.57
P <380	TOOL STEELS A2, D2, H13, P20, T15	Side Cutting 	2 (*)	0.05	SFM (Vc)	328 (262-394)						
					RPM	5012	4009	3341	2506	2005	1671	1253
					Fz	.0016	.0028	.0035	.0041	.0048	.0054	.0057
					FEED	48.54	67.25	69.46	62.15	58.25	54.06	42.62
M	STAINLESS STEELS 300 304, 316, 304L, 316LSUS316	Side Cutting 	2 (*)	0.05	SFM (Vc)	482 (386-578)						
					RPM	7365	5892	4910	3682	2946	2455	1841
					Fz	.0016	.0028	.0035	.0041	.0048	.0054	.0056
					FEED	71.33	98.82	102.07	91.34	85.60	79.45	62.20
M	STAINLESS STEELS 400 416, 420F, 430F, 440F	Side Cutting 	2 (*)	0.05	SFM (Vc)	699 (559-839)						
					RPM	10681	8545	7120	5340	4272	3560	2670
					Fz	.0019	.0033	.0041	.0049	.0057	.0064	.0066
					FEED	123.63	169.55	174.93	157.69	147.34	136.24	105.97
M	STAINLESS STEELS (PH) 17-4PH, 15-5PH, 13-8PH	Side Cutting 	2 (*)	0.05	SFM (Vc)	440 (352-528)						
					RPM	6723	5379	4482	3362	2689	2241	1681
					Fz	.0016	.0028	.0035	.0041	.0048	.0054	.0056
					FEED	65.11	90.21	93.17	83.38	78.14	72.53	56.38
S	TITANIUM Ti6Al4V, Ti5Al5V5Mo, Ti7Al4Mo	Side Cutting 	2 (*)	0.05	SFM (Vc)	381 (305-457)						
					RPM	5822	4657	3881	2911	2329	1941	1455
					Fz	.0013	.0022	.0028	.0033	.0038	.0044	.0046
					FEED	45.38	60.51	64.18	57.07	53.36	51.80	40.22
S	HIGH-TEMPERATURE ALLOYS INCONEL, HASTELLOY, RENE	Side Cutting 	2 (*)	0.05	SFM (Vc)	108 (86-130)						
					RPM	1650	1320	1100	825	660	550	413
					Fz	.0013	.0022	.0028	.0032	.0038	.0044	.0045
					FEED	12.86	17.15	18.19	15.98	15.13	14.55	11.21

Side Cutting

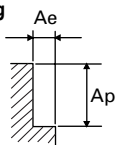

- NOTES:**
- ▶ The above recommendations are based on ideal conditions; for smaller taper machining centers or less rigid conditions please adjust parameters accordingly on diameters greater than 1/2."
 - ▶ Finish cuts typically require reduced cutting feeds and speeds; also, it is recommended the radial width of cut (AE) should not exceed 2%xD1.
 - ▶ If product's length of cut (L.O.C.) is below 2D, it must be applied L.O.C. x 90%.

4-FLUTE RECOMMENDED CUTTING CONDITIONS – METRIC

GMF52 | GMF53 | GMF54 | GMF55 | GMF56 | GMF57 |
GMF58 | GMF59 | GMF60 | GMF61 | GMF62 | GMF63 SERIES

RPM = rev./min. FEED = in./min.
SFM = ft./min. Fz = in./tooth

ISO Hardness (BHN)	Work Materials	Speed and Feed Recommendations				Diameter (mm)											
		Type of Cut	Ap x D1	Ae x D1	Parameters	3	4	5	6	8	10	12	14	16	18	20	25
P < 300	CARBON STEELS 1.1191 (C45) 1.0726 (35 S 20) 1.0715 (9 SMn 28) 1.0718 (9 SMn Pb 28)	Side Cutting 	1.5 (1.2)	0.5	SFM (Vc)	499 (399-598)					551 (441-661)						
					RPM	16128	12096	9677	8064	6048	5348	4456	3820	3342	2971	2674	2139
					Fz	.0002	.0003	.0004	.0006	.0011	.0015	.0019	.0019	.0021	.0023	.0026	.0025
					FEED	12.70	15.24	16.76	20.32	25.72	32.00	32.98	29.47	27.90	27.60	27.37	21.56
		Slotting 	1 (0.8)	1	SFM (Vc)	499 (399-598)					551 (441-661)						
					RPM	16128	12096	9677	8064	6048	5348	4456	3820	3342	2971	2674	2139
					Fz	.0002	.0003	.0004	.0006	.0011	.0015	.0019	.0019	.0021	.0023	.0026	.0025
					FEED	12.70	15.24	16.76	20.32	25.72	32.00	32.98	29.47	27.90	27.60	27.37	21.56
P > 300 P < 380	ALLOY STEELS 1.2330 (35 CrMo 4) 1.6565 (40NiCrMo6) 1.7033 (34Cr4) 1.6523 (21 NiCrMo2)	Side Cutting 	1.5 (1.2)	0.5	SFM (Vc)	351 (281-421)					384 (307-461)						
					RPM	11353	8515	6812	5677	4257	3724	3104	2660	2328	2069	1862	1490
					Fz	.0002	.0003	.0004	.0006	.0011	.0015	.0019	.0019	.0021	.0023	.0026	.0025
					FEED	8.94	10.73	11.80	14.30	18.10	22.29	22.97	20.53	19.43	19.22	19.06	15.01
		Slotting 	1 (0.8)	1	SFM (Vc)	351 (281-421)					384 (307-461)						
					RPM	11353	8515	6812	5677	4257	3724	3104	2660	2328	2069	1862	1490
					Fz	.0002	.0003	.0004	.0006	.0011	.0015	.0019	.0019	.0021	.0023	.0026	.0025
					FEED	8.94	10.73	11.80	14.30	18.10	22.29	22.97	20.53	19.43	19.22	19.06	15.01
P < 380	TOOL STEELS 1.2363 (X100 CrMo V 5 1) 1.2379 (X155 CrV Mo 12 1) 1.2344 (X40 CrMo V 5 1) 1.3243 (S 6-5-2-5)	Side Cutting 	1.5 (1.2)	0.5	SFM (Vc)	210 (168-252)					230 (184-276)						
					RPM	6791	5093	4074	3395	2546	2228	1857	1592	1393	1238	1114	891
					Fz	.0001	.0002	.0003	.0004	.0007	.0011	.0013	.0013	.0015	.0016	.0018	.0018
					FEED	3.21	4.81	5.13	5.88	7.62	9.47	9.36	8.52	8.11	7.99	7.90	6.32
		Slotting 	1 (0.8)	1	SFM (Vc)	210 (168-252)					230 (184-276)						
					RPM	6791	5093	4074	3395	2546	2228	1857	1592	1393	1238	1114	891
					Fz	.0001	.0002	.0003	.0004	.0007	.0011	.0013	.0013	.0015	.0016	.0018	.0018
					FEED	3.21	4.81	5.13	5.88	7.62	9.47	9.36	8.52	8.11	7.99	7.90	6.32
K < 260	CAST IRON 0.6020 (GG20) 0.8145 (GTS-45-06) 0.7060 (GGG-60)	Side Cutting 	1.5 (1.2)	0.5	SFM (Vc)	367 (294-441)					404 (323-484)						
					RPM	11884	8913	7130	5942	4456	3915	3263	2797	2447	2175	1958	1566
					Fz	.0002	.0004	.0006	.0008	.0013	.0019	.0023	.0024	.0026	.0029	.0032	.0031
					FEED	11.23	14.04	15.72	18.71	23.86	29.60	29.80	26.86	25.05	25.01	24.97	19.48
		Slotting 	1 (0.8)	1	SFM (Vc)	367 (294-441)					404 (323-484)						
					RPM	11884	8913	7130	5942	4456	3915	3263	2797	2447	2175	1958	1566
					Fz	.0002	.0004	.0006	.0008	.0013	.0019	.0023	.0024	.0026	.0029	.0032	.0031
					FEED	11.23	14.04	15.72	18.71	23.86	29.60	29.80	26.86	25.05	25.01	24.97	19.48

CHART CONTINUES ON NEXT PAGE ►

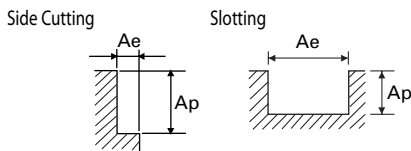

V7 Plus A

4-FLUTE RECOMMENDED CUTTING CONDITIONS – METRIC

**GMF52 | GMF53 | GMF54 | GMF55 | GMF56 | GMF57 |
GMF58 | GMF59 | GMF60 | GMF61 | GMF62 | GMF63 SERIES**

RPM = rev./min. FEED = in./min.
SFM = ft./min. Fz = in./tooth

ISO Hardness (BHN)	Work Materials	Speed and Feed Recommendations				Diameter (mm)											
		Type of Cut	Ap x D1	Ae x D1	Parameters	3	4	5	6	8	10	12	14	16	18	20	25
M	STAINLESS STEELS 300 1.4301 (X5 CrNi 18 10) 1.4436 (X3 CrNiMo 17 13 3) 1.4306 (X2 CrNi 19 11) 1.4435 (X2 CrNiMo 18 14 3)	Side Cutting 	1.5 (1.2)	0.5	SFM (Vc)	348 (278-417)											
					RPM	11247	8435	6748	5623	4218	3374	2812	2410	2109	1874	1687	1350
					Fz	.0002	.0003	.0005	.0007	.0011	.0019	.0022	.0023	.0024	.0028	.0030	.0030
		FEED	8.86	10.63	13.82	15.94	18.60	25.50	24.35	22.39	20.59	20.66	20.46	16.37			
		Slotting 	1 (0.8)	1	SFM (Vc)	348 (278-417)											
					RPM	11247	8435	6748	5623	4218	3374	2812	2410	2109	1874	1687	1350
Fz	.0002				.0003	.0005	.0007	.0011	.0019	.0022	.0023	.0024	.0028	.0030	.0030		
FEED	8.86	10.63	13.82	15.94	18.60	25.50	24.35	22.39	20.59	20.66	20.46	16.37					
M	STAINLESS STEELS 400 1.4005 (X12 CrS 13) 1.4104 (X12 CrMoS 17)	Side Cutting 	1.5 (1.2)	0.5	SFM (Vc)	486 (388-583)											
					RPM	15703	11777	9422	7852	5889	4711	3926	3365	2944	2617	2355	1884
					Fz	.0002	.0002	.0004	.0005	.0009	.0013	.0015	.0017	.0018	.0020	.0022	.0022
		FEED	9.89	11.13	13.35	16.07	20.40	25.22	24.11	22.26	20.87	20.61	20.40	16.32			
		Slotting 	1 (0.8)	1	SFM (Vc)	486 (388-583)											
					RPM	15703	11777	9422	7852	5889	4711	3926	3365	2944	2617	2355	1884
Fz	.0002				.0002	.0004	.0005	.0009	.0013	.0015	.0017	.0018	.0020	.0022	.0022		
FEED	9.89	11.13	13.35	16.07	20.40	25.22	24.11	22.26	20.87	20.61	20.40	16.32					
M	STAINLESS STEELS (PH) 1.4594 (Z7 CNU 15.05)	Side Cutting 	1.5 (1.2)	0.5	SFM (Vc)	312 (249-374)											
					RPM	10080	7560	6048	5040	3780	3024	2520	2160	1890	1680	1512	1210
					Fz	.0002	.0003	.0005	.0007	.0011	.0019	.0022	.0023	.0024	.0027	.0030	.0030
		FEED	7.94	9.52	12.38	14.29	16.67	22.86	21.83	20.07	18.45	18.25	18.10	14.48			
		Slotting 	1 (0.8)	1	SFM (Vc)	312 (249-374)											
					RPM	10080	7560	6048	5040	3780	3024	2520	2160	1890	1680	1512	1210
Fz	.0002				.0003	.0005	.0007	.0011	.0019	.0022	.0023	.0024	.0027	.0030	.0030		
FEED	7.94	9.52	12.38	14.29	16.67	22.86	21.83	20.07	18.45	18.25	18.10	14.48					
S	TITANIUM Ti6Al4V Ti5Al5V5Mo Ti7Al4Mo	Side Cutting 	1	0.35	SFM (Vc)	190 (152-228)											
					RPM	6154	4615	3692	3077	2308	1846	1538	1319	1154	1026	923	738
					Fz	.0002	.0003	.0004	.0006	.0010	.0017	.0020	.0021	.0022	.0024	.0027	.0027
		FEED	3.88	5.09	6.40	7.75	9.09	12.21	12.11	11.01	9.99	10.01	9.89	8.02			
		Slotting 	0.5	1	SFM (Vc)	190 (152-228)											
					RPM	6154	4615	3692	3077	2308	1846	1538	1319	1154	1026	923	738
Fz	.0002				.0003	.0004	.0006	.0010	.0017	.0020	.0021	.0022	.0024	.0027	.0027		
FEED	3.88	5.09	6.40	7.75	9.09	12.21	12.11	11.01	9.99	10.01	9.89	8.02					
S	HIGH-TEMPERATURE ALLOYS INCONEL HASTELLOY RENE	Side Cutting 	1	0.25	SFM (Vc)	85 (68-102)											
					RPM	2759	2069	1655	1379	1035	828	690	591	517	460	414	331
					Fz	.0002	.0003	.0003	.0005	.0007	.0013	.0015	.0016	.0017	.0019	.0021	.0020
		FEED	2.17	2.28	2.09	2.61	3.10	4.30	4.13	3.72	3.50	3.48	3.52	2.71			
		Slotting 	0.5	1	SFM (Vc)	85 (68-102)											
					RPM	2759	2069	1655	1379	1035	828	690	591	517	460	414	331
Fz	.0002				.0003	.0003	.0005	.0007	.0013	.0015	.0016	.0017	.0019	.0021	.0020		
FEED	2.17	2.28	2.09	2.61	3.10	4.30	4.13	3.72	3.50	3.48	3.52	2.71					

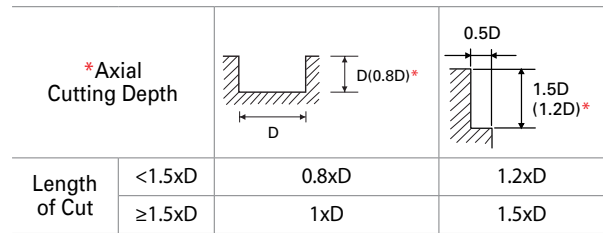

NOTES:

- ▶ Feed to be reduced by approximately 50% if L.O.C. (length of cut) is over 3xD
- ▶ The above recommendations are based on ideal conditions; for smaller taper machining centers or less rigid conditions, please adjust parameters accordingly on diameters greater than 1/2."
- ▶ In profile operations, engaging more than 2xD, reduce the radial depth of cut by 50%-60%.
- ▶ Finish cuts typically require reduced cutting feeds and speeds; also, it is recommended the radial width of cut (AE) should not exceed 2%xD1.

4-FLUTE RECOMMENDED CUTTING CONDITIONS – METRIC

GMG55 | GMG56 SERIES

RPM = rev./min. FEED = in./min.
SFM = ft./min. Fz = in./tooth

ISO Hardness (BHN)	Work Materials	Speed and Feed Recommendations				Diameter (mm)										
		Type of Cut	Ap x D1	Ae x D1	Parameters	3	4	5	6	8	10	12	16	18	20	25
P < 300	CARBON STEELS 10**, 11**, 12**, 12L**, 15**		1	0.5	SFM (Vc)	531 (425-638)										
					RPM	17189	12892	10313	8594	6446	5157	4297	3223	2865	2578	2063
					Fz	.0010	.0011	.0012	.0016	.0024	.0026	.0028	.0030	.0031	.0035	.0039
					FEED	67.67	54.81	48.72	54.14	60.90	52.78	47.37	38.07	36.09	36.54	32.16
P > 300 P < 380	ALLOY STEELS 41**, 43**, 51**, 86**		1	0.5	SFM (Vc)	371 (297-445)										
					RPM	11990	8992	7194	5995	4496	3597	2997	2248	1998	1798	1439
					Fz	.0010	.0011	.0012	.0016	.0024	.0026	.0028	.0029	.0031	.0035	.0039
					FEED	47.20	38.23	33.99	37.76	42.48	36.82	33.04	26.20	24.86	25.49	22.43
P < 380	TOOL STEELS A2, D2, H13, P20, T15		1	0.5	SFM (Vc)	223 (178-268)										
					RPM	7215	5411	4329	3608	2706	2165	1804	1353	1203	1082	866
					Fz	.0007	.0007	.0008	.0011	.0017	.0018	.0019	.0020	.0022	.0025	.0028
					FEED	19.32	16.19	14.32	15.91	17.90	15.34	13.92	11.08	10.60	10.74	9.54
K < 260	CAST IRON Gray, Malleable, Ductile		1	0.5	SFM (Vc)	390 (312-469)										
					RPM	12626	9470	7576	6313	4735	3788	3157	2367	2104	1894	1515
					Fz	.0012	.0013	.0015	.0020	.0029	.0032	.0034	.0037	.0039	.0044	.0049
					FEED	61.64	49.21	44.14	49.71	55.18	48.32	43.25	34.67	32.81	33.40	29.59
M	STAINLESS STEELS 300 304, 316, 304L, 316LSUS316		1	0.5	SFM (Vc)	279 (223-335)										
					RPM	9019	6764	5411	4509	3382	2706	2255	1691	1503	1353	1082
					Fz	.0008	.0008	.0010	.0016	.0018	.0020	.0022	.0024	.0025	.0026	.0027
					FEED	28.41	21.30	21.30	29.12	23.97	21.30	19.53	15.98	15.15	13.85	11.59
M	STAINLESS STEELS 400 416, 420F, 430F, 440F		1	0.5	SFM (Vc)	253 (202-303)										
					RPM	8170	6127	4902	4085	3064	2451	2042	1532	1362	1225	980
					Fz	.0006	.0006	.0010	.0012	.0016	.0018	.0020	.0021	.0023	.0023	.0023
					FEED	19.30	14.47	19.30	19.30	19.30	17.37	16.08	13.03	12.65	11.19	9.11
M	STAINLESS STEELS(PH) 17-4PH, 15-5PH, 13-8PH		1	0.5	SFM (Vc)	253 (202-303)										
					RPM	8170	6127	4902	4085	3064	2451	2042	1532	1362	1225	980
					Fz	.0008	.0008	.0010	.0016	.0018	.0020	.0022	.0024	.0025	.0026	.0027
					FEED	25.73	19.30	19.30	26.38	21.71	19.30	17.69	14.47	13.72	12.54	10.50
S	TITANIUM Ti6Al4V Ti5Al5V5Mo Ti7Al4Mo		0.3	0.5	SFM (Vc)	154 (123-185)										
					RPM	4987	3740	2992	2493	1870	1496	1247	935	831	748	598
					Fz	.0007	.0007	.0009	.0015	.0016	.0018	.0019	.0021	.0023	.0023	.0024
					FEED	14.14	10.60	10.37	14.53	11.78	10.60	9.62	7.95	7.59	6.83	5.75
S	HIGH-TEMPERATURE ALLOYS INCONEL HASTELLOY, RENE		0.3	0.2	SFM (Vc)	69 (55-83)										
					RPM	2228	1671	1337	1114	836	668	557	418	371	334	267
					Fz	.0006	.0006	.0007	.0011	.0012	.0014	.0015	.0017	.0018	.0018	.0019
					FEED	4.91	3.68	3.58	4.91	4.08	3.68	3.33	2.76	2.63	2.37	2.02

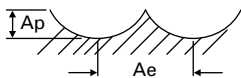

See notes on next page









6-FLUTE RECOMMENDED CUTTING CONDITIONS – METRIC

GMG12 | GMG13 | GMG14 | GMG15 | GMG16 |

GMG17 | GMG18 | GMG19 SERIES

RPM = rev./min.
SFM = ft./min.

FEED = in./min.
Fz = in./tooth

ISO Hardness (BHN)	Work Materials	Speed and Feed Recommendations				Diameter (mm)						
		Type of Cut	Ap x D1	Ae x D1	Parameters	6	8	10	12	16	20	25
P < 300	CARBON STEELS 10**, 11**, 12**, 12L**, 15**	Side Cutting 	2 (*)	0.05	SFM (Vc)	984 (787-1181)						
					RPM	15915	11937	9549	7958	5968	4775	3820
					Fz	.0027	.0046	.0057	.0068	.0080	.0089	.0091
					FEED	255.65	327.08	324.83	325.20	284.79	253.77	209.33
P > 300 P < 380	ALLOY STEELS 41**, 43**, 51**, 86**	Side Cutting 	2 (*)	0.05	SFM (Vc)	666 (533-799)						
					RPM	10769	8077	6462	5385	4039	3231	2585
					Fz	.0020	.0033	.0042	.0050	.0059	.0066	.0069
					FEED	127.20	162.18	161.80	162.81	142.14	127.45	106.24
P < 380	TOOL STEELS A2, D2, H13, P20, T15	Side Cutting 	2 (*)	0.05	SFM (Vc)	328 (262-394)						
					RPM	5305	3979	3183	2653	1989	1592	1273
					Fz	.0016	.0028	.0035	.0041	.0048	.0054	.0057
					FEED	51.38	66.73	66.17	65.79	57.80	51.51	43.31
M	STAINLESS STEELS 300 304, 316, 304L, 316LSUS316	Side Cutting 	2 (*)	0.05	SFM (Vc)	482 (386-579)						
					RPM	7799	5849	4679	3899	2924	2340	1872
					Fz	.0016	.0028	.0035	.0041	.0048	.0054	.0056
					FEED	75.53	98.10	97.27	96.71	84.97	75.71	63.22
M	STAINLESS STEELS 400 416, 420F, 430F, 440F	Side Cutting 	2 (*)	0.05	SFM (Vc)	699 (559-839)						
					RPM	11300	8475	6780	5650	4238	3390	2712
					Fz	.0019	.0033	.0041	.0049	.0057	.0064	.0066
					FEED	130.80	168.17	166.56	166.83	146.14	129.73	107.63
M	STAINLESS STEELS (PH) 17-4PH, 15-5PH, 13-8PH	Side Cutting 	2 (*)	0.05	SFM (Vc)	440 (352-528)						
					RPM	7109	5332	4265	3554	2666	2133	1706
					Fz	.0016	.0028	.0035	.0041	.0048	.0054	.0056
					FEED	68.85	89.42	88.67	88.16	77.46	69.02	57.23
S	TITANIUM Ti6Al4V Ti5Al5V5Mo Ti7Al4Mo	Side Cutting 	2 (*)	0.05	SFM (Vc)	381 (304-457)						
					RPM	6154	4615	3692	3077	2308	1846	1477
					Fz	.0013	.0022	.0028	.0033	.0038	.0044	.0046
					FEED	47.97	59.97	61.06	60.33	52.88	49.28	40.82
S	HIGH-TEMPERATURE ALLOYS INCONEL HASTELLOY, RENE	Side Cutting 	2 (*)	0.05	SFM (Vc)	108 (87-130)						
					RPM	1751	1313	1050	875	657	525	420
					Fz	.0013	.0022	.0028	.0032	.0038	.0044	.0045
					FEED	13.65	17.06	17.37	16.96	15.04	13.90	11.41

NOTES: ▶ The above recommendations are based on ideal conditions; for smaller taper machining centers or less rigid conditions please adjust parameters accordingly on diameters greater than 12mm.

▶ Finish cuts typically require reduced cutting feeds and speeds; also, it is recommended the radial width of cut (AE) should not exceed 2%xD1.

▶ If product's length of cut (L.O.C.) is below 2D, it must be applied L.O.C. x 90%.

TitaNox Power:

▶ AEROSPACE MATERIALS
HAVE MET THEIR MATCH.

FOR TITANIUM, STAINLESS STEEL AND ALLOY STEELS

When machining titanium, stainless steels, alloy steels and other aerospace materials, remember this: TitaNox end mills rule.

- ▶ Variable helix and variable pitch for excellent stability in the cutting zone
- ▶ 4-flute and 5-flute designs
- ▶ Carbide end mill with extra rigidity, extreme durability in high-speed machining
- ▶ Square, radius and chamfered end geometries
- ▶ Standard and extended lengths
- ▶ Inch and metric sizes



The perfect match for aerospace

This tool is a superior carbide end mill that won't back down when the going gets tough.

- ▶ Advanced coating for better wear resistance, thermal stability
- ▶ Optimized edge design for excellent performance in heavy cutting applications
- ▶ Excellent performance in difficult-to-machine materials; perfect solution for aerospace
- ▶ Less wear, longer tool life due to premium grade carbide and coating



TitaNox 4-FLUTE DOUBLE-CORE END MILLS

Let the chips fly.

For heavy cutting in slotting and profiling applications, our true double-core design has one purpose – removing material faster.

- ▶ Greater stability and rigidity with highly rigid true double core design
- ▶ Excellent chip evacuation due to innovative large gullet configuration
- ▶ Variable pitch and variable helix design provide for higher performance and less vibration



TitaNox 5-FLUTE END MILLS

Cut the toughest materials and the chatter.

Built to handle high-speed machining and fine finishing. With TitaNox, you won't find a better choice or a better value.

- ▶ Fast finishing, smooth cutting and reduced chatter in tough materials with 5-flute variable helix geometry
- ▶ The perfect choice for profiling, finishing, high-speed machining and more

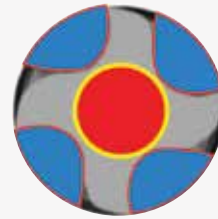
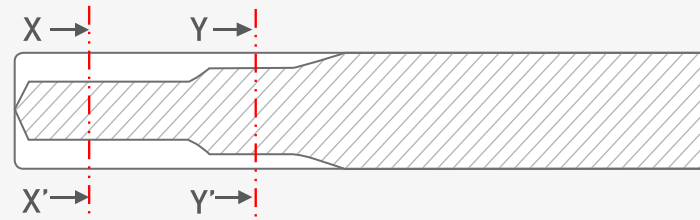

SECTION X-X'
Excellent chip
evacuation



SECTION Y-Y'
Higher rigidity

▲ The illustration above detailed along the SECTION X-X' axis shows how the **4-flute design** starts the cut with aggressive chip evacuation. The SECTION Y-Y' axis shows how the double core comes into play, providing perfect slotting and profiling operations through its extra-rigid double-core design.

GUIDE TO ICONS

The tool is made of
micrograin carbide



Helix Angle

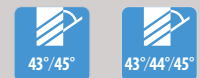

No. of Flutes



Type of Shank

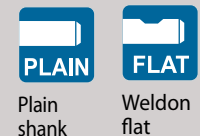

Tool Ends:

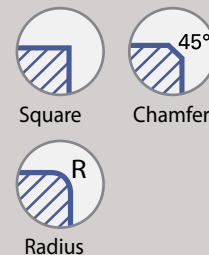

Cutting Conditions





SELECTION GUIDE

ITEM	MODEL	DESCRIPTION	DIAMETER		PAGE
			Min.	Max.	

INCH

UGMG42		4-FLUTE DOUBLE-CORE STANDARD LENGTH (Plain Shank)	CORNER RADIUS	1/4	1	46
UGMG43		4-FLUTE DOUBLE-CORE STANDARD LENGTH (Weldon Flat Shank)	CORNER RADIUS	3/8	1	47
UGMH12		5-FLUTE STANDARD LENGTH (Plain Shank)	SQUARE END	1/8	1-1/4	48
UGMG32			CHAMFER	1/8	1	48
UGMG34			CORNER RADIUS	1/8	1-1/4	48
UGMH06		5-FLUTE EXTENDED LENGTH (Plain Shank)	SQUARE END	1/8	1	49
UGMH07			CORNER RADIUS	1/8	1	49

METRIC

GMG40		4-FLUTE DOUBLE-CORE EXTENDED LENGTH (Plain Shank)	CORNER RADIUS	6.0	25.0	47
GMG24 GMG26		5-FLUTE STANDARD LENGTH (Plain Shank)	CHAMFER	6.0	25.0	50
GMG28 GMG30			CORNER RADIUS	6.0	25.0	50

RECOMMENDED CUTTING CONDITIONS

52-57



⊙ Excellent ○ Good

P				M	K	N	S
Carbon Steels	Alloy Steels	Prehardened Steels	Hardened Steels	Stainless Steels	Cast Iron	Aluminum	Titanium
~HB225	HB225~352	HRC30~40	HRC40~45				

○	○	○		⊙	○		⊙
○	○	○		⊙	○		⊙

○	○	○		⊙	○		⊙
○	○	○		⊙	○		⊙
○	○	○		⊙	○		⊙
○	○	○		⊙	○		⊙
○	○	○		⊙	○		⊙

○	○	○		⊙	○		⊙
---	---	---	--	---	---	--	---

○	○	○		⊙	○		⊙
○	○	○		⊙	○		⊙

4-FLUTE DOUBLE-CORE STANDARD LENGTH (PLAIN SHANK)

UGMG42 SERIES

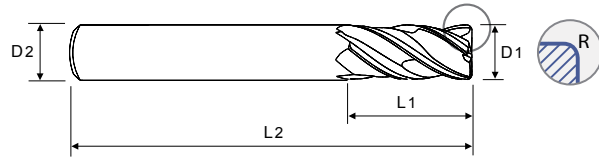

Pages 52-53

Unit: INCH

OD (D ₁)	SD (D ₂)	LOC (L ₁)	OAL (L ₂)	Corner Radius							
				.010	.015	.030	.060	.090	.125	.190	.250
				EDP No.	EDP No.	EDP No.	EDP No.	EDP No.	EDP No.	EDP No.	EDP No.
1/4	1/4	9/16	2-1/2	UGMG42802	UGMG42016	UGMG42901	UGMG42902				
		3/4	2-1/2			UGMG42924	UGMG42925				
		1	3			UGMG42S926*	UGMG42S927*				
3/8	3/8	1/2	2-1/2			UGMG42K998	UGMG42K999	UGMG42K801			
		7/8	2-1/2			UGMG42928	UGMG42929	UGMG42930			
		13/16	2-1/2	UGMG42931		UGMG42905	UGMG42906	UGMG42907			
		1	3	UGMG42932	UGMG42803	UGMG42933	UGMG42934	UGMG42935			
		1-1/4	3	UGMG42S936*	UGMG42S804*	UGMG42S937*	UGMG42S938*	UGMG42S939*			
1/2	1/2	1	3	UGMG42940		UGMG42908	UGMG42909	UGMG42910	UGMG42911		
		1-1/4	3-1/2		UGMG42805	UGMG42912	UGMG42941	UGMG42942	UGMG42943		
		1-5/8	4			UGMG42S944*	UGMG42S945*	UGMG42S946*	UGMG42S947*		
		2	4			UGMG42S806*	UGMG42S807*	UGMG42S808*	UGMG42S809*		
5/8	5/8	1-1/4	3-1/2			UGMG42040	UGMG42913	UGMG42914	UGMG42915		
		1-5/8	4			UGMG42948	UGMG42949	UGMG42950	UGMG42951		
		2	4			UGMG42S952*	UGMG42S953*	UGMG42S954*	UGMG42S955*		
		3-1/4	6			UGMG42S956*	UGMG42S957*	UGMG42S958*	UGMG42S959*		
3/4	3/4	1-1/2	4			UGMG42048	UGMG42916	UGMG42917	UGMG42918	UGMG42919	UGMG42960
		1-7/8	4			UGMG42961	UGMG42962	UGMG42963	UGMG42964	UGMG42965	UGMG42966
		2-1/4	5			UGMG42967	UGMG42968	UGMG42969	UGMG42970	UGMG42971	UGMG42972
		3-1/4	6			UGMG42S973*	UGMG42S974*	UGMG42S975*	UGMG42S976*	UGMG42S977*	UGMG42S978*
1	1	2	5			UGMG42064	UGMG42920	UGMG42921	UGMG42922	UGMG42923	UGMG42979
		2-5/8	5			UGMG42980	UGMG42981	UGMG42982	UGMG42983	UGMG42984	UGMG42985
		3	6			UGMG42986	UGMG42987	UGMG42988	UGMG42989	UGMG42990	UGMG42991
		4-1/4	7			UGMG42S992*	UGMG42S993*	UGMG42S994*	UGMG42S995*	UGMG42S996*	UGMG42S997*

* Length of cut in excess of 3xD on 45° single-helix requires feed reduction of approximately 50%.

4-FLUTE DOUBLE-CORE STANDARD LENGTH (WELDON FLAT SHANK)

UGMG43 SERIES

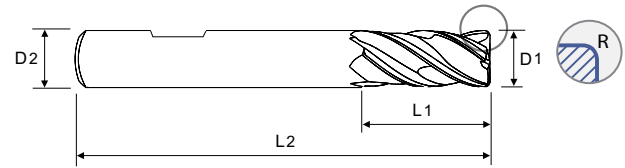

Pages 52–53

Unit: **INCH**

OD (D ₁)	SD (D ₂)	LOC (L ₁)	OAL (L ₂)	Corner Radius					
				.010	.030	.060	.090	.125	.190
				EDP No.	EDP No.	EDP No.	EDP No.	EDP No.	EDP No.
3/8	3/8	13/16	2-1/2	UGMG43024	UGMG43905	UGMG43906	UGMG43907		
1/2	1/2	1	3	UGMG43032	UGMG43908	UGMG43909	UGMG43910	UGMG43911	
		1-1/4	3-1/2		UGMG43912	UGMG43924			
5/8	5/8	1-1/4	3-1/2		UGMG43040	UGMG43913	UGMG43914	UGMG43915	
3/4	3/4	1-1/2	4		UGMG43048	UGMG43916	UGMG43917	UGMG43818	UGMG43919
1	1	2	5		UGMG43064	UGMG43920	UGMG43921	UGMG43922	UGMG43923

4-FLUTE DOUBLE-CORE EXTENDED LENGTH (PLAIN SHANK)

GMG40 SERIES

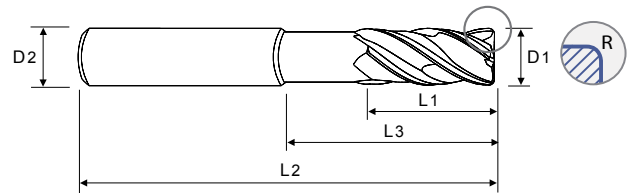

Pages 55–56

Unit: **METRIC**

OD (D ₁)		SD (D ₂)	LOC (L ₁)	LBS (L ₃)	OAL (L ₂)	Corner Radius						
Metric	Inch					0.50	1.00	1.50	2.00	3.00	3.50	4.00
						EDP No.	EDP No.	EDP No.	EDP No.	EDP No.	EDP No.	EDP No.
6	.2362	6	13	20	57	GMG40060	GMG40901					
8	.315	8	19	25	63	GMG40080	GMG40902	GMG40903	GMG40904			
10	.3937	10	22	30	72	GMG40100	GMG40905	GMG40906	GMG40907			
12	.4724	12	26	35	83	GMG40120	GMG40908	GMG40909	GMG40910	GMG40911		
14	.5512	14	26	35	83		GMG40140		GMG40912			
16	.6299	16	35	43	92		GMG40160	GMG40913	GMG40914	GMG40915	GMG40916	
20	.7874	20	44	56	110		GMG40200	GMG40917	GMG40918	GMG40919	GMG40920	GMG40921
25	.9843	25	55	70	130		GMG40250	GMG40922	GMG40923	GMG40924		GMG40925



5-FLUTE STANDARD LENGTH (PLAIN SHANK)

UGMH12 | UGMG32 | UGMG34 SERIES

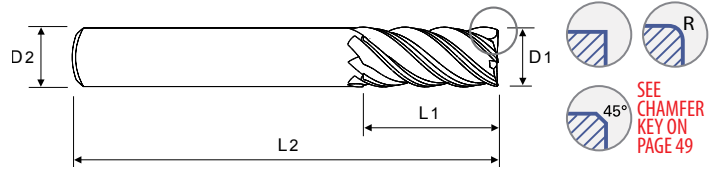

Page 54

Unit: INCH

OD (D1)	SD (D2)	LOC (L1)	OAL (L2)	Square End	Chamfer	Corner Radius						
						.015	.030	.060	.090	.125	.190	.250
						EDP No.	EDP No.	EDP No.	EDP No.	EDP No.	EDP No.	EDP No.
1/8	1/8	1/4	1-1/2	UGMH12008	UGMG32008	UGMG34008	UGMG34950					
		3/8	1-1/2	UGMH12901	UGMG32901	UGMG34901	UGMG34951					
		1/2	2-1/2	UGMH12S902*		UGMG34S952*	UGMG34S953*					
		3/4	2-1/2	UGMH12S903*		UGMG34S954*	UGMG34S955*					
3/16	3/16	5/16	2	UGMH12012	UGMG32012	UGMG34012	UGMG34956					
		9/16	2	UGMH12904	UGMG32902	UGMG34902	UGMG34957					
		3/4	2-1/2	UGMH12S905*		UGMG34S958*	UGMG34S959*					
1/4	1/4	3/8	2	UGMH12016	UGMG32016	UGMG34960	UGMG34016	UGMG34961				
		1/2	2-1/2	UGMH12906		UGMG34962	UGMG34963	UGMG34964				
		3/4	2-1/2	UGMH12907	UGMG32903	UGMG34903	UGMG34904	UGMG34905				
		1	3	UGMH12S908*		UGMG34S965*	UGMG34S966*	UGMG34S967*				
		1-1/4	3	UGMH12S909*		UGMG34S968*	UGMG34S969*	UGMG34S970*				
5/16	5/16	7/16	2"	UGMH12020	UGMG32020	UGMG34971	UGMG34020	UGMG34972				
		13/16	2-1/2	UGMH12910	UGMG32904	UGMG34906	UGMG34907	UGMG34908				
		1	3	UGMH12S911*		UGMG34S973*	UGMG34S974*	UGMG34S975*				
3/8	3/8	1/2	2-1/2	UGMH12024	UGMG32024	UGMG34976	UGMG34024	UGMG34909	UGMG34977			
		1	3	UGMH12912	UGMG32905	UGMG34910	UGMG34911	UGMG34912	UGMG34978			
		1-1/4	3	UGMH12S913*		UGMG34S979*	UGMG34S980*	UGMG34S981*	UGMG34S982*			
		1-1/2	4	UGMH12S914*		UGMG34S983*	UGMG34S984*	UGMG34S985*	UGMG34S986*			
1/2	1/2	5/8	2-1/2	UGMH12032	UGMG32032	UGMG34032	UGMG34913	UGMG34914	UGMG34987	UGMG34988		
		1	3	UGMH12915	UGMG32906	UGMG34915	UGMG34916	UGMG34917	UGMG34918	UGMG34919		
		1-1/4	3-1/2	UGMH12916	UGMG32907	UGMG34920	UGMG34921	UGMG34922	UGMG34923	UGMG34924		
		1-5/8	4	UGMH12S917*		UGMG34S989*	UGMG34S990*	UGMG34S991*	UGMG34S992*	UGMG34S993*		
		2	4	UGMH12S918*		UGMG34S994*	UGMG34S995*	UGMG34S996*	UGMG34S997*	UGMG34S998*		
5/8	5/8	3/4	3	UGMH12040	UGMG32040	UGMG34040	UGMG34925	UGMG34999	UGMG34801			
		1-1/4	3-1/2	UGMH12919	UGMG32908	UGMG34926	UGMG34927	UGMG34928	UGMG34929	UGMG34930		
		1-5/8	4	UGMH12920			UGMG34802	UGMG34803	UGMG34804	UGMG34805		
		2-1/8	4-1/2	UGMH12S921*			UGMG34S806*	UGMG34S807*	UGMG34S808*	UGMG34S809*		
		2-1/2	5	UGMH12S922*			UGMG34S810*	UGMG34S811*	UGMG34S812*	UGMG34S813*		
3/4	3/4	1	3-1/2	UGMH12048	UGMG32048		UGMG34048	UGMG34931	UGMG34932	UGMG34814	UGMG34815	UGMG34816
		1-1/2	4	UGMH12923	UGMG32909	UGMG34933	UGMG34934	UGMG34935	UGMG34936	UGMG34937	UGMG34938	UGMG34817
		1-7/8	5	UGMH12924			UGMG34818	UGMG34819	UGMG34820	UGMG34821	UGMG34822	UGMG34823
		2-1/4	5	UGMH12925			UGMG34824	UGMG34825	UGMG34826	UGMG34827	UGMG34828	UGMG34829
		2-3/4	5	UGMH12S926*			UGMG34S830*	UGMG34S831*	UGMG34S832*	UGMG34S833*	UGMG34S834*	UGMG34S835*
		3-1/4	6	UGMH12S927*			UGMG34S836*	UGMG34S837*	UGMG34S838*	UGMG34S839*	UGMG34S840*	UGMG34S841*
1	1	1-1/8	4	UGMH12064	UGMG32064		UGMG34064	UGMG34939	UGMG34940	UGMG34842	UGMG34843	UGMG34844
		1-1/2	4	UGMH12928	UGMG32910	UGMG34941	UGMG34942	UGMG34943	UGMG34944	UGMG34945	UGMG34946	UGMG34845
		2	5	UGMH12929	UGMG32911		UGMG34947	UGMG34948	UGMG34949	UGMG34846	UGMG34847	UGMG34848
		2-5/8	5	UGMH12930			UGMG34849	UGMG34850	UGMG34851	UGMG34852	UGMG34853	UGMG34854
		3-1/4	6	UGMH12S931*			UGMG34S855*	UGMG34S856*	UGMG34S857*	UGMG34S858*	UGMG34S859*	UGMG34S860*
		4-1/4	7	UGMH12S932*			UGMG34S861*	UGMG34S862*	UGMG34S863*	UGMG34S864*	UGMG34S865*	UGMG34S866*
1-1/4	1-1/4	1-1/2	4-1/2	UGMH12116			UGMG34116	UGMG34867	UGMG34868	UGMG34869	UGMG34870	
		2	4-1/2	UGMH12933			UGMG34871	UGMG34872	UGMG34873	UGMG34874	UGMG34875	
		2-5/8	5-1/2	UGMH12934			UGMG34876	UGMG34877	UGMG34878	UGMG34879	UGMG34880	
		3-1/4	6	UGMH12935			UGMG34881	UGMG34882	UGMG34883	UGMG34884	UGMG34885	
		4-1/2	7	UGMH12S936*			UGMG34S886*	UGMG34S887*	UGMG34S888*	UGMG34S889*	UGMG34S890*	

*Length of cut in excess of 3xD on 45° single-helix requires feed reduction of approximately 50%.

5-FLUTE EXTENDED LENGTH (PLAIN SHANK)

UGMH06 | UGMH07 SERIES



Page 54

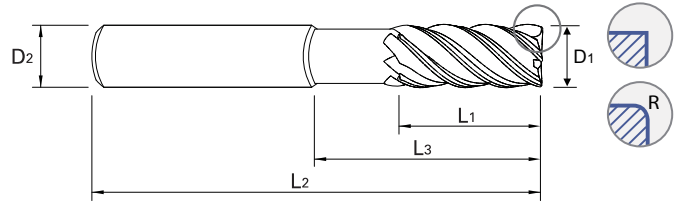

Unit: INCH

OD (D ₁)	SD (D ₂)	LOC (L ₁)	LBS (L ₃)	OAL (L ₂)	Square End	Corner Radius					
						.030	.060	.090	.125	.190	.250
						EDP No.	EDP No.	EDP No.	EDP No.	EDP No.	EDP No.
1/8	1/8	5/32	3/8	3	UGMH06008	UGMH07008					
		5/32	1/2	3	UGMH06901	UGMH07901					
		5/32	5/8	3	UGMH06902	UGMH07902					
3/16	3/16	7/32	1/2	3	UGMH06012	UGMH07012					
		7/32	3/4	3	UGMH06903	UGMH07903					
		7/32	1	3	UGMH06904	UGMH07904					
1/4	1/4	3/8	3/4	4	UGMH06016	UGMH07016	UGMH07905				
		3/8	1-1/8	4	UGMH06905	UGMH07906	UGMH07907				
		3/8	2-1/8	4	UGMH06906	UGMH07908	UGMH07909				
3/8	3/8	1/2	1-1/8	4	UGMH06024	UGMH07024	UGMH07910	UGMH07911			
		1/2	2-1/8	4	UGMH06907	UGMH07912	UGMH07913	UGMH07914			
		1/2	3-1/8	5	UGMH06923	UGMH07804	UGMH07805	UGMH07806			
		1/2	3-1/8	6	UGMH06908	UGMH07915	UGMH07916	UGMH07917			
		1/2	4-1/8	6	UGMH06909	UGMH07918	UGMH07919	UGMH07920			
1/2	1/2	5/8	1-1/2	4	UGMH06032	UGMH07032	UGMH07921	UGMH07922	UGMH07923		
		5/8	2-1/4	4	UGMH06910	UGMH07924	UGMH07925	UGMH07926	UGMH07927		
		5/8	3-3/8	5	UGMH06924	UGMH07807	UGMH07808	UGMH07809	UGMH07810		
		5/8	3-3/8	6	UGMH06911	UGMH07928	UGMH07929	UGMH07930	UGMH07931		
		5/8	4-1/8	6	UGMH06912	UGMH07932	UGMH07933	UGMH07934	UGMH07935		
5/8	5/8	3/4	1-5/8	4	UGMH06040	UGMH07040	UGMH07936	UGMH07937	UGMH07938		
		3/4	2-3/8	6	UGMH06913	UGMH07939	UGMH07940	UGMH07941	UGMH07942		
		3/4	3-3/8	6	UGMH06914	UGMH07943	UGMH07944	UGMH07945	UGMH07946		
		3/4	4-1/8	6	UGMH06915	UGMH07947	UGMH07948	UGMH07949	UGMH07950		
3/4	3/4	1-1/8	2	4	UGMH06048	UGMH07048	UGMH07951	UGMH07952	UGMH07953	UGMH07954	UGMH07955
		1-1/8	2-5/8	5	UGMH06916	UGMH07956	UGMH07957	UGMH07958	UGMH07959	UGMH07960	UGMH07961
		1-1/8	3-1/4	6	UGMH06917	UGMH07962	UGMH07963	UGMH07964	UGMH07965	UGMH07966	UGMH07967
		1-1/8	4-1/4	7	UGMH06918	UGMH07968	UGMH07969	UGMH07970	UGMH07971	UGMH07972	UGMH07973
1	1	1-1/4	2-1/4	4	UGMH06064	UGMH07064	UGMH07974	UGMH07975	UGMH07976	UGMH07977	UGMH07978
		1-1/4	2-5/8	5	UGMH06919	UGMH07979	UGMH07980	UGMH07981	UGMH07982	UGMH07983	UGMH07984
		1-1/4	3-1/4	6	UGMH06920	UGMH07985	UGMH07986	UGMH07987	UGMH07988	UGMH07989	UGMH07990
		1-1/4	4-1/4	7	UGMH06921	UGMH07991	UGMH07992	UGMH07993	UGMH07994	UGMH07995	UGMH07996
		1-1/4	5-1/4	8	UGMH06922	UGMH07997	UGMH07998	UGMH07999	UGMH07801	UGMH07802	UGMH07803

CHAMFER KEY UGMG32

Mill Diameter (in.)	Chamfer Size
1/8	.004
3/16	.006
1/4	.007
5/16	.007
3/8	.011
1/2	.013
5/8	.015
3/4	.019
1	.019

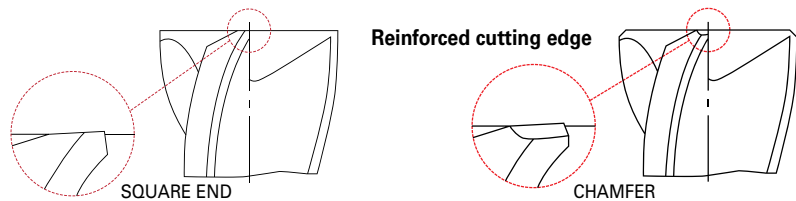

5-FLUTE STANDARD LENGTH (PLAIN SHANK)

GMG24 | GMG26 | GMG28 | GMG30 SERIES



Page 57

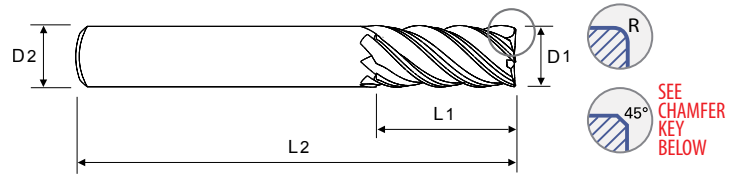

Unit: METRIC

OD (D ₁)		SD (D ₂)	LOC (L ₁)	OAL (L ₂)	Chamfer
Metric	Inch				EDP No.
6	.2362	6	10	54	GMG24060
		6	13	57	GMG26060
8	.315	8	12	58	GMG24080
		8	19	63	GMG26080
10	.3937	10	14	66	GMG24100
		10	22	72	GMG26100
12	.4724	12	16	73	GMG24120
		12	26	83	GMG26120
16	.6299	16	22	82	GMG24160
		16	36	92	GMG26160
20	.7874	20	26	92	GMG24200
		20	44	104	GMG26200
25	.9843	25	29	100	GMG24250
		25	54	121	GMG26250

CHAMFER KEY GMG24 GMG26

Mill Diameter		Chamfer Size (mm)
Metric	Inch	
6	.2362	0.20
8	.315	0.20
10	.3937	0.30
12	.4724	0.35
16	.6299	0.40
20	.7874	0.50
25	.9843	0.50

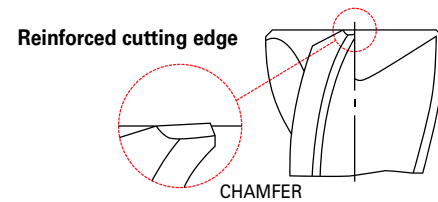

OD (D ₁)		SD (D ₂)	LOC (L ₁)	OAL (L ₂)	Corner Radius								
Metric	Inch				0.30	0.50	1.00	1.50	2.00	2.50	3.00	4.00	5.00
						EDP No.	EDP No.	EDP No.	EDP No.	EDP No.	EDP No.	EDP No.	EDP No.
6	.2362	6	10	54		GMG28060							
		6	13	57	GMG30060	GMG30901	GMG30902						
8	.315	8	12	58		GMG28080							
		8	19	63		GMG30080	GMG30903	GMG30904	GMG30905				
10	.3937	10	14	66		GMG28100							
		10	22	72		GMG30100	GMG30906	GMG30907	GMG30908				
12	.4724	12	16	73		GMG28120							
		12	26	83		GMG30120	GMG30909	GMG30910	GMG30911	GMG30912	GMG30913		
16	.6299	16	22	82		GMG28160							
		16	36	92		GMG30160	GMG30914	GMG30915	GMG30916	GMG30917	GMG30918		
20	.7874	20	26	92		GMG28200							
		20	44	104		GMG30200	GMG30919	GMG30920	GMG30921	GMG30922	GMG30923	GMG30924	
25	.9843	25	29	100		GMG28250							
		25	54	121		GMG30250	GMG30925	GMG30926	GMG30927	GMG30928	GMG30929	GMG30930	

5-flute TitaNox – ideal for peel milling.

For peel milling applications, the 5-flute TitaNox is the preferred choice of the pros. Why TitaNox? First, the raw power of its 5-flute corner radius design provides seemingly effortless performance in materials ranging from stainless to titanium. Second, unlike slotting operations that push through materials, the high-speed cutting ability of the TitaNox 5-flute design provides precise cutting to produce an ultra-fine finish, pass after pass.



CASE STUDY

5-Flute Variable Helix End Mills vs. Two Competitors

Cutting Conditions			
Milling Method	Down & Side Cutting 	Feed	15.669 in./min.
Work Material	- DIN : Ti6Al4V (Titanium) - WR : 3.7165.1	Axial Depth	.710"
		Radial Depth	.141"
Size	Ø12 × Ø12 × 26 × 83	Coolant	Wet Cut
RPM	1591 rev./min.	Machine	Machining Center

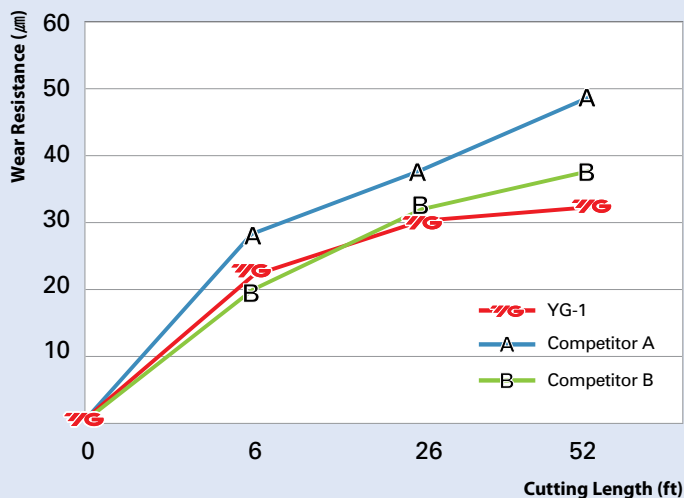

TitaNox Power

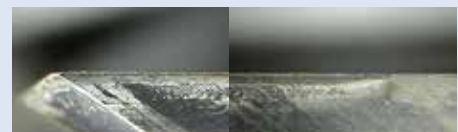

Competitor A

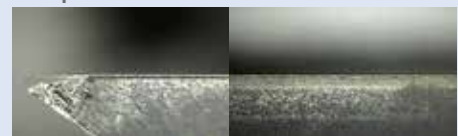

Competitor B

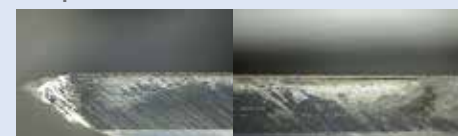

4-FLUTE DOUBLE-CORE RECOMMENDED CUTTING CONDITIONS – INCH

UGMG42 | UGMG43 SERIES

RPM = rev./min. Feed = in./min.
SFM = ft./min. Fz = in./tooth

ISO Hardness (Brinell)	Work Materials	Speed and Feed Recommendations					Diameter (in.)						
		Type of Cut	Ap x D1	Ae x D1	Vc (SFM)	Parameters	1/4	5/16	3/8	1/2	5/8	3/4	1
P <300	CARBON STEELS 10**, 11**, 12**, 12L**, 15**	Side Cutting 	1 *(0.7)	0.4	525 (420-630)	RPM	8021	6417	5347	4010	3208	2674	2005
						Fz	.0011	.0014	.0017	.0021	.0025	.0030	.0033
		Slotting 	1 *(0.7)	1	410 (328-492)	RPM	6266	5013	4178	3133	2507	2089	1567
						Fz	.0010	.0013	.0017	.0019	.0025	.0028	.0033
P <300 P <380	ALLOY STEELS 41**, 43**, 51**, 86**	Side Cutting 	1 *(0.7)	0.4	492 (394-591)	RPM	7520	6016	5013	3760	3008	2507	1880
						Fz	.0010	.0014	.0017	.0019	.0025	.0028	.0033
		Slotting 	1 *(0.7)	1	394 (315-472)	RPM	6016	4813	4010	3008	2406	2005	1504
						Fz	.0010	.0013	.0017	.0019	.0025	.0028	.0030
P <380	TOOL STEELS A2, D2, H13, P20, T15	Side Cutting 	1 *(0.7)	0.4	492 (394-591)	RPM	7520	6016	5013	3760	3008	2507	1880
						Fz	.0011	.0014	.0018	.0021	.0026	.0030	.0033
		Slotting 	1 *(0.7)	1	394 (315-472)	RPM	6016	4813	4010	3008	2406	2005	1504
						Fz	.0011	.0014	.0017	.0021	.0025	.0030	.0033
K <260	CAST IRON Gray, Malleable, Ductile	Side Cutting 	1 *(0.7)	0.4	574 (459-689)	RPM	8773	7018	5849	4386	3509	2924	2193
						Fz	.0008	.0011	.0014	.0017	.0021	.0024	.0028
		Slotting 	1 *(0.7)	1	459 (367-551)	RPM	7018	5615	4679	3509	2807	2339	1755
						Fz	.0008	.0011	.0014	.0017	.0021	.0024	.0026
M	STAINLESS STEELS 300 304, 316, 304L, 316L, SUS316	Side Cutting 	1 *(0.7)	0.4	344 (276-413)	RPM	5264	4211	3509	2632	2106	1755	1316
						Fz	.0010	.0013	.0016	.0019	.0024	.0028	.0032
		Slotting 	1 *(0.7)	1	279 (223-335)	RPM	4261	3409	2841	2131	1704	1420	1065
						Fz	.0010	.0013	.0016	.0019	.0024	.0028	.0032
						Feed (IPM)	16.57	18.36	18.70	15.94	16.57	15.94	13.55

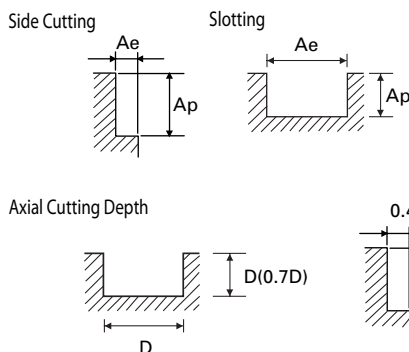

- NOTES:**
- ▶ Maximum recommended depth shown
 - ▶ Finish cuts typically require reduced feed rates and/or higher spindle speed, with radial width of 2% x D1 or less
 - ▶ Feed to be reduced by approximately 50% if L.O.C. (length of cut) is over 3x D
 - ▶ Reduce speed and feed recommendations for materials harder than listed
 - ▶ Recommendations above are based on ideal conditions. Adjust parameters accordingly for smaller taper machining centers or less rigid conditions

NEXT PAGE ▶

*(0.7D): UGMG42K998, UGMG42K999, UGMGK801
0.7D cutting depth for slotting and side cutting applications due to short double-core length

**4-FLUTE DOUBLE-CORE
RECOMMENDED CUTTING CONDITIONS – INCH**
UGMG42 | UGMG43 SERIES

RPM = rev./min. Feed = in./min.
SFM = ft./min. Fz = in./tooth

ISO Hardness (Brinell)	Work Materials	Speed and Feed Recommendations					Diameter (in.)						
		Type of Cut	Ap x D1	Ae x D1	Vc (SFM)	Parameters	1/4	5/16	3/8	1/2	5/8	3/4	1
M	STAINLESS STEELS 400 416, 420F, 430F, 440F	Side Cutting 	1 *(0.7)	0.4	509 (407-610)	RPM	7770	6216	5180	3885	3108	2590	1943
						Fz	.0013	.0018	.0022	.0026	.0034	.0037	.0045
						Feed (IPM)	41.85	44.64	46.50	40.69	41.85	38.75	34.87
		Slotting 	1 *(0.7)	1	410 (328-492)	RPM	6266	5013	4178	3133	2507	2089	1567
						Fz	.0013	.0018	.0022	.0026	.0032	.0037	.0041
						Feed (IPM)	33.75	36.00	37.50	32.81	31.87	31.25	25.78
M	STAINLESS STEELS (PH) 17-4PH, 15-5PH, 13-8PH	Side Cutting 	0.6	0.4	144 (115-173)	RPM	2206	1765	1471	1103	882	735	551
						Fz	.0006	.0008	.0010	.0013	.0016	.0018	.0021
						Feed (IPM)	5.61	5.81	6.16	5.61	5.54	5.28	4.54
		Slotting 	0.5	1	118 (94-142)	RPM	1805	1444	1203	902	722	602	451
						Fz	.0006	.0008	.0010	.0013	.0016	.0018	.0021
						Feed (IPM)	4.59	4.75	5.04	4.59	4.54	4.32	3.71
S	TITANIUM Ti6Al4V Ti5Al5V5Mo Ti7Al4Mo	Side Cutting 	1 *(0.7)	0.4	230 (184-276)	RPM	3509	2807	2339	1755	1404	1170	877
						Fz	.0013	.0019	.0022	.0026	.0034	.0037	.0045
						Feed (IPM)	18.90	21.00	21.00	18.37	18.90	17.50	15.75
		Slotting 	1 *(0.7)	1	180 (144-217)	RPM	2757	2206	1838	1379	1103	919	689
						Fz	.0013	.0018	.0022	.0026	.0034	.0037	.0041
						Feed (IPM)	14.85	15.84	16.50	14.44	14.85	13.75	11.34

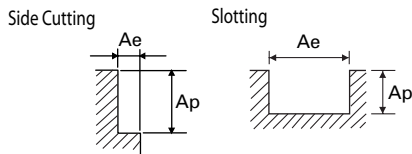

- NOTES:**
- ▶ Maximum recommended depth shown
 - ▶ Finish cuts typically require reduced feed rates and/or higher spindle speed, with radial width of 2% x D1 or less.
 - ▶ Feed to be reduced by approximately 50% if L.O.C. (length of cut) is over 3xD
 - ▶ Reduce speed and feed recommendations for materials harder than listed
 - ▶ Recommendations above are based on ideal conditions.
Adjust parameters accordingly for smaller taper machining centers or less rigid conditions.

Axial Cutting Depth

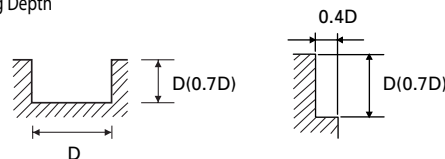

* (0.7D): UGMG42K998, UGMG42K999, UGMGK801
0.7D cutting depth for slotting and side cutting applications due to short double-core length

5-FLUTE RECOMMENDED CUTTING CONDITIONS – INCH

UGMH12 | UGMG32 | UGMG34 | UGMH06 | UGMH07 SERIES

RPM = rev./min.
SFM = ft./min.

Feed = in./min.
Fz = in./tooth

ISO Hardness (Brinell)	Work Materials	Speed and Feed Recommendations	Diameter (in.)															
			Type of cut	Ap x D1	Ae x D1	Vc (SFM)	Parameters	1/8	3/16	1/4	5/16	3/8	1/2	9/16	5/8	11/16	3/4	1
P < 300	CARBON STEELS 10**, 11**, 12**, 12L**, 15**	Side Cutting 	1.5	0.3	472 (378-567)	RPM	14438	9625	7219	5775	4813	3609	3208	2888	2625	2406	1805	1444
						Fz	.0004	.0007	.0013	.0015	.0020	.0025	.0027	.0030	.0033	.0035	.0040	.0046
						Feed (IPM)	28.88	33.69	48.32	43.20	47.37	44.76	43.58	43.20	42.89	42.16	35.88	33.21
P < 300 P < 380	ALLOY STEELS 41**, 43**, 51**, 86**	Side Cutting 	1.5	0.3	331 (265-398)	RPM	10127	6751	5063	4051	3376	2532	2250	2025	1841	1688	1266	1013
						Fz	.0004	.0007	.0013	.0015	.0020	.0025	.0027	.0030	.0033	.0035	.0040	.0046
						Feed (IPM)	20.25	23.63	33.89	30.30	33.22	31.40	30.57	30.30	30.08	29.57	25.17	23.29
P < 380	TOOL STEELS A2, D2, H13, P20, T15	Side Cutting 	1.5	0.3	197 (157-236)	RPM	6016	4010	3008	2406	2005	1504	1337	1203	1094	1003	752	602
						Fz	.0003	.0005	.0009	.0011	.0014	.0017	.0019	.0021	.0023	.0024	.0028	.0033
						Feed (IPM)	9.02	10.03	14.21	12.79	13.82	13.03	12.89	12.79	12.49	12.24	10.51	9.93
K < 260	CAST IRON Gray, Malleable, Ductile	Side Cutting 	1.5	0.3	348 (278-417)	RPM	10628	7085	5314	4251	3543	2657	2362	2126	1932	1771	1328	1063
						Fz	.0006	.0008	.0017	.0019	.0025	.0031	.0034	.0038	.0041	.0044	.0050	.0057
						Feed (IPM)	31.88	28.34	44.98	40.17	43.93	41.32	40.45	40.17	39.18	38.70	32.95	30.29
M	STAINLESS STEELS 300 304, 316, 304L, 316L, SUS316	Side Cutting 	1.5	0.3	269 (215-323)	RPM	8222	5481	4111	3289	2741	2055	1827	1644	1495	1370	1028	822
						Fz	.0004	.0005	.0012	.0013	.0015	.0025	.0026	.0027	.0028	.0030	.0035	.0041
						Feed (IPM)	16.44	13.70	24.28	20.72	20.50	25.49	23.38	22.33	20.60	20.50	17.80	16.85
M	STAINLESS STEELS 400 416, 420F, 430F, 440F	Side Cutting 	1.5	0.3	384 (307-461)	RPM	11731	7820	5865	4692	3910	2933	2607	2346	2133	1955	1466	1173
						Fz	.0003	.0004	.0009	.0010	.0012	.0018	.0020	.0021	.0022	.0024	.0028	.0033
						Feed (IPM)	17.60	15.64	27.71	23.09	23.09	26.56	26.17	24.94	23.93	23.48	20.49	19.36
M	STAINLESS STEELS (PH) 17-4PH, 15-5PH, 13-8PH	Side Cutting 	1.5	0.3	194 (155-232)	RPM	5915	3944	2958	2366	1972	1479	1315	1183	1076	986	739	592
						Fz	.0004	.0005	.0012	.0013	.0015	.0025	.0026	.0027	.0028	.0030	.0035	.0041
						Feed (IPM)	11.83	9.86	17.47	14.91	14.75	18.34	16.82	16.07	14.82	14.75	12.81	12.13
S	TITANIUM Ti6Al4V Ti5Al5V5Mo Ti7Al4Mo	Side Cutting 	1.5	0.2	226 (181-272)	RPM	6918	4612	3459	2767	2306	1730	1537	1384	1258	1153	865	692
						Fz	.0004	.0004	.0011	.0011	.0013	.0022	.0023	.0024	.0025	.0027	.0031	.0036
						Feed (IPM)	13.84	9.22	18.38	15.80	15.43	19.41	17.86	16.89	15.60	15.66	13.45	12.45

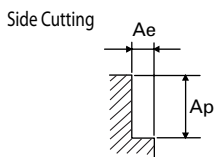

NOTES: ▶ Maximum recommended depth shown

- ▶ Finish cuts typically require reduced feed rates and/or higher spindle speed, with radial width of 2% x D1 or less
- ▶ Feed to be reduced by approximately 50% if L.O.C. (length of cut) is over 3xD
- ▶ Reduce speed and feed recommendations for materials harder than listed.
- ▶ Recommendations above are based on ideal conditions.

Adjust parameters accordingly for smaller taper machining centers or less rigid conditions.

4-FLUTE DOUBLE-CORE RECOMMENDED CUTTING CONDITIONS – METRIC

GMG40 SERIES

RPM = rev./min. Feed = in./min.
SFM = ft./min. Fz = in./tooth

ISO Hardness (Brinell)	Work Materials	Speed and Feed Recommendations					Diameter (mm)							
		Type of Cut	Ap x D1	Ae x D1	Vc (SFM)	Parameters	6	8	10	12	14	16	20	25
P <300	CARBON STEELS 10**, 11**, 12**, 12L**, 15**	Side Cutting 	1	0.4	525 (420-630)	RPM	8488	6366	5093	4244	3638	3183	2546	2037
						Fz	.0011	.0014	.0017	.0021	.0023	.0025	.0030	.0033
						Feed (IPM)	36.09	35.09	33.69	35.42	33.23	31.58	30.88	26.95
		Slotting 	1	1	410 (328-492)	RPM	6631	4974	3979	3316	2842	2487	1989	1592
						Fz	.0010	.0013	.0017	.0019	.0022	.0025	.0028	.0033
						Feed (IPM)	26.11	26.63	26.32	25.59	25.06	24.67	21.93	21.05
P <300 P <380	ALLOY STEELS 41**, 43**, 51**, 86**	Side Cutting 	1	0.4	492 (394-591)	RPM	7958	5968	4775	3979	3410	2984	2387	1910
						Fz	.0010	.0014	.0017	.0019	.0022	.0025	.0028	.0033
						Feed (IPM)	31.33	32.90	31.58	30.70	30.08	29.61	26.32	25.26
		Slotting 	1	1	394 (315-472)	RPM	6366	4775	3820	3183	2728	2387	1910	1528
						Fz	.0010	.0013	.0017	.0019	.0022	.0025	.0028	.0030
						Feed (IPM)	25.06	25.57	25.26	24.56	24.06	23.69	21.05	18.53
P <380	TOOL STEELS A2, D2, H13, P20, T15	Side Cutting 	1	0.4	492 (394-591)	RPM	7958	5968	4775	3979	3410	2984	2387	1910
						Fz	.0011	.0014	.0018	.0021	.0024	.0026	.0030	.0033
						Feed (IPM)	33.84	32.90	34.59	33.21	32.22	31.49	28.95	25.26
		Slotting 	1	1	394 (315-472)	RPM	6366	4775	3820	3183	2728	2387	1910	1528
						Fz	.0011	.0014	.0017	.0021	.0023	.0025	.0030	.0033
						Feed (IPM)	27.07	26.32	25.26	26.57	24.92	23.69	23.16	20.21
K <260	CAST IRON Gray, Malleable, Ductile	Side Cutting 	1	0.4	574 (459-689)	RPM	9284	6963	5570	4642	3979	3482	2785	2228
						Fz	.0008	.0011	.0014	.0017	.0019	.0021	.0024	.0028
						Feed (IPM)	30.70	30.70	30.70	30.70	30.08	29.06	26.32	24.56
		Slotting 	1	1	459 (367-551)	RPM	7427	5570	4456	3714	3183	2785	2228	1783
						Fz	.0008	.0011	.0014	.0017	.0019	.0021	.0024	.0026
						Feed (IPM)	24.56	24.56	24.56	24.56	24.06	23.25	21.05	18.81
M	STAINLESS STEELS 300 304, 316, 304L, 316L, SUS316	Side Cutting 	1	0.4	344 (276-413)	RPM	5570	4178	3342	2785	2387	2089	1671	1337
						Fz	.0010	.0013	.0016	.0019	.0022	.0024	.0028	.0032
						Feed (IPM)	21.67	22.50	22.00	20.83	20.68	20.31	18.75	17.00
		Slotting 	1	1	279 (223-335)	RPM	4509	3382	2706	2255	1933	1691	1353	1082
						Fz	.0010	.0013	.0016	.0019	.0022	.0024	.0028	.0032
						Feed (IPM)	17.54	18.22	17.81	16.87	16.74	16.44	15.18	13.76

NEXT PAGE ►

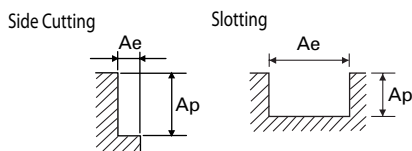

- NOTES:**
- ▶ Maximum recommended depth shown
 - ▶ Finish cuts typically require reduced feed rates and/or higher spindle speed, with radial width of 2% x D1 or less.
 - ▶ Reduce speed and feed recommendations for materials harder than listed.
 - ▶ Recommendations above are based on ideal conditions. Adjust parameters accordingly for smaller taper machining centers or less rigid conditions.

4-FLUTE DOUBLE-CORE RECOMMENDED CUTTING CONDITIONS – METRIC

GMG40 SERIES

 RPM = rev./min.
SFM = ft./min.

 Feed = in./min.
Fz = in./tooth

ISO Hardness (Brinell)	Work Materials	Type of Cut	Speed and Feed Recommendations				Diameter (mm)							
			Ap x D1	Ae x D1	Vc (SFM)	Parameters	6	8	10	12	14	16	20	25
M	STAINLESS STEELS 400 416, 420F, 430F, 440F	Side Cutting 	1	0.4	509 (407-610)	RPM	8223	6167	4934	4112	3524	3084	2467	1974
						Fz	.0013	.0018	.0022	.0026	.0030	.0034	.0037	.0045
						Feed (IPM)	44.29	44.29	44.29	43.06	42.18	41.52	36.91	35.43
		Slotting 	1	1	410 (328-492)	RPM	6631	4974	3979	3316	2842	2487	1989	1592
						Fz	.0013	.0018	.0022	.0026	.0029	.0032	.0037	.0041
						Feed (IPM)	35.72	35.72	35.72	34.72	33.12	31.62	29.76	26.19
M	STAINLESS STEELS (PH) 17-4PH, 15-5PH, 13-8PH	Side Cutting 	0.6	0.4	144 (115-173)	RPM	2334	1751	1401	1167	1000	875	700	560
						Fz	.0006	.0008	.0010	.0013	.0014	.0016	.0018	.0021
						Feed (IPM)	5.94	5.76	5.87	5.94	5.67	5.50	5.03	4.61
		Slotting 	0.5	1	118 (94-142)	RPM	1910	1432	1146	955	819	716	573	458
						Fz	.0006	.0008	.0010	.0013	.0014	.0016	.0018	.0021
						Feed (IPM)	4.86	4.71	4.80	4.86	4.64	4.50	4.11	3.77
S	TITANIUM Ti6Al4V Ti5Al5V5Mo Ti7Al4Mo	Side Cutting 	1	0.4	230 (184-276)	RPM	3714	2785	2228	1857	1592	1393	1114	891
						Fz	.0013	.0019	.0022	.0026	.0030	.0034	.0037	.0045
						Feed (IPM)	20.00	20.83	20.00	19.45	19.05	18.75	16.67	16.00
		Slotting 	1	1	180 (144-217)	RPM	2918	2188	1751	1459	1251	1094	875	700
						Fz	.0013	.0018	.0022	.0026	.0030	.0034	.0037	.0041
						Feed (IPM)	15.71	15.71	15.71	15.28	14.97	14.73	13.10	11.52

Side Cutting

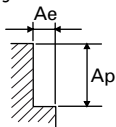

Slotting

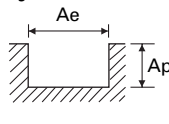

NOTES: ▶ Maximum recommended depth shown

▶ Finish cuts typically require reduced feed rates and/or higher spindle speed, with radial width of 2% x D1 or less.

▶ Reduce speed and feed recommendations for materials harder than listed.

▶ Recommendations above are based on ideal conditions.

Adjust parameters accordingly for smaller taper machining centers or less rigid conditions.

5-FLUTE

RECOMMENDED CUTTING CONDITIONS – METRIC

GMG24 | GMG26 | GMG28 | GMG30 SERIES

RPM = rev./min.
SFM = ft./min.Feed = in./min.
Fz = in./tooth

ISO Hardness (Brinell)	Work Materials	Type of Cut	Speed and Feed Recommendations				Diameter (in.)								
			Ap x D1	Ae x D1	Vc (SFM)	Parameters	6	8	10	12	14	16	18	20	25
P <300	CARBON STEELS 10**, 11**, 12**, 12L**, 15**	Side Cutting 	1.5	0.3	472 (378-567)	RPM	7639	5730	4584	3820	3274	2865	2546	2292	1833
						Fz	.0013	.0015	.0020	.0025	.0027	.0030	.0033	.0035	.0040
						Feed (IPM)	51.13	42.86	45.11	47.37	44.47	42.86	41.61	40.15	36.45
P <300 P <380	ALLOY STEELS 41**, 43**, 51**, 86**	Side Cutting 	1.5	0.3	331 (265-398)	RPM	5358	4019	3215	2679	2296	2009	1786	1607	1286
						Fz	.0013	.0015	.0020	.0025	.0027	.0030	.0033	.0035	.0040
						Feed (IPM)	35.86	30.06	31.64	33.23	31.19	30.06	29.18	28.16	25.57
P <380	TOOL STEELS A2, D2, H13, P20, T15	Side Cutting 	1.5	0.3	197 (157-236)	RPM	3183	2387	1910	1592	1364	1194	1061	955	764
						Fz	.0009	.0011	.0014	.0017	.0019	.0021	.0023	.0024	.0028
						Feed (IPM)	15.04	12.69	13.16	13.79	13.16	12.69	12.11	11.65	10.68
K <260	CAST IRON Gray, Malleable, Ductile	Side Cutting 	1.5	0.3	348 (278-417)	RPM	5623	4218	3374	2812	2410	2109	1874	1687	1350
						Fz	.0017	.0019	.0025	.0031	.0034	.0038	.0041	.0044	.0050
						Feed (IPM)	47.60	39.85	41.84	43.73	41.27	39.85	38.01	36.86	33.48
M	STAINLESS STEELS 300 304, 316, 304L, 316L, SUS316	Side Cutting 	1.5	0.3	269 (215-323)	RPM	4350	3263	2610	2175	1864	1631	1450	1305	1044
						Fz	.0012	.0013	.0015	.0025	.0026	.0027	.0028	.0030	.0035
						Feed (IPM)	25.69	20.55	19.52	26.97	23.86	22.16	19.98	19.52	18.09
M	STAINLESS STEELS 400 416, 420F, 430F, 440F	Side Cutting 	1.5	0.3	384 (307-461)	RPM	6207	4655	3724	3104	2660	2328	2069	1862	1490
						Fz	.0009	.0010	.0012	.0018	.0020	.0021	.0022	.0024	.0028
						Feed (IPM)	29.32	22.91	21.99	28.10	26.71	24.74	23.22	22.36	20.82
M	STAINLESS STEELS (PH) 17-4PH, 15-5PH, 13-8PH	Side Cutting 	1.5	0.3	194 (155-232)	RPM	3130	2348	1878	1565	1341	1174	1043	939	751
						Fz	.0012	.0013	.0015	.0025	.0026	.0027	.0028	.0030	.0035
						Feed (IPM)	18.48	14.79	14.05	19.41	17.16	15.94	14.38	14.05	13.01
S	TITANIUM Ti6Al4V Ti5Al5V5Mo Ti7Al4Mo	Side Cutting 	1.5	0.3	226 (181-272)	RPM	3661	2745	2196	1830	1569	1373	1220	1098	879
						Fz	.0011	.0011	.0013	.0022	.0023	.0024	.0025	.0027	.0031
						Feed (IPM)	19.46	15.67	14.70	20.54	18.22	16.75	15.13	14.92	13.66

Side Cutting

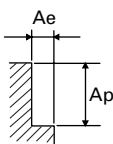
**NOTES:** ▶ Maximum recommended depth shown

▶ Finish cuts typically require reduced feed rates and/or higher spindle speed, with radial width of 2% x D1 or less.

▶ Reduce speed and feed recommendations for materials harder than listed.

▶ Recommendations above are based on ideal conditions.

Adjust parameters accordingly for smaller taper machining centers or less rigid conditions.

ALU-POWER HPC: THE ULTIMATE EDGE IN AEROSPACE ALUMINUM.

FOR ALUMINUM, ALUMINUM DIE CAST, NON-FERROUS ALLOYS AND PLASTICS

YG-1's first 3-flute, high-performance, solid carbide end mills are made especially for rough-cutting aluminum without the usual chip-wrap meltdown.

- ▶ 3-flute ultra-micrograin carbide design
- ▶ Variety of sizes and shapes are available, including square end, corner radius and extended reach
- ▶ DLC-coated and uncoated, polished
- ▶ H6 tolerance shanks



More balanced cutting performance, excellent heat dissipation.

ALU-POWER HPC highly polished 3-flute end mills keep their cool, and provide outstanding chip evacuation.

- ▶ Excellent in true high-speed, HP machining
- ▶ Excellent ramping due to rigid design
- ▶ Less vibration, better heat dissipation; able to counteract extreme radial forces for cooler, smoother running, longer tool life
- ▶ Outstanding chip evacuation

The Anatomy of Efficiency

Specialized design of corner gash

- ▶ Unique flute design and superior corner protection adds both tool life and protection against catastrophic failure in high feed applications
- ▶ Polished flutes for excellent chip flow



DLC (diamond-like carbon) coating

- ▶ Excels in hard aluminum and high speeds
- ▶ Provides edge strength and unsurpassed tool life



Cylindrical land

- ▶ Increased performance in a variety of cutting conditions
- ▶ Also helps reduce vibration and chatter

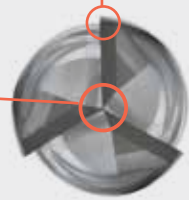

Available in a wide variety of sizes and corner radii

Ideal symmetrical shape

- ▶ 3-flute design "to the center" (all 3 flutes come to center)
- ▶ Designed with high spindle speeds in mind
- ▶ Highly effective in vertical ramping up to 20 degrees and step-over plunging applications



Engineered flute design

- ▶ Effective chip evacuation at high feed rates with lower cutting forces than competitive products

GUIDE TO ICONS

The tool is made of micrograin carbide



Helix Angle



Tool Ends



Square

Cutting Conditions



No. of Flutes



Type of Shank



Plain Shank











Radius

SELECTION GUIDE

ITEM	MODEL	DESCRIPTION	DIAMETER		PAGE
			Min.	Max.	

INCH

JAG95		3-FLUTE STANDARD LENGTH (Plain Shank) COATED	SQUARE END	1/8	1	62
JAG97			CORNER RADIUS	1/8	1	62
E5G95		3-FLUTE STANDARD LENGTH (Plain Shank) UNCOATED	SQUARE END	1/8	1	63
E5G97			CORNER RADIUS	1/8	1	63
JAG96		3-FLUTE EXTENDED LENGTH (Plain Shank) COATED	SQUARE END	1/4	1	64
JAG98			CORNER RADIUS	1/4	1	64
E5G96		3-FLUTE EXTENDED LENGTH (Plain Shank) UNCOATED	SQUARE END	1/4	1	64
E5G98			CORNER RADIUS	1/4	1	64

RECOMMENDED CUTTING CONDITIONS

66-67

Work Materials

Aluminum, Non-Ferrous and Non-Metallic Materials

Compared to conventional aluminum-specific end mills, the ALU-POWER HPC provides more versatile performance. Its high-performance design allows you to cut deeper and run at both faster and slower cutting speeds and feeds.

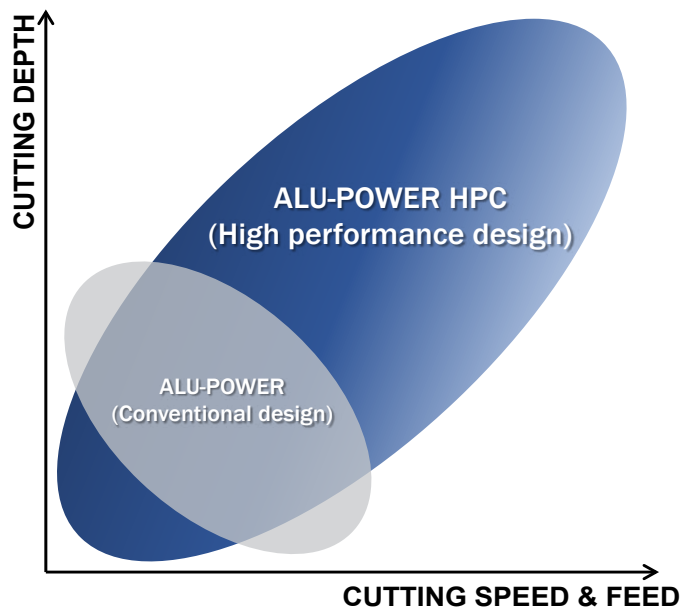

⊙ Excellent ○ Good

N			
Aluminum	Aluminum Die Cast	Non-Ferrous Alloys	Plastics

⊙	⊙	○	○
⊙	⊙	○	○
⊙	⊙	○	○
⊙	⊙	○	○
⊙	⊙	○	○
⊙	⊙	○	○
⊙	⊙	○	○
⊙	⊙	○	○
⊙	⊙	○	○



▲ **Rough cutting**

Ultra-micrograin carbide supplies the rigidity to keep the chips flying. Highly polished 3-flute design ensures they'll keep flying – cut after cut.

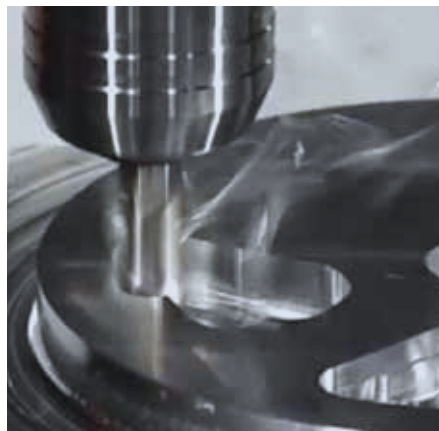

▲ **Ramping**

In steep, aggressive ramping conditions, the ALU-POWER HPC holds its own to resist the torsional stress from extreme helical output.



▲ **Side cutting**

No one offers a cooler-running super high-speed end mill. While others melt down the materials they're cutting, ALU-POWER HPC keeps cutting cool in aluminum.

3-FLUTE STANDARD LENGTH (PLAIN SHANK) – COATED

JAG95 | JAG97 SERIES



Pages 66–67

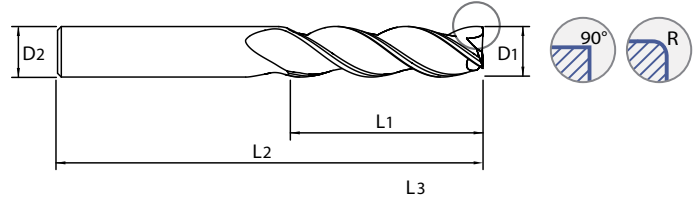

Unit: INCH

OD (D ₁)	SD (D ₂)	LOC (L ₁)	OAL (L ₂)	Square End	Corner Radius						
					.010	.030	.060	.090	.120	.190	.250
					EDP No.	EDP No.	EDP No.	EDP No.	EDP No.	EDP No.	EDP No.
1/8	1/8	1/4	1-1/2	JAG95008	JAG97008	JAG97901					
		3/8	1-1/2	JAG95901	JAG97902	JAG97903					
3/16	3/16	5/16	2	JAG95012	JAG97012	JAG97904					
		9/16	2	JAG95902	JAG97905	JAG97906					
1/4	1/4	3/8	2	JAG95016	JAG97016	JAG97907	JAG97908				
		5/8	2-1/2	JAG95903	JAG97909	JAG97910	JAG97911				
		1-1/4	3-1/4	JAG95904	JAG97912	JAG97913	JAG97914				
5/16	5/16	7/16	2	JAG95020	JAG97020	JAG97915	JAG97916	JAG97917			
		5/8	2-1/2	JAG95905	JAG97918	JAG97919	JAG97920	JAG97921			
		1-1/4	3-1/2	JAG95906	JAG97922	JAG97923	JAG97924	JAG97925			
3/8	3/8	1/2	2	JAG95024	JAG97024	JAG97926	JAG97927	JAG97928	JAG97929		
		1	2-1/2	JAG95907	JAG97930	JAG97931	JAG97932	JAG97933	JAG97934		
		1-1/2	3-1/2	JAG95908	JAG97935	JAG97936	JAG97937	JAG97938	JAG97939		
		2	4	JAG95909	JAG97940	JAG97941	JAG97942	JAG97943	JAG97944		
7/16	7/16	9/16	2-1/2	JAG95028	JAG97028	JAG97945	JAG97946	JAG97947	JAG97948		
		1-1/4	2-3/4	JAG95910	JAG97949	JAG97950	JAG97951	JAG97952	JAG97953		
		2	4	JAG95911	JAG97954	JAG97955	JAG97956	JAG97957	JAG97958		
1/2	1/2	5/8	2-1/2	JAG95032	JAG97032	JAG97959	JAG97960	JAG97961	JAG97962	JAG97963	
		1	3	JAG95927	JAG97879	JAG97880	JAG97881	JAG97882	JAG97883	JAG97884	
		1-1/4	3	JAG95912	JAG97964	JAG97965	JAG97966	JAG97967	JAG97968	JAG97969	
		1-5/8	4	JAG95913	JAG97970	JAG97971	JAG97972	JAG97973	JAG97974	JAG97975	
		2	4	JAG95914	JAG97976	JAG97977	JAG97978	JAG97979	JAG97980	JAG97981	
		2-1/2	5	JAG95915	JAG97982	JAG97983	JAG97984	JAG97985	JAG97986	JAG97987	
5/8	5/8	3/4	3	JAG95040	JAG97040	JAG97994	JAG97995	JAG97996	JAG97997	JAG97998	
		1-5/8	3-1/2	JAG95917	JAG97999	JAG97801	JAG97802	JAG97803	JAG97804	JAG97805	
		2-1/2	5	JAG95918	JAG97806	JAG97807	JAG97808	JAG97809	JAG97810	JAG97811	
		3	5-1/4	JAG95919	JAG97812	JAG97813	JAG97814	JAG97815	JAG97816	JAG97817	
3/4	3/4	1	3	JAG95048	JAG97048	JAG97818	JAG97819	JAG97820	JAG97821	JAG97822	JAG97823
		1-5/8	4	JAG95920	JAG97824	JAG97825	JAG97826	JAG97827	JAG97828	JAG97829	JAG97830
		2-1/4	5	JAG95921	JAG97831	JAG97832	JAG97833	JAG97834	JAG97835	JAG97836	JAG97837
		3-1/4	6	JAG95922	JAG97838	JAG97839	JAG97840	JAG97841	JAG97842	JAG97843	JAG97844
		4	6-1/4	JAG95923	JAG97845	JAG97846	JAG97847	JAG97848	JAG97849	JAG97850	JAG97851
1	1	1-1/4	3	JAG95064	JAG97064	JAG97852	JAG97853	JAG97854	JAG97855	JAG97856	JAG97857
		1-1/4	4	JAG95928	JAG97885	JAG97886	JAG97887	JAG97888	JAG97889	JAG97890	JAG97891
		2	5	JAG95924	JAG97858	JAG97859	JAG97860	JAG97861	JAG97862	JAG97863	JAG97864
		3-1/4	6	JAG95925	JAG97865	JAG97866	JAG97867	JAG97868	JAG97869	JAG97870	JAG97871
		4	7	JAG95926	JAG97872	JAG97873	JAG97874	JAG97875	JAG97876	JAG97877	JAG97878

3-FLUTE STANDARD LENGTH (PLAIN SHANK) – UNCOATED

E5G95 | E5G97 SERIES



Pages 66–67

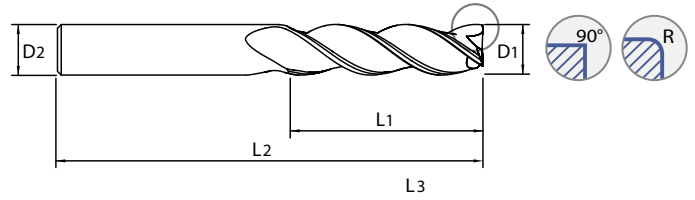

Unit: INCH

OD (D1)	SD (D2)	LOC (L1)	OAL (L2)	Square End	Corner Radius							
					.010	.030	.060	.090	.120	.190	.250	
					EDP No.	EDP No.	EDP No.	EDP No.	EDP No.	EDP No.	EDP No.	
1/8	1/8	1/4	1-1/2	E5G95008	E5G97008	E5G97901						
		3/8	1-1/2	E5G95901	E5G97902	E5G97903						
3/16	3/16	5/16	2	E5G95012	E5G97012	E5G97904						
		9/16	2	E5G95902	E5G97905	E5G97906						
1/4	1/4	3/8	2	E5G95016	E5G97016	E5G97907	E5G97908					
		5/8	2-1/2	E5G95903	E5G97909	E5G97910	E5G97911					
		1-1/4	3-1/4	E5G95904	E5G97912	E5G97913	E5G97914					
5/16	5/16	7/16	2	E5G95020	E5G97020	E5G97915	E5G97916	E5G97917				
		5/8	2-1/2	E5G95905	E5G97918	E5G97919	E5G97920	E5G97921				
		1-1/4	3-1/2	E5G95906	E5G97922	E5G97923	E5G97924	E5G97925				
3/8	3/8	1/2	2	E5G95024	E5G97024	E5G97926	E5G97927	E5G97928	E5G97929			
		1	2-1/2	E5G95907	E5G97930	E5G97931	E5G97932	E5G97933	E5G97934			
		1-1/2	3-1/2	E5G95908	E5G97935	E5G97936	E5G97937	E5G97938	E5G97939			
		2	4	E5G95909	E5G97940	E5G97941	E5G97942	E5G97943	E5G97944			
7/16	7/16	9/16	2-1/2	E5G95028	E5G97028	E5G97945	E5G97946	E5G97947	E5G97948			
		1-1/4	2-3/4	E5G95910	E5G97949	E5G97950	E5G97951	E5G97952	E5G97953			
		2	4	E5G95911	E5G97954	E5G97955	E5G97956	E5G97957	E5G97958			
1/2	1/2	5/8	2-1/2	E5G95032	E5G97032	E5G97959	E5G97960	E5G97961	E5G97962	E5G97963		
		1	3	E5G95927	E5G97879	E5G97880	E5G97881	E5G97882	E5G97883	E5G97884		
		1-1/4	3	E5G95912	E5G97964	E5G97965	E5G97966	E5G97967	E5G97968	E5G97969		
		1-5/8	4	E5G95913	E5G97970	E5G97971	E5G97972	E5G97973	E5G97974	E5G97975		
		2	4	E5G95914	E5G97976	E5G97977	E5G97978	E5G97979	E5G97980	E5G97981		
		2-1/2	5	E5G95915	E5G97982	E5G97983	E5G97984	E5G97985	E5G97986	E5G97987		
5/8	5/8	3	5	E5G95916	E5G97988	E5G97989	E5G97990	E5G97991	E5G97992	E5G97993		
		3/4	3	E5G95040	E5G97040	E5G97994	E5G97995	E5G97996	E5G97997	E5G97998		
		1-5/8	3-1/2	E5G95917	E5G97999	E5G97801	E5G97802	E5G97803	E5G97804	E5G97805		
		2-1/2	5	E5G95918	E5G97806	E5G97807	E5G97808	E5G97809	E5G97810	E5G97811		
3/4	3/4	3	5-1/4	E5G95919	E5G97812	E5G97813	E5G97814	E5G97815	E5G97816	E5G97817		
		1	3	E5G95048	E5G97048	E5G97818	E5G97819	E5G97820	E5G97821	E5G97822	E5G97823	
		1-5/8	4	E5G95920	E5G97824	E5G97825	E5G97826	E5G97827	E5G97828	E5G97829	E5G97830	
		2-1/4	5	E5G95921	E5G97831	E5G97832	E5G97833	E5G97834	E5G97835	E5G97836	E5G97837	
		3-1/4	6	E5G95922	E5G97838	E5G97839	E5G97840	E5G97841	E5G97842	E5G97843	E5G97844	
1	1	4	6-1/4	E5G95923	E5G97845	E5G97846	E5G97847	E5G97848	E5G97849	E5G97850	E5G97851	
		1-1/4	3	E5G95064	E5G97064	E5G97852	E5G97853	E5G97854	E5G97855	E5G97856	E5G97857	
		1-1/4	4	E5G95928	E5G97885	E5G97886	E5G97887	E5G97888	E5G97889	E5G97890	E5G97891	
		2	5	E5G95924	E5G97858	E5G97859	E5G97860	E5G97861	E5G97862	E5G97863	E5G97864	
		3-1/4	6	E5G95925	E5G97865	E5G97866	E5G97867	E5G97868	E5G97869	E5G97870	E5G97871	
		4	7	E5G95926	E5G97872	E5G97873	E5G97874	E5G97875	E5G97876	E5G97877	E5G97878	

3-FLUTE EXTENDED LENGTH (PLAIN SHANK) – COATED

JAG96 | JAG98 SERIES



Pages 66–67

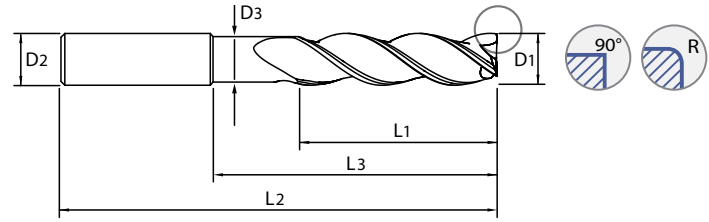

Unit: INCH

OD (D1)	SD (D2)	LOC (L1)	LBS (L3)	Neck Dia. (D3)	OAL (L2)	Square End	Corner Radius						
							.010	.030	.060	.090	.120	.190	.250
							EDP No.	EDP No.	EDP No.	EDP No.	EDP No.	EDP No.	EDP No.
1/4	14	3/8	3/4	.220	2-1/2	JAG96016	JAG98016	JAG98901	JAG98902				
		3/8	1-1/8	.220	3	JAG96901	JAG98903	JAG98904	JAG98905				
3/8	3/8	1/2	1-1/8	.345	3	JAG96024	JAG98024	JAG98906	JAG98907	JAG98908	JAG98909		
		1/2	2-1/8	.345	4	JAG96902	JAG98910	JAG98911	JAG98912	JAG98913	JAG98914		
1/2	1/2	5/8	1-3/8	.470	3	JAG96032	JAG98032	JAG98915	JAG98916	JAG98917	JAG98918	JAG98919	
		5/8	2-1/4	.470	4	JAG96903	JAG98920	JAG98921	JAG98922	JAG98923	JAG98924	JAG98925	
		5/8	3-3/8	.470	5	JAG96904	JAG98926	JAG98927	JAG98928	JAG98929	JAG98930	JAG98931	
		5/8	4-1/4	.470	6	JAG96905	JAG98932	JAG98933	JAG98934	JAG98935	JAG98936	JAG98937	
5/8	5/8	3/4	1-5/8	.585	4	JAG96040	JAG98040	JAG98938	JAG98939	JAG98940	JAG98941	JAG98942	
		3/4	3-3/8	.585	6	JAG96906	JAG98943	JAG98944	JAG98945	JAG98946	JAG98947	JAG98948	
3/4	3/4	1	2	.710	4	JAG96048	JAG98048	JAG98949	JAG98950	JAG98951	JAG98952	JAG98953	JAG98954
		1	3-3/8	.710	6	JAG96907	JAG98955	JAG98956	JAG98957	JAG98958	JAG98959	JAG98960	JAG98961
		1	5	.710	7	JAG96908	JAG98962	JAG98963	JAG98964	JAG98965	JAG98966	JAG98967	JAG98968
1	1	1-1/4	2-5/8	.960	5	JAG96064	JAG98064	JAG98969	JAG98970	JAG98971	JAG98972	JAG98973	JAG98974
		1-1/4	3-3/8	.960	6	JAG96909	JAG98975	JAG98976	JAG98977	JAG98978	JAG98979	JAG98980	JAG98981
		1-1/4	4-3/8	.960	7	JAG96910	JAG98982	JAG98983	JAG98984	JAG98985	JAG98986	JAG98987	JAG98988
		1-1/4	6	.960	9	JAG96911	JAG98989	JAG98990	JAG98991	JAG98992	JAG98993	JAG98994	JAG98995

3-FLUTE EXTENDED LENGTH (PLAIN SHANK) – UNCOATED

E5G96 | E5G98 SERIES



Pages 66–67

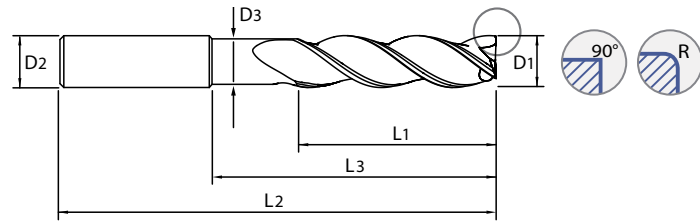

Unit: INCH

OD (D1)	SD (D2)	LOC (L1)	LBS (L3)	Neck Dia. (D3)	OAL (L2)	Square End	Corner Radius						
							.010	.030	.060	.090	.120	.190	.250
							EDP No.	EDP No.	EDP No.	EDP No.	EDP No.	EDP No.	EDP No.
1/4	14	3/8	3/4	.220	2-1/2	E5G96016	E5G98016	E5G98901	E5G98902				
		3/8	1-1/8	.220	3	E5G96901	E5G98903	E5G98904	E5G98905				
3/8	3/8	1/2	1-1/8	.345	3	E5G96024	E5G98024	E5G98906	E5G98907	E5G98908	E5G98909		
		1/2	2-1/8	.345	4	E5G96902	E5G98910	E5G98911	E5G98912	E5G98913	E5G98914		
1/2	1/2	5/8	1-3/8	.470	3	E5G96032	E5G98032	E5G98915	E5G98916	E5G98917	E5G98918	E5G98919	
		5/8	2-1/4	.470	4	E5G96903	E5G98920	E5G98921	E5G98922	E5G98923	E5G98924	E5G98925	
		5/8	3-3/8	.470	5	E5G96904	E5G98926	E5G98927	E5G98928	E5G98929	E5G98930	E5G98931	
		5/8	4-1/4	.470	6	E5G96905	E5G98932	E5G98933	E5G98934	E5G98935	E5G98936	E5G98937	
5/8	5/8	3/4	1-5/8	.585	4	E5G96040	E5G98040	E5G98938	E5G98939	E5G98940	E5G98941	E5G98942	
		3/4	3-3/8	.585	6	E5G96906	E5G98943	E5G98944	E5G98945	E5G98946	E5G98947	E5G98948	
3/4	3/4	1	2	.710	4	E5G96048	E5G98048	E5G98949	E5G98950	E5G98951	E5G98952	E5G98953	E5G98954
		1	3-3/8	.710	6	E5G96907	E5G98955	E5G98956	E5G98957	E5G98958	E5G98959	E5G98960	E5G98961
		1	5	.710	7	E5G96908	E5G98962	E5G98963	E5G98964	E5G98965	E5G98966	E5G98967	E5G98968
1	1	1-1/4	2-5/8	.960	5	E5G96064	E5G98064	E5G98969	E5G98970	E5G98971	E5G98972	E5G98973	E5G98974
		1-1/4	3-3/8	.960	6	E5G96909	E5G98975	E5G98976	E5G98977	E5G98978	E5G98979	E5G98980	E5G98981
		1-1/4	4-3/8	.960	7	E5G96910	E5G98982	E5G98983	E5G98984	E5G98985	E5G98986	E5G98987	E5G98988
		1-1/4	6	.960	9	E5G96911	E5G98989	E5G98990	E5G98991	E5G98992	E5G98993	E5G98994	E5G98995

CASE STUDY | Field Test Report

The Goal: Reduce cycle time by at least 25%.

The Test:

Three YG-1 3-flute ALU-POWER HPC end mills are pitted against two strong competitors using similar configurations for milling aluminum alloy.

Cutting Conditions		
Material	7075 T-6 (Ribs)	
Machine	5-axis horizontal machining center	
Coolant	High pressure	
Tool Holder	Shrink-fit Haimer	
Speed (mm)	RPM	V _c (SMM)
25mm tool	33,000	2,594
20mm tool	30,000	1,886
16mm tool	26,000	1,308
Speed (in.)	RPM	SFM
.9843 in. tool	33,000	8,510
.7874 in. tool	30,000	6,189
.6299 in. tool	26,000	4,291
Feed (mm)	m/min	mm/rev
25mm tool	20	.6071
20mm tool	24.5	.8179
16mm tool	11.4	.4420
Feed (in.)	in./min	in./rev
.9843 in. tool	787.4	.0239
.7874 in. tool	964.565	.0322
.6299 in. tool	452.755	.0174
Step (mm)	0.5 – 18	
Step (in.)	.01968 – .7087	
Axial (mm)	13	
Axial (in.)	.5118	
Competitor	U.S. Manufacturer and UK Manufacturer	
YG-1 Tools	3 ALU-POWER HPC Tools	
Fixture	Screws & Vacuum	

The Results:

Saved up to \$2 million by improving the process by 27%.

The combination of advanced geometry and the superior coating of the YG-1 3-Flute ALU-POWER HPC end mills beat both competitors in:

- ▶ Trochoidal machining
- ▶ Peel milling
- ▶ Cutter path performance

These process improvements resulted in a savings of seven minutes per part. The process was rolled out to all machines in the company.

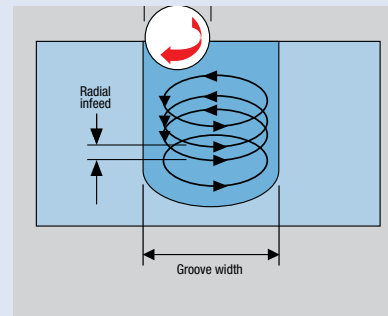

▲ **In trochoidal milling applications,** the cutter follows a spiral path by moving radially as it rotates, providing faster machining times, lower tooling costs and reduced loads on machine components.

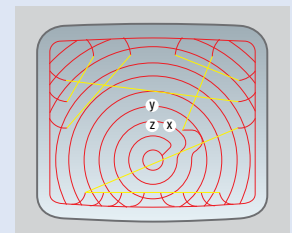

▲ Outstanding chip evacuation through deep gullet design coupled with high-speed milling leaves a well-defined, clean cutter path.

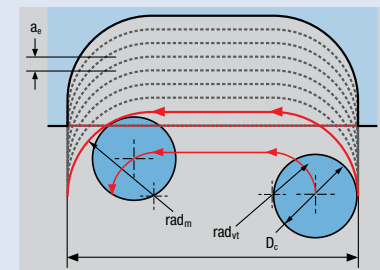

◀ **Peel milling applications** benefit from ALU-POWER HPC's super-sharp high-speed milling ability.



RECOMMENDED CUTTING CONDITIONS – INCH

JAG95 | JAG96 | JAG97 | JAG98 SERIES
E5G95 | E5G96 | E5G97 | E5G98 SERIES

RPM = rev./min. Feed = in./min.
Vc = ft./min. Fz = in./tooth

Speed and Feed Recommendations							Diameter (D)						
ISO Hardness (BHN)	Coolant	Cutting Method	Ap x D	Ae x D	Vc (SFM)	Parameters	1/8	1/4	3/8	1/2	5/8	3/4	1
N < 16% Silicon ALUMINUM ALLOYS: 2024, 5052, 5086, 6061, 6063, 7075	Emulsion	Slotting 	1	1	2000	RPM	61100	30500	20400	15300	12200	10200	7600
					1300~10000	Fz	.0010	.0030	.0045	.0060	.0066	.0075	.0100
						Feed (IPM)	183	275	275	275	242	230	228
		Profiling 	1.5	0.5	3000	RPM	91700	45800	30600	23000	18300	15300	11500
					1600~10000	Fz	.0010	.0030	.0045	.0060	.0066	.0075	.0100
						Feed (IPM)	275	412	413	414	362	344	345
		HSM 	2	0.05	8000	RPM	244500	122200	81500	61100	48900	40700	30600
					1600~10000	Fz	.0021	.0055	.0105	.0140	.0150	.0165	.0195
						Feed (IPM)	1540	2016	2567	2566	2201	2015	1790
N > 16% Silicon ALUMINUM DIE CAST ALLOYS: A-390, A392, B-390 [YG-1 recommends the use of coated tools only]	Emulsion	Slotting 	1	1	600	RPM	18336	9168	6112	4584	3667	3056	2292
					(480 – 720)	Fz	.0010	.0030	.0045	.0060	.0066	.0075	.0100
						Feed (IPM)	55	83	83	83	73	69	69
		Profiling 	1.5	0.5	800	RPM	24448	12224	8149	6112	4890	4075	3056
					(640 – 960)	Fz	.0010	.0030	.0045	.0060	.0066	.0075	.0100
						Feed (IPM)	73	110	110	110	97	92	92
		HSM 	2	0.05	1200	RPM	36672	18336	12224	9168	7334	6112	4584
					(960 – 1440)	Fz	.0021	.0055	.0105	.0140	.0150	.0165	.0195
						Feed (IPM)	231	303	385	385	330	303	268
N NON-FERROUS ALLOYS: COPPER ALLOYS, ALUMINUM BRONZE, BRASS, NAVAL BRASS, RED BRASS	Emulsion	Slotting 	1	1	880	RPM	26893	13446	8964	6723	5379	4482	3362
					(704 – 1056)	Fz	.0008	.0020	.0040	.0050	.0055	.0060	.0070
						Feed (IPM)	65	81	108	101	89	81	71
		Profiling 	1.5	0.5	1150	RPM	35144	17572	11715	8786	7029	5857	4393
					(920 – 1380)	Fz	.0008	.0020	.0040	.0050	.0055	.0060	.0070
						Feed (IPM)	84	105	141	132	116	105	92
		HSM 	2	0.05	1850	RPM	56536	28268	18845	14134	11307	9423	7067
					(1480 – 2220)	Fz	.0017	.0045	.0085	.0115	.0130	.0140	.0160
						Feed (IPM)	288	382	481	488	441	396	339

Profiling/HSM

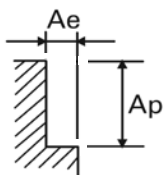

Slotting

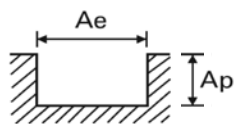

- NOTES:**
- ▶ All cutting data are target values.
 - ▶ Maximum recommended depth shown.
 - ▶ Finish cuts typically require reduced feed rates and/or higher spindle speed, with radial width of 2%xD or less
 - ▶ Reduce speed and feed recommendations for materials harder than listed.
 - ▶ Reduce cut depth and feed by 50% for long-flute or long-reach tools.
 - ▶ Above recommendations are based on ideal conditions. Adjust parameters accordingly for smaller taper machining centers or less rigid conditions.
 - ▶ HSM = high-speed machining

RECOMMENDED CUTTING CONDITIONS – INCH

JAG95 | JAG96 | JAG97 | JAG98 SERIES
E5G95 | E5G96 | E5G97 | E5G98 SERIES

RPM = rev./min. Feed = in./min.
Vc = ft./min. Fz = in./tooth

Speed and Feed Recommendations							Diameter (D)						
ISO Hardness (BHN)	Coolant	Cutting Method	Ap x D	Ae x D	Vc (SFM)	Parameters	1/8	1/4	3/8	1/2	5/8	3/4	1
N NON-FERROUS ALLOYS: COPPER ALLOYS, BERYLLIUM COPPER, C110, MANGANESE BRONZE, TIN BRONZE	Emulsion	Slotting 	1	1	300	RPM	9168	4584	3056	2292	1834	1528	1146
					(240-360)	Fz	.0008	.0020	.0040	.0050	.0055	.0060	.0070
						Feed (IPM)	22	28	37	34	30	28	24
		Profiling 	1.5	0.5	450	RPM	13752	6876	4584	3438	2750	2292	1719
					(360-540)	Fz	.0008	.0020	.0040	.0050	.0055	.0060	.0070
						Feed (IPM)	33	41	55	52	45	41	36
		HSM 	2	0.05	750	RPM	22920	11460	7640	5730	4584	3820	2865
					(600-900)	Fz	.0017	.0045	.0085	.0115	.0130	.0140	.0160
						Feed (IPM)	117	155	195	198	179	160	138
PLASTICS: ABS, POLYCARBONATE, PVC, POLYCARBOLENE	Air	Slotting 	1	1	1670	RPM	51035	25518	17012	12759	10207	8506	6379
					(1336-2004)	Fz	.0015	.0040	.0075	.0100	.0110	.0120	.0140
						Feed (IPM)	230	306	383	383	337	306	268
		Profiling 	1.5	0.5	2070	RPM	63259	31630	21086	15815	12652	10543	7907
					(1656-2484)	Fz	.0015	.0040	.0075	.0100	.0110	.0120	.0140
						Feed (IPM)	285	380	474	474	418	380	332
		HSM 	2	0.05	3350	RPM	102376	51188	34125	25594	20475	17063	12797
					(2680-4020)	Fz	.0034	.0090	.0170	.0230	.0250	.0275	.0320
						Feed (IPM)	1044	1382	1740	1766	1536	1408	1229

Profiling/HSM

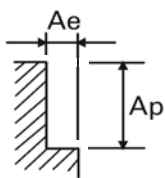

Slotting

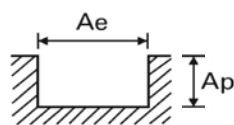

NOTES:

- ▶ All cutting data are target values.
- ▶ Maximum recommended depth shown.
- ▶ Finish cuts typically require reduced feed rates and/or higher spindle speed, with radial width of 2%xD or less
- ▶ Reduce speed and feed recommendations for materials harder than listed.
- ▶ Reduce cut depth and feed by 50% for long-flute or long-reach tools.
- ▶ Above recommendations are based on ideal conditions. Adjust parameters accordingly for smaller taper machining centers or less rigid conditions.
- ▶ HSM = high-speed machining

Minicut Cobalt:

▶ RIDING THE WAVE OF TECHNOLOGY.



FOR TITANIUM, ALUMINUM AND STAINLESS STEEL ALLOYS

From its precise machine-polished flute design to its milled shiny rake face, the Minicut Wave Cut is built to stay sharp in the most demanding aerospace materials.

- ▶ Variable helix in both 3- and 6-flute designs takes on high feed rates without producing damaging chatter.
- ▶ With a cobalt content of 8%, Minicut retains hardness while resisting heat in tough conditions.

The Minicut high-performance cobalt end mill line was designed to produce outstanding performance in the lower-speed machines used in the aerospace industry.

- ▶ Rigid cobalt design holds its own at lower speeds and high feed rates.
- ▶ From center cutting to fine finishing to efficient roughing, the Minicut line offers many productive choices for aerospace operations.
- ▶ Wave cutting action produced by variable-helix flute design minimizes vibration and chatter.







Pick the performer that's perfect for your project.





For optimum performance with maximum chip load per tooth, the 993 meets your titanium work head-on. In aluminum, nothing roughs better than the 930, with its aggressive 3-flute design and its ability to handle high feed rates at lower machine speeds. The 865 features excellent finishing for titanium and high-tensile materials. And for reduced spindle load with high removal rates in titanium and stainless steels, choose the 836 for improved chip control.

SELECTION GUIDE

◎ Excellent ○ Good

ITEM	MODEL	DESCRIPTION	DIA.		S	N	M	PAGE
			Min.	Max.	Titanium	Aluminum	Stainless Steel	
993 MINICUT WAVE CUT		4-FLUTE & 6-FLUTE WAVE CUT ROUGHING END MILLS	CHAMFER	3/4	2	◎	○	70
930 MINICUT WAVE CUT		3-FLUTE WAVE CUT ROUGHING END MILLS	SQUARE END	3/8	1-1/4	◎		71
865		4-FLUTE & 6-FLUTE FINISHING END MILLS	SQUARE END	1	2	◎	○	72
836		4-FLUTE & 6-FLUTE ROUGHERS WITH CHIP BREAKERS	CHAMFER	1	2	◎	○	73

METRIC

993M MINICUT WAVE CUT		4-FLUTE & 6-FLUTE WAVE CUT ROUGHING END MILLS	CHAMFER	20.0	50.0	◎	○	70
930M MINICUT WAVE CUT		3-FLUTE WAVE CUT ROUGHING END MILLS	SQUARE END	10.0	32.0	◎		71
865M		4-FLUTE & 6-FLUTE FINISHING END MILLS	SQUARE END	20.0	50.0	◎	○	72
836M		4-FLUTE & 6-FLUTE ROUGHERS WITH CHIP BREAKERS	CHAMFER	20.0	50.0	◎	○	73

RECOMMENDED CUTTING CONDITIONS

75-77

GUIDE TO ICONS

This tool is made
of cobalt.

CO

Helix Angle

National
Aerospace
Standards

NAS

Tool Ends

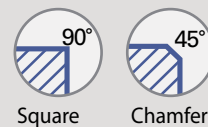

No. of Flutes



Type of Shank



Weldon Flat

Cutting Conditions



Center Cutting Geometry



993/993M 4-FLUTE AND 6-FLUTE WAVE CUT ROUGHING END MILLS



Page 75

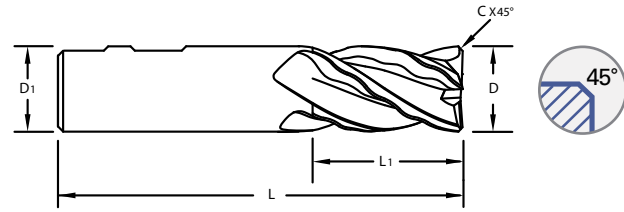

993

Unit: INCH

Mill Diameter (D)	Shank Diameter (D1)	Length of Cut (L1)	Overall Length (L)	Number of Flutes	Chamfer (CH)	EDP No.
3/4	3/4	1-5/8	3-7/8	4	.030	993-2416
		2-1/4	4-1/2	4	.030	993-2422
		3	5-1/4	4	.030	993-2430
1	1	2	4-1/2	6	.040	993-3220A
		2	4-1/2	4	.040	993-3220*
		3	5-1/2	6	.040	993-3230A
		3	5-1/2	4	.040	993-3230*
		4	6-1/2	6	.040	993-3240A
		4	6-1/2	4	.040	993-3240*
1-1/4	1-1/4	2	4-1/2	6	.060	993-4020A
		2	4-1/2	4	.060	993-4020*
		3	5-1/2	6	.060	993-4030A
		3	5-1/2	4	.060	993-4030*
		4	6-1/2	6	.060	993-4040A
		4	6-1/2	4	.060	993-4040*
		6	8-1/2	6	.060	993-4060A
1-1/2	1-1/4	2	4-1/2	6	.060	993-4820-40A
		3	5-1/2	6	.060	993-4830-40A
		4	6-1/2	6	.060	993-4840-40A
2	2	2	5-3/4	6	.060	993-6420A
		3	6-3/4	6	.060	993-6430A
		4	7-3/4	6	.060	993-6440A
		6	9-3/4	6	.060	993-6460A
		8	11-3/4	6	.060	993-6480A

993M

Unit: INCH

Mill Diameter (D)	Shank Diameter (D1)	Length of Cut (L1)	Overall Length (L)	Number of Flutes	Chamfer (CH)	EDP No.
20	20	38	104	4	0.8	993M-2038
		75	141	4	0.8	993M-2075
25	25	45	121	6	1.0	993M-2545A
		45	121	4	1.0	993M-2545*
		90	166	6	1.0	993M-2590A
		90	166	4	1.0	993M-2590*
32	32	53	132	6	1.5	993M-3253A
		53	132	4	1.5	993M-3253*
		106	186	6	1.5	993M-32106A
		106	186	4	1.5	993M-32106*
40	32	63	143	6	1.5	993M-4063-32A
		125	205	6	1.5	993M-40125-32A
50	50	75	177	6	1.5	993M-5075A
		106	208	6	1.5	993M-50106A
		150	252	6	1.5	993M-50150A

Reinforced cutting edge

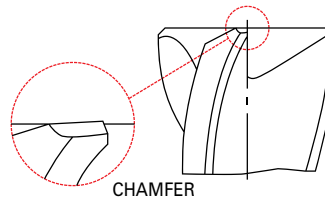

*1" and 1-1/4" end mills with 4 flutes available upon request

Price and delivery available upon request for:

- ▶ Other dimensions
- ▶ Corner radius or chamfer
- ▶ Ball nose
- ▶ Left hand
- ▶ Extended neck
- ▶ Coating

930/930M 3-FLUTE ROUGHING END MILLS



Page 77

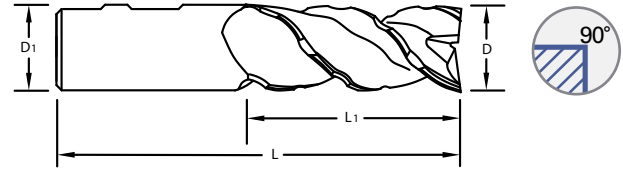

930

Unit: INCH

Mill Diameter (D)	Shank Diameter (D ₁)	Length of Cut (L ₁)	Overall Length (L)	EDP No.
3/8	3/8	3/4	2-1/2	930-1208
		1-3/8	3-1/8	930-1213
1/2	1/2	1-1/4	3-1/4	930-1612
		2	4	930-1620
		3	5	930-1630
5/8	5/8	1-5/8	3-3/4	930-2016
3/4	3/4	1-5/8	3-7/8	930-2416
		2-1/4	4-1/2	930-2422
		3	5-1/4	930-2430
1	1	2	4-1/2	930-3220
		3	5-1/2	930-3230
		4	6-1/2	930-3240
1-1/4	1-1/4	2	4-1/2	930-4020
		3	5-1/2	930-4030

Price and delivery available upon request for:

- ▶ Other dimensions
- ▶ Corner radius or chamfer
- ▶ Ball nose
- ▶ Left hand
- ▶ Extended neck
- ▶ Coating

930M

Unit: INCH

Mill Diameter (D)	Shank Diameter (D ₁)	Length of Cut (L ₁)	Overall Length (L)	EDP No.
10	10	16	66	930M-1016
		22	72	930M-1022
12	12	26	83	930M-1226
		53	110	930M-1253
16	16	32	92	930M-1632
		63	123	930M-1663
20	20	38	104	930M-2038
		75	141	930M-2075
25	25	45	121	930M-2545
		90	166	930M-2590
30	25	45	121	930M-3045
		90	166	930M-3090
32	32	53	133	930M-3253
		106	186	930M-32106

Reinforced cutting edge

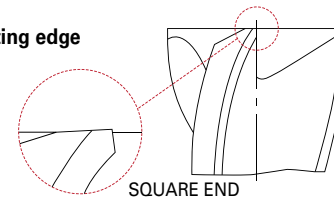

The Minicut Wave Cut advantage

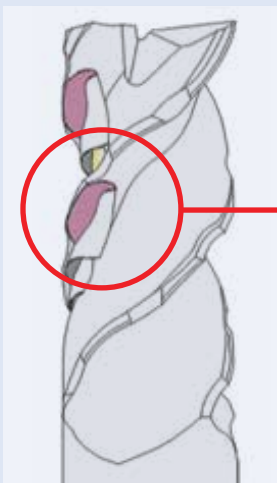

The Minicut Wave Cut opened a new chapter in cobalt end mills. With its unique geometry that puts more cutting force to the cutting edge, Minicut Wave Cut took the lead over other cutters used to machine exotic materials.

During chip formation, as the chip begins to curl within the gullet space, this unique geometry provides less space in which to curl at the two extremities of the interrupted cutting edge, compared to the central portion. The sinusoidal gullet, in fact, reaches its maximum amplitude at the middle of the interrupted cutting edge. This uneven curling space creates a springing effect on the chips and, combined with the shearing force, produces the phenomenon of chip ejection from the work area.

865/865M 4-FLUTE AND 6-FLUTE FINISHING END MILLS



Page 76

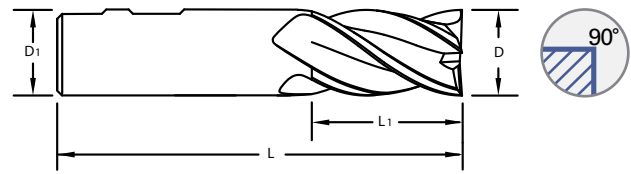

865

NAS type 46 & 66

Unit: INCH

Mill Diameter (D)	Shank Diameter (D1)	Length of Cut (L1)	Overall Length (L)	Number of Flutes	EDP No.
1	1	2	4-1/2	6	865-3220A
		3	5-1/2	6	865-3230A
		4	6-1/2	6	865-3240A
1-1/4	1-1/4	2	4-1/2	6	865-4020A
		3	5-1/2	6	865-4030A
		4	6-1/2	6	865-4040A
		6	8-1/2	6	865-4060A
1-1/2	1-1/4	2	4-1/2	6	865-4820A
		3	5-1/2	6	865-4830A
		4	6-1/2	6	865-4840A
2	2	3	6-3/4	6	865-6430A
		4	7-3/4	6	865-6440A
		6	9-3/4	6	865-6460A
		8	11-3/4	6	865-6480A

Price and delivery available upon request for:

- ▶ Other dimensions
- ▶ Left hand
- ▶ Corner radius or chamfer
- ▶ Extended neck
- ▶ Ball nose
- ▶ Coating

865M

Unit: INCH

Mill Diameter (D)	Shank Diameter (D1)	Length of Cut (L1)	Overall Length (L)	Number of Flutes	EDP No.
20	20	38	104	4	865M-2038
		75	141	4	865M-2075
25	25	45	121	6	865M-2545A
		90	166	6	865M-2590A
32	32	53	132	6	865M-3253A
		106	186	6	865M-32106A
40	32	63	143	6	865M-4063A
		125	205	6	865M-40125A
50	50	75	177	6	865M-5075A
		106	208	6	865M-50106A
		150	252	6	865M-50150A

Reinforced cutting edge

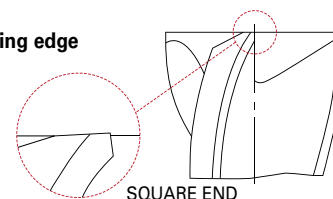

Need assistance?

Minicut has sales representatives and distributor facilities all over the world to serve you better.

Call toll free: 800-800-2011

Email: sales@minicut.com

You can also visit our website – it's your 24/7 resource!

minicut.com



836/836M 4-FLUTE AND 6-FLUTE ROUGHER WITH CHIP BREAKER



Page 76-77

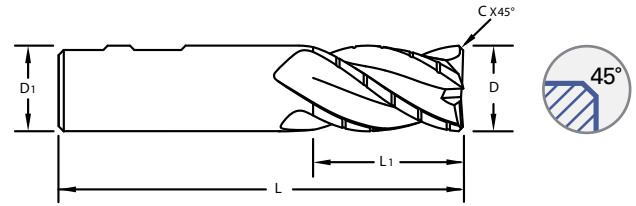

836

Unit: INCH

Mill Diameter (D)	Shank Diameter (D ₁)	Length of Cut (L ₁)	Overall Length (L)	Number of Flutes	Chamfer (CH)	EDP No.
1	1	2	4-1/2	6	.040	836-3220A
		3	5-1/2	6	.040	836-3230A
		4	6-1/2	6	.040	836-3240A
1-1/4	1-1/4	2	4-1/2	6	.060	836-4020A
		3	5-1/2	6	.060	836-4030A
		4	6-1/2	6	.060	836-4040A
1-1/2	1-1/4	2	4-1/2	6	.060	836-4820A
		3	5-1/2	6	.060	836-4830A
		4	6-1/2	6	.060	836-4840A
2	1-1/4	2	4-1/2	6	.060	836-6420-40A
2	2	2	5-3/4	6	.060	836-6420A
		3	6-3/4	6	.060	836-6430A
		4	7-3/4	6	.060	836-6440A
		6	9-3/4	6	.060	836-6460A

Price and delivery available upon request for:

- ▶ Other dimensions
- ▶ Corner radius or chamfer
- ▶ Ball nose
- ▶ Left hand
- ▶ Extended neck
- ▶ Coating

836M

Unit: INCH

Mill Diameter (D)	Shank Diameter (D ₁)	Length of Cut (L ₁)	Overall Length (L)	Number of Flutes	Chamfer (CH)	EDP No.
20	20	38	104	4	0.8	836M-2038
		75	141	4	0.8	836M-2075
25	25	45	121	6	1.0	836M-2545A
		90	166	6	1.0	836M-2590A
32	32	53	132	6	1.5	836M-3253A
		106	186	6	1.5	836M-32106A
40	32	63	143	6	1.5	836M-4063A
		125	205	6	1.5	836M-40125A
50	50	75	177	6	1.5	836M-5075A
		106	208	6	1.5	836M-50106A
		150	252	6	1.5	836M-50150A

Reinforced cutting edge

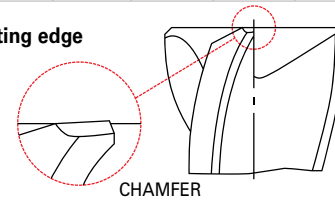

CHAMFER

Need something special?

If you need special cutting tools or modifications to existing tools, we offer a complete range of engineering services. We can design and manufacture to your exact specifications.



CASE STUDY | Field Test Report

The Goal: Test 993-6440A 6-Flute Against Competitor

The Test:

Rough cutting titanium 6Al4V aircraft structures using Cincinnati 3-spindle, 5-axis gantry machine at a feed rate of 4.4 inch/min.

Cutting Conditions	
Milling Method	Profiling
Material	Titanium 6Al4V
Machine	Cincinnati 3-spindle, 5-axis gantry machine
Coolant	External
Tool Holder	Milling, side lock
Speed (SFM)	60
RPM	115
Feed (inch/min.)	4.4
Axial Engagement (inch) A_p	3.2
Radial Engagement (inch) A_e	0.85

The Results:

Saved customer \$62,000 in operational costs.

The combination of Minicut geometry and exceptional quality beat competitors and allowed a savings of \$62,000 in operational costs. Tool life also was improved by 35%.

- ▶ End mills show clean, predictable flank wear
- ▶ No evidence of chipping

The test exhibited exceptional quality while profiling titanium at 115 rev/min.



▲ Aircraft-grade titanium 6Al4V is easily cut using the Minicut Wave Cut's ability to operate efficiently at lower RPMs.



▲ Extensive rough cutting is possible with the aggressive wave action of the 6-flute 993 Minicut Wave Cut.

RECOMMENDED CUTTING CONDITIONS

993*
(INCH)

ISO Hardness (Brinell)	Work Materials	Speed and Feed Recommendations					Diameter (in.)				
		Type of Cut	Ap x D	Ae x D	Speed	Parameters	3/4	1	1-1/4	1-1/2	2
S	TITANIUM ALLOY	Side Cutting 	1.5	0.2-0.5	50-80 (SFM)	RPM (rev/min)	254	191	153	127	96
						Fz (inch/tooth)	.0035	.0040	.0050	.0055	.0060
						Feed (inch/min)	5.3	4.6	4.6	4.2	3.5
		Slotting 	0.5-0.8	1	50-80 (SFM)	RPM (rev/min)	254	191	153	127	96
						Fz (inch/tooth)	.0025	.0030	.0040	.0045	.0050
						Feed (inch/min)	3.8	3.4	3.7	3.4	2.9
M	STAINLESS STEEL	Side Cutting 	1.5	0.2-0.5	40-80 (SFM)	RPM (rev/min)	203	153	122	102	76
						Fz (inch/tooth)	.0035	.0040	.0050	.0055	.0060
						Feed (inch/min)	4.3	3.7	3.7	3.4	2.7
		Slotting 	0.5-0.8	1	40-80 (SFM)	RPM (rev/min)	203	153	122	102	76
						Fz (inch/tooth)	.0025	.0030	.0040	.0045	.0050
						Feed (inch/min)	3.0	2.8	2.9	2.8	2.3

* Feeds are given for 6-flute end mills.

993M*
(METRIC)

ISO Hardness (Brinell)	Work Materials	Speed and Feed Recommendations					Diameter (mm)				
		Type of Cut	Ap x D	Ae x D	Speed	Parameters	20	25	32	40	50
S	TITANIUM ALLOY	Side Cutting 	1.5	0.2-0.5	15-25 (m/min)	RPM (rev/min)	239	191	149	119	95
						Fz (mm/tooth)	.089	.102	.127	.140	.152
						Feed (mm/min)	127	116	114	100	87
		Slotting 	0.5-0.8	1	15-25 (m/min)	RPM (rev/min)	239	191	149	119	95
						Fz (mm/tooth)	.064	.076	.102	.114	.127
						Feed (mm/min)	91	87	91	82	73
M	STAINLESS STEEL	Side Cutting 	1.5	0.2-0.5	12-25 (m/min)	RPM (rev/min)	191	153	103	95	76
						Fz (mm/tooth)	.089	.102	.127	.140	.152
						Feed (mm/min)	102	93	78	80	69
		Slotting 	0.5-0.8	1	12-25 (m/min)	RPM (rev/min)	191	153	103	95	76
						Fz (mm/tooth)	.064	.076	.102	.114	.127
						Feed (mm/min)	73	70	63	65	58

* Feeds are given for 6-flute end mills.

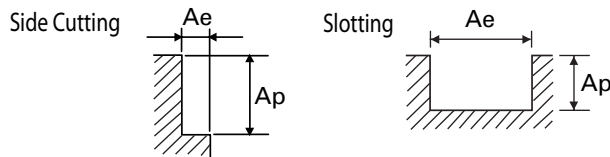



NOTES: ▶ Coolant needs to be used when machining (slotting or profiling) with these end mills.

▶ For long-length tools or less rigid conditions, reduce speeds and feeds accordingly.



RECOMMENDED CUTTING CONDITIONS

865*
(INCH)

ISO Hardness (Brinell)	Work Materials	Type of Cut	Speed and Feed Recommendations				Diameter (in.)				
			Ap x D	Ae x D	Speed	Parameters	3/4	1	1-1/4	1-1/2	2
S	TITANIUM ALLOY	Side Cutting 	1.5	0.03-0.05	50-80 (SFM)	RPM (rev/min)	254	191	153	127	96
						Fz (inch/tooth)	.0040	.0045	.0050	.0055	.0060
						Feed (inch/min)	6.1	5.2	4.6	4.2	3.5
M	STAINLESS STEEL	Side Cutting 	1.5	0.03-0.05	40-80 (SFM)	RPM (rev/min)	203	153	122	102	76
						Fz (inch/tooth)	.0040	.0045	.0050	.0055	.0060
						Feed (inch/min)	4.9	4.1	3.7	3.4	2.7





* Feeds are given for 6-flute end mills.

865M*
(METRIC)

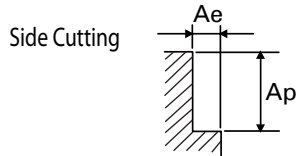
ISO Hardness (Brinell)	Work Materials	Type of Cut	Speed and Feed Recommendations				Diameter (mm)				
			Ap x D	Ae x D	Speed	Parameters	20	25	32	40	50
S	TITANIUM ALLOY	Side Cutting 	1.5	0.03-0.05	15-25 (m/min)	RPM (rev/min)	239	191	149	119	95
						Fz (mm/tooth)	.089	.102	.127	.140	.152
						Feed (mm/min)	127	116	114	100	87
M	STAINLESS STEEL	Side Cutting 	1.5	0.03-0.05	12-25 (m/min)	RPM (rev/min)	191	153	119	95	76
						Fz (mm/tooth)	.089	.102	.127	.140	.152
						Feed (mm/min)	102	93	91	80	69

* Feeds are given for 6-flute end mills.

836*
(INCH)

ISO Hardness (Brinell)	Work Materials	Type of Cut	Speed and Feed Recommendations				Diameter (in.)				
			Ap x D	Ae x D	Speed	Parameters	3/4	1	1-1/4	1-1/2	2
S	TITANIUM ALLOY	Side Cutting 	1.5	0.2-0.5	50-80 (SFM)	RPM (rev/min)	254	191	153	127	96
						Fz (inch/tooth)	.0035	.0035	.0040	.0040	.0050
						Feed (inch/min)	5.3	4.0	3.7	3.0	2.9
		Slotting 	0.5-0.8	1	50-80 (SFM)	RPM (rev/min)	254	191	153	127	96
						Fz (inch/tooth)	.0025	.0025	.0030	.0030	.0040
						Feed (inch/min)	3.8	2.9	2.8	2.3	2.3
M	STAINLESS STEEL	Side Cutting 	1.5	0.2-0.5	40-80 (SFM)	RPM (rev/min)	203	153	122	102	76
						Fz (inch/tooth)	.0035	.0035	.0040	.0040	.0050
						Feed (inch/min)	4.3	3.2	2.9	2.4	2.3
		Slotting 	0.5-0.8	1	40-80 (SFM)	RPM (rev/min)	203	153	122	102	76
						Fz (inch/tooth)	.0025	.0025	.0030	.0030	.0040
						Feed (inch/min)	3.0	2.3	2.2	1.8	1.8

* Feeds are given for 6-flute end mills.

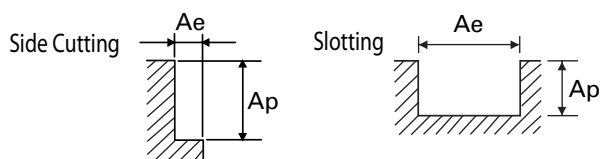

NOTES: ▶ Coolant needs to be used when machining (slotting or profiling) with these end mills.

▶ For long-length tools or less rigid conditions, reduce speeds and feeds accordingly.

RECOMMENDED CUTTING CONDITIONS

836M*
(METRIC)

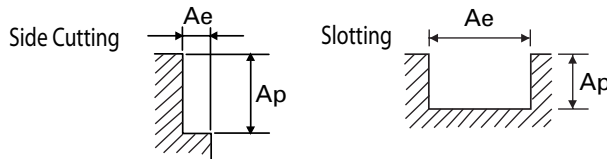
ISO Hardness (Brinell)	Work Materials	Speed and Feed Recommendations*				Diameter (mm)					
		Type of Cut	Ap x D	Ae x D	Speed	Parameters	20	25	32	40	50
S	TITANIUM ALLOY	Side Cutting 	1.5	0.2-0.5	15-25 (m/min)	RPM (rev/min)	239	191	149	119	95
						Fz (mm/tooth)	.089	.089	.102	.102	.127
						Feed (mm/min)	127	102	91	73	73
		Slotting 	0.5-0.8	1	15-25 (m/min)	RPM (rev/min)	239	191	149	119	95
						Fz (mm/tooth)	.064	.076	.102	.114	.102
						Feed (mm/min)	91	87	91	82	58
M	STAINLESS STEEL	Side Cutting 	1.5	0.2-0.5	12-25 (m/min)	RPM (rev/min)	191	153	103	95	76
						Fz (mm/tooth)	.089	.089	.102	.102	.127
						Feed (mm/min)	102	82	63	58	58
		Slotting 	0.5-0.8	1	12-25 (m/min)	RPM (rev/min)	191	153	103	95	76
						Fz (mm/tooth)	.064	.076	.102	.114	.102
						Feed (mm/min)	73	70	63	65	47



* Feeds are given for 6-flute end mills.

930
(INCH)

ISO Hardness (Brinell)	Work Materials	Speed and Feed Recommendations				Diameter (in.)						
		Type of Cut	Ap x D	Ae x D	Speed	Parameters	3/8	1/2	5/8	3/4	1	1-1/4
N	ALUMINUM ALLOY	Side Cutting 	1.5	0.2-0.5	1000-2000 (SFM)	RPM (rev/min)	12730	10600	7950	6360	5100	3970
						Fz (inch/tooth)	.0026	.0039	.0052	.0065	.0092	.0118
						Feed (inch/min)	100	124	124	124	140	140
		Slotting 	0.5-0.8	1	1000-2000 (SFM)	RPM (rev/min)	12730	10600	7950	6360	5100	3970
						Fz (inch/tooth)	.0020	.0030	.0040	.0050	.0070	.0090
						Feed (inch/min)	76	95	95	95	107	107

930M
(METRIC)

ISO Hardness (Brinell)	Work Materials	Speed and Feed Recommendations				Diameter (mm)						
		Type of Cut	Ap x D	Ae x D	Speed	Parameters	10	12	16	20	25	32
N	ALUMINUM ALLOY	Side Cutting 	1.5	0.2-0.5	300-600 (m/min)	RPM (rev/min)	1100	9800	7800	6100	5100	3800
						Fz (mm/tooth)	.066	.099	.132	.165	.234	.300
						Feed (mm/min)	2178	2911	3089	3020	3580	3420
		Slotting 	0.5-0.8	1	300-600 (m/min)	RPM (rev/min)	11000	9800	7800	6100	5100	3800
						Fz (mm/tooth)	.051	.076	.102	.127	.178	.229
						Feed (mm/min)	1683	2234	2387	2324	2723	2611

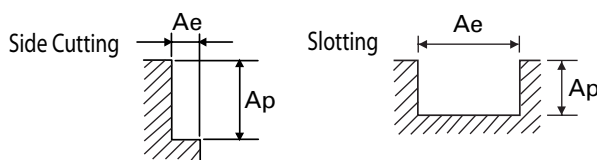
**NOTES:** ▶ Coolant needs to be used when machining (slotting or profiling) with these end mills.

▶ For long-length tools or less rigid conditions, reduce speeds and feeds accordingly.



TANK-POWER: ▲ AEROSPACE MATERIAL? DRIVE A TANK THROUGH IT.

DESIGNED TO PERFORM WHERE OTHERS WON'T—STAINLESS STEELS, TITANIUM, ALLOY STEELS AND MORE—TANK-POWER'S POWDERED METAL TECHNOLOGY SHINES WITH OUTSTANDING VALUE

Premium HSS-PM TANK-POWER end mills are the smart choice for high-production metal removal in a range of aerospace materials.



- ▶ 2 to 8 flutes
- ▶ Regular and long lengths, extended neck
- ▶ Plain or Weldon flat shank
- ▶ Coarse-pitch or fine-pitch roughing, slotting, side cutting
- ▶ Uncoated or TiAlN coatings are available with TANK-POWER end mills

With **TANK-POWER end mills**, faster feed & speed than normal HSS can be applied to hardened steels up to Rc 45. Accordingly, YPM made by powder metallurgy makes much higher productivity possible.



TANK-POWER two-flute ball end mills can take on the toughest materials, so you can rough, slot, profile and finish with one versatile tool..



TANK-POWER roughers are metal-removal monsters made to plow through anything. They're designed for heavy cuts in any aerospace material, generating small chips that are easily removed.



GUIDE TO ICONS

Tool Construction



Helix Angle



No. of Flutes



Type of Periphery



Type of Shank



Plain shank

Weldon flat

Cutting Conditions







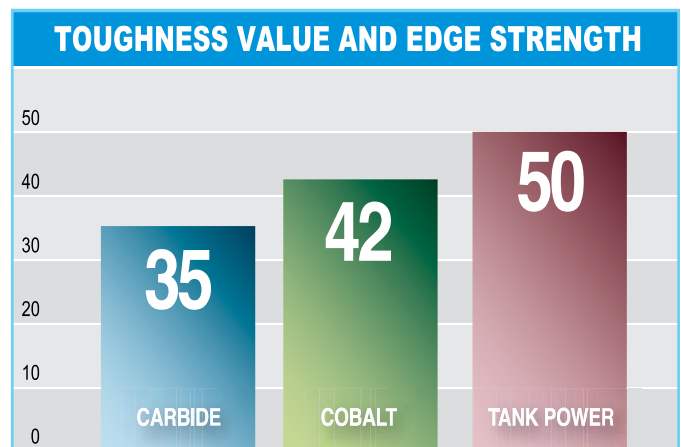
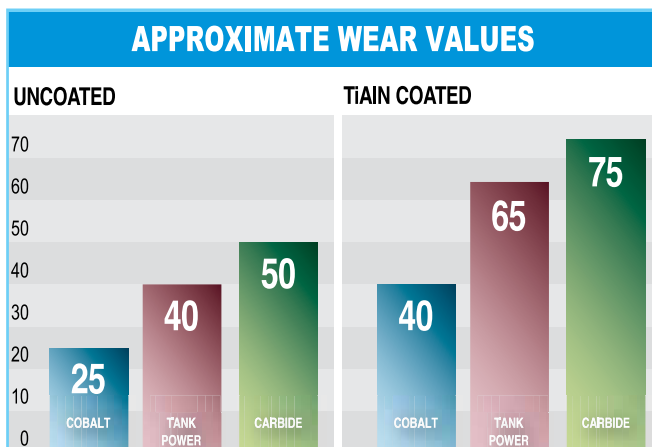



Tough tools, tough edges for tough materials

The numbers don't lie: For longer tool life and higher feed rates, TANK-POWER end mills are the smart choice.



SELECTION GUIDE – INCH

SERIES	MODEL	DESCRIPTION	SIZE		PAGE
			Min.	Max.	
E9985		PREMIUM HSS-PM, 4-FLUTE REGULAR LENGTH	D1/8	D1	82
E9988		PREMIUM HSS-PM, 3- AND 4-FLUTE 60° HELIX REGULAR LENGTH	D1/4	D1	83
E9992		PREMIUM HSS-PM, 2-FLUTE REGULAR LENGTH BALL NOSE	R1/16	R1/2	84
E9990		PREMIUM HSS-PM, MULTI-FLUTE REGULAR LENGTH FINE-PITCH ROUGHING	D1/4	D1-1/4	85
E9991		PREMIUM HSS-PM, MULTI-FLUTE REGULAR LENGTH COARSE-PITCH ROUGHING	D1/4	D1-1/4	86
E9A86		PREMIUM HSS-PM, MULTI-FLUTE LONG LENGTH FINE-PITCH ROUGHING	D5/16	D1-1/4	87
E9A87		PREMIUM HSS-PM, MULTI-FLUTE LONG LENGTH COARSE-PITCH ROUGHING	D5/16	D1-1/4	88
E9921		PREMIUM HSS-PM, MULTI-FLUTE FINE-PITCH ROUGHING EXTENDED NECK CENTER CUTTING	D1/2	D1-1/4	89
EP9993		H30 SPECIAL 8-FLUTE COATED FINE-PITCH ROUGHING	2	2	90

RECOMMENDED CUTTING CONDITIONS

90-92

P					H	M	K	N					S	
Carbon Steels	Alloy Steels	Prehardened Steels	Hardened Steels		High Hardened Steels	Stainless Steels	Cast Iron	Copper	Graphite	Aluminum	Acrylic	CFRP	Titanium	High-Temperature Alloy
~HRc20	HRc20~30	HRc30~40	HRc40~45	HRc45~55	HRc55~70									
◎	◎	◎				◎	◎	○		○			○	○
◎	◎	◎				◎	◎	○		○			○	○
◎	◎	◎				◎	◎	○		○			○	○
◎	◎	◎				◎	◎	○		○			○	○
◎	◎	◎				◎	◎	○		○			○	○
◎	◎	◎				◎	◎	○		○			○	○
◎	◎	◎				◎	◎	○		○			○	○
◎	◎	◎				◎	◎	○		○			○	○
◎	◎	◎				◎	◎	○		○			○	○
◎	◎	◎				◎	◎	○		○			◎	○

PREMIUM HSS-PM, 4-FLUTE REGULAR LENGTH

E9985 SERIES WELDON FLAT SHANK



Page 90

Unit: INCH

Mill Diameter	Shank Diameter	Length of Cut	Overall Length	No. of Flutes	EDP No.	
					Uncoated	Coated
1/8	3/8	3/8	2-5/16	4	E9985008	E9985008TF
3/16	3/8	1/2	2-3/8	4	E9985012	E9985012TF
1/4	3/8	5/8	2-7/16	4	E9985016	E9985016TF
5/16	3/8	3/4	2-1/2	4	E9985020	E9985020TF
3/8	3/8	3/4	2-1/2	4	E9985024	E9985024TF
1/2	1/2	1-1/4	3-1/4	4	E9985032	E9985032TF
5/8	5/8	1-5/8	3-3/4	4	E9985040	E9985040TF
3/4	3/4	1-5/8	3-7/8	4	E9985048	E9985048TF
7/8	7/8	1-7/8	4-1/8	4	E9985056	E9985056TF
1	1	2	4-1/2	4	E9985064	E9985064TF

Mill Dia. Tolerance (inch)	
0~+.0010	** 0~+.0015

** The shank of end mills is the same diameter as the cutting portion.

PREMIUM HSS-PM, 3- & 4-FLUTE 60° HELIX REGULAR LENGTH

E9988 SERIES WELDON FLAT SHANK



Page 90

Unit: **INCH**

Mill Diameter	Shank Diameter	Length of Cut	Overall Length	No. of Flutes	EDP No.	
					Uncoated	Coated
1/4	3/8	5/8	2-7/16	3	E9988016	E9988016TF
5/16	3/8	3/4	2-1/2	3	E9988020	E9988020TF
3/8	3/8	3/4	2-1/2	3	E9988024	E9988024TF
7/16	3/8	1	2-11/16	3	E9988028	E9988028TF
1/2	1/2	1-1/4	3-1/4	3	E9988032	E9988032TF
5/8	5/8	1-5/8	3-3/4	3	E9988040	E9988040TF
3/4	3/4	1-5/8	3-7/8	3	E9988048	E9988048TF
7/8	3/4	1-7/8	4-1/8	4	E9988901	E9988901TF
	7/8	1-7/8	4-1/8	4	E9988056	E9988056TF
1	1	2	4-1/2	4	E9988064	E9988064TF

Mill Dia. Tolerance (inch)	
0~+.0010	** 0~+.0015

** The shank of end mills is the same diameter as the cutting portion.

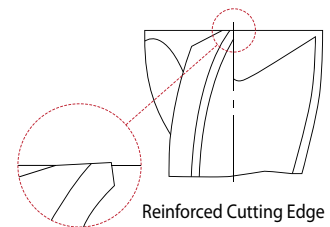

PREMIUM HSS-PM, 2-FLUTE REGULAR LENGTH BALL NOSE

E9992 SERIES WELDON FLAT SHANK

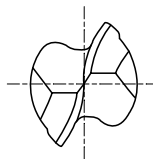

Page 91

Unit: **INCH**

Mill Diameter	Shank Diameter	Length of Cut	Overall Length	No. of Flutes	Radius of Ball Nose	EDP No.	
					R ($\pm .001$)	Uncoated	Coated
1/8	3/8	3/8	2-5/16	2	R1/16	E9992008	E9992008TF
3/16	3/8	1/2	2-3/8	2	R3/32	E9992012	E9992012TF
1/4	3/8	5/8	2-7/16	2	R1/8	E9992016	E9992016TF
5/16	3/8	3/4	2-1/2	2	R5/32	E9992020	E9992020TF
3/8	3/8	3/4	2-1/2	2	R3/16	E9992024	E9992024TF
1/2	1/2	1	3	2	R1/4	E9992032	E9992032TF
5/8	5/8	1-3/8	3-1/2	2	R5/16	E9992040	E9992040TF
3/4	3/4	1-5/8	3-7/8	2	R3/8	E9992048	E9992048TF
7/8	7/8	2	4-1/4	2	R7/16	E9992056	E9992056TF
1	1	2-1/4	4-3/4	2	R1/2	E9992064	E9992064TF

Mill Dia.
Tolerance (inch)

0--.0015

PREMIUM HSS-PM, MULTI-FLUTE REGULAR LENGTH FINE-PITCH ROUGHING

E9990 SERIES WELDON FLAT SHANK

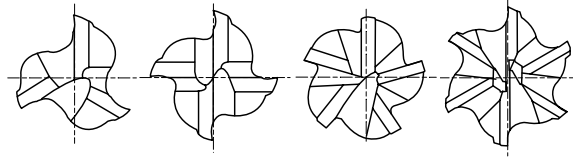

Page 91

Unit: **INCH**

Mill Diameter	Shank Diameter	Length of Cut	Overall Length	No. of Flutes	EDP No.	
					Uncoated	Coated
1/4	3/8	5/8	2-7/16	3	E9990016	E9990016TF
	3/8	1-1/8	2-15/16	3	E9990907	E9990907TF
5/16	3/8	3/4	2-1/2	3	E9990020	E9990020TF
3/8	3/8	3/4	2-1/2	4	E9990024	E9990024TF
7/16	3/8	1	2-11/16	4	E9990028	E9990028TF
1/2	1/2	1-1/4	3-1/4	4	E9990032	E9990032TF
	1/2	1-5/8	3-5/8	4	E9990908	E9990908TF
9/16	1/2	1-3/8	3-3/8	4	E9990036	E9990036TF
5/8	5/8	1-5/8	3-3/4	4	E9990040	E9990040TF
3/4	3/4	1-5/8	3-7/8	4	E9990048	E9990048TF
	5/8	1-5/8	3-7/8	4	E9990948	E9990948TF
3/4	3/4	2-1/2	4-3/4	4	E9990909	E9990909TF
7/8	7/8	1-7/8	4-1/8	5	E9990056	E9990056TF
	3/4	1-7/8	4-1/8	5	E9990901	E9990901TF
1	1	2	4-1/2	5	E9990064	E9990064TF
	1	3	5-1/2	5	E9990905	E9990905TF
1-1/8	1	2	4-1/2	6	E9990108	E9990108TF
1-1/4	1-1/4	2	4-1/2	6	E9990116	E9990116TF
	1-1/4	3	5-1/2	6	E9990906	E9990906TF

Mill Dia. Tolerance (inch)	
up to 1	0~+.0030
over 1	0~+.0060

PREMIUM HSS-PM, MULTI-FLUTE REGULAR-LENGTH COARSE-PITCH ROUGHING

E9991 SERIES WELDON FLAT SHANK

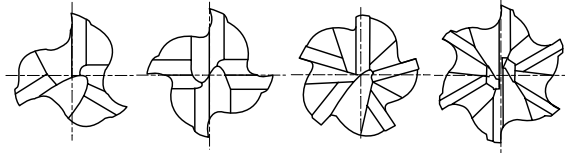

Page 91

Unit: **INCH**

Mill Diameter	Shank Diameter	Length of Cut	Overall Length	No. of Flutes	EDP No.	
					Uncoated	Coated
1/4	3/8	5/8	2-7/16	3	E9991016	E9991016TF
	3/8	1-1/8	2-15/16	3	E9991902	E9991902TF
5/16	3/8	3/4	2-1/2	3	E9991020	E9991020TF
3/8	3/8	3/4	2-1/2	4	E9991024	E9991024TF
7/16	3/8	1	2-11/16	4	E9991028	E9991028TF
1/2	1/2	1-1/4	3-1/4	4	E9991032	E9991032TF
	1/2	1-5/8	3-5/8	4	E9991903	E9991903TF
9/16	1/2	1-3/8	3-3/8	4	E9991036	E9991036TF
5/8	5/8	1-5/8	3-3/4	4	E9991040	E9991040TF
3/4	3/4	1-5/8	3-7/8	4	E9991048	E9991048TF
	5/8	1-5/8	3-7/8	4	E9991948	E9991948TF
3/4	3/4	2-1/2	4-3/4	4	E9991904	E9991904TF
7/8	7/8	1-7/8	4-1/8	5	E9991056	E9991056TF
	3/4	1-7/8	4-1/8	5	E9991901	E9991901TF
1	1	2	4-1/2	5	E9991064	E9991064TF
	1	3	5-1/2	5	E9991905	E9991905TF
1-1/8	1	2	4-1/2	6	E9991108	E9991108TF
1-1/4	1-1/4	2	4-1/2	6	E9991116	E9991116TF
	1-1/4	3	5-1/2	6	E9991906	E9991906TF

Mill Dia. Tolerance (inch)	
up to 1	0~+.0030
over 1	0~+.0060

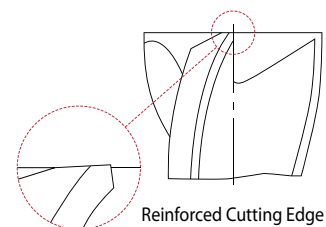

PREMIUM HSS-PM, MULTI-FLUTE LONG-LENGTH FINE-PITCH ROUGHING

E9A86 SERIES WELDON FLAT SHANK

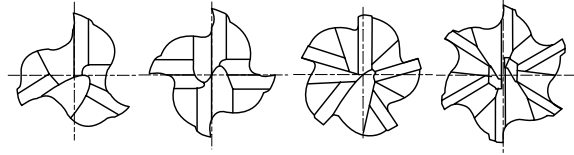

Page 91

Unit: **INCH**

Mill Diameter	Shank Diameter	Length of Cut	Overall Length	No. of Flutes	EDP No.	
					Uncoated	Coated
5/16	3/8	1-3/8	3-3/16	3	E9A86020	E9A86020TF
3/8	3/8	1-1/2	3-1/4	4	E9A86024	E9A86024TF
	3/8	1-1/2	4	4	E9A86924	E9A86924TF
1/2	1/2	2	4	4	E9A86032	E9A86032TF
5/8	5/8	2-1/2	4-5/8	4	E9A86040	E9A86040TF
3/4	5/8	3	5-1/8	4	E9A86048	E9A86048TF
	3/4	3	5-1/4	4	E9990902	E9990902TF
7/8	3/4	3-1/2	5-3/4	5	E9A86056	E9A86056TF
	7/8	3-1/2	5-3/4	5	E9A86956	E9A86956TF
1	1	4	6-1/2	5	E9990903	E9990903TF
1-1/4	3/4	4	6-1/4	6	E9A86116	E9A86116TF
	1-1/4	4	6-1/2	6	E9990904	E9990904TF

Mill Dia. Tolerance (inch)	
up to 1	0~+.0030
over 1	0~+.0060

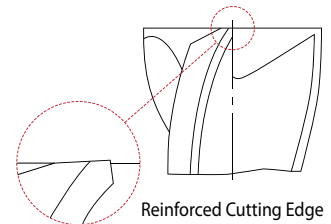

PREMIUM HSS-PM, MULTI FLUTE-LONG-LENGTH COARSE-PITCH ROUGHING

E9A87 SERIES WELDON FLAT SHANK

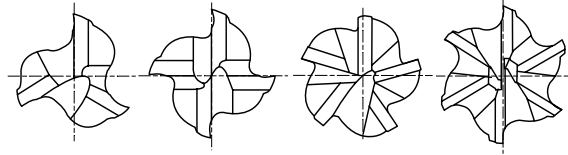

Page 91

Unit: **INCH**

Mill Diameter	Shank Diameter	Length of Cut	Overall Length	No. of Flutes	EDP No.	
					Uncoated	Coated
5/16	3/8	1-3/8	3-3/16	3	E9A87020	E9A87020TF
3/8	3/8	1-1/2	3-1/4	4	E9A87024	E9A87024TF
	3/8	1-1/2	4	4	E9A87924	E9A87924TF
1/2	1/2	2	4	4	E9A87032	E9A87032TF
5/8	5/8	2-1/2	4-5/8	4	E9A87040	E9A87040TF
3/4	5/8	3	5-1/8	4	E9A87048	E9A87048TF
	3/4	3	5-1/4	4	E9A87948	E9A87948TF
7/8	3/4	3-1/2	5-3/4	5	E9A87056	E9A87056TF
	7/8	3-1/2	5-3/4	5	E9A87956	E9A87956TF
1	1	4	6-1/2	5	E9A87064	E9A87064TF
1-1/4	3/4	4	6-1/4	6	E9A87116	E9A87116TF
	1-1/4	4	6-1/2	6	E9A87917	E9A87917TF

Mill Dia. Tolerance (inch)	
up to 1	0~+.0030
over 1	0~+.0060

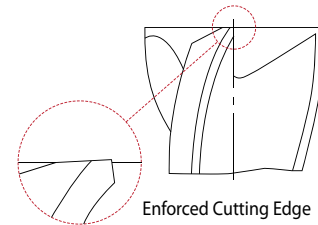

PREMIUM HSS-PM, MULTI-FLUTE FINE-PITCH ROUGHING EXTENDED NECK CENTER CUTTING

E9921 SERIES WELDON FLAT SHANK

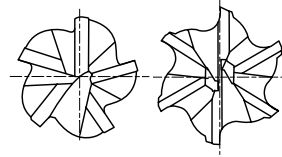

Page 91

Unit: **INCH**

Mill Diameter	Shank Diameter	Length of Cut	Reach Extended Neck	Overall Length	No. of Flutes	EDP No.	
						Uncoated	Coated
1/2	1/2	1-1/4	3	5	5	EP20322	EP20322F
5/8	5/8	1-5/8	4	6-1/8	5	EP20402	EP20402F
3/4	3/4	1-5/8	4	6-1/4	5	EP20482	EP20482F
	3/4	1-5/8	6	8-1/4	5	EP20484	EP20484F
1	1	2	4	6-1/2	6	EP20642	EP20642F
	1	2	6	8-1/2	6	EP20643	EP20643F
1-1/4	1 1/4	2	4	6-1/2	6	EP21161	EP21161F
	1 1/4	2	6	8-1/2	6	EP21162	EP21162F

Mill Dia. Tolerance (inch)	
up to 1	0~+.0030
over 1	0~+.0060

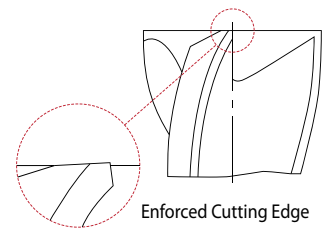

H30 SPECIAL 8-FLUTE COATED FINE-PITCH ROUGHING

EP9993 SERIES

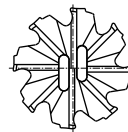

Page 92

Unit: **INCH**

Mill Diameter	Shank Diameter	Length of Cut	Overall Length	No. of Flutes	EDP No.	
					Plain Shank	Weldon Flat
2	2	4	7-3/4	8	EP99930087	EP99930087M
2	2	6	9-3/4	8	EP99930088	EP99930088M

Mill Dia. Tolerance (inch)	
up to 1	0~+.0030
over 1	0~+.0060

RECOMMENDED CUTTING CONDITIONS – INCH

E9985 SERIES

MATERIAL	P									
	STRUCTURAL STEELS CARBON STEELS		STRUCTURAL STEELS CARBON STEELS CAST IRONS		CARBON STEELS ALLOY STEELS TOOL STEELS		PREHARDENED STEELS ALLOY STEELS TOOL STEELS		ALLOY STEELS TOOL STEELS AUSTENITIC STAINLESS STEELS	
HARDNESS			~HRC20		HRC20~HRC30		HRC30~HRC35		HRC35~HRC40	
STRENGTH	~ 500N/mm ²		500~800N/mm ²		800~1000N/mm ²		1000~1100N/mm ²		1100~1300N/mm ²	
DIAMETER	RPM	FEED	RPM	FEED	RPM	FEED	RPM	FEED	RPM	FEED
	1/8	6300	17.7	6000	14.4	4250	10.4	2700	7.2	2320
3/16	4600	19.7	4100	16.1	3040	12.6	2070	8.5	1780	6.2
1/4	3800	22.1	3300	18.1	2500	13.0	1700	9.7	1400	7.1
5/16	3100	22.4	2600	18.9	2000	14.2	1400	9.4	1150	7.2
3/8	2500	24.8	2200	20.5	1680	15.0	1180	10.2	960	7.7
1/2	1900	22.1	1720	18.5	1270	14.4	860	9.3	690	2.7
5/8	1600	20.1	1410	16.9	1000	13.3	690	8.9	620	6.7
3/4	1400	17.7	1150	15.2	830	11.5	580	7.3	470	5.7
7/8	1030	15.8	930	12.4	675	9.8	470	6.3	390	5.1
1	1000	14.6	830	11.8	620	8.8	420	5.6	360	4.9

► The feed, in long & extra long types, should be reduced by around 50%.

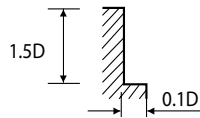

RPM = rev./min. FEED = inch/min.

E9988 SERIES

MATERIAL	P					
	STRUCTURAL STEELS CARBON STEELS CAST IRONS		CARBON STEELS ALLOY STEELS TOOL STEELS		ALLOY STEELS, TOOL STEELS AUSTENITIC STAINLESS STEELS	
HARDNESS	~HRC20		HRC20 ~ HRC30		HRC30 ~ HRC40	
STRENGTH	500 ~ 800N/mm ²		800 ~ 1000N/mm ²		1000 ~ 1300N/mm ²	
DIAMETER	RPM	FEED	RPM	FEED	RPM	FEED
	1/4	3850	7.9	2500	5.3	1900
5/16	3050	7.9	2100	6.3	1700	3.5
3/8	2700	8.5	1700	6.3	1450	3.8
1/2	1850	9.7	1200	6.3	960	4.1
5/8	1300	11.0	845	8.5	690	5.4
3/4	895	14.6	580	11.9	475	7.9
7/8	720	16.6	475	14.0	380	8.8
1	630	19.0	415	16.0	335	10.0

► The feed, in long & extra long types, should be reduced by around 50%.

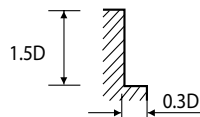

RPM = rev./min. FEED = inch/min.

RECOMMENDED CUTTING CONDITIONS – INCH

E9992 SERIES

MATERIAL	P							
	STRUCTURAL STEELS CARBON STEELS		STRUCTURAL STEELS CARBON STEELS CAST IRONS		CARBON STEELS ALLOY STEELS TOOL STEELS		PREHARDENED STEELS ALLOY STEELS TOOL STEELS	
HARDNESS			~HRC20		HRC20 ~ HRC30		HRC30 ~ HRC40	
STRENGTH	~500N/mm ²		500 ~ 800N/mm ²		800 ~ 1000N/mm ²		1000 ~ 1300N/mm ²	
DIAMETER	RPM	FEED	RPM	FEED	RPM	FEED	RPM	FEED
1/8	6800	12.3	5300	8.2	3550	4.5	1850	2.1
3/16	5100	15.3	4000	10.3	2650	5.7	1350	2.7
1/4	4050	16.8	3150	11.2	2100	6.2	1100	3.0
5/16	3250	18.1	2550	12.2	1700	6.9	860	3.0
3/8	2750	19.9	2100	13.4	1450	7.6	700	3.4
1/2	2100	17.8	1600	12.0	1100	6.8	530	2.9
5/8	1600	16.6	1250	11.1	860	6.1	425	2.8
3/4	1350	14.7	1050	9.8	700	5.4	360	2.5
7/8	1100	12.6	865	8.4	560	4.6	300	2.1
1	890	10.5	690	7.0	445	3.9	235	1.7

► The feed, in long & extra long types, should be reduced by around 50%.

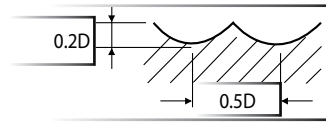

RPM = rev./min. Feed = inch/min.

E9990 | E9991 | E9A86 | E9A87 | E9921 SERIES

MATERIAL	P								M	
	STRUCTURAL STEELS CARBON STEELS		STRUCTURAL STEELS CARBON STEELS CAST IRONS		CARBON STEELS ALLOY STEELS TOOL STEELS		PREHARDENED STEELS ALLOY STEELS TOOL STEELS		STAINLESS STEELS	
HARDNESS	~HRC20		HRC20 ~ HRC30		HRC30 ~ HRC35		HRC35 ~ HRC40			
STRENGTH	~800N/mm ²		800 ~ 1000N/mm ²		1000 ~ 1100N/mm ²		1100 ~ 1300N/mm ²			
DIAMETER	RPM	FEED	RPM	FEED	RPM	FEED	RPM	FEED	RPM	FEED
1/4	2650	7.8	2050	6.3	1450	4.4	1200	3.4	1900	5.6
3/8	1900	13.1	1500	10.1	1050	6.4	885	5.2	1270	8.6
1/2	1450	14.2	1100	11.4	805	7.9	665	6.1	950	9.3
5/8	1150	14.2	905	11.4	630	7.9	525	6.1	760	9.7
3/4	960	14.4	780	11.4	540	7.9	445	6.1	630	9.5
7/8	845	14.5	615	11.4	445	7.8	375	6.1	540	9.3
1	740	14.0	560	10.6	395	7.4	315	6.0	470	9.0

► The feed, in long & extra long types, should be reduced by around 50%.

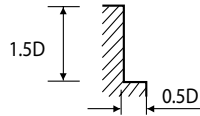

RPM = rev./min. Feed = inch/min.

RECOMMENDED CUTTING CONDITIONS – INCH

EP9993 SERIES

MATERIAL	P											
	CARBON STEELS 1018,1040,1080,1090,10L50,1140, 1212,12L15,1525,1536				ALLOY STEELS 4140, 4150, 4320, 5120, 5150, 8630, 86L20, 50100				TOOL STEELS A2, D2, H13, L2, M2, P20, S7, T15, W2			
ISO HARDNESS (BHN)	P > 175 P < 250				P > 250 P < 350				P < 350			
DIAMETER	SFM (Vc)	RPM	Fz	Feed (IPM)	SFM (Vc)	RPM	Fz	Feed (IPM)	SFM (Vc)	RPM	Fz	Feed (IPM)
2	200 (185-225)	382	0.0040	12	155 (135-165)	296	0.0040	9	100 (80-110)	191	0.0040	6

MATERIAL	M											
	STAINLESS STEEL (FREE MACHING) 303, 416, 420F, 430F 440F				STAINLESS STEEL (DIFFICULT) 304, 304L, 316, 316L				STAINLESS STEEL (PH) 13-8 PH, 15-5PH, 17-4 PH, Custom 450			
ISO HARDNESS (BHN)	M < 250				M < 275				M < 325			
DIAMETER	SFM (Vc)	RPM	Fz	Feed (IPM)	SFM (Vc)	RPM	Fz	Feed (IPM)	SFM (Vc)	RPM	Fz	Feed (IPM)
2	125 (105-140)	239	0.0040	8	110 (90-125)	210	0.0035	6	110 (90-120)	210	0.0030	5

MATERIAL	S															
	NICKEL, COBALT AND IRON-BASED SUPERALLOYS Inconel 601, 617, 625, Incoly 800, Monel 400				NICKEL, COBALT AND IRON-BASED SUPERALLOYS (DIFFICULT) Inconel 718, 750X, Incoly 925, Waspaloy, Hastelloy, Rene				TITANIUM BASE ALLOY Pure Titanium, Ti6Al4V, Ti6Al2Sn4Zr2Mo, Ti4Al4Mo2Sn0.5Si				TITANIUM BASE ALLOY (DIFFICULT) Ti10Al2Fe3Al, Ti5Al5V5Mo3Cr, Ti7Al4Mo, Ti3Al8V6Cr4Zr4Mo, Ti6Al6V6Sn, Ti15V3, Cr3Sn3Al			
ISO HARDNESS (BHN)	S < 300				S < 400				S < 350				S < 450			
DIAMETER	SFM (Vc)	RPM	Fz	Feed (IPM)	SFM (Vc)	RPM	Fz	Feed (IPM)	SFM (Vc)	RPM	Fz	Feed (IPM)	SFM (Vc)	RPM	Fz	Feed (IPM)
2	40 (25-50)	76	0.0035	2	35 (25-50)	67	0.0030	2	70 (55-80)	134	0.0035	4	40 (30-50)	76	0.0030	2

- ▶ Maximum recommended depth shown
- ▶ Finish cuts typically require reduced feed and cutting speeds; also the radial width of cut recommended is not more than 2%xD1
- ▶ Reduce speed & feed for material harder than listed
- ▶ Above recommendations are based on ideal conditions; for smaller taper machining centers or less rigid conditions please adjust parameters accordingly on diameters greater than 1/2"
- ▶ On long-reach tools (more than 2xD1 in flute length) in profile operations, reduce the radial depth of cut by 50%–60% on slot

HOLEMAKING

The Cutting Edge in Holemaking.

Maintaining precise diameters in hard-to-cut aircraft materials can be extremely challenging. But with YG-1's super-sharp drill-point geometry, advanced flute design with coolant holes and superior coating, the DREAM DRILL•INOX, DREAM DRILL•ALU and DREAM DRILL•FLAT BOTTOM is a dream come true for aerospace manufacturers.

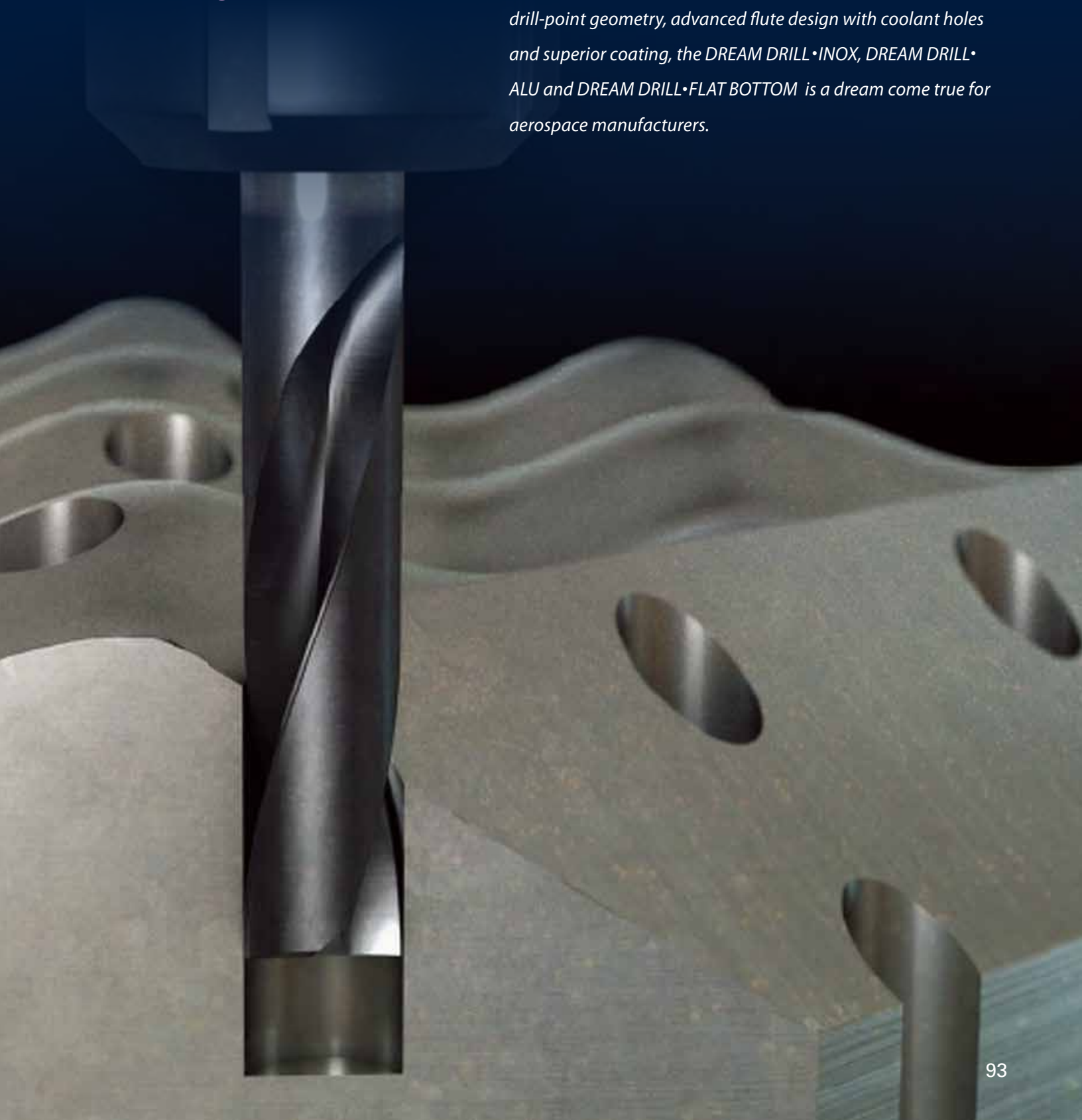

DREAM DRILL: THE POINT IS ADVANCED TECHNOLOGY.

FOR STEELS, STAINLESS STEELS, TITANIUM AND NON-FERROUS METALS

YG-1's advanced point geometry is literally cutting-edge technology at the business end of every DREAM DRILL. And it's just the beginning of a long list of features that boost productivity.



- ▶ High-strength cutting edges for extended tool life, versatile use
- ▶ Multilayer coating for better productivity, reliability and longer tool life
- ▶ Rapid chip evacuation with special cutting edge designs on point and chip breakers on leading edges

DREAM DRILL

Drills that earn their name honestly, every day.

If higher productivity is your destination, YG-1 DREAM DRILLS are your tickets to success. And the DREAM DRILL line has virtually every drill you need. (If we don't make it, we will. Just ask.)

- ▶ Chip-breaking cutting edges
- ▶ General- and special-purpose drills for high-speed, high-stability, accurate operations
- ▶ All high-quality solid carbide
- ▶ Wide range of sizes in stub, short, long and extra-long lengths



DREAM DRILL•INOX with special flute shape and geometry for working in stainless steel

- ▶ TiAlN-coated DREAM DRILLS with coolant holes for deep holemaking in stainless steels, alloys and titanium
- ▶ Excellent chip evacuation
- ▶ Point R thinning achieves superior centering and chip curling
- ▶ Special thinning minimizes cutting load, extends tool life



DREAM DRILL•ALU with coolant holes for aluminum and aluminum alloys

- ▶ Optimized thinning prevents chip welding
- ▶ Wider, deeper flute gullets for maximum chip removal
- ▶ Special geometry and smooth DLC coating minimize built-up edge, maximize finishes



DREAM DRILL•FLAT BOTTOM with true 180-degree point

- ▶ The master tool that does it all and does it well: cross drilling, guide drilling, curved surfaces and chained holes, blind holes for threading, inclined entry and exit, counter boring and thin plate drilling (see page 124)
- ▶ High-strength cutting edge to improve tool life
- ▶ 180° point angle for versatile use in a variety of holemaking applications

GUIDE TO ICONS

Tool Material



Micrograin Carbide

Tolerance of Shank Diameter



Standard of Tools



Coolant Pressure



Helix Angle



Tolerance of Outside Diameter



Cutting Conditions





Point Angle





SELECTION GUIDE

SERIES	MODEL	DESCRIPTION	SIZE		PAGE
			Min.	Max.	

DREAM DRILL•INOX - INCH

3xD DH463 DH714		CARBIDE, DREAM DRILL•INOX with Coolant Holes	STUB	D1/8	D5/8	98
5xD DH464 DH715		CARBIDE, DREAM DRILL•INOX with Coolant Holes	LONG	D13/64	D/2	100

DREAM DRILL•INOX - METRIC

3xD DH451		CARBIDE, DREAM DRILL•INOX with Coolant Holes	SHORT	.1181	.7874	101
5xD DH452		CARBIDE, DREAM DRILL•INOX with Coolant Holes	LONG	.0394	.7874	105
8xD DH453		CARBIDE, DREAM DRILL•INOX with Coolant Holes	EXTRA LONG	.1181	.7874	109

RECOMMENDED CUTTING CONDITIONS

113

DREAM DRILL•ALU - INCH

5xD DGE466 DGE718		CARBIDE, DREAM DRILL•ALU with Coolant Holes	LONG	D13/64	D1/2	114
-------------------------	---	---	------	--------	------	-----

DREAM DRILL•ALU - INCH

5xD DGE433		CARBIDE, DREAM DRILL•ALU with Coolant Holes	LONG	.1181	.7874	115
---------------	---	---	------	-------	-------	-----

RECOMMENDED CUTTING CONDITIONS

119

DREAM DRILL•FLAT BOTTOM - INCH

2xD DPP447		CARBIDE, DREAM DRILL•FLAT BOTTOM without Coolant Holes	SHORT	D3.0	D20.0	120
---------------	---	--	-------	------	-------	-----

RECOMMENDED CUTTING CONDITIONS

124



◎ : Excellent ○ : Good

P			H	M	K	N				S	
Carbon Steels	Alloy Steels	Prehardened Steels	Hardened Steels		Stainless Steels	Cast Iron	Aluminum	Copper	Bronze	CFRP	Titanium
~HB225	HB225~325	HRc30~45	HRc45~55	HRc55~							

◎	◎	○			◎		○				○
◎	◎	○			◎		○				○

◎	◎	○			◎		○				○
◎	◎	○			◎		○				○
◎	◎	○			◎		○				○

							◎				
--	--	--	--	--	--	--	---	--	--	--	--

							◎				
--	--	--	--	--	--	--	---	--	--	--	--

◎	◎	◎	○		○	◎	○	○			
---	---	---	---	--	---	---	---	---	--	--	--

CARBIDE, DREAM DRILL•INOX WITH COOLANT HOLES

STUB

DH463 | DH714 SERIES



Page 113

3 × D

Unit: INCH

EDP No.	Drill Diameter		Shank Diameter	Flute Length	Overall Length
	Fractional	Decimal			
TiAlN	D ₁		D ₂	L ₁	L ₂
DH714008	1/8	.1250	3/16	1.102	2.992
DH463008	1/8	.1250	15/64	1.102	2.992
DH714011	11/64	.1719	3/16	1.417	3.386
DH463011	11/64	.1719	15/64	1.417	3.386
DH714012	3/16	.1875	3/16	1.575	3.543
DH463012	3/16	.1875	15/64	1.575	3.543
DH463013	13/64	.2031	15/64	1.082	3.228
DH714013	13/64	.2031	1/4	1.082	3.228
DH463014	7/32	.2188	15/64	1.181	3.228
DH714014	7/32	.2188	1/4	1.181	3.228
DH463015	15/64	.2344	15/64	1.181	3.228
DH714015	15/64	.2344	1/4	1.181	3.228
DH714016	1/4	.2500	1/4	1.279	3.465
DH463016	1/4	.2500	17/64	1.279	3.465
DH463206	F	.2570	17/64	1.279	3.465
DH714206	F	.2570	5/16	1.279	3.465
DH463017	17/64	.2656	17/64	1.378	3.465
DH714017	17/64	.2656	5/16	1.378	3.465
DH463209	I	.2720	.2720	1.378	3.465
DH714209	I	.2720	5/16	1.378	3.465
DH463018	9/32	.2812	5/16	1.476	3.701
DH463019	19/64	.2969	5/16	1.476	3.701

EDP No.	Drill Diameter		Shank Diameter	Flute Length	Overall Length
	Fractional	Decimal			
TiAlN	D ₁		D ₂	L ₁	L ₂
DH463020	5/16	.3125	5/16	1.575	3.701
DH463021	21/64	.3281	11/32	1.673	3.937
DH714021	21/64	.3281	3/8	1.673	3.937
DH463217	Q	.3320	11/32	1.673	3.937
DH714217	Q	.3320	3/8	1.673	3.937
DH463022	11/32	.3438	11/32	1.772	3.937
DH714022	11/32	.3438	3/8	1.772	3.937
DH714023	23/64	.3594	3/8	1.870	4.174
DH463023	23/64	.3594	25/64	1.870	4.174
DH714221	U	.3680	3/8	1.870	4.174
DH463221	U	.3680	25/64	1.870	4.174
DH714024	3/8	.3750	3/8	1.969	4.174
DH463024	3/8	.3750	25/64	1.969	4.174
DH463025	25/64	.3906	25/64	1.969	4.174
DH714025	25/64	.3906	7/16	1.969	4.174
DH463026	13/32	.4062	27/64	2.067	4.567
DH714026	13/32	.4062	7/16	2.067	4.567
DH463027	27/64	.4219	27/64	2.165	4.567
DH714027	27/64	.4219	7/16	2.165	4.567
DH714028	7/16	.4375	7/16	2.264	4.803
DH463028	7/16	.4375	15/32	2.264	4.803
DH463029	29/64	.4531	15/32	2.264	4.803

► Other shank types are available on your request.

► NEXT PAGE

CARBIDE, DREAM DRILL•INOX WITH COOLANT HOLES

STUB

DH463 | DH714 SERIES



Page 113

3 × D

Unit: INCH

EDP No.	Drill Diameter		Shank Diameter	Flute Length	Overall Length
	Fractional	Decimal			
TiAlN	D1		D2	L1	L2
DH714029	29/64	.4531	1/2	2.264	4.803
DH463030	15/32	.4688	15/32	2.362	4.803
DH714030	15/32	.4688	1/2	2.362	4.803
DH463031	31/64	.4844	1/2	2.461	5.039
DH463032	1/2	.5000	1/2	2.559	5.039
DH463033	33/64	.5156	35/64	2.657	5.276
DH714033	33/64	.5156	9/16	2.657	5.276
DH463034	17/32	.5312	35/64	2.756	5.276
DH714034	17/32	.5312	9/16	2.756	5.276

EDP No.	Drill Diameter		Shank Diameter	Flute Length	Overall Length
	Fractional	Decimal			
TiAlN	D1		D2	L1	L2
DH463035	35/64	.5469	35/64	2.756	5.276
DH714035	35/64	.5469	9/16	2.756	5.276
DH714036	9/16	.5625	9/16	2.854	5.512
DH463036	9/16	.5625	37/64	2.854	5.512
DH463037	37/64	.5781	37/64	2.953	5.512
DH714037	37/64	.5781	5/8	2.953	5.512
DH463038	19/32	.5937	5/8	3.051	5.709
DH463039	39/64	.6094	5/8	3.051	5.709
DH463040	5/8	.6250	5/8	3.150	5.709

► Other shank types are available on your request.

CARBIDE, DREAM DRILL•INOX WITH COOLANT HOLES

LONG

DH464 | DH715 SERIES

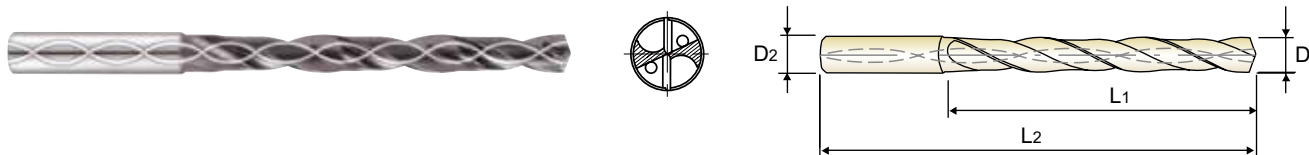

Page 113

5 × D

Unit: INCH

EDP No.	Drill Diameter		Shank Diameter	Flute Length	Overall Length
	Fractional	Decimal			
TiAlN	D ₁		D ₂	L ₁	L ₂
DH464013	13/64	.2031	15/64	1-3/4	3-15/16
DH715013	13/64	.2031	1/4	1-3/4	3-15/16
DH464014	7/32	.2188	15/64	1-57/64	3-15/16
DH715014	7/32	.2188	1/4	1-57/64	3-15/16
DH464015	15/64	.2344	15/64	1-57/64	3-15/16
DH715015	15/64	.2344	1/4	1-57/64	3-15/16
DH715016	1/4	.2500	1/4	2-3/64	4-19/64
DH464016	1/4	.2500	17/64	2-3/64	4-19/64
DH464206	F	.2570	17/64	2-13/64	4-19/64
DH715206	F	.2570	5/16	2-13/64	4-19/64
DH464017	17/64	.2656	17/64	2-13/64	4-19/64
DH715017	17/64	.2656	5/16	2-13/64	4-19/64
DH464209	I	.2720	.2720	2-13/64	4-19/64
DH715209	I	.2720	5/16	2-13/64	4-19/64
DH464018	9/32	.2812	5/16	2-23/64	4-41/64
DH464019	19/64	.2969	5/16	2-33/64	4-41/64
DH464020	5/16	.3125	5/16	2-33/64	4-41/64
DH464021	21/64	.3281	11/32	2-43/64	5
DH715021	21/64	.3281	3/8	2-43/64	5
DH464217	Q	.3320	11/32	2-43/64	5
DH715217	Q	.3320	3/8	2-43/64	5
DH464022	11/32	.3438	11/32	2-27/32	5

EDP No.	Drill Diameter		Shank Diameter	Flute Length	Overall Length
	Fractional	Decimal			
TiAlN	D ₁		D ₂	L ₁	L ₂
DH715022	11/32	.3438	3/8	2-27/32	5
DH715023	23/64	.3594	3/8	3	5-23/64
DH464023	23/64	.3594	25/64	3	5-23/64
DH715221	U	.3680	3/8	3	5-23/64
DH464221	U	.3680	25/64	3	5-23/64
DH715024	3/8	.3750	3/8	3-5/32	5-23/64
DH464024	3/8	.3750	25/64	3-5/32	5-23/64
DH464025	25/64	.3906	25/64	3-5/32	5-23/64
DH715025	25/64	.3906	7/16	3-5/32	5-23/64
DH464026	13/32	.4062	27/64	3-5/16	5-7/8
DH715026	13/32	.4062	7/16	3-5/16	5-7/8
DH464027	27/64	.4219	27/64	3-15/32	5-7/8
DH715027	27/64	.4219	7/16	3-15/32	5-7/8
DH715028	7/16	.4375	7/16	3-5/8	6-7/32
DH464028	7/16	.4375	15/32	3-5/8	6-7/32
DH464029	29/64	.4531	15/32	3-25/32	6-7/32
DH715029	29/64	.4531	1/2	3-25/32	6-7/32
DH464030	15/32	.4688	15/32	3-25/32	6-7/32
DH715030	15/32	.4688	1/2	3-25/32	6-7/32
DH464031	31/64	.4844	1/2	3-15/16	6-37/64
DH464032	1/2	.5000	1/2	4-3/32	6-37/64

► Other shank types are available on your request.

CARBIDE, DREAM DRILL•INOX WITH COOLANT HOLES

SHORT

DH451 SERIES

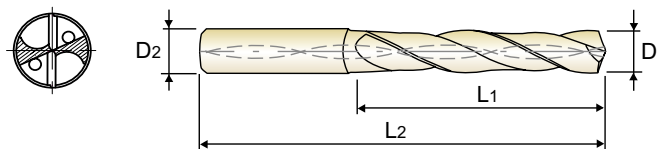

Page 113

3 × D

Unit: METRIC

EDP No.	Drill Diameter			Shank Diameter D ₂	Flute Length L ₁	Overall Length L ₂
	Metric	Fractional	Decimal			
TiAIN	D ₁					
DH451030	3.0		.1181	6	20	62
DH451031	3.1		.1220	6	20	62
DH451008F	3.175	1/8	.1250	6	20	62
DH451032	3.2		.1260	6	20	62
DH451033	3.3		.1299	6	20	62
DH451034	3.4		.1339	6	20	62
DH451035	3.5		.1378	6	20	62
DH451009F	3.572	9/64	.1406	6	20	62
DH451036	3.6		.1417	6	20	62
DH451037	3.7		.1457	6	20	62
DH451038	3.8		.1496	6	24	66
DH451039	3.9		.1535	6	24	66
DH451010F	3.969	5/32	.1563	6	24	66
DH451040	4.0		.1575	6	24	66
DH451041	4.1		.1614	6	24	66
DH451042	4.2		.1654	6	24	66
DH451043	4.3		.1693	6	24	66
DH451011F	4.366	11/64	.1719	6	24	66
DH451044	4.4		.1732	6	24	66
DH451045	4.5		.1772	6	24	66
DH451046	4.6		.1811	6	24	66
DH451047	4.7		.1850	6	24	66
DH451012F	4.763	3/16	.1875	6	24	66
DH451048	4.8		.1890	6	28	66
DH451049	4.9		.1929	6	28	66
DH451050	5.0		.1969	6	28	66
DH451051	5.1		.2008	6	28	66
DH451013F	5.159	13/64	.2031	6	28	66
DH451052	5.2		.2047	6	28	66

EDP No.	Drill Diameter			Shank Diameter D ₂	Flute Length L ₁	Overall Length L ₂
	Metric	Fractional	Decimal			
TiAIN	D ₁					
DH451053	5.3		.2087	6	28	66
DH451054	5.4		.2126	6	28	66
DH451055	5.5		.2165	6	28	66
DH451014F	5.556	7/32	.2188	6	28	66
DH451056	5.6		.2205	6	28	66
DH451057	5.7		.2244	6	28	66
DH451058	5.8		.2283	6	28	66
DH451059	5.9		.2323	6	28	66
DH451015F	5.953	15/64	.2344	6	28	66
DH451060	6.0		.2362	6	28	66
DH451061	6.1		.2402	8	34	79
DH451062	6.2		.2441	8	34	79
DH451063	6.3		.2480	8	34	79
DH451016F	6.350	1/4	.2500	8	34	79
DH451064	6.4		.2520	8	34	79
DH451065	6.5		.2559	8	34	79
DH451006L	6.528	F	.2570	8	34	79
DH451066	6.6		.2598	8	34	79
DH451067	6.7		.2638	8	34	79
DH451017F	6.747	17/64	.2656	8	34	79
DH451068	6.8		.2677	8	34	79
DH451069	6.9		.2717	8	34	79
DH451009L	6.909	I	.2720	8	34	79
DH451070	7.0		.2756	8	34	79
DH451071	7.1		.2795	8	41	79
DH451018F	7.144	9/32	.2812	8	41	79
DH451072	7.2		.2835	8	41	79
DH451073	7.3		.2874	8	41	79
DH451074	7.4		.2913	8	41	79

► Other shank types are available on your request.

► NEXT PAGE

CARBIDE, DREAM DRILL•INOX WITH COOLANT HOLES

SHORT

DH451 SERIES

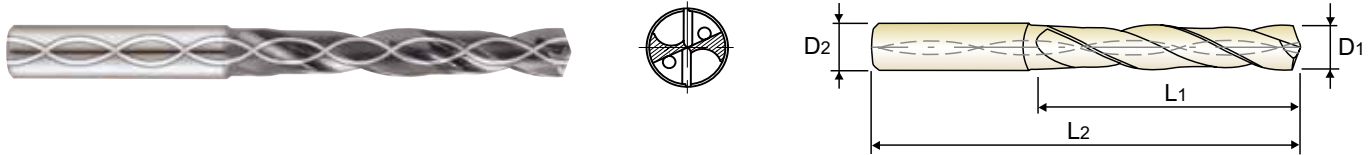

DIN 6537
MG
h6
m7
140°
20 bar
Page 113

3 × D

Unit: METRIC

EDP No.	Drill Diameter			Shank Diameter D ₂	Flute Length L ₁	Overall Length L ₂
	Metric	Fractional	Decimal			
TiAlN	D ₁					
DH451075	7.5		.2953	8	41	79
DH451019F	7.541	19/64	.2969	8	41	79
DH451076	7.6		.2992	8	41	79
DH451077	7.7		.3031	8	41	79
DH451078	7.8		.3071	8	41	79
DH451079	7.9		.3110	8	41	79
DH451020F	7.938	5/16	.3125	8	41	79
DH451080	8.0		.3150	8	41	79
DH451081	8.1		.3189	10	47	89
DH451082	8.2		.3228	10	47	89
DH451083	8.3		.3268	10	47	89
DH451021F	8.334	21/64	.3281	10	47	89
DH451084	8.4		.3307	10	47	89
DH451017L	8.433	Q	.3320	10	47	89
DH451085	8.5		.3346	10	47	89
DH451086	8.6		.3386	10	47	89
DH451087	8.7		.3425	10	47	89
DH451022F	8.731	11/32	.3438	10	47	89
DH451088	8.8		.3465	10	47	89
DH451089	8.9		.3504	10	47	89
DH451090	9.0		.3543	10	47	89
DH451091	9.1		.3583	10	47	89
DH451023F	9.128	23/64	.3594	10	47	89
DH451092	9.2		.3622	10	47	89
DH451093	9.3		.3661	10	47	89
DH451021L	9.347	U	.3680	10	47	89
DH451094	9.4		.3701	10	47	89
DH451095	9.5		.3740	10	47	89
DH451024F	9.525	3/8	.3750	10	47	89
DH451096	9.6		.3780	10	47	89

EDP No.	Drill Diameter			Shank Diameter D ₂	Flute Length L ₁	Overall Length L ₂
	Metric	Fractional	Decimal			
TiAlN	D ₁					
DH451097	9.7		.3819	10	47	89
DH451098	9.8		.3858	10	47	89
DH451099	9.9		.3898	10	47	89
DH451025F	9.922	25/64	.3906	10	47	89
DH451100	10.0		.3937	10	47	89
DH451101	10.1		.3976	12	55	102
DH451102	10.2		.4016	12	55	102
DH451103	10.3		.4055	12	55	102
DH451026F	10.319	13/32	.4062	12	55	102
DH451104	10.4		.4094	12	55	102
DH451105	10.5		.4134	12	55	102
DH451106	10.6		.4173	12	55	102
DH451107	10.7		.4212	12	55	102
DH451027F	10.716	27/64	.4219	12	55	102
DH451108	10.8		.4252	12	55	102
DH451109	10.9		.4291	12	55	102
DH451110	11.0		.4330	12	55	102
DH451111	11.1		.4370	12	55	102
DH451028F	11.113	7/16	.4375	12	55	102
DH451112	11.2		.4409	12	55	102
DH451113	11.3		.4448	12	55	102
DH451114	11.4		.4488	12	55	102
DH451115	11.5		.4527	12	55	102
DH451029F	11.509	29/64	.4531	12	55	102
DH451116	11.6		.4566	12	55	102
DH451117	11.7		.4606	12	55	102
DH451118	11.8		.4645	12	55	102
DH451119	11.9		.4685	12	55	102
DH451030F	11.906	15/32	.4688	12	55	102
DH451120	12.0		.4724	12	55	102

► Other shank types are available on your request.

► NEXT PAGE

CARBIDE, DREAM DRILL•INOX WITH COOLANT HOLES

SHORT

DH451 SERIES

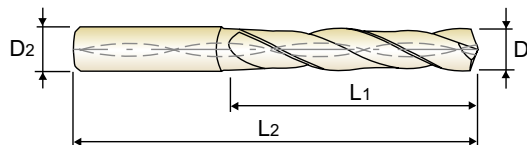

Page 113

3 x D

Unit: **METRIC**

EDP No.	Drill Diameter			Shank Diameter D ₂	Flute Length L ₁	Overall Length L ₂
	Metric	Fractional	Decimal			
TiAlN	D ₁					
DH451121	12.1		.4764	14	60	107
DH451122	12.2		.4803	14	60	107
DH451123	12.3		.4843	14	60	107
DH451031F	12.303	31/64	.4844	14	60	107
DH451124	12.4		.4882	14	60	107
DH451125	12.5		.4921	14	60	107
DH451126	12.6		.4961	14	60	107
DH451032F	12.7	1/2	.5000	14	60	107
DH451128	12.8		.5039	14	60	107
DH451129	12.9		.5079	14	60	107
DH451130	13.0		.5118	14	60	107
DH451131	13.1		.5157	14	60	107
DH451132	13.2		.5197	14	60	107
DH451133	13.3		.5236	14	60	107
DH451134	13.4		.5276	14	60	107
DH451135	13.5		.5314	14	60	107
DH451136	13.6		.5354	14	60	107
DH451137	13.7		.5394	14	60	107
DH451138	13.8		.5433	14	60	107
DH451139	13.9		.5472	14	60	107
DH451140	14.0		.5512	14	60	107
DH451141	14.1		.5551	16	65	115
DH451142	14.2		.5591	16	65	115
DH451036F	14.288	9/16	.5625	16	65	115
DH451143	14.3		.5630	16	65	115
DH451144	14.4		.5669	16	65	115
DH451145	14.5		.5708	16	65	115
DH451146	14.6		.5748	16	65	115
DH451147	14.7		.5787	16	65	115
DH451148	14.8		.5827	16	65	115

EDP No.	Drill Diameter			Shank Diameter D ₂	Flute Length L ₁	Overall Length L ₂
	Metric	Fractional	Decimal			
TiAlN	D ₁					
DH451149	14.9		.5866	16	65	115
DH451150	15.0		.5905	16	65	115
DH451151	15.1		.5945	16	65	115
DH451152	15.2		.5984	16	65	115
DH451153	15.3		.6024	16	65	115
DH451154	15.4		.6063	16	65	115
DH451155	15.5		.6102	16	65	115
DH451156	15.6		.6142	16	65	115
DH451157	15.7		.6181	16	65	115
DH451158	15.8		.6220	16	65	115
DH451040F	15.875	5/8	.6250	16	65	115
DH451159	15.9		.6260	16	65	115
DH451160	16.0		.6299	16	65	115
DH451161	16.1		.6339	18	73	123
DH451162	16.2		.6378	18	73	123
DH451163	16.3		.6417	18	73	123
DH451164	16.4		.6457	18	73	123
DH451165	16.5		.6495	18	73	123
DH451166	16.6		.6535	18	73	123
DH451167	16.7		.6575	18	73	123
DH451168	16.8		.6614	18	73	123
DH451169	16.9		.6654	18	73	123
DH451170	17.0		.6692	18	73	123
DH451171	17.1		.6732	18	73	123
DH451172	17.2		.6772	18	73	123
DH451173	17.3		.6811	18	73	123
DH451174	17.4		.6850	18	73	123
DH451044F	17.463	11/16	.6875	18	73	123
DH451175	17.5		.6889	18	73	123
DH451176	17.6		.6929	18	73	123

► Other shank types are available on your request.

► NEXT PAGE

CARBIDE, DREAM DRILL•INOX WITH COOLANT HOLES

SHORT

DH451 SERIES

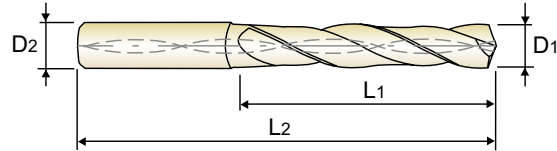

Page 113

3 × D

Unit: **METRIC**

EDP No.	Drill Diameter			Shank Diameter	Flute Length	Overall Length
	Metric	Fractional	Decimal			
TiAIN	D ₁			D ₂	L ₁	L ₂
DH451177	17.7		.6968	18	73	123
DH451178	17.8		.7008	18	73	123
DH451179	17.9		.7047	18	73	123
DH451180	18.0		.7087	18	73	123
DH451181	18.1		.7126	20	79	131
DH451182	18.2		.7165	20	79	131
DH451183	18.3		.7205	20	79	131
DH451184	18.4		.7244	20	79	131
DH451185	18.5		.7283	20	79	131
DH451186	18.6		.7323	20	79	131
DH451187	18.7		.7362	20	79	131
DH451188	18.8		.7402	20	79	131
DH451189	18.9		.7441	20	79	131

EDP No.	Drill Diameter			Shank Diameter	Flute Length	Overall Length
	Metric	Fractional	Decimal			
TiAIN	D ₁			D ₂	L ₁	L ₂
DH451190	19.0		.7480	20	79	131
DH451048F	19.050	3/4	.7500	20	79	131
DH451191	19.1		.7520	20	79	131
DH451192	19.2		.7559	20	79	131
DH451193	19.3		.7598	20	79	131
DH451194	19.4		.7638	20	79	131
DH451195	19.5		.7676	20	79	131
DH451196	19.6		.7717	20	79	131
DH451197	19.7		.7756	20	79	131
DH451198	19.8		.7795	20	79	131
DH451199	19.9		.7835	20	79	131
DH451200	20.0		.7874	20	79	131

► Other shank types are available on your request.

CARBIDE, DREAM DRILL•INOX WITH COOLANT HOLES

LONG

DH452 SERIES

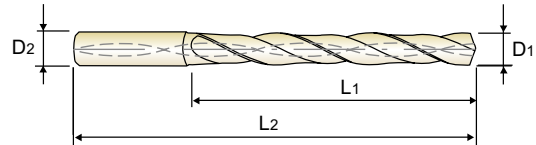

Page 113

5 x D

Unit: **METRIC**

EDP No.	Drill Diameter			Shank Diameter D2	Flute Length L1	Overall Length L2
	Metric	Fractional	Decimal			
TiAlN	D1			D2	L1	L2
DH452010	1.0		.0394	3	8	55
DH452011	1.1		.0433	3	12	55
DH452012	1.2		.0472	3	12	55
DH452013	1.3		.0512	3	12	55
DH452014	1.4		.0551	3	12	55
DH452015	1.5		.0591	3	16	55
DH452004F	1.588	1/16	.0625	3	16	55
DH452016	1.6		.0630	3	16	55
DH452017	1.7		.0669	3	16	55
DH452018	1.8		.0709	3	16	55
DH452019	1.9		.0748	3	16	55
DH452005F	1.984	5/64	.0781	3	16	55
DH452020	2.0		.0787	4	21	57
DH452021	2.1		.0827	4	21	57
DH452022	2.2		.0866	4	21	57
DH452023	2.3		.0906	4	21	57
DH452006F	2.381	3/32	.0938	4	21	57
DH452024	2.4		.0945	4	21	57
DH452025	2.5		.0984	4	21	57
DH452026	2.6		.1024	4	21	57
DH452027	2.7		.1063	4	21	57
DH452007F	2.778	7/64	.1094	4	21	57
DH452028	2.8		.1102	4	21	57
DH452029	2.9		.1142	4	21	57
DH452030	3.0		.1181	6	28	66
DH452031	3.1		.1220	6	28	66
DH452008F	3.175	1/8	.1250	6	28	66
DH452032	3.2		.1260	6	28	66
DH452033	3.3		.1299	6	28	66
DH452034	3.4		.1339	6	28	66

EDP No.	Drill Diameter			Shank Diameter D2	Flute Length L1	Overall Length L2
	Metric	Fractional	Decimal			
TiAlN	D1			D2	L1	L2
DH452035	3.5		.1378	6	28	66
DH452009F	3.572	9/64	.1406	6	28	66
DH452036	3.6		.1417	6	28	66
DH452037	3.7		.1457	6	28	66
DH452038	3.8		.1496	6	36	74
DH452039	3.9		.1535	6	36	74
DH452010F	3.969	5/32	.1563	6	36	74
DH452040	4.0		.1575	6	36	74
DH452041	4.1		.1614	6	36	74
DH452042	4.2		.1654	6	36	74
DH452043	4.3		.1693	6	36	74
DH452011F	4.366	11/64	.1719	6	36	74
DH452044	4.4		.1732	6	36	74
DH452045	4.5		.1772	6	36	74
DH452046	4.6		.1811	6	36	74
DH452047	4.7		.1850	6	36	74
DH452012F	4.763	3/16	.1875	6	36	74
DH452048	4.8		.1890	6	44	82
DH452049	4.9		.1929	6	44	82
DH452050	5.0		.1969	6	44	82
DH452051	5.1		.2008	6	44	82
DH452013F	5.159	13/64	.2031	6	44	82
DH452052	5.2		.2047	6	44	82
DH452053	5.3		.2087	6	44	82
DH452054	5.4		.2126	6	44	82
DH452055	5.5		.2165	6	44	82
DH452014F	5.556	7/32	.2188	6	44	82
DH452056	5.6		.2205	6	44	82
DH452057	5.7		.2244	6	44	82
DH452058	5.8		.2283	6	44	82

► Other shank types are available on your request.

► NEXT PAGE

CARBIDE, DREAM DRILL•INOX WITH COOLANT HOLES

LONG

DH452 SERIES

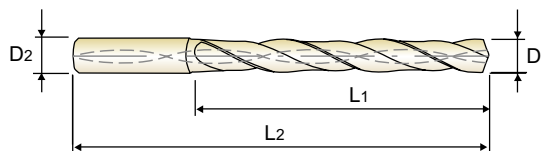

Page 113

5 × D

Unit: METRIC

EDP No.	Drill Diameter			Shank Diameter D ₂	Flute Length L ₁	Overall Length L ₂
	Metric	Fractional	Decimal			
TiAlN	D ₁					
DH452059	5.9		.2323	6	44	82
DH452015F	5.953	15/64	.2344	6	44	82
DH452060	6.0		.2362	6	44	82
DH452061	6.1		.2402	8	53	91
DH452062	6.2		.2441	8	53	91
DH452063	6.3		.2480	8	53	91
DH452016F	6.350	1/4	.2500	8	53	91
DH452064	6.4		.2520	8	53	91
DH452065	6.5		.2559	8	53	91
DH452006L	6.528	F	.2570	8	53	91
DH452066	6.6		.2598	8	53	91
DH452067	6.7		.2638	8	53	91
DH452017F	6.747	17/64	.2656	8	53	91
DH452068	6.8		.2677	8	53	91
DH452069	6.9		.2717	8	53	91
DH452009L	6.909	I	.2720	8	53	91
DH452070	7.0		.2756	8	53	91
DH452071	7.1		.2795	8	53	91
DH452018F	7.144	9/32	.2812	8	53	91
DH452072	7.2		.2835	8	53	91
DH452073	7.3		.2874	8	53	91
DH452074	7.4		.2913	8	53	91
DH452075	7.5		.2953	8	53	91
DH452019F	7.541	19/64	.2969	8	53	91
DH452076	7.6		.2992	8	53	91
DH452077	7.7		.3031	8	53	91
DH452078	7.8		.3071	8	53	91
DH452079	7.9		.3110	8	53	91
DH452020F	7.938	5/16	.3125	8	53	91
DH452080	8.0		.3150	8	53	91

EDP No.	Drill Diameter			Shank Diameter D ₂	Flute Length L ₁	Overall Length L ₂
	Metric	Fractional	Decimal			
TiAlN	D ₁					
DH452081	8.1		.3189	10	61	103
DH452082	8.2		.3228	10	61	103
DH452083	8.3		.3268	10	61	103
DH452021F	8.334	21/64	.3281	10	61	103
DH452084	8.4		.3307	10	61	103
DH452017L	8.433	Q	.3320	10	61	103
DH452085	8.5		.3346	10	61	103
DH452086	8.6		.3386	10	61	103
DH452087	8.7		.3425	10	61	103
DH452022F	8.731	11/32	.3438	10	61	103
DH452088	8.8		.3465	10	61	103
DH452089	8.9		.3504	10	61	103
DH452090	9.0		.3543	10	61	103
DH452091	9.1		.3583	10	61	103
DH452023F	9.128	23/64	.3594	10	61	103
DH452092	9.2		.3622	10	61	103
DH452093	9.3		.3661	10	61	103
DH452021L	9.347	U	.3680	10	61	103
DH452094	9.4		.3701	10	61	103
DH452095	9.5		.3740	10	61	103
DH452024F	9.525	3/8	.3750	10	61	103
DH452096	9.6		.3780	10	61	103
DH452097	9.7		.3819	10	61	103
DH452098	9.8		.3858	10	61	103
DH452099	9.9		.3898	10	61	103
DH452025F	9.922	25/64	.3906	10	61	103
DH452100	10.0		.3937	10	61	103
DH452101	10.1		.3976	12	71	118
DH452102	10.2		.4016	12	71	118
DH452103	10.3		.4055	12	71	118

► Other shank types are available on your request.

► NEXT PAGE

CARBIDE, DREAM DRILL•INOX WITH COOLANT HOLES

LONG

DH452 SERIES

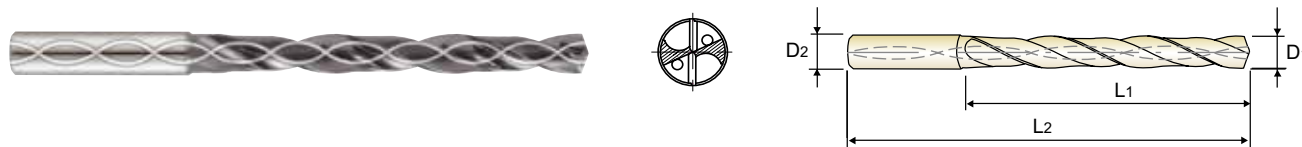

Page 113

5 × D

Unit: **METRIC**

EDP No.	Drill Diameter			Shank Diameter D ₂	Flute Length L ₁	Overall Length L ₂
	Metric	Fractional	Decimal			
TiAlN	D ₁			D ₂	L ₁	L ₂
DH452026F	10.319	13/32	.4062	12	71	118
DH452104	10.4		.4094	12	71	118
DH452105	10.5		.4134	12	71	118
DH452106	10.6		.4173	12	71	118
DH452107	10.7		.4212	12	71	118
DH452027F	10.716	27/64	.4219	12	71	118
DH452108	10.8		.4252	12	71	118
DH452109	10.9		.4291	12	71	118
DH452110	11.0		.4330	12	71	118
DH452111	11.1		.4370	12	71	118
DH452028F	11.113	7/16	.4375	12	71	118
DH452112	11.2		.4409	12	71	118
DH452113	11.3		.4448	12	71	118
DH452114	11.4		.4488	12	71	118
DH452115	11.5		.4527	12	71	118
DH452029F	11.509	29/64	.4531	12	71	118
DH452116	11.6		.4566	12	71	118
DH452117	11.7		.4606	12	71	118
DH452118	11.8		.4645	12	71	118
DH452119	11.9		.4685	12	71	118
DH452030F	11.906	15/32	.4688	12	71	118
DH452120	12.0		.4724	12	71	118
DH452121	12.1		.4764	14	77	124
DH452122	12.2		.4803	14	77	124
DH452123	12.3		.4843	14	77	124
DH452031F	12.303	31/64	.4844	14	77	124
DH452124	12.4		.4882	14	77	124
DH452125	12.5		.4921	14	77	124
DH452126	12.6		.4961	14	77	124
DH452032F	12.7	1/2	.5000	14	77	124

EDP No.	Drill Diameter			Shank Diameter D ₂	Flute Length L ₁	Overall Length L ₂
	Metric	Fractional	Decimal			
TiAlN	D ₁			D ₂	L ₁	L ₂
DH452128	12.8		.5039	14	77	124
DH452129	12.9		.5079	14	77	124
DH452130	13.0		.5118	14	77	124
DH452131	13.1		.5157	14	77	124
DH452132	13.2		.5197	14	77	124
DH452133	13.3		.5236	14	77	124
DH452134	13.4		.5276	14	77	124
DH452135	13.5		.5314	14	77	124
DH452136	13.6		.5354	14	77	124
DH452137	13.7		.5394	14	77	124
DH452138	13.8		.5433	14	77	124
DH452139	13.9		.5472	14	77	124
DH452140	14.0		.5512	14	77	124
DH452141	14.1		.5551	16	83	133
DH452142	14.2		.5591	16	83	133
DH452036F	14.288	9/16	.5625	16	83	133
DH452143	14.3		.5630	16	83	133
DH452144	14.4		.5669	16	83	133
DH452145	14.5		.5708	16	83	133
DH452146	14.6		.5748	16	83	133
DH452147	14.7		.5787	16	83	133
DH452148	14.8		.5827	16	83	133
DH452149	14.9		.5866	16	83	133
DH452150	15.0		.5905	16	83	133
DH452151	15.1		.5945	16	83	133
DH452152	15.2		.5984	16	83	133
DH452153	15.3		.6024	16	83	133
DH452154	15.4		.6063	16	83	133
DH452155	15.5		.6102	16	83	133
DH452156	15.6		.6142	16	83	133

► Other shank types are available on your request.

► NEXT PAGE

CARBIDE, DREAM DRILL•INOX WITH COOLANT HOLES

LONG

DH452 SERIES

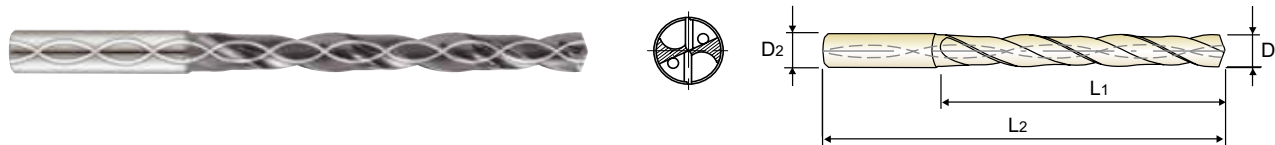

Page 113

5 × D

Unit: **METRIC**

EDP No.	Drill Diameter			Shank Diameter D ₂	Flute Length L ₁	Overall Length L ₂
	Metric	Fractional	Decimal			
TiAlN	D ₁					
DH452157	15.7		.6181	16	83	133
DH452158	15.8		.6220	16	83	133
DH452040F	15.875	5/8	.6250	16	83	133
DH452159	15.9		.6260	16	83	133
DH452160	16.0		.6299	16	83	133
DH452161	16.1		.6339	18	93	143
DH452162	16.2		.6378	18	93	143
DH452163	16.3		.6417	18	93	143
DH452164	16.4		.6457	18	93	143
DH452165	16.5		.6495	18	93	143
DH452166	16.6		.6535	18	93	143
DH452167	16.7		.6575	18	93	143
DH452168	16.8		.6614	18	93	143
DH452169	16.9		.6654	18	93	143
DH452170	17.0		.6692	18	93	143
DH452171	17.1		.6732	18	93	143
DH452172	17.2		.6772	18	93	143
DH452173	17.3		.6811	18	93	143
DH452174	17.4		.6850	18	93	143
DH452175	17.5		.6889	18	93	143
DH452176	17.6		.6929	18	93	143
DH452177	17.7		.6968	18	93	143
DH452178	17.8		.7008	18	93	143

EDP No.	Drill Diameter			Shank Diameter D ₂	Flute Length L ₁	Overall Length L ₂
	Metric	Fractional	Decimal			
TiAlN	D ₁					
DH452179	17.9		.7047	18	93	143
DH452180	18.0		.7087	18	93	143
DH452181	18.1		.7126	20	101	153
DH452182	18.2		.7165	20	101	151
DH452183	18.3		.7205	20	101	151
DH452184	18.4		.7244	20	101	153
DH452185	18.5		.7283	20	101	153
DH452186	18.6		.7323	20	101	151
DH452187	18.7		.7362	20	101	153
DH452188	18.8		.7402	20	101	153
DH452189	18.9		.7441	20	101	153
DH452190	19.0		.7480	20	101	153
DH452048F	19.050	3/4	.7500	20	101	153
DH452191	19.1		.7520	20	101	151
DH452192	19.2		.7559	20	101	151
DH452193	19.3		.7598	20	101	151
DH452194	19.4		.7638	20	101	151
DH452195	19.5		.7676	20	101	153
DH452196	19.6		.7717	20	101	151
DH452197	19.7		.7756	20	101	151
DH452198	19.8		.7795	20	101	153
DH452199	19.9		.7835	20	101	151
DH452200	20.0		.7874	20	101	153

► Other shank types are available on your request.

CARBIDE, DREAM DRILL•INOX WITH COOLANT HOLES

EXTRA LONG

DH453 SERIES

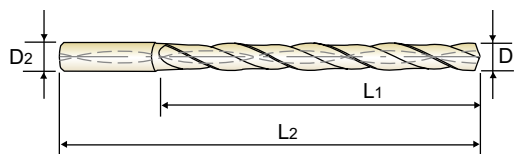

Page 113

8 × D

Unit: **METRIC**

EDP No.	Drill Diameter			Shank Diameter D2	Flute Length L1	Overall Length L2
	Metric	Fractional D1	Decimal			
DH453030	3.0		.1181	6	34	72
DH453031	3.1		.1220	6	34	72
DH453008F	3.175	1/8	.1250	6	34	72
DH453032	3.2		.1260	6	34	72
DH453033	3.3		.1299	6	34	72
DH453034	3.4		.1339	6	34	72
DH453229G	3.454	#29	.1360	6	34	72
DH453035	3.5		.1378	6	34	72
DH453009F	3.572	9/64	.1406	6	34	72
DH453036	3.6		.1417	6	34	72
DH453037	3.7		.1457	6	34	72
DH453038	3.8		.1496	6	43	81
DH453039	3.9		.1535	6	43	81
DH453010F	3.969	5/32	.1563	6	43	81
DH453040	4.0		.1575	6	43	81
DH453221G	4.038	#21	.1590	6	43	81
DH453041	4.1		.1614	6	43	81
DH453042	4.2		.1654	6	43	81
DH453043	4.3		.1693	6	43	81
DH453011F	4.366	11/64	.1719	6	43	81
DH453044	4.4		.1732	6	43	81
DH453045	4.5		.1772	6	43	81
DH453046	4.6		.1811	6	43	81
DH453047	4.7		.1850	6	43	81
DH453012F	4.763	3/16	.1875	6	57	95
DH453048	4.8		.1890	6	57	95
DH453049	4.9		.1929	6	57	95
DH453050	5.0		.1969	6	57	95
DH453051	5.1		.2008	6	57	95
DH453013F	5.159	13/64	.2031	6	57	95

EDP No.	Drill Diameter			Shank Diameter D2	Flute Length L1	Overall Length L2
	Metric	Fractional D1	Decimal			
DH453052	5.2		.2047	6	57	95
DH453053	5.3		.2087	6	57	95
DH453054	5.4		.2126	6	57	95
DH453055	5.5		.2165	6	57	95
DH453014F	5.556	7/32	.2188	6	57	95
DH453056	5.6		.2205	6	57	95
DH453057	5.7		.2244	6	57	95
DH453058	5.8		.2283	6	57	95
DH453059	5.9		.2323	6	57	95
DH453015F	5.953	15/64	.2344	6	57	95
DH453060	6.0		.2362	6	57	95
DH453061	6.1		.2402	8	76	114
DH453062	6.2		.2441	8	76	114
DH453063	6.3		.2480	8	76	114
DH453016F	6.350	1/4	.2500	8	76	114
DH453064	6.4		.2520	8	76	114
DH453065	6.5		.2559	8	76	114
DH453106L	6.527	F	.2570	8	76	114
DH453066	6.6		.2598	8	76	114
DH453067	6.7		.2638	8	76	114
DH453017F	6.747	17/64	.2656	8	76	114
DH453068	6.8		.2677	8	76	114
DH453069	6.9		.2717	8	76	114
DH453009L	6.909	I	.2720	8	76	114
DH453070	7.0		.2756	8	76	114
DH453071	7.1		.2795	8	76	114
DH453018F	7.144	9/32	.2813	8	76	114
DH453072	7.2		.2835	8	76	114
DH453073	7.3		.2874	8	76	114
DH453074	7.4		.2913	8	76	114

► Other shank types are available on your request.

► NEXT PAGE

CARBIDE, DREAM DRILL•INOX WITH COOLANT HOLES

EXTRA LONG

DH453 SERIES

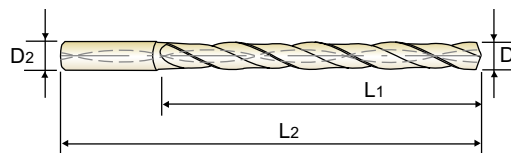

Page 113

8 × D

Unit: METRIC

EDP No.	Drill Diameter			Shank Diameter D ₂	Flute Length L ₁	Overall Length L ₂
	Metric	Fractional	Decimal			
TiAlN	D ₁			D ₂	L ₁	L ₂
DH453075	7.5		.2953	8	76	114
DH453019F	7.541	19/64	.2969	8	76	114
DH453076	7.6		.2992	8	76	114
DH453077	7.7		.3031	8	76	114
DH453078	7.8		.3071	8	76	114
DH453079	7.9		.3110	8	76	114
DH453020F	7.938	5/16	.3125	8	76	114
DH453080	8.0		.3150	8	76	114
DH453081	8.1		.3189	10	95	142
DH453082	8.2		.3228	10	95	142
DH453083	8.3		.3268	10	95	142
DH453021F	8.334	21/64	.3281	10	95	142
DH453084	8.4		.3307	10	95	142
DH453117L	8.432	Q	.3320	10	95	142
DH453085	8.5		.3346	10	95	142
DH453086	8.6		.3386	10	95	142
DH453087	8.7		.3425	10	95	142
DH453022F	8.731	11/32	.3438	10	95	142
DH453088	8.8		.3465	10	95	142
DH453089	8.9		.3504	10	95	142
DH453090	9.0		.3543	10	95	142
DH453091	9.1		.3583	10	95	142
DH453023F	9.128	23/64	.3594	10	95	142
DH453092	9.2		.3622	10	95	142
DH453093	9.3		.3661	10	95	142
DH453121L	9.347	U	.3680	10	95	142
DH453094	9.4		.3701	10	95	142
DH453095	9.5		.3740	10	95	142
DH453024F	9.525	3/8	.3750	10	95	142
DH453096	9.6		.3780	10	95	142

EDP No.	Drill Diameter			Shank Diameter D ₂	Flute Length L ₁	Overall Length L ₂
	Metric	Fractional	Decimal			
TiAlN	D ₁			D ₂	L ₁	L ₂
DH453097	9.7		.3819	10	95	142
DH453098	9.8		.3858	10	95	142
DH453099	9.9		.3898	10	95	142
DH453025F	9.922	25/64	.3906	10	95	142
DH453100	10.0		.3937	10	95	142
DH453101	10.1		.3976	12	114	162
DH453102	10.2		.4016	12	114	162
DH453103	10.3		.4055	12	114	162
DH453026F	10.319	13/32	.4063	12	114	162
DH453104	10.4		.4094	12	114	162
DH453105	10.5		.4134	12	114	162
DH453106	10.6		.4173	12	114	162
DH453107	10.7		.4212	12	114	162
DH453027F	10.716	27/64	.4219	12	114	162
DH453108	10.8		.4252	12	114	162
DH453109	10.9		.4291	12	114	162
DH453110	11.0		.4330	12	114	162
DH453111	11.1		.4370	12	114	162
DH453028F	11.113	7/16	.4375	12	114	162
DH453112	11.2		.4409	12	114	162
DH453113	11.3		.4448	12	114	162
DH453114	11.4		.4488	12	114	162
DH453115	11.5		.4527	12	114	162
DH453029F	11.509	29/64	.4531	12	114	162
DH453116	11.6		.4566	12	114	162
DH453117	11.7		.4606	12	114	162
DH453118	11.8		.4645	12	114	162
DH453119	11.9		.4685	12	114	162
DH453030F	11.906	15/32	.4688	12	114	162
DH453120	12.0		.4724	12	114	162

► Other shank types are available on your request.

► NEXT PAGE

CARBIDE, DREAM DRILL•INOX WITH COOLANT HOLES

EXTRA LONG

DH453 SERIES

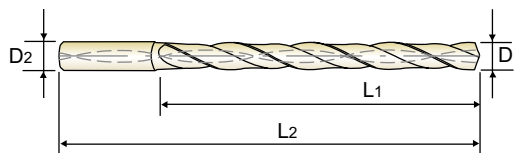

Page 113

8 x D

Unit: METRIC

EDP No.	Drill Diameter			Shank Diameter D2	Flute Length L1	Overall Length L2
	Metric	Fractional	Decimal			
TiAlN	D1			D2	L1	L2
DH453121	12.1		.4764	14	133	178
DH453122	12.2		.4803	14	133	178
DH453123	12.3		.4843	14	133	178
DH453031F	12.303	31/64	.4844	14	133	178
DH453124	12.4		.4882	14	133	178
DH453125	12.5		.4921	14	133	178
DH453126	12.6		.4961	14	133	178
DH453032F	12.7	1/2	.5000	14	133	178
DH453128	12.8		.5039	14	133	178
DH453129	12.9		.5079	14	133	178
DH453130	13.0		.5118	14	133	178
DH453033F	13.097	33/64	.5156	14	133	178
DH453131	13.1		.5157	14	133	178
DH453132	13.2		.5197	14	133	178
DH453133	13.3		.5236	14	133	178
DH453134	13.4		.5276	14	133	178
DH453135	13.5		.5314	14	133	178
DH453136	13.6		.5354	14	133	178
DH453137	13.7		.5394	14	133	178
DH453138	13.8		.5433	14	133	178
DH453139	13.9		.5472	14	133	178
DH453140	14.0		.5512	14	133	178
DH453141	14.1		.5551	16	152	203
DH453142	14.2		.5591	16	152	203
DH453036F	14.288	9/16	.5625	16	152	203
DH453143	14.3		.5630	16	152	203
DH453144	14.4		.5669	16	152	203
DH453145	14.5		.5709	16	152	203
DH453146	14.6		.5748	16	152	203
DH453147	14.7		.5787	16	152	203

EDP No.	Drill Diameter			Shank Diameter D2	Flute Length L1	Overall Length L2
	Metric	Fractional	Decimal			
TiAlN	D1			D2	L1	L2
DH453148	14.8		.5827	16	152	203
DH453149	14.9		.5866	16	152	203
DH453150	15.0		.5905	16	152	203
DH453151	15.1		.5945	16	152	203
DH453152	15.2		.5984	16	152	203
DH453153	15.3		.6024	16	152	203
DH453154	15.4		.6063	16	152	203
DH453155	15.5		.6102	16	152	203
DH453156	15.6		.6142	16	152	203
DH453157	15.7		.6181	16	152	203
DH453158	15.8		.6220	16	152	203
DH453040F	15.875	5/8	.6250	16	152	203
DH453159	15.9		.6260	16	152	203
DH453160	16.0		.6299	16	152	203
DH453161	16.1		.6339	18	171	222
DH453162	16.2		.6378	18	171	222
DH453163	16.3		.6417	18	171	222
DH453164	16.4		.6457	18	171	222
DH453165	16.5		.6496	18	171	222
DH453166	16.6		.6535	18	171	222
DH453167	16.7		.6575	18	171	222
DH453168	16.8		.6614	18	171	222
DH453169	16.9		.6654	18	171	222
DH453170	17.0		.6693	18	171	222
DH453171	17.1		.6732	18	171	222
DH453172	17.2		.6772	18	171	222
DH453173	17.3		.6811	18	171	222
DH453174	17.4		.6850	18	171	222
DH453175	17.5		.6890	18	171	222
DH453176	17.6		.6929	18	171	222

► Other shank types are available on your request.

► NEXT PAGE

CARBIDE, DREAM DRILL•INOX WITH COOLANT HOLES

EXTRA LONG

DH453 SERIES

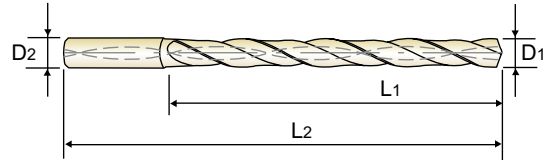

Page 113

8 × D

Unit: **METRIC**

EDP No.	Drill Diameter			Shank Diameter D ₂	Flute Length		Overall Length L ₂
	Metric	Fractional	Decimal		L ₁	L ₂	
TiAlN	D ₁			D ₂	L ₁	L ₂	
DH453177	17.7		.6968	18	171	222	
DH453178	17.8		.7008	18	171	222	
DH453179	17.9		.7047	18	171	222	
DH453180	18.0		.7087	18	171	222	
DH453181	18.1		.7126	20	190	243	
DH453182	18.2		.7165	20	190	243	
DH453183	18.3		.7205	20	190	243	
DH453184	18.4		.7244	20	190	243	
DH453185	18.5		.7283	20	190	243	
DH453186	18.6		.7323	20	190	243	
DH453187	18.7		.7362	20	190	243	
DH453188	18.8		.7402	20	190	243	
DH453189	18.9		.7441	20	190	243	

EDP No.	Drill Diameter			Shank Diameter D ₂	Flute Length		Overall Length L ₂
	Metric	Fractional	Decimal		L ₁	L ₂	
TiAlN	D ₁			D ₂	L ₁	L ₂	
DH453190	19.0		.7480	20	190	243	
DH453048F	19.050	3/4	.7500	20	190	243	
DH453191	19.1		.7520	20	190	243	
DH453192	19.2		.7559	20	190	243	
DH453193	19.3		.7598	20	190	243	
DH453194	19.4		.7638	20	190	243	
DH453195	19.5		.7677	20	190	243	
DH453196	19.6		.7717	20	190	243	
DH453197	19.7		.7756	20	190	243	
DH453198	19.8		.7795	20	190	243	
DH453199	19.9		.7835	20	190	243	
DH453200	20.0		.7874	20	190	243	

► Other shank types are available on your request.



CARBIDE, DREAM DRILL•INOX with COOLANT HOLES, TiAIN-COATED
RECOMMENDED CUTTING CONDITIONS

DH451 | DH463 | DH714 | DH452 | DH464 | DH715 | DH453 SERIES

WORK MATERIAL			P			M						N		
			CARBON STEELS ALLOY STEELS			STAINLESS STEELS			STAINLESS STEELS			ALUMINUM		
STRENGTH						< 800 N/mm ²			> 800 N/mm ²			< 10% Si		
DRILLING SPEED (SFM)			260 ~ 410 ft/min			120 ~ 230 ft/min			60 ~ 140 ft/min			490 ~ 720 ft/min		
DIAMETER			RPM	FEED	IPR	RPM	FEED	IPR	RPM	FEED	IPR	RPM	FEED	IPR
Metric (mm)	Decimal	Fractional												
1.0	.0394		26000	0.02	.001	12000	0.02	.001	6200	0.02	.001	48000	0.04	.002
1.5	.0591		18000	0.03	.001	9000	0.03	.001	5400	0.02	.001	43000	0.05	.002
2.5	.0984		10800	0.05	.002	7000	0.04	.002	4200	0.03	.001	25500	0.08	.003
3.0	.1181	1/8	13000	0.04	.002	7400	0.04	.002	4700	0.02	.001	23000	0.12	.005
4.0	.1575	5/32	10000	0.05	.002	5600	0.05	.002	3600	0.03	.001	17500	0.18	.007
5.0	.1969	13/64	8000	0.05	.002	4400	0.05	.002	2800	0.03	.001	14000	0.20	.008
6.0	.2362	15/64	6600	0.06	.002	3700	0.06	.002	2400	0.04	.002	11700	0.25	.010
8.0	.3150	5/16	5000	0.08	.003	2800	0.08	.003	1800	0.06	.002	8800	0.30	.012
10.0	.3937	25/64	4000	0.10	.004	2200	0.10	.004	1400	0.08	.003	7000	0.40	.016
12.0	.4724	15/32	3300	0.12	.005	1900	0.12	.005	1200	0.10	.004	5800	0.50	.020
14.0	.5512	35/64	2800	0.15	.006	1600	0.15	.006	1000	0.12	.005	5000	0.60	.024
16.0	.6299	5/8	2500	0.20	.008	1400	0.20	.008	900	0.15	.006	4380	0.80	.031
18.0	.7087	45/64	2200	0.22	.009	1250	0.22	.009	800	0.17	.007	3900	1.00	.039
20.0	.7874	25/32	2000	0.24	.009	1120	0.24	.009	720	0.19	.007	3500	1.20	.047

WORK MATERIAL			N						S		
			ALUMINUM			NON-FERROUS			TITANIUM TITANIUM ALLOYS		
STRENGTH			< 10% Si								
DRILLING SPEED (SFM)			390 ~ 570 ft/min			390 ~ 490 ft/min			80 ~ 160 ft/min		
DIAMETER			RPM	FEED	IPR	RPM	FEED	IPR	RPM	FEED	IPR
Metric (mm)	Decimal	Fractional									
1.0	.0394		38000	0.03	.001	38000	0.02	.001	8100	0.01	.0004
1.5	.0591		32000	0.04	.002	25500	0.03	.001	7500	0.01	.0004
2.5	.0984		19500	0.06	.002	15500	0.05	.002	4500	0.02	.001
3.0	.1181	1/8	18500	0.10	.004	16000	0.08	.003	5300	0.03	.001
4.0	.1575	5/32	13900	0.15	.006	11900	0.10	.004	4000	0.04	.002
5.0	.1969	13/64	11000	0.18	.007	9500	0.12	.005	3200	0.05	.002
6.0	.2362	15/64	9300	0.25	.010	8000	0.15	.006	2650	0.06	.002
8.0	.3150	5/16	7000	0.30	.012	6000	0.18	.007	2000	0.07	.003
10.0	.3937	25/64	5600	0.35	.014	4800	0.22	.009	1600	0.08	.003
12.0	.4724	15/32	4600	0.40	.016	4000	0.26	.010	1300	0.10	.004
14.0	.5512	35/64	4000	0.50	.020	3400	0.30	.012	1100	0.12	.005
16.0	.6299	5/8	3500	0.60	.024	3000	0.40	.016	1000	0.14	.006
18.0	.7087	45/64	3100	0.70	.028	2650	0.45	.018	900	0.16	.006
20.0	.7874	25/32	2800	0.80	.031	2400	0.50	.020	800	0.18	.007

▶ Recommend to reduce the feed rate as following
 DH463/DH714/DH451(3xD), DH464/DH714/DH452(5xD) : Feed 100%
 DH453(8xD) : Feed 85%

RPM = rev./min.
 FEED = mm/rev.
 IPR = inch/rev

CARBIDE, DREAM DRILL•ALU WITH COOLANT HOLES

LONG

DGE466 | DGE718 SERIES

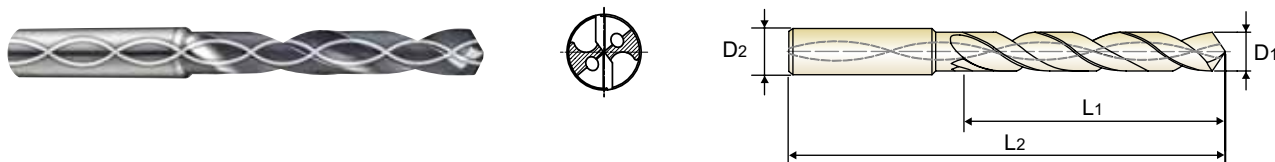

MG h6 118° 20 bar Page 119

5 × D

Unit: INCH

EDP No.	Drill Diameter		Shank Diameter	Flute Length	Overall Length
	Fractional	Decimal			
DLC	D1		D2	L1	L2
DGE466013	13/64	.2031	15/64	1-3/4	3-15/16
DGE718013	13/64	.2031	1/4	1-3/4	3-15/16
DGE466014	7/32	.2188	15/64	1-57/64	3-15/16
DGE718014	7/32	.2188	1/4	1-57/64	3-15/16
DGE466015	15/64	.2344	15/64	1-57/64	3-15/16
DGE718015	15/64	.2344	1/4	1-57/64	3-15/16
DGE718016	1/4	.2500	1/4	2-3/64	4-19/64
DGE466016	1/4	.2500	17/64	2-3/64	4-19/64
DGE466206	F	.2570	17/64	2-13/64	4-19/64
DGE718206	F	.2570	5/16	2-13/64	4-19/64
DGE466017	17/64	.2656	17/64	2-13/64	4-19/64
DGE718017	17/64	.2656	5/16	2-13/64	4-19/64
DGE466209	I	.2720	.272	2-13/64	4-19/64
DGE718209	I	.2720	5/16	2-13/64	4-19/64
DGE466018	9/32	.2812	5/16	2-23/64	4-41/64
DGE466019	19/64	.2969	5/16	2-33/64	4-41/64
DGE466020	5/16	.3125	5/16	2-33/64	4-41/64
DGE466021	21/64	.3281	11/32	2-43/64	5
DGE718021	21/64	.3281	3/8	2-43/64	5
DGE466217	Q	.3320	11/32	2-43/64	5
DGE718217	Q	.3320	3/8	2-43/64	5
DGE466022	11/32	.3438	11/32	2-27/32	5

EDP No.	Drill Diameter		Shank Diameter	Flute Length	Overall Length
	Fractional	Decimal			
DLC	D1		D2	L1	L2
DGE718022	11/32	.3438	3/8	2-27/32	5
DGE718023	23/64	.3594	3/8	3	5-23/64
DGE466023	23/64	.3594	25/64	3	5-23/64
DGE718221	U	.3680	3/8	3	5-23/64
DGE466221	U	.3680	25/64	3	5-23/64
DGE718024	3/8	.3750	3/8	3-5/32	5-23/64
DGE466024	3/8	.3750	25/64	3-5/32	5-23/64
DGE466025	25/64	.3906	25/64	3-5/32	5-23/64
DGE718025	25/64	.3906	7/16	3-5/32	5-23/64
DGE466026	13/32	.4062	27/64	3-5/16	5-7/8
DGE718026	13/32	.4062	7/16	3-5/16	5-7/8
DGE466027	27/64	.4219	27/64	3-15/32	5-7/8
DGE718027	27/64	.4219	7/16	3-15/32	5-7/8
DGE718028	7/16	.4375	7/16	3-5/8	6-7/32
DGE466028	7/16	.4375	15/32	3-5/8	6-7/32
DGE466029	29/64	.4531	15/32	3-25/32	6-7/32
DGE718029	29/64	.4531	1/2	3-25/32	6-7/32
DGE466030	15/32	.4688	15/32	3-25/32	6-7/32
DGE718030	15/32	.4688	1/2	3-25/32	6-7/32
DGE466031	31/64	.4844	1/2	3-15/16	6-37/64
DGE466032	1/2	.5000	1/2	4-3/32	6-37/64

► Other shank types are available on your request.

CARBIDE, DREAM DRILL•ALU WITH COOLANT HOLES

LONG

DGE433 SERIES

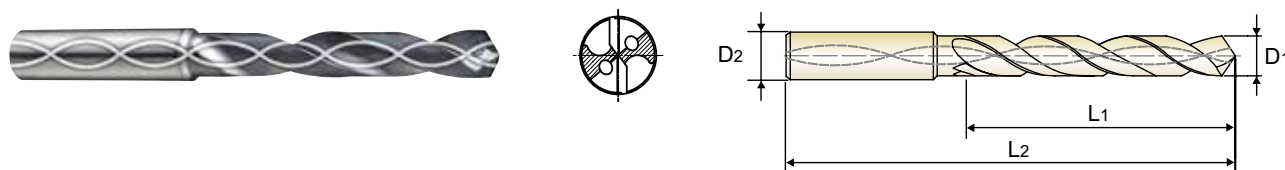

Page 119

5 × D

Unit: METRIC

EDP No.	Drill Diameter			Shank Diameter	Flute Length	Overall Length
	Metric	Fractional	Decimal			
DLC	D1			D2	L1	L2
DGE433030	3.0		.1181	6	28	66
DGE433031	3.1		.1220	6	28	66
DGE433008F	3.175	1/8	.1250	6	28	66
DGE433032	3.2		.1260	6	28	66
DGE433033	3.3		.1299	6	28	66
DGE433034	3.4		.1339	6	28	66
DGE433035	3.5		.1378	6	28	66
DGE433009F	3.572	9/64	.1406	6	28	66
DGE433036	3.6		.1417	6	28	66
DGE433037	3.7		.1457	6	28	66
DGE433038	3.8		.1496	6	36	74
DGE433039	3.9		.1535	6	36	74
DGE433010F	3.969	5/32	.1563	6	36	74
DGE433040	4.0		.1575	6	36	74
DGE433041	4.1		.1614	6	36	74
DGE433042	4.2		.1654	6	36	74
DGE433043	4.3		.1693	6	36	74
DGE433011F	4.366	11/64	.1719	6	36	74
DGE433044	4.4		.1732	6	36	74
DGE433045	4.5		.1772	6	36	74
DGE433046	4.6		.1811	6	36	74
DGE433047	4.7		.1850	6	36	74
DGE433012F	4.763	3/16	.1875	6	36	74
DGE433048	4.8		.1890	6	44	82

EDP No.	Drill Diameter			Shank Diameter	Flute Length	Overall Length
	Metric	Fractional	Decimal			
DLC	D1			D2	L1	L2
DGE433049	4.9		.1929	6	44	82
DGE433050	5.0		.1969	6	44	82
DGE433051	5.1		.2008	6	44	82
DGE433013F	5.159	13/64	.2031	6	44	82
DGE433052	5.2		.2047	6	44	82
DGE433053	5.3		.2087	6	44	82
DGE433054	5.4		.2126	6	44	82
DGE433055	5.5		.2165	6	44	82
DGE433014F	5.556	7/32	.2188	6	44	82
DGE433056	5.6		.2205	6	44	82
DGE433057	5.7		.2244	6	44	82
DGE433058	5.8		.2283	6	44	82
DGE433059	5.9		.2323	6	44	82
DGE433015F	5.953	15/64	.2344	6	44	82
DGE433060	6.0		.2362	6	44	82
DGE433061	6.1		.2402	8	53	91
DGE433062	6.2		.2441	8	53	91
DGE433063	6.3		.2480	8	53	91
DGE433016F	6.350	1/4	.2500	8	53	91
DGE433064	6.4		.2520	8	53	91
DGE433065	6.5		.2559	8	53	91
DGE433006L	6.528	F	.2570	8	53	9
DGE433066	6.6		.2598	8	53	91
DGE433067	6.7		.2638	8	53	91

► Other shank types are available on your request.

► NEXT PAGE

CARBIDE, DREAM DRILL•ALU WITH COOLANT HOLES

LONG

DGE433 SERIES

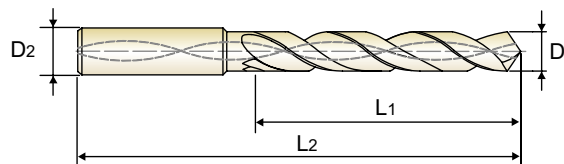

Page 119

5 x D

Unit: METRIC

EDP No.	Drill Diameter			Shank Diameter	Flute Length	Overall Length
	Metric	Fractional	Decimal			
DLC	D1			D2	L1	L2
DGE433017F	6.747	17/64	.2656	8	53	91
DGE433068	6.8		.2677	8	53	91
DGE433069	6.9		.2717	8	53	91
DGE433009L	6.909	I	.2720	8	53	91
DGE433070	7.0		.2756	8	53	91
DGE433071	7.1		.2795	8	53	91
DGE433018F	7.144	9/32	.2812	8	53	91
DGE433072	7.2		.2835	8	53	91
DGE433073	7.3		.2874	8	53	91
DGE433074	7.4		.2913	8	53	91
DGE433075	7.5		.2953	8	53	91
DGE433019F	7.541	19/64	.2969	8	53	91
DGE433076	7.6		.2992	8	53	91
DGE433077	7.7		.3031	8	53	91
DGE433078	7.8		.3071	8	53	91
DGE433079	7.9		.3110	8	53	91
DGE433020F	7.938	5/16	.3125	8	53	91
DGE433080	8.0		.3150	8	53	91
DGE433081	8.1		.3189	10	61	103
DGE433082	8.2		.3228	10	61	103
DGE433083	8.3		.3268	10	61	103
DGE433021F	8.334	21/64	.3281	10	61	103
DGE433084	8.4		.3307	10	61	103
DGE433017L	8.433	Q	.3320	10	61	103
DGE433085	8.5		.3346	10	61	103
DGE433086	8.6		.3386	10	61	103

EDP No.	Drill Diameter			Shank Diameter	Flute Length	Overall Length
	Metric	Fractional	Decimal			
DLC	D1			D2	L1	L2
DGE433087	8.7		.3425	10	61	103
DGE433022F	8.731	11/32	.3438	10	61	103
DGE433088	8.8		.3465	10	61	103
DGE433089	8.9		.3504	10	61	103
DGE433090	9.0		.3543	10	61	103
DGE433091	9.1		.3583	10	61	103
DGE433023F	9.128	23/64	.3594	10	61	103
DGE433092	9.2		.3622	10	61	103
DGE433093	9.3		.3661	10	61	103
DGE433021L	9.347	U	.3680	10	61	103
DGE433094	9.4		.3701	10	61	103
DGE433095	9.5		.3740	10	61	103
DGE433024F	9.525	3/8	.3750	10	61	103
DGE433096	9.6		.3780	10	61	103
DGE433097	9.7		.3819	10	61	103
DGE433098	9.8		.3858	10	61	103
DGE433099	9.9		.3898	10	61	103
DGE433025F	9.922	25/64	.3906	10	61	103
DGE433100	10.0		.3937	10	61	103
DGE433101	10.1		.3976	12	71	118
DGE433102	10.2		.4016	12	71	118
DGE433103	10.3		.4055	12	71	118
DGE433026F	10.319	13/32	.4062	12	71	118
DGE433104	10.4		.4094	12	71	118
DGE433105	10.5		.4134	12	71	118
DGE433106	10.6		.4173	12	71	118

► Other shank types are available on your request.

► NEXT PAGE

CARBIDE, DREAM DRILL•ALU WITH COOLANT HOLES

LONG

DGE433 SERIES

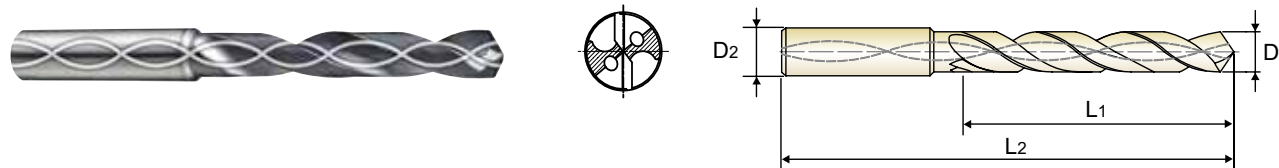

Page 119

5 × D

Unit: METRIC

EDP No.	Drill Diameter			Shank Diameter	Flute Length	Overall Length
	Metric	Fractional	Decimal			
DLC	D1			D2	L1	L2
DGE433107	10.7		.4212	12	71	118
DGE433027F	10.716	27/64	.4219	12	71	118
DGE433108	10.8		.4252	12	71	118
DGE433109	10.9		.4291	12	71	118
DGE433110	11.0		.4330	12	71	118
DGE433111	11.1		.4370	12	71	118
DGE433028F	11.113	7/16	.4375	12	71	118
DGE433112	11.2		.4409	12	71	118
DGE433113	11.3		.4448	12	71	118
DGE433114	11.4		.4488	12	71	118
DGE433115	11.5		.4527	12	71	118
DGE433029F	11.509	29/64	.4531	12	71	118
DGE433116	11.6		.4566	12	71	118
DGE433117	11.7		.4606	12	71	118
DGE433118	11.8		.4645	12	71	118
DGE433119	11.9		.4685	12	71	118
DGE433030F	11.906	15/32	.4688	12	71	118
DGE433120	12.0		.4724	12	71	118
DGE433121	12.1		.4764	14	77	124
DGE433122	12.2		.4803	14	77	124
DGE433123	12.3		.4843	14	77	124
DGE433031F	12.303	31/64	.4844	14	77	124
DGE433124	12.4		.4882	14	77	124
DGE433125	12.5		.4921	14	77	124
DGE433126	12.6		.4961	14	77	124
DGE433032F	12.7	1/2	.5000	14	77	124

EDP No.	Drill Diameter			Shank Diameter	Flute Length	Overall Length
	Metric	Fractional	Decimal			
DLC	D1			D2	L1	L2
DGE433128	12.8		.5039	14	77	124
DGE433129	12.9		.5079	14	77	124
DGE433130	13.0		.5118	14	77	124
DGE433131	13.1		.5157	14	77	124
DGE433132	13.2		.5197	14	77	124
DGE433133	13.3		.5236	14	77	124
DGE433134	13.4		.5276	14	77	124
DGE433135	13.5		.5314	14	77	124
DGE433136	13.6		.5354	14	77	124
DGE433137	13.7		.5394	14	77	124
DGE433138	13.8		.5433	14	77	124
DGE433139	13.9		.5472	14	77	124
DGE433140	14.0		.5512	14	77	124
DGE433141	14.1		.5551	16	83	133
DGE433142	14.2		.5591	16	83	133
DGE433036F	14.288	9/16	.5625	16	83	133
DGE433143	14.3		.5630	16	83	133
DGE433144	14.4		.5669	16	83	133
DGE433145	14.5		.5708	16	83	133
DGE433146	14.6		.5748	16	83	133
DGE433147	14.7		.5787	16	83	133
DGE433148	14.8		.5827	16	83	133
DGE433149	14.9		.5866	16	83	133
DGE433150	15.0		.5905	16	83	133
DGE433151	15.1		.5945	16	83	133
DGE433152	15.2		.5984	16	83	133

► Other shank types are available on your request.

► NEXT PAGE

CARBIDE, DREAM DRILL•ALU WITH COOLANT HOLES

LONG

DGE433 SERIES

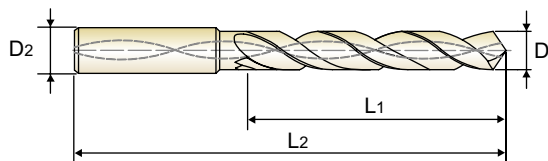

DIN 6537
MG
h6
m7
118°
20 bar
Page 119

5 × D

Unit: **METRIC**

EDP No.	Drill Diameter			Shank Diameter	Flute Length	Overall Length
	Metric	Fractional	Decimal			
DLC	D1			D2	L1	L2
DGE433153	15.3		.6024	16	83	133
DGE433154	15.4		.6063	16	83	133
DGE433155	15.5		.6102	16	83	133
DGE433156	15.6		.6142	16	83	133
DGE433157	15.7		.6181	16	83	133
DGE433158	15.8		.6220	16	83	133
DGE433040F	15.875	5/8	.6250	16	83	133
DGE433159	15.9		.6260	16	83	133
DGE433160	16.0		.6299	16	83	133
DGE433161	16.1		.6339	18	93	143
DGE433162	16.2		.6378	18	93	143
DGE433163	16.3		.6417	18	93	143
DGE433164	16.4		.6457	18	93	143
DGE433165	16.5		.6495	18	93	143
DGE433166	16.6		.6535	18	93	143
DGE433167	16.7		.6575	18	93	143
DGE433168	16.8		.6614	18	93	143
DGE433169	16.9		.6654	18	93	143
DGE433170	17.0		.6692	18	93	143
DGE433171	17.1		.6732	18	93	143
DGE433172	17.2		.6772	18	93	143
DGE433173	17.3		.6811	18	93	143
DGE433174	17.4		.6850	18	93	143
DGE433175	17.5		.6889	18	93	143
DGE433176	17.6		.6929	18	93	143

EDP No.	Drill Diameter			Shank Diameter	Flute Length	Overall Length
	Metric	Fractional	Decimal			
DLC	D1			D2	L1	L2
DGE433177	17.7		.6968	18	93	143
DGE433178	17.8		.7008	18	93	143
DGE433179	17.9		.7047	18	93	143
DGE433180	18.0		.7087	18	93	143
DGE433181	18.1		.7126	20	101	153
DGE433182	18.2		.7165	20	101	153
DGE433183	18.3		.7205	20	101	153
DGE433184	18.4		.7244	20	101	153
DGE433185	18.5		.7283	20	101	153
DGE433186	18.6		.7323	20	101	153
DGE433187	18.7		.7362	20	101	153
DGE433188	18.8		.7402	20	101	153
DGE433189	18.9		.7441	20	101	153
DGE433190	19.0		.7480	20	101	153
DGE433048F	19.050	3/4	.7500	20	101	153
DGE433191	19.1		.7520	20	101	153
DGE433192	19.2		.7559	20	101	153
DGE433193	19.3		.7598	20	101	153
DGE433194	19.4		.7638	20	101	153
DGE433195	19.5		.7676	20	101	153
DGE433196	19.6		.7717	20	101	153
DGE433197	19.7		.7756	20	101	153
DGE433198	19.8		.7795	20	101	153
DGE433199	19.9		.7835	20	101	153
DGE433200	20.0		.7874	20	101	153

► Other shank types are available on your request.

DREAM DRILL•ALU

CARBIDE, DREAM DRILLS•ALU with COOLANT HOLES, DLC-COATED RECOMMENDED CUTTING CONDITIONS

DGE466 | DGE718 | DGE433 SERIES

WORK MATERIAL		N								
		ALUMINUM ALLOY CASTING ALUMINUM DIE CASTING				WROUGHT ALUMINUM ALLOY				
DRILLING SPEED(SFM)		240 ~ 650 ft/min				240 ~ 650 ft/min				
DIAMETER		RPM	FEED	IPR	RPM	FEED	IPR	RPM	FEED	IPR
Metric(mm)	Decimal									
3.0~6.0	.1181 ~ .2362	8000 ~ 15000	0.2 ~ 0.5	.008 .020	8000 ~ 15000	0.15 ~ 0.3	.006 .012	8000 ~ 15000	0.15 ~ 0.3	.006 .012
~10.0	~.3937	6000 ~ 10500	0.3 ~ 1.0	.012 .039	6000 ~ 10500	0.20 ~ 0.4	.008 .016	6000 ~ 10500	0.20 ~ 0.4	.008 .016
~14.0	~.5512	4500 ~ 5800	0.3 ~ 1.0	.012 .039	4500 ~ 5800	0.20 ~ 0.4	.008 .016	4500 ~ 5800	0.20 ~ 0.4	.008 .016
~20.0	~.7874	3200 ~ 4600	0.3 ~ 1.0	.012 .039	3200 ~ 4600	0.30 ~ 1.0	.012 .039	3200 ~ 4600	0.30 ~ 1.0	.012 .039

RPM = rev./min.
FEED = mm/rev.
IPR = inch/rev.

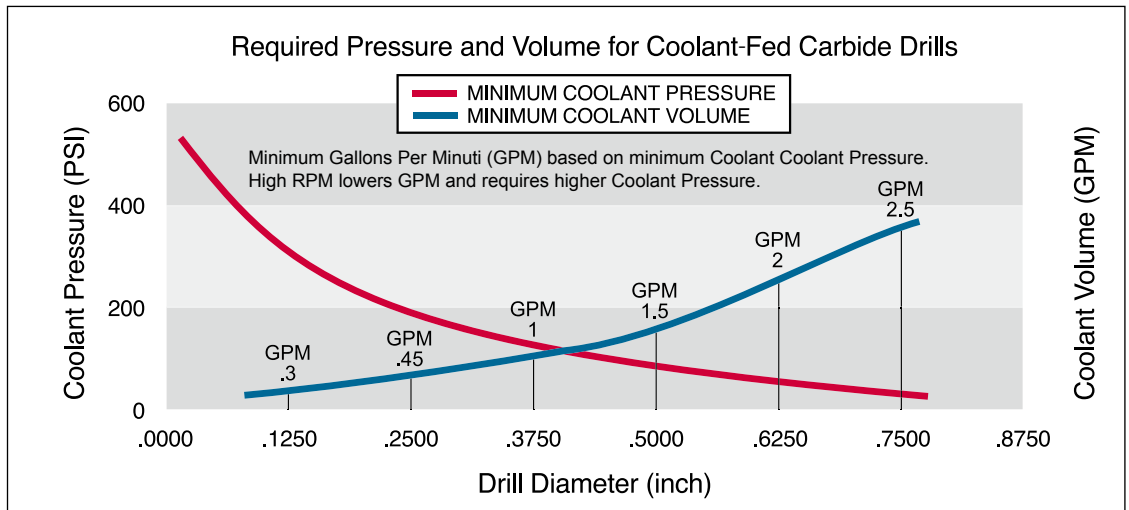
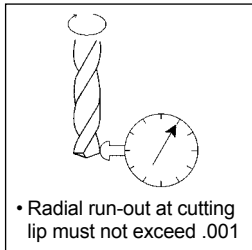
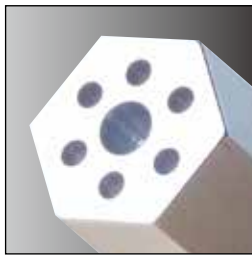

DREAM DRILL•FLAT BOTTOM

CARBIDE, DREAM DRILL•FLAT BOTTOM WITHOUT COOLANT HOLES

SHORT

DPP447 SERIES

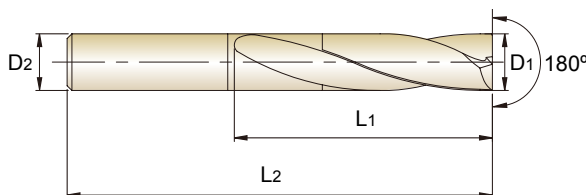

Page 124

2 x D

Unit: METRIC

EDP No.	Drill Diameter			Shank Diameter D2	Flute Length L1	Overall Length L2
	Metric	Fractional	Decimal			
X-Coating	D1			D2	L1	L2
DPP447030	3		.1181	6	16	50
DPP447031	3.1		.1220	6	16	50
DPP447008F	3.175	1/8	.1250	6	16	50
DPP447032	3.2		.1260	6	16	50
DPP447033	3.3		.1299	6	16	50
DPP447034	3.4		.1339	6	18	50
DPP447035	3.5		.1378	6	18	50
DPP447036	3.6		.1417	6	18	50
DPP447037	3.7		.1457	6	18	50
DPP447038	3.8		.1496	6	18	50
DPP447039	3.9		.1535	6	18	50
DPP447010F	3.969	5/32	.1563	6	18	50
DPP447040	4		.1575	6	18	50
DPP447041	4.1		.1614	6	20	60
DPP447042	4.2		.1654	6	20	60
DPP447043	4.3		.1693	6	20	60
DPP447044	4.4		.1732	6	20	60
DPP447045	4.5		.1772	6	22	60
DPP447046	4.6		.1811	6	22	60
DPP447047	4.7		.1850	6	22	60
DPP447012F	4.763	3/16	.1875	6	22	60
DPP447048	4.8		.1890	6	22	60
DPP447049	4.9		.1929	6	22	60
DPP447050	5		.1969	6	22	60

EDP No.	Drill Diameter			Shank Diameter D2	Flute Length L1	Overall Length L2
	Metric	Fractional	Decimal			
X-Coating	D1			D2	L1	L2
DPP447051	5.1		.2008	6	24	60
DPP447052	5.2		.2047	6	24	60
DPP447053	5.3		.2087	6	24	60
DPP447054	5.4		.2126	6	24	60
DPP447055	5.5		.2165	6	24	60
DPP447014F	5.556	7/32	.2188	6	24	60
DPP447056	5.6		.2205	6	24	60
DPP447057	5.7		.2244	6	26	60
DPP447058	5.8		.2283	6	26	60
DPP447059	5.9		.2323	6	26	60
DPP447060	6		.2362	6	26	60
DPP447061	6.1		.2402	8	28	70
DPP447062	6.2		.2441	8	28	70
DPP447063	6.3		.2480	8	28	70
DPP447016F	6.35	1/4	.2500	8	30	70
DPP447064	6.4		.2520	8	30	70
DPP447065	6.5		.2559	8	30	70
DPP447066	6.6		.2598	8	30	70
DPP447067	6.7		.2638	8	30	70
DPP447068	6.8		.2677	8	30	70
DPP447069	6.9		.2717	8	30	70
DPP447070	7		.2756	8	30	70
DPP447071	7.1		.2795	8	34	70
DPP447018F	7.144	9/32	.2812	8	34	70

► Other shank types are available on your request.

► NEXT PAGE

DREAM DRILL•FLAT BOTTOM

CARBIDE, DREAM DRILL•FLAT BOTTOM WITHOUT COOLANT HOLES

SHORT

DPP447 SERIES

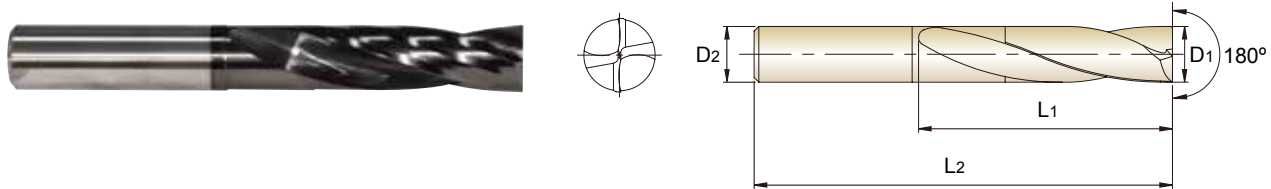

Page 124

2 × D

Unit: METRIC

EDP No.	Drill Diameter			Shank Diameter D2	Flute Length L1	Overall Length L2
	Metric	Fractional	Decimal			
X-Coating	D1			D2	L1	L2
DPP447072	7.2		.2835	8	34	70
DPP447073	7.3		.2874	8	34	70
DPP447074	7.4		.2913	8	34	70
DPP447075	7.5		.2953	8	34	70
DPP447076	7.6		.2992	8	34	70
DPP447077	7.7		.3031	8	34	70
DPP447078	7.8		.3071	8	34	70
DPP447079	7.9		.3110	8	34	70
DPP447020F	7.938	5/16	.3125	8	34	70
DPP447080	8		.3150	8	34	70
DPP447081	8.1		.3189	10	38	80
DPP447082	8.2		.3228	10	38	80
DPP447083	8.3		.3268	10	38	80
DPP447021F	8.334	21/64	.3281	10	38	80
DPP447084	8.4		.3307	10	38	80
DPP447085	8.5		.3346	10	38	80
DPP447086	8.6		.3386	10	38	80
DPP447087	8.7		.3425	10	40	80
DPP447088	8.8		.3465	10	40	80
DPP447089	8.9		.3504	10	40	80
DPP447090	9		.3543	10	40	80
DPP447091	9.1		.3583	10	42	80
DPP447023F	9.128	23/64	.3594	10	42	80
DPP447092	9.2		.3622	10	42	80

EDP No.	Drill Diameter			Shank Diameter D2	Flute Length L1	Overall Length L2
	Metric	Fractional	Decimal			
X-Coating	D1			D2	L1	L2
DPP447093	9.3		.3661	10	42	80
DPP447094	9.4		.3701	10	42	80
DPP447095	9.5		.3740	10	42	80
DPP447024F	9.525	3/8	.3750	10	42	80
DPP447096	9.6		.3780	10	42	80
DPP447097	9.7		.3819	10	45	80
DPP447098	9.8		.3858	10	45	80
DPP447099	9.9		.3898	10	45	80
DPP447100	10		.3937	10	45	80
DPP447101	10.1		.3976	12	46	90
DPP447102	10.2		.4016	12	46	90
DPP447103	10.3		.4055	12	46	90
DPP447026F	10.319	13/32	.4062	12	46	90
DPP447104	10.4		.4094	12	48	90
DPP447105	10.5		.4134	12	48	90
DPP447106	10.6		.4173	12	48	90
DPP447107	10.7		.4212	12	48	90
DPP447108	10.8		.4252	12	48	90
DPP447109	10.9		.4291	12	48	90
DPP447110	11		.4330	12	48	90
DPP447111	11.1		.4370	12	50	90
DPP447028F	11.113	7/16	.4375	12	50	90
DPP447112	11.2		.4409	12	50	90
DPP447113	11.3		.4448	12	50	90

▶ Other shank types are available on your request.

▶ NEXT PAGE

DREAM DRILL•FLAT BOTTOM

CARBIDE, DREAM DRILL•FLAT BOTTOM WITHOUT COOLANT HOLES

SHORT

DPP447 SERIES

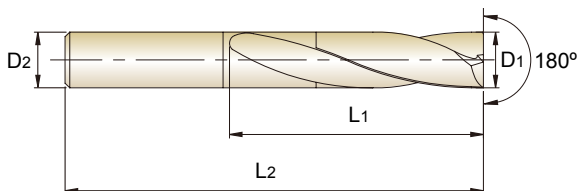

Page 124

2 × D

Unit: **METRIC**

EDP No.	Drill Diameter			Shank Diameter	Flute Length	Overall Length
	Metric	Fractional	Decimal			
X-Coating	D1			D2	L1	L2
DPP447114	11.4		.4488	12	50	90
DPP447115	11.5		.4527	12	50	90
DPP447029F	11.509	29/64	.4531	12	50	90
DPP447116	11.6		.4566	12	50	90
DPP447117	11.7		.4606	12	52	90
DPP447118	11.8		.4645	12	52	90
DPP447119	11.9		.4685	12	52	90
DPP447030F	11.906	15/32	.4688	12	52	90
DPP447120	12		.4724	12	52	90
DPP447121	12.1		.4764	14	54	100
DPP447122	12.2		.4803	14	54	100
DPP447123	12.3		.4843	14	54	100
DPP447124	12.4		.4882	14	54	100
DPP447125	12.5		.4921	14	54	100
DPP447126	12.6		.4961	14	54	100
DPP447127	12.7		.5000	14	56	100
DPP447128	12.8		.5039	14	56	100
DPP447129	12.9		.5079	14	56	100
DPP447130	13		.5118	14	56	100
DPP447131	13.1		.5157	14	58	100
DPP447132	13.2		.5197	14	58	100
DPP447133	13.3		.5236	14	58	100
DPP447134	13.4		.5276	14	58	100
DPP447135	13.5		.5314	14	58	100

EDP No.	Drill Diameter			Shank Diameter	Flute Length	Overall Length
	Metric	Fractional	Decimal			
X-Coating	D1			D2	L1	L2
DPP447136	13.6		.5354	14	58	100
DPP447137	13.7		.5394	14	58	100
DPP447138	13.8		.5433	14	58	100
DPP447139	13.9		.5472	14	58	100
DPP447140	14		.5512	14	58	100
DPP447141	14.1		.5551	16	62	105
DPP447142	14.2		.5591	16	62	105
DPP447036F	14.288	9/16	.5625	16	62	105
DPP447143	14.3		.5630	16	62	105
DPP447144	14.4		.5669	16	62	105
DPP447145	14.5		.5709	16	62	105
DPP447146	14.6		.5748	16	62	105
DPP447147	14.7		.5787	16	62	105
DPP447148	14.8		.5827	16	62	105
DPP447149	14.9		.5866	16	62	105
DPP447150	15		.5905	16	62	105
DPP447151	15.1		.5945	16	64	115
DPP447152	15.2		.5984	16	64	115
DPP447153	15.3		.6024	16	64	115
DPP447154	15.4		.6063	16	64	115
DPP447155	15.5		.6102	16	64	115
DPP447156	15.6		.6142	16	64	115
DPP447157	15.7		.6181	16	64	115
DPP447158	15.8		.6220	16	64	115

► Other shank types are available on your request.

► NEXT PAGE

DREAM DRILL•FLAT BOTTOM

CARBIDE, DREAM DRILL•FLAT BOTTOM WITHOUT COOLANT HOLES

SHORT

DPP447 SERIES

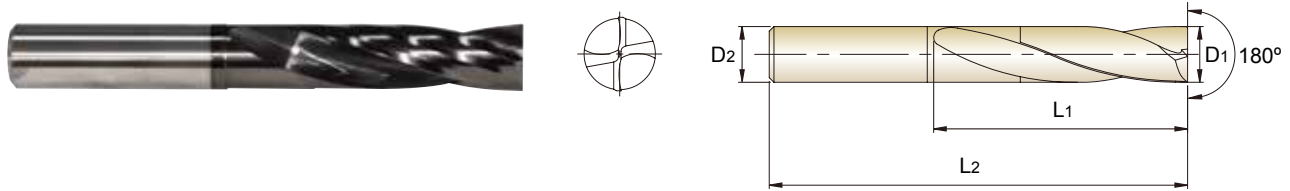

Page 124

2 × D

Unit: METRIC

EDP No.	Drill Diameter			Shank	Flute Length	Overall Length
	Metric	Fractional	Decimal			
X-Coating	D1			D2	L1	L2
DPP447040F	15.875	5/8	.6250	16	64	115
DPP447159	15.9		.6260	16	64	115
DPP447160	16		.6299	16	64	115
DPP447165	16.5		.6496	18	70	125
DPP447170	17		.6693	18	70	125
DPP447044F	17.463	11/16	.6875	18	70	125
DPP447175	17.5		.6890	18	70	125

EDP No.	Drill Diameter			Shank	Flute Length	Overall Length
	Metric	Fractional	Decimal			
X-Coating	D1			D2	L1	L2
DPP447180	18		.7087	18	70	125
DPP447185	18.5		.7283	20	75	135
DPP447190	19		.7480	20	75	135
DPP447048F	19.05	3/4	.7500	20	75	135
DPP447195	19.5		.7677	20	75	145
DPP447200	20		.7874	20	75	145

► Other shank types are available on your request.

DREAM DRILL FLAT BOTTOM

CARBIDE, DREAM DRILL•FLAT BOTTOM without COOLANT HOLES, X-COATED RECOMMENDED CUTTING CONDITIONS

DPP447 SERIES

WORK MATERIAL	P								M		K		N		
	STRUCTURAL STEELS		CARBON STEELS ALLOY STEELS		PREHARDENED STEELS		HARDEND STEELS		STAINLESS STEELS		CAST IRON		ALUMINUM		
STRENGTH			<HB225		HRC30 ~ 40		HRC40 ~ 50		~ 200 HB						
DRILLING SPEED	80 m/min		70 m/min		38 m/min		25 m/min		30 m/min		68 m/min		165 m/min		
DIAMETER															
	RPM	FEED	RPM	FEED	RPM	FEED	RPM	FEED	RPM	FEED	RPM	FEED	RPM	FEED	
Metric(mm)	Decimal														
3.0	.1181	8350	0.05	7250	0.05	3890	0.05	2790	0.03	3180	0.02	7250	0.04	17850	0.06
4.0	.1575	6250	0.07	5410	0.07	2940	0.06	2100	0.04	2380	0.03	5410	0.06	13130	0.08
5.0	.1969	5040	0.08	4360	0.08	2310	0.08	1680	0.05	1910	0.04	4360	0.07	10500	0.10
6.0	.2362	4200	0.10	3630	0.10	1890	0.09	1370	0.06	1590	0.05	3630	0.09	8930	0.12
8.0	.3150	3150	0.14	2730	0.13	1470	0.12	1050	0.08	1190	0.06	2730	0.12	6670	0.16
10.0	.3937	2520	0.17	2160	0.17	1160	0.15	840	0.10	955	0.08	2160	0.15	5360	0.20
12.0	.4724	2100	0.21	1790	0.21	1000	0.18	690	0.12	796	0.10	1790	0.18	4470	0.24
16.0	.6299	1580	0.28	1370	0.28	740	0.24	530	0.16	597	0.12	1370	0.24	3360	0.32
20.0	.7874	1260	0.35	1110	0.34	580	0.31	420	0.20	477	0.15	1110	0.30	2680	0.40

RPM = rev./min.
FEED = mm/rev.

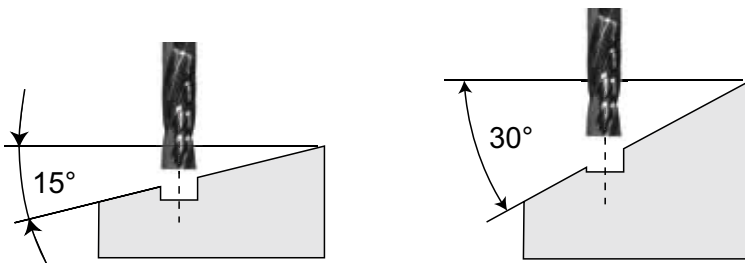

Surface Angle	Cutting Conditions	
	RPM	FEED
0° ~ 15°	100%	100%
15° ~ 30°	100%	50%
30° ~	70%	30%

- ▶ The cutting conditions are for 2xD.
- ▶ The rigid and precise machine and holder are required.
- ▶ The recommended depth of hole is measured from the highest point of the hole on drilling in inclined and angled surfaces.
- ▶ The recommended cutting conditions are those for drilling on flat and horizontal surfaces.
- ▶ Please adjust feed rate according to the above surface angle when drilling on an inclined surface.
 - The recommended feed rate 50% or lower, in case of 15°~30° of the incline angle.
 - The recommended feed rate 30% or lower and RPM 70%, in case of 30° ~ of the incline angle.
- ▶ Please decrease cutting speed as material hardness increases.
- ▶ Only use drilling tool. Side milling, traversing, helical milling are not usable.

VARIETY OF DRILLING

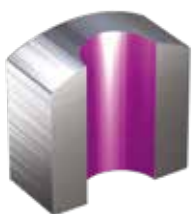

Curved Surface



Chained Hole



Blind Hole for Threading



Guide Drilling



Cross Drilling



Inclined Entry

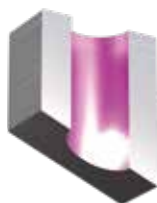

Inclined Exit



Counter Boring

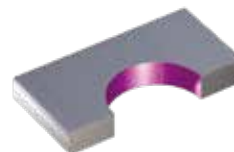

Thin Plate

THREADING

YG-1's application-specific designs put a new spin on threading and tapping.

Aerospace applications are some of the most challenging in the metalworking world, and this is especially true for threading aerospace components. YG-1 addresses these challenges with advanced threading tools designed to produce high-quality threads at a low cost per hole.





Threading Tools:
FOR THE CRITICAL DIMENSIONS OF AEROSPACE.

THE RIGHT TOOLS FOR THE RIGHT STUFF



YG-1 Thread Mills

For carbon steels, alloy steels, heat-treated steels, stainless steels, non-ferrous materials, titanium alloy, chrome-nickel alloy

- ▶ Versatility with a single tool milling left and right hand threads in blind and through holes
- ▶ High-quality thread finish with full threads to the bottom of the hole
- ▶ Achieve consistent close tolerance pitch diameter
- ▶ Excellent option for underpowered machines when threading large diameter holes
- ▶ One tool can be used in a wide range of materials

Threading Tools



YG-1 TiNi Taps

For titanium and nickel-based alloys up to 45Rc

- ▶ Powdered metal for wear and heat resistance
- ▶ Finish options: Oxide, TiCN, and Hardslick
- ▶ Low helix spiral flute taps with modified bottoming chamfer for blind hole applications
- ▶ Spiral point taps with plug chamfer for through hole applications
- ▶ Pitch limits for 2B and 3B Class of Fit



YG-1 Taps for Stainless Steels

- ▶ High vanadium HSSE-V3 material for wear resistance
- ▶ Finish options: Bright, Oxide, TiN, and Hardslick
- ▶ High helix spiral flute taps with modified bottoming chamfer for blind hole applications
- ▶ Spiral point taps with plug chamfers for through hole applications
- ▶ Wide range of pitch limits
- ▶ Extended length taps standard



YG-1 Screw Thread Insert Taps

For tapping STI threads in soft materials

- ▶ HSSE-V3 material for wear resistance
- ▶ HSS material for all applications
- ▶ Finish options: Bright and Hardslick
- ▶ High helix spiral flute taps with bottoming chamfers for blind hole applications
- ▶ Spiral point taps with plug chamfers for through hole applications
- ▶ Straight flute taps with bottoming and plug chamfers for through and blind hole applications

SELECTION GUIDE

TiNi SPIRAL FLUTE TAPS - INCH/METRIC

SERIES	MODEL	Tool Material	Standard	Work Material	Dimensions	Tolerance	Chamfer	Thread Depth	Surface Treatment	PAGE
B3/B5/D6		P-HSS	UNC/UNF	Ti Ni	USCTI 302A	H	2 ~ 3P	2.5D	Steam Oxide TiCN Hardslick	130

TiNi SPIRAL POINT TAPS - INCH/METRIC

SERIES	MODEL	Tool Material	Standard	Work Material	Dimensions	Tolerance	Chamfer	Thread Depth	Surface Treatment	PAGE
I3/M8/I5/J6		P-HSS	UNC/UNF	Ti Ni	USCTI 302A	H	4 ~ 5P	3.0D	Steam Oxide Bright/TiCN Hardslick	131

SS SPIRAL FLUTE TAPS - INCH/METRIC

SERIES	MODEL	Tool Material	Standard	Work Material	Dimensions	Tolerance	Chamfer	Thread Depth	Surface Treatment	PAGE
G7/G8/G9/H0		P-HSS	UNC/UNF	VA	USCTI Long Shank	H	2 ~ 3P	2.5D	TiN Hardslick	132
B1/B0/B2/D2		HSSE-V3	UNC/UNF	VA	USCTI 302A	H	2 ~ 3P		Bright Steam Oxide TiN/Hardslick	133
BS/BT		HSSE-V3	M/MF	VA	USCTI 302A	D	2 ~ 3P		Steam Oxide Hardslick	136
E6/E8/E9		HSSE-V3	M/MF	VA	DIN Length-ANSI Shank	D	2 ~ 3P		Steam Oxide TiCN Hardslick	137

SS SPIRAL POINT TAPS - INCH/METRIC

SERIES	MODEL	Tool Material	Standard	Work Material	Dimensions	Tolerance	Chamfer	Thread Depth	Surface Treatment	PAGE
M0/M1/M2/M3		P-HSS	UNC/UNF	VA	USCTI Long Shank	H	4 ~ 5P	3.0D	TiN Hardslick	138
I0/I2/J2		HSSE-V3	UNC/UNF	VA	USCTI 302A	H	4 ~ 5P		Steam Oxide TiN Hardslick	139
O9/IA		HSSE-V3	M/MF	VA	USCTI 302A	D	4 ~ 5P		Steam Oxide Hardslick	142
K3/K5/K6		HSSE-V3	M/MF	VA	DIN Length-ANSI Shank	D	4 ~ 5P		Steam Oxide TiCN Hardslick	143

SCREW THREAD INSERT TAPS TAPS - INCH/METRIC

SERIES	MODEL	Tool Material	Standard	Work Material	Dimensions	Tolerance	Chamfer	Thread Depth	Surface Treatment	PAGE
ST/SI		HSSE-V3	UNC/UNF	GS	USCTI 322	2B	1.5 ~ 2P	2.5D	Hardslick	144
T7406		HSS	UNC/UNF	GS	USCTI 322	H	1.5 ~ 2P		Bright	145
T7425		HSS	M/MF	GS	USCTI 322A	D	1.5 ~ 2P		Bright	146
ST/SI		HSSE-V3	UNC/UNF	GS	USCTI 322	2B	4 ~ 5P	3.0D	Hardslick	147
T7436		HSS	UNC/UNF	GS	USCTI 322	H	4 ~ 5P		Bright	148
T7415		HSS	M/MF	GS	USCTI 322A	D	4 ~ 5P		Bright	149
T7426		HSS	UNC/UNF	GS	USCTI 322	H	4 ~ 5P 1.5 ~ 2P	2.0D	Bright	150
T7405		HSS	M/MF	GS	USCTI 322A	D	4 ~ 5P 1.5 ~ 2P		Bright	151

THREAD MILLS - INCH

- ▶ For blind holes and through holes with one single tool.
- ▶ Higher cutting speed and feed than taps.

SERIES	MODEL	Description	Page
TE		SOLID CARBIDE THREAD MILL FOR UNIFIED INTERNAL THREADS - ANSI B 1.1	152
TD		SOLID CARBIDE THREAD MILL FOR METRIC INTERNAL THREADS - DIN 13	153
TF TG		SOLID CARBIDE THREAD MILL FOR UNIFIED INTERNAL THREADS - ANSI B 1.20.1(NPT) / ANSI B1.20.3(NPTF)	154



SPIRAL FLUTE TAPS MODIFIED BOTTOMING STYLE FOR TITANIUM ALLOYS & NICKEL BASE ALLOYS UP TO 38 ~ 45HRC

B3 | B5 | D6 SERIES

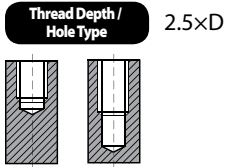

USCTI

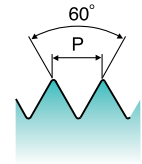

Ti Ni
P-HSS
UNC UNF
USCTI 302A
2P~3P
Steam Oxide
TiCN
Hardslick
R15

SIZE	Thread Per Inch		Limit	No. of Flutes	EDP No.		
	UNC	UNF			Steam Oxide	TiCN	Hardslick
#2	56	—	H2	3	B3082	B5082	D6082
#4	40	—	H2	3	B3162	B5162	D6162
#5	40	—	H2	3	B3202	B5202	D6202
#6	32	—	H3	3	B3243	B5243	D6243
#8	32	—	H3	3	B3283	B5283	D6283
#10	24	—	H3	3	B3323	B5323	D6323
	—	32			B3343	B5343	D6343
1/4	20	—	H3	3	B3403	B5403	D6403
			H5		B3405	B5405	D6405
	—	28	H3		B3423	B5423	D6423
			H4		B3424	B5424	D6424
5/16	18	—	H3	3	B3443	B5443	D6443
			H5		B3445	B5445	D6445
	—	24	H3		B3463	B5463	D6463
3/8	16	—	H3	3	B3483	B5483	D6483
			H5		B3485	B5485	D6485
	—	24	H3		B3503	B5503	D6503
			H4		B3504	B5504	D6504
7/16	14	—	H3	3	B3523	B5523	D6523
			H5		B3525	B5525	D6525
	—	20	H3		B3543	B5543	D6543
			H5		B3545	B5545	D6545
1/2	13	—	H3	3	B3563	B5563	D6563
			H5		B3565	B5565	D6565
	—	20	H3		B3583	B5583	D6583
			H5		B3585	B5585	D6585
9/16	12	—	H3	3	B3603	B5603	D6603
			H5		B3605	B5605	D6605
	—	18	H3		B3623	B5623	D6623
			H5		B3625	B5625	D6625
5/8	11	—	H3	4	B3643	B5643	D6643
			H5		B3645	B5645	D6645
	—	18	H3		B3663	B5663	D6663
			H5		B3665	B5665	D6665
3/4	10	—	H3	4	B3703	B5703	D6703
			H5		B3705	B5705	D6705
	—	16	H3		B3723	B5723	D6723
			H5		B3725	B5725	D6725

▶ TiN coated available: H9 series

TiNi Spiral Flute Taps

SPIRAL POINT TAPS PLUG STYLE FOR TITANIUM ALLOYS & NICKEL BASE ALLOYS UP TO 38 ~ 45HRC

I3 | M8 | I5 | J6 SERIES

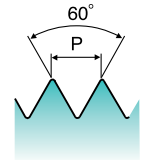
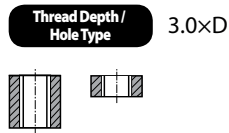

Ti Ni
P-HSS
UNC UNF
USCTI 302A
4P~5P
Steam Oxide
Bright
TiCN
Hardslick

SIZE	Thread Per Inch		Limit	No. of Flutes	EDP No.			
	UNC	UNF			Steam Oxide	Bright	TiCN	Hardslick
#2	56	—	H2	2	I3082	M8082	I5082	J6082
#4	40	—	H2	2	I3162	M8162	I5162	J6162
#5	40	—	H2	3	I3202	M8202	I5202	J6202
#6	32	—	H3	3	I3243	M8243	I5243	J6243
#8	32	—	H3	3	I3283	M8283	I5283	J6283
#10	24	—	H3	3	I3323	M8323	I5323	J6323
	—	32			I3343	M8343	I5343	J6343
1/4	20	—	H3	3	I3403	M8403	I5403	J6403
			H5		I3405	M8405	I5405	J6405
	28	H3	I3423		M8423	I5423	J6423	
		H4	I3424		M8424	I5424	J6424	
5/16	18	—	H3	3	I3443	M8443	I5443	J6443
			H5		I3445	M8445	I5445	J6445
	24	H3	I3463		M8463	I5463	J6463	
3/8	16	—	H3	3	I3483	M8483	I5483	J6483
			H5		I3485	M8485	I5485	J6485
	24	H3	I3503		M8503	I5503	J6503	
		H4	I3504		M8504	I5504	J6504	
7/16	14	—	H3	3	I3523	M8523	I5523	J6523
			H5		I3525	M8525	I5525	J6525
	20	H3	I3543		M8543	I5543	J6543	
		H5	I3545		M8545	I5545	J6545	
1/2	13	—	H3	3	I3563	M8563	I5563	J6563
			H5		I3565	M8565	I5565	J6565
	20	H3	I3583		M8583	I5583	J6583	
		H5	I3585		M8585	I5585	J6585	
9/16	12	—	H3	3	I3603	M8603	I5603	J6603
			H5		I3605	M8605	I5605	J6605
	18	H3	I3623		M8623	I5623	J6623	
		H5	I3625		M8625	I5625	J6625	
5/8	11	—	H3	3	I3643	M8643	I5643	J6643
			H5		I3645	M8645	I5645	J6645
	18	H3	I3663		M8663	I5663	J6663	
		H5	I3665		M8665	I5665	J6665	
3/4	10	—	H3	3	I3703	M8703	I5703	J6703
			H5		I3705	M8705	I5705	J6705
	16	H3	I3723		M8723	I5723	J6723	
		H5	I3725		M8725	I5725	J6725	



EXTENDED LENGTH SPIRAL FLUTE TAPS MODIFIED BOTTOMING STYLE FOR STAINLESS STEELS

G7 | G8 | G9 | H0 SERIES

Extended length for greater reach

Thread Depth / Hole Type 2.5xD

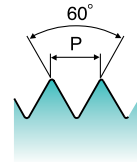
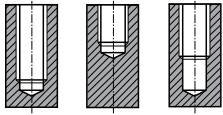

VA
P-HSS
UNC UNF
USCTI Long Shank
2P~3P
TiN
Hardslick
R45

SIZE	Thread Per Inch		Limit	No. of Flutes	EDP No.			
	UNC	UNF			TiN 4" OAL	TiN 6" OAL	Hardslick 4" OAL	Hardslick 6" OAL
#4	40	—	H2	3	G7162	—	G9162	—
#6	32	—	H3	3	G7243	G8243	G9243	H0243
#8	32	—	H3	3	G7283	G8283	G9283	H0283
#10	24	—	H3	3	G7323	G8323	G9323	H0323
	—	32	H3	3	G7343	G8343	G9343	H0343
1/4	20	—	H3	3	G7403	G8403	G9403	H0403
	—	28	H3	3	—	G8423	—	H0423
5/16	18	—	H3	3	—	G8443	—	H0443
	—	24	H3	3	—	G8463	—	H0463
3/8	16	—	H3	3	—	G8483	—	H0483
	—	24	H3	3	—	G8503	—	H0503
7/16	14	—	H3	3	—	G8523	—	H0523
	—	20	H3	3	—	G8543	—	H0543
1/2	13	—	H3	3	—	G8563	—	H0563
	—	20	H3	3	—	G8583	—	H0583
5/8	11	—	H3	4	—	G8643	—	H0643

SS Spiral Flute Taps

SPIRAL FLUTE TAPS MODIFIED BOTTOMING STYLE FOR STAINLESS STEELS

B1 | B0 | B2 | D2 SERIES

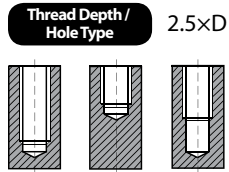

USCTI

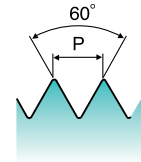

VA
HSSE-V3
UNC UNF
USCTI 302A
2P~3P
Bright
Steam Oxide
TiN
Hardslick
R45

SIZE	Thread Per Inch		Limit	No. of Flutes	EDP No.			
	UNC	UNF			Bright	Steam Oxide	TiN	Hardslick
#2	56	—	H2	2	B1082	B0082	B2082	D2082
#3	48	—	H2	2	—	B0122	—	D2122
#4	40	—	H2	2	B1162	B0162	B2162	D2162
			H3		—	B0163	—	D2163
			H4		—	B0164	—	D2164
			H5		B1165	B0165	—	D2165
			H6		B1166	B0166	—	D2166
#5	—	48	H2	—	—	B0182	—	D2182
#5	40	—	H2	3	B1202	B0202	B2202	D2202
#6	32	—	H2	3	—	B0242	—	D2242
			H3		B1243	B0243	B2243	D2243
			H4		—	B0244	—	D2244
			H5		—	B0245	—	D2245
			H7		—	B0247	—	D2247
	—	40	H2		—	B0262	—	D2262
			H3		—	B0263	—	D2263
#8	32	—	H2	3	—	B0282	—	D2282
			H3		B1283	B0283	B2283	D2283
			H4		—	B0284	—	D2284
			H5		—	B0285	—	D2285
			H6		—	B0286	—	D2286
	—	36	H7		—	B0287	—	D2287
			H3		—	B0303	—	D2303
#10	24	—	H2	3	—	B0322	—	D2322
			H3		B1323	B0323	B2323	D2323
			H5		—	B0325	—	D2325
			H7		—	B0327	—	D2327
	—	32	H2		—	B0342	—	D2342
			H3		B1343	B0343	B2343	D2343

▶ NEXT PAGE



SPIRAL FLUTE TAPS MODIFIED BOTTOMING STYLE FOR STAINLESS STEELS

B1 | B0 | B2 | D2 SERIES

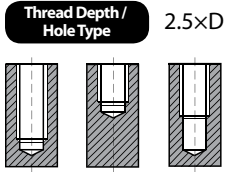

USCTI

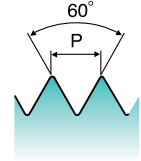

VA
HSSE-V3
UNC UNF
USCTI 302A
2P~3P
Bright
Steam Oxide
TiN
Hardslick
R45

SIZE	Thread Per Inch		Limit	No. of Flutes	EDP No.			
	UNC	UNF			Bright	Steam Oxide	TiN	Hardslick
#12	24	—	H3	3	—	B0363	—	D2363
	28	—	H3		—	B0383	—	D2383
1/4	20	—	H2	3	—	B0402	—	D2402
			H3		B1403	B0403	B2403	D2403
			H5		B1405	B0405	B2405	D2405
			H7		—	B0407	—	D2407
	—	28	H2		—	B0422	—	D2422
			H3		B1423	B0423	B2423	D2423
			H4		—	B0424	—	D2424
			H5		—	B0425	—	D2425
			H6		—	B0426	—	D2426
			H7		—	B0427	—	D2427
5/16	18	—	H3	3	B1443	B0443	B2443	D2443
			H5		B1445	B0445	B2445	D2445
			H7		—	B0447	—	D2447
	—	24	H3		B1463	B0463	B2463	D2463
			H4		—	B0464	—	D2464
			H5		—	B0465	—	D2465
			H7		—	B0467	—	D2467
3/8	16	—	H3	3	B1483	B0483	B2483	D2483
			H5		B1485	B0485	B2485	D2485
			H7		—	B0487	—	D2487
	—	24	H3		B1503	B0503	B2503	D2503
			H4		—	B0504	—	D2504
			H5		—	B0505	—	D2505

▶ NEXT PAGE

SS Spiral Flute Taps

SPIRAL FLUTE TAPS MODIFIED BOTTOMING STYLE FOR STAINLESS STEELS

B1 | B0 | B2 | D2 SERIES

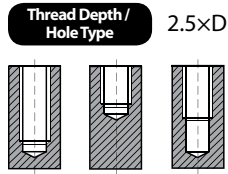

USCTI

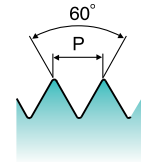

VA
HSSE-V3
UNC UNF
USCTI 302A
2P~3P
Bright
Steam Oxide
TiN
Hardslick
R45

SIZE	Thread Per Inch		Limit	No. of Flutes	EDP No.			
	UNC	UNF			Bright	Steam Oxide	TiN	Hardslick
7/16	14	—	H3	3	B1523	B0523	B2523	D2523
			H5		B1525	B0525	B2525	D2525
			H7		—	B0527	—	D2527
	—	20	H3		B1543	B0543	B2543	D2543
			H5		B1545	B0545	B2545	D2545
			H7		—	B0547	—	D2547
1/2	13	—	H3	3	B1563	B0563	B2563	D2563
			H5		B1565	B0565	B2565	D2565
			H7		—	B0567	—	D2567
	—	20	H3		B1583	B0583	B2583	D2583
			H5		—	B0585	—	D2585
			H6		—	B0586	—	D2586
9/16	12	—	H3	3	B1603	B0603	B2603	D2603
	—	18	H3		B1623	B0623	B2623	D2623
5/8	11	—	H3	4	B1643	B0643	B2643	D2643
			H5		B1645	B0645	B2645	D2645
	—	18	H3		B1663	B0663	B2663	D2663
			H5		B1665	B0665	B2665	D2665
3/4	10	—	H3	4	B1703	B0703	B2703	D2703
			H6		—	B0706	—	D2706
	—	16	H3		B1723	B0723	B2723	D2723
			H5		B1725	B0725	B2725	D2725
7/8	9	—	H4	4	B1744	B0744	B2744	D2744
	—	14	H4		B1764	B0764	B2764	D2764
1	8	—	H4	4	B1784	B0784	B2784	D2784
	—	12	H4		B1804	B0804	B2804	D2804

METRIC SPIRAL FLUTE TAPS MODIFIED BOTTOMING STYLE FOR STAINLESS STEELS

BS | BT SERIES

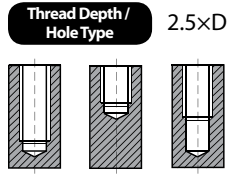

USCTI

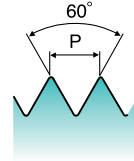

VA
HSSE-V3
M MF
USCTI 302A
2P~3P
Steam Oxide
Hardslick
R45

SIZE	Pitch	Limit	No. of Flutes	EDP No.	
				Steam Oxide	Hardslick
M3	0.5	D3	3	BS203	BT203
M3.5	0.6	D4	3	BS224	BT224
M4	0.7	D4	3	BS244	BT244
M5	0.8	D4	3	BS284	BT284
M6	1.0	D5	3	BS315	BT315
M7	1.0	D5	3	BS345	BT345
M8	1.25	D5	3	BS365	BT365
	1.0	D5	3	BS375	BT375
M10	1.5	D6	3	BS426	BT426
	1.25	D5	3	BS435	BT435
M12	1.75	D6	3	BS506	BT506
	1.25	D5	3	BS525	BT525
M14	2.0	D7	3	BS547	BT547
	1.5	D6	3	BS556	BT556
M16	2.0	D7	3	BS607	BT607
	1.5	D6	3	BS616	BT616
M18	2.5	D7	4	BS657	BT657
	1.5	D6	4	BS676	BT676

SS Spiral Flute Taps

METRIC SPIRAL FLUTE TAPS MODIFIED BOTTOMING STYLE FOR STAINLESS STEELS

E6 | E8 | E9 SERIES

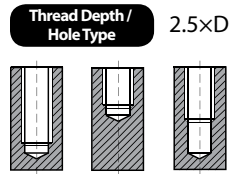

DIN Length-ANSI Shank

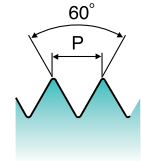

VA
HSSE-V3
M MF
2P~3P
Steam Oxide
TiCN
Hardslick
R45

SIZE	Pitch	Limit	No. of Flutes	EDP No.		
				Steam Oxide	TiCN	Hardslick
M3	0.5	D3	3	E6203	E8203	E9203
M3.5	0.6	D4	3	E6224	E8224	E9224
M4	0.7	D4	3	E6244	E8244	E9244
M5	0.8	D4	3	E6284	E8284	E9284
M6	1.0	D5	3	E6315	E8315	E9315
M7	1.0	D5	3	E6345	E8345	E9345
M8	1.25	D5	3	E6365	E8365	E9365
	1.0			E6375	E8375	E9375
M10	1.5	D6	3	E6426	E8426	E9426
	1.25	D5		E6435	E8435	E9435
M12	1.75	D6	3	E6506	E8506	E9506
	1.25	D5		E6525	E8525	E9525
M14	2.0	D7	3	E6547	E8547	E9547
	1.5	D6		E6556	E8556	E9556
M16	2.0	D7	3	E6607	E8607	E9607
	1.5	D6	4	E6616	E8616	E9616
M18	2.5	D7	4	E6657	E8657	E9657
	1.5	D6		E6676	E8676	E9676



EXTENDED LENGTH SPIRAL POINT TAPS PLUG STYLE FOR STAINLESS STEELS

M0 | M1 | M2 | M3 SERIES

Extended length for greater reach

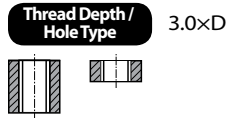

USCTI Long Shank

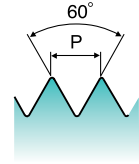

VA
P-HSS
UNC UNF
USCTI Long Shank
4P~5P
TiN
Hardslick

SIZE	Thread Per Inch		Limit	No. of Flutes	Maximum Tapping Depth	EDP No.			
	UNC	UNF				TiN 4" OAL	TiN 6" OAL	Hardslick 4" OAL	Hardslick 6" OAL
#4	40	—	H2	2	0.844	M0162	—	M2162	—
#6	32	—	H3	2	1.031	M0243	M1243	M2243	M3243
#8	32	—	H3	3	1.125	M0283	M1283	M2283	M3283
#10	24	—	H3	3	1.312	M0323	M1323	M2323	M3323
	—	32				M0343	M1343	M2343	M3343
1/4	20	—	H3	3	1.500	M0403	M1403	M2403	M3403
	—	28				—	M1423	—	M3423
5/16	18	—	H3	3	1.688	—	M1443	—	M3443
	—	24			1.688	—	M1463	—	M3463
3/8	16	—	H3	3	1.875	—	M1483	—	M3483
	—	24			—	—	M1503	—	M3503
7/16	14	—	H3	3	—	—	M1523	—	M3523
	—	20			—	—	M1543	—	M3543
1/2	13	—	H3	3	—	—	M1563	—	M3563
	—	20			—	—	M1583	—	M3583
9/16	12	—	H3	3	—	—	M1603	—	M3603
	—	18			—	—	M1623	—	M3623
5/8	11	—	H3	3	—	—	M1643	—	M3643

SS Spiral Point Taps Plug Style

SPIRAL POINT TAPS PLUG STYLE FOR STAINLESS STEELS

10 | 12 | J2 SERIES

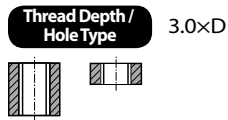

USCTI

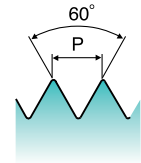

VA
HSSE-V3
UNC UNF
USCTI 302A
4P~5P
Steam Oxide
TiN
Hardslick

SIZE	Thread Per Inch		Limit	No. of Flutes	EDP No.			
	UNC	UNF			Steam Oxide	TiN	Hardslick	
#2	56		H2	2	I0082	I2082	J2082	
			H3		I0083	—	J2083	
			H4		I0084	—	J2084	
#3	48	—	H2	2	I0122	—	J2122	
#4	40	—	H2	2	I0162	I2162	J2162	
			H3		I0163	—	J2163	
			H4		I0164	—	J2164	
			H5		I0165	—	J2165	
	—	48		H6	2	I0166	—	J2166
				H2		I0182	—	J2182
				H4		I0184	—	J2184
				H5		I0185	—	J2185
#5	40	—	H2	3	I0202	I2202	J2202	
#6	32	—	H3	3	I0243	I2243	J2243	
			H3		I0244	—	J2244	
			H4		I0245	—	J2245	
	—	40		H7	3	I0247	—	J2247
				H2		I0262	—	J2262
				H3		I0263	—	J2263
#8	32	—	H2	3	I0282	—	J2282	
			H3		I0283	I2283	J2283	
			H4		I0284	—	J2284	
	—	36		H5	3	I0285	—	J2285
				H7		I0287	—	J2287
				H2		I0302	—	J2302
#10	24	—	H3	3	I0323	I2323	J2323	
			H4		I0324	—	J2324	
			H5		I0325	—	J2325	
	—	32		H2	3	I0342	—	J2342
				H3		I0343	I2343	J2343
				H4		I0344	—	J2344

▶ NEXT PAGE

SS Spiral Point Taps

SPIRAL POINT TAPS PLUG STYLE FOR STAINLESS STEELS

I0 | I2 | J2 SERIES

Thread Depth / Hole Type 3.0xD

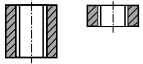

USCTI

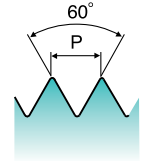

VA
HSSE-V3
UNC UNF
USCTI 302A
4P~5P
Steam Oxide
TiN
Hardslick

SIZE	Thread Per Inch		Limit	No. of Flutes	EDP No.						
	UNC	UNF			Steam Oxide	TiN	Hardslick				
#10	—	32	H5	3	I0345	—	J2345				
			H6		I0346	—	J2346				
			H7		I0347	—	J2347				
#12	24	—	H3	3	I0363	—	J2363				
	—	28			I0383	—	J2383				
1/4	20	—	H2	3	I0402	—	J2402				
			H3		I0403	I2403	J2403				
			H5		I0405	I2405	J2405				
			H7		I0407	—	J2407				
	—	28	—		H2	I0422	—	J2422			
					H3	I0423	I2423	J2423			
					H4	I0424	—	J2424			
					H5	I0425	—	J2425			
					H6	I0426	—	J2426			
					H7	I0427	—	J2427			
					5/16	18	—	H3	I0443	I2443	J2443
								H5	I0445	I2445	J2445
								H7	I0447	—	J2447
						—	24	—	H3	I0463	I2463
H4	I0464	—	J2464								
H5	I0465	—	J2465								
3/8	16	—	H6	I0466	—	J2466					
			H7	I0467	—	J2467					
			H3	I0483	I2483	J2483					
	—	24	—	H5	I0485	I2485	J2485				
				H7	I0487	—	J2487				
				H3	I0503	I2503	J2503				
				H4	I0504	—	J2504				
			H5	I0505	—	J2505					
			H7	I0507	—	J2507					

▶ NEXT PAGE

SS Spiral Point Taps Plug Style

SPIRAL POINT TAPS PLUG STYLE FOR STAINLESS STEELS

10 | 12 | J2 SERIES

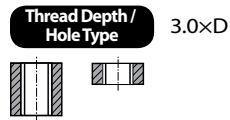

USCTI

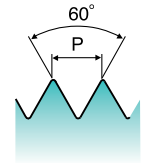

VA
HSSE-V3
UNC UNF
USCTI 302A
4P~5P
Steam Oxide
TiN
Hardslick

SIZE	Thread Per Inch		Limit	No. of Flutes	EDP No.		
	UNC	UNF			Steam Oxide	TiN	Hardslick
7/16	14	—	H3	3	I0523	I2523	J2523
			H5		I0525	I2525	J2525
	—	20	H3		I0543	I2543	J2543
			H5		I0545	I2545	J2545
1/2	13	—	H3	3	I0563	I2563	J2563
			H5		I0565	I2565	J2565
	—	20	H7		I0567	—	J2567
			H3		I0583	I2583	J2583
9/16	12	—	H5	3	I0585	—	J2585
			H3		I0603	I2603	J2603
	—	18	H3		I0623	I2623	J2623
			H3		I0643	I2643	J2643
5/8	11	—	H5	3	I0645	I2645	J2645
			H7		I0647	—	J2647
			H3		I0663	—	J2663
	—	18	H5		I0665	I2665	J2665
			H7		I0667	—	J2667
			H3		I0703	I2703	J2703
3/4	10	—	H5	3	I0725	I2725	J2725
	—	16	H3		I0744	I2744	J2744
7/8	9	—	H4	3	I0766	I2766	J2766
	—	14	H6		I0784	I2784	J2784
1	8	—	H4	3	I0806	I2806	J2806
	—	12	H6				

METRIC SPIRAL POINT TAPS PLUG STYLE FOR STAINLESS STEELS

09 | IA SERIES

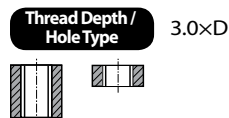

USCTI

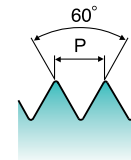

VA
HSSE-V3
M MF
USCTI 302A
4P~5P
Steam Oxide
Hardslick

SIZE	Pitch	Limit	No. of Flutes	EDP No.	
				Steam Oxide	Hardslick
M3	0.5	D3	3	O9203	IA203
M3.5	0.6	D4	3	O9224	IA224
M4	0.7	D4	3	O9244	IA244
M5	0.8	D4	3	O9284	IA284
M6	1.0	D5	3	O9315	IA315
M7	1.0	D5	3	O9345	IA345
M8	1.25	D5	3	O9365	IA365
	1.0			O9375	IA375
M10	1.5	D6	3	O9426	IA426
	1.25	D5		O9435	IA435
M12	1.75	D6	3	O9506	IA506
	1.25	D5		O9525	IA525
M14	2.0	D7	3	O9547	IA547
	1.5	D6		O9556	IA556
M16	2.0	D7	3	O9607	IA607
	1.5	D6		O9616	IA616
M18	2.5	D7	3	O9657	IA657
	1.5	D6		O9676	IA676

SS Spiral Point Taps Plug Style

METRIC SPIRAL POINT TAPS PLUG STYLE FOR STAINLESS STEELS

K3 | K5 | K6 SERIES

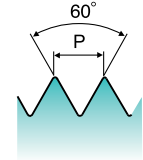
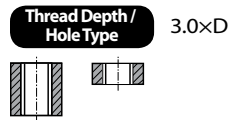

VA
HSSE-V3
M MF
4P~5P
Steam Oxide
TiCN
Hardslick

SIZE	Pitch	Limit	No. of Flutes	EDP No.		
				Steam Oxide	TiCN	Hardslick
M3	0.5	D3	3	K3203	K5203	K6203
M3.5	0.6	D4	3	K3224	K5224	K6224
M4	0.7	D4	3	K3244	K5244	K6244
M5	0.8	D4	3	K3284	K5284	K6284
M6	1.0	D5	3	K3315	K5315	K6315
M7	1.0	D5	3	K3345	K5345	K6345
M8	1.25	D5	3	K3365	K5365	K6365
	1.0			K3375	K5375	K6375
M10	1.5	D6	3	K3426	K5426	K6426
	1.25	D5		K3435	K5435	K6435
M12	1.75	D6	3	K3506	K5506	K6506
	1.25	D5		K3525	K5525	K6525
M14	2.0	D7	3	K3547	K5547	K6547
	1.5	D6		K3556	K5556	K6556
M16	2.0	D7	3	K3607	K5607	K6607
	1.5	D6		K3616	K5616	K6616
M18	2.5	D7	3	K3657	K5657	K6657
	1.5	D6		K3676	K5676	K6676



SPIRAL FLUTE STI TAPS BOTTOMING STYLE

ST | SI SERIES

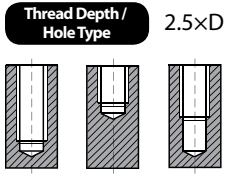

USCTI

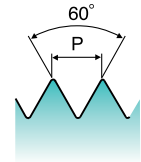

SIZE	Thread Per Inch		Limit	No. of Flutes	EDP No.
	UNC	UNF			Hardslick
#4	40	—	2B	3	ST162
	—	48			SI182
#5	40	—	2B	3	ST202
	—	44			SI222
#6	32	—	2B	3	ST242
	—	40			SI262
#8	32	—	2B	3	ST282
	—	36			SI302
#10	24	—	2B	3	ST322
	—	32			SI342
#12	24	—	2B	3	ST362
	—	28			SI382
1/4	20	—	2B	3	ST402
	—	28			SI422
5/16	18	—	2B	3	ST442
	—	24			SI462
3/8	16	—	2B	3	ST482
	—	24			SI502
7/16	14	—	2B	3	ST522
	—	20			SI542
1/2	13	—	2B	3	ST562
	—	20			SI582
9/16	12	—	2B	4	ST602
	—	18			SI622
5/8	11	—	2B	4	ST642
	—	18			SI662
3/4	10	—	2B	4	ST702
	—	16			SI722

Screw Thread Insert Taps

SPIRAL FLUTE STI TAPS BOTTOMING STYLE HIGH HELIX FOR GENERAL PURPOSE

T7406 SERIES

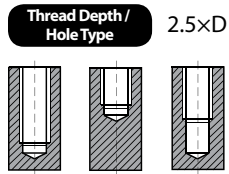

USCTI

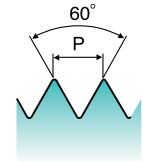

GS
HSS
UNC UNF
USCTI 322
1.5P~2P
Bright
R50

SIZE	Thread Per Inch		Limit	No. of Flutes	EDP No.
	UNC	UNF			Bright
#2	56	—	H2	2	T7406082
#3	48	—	H2	2	T7406122
#4	40	—	H2	2	T7406162
	—	48		3	T7406182
#6	32	—	H2	3	T7406242
	—	40	H3		T7406243
	—	40	H2		T7406262
#8	32	—	H2	3	T7406282
	—	36	H3		T7406283
	—	36	H2		T7406302
#10	24	—	H2	3	T7406322
	—	32	H3		T7406323
	—	32	H2		T7406342
	—	32	H3		T7406343
1/4	20	—	H2	3	T7406402
	—	28	H3		T7406403
	—	28	H2		T7406422
	—	28	H3		T7406423
5/16	18	—	H3	3	T7406443
	—	24	H4		T7406444
	—	24	H2		T7406462
	—	24	H3		T7406463
3/8	16	—	H3	3	T7406483
	—	24	H4		T7406484
	—	24	H2		T7406502
	—	24	H3		T7406503
7/16	14	—	H3	4	T7406523
	—	20	H4	4	T7406524
	—	20	H3	3	T7406543
	—	20	H4	3	T7406544
1/2	13	—	H3	4	T7406563
	—	20	H4		T7406564
	—	20	H3		T7406583
	—	20	H4		T7406584

METRIC SPIRAL FLUTE STI TAPS BOTTOMING STYLE HIGH HELIX FOR GENERAL PURPOSE

T7425 SERIES

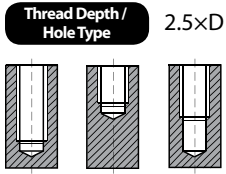

USCTI

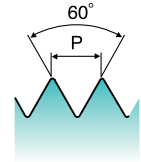

GS
HSS
M MF
USCTI 322A
1.5P~2P
Bright
R50

SIZE	Pitch	Limit	No. of Flutes	EDP No.
				Bright
M2	0.40	D2	2	T7425132
M2.5	0.45	D2	2	T7425172
M3	0.50	D2	3	T7425202
M4	0.70	D3	3	T7425243
M5	0.80	D3	3	T7425283
M6	1.00	D3	3	T7425313
M8	1.25	D3	3	T7425363
M10	1.50	D4	3	T7425424
M12	1.75	D4	3	T7425504

Screw Thread Insert Taps

SPIRAL POINT STI TAPS PLUG STYLE

ST | SI SERIES

Thread Depth / Hole Type 3.0xD

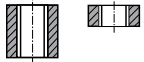

USCTI

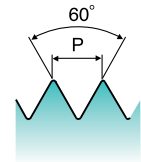

GS
HSSE-V3
UNC UNF
USCTI 322
4P~5P
Hardslick

SIZE	Thread Per Inch		Limit	No. of Flutes	EDP No.
	UNC	UNF			Hardslick
#4	40	—	2B	3	SI162
	—	48			ST182
#6	32	—	2B	3	SI242
	—	40			ST262
#8	32	—	2B	3	SI282
	—	36			ST302
#10	24	—	2B	3	SI322
	—	32			ST342
1/4	20	—	2B	3	SI402
	—	28			ST422
5/16	18	—	2B	3	SI442
	—	24			ST462
3/8	16	—	2B	3	SI482
	—	24			ST502
7/16	14	—	2B	3	SI522
	—	20			ST542
1/2	13	—	2B	3	SI562
	—	20			ST582
9/16	12	—	2B	3	SI602
	—	18			ST622
5/8	11	—	2B	3	SI642
	—	18			ST662
3/4	10	—	2B	3	SI702
	—	16			ST722

Screw Thread Insert Taps

SPIRAL POINT STI TAPS PLUG STYLE FOR GENERAL PURPOSE

T7436 SERIES

Thread Depth / Hole Type 3.0xD

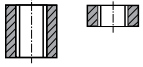

USCTI

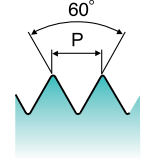

GS
HSS
UNC UNF
USCTI 322
4P~5P
Bright

SIZE	Thread Per Inch		Limit	No. of Flutes	EDP No.
	UNC	UNF			Bright
#2	56	—	H2	2	T7436082
#3	48	—	H2	2	T7436122
#4	40	—	H1	2	T7436161
	—	48	H2		T7436162
#5	40	—	H2	2	T7436182
#6	32	—	H2	2	T7436202
	—	40	H3		T7436242
#8	32	—	H2	2	T7436243
	—	36	H2		T7436262
#10	24	—	H2	2	T7436282
	—	32	H3		T7436283
1/4	20	—	H2	3	T7436302
	—	28	H3		T7436322
3/8	18	—	H2	3	T7436323
	—	24	H3		T7436342
7/16	16	—	H2	3	T7436343
	—	20	H3		T7436402
1/2	14	—	H2	3	T7436403
	—	20	H3		T7436422
	13	—	H3	4	T7436423
	—	20	H4		T7436443
	16	—	H3	3	T7436444
	—	24	H4		T7436462
	14	—	H2	3	T7436463
	—	20	H3		T7436483
	13	—	H3	3	T7436484
	—	20	H4		T7436502
	14	—	H2	3	T7436503
	—	20	H3		T7436523
	13	—	H4	3	T7436524
	—	20	H3		T7436543
	13	—	H4	4	T7436544
	—	20	H3		T7436563
	13	—	H4	4	T7436564
	—	20	H3		T7436583
	13	—	H4	4	T7436584
	—	20	H3		T7436584

Screw Thread Insert Taps

METRIC SPIRAL POINT STI TAPS PLUG STYLE FOR GENERAL PURPOSE

T7415 SERIES

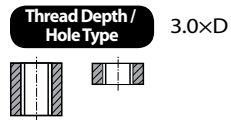

USCTI

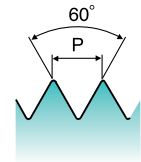

GS
HSS
M MF
USCTI 322A
4P~5P
Bright

SIZE	Pitch	Limit	No. of Flutes	EDP No.
				Bright
M2	0.4	D2	2	T7415132
M2.5	0.45	D2	2	T7415172
M3	0.5	D2	3	T7415202
M4	0.7	D3	3	T7415243
M5	0.8	D3	3	T7415283
M6	1.0	D3	3	T7415313
M8	1.25	D3	3	T7415363
M10	1.5	D4	3	T7415424
M12	1.75	D4	3	T7415504



STRAIGHT FLUTE STI TAPS PLUG AND BOTTOMING STYLE FOR GENERAL PURPOSE

T7426 SERIES

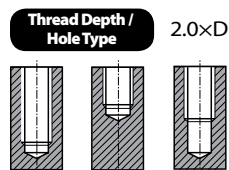

USCTI

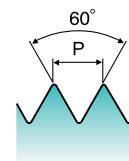

GS
HSS
UNC UNF
USCTI 322
4P~5P Plug
1.5P~2P Bottoming
Bright

SIZE	Thread Per Inch		Limit	No. of Flutes	EDP No.	
	UNC	UNF			Plug	Bottoming
#2	56	—	H2	3	T7426087	T7426088
#3	48	—	H2	3	T7426127	T7426128
#4	40	—	H1	3	T7426167H1	T7426168H1
	—	48	H2		T7426167	T7426168
#5	40	—	H2	3	T7426187	T7426188
	—	—	—	—	T7426207	T7426208
#6	32	—	H2	3	T7426247H2	T7426248H2
	—	40	H3		T7426247	T7426248
#8	32	—	H2	3	T7426267	T7426268
	—	36	H3		T7426287H2	T7426288H2
#10	24	—	H2	3	T7426287	T7426288
	—	32	H3		T7426307	T7426308
1/4	20	—	H2	3	T7426327H2	T7426328H2
	—	28	H3		T7426327	T7426328
5/16	18	—	H2	4	T7426347H2	T7426348H2
	—	24	H3		T7426347	T7426348
3/8	16	—	H2	4	T7426407H2	T7426408H2
	—	24	H3		T7426407	T7426408
7/16	14	—	H2	4	T7426427H2	T7426428H2
	—	20	H3		T7426427	T7426428
1/2	13	—	H3	4	T7426447	T7426448
	—	20	H4		T7426447H4	T7426448H4
	—	—	H2		T7426467H2	T7426468H2
	—	—	H3		T7426467	T7426468
	—	—	H3		T7426487	T7426488
	—	—	H4		T7426487H4	T7426488H4
	—	—	H2		T7426507H2	T7426508H2
	—	—	H3		T7426507	T7426508
	—	—	H3		T7426527	T7426528
	—	—	H4		T7426527H4	T7426528H4
	—	—	H3		T7426547	T7426548
	—	—	H4		T7426547H4	T7426548H4
	—	—	H3		T7426567	T7426568
	—	—	H4		T7426567H4	T7426568H4
	—	—	H3		T7426587	T7426588
	—	—	H4		T7426587H4	T7426588H4

Screw Thread Insert Taps

METRIC STRAIGHT FLUTE STI TAPS PLUG AND BOTTOMING STYLE FOR GENERAL PURPOSE

T7405 SERIES

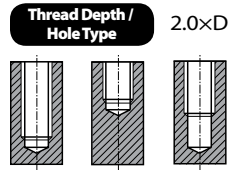

USCTI

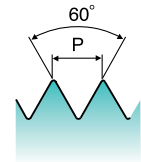

GS
HSS
M
USCTI 322A
4P~5P Plug
1.5P~2P Bottoming
Bright

SIZE	Pitch	Limit	No. of Flutes	EDP No.	
				Plug	Bottoming
M2	0.4	D2	2	T7405137	T7405138
M2.5	0.45	D2	2	T7405177	T7405178
M3	0.5	D2	3	T7405207	T7405208
M4	0.7	D3	3	T7405247	T7405248
M5	0.8	D3	3	T7405287	T7405288
M6	1.0	D3	3	T7405317	T7405318
M8	1.25	D3	3	T7405367	T7405368
M10	1.5	D4	3	T7405427	T7405428
M12	1.75	D4	3	T7405507	T7405508

PREMIUM HSS-PM, MULTI FLUTE REGULAR LENGTH FINE PITCH ROUGHING

TE SERIES

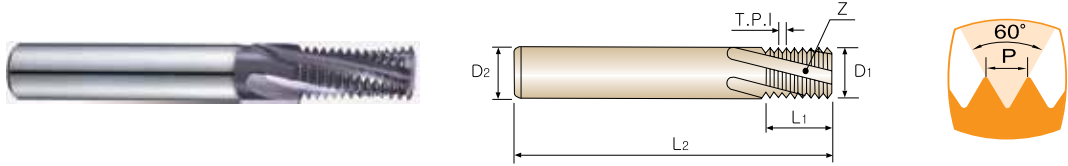

- ▶ Material: solid carbide
- ▶ Shank: plain straight
- ▶ Spiral angle: 15°

Unit : Inch

SIZE	Pitch	Cutter Diameter D ₁	Shank Diameter D ₂	Thread Length L ₁	Overall Length L ₂	No. of Flutes Z	EDP No.
							TIAIN
#2	56	.065	.125	.125	2.000	3	TE080
#3	48	.075	.125	.167	2.000	3	TE120
#5	44	.095	.125	.228	2.000	3	TE220
#4	40	.085	.125	.175	2.000	3	TE160
#8	36	.115	.125	.250	2.000	3	TE300
#6	32	.100	.125	.218	2.000	3	TE240
#8	32	.115	.125	.250	2.000	3	TE280
#10	32	.120	.125	.312	2.000	3	TE340
1/2	32	.370	.375	1.000	3.500	4	TEF90
#10	28	.120	.125	.312	2.000	3	TEK90
1/4	28	.180	.187	.500	2.500	3	TE420
1/2	28	.370	.375	1.000	3.500	4	TE590
#10	24	.120	.125	.312	2.000	3	TE320
5/16	24	.235	.250	.625	2.500	3	TE460
3/8	24	.285	.312	.750	3.000	4	TE500
1/2	24	.370	.375	1.000	3.500	4	TE570
1/4	20	.180	.187	.500	2.500	3	TE400
7/16	20	.335	.375	.875	3.500	4	TE540
1/2	20	.370	.375	1.000	3.500	4	TE580
5/16	18	.235	.250	.625	2.500	3	TE440
9/16	18	.370	.375	.875	3.500	4	TE620
3/8	16	.285	.312	.750	3.000	4	TE480
3/4	16	.490	.500	1.250	3.500	4	TE720
7/16	14	.305	.312	.750	3.000	4	TE520
7/8	14	.490	.500	1.250	3.500	4	TE760
1/2	13	.350	.375	.875	3.500	4	TE560
9/16	12	.370	.375	.875	3.500	4	TE600
3/4	12	.495	.500	1.250	3.500	4	TE710
5/8	11	.470	.500	1.250	3.500	4	TE640
3/4	10	.495	.500	1.250	3.500	4	TE700
7/8	9	.620	.625	1.375	4.000	4	TE740
1	8	.620	.625	1.375	4.000	4	TE780
	12	.745	.750	1.500	4.000	5	TE800
1-1/8 & 1-1/4	7	.745	.750	1.572	4.500	5	TE820

Thread Mills

SOLID CARBIDE THREAD MILL FOR METRIC INTERNAL THREADS - DIN 13

TD SERIES

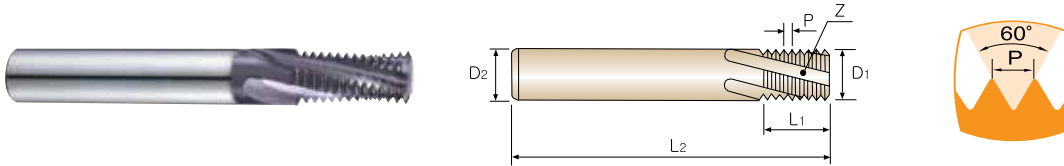

- ▶ Material: solid carbide
- ▶ Shank: plain straight
- ▶ Spiral angle: 15°

Unit : Inch

SIZE	Pitch (mm)	Cutter Diameter	Shank Diameter	Thread Length	Overall Length	No. of Flutes	EDP No.
	P	D ₁	D ₂	L ₁	L ₂	Z	TIAIN
M3	0.50	.085	.125	.178	2.000	3	TD200
M4	0.70	.115	.125	.276	2.000	3	TD240
M4.5	0.75	.120	.125	.250	2.000	3	TD260
M8	0.75	.235	.250	.625	2.500	3	TD380
M5	0.80	.120	.125	.312	2.000	3	TD280
M6	1.00	.170	.187	.500	2.500	3	TD310
M12	1.00	.360	.375	.875	3.500	4	TD530
M8	1.25	.235	.250	.625	2.500	3	TD360
M10	1.50	.300	.312	.750	3.000	4	TD420
M14	1.50	.370	.375	.875	3.500	4	TD550
M18	1.50	.490	.500	1.250	3.500	4	TD670
M12	1.75	.360	.375	.875	3.500	4	TD500
M16	2.00	.470	.500	1.250	3.500	4	TD600
M20	2.50	.495	.500	1.250	3.500	4	TD700
M24	3.00	.620	.625	1.375	4.000	4	TD780

SOLID CARBIDE THREAD MILL FOR UNIFIED INTERNAL THREADS ANSI B 1.20.1(NPT) / ANSI B1.20.3(NPTF)

TF | TG SERIES

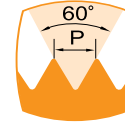
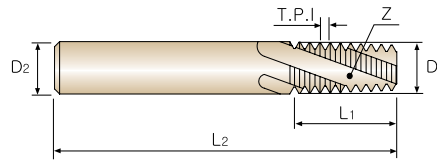

- ▶ Material: solid carbide
- ▶ Shank: plain straight
- ▶ Spiral angle: 15°

TF Series (NPT)

Unit : Inch

SIZE	Pitch	Cutter Diameter	Shank Diameter	Thread Length	Overall Length	No. of Flutes	EDP No.
	TPI	D ₁	D ₂	L ₁	L ₂	Z	TiAIN
1/16 & 1/8	27	.245	.250	.437	2.500	3	TF020
1/4 & 3/8	18	.305	.312	.625	3.000	4	TF400
1/4 & 3/8	18	.363	.375	.680	3.500	4	TF480
1/2 & 3/4	14	.495	.500	.875	3.500	4	TF560
1" - 2"	11.5	.620	.625	1.125	4.000	4	TF780
2-1/2" - 6"	8	.745	.750	1.500	5.000	4	TFF40

TG Series (NPTF)

Unit : Inch

SIZE	Pitch	Cutter Diameter	Shank Diameter	Thread Length	Overall Length	No. of Flutes	EDP No.
	TPI	D ₁	D ₂	L ₁	L ₂	Z	TiAIN
1/16 & 1/8	27	.245	.250	.437	2.500	3	TG020
1/4 & 3/8	18	.305	.312	.625	3.000	4	TG400
1/2 & 3/4	14	.495	.500	.875	3.500	4	TG560
1" - 2"	11.5	.620	.625	1.125	4.000	4	TG780
2-1/2" - 6"	8	.745	.750	1.500	5.000	4	TGF40

RECOMMENDED CUTTING SPEED

Unit : Inch

Material	Cutting Speed (SFM)	Feed per Tooth (fz)	
		Cutter Diameter < 5/16	Cutter Diameter > 5/16
P LOW CARBON STEELS MEDIUM CARBON STEELS	250 - 400	.0008 - .0016	.0016 - .0040
	HIGH CARBON STEELS	250 - 350	.0008 - .0016
	ALLOY STEELS	250 - 300	.0008 - .0016
	HEAT-TREATED STEELS	200 - 300	.0008 - .0016
M STAINLESS STEELS	150 - 250	.0004 - .0008	.0008 - .0024
K CAST IRON	200 - 350	.0008 - .0016	.0016 - .0040
S CHROME-NICKEL ALLOYS TITANIUM ALLOYS	70 - 200	.0004 - .0008	.0008 - .0024
N NON-FERROUS MATERIAL	350 - 1000	.0012 - .0020	.0020 - .0040

CUTTING SPEED FORMULAS

N - R.P.M.

SFM - Recommended Cutting Speed

d - Diameter of Cutter

fz - Recommended Feed per Tooth

Z - Number of Teeth

F₁ - Feed at Cutting Edge

F₂ - Feed at Center Line of Cutting

D - Major Diameter of Component

CALCULATE R.P.M. OF CUTTER:

$$N = \frac{12 \times \text{SFM}}{d \times \pi}$$

CALCULATE FEED PER REVOLUTION:

$$F_1 = fz \times Z \times N$$

CALCULATE FEED AT TOOL CENTER LINE:

$$F_2 = \frac{F_1 \times (D - d)}{D}$$

Want more? We've got you 'covered!'

You can view or download all these catalogs, and more – right from our website. Just visit yg1usa.com, or contact your YG-1 representative and request your own copies.



TOOLING SYSTEMS

YG-1 Tool Holders:
**Power and precision are
built in.**

From the moment you pick up a YG-1 tool holder, you can feel the power and precision that's built in. From high-quality, high-torque hydraulic chucks to NC drill chucks to shrink-to-fit chucks, YG-1 has an incredible selection. Their easy-to-use and precise operation make them the choice of today's aerospace manufacturers. And their efficient operation in demanding applications makes YG-1 the best you can get.



Tool Holders: PRODUCTIVITY READY FOR TAKEOFF.

FROM THE GLOBAL LEADER IN CUTTING TOOLS

- ▶ AT3 or better accuracy on all shank tapers
- ▶ Accurate and rigid tool holder mounting to spindle
- ▶ Shrink fit holder diameter held to H5 grade tolerance limit

Higher productivity through innovation

YG-1 brings you superior-quality tool holders at an excellent value. We're your one-stop tooling solution with everything you need. That's why our customers say, "YG-1 and done."

- ▶ Wide variety of tapers for all available chuck styles and holders (see chart next page)
- ▶ Straight shanks and accessories also available
- ▶ ER nuts, wrenches and stop screws; sealed ER collets, tap ER collets (inch and metric)
- ▶ Standard and dual contact shrink-fit holders with coolant channels and extensions (inch and metric)



- ▶ End mill holders – Standard and dual contact, high balanced type, coolant channel types, stub, standard and extended lengths
- ▶ Hydraulic chucks with extra short and extra long reach
- ▶ High-speed balanced power milling chucks

SELECTION GUIDE

MODEL	DESCRIPTION	PAGE
	HYDRAULIC CHUCK	160
	• CAT	160
	• BT	166
	DUAL CONTACT HYDRAULIC CHUCK	
	• CCT	172
	• CBT	175
	• HSK	178
	HYDRAULIC CHUCK COLLET (REDUCTION SLEEVE)	183
	SHRINK-FIT HOLDER	191
	• CAT	191
	• BT	193
	DUAL CONTACT SHRINK-FIT HOLDER	
	• CCT	195
	• CBT	197
	• HSK	199
	SHRINK-FIT EXTENSION	
	• ST	201
	END MILL HOLDER (SIDE LOCK)	204
	• CAT	204
	• BT	210
	DUAL CONTACT END MILL HOLDER	
	• CCT	215
	• CBT	216
• HSK (COOLANT CHANNEL TYPE)	217	
	ER COLLET CHUCK	218
	• CAT	218
	• BT	220
	DUAL CONTACT ER COLLET CHUCK	
	• HSK	223
	ER COLLET CHUCK	
	• SHORT	224
	• TENSION (For Tapping)	224
	NC ER COLLET CHUCK	
• NC (For CNC Lathe)	225	
ACCESSORIES & PARTS	226	
	POWER MILLING CHUCK	236
	• CAT	236
	• BT	236
	DUAL CONTACT HIGH-SPEED POWER MILLING CHUCK	
	• CCT	237
	• CBT	238
	• HSK	238
ACCESSORIES & PARTS	239	

Hydraulic Chuck



Pages 160–190

HYDRAULIC CHUCK (SLIM)

CAT

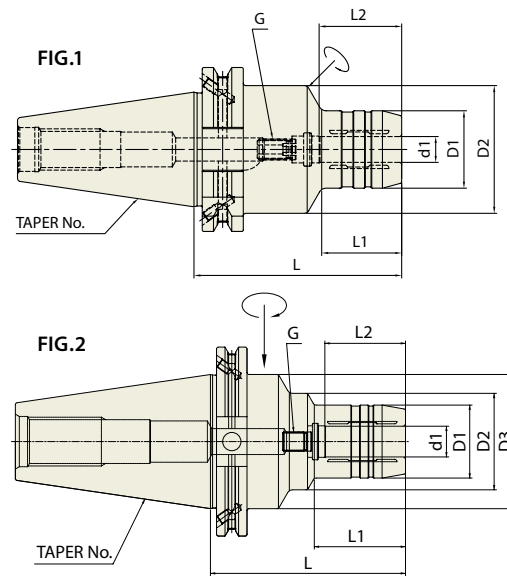

ASME B5.50 - CAT	Taper Accuracy AT3	G Value 2.5	RPM 25,000	Run-Out (at 3D) ≤0.00012"	Coolant System AD/B
---------------------	-----------------------	----------------	---------------	------------------------------	------------------------

ASME B5.50-2009-CAT

Unit : inch

EDP No.	TAPER No.	MODEL No.	d1	D1	D2	D3	L	L1	L2	G	Remarks
WK020	40	CAT40 AD/B - HC 1/4 - 4.00	0.250	1.024	1.750	-	4.000	1.280	1.063	M5x0.8mm	FIG.1
WK022		CAT40 AD/B - HC 3/8 - 4.00	0.375	1.181	1.750	-	4.000	1.634	1.260	M6x1.0mm	
WK024		CAT40 AD/B - HC 1/2 - 4.00	0.500	1.260	1.750	-	4.000	1.634	1.457	M10x1.0mm	
WK026		CAT40 AD/B - HC 5/8 - 4.00	0.625	1.496	1.750	-	4.000	1.949	1.654	M10x1.0mm	
WK028		CAT40 AD/B - HC 3/4 - 4.00	0.750	1.654	1.750	-	4.000	1.949	1.654	M10x1.0mm	
WK030		CAT40 AD/B - HC 1 - 4.00	1.000	2.165	2.480	-	4.000	2.618	1.890	M16x1.0mm	
WK032		CAT40 AD/B - HC 1 1/4 - 4.00	1.250	2.480	3.150	-	4.000	1.378	2.165	M16x1.0mm	
WL020	50	CAT50 AD/B - HC 1/4 - 4.00	0.250	1.024	1.978	2.752	4.000	1.280	1.063	M5x0.8mm	FIG.2
WL022		CAT50 AD/B - HC 3/8 - 4.00	0.375	1.181	1.978	2.752	4.000	1.417	1.260	M6x1.0mm	
WL024		CAT50 AD/B - HC 1/2 - 4.00	0.500	1.260	1.978	2.752	4.000	1.634	1.457	M10x1.0mm	
WL026		CAT50 AD/B - HC 5/8 - 4.00	0.625	1.496	1.978	2.752	4.000	1.870	1.654	M10x1.0mm	
WL028		CAT50 AD/B - HC 3/4 - 4.00	0.750	1.654	1.978	2.752	4.000	1.949	1.654	M10x1.0mm	
WL030		CAT50 AD/B - HC 1 - 4.00	1.000	2.244	2.480	2.752	4.000	1.949	1.890	M16x1.0mm	
WL032		CAT50 AD/B - HC 1 1/4 - 4.00	1.250	2.520	-	2.752	4.000	2.559	2.165	M16x1.0mm	

► Applicable hydraulic chuck collets (reduction sleeves) on pages 183–190.

Hydraulic Chuck

CAT

HYDRAULIC CHUCK (SLIM)

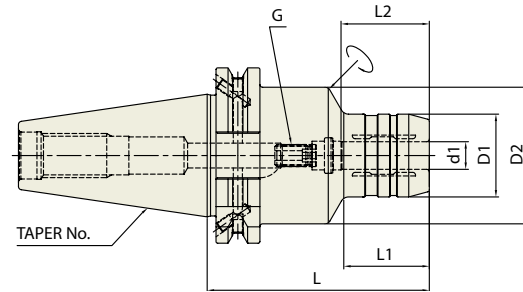

ASME B5.50 - CAT	Taper Accuracy AT3	G Value 2.5	RPM 25,000	Run-Out (at 3D) ≤0.00012"	Coolant System AD/B
-------------------------	------------------------------	-----------------------	----------------------	-------------------------------------	-------------------------------

ASME B5.50-2009-CAT

Unit : mm

EDP No.	TAPER No.	MODEL No.	d1	D1	D2	L	L1	L2	G
WK060	40	CAT40 AD/B - HC 6 - 80.5	6	26	49.5	80.5	29.5	27	M5x0.8
WK062		CAT40 AD/B - HC 6 - 110	6	26	49.5	110	29.5	27	M5x0.8
WK064		CAT40 AD/B - HC 8 - 80.5	8	28	49.5	80.5	30	27	M6x1.0
WK066		CAT40 AD/B - HC 8 - 110	8	28	49.5	110	30	27	M6x1.0
WK068		CAT40 AD/B - HC 10 - 80.5	10	30	49.5	80.5	31	32	M8x1.0
WK070		CAT40 AD/B - HC 10 - 110	10	30	49.5	110	31	32	M8x1.0
WK072		CAT40 AD/B - HC 12 - 80.5	12	32	49.5	80.5	31.5	37	M10x1.0
WK074		CAT40 AD/B - HC 12 - 110	12	32	49.5	110	31.5	37	M10x1.0
WK076		CAT40 AD/B - HC 16 - 80.5	16	38	49.5	80.5	33	42	M12x1.0
WK078		CAT40 AD/B - HC 16 - 110	16	38	49.5	110	33	42	M12x1.0
WK080		CAT40 AD/B - HC 20 - 80.5	20	42	49.5	80.5	34	42	M16x1.0
WK082		CAT40 AD/B - HC 20 - 110	20	42	49.5	110	34	42	M16x1.0
WK084		CAT40 AD/B - HC 25 - 80.5	25	55	66	80.5	22	48	M16x1.
WK086		CAT40 AD/B - HC 32 - 80.5	32	63	80	80.5	25.5	55	M16x1.0
WL060	50	CAT50 AD/B - HC 6 - 80.5	6	26	49.5	80.5	30	27	M5x0.8
WL062		CAT50 AD/B - HC 8 - 80.5	8	28	49.5	80.5	30	27	M6x1.0
WL064		CAT50 AD/B - HC 10 - 80.5	10	30	49.5	80.5	32	32	M8x1.0
WL066		CAT50 AD/B - HC 12 - 80.5	12	32	49.5	80.5	35	37	M10x1.0
WL068		CAT50 AD/B - HC 16 - 80.5	16	38	49.5	80.5	40	42	M12x1.0
WL070		CAT50 AD/B - HC 20 - 80.5	20	42	49.5	80.5	40	42	M16x1.0

► Applicable hydraulic chuck collets (reduction sleeves) on page 193-190.

Hydraulic Chuck

HYDRAULIC CHUCK (POWER E HYDRO)

CAT

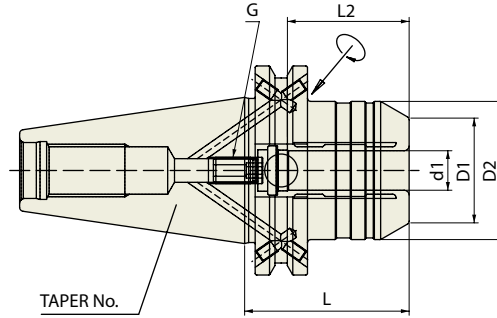

ASME B5.50 - CAT	Taper Accuracy AT3	G Value 2.5	RPM 25,000	Run-Out (at 3D) ≤0.00012"	Coolant System AD/B
-------------------------	------------------------------	-----------------------	----------------------	-------------------------------------	-------------------------------

ASME B5.50-2009-CAT

Unit : inch

EDP No.	TAPER No.	MODEL No.	d1	D1	D2	L	L2	G
WK022PE	40	CAT40 AD/B - HC 3/4P - 2.539	0.75	1.496	1.938	2.539	1.889	M8x1.0mm
WK023PE		CAT40 AD/B - HC 3/4P - 4.000	0.75	1.496	1.938	4.000	1.889	M8x1.0mm
WL028PE	50	CAT50 AD/B - HC 1 1/4P - 3.188	1.25	2.303	2.834	3.188	2.244	M8x1.0mm
WL030PE		CAT50 AD/B - HC 1 1/4P - 6.000	1.25	2.303	2.834	6.000	2.244	M8x1.0mm

Unit : mm

EDP No.	TAPER No.	MODEL No.	d1	D1	D2	L	L2	G
WK102PE	40	CAT40 AD/B - HC 20P - 64.5	20	38	49.25	64.5	48	M8x1.0
WK103PE		CAT40 AD/B - HC 20P - 101.6	20	38	49.25	101.6	48	M8x1.0
WL104PE	50	CAT50 AD/B - HC 32P - 81	32	58.5	72	81	57	M8x1.0
WL106PE		CAT50 AD/B - HC 32P - 152.4	32	58.5	72	152.4	57	M8x1.0

- ▶ High clamping torque power version (please refer to the technical information on page 1420 in the YU19 Cutting Tools catalog)
- ▶ Applicable for milling (roughing and finishing)
- ▶ Applicable hydraulic chuck collets (reduction sleeves) on pages 183–190

HYDRAULIC CHUCK (SHORT & RIGID)

CAT

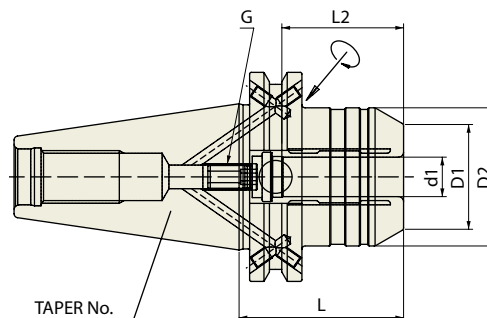

ASME B5.50 - CAT	Taper Accuracy AT3	G Value 2.5	RPM 25,000	Run-Out (at 3D) ≤0.00012"	Coolant System AD/B
-------------------------	------------------------------	-----------------------	----------------------	-------------------------------------	-------------------------------

ASME B5.50-2009-CAT

Unit : inch

EDP No.	TAPER No.	MODEL No.	d1	D1	D2	L	L2	G
WK020SNR	40	CAT40 AD/B - HC 1/2S - 2.52	0.500	1.260	1.654	2.520	1.457	M8x1.0mm
WK021SNR		CAT40 AD/B - HC 5/8S - 2.52	0.625	1.362	1.752	2.520	1.654	M10x1.0mm
WK022SNR		CAT40 AD/B - HC 3/4S - 2.52	0.750	1.469	1.949	2.520	1.654	M10x1.0mm
WK024SNR		CAT40 AD/B - HC 1S - 3.50	1.000	2.244	2.598	3.500	1.890	M16x1.0mm
WL020SNR	50	CAT50 AD/B - HC 1/2S - 3.19	0.500	1.879	2.752	3.189	1.457	M8x1.0mm
WL022SNR		CAT50 AD/B - HC 5/8S - 3.19	0.625	1.819	2.752	3.189	1.654	M8x1.0mm
WL024SNR		CAT50 AD/B - HC 3/4S - 3.19	0.75	2.185	2.752	3.189	1.654	M10x1.0mm
WL026SNR		CAT50 AD/B - HC 1.00S - 3.19	1.000	2.185	2.752	3.189	1.890	M16x1.0mm
WL028SNR		CAT50 AD/B - HC 1.25S - 3.19	1.250	2.185	2.752	3.189	2.165	M16x1.0mm

Unit : mm

EDP No.	TAPER No.	MODEL No.	d1	D1	D2	L	L2	G
WK100SNR	40	CAT40 AD/B - HC 12S - 50	12	32	42	50	37	M8x1.0
WK102SNR		CAT40 AD/B - HC 20S - 64.5	20	37	49.5	64.5	42	M16x1.0
WL100SNR	50	CAT50 AD/B - HC 12S - 50	12	32	42	50	37	M8x1.0
WL102SNR		CAT50 AD/B - HC 20S - 64.5	20	37	49.5	64.5	42	M16x1.0
WL104SNR		CAT50 AD/B - HC 32S - 81	32	55	72	81	55	M16x1.0

► Applicable hydraulic chuck collets (reduction sleeves) on pages 183–190.

Hydraulic Chuck

HYDRAULIC CHUCK (RADIAL TOOL LENGTH PRE-SETTING TYPE)

CAT

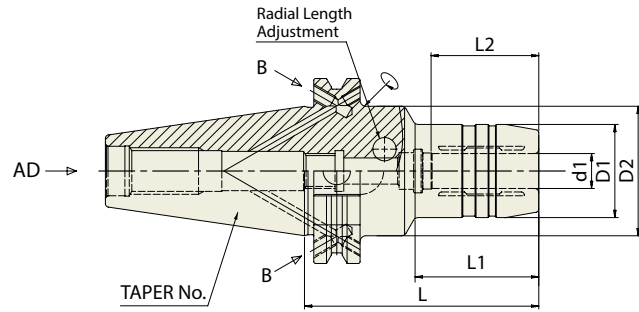

ASME B5.50 - CAT	Taper Accuracy AT3	G Value 2.5	RPM 25,000	Run-Out (at 3D) ≤0.00012"	Coolant System AD/B
----------------------------	------------------------------	-----------------------	----------------------	-------------------------------------	-------------------------------

ASME B5.50-2009-CAT

Unit : mm

EDP No.	TAPER No.	MODEL No.	d1	D1	D2	L	L1	L2
WK100HCR	40	CAT40 AD/B - HCR 12 - 80.5	12	32	49.5	80.5	31.5	37
WK102HCR		CAT40 AD/B - HCR 20 - 80.5	20	42	49.5	80.5	34	42
WK104HCR		CAT40 AD/B - HCR 32 - 110	32	64	80	110	50	55
WL100HCR	50	CAT50 AD/B - HCR 12 - 80.5	12	32	49.5	80.5	31.5	37
WL102HCR		CAT50 AD/B - HCR 20 - 80.5	20	42	49.5	80.5	34	42
WL104HCR		CAT50 AD/B - HCR 32 - 100	32	60	60	100	-	55

► Applicable hydraulic chuck collets (reduction sleeves) on pages 183–190.

Hydraulic Chuck

HYDRAULIC CHUCK (FOR MOULD)

CAT

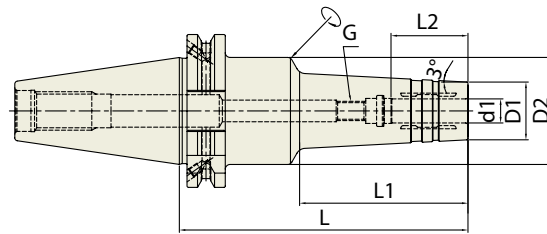

ASME B5.50 - CAT	Taper Accuracy AT3	G Value 2.5	RPM 25,000	Run-Out (at 3D) ≤0.00012"	Coolant System AD/B
-------------------------	------------------------------	-----------------------	----------------------	-------------------------------------	-------------------------------

ASME B5.50-2009-CAT

Unit : inch

EDP No.	TAPER No.	MODEL No.	d1	D1	D2	L	L1	L2	G	
WK020HMC	40	CAT40 AD/B - HMC 1/4 - 4.72	0.250	0.787	1.949	4.724	2.756	1.063	M5x0.8mm	
WK022HMC		CAT40 AD/B - HMC 1/4 - 5.91	0.250	0.787	1.949	5.906	3.937	1.063	M5x0.8mm	
WK024HMC		CAT40 AD/B - HMC 5/16 - 4.72	0.313	0.866	1.949	4.724	2.756	1.063	M6x1.0mm	
WK026HMC		CAT40 AD/B - HMC 5/16 - 5.91	0.313	0.866	1.949	5.906	3.937	1.063	M6x1.0mm	
WK028HMC		CAT40 AD/B - HMC 3/8 - 4.72	0.375	0.945	1.949	4.724	2.756	1.260	M8x1.0mm	
WK030HMC		CAT40 AD/B - HMC 3/8 - 5.91	0.375	0.945	1.949	5.906	3.937	1.260	M8x1.0mm	
WK032HMC		CAT40 AD/B - HMC 1/2 - 4.72	0.500	1.024	1.949	4.724	2.756	1.457	M10x1.0mm	
WK034HMC		CAT40 AD/B - HMC 1/2 - 5.91	0.500	1.024	1.949	5.906	3.937	1.457	M10x1.0mm	
WK036HMC		CAT40 AD/B - HMC 5/8 - 4.72	0.625	1.260	1.949	4.724	2.756	1.654	M12x1.0mm	
WK038HMC		CAT40 AD/B - HMC 5/8 - 5.91	0.625	1.260	1.949	5.906	3.937	1.654	M12x1.0mm	
WK040HMC		CAT40 AD/B - HMC 3/4 - 4.72	0.750	1.339	1.949	4.724	2.756	1.654	M16x1.0mm	
WK042HMC		CAT40 AD/B - HMC 3/4 - 5.91	0.750	1.339	1.949	5.906	3.937	1.654	M16x1.0mm	
WL020HMC		50	CAT50 AD/B - HMC 1/4 - 5.91	0.250	0.787	1.752	5.906	3.937	1.063	M5x0.8mm
WL022HMC			CAT50 AD/B - HMC 5/16 - 5.91	0.313	0.866	1.752	5.906	3.937	1.063	M6x1.0mm
WL024HMC	CAT50 AD/B - HMC 3/8 - 5.91		0.375	0.945	1.752	5.906	3.937	1.260	M8x1.0mm	
WL026HMC	CAT50 AD/B - HMC 1/2 - 5.91		0.500	1.024	1.752	5.906	3.937	1.457	M10x1.0mm	
WL028HMC	CAT50 AD/B - HMC 5/8 - 5.91		0.625	1.260	1.752	5.906	3.937	1.654	M12x1.0mm	
WL030HMC	CAT50 AD/B - HMC 3/4 - 5.91		0.750	1.339	1.752	5.906	3.937	1.654	M16x1.0mm	

Unit : mm

EDP No.	TAPER No.	MODEL No.	d1	D1	D2	L	L1	L2	G	
WK100HMC	40	CAT40 AD/B - HMC 6 - 120	6	20	49.5	120	70	27	M5X0.8	
WK102HMC		CAT40 AD/B - HMC 6 - 150	6	20	49.5	150	100	27	M5X0.8	
WK104HMC		CAT40 AD/B - HMC 8 - 120	8	22	49.5	120	70	27	M6X1.0	
WK106HMC		CAT40 AD/B - HMC 8 - 150	8	22	49.5	150	100	27	M6X1.0	
WK108HMC		CAT40 AD/B - HMC 10 - 120	10	24	49.5	120	70	32	M8X1.0	
WK110HMC		CAT40 AD/B - HMC 10 - 150	10	24	49.5	150	100	32	M8X1.0	
WK112HMC		CAT40 AD/B - HMC 12 - 120	12	25	49.5	120	70	37	M10X1.0	
WK114HMC		CAT40 AD/B - HMC 12 - 150	12	25	49.5	150	100	37	M10X1.0	
WK116HMC		CAT40 AD/B - HMC 16 - 120	16	32	49.5	120	70	42	M12X1.0	
WK118HMC		CAT40 AD/B - HMC 16 - 150	16	32	49.5	150	100	42	M12X1.0	
WK120HMC		CAT40 AD/B - HMC 20 - 120	20	34	49.5	120	70	42	M16X1.0	
WK122HMC		CAT40 AD/B - HMC 20 - 150	20	34	49.5	150	100	42	M16X1.0	
WL100HMC		50	CAT50 AD/B - HMC 6 - 150	6	20	44.5	150	100	27	M5X0.8
WL102HMC			CAT50 AD/B - HMC 8 - 150	8	22	44.5	150	100	27	M6X1.0
WL104HMC	CAT50 AD/B - HMC 10 - 150		10	24	44.5	150	100	32	M8X1.0	
WL106HMC	CAT50 AD/B - HMC 12 - 150		12	25	44.5	150	100	37	M10X1.0	
WL108HMC	CAT50 AD/B - HMC 16 - 150		16	32	44.5	150	100	42	M12X1.0	
WL110HMC	CAT50 AD/B - HMC 20 - 150		20	34	44.5	150	100	42	M16X1.0	

► Applicable hydraulic chuck collets (reduction sleeves) on pages 183-190.

Hydraulic Chuck

HYDRAULIC CHUCK (SLIM)

BT

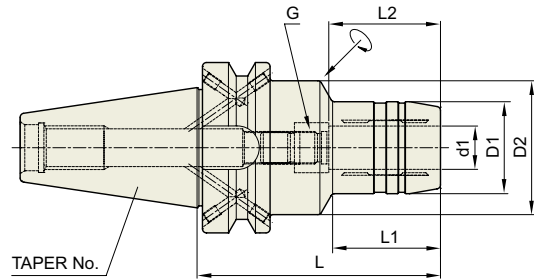

JIS B6339 - BT	Taper Accuracy AT3	G Value 2.5	RPM 25,000	Run-Out (at 3D) ≤0.00012"	Coolant System AD or AD/B
-------------------	---------------------------------	-----------------------	----------------------	--	--

JIS B6339/MAS 403-BT

Unit : inch

EDP No.	TAPER No.	MODEL No.	d1	D1	D2	L	L1	L2	G
WG020	30	BT30 - HC 1/4 - 2.75	0.250	1.024	1.752	2.750	1.161	1.063	M5x0.8mm
WG022		BT30 - HC 5/16 - 2.75	0.313	1.102	1.752	2.750	1.181	1.063	M6x1.0mm
WG024		BT30 - HC 3/8 - 2.95	0.375	1.181	1.752	2.953	1.220	1.260	M8x1.0mm
WG026		BT30 - HC 1/2 - 3.35	0.500	1.260	1.772	3.346	1.575	1.457	M10x1.0mm
WG028		BT30 - HC 5/8 - 3.54	0.625	1.496	1.772	3.543	1.811	1.654	M10x1.0mm
WG030		BT30 - HC 3/4 - 3.54	0.750	1.654	1.772	3.543	1.890	1.654	M6x1.0mm
WH020	40	BT40 AD/B - HC 1/4 - 3.54	0.250	1.024	1.752	3.543	1.181	1.063	M5x0.8mm
WH022		BT40 AD/B - HC 5/16 - 3.54	0.313	1.102	1.752	3.543	1.280	1.063	M6x1.0mm
WH024		BT40 AD/B - HC 3/8 - 3.54	0.375	1.181	1.752	3.543	1.260	1.260	M8x1.0mm
WH026		BT40 AD/B - HC 1/2 - 3.54	0.500	1.260	1.752	3.543	1.378	1.457	M10x1.0mm
WH028		BT40 AD/B - HC 5/8 - 3.54	0.625	1.496	1.870	3.543	1.575	1.654	M12x1.0mm
WH030		BT40 AD/B - HC 3/4 - 3.54	0.750	1.654	1.870	3.543	1.575	1.654	M16x1.0mm
WH032		BT40 AD/B - HC 1" - 3.94	1.000	1.969	2.362	3.937	1.772	1.890	M16x1.0mm
WH034		BT40 AD/B - HC 1 1/4 - 4.13	1.250	2.362	-	4.134	-	2.165	M16x1.0mm

► Applicable hydraulic chuck collets (reduction sleeves) on pages 183–190.

Hydraulic Chuck

HYDRAULIC CHUCK (SLIM)

BT

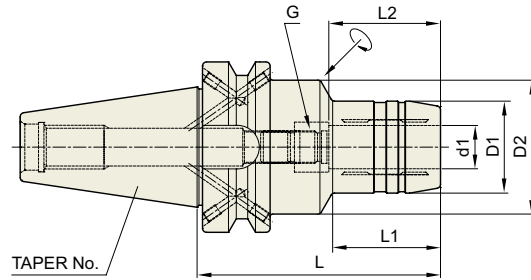

JIS B6339 - BT	Taper Accuracy AT3	G Value 2.5	RPM 25,000	Run-Out (at 3D) ≤0.00012"	Coolant System AD or AD/B
-------------------	---------------------------------	-----------------------	----------------------	--	--

JIS B6339/MAS 403-BT

Unit : mm

EDP No.	TAPER No.	MODEL No.	d1	D1	D2	L	L1	L2	G
WG100	30	BT30 - HC 6 - 70	6	26	44.5	70	29.5	27	M5x0.8
WG102		BT30 - HC 8 - 70	8	28	44.5	70	30	27	M6x1.0
WG104		BT30 - HC 10 - 75	10	30	44.5	75	31	32	M8x1.0
WG106		BT30 - HC 12 - 85	12	32	45	85	45	37	M10x1.0
WG108		BT30 - HC 14 - 85	14	34	45	85	45	37	M10x1.0
WG110		BT30 - HC 16 - 90	16	38	45	90	50	42	M10x1.0
WG112		BT30 - HC 18 - 90	18	40	45	90	50	42	M10x1.0
WG114		BT30 - HC 20 - 90	20	42	45	90	50	42	M6x1.0
WH100	40	BT40 AD/B - HC 6 - 90	6	26	44.5	90	43	27	M5x0.8
WH102		BT40 AD/B - HC 8 - 90	8	28	44.5	90	44.5	27	M6x1.0
WH104		BT40 AD/B - HC 10 - 90	10	30	44.5	90	44.5	32	M8x1.0
WH106		BT40 AD/B - HC 12 - 90	12	32	44.5	90	44.5	37	M10x1.0
WH108		BT40 AD/B - HC 14 - 90	14	34	44.5	90	44.5	37	M10x1.0
WH110		BT40 AD/B - HC 16 - 90	16	38	44.5	90	47.5	42	M12x1.0
WH112		BT40 AD/B - HC 18 - 90	18	40	44.5	90	47.5	42	M12x1.0
WH114		BT40 AD/B - HC 20 - 90	20	42	44.5	90	47.5	42	M16x1.0
WH116		BT40 AD/B - HC 25 - 100	25	50	60	100	47.5	48	M16x1.0
WH118		BT40 AD/B - HC 32 - 105	32	60	-	105	-	55	M16x1.0

► Applicable hydraulic chuck collets (reduction sleeves) on pages 183–190.

Hydraulic Chuck

HYDRAULIC CHUCK (POWER E HYDRO)

BT

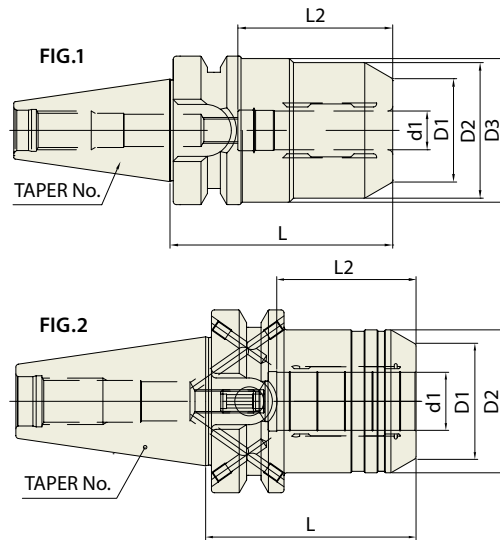

JIS B6339 - BT	Taper Accuracy AT3	G Value 2.5	RPM 25,000	Run-Out (at 3D) ≤0.00012"	Coolant System AD or AD/B
-------------------	------------------------------	-----------------------	----------------------	-------------------------------------	-------------------------------------

JIS B6339/MAS 403-BT

Unit : inch

EDP No.	TAPER No.	MODEL No.	d1	D1	D2	D3	L	L2	G	FIG.
WG002PE	30	BT30 - HC 3/4P - 3.543	0.75	1.496	1.653	1.751	3.543	1.889	M8x1.0mm	1
WH002PE	40	BT40 AD/B - HC 3/4P - 2.854	0.75	1.496	1.938	-	2.854	1.889	M8x1.0mm	2
WI003PE	50	BT50 AD/B - HC 1 1/4P - 3.543	1.25	2.303	2.834	-	3.543	2.244	M8x1.0mm	2

Unit : mm

EDP No.	TAPER No.	MODEL No.	d1	D1	D2	D3	L	L2	G	FIG.
WG100PE	30	BT30 - HC 12P - 69	12	32	42	44.5	69	41	M8x1.0	1
WG102PE		BT30 - HC 20P - 90	20	38	42	44.5	90	48	M8x1.0	1
WH100PE	40	BT40 AD/B - HC 12P - 58	12	32	42	-	58	41	M8x1.0	2
WH102PE		BT40 AD/B - HC 20P - 72.5	20	38	49.25	-	72.5	48	M8x1.0	2
WI100PE	50	BT50 AD/B - HC 20P - 83.5	20	38	49.25	-	83.5	48	M8x1.0	2
WI102PE		BT50 AD/B - HC 32P - 90	32	58.5	72	-	90	57	M8x1.0	2

- ▶ High clamping torque power version (please refer to the technical information on page 1420 in the YU19 Cutting Tools catalog)
- ▶ Applicable for milling (roughing and finishing)
- ▶ Applicable hydraulic chuck collets (reduction sleeves) on pages 183-190

Hydraulic Chuck

HYDRAULIC CHUCK (SHORT & RIGID)

BT

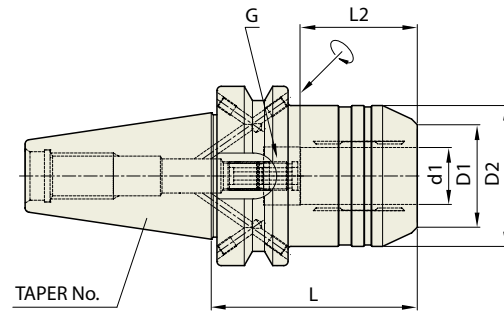

JIS B6339 - BT	Taper Accuracy AT3	G Value 2.5	RPM 25,000	Run-Out (at 3D) ≤0.00012"	Coolant System AD or AD/B
-------------------	------------------------------	-----------------------	----------------------	-------------------------------------	-------------------------------------

JIS B6339/MAS 403-BT

Unit : mm

EDP No.	TAPER No.	MODEL No.	d1	D1	D2	L	L2	G
WG100SNR	30	BT30 - HC 20S - 85	20	41	44	85	42	M6x1.0
WH100SNR	40	BT40 AD/B - HC 12S - 58	12	32	42	58	37	M8x1.0
WH102SNR		BT40 AD/B - HC 20S - 72.5	20	38	49.25	72.5	42	M8x1.0

► Applicable hydraulic chuck collets (reduction sleeves) on pages 183–190.

Hydraulic Chuck

HYDRAULIC CHUCK (RADIAL TOOL LENGTH PRE-SETTING TYPE)

BT

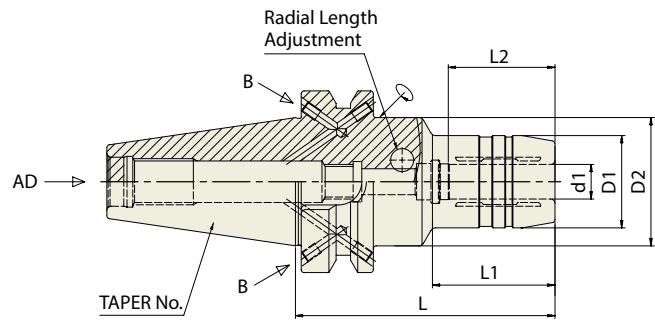

JIS B6339 - BT	Taper Accuracy AT3	G Value 2.5	RPM 25,000	Run-Out (at 3D) ≤0.00012"	Coolant System AD or AD/B
-------------------	------------------------------	-----------------------	----------------------	------------------------------	-------------------------------------

JIS B6339/MAS 403-BT

Unit : mm

EDP No.	TAPER No.	MODEL No.	d1	D1	D2	L	L1	L2
WG100HCR	30	BT30 - HCR 12 - 85	12	32	44.5	85	40	37
WG102HCR		BT30 - HCR 20 - 85	20	44	-	85	-	42
WH100HCR	40	BT40 AD/B - HCR 12 - 90	12	32	44.5	90	42.5	37
WH102HCR		BT40 AD/B - HCR 20 - 90	20	42	44.5	90	47.5	42
WH104HCR		BT40 AD/B - HCR 32 - 105	32	60	-	105	-	55

► Applicable hydraulic chuck collets (reduction sleeves) on pages 183-190.

HYDRAULIC CHUCK (FOR MOULD)

BT

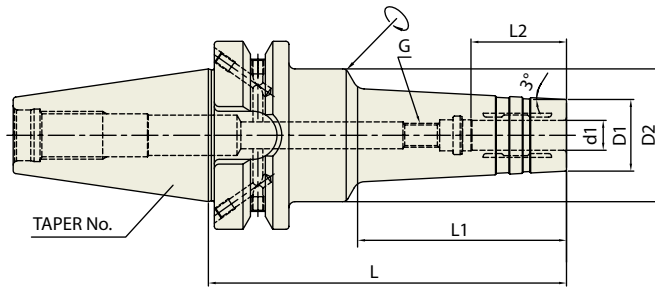

JIS B6339 - BT	Taper Accuracy AT3	G Value 2.5	RPM 25,000	Run-Out (at 3D) ≤0.00012"	Coolant System AD/B
-------------------	---------------------------------	-----------------------	----------------------	--	----------------------------------

JIS B6339/MAS 403-BT

Unit : mm

EDP No.	TAPER No.	MODEL No.	d1	D1	D2	L	L1	L2	G
WH100HMC	40	BT40 AD/B - HMC 6 - 120	6	20	44.5	120	70	27	M5×0.8
WH102HMC		BT40 AD/B - HMC 6 - 150	6	20	44.5	150	100	27	M5×0.8
WH104HMC		BT40 AD/B - HMC 8 - 120	8	22	44.5	120	70	27	M6×1.0
WH106HMC		BT40 AD/B - HMC 8 - 150	8	22	44.5	150	100	27	M6×1.0
WH108HMC		BT40 AD/B - HMC 10 - 120	10	24	44.5	120	70	32	M8×1.0
WH110HMC		BT40 AD/B - HMC 10 - 150	10	24	44.5	150	100	32	M8×1.0
WH112HMC		BT40 AD/B - HMC 12 - 120	12	25	44.5	120	70	37	M10×1.0
WH114HMC		BT40 AD/B - HMC 12 - 150	12	25	44.5	150	100	37	M10×1.0
WH116HMC		BT40 AD/B - HMC 16 - 120	16	32	44.5	120	70	42	M12×1.0
WH118HMC		BT40 AD/B - HMC 16 - 150	16	32	44.5	150	100	42	M12×1.0
WH120HMC		BT40 AD/B - HMC 20 - 120	20	36	43.75	120	-	42	M16×1.0
WH122HMC		BT40 AD/B - HMC 20 - 150	20	36	46.9	150	-	42	M16×1.0

► Applicable hydraulic chuck collets (reduction sleeves) on pages 183-190.

Hydraulic Chuck

DUAL CONTACT HYDRAULIC CHUCK (SLIM)

CCT

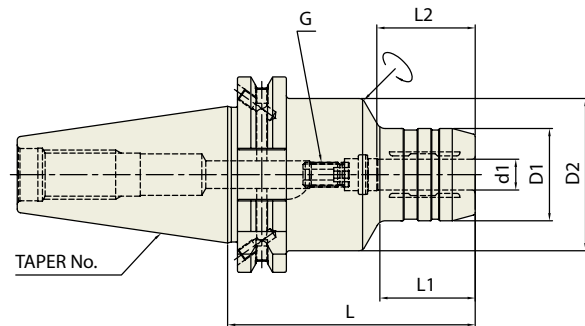

CCT	Taper Accuracy AT3	G Value 2.5	RPM 25,000	Run-Out (at 3D) ≤0.00012"	Coolant System AD/B
-----	------------------------------	-----------------------	----------------------	-------------------------------------	-------------------------------

CCT (CAT DUAL CONTACT)

Unit : inch

EDP No.	TAPER No.	MODEL No.	d1	D1	D2	L	L1	L2	G
WB020	40	CCT40 AD/B - HC 1/4 - 3.54	0.250	1.024	1.752	3.543	1.280	1.063	M5x0.8mm
WB022		CCT40 AD/B - HC 5/16 - 3.54	0.313	1.102	1.752	3.543	1.280	1.063	M6x1.0mm
WB024		CCT40 AD/B - HC 3/8 - 3.54	0.375	1.181	1.752	3.543	1.634	1.260	M8x1.0mm
WB026		CCT40 AD/B - HC 1/2 - 3.54	0.500	1.260	1.752	3.543	1.634	1.457	M10x1.0mm
WB028		CCT40 AD/B - HC 5/8 - 3.54	0.625	1.496	1.752	3.543	1.949	1.654	M10x1.0mm
WB030		CCT40 AD/B - HC 3/4 - 3.54	0.750	1.654	1.752	3.543	1.949	1.654	M10x1.0mm
WB032		CCT40 AD/B - HC 1" - 3.94	1.000	2.165	2.480	3.937	2.559	1.890	M16x1.0mm
WB034		CCT40 AD/B - HC 1 1/4 - 4.13	1.250	2.480	3.150	4.134	1.378	2.165	M16x1.0mm
WC020	50	CCT50 AD/B - HC 1/4 - 3.54	0.250	1.024	1.969	3.543	1.181	1.063	M5x0.8mm
WC022		CCT50 AD/B - HC 5/16 - 3.54	0.313	1.102	1.969	3.543	1.181	1.063	M6x1.0mm
WC024		CCT50 AD/B - HC 3/8 - 3.54	0.375	1.181	1.969	3.543	1.260	1.260	M8x1.0mm
WC026		CCT50 AD/B - HC 1/2 - 3.54	0.500	1.260	1.969	3.543	1.378	1.457	M10x1.0mm
WC028		CCT50 AD/B - HC 5/8 - 3.54	0.625	1.496	1.969	3.543	1.575	1.654	M10x1.0mm
WC030		CCT50 AD/B - HC 3/4 - 3.54	0.750	1.654	1.969	3.543	1.575	1.654	M10x1.0mm
WC032		CCT50 AD/B - HC 1" - 4.13	1.000	2.244	2.480	4.134	2.047	1.890	M16x1.0mm
WC034		CCT50 AD/B - HC 1 1/4 - 4.53	1.250	2.480	2.953	4.528	2.441	2.165	M16x1.0mm

► Applicable hydraulic chuck collets (reduction sleeves) on pages 183–190.

Hydraulic Chuck

HYDRAULIC CHUCK (POWER E HYDRO)

CCT

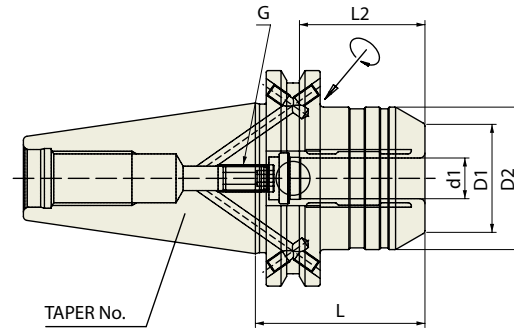

CCT	Taper Accuracy AT3	G Value 2.5	RPM 25,000	Run-Out (at 3D) ≤0.00012"	Coolant System AD/B
-----	------------------------------	-----------------------	----------------------	-------------------------------------	-------------------------------

CCT (CAT DUAL CONTACT)

Unit : inch

EDP No.	TAPER No.	MODEL No.	d1	D1	D2	L	L2	G
WB030PE	40	CCT40 AD/B - HC 3/4P - 2.539	0.75	1.496	49.25	2.539	1.889	M8x1.0mm
WB031PE		CCT40 AD/B - HC 3/4P - 4.000	0.75	1.496	49.25	4.000	1.889	M8x1.0mm

Unit : mm

EDP No.	TAPER No.	MODEL No.	d1	D1	D2	L	L2	G
WB130PE	40	CCT40 AD/B - HC 20P - 64.5	20	38	49.25	64.5	48	M8x1.0
WB131PE		CCT40 AD/B - HC 20P - 101.6	20	38	49.25	101.6	48	M8x1.0

- ▶ High clamping torque power version (please refer to the technical information on page 1420 in the YU19 Cutting Tools catalog)
- ▶ Applicable for milling (roughing and finishing)
- ▶ Applicable hydraulic chuck collets (reduction sleeves) on pages 183–190

Hydraulic Chuck

DUAL CONTACT HYDRAULIC CHUCK (FOR MOULD)

CCT

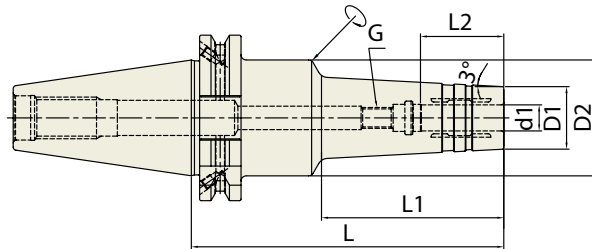

CCT	Taper Accuracy AT3	G Value 2.5	RPM 25,000	Run-Out (at 3D) ≤0.00012"	Coolant System AD/B
-----	------------------------------	-----------------------	----------------------	-------------------------------------	-------------------------------

CCT (CAT DUAL CONTACT)

Unit : inch

EDP No.	TAPER No.	MODEL No.	d1	D1	D2	L	L1	L2	G	
WB020HMC	40	CCT40 AD/B - HMC 1/4 - 4.72	0.250	0.787	1.949	4.724	2.756	1.063	M5x0.8mm	
WB022HMC		CCT40 AD/B - HMC 1/4 - 5.91	0.250	0.787	1.949	5.906	3.937	1.063	M5x0.8mm	
WB024HMC		CCT40 AD/B - HMC 5/16 - 4.72	0.313	0.866	1.949	4.724	2.756	1.063	M6x1.0mm	
WB026HMC		CCT40 AD/B - HMC 5/16 - 5.91	0.313	0.866	1.949	5.906	3.937	1.063	M6x1.0mm	
WB028HMC		CCT40 AD/B - HMC 3/8 - 4.72	0.375	0.945	1.949	4.724	2.756	1.260	M8x1.0mm	
WB030HMC		CCT40 AD/B - HMC 3/8 - 5.91	0.375	0.945	1.949	5.906	3.937	1.260	M8x1.0mm	
WB032HMC		CCT40 AD/B - HMC 1/2 - 4.72	0.500	1.024	1.949	4.724	2.756	1.457	M10x1.0mm	
WB034HMC		CCT40 AD/B - HMC 1/2 - 5.91	0.500	1.024	1.949	5.906	3.937	1.457	M10x1.0mm	
WB036HMC		CCT40 AD/B - HMC 5/8 - 4.72	0.625	1.260	1.949	4.724	2.756	1.654	M12x1.0mm	
WB038HMC		CCT40 AD/B - HMC 5/8 - 5.91	0.625	1.260	1.949	5.906	3.937	1.654	M12x1.0mm	
WB040HMC		CCT40 AD/B - HMC 3/4 - 4.72	0.750	1.339	1.949	4.724	2.756	1.654	M16x1.0mm	
WB042HMC		CCT40 AD/B - HMC 3/4 - 5.91	0.750	1.339	1.949	5.906	3.937	1.654	M16x1.0mm	
WC020HMC		50	CCT50 AD/B - HMC 1/4 - 5.91	0.250	0.787	1.752	5.906	3.937	1.063	M5x0.8mm
WC022HMC			CCT50 AD/B - HMC 5/16 - 5.91	0.313	0.866	1.752	5.906	3.937	1.063	M6x1.0mm
WC024HMC	CCT50 AD/B - HMC 3/8 - 5.91		0.375	0.945	1.752	5.906	3.937	1.260	M8x1.0mm	
WC026HMC	CCT50 AD/B - HMC 1/2 - 5.91		0.500	1.024	1.752	5.906	3.937	1.457	M10x1.0mm	
WC028HMC	CCT50 AD/B - HMC 5/8 - 5.91		0.625	1.260	1.752	5.906	3.937	1.654	M12x1.0mm	
WC030HMC	CCT50 AD/B - HMC 3/4 - 5.91		0.750	1.339	1.752	5.906	3.937	1.654	M16x1.0mm	

Unit : mm

EDP No.	TAPER No.	MODEL No.	d1	D1	D2	L	L1	L2	G	
WB100HMC	40	CCT40 AD/B - HMC 6 - 120	6	20	49.5	120	70	27	M5X0.8	
WB102HMC		CCT40 AD/B - HMC 6 - 150	6	20	49.5	150	100	27	M5X0.8	
WB104HMC		CCT40 AD/B - HMC 8 - 120	8	22	49.5	120	70	27	M6X1.0	
WB106HMC		CCT40 AD/B - HMC 8 - 150	8	22	49.5	150	100	27	M6X1.0	
WB108HMC		CCT40 AD/B - HMC 10 - 120	10	24	49.5	120	70	32	M8X1.0	
WB110HMC		CCT40 AD/B - HMC 10 - 150	10	24	49.5	150	100	32	M8X1.0	
WB112HMC		CCT40 AD/B - HMC 12 - 120	12	25	49.5	120	70	37	M10X1.0	
WB114HMC		CCT40 AD/B - HMC 12 - 150	12	25	49.5	150	100	37	M10X1.0	
WB116HMC		CCT40 AD/B - HMC 16 - 120	16	32	49.5	120	70	42	M12X1.0	
WB118HMC		CCT40 AD/B - HMC 16 - 150	16	32	49.5	150	100	42	M12X1.0	
WB120HMC		CCT40 AD/B - HMC 20 - 120	20	34	49.5	120	70	42	M16X1.0	
WB122HMC		CCT40 AD/B - HMC 20 - 150	20	34	49.5	150	100	42	M16X1.0	
WC100HMC		50	CCT50 AD/B - HMC 6 - 150	6	20	44.5	150	100	27	M5X0.8
WC102HMC			CCT50 AD/B - HMC 8 - 150	8	22	44.5	150	100	27	M6X1.0
WC104HMC	CCT50 AD/B - HMC 10 - 150		10	24	44.5	150	100	32	M8X1.0	
WC106HMC	CCT50 AD/B - HMC 12 - 150		12	25	44.5	150	100	37	M10X1.0	
WC108HMC	CCT50 AD/B - HMC 16 - 150		16	32	44.5	150	100	42	M12X1.0	
WC110HMC	CCT50 AD/B - HMC 20 - 150		20	34	44.5	150	100	42	M16X1.0	

► Applicable hydraulic chuck collets (reduction sleeves) on pages 183-190.

DUAL CONTACT HYDRAULIC CHUCK (SLIM)

CBT

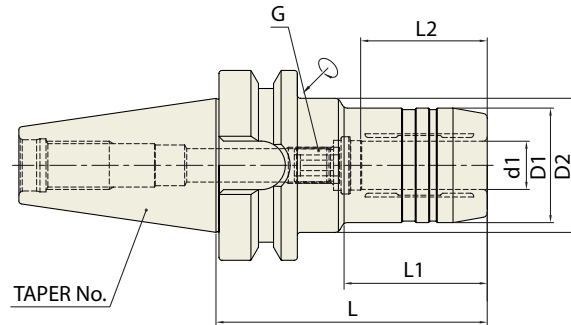

CBT	Taper Accuracy AT3	G Value 2.5	RPM 25,000	Run-Out (at 3D) ≤0.00012"	Coolant System AD
-----	------------------------------	-----------------------	----------------------	-------------------------------------	-----------------------------

CBT (BT DUAL CONTACT)

Unit : inch

EDP No.	TAPER No.	MODEL No.	d1	D1	D2	L	L1	L2	G
WD020	30	CBT 30 - HC 1/4 - 2.76	0.250	1.024	1.752	2.756	1.161	1.063	M5x0.8mm
WD022		CBT 30 - HC 5/16 - 2.76	0.313	1.102	1.752	2.756	1.181	1.063	M6x1.0mm
WD024		CBT 30 - HC 3/8 - 2.95	0.375	1.181	1.752	2.953	1.220	1.260	M8x1.0mm
WD026		CBT 30 - HC 1/2 - 3.35	0.500	1.260	1.772	3.346	1.575	1.457	M10x1.0mm
WD028		CBT 30 - HC 5/8 - 3.54	0.625	1.496	1.772	3.543	1.811	1.654	M10x1.0mm
WD030		CBT 30 - HC 3/4 - 3.54	0.750	1.654	1.772	3.543	1.890	1.654	M16x1.0mm
WE020	40	CBT 40 - HC 1/4 - 3.54	0.250	1.024	1.752	3.543	1.181	1.063	M5x0.8mm
WE022		CBT 40 - HC 5/16 - 3.54	0.313	1.102	1.752	3.543	1.280	1.063	M6x1.0mm
WE024		CBT 40 - HC 3/8 - 3.54	0.375	1.181	1.752	3.543	1.260	1.260	M8x1.0mm
WE026		CBT 40 - HC 1/2 - 3.54	0.500	1.260	1.752	3.543	1.378	1.457	M10x1.0mm
WE028		CBT 40 - HC 5/8 - 3.54	0.625	1.496	1.870	3.543	1.575	1.654	M12x1.0mm
WE030		CBT 40 - HC 3/4 - 3.54	0.750	1.654	1.870	3.543	1.575	1.654	M16x1.0mm
WE032		CBT 40 - HC 1 - 3.94	1.000	1.969	2.362	3.937	1.772	1.890	M16x1.0mm
WE034		CBT 40 - HC 1 1/4 - 4.13	1.250	2.362	-	4.134	-	2.165	M16x1.0mm

Unit : mm

EDP No.	TAPER No.	MODEL No.	d1	D1	D2	L	L1	L2	G
WD100	30	CBT 30 - HC 6 - 70	6	26	44.5	70	29.5	27	M5x0.8
WD102		CBT 30 - HC 8 - 70	8	28	44.5	70	30	27	M6x1.0
WD104		CBT 30 - HC 10 - 75	10	30	44.5	75	31	32	M8x1.0
WD106		CBT 30 - HC 12 - 85	12	32	45	85	45	37	M10x1.0
WD108		CBT 30 - HC 14 - 85	14	34	45	85	45	37	M10x1.0
WD110		CBT 30 - HC 16 - 90	16	38	45	90	50	42	M10x1.0
WD112		CBT 30 - HC 18 - 90	18	40	45	90	50	42	M10x1.0
WD114		CBT 30 - HC 20 - 90	20	42	45	90	50	42	M6x1.0
WE100	40	CBT 40 - HC 6 - 90	6	26	44.5	90	43	27	M5x0.8
WE102		CBT 40 - HC 8 - 90	8	28	44.5	90	44.5	27	M6x1.0
WE104		CBT 40 - HC 10 - 90	10	30	44.5	90	44.5	32	M8x1.0
WE106		CBT 40 - HC 12 - 90	12	32	44.5	90	44.5	37	M10x1.0
WE108		CBT 40 - HC 14 - 90	14	34	44.5	90	44.5	37	M10x1.0
WE110		CBT 40 - HC 16 - 90	16	38	44.5	90	47.5	42	M12x1.0
WE112		CBT 40 - HC 18 - 90	18	40	44.5	90	47.5	42	M12x1.0
WE114		CBT 40 - HC 20 - 90	20	42	44.5	90	47.5	42	M16x1.0
WE116		CBT 40 - HC 25 - 100	25	50	60	100	47.5	48	M16x1.0
WE118		CBT 40 - HC 32 - 105	32	60	-	105	-	55	M16x1.0

► Applicable hydraulic chuck collets (reduction sleeves) on pages 183-190.

Hydraulic Chuck

DUAL CONTACT HYDRAULIC CHUCK (POWER E HYDRO)

CBT

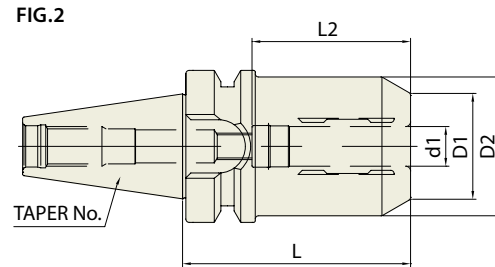
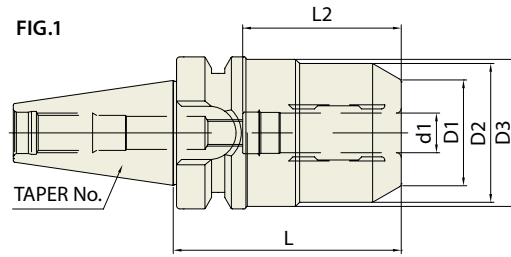

CBT	Taper Accuracy AT3	G Value 2.5	RPM 25,000	Run-Out (at 3D) ≤0.00012"	Coolant System AD
-----	------------------------------	-----------------------	----------------------	-------------------------------------	-----------------------------

CBT (BT DUAL CONTACT)

Unit : inch

EDP No.	TAPER No.	MODEL No.	d1	D1	D2	D3	L	L2	G	FIG.
WD030PE	30	CBT 30 - HC 3/4P - 3.543	0.75	1.496	1.653	1.751	3.543	1.889	M8x1.0mm	1
WE030PE	40	CBT 40 - HC 3/4P - 2.854	0.75	1.496	1.938	-	2.854	1.889	M8x1.0mm	2

Unit : mm

EDP No.	TAPER No.	MODEL No.	d1	D1	D2	D3	L	L2	G	FIG.
WD112PE	30	CBT 30 - HC 12P - 69	12	32	42	44.5	69	41	M8x1.0	1
WD120PE		CBT 30 - HC 20P - 90	20	38	42	44.5	90	48	M8x1.0	1
WE112PE	40	CBT 40 - HC 12P - 58	12	32	42	-	58	41	M8x1.0	2
WE120PE		CBT 40 - HC 20P - 72.5	20	38	49.25	-	72.5	48	M8x1.0	2

- ▶ High clamping torque power version (please refer to the technical information on page 1420 in the YU19 Cutting Tools catalog)
- ▶ Applicable for milling (roughing and finishing)
- ▶ Applicable hydraulic chuck collets (reduction sleeves) on pages 183-190

DUAL CONTACT HYDRAULIC CHUCK (FOR MOULD)

CBT

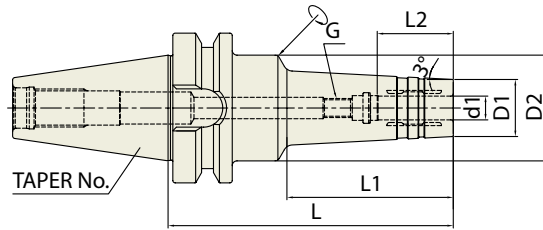

CBT	Taper Accuracy AT3	G Value 2.5	RPM 25,000	Run-Out (at 3D) ≤0.00012"	Coolant System AD
-----	------------------------------	-----------------------	----------------------	-------------------------------------	-----------------------------

CBT (BT DUAL CONTACT)

Unit : inch

EDP No.	TAPER No.	MODEL No.	d1	D1	D2	L	L1	L2	G
WE020HMC	40	CBT 40 - HMC 1/4 - 4.72	0.250	0.787	1.752	4.724	2.756	1.063	M5x0.8mm
WE022HMC		CBT 40 - HMC 1/4 - 5.91	0.250	0.787	1.752	5.906	3.937	1.063	M5x0.8mm
WE024HMC		CBT 40 - HMC 5/16 - 4.72	0.313	0.866	1.752	4.724	2.756	1.063	M6x1.0mm
WE026HMC		CBT 40 - HMC 5/16 - 5.91	0.313	0.866	1.752	5.906	3.937	1.063	M6x1.0mm
WE028HMC		CBT 40 - HMC 3/8 - 4.72	0.375	0.945	1.752	4.724	2.756	1.260	M8x1.0mm
WE030HMC		CBT 40 - HMC 3/8 - 5.91	0.375	0.945	1.752	5.906	3.937	1.260	M8x1.0mm
WE032HMC		CBT 40 - HMC 1/2 - 4.72	0.500	1.024	1.752	4.724	2.756	1.457	M10x1.0mm
WE034HMC		CBT 40 - HMC 1/2 - 5.91	0.500	1.024	1.752	5.906	3.937	1.457	M10x1.0mm
WE036HMC		CBT 40 - HMC 5/8 - 4.72	0.625	1.260	1.752	4.724	2.756	1.654	M12x1.0mm
WE038HMC		CBT 40 - HMC 5/8 - 5.91	0.625	1.260	1.752	5.906	3.937	1.654	M12x1.0mm
WE040HMC		CBT 40 - HMC 3/4 - 4.72	0.750	1.339	1.722	4.724	-	1.654	M16x1.0mm
WE042HMC		CBT 40 - HMC 3/4 - 5.91	0.750	1.339	1.846	5.906	-	1.654	M16x1.0mm

Unit : mm

EDP No.	TAPER No.	MODEL No.	d1	D1	D2	L	L1	L2	G
WE100HMC	40	CBT 40 - HMC 6 - 120	6	20	44.5	120	70	27	M5x0.8
WE102HMC		CBT 40 - HMC 6 - 150	6	20	44.5	150	100	27	M5x0.8
WE104HMC		CBT 40 - HMC 8 - 120	8	22	44.5	120	70	27	M6x1.0
WE106HMC		CBT 40 - HMC 8 - 150	8	22	44.5	150	100	27	M6x1.0
WE108HMC		CBT 40 - HMC 10 - 120	10	24	44.5	120	70	32	M8x1.0
WE110HMC		CBT 40 - HMC 10 - 150	10	24	44.5	150	100	32	M8x1.0
WE112HMC		CBT 40 - HMC 12 - 120	12	25	44.5	120	70	37	M10x1.0
WE114HMC		CBT 40 - HMC 12 - 150	12	25	44.5	150	100	37	M10x1.0
WE116HMC		CBT 40 - HMC 16 - 120	16	32	44.5	120	70	42	M12x1.0
WE118HMC		CBT 40 - HMC 16 - 150	16	32	44.5	150	100	42	M12x1.0
WE120HMC		CBT 40 - HMC 20 - 120	20	34	43.8	120	-	42	M16x1.0
WE122HMC		CBT 40 - HMC 20 - 150	20	34	46.9	150	-	42	M16x1.0

► Applicable hydraulic chuck collets (reduction sleeves) on pages 183-190.

Hydraulic Chuck

DUAL CONTACT HYDRAULIC CHUCK (SLIM)

HSK

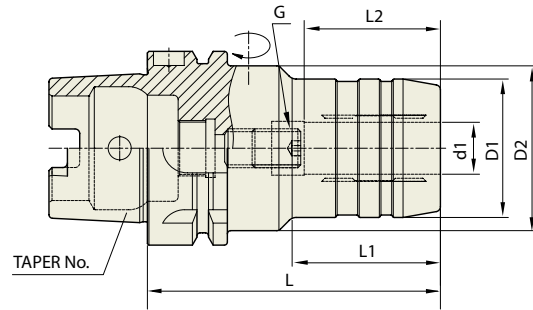

DIN 69893 - HSK	Taper Accuracy -	G Value 2.5	RPM 25,000	Run-Out (at 3D) ≤0.00012"	Coolant System AD
--------------------	------------------------	----------------	---------------	---------------------------------	-------------------------

DIN 69893/ISO 12164-1 HSK FROM A

Unit : inch

EDP No.	TAPER No.	MODEL No.	d1	D1	D2	L	L1	L2	G
WQ020	63A	HSK 63A - HC 1/4 - 2.76	0.250	1.024	1.969	2.756	0.945	1.063	M5x0.8mm
WQ022		HSK 63A - HC 3/8 - 3.15	0.375	1.181	1.969	3.150	1.378	1.260	M8x1.0mm
WQ024		HSK 63A - HC 1/2 - 3.35	0.500	1.260	1.969	3.346	1.575	1.457	M10x1.0mm
WQ026		HSK 63A - HC 3/4 - 3.54	0.750	1.654	1.969	3.543	1.890	1.654	M16x1.0mm
WQ028		HSK 63A - HC 1" - 4.72	1.000	2.244	2.480	4.724	2.323	1.890	M16x1.0mm
WQ030		HSK 63A - HC 1 1/4 - 4.92	1.250	2.520	2.953	4.921	2.480	2.165	M16x1.0mm
WR020	100A	HSK 100A - HC 1/4 - 2.95	0.250	1.024	1.969	2.953	1.024	1.063	M5x0.8mm
WR022		HSK 100A - HC 3/8 - 2.95	0.375	1.181	1.969	3.543	1.654	1.260	M8x1.0mm
WR024		HSK 100A - HC 1/2 - 3.74	0.500	1.260	1.969	3.740	1.850	1.457	M10x1.0mm
WR026		HSK 100A - HC 3/4 - 4.13	0.750	1.654	1.969	4.134	2.323	1.654	M16x1.0mm
WR028		HSK 100A - HC 1" - 4.33	1.000	2.244	2.480	4.331	2.441	1.890	M16x1.0mm
WR032		HSK 100A - HC 1 1/4 - 4.33	1.250	2.520	2.953	4.331	2.441	2.165	M16x1.0mm

► Applicable hydraulic chuck collets (reduction sleeves) on pages 183–190.

HYDRAULIC CHUCK (POWER E HYDRO)

HSK

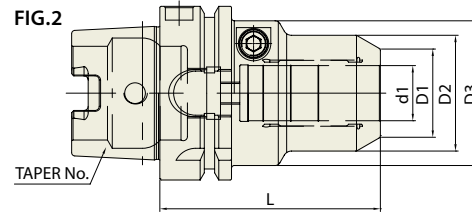
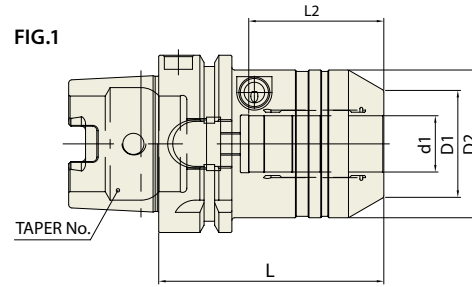

DIN 69893 - HSK	Taper Accuracy -	G Value 2.5	RPM 25,000	Run-Out (at 3D) ≤0.00012"	Coolant System AD
-----------------	------------------	-------------	------------	---------------------------	-------------------

DIN 69893/ISO 12164-1-HSK FORM A

Unit : inch

EDP No.	TAPER No.	MODEL No.	d1	D1	D2	D3	L	L2	G	FIG.
WQ002PE	63A	HSK 63A - HC 3/4P - 3.149	0.75	1.496	2.066	-	3.149	1.889	M8x1.0mm	1
WQ003PE		HSK 63A - HC 3/4P - 5.118	0.75	1.496	2.066	-	5.118	1.889	M8x1.0mm	1
WR002PE	100A	HSK 100A - HC 1 1/4P - 3.937	1.25	2.303	2.834	-	3.937	2.244	M8x1.0mm	1

Unit : mm

EDP No.	TAPER No.	MODEL No.	d1	D1	D2	D3	L	L2	G	FIG.
WQ100PE	63A	HSK 63A - HC 12P - 80	12	32	42	52.5	80	41	M8x1.0	2
WQ102PE		HSK 63A - HC 20P - 80	20	38	52.5	-	80	48	M8x1.0	1
WR100PE	100A	HSK 100A - HC 20P - 90	20	38	52.5	-	90	48	M8x1.0	1
WR102PE		HSK 100A - HC 32P - 100	32	58.5	72	-	100	57	M8x1.0	1

- ▶ High clamping torque power version (please refer to the technical information on page 1420 in the YU19 Cutting Tools catalog)
- ▶ Applicable for milling (roughing and finishing)
- ▶ Applicable hydraulic chuck collets (reduction sleeves) on pages 183–190

Hydraulic Chuck

DUAL CONTACT HYDRAULIC CHUCK (SHORT & RIGID)

HSK

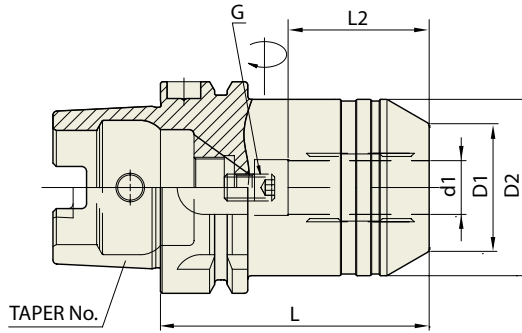

DIN 69893 - HSK	Taper Accuracy -	G Value 2.5	RPM 25,000	Run-Out (at 3D) ≤0.00012"	Coolant System AD
--------------------	------------------------	----------------	---------------	---------------------------------	-------------------------

DIN 69893/ISO 12164-1-HSK FORM A

Unit : mm

EDP No.	TAPER No.	MODEL No.	d1	D1	D2	L	L2	G
WQ100SNR	63A	HSK 63A - HC 12S - 80	12	32	42	80	37	M8x1.0
WQ102SNR		HSK 63A - HC 20S - 80	20	38	52.5	80	42	M8x1.0
WR100SNR	100A	HSK 100A - HC 12S - 85	12	32	42	85	35	M8x1.0
WR102SNR		HSK 100A - HC 20S - 90	20	38	52.5	90	42	M8x1.0

► Applicable hydraulic chuck collets (reduction sleeves) on pages 183–190.

Hydraulic Chuck

HSK

DUAL CONTACT HYDRAULIC CHUCK (RADIAL TOOL LENGTH PRE-SETTING TYPE)

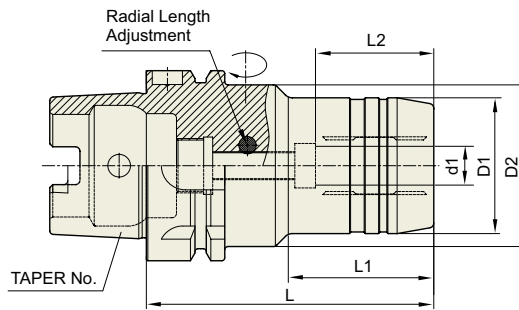

DIN 69893 - HSK	Taper Accuracy -	G Value 2.5	RPM 25,000	Run-Out (at 3D) ≤0.00012"	Coolant System AD
-----------------	------------------	-------------	------------	---------------------------	-------------------

DIN 69893/ISO 12164-1-HSK FORM A

Unit : mm

EDP No.	TAPER No.	MODEL No.	d1	D1	D2	L	L1	L2
WQ100HCR	63A	HSK 63A - HCR 6 - 85	6	26	50	85	33	27
WQ102HCR		HSK 63A - HCR 8 - 85	8	28	50	85	33	27
WQ104HCR		HSK 63A - HCR 10 - 85	10	30	50	85	38	32
WQ106HCR		HSK 63A - HCR 12 - 95	12	32	50	95	40	37
WQ108HCR		HSK 63A - HCR 14 - 95	14	34	50	95	46	37
WQ110HCR		HSK 63A - HCR 16 - 95	16	38	50	95	51	42
WQ112HCR		HSK 63A - HCR 18 - 95	18	40	50	95	52	42
WQ114HCR		HSK 63A - HCR 20 - 100	20	42	50	100	51	42
WQ116HCR		HSK 63A - HCR 25 - 120	25	57	63	120	54.5	48
WQ118HCR		HSK 63A - HCR 32 - 125	32	64	75	125	57.5	55
WR100HCR	100A	HSK 100A - HCR 6 - 90	6	26	63	90	33	27
WR102HCR		HSK 100A - HCR 8 - 90	8	28	63	90	33	27
WR104HCR		HSK 100A - HCR 10 - 95	10	30	63	95	36	32
WR106HCR		HSK 100A - HCR 12 - 100	12	32	63	100	40	37
WR108HCR		HSK 100A - HCR 14 - 100	14	34	63	100	41	37
WR110HCR		HSK 100A - HCR 16 - 105	16	38	63	105	46	42
WR112HCR		HSK 100A - HCR 18 - 105	18	40	63	105	46	42
WR114HCR		HSK 100A - HCR 20 - 105	20	42	75	105	51	42
WR116HCR		HSK 100A - HCR 25 - 115	25	57	75	115	55.5	48
WR118HCR		HSK 100A - HCR 32 - 120	32	64	75	120	63.5	55

► Applicable hydraulic chuck collets (reduction sleeves) on pages 183–190.

Hydraulic Chuck

DUAL CONTACT HYDRAULIC CHUCK (FOR MOULD)

HSK

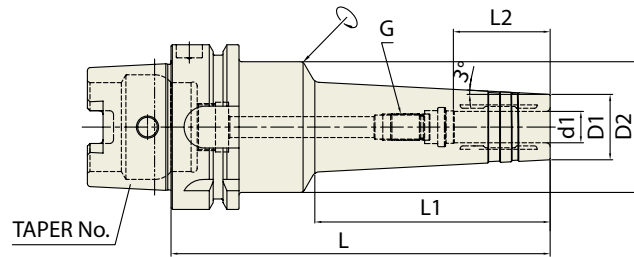

DIN 69893 -HSK	Taper Accuracy -	G Value 2.5	RPM 25,000	Run-Out (at 3D) ≤0.00012"	Coolant System AD
-------------------	------------------------	----------------	---------------	---------------------------------	-------------------------

DIN 69893/ISO 12164-1-HSK FORM A

Unit : inch

EDP No.	TAPER No.	MODEL No.	d1	D1	D2	L	L1	L2	G
WQ020HMC	63A	HSK 63A - HMC 1/4 - 5.71	0.250	0.787	1.969	5.709	3.543	1.063	M5x0.8mm
WQ022HMC		HSK 63A - HMC 5/16 - 5.71	0.313	0.866	1.969	5.709	3.543	1.063	M6x1.0mm
WQ024HMC		HSK 63A - HMC 3/8 - 5.71	0.375	0.945	1.969	5.709	3.543	1.260	M8x1.0mm
WQ026HMC		HSK 63A - HMC 1/2 - 5.71	0.500	1.024	1.969	5.709	3.543	1.457	M10x1.0mm
WQ028HMC		HSK 63A - HMC 5/8 - 5.71	0.625	1.260	1.969	5.709	3.543	1.654	M12x1.0mm
WQ030HMC		HSK 63A - HMC 3/4 - 5.71	0.750	1.339	1.969	5.709	3.543	1.654	M16x1.0mm
WR100HMC	100A	HSK 100A - HMC 1/4 - 5.71	0.250	0.787	1.969	5.709	3.543	1.063	M5x0.8mm
WR102HMC		HSK 100A - HMC 5/16 - 5.71	0.313	0.866	1.969	5.709	3.543	1.063	M6x1.0mm
WR104HMC		HSK 100A - HMC 3/8 - 5.71	0.375	0.945	1.969	5.709	3.543	1.260	M8x1.0mm
WR106HMC		HSK 100A - HMC 1/2 - 5.71	0.500	1.024	1.969	5.709	3.543	1.457	M10x1.0mm
WR108HMC		HSK 100A - HMC 5/8 - 5.71	0.625	1.260	1.969	5.709	3.543	1.654	M12x1.0mm
WR110HMC		HSK 100A - HMC 3/4 - 5.71	0.750	1.339	1.969	5.709	3.543	1.654	M16x1.0mm

Unit : mm

EDP No.	TAPER No.	MODEL No.	d1	D1	D2	L	L1	L2	G
WQ100HMC	63A	HSK 63A - HMC 6 - 145	6	20	50	145	90	27	M5x0.8
WQ102HMC		HSK 63A - HMC 8 - 145	8	22	50	145	90	27	M6x1.0
WQ104HMC		HSK 63A - HMC 10 - 145	10	24	50	145	90	32	M8x1.0
WQ106HMC		HSK 63A - HMC 12 - 145	12	25	50	145	90	37	M10x1.0
WQ108HMC		HSK 63A - HMC 16 - 145	16	32	50	145	90	42	M12x1.0
WQ110HMC		HSK 63A - HMC 20 - 145	20	34	50	145	90	42	M16x1.0
WR200HMC	100A	HSK 100A - HMC 6 - 150	6	20	50	150	90	27	M5x0.8
WR202HMC		HSK 100A - HMC 8 - 150	8	22	50	150	90	27	M6x1.0
WR204HMC		HSK 100A - HMC10 - 150	10	24	50	150	90	32	M8x1.0
WR206HMC		HSK 100A - HMC12 - 150	12	25	50	150	90	37	M10x1.0
WR208HMC		HSK 100A - HMC16 - 150	16	32	50	150	90	42	M12x1.0
WR210HMC		HSK 100A - HMC20 - 150	20	34	50	150	90	42	M16x1.0

► Applicable hydraulic chuck collets (reduction sleeves) on pages 183–190.

HYDRAULIC CHUCK COLLET (REDUCTION SLEEVE: OPEN TYPE)

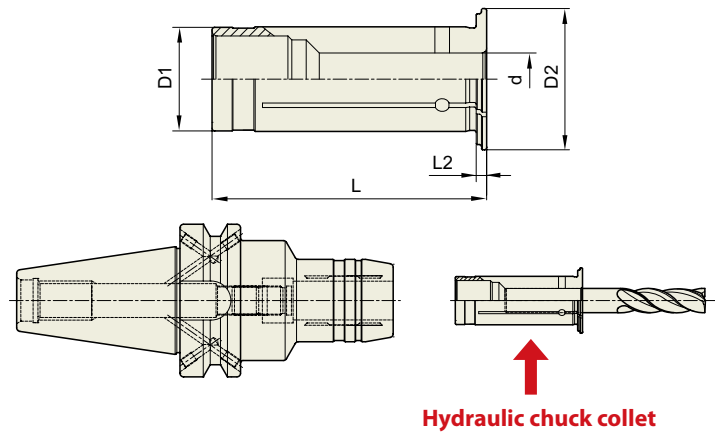

METRIC / INCH

Unit : inch

EDP No.	TYPE	d	D1	D2	L	L2	
412108	HK12	1/8"	0.125	0.472	0.748	1.850	0.079
412316		3/16"	0.188	0.472	0.748	1.850	0.079
412104		1/4"	0.250	0.472	0.748	1.850	0.079
412516		5/16"	0.313	0.472	0.748	1.850	0.079
420108	HK20	1/8"	0.125	0.787	1.063	2.067	0.079
420316		3/16"	0.188	0.787	1.063	2.067	0.079
420104		1/4"	0.250	0.787	1.063	2.067	0.079
420516		5/16"	0.313	0.787	1.063	2.067	0.079
420308		3/8"	0.375	0.787	1.063	2.067	0.079
420102		1/2"	0.500	0.787	1.063	2.067	0.079
420508	HK32	5/8"	0.625	0.787	1.063	2.067	0.079
432108		1/8"	0.125	1.260	1.535	2.500	0.118
432316		3/16"	0.188	1.260	1.535	2.500	0.118
432104		1/4"	0.250	1.260	1.535	2.500	0.118
432516		5/16"	0.313	1.260	1.535	2.500	0.118
432308		3/8"	0.375	1.260	1.535	2.500	0.118
432102		1/2"	0.500	1.260	1.535	2.500	0.118
432508		5/8"	0.625	1.260	1.535	2.500	0.118
432304	3/4"	0.750	1.260	1.535	2.500	0.118	
432100	1	1.000	1.260	1.535	2.500	0.118	

► Other special sizes of hydraulic chuck collets can be supplied on request.

Feature

The wall of hydraulic chuck collet (reduction sleeve) is cut by high-precision wire-cutting to guarantee precise I.D and strong clamping power.

Chucking Method

Please assemble cutting tool with collet first, and then insert collet into hydraulic chuck.

Hydraulic Chuck

HYDRAULIC CHUCK COLLET (REDUCTION SLEEVE: CLOSED TYPE)

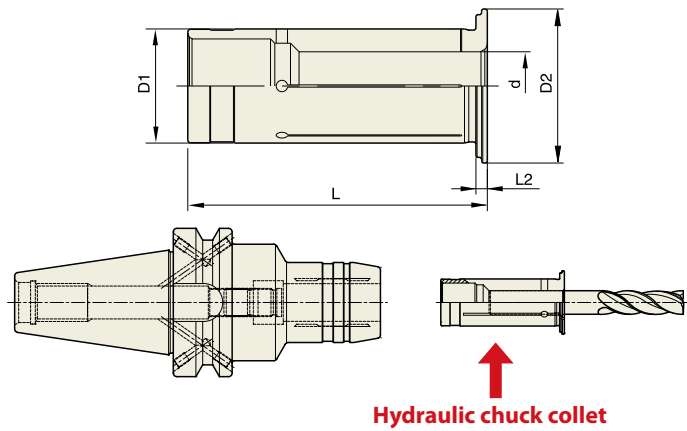

METRIC / INCH

							Unit : inch
EDP No.	TYPE		d	D1	D2	L	L2
512108	HS12	1/8"	0.125	0.472	0.748	1.850	0.079
512316		3/16"	0.188	0.472	0.748	1.850	0.079
512104		1/4"	0.250	0.472	0.748	1.850	0.079
512516		5/16"	0.313	0.472	0.748	1.850	0.079
520108	HS20	1/8"	0.125	0.787	1.063	2.067	0.079
520316		3/16"	0.188	0.787	1.063	2.067	0.079
520104		1/4"	0.250	0.787	1.063	2.067	0.079
520516		5/16"	0.313	0.787	1.063	2.067	0.079
520308		3/8"	0.375	0.787	1.063	2.067	0.079
520102		1/2"	0.500	0.787	1.063	2.067	0.079
520508		5/8"	0.625	0.787	1.063	2.067	0.079
532108	HS32	1/8"	0.125	1.260	1.535	2.500	0.118
532316		3/16"	0.188	1.260	1.535	2.500	0.118
532104		1/4"	0.250	1.260	1.535	2.500	0.118
532516		5/16"	0.313	1.260	1.535	2.500	0.118
532308		3/8"	0.375	1.260	1.535	2.500	0.118
532102		1/2"	0.500	1.260	1.535	2.500	0.118
532508		5/8"	0.625	1.260	1.535	2.500	0.118
532304		3/4"	0.750	1.260	1.535	2.500	0.118
532100		1	1.000	1.260	1.535	2.500	0.118

► Other special sizes of hydraulic chuck collets can be supplied on request.

Feature The wall of hydraulic chuck collet (reduction sleeve) is cut by high-precision wire-cutting to guarantee precise I.D and strong clamping power.

Chucking Method Please assemble cutting tool with collet first, and then insert collet into hydraulic chuck.

Hydraulic Chuck

HYDRAULIC CHUCK COLLET (REDUCTION SLEEVE: OPEN TYPE)

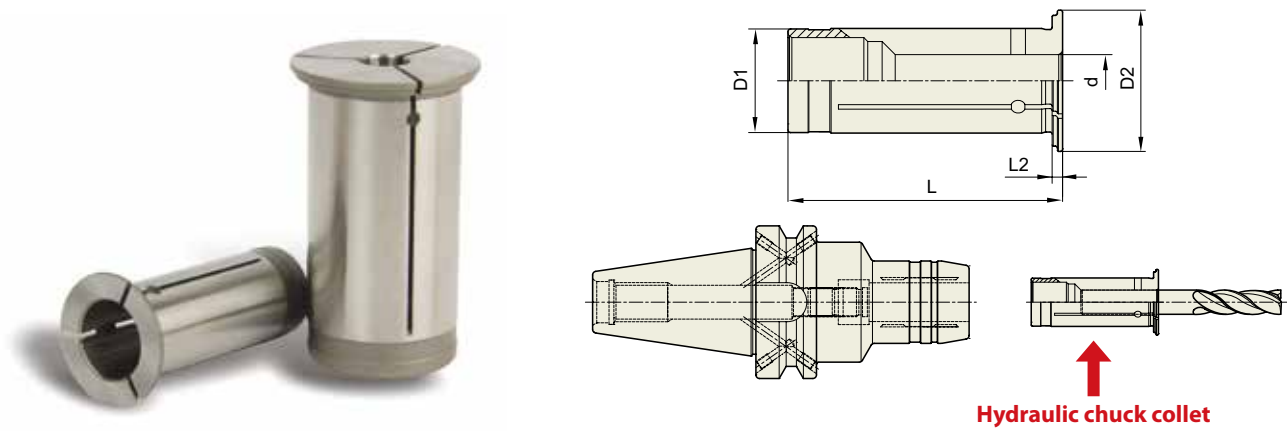

INCH / INCH

EDP No.	TYPE	d	D1	D2	L	L2	Unit : inch
612108	HK1/2"	1/8"	0.125	0.500	0.748	1.850	0.079
612316		3/16"	0.188	0.500	0.748	1.850	0.079
612104		1/4"	0.250	0.500	0.748	1.850	0.079
612516		5/16"	0.313	0.500	0.748	1.850	0.079
625108	HK3/4"	1/8"	0.125	0.750	1.063	2.067	0.079
625316		3/16"	0.188	0.750	1.063	2.067	0.079
625104		1/4"	0.250	0.750	1.063	2.067	0.079
625516		5/16"	0.313	0.750	1.063	2.067	0.079
625308		3/8"	0.375	0.750	1.063	2.067	0.079
625102		1/2"	0.500	0.750	1.063	2.067	0.079
625508	5/8"	0.625	0.750	1.063	2.067	0.079	
632108	HK1 1/4"	1/8"	0.125	1.250	1.535	2.500	0.118
632316		3/16"	0.188	1.250	1.535	2.500	0.118
632104		1/4"	0.250	1.250	1.535	2.500	0.118
632516		5/16"	0.313	1.250	1.535	2.500	0.118
632308		3/8"	0.375	1.250	1.535	2.500	0.118
632102		1/2"	0.500	1.250	1.535	2.500	0.118
632508		5/8"	0.625	1.250	1.535	2.500	0.118
632304		3/4"	0.750	1.250	1.535	2.500	0.118
632100	1	1.000	1.250	1.535	2.500	0.118	

► Other special sizes of hydraulic chuck collets can be supplied on request.

Feature The wall of hydraulic chuck collet (reduction sleeve) is cut by high-precision wire-cutting to guarantee precise I.D and strong clamping power.

Chucking Method Please assemble cutting tool with collet first, and then insert collet into hydraulic chuck.

Hydraulic Chuck

HYDRAULIC CHUCK COLLET (REDUCTION SLEEVE: CLOSED TYPE)

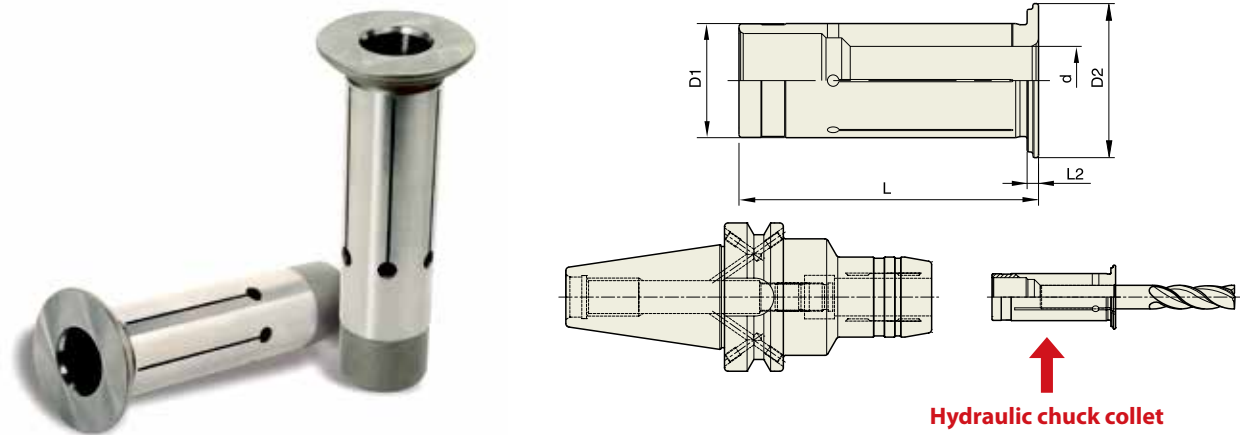

INCH / INCH

Unit : inch

EDP No.	TYPE	d	D1	D2	L	L2	
712108	HS1/2"	1/8"	0.125	0.500	0.748	1.850	0.079
712316		3/16"	0.188	0.500	0.748	1.850	0.079
712104		1/4"	0.250	0.500	0.748	1.850	0.079
712516		5/16"	0.313	0.500	0.748	1.850	0.079
725108	HS3/4"	1/8"	0.125	0.750	1.063	2.067	0.079
725316		3/16"	0.188	0.750	1.063	2.067	0.079
725104		1/4"	0.250	0.750	1.063	2.067	0.079
725516		5/16"	0.313	0.750	1.063	2.067	0.079
725308		3/8"	0.375	0.750	1.063	2.067	0.079
725102		1/2"	0.500	0.750	1.063	2.067	0.079
725508	5/8"	0.625	0.750	1.063	2.067	0.079	
732108	HS1 1/4"	1/8"	0.125	1.250	1.535	2.500	0.118
732316		3/16"	0.188	1.250	1.535	2.500	0.118
732104		1/4"	0.250	1.250	1.535	2.500	0.118
732516		5/16"	0.313	1.250	1.535	2.500	0.118
732308		3/8"	0.375	1.250	1.535	2.500	0.118
732102		1/2"	0.500	1.250	1.535	2.500	0.118
732508		5/8"	0.625	1.250	1.535	2.500	0.118
732304		3/4"	0.750	1.250	1.535	2.500	0.118
732100	1	1.000	1.250	1.535	2.500	0.118	

► Other special sizes of hydraulic chuck collets can be supplied on request.

Feature The wall of hydraulic chuck collet (reduction sleeve) is cut by high-precision wire-cutting to guarantee precise I.D and strong clamping power.

Chucking Method Please assemble cutting tool with collet first, and then insert collet into hydraulic chuck.

Hydraulic Chuck

HYDRAULIC CHUCK COLLET (REDUCTION SLEEVE: OPEN TYPE)

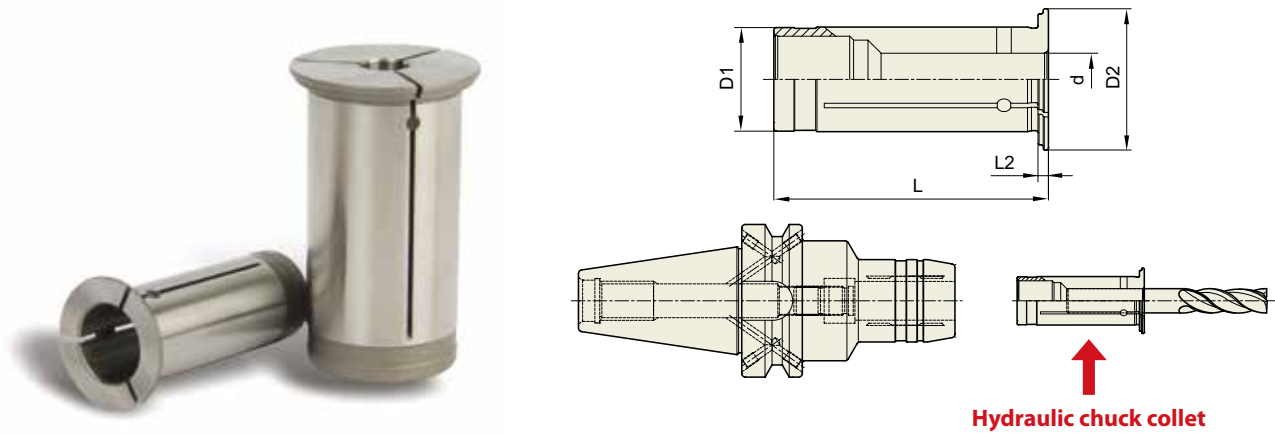

METRIC / METRIC

Unit : mm

EDP No.	TYPE	d	D1	D2	L	L2
812030	HK12	3	12	19	47	2
812040		4	12	19	47	2
812050		5	12	19	47	2
812060		6	12	19	47	2
812070		7	12	19	47	2
812008		8	12	19	47	2
820030	HK20	3	20	27	52.5	2
820040		4	20	27	52.5	2
820050		5	20	27	52.5	2
820060		6	20	27	52.5	2
820070		7	20	27	52.5	2
820080		8	20	27	52.5	2
820090		9	20	27	52.5	2
820100		10	20	27	52.5	2
820110		11	20	27	52.5	2
820120		12	20	27	52.5	2
820130		13	20	27	52.5	2
820140	14	20	27	52.5	2	
820150	15	20	27	52.5	2	
820160	16	20	27	52.5	2	
832060	HK32	6	32	39	63.5	3
832080		8	32	39	63.5	3
832100		10	32	39	63.5	3
832120		12	32	39	63.5	3
832140		14	32	39	63.5	3
832160		16	32	39	63.5	3
832180		18	32	39	63.5	3
832200		20	32	39	63.5	3
832250		25	32	39	63.5	3

▶ Other special sizes of hydraulic chuck collets can be supplied on request.

Feature

The wall of hydraulic chuck collet (reduction sleeve) is cut by high-precision wire-cutting to guarantee precise I.D and strong clamping power.

Chucking Method

Please assemble cutting tool with collet first, and then insert collet into hydraulic chuck.

Hydraulic Chuck

HYDRAULIC CHUCK COLLET (REDUCTION SLEEVE: CLOSED TYPE)

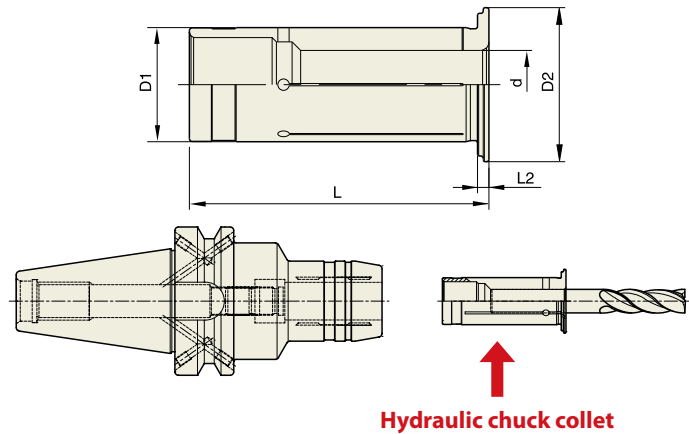

METRIC / METRIC

Unit : mm

EDP No.	TYPE	d	D1	D2	L	L2		
912030	HS12	3	3	12	19	47	2	
912040		4	4	12	19	47	2	
912050		5	5	12	19	47	2	
912060		6	6	12	19	47	2	
912070		7	7	12	19	47	2	
912080		8	8	12	19	47	2	
920030		HS20	3	3	20	27	52.5	2
920040			4	4	20	27	52.5	2
920050	5		5	20	27	52.5	2	
920060	6		6	20	27	52.5	2	
920070	7		7	20	27	52.5	2	
920080	8		8	20	27	52.5	2	
920090	9		9	20	27	52.5	2	
920100	10		10	20	27	52.5	2	
920110	11		11	20	27	52.5	2	
920120	12		12	20	27	52.5	2	
920130	13		13	20	27	52.5	2	
920140	14		14	20	27	52.5	2	
920150	15		15	20	27	52.5	2	
920160	16		16	20	27	52.5	2	
932060	HS32		6	6	32	39	63.5	3
932080			8	8	32	39	63.5	3
932100		10	10	32	39	63.5	3	
932120		12	12	32	39	63.5	3	
932140		14	14	32	39	63.5	3	
932160		16	16	32	39	63.5	3	
932180		18	18	32	39	63.5	3	
932200		20	20	32	39	63.5	3	
932250		25	25	32	39	63.5	3	

► Other special sizes of hydraulic chuck collets can be supplied on request.

Feature

The wall of hydraulic chuck collet (reduction sleeve) is cut by high-precision wire-cutting to guarantee precise I.D and strong clamping power.

Chucking Method

Please assemble cutting tool with collet first, and then insert collet into hydraulic chuck.

Hydraulic Chuck

HYDRAULIC CHUCK COLLET (REDUCTION SLEEVE: OPEN TYPE)

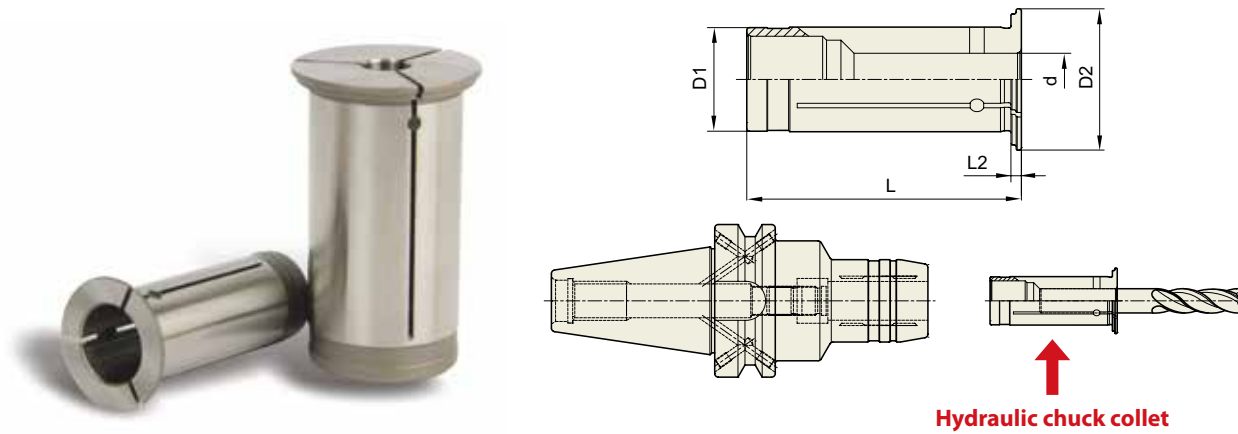

INCH / METRIC

Unit : inch

EDP No.	TYPE		d	D1	D2	L	L2
101203	HK1/2"	3	3mm	0.500	0.748	1.850	0.079
101204		4	4mm	0.500	0.748	1.850	0.079
101205		5	5mm	0.500	0.748	1.850	0.079
101206		6	6mm	0.500	0.748	1.850	0.079
101208		8	8mm	0.500	0.748	1.850	0.079
102503	HK3/4"	3	3mm	0.750	1.063	2.067	0.079
102504		4	4mm	0.750	1.063	2.067	0.079
102505		5	5mm	0.750	1.063	2.067	0.079
102506		6	6mm	0.750	1.063	2.067	0.079
102508		8	8mm	0.750	1.063	2.067	0.079
102510		10	10mm	0.750	1.063	2.067	0.079
102512	HK1 1/4"	12	12mm	0.750	1.063	2.067	0.079
102514		14	14mm	0.750	1.063	2.067	0.079
103208		8	8mm	1.250	1.535	2.500	0.118
103210	HK1 1/4"	10	10mm	1.250	1.535	2.500	0.118
103212		12	12mm	1.250	1.535	2.500	0.118
103214		14	14mm	1.250	1.535	2.500	0.118
103216		16	16mm	1.250	1.535	2.500	0.118
103218		18	18mm	1.250	1.535	2.500	0.118
103220		20	20mm	1.250	1.535	2.500	0.118
103225		25	25mm	1.250	1.535	2.500	0.118

▶ Other special sizes of hydraulic chuck collets can be supplied on request.

Feature

The wall of hydraulic chuck collet (reduction sleeve) is cut by high-precision wire-cutting to guarantee precise I.D and strong clamping power.

Chucking Method

Please assemble cutting tool with collet first, and then insert collet into hydraulic chuck.

Hydraulic Chuck

HYDRAULIC CHUCK COLLET (REDUCTION SLEEVE: CLOSED TYPE)

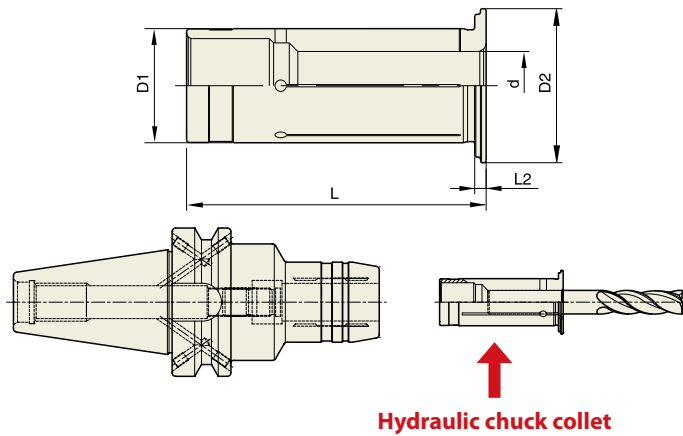

INCH / METRIC

Unit : inch

EDP No.	TYPE		d	D1	D2	L	L2
111203	HS1/2"	3	3mm	0.500	0.748	1.850	0.079
111204		4	4mm	0.500	0.748	1.850	0.079
111205		5	5mm	0.500	0.748	1.850	0.079
111206		6	6mm	0.500	0.748	1.850	0.079
111208		8	8mm	0.500	0.748	1.850	0.079
112503	HS3/4"	3	3mm	0.750	1.063	2.067	0.079
112504		4	4mm	0.750	1.063	2.067	0.079
112505		5	5mm	0.750	1.063	2.067	0.079
112506		6	6mm	0.750	1.063	2.067	0.079
112508		8	8mm	0.750	1.063	2.067	0.079
112510		10	10mm	0.750	1.063	2.067	0.079
112512		12	12mm	0.750	1.063	2.067	0.079
112514	14	14mm	0.750	1.063	2.067	0.079	
113208	HS1 1/4"	8	8mm	1.250	1.535	2.500	0.118
113210		10	10mm	1.250	1.535	2.500	0.118
113212		12	12mm	1.250	1.535	2.500	0.118
113214		14	14mm	1.250	1.535	2.500	0.118
113216		16	16mm	1.250	1.535	2.500	0.118
113218		18	18mm	1.250	1.535	2.500	0.118
113220		20	20mm	1.250	1.535	2.500	0.118
113225	25	25mm	1.250	1.535	2.500	0.118	

► Other special sizes of hydraulic chuck collets can be supplied on request.

- Feature** The wall of hydraulic chuck collet (reduction sleeve) is cut by high-precision wire-cutting to guarantee precise I.D and strong clamping power.
- Chucking Method** Please assemble cutting tool with collet first, and then insert collet into hydraulic chuck.

Shrink-Fit Holder

Pages 191-203



SHRINK-FIT HOLDER

CAT

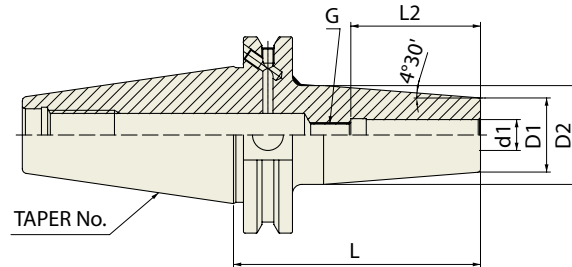

ASME B5.50 - CAT	Taper Accuracy AT3	G Value 2.5	RPM 25,000	Run-Out (at 3D) ≤0.00012"	Coolant System AD/B
-------------------------	------------------------------	-----------------------	----------------------	-------------------------------------	-------------------------------

ASME B5.50-2009-CAT

Unit : inch

EDP No.	TAPER No.	MODEL No.	d1	D1	D2	L	L2	G
VK020	40	CAT40 AD/B - SFH 1/8 - 3.15	0.125	0.394	0.748	3.150	0.354	-
VK022		CAT40 AD/B - SFH 3/16 - 3.15	0.188	0.394	0.748	3.150	0.472	-
VK024		CAT40 AD/B - SFH 1/4 - 3.15	0.250	0.827	1.063	3.150	1.417	M5x0.8mm
VK026		CAT40 AD/B - SFH 1/4 - 6.30	0.250	0.827	1.063	6.300	1.417	M5x0.8mm
VK028		CAT40 AD/B - SFH 3/8 - 3.15	0.375	0.945	1.260	3.150	1.654	M8x1.0mm
VK030		CAT40 AD/B - SFH 3/8 - 6.30	0.375	0.945	1.260	6.300	1.654	M8x1.0mm
VK032		CAT40 AD/B - SFH 1/2 - 3.15	0.500	0.945	1.260	3.150	1.811	M10x1.0mm
VK034		CAT40 AD/B - SFH 1/2 - 6.30	0.500	0.945	1.260	6.300	1.850	M10x1.0mm
VK036		CAT40 AD/B - SFH 5/8 - 3.15	0.625	1.063	1.339	3.150	1.969	M12x1.0mm
VK038		CAT40 AD/B - SFH 5/8 - 6.30	0.625	1.063	1.339	6.300	1.969	M12x1.0mm
VK040		CAT40 AD/B - SFH 3/4 - 3.15	0.750	1.299	1.654	3.150	2.047	M16x1.0mm
VK042		CAT40 AD/B - SFH 3/4 - 6.30	0.750	1.299	1.654	6.300	2.047	M16x1.0mm
VK044		CAT40 AD/B - SFH 1" - 3.94	1.000	1.732	2.087	3.937	2.283	M16x1.0mm
VK046		CAT40 AD/B - SFH 1" - 6.30	1.000	1.732	2.087	6.300	2.283	M16x1.0mm
VK048		CAT40 AD/B - SFH 1 1/4 - 3.94	1.250	1.732	2.087	3.937	2.283	M16x1.0mm
VK050		CAT40 AD/B - SFH 1 1/4 - 6.30	1.250	1.732	2.087	6.300	2.283	M16x1.0mm
VL020	50	CAT50 AD/B - SFH 1/8 - 3.15	0.125	0.394	0.748	3.150	0.354	-
VL022		CAT50 AD/B - SFH 3/16 - 3.15	0.188	0.394	0.748	3.150	0.472	-
VL024		CAT50 AD/B - SFH 1/4 - 3.15	0.250	0.827	1.063	3.150	1.417	M5x0.8mm
VL026		CAT50 AD/B - SFH 1/4 - 6.30	0.250	0.827	1.063	6.300	1.417	M5x0.8mm
VL028		CAT50 AD/B - SFH 3/8 - 3.15	0.375	0.945	1.260	3.150	1.575	M8x1.0mm
VL030		CAT50 AD/B - SFH 3/8 - 6.30	0.375	0.945	1.260	6.300	1.575	M8x1.0mm
VL032		CAT50 AD/B - SFH 1/2 - 3.15	0.500	0.945	1.260	3.150	1.850	M10x1.0mm
VL034		CAT50 AD/B - SFH 1/2 - 6.30	0.500	0.945	1.260	6.300	1.850	M10x1.0mm
VL036		CAT50 AD/B - SFH 5/8 - 3.15	0.625	1.063	1.339	3.150	1.969	M12x1.0mm
VL038		CAT50 AD/B - SFH 5/8 - 6.3	0.625	1.063	1.339	6.300	1.969	M12x1.0mm
VL040		CAT50 AD/B - SFH 3/4 - 3.15	0.750	1.299	1.654	3.150	2.047	M16x1.0mm
VL042		CAT50 AD/B - SFH 3/4 - 6.3	0.750	1.299	1.654	6.300	2.047	M16x1.0mm
VL044		CAT50 AD/B - SFH 1" - 3.94	1.000	1.732	2.087	3.937	2.283	M16x1.0mm
VL046		CAT50 AD/B - SFH 1" - 6.30	1.000	1.732	2.087	6.300	2.283	M16x1.0mm
VL048		CAT50 AD/B - SFH 1 1/4 - 3.94	1.250	1.732	2.087	3.937	2.283	M16x1.0mm
VL050		CAT50 AD/B - SFH 1 1/4 - 6.30	1.250	1.732	2.087	6.300	2.283	M16x1.0mm

Shrink-Fit Holder

SHRINK-FIT HOLDER (COOLANT CHANNEL TYPE)

CAT

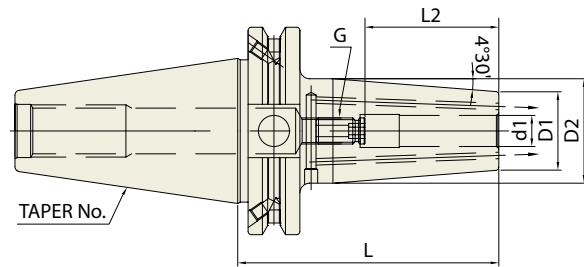

ASME B5.50 - CAT	Taper Accuracy AT3	G Value 2.5	RPM 25,000	Run-Out (at 3D) ≤0.00012"	Coolant System AD/B+C
----------------------------	------------------------------	-----------------------	----------------------	-------------------------------------	---------------------------------

ASME B5.50-2009-CAT

Unit : inch

EDP No.	TAPER No.	MODEL No.	d1	D1	D2	L	L2	G	
VK028J	40	CAT40 AD/B - SFH 3/8C - 3.15	0.375	0.945	1.260	3.150	1.654	M8x1.0mm	
VK030J		CAT40 AD/B - SFH 3/8C - 6.30	0.375	0.945	1.260	6.300	1.654	M8x1.0mm	
VK032J		CAT40 AD/B - SFH 1/2C - 3.15	0.500	0.945	1.260	3.150	1.850	M10x1.0mm	
VK034J		CAT40 AD/B - SFH 1/2C - 6.30	0.500	0.945	1.260	6.300	1.850	M10x1.0mm	
VK036J		CAT40 AD/B - SFH 5/8C - 3.15	0.625	1.063	1.339	3.150	1.969	M12x1.0mm	
VK038J		CAT40 AD/B - SFH 5/8C - 6.30	0.625	1.063	1.339	6.300	1.969	M12x1.0mm	
VK040J		CAT40 AD/B - SFH 3/4C - 3.15	0.750	1.299	1.654	3.150	2.047	M16x1.0mm	
VK042J		CAT40 AD/B - SFH 3/4C - 6.30	0.750	1.299	1.654	6.300	2.047	M16x1.0mm	
VK044J		CAT40 AD/B - SFH 1C - 3.94	1.000	1.732	2.087	3.940	2.283	M16x1.0mm	
VK046J		CAT40 AD/B - SFH 1C - 6.30	1.000	1.732	2.087	6.300	2.283	M16x1.0mm	
VK048J		CAT40 AD/B - SFH 1 1/4C - 3.94	1.250	1.732	2.087	3.940	2.283	M16x1.0mm	
VK050J		CAT40 AD/B - SFH 1 1/4C - 6.30	1.250	1.732	2.087	6.300	2.283	M16x1.0mm	
VL028J		50	CAT50 AD/B - SFH 3/8C - 3.15	0.375	0.945	1.260	3.150	1.575	M8x1.0mm
VL030J			CAT50 AD/B - SFH 3/8C - 6.30	0.375	0.945	1.260	6.300	1.575	M8x1.0mm
VL032J	CAT50 AD/B - SFH 1/2C - 3.15		0.500	0.945	1.260	3.150	1.850	M10x1.0mm	
VL034J	CAT50 AD/B - SFH 1/2C - 6.30		0.500	0.945	1.260	6.300	1.850	M10x1.0mm	
VL036J	CAT50 AD/B - SFH 5/8C - 3.15		0.625	1.063	1.339	3.150	1.969	M12x1.0mm	
VL038J	CAT50 AD/B - SFH 5/8C - 6.3		0.625	1.063	1.339	6.300	1.969	M12x1.0mm	
VL040J	CAT50 AD/B - SFH 3/4C - 3.15		0.750	1.299	1.654	3.150	2.047	M16x1.0mm	
VL042J	CAT50 AD/B - SFH 3/4C - 6.3		0.750	1.299	1.654	6.300	2.047	M16x1.0mm	
VL044J	CAT50 AD/B - SFH 1C - 3.94		1.000	1.732	2.087	3.940	2.283	M16x1.0mm	
VL046J	CAT50 AD/B - SFH 1C - 6.30		1.000	1.732	2.087	6.300	2.283	M16x1.0mm	
VL048J	CAT50 AD/B - SFH 1 1/4C - 3.94		1.250	1.732	2.087	3.940	2.283	M16x1.0mm	
VL050J	CAT50 AD/B - SFH 1 1/4C - 6.30		1.250	1.732	2.087	6.300	2.283	M16x1.0mm	

► Effective cooling by coolant through cooling channel bores.

Shrink-Fit Holder

SHRINK-FIT HOLDER

BT

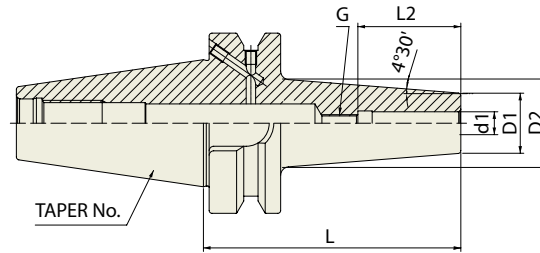

JIS B6339 - BT	Taper Accuracy AT3	G Value 2.5	RPM 25,000	Run-Out (at 3D) ≤0.00012"	Coolant System AD or AD/B
----------------	------------------------------	-----------------------	----------------------	-------------------------------------	-------------------------------------

JIS B6339/MAS 403-BT

Unit : inch

EDP No.	TAPER No.	MODEL No.	d1	D1	D2	L	L2	G
VG020	30	BT30 - SFH 1/8 - 2.36	0.125	0.394	0.629	2.362	0.354	-
VG022		BT30 - SFH 3/16 - 2.36	0.188	0.394	0.629	2.362	0.472	-
VG024		BT30 - SFH 1/4 - 2.36	0.250	0.827	1.062	2.362	1.417	M5x0.8mm
VG026		BT30 - SFH 3/8 - 2.36	0.375	0.945	1.180	2.362	1.654	M8x1.0mm
VG028		BT30 - SFH 1/2 - 3.15	0.500	0.945	1.260	3.150	1.850	M10x1.0mm
VG030		BT30 - SFH 5/8 - 3.15	0.625	1.063	1.339	3.150	1.969	M12x1.0mm
VG032		BT30 - SFH 3/4 - 3.54	0.750	1.299	1.654	3.543	2.008	M16x1.0mm
VH020	40	BT40 AD/B - SFH 1/8 - 3.54	0.125	0.394	0.748	3.543	0.354	-
VH022		BT40 AD/B - SFH 3/16 - 3.54	0.188	0.394	0.748	3.543	0.472	-
VH024		BT40 AD/B - SFH 1/4 - 3.54	0.250	0.827	1.063	3.543	1.417	M5x0.8mm
VH026		BT40 AD/B - SFH 1/4 - 6.30	0.250	0.827	1.063	6.300	1.417	M5x0.8mm
VH028		BT40 AD/B - SFH 3/8 - 3.54	0.375	0.945	1.260	3.543	1.654	M8x1.0mm
VH030		BT40 AD/B - SFH 3/8 - 6.30	0.375	0.945	1.260	6.300	1.654	M8x1.0mm
VH032		BT40 AD/B - SFH 1/2 - 3.54	0.500	0.945	1.260	3.543	1.850	M10x1.0mm
VH034		BT40 AD/B - SFH 1/2 - 6.30	0.500	0.945	1.260	6.300	1.850	M10x1.0mm
VH036		BT40 AD/B - SFH 5/8 - 3.54	0.625	1.063	1.339	3.543	1.969	M12x1.0mm
VH038		BT40 AD/B - SFH 5/8 - 6.30	0.625	1.063	1.339	6.300	1.969	M12x1.0mm
VH040		BT40 AD/B - SFH 3/4 - 3.54	0.750	1.299	1.654	3.543	2.047	M16x1.0mm
VH042		BT40 AD/B - SFH 3/4 - 6.30	0.750	1.299	1.654	6.300	2.047	M16x1.0mm
VH044		BT40 AD/B - SFH 1" - 3.94	1.000	1.732	2.087	3.937	2.283	M16x1.0mm
VH046		BT40 AD/B - SFH 1" - 6.30	1.000	1.732	2.087	6.300	2.283	M16x1.0mm

Shrink-Fit Holder

SHRINK-FIT HOLDER (COOLANT CHANNEL TYPE)

BT

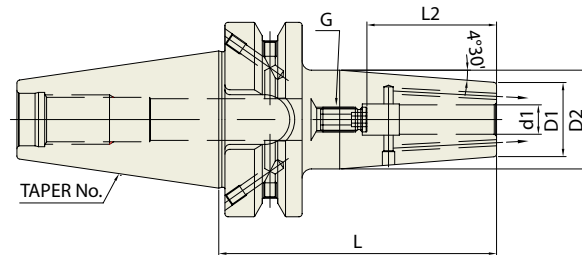

JIS B6339 - BT	Taper Accuracy AT3	G Value 2.5	RPM 25,000	Run-Out (at 3D) ≤0.00012"	Coolant System AD+C or AD/B+C
----------------	------------------------------	-----------------------	----------------------	-------------------------------------	---

JIS B6339/MAS 403-BT

Unit : inch

EDP No.	TAPER No.	MODEL No.	d1	D1	D2	L	L2	G
VG024J	30	BT30 - SFH 1/4C - 2.36	0.250	0.827	1.063	2.360	1.417	M5x0.8mm
VG026J		BT30 - SFH 3/8C - 2.36	0.375	0.945	1.180	2.360	1.654	M8x1.0mm
VG028J		BT30 - SFH 1/2C - 3.15	0.500	0.945	1.260	3.150	1.850	M10x1.0mm
VG030J		BT30 - SFH 5/8C - 3.15	0.625	1.063	1.339	3.150	1.969	M12x1.0mm
VG032J		BT30 - SFH 3/4C - 3.54	0.750	1.299	1.654	3.540	2.008	M16x1.0mm
VH024J	40	BT40 AD/B - SFH 1/4C - 3.54	0.250	0.827	1.063	3.540	1.417	M5x0.8mm
VH026J		BT40 AD/B - SFH 1/4C - 6.30	0.250	0.827	1.063	6.300	1.417	M5x0.8mm
VH028J		BT40 AD/B - SFH 3/8C - 3.54	0.375	0.945	1.260	3.540	1.654	M8x1.0mm
VH030J		BT40 AD/B - SFH 3/8C - 6.30	0.375	0.945	1.260	6.300	1.654	M8x1.0mm
VH032J		BT40 AD/B - SFH 1/2C - 3.54	0.500	0.945	1.260	3.540	1.850	M10x1.0mm
VH034J		BT40 AD/B - SFH 1/2C - 6.30	0.500	0.945	1.260	6.300	1.850	M10x1.0mm
VH036J		BT40 AD/B - SFH 5/8C - 3.54	0.625	1.063	1.339	3.540	1.969	M12x1.0mm
VH038J		BT40 AD/B - SFH 5/8C - 6.30	0.625	1.063	1.339	6.300	1.969	M12x1.0mm
VH040J		BT40 AD/ 4C - 3.54	0.750	1.299	1.654	3.540	2.047	M16x1.0mm
VH042J		BT40 AD/B - SFH 3/4C - 6.30	0.750	1.299	1.654	6.300	2.047	M16x1.0mm
VH044J		BT40 AD/B - SFH 1C - 3.94	1.000	1.732	2.087	3.940	2.283	M16x1.0mm
VH046J	BT40 AD/B - SFH 1C - 6.30	1.000	1.732	2.087	6.300	2.283	M16x1.0mm	

► Effective cooling by coolant through cooling channel bores.

Shrink-Fit Holder

DUAL CONTACT SHRINK-FIT HOLDER

CCT

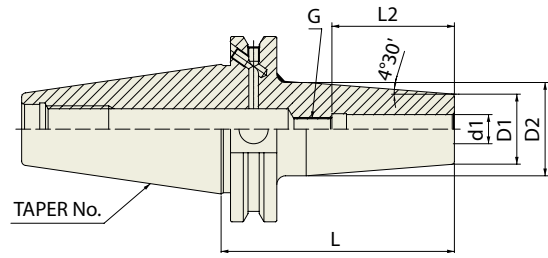

CCT	Taper Accuracy AT3	G Value 2.5	RPM 25,000	Run-Out (at 3D) ≤0.00012"	Coolant System AD/B
-----	------------------------------	-----------------------	----------------------	-------------------------------------	-------------------------------

CCT (CAT DUAL CONTACT)

Unit : inch

EDP No.	TAPER No.	MODEL No.	d1	D1	D2	L	L2	G	
VB020	40	CCT40 AD/B - SFH 1/8 - 3.15	0.125	0.394	0.748	3.150	0.354	-	
VB022		CCT40 AD/B - SFH 3/16 - 3.15	0.188	0.394	0.748	3.150	0.472	-	
VB024		CCT40 AD/B - SFH 1/4 - 3.15	0.250	0.827	1.063	3.150	1.417	M5x0.8mm	
VB026		CCT40 AD/B - SFH 1/4 - 6.30	0.250	0.827	1.063	6.300	1.417	M5x0.8mm	
VB028		CCT40 AD/B - SFH 3/8 - 3.15	0.375	0.945	1.260	3.150	1.654	M8x1.0mm	
VB030		CCT40 AD/B - SFH 3/8 - 6.30	0.375	0.945	1.260	6.300	1.654	M8x1.0mm	
VB032		CCT40 AD/B - SFH 1/2 - 3.15	0.500	0.945	1.260	3.150	1.850	M10x1.0mm	
VB034		CCT40 AD/B - SFH 1/2 - 6.30	0.500	0.945	1.260	6.300	1.850	M10x1.0mm	
VB036		CCT40 AD/B - SFH 5/8 - 3.15	0.625	1.063	1.339	3.150	1.969	M12x1.0mm	
VB038		CCT40 AD/B - SFH 5/8 - 6.30	0.625	1.063	1.339	6.300	1.969	M12x1.0mm	
VB040		CCT40 AD/B - SFH 3/4 - 3.15	0.750	1.299	1.654	3.150	2.047	M16x1.0mm	
VB042		CCT40 AD/B - SFH 3/4 - 6.30	0.750	1.299	1.654	6.300	2.047	M16x1.0mm	
VB044		CCT40 AD/B - SFH 1" - 3.94	1.000	1.732	2.087	3.937	2.283	M16x1.0mm	
VB046		CCT40 AD/B - SFH 1" - 6.30	1.000	1.732	2.087	6.300	2.283	M16x1.0mm	
VB048		CCT40 AD/B - SFH 1 1/4 - 3.94	1.250	1.732	2.087	3.937	2.283	M16x1.0mm	
VB050		CCT40 AD/B - SFH 1 1/4 - 6.30	1.250	1.732	2.087	6.300	2.283	M16x1.0mm	
VC020		50	CCT50 AD/B - SFH 1/8 - 3.15	0.125	0.394	0.748	3.150	0.354	-
VC022			CCT50 AD/B - SFH 3/16 - 3.15	0.188	0.394	0.748	3.150	0.472	-
VC024			CCT50 AD/B - SFH 1/4 - 3.15	0.250	0.827	1.063	3.150	1.417	M5x0.8mm
VC026			CCT50 AD/B - SFH 1/4 - 6.30	0.250	0.827	1.063	6.300	1.417	M5x0.8mm
VC028	CCT50 AD/B - SFH 3/8 - 3.15		0.375	0.945	1.260	3.150	1.575	M8x1.0mm	
VC030	CCT50 AD/B - SFH 3/8 - 6.30		0.375	0.945	1.260	6.300	1.575	M8x1.0mm	
VC032	CCT50 AD/B - SFH 1/2 - 3.15		0.500	0.945	1.260	3.150	1.850	M10x1.0mm	
VC034	CCT50 AD/B - SFH 1/2 - 6.30		0.500	0.945	1.260	6.300	1.850	M10x1.0mm	
VC036	CCT50 AD/B - SFH 5/8 - 3.15		0.625	1.063	1.339	3.150	1.969	M12x1.0mm	
VC040	CCT50 AD/B - SFH 5/8 - 6.30		0.625	1.063	1.339	6.300	1.969	M12x1.0mm	
VC042	CCT50 AD/B - SFH 3/4 - 3.15		0.750	1.299	1.654	3.150	2.047	M16x1.0mm	
VC044	CCT50 AD/B - SFH 3/4 - 6.30		0.750	1.299	1.654	6.300	2.047	M16x1.0mm	
VC046	CCT50 AD/B - SFH 1" - 3.94		1.000	1.732	2.087	3.937	2.283	M16x1.0mm	
VC048	CCT50 AD/B - SFH 1" - 6.30		1.000	1.732	2.087	6.300	2.283	M16x1.0mm	
VC050	CCT50 AD/B - SFH 1 1/4 - 3.94		1.250	1.732	2.087	3.937	2.283	M16x1.0mm	
VC052	CCT50 AD/B - SFH 1 1/4 - 6.30		1.250	1.732	2.087	6.300	2.283	M16x1.0mm	

Shrink-Fit Holder

DUAL CONTACT SHRINK-FIT HOLDER (COOLANT CHANNEL TYPE)

CCT

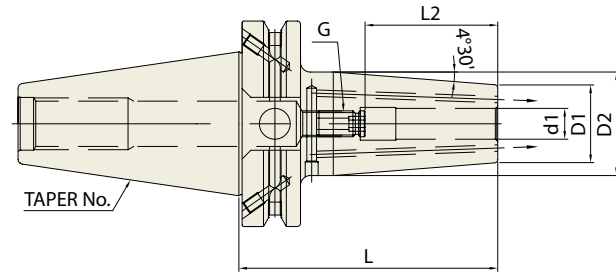

CCT	Taper Accuracy AT3	G Value 2.5	RPM 25,000	Run-Out (at 3D) ≤0.00012"	Coolant System AD/B+C
-----	------------------------------	-----------------------	----------------------	-------------------------------------	---------------------------------

CCT (CAT DUAL CONTACT)

Unit : inch

EDP No.	TAPER No.	MODEL No.	d1	D1	D2	L	L2	G
VB024J	40	CCT40 AD/B - SFH 1/4C - 3.15	0.250	0.827	1.063	3.150	1.417	M5x0.8mm
VB026J		CCT40 AD/B - SFH 1/4C - 6.30	0.250	0.827	1.063	6.300	1.417	M5x0.8mm
VB028J		CCT40 AD/B - SFH 3/8C - 3.15	0.375	0.945	1.260	3.150	1.654	M8x1.0mm
VB030J		CCT40 AD/B - SFH 3/8C - 6.30	0.375	0.945	1.260	6.300	1.654	M8x1.0mm
VB032J		CCT40 AD/B - SFH 1/2C - 3.15	0.500	0.945	1.260	3.150	1.850	M10x1.0mm
VB034J		CCT40 AD/B - SFH 1/2C - 6.30	0.500	0.945	1.260	6.300	1.850	M10x1.0mm
VB036J		CCT40 AD/B - SFH 5/8C - 3.15	0.625	1.063	1.339	3.150	1.969	M12x1.0mm
VB038J		CCT40 AD/B - SFH 5/8C - 6.30	0.625	1.063	1.339	6.300	1.969	M12x1.0mm
VB040J		CCT40 AD/B - SFH 3/4C - 3.15	0.750	1.299	1.654	3.150	2.047	M16x1.0mm
VB042J		CCT40 AD/B - SFH 3/4C - 6.30	0.750	1.299	1.654	6.300	2.047	M16x1.0mm
VB044J		CCT40 AD/B - SFH 1C - 3.94	1.000	1.732	2.087	3.940	2.283	M16x1.0mm
VB046J		CCT40 AD/B - SFH 1C - 6.30	1.000	1.732	2.087	6.300	2.283	M16x1.0mm
VB048J		CCT40 AD/B - SFH 1 1/4C - 3.94	1.250	1.732	2.087	3.940	2.283	M16x1.0mm
VB050J		CCT40 AD/B - SFH 1 1/4C - 6.30	1.250	1.732	2.087	6.300	2.283	M16x1.0mm
VC024J	50	CCT50 AD/B - SFH 1/4C - 3.15	0.250	0.827	1.063	3.150	1.417	M5x0.8mm
VC026J		CCT50 AD/B - SFH 1/4C - 6.30	0.250	0.827	1.063	6.300	1.417	M5x0.8mm
VC028J		CCT50 AD/B - SFH 3/8C - 3.15	0.375	0.945	1.260	3.150	1.654	M8x1.0mm
VC030J		CCT50 AD/B - SFH 3/8C - 6.30	0.375	0.945	1.260	6.300	1.654	M8x1.0mm
VC032J		CCT50 AD/B - SFH 1/2C - 3.15	0.500	0.945	1.260	3.150	1.850	M10x1.0mm
VC034J		CCT50 AD/B - SFH 1/2C - 6.30	0.500	0.945	1.260	6.300	1.850	M10x1.0mm
VC036J		CCT50 AD/B - SFH 5/8C - 3.15	0.625	1.063	1.339	3.150	1.969	M12x1.0mm
VC040J		CCT50 AD/B - SFH 5/8C - 6.30	0.625	1.063	1.339	6.300	1.969	M12x1.0mm
VC042J		CCT50 AD/B - SFH 3/4C - 3.15	0.750	1.299	1.654	3.150	2.047	M16x1.0mm
VC044J		CCT50 AD/B - SFH 3/4C - 6.30	0.750	1.299	1.654	6.300	2.047	M16x1.0mm
VC046J		CCT50 AD/B - SFH 1C - 3.94	1.000	1.732	2.087	3.940	2.283	M16x1.0mm
VC048J		CCT50 AD/B - SFH 1C - 6.30	1.000	1.732	2.087	6.300	2.283	M16x1.0mm
VC050J		CCT50 AD/B - SFH 1 1/4C - 3.94	1.250	1.732	2.087	3.940	2.283	M16x1.0mm
VC052J		CCT50 AD/B - SFH 1 1/4C - 6.30	1.250	1.732	2.087	6.300	2.283	M16x1.0mm

► Effective cooling by coolant through cooling channel bores.

Shrink-Fit Holder

DUAL CONTACT SHRINK-FIT HOLDER

CBT

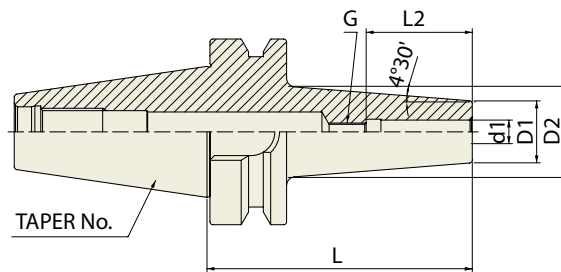

CBT	Taper Accuracy AT3	G Value 2.5	RPM 25,000	Run-Out (at 3D) ≤0.00012"	Coolant System AD
-----	------------------------------	-----------------------	----------------------	-------------------------------------	-----------------------------

CBT (BT DUAL CONTACT)

Unit : inch

EDP No.	TAPER No.	MODEL No.	d1	D1	D2	L	L2	G
VD020	30	CBT30 - SFH 1/8 - 2.36	0.125	0.394	0.629	2.362	0.354	-
VD022		CBT30 - SFH 3/16 - 2.36	0.188	0.394	0.629	2.362	0.472	-
VD024		CBT30 - SFH 1/4 - 2.36	0.250	0.827	1.062	2.362	1.417	M5x0.8mm
VD026		CBT30 - SFH 3/8 - 2.36	0.375	0.945	1.180	2.362	1.614	M8x1.0mm
VD028		CBT30 - SFH 1/2 - 3.15	0.500	0.945	1.260	3.150	1.850	M10x1.0mm
VD030		CBT30 - SFH 5/8 - 3.15	0.625	1.063	1.339	3.150	1.969	M12x1.0mm
VD032		CBT30 - SFH 3/4 - 3.54	0.750	1.299	1.654	3.543	2.047	M16x1.0mm
VE020		40	CBT40 - SFH 1/8 - 3.54	0.125	0.394	0.748	3.543	0.354
VE022	CBT40 - SFH 3/16 - 3.54		0.188	0.394	0.748	3.543	0.472	-
VE024	CBT40 - SFH 1/4 - 3.54		0.250	0.827	1.063	3.543	1.417	M5x0.8mm
VE026	CBT40 - SFH 1/4 - 6.30		0.250	0.827	1.063	6.300	1.417	M5x0.8mm
VE028	CBT40 - SFH 3/8 - 3.54		0.375	0.945	1.260	3.543	1.654	M8x1.0mm
VE030	CBT40 - SFH 3/8 - 6.30		0.375	0.945	1.260	6.300	1.654	M8x1.0mm
VE032	CBT40 - SFH 1/2 - 3.54		0.500	0.945	1.260	3.543	1.850	M10x1.0mm
VE034	CBT40 - SFH 1/2 - 6.30		0.500	0.945	1.260	6.300	1.850	M10x1.0mm
VE036	CBT40 - SFH 5/8 - 3.54		0.625	1.063	1.339	3.543	1.969	M12x1.0mm
VE038	CBT40 - SFH 5/8 - 6.30		0.625	1.063	1.339	6.300	1.969	M12x1.0mm
VE040	CBT40 - SFH 3/4 - 3.54		0.750	1.299	1.654	3.543	2.047	M16x1.0mm
VE042	CBT40 - SFH 3/4 - 6.30		0.750	1.299	1.654	6.300	2.047	M16x1.0mm
VE044	CBT40 - SFH 1" - 3.94		1.000	1.732	2.087	3.937	2.283	M16x1.0mm
VE046	CBT40 - SFH 1" - 6.30		1.000	1.732	2.087	6.300	2.283	M16x1.0mm

Shrink-Fit Holder

DUAL CONTACT SHRINK-FIT HOLDER (COOLANT CHANNEL TYPE)

CBT

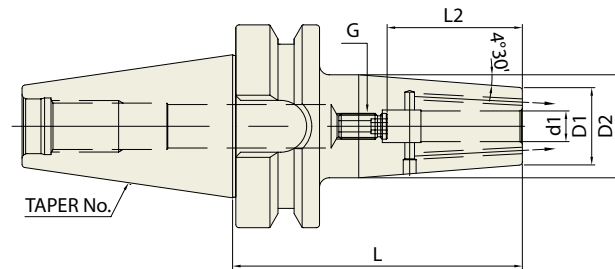

CBT	Taper Accuracy AT3	G Value 2.5	RPM 25,000	Run-Out (at 3D) ≤0.00012"	Coolant System AD+C
-----	------------------------------	-----------------------	----------------------	-------------------------------------	-------------------------------

CBT (BT DUAL CONTACT)

Unit : inch

EDP No.	TAPER No.	MODEL No.	d1	D1	D2	L	L2	G
VD024J	30	CBT30 - SFH 1/4C - 2.36	0.250	0.827	1.062	2.360	1.417	M5x0.8mm
VD026J		CBT30 - SFH 3/8C - 2.36	0.375	0.945	1.180	2.360	1.614	M8x1.0mm
VD028J		CBT30 - SFH 1/2C - 3.15	0.500	0.945	1.260	3.150	1.850	M10x1.0mm
VD030J		CBT30 - SFH 5/8C - 3.15	0.625	1.063	1.339	3.150	1.969	M12x1.0mm
VD032J		CBT30 - SFH 3/4C - 3.54	0.750	1.299	1.654	3.540	2.047	M16x1.0mm
VE024J	40	CBT40 - SFH 1/4C - 3.54	0.250	0.827	1.063	3.540	1.417	M5x0.8mm
VE026J		CBT40 - SFH 1/4C - 6.30	0.250	0.827	1.063	6.300	1.417	M5x0.8mm
VE028J		CBT40 - SFH 3/8C - 3.54	0.375	0.945	1.260	3.540	1.654	M8x1.0mm
VE030J		CBT40 - SFH 3/8C - 6.30	0.375	0.945	1.260	6.300	1.654	M8x1.0mm
VE032J		CBT40 - SFH 1/2C - 3.54	0.500	0.945	1.260	3.540	1.850	M10x1.0mm
VE034J		CBT40 - SFH 1/2C - 6.30	0.500	0.945	1.260	6.300	1.850	M10x1.0mm
VE036J		CBT40 - SFH 5/8C - 3.54	0.625	1.063	1.339	3.540	1.969	M12x1.0mm
VE038J		CBT40 - SFH 5/8C - 6.30	0.625	1.063	1.339	6.300	1.969	M12x1.0mm
VE040J		CBT40 - SFH 3/4C - 3.54	0.750	1.299	1.654	3.540	2.047	M16x1.0mm
VE042J		CBT40 - SFH 3/4C - 6.30	0.750	1.299	1.654	6.300	2.047	M16x1.0mm
VE044J		CBT40 - SFH 1C - 3.94	1.000	1.732	2.087	3.940	2.283	M16x1.0mm
VE046J	CBT40 - SFH 1C - 6.30	1.000	1.732	2.087	6.300	2.283	M16x1.0mm	

► Effective cooling by coolant through cooling channel bores.

Shrink-Fit Holder

DUAL CONTACT SHRINK-FIT HOLDER

HSK

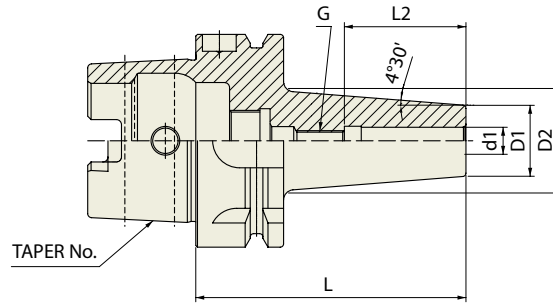

DIN 69893 - HSK	Taper Accuracy AT3	G Value 2.5	RPM 25,000	Run-Out (at 3D) ≤0.00012"	Coolant System AD
--------------------	------------------------------	-----------------------	----------------------	-------------------------------------	-----------------------------

DIN 69893/ISO 12164-1-HSK FORM A

Unit : inch

EDP No.	TAPER No.	MODEL No.	d1	D1	D2	L	L2	G
VQ020	63A	HSK 63A - SFH 1/8 - 3.15	0.125	0.394	0.728	3.150	0.354	-
VQ022		HSK 63A - SFH 3/16 - 3.15	0.188	0.394	0.728	3.150	0.472	-
VQ024		HSK 63A - SFH 1/4 - 3.15	0.250	0.827	1.063	3.150	1.417	M5x0.8mm
VQ026		HSK 63A - SFH 1/4 - 6.30	0.250	0.827	1.063	6.300	1.417	M5x0.8mm
VQ028		HSK 63A - SFH 3/8 - 3.35	0.375	0.945	1.260	3.346	1.654	M8x1.0mm
VQ030		HSK 63A - SFH 3/8 - 6.30	0.375	0.945	1.260	6.300	1.654	M8x1.0mm
VQ032		HSK 63A - SFH 1/2 - 3.54	0.500	0.945	1.260	3.543	1.850	M10x1.0mm
VQ034		HSK 63A - SFH 1/2 - 6.30	0.500	0.945	1.260	6.300	1.850	M10x1.0mm
VQ036		HSK 63A - SFH 5/8 - 3.74	0.625	1.063	1.339	3.740	1.969	M12x1.0mm
VQ038		HSK 63A - SFH 5/8 - 6.30	0.625	1.063	1.339	6.300	1.969	M12x1.0mm
VQ040		HSK 63A - SFH 3/4 - 3.94	0.750	1.299	1.654	3.937	2.047	M16x1.0mm
VQ042		HSK 63A - SFH 3/4 - 6.30	0.750	1.299	1.654	6.300	2.047	M16x1.0mm
VQ046		HSK 63A - SFH 1" - 4.53	1.000	1.732	2.087	4.528	2.283	M16x1.0mm
VQ048		HSK 63A - SFH 1" - 6.30	1.000	1.732	2.087	6.300	2.283	M16x1.0mm
VR020	100A	HSK 100A - SFH 1/8 - 3.15	0.125	0.394	0.648	3.150	0.354	-
VR022		HSK 100A - SFH 3/16 - 3.15	0.188	0.394	0.648	3.150	0.472	-
VR023		HSK 100A - SFH 1/4 - 3.15	0.250	0.827	1.063	3.150	1.417	M5x0.8mm
VR024		HSK 100A - SFH 3/8 - 3.54	0.375	0.945	1.260	3.543	1.654	M8x1.0mm
VR026		HSK 100A - SFH 3/8 - 6.30	0.375	0.945	1.260	6.300	1.654	M8x1.0mm
VR028		HSK 100A - SFH 1/2 - 3.74	0.500	0.945	1.260	3.740	1.850	M10x1.0mm
VR030		HSK 100A - SFH 1/2 - 6.30	0.500	0.945	1.260	6.300	1.850	M10x1.0mm
VR032		HSK 100A - SFH 5/8 - 3.94	0.625	1.063	1.339	3.937	1.969	M12x1.0mm
VR034		HSK 100A - SFH 5/8 - 6.30	0.625	1.063	1.339	6.300	1.969	M12x1.0mm
VR036		HSK 100A - SFH 3/4 - 4.13	0.750	1.299	1.654	4.134	2.047	M16x1.0mm
VR038		HSK 100A - SFH 3/4 - 6.30	0.750	1.299	1.654	6.300	2.047	M16x1.0mm
VR040		HSK 100A - SFH 1" - 4.53	1.000	1.732	2.087	4.528	2.283	M16x1.0mm
VR042		HSK 100A - SFH 1" - 6.30	1.000	1.732	2.087	6.300	2.283	M16x1.0mm
VR044		HSK 100A - SFH 1 1/4 - 4.72	1.250	1.732	2.087	4.724	2.283	M16x1.0mm
VR046		HSK 100A - SFH 1 1/4" - 6.30	1.250	1.732	2.087	6.300	2.283	M16x1.0mm

Shrink-Fit Holder

DUAL CONTACT SHRINK-FIT HOLDER (COOLANT CHANNEL TYPE)

HSK

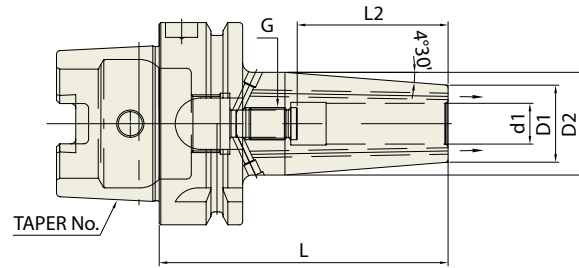

DIN 69893 - HSK	Taper Accuracy AT3	G Value 2.5	RPM 25,000	Run-Out (at 3D) ≤0.00012"	Coolant System AD+C
--------------------	---------------------------------	-----------------------	----------------------	--	----------------------------------

DIN 69893/ISO 12164-1-HSK FORM A

Unit : inch

EDP No.	TAPER No.	MODEL No.	d1	D1	D2	L	L2	G	
VQ024J	63A	HSK 63A - SFH 1/4C - 3.15	0.250	0.827	1.063	3.150	1.417	M5x0.8mm	
VQ026J		HSK 63A - SFH 1/4C - 6.30	0.250	0.827	1.063	6.300	1.417	M5x0.8mm	
VQ028J		HSK 63A - SFH 3/8C - 3.35	0.375	0.945	1.260	3.350	1.654	M8x1.0mm	
VQ030J		HSK 63A - SFH 3/8C - 6.30	0.375	0.945	1.260	6.300	1.654	M8x1.0mm	
VQ032J		HSK 63A - SFH 1/2C - 3.54	0.500	0.945	1.260	3.540	1.850	M10x1.0mm	
VQ034J		HSK 63A - SFH 1/2C - 6.30	0.500	0.945	1.260	6.300	1.850	M10x1.0mm	
VQ036J		HSK 63A - SFH 5/8C - 3.74	0.625	1.063	1.339	3.740	1.969	M12x1.0mm	
VQ038J		HSK 63A - SFH 5/8C - 6.30	0.625	1.063	1.339	6.300	1.969	M12x1.0mm	
VQ040J		HSK 63A - SFH 3/4C - 3.94	0.750	1.299	1.654	3.940	2.047	M16x1.0mm	
VQ042J		HSK 63A - SFH 3/4C - 6.30	0.750	1.299	1.654	6.300	2.047	M16x1.0mm	
VQ046J		HSK 63A - SFH 1C - 4.53	1.000	1.732	2.087	4.530	2.283	M16x1.0mm	
VQ048J		HSK 63A - SFH 1C - 6.30	1.000	1.732	2.087	6.300	2.283	M16x1.0mm	
VR023J		100A	HSK 100A - SFH 1/4C - 3.54	0.250	0.827	1.063	3.540	1.417	M5x0.8mm
VR024J			HSK 100A - SFH 3/8C - 3.54	0.375	0.945	1.260	3.540	1.654	M8x1.0mm
VR026J	HSK 100A - SFH 3/8C - 6.30		0.375	0.945	1.260	6.300	1.654	M8x1.0mm	
VR028J	HSK 100A - SFH 1/2C - 3.74		0.500	0.945	1.260	3.740	1.850	M10x1.0mm	
VR030J	HSK 100A - SFH 1/2C - 6.30		0.500	0.945	1.260	6.300	1.850	M10x1.0mm	
VR032J	HSK 100A - SFH 5/8C - 3.94		0.625	1.063	1.339	3.940	1.969	M12x1.0mm	
VR034J	HSK 100A - SFH 5/8C - 6.30		0.625	1.063	1.339	6.300	1.969	M12x1.0mm	
VR036J	HSK 100A - SFH 3/4C - 4.13		0.750	1.299	1.654	4.130	2.047	M16x1.0mm	
VR038J	HSK 100A - SFH 3/4C - 6.30		0.750	1.299	1.654	6.300	2.047	M16x1.0mm	
VR040J	HSK 100A - SFH 1C - 4.53		1.000	1.732	2.087	4.530	2.283	M16x1.0mm	
VR042J	HSK 100A - SFH 1C - 6.30		1.000	1.732	2.087	6.300	2.283	M16x1.0mm	
VR044J	HSK 100A - SFH 1 1/4C - 4.72		1.250	1.732	2.087	4.720	2.283	M16x1.0mm	
VR046J	HSK 100A - SFH 1 1/4C - 6.30		1.250	1.732	2.087	6.300	2.283	M16x1.0mm	

► Effective cooling by coolant through cooling channel bores.

Shrink-Fit Holder

SHRINK-FIT EXTENSION

ST

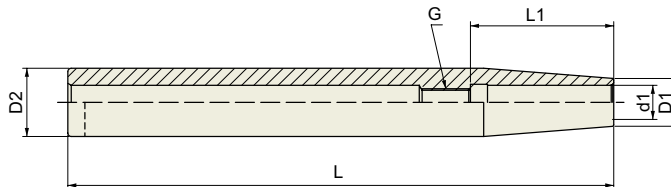

INCH

Unit : inch

EDP No.	TAPER No.	MODEL No.	d1	D1	D2	L	L1	G
VS010	ST1/2	ST 1/2 - SFH 1/8 - 6.30	0.125	0.394	0.500	6.300	0.354	-
VS011		ST 1/2 - SFH 3/16 - 6.30	0.188	0.394	0.500	6.300	0.472	-
VS012		ST 1/2 - SFH 1/4 - 6.30	0.250	0.394	0.500	6.300	1.417	M5x0.8mm
VS020	ST5/8	ST 5/8 - SFH 1/8 - 6.30	0.125	0.394	0.625	6.300	0.354	-
VS021		ST 5/8 - SFH 3/16 - 6.30	0.188	0.394	0.625	6.300	0.472	-
VS022		ST 5/8 - SFH 1/4 - 6.30	0.250	0.394	0.625	6.300	1.417	M5x0.8mm
VS023		ST 5/8 - SFH 5/16 - 6.30	0.313	0.472	0.625	6.300	1.535	M6x1.0mm
VS030	ST3/4	ST 3/4 - SFH 1/8 - 6.30	0.125	0.394	0.750	6.300	0.354	-
VS031		ST 3/4 - SFH 3/16 - 6.30	0.188	0.394	0.750	6.300	0.472	-
VS032		ST 3/4 - SFH 1/4 - 6.30	0.250	0.551	0.750	6.300	1.417	M5x0.8mm
VS033		ST 3/4 - SFH 5/16 - 6.30	0.313	0.551	0.750	6.300	1.417	M6x1.0mm
VS034		ST 3/4 - SFH 3/8 - 6.30	0.375	0.551	0.750	6.300	1.654	M8x1.0mm
VS035		ST 3/4 - SFH 1/2 - 6.30	0.500	0.630	0.750	6.300	1.850	M10x1.0mm
VS040	ST1	ST 1 - SFH 1/8 - 6.30	0.125	0.394	1.000	6.300	0.354	-
VS041		ST 1 - SFH 3/16 - 6.30	0.188	0.394	1.000	6.300	0.472	-
VS042		ST 1 - SFH 1/4 - 6.30	0.250	0.551	1.000	6.300	1.417	M5x0.8mm
VS043		ST 1 - SFH 5/16 - 6.30	0.313	0.551	1.000	6.300	1.417	M6x1.0mm
VS044		ST 1 - SFH 3/8 - 6.30	0.375	0.787	1.000	6.300	1.654	M8x1.0mm
VS045		ST 1 - SFH 1/2 - 6.30	0.500	0.787	1.000	6.300	1.850	M10x1.0mm
VS046		ST 1 - SFH 5/8 - 6.30	0.625	0.866	1.000	6.300	1.929	M12x1.0mm
VS050	ST1-1/4	ST 1 - 1/4 - SFH 1/8 - 6.30	0.125	0.394	1.250	6.300	0.354	-
VS051		ST 1 - 1/4 - SFH 3/16 - 6.30	0.188	0.394	1.250	6.300	0.472	-
VS052		ST 1 - 1/4 - SFH 1/4 - 6.30	0.250	0.551	1.250	6.300	1.417	M5x0.8mm
VS053		ST 1 - 1/4 - SFH 5/16 - 6.30	0.313	0.551	1.250	6.300	1.417	M6x1.0mm
VS054		ST 1 - 1/4 - SFH 3/8 - 6.30	0.375	0.945	1.250	6.300	1.654	M8x1.0mm
VS055		ST 1 - 1/4 - SFH 1/2 - 6.30	0.500	0.945	1.250	6.300	1.850	M10x1.0mm
VS056		ST 1 - 1/4 - SFH 5/8 - 6.30	0.625	1.063	1.250	6.300	1.929	M12x1.0mm
VS057		ST 1 - 1/4 - SFH 3/4 - 6.30	0.750	1.063	1.250	6.300	2.008	M16x1.0mm

SHRINK-FIT EXTENSION

ST

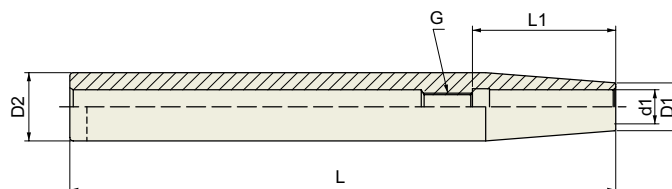

METRIC (STANDARD)

Unit : mm

EDP No.	TAPER No.	MODEL No.	d1	D1	D2	L	L1	G
VS010M	12	ST12 - SFH3 - 120	3	8	12	120	10	-
VS011M		ST12 - SFH4 - 120	4	8	12	120	12	-
VS012M		ST12 - SFH5 - 120	5	10	12	120	15	-
VS013M		ST12 - SFH6 - 120	6	10	12	120	36	M5×0.8
VS020M	16	ST16 - SFH3 - 120	3	10	16	120	10	-
VS021M		ST16 - SFH4 - 120	4	10	16	120	12	-
VS022M		ST16 - SFH5 - 120	5	10	16	120	15	-
VS023M		ST16 - SFH6 - 120	6	10	16	120	36	M5×0.8
VS024M		ST16 - SFH8 - 120	8	12	16	120	36	M6×1.0
VS030M	20	ST20 - SFH3 - 120	3	10	20	120	10	-
VS031M		ST20 - SFH4 - 120	4	10	20	120	12	-
VS032M		ST20 - SFH5 - 120	5	10	20	120	15	-
VS033M		ST20 - SFH6 - 120	6	10	20	120	36	M5×0.8
VS034M		ST20 - SFH8 - 120	8	12	20	120	36	M6×1.0
VS035M		ST20 - SFH10 - 120	10	14	20	120	41.5	M8×1.0
VS036M		ST20 - SFH12 - 120	12	16	20	120	46	M10×1.0

Shrink-Fit Holder

SHRINK-FIT EXTENSION

ST

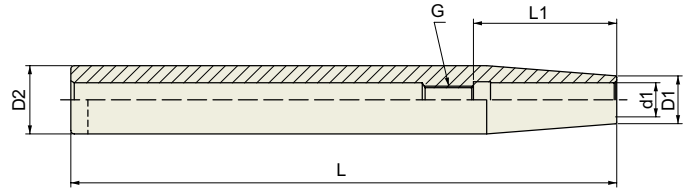

METRIC (EXTENDED)

								Unit : mm
EDP No.	TAPER No.	MODEL No.	d1	D1	D2	L	L1	G
VS110M	12	ST12 - SFH 3 - 160	3	8	12	160	10	-
VS111M		ST12 - SFH 4 - 160	4	8	12	160	12	-
VS112M		ST12 - SFH 5 - 160	5	10	12	160	15	-
VS113M		ST12 - SFH 6 - 160	6	10	12	160	36	M5×0.8
VS210M	16	ST16 - SFH 3 - 160	3	10	16	160	10	-
VS211M		ST16 - SFH 4 - 160	4	10	16	160	12	-
VS212M		ST16 - SFH 5 - 160	5	10	16	160	15	-
VS213M		ST16 - SFH 6 - 160	6	10	16	160	36	M5×0.8
VS214M		ST16 - SFH 8 - 160	8	12	16	160	36	M6×1.0
VS310M	20	ST20 - SFH 3 - 160	3	10	20	160	10	-
VS311M		ST20 - SFH 4 - 160	4	10	20	160	12	-
VS312M		ST20 - SFH 5 - 160	5	10	20	160	15	-
VS313M		ST20 - SFH 6 - 160	6	10	20	160	36	M5×0.8
VS314M		ST20 - SFH 8 - 160	8	12	20	160	36	M6×1.0
VS315M		ST20 - SFH 10 - 160	10	14	20	160	41.5	M8×1.0
VS316M		ST20 - SFH 12 - 160	12	16	20	160	46	M10×1.0
VS410M	25	ST25 - SFH 3 - 160	3	10	25	160	10	-
VS411M		ST25 - SFH 4 - 160	4	10	25	160	12	-
VS412M		ST25 - SFH 5 - 160	5	15	25	160	15	-
VS413M		ST25 - SFH 6 - 160	6	20	25	160	36	M5×0.8
VS414M		ST25 - SFH 8 - 160	8	20	25	160	36	M6×1.0
VS415M		ST25 - SFH 10 - 160	10	20	25	160	41.5	M8×1.0
VS416M		ST25 - SFH 12 - 160	12	20	25	160	46	M10×1.0
VS417M		ST25 - SFH 14 - 160	14	20	25	160	46	M10×1.0
VS418M	ST25 - SFH 16 - 160	16	22	25	160	49	M12×1.0	
VS510M	32	ST32 - SFH 6 - 160	6	20	32	160	36	M5×0.8
VS511M		ST32 - SFH 8 - 160	8	20	32	160	36	M6×1.0
VS512M		ST32 - SFH 10 - 160	10	24	32	160	41.5	M8×1.0
VS513M		ST32 - SFH 12 - 160	12	24	32	160	46	M10×1.0
VS514M		ST32 - SFH 14 - 160	14	27	32	160	46	M10×1.0
VS515M		ST32 - SFH 16 - 160	16	27	32	160	49	M12×1.0
VS516M		ST32 - SFH 18 - 160	18	27	32	160	49	M12×1.0
VS517M		ST32 - SFH 20 - 160	20	27	32	160	51	M16×1.0

End Mill Holder (Side Lock)



Pages 204–217

END MILL HOLDER

CAT

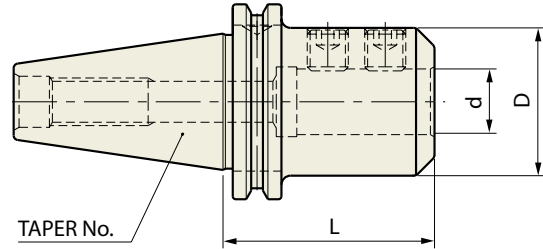

ASME B5.50 - CAT	Taper Accuracy AT3	G Value 6.3	RPM 15,000	Coolant System AD
---------------------	--------------------------	----------------	---------------	-------------------------

ASME B5.50-2009-CAT

■ STUB

Unit : inch

EDP No.	TAPER No.	MODEL No.	d	D	L
AK206	40	CAT40 - EMH 1/2 - 1.75	0.500	1.25	1.75
AK208		CAT40 - EMH 5/8 - 1.75	0.625	1.50	1.75
AK210		CAT40 - EMH 3/4 - 1.75	0.750	1.75	1.75
AK214		CAT40 - EMH 1" - 1.75	1.000	1.75	1.75
AK217		CAT40 - EMH 1 1/4 - 2.00	1.250	2.25	2.00

- ▶ High balanced end mill holders on page 208–209.
- ▶ Set screws for end mill holders on page 217.

End Mill Holder (Side Lock)

END MILL HOLDER

CAT

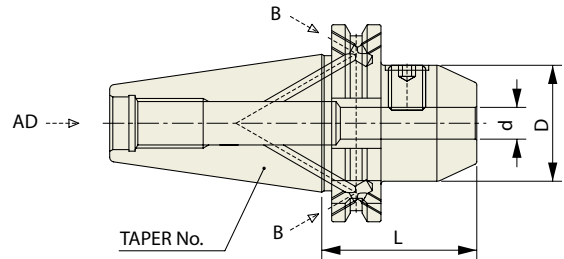

ASME B5.50 - CAT	Taper Accuracy AT3	G Value 6.3	RPM 15,000	Coolant System AD/B
---------------------	-----------------------	----------------	---------------	------------------------

ASME B5.50-2009-CAT

■ STANDARD

Unit : inch

EDP No.	TAPER No.	MODEL No.	d	D	L
AK000B	40	CAT40 AD/B - EMH 1/8 - 2.50	0.125	0.69	2.50
AK001B		CAT40 AD/B - EMH 3/16 - 2.50	0.187	0.69	2.50
AK002B		CAT40 AD/B - EMH 1/4 - 2.50	0.250	0.78	2.50
AK003B		CAT40 AD/B - EMH 5/16 - 2.50	0.312	0.88	2.50
AK004B		CAT40 AD/B - EMH 3/8 - 2.50	0.375	1.00	2.50
AK005B		CAT40 AD/B - EMH 7/16 - 2.50	0.437	1.13	2.50
AK006B		CAT40 AD/B - EMH 1/2 - 2.63	0.500	1.25	2.63
AK008B		CAT40 AD/B - EMH 5/8 - 3.75	0.625	1.50	3.75
AK010B		CAT40 AD/B - EMH 3/4 - 3.75	0.750	1.75	3.75
AK012B		CAT40 AD/B - EMH 7/8 - 4.00	0.875	1.88	4.00
AK014B		CAT40 AD/B - EMH 1" - 4.00	1.000	2.00	4.00
AK017B		CAT40 AD/B - EMH 1 1/4 - 4.25	1.250	2.50	4.25
AK021B		CAT40 AD/B - EMH 1 1/2 - 4.63	1.500	2.50	4.63
AL002B		50	CAT50 AD/B - EMH 1/4 - 2.50	0.250	0.78
AL003B	CAT50 AD/B - EMH 5/16 - 2.50		0.312	0.88	2.50
AL004B	CAT50 AD/B - EMH 3/8 - 2.50		0.375	1.00	2.50
AL005B	CAT50 AD/B - EMH 7/16 - 2.63		0.437	1.13	2.63
AL006B	CAT50 AD/B - EMH 1/2 - 2.63		0.500	1.25	2.63
AL008B	CAT50 AD/B - EMH 5/8 - 3.75		0.625	1.50	3.75
AL010B	CAT50 AD/B - EMH 3/4 - 3.75		0.750	1.75	3.75
AL012B	CAT50 AD/B - EMH 7/8 - 3.75		0.875	1.88	3.75
AL014B	CAT50 AD/B - EMH 1" - 4.00		1.000	2.00	4.00
AL017B	CAT50 AD/B - EMH 1 1/4 - 4.00		1.250	2.50	4.00
AL021B	CAT50 AD/B - EMH 1 1/2 - 4.00		1.500	2.50	4.00
AL029B	CAT50 AD/B - EMH 2" - 5.63		2.000	3.75	5.63

- ▶ High balanced end mill holders are available on request.
- ▶ Set screws for end mill holders on page 217.

End Mill Holder (Side Lock)

END MILL HOLDER

CAT

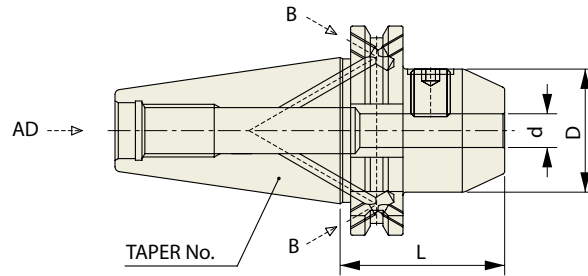

ASME B5.50 - CAT	Taper Accuracy AT3	G Value 6.3	RPM 15,000	Coolant System AD/B
----------------------------	------------------------------	-----------------------	----------------------	-------------------------------

ASME B5.50-2009-CAT

■ EXTENDED

Unit : inch

EDP No.	TAPER No.	MODEL No.	d	D	L	
AK104B	40	CAT40 AD/B - EMH 3/8 - 4.50	0.375	1.00	4.50	
AK106B		CAT40 AD/B - EMH 1/2 - 4.63	0.500	1.25	4.63	
AK108B		CAT40 AD/B - EMH 5/8 - 5.75	0.625	1.50	5.75	
AK110B		CAT40 AD/B - EMH 3/4 - 5.75	0.750	1.75	5.75	
AK112B		CAT40 AD/B - EMH 7/8 - 6.00	0.875	1.88	6.00	
AK114B		CAT40 AD/B - EMH 1" - 6.00	1.000	2.00	6.00	
AK117B		CAT40 AD/B - EMH 1 1/4 - 6.25	1.250	2.50	6.25	
AK121B		CAT40 AD/B - EMH 1 1/2 - 6.63	1.500	2.50	6.63	
AL104B		50	CAT50 AD/B - EMH 3/8 - 4.50	0.375	1.00	4.50
AL106B			CAT50 AD/B - EMH 1/2 - 4.63	0.500	1.25	4.63
AL108B	CAT50 AD/B - EMH 5/8 - 5.75		0.625	1.50	5.75	
AL110B	CAT50 AD/B - EMH 3/4 - 5.75		0.750	1.75	5.75	
AL112B	CAT50 AD/B - EMH 7/8 - 5.75		0.875	1.88	5.75	
AL114B	CAT50 AD/B - EMH 1" - 6.00		1.000	2.00	6.00	
AL117B	CAT50 AD/B - EMH 1 1/4 - 6.00		1.250	2.50	6.00	
AL121B	CAT50 AD/B - EMH 1 1/2 - 6.00		1.500	2.50	6.00	
AL129B	CAT50 AD/B - EMH 2" - 7.63		2.000	3.75	7.63	

- ▶ High balanced end mill holders are available on request.
- ▶ Set screws for end mill holders on page 217.

End Mill Holder (Side Lock)

END MILL HOLDER (COOLANT CHANNEL TYPE)

CAT

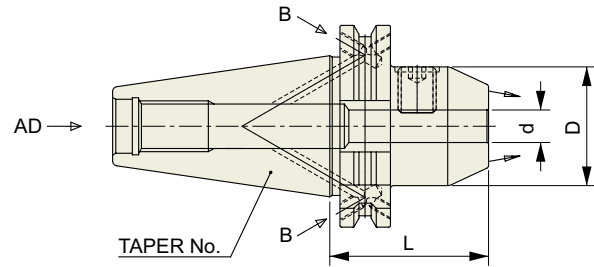

ASME B5.50 - CAT	Taper Accuracy AT3	G Value 6.3	RPM 15,000	Coolant System AD/B+C
----------------------------	------------------------------	-----------------------	----------------------	---------------------------------

ASME B5.50-2009-CAT

Unit : inch

EDP No.	TAPER No.	MODEL No.	d	D	L
AK002C	40	CAT40 AD/B - EMH 1/4C - 1.97	0.250	0.780	1.969
AK003C		CAT40 AD/B - EMH 5/16C - 1.97	0.313	0.880	1.969
AK004C		CAT40 AD/B - EMH 3/8C - 1.97	0.375	1.000	1.969
AK005C		CAT40 AD/B - EMH 1/2C - 1.97	0.500	1.250	1.969
AK008C		CAT40 AD/B - EMH 5/8C - 2.48	0.625	1.500	2.480
AK010C		CAT40 AD/B - EMH 3/4C - 2.48	0.750	1.750	2.480
AK012C		CAT40 AD/B - EMH 1C - 3.94	1.000	2.000	3.937
AK017C		CAT40 AD/B - EMH 1 1/4C - 3.94	1.250	2.500	3.937
AL002C		50	CAT50 AD/B - EMH 1/4C - 2.48	0.250	0.780
AL003C	CAT50 AD/B - EMH 5/16C - 2.48		0.313	0.880	2.480
AL004C	CAT50 AD/B - EMH 3/8C - 2.48		0.375	1.000	2.480
AL005C	CAT50 AD/B - EMH 1/2C - 2.48		0.500	1.250	2.480
AL008C	CAT50 AD/B - EMH 5/8C - 2.48		0.625	1.500	2.480
AL010C	CAT50 AD/B - EMH 3/4C - 2.48		0.750	1.750	2.480
AL012C	CAT50 AD/B - EMH 1C - 3.15		1.000	2.000	3.150
AL017C	CAT50 AD/B - EMH 1 1/4C - 3.94		1.250	2.500	3.937

- ▶ High balanced end mill holders are available on request.
- ▶ Set screws for end mill holders on page 217.

End Mill Holder (Side Lock)

HIGH BALANCED END MILL HOLDER

CAT

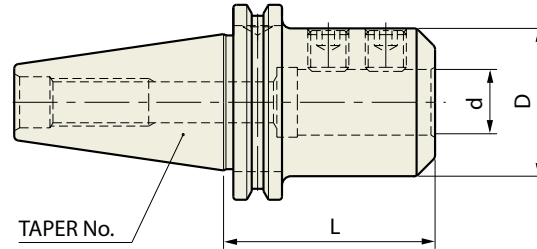

ASME B5.50 - CAT	Taper Accuracy AT3	G Value 2.5	RPM 25,000	Coolant System AD
---------------------	--------------------------	----------------	---------------	-------------------------

ASME B5.50-2009-CAT

■ STUB

Unit : inch

EDP No.	TAPER No.	MODEL No.	d	D	L
AK206B25	40	CAT40 - EMH 1/2 - 1.75	0.500	1.25	1.75
AK208B25		CAT40 - EMH 5/8 - 1.75	0.625	1.50	1.75
AK210B25		CAT40 - EMH 3/4 - 1.75	0.750	1.75	1.75
AK214B25		CAT40 - EMH 1" - 1.75	1.000	1.75	1.75
AK217B25		CAT40 - EMH 1 1/4 - 2.00	1.250	2.25	2.00

■ STANDARD

Unit : inch

EDP No.	TAPER No.	MODEL No.	d	D	L	
AK000B25	40	CAT40 - EMH 1/8 - 2.50	0.125	0.69	2.50	
AK001B25		CAT40 - EMH 3/16 - 2.50	0.187	0.69	2.50	
AK002B25		CAT40 - EMH 1/4 - 2.50	0.250	0.78	2.50	
AK003B25		CAT40 - EMH 5/16 - 2.50	0.312	0.88	2.50	
AK004B25		CAT40 - EMH 3/8 - 2.50	0.375	1.00	2.50	
AK005B25		CAT40 - EMH 7/16 - 2.50	0.437	1.13	2.50	
AK006B25		CAT40 - EMH 1/2 - 2.63	0.500	1.25	2.63	
AK008B25		CAT40 - EMH 5/8 - 3.75	0.625	1.50	3.75	
AK010B25		CAT40 - EMH 3/4 - 3.75	0.750	1.75	3.75	
AK012B25		CAT40 - EMH 7/8 - 4.00	0.875	1.88	4.00	
AK014B25		CAT40 - EMH 1" - 4.00	1.000	2.00	4.00	
AK017B25		CAT40 - EMH 1 1/4 - 4.25	1.250	2.50	4.25	
AK021B25		CAT40 - EMH 1 1/2 - 4.63	1.500	2.50	4.63	
AL002B25		50	CAT50 - EMH 1/4 - 2.50	0.250	0.78	2.50
AL003B25			CAT50 - EMH 5/16 - 2.50	0.312	0.88	2.50
AL004B25	CAT50 - EMH 3/8 - 2.50		0.375	1.00	2.50	
AL005B25	CAT50 - EMH 7/16 - 2.63		0.437	1.13	2.63	
AL006B25	CAT50 - EMH 1/2 - 2.63		0.500	1.25	2.63	
AL008B25	CAT50 - EMH 5/8 - 3.75		0.625	1.50	3.75	
AL010B25	CAT50 - EMH 3/4 - 3.75		0.750	1.75	3.75	
AL012B25	CAT50 - EMH 7/8 - 3.75		0.875	1.88	3.75	
AL014B25	CAT50 - EMH 1" - 4.00		1.000	2.00	4.00	
AL017B25	CAT50 - EMH 1 1/4 - 4.00		1.250	2.50	4.00	
AL021B25	CAT50 - EMH 1 1/2 - 4.00		1.500	2.50	4.00	
AL029B25	CAT50 - EMH 2" - 5.63		2.000	3.75	5.63	

► Set screws for End Mill Holders on page 217.

End Mill Holder (Side Lock)

HIGH BALANCED END MILL HOLDER

CAT

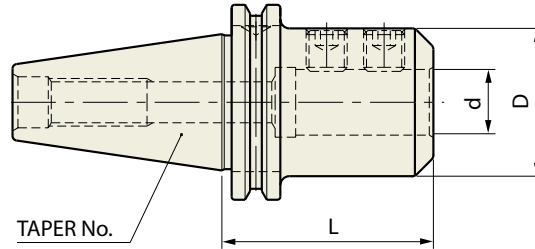

ASME B5.50 - CAT	Taper Accuracy AT3	G Value 2.5	RPM 25,000	Coolant System AD
----------------------------	------------------------------	-----------------------	----------------------	-----------------------------

ASME B5.50-2009-CAT

■ EXTENDED

Unit : inch

EDP No.	TAPER No.	MODEL No.	d	D	L	
AK104B25	40	CAT40 - EMH 3/8 - 4.50	0.375	1.00	4.50	
AK106B25		CAT40 - EMH 1/2 - 4.63	0.500	1.25	4.63	
AK108B25		CAT40 - EMH 5/8 - 5.75	0.625	1.50	5.75	
AK110B25		CAT40 - EMH 3/4 - 5.75	0.750	1.75	5.75	
AK112B25		CAT40 - EMH 7/8 - 6.00	0.875	1.88	6.00	
AK114B25		CAT40 - EMH 1" - 6.00	1.000	2.00	6.00	
AK117B25		CAT40 - EMH 1 1/4 - 6.25	1.250	2.50	6.25	
AK121B25		CAT40 - EMH 1 1/2 - 6.63	1.500	2.50	6.63	
AL104B25		50	CAT50 - EMH 3/8 - 4.50	0.375	1.00	4.50
AL106B25			CAT50 - EMH 1/2 - 4.63	0.500	1.25	4.63
AL108B25	CAT50 - EMH 5/8 - 5.75		0.625	1.50	5.75	
AL110B25	CAT50 - EMH 3/4 - 5.75		0.750	1.75	5.75	
AL112B25	CAT50 - EMH 7/8 - 5.75		0.875	1.88	5.75	
AL114B25	CAT50 - EMH 1" - 6.00		1.000	2.00	6.00	
AL117B25	CAT50 - EMH 1 1/4 - 6.00		1.250	2.50	6.00	
AL121B25	CAT50 - EMH 1 1/2 - 6.00		1.500	2.50	6.00	
AL129B25	CAT50 - EMH 2" - 7.63		2.000	3.75	7.63	

► Set screws for End Mill Holders on page 217.

End Mill Holder (Side Lock)

END MILL HOLDER

BT

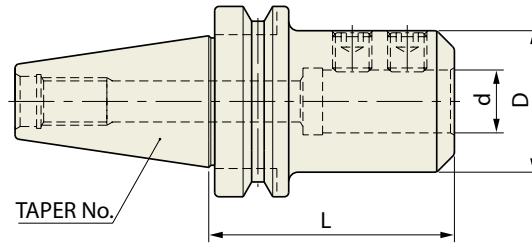

JIS B6339 - BT	Taper Accuracy AT3	G Value 6.3	RPM 15,000	Coolant System AD
-------------------	-----------------------	----------------	---------------	----------------------

JIS B6339/MAS 403-BT

■ STUB

Unit : inch

EDP No.	TAPER No.	MODEL No.	d	D	L
AH206	40	BT40 - EMH 1/2 - 1.25	0.500	1.25	1.25
AH208		BT40 - EMH 5/8 - 1.38	0.625	1.50	1.38
AH210		BT40 - EMH 3/4 - 1.44	0.750	1.75	1.44
AH214		BT40 - EMH 1" - 2.50	1.000	2.00	2.50
AH217		BT40 - EMH 1 1/4 - 2.50	1.250	2.50	2.50

■ STANDARD

Unit : inch

EDP No.	TAPER No.	MODEL No.	d	D	L
AI002	50	BT50 - EMH 1/4 - 3.00	0.250	0.78	3.00
AI004		BT50 - EMH 3/8 - 3.00	0.375	1.00	3.00
AI006		BT50 - EMH 1/2 - 3.00	0.500	1.25	3.00
AI008		BT50 - EMH 5/8 - 3.00	0.625	1.50	3.00
AI010		BT50 - EMH 3/4 - 3.00	0.750	1.75	3.00
AI012		BT50 - EMH 7/8 - 4.00	0.875	1.88	4.00
AI014		BT50 - EMH 1" - 4.25	1.000	2.00	4.25
AI017		BT50 - EMH 1 1/4 - 4.25	1.250	2.50	4.25
AI021		BT50 - EMH 1 1/2 - 4.25	1.500	2.50	4.25
AI029		BT50 - EMH 2" - 5.00	2.000	3.75	5.00

■ EXTENDED

Unit : inch

EDP No.	TAPER No.	MODEL No.	d	D	L
AI104	50	BT50 - EMH 3/8 - 6.00	0.375	1.00	6.00
AI106		BT50 - EMH 1/2 - 6.00	0.500	1.25	6.00
AI108		BT50 - EMH 5/8 - 6.00	0.625	1.50	6.00
AI110		BT50 - EMH 3/4 - 6.00	0.750	1.75	6.00
AI112		BT50 - EMH 7/8 - 6.00	0.875	1.88	6.00
AI114		BT50 - EMH 1" - 6.00	1.000	2.00	6.00
AI117		BT50 - EMH 1 1/4 - 6.00	1.250	2.50	6.00
AI121		BT50 - EMH 1 1/2 - 6.00	1.500	2.50	6.00
AI129		BT50 - EMH 2" - 6.00	2.000	3.75	6.00

- ▶ High balanced end mill holders on page 213-214.
- ▶ Set screws for end mill holders on page 217.

End Mill Holder (Side Lock)

END MILL HOLDER

BT

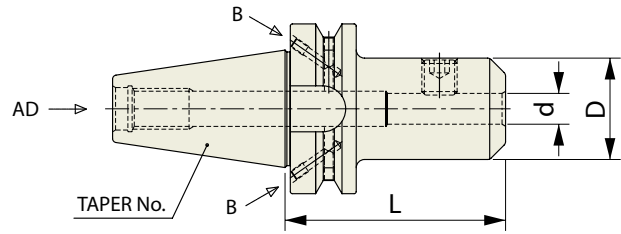

JIS B6339 - BT	Taper Accuracy AT3	G Value 6.3	RPM 15,000	Coolant System AD/B
--------------------------	------------------------------	-----------------------	----------------------	-------------------------------

JIS B6339/MAS 403-BT

STANDARD

Unit : inch

EDP No.	TAPER No.	MODEL No.	d	D	L
AH000B	40	BT40 AD/B - EMH 1/8 - 2.50	0.125	0.69	2.50
AH001B		BT40 AD/B - EMH 3/16 - 2.50	0.187	0.69	2.50
AH002B		BT40 AD/B - EMH 1/4 - 2.50	0.250	0.78	2.50
AH003B		BT40 AD/B - EMH 5/16 - 2.50	0.312	0.88	2.50
AH004B		BT40 AD/B - EMH 3/8 - 2.50	0.375	1.00	2.50
AH005B		BT40 AD/B - EMH 7/16 - 2.50	0.437	1.13	2.50
AH006B		BT40 AD/B - EMH 1/2 - 2.50	0.500	1.25	2.50
AH008B		BT40 AD/B - EMH 5/8 - 2.50	0.625	1.50	2.50
AH010B		BT40 AD/B - EMH 3/4 - 2.50	0.750	1.75	2.50
AH012B		BT40 AD/B - EMH 7/8 - 3.50	0.875	1.88	3.50
AH014B		BT40 AD/B - EMH 1" - 3.75	1.000	2.00	3.75
AH017B		BT40 AD/B - EMH 1 1/4 - 3.75	1.250	2.50	3.75
AH021B		BT40 AD/B - EMH 1 1/2 - 4.25	1.500	2.50	4.25

EXTENDED

Unit : inch

EDP No.	TAPER No.	MODEL No.	d	D	L
AH104B	40	BT40 AD/B - EMH 3/8 - 4.00	0.375	1.00	4.00
AH106B		BT40 AD/B - EMH 1/2 - 4.00	0.500	1.25	4.00
AH108B		BT40 AD/B - EMH 5/8 - 4.00	0.625	1.50	4.00
AH110B		BT40 AD/B - EMH 3/4 - 4.00	0.750	1.75	4.00
AH114B		BT40 AD/B - EMH 1" - 5.00	1.000	2.00	5.00
AH117B		BT40 AD/B - EMH 1 1/4 - 5.00	1.250	2.50	5.00
AH121B		BT40 AD/B - EMH 1 1/2 - 6.00	1.500	2.50	6.00

- ▶ High balanced end mill holders are available on request.
- ▶ Set screws for end mill holders on page 217.

End Mill Holder (Side Lock)

END MILL HOLDER (COOLANT CHANNEL TYPE)

BT

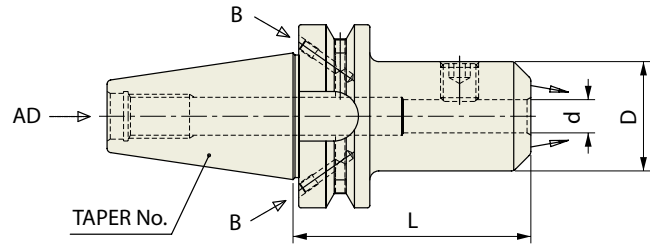

JIS B6339 - BT	Taper Accuracy AT3	G Value 6.3	RPM 15,000	Coolant System AD/B+C
--------------------------	------------------------------	-----------------------	----------------------	---------------------------------

JIS B6339/MAS 403-BT

Unit : inch

EDP No.	TAPER No.	MODEL No.	d	D	L
AH002C	40	BT40 AD/B - EMH 1/4C - 1.97	0.250	0.780	1.969
AH003C		BT40 AD/B - EMH 5/16C - 1.97	0.313	0.880	1.969
AH004C		BT40 AD/B - EMH 3/8C - 2.48	0.375	1.000	2.480
AH006C		BT40 AD/B - EMH 1/2C - 2.48	0.500	1.250	2.480
AH008C		BT40 AD/B - EMH 5/8C - 2.48	0.625	1.500	2.480
AH010C		BT40 AD/B - EMH 3/4C - 2.48	0.750	1.750	2.480
AH012C		BT40 AD/B - EMH 1C - 3.54	1.000	2.000	3.543
AH014C		BT40 AD/B - EMH 1 1/4C - 3.94	1.250	2.500	3.937

- ▶ High balanced end mill holders are available on request.
- ▶ Set screws for end mill holders on page 217.

End Mill Holder (Side Lock)

HIGH BALANCED END MILL HOLDER

BT

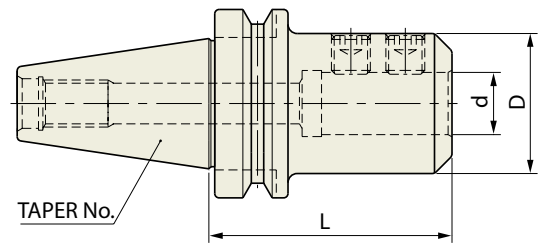

JIS B6339 - BT	Taper Accuracy AT3	G Value 2.5	RPM 25,000	Coolant System AD
--------------------------	------------------------------	-----------------------	----------------------	-----------------------------

JIS B6339/MAS 403-BT

STUB

Unit : inch

EDP No.	TAPER No.	MODEL No.	d	D	L
AH206B25	40	BT40 - EMH 1/2 - 1.25	0.500	1.25	1.25
AH208B25		BT40 - EMH 5/8 - 1.38	0.625	1.50	1.38
AH210B25		BT40 - EMH 3/4 - 1.44	0.750	1.75	1.44
AH214B25		BT40 - EMH 1" - 2.50	1.000	2.00	2.50
AH217B25		BT40 - EMH 1 1/4 - 2.50	1.250	2.50	2.50

STANDARD

Unit : inch

EDP No.	TAPER No.	MODEL No.	d	D	L
AH000B25	40	BT40 - EMH 1/8 - 2.50	0.125	0.69	2.50
AH001B25		BT40 - EMH 3/16 - 2.50	0.187	0.69	2.50
AH002B25		BT40 - EMH 1/4 - 2.50	0.250	0.78	2.50
AH003B25		BT40 - EMH 5/16 - 2.50	0.312	0.88	2.50
AH004B25		BT40 - EMH 3/8 - 2.50	0.375	1.00	2.50
AH005B25		BT40 - EMH 7/16 - 2.50	0.437	1.13	2.50
AH006B25		BT40 - EMH 1/2 - 2.50	0.500	1.25	2.50
AH008B25		BT40 - EMH 5/8 - 2.50	0.625	1.50	2.50
AH010B25		BT40 - EMH 3/4 - 2.50	0.750	1.75	2.50
AH012B25		BT40 - EMH 7/8 - 3.50	0.875	1.88	3.50
AH014B25		BT40 - EMH 1" - 3.75	1.000	2.00	3.75
AH017B25		BT40 - EMH 1 1/4 - 3.75	1.250	2.50	3.75
AH021B25		BT40 - EMH 1 1/2 - 4.25	1.500	2.50	4.25
AI002B25		50	BT50 - EMH 1/4 - 3.00	0.250	0.78
AI004B25	BT50 - EMH 3/8 - 3.00		0.375	1.00	3.00
AI006B25	BT50 - EMH 1/2 - 3.00		0.500	1.25	3.00
AI008B25	BT50 - EMH 5/8 - 3.00		0.625	1.50	3.00
AI010B25	BT50 - EMH 3/4 - 3.00		0.750	1.75	3.00
AI012B25	BT50 - EMH 7/8 - 4.00		0.875	1.88	4.00
AI014B25	BT50 - EMH 1" - 4.25		1.000	2.00	4.25
AI017B25	BT50 - EMH 1 1/4 - 4.25		1.250	2.50	4.25
AI021B25	BT50 - EMH 1 1/2 - 4.25		1.500	2.50	4.25
AI029B25	BT50 - EMH 2" - 5.00		2.000	3.75	5.00

► Set screws for end mill holders on page 217.

End Mill Holder (Side Lock)

HIGH BALANCED END MILL HOLDER

BT

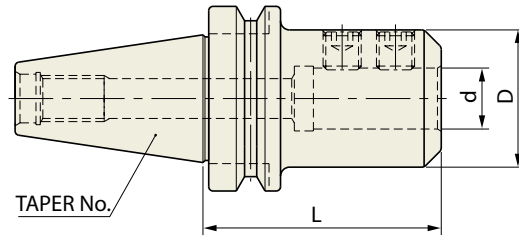

JIS B6339 - BT	Taper Accuracy AT3	G Value 2.5	RPM 25,000	Coolant System AD
-------------------	-----------------------	----------------	---------------	----------------------

JIS B6339/MAS 403 - BT

■ EXTENDED

Unit : inch

EDP No.	TAPER No.	MODEL No.	d	D	L
AH104B25	40	BT40 - EMH 3/8 - 4.00	0.375	1.00	4.00
AH106B25		BT40 - EMH 1/2 - 4.00	0.500	1.25	4.00
AH108B25		BT40 - EMH 5/8 - 4.00	0.625	1.50	4.00
AH110B25		BT40 - EMH 3/4 - 4.00	0.750	1.75	4.00
AH114B25		BT40 - EMH 1" - 5.00	1.000	2.00	5.00
AH117B25		BT40 - EMH 1 1/4 - 5.00	1.250	2.50	5.00
AH121B25		BT40 - EMH 1 1/2 - 6.00	1.500	2.50	6.00
AI104B25		50	BT50 - EMH 3/8 - 6.00	0.375	1.00
AI106B25	BT50 - EMH 1/2 - 6.00		0.500	1.25	6.00
AI108B25	BT50 - EMH 5/8 - 6.00		0.625	1.50	6.00
AI110B25	BT50 - EMH 3/4 - 6.00		0.750	1.75	6.00
AI112B25	BT50 - EMH 7/8 - 6.00		0.875	1.88	6.00
AI114B25	BT50 - EMH 1" - 6.00		1.000	2.00	6.00
AI117B25	BT50 - EMH 1 1/4 - 6.00		1.250	2.50	6.00
AI121B25	BT50 - EMH 1 1/2 - 6.00		1.500	2.50	6.00
AI129B25	BT50 - EMH 2" - 6.00		2.000	3.75	6.00

► Set screws for end mill holders on page 217.

End Mill Holder (Side Lock)

DUAL CONTACT SIDE LOCK ARBOR

CCT

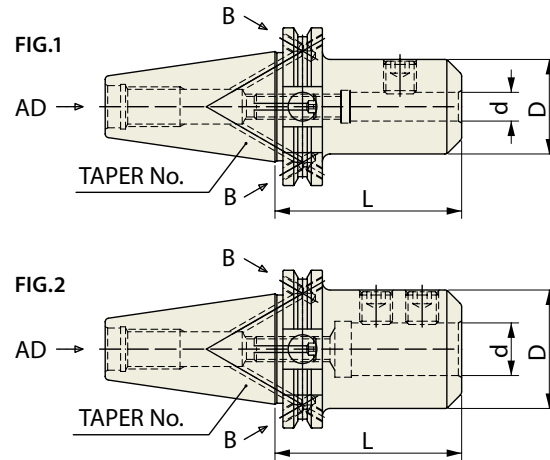

CCT	Taper Accuracy AT3	G Value 2.5	RPM 25,000	Coolant System AD/B
------------	------------------------------	-----------------------	----------------------	-------------------------------

CCT (CAT DUAL CONTACT)

EDP No.	TAPER No.	MODEL No.	d	D	L	FIG.	Unit : inch	
AB020	40	CCT40 AD/B - SLA 1/4 - 2.36	0.250	0.780	2.362	1		
AB022		CCT40 AD/B - SLA 5/16 - 2.36	0.313	0.880	2.362	1		
AB024		CCT40 AD/B - SLA 3/8 - 2.36	0.375	1.000	2.362	1		
AB026		CCT40 AD/B - SLA 1/2 - 2.36	0.500	1.250	2.362	1		
AB028		CCT40 AD/B - SLA 5/8 - 3.54	0.625	1.500	3.543	1		
AB030		CCT40 AD/B - SLA 3/4 - 3.54	0.750	1.750	3.543	1		
AB032		CCT40 AD/B - SLA 1" - 3.54	1.000	2.000	3.543	2		
AB034		CCT40 AD/B - SLA 1 1/4 - 3.54	1.250	2.500	3.543	2		
AC020		50	CCT50 AD/B - SLA 1/4 - 3.54	0.250	0.780	3.543	1	
AC022			CCT50 AD/B - SLA 5/16 - 3.54	0.313	0.880	3.543	1	
AC024	CCT50 AD/B - SLA 3/8 - 3.54		0.375	1.000	3.543	1		
AC026	CCT50 AD/B - SLA 1/2 - 3.54		0.500	1.250	3.543	1		
AC028	CCT50 AD/B - SLA 5/8 - 4.13		0.625	1.500	4.134	1		
AC030	CCT50 AD/B - SLA 3/4 - 4.13		0.750	1.750	4.134	1		
AC032	CCT50 AD/B - SLA 1" - 4.13		1.000	2.000	4.134	2		
AC034	CCT50 AD/B - SLA 1 1/4 - 4.13		1.250	2.500	4.134	2		

► Set screws for end mill holders on page 217.

End Mill Holder (Side Lock)

DUAL CONTACT SIDE LOCK ARBOR

CBT

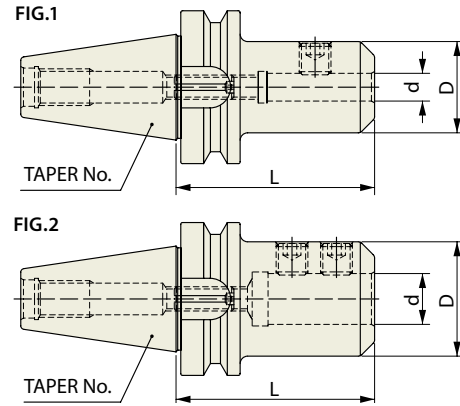

CBT	Taper Accuracy AT3	G Value 2.5	RPM 25,000	Coolant System AD
------------	------------------------------	-----------------------	----------------------	-----------------------------

CBT (BT DUAL CONTACT)

Unit : inch

EDP No.	TAPER No.	MODEL No.	d	D	L	FIG.
AD020	30	CBT30 - SLA 1/4 - 2.36	0.250	0.780	2.362	1
AD022		CBT30 - SLA 5/16 - 2.36	0.313	0.880	2.362	1
AD024		CBT30 - SLA 3/8 - 2.36	0.375	1.000	2.362	1
AD026		CBT30 - SLA 1/2 - 2.36	0.500	1.250	2.362	1
AD028		CBT30 - SLA 5/8 - 2.95	0.625	1.500	2.953	1
AD030		CBT30 - SLA 3/4 - 2.95	0.750	1.750	2.953	2
AD032		CBT30 - SLA 1" - 2.95	1.000	2.000	2.953	2
AE020		40	CBT40 - SLA 1/4 - 2.36	0.250	0.780	2.362
AE022	CBT40 - SLA 5/16 - 2.36		0.313	0.880	2.362	1
AE024	CBT40 - SLA 3/8 - 2.36		0.375	1.000	2.362	1
AE026	CBT40 - SLA 1/2 - 2.36		0.500	1.250	2.362	1
AE028	CBT40 - SLA 5/8 - 3.54		0.625	1.500	3.543	1
AE030	CBT40 - SLA 3/4 - 3.54		0.750	1.750	3.543	1
AE032	CBT40 - SLA 1" - 3.54		1.000	2.000	3.543	2
AE034	CBT40 - SLA 1 1/4 - 3.54		1.250	2.500	3.543	2

► Set screws for end mill holders on page 217.

End Mill Holder (Side Lock)

HSK

DUAL CONTACT END MILL HOLDER (COOLANT CHANNEL TYPE)

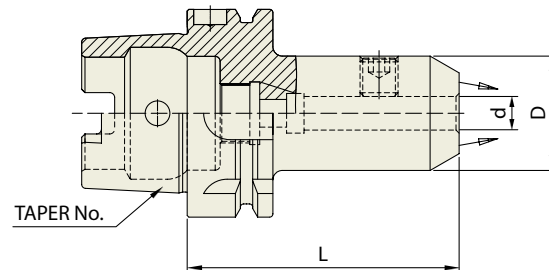

DIN 69893 - HSK	Taper Accuracy -	G Value 2.5	RPM 25,000	Coolant System AD+C
---------------------------	----------------------------	-----------------------	----------------------	-------------------------------

DIN 69893/ISO 12164-1-HSK FORM A

Unit : inch

EDP No.	TAPER No.	MODEL No.	d	D	L	
AQ020C	63A	HSK63A - EMH 1/4C - 2.56	0.250	0.780	2.559	
AQ022C		HSK63A - EMH 5/16C - 2.56	0.313	0.880	2.559	
AQ024C		HSK63A - EMH 3/8C - 2.56	0.375	1.000	2.559	
AQ026C		HSK63A - EMH 1/2C - 3.15	0.500	1.250	3.150	
AQ028C		HSK63A - EMH 5/8C - 3.15	0.625	1.500	3.150	
AQ030C		HSK63A - EMH 3/4C - 3.15	0.750	1.750	3.150	
AQ032C		HSK63A - EMH 1C - 4.33	1.000	2.000	4.331	
AQ034C		HSK63A - EMH 1 1/4C - 4.33	1.250	2.500	4.331	
AR020C		100A	HSK100A - EMH 1/4C - 3.15	0.250	0.780	3.150
AR022C			HSK100A - EMH 5/16C - 3.15	0.313	0.880	3.150
AR024C	HSK100A - EMH 3/8C - 3.15		0.375	1.000	3.150	
AR026C	HSK100A - EMH 1/2C - 3.15		0.500	1.250	3.150	
AR028C	HSK100A - EMH 5/8C - 3.94		0.625	1.500	3.937	
AR030C	HSK100A - EMH 3/4C - 3.94		0.750	1.750	3.937	
AR032C	HSK100A - EMH 1C - 3.94		1.000	2.000	3.937	
AR034C	HSK100A - EMH 1 1/4C - 3.94		1.250	2.500	3.937	

END MILL HOLDER SCREWS

HEXAGON SOCKET SET SCREW (FLAT TYPE)

EDP No.	SCREW	END MILL Dia.
ZZ000	UNC #8 - 32	1/8
ZZ001	UNF #10 - 32	3/16
ZZ002	UNF 1/4 - 28	1/4
ZZ003	UNF 5/16 - 24	5/16
ZZ004	UNF 3/8 - 24	3/8
ZZ005	UNF 3/8 - 24	7/16
ZZ006	UNF 7/16 - 20	1/2
ZZ007	UNF 1/2 - 20	5/8
ZZ008	UNF 5/8 - 18	3/4
ZZ009	UNF 5/8 - 18	7/8
ZZ010	UNF 3/4 - 16	1"
ZZ011	UNF 3/4 - 16	1 1/4
ZZ012	UNF 3/4 - 16	1 1/2
ZZ013	UN 1" - 14	2"

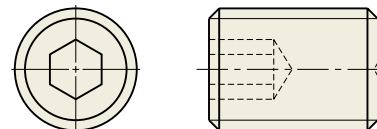

Collet Chuck



Pages 218–235

ER COLLET CHUCK



CAT

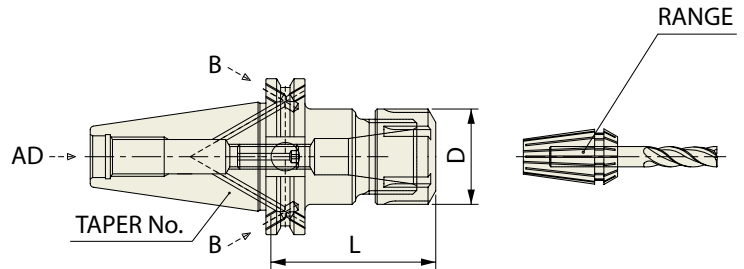

ASME B5.50 - CAT	Taper Accuracy AT3	G Value 6.3	RPM 15,000	Coolant System AD/B
-------------------------	------------------------------	-----------------------	----------------------	-------------------------------

ASME B5.50-2009-CAT

■ STUB

Unit : inch

EDP No.	TAPER No.	MODEL No.	CLAMPING RANGE	D	L	COLLET SERIES
BK232B	40	CAT40 AD/B - ER 20 - 2.55	0.039 - 0.511	1.26	2.55	ER20
BK233B		CAT40 AD/B - ER 25 - 2.50	0.039 - 0.629	1.65	2.50	ER25
BK234B		CAT40 AD/B - ER 32 - 2.70	0.078 - 0.787	1.88	2.70	ER32

■ STANDARD

Unit : inch

EDP No.	TAPER No.	MODEL No.	CLAMPING RANGE	D	L	COLLET SERIES
BK030B	40	CAT40 AD/B - ER 11 - 3.00	0.019 - 0.275	0.75	3.00	ER11
BK031B		CAT40 AD/B - ER 16 - 3.00	0.019 - 0.393	1.10	3.00	ER16
BK032B		CAT40 AD/B - ER 20 - 4.00	0.039 - 0.511	1.33	4.00	ER20
BK133B		CAT40 AD/B - ER 25 - 4.00	0.039 - 0.629	1.65	4.00	ER25
BK134B		CAT40 AD/B - ER 32 - 4.00	0.078 - 0.787	1.96	4.00	ER32
BK136B		CAT40 AD/B - ER 40 - 4.00	0.118 - 1.024	2.48	4.00	ER40
BL031B	50	CAT50 AD/B - ER 16 - 4.00	0.031 - 0.406	1.10	4.00	ER16
BL032B		CAT50 AD/B - ER 20 - 4.00	0.039 - 0.511	1.33	4.00	ER20
BL033B		CAT50 AD/B - ER 25 - 4.00	0.039 - 0.629	1.65	4.00	ER25
BL034B		CAT50 AD/B - ER 32 - 4.00	0.078 - 0.787	1.96	4.00	ER32
BL036B		CAT50 AD/B - ER 40 - 4.00	0.118 - 1.024	2.48	4.00	ER40

■ EXTENDED

Unit : inch

EDP No.	TAPER No.	MODEL No.	CLAMPING RANGE	D	L	COLLET SERIES
BK331B	40	CAT40 AD/B - ER 16 - 6.00	0.019 - 0.393	1.10	6.00	ER16
BK332B		CAT40 AD/B - ER 20 - 6.00	0.039 - 0.511	1.33	6.00	ER20
BK333B		CAT40 AD/B - ER 25 - 6.00	0.039 - 0.629	1.65	6.00	ER25
BK334B		CAT40 AD/B - ER 32 - 6.00	0.078 - 0.787	1.96	6.00	ER32
BL331B	50	CAT50 AD/B - ER 16 - 6.00	0.031 - 0.406	1.10	6.00	ER16
BL332B		CAT50 AD/B - ER 20 - 6.00	0.039 - 0.511	1.33	6.00	ER20
BL333B		CAT50 AD/B - ER 25 - 6.00	0.039 - 0.629	1.65	6.00	ER25
BL334B		CAT50 AD/B - ER 32 - 6.00	0.078 - 0.787	1.96	6.00	ER32

■ EXTRA EXTENDED

Unit : inch

EDP No.	TAPER No.	MODEL No.	CLAMPING RANGE	D	L	COLLET SERIES
BK432B	40	CAT40 AD/B - ER 20 - 8.00	0.039 - 0.511	1.33	8.00	ER20

- ▶ High balanced ER collet chucks are available on request.
- ▶ Supplied without wrench.

- ▶ ER collets on pages 227–235 and nut / wrench / stop screw on page 226.

Collet Chuck

HIGH BALANCED ER COLLET CHUCK

CAT

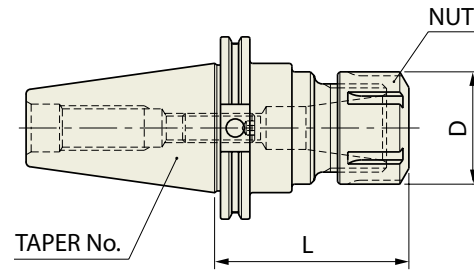

ASME B5.50 - CAT	Taper Accuracy AT3	G Value 2.5	RPM 25,000	Coolant System AD
-------------------------	------------------------------	-----------------------	----------------------	-----------------------------

ASME B5.50-2009-CAT

STUB

Unit : inch

EDP No.	TAPER No.	MODEL No.	CLAMPING RANGE	D	L	COLLET SERIES
BK232B25	40	CAT40 - ER 20 - 2.55	0.039 - 0.511	1.339	2.55	ER20
BK233B25		CAT40 - ER 25 - 2.50	0.039 - 0.629	1.654	2.50	ER25
BK234B25		CAT40 - ER 32 - 2.70	0.078 - 0.787	1.969	2.70	ER32

STANDARD

Unit : inch

EDP No.	TAPER No.	MODEL No.	CLAMPING RANGE	D	L	COLLET SERIES
BK030B25	40	CAT40 - ER 11 - 3.00	0.019 - 0.275	0.748	3.00	ER11
BK031B25		CAT40 - ER 16 - 2.88	0.019 - 0.393	1.102	2.88	ER16
BK032B25		CAT40 - ER 20 - 4.00	0.039 - 0.511	1.339	4.00	ER20
BK133B25		CAT40 - ER 25 - 4.00	0.039 - 0.629	1.654	4.00	ER25
BK134B25		CAT40 - ER 32 - 4.00	0.078 - 0.787	1.969	4.00	ER32
BL031B25	50	CAT50 - ER 16 - 4.00	1/32 - 13/32	1.102	4.88	ER16
BL032B25		CAT50 - ER 20 - 4.00	0.039 - 0.511	1.339	4.00	ER20
BL033B25		CAT50 - ER 25 - 4.00	0.039 - 0.629	1.654	4.00	ER25
BL034B25		CAT50 - ER 32 - 4.00	0.078 - 0.787	1.969	4.00	ER32

EXTENDED

Unit : inch

EDP No.	TAPER No.	MODEL No.	CLAMPING RANGE	D	L	COLLET SERIES
BK331B25	40	CAT40 - ER 16 - 4.88	0.019 - 0.393	1.102	4.88	ER16
BK332B25		CAT40 - ER 20 - 6.00	0.039 - 0.511	1.339	6.00	ER20
BK333B25		CAT40 - ER 25 - 6.00	0.039 - 0.629	1.654	6.00	ER25
BK334B25		CAT40 - ER 32 - 6.00	0.078 - 0.787	1.969	6.00	ER32
BL331B25	50	CAT50 - ER 16 - 6.88	1/32 - 13/32	1.102	6.88	ER16
BL332B25		CAT50 - ER 20 - 6.00	0.039 - 0.511	1.339	6.00	ER20
BL333B25		CAT50 - ER 25 - 6.00	0.039 - 0.629	1.654	6.00	ER25
BL334B25		CAT50 - ER 32 - 6.00	0.078 - 0.787	1.969	6.00	ER32

EXTRA EXTENDED

Unit : inch

EDP No.	TAPER No.	MODEL No.	CLAMPING RANGE	D	L	COLLET SERIES
BK432B25	40	CAT40 - ER 20 - 8.00	0.039 - 0.511	1.339	8.00	ER20

- ▶ Supplied without wrench.
- ▶ ER collets on pages 227-235 and Nut / Wrench / Stop Screw on page 226.

Collet Chuck

ER COLLET CHUCK

BT

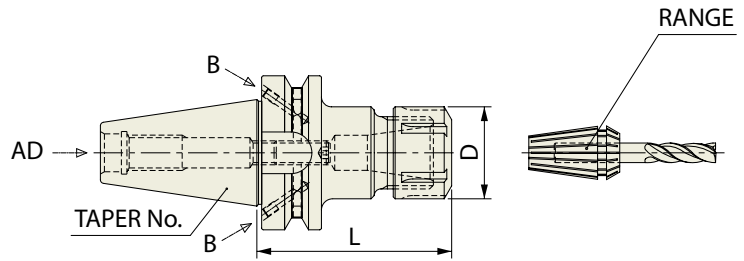

JIS B6339 - BT	Taper Accuracy AT3	G Value 6.3	RPM 15,000	Coolant System AD/B
-------------------	-----------------------	----------------	---------------	------------------------

JIS B6339/MAS 403-BT

■ STUB

Unit : inch

EDP No.	TAPER No.	MODEL No.	CLAMPING RANGE	D	L	COLLET SERIES
BH232B	40	BT40 AD/B - ER 20 - 2.20	0.039 - 0.511	1.33	2.20	ER20
BH233B		BT40 AD/B - ER 25 - 2.50	0.039 - 0.629	1.65	2.50	ER25
BH234B		BT40 AD/B - ER 32 - 2.40	0.078 - 0.787	1.96	2.40	ER32

■ STANDARD

Unit : inch

EDP No.	TAPER No.	MODEL No.	CLAMPING RANGE	D	L	COLLET SERIES
BH030B	40	BT40 AD/B - ER 11 - 3.00	0.019 - 0.275	0.75	3.00	ER11
BH031B		BT40 AD/B - ER 16 - 3.00	0.019 - 0.393	1.10	3.00	ER16
BH032B		BT40 AD/B - ER 20 - 4.00	0.039 - 0.511	1.33	4.00	ER20
BH133B		BT40 AD/B - ER 25 - 4.00	0.039 - 0.629	1.65	4.00	ER25
BH134B		BT40 AD/B - ER 32 - 4.00	0.078 - 0.787	1.96	4.00	ER32
BH136B		BT40 AD/B - ER 40 - 4.00	0.118 - 1.024	2.48	4.00	ER40

■ EXTENDED

Unit : inch

EDP No.	TAPER No.	MODEL No.	CLAMPING RANGE	D	L	COLLET SERIES
BH331B	40	BT40 AD/B - ER 16 - 6.00	0.019 - 0.393	1.10	6.00	ER16
BH332B		BT40 AD/B - ER 20 - 6.00	0.039 - 0.511	1.33	6.00	ER20
BH333B		BT40 AD/B - ER 25 - 6.00	0.039 - 0.629	1.65	6.00	ER25
BH334B		BT40 AD/B - ER 32 - 6.00	0.078 - 0.787	1.96	6.00	ER32

■ EXTRA EXTENDED

Unit : inch

EDP No.	TAPER No.	MODEL No.	CLAMPING RANGE	D	L	COLLET SERIES
BH432B	40	BT40 AD/B - ER 20 - 8.00	0.039 - 0.511	1.33	8.00	ER20

- ▶ High balanced ER collet chucks are available on request.
- ▶ Supplied without wrench.
- ▶ ER collets on pages 227-235 and nut / wrench / stop screw on page 226.

Collet Chuck

ER COLLET CHUCK

BT

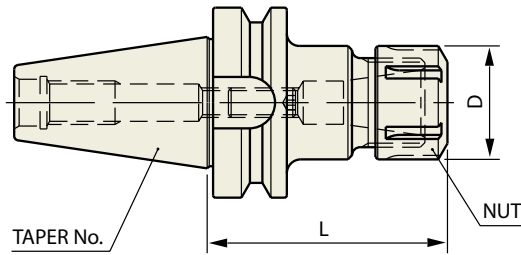

JIS B6339 -BT	Taper Accuracy AT3	G Value 6.3	RPM 15,000	Coolant System AD
------------------	-----------------------	----------------	---------------	----------------------

JIS B6339/MAS 403-BT

■ STANDARD

Unit : inch

EDP No.	TAPER No.	MODEL No.	CLAMPING RANGE	D	L	COLLET SERIES
BI031	50	BT50 - ER 16 - 4.88	0.019 - 0.393	1.102	4.88	ER16
BI032		BT50 - ER 20 - 2.63	0.039 - 0.511	1.339	2.63	ER20
BI033		BT50 - ER 25 - 2.63	0.039 - 0.629	1.654	2.63	ER25
BI034		BT50 - ER 32 - 4.00	0.078 - 0.787	1.969	4.00	ER32

■ EXTENDED

Unit : inch

EDP No.	TAPER No.	MODEL No.	CLAMPING RANGE	D	L	COLLET SERIES
BI331	50	BT50 - ER 16 - 6.00	0.019 - 0.393	1.102	6.00	ER16
BI332		BT50 - ER 20 - 6.00	0.039 - 0.511	1.339	6.00	ER20
BI333		BT50 - ER 25 - 6.00	0.039 - 0.629	1.654	6.00	ER25
BI334		BT50 - ER 32 - 6.00	0.078 - 0.787	1.969	6.00	ER32

- ▶ High balanced ER collet chucks are available on request.
- ▶ Supplied without wrench.
- ▶ ER collets on pages 227-235 and nut / wrench / stop screw on page 226.

Collet Chuck

HIGH BALANCED ER COLLET CHUCK

BT

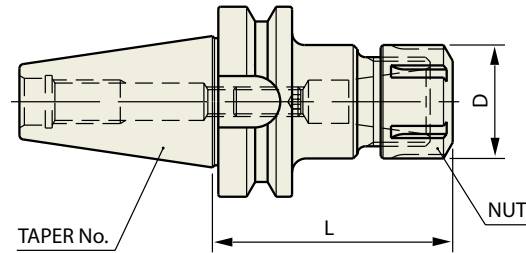

JIS B6339 - BT	Taper Accuracy AT3	G Value 2.5	RPM 25,000	Coolant System AD
--------------------------	------------------------------	-----------------------	----------------------	-----------------------------

JIS B6339/MAS 403-BT

■ STUB

Unit : inch

EDP No.	TAPER No.	MODEL No.	CLAMPING RANGE	D	L	COLLET SERIES
BH232B25	40	BT40 - ER 20 - 2.20	0.039 - 0.511	1.339	2.20	ER20
BH233B25		BT40 - ER 25 - 2.50	0.039 - 0.629	1.654	2.50	ER25
BH234B25		BT40 - ER 32 - 2.40	0.078 - 0.787	1.969	2.40	ER32

■ STANDARD

Unit : inch

EDP No.	TAPER No.	MODEL No.	CLAMPING RANGE	D	L	COLLET SERIES
BH030B25	40	BT40 - ER 11 - 3.00	0.019 - 0.275	0.748	3.00	ER11
BH031B25		BT40 - ER 16 - 2.88	0.019 - 0.393	1.102	2.88	ER16
BH032B25		BT40 - ER 20 - 4.00	0.039 - 0.511	1.339	4.00	ER20
BH133B25		BT40 - ER 25 - 4.00	0.039 - 0.629	1.654	4.00	ER25
BH134B25		BT40 - ER 32 - 4.00	0.078 - 0.787	1.969	4.00	ER32
BI031B25	50	BT50 - ER 16 - 4.88	1/32 - 13/32	1.102	4.88	ER16
BI032B25		BT50 - ER 20 - 2.63	0.039 - 0.511	1.339	2.63	ER20
BI033B25		BT50 - ER 25 - 2.63	0.039 - 0.629	1.654	2.63	ER25
BI034B25		BT50 - ER 32 - 4.00	0.078 - 0.787	1.969	4.00	ER32

■ EXTENDED

Unit : inch

EDP No.	TAPER No.	MODEL No.	CLAMPING RANGE	D	L	COLLET SERIES
BH331B25	40	BT40 - ER 16 - 4.88	0.019 - 0.393	1.102	4.88	ER16
BH332B25		BT40 - ER 20 - 6.00	0.039 - 0.511	1.339	6.00	ER20
BH333B25		BT40 - ER 25 - 6.00	0.039 - 0.629	1.654	6.00	ER25
BH334B25		BT40 - ER 32 - 6.00	0.078 - 0.787	1.969	6.00	ER32
BI331B25	50	BT50 - ER 16 - 6.00	1/32 - 13/32	1.102	6.00	ER16
BI332B25		BT50 - ER 20 - 6.00	0.039 - 0.511	1.339	6.00	ER20
BI333B25		BT50 - ER 25 - 6.00	0.039 - 0.629	1.654	6.00	ER25
BI334B25		BT50 - ER 32 - 6.00	0.078 - 0.787	1.969	6.00	ER32

■ EXTRA EXTENDED

Unit : inch

EDP No.	TAPER No.	MODEL No.	CLAMPING RANGE	D	L	COLLET SERIES
BH432B25	40	BT40 - ER 20 - 8.00	0.039 - 0.511	1.339	8.00	ER20

- ▶ Supplied without wrench.
- ▶ ER collets on pages 227–235 and nut / wrench / stop screw on page 227–235.

Collet Chuck

DUAL CONTACT ER COLLET CHUCK

HSK

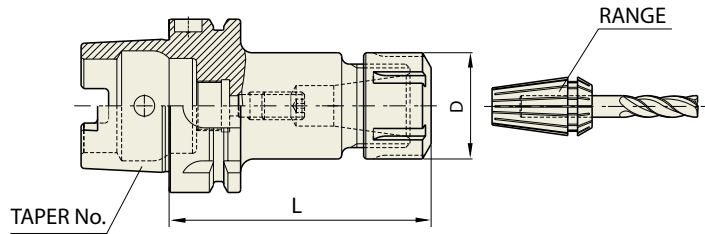

DIN 69893 - HSK	Taper Accuracy -	G Value 2.5	RPM 25,000	Coolant System AD
---------------------------	----------------------------	-----------------------	----------------------	-----------------------------

DIN 69893/ISO 12164-1-HSK FORM A

Unit : inch

EDP No.	TAPER No.	MODEL No.	CLAMPING RANGE	D	L	COLLET SERIES
BQ010	63A	HSK63A - ER 16 - 3.94	0.019 - 0.393	1.10	3.94	ER16
BQ012		HSK63A - ER 20 - 3.94	0.039 - 0.511	1.33	3.94	ER20
BQ014		HSK63A - ER 25 - 3.94	0.039 - 0.629	1.65	3.94	ER25
BQ016		HSK63A - ER 32 - 3.94	0.078 - 0.787	1.96	3.94	ER32
BQ018		HSK63A - ER 40 - 4.72	0.118 - 1.18	2.48	4.72	ER40
BR010	100A	HSK100A - ER 16 - 3.94	0.019 - 0.393	1.10	3.94	ER16
BR012		HSK100A - ER 20 - 3.94	0.039 - 0.511	1.33	3.94	ER20
BR014		HSK100A - ER 25 - 3.94	0.039 - 0.629	1.65	3.94	ER25
BR016		HSK100A - ER 32 - 3.94	0.078 - 0.787	1.96	3.94	ER32
BR018		HSK100A - ER 40 - 4.72	0.118 - 1.18	2.48	4.72	ER40

- ▶ Supplied without wrench.
- ▶ ER collets on pages 227–235 and nut / wrench / stop screw on page 226.

Collet Chuck

ER COLLET CHUCK (SHORT)

CAT/BT

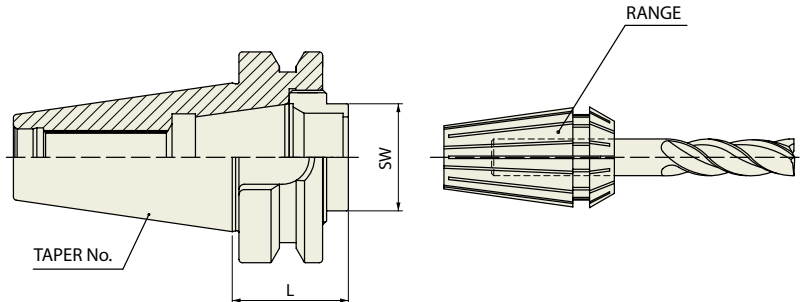

ASME B5.50-2009-CAT

Unit : inch

EDP No.	TAPER No.	MODEL No.	L	ER WRENCH
BK020SHT	40	CAT40 - ER32 - SHORT	1.063	32 (for Hex. Nut)
BL020SHT	50	CAT50 - ER32 - SHORT	1.063	32 (for Hex. Nut)

JIS B6339/MAS 403-BT

Unit : inch

EDP No.	TAPER No.	MODEL No.	L	ER WRENCH
BH020SHT	40	BT40 - ER32 - SHORT	1.378	32 (for Hex. Nut)

TENSION ER COLLET CHUCK (For TAPPING)

K

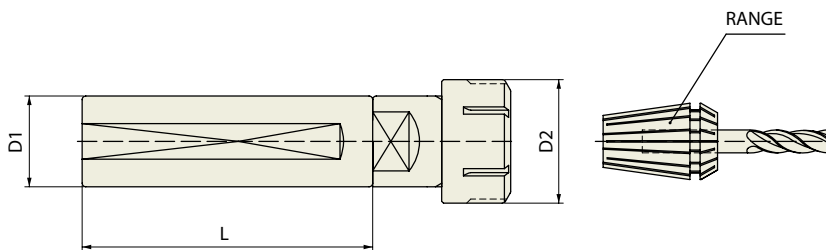

STRAIGHT-K

Unit : inch

EDP No.	TAPER No.	MODEL No.	D1	D2	L
BS110	K	K1 - ERT 16 - 2.76	1.000	1.102	2.756
BS111		K1 - ERT 20 - 3.15	1.000	1.339	3.150
BS112		K1 1/4 - ERT 16 - 2.76	1.250	1.102	2.756
BS113		K1 1/4 - ERT 20 - 3.15	1.250	1.339	3.150
BS114		K1 1/4 - ERT 25 - 3.15	1.250	1.654	3.150
BS115		K1 1/4 - ERT 32 - 3.15	1.250	1.969	3.150

▶ Supplied without wrench.

▶ ER collets on pages 227-235 and nut / wrench / stop screw on page 1226.

Collet Chuck

ER COLLET CHUCK (FOR CNC LATHE)

NC

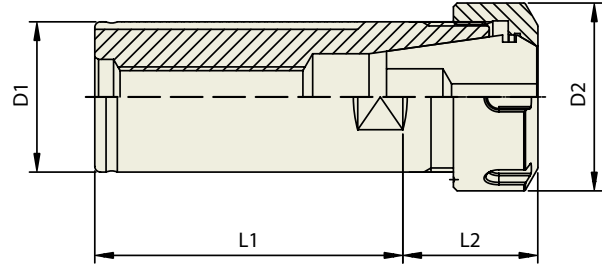

NC

Unit : inch

EDP No.	TAPER No.	MODEL No.	D1	D2	L1	L2
BN110	NC	NC 1 - ER11	1.000	0.748	2.559	1.260
BN111		NC 1 - ER16	1.000	1.102	2.559	1.260
BN112		NC 1 - ER20	1.000	1.339	2.559	1.260
BN113		NC 1 - ER25	1.000	1.654	2.559	1.260
BN114		NC 1 1/4 - ER20	1.250	1.339	2.756	1.260
BN115		NC 1 1/4 - ER25	1.250	1.654	2.756	1.496
BN116		NC 1 1/4 - ER32	1.250	1.969	2.756	1.496
BN117		NC 1 1/4 - ER40	1.250	2.480	2.953	1.496
BN118		NC 1 1/2 - ER25	1.500	1.654	2.953	2.087
BN119		NC 1 1/2 - ER32	1.500	1.969	2.953	2.087
BN120		NC 1 1/2 - ER40	1.500	2.480	2.953	2.087

- ▶ Supplied without wrench.
- ▶ ER collets on pages 227–235 and nut / wrench / stop screw on page 226.

Collet Chuck

ER NUT

FIG.1

EDP No.	SERIES	TYPE
ZZ061	ER11 - NUT	FIG.1
ZZ063	ER16 - NUT	FIG.1
ZZ066	ER20 - NUT	FIG.1

FIG.2

EDP No.	SERIES	TYPE
ZZ069	ER25 - NUT	FIG.2
ZZ072	ER32 - NUT	FIG.2
ZZ077	ER40 - NUT	FIG.2

FIG.1



FIG.2

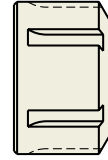

ER WRENCH

FIG.1

EDP No.	SERIES	TYPE
ZZ062	ER11	FIG.1
ZZ064	ER16	FIG.1
ZZ067	ER20	FIG.1

EDP No.	SERIES	TYPE
ZZ070	ER25	FIG.2
ZZ073	ER32	FIG.2
ZZ076	ER40	FIG.2



FIG.1



FIG.2

► Design and shape could be changed without prior notice.

ER STOP SCREW

FIG.1

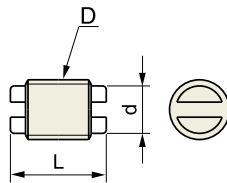

FIG.2

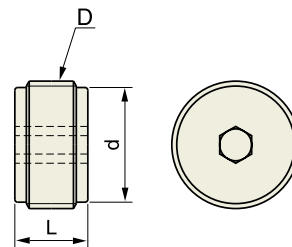

FIG.1

EDP No.	SERIES	L	d	D	TYPE
ZZ060	ER11	0.50	0.25	UN 5/16 - 18	FIG.1

FIG.2

EDP No.	SERIES	L	d	D	TYPE
ZZ065	ER16	0.50	0.35	UN 7/16 - 16	FIG.2
ZZ068	ER20	0.50	0.48	UN 9/16 - 16	FIG.2
ZZ071	ER25	0.50	0.60	UN 11/16 - 16	FIG.2
ZZ074	ER32	0.50	0.79	UN 7/8 - 16	FIG.2

Collet Chuck

ER COLLET (INCH TYPE)

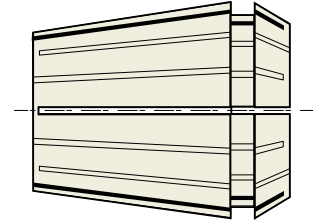

Unit : inch

ER 11		ER 16		ER 20		ER 25		ER 32		ER 40	
EDP No.	CLAMPING CAPACITY	EDP No.	CLAMPING RANGE	EDP No.	CLAMPING RANGE	EDP No.	CLAMPING RANGE	EDP No.	CLAMPING RANGE	EDP No.	CLAMPING RANGE
110116	1/16	160116	1/16	200116	1/16	250116	1/16	320332	3/32	400108	1/8
110332	3/32	160332	3/32	200332	3/32	250332	3/32	320108	1/8	400532	5/32
110108	1/8	160108	1/8	200108	1/8	250108	1/8	320532	5/32	400316	3/16
110532	5/32	160532	5/32	200532	5/32	250532	5/32	320316	3/16	400732	7/32
110316	3/16	160316	3/16	200316	3/16	250316	3/16	320732	7/32	400104	1/4
110732	7/32	160732	7/32	200732	7/32	250732	7/32	320104	1/4	400932	9/32
110104	1/4	160104	1/4	200104	1/4	250104	1/4	320932	9/32	400516	5/16
		160932	9/32	200932	9/32	250932	9/32	320516	5/16	401132	11/32
		160516	5/16	200516	5/16	250516	5/16	321132	11/32	400308	3/8
		161132	11/32	201132	11/32	251132	11/32	320308	3/8	401332	13/32
		160308	3/8	200308	3/8	250308	3/8	321332	13/32	400716	7/16
		161332	13/32	201332	13/32	251332	13/32	320716	7/16	401532	15/32
				200716	7/16	250716	7/16	321532	15/32	400102	1/2
				201532	15/32	251532	15/32	320102	1/2	401732	17/32
				200102	1/2	250102	1/2	321732	17/32	400916	9/16
						251732	17/32	320916	9/16	401932	19/32
						250916	9/16	321932	19/32	400508	5/8
						251932	19/32	320508	5/8	402132	21/32
						250508	5/8	322132	21/32	401116	11/16
								321116	11/16	402332	23/32
								322332	23/32	400304	3/4
								320304	3/4	402532	25/32
										401316	13/16
										402732	27/32
										400708	7/8
										402932	29/32
										401516	15/16
										403132	31/32
										401000	1
ER11S07	STANDARD SET	ER16S12	STANDARD SET	ER20S15	STANDARD SET	ER25S19	STANDARD SET	ER32S22	STANDARD SET	ER40S29	STANDARD SET
Ø1/16" to 1/4"		Ø1/16" to 13/32"		Ø1/16" to 1/2"		Ø1/16" to 5/8"		Ø3/32" to 3/4"		Ø1/8" to 1"	
7pcs		12pcs		15pcs		19pcs		22pcs		29pcs	

Collet Chuck

ER COLLET (METRIC TYPE)



Unit : mm

ER 8		ER 11		ER 16		ER 20	
EDP No.	CLAMPING RANGE	EDP No.	CLAMPING RANGE	EDP No.	CLAMPING RANGE	EDP No.	CLAMPING RANGE
208010	1.0 - 0.5	211010	1.0 - 0.5	216010	1.0 - 0.5	220010	1.0 - 0.5
208015	1.5 - 1.0	211015	1.5 - 1.0	216015	1.5 - 1.0	220015	1.5 - 1.0
208020	2.0 - 1.5	211020	2.0 - 1.5	216020	2.0 - 1.0	220020	2.0 - 1.0
208025	2.5 - 2.0	211025	2.5 - 2.0	216025	2.5 - 2.0	220025	2.5 - 2.0
208030	3.0 - 2.5	211030	3.0 - 2.5	216030	3.0 - 2.0	220030	3.0 - 2.0
208035	3.5 - 3.0	211035	3.5 - 3.0	216040	4.0 - 3.0	220040	4.0 - 3.0
208040	4.0 - 3.5	211040	4.0 - 3.5	216050	5.0 - 4.0	220050	5.0 - 4.0
208045	4.5 - 4.0	211045	4.5 - 4.0	216060	6.0 - 5.0	220060	6.0 - 5.0
208050	5.0 - 4.5	211050	5.0 - 4.5	216070	7.0 - 6.0	220070	7.0 - 6.0
		211055	5.5 - 5.0	216080	8.0 - 7.0	220080	8.0 - 7.0
		211060	6.0 - 5.5	216090	9.0 - 8.0	220090	9.0 - 8.0
		211065	6.5 - 6.0	216100	10.0 - 9.0	220100	10.0 - 9.0
		211070	7.0 - 6.5			220110	11.0 - 10.0
						220120	12.0 - 11.0
						220130	13.0 - 12.0
208000	STANDARD SET	211000	STANDARD SET	216000	STANDARD SET	220000	STANDARD SET
Ø1.0 - 5.0mm		Ø1.0 - 7.0mm		Ø1.0 - 10.0mm		Ø2.0 - 13.0mm	
9pcs		13pcs		10pcs		12pcs	
108110	WOODEN TRAY ZWT 8	011110	WOODEN TRAY ZWT 11	016110	WOODEN TRAY ZWT 16	020110	WOODEN TRAY ZWT 20

Collet Chuck

ER COLLET (METRIC TYPE)



Unit : mm

ER 25		ER 32		ER 40		ER 50	
EDP No.	CLAMPING RANGE	EDP No.	CLAMPING RANGE	EDP No.	CLAMPING RANGE	EDP No.	CLAMPING RANGE
225010	1.0 - 1.5	232020	2.0 - 1.0	240030	3.0 - 2.0	250060	6.0 - 4.0
225015	1.5 - 1.0	232025	2.5 - 2.0	240040	4.0 - 3.0	250080	8.0 - 6.0
225020	2.0 - 1.0	232030	3.0 - 2.0	240050	5.0 - 4.0	250100	10.0 - 8.0
225025	2.5 - 2.0	232040	4.0 - 3.0	240060	6.0 - 5.0	250120	12.0 - 10.0
225030	3.0 - 2.0	232050	5.0 - 4.0	240070	7.0 - 6.0	250140	14.0 - 12.0
225040	4.0 - 3.0	232060	6.0 - 5.0	240080	8.0 - 7.0	250160	16.0 - 14.0
225050	5.0 - 4.0	232070	7.0 - 6.0	240090	9.0 - 8.0	250180	18.0 - 16.0
225060	6.0 - 5.0	232080	8.0 - 7.0	240100	10.0 - 9.0	250200	20.0 - 18.0
225070	7.0 - 6.0	232090	9.0 - 8.0	240110	11.0 - 10.0	250220	22.0 - 20.0
225080	8.0 - 7.0	232100	10.0 - 9.0	240120	12.0 - 11.0	250240	24.0 - 22.0
225090	9.0 - 8.0	232110	11.0 - 10.0	240130	13.0 - 12.0	250250	25.0 - 23.0
225100	10.0 - 9.0	232120	12.0 - 11.0	240140	14.0 - 13.0	250260	26.0 - 24.0
225110	11.0 - 10.0	232130	13.0 - 12.0	240150	15.0 - 14.0	250280	28.0 - 26.0
225120	12.0 - 11.0	232140	14.0 - 13.0	240160	16.0 - 15.0	250300	30.0 - 28.0
225130	13.0 - 12.0	232150	15.0 - 14.0	240170	17.0 - 16.0	250320	32.0 - 30.0
225140	14.0 - 13.0	232160	16.0 - 15.0	240180	18.0 - 17.0	250340	34.0 - 32.0
225150	15.0 - 14.0	232170	17.0 - 16.0	240190	19.0 - 18.0		
225160	16.0 - 15.0	232180	18.0 - 17.0	240200	20.0 - 19.0		
		232190	19.0 - 18.0	240210	21.0 - 20.0		
		232200	20.0 - 19.0	240220	22.0 - 21.0		
				240230	23.0 - 22.0		
				240240	24.0 - 23.0		
				240250	25.0 - 24.0		
				240260	26.0 - 25.0		
				240270	27.0 - 26.0		
				240280	28.0 - 27.0		
				240290	29.0 - 28.0		
				240300	30.0 - 29.0		
225000	STANDARD SET	232000	STANDARD SET	240000	STANDARD SET	250000	STANDARD SET
Ø2.0 - 16.0mm		Ø3.0 - 20.0mm		Ø4.0 - 26.0mm		Ø12.0 - 34.0mm	
15pcs		18pcs		23pcs		12pcs	
025110	WOODEN TRAY ZWT 25	032110	WOODEN TRAY ZWT 32	040110	WOODEN TRAY ZWT 40	050110	WOODEN TRAY ZWT 50

Collet Chuck

SEALED ER COLLET (INCH TYPE)

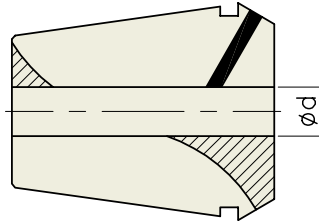

Unit : inch

ER 11S		ER 16S		ER 20S		ER 25S		ER 32S		ER 40S	
EDP No.	CLAMPING CAPACITY	EDP No.	CLAMPING CAPACITY	EDP No.	CLAMPING CAPACITY	EDP No.	CLAMPING CAPACITY	EDP No.	CLAMPING CAPACITY	EDP No.	CLAMPING CAPACITY
110108S	1/8	160108S	1/8	200108S	1/8	250108S	1/8	320108S	1/8	400108S	1/8
110532S	5/32	160532S	5/32	200532S	5/32	250532S	5/32	320532S	5/32	400532S	5/32
110316S	3/16	160316S	3/16	200316S	3/16	250316S	3/16	320316S	3/16	400316S	3/16
110732S	7/32	160732S	7/32	200732S	7/32	250732S	7/32	320732S	7/32	400732S	7/32
110104S	1/4	160104S	1/4	200104S	1/4	250104S	1/4	320104S	1/4	400104S	1/4
		160932S	9/32	200932S	9/32	250932S	9/32	320932S	9/32	400932S	9/32
		160516S	5/16	200516S	5/16	250516S	5/16	320516S	5/16	400516S	5/16
		161132S	11/32	201132S	11/32	251132S	11/32	321132S	11/32	401132S	11/32
		160308S	3/8	200308S	3/8	250308S	3/8	320308S	3/8	400308S	3/8
		161332S	13/32	201332S	13/32	251332S	13/32	321332S	13/32	401332S	13/32
				200716S	7/16	250716S	7/16	320716S	7/16	400716S	7/16
				201532S	15/32	251532S	15/32	321532S	15/32	401532S	15/32
				200102S	1/2	250102S	1/2	320102S	1/2	400102S	1/2
						251732S	17/32	321732S	17/32	401732S	17/32
						250916S	9/16	320916S	9/16	400916S	9/16
						251932S	19/32	321932S	19/32	401932S	19/32
						250508S	5/8	320508S	5/8	400508S	5/8
								322132S	21/32	402132S	21/32
								321116S	11/16	401116S	11/16
								322332S	23/32	402332S	23/32
								320304S	3/4	400304S	3/4
										402532S	25/32
										401316S	13/16
										402732S	27/32
										400708S	7/8
										402932S	29/32
										401516S	15/16
										403132S	31/32
										401000S	1
ER11S05S	STANDARD SET	ER16S10S	STANDARD SET	ER20S13S	STANDARD SET	ER25S17S	STANDARD SET	ER32S21S	STANDARD SET	ER40S29S	STANDARD SET
Ø1/8" to 1/4"		Ø1/8" to 13/32"		Ø1/8" to 1/2"		Ø1/8" to 5/8"		Ø1/8" to 3/4"		Ø1/8" to 1"	
5pcs		10pcs		13pcs		17pcs		21pcs		29pcs	

► Metric sealed ER collets are available on request.

Collet Chuck

TAP ER COLLET (INCH TYPE: ANSI)

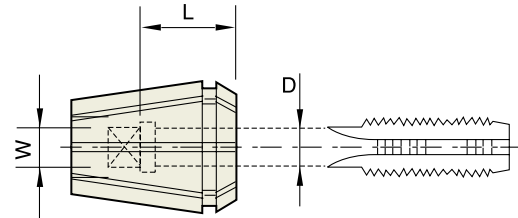

Below standard Tap ER Collet conforms to ANSI (for standard taps)

Unit : inch

RD 11TC						RD 16TC						RD 20TC					
EDP No.	TAP		D(Φ)	W(□)	L	EDP No.	TAP		D(Φ)	W(□)	L	EDP No.	TAP		D(Φ)	W(□)	L
	Inch	Metric					Inch	Metric					Inch	Metric			
11TC1411	#6	M3	0.141	0.110	0.472	16TC1411	#6	M3	0.141	0.110	0.709	20TC1411	#6	M3	0.141	0.110	0.709
11TC1613	#8	M4	0.168	0.131	0.472	16TC1613	#8	M4	0.168	0.131	0.709	20TC1613	#8	M4	0.168	0.131	0.709
11TC1915	#10	M4.5+M5	0.194	0.152	0.472	16TC1915	#10	M4.5+M5	0.194	0.152	0.709	20TC1915	#10	M4.5+M5	0.194	0.152	0.709
11TC2216	#12	-	0.220	0.165	0.551	16TC2216	#12	-	0.220	0.165	0.709	20TC2216	#12	-	0.220	0.165	0.709
11TC2519	1/4	M6	0.255	0.191	0.551	16TC2519	1/4	M6	0.255	0.191	0.709	20TC2519	1/4	M6	0.255	0.191	0.709
						16TC3123	5/16	M7+M8	0.318	0.238	0.709	20TC3123	5/16	M7+M8	0.318	0.238	0.866
						16TC3224	7/16	-	0.323	0.242	0.709	20TC3622	3/8	M10	0.367	0.275	0.866
												20TC3224	7/16	-	0.323	0.242	0.866
												20TC3828	1/2	M12	0.381	0.286	0.866

RD 25TC						RD 32TC						RD 40TC					
EDP No.	TAP		D(Φ)	W(□)	L	EDP No.	TAP		D(Φ)	W(□)	L	EDP No.	TAP		D(Φ)	W(□)	L
	Inch	Metric					Inch	Metric					Inch	Metric			
25TC1411	#6	M3	0.141	0.110	0.709	32TC1411	#6	M3	0.141	0.110	0.709	40TC1411	#6	M3	0.141	0.110	0.709
25TC1613	#8	M4	0.168	0.131	0.709	32TC1613	#8	M4	0.168	0.131	0.709	40TC1613	#8	M4	0.168	0.131	0.709
25TC1915	#10	M4.5+M5	0.194	0.152	0.709	32TC1915	#10	M4.5+M5	0.194	0.152	0.709	40TC1915	#10	M4.5+M5	0.194	0.152	0.709
25TC2216	#12	-	0.220	0.165	0.709	32TC2216	#12	-	0.220	0.165	0.709	40TC2216	#12	-	0.220	0.165	0.709
25TC2519	1/4	M6	0.255	0.191	0.709	32TC2519	1/4	M6	0.255	0.191	0.709	40TC2519	1/4	M6	0.255	0.191	0.709
25TC3123	5/16	M7+M8	0.318	0.238	0.866	32TC3123	5/16	M7+M8	0.318	0.238	0.866	40TC3123	5/16	M7+M8	0.318	0.238	0.866
25TC3622	3/8	M10	0.367	0.275	0.866	32TC3627	3/8	M10	0.367	0.275	0.866	40TC3627	3/8	M10	0.367	0.275	0.866
25TC3224	7/16	-	0.323	0.242	0.866	32TC3224	7/16	-	0.323	0.242	0.866	40TC3224	7/16	-	0.323	0.242	0.866
25TC3828	1/2	M12	0.381	0.286	0.866	32TC3828	1/2	M12	0.381	0.286	0.866	40TC3828	1/2	M12	0.381	0.286	0.866
25TC4232	9/16	M14	0.429	0.322	0.984	32TC4232	9/16	M14	0.429	0.322	0.984	40TC4232	9/16	M14	0.429	0.322	0.984
25TC4836	5/8	M16	0.480	0.360	0.984	32TC4836	5/8	M16	0.480	0.360	0.984	40TC4836	5/8	M16	0.480	0.360	0.984
25TC5440	11/16	M18	0.542	0.406	0.984	32TC5440	11/16	M18	0.542	0.406	0.984	40TC5440	11/16	M18	0.542	0.406	0.984
25TC5944	3/4	-	0.590	0.442	0.984	32TC5944	3/4	-	0.590	0.442	0.984	40TC5944	3/4	-	0.590	0.442	0.984
						32TC6548	13/16	M20	0.652	0.489	0.984	40TC6548	13/16	M20	0.652	0.489	0.984
												40TC6952	7/8	M22	0.697	0.523	0.984
												40TC7657	15/16	M24	0.760	0.570	0.984
												40TC8060	1	M25	0.800	0.600	1.102

Collet Chuck

TAP ER COLLET (INCH TYPE: ANSI)

CAT/BT

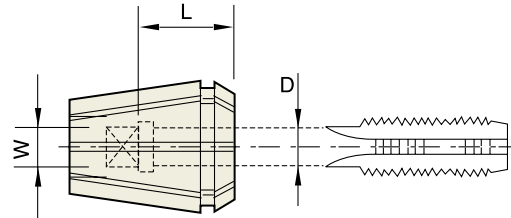

Below standard Tap ER Collet conforms to ANSI (For pipe taps)

Unit : inch

RD 16TCP						RD 20TCP						RD 25TCP					
EDP No.	TAP		D(Φ)	W(□)	L	EDP No.	TAP		D(Φ)	W(□)	L	EDP No.	TAP		D(Φ)	W(□)	L
	Inch	Metric					Inch	Metric					Inch	Metric			
16TP3123	1/8(SS)	-	0.312	0.234	0.709	20TP3123	1/8(SS)	-	0.312	0.234	0.787	25TP3123	1/8(SS)	-	0.312	0.234	0.787
16TP4332	1/8(LS)	-	0.437	0.328	0.709	20TP4332	1/8(LS)	-	0.437	0.328	0.787	25TP4332	1/8(LS)	-	0.437	0.328	0.787
												25TP5642	1/4	-	0.562	0.420	0.787

RD 32TCP						RD 40TCP					
EDP No.	TAP		D(Φ)	W(□)	L	EDP No.	TAP		D(Φ)	W(□)	L
	Inch	Metric					Inch	Metric			
32TP3123	1/8(SS)	-	0.312	0.234	0.787	40TP3123	1/8(SS)	-	0.312	0.234	0.787
32TP4332	1/8(LS)	-	0.437	0.328	0.787	40TP4332	1/8(LS)	-	0.437	0.328	0.787
32TP5642	1/4	-	0.562	0.420	0.787	40TP5642	1/4	-	0.562	0.420	0.787
						40TP7053	3/8	-	0.700	0.530	0.866
						40TP6851	1/2	-	0.687	0.515	0.866
						40TP9067	3/4	-	0.906	0.679	0.945

▶ SS: Short Series / LS: Long Series

Collet Chuck

TAP ER COLLET (METRIC TYPE: JIS)

NC

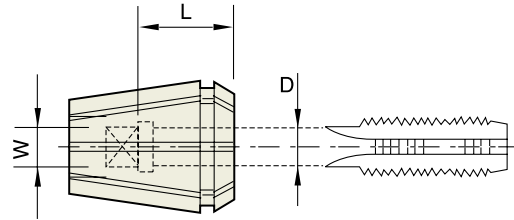

Below standard Tap ER Collet conforms to JIS

Unit : mm

RDT 16					RDT 20					RDT 25					RDT 32					RDT 40												
EDP No.	TAP	D(Φ)	W(□)	L	EDP No.	TAP	D(Φ)	W(□)	L	EDP No.	TAP	D(Φ)	W(□)	L	EDP No.	TAP	D(Φ)	W(□)	L	EDP No.	TAP	D(Φ)	W(□)	L								
16T30025	M2	3.0	2.5	15																												
16T40032	M3	4.0	3.2	15	20T40032	M3	4.0	3.2	15	25T40032	M3	4.0	3.2	15																		
16T50040	M4	5.0	4.0	15	20T50040	M4	5.0	4.0	15	25T50032	M4	5.0	4.0	15	32T50040	M4	5.0	4.0	15													
16T55045	M5	5.5	4.5	15	20T55045	M5	5.5	4.5	15	25T55045	M5	5.5	4.5	15	32T55045	M5	5.5	4.5	15													
16T60045	M6	6.0	4.5	15	20T60045	M6	6.0	4.5	15	25T60045	M6	6.0	4.5	15	32T60045	M6	6.0	4.5	15													
16T62050	M8	6.2	5.0	15	20T62050	M8	6.2	5.0	20	25T62050	M8	6.2	5.0	20	32T62050	M8	6.2	5.0	20	40T62050	M8	6.2	5.0	20								
					20T70055	M10	7.0	5.5	20	25T70055	M10	7.0	5.5	20	32T70055	M10	7.0	5.5	20	40T70055	M10	7.0	5.5	20								
										25T85065	M12	8.5	6.5	20	32T85065	M12	8.5	6.5	20	40T85065	M12	8.5	6.5	25								
										25T10580	M14	10.5	8.0	20	32T10560	M14	10.5	8.0	20	40T10580	M14	10.5	8.0	25								
															32T12510	M16	12.5	10.0	20	40T12510	M16	12.5	10.0	25								
															32T14011	M18	14.0	11.0	20	40T14011	M18	14.0	11.0	25								
																				40T15012	M20	15.0	12.0	28								
																				40T17013	M22	17.0	13.0	28								
																				40T19015	M24	19.0	15.0	28								

Collet Chuck

TAP ER COLLET (METRIC TYPE: DIN)

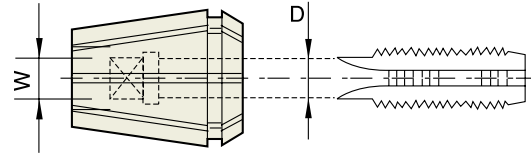

Below standard Tap ER Collet conforms to DIN

Unit : mm

DIN STANDARD			RD 11TCD			RD 16TCD			RD 20TCD		
DIN 374/376	DIN 352/2181	DIN 371	EDP No.	D(∅)	W(□)	EDP No.	D(∅)	W(□)	EDP No.	D(∅)	W(□)
M5	M3	M3	11TD3527	3.5	2.7	16TD3527	3.5	2.7	20TD3527	3.5	2.7
M5.5	M3.5	M3.5	11TD4030	4.0	3.0	16TD4030	4.0	3.0	20TD4030	4.0	3.0
M6	M4	M4	11TD4534	4.5	3.4	16TD4534	4.5	3.4	20TD4534	4.5	3.4
M5	-	-	11TD5040	5.0	4.0	16TD5040	5.0	4.0	20TD5040	5.0	4.0
M7	-	-	11TD5543	5.5	4.3	16TD5543	5.5	4.3	20TD5543	5.5	4.3
M8	M4.5-M8	M4.5-M8	11TD6049	6.0	4.9	16TD6049	6.0	4.9	20TD6049	6.0	4.9
M9+M10	M9+M10	M7				16TD7055	7.0	5.5	20TD7055	7.0	5.5
M11	M11	M8							20TD8062	8.0	6.2
M12	M12	M9							20TD9070	9.0	7.0
-	-	M10							20TD10080	10.0	8.0
M13+M14	M13+M14	-									
M15-M17	M15-M17	-									
M18+M19	M18+M19	-									
M20+M21	M20+M21	-									
M22-M26	M22-M26	-									
M27+M28	M27+M28	-									
M29-M32	M29-M32	-									
M33	M33	-									
M34-M38	M34-M38	-									
M39-M42	M39-M42	-									

Collet Chuck

TAP ER COLLET (METRIC TYPE : DIN)

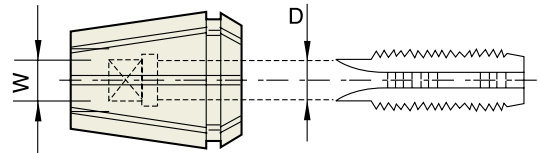

Below standard Tap ER Collet conforms to DIN

Unit : mm

RD 25TCD			RD 32TCD			RD 40TCD			RD 50TCD		
EDP No.	D(∅)	W(□)	EDP No.	D(∅)	W(□)	EDP No.	D(∅)	W(□)	EDP No.	D(∅)	W(□)
25TD3527	3.5	2.7	32TD3527	3.5	2.7	40TD3527	3.5	2.7			
25TD4030	4.0	3.0	32TD4030	4.0	3.0	40TD4030	4.0	3.0			
25TD4534	4.5	3.4	32TD4534	4.5	3.4	40TD4534	4.5	3.4			
25TD5040	5.0	4.0	32TD5040	5.0	4.0	40TD5040	5.0	4.0			
25TD5543	5.5	4.3	32TD5543	5.5	4.3	40TD5543	5.5	4.3			
25TD6049	6.0	4.9	32TD6049	6.0	4.9	40TD6049	6.0	4.9			
25TD7055	7.0	5.5	32TD7055	7.0	5.5	40TD7055	7.0	5.5			
25TD8062	8.0	6.2	32TD8062	8.0	6.2	40TD8062	8.0	6.2	50TD8062	8.0	6.2
25TD9080	9.0	7.0	32TD9070	9.0	7.0	40TD9070	9.0	7.0	50TD9070	9.0	7.0
25TD10090	10.0	8.0	32TD10080	10.0	8.0	40TD10080	10.0	8.0	50TD10080	10.0	8.0
25TD11090	11.0	9.0	32TD11090	11.0	9.0	40TD11090	11.0	9.0	50TD11090	11.0	9.0
25TD12090	12.0	9.0	32TD12090	12.0	9.0	40TD12090	12.0	9.0	50TD12090	12.0	9.0
25TD140110	14.0	11.0	32TD140110	14.0	11.0	40TD140110	14.0	11.0	50TD140110	14.0	11.0
25TD160120	16.0	12.0	32TD160120	16.0	12.0	40TD160120	16.0	12.0	50TD160120	16.0	12.0
						40TD180145	18.0	14.5	50TD180145	18.0	14.5
						40TD200160	20.0	16.0	50TD200160	20.0	16.0
						40TD220180	22.0	18.0	50TD220180	22.0	18.0
									50TD250200	25.0	20.0
									50TD280220	28.0	22.0
									50TD320240	32.0	24.0

Power Milling Chuck



Pages 236-239

POWER MILLING CHUCK

CAT

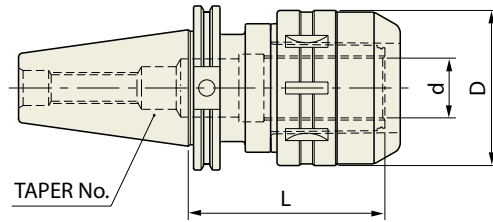

ASME B5.50 - CAT	Taper Accuracy AT3	G Value -	RPM -	Coolant System AD
---------------------	-----------------------	--------------	----------	----------------------

ASME B5.50-2009-CAT

■ STANDARD

Unit : inch

EDP No.	TAPER No.	MODEL No.	d	D	L
LK010	40	CAT40 - C3/4 - 4.13	0.750	2.126	4.13
LK014		CAT40 - C1" - 4.13	1.000	2.461	4.13
LK017		CAT40 - C1 1/4 - 4.13	1.250	2.835	4.13
LL010	50	CAT50 - C3/4 - 4.13	0.750	2.126	4.13
LL014		CAT50 - C1" - 4.13	1.000	2.461	4.13
LL017		CAT50 - C1 1/4 - 4.13	1.250	2.835	4.13

► Collets / wrenches for power milling chucks on page 239.

POWER MILLING CHUCK

BT

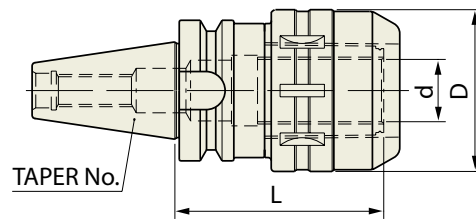

JIS B6339 - BT	Taper Accuracy AT3	G Value -	RPM -	Coolant System AD
-------------------	-----------------------	--------------	----------	----------------------

JIS B6339/MAS 403-BT

■ STANDARD

Unit : inch

EDP No.	TAPER No.	MODEL No.	d	D	L
LH010	40	BT40 - C 3/4 - 3.56	0.750	2.126	3.56
LH014		BT40 - C1" - 4.13	1.000	2.461	4.13
LH017		BT40 - C1 1/4 - 4.13	1.250	2.835	4.13
LI010	50	BT50 - C 3/4 - 4.13	0.750	2.126	4.13
LI014		BT50 - C1" - 4.13	1.000	2.461	4.13
LI017		BT50 - C1 1/4 - 4.13	1.250	2.835	4.13

► Collets / wrenches for power milling chucks on page 239.

Power Milling Chuck

DUAL CONTACT HIGH SPEED POWER MILLING CHUCK

CCT

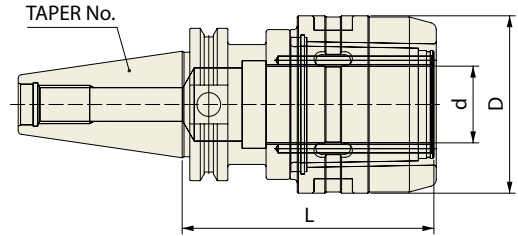

CCT	Taper Accuracy AT3	G Value 6.3	RPM 20,000	Coolant System AD
------------	------------------------------	-----------------------	----------------------	-----------------------------

CCT (CAT DUAL CONTACT)

Unit : inch

EDP No.	TAPER No.	MODEL No.	d	D	L
LB020	40	CCT40 - C 3/4 - 4.13HS	0.750	2.126	4.13
LB022		CCT40 - C 1" - 4.13HS	1.000	2.461	4.13
LB024		CCT40 - C 1 1/4 - 4.13HS	1.250	2.835	4.13
LB026		CCT40 - C 1 1/4 - 5.31HS	1.250	2.835	5.31
LC020	50	CCT50 - C 3/4 - 4.13HS	0.750	2.126	4.13
LC022		CCT50 - C 1" - 4.13HS	1.000	2.461	4.13
LC024		CCT50 - C 1 1/4 - 4.13HS	1.250	2.835	4.13
LC026		CCT50 - C 1 1/4 - 5.31HS	1.250	2.835	5.31
LC028		CCT50 - C 1 1/4 - 6.5HS	1.250	2.835	6.50

► Collets / wrenches for power milling chucks on page 239.

Power Milling Chuck

DUAL CONTACT HIGH SPEED POWER MILLING CHUCK

CBT

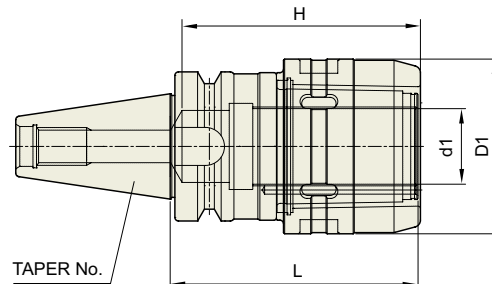

CBT	Taper Accuracy AT3	G Value 6.3	RPM 20,000	Coolant System AD
------------	------------------------------	-----------------------	----------------------	-----------------------------

CBT (BT DUAL CONTACT)

Unit : inch

EDP No.	TAPER No.	MODEL No.	d1	D1	L
LE020	40	CBT40 - C 3/4 - 3.15HS	0.750	2.126	3.15
LE022		CBT40 - C 3/4 - 4.13HS	0.750	2.126	4.13
LE024		CBT40 - C 1" - 4.13HS	1.000	2.461	4.13
LE026		CBT40 - C 1 1/4 - 3.54HS	1.250	2.835	3.54
LE028		CBT40 - C 1 1/4 - 4.13HS	1.250	2.835	4.13
LE030		CBT40 - C 1 1/4 - 5.31HS	1.250	2.835	5.31

► Collets / wrenches for power milling chucks on page 239.

DUAL CONTACT HIGH SPEED POWER MILLING CHUCK

HSK

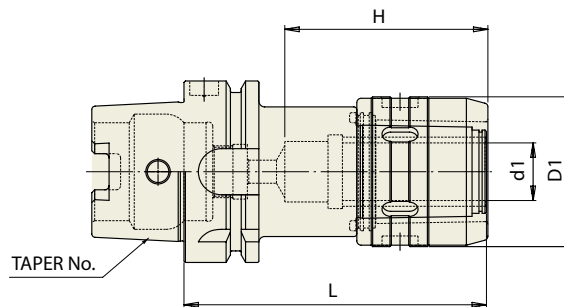

DIN 69893 - HSK	Taper Accuracy -	G Value 6.3	RPM 20,000	Coolant System AD
------------------------	----------------------------	-----------------------	----------------------	-----------------------------

DIN 69893/ISO 12164-1-HSK FORM A

Unit : inch

EDP No.	TAPER No.	MODEL No.	d1	D1	L
LQ020	63A	HSK63 A - C 3/4 - 4.13HS	0.750	2.126	4.13
LQ022		HSK63 A - C 1" - 4.72HS	1.000	2.461	4.72
LQ024		HSK63 A - C 1 1/4 - 5.31HS	1.250	2.835	5.31
LR020	100A	HSK100 A - C 3/4 - 4.33HS	0.750	2.126	4.33
LR022		HSK100 A - C 1" - 5.12HS	1.000	2.461	5.12
LR024		HSK100 A - C 1 1/4 - 5.31HS	1.250	2.835	5.31

► Collets / wrenches for power milling chucks on page 239.

Power Milling Chuck

POWER MILLING CHUCK COLLET

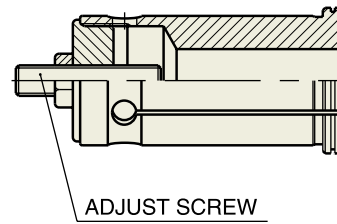

Unit : inch			Unit : inch			Unit : inch		
EDP No.	TYPE	D	EDP No.	TYPE	D	EDP No.	TYPE	D
MZ002	C3/4	1/4	MZ102	C1	1/4	MZ302	C1 1/4	1/4
MZ003	C3/4	5/16	MZ103	C1	5/16	MZ303	C1 1/4	5/16
MZ004	C3/4	3/8	MZ104	C1	3/8	MZ304	C1 1/4	3/8
MZ006	C3/4	1/2	MZ106	C1	1/2	MZ306	C1 1/4	1/2
MZ008	C3/4	5/8	MZ108	C1	5/8	MZ308	C1 1/4	5/8
			MZ110	C1	3/4	MZ310	C1 1/4	3/4
						MZ312	C1 1/4	7/8
						MZ314	C1 1/4	1"

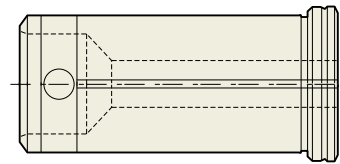

Unit : inch			Unit : inch			Unit : inch		
EDP No.	TYPE	D	EDP No.	TYPE	D	EDP No.	TYPE	D
MY002	C3/4	1/4	MY102	C1	1/4	MY302	C1 1/4	1/4
MY003	C3/4	5/16	MY103	C1	5/16	MY303	C1 1/4	5/16
MY004	C3/4	3/8	MY104	C1	3/8	MY304	C1 1/4	3/8
MY006	C3/4	1/2	MY106	C1	1/2	MY306	C1 1/4	1/2
MY008	C3/4	5/8	MY108	C1	5/8	MY308	C1 1/4	5/8
			MY110	C1	3/4	MY310	C1 1/4	3/4
						MY312	C1 1/4	7/8
						MY314	C1 1/4	1"

WRENCH

Unit : inch	
EDP No.	SERIES
ZZ056	C3/4
ZZ057	C1
ZZ058	C1 1/4



Charlotte Technical Center

**DESIGN, SIMULATE,
PRODUCE and TEST.**
Turnkey custom-engineered
tooling solutions.

Bring us your special orders. The YG-1 Technical Center is your one-stop center for all your tool-making needs. With state-of-the-art manufacturing assets including a full assortment of top-of-the-line CNC stations, multiple high-performance grinding and milling machines, plus flexible programming testing modules, the YG-1 Technical Center gives you a turnkey solution to tool design, testing and manufacturing.





"I really like seeing the tools demonstrated and actually cutting. It's very helpful to see how the tools perform in actual conditions in a wide variety of different materials and styles."

- Tier 1 automotive manufacturer



Collaboration Is Key

From your first design concepts to prototyping to final tooling, YG-1 will work with you at every turn. This partnership keeps our customers on the cutting edge with the most cost-effective tooling solutions in the industry. For group training or collaboration with our designers and engineers, the Tech Center features an expansive training room with a live demonstration area.

Design

- ▶ Advanced CAD/CAM-assisted application simulation to ensure precise design integrity
- ▶ On-site R&D specialists for advanced high-production solutions
- ▶ Expertise in aerospace, automotive, power generation and general engineering

Simulate

- ▶ Computer-aided simulation to ensure cost-effective manufacturing
- ▶ Solution application for high-strength alloys and composites required for aerospace industry
- ▶ Three-dimensional simulation provides predictable performance data consistency

Produce

- ▶ Multiple CNC stations and high-performance grinding and milling machines
- ▶ World-class microfine carbide blanks to ensure increased tool life
- ▶ Latest-generation PVD and CVD coatings for pressure-resistant performance

Test

- ▶ Threshold testing in extreme applications for reliable performance
- ▶ Laser-assisted measuring for high-tolerance reliability
- ▶ Prototype testing in actual conditions to ensure best cost per piece



Call us or contact your distributor partners to discuss your machining solution needs.

YU-AS19

BEST VALUE IN THE WORLD OF CUTTING TOOLS



A E R O S P A C E S O L U T I O N S

*Helping Aerospace Manufacturers
Reach New Heights in Productivity*

**HIGH-PERFORMANCE TOOLS
for Milling, Holemaking and Threading**

V7 PLUS A



ALU-POWER HPC



MINICUT



TITANOX



TANK-POWER



DREAM DRILLS

