

# WORTHINGTON

## DISTRIBUTION

CELEBRATING **25** YEARS  
TECHNOLOGY. INNOVATION. AUTOMATION



800-282-8864

NATIONAL DISTRIBUTOR | WWW.WORTHDIST.COM





Jump start to a new level  
of comfort.

Leviton and Samsung SmartThings  
have teamed up to offer the perfect  
home automation starter kit.



#### **LEVITON AND SAMSUNG SMARTTHINGS**

Get your next smart home project off on the right foot. The bundled kit includes the Samsung SmartThings Hub, and a wireless Leviton Z-Wave universal dimmer and light switch. Expand from there with other easy plug-ins like thermostats, sensors and extra lighting controls.

Learn more at [Leviton.com/smartthings](http://Leviton.com/smartthings)

**THE FUTURE IS ON®**

**LEVITON®**



A dream is just a dream  
until you build it.

Floating cities. Flying cars.  
The future we dreamed of  
as kids – we're making it  
real, one product at a time.



**DECORA SMART LIGHTING CONTROL**

Automate your home easily with a flexible cloud-based ecosystem that ensures comfort, safety, and lower energy bills – all controlled by your smartphone or tablet.

Learn more at [Leviton.com/decorasmart](http://Leviton.com/decorasmart)

**THE FUTURE IS ON®**

**LEVITON®**



# WORTHINGTON STAFF

## RICHARD F. SCHOLL, JR.

Founder



## NOLAN MALE

**Customer Service Manager**  
Nolan recently became our Customer Service Manager. His experience on our technical sales team and knowledge of the products we carry gives him a unique perspective on our customer's needs.



## RICHIE SCHOLL

**President**  
Richie has a background in information systems and has been with Worthington since its inception. His focus is on network and telephony products as well as bringing dealers the right products and systems with the support to back them up.



## STEVE HOH

**Technical Sales**  
Steve has extensive field experience as an alarm and A/V system installer. His product specialties include surveillance systems, IP telephony, security, and, commercial audio.



## JOHN ZITZELMAN

**Technical Sales**  
John has experience with board-level electronics and has extensive customer service experience. He specializes in automation gateways and plays a major role in the Worthington window treatment program.



## JOEL DEYOUNG

**Technical Sales**  
Joel has broad experience with the range of Z-Wave devices that are on the market today. Joel is our Lutron champion and specializes in sales and support of Z-Wave hubs and gateways.



## CHRIS KUBRAK

**Purchasing**  
Chris's time on our Technical Sales Team provides him with invaluable experience in the Purchasing position. His knowledge of our systems and how they work together helps us ensure we have the products you need when you need them.



## BARRY HAMPE

**Technical Sales**  
Barry has experience with computer systems and networking and has been with Worthington for 10 years. He has experience with nearly all the products we carry and specializes in the Z-Wave ecosystem and Omni.



## MEET THE TEAM







## Business Simplified

Dear Professional Dealer/Installer,

At Worthington Distribution our goal is to be more than just another supplier. We're competitive on price and we stock the products you use, but for us there is still more to it. Before a product shows up in the catalog or our email or flyer, we put it through its paces on our own. We want to make sure it performs as we say it will and that it aligns with what our dealers want. That hands-on experience also make us able to support you on the products you get here.

Today's systems are rarely comprised of products from one single manufacturer. We consider it our job to test that interoperability and advise you about how products work together.

The last year has seen a dramatic increase in consumer awareness of automation devices and systems. There's no doubt that it has changed the way we all do business. We have begun carrying a variety of the devices and systems that end users are increasingly familiar with. Even though they are available to end users, there will always be market for the professional installer.

We've also made it a priority to make it easier for you to gain from our knowledge and experience. Our "First Hands-On" video series is how we get you information on new products as quickly as possible. They are typically five minutes or less and we publish them as soon as we get our hands on new products. Keep an eye out for these videos in our e-mail newsletters. We also host periodic live webinars that focus on a specific product or system. They run about one hour and are free to installers. This interactive format is the best way to learn about new products. Our latest update is our new online knowledge base. Here you will find many step-by-step tutorials with screenshots and videos.

For those of you who have done business with us, we thank you very much and we appreciate your business. If you have not, we would like the opportunity to earn your business. We enjoy what we do and we take pride in it. Give us a call today to experience the Worthington difference.

Sincerely,

A handwritten signature in black ink that reads "Rich".

Rich Scholl  
Founder

A handwritten signature in black ink that reads "Richie".

Richie Scholl  
President



**Category Index**

<b>Z-Wave</b>	<b>9-33</b>		
Accessories			
Controllers			
Garage Door/Door Locks			
Sensors			
<b>Lighting Control</b>	<b>42-66</b>		
Boxes/Wallplates			
Centralized Dimming			
Occupancy			
RadioRA 2/Caséta			
UPB			
ZigBee			
<b>Energy Technologies</b>	<b>66-67</b>		
<b>Power Quality</b>	<b>68-69</b>		
Battery Backup/UPS			
Structured Wiring			
Whole House Surge			
<b>Window Treatments</b>	<b>71-78</b>		
<b>Automation</b>	<b>81-110</b>		
Accessories			
Audio			
Controllers			
HVAC			
Interfaces			
iPad/iPod Mounts			
Lighting			
Software			
Touchscreens			
Vehicle Detection			
Wireless			
<b>Irrigation</b>	<b>111</b>		
<b>Security</b>	<b>113-139</b>		
Access Control			
Accessories			
Cameras			
Contacts			
Door Strikes/Maglocks			
Environmental			
Keypad Locks			
Lighting			
Motion/Occupancy			
Panels			
Wireless			
<b>Video Surveillance</b>	<b>141-148</b>		
Cameras			
DVRs			
IP Cameras and NVRs			
<b>Multiroom A/V</b>	<b>150-163</b>		
Commercial			
Intercom			
iPod			
IR Distribution			
Multi-Source			
Single-Source			
<b>Speakers</b>	<b>166-170</b>		
All Weather			
Rock			
In-Ceiling/In-Wall			
Sound Dampening			
Subwoofers			
<b>A/V Distribution</b>	<b>171-176</b>		
Cat 5e			
Standard			
<b>Home Theater</b>	<b>177-185</b>		
Cables			
Cooling			
Mounts			
Projection			
Racks			
Speakers			
<b>Communication</b>	<b>187-195</b>		
Door Stations			
Headsets			
Intercom Systems			
Phone Systems			
IP Phone Systems			
<b>Central Vacuum</b>	<b>196</b>		
<b>Structured Wiring</b>	<b>197-213</b>		
Accessories			
Audio			
Data Modules			
Enclosures			
Phone Modules			
Power Modules			
Video Modules			
Wallplates and Inserts			
<b>Tools</b>	<b>214-217</b>		
Installation			
Labeling			
<b>Installation Materials</b>	<b>219-222</b>		
Accessories			
Brackets/Mudrings			
<b>Wire and Cable</b>	<b>224-225</b>		

Check out our sales flyer for monthly deals and savings!

**Manufacturer Index**

New Manufacturers	
Dome	• Z-Wave Devices
Domotz	• Networking Alerts
Router Limits	• Web Content Control
SmartThings	• Z-Wave Hub
URC	• A/V Control
Wink	• Z-Wave Hub

2GIG Technologies	114-115, 117-118
ACNC	195
Aeotec	19
Alarm.com	118
Alarm Controls	139
Altronix	135
Aprilaire	106
Arlington	219, 221
Arlo	148
ATW Security	124
August	27
Baldwin	24
Belden	216-217
BitWise	35, 91
Carlon	220, 222
CarTell	110
CasaTunes	161
CE Labs	176
Centralite	15, 61-63
Channel Vision	212-213
Comelit	193
Dakota Alert	109
DataComm	211
Dome	21
Domotz	65
Draper	179
DSC Security	120-124
Dymo/Rhino	214
Dynamat	170
Ecolink	23
ELK Products	102-104, 134
Encore	132
ESI	76-78
EverFocus	147
Fibaro	10-12
FortrezZ	29
Global Cache	36
Grandstream	190-191
Greenfield	94
GRI	136

Harmony Remotes	38
HomeSeer	23, 33, 94
IntelliTouch	192
Ion Security	125
IPDatatel	126
iPort	37
Jasco	33
JBL	178
Keri Systems	138
Key Digital	172-173, 177
Kwikset	24
Legrand	162, 204-209
Leviton	16-18, 66-68, 81-95, 97-101, 198-202
Leviton Omni	81-95, 97-101
Logenex	192
Lutron	45-50, 52-54
Luxul	64-65
Macurco	132
Middle Atlantic	180-183
Mini-Clik	111
Muxlab	175
Napco	129-132
NEC	188-189
Nest	41
Nortek (Linear)	23
NuTone	196
Legrand Digital Audio	162
Optex	125
Optoma	179
PCS	56-57
Platinum Tools	215
Pristine	72

Proficient Audio	166-168
Rachio	111
Radio Thermostat	31
RCS	31, 107
Resolution Products	128
Router Limits	65
Russound	150-155, 157-159
Schlage	26-27
Seco-Larm	139
SensorSwitch	94
Sillites	79
Simply Automated	58-59
SmartThings	15
Snom	190-191
Somfy	72-74
Speco Technologies	142-145, 169
System Sensor	132
Telguard	23, 126
Trane	31
Tripp-Lite	69
URC	39
USP	137
Vera Control, Inc	18
Visonic	125
Wavenet Wire	224-225
WGL & Associates	111
Wheelock	132
Wilson (zBoost)	126
Wink	26
Winland	137
Xantech	160
Yale	25
Zipato	13

**The Worthington Difference**

**Knowledge Base**

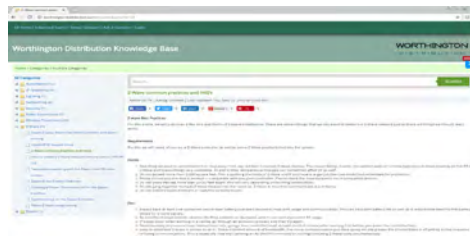

- Product Information
- Product Tips
- How-to-Articles
- Common Practices and FAQs for Z-Wave and other products

<http://www.worthingtondistribution.com/kb/>

**Webinars and Online Trainings**



- Recorded Webinars and Online Trainings
- Worthington University Schedule and Sign Up
- Manufacturer Trainings

<http://www.worthingtonu.com>





## EVERYTHING IS CONNECTED



INTUITIVE INTERFACE

### SMART HOME SOLUTION



MODULARITY



WIRELESS NETWORK



REMOTE ACCESS



IoT PLUGINS

The FIBARO smart home system is an ecosystem that allows your customers to control and manage all of their smart home devices. FIBARO can integrate with legacy home security systems, allowing for whole home security and control of safety products like sensors, door locks, intercoms and cameras as well as lifestyle devices like thermostats, lights and entertainment. FIBARO, where everything is connected.

## Understanding Z-Wave Technology

### A Mesh Network

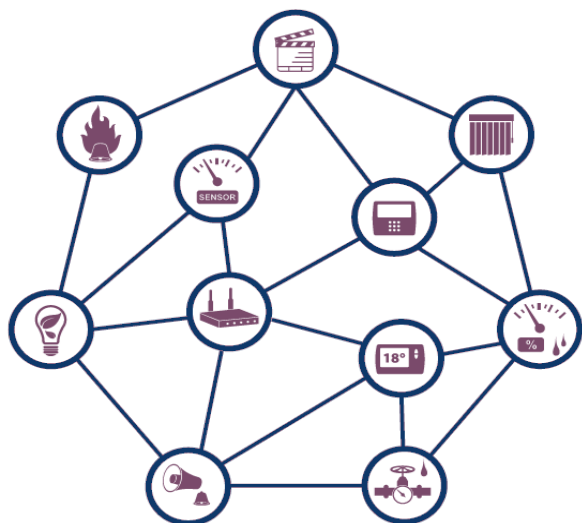

- Z-Wave is a 900MHz radio frequency mesh network communication technology which allows devices in the home to work together
- A key advantage of Z-Wave is that all Z-Wave devices can be added to any Z-Wave network
- Z-Wave is a communication standard at both the radio and protocol level. This ensures all Z-Wave products can work together (see Z-Wave - Interoperability for further details).
- Being a mesh network, Z-Wave uses other devices already on the network to deliver messages from one device to another. This applies to all devices that are plugged in or permanently powered. Battery devices do not repeat messages.
- The more devices that exist on a Z-Wave network, the better the network coverage
- To achieve Z-Wave certification, a Z-Wave device must be able to achieve 131' open air communication
- Due to construction materials and large metal objects, plan on typical installed communication distances of 30' to 35'

### Interoperability



- Z-Wave devices are designed to be learned into any Z-Wave controller. Certain controllers may limit functionality with some Z-Wave devices.
- The most important example of product differentiation in the Z-Wave ecosystem centers around lighting devices. To know if a light is on or off, the controller should poll the device for a status update. Leviton devices are unique because they have the ability to tell a controller or keypad that their status has changed without being polled.

### Primary Controller

- Every Z-Wave network is created with a primary controller
- The primary controller is responsible for adding and removing devices to the Z-Wave network



#### • Gateway Controller

- A gateway controller often (but not always) connects to a Local Area Network (LAN) and provides Z-Wave control in the home and from mobile interfaces such as an iOS device or Android phone
- Gateway controllers allow for advanced network maintenance functions, lock communication setup, and some provide interfaces to other technologies

### Network Wide Inclusion (NWI) and Explorer Frames

Network Wide Inclusion (NWI) was developed to make the installation of new devices into a Z-Wave network easier. NWI will use the existing devices in your Z-Wave network to route the information about the new device being added, to the controller that is handling the inclusion process. NWI started to appear in devices in 2011, and a large number of the total devices in your network as well as your inclusion controller, have to support NWI for the technology to work.

The Explorer Frame technology started appearing in 2013. It is used when the regular Z-Wave routing fails, perhaps because a Z-Wave node was unplugged or it failed.

All devices with the Z-Wave Plus mark will have NWI and support for Explorer Frames. Check the catalog of Certified Z-Wave Products at <http://Products.Z-WaveAlliance.org>; the advanced search allows you to look for devices supporting NWI and the Explorer Frame.

### Certified Installer Toolkit (CIT)

The Certified Installer Toolkit (CIT) is a tool for installers to test a Z-Wave network prior to completion to ensure a robust, reliable mesh network is in place. It is a powerful tool for troubleshooting and diagnosing problems. It may be left behind for logging or even permanent off-site maintenance.

Developed by the Z-Wave Alliance with the latest capabilities & offerings; the Z-Wave Certified Installer Toolkit is a versatile tool for every installer:

- Comprehensive network diagnostics & device management, accessible from anywhere in the world
- Rapidly identifies potential problems
- Spectrum analyzer shows noise in the Z-Wave channels
- Routing table displays which nodes are neighbors
- Network map graphically displays how nodes are connected to each other
- Z-Wave network sniffer (ZNIffer) shows what is actually sent by nodes and identify the type of message
- Displays advanced node information such as device version, battery level, Z-Wave library version, and more
- Access to Z-Wave device product information including manuals and technical data
- The CIT may be left at a site for long-term testing allowing you to connect to it remotely

The CIT is Z-Wave Plus certified as a controller. As a fully capable controller it can set configuration parameters and communicate with all nodes on the network, including those using Z-Wave S0 security.

The CIT is available only to Z-Wave Alliance members. Contact the Z-Wave Alliance at <http://Z-WaveAlliance.org> and find out about the membership program for integrators. Contact Worthington Distribution to learn about the benefits of integrator membership in the Z-Wave Alliance and the latest Z-Wave products available for you to start installing today.

**Troubleshoot and diagnose Z-Wave networks.**





Fibaro is a leading manufacturer of residential IoT solutions and designs. They are engineers and manufacturers of innovative and compact smart home devices that make up the advanced home intelligence platform, known as the Fibaro System. Many of Fibaro's sensors have built-in Z-Wave network range testers, support wireless firmware updates, and feature auto inclusion.

Fibaro's wireless Z-Wave smart home system can be controlled from anywhere in the world via smartphone, laptop and/or tablet. The system, along with a suite of Fibaro accessory devices and sensors allows users to create easy to access scenes, manage energy usage, and integrate hundreds of devices including cameras, lights, locks, shades and numerous household systems, including entertainment.

### Home Center Controllers

The Fibaro Home Center controllers are comprehensive Z-Wave gateways with a stunning user interface, full home control, and automation capability. They include an extensive library of 3rd party plug-ins for smart TVs, VOIP (HC2 only), cameras, thermostats, alarm panels, and media players. Multi-media integrations can be made with Virtual Device Creation via RS232 or HTTP as well. Home Center 2 also allows for legacy alarm integration and includes a detailed energy management panel.

Features	Home Center 2 (HC2)	Home Center lite (HCL)
Graphic Scene Editor	Yes	Yes
LUA Programming	Yes	No
LUA Based Scenes	Yes	No
LUA Based Devices	Yes	No
Virtual Multimedia devices	Yes	Yes
Lili - Voice Control	Yes	No
Voice Over IP server	Yes	No
Expansion Slots	No	Yes
Processor	Intel Atom 1.6Ghz	ARM Cortex-A8 (720MHz)



FIBFGHCL	Fibaro Home Center Lite	227.31
FIBFGHC2	Fibaro Home Center 2	608.88

For information on third party plug-in's, see page 12!

### Home Center Controller's Interface

The Home Center's interface allows you to install additional sets of icons for rooms, devices, scenes, etc., without having to interfere with the graphics. Fibaro has also made it possible to change the arrangement of particular icons and to move them about in such a way so that the ones used most frequently are always close at hand. The Everyday Activities Bar has been designed for users to create their own shortcuts to the scenes they use most often.



### 500 Series Z-Wave

The Z-Wave chip continues to be developed at an exciting pace, generation after generation improving upon the core technology, generation after generation improving upon just how perfect the Z-Wave chip is for home automation. Z-Wave takes another leap forward with release of Z-Wave 500 series, a next-generation upgrade to the Z-Wave chip and Z-Wave module. The 500 series of Z-Wave has been developed as an upgrade to both the predecessors. End users and consumers won't directly see the differences between the different Z-Wave chips, but they'll certainly see the benefits inherent in the 500 series.

A few benefits of the 500 series chips are:

- Network-Wide inclusion
- OTA or Over The Air Updates
- Increased Bandwidth
- New Skills with IR learning/generation



For any further questions on 500 series Z-Wave, give us a call at 800-282-8864!

**Fibaro Scene Control**



The Fibaro Swipe is a revolutionary gesture-control pad that provides control of home automation devices within the Fibaro eco-system without actually touching anything. The control is made possible by associating a gesture to a command. The placement and possibilities of the Fibaro Swipe are truly

endless. Mount Swipe under the countertop or behind the wall for completely seamless integration. Imagine swiping up to open the roller shades, swiping down to turn off the lights, swiping right and the music comes on, swiping left to turn the TV on. With four short swipes, the living room is transformed into a home theater! Swipe's only limit is your imagination.

FIBFGG-001	Fibaro Swipe	122.40
------------	--------------	--------

**Z-Wave Sensors**

- Compact sensor comes in 7 colors
- Temperature sensor capability - call for more info
- Dual tamper (opening device or movement)
- Binary input terminal allows for additional expandability of wired binary devices (smoke, CO, motion detectors)
- Binary input can incorporate push button switches
- Remote auto firmware update (HCL or HC2)
- Scene activator for lighting and security system



FIBFGK-10*	Door / Window Sensor	40.58
------------	----------------------	-------

\* 1-White, 2-Silver, 3-Black, 4-Sand, 5-Caramel, 6-Brick, 7-Brown

**Flood Sensor**

- Universal, Z-Wave-compatible, water and temperature sensor
- Battery or VDC powered (12/24 VDC)
- Alarm panel integration capable
- Built in LED indicator and acoustic alarm
- Dual tamper protection (movement or opening device)
- Built-in Z-Wave network range tester
- Remote automatic firmware update with HCL or HC2



FIBFGFS-101	Fibaro Flood Sensor	48.70
-------------	---------------------	-------

**Motion Sensor**

- Wide angle, ultra sensitive detection with finite adjustment capability
- Visual color LED alerts of temperature, alarms, and battery status
- User selected color alert, intensity, duration, or off
- Built in Z-Wave network range tester
- Convenient small size and tamper protection



FIBFGMS-001ZW5	Fibaro Motion Sensor	48.70
----------------	----------------------	-------

**Z-Wave devices coming soon!**

**Key Fob**

FIBFGKF-601	Fibaro 6-button Key Fob	CALL
-------------	-------------------------	------

The Fibaro KeyFob is a Z-Wave Plus compatible, battery-powered, compact remote control. Six buttons allow you to control other devices through the Z-Wave network and run various scenes defined in FIBARO System. Configure actions for one, two, three clicks and holding the button to suit all your needs. Built-in locking system will ensure that unauthorized person will not take control of your home.



**Roller Shutter controller**

FIBFGRM-222	Roller Shutter Controller, use on any limit switch AC motor, Z-Wave range tester	56.82
-------------	--	-------



The Fibaro Roller Shutter Controller is a universal, Z-Wave compatible, electric motor controller. The device allows for controlling motors of roller blinds, awnings, venetian blinds, gates and others, which are single phase AC powered.

**For Audio, Security, and Intercom devices, please refer to the next page!**



This small, but very powerful Fibaro Button allows the user to run five preprogrammed scenes along with a Panic Scene. Different scenes can be triggered with a single push, double push or by holding the Button down. This useful device is battery powered and comes in 8 different colors.

FIBFGPB-101-*	Fibaro Button	40.58
---------------	---------------	-------

\* 1-White, 2-Black, 3-Red, 4-Yellow, 5-Green, 6-Blue, 7-Brown, 8-Orange

**Z-Wave RGBW Controller**

The FIBARO RGBW Controller is a universal, Z-Wave compatible module that controls LED, RGB, RGBW strips, halogen lights and fans via 12 or 24 VDC. Change the color of the lights right from your mobile device. The controller supports up to four 0-1 OV passive analog sensors such as temperature sensors, humidity sensors, wind sensors, air quality sensors and light sensors. All IN and OUT terminals may be user-configured for LED control or OV-1 OV signal readouts.

FIBFGRGBWM-441	RGB/RGBW Controller for compatible LED color changing lights	56.82
----------------	--	-------



Use the preconfigured scenes or create your own custom RGBW scenes for a personalized lighting experience.

**Built-In Range Testing**

Fibaro sensors that feature built-in range testing can tell you if your placement of the device is within the Z-Wave network. When successfully included in the network, a green light means direct communication with the primary controller, amber means it is repeating through another node, and red means out of range.







**Russound Audio Plug-ins**

Fibaro offers plug-ins for Russound's streaming devices including the Russound MCA88X, XSOURCE, XZONE4, and XZONE70V. The plug-in will give you the ability to control your sources, volume control and play/pause and skip functions.



RSXSOURCE	Russound Single Source Streamer	246.00
RSXZONE4	Russound 4 Zone Streaming amplifier	1,169.00
RSXZONE70V	Russound 4 Zone Streaming 70V Amplifier	715.00
RSMCA-88X	Eight Source, Eight Zone Controller Amplifier with built in streamer	1,749.00

**You can view the entire Russound product line on pages 150-159.**



**Security Integration Plug-ins**

The Fibaro Home Center Controllers will integrate with the DSC Powerseries panels to create not only a very robust security system, but you will also have the ability to trigger automation based on the state of the sensors on the DSC panel. This integration requires an IP bridge piece from Global Cache. The Global Cache GCIP2SL will give you the ability to go from the DSC IT100 hardwired serial module to an IP communication to speak with the Home Center Controller.



**You can view the entire DSC product line on pages 120-124.**



**Camera Integration Plug-ins**



Integration with security cameras doesn't get any more seamless than this! All you need to do is download the Speco Technologies Plug-in specifically for your camera and you can then add it to your Fibaro via an IP address to view your live feed. Not all Speco Cameras are supported at this time.

**You can view the entire Speco Technologies product line on pages 142-143.**



**IP Phone/Intercom Integration**

Fibaro offers a VOIP server exclusively with the Fibaro Home Center 2, which means we have the ability to program phone extensions and create a local/remote phone system. This also means that we can include an outdoor video intercom unit to work with the phones inside your home.

GRAGXV3275	Grandstream Android powered 7" color touchscreen desk phone with camera	212.06
LSAINDS1-S	Leviton IP enabled SIP door station	498.60
LGXTPC	Logenex Teleport IP Door station controller only	389.33
LGXTP202XVC	Surface mount IP video door station with Panning Camera	

**For a complete listing of Grandstream IP phone options, please refer to pages 190-192.**



GRAGXV3275



LSAINDS1-S



LGXTP202XVC



**Global Cache Parts for Fibaro Integration**

GCWF2IR	Wireless to IR, control IR devices over Wi-Fi, 3 emitters, 1 blaster, power supply	109.91
GCIP2IR	Wired to IR, control IR devices over IP, 3 emitters, 1 blaster, power supply	91.18
GCWF2SL	Wireless to serial, control serial over Wi-Fi, power supply	109.91
GCIP2SL	Wired to serial, control serial over IP, power supply	91.18



GCIP2SL



GCWF2IR

**Other Plug-ins Worth Mention**



Fibaro has a large variety of plug-ins to work with their Home Center Controllers. For additional information please contact Worthington Distribution.

**Zipato Automation Controllers**



Zipabox is a next-generation automation controller that lets you control all of your home electronics. Most often it uses simple, reliable, low-power radio waves that easily travel through walls, floors and cabinets but it can also use existing powerlines or BUS wires to connect your home electronics. Zipabox can control many electronic devices in your house, such as appliances, window shades, thermostats, and home lighting.



**ZIPBZWUS** Expandable Z-Wave Automation Controller 156.59

The ZipaMini plugs into any outlet in the home and automatically talks to all the connected devices in the house, connecting them to the cloud so that consumers can control them using tablets, smart phones, computers or TVs— at home or on the go. The ZipaMini Gateway supports a variety of communication standards including: Z-Wave, ONVIF, IP and UPnP.



**ZIPBMINITVZWUS** ZipaMini Hub 77.90

**Zipatile**

<b>ZIPZTWUSZBEE</b>	Zipatile touchscreen controller with Z-Wave AND ZigBee - Black	298.22
<b>ZIPZTWUSZBEEWH</b>	Zipatile touchscreen controller with Z-Wave AND ZigBee - White	298.22



ZipaTile with Z-wave and Zigbee is the complete home control system in the form of a single device. It can be easily mounted on any wall, in any home. Featuring a large number of built-in sensors and hardware modules, ZipaTile will replace numerous home devices such as a security system, thermostat, automation controller, IP camera, alarm siren, or intercom. This brings it all together in one, smart and beautiful device.

- SIP Server client
- Door phone control
- Conference calls
- Video calls
- Dual-network IP connectivity
- Remote control with smartphone



**Expansion Options**



<b>ZIPBMBACKUPV2</b>	Provides whole system with up to 24 hours of power autonomy	77.90
<b>ZIPBZMIGBEE</b>	Add ZigBee to Zipabox	46.43
<b>ZIPBZMSERIAL</b>	Add RS-232/485 and USB to Zipabox	38.56
<b>ZIPBZMSECURITY</b>	Add up to 6 wired security zones and RS-232/485 to Zipabox	109.37
<b>ZIPBZMPOWER</b>	Add power metering for 4 circuits to Zipabox	117.24
<b>ZIPAMPCLAMP35</b>	AC current sensor with DC male plug. For use with the power module	19.67

**Security Sensors**

<b>ZIPVSZD2102US</b>	Magnetic door and window contact	34.62
<b>ZIPVSZP3102US</b>	Multi-sensor duo, passive infrared receiver, temperature sensor	36.98
<b>ZIPPHPSM01US</b>	Multi-sensor trio, door/window contact, temperature sensor, and light sensor	38.56
<b>ZIPPHPSM02US</b>	Multi-sensor quad, door/window contact, presence detector, temperature sensor, and light sensor	46.43
<b>ZIPPHPSG01US</b>	Smoke Sensor	46.43



**ZIPVSZP3102US**



**ZIPPHPSM02US**



**ZIPPHPSG01US**

**ZIPPHPSM01US**

**Accessories**

<b>ZIPB3GUSB</b>	Plug-in stick for 3G backup connectivity	37.77
<b>ZIPWTRFIDUS</b>	RFID reader and key tag, up to 20 codes	46.43
<b>ZIPHPAN04US</b>	MicroModule double switch, 6A or 1500W	46.43
<b>ZIPHPAN08US</b>	MicroModule motor controller, 230V for blinds, shutters, etc., 1.8 amp max. output	46.43
<b>ZIPRGBWE27ZWUS</b>	RGBW LED bulb, control bright, dim, and thousands of colors via Z-Wave	46.43
<b>ZIPRMZXT120US</b>	IR Extender	62.16
<b>ZIPHPSR03-2BUS</b>	4-Button Remote/Keyfob	46.43
<b>ZIPHPSE02US</b>	Multi-sound indoor siren	62.16



**ZIPHPSE02US**



**ZIPRGBWE27ZWUS**



**ZIPWTRFIDUS**



Largest quality range  
of Z-Wave products.



11 Years Experience • 35 Products • 85 Countries • 100% Reliability

When it comes to building their systems upon reliable Z-Wave technology, brands turn to Aeotec. Available for over 10 years and in over 83 countries, we've built our reputation upon the largest and highest-quality range of Z-Wave products, designing and producing each one in-house for multi-nationals and niche players.

The latest from Aeotec.



**Smart plug with energy metering.**

Smart Switch 6 - Convert any wall outlet into a Z-Wave wall outlet just by plugging it in - it's plug and play.



**Make any switch or outlet Z-Wave connected.**

Nano Switch & Nano Dimmer - Install behind a switch. Convert any light or socket to a Z-Wave controllable switch or dimmer.



**Amplify and extend any Z-Wave network.**

Range Extender 6 - Receive Z-Wave signals, amplify them and then rebroadcast them to your Z-Wave network, boosting its range and quality.

decora smart™ Wi-Fi

Leviton offers a revolutionary new innovative Wi-Fi based lighting system that uses your Smartphone. Simply download the free app which is available for Android and iOS devices. The app is used to control the system, and it also adjusts scenes and schedules that are built into the devices. This allows for a full lighting system, **no hardware controller needed!** Keep an eye out later this year for integration with other home automation devices from other manufacturers.



- ①  **Decora Smart Switch**
  - ②  **Decora Smart 600W Dimmer**
  - ③  **Decora Smart Plug-In Dimmer**
  - ④  **Decora Smart Plug-in Outlet**
  - ⑤  **Decora Smart 1000W Dimmer**
  - ⑥  **Voice Control and Activation**
  - ⑦  **Remote access and control**
- Keep an eye out for cloud-to-cloud functionality with other manufacturers coming soon!**

LEVITON decora® smart™



LEVDW1KD-1BZ



LEVDW15S-1BZ

Wi-Fi Dimmers

LEVDW1KD-1BZ	Wi-Fi Dimmer. 1000W incandescent, 450W CFL and LED, 1000VA Mark 10 ballasts, 120VAC. Neutral required.	49.95
LEVDW6HD-1BZ	Wi-Fi Dimmer. 600W incandescent, 300W CFL and LED, 120VAC. Neutral required.	44.95
LEVDD00R-DLZ	Matching remote dimmer with LED indicator. Neutral required.	22.03

White and Light Almond included.  
Call for Ivory, Gray, Black, and Brown color change kits.

Wi-Fi Switches

LEVDW15S-1BZ	Wi-Fi Switch. 15A, 120VAC. Neutral required.	44.95
LEVDD0SR-1Z	Coordinating remote switch, no LED indicator.	18.15
LEVDD0SR-DLZ	Matching remote switch, with LED indicator. Neutral required.	20.73

White and Light Almond included.  
Call for Ivory, Gray, Black, and Brown color change kits.

Wi-Fi Plug-Ins



LEVDW3HL-1BW



LEVDW15A-1BW

LEVDW3HL-1BW	Wi-Fi Plug-In Dimmer. 300W incandescent, 100W CFL and LED. 120VAC.	39.96
LEVDW15A-1BW	Wi-Fi Appliance Module. 15A, 120VAC.	39.96

Coming Soon! decora smart™ Home Kit

**Hey Siri®,**  
Turn On my...  
Smart Home from Leviton



No matter which compatible accessories you choose, the Apple HomeKit app makes it easy to set up and control all of them, all from one place. Over 50 brands worldwide are committed to providing products that are compatible with HomeKit, and the number of available accessories is growing every day. Leviton will be releasing an entire HomeKit line in the decora smart™ style. All of the great Leviton devices you are familiar with and love will be controlled from the Apple HomeKit App. Release is expected Q2 of 2017.





**SmartThings**



**Whole House Automation  
Made Simple**



SmartThings Hub

LEVDZ6HD-1BZ

LEVDZ15S-1BZ

LEVSTKIT-2DS SmartThings Bundle. Includes the SmartThings Hub, (1) LEVDZ6HD-1BZ Dimmer and (1) LEVDZ15S-1BZ Switch 189.85

LEVDZ6HD-1BZ Z-Wave Plus 600W Dimmer, 120VAC. 44.95

LEVDZ15S-1BZ Z-Wave Plus 15A Switch, 120VAC. 44.95

White and Light Almond included

Start your next smart home project with the Samsung SmartThings Hub and Leviton Vizia RF + bundle. Wirelessly control lighting in the home to protect property, save energy, and make everyday living more fun with app control and automation. Set Leviton lighting controls to activate when there's motion, or turn off when there isn't, and automate multiple lights with one button. Connect all of your smart devices to one hub for simple control of your home. SmartThings is a refined hub that allows for powerful user control.

**SmartThings uses geofencing to work with your favorite Leviton products!**

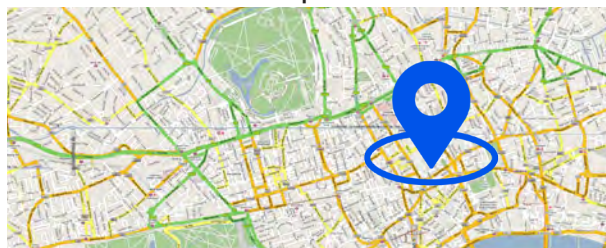

**Works with SmartThings**



SmartThings can talk to your favorite Z-wave and Zigbee devices. Give us a call to learn more about water valves, locks, specialty sensors, cameras, voice assistants, and more!

**decora smart™ Z-Wave**



LEVDZ1KD-1BZ



LEVDZ15S-1BZ

The new Decora Smart™ with Z-Wave Plus Technology family of products features five devices including in-wall dimmers, a switch, and plug-in modules for appliances and lamps. The family of solutions utilizes the latest generation of technology for advanced wireless lighting control products. In-Wall Dimmers and switches boast the new Leviton design with true rocker action, pressing the top to turn on and the bottom to turn off. Vanishing LEDs to the left of the Dimmer paddle show current and target light level with real-time feedback.

**Z-Wave Switches**

LEVDZ15S-1BZ Z-Wave Switch. 15A, 120VAC. 44.95  
Neutral required.

LEVDD0SR-1Z Coordinating remote switch, no LED 18.15  
indicator

LEVDD0SR-DLZ Matching remote switch, with LED 20.73  
indicator. Neutral required.

White and Light Almond included.

Call for Ivory, Gray, Black, and Brown color change kits.

**Z-Wave Dimmers**

LEVDZ1KD-1BZ Z-Wave Dimmer. 1000W incandescent, 450W CFL and LED, 1000VA Mark 10 ballasts, 120VAC. Neutral required. 49.95

LEVDZ6HD-1BZ Z-Wave Dimmer. 600W incandescent, 300W CFL and LED, 120VAC. Neutral required. 44.95

LEVDD00R-DLZ Matching remote dimmer with LED indicator. Neutral required. 22.03

White and Light Almond included.

Call for Ivory, Gray, Black, and Brown color change kits.



LEVDPD3-2BW



LEVVR15-1LZ



LEVDZ15S-1BZ

**Z-Wave Plug-Ins**

LEVDPD3-2BW Z-Wave Plug-In Dimmer. 300W incandescent, 100W CFL and LED. 120VAC. 27.35

LEVDZ15S-1BZ Z-Wave Appliance Module. 15A, 120VAC. 44.95

LEVVR15-1LZ Tamper Resistant split outlet 15A Top controlled bottom on. 300 series. White, Ivory, and Light Almond colors included. 51.83

**Works With SmartThings: Lumina RF**

Leviton's powerful wireless Lumina RF products ensure energy savings in new construction and retrofit, controlling lamps, fans, shades, pumps, and more! These devices are compatible with Samsung SmartThings. This 2.4GHz mesh network technology has a proven track record in light commercial applications for distance and reliability. Lumina RF solutions are ideal for restaurants, cafes and coffee shops, retail shops, franchise stores, small and private office spaces, and more.

**Lumina RF Load Control Options**



**LSAZSS10-G0Z**

LEVDL3HL-1BW	Lumina RF Plug-In Dimmer. 300W incandescent, 100W CFL and LED.	34.96
LEVDL15A-1BW	Lumina RF Plug-In Appliance Module. 15A.	34.96
LEVDL1KD-1BZ	Lumina RF Dimmer. 1000W incandescent, 450W CFL and LED, 1000VA Mark 10 ballasts.	49.95
LEVDL6HD-1BZ	Lumina RF Dimmer. 600W incandescent, 300W CFL and LED	44.95
LSAZSS10-G0Z	Lumina RF Switch. 10A,120-277VAC. No neutral.	69.94
LSAZSS10-N0Z	Lumina RF Switch. 10A,120-277VAC. Neutral required.	69.94
LSA73A00-3ZB	Lumina RF Heavy duty load control module. 30A, 120/240VAC.	179.86

**Lumina RF Sensors**



**LSALURMD-W**



**LSALURDW-W**

LSALURDW-W	Lumina RF Door/Window contact	37.35
LSALURMD-W	Lumina RF Motion Detector	51.96

**Thermostats**



**LSARC1000WHZB**



**Easily adjust the display**

LSARC1000WHZB	Lumina RF Thermostat: conventional single stage, heat pump and dual fuel systems	208.83
LSARC2000WHZB	Lumina RF Thermostat: conventional 2 stage, 3 stage heat pump, dual fuel systems, humidity and dehumidification	248.80

**Vizia RF + Programming Tools and Serial Interface**

LEVVR0P-1LW*	Vizia RF + plug-in Z-Wave serial interface with beaming support, Use with Omni controllers. Includes RJ-11 and standard serial cable.	89.15 or FREE
LEVVRUSB-1US*	USB adapter for use with the Leviton Vizia RF + Installer software	69.92

Download the FREE Vizia RF + Installer Software from [www.leviton.com/rfinstaller](http://www.leviton.com/rfinstaller)



**LEVVRUSB-1US\***



**LEVVR0P-1LW\***

Receive a FREE Vizia RF + serial module when purchasing \$500 of Vizia RF +. Call for details.

\* Not compatible with SmartThings

**Vizia RF + Scene Controllers**

**Scene Controllers**

- 4 Buttons (single push)
- Dim / Bright
- IR Receiver
- Control scenes On / Off

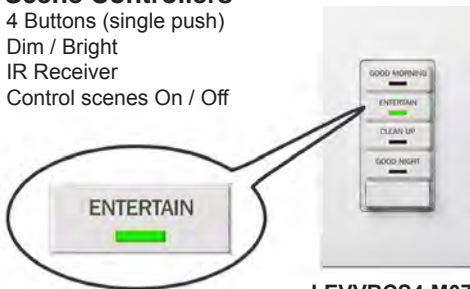

**LEVVRCS4-M0Z\***

\* Not compatible with SmartThings

LEVVRCS4-M0Z*	Vizia RF + 4-Button Scene Controller: 4 buttons, dim, bright, IR, beaming support	109.55
---------------	---	--------

White, Ivory, and Light Almond included

**Vizia RF + Zone Controllers**

**Zone Controllers**

- 4 On / Off Rockers (Left on, Right off)
- Dim / Bright
- IR Receiver
- Control loads On / Off

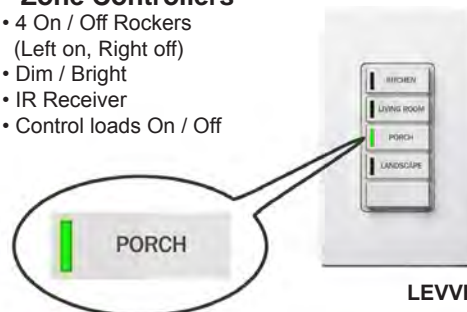

**LEVVRCS4-M0Z\***

\* Not compatible with SmartThings

LEVVRCS4-M0Z*	Vizia RF + 4-Button Zone Controller: 4 on/off rockers, dim, bright, IR, beaming support	115.03
---------------	---	--------

White, Ivory, and Light Almond included



Vera Control, Inc. Vera Smart Home Controller

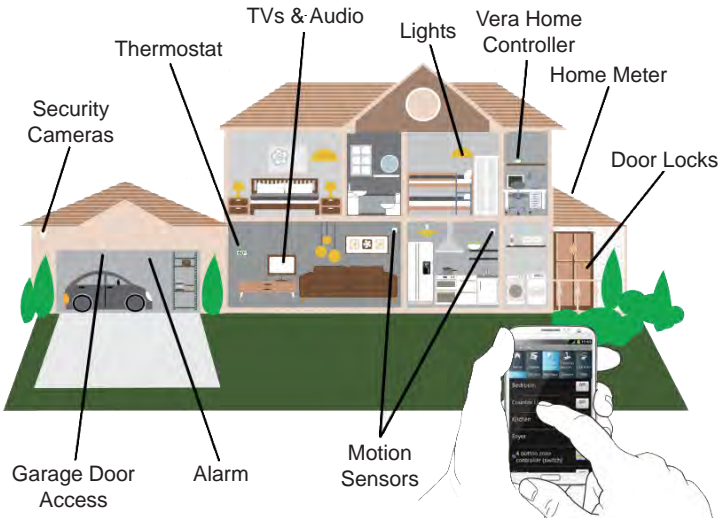

- No Monthly Fee: Secure, remote access from any web-enabled device
- Vera Control, Inc. guarantees compatibility with all Z-Wave certified devices including locks, scene controllers, sensors, lighting controllers, thermostats, energy metering and more
- Vera's advanced energy metering capabilities allow homeowners to take control of their energy bill and start saving money
- Stream live video from IP cameras; store video footage on Vera Control, Inc.'s secure servers that can be accessed from anywhere
- Bridge multiple Vera controllers over Ethernet, allowing two separate Z-Wave networks to operate as a single system
- No broadband connection is needed for local control. Vera can be set up and configured without an internet connection
- MiOS, Vera's home control engine, has open architecture allowing developers to create new apps and products that can integrate with Vera
- There is an active Vera Control, Inc. community that offers applications that extend the capabilities of a Vera. Examples include weather forecasting, media control, alarm panel integration, and remote live video streaming.

IP Cameras



Model	Specifications	Price
MICVISTACAM-700	1280 x 720 High Definition 720p Pan/Tilt Wireless Camera, Microphone, IR Night Vision, SD Card Support	81.18
MICVISTACAM-900	1920 x 1080 High Definition 1080p ePTZ Wireless Camera, Microphone, IR Night Vision, SD Card Support	CALL
MICVISTACAM1100	1280 x 720 High Definition 720p Outdoor Wireless Camera, Microphone, IR Night Vision, SD Card Support	221.07
MICVISTACAM1101	1920 x 1080 High Definition 1080p Wireless Camera, Microphone, Weatherproof Enclosure, IR Night Vision, PoE, Motion/Audio detection	CALL



MICVERAEDGE-US



MICVERAPLUS-US

Easy yet powerful one-app control for cameras, door locks, sensors, thermostats and other home automation and security devices (sold separately) you can view and control from anywhere! Create custom scenes and sequences. Use a smart phone, tablet or computer for control and set up. Provides home and small business security, energy savings and peace of mind. Compatible with 1200+ devices from most major brands.

MICVERAEDGE-US	VeraEdge Smart Home Z-Wave Controller	74.94
MICVERAPLUS-US	VeraPlus Smart Home Controller with Bluetooth, ZigBee, and Wi-Fi features	112.41

New VeraSecure Controller

- Compatible with a wide range of wireless devices that use ZigBee, Bluetooth, Z-Wave, and Wi-Fi technologies.
- Built-in Telit 3G Module for secondary alarm reporting
- 4-8 Hours backup via internal battery
- Built-in Siren for local alarm notification
- Optional 2-Way audio for CMS (Central Monitoring Service), preset phone number, or in app communication
- CPU: 880MHz MIPS SoC
- Flash: NAND 128MB
- Memory: DDR3 512MB
- Z-Wave: Z-Wave/Z-Wave Plus
- ZigBee: HA 1.2
- Bluetooth: 4.0 + BLE
- Wi-Fi: 802.11 a/b/g/n/ac
- USB Port: USB 2.0
- WAN Port: Gigabit Ethernet
- VeraLink (345MHz)
- Battery: 2400mAh/18Wh

MICVERASECURE-US	VeraSecure Smart Home Z-Wave Controller with Security Features	CALL
------------------	--	------

Z-Wave Interoperability

Vera Control, Inc. guarantees compatibility with all Z-Wave certified devices



**The Vera Control, Inc. Smart Home Controller**

The Vera Control, Inc. Smart Home Controller works with all Z-Wave certified devices



**Sensors**

Z-Wave sensors report activity. Control Z-Wave devices or receive notifications based on sensor activity.



**Electronic Locks**

Lock doors at night or open the door for guests from anywhere in the world. Receive notifications when the door is unlocked.



**Wireless Cameras**

Keep an eye on your home from an iOS or Android mobile phone



**Thermostats**

HVAC systems consume the largest amount of residential electricity. Z-Wave thermostats make saving energy easy.



**Lighting Controls**

Z-Wave technology offers a wide range of control devices to simplify a homeowner's life or save energy

**Box/Fixture Mount Modules (Nano/Micro)**

AEOZW139-US	Nano switch module, 15A	35.82
AEOZW116-US	Nano switch module, 15A with load monitoring	37.87
AEOZW130-US	Dual Nano switch module, 15A with load monitoring	37.87
AEOZW111-US	Nano Dimmer module with load monitoring, 150W, Z-Wave Plus	37.87
AEOZW140-US	Dual Nano switch module	38.40



AEOZW111-US



AEOZW139-US

**Doorbell and Siren**

AEOZW056-US	Wireless doorbell with plug-in chime. Doorbell button to the chime unit is 433MHz. Chime unit can send, repeat and transmit Z-Wave. Choose between multiple chimes.	38.90
AEOZW080-US	Plug-in 110dB siren with battery backup. Siren can send, repeat and transmit Z-Wave.	37.63



AEOZW080-US



AEOZW056-US

**Network Devices**

AEOZW117-A	Range Extender 6. Plug-in Z-Wave repeater, extend Z-Wave networks	20.38
AEODSA03202W-US	Minimote, 4-button scene controller, can be used as an inclusion controller or a primary remote, white	35.14



AEOZW117-A



AEODSA03202W-US

**Smart Energy Interfaces**

AEODSB28-US	Smart energy meter, 2nd generation, highly accurate power factoring	35.14
AEOZW095-US	Gen5 energy meter, highly accurate power factoring	73.95



AEODSB28-US



AEOZW095-US

**Load Control Modules**



AEOZDSC11101-US



AEOZW096-A02

AEOZW075-A02	Gen5 15A appliance module	32.37
AEOZW096-A02	Smart Switch 6, 15A with USB port and LED to indicate energy usage	40.14
AEOZW099	Smart Dimmer 6, 300W with USB	40.14
AEOZDSC11101-US	Z-Wave 15A power strip, 6 outlets, 4 controlled, reports consumption in W or accumulated kWh usage	59.82
AEOZW078-A	90-260VAC, 40A, heavy-duty appliance switch with load monitoring, IP43 rated for outdoor applications	81.37

**Sensors**



AEOZW112-US



AEOZW100-A



AEOSDE010

AEOZW120	Door/window sensor Gen5	27.62
AEOZW112-US	Door/window sensor 6	34.61
AEOZW089-US	Recessed door/window contact	31.07
AEOZW097	Retrofit any electronics that have 12V dry contact output to a Z-Wave network. You'll know if they're on/off or open/closed.	30.79
AEOZW074	Gen5 multisensor: motion, temperature, humidity, light	32.93
AEOZW100-A	Multisensor 6, Gen5, motion, temperature, humidity, light, UV, vibration	40.14
AEODSE010	Recessor for Multisensor 6	11.76

**Other Devices**

AEOZW121-A	RGBW LED Strip, 5M (16.5')	125.47
AEOZW062-A	Garage door controller	81.52
AEOZW088-US	Keyfob remote, Gen5, 4 buttons, 8 scenes	31.20
AEOZW090-A	Z-Stick, Gen5	33.57
AEOZW129W	2-button Wallmote, white	39.79
AEOZW130W	4-button Wallmote, white	39.79

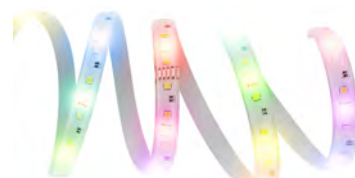

AEOZW121-A



AEOZW062-A

Looking for something else?  
Aeotec is adding new products all the time. Give us a call today.



dôme



Dome is the premier home automation brand from Elexa Consumer Products Inc. offering high quality Z-Wave devices. Attention to detail, top-rated components and top-notch engineering make Dome products the smart choice for integrators and end users alike. Dome's line of Z-Wave products was created with one goal in mind: to provide superior quality home automation devices at an affordable price. Their versatile devices are designed to integrate flawlessly with other Z-Wave products, enabling homeowners to create a truly custom smart home experience. Dome's products have been tested to work reliably with SmartThings, Vera, Staples Connect, HomeSeer, URC, Nexia, and more.



**Dome Z-Wave Sensors**



Add the Dome Leak Detector to your next installation to prevent the next disaster!

- Battery powered and low-profile
- Flexible mounting and external sensor probe optional.

DOMDMWS1 Dome Leak Sensor 34.34



The Dome Door/window sensors have some unique features that make this sensor special!

- Battery powered and low-profile
- Versatile applications with doors, windows, garage doors and even cabinets and drawers.

DOMDMWD1 Dome Door/window sensor 24.04



Detect presence and trigger events in every room with the Dome Motion sensor!

- Low profile and versatile mounting
- Battery powered
- Adjustable sensitivity
- Built in light sensor and extra wide 110° area of detection!

DOMDMMS1 Dome Motion sensor 30.90



Be in the know with Dome's Siren sensor with unique sounds!

- Three volume levels with multiple sounds for non-critical event notifications.
- Battery powered and flexible mounting as well as low profile.
- Alert those nearby with visual AND audio alerts.

DOMDMMS1 Dome Motion sensor 30.90

**Z-Wave Water Valve Controller**



Control your home's water autonomously with the Dome Water Valve Controller. With this amazing device, you can automate any quarter-turn valve in your house to provide a peace of mind that even the insurance companies appreciate! Due to the flood prevention aspect, many insurance companies will offer a premium reduction. In addition to these benefits, This device has a built in range extender as well as an extra long cord for easy installation. The best part of this device is that you do not need a plumber to install it! The valve installs on existing valves (up to 1-1/2") for ease of installation! This easy to install device only requires a screwdriver for installation.

DOMDMWV1 Water Valve Controller 68.68

**Other Z-wave Devices**



Automate every light and device in your house with the Dome Smart Plug. With this low profile device, you can control a single outlet and not obstruct your other receptacle. This Smart Plug will not only repeat the Z-wave signal but it will also read the amount of energy that your devices are using.

DOMDMOF1 Dome On/Off Smart Plug 30.91



With this one-of-a-kind device from Dome, you can humanely eliminate rodents with an electrical jolt. The Mouser from Dome would be able to send you a notification should it encounter an unwanted guest. The device is battery operated and is easy clean-up.

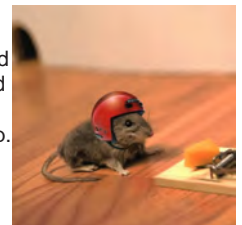

DOMDMMZ1 Dome Mouser 54.94

**Z-Wave Do's and Don't's**

- Always have at least one hardwired device near battery operated devices to help with range and communication. This can help with battery life as well as it reduces the need for the battery device to re-send signals.
- Be mindful of large metallic objects, like filing cabinets or ductwork, which can severely restrict RF range.
- If issues occur when learning in a device, go through an exclusion process and then try again.
- When learning in a secure-class device (door lock, garage door controller) wait at least one full minute after learning it in before you move the controller/lock.
- Keep in mind that Z-Wave is similar to Wi-Fi. There is limited amount of bandwidth. The more communication you have going on, the greater the chance there is of getting a slow response or losing communications. This is especially true with sending an All On/Off command or locking/unlocking Z-Wave locks simultaneously.



- We do not recommend outdoor mounted Z-Wave Devices. Exterior walls can severely impede RF transmission, causing reliability issues in your Z-Wave network.
- Avoid exceeding more than 5,000 square feet. We can assist in finding a suitable solution for your larger installations.
- Please do not assume that a product is compatible with any given controller. Please check the manufacturer's list of compatible devices.
- Avoid placing devices more than 25-35 feet apart. This will vary depending on building construction.
- Avoid ganging together multiple Z-Wave devices into the same ox. Z-Wave is meant to communicate at a distance.
- Avoid installing Z-Wave dimmers or switches in metal boxes. This will impede the Z-Wave transmission.



Keeping  
the water  
out of here...



So you can  
enjoy the water  
here

Our water damage prevention system will give you the peace of mind that your home is protected even when you're away.

## AUTOMATED WATER CONTROL

### FLOW METER

Get reports on consumption, detect leaks or unwanted use!

### AUTOMATED SHUT-OFF VALVES

Indoor & Outdoor installed Units now Available!

### WATER SENSORS

Detect floods instantly and alert the system to turn off the water!



[fortrezz.com](http://fortrezz.com)

(704) 940-9118

**FORTREZZ**

2GIG-PD300EMZ51	Plug-in Lamp Module, 300W, dimmable	29.51
2GIG-PS15EMZ5-1	Plug-in Appliance Module, 15A, relay	32.20
2GIG-WD500Z5-1	Decorator single-pole 500W neutral dimmer	32.20
2GIG-WS15Z5-1	Decorator single-pole neutral switch, 15A	32.20
2GIG-WO15EMZ5-1	Wall Outlet, 15A, one side controlled	32.20
2GIG-FS20Z-1	Isolated contact Fixture Module, rating: 20A 277VAC, 1HP 120/240VAC, 960W Inc.	32.20
2GIG-WT00Z5-1	Z-Wave Transmitter for 3-ways	32.20
2GIG-WA105DBZ-1	105dB Z-Wave Siren	40.28
2GIG-WADWAZ-1	Door/Window Sensor with external input	26.32
2GIG-WAPIRZ-1	PIR Motion Sensor	34.91
2GIG-WF00Z-1	Smart Water Leak Sensor	26.82
2GIG-GB00Z-2	Smart Glass Break Detector w/Z-Wave test button	27.48
2GIG-WI15VZ-1	15-Zone Z-Wave Irrigation Controller	74.65

\* Wall dimmer and switch are white, color trim kits are available in Almond, Black, Brown and Ivory. Call for details.

**New for 2017 are Z-Wave Plus Certified devices which have better range and use Network Wide Inclusion.**

Compatible with virtually any automatic garage door opener connected to a sectional garage door, installers only need to 'pair' the unit into a gateway, mount the unit, connect two wires and plug it in.



Providing both audible and visual warnings prior to door movement, the GD00Z-5 meets UL 325-2010 safety requirements. These built-in measures (in addition to the safety features that come with the garage door opener) make this a safe way to remotely open / close a garage door.

LNGD00Z-5	Z-Wave Garage Door Remote Controller Accessory	74.65
-----------	--	-------



- Wirelessly control the bulb from anywhere (requires Z-Wave Apps for iOS or Android)
- Turn the bulb ON, OFF, or use its dimming features to adjust to 100 levels of brightness
- Acts as a wireless repeater to extend the Z-Wave mesh network to cover longer distances
- Integrates with other Z-Wave certified products from Linear and 2GIG by Linear

2GIG-LB60Z-1	Z-Wave Smart LED Light Bulb - 750 Lumens, equivalent to a 60 watt incandescent light bulb	13.43
--------------	---	-------



ECOTILTZWAVE2	Z-Wave Garage Door Tilt Sensor - US Frequency	26.23
ECODWZWAVE2.5	Z-Wave Plus Door/Window Sensor with external input	23.73
ECOPIRZWAVE2.5	Z-Wave Plus Motion Detector with Pet Immunity	27.48



ECOTILTZWAVE2



ECODWZWAVE2.5



ECOPIRZWAVE2.5



**Add Alexa Voice Control to Leviton Omni Systems**

Using the HomeSeer HSHT-ZEE, we now have the ability to add Amazon Alexa voice control to Leviton Omni Systems\*. The required components are a Leviton Omni System (LTe, Ile or Pro II), an HSHT-ZEE and an Amazon Echo or Echo Dot (1 or 2).

**“Alexa, tell HomeSeer to set the security mode to arm away.”**



**With Alexa, you can control:**

- Lighting
- Thermostats
- Security
- Outputs
- Flags
- Buttons
- HomeSeer Events
- And More

**“Alexa, tell HomeSeer to set the living room heat to 72 degrees.”**

\*Plug-in required. Call for details.



HSHT-ZEE

- Z-Wave controller built-in
- Built-in web server for remote access
- Easy-to-use web interface allows easy access and control with any browser
- Compatible with Linux Plug-Ins (up to 5)
- Creates alerts, announcements and reminders by email and text message
- Includes calendar-based functions for easy scheduling
- Includes true 'trigger-based' automation with advanced conditional options
- Built-in power failure recovery feature runs events missed during outages when power is restored

The HomeTroller ZEE is an advanced home automation controller that's designed to simplify your life by integrating and automating the major systems of your home! Use it to monitor and control lighting, appliances, door locks, thermostats, window shades, water heaters, valves, and more!

HSHT-ZEE	Home Automation Controller w/Z-Wave	158.19
HSHTZEEWIFI	Wi-Fi Adapter for ZEE and Z-NET	15.80
HSISM200	Z-Wave MultiSensor/Indicator	67.95
HSHT-S6	HomeTroller S6 Controller	750.30
HSZ-NET	Network Enabled Z-Wave Interface	120.72

**Other HomeSeer products available. Give us a call!**



## Z-Wave Locks

Kwikset, the leader in residential security, provides a smarter way to expand your smart home solution with a complete line of wireless enabled door locks. With a supporting Z-Wave system, you can control your lock from anywhere. Wirelessly communicate with other devices in the home and never worry about forgetting to lock your door again.

- Motorized locking mechanism enable true remote locking and unlocking
- Tapered deadbolt design permits misaligned doors to lock & unlock with ease
- Features SmartKey(R) Re-Key Technology with BumpGuard(TM) Protection
- 128-bit Advanced Encryption Standards (AES) Communication
- 30 user access code capacity, 4-8 digit code length (applies to touchpad and touchscreen product)
- Indoor temperature range 32 F to 176 F
- Outdoor temperature range -40 F to 176 F
- Supported by 2GIG, Vera Control, Fibaro, SmartThings, HomeSeer, and more



SmartCode 910 TRL    SmartCode 910 CNT    SmartCode 912 Lever

### SmartCode 910 Series Motorized Deadbolts

BD99100-\*\*\*    Z-Wave Motorized Deadbolt    137.39

\*\*\* SmartCode 910 Traditional  
026-Polished Brass, 005-Satin Nickel, 006-Venetian Bronze

\*\*\* SmartCode 910 Contemporary  
011-Satin Nickel, 012-Satin Chrome, 013-Polished Chrome, 014-Venetian Bronze

### 912 Series Motorized Lever Locks

BD99120-\*\*\*    Z-Wave Motorized Lever Lock    168.62

\*\*\* 005-Satin Nickel, 006-Venetian Bronze, 026-Polished Brass

**Kwikset Non-RF Motorized Locks are available.  
Call for details.**



SmartCode 914

### 914 Series

- 10-button keypad vs 5-button on 910
- Smaller inside compartment with metal battery cover

### 916 Series

- 10-button touch keypad
- Smaller inside compartment with metal battery cover



SmartCode 916

### SmartCode 914 Series Motorized Deadbolts

BD99140-\*\*\*    Motorized Deadbolt with full 10-button keypad    177.61

\*\*\* 001-Polished Brass, 002-Satin Nickel, 003-Venetian Bronze

### SmartCode 916 Series Motorized Deadbolts

BD99160-\*\*\*    Motorized Deadbolt with touchscreen keypad    206.83

\*\*\* 001-Polished Brass, 002-Satin Nickel, 003-Venetian Bronze



Signature Series TRL

### Your deadbolt just got smarter.

Control and monitor your lock from anywhere with discreetly integrated wireless technology. Available in both a traditional round and contemporary square design.

### Signature Series Motorized Deadbolts

BD99100-06#    Traditional round - no keypad    115.41

# 1-Polished Brass, 2-Satin Nickel, 3-Venetian Bronze

BD99100-06%    Contemporary Square - no keypad    115.28

% 4-Satin Nickel, 5-Venetian Bronze

**Looking for ZigBee Locks to Integrate with your Leviton Omni System? See page 88.**

## Baldwin Locks



SOHO Style    Boulder Style

BALDWIN



SOHO Style    Boulder Style

Worthington carries Baldwin locks. Give us a call today!

## 910 vs 914/916 Interior Comparison

910 & Signature Series

914/916

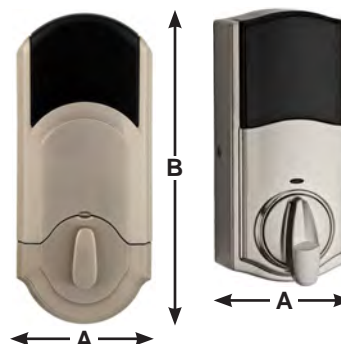

It is important to take into account the interior footprint of the lockset. SmartCode 914 and 916 models have a 40% reduced interior size to the SmartCode 910 and Signature Series models.

Series	"A"	"B"
910	3.25"	7.25"
914	2.75"	5.75"
916	2.75"	5.75"



**Yale Locks**

- Push button or capacitive interfaces
- Indoor temperature range 5°F to 140°F
- Outdoor temperature range 5°F to 140°F
- Directly supported by 2GIG (v1.9 and later), Vera Control, and HomeSeer
- Support via the Leviton VRC0P (rev 3) Z-Wave interface with Leviton Security and Automation and ELK
- When using the Leviton VRC0P, it is recommended to use the Leviton VRUSB-1US USB stick (page 17) and the free Leviton RFinstaller software to set up and configure the Z-Wave network
- Yale deadbolts come standard with a K Keyway. Optional keyways available.

Looking for ZigBee? See page 88



YALL210ZW605



YALL200ZW0BP

**Z-Wave Communicating Entry Lever Sets**

YALL220ZW+	Motorized Z-Wave Entry Lever Set with capacitive touch keypad	206.08
YALL210ZW+	Motorized Z-Wave Entry Lever Set with pinpad	187.35

+605-Bright Brass, 0BP-Oil Rubbed Bronze, or 619-Satin Nickel



Norwood



Marina



McClure



Academy



Milan



Cascade

**Lever Options for Yale Lever Locks (Norwood Is Standard)**

YALYR05D8+*	Alternate levers for Yale Lever Locks	19.73
-------------	---------------------------------------	-------

+ 2-Cascade, 3-Milan,4-Marina,5-McClure,7-Academy,8-Norwood  
\* 3-Polished Brass, N-Satin Nickel, K-Oil Rubbed Bronze

**Yale Commercial Grade Locks**



- ANSI/BMHA Grade 1
- Weather Resistant Gasket
- 9V Battery Backup

Ideal for employee entrances, delivery or back entry.



YALNTB610ZW2626	Motorized Z-Wave Commercial (Grade 1) Lever with pinpad - Satin Chrome	374.70
YALNTB620ZW2626	Motorized Z-Wave Commercial (Grade 1) Lever with capacitive touch keypad - Satin Chrome	387.19

**Z-Wave Communicating Deadbolts**

YALD226ZW2+	Motorized Z-Wave Deadbolt with capacitive touch keypad	206.08
YALD110ZW+	Keyless Motorized Z-Wave Deadbolt with pinpad. Key Free. B1L series.	137.39
YALYRD120ZW+	Keyless Motorized Z-Wave Deadbolt with capacitive touch keypad. Key Free. T1L Series.	174.86
YALD216ZW2+	Motorized Z-Wave Deadbolt with pinpad	168.62

+605-Bright Brass, 0BP-Oil Rubbed Bronze, or 619-Satin Nickel



YALD216ZW20BP



YALD262ZW2619



YALYRD120ZW605



YALD110ZW619



YALD110ZW619



**Bluetooth Communicating Deadbolt with Z-Wave**

YALD446ZW2+	Motorized Bluetooth Deadbolt with capacitive touch keypad. Also contains Z-Wave radio.	206.08
-------------	--	--------

+605-Bright Brass, 0BP-Oil Rubbed Bronze, or 619-Satin Nickel

Forget carrying around keys; lock and unlock your home with your smartphone. Share digital keys with friends and family, view access history and customize lock settings and pin codes, all from your Yale Assure app.

The Assure Lock with Bluetooth also includes a Z-Wave Module to seamlessly integrate into most home automation and alarm systems. Enjoy the best of both worlds, key free unlocking at the door from Bluetooth and advanced smart home features and remote access with your Z-Wave controller.

**Non-Communicating Locks**

YALD220NR+	Motorized Deadbolt with touch keypad	149.88
YALD210NR+	Motorized Deadbolt with pinpad	119.90

+605-Bright Brass, 0BP-Oil Rubbed Bronze, or 619-Satin Nickel

Z-Wave Locks

Deadbolts		
SCHBE469CAM*	Camelot Z-Wave Motorized Touchscreen Deadbolt: *605-Bright Brass, 619-Satin Nickel	176.57
SCHBE469CAM716	Camelot Z-Wave Motorized Touchscreen Deadbolt, Aged Bronze	177.38
SCHBE469CAM622	Camelot Z-Wave Motorized Touchscreen Deadbolt, Black	184.70
SCHBE469CEN*	Century Z-Wave Motorized Touchscreen Deadbolt: *619-Satin Nickel, 625-Bright Chrome, 626-Satin Chrome	174.55
SCHBE469CEN716	Century Z-Wave Motorized Touchscreen Deadbolt, Aged Bronze	176.58
SCHBE469CEN622	Century Z-Wave Motorized Touchscreen Deadbolt, Black	185.10

- Direct support by 2GIG, Vera Control, Fibaro, SmartThings, and HomeSeer
- Support via the Leviton VRC0P (rev 3) Z-Wave interface with Leviton Omni and ELK
- When using the Leviton VRC0P, it is recommended to use the Leviton VRUSB-1US USB stick (page 17) and the free Leviton RF Installer Tool software to set up and configure the Z-Wave network



Camelot

Century

Budget Deadbolts

By removing the siren and lighted touchscreen, Schlage is able to offer these deadbolts at a reduced price. These deadbolts are dealer-exclusive!

SCHBE468CAM*	Camelot Z-Wave Motorized Touchscreen Deadbolt: *505-Bright Brass, 619-Satin Nickel, 625-Bright Chrome, 716-Aged Bronze	154.25
SCHBE468CEN*	Century Z-Wave Motorized Touchscreen Deadbolt: *619-Satin Nickel, 625-Bright Chrome, 626-Satin Chrome, 716-Aged Bronze	154.25

Deadbolt with Matching Lever (Specify Left or Right Handed)

SCHFE469CAM*	Camelot Z-Wave Motorized Touchscreen Deadbolt with Matching Lever Set (ACC - Accent Style Levers)	263.85
SCHFE469CEN+	Century Z-Wave Motorized Touchscreen Deadbolt with Matching Lever Set (MER - Merano Style Levers)	263.85

\*605-Bright Brass, 619-Satin Nickel, 716-Aged Bronze; +619-Satin Nickel, 625-Bright Chrome, 626-Satin Chrome, 716-Aged Bronze

If you need assistance in determining whether you have a right handed or left handed door, give Worthington Distribution a call. Other lever styles available.



Century

Lever Set

Camelot

Entry Lever Set

SCHFE599*	Z-Wave Lever Set (with clutch): *505-Bright Brass, 716-Aged Bronze	168.45
SCHFE599619	Z-Wave Lever Set (with clutch), Satin Nickel	166.43

Non-Communicating Deadbolts and Entry Sets available. Call for pricing.

Automation Hub and Touchscreen

Wink Hub 2 can control the following types of devices:

Lights. Power. Security. Now they're all connected through a single app, so you don't need a different one for every product. Simple controls and Amazon Alexa™ support allow you to monitor and manage everything in your home.

There are a lot of smart home brands out there. Nest, Lutron, Jasco, Kwikset, and more. They couldn't always connect or communicate with each other, until Wink. Now you have more choice in what smart devices are right for your home. And more ways they can work together so they're even smarter.

- Z-Wave
- ZigBee
- WiFi
- Lutron Caseta
- Kidde
- Bluetooth LE



WINKPRLAY-WH01

WINKHUB-2US	Wink Hub 2. Supports Z-Wave, ZigBee, Caseta, WiFi, Kidde and Bluetooth LE Devices.	98.40
WINKPRLAY-WH01	Wink Relay. 2 Switches and Touchscreen for Wink Hub. Mounts to a Single-Gang Box.	68.94



WINKHUB-2US



**AUGAB01M01G01**  
**AUGAK01M01G01**

**AUGSL02M02S02**

- Works with wired doorbells
- 2 way talk/ 1 way camera
- Lock/Unlock your August Smart Lock from anywhere

- Does not affect outer hardware
- Unlock when phone is near lock
- Doorbell/Intercom
- Optional Keypad
- Works with Nest
- Harmony Remote compatible

August Smart Lock works with the free August app to create keys, grant access, view the activity log, and more, available for Android™ and iOS®.

AUGSL02M02S02	Smart Lock Home Kit - Silver	189.88
AUGSL02M02G02	Smart Lock Home Kit - Dark Grey	189.88
AUGAB01M01S01	Doorbell Cam - Silver	165.11
AUGAB01M01G01	Doorbell Cam - Dark Grey	165.11
AUGAC02	Connect Bridge - Required	66.04
AUGAK01M01G01	Smart Keypad	66.04



The Schlage Sense Smart deadbolt is compatible with Bluetooth technology - which allows you to unlock your door using your iPhone®, iPad® or any other smartphone or tablet. That connectivity puts you in total control of your home using a device that's probably already in your pocket.

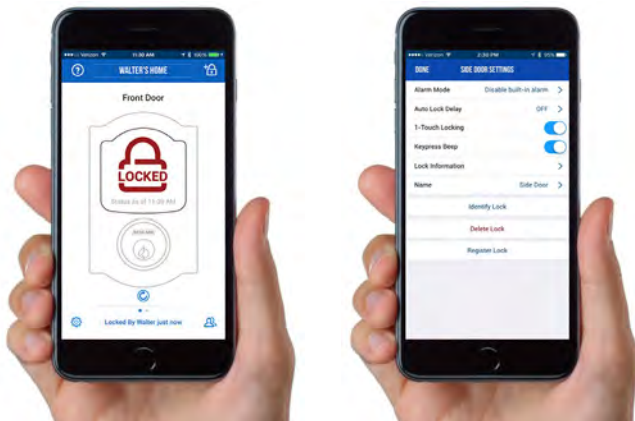

Camelot

Century

Create schedules/send lock codes. Over the air firmware updates.

SCHBE479CAM619	Camelot style Apple HomeKit-compatible motorized Bluetooth deadbolt - Satin Nickel	194.84
SCHBE479CAM716	Camelot style Apple HomeKit compatible motorized Bluetooth deadbolt - Aged Bronze	196.88
SCHBE479CEN619	Century style Apple HomeKit-compatible motorized Bluetooth deadbolt - Satin Nickel	194.84
SCHBE479CEN622	Century style Apple HomeKit-compatible motorized Bluetooth deadbolt - Matte Black	205.00

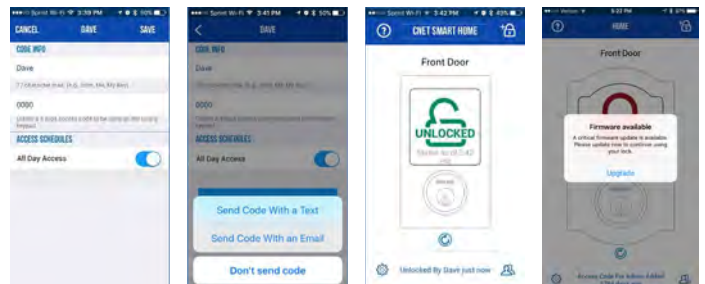



# zipato® ZIPATILE

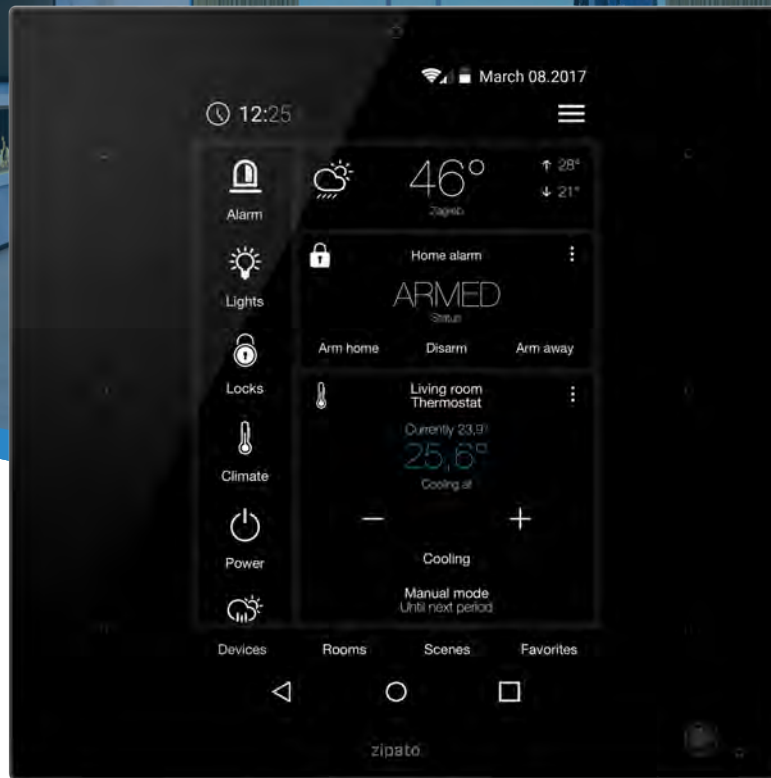

## ALL IN ONE HOME CONTROL



Security  
alarm



Video  
monitoring



Video  
Intercom



Smart  
thermostat



Wall  
controller



Home  
automation



your home is under control

[www.zipato.com](http://www.zipato.com)

**Z-Wave Water Flow Meter**

FRTFMINLC075R10	3/4" Brass Series, Lead Free	181.20
FRTFMINLC100R10	1" Brass Series, Lead Free	252.11



FRTFMINLC\*\*\*R10

The flow meter keeps track of water usage and reports the total cumulative gallons used. Great for detecting leaks and unwanted usage. The flow meter also reports if water is flowing or not. Also detects small vs. large flow.

**Z-Wave Input / Output Module**

FRTMIMOLITEUS	1 Input, 1 Form-C Output Z-Wave Module	47.76
FRTMIMO2US	2 Input, 2 Form-C Output Z-Wave Module	63.67



FRTMIMOLITEUS



FRTMIMO2US

**Looking to convert non-Z-Wave devices to Z-Wave?  
Need a Z-Wave controllable contact closure?**

The MIMO and MIMOLite are the answer to your needs. MIMOLite has 1 input and 1 output while the MIMO has 2 inputs and 2 outputs.

**Z-Wave Water Sensors**

FRTFTS05US	Flood and temperature sensor (Gen 3). Pair with a WV-01 to turn off water. Requires 2 AA batteries.	39.81
FRTFTS05PUS	Flood and temperature sensor (Gen 3) with probe and permanent power (USB). Pair with a WV-01 to turn off water. Requires 2 AA batteries. Temperature sensing at probe.	50.95



FRTFTS05US



FRTFTS05PUS

**Z-Wave Sounders**



FRTSSA1US

**FRTSSA1/2US**

- 117dB sounder for auditory notification
- 5 LED's for visual notification
- LED's and sounder can be controlled via standard lighting level commands
- Choose Red or Clear lens
- Use with sensors and valves for alarm



FRTSSA2US

FRTSSA1US	Z-Wave siren/strobe, 12VDC with 9V battery backup. Use with FTS05US or FTS05PUS. Clear lens.	35.61
FRTSSA2US	Z-Wave siren/strobe, 12VDC with 9V battery backup. Use with FTS05US or FTS05PUS. Red lens.	35.61

**Z-Wave Controlled Water Valves**

**Choose Indoor or Outdoor**

**Indoor Actuator**

FRTWV01ACTUS	Motorized water valve actuator. Includes actuator and wired water sensor. Use with FTS05(P)US or with a gateway to turn water off/on. Requires ball valve.	281.02
--------------	--	--------

**Outdoor Actuator w/Cable to Indoor Control Panel**

FRTWV02ACT25US	Motorized water valve actuator. Includes actuator, wired water sensor and cable connected to indoor control panel. Use with FTS05(P)US or with a gateway to turn water off/on. Requires ball valve. 25' cable.	311.00
FRTWV02ACT50US	Outdoor actuator w/50' cable.	322.24
FRTWV02ACT75US	Outdoor actuator w/75' cable.	333.48



FRTWV01ACTUS



FRTWV02ACT\*\*US

- Choose ball valve size

- Choose cable length (25', 50', 75')
- Choose ball valve size

**Choose Water Valve Size**

**FRTBVALVE\*\*\***



- Choose ball valve size
- 3/4"
- 1"
- 1-1/4"
- Attach to Indoor or Outdoor Actuator

FRTBVALVE075	3/4" Ball Valve for use with FortrezZ WV01ACTUS Indoor Actuator and WV02ACT**US Outdoor Actuators	37.47
FRTBVALVE100	1" Ball Valve for use with FortrezZ WV01ACTUS Indoor Actuator and WV02ACT**US Outdoor Actuators	47.46
FRTBVALVE125	1-1/4" Ball Valve for use with FortrezZ WV01ACTUS Indoor Actuator and WV02ACT**US Outdoor Actuators	81.18

**Connect Z-Wave**

FortrezZ Z-Wave water valve units can be paired with FortrezZ Water Sensors (FTS05US or FTS05PUS) to create a leak shut off system. You can also use a Z-Wave controller to pair water sensors, water valves, flow meters and sounders together to create a complete water monitoring solution.

**Questions? Give us a call today!**

# August pro



## August Smart Lock

With the August Smart Lock, your smartphone is a smart key—and more.

## August Smart Keypad

Create unique, custom entry codes for guests with the August Smart Keypad.

## August Doorbell Cam

August Doorbell Cam lets you see and speak to visitors at your front door, and eliminates the need for August Connect.

## August Connect

August Connect gives you remote control of your August Smart Lock.

## GROW YOUR BUSINESS WITH AUGUST HOME

August Home is the leading provider of smart locks and smart home access products and services that make life more simple and secure. At August Home, we help you give your customer total control over their front door, from anywhere.

## BECOME AN AUGUST PRO

Start to sell and install award winning smart home access products. You'll get professional pricing and terms, exclusive training and tools, VIP support, and customer referrals to help you grow your business.

Learn more at [august.com/pro](https://august.com/pro)





**SCHTZEMT524**

**Trane (sold through sister company Schlage for the Nexia system)**

- Supports conventional single and multistage systems as well as heat pumps
- Supports dual fuel systems (Rh and Rc terminals)
- A 24VAC common connection is required



SCHTZEMT524	Trane Z-Wave thermostat, single, multistage, or heat pump, common required	89.93
SCHXL624	Trane Z-Wave programmable thermostat	147.38
SCHTEMPSENSOR	Indoor Remote Temperature Sensor for TZEMT524 and XL624	24.98

**Residential Control Technologies**

- Supports conventional single and multistage systems as well as heat pumps
- Supports dual fuel systems (Rh and Rc terminals)
- A 24VAC common connection is required
- Remote control of energy savings mode as well as set points and mode



RCSTZ45	RCS Z-Wave thermostat, single, multistage, or heat pump, common required	139.58
RCSTBZ48	RCS Z-Wave thermostat, single, multistage, or heat pump, can run on batteries	139.58
RCSRTS3	Flush remote temperature sensor for RCSTZ45	23.42
RCSRTS4	Surface remote temperature sensor for RCSTZ45	23.42

**Radio Thermostat Corporation of America**

- Touchscreen for easy control of HVAC
- Supports conventional single and multistage systems as well as heat pumps
- Supports dual fuel systems (Rh and Rc terminals)
- Can run off of 4x "AAA" batteries, a 24VAC common connection is not required



RADCT32B	Z-Wave thermostat, single, multistage, or heat pump, battery option	83.90
RADCT101	Z-Wave thermostat, 2 stage heat/2 stage cool with Heat Pump and PTAC support	72.37
RADCT110RT-S	Z-Wave thermostat, 2 stage heat/2 stage cool with Heat Pump	91.09
RADCT110RT-P	Same as above with push terminals instead of screw terminals	92.10
RADCT80	Z-Wave thermostat, requires RADZWAVE300	114.79
RADZWAVE300	Z-Wave U-Snap module for RADCT80 (required for Z-Wave control)	18.32
RADRTMV-01	Wi-Fi U-Snap module for RADCT80 (required for optional Wi-Fi control)	38.23

Tech Tip: Confirm thermostat compatibility with your Z-Wave controller before ordering



**RCSTZ45**



**RADCT32B**



**RADCT110RT-\***

**Stelpro 120V / 240V Z-Wave Thermostat**

The Stelpro thermostat for the smart home is the first ever Z-Wave line voltage thermostat in North America. Stelpro thermostats can easily be integrated into the Z-Wave network of your home, allowing you to adjust the temperature in rooms of your home from a distance. The Z-Wave technology also allows you to activate scenes, setting in motion several actions such as adjusting the temperature and lighting, activation of safety and entertainment systems and more.



STESTZW402WB+	120VAC / 240VAC Z-Wave Thermostat	63.95
---------------	-----------------------------------	-------

**Miscellaneous Z-Wave Devices**

The DB100Z and the FASMOKECO allow you to monitor your doorbell button and smoke/carbon monoxide.

SCHFASMOKECO	Z-Wave Smoke/CO Detector	44.96
SCHDB100Z	Z-Wave Doorbell Sensor	43.72



**SCHDB100Z**

**SCHFASMOKECO**



The Telguard GDC1 is a Z-Wave garage door opener that is based on Z-Wave mesh networking technology allowing it to integrate seamlessly with existing Z-Wave controllers from many manufacturers. The GDC1 is based on the Binary Switch Command Class and may show up in your controller as a light switch. The standard GDC1 functionality will work as follows:

- Turn GDC1 "on" = Open the garage door
- Turn GDC1 "off" = Close the garage door

TELTG-GDC101	Universal Z-Wave Garage Door Controller	91.18
--------------	---	-------

**Includes components necessary for installation.**



# wink

## A SIMPLER, SMARTER HOME

37 BRANDS  
HUNDREDS OF PRODUCTS  
1 SIMPLE APP

### THE SMART HOME SOLUTION FOR EVERY CUSTOMER.



NOW AVAILABLE AT

**WORTHINGTON**  
DISTRIBUTION

**Dimmers**

JAS45712	In-Wall Decorator Style Dimmer, 600W Incandescent, 150W CFL/LED, White and Light Almond	33.76
JAS45715	In-Wall Decorator Style Dimmer, 1000W Incandescent only, White and Light Almond	36.26
JAS45742	In-Wall Toggle Style Dimmer, 600W Incandescent, 150W CFL/LED, White	33.45
JAS45762	In-Wall Toggle Style Dimmer, 600W Incandescent, 150W CFL/LED, Light Almond	33.45



JAS45712



JAS45742



JAS45762

Please check compatibility when dimming LED and CFL bulbs.

**Switches**

JAS45709	In-Wall Decorator Style Switch, 960W Incandescent or 15A Resistive, White and Light Almond	31.24
JAS45740	In-Wall Toggle Style Switch, 960W Incandescent or 15A Resistive, White	30.93
JAS45760	In-Wall Toggle Style Switch, 960W Incandescent or 15A Resistive, Light Almond	30.93

**Add-On for 3-Way Circuits**

JAS45710	In-Wall Decorator Style Add-On, use with 45709 and 45712, White and Light Almond	12.18
JAS45741	In-Wall Toggle Style Add-On, use with 45740 and 45742, White	11.87
JAS45761	In-Wall Toggle Style Add-On, use with 45760 and 45762, Light Almond	11.87

**Color Change Kits**

JAS1394*	Color change kit for dimmers/switches	1.45
JAS3535+	Color change kit for dimmers/switches	1.45

\*0-Black dimmer, 1-Black switch/add-on, 3-Brown dimmer, 4-Brown switch/add-on, 5-Ivory dimmer, 6-Ivory switch/add-on

+8-Light Almond-dimmer, 9-Light Almond switch/add-on

**Plug-Ins and Other Devices**

JAS45705	In-Wall Decorator Style Duplex Receptacle, 15A, White	29.96
JAS45702	Plug-In Lamp Module, 300W Incandescent, 100W CFL/LED, White	30.49
JAS45652WB	Energy Monitoring Plug-In Lamp Module, 300W Incandescent only, White	35.48
JAS45703	Plug-In Appliance Module, 15A Resistive, 960W Incandescent, White	28.68
JAS45653WB	Energy Monitoring Plug-In Appliance Module, 15A Resistive, 960W Incandescent, White	33.67
JAS45704	Outdoor Plug-In Appliance Module, 15A Resistive, 960W Incandescent, Black	31.52
JAS45631	Group/Scene Keypad Controller, wall-mount, battery powered [Retail Packaging]	36.22
JAS45734	Energy Monitoring Outdoor Contactor, 40AMP-240V for large loads	119.78
JAS32563	Hinge Pin Door Sensor, up to 5/16" diameter	37.59
JAS35931	LED Bulb, 60W equivalent, 2700K color temp.	22.32

\*\* Fan must be set on High at the "Pull Chain" \*\*



JAS45704

JAS32563

JAS45705



JAS45631

JAS35931

JAS45703

For more HomeSeer products see page 23.

**HomeSeer®**

HSHSWD100	Z-Wave Plus dimmer, 600W incandescent, 150W LED/CFL, White	42.82
HSHS-WS100+	Z-Wave Plus switch, 15A, 900W incandescent, 200W LED/CFL, 1/2HP motor, White	37.78
HSHS-WA100+	Companion switch for HSHSWD100 and HSHS-WS100+, supports up to 5-way	17.80

Light Almond color change kits available. Call for details.



HomeSeer dimmers and switches support additional features for Home Automation. Double-tap, triple-tap, and press-and-hold.

HSHS-WS100+, HSHSWD100 and HSHS-WA100+ shown in a Lutron Claro Wall-plate (LUCW3WH - See Page 50).



# ***Be alerted anytime a vehicle enters an area.***



## **DCPA-2500**

- Wireless vehicle sensing probe
- 1/2 mile wireless range from sensor to receiver
- Easy installation in just minutes
- Avoid trenching all the way to the house
- Long battery life
- Multiple relay outputs can be connected to other control panels
- Monitor up to 4 different zones



## **DCMT-2500**

- Wireless motion detector
- 1/2 mile wireless range
- Detects people and vehicles

*Dakota Alert has sensors for your backyard, driveway, porch, outbuildings and more...*



## **BBT-2500**

- Solar Powered Wireless Breakbeam
- 1/2 mile wireless range
- Detects people and vehicles
- 300 ft detection range
- No trenching
- No wiring
- Easy installation

# **DA**<sup>TM</sup>

# **Dakota Alert**<sup>®</sup>

**WIRELESS SECURITY EQUIPMENT**

**[www.DakotaAlert.com](http://www.DakotaAlert.com) • 605.356.2772**

Bitwise by Leviton

# BitWise

- Controls A/V components
- Pre-designed templates make it simple to create stunning user interfaces
- Free iOS and Android apps
- Optional handheld remote
- Integration with Omni controllers
- Great for: Residential, commercial, conference rooms, classrooms, sports bars and more!



Simple A/V programming for outstanding results!



Add-On Hardware and Accessories

Controllers



Leviton's network-enabled controllers are the heart of every BitWise Controls installation. These devices provide the intelligence and connectivity to control virtually any TV, Blu-ray, AV receiver, projector, and other gear. Each BitWise system is comprised of one or more controllers, which allow other systems in your home to interact with one another. Your system can scale from a single room to an entire home or building. BitWise controls can integrate with your favorite Leviton Omni controller for control of security, lighting, HVAC, shades, and more.

Hardwired remotes are a great solution for users that may not be familiar with or prefer not to use an iPad. This is also a great backup tool in case your phone or tablet has a low battery or goes missing during the "big game!"

BITBWBC1	BC1 Controller, 8 IR ports, 4 GPIO, 4 relays, 1 IR input	928.66
BITBWBC2	BC2 Controller, 4 IR ports, 2 RS-232, 2 GPIO, 2 relays	592.93
BITBWBC4	BC4 Controller, 4 IR ports, 1 RS-232, 1 GPIO	329.14

BITBWIRL	USB IR learner. Great labor saving tool. Learn IR codes from existing remote controls.	154.50
BITBWRMT	RF hard-button remote control. Requires BITBWRRR wireless receiver.	95.91
BITBWRRR	RF receiver for hard-button remote	59.94
BITBWIRI	IR to RS232 receiver module	89.33
BITBWEAR	Rack ears for BC2 controller	38.67
BITEN928	IR emitter single head, each	9.60

Project Editor Software

Project Editor Software is FREE software used by professional installers to create and manage project files for BitWise hardware installations. Simply drag and drop and pull-down menus.

Project Editor permits customization for iOS, Android, and the Leviton OmniTouch 7 touchscreen. Prefabricated templates can save hours of initial labor, see page 91 for more details.

Custom Programming

Need a Bitwise solution but don't have the time to learn something new? Let us help!

Our trained and experienced team is here to back you up with pre-programmed systems. Just give us all the details of the job and how you need the system to operate and we will ship it to you configured and ready to install.

Call Barry at Worthington today!



Barry Hampe  
Technical Representative  
BitWise Expert

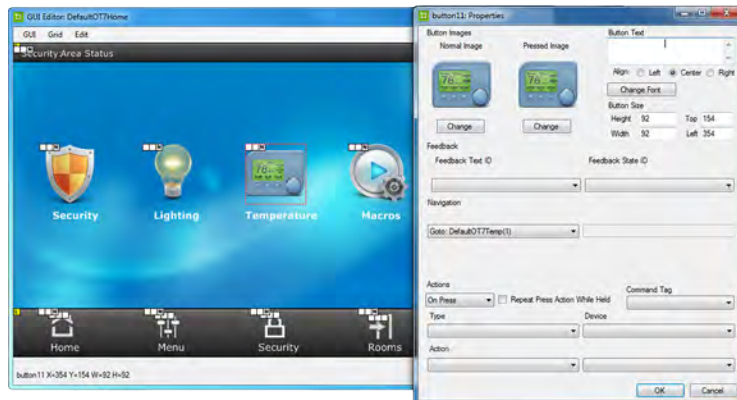

Project Editor Software



**iTach Flex™ Family of Products**

Global Caché's Flex is an industry first, a tiny device that connects previously unconnected hardware to a WiFi or TCP/IP network so it can be controlled and automated by the controller of your choice. Based on open systems and standards, the Flex allows for easy integration in any control environment, from high-end proprietary systems to apps on a smart phone or tablet. The Flex connects anything IR, serial, or relay (with sensor input) to a network, and supports HTTP for browser control from anywhere in the world.



With its small form-factor and changeable output, Flex is the ultimate solution for TCP/IP control of any device requiring an IR, serial, or contact-closure input.

**Flex Key Features**

- Connects almost any electrical device to a WiFi or IP (wired Ethernet) network instantly
- Access, monitor, automate, and control standalone equipment
- Web-based control protocol using HTTP
- Tiny footprint
- 4-conductor Flex Link Port allows for versatility using Flex Link cables
- Built in IR learning and access commands to cloud-based IR database
- Mounting dock for simple installation
- Made in the USA and RoHS compliant

Want to know which apps works with Global Caché? Check out their strategic partnerships at: [www.globalcache.com/partners/control-apps/](http://www.globalcache.com/partners/control-apps/)



<b>GCFLC-SL-232</b>	<b>GCFLC-SL-485</b>	<b>GCFLC-RS</b>
GCFLC-SL-232 Flex Link RS232 serial cable	GCFLC-SL-485 Flex Link RS485 serial cable	GCFLC-RS Flex Link relay and sensor cable
GCFLC-SL-MJ Flex Link RS232 mini-jack serial cable	GCFLC-3E Flex Link three IR emitter cable	GCFLC-2E1B Flex Link two IR emitter one IR blaster cable
GCFLC-SL-485 Flex Link RS485 serial cable	GCFLC-T3 Flex Link tri-port cable	GCFLC-BL Flex Link IR blaster cable
GCFLC-RS Flex Link relay and sensor cable		
GCFLC-3E Flex Link three IR emitter cable		
GCFLC-2E1B Flex Link two IR emitter one IR blaster cable		
GCFLC-BL Flex Link IR blaster cable		
GCFLC-T3 Flex Link tri-port cable		



<b>GCFLC-T3</b>	<b>GCFLEX-IP/IP-P</b>	<b>GCFLEX-WIFI</b>
GCFLC-T3 Flex Link tri-port cable	GCFLEX-IP Wired Flex network interface	GCFLEX-IP-P PoE Flex network interface
		GCFLEX-WIFI Wi-Fi Flex network interface

For a complete Flex control solution, combine a Flex Link cable from the table to the left... **... with the Flex module from the table below which matches your wiring.**

**Other Global Caché Products**



Worthington Distribution carries Global Caché's full product range, including the GC-100 series of network adaptors. For sales information on products not shown on this page please contact us at (800) 282-8864 or email us [sales@worthdist.com](mailto:sales@worthdist.com).

**iTach (non-Flex) Modules**

The innovative design of the Global Caché iTach allows for easy and flexible integration into any networked control solution. The iTach is a simple wired or wireless conduit between you and your device over a network or the Internet. This is instant network-enabling at its best, delivering the power of choice at a cost-effective price.



<b>GCWF2IR</b>	<b>GCIP2IR</b>	<b>GCIP2IR-P</b>	<b>GCWF2SL</b>	<b>GCIP2SL</b>	<b>GCIP2SL-P</b>	<b>GCWF2CC</b>	<b>GCIP2CC</b>	<b>GCIP2CC-P</b>
GCWF2IR Wireless IR network interface	GCIP2IR Wired IR network interface	GCIP2IR-P PoE IR network interface	GCWF2SL Wireless serial interface	GCIP2SL Wired serial interface	GCIP2SL-P PoE serial interface	GCWF2CC Wireless contact-closure interface	GCIP2CC Wired contact-closure interface	GCIP2CC-P PoE contact-closure interface

**Automation Solutions with Fibaro**

Looking for a simple and convenient way to combine home theater control with top-of-the-line home automation? Use a Fibaro Home Center 2 with their Global Caché plug-in for iTach modules. The setup and integration is fast and easy, plus your customers will love Fibaro's intuitive control interface.

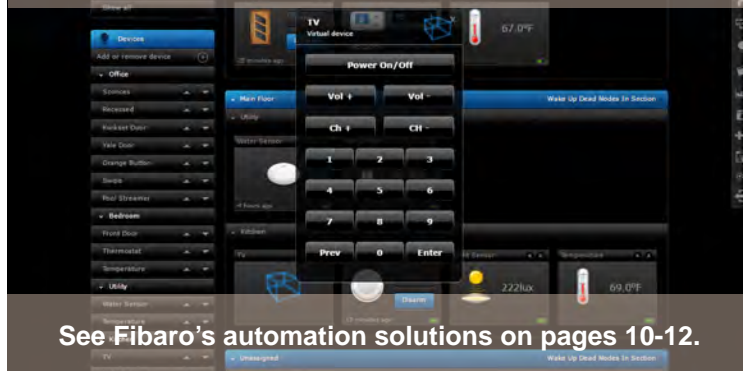

See Fibaro's automation solutions on pages 10-12.

**iTach Sensors and Accessories**

<b>GCIT-SV1</b>	<b>GCIT-SP1</b>	<b>GCIT-SC1</b>	<b>GCG-IR-E</b>	<b>GC-CGX</b>	<b>GC-CXG</b>
GCIT-SV1 "Video out" sensor	GCIT-SP1 AC/DC voltage sensor	GCIT-SC1 Contact-closure sensor	GCG-IR-E Additional IR emitter	GC-CGX Global Cache to Xantech conversion cable	GC-CXG Xantech to Global Cache conversion cable



## iPort Product Selection

iPort offers multiple solutions for mounting and charging an iPad. Use the following table to find your customer's iPad model and the mounting solution. More details and additional accessories (when available) for each mounting solution can be found at the bottom of this page.



Customer's iPad Model	Removable Table-Top or Wall-Mounted		Recessed Wall-Mounted		Surface Wall-Mounted	
	Launchport Sleeve (Wall or BaseStation sold separately)		Control Mount Model		Surface Mount Bezel (splitter sold separately)	
iPad Pro 12.9"					DAN70743 (black)	335.00
					DAN70744 (silver)	335.00
					DAN70745 (white)	335.00
iPad Pro 9.7"*	DAN70300 (black)	105.00	DAN70095 (white) 244.00		DAN70703 (black)	230.00
iPad Air 2	DAN70301 (white) 105.00				DAN70704 (silver)	230.00
iPad Air 1					DAN70705 (white)	230.00
iPad mini 4	DAN70304 (black)	99.00	DAN70094 (white) 209.00		DAN70722 (black)	195.00
	DAN70305 (white) 99.00				DAN70723 (silver)	195.00
					DAN70724 (white)	195.00
iPad mini 3	DAN70181 (black) 105.00 DAN70182 (white) 105.00		DAN70093 (white) 244.00		DAN70700 (black)	195.00
iPad mini 2					DAN70701 (silver)	195.00
iPad mini 1					DAN70702 (white)	195.00
iPad 4th gen.						
iPad 3rd gen.						
iPad 2						
iPad						

\*Please note: The iPad Pro 9.7" model's top speakers and camera flash may be covered.

LaunchPort is the revolutionary charging and mounting system that forever changes how your customer can use their iPad. The LaunchPort system consists of a Sleeve and any number of Stations. A Sleeve is a protective case that fits onto your iPad. A Station is the mount and charging unit that connects to and holds a Sleeve. The LaunchPort system inductively charges the iPad while it's mounted on a Station. There are two types of Stations, one for the table and one for the wall.

DAN70170	LaunchPort WallStation (black)	140.00
DAN70142	LaunchPort WallStation (white)	140.00
DAN70141	LaunchPort BaseStation (silver)	140.00
DAN70158	LaunchPort BaseStation (black)	140.00



DAN70141



DAN70142



DAN70170

Control Mount is the original in-wall mount for iPad, ideal for both residential and commercial applications. Use an iPad as a touch panel control or information center in the home, or leverage iPads in the office as digital signage screens or conference room schedulers. With its small, minimalist and paintable bezel, Control Mount will blend into a variety of decors, maintaining the elegance of your customer's space.

## iPort Sales Opportunities



iPort



It's inevitable, you're going to have some customers who just want to use an iPad instead of a dedicated touchscreen to control the systems you install for them. Instead of selling against that, use it as a sales opportunity. Give that customer a unique experience and reclaim some of your lost revenue by offering your customer a mounting and charging solution from iPort.

iPad is everywhere, in business and homes. There are thousands of smart devices now that help make your life better like smart door locks, smart lighting and even digital music systems. All these devices come to life on your iPad screen where you can control them as you desire. We believe there should be an easy way to place your iPad on a wall, to keep it fully charged and readily available. Turn your iPad into a smart touch controller with Surface Mount: the elegant frame that allows you to mount iPad onto any surface.

DAN70718	PoE Splitter - for all bezels, requires PoE	84.00
DAN70719	PoE Injector	35.00
DAN70720	Glass Mounting Kit	14.00



Lutron button kits are available for Launchport and Surface mount bezels to provide hard-button lighting control.

Want to know more about iPort's mounting solutions?  
Just give us a call!  
(800) 282-8864

Logitech Harmony Products

Streamline your life with intuitive, integrated control of both home entertainment and home control devices. Change channels, adjust volume, fast-forward, or rewind using gestures on the bright 2.4" touchscreen. Easily find the right button, even in the dark, with motion-activated, backlit controls. Keep your eyes on your entertainment, not your remote, with vibration feedback. Customize the dedicated media playback, cable/satellite, and DVR controls to your preferences. Control and adjust smart home devices with dedicated controls. Keep Harmony Elite charged and ready with the convenient charging station. The replaceable battery has 20% greater capacity than previous generation Harmony remotes.

Harmony Pro Remote

HAR915-000273	Harmony Pro Remote	300.00
---------------	--------------------	--------

Logitech Harmony has come up with a solution for the dealers in this field. They have started to offer the Harmony Pro remote. This remote will have an extended warranty, more durable plastic and it is not sold online for retail customers giving our dealers a little piece of mind!

Benefits of the Harmony Pro version:

1. Extended warranty.
2. More durable plastic and more durable feel.
3. Not for sale online. **DEALER ONLY!**



Harmony Hub

HAR915-000238	Harmony Hub	74.99
---------------	-------------	-------

The parts or kits below that show the Harmony Hub have it included. The Remote uses RF to communicate with it. The hub has a built-in IR blaster and includes two additional IR blasters so you can place it in a rack or cabinet with no issues. It also supports iOS and Android with free apps that let you use a smartphone as an additional remote.

The Harmony Hub connects to your network to enable integration with Nest, Caseta and many more. You can add the Home Hub extender to support Z-Wave and ZigBee products.



Home Hub Extender

HAR915-000253	Harmony Home Hub Extender	74.99
---------------	---------------------------	-------

Harmony Home Hub Extender integrates ZigBee®, Z-Wave™ and Z-Wave Plus compatible devices with your existing Harmony Hub. You can include these devices in your programmed schedules and activities for enhanced home control. Or, you can use your Harmony remote or app to control devices connected to an existing smart home control platform.



Home Hub Controllers

HAR915-000256	Harmony Elite Controller and Hub	262.49
HAR915-000239	Harmony Companion Controller and Hub	112.49
HAR915-000245	Add-on Smart Control Controller	22.49

Universal IR Remotes

HAR915-000230	Harmony 350 IR Remote	37.49
HAR915-000159	Harmony 650 IR Remote	59.99
HAR915-000224	Harmony Ultimate One IR Remote	187.49

HAR915-000256



HAR915-000245



HAR915-000239



HAR915-000230



HAR915-000159



HAR915-000224



Smart Phone App

Program and control devices through the highly intuitive Harmony Remote Smart phone app. The app is available through the iOS and Android app stores.

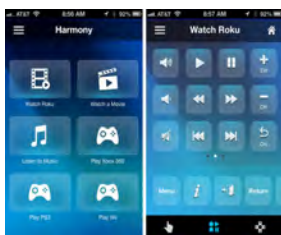

With the Logitech Harmony app, you will have the ability to control any devices in your system including TV's, DVR's, Lights and Locks. This intuitive interface also includes scenes that would make your home theatre very easy to control and enjoy!



URC HomeSet



URCHS-R100



URCHS-C100



URCTRF-ZW2



URC, with 25+ years of experience in the smart home automation and control industry, introduces HomeSet, a streamlined system optimized for the home security solutions channel. This is a completely new system built from the ground up by URC - new technology, new hardware, new software. It utilizes cloud-based programming and maintenance, and offers cloud compatibility with other cloud-based systems. HomeSet integrates with Z-wave devices, Nest, and hundreds of other popular devices and can control up to eight (8) rooms.

URCHS-R100	URC HomeSet Wi-Fi Remote Control - Hub Required	180.00
URCHS-C100	URC HomeSet Control Hub	180.00
URCTRF-ZW2	URC HomeSet Z-Wave Gateway	138.00

URC HomeSet Interface

The included HomeSet app is unique and allows rapid launching of up to eight embedded apps including full compatibility with control apps from all lines that we carry including Nest, Fibaro, and Leviton. For example, the app will give you the ability to efficiently switch from your URC app to your Lutron lighting app and turn off your lights before switching back to the URC HomeSet app.

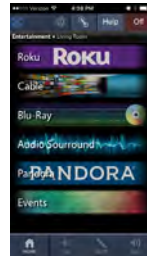

- Link your HomeSet App with your favorite streaming apps including Roku, Pandora and Hulu.
- Create custom buttons to run a scene for any kind of situation!
- Add your favorite T.V. channels to your favorites tab to get a quick shortcut so you don't miss any action!



# HomeSet™

## Add Home Automation to Every Security Installation

### Smart Home Control for the Security Channel

- Works with top A/V and smart home brands
- Secure, cloud-based technology
- Easy to install - but not DIY
- Fully expandable up to 8 rooms
- Free Mobile App included
- Backed by URC® - 25+ years and 100,000,000 remote controls strong
- Everything you need to install home A/V control on an existing Wi-Fi network





# Caséta Wireless

Increase revenue and easily add lighting control to every job



## NEW! Features and Benefits:

- ELV+ Dimmer — ideal for LED and ELV loads as well as incandescent, halogen, MLV and more.
- Plug in lamp dimmer can now extend the wireless range of a system by 30 ft (limit 1 per system).
- Amazon Alexa integration — ask Alexa to brighten or dim the lights, or turn on a scene.
- Nest Home/Away Assist — automatically turns lights on upon arrival and off when everyone leaves. If Nest Cam detects a person while away, lights can turn on to make it look like you're home.
- Samsung SmartThings — control Lutron lights and shades alongside locks, sensors, and more through the SmartThings app.
- Also works with other leading brands like: Apple HomeKit®, Alarm.com, ELK, Logitech, and more!



The Smart Bridge PRO, Lutron App for smart devices, 4-button Pico remote PRO, in-wall dimmer PRO and plug-in lamp dimmer

See page 50 for more information.

 **LUTRON**  
lutron.com/caseta

Apple, HomeKit, and Siri are trademarks of Apple Inc, registered in the U.S. and other countries. Android is a trademark of Google Inc.

**Nest Learning Thermostat**

Most people leave the house at one temperature and forget to change it. So the Nest Learning Thermostat learns your schedule, programs itself and can be controlled from your phone. Teach it well and the Nest Thermostat can lower your customers' heating and cooling bills up to 20%. That is just one of many great selling points.

Use the Nest app to connect to your thermostat from a phone. Getting in early? Change the temperature miles from home.

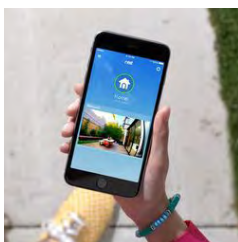

Questions about additional features?  
Give us a call at Worthington Distribution!

NEST3008US	Nest 3rd Generation Thermostat - Silver	209.99
NEST3016US	Nest 3rd Generation Thermostat - Carbon black	209.99
NEST3017US	Nest 3rd Generation Thermostat - White	209.99
NEST3021US	Nest 3rd Generation Thermostat - Copper	209.99

**Nest Protect**

-If Nest Protect sees smoke or carbon monoxide levels rising, you'll get a friendly heads-up warning before it sounds an alarm.

-Usually Nest Protect has its light turned off, but when you walk underneath it in the dark, the pathlight will turn on to light your way.

-If one Nest Protect senses danger, every Nest Protect in the house speaks up. For example: the Nest Protect in the bedroom will tell you if there's smoke in the living room. In addition to alarm sounds, Nest Protect uses a human voice to help kids wake up.



NESS3004PWBUS	Protect Smoke Alarm - battery-operated	108.00
NESS3005PWLUS	Protect Smoke Alarm - hardwired - 110VAC	108.00

**Google Home - Voice Control**



Google Home is a voice-activated speaker powered by the Google Assistant. Ask it questions. Tell it to do things. It's your own Google, always ready to help. Just start with, "Ok Google".

With Google home, you can gain voice control of all of your favorite home automation equipment including Nest, SmartThings and Philips Hue products in addition to a barrage of other features.

NESWNGOGA3A0041	Google Home Voice Control	103.99
-----------------	---------------------------	--------

**Skybell**

NESWNSKPP02301B	Skybell Pro - Bronze	166.80
NESWNSKPP02301S	Skybell Pro - Silver	166.80

The Skybell doorbell will allow you to answer your doorbell from anywhere in the world with your smart phone! This doorbell wires into your existing doorbell setup for easy installation.



**Nest Cam indoor/outdoor**

60 second setup - Android or iOS app to find your Wi-Fi network, live stream in under a minute. High quality video - get into the details with 1080p high-definition video. Field of View - 130 degrees diagonal, plus Night Vision and Zoom, means you don't miss a thing. Cloud Video Recording (CVR) - review footage and make clips with optional secure offsite recording. Stay connected with Two-Way Talk, Intelligent Alerts, Scheduling and Mobile & Web apps.



NESNC1103US	Nest Cam Indoor camera	179.99
NESNC2100ES	Nest Cam Outdoor Camera	179.99

**Become a Nest Pro!**



The Nest family of products includes the Nest Learning Thermostat, Nest Protect, Nest Cam Indoor and Nest Cam Outdoor. Become a Nest Pro and start to sell and install the award-winning products that are making the home more thoughtful. You'll get exclusive training and tools, live VIP support, and customer referrals to help your business grow!

**Scan the code or go to [pro.nest.com](http://pro.nest.com) to get certified.**

**Works with Nest**



When products work with Nest you don't have to tell them how to connect. Or what to do. They just work. In real homes, for real people. Just look for the Works with Nest logo. Today, lots of brands that your customers already use can connect to Nest like your Philips Hue Lights and your Yale and Kwikset locks.

**Philips Hue**

NESWNP456194	Philips Hue starter kit	174.86
--------------	-------------------------	--------

The Philips Hue starter kit includes the Philips Hue Hub as well as 3 RGBW LED bulbs.



Philips Hue lighting kits give you the option to either remotely control your lights or to set them on a schedule. With your color lighting at your finger tips, you can set any mood you'd like! With the advanced scene option, you can choose images to base your color scene on.



LEVITON Omni-Bus	CENTRALITE Elegance XL	Simply Brilliant	LEVITON HLC	PCS PulseWorx	CENTRALITE Azela	LUTRON Caséia	LUTRON Radiora 2	CENTRALITE JetStream	JASCO Z-Wave	LEVITON Vizia RF +	
N	Y	Y	N	N	N	N	Y	N	Y	Y	Fan Speed Control
Y	Y	N	N	Y	N	N	Y	N	N	Y	Elec. Low Voltage
256	720	256	256	256	256	100	200	200	232	128 (232)	Max. Devices
N	N	Y	Y	Y	Y	Y	Y	Y	Y	Y	Retrofittable
600	2400	900	2400	2400	800	600	1000	800	600	1000	Max. Dimmer Watt.
14	20	8	15	8	8	5	8	8	15	15	Max. Switch Amp.
Y	Y	N	Y	Y	N	Y	Y	N	Y	Y	LED Supported
Bus	Bus	Coupler/ Repeater	Coupler/ Repeater	Coupler/ Repeater	Mesh Network	N/A	Fixed Repeater	Mesh Network	Mesh Network	Mesh Network	Network Integrity
Central Cabinet	Central Cabinet	Neutral Required	Neutral Required	Neutral Required	Neutral Required	Standard	Standard	Neutral Required	Neutral Required	Standard	Wiring
Y Built-In 3.0+	Y Built-In 2.10+	Y Built-In 2.7+	Y Built-In 2.7+	Y Built-In 2.7+	Y Built-In 3.7+	N	Y Built-In 3.3B+	Y Built-In 2.14+	Y Built-In 2.14+	Y Built-In 2.14+	Omni-Supported
Y	O	Y	N	Y	N	N	Y	In Base	N	N	I/O Modules
N	N	Y	N	Y	N	N	N	N	Y	Y	Controlled Recpts.
N	N	Fixture / Dimming	N	Y	N	N	Y	N	N	N	Wired Modules
IP	RS-232	RS-232 PIM	RS-232 PIM	RS-232 PIM	RS-232 ZIM	N/A	RS-232	RS-232 PIM	RS-232 PIM	RS-232 PIM	Omni Interface
N	L,A	L,A	L,A	L,A	L,A	L	L, A	N/A	L,A	L,A	Plug-In Modules
Y	Y	N	Y	Y	Y	N	Y	Y	N	Y	Two-Way w/ Omni
N	N	N	N	N	N	Y	Y	N	N	Y	Two-Wire Devices*
Y	Y	Y	Y	Y	Y	Y	Y	Y	Y	Y	Scene Capable
Y	N	N	Y	Y	N	Y	Y	Y	Y	Y	Wireless Remote
<b>Wired</b>		<b>UPB</b>			<b>Wireless/RF</b>						

Y=Yes; N=No; O=Available as an Option; N/A=Not Available; L=Lamp; A=Appliance

\*Dimmable fluorescents supported

The information in this chart was gathered from manufacturer websites, tech support and literature. Confirm specs with Worthington prior to ordering. Worthington Distribution's knowledgeable staff can help with any questions you may have.





### Elegance XL and JetStream

When it comes to speed and reliability, there is no substitute for a hard-wired lighting system. Elegance XL is the value leader for any size home. Dimming cabinets combined with multi-button keypads eliminate wall clutter. JetStream is a mesh wireless solution that can be used for simple to elaborate applications.



### RadioRA 2

A wireless total home control system engineered to be as solid as a hardwired system. The ultra-reliable fixed repeater network is flexible for retrofit and new installations. It is a scalable solution for basic to the most advanced applications.



### Universal Power Line Bus (UPB)

A reliable power line technology, UPB is available from 3 companies: PCS, Leviton Security and Automation, and Simply Automated. Omni users can program devices from the controller. Other implementations use free UPStart PC programming software.



### ZigBee

A wireless technology with many chip manufacturers and implementations. Look for products that use the Home Automation profile. Before the Home Automation profile, all ZigBee products used the same radio technology but products were not interoperable.

Lighting Manufacturer	Application	Technology	Page
Aeotec	Mesh Wireless	Z-Wave	19
Centralite	Mesh Wireless	JetStream	61
Centralite	Hardwired	Elegance XL	63
GE / Jasco	Mesh Wireless	Z-Wave	33
HLC ( HAI Lighting Control )	Powerline Carrier	UPB	89
Leviton Vizia RF+	Mesh Wireless	Z-Wave	16-17
Linear	Mesh Wireless	Z-Wave	23
Lutron RadioRA 2	Fixed Repeater Wireless	ClearConnect	45-50
PulseWorx (PCS)	Powerline Carrier	UPB	56-57
Simply Automated	Powerline Carrier	UPB	58-59



### Z-Wave

A wireless technology with a standardized radio protocol. Z-Wave solutions exist for more than just lighting. It is an RF technology for controlling thermostats, window treatments, locks, water valves, sirens, and many more devices!

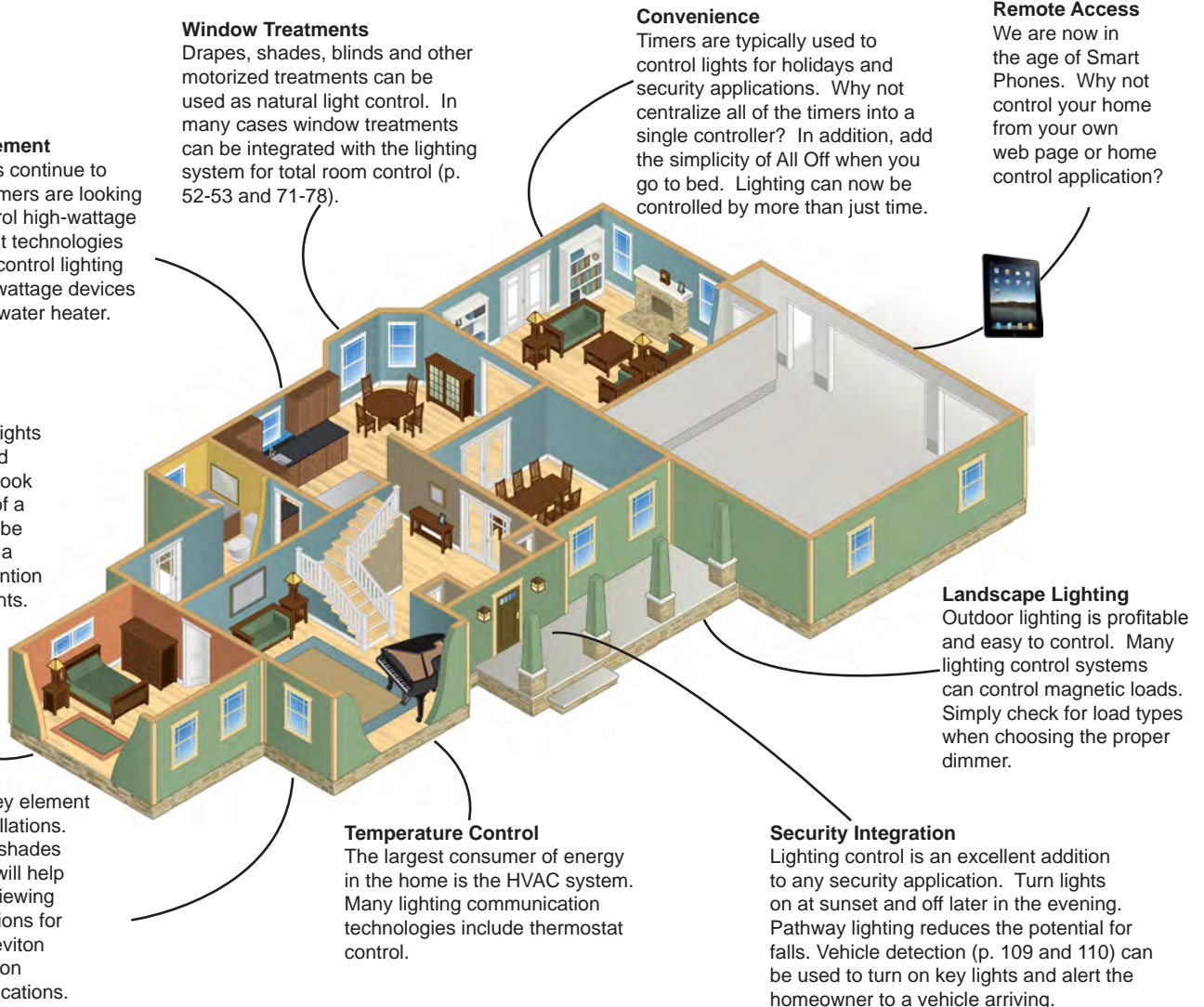

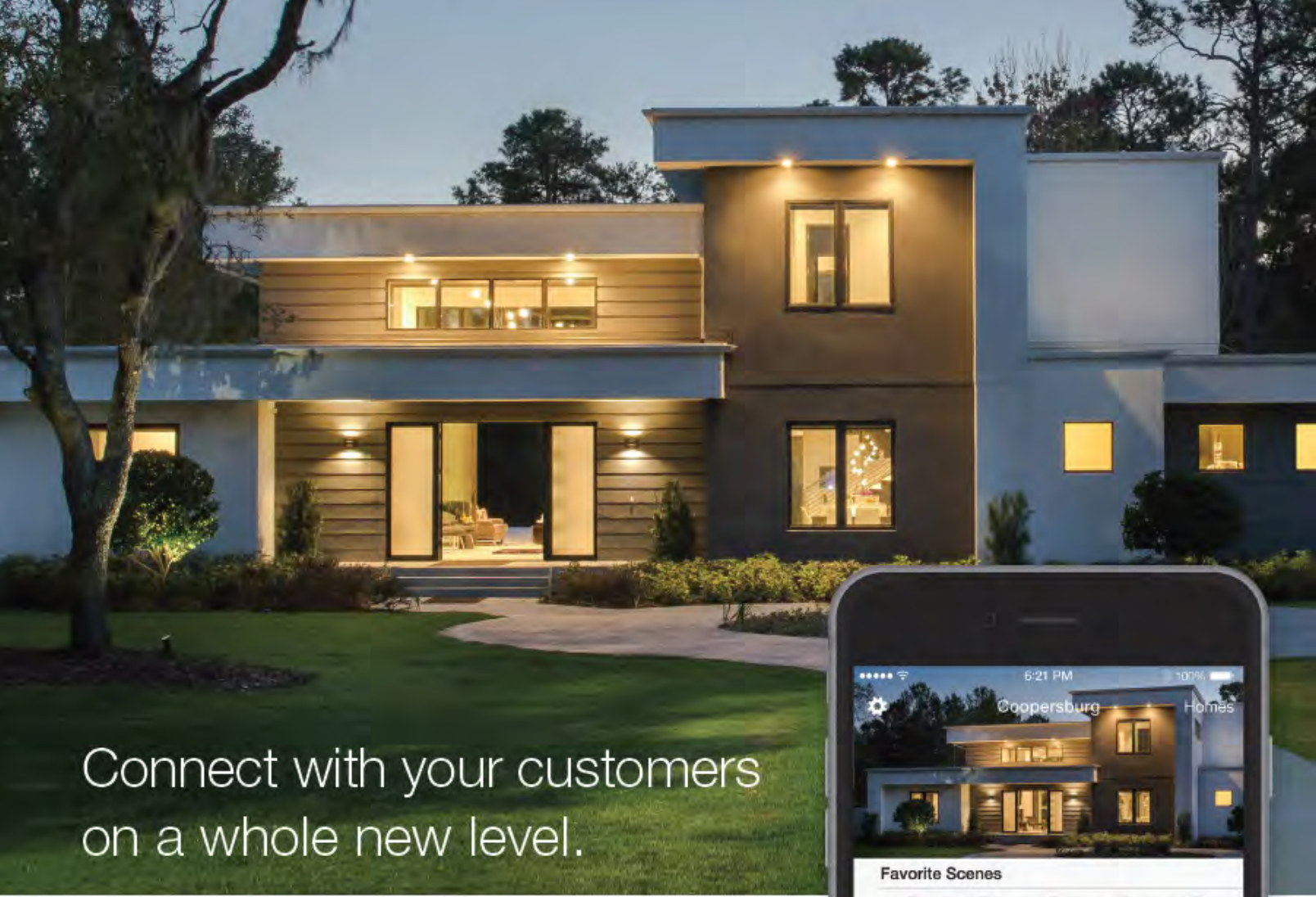

Connect with your customers on a whole new level.

**Lutron Connect for RadioRA 2**  
A suite of cloud-connected smart home features that include\*:

- FREE remote access — for control from anywhere
- Amazon Alexa integration — provides voice-activated scene and room control for lights, shades, and temperature
- Geofencing — automatically sends notifications when users leave a predetermined area, ensuring that lights aren't mistakenly left on
- Nest Learning Thermostat support — enables light, shade, and temperature control from one convenient app

**See pages 45–49 for more information.**

\* Lutron Connect Bridge required

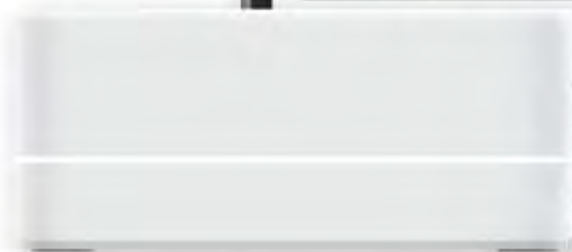

Lutron Connect Bridge and Lutron Connect app



# RadioRA 2

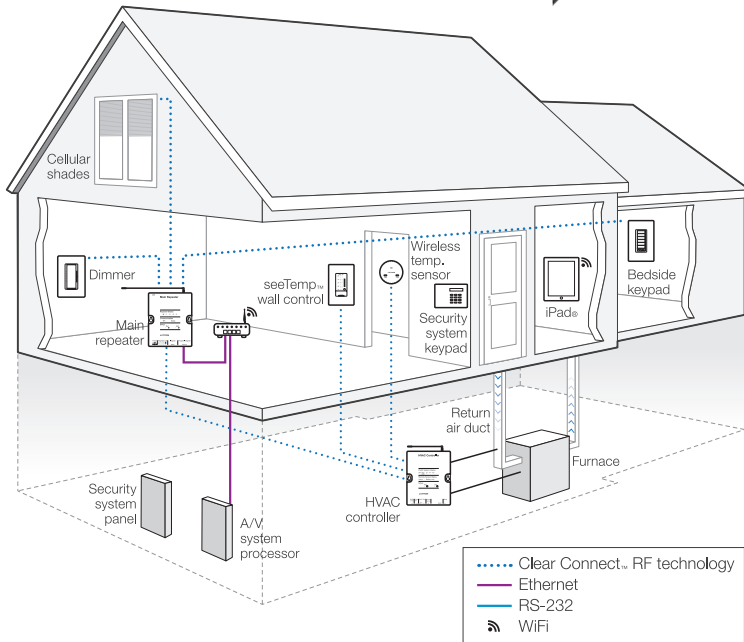

RadioRA 2 is a robust wireless home control system that provides convenient and intuitive control of lights, shades, temperature, and appliances in a single room or throughout an entire home. RadioRA 2 uses standard wiring topography familiar to any electrician, making it perfect for any new or retrofit installation. The system is scalable, programs quickly, and operates with ultimate reliability thanks to Lutron's Clear Connect™ RF Technology.

RadioRA 2 is one of the most exciting lighting systems to enter the automation marketplace. Clear Connect™ RF Technology allows systems to grow from a simple home theater application with a handful of devices to a complete 200 device automated home. The brand new Connect Bridge takes this full eco-system product to the next level of automated control.

## Heart of the System: Main and Auxiliary Repeaters

RadioRA 2 uses a fixed repeater network to ensure a smooth, ultra-reliable, error-free lighting system. The core of any whole house RadioRA 2 installation starts with a main repeater. The main repeater uses wireless ClearConnect™ RF technology to talk to any RadioRA 2 device. The main repeater also incorporates a serial and Ethernet port for integration to third party automation systems as well as the Lutron Home Control+ app.

LURRMAINREPWH	RadioRA 2 Main Repeater	311.63
LURRAUXREPWH	RadioRA 2 Auxiliary Repeater	186.73



LURRAUXREPWH

LURRMAINREPWH

Lutron guarantees communication 30ft in any direction through any construction from a repeater; greater distances are common. To extend the size of a system simply use an Auxiliary Repeater. Up to 60ft from a main repeater, auxiliary repeaters are connected via a wireless RF link. For remote locations up to 1000ft away, simply use 18/2 and 22/2 shielded to hard-wire an auxiliary repeater for full control.

## Guaranteed Reliability

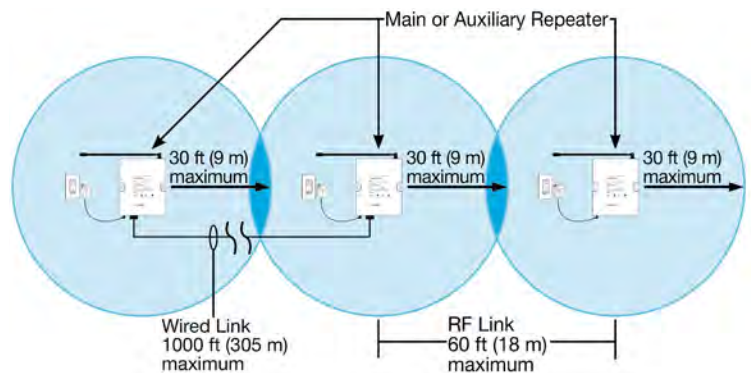

## Connect Bridge

Turn Your Lights On  
Adjust Your Thermostat  
Disarm Your Security System  
**Just by driving home...**



LUCONNECTBDG1



The Lutron Connect Bridge provides geofencing to trigger lighting and HVAC scenes within the home. By utilizing the Connect Bridge, remote access for control and monitoring the RadioRA 2 system is now FREE via the Lutron Connect app. Cloud-based timeclock syncing ensures accurate system time. Simply make sure the Connect Bridge is connected to the same network as your Main Repeater.

LUCONNECTBDG1	Connect bridge. Provides remote access for control and monitoring of the RadioRA 2 system via the FREE Lutron Connect app.	187.35
---------------	--	--------

## Total Home Control

### Benefits of total home control

- Save Energy
- Add convenience to your daily life
- Create just the right mood or ambiance
- Control from inside or outside your home
- Implement cutting-edge technology in your home





**Dimmers**

LURRD6CL*	RadioRA 2 600W Incandescent, 450W Magnetic Low Voltage, 150W CFL LED Dimmer. Two wire, no neutral required. <b>**LED and CFL Friendly**</b>	93.05
LURRD2ANF*	RadioRA 2 2A fan speed controller	124.28
LURRD10ND*	RadioRA 2 1000W Neutral wire, incandescent, magnetic low voltage, halogen dimmer. Single pole or multi-location. <b>**LED and CFL Friendly**</b>	124.28
LURRD6NA*	RadioRA 2 600W adaptive dimmer for incandescent, magnetic low voltage, and electronic low voltage. <b>**LED and CFL Friendly**</b>	124.28
LURDRD*	RadioRA 2 remote dimmer for 120V 3-way applications.	24.98



LURRD6CLDS



LURRD6CLBL



LURRD8ANSMN

Gloss: WH-White, IV-Ivory, AL-Almond, LA-Light Almond, GR-Gray, BR-Brown, BL-Black  
Satin: HT-Hot, MR-Merlot, PL-Plum, TQ-Turquoise, TP-Taupe, ES-Eggshell, BI-Biscuit, SW-Snow, PD-Palladium, MN-Midnight, SI-Sienna, TC-Terracotta, GB-Greenbriar, BG-Bluestone, MS-Mocha Stone, GS-Goldstone, DS-Desert Stone, ST-Stone, LS-Limestone

See page 50 for color samples

**LED Dimming Answers**

Before you commit yourself or your customer to investing in LED technology, you should understand its limitations, especially when it comes to dimming control compatibility. There are over 4,000 manufacturers of LEDs in the world without a formal manufacturing standard. This makes it very difficult to engineer a dimmer for all devices.

Just because a fixture says it is dimmable does not mean it will perform well, due to the lack of a formal standard. Manufacturers may not indicate anything about performance; “dimmable” may only pertain to compatibility with specific dimmers. This has resulted in dimmable products that do not work as claimed. Some issues are lights that never turn off completely, flicker, pop-on, or drop-off.

Visual deficiencies may not be the only problem. In-rush current can greatly damage a dimmer not suited for LEDs. In-rush current can be 10x the operating power of an LED and this occurs every half-cycle or 120 times per second (60Hz). Simply put, this means 10 LED fixtures operating at 10W each can total 1000W, 120 times per second. The only way to know for sure if a particular LED lamp or fixture will work with a particular dimmer is to test it. Lutron has done extensive testing with many manufacturers and has performance report cards available to ensure exceptional results.

**For full details regarding \*\*LED and CFL Friendly Dimmers\*\* contact Lutron: [www.lutron.com/LED](http://www.lutron.com/LED)**

For additional questions, please call Worthington 800-282-8864



**Sell Your Customer a System Not Just A Dimmer**

Talking to a customer about a price per dimmer can be very intimidating for that person. Talking about the cost of a lighting system is much more inviting. This gives you a reason to explain what the entire system will do rather than just an individual switch or keypad.

The chart below outlines typical lighting systems with components. If you would like a spreadsheet with your company logo and retail pricing give us a call. This chart sells lighting systems and helps estimate prices in a snap!

RadioRA 2 “Budget” Home Light Control System			Entry System	Premium System	Elite System
Part Number	Description	Retail	5 Dimmer	10 Dimmer	20 Dimmer
LURRD6CLWH	600W RF Dimmer INC, MLV,150W CFL LED	\$149	5	10	20
LURDRDWH	Remote Dimmer	\$40	0	1	2
LURRDW6BRLWH	Wall-Mounted seeTouch RF Keypad	\$299	0	1	2
LULRF2OCR2BP	Radio Powr Savr Occupancy Sensor	\$85	0	1	1
LULR3BHSW	Car Visor RF Transmitter	\$50	1	1	1
LURRVCRXWH	Car Visor RF Receiver	\$299	1	1	1
LURRMAINREPWH	Main RF Repeater	\$499	1	1	1
LUCONNECTBDG1	Remote Connect Bridge	\$299	1	1	1
<b>Total Retail Price of Components</b>			<b>\$1892</b>	<b>\$3061</b>	<b>\$4890</b>
<b>Total Dealer Price of Components</b>			<b>\$1234</b>	<b>\$1911</b>	<b>\$3053</b>
<b>Materials Profit</b>			<b>\$658</b>	<b>\$1150</b>	<b>\$1837</b>

# Welcome to the family... GRAFIK T

RadioRA 2 accessories have always come in beautiful color palettes. There are now two families of components available. Welcome the next generation of elegance and style with GRAFIK T. GRAFIK T is a Lutron level 2 product line.

## Grafik T CL Hybrid Keypads and Dimmers

Grafik T CL Hybrid Keypads have an LED lightbar with a responsive touch interface that provides users with one-touch control. They are available in multiple engraved button configurations.

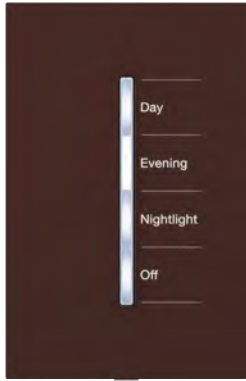

LURRTGH4BR

### RadioRA 2 Grafik T CL Hybrid Keypad with 250W LED, 600W INC/HAL, 300VA MLV dimmer.

LURRTGH2B	2-button	342.85
LURRTGH4B	4-button	342.85
LURRTGH5B	5-button	342.85
LURRTGH6B	6-button	342.85

### RadioRA 2 GrafikT Touch Dimmer. 250W LED 600W INC 300VA MLV.

LURRTG25LW	No neutral	155.50
LURRTG5NEW	Phase selectable	186.73
LURRTG5ANSW	120V 5A Switch	155.50



LURRTG25LW

Wallplates must be added separately



Multi-gang Wallplate

## Multi-gang Wallplates

With the Lutron product line, we can mix and match Grafik T and Architectural devices as well as multiple Grafik T devices. For more configurations give us a call at 800-282-8864.

## Grafik T Wallplates

Grafik T and Architectural wallplates are available in architectural matte and clear glass finishes. These wallplates provide a level of sophistication like none other.

Give us a call today to discuss all available options.  
800-282-8864



Plastic



Glass

## Classic Decorator Style Keypads

Do not be concerned about choosing the correct button kit. Lutron's innovative keypads have the same body and all button configurations are interchangeable within each family of keypad. Every keypad comes with a pack of premium clear stickers for temporary use until the homeowner becomes familiar with the system. Each keypad comes with a free engraving certificate to simply change the button configuration, color, and text.



LURRDW3BRLWH



LURRDW6BRLGB



LURRDW6BRLMN



LURRDH3BDSS



LURRDH6BRLDWH



LURRDH6BRLDTC

## Wall-Mounted Keypads

RadioRA 2 wall mounted keypads. 6-button with raise/lower is most popular. 110VAC Only.

LURRDW7B*	7-button	186.73
LURRDW6BRL*	6-button with raise/lower	186.73
LURRDW3BRL*	3-button with raise/lower	186.73
LURRDW3BD*	Dual group, 3-buttons in each group	186.73
LURRDW2RLD*	Dual group, 3-buttons in top group and 2 buttons with raise/lower in bottom group	186.73

## Hybrid Keypads

RadioRA 2 hybrid keypads. With built in 450W dimmer. 6-button with raise/lower is most popular.

LURRDH1RLD*	3-button, with raise/lower dual group	249.18
LURRDH2RLD*	2-button with raise/lower dual group	249.18
LURRDH3BSRL*	3-button with raise/lower	249.18
LURRDH4S*	4-button	249.18
LURRDH5BRL*	5-button with raise/lower	249.18
LURRDH6BRLD*	6-button with raise/lower	249.18

All keypads are available in 26 different colors

### Lutron Connect™ App

Homeowners may edit their own lighting levels right from the app. No need to roll a truck just to change a scene. A unique and valuable system asset.



### 3-Way, No Wires? No Problem!

The Pico wireless keypads can be used to control ANY Lutron RadioRA 2 switch, dimmer, or plug-in device. This allows for a simple way to place an auxiliary or remote switch anywhere in a home.

Programming only takes 12 seconds, easy and fundamental. Simply press and hold the on/off button on the dimmer for 6 seconds. Then press the "Off" button on the Pico controller for 6 seconds. That is it, you are done and your hands are the only programming tools required!

### Pico Applications

Adjust lights from anywhere in a space with a Pico wireless controller. This versatile and easy-to-use control requires no wires and is compatible with a wide variety of Lutron lighting and automated window treatment solutions.

**All Picos include double-sided tape and bracket for these great application ideas:**

- Under a granite countertop
- Behind a bed headboard
- Car visor
- Turn lights on when walking to your home at night
- At the bottom or top of the steps
- Lamp behind furniture (use a plug-in module)
- Any retrofit application



### Plug-In Modules



Model	Description	Price
LURRD3LD*	RadioRA 2 tabletop lamp dimmer 300W incandescent and magnetic low voltage	93.05
LURR3PD1*	RadioRA 2 plug-in dimmer 300W incandescent and magnetic low voltage	93.05
LURR15APS1*	RadioRA 2 plug-in relay 15A/0.5 HP all load types	93.05

\* Available in Satin SW-Snow or MN-Midnight

### RadioRA 2 Training

#### RadioRA 2 Level 1 Training

Duration: 6-hours self paced online or 1 day in-classroom

- Online or classroom certification, call for details
- System size: up to 100 devices
- Systems are designed and programmed using RadioRA 2 Essential Software

#### RadioRA 2 Level 2 Training

Duration: 2-day in-classroom

- System size: up to 200 devices
- Specialty hardware such as the wallbox power and softswitch modules
- Systems are designed and programmed using RadioRA 2 Inclusive Software
- Training dates listed below for Level 2 training

#### Call to pre-register

April 5, 2017 – Tarrytown, NY  
 April 12, 2017 – Chicago, IL  
 April 12, 2017 – Charlotte, NC  
 April 20, 2017 – Washington, DC  
 April 27, 2017 – Toronto, ON  
 June 29, 2017 – Coopersburg, PA  
 July 27, 2017 – Irvine, CA

June 29, 2017 – Coopersburg, PA  
 July 27, 2017 – Irvine, CA  
 September 28, 2017 – Plantation, FL  
 November 2, 2017 – Coopersburg, PA  
 November 9, 2017 – Vancouver, BC  
 November 30, 2017 – Irvine, CA  
 December 11, 2017 – Coopersburg, PA

### Pico™ Wireless Keypads

- Utilizes Lutron's ultra-reliable Clear Connect™ RF technology
- Easily add a new or additional point of control without the need for new wires
- Use as a handheld control, car visor control, wall-mount, or tabletop control
- Available in 4-button configurations and 5 finish options
- Text and icon labeling options available for lighting and window treatments
- 10-year battery life
- Simple two-step programming



Clear Connect™ RF



#### LUPJ23BRLGWHL01

#### LURRD6CLBG

LUPJ22BGWHL01	2-button Pico on/off with light icons; white	15.61
LUPJ23BRLGWHL01	5-button Pico with raise lower light icon; and favorite button; white	13.11
LUPJ24BGWHEL1	New 4-button scene Pico, each button is programmable. Free custom engraving.	61.83

Nearly 100 different color and button options! Call for more choices.

### Pico Accessories



Pico with Car Visor Clip



Pico Pedestal Mounted



Dual Tabletop Pedestal

LULPED1*	Tabletop Pedestal Single Pico	9.37
LULPED2*	Tabletop Pedestal Dual Pico Keypads	18.74
LUPICOWBXADAPT	Pico Wallplate Adapter Kit	5.00
LUPICOCARVISORC	Pico Car Visor Adapter Kit	5.62
A1ILV1	Single Gang Retrofit Low Voltage Bracket	0.92

\* Available in Gloss WH-White or BL-Black



**Radio Powr Savr™ Occupancy and Vacancy Sensors**

Lutron occupancy sensors are another great solution for standalone applications. Any Lutron RadioRA 2 dimmer or switch can work with any of the following sensors. These sensors can be paired with any RadioRA 2 switch or dimmer just like a Pico controller using a simple two-step button push process.

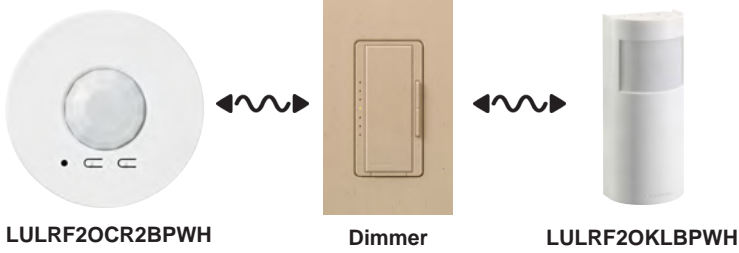

LULRF2OCR2BPWH	Ceiling occupancy/vacancy sensor; white	53.08
LULRF2VCR2BPWH	Ceiling vacancy only sensor; white	53.08
LULRF2OKLBPWH	Corner mount occupancy/vacancy sensor	53.08

**Call for additional models**

**Car Visor Control**

One of the most popular add-on sales for RadioRA systems has been the ability to control entry lighting from a car visor. With RadioRA 2, this is easily accomplished by adding a visor transmitter and a receiver. RadioRA 2 Visor Controls allow lights, shades / draperies, and other equipment to be controlled from the car with just a touch of a button on a Visor Control Transmitter or a HomeLink® compatible visor control.



LULR3BHSW	RadioRA 2 Car Visor Receiver	186.73
LURRVCRXWH	RadioRA 2 Car Visor Transmitter	30.60

**Security and Integration**

RadioRA 2 devices for interior lighting set to FULL ON

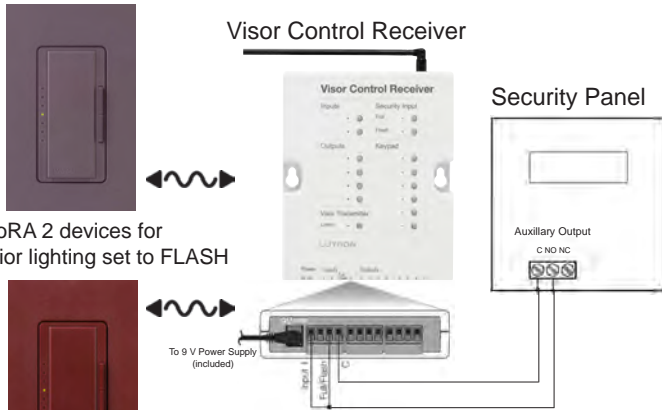

RadioRA 2 devices for exterior lighting set to FLASH

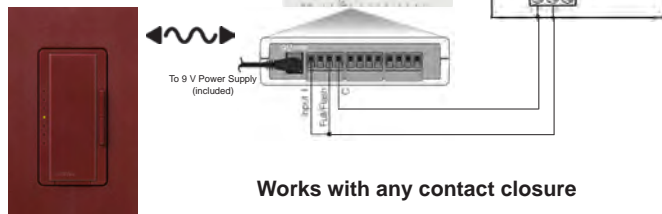

**Works with any contact closure**

RadioRA 2 is frequently interfaced with other systems within a home, such as security and fire alarm systems. Audible alarms are commonly utilized with these systems; however, the integration of lighting adds an enhanced level of security and peace of mind for the homeowner and their family. Simple programming allows an "ALL ON" feature to scare intruders while flashing exterior lights.

**RadioRA 2 Integration Numbers**

Integration Settings		
Telnet Logins	IDs	
Device/Zone	Enable for Integration	Integration ID
Dining Room	✓	2
Dining Room > Left > Left Hybrid (RRD-H58RL-WH)	✓	12
Dining Room > Left Dimmer	✓	10
Dining Room > Left Side	✓	11
Dining Room > Right > Right Hybrid (RRD-H58RL-WH)	✓	15
Dining Room > Right Dimmer	✓	13
Dining Room > Right Side	✓	14
Dining Room>Main Repeater 001 (RR-MAIN-REP-WH)	✓	1

When programming for Omni integration, simply note the integration ID numbers that are conveniently located in the Lutron Essentials software. Use these numbers as the address for each component in PC access and have full home automation control with one of the lighting industry's premier lighting systems.

**Tabletop Keypads**

LURRT5RL*	RadioRA 2 tabletop keypad - 5 buttons with raise/lower, corded or cordless capable via 2 AAA batteries	249.18
LURRT10RL*	RadioRA 2 tabletop keypad - 10 buttons with raise/lower, corded or cordless capable via 2 AAA batteries	280.40
LURRT15RL*	RadioRA 2 tabletop keypad - 15 buttons with raise/lower, corded or cordless capable via 2 AAA batteries	311.63

\*-Satin: SW-Snow, MN-Midnight

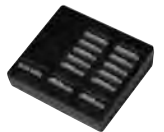

**HVAC Control**

Lutron offers a number of solutions for controlling HVAC systems. The first method uses the TouchPro™ thermostat which wires directly to the HVAC system and links to RadioRA 2 through Clear Connect.™ The second employs a HVAC controller, wireless temperature sensor, and seeTemp™ decorator style wall controller. A stylish hybrid of these two methods is to use the TouchPro™ and the seeTemp™ together. No matter which method is used all are controllable from Lutron's iPhone and iPad application.

LULRHVLHVAC	RadioRA 2 TouchPro™ thermostat	281.02
LULRDWSTF*	RadioRA 2 seeTemp™ 110VAC wall controller, no HVAC wiring needed	124.28
LULRHVAC1WH	RadioRA 2 HVAC controller	217.95
LULRF2TWRB*	RadioRA 2 wireless temperature sensor	74.94
LULRHVACPKGWH	RadioRA 2 HVAC package includes LULRDWSTFWH, LULRHVAC1WH, and LULRF2TWRBSW	374.08

\* Available in 26 different colors



LULRHVLHVAC

LULRHVAC1WH

LULRDWSTF\*  
LULRF2TWRB\*

Lutron provides wired relay outputs to control HVAC equipment.



### Color Option Samples



With RadioRA 2 you have a large color pallet to choose from along with matching wallplates. Gloss options are traditional colors which work with nearly all other devices in the home. For applications where the customer is looking for that extra touch, look to the Satin Color™ choices. These custom

colors allow wall devices to match the decor and room surfaces. The result will please even the most discerning tastes.

LUSCCK1	Sample Satin Color keychain	18.74
LUSCFD1	Sample Satin Color palette	6.24
LUDGCK1	Sample Designer Gloss keychain	18.74

### RadioRA 2 Dimmer and Switch Color Change Kits

LURKD**/††	Dimmer color change kit	9.37
LURKD10**/††	Dimmer color change kit, 10-pack	84.31
LURKS**/††	Switch color change kit	9.37
LURKS10**/††	Switch color change kit, 10-pack	84.31
LURKAD**/††	Remote dimmer color change kit	9.37
LURKAD10**/††	Remote dimmer color change kit, 10-pack	84.31
LURKAS**/††	Remote switch color change kit	9.37
LURKAS10**/††	Remote switch color change kit, 10-pack	84.31

††-Gloss: WH-White, IV-Ivory, AL-Almond, LA-Light Almond, GR-Gray, BR-Brown, BL-Black

\*\*-Satin: HT-Hot, MR-Merlot, PL-Plum, TQ-Turquoise, TP-Taupe, ES-Eggshell, BI-Biscuit, SW-Snow, PD-Palladium, MN-Midnight, SI-Sienna, TC-Terracotta, GB-Greenbriar, BG-Bluestone, MS-Mocha Stone, GS-Goldstone, DS-Desert Stone, ST-Stone, LS-Limestone



LUCW1BI

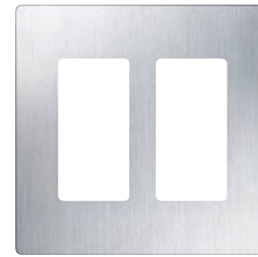

LUCW2SS



LULWTGSI

### Claro Designer Gloss Wallplates

LUCW1††	Claro 1-gang screwless wallplate	3.12
LUCW2††	Claro 2-gang screwless wallplate	6.24
LUCW3††	Claro 3-gang screwless wallplate	9.49

4, 5, and 6 gang wallplates available

### Satin Wallplates

LUSC1**	Satin 1-gang screwless wallplate	5.68
LUSC2**	Satin 2-gang screwless wallplate	8.87
LUSC3**	Satin 3-gang screwless wallplate	11.99

4, 5, and 6 gang wallplates available

### Grafik T Wallplates

LULWTG**	Grafik T 1-gang plastic wallplate	11.99
----------	-----------------------------------	-------

2, 3, and 4 gang wallplates available.  
Call for information on glass wallplates.

### Stainless Steel Wallplates

LUCW1SS	Claro 1-gang screwless stainless steel wallplate	7.37
LUCW2SS	Claro 2-gang screwless stainless steel wallplate	13.61
LUCW3SS	Claro 3-gang screwless stainless steel wallplate	19.86
LUCW4SS	Claro 4-gang screwless stainless steel wallplate	25.60

### Power Modules and Synthetic Loads

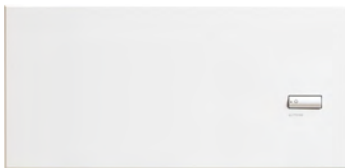

LULQRJWPM6P

The Wallbox Power Module can control 6 loads independently. The WPM is designed to be placed in closets, equipment rooms, and other locations where it is hidden from view. Homeowners use keypads or the Lutron HomeControl+ App to control the WPM. Level 2 Certification required.



LUPHPMPADVWH

LULQRJWPM6P	RadioRA 2 Wallbox Power Module. 120V 2000W. 6 load dimming module. Fits in 4-gang box.	524.58
LULMJ16RDVB	RadioRA 2 RF Softswitch Module. 16A 120/277V relay module. Fits in junction box.	93.05
LULMJCCO124B	RadioRA 2 RF Contact Closure Output module. Fits in junction box.	61.83
LULMJ5TDVB	RadioRA 2 RF 0-10V module. Fits in junction box.	124.28
LUPHPMPA120WH	Phase-adaptive power module 120V 16A. Fits in 2-gang box.	206.08
LUPHPMPADVWH	Phase-adaptive power module 120-277V 16A. Fits in 2-gang box.	287.27
LUPHPMSWDVWH	Switching power module 120-277V 16A. Fits in 2-gang box.	162.37
LULUTLBXWH	Synthetic minimum load. Used when a dimmer or switch's minimum load cannot be met.	93.68



LULMJ16RDVB

Modules can be mounted inside or outside a junction box on 1/2" NPT knockout

### GRAFIK Eye QS Wireless



LUQSGRJ6PTWH



LUQSGRJ6PWH

For an easy and efficient way to control both electric light and daylight, look to GRAFIK Eye QS. Fully customizable, GRAFIK Eye QS adjusts lights and shades for any task or activity at the touch of a button. You'll save energy while meeting the aesthetic, functional, and regulatory needs of any project or space.

LUQSGRJ4PWH	4-zone GRAFIK Eye QS, white cover	693.20
LUQSGRJ4PTWH	4-zone GRAFIK Eye QS, translucent cover	693.20
LUQSGRJ6PWH	6-zone GRAFIK Eye QS, white cover	793.12
LUQSGRJ6PTWH	6-zone GRAFIK Eye QS, translucent cover	793.12

For other color options visit [Lutron.com](http://Lutron.com)

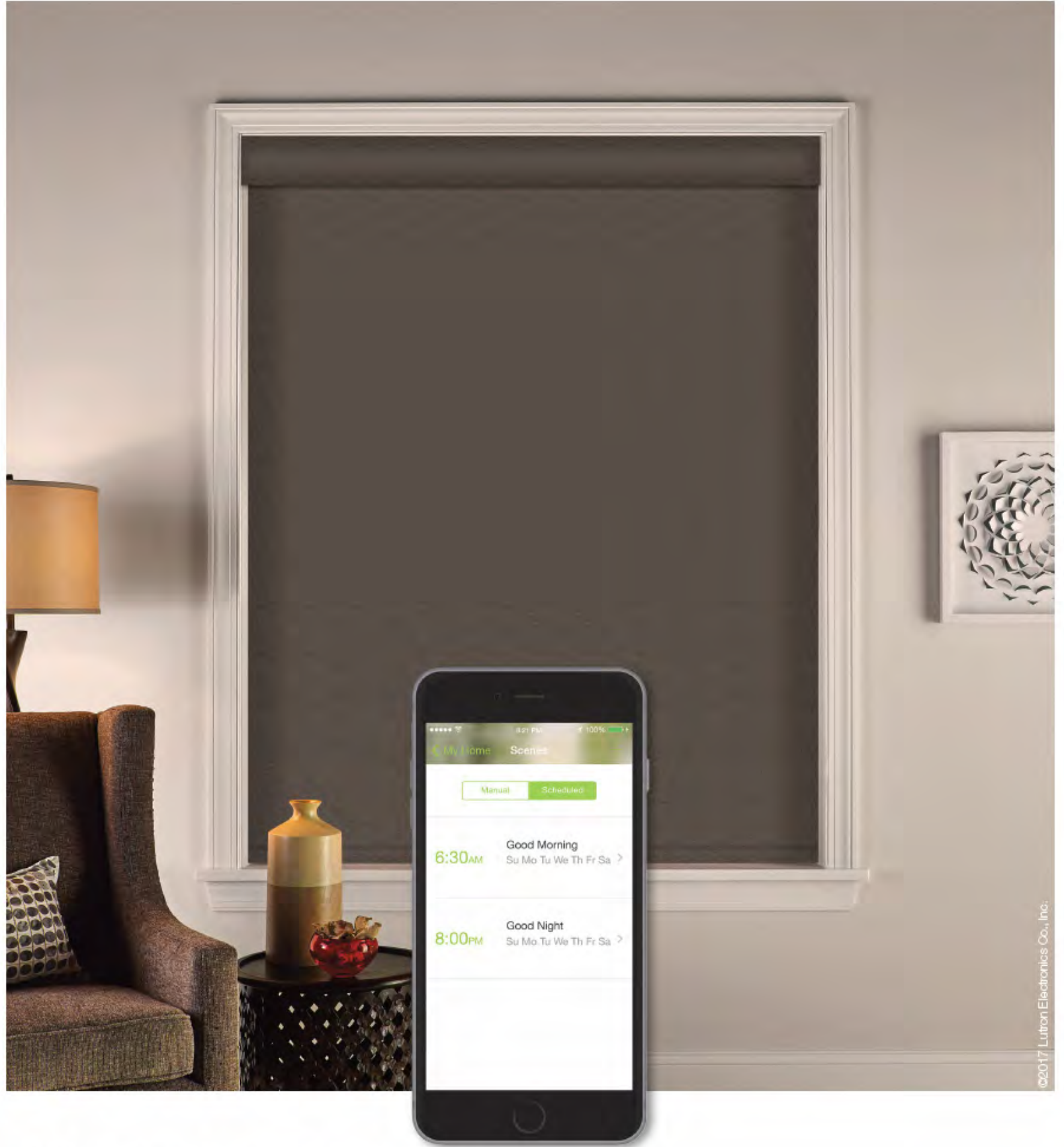

©2017 Lutron Electronics Co., Inc.

## When beauty meets technology

Lutron intelligent shades automatically adjust when you want them to. Whether it's morning, evening, or somewhere in between, our shades provide unparalleled convenience and comfort. Ask your local Representative or visit [lutron.com/triathlon](http://lutron.com/triathlon) for more information.

See pages 52-53 for more details.





# Sivoia QS Triathlon

## Automated Window Treatments

Sivoia QS Triathlon is one of the most fashionable, flexible, and affordable automated shading systems available today. This battery-powered solution offers a industry leading battery life for easy installation and maintenance, perfect for retrofit applications. Available in roller shade or insulating honeycomb styles, these shades have a wide variety of beautiful fabric colors and textures to meet the functional and aesthetic needs of any space. Able to work as a standalone or a system solution, these shades can be controlled at the touch of a button.



### Flexible Convenient Control

Adjust shades with a wire-free handheld or wall-mounted control from anywhere in the home. Shades can be controlled from the simplest Pico wireless remote to a smart phone. All of Lutron's controls are ultra-reliable and intuitive to understand. The Triathlon shading solutions easily integrate with RadioRA 2 lighting for full control anywhere in the world! RadioRA 2 keypads can be used to control shades and lighting loads at the same time.



**Pico Wireless Remote**  
10 Year Battery Life!



**RadioRA 2 Keypad**

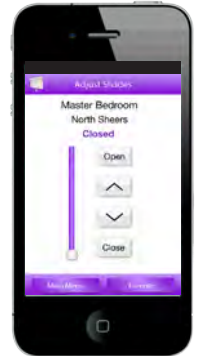

**HomeControl + App**

### Install Shades in 15 Minutes

Installation of roller or honeycomb shades is simple. The only tools you'll need are a tape measure and drill. Visit [www.worthington.com](http://www.worthington.com) to view a video of how easy it is to install a Triathlon automated window treatment!

### Opportunity

Lutron Triathlon automated shades offer a simple scalable way to offer precision natural light control. If you are installing a dimmer to control artificial light, why not control natural light? There are approximately 500,000 new homes built every year compared to over 100 million existing homes. This can be a perfect lead-in to call back existing clients for retrofit applications.

**Are you offering automated window treatments as part of your installation? Starting at only \$285!**

- \$4 Billion Industry
- 100 Million Existing Homes
- Excellent for wireless retrofit
- Perfect for new hard-wired installations
- Easy way to increase revenue
- Scalable for any application

### Applications

Lutron Triathlon shades are perfect for these applications and more!



- Windows behind a bathtub
- Commercial offices
- Whole house residential
- Home theaters
- Every RadioRA 2 installation
- Hard-to-reach windows
- Any retrofit where pulling wire is difficult
- Stairwell windows
- Glass or French doors

### Specialty Applications

Give us a call for specialty applications that are outside of a standard window treatment.

- Angled windows
- Bottom-up roller and honeycomb shades
- Custom printed graphics
- Custom colors
- Arched windows
- Silhouettes
- Dual roller shades
- Draperies
- Roman shades
- Curved drapes

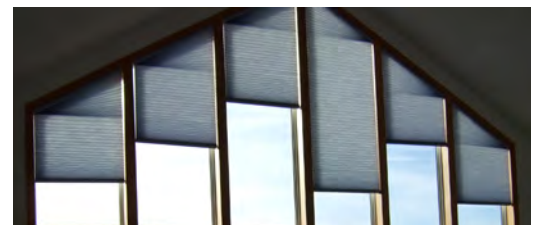

### 3 to 5 Year Battery Life

#### Battery replacement is easy!

Lutron's exclusive Tap n' Tilt technology allows almost anyone to change batteries every 3-5 years.



Simply press the release buttons, allowing the headrail to tilt forward

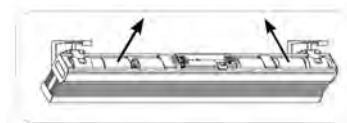

Change the batteries...



And snap the headrail back in place.

**1-800-282-8864 (Phone)**  
[www.worthdist.com](http://www.worthdist.com)

**WORTHINGTON**  
DISTRIBUTION

**1-866-542-0470 (Fax)**  
[sales@worthdist.com](mailto:sales@worthdist.com)

**Honeycomb Fabrics**

Triathlon Honeycomb Insulating Shades have three different types, with various color choices within each. Each fabric allows a different amount of light to enter a room while providing energy saving insulation and privacy. Honeycomb Insulating Shades can double the R-value of a triple-pane window!



**Light-Filtering Single Cell**



**Light-Filtering Double Cell**



**Room Darkening Single Cell**

**Software**

Easily keep track of all your jobs with the Lutron Shade Configuration Tool!



**Online Certification**

- Step 1: Register with [lutron.learn.com](http://lutron.learn.com)
- Step 2: Complete online training
- Step 3: Purchase a roller and honeycomb binder along with your choice of either the roller OR honeycomb demo kit.

**Roller Fabrics**

There are three families of fabric for Triathlon Roller Shades: Blackout, Translucent, and Sheer. Each fabric allows a different amount of light to enter a room while providing varied levels of privacy. Large 8"x10" samples are easily removed from the binder, simply add a suction cup to hang the sample on the window and a customer can easily determine which choice is best.

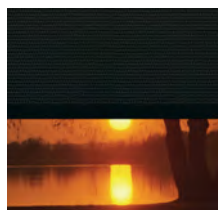

**Blackout**

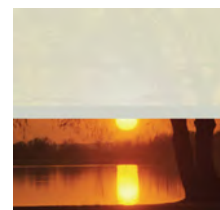

**Translucent**

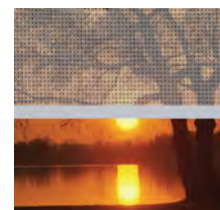

**Sheer**

**Triathlon WIDR**

The Triathlon WIDR series of shades offers a wider, taller, longer battery life shade up to 12' x 12"! These shades also can employ Lutron's new Battery Boost option, enhancing battery life up to 80%. Triathlon WIDR shades are available as a standalone or system solution.

**12 ft. X 12 ft.  
D-Cell Battery-Powered Shades!**

Give us a call today to learn more.  
1-800-282-8864



**Fabric Choice Is Simple!**

Fabric selection has never been easier with the use of Lutron's fabric binders. There are color choices to match any decor. Typically the fabric binder is left with the customer for a few days to make a decision, similar to carpet samples.

LUROLLERBINDER	Complete roller fabric sample binder. Real fabric samples, all colors and styles included.	124.90
LUHONEYCOMBBIND	Complete honeycomb fabric sample binder. Real fabric samples, all colors and styles included.	93.68

**Demonstration Sales Equipment**

The Lutron shade demonstration kit is truly one of the finest pieces of demonstration equipment in the industry. It is a fully operational shade accompanied with a tabletop Pico controller. The shade is mounted within a stand-up tabletop window frame that easily collapses into an 8"x8"x36" black carrying case embroidered with the Lutron logo. Because the shade is battery-operated, it allows a simple demonstration anywhere, from your customer's kitchen table to a trade show booth.

LUHONEYCOMBDEMO	Portable tabletop honeycomb demonstration shade with Pico controller	499.00
LUROLLERDEMO*	Portable tabletop roller demonstration shade with Pico controller	593.28

\*Roller Demo Color - 1-Red, 2-Dark Gray, 3-Charcoal/Brown, 4-Twill, 5-Nutmeg

**LUHONEYCOMBDEMO**



**Purchase the demo equipment from Worthington and receive \$50 off your first shade order!**



**Shade In Bag**



**Collapsed**



**Folding**



**Open**



**Closed**



# Caséta™ Wireless

The Smart Way to a Connected Home  
**Amazingly Simple. Amazingly Affordable.**

**Control your lights at home**

**Pico**  
Wireless Remote Control

**In-Wall Dimmer**  
(No neutral) Switch available

**Pico**  
Wireless Remote Control

**Plug-In Lamp Dimmer**

**or anywhere**

**Amazingly Simple**

1. Download FREE app.
2. No programming. Sets up in minutes.
3. Control and schedule your lights from anywhere.

**Smart Bridge Pro and Smart Device**



**No New Wiring Required!**

Retail prices shown below. Call for your dealer pricing today!

### Starter Kits

LUPPKG1WWH	Caséta In-wall Light Dimmer with Pico	59.95
LUPPKG1PWH	Caséta Plug-in Lamp Dimmer with Pico	59.95
LUPBDGPKG2W	Smart Bridge Dimmer Kit with 2 600W dimmers, 2 Pico® Remotes, 2 single pedestals, 2 wallplates	189.95

Kits are available in white only

### Dimmers and Switches

LUPD6WCL*	Caséta In-wall Dimmer. 150W LED/CFL, 600W incandescent/halogen. <b>No neutral.</b>	54.95
LUPD10NXD*	Caséta In-wall Dimmer. 250W LED/CFL, 1000W INC, HAL, MLV. <b>Neutral optional.</b>	98.00
LUPD5WSDV*	Caséta In-wall Switch. 600W incandescent/halogen, ELV, MLV, 5A LED/CFL. 3A fan. <b>No neutral.</b>	89.00
LUPD6ANS*	Caséta In-wall Switch. 720W incandescent/halogen, ELV, MLV, 6A LED/CFL. 3A fan. <b>Neutral required.</b>	64.95
LUPD3PCLWH	Caséta Plug-In Dimmer 300W Incandescent, 150W CFL or LED Will act as a range extender	54.95

\*Available in WH-White, LA-Light Almond, IV-Ivory, BL-Black

### Control Multiple Locations

Caséta Wireless allows for more than control of a single device. A Pico remote control can be simply paired to control multiple dimmers or plug-in dimmers. Dimmers can also be easily paired with multiple Picos for his and her control of single or multiple devices.

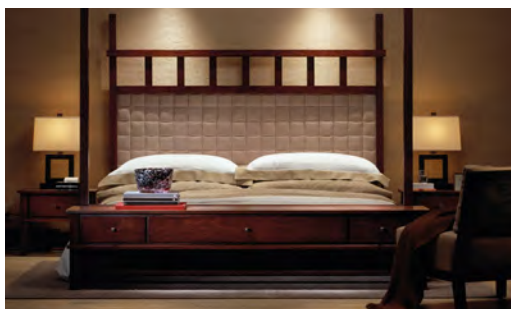

### Caséta Smart Bridge

The Smart Bridge allows control of your Caséta lighting devices, temperature controls, and shades from a smartphone. Caséta utilizes ultra-reliable ClearConnect™ wireless technology. The Smart Bridge allows control via the Lutron app. The Smart Bridge Pro allows third-party integration such as Nest and control via the Lutron app.



Wireless Switch



Wireless Dimmer



Wireless Pico



LULBDGPRO2WH



LULHVLV2WIFI

LULBDG2WH	Caséta Smart Bridge	79.95
LULBDGPRO2WH	Caséta Smart Bridge Pro. For integration with third-party devices.	150.00
LULHVLV2WIFI	Lutron Wireless Thermostat	331.00

### Pico Wireless Remote and Accessories

LUPJ2WALLWHL01	Pico Remote Control with Wallmount Kit	23.95
LUPJ23BRLGW*	Pico Remote Control	13.11
LUPICOWBXADAPT	Pico Wallplate Adapter Bracket	5.00
LULPED1*	Pico Pedestal Single Mount	9.37
LUPICOCARVISORC	Pico Car Visor Mount Clip	5.62

\*Available in WH-White or BL-Black



Decora Wallplates

	White	Ivory	Light Almond	Ebony/Black	Brown	
	LEV80401-W	LEV80401-I	LEV80401-T	LEV80401-E	LEV80401	0.42
	LEV80409-W	LEV80409-I	LEV80409-T	LEV80409-E	LEV80409	0.83
	LEV80411-W	LEV80411-I	LEV80411-T	LEV80411-E	LEV80411	1.25
	LEV80412-W	LEV80412-I	LEV80412-T	LEV80412-E	LEV80412	5.07
	LEV80423-W	LEV80423-I	LEV80423-T	LEV80423-E	LEV80423	8.41
	LEV80436-W	LEV80436-I	LEV80436-T	LEV80436-E	LEV80436	10.54
	LEV80405-W	LEV80405-I	LEV80405-T	LEV80405-E	LEV80405	0.83
	LEV80421-W	LEV80421-I	LEV80421-T	LEV80421-E	LEV80421	2.48
	LEV80431-W	LEV80431-I	LEV80431-T	LEV80431-E	LEV80431	4.87

Decora Plus Screwless Wallplates

	LEV80301-SW	LEV80301-SI	LEV80301-ST	LEV80301-SE	LEV80301-SO	4.76
	LEV80309-SW	LEV80309-SI	LEV80309-ST	LEV80309-SE	LEV80309-SO	9.32
	LEV80311-SW	LEV80311-SI	LEV80311-ST	LEV80311-SE	LEV80311-SO	13.99
	LEV80312-SW	LEV80312-SI	LEV80312-ST	LEV80312-SE	LEV80312-SO	19.02

Decora Nylon Wallplates

	LEV80401-NW	LEV80401-NI	LEV80401-NT	LEV80401-NE	LEV80401-N0	0.52
	LEV80409-NW	LEV80409-NI	LEV80409-NT	LEV80409-NE	LEV80409-N0	1.04
	LEV80411-NW	LEV80411-NI	LEV80411-NT	N/A	LEV80411-N0	1.56
	LEV80412-NW	LEV80412-NI	LEV80412-NT	N/A	LEV80412-N0	5.07

Standard Wallplates

	LEV80701-W	LEV80701-I	LEV80701-T	LEV80701-E	LEV80701	0.31
	LEV80709-W	LEV80709-I	LEV80709-T	LEV80709-E	LEV80709	0.62
	LEV80703-W	LEV80703-I	LEV80703-T	LEV80703-E	LEV80703	0.31
	LEV80705-W	LEV80705-I	LEV80705-T	LEV80705-E	LEV80705	0.66
	LEV80414-W	LEV80414-I	LEV80414-T	LEV80414-E	LEV80414	2.66
	LEV88033	3-gang box mount blank plate for the 3-gang repeater box-White only				3.01

Give us a call about wallplate configurations that are not listed above

Studio Series Decorator Wallplates



ONQWP5001-CY



ONQWP5002-CR



ONQWP5003-MS

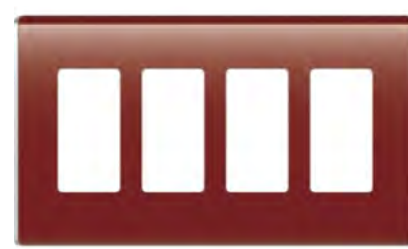

ONQWP5004-BD

ONQWP5001-**	Single Gang	3.38
ONQWP5002-**	Two Gang	2.26
ONQWP5003-**	Three Gang	3.20
ONQWP5004-**	Four Gang	4.13

\*\*Color - AL-Aloe, BD-Bordeaux, CP-Cameo Pink, CM-Cement, CR-Citrus, CZ-Cozumel, CY-Cyan, GB-Gloss Black, KK-Khaki, LA-Light Almond, MS-Moss, NV-Nirvana, SD-Sand, SP-Spanish Red, TP-Taupe, TI-Titanium, WH-White

For specialty plates, please refer to the manufacturer pages!

**Powerline Control Systems offers two types of lighting controls: SimpleWorx™ and PulseWorx®**

SimpleWorx is powered by SPC™ (Simple Powerline Communication), a rock-solid technology, while offering efficient solutions for remotely turning lights on and off. SPC provides super reliable one-way ON OFF control of lights and appliances using the 120v wiring that is already in place and offers a money back guarantee along with significant benefits above older powerline technologies or traditional wired and RF solutions.

SimpleWorx is basically a variety of transmitter and receiver devices, consisting of wire-in and plug-in, timers, keypads, switches, fixture and plug-in modules, which are super easy to install and set up. Pushing a button on each device is all that is needed to set-up your system. At last a really simple easy to install, and very reliable powerline lighting control product! One, two, three and you're done! SimpleWorx is a stand-alone simple-to-set-up lighting control like the X10 systems of the past. But better! Up to 5000' signal transmission without a coupler.

**SimpleWorx Transmitter Modules**

PCSSWX-DAT4	Digital Astronomical Timer, 16-event, 4-channel clock	109.91
PCSSWX-KPT4-*	Keypad Transmitter, wall-mount, 4-button, white or black	49.96
PCSSWX-DKT4-*	Desktop Keypad Transmitter, 4-button, white or black	69.94
PCSSWX-DST-*	Desktop Switch Transmitter, white or black	69.94
PCSSWX-FMT-AC	Fixture Module Transmitter - 120V input triggers signal	49.96
PCSSWX-FMT-CC	Fixture Module Transmitter - contact closure input triggers signal	49.96
PCSSWX-PMT-CC	Plug-In Module Transmitter - contact closure input triggers signal	59.95



PCSSWX-DAT4



PCSSWXWSXR15W

**SimpleWorx Transceiver Modules**

This module will both send and receive SPC signals to control and be controlled

PCSSWXWSXR15*	Wall Switch Transceiver - 120V input w/10A load, 800watt incandescent	49.96
---------------	---	-------

\*Specify W-White, I-Ivory, A-Almond (LA-Light Almond, B-Black, G-Gray, BR-Brown are special order)



PCSSWX-DKT4B



PCSSWX-KPT4-B

**SimpleWorx Receiver Modules**

PCSSWX-RAM-15*	Receptacle Module, top controlled, 15A	49.96
PCSSWX-FMR-AC	Fixture Module Relay - 120V output, 20A max load	49.96
PCSSWX-PMR-AC	Plug-In Module Relay - 120V output, 15A max load	49.96
PCSSWX-PMR-CC	Plug-In Module Receiver - contact closure, 8A max load	59.95
PCSSWX-SST	Plug-In Sunrise Sunset Timer - Astronomical Clock, 10 presets, 15A max load	74.94
PCSSWX-RWS-*	Remote Wall Switch for 3-way or 4-way - Red LED	24.98

\*Specify W-White, I-Ivory, A-Almond (LA-Light Almond, B-Black, G-Gray, BR-Brown are special order)



PCSSWX-RAM-15-A



PCSSWX-PMR-AC



PCSSWX-FMR-AC



Integrate with UPB Lighting Control

**PulseWorx®** lighting controls are shown on the next page. They enable you to provide one-touch control over any of your home's lights via keypads, dimmers, switches, and plug-in receivers. All while working within the current framework, which already exists in any home. No new wires are required.

Utilizing UPB® technology, invented by PCS, the dimmers and keypads use the standard residential wiring (120/208/240V electrical system with a neutral wire at each switch location) to control and create dramatic scenes without having to run additional wiring—providing an affordable, flexible lighting control option.

PulseWorx is modular, so you can start in one room and expand as your budget allows, along with your needs and wants. Installation is simple, attach or replace a switch with a PulseWorx Wall Switch or Dimmer by connecting the switch's line, load, ground, and neutral wire and you're ready to start creating lighting scenes like Good Morning, Dinner Time, Movie Time, Party and Good Night from an installed keypad with just a few button presses.

Pulseworx can be used as a stand-alone system. It has been used very often with central controllers like the Leviton Omni or ELK M1. Full bi-directional communication not only simplifies programming but also provides verification of any UPB signal sent, further bolstering the system's capabilities.

**Title 24 Timer**

The T24 timer is a stand-alone multi-channel timer that can control, via relays or with relays and T24 commands, up to four circuits. The timer has a 2-line LCD display and a menu system where the basic functions of the timer can be configured. In addition, you can connect the timer to a USB or network connection and perform that configuration from the T24 software.

The timer has easy to use front panel controls. There is a row of four buttons, a row of 4 LEDs, and a second row of four buttons. There is a USB port for connecting the timer to a computer for setup using the T24 software. If the optional network board is installed there is a location to plug in a network cable.

- Four channels used for either outputs or inputs (Occupancy sensor, on/off switch, etc.)
- Output relays for 120VAC or 277VAC, 20Amp
- On/Off control or multi-level control using T24 0-10V Receiving Modules
- Schedules contain up to 250 timed events, four schedules, non-volatile memory
- Astronomical calculation of sunrise and sunset

PCST24-T4	Title 24 Timer - 4 Channel Timer	374.70
PCST24-RM	Receiving Module 0-10v - Title 24 Timer	35.97
PCST24-NA	Network Adapter - Title 24 Timer	124.90



PCST24-T4

1-800-282-8864 (Phone)

www.worthdist.com

**WORTHINGTON**  
DISTRIBUTION

1-866-542-0470 (Fax)

sales@worthdist.com

**Universal Powerline Bus (UPB®)** is a highly reliable, cost-effective, 2-way communication technology which enables control products to utilize existing powerlines for both residential and commercial applications. The award-winning UPB® technology was developed by Powerline Control Systems (PCS) and has been awarded several patents for its innovation.

**Interfaces and Controllers**

The new PulseWorx Gateway (PGW) is the ultimate interface to any PulseWorx system that empowers the use of mobile devices, smart phones and/or tablets, to control the full line of PulseWorx/UPB products and will also communicate to all UPB licensee products.

PCSPGW	Pulseworx Gateway Interface. Control with mobile phones or tablets.	239.81
PCSTEC	Timed Event Controller, 20 timed events, serial control	149.88
PCSPIM-IP	UPB Powerline Interface Module-Ethernet program and control from a PC	199.84
PCSPIMR	UPB Powerline Serial Interface Module, control from a security or automation system	74.94
PCSPIMU	UPB Powerline Interface Module-USB program and control from a PC	74.94



**PCSPGW**

**In-Wall Load Control Modules**

PCSWS1DL-6-*	600 watt / 5 amp UPB wall switch/dimmer for <b>incandescent and CFL/LED lights</b>	74.69
PCSWS1DL-10-*	1000 watt / 8 amp UPB wall switch/dimmer for <b>incandescent and CFL/LED lights</b>	87.54
PCSWS1DL-15-*	1500 watt UPB wall switch, single or 3-way, dimmer or switch (+ see note)	180.26
PCSWS1DL-24-*	2400 watt UPB wall switch, single or 3-way, dimmer or switch (+ see note)	231.76
PCSWS1R-15-*	Relay wall switch, 15A, single or 3-way, auto off timer	74.69
PCSRM1-15-*	Duplex Receptacle, top controlled, 15A	61.95

\*Specify W-White, B-Black, LA-Light Almond, (I-Ivory, A-Almond, G-Gray, BR-Brown are special order)

+Don't forget to order the matching wallplate when you order the high wattage dimmers (1500, 2400)



**PCSWS1DL-15-W**  
**PCSWS1DL-24-W**

**Accessories for In-Wall Devices**

PCSLDS-120V	LED Dimming Stabilizer, 15A	18.74
PCSILR-10K	In-line 10K Load Resistor, resolves LED issues	12.49
PCSRWS-*	Wired remote switch for 3- and 4-way circuits	24.98
PCSLCP-U	Lighting Control Panel	398.68

Standard colors for most devices are White, Black and Light Almond. Other colors that may be available: Ivory, Almond, Brown, and Gray. Call to verify availability.



**PCSLCP-U**



**PCSLDS-120V**



**PCSWS1DL-6-W**  
**PCSWS1DL-10-W**

**PulseWorx Controllers (Neutral Required)**

PCSKPCW-6-*	Wall-mounted 6-button keypad, bright/dim and IR receiver	98.92
PCSKPCW-7-*	Wall-mounted 7-button keypad, bright/dim. Updated look!	158.87
PCSKPCW-8-*	Wall-mounted 8-button keypad, each button is programmable	98.92
PCSKPLD-6-*	Wall-mounted 6-button keypad with 400 watt load control, bright/dim	144.88
PCSKPLD-7-*	Wall-mounted 7-button keypad with 400 watt load control, bright/dim	184.85
PCSKPLD-8-*	Wall-mounted 8-button keypad with 400 watt load control, each button is programmable	144.88
PCSKPLR-6-*	Wall-mounted 6-button keypad with 10 amp relay, scene bright/dim	144.88
PCSKPLR-7-*	Wall-mounted 7-button keypad with 10 amp relay, scene bright/dim	184.85
PCSKPLR-8-*	Wall-mounted 8-button keypad with 10 amp relay; each button is programmable	144.88
PCSKPCD-6-*	PulseWorx Desktop Controller, 6-button, Blue backlights	124.90
PCSKPCD-7-*	PulseWorx Desktop Controller, 7-button, White backlights	174.86
PCSKPCD-8-*	PulseWorx Desktop Controller, 8-button, Blue backlights	124.90

\*Standard colors: W-White, B-Black, LA-Light Almond, (I-Ivory, A-Almond, G-Gray, BR-Brown are special order for 6 & 8-button only)



**PCSKPCW-7-W**



**PCSRM1-15-W**



**PCSLM1-4**



**PCSKPCW-6-W**

**Load Control Modules**

PCSFMD2-4	2-Channel Fixture Module Dimmer, 400 watt	89.93
PCSFMR1-20	PulseWorx Fixture Module Relay 1 channel, 20A	89.93
PCSLM1-4	Lamp Module, 1 channel, 400 watt, pass-thru	61.95
PCSAM1-12	Appliance Module, 1 channel, 12 amp, pass-thru	61.95
PCSOCM	Output Control Module, 2 controlled relays	74.94
PCSICM	Input Module, 2 dry contact or low voltage inputs	74.94

**Accessories**

PCSPPC-1	Passive hardwired UPB Phase Coupler	49.96
PCSSPR-1	Split-phase Repeater, Omni Compatible	224.82
PCSTPR-120	3-Phase Repeater, Omni Compatible	324.74
PCSHLF-20	Powerline Wire-in Filter, 20 amps	236.81
PCSILC	In-Line Choke Filter	14.99

**Accessories will ensure proper operation when used correctly**



**Universal Dimmer/Controller Bases**

- Reliable UPB powerline communication
- Unique dimmer base design
- Keypads can control one or two loads
- Interchangeable faceplates allow the dealer to customize the button layout based on the customer's needs



SAUS2-40	900 watt switch/dimmer base. Add faceplate.	59.95
SAUS22-40	550 watt x2 switch/dimmer base. Add faceplate.	134.89
SAUS1-40	900 watt switch/dimmer base. Add faceplate.	52.46
SAUCQF	3-Speed fan controller base. Add faceplate.	67.45
SAUCQT-40A	Scene controller base. Add ZS24BS or ZS24OS four button/LED faceplate.	56.20
SAZTP2*	Tabletop base & cord, accepts US240 base & faceplate (* Specify W-White, BK-Black)	18.74
SAUS2TP-W	Plug-in universal tabletop controller US240 base. Add faceplate.	71.19
SAUSR-40A	Remote Switch Base with dual blue/green LEDs (for 3-and 4-way applications)	17.49



SAZS12-W



SAZS22-W



SAUS2-40



SAZS280-W



SAZS28B-W



SAZS250-W

**Controller-Style Faceplates**

For use with SAUS2-40, SAUS22-40 bases

SAZS24B-*	Quad 'Thin Bar' button faceplate	11.24
SAZS26B-*	Quad 'Thin Bar' button with 2 rocker faceplate	18.74
SAZS28B-*	Eight 'Thin Bar' button faceplate	18.74
SAZS24O-*	Quad 'Oval' button faceplate	11.24
SAZS25O-*	Quad 'Oval' button with 1 rocker faceplate	14.99
SAZS26O-*	Quad 'Oval' button with 2 rocker faceplate	18.74
SAZS28O-*	Eight 'Oval' button faceplate	18.74
SAZS24BS-*	Quad 'Thin' faceplate SAUCQT-40 & SAUCQF	18.74
SAZS24OS-*	Quad 'Oval' faceplate SAUCQT-40 & SAUCQF	18.74

\* = Specify W-White, A-Almond, LA-Light Almond, I-Ivory, BK-Black, BN-Brown

**Communication Control**

SAUCS-01	UPB Controller, Scheduler, RS232	118.66
SAUMC-DB9-W	Plug-in Serial-UPB Power Line Interface Module, serial cable included - White	71.19
SAUMC-USB-W	Plug-in USB to UPB Power Line Interface Module, USB cable included - White	71.19

**Rocker Style Faceplates**

SAZS11-*	Single Rocker faceplate	3.33
SAZS12-*	Dual 'Tall' Rocker faceplate, for use with SAUS2-40, SAUS22-40 and SAUSR-40A bases	10.30
SAZS22-*	Dual 'Short' Rocker faceplate	10.30
SAZS23-*	Triple Rocker faceplate	14.99
SAZS24-*	Quad Rocker faceplate	18.74

\* = Specify W-White, A-Almond, LA-Light Almond, I-Ivory, BK-Black, BN-Brown

**Prices shown are dealer prices**
**Coupling and Repeating**

SAZPCI-W	Inverted Coupler-Passive, wires to 220VAC circuit	52.46
SAZPCI-B	Inverted Coupler-Passive breaker mount, Compatible: Cutler-Hammer, Square D, Murray	52.46
SAZPCI-P30A	Inverted Coupler - Plugs into a 30 Amp, 220 VAC outlet (NEMA 10-30 configuration)	59.95
SAZPCI-P50A	Inverted Coupler - Plugs into a 50 Amp, 220 VAC outlet (NEMA 10-50 configuration)	59.95
SAUTR	UPB hard-wired Coupler/Repeater/PIM for 3-phase, serial DB-9 cable included	268.54

**Load Control Modules**

SAUML-E-W	2-Prong, plug-in, 300 watt UPB Lamp Module with local sensing - White	46.84
SAUML-20-W	3-Prong, plug-in, 400 watt UPB Lamp Module with local sensing, count-down timer and pass through outlet - White	56.20
SAUMA-E-W	2-Prong, plug-in 12 Amp UPB Appliance Module - White	46.84
SAUMA-20-W	3-Prong, plug-in 15 Amp UPB Appliance Module with local sensing, count-down timer and pass through outlet - White	56.20
SAUMI-32-W	Plug-in UPB I/O module, 3 input (4-5V AC/DC, 2 closure, 1 audio), 2 output (60V AC/DC) - White	71.19
SAUFR-30	UPB In-line 12 Amp Fixture Relay Module, built-in count-down timers - White	63.70
SAUFD-30	UPB In-line 300 watt Fixture Dimming Module, built-in count-down timers - White	63.70
SAURD-30-*	UPB top controlled outlet, 12 Amp, bottom on, built-in count-down timers (* Specify W-White, A-Almond, I-Ivory, LA-Light Almond)	71.19

**Noise Filtering and Isolation**

SAZNF10A-P	Plug-in 10 Amp, blocks noise above 4 kHz	22.48	SAZNF10A-W	Wire-in 10 Amp, blocks noise above 4 kHz	17.49
------------	--	-------	------------	--	-------

**Simply Automated has two styles of lighting control to suit your needs.**

First is "PC-Configured" UPB for Home Automation. This is the most versatile and allows you to custom program all your devices. Then you can integrate the system to a master automation system for control. "PC-Configured" UPB includes the devices on the opposite pages and the first section below.

Second is the "Anywhere Virtual Lighting." This is very simple to use for lighting as a stand-alone solution. This is a good option to replace some of those old X10 remote circuits. Configuring devices is simply button taps. These are in the bottom section of this page.

**PC-Configured Complete Devices (Base and Faceplate Included)**

The devices shown here and on the facing page are "PC-Configured" devices and require a Powerline Interface Module (PIM) or a programmer (UCS). But, the devices on this page are pre-assembled with base and faceplate plus they are programmed as a specific device. They are ready to install and configure in your UPB network. The Powerline Interface Module (PIM) options are available on the opposite page.

SAUCQF-W	UPB 3-Speed Fan Controller with white faceplate	76.81
SAUS11-40-W	UPB Wall Switch, single or 3-way, dimming or switching, 900 watt (requires neutral)	54.96
SAUSR1-40A-W	Complete Remote Switch (for 3- and 4-way applications)	22.48
SAUS28B40-W	UPB 8-button 'Bar Style' Switch/keypad, single or 3-way, dimming or switching, 900 watt	74.94
SAUS28O40-W	UPB 8-button 'Oval Style' Switch/keypad, single or 3-way, dimming or switching, 900 watt	74.94
SAUCQT-40A-W	UPB 4-button 'Oval Style' Scene Controller keypad w/4 status LEDs (no local output)	74.94
SAUS28OTP-*	Plug-in 8 oval button tabletop controller (* Specify W-White, BK-Black)	89.93
SAUSQT-*	Plug-in 4 oval button tabletop controller with 4 status LEDs (* W-White or BK-Black)	93.68



**Anywhere Virtual Lighting Control**

A simple, cost-effective alternative, versus running new wiring or using costly integration products.

Anywhere Virtual Remote Lighting Control Products and Accessories are configurable via push button only. The button chooses any 1 of 4 channels (except US2-V0, which have fixed transmit channels). Any number of units can be on each channel, so each switch rocker can control all units on that rocker's channel. The Anywhere switches replace existing mechanical wall switches (neutral required), utilize same wires of existing wall switches - no traveler wires or batteries needed! Turn on/off circuits from one or more switches and turn on/off any accessory. Transmits over one mile on a 12 AWG circuit.

SAV3WAY-A	Anywhere Virtual 3-Way On/Off Switch Kit, Single Rocker (2) US1-V0 900 Watt Anywhere On/Off Switches, white	53.71
SAV3WAY-B	Anywhere Virtual 3-Way On/Off Switch Kit, Dual Rocker (1) US2-V02 & (1) US1-V0 900 Watt Anywhere On/Off Switches, top-dual rocker controls US2-V02 local load/circuit, and bottom-dual rocker remotely controls US1-V0 local load/circuit. White	53.71
SAUS1-V0	Single Rocker Anywhere Virtual Accessory Switch, White	30.91
SAUS2-V02	Two Rocker Anywhere Virtual Accessory Switch, White	30.91
SAUS2-V03	Three Rocker Anywhere Virtual Accessory Switch, White	35.60
SAUS2-V04	Four Rocker Anywhere Virtual Accessory Switch, White	41.84
SAUMA-V0	Anywhere Virtual Appliance Relay Module, plug-in, 15A	29.98
SAUFR-V0	Anywhere Virtual Fixture Relay Module, wire-in, 12A	29.98
SAURD-30-*	Anywhere Virtual Controlled Receptacle, wire-in, 12A order color needed (W-White, I-Ivory, LA-Light Almond, or A-Almond)	71.19
SAUCS-V0	Anywhere Controller Scheduler-Timer	62.45

Prices shown are dealer prices



Color change on any SAUS1-V0 switch using any SAZS11 faceplate on page 58.

\* Phase coupler may be needed when switches are on different phase circuits and phase alignment is not possible, especially if the home has more than 1 breaker panel or is greater than 2500 Sq. Ft.

SAZPCI-W	Inverted Coupler-Passive, wires to 220VAC circuit	52.46
SAZPCI-B	Inverted Coupler-Passive breaker mount, Compatible: Cutler-Hammer, Square D, Murray	52.46
SAZPCI-P30A	Inverted Coupler - Plugs into a 30 Amp, 220 VAC outlet (NEMA 10-30 configuration)	59.95
SAZPCI-P50A	Inverted Coupler - Plugs into a 50 Amp, 220 VAC outlet (NEMA 10-50 configuration)	59.95



# Everything you need for a Smart Home...

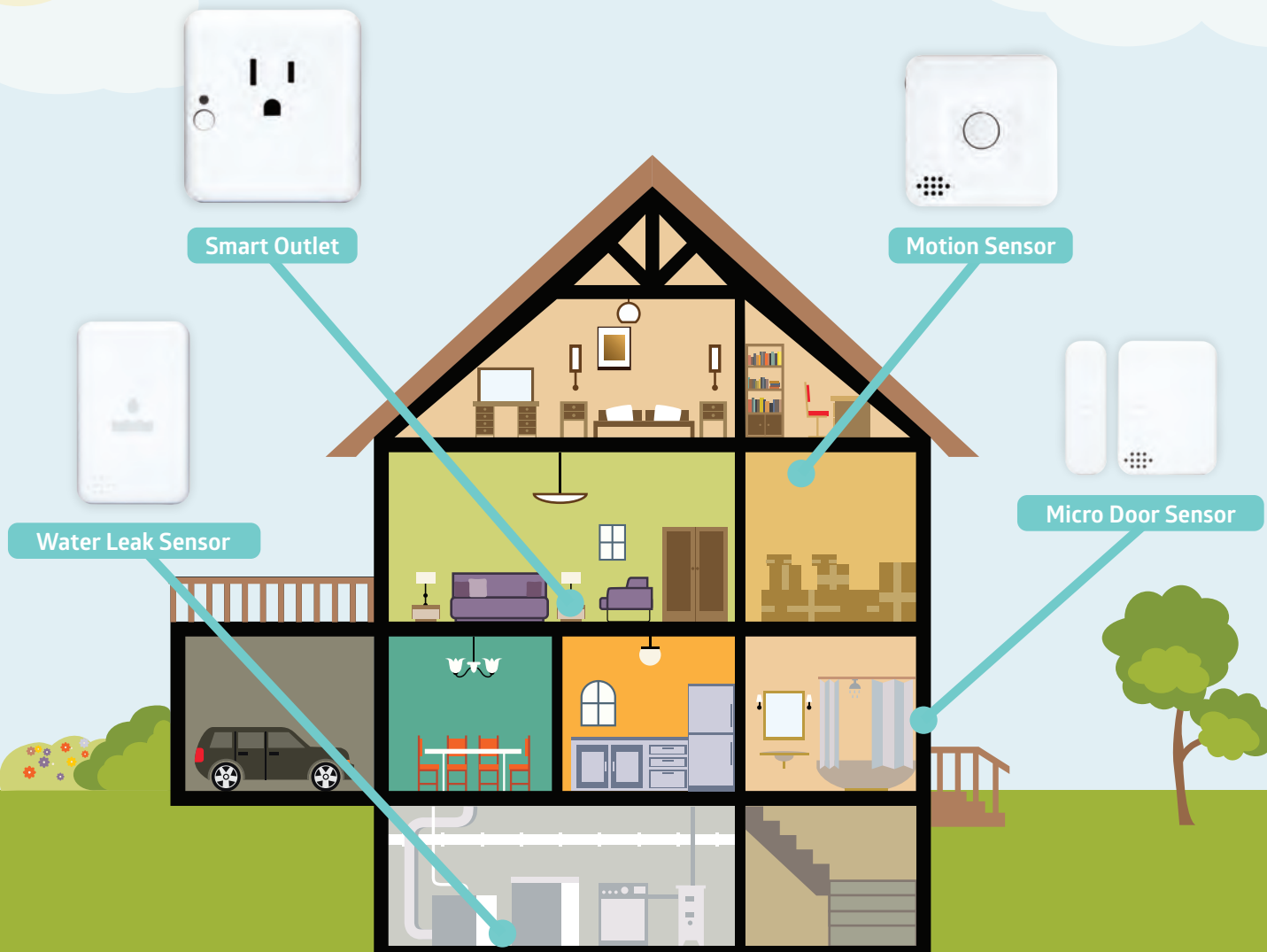

...under one roof.

works with  SAMSUNG  
SmartThings™

Centralite®

 zigbee



JetStream - Wireless Lighting from CentraLite

With JetStream, there are no external repeaters, antennas, base stations, or separate controllers required. Any button can control any scene, event, or load from anywhere in the house! To configure the system, simply discover all devices, create scenes, and assign scenes or loads to buttons.

JetStream uses the popular ZigBee™ wireless communication. Nodes (any device on the system) act as repeaters to create a true self-healing mesh network. Dynamic routing algorithms in each device ensure that signals take the quickest and most efficient route from point A to point B. All this adds up to higher reliability and fewer callbacks.

Pro Pak

Includes everything needed to get a system up and running

CL6255006-SCW	(5) 3-button Dimmers, (1) RS-232 Bridge, Includes White and Light Almond colors	505.84
---------------	---	--------

Dimmers & Switches

CL3385001-SC*	1-button 800W dimmer	69.94
CL3385003SC-*	3-button 800W dimmer	79.94
CL3385001-RSC*	1-button 8 Amp relay switch	69.94
CL3385003-RSC*	3-button 8 Amp relay switch	79.94

\*=W-White, I-Ivory, LA-Light Almond, B-Black

Accessories

CL4255003	Car Remote	53.96
CL4255008	8-button tabletop controller, White	98.92
CL4255050	Plug-In lamp module, White	64.95
CL3155000	RS-232 Bridge with Time Clock	158.87
CL3155002	USB Bridge - required for system setup	128.90

Screwless Wallplates

Not Included with Dimmers/Keypads

CL1072001-*	Single-Gang Wallplate	4.00
CL1072002-*	Double-Gang Wallplate	6.00
CL1072003-*	Triple-Gang Wallplate	8.99

JetStream Features:

- 200+ devices in network
- 100 scenes
- 50 timed events (with RS-232 bridge)
- Soft On / Off
- 512 dim levels
- Adjustable LED intensity on buttons
- Configuration is stored in each device, plus a backup is made on PC
- Custom engraving available

JetStream setup software is free to dealers and is a quick and powerful tool used to configure systems. First, add all devices to the network and name them. Next create scenes with input from your customer. The only thing left then is to assign scenes or loads to buttons. JetStream allows you to group loads by room for easy scene configuration.



CL3385001



CL3385003



CL3155002

Centralite 3-Series ZigBee devices



ZigBee Lighting and Appliance Solutions

CL4257050-RZHAC	Smart Outlet	39.97
CL4257050-ZHAC	Smart Dimming Outlet	43.72
CL3110-WG	In-wall Dimmer, 800W, 120V, White	43.72
CL3115-WG	In-wall Relay Switch, 1000W, White	39.97
CL3117-WG	In-wall Remote Switch, 120V, White	21.23

CL3157100-BN

Pearl Thermostat

Capacitive touch controls. Two stage heat. Two stage cool. Optional humidity sensor. Built-in power amplifier for exceptional range. Over the air firmware updates.

CL3157100-WN



CL3157100-BN	Pearl Thermostat Black	106.16
CL3157100-SN	Pearl Thermostat Black - Stainless Bezel	106.16
CL3157100-WN	Pearl Thermostat White	106.16

Sensors and Accessories

CL3300-G	Door/Window Sensor	29.98
CL3305-G	Motion Sensor	29.98
CL3310-G	Temp and Humidity Sensor	34.97
CL3315-G	Water Sensor	33.72
CL3420	Night Light Repeater	46.21
CL4257020	Smoke Listener	53.71



CL3305-G



CL3300-G



CL3315-G



CL3310-G

Centralite 3-Series ZigBee products tested to work with the Zipato Zipabox



Keypad Overview

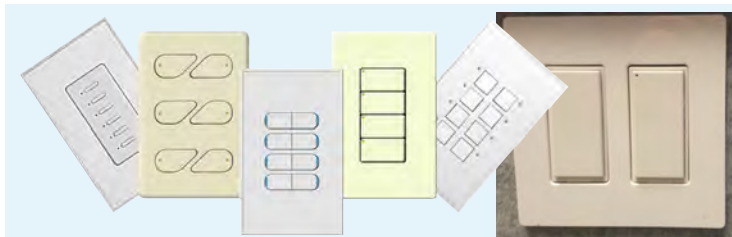

CentralLite offers a range of keypads which are sure to match your installation needs. CentralLite's Traditional and Europa series are the original and most cost-effective options. From there the Ultra- and Mystique-Mercedes keypads offer a more elegant look and feel at a middle of the road price. Finally, we have the Finesse keypads which feature backlit, engravable buttons for the ultimate modern styling.

Worthington Distribution is CentralLite's master distributor.

We have great stocking levels and provide technical support before and after the sale, so be sure to get your CentralLite parts here!

Custom Button Engraving



CentralLite keypads ship with blank buttons. Engraving is available at \$3.50 per button (\$25 minimum order). We recommend hand-labeling the blank buttons for your customer for the first 30 days or so until they are comfortable with them. At that point, the customer should know exactly which labels they would like. Engraving adds a professional touch to your work.

Finesse Premium Backlit Key pads

Order 1 Plate and 1 Assembly per complete keypad

CL1410101-(1,2,7)	Finesse 2-Button Keypad Plate	21.98
CL3412102-*	Finesse 2-Button Keypad Assembly	84.93
CL1410102-(1,2,7)	Finesse 4-Button Keypad Plate	21.98
CL3412104-*	Finesse 4-Button Keypad Assembly	84.93
CL1410103-(1,2,7)	Finesse 6-Button Keypad Plate	21.98
CL3412106-*	Finesse 6-Button Keypad Assembly	84.93
CL1410104-(1,2,7)	Finesse 8-Button Keypad Plate	21.98
CL3412108-*	Finesse 8-Button Keypad Assembly	84.93



CL1410104-7 & CL3412108-LL

With curved, back-lit buttons, CentralLite's Finesse keypads put a modern twist on wall decor. Custom engraving on keypad buttons allows the back-light to show through the text, providing a stylish effect.

Plate Options: 1-Black, 2-White, 7-Light Almond

\*Assembly Color Options: BW-Black Button/White Frame, BB-Black Frame/Button, WB-White Button/Black Frame, WW-White Frame/Button, BL-Black Button, Light Almond Frame, LB-Light Almond Button, Black Frame, LL-Light Almond Button/Frame

Traditional and Europa Key pads



CL3271002-A Europa

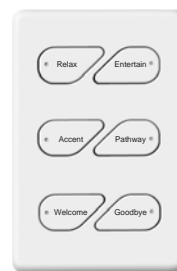

Both styles can be custom-engraved.



CL3382004-W Traditional

CL327#002-*	Europa 2-Button Keypad	21.98
CL327#004-*	Europa 4-Button Keypad	42.97
CL327#006-*	Europa 6-Button Keypad	64.95
CL3382001-†	Traditional 1-Button Keypad	23.08
CL3382002-†	Traditional 2-Button Keypad	33.57
CL3382003-†	Traditional 3-Button Keypad	45.06
CL3382004-†	Traditional 4-Button Keypad	56.65

\*=A-Almond, B-Black, I-Ivory, LA-Light Almond, W-White  
†=A-Almond, I-Ivory, LA-Light Almond, W-White  
Call for alternative wiring and LED color options.  
# = 1- RJ45, 2-Screw Terminal

Ultra- and Mystique-Mercedes Key pads



CLULTS10606AAB2



CLMYSS10404AIG

CLULTS10202A*†2	Ultra Mercedes 2-Button Keypad	66.20
CLULTS10404A*†2	Ultra Mercedes 4-Button Keypad	83.68
CLULTS10606A*†2	Ultra Mercedes 6-Button Keypad	92.43
CLMYSS10101A*†	Mystique Mercedes 1-Button Keypad	79.94
CLMYSS10202A*†	Mystique Mercedes 2-Button Keypad	96.17
CLMYSS10303A*†	Mystique Mercedes 3-Button Keypad	111.16
CLMYSS10404A*†	Mystique Mercedes 4-Button Keypad	126.15

\*W-White, I-Ivory, A-Almond, B-Black  
†= LED color B-Blue, G-Green  
Call us for additional wallplate assembly options.

App Controls

Looking to control your Elegance XL system on your smartphone or tablet? Check out these customizable solutions!



BitWise Controls - Page 35

**Centralite Elegance XL - Reliable Hardwired Lighting Control**

Hard-wired inputs and hard-wired outputs make for lightning-fast response times from keypad or RS-232 commands.

**Reasons You Should Choose**



Elegance XL works with almost any lighting load: magnetic low voltage, LED, CFL, and small motor (e.g. bathroom fan) loads.

Avoid RF issues like transmission distance, large load counts, and metallic building materials.

**Third-party integration via RS-232:**



With five different styles of engravable keypads you can match your customer's tastes perfectly.

**How to Specify an Elegance XL System:**

**1 Start with an MCP**  
A Master Control Panel and rough-in box is required for every Elegance XL system.

**2 Add output modules**  
Up to 8 dimmer panels, LVRB, HVRB, or FSC boards are supported on each MCP.

**3 Add SuperStars**  
Add enough SuperStar boards to cover the number of desired buttons.

**4 Add keypads**  
A list of compatible Centralite keypads can be found on page 54.

**System Components**

CL3152096	MCP (Master Control Panel), one required per system, requires rough-in box, supports 192 loads	1,099.12
CL1252300	Rough-In Box for MCP, required to mount MCP	49.96
CL7252024	24 Load Dimmer Panel with SuperStar input, supports 24 lighting loads and 96 button inputs	1,748.60
CL7252024-NS	24 Load Dimmer Panel, supports 24 lighting loads	1,476.82

**SuperStars (Keypad Inputs)**

CL4152040	SuperStar Board Only, 96 button inputs, can mount in bottom half of CL7252024-NS	539.57
CL4252241	SuperStar mounted in enclosure, 96 total button inputs	649.48
CL4252202	STAR Pak, includes (2) STAR input boards mounted in enclosure, 48 total button inputs	419.66
CL4252203	STAR Pak, includes (3) STAR input boards mounted in enclosure, 72 total button inputs	554.56
CL4252204	STAR Pak, includes (4) STAR input boards mounted in enclosure, 96 total button inputs	689.45

**System Options**

CL3321005	Keychain Remote Kit, includes (2) remotes and a receiver, wires to SuperStar like a keypad button	124.90
CL1320500	Extra Keychain Remote, use with above kit	37.97
CL4152001	Fan Speed Controller (FSC), connect up to 4 ceiling fans, provides low/medium/high/off control	484.61
CL4252311	(1) Fan Speed Controller in enclosure	619.50
CL4252312	(2) Fan Speed Controllers in enclosure	1,074.14
CL3152080	Low Voltage Relay Board (LVRB), 16 relays, use for landscape lighting, window treatments, etc.	484.61
CL4252411	(1) Low Voltage Relay Board in enclosure	619.50
CL4252412	(2) Low Voltage Relay Boards in enclosure	1,074.14
CL3152070	High Voltage Relay Board (HVRB), 16 relays, great for motor loads, heavy loads, etc.	484.61
CL4252511	(1) High Voltage Relay Board in enclosure	619.50
CL4252512	(2) High Voltage Relay Boards in enclosure	1,074.14



**CL3152096**



**CL7252024**



**CL4152001**



**CL3152080**



**CL3152070**

**Questions? Give Worthington a call today.**



Luxul Hard-Wired Networking Products

Luxul is the leading innovator of simple-to-deploy professional grade IP networking solutions for use by custom installation professionals. Designed for use in both residential and commercial environments, the Luxul family offers a complete line of solutions that simplify network design and deployment, resulting in a scalable network that is both powerful and easy to install.

The top 4 reasons why Luxul is sold by Worthington Distribution:

- Simple installation and setup
- Products aren't sold through online retailers
- Lifetime dealer support
- Luxul's 3-year warranty

Stay connected with Luxul's wired networking products.

AV Series Switches

The Perfect Blend of Design and Functionality

- Specifically designed to integrate with rack-mount AV equipment
- Eliminates the installation issue of switches which have ports on the front and AV equipment which have Ethernet connections on the back
- Rear-facing RJ45 ports feature standard LED feedback
- Front-facing display shows port status with selectable blue or green LEDs



LUXAMS-4424P

Part Number	Total Ports	POE	POE Ports	Managed	Stackable	Rack Mount	Port Speed	Price
LUXAMS-4424P*	26	Yes	24	Yes	Yes	Yes	Gigabit	759.39
LUXAMS-2616P*	28	Yes	16	Yes	No	Yes	Gigabit	618.26
LUXAMS-1208P*	10	Yes	8	Yes	No	Yes	Gigabit	281.02
LUXAMS-2600*	28	No	-	Yes	No	Yes	Gigabit	393.44
LUXAGS-1024	24	No	-	No	No	Yes	Gigabit	197.34
LUXAGS-1016	16	No	-	No	No	Yes	Gigabit	141.14
LUXAGS-1008M	8	No	-	No	No	No	Gigabit	73.69

\* HD video over IP compatible

Switches

Part Number	Total Ports	POE	POE Ports	Managed	Stackable	Rack Mount	Port Speed	Price
LUXXMS-7048P*	52	Yes	48	Yes	Yes	Yes	Gigabit	1,686.15
LUXXMS-5248P*	52	Yes	48	Yes	No	Yes	Gigabit	1,292.72
LUXXMS-2624P*	26	Yes	24	Yes	No	Yes	Gigabit	646.98
LUXXFS-1816P	18	Yes	16	Yes	No	Yes	10/100	337.23
LUXXMS-1010P	10	Yes	8	Yes	No	Yes	Gigabit	224.82
LUXXFS-1084P	8	Yes	4	No	No	No	10/100	70.43
LUXXMS-1024	28	No	-	Yes	No	Yes	Gigabit	337.21
LUXXGS-1024S	24	No	-	No	No	Yes	Gigabit	168.59
LUXXVS-F5	5	No	-	No	No	No	10/100	12.37
LUXXGS-1008	8	No	-	No	No	No	Gigabit	44.96

\* HD video over IP compatible



LUXXMS-7048P



LUXXMS-2624P



Front



Rear



LUXXFS-1084P

LUXXGS-1008

Routers

Luxul's Epic 4 Gigabit routers provide an optimal platform for setting up the ultimate residential or commercial network. They allow for up to 512 concurrent device routing entries. The Epic 4 routers also feature an intuitive interface with advanced management, including firewall, QoS, VLAN, VPN and other capabilities which ensure the optimal performance, scalability and security of your network.



LUXABR-4500  
LUXXBR-4500

- Model LUXABR-4500 complements Luxul's AV Series switches and features the same configurable LEDs and ports on the back
- Both units include rack-mount hardware and are 1 rack unit high

LUXABR-4500	Epic 4 Gigabit router - ports on back	197.34
LUXXBR-4500	Epic 4 Gigabit router - ports on front	197.34

PoE Injectors and Accessories



LUXXPE-2500



LUXCAB-05SFP10G



LUXXSA-SFP1



LUXXSA-SFP10G

LUXXPE-2500	Single port PoE/PoE+ injector	30.91
LUXXSA-SFP1	Gigabit SFP/Mini-GBIC transceiver	67.45
LUXCAB-05SFP10G	18" SFP+ Gigabit stacking cable	84.93
LUXXSA-SFP10G	10 Gigabit SFP+ MMF Mini-GBIC module	112.41

Luxul Wireless Networking Products

Luxul's wireless networking products have you covered.

Luxul's Wireless Products Make Any Installer Look Like a Network Technician

Most homes have multiple wireless devices: laptops, game systems, smart phones, tablets, Wi-Fi remotes, smart speakers, and more. In our wirelessly-connected world, many installers overlook the chance to provide a networking solution. Luxul simplifies Wi-Fi installations with superior coverage, pre-configured and modular solutions, and a wide range of powered-over-ethernet (PoE) access points. Easy to install and manage, with pleasing form factors, every one of your projects should include a Luxul wireless network.

Wireless Access Point Controller and Kits

XWC-1000 - Seamless Roaming and Simple Deployment

Historically, access point management has been expensive and confusing. Luxul has changed this with their XWC-1000 wireless controller with Roam Assist™ technology. Luxul's XWC-1000 is simple to configure and provides plug-and-play integration with up to 16 access points. All of these features are done at a fraction of the cost of their competitors' solutions.

The Benefits of Wireless Access Point Management:

- Allows users to seamlessly roam without dropping connectivity
- Removes the burden of determining the best access point from your customers' mobile devices which improves performance
- Centralizes access point setup, which makes managing network settings easier

Add a Luxul controller kit to every job where your customer needs multiple access points for their wireless devices.



LUXXWS-2510

LUXXWS-1310

LUXXWC-1000	Wireless Controller, works with all Luxul APs, supports up to 16 access points	224.82
LUXXWS-2510	Kit - Wireless Controller with (2) XAP-1510 high-power access points	843.08
LUXXWS-1310	Kit - Wireless Controller with (3) XAP-310 standard-power access points	393.44



LUXXWC-1000

Wireless Access Points



LUXXAP-1510

LUXXAP-1230

LUXXAP-310

LUXXAP-1240

All of Luxul's wireless access points are PoE/PoE+-powered for easy installation

Wireless Routers with AP Management

Luxul's XWR-3100 and XWR-1200 routers provide high-speed, concurrent dual-band Wi-Fi with the addition of their exclusive Roam Assist™ technology. These routers have wireless access point management for up to two Luxul access points, allowing an installer to provide seamless wireless coverage for almost any size residence or commercial space.

802.11ac wireless on concurrent 2.4 and 5GHz		Now with built-in control for up to two XAP models!
LUXXWR-1200	Dual-band wireless AC1200 router	123.65
LUXXWR-3100	Dual-band wireless AC3100 router	247.30

Long-Range Wireless Bridging and Coverage

Shared Networking Without a Cable Run

Luxul's outdoor bridging modules provide connectivity to remote locations such as outbuildings or guest houses. They provide high-speed, dual-band Wi-Fi to anywhere within their "line-of-sight." This means you can share a network between two or more buildings up to two miles apart. Alternatively, the individual modules can be used as a long-range access point to provide Wi-Fi coverage to a large, open space.



LUXXWO-BKT1

	Use the XWO-BAP1 to add another location for a point-to-multi-point bridging application or for long-range outdoor Wi-Fi coverage.	The XWO-BKT1 contains two point-to-point bridged modules. No configuration required!
LUXXWO-BAP1	Additional bridge module/outdoor access point	337.23
LUXXWO-BKT1	Pre-configured outdoor bridge kit	674.46

Part Number	Coverage Range (max)	5GHz	2.4GHz	Max Clients	Roam Assist	Coverage Pattern	Price
LUXXAP-1510*	8000 ft <sup>2</sup>	Yes	Yes	128	Yes	Omni	337.23
LUXXAP-1410*	8000 ft <sup>2</sup>	Yes	Yes	128	Yes	Omni	247.30
LUXXAP-1240†	1/4 mile	No	Yes	50+	Yes	Directional	197.34
LUXXAP-1230	7000 ft <sup>2</sup>	No	Yes	50+	Yes	Omni	281.00
LUXXAP-310	2000 ft <sup>2</sup>	No	Yes	20+	Yes	Omni	84.93

\* 802.11ac with beamforming on 2.4GHz band, XAP-1510 on 5GHz band

† Outdoor-rated

Domotz Remote Management



Luxul's Domotz Box Pro allows you to access your customer's network remotely to perform maintenance, get real-time system alerts, and provide remote tech support all without setting up a VPN.

LUXXRM-DTZ1	Domotz Box Pro	112.41
-------------	----------------	--------

## USB Charger with Tamper-Resistant Receptacles



LEVT5632-W



LEV47112-W



LEVUSB4P-W

Leviton's T5632 offers a combined 3.6A of charging power and a 15A/125V Tamper-Resistant Receptacle. It allows you to charge 2 USB devices at once, while still leaving the receptacles open for further charging needs. The LEV47112 hangs in an adjacent Decora port to give your customer a place to hang their device while charging.

LEVT5632-*	3.6A Dual USB Charger with 120VAC Receptacle	23.18
LEV47112-*	Decora Mobile Device Station	7.94
LEVUSB4P-*	4-Port USB Charger, 4.2 Amp, 25W, 125V	25.34

\* Specify color: W-White, T-Light Almond, E-Black

## Wall-Mount Devices with Built-In Night-Lights



LEVGFNL1-W



LEV6526-W



LEV6527-W

LEVT6525-*	Decora Tamper-Resistant Receptacle with LED Guide Light, 15A-125VAC	7.87
LEVGFNL1-*	15A-125V Receptacle, Tamper-Resistant Duplex GFCI/Guide Light with LED indicator	22.98
LEV6526-*	Decora Single Pole Switch/LED Guide Light, 15A-120VAC, 1/2 HP	9.18
LEV6527-*	Decora Full LED Guide Light, 1W-120VAC	17.21

\* Specify color: W-White, T-Light Almond, E-Black

## Rocker Slide Dimmers



LEVDL06-1LZ

LEVDSL06-1LZ	600W Incandescent, 300W LED/CFL, No Neutral	21.20
LEVDSM10-1LZ	1000W, 1000VA MLV, 450W LED/CFL, No Neutral	33.49
LEVDSSE06-10Z	300W LED/CFL, 600VA ELV, Single Pole/3-Way, Neutral Required	59.56

\* W-White, I-Ivory, T-Light Almond  
Color change kits available in W-White, I-Ivory, T-Light Almond, G-Gray, E-Black, B-Brown and R-Red

## Humidity Sensor and Fan Control Wall Switch

The Leviton Humidity Sensor and Fan Control automatically detects excess humidity in a room and activates the ventilation fan to lessen condensation which helps reduce mold and mildew. The sensor also helps reduce energy usage by automatically operating the fan only when needed to control excess humidity.



LEVIPHS5-1LW

LEVIPHS5-1L*	Humidity Sensor and Fan Control - 600W Incandescent, 150W LED/CFL, 1/6 HP (3A) Fan	30.73
--------------	--	-------

\* Specify color: W-White, I-Ivory, T-Light Almond

## Bluetooth Dimmers and Switches



- Control manually using free iOS or Android App
- Local control within a 30-foot range
- Name your device
- Astrological timed events
- No other hardware needed



LEVDDL06-BLZ

LEVDDL06-BLZ	Bluetooth Dimmer, 600W Inc/Hal, 300W LED/CFL, No Neutral	36.28
LEVDDMX1-BLZ	Bluetooth Dimmer, 1000W Inc/Hal, 450W LED/CFL, MLV, Neutral Req.	48.21
LEVDDDE06-BLZ	Bluetooth Dimmer, 600W, 300W LED/CFL, ELV, Neutral Required	60.65
LEVDDDS15-BDZ	Bluetooth Switch, 1800W Inc/Hal, 600W LED/CFL, 15A, Neutral Req/	45.61
LEVDDDF01-BLZ	Bluetooth Fan Speed Control, 1.5A, Neutral Required	40.02

## Toggle Slide Controls



LETSL06-W

Leviton's toggle style controls provide your customers with single pole and 3-way applications. This is a great touch for your traditional toggle controls as it has a separate ON/OFF toggle switch that preserves selected settings. This slim, compact device fits effortlessly into a standard wallbox.

## Rated for CFLs and LEDs!

LEVTSL06-1L*	Toggle Slide Dimmer, 600W Incandescent/Halogen, 300W LED/CFL, No Neutral, Single Pole/3-Way, Locator Light	15.61
LEVTSM10-1L*	Toggle Slide Dimmer, 1000W Incandescent/Halogen, 400W LED/CFL, 1000VA MLV, No Neutral, Single Pole/3-Way, Locator Light	18.74
LEVTSF01-10*	20A-125V Receptacle, Tamper-Resistant Duplex GFCI/Guide Light with LED indicator	15.92

\* Specify color: W-White, T-Light Almond, I-Ivory



Occupancy Sensors - Simple Lighting Automation

One of the simplest ways to offer your customers lighting automation is to use one of Leviton's occupancy sensors. Occupancy sensors add entry level automation where it is needed without adding the cost of whole home control by providing automatic ON/OFF switching of lighting loads for enhanced convenience, security and long-term energy savings. See the below examples for some of the most common uses of occupancy sensors.

Scenario #1 - Bathroom



**The Need:** A way to provide light in a bathroom without your customer having to find a light switch in the middle of the night.

**The Solution:** A night-light wall switch occupancy sensor. This product can replace an existing light switch and provides a soft, low wattage LED light to allow your customer to safely find their way into the room at night.

LEVOSSNL-IDW

LEVOSSNL-ID*	800W incandescent or 1200VA fluorescent, 180 degree view, auto on/off	47.74
LEVOSS10-INW	800W incandescent or 1200VA fluorescent, 180 degree view, manual on/auto off, Title 24	47.74

\* Specify color: W-White, I-Ivory, T-Light Almond

**We carry Leviton's full line of occupancy sensors, which are designed to fit a wide range of applications including outdoor and commercial installations.**

**Please call us for more information or for pre-sales design assistance (800) 282-8864.**

Scenario #2 - Laundry Room



LEVODC0S-I1W

**The Need:** A way to turn on the light in a laundry room while your customer has a basket of laundry in their hands.

**The Solution:** A ceiling-mount self-contained sensor. This product will turn on the light when they enter the laundry room and will turn it off after they leave.

LEVODC0S-I1W	1000W incandescent or 1000VA fluorescent, 360-degree view, White	79.01
--------------	--	-------

Scenario #3 - Foyer

**The Need:** A way to conveniently ensure that your customer doesn't walk into an unlit home.

**The Solution:** A wall-mount occupancy or vacancy sensor mounted by the entrance way.

LEVIPS05-1LZ	5A relay occupancy sensor. Single pole, 180 degree view, 900 sq. ft. coverage.	25.98
LEVIPS15-1LZ	15A relay occupancy sensor. Single pole & 3-way, 180 degree view, 900 sq. ft. coverage.	28.09
LEVIPSD6-1LZ	Occupancy detector and dimmer. 180 degree view, Single Pole & 3-Way, 600 Watt Incandescent, 150W Dimmable LED & CFL.	31.47
LEVIPV05-1LZ	5A relay vacancy sensor. Single pole, 180 degree view, 900 sq. ft. coverage.	25.98

1LZ includes white, ivory, and light almond

EZ-MAX Commercial Lighting Control System by Leviton

Now you can offer simple energy management systems that pay for themselves, sometimes in as little as one year. If you're like many installers in our industry, your business has been affected by the economy. Although we focus on residential systems integration here at Worthington, our goal is to help you branch out into related areas of business that can help keep you in the black in these trying times. With energy costs on the rise, many commercial building managers are exploring energy saving options. Although residential energy management can be difficult to justify to a homeowner from a cost perspective, on the commercial side, energy management offers proven savings. EZ-MAX from Leviton is one of these products that we would like to introduce. It's a flexible lighting control cabinet that lends itself to timer and dusk to dawn lighting applications and even area lighting when local keypads are attached. See the scenarios below for a better idea of where EZ-MAX is a good fit.

EZ-MAX Relay Panels and Relay Cards

LEVRELAY-L30	1-pole, NO/NC relay card, 30A, 120-277V	28.99
LEVRELAY-2PL	2-pole, NO relay card, 20A, 208-480V	39.32
LEVR08BD	8 Relay Panel only, no relays	495.77
LEVR08BD-L04	8 Relay Panel, (4) 30A NO/NC relays	636.03
LEVR08BD-L08	8 Relay Panel, (8) 30A NO/NC relays	764.30
LEVR08BD-208	8 Relay Panel, (8) 20A, 2-Pole NO relays	861.45

EZ-MAX Accessories

LEVPCOUT	Outdoor Photocell for EZ-MAX	174.86
LEVLVS-2W	2-button low-voltage switch	38.14
LEVLVS-5W	5-button low-voltage switch	38.14



LEVRELAY-2PL



LEVR08BD

Features:

- Easy programming using an offline editor or wizard-driven LCD display and oversized buttons
- Easy standard programming configuration
  - Occupancy sensors: manual-ON or auto-ON applications
  - Photocells: interior or exterior application modes
  - Photocell light level trip points: on or off
- Integrated astronomical time clock
- Time clock and scheduler
- Sunrise/sunset time clock events
- Integrated astronomical time clock
- Accepts input from momentary, maintained or toggle switches as well as low-voltage input from photocells and occupancy sensors for a comprehensive yet easily installed energy management solution

Scenario:

This could range from a small fabrication shop to a section of a large warehouse. EZ-MAX takes simple scheduling to the next level. Include wall-mounted low voltage switches to provide users with local control and add occupancy sensors for even more energy savings. EZ-MAX will evaluate the status of the schedule, switches, and sensors to determine the power state of a load for maximum energy savings.



## The Complete Surge Protection Solution

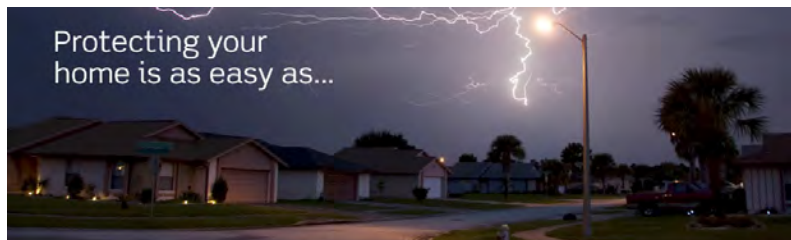

Protecting your home is as easy as...

### Whole Home Surge Protection Starting at \$49.89!

A common misconception many homeowners have is that they can protect their home from dangerous lightning strikes and voltage surges simply by plugging their TV or computer into a power strip or just installing a surge protective panel. A power surge will travel through any wire into a house, leaving common appliances and sensitive electronic equipment vulnerable to serious damage.

To provide the most reliable protection, a whole house surge protection network is needed. A whole house surge protection network requires three types of surge protective devices at three levels within the home to effectively protect your electronic devices from the ruining effects of voltage surges.

### Panel Mount Surge Protectors - Type 2



LEV51110-SRG

Installing a Type 2 panel-mount surge protector is an important step in preventing damage to your customer's expensive electronics. In most cases, a panel-mounted surge protector is the only defense against transient voltage for line voltage devices, such as automated lights. Any automated lighting installation isn't complete without some form of whole-house surge protection.

LEV51110-SRG	Panel-mounted surge protection for power, includes surface-mount brackets & flush-mount cover, 120/240VAC, 48kA max surge current rating, status line 1 & 2 with LEDs.	49.89
LEV51120-1	Panel-mounted surge protection device for power, 120/240VAC, status line 1 & 2 w/ LEDs, compatible with powerline carrier (PLC).	197.04
LEV32120-1	Panel-mounted surge protection device, 120/240VAC w/ LEDs, <b>use with generators.</b>	386.65



LEV5120-1

### Secondary Surge Arresters - Type 1



LEV51120-3R



LEV55240-ASA

Typically mounted on the service side of the main service panel, Leviton's Type 1 SPDs prevent large, external transient spikes from entering into the home's electrical wiring. Listed models have a status LED so your customer can tell at a glance if their home is still protected.

LEV51120-3R	120/240V Single Phase Panel Protector in a NEMA 3R Enclosure	260.55
LEV55240-ASA	120/240V Parallel Wired Surge Arrester, NEMA 3R Rated	134.45

### Point Surge Protection - Power Strips and Receptacles - Type 3

Protecting a circuit breaker panel may not be enough to stop a surge. Point-to-point surge protection is a must to feel confident that valuable electronic devices are protected.

Leviton's surge protection strips provide superior protection for everyday use in professional work areas and home offices, protecting computers, peripherals, and other electronic devices from damaging surges, voltage transients and noise spikes.

Part No.	Protects	Recommended App.	Note	Price
LEVS1000-PS	6 Outlets	Power	6 Standard Outlets	18.61
LEVS1000-PTC	6 Outlets	Power+Telco/Coax	6 Standard Outlets	23.54
LEVS2000-PS	9 Outlets	Power	6 Standard + 3 Wide Outlets	29.74
LEVS2000-PTC	9 Outlets	Power+Telco/Coax	6 Standard + 3 Wide Outlets	35.93
LEV5505-190	19" rack mount protector	12 receptacles	Breaker, switch & LEDs	92.30
LEV5280-*	Dual receptacle	Receptacle	Fault LED	31.24

\* W-White, I-Ivory, B-Blue, GY-Grey, T-Light Almond, blank-Brown

For customers who worry about having bulky power strips or for installations where space is a concern, Leviton offers a line of surge protection receptacles. The low cost of these receptacles, combined with their ease of installation, means they can be placed anywhere you have a standard electrical outlet. So with a small investment, your customer can have the assurance that their equipment is well-protected. This is an excellent solution for recessed TV boxes, structured wiring cans, or a computer in a home office.



LEV5280-T

Protect your customer's valuable investment with Leviton surge receptacles!



LEVS2000-PTC



LEVS1000-PTC



LEV5505-190

### Leviton's "True Whole-House Surge Protection" Limited Warranty

Service Entrance: Up to \$25,000 for Connected Equipment Limited Lifetime Product Replacement. This warranty is for the benefit of the original consumer purchaser only and will continue for as long as such original purchaser uses the Leviton Surge Protective Device stated within this warranty program.

Please visit [www.leviton.com/warranty](http://www.leviton.com/warranty) for full warranty details.

**Green Power Surge and UPS**

The ECO-UPS System connects to your computer's USB port. When your computer shuts down or enters standby, the UPS waits three minutes to make sure your computer is not rebooting or temporarily unable to communicate, then Green Outlet technology automatically cuts power to the designated energy-saving outlets. Cutting power to the energy-saving outlets prevents idle devices from wasting electricity. The battery-backup outlets and surge-only outlets remain powered, supporting always-on devices like routers and broadband modems. When your computer starts up again, Green Outlet technology automatically restores power to the energy-saving outlets and your entire system is ready to use.



**TRLECO350UPS**



**TRLECO650LCD**



**TRLTLP76MSG**



**TRLAV550SC**

TRLBC350	UPS 350VA, 180 watts, 3 UPS supported outlets; 3 surge only outlets	50.58
TRLECO350UPS	UPS 350VA, 180 watts, 3 UPS supported outlets; 3 surge only outlets, 2 are designated Eco outlets	56.83
TRLECO550UPS	UPS 550VA, 300 watts, 4 UPS supported outlets; 4 surge only outlets, 3 are designated Eco outlets	76.19
TRLECO650LCD	UPS 650VA, 325 watts, 4 UPS supported outlets; 4 surge only outlets, 4 are designated Eco outlets	86.81
TRLTLP1210SATG	12 Outlet Surge, 2-line coax, 1-line RJ11/RJ45, Home/Business Theater Surge Suppressor	84.93
TRLTLP76MSG	6 individually controlled Eco outlets plus 1 always-on outlet, 1080 joules Home/Business Surge Suppressor	26.85
TRLAV550SC	Structured Wiring UPS 550VA, mounts in can or on a wall. Regulated 12VDC output for 4 devices, 4 110VAC outlets.	231.06
TLRBC11A	UPS Replacement Battery Cartridge Kit. 4 batteries for major brand UPS systems. Call for compatibility.	237.31

**Worthington Distribution has access to Tripp-Lite's full line of UPS products. If you don't see a model on this page, call or email!**

*Rack Mount Power Conditioning*



Select Series UPS backup systems are a competitively priced option for ensuring uptime of electronic components in the event of a power outage. Select Series UPS models are available in compact form factors when space is at a premium, in capacities to support a wide range of installations.



**MAUPS-S500R**

**MAP**

MAUPS-S500R	Select Series UPS Backup power, 1RU, 500VA, 6 outlets, 10 ft cord	462.00
MAUPS-S1000R	Select Series UPS Backup power, 1RU, 1000VA, 6 outlets, 10 ft cord	663.00
MAUPS-S1500R	Select Series UPS Backup power, 2RU, 1500VA, 8 outlets, 10 ft cord	771.00
MAUPS-S2200R	Select Series UPS Backup power, 2RU, 2200VA, 8 outlets, 10 ft cord	925.50

**Middle Atlantic Series Protection Power Distribution**



**MAPD-920R-SP**

Middle Atlantic's Series Protection Power Distribution products feature the industry's fastest-responding surge protection technology. Their patented non-degrading protection won't contaminate the system ground, automatically disconnects devices to protect from sustained over and under voltage events, and provides automatic recovery after these events to minimize system downtime.

**Features/Benefits:**

- Industry's fastest patented non-degrading surge technology
- Protects equipment without contaminating system ground
- Industry-leading 12-year warranty
- 100% MOV-free design – unlike any competitive offering
- Connected devices automatically disconnect from over- and under-voltage
- Automatic recovery – does not require hard reset after a surge event



**MAPD-920R-SP Rear**



**MAPD-415R-SP**



**MAPD-415R-SP Rear**

**MAP**

MAPD-915R-SP	Rackmount Power, 9 Outlet, 15A, 120 volt, Series Surge, 9 ft cord	471.00
MAPD-920R-SP	Rackmount Power, 9 Outlet, 20A, 120 volt, Series Surge, 9 ft cord	597.75
MAPD-415R-SP	Half Rackmount Power, 4 Outlet, 15A, 120 volt, Series Surge, 9 ft cord	275.25
MAPD-420R-SP	Half Rackmount Power, 4 Outlet, 20A, 120 volt, Series Surge, 9 ft cord	306.75

**Middle Atlantic MAP prices are shown. Please call or login to the Dealer Store for aggressive dealer pricing.**



THE POWER OF SOMFY

# Happiness

is Performance and Profits

Take your business to the next level by offering Somfy-powered shades, blinds, draperies, and awnings. Our wide variety of interfaces seamlessly integrates with most home automation systems regardless of brand or technology.

Somfy now offers the quietest, strongest motor on the market, the Sonesse® ULTRA 50, available in both line and low-voltage versions. Choose from Radio Technology Somfy® (RTS), wired and RS485 network options. This shading solution provides energy savings, glare reduction and privacy wherever silence is important.



Somfy Connect™  
Universal Automation  
Interface (UAI)



Universal RTS Interface



myLink™ RTS Smartphone and  
Tablet Interface



Z-Wave® to RTS Interface

Visit [www.somfysystems.com/worthington](http://www.somfysystems.com/worthington) or call 877-577-6639 to learn more.



© Copyright Somfy Systems, Inc. 02/2017  
IMAGES: © somfy sas/Mike Kaskel

**somfy** Building  
happiness

Worthington Distribution's Window Treatment Solutions

We offer a wide variety of automated solutions. From small, battery-powered roller shades hung in a hard-to-reach place to sun-blocking awnings for a patio, we carry it all. You can rely on our expertise to ensure that you get the right treatment, drive option, and controls to get your job done right. If you have any questions, please feel free to send an e-mail to [shades@worthdist.com](mailto:shades@worthdist.com) or call us at 1-800-282-8864.

Automated shading and control solutions by:



Window Treatment Video Series

Let a Worthington expert illustrate how easily treatments can be specified and ordered through Worthington Distribution. This video series walks you through each step of the process - from a basic overview of shading options all the way to ordering and installation.



Part 1: Overview



Part 2: Ease of Installation



Part 3: How to Sell Treatments

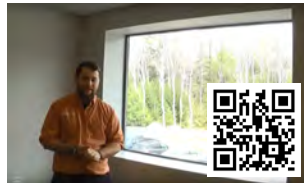

Part 4: How to Quote/Order

Check out our YouTube channel for these great videos as well as first hands-on reviews, intensive product overviews, and technical trainings.  
[www.youtube.com/worthingtondist](http://www.youtube.com/worthingtondist)

Window Treatment Video Series Overview

<b>Part 1: Overview</b>	Join Joel in our conference room for a demonstration of blackout shade materials versus light filtering materials followed by a brief introduction to Lutron's fabric binders.
<b>Part 2: Ease of Installation</b>	Tune in to see Joel and Nolan go head-to-head, installing a Lutron shading solution versus an in-wall dimmer. You may be surprised by the results!
<b>Part 3: How to Sell Treatments</b>	Check out this video to see some of the sales tools available to help sell Lutron shading solutions. This includes an in-depth review of Lutron's fabric binders and a walkthrough of Lutron's SCT software.
<b>Part 4: How to Quote/Order</b>	In the final part of our video series Joel covers the six pieces of information we need to properly quote a Lutron window treatment: measurement, inside/outside mounting, fabric information, which power option, additional hardware (such as a fascia), and finally a picture of the window.



Roller Shades  
pages 52-53 and 72



Drapery Tracks  
page 74

Worthington Distribution provides shading solutions for every installation - from a single-room home theater to an entire commercial complex.



Honeycomb Shades  
pages 52-53 and 72



Exterior Shades/Awnings  
page 72

Have shading questions?

Give us a call at (800) 282-8864 or e-mail [shades@worthdist.com](mailto:shades@worthdist.com).

Sales Tools for Shading Solutions

Don't go to a shading sales pitch empty-handed.

Trying to explain automated shades or showing your customer a website just doesn't have the impact of a working demo or a fabric sample book. Setting up a demo shade and handing your customer the remote takes a few minutes, and you'll be amazed at how the shades will sell themselves. Once you've piqued their interest, let your customer explore their fabric options and they'll decide which fabric they'd like. You'll soon find that automated shades are one of the easiest things you can sell to your customers.

Somfy's Black Case demo kit includes an RTS roller or cellular shade, remote control, and over-the-door hooks. It allows you to quickly set up a working demonstration of Somfy's motors in action.



Free shipping on Somfy demo products

SOMFY BLACK CASE	Portable over-door demonstration shade with RTS remote	249.00
PRISTINE FABRIC BINDER	Roller shade fabric book for Pristine shades	35.00

Check out page 53 to see demo products for Lutron shading solutions.





**Interior Treatments Powered by Somfy**



When considering your options for motorized window treatments remember that Somfy's motorization provides the most flexibility in the industry. They offer three options for power: wireless battery as well as hard-wired low voltage and AC. Somfy also has a huge range of integration and control options.

**Contact us for more details 800-282-8864**

**Pristine Roller Shade Pricing Example**



For the pricing below we are going to assume the following:

- We're using the window on the right in this photo.
- It has been measured correctly, and the measurements are 35 7/8" wide by 58 1/4" high.
- The customer has chosen a Phifer SheerWeave 3000 fabric.
- We're using a 24VDC RTS motor.
- No fascia or side rails are required.

Sample Pricing	Dealer	MSRP
Fabric	67.91	126.00
Motor	418.26	776.00
<b>Total</b>	<b>486.17</b>	<b>902.00</b>

**Dealer's Profit \$415.83!**

Need to know how much you can make selling automated treatments on your next installation? Send your measurements to us and we'll respond with a quote within 48 hours.

Send quote requests to [shades@worthdist.com](mailto:shades@worthdist.com)

**We Now Offer Cellular Shades with Somfy Motorization**

You asked and we listened! Worthington Distribution now has cellular shading options using fabrics from Levolor Kirsch. Adding Somfy battery-powered motors to these treatments makes them the perfect fit for bathrooms or other hard-to-reach areas.



**SDN 2.0 Bus Distribution Components**

SDN 2.0 products are backed by an SDN 2.0 Certified Quality Promise which means these products have been designed to meet the highest standards for Somfy Digital Network™ system components and validated by Somfy engineers.

SOM1870260	SDN 2.0 data panel	156.36
SOM1870261	SDN 2.0 extender	113.16
SOM1822440	SDN 2.0 bus and sensor station power supply	756.74
SOM1870262	SDN 2.0 data hub	1,138.66
SOM1870263	SDN 2.0 data hub plus	1,474.60
SOM1870259	SDN2.0 power panel	1,474.60

**12VDC Power Options**

**Somfy's Solar Pack**

The WireFree™ solar pack harnesses solar energy with an easy-to-conceal collector and reduces the need for battery replacement for at least 5 years. Be sure to purchase a SOM9018620 charging kit with your first solar pack to pre-charge the batteries and ensure optimum performance.



SOM9019235 - Installed



SOM9019235

**Our 12VDC shade pricing includes a single battery wand. Use any of the following products to replace or supplement the included battery wand. These power solutions are also compatible with retrofit blind motors.**

SOM9019235	WireFree solar pack with rechargeable batteries	105.32
SOM9018621	Replacement batteries for solar pack	26.65
SOM9018620	Pre-installation AC charger for solar pack	49.65
SOM9014020	Additional reloadable battery tube	20.47
SOM9014834	8 AA lithium battery package	27.96
SOM9013263	Wall mounting clips for battery tube	1.80
SOM1822445	12VDC plug-in power supply, 10' cable (white)	78.08

**Limit Setting Accessories**

**24VDC Contact-Closure and RS-485 Motor Limit Setting**

SOM9014599	Limit tool for ST-30DCT and RS-485 motors	29.71
SOM9014793	Cable for use with SOM9014599	11.44

**RTS motor limits are set with an RTS remote (remotes on next page)**

**110VAC RS-485 Motor Limit Setting**

SOM9017142	Hand-held limit setting and address reader tool	365.03
------------	---	--------

**Automated Exterior Treatments**



**Zip Screens**

SunStopper's Zip Screen retractable shading system provides simple control for expanded outdoor living. The Zip Screen will reduce sun glare and heat, add privacy, and create a virtually bug-proof environment with its side-fabric-retention system.



**Motorized Awnings**

Extended or retracted, Sunstopper retractable awnings enhance the curb appeal of a home. It simply retracts back at the touch of a button with no unsightly poles left behind. It can be mounted on a wall, under a soffit, or onto a roof.



**Exterior Roller Shades**

In addition to adding privacy, exterior solar shading solutions are even more effective than interior mounted shades at reducing heating and cooling costs. By affecting room temperatures up to 20 degrees it can reduce these costs by as much as 40 percent

*Exterior Shading Solutions*



**Make Worthington Distribution Your Integration Experts**

Worthington Distribution has been in the automated shading business for over a decade. Give us a call or send us an email with any questions or to request a quote. We have the knowledge and resources to make your next integrated shading job successful.

**Call us**  
**(800) 282-8864**  
or email [shades@worthdist.com](mailto:shades@worthdist.com)



**Somfy myLink™**



**Control Treatments powered by Somfy with your voice!**

The Somfy myLink can be controlled with Alexa by Amazon. This gives you the ability to open and close shades without the need for an RTS remote or using the app on your smartphone.

**App available on iOS and Android!**

**Features/Benefits of Somfy myLink:**

- Use your touchscreen device like an RTS remote - while at home or anywhere you have Internet access!
- Easy to set-up - purchase and plug in a myLink module and follow the on-screen prompts to connect it to your RTS shades.
- On larger installations, multiple myLinks can work together to create a seamless RTS control network.
- Create automated scenes at a specific time of day or based on astronomical events like sunrise or sunset.

SOM1811403	myLink RTS smartphone and tablet interface	265.33
------------	--	--------

**Somfy Connect Universal Automation Interface (UAI)**

**Simplified third-party integration.**

The Somfy Connect™ Universal Automation Interface (UAI) offers a single point of communication between third party automation systems and Somfy Digital Network™ (SDN) motorized shading systems. It is compatible with Somfy Synergy™ API as well as drivers from popular home automation systems which makes it easy to integrate custom automation programming.

**Features/Benefits of the Somfy Connect UAI:**

- Single integration point for third party automation systems
- Compatible with SDN systems
- Works with Somfy Synergy API for easy integration
- Only one required per system
- Ethernet and RS232 in, RS485 out
- Embedded programming software



SOM1870264



Scan the QR code for the Somfy Connect UAI spec sheet.

SOM1870264	Somfy Connect Universal Automation Interface	265.33
------------	--	--------

**Third-Party RTS Control Accessories**



SOM1810872



SOM1810493

**Omni Speaks Somfy**

With firmware versions 3.14 and later, Leviton Security & Automation's Omni Pro II, IIe, and LTe controllers natively speak the RS-485 needed to operate RTS motors via the Somfy URTSI.

SOM1810872	16-channel universal RTS interface (URTSI)	417.98
SOMHAI CBL	6' cable, connects an Omni with the URTSI	9.99
SOM1810493	RTS dry contact interface (single channel)	71.41
LSA10A07	4 relay board: Use 3 relays per SOM1810493	48.71

**Somfy RTS Transmitters and Automation Accessories**



SOM1810633



SOM1810813



SOM1805237



SOM9013708

SOM1810632	1-channel Telis Pure remote	56.36
SOM1810633	4-channel plus all-channel Telis Pure remote	73.17
SOM1811081	16-channel Telis Pure remote	233.39
SOM1810813	DecoFlex 5-channel wireless in-wall controller	137.92
SOM1810791	RTS repeater. Limit one per system.	189.64
SOM9013707	Sunis indoor RTS transmitter: Open/close 1 RTS channel based on light level	202.97
SOM9013708	Thermo Sunis indoor RTS transmitter: Same as SOM9013707, but adds temperature sensing.	233.39
SOM1805237	Chronis Pure RTS timer. Weekday/weekend scheduler. Program up to two events (one up/one down command) per day.	185.32

**Additional SDN Accessories**



SOM1811252



SOM1811253

SOM1811252	6-button SDN Decoflex keypad, white	129.81
SOM1811253	8-button SDN Decoflex keypad, white	140.12
SOM1822294	RTS to RS-485 receiver for SDN	92.50
SOM9015260	USB to RS-485 converter for PC programming	386.03

**Z-Wave and ZigBee HA Integration Accessories**



Most RS-485 motors can speak Z-Wave or ZigBee HA.

RTS motors use the Z-Wave to RTS plug-in interface.



SOM1870171  
SOM1870220

SOM1870171	Add Z-Wave to ST30-485 and legacy ILT motors	264.99
SOM1870220	Add ZigBee HA to an RS-485 motor	355.96
SOM1811265	Plug-in Z-Wave to RTS wireless interface	344.83

Don't see a part you need?  
Worthington Distribution carries Somfy's entire line of motors and motor accessories.  
Contact us for pricing and availability.



Glydea® and Irismo™ Motorized Drapery Tracks

Motorized draperies add distinction to any living space and are great for home theaters, too. Somfy's Glydea® and Irismo™ are the most innovative motorized drapery solution available today. This powerful yet quiet solution, featuring flexible power options, will elevate your experience with motorized draperies so that you can effortlessly create a comfortable and convenient interior space.



Have questions about Somfy drapery tracks or do you need pricing?  
Give us a call at (800) 282-8864 or email [shades@worthdist.com](mailto:shades@worthdist.com) for answers or to request a quote.

**Other Glydea® and Irismo™ Features:**

- **Touch Control** - Tug on the fabric and the motor will engage.
- **Manual Override** - Holding the fabric while the motor is engaged causes it to stop.
- **Control options** - Seamlessly integrates with third-party systems.
- **Power options** -- WireFree, Plug-and-play, and Wired solutions suitable for any new or retrofit project.

**Belt-driven track**  
**Quiet operation, <44dB**  
**Overlap arm**  
**Heavy duty master carrier**

**Mounting bracket options:**

<b>One-Touch Ceiling</b>	<b>Wall or Ceiling Adjustable</b>
<b>Swivel Ceiling</b>	<b>Dual-track Wall or Ceiling</b>

**Two carrier options:**

- Pinch Pleat**
- Ripplefold**

**Sample Track Configurations:**

- Single Draw
- Split Draw
- Single 90° Bend
- Dual 90° Bend
- Quad Bend Multi-Angle
- Single Curve

Many other configuration options are available. Contact Worthington Distribution for details.

Glydea Control Options

<b>RTS</b> 	<b>SDN (RS-485)</b> 	<b>Contact Closure</b> 	<b>Z-Wave or ZigBee</b> 
----------------	-------------------------	----------------------------	-----------------------------

Glydea Options and Accessories

SOM9014999	Charge for custom curving/bending, per bend	106.09
SOM9019872	Special packaging charge, per track	106.66
<b>Glydea Limit Setting</b>		
SOM9014599	Limit tool for the Glydea drapery motor. Required for any non-RTS motorized drapery	29.71
SOM9015443	Cable for use with SOM9014599, Glydea motors	7.80

Irismo 45 Wireless Drapery Tracks

**Now There's a Fully Wireless Drapery Track from Somfy!**  
Utilizing a rechargeable lithium-ion battery and their flexible RTS controls, Somfy's Irismo provides a truly wire-free drapery track.

**Irismo 45 Features/Benefits:**

- Compatible with Glydea hardware - tracks, carriers, and brackets
- Can run on a single charge for up to 9 months
- Rated to carry up to 99 pounds of fabric and track lengths to 33 feet
- Irismo 45 systems are easy to specify, install and operate

**Great for home theaters!**

**RTS**  
Radio Technology Somfy™

**Irismo 45 WireFree Track Configurations:**

- Single Draw
- Split Draw

Irismo 45 Power Accessories

SOM1002945	Charger for Irismo 45 batteries	68.57
SOM9019741	Additional battery pack for Irismo 45 motor	227.74

Glydea Sample Pricing

For the pricing below we are going to assume the following:

- We're using the sliding glass door in this photo.
- Its width has been measured correctly, and is 138 5/8" wide.
- This will be a left-drawn drapery.
- The customer will be installing a pinch pleat drapery.
- We're using RTS controls.
- The track will be wall-mounted.

Sample Pricing	Dealer	MSRP
Track, carriers, and motor	475.57	915.00
Brackets	20.66	39.75
<b>Total</b>	<b>496.23</b>	<b>954.75</b>

**Dealer's Profit \$458.52!**

Need to know how much you can make selling motorized treatments on your next installation? Send your measurements to us and we'll respond with a quote within 48 hours.

Send quote requests to [shades@worthdist.com](mailto:shades@worthdist.com)

# Introducing VeraPlus Controller

*with Z-Wave, Wi-Fi plus ZigBee & Bluetooth*

Extra processing power, twice the memory and multiple protocols distinguish Vera's new high performance controller. Specify the sensors, alarms, thermostats, door locks or other devices you think best for each customer, without worrying about compatibility. 880-MHz Dual Core CPU delivers ultra-fast response. Control over 200 devices in one home, from anywhere. Works locally if Internet goes out. No monthly fees required!



One Touch Control



Custom Scenes



Geofencing



Texts & E-mail Alerts



Energy Monitoring



## VeraEdge Controller

*High Performance Z-Wave & Wi-Fi Security & Automation*

Compatibility with most Z-Wave and Wi-Fi devices. With powerful 600-MHz processor and 128MB flash memory, VeraEdge controls over 100 devices in one location. Like VeraPlus, the VeraEdge features the Vera Dashboard app for advanced home security and automation, which customers easily operate from their PC, smartphone or laptop. Convenient interactive installation wizards guide your customers' simple set up.



## VistaCam 700 Indoor Camera

*Versatile High Performance Low Cost Indoor HD Wi-Fi Camera*

Elegant wireless home security camera featuring built-in microphone, night vision, and easy WPS Wi-Fi setup (plus Ethernet too). High Definition image quality (720p), built-in IR illumination (16-foot range), motion detection, great value and quick setup. View from anywhere on smartphone, tablet or laptop. Use independently, or watch (and capture) all cameras with the Vera Dashboard app. Great deal!



## VistaCam 1100 Outdoor Camera

*Weatherproof HD Wi-Fi Camera with Power Supply for Outdoors*

Rugged high def outdoor camera is weatherized (including built-in heater to remove snow!) and uses one-cable Power-Over-Ethernet and Wi-Fi for quick installation, even away from your customers' homes. Includes Wi-Fi PoE adapter. HD (720p) video, motion detection. Built-in microphone, IR illumination for night vision. View from anywhere. Works by itself, or view and record (with motion activation) using a Vera controller and the Dashboard app.





## Introduction to ESI Products



## Add intelligent controls to dumb motors...

ESI's RP- and RQ-series motor controls basically do one thing - they convert almost any standard AC or DC limit-switch motor into a smart motor.

## ... Or use motors with embedded intelligence.

ESI's M40Q and M50Q motors have RQ technology built right into the motor which eliminates the need for an extra controller and can reduce wiring costs.



## Meet ESI's RP60 motor controls.

RP60 motor controls are one of ESI's longest-selling product ranges. They provide smart control of virtually any AC or DC standard motor. Although some of the RP60-series controllers have been discontinued and replaced by similar products in their RQ60-series, it's still important to have a knowledge of RP60 controllers since these same controls also work with the RQ60 controllers.

NOTE: To identify an RP60 controller check the "phone" jacks, any EYE, AUX, or BUS port will be grey.

## RP60 Controller Features/Benefits:

- Adds intelligent control of standard motors from a contact closure, IR, RF, or serial input, see control options listed below
- Controller can be calibrated to a connected standard motor to learn the upper and lower limits allowing you to reliably move the motor to any percentage from 0-99%
- Two intermediate positions can be set to allow your customer to consistently move the motor to the same levels with a single button press
- Controllers can be programmed via a 24-channel remote/keypad or serially using the ESI GUI software, available for free from ESI's website

## Introducing ESI's RQ60 motor controls.

RQ60 motor controllers build upon the RP60-series, both figuratively and literally. ESI's RQ60 motor controllers have all of the same features and can use the same input and control modules as the RP60 controllers while adding two-way RS-232 feedback and scene control, along with a few other features. The flexible control options make ESI's RQ60 motor controllers the perfect solution for almost any motor control installation.

NOTE: To identify an RQ60 controller check the "phone" jacks, any QEYE, QAUX, or BUS port will be red and 8-BUS ports will be black.

## RQ60 Controller Features/Benefits:

- Has all of the same features as RP60-series controllers
- Board-only models can be installed in ESI's custom panels
- Provides two-way RS-232 feedback via an RQ Bridge serial interface for integration into third-party automation systems
- Four intermediate positions can be set via a remote control/keypad to allow your customer to consistently move the motor to the same levels with a single button press
- RQ control options can be programmed via the RQ Desktop Programmer software, available for free from ESI's website

## RP60 Motor Controllers in Plug-and-Play Plastic Boxes



ESIRP60ABMH



ESIRP60ABMH2



ESIRP60DBM4

ESIRP60ABMH	AC motor controller in plastic box	162.00
ESIRP60ABMH2	Dual AC motor controllers in a single box	174.66
ESIRP60DBM2	Dual DC motor controllers in a single box	172.12
ESIRP60DBM4	Four DC motor controllers in a single box	194.44
ESIRP60DBMSEQ	Sequential dual DC motor controllers	173.25

## RQ60 Single-Motor Controllers



ESIRQ60AUMH115



ESIRQ60DBM



ESIRQ60DUM

ESIRQ60AUMH115	Board-only 115VAC motor controller	136.50
ESIRQ60AUMHE230	Board-only 230VAC motor controller	136.50
ESIRQ60DBM	12-24VDC motor controller in plastic box	140.25
ESIRQ60DUM	Board-only 12-24VDC motor controller	112.50

See the next page for new, multi-motor RQ60 controllers

## RP-Series Input and Control Options



ESIR2D7



ESIK24ST



ESIRR433



ESIT24S

ESIR2D7	RS-232 input module	98.81
ESIK24ST	24-channel hard-wired keypad*	93.19
ESIK24STRF433	24-channel RF keypad*	121.88
ESIT24S	24-channel IR remote control*	52.88
ESIT24SDUAL433	24-channel dual IR/RF remote control*	74.59
ESIRR433	433MHz radio receiver	59.25
ESIPSI-60	Programmable contact closure input board	43.12
ESIPSIB	ESIPSI-60 in plug-and-play box	66.94

\* Also available in 1, 2, 3, 4, 6, and 12 channels at the same price

## RQ-Series Input and Control Options



ESIRQMSTSWITCH



ESIRQSCNSWITCH



ESIQSIB

ESIRQBRIDGE232	RS-232 input/output module	78.75
ESIRQMSTSWITCH	Programmable RQ Master Switch, sends RQ commands based on button presses, includes button labels	CALL
ESIRQSCNSWITCH	Programmable RQ Scene Switch, sends RQ commands based on button presses, labeled for up/stop/down	CALL
ESIQSIB	Programmable contact-closure input board	73.29
ESIPWRSPLITTER	8-conductor power injector/splitter	73.29

**ESI Project Solutions**

**Flexible Motor Control Solutions for Virtually Any-Size Installation**

ESI has solutions for just about any hard-wired motorized residential or commercial shading project. Options include centralized control solutions using 4-motor RQ controllers and custom panels or distributed networks using ESI's RQ-embedded motors. If you're looking to use ESI controls in any installations, please contact Worthington Distribution to help determine the best solution for your particular installation.

**RQ-Embedded Motors and Accessories**

With embedded RQ technology, the M40Q and M50Q series motors are perfect for integrated installations in both commercial and residential applications. The M40Q motors are ideal for use with roller shades or blinds using a 36mm ID tube or larger. The M50Q motors should be used with roller shades and blinds using a 46mm ID tube or larger.

**RQ-Embedded Motors Features/Benefits:**

- Embedded RQ and RP functionality
- Can be bussed with other RQ motors or RQ/PR motor controls to form an ESI Network
- Integrated manual inputs for use with dry contact switches
- Limits can be set from motor head or via RQ bus commands
- Crown and drive adaptors are available for a range of the most popular roller tubes in the industry, contact Worthington Distribution for options



**ESIM50Q634APS**



**ESISPBRQMOTOR**

ESIM40Q430APS	4 Nm 30 RPM RQ-embedded motor	300.75
ESIM40Q915APS	9 Nm 15 RPM RQ-embedded motor	300.75
ESIM50Q634APS	6 Nm 34 RPM RQ-embedded motor	270.75
ESIM50Q1234APS	12 Nm 34 RPM RQ-embedded motor	215.83
ESISPBRQMOTOR	8P8C RQ motor splitter	19.68
ESICBL1FTQEQM8P	1 foot RQ-motor to 8P8C cable	12.41
ESICBL6FTQEQM8P	6 foot RQ-motor to 8P8C cable	15.79
ESIPCM4050UNIV	6 foot unterminated power cord	13.50
ESIPCM4050US	6 foot power cord, grounded plug	14.25
ESIPCM40506MPL	18 foot plenum-rated power cord	39.00

**RQ60 Multi-Motor Controllers**

ESI's RQ controllers enable centralized switching of four AC motors from a single control unit. Each motor has independent RQ control with bi-directional communication as well as independent and group manual inputs. RP commands can be isolated to the local four-motor controller or passed along the RQ Bus for communication with all connected devices in larger projects.

**RQ60 Multi-Motor Controllers Features/Benefits:**

- Available for AC or DC motors
- Available as panel-mountable boards or in plug-and-play plastic boxes
- Each motor has its own, independent RQ address
- Allows four motors to count as a single ESI "node" for determining maximum network cable runs and node counts
- Reduces installation costs, one four-motor controller is less expensive than four single-motor controllers



**ESIRQ60ABMH4115**



**ESIRQ60AUMH4115**

ESIRQ60ABMH4115	115VAC 4-motor controller, plastic box	CALL
ESIRQ60ABMHE423	230VAC 4-motor controller, plastic box	CALL
ESIRQ60AUMH4115	Board-only 115VAC 4-motor controller	CALL
ESIRQ60AUMHE423	Board-only 230VAC 4-motor controller	CALL
ESIRQ48X10B115	ESIRQ60AUMH4115 mounted in a UL-listed 8x10 metal enclosure	CALL

**ESI UL-Listed Custom and Open Panels**

**Additional Features:**

- **Turn-key motor control solution** - Just connect your input power, connect the controllers to the motors, and calibrate the controllers to the motors.
- **Saves hours in the field** - ESI powers and tests all of the connections in each panel prior to shipping to ensure that all of the connections are secure, removing many potential failure points during troubleshooting.



See the next page for iOS and Android touchscreen controls for custom panels, RQ60 controllers, and RQ-embedded motors.

Convenient terminals for the incoming power feed

Power and communication cables are pre-wired

Available for AC or DC standard motors

Built to UL-325 standards

Automation accessories, such as an RQ bridge, can be mounted inside of the panel

Controllers are programmed and labeled to the installer's specifications

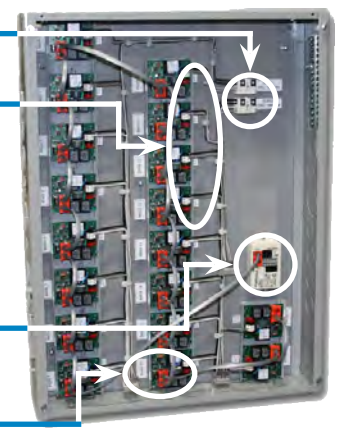

**ESI CUSTOM PANEL**

ESICUSTOMPANEL1	8" x 8" x 4" preprogrammed custom panel mounted in a steel enclosure, for up to 4 devices	309.00
ESICUSTOMPANEL2	12" x 12" x 4" preprogrammed custom panel mounted in a steel enclosure, for up to 8 devices	386.25
ESICUSTOMPANEL3	12" x 18" x 4" preprogrammed custom panel mounted in a steel enclosure, for up to 10 devices	541.50
ESICUSTOMPANEL4	12" x 24" x 4" preprogrammed custom panel mounted in a steel enclosure, for up to 16 devices	633.00
ESICUSTOMPANEL5	18" x 24" x 4" preprogrammed custom panel mounted in a steel enclosure, for up to 24 devices	815.25

To determine custom panel pricing select the appropriately-sized panel above and add RQ60 board-only controllers from the previous page.

**ESI Touchscreen Interfaces from Worthington Distribution**

**Custom Touchscreen Interfaces for ESI RQ Products**

Leviton's Bitwise controllers provide the ideal IP bridge for two-way communication with ESI's RQ-series products. The ultra-flexible programming interface provided by Bitwise allows an installer to provide a uniquely-customized interface for any residential or commercial customer. Worthington Distribution offers both a do-it-yourself template for any installer interested in laying-out their own motor control interface as well as professionally-built custom interfaces created by Worthington staff for installers who are more interested in having a turn-key control solution.



**BITSHADES interface displayed on iOS and Android**

The same interface can be used on both iOS and Android devices without creating a new layout for different screen resolutions.



**The BITSHADES Bitwise ESI Template**

Worthington Distribution has created a unique template for Bitwise which has been tailored specifically for ESI RQ-series control and feedback. The integration requires a Bitwise BC1 or BC2 automation controller along with an RQ Bridge for each installation.

**BITSHADES Template Features/Benefits:**

- Contains serial strings for control and feedback of RQ devices addressed from 001-050
- All art assets are provided to create an intuitive touchscreen interface
- The template price also includes one-on-one technical support and training on modifying the template and using the Bitwise Project Editor software
- Use the same interface on multiple devices: iOS, Android, or even on a dedicated Leviton OmniTouch 7 on-wall touchscreen

**The BITSHADES template is a one-time purchase. Once you own it, you may use it for any future jobs. There are no additional licensing fees.**

BITSHADES	Bitwise ESI template	149.00
BITBWBC1	BC1 Controller, 8 IR ports, 4 GPIO, 4 relays, 1 IR input	928.66
BITBWBC2	BC2 Controller, 4 IR ports, 2 RS-232, 2 GPIO, 2 relays	592.93
BITBWRMT	RF hard-button remote control. Requires BITWRRR receiver.	95.91
BITBWRRR	RF receiver for hard-button remote	59.94
LSA99A00-1	OmniTouch 7 on-wall touchscreen, white	398.68
LSA99A00-2	OmniTouch 7 on-wall touchscreen, black	398.68

**Additional Products Compatible with Bitwise**

If you plan to install Bitwise for control of an RQ network you may also want to offer integration with the following:

**Displays**

**Lutron RadioRA 2 lighting**

**Nest thermostats**

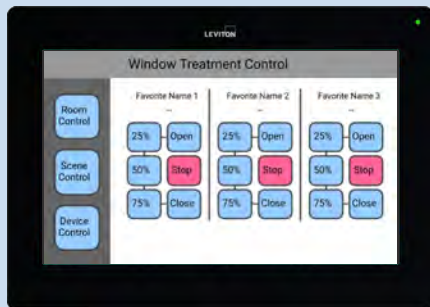

**LSA99A00-2 with the BITSHADES interface**

**On-Wall Touchscreen Controls**

In addition to offering your customers a shading control solution on their iOS and Android devices, you can also offer them a dedicated, on-wall touchscreen solution with Leviton's OmniTouch 7 touchscreens. These elegant screens are the perfect answer to the customer who doesn't like the look of ESI's keypads. By mounting the control-point to the wall, you ensure that your customer never needs to search for a remote or iPad when they want to operate their window coverings.

**Worthington Distribution Custom Programming**

**Need a Bitwise solution but don't have the time to learn something new? Let Worthington Distribution help!**

Our trained and experienced team is here to back you up with pre-programmed systems. Just give us all the details of the job and how you need the system to operate and we will ship it to you configured and ready to install.

**Call Barry at Worthington today!**



**Barry Hampe**  
Technical Representative  
BitWise Expert

**Russound MCA-series**

**Leviton Security & Automation Omni**

**DSC**

... and many more

**Contact Worthington Distribution with any questions related to ESI or Bitwise.**

**By phone at (800) 282-8864 or by email at [sales@worthdist.com](mailto:sales@worthdist.com)**



**Floor Rings**

Combining Sillites' self-contained receptacles with their floor rings is an inexpensive way to provide convenient power in wood, carpet, or tile floors.

**Floor Ring Features/Benefits:**

- Installs in minutes
- ETL tested to meet UL 514D standards when used with Sillites' self-contained receptacles
- Can support up to 300 pounds



SILFRAB	Floor ring, antique bronze	16.99
SILFRBN	Floor ring, brushed nickel	16.99

**SILFRAB with SILSCRW**

**Sillites Candles**



**SILSL7BN**

Add a touch of elegance with Sillites' direct plug-in candles. With Sillites, you totally eliminate the need for extension cords. Since the candles are available in two sizes, each with four different finishes, you're sure to find an option which matches your customer's décor.

SILSL7*	7" tall candle with lamp, drip cap, and white PVC sleeve (Made to order)	40.97
SILSL9*	9" tall candle with lamp, drip cap, and white PVC sleeve	40.97

\* AB-Antique Bronze, PB-Polished Brass, BN-Brushed Nickel, MB-Matte Black

Replace the included white PVC sleeve with one of the below sleeves for a more traditional look for your Sillites candle.

SILGBS†	Golden beeswax sleeve for Sillites candle	9.09
SILIBS†	Ivory beeswax sleeve for Sillites candle	9.09

† 7 for 7" sleeve or 9 for 9" sleeve

**Self-Contained Receptacles**

Because Sillites' self-contained receptacles are UL listed, they can be used to supply power just about anywhere!



**Inside of a window jamb to power automated treatments**

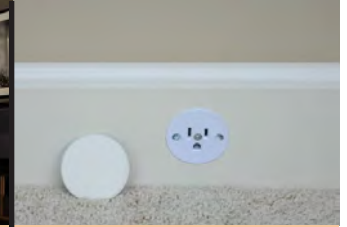

**Unobtrusively through the moulding**



**On the side of cabinets to power kitchen gadgets**



**In the floor using an optional floor ring**

SILSCRW	Self-contained receptacle, white, 125V, 15A & TR rated for use with 12/2 or 14/2 cables	12.94
SILSCRMB	Self-contained receptacle, black, 125V, 15A & TR rated for use with 12/2 or 14/2 cables	12.94
SILSCRBR	Self-contained receptacle, brown, 125V, 15A & TR rated for use with 12/2 or 14/2 cables	12.94



U.S. Patent #6601977

**Self-Contained Receptacles**

Use in Floors, Windows, Cabinets & Mantels

**Direct Plug-in Window Candles**

The Elegant Plug-In Candle for Your Window Sills

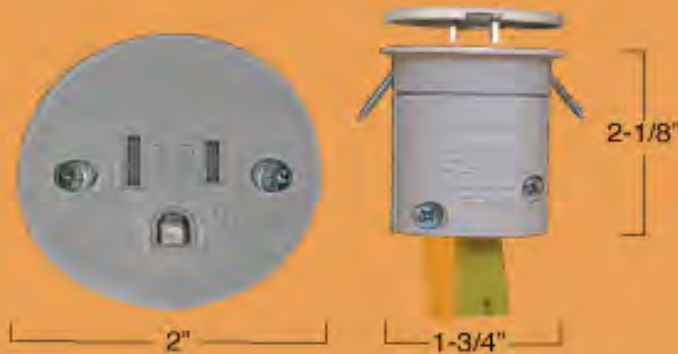

- NO J-BOX NEEDED!!
- For use with one or two 12/2 or 14/2 NM wire sections
- Tamper resistant
- Rated for 125 volt 15 amp operation
- Meets UL 498 and UL 514C with Floor Ring added
- Can be wired to GFI or arc fault breaker or receptacle
- Brown #SCRBR, Black #SCRMB, or White #SCRW

805 S. Glynn Street, Suite 127-345 • Fayetteville, GA 30214  
Ph. 770-755-5654 • Fax 678-868-2440 • www.Sillites.com



## SUPERCARGE YOUR OmniPro II

# “Alexa, tell HomeSeer to...



*... set the security system to arm away."*  
*... lock the kitchen door."*  
*... turn off the bedroom light."*  
*... set the thermostat to 72."*  
*... dim all living rooms lights to 50%."*  
*... open the garage door."*



HomeTroller Zee S2

Contact Worthington  
for HomeSeer/OmniPro II  
integration info

also works with  
HomeTroller-SEL & S6

home controllers, z-wave products & more

**HomeSeer**  
www.homeseer.com

Upload / Download	Internet Control	Thermostats	FCC/JUL Security	Zone/Inputs (max)	Vocabulary (words)	Outputs (max)	Touchscreen	# of Consoles	Max Wireless	Astronomical Clock	Phone Access	Ethernet / Wi-Fi	Serial Ports (max)	UPB Support	Lock Support	Z-Wave Support	Vizia-RF+ Support	ZigBee Support	
Y / Y	Y	64	Y	16 (176)	Y (550)	8 (136)	Y	16	O 128	Y	Y	Y / N	5 (6)	Y	Y (16)	Y	Y	Y	OmniPro II
Y / Y	Y	4	Y	16 (48)	Y (550)	8 (8)	Y	8	O 16 (64)	Y	Y	Y / N	5 (6)	Y	Y (4)	Y	Y	Y	Omni Ile
Y / Y	Y	4	Y	16 (32)	Y (550)	8 (8)	Y	4	O 16 (64)	Y	Y	Y / N	5	Y	Y (4)	Y	Y	Y	Omni LTe
Y / Y	Y	40*	N	N/A (40*)	N	N/A	Y	16	40*	Y	N	Y / N	N/A	N	N	N	N	N	Lumina RF Gateway
Y / Y	Y	232*	N	N/A (232*)	N	O (232*)	O	N/A	O (232*)	Y	N	Y / N	N/A	N	Y	Y	Y	Y	from Leviton
Y / Y	Y	232*	Y	6 (6)	N	O (232*)	O	N/A	O (232*)	Y	N	Y / Y	O (1)	N	Y	Y	N	O	ZipaBox
Y / Y	Y	232*	N	N/A (232*)	N	O (232*)	O	N/A	O (232*)	Y	N	Y / Y	O (8)	P	Y	Y	Y	Y	VeraPlus
Y / Y	Y	100*	N	N/A (100*)	N	O (100*)	O	N/A	O (100*)	Y	N	Y / Y	O (8)	P	Y	Y	Y	Y	VeraEdge
Y / Y	Y	232*	P	N/A (232*)	O	O (232*)	O	N/A	O (232*)	Y	N	Y / N	1	N	Y	Y	N	P	HC2
Y / Y	Y	232*	N	N/A (232*)	O	O (232*)	O	N/A	O (232*)	Y	N	Y / N	N/A	N	N	Y	N	N	HCL
Y / Y	Y	4	Y	2 (60)	Y (254)	2	Y	4	60	Y	N	N/A	N/A	N	Y	Y	N	N	GC2
Y / Y	Y	4	Y	2 (100)	Y (254)	2	Y	4	100	Y	N	N / P	N/A	N	Y	Y	N	N	GC3
Y / Y	Y	O 4	Y	8 (32)	O (256)	2 (14)	Y	8	O 32	N	O	O / N	O (1)	N	Y	Y	N	N	1832
Y / Y	Y	16	Y	16 (208)	Y (500+)	13 (205)	Y	16	O 48	Y	Y	Y / N	1 (8)	Y	P	Y	Y	N	M1 Gold
Y / Y	Y	232*	N	N/A (232*)	N/A	O (232*)	Y	N/A	O (232*)	Y	N	Y / O	O (4)	Y	Y	Y	N	N	HT-ZEE S2

Y=Yes; N=No; O=Optional; P=Pending; N/A=Not Applicable; \*=Total Devices

The information in this chart was gathered from manufacturer websites, tech support and literature.

Confirm specs with Worthington Distribution prior to ordering.

Worthington Distribution's knowledgeable staff can help with any questions you may have. Call today!



### Five Questions when Choosing an Omni Controller



1. How many security points or automation inputs will your installation require?

- Greater than 48 - OmniPro II
- 48 or less - Omni Ile, OmniPro II
- 16 hardwired (32 with wireless) or less - Omni LTE



2. Will you be connecting to a third party distributed audio system such as Russound, Xantech or Proficient?

- Yes - OmniPro II



3. How many thermostats will your project require?

- Greater than 4 - OmniPro II
- 4 or less - Any of the controllers



4. How much lighting will your project require?

- Greater than 64 loads/8 rooms - OmniPro II
- 64 loads/8 rooms or less - Omni Ile or OmniPro II
- 32 loads/4 rooms or less - Any controller



5a. Does your project require access readers?

- Greater than 4 readers - OmniPro II
- 4 or less - Omni Ile, Omni LTE

5b. Does your project require locks/maglocks/strikes?

- Greater than 8 - OmniPro II
- 8 or less - Omni Ile, Omni LTE

### Connectivity Partners

Connectivity Partners	Products	Page
Irrigation	WGL & Associates Rain 8	111
Lighting	Leviton Vizia rf +: Z-Wave	16-17
	Centralite JetStream, 3-Series, Elegence XL	61-63
	PCS Pulseworx	57
	Lutron RadioRA 2	45-50
	GE and Jasco Z-Wave Devices	33
Interfaces	Simply Automated UPB Devices	58-59
	BitWise A/V and Omni Control using Phones/Tablets	35, 91
Large Load Control	GrandStream Android Phones on IP Phone System	190-191
	HomeSeer Integration with Amazon Echo (Alexa), Android/iOS App	23
Access Control	RCS Z-Wave 30 Amp Contactor	107
	Seco-Larm Deadbolts, Magnetic Locks, Door Strikes	138
Communicating Locks	Alarm Controls Magnetic Locks, Door Strikes	139
	Kwikset & Baldwin Deadbolts and Entry Sets: Z-Wave and ZigBee	24
	Yale Deadbolts and Entry Sets: Z-Wave and ZigBee	25
Wireless Sensors	Schlage Deadbolts and Entry Sets: Z-Wave	26
	Ion Wireless transmitters compatible with the LSA42A00-2 GE Receiver	128
Wireless Networking	Resolution Products Wireless transmitters compatible with the LSA42A00-2 GE Receiver	128
	Luxul Wireless Enhanced antenna solutions for Wi-Fi access points	64-65
Water Detection	Winland WaterBug, EnviroAlert	137
	GRI Water Sensors	136
Water Shutoff	GreenField Direct KZValve	94
Structured Wiring	Leviton Leviton Integrated Networks	198-202
	Legrand OnQ and Greyfox	204-209
Whole House Audio	Russound MCA-88, MCA-88X, MCA-66, CAA66, CAS44, CA4	150-155
Window Coverings	Somfy Controls / Motors for window treatments featuring Z-Wave	72-74
	ESI Motor Controls	76-78
	Lutron Automated shades controlled by RadioRA 2 and Caseta	52-53
Vehicle Detection	Cartell Vehicle Detection Probes	110
	Dakota Alert Hardwired and Wireless Sensors	109
Temperature Control (Z-Wave)	RCS RCSTZ45 Thermostat	31
	RCS RCSTBZ48 Thermostat	31
	Radio Thermostat CT110 Thermostat	31
	2GIG 2GIG-GC-TBZ48 Thermostat	31
	Trane SCHTZMT400 Thermostat	31

**Questions about whether or not something works? Give us a call today!**

	<b>Omni Pro II</b> AUTOMATION	<b>OMNI IIe</b> AUTOMATION	<b>OMNIILe</b> AUTOMATION
Russound, Proficient, Xantech Audio Integration	Yes	No	No
Hi-Fi 2 Audio Integration	Yes	Yes	Yes
Communicating Thermostats	64	4	4
Inputs - On Board / With All Expansion	16 / 176	16 / 48	16 / 32
Voltage Outputs - On Board / With All Expansion	8 / 136	8 / 8	8 / 8
Consoles	16	8	4
Supported IP Touchscreens (5.7e, OmniTouch 7)	16	16	16
Serial Ports - On Board / With All Expansion	5 / 6	5 / 6	5 / 6
Flash Firmware Upgrade	Yes	Yes	Yes
Ethernet Port	Yes	Yes	Yes
2-Wire Smoke Loops *	4	4	4
User Codes	99	16	16
Access Control Cards / Keytags	99	16	16
Access Control Readers	16	4	4
ZigBee and Z-Wave Lock Support	16	4	4
Programming Lines	1500	500	300
Vocabulary	550	550	550
Custom Vocabulary	Yes	No	No
Maximum Auxiliary Current	1 Amp	1 Amp	1 Amp
Maximum Bell Current	1 Amp	1 Amp	1 Amp
Driver Support for DSC Power Series	No	No	No
UL Listed for Residential Burglary and Fire	Yes	Yes	Yes
Reporting Formats: Contact ID, 4/2, 3/1	Yes	Yes	Yes
Removable Terminal Strips	Yes	Yes	Yes
Warranty	3 years	2 years	2 years

### Lighting Options and Capacities

<b>UPB</b>	Home Lighting Control (HLC)	31 Rooms**	8 Rooms**	4 Rooms**
	Simply Automated - Simply Brilliant	256 Addresses	64 Addresses	32 Addresses
	PCS - Pulseworx	256 Addresses	64 Addresses	32 Addresses
<b>Z-Wave</b>	Leviton - Vizia RF + (2-Way)	30 Rooms**	8 Rooms**	4 Rooms**
	Standard Z-Wave	64 Devices	64 Devices	32 Devices
<b>Zigbee</b>	Centralite - JetStream	200 Devices	64 Devices	32 Devices
	ZigBee Plug-In Modules	256 Addresses	64 Devices	32 Devices
<b>Lutron</b>	RadioRA	64 Devices	64 Devices	N/A
	RadioRA 2	200 Devices	64 Devices	N/A
<b>X10</b>	Leviton DHC, ACT	256 Addresses	64 Addresses	32 Addresses
<b>Hardwired</b>	Omni-Bus	192 Devices	64 Devices	32 Devices
	KNX Interface	192 Devices	64 Devices	32 Devices
	Centralite Elegance XL	192 Devices	64 Devices	32 Devices
	Schneider Electric C-Bus	256 Devices	64 Devices	32 Devices

\* Worthington recommends wiring for 4-wire smokes with Omni controllers.

\*\* A Room = 8 devices (Programming on the 8s). The controller tracks devices in a room and offers room status in addition to individual device status.

## OmniPro II

- "Go-To" Choice of Omni controllers
- Hi-Fi 2, Russound, Xantech, and Proficient Distributed Audio Support
- Integrated Ethernet port for connectivity
- Expandable for up to 176 security / automation points
- Plug and play with Omnistat thermostats
- Full support for numerous lighting systems
- Ethernet access using Snap-Link or PC Access
- Up to 6 serial ports for integration with third party systems



The OmniPro II offers the greatest number of third party drivers





LSA20A00-2***	OmniPro II controller in enclosure, RJ-31x, manuals, lock, keys, <b>requires</b> 7Ah battery, 24/40VA transformer	998.20
LSA20A00-8***	OmniPro II controller on a Leviton, Open House, Legrand, and UStec structured wiring plate, RJ-31x, manuals, wiring diagram decal, <b>requires</b> 7Ah battery, 24/40VA transformer	998.20
LSA20A00-5	OmniPro II commercial controller in an enclosure, RJ-31x, manuals, lock, keys, <b>requires</b> 7Ah battery, 24/40VA transformer	1,297.64
LSA20A00-21***	OmniPro II controller board only (order resistors separately), <b>requires</b> 7Ah battery, 24/40VA transformer	956.58

80 language options are available

## Omni Ile

- The workhorse of the Omni family. Excellent value!
- Hi-Fi 2 Distributed Audio Support
- Integrated Ethernet port for connectivity
- Expandable for up to 48 security / automation points
- Plug and play with Omnistats
- Full support for numerous lighting systems
- Ethernet access using Snap-Link or PC Access
- Up to 6 serial ports for integration with third party systems



LSA20A00-50	Omni Ile controller in enclosure, RJ-31x, manuals, lock, keys, <b>requires</b> 7Ah battery, 24/40VA transformer	698.44
LSA20A00-52***	Omni Ile controller on a Leviton, Open House, OnQ, and UStec structured wiring plate, RJ-31x, manuals, wiring diagram decal, <b>requires</b> 7Ah battery, 24/40VA transformer	698.44
LSA20A00-53***	Omni Ile controller board only (order resistors separately), <b>requires</b> 7Ah battery, 24/40VA transformer	668.99

80 language options are available

## Omni LTe

- Integrated Ethernet port for connectivity
- Hi-Fi 2 Distributed Audio Support
- Expandable for up to 32 security / automation points
- Plug and play with Omnistats
- Full support for numerous lighting systems
- Ethernet access using Snap-Link or PC Access
- Up to 6 serial ports for integration with third party systems



LSA20A00-70	Omni LTe controller in enclosure, RJ-31x, manuals, lock, keys, <b>requires</b> 7Ah battery, 24/40VA transformer	457.43
LSA20A00-72	Omni LTe controller on a Leviton, Open House, OnQ, and UStec structured wiring plate, RJ-31x, manuals, wiring diagram decal, <b>requires</b> 7Ah battery, 24/40VA transformer	457.43
LSA20A00-73	Omni LTe controller board only, <b>requires</b> 7Ah battery, 24/40VA transformer	408.42

### Worthington Distribution Packages

**LSAKIT15 OmniPro II in Enclosure Kit** 1,249.99

OmniPro II controller in enclosure, 16 zone expander, surface-mount console, flush-mount kit, temperature sensor, serial cable, RJ-31x, manuals, lock and key, **includes free transformer and battery!**

1,249.99

**LSAKIT15S OmniPro II for Structured Wiring**

OmniPro II controller on a Leviton, Open House, Legrand, and UStec structured wiring plate, 16-zone expander, surface-mount console, flush-mount kit, temperature sensor, serial cable, RJ-31x, manuals, **includes free transformer and battery!**



Enclosure Kit



Backplane Kit

**LSAKIT12E Omni Ile in Enclosure Kit** 864.99

Omni Ile controller in enclosure, surface-mount console, flush-mount kit, temperature sensor, serial cable, RJ-31x, manuals, lock and key, **includes free transformer and battery!**

**LSAKIT12ES Omni Ile for Structured Wiring** 864.99

Omni Ile controller on a Leviton, Open House, OnQ, and UStec structured wiring plate, surface-mount console, flush-mount kit, temperature sensor, serial cable, RJ-31x, manuals, **includes free transformer and battery!**

### Text and Email Notification Board

#### Features

- Send email or SMS texts based on any programming line
- 100 User Programmable Messages
- 8 Customizable Email Addresses
- Adds Network Time Sync to Omni/Lumina Controllers
- **No service fees or contracts**



LSA20A30-1	Omni Notifier, supports Omni/Lumina controllers with Ethernet	119.90
------------	---	--------



Zone Expansion



LSA10A06	LSA17A00-1	LSA17A00-9
LSA10A06	16-zone expansion module with accessory kit, maximum of 2 per OmniPro II, Omni IIe, Lumina or Lumina Pro system. For zones 17-32 and zones 33-48	98.92
LSA17A00-1	16-zone/16 output expansion enclosure, lock and key, max 8 per OmniPro II or Lumina Pro system, <b>requires</b> 7Ah battery, 24/40VA transformer	249.13
LSA17A00-9	16-zone/16 output expansion on a Leviton, Open House, Legrand, and UStec structured wiring plate, max 8 per OmniPro II or Lumina Pro, <b>requires</b> 7Ah battery, 24/40VA transformer	261.90
LSA17A00-8	16-zone/16 output expansion board only, max 8 per OmniPro II or Lumina Pro system, <b>requires</b> 7Ah battery, 24/40VA transformer, no mounting hardware included	215.17

Omni Pro II

Hardware	Zones	Outputs
Main Controller *	1 - 16	1 - 8
10A06	16 Zone expander. Up to 2	17 - 48
45A00-1	64 Zone Leviton wireless receiver. Up to 2	49 - 176
42A00-2	64 Zone GE wireless receiver: Up to 2	49 - 176
17A00	16 Zone, 16 Output Expansion enclosure up to 8. Requires battery and transformer.	9 - 136

OMNI IIe

Hardware	Zones	Outputs
Main Controller*	1 - 16	1 - 8
10A06	16 Zone expander - up to 2	17 - 48
45A00-1	64 Zone Leviton wireless receiver	33 - 48
42A00-2	64 Zone GE wireless receiver	33 - 48

OMNI LTe

Hardware	Zones	Outputs
Main Controller*	1 - 16	1 - 8
45A00-1	64 Zone Leviton wireless receiver	17 - 32
42A00-2	64 Zone GE wireless receiver	17 - 32

\* Zone 15 is often the outdoor temperature sensor. Output 8 and Zone 16 are used for thermostat communication. Zones 1-4 can be used for 2-wire smokes. Worthington recommends 4-wire smoke detectors starting on Zone 5. 4-wire smokes can be wired to all 48 zones.



**Wireless receivers and transmitters are available on page 87**



**Thermostats - page 95**



**LSA10A11**

Popular Add-on Items

ATWBLOODHOUND	Flush-mount sounder, 90mA, 104dB	8.99
ATWDOBERMANPLUS	Piezo siren with strobe, surface-mount, outdoor, 104dB, 180mA	17.36
LSARC1000WH	Thermostat: conventional single-stage, heat pump and dual fuel systems	149.88
LSARC2000WH	Thermostat: conventional 2-stage, 3-stage heat pump, dual fuel systems, with humidity	197.84
LSA31A00-7	Enhanced extended range indoor/outdoor temperature sensor with bracket	43.96
LSA31A00-8	Enhanced extended range indoor/outdoor temp/humidity sensor with bracket	84.96
LSA36A05-4	RJ-11 to DB-9M connectivity cable. Use with Russound, Lutron, RadioRA 2, Jandy & Centralite.	14.75

2-Way Voice

LSA10A11	2-way voice board: Features a line level output and relay. Includes a 12VDC trigger for speech over a Russound CAV6.6, MCA-C5, MCA-88, or Hi-Fi 2.	98.67
LSA28A00-1	Speaker and microphone for 10A11, surface-mount enclosure, maximum 2 per installation	42.83
LSA28A00-2	Speaker and microphone for 10A11, flush-mount enclosure, maximum 2 per installation	36.41

System Consoles



LSA33A00-1 with LSA33A00-3

LSA33A00-1

LSA33A00-1	LCD surface-mount console, silk-screen front	113.23
LSA33A00-23	International version of the LSA33A00-1: uses icons instead of text on the arming buttons	125.60
LSA33A00-4	LCD surface-mount console with speaker and microphone, silk screen front, connector kit	148.20
LSA33A00-3	Flush-mount kit for LCD keypads	19.93

**One standard console should be on each installation for setup and backup disarming functionality**

**4-Wire Smoke Detection (12VDC 4-wire smoke loop)**

DSCFSA410B	DSC 4-wire basic smoke	30.80
DSCFSA410BT	DSC 4-wire smoke with heat	30.80
DSCFSA410BST	DSC 4-wire smoke with heat and 85 dB sounder	26.95

**4-Wire Smoke Detection Accessories**

DSCPRM2W	DSC 4-wire Polarity Reversal Module, forces all 4-wire smokes with sounders to sound	23.62
DSCRM2	DSC 4-wire Smoke Loop Power Supervision Relay	15.29



DSCRM2



DSC Smoke Detectors



Heat

**2-Wire Smoke Detection (12VDC 2-wire smoke loop)**

DSCFSA210B	2-wire basic photoelectric smoke detector	29.26
------------	---	-------

**Heat Detection (12VDC systems, 4-wire loop)**

SYS5601P	Single-Circuit, 135° fixed temp & rate-of-rise	11.30
SYS5602	Single-Circuit, 194° fixed temp & rate-of-rise	11.30
SYS5603	Single-Circuit, 135° Fixed	11.30
SYS5604	Single-Circuit, 194° Fixed	11.30

**Glass Break Sensors (12VDC, 4-conductor wire)**

DSCAC100	DSC wall-mount glassbreak detector	27.02
DSCAC500	DSC ceiling-mount glassbreak detector	35.51

**CO and Gas Detection**

MCCM-E1	Macurco carbon monoxide detector with test/hush	70.17
MCGD2A	Macurco combustible gas detector, 12 or 24V, 2 relays	104.38

**Water Sensor**

GRI2600	Powered (4 wires) water sensor. Uses 12VDC Aux and wires into a zone loop.	15.16
GRI2600T	Powered (4 wires) water sensor with 2 probes. Uses 12VDC Aux and wires into a zone loop.	21.45

**Occupancy**

SNCM-9-R	12VAC/VDC occupancy sensor, 30 seconds to 20 min., SPDT relay, 13mA draw	82.43
----------	--	-------

**Vehicle Detection**



- Annunciation Options
- Text or email notification
  - Post a Keypad Message
  - Add a 12VDC Sounder

12VDC Sounder



Out 1 GND

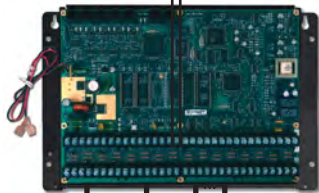

+12VDC GND Z+Z-

Enhance your automation installation with Vehicle Detection.

Hardwired - Cartell page 110  
Wireless - Dakota Alert page 109  
Leviton Wireless - page 87

**Magnetic Contacts (10 pack)**

GRI20RS-12-*	3/8" stubby, 12" leads, 1/2" gap, white or brown	25.10
GRI20RS-T-*	3/8" stubby, terminals, 1/2" gap, white or brown	28.23
GRI100-12-*	Mini surface contact, terminals, 1/2" gap, white or brown	24.11
GRI7377-W	3/8" stubby with terminals and 1K resistor for use with Omni Controllers, 3/4" gap. 1 per zone loop.	40.84
GRI180RS-12-*	3/4" standard, 12" leads, 5/8" gap,	34.47
GRI4400A	Rail mount garage door, 2 1/2" wide gap, white or brown, each	23.01



**GRI20RS-12:** This is the standard door and window contact. It has 12" leads for easy installation and 1/2" gap allowance to give some fudge factor.



**GRI4400A:** In many homes a customer would like to know if the garage door is down when they go to bed. Use the GRI4400A and wire into a zone. Include in the night mode a message if the garage door is left open.



GRI7377-W

Speed up installations by using the GRI7377-W with a built-in EOL resistor. Each contact contains a built-in 1K resistor and screw terminals. Simply attach 2-conductor wire to the contact at the end of the loop and connect the other side of the wire to the Omni Zone terminals. The loop is correctly supervised for a professional installation.

**Motion Detectors (12VDC, 4-conductor wire)**

NAPP1510	Napco 30' x 30' PIR	12.13
NAPP1680PT	Napco 45' x 45' PIR w/ 65lb pet immunity	19.96
NAPC100STE	Napco 30' x 35' microwave/PIR	20.66
DSCLC100PI6P	DSC economy pet immune PIR	52.70
DSCBV500	DSC 360 degree ceiling mount PIR	27.85
DSCBV600	DSC dual-element pet immune PIR	25.87
OXLX402	Outdoor PIR motion detector, form C relay	78.69



DSCBV500



DSCBV600

**Sounders and Strobes**

ATWSGST-W	Single-gang flush indoor siren 105dB, 20mA	8.74
ATWBULLDOG	Surface-mount indoor/outdoor siren, 105dB, 110mA	8.99
ATWBLOODHOUND	Single-gang box mount indoor/outdoor siren, 104dB, 180mA	8.99
ATWDOBERMAN	Surface-mount sounder and strobe, 180mA, 105dB, 90mA strobe only	16.61



ATWDOBERMAN



ATWSGST-W



ATWBULLDOG

The maximum sounder output for Omni and Lumina controllers is 1 Amp for interior and exterior outputs combined.

**Leviton Supervised Wireless**

LSA45A00-1	64 Transmitter wireless receiver, compatible with LSA transmitters only	124.85
LSA46A00-1	3-zone door and window transmitter, mercury tilt switch for garage doors, supports remote sensor	36.72
LSA48A00-1	Wireless 4-button keyfob, each button is learned as a separate zone and can be assigned any function	34.62
LSA63A00-1	Wireless driveway sensor	176.96
LSA56A00-1	Wireless recessed door contact	39.87
LSA47A00-2	Wireless quad pet immune motion detector	89.18
LSA57A00-1	Wireless vanishing contact	56.06
LSA58A00-1	Wireless surface mount mini door contact	39.87
LSA50A00-1	Wireless pendant panic alert	34.62
LSA61A00-1	Wireless glassbreak	110.92
IONMICRA-HA	45A00-1 compatible window sensor	24.98
IONPLUNGER-HA	45A00-1 compatible door sensor	24.98



LSA47A00-2



LSA48A00-1



LSA46A00-1



LSA50A00-1



LSA57A00-1



LSA58A00-1



LSA61A00-1

**Supervised Wireless Receiver for Interlogix + Interlogix Compatible Transmitters**



**GE Compatible Wireless**



LSA42A00-2

Using the Interlogix GE wireless receiver will give you the ability to monitor GE wireless devices through your Omni panel.



IONPLUNGER



IONMICRA



LSA42A00-2	64 zone wireless receiver, compatible with GE, Caddx and ITI wireless	258.52
RESRE100	4-button keyfob	16.24
RESRE101	Door/window, also supports external	21.23
RESRE103	Panic, wrist band	18.74
RESRE104	Vehicle detector	94.92
RESRE105	Temperature range sensor	24.98
RESRE106	Tilt sensor, great for garage doors	24.98
RESRE110P	PIR, pet immune to 60lb	49.96
RESRE112	Photoelectric smoke	53.71
RESRE113	Wireless CO detector	59.95
RESRE119	Home disaster transmitter	41.22
RESRE122	NanoMax door/window, supports external input	23.11
RESRE151	Hidden panic	24.98
RESRE152	PINpad keyfob, remote keypad	41.22



Door / Window



Wireless Vehicle Detector



Wireless Smoke



NanoMax Contact

**Interlogix Compatible iON Security Transmitters**

IONMICRA-G	Interlogix compatible concealed wireless window sensor	24.98
IONPLUNGER-G	Interlogix compatible concealed wireless door sensor	24.98
IONFDB75	3/4" Forstner drill bit for drilling perfect holes	6.24

**Use Existing Line-Voltage Smoke Detectors**



Wirelessly monitor ANY single or linked UL listed hardwired smoke detector in any home. Simply install ONE FireFighter within 6 inches of any one of the existing smoke detectors.

**GE Compatible Wireless**



ENCEC-FF319	Interlogix/GE compatible line-voltage smoke detector interface, UL listed, detects the tone of the sounder in traditional smoke detectors, one needed per installation	36.22
-------------	--	-------

Wireless Notification From Line Voltage Smoke Detectors



ZigBee HA Integration for Omni Controllers

# Kwikset



BD99100-01*	ZigBee HA Standard Motorized Deadbolt, * 5-Polished Brass, 6-Satin Nickel, 7-Venetian Bronze	137.39
BD99120-00*	ZigBee HA Motorized Lever Lock, * 7-Polished Brass, 8-Satin Nickel, 9-Venetian Bronze	168.62

## ZigBee Interface Module



The ZIM is a wireless coordinator for ZigBee products; plugs into a serial port on an Omni or Lumina controller. Allows control of other ZigBee products such as lighting control, locks, shades, and more!

See page 97 for additional ZigBee products.

LSA81A00-3WHZB	Serial ZigBee Interface Module (ZIM)	242.81
----------------	--------------------------------------	--------

- The ZigBee Interface Module is designed to work with ZigBee HA Profile products
- Products on this page feature ZigBee HA communication
- ZigBee HA Profile products work together to form a communication mesh



YALD220ZBHA+	Motorized ZigBee HA Deadbolt with capacitive touch keypad	206.08
YALD240ZBHA+	Keyless Motorized ZigBee HA Deadbolt with capacitive touch keypad. No lock cylinder.	206.08
YALD210ZBHA+	Motorized ZigBee HA Deadbolt with pinpad	168.62
YALL220ZBHA+	Motorized ZigBee HA Entry Lever Set with capacitive touch keypad	206.08
YALL210ZBHA+	Motorized ZigBee HA Entry Lever Set with pinpad	187.35

(+605-Bright Brass, 0BP-Oil Rubbed Bronze, or 619-Satin Nickel)

## Z-Wave Lock Integration

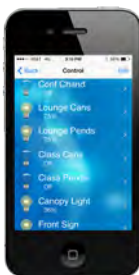

**ONLY** Leviton Vizia RF + Z-Wave products are 2-way with Omni controllers (unless the Omni is programmed to poll for status updates). See pages 16-17 for Leviton Vizia RF + products and information on beaming compatibility.

- The 2-way capability of Vizia RF + becomes important when using interfaces such as Snap-Link Mobile or touchscreens
- Other Z-Wave devices may have beaming support; however, if the state is changed manually the Omni is not notified.
- Beaming capability in Z-Wave devices is required to enable the automation controller to wake and communicate with locks

See pages 24-26 for Z-Wave locks.



- Use a Leviton VRC0P '3' series Z-Wave serial interface for each installation
- Each installer will need a Leviton VRUSB-1US USB stick to enroll the lock on the Z-Wave network
- Download the Vizia RF + Installer Software: [www.leviton.com/rfinstaller](http://www.leviton.com/rfinstaller)
- 'Beaming Compatible' Z-Wave devices are required for extending communication to Z-Wave Locks

LEVVRUSB-1US	USB adapter for RF+ Installer software	69.92
LEVVRC0P-1LW	Vizia RF + Z-Wave serial interface module	89.15

**Purchase \$500 of Vizia RF + and receive a FREE VRC0P serial module**

## Access Control Power Supplies



### LSA83A00-1

- Output: up to 5 amps @ 12VDC
- Connect up to 2 12VDC 8Ah batteries for backup
- Can power up to 8 readers with door strikes

LSA83A00-1	12VDC 5A power supply in an enclosure	287.27
LSA83A00-2	12VDC 5A power supply on mounting plate	287.27
UB1250	Battery, rechargeable, 12V, 5Ah	10.61

### LSA54A00-1

- Brushed stainless design for outdoor applications
- Piezoelectric buttons can be used with a bare finger or gloves
- Connects to an Omni controller via the serial port
- Vandal resistant



LSA54A00-1	Outdoor Brushed Stainless Serial Keypad	281.89
------------	---	--------

## Access Control Reader and Door Strike

- 26-bit proximity card reader
- Connects to an Omni controller serial port
- Durable and scratch-resistant polycarbonate housing
- Full epoxy potting ensures full-weather resistance
- 2 color LEDs and piezo sounder ensures an intuitive interface
- Doorstrikes can be connected directly to the reader
- Seamless integration in 3.0 firmware and software



LSA78A00-2



LSA79A00-1





LSA75A00-2



LSA78A00-1

LSA75A00-2	Access Control Card Reader: Requires 3.0+ firmware and power supply	186.53
LSA78A00-1	Pack of 10 access control cards	39.63
LSA78A00-2	Pack of 10 key tags	52.08
LSA79A00-1	Fail secure 12VDC door strike	48.69
ACSSREX-100	Request-to-exit motion, form C	83.27

Lighting Control Dimmers and Switches (Requires Neutral)

		LSA35A00-1	600W incandescent UPB dimmer with tri-colored LEDs, white	59.88
		LSA35A00-1CFL	600W incandescent, LED, and compact fluorescent UPB dimmer. Tri-colored LEDs, white.	59.68
		LSA35A00-3	600W incandescent only UPB non-dim switch. Tri-colored LEDs, white	59.88
		LSA40A00-1	15A UPB relay switch. Any load type. Tri-colored LEDs, white	76.16
		LSA71A00-1	UPB 30A 120/240V load control module	266.57
		LSA37A00-1	Auxiliary switch for 35A00-1, 40A00-1, and 55A00-1 3-way applications, white	24.89
See below for color change kits.				



Lighting Control High Wattage Dimmers (Requires Neutral)

LSA55A00-1*	1000W inductive UPB dimmer w/ tri-colored LED, fits in single gang box *WH-White, IV-Ivory (AL-Almond, BL-Black, BR-Brown while supplies last)	128.70
LSA55A00-3*	2400W inductive UPB dimmer with tri-colored LEDs. (*WH-White, IV-Ivory)	388.34

Lighting Control Keypads (Requires Neutral)

LSA38A00-1	6-button UPB room controller with IR (scene switch), white	108.91
LSA38A14-1	IR Handheld remote control for the 6-button room controller - Free on request with purchase of LSA38A00-1 (while supplies last)	39.01
LSA38A00-2	8-button UPB house controller (house status switch), white	129.37
LSA38A16-*	Tabletop cradle with UPB room controller (WH-White, BL-Black)	148.38
LSA38A15-*	Tabletop cradle for UPB room controller (WH-White, BL-Black)	34.46



Custom Engraving

LSA38A06-2 Custom engraving coupon for HLC controllers FREE\*

For Engraving details please scan the QR code below.

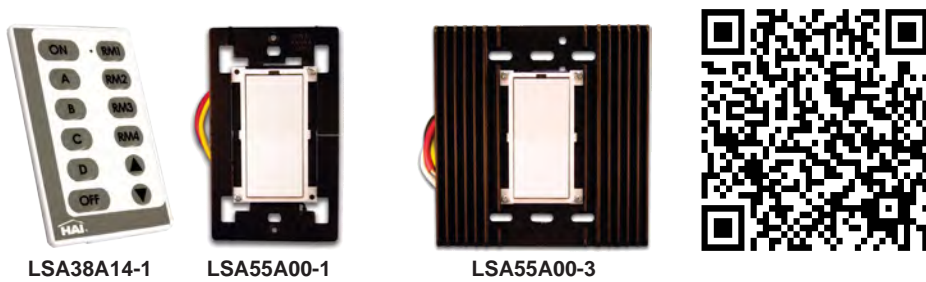

Lighting Control Plug-In Devices

LSA59A00-1	300W UPB lamp module	60.43
LSA60A00-1	15A appliance module	76.16

2400 Watt Dimmer Wallplates

LSA55A03-*	2400W (1-White, 2-Ivory)	12.29
------------	--------------------------	-------

Lighting Color Change Kits

LSA35A14-*	Change kit for 35A00 dimmer, 40A00 switch, 37A00 auxiliary	4.10
LSA38A04-*	6-button room controller	3.34
LSA38A05-*	8-button house controller	3.34

\*WH-White, IV-Ivory, AL-Almond, BL-Black, BR-Brown, GR-Gray, or LTA-Lt. Almond

Key Features of Home Lighting Control

- Home Lighting Control (HLC) uses proven UPB technology with over a 10-year track record for reliability and ease of installation
- "Programming on the 8's" technology makes it easy to list rooms and devices on touchscreens and mobile interfaces. No additional programming required.
- Complete 2-way scene-based lighting system with room controllers, whole-house status monitoring and individual load control
- 3-phase repeater is available for small commercial or residential MDU applications
- Gen III dimmers provide automatic time out, ability to switch dim/non-dim in the field, better CFL/LED compatibility, and better tolerance for power frequency variations



Home Lighting Control on OmniTouch 7 (above)  
Home Lighting Control on an iPhone (left)



LED lighting loads are more popular than ever, but dimming them can be a challenge. We have tested many different LED dimmers with many different LED bulbs. The Leviton 35A00-1CFL is one of the best performers we have seen. It's also one of the most economical. It's one more reason to make HLC your go-to lighting on Omni systems.



OmniTouch 7 Touchscreen

7" Touchscreen for  
Leviton Omni Controllers



Temperature Control



Cameras



Audio



Home Screen



Lighting

The capacitive touch glass-front touchscreen from Leviton features a 7" diagonal viewing area for control of your security, energy, and entertainment settings. No set up required other than entering the automation controller's IP address and adjusting the port and encryption keys. Designed for the OmniPro II, Omni Ile, Omni LTe, and Lumina RF Gateway automation systems.

Specifications:

- Large 7" diagonal viewing area with minimal black or white surround
- Glass-front high resolution capacitive touchscreen
- Modern, easy-to-use interface with swipe capability
- PoE connection provides all power and communication
- Firmware updates via Ethernet
- Digital amplifier and speaker
- Intercom capabilities with use of Grandstream SIP server
- An installation which features the OmniTouch 7 Touchscreen must contain a standard LCD console (LSA33A00-1) for UL Listing

LSA99A00-*	Ethernet-enabled 7" PoE In-Wall Touchscreen (*1 - White, 2 - Black)	398.68
LSA99A10-*	Trim kit for replacing a 5.7, 5.7e or 3.9 touchscreen	25.72
LSA90A00-1	PoE Injector: Use with the OmniTouch 7	50.57
LSAPOENS-8PT	8-port (8 PoE) 10/100 Mbps Ethernet Switch	179.84
LEVPOEMP-KIT	PoE Switch Mounting Kit for Structured Wiring Systems	119.89

Intercom and IP Doorstation

The latest firmware for OmniTouch 7 includes an IP intercom icon. It uses the SIP communication standard, which offers great interoperability. Use the Grandstream UCM610x (page 190) to enable the features on OmniTouch 7 screens including intercom between OmniTouch 7 screens and Grandstream IP phones. Add the Leviton IP door station to have full video and 2-way voice with your front door.

See page 190 for more GrandStream IP phones that work with the Leviton Door Station



PoE (Power over Ethernet)

PoE is an efficient way to power supported network devices like the OmniTouch 7 and IP cameras. With PoE, a single Cat 5e/6 cable carries Ethernet data and power from a PoE switch to a device. When more than one PoE device is in use on a job, it is recommended to use a PoE switch rather than injectors to keep the installation clean and more energy efficient.



LUXXMS-2624P



LUXXFS-1084P



LUXXMS-1010P



GRAUCM6102

LUXXFS-1084P	8-port (4 PoE) 10/100 Mbps Compact Ethernet Switch, unmanaged, full 15.4 W per port	70.43
LUXXMS-1010P	10-port (8 PoE) 10/100/1000 Mbps Ethernet Switch, 1U rack, full 15.4 W per port	224.82
LUXXMS-2624P	26-port (24 PoE) 10/100/1000 Mbps Ethernet Switch, 1U rack, managed, 320W PoE budget	646.98

What you need for an intercom solution with the OmniTouch 7:

1. Newest firmware on your OmniTouch 7
2. Grandstream PBX SIP server
3. PoE power source
4. The new Leviton IP Doorstation!

LSAINDS1-S	Leviton IP Door station. SIP server and POE required.	498.60
GRAUCM6102	IP SIP Server and PBX, up to 150 extensions, 2 analog CO lines, 30 concurrent calls	232.50



Bitwise by Leviton

# BitWise



- Controls A/V components
- Pre-designed templates make it simple to create stunning user interfaces
- Free iOS and Android apps
- Optional handheld remote
- Integration with Omni controllers
- Great for: Residential and commercial (conference rooms, classrooms, sports bars) and more!



Add-On Hardware and Accessories



**BITWRRR**

**BITBWRMT**

BITBWIRL	USB IR learner. Great labor saving tool. Learn IR codes from existing remote controls.	154.50
BITBWRMT	RF hard-button remote control. Requires BITWRRR wireless receiver.	95.91
BITWRRR	RF receiver for hard-button remote	59.94
BITBWIRI	IR to RS232 receiver module	89.33
BITBWEAR	Rack ears for BC2 controller	38.67
BITEN928	IR emitter single head, each	9.60

Controllers



Leviton's network-enabled controllers are the heart of every BitWise installation. These devices provide the intelligence and connectivity to control virtually any TV, Blu-ray, AV receiver, projector, and other gear. Each BitWise system is comprised of one or more controllers, which allow the other systems in your home to interact with one another. Your system can scale from a single room to an entire home or building. BitWise can integrate your favorite Leviton Omni controller for control of security, lighting, HVAC, shades, and more.

BITWBBC1	BC1 Controller, 8 IR ports, 4 GPIO, 4 relays, 1 IR input	928.66
BITWBBC2	BC2 Controller, 4 IR ports, 2 RS-232, 2 GPIO, 2 relays	592.93
BITWBBC4	BC4 Controller, 4 IR ports, 1 RS-232, 1 GPIO	329.14

Emitters not included and must be purchased separately.

Custom OmniTouch 7 Touchscreen



Home Theater



Floorplan View



Home Screen

**BITEVOLUTION** For OmniTouch 7 and Bitwise app for iOS and Android 199.00

This customization can be deployed to the OmniTouch 7, iOS, and Android devices. Unlimited uses and price includes 2 hours of support.

**Custom Programming is available from Worthington for BitWise controllers and more. Give us call today!**

If you have a customer that wants the next level of automation and control, look no further than the Worthington template package! The new release of BitWise Project Editor software allows customization of the OmniTouch 7! Our graphics expert has created the look and feel of a standard touchscreen but added great features like floorplan views, weather forecasts, home theater control, built in help pages, and more!

Hi-Fi 2 Distributed Audio

Hi-Fi 2 Systems

LSA95A00-1	8-Source, 8-Zone Kit in enclosure, 4 RIMs (4 sources can be plugged in directly), 8 VSCs, IR Remote	1,897.02
LSA95A00-2	8-Source, 8-Zone Kit for structured wiring, 4 RIMs (4 sources can be plugged in directly), 8 VSCs, IR Remote	1,897.02
LSA95A01-1	8-Source, 8-Zone Amplifier Only	1,398.07

Hi-Fi 2 Expansion Systems Zones 9-16

LSA95A12-1	8-Source, 8-Zone Expansion Kit in enclosure, 8 VSCs. Must be mounted within 6" of the main Hi-Fi 2 system, interconnect cable.	1,797.29
LSA95A12-2	8-Source, 8-Zone Expansion Kit for structured wiring, 8 VSCs. Must be mounted within 6" of the main Hi-Fi 2 system, interconnect cable.	1,797.29
LSA95A18-1	8-Source, 8-Zone Expansion Amplifier only, <b>expansion cable sold separately</b>	1,348.00

Hi-Fi 2 Volume and Source Selection (VSC) Keypad

LSA95A03-1	Hi-Fi 2 Keypad with OLED display and IR receiver	129.10
LSA95A11-*	Hi-Fi 2 Keypad (VSC) color change kit	2.75

\*WH-White, IV-Ivory, AL-Almond, BL-Black, LTA-Lt. Almond



LSA95A04-1

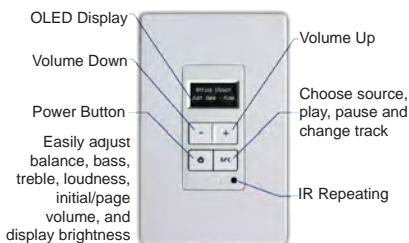

LSA95A03-1



LSA95A05-1

Hi-Fi 2 Remote Input Module (RIM)

Hi-Fi 2 allows the installer to locate Remote Input Modules (RIMs) near sources to make audio available in each room with a Volume Source Control (VSC) and speakers. The amplifiers mount on a closet wall or in a structured wiring cabinet for a clean installation. Hi-Fi supports up to eight zones and six sources. It fully integrates with Omni controllers, touchscreens, and software packages.

LSA95A04-1	Hi-Fi 2 Remote Input Module (RIM)	48.96
LSA95A10-*	Hi-Fi 2 Remote Input Module color change kit	2.75

\*WH-White, IV-Ivory, AL-Almond, BL-Black, LTA - Lt. Almond  
See next page for the Bluetooth Remote Input Module (RIM)



LSA95A00-2



LSA95A00-1

Hi-Fi 2 Features

- 8-Source / 8-Zone with 50 Watts per zone digital amplification
- Expandable to 8-Source / 16-Zone with the LSA95A12
- Keypads feature a crisp OLED display
- Simple 4-Button interface for power, volume, source selection and audio settings
- Input 8 can be used as a system page
- Built-in serial or Ethernet communication
- Built-in power supply
- Compatible with OmniPro II, Omni IIe, Omni LTe, Lumina Pro and Lumina controllers
- Compatible with OmniTouch 7 touchscreens



Flexible Source Wiring

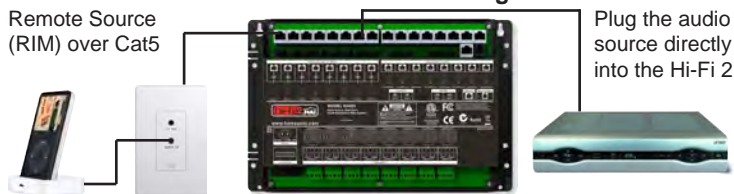

Hi-Fi 2 Accessories

LSA95A09-1	Hi-Fi 2 vented enclosure	81.70
LSA95A05-1	IR remote control for the Hi-Fi 2	23.73
LSA95A16-1	Hi-Fi 2 expansion cable	14.99

Hi-Fi 2 Source Cables

LSA95A14-1	Retractable male 3.5mm to male 3.5mm cable, for use with Hi-Fi 2 RIM	7.55
LSA95A13-1	Retractable male 3.5mm to male RCA cable, for use with Hi-Fi 2 RIM	7.55

Hi-Fi 2 4-Source 4-Zone Distributed Audio



LSA95A00-3*	Hi-Fi 2 4x4 System: Includes the Hi-Fi 4x4, 2 Remote Input Modules (RIM), 4 OLED Volume-Source Controls (VSC), remote control & power supply; Mount directly into a Leviton Structured Media Center wiring enclosure.	948.42
LSA95A02-3	Hi-Fi 2 4x4 Controller Only	698.44

Hi-Fi 2 4x4 Features

- 4-Source / 4-Zone with 40 Watts per zone digital amplification
- Keypads feature a crisp OLED display
- Simple 4-Button interface for power, volume, source selection and audio settings
- Built-in serial or Ethernet communication
- Compatible with OmniPro II, Omni IIe, Omni LTe, Lumina Pro and Lumina controllers
- Compatible with OmniTouch 7 touchscreens





**CasaTunes Internet Music Streamers**



CasaTunes focuses on the design of multi-room music servers. CasaTunes is the ideal solution for 3 rooms or as many as 24. This is what customers will typically interact with every time they want to listen to their music. It has to be simple, reliable and, well, fun!

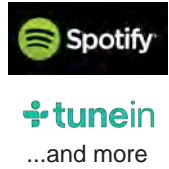

**Multi-Source Streamers**



**CASCT-2**

**CASCT-3S**

The CasaTunes Streamers supply 3 to 8 sources of streaming music to your existing system. Each stream can be your iTunes or Windows Media songs, streams from internet music services, audio from uPnP/DLNA media servers, even music sent to CasaTunes via AirPlay from your iPad or iPhone.

CASCT-1	One-stream controller	389.00
CASCT-2	Two-stream controller	520.00
CASCT-3S	Three-stream controller	750.00
CASCT-4S	Four-stream controller	1,050.00
CASCT-8S	Eight-stream controller	1,395.00

**Works with these great systems and more!**



CasaTunes is a great reason to contact any customer that might have an aging whole-home music system. The CasaTunes streamers allow a simple upgrade path to take a dated system and add modern app and streaming control! New or legacy whole home audio systems like the Russound CAV6.6 are perfect for integration with any of the CasaTunes streamers. Integration is via serial or network depending on the system.

**Bluetooth Remote Input Module (RIM)**



The Bluetooth Remote Input Module (RIM) allows Bluetooth-enabled devices to connect and act as music servers for the Hi-Fi 2 distributed audio system. Play music from Pandora, Spotify, Rhapsody, iTunes, or any other service compatible with Bluetooth enabled portable audio devices.

Available only in white.



LSA95A04-2	Bluetooth Remote Input Module (RIM) for Hi-Fi 2	178.83
LSA95A15-*	Color change for the Bluetooth RIM	11.47

\*WH-White, IV-Ivory, AL-Almond, BL-Black, LTA-Lt. Almond

**Hi-Fi 2 App**

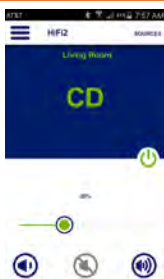

The Leviton Hi-Fi 2 whole home audio controllers can use a standalone app; an Omni controller is not needed. The app, for Android or iOS allows a user to control a Hi-Fi 2 directly over Wi-Fi and IP. Configuration is easy, just click "Discover" and the app does the rest.

**OmniTouch 7 Integration**

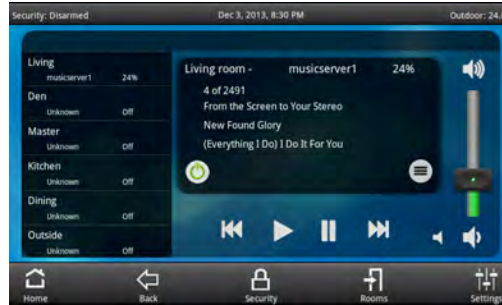

CasaTunes provides meta-data on the OLED VSC keypads and OmniTouch 7. Set up takes just minutes and configures the Leviton Hi-Fi 2 for you!



**App Control - More than just song selection!**



We carry all CasaTunes products. Give us a call for additional parts.

**2-Way Voice Integration with Hi-Fi 2 Page Input**

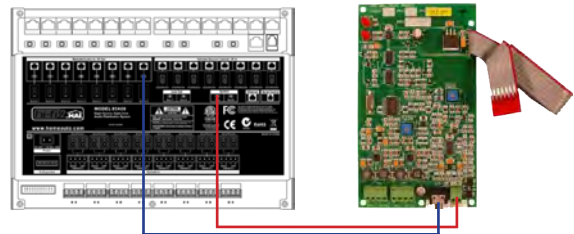

Looking to have the Omni speak throughout the house or looking to use any phone in the house as an "All Page?" It is simple. Just add an LSA10A11 two-way voice board and connect it to the Hi-Fi 2. Start with an 1/8" mono jack and attach the two leads to the trigger output of the LSA10A11 board. If you need a cable, an IR emitter works great, just cut off the flasher. Next, use a stereo 1/8" connection between the audio out on the LSA10A11 and input 8 on the Hi-Fi 2 (mono does not work). Use the Hi-Fi 2 software to set up page zones and volume. Any time the LSA10A11 is active (LED is on) the page feature will activate.

LSA10A11	2-way Voice Board - Features a line level output and relay. Includes a 12VDC trigger for speech over a Russound CAV6.6, MCA-C5, MCA-88, or Hi-Fi 2.	98.67
----------	---	-------



# HomeSeer

Voice Control with Leviton Omni Panels



The HomeSeer Hometroller Zee is a home gateway that has a driver for Omni panels and also supports Amazon Alexa. This setup will allow you to use Alexa to control anything on an Omni panel! All you will need is the below controller and an Alexa enabled interface (echo/echo dot, etc.).

Upon purchase of the Homeseer Hometroller Zee S2, you will receive a video walkthrough. In the meantime, if you want to check out our overview video, check out our YouTube channel. [www.youtube.com/worthingtondist](http://www.youtube.com/worthingtondist)

HSHT-ZEE Homeseer Hometroller Zee S2 - \*\*Paid Plug-in required for Omni Driver 158.19



### Things we can do with Alexa:

- “Alexa, Tell Homeseer to arm my Omni Security System to away.”
- “Alexa, Tell Homeseer to turn on the kitchen lights.”
- “Alexa, Tell Homeseer to set back the thermostat to 65.”
- “Alexa, Tell Homeseer to lock all of the doors.”



Water & Gas Control

#### Sensors and Accessories

GRI2600	Hardwired 12VDC water sensor	15.16
GRIT8000-G	Hardwired freeze sensor, 32-degree switch, NC	32.30
WIWB200	WaterBug 200, includes 1 sensor, expand to 6	55.71
WIW-S-U	Additional sensors for the WIWB200	19.48
RESRE119	Water and low temp sensor for GE wireless (LSA42A00-2 compatible)	41.22
ELK912	12V Relay for valve status monitoring	6.16

#### Omni Compatible Motorized Water Valves

GRNASV050	1/2" Motorized water valve, handle, power supply	337.40
GRNASV075	3/4" Motorized water valve, handle, power supply	375.92
GRNASV100	1" Motorized water valve, handle, power supply	318.15
GRNASV150	1 1/2" Motorized water valve, handle, power sup.	656.56
GRNASV200	2" Motorized water valve, handle, power supply	843.65
GRNASV075G	3/4" Motorized gas valve, handle, power supply	582.27
GRNASV100G	1" Motorized gas valve, handle, power supply	637.30

The average flood insurance claim is over \$10,000. Give your home or business 24/7 protection from interior flooding with an automated water valve. Add it to your home control system and the water supply can be controlled remotely giving you total control from home or away.

- Integrates with Omni and other Automation Controls
- Fast Action Opening and Closing
- Possible Insurance Discounts
- Stainless Steel construction
- NSF mark ensuring the valve is safe for use with drinking water



For Z-Wave controlled water valves see FortrezZ on page 29

- Vacation homes need constant monitoring for low temperature, water damage, security and fire protection
- The Omni is perfect for monitoring and automating vacation homes
- Monitor for water leaks, flooding or low temperature conditions
- Install a temperature sensor in a closet. Program the valve to close if the temperature drops to 40°.
- Provide home control via the Snap-Link App

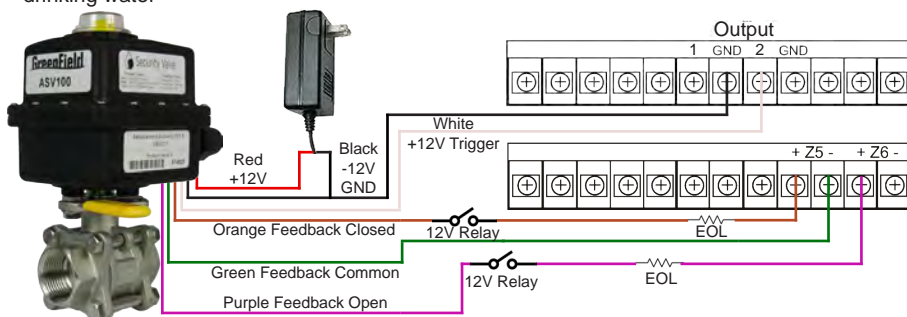

Valve	Function	Connected to
Red	Power (+) Positive	+12 VDC Supply
Black	Power (-) Negative	-12 VDC Supply & GND
White	+12 VDC trigger	+12 Output
Orange	Feedback closed	Zone +: Relay, EOL in series
Green	Feedback common	Zone -
Purple	Feedback open	Zone +: Relay, EOL in series

Note: Open/Close condition; the zone becomes 'Secure'

Omnistat2 - Hardwired

LSARC1000WH	Thermostat: conventional single stage, heat pump and dual fuel systems. White.	149.88
LSARC2000WH	Thermostat: conventional 2 stage, 3 stage heat pump, dual fuel systems, humidity and dehumidification. White.	197.84

Choosing the Correct Thermostat	RC2000	RC1000
Humidifier and dehumidifier control	•	
Humidity sensing and display	•	
Master thermostat for damper control applications	•	
Supports up to 2-stage conventional & 2-stage heat pump with 3rd-stage auxiliary heat	•	
Supports Temperature Display Control	•	
Supports dual fuel systems	•	•
Automatic heat/cool changeover	•	•
Filter reminder for peak efficiency	•	•
Seven day schedule with copy function	•	•
Fan cycle mode periodically circulates air	•	•
Graphical display of HVAC usage by week	•	•
Indoor sensor averaging with remote sensor	•	•
Motion activated multi-color adjustable backlight	•	•
Temperature readings in Fahrenheit or Celsius	•	•
Learns a home's heating and cooling patterns	•	•
Communicates with Omni systems	•	•
Settings for Home, Night, Away, and Vacation	•	•

Omni Integration

- Wires directly to the Omni or Lumina controller
- Only 3 conductors needed for communication
- Complete 2-way communication
- Automated setbacks (choose your approach)
  - Built-in thermostat set point time schedule
  - Automatically change to set points stored in the thermostat based on arming level
- Use controller logic to control set points
- Manual override with hold capability



RC1000

Easy To Use

- Simplified and advanced menu structures
- Automatic changeover between heat & cool
- Fan cycling for maximum comfort
- All models meet the EPA's ENERGY STAR guidelines for energy efficiency
- Outdoor temperature display
- Time display synced with the controller
- Select from over 100 different backlight colors
- Available in Black, Silver, and White



A Large Display Makes Programming Easy

Omni and Lumina Temperature Sensors

LSA31A00-7	Enhanced Extended Range Indoor/Outdoor Temperature Sensor with mounting bracket	43.96
LSA31A00-8	Enhanced Extended Range Indoor/Outdoor Temperature and Humidity Sensor w/ bracket	84.96
LSA14A00-8	Water Temperature Sensor module & probe	78.60



LSA31A00-7

Outdoor temperature is displayed on thermostats.

Omnistat2 - ZigBee Wireless

LSARC1000WHZB	ZigBee HA Thermostat: conventional single stage, heat pump and dual fuel systems	208.83
LSARC2000WHZB	ZigBee HA Thermostat: conventional 2 stage, 3 stage heat pump, dual fuel systems, humidity and dehumidification	248.80
LSA81A00-3WHZB	ZigBee HA serial interface	242.81

Omnistat2 Temperature Display Controller

The TDC is a simple-to-use interface that can be added to RC2000 series thermostats (hard-wired and ZigBee). Start with the kit, which includes the interface module that connects the TDC to the thermostat. Use the LEV47603-110 Cat 5e wiring module to add up to 3 more TDCs for a total of 4 per RC thermostat.



LSA95A03-1TWH	TDC only, add up to 3 for 4 TDCs per stat	118.90
LEV47603-110	Bridged Cat 5e module, use to add TDCs	22.14

A great solution to get a "regular thermostat" off the wall!



ZigBee

Omnistat2 ZigBee thermostats provide precise digital control over the heating, ventilation, and air conditioning (HVAC) systems. The RC-1500 thermostat communicates with control systems via mesh networking technology and has a high-power radio with a range of over 200 feet. These thermostats can be utilized when running a new communication wire is challenging. Check out page 97 for other great Leviton ZigBee products.

Thermostat Accessories

LSA29A00-1	Relay Isolation Module: use with first generation Omnistats or Omnistat2's with non-standard voltages	116.32
LSA29A00-2	Relay Isolation Module for use with water furnaces	107.98
LSA30A00-2	Thermostat Power Stealing Boost Module, increases available current to prevent thermostats from resetting	39.96
LSA65A18-1	Backplate Trim ring for Omnistat2 retrofits	25.32
LSA23A00-1	Surface Indoor Temperature Sensor for thermostats, allows remote mounting of an Omnistat or Omnistat2	34.19
LSA23A00-2	Flush Indoor Temperature Sensor for thermostats, allows remote mounting of an Omnistat or Omnistat2	38.47



LSA23A00-2



LSA23A00-1





# Yale Works for You<sup>SM</sup>

In Residential and Small Business



The features you need, the quality you expect, and a price that will surprise you from the leader in residential lock technology.



### nexTouch™ Wireless

Need a connected solution for securing a small business?

- Integrates seamlessly with existing alarm systems
- Easy to deploy
- Create new RMR opportunities



### Look Door Viewer™

See who came to the door,

- Easy to install, replaces existing peephole
- Yale Look App
  - Live View** - two-way conversations with visitors
  - News Feed** - view all of the activity at your door in one place by time and date



### Assure Lock™ with Bluetooth®

Your phone is your key.

- Two ways to access: use your Bluetooth mobile phone or keypad
- Yale Assure App
  - Keys** - share digital keys with friends, family, or employees, from anywhere
  - Users** - control who can access your home or business and when; get a message when someone enters or exits

**Worthington Sales, Customer Service, Tech Support, and Training**  
24 Hour Order Line and Tech Support 800-282-8864



**Lumina Gateway - Light Commercial Energy Management**

- Apps and cloud services for mobile devices
- 200ft wireless range
- Supports Android App, iOS App and Touchscreen
- Control and Scheduling Capabilities
- Leviton Lighting and Load Controllers on this Page
- Leviton Wireless thermostats
- Leviton Binary Sensors (Door/Window, Motion, Occupancy)



The Lumina RF Gateway is a quick and cost-effective solution that performs similarly to an Omni, but without the wired inputs and outputs. With built-in wireless communication, the Lumina RF Gateway is ready to take on applications where lighting, HVAC, and high current loads need to be automated.

The Lumina RF Gateway has options like iOS and Android apps and a touchscreen. Robust Lumina RF wireless communications make it just as suitable for light commercial applications. Installing the Lumina RF Gateway in commercial spaces like restaurants, offices, and retail shops can provide business operators with significant energy savings. Pair the Lumina RF Gateway with lighting controls and thermostats and use basic automation routines to turn off lights and set back thermostats whenever possible.

LSA74A00-1	Lumina RF Gateway with on-board ZigBee	249.80
------------	--	--------

**ZigBee HA Load Control Modules for Lumina Gateway and Omni**



LSAZSS10-G0Z



LSAZSS10-G0Z	10A, 120/277 VAC Switch, ZigBee	69.94
LSA73A00-3ZB	30A ZigBee HA RF control module	179.86
LEVDL1KD-1BZ	Lumina RF Full Phase 1000W Dimmer	49.95
LEVDL6HD-1BZ	Lumina RF Full Phase 600W Dimmer	44.95
LEVDL15S-1BZ	Lumina RF 15A Switch	44.95
LEVDL15A-1BW	Lumina RF 15A Plug-in Switch	34.96
LEVDL3HL-1BW	Lumina RF 300W Plug-in Dimmer	34.96

**ZigBee HA Thermostats for Lumina Gateway and Omni**

LSARC1000WHZB	ZigBee Thermostat: conventional single stage, heat pump and dual fuel systems	208.83
LSARC2000WHZB	ZigBee Thermostat: conventional 2 stage, 3 stage heat pump, dual fuel systems, humidity and dehumidification	248.80



**Wireless Sensors for Lumina Gateway**

LSALURDW-W	Lumina RF Door/Window Sensor	37.35
LSALURMD-W	Lumina RF Motion Sensor	51.96
LSAZSC04-IAW	Lumina RF Occupancy Sensor, 450 sq ft	79.94
LSAZSC15-IAW	Lumina RF Occupancy Sensor, 1500 sq ft	79.94



LSALURDW-W



LSALURMD-W



LSAZSC04-IAW  
LSAZSC15-IAW

**Somfy Window Treatment Motor Controls for Lumina Gateway and Omni**



Schedule window treatment positions to save energy



SOM1870221	Add ZigBee HA Profile to a Glydea drape motor	180.00
SOM1870220	Add ZigBee HA Profile to an RS-485 or ILT motor	355.96

**Omnistat3 Hospitality Thermostat**

Occupancy

Plug-in

Motion

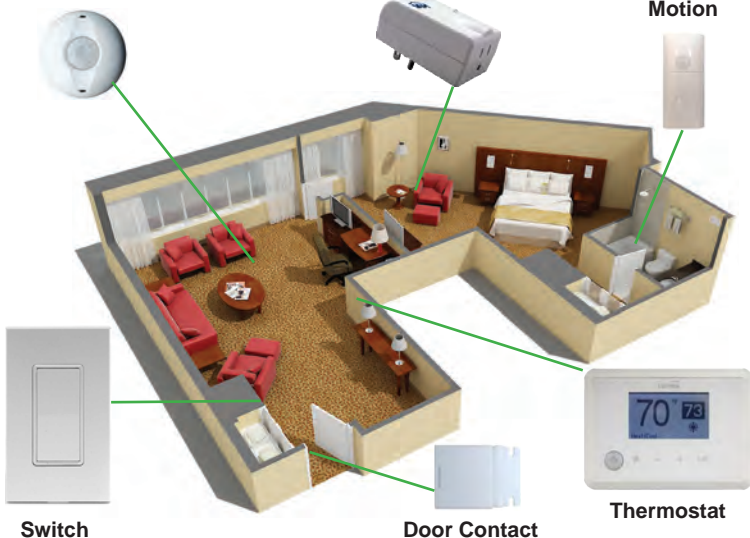

Switch

Door Contact

Thermostat

Works with the following Lumina RF products:

- Door Window Sensor
- Motion Sensor
- Occupancy sensors
- Line Voltage Load Control Modules
- Plug-in Load Control Module
- Switches



Leviton guest room solutions offer reliable, cost-effective control of HVAC, lighting, and electrical loads to create scalable alternatives to traditional hospitality guest room controls. Upgrade guest rooms to enhance guest experiences, improve the working environment for staff, increase energy savings and meet energy code compliance requirements

LSARC500-2EW	Hospitality Thermostat: Conventional 2 stage, 3 stage heat pump, 2-pipe, and 4-pipe systems.	159.87
--------------	--	--------

Omni-Bus-Lighting



Overview:

- Hardwired lighting system
- Modular/Centralized installation
- Commercial or large residential applications
- Can interface with Omni and Lumina Gateway
- 120V/60Hz or 220V/50Hz
- Dimming and Switching Modules
- DIN Rail Mounted

BitWise

- Pre-designed templates make it simple to create stunning user interfaces
- Free iOS and Android apps
- Optional handheld remote
- Integration with Omni controllers
- Great for: Residential and commercial (conference rooms, classrooms, sports bars and more!)



Features:

- The Omni-Bus Lighting Control Network is a hardwired and wireless lighting solution
- Omni-Bus products work as stand-alone or with an Omni Controller
- An Omni home control system has the ability to change your light settings by the time of day, a set schedule, by the triggering of events (including motion), via a telephone call, touchscreen, smart phone, or by a computer connected to the Internet
- Utilizes the DIN rail standard for mounting load control modules
- Supports CFL, LED, electronic low-voltage, halogen, and incandescent loads
- Dimmer or switch modules feed power to the load
- Keypad buttons are associated with load modules for individual, group control or scene control
- Low voltage relay interface (irrigation valves, gates, etc.)

Omni-Bus Core Modules (Required on each system)

The first step in the Omni bus process is to figure out how many modules you will have in your system. What follows are the required devices to get your system going.

LSA117A00-1	Omni-Bus Interface Translator - Serial connection to Omni controllers, RF receiver for RF keypads, Ethernet port - DIN Rail Mount	498.93
LSA123A00-1	Omni-Bus Power Supply Module - 24VDC 2.5A - DIN Rail Mount	128.90
LSA124A00-1	Omni-Bus Power Supply Interface - 2A supervision of power to the Omni-Bus network - DIN Rail Mount	99.08
LSA120A00-1	Omni-Bus 8-way Splitter, connects 8 Cat5 drops to a single Cat5 port - DIN Rail Mount	49.16
LSA122A00-1	Omni-Bus Termination Plug, one per system	9.89
LSA121A00-1	Omni-Bus Jumper Plugs, use on any unused Omni-Bus ports. Sold in packs of 10.	25.18
LSA116A00-1	USB Programming Interface + software license	246.05



Omni-Bus Input and Output Modules

LSA110A00-2	Omni-Bus Dimming Module, 600W leading edge dimming for incandescent, halogen, electronic or magnetic loads or, 300W trailing edge dimming for CFL/ LED - DIN Rail Mount	168.59
LSA112A00-1	Omni-Bus Relay Module, 4 relays, 2A each - DIN Rail Mount	99.28
LSA111A00-1	Omni-Bus Switch - 1500W @ 110VAC -DIN Rail Mount	98.67
LSA110A00-1	220V 400W Dimmer for international markets	108.81
LSA114A00-1	Omni-Bus 6-Channel Universal Switch Interface, 6 inputs and 6 two-lead bi-color or single-color LED outputs - DIN Rail Mount - Add 114A01-1	48.56
LSA114A01-1	Cable assemblies for 114A00-1 interface.12 pack.	18.86



The Omni-Bus lighting system offers hardwired keypads, as well as wireless keypads and keyfobs. Continue reading below for more information.



**Omni-Bus Keypads**

LEVOBKND-10W	1-button Omni-Bus Decora low voltage keypad, NEMA form factor, white	74.94
LEVOBKND-20W	2-button Omni-Bus Decora low voltage keypad, NEMA form factor, white	74.94
LEVOBKND-40W	4-button Omni-Bus Decora low voltage keypad, NEMA form factor, white	74.94

Call for additional colors and engraving information



LEVOBKND-10W



LEVOBKND-20W



LEVOBKND-40W

- These hard-wired Omni-Bus keypads are wired using Cat5e/6
- Push Button On/Off control
- Custom engraving available
- Can be daisy-chained for a more seamless and easy installation
- The last device in the daisy chain needs a jumper to complete the circuit

**Omni-Bus Wireless**

LSA115A00-1	Omni-Bus RF Wireless Transceiver	97.52
-------------	----------------------------------	-------

- Omni-Bus wireless transceiver creates the ability to use wireless devices on the Omni-Bus network.
- This supports up to 256 devices including keypads and keyfobs.



LSA113A00-2	1-Button Omni-Bus wireless keypad	46.76
LSA113A00-4	2-Button Omni-Bus wireless keypad	54.23
LSA113A00-7	3-Button Omni-Bus wireless keypad	63.55



LSA113A00-2



LSA113A00-4



LSA113A00-7

**Key Fobs**

LSA125A00-1	6-Channel Omni-Bus key fob - Green	34.62
LSA125A00-2	6-Channel Omni-Bus key fob - Red	38.97

LSA125A00-1



LSA125A00-2



**Omni-Bus Enclosures**

Can accommodate Omni-Bus modules or any other DIN rail mount load control or other 3rd party control equipment that is ANSI-standard. Vented enclosure. ETL and UL listed to UL and CSA Standards as an Industrial Controls Equipment Enclosure.

LSADINRK-001	1 Rail: 3 modules total	49.96
LSADINRK-A03	3 Rail: 5 modules per rail, 4 modules if 17A00-1 is used	176.61
LSADINRK-A06	5 Rail: 6 modules per rail, 5 modules if 17A00-1 is used	CALL



LSADINRK-001



LSADINRK-A03

**Omni-Bus Accessories and Accessory Modules**

These devices are supplemental to but not required for your Leviton Omni-Bus installation.



LSA126A00-1



LSA118A00-1

LSA126A00-1	Omni-Bus Scene Control, stores button scene information. Can be used for stand-alone installations or with an Omni controller - DIN Rail Mount.	138.99
LSA118A00-1	Omni-Bus Digital Addressable Lighting Interface (DALI) Module, includes On/Off switching, dimming, group, broadcast and scene commands - DIN Rail Mount	148.61
LSA116A00-1	USB Programming Interface + software license	246.05
LSA119A00-1	Omni-Bus 3-way splitter	21.98
LSA95A20-1	Single-gang metal switch box	10.07

**Need help designing an Omni-Bus lighting system?  
Give us a call at 800-282-8864.**



**Controller Mounting Package**

The best way to take your installation to the next level of professionalism is to use these other great products from Leviton. Structured wiring is important and adds unlimited value for trouble shooting purposes and service work after the install.

We understand and appreciate the value of a proper installation. Let us say thank you by extending a discount! For less than \$225 you can have everything to mount your favorite Omni in a structured wiring cabinet.

**10% Off All Year!**

Purchase an Omni Mounting Kit and save 10% off our dealer price.



LEV47612-UBK



LEV47612-SBK



LEV47605-ACS



ELKTRG2440

LEV47605-42N	42" enclosure only	62.67
LEV47605-42S	42" vented hinged door	63.75
LEV47612-42B	Extender bracket for 42 inch enclosure, adds 2 inch depth	40.72
LEV47612-UBK	Universal battery bracket	26.03
LEV47605-ACS	Surge protected, 2-outlet	22.46
LEV47605-ACN	Non-surge protected, 2-outlet. Great for UPB.	9.77
ELKTRG2440	Transformer, 24VAC, 40VA	10.40
UB1270	Battery, rechargeable, 12V, 7Ah	13.10
	Regular	248.59
LEVOMNISWKIT	Omni Mounting Kit. Must be purchased together for discount.	<b>222.80</b>



**Controller Hardware Accessories**



LSA20A07-2



ELK1280



LSA21A06



LSA103480

HAI101905	Bag of 10 stand-offs for add-on boards	2.49
LSA103480	16 piece pack of 1000 Ohm resistors	1.29
LSA20A07-2	Structured Wiring Plate for Omni Pro II, IIe, LTe, and 17A00 Expander, fits Leviton, Open House, Legrand, and UStec enclosures	43.72
HAIENLG	Enclosure only for Omni Pro II, IIe, LTe, and 17A00 Expander. Must add keys and lock.	28.68
LSA21A06	Enclosure lock and keys	9.32
PRBTM5D4-W	1x4 - 110 block - on-wall mount enclosure	13.88
ELKTRG2440	Transformer, 24VAC, 40VA, auto-resetting, grounded, use with LSA Controllers	10.40
ELK1280	Battery, rechargeable, 12V, 8 Ahr	18.54

**Got What it Takes?**

Do you measure up with some of the best in the industry? Check out the wiring below of a Leviton structured wiring enclosure. Keep an eye out for our 2017 installer contests this year!



**Steve Merola**  
Futuristic Home Inc.  
Point Lookout, NY

**Relay Modules**

LSA10A07	4-relay Module with mounting tape	48.71
LSA19A00	8-relay Module with mounting tape	78.91
LSA19A00-1H	8-relay module with controller mounting kit	78.81



Omni controllers and expanders use 12VDC triggers. For dry contact closure, add a relay board.

**Firmware Chip Upgrades**

LSA20A04-2	OmniPro II Chip Upgrade		54.89
LSA20A04-50	Omni IIe Chip Upgrade		54.89
LSA20A04-1	Omni II Chip Upgrade		54.89

Call to determine if you need a chip upgrade. New controllers use flash. For questions about legacy Aegis and OnQ panels give us a call!

**Software**

LSA1105W	Dealer Software for Windows®, for the Omni family of controllers	135.08
LSA1106W	End User Software for Windows, without dealer sections	50.06

Snap-Link provides remote access for OmniPro II, IIe. Includes a skin for PC touchscreens and free updates for registered users. Snaplink is available on the iOS and Android app stores.

**Snap Link Mobile**

Snap Link Mobile puts home and business control in the palm of your hand with zero monthly fees! Simply purchase the app from the store and get instant access to your Leviton automation system. You can even access multiple properties from a single app.

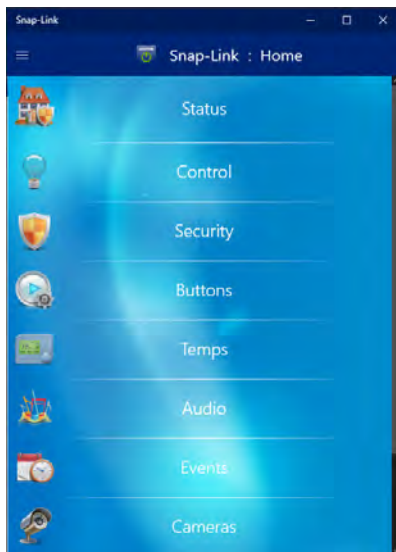

**Zero monthly fees!**



Available through your favorite App store for Android, iOS, and Windows 10 devices.

**Heavy Load Control Modules**



LSA72A00-1



LSA71A00-1

LSA72A00-1	12VDC input 20A load control module	54.01
LSA71A00-1	HLC 30A 120/240 load control module	266.57

**Cellular and Internet Communicators**



**TELGUARD**

Telguard communicators connect to any alarm panel's phone terminals. The panel thinks it is dialing a central station, but the Telguard intercepts the dial out and transmits it to their data center. From there, dealers can set to forward to a central station of their choice or automatically notify their customers by email or text message.



TELTG1VX003	TG-1 Express Verizon, Primary Cell	132.39
TELTG1G0004B	TG-1B AT&T, Primary or Backup	151.13

**NAPCO**

- Full event reporting from any panel, anywhere, field-proven to work virtually anywhere in US, on Panels using Contact ID or 4/2.
- Reports to any Central.
- No radio activation fee. No special equipment.
- Primary or Backup Alarm Communications. Backup Mode supervises telco and only sends GSM reports when it's not functioning



NAPSLECDMA	Starlink Up/Downloadable Verizon Universal Alarm Communicator	99.87
------------	---	-------

**Text and Email Notification Board**

**Features**

- Send email or SMS texts based on any programming line
- 100 User Programmable Messages
- 8 Customizable Email Addresses
- Adds Network Time Sync to Omni/Lumina Controllers
- **No service fees or contracts**



LSA20A30-1	Omni Notifier, supports Omni/Lumina controllers with Ethernet	119.90
------------	---	--------

**Serial Boards and Cables**

LSA10A17-1	RS-232/485 Serial Board, max 1 per system	171.53
LSA21A05-2	7' RJ11 line cord with modular RJ11 to DB9 adapter (programming cable)	13.66
LSA36A05-4	RJ-11 to DB-9M straight through serial. Use with Russound, Lutron, RadioRA 2, Jandy & CentraLite	14.75
LSA36A05-2	Serial PC to LSA UPB PIM (UpStart)	21.25
BL180503	DB9F to DB9F 6' null cable for 10A17-1 Serial	1.22
ELKUSB232	USB to RS-232 interface. Requires LSA21A05-2.	23.95



LSA10A17-1



BL180503



LSA36A05-4



LSA21A05-2

**ELK M1 Gold Basic Controllers**

ELKM1GOLD	M1 Gold Controller in 14" Enclosure	358.24
ELKM1GCB	M1 Gold Control board only (in clam case). Terminal strips not included.	335.95
ELKM1BLOCKS	Replacement plug-in terminals for M1 Gold	15.33

**ELK M1 Gold Installation Kits**



**ELKM1GSYS4**

**ELKM1GSYS4S**

ELKM1GSYS3	Includes: M1 Gold in enclosure, transformer, battery, speaker, and RJ31X. No keypad.	385.42
ELKM1GSYS4	Includes: M1 Gold in enclosure, transformer, battery, M1KP keypad, speaker, and RJ31X	497.24
ELKM1GSYS4S	Includes: M1 Gold in enclosure, transformer, battery, M1KP2 keypad, speaker and RJ31X	477.24
ELKM1GK	Includes: M1 Gold, transformer, M1KP keypad, battery, speaker, and RJ31X. No enclosure.	475.95
ELKM1GKS	M1 Gold, transformer, M1KP2 Keypad, battery, speaker, and RJ31X. No enclosure.	455.95

**ELK Two-Way Wireless Kits**



**ELKM1GSYS4STW**

**ELKM1XRFTWKIT**

See the next page for more ELK Two-Way Wireless accessories.

ELKM1GSYS4STW	Includes: M1GSYS4S kit, M1XRFTW transceiver, and 6010 key fob	520.19
ELKM1XRFTWKIT	Includes: M1XRFTW transceiver, (2) 6010 key fobs, (2) 6020 slimline door/window sensors, and (1) 6030P motion with pet immunity	258.75

**ELK Mounting Accessories**

ELKSWB14	14" structured wiring enclosure, hinged door	28.21
ELKSWFD14	Flush mount door for the 14" enclosure	21.23
ELKSWB28	28" structured wiring enclosure, hinged door	70.76
ELKSWNS1	Nylon standoffs, 1/4" spacing, fits .156" hole	4.74
ELKSWS	Battery shelf	9.64
ELKSWP3	Mounting plate for M1 boards	6.76

ELK products are listed at MAP.

Please log in to the Worthington Distribution Dealer Store, email us, or call us for your low dealer pricing.

**What's Under ELK's Hood?**



**M1 Gold Specifications**

Voice Capability - Voice announcements for alarms, descriptions, status, etc. with an integrated voice dialer	Yes
On-board Input Zones with maximum expansion	16 208
On-board Outputs with maximum expansion	13 (1 form C relay) 205
Built-in Serial Port	Yes
Power Terminals	4 Total: 3 Auxiliary, 1 Switched
Master Power Switch and Low Battery Disconnect	Yes
Keypad Diagnostics	Zone Voltage Display and Volt/Current Meter
Two-Way Listen-In Capability	Central Station Alarm Verification User Activated through Telephone
Automation ("Whenever/And/Then") Rules Capacity	528
Maximum Keypads Supported	16
Flash Updated Firmware	Yes
Vocabulary	500+ Words and Phrases
Custom Words and Phrases	Yes
Removable Terminal Strips	Yes
Serial (RS232) ports supported	8
Maximum thermostats supported	16
Total wireless zones	144
Total number of users supported	199
Remote Options: Apple, Android, Cloud Service, and PC	Yes (requires the M1XEP)
E-mail Notifications	Yes (requires the M1XEP)
Advanced lighting options	Yes
Analog zone definitions supported	Yes
Ability to create custom Serial ASCII strings	Yes
Z-Wave Lock Support	Yes
Sunset / Sunrise	Calculated
Time-stamped Event History Log	512
Menu-driven keypad programming	Yes
Smoke Detection	4 wire (any zone) 2 wire (zone 16)
Maximum Security Partitions	8
Distributed Audio Support	Russound, Nuvo, Proficient
Auxiliary Power	1 amp continuous
Overload Protection	PTC (fuseless), resettable
UL Listings	Residential Burglary & Fire Commercial Burglary



ELK M1 Interfaces

	ELKM1KPNV	ELKM1KP*	ELKM1KP2	ELKM1KP3	ELKM1KPAS	
See next page for keypad accessories.						
	Description	Navigator 3.5" color touchscreen keypad	LCD keypad. 16 character, 2-line screen. * LCD color: blank-green, B-blue	Low-Profile LCD keypad. 16 character, 2-line Blue screen. Flush-mount option.	Low-Profile LCD keypad with cover. 16 character, 2-line Blue screen.	Decorator arming station with status LEDs
	Physical Dimensions	4.25"W x 3.38"H x .59"D	6.87"W x 5.25"H x 1.32"D	4.65"W x 5.5"H x 1"D	3.97"W x 5.43"H x 1.19"D	1.81"W x 2.75"H x 1"D
	Door Cover	No	Yes	No	Yes	No
	Zone Input	Yes (1)	Yes (1)	Yes (1)	Yes (1)	No
	Programmable Output	Yes (1)	Yes (1)	Yes (1)	Yes (1)	No
Optional 26-Bit Wiegand Proximity Reader	No	Yes- Internal & External	Yes- External Only	Yes- External Only	No	
Internal Temp Sensor	No	Yes	No	No	No	
Function "F" Keys	6	6	4	4	6 (uses "F" key)	
LCD Display	Full color, touch	Green or Blue	Blue	Blue	N/A	
Key Backlighting	N/A	Amber	Blue	Blue	Blue	
Mounting Options	Surface Mount Only	Surface Mount Only	Surface or Flush Mount	Surface Mount Only	Standard Electrical Box	
Price	185.00	115.95	95.95	107.56	70.92	

ELK M1 Two-Way Wireless Security

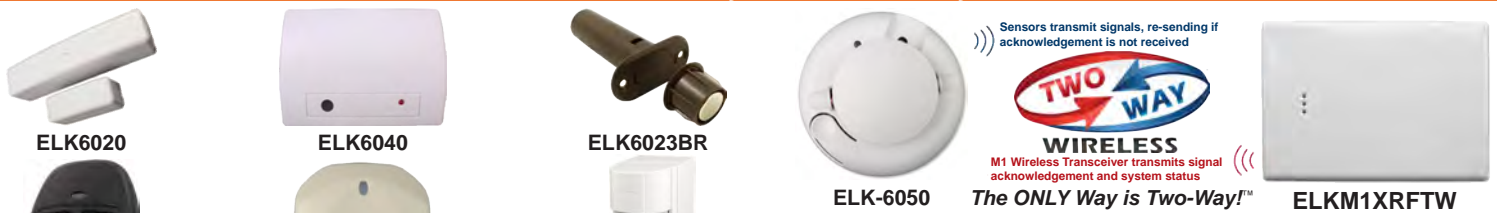

Sensors transmit signals, re-sending if acknowledgement is not received

**WIRELESS**  
M1 Wireless Transceiver transmits signal acknowledgement and system status

**The ONLY Way is Two-Way!™**

ELKM1XRFTW	144 zone two-way wireless transceiver. For use with ELK two-way transmitters.	99.95
ELK6010	Two-way four button keyfob	38.65
ELK-6011	Two-way water resistant panic button & lanyard	37.95
ELK6020	Two-way slim line door/window sensor, white	37.76
ELK6020BR	Two-way slim-line door/window sensor, brown	37.76
ELK6021	Two-way mini door/window sensor	35.05
ELK6022	Two-way universal 3-zone sensor	52.21
ELK6023	Two-way recessed door contact, white	38.95
ELK6023BR	Two-way recessed door contact, brown	38.95
ELK6030	Two-way motion detector	75.95
ELK6030P	Two-way pet-immune motion detector	84.49
ELK6032	Two-way outdoor motion detector	239.95
ELK6040	Two-way glass break	81.95
ELK-6050	Two-way smoke and 135° heat detector	89.95

**TECH TIP:**  
With ELK two-way wireless smokes, if one detector senses smoke, the sounders in all of the detectors will go off.

	True two-way signal confirmation.		Status LEDs provide system information and installation confidence.
Encrypted to defend against interference, hacking, and jamming.		900 MHz frequency hopping ensures signals get through.	

Avoid the vulnerability of traditional wireless sensors with ELK's Two-Way Wireless technology.

Scan the QR code to learn more about the benefits to using ELK's Two-Way Wireless.

**ELK M1 Keypad Accessories**

ELKM1BBKN	Surface-mount back box for M1KPNV	6.95
ELKM1BZBKN	(2) Black color change kits for the M1KPNV	11.95
ELKM1BZSKN	(2) Silver color change kits for the M1KPNV	11.95
ELKM1BBK2	Flush mount backbox for the M1KP2 keypad	6.09

**ELK M1 Access Control**



<b>ELKM1KAM</b>	<b>ELKM1KAM</b>	Door access module. Use in place of a keypad, support for 26 bit Wiegand readers, Dallas iButton, Form "C" Relay, 3 indicator outputs, 2 inputs and selectable time settings for door hold and request to exit.	92.12
<b>ELKM1PRC</b>	<b>ELKM1PRC</b>	Pack of 10 proximity cards	29.50
<b>ELKM1PRF</b>	<b>ELKM1PRF</b>	Pack of 10 proximity fobs	49.95
<b>ELKM1PR</b>	<b>ELKM1PR</b>	Internal Wiegand-compatible proximity reader for M1KP keypad	53.95
<b>ELK106055</b>	<b>ELK106055</b>	Surface-mount external proximity reader for ELKM1KAM or compatible M1 keypads	59.95
<b>ELKW035A</b>	<b>ELKW035A</b>	Wire harness for connecting ELK106055 to an M1KP or M1KPB keypad	2.50
<b>ELKW039A</b>	<b>ELKW039A</b>	Wire harness for connecting ELK106055 to an M1KP2 or M1KP3 keypad	2.50

**Need mag-locks or door strike devices for your ELK system? See Alarm Controls and Seco-Larm on page 139 for options.**

**ELK M1 Lighting/Thermostat Integration**

**Truly Unbiased Integration**



**ELKM1XSP**

Because ELK doesn't make their own lighting control products or thermostats, they can offer unbiased integration with all of their Integration Partners.

The M1XSP serial port expander is a three-in-one product which provides an additional remote serial port, integration for serially controlled lighting systems, or adaptor for communicating thermostats.

**Check out ELK's website for a list of Integration Partners.**

ELKM1XSP	Serial port expander	76.95
----------	----------------------	-------



**ELKM1XSLZW**

**ELKM1XSLU**

**ELKM1XSLC**

ELKM1XSLZW	M1 to Z-Wave serial interface, VRC0P-1LW required, sold separately, see page 17	104.95
ELKM1XSLU	M1 to Lutron RadioRA 2 serial interface	209.95
ELKM1XSLC	M1 to Lutron Caseta serial interface	249.95

**ELK products are listed at MAP.**

**Please log in to the Worthington Distribution Dealer Store, email us, or call us for your low dealer pricing.**

**ELK M1 Communication Interfaces**



**ELKM1XEP**

**ELKC1M14GSM**

**ELKIP232**

ELKC1M14GSM	Dual-Path Communicator. Communicates via IP and cellular to central station monitoring and allows local or remote programming.	289.95
ELKM1XEP	Ethernet port - for programming, monitoring, e-mail notification, and remote control	163.95
ELKIP232	IP to serial Interface	128.83

**ELK M1 Input and Output Expanders**

ELKM1XIN	16 zone input expander	71.95
ELKM1XOVR	Output expander, 8 relays, 8 voltage outputs	106.95
ELKM1RB	Relay board, 8 form "C" relays for use with ELKM1XOVR, or M1 controller	56.50
ELKW018B	4-pin cable for connecting expanders at the M1 controller	2.69
ELKM1XRFEF	144 zone wireless receiver. For use with Interlogix transmitters.	99.95
ELKM1XRF2H	144 zone wireless receiver. For use with Honeywell 5800 series transmitters.	99.95

**ELK M1 Databus Wiring Hubs**

ELKM1DBH	Passive wiring hub. Use with 8 conductor cable (Cat 5) to connect keypads and expanders.	29.81
ELKM1DBHR	Retrofit hub for 4 conductor wiring. Connect 4 bus branches per hub (2 hubs per system).	54.95

**ELK M1 Temperature Accessories**



**ELKM1ZTS**

**ELKM1ZTSR**

ELKM1ZTS	Temperature sensor. Max 1 per zone, wire to zones 1-16.	53.95
ELKM1ZTSR	Remote temp sensor. Stainless steel bullet on a 7' cable, max 1 per zone, wire to zones 1-16.	75.95

**ELK M1 Motorized Water Valve**

ELKWSV2	12VDC Water valve with 1" fittings	359.95
ELKP1417	14VDC 1.7 Amp power supply	19.99

- Rapid Action - Opening and Closing
- Manual Override Handle
- Connections: 18 gauge, 4 conductor cord
- Stainless Steel Grade 316 Safe for Drinking Water
- Integrate with security system or on/off pushbutton



**ELKWSV2**

**ELK M1 Software**

ELKRP	Programming software ( <b>Free</b> download)	Free
ELKUSB232	USB to RS-232 serial adapter	23.95

**M1ToGo Free PC Software**

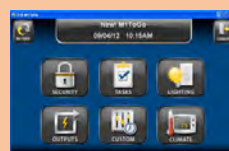

M1ToGo software provides internet remote access from a Windows® based PC to M1 systems from anywhere in the world. Users can access security, lighting, energy management, door access and any other systems connected and controlled through the M1. Download M1ToGo from the ELK web site.



# MAKE YOUR HOUSE A FULLY AUTOMATED CONNECTED HOME



## Control and schedule from anywhere!

Z-Wave is a wireless technology that makes regular household products into smart devices that securely "talk" to each other. Jasco's Connected Home Collection allows you to control and schedule lights, pool pumps, water heaters and more from anywhere using your phone, tablet or PC. Visit [www.easyzwave.com](http://www.easyzwave.com) for more info.

# JASCO



**Aprilaire Communicating Thermostats and Accessories**

For 75 years, Aprilaire has been committed to the success of HVAC contractors by providing solutions designed for consumer health, comfort, protection and energy savings. Their new line of Wi-Fi thermostats continues that tradition.

Clean and simple, the Aprilaire Wi-Fi Thermostat app has intuitive temperature control features designed so anyone can understand and use them to effectively deliver comfort and energy savings.

But that's not all. Aprilaire, the #1 provider of indoor air quality solutions, also offers SmartIAQ: the ability to balance all aspects of indoor air quality, including Temperature, Humidity, Air Purity, and Fresh Air. (IAQ = Indoor Air Quality)

APR8800	Universal Communicating Programmable Touchscreen Thermostat 2 Heat / 2 Cool, or Heat Pump 4 Heat / 2 Cool (RS485)	238.81
APR8810	Wi-Fi Automation Thermostat with Event-Based™ Air Cleaning 2 Heat / 2 Cool, or Heat Pump 4 Heat / 2 Cool	137.39
APR8820	Wi-Fi Automation Thermostat with Integrated IAQ solution 2 Heat / 2 Cool, or Heat Pump 4 Heat / 2 Cool	187.35
APR8830	Touchscreen Wi-Fi Automation IAQ Thermostat 3 Heat / 3 Cool, or Heat Pump 4 Heat / 2 Cool	237.31
APR8840	Color Touchscreen Wi-Fi Automation IAQ Thermostat 3 Heat / 3 Cool, or Heat Pump 4 Heat / 2 Cool	312.25
APR8081	Temperature support module, supports 2 temperature readings (8051, 8052, 8053) for averaging and/or monitoring	69.72
APR8082	Temperature/relative humidity module, supports 1 temp. and 1 RH reading, can be remoted using 8051, 8052, 8053	100.04
APR8051	Flush-mount temperature sensor for use with 8800, 8081/82	15.01
APR8052	Duct-mount or outdoor temp sensor for use with 8800, 8081/82	4.87
APR8053	Surface-mount temperature sensor for use with 8800, 8081/82	10.72
APR8819	Communication distribution panel - supports (8) RS485 thermostats	102.67
APR8029	24VAC, 40VA transformer with protection	14.99
APR8811	RS-485 to RS-232 Protocol Adapter - supports 32 thermostats	97.60



APR8800



APR8820 APR8620W  
APR8830 APR8910W



APR8819



APR8810  
APR8476W



APR8840

Proud Partners with These Top Integration Specialists



**Wi-Fi Thermostats Work with the Aprilaire Wi-Fi Thermostat App**

APR8476W	Universal Wi-Fi Programmable Thermostat with Event-Based™ Air Cleaning	92.93
APR8620W	Universal Wi-Fi Touchscreen Thermostat with Event-Based™ Air Cleaning and Humidity or Ventilation Control	139.39
APR8910W	2 Part Universal Wi-Fi IAQ Thermostat with LCD Touchscreen	180.11
APR8920W	Color Touchscreen Wi-Fi IAQ thermostat works with the Aprilaire Wi-Fi Thermostat App	261.42



**Non-Communicating Thermostats**

APR8620	Universal Touchscreen Thermostat - 2 Heat / 2 Cool, or Heat Pump 4 Heat / 2 Cool	133.62
APR8710	Wireless Programmable Thermostat - 2 Heat / 2 Cool or Heat Pump 3 Heat / 2 Cool	134.89
APR8444	Standard Non-Programmable Thermostat - 1 Heat / 1 Cool	33.25
APR8446	Heat Pump Non-Programmable Thermostat - 2 Heat / 1 Cool	36.37
APR8448	Universal Non-Programmable Thermostat - 2 Heat / 2 Cool or Heat Pump 3 Heat / 2 Cool	48.21
APR8463	Standard Programmable (5+2 Day) Thermostat - 1 Heat / 1 Cool	44.49
APR8465	Heat Pump Programmable (5+2 Day) Thermostat - 2 Heat / 1 Cool	46.99
APR8466	Universal Programmable Thermostat - 2 Heat / 2 Cool or Heat Pump 3 Heat / 2 Cool	57.85



APR8710



APR8400 Series

**Thermostats**



RCSTR65

RCSTR65	Serial thermostat with RS-485 interface, includes TS65 wall display unit and control unit with RS-485 interface. <b>RS-232 Converter required for PC's and RS-232 controllers.</b>	186.41
RCSTZ45	Z-Wave thermostat, all-in-one unit with full wall display unit. Connect directly to HVAC system.	139.58
RCSTBZ48	Battery Z-Wave thermostat, no "C" wire required, long battery life, USB upgradable firmware	139.58

**Use the RCSTZ45 when you need a Z-Wave thermostat with support for Remote Temperature Sensors.**

**Remote Temperature Sensor Configurations**

Use the list below to correctly determine which temperature sensor to use for your application: RS15 sensors can be used with TS16 and TS40 WDUs; OS5 sensors are used with ZCVx model HVAC control units for outside temperature. RTS3 and RTS4 sensors are for TS65 WDUs and TZ45/TZB48 thermostats..

RCSOS5	Outside temperature sensor for ZC4 control units	27.17
RCSRTS3	Remote temperature sensor for TZ45 (up to 2) and WDUs supporting 2-wire sensors-flush	23.42
RCSRTS4	Remote temperature sensor for TZ45 (up to 2) and WDUs supporting 2-wire sensors-surface	23.42



RCSRTS4

**Standard HVAC Zone Control Units**



RCSZC4

RCSZC4	HVAC 4-zone controller for STD or heat pump HVAC systems	186.41
--------	--	--------

Can be used with any RCS Communicating Thermostat.

**Dampers**

RCS6RD*	6" round spring return, 24VAC, 2-wire	82.43
RCS8RD*	8" round spring return, 24VAC, 2-wire	84.31
RCS10RD*	10" round spring return, 24VAC, 2-wire	92.74
RCS12RD*	12" round spring return, 24VAC, 2-wire	102.11
RCS14RD*	14" round spring return, 24VAC, 2-wire	111.47
RCS16RD*	16" round spring return, 24VAC, 2-wire	120.84
RCS6RDM*-FP	6" round modulating, 24VAC, 3-wire	149.88
RCS8RDM*-FP	8" round modulating, 24VAC, 3-wire	154.56
RCS10RDM*-FP	10" round modulating, 24VAC, 3-wire	159.25
RCS12RDM*-FP	12" round modulating, 24VAC, 3-wire	163.93
RCS14RDM*-FP	14" round modulating, 24VAC, 3-wire	168.62
RCS16RDM*-FP	16" round modulating, 24VAC, 3-wire	173.30
RCS18RDM*-FP	18" round modulating, 24VAC, 3-wire	182.67
RCS12RDB	12" round barometric bypass	65.57
RCS14RDB	14" round barometric bypass	70.26

Replace \* with NO for Normally Open or NC for Normally Closed

**Zone Control Unit Transformers**

ELKTRG2440	Plug-in transformer, 120/24VAC, 40VA	10.40
------------	--------------------------------------	-------

**Z-Wave Large Load Control and Power Monitoring**



RCSPC40DR-ZW	Normally closed Z-Wave controlled 40 amp contactor, 120/208/240 VAC	186.41
RCSPC40LC-ZW	Normally open Z-Wave controlled 40 amp contactor, 120/208/240 VAC	186.41
RCSPMC40DR-ZW	Normally closed Z-Wave controlled 40 amp contactor, 120/208/240 VAC with current sensing	214.52
RCSPMC40LC-ZW	Normally open Z-Wave controlled 40 amp contactor, 120/208/240 VAC with current sensing	214.52

Use PMC40 only with controllers from Vera Control, Inc. **See Page 18.**

To select which version of the contactor to use, determine whether you need normally closed or normally open.

An example installation requiring a normally closed contactor would be a water heater. Water heaters are usually always on and would only have power removed to save energy.

An example installation requiring a normally open contactor would be a pool pump or pond pump. Pumps are usually only on when you would need them to be.

**To ensure a properly working system, always confirm damper operation and wiring style before ordering.**

**Remote Temperature Monitoring**

**Questions? Give us a call today!**

Keeping an eye on the temperature is important for both comfort and protection from damage.

Coming home to a house that is too warm or too cold is never a comfortable experience. By using communicating thermostats in conjunction with an automation controller (Vera Control, Fibaro, or HomeSeer), you have the ability to not only see the temperature but to also set it to a level that suits you from anywhere in the world before you arrive.

Protect your investments by being able to see if the temperature is getting too low which could lead to pipes freezing and water damage, or getting too high which may damage electronics and other devices.

**Worthington carries the full RCS product line. Call or visit our online Dealer Store for details.**



# Arlo Video System Supported by Telguard Now Available!



You can now find the Arlo Video System supported by Telguard at Worthington Distribution.

- ▶ World's Only 100% Wire-free HD Security Camera.
- ▶ Delivers HD (720p) Video via the Internet.
- ▶ Waterproof (IP65) - for Outdoor/Indoor Use.
- ▶ Fast/Flexible Installation - Magnetic Mount.
- ▶ Integrates Easily with Telguard's Interactive Solution, HomeControl Flex.



Learn more at [Telguard.com/arlo](http://Telguard.com/arlo) or call  
1-800-229-2326, Option 5.

System is comprised of Arlo Base Station and Arlo Wire-free HD Cameras, all sold separately.



**TELGUARD**



**2500 Series Kits (1/2 mile range\*)**

DADCPA-2500	Wireless Driveway Probe Alert, 50' Cable, PT-2500 transmitter and DCR-2500 receiver, includes 4x CR123-A batteries, 1/2 mile range,* reminder beep/LED, and counter	186.10
DADCMA-2500	Wireless Motion Alert, 1/2 mile range,* MT-2500 transmitter and receiver, requires one 9V battery, reminder beep/LED, and counter	101.17
DAUTDCR-2500	Universal Transmitter Kit. Can be used as Panic Button or as a Wireless Doorbell. Includes magnet for use as Wireless Door Contact. Also contains inputs for both N/C and N/O sensors. Includes DCR-2500.	74.94
DAIRDCR-2500	Wireless PIR Kit 1/2 mile range,* transmitter and CR-2500 receiver, requires one 9V battery, reminder beep/LED, and counter	89.93
DABBA-2500	Break Beam Kit 1/2 mile range,* transmitter and CR-2500 receiver. Solar recharging of the batteries extends operating time.	223.57

\*Range varies due to terrain/objects that can cause RF interference.



DADCMA-2500



DADCPA-2500



DABBA-2500



DAUTDCR-2500

**2500 Series Expansion (1/2 mile range\*)**

With 4 Channels available, you can add more transmitters to expand your coverage. Mix and match transmitters to your needs.

DABBT-2500	Solar-Recharged Wireless Break-Beam sensor-transmitter, use with DCR-2500 or PR-2500	188.60
DAUT-2500	Universal Transmitter. Includes magnet for use as Wireless Door Contact. Also contains inputs for both N/C and N/O sensors.	29.98
DADCMT-2500	Motion Transmitter (Green Box). Can hide in foliage for hidden detection.	63.70
DADCPT-2500	Driveway Probe with Transmitter and 50' cable. 1/2 mile range,*	151.13
DAIR-2500	Wireless PIR (White Box) Good to wall-mount on the porch	57.45
There is no limit to the number of receivers you can use. Have one on each floor and in out buildings. The portable model can hang on your belt.		
DADCR-2500	Plug-in Receiver for 2500 series	53.71
DAPR-2500	Portable Battery-Powered Receiver for 2500 series	52.46



DAPR-2500



DAIRDCR-2500



DAUT-2500

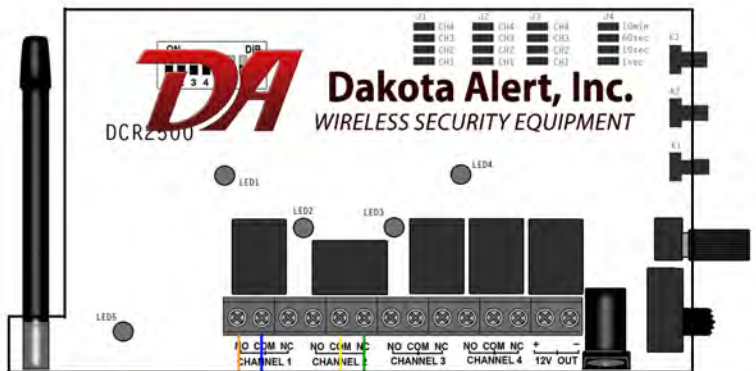

Light Control Input Module

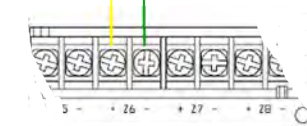

Alarm Panel

**MURS (Multi-Use Radio Service) Alert (Several mile range\*)**

DAMAT	MURS PIR transmitter, for mounting on a tree or post, requires six AA batteries	98.67
DAM538-HT	MURS Hand-Held Transceiver, receives alerts from MURS devices as well as two-way communication w/ other transceivers, includes charger and batteries	73.63
DAMURSHTKIT	MURS MAT Kit, includes one PIR transmitter and one M538-HT transceiver	165.49
DAMAPS	MURS Alert Probe Sensor transmitter, 50' direct burial cable	198.59
DAMAPSHTKIT	MURS MAPS Kit, includes one probe transmitter and one M538-HT transceiver	264.16
DAMURSCHIME	MURS Chime Module for M538-BS, connects to NO output, requires two AA batteries	11.24

**Coming this Summer:**

The Dakota Alert Smart Push is an easy to install Wi-Fi push notification module that can be used with the Dakota Alert DCR-2500 or any control panel that has NO or NC outputs. The Smart Push will send a push notification to the Dakota Alert app (Android or iOS) running on your smart phone any time one of the input zones is activated. The Smart Push has four hard wired inputs that the user can identify and name through the app. The push notification that appears on the users phone will give the time and date of activation as well as the custom alert message that the user creates. Part number and price to be announced in June.

**Self-Contained Vehicle Sensors - Bury 50' from Cross-Traffic**

CTCP-3-100-5W	Self-contained unit with 100' cable, power supply required, can be powered from security controller board	162.99
CTCP-3-200-5W	Self-contained unit with 200' cable, power supply required, can be powered from security controller board	233.25
CTCP-3-300-5W	Self-contained unit with 300' cable, power supply required, can be powered from security controller board	303.51
CTCP-3-500-5W	Self-contained unit with 500' cable, power supply required, can be powered from security controller board	444.02
MGT12500SPS	Power supply for self-contained CarTell detector, 12VDC 500mA	4.93



Installation is as simple as burying the probe, which is 21" long and 2" diameter, 6" to the side of the driveway. Bury the included and connected direct burial wire up to the house. Then connect two conductors to a 12VDC power supply, and the remaining two conductors to an input of your favorite controller. Also connects directly to gate operators to provide free exit.

**Controllers - Use with CT6 and Short Driveway Probes**

CT2B	Controller, adjustable sensitivity, enclosure, power supply, manual	137.70
CTCF2C	Controller, adjustable sensitivity, 15A/120VAC timer relay, enclosure, power supply, manual	223.88



When using the CT2B/CTCF2C controller, mount the controller next to the security system or automation controller. Splice using only CTCA1. Multiple probes can be wired to a controller; the controller closes a contact when motion is detected on any of the probes.

**CT6 Probes - Bury 50' from Cross-Traffic**

CT610	Probe with 10' cable, requires a Cartell controller, use CT2B or CTCF2C listed above	33.72
CT650	Probe with 50' cable, requires a Cartell controller, use CT2B or CTCF2C listed above	44.96
CT6100	Probe with 100' cable, requires a Cartell controller, use CT2B or CTCF2C listed above	65.57
CT6150	Probe with 150' cable, requires a Cartell controller, use CT2B or CTCF2C listed above	87.12
CT6200	Probe with 200' cable, requires a Cartell controller, use CT2B or CTCF2C listed above	108.66
CT6250	Probe with 250' cable, requires a Cartell controller, use CT2B or CTCF2C listed above	130.21
CT6500	Probe with 500' cable, requires a Cartell controller, use CT2B or CTCF2C listed above	237.93
CT61000	Probe with 1000' cable, requires a Cartell controller, use CT2B or CTCF2C listed above	453.39
CT61500	Probe with 1500' cable, requires a Cartell controller, use CT2B or CTCF2C listed above	668.84
CT6A	Detached probe, requires a Cartell controller and Cartell direct burial wire	66.51
CTCA1	Epoxy-based splice kit, 3M product	56.20



**Short Driveway Probes - Bury 10' from Cross-Traffic**

CTSD610	Short driveway probe with 10' cable, requires a Cartell controller, use CT2B or CTCF2C listed above	86.18
CTSD650	Short driveway probe with 50' cable, requires a Cartell controller, use CT2B or CTCF2C listed above	97.42
CTSD6100	Short driveway probe with 100' cable, requires a Cartell controller, use CT2B or CTCF2C listed above	112.41

**Annunciator Plates**

CTA1	Sleek hardwired annunciator, mounts in 1-gang box, volume control and mute, 3 tones to identify different driveways	70.26
CT-11	Outdoor annunciator plate, weatherproof	79.62

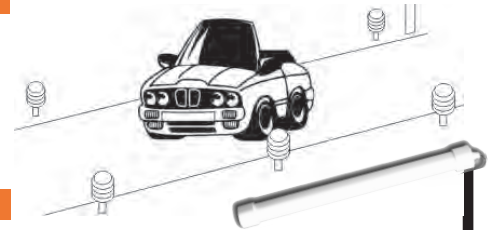

**Photocells**

CTFC6	Self-stick Photocell, attaches to inside of window, use with CTCF2C	17.80
CTFC12	Outdoor photocell, weatherproof, use with CTCF2C	32.79

Dealers will tell you that vehicle detection is the one system enhancement that all customers rave about. Worthington Distribution endorses Cartell vehicle detectors by Preferred Technologies for their outstanding performance. Cartell vehicle detectors provide annunciation, the ability to perform lighting control and video switching control.

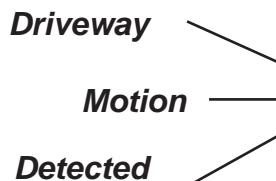
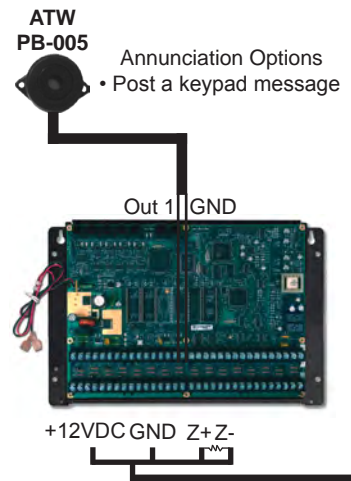

**Rain8 Pro2/Pro Irrigation Controllers**



**WGL41012**  
**WGL41017**

For Omni integration, we recommend the Pro UPB model

The Pro version includes the following new features: On/Off button for each zone, LED indicators for each zone, all valve wires/connections protected against lightning, all RS-232 and network connections are protected against ESD and lightning, and each output has a self-resetting electronic fuse. UPB adds support for both LINK and DIRECT modes.

WGL41012	Pro2 8-zone irrigation controller with serial interface, transformer, RS-232 cable	202.68
WGL41017	Pro2 8-zone serial irrigation controller expansion module	180.56
WGL41020	Pro 8-zone UPB irrigation controller, 20VA transformer, RS-232 cable, Gen 2 compatible	202.68
WGL41030	Pro 8-zone UPB irrigation controller expansion module	181.80

**Rain8 Irrigation Controllers**



WGL41050	8-zone irrigation controller with serial interface, transformer, RS-232 cable, does not use X10	115.97
WGL41055	8-zone serial irrigation controller expansion module	107.00
WGL41060	8-zone UPB irrigation controller, 20VA transformer, RS-232 cable, requires UPB PIM	125.84
WGL41065	8-zone UPB irrigation controller expansion module	112.16

**Accessories for Rain8/Rain8 Pro Irrigation Controllers**

LSA36A00-1	Gen 2 UPB powerline interface module for use with WGL UPB irrigation controllers	62.62
LSA36A05-2	PIM to PC Cable. Modular to DB9 for connecting 36A00-1 to a computer	9.18

**Using the Rain8upb/Rain8upb Pro with a Leviton Omni Controller**

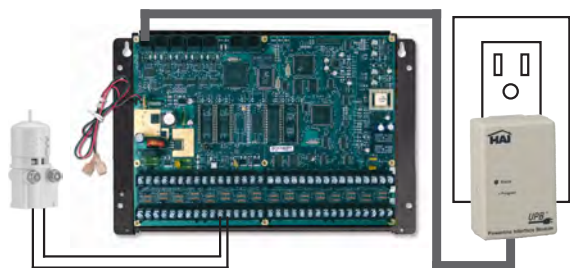

GH502 connected to a zone on an Omni with UPB PIM plugged into an outlet.

- Download Rain8 software from WGL
- Connect a Rain8upb/Rain8upb Pro to your PC and configure your Network ID, UPB device numbers and maximum allowed run times
- Program your Leviton units for the number of valves you will be controlling
- Program your Leviton flags for the desired run times for each valve
- Be sure to test your configuration

Visit [www.worthingtonsolutions.com](http://www.worthingtonsolutions.com)

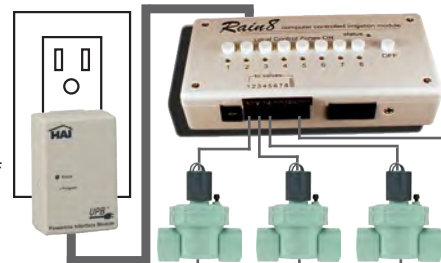

Rain8upb Pro connected to valves with UPB PIM plugged into an outlet.

*IP Enabled Irrigation Controllers*



**IP Enabled Irrigation Controllers**



RAC8ZULW	8-Zone Smart Irrigation Controller, includes controller, power supply and quick start guide	159.87
RAC16ZULW	16-Zone Smart Irrigation Controller, includes controller, power supply and quick start guide	199.84

Rachio Iro smart sprinkler controller gives you the freedom to control your sprinkler from your mobile device. Cloud-based weather data and embedded software can help deliver 20%+ energy savings to your irrigation water bills. Available in 8 and 16 zone configurations.

Looking for other Mini-Clik products? Give us a call.

**Mini-Clik**

**Mini-Clik Sensors**



**GH502**

GHBP-SW	Bypass switch box w/ no-strip wire connectors & double-backed tape for mounting	20.13
GH401	Freeze sensor, 3° C (37° F) setpoint, 25' wire, screws, 24VAC, 6A	31.53
GH401R	Same as above but switches "On" instead of "Off"	29.23
GH502	Rain sensor, adjusts for rainfall of 1/8" to 1", includes 25' wire, aluminum mount	23.94
GH440200	Replacement Cap and Cork for GH502	4.72
GH601	Wind sensor, adjustable wind control, 12-35 mph shut down, 24VAC, 5A	104.74
GHSGM	Gutter Mount for Sensors	2.70





# The Choice For Commercial Audio

Installers have been using Speco Technologies commercial audio products for over 50 years, and for good reason. We offer a complete line of reliable, high-quality products at a price point that will fit into almost any budget. Whether you're looking to install in a gym, office, retail space, bar, restaurant, or anything in between, Speco Technologies has the product for you. Contact your local distributor today and ask for Speco Technologies by name, visit [www.specotech.com](http://www.specotech.com) or call 1.800.645.5516 and request a free catalog.

For More Information,  
Call 1.800.645.5516 or Visit [www.specotech.com](http://www.specotech.com)







### Door Strikes

There are two types of locking methods. "Fail-secure" means that the lock will continue to hold when power is lost, providing a secure perimeter. "Fail-safe" means that a lock will release when power is lost to allow easy exit in case of emergency.



Page 139



### Fully Integrated Security

2GIG is revolutionizing the security industry by integrating GSM and broadband communication (no phone line needed), wireless security, Z-Wave automation, 2-way voice, and a high resolution touchscreen in a single package.



Pages 114-118



### PowerSeries Hybrid

As of version 4.6, the PowerSeries controller will now support 2-way wireless. DSC makes it easy for you to stay ahead of the technology curve with the easiest to sell, easiest to install and easiest to use security systems anywhere.



Pages 120-124



### Commercial and residential

Fire, Burglary and Security Control Alarm, Video, Temperature, Lighting & Locking via Z-Wave: New App for iPhone/Android and/or New Touchscreen/Tablet provide services your customers will love!



Page 129-131

### Fire Supervision

For residential, the most common types of fire supervision are smoke detectors. Heat detectors and carbon monoxide detectors are also desired in some installations. Whether you are doing smoke-only or a full blown fire system, you must be sure to follow all local, state and national codes. Doing so will not only protect the homeowners, but it will protect you and your company as well. Life safety is the most important part of monitoring a home.



### Wireless

Wireless devices are available from almost every manufacturer that makes a security system. While not as reliable as hardwired, wireless allows you to complete installations where a security zone was not designed to be. Wireless is the preferred choice for retrofit applications as well. DSC offers their Neo system which is completely wireless, including the keypads and sirens, which are a limitation of traditional wireless.



### Wireless Locks

Wireless locks from Kwikset are available for use with 2GIG Go Control Panels as well as Napco (additional module required). When a code is entered on the pinpad, the door will unlock and a signal can be sent to the security panel to disarm the system. No more having to enter codes twice or worry about running out of time to disarm due to fumbling with keys.



### Security Devices

There is a security device for almost any application. Magnetic contacts protect doors and windows, motion detectors monitor areas where no one should be, smoke detectors help with life safety, and glass breaks add further protection to doors and windows. These are just a few examples. For a complete security system, a combination of all of these devices works best.

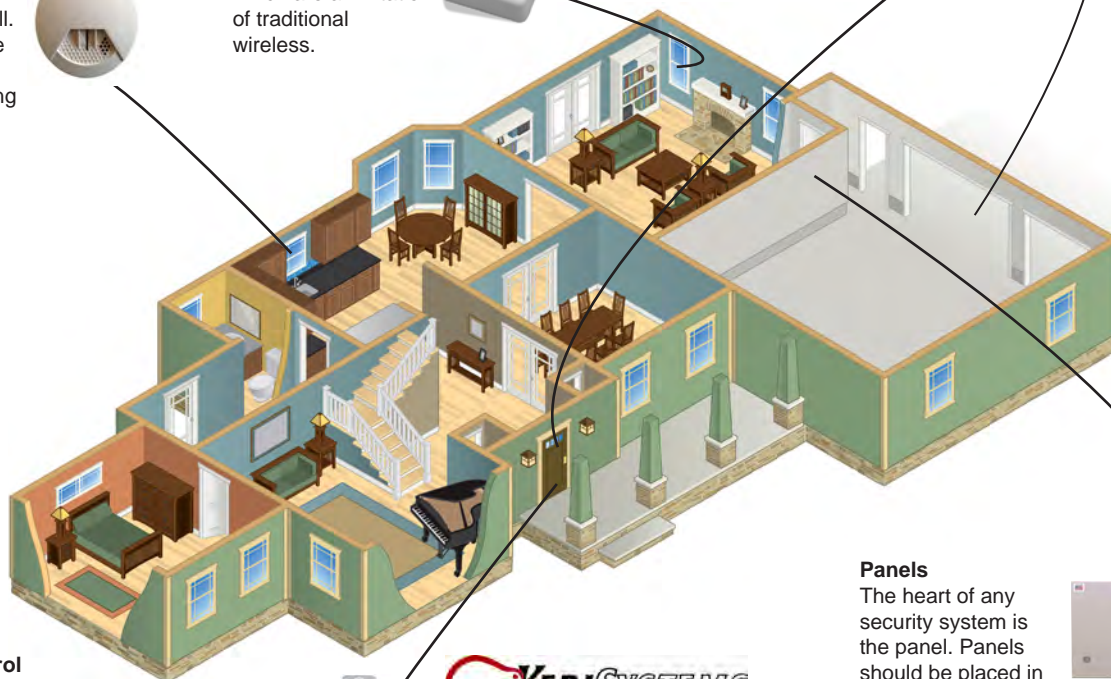

### Access Control

Whether you are trying to allow easy entry to a home or are trying to prevent unauthorized people from getting in, access control covers both situations. Either by using a keypad or a reader, you limit who has access. Some systems integrate cameras to be able to view who is at the door and most systems allow for many user codes. In some cases, levels of access are available.



Keri Systems access control systems are the perfect choice for 1 to 256 doors. Networked controllers make routine maintenance like adding and removing users or modifying schedules easy for building managers.

Page 138

### Panels

The heart of any security system is the panel. Panels should be placed in a somewhat secure area that is not normally viewed by most people. Many sizes and types are available to fit almost any application. Choosing the proper size panel for the installation is an essential component of a security system. Too many zones and the system is overly complicated; too few zones could mean a weak system.



**2GIG GC2 Security & Home Automation System**

2GIG-CP21-345E	GO! Control 2 Panel touchscreen with 2-way voice, wireless receiver, Z-Wave transceiver, battery backup, <b><u>purchase cell module separately</u></b>	153.63
2GIG-CP21-345E2	Same as above, adds AC2 plug for transformer to avoid hardwiring	154.89
2GIG-CPX1-345E	Non-branded version of above	152.38
2GIG-FP6-20PK	Blank name plates, for above, to print with your own logo, pack of 20	74.93
2GIG-CP-DESK	Desk/Table stand for the Go! Touchscreen	8.74

**2GIG GC2 Controller Kits - Purchase Cellular Interface Separately**

2GIG-GCKIT311	(1) 2GIG-CP21-345E, (3) 2GIG-DW10, (1) 2GIG-PIR1, (1) 2GIG-KEY2	256.45
2GIG-GCKIT410	(1) 2GIG-CP21-345E, (4) 2GIG-DW10, (1) 2GIG-PIR1	266.80
2GIG-GCKIT30IMG	(1) 2GIG-CP21-345E, (3) 2GIG-DW10, (1) 2GIG-XCVR2-345, (1) 2GIG-IMAGE1	322.24

- Color Touchscreen Display
- Fully Self-Contained
- Snap-in GSM Radio
- Updated Z-Wave Home Control
- Remotely Control Panel Settings
- Two-way Voice Over Cellular
- Over-the-air Update Functionality
- Customer Messaging Capable
- 60 Wireless Zones
- 2 Hardwire Zones
- 24-hour Backup Battery
- 32 User Codes
- Quick Arm/Exit

**Wireless Security, Z-Wave Automation, GSM Wireless Connectivity and a Touchscreen in an All-In-One System**
**TS-1 Wireless Touchscreen for 2GIG GC2**

2GIG-TS1-E	2-way Wireless Touchscreen	118.67
2GIG-TS1-DESK	Desk/Table stand for the TS-1 Touchscreen	8.11
2GIG-XCVR2-345	900 MHz Transceiver, one per GoController for use with the 2GIG-TS1, 2GIG-IMAGE1, and 2GIG-BRIDG1-900	14.36

**Image Sensor**

2GIG-IMAGE1	Wireless Motion Detector Image Sensor, requires 2GIG-XCVR2-345 GC2 only	93.69
-------------	---	-------



- Pet immune wireless motion detector with color camera
- IR illuminated black and white night vision
- Send e-mails or MMS alerts with images attached
- Requires Firmware 1.10 or higher
- Requires a XCVR2 900MHz transceiver
- Requires an Alarm.com account with an Image Sensor Plan

**2GIG Network Camera**

2GIG-CAM-HD100	HD Indoor IP Camera with IR	134.90
----------------	-----------------------------	--------

**Cellular Interfaces for 2GIG GC2**

2GIG-GC3GAX-A	Alarm.com AT&T GSM 3G Module-GC2	89.93
2GIG-GCCDMVX-A	Alarm.com Verizon CDMA Module-GC2	89.93
2GIG-LTEV-A-GC2	Alarm.com Verizon 4G LTE Module-GC2	123.65
2GIG-GC3GA-T	Telguard AT&T GSM 3G Module-GC2	89.93
2GIG-GCCDMVX-NE	SecureNet Cellular GSM 3G Module-GC2	89.93
2GIG-GC3GUP-U	Uplink Cellular Radio Card-GC2	89.93

**IP Communicator for 2GIG GC2**

2GIG-BRDG1-900	Go!Bridge IP Communicator, requires 2GIG-XCVR2-345	67.45
----------------	--	-------

**2GIG-BRDG1-900**

**2GIG-TS1-E**

**2GIG-CAM-HD100**
**Firmware Updates for 2GIG GC2**

2GIG-UPCBL2	Firmware update cable for the TS1 and Go!	23.12
2GIG-UPDV	Easy Updater for GC2 panels, no PC required	68.70

**2GIG Accessories**

Looking to sell 2GIG from your iPhone or iPad?

- On your Apple device browse to 2GIG.com
- Under Dealer Materials, choose Dealer Site
- You will need a login. If you do not have one, apply for one.
- In the Dealer Site, on the left, look under Marketing for "Go! Control Demo App"
- Follow the instructions for loading the app

2GIG-GC-POTS	POTS Module for the 2GIG-CP21-345E, second generation Go! Controller	11.24
2GIG-ANT2X	Optional External GSM Attic Antenna, 10 ft	28.73
2GIG-ANT3X	Replacement External In-wall Antenna	7.48
2GIG-AC1	Replacement plug-in power supply	11.23
2GIG-BATT2X	Optional Extended Battery Pack, 24hr	21.22



2GIG-DEMOKIT	Demo kit with CNTRL2, TSTAT, KEY2 and a DW10	299.00
--------------	--	--------

**Recommended Additions for a GREAT 2GIG demo**

2GIG-GCCDMVX-A	Verizon CDMA Module w/ ANT3X antenna	89.93
2GIG-CAM-HD100	HD Indoor IP Camera with IR	134.90
2GIG-PD300EMZ51	Lamp Module, 300W Incandescent	29.51
BD99100-005*	Standard Z-wave Deadbolt - Satin Nickel	137.39



**Wireless Devices for GC2 and GC3**

2GIG-DW10	Thin Door/Window Contact with external input	21.25
2GIG-DW20R	Recessed Door Contact	23.09
2GIG-DW40	Ultra-Compact D/W Sensor with bypass	23.73
2GIG-GB1	Glass Break Detector	46.21
2GIG-KEY2	4-Button Key Ring Remote	19.98
2GIG-TILT1-345	2GIG 345 MHz Tilt Sensor	23.09
2GIG-DBELL1-345	Wireless Doorbell	26.85
2GIG-PAD1	Wireless Keypad	37.48
2GIG-F1-345	Fall Detector Pendant	43.78
2GIG-PHB2-345	Personal Help Button Pendant	31.69
2GIG-PHB1-345	Personal Help Button Pendant-Wristband	31.69
2GIG-PANIC1	Panic Button Remote	23.73
2GIG-PIR1	Passive Infrared Motion Detector	48.71
2GIG-SMKT3	Smoke, Heat, and Freeze Detector	56.20
2GIG-SDS1-345	Smoke Ring Detector and transmitter	32.20
2GIG-FF-345	Smoke Detector Takeover Module	36.25
2GIG-CO3	Wireless Carbon Monoxide Detector	73.69
2GIG-FT1-345	Flood and Temp Sensor	38.09
2GIG-TAKE	8-Channel takeover transmitter. Converts 8 hard-wired loops to 2GIG wireless zones.	47.47
2GIG-TAKE-KIT1	Includes 2GIG-TAKE Module, a UL-rated plastic enclosure, and a 12/24VDC Power Supply Board with backup battery charging circuit. Will allow you to add up to two (2) additional Super Switch Takeover Modules.	80.56



*Z-Wave Sensors and Controls*

2GIG-LB60Z-1	Z-Wave Dimmable LED Light Bulb	13.43
2GIG-LB65R6Z-1	Recessed Lighting Retrofit Kit with LED Bulb	32.20
2GIG-LBR30Z-1	LED 65-watt Equiv. Indoor Flood Light Bulb	29.51
2GIG-PD300EMZ51	Plug-in Lamp Module, 300W, dimmable	29.51
2GIG-PS15EMZ5-1	Plug-in Appliance Module, 15A, relay	32.20
2GIG-WA00Z-1	Wall Switch Battery-Power Scene Controller	32.20
2GIG-WD500Z5-1	Decorator 500W Dimmer with neutral	32.20
2GIG-WD1000Z-1	Decorator 1000W Dimmer with neutral	40.24
2GIG-WS15Z5-1	Decorator Switch, 15A with neutral	32.20
2GIG-WT00Z5-1	Virtual 3-Way Accessory switch	32.20
2GIG-GC-TBZ48	Battery-Powered Z-Wave Thermostat 2H/2C or Heatpump 3H/2C	78.06



2GIG-WO15EMZ5-1	Wall Outlet, 15A, one side controlled	32.20
2GIG-FS20Z-1	Isolated contact Fixture Module, relay: 20A 277VAC, 1HP 120/240VAC, 960W Inc.	32.20
2GIG-GB00Z-2	Glass Break Detector, battery-powered	27.48
2GIG-WA105DBZ-1	Z-Wave 105 dB Siren	40.28
2GIG-WADWAZ-1	Z-Wave Door Window Sensor	26.32
2GIG-WAPIRZ-1	Z-Wave PIR Motion Detector	34.91
2GIG-WF00Z-1	Z-Wave Water Sensor with Ant - AC pwr	26.82
2GIG-WL00Z-1	Z-Wave Pipe-mount Water Flow Detector	74.65
2GIG-WDKIT*	Color Change for WD500Z-1 and WD1000Z-1	3.48
2GIG-WTWSKIT*	Color Change for WS15Z-1, WS15Z5-1, WT00Z-1 and WT00Z5-1	3.48

\* = AL-Almond, BL-Black, and BR-Brown paddles.



Note: Z-Wave sensors are best for Automation. Use the 345 MHz sensors in the upper section for notifying Alarm.com or central station.

# Kwikset



Kwikset SmartCode™ locks with Home Connect™ technology are the industry's leading wireless access control lock solution for the smart home.

Providing access control via locks as a natural extension of our partners' current offering delivers remote access and convenience to customers. With multiple finishes, decor-friendly styles that span traditional to contemporary, and interface options from keypads to touchscreens, the simple installation of a Kwikset electronic lock provide customers a world of wireless possibilities.



For more information, visit [www.kwikset.com/smartcode](http://www.kwikset.com/smartcode) - 1-866-863-6584



SmartCode™  
916



SmartCode™  
914



SmartCode™  
912 Lever



SmartCode™  
910



SmartCode™  
910 Contemporary



Signature Series  
Contemporary



Signature Series  
Traditional





**2GIG-KIT311-GC3**

- 7" capacitive touchscreen
- 100 Wireless Zones · 2 Wired Zones
- 32 Keyfobs · 4 Keypads · 100 Users
- External siren output · 2 Open Collector Outputs
- 5-day weather forecast
- Arm button on home screen
- User-replaceable cell radio, no tools to install
- 3G AT&T, CDMA Verizon, or Rogers Network

**The Image sensor and transceiver for the GC3 is not compatible with the GC2**

The GC3 is the next level of all-in-one 2GIG controller. With a 7" color, capacitive touchscreen and an upgraded user-interface, homeowners will love how much faster and easier it is to use. Dealers will appreciate how much time they'll save during installation. Improvements include single-screen zone programming, elimination of redundant steps, One-Touch Arming, and easy-to-see Status. These features, along with many others, make the GC3 customer experience the most intuitive of any security control system in the industry. Period.

Smart Home Control has been at the heart of all 2GIG panels since the very beginning. The new 2GIG GC3 makes working with smart home devices simpler than ever before. Programming new smart home devices is a snap with clear, step-by-step menus. The security and automation chips have been built with a modular design, allowing for incorporation of other emerging solutions to stay current in the ever-changing world of technology.

2GIG-GC3-345	GC3 Panel touchscreen with 2-way voice, wireless receiver, Z-Wave transceiver, battery backup, <u>purchase radio separately</u>	243.56
2GIG-KIT311-GC3	GC3 Panel, (3) 2GIG-DW10, (1) 2GIG-PIR1, (1) 2GIG-KEY2	368.46
2GIG-GC3GAX-A	GC3 AT&T GSM 3G cell radio	89.93
2GIG-CDMAVAGC3	GC3 CDMA Verizon cell radio	89.93
2GIG-IMAGE2	Image Sensor for GC3, requires transceiver	93.69
2GIG-XCVR3-GC3	Transceiver for GC3 Panels with Image sensor	18.80
2GIG-GC3-DEMOKI	Demo kit in plastic travel case with GC3 panel GC-TBZ48 GoControl Thermostat 2GIG-KEY2-345 Keyfob 2GIG-DW10-345 Wireless Sensor	623.25



*Hybrid Controller*

**A Hybrid panel that is modular and customizable.**

Vario security systems allow you to buy only what you need to get the job done. The equipment and offered services provide you proper coverage at the right price. The modular approach allows you to buy only what you need for your application. Vario allows you to set up multiple security areas, with different settings, off one panel. Therefore, whether you need to protect family or inventory, Vario can adapt to get it done. In our modern and ever-changing world, security should never be rigid.

2GIG-V-KIT1	2GIG Vario LCD Keypad Kit Includes 2GIG Vario Main Board, 2GIG Vario Panel Enclosure, 2GIG Vario Wireless Receiver, 2GIG Vario LCD Icon Keypad w/ Prox, and 2GIG Vario Plug-In Power Supply	197.18
2GIG-V-KIT2	2GIG Vario LCD Keypad Kit Includes 2GIG Vario Main Board, 2GIG Vario Panel Enclosure, 2GIG Vario Wireless Receiver, 2GIG Vario Elegant Keypad w/ Prox, and 2GIG Vario Plug-In Power Supply	263.86
2GIG-V-KEYPROX*	2GIG Vario Elegant Keypad with Prox (Wht-White, Blk-Black)	161.12
2GIG-V-LCDPROX	2GIG Vario LCD Icon Keypad with Prox	91.88
2GIG-V-BRD	2GIG Vario Main Board	73.85
2GIG-V-ZE8	2GIG Vario Zone Expansion Board	57.47
2GIG-V-8OUT	2GIG Vario 8 Voltage Output Expander	77.88
2GIG-V-4ROUT	2GIG Vario 4 Relay Output Expander	81.63
2GIG-V-PS3A	2GIG Vario Switching Power Supply	22.56
2GIG-V-VOICEMOD	2GIG Vario Digital Voice Module	62.01
2GIG-V-MICSPK	2GIG Vario Microphone / Speaker Module	52.63
2GIG-V-RECU	2GIG Only Vario Wireless Receiver	72.50
2GIG-V-RECH	2GIG and Honeywell Wireless Receiver	99.36
2GIG-V-BOX	2GIG Vario Panel Enclosure	19.87
2GIG-V-ACCBOX	2GIG Vario Accessory Enclosure	28.46
2GIG-V-AC5	2GIG Vario Plug-In Power Supply	17.19
2GIG-V-PSUSA	2GIG Vario Power Supply for Structured Wiring Cabinets	22.56
2GIG-V-RS232	2GIG Vario RS232 Update/ Connectivity Cable	40.82



**2GIG-V-KIT1**



**2GIG-V-KIT2**



**2GIG-V-KEYPROXB**



**2GIG-V-LCDPROX**



**2GIG-V-RECU  
2GIG-V-RECH**



**2GIG-V-MICSPK**

**Cellular Modules have not been released at time of printing, call for updated parts list**



Alarm.com Products



ALAADC-VDB101



ALAADC-VDB102



ALAADC-T2000

ALAADC-T2000	Smart Thermostat, White	89.93
ALAADC-VDB101	Wifi Doorbell Camera (Satin Nickel)	148.63
ALAADC-VDB102	Wifi Doorbell Camera (Bronze)	148.63
ALAADC-BOSBC23HW	Bed Sensor System w/ 2GIG xmitter	124.90
ALAZ-QBBIOZW	Safetech Quickbox, Z-Wave lockbox	398.43
ALAADC-V620-PT	Indoor Pan/Tilt, Wi-Fi Camera w/ PS	231.06
ALAADC-V520-IR	Indoor Wireless IR IP Camera with PS	111.16
ALAADC-V720	Outdoor POE IR IP Camera with PS	236.06
ALAADC-V721W	Outdoor Wireless IR IP Camera with PS	164.87
ALAADC-VS420	4-channel Analog-to-IP Video Server	412.17
ALAADC-VS121	Analog-to-IP Video Server	89.93
ALAADC-POE	POE Injector for the ALAADC-V720	43.72
ALAADC-SVR100	ADC Stream Video Recorder (1TB)	286.02
ALAADC-SVR1002	ADC Stream Video Recorder (2TB)	373.45

Alarm.com cameras only work in conjunction with the Alarm.com service



ALAADC-V520-IR  
IR Illumination



ALAADC-V720  
ALAADC-V721W  
Outdoor Bullet



ALAADC-V620-PT

2GIG Compatible Z-Wave Sounder

FRTSSA\*US

- 117dB sounder for auditory notification
- 5 LED's for visual notification
- LED's and sounder can be controlled via standard lighting level commands



FRTSSA1US

FRTSSA*US	Z-Wave Siren/strobe, 12VDC with 9V battery backup. 1 - Clear lens, 2 - Red lens	35.61
-----------	---	-------

Wireless Takeovers Have Never Been Easier



2GIG offers a great line of competitively priced wireless sensors; however, if the wireless is not 2GIG or Honeywell 5800 series look to Resolution Products. The translator products allow DSC, GE or Napco wireless products to work with 2GIG.

RESRE524X	Translator and Repeater, RF to RF 2GIG, Honeywell, Interlogix and Napco support	71.19
RESRE508X	Hardwire to 2GIG, Honeywell, Interlogix or Napco	71.19

2GIG is compatible with Honeywell 5800 series wireless without a translator

Z-Wave Large Load Control

ELK9200	60 Amp double pole relay with 110VAC coil in an enclosure. Plug into an appliance module for control of 110/220 VAC high current loads.	60.53
---------	---	-------



- Pre-Wired Terminal Lugs for Easy Installation
- Ideal for Water Heaters, Motors, Pumps, etc
- Heavy Duty "Lockable" Metal Enclosure

Resolution Products Sensors for 2GIG



Resolution products also makes wireless sensors that are compatible with 2GIG. This includes sensors that are not available in the 2GIG line. There are also alternative transmitters that may meet your design needs better.

RESRE200RW	Keyfob	16.24
RESRE201	Door/Window sensor, with hardwire inputs	21.23
RESRE203	Panic, water resistant	18.74
RESRE204	Driveway Detector, uses C size battery	94.92
RESRE205	Below 40° or above 100° Temp Sensor	24.98
RESRE206	Tilt Sensor, great for garage doors	24.98
RESRE209	Glass Break	59.95
RESRE210T	PIR, Pet immune to 60 lbs	39.97
RESRE212T	Wireless Photoelectric Smoke	53.71
RESRE213T	Wireless Carbon Monoxide Detector	59.95
RESRE219	Home Disaster (Flood/Hi-Lo Temp) Sensor	41.22
RESRE222T	NanoMax (super tiny d/w sensor)	17.49
RESRE252T	Wireless Pinpad for 2GIG Controllers	41.22
RESRE116-U	Wireless Sounder with Transmitter	79.94
RESRE116	Wireless Sounder Receiver Only (add additional sounders to the transmitter)	67.45



RESRE205



RESRE252T



RESRE212T

Concealed Wireless Ion Security Sensors

Recessed plunger or magnetic contacts for doors and windows

IONMICRA-2G	2GIG compatible wireless window sensor: less than 1/2" deep x 3/4" wide	24.98
IONPLUNGER-2G	2GIG compatible wireless door sensor: less than 1" deep x 3/4" wide	24.98
IONFDB75	3/4" Forstner drill bit for Ion Sensors	6.24

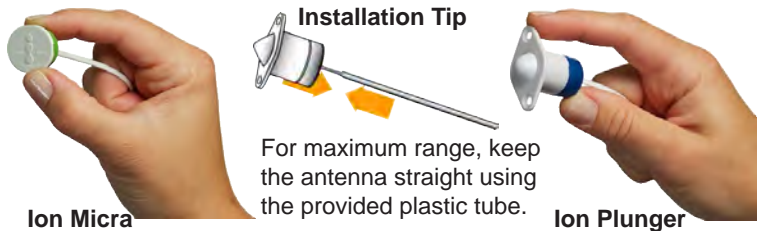

Installation Tip

For maximum range, keep the antenna straight using the provided plastic tube.

Ion Micra

Ion Plunger

Utilize the Existing AC smokes

Monitoring AC-powered smokes with a security system has always been a challenge. There is no UL or NEC approved way to tie AC smokes into a low voltage system. Now, using wireless transmitters, we have options we didn't have before. Now you can transmit to a central station without affecting the UL protection of the smokes. FireFighter monitors the existing UL smoke detectors and when an alarm is detected a wireless signal is sent to the control panel. The 2GIG SmokeRing mounts like an extra base to the smoke and ties into the interconnect wire.

ENCEC-FF345	Firefighter Smoke Detector sensor	CALL
2GIG-FF-345	Firefighter Smoke Detector sensor ( New)	36.25
2GIG-SDS1-345	Smoke Ring Detector and transmitter	32.20



PowerSeries  
**neo**

Expand  
your  
Horizons



Infused with industry-leading PowerG 2-way wireless communication, PowerSeries Neo's unique combination of trusted hybrid and wireless technologies provides a myriad of installation options.

Adaptable, highly secure PowerG wireless devices and peripherals can be installed in even the toughest locations – shaving hours off a job and significantly reducing complexity. Dealers benefit from decreased operational costs while providing a multitude of expansion possibilities for residential through to scalable commercial installations.

**Welcome to Security Redefined.**

[www.dsc.com](http://www.dsc.com)

©2015 Tyco Security Products

with  
**PowerG**  
Technology



**DSC**

From Tyco Security Products



## PowerSeries Neo Control Kits

PowerSeries Neo captures the flexibility of a modular, hardwired system with the simplicity of a wide range of wireless devices and peripherals, resulting in a ground-breakingly comprehensive and versatile hybrid system best suited for residential through to scalable commercial installations.

PowerSeries Neo is compatible with leading-edge interactive solutions supported by DSC, allowing for a variety of smart home control monitoring features. Anticipating future needs by infinite opportunities to maximize the system, PowerSeries Neo becomes an undisputed first-class investment for the long term of any business.

Four control panels ranging in capacity from 16 to 128 zones provide PowerSeries Neo with a reliable heartbeat to cater to a range of security system installations with even the most demanding partitioning requirements. These panels fully integrate with the extensive selection of PowerG-enabled devices which have been created with simplicity of installation and user-friendliness in mind. The bundled power of PowerSeries Neo is harnessed by distinctive software solutions, reminding you every step of the way that this isn't your typical security system.

DSCHS32119CP01	Contains one HS2032NK in a large cabinet, HS2LCDRF9ENG full message hardwired keypad with built-in PowerG transceiver, battery, transformer, and interior siren	233.14
DSCHS2016NKCP01	Neo HS2016 Control panel in a large cabinet. 6 zones expandable to 16.	52.90
DSCHS2032NKCP01	Neo HS2032 Control panel in a large cabinet. 8 zones, expandable to 32.	68.53
DSCHS2064NKCP01	Neo HS2064 Control panel in a large cabinet. 8 zones, expandable to 64.	89.03
DSCHS2128NKCP01	Neo HS2128 Control panel in a large cabinet. 8 zones, expandable to 128.	226.81



## PowerSeries Neo Keypads

DSCHS2TCHP*	PowerSeries Neo 7" TouchScreen (White or Black)	220.15
DSCHS2LCDENG	Full Message Hardwired Keypad	108.46
DSCHS2LCDP	Full Message Hardwired Keypad with Prox Support	116.11
DSCHS2LCDRF9ENG	Full Message Hardwired Keypad with Built-in PowerG Transceiver	134.38
DSCHS2LCDRFP9	Full Message Hardwired Keypad with Built-in PowerG Transceiver and Prox Support	142.02
DSCHS2ICNENG	ICON Hardwired Keypad	56.92
DSCHS2ICNP	ICON Hardwired Keypad with Prox Support	64.56
DSCHS2ICNRF9ENG	ICON Hardwired Keypad with Built-in PowerG Transceiver	78.09
DSCHS2LCDWF9ENG	Wireless Full Message LCD Keypad	123.83
DSCHS2LCDWFP9EN	Wireless Full Message LCD Keypad with Prox Support	145.23
DSCHS2LCDWFPV9	Wireless Full Message LCD Keypad with Prox Support and Voice Prompt	175.81
DSCMPT8PK	Mini Prox Tag (Sold in 8 Pack)	14.15



Full Message Keypad



DSCHS2TCHPWHT

## Neo PowerG Wireless

**PowerG Wireless will only function on a Neo panel with PowerG transceiver.**

DSCPG9938	Wireless PowerG Panic Key	38.84	DSCPG9985	Wireless PowerG Flood Detector	50.70
DSCPG9949	Wireless PowerG 2-button Key	26.13	DSCPG9984P	Wireless PowerG Dual Tech Motion	77.20
DSCPG9939	Wireless PowerG 4-button Key	29.79	DSCPG9994	Wireless PowerG Outdoor PIR Detector	185.29
DSCPG9929	Wireless PowerG In-line 4-button Key	38.58	DSCPG9922	Wireless PowerG Glass Break Detector	84.08
DSCPG9975	Wireless PowerG Vanish Door/Window	31.04	DSCPG9926	Wireless PowerG Smoke Detector	77.95
DSCPG9945	Wireless PowerG Door/Window with Input	29.35	DSCPG9916	Wireless PowerG Smoke & Heat Detector	73.85
DSCPG9904P	Wireless PowerG PIR Motion Detector	65.88	DSCPG9913	Wireless PowerG CO Detector	81.12
DSCPG9924	Wireless PowerG Curtain PIR Detector	50.96	DSCPG9905	Wireless PowerG Temperature Detector	50.96
DSCPG9911B	Wireless PowerG Outdoor Siren	123.29	DSCPG9901	Wireless PowerG Indoor Siren	58.32

**Wireless Range is estimated to be 1.25 miles open air**

## PowerSeries Neo Modules

DSCHSM2HOST9	PowerG Host Transceiver Module	87.50	DSCCD8080VZ	CDMA Alarm.com w/o Image Sensor	229.32
DSCPG9920	Wireless PowerG Repeater	104.45	DSCCD8080IVZ	CDMA Alarm.com supports Image Sensor	252.25
DSCHSM2108	Neo 8-Hardwired Zone Expander Module	31.97	DSC3G8080AT	AT&T Alarm.com w/o Image Sensor	229.32
DSCHSM2300	Neo Power Supply Module	56.52	DSC3G8080IAT	AT&T Alarm.com supports Image Sensor	252.25
DSCHSM2208	Neo 8 Output Module	34.50	DSC3G2080REUSA	C24 HSPA Cellular Alarm Communicator	194.92
DSCHSM2204	Neo High Current 4 Output Module	67.76	DSCTL2803GREUSA	Dual Path IP and C24 HSPA Communicator	245.37
			DSCTL280RE	Internet Alarm Communicator (3rd party)	118.48
			DSCPCL422	Communicator Remote Mounting Module	26.75

**Neo and Standard PowerSeries modules are not interchangeable.**



**DSC Touch with Alarm.com**

Uniquely based on Google's Android operating system and integrated with Alarm.com, DSC Touch employs Wi-Fi, Bluetooth and Z-Wave technology for a completely wire-free install and 'all-in-one' wireless communications. Built-in cellular radios enable DSC Touch to communicate with Alarm.com's cloud for home automation features and mobile applications (iOS and Android). Offering wireless connectivity, security, and home control all together through the easy-to-use interface, DSC Touch is the next generation in keypad, alarm, and home control technology for the connected home.

- 7-inch LCD resistive, single touch, 24bit RGB Touchscreen with 800 x 480 resolution
- 59 zones. Compatible with DSC 433Mhz one-way-wireless products (page 124)
- Dual-path connectivity with integrated WiFi and Cellular
- Wi-Fi, Z-Wave, Bluetooth and Image Sensor radio connectivity for smart home automation
- Up to 242 role-based user codes (Dealer, Installer, Master, User, Guest, Duress)
- Remote services powered by Alarm.com
- Built-in front 0.3MP Fixed Focus camera for system Disarm and Alarm photos
- Contact app provides contact info of security provider and displays messages.
- Software updates over WiFi and manually with a SD card
- Built-in siren
- Built-in two-way voice
- Photo frame screensaver
- SD card slot for photos



**ALARM.COM**



DSCKIT46794HAT	Alarm.com 310 kit with (1) WS4904P wireless pet immune motion detector, (3) WS4945 wireless door/window contacts. Xfrmer and Batt, <b>AT&amp;T communicator.</b>	415.07
DSCKIT46799VZ	Alarm.com 310 kit with (1) WS4904P wireless pet immune motion detector, (3) WS4945 wireless door/window contacts, Xfrmer and Batt, <b>Verizon communicator.</b>	415.07

**DSC Impassa with Alarm.com**

DSCSCW457AATNT	Alarm.com Impassa stand-alone unit with integrated 3G8055 AT&T cellular communicator with on-board Z-Wave exclusive to Alarm.com, Requires 16VDC transformer.	321.04
DSCSCW457AVZNT	Alarm.com Impassa stand-alone unit with integrated 3G8055 Verizon cellular communicator with on-board Z-Wave exclusive to Alarm.com. Requires 16VDC transformer.	321.04
DSCKIT45799AAT	Alarm.com 311 kit with (1) WS4904P wireless pet immune motion detector, (1) WT4939 wireless keyfob, (3) WS4945 wireless door/window contacts. Xfrmer and Batt, AT&T communicator.	458.63
DSCKIT45799AVZ	Alarm.com 311 kit with (1) WS4904P wireless pet immune motion detector, (1) WT4939 wireless keyfob, (3) WS4945 wireless door/window contacts, Xfrmer and Batt, Verizon communicator.	458.63



**ALARM.COM**





**The above controls and kits will not support the Alarm.com Image Sensor.  
If you ever intend to add an Image sensor, order kits below.**

**Impassa Alarm.com Kits with Image Sensor Support**

DSCKIT45799AIAT	Same as DSCKIT457-99AAT with the addition of an Alarm.com image sensor	626.80
DSCKIT45799AIVZ	Same as DSCSCW457AVZNT with the addition of an Alarm.com image sensor	626.80

**Impassa Products with TelGuard Home Control**

	<b>TELGUARD</b>	All kits include control/keypad, manuals, battery, RJ31X, and transformer		
	<b>IMPASSA Control</b>	DSCKIT45792	Impassa 92 3G-ready kit with (1) WS4904P wireless pet immune motion detector, (1) WT4939 wireless keyfob, (3) WS4955 wireless door/window contacts	298.11
		DSCKIT457-96H	Impassa 96H with integrated C24 HSPA (3G) communicator kit with (1) WS4904P wireless pet immune motion detector, (1) WT4939 wireless keyfob, (3) EVDW4975 vanishing contacts	420.41
		DSCKIT457-99H	Impassa 99H with integrated C24 HSPA (3G) communicator kit with (1) WS4904P wireless pet immune motion detector, (1) WT4939 wireless keyfob, (3) WS4945 door/window contacts	420.41
		DSCTL2553G	Redundant IP and HSPA (3G) wireless alarm communicator for the Impassa, C24 provider	236.24
		DSCTL2553G-TEL	Redundant IP and HSPA (3G) wireless alarm communicator for the Impassa, Telguard provider	233.90
		DSC3G2055-USA	HSPA (3G) wireless alarm communicator for the Impassa, C24 provider	185.29
		DSC3G2055-TEL	HSPA (3G) wireless alarm communicator for the Impassa, Telguard provider	183.45
		DSCSCW9057DMK	Desk stand for Impassa control	16.05

**CONNECT 24**  
From Your Security Products

**Two-Way Wireless Devices**

These devices are only supported by the DSC two-way Impassa and Powerseries 4.6 controls

DSCWT5500	Wire-free keypad	125.07
DSCWT5500D	Wire-free keypad with stand & transformer	142.05
DSCWT5500P	Wire-free keypad with proximity reader	148.23
DSCWT5500X	Transformer for WT5500 keypad	10.19
DSCWTK5504	Wire-free touchscreen	154.40
DSCWTK5504D	Wire-free touchscreen with stand	162.13
DSCWT4989	2-way wireless keyfob w/ icon display	41.69
DSCWT4901	Wireless indoor siren	55.58
DSCWT4911B	Wireless outdoor siren, blue lens	115.81
DSCWT4911R	Wireless outdoor siren, red lens	115.81



**DSCWTK5504**



**DSCWT4901**



**DSCWT4989**



**DSCWT5500**

Standard one-way wireless devices are listed on page 124

**PowerSeries Residential Control Kits**

Today's PowerSeries product family not only protects people, premises and possessions, but also provides unprecedented levels of convenience, comfort and control. DSC makes it easy for you to stay ahead of the technology curve with the easiest to sell, easiest to install and easiest to use security systems anywhere. There are 3 basic sizes available: 6 to 16 zone, 8 to 32 zone, and 8 to 64 zone capability. 16.5 Volt transformer sold separately.



**All kits below are in enclosure and include battery, RJ31X, and indoor siren. Transformer is sold separately.**

DSCKIT16120NT	PC1616SNK in enclosure, RFK5501 keypad w/ wireless receiver, LC100PI motion	134.84
DSCKIT3251NT	PC1832NK panel in enclosure, PK5500 full-message keypad	206.11
DSCKIT32POWER5N	PC1832NK panel in enclosure, PK5501 picture icon keypad, LC100PI motion	146.79
DSCKIT32-16CP01	PC1832 panel in enclosure, RFK5501 keypad with wireless receiver, LC100PI motion	149.95
DSCKIT32219NT	PC1832 panel in enclosure, RFK5500 keypad with wireless receiver, LC100PI motion	235.56
DSCPC1864NK	PC1864 panel in enclosure	89.09

**PowerSeries Keypads**

DSCPK5500	64-zone LCD full message keypad, input/output terminal, FAP keys, full 32-character phrases	98.02
DSCPK5501	64-zone LCD picture icon keypad, input/output terminal, Fire, Ambulance, Police keys	59.45
DSCRFK5500	Same as DSCPK5500, with integrated 32 zone RF receiver	146.07
DSCRFK5501	Same as DSCPK5501, with integrated 32 zone RF receiver	82.63
DSCRFK5564	Same as DSCPK5500, with integrated 64 zone RF receiver for PC1864 V4.6 or later	146.07



**DSCPK5500**



**DSCPTK5507**

**PowerSeries Touchscreen Security Interface**  
7" full color display, 800x480 resolution, slim modern design, intuitive LED indication of security system status, picture frame feature, clock feature, intuitive user interface, customizable home screen, customizable wallpaper, menu user programming, installer programming, virtual keypad, SD card, photos, compatible with PC1864, PC1832, PC1616 control panels, approvals: IC, FCC.

DSCPTK5507*	7" LCD Touchscreen for PowerSeries controls, customizable and intuitive (* White or Silver)	231.15
DSCWTK5504	2-way Wireless 4.3" Touchscreen Arming Station	154.40

**PowerSeries Modules**

DSCPC5108	8-hardwire zone expander; adds 8 zones and 125 mA aux power	37.07
DSCPC5100	Addressable zone expander; adds up to 32 addressable devices	36.92
DSCPC5200	Power supply module; 1 Amp	58.20
DSCPC5204	Power supply module; adds 4 programmable high-current outlets, rated at 1 Amp	72.94
DSCPC5208	Output module; adds 8 programmable low-current outputs	36.12
DSCESCORT5580TC	Telephone Interface, turns any touch tone phone into a talking keypad	102.49
DSCIT100	Data interface module; supports bi-directional RS232 commands for third party interface, use for Leviton Security & Automation Lumina integration, Control 4, and more.	53.51



**DSCIT100**



**DSCPC5108**

**Telguard HomeControl Connectivity**

Telguard HomeControl is the ideal platform to extend current service capabilities, both within and beyond the existing customer base. Telguard HomeControl has innovative, easy-to-use security devices that protect your customers while building loyalty and brand recognition. They ensure revenue growth in the ever-changing technology market. And with Telguard HomeControl's modular approach to home automation, dealers can upsell and offer upgrade devices year after year.

DSCIT230	RS-422 interface module for HomeControl Gateway, PowerSeries V4.5 or later	64.21
DSCASG10001T5NA	Interactive hub, compatible with Telguard Home Control Service and DSC PowerSeries v4.6	114.66
DSCC24-CAM54IR	HomeControl IP54 rated indoor/outdoor IR illuminated camera	180.57
DSCC24-CAMBRK	Bracket for DSCC24-CAM54IR	7.64
DSCC24-CAMANL	HomeControl analog camera adapter	114.66
DSCTBZ48D	Z-Wave Standard or Heat-pump Thermostat, 24VAC or battery-powered	145.23

**Approved Z-Wave Modules**

BD99140*	Kwikset Motorized Deadbolt with full 10-button keypad. See pages 20-21 for details.	177.61
YALD240ZW*	Yale Keyless Deadbolt with capacitive touchscreen. See pages 20-21 for details.	206.08
JAS45712	600W CFL/LED Dimmer, neutral required	33.76
JAS45709	In-Wall On/Off Switch, 15A	31.24



**Programming**

DSCPCLINK-SCW	Direct connect DB-9 cable	11.47
DSCPCLINK-USB	PCLINK-USB Local download kit	61.08

All programming software packages can be downloaded from the manufacturer's website after registration: [www.dsc.com](http://www.dsc.com)

**PowerSeries Modules and Communicators**

DSCTL300	T-Link Universal IP Alarm Communicator; compatible with ANY alarm panel that uses Contact ID format, reports to 2 different IP addresses, 4 programmable inputs. Reports to Central Station with Sur-Gard IP receiver.	193.01
DSCTL300CF	Commercial Fire Approved T-Link Universal IP Alarm Communicator; compatible with ANY alarm panel that uses Contact ID format, reports to 2 different IP addresses, 4 programmable inputs. Reports to Central Station with Sur-Gard IP receiver.	397.33
DSCTLINKTL250	T-Link Internet Alarm Communicator; supports PowerSeries and Maxsys control panels, supports DHCP, download control panel programming over the internet, reports to 2 different IP addresses with Sur-Gard IP receiver	193.01
DSCTL260R-NA	T-Link Internet/Intranet Alarm Communicator; supports PowerSeries V4.1 or higher control panels, remote uploading and downloading, interface for C24 hub	108.09
DSC3G2060R-USA	HSPA (3G) Cellular Alarm Communicator for PowerSeries controls, supports PowerSeries V4.1 or higher control panels, remote uploading and downloading, interface for C24 hub	192.62
DSCTL2603GR-USA	Fully redundant Internet and HSPA dual-path alarm communicator, supports PowerSeries V4.1 or higher control panels, remote uploading and downloading, interface for C24 hub	236.24
DSC3G4000USA	HSPA Universal Cellular Alarm Communicator, works on ANY control panel using Contact ID via CONNECT24™ to a Central Station Sur-Gard IP receiver	123.83
DSC3G4010USA	HSPA Universal Cellular Alarm Communicator, works on ANY control panel using Contact ID direct to any central station using Sur-Gard system	160.52
DSC3G4010CFUSA	Commercial Fire Approved HSPA Fire Alarm communicator. Works on ANY fire panel using Contact ID direct to central station using Sur-Gard system. Approved for commercial fire applications.	305.76
DSC3G4010UPG	3G3070 Alarm HSPA Upgrade Kit	82.43



**DSCTL300**



**DSCTL300CF**



**DSC3G4010CFUSA**

**PowerSeries Wireless Receivers**

DSCTR5164433	Wireless two-way receiver for PowerSeries control, supports 64 wireless zones and 16 wireless keys, ver 4.6 or later	88.29
DSCRF5132-433	Wireless receiver for PowerSeries control, supports 32 wireless zones and 16 wireless keys	59.10
DSCRF5108433	Low-cost alternative when only a few zones are needed. Supports 8 detectors, 8 wireless keys, and 2 wireless outputs.	54.78
DSCPC5320	Connect up to 4 wireless receivers for increased coverage, for PowerSeries	60.20
DSCRXL2433	Universal wireless relay module, 2 on-board relays, can be independent of security system for access and light control	43.23

DSC PowerSeries panels with firmware of 4.6, and with the DSCTR5164433 receiver, can now support wire-free keypads and other 2-way wireless devices (not sirens). See page 122 for 2-way devices. If you need a wireless siren, please call Worthington technical support for assistance.

**Wireless Devices for all Versions of DSC Controls**



**DSCWS4916**



**DSCWS4965**



**DSCWS4904P**



**DSCWS4985**



**DSCEVDW4917**



**DSCEVDW4975**



**DSCWLS912L433**



**DSCWS4939**

DSCWS4913	Wireless carbon monoxide detector	76.43
DSCWS4904P	Wireless PIR (85 lb pet-immune)	77.20
DSCWS4965	Tri-Zone wireless door/window contact	35.43
DSCEVDW4917	Wireless recessed door transmitter	39.37
DSCEVDW4975	Vanishing wireless door contact	26.50
DSCWS4945	Wireless door/window contact N/C	26.50
DSCWS4945N	Wireless door/window contact N/O	31.65
DSCWS4985	Wireless flood detector	46.33

DSCWS4936	Wireless smoke/heat	60.79
DSCWLS912L433	Wireless glassbreak	67.12
DSCEVDW4927SS	Wireless shock sensor with contact	44.71
DSCWS4938	1-button personal panic	36.22
DSCWS4949	2-button wireless keyfob	23.62
DSCWS4939	4-button wireless keyfob	31.26
DSCWS4959	12-button wireless keyfob	32.52

**DSC compatible wireless devices manufactured by other vendors can be found on pages 125 & 128**





**Hardwired Photoelectric Smoke Detectors**



**FSA Series Smokes**

**TECHNICAL NOTE:**

The proper installation of a 4-wire smoke detector system includes an end-of-line relay to supervise the power lines of the smokes. If you use smokes with sounders, you also need a polarity-reversing relay to cause all sounders to trigger when the alarm occurs.

DSCFSA210B	2-wire, basic smoke	29.26
DSCFSA210BT	2-wire with heat sensor	30.09
DSCFSA210BST	2-wire w/ heat sensor and 85 dB sounder	26.95
DSCFSA410B	4-wire, basic smoke	30.80
DSCFSA410BT	4-wire with heat sensor	30.80
DSCFSA410BS	4-wire with 85 dB sounder	33.90
DSCFSA410BST	4-wire w/ heat sensor and 85 dB sounder	26.95

**Fire Alarm Necessities**

DSCPRM2W	Polarity reversal module, for use with 2-wire smoke detectors, will convert 2-wire smokes to 4-wire, need 1 per zone	23.62
DSCPRM2WC	Polarity reversal module, same as above, in plastic case	28.83
DSCPRM4W	Polarity reversal module, for use with 4-wire smoke detectors	19.68
DSCPRM4WC	Polarity reversal module, same as above, in plastic case	28.83
DSCRM2	EOL power supervisory relay, 4-wire smoke circuit supervision	15.29

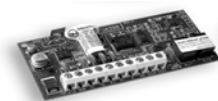

**DSCPRM4W**

**DSC Motion Detectors**

DSCLC120PI	Digital PIR detector with 55 lb. pet immunity	22.13
DSCBV500	Ceiling-mount 360 degree PIR	27.85
DSCBV501GB	Ceiling-mount 360 degree PIR with built-in glassbreak	46.06
DSCBV600	Dual-element, pet-immune PIR	25.87
DSCLC100PI6P	Quad linear technology, pet-immune	52.70
DSCLC103PIMSK	Dual tech, PIR/microwave, pet-immune 55 lb, anti-masking	59.19
DSCLC104PIMWW	Dual tech, PIR/microwave, pet-immune 55 lb, quad linear technology	44.78
DSCLC151	Outdoor dual tech PIR/microwave with adjustable pet immunity	77.20
DSCLC171	Outdoor dual tech double PIR/microwave with adjustable pet immunity	120.44



**DSCBV500**



**DSCLC151**



**DSCLC100PI6P**



**DSCLC103PIMSK**



**DSCBV600**



**DSCLC171**

**Sirens**

DSCSD15W	15W Dual Tone Surface Mount Siren, 12VDC	3.82
DSCSD30W	30W Dual Tone Surface Mount Siren, 12VDC	7.64



**DSC Glass Breakage Devices**



**DSCAC500**



**DSCAC100**



**DSCAFT100**

DSCAC100	Wall-mount, up to 25', jumper-selected sensitivity	27.02
DSCAC500	Ceiling-mount, up to 25' away	35.51
DSCAFT100	Glassbreak simulator; the accurate way to test your glassbreaks	101.06

*Sirens and Low Current Sounders*



**Piezo Sirens**

ATWSGST-W	Piezo siren, single-gang flush, indoor, 105dB, 20mA	8.74
ATWBULLDOG	Piezo siren, surface-mount, indoor/outdoor, 105dB, 110mA	8.99
ATWBLOODHOUND	Piezo siren, 1-gang box mount, indoor/outdoor, 104dB, 90mA	8.99
ATWDOBERMANPLUS	Piezo siren with strobe, surface-mount, outdoor, 104dB, 180mA	17.36
ATWPC-300	Multi-tone piezo chime, single-gang, flush, 3-tone, 80 dB	15.36



**ATWBULLDOG**



**ATWSGST**

**Sirens (built-in driver)**

ATWDS-50	5" dual tone 15W siren	6.00
ATWDS-406	4" x 6" dual tone 25W siren	11.74
ATWDS-301SET	Siren in stainless steel enclosure with tampers, 25W	33.41



**ATWDS-406**



**ATWDOBERMANPLUS**

**8 Ohm Siren Speakers (driver separate)**

ATWFK-56	Flush-mount 15W speaker	6.87
ATWH-508	Speaker horn, 30W peak	11.49
ATWSTL-1*	Strobe for DS-301SET or H-301SET (*amber, blue, clear, red)	9.74

**Hardwire Detectors for any Security System**

**Micro PIR**

Some of the smallest PIRs in the industry. The Clip PIR is 2-3/4" tall and 1-1/4" wide. The Spy PIR recesses into a 7/8" hole and is 2-3/4" wide.

VISCLIP-1	Micro PIR, wide angle, 30' x 40'	32.25
VISCLIP-4N	Micro PIR, 12' solid curtain	32.25
VISSPY-1	Micro PIR, flush-mount, 35' long range	46.66
VISSPY-2	Micro PIR, flush-mount, 25' 50°	46.66
VISSPY-3	Micro PIR, flush-mount, 25' 100°	46.66
VISSPY-4	Micro PIR, flush-mount, 12' solid curtain	46.66
VISSPY-RTE-B	Micro PIR, for access, contact output	47.30



**VISDISC**



**VISSPY FAMILY**



**VISCLIP-1**

**Motion Detectors**

VISDISC	Small 360° ceiling-mount, 36" at 12' height	31.37
VISDUO240E	Small dual-tech PIR, digital, ceiling-mount	55.11
VISNEXTDUOK985	Dual tech, 80lb pet immune w/ TSI, 40'	38.36
VISMR-4000	Flush-mount in 1-gang box, 45' x 45'	45.98
VISK940-UL	Pet immune 40lb, 30' x 30'	12.79
VISNEXTK985	Pet Immune 85lb, 50' x 50'	19.71
VISDUO200E	Small digital dual PIR 40' x 40'	37.86



**VISSPY-RTE-A**

**VISMR-4000**

**VISDL-125C**

**Specialty Devices**

VISDA-5	Request-to-exit PIR detector	43.78
VISDL-125C	Voice dialer, 12VDC power supply not included	92.09
VISSPY-RTE-A	Micro PIR, flush-mount, 12' solid curtain request-to-exit	47.30

While the best solution for security monitoring is still a central station, many homeowners are requesting that their security systems call their cell phones, either as a primary or secondary notification. The DL-125C is an automatic programmable speech dialer with two alarm inputs designed for verbal reporting of two separate events.

*Alternative Wireless Contacts*



Ion Security was formed with the purpose of creating new, innovative wireless products for the residential and commercial security markets. The products below are examples of new styles of transmitters. They are compatible with the GE, 2GIG, Omni, and DSC wireless receivers and have an expected range of 500 feet. Please specify which receiver you are working with.



**IONMICRA-G**

**IONPLUNGER-G**

IONMICRA-HA	Omni compatible concealed wireless window sensor, 1/2" deep, 3/4" wide, low profile magnet	24.98
IONPLUNGER-HA	Omni compatible concealed wireless door sensor, 1" deep, 3/4" wide	24.98
IONMICRA-2G	2GIG compatible concealed wireless window sensor, 1/2" deep, 3/4" wide, low profile magnet	24.98
IONPLUNGER-2G	2GIG compatible concealed wireless door sensor, 1" deep, 3/4" wide	24.98
IONMICRA-G	GE/Qolsys compatible concealed wireless window sensor, 1/2" deep, 3/4" wide, low profile magnet	24.98
IONPLUNGER-G	GE/Qolsys compatible concealed wireless door sensor, 1" deep, 3/4" wide	24.98
IONMICRA-D	DSC compatible concealed wireless window sensor, 1/2" deep, 3/4" wide, low profile magnet	24.98
IONPLUNGER-D	DSC compatible concealed wireless door sensor, 1" deep, 3/4" wide	24.98
IONFDB75	3/4" Forstner drill bit for drilling perfect holes	6.24

*Specialty Motion Detectors*



OXXK-08	Ceiling-mount residential pet tolerant PIR, 25ft. x 25ft.	33.72
OXLX402	Outdoor PIR motion detector, double shielded, form C relay output	78.69
OXBX80N	80' x 3' outdoor narrow PIR, protects perimeter windows/doors, NO/NC relay	132.39
OXHX40	High-mount outdoor motion detector, 10' high, 40' range	151.13
OXFTNST	Compact outdoor dual detector for windows, doors, balconies, etc.	84.93



**OXLX402**



**OXHX40**

Many detectors are also available in a battery-powered version that can be added to any wireless system with a transmitter.

**Photoelectric Beam Detectors**

OXAX100TF	100' outdoor photoelectric beam, quick optical alignment, NO or NC relay	199.84
OXAX200TFR	200' wireless outdoor photoelectric beam	517.09
OXBX100PLUS	BoundaryGard 100' outdoor photobeam for multiple windows/doors, NO/NC relay	137.39



**OXAX200TFR**



**OXBX100PLUS**

Other beam detectors available from Optex through Worthington Distribution. Call for details.

TELTG1LAX01	TG-1 Express LTE-A, Primary Residential Alarm Communicator for AT&T LTE Network	138.64
TELTG1VX003	TG-1 Express Verizon, Primary Residential Alarm Communicator for Verizon Network	132.39
TELTG1LA001B	TG-1B LTE-A Primary and Back-up Residential Cellular Only Alarm Communicator	158.62

TG-1 Express has been tested successfully on a Leviton Omni Controller.



**TG1 Express**



Universal Alarm Transceivers

NAPSLECDMA-Z	StarLink Connect™ Universal Cell communicator with Z-Wave - Verizon	149.83
NAPSLECDMA	StarLink™ Up/Downloadable Verizon Universal Alarm Communicator	99.87
NAPSLEGSM34G	StarLink™ Up/Downloadable GSM 3G / 4G Universal Alarm Communicator	99.87
NAPSLEANTEXT	High quality remote antenna with 15 feet of high performance low-loss coaxial cable	68.15
NAPSLECDMAFIRE	Sole Path Fire Alarm Cellular Communicator (Red), Verizon	129.83
NAPSLEGSMFIRE	Sole Path Fire Alarm Cellular Communicator (Red), ATT GSM	149.83
NAPSLEANTEXT	High quality remote antenna, 15 ft Coax, bracket	68.15

Starlink CDMA has been tested successfully on a Leviton Omni Controller.



**NAPSLECDMAFIRE**



Universal Alarm Transceivers

DSCTL300	T-Link Universal IP Alarm Communicator; compatible with ANY alarm panel that uses Contact ID format	193.01
DSCTL300CF	Commercial Fire Approved T-Link Universal IP Alarm Communicator; compatible with ANY alarm panel that uses Contact ID format	397.33
DSC3G4000USA	HSPA Universal Cellular Alarm Communicator, works on ANY control panel using Contact ID via CONNECT24™	123.83
DSC3G4010USA	HSPA Universal Cellular Alarm Communicator, works on ANY control panel using Contact ID direct to any central station using Sur-Gard system	160.52
DSC3G4010CFUSA	Commercial Fire Approved HSPA Fire Alarm Communicator. Works on ANY fire panel using Contact ID direct to central station using Sur-Gard system. Approved for commercial fire applications.	305.76



Universal Alarm Transceivers

IPD-CAT-CDMA	Universal cellular-only alarm transceiver, keypad emulator for GE, Honeywell, and DSC	114.91
IPD-BAT-CDMA	Hardwired broadband alarm transceiver with cellular backup	149.82
IPDBATCDMAWIFI	Wi-Fi alarm transceiver with cellular backup	173.55
IPD-BAT-WIFI	Wi-Fi Broadband alarm transceiver - Compatible with DSC, GE, and Honeywell	102.42
IPD-BAT-CDMA	Hardwired Broadband alarm transceiver - Only for DSC, GE, and Honeywell	149.82
IPD-BAT-CU-ANT	CDMA Cellular Antenna	4.93



**IPDatatel works with most alarm panels. However, it will not support the Leviton Omni Controller**



Universal Cellular Booster

Wilson Electronics cell signal boosters are perfect for GSM installations with weak signal strength inside the home. The kit places an antenna outside to capture the signal and repeats the cell connection in the home. As an added benefit, it improves your customer's standard cell connections as well! This model will work with all US carriers. Installation is simple. Just mount the outdoor antenna and run coax from the antenna to the indoor unit, mounted central to the structure. No programming or configuration is necessary.

WIX470103	Connect 4G 5-band Amplifier Kit - Boosts 4G LTE & 3G signals for the entire home, up to 5000 sq ft	431.99
WIX471104	Connect 4G-X is the most powerful consumer signal booster sold, boosting 4G LTE and below for all North American carriers. 7500 sq ft	853.84

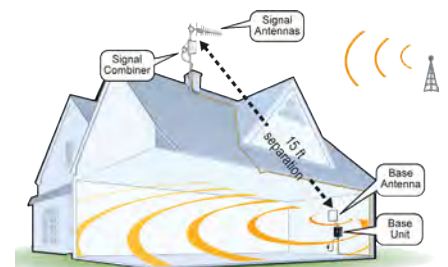



# Open to Anything!



## 2GIG Vario System. Hybrid Wireless/Wired Security. For Commercial and Residential.

We believe that the best devices have no limits. That's why we've left the 2GIG Vario Panel open. Open to all applications. Open to all types of customers. Open to all accessories. Vario Hybrid Wires/Wireless Security & Control Solution meets the needs of both the residential and the commercial customers.



 **2GIG.**  
**VARIO**

Visit [2GIG.com](http://2GIG.com) for more information on the latest Smart devices with features your customers will love.

Resolution Products offers an array of common usage and specialty wireless security devices. Most notable are their takeover translators. Now you can replace that "other guy's" control panel without needing to replace all the wireless devices in the house. They also carry repeaters and other devices compatible with major wireless security panels.

### Universal Takeover Translators

#### Wireless Takeover Translator / Repeater

- Enrolls up to 63 devices, with unique ID for each
- Translates each sensor's alarm, supervisory and trouble signals
- Rechargeable back-up battery (included)
- External 12VDC power supply required (now included)
- Dual antennas for Receive/Transmit diversity ensure reliable range
- Separate ID for supervision of translator's tamper, power supply and battery
- Field configurable RF settings for both sensor and panel format
- Can operate as a repeater by setting the "Panel" and "Sensor" formats to the same manufacturer settings.

RESRE508X	Universal Hardwire Takeover Hardwire to 2GIG, Honeywell, Interlogix or Napco	71.19
RESRE524X	Universal Wireless Takeover/Repeater. Convert between 2GIG, Honeywell, Interlogix or Napco. Will also repeat same signal.	71.19

#### Hardwire Takeover Translator

- 8 Hardwire loops with automatic end-of-line resistor detection
- Unique wireless ID (or loop) for each zone
- Unique wireless ID for the device itself
- Transmit diversity for long reliable range
- External 12VDC power supply (now included)
- Rechargeable back-up battery (now included)
- Device low battery detect and device tamper detect
- Field configurable RF settings



### Alternative Wireless Security Devices

#### NanoMax Features

- Full FCC Transmit power for maximum range
- External Contact Support
- Cover Tamper
- 1" Magnet Gap
- 6-year battery life

**RESRE122**  
**RESRE222T**  
**RESRE322**



#### Wireless Smoke



**RESRE112**  
**RESRE212T**  
**RESRE212**

#### Interlogix/Qolsys Compatible

RESRE100	4-button Keyfob	16.24
RESRE101	Door/Window, also supports external	21.23
RESRE103	Panic, Wrist Band	18.74
RESRE104	Driveway Sensor	94.92
RESRE106	Tilt Sensor, great for garage doors	24.98
RESRE110P	PIR, Pet Immune to 85lb, 40 ft range	49.96
RESRE112	Photoelectric Smoke	53.71
RESRE113	Wireless CO Detector	59.95
RESRE118	Trident Leak and Temp Sensor	31.22
RESRE119	Home Disaster Transmitter	41.22
RESRE122	NanoMax Door/Window, supports external	23.11
RESRE151	Hidden Panic	24.98
RESRE152	Pinpad Keyfob, Remote keypad	41.22

#### 2GIG/Honeywell Compatible

RESRE200RW	2GIG/Honeywell 4-button Keyfob	16.24
RESRE201	Honeywell Door/Window, supports external	21.23
RESRE201T	2GIG-only Door/Window, supports external	16.24
RESRE203	2GIG/Honeywell Panic, Wrist Band	18.74
RESRE204	2GIG/Honeywell Driveway Sensor	94.92
RESRE206	2GIG/Honeywell Tilt Sensor	24.98
RESRE210P	2GIG/Honeywell PIR, Pet Immune to 85lb	49.96
RESRE212	Honeywell Compatible Photoelectric Smoke	53.71
RESRE212T	2GIG-only Compatible Photoelectric Smoke	53.71
RESRE213	Honeywell Compatible Carbon Monoxide	59.95
RESRE213T	2GIG-only Compatible Carbon Monoxide	59.95
RESRE218	Honeywell Trident Leak and Temp Sensor	31.22
RESRE219	Home Disaster Transmitter	41.22
RESRE222	Honeywell Compatible NanoMax	23.11
RESRE222T	2GIG-only Compatible NanoMax	17.49
RESRE252T	2GIG-only Compatible Pinpad	41.22

#### Universal Wireless Siren

RESRE116-U	Wireless Universal Siren with Transmitter	79.94
RESRE116	Wireless Siren only	67.45

#### Motion Detector

- Up to 85 pound Pet-immune
- 44 foot range
- Walk test LED
- External contact
- 6-8 year battery life
- Low Battery indication
- Strong, reliable RF signal
- 2.5 x 4.5 x 2 inches



**RESRE110P**  
**RESRE210P**  
**RESRE310P**

#### Temperature Sensor

- 3 loops:
- Below 40° **RESRE118**
- Water Sensor **RESRE218**
- Above 100° **RESRE318**



#### RESRE116-U



#### Wireless Sounder

- Two piece sounder system compatible with any panel with siren terminals
- Siren can be set high or low and follows the siren pattern
- Siren unit plugs into an AC outlet and has battery backup

#### Vehicle Detector

- 15' radius
- Only detects metal moving
- 3-5 years on 2 C Batteries



**RESRE104**  
**RESRE204**  
**RESRE304**

#### Wireless Pinpad

- A secure keyfob which requires a code for disarm
- 1-button arming
- 4-6 year battery

**RESRE152**  
**RESRE252T**



**RESRE119**  
**RESRE219**  
**RESRE319**

#### Disaster Sensor, 3 sensors in one

- Temp sensor triggers below 40°
- Remote Titanium Probe makes installation easy and resists corrosion
- Can report temps over 100°



#### DSC Compatible

RESRE300	4-button Keyfob	16.24
RESRE301	Door/Window	21.23
RESRE304	Driveway Sensor	94.92
RESRE306	Tilt Sensor	24.98
RESRE310P	PIR, Pet Immune to 85lb, 40 ft range	49.96
RESRE318	Trident Leak and Temp Sensor	31.22
RESRE319	Home Disaster Transmitter	41.22
RESRE322	DSC Compatible NanoMax	23.11





**Firewolf Fire Alarm and Integrated Fire/Burg Kits**

Scalable 32 to 255 points of addressable, conventional, and/or commercial wireless. UL864, 9th Edition. Pre-isolated Fire & Burg bus, separate, generous power supplies & separate service loops. More value out of the box with easy-to-use, menu-driven keypads. Cellular and internet reporting options are coming soon. Familiar Napco software. In housing battery capacity up to 32Ah. Dual line DACT, 4 Amps NAC.

NAPGEMCFW32CNVK	GEM-C 32 Zone Conventional Commercial Fire Alarm Panel Kit, includes: - Small 14x16 Mercantile Grade Red Enclosure - GEMC-PS24V4A-R 4Amp, 24V Power Supply - GEMC-F8ZCPIM Conventional 8-zone 2-wire Fire Input Module - GEMC-FK1 Red LCD Fire Keypad/Remote Annunciator	360.41
NAPGEMCFW32KT	GEM-C 32 Zone Commercial Fire Alarm Panel Kit, includes: - Small 14x16 Mercantile Grade Red Enclosure - GEMC-PS24V4A-R 4Amp, 24V Power Supply - GEMC-FW-SLC 32 Point Addressable Fire SLC Module - GEMC-FK1 Red LCD Fire Keypad/ Remote Annunciator	384.77
NAPGEMCCOMBO32K	GEM-C 32 Zone Commercial Combo Fire/Burg Alarm Panel Kit, includes: - Large 14x25 Mercantile Grade Red Enclosure - GEMC-PS24V4A-R 4Amp, 24V Power Supply - GEMC-BM/PS Burg Module with Power Supply - GEMC-FW-SLC 32 Point Addressable Fire SLC Module - GEMC-FK1 Red LCD Fire Keypad/Remote Annunciator	389.64
NAPGEMCCOMBO128	GEM-C 128 Zone Commercial Combo Fire/Burg Alarm Panel Kit, includes: - Large 14x25 Mercantile Grade Red Enclosure - GEMC-PS24V7A-R 7Amp, 24V Power Supply - GEMC-BM/PS Burg Module with Power Supply - GEMC-FW-SLC 128 Point Addressable Fire SLC Module - GEMC-FK1 Red LCD Fire Keypad/Remote Annunciator	672.16



**Firewolf Panel with Keypad**

**Modules for GEMC Panels**

NAPGEMCFK1	LCD Fire Keypad for GEM-C Combo System, Red	131.47
NAPGEMCF8ZCPIM	Conventional 8-zone 2-wire fire input module. Plugs into GEM-C Motherboard to provide support for conventional 2-wire smoke/fire detection device.	48.66
NAPGEMCFWSLC	Addressable SLC Fire Module, supports up to 128 addressable SLC Fire devices. Connects to the GEM-C control panel (2 max).	146.08
NAPGEMCBK1	LCD Burg Keypad for GEM-C Combo System, Requires GEM-C-BM/PS module.	97.37
NAPGEMCBMPS	Burg Module, with power supply, provides isolated 4-wire burg bus for burg keypads and devices, plus 12V power output.	77.89
NAPGEMCBSLC	Addressable SLC Burg Module, supports up to 128 addressable SLC burg devices. Connects to the GEM-C control panel (2 max).	146.08
NAPGEMCRECV	Commercial Fire and Burg UL-approved wireless receiver, max of (4) receivers.	121.73
NAPGEMCCOMOD	Module generates the required 4-pulse cadence for carbon monoxide.	16.51



**NAPGEMCFK1**

**NAPGEMCBK1**



**NAPFWCFSLCSMK  
NAPFWCFSLCSMK6B**

**UL Commercial-rated wireless burglary and fire devices are available. See Page 131**

**Addressable Analog SLC Fire Devices**

NAPFWCFSLCPULL	Addressable SLC Fire Pull Station	63.70
NAPFWCFSLCSMK6B	Base required for FWCFSLCSMK and FWCFSLCHEAT devices	4.68
NAPFWCFSLCSMK	Addressable Analog SLC Photoelectric Smoke Detector	43.72
NAPFWCFSLCHEAT	Addressable Analog SLC Heat Detector 135°F fixed temperature	41.22
NAPFWCFSLCPRG2	Programmer needed for programming address into SLC devices Note: Auto-configure from panel can be used to program smokes and heats	137.32
NAPFWCFSLCDUCT	Addressable Analog SLC Photoelectric Duct Smoke Detector	123.65
NAPFWCFSLCDUCTR	Remote annunciator plate for FWCFSLCDUCT detector. Test / Reset.	58.40
NAPGEMC24VR	Add On 24V Regulator, required for FWCFSLCDUCT	38.92

**Addressable Analog SLC Burglary Devices**

NAPGEMCBSLC1PT	Burg Device - 1 Point Input Module	11.67
NAPGEMCBSLCDT	Burg Device - Dual Tech Motion Detector, PIR and Microwave, Range 40'x40'	72.04
NAPGEMCBSLCPIR	Burg Device - PIR Motion Detector, Range 50'x50'	97.37
NAPGEMCBSLCGB	Burg Device - Acoustic Glass Break Sensor, Max Range 25'	97.37





### Residential Burglary System Kits

NAP816PERFPAK	GEM-P816 panel, RP3DGTL keypad, and transformer	107.70
NAP816PREMPAK	GEM-P816 panel, GEM-RP1CAE2 keypad, and transformer	160.61
NAPGEMK120PAK	GEM-P1632 panel, GEM-K4RF keypad with RF receiver, PIR1680PT, siren, transformer & battery	116.41
NAPK1632INTROPK	GEM-P1632 panel in large enclosure, GEMK1CA keypad, and transformer	163.92
NAPGEMP1632INTR	GEM-P1632 panel and GEMRP1CAE2 keypad	163.92
NAPGEM1632DK1WL	310 Kit: GEM-P1632 panel, GEM-D1CA keypad, RECV-32, (3) TRANS-LP, & PET-PIR	292.22
NAPGEMP1664DK1P	GEM-P1664 panel in large enclosure, GEM-D1CA keypad and transformer	165.31
NAPGEMP1664VSP	GEM-P1664 panel in large enclosure, GEM-K1VPS (built-in voice prompts, PIR, and siren) & xformer	185.96



### Gemini Controller Quick Chart

(Control panel in enclosure only, Needs transformer, battery & keypad)

Part Number	On-board Zones	Maximum Total Zones	Maximum Wired Zones	Maximum Wireless Zones	Maximum Fire Zones	2-wire Fire Zones	Price
NAPGEMP816	8	16	16	16	16	2	69.57
NAPGEMP1632	8	32	32	32	32	2	84.32
NAPGEMP1664	8	64	64	64	64	2	88.57
NAPGEMP3200	8	48	32	48	32	2	130.88
NAPGEMP9600	8	96	96	96	96	8	253.50
NAPGEMX255	8	255	255	255	255	8	339.90

Commercial Burglary versions in mercantile-rated enclosures of the NAPGEM3200, NAPGEM9600, and NAPGEMX255 available. Call for information.

### Gemini Keypads

NAPGEMEZM8	8-zone Expander for all Gemini panels GEM-P816 and above	65.35
NAPGEMDK1CA	Blue backlit 2-line custom LCD keypad with door, 4-zone expander	112.11
NAPGEMRP1CAE2	Green backlit 2-line custom LCD keypad with 4-zone expander, interior/instant keys	109.96
NAPGEMK1CA	Green backlit 2-line custom LCD keypad with 4-zone expander, stay/away keys	109.37
NAPGEMK1VPS	Blue backlit 2-line custom LCD keypad with natural voice prompts, integral PIR, siren and 4-zone expander	135.62
NAPGEMK2AS	Green backlit fixed English LCD keypad, stay/away keys	66.05
NAPGEMRP2ASE2	Green backlit fixed English LCD keypad, interior/instant keys	66.07
NAPGEMK3DGTL	Digital display red LED keypad	52.78
NAPGEMBIOREADER	Indoor/outdoor digital keypad with advanced optical biometric fingerprint reader	247.24
NAPIREMOTEMOD12	iRemote Control Internet Module provides remote Gemini Virtual Keypad, 12 months free service (no Z-Wave). Service starts @ \$2.50 per month	146.86
NAPIBRZREMOTE	Z-Wave™ Remote Control Module for home control, includes 12 months free service Integration with Control4 & Savant, plus Z-Wave. Service starts @ \$2.50 per month	165.57
NAPIBRWIFIMOD	Needed for local iBridge system control, in cases where remote access will not be required	97.37
NAPISEEWLAP	Wireless access point, 802.11B/G/N, with power for wireless touchscreens and IP cameras	63.27
NAPIBRITABHW	Hardwired iBridge Touchscreen Tablet	272.73
NAPIBRITAB	iBridge Wireless Touchscreen Tablet with magnetic mounting frame	292.22
NAPIBRITABKIT	iBridge Wireless Touchscreen Tablet with mounting frame, charging station plus ISSEEWLAP	350.67
NAPIBRITABSTAND	Angled tabletop stand/docking station for use with IBR-ITABKIT Touchscreen (not included)	29.18



**NAPGEMRP1CAE2**



**NAPGEMK1VPS**



**NAPIBRITAB**



**NAPGEMBIOREADER**



**NAPISEEWLAP**



**NAPIBRZREMOTE**



**NAPSLEGS34G**

### Cellular and Other Panel Modules

NAPSLECDMA-Z	StarLink Connect™ Universal Cell communicator with Z-Wave - Verizon	149.83
NAPSLECDMA	StarLink™ Up/Downloadable Verizon Universal alarm communicator	99.87
NAPSLEGS34G	StarLink™ Up/Downloadable GSM 3G / 4G Universal alarm communicator	99.87
NAPSLEDLCLBL	Optional, allows up/downloading of Napco Gemini series panel (GEM-P816, P1632, P1664, P3200, P9600 & X255)	3.85
NAPSLEGS8D34G	StarLink™ Up/Downloadable GSM 3G / 4G alarm communicator for Express, GEM-P800 and GEM-P801 series panels	106.86
NAPSLEANTEXT	High quality remote antenna with 15 feet of high performance low-loss coaxial cable	68.15
NAPPCIMINIUSB	High speed serial local PC download interface with USB	64.14

**Hardwired Motion Detectors**

NAPC100STE	Adaptive slimline PIR 30' x 35' range	20.66
NAPC100STE20	20' economy adaptive dual-tech motion, 20' range	19.56
NAPC100STEAM	Antimask with lookdown 50' x 40' range	21.81
NAPC100STLRE	Adaptive slimline PIR 30' x 35' range	25.27
NAPC200AP	Dual Tech microwave/PIR with pet immunity up to 100lb, 40' x 40' range	25.27
NAPP1510	Economical PIR with look-down, 30' x 30'	12.13
NAPP1680PT	Microprocessor PIR with 65lb pet immunity, 50' x 50' range	19.96
NAPIQPROFILER	"Self-Installing" PIR with 50lb pet immunity, 50' x 50' range	22.28
NAPIQVISION	PIR with 30lb pet immunity, 40' x 40' range	17.05
NAPM7300STE	Commercial adaptive microwave/PIR motion detector, 70' x 60' range	93.38



**Wired UL Life Safety Devices**

NAPFW2	2-wire photoelectric smoke detector	30.26
NAPFW2H	2-wire photoelectric smoke with heat detector	33.96
NAPFW2S	2-wire photoelectric smoke detector with sounder	29.18
NAPFWRM1	Reversing relay module, for interconnected sounders	20.41
NAPFW4	4-wire photoelectric smoke detector	37.64
NAPFW4H	4-wire photoelectric smoke detector with heat	41.27
NAPFT2200	Fire EOL relay module & 2.2k resistor module	10.93
NAPFT279	Fire EOL relay module & resistor module	12.44



**Wireless Security Devices**

NAPGEMTRANS2	Wireless door/window transmitter with remote sensor input	36.30
NAPGEMTRANSLP	Wireless low profile door/window transmitter with remote sensor input, white	32.74
NAPGEMTRANSLPBN	Wireless low profile door/window transmitter with remote sensor input, brown	32.74
NAPGEMRTRANS	Wireless recessed door/window transmitter	40.69
NAPGEMPIRPET	Wireless 50' x 50' PIR with 40lb pet immunity	97.08
NAPGEMPIR	Wireless 50' x 50' PIR	92.53
NAPGEMDT	Wireless adaptive Microwave/PIR sensor, 40' x 40' range	112.35
NAPGEMKEYF	Wireless 4-button keyfob transmitter	40.78
NAPGEMSMK	Wireless photoelectric smoke detector	83.91
NAPGEMHEAT	Wireless Rate-of-Rise 135 degree heat detector	48.60
NAPGEMGB	Wireless Gemini glassbreak, 25' coverage	83.15
NAPGEMWPPANIC	Wireless waterproof personal panic pendant	40.79
NAPGEMRECV255	255-point crystal-controlled wireless receiver module	204.66
NAPGEMRECV32	32-point crystal-controlled wireless receiver module	48.12
NAPGEMRECV96	96-point crystal-controlled wireless receiver module	141.65



**Wireless UL Commercial Devices**

NAPGEMCWLCO	Wireless Commercial Carbon Monoxide Detector	83.73
NAPGEMCWLHEAT	Wireless Commercial Fire Device - Heat Detector, 135 F	46.71
NAPGEMCWLSMK	Wireless Commercial Fire Device - Photoelectric Smoke Detector	87.63
NAPGEMCWLDT	Wireless Commercial Dual Technology Motion Detector, Range 40'x40'	111.99
NAPGEMCWLGB	Wireless Commercial Acoustic Glass Break Sensor, Max Range 25'	97.37
NAPGEMCWLPIR	Wireless Commercial PIR Motion Detector, Range 50'x50'	97.37
NAPGEMCWLWD2	Wireless 2 input Module, suitable for Commercial Fire and/or Burg	38.92



NAPGEMGB



NAPGEMSMK



NAPGEMHEAT



NAPGEMWPPANIC



NAPGEMTRANSLP  
NAPGEMTRANSLPBN

**System Sensor Combination Smoke & CO**

SYSCOSMO-2W	Combination CO & Smoke Detector, 2-wire, requires COSMOD2W	93.09
SYSCOSMOD2W	2-wire i4 Interface Module, connect up to 12 compatible detectors	47.40
SYSCOSMO-4W	Combination CO & Smoke Detector, 4-wire, requires COSMOD4W	83.41
SYSCOSMOD4W	4-wire i4 Interface Module, connect up to 12 compatible detectors	40.98

**SYSCOSMO2W**



**SYSCOSMOD2W**

The i4 Series Combination CO/Smoke Detector includes a variety of features that simplify installation and maintenance while increasing the level of protection for your customers.

- Single device for CO and smoke detection that uses less wiring and fewer junction boxes
- Compatible with a wide range of control panels with the use of the required i4 Interface Module
- Sends distinct smoke and CO signals to the panel
- Sounds Temp 3 for smoke and Temp 4 for CO
- RealTest® enables functional gas testing using canned CO
- Drift compensation and smoothing algorithms provide false alarm immunity
- Replaceable electrochemical CO cell with 6-year end-of-life timer signals the panel and chirps to alert the homeowner

- LEDs display operational, CO and smoke status
- Versatile mounting allows for wall or ceiling placement
- Built-in 85dB sounder

**Call for Compatibility: As of press time, we were unable to test with all panels**

**System Sensor Heat Detectors**



SYS5601P	Single-circuit Heat Detector, 135 fixed/rate-of-rise, non-powered	11.30
SYS5602	Single-circuit Heat Detector, 194 fixed/rate-of-rise, non-powered	11.30
SYS5603	Single-circuit Heat Detector, 135 fixed temperature, non-powered	11.30
SYS5604	Single-circuit Heat Detector, 194 fixed temperature, non-powered	11.30

**Compatible with all EOL supervised control panels. N/O circuit. Power is not required.**

**COOPER Wheelock®**

*Commercial Horn Strobes*



WHEHSR	Wall-mount Horn/Strobe - Red Candela 15/1575/30/75/95/110/135/185	53.84
WHESTR	Wall-mount Strobe only - Red Candela 15/1575/30/75/95/110/135/185	40.34

The Wheelock® Exceder Series of notification appliances features a sleek modern design that will please building owners with reduced total cost of ownership. Installers will benefit from its comprehensive feature list, including the most candela options in one appliance, low current draw, no tools needed for setting changes, voltage test points, 12/24 VDC operation, universal mounting base and multiple mounting options for both new and retrofit construction

**MACURCO**  
GAS DETECTION

*Gas Detection*

MCCM-E1	Carbon Monoxide Fixed Gas Detector, surface or 1-gang flush-mount	70.17
MCCME1-FTG	Carbon Monoxide Field Test Gas, aerosol, 20-30 tests per canister	55.22
MCGD-2B	Combustible Fixed Gas Detector, Methane or Propane, surface or 1-gang flush-mount	104.38
MCGD2A	Combustible Fixed Gas Detector, Methane or Propane, surface or 2-gang flush-mount	104.38



**MCCM-E1**



**MCGD2A**

The CM-E1 is a low voltage detector of Carbon Monoxide (CO). The CM-E1 is designed for connection to UL-Listed Fire Alarm/Burglary Control Panels. Alarm control panels that work on 12 or 24 VDC can provide battery backup to the CM-E1 detectors.

The GD-2B and GD2A are low voltage electronic detectors of combustible, heating type gases: methane (natural gas) and propane (LP) gas.. Both are designed for connection to Fire Alarm/Burglary Control Panels. Both detectors are intended for installation in buildings in locations such as residences.

**encore™**

*Line-Voltage Smoke Monitoring*

FireFighter is the easiest, most cost-effective way to add fire alarm monitoring to your new control panel. It's great for existing line-voltage smokes

FireFighter's unique technology monitors the existing UL smoke detectors within the home. When an alarm is detected a wireless signal is sent to the control panel which in turn contacts the central monitoring station.

2GIG-FF-345	Firefighter for 2GIG Wireless	36.25
ENCEC-FF319	Firefighter for Interlogix Wireless	36.22
ENCEC-FF433	Firefighter for DSC Wireless	36.22





**POWERFUL.  
FLEXIBLE.  
INTELLIGENT.**



## M1 Security and Automation Controls

provide the ideal combination of security, energy management, and integrated control solutions for comfort, convenience and simplicity.

- Rock solid security and life safety with comprehensive detection and state-of-the-art reporting capabilities
- Fast microprocessor enhances speed, capability and security
- Wireless sensors with multi-level security to prevent hacking
- Event notifications via phone call, email or text to keep customers informed
- Intelligent control solutions for lights, thermostats, locks, gates, garage doors, water valves and more
- Smart features and flexible integration capabilities help reduce energy costs without sacrificing comfort
- Remote control options for smart phones, tablets, web browsers and more, with or without monthly fees

Great for residences, businesses, restaurants, fitness centers, schools, municipal buildings and more!

## **NEW!** C1M1 DUAL-PATH ALARM COMMUNICATOR

- Significantly reduces transmission time of emergency messages, by eliminating dial capture, data bus decoding and cloud servers
- Utilizes IP and cellular pathways and automatically chooses the best pathway for reliable communications
- Provides remote access with no port forwarding or extra fees
- Supports the FREE ElkLink Mobile app for iOS and Android
- Supports third-party apps, eKeypad (iOS) and M1 Touch Pro (Android)
- Supports connectivity with IP based M1 integration partners
- Provides email and text message alerts for arm, disarm, and alarms



**CEPro**  
2016 BEST  
WINNER

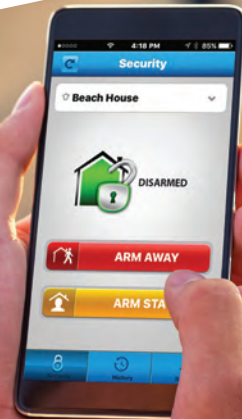

**ELK**  
PRODUCTS

(800)797-9355 | [www.elkproducts.com](http://www.elkproducts.com)

Elk requires we publish MAP prices. Please call 800-282-8864 or use your on-line account for discounted Worthington Distribution Dealer prices.

**Siren and Voice Drivers**

ELK100	High perf. driver with 2 inputs & 2 volume levels	17.80
ELK110	Voice siren driver module for CO, intruder, and fire	33.23
ELK120	Recordable annunciator, 8 minutes, 4 channels	82.79
ELK124	Recordable annunciator in enclosure, 8 channels	119.81



ELK100



ELK110



ELK120



ELK124

**Universal Accessories**

ELK9002	B Connectors (Plain), 500 pieces-Yellow	18.12
ELK9022	B Connectors (Gel), 500 pieces-White	21.68
ELK930	Telephone and doorbell ring detector	46.33
ELK999	Double-sided tape, 130 pc., 1/2" x 1" and 1/2" x 1/4"	7.81
ELK999A	Double-sided tape, 156 pc., assorted thickness	8.50



ELK9002/  
ELK9022



ELK930

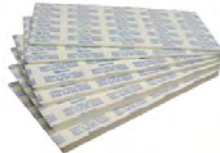

ELK999A

**Relay Modules and Timers**

ELK912	12V compact relay module, SPDT	6.16
ELK912B6	12/24V relay with big terminals, SPDT, 6-pack	32.95
ELK924	12/24V sensitive relay module, 1mA trigger DPDT	9.75
ELK9244	ELK924 sensitive relay, 4-pack	35.00
ELK960	12/24V delay timer, adjustable 1 sec.-60 min.	20.45
ELK9200	Heavy Duty Relay Contactor 110VAC Coil, 220VAC 60A load	60.53



ELK912



ELK912B6



ELK924



ELK9200

**Power Supplies**

ELKP624	6, 12, or 24VDC power supply / battery charger	16.75
ELKP1215	12VDC power supply / battery charger kit with transformer	41.95
ELKP1417	14VDC 1.7A plug-in power supply	19.99



ELKP624



ELKP1215



ELKP1417

**Speakers**

ELKSP30	Exterior surface-mount 30W, 8 Ohm Speaker	12.10
ELKSP35	Interior surface-mount 20W with hardware	5.69
ELK73	Compact Echo speaker 20W 8 Ohm fits single gang box	8.77
ELKSP12F	Interior flush mount 12W fits single gang box	6.26
ELK1RT	30W speaker in stainless steel enclosure	40.55
ELKSL1*	Strobe for above speaker *- color: A-Amber, B-Blue, C-Clear, R-Red	20.29



ELK1RT



ELKSP30

ELK73

ELKSP12F

**Sirens (Compact, Self-Contained)**

ELK74	Interior compact 105db with hardware (paintable)	10.01
ELKSS36	Two-tone interior siren	6.58
ELK150RT	118db siren in stainless steel enclosure. Use ELKSL1 to add strobe.	45.68
ELKSS30	Two-tone siren, 120db, surface	12.01



ELK150RT



ELKSS30

ELK74

ELKSS36

**Power Products**

ELKBLT	Battery analyzer, 12V, .5A to 65A	143.00
ELKP1216	Plug-In Power Supply 12VDC 1.5A 2.5mm jack	19.99
ELK1250	Rechargeable 12V, 5Ahr battery	13.02
ELK1280	Rechargeable 12V, 8Ahr battery	18.54
ELKTRG2440	Transformer, 24V, 40VA, LED, ground, PTC	10.40
ELKTRG1640	Transformer, 16V, 45VA, LED, ground, PTC	10.40



ELK1280



ELK1250



ELKBLT



ELKTRG1640/2440



**Power Supplies - Great for Adding More Power to your Leviton Omni Controller**

ALTAL624	1.2A @ 12VDC & 0.75A @ 24VDC, requires 24VAC transformer feed, see below, board only	10.18
ALTAL624E	1.2A @ 12VDC & 0.75A @ 24VDC in enclosure, requires 24VAC transformer feed, see below	44.85
ALTSMP3E	2.5A @ 12VDC, 6VDC or 24VDC requires 24VAC 100VA transformer feed, with enclosure	50.48
ALTSMP5	4A @ 12VDC, 6VDC or 24VDC @ 4 amp of continuous output, requires 24VAC 100VA transformer feed, board only	39.11
ALTAL175ULB	1.75A @ 12/24VDC power supply with fire alarm interface, 2 power limited outputs, board only	51.40
ALTAL300ULB	2.5A @ 12/24VDC supervised AC and battery monitoring, limited output, board only	66.41
ALTAL300ULXR	UL fire listed 2.5A @ 12VDC or 24VDC in enclosure, supervised power supply/charger, 115VAC input	133.41
ALTAL400ULXB2	UL burglary listed 4A @ 12VDC or 3A @ 24VDC board only, power supply/charger, 115VAC input	115.36
ALTAL600ULM	6A @ 12/24VDC multi output power supply in enclosure, with fire alarm interface and power supervision	219.71
ALTAL600ULACM	6A @ 12/24VDC access power controller in enclosure with fire alarm interface, 8 fail safe or fail secure	235.62



ALTAL624



ALTAL624E



ALTAL175ULB



ALTAL400ULXB2



ALTSMP5



ALTAL600ULM

**CCTV Power Supplies**

ALTSAV4D	UL CCTV listed, 4 PTC outputs, 12VDC @ 5 amp, with power linecord	61.19
ALTSAV9D	UL CCTV listed, 9 PTC outputs, 12VDC @ 5 amp, with power linecord	71.90
ALTSAV18D	UL CCTV listed, 18 PTC outputs, 12VDC @ 5 amp, with power linecord	116.27
ALTV248	8 fuse-protected regulated outputs, 24VAC @ 4A power supply, 115VAC input	62.79
ALTV2416	16 fuse-protected regulated outputs, 24VAC @ 8A power supply, 115VAC input	101.31
ALTV615DC616UL	16 fuse-protected regulated outputs, 6-15VDC @ 6A power supply, 115VAC input	147.37
ALTV615DC1016	16 fuse-protected regulated outputs, 6-15VDC @ 10A power supply, 115VAC input	153.00
ALTALTV2432600U	12.5A @ 24VAC or 20A @ 28VAC 32 fused outputs; wall-mount	227.04
ALTR2416300UL	25A @ 24VAC or 10A @ 28VAC 16 fused outputs 2U rack-mount power supply	226.43



ALTSAV4D



ALTSAV9D



ALTV248



ALTV615DC616UL



ALTV615DC1016

**Low Voltage Coil DPDT Relays**

ALTRBSN	12V/24VDC 15mA coil, 2A @ 115VAC/28VDC	7.96
ALTRBST	6V/12V/24VDC, 30mA coil, 2A @ 115VAC/28VDC	7.96
ALTRDC12	12VDC 86mA coil draw, 10A @ 120VAC/28VDC	14.14
ALTRAC24	24VAC 86mA coil draw, 10A @ 120VAC/28VDC	14.14
ALTRAC120	120VAC 12mA coil draw, 10A @ 120VAC/28VDC	14.14

**Timers**

ALT6062	12V/24VDC, 1-60 mins, 8A @ 115VAC/28VDC	16.15
ALTAT4	4 ch. 12/24V AC/DC, 10A @ 115VAC/28VDC	153.00
ALTDL1	Door control timer, 12/24V AC/DC, 1 sec. to 1 min.	28.28
ALTDL3	Same as above with rectified voltage output	36.72
ALTPT724A	Annual event timer 50 daily/weekly events	65.49

**Siren Drivers**



ALTALSD1

ALTALSD1	6V/12VDC operation, steady & yelp, current draw .5A to 1.8A depending on speaker	11.38
ALTALSD2	Same as above except current draw .3A to 1.22A depending on speaker	11.38

**Note:** Leviton Omni controller bell output is rated for 1A - Use Altronix for UL listing integrity

**Batteries and Plug-in Transformers**



ELKTRG2440

ELKTRG2440	Self resetting 24VAC/40VA transformer	10.40
ELKTRG1640	Self resetting 16.5VAC/40VA transformer	10.40
UB1250	12VDC/5AH sealed lead acid battery	10.61
UB1270	12VDC/7AH sealed lead acid battery	13.10

**Worthington Distribution Carries the Full Altronix Product Line - Call for Pricing and Availability**





Security Contacts

**3/8" recessed stubby contact with 12" leads, 0.6" x 0.375" diameter, 1/2" gap (price per 10-pk)**

GRI20RS-12-*	Standard model without resistor. Available in white or brown.	25.10
GRI7777-*	Model with 1K resistor for use with Leviton Security and Automation Omni	37.72
GRI20RS-12-*W2	Model with 2.2K resistor for use with ELK and Napco controls	37.72
GRI20RS-12-*W5	Model with 5.6K resistor for use with DSC panels	37.72
GRIN20RS-12-*	Rare Earth model without resistor. Magnet is 1/8" thick.	29.23
GRIN20RS-12-*W1	Rare Earth model with 1K resistor for use with Omni	41.84
GRIN20RS-12-*W2	Rare Earth model with 2.2K resistor for use with ELK and Napco controls	41.84
GRIN20RS-12-*W5	Rare Earth model with 5.6K resistor for use with DSC panels	41.84



GRI20RS-12-W

Note: When using contacts with resistors, use only one per zone



GRIN20RS-12-W



GRI20RS-T-W



GRIN20RS-T-W

\*- designates color option white or brown

**3/8" recessed stubby contact with screw terminals, 1.25" x 0.375" dia, .5" gap (price per 10-pk)**

GRI20RS-T-*	Standard model without resistor. Available in white or brown.	28.23
GRI7377-*	Model with 1K resistor for use with Leviton Security and Automation Omni	40.84
GRI7147-*	Model with 2.2K resistor for use with ELK and Napco controls	40.84
GRI8115-*	Model with 5.6K resistor for use with DSC panels	40.84
GRIN20RS-T-*	Rare Earth model without resistor. Magnet is 1/8" thick.	32.35
GRIN20RS-T-*W1K	Rare Earth model with 1K resistor for use with Omni. Magnet is 1/8" thick.	44.96
GRI7714-*	Rare Earth model with 2.2K resistor for use with ELK and Napco controls	44.96
GRI7397-*	Rare Earth model with 5.6K resistor for use with DSC panels. Magnet is 1/8" thick.	44.96

**Miniature surface mount contact, 1.75" x .375" x .302", 1" gap (price per 10-pack)**

GRI100-12-*	Standard model with 12" leads, without resistor. Available in white or brown.	24.11
GRI100-12-*W1K	Model with 12" leads and 1K resistor for use with LS&A Omni	36.72
GRI100-12-*W2.2	Model with 12" leads and 2.2K resistor for use with ELK and Napco controls	36.72
GRI100-12-*W5.6	Model with 12" leads and 5.6K resistor for use with DSC panels	36.72
GRI100-T-*	Standard model with terminals, without resistor. Available in white or brown.	25.48
GRI100-T-*W1K	Model with terminals and 1K resistor for use with LS&A Omni	38.09
GRI100-T-*W2.2K	Model with terminals and 2.2K resistor for use with ELK and Napco controls	38.09
GRI100-T-*W5.6K	Model with terminals and 5.6K resistor for use with DSC panels	38.09



GRI100-T-W

Note: When using contacts with resistors, use only one per zone



GRI100-12-W

**3/4" recessed door contact, 0.99" x 0.75" dia, 5/8" gap on steel (price per 10-pack)**

GRI180RS-12-*	Standard model with 12" leads, without resistor. Available in white or brown.	34.47
GRI8080RS-T-*	Standard model with terminals, without resistor. Available in white or brown.	34.47
3/4" dome switch, pressure switch, 1.105" x 0.74" dia		
GRIDS-01-*	Standard model with 12" leads, without resistor. Available in white or brown.	37.35
GRIDS-01T-*	Standard model with terminals, without resistor. Available in white or brown.	40.72



GRI180RS-12-W



GRIDS-01T-W

**Industrial and Overhead Door Contact (Sold Individually)**

GRI4460A	Mini industrial set, 1" wide gap, armored lead	1.5" x .586" x .426"	Steel Doors	8.52
GRI4532	Floor-mount overhead door set, 3" wide gap	3.5" x 1.5" x .4"	Overhead Doors	10.24
GRI4400A	Rail-mount overhead door set, 2 1/2" wide gap	3.07 x 2.6 x 1.8	Overhead Doors	23.01
GRI4700-A	Track-mount overhead door set, 3" wide gap	1.75" to 4" channel	Overhead Doors	35.26



GRI4400A



GRI4532

**GRI makes over 7,000 standard and custom contacts. Log on to [www.grisk.com](http://www.grisk.com) for more options**

Specialty Devices

GRI has a wide selection of specialty devices, call for details

GRIDM-1	Garage Monitor and Closer	59.07
GRIDPA-10D	Pool door alarm, notifies if children open door to pool area, 7-second delay for adults	42.28
GRICC-01	Current controller, control a closet light with just a door contact	35.66
GRISP-17	Panic button - single-gang stainless plate with red panic button and guard ring	17.07
GRI2600	Water sensor, normally closed, 4-wire, 12VDC	15.16
GRI2600T	Water sensor with terminals for 2 included remote sensors (GRI2600T-P), 4 wire	21.45
GRI2800	Surface mount water sensor, 2 wire, requires relay for security system	13.29
GRIWVS	Water shut-off valve w/ sensor, 1" pipe, additional locations with GRI2600	243.87
GRIHVACO	Protect outside HVAC unit from theft damage	24.77
GRIT8000-G	Freeze alarm, thermal 32-degree switch	32.30
GRIE-Z58COM-W	E-Z duct raceway 5/8" combo pack of connectors	7.77
GRIE-Z586-W	E-Z duct raceway 5/8" 6-pack of 6-ft lengths	38.89
GRIE-ZQR6-W	E-Z duct 1/4 round wire raceway- 6-pack	46.55
GRIPW375W	Pre-wire plug- low cost way to pre-wire new construction projects, 10-pack	1.12



GRIHVACO



GRIPW375W



GRI2600



GRIE-ZQR6-W



GRIDPA-10D

EnviroAlert



WIEA800-IP



WITEMP-UL-S

WIEA800-IP	12-zone (8 wireless, 4 hardwired), temperature, humidity, water, gases, dry contacts and more. Cloud based access available (requires a fee-based subscription).	360.71
WIEA40012	4-zone, allows up to four external sensors: temp, humidity, and water detection	229.57
WIEA20012	2-zone, with on-board temperature sensor on 1st zone, choose your 2nd zone sensor	85.43
WITEMP-H-S	Stainless steel high temp probe (+32° to +302° F) (also available in waterproof, see below)	51.46
WITEMP-L-S	Stainless steel low temp probe (-58° to +158° F) (also available in waterproof, see below)	33.10
WIHA-IIIPLUS	Humidity sensor (5% to 95% R.H.)	120.03
WIW-S-S	Supervised water sensor, surface (for use with WB800 and EnviroAlert products)	28.35
WITEMP-UL-S	Ultra-low temp probe (-112° to +32° F) (For use only with EA800-IP)	66.20
WITEMP-L-W	Waterproof low temp probe (-58° to +158° F)	35.72
WITEMP-H-W	Waterproof high temp probe (+32° to +221° F)	54.33
WIEAWTS	Wireless temperature sensor* (+32° to +122° F)	95.55
WIEA-WHS	Wireless humidity sensor* (5% to 95% R.H.)	106.41
WIEA-WMFS	Wireless multi-function sensor*, requires Winland temp probe or W-S-S water sensor	91.43
WIW-UC-S	Water Sensor, Under-Carpet style, Supervised (will alarm if lead is cut)	49.84

\*Wireless sensors are only for use with the EA800-IP

Temperature and Humidity Alerts



WITA-1

WITA-1	Temp Alert with dry contact output, adjustable high and low set points	65.20
WITA-2HL	Temp Alert with 2 dry contact outputs, adjustable high and low set points	62.45
WITA-40	Fixed Temp Alert with 2 dry contact outputs, NC for above 40° F/NO for below 40° F	15.86
WIMTA-1	Mechanical Temp Alert, 2 dry contact outputs, 50° to +130° F Operating Temperature	57.33

WaterBugs and Accessories



WIWB200

WIWB200	WaterBug 200, 12 or 24VAC or VDC, includes 1 WIW-S-U, use up to 6 sensors	55.71
WIWB350	WaterBug 350, 9V battery (battery not included), includes 1 WIW-S-U, use up to 6 sensors	96.17
WIWB800	WaterBug 800, 12 or 24VAC/VDC, includes 4 WIW-S-S, up to 8 zones or 16 sensors	279.78
WIW-S-U	Additional surface sensor for WB-200 and WB-350, 15' cable	19.48
WIW-UC-U	Under-carpet sensor for WB-200 and WB-350, 15' cable	62.20

Power Alert

WIPS-110	Power Alert, provides contact closure after 3-8 minutes of power loss, includes 15' of cable	49.84
----------	--	-------

Worthington carries the full line of USP Products.



Miscellaneous Sensors

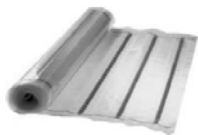

USP908

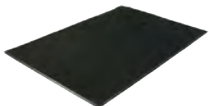

USPWPM

USP904	Pressure mat, 24" x 30", use with security/automation panels	68.01
USP904PR	Pressure mat, 24" x 24", use with security/automation panels, pet resistant, activates at 60 lbs.	77.31
USP908	Pressure mat, 14" x 24" roll, use with security/automation panels	40.09
USP908PR	Pressure mat, 14" x 24" roll, use with security/automation panels, pet resistant, activates at 60 lbs.	44.40
USP330W	Vibration sensor, use on walls, doors, windows, safes, etc., NC contact, non-powered, 10-pack	38.72
USPHUB2A-ES	Hold-up button, latching, double pole, double throw	13.86
USPF20	Temperature supervisory switch, opens at 40° F, use with security/automation panels	13.05
USPWLS	Water level sensor, NC/NO, use with security/automation panels	12.93
USP714*	Stick-on window glass break sensor, no power required. *B - Bronze, W-White	10.55
USPPLS	Power loss sensor for 110VAC, dry contact output, automatic reset	23.29
USP654	"Emergency" switch	2.44
USPCOR2	Foot triggered Hold Up Rail, DPDT latching relay, stainless steel	229.50
USPWPM-24	900MHz Wireless Pressure Mat - 18" x 24", embedded transmitter	273.28
USPBA-1	Portable beam motion detector, 15' range, built-in sounder	39.28

Dialers

USPAD2001	2-zone, calls up to 4 numbers	158.62	USPAD2000	4-zone, calls up to 8 numbers	192.10
-----------	-------------------------------	--------	-----------	-------------------------------	--------

**DOORS.NET Controllers, Readers, Cards/Tags and Peripherals**

**New this year: Remote Monitoring/Control and Bio-readers**

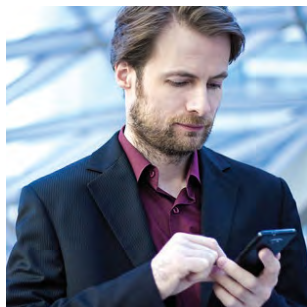

**Remote Access:**

Dealers have been asking for a way to access the system remotely with a smart phone or tablet. A new software called "DOORS.WEB" allows you this access. Just install it on the server and use any current browser. Users can now edit cardholders, open doors, lock doors, even lock-down the facility during an emergency.

**Bio-Readers:**

No more concerns about lost or stolen cards. No more shared codes. The finger is the key.

KSNXT-KIT4	NXT 4-door distributor kit, includes all the key Keri NXT components required to install a 4-door system, including readers, controller, adapter for direct PCB Ethernet connection, power supply and software	1,540.02
KSNXT-KIT2	NXT 2-door distributor kit, components for a 2-door system	934.25
KSNXT-2D	2-door access controller, 50K cardholders, expandable to 1024 doors	861.81
KSNXT-2D-MSC	Mercury-powered 2-door access controller, 50K cardholders, expandable to 1024 doors	929.26
KSNXT-4D	4-door access controller, 50K cardholders, expandable to 1024 doors	1,405.12
KSNXT-4D-MSC	Mercury-powered 4-door access controller, 50K cardholders, expandable to 1024 doors	1,569.99
KSNXT-4X4	4 x 4 I/O - optional local door control module, adds inputs and outputs to controller	177.36

**Cards Readers and Keypads**

KSNXT-1R	Euro-mount proximity reader - Entry/Access Version, 3.25" x 3.25" x 0.625	118.66
KSNXT-3R	Door-frame proximity reader - Entry/Access Version, 3.75" x 1.6" x 0.625	101.17
KSNXT-5R	Wall switch proximity reader - Entry/Access Version	118.66
KSNXT-KPK	Keypad Kit (includes NXT-6RK and NXT-RM3)	408.42
KSNXT-RM3	Reader interface module (for Wiegand & MS compatibility)	49.96
KSNXT-6RK	Keypad Prox Reader, uses Wiegand cards (requires NXT-RM3)	373.45
KSKPS-4-1	Power Supply for Keri controllers - 12VDC @ 2.5A, battery ready, no enclosure	83.68
KSKPS-5-1	Power Supply for Keri controllers - 12VDC @ 2.5A, battery ready, with enclosure	112.41

**Software and Licenses**

KSDNET-APP	DOORS.NET Standard Edition - Access Control Software (free, request with controller)	Free
KSAPL-I2PC	Mini Appliance Pre-loaded with DOORS.NET - no need to deal with the client's PC or Windows issues. Safer and more secure	448.39
KSDNET-ADD-CL	Doors.NET Additional Client License - allows system access from multiple locations	322.24
KSDOORSWEB	Doors.Web Remote Access Software - allows current browsers to access and control system - Requires additional client licenses for each simultaneous remote connection	322.24

Have questions about licenses and Keri Systems? Give Worthington Distribution a call, (800) 282-8864.

**Cards and Tags**

**Please Order the Correct Card for Your Keri System**

KSNXT-C	Standard light proximity card, formatted for Keri DOORS.NET Controllers (Pack of 25)	56.83
KSNXT-K	Proximity key tag, formatted for Keri DOORS.NET Controllers (Pack of 25)	120.22
KSNXT-I	Multi-technology card without magnetic stripe for DOORS.NET Controllers (Pack of 25)	126.77
KSKC-10X	Standard light proximity card, formatted for Keri Tiger II Controllers (Pack of 25)	62.76
KSPKT-10X	Proximity key tag, formatted for Keri Tiger II Controllers (Pack of 25)	124.59
KSKC-26X	Standard light proximity card, formatted for Keri Intelliprox 2000 Controllers (Pack of 25)	116.47
KSPKT-26X	Proximity key tag, formatted for Keri Intelliprox 2000 Controllers (Pack of 25)	198.90
KSPSC-1	Standard Wiegand Light Proximity Card (Pack of 25)	60.89



**Wiegand & HID Compatible Accessories Available**

**Intelliprox 2000 Single-Door Access Control**

All BioSync readers communicate in Wiegand - KSNXT-RM3 required for NXT systems

KSKBF-1FP	BioSync Fingerprint - only Reader	748.15
KSKBF-2PR	BioSync PR Fingerprint + Proximity Reader	843.08
KSKBF-3KP	BioSync KP Fingerprint + Keypad Reader	943.00
KSKBF-CNV	Ethernet-to-RS485 converter - one per system	137.39
KSDNET-BIO	BioManager Software (Free with purchase of BioSync Reader)	Free



Solid Biometric Technology at an Affordable Price!

**Tiger II systems available and upgradable to Doors.net. Call for information**

**NXT readers now support HID cards without an interface card**



**Magnetic Locks**

Electromagnetic locks, commonly called “mag-locks,” use a powerful magnet to hold the door shut. The door is released when power is removed. Electromagnetic locks are “fail-safe devices.” They can be controlled by access, telephone, and intercom systems. Depending on output of the system, a relay may be required.



ACS600S	Electromagnetic lock with 600 lbs. holding force, 12/24VDC, 400mA @ 12VDC, good for interior doors, UL listed	95.24
ACS600L	Electromagnetic lock with 600 lbs. holding force, status LED, 12/24VDC, 400mA @ 12VDC, good for interior doors, UL listed	113.45
ACS600LB	Electromagnetic lock with 600 lbs. holding force, bond sensor, door status sensor and status LED, 12/24VDC, 400mA @ 12VDC, good for interior doors, UL listed	149.88
ACS600D	Double electromagnetic lock with 600 lbs. holding force. 12/24VDC, 400mA @ 12VDC, good for double doors, UL listed	157.16
ACS600DLB	Double electromagnetic lock with 600 lbs. holding force, bond sensor, door status sensor and status LED, 12/24VDC, 400mA @ 12VDC, good for interior doors, UL listed	208.16
ACS600WP	Weatherproof electromagnetic lock with 600 lbs. holding force, 12/24VDC, 400mA @ 12VDC, good for gates	126.46
ACS1200S	Electromagnetic lock with 1200 lbs. holding force, 12/24VDC, 400mA @ 12VDC, good for exterior doors, UL listed	120.22
ACS1200L	Electromagnetic lock with 1200 lbs. holding force, status LED, 12/24VDC, 400mA @ 12VDC, good for exterior doors, UL listed	138.95
ACS1200LB	Electromagnetic lock with 1200 lbs. holding force, bond sensor, door status sensor and status LED, 12/24VDC, 400mA @ 12VDC, good for exterior doors, UL listed	192.55
ACS1200D	Double electromagnetic lock with 1200 lbs. holding force, 12/24VDC, 400mA @ 12VDC, good for double doors, UL listed	257.59
ACS1200WP	Weatherproof electromagnetic lock with 1200 lbs. holding force, 12/24VDC, 400mA @ 12VDC, good for gates	171.73

Also available in Dark Bronze finish. Call for part numbers. Additional mounting plates available for difficult installs.

**Electric Strikes**

ACSAES-100	BHMA Grade 1 Dual Voltage Electric Strike	83.26
ACSAES-200	BHMA Grade 2 Dual Voltage Electric Strike	95.75



**ACSAES-100**

**Power Supplies**

ACSAPS-300	3 Amps at 12VDC, 1.5 Amps at 24VDC	131.14	Sufficient power to support up to three magnetic locks or electric strikes plus required exit devices, thermal protection, Form C relay contacts, (SPDT), AC power status, tamper switch and camlock. Cabinet size: 14" L x 8-1/2" W x 3-1/2" D. UL listed
ACSAPS-300FT	ACSAPS-300 with one ACSPDFT Fire Module	168.62	
ACSAPS-3004C	ACSAPS-300 with one ACSPD4C, four output distribution	168.62	

**Door Release Devices**

ACSEB-1	Red Mushroom request-to-exit button NO/NC	52.56
ACSTS-2	Request-to-exit, 2" green, illuminated LED button on 1-gang plate, SPDT	30.19
ACSNTS-1	No-Touch request-to-exit, 4" range, delay	52.56
ACSTS-2T	Timed request-to-exit, 2" green, illuminated LED button on 1-gang plate, SPDT, 2-45 second adjustable	74.94
ACSTS-14	Pneumatic timed request-to-exit. Green mushroom button NO/NC	180.58
ACSTS-18	Under counter door release switch	20.30
ACSREB-1	Push-to-exit bar for 36" door	91.06
ACSSREX-100	Request-to-exit motion detector	83.27
ACSKP-100	Digital Keypad, surface-mount, indoor use	49.44
ACSKP-200	Weatherproof Digital Keypad, flush-mount	119.69
ACSKP-300	Mullion-mount Digital Keypad, card reader	119.69
ACSKP-400	Weatherproof Digital Keypad, surface-mount	119.69
ACSDE-1	Delayed Egress Station, double gang plate, alarm with keyswitch reset	125.41



**ACSTS-2**



**ACSTS-18**



**ACSKP-400**



**ACSNTS-1**



**ACSSREX-100**



**ACSREB-1**

*Locks and Release Devices*

**SECO-LARM®**

SLSD-998C-NUQ	Surface-Mount Electric Rim Strike - for many panic-bar doors	187.35
SLSK990A	Door strike, fail-secure 12VDC, 800 mA for doors with wood frames	22.04
SLSD-996CNUQ	Universal door strike, can be used in wood or metal frames, 3 faceplate styles, 280mA	74.94
SLE941SA600	Electromagnetic lock with 600 lbs. holding force, 12/24VDC, 500mA @ 12VDC, good for medium security doors	68.70
SLE941SA1200	Electromagnetic lock with 1200 lbs. holding force. 12/24VDC, 500mA @ 12VDC, good for high security doors	86.18
SLSD-997B-GBQ	Electric deadbolt, 5/8" bolt extension, fail safe, door position output, 12 VDC	106.16
SLSD-927PKC-NEQ	No-touch, request to exit single-gang plate, sensing range to 4"	27.48
SLSS-075C-PE	Plastic surface-mount push-button (also good for panic) NO/NC	2.19



**SLSD-998C-NUQ**

# Speco's Value Line

If you're looking for an economical option for HD video surveillance Speco has it in both HD-TVI and IP.

## HD-TVI Solutions

## IP Solutions



### 2MP Resolution

Intensifer® T or IR LEDs

Supports up to 1080p @ 30fps

Weather Resistant

Fixed or Varifocal Lenses

### 3MP or 2MP Resolution

Supports up to 1080p @ 30fps

IR LEDs

Built-in Standard PoE

Weather Resistant

Fixed or Varifocal Lenses

#### HD-TVI Value Line Cameras

VLD2TW	HD-TVI 2MP IR Dome Camera, 3.6mm Fixed Lens, White Housing
VLB2TW	HD-TVI 2MP IR Bullet Camera, 3.6mm Fixed Lens, White Housing
HT71TG	HD-TVI Mini-Turret Color Camera, 2.9mm Fixed Lens, Dark Grey Housing
HT71TW	HD-TVI Mini-Turret Color Camera, 2.9mm Fixed Lens, White Housing
HINT71TG	Intensifer® T HD-TVI Mini-Turret Camera, 2.9mm Fixed Lens, Dark Grey Housing
HINT71TW	Intensifer® T HD-TVI Mini-Turret Camera, 2.9mm Fixed Lens, White Housing
HTMD2T	HD-TVI 2MP IR Mini-Dome Camera with Junction Box, 3.6mm Fixed Lens, White Housing
VLD1TW	HD-TVI 2MP IR Dome Camera, 2.8-12mm lens, White Housing
VLB1TW	HD-TVI 2MP IR Bullet Camera, 2.8-12mm lens, White Housing

#### IP Value Line Cameras

O3VLD1	3MP Vandal Resistant Dome IP Camera, 2.8mm Fixed Lens, White Housing
O3VLB3	3MP Bullet IP Camera, 2.8mm Fixed Lens, Dark Grey Housing
O2VLD5	2MP Dome IP Camera, 3.6mm Fixed Lens, White Housing
O2VLB5	2MP Bullet IP Camera, 3.6mm Fixed Lens, White Housing
O2VLD6	2MP Dome IP Camera, 2.8-12mm Lens, White Housing
O2VLB6	2MP Bullet IP Camera, 2.8-12mm Lens, White Housing





### AHD- Analog HD

EverFocus offers a full line of AHD CCTV gear from cameras to recorders. Analog HD will send high resolution video (1080P) via the coaxial cable that all analog systems are already wired with!



Page 147



### Flexible Intensifier

See in low light in color at night. The advanced Noise Reduction circuitry in the Intensifier camera coupled with the virtual 3D filter that is built into the DSP will allow your DVR to have 30% better compression.



Page 142-145



### IP Cameras

Channel Vision's IP Cameras offer superior image quality with 1.3 and 2 megapixel bullet and dome options and have the ability to deliver images up to 1080p at 30 frames per second.



Page 193



### Bullet Cameras

Generally meant for outdoor use, bullet cameras allow for a greater range of lenses to fit your situation. Most models also include a sun screen to stop glare.

See page 142-145 for Speco Technologies, 147 for EverFocus.

## We Are Your CCTV Experts

Worthington's Technical Sales staff has years of experience designing CCTV systems for both residential and commercial applications. Our selection of products from Speco, EverFocus and more let us build you a solution for any job. From economical to full-featured, we can help you land that job.



### Dome Cameras

When using cameras indoors, most homeowners prefer the look of a dome camera to that of a bullet. Dome cameras come in surface or flush mount versions and can have fixed or vari-focal lenses.

Weatherproof domes can be mounted outside under overhangs and mounts are available if an overhang is not. Dome cameras may also have color choices.

See page 142-145 for Speco Technologies, 147 for EverFocus.



### Touchscreen Integration

DVR's typically are designed for standalone operation, remote access with a web browser or custom applications for cell phones. Look to Everfocus for integration with Omni via refreshing JPEG images, page 91.

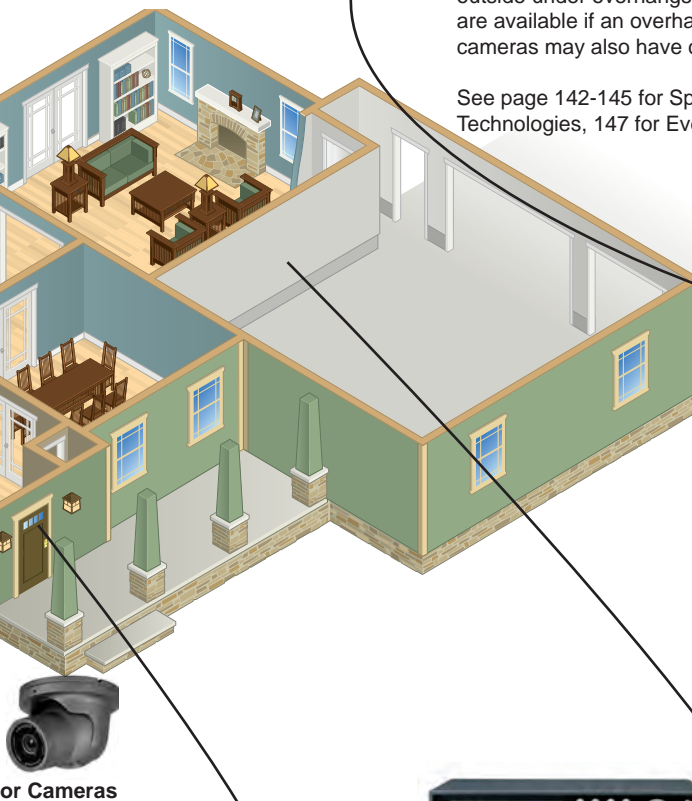

### Door Cameras

A good selling feature for adding security cameras to a residential install is the ability to see who is at the door before you answer it. Door cameras give peace of mind to spouses who are home alone, allow them to avoid unwanted guests, and are a good crime deterrent as well.

See page 142-145 for Speco Technologies, 147 for EverFocus.



### DVR

A DVR is a good way to keep track of the activity that occurs inside or outside of a residence and can help aid police by providing evidence.

See page 142-145 for Speco Technologies, 147 for EverFocus.



2MP IP Dome Cameras



Camera Type	Indoor/Outdoor Dome	Indoor/Outdoor Dome	Indoor/Outdoor Dome	Indoor/Outdoor Mini-Dome	Indoor Mini-Dome	Indoor/Outdoor Vandal Dome
<b>Low-Light Technology</b>	50' IR	65' IR	98' IR	30' IR	30' IR	65' IR
<b>Resolution</b>	2MP (1080p)	2MP (1080p)	3MP	2MP (1080p)	2MP (1080p)	2MP (1080p)
<b>Lens</b>	3.6mm	2.8-12mm	2.8mm	3.7mm	3.7mm	3-9mm motorized
<b>Concealed Cable</b>	Yes	Yes	Yes	Yes	Yes	Yes
<b>Power</b>	PoE 6W	PoE 6W	PoE 4W	PoE 7W	PoE 7W	PoE 10.4W
<b>Size (inches)</b>	5.7 Dia. x 4.5 H	5.7 Dia. x 4.5 H	4.3 Dia. x 3.2 H	4.8 Dia. x 2.2 H	4.8 Dia. x 2.2 H	5.5 Dia. x 4.8 H
<b>Special</b>	Value Priced	Value Priced	Value Priced	Pancake Style	Pancake Style	Heater
<b>Part Number</b>	STO2VLD5	STO2VLD6	STO3VLD1	STO2MD2	STO2DP9	STO2D11M
<b>Price</b>	86.18	111.16	111.16	198.59	186.10	423.41

IP Video Recorders - NVR



**EZ-Camera Autofind:**

All Speco NVRs feature Autofind. The NVR creates a separate network that is dedicated to the IP cameras and automatically detects Speco cameras on that network. They appear on the screen within 60 seconds of being connected. NSP series NVRs have a built in PoE switch with a port for each camera. Autofind gives you all the advantages of IP video but removes the networking hassle often associated with it.

**NS Series - Add Your Own PoE Switch**

STN16NS2TB	16-channel NVR, 2TB HDD, desktop/rack	685.70
MAU2V	2-space Vented Rack Shelf - Fits NS NVRs	57.75
STN4WNS1TB	4-channel NVR, 1TB HDD, wall-mount (9TB HDD max)	423.41
STN16WNS2TB	16-channel NVR, 2TB HDD, wall-mount (12TB HDD max)	685.70
Available HDD sizes: 1TB, 2TB, 3TB, 4TB, 6TB		
STN32NS9TB	32-channel NVR, 9TB HDD, desktop/rack, Supports up to 4K (8MP) on select channels, hard drives from 2TB to 18TB	1,410.12

**What's the difference between NS and NSP/NSL/NSF**

Both the NS and NSP series recorders automatically detect Speco IP cameras in under 60 seconds. No IP addresses or credentials to worry about. The NSP, NSF and NSL models add a self-contained PoE switch that lets you simply plug in the cameras and go. The NS models require you to add your own PoE switch.



**NS/NSP/NSF Series**

**NSP Series - PoE Switch Built-In**

STN4NSP1TB	4-channel NVR, 4-port PoE switch, 1TB HDD, desktop (6 TB HDD max)	585.78
STN8NSP1TB	8-channel NVR, 8-port PoE switch, 1TB HDD, desktop (8TB max)	623.25
STN16NSF2TB	16-channel NVR, 16-port PoE switch, 2TB HDD, desktop (8 TB HDD max)	1,085.38
MAU2V	2-space Vented Rack Shelf - Fits NSP NVRs	57.75
STN4WNSP1TB	4-channel NVR, 1TB HDD, 4-port PoE Switch, wall-mount	585.78
STN8WNSP1TB	8-channel NVR, 1TB HDD, 8-port PoE switch, wall-mount	623.25



**NSL Series**

**NSL Series - PoE Switch Built-In - No Front Panel Controls**

STN4NSL1TB	4-channel NVR, 4-port PoE switch, 1TB HDD, desktop	262.29
STN8NSL2TB	8-channel NVR, 8-port PoE switch, 2TB HDD, desktop	460.88

Available HDD sizes: 1TB, 2TB

MUX500110	Extend 2 IP cams 650' at 100Mbps or 1 mile at 25Mbps	527.08
MUX500111	Extend 1 IP cam 1600' w/ 14 Watts of PoE	79.31



**IP Bullet Cameras**



Indoor/Outdoor Bullet	Indoor/Outdoor Bullet	Indoor/Outdoor Bullet	Indoor/Outdoor Bullet	Indoor/Outdoor Bullet	Camera Type
50' IR	80' IR	98' IR	50' IR	Intensifier	<b>Low-Light Technology</b>
2MP (1080p)	2MP (1080p)	3MP	2MP (1080p)	2MP (1080p)	<b>Resolution</b>
3.6mm	2.8-12mm	2.8mm	3.6mm	2.8-12mm motorized	<b>Lens</b>
Yes	Yes	Yes	Yes	Yes	<b>Concealed Cable</b>
PoE 6W	PoE 6W	PoE 4W	PoE 7W	PoE 6W	<b>Power</b>
7.2 x 2.5	8.62 x 3.43	6.9 x 2.75	8.7 x 3.0	11.4 x 3.5	<b>Size (inches)</b>
Value Priced	Value Priced	Value Priced	2-Way Audio	Heater	<b>Special</b>
STO2VLB5	STO2VLB6	STO3VLB3	STO2B6	STO2IB8M	<b>Part Number</b>
86.18	111.16	111.16	248.55	330.98	<b>Price</b>

**IP/Analog Hybrid Video Recorders**

HS series hybrid recorders provide the ultimate in flexibility at a great price point. Offered in 8 and 16 channel units, the installer can configure each channel to be IP or 950H analog. It's perfect for analog upgrades where some analog cameras can stay in place and new installs where some cameras don't need to be very high resolution. One IP channel can record at 5MP and the rest at 1080p, and analog channels record at 720p.

STD8HS1TB	8-channel Hybrid NVR, 1TB HDD	610.76
STD8HS2TB	8-channel Hybrid NVR, 2TB HDD	673.21
STD8HS3TB	8-channel Hybrid NVR, 3TB HD	773.13
STD16HS2TB	16-channel Hybrid NVR, 2TB HDD	723.17
STD16HS3TB	16-channel Hybrid NVR, 3TB HDD	823.09
STD16HS4TB	16-channel Hybrid NVR, 4TB HDD	898.03
Available HDD sizes: 1TB, 2TB, 3TB, 4TB, 6TB, 9TB, 12TB		



**Luxul Networking**

LUXXMS-1010P	10-port Switch, 8 ports PoE, 15.4W per port	224.82
LUXXFS-1816P	Switch, 16 Fast Ethernet PoE+ ports and 2 Gigabit uplink ports, perfect for 16-channel NVRs	337.23
LUXXMS-2624P	Switch, 24 Gigabit PoE+ ports and 2 Gigabit/SFP ports, managed	646.98



LUXXFS-1816P



LUXXMS-2624P

**3MP, 4MP, and 8MP/4K IP Cameras**

STO3VLB3	3MP Indoor/Outdoor Bullet, 2.8mm lens, 98' IR, UL Listed, Junction Box Included	111.16
STO3VLD1	3MP Indoor/Outdoor Dome, 2.8mm lens, 98' IR, UL Listed, Junction Box Included	111.16
STO3VFBM	3MP Indoor/Outdoor Bullet, 2.7-12mm motorized lens, 190' IR, UL Listed, Junction Box Included	136.14
STO3VFD1	3MP Indoor/Outdoor Dome, 2.7-12mm motorized lens, 98' IR, UL Listed, Junction Box Included	136.14
STO4B7	4MP Indoor/Outdoor Bullet, 2.8mm lens, 98' IR, UL Listed, Junction Box Included	143.64
STO4D1	4MP Indoor/Outdoor Dome, 2.8mm lens, 98' IR, UL Listed, Junction Box Included	173.61
STO4B2M	4MP Indoor/Outdoor Bullet, 2.7-12mm motorized lens, 160' IR, UL Listed, Junction Box Included	298.51
STO4D2M	4MP Indoor/Outdoor Dome, 2.7-12mm motorized lens, 160' IR, UL Listed, Junction Box Included	298.51
STO8B2M	8MP/4K Indoor/Outdoor Bullet, 2.8-12mm motorized lens, 160' IR, UL Listed, Junction Box Included	348.47
STO8D2M	8MP/4K Indoor/Outdoor Dome, 2.8-12mm motorized lens, 160' IR, UL Listed, Junction Box Included	348.47

**PTZ IP Cameras**

PTZ cameras are great in applications where there will be a guard monitoring to video. They can also be configured to run a pre-determined tour. In this mode, the camera can sweep back and forth and cover a large area.

STO2P12X	2MP Indoor/Outdoor PTZ IP Camera, 5.1-61.1mm, 12x optical zoom lens	373.45
STO2P4X	2MP Indoor/Outdoor Mini-PTZ IP Camera, 2.7-11mm, 4x optical zoom lens	168.62
STO4P30X	4MP Indoor/Outdoor PTZ IP Camera, 4.5-135mm, 30x optical zoom lens	935.50
STKBDPTZ1	IP PTZ Keyboard Controller	311.63



STO2P4X



STO4P30X

**TVI Cameras - 1080p Over Coax**



Camera Type	Indoor/Outdoor Dome	Indoor/Outdoor Dome	Indoor/Outdoor Vandal Dome	Indoor/Outdoor Mini Dome	Indoor/Outdoor Dome	Indoor/Outdoor Mini Turret	Indoor/Outdoor Mini Turret
<b>Low-Light Technology</b>	32' IR	100' IR	Intensifier	50' IR	66' IR	Intensifier	35' IR
<b>Resolution</b>	1080p	1080p	1080p	1080p	1080p	1080p	1080p
<b>Lens</b>	3.6mm	2.8-12mm Auto-Iris	2.8-12mm Auto-Iris	3.6mm	3.6mm	2.9mm	2.9mm
<b>Heater</b>	No	No	No	No	Yes	No	No
<b>Concealed Cable</b>	Yes	Yes	Yes	Yes	Yes	Yes	Yes
<b>Power</b>	12VDC 400mA	12VDC 400mA	12VDC/24VAC 500mA/195mA	12VDC 200mA	12VDC/24VAC 500mA/195mA	12VDC 100mA	12VDC 100mA
<b>Size (inches)</b>	4.5 Dia. x 5 H	5.7 Dia. x 4.5 H	5.1 Dia. x 3.5 H	3.5 Dia. x 2.3 H	4.7 Dia. x 3.5 H	2.36 Dia. x 2.2 H	2.36 Dia. x 2.2 H
<b>Part Number</b>	STVLD2TW	STVLD1TW	STHT7246T	STHTMD2T	STHT5941T	STHINT71T* * White or Grey	STHT71T* * White or Grey
<b>Price</b>	57.45	81.18	161.12	161.12	161.12	86.18	86.18

**TVI Technology Explained**



TVI is an analog video standard that transmits 1080p video over coax cable. Use Speco's new TVI cameras and recorders and upgrade your existing analog over coax systems to full 1080p HD - no new wiring! TVI gives you the 2 Megapixel performance you thought you could only get on IP systems but it runs over coax - even RG59 - up to 1000'. TVI recorders are backwards compatible with traditional cameras. That means you can upgrade an older system and still leave some of the existing cameras in place. TVI systems are also great for budget-conscious new installs.

**VT Series Recorders**

STD4VT1TB	4-channel, 1TB	286.02
STD4VT2TB	4-channel, 2TB	335.98
STD8VT2TB	8-channel, 2TB	460.88
STD8VT3TB	8-channel, 3TB	573.29
STD16VT3TB	16-channel, 3TB	623.25
STD16VT4TB	16-channel, 4TB	685.70
STD8HT2TB	8-channel, 2TB, Hybrid - also supports IP	685.70
STD16HT4TB	16-channel, 4TB, Hybrid - also supports IP	1,147.83

VT recorders use the same user interface as IP NVR models and also support the same smartphone apps. They also feature EZ Setup, which speeds initial configuration of networking, DDNS, and recording. HDMI video output supports high definition monitors. Searching is made simple by using still thumbnail images to narrow down the time of an event. Users can then easily copy the video to a USB drive.



**VT Series Wall-Mount Recorders**

STD4WVT1TB	4-channel, 1TB	273.53
STD4WVTP1TB	4-channel, 1TB, 12VDC 3A power	335.98
STD4WVT2TB	4-channel, 2TB	323.49
STD4WVTP2TB	4-channel, 2TB, 12VDC 3A power	385.94
STD8WVT2TB	8-channel, 2TB	448.39
STD8WVTP2TB	8-channel, 2TB, 12VDC 5A power	510.84
STD8WVT3TB	8-channel, 3TB	560.80
STD8WVTP3TB	8-channel, 3TB, 12VDC 5A power	623.25
STD16WVT3TB	16-channel, 3TB	623.25
STD16WVT4TB	16-channel, 4TB	685.70



VT wall mount recorders are exactly the same as the standard desktop/rackmount versions, but they come in a metal wall mount enclosure. They are great for equipment rooms and look like a security panel when installed. Models with P in the part number include a 12V power supply to power the cameras.

**Altronix Power Supplies for Cameras**

ALTV615DC48ULM3	12VDC, 4A, 8 fused outputs	89.97
ALTV615DC616UL	12VDC, 6A, 16 fused outputs	147.37
ALTSAV4D	12VDC, 5A, 4 PTC protected outputs	61.19
ALTV248	24VAC, 4 Amp, 8 fused outputs	62.79



**TVI Cameras - 1080p Over Coax**



Indoor/Outdoor Bullet	Indoor/Outdoor Bullet	Indoor/Outdoor Bullet	Camera Type
60' IR	100' IR	Intensifier	<b>Low-Light Technology</b>
1080p	1080p	1080p	<b>Resolution</b>
3.6mm	2.8-12mm Auto-Iris	2.8-12mm Auto-Iris	<b>Lens</b>
No	No	Yes	<b>Heater</b>
Yes	Yes	Yes	<b>Concealed Cable</b>
12VDC 400mA	12VDC 400mA	12VDC/24VAC 500mA/195mA	<b>Power</b>
2.5 Dia. x 7.2 L	3.4 Dia. x 8.3 L	3.9 Dia. x 8.3 L	<b>Size (inches)</b>
STVLB2TW	STVLB1TW	STHTINT70T	<b>Part Number</b>
57.45	81.18	211.08	<b>Price</b>

**Cable**

Siamese cable includes 95% bare copper RG59 and braided 18/2 for power. It's the fastest way to wire for cameras.

WAVH59182BCRBK2	1000' Black Siamese Cable	153.63
WAVH59182BCRBK3	500' Black Siamese Cable	77.44



**Battery Backup**

Using a battery backup on a camera system not only ensures constant recording through power interruptions, it also protects the recorder from damage that can occur as a result of brief outages.



TRLBC350	350 VA Strip-Style Battery Backup	50.58
----------	-----------------------------------	-------

**TVI Camera Features**



**Heater**

Have you ever had a camera fog up or accumulate condensation on the inside of the glass? It happens because the air outside the camera is cold and dry, and inside is warm.

Some cameras shown here features a heater circuit. It's has a pair of large resistors that get powered periodically when it's cold. They heat up the glass and prevent fog and condensation.

**IR Illumination**

This is the most popular form of night capable camera. It uses invisible Infrared light and switches to black and white to provide video in the dark. The biggest pro is that it can produce an image in total blackness. The con is that it can only light up so far from the camera, and can wash out when the IR hits a reflective object.

**Intensifier Illumination - Color Image at Night**

Intensifier uses a chip in the camera to amplify any light that is in the scene. Pros include a full color image at night and low power consumption. The con? There has to be some amount of ambient light for the camera to use.



**TVI Baluns**

Do you want to run your TVI cameras over Cat 5/6? It's no problem with these baluns. They give you a BNC to RJ45 connector and convert the video signal to be transmitted over twisted pair.



**STTVIUTP STTVIUTPPT**

STTVIUTP	TVI Balun	5.00
STTVIUTPPT	TVI Balun with Pigtail	6.24

**TVI Kits**

STZIPT4B1	4-channel 1TB DVR, (4) TVI outdoor bullet cameras w/ 60' IR 12VDC	410.92
STZIPT4D1	4-channel 1TB DVR, (4) TVI outdoor dome cameras w/ 30' IR 12VDC	410.92
STZIPT84B2	8-channel 2TB DVR, (4) TVI outdoor bullet cameras w/ 60' IR 12VDC	623.25
STZIPT84D2	8-channel 2TB DVR, (4) TVI outdoor dome cameras w/ 30' IR 12VDC	623.25
STZIPT88B2	8-channel 2TB DVR, (8) TVI outdoor bullet cameras w/ 60' IR 12VDC	873.05
STZIPT88D2	8-channel 2TB DVR, (8) TVI outdoor dome cameras w/ 30' IR 12VDC	873.05
STZIPT8BD2	8-channel 2TB DVR, (4) TVI outdoor bullet cameras w/ 60' IR, (4) TVI outdoor dome cameras w/ 30' IR 12VDC	873.05

Save big with Speco's TVI kits. Just add wire and a 12VDC power supply and you are ready to go.





## Home access **anywhere.**

The Schlage Connect™ Touchscreen Deadbolt combines advanced features and compatibility with your home automation system, allowing you to control your lock from anywhere.\*

\* Remote and smartphone access require a compatible smart home or security system. Features dependent on platform provider.

© 2017 Schlage Lock Company

**ALLEGION** 

**Analog HD (AHD) DVRs - 1080p Resolution**

All the models below provide a JPG output for each channel. This makes them a great solution for showing analog cameras on OmniTouch 7 screens and the SnapLink Mobile App.

EFECORFHD4F1T	AHD 4-channel 1080p DVR, 1TB hard drive	262.29
EFECORFHD4F2T	AHD 4-channel 1080p DVR, 2TB hard drive	380.94
EFECORFHD8F1T	AHD 8-channel 1080p DVR, 1TB hard drive	318.50
EFECORFHD8F4T	AHD 8-channel 1080p DVR, 2TB hard drive	499.60
EFECORFHD16F2T	AHD 16-channel 1080p DVR, 2TB hard drive	493.36

**New AHD Equipment - Record in Full 1080p Over Coax!**  
**About AHD:** Analog High Definition, or AHD, is a new video transmission technology from EverFocus. It allows video to be sent in full HD resolution over standard coax cable - even RG59. AHD recorders are also compatible with 720p, 960H, or standard analog cameras. This makes it great for retrofit installations since you can leave some of the original cameras in place and upgrade others.



The AHD DVRs have an MJPEG video stream that can be enabled in the setup menu. This stream is compatible with the OmniTouch 7 and SnapLink Mobile apps. Since AHD cameras don't run over IP, these systems couple well with Omni systems. There is no need for complicated managed switches or the configuration of VLANs. The end user experience is still a 1080p picture, but the set up is drastically easier.



**Analog HD (AHD) Cameras - 1080p Resolution**

Analog HD (AHD) cameras send a 720p or 1080p signal over standard coax cable to AHD DVRs. It dramatically reduces system cost and set up time and allows you to offer HD video surveillance upgrades to customers with standard analog systems in place. All models feature a defog function that can be set to periodically heat up the cover to reduce fogging.



Outdoor Color Dome	Indoor IR Dome	Indoor Color Dome	Outdoor Color Dome	Indoor IR Dome	Camera Type
-	100' IR	-	-	100' IR	<b>Low-Light Technology</b>
720p	720p	1080p	1080p	1080p	<b>Resolution</b>
2.8-12mm Auto-iris	2.8-12mm Auto-iris	3.6mm	2.8-12mm Auto-iris	2.8-12mm Auto-iris	<b>Lens</b>
Yes	Yes	Yes	Yes	Yes	<b>Concealed Cable</b>
12VDC/24VAC 1.6W/1.7W	12VDC/24VAC 3.7W/3.5W	12VDC 1.2W	12VDC/24VAC 1.6W/1.7W	12VDC/24VAC 3.7W/3.5W	<b>Power</b>
Defog available in black and white	Defog available in black and white	Defog available in black and white	Defog available in black and white	Defog available in black and white	<b>Special</b>
5.24 Dia. x 3.8	5.24 Dia. x 3.8	4.25 Dia. x 3.54	5.24 Dia. x 3.8	5.24 Dia. x 3.8	<b>Size (inches)</b>
EFED910	EFED930	EFECD900F	EFED910F	EFED930FB	<b>Part Number</b>
93.68	111.16	56.20	93.68	111.16	<b>Price</b>

**Battery Backup**



Using a battery backup on a camera system not only ensures constant recording through power interruptions, it also protects the recorder from damage that can occur as a result of brief outages.

TRLBC350	350 VA Strip-Style Battery Backup	50.58
----------	-----------------------------------	-------

**Cable**

Siamese cable includes 95% bare copper RG59 and braided 18/2 for power. It's the fastest way to wire for cameras.

WAVH59182BCRBK2	1000' Black Siamese Cable	153.63
WAVH59182BCRBK3	500' Black Siamese Cable	77.44

**Altronix Power Supplies for Cameras**

ALTV615DC48ULM3	12VDC, 4A, 8 fused outputs	89.97
ALTV615DC616UL	12VDC, 6A, 16 fused outputs	147.37
ALTSAV4D	12VDC, 5A, 4 PTC protected outputs	61.19
ALTV248	24VAC, 4 Amp, 8 fused outputs	62.79



IP Cameras



CV6531	1.3MP Indoor Dome, 12VDC, 4.2mm, 15' IR, MJPEG / MPEG4 / H.264	38.97
CV6535	2MP indoor Mini Pancake, POE, 2.8mm, MJPEG / MPEG4 / H.264	158.87
CV6533	2MP indoor Mini Dome, POE, 2.8mm, MJPEG / MPEG4 / H.264	168.86
CV6543	2MP Outdoor Bullet, POE, 3.6-16mm, 60' IR, MJPEG / MPEG4 / H.264	366.71
CV6545	4MP Outdoor Bullet, POE, 2.8mm, 45' IR, MJPEG / MPEG4 / H.264	CALL
CV6565	2MP Outdoor Dome, POE, 3-9mm, 45' IR, MJPEG / MPEG4 / H.264	247.80
CVNVR-04N-1000	4-Channel NVR, 1TB hard drive, time/event search	489.61
CVNVR-04N-2000	4-Channel NVR, 2TB hard drive, time/event search	520.58
CVNVR-09N-2000	9-Channel NVR, 2TB hard drive, time/event search	550.56
CVNVR-09N-3000	9-Channel NVR, 3TB hard drive, time/event search	589.53

Channel Vision IP cameras have a clear MJPEG stream that can be viewed on an OmniTouch7



Security Video

All cameras/kits include 12 months of iSeeVideo network service.

NAPISEEVCMP12	Indoor fixed lens pan/tilt camera. VGA Res (640 X 480).	175.98
NAPISVWLCAM	Wireless indoor fixed lens IP camera. VGA Res (640 X 480).	119.19
NAPISVWLCAMPT	Wireless indoor fixed lens pan/tilt camera. VGA Res (640 X 480).	185.96
NAPISVWLHDCAM	Wireless HD indoor fixed lens IP camera. 720P Res (1280 X 720).	161.67
NAPISVWLOCAM	Wireless outdoor fixed lens IP camera. VGA Res (640 X 480).	212.84
NAPISVWLOHD	Wireless HD outdoor fixed lens IP camera. 720P Res (1280 X 720).	238.43
NAPISEESCHGW12	Single-channel video gateway converts analog cameras to IP.	125.39
NAPISEEREPT01	Wi-Fi repeater to extend range for iSeeVideo Wi-Fi cameras.	63.27
NAPISEEWLAP	Wireless access point, 802.11B/G/N, with power supply for IP cameras.	63.27
NAPISVWLOKIT3	Wireless Outdoor Camera Kit: (1) ISVWLOCAM and (1) ISEEWLAP	278.58
NAPISVWLHDKIT4	Wireless Megapixel Camera Kit: (1) ISVWLHDCAM and (1) ISEEWLAP	233.76
NAPISVWLOHDKIT6	Wireless MP Outdoor Camera Kit: (1) ISVWLOHD and (1) ISEEWLAP	301.96
NAPISEEIVR25012	iSeeVideo Internet Recorder. Record up to 6 cameras for up to 30 days.	322.37
NAPISEEIVR1T12	iSeeVideo Internet Recorder. Record up to 6 cameras for up to 3 months.	388.81



Security Video

2GIG-CAM-100W	Indoor Camera, 1.3MP, Wi-Fi, Ethernet	93.99
2GIG-CAM-250P	Outdoor Mini-Dome Camera, 2MP, Ethernet, PoE, White	120.84
2GIG-CAM-250PB	Outdoor Mini-Dome Camera, 2MP, Ethernet, PoE, Black	120.84
2GIG-NVR-1-1T	4 channel NVR, 4 PoE ports, Mouse, 1 TB	335.67
2GIG-MNT-250	Camera Mount for 2GIG-CAM-250P	10.74
2GIG-MNT-250B	Camera Mount for 2GIG-CAM-250PB	10.74



2GIG has launched their own stand-alone IP camera system that is very easy to install. A 2GIG Go Control panel is not required.



Wireless Security Video

The Arlo Video System offers a new perspective to home security. The Arlo Wire-free HD Camera breaks the mold of traditional security cameras and gives users the freedom to install cameras across 100% of their property, indoors or out. The combination of easy installation, battery-operated wire-free design, and waterproof construction makes it a perfect fit for virtually any placement, even in a tree. Can be installed in 10 minutes or less. Low maintenance and user-friendly, the Arlo Video System gives users the ability to make adjustments themselves, including relocating the camera and replacing batteries.

ARLVMC3030	Arlo Wire-free HD Camera	116.00
ARLVMB3000	Arlo Base Station (one required)	67.00

**Integrate the Arlo Video System with HomeControl Flex from Telguard.** With HomeControl Flex and an Arlo Wire-free HD Camera, enable remote viewing of event-triggered clips, images and live video from anywhere, on a smartphone, computer or tablet.



**EVERYTHING IS CONNECTED**

YOUR HOME  
YOUR WAY



IMAGINATION

**SMART HOME SOLUTION**



The FIBARO smart home system is an ecosystem that allows your customers to control and manage all of their smart home devices. FIBARO can integrate with legacy home security systems, allowing for whole home security and control of safety products like sensors, door locks, intercoms and cameras as well as lifestyle devices like thermostats, lights and entertainment. FIBARO, where everything is connected.

[www.fibaro.com](http://www.fibaro.com)

MCA-88X 8-Zone Whole House Audio with XStream™

Next Generation Multizone Audio Controller Has Arrived

Building on Russound's legendary reliability, simplicity, and sound quality, the new multizone controllers now offer lightning fast response time, an array of digital inputs, and quicker configuration. The evolutionary MCA-88X, an 8-source, 8-zone controller, features built-in XStream™ Technology, enabling popular streaming content from the cloud, home network, tablets and phones—all from a single component. The intuitive MyRussound™ app conveniently controls the entire system and displays metadata using tablets and phones. In addition, a wide assortment of keypads, touchscreens and hand-held remotes ensures optimum control for any location. Engineered for flexible configuration and easy integration, the controllers satisfy any design challenge. The system allows multiple controllers to be combined to create up to 48 independent zones. The new Russound line of multizone controllers delivers the perfect balance of popular music content, audio performance and optimal control.

Features:

- 8 zones: 40W/Ch zones 1-6, zones 7 and 8 line out only
- Fixed / variable line out for all 8 zones
- 6 amplified zones @40 wpc
- Built-in XStream™ streaming audio source (MCA-88X)
- 8 analog inputs / 3 digital coax inputs / 1 optical input
- Input 8 can be reassigned as an auto-sensing page
- Source loop outputs for all sources
- 6 routed IR outputs plus a global IR out
- Built-in IR learner and library IR codes
- RS232 and IP controllable
- Global 12v trigger in/out
- Programming software is a free download
- Programming and updates via USB port or Ethernet
- Zone Linking locks multiple zones together for all functionality
- Source Linking ensures selected zones always play the same source
- Source Mapping allows sources to only be available in selected zones
- Audiophile quality DACs support high resolution audio (24 bit/192kHz)
- Adjustable bass, treble, balance and loudness
- Connection for optional BTC-1X Bluetooth transceiver
- Rackmountable
- Expandable to up to 48 zones
- Compatible with Leviton OmniPro II

Double Warranty with Russound Speakers! See p.157



RSMCA-88X Front



RSMCA-88X Back

RSKT2-88X	MCA-88X, (6) white MDK-C6 keypads, remote, (7) 845.1 emitters, rack ears	2,899.00
RSMCA-88X	8-source audio input, 1-XStream source, 8-zone audio output with 40W/Ch (zones 1-6, line out 7-8), routed IR, RS-232, paging, rack ears,	1,749.00



Look on page 152 for Russound MCA-88 which has all the features of the MCA-88X without the XStream™ streaming audio source. It can be used for expanding beyond the 8 zones of the MCA-88X.



Four-Stream Four-Zone Audio



RSXZONE4



Features:

- 4 independent streaming audio players
- 4 amplified zones, expandable to 16 zones
- Dedicated stream per zone
- Controllable by the XTS Touchscreen or the MyRussound App
- XStream™ complement of streaming sources including Spotify, Pandora, AirPlay and more
- Mix and match with other XStream Series components for versatile system designs

The XZone4 Four-Stream, Four-Zone Audio System is a complete streaming media solution that gives Russound installers a single-box package that is easy to install via a simple browser-based configuration, using a smartphone, tablet, or laptop.

As part of the scalable XStream Series of products, the XZone4 can be used with other XZone4 devices or any other XStream product (XSource) to become part of a single system of up to 16 zones of audio. It works with the MyRussound App for iOS/Android phones and tablets.

Russound created the XZone4 to become the go-to solution for bringing streaming media to wholehouse audio customers. The XZone4 is a 1U rack-mountable component offering four independent audio streams that support up to four rooms of audio in a home or business, and can easily scale up to 16 total audio zones by linking up one or more of the other XStream series products.



RSXZONE4	Four-Stream, Four-Zone Audio System	1,169.00
----------	-------------------------------------	----------



**User Interfaces**

**Russound XTS Touchscreen**

- 4.7" (11.9 cm) High Resolution Quad HD Display
- Horizontal or Vertical Orientation Mounting
- Runs MyRussound™ App
- Powerful Cortex-A9 Processor
- Supports all MCA-series controllers, Russound streaming sources and the new Russound 70V amplifier
- Controls any zone in a supported Russound system
- Gigabit Ethernet, with 802.3af POE



**RSXTS**

**XTS Touchscreen Interface**

RSXTS	Touchscreen for the MCA series controllers, X-Zone4 controllers, X-Source streamers, and Russound 70V	389.00
-------	---	--------

**MCA Keypads and Remotes**

RSMDK-C6	2-gang keypad for use with the MCA controllers, White	209.00
RS1550-534***	MDK-C6 Keypad Color Change Kits (***) 492-White, 485-Light Almond, 461-Bone, 454-Black, 478-Brown, 485-Almond)	8.00
RSSLK-1	Single-gang keypad for use with the MCA controllers, White	155.00
RSDTS2-*	Desktop stand for the MDK-C6 keypad (*W-White, B-Black)	55.00
RSUSRC	Universal/Learning Remote for use with all Russound keypads and controllers	29.00
RS2500-521065	Advanced Programming cable for KP4, KP6, KPL, ISK1, ISK2, ISK3, ISH1	12.60

**MCA and RNET Sources**

RSBTC-1X	External Bluetooth Receiver for MCA-66, MCA-88, and MCA-88X with Bluetooth port	75.98
RSST1	RNET-enabled Tuner with RDS Support. 1/2 rack width, Compatible with MCA & C-Series controllers.	210.00
RSBSK1	RNET-enabled 2 piece Bluetooth interface for MCA systems	129.00

**RNET Serial Connection Sharing**

AVOSR-2	Serial Adapter for connecting 2 controllers to Russound RNET systems	85.00
X781ERGPS	12VDC Power Supply	9.89



**RSSLK-1**



**RSMDK-C6**



**RSBTC-1X**



**RSUSRC**

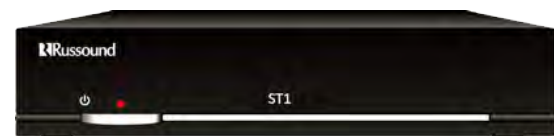

**RSST1**

**Using A-BUS on an MCA-Series System**

**Add rooms to an MCA-series without purchasing additional controllers**

How many times are you designing a system only to find you need 1 or 2 extra rooms? Instead of eliminating the zones or purchasing another controller, there is a less expensive solution: A-BUS subzoning. Simply add an A-BUS Hub and wire CAT-5 to an A-BUS keypad. The keypad gives separate on/off/volume, yet plays the same source audio as the primary zone. Responds to All On/Off and Page events as configured for the primary zone. The sub-zone will support a local source by adding an RSA-LC3.

RSA-H2	Surface-mount single-source, 2-zone hub, (4) IR emitter jacks	82.00
RSA-PS	Power Supply required for A-bus hub	85.00
RSA-K4	A-BUS LCD amplified keypad with IR receiver	99.00
RSA-LC3	A-BUS local source input with auto sensing	68.00

**Primary zone must be on for sub-zones to operate**

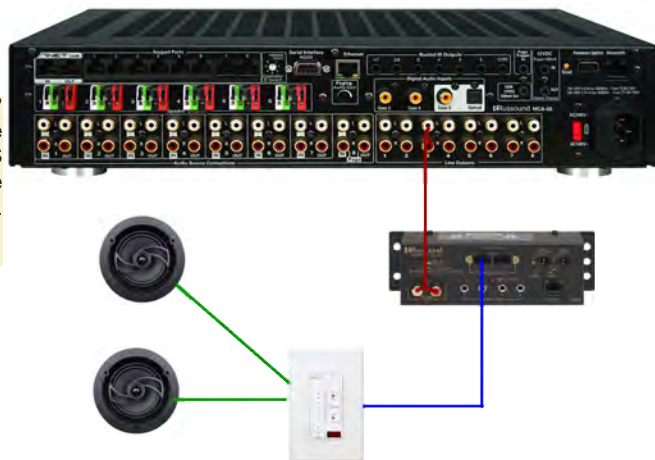

**Digital Media Streamer**



The XSource Streaming Audio Player is a multi-use streaming media solution with a tiny form factor for easy integration with external amplifiers or whole-house receivers.

Designed for scalability, the XSource includes native support for high resolution audio and the full complement of sources available in all of Russound's XStream series of products. The XSource also supports playback from connected USB storage devices.

XSource can be integrated with other XStream series components, Russound MCA-Series and C-Series controllers, or can operate as a stand-alone streaming source that can be used alongside any amplifier or multiroom audio system. It offers both analog and digital outputs as well as built-in Ethernet connectivity. The innovative built-in clip allows the physical coupling of multiple units. Couple four units together to fit a standard 17" rack width.



RSXSOURCE



**Use as a source for MCA-series, C-series, CAV, CAM, CAA, and stand-alone amplifiers. Uses are limited by your imagination.**

RSXSOURCE	XSource Streaming Audio Player	246.00
-----------	--------------------------------	--------

**MCA-88 8-Zone Whole House Audio**

RSMCA-88 Front



RSMCA-88 Back

**Features:**

- Expansion for MCA-88X system or stand-alone
- 8 zones: 40W/Ch zones 1-6, zones 7 and 8 line out only
- Fixed / variable line out for all 8 zones
- 6 amplified zones @40 wpc
- 8 analog inputs / 3 digital coax inputs / 1 optical input
- Input 8 can be reassigned as an auto-sensing page
- Source loop outputs for all sources
- 6 routed IR outputs plus a global IR out
- Built-in IR learner and library IR codes
- RS232 and IP controllable
- Global 12v trigger in/out
- Programming software is a free download
- Programming and updates via USB port or Ethernet
- Zone Linking locks multiple zones together for all functionality
- Source Linking ensures selected zones always play the same source
- Source Mapping allows sources to only be available in selected zones
- Audiophile quality DACs support high resolution audio (24 bit/192kHz)
- Adjustable bass, treble, balance and loudness
- Connection for optional BTC-1X Bluetooth transceiver
- Rackmountable
- Expandable to up to 48 zones
- Compatible with Leviton OmniPro II

Double Warranty with Russound Speakers! See p.157



RSKT2-88	MCA-88, (6) white MDK-C6 keypads, remote, (8) 845.1 emitters, rack ears	2,729.00
RSMCA-88	8-source audio input, 8-zone audio output with 40W/Ch (zones 1-6, line out 7-8), routed IR, RS-232, paging, rack ears	1,575.00
RSBTC-1X	External Bluetooth receiver using Bluetooth port	75.98

**MCA-66 6-Zone Whole House Audio**



RSMCA-66 Front



RSMCA-66 Back

**Features:**

- Fixed / variable line out for Zone 1 and 2
- 6 amplified zones @20 wpc
- 6 analog inputs / 3 digital coax inputs / 1 optical input
- Connection for optional BTC-1X Bluetooth transceiver
- RS232 and IP controllable
- 6 routed IR outputs plus a global IR out
- Built-in IR learner and library IR codes
- RS232 and IP controllable
- Global 12v trigger in/out
- Programming software is a free download
- Programming and updates via USB port or Ethernet
- Zone Linking locks multiple zones together for all functionality
- Source Linking ensures selected zones always play the same source
- Source Mapping allows sources to only be available in selected zones
- Audiophile quality DACs support high resolution audio (24 bit/192kHz)
- Adjustable bass, treble, balance and loudness
- Rackmountable
- Expandable to up to 36 zones

Double Warranty with Russound Speakers! See p.157



RSKT2-66	MCA-C3, (6) white MDK-C6 keypads, remote, (6) 845.1 emitters, rack ears	1,999.00
RSMCA-66	6-source audio input, 6-zone audio output with 20W/Ch, routed IR, RS-232, paging, power management, rack ears	1,149.00
RSBTC-1X	External Bluetooth receiver using Bluetooth port	75.98

The MCA-66 and MCA-88 also support Bluetooth streaming through an optional external receiver, the BTC-1X.



RSBTC-1X

The A-BUS system from Russound has long been known as the easiest distributed audio system to install due to its simplified wiring structure. That's why the installation professionals love it. But why do they keep recommending it? Because their customers love it, of course!

**A-BUS Amplified Volume Control Keypads and Accessories**



**RSA-K4**

**Amplified Keypads**

RSA-K4	A-BUS amplified keypad with IR receiver, pre-amp output, system status, 1 through 4 source selection depending on hub used, white.	99.00
--------	--	-------

**Local Source Modules**

RSA-LC3	A-BUS local source input with IR emitter output, auto sensing to override audio on source one, white.	68.00
RSBTA-2	Bluetooth enabled local source module for A-BUS systems, override audio on source one, white.	79.00

- A huge benefit of A-BUS is the Local Source feature
- Local Source allows a customer access to "whole house" sources connected at the hub as well as audio sources in the room
- Local source is great for portable media (iPhone, iPod, iPad, Android) as well as media in the room such as televisions and media streamers



4-Conductor Speaker Wire



**RSA-K4**



Cat 5e Run



**RSA-LC3**

Or



**RSBTA-2**



Cat 5e Run

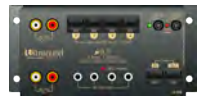

**A-BUS Hub**

**RSA-LC3**

- Wire in between the A-BUS hub and the volume control
- When audio is sensed on the front RCA jacks, the module will automatically switch from the main source to the local source. When audio is removed, the module will return to the audio provided by the hub.
- Adjustments for switching sensitivity and delay
- Infrared emitter port allows control of the local source via infrared repeating

**RSBTA-2**

- Bluetooth local source module for A-BUS systems and subzones
- Acts like an A-LC3 but uses Bluetooth instead of analog RCA inputs to receive audio from a personal music player, smart-phone, tablet or PC
- Stream Bluetooth audio from up to 15 meters away
- Custom naming for easy identification
- Bluetooth 2.1 and EDR/Class 1 with A2DP Profile

**A-BUS Hubs / Source**

RSA-H4D-*	In-wall single-source 4-zone hub, double-gang work box, (4) IR emitter jacks, requires A-PS	99.00
RSA-H484	Surface-mount 4-source, 4-zone hub, (4) routed IR emitter jacks, (1) common IR jack, 12V trigger	309.00
RSA-H4	Surface-mount single-source, 4-zone hub, (4) IR emitter jacks, IR link input/output, confirmation LED	113.00
RSA-H2	Surface-mount single-source, 2-zone hub, (4) IR emitter jacks, IR confirmation LED	82.00
RSA-PS	A-BUS power supply, 24VDC, detachable power cord, provides clean and regulated power	85.00

(\*W-White and Almond, B-Bone, BL-Black, BR-Brown)



**RSA-H4D**



**RSA-H4**

**Look on pages 217 through 225 for Rough-in Boxes, Tools, and Cable**

**Cabling**

In most residential installs, you would use standard PVC Cat5 for the run from the hub to the keypad. If you are working in a commercial building, you may be required to use plenum-rated cable. If the ceiling you are running cable through is part of the air-return, it will be required.

WAV5E04UR**1	Standard PVC Cat 5e: 24AWG, 4 pair, 350MHZ	CMR	(BK, BL, GN, GY, OR, PK, PR, RD, WH, YL)	1000' Pull Box	63.07
WAV5E04UP3**	Plenum Cat 5e, 24AWG, 4 pair, 350MHZ	CMP	(BL, GN, GY, OR, RD, WH)	1000' RIB	143.64

WH-(white), YL-(yellow), OR-(orange), GN-(green), BL-(blue), BK-(black), GY-(gray), PR-(purple), PK-(pink), RD-(red)

The cable below is a combination cable of 16/4 speaker wire and Cat5e. If you pre-wire with this cable, the customer can later upgrade to a higher level system like a MCA-66 or MCA 88 without re-wiring.

WAVH15E164MYL2	1 Cat 5e + 16/4 Audio Cable PVC: CAT 5e + 16/4 audio cable	CM	(YL)	500' Reel	159.87
----------------	--	----	------	-----------	--------



CAA66 Multi-Source / Multi-Zone Audio System



Features:

- 6 audio inputs
- 6 zones with 40W per zone
- Serial port
- IR library and learning IR
- Routed IR source selection
- 12VDC mute input, trigger output
- Preamp or fixed output zones (1/2)
- Bass, treble, and loudness control
- Link 6 CAA66s for a 6x36 system
- Compatible with Leviton OmniPro II

Double Warranty with Russound Speakers! See p.157



RSCAA66	6-source input, 6-zone output with 40W per zone, serial port, routed IR, mute in, trigger output, fixed or variable preamp outputs for zones 1 and 2, controller link, punchdown tool	819.00
RSCAA66L-W	CAA66, (6) white KPL keypads, remote, (6) 845.1 IR emitters, rack ears	1,329.00
RSCAA66K-W	CAA66, (6) white KP6 keypads, remote, (6) 845.1 IR emitters, rack ears	1,079.00
RSUSRC	Universal Systems Remote for use with all Russound systems	29.00



RSKP6

CAA66 Keypads

RSKPL-W	Single-gang LCD keypad for CAA66 controllers	149.00
RSKP6-W	Single-gang 6-source keypad for CAA66 controllers	79.00
RSKPSC-W	Source control keypad for CAA66 controllers, works with KP6 and KPL	39.00

White and Almond included

CAA66 Keypad Color Change Kits

RSKPL6-*	Color change kit for RSCAA66L (Quantity 6 inserts)	18.00
RSKP66-*	Color change kit for RSCAA66K (Quantity 6 inserts)	18.00
RSKPSC6-*	Color change kit for RSKPSC (Quantity 6 inserts)	18.00

(\*W-White, A-Almond, B-Bone, BL-Black, BR-Brown)



RSKPL-W RSKPSC-W

CA-4 Multi-Source / Multi-Zone Audio System (non-A-BUS)



RSCA4-KP



RSCA4

Features:

- 4 audio inputs
- 4 zones with 30W per zone
- Use 2 systems for an 8-zone system
- Party mode on command
- Command for All Zones Off
- Source grouping
- Bass, treble, loudness control
- Serial port
- 12VDC mute input, trigger output
- Keypad/speaker connection plate
- Compatible with Leviton OmniPro II one-way communication

Double Warranty with Russound Speakers! See p.157



RSCA4-KT1	CA4 controller, (4) CA4-KP keypads, CA4-WP wallplate, remote, (4) 845.1 emitters, rack ears	589.00
RSCA-4	4-source input, 4-zone output with 30 watts per zone, RS-232 (1-Way Leviton communication), routed IR, rack ears	419.00
RSCA4-WP	Single-gang in-wall connection plate for the CA4 system. 4 RJ-45 inputs, 4 RJ-45 outputs, and 4 pair of speakers	35.00
RSCA4-KP	Single-gang keypad for the CA4	59.00
RS1200-53-10**	CA-KP color change kit (**-57-White, 64-Almond, 95-Bone, 71-Black, 95-Brown), includes kits for 4 keypads and 1 wall port	18.00
RSUSRC	Universal Systems Remote for use with all Russound systems	29.00

Russound Wallplate and Box Solutions

RSHTP-2	Home Theater 2-gang plate, binding posts for 5.1, 6.1 and 7.1, 2 "F" connectors, 2 RCAs for subs	32.00
RSWPB37-23	Vertical self-closing cover with 3/8" gasket and 2 mounting screws	13.90
RSWPB37-23FS	Same as above, mounts to flat surface w/ 4 screws	15.70



RSHTP-2



**70-Volt Commercial Audio Amplifier with Built-in Media Streaming**

The Russound XZone70V features built-in XStream technology, enabling popular streaming content from the cloud, home network, AirPlay™ enabled tablets, and phones - all from a single component. The built-in audio streamer offers the best audio content from the internet or even a user's personal networked audio collection using DLNA. The rear panel even includes a USB port for playing content from a Flash Drive or an externally powered USB hard drive.

- 70v/100v/4Ω operation - Powerful 300W output - Controllable by the XTS Touchscreen or the MyRussound App - 3.5mm auxiliary audio input
- XStream™ complement of streaming sources including: SiriusXM for Business, Spotify, Pandora, AirPlay and more
- Mix and match with other XStream Series components for versatile system designs - USB Port for flash-based or hard drive audio
- Mic Input with phantom power support



RSXZONE70V	70V 300 Watt Streaming Mixing Amplifier with Mic input	715.00
RSAW70V6B	70V surface-mount Indoor/Outdoor Speaker, 70V: 7.5W, 15W, 30W, 60W, 6 Ohm - Black	239.00
RSAW70V6W	70V surface-mount Indoor/Outdoor Speaker, 70V: 7.5W, 15W, 30W, 60W, 6 Ohm - White	239.00
RSALT-70V-50	70V 50 Watt Volume Control - White	22.50



**High Resolution Digital Amplifiers**

RSTVA2.1	2-channel TV amplifier with sub out, 35w@ 4Ω, IR learning, digital in, designed for flat panel TVs	165.00
RSD250-LS	1-zone/2-channel amplifier, auto A/B amplified switching capabilities, 12VDC in/out, video sensing, line-level or speaker-level switching, 50W/Ch @ 8Ω (75W/CH @ 4Ω), bridgeable to 140W @ 8Ω, gain control. Includes surface/rack mounting hardware.	199.00
RSD850	8-channel amplifier: 35w@8Ω, 50w@4Ω, bridgeable to 100w, 12VDC input and output trigger, auto signal-sensing, separate gain controls, thermal and short protection, rack ears, bus input-output	599.00
RSD1650	16-Channel Amplifier 50w@8Ω, 80w@4Ω, bridgeable to 160w, global and zone input trigger auto signal-sensing, separate gain controls, thermal and short protection, rack ears	999.00



**RSTVA2.1**

Amplifier Features	TVA2.1	P75	P125	D250-LS	D850	D1650	A250	A2100
Total channels	2	2	2	2	8	16	2	2
Auto signal sensing inputs	Y	Y	Y	Y	Y	Y	Y	Y
Separate channel gain controls	-	-	Y	Y	Y	Y	-	-
Short-circuit protection	Y	Y	Y	Y	Y	Y	-	-
Rack mount ears included	N/A	N/A	N/A	Y	Y	Y		
12-volt trigger input and output	-	-	Y	Y	Y	Y	Y	Y
Bus input and output	-	-	N	-	Y	Y	-	-
Source loop outputs	-	Y	Y	-	-	-	Y	Y
Local source switching	-	Y	Y	Y	-	-	-	-
Front panel controls	-	Y	Y	-	-	-	-	-



**RSD250-LS**



**RSP75**



**RSD850**



**RSD1650**

**Integration Amplifiers**

RSP75	2-channel amplifier, 60w@8Ω, 75w@4Ω, bridged mono 160w@8Ω, auto signal-sensing source selection, thermal and short protection, local source switching, front panel controls	99.99
RSP125	2-channel amplifier, 80w@8Ω, 125w@4Ω, bridged mono 250w@8Ω, 12VDC input and output trigger, auto signal-sensing source selection, separate gain controls, thermal and short protection, local source switching, front panel controls	309.00
RSA2100	2-channel amplifier, 100w@ 8Ω, bridged mono 200w@8Ω, 12VDC input trigger, auto signal-sensing	239.00



**RSP125**



**RSA2100**



## The Next Generation of Streaming Audio



### XZone4

4 Stream, 4 Zone Audio System

Four powerful zones. Four independent streams. One slender chassis.



### XTS

Wall-Mounted Color Touchscreen  
Elegant, intuitive control available instantly  
wherever you want it



### XSource

Streaming Audio Player  
The perfect addition to any system to add AirPlay,  
streaming audio, and app control





Change from a ceiling speaker to a wall speaker by changing the grill



Say goodbye to crooked in-wall installations, simply rotate the grill until it is level!

**Double the warranty on your Russound controllers by using Russound speakers.**

**Acclaim Edgeless Speakers**

RSRSF-610	Edgeless 2-way speaker: 6.5" Poly woofer, ¾" pivoting PEI tweeter, 5 - 120 watts, pair	55.00
RSRSF-610T	Edgeless single-point stereo: 6.5" IMPP Ribbed woofer, two tweeters, 5 - 150 watts, each	49.00
RSRSF-620	Edgeless 2-way speaker: 6.5" Poly woofer, 1" pivoting Silk tweeter, 5 - 150 watts, pair	89.00
RSRSF-820	2-way speaker: 8" Poly woofer, 1" pivoting Silk tweeter, 5 - 150 watts, pair	119.00

**Acclaim Angled Edgeless Speakers**

RSRSA-635	2-way 15° angled speaker: 6.5" IMPP woofer, 1" pivoting Teteron tweeter, 5 - 150 watts, each	129.00
-----------	--	--------

**Acclaim Edgeless Speaker Grilles**

RSRSG-6RW	Replacement round speaker grilles for Russound RSA-6 model speakers - white	9.00
RSRSG-6SW	Square speaker grilles for in-wall Russound RSA-6 and RSF-6 speaker installations - white	9.00
RSRSG-8RW	Replacement round speaker grilles for Russound RSA-8 and RSF-8 model speakers - white	9.00
RSRSG-8SW	Square speaker grilles for in-wall Russound RSA-8 and RSF-8 speaker installations - white	9.00

Limited Lifetime Warranty on Indoor Speakers

**Acclaim Edgeless Speaker Rough-In Brackets**

RSSB-C67	Rough-in bracket for Acclaim 6½" Edgeless speakers, Pair	Pair 15.00
RSSB-C80	Rough-in bracket for Acclaim 8" Edgeless speakers, Pair	Pair 15.00

**High-Performance Fire-Rated Flexbox Speaker Back Boxes**

Fire-rated speakers or enclosures are required in most municipalities. If there is living space above or on the other side of the wall you should have a fire barrier.

RSFBC1-FR	In-ceiling, high-performance, fire-rated, speaker back box: 14"W x 6"D x 17.5"H. Recommended for retrofit applications.	99.00
-----------	---	-------



Flexbox speaker back boxes reduce background noise, provide a moisture barrier, diffuse distortion, and improve sound quality. The flexible construction allows for easy installation in retrofit or new construction settings. Boxes are flame retardant and meet ASTM E119 and UL 263/ NFPA 251 (1-hour) and ASTM E84/ NFPA 70 standards. Sound Transmission Class (STC) is 32 dB.

**In-Ceiling Retrofit Installation**

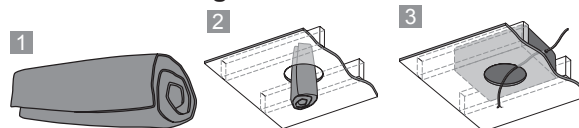

**Acclaim 5 OutBack™ Outdoor Speakers (Weather Resistant)**



**Outback Bracket**



**Outback Stand**



**Outback Bookshelf**

The Acclaim 5 Outback speakers provide a unique mounting system. Each speaker includes a foot for bookshelf applications and a tapered bracket that allows wall, corner, or pole mounting.

RS5B45*	Indoor/outdoor: 4" polypropylene cone, 1" Teteron™ tweeter, power handling from 10 - 100 watts, 8Ω, pair	99.00
RS5B55*	Indoor/outdoor: 5.25" polypropylene cone, 1" Teteron™ tweeter, power handling from 10 - 125 watts, 8Ω, pair	130.00
RS5B65*	Indoor/outdoor: 6.5" polypropylene cone, 1" Teteron™ tweeter, power handling from 10 - 150 watts, 8Ω, pair	175.00
RS5B65S*	Single-point stereo indoor/outdoor: 6.5" injection-molded polypropylene cone, (2) 1" Teteron™ tweeters, multiple mounting options, power handling from 10 - 150 watts, 8Ω, pair	125.00

(\*W-White, BL-Black)

**OutBack™ Rock Speakers**

RS5R82-G	8" 2-way Outdoor Rock Speaker: Gray Granite - each	119.00
RS5R82-S	8" 2-way Outdoor Rock Speaker: Sandstone - each	119.00
RS5R82-W	8" 2-way Outdoor Rock Speaker: Weathered Granite - each	119.00



Sandstone



Weathered Granite



Gray Granite

**ALTx Series 1x, 2x, 4x, 8x Autoformer Impedance Matching Volume Controls - 126W**

RSALT-126R	Decorator plate and knob, 126W stereo impedance matching volume control, 12 steps of attenuation, detachable 12-gauge connector, lifetime warranty. White and Light Almond included. Color change kits available separately (Almond, Black, Bone, Brown)	19.99
RSWALTX-2	Weatherproof plate and knob, 126W stereo impedance matching volume control, fits a standard 3/4" PVC outdoor conduit, gray	67.80
RSTBL-75	Tabletop, 126W stereo 1x, 2x, 4x, 8x selectable impedance matching volume control w/ headphone jack speaker override	75.60
RSEZB-8	EZ-connect speaker terminal block, 1 amplifier input, 8-pair speaker outputs, 14-gauge snap connector	29.00

**Impedance Matching Volume Controls: A Great Value**

In today's high tech digital world, sometimes we overlook the simple solutions. What can be simpler to offer, specify, or install than impedance matching volume controls?

Turn it on, off, up or down. Russound volume controls allow customers to enjoy the music anywhere in their home. Russound is known for their autoformer impedance matching technology, long term reliability, and lifetime warranty.

Start with an amplifier (page 155). For background audio throughout the home budget 20 watts per channel (8Ωs) per room. Choose if you want to use a speaker switcher (below) and the appropriate volume controls. If a speaker switcher is not being used consider using the EZB-8 distribution block for a clean installation.



**RSEZB-8**



**RSALT-126R**

**Single Source Resistor-Based Speaker Selectors**



**RSSS-6.2**

RSSS-4.2	4-pair speaker selector, 100W/Ch RMS, for use with 4Ω stable amplifiers	65.00
RSSS-6.2	6-pair speaker selector, 70W/Ch RMS, for use with 4Ω stable amplifiers	89.00

**A/B Speaker Selectors**



**RSAB-3.2**



RSAB-1.2*	Decorator style in-wall A/B speaker/amplifier selector (*W-White, LA-Light Almond, A-Almond, B-Bone, BL-Black, BR-Brown)	24.00
RSAB-2.2	Freestanding manual A/B speaker/amplifier selector	45.00
RSAB-3.2	Auto A/B speaker level switching, selectable delay and sensitivity, 110VAC	75.00

Occasionally, the question comes up: "How do I get the sound from my C-series controller into the home theater?" You can share one pair of speakers using the RSAB-3.2. When the theater is off, the C-series can take over the speakers. You can use a keypad or the MyRussound app to control the C-Series controller.

**Autoformer-Based Speaker Selectors with UltraMatch™ Volume Controls**



**RSSDB-4.1**

RSSDB-4.1	4-pair speaker selector with UltraMatch™ Volume Controls, 2x, 4x, 8x impedance settings, 200w/Ch RMS, detachable 14-gauge color-coded snap connectors, zone identifying labels	239.00
-----------	--	--------

**Autoformer-Based Speaker Selectors**



**RSPRO-6HP**



**RSPRO-12HP**

RSPRO-6HP	6-pair speaker selector with adjustable impedance matching, 100W/Ch RMS w/ subsonic filter built in, detachable 14-gauge color-coded snap connectors, zone identifying labels	205.00
RSPRO-8HP	8-pair speaker selector with adjustable impedance matching, 200W/Ch RMS w/ subsonic filter built in, detachable 14-gauge color-coded snap connectors, zone identifying labels	235.00
RSPRO-12HP	12-pair speaker selector with adjustable impedance matching, 200W/Ch RMS w/ subsonic filter built in, detachable 14-gauge color-coded snap connectors, zone identifying labels	279.00

**Speaker Wire**

WAVAC1202RWH2	12/2 Audio Cable: 12AWG, 2C 65 strand oxygen free copper	CMR	(White)	500' Pull Box	118.66
WAVAC1402RWH15	14/2 Audio Cable: 14AWG, 2C 105 strand oxygen free copper	CMR	(White)	500' Pull Box	88.68
WAVAC1402RBL15	14/4 Audio Cable: 14AWG, 4C 105 strand oxygen free copper	CMR	(BL-Blue)	500' Pull Box	88.68
WAVAC1402OSPBK1	14/2 Direct Burial Audio cable, 2C 65 strand oxygen free copper	CM	(Black)	500' Pull Box	99.92
WAVAC1602R**15	16/2 Audio Cable: 16AWG, 2C 65 strand oxygen free copper	CMR	(BL-Blue, WH-White)	500' Pull Box	58.70
WAVAC1604R**15	16/4 Audio Cable: 16AWG, 4C 65 strand oxygen free copper	CMR	(BK-Black, WH-White)	500' Pull Box	99.92

**Russound SaphIR Infrared**



- Many custom audio-video systems use infrared commands to operate source equipment
- Infrared commands cannot pass through walls or cabinet doors
- Russound's SaphIR® infrared repeating products allow installers to place audio/video products in locations that are aesthetically pleasing or more convenient
- Use an infrared receiver to capture a command, a distribution block to inject power and an emitter to issue the command to the audio/video component
- For shorter distances, use the supplied cables; for longer distances, Category 5 cable works great
- Blue signal confirmation LED allows customers to visually confirm that an infrared command has been received

RSSLM-1K	Universal Surface Mount IR Kit: (1) SLM-1 Slim receiver, (1) CB-140 connecting block, (4) IRE-1 emitters	34.00
RSSLM-1	Slim design surface-mount universal IR receiver (LED, LCD, Plasma, CFL)	39.00
RSCB-140	Compact IR connecting block, (1) receiver input, (4) emitter outputs	19.00
RSIRE-1	Low profile IR emitter	5.00

- The 1/8" mini plug is plugged into a connecting block
- The emitter side is placed over top of an A/V components' IR receiver window
- Russound emitters are compatible with most IR repeating systems
- Miniature head unobtrusively attaches to your equipment
- Plug-in design installs quickly
- 10' (3 m) cable accommodates most installation scenarios

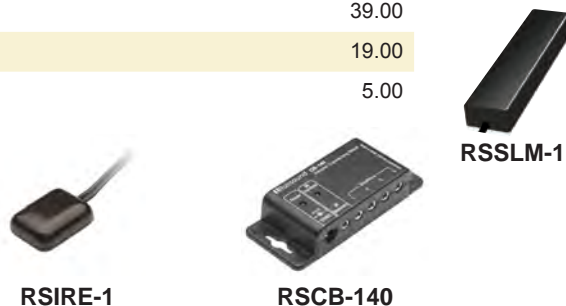

**ComPoint Intercom**

**ComPoint™**

**The Music Lover's Intercom Solution**



**RSISK3 Outdoor Intercom Station**



**RSISSP Single Gang Speaker**



**RSISK2 Advanced Keypad:**

- LCD with assignable descriptions
- Volume Control and Do Not Disturb
- Integrated 50 WPCH relay allows sharing speakers with whole house audio
- Integrated paging amplifier and microphone
- Selectable amber or green backlighting



**RSISH1 System Hub**

RSISH1	System hub, (6) intercom zones, (2) door stations, (7) chimes, link 6 hubs for 36 stations, requires RSISPS	219.00
RSISPS	ComPoint power supply	39.00
RSISK2-W	Advanced LCD ComPoint keypad, assignable zone names, White only	169.00
RS49-7039*	ISK2 color change kits: (* A-White, B-Almond, C-Bone, D-Brown, E-Black)	1.59
RSISK3-AB	Weatherproof door station, plated die-cast zinc. Antique Brass finish.	125.00

**ComPoint products are sold individually. Kits are no longer available.**

**ComPoint Accessories**

RSISSP	Single-gang speaker for ComPoint, White and Almond included	20.00
RS2500-521065	Advanced programming cable for KP4, KP6, KPL, ISK1, ISK2, ISK3, ISH1, MDK-C5 and BGK1	12.60
RSISDR1	Door strike release module, NO and NC contacts, relay rated for 1A @ 12VDC	49.00



**Single-Gang Boxes**

A1ILV1	Low-voltage mounting bracket, old work, single gang, plastic, adj. 1/4" - 1" walls	0.92
A1ILV2	Low-voltage mounting bracket, old work, double gang, plastic, adj. 1/4" - 1" walls	1.40
A1ILV3	Low-voltage mounting bracket, old work, 3-gang, plastic, adj. 1/4" - 1" walls	2.37
A1ILVMB1	Low-voltage mounting bracket, new construction, single gang, plastic	0.77
A1ILVMB2	Low-voltage mounting bracket, new construction, double gang, plastic	1.34



**Designer Infrared Emitters**

10-pk 5-pk Each



X282D	Standard designer emitter, non-visible, 10' cable	74.32	N/A	9.62
X282TPD	Twin plug mini designer emitter, dual plug - single emitter	N/A	N/A	9.62
X283D	Mini blink-IR designer emitter, visible, low-output version, 10' cable	74.32	38.47	9.62
X283TPD	Twin plug mini blink-IR designer emitter, dual plug - single emitter	N/A	N/A	9.62
X284D	Dual mini emitter, non-visible, wire is 7' to junction, 3' to each emitter	83.06	N/A	10.49
X286D	Dual blink-IR emitter, visible, wire is 7' to junction, 3' to each emitter	91.80	N/A	10.49
X28DES	Designer emitter shield cover, use to block interference	N/A	N/A	2.62

**Power Supplies**

X781ERGPS	Regulated 12VDC power supply, powers basic Xantech IR systems, uses 2.1mm coax plug			9.89
X782ERGPS	12VDC high-current power supply, powers large Xantech IR systems, uses 2.1mm coax plug			9.89

**Modules**

XCBCSM1	Current sensor connecting block, requires CSM1 and 781ERGPS power supply			28.85
XCSM1	Current sensing module, requires CBCSM1 and 781ERGPS for stand-alone operation			56.39

**Programming and Controllers**

XRC68X	IR remote programmer, use to program universal learning devices, req. 2 AA batteries (See below)	89.93		
XISM4	The ISM4 eliminates the need for multiple remote controls. Simply walk up and press the power button on one of the devices. Automatic status control of up to 4 devices, 4 IR ports, 4 sensor inputs, bi-directional RS-232 port for status, can be used with all Xantech sensor modules, IR pass-through, XPS programming feature allows for programming without a PC. Includes power supply and (1) video sensor.	209.83		
UBD5312	Alkaline AA Batteries. Sold in 2packs.	0.80		

**Cables and Volume Control Accessories**

X784-00	50' emitter extension cable w/ 3.5mm plug & jack on opposite ends, also works for IR receivers	4.81		
X05913778	Programming cable: RS-232 to keypad	5.25		
X6017400	1' mono cable - 3.5mm / 3.5mm plug, used to create a direct connection to devices	2.19		
XXVCD100	100W rotary impedance matching volume control, decorator style	39.57		



X784-00

**Remote Control Switchers**

X680-10	Remote AC switcher, 6 AC receptacles rated at 5A each, 15A total, outlets controlled individually or as a group, requires RC68X hand-held programmer	244.80		
XAC1	Controlled AC outlet, maximum switching current: 15A continuous @ 120VAC	73.74		
XCC12	Remote relay module, 1 DPDT relay rated at 5A, 30VDC, 2 normally open & 2 normally closed contacts, requires power supply and RC68X	89.93		
XRT8	1x8 addressable IR router, requires power supply & RC68X	151.08		
XRT16-10	1x16 addressable IR router, requires power supply & RC68X	236.06		
XRP41AV	IR remote control A/V pre-amplifier w/ power supply, requires RC68X	187.97		



XRT8



XRP41AV



XCC12

**CasaTunes Internet Music Streamers**



CasaTunes focuses on the design of multi-room music servers. CasaTunes is the ideal solution for 3 rooms or as many as 24. This is what customers will typically interact with every time they want to listen to their music. It has to be simple, reliable and, well, fun!



...and more

**Multi-Source Streamers**



CASCT-2



CASCT-3S

The CasaTunes Streamers supply 3 to 8 sources of streaming music to your existing system. Each stream can be your iTunes or Windows Media songs, streams from internet music services, audio from uPnP/DLNA media servers, even music sent to CasaTunes via AirPlay from your iPad or iPhone.

CASCT-1	One-stream controller	389.00
CASCT-2	Two-stream controller	520.00
CASCT-3S	Three-stream controller	750.00
CASCT-4S	Four-stream controller	1,050.00
CASCT-8S	Eight-stream controller	1,395.00

**App Control - More than just song selection!**

The CasaTunes app gives you the ability to not only control the sources you are using but it will also give you full control of your zones as well. What that means is that you will be able to adjust the volume and source on any zone as long as you are on the same wifi network.



**OmniTouch 7 Integration**

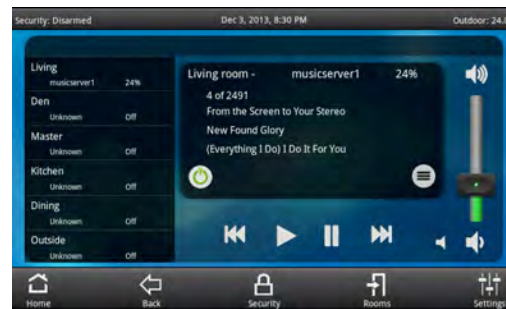

CasaTunes provides meta-data on the OLED VSC keypads and OmniTouch 7. Set up takes just minutes and configures the Leviton Hi-Fi 2 for you!



**Works with these great systems and more!**



CasaTunes is a great reason to contact any customer that might have an aging whole-home music system. The CasaTunes streamers allow a simple upgrade path to take a dated system and add modern app and streaming control. New or legacy whole home audio systems like the Russound CAV6.6 are perfect for integration with any of the CasaTunes streamers. Integration is via serial or network depending on the system.

**Our favorite features**

**Airplay**

CasaTunes' built in Airplay Switch supports both transmitting and receiving of airplay signals. All wired and wireless devices and speakers are published as Airplay targets and kept in perfect sync. In addition to seamlessly adding wireless rooms with any Airplay enabled device, Casatunes can transmit any application running on an iOS device directly to any wired or wireless room in the house. Users do not need to learn a new way to play music, just use the native app on their iPhone, iPad, or iPod touch.

**Built In Music**

All CD Lossless Quality + Hi Res Formats  
Digital to Analog Conversion up to 24 Bit/192khz  
Internet Music  
Windows & iTunes Disk Based Music  
CasaTunes Air – any music service running on an iOS device  
**For any questions on features, give us a call today!!**

**Suggested Controllers**

With the Leviton Hi-fi 2 controllers paired with a CasaTunes music streamer, you will gain full control of your zones and sources within the CasaTunes app.



**The CasaTunes controllers also have the ability to push Metadata to the Hi-fi2 keypads.**

LSA95A00-1	Hi-Fi 2, 8 Zone-8 Source Kit in Enclosure	1,897.02
LSA95A00-2	Hi-Fi 2, 8 Zone-8 Source Kit	1,897.02
LSA95A00-3	Hi-Fi 2, 4 Zone-4 Source Kit in Enclosure	948.42
LSA95A01-1	Hi-Fi 2, 4 Zone-4 Source board only	1,398.07

The CasaTunes music streamers will work wonderfully with the Russound series of amplifiers. The music streamers listed above would be a perfect compliment to the Russound amplifiers listed below.



**The CasaTunes products will also work with any Russound legacy products including the CAV6.6 and others.**

RSP75	2-Channel 75W Amplifier	99.99
RSP125	2-Channel 125W Amplifier	309.00
RSD850	8-Channel 50W per channel Amplifier	599.00
RSD1650	16-Channel 50W per channel Amplifier	999.00

**OnQ Digital Audio System**



**OnQ®  
Digital  
Audio**

**Connect a Home to Limitless Listening**

Listening freedom comes easier with the On-Q Digital Audio System, delivering streaming source variety, quality audio, and the convenience of app control, all through a structured wiring platform.



**The Music Your Customers Love**

Anyone can listen to all of their favorite music – from iTunes, streaming services, mobile devices, and more – all of the time. Streaming services include Pandora, iHeart Radio, Napster, SiriusXM, tunein, Spotify and more.

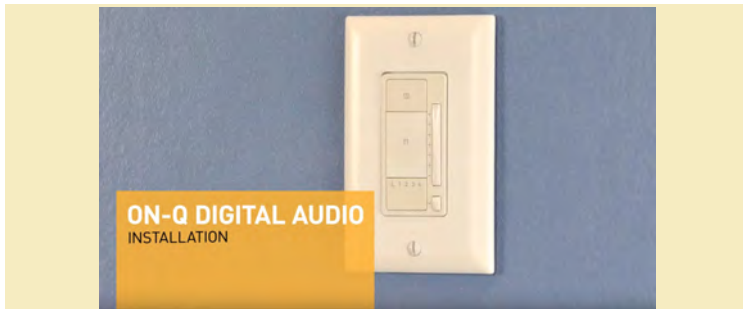

**Repeatable, Simple Installation**

The Digital Audio System's structured wiring-based infrastructure offers easy installation with a repeatable solution.



*Digital Audio App*

**Control at Your Customers' Fingertips**

The sleek and intuitive OnQ Digital Audio app puts the power to hear anything your customers want right in palm of their hand.

**Scan the QR code for a video tutorial on installing the OnQ Digital Audio System.**



**Scan the QR code for a video showing how easy it is to use the Digital Audio App.**



<b>ONQAU7007-WH</b>	<b>ONQAU7008-NI</b>	<b>ONQAU7010-LA</b>	<b>ONQAU7010-WH</b>	<b>ONQAU7154-WH</b>	
ONQPW1020	Power distribution module for four keypads	51.22	ONQAU7007-*	Global source input	69.12
ONQAU7000	Main distribution module	145.13	ONQAU7008-*	Local source input	82.93
ONQAU7001	Input module	234.99	ONQAU7010-*	Amplified keypad	124.40
ONQAU7004	Expansion module	89.85	* - Select color: LA-Light Almond, NI-Nickel, WH-White		

ONQAU7052-WH	Two-room expansion kit: (1) AU7004, (2) AU7010-WH, (1) PW1020, and (1) PW1060	466.98
ONQAU7054-WH	Four-room expansion kit: (1) AU7004, (4) AU7010-WH, (1) PW1020, and (1) PW1060	703.34
ONQAU7152-WH	Two-room, single-source kit: (1) AU7000, (1) AU7001, (2) AU7010-WH, (1) PW1020, (1) PW1060, & (1) PW7760	780.01
ONQAU7154-WH	Four-room, single-source kit: (1) AU7000, (1) AU7001, (4) AU7010-WH, (1) PW1020, (1) PW1060, & (1) PW7760	1,023.47
ONQAU7252-WH	Two-room, multi-source kit: (1) AU7000, (1) AU7001, (1) AU7007-WH, (2) AU7010-WH, (1) PW1020, (1) PW1060, (1) PW7760	847.62
ONQAU7254-WH	Four-room, multi-source kit: (1) AU7000, (1) AU7001, (1) AU7007-WH, (4) AU7010-WH, (1) PW1020, (1) PW1060, (1) PW7760	1,091.08



Speaker Selectors

Proficient speaker selectors are a great solution for whole house audio. With these simple devices you can distribute audio to free standing, in-wall, or in-ceiling speakers across your home.

PFSS4VC	Four-Pair Transformer-based on/off speaker selector with volume controls provides quick, convenient access for up to four stereo pairs. 60 watts power handling per channel.	245.00
PFSS8P	Eight-Pair Resistor-based on/off speaker selector provides quick, convenient access for up to eight stereo pairs. 125 watts of power handling per channel.	125.00
PFSS4P	Four-Pair resistor-based on/off speaker selector provides quick, convenient access for up to four stereo pairs. 125 watts power handling per channel.	70.00

PFSS4VC



PFSS4P



Volume Controls

PFVC60I*	60-watt impedance-balancing volume control with autoformer, quick & secure wire connecting system, fits in most single-gang J-boxes and plaster rings.	28.00
PFVC45I*	45-watt impedance-balancing volume control with autoformer, features removable wire block terminal for easy connection, fits in most single-gang J-boxes and plaster rings.	15.00
PFVCS60*	60-watt stereo volume control with autoformer, features quick & secure wire connecting system, fits in most single-gang J-boxes and plaster rings.	21.00
PFVC60SL*	60-watt slider stereo volume control with removable screw down wire terminal design, fits in most single-gang J-boxes and plaster rings.	33.00
PFVC60AW	60-watt weather-resistant volume control sealed against dust and moisture, fits onto 3/4" conduit or can be surface mounted, available in Gray	40.00

\*Volume controls include white, bone and almond plates, inserts and knobs.



PFVC60I



PFVC60SL



PFVC60AW

Brackets and Back Boxes

PFPCB-IW500	One pair of pre-construction brackets, Fits 5-1/4" in-wall LCR speakers	20.00
PFPCB-C800	One pair of pre-construction brackets, Fits 8" ceiling, TT ceiling and ceiling LCR speakers	20.00
PFPCB-C600	One pair of pre-construction brackets, Fits 6-1/2" ceiling, TT ceiling and ceiling LCR speakers	20.00
PFPCB-C500	One pair pre-construction brackets, Fits 5-1/4" ceiling speakers	20.00
PFPCB-W800	One pair pre-construction brackets, Fits 8" In-wall speakers	20.00
PFPCB-W600	One pair pre-construction brackets, Fits 6 1/2" in-wall speakers	20.00
PFBB-C800	Metal back box for 8" ceiling speakers, 8" single stereo speakers and 8" ceiling LCR speakers	50.00
PFCTB-C600	Ceiling tile bracket. Fits 6 1/2" ceiling speakers, single stereo ceiling speakers and ceiling LCR speakers	16.00
PFCTB-C800	Ceiling tile bracket. Fits 8" ceiling speakers, single stereo ceiling speakers and ceiling LCR speakers	16.00
PFBB-C650	Metal back box. Fits 6 1/2" ceiling speakers, single stereo ceiling speakers and ceiling LCR speakers.	50.00
PFBB-W600	Metal back box for 6 1/2" In-wall speakers	50.00
PFCMB-24	Mounting bars to attach BB-C650 to standard 24" ceiling joists, each	15.00
PFPCB-IW600	Pre-construction bracket for IW650 and IW625	20.00

IR Devices

PFPAS80313	IR Shelf top kit, shelf top receiver, router, power supply, 4 IR flashers	85.00
PFPAS80315	IR Plasma kit, Plasma receiver, router, power supply, 4 IR flashers	135.00
PFPAS80311	IR Fisheye kit, fisheye hub, router, power supply, 4 IR flashers	120.00
PFPAS82200	IR router	30.00

PFPAS80315

Contains all components needed for 1-room system setup including:

- IR Plasma Receiver
- IR Router
- Power Supply
- 4 Single IR Flashers



PFPAS80313

Complete IR system including:

- Shelf-Top IR Receiver
- IR router
- Power Supply
- 4 Single IR Flashers



## Speaker Selectors

Proficient speaker selectors are a great solution for whole house audio. With these simple devices you can distribute audio to free standing, in-wall, or in-ceiling speakers across your home.

PFSS4VC	Four-Pair Transformer-based on/off speaker selector with volume controls provides quick, convenient access for up to four stereo pairs. 60 watts power handling per channel.	245.00
PFSS8P	Eight-Pair Resistor-based on/off speaker selector provides quick, convenient access for up to eight stereo pairs. 125 watts of power handling per channel.	125.00
PFSS4P	Four-Pair resistor-based on/off speaker selector provides quick, convenient access for up to four stereo pairs. 125 watts power handling per channel.	70.00

PFSS4VC



PFSS4P



## Volume Controls

PFVC60I*	60-watt impedance-balancing volume control with autoformer, quick & secure wire connecting system, fits in most single-gang J-boxes and plaster rings.	28.00
PFVC45I*	45-watt impedance-balancing volume control with autoformer, features removable wire block terminal for easy connection, fits in most single-gang J-boxes and plaster rings.	15.00
PFVCS60*	60-watt stereo volume control with autoformer, features quick & secure wire connecting system, fits in most single-gang J-boxes and plaster rings.	21.00
PFVC60SL*	60-watt slider stereo volume control with removable screw down wire terminal design, fits in most single-gang J-boxes and plaster rings.	33.00
PFVC60AW	60-watt weather-resistant volume control sealed against dust and moisture, fits onto 3/4" conduit or can be surface mounted, available in Gray	40.00

\*Volume controls include white, bone and almond plates, inserts and knobs.



PFVC60I



PFVC60SL



PFVC60AW

## Brackets and Back Boxes

PFPCB-IW500	One pair of pre-construction brackets, Fits 5-1/4" in-wall LCR speakers	20.00
PFPCB-C800	One pair of pre-construction brackets, Fits 8" ceiling, TT ceiling and ceiling LCR speakers	20.00
PFPCB-C600	One pair of pre-construction brackets, Fits 6-1/2" ceiling, TT ceiling and ceiling LCR speakers	20.00
PFPCB-C500	One pair pre-construction brackets, Fits 5-1/4" ceiling speakers	20.00
PFPCB-W800	One pair pre-construction brackets, Fits 8" In-wall speakers	20.00
PFPCB-W600	One pair pre-construction brackets, Fits 6 1/2" in-wall speakers	20.00
PFBB-C800	Metal back box for 8" ceiling speakers, 8" single stereo speakers and 8" ceiling LCR speakers	50.00
PFCTB-C600	Ceiling tile bracket. Fits 6 1/2" ceiling speakers, single stereo ceiling speakers and ceiling LCR speakers	16.00
PFCTB-C800	Ceiling tile bracket. Fits 8" ceiling speakers, single stereo ceiling speakers and ceiling LCR speakers	16.00
PFBB-C650	Metal back box. Fits 6 1/2" ceiling speakers, single stereo ceiling speakers and ceiling LCR speakers.	50.00
PFBB-W600	Metal back box for 6 1/2" In-wall speakers	50.00
PFCMB-24	Mounting bars to attach BB-C650 to standard 24" ceiling joists, each	15.00
PFPCB-IW600	Pre-construction bracket for IW650 and IW625	20.00

## IR Devices

PFPAS80313	IR Shelf top kit, shelf top receiver, router, power supply, 4 IR flashers	85.00
PFPAS80315	IR Plasma kit, Plasma receiver, router, power supply, 4 IR flashers	135.00
PFPAS80311	IR Fisheye kit, fisheye hub, router, power supply, 4 IR flashers	120.00
PFPAS82200	IR router	30.00

PFPAS80315

Contains all components needed for 1-room system setup including:

- IR Plasma Receiver
- IR Router
- Power Supply
- 4 Single IR Flashers



PFPAS80313

Complete IR system including:

- Shelf-Top IR Receiver
- IR router
- Power Supply
- 4 Single IR Flashers



# PROFICIENT Protege™

Thin-Bezel Architectural Speakers



## Same Sound. Same Specs. Sleek New Look.

Proficient has launched the biggest change in our product line. Protege in-ceiling and in-wall speakers have a new thin-bezel design that cleans up the look of your audio installations without making you change the way you spec and install speakers.

Every Protege speaker is derived directly from an existing Proficient model. The acoustical & electrical engineering are the same. The features & sound are the same, as well as the cut-out templates.

Even installation is the same – except the magnetic grille is actually easier to install and remove. The magnets are mounted behind the baffle so they can't pull loose, as they often do with bezel-free designs that have the grille magnets glued to the front.

The Protege line includes 18 in-ceiling speakers, 10 in-wall speakers, two in-wall subs and an in-ceiling subwoofer. Quality built, of course. Exactly what you'd expect from Proficient.

[proficientaudio.com](http://proficientaudio.com)



**In-Ceiling LCR Speakers - priced each**

PFC841	LCR, woofer & tweeter bridge fixed at 15°, 8" graphite woofer, 1" pivoting silk dome tweeter, +-3dB bass & treble contour switches, 150W	185.00
PFC661	LCR, woofer & tweeter bridge fixed at 15°, 6-1/2" graphite woofer, 1" pivoting silk dome tweeter, 125W	135.00
PFC656	LCR, woofer & tweeter bridge fixed at 15°, 6-1/2" polypropylene woofer, 1" pivoting silk dome tweeter, 125W	110.00
PFC651	LCR, woofer & tweeter bridge fixed at 15°, 6-1/2" polypropylene woofer, 1" pivoting silk dome tweeter, 125W	90.00



PFC841

PFC661

PFC651

**In-Wall LCR Speakers - priced each**

PFIW630	LCR, two 6 1/2" graphite woofers, 1" soft dome pivoting tweeter, bass/treble contour switch, 125W	200.00
PFIW530	LCR, two 5 1/4" graphite woofers, 1" aluminum pivoting tweeter, bass/treble contour switch, 100W	140.00



PFIW630

PFIW530

**Center Channel Speakers - priced each**

PFCC550	Cabinet Center, two 5 1/4" Kevlar woofers, 3" Kevlar midrange, 1" aluminum dome tweeter, 125W	175.00
PFCC540	Cabinet Center, two 5 1/4" Graphite woofers, 1" aluminum dome tweeter, 100W	135.00
PFCC400	Cabinet Center, two 4" poly woofers, 1" aluminum dome tweeter, 85W	100.00
PFGL6	Dual 6 1/2" LCR speaker	315.00

PFCC550



PFGL6



**In-Ceiling Speakers - priced per pair**

PFC801	8" graphite woofer, 1" aluminum pivoting tweeter, bass/treble contour switch, 150W	245.00
PFC791	8" polypropylene woofer, 1" soft dome pivoting tweeter, 125W	165.00
PFC641	6 1/2" graphite woofer, 1" aluminum pivoting tweeter, bass/treble contour switch, 125W	190.00
PFC626	6 1/2" graphite woofer, 1" silk dome pivoting tweeter, 100W	155.00
PFC621	6 1/2" polypropylene woofer, 1" silk dome pivoting tweeter, 100W	130.00
PFC612	6 1/2" polypropylene woofer, 1" soft dome pivoting tweeter, 85W	105.00
PFC606	6 1/2" polypropylene woofer, 3/4" soft dome tweeter, 75W	85.00
PFC501	5 1/4" polypropylene woofer, 1/2" polyamide hard dome pivoting tweeter, 75W	95.00



PFC825TT

PFC791

PFC606

**Single Point Speakers - priced each**

PFC825TT	Single Point, 8" dual voice coil graphite woofer, twin 1" aluminum pivoting tweeter, bass/treble contour switch, 150W, each	135.00
PFC625TT	Single Point, 6 1/2" dual voice coil polypropylene woofer, twin 1/2" hard dome tweeter, 75W, each	80.00

**In-Wall Speakers - priced per pair**

PFW802	8" graphite woofer, 1" aluminum pivoting tweeter, bass/treble contour switch, 150W	240.00
PFW682	6 1/2" graphite woofer, 1" aluminum pivoting tweeter, bass/treble contour switch, 125W	200.00
PFW672	6 1/2" polypropylene woofer, 1" silk dome pivoting tweeter, bass/treble contour switch, 100W	150.00
PFW667	6 1/2" polypropylene woofer, 3/4" soft dome tweeter, 75W	95.00



PFW802

PFW672

PFW667

Signature Series Speakers

There are few things in life that appeal to people more than a timeless design. And the new Proficient Signature Series fits right into that genre: a one-of-a-kind statement of power and performance that sits at the top of Proficient's line of loudspeakers.

In-Ceiling Speakers - priced per pair

PFC895S	Signature 8" Ceiling Speakers, 8" Kevlar Woofers, 1" pivoting aluminum dome tweeters, 175 Watts, 8 Ohms impedance	285.00
PFC695S	Signature 6" Ceiling Speakers, 6-1/2" Kevlar Woofers, 1" pivoting aluminum dome tweeters, 150 Watts, 8 Ohms impedance	225.00



PFC895S



PFC695S

In-Ceiling LCR Speakers - priced each

PFC1075S	Signature 10" Ceiling LCR Speaker, Woofer & midrange/tweeter bridge fixed at 15°, 1" pivoting aluminum dome tweeter, 200 Watts, 4 Ohms impedance	300.00
PFC875S	Signature 8" Ceiling LCR Speaker, woofer & Tweeter bridge fixed at 15°, 1" pivoting aluminum dome tweeter, 175 Watt, 8 Ohms impedance	200.00
PFC675S	Signature 6-1/2" Ceiling LCR Speaker, Woofer and tweeter bridge fixed at 15°, 1" pivoting aluminum dome tweeter, 125 Watt, 8 Ohm impedance	150.00



PFC1075S



PFC875S



PFC675S

In-Wall LCR Speakers - priced each

PFIW675S	6-1/2" In-wall LCR Speaker, Two Kevlar woofers, 1" pivoting aluminum dome tweeter, 150 Watts, 8 Ohms impedance	240.00
PFIW575S	5-1/4" In-wall LCR speaker, Two Kevlar woofers, 1" pivoting aluminum dome tweeter, 125 Watts, 8 Ohms impedance	170.00

PFIW675S



The IW675s is the audio equivalent of a big-block V-8 engine. It can go head-to-head with any home theater speaker made today. Its bulletproof Kevlar drivers sound incredibly natural and handle tons of power. The versatile design fits any standard stud bay, horizontally

or vertically. The IW675S is the in-wall for hardcore home theater enthusiasts.

PFIW575S



This is the speaker you need for a high-performance, yet compact in-wall home theater or media room system. The IW575S's Kevlar woofers and aluminum tweeter deliver dynamic, high-impact, realistic surround sound. The

speaker's compact frame lets you mount it horizontally or vertically in a standard 16-inch-on-center stud space.

In-Wall Speakers - priced per pair

PFW695S	6-1/2" Inwall Speakers, Kevlar woofers, 1" pivoting aluminum dome tweeter, 150 Watts, 8 Ohms impedance	240.00
PFW895S	5-1/4" inwall speaker, Kevlar woofers, 1" pivoting aluminum dome tweeter, 125 Watts, 8 Ohms impedance	275.00

PFW895S



Proficient's finest in-wall speaker, the W895s, is a fantastic product. Its big cast-basket Kevlar woofer gives it powerful deep bass, yet it's so sensitive you can drive it to loud levels with a 10-watt amplifier. It's a superb choice for stereo, multiroom or any channel of a home theater system—and the easiest way to build a concealed high-end sound system.

PFW695S



Here's the best 6½-inch single-woofer in-wall Proficient has ever offered. The W695s has a Kevlar-cone woofer for ultra-deep bass power and low distortion, and a pivoting aluminum-dome tweeter for clear, extended treble. High sensitivity means that even a low-powered amplifier can get the W695S really cranking!

### Floor-Standing Subs - priced each

PFFS12	Subwoofer with 12" long excursion treated paper cone woofer and 250W multi-voltage amplifier, slotted rear-firing port eliminates vent noise and distortion, black wood grain finish & chrome feet, LFE input, auto power	310.00
PFFS10	Subwoofer with 10" long excursion treated paper cone woofer and 120W multi-voltage amplifier, slotted rear-firing port eliminates vent noise and distortion, black wood grain finish & chrome feet, LFE input, auto power	250.00
PFFS8	Subwoofer with 8" long excursion treated paper cone woofer and 80W multi-voltage amplifier, slotted rear-firing port eliminates vent noise and distortion, black wood grain finish & chrome feet, LFE input, auto power	190.00

PFFS12



PFFS10



PFFS8



### Outdoor Rock Speakers - priced per pair

PFR800*	One pair 8" graphite woofer, 1" polyamide dome tweeter and 90W of power handling	220.00
PFR650*	One pair 6 1/2" graphite woofer, 1" polyamide dome tweeter and 60W of power handling	165.00



\*-G=Granite (Left)\* -S= Sandstone (Right)

### Single Stereo Outdoor Speakers - priced each

PFAW600TT*	Single Point, 6 1/2" dual voice coil polypropylene woofer, two 1" Supernil soft dome pivoting tweeters, 125W	165.00
PFAW500TT*	Single Point, 5 1/4" dual voice coil polypropylene woofer, two 1" Supernil soft dome pivoting tweeters, 100W	125.00

\*WHT for White, BLK for Black

PFAW500TTWHT



All Proficient outdoor speakers include swivel mounting brackets.

### Outdoor Speakers - priced per pair

PFAW830*	8" polypropylene woofer, 3" graphite mid, 1" Supernil soft dome pivoting tweeter, 175W	295.00
PFAW650*	6 1/2" polypropylene woofer, 1" Supernil soft dome pivoting tweeter, 150W	220.00
PFAW525*	5 1/4" polypropylene woofer, 1" Supernil soft dome pivoting tweeter, 125W	170.00
PFAW400*	4" polypropylene woofer, 3/4" Supernil soft dome pivoting tweeter, 100W	130.00

\*WHT for White, BLK for Black

All Proficient outdoor speakers include swivel mounting brackets.



PFAW830BLK



PFAW650BLK



PFAW525WHT



PFAW400WHT

### In-Wall/Ceiling Sub System - priced each

PFIWS105	10" in-wall long excursion treated paper cone woofer, inverted ferrite magnet, 250W	225.00
PFIWS85	Dual 8" in-wall long excursion graphite woofers, 200W	275.00
PFICS11	10" in-ceiling long excursion graphite woofer, 175W	170.00
PFBB-IWS10	Wood back box for PFIWS105, MDF dampened to reduce translational energy to wall, fits standard 16" stud bay	115.00
PFM3	180W high-current mono amp with built-in crossover network, features adjustments for subwoofer fine-tuning to individual room acoustics, includes bolt-on rack ears	325.00

PFM3



PFIWS105



PFICS11



### Speaker Cover Plates

PFPCP-800	One pair of white cover plates for 8" ceiling, LCR and single stereo speakers	20.00
PFPCP-600	One pair of white cover plates for 6 1/2" ceiling, LCR and single stereo speakers	20.00
PFPCW-600	One pair of white cover plates for 6 1/2" in-wall speakers	20.00



**How is Commercial Audio Different?**

The rules for residential audio, in most cases, don't apply for a restaurant, bar, or commercial building. The intended result is still good sound, but there are differences between commercial and residential design. With a residential system you are typically trying to please one or two listeners in a small area, while a commercial system must satisfy many listeners over a larger area. For example, a restaurant will have tables with people seated facing several different directions, so a residential system cannot provide a stereo image for all listeners. Commercial systems are designed to overcome the issues that a residential speaker system cannot. For example, you can install a large number of speakers on very long daisy-chained wire runs with a 25V/70V system. Commercial systems use higher voltage to result in lower current when distributing power to a sound system. This allows longer runs without overheating or wasted current. 70 volt systems are the most common, and most energy efficient, but some local electrical codes limit low-voltage installers to 25 volt systems. Commercial systems should not be used in residences.

**25/70 Volt Commercial Amplifiers**

STPVL15A	PVL-Series 15W amplifier, 2 mic inputs, and 1 AUX input	85.31
STPVL30A	PVL-Series 30W amplifier, 2 mic inputs, and 1 AUX input	116.16
STPBM30	Contractor Series 30W amplifier, 2 mic inputs, 1 RCA, telephone page input	151.50
STPMM60A	60W PA mixer power amplifier with 6 inputs	321.24
STPBM120AU	120W PA mixer amplifier with USB input. Includes Tuner and CD player	673.46
STPMM120A	120W PA mixer power amplifier with 6 inputs	423.66
STPL200M	160W, 5-source, 4-zone, matrix distribution PA amplifier	480.86
STPFA	Digital AM/FM tuner with 30 presets	177.61



**STPFA**



**STPL200M**

**25/70 Volt Speakers**



**STSP30PT**



**STSP5MAT**



**STSP6AWXT**



**STG86TG**



**STSPG86TC**



**STSPC40RT**



**STPVL30A**

STSP5MAT	5.25" commercial in-ceiling speaker, flame-retardant ABS back box, 2W - 50W, each	52.46
STSP6MAT	6.5" commercial in-ceiling speaker, flame-retardant ABS back box, 2W - 60W, each	59.95
STBRC6F	In-ceiling bracket for SP5MAT and other 6" speakers, 8.375" cutout dim, pair	30.35
STBRC8F	In-ceiling bracket for SP6MAT and other 8" speakers, 9.875" cutout dim, pair	30.35
STSP6AWXT*	6.5" all-weather design surface-mount speaker with transformer, 3W - 50W, pair (* blank for black, W for white)	137.39
STSPC40RT	6.5" x 11" Weather Resistant Horn Speaker	62.45
STSP30PT*	Hanging 5.25" pendant speaker with hanging chain, 2.5 - 30W, each (* blank for white, B for black)	64.95
STSPG66T	6" Contractor Series Speaker, 7.625" cutout, 0.25W to 5W, each	16.86
STSPG86T	8" Dual Cone Modern Grille Ceiling Speaker with Transformer, uses STBRC8F bracket, 1/4W - 5W, each	18.49
STSPG86TC	8" Dual Cone Modern Grille Ceiling Speaker with Transformer & Volume Control, uses STBRC8F bracket, 1/4W - 5W, each	24.36
STG86TG	8" Dual Cone Classic Grille Ceiling Speaker with Transformer, 1/4W - 5W, each	18.49
STTS8	Speaker ceiling support for G86TG, T-bar bridge for ceiling support of 8" speaker, top hat, & bracket, each	7.24
STSTH8	Top Hat, metal back box for 8" speakers, each	12.12
STSPCDC6	Residential 8 Ohm in-ceiling speakers, 7.5" cutout, use STBRC6F rough-in	62.45

**Commercial Audio Accessories**

STWAT10W	10W, 70 volt, mono attenuator, single-gang white plate	16.42
STWAT50	50W, 70 volt, mono attenuator, single-gang stainless steel plate	20.73
STMUHF101	UHF 1-channel wireless receiver for microphone	179.61
STMUHFHH	UHF wireless handheld microphone	93.05
STMUHFLP	UHF wireless lapel microphone	93.05
STMCHH100A	Handheld dynamic microphone - wired	16.61
STMHL5S	Gooseneck adjustable desktop microphone, lockable talk switch	57.08
STMCA20	20' microphone cable XLR connectors	19.48



**STMUHFLP**



**STMUHF101**



**STMUHFHH**



**STWAT10W**

Free Audio Design service at [www.specotech.com](http://www.specotech.com)

**Allow Your Speakers to Perform to Their Maximum Potential**

Sometimes you don't hear the difference between top quality speakers and generic models. Is the problem the speaker or the place it was installed?



Sometimes even the very best speakers don't sound their best when installed in a standard wall or ceiling structure. Without an enclosure system, sound resonates throughout the surrounding structure, creating muddy, back-wave distortion and unwanted noise and vibration to adjacent rooms. Dynamat's revolutionary enclosure systems dramatically improve sound quality and reduce unwanted noise to other rooms. In-wall and in-ceiling speakers now sound like speakers mounted in solid, well-crafted cabinets. Before you invest in top quality speakers, make sure you are installing them in a top quality location.



**In-Wall Speaker Enclosures**

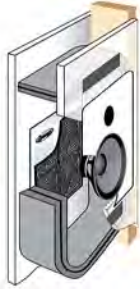

**En-Wall** significantly reduces wall vibration, projects more clear sound into the room and reduces unwanted noise transfer through walls. It combines Dynamat Xtreme, DynaXorb and the SoundSnake to damp, diffuse, and decouple in-wall speakers. En-Wall encases in-wall speakers creating an optimal acoustic environment for delivering premium sound quality.

En-Wall is an easy-to-retrofit speaker enclosure for in the wall. It reduces the sonic cancellations that are often created from in-wall speakers operating in long, shallow spaces. Kits for En-Wall are available in single speaker packages for either 4" or 6" stud walls.

**En-Wall Enclosure System**

DYN50504	(1) 1.5" x 3.5" x 54" SoundSnake w/ Dynil (4) 6" x 6" DynaXorb (1) 12" x 18" Dynamat Xtreme (2) 4" x 10" Dynamat Xtreme	44.48
DYN50506	(1) 1.5" x 5.5" x 54" SoundSnake w/ Dynil (4) 6" x 6" DynaXorb (1) 12" x 18" Dynamat Xtreme (2) 4" x 10" Dynamat Xtreme	46.82

**Ceiling Speaker Enclosures**

**DynaBox** is a ceiling speaker enclosure. It completely encases the speaker, effectively reducing sound migration between ceilings and floors. DynaBox projects more clear sound into the room and reduces unwanted sound traveling outside the room. It is designed to be folded and is easy to retrofit.

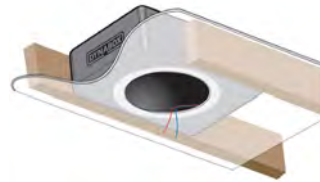

**DYN50306**

DYN50306	Kit includes: (1) DynaBox 17" x 12" x 6.5" (1) SoundSnake 1.5" x 5.5" x 54" (1) Back-Wave Foam 13.5" x 9" x 1"	79.60
----------	---	-------

**Reduce Sound Created by HVAC and Appliances**

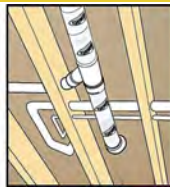

**DYN50455**

Unwanted noise produced by vibrating sheet metal is a common problem in every household. Dishwashers, air conditioners, duct work, and piping create irritating noise problems that keep you from enjoying music, movies and everyday family life. Many home theaters are also adding multimedia systems with metal enclosures that include fans. All these items are made from sheet metal and can be made quieter with an application of Dynamat Xtreme.

**Dynamat Xtreme**

DYN50400	Utility pack, (24) 4" x 10" pieces	51.50
DYN50455	Bulk pack, (9) 18" x 32" pieces	145.18

**Application Note**

**Quiet your Equipment Rack.**  
Reduce the sound of computers and DVRs.



**Don't block air vents! Cover as much surface area as possible.**

**Reduce Sound Through the Floors**

**DynaPad** is an effective sound barrier that reduces sound transmission through floors. It can be used on any floor above or below to block outside noise and keep your theater sounds inside your theater. Installed under the carpet in the upstairs bedroom, DynaPad ensures a quiet sleep even if the kitchen dishwasher is running.

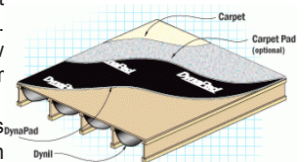

**DynaPad Sound Barrier**

DYN50110	54 in. x 25 ft. long roll	580.77
----------	---------------------------	--------

**Keep appliance noise out of your TV room.**





The Experts in Digital Video Technology and Solutions™

### HDMI Matrix Switchers

HDMI Matrix Switchers allow you to share multiple HD sources to multiple HD displays. Some units use standard wiring and some use a hybrid with Cat 5e. Control can also be passed over the same Cat 5e cable.



Pages 172-173



### A/V Custom Controls™

On Controls and BitWise give you the ability to customize an interface to support your customer's needs. Using these utilities will enhance the user experience and give the customer a very easy solution for app and remote control.



Page 91



### A/V Distribution over Cat 5e

MuxLab is a leading designer of value-added connectivity hardware allowing CCTV and audio-video equipment to be connected via cost-effective copper twisted pair. Today, almost any type of signal can be sent over Cat 5e using MuxLab baluns.



Page 175

### Matrix Switchers

Matrix switchers allow you to share multiple sources to multiple displays. Some units use standard wiring and some are hybrid with Cat 5e.

See page 172-173 for Key Digital, 176 for CE Labs, and 150-159 for Russound.



### Switches

Switches allow you to send multiple sources to multiple displays, however all displays show the same content.

### Distribution Amplifiers

Distribution amplifiers allow you to take a single source and send it to multiple displays without quality loss.

See page 172-173 for Key Digital and 176 for CE Labs.

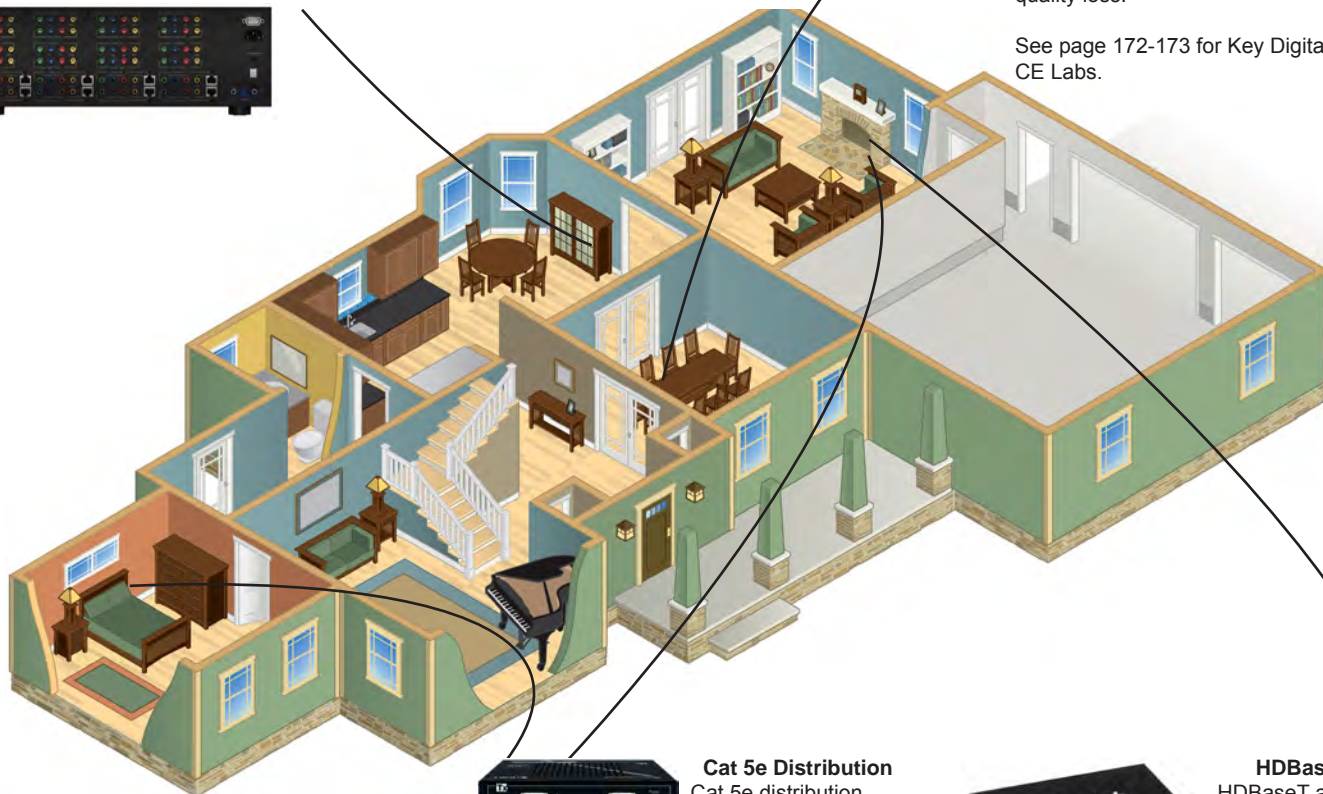

### 4K Video

When looking for more than 1080P resolution check out 4K quality video. As opposed to the 720 or 1080 lines of resolution, 4K video features 4,000 lines of resolution bringing the T.V./projector screen to life!

See page 172-173 for Key Digital and 176 for CE Labs.



### Cat 5e Distribution

Cat 5e distribution allows you to use inexpensive UTP wire to distribute signals to locations where the proper wire is either not available or not cost-effective. Baluns allow for point to point distribution and matrices allow switching.

See page 172-173 for Key Digital and 176 for CE Labs.



### HDBaseT

HDBaseT allows for video (up to 1080p), Ethernet and IR/Serial Control all over a single Cat 5e up to 100m (330ft). By combining all of these signals into a single cable, installations become easier for both the installer and the homeowner.

See page 172-173 for Key Digital and 176 for CE Labs.



**HDMI Extenders**



Technology	HDBaseT	HDBaseT	HDBaseT	HDBaseT	HDBaseT	HDBaseT
<b>Single Cat 5</b>	Yes	Yes	Yes	Yes	Yes	Yes
<b>4K Support</b>	Yes	Yes	Yes	Yes	Yes	Yes
<b>EDID Control</b>	Yes	Yes	Yes	Yes	Yes	Yes
<b>Audio De-Embed</b>	No	No	No	No	Yes	Yes
<b>Full Buffer</b>	Yes	Yes	Yes	Yes	Yes	Yes
<b>2-Way IR / RS-232</b>	Yes	Yes	Yes	Yes	Yes	Yes
<b>Ethernet</b>	No	No	No	No	No	No
<b>HDMI Pass-Through</b>	No	No	No	No	No	No
<b>Distance @ 4K On Any Cat 5e/6</b>	150'	150'	125'	125'	150'	150'
<b>Distance @ 4K On KD Cat 5e/6</b>	125'	125'	150'	150'	125'	125'
<b>Distance @ 1080p On Any Cat 5e/6</b>	230'	230'	200'	200'	230'	230'
<b>Distance @ 1080p On KD Cat 5e/6</b>	250'	250'	250'	250'	250'	250'
<b>Part Number</b>	KDGKD-X222	KDGKD-X222PO	KDGKD-X422POA	KDGKD-X422WP	KDGKD-IP120POET	KDGKD-IP120POER
<b>Price</b>	198.00	233.00	350.00	CALL	321.00	292.00

**HD over IP**



HD over IP-TX	HD over IP-RX
KDGKD-IP120TX	KDGKD-IP120RX
233.00	204.00

Key Digital's HD over IP solutions create an expandable HDMI over IP system that can be scaled to fit any installation. Add up to 1024 transmitter(tx) units and an unlimited number of receiver(rx) units for the ultimate custom video solution. These modules can be connected through a network IP switch or point-to-point and is an ideal standard for large video distribution applications.

- Wi-Fi extender: up to 100 ft.
- IP over Coaxial: up to 1,000 ft.
- Supports up to 1080p and compatible with DVI1.0/HDMI/HDCP1.x
- Up to 400 ft. @1080p using CAT5e/6 UTP/STP cable

**Video Converter**



KDGKD-VCS500	Video Converter/Scaler, converts VGA HDMI, also embeds analog audio input into HDMI output, up-scales VGA to 720p or 1080p	175.00
--------------	--	--------

**Audio Devices**



**KDGKD-DAXAA**

KDGKD-DAXAA	2-channel PCM Coaxial and Optical Digital to Analog L/R Audio Converter	49.00
-------------	---	-------

**Champion ProK HDMI Cables**

CL3/FT4 UL Rated, 31.5 Gbps, 1080p, Ultra HD/4K, Ethernet, Arc with RedMere Technology



KDGKD-HIFI30PRO	VW1 Rated 30' HDMI Cable, 4K Support	62.00
KDGKD-HIFI40PRO	VW1 Rated 40' HDMI Cable, 4K Support	79.00

**Champion HDMI Cables**

KDGKD-HIFI3	VW1 Rated 3' HDMI Cable, 4K Support	6.00
KDGKD-HIFI6	VW1 Rated 6' HDMI Cable, 4K Support	7.00
KDGKD-HIFI9	VW1 Rated 9' HDMI Cable, 4K Support	9.00
KDGKD-HIFI12X	CL3 Rated 12' HDMI Cable, 4K Support	12.00
KDGKD-HIFI16X	CL3 Rated 16' HDMI Cable, 4K Support	14.00
KDGKD-HIFI20X	CL3 Rated 20' HDMI Cable, 4K Support	17.00

**Video Wall Processor**



KDGKD-VW4X4PRO	4 Inputs to 4 Outputs Video Wall Processor, supports Seamless Matrix Switching	2,100.00
----------------	--	----------

Make standard consumer TVs and monitors into a huge video wall with the Key Digital HDMI Video Wall Processor. Four HDMI/VGA inputs accept digital/analog video and audio from computers, media players, and other sources. With the eight onboard video wall processing modes, the four outputs can be configured to display video from a single input over a four-output video wall (See left). Adjustments such as bezel compensation let you fine-tune your video wall to fit different screen types.



**Video Wall Modes**

HDMI Switchers

Working with HDMI signals can be complicated. Any installer who has dealt with the pitfalls of HDMI certainly knows that. They also know that there is no shortage of low-cost HDMI switching and transmission accessories that don't always get the job done well. With the Champion Series from Key Digital, you no longer need to sacrifice quality and performance for price. Champion has been designed to compete at the prices of the low-cost brands while still incorporating the features and performance that Key Digital is known for.

- 3D Ready** - Capability to pass 3D stereoscopic signal formats
- 4K Resolution Support** - 4096x2160/24 video resolution support
- Light Buffer Technology** - Multiple output viewing mode is supported by a dynamic realignment in clocking that may appear as a short blink when multiple displays/outputs select a single source/input. This dynamic re-clocking improves video quality on all displays and does not affect switcher performance during non-switching operation, built into matrix switchers.
- Wide Resolution Support** - Supports all SD, HD, UHD 4K and VESA (VGA, SVGA, XGA, WXGA, SXGA, UXGA) resolutions up to 1080p (60Hz & 50Hz)
  - »» SD & HD: 480i, 480p, 720p, 1080i, 1080p
  - »» VESA / VGA (RGBHV): From 640x480p up to 1920x1200p
- Supports lossless compressed digital audio** - Dolby® TrueHD, Dolby® Digital Plus and DTS™-HD Master Audio



KDGKD-4X4CSA



KDGKD-8X8CSA

All Models Support 4K		
KDGKD-8X8CSA	8x8 HDMI Matrix Switcher, IR/RS-232/ front panel control, supports lossless compressed digital audio, audio de-embedding, internal EDID library with 9 configurations	1,896.00
KDGKD-4X4CSA	4x4 HDMI Matrix Switcher, IR/RS-232/ front panel control, supports lossless compressed digital audio, audio de-embedding, internal EDID library with 9 configurations	758.00
KDGKD-4X1CSK	4 In to 1 Out HDMI Switcher Version 2.2	146.00
KDGKD-2X1CSK	2 In to 1 Out HDMI Switcher Version 2.2	105.00
KDGKD-DA1X4	1 In to 4 Out HDMI Distribution Amp	160.00
KDGKD-DA1X2	1 In to 2 Out HDMI Distribution Amp	131.00



KDGKD-4X1CSK



KDGKD-DA1X2

MultiView Matrix

The MultiView Matrix switcher allows you to arrange up to 4 inputs in a variety of layouts on up to two outputs. It's great for corporate conference rooms, sports bars, or even the avid home sports enthusiast. Switching times are the fastest we have ever seen!



KDGKD-MLV4X2	4 Inputs to 2 Outputs MultiView Seamless Matrix Switcher, supports Ultra HD/4K	1,610.00
--------------	--	----------

Compass Control System

KDGKD-MC1000	Compass Control Master Controller	605.00
KDGKD-ZRX200	ZigBee Receiver for KD-ZRC300 Remote	110.00
KDGKD-ZRC300	Handheld Hard Button Remote	137.50



HDBaseT HDMI Matrix Switchers



<p><b>KDGKD-PRO6X6CC</b> Included HDBaseT Cat 6e/6 receivers for each output <b>Compass Control Built-In</b></p>		
KDGKD-PRO8X8CC	8x8 HDMI Matrix Switcher, HDBaseT single Cat 5e/6 output, simultaneous availability of HDMI and HDBaseT outputs, 8 Cat 5e/6 receivers included, independent PCM audio and IR inputs/ outputs, 1080p, 3D ready, 4K support, control via IR, RS-232, TCP/IP, front panel	4,200.00
KDGKD-PRO6X6CC	Same as above but 6x6, 6 Cat 5e/6 receivers included	3,150.00
KDGKD-HD4X1PROK	4 to 1 HDMI Switcher with audio de-embedder of coaxial	252.00



# EMPOWERED



From security and control systems, to streaming media and distributed AV, the network is the foundation on which modern integrated systems are built. Luxul's complete line of switches, routers, and wireless networking equipment makes everything work better. Luxul. Empowering.

**LUXUL**





MuxLab Inc. is a leading designer of value-added connectivity hardware allowing CCTV and audio-video equipment to be connected via cost-effective copper twisted pair. For almost 30 years, the MuxLab brand has been synonymous with quality, performance and reliability.

### Audio-Video Baluns

MUX500050-2PK	RGB male & digital audio 1080i/p - 500' 2-pack	96.17
MUX500052-2PK	RGB male & analog audio 1080i/p - 500' 2-pack	96.17
MUX500058-2PK	RGB male & stereo audio balun 1080i/p - 500' 2-pack	159.87
MUX500054-2PK	Component video/IR pass-thru balun 2-pack	96.17
MUX500001	Stereo audio-video balun - 2200' *	44.34
MUX500012	Dual audio-video balun - 1000' *	44.34
MUX500019	Analog audio balun - 5000' *	19.36
MUX500027	Stereo audio balun - 5000' *	29.98
MUX500028-2PK	Stereo Hi-Fi balun - 3250' * 2-pack	63.07
MUX500033	Quad audio balun - 5000' *	44.34
MUX500039	Audio/RS232/IR over IP Extender Kit w/POE	37.47
MUX500200	Audio-video distribution hub - 2200' *	428.41

\* - When used with a DVR, maximum distance for video is 1,000 - 1,500 ft.



MUX500200



MUX500019



MUX500027



MUX500028



MUX500033

### HDMI Matrix Switches



MUX500419POEUS

MUX500416POEUS

MUX500419POEUS	HDMI 8x8 Matrix Switch, 4HDMI+4HDBT, PoE	2,605.41
MUX500468-POE	HDMI 4x8 Matrix Switch, 4HDMI+4HDBT, PoE	3,560.90
MUX500416POEUS	HDMI 4x4 Matrix Switch, HDBT, PoE	1,318.94
MUX500418-POE	HDMI 4x8 Matrix Switch, HDBT, PoE	2,702.84
MUX500469POEUS	HDMI 8x8 Matrix Switch, HDBT, PoE	4,021.78
MUX500480US	Multimedia Matrix, 16x16 HDMI 2.0 4K	6,562.25

### ProDigital Network Controller

MUX500811	Network Controller	296.01
-----------	--------------------	--------



The Network Controller allows users to manage their hub-installed MuxLab products via an Ethernet Web interface.

### HDMI Over Dual Cat5e / Cat6



MUX500401

MUX500402

MUX500401	HDMI Extender Kit, up to 150ft**	173.61
MUX500402	HDMI Passive Extender Kit, up to 100ft**	144.88

\*\* Requires (2) Cat 5e/Cat 6 cables for maximum distance

### HDMI Over Single Cat5e / Cat6



MUX500451

MUX500450

MUX500450	HDMI Mono Extender Kit w/ IR, up to 330ft	330.98
MUX500451	HDMI Mono Extender Kit, up to 230ft	263.54
MUX500453	HDMI/LAN Extender Kit, up to 330ft	360.96
MUX500753	HDMI/RS232 Over IP Extender kit w/ PoE	472.12
MUX500752	HDMI Over IP Extender Kit w/ Poe	458.38

### Specialty 4K / HDMI Extenders



MUX500759

MUX500780

MUX500754	Video Wall over IP with PoE	490.86
MUX500758	4K over IP Extender Kit with PoE	658.22
MUX500759	Video Wall 4K over IP, PoE Extender Kit	723.17
MUX500757	HDMI over IP H.264 Extender Kit with PoE	559.55
MUX500465	HDMI Over Coax Extender Kit, up to 500ft using 1 coax cable	394.68
MUX500780	HDMI Wireless Extender Kit, 100ft	263.54

### VGA Baluns



MUX500040

MUX500042

MUX500041-WP-US

MUX500040	VGA Balun II video balun PC side. 350ft.	53.71
MUX500042	VGA Balun II video balun monitor side. 350ft.	53.71
MUX500040-42-PK	VGA Balun II Kit. Includes (1) MUX500040 and (1) MUX500042. 350ft.	96.17
MUX500041-WP-US	VGA Balun II wallplate display side. 350ft.	69.94
MUX500043-WP-US	VGA Balun II wallplate source side. 350ft.	69.94

**Digital Signage**

CE Labs media players make it easy to offer digital signage solutions to your customers. Content can be created easily in PowerPoint and exported as video to the player. This means your customers don't need an expensive content service tied to their players.

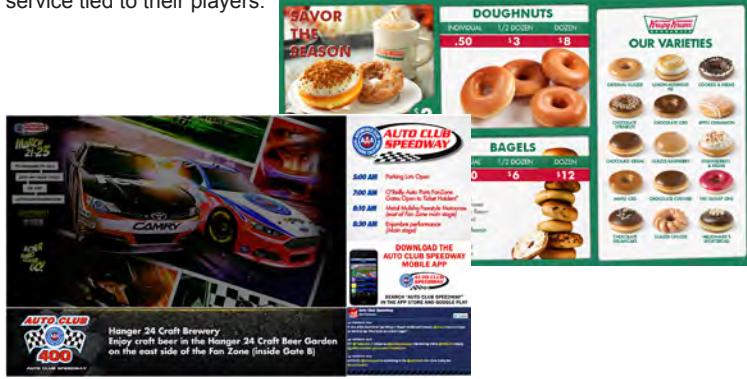

**Network HD Media Players**

CELMP70	HD Digital Media Player, up to 1080p, Ethernet, 8GB SD card included, HDMI output, software included	286.02
CELMP700T	HD Digital Media Player, up to 1080p, Ethernet, 8GB SD card included, dual screen support, web browser, HDMI/VGA/Composite outputs, software included	454.64
CELMP80RA	4K UHD Digital Media Player, Ethernet, SD or USB storage, HDMI output, software included	360.96



**CELMP700T**



**CELMP70**

**Cat 5 Distribution**



**CELHM1CK-3**

CELHX70M	HDBaseT HDMI Extender, 4K x 2K, 230' over Cat 5e/6	200.96
CELHX40M	HDMI Extender, Cat 5e/6, 230' 1080i, 130' 1080p, EDID backup in transmitter	112.29
CELHX1K-3	HDMI UTP Single Cat 5e/6 Extender 328ft	362.09
CELHM1CK-3	HDMI UTP Cat5 e/6 Extender 328ft w/RS-232 & IR Pass-Thru	393.31
CELC5-HDP	Passive HD Video Balun with SPDIF, 200' range, 1080i, buy one for each end	34.85
CELVG5EK	Cat 5 VGA Extender Kit (w/RX and TX units)	137.27
CELVG5EKL	Cat 5 VGA Extender Kit (w/RX and TX units) and LOOP through	149.76



**CELHX1K-3**



**CELC5-HDP**

**HDMI Products**



**CELHA8-3**

CELHA8-3	HDMI 1 In, 8 Out Distribution Amp v1.3b with side entry and strain relief	287.15
CELUH8-4K	HDMI 1 In, 8 Out Distribution Amp, 4K, cascadeable, with side entry and strain relief	187.35
CELHM41SR	4x1 HDMI Selector Switch, auto source detection, RS-232 control, remote included	106.04

**HD Switchers**



**CELSW204HD**



**CELSW808HD**

CELSW204HD	4 Input, 2 Output High Definition Component Video Switch with SPDIF Digital Audio, RS-232 control, includes IR remote and rack ears	179.73
CELSW404HD	4 Input, 4 Output High Definition Component Video Switch with SPDIF Digital Audio, RS-232 control, includes IR remote and rack ears	999.08
CELSW808HD	8 Input, 8 Output High Definition Component Video Switch with SPDIF Digital Audio, RS-232 control, includes IR remote and rack ears	1,623.58

**TV Wall Processor**



**CELDVPS44**

CELDVPS44	4x4 HDMI Matrix TV Wall Processor, 4 separate sources on 4 displays or 1 source coordinated on all 4 displays	2,372.98
-----------	---	----------



**HDMI Cables**



BL181278	3Ft. M/M gold plated 1080p, CL3, 28AWG	2.04	BL181290	30Ft. M/M gold plated 1080p, CL3, 28AWG	15.08
BL181279	6Ft. M/M gold plated 1080p, CL3, 28AWG	2.27	BL181294	50Ft. M/M gold plated 1080p, CL3, 28AWG	23.62
BL181267	10Ft. M/M gold plated 1080p, CL3, 28AWG	2.74	BL181296	60Ft. M/M gold plated 1080p, CL3, 28AWG	41.88
BL181268	15Ft. M/M gold plated 1080p, CL3, 28AWG	3.83	BL181276	75Ft. M/M gold plated 1080p, CL3, 28AWG	47.52
BL181269	20Ft. M/M gold plated 1080p, CL3, 28AWG	5.86	BL181277	100Ft. M/M gold plated 1080p, CL3, 28AWG	64.94

**Key Digital HDMI over Single Cat-5e/6**

KDGKD-X222	230' - 1080p, IR/RS-232, Tx/Rx set	198.00
KDGKD-X222PO	Same as above with Power over HDBaseT	233.00
KDGKD-X422POA	230' - 1080p, 125' - 4K, IR/RS-232, Tx/Rx set, Power over HDBaseT	350.00
KDGKD-X422WP	230' - 1080p, 125' - 4K, IR/RS-232, Tx/Rx set, Power over HDBaseT with Wallplate Transmitter	CALL



**Not sure which one you need? Give us a call today!**

Worthington carries the full line of Key Digital products. For more information see pages 172-173 or give us a call.

**Miscellaneous Cables**



	Audio L/R	Composite	Optical Audio	RG59 BNC M	RG6 "F" Nickel	RG6 "F" Gold
3 Ft	BL201801 1.08	BL201902 0.81	BL201601 1.04	BL202356 0.99	BL202702 0.46	BL202712 0.51
6 Ft	BL201802 1.35	BL201903 1.01	BL201602 1.63	BL202350 1.13	BL202703 0.63	BL202713 0.69
12 Ft	BL201803 0.88	BL201904 1.30	BL201603 2.70	BL202351 1.54	BL202704 0.94	BL202714 1.01
25 Ft	BL201804 1.42	BL201905 2.27	N/A	BL202352 2.46	BL202705 1.92	BL202715 1.61
50 Ft	BL201805 2.92	BL201906 4.21	BL201606 7.56	BL202353 4.02	BL202706 3.04	BL202716 3.06
75 Ft	BL201806 3.67	BL201907 6.84	N/A	BL202355 5.97	BL202707 4.81	BL202717 4.83
100 Ft	BL201807 5.06	BL201908 9.86	N/A	BL202354 7.92	BL202708 6.02	BL202718 6.05

**PC Cables**



	SVGA M/M	SVGA/3.5mm M/M	VGA M/M (Ferrite)	VGA M/F (Ferrite)	DB9 M/M	DB9 M/F
6 Ft	BL180441 3.04	BL180551 3.58	BL180455 3.17	BL180463 3.74	BL180211 2.67	BL180215 1.13
10 Ft	BL180442 3.87	BL180552 4.70	BL180456 4.01	BL180464 4.40	BL180212 1.61	BL180216 1.47
15 Ft	BL180443 6.01	BL180553 6.20	BL180457 6.08	BL180465 6.10	BL180213 2.24	BL180217 2.24
25 Ft	BL180444 9.18	BL180554 9.07	BL180458 8.37	BL180466 9.27	BL180214 3.01	BL180218 2.65
50 Ft	BL180445 15.24	BL180556 16.17	BL180459 15.31	BL180467 15.34	N/A	BL180219 5.67
75 Ft	N/A	BL180557 24.06	BL180460 22.21	BL180468 22.76	N/A	N/A
100 Ft	N/A	BL180558 30.50	BL180461 28.76	BL180469 28.78	N/A	N/A

**Network Patch Cables**



	Booted Cat 5E*	Non-Boot Cat 5E*	Shielded Cat 5E*	Booted Cat 6*	Non-Boot Cat 6*	Shielded Cat 6*
0.5 Ft	BL100516 0.42	BL100416 0.40	BL100614 0.73	BL100716 0.63	BL100100 0.63	BL100816 1.48
1 Ft	BL100501 0.45	BL100401 0.43	BL100601 0.73	BL100701 0.70	BL100101 0.69	BL100801 1.63
3 Ft	BL100503 0.65	BL100402 0.63	BL100603 1.07	BL100703 0.99	BL100103 0.97	BL100803 2.24
5 Ft	BL100504 0.86	BL100403 0.85	BL100604 1.34	BL100704 1.30	BL100105 1.28	BL100804 2.85
7 Ft	BL100505 1.04	BL100404 1.03	BL100605 1.59	BL100705 1.58	BL100107 1.57	BL100805 3.46
10 Ft	BL100506 1.40	BL100405 1.39	BL100606 2.02	BL100706 2.02	BL100108 2.01	BL100806 4.41
15 Ft	BL100507 1.82	BL100406 1.81	BL100607 2.67	BL100707 2.74	BL100109 2.73	BL100807 5.89
25 Ft	BL100508 2.84	BL100407 2.82	BL100608 4.02	BL100708 4.20	BL100111 4.18	BL100808 8.92
50 Ft	BL100509 5.44	BL100408 5.43	BL100609 7.53	BL100709 7.87	BL100112 7.86	BL100809 16.83
75 Ft	BL100510 8.07	BL100409 8.06	BL100610 11.18	BL100710 11.53	BL100113 11.52	BL100810 25.06

\* - Available in BK-Black, BL-Blue, GY-Gray, GN-Green, OR-Orange, PU-Purple, RD-Red, WT-White, and YW-Yellow



Leviton Architectural Edition

Leviton Architectural Edition.  
HOME ENTERTAINMENT SYSTEMS



powered by

Great paired up with Leviton Security and Automation Whole House Audio!



See page 92-93 for Leviton whole house audio.

"9 OF 10 MAJOR LIVE CONCERTS ARE PERFORMED WITH JBL LOUDSPEAKERS"

**On-the-Wall Modular Home Theater System**

JBL Systems measure up to a higher standard than typical home theaters because more JBL speakers are found in film recording studios and movie theaters than any other brand.

- Five-channel system that's expandable to 6.1 and 7.1 surround-sound operation with the addition of optional AESS5 satellite speaker(s)
- Includes 5 architectural-grade adjustable mounting brackets
- Includes 8" - 100W subwoofer and input RCA cable
- Video magnetic shielding provides the satellites the option to be located right next to a TV screen without causing any problems



LEVAEH50*	On-wall or ceiling mounted (4) 2-way satellite speakers, (1) center channel, (1) powered sub- *Black or White	299.02
LEVAESS5*	Additional satellite speaker for AEH50 - *BL-Black or WH-White	34.76

**Home Theater Speaker Solutions**

JBL built-in home theater systems are designed for custom installers and system integrators who need maximum flexibility and performance.



LEVAEI65



LEVAEI55



LEVAECCS-VCE



LEVAESUB-12

LEVAEI65	6.5" in-wall, 80W, 8 Ohm, pair	156.15
LEVLAE5I	Dual 5.25" in-wall center channel, 120W, 8 Ohm, each	231.02
LEVAECCS-VCE	Dual 5" shelf-mount center channel, 300W 8 Ohm, each	125.61
LEVAEC65	6.5" ceiling, 80W, 8 Ohm, pair	120.78
LEVAESUB-12	Powered subwoofer, 12" woofer, 250W, each	487.78

**Multi-Room Music In-Wall and Outdoor**

The JBL ceiling and in-wall speakers in the Leviton program feature JBL's famous EOS® waveguide technology used in professional sound systems.

LEVAEI65	6.5" in-wall speaker, 80W, 8 Ohm, pair	156.15
LEVAEC65	6.5" ceiling speaker, 80W, 8 Ohm, pair	120.78
LEVAEI80	8" in-wall speaker, 100W, 8 Ohm, pair	192.76
LEVAEC80	8" ceiling speaker, 100W, 8 Ohm, pair	168.34
LEVAEM65	6.5" DVC stereo, 100W, 8 Ohm, each	109.80



LEVAEM65



LEVAEI65



LEVAEC65

**Soundbar with Subwoofer**

- Bluetooth connectivity to wirelessly stream music through any Bluetooth enabled device
- JBL SoundShift™ works with the TV and wireless mobile device at the same time to allow automatic switching between the sound from the TV or the sound from a phone or tablet
- Cinematic sound with Dolby® Digital and Harman Display Surround sound
- Harman Volume makes sudden volume changes smooth and consistent reducing the impact of loud commercials and low dialogue volume



LEVLAESB	Bluetooth Soundbar with Wireless Subwoofer	79.60
----------	--	-------

**Pre-Wire Brackets and Accessories**

LEVAEPC8-KIT	8" ceiling, pair	23.19
LEVPC55-KIT	6.5" ceiling, pair	19.32
LEVAEPI6-KIT	6.5" wall, pair	19.32
LEVAEPI8-KIT	8" wall, pair	23.19
LEVAEHTK	7.1 HT interface plate	70.37
LEVAEPIS-KIT	Shelf for AEI55	33.82
WAVAC1402RWH15	14/2 Audio Cable, 14AWG, 500' box white	88.68
WAVAC1602RWH15	16/2 Audio Cable, 16AWG, 500' box white	58.70

See pages 224-225 for speaker wire.

**Home Theater Series Projectors**



**OPTGT1080**

Complete the home theater of your dreams with one of these HD projectors. With contrast ratios up to 600000:1 you will get a clear, crisp picture every time. If you have sources that are not HD, Worthington carries several products to upconvert them; this is also known as scaling. These projectors all have full 3D support.

Worthington carries many Optoma projectors for applications ranging from home theater to commercial and even interactive projectors (see below).

	Projection Distance	Native Resolution	Brightness	Contrast	Image	Lamp Watts	Lamp Life	
OPTHD91+	4.3'–56.1'	1080p (1920x1080)	1500 Lumens	600000:1	30"–300"	147W LED	20000 hours	3,078.90
OPTGT1080	1.64'–11'	1080p (1920x1080)	2800 Lumens	25000:1	45.3"–300"	190W	5000 hours	691.90
OPTEH515	4.27'–26.24'	1080p (1920x1080)	5500 Lumens	10000:1	27.2"–301.1"	365W	4000 hours	1,648.90

**Interactive Projectors by Optoma**

TouchBeam finger-touch interactive technology enables several people to work simultaneously on the screen without using a pen. The throw ratio of 0.25:1 means that it can project a 100" image from just 1.8' away. And having the projector installed so close to the screen avoids any shadows being cast across the screen.

OPTEH319USTI	1080p, 3500 lumens, 18000:1 contrast, 16W speaker	1,582.90
OPTEH320USTI	1080p, 4000 lumens, 20000:1 contrast, 16W speaker	1,586.20
OPTOWM2100	Adjustable wall-mount for EH319USTI and EH320USTI	196.90



**Scribe by Draper - Write-On Fixed Projector Screen**



- **Magnetic surface**
- **80% lower gloss than traditional whiteboards**
- **Low profile black bezel**
- **Easy flush wall mounting with sliding brackets**
- **Use any dry erase markers**
- **Ships with markers, cleaner, eraser**

DR800317	87" Screen, Size: 46.125" x 73.75" (16:10)	566.39
DR800318	94" Screen, Size: 46.125" x 82.125" (16:9)	569.52

In today's collaborative classrooms and meeting rooms, interaction between a projected image, speaker, and audience enriches presentations and empowers learning. When a presenter adds comments, colors, or drawings to an image, the audience needs a clear view of both the image and the additions.

Worthington carries the full Draper line. Call for more information.



**Clarion (Fixed/Permanently-Tensioned)**

If motorized is not what you are looking for, take a look at these cost-effective wall/ceiling-mounted permanent screens. One-inch square, tubular aluminum frame creates a very clean, non-wrinkled viewing surface to enjoy your movies. Screens have 2" black vinyl borders. M1300 Finish listed.\*



**DR252139**

DR252139	65" Screen, Size: 31.75" x 56.5" (16:9)**	465.02
DR252140	73" Screen, Size: 36" x 64" (16:9)**	491.15
DR252141	82" Screen, Size: 40.5" x 72" (16:9)**	546.54
DR252016	92" Screen, Size: 45" x 80" (16:9)**	622.82
DR252017	106" Screen, Size: 52" x 92" (16:9)**	775.39

\*Other finishes are available. \*\*Other formats avail. Call for information.

**Silhouette (Motorized Tab-Tensioned)**

If you are looking for a motorized screen to give your customer's home theater that "wow" factor, these wall/ceiling mount projection screens are for you. Matte White Finish listed.\*



**DR107250**

DR107321	82" Screen, Size: 40.5" x 72" (16:9)**	1,729.99
DR107250	92" Screen, Size: 45" x 80" (16:9)**	1,588.40
DR107397	100" Screen, Size: 49" x 87" (16:9)**	1,607.21
DR107251	106" Screen, Size: 52" x 82" (16:9)**	1,628.11
DR107409	110" Screen, Size: 54" x 96" (16:9)**	1,638.56

\*Other finishes are available. \*\*Other formats avail. Call for information.

**Other screen types available. Call for more information.**

DR121222	LVC-IV Motor Control Board. Used to connect screens to control systems such as Leviton's Omni panels.	133.76
----------	---	--------

Middle Atlantic Products



Middle Atlantic - What Great Systems are Built On

Middle Atlantic Products is a part of the Commercial AV division of Legrand, North America. All Middle Atlantic products are designed and engineered to meet the needs of installers and built in ways to save time and simplify the job.

- **An established company** - Middle Atlantic Products has been manufacturing products since 1979
- **A wide range of products** - from the ease of pre-assembled Essex racks to custom-built furniture with integrated racks, Middle Atlantic has exactly what you need to provide a professional solution
- **Short lead times** - Middle Atlantic builds all of their products in-house and has three warehouses to serve every region quickly and efficiently

At the heart of every great system, you'll find Middle Atlantic Products.

Visit [www.middleatlantic.com](http://www.middleatlantic.com) to learn more.

Essex Bundled Accessory Packages

Bundled accessory packages enable easy ordering of frequently utilized options under a single part number.

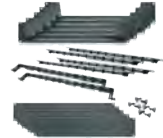

Part Number	MABUNDLE-SMALL	MABUNDLE-MEDIUM	MABUNDLE-LARGE
<b>Fits Essex Racks</b>	10-18 RU	21-27 RU	35-42 RU
<b>Shelves</b>	(2) 2 RU	(4) 2 RU	(4) 2 RU and (2) 4 RU
<b>Blank Panels</b>	(2) 2 RU	(4) 2 RU	(6) 2 RU
<b>Lacer Bars</b>	(4) straight	(4) straight and (4) 2" offset	(8) straight and (4) 2" offset
<b>Rack Screws</b>	50	100	200
<b>MAP</b>	117.75	240.75	399.00

Additional Universal Essex Accessories

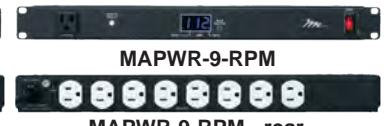
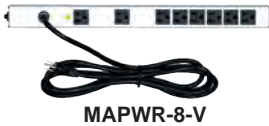

**Vertical Power Distribution**

		MAP
MAPWR-8-V	8 outlet, 15A max. vertical power strip	61.50
MAPWR-16-V	16 outlet, 15A max. vertical power strip	93.00
MAPWR-24-V	24 outlet, 15A max. vertical power strip	108.00

**Horizontal Power Distribution**

		MAP
MAPWR-9-RP	9 outlet, 15A max. horizontal surge protector	77.25
MAPWR-9-RPM	9 outlet, 15A max. horizontal surge protector with local meter for current, voltage, and kWh	108.00

**Vertical Cable Management**

		MAP
MALACE12-2PK	12 space lacing strip, 2 pack	20.25
MALACE18-2PK	18 space lacing strip, 2 pack	25.50
MALACE21-2PK	21 space lacing strip, 2 pack	27.75
MALACE27-2PK	27 space lacing strip, 2 pack	33.75
MALACE35-2PK	35 space lacing strip, 2 pack	40.50
MALACE42-2PK	42 space lacing strip, 2 pack	42.75

**Rack Panels**

		MAP
MAVPANEL-1U-2PK	1 space vented panel, 2 pack	20.25
MAVPANEL-2U-2PK	2 space vented panel, 2 pack	24.00
MAVPANEL-3U-2PK	3 space vented panel, 2 pack	27.00
MAFBPANEL-1U-2P	1 space blank panel, 2 pack	13.50
MAFBPANEL-2U-2P	2 space blank panel, 2 pack	20.25
MAFBPANEL-3U-2P	3 space blank panel, 2 pack	24.00

**Horizontal Cable Management**

		MAP
MALB-1A-4PK	"L" bar, 4 pack	13.50
MALB-2A-4PK	2" offset "L" bar, 4-pack	23.25
MALB-4A-4PK	4" offset "L" bar, 4-pack	26.25

**Thermal Management**

		MAP
MAFANPNL-2DC	3 space dual fan panel	92.25
MAFANTOP-138DC	Dual fan top, up to 2 per QAR/MMR rack	99.75
MAFC-DC	Thermostatic fan controller for up to 4 fans	107.25

**Locking Drawers**

MARKDRAWER-2U-L	2 space locking storage drawer	94.50
MARKDRAWER-4U-L	4 space locking storage drawer	120.75

**Rack Shelves**

MARKSHELF-2U-2P	2 space rack shelf, 2 pack	85.50
MARKSHELF-4U-2P	4 space rack shelf, 2 pack	120.75

MAP prices are shown. Please call or login to the Dealer Store for aggressive dealer pricing.



**QAR Series - Essex Quick Assembly Racks**



QAR rack

The Essex Quick Assembly Rack is an affordable, easy to build knock down rack. It features an innovative patent-pending snap-together design making it integration-ready in 5 minutes or less. The QAR Series provides the perfect foundation for entry level AV systems and can be outfitted with power and accessory options to suit any application.

**Features/benefits:**

- Patent-pending snap-together design saves 30 minutes or more of assembly time
- UL Listed, 800 lb. weight capacity
- Sleek metallic grey finish
- Includes lockable casters and a bracket for easy mounting of power and vertical lacing strips
- Generous facilities for bottom cable entry and passive ventilation for efficient airflow

Scan the QR code to see QAR in action.



		MAP		MAP	
MAQAR-12-20	12 space, 20" deep QAR rack	250.50	MAQAR-27-20	27 space, 20" deep QAR rack	292.50
MAQAR-12-24	12 space, 24" deep QAR rack	296.25	MAQAR-27-24	27 space, 24" deep QAR rack	337.50
MAQAR-18-20	18 space, 20" deep QAR rack	267.75	MAQAR-35-20	35 space, 20" deep QAR rack	315.75
MAQAR-18-24	18 space, 24" deep QAR rack	312.75	MAQAR-35-24	35 space, 24" deep QAR rack	361.50
MAQAR-21-20	21 space, 20" deep QAR rack	278.25	MAQAR-42-20	42 space, 20" deep QAR rack	347.25
MAQAR-21-24	21 space, 24" deep QAR rack	323.25	MAQAR-42-24	42 space, 24" deep QAR rack	392.25

**RCS Series - Essex Pre-Configured Rack System**

**Pre-Configured and Installation-Ready Racks**

Middle Atlantic's RCS series of pre-built equipment racks include everything you need for a rack: a reversible glass door, blank faceplates, pre-installed shelves, casters, sides, rear panel, and venting fans. Even though every RCS Series rack includes shelves for convenient equipment mounting, they are built on a professional rackmount foundation and accept both professional rackmount as well as shelf-mounted consumer components.

**Features/benefits:**

- Fully welded steel construction
- Ships fully assembled to save time
- Locking removable side panels for easy integration
- Glass front door, locking rear access panel standard
- Includes accommodations for vertical power strips and thermostatic fan controller
- Ideal for installations in closets, basements, equipment rooms, and other spaces
- Certifications: UL Listed, RoHS, and Greenguard

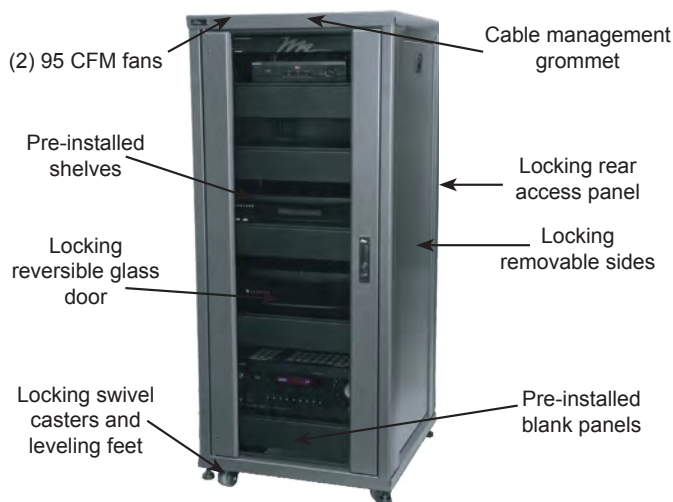

Model	MARCS-4224	MARCS-3524	MARCS-2724	MARCS-1824
<b>Racking Weight Rating</b>	1,200 lbs.	1,000 lbs.	750 lbs.	500 lbs.
<b>Shelves*</b>	(5) 2 space, 16" deep (2) 2 space, 18" deep (2) 3 space, 20" deep	(5) 2 space, 16" deep (1) 2 space, 18" deep (1) 3 space, 20" deep	(4) 2 space, 16" deep (1) 2 space, 18" deep	(3) 2 space, 16" deep
<b>2 Space Blanks</b>	9	7	5	3
<b>Racking Height</b>	42 space	35 space	27 space	18 space
<b>MAP</b>	1,228.50	1,064.25	737.25	573.00

\* Shelves and panels are pre-installed

Worthington Distribution wants to be your source for Middle Atlantic.

Save 5%\*  
with



Mention our catalog listing on your next order for any Middle Atlantic products and we'll take 5% off!

\*5% off applies to a single order of Middle Atlantic products placed between April 1, 2017 and March 31, 2018. Offer must be redeemed at time of purchase. Offer subject to end without notice.



See the next page for Essex multi-mount racks.

MAP prices are shown. Please call or login to the Dealer Store for aggressive dealer pricing.

**MMR Series - Essex Multi-Mount Racks**

Middle Atlantic's most versatile rack system!



MMR rack with optional casters and solid front door

The Essex Multi-Mount Rack is a fully-welded equipment mounting solution offering exceptional versatility at an affordable price. MMR Series racks feature the flexibility to be installed desktop, floor-standing, or wall-mounted in one of three distinct ways.

**Features/benefits:**

- Five installation options - floor-standing, desktop, or 3 wall-mount configurations: easy-access pivot, quick hang bracket, or direct-to-wall
- UL Listed, 250 lb. weight capacity
- Sleek metallic grey finish
- Passive ventilation for efficient airflow

Scan the QR code to see MMR's mounting versatility.



		MAP	Quick Hang Wall-Mount Bracket	Pivoting Wall-Mount Bracket
MAMMR-1020	10 space, 20" deep MMR rack	260.25	MAHANG-MMR10 63.75	MAPIVOT-MMR-10 143.25
MAMMR-1220	12 space, 20" deep MMR rack	294.75	MAHANG-MMR12 75.75	MAPIVOT-MMR-12 156.00
MAMMR-1620	16 space, 20" deep MMR rack	347.25	MAHANG-MMR16 93.75	MAPIVOT-MMR-16 173.25
MAMMR-1624	16 space, 24" deep MMR rack	356.25	MAHANG-MMR16 93.75	MAPIVOT-MMR-16 173.25
MAMMR-1820	18 space, 20" deep MMR rack	387.00	MAHANG-MMR18 105.75	MAPIVOT-MMR-18 186.00
MAMMR-1824	18 space, 24" deep MMR rack	418.50	MAHANG-MMR18 105.75	MAPIVOT-MMR-18 186.00
MACASTERS-K	Set of four casters for floor-standing MMR racks			53.25

See below for solid front/rear doors, plexi front/rear doors, power strips, and cable management options for the MMR series.

	Solid Front/Rear Door		Plexi Front/Rear Door		Vertical Power		Vertical Cable Lacing (2 pack)	
10 space	MADOOR-S10	90.75	MADOOR-P10	143.25	MAPWR-8-V	61.50	-	-
12 space	MADOOR-S12	95.25	MADOOR-P12	156.00	MAPWR-8-V	61.50	-	-
16 space	MADOOR-S16	105.00	MADOOR-P16	190.50	MAPWR-8-V	61.50	-	-
18 space	MADOOR-S18	115.50	MADOOR-P18	207.75	MAPWR-16-V	93.00	MALACE18-2PK	25.50

**RackLink - Web-Enabled Power Strips**

A practical, web-enabled power management system which sets a new standard for cost-effective capabilities. Set-up takes less than five minutes. RackLink modules monitor the power and temperature conditions of your system, log and alert you to any irregularities, and even reboot to correct network problems on their own.

**Features/benefits:**

- Individual outlet control
- Monitor power and temperature
- Autoping network device diagnostic/utility
- Event logging and notification
- User defined thresholds
- IP and RS-232 connectivity
- Emergency power off with automatic recovery option

Use RackLink to troubleshoot and power-cycle equipment without sending a truck to the job-site.

		MAP
MARLNKMON115NS	In-line, 15A max load, 1 unswitched outlet	408.00
MARLNKMON120NS	In-line, 20A max load, 1 unswitched outlet	415.50
MARLNK-SW215-NS	In-line, 15A max load, 2 outlets (1 is controlled)	432.00
MARLNK-SW220-NS	In-line, 20A max load, 2 outlets (1 is controlled)	440.25
MARLNK-SW715R	Rackmount, 15A max load, 7 outlets (5 are controlled)*	816.75
MARLNKSW715RNS	Rackmount, 15A max load, 7 outlets (5 are controlled)	799.50
MARLNK-SW620R	Rackmount, 20A max load, 6 outlets (4 are controlled)*	849.00
MARLNKSW620RNS	Rackmount, 20A max load, 6 outlets (4 are controlled)	832.50

\* Two-stage surge suppression, can dissipate 711 Joules

Additional configurations available, contact Worthington Distribution for details.



**Other Power Conditioning Products**



Middle Atlantic has a wide range of rack-mounted power distribution and surge protection products and Worthington Distribution carries Middle Atlantic's full line.

See page 69 or contact Worthington Distribution for additional power conditioning options.

MAP prices are shown. Please call or login to the Dealer Store for aggressive dealer pricing.

**Middle Atlantic's Configurator Tool**

**Simplify Rack Installations with Middle Atlantic's Configurator**

Middle Atlantic has made specifying and ordering their products easier than ever with their configurator tool. The Configurator guides you through laying out a rack, provides you with list pricing, and even calculates shipping. Best of all, registering for Middle Atlantic's Configurator is free!

**Check out these great features of the Middle Atlantic Configurator**



**Browse & Design**  
Use the guide or explore on your own

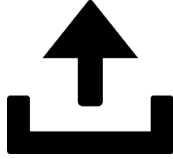

**Export Your System**  
Export A & E's, quotes, CAD files, and more



**24/7 Online Access**  
Always available online with no downloads



**Free Factory Assembly**  
Saves you time



**Freight Quotes**  
Know exactly what it will cost to deliver



**Scan the QR code to see a demo of the Configurator.**

**Contact us to learn more about the Configurator.**

**RSH Custom-Built Rackshelves**

**Features/Benefits of Middle Atlantic Products' Custom Rackshelves:**

- Allows for installation of virtually any product into a standard 19" enclosure
- Includes a custom-cut faceplate for a clean look with no gaps around the component
- Can be ordered in an anodized finish or a brushed, paintable finish

**Middle Atlantic guarantees shipment within 48 hours, and most custom rackshelves ship same-day**

Custom Rackshelf Search

Select Manufacturer & Model

Manufacturer:  OR

Model:

Select finish for front face

black brushed & anodized  black textured powder coat

Select Whole Shelf or Front Plate Only?

Whole Shelf  Front Plate Only

Middle Atlantic has dimensions for over 10,000 products in their database.

To find the correct custom rack shelf model number browse to <http://www.middleatlantic.com/resources/rsh-lookup> and search by manufacturer and model number or by keyword.

If your product isn't listed, you can enter the product dimensions to create a new part number.

All custom shelves follow this MSRP pricing		2-5 sp.	6-12 sp.
MARSH4A	Black Anodized Finish	172.42	192.70
MARSH4S	Black Brushed Finish	144.52	182.56

**Low-Cost, Wall-Mount DVR/NVR Enclosure Solution**



**Don't leave a rat's nest of wires like this behind. Use a low-profile WRS rack for a clean, secure, and professional installation.**

**Clean Up Your Recording Devices**

Middle Atlantic has solutions to mount NVRs and DVRs which will make your installations look great.

Use the components shown below for a trim and economical mounting option. The four rack units of space provides you with enough room for a DVR/NVR, a battery backup, and a network switch, all in a lockable on-wall enclosure.

**The approximate shipping cost for these Middle Atlantic components is just \$23!**

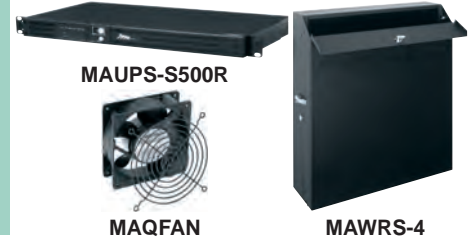

		MAP
MAWRS-4	4-space Vertical Wall Rack. Holds equipment up to 23" deep	397.50
MAQFAN	50 CFM Fan with Cord	75.00
MAUPS-S500R	1 RU 500VA Uninterruptible Power Supply (UPS)	462.00

**Don't forget to add a PoE switch. See Luxul on pages 64 and 65**



**Additional Rack Options**

**Middle Atlantic offers a full line of equipment rack solutions, including...**



**Visit [www.middleatlantic.com](http://www.middleatlantic.com) for all of their rack options.**

**Worthington Distribution has access to Middle Atlantic's entire line of products.**

**If the part you are looking for is not listed in our catalog, please call (800) 282-8864 for price and availability.**

**MAP prices are shown. Please call or login to the Dealer Store for aggressive dealer pricing.**



# WiFi, IP, HTTP Enable Serial, Relay and IR Devices

Make your installs IoT ready.

Engineered to work in any control environment.

Connect and control using any smartphone, tablet, PC, or controller.

Access, monitor, and control stand-alone equipment with the software of your choice.

Wired (TCP/IP), wireless (WiFi), and PoE models available.

HTTP compatible.

Tiny footprint, stylish enclosure.

Simple to install and easy to use.

Ask about our partner programs.



GC-100 Network Adapters



iTach Devices



Flex Link Cables



Flex WiFi and  
Flex Link 3 Emitter Cable



Flex IP and  
Flex Link Relay RS232 Cable



Flex IP and  
Flex Link Relay & Sensor Cable

**Affordable Flat Panel Mounts from Worthington Distribution**

Have you been priced out of installing home theater display mounts by big box stores? We have your solution. Worthington Distribution is your source for low-cost, high-quality flat panel display mounts. All of these mounts are made of 1/4" high-quality steel, have a black scratch-resistant coating, and include all of the hardware you need to hang most displays. We back up these mounts with a no-hassle return policy: if you purchase one of these mounts and are dissatisfied with the quality of the materials or the packaging, we will take the mount back. Best of all, purchase any four mounts from this page, and receive a fifth one free.



Mount	Size	Capacity	Adjustments	Hole Pattern	Profile	Price
BL502676	LED 23-50"	77 lbs.	Fixed	Universal 50x50mm to 440x440mm	0.2" (5mm)	25.98
BL502677	LED 26-65"	100 lbs.	Fixed	Universal 50x50mm to 640x640mm	0.2" (5mm)	27.81
BL502670	32-50"	100 lbs.	Fixed	Universal 50x50mm to 650x400mm	1.1" (28mm)	25.95
BL502671	36-63"	165 lbs.	Fixed	Universal 50x50mm to 800x400mm	1.1" (28mm)	31.80
BL502669	23-37"	77 lbs.	Tilts -5° to +15°	Universal 50x50mm to 450x300mm	2.36" (60mm)	30.00
BL502672	32-50"	100 lbs.	Tilts -5° to +15°	Universal 50x50mm to 600x400mm	2.36" (60mm)	34.05
BL502673	36-63"	132 lbs.	Tilts -5° to +15°	Universal 50x50mm to 800x400mm	2.36" (60mm)	41.85
BL502647BK	32-55"	88 lbs.	Tilts +10° pans and swivels	Universal 75x75mm to 400x200mm	3.7 to 22" (95 to 575mm)	76.26
BL502826	32-55"	110 lbs.	Tilts -5° to +15° pans and swivels	Universal 50x50mm to 600x400mm	4.5 to 22.5" (113 to 572mm)	101.85
BL502827	37-65"	132 lbs.	Tilts -5° to +15° pans and swivels	Universal 50x50mm to 800x400mm	4.5 to 22.5" (113 to 572mm)	108.75

**Buy 4 mounts get 1 FREE!** Free mount is of equal or lesser value.

**Projector Mount**



BL502664BK

Mount	Capacity	Adjustments	Profile	Price
BL502664BK	Fits most small to large projectors up to 44 lbs.	Pitch ± 20° Roll ± 20° Rotate 360°	22.6 to 32.5" from ceiling	26.60

**Additional Home Theater Accessories**

**De-Clutter with Residential Racks**



Middle Atlantic has a line of pre-configured racks which are priced to compete with the big box stores' off-the-shelf rack systems, while keeping Middle Atlantic's high standards of quality. These racks come with a reversible glass door, pre-installed shelves with blank face plates, casters, sides, rear panel, and venting fans to save you time in the field.

See pages 180-183 for more details.

**Hide the Connections with a Recessed TV Box**

Looking to keep a slim profile between the display and the wall? Plan to install an Arlington Industries TVB810 recessed TV box behind the display. This 8"x10" box comes with all of the hardware you need to set up a line-voltage outlet, a pass-through for your video cables, and even has a molded hanger to manage any cables which are longer than you need.

See page 221 for more details.



**Get Connected with Home Theater Cables**

Don't forget the cables when you make your bid to your customer. Worthington Distribution can be your source for high-quality, low-cost home theater cables. Our HDMI cables are Category 2 certified to support resolutions up to 4K. We also have component video, coaxial, SVGA, and even composite cables to meet any home theater need.

See page 177 for more details.



**Control It All with a Mobile Device**



With the universal remotes of the future you can offer full control of your customer's systems through a free app for their iPad, iPhone or Android. URC devices send commands over the network from the app and translates them to IR or serial to control devices.

See page 39 for more details.





Dedicate iPad in premium enclosures for convenient control throughout the home. Now with programmable buttons for shortcuts to key functions for a better control experience.



## LaunchPort

hold. charge. protect.

Wireless Charging & Mobility  
for iPad on Table or Wall.

*With Optional Programmable  
Buttons on iPad Sleeve*



## Surface Mount

Elegantly mount on any surface.

Stationary Mounting & PoE  
Charging System for iPad.

*With Optional Programmable  
Buttons on iPad Bezel*



## xPRESS

The audio keypad for Sonos.

Instant Control for Any  
Sonos Device.



Enhancing the User Experience of  
the Connected Home.





### Grandstream IP Phone system

The Grandstream IP phone system offers great features at a very affordable price. It supports standard analog as well as IP phone lines. Use the Android system phones and run apps from Google Play.



Page 190-191



### Selective Call Intercom

A Cat 5 intercom with station capability and color LCD displays at each station. Selective Call is easy to use and easy for a single technician to install. All that's required is connecting and naming stations.



Page 193



### Teleport IP Door Station

The Teleport is an IP video door station that can be used with a Grandstream system. It rings the system phones and can then ring a smartphone app if unanswered.



Page 192



### Leviton IP door station

Leviton's new IP door station is a great addition to our Telephone/Communications arsenal. With a tamper-proof case and new sleek design, it can be integrated with the Grandstream SIP server.



Page 192

### 7-inch Android

This is the top of the Grandstream phone range. With no hard buttons, a 7-inch touchscreen, and fixed capacitive touch navigation buttons, it's like a tablet and system phone combined.



### Cat5 Intercom Station

Place intercom stations in frequently used rooms.



### Telephone System KSU

The brains of the operation. The KSU is where phone lines and phone stations are connected. It is mounted in the utility or media closet and should be close to the structured wiring enclosure for easy connection.



### Cat 5 Intercom Hub

Mounts in the structured wiring enclosure and connects to all stations.

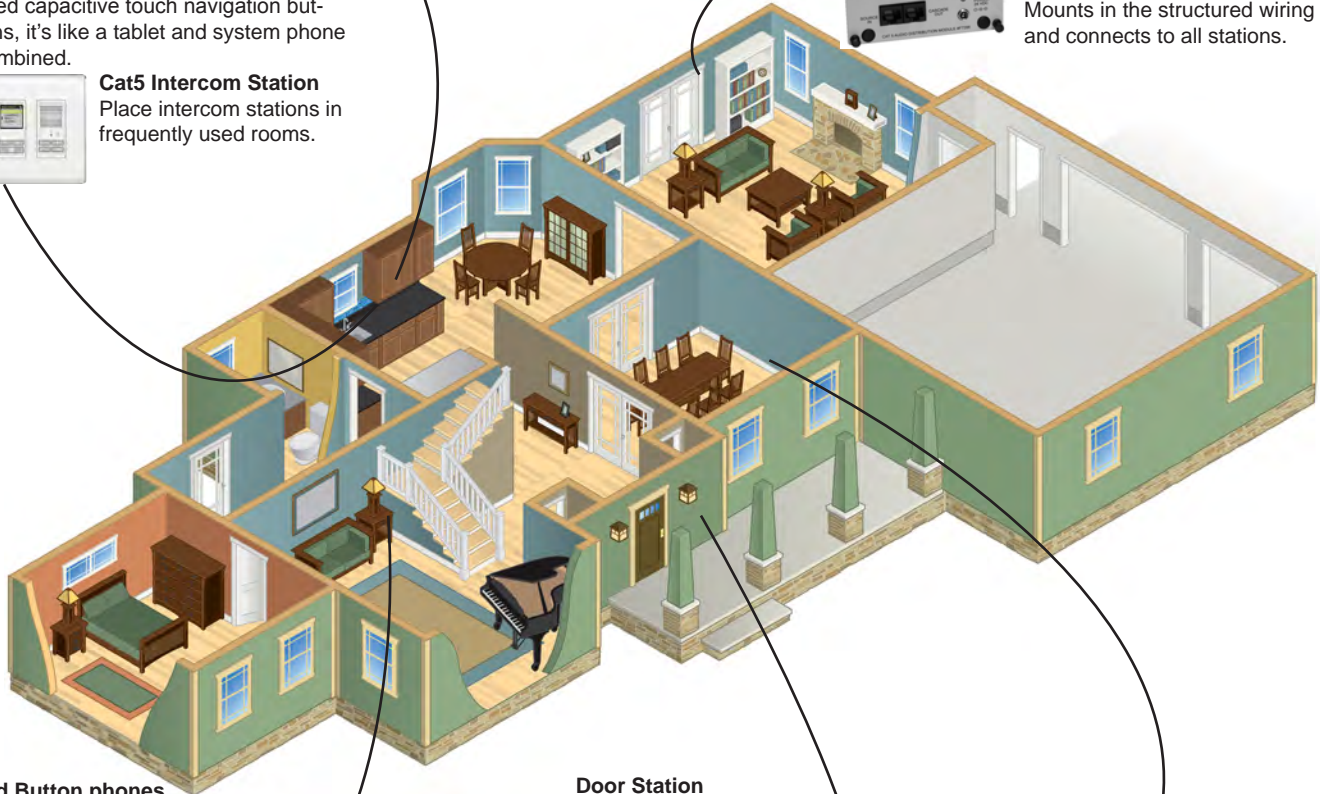

### Hard Button phones

GXV3240 is the most popular of the hard button Grandstream phones. It offers plenty of configurable buttons plus a 4.3 inch touchscreen. Use these in moderately-used areas.



### Cat5 Intercom Station

Most Cat 5 intercom systems offer a single interior keypad style.



### Door Station

On the Grandstream, a door chime tone can be played through all phones when a guest presses the button. A user inside can then answer the call and talk to the guest, and even buzz them in if door strikes are in use.



### Door Station

Intercoms offer a variety of door stations. Some have cameras integrated that can be connected for inside viewing.



### GXP2140

This phone is the entry-level model. It has fewer buttons and it is best suited for less-often used areas like bedrooms, garages, and basements.



### Cat 5 Intercom Station

Selective Call from Legrand automatically orders the room list at each station by popularity.



**SL1100 System Kits**

Part No.	Kit	CO x TDM x Analog	Phones	Voice Mail	Additional	Price
NEC1100001	Basic System Kit	4 x 8 x 4	(3) Digital 12-Button Black, 1100061	N/A	4-Port CO Board	569.00
NEC1100005	Digital Quick-Start w/ 12-Button Phones	4 x 8 x 4	(6) Digital 12-Button Black, 1100061	2-Port/15-Hour	4-Port CO Board, Install Cable, 25pk Desi Labels	1,199.00
NEC1100009	Digital Quick-Start w/ 24-Button Phones	4 x 8 x 4	(6) Digital 24-Button Black, 1100063	2-Port/15-Hour	4-Port CO Board, Install Cable, 25pk Desi Labels	1,299.00
NEC1100013	IP Quick-Start w/ 24-Button Phones	0 x 8 x 4	(6) IP 24-Button Black, 1100161	2-Port/15-Hour	16-Channel VoIP Board w/ 4 SIP Trunk Ports, 25pk Desi Labels	1,499.00



NEC1100001



NEC1100005



NEC1100013



NEC1100009

**SL1100 Digital Telephones**

All SL1100 telephones are equipped with:

- Full-duplex Hands-free
- Backlit 3-line/24-character display
- Backlit Dialpad
- User Programmable Function Keys with Red/Green LED's
- (4) Soft Keys
- (9) Fixed Feature Keys
- Navigator Key
- 2-step Leg Angle Adjustment
- Headset Jack
- 9-ft handset cord

NEC1100061	12-Button Digital Telephone in Black	109.00
NEC1100060	12-Button Digital Telephone in White	109.00
NEC1100063	24-Button Digital Telephone in Black	139.00
NEC1100062	24-Button Digital Telephone in White	139.00

SL1100 Digital phones feature 6' line cord and wall mounting hardware



NEC1100061



NEC1100062



NEC1100161



NEC1100160

**SL1100 IP Telephones**

SL1100 IP Telephones:

- Do NOT require a SIP Station License
- Are equipped with (2) RJ-45 jacks for pass-through to PC
- Require power from PoE switch, PoE injector, or NEC690631 power supply
- Are NOT supplied with a Cat 5 patch cord
- Require NEC1100162 if being wall-mounted

NEC1100161	24-Button Station in Black	159.00
NEC1100160	24-Button Station in White	159.00
NEC1100162	Wall Mount for IP Telephones	10.00
LSA90A00-1	PoE Injector	49.01
NEC690631	Power supply for IP telephones	23.63

**ML440 SIP-DECT Cordless Phones**



NEC730650



NEC730651

NEC1100007	Starter Kit, includes (3) ML440 Handsets with Chargers, (1) AP20 DECT Access Point, (1) 1100111 SL1100 VoIP Board	999.00
NEC730653	Bundle, includes (3) ML440 Handsets with Chargers and (1) AP20 DECT Access Point	900.00
NEC730650	ML440 DECT Handset with Charger, requires at least (1) AP20 DECT Access Point	245.00
NEC730651	AP20 DECT Access Point, PoE compatible, requires SIP Daughter board to be installed in system	390.00



**SL1100 KSU Equipment**

NEC1100010	Main KSU, includes CPU board, 8 digital x 4 analog station board, voice mail daughter board, memory daughter board, power supply	309.00
NEC1100011	Expansion KSU, includes expansion board, 8 digital x 4 analog station board, power supply	189.00
NEC1100110	Expansion Unit Interface Card	69.00
NEC808920	Installation Cable	30.00



NEC1100010



NEC1100011



NEC1100110

**SL1100 Trunk Cards and SIP Trunking**

NEC1100022	4-port CO Trunk Daughter Board	99.00
NEC1100024	T1/PRI Interface Card	599.00
NEC1100093	2-Port SIP Trunk License, required after the first 4 SIP trunks that come with the IP Daughter Board, 32 Max SIP Trunks	49.00



NEC1100022



NEC1100024

**SL1100 Station Interface Cards and Licenses**

NEC1100020	8-port Digital Station Card	89.00
NEC1100021	8-port Analog Station Card	189.00
NEC1100089	1-port License for 3rd Party SIP Station	30.00
NEC1100081	SIP Encryption License	169.00
NEC1100085	1-port Mobile Extension License, required after the first 4 which are included with the CPU card	100.00



NEC1100020



NEC1100021

**SL1100 VoIP Daughter Board**

NEC1100111	16-channel IP Daughter Board - Includes 4 SIP Trunk Ports	249.00
NEC1100082	16-channel VoIP Upgrade - Max 32 channels per System	119.00



NEC1100111

**SL1100 InMail**

NEC1100112	2-port, 15-Hour Voice Mail Card	379.00
NEC1100113	4-port, 40-Hour Voice Mail Card	599.00
NEC1100083	2-port Upgrade License, Note: a max of 16 ports are supported	125.00
NEC1100084	InMail Advanced Feature License, adds email notification, cascading message notification, find me/follow me, password option, hotel/motel	300.00



NEC1100112

**SL1100 Door Stations**

NEC922450	Door Intercom Station, charcoal, wires back to DSX using 2 conductors	80.00
-----------	---	-------

- A guest presses the button on the door station and phones chime
- There are multiple chime sounds to choose from



NEC922450



CVDP-0***P	NEC-compatible door station, large form factor, includes surface mount box	181.85
CVDP-6***P	Same as above, has color camera built-in	273.23
CVIU-0***P	NEC-compatible door station, 1-gang form factor, mounts in 1-gang box or mud ring	123.90
CVIU-6***P	Same as above, has color camera built-in	212.58

\*\*\* 212-White, 222-Polished Brass, 232-Antique Brass, 242-Chrome, 252-Oil Rubbed Bronze, 262-Antique Copper, 272-Satin Silver, 282-Black, 302-Satin Nickel

**SL1100 Licenses**

NEC1100091	ACD License, enables automatic call distribution feature, provides 2 ACD groups and 16 agents	109.00
NEC1100092	SL NET License, provides VoIP connection between up to 5 SL1100 sites, includes: central network attendant, central or local voice mail, intercom between all sites, share trunks between sites, BLF and central park orbit between sites	199.00
NEC1100086	Hotel/Motel License, adds features: wake-up call, single digit dialing menu, message waiting, room-to-room calling restriction, toll restriction when checked in, room status, reports	249.00
NEC1100085	Single Mobile Extension License, allows a programmed remote phone number (usually cell phone) to act as an internal extension	100.00
NEC1100087	Single Desktop Client License, provides user with desktop and softphone features, Microsoft Outlook integration and call pop-up	55.00



Pure IP telephone systems offer features of traditional digital systems with many added benefits. IP phones come in many varieties from simple to full-featured with large color touchscreen interfaces. Some even run Android to support apps. Grandstream systems show local weather data (including graphics on touchscreen models) on the phone's display. Ask us about Grandstream's IP camera lineup. Pairing them with your Grandstream IP phone systems lets users view cameras in real-time on the phone's display (select models).

**IP PBX**

GRAUCM6102	IPPBX, up to 150 extensions, 2 analog CO lines, 30 concurrent calls	232.50
GRAUCM6104	IPPBX, up to 150 extensions, 4 analog CO lines, 45 concurrent calls	292.54
GRAUCM6108	IPPBX, up to 150 extensions, 8 analog CO lines, 60 concurrent calls, rack mount	498.21
GRAUCM6116	IPPBX, up to 150 extensions, 16 analog CO lines, 60 concurrent calls, rack mount	637.44

Use Gateways Listed Below to Add More Analog CO Lines

The UCM6100 series IP PBX supports from a few users up to 150. It features full voice mail built in with no licensing fees for users or features. All set up is performed through a web-based portal and can be done locally or remotely.



**SIP-DECT Wireless Phones**



GRADP720



GRADP750

GRADP750	Cordless phone SIP-DECT base station, handles total of 5 GRADP720 phones, PoE powered	53.65
GRADP720	SIP-DECT Cordless Phone, color display, HD audio, charging cradle included	51.62

Grandstream's SIP-DECT cordless phones use the robust DECT 1.9GHz wireless technology to communicate from the DP720 phones to the DP750 base and standard SIP communication from the base to the PBX. Each DP750 base can support up to five DP720 phones. This system provides an approximate range of 150' indoors.

**SIP-DECT Multi-Cell Wireless Phones**

SNOM700	SIP-DECT Multi-Cell Base Station, up to 40 base stations and 200 M25 or M65 handsets per system, ~150' indoor range, PoE-powered	315.51
SNOM25	Basic Multi-Cell Handset, 1.4" TFT display, 75 hr standby	94.54
SNOM65	Premium Multi-Cell Handset, 2" backlit display, tri-color LED indicator, HD audio, 250 hr standby	185.81

Snom is a German company known for high-quality IP telephony products. Their SIP-DECT wireless phones are the perfect choice when a large number of wireless phones are required or a large area needs to be covered. One system can have up to 40 base stations and 200 handsets. The phones use DECT wireless to the bases where the call is converted to SIP and handed to the IPPBX. Multi-Cell means a phone can hop from base to base as it moves - just like your cell phone hops from tower to tower as you drive. That's how this system can cover large areas. You can even place base stations in multiple buildings so the user can carry one cordless phone across an entire campus or estate.



SNOM700



SNOM25



SNOM65

**Video Door Station and OmniTouch 7**



See page 192 for IP video door intercom stations. They connect to the Grandstream PBX just like a phone and can be set to dial a group of phones.

Grandstream PBXs can also be used to enable the intercom feature of the Leviton OmniTouch 7.

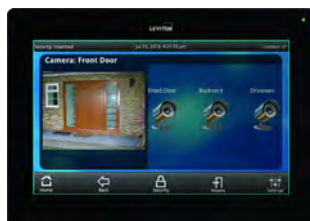

**Analog CO Gateways**

GRAGXW4104	FXO Gateway, adds up to 4 CO lines to a UCM6100 series PBX	186.50
GRAGXW4108	FXO Gateway, adds up to 8 CO lines to a UCM6100 series PBX	254.21



GRAGXW4104

**Endpoints - IP Phones - Android Powered**

Grandstream Android phones offer the latest in IP communication. The Android OS allows users to install any app from Google Play. It turns the phone into a full controller for any automation system. We have used apps from Leviton, Speco, EverFocus, Lutron, Russound, Vera, and more, they look great. Both models are PoE and feature dual switched network ports.

GRAGXV3275	Android Powered, 7" color touchscreen, capacitive touch dedicated nav buttons, HD audio, Bluetooth, built-in front-facing cam	212.06
GRAGXV3240	Android Powered, 4.3" color touchscreen, standard push buttons, HD audio, Bluetooth, built-in front-facing cam	155.85



**Endpoints - IP Phones**

Grandstream IP phones feature modern convenience. They are PoE-powered and feature dual switched network ports. Weather info and forecast are displayed on all phones.

GRAGXP2170	4 programmable keys on display, 48 on-screen customizable BLF keys, 4.3" color LCD screen, HD audio, Bluetooth	104.40
GRAGXP2160	6 programmable keys on display, 24 labeled programmable keys, 4.3" color LCD screen, HD audio, Bluetooth	100.92
GRAGXP2140	4 programmable keys on display, 4.3" color LCD screen, HD audio, Bluetooth	88.15
GRAGXP2130	3 programmable keys on display, 6 labeled programmable keys, 2.8" color LCD screen, HD audio	66.43
GRAGXP1610	3 programmable keys on display, monochrome LCD	33.21
GRAGXP2200EXT	Expansion module for GXP2130 and GXP2140, adds 24 programmable keys, LCD screen in place of paper labels	83.03



**IP Conference Phone**

The GAC2500 conference phone is a great addition to the Grandstream system and is a great fit in any conference room. Its 4.3" touchscreen and Android operating system make it easy to use - anyone who has used a smartphone will be familiar with it. Android means it can also run conferencing apps like Skype and Google Hangouts. Built-in Bluetooth allows users to sync headsets and mobile devices.

GRAGAC2500	Android-Powered Enterprise Conference Phone, PoE powered, 4.3" color touchscreen, 3 cardioid mics for 12' pickup distance in any direction, HD audio	334.69
------------	--	--------



**IP Paging Module**

Paging is an important part of many phone systems. The Snom PA1 paging module connects and registers to your Grandstream system like any other extension. Users simply dial its extension, announce their message, and hang up, then the PA1 plays the announcement. Use the programmable buttons on your phones to enable 1-touch paging. Add multiple PA1 for multi-zone paging.

SNOPA1	SIP Paging Module, PoE-powered, 4 watt amplifier, line outputs	119.60
SNOPA1PSU	Power supply, use when PoE is not available	18.68



**SNOM**



Leviton's new IP Door Intercom Station is a great addition to the Omni system when OmniTouch 7 screens are in use, but it can also be used with a Grandstream or other SIP-based IP phone system. Simply configure the door station to dial a specific extension group when the call button is pressed. The built-in relay can be triggered by dialing a code when connected. It can be used to release a door strike, mag lock, or gate. The door station also features a built-in LED light for better nighttime video.



- Use with or without Leviton Omni system
- PoE powered
- SIP compliant
- Built-in relay to operate door strike/mag lock/gate
- LED lights up the subject in the dark
- Tamper alarm sounds if mounting hardware is compromised

LSAINDS1-S	IP Door Intercom Station	498.60
LSA90A00-1	PoE Injector	49.01
LUXXFS-1084P	8-port Switch, 4 ports PoE	70.43
LUXXFS-1816P	18-port Switch, 16 ports PoE+	337.23



The Teleport is a SIP video door station. It features a durable door unit with camera and a separate indoor controller. Since it follows the SIP protocol, it can be registered to a Grandstream system like any other IP phone. You program it to dial an extension or group when the button is pressed. It then rings those phones and when using Grandstream's Android phones you even see the person at the door. To take it to the next level, install a SIP app on a smartphone and register it to the Grandstream as well. You can set it so that the system phones ring a few times and if unanswered, the smartphone rings. Answer the call there and get video too!

If you need a doorbell that calls a smartphone without an IP PBX in the mix, use the Teleport no-charge cloud service. The free Teleport app is available for iOS and Android.



- Connects to Grandstream like an extension
- Rings a selected group of phones when button is pressed
- Use Grandstream Android phones to see live video of door when answered
- Load SIP app on smartphones and have them ring if not answered inside and also view live video from the door

**Also great for gates. A contact closure can be activated by dialing a user-defined code and it can open the gate.**

LGXTPC	Teleport controller only, must use one of below door stations	389.33
LGXTP202XVC	Surface-mount IP video door station with Panning Camera (requires LGXTPC)	200.64
LGXTPEF*VC	Elite series flush door station (req. LGXTPC)	466.46
LGXBXR300EVC	Backbox, required for above door station	30.53

\* AB-Antique Brass, AN-Antique Nickel, B-Bronze, OR-Oil Rubbed, C-Copper, ORB-Oil Rubbed Bronze, PB-Polished Brass, SB-Satin Brass



LGXTPC

LGXTP202XVC

**Use with Grandstream's IP PBX and Android-Powered Phones - Door Station Rings Phones and Shows Video**

**On-Hold Plus™**  
on-hold audio products that mean business

**OHP 8000 Features:**

- Ready to go right out of the box. Pre-loaded with nearly 3 hours of fully licensed music and messages
- Free on-hold production personalization provided automatically when product is registered
- Rugged extruded aluminum enclosure with wall mounting capability
- 128MB USB flash drive included (preloaded with music and "thanks for holding" messages)
- Works with any ordinary USB Flash drive
- Built-in monitoring speaker
- Trigger switch input
- MessageStudio On-Hold Audio Creator Software
- 3-Year warranty

**MessageStudio Software**

With the included MessageStudio, you're just a few mouse clicks away from your own, professional-sounding, custom on-hold audio presentation.



ITOHP8000	USB Music On-Hold Player, works great with NEC phone systems, great attachment item on phone system jobs	171.11
-----------	--	--------



**Video Door Entry Systems**

- HFX-7000M:** Single-family kit with Quadra and mini-hf
- New interior monitor model mini handsfree with vivid 4.3" Color screen
  - New Quadra exterior door station with touch button
  - Kit is expandable to 4 exterior door stations and 4 interior monitors
  - Improved touch capacitive technology for both exterior and interior stations



**CYXHFX-7000M**



**CYXHFX-8000M**

- HFX-8000M:** Single-family kit with Quadra and Icona
- New Icona interior monitor with 4.3" Color screen
  - New Quadra exterior door station with touch button
  - Kit is expandable to 4 exterior door stations and 4 interior monitors
  - Improved touch capacitive technology for both exterior and interior stations
  - Swipe function: icons appear on the control console with a simple swipe



**CYXHFX-9000M**



**CYX8513HIM**

- HFX-9000M:** Single-family kit with Quadra and 7" Maxi monitor
- New Quadra exterior door station with touch button
  - New Maxi interior monitor with vivid 7" Lcd screen
  - Improved touch capacitive buttons
  - Expandable to 4 exterior stations and 8 interior monitors
  - Blue LED courtesy light



**CYX8531**

- 8531 – IP kit with Icona monitor & Wi-Fi app**
- Video entry compatible: monitor / smart devices
  - Kit must be connected to router or another device to guarantee Wi-Fi connectivity
  - 16 appliances including door entry monitors, smartphones, tablets & PC's can be connected
  - Intercom communication is compatible between all 16 devices served
  - Includes new Icona monitor
  - Includes Ikall metal door entry station

- 8513HIM – VIP kit with Wi-Fi 3G/4G remote app only**
- Mobile device door entry via Wi-Fi network or remotely on 3G/4G
  - Includes single push button IKall metal
  - Gateway serves up to 16 appliances
  - Intercom communication between all appliances

**Do you have a larger application?  
Between 1 and 240 apartments?  
We can custom design a Comelit door  
entry system for you.**

**2-Wire Analog Kits**

CYXHFX-7000M	Single-family kit with Quadra and mini-hf	269.78
CYXEX-7000H	Expansion Monitor for HFX-7000M kit	159.87
CYXHFX-8000M	Single-family kit with Quadra and Icona	327.24
CYXEX-8000H	Expansion Monitor for HFX-8000M kit	204.84
CYXHFX-9000M	Single-family kit with Quadra and 7" Maxi monitor	387.19
CYXEX-9000H	Expansion Monitor for HFX-9000M kit	362.21
CYXEX-DSQ	Quadra Door Station and switching kit	159.87

**IP-Enabled Kits**

CYX8513HIM	VIP kit with Wi-Fi 3G/4G remote app only	823.09
CYX8531	IP kit with Icona monitor & Wi-Fi app	1,224.02

Expansion monitors and accessories available. Please call for details

**Telephone Entry Systems**



**CVIU-0212/  
CVIU-6212**



**CVDP-0212/  
CVDP-6212**



**CVP-0920**

CVIU-0**2	Single-gang mount door station (2 3/4" x 4 1/2")	97.92
CVIU-6**2	Same as above with color camera (3.8mm, 380 lines of resolution)	187.35
CVDP-0**2	Door station with mounting box (4 3/8" x 6 1/2")	161.87
CVDP-6**2	Same as above with color camera	253.80
CVP-0920	Single door telephone entry controller (2-door model also available)	178.86
CVP-0922	Mobile Intercom Connect. Door entry controller can call out to cell phone.	99.92
CVP-0925	Paging module (enables paging from CVP-0920 through audio system)	24.98
CVTE-0212	Telephone entry kit; includes: (1) P-0920 & (1) IU-0212 white front door intercom unit	266.19
CVTE-0282	Telephone entry kit; includes: (1) P-0920 & (1) IU-0282 black front door intercom unit	266.19
CVTE110DS	Door strike controller, required to operate a door strike	34.97

\*\* Available in - 21-White, 22-Brass, 23-Atq. Brass, 24-Chrome, 25-Oil Rubbed Bronze, 26-Atq. Copper, 27-Satin Silver, 28-Black, 30-Satin Nickel

For additional Channel Vision parts see pages 212-213



# GRANDSTREAM

CONNECTING THE WORLD

## Unified Communications Solutions



Easy-to-manage and customizable set of unified communication features that centralizes an organization's communication system.



UCM6200 Series



UCM6500 Series

## Recently Released GXP Phones



Innovative, high-performance IP phones built for enterprise users looking for an enhanced telephony experience with rich features & outstanding visual technology.



GXP1782



GXP2135



GXP2170

## IP Video Surveillance Solutions



Complete line of IP video surveillance solutions with rich security features that deliver reliable, uninterrupted IP technology.



GXV3674



GXV3611



GXV3610



GDS3710

Talk to a Worthington representative today!  
(800) 282-8864





**ACNC DoorBell Fon Door Answering System Kits**

- Simply remove the existing doorbell button and replace it with the door speaker. Only two wires are required.
- Install the controller where all of the phone wires are connected.
- Connect the incoming line to the terminals marked "telephone" and connect all phones to the terminals marked "phones."
- Find the doorbell wire and connect it to terminals marked "door station 1" or "2." DoorBell Fon can handle two door stations.
- Press the button and the phones will ring with a distinctive ring; pick up the phone and you are connected to the door.



**ACNCDP38NBF**



**ACNCDP28NIT**



**ACNCDP28C**

ACNCDP28IT	DoorBell Fon door answering system w/ surface-mount ivory door box. Rings up to five phones in the home three times when door station button is pressed. Just pick up your phone to talk to the person at the door. Connect up to two door stations. Usually no new wiring is required as it uses two-conductor wire already at the doorbell. Includes controller, power supply and door speaker.	156.12
ACNCDP28C	DoorBell Fon Controller Only	106.16
ACNCDP38*F	Liberty Style DoorBell Fon door answering system w/ flush-mount, use 2-gang masonry box, solid brass	206.08
ACNCDP28*F	Standard Style DoorBell Fon door answering system w/ flush-mount, use 2-gang masonry box, solid brass	206.08
ACNCDP38BXFS	Surface Mount backbox for flush mount stations	22.48

\* = B-Solid Brass, S-Brushed Aluminum, BK-Black, BZ-Bronze

**Door Boxes and Accessories (\* = B-Solid Brass, S-Brushed Aluminum, BK-Black, BZ-Bronze)**

ACNCDP28NIT	Surface-mount door box, used to add second station-Ivory	57.45	ACNCDP28NBF	Standard style 2-gang flush-mount door box, add second station-Brass	108.66
ACNCDP38NBF	Liberty style 2-gang flush-mount door box, add second station-Brass	108.66	ACNCDP28NBKF	Standard style 2-gang flush-mount door box, add second station-Black	108.66
ACNCDP38NBKF	Liberty style 2-gang flush-mount door box, add second station-Black	108.66	ACNCDP28NBZF	Standard style 2-gang flush-mount door box, add second station-Bronze	108.66
ACNCDP38NBZF	Liberty style 2-gang flush-mount door box, add second station-Bronze	108.66	ACNCDP28NSF	Standard style 2-gang flush-mount door box, add second station-Brushed Aluminum	108.66
ACNCDP38NSF	Liberty style 2-gang flush-mount door box, add second station-Brushed Aluminum	108.66			

ACNCDP29CI	Door chime interface, used to ring existing door bell as well as phones	53.71
ACNCDP29SW/IM	Door strike controller for DoorBell system/intercom module	53.71



**ACNCDP38NBKF**

**ACNCDP38NSF**

**ACNCDP38NBZF**



**ACNCDP28NBF**

**ACNCDP28NBZF**

**ACNCDP28NSF**

**Door Strike/Intercom Module Wiring**

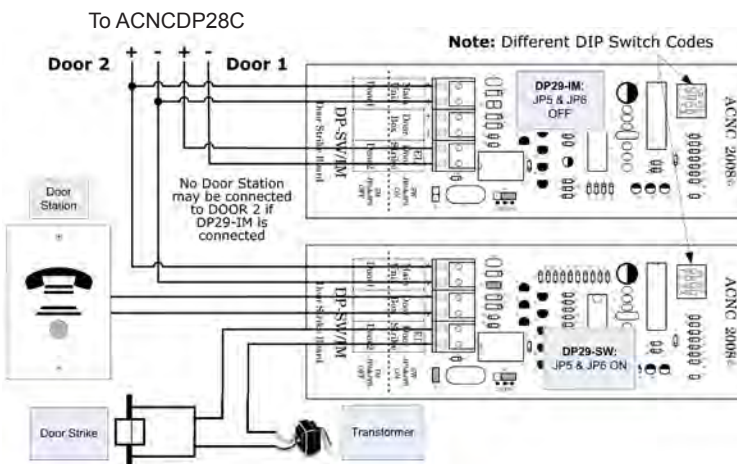

**S Series Door Boxes**



These super-thin door stations are designed to easily fit on door trim like a regular doorbell switch. Manufactured in sturdy aluminum, you can choose between a powder-coated black finish or a silver colored door station. Either color will provide an elegant solution for any application.

ACNCDP38NBKS	Station only - Black	66.20
ACNCDP38NSS	Station only - Silver	66.20
ACNCDP38BKS	Black Kit, station and DP28-C	166.12
ACNCDP38SS	Silver Kit, station and DP28-C	166.12



**PP Series Power Units**

NuTone PurePower Series Central Vacuums offer powerful and peaceful cleaning along with unmatched filtration for the cleanest indoor air, all at an affordable price.

NUPP500	Bagged PurePower series unit, up to 4000 square foot homes, use NU391 bags	319.04
NUPP600	Hybrid PurePower series unit, up to 7000 square foot homes, can be used with or without NU391 bags	434.83
NUPP650	Hybrid PurePower series unit, up to 9000 square foot homes, can be used with or without NU391 bags	578.91



**NUPP500**

**NUPP600**



**NUPP650**



**Electrified Inlets + Brackets**

NUCI358W	Electrified wall inlet valve and rough-in kit	9.37
NU326N	Existing home inlet kit	34.06

Kit includes all required hardware with 330NIV inlet, 8-inch length of Superflex tubing for your convenience, CF329 Mounting Plate, inlet frame, and tubing guard. No extra "surprise" parts to shop for.



**NUCI358W**

**Standard Inlets and Rough-In Kits**

NUCI3301RK	Single inlet rough-in kit for CI330 / CI335	44.00
NUCI3303RK	Three inlet rough-in kit for CI330 / CI335	60.63
NUCF329	Inlet mounting plate	2.95
NUCF372	Utility inlet	3.05
NUCF361	Mounting bracket with plaster guard	7.14

**Automatic Dustpans**

NUCI367W	Automatic Dustpan, "push to open" style operation.	36.02
NUCI365W	Flush Mount Automatic Dustpan, "slide to open" style operation. Usually used in kitchen islands.	41.17
NUCI366W	Automatic Dustpan Trim Plate, white only	3.56



**NUCI365W**



**NUCI367W**

**Fittings and Pipe**

NUCF362	Flanged ell-standard	1.57
NUCF364	Flanged tee	2.35
NUCF366	Straight flange	1.36
NUCF368	90-Degree street ell	0.70
NUCF369	45-Degree street ell	0.70
NUCF382	90-Degree sweep ell	0.82
NUCF382XS	90-Degree short socket ell	1.27
NUCF383	90-Degree tee	1.12
NUCF384	3-way ell	1.84
NUCF385	45-Degree ell	0.61
NUCF386	30-Degree ell	1.05
NUCF387	45-Degree wye	1.22
NUCF388	Stop coupling	0.37
NUCF389	End cap	1.00
NUCF367	Flex tubing, 36", each	7.01
NU392	Muffler	14.28
NUCF380	Pipe support w/wire clip	0.41
NUCI330	Exhaust vent	3.07
NUCF328	Plaster guard	1.36
NU399	Extension sleeve	3.57
NU376UL	100', 18/2 wire	36.71
NU393	Metal wall cap	15.80



**NUCF367**



**NUCF380**



**NU392**



**NUCF388**



**NUCI330**

**Hoses, Cords, Tools and Accessories**

NUCA130	Washable hose sock for 30'-32' hoses	30.88
NUCH515	Deluxe 30' current carrying hose w/ comfort grip, Frost White	176.82
NUCH615	Direct connect 30' current carrying crushproof hose w/ ergonomic swivel handle, Frost White	176.82
NUCS200	Standard tool set, includes floor/rug tool, wands, upholstery brush, dusting brush, tool caddy	68.96
NUCK135	Ratcheting wand, extendable 22"-39"	13.76
NUCS100	50' Ultra Deluxe Garage Kit. Includes: orange hose, upholstery tool, crevice tool and more	64.32
NUCT156B	Natural Bristle Hardwood Floor Tool	13.09
NUCT157B	Extra Wide Natural Bristle Hardwood Floor Tool	18.52
NUCT105	Round dusting brush w/ nylon bristles, Gray	2.31
NUCT700	Deluxe power brush, see below for wands	145.91

Use CT170 for CH520/CH620, use CT175 for CH515/CH615

NUCT170	Wand for CH520/CH620 hoses for CT700	27.02
NUCT175	Wand for CH515/CH615 hoses for CT700	27.02
NU376UL	UL Listed 18/2 wire, 100'	36.71
NU391	Pack of 3 bags, 6 gallon capacity, for use with all Advantage, Classique, and PP500 power units	5.95
NUVX3916	Pack of 3 bags, 6 gallon capacity, for use with VX475 series power units	12.73
NUVX3918	Pack of 3 bags, 8 gallon capacity, for use with VX550/VX1000 series power units	44.15
NUVX3918STD	Same as above but with HEPA filtration	11.25

**Tool Kits and Garage Kits**

NUCS600	Kit contains the following: CH615 hose, CT700 power brush, CT158 floor brush, CK135 ratcheting wand, CT175 ratcheting wand, CT105 dusting brush, CT106G upholstery tool, CT110 crevice tool, and CA130 hose sock	427.11
NUCS400	Air Turbine Kit, CK120 plus: turbine brush, hose, hose sock	236.71

**System design questions? Worthington can help!**



### Twist & Mount

Twist & Mount patch panels allow installers to punch-down Cat 5e or Cat 6 cabling on component-rated commercial patch panels. The low profile of the Twist & Mount provides extra room for patch cord bend radii in the Structured Media Center.



Pages 198-202



### Digital Audio System

Distributing audio from four sources to up to sixteen zones, the modular and scalable Digital Audio System fits neatly into a standard On-Q enclosure for a simple and straightforward install, while providing unprecedented source variety through access to streaming services.



Pages 204-209



### Designer Enclosure Covers

Designed for Channel Vision's enclosures, the designer covers provide more space inside the enclosure and they enable increased airflow with the use of top and bottom vent holes or an optional fan kit (model C-1322).



Pages 212-213



### Nose Plates

Cut a hole in the wall and install the low-voltage mounting plate bracket. Then simply pull your cables through the mounted low-voltage mounting plate bracket and then through the recessed low-voltage cable plate.



Page 211

### Wallplates

Wallplates complete your structured wiring installation and hold all the jacks in place for your wire termination. Generally 1-6 ports are available per plate.



### Jacks

Jacks come in a variety of formats to allow for all types of wiring including phone, data, "F", RCA, BNC and many more.



### Data Termination



Data runs are generally terminated to a patch panel or a phone/data termination module. Once the data runs are terminated, you can then connect them to your router or switch. Cat 5e can give you all the way up to Gigabit connectivity and is most often used. Cat 6 is becoming more popular now for "high" bandwidth applications.



### Telephone

Telephone runs are terminated to a patch panel or phone/data termination module. Once the phone runs are terminated, you can connect them to your phone distribution block or to your phone system. Cat 5e has become the standard wiring to use for phone runs. You can use either 6-conductor or Cat 5e jacks to terminate on the room side.

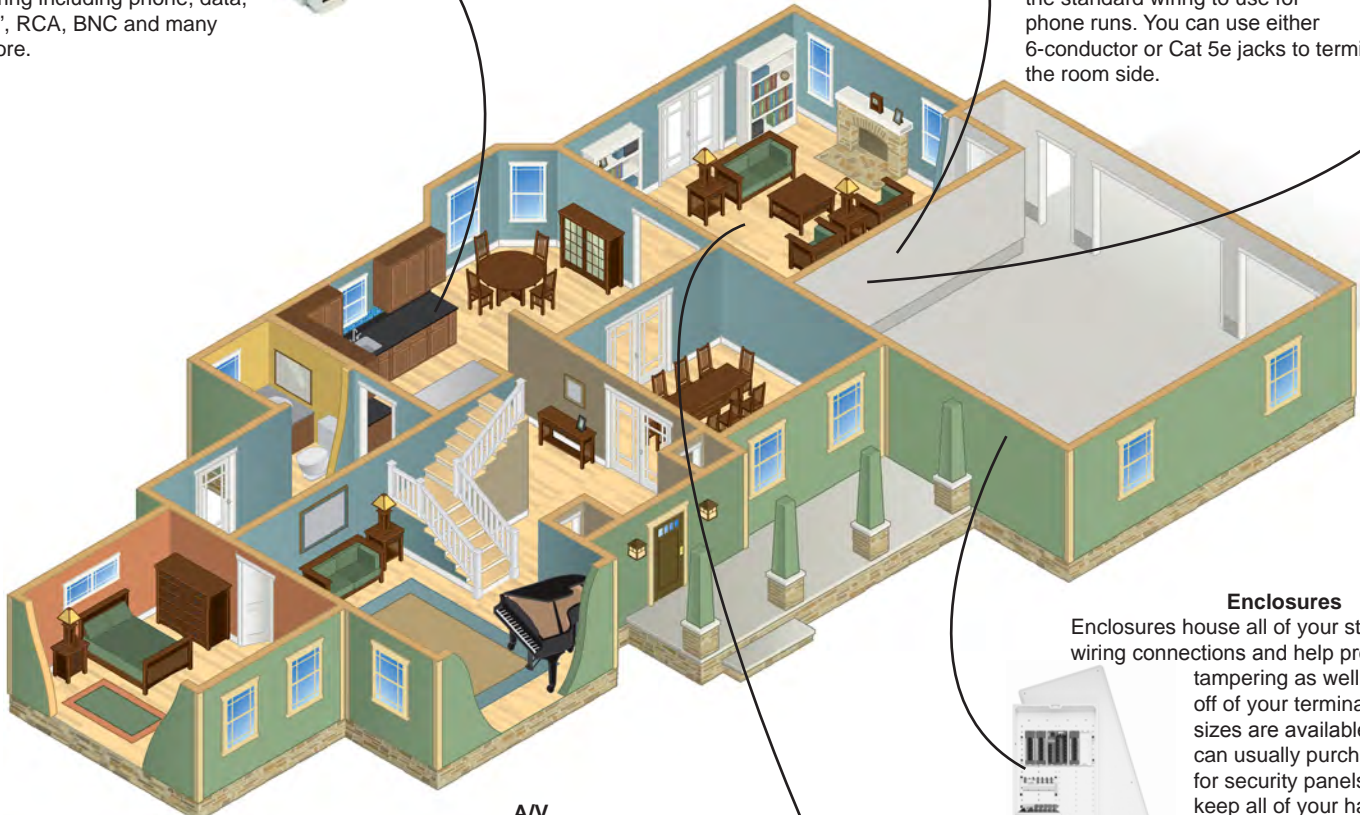

### A/V

Today, you want to have as many wires to the A/V locations as possible. CATV amplifiers allow for balanced distribution to all of your rooms. You will usually also have two or more Cat 5e runs that need to be terminated for network, IR or for future-proofing your installation. Most manufacturers have jacks and plates for IR, HDMI, VGA and any type of connection that you may require.



### Enclosures

Enclosures house all of your structured wiring connections and help prevent tampering as well as keep dust off of your terminations. Many sizes are available and you can usually purchase mounts for security panels and more to keep all of your hardware in one place.



**Enclosure Configuration Tools**



For enclosure configuration assistance, go to:  
[leviton.com/homeconfig](http://leviton.com/homeconfig)  
 Enter the details of your installation and Leviton will provide you with a complete structured media solution.

**Retrofit Enclosure**



**Media Versatile Panel**

The Media Versatile Panel was made for custom retrofits and remodeling. Its plywood backing and open architecture allows for simple, flexible mounting of all components. This industrial-grade panel can be surface mounted or recessed in the wall. Optional mounting brackets are available for non-standard stud spacing.



LEV47602-24E

LEV47602-BKE

**Features/Benefits:**

- 24" high, 18-gauge steel panel available in black powder-coat finish
- Eight 1" or 1.5" conduit knock-outs on top and bottom facilitate cable entry and routing
- Wall-mount or recess
- Securible door provides maximum protection from dust and unauthorized entry
- 3/8" plywood backing allows open architecture for customizing layout and can accommodate a wide variety of Structured Media distribution modules

LEV47602-24E	24" media versatile panel	63.65
LEV47602-BKE	Surface mount brackets for LEV47602-24E	12.99

**Concrete-Mount Structured Media Enclosures**

LEV48605-21E	21" concrete-mount enclosure*	75.39
LEV48605-28E	28" concrete-mount enclosure*	98.11
LEV48605-42E	42" concrete-mount enclosure*	120.37

\* Cover sold separately, see page 199 for options

**Multi-Dwelling Unit (MDU) Enclosures**

These enclosures feature the same hole patterns and benefits of Leviton's other structured media centers with the addition of extra knockouts in the top and bottom of the enclosure. These knockouts are optimized for multi-dwelling installations where multiple runs are needed. The 28" and 42" enclosures are available with two distinct hole patterns, illustrated below. All models listed come with a flush-mount screw-on cover.

**MDU Configuration A**

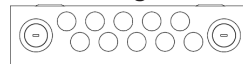

TOP

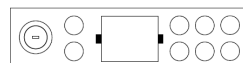

BOTTOM

**MDU Configuration B**

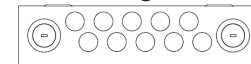

TOP

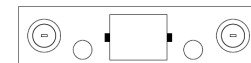

BOTTOM

\*Knockout sizes support 1" & 2" commercial conduit

LEV47605-4MG	42" MDU enclosure with cover, configuration A	95.76
LEV47605-2MG	28" MDU enclosure with cover, configuration A	64.71
LEV47605-1MG	14" MDU enclosure with cover, configuration A	32.07
LEV47605-M42	42" MDU enclosure with cover, configuration B	64.71
LEV47605-M28	28" MDU enclosure with cover, configuration B	45.13

See page 222 for conduit solutions from Carlon

**Compact Structured Media MDU Enclosures**



LEV47605-MDU



Enclosure with Cover



LEV47604-F6S

**Features/Benefits:**

- Economical solution for multi-dwelling unit (MDU) connectivity
- Flexibility to accommodate a variety of telephone/video distribution configurations
- Available empty with cover or in two pre-configured kits
- Snap-on cover requires no tools or fasteners
- Molded-in brackets provide quick snap-in convenience for expansion boards
- Angled video-splitter shelf for easy installation
- Hosts three expansion boards and one TV splitter
- Constructed of sturdy white ABS molded plastic
- Listed for communications equipment (cULus listing)

LEV47605-MDU	Compact MDU enclosure only	19.58
LEV47605-MDC	Compact MDU enclosure cover only	12.93
LEV47604-F6	Compact MDU enclosure with phone module	31.62
LEV47604-F6S	Same as above with additional video module	43.60

**Category Rated UTP Patch Cables (\*W-White, Y-Yellow, R-Red, B-Blue, S-Grey, E-Black, G-Green)**



Cat 5e		
LEV5G460-3*	Cat 5e patch cord, 3'	2.09
LEV5G460-5*	Cat 5e patch cord, 5'	2.39
LEV5G460-7*	Cat 5e patch cord, 7'	2.67
LEV5G460-15*	Cat 5e patch cord, 15'	4.06

Cat 6		
LEV62460-3*	Cat 6 patch cord, 3'	3.43
LEV62460-5*	Cat 6 patch cord, 5'	4.35
LEV62460-7*	Cat 6 patch cord, 7'	5.26
LEV62460-10*	Cat 6 patch cord, 10'	6.11





**42" Enclosures and Covers**

LEV47605-42W	42" enclosure with flush door	93.71
LEV47605-42N	42" enclosure only	62.67
LEV47605-F42	42" flush mount door	36.56
LEV47605-42D	42" hinged door	49.97
LEV47605-42S	42" vented hinged door	63.75

**28" Enclosures and Covers**

LEV47605-28W	28" enclosure with flush door	62.67
LEV47605-28N	28" enclosure only	43.09
LEV47605-F28	28" flush mount door	20.90
LEV47605-28D	28" hinged door	37.02
LEV47605-28S	28" vented hinged door	46.83

**14" Enclosures and Covers**

LEV47605-140	14" enclosure with flush door	30.04
LEV47605-14E	14" enclosure only	22.72
LEV47605-14C	14" flush mount door	15.67
LEV47605-14D	14" hinged door	27.42
LEV47605-14S	14" vented hinged door	32.65

**Enclosure Power Options**



<b>LEV48212-6S</b>	Surge protected, 6-outlet	78.10
<b>LEV47605-DP</b>	Surge protected, 4-outlet	60.56
<b>LEV47605-NDP</b>	Non-surge protected, 4-outlet	32.21
<b>LEV47605-ACS</b>	Surge protected, 2-outlet	22.46
<b>LEV47605-ACN</b>	Non-surge protected, 2-outlet	9.77
<b>LEV47605-PSA</b>	12VDC 9 plug power supply with 1 AC outlet	137.94
<b>LEV47605-PSB</b>	Mini 12VDC 3 plug power supply	66.57
<b>LEV47605-PSC</b>	12VDC 6 plug and 2 AC receptacle	132.76

**Enclosure Bracket Options**

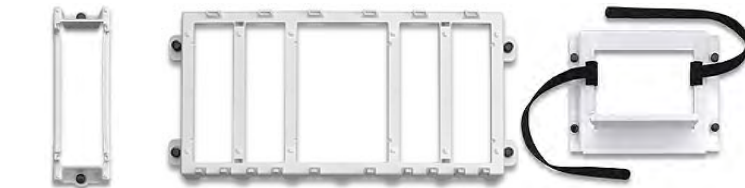

<b>LEV47612-SBK</b>	Single module mounting bracket	15.67
<b>LEV47612-EBK</b>	Full size expansion bracket	25.50
<b>LEV47612-HBK</b>	Half size 3 module mounting bracket	19.52
<b>LEV47612-DBK</b>	Data bracket for modem/router/switch	19.52
<b>LEV47612-6SB</b>	6" universal security bracket	19.52
<b>LEV47612-1SB</b>	12" universal security bracket	32.54
<b>LEV47612-UBK</b>	Universal battery bracket	26.03
<b>LEV47612-HSB</b>	Half width 6" universal security plate	16.91
<b>LEV47612-FSB</b>	Full width 12" universal security plate	22.12

**What's In Today's Structured Wiring Panel?**

It's true, end-users are no longer reliant on telephone service from their phone company, and digital cable doesn't usually work with coaxial splitters. This has led many installers to think that they don't need to install a structured wiring enclosure. Even without needing a place to run phone lines, there's still a lot of copper being run through a modern home's walls and you still need a place to terminate those wires. Leviton provides the best, most customizable options for structured wiring.

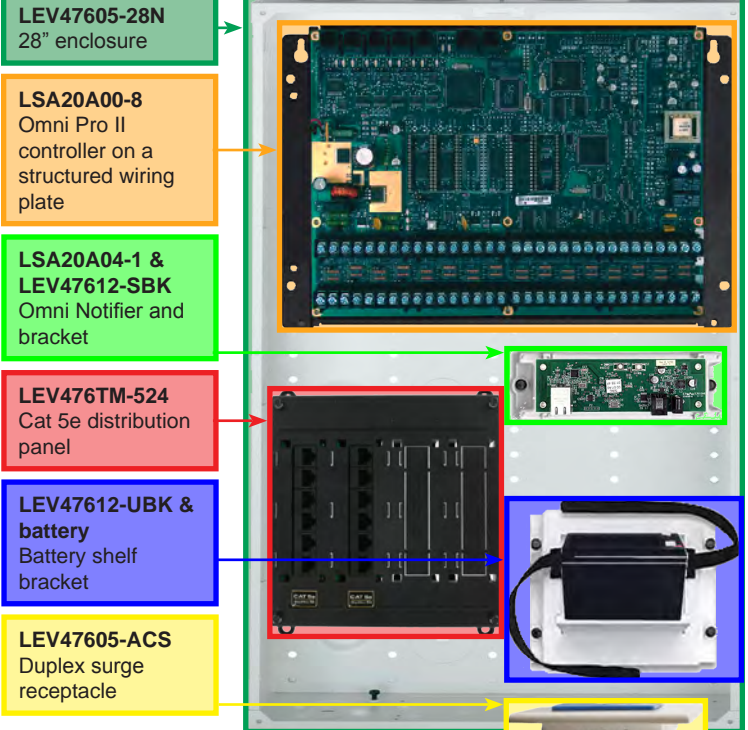

**Not Pictured:**

- Cover for enclosure
- 24VAC transformer for Omni Pro II
- Interconnect cables

**RF Transparent Enclosure**

Leviton's RF Transparent Structured Media Enclosure is designed to be used for any wireless home network. The enclosure is 30" in height and includes a vented hinged door. The enclosure expands the reach of wireless signals using ABS polymer construction to diminish interference.

- Ideal for:**
- Z-Wave
  - ZigBee
  - Wi-Fi
  - Wireless security receivers



LEV49605-30W RF transparent structured media enclosure 96.80

**Enclosure Accessories**

<b>LEV5L000-L0K</b>	Lock kit for hinged door	8.51
<b>LEV47612-28B</b>	Extender bracket for 28" enclosures	37.35
<b>LEV47612-42B</b>	Extender bracket for 42" enclosures	40.72

**Extender Bracket Benefits**

- Adds 2 Inch Depth
- Adds Wire Management
- Adds Ventilation
- Allows Larger Modules
- Available for 28" and 42" enclosures



Twist and Mount Patch Panels



LEV476TM-624



LEV476TM-512

Twist & Mount Patch Panels Features and Benefits:

- Low-profile, high-density, component-rated patching for both voice and gigabit ethernet connections
- Simple twist and mount installation
- Offered in Cat 6, Cat 5e, and combination Cat 6/Cat 5e configurations
- Universal T568A and T568B wiring labels ensure compatibility in both residential and commercial installations
- Manufactured from black ABS plastic
- Meet or exceed all TIA-568-C.2 bend radius requirements
- Available in 12- and 24-port versions

LEV476TM-524	24-port Cat 5e twist & mount module	102.18
LEV476TM-624	24-port Cat 6 twist & mount module	147.96
LEV476TM-654	24-port dual Cat 5e/Cat 6 twist & mount module	125.06
LEV476TM-512	12-port Cat 5e twist & mount module	62.23
LEV476TM-612	12-port Cat 6 twist & mount module	75.19
LEV476TM-652	12-port dual Cat 5e/Cat 6 twist & mount module	68.71
LEV476TM-EX5	Cat 5e twist & mount expansion board	25.54
LEV476TM-EX6	Cat 6 twist & mount expansion board	37.00

Pre-Configured Structured Media Panels

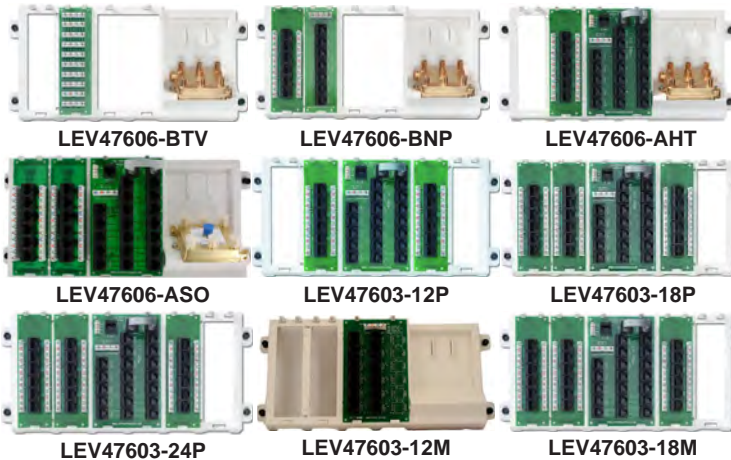

LEV47606-BTV	4x9 phone and 1x6 video	51.26
LEV47606-BNP	4x6 phone and 1x6 2ghz video	75.49
LEV47606-AHT	Phone board, 6-port patch, and 1x6 video	94.34
LEV47606-ASO	Phone board, 12-port patch, and 1x6 video	116.41
LEV47603-12P	12-port voice/data distribution panel	119.62
LEV47603-18P	18-port voice/data distribution panel	142.14
LEV47603-24P	24-port voice/data distribution panel	163.93
LEV47603-12M	12-port 4 phone line distribution	40.60
LEV47603-18M	18-port 4 phone line distribution	58.97
LEV47603-8C1	Same as above with 6-port patch	76.14

Router and Switches



LEV47611-WG4



LEV47611-5PT



LEV47611-8GB

Wireless Gigabit Router Features and Benefits:

- IEEE 802.11a/b/g/n dual band (2.4GHz & 5GHz simultaneous) wireless technology capable up to 300+300 Mbps data rate
- Advanced security: 64/128-bit WEP, WPA/WPA2 and WPA-PSK/WPA2-PSK (TKIP/AES encryption)
- Supports Wi-Fi® Protected setup (WPS), NAT firewall, IP/port/URL-based access control, and MAC address filtering
- 1 WAN and 4 LAN RJ-45 ports
- Supports dual-SSID to access different networks through a single AP
- Supports NTP, Virtual Server, UPnP, and DMZ f

LEV47611-WG4	Wireless gigabit router	93.55
LEV47611-5PT	10/100 5-port switch	28.08
LEV47611-8GB	10/100/1000 8-port switch	80.10

Stand-Alone Modules with Brackets



LEV47605-C5B	6-port Cat 5e patch board on bracket	22.43
LEV47611-C6B	6-port Cat 6 patch board on bracket	33.11
LEV47609-TSV	4x6 phone with RJ31X jack on bracket	37.77
LEV47616-DSB	DSL filter board on bracket	35.07
LEV47689-B	4x9 bridged 110 board on bracket	22.18

Half-Width Pre-Configured Media Panels

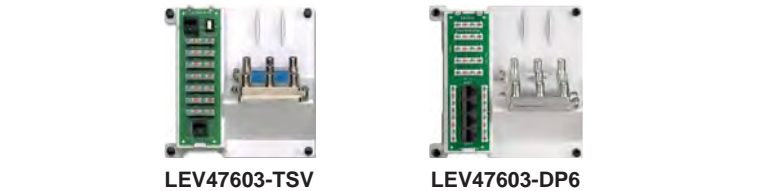

LEV47603-TSV	4x6 phone with RJ31x and 1x8 video	52.07
LEV47603-DP6	4x4 phone, 4-port data, and 1x6 video	49.47

Leviton also offers a full line of expansion boards which are compatible with their pre-configured media panels and enclosure brackets.



Contact Worthington Distribution by phone, (800) 282-8864 or via email at [sales@worthdist.com](mailto:sales@worthdist.com) to learn more or to request a structured wiring quote.



To determine available colors: Match the listed color code letters for each wallplate or snap-in with the color wheels below.

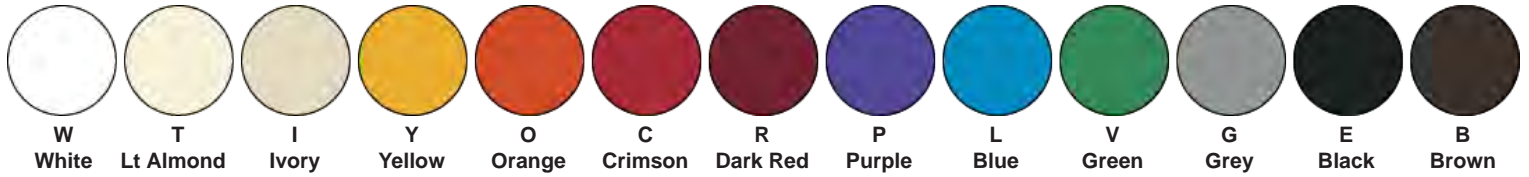

**Quickport Wallplates and Decorator Inserts**

LEV41642-B	LEV41643-I	LEV41644-W	LEV41646-I	LEV41080-1BP
LEV41080-2WP	LEV41080-3IP	LEV41080-4BP	LEV41080-6IP	
LEV41080-6*P	6-port flush-mount wallplate	1.27		
LEV41080-4*P	4-port flush-mount wallplate	1.27		
LEV41080-3*P	3-port flush-mount wallplate	1.27		
LEV41080-2*P	2-port flush-mount wallplate	1.27		
LEV41080-1*P	1-port flush-mount wallplate	1.27		
LEV41081-4?P	4-port angled flush-mount wallplate	1.30		
LEV41081-2?P	2-port angled flush-mount wallplate	1.30		
LEV41646-*	6-port decorator insert	3.11		
LEV41644-*	4-port decorator insert	3.11		
LEV41643-*	3-port decorator insert	3.11		
LEV41642-*	2-port decorator insert	3.11		

\* Available in W, T, I, G, E, and B  
 ? Available in W, T, and I

**Data/Voice Quickport Snap-Ins**

	LEV5EHOM-R#5	Home 5e connector	2.30
	LEV61HOM-R*6	Home 6 connector	4.25
	LEV41108-R†5	Cat 5 connector	3.31
	LEV41108-R†3	Cat 3 connector	2.11
	LEV41106-RL5	6P6C USOC voice connector	CALL
	LEV41108-R†8	8P8C USOC voice connector	2.11
	LEV41106-RC6		

‡ Available in W, T, I, L, G, E, and B  
 \* Available in W, T, I, G, E, and B  
 † Available in W, T, I, Y, O, C, R, P, B, V, G, E, and B

**Audio/Video Quickport Snap-Ins**

	LEV41084-B*F	Standard BNC	4.03
	LEV40832-B*	Gold-plated BNC	4.48
	LEV40839-S~S	3.5mm stereo screw terminal	6.97
	LEV41084-F*F	1GHz Standard F-connector	1.61
	LEV40831-B*	2.5GHz gold-plated F-connector	2.41
	LEV40830-B^E	RCA pass-through, black stripe	2.49
	LEV40830-B^R	RCA pass-through, red stripe	2.49
	LEV40834-^	HDMI pass-through	10.35

\* Available in W, T, I, G, E, and B  
 ~ Available in W and I  
 ^ Available in W, T, I, and E  
 (Additional configurations available, contact us for details)

**Miscellaneous Quickport Snap-Ins**

	LEV41084-B^	Snap-in blanks, 10 pack	1.50
	LEV40835-~	USB pass-through	8.62

^ Available in W, T, I, and E  
 ~ Available in W and I

**Retrofit Home Theater Solutions**

**QuickPlate® Tempo Wallplates**

QuickPlate Tempo wallplates allow for fast, one-step installations. They feature rear wings which tighten the wallplate to the wallboard, eliminating the need for a box or mounting brackets. The wallplates are available in both a 2-port and 4-port configuration and have ID windows on the top and bottom of their faces.



LEV42090-2WS front/rear

Solutions for last-minute changes!

**Pass-Through Brush Insert**

Avoid terminating cables by using a pass-through insert. It has brushes to cover the opening in the wall and fits into a decorator-style opening.



LEV41075-DBW

LEV42090-2♦S	2-port QuickPlate Tempo wallplate	2.75
LEV42090-4♦S	4-port QuickPlate Tempo wallplate	2.75
LEV41075-DBW	Single-gang pass-through decorator insert	3.98

♦ Select color W-White, T-Light Almond, I-Ivory, G-Grey, or B-Black

**Installation Tools**

PT100004C	PT13007C	ICMCPLCCT-SLMR	LEV47615-PTT
PT100004C	EZ-RJ45 crimp tool	49.42	
PT100003C	50-pack of EZ-RJ45 connectors	24.79	
PT13007C	110 punchdown tool	43.47	
PT15015C	UTP cable stripping tool	8.96	
PT10500C	Coax cable stripping tool	7.41	
ICMCPLCCT-SLMR	Coax master compression tool	88.77	
ICMFNSNS6U	RG6 F-connectors, 5-pack	2.19	
ICMFNSNS59BNCU	RG59 male BNC connectors, 5-pack	10.62	
LEV47615-PTT	Palm termination tool	2.89	



**Passive Audio Distribution Systems**

Use either of the below solutions when you have amplified audio that you need to distribute to multiple locations.

**Solution 1: Impedance Matching at the Distribution Module**



**LEVSGAMP**

**LEVSGVST-W**

LEVSGAMP	6-room impedance-matching distribution module. Use with SGVST-W volume controls.	149.82
LEVSGVST-W	Transformer-free volume control	44.23
LEVSGVCK-*	Color change kit for SGVST-W	5.73

\* Choose color I-Ivory, E-Black, LA-Light Almond

**Solution 2: Impedance Matching at the Volume Controls**



**LEV48211-6A**

**LEVSGVSM-W**

LEV48211-6A	1x6 passive audio distribution module. Use with SGVSM-W volume controls.	38.31
LEVSGVSM-W	Impedance-matching volume control	52.07
LEVSGVCK-*	Color change kit for SGVSM-W	5.73

\* Choose color I-Ivory, E-Black, LA-Light Almond

**Spec Grade® Speakers and Accessories**

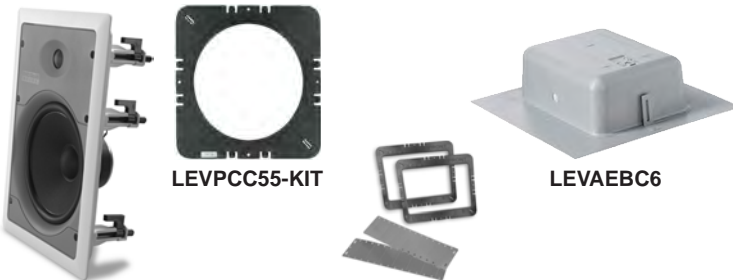

<b>LEVSGI65-W</b>		
LEVSGC65-W	6.5" In-ceiling speaker - pair	58.70
LEVSGI65-W	6.5" In-wall speaker - pair	69.78
LEVPC55-KIT	Pre-construction kit for SGC65-W	19.32
LEVAEPI6-KIT	Pre-construction kit for SGI65-W	19.32
LEVAEBC6	Fire-rated back box for 6.5" ceiling speakers	87.50



For 5.1 and 7.1 home theater speaker solutions, check out the JBL by Leviton solutions on page 178.

**Home Theater and Multi-Room Wallplates**



**LEVAEHTK**

**Home Theater Interface Wallplate**

- Designed for easy installation of cables using low-voltage rings and standard low-voltage junction boxes
- Accommodates 5.1 to 7.1 channel surround-sound systems
- RCA connectors for subwoofer connection and two extra QuickPort® openings

Speaker wallplates allow simple connections to any home theater or distributed audio system.

**Multi-Room Audio Wallplate**

- Designed for easy installation of cables using low-voltage rings and standard low-voltage junction boxes
- Accommodates left and right audio speakers
- Two extra openings for additional QuickPort connectors (e.g., adding a subwoofer or 3.5 mm stereo phone jack)



**LEVAEMRK**



**LEV40951-1PW**



**LEV40952-2PW**

LEVAEHTK	Home theater interface wallplate	70.37
LEVAEMRK	Multi-room audio wallplate	24.76
LEV40951-1P*	Single spring-clip wallplate	7.33
LEV40952-2P*	Dual spring-clip wallplate	9.77

\* Choose color W-White or I-Ivory

**Recessed Line/Low Voltage Boxes**



<b>LEV689-W</b>		
LEV689-*	1-gang recessed plate/box with 15A receptacle	4.37
LEV690-*	2-gang recessed plate/box with 15A receptacle and six quickport low voltage inputs	11.77
LEV47617-REB	Recessed entertainment box. Three 1-gang knockouts for line or low voltage connections	25.09
LEV47617-RBH	Same as above with high profile cover	20.56
LEV47617-HPC	High profile cover for 47617-REB	14.96
LEV47617-LPF	Low profile cover for 47617-REB	6.57
LEV47617-PLT	Blank snap-in plate for 47617-REB	2.75

\* E-Black, I-Ivory, W-White, T-Light Almond

# The Alarm.com **Smart Thermostat**

now with remote temperature sensing

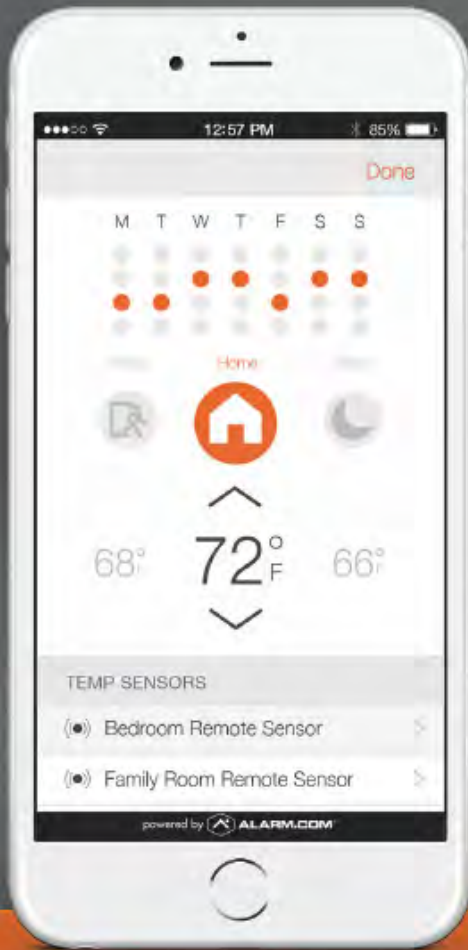

Precision Comfort

Responsive Saving

Installer Toolkit

The **Alarm.com Smart Thermostat** represents the next generation of connected devices. And with Temperature Sensors, it will ensure comfort where it's needed most. This streamlined hardware, combined with sophisticated cloud services and an ecosystem of smart devices, provides an uncompromising energy management solution.



**TechHome**<sup>®</sup>



Mark of Excellence

2015 Energy Efficiency  
**PRODUCT OF THE YEAR**



Alarm.com products are available at your local Worthington branch.

For more information about becoming an Alarm.com Dealer visit:

[www.alarm.com](http://www.alarm.com)

## Metal Structured Wiring Enclosures

## The connected home starts in the structured wiring enclosure...

Structured wiring solutions from Legrand simplify installations and reduce time on-site. Legrand specializes in meeting the right specifications for any residential or light commercial project with solutions that exceed your needs.

Start with a strong foundation. From rugged enclosures to high-performance outlets, wall plates, and connectors, OnQ products from Legrand guarantee a smooth installation that's designed to last.

## Metal Enclosures Features/Benefits:

- Flush and surface installation options
- Flanged covers hide drywall openings
- UL listed for fire and security alarm equipment
- Made in the USA
- Cable guard insert protects cables and equipment from dust, paint, and debris between rough-in and trim out
- Includes 3 powder-coated openings for cable pass-through

Enclosure Description	12" Enclosure		14" Enclosure		20" Enclosure	
Enclosure Dimensions	12.13" H x 12" W x 3.7" D		14" H x 14.25" W x 3.6"D		20" H x 14.25" W x 3.6" D	
Enclosure with Screw-On Cover	ONQEN1200	27.73	ONQEN1400	29.98	ONQEN2000	46.80
Enclosure with Hinged Cover	-	-	ONQEN1450	56.57	ONQEN2050	65.54
Enclosure Only	-	-	ONQEN1480	22.67	ONQEN2080	29.16
Screw-On Cover Only	ONQEN1220	13.33	ONQEN1420	17.36	ONQEN2020	21.18
Hinged Cover Only	-	-	ONQEN1460	33.75	ONQEN2060	39.03
Enclosure Only with Stackable Knockouts*	-	-	ONQEN1485	22.67	ONQEN2085	29.16
Enclosure Depth Extender**	-	-	-	-	-	-

Enclosure Description	28" Enclosure		42" Enclosure	
Enclosure Dimensions	28" H x 14.25" W x 3.6"D		42" H x 14.25" W x 3.6" D	
Enclosure with Screw-On Cover	ONQEN2800	62.57	ONQEN4200	93.68
Enclosure with Hinged Cover	ONQEN2850	81.81	ONQEN4250	124.90
Enclosure Only	ONQEN2880	32.66	ONQEN4280	71.19
Screw-On Cover Only	ONQEN2820	24.86	ONQEN4220	43.22
Hinged Cover Only	ONQEN2860	49.34	ONQEN4260	62.39
Enclosure Only with Stackable Knockouts*	ONQEN2885	32.66	ONQEN4285	71.19
Enclosure Depth Extender**	ONQ364450-03	36.08	ONQ364450-04	46.39



ONQEN2850

\* Enclosures have five knockout locations and allow vertical alignment of two enclosures for cable pass-through

\*\* Extenders add 2.5" of enclosure depth

## Plastic Structured Wiring Enclosures and Modules for MDU



ONQEN0802

ONQEN0800	8" plastic MDU enclosure and cover	21.63
ONQEN0801	8" plastic MDU enclosure cover only	8.29
ONQEN0802	8" plastic MDU enclosure kit with 1x6 phone, 1x4 1GHZ video splitters	43.88
ONQEN0806	Six-pack of 8" plastic MDU enclosures and covers	116.81
ONQTM0106	1x6 phone splitter module for ONQEN0800	17.29
ONQTM0404	1x4 phone and 1x4 Cat 5e data combo splitter module for ONQEN0800	20.73
ONQVM0108	1x8 1GHZ coax video splitter module for ONQEN0800	8.19
ONQVM0208	1x8 2GHZ coax video splitter module for ONQEN0800	8.19



**Power Management Solutions**

Once you have a structured wiring enclosure you'll need to supply power to the modules mounted inside of it. OnQ by Legrand has a power solution for whichever configuration of AC or DC power that you'll need.



**ONQPW7760**



**ONQPW1240**

ONQPW7760	12VDC, 18W power supply	14.25
ONQPW7725	12VDC, 30W power supply	49.89
ONQPW1030	24VDC, 30W power supply	49.27
ONQPW1060	24VDC, 60W power supply	91.89
ONQPW1120	24VDC, 120W power supply kit, includes: (2) ONQPW1060, (1) ONQPW1006, velcro straps, mounting bracket	202.48
ONQPW1240	24VDC, 240W power supply kit, includes: (4) ONQPW1060, (2) ONQPW1006, velcro straps, (2) mounting brackets, and a custom power strip	385.94
ONQPW1458	48VDC, 100W power supply	41.59



**ONQF7526**



**ONQPW1006**

ONQ364569-02V1	Decora surge protected outlet kit	24.09
ONQF7526	Duplex surge protected outlet kit	8.84
ONQPW1006	Twin power supply bracket kit	9.99



**ONQPW1012**



**ONQAC1031**

ONQPW1012	Universal power distribution module	86.18
ONQPW1013	Intuity bridge power module	20.73
ONQPW1020	Digital audio power distribution module	51.22
ONQAC1031	Half-width enclosure power strip module	31.92

**Structured Wiring Solutions for Builders**

Legrand's OnQ structured wiring line is a perfect fit for new home construction.

Their range of wiring cans, modules, audio systems, intercoms, and automation are easy to install and most importantly, repeatable.



**Video and Voice Modules**



**ONQCO1045**



**ONQCO1110**

ONQ364400-04	4 coax, 6 110 voice combo module	28.30
ONQCO1045	8 coax, 10 RJ45 voice combo module*	37.16
ONQCO1110	8 coax, 10 110 voice combo module*	37.16
ONQCO2110-V1	8 coax, 10 110 voice combo module for MoCA*	40.74

\* Has built-in RJ31X line seizure



**ONQVM1002**

ONQVM1000	1x4 enhanced passive video splitter or combiner	15.44
ONQVM1002	1x8 enhanced passive video splitter or combiner	29.41



**ONQTM1045**



**ONQ1267062-01V1**

ONQTM1110	10-way 110 voice module with RJ31X	27.99
ONQTM1045	10-way RJ45 voice module with RJ31X	31.30
ONQ1267062-01V1	6-way basic 110 voice module with RJ31X	24.91

Networking Products

Future-proofed home networking. Reliable in-home communication. Blazing internet connections.

Data products from Legrand will change the way you work, play, and interact.

Dependable home networking solutions have never been more critical. Users view bandwidth-devouring devices such as smartphones, tablets, televisions, laptops and gaming systems as essential components of their daily lifestyles. The exponential growth of these products, coupled with the content delivery transition from physical media to streaming, necessitates comprehensive home networking solutions that support this new reality.

Legrand's home networking solutions include wired, wireless, and powerline options.



Wired



Wireless



Powerline

Wired Routers and Switches



ONQDA1458



ONQDA1054

ONQDA1008	8 port Gigabit switch	110.56
ONQDA1458	8 port Gigabit switch, 4 ports PoE	173.95
ONQDA1054	4 port Gigabit router and switch	118.90

Wireless Access Points



ONQDA1104



ONQDA1101

ONQDA1104	802.11ac low profile wireless access point	290.27
ONQDA1101	802.11n in-wall/ceiling wireless access point	192.12
ONQDA2131-V1A	802.11n outdoor wireless access point	120.53

Network Interface Modules



ONQ363486-01



ONQAC1014

ONQ363486-01	8 port Cat 5e module, 110 punchdown	41.47
ONQAC1000	6 port Cat 5e module, RJ45	30.06
ONQAC1001	6 port module, unpopulated	16.32
ONQAC1012	6 port Cat 5e module, RJ45	35.27
ONQAC1013	6 port Cat 6 module, RJ45	47.52
ONQAC1014	12 port Cat 5e module, RJ45	53.62
ONQAC1015	12 port Cat 6 module, RJ45	72.24

Powerline Networking

Powerline network adapters allow you to add network drops without running new wires.

Powerline networking utilizes existing electrical lines in a home to deliver fast, reliable & convenient network connectivity. Adapters plug directly into electrical outlets and are best used to expand existing networks.

Application 1: One-to-One Networking, use ONQDA2300-V1

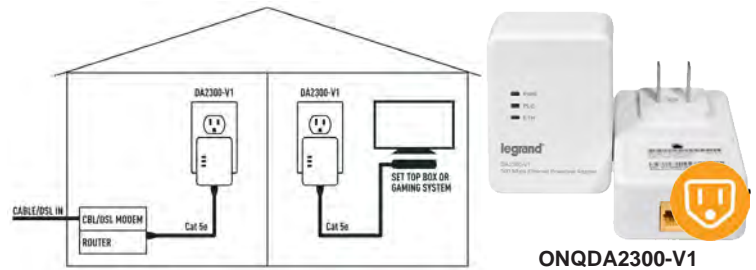

Application 2: One-to-Many Networking, use ONQDA2301-V1 and ONQDA2304-V1

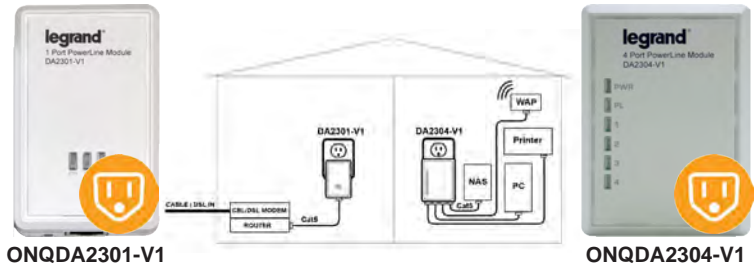

Power Over Ethernet



ONQDA2401



ONQAC1025

ONQDA2400	4 port PoE injector	74.64
ONQDA2401	4 port high performance PoE injector	142.36
ONQAC1025	PoE injector mounting plate, holds up to four ONQDA2400 or ONQDA2401 modules	4.52

ONQDA2300-V1	Powerline networking kit. Includes: (2) 500 Mbps powerline network adapters and (2) 3 foot Ethernet cables	82.92
ONQDA2301-V1	Gigabit powerline network adapter	62.45
ONQDA2304-V1	4-port Gigabit powerline network adapter	76.19



Data Connectivity

Legrand guarantees today's home technologies are easy to use and enjoy, offering connectivity components that add convenience, eliminate clutter, and boost performance.

Quality content deserves quality connections. Legrand's data connectivity products simplify use with cleaner installations and convenient access points, while maintaining the highest standard of performance. Organize wires and cables, charge devices faster, and deliver top speeds with Legrand.

COLOR KEY:

\* Leave blank for brown



Keystone Decorator Straps and Wallplates



ONQWP3410      ONQWP3413-IV      ONQWP3404-GY

ONQWP3410-XX	Blank decorator insert	0.51
ONQWP3411-XX	1-keystone port decorator strap <sup>1</sup>	0.76
ONQWP3412-XX	2-keystone port decorator strap <sup>2</sup>	0.76
ONQWP3413-XX	3-keystone port decorator strap	0.76
ONQWP3414-XX	4-keystone port decorator strap	0.76
ONQWP3416-XX	6-keystone port decorator strap	0.76
ONQWP3401-XX	1-keystone port wall plate <sup>3</sup>	0.70
ONQWP3402-XX	2-keystone port wall plate <sup>4</sup>	0.70
ONQWP3403-XX	3-keystone port wall plate	0.70
ONQWP3404-XX	4-keystone port wall plate	0.70
ONQWP3406-XX	6-keystone port wall plate	0.70

XX Available in BK, BR, IV, LA, WH, GY, and SS

<sup>1</sup> LA and WH available in 10-packs, part number ONQWP3411-XX-10

<sup>2</sup> LA and WH available in 10-packs, part number ONQWP3413-XX-10

<sup>3</sup> LA and WH available in 10-packs, part number ONQWP3401-XX-10, or in 25-packs, model ONQWP3401-XX-25

<sup>4</sup> LA and WH available in 10-packs, part number ONQWP3402-XX-10, or in 25-packs, model ONQWP3402-XX-25

Audio/Video Keystones



ONQWP3481-BK      ONQWP1234-IV      ONQWP3457-WH

ONQWP3479-††	F connector keystone, nickel <sup>1</sup>	0.80
ONQWP3480-††	Recessed F connector keystone, gold	1.24
ONQWP3481-††	Recessed F connector keystone, nickel <sup>2</sup>	1.06
ONQWP1234-??	HDMI pass-through keystone	8.37
ONQWP1215-??	3.5mm stereo pass-through keystone	4.51
ONQWP3457-??	Audio binding post keystones (pair)	4.35
ONQWP3456-??	L/R speaker keystone	2.91

†† Available in BK, BR, IV, LA, and WH

?? Available in BK, BR, LA, and WH

<sup>1</sup> LA and WH available in 50-packs, part number ONQWP3479-††-50

<sup>2</sup> LA and WH available in 50-packs, part number ONQWP3481-††-50

Quick Connect Voice/Data Keystone Inserts

Legrand's Quick Connect keystone inserts are designed to work with their Punch & Go installation tool, model ONQAC3400 listed on the next page. Legrand's Punch & Go tool terminates all of the wires simultaneously, which makes installations incredibly quick and easy. Alternatively, Quick Connect keystones can be terminated with any standard 110 punchdown tool.



ONQWP3473-IV      ONQWP3475-BE      ONQWP3476-GN

ONQWP3473-**	RJ25 6P6C Quick Connect keystone insert <sup>1</sup>	1.79
ONQWP3475-**	Cat 5e RJ45 Quick Connect keystone insert <sup>2</sup>	2.21
ONQWP3476-**	Cat 6 RJ45 Quick Connect keystone insert <sup>3</sup>	4.08

\*\* Available in BE, BK, BR, GY, GN, IV, LA, OR, RE, WH, and YE

<sup>1</sup> LA and WH available in 10-packs, part number ONQWP3473-\*\*-10

<sup>2</sup> LA and WH available in 10-packs, part number ONQWP3475-\*\*-10. BE, LA, and WH available in 50-packs, part number ONQWP3475-\*\*-50. WH available in 100-packs, model ONQWP3475-WH-100

<sup>3</sup> LA and WH available in 10-packs, part number ONQWP3476-\*\*-10. WH available in 25-packs, model ONQWP3476-WH-25

Other Voice/Data Keystone Inserts



ONQWP3425-RE      ONQWP3451-WH      ONQWP3560-OR

ONQWP3425-††	RJ25 6P6C keystone insert	1.76
ONQWP3450-‡‡	Cat 5e RJ45 keystone insert	2.26
ONQWP3451-^^	Cat 5e RJ45 pass-through keystone	4.51
ONQWP3460-‡‡	Cat 6 RJ45 keystone connector	4.25
ONQWP3560-‡‡	Cat 6 Snap & Go keystone connector	5.48

†† Available in BK, BR, IV, LA, and WH

‡‡ Available in BE, BK, BR, GY, IV, LA, OR, RE, and WH

^^ Available in BK and WH

Miscellaneous Keystone Inserts



ONQWP3455-IV      ONQWP1220-WH

ONQWP3455-??	10-pack of blank keystone inserts	2.16
ONQWP1220-??	USB A/A pass-through keystone insert	2.85

?? Available in BK, BR, LA, and WH

Additional keystone options are available. Contact Worthington Distribution for details, (800) 282-8864 or sales@worthdist.com



Data Connectivity (continued)

Home Theater Straps

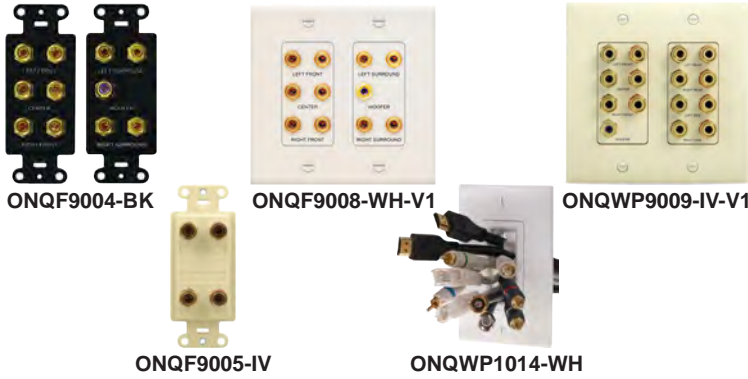

ONQF9004-††	2-gang 5.1 home theater strap, no wallplate	22.53
ONQF9005-††	Dual speaker strap	15.39
ONQF9006-††	Single speaker strap	5.52
ONQF9008-##-V1	2-gang 5.1 home theater strap and wallplate	20.63
ONQWP9009-††-V1	2-gang 7.1 home theater strap and wallplate	29.91
ONQWP1014-WH	Cable access strap	4.13
ONQWP1011-♦♦	HDMI plus two keystone strap	16.99

†† Available in BK, BR, IV, LA, and WH  
 ## Available in BK, LA, and WH  
 ♦♦ Available in LA and WH

Low Voltage Brackets

Crafted with durable heavy-duty plastic, QnQ low-voltage brackets feature an open back as well as an integrated cable management system for clean connections and easy installation.



ONQAC1009-01	1-gang low voltage bracket, new construction, nail on	0.57
ONQAC1009-02	2-gang low voltage bracket, new construction, face mount	1.31
ONQAC1009-11	1-gang low voltage bracket, new construction, face mount	0.75
ONQAC1010-01	1-gang low voltage bracket, retrofit	1.01
ONQAC1010-02	2-gang low voltage bracket, retrofit	1.37
ONQAC1010-03	3-gang low voltage bracket, retrofit	1.66

Installation Tools and Connectors

Legrand helps you complete installations with speed and ease by offering tools and connectors designed to ensure accuracy, precision, and quality.

Complete any installation with confidence and incredible efficiency. Providing the tools to make quality terminations and secure connections, quickly and easily, Legrand's crimpers, strippers, testers and more help installers keep things fast, stable, and accurate.

Installation Tools



ONQ362721-02	RG6 coax stripper	22.88
ONQ363292-01	Cat 5e strip and fit tool	18.27
ONQ363293-01	110 punchdown tool	61.10
ONQ364406-01	RJ45 modular plug hand tool	62.19
ONQ364555-01	EZ RJ45 modular plug hand tool	62.38
ONQAC3400	Punch & Go tool for Quick Connect keystones	24.52
ONQAC3401	Replacement blade for ONQAC3400	5.40
ONQAC1018	Radial taper compression tool	108.36
ONQAC3007	Adjustable compression tool	52.13
ONQAC4006	Cable tie tool	49.06

Connectors



ONQAC3000100	100-pack RG6U/quad conical F connector <sup>1</sup>	41.47
ONQ364405-01	25-pack RJ45 Cat 5e plugs	10.50
ONQAC345050	50-pack EZ RJ45 Cat 5e plugs	31.10
ONQAC346025	25-pack EZ RJ45 Cat 6 plugs	17.96
ONQAC3003-10	10-pack RG6U/quad BNC connectors <sup>2</sup>	25.90
ONQAC3006-10	10-pack F connector coupler	4.56
ONQAC3006-50	50-pack F connector coupler	20.53
ONQAC3008-10	10-pack RG6U/quad F connectors <sup>2</sup>	7.59
ONQAC3008-50	50-pack RG6U/quad F connectors <sup>2</sup>	33.70

<sup>1</sup> Use with ONQAC1018  
<sup>2</sup> Use with ONQAC3007

Worthington Distribution carries Legrand's full line of OnQ products. If you don't see a product listed in our catalog please contact us for pricing and availability, (800) 282-8864 or sales@worthdist.com.



**Intuity Home Automation**

**The smart home just got a lot smarter.**

Harnessing Legrand's world-renowned experience and expertise in providing quality data, lighting, and power control to millions, Intuity Home Intelligence, the latest in On-Q home automation, enlightens your space with a digital platform of integrated systems, offering true comfort, entertainment, and peace of mind which is all easily managed through elegant app control.

Legrand's Intuity system takes a unique approach to home automation. Instead of the Intuity hub controlling every aspect of the home itself, it ties many of Legrand's stand-alone systems together into a cohesive automation installation.

**Intuity provides control of any or all of the following:**

- **Multi-room Audio** - See page 162 for Legrand's Digital Audio system
- **Lighting Control** - Add the ONQHA7020 RFLC Bridge to control Legrand's RF Lighting Controls
- **Whole-house Intercom** - See Legrand's Selective Call Intercom below
- **Thermostats and Door Locks** - Intuity works with Nest thermostats, alternatively add the ONQHA7040 Z-Wave Bridge for support of Z-Wave door locks and thermostats
- **Security Alarm control** - See page 120 for DSC Neo security panels



ONQHA7110-NI with iPad mini (sold separately)

ONQHA7110-**	Intuity Command Center	221.15
ONQHA7000	Intuity Controller	234.99
ONQHA7020	Intuity RFLC Bridge	124.40
ONQHA7040	Intuity Z-Wave Bridge	124.40
ONQPW1013	Intuity Bridge Power Module	20.73
ONQPW7760	12VDC 1.5A Power Supply	14.25

\*\* Available in WH-White, LA-Light Almond, or NI-Nickel



ONQHA7000



ONQHA7020



ONQHA7040



ONQPW1013

**IP Video Solutions**

**Allow your customers to keep a watchful eye on their home.**

Providing clear, high-definition images, even in total darkness, Legrand Indoor and Outdoor IP cameras are the ideal solution for any homeowner. While at home, live camera feeds can be viewed on networked computers and devices. While away, remote access and control is convenient with the Legrand Camera or Intuity apps. All cameras install easily over a single-gang electrical box and are powered with a single PoE cable.



ONQCM7020	Indoor dome IP camera	373.20
ONQCM7000	Outdoor bullet IP camera	276.45
ONQCM7120	NVR for structured wiring enclosure	352.47

**Intuity Sales Pieces**

**Looking for more information on Intuity Home Automation?**



Scan the QR code above for an Intuity sales brochure.

Scan the QR code below for a video overview of Intuity.



**Selective Call Intercom**

**Delivering convenient room-to-room communication.**

The Selective Call Intercom's high resolution LCD screens and customizable room naming offer intuitive navigation, making the system a breeze to use. Additionally, quick control for room grouping, monitoring, do not disturb, and mute options are all right at your fingertips. The On-Q radiant Selective Call Intercom was designed to integrate seamlessly into Legrand's Intuity Home Automation system, offering a full solution for complete home control.



ONQIC7400-**	Kit: (4) IC7001-**, (1) IC5010, (1) PW1030	912.84
** - WH-White, LA-Light Almond		
ONQIC7001-LA	Intercom room unit, light almond	199.63
ONQIC7001-NI	Intercom room unit, nickel	199.63
ONQIC7001-WH	Intercom room unit, white	199.63
ONQIC5010	Selective Call hub module	251.04
ONQIC5002-*	Intercom door unit	149.11
ONQIC5003-*	Intercom video door unit	345.75
ONQIC5006-BK	Surface-mount box for outdoor units	14.76

\* Available in AB-Antique Brass, BS-Brushed Stainless, OB-Oil-Rubbed Bronze, SB-Shiny Brass, WH-White



# Who's Watching the Driveway?

## The Security of Knowing

Professional Vehicle Detection that Easily Integrates into Security and Home Automation Systems

A DriveGuard™ driveway alarm from Cartell provides your customers with the security and peace of mind they'll get from knowing a vehicle is entering their driveway before it gets to their home. You also get the industry's most dependable driveway alarm, backed by an unmatched 5-year warranty. The Cartell DriveGuard™:

- Enhances Any Home System with Professional Vehicle Detection
- Adds Functionality to Security and Home Automation Systems
- Is Designed for Easy Integration into Existing Systems
- Turns On Lights – Inside and Out
- Sounds Audio Alarms
- Activates Cameras
- Activates Remote Notifications – Smartphone, Tablet, Computer\*
- Is a Highly Dependable Technology – Better than Motion Detectors
- Offers an Industry-Leading 5-Year Warranty



  
**cartell**  
driveway alarms

*You're Not Alone*

Whether your customer is home or away,  
Cartell DriveGuard is keeping watch.  
Find out more at

[www.cartell.com](http://www.cartell.com)



Made in the USA



\*When integrated with a system that supports such features



## Keystone Plates - Standard Size

DAT20-300+*	Keystone plate, choose color and number of ports.	0.51
*AL-Almond, BK-Black, BR-Brown, GY-Gray, IV-Ivory, LA-Lt Alm., WH-White		
+1-1-Port, 2-2-Port, 3-3-Port, 4-4-Port, 5-5-Port, 6-6-Port		

## Décor Plate Insert

DAT20-51+*	Keystone insert, choose color and number of ports.	7.49
10-pack, *5-Almond, 3-Ivory, 2-White		
+4-1-Port, 5-2-Port, 6-3-Port, 7-4-Port		

## Keystone Inserts

DAT20-3425-**	Cat 5e data jack	1.29
DAT20-3102-*	Jack w/ "F" connector, 10-pack	4.37
DAT20-3104-WH	RCA to "F," white only	1.87
*AL-Almond, IV-Ivory, LA-Lt Alm., WH-White - Other Colors Available		

## HD Cable Active Linx

DAT46-8599-LX	HD Cable Active Linx - Use in conjunction with TrueStream Pro HD Cables to run cables up to 200 ft.	48.65
---------------	---	-------



For HDMI Cables, please refer to Page 177.

## Low Voltage Cable Plate

DAT45-0001-*	1-gang recessed	1.56
DAT45-0002-*	2-gang recessed	2.31
DAT45-0003-WH	3-gang recessed, White	4.37
DAT45-0060	5.1 surround 2-gang plate	20.98
DAT45-0008-*	Easy mount, retrofit	2.37
DAT45-0009-*	Easy mount, slim fit, retrofit	2.37



DAT45-0003



DAT45-0009

\*BR-Brown, LA-Light Almond, WH-White

## HDMI Décor and Keystone Inserts

DAT20-4501-WH	Decor wallplate insert with 90 degree HDMI connector	5.35	DAT20-4502-WH	Decor wallplate insert with 90 degree dual HDMI connector	10.18
DAT20-4503-WH	Standard wallplate with HDMI connector & pigtail	6.66	DAT20-4505-WH	Standard wallplate with dual HDMI connector and pigtails	10.39
DAT20-4504-WH	HDMI keystone insert	6.93			

## Low/Line Voltage Cable Plates



DAT45-0021

Install low-voltage cables and power behind your flat panel TV, your amplifier or other audio/video devices, flush to the wall surface.

The 45-0021 recessed low-voltage cable plate with recessed power can be installed upright or upside down.

DAT45-0021-*	Recessed w/ recessed power	13.68
DAT45-0022-WH	Kit with locking inlet	83.62
DAT45-0024-WH	Kit with straight blade inlet	43.65
*BK-Black, GY-Grey, WH-White		

## Décor Insert w/Flexible Opening



Install low voltage cables behind your HDTV, amplifier or other audio video devices.

Designed to be installed onto a low voltage mounting bracket (sold separately) that is installed into the wall.

DAT45-0016-BK	Décor Insert w/Flexible Opening, Black	1.87
DAT45-0016-IV	Décor Insert w/Flexible Opening, Ivory	1.87
DAT45-0016-LA	Décor Insert w/Flexible Opening, Light Almond	1.87
DAT45-0016-WH	Décor Insert w/Flexible Opening, White	1.87

## Connectors, Adapters, and Splitters

DAT41-0060	BNC male to RCA male	0.80	DAT41-0065	BNC male to RCA female	0.50
DAT41-0015	BNC male right angle clamp RG6U	1.49	DAT41-0070	BNC male to F female, 10-pack	6.49
DAT42-0016	RCA male to F female	0.44	DAT41-0075	BNC female to F male	0.57
DAT41-0052	BNC "T" adapter, 1 male 2 female	0.60	DAT41-0080	BNC female to RCA male	0.54
DAT41-0055	BNC double female adapter	0.37	DAT42-0010	RCA female to F male	0.57
DAT42-0005	RCA male to F male	0.72	DAT30-1400	F connector splice	0.16
DAT42-0015	RCA female to F female	0.72	DAT30-1200	Twist-on RG6 F connector	0.21
DAT30-1101	Twist-on RG59 F connector, 10-pack	1.87	DAT41-0030	Twist-on RG59 BNC male	0.50
DAT30-1201	Twist-on RG6 quad F connector	0.21	DAT41-0036	Twist-on RG11 BNC male	0.96
DAT41-0035	Twist-on RG6 BNC male	0.50	DAT41-0049	Twist-on RG59 BNC female	0.67
DAT41-0081	Twist-on RG6 quad BNC male	0.62			



DAT41-0010/15



DAT42-0015



DAT41-0052



DAT41-0055



DAT41-0060



DAT41-0065



DAT41-0070



DAT41-0075



DAT41-0080

**50" Enclosure**



**CVC-0150E**

Enclosures include screws, grommets, wire management straps, cable identifiers & cardboard rough-in cable protector

CVC-0150E	50" enclosure only	91.93
CVC-0150D	50" smoke hinged door	135.08
CVC-0150HC	50" hinged cover only	40.97

Cover and enclosure are sold separately.

**38" Enclosure**

Enclosures include screws, grommets, wire mgmt straps, cable identifiers & cardboard rough-in cable protector.

CVC-0138E	38" enclosure only	62.70
CVC-0138D	38" smoke hinged door	115.62
CVC-0138HC	38" hinged cover only	30.23

Cover and enclosure are sold separately.



**CVC-0138D**

**19" and 28" Enclosures**



**CVC-0119E**

Enclosures include screws, grommets, wire mgmt straps, cable identifiers & cardboard rough-in cable protector.

CVC-0119C	19" cover only	9.99
CVC-0119E	19" enclosure only	31.47
CVC-0128HC	28" hinged cover only	22.23
CVC-0128E	28" enclosure only	39.97

**RF Splitters**



**CVC-0232**



**CVC-0234**



**CVC-0314**

CVC-0232	1x2 RF splitter, 5-2300MHz	9.65
CVC-0234	1x4 RF splitter, 5-2300MHz	11.02
CVC-0314	1 in 4 out splitter, DC/IR passing	29.98
CVC-0333	2 in 8 out w/ active return path, FIOS compatible	109.09
CVC-0332	1 in 16 out amp 1dB gain, DC/IR passing	68.94
CVC-0214	1x6 RJ45, 1x4 RF splitter module	27.28

**Data Network Modules**



**CVC-0554**



**CVC-0538**



**CVC-0622**



**CVC-0588**

CVC-0538	Cat 6 network module 8-port, 110 x 8, RJ45	38.97
CVC-0508	Cat-5e network module 8-port, 8x 110, 8x RJ45	22.98
CVC-0554	Wireless router with 4 ports - 802.11N	76.94
CVC-0575	6x6 data/patch module	14.94
CVC-0588	8-port gigabit Ethernet switch	64.95
CVC-0622	Fiber optics plate with lid and coupler	24.98

**Enclosure Accessories**



**CVC-0408**



**CVC-0409**



**CVC-1328/29/30**



**CVC-1333**

**CVC-1351**



**CVC-0702**



**CVC-1352**



**CVC-1322**



**CVC-1324**



**CVC-0702**



**CVC-1325**



**CVC-1001**



**CVC-1201**

CVC-0408	Cat 5e, RJ45 interconnect, 1'	1.10
CVC-0409	Cat 5e, RJ45 interconnect, 3'	1.30
CVC-1328	Mounting clips for 3/8" drywall - 4-pc/bag	2.60
CVC-1329	Mounting clips for 1/2" drywall - 4-pc/bag	2.60
CVC-1330	Mounting clips for 5/8" drywall - 4-pc/bag	2.60
CVC-1333	RJ31X module	2.50
CVC-1351	50" depth extension ring	48.50
CVC-1352	Replacement angled latch for 28" and 38"	2.20
CVC-1322	Fan kit for designer doors	19.98
CVC-1324	Universal hinge kit (3 pc)	12.43
CVC-1325	Strain relief clips, 100-pack	79.94
CVC-0702	Bracket and power strip; 6 outlets	13.99
CVC-1001	Speaker module 2 pair in x 8 pair out	49.96
CVC-1201	IR distribution, 8 in 1 out terminal strip	29.98

**Telephone Distribution Modules**

CVC-0410	4 CO-line surge protector module	32.97
CVC-0432	110-punch, 4x8 telephone w/ RJ31x	38.97
CVC-0436	RJ45, 4x8 telephone w/ RJ31x	27.98
CVC-0437	RJ45, 4x12 telephone w/ RJ31x	31.97
CVC-0438	4x7 locations w/110 punch downs	19.48
CVC-0439	4x15 locations w/110 punch downs	32.97
CVC-0441	110 telecom module - 100 pair w/ RJ31x	34.97
CVC-0476	1x6 telephone module	12.49



**CVC-0410**



**CVC-0432**



**CVC-0436**



**CVC-0438**



**CVC-0439**



**CVC-0441**



**CVC-0437**



**CVC-0476**

**RF Modulation with Digital Cable**



**CVP-0328**

- Easy Source Switching between Cable and Modulator
- Combines Cable TV with Modulated Signals
- Eliminates Cable Interference without Filters
- Eliminates Call Backs
- RF Amplifier Unity Gain on All Outputs

CVP-0321	2x1 Affinity module, CATV or Digital CATV in and 1 modulator input	78.94
CVP-0328	3x8 Affinity module, CATV or Digital CATV in and 2 modulator inputs, output to up to 8 locations	174.86
CVA-0511	Mini remote control for use with Affinity modules, requires IR-4101	5.00

**Adapters**

CV2105	Female "F" connector to male BNC connector	0.45
CV2107	Female "3-way" connector	1.50
CV2108	Female BNC "splice" connector	0.50
CV2115	Female "F" connector to male UHF connector	1.00
CV2120	2 female, 1 male BNC "T" connector	0.75
CV2123	Male BNC "right angle" connector	0.99
CV2126	Female "F" connector to RCA male connector	0.56
CV2127	Female RCA connector to BNC male connector	0.56
CV2129	Female BNC connector to RCA male connector	0.56
CV2203	Male "F" to male "F" connector "coupler"	0.75

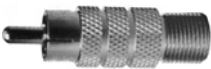

**CV2126**



**CV2127**



**CV2129**

**iPod/iPad On-Wall Docks**



**CVA0604**

Transform your Apple iPad® into a cost-effective wireless on-wall touchscreen panel with Channel Vision's newest On-Wall Dock. With this dock, the iPad securely mounts to the wall creating a touchscreen controller ideal for home theater, whole-house automation, security, and A/V applications. Be able to mount your iPad horizontally or vertically and easily remove the tablet

when needed for portable use. When the iPad is removed, it becomes the perfect place to display your favorite photo.

CVA0604	On-wall dock for iPad, easily remove iPad for portable use, mounts vertically or horizontally, charges iPad (Supports devices with Lightning Connector), Black	155.88
---------	--	--------

The Channel Vision Wall-Dock Station for iPod for Distributed Audio supports RS-232 and IR control. The dock connector easily adjusts to fit any iPod and has a non-skid pad to help keep the music player secure. With its elegant and contemporary styling, it fits into any home setting and provides the convenience of accessing an iPod from anywhere in the home.

CVA0318	On-wall Bluetooth Audio Micro USB Docking Station for Crescendo CAT5 Audio Systems. Charge and play at the same time.	124.90
CVA0505	IR remote control for use with A-Bus systems	11.99

**Accessories and Infrared Devices**

CVIR-5001	All-in-one IR system, includes plasma proof IR receiver with built-in connecting block, 4 emitters	66.72
CVIR5010	Long distance plasma proof IR kit for distances up to 1000 feet	48.96
CVIR-5011	Uverse ready IR repeating kit	77.94
CVIR-2400	Remote head IR receiver, plasma proof, small footprint receiver for hidden applications	51.86
CVIR-2005	J-box IR receiver, mounts in a single gang low-voltage mud ring	53.48
CVIR-1203	Amplified IR hub, 4 emitter ports, status LEDs, screw term. or mini plug. PS included, req. emitters.	23.08
CVG-IRB-W	Snap-in insert for structured wiring plate, converts 3-conductor IR wiring to 3.5mm jack	2.25
CVIR-4500	IR over coax kit, use with Affinity modules to switch sources	58.37

**CVIR5010**

By keeping the IR5010 on your truck, you can stock one kit for nearly every IR application. Receiver is CFL, LCD and plasma proof and the kit includes options for surface, stick-on and recessed-mounting.



**CVIR5010**

**CVG-IRB-W**

**Accessories and Infrared Devices**

CVHS2	2-way splitter/combiner	4.75
CVHS3	3-way splitter/combiner	6.49
CVHS4	4-way splitter/combiner	8.47
CVHS6	6-way splitter/combiner	16.94
CVHS8	8-way splitter/combiner	19.73
CVHS16	16-way splitter/combiner	39.82



**CVHS2**

**IP Cameras/NVR**

CV6565	2MP (1080p) outdoor IP dome camera with IR, weatherproof/vandal proof, varifocal 3-10.5mm lens, PoE, analog/IP video simultaneously	247.80
CV6543	2MP (1080p) outdoor IP bullet camera with IR, weatherproof/vandal proof, varifocal 3-16mm lens, PoE, analog/IP video simultaneously	366.71
CV6533	2MP (1080p) indoor IP dome camera, 2.8mm lens, PoE, event triggered micro SD recording	168.86
CVW4001	H.264 4-channel video server, PoE	398.68
CVNVR-04N-1000	4-channel NVR, 1TB HDD	489.61
CVNVR-04N-2000	4-channel NVR, 2TB HDD	520.58
CVNVR-09N-3000	9-channel NVR, 3TB HDD	589.53



**CV6533**

**CV6565**

**CV6543**



**RHINO 6000 Hard Case Kit**



**DM1734520**

- PC-compatibility lets you download/upload and print labels from your PC
- Over 250 pre-programmed industry terms and symbols, plus storage for 1000+ custom labels
- "Hot Keys" instantly format wire wrap, flags, patch panel labels, fixed length labels and more
- Uses RHINO labels up to 1" wide
- Includes RHINO 6000 printer, hard carry case, two labels (1734524, 18443), AC adapter, rechargeable battery pack, RHINO CONNECT software (1738636), and USB cable

DM1734520	RHINO 6000 Hard Case Kit, see above	291.43
DM1734519	RHINO 6000 Printer, incl. label (1734524), AC adpt. (15519) and rech. battery (1738637)	208.17
DM1738636	RHINO CONNECT Software, print from your PC to your 6000 or 6500 printer and more	166.53

**RHINO 5200 Hard Case Kit**



**DM1756589**

- "Hot Keys" instantly format wire wraps, patch panel and fixed length labels and more
- Prints Code 39 and Code 128 bar codes
- Smart on-screen alerts; 100 memory locations
- Uses RHINO labels up to 3/4" wide
- Includes RHINO 5200 printer, hard carry case, two labels (18489, 18443), AC adapter/charger and rechargeable lithium-ion battery

DM1756589	RHINO 5200 Hard Case Kit, incl. 1755749, 18489, 18443, 15519, 1760413 and rechargeable lithium-ion battery	179.86
DM1755749	RHINO 5200 printer only	127.69

**RHINO 4200 Printer**



**DM1835374**

- Easy to navigate QWERTY keyboard
- "Hot Keys" instantly format wire wraps, flags, fixed length labels and more
- Uses RHINO labels up to 3/4" wide
- Adds "Favorites" and "Custom" keys to increase labeling productivity and reduce labeling time

DM1801611	RHINO 4200 Printer	77.71
DM1835374	RHINO 4200 Printer Kit. Includes 4200 Printer, AC Adapter, Case, Labels.	135.30

**XTL Labelers and Labels**



**DM1868815**

Jobsite tested and packed with features, the DYMO® XTL™ 300 and XTL 500 label makers help simplify industrial labeling for a more efficient, frustration-free experience. By incorporating cues from today's technology, XTL label makers offer a familiarity that makes using them easy.

DM1868815	XTL 500 Hard Case Kit. Includes: XTL 500, Carrying Case, AC Adapter, USB Cable, Battery, (1) 2 in x 23 ft All-Purpose Vinyl-Black/White, (1) 1 1/2 in x 1 9/16 in Laminated Wire/Cable Wrap-Black/White, 150 labels, Quick Start Guide, and Software Download Card.	485.71
DM1868814	XTL 300 Hard Case Kit. Includes: XTL 300, Carrying Case, AC Adapter, USB Cable, Battery, (1) 1 in x 23 ft All-Purpose Vinyl-Black/White, (1) 13/16 in x 1 9/16 in Laminated Wire/Cable Wrap-Black/White, 150 labels, Lanyard, Quick Start Guide, and Software Download Card.	291.43

**RHINO Labels - Buy 4 Get 1 Free!**

- Industrial-strength adhesive for labels that stick and stay stuck
- Split-back design for easy application

Part No.	Material	Size	Color	Price
<b>Flexible Nylon - Wire/cable, flat, curved, rough or smooth surfaces</b>				
DM18488	Flexible Nylon	1/2"	White	18.53
DM18489	Flexible Nylon	3/4"	White	20.46
DM1734524	Flexible Nylon	1"	White	22.43
DM18490	Flexible Nylon	1/2"	Yellow	18.53
DM18491	Flexible Nylon	3/4"	Yellow	20.46
DM1734525	Flexible Nylon	1"	Yellow	22.40
<b>Vinyl - Use for indoor/outdoor applications, great for curved surfaces</b>				
DM18444	Vinyl	1/2"	White	15.78
DM18443	Vinyl	3/8"	White	15.59
DM18432	Vinyl	1/2"	Yellow	15.78
DM18433	Vinyl	3/4"	Yellow	19.42
DM1805416	Vinyl	1/2"	Red	15.78
DM1805422	Vinyl	3/4"	Red	19.42
DM1805435	Vinyl	1/2"	Black	15.78

Other Vinyl Colors/Sizes available. Call for details.

**Other label styles and sizes available.  
Give Worthington a call today!**

Part No.	Length	Size	Color	Price
<b>Vinyl - Use for indoor/outdoor applications, great for curved surfaces</b>				
DM1868751	23'	1/2"	White	17.34
DM1868752	23'	3/4"	White	20.46
DM1868753	23'	1"	White	31.56
DM1868754	23'	1-1/2"	White	37.47
DM1868755	23'	2"	White	45.79
DM1868772	23'	3/4"	Yellow	20.46
DM1868762	23'	3/4"	Red	20.46

Other Vinyl Colors/Sizes available. Call for details.

Part No.	Length	Size	Color	Price
<b>Laminate Wire Wraps - Ideal for wire/cables</b>				
DM1868704	13/16"	13/16"	White	35.87
DM1868705	1-9/16"	13/16"	White	25.94
DM1868706	4"	13/16"	White	31.29

Part No.	Length	Size	Color	Price
<b>Pre-Sized Safety Labels - Color indicates Header color</b>				
DM1868715	4"	2"	Blue	33.20
DM1868716	4"	2"	Red	33.20

**Category Wire (UTP) Termination**



PT100054C



PT100003C



PT15015

PT100008	EZ-RJ-45® Combo 24, includes crimp tool and 24 Cat 5/5e connectors	57.33
PT100004C	EZ-RJ-45 crimp tool	49.42
PT100054C	EZ-RJ-45 heavy duty professional crimp tool for Cat 5/5e, Cat 6 and RJ-11/12 connectors	67.43
PT100003C	EZ-RJ-45 Cat 5/5e connectors, 50 pieces	24.79
PT100010C	EZ-RJ-45 Cat 6+ connectors, 50 pieces	28.02
PT100022	EZ-RJ45 Shielded Cat5e/6, (External Ground), 50 pieces	70.18
PT100026C	EZ-RJ12/11 connectors, 50-piece clamshell, use with EZ-RJPRO crimp tool	14.05
PT202035J	Strain relief for Cat 5/5e EZ-RJ-45 connectors, 100 piece jar	19.41
PT202036J	Strain relief for Cat 6 EZ-RJ-45 connectors, 100 piece jar	19.41
PT13032C	NeverDull 66 style blade for 13006C	11.95
PT13033C	NeverDull 110 style blade for 13006C	11.95
PT13155C	Pro-Strike Punchdown impact tool w/ 110 blade	37.43
PT13159C	Pro-Strike Punchdown impact tool w/ 110 and 66 blades	37.43
PT15015C	Cat 5 cable jacket stripper	8.96
PT13501C	Xpress Jack, jack termination tool. Use PT13522C for Leviton Jacks (See Below).	59.91

**Miscellaneous Tools/Connectors**



PT15003C



PT10514C



PT15030C

PT13522C	Maxim 6 self-adjusting wire stripper	29.94
PT15030C	2-level coaxial cable stripper for RG-58/59/62/6/6 Quad/Mini Coax	10.45
PT10514C	CCS-6 cable cutter	14.95
PT15003C	ProStrip 10/20 wire strippers	11.20
PT15010C	Stripper for plenum jacket, NYC code firewire, speaker wire, fiber and more	22.44
PT12100	Connector pressing telecom pliers, use with model 18110 connectors	11.22
PT19101	33-piece precision screwdriver set	15.70
PT13022	Punchdown tool extension (66 and 110), great for structured wiring punchdowns	13.45
PT13021	66/110 combo blade, cutting blade for 66 and 110 blocks	10.45
PTTP150	Tone and probe set, includes a carrying case, 9V batteries and user instructions	24.32
PT90170	10Gig termination kit	179.86
PT90173	EZ-RJPRO Termination Pod	213.58
PT12507C	Tele-Titan Modular Plug Crimp Tool	26.19
PT18110	Telecom Splicing Connectors, use 12100 pliers	0.12



PTTP150



PT90170

**EZ-SnapJacks (Connectors sold in 10-packs)**

PT705\*-1 Cat 5/5e, bulk, bagged, 10-pack 29.85

\*AL-Almond, BK-Black, BL-Blue, BR-Brown, GN-Green, IV-Ivory, LA-Light Almond, OR-Orange, RD-Red, WH-White or YL-Yellow

PT706\*\*-1 Cat 6, bulk, bagged, 10-pack 32.47

\*\*AL-Almond, BK-Black, BL-Blue, BR-Brown, GN-Green, IV-Ivory, LA-Light Almond, OR-Orange, RD-Red, WH-White or YL-Yellow



**EZ-SnapJacks**

First the EZ-RJ45®, now the EZ-SnapJack! You may never again need a punchdown tool. At least for your wall jacks! The patented EZ-SnapJack is self-terminating and quickly installs for professional results in a snap.

- Save time – No need for eight punch downs
- Repair damaged jacks on the spot
- EZ-SnapJacks are reuseable
- Wire guide ensures pairs stay in proper order for fast, easy termination
- Reduced tool cost, no PDT required
- Your tool bag weighs less
- Available for Cat 5e and Cat 6
- Designed to fit industry standard wallplates
- Commercial network installations, new or retrofit
- Home automation installations, new or retrofit

**Testers**

PTTCB360K1 Cable Prowler PRO Test Kit 608.85



PTTCB360K1

• **Includes:** Cable Prowler main unit, #1-8 Network/Tel Test and ID Remotes, #1-8 Push on Coax Remotes, #1-12 RJ45 Data Remote set, Micro USB cable, No-Fault cable - Qty 2, RJ45 Port Saver, RJ45 to Alligator 12 inch, F Female to F Female adapters, set of 2, BNC Female to F Female adapter, BNC Female to F Male adapter, Heavy duty case

• Multilingual (English, French, Spanish)

PTT129K1 VDV MapMaster Kit 162.33

The VDV 2.0 MapMaster combines continuity testing, mapping, tone generation and length measurement functions in a single tester. This kit includes the tester and all the accessories required for voice, data and video testing & mapping in the field. It's packaged in a rugged double-walled, blow-molded case with custom cut out, high density EVA foam to help protect your equipment for years to come.



PTT129K1

**F-Conn Universal Compression Connectors** (Connectors sold in 5-packs)

F Connector			RCA Connector			BNC Connector		
ICMFSNS6U	RG6, Nickel	2.19	ICMFSNS6RCAU	RG6, Nickel	6.12	ICMFSNS6BNCU	RG6, Nickel	10.62
ICMFSNS59U	RG59, Nickel	2.19	ICMFSNS59RCAU	RG59, Nickel	6.12	ICMFSNS59BNCU	RG59, Nickel	10.62



ICMFSNS6RCAU



ICMFSNS59BNCU



ICMFSNS6U



ICMFSNS6BNCU

**Right-Angle Connectors** (Connectors sold in 5-packs)

ICMFSNS6URA	Right-angle F for RG6, Nickel	9.74
ICMFSNS59URA	Right-angle F for RG59, Nickel	1.95
ICMFSBNC6URA	Right-angle BNC for RG6, Nickel	14.43
ICMFSBNC59URA	Right-angle BNC for RG59, Nickel	14.43
ICMFSRCA59URA	Right-angle RCA for RG59, Nickel	11.18
Requires ICMLMTIP-RA tip in ICMCPLCCT-SLMR tool for compression.		

**Color Bands**

ICMFSCR*	Universal color bands for F, RCA, and BNC (bag of 100)	3.75
*R-Red, W-White, Y-Yellow, B-Blue, G-Green, BK-Black, O-Orange, P-Purple		

**Cable Pro and F-Conn are the choice of professionals**

Belden's TRUE 360° compression connectors and tools work together as a complete integrated system. One easy-to-use Cable Pro tool is able to compress a variety of F-Conn F, RCA, and BNC type connectors to fit RG59, RG6, mini coax, and a variety of plenum size cable.

**Professional Compression Tools and Accessories**

ICMCPLCCT-SLMR	Linear compliant compression tool, solid steel construction, includes four tips to compress nickel and gold, right angle and splice connectors in F, RCA, and BNC. Compatible with Leviton and OnQ connectors.	88.77
ICMLMTIP-RA	Tip for use with right-angle connectors in SLMR compression tools	2.39
ICMLMTIP-WP	Tip for use with wallplate snap-in connectors in SLMR compression tools	2.39
PT15030C	2-level coaxial cable stripper for RG-59/6/Mini Coax. Be sure to use the FIT6 Flaring and Insertion tool for easier termination.	10.45
ICMFIT6	Flaring and Insertion tool, used to separate the cable jacket for easier installation of the F connector. Also folds back foil and braiding.	13.11
ICMCPPT-1	Pocket Toner, loud audio tone identifies line carrying signal	21.87



ICMCPLCCT-SLMR



ICMFIT6





ICMCPPT-1



PT15030C

**Mini-Coax Connectors** (Connectors sold in 5-packs)

	ICMFS1BNC	Mini-Coax BNC connector for 25-26ga wire. Great for component video. Orange.	10.30
	ICMFS1RCA	Mini-Coax RCA connector for 25-26ga wire. Great for component video. Orange.	8.37
	ICMFSNS15BNC	Mini-Coax BNC connector for 22-24ga wire. Great for component video. Purple.	10.43
	ICMFS15RCA	Mini-Coax RCA connector for 22-24ga wire. Great for component video. Purple.	8.37
	ICMFSNS15	Mini-Coax "F" connector for 22-24ga wire - 5-pack.	3.81
One piece connectors listed, call for multi-piece connectors.			

ICMFS1RCA

ICMFSNS15BNC

**Why use Belden Compression Connectors?**

Belden BNC, RCA and F Compression Connectors exceed SCTE Standards for signal ingress, egress and water migration, while providing exceptional aesthetic and strength characteristics. They ensure optimal connector performance by offering:

- Visual confirmation of cable entry
- Better performance with improved signal impedance
- A simple product and installation process removes installation inconsistencies

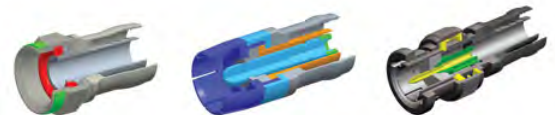



**Splice Connectors** (Connectors sold in 5-packs)

ICMFS6US	RG6 F splice, Nickel	5.18
ICMFS59US	RG59 F splice, Nickel	5.18
ICMFS6RCAUS	RG6 RCA splice, Nickel	6.37
ICMFS1RCASST	25-26ga Mini-Coax RCA splice, Nickel	11.58
ICMFS15RCASST	22-24ga Mini-Coax RCA splice, Nickel	10.43
ICMFS6BNCUS	RG6 BNC splice, Nickel	10.62
ICMFS59BNCUS	RG59 BNC splice, Nickel	10.62
ICMFS1BNCSSST	25-26ga Mini-Coax BNC splice, Nickel, 6pk	12.59
ICMFS15BNCSSST	22-24ga Mini-Coax BNC splice, Nickel, 6pk	12.09

Splice connectors give maximum flexibility in creating custom wiring installations.

**Insert Modules** (Universal insert for structured wiring, priced each)

HIPUAM	Use with splice connectors, Almond	0.06
HIPUIM	Use with splice connectors, Ivory	0.06
HIPUKM	Use with splice connectors, Black	0.06
HIPULAM	Use with splice connectors, Lt. Alm.	0.06
HIPUWM	Use with splice connectors, White	0.06

**Color O-Rings** (Use with RCA/BNC splices, priced in 100 bag)

HIPOB	Blue, specifies insert as the Blue channel of an RGB connection	2.50
HIPOG	Green, specifies insert as the Green channel of an RGB connection	2.50
HIPOK	Black, specifies insert as the Black channel of an RGB connection or as the left channel of Line Level Audio	2.50
HIPOO	Orange, specifies insert as a Digital Coaxial Audio connection	2.50
HIPOP	Purple, specifies insert as a Subwoofer connection	2.50
HIPOR	Red, specifies insert as the Red channel of an RGB connection or as the left channel of Line Level Audio	2.50
HIPOW	White, specifies insert as the right channel of Line Level Audio	2.50
HIPOY	Yellow, specifies insert as a Composite Video connection	2.50



ICMFS6US

**Create a Splice** (Follow these three steps to create a complete unit)

**1.) Choose a splice**

- "F", RCA or BNC
- RG6, RG59 or Mini-Coax
- Nickel or Gold



**2.) Choose an insert module**

- Almond or Light Almond
- Ivory
- White or Black



**3.) Add Color O-Rings**

- HIP rings for splices
- ICM rings for connectors
- Call with any questions



**Coaxial Wire**

WAVH59182NVRBK3	18/2 + RG59 Siamese wire, 500' roll with Black jacket	52.46
WAVRG6URBK1	RG6, 60% shield, 3.0GHz rated, 1000' box with Black jacket	46.21
WAVRG6QRWH	RG6, Quad shield, 3.0GHz rated, 1000' box with White jacket	57.45

**Worthington carries many other types of wire. Give us a call today!**

**Starter Kits**

ICMSTARTERKIT	Universal starter kit, selection of tools, connectors, color bands, inserts and more	199.40
ICMSLMPSAKIT	Basic starter kit, includes ICMCPLCCT-SLM and PSA59/6 strip tool	96.49
ICMDBPSAKIT	Double Bubble starter kit, includes Double Bubble compression tool and stripper	80.41
ICMDBSTARTER	Double Bubble starter kit, includes compression tool, stripper and a selection of assorted connectors	154.38

**Double Bubble 360 Tools and Connectors (Connectors sold in 5-packs)**

ICMCPLCRBC-BR	Double Bubble Compression Tool-Blue	70.76
---------------	-------------------------------------	-------



ICMCPLCRBC-B



ICM Double Bubble Connectors, F, RCA, BNC

ICMDB6U	F connector for RG6	1.50
ICMDB6PL2	F connector for RG6 Plenum	1.50
ICMDB6RCAU	RCA connector for RG6	5.31
ICMDB6RCAPL2	RCA connector for RG6 Plenum	5.31
ICMDB6BNCU	BNC connector for RG6	8.37
ICMDB6BNCPL2	BNC connector for RG6 Plenum	8.37
ICMDB59U	F connector for RG59	1.50
ICMDB59PL2/4	F connector for RG59 Plenum	1.50
ICMDB59RCAU	RCA connector for RG59	5.31
ICMDB59BNCU	BNC connector for RG59	8.37
ICMDB59BNCPL2/4	BNC connector for RG59 Plenum	8.37

# Simply Automated Anywhere 3-Way Switch Kits



**2-Rocker Kit  
Now Available**

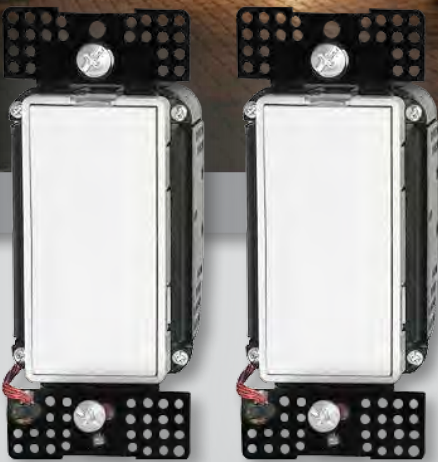

## Professional Grade

Two high quality professional grade 900W switches replace existing mechanical wall switches, utilize same wires of existing wall switches - no traveler wires or batteries needed! Turn on/off circuits from both switches (neutral wire required).

- **3-Way control of lights anywhere on your property without running new wires!**
- **Includes two (2) professional grade 900W switches – LED compatible**
- **A simple cost effective alternative for the professional electrician**

A simple cost effective alternative for the professional electrician - versus running costly new wiring or using wireless consumer DIY options that do not always work. Employs Simply Automated's advanced powerline technology – transmits over 1 mile. Wall plates sold separately.

6108 Avenida Encinas, Suite B  
Carlsbad, CA 92001 USA  
800-630-9234 | 760-431-2100  
[www.simply-automated.com](http://www.simply-automated.com)





## Plastic Push-In Connectors for Metal Enclosures



AIINM940

Part #	Description	Box Qty.	Each Price
AIINM940	Connector for 3/8" knockout	100	0.12
AIINM95	Connector for 3/4" knockout	50	0.21
AIINM96	Connector for 1" knockout	50	0.21

## Low Profile Outdoor Weatherproof Line Voltage Box



AIIDBVS1\*

Part #	Description	Box Qty.	Each Price
AIIDBVS1*	New siding	4	12.22
AIIDBVM1*	Stucco	4	9.59
AIIDBVR1*	Retrofit	4	12.22
AIIDBVR131*	Retrofit siding 1/4"-5/16" lap	4	13.96
AIIDBVR141*	Retrofit siding 1/2" lap	4	13.96
AIIDBVR151*	Retrofit siding 5/8" lap	4	13.96
AIIDBVR171*	Retrofit siding dutch lap	4	13.96

\*Available Covers: C-Clear, W-White



AIIDBVR131\*

## Outdoor Weatherproof While-In-Use Line Voltage Box



AIIDBPV1

Part #	Description	Box Qty.	Each Price
AIIDBPV1	Dri-box w/ cover, base, and wallplate, vertical, 1-gang	4	9.52
AIIDBPH1*	Same as above but horiz.	4	9.52
AIIDBP2*	Dri-box w/ cover & base w/ wallplate, vertical, 2-gang	4	16.26

\*Available Covers: C-Clear, No Suffix-White

## Dual Voltage Device Box



AIILVDR2

Part #	Description	Box Qty.	Each Price
AIILVD2	Power and low voltage box for new construction	25	3.05
AIILVDR2	Power and low voltage box for existing construction	25	3.90

## Line Voltage Box



AIIF101

Part #	Description	Box Qty.	Each Price
AIIF101	1-gang for new construction	50	1.54
AIIF101F	1-gang screw-on non-metallic vapor box	25	3.11
AIIF101H	1-gang for new construction - horizontal	25	1.71
AIIF102	2-gang for new construction	25	2.34
AIIF103	3-gang for new construction	50	3.27
AIIF104	4-gang for new construction	10	5.46



AIIF102

## In/Out Box - Adjustable Outlet Box 1/2" - 1 1/2"



AIIFA101

Part #	Description	Box Qty.	Each Price
AIIFA101	1-gang, non-metallic	25	2.26
AIIFA102	2-gang, non-metallic	10	2.91
AIIFA103	3-gang, non-metallic	10	5.18
AIIFA104	4-gang, non-metallic	1	6.48

## Line Voltage Box Extenders



AIIBE1

Part #	Description	Box Qty.	Each Price
AIIBE1	1-gang for old construction	25	1.09
AIIBE1R	Round ceiling box extender for old construction	25	1.91
AIIBE2	2-gang for old construction	25	1.52
AIIBE3	3-gang for old construction	25	3.17
AIIBE4	4-gang for old construction	25	4.36

## Recessed Duplex Receptacle Box



AIIDVFR1W

Part #	Description	Box Qty.	Each Price
AIIDVFR1W	1-gang with retrofit box	4	7.13
AIIDVFR2W	2-gang with retrofit box, for power or low-voltage	4	11.10

## Recessed TV Box



AIITVB613

Part #	Description	Box Qty.	Each Price
AIITVB613	13" wide box fits in 16" O.C. studs for horizontal or vertical installation	1	11.80
AIITVBS613	Same as above but steel	1	29.50
AIITVBU505*	2-gang - duplex receptacle kit with retrofit line/low box, white - *BL-Black	1	9.18
AIICED130	TV box w/slotted cover	1	2.16
AIITVL508	Low-Profile TV box for shallow wall depths, great for flat TVs	1	14.09
AIITVBRA1K	1-gang TV Bridge Kit	1	44.45
AIITVBRA2K	2-gang TV Bridge Kit	1	54.68

## Garden Posts

Part #	Description	Box Qty.	Each Price
AIIGP19*	19.5" post for GFCI outlet	6	23.28
AIIGP26*	26" post for GFCI outlet	6	39.31
AIIGPD19*	19.5" post for GFCI outlet w/ in-use cover	6	20.95
AIIGPBK35*	35" post with bollard light fixture	1	141.62
AIIGPD9*	9" deck mount for GFCI outlet/light fixture	1	20.95
AIIGP37*	37" post for GFCI outlet/light fixture	4	59.27
AIIGPX18*	18" extender for above post	4	31.75
AIIGPL19*	19.5" low profile post for light fixtures	6	15.87
AIIGPI75*	Up to a 75 watt flood light for posts	4	25.09
AIIGPF13*	13 watt fluorescent flood light	4	44.43
AIIGPP60*	Pagoda-style light fixture; style 1	4	26.60
AIIGPP60L*	Pagoda-style light fixture; style 2	4	29.43

\*B-Black and BR-Bronze. Other Colors Available. Call for Pricing.



AIIGP19



AIIGPI75



AIIGPD19



AIIGPBK35



AIIGPD9



AIIGP37



AIIGPL19



AIIGPF13



AIIGPP60



AIIGPP60L



**Line Voltage boxes (No upcharge for broken cases)**



**CARB122A**



**CARB120R**





		Box Qty.	Ea. Price
CARB122A-UPC	1-gang box with nails 3 1/2" depth, 22 cubic in.	100	0.84
CARB232A-UPC	2-gang box with nails 3" depth, 32 cubic in.	50	1.82
CARB455AH	4-gang box with nails 2 1/2" depth, 60 cubic in.	25	7.69
CARB120R	1-gang box, old work case, 3 5/8" depth, 20 cubic in.	50	3.21
CARB225R-UPC	2-gang box, old work case, 2 3/4" depth, 25 cubic in.	30	5.78
CARB355R	3-gang box, old work case, 3 11/16" depth, 55 cubic in.	6	10.64
CARB520A-UPC	Ceiling box with nails, 4" dia., 20 cubic in.	75	2.09

**Flexible Electrical Non-metallic Tubing**



Part No.	Color	Nom. I.D.	Nom. O.D.	Min. Bend Radius	Coil Length (ft.)	Wt. per 100 ft. (lbs.)	Price per roll
CAR12005-200	Blue	0.56	0.84	6"	200	10	124.00
CAR12005Y-200	Yellow	0.56	0.84	6"	200	10	144.00
CAR12005R-200	Red	0.56	0.84	6"	200	10	148.00
CAR12007-100	Blue	0.76	1.05	6"	100	14	87.00
CAR12007Y-100	Yellow	0.76	1.05	6"	100	14	99.00
CAR12007R-100	Red	0.76	1.05	6"	100	14	111.00
CAR12008-100	Blue	1	1.315	6"	100	22	130.00
CAR12008Y-100	Yellow	1	1.315	6"	100	22	150.00
CAR12008R-100	Red	1	1.315	6"	100	22	213.00

**Flexible Electrical Non-metallic Tubing Accessories**

		Carton Qty.	Price each		Carton Qty.	Price each	
CARA240D	1/2" ENT quick connector adapter	150	1.04	CARE943D	1/2" ENT male term. adapter	150	0.27
CARA243D	1/2" ENT quick connector threaded adapter	150	1.57	CARE940E	3/4" ENT standard coupling	100	0.26
CARA253D	1/2" ENT quick connector snap-in adapter	150	1.10	CARE943E	3/4" ENT male term. adapter	125	0.45
CARA240E	3/4" ENT quick connector adapter	100	1.37	CARE940F	1" ENT standard coupling	50	0.39
CARA243E	3/4" ENT quick connector threaded adapter	100	2.81	CARE943F	1" ENT male term. adapter	50	0.60
CARA253E	3/4" ENT quick connector snap-in adapter	100	1.95				
CARA240F	1" ENT quick connector adapter	50	2.58		<b>CARA240D</b>		<b>CARE943D</b>
CARA243F	1" ENT quick connector threaded adapter	50	4.47		<b>CARE940E</b>		<b>CARE943E</b>
CARA253F	1" ENT quick connector snap-in adapter	50	3.00		<b>CARE940F</b>		
CARE940D	1/2" ENT standard coupling	150	0.20				

The Box/Carton Quantities are Noted for Reference Only. No Minimum Purchase is Required.

**Low-Cost Alternatives**

*Line Voltage Accessories for the Home*

**Power Strips/Remote Control**



**BL215001**



**BL215002**



**BL215010**



**BL215018**



**BL210561**



**BL210563**



**BL215025**

BL215001	6 outlet strip with surge, 3' cord, 15A, 90J	4.02	BL215025	Remote controlled outlet, 120VAC, 10A	13.03
BL215002	6 outlet strip with surge, 6' cord, 15A, 90J	5.00	BL210561	25' outdoor extension cord, 12GA, triple tap	29.05
BL215010	6 outlet strip with surge, 12' cord, 15A, 90J	8.07	BL210563	50' outdoor extension cord, 12GA, triple tap	53.99
BL215018	8 outlet HD strip, 15A circuit breaker, 5' cord	14.65	<b>Other Surge Strips Available. Call for Details.</b>		



## Structured Cable Management Systems (No Upcharge for Broken Cases)

		Case	Each
AIINM904	Snap-in blank for knockouts, 1½", gray plastic	25	0.36
AIISB130	Bushing, non-metallic for metal studs, fits standard 1" knockout	100	0.20
AII4404	Snap-in bushing for knockouts, 1½", gray plastic	250	0.25
AIIBC25	1/4" beam clamp for use with the above two cable hangers	25	0.69
AIILV1	Low-voltage mounting bracket, old work, single gang, plastic, adj. ¼" - 1" walls	100	0.92
AIILVA1	Adjustable depth 1-gang low-voltage mounting bracket for new construction	25	2.09
AIILV1RP	Super sturdy low-voltage mounting bracket, old work, single gang, plastic, adj. ¼" - 1" walls	25	1.97
AIILV2	Low-voltage mounting bracket, old work, double gang, plastic, adj. ¼" - 1" walls	50	1.40
AIILVA2	Adjustable depth 2-gang low-voltage mounting bracket for new construction	10	2.66
AIILV2RP	Super sturdy low-voltage mounting bracket, old work, double gang, plastic, adj. ¼" - 1" walls	10	3.17
AIILV3	Low-voltage mounting bracket, old work, 3-gang, plastic, adj. ¼" - 1" walls	50	2.37
AIILV4	Low-voltage mounting bracket, old work, 4-gang, plastic, adj. ¼" - 1" walls	50	3.96
AIILVMB1	Low-voltage mounting bracket, new construction, single gang, plastic	100	0.77
AIILVMB2	Low-voltage mounting bracket, new construction, double gang, plastic	50	1.34
AIILVS1	Screw-on new construction bracket, single gang, low-voltage mounting bracket	50	0.52
AIILVN1	Nail-on new construction bracket, single gang, low-voltage mounting bracket	50	0.46
AIILVR1	Low-voltage mounting bracket, old work, round, plastic, adj. ¼" - 1" walls	25	1.55
AIIBE1	Single-gang box extender, add up to 1½" to boxes set back from wall surface	25	1.09
AIIBE2	Double-gang box extender, add up to 1½" to boxes set back from wall surface	25	1.52
AIISP100	Safety plate, flat 16 gauge steel, 1½" x 2¾"	100	0.16
AIIDVFR1W	Indoor IN BOX, recessed single gang box, great for kitchens/behind furniture	4	7.13
AIIDVFR2W	Indoor IN BOX, recessed double gang box, great for kitchens/behind furniture	4	11.10
AIITVB613	TV Box, recessed double gang electrical box with 2 low voltage knock outs	1	11.80
AIITVBU505	TV Box recessed power/low voltage box, old work. Includes box, receptacle, CEDH1 and wallplate	4	9.18
AIITVBU507*	TV Box, 3-gang recessed with one power and two low-voltage openings. *B-Black (leave off for White)	1	10.49
AIIT205	CableWay, cable runway support system, 5 foot trough for line or low voltage	10	12.59
AIIT23A	CableWay, cable runway support system, 90 degree fitting for corners	10	4.60
AIIT23C	CableWay, cable runway support system, coupling for joining T205	10	1.24
AIIT23E	CableWay, cable runway support system, end cap for terminating T205	10	0.99
AIIT23H	CableWay, cable runway support system, hanger bracket for T205	10	1.64
AIIT23T	CableWay, cable runway support system, "T" adapter	10	7.13

## The Scoop Series Entrance Plates and Hoods

AIICE1	Single-gang, reversible-White	1.37	AIICE1BL	Single-gang, reversible-Black	1.44
AIICE2	Double-gang, reversible-White	2.09	AIICE2BL	Double-gang, reversible-Black	2.09
AIICER1	CE1 w/ removable plate-White	1.80	AIICER1BL	CE1 w/ removable plate-Black	1.80
AIICER2	CE2 w/ removable plate-White	2.52	AIICER2BL	CE2 w/ removable plate-Black	2.52
AIICED1	Single-gang reversible, decorator style-White	1.37	AIICED1BL	Single-gang reversible, decorator style-Black	1.44

## Weatherproof Covers

AIIDBK88C	Weatherproof, non-metallic keypad enclosure, 7-1/4" x 7-3/4" x 1-1/2"-Clear	11.80
AIIDBK88W	Weatherproof, non-metallic keypad enclosure, 7-1/4" x 7-3/4" x 1-1/2"-White	11.80
AIIDBPH1C	Horizontal while-in-use cover for outlets-Clear	9.52



## D-Rings

AIID22	Non-damaging wire management ring, 2.25" x 2"	1.05
AIID33	Non-damaging wire management ring, 3.25" x 3.25"	1.15
AIID35	Non-damaging wire management ring, 3.25" x 5"	1.52



**Structured Cable Management Systems (No Upcharge for Broken Cases)**

CARSC100A



CARSC300PRB

		Case	Each
CARSC100A	Single-gang low-voltage bracket	24	1.17
CARSC100ADJC	Single-gang adjustable low-voltage bracket, cut-off	24	2.96
CARSC100RR	Single-gang old-work bracket, low-voltage	12	0.97
CARSC200A	Dual-gang low-voltage bracket	24	1.79
CARSC200ADJC	Dual-gang adjustable low-voltage bracket, cut-off	20	5.13
CARSC200DV	Dual-gang dual-voltage box	16	1.86
CARSC200RR	Dual-gang old-work bracket, low-voltage	6	2.22
CARSC300A	Triple-gang low-voltage bracket	5	3.18
CARSC300PRB	Triple-gang recessed dual voltage TV bracket	20	13.26
CARSC12CC	1/2" three wire stacking staples, 10 pack	10	5.41
CARSC14CC	1/4" coaxial staple, 10 pack	10	75.70
CARSC34CC	#6 SER (service entrance staple), 10-pack	20 pack	58.30

**Resi-Gard Adapters (No Upcharge for Broken Cases)**

CARSCA243E

		Case	Each
CARSCA240E	3/4" Resi-Gard quick connector adapter	25	0.85
CARSCA243E	3/4" Resi-Gard quick connector threaded adapter	25	1.39
CARSCA253E	3/4" Resi-Gard quick connector snap-in adapter	25	1.06
CARSCA240F	1" Resi-Gard quick connector adapter	20	1.44
CARSCA243F	1" Resi-Gard quick connector threaded adapter	20	1.85
CARSCA253F	1" Resi-Gard quick connector snap-in adapter	20	1.62

**Resi-Gard Conduit (No Upcharge for Broken Cases)**

CARSC E943J



CARSC E977JC



Resi-Gard

		Case	Each
CARSC E4X1-100	3/4" Resi-Gard, 100'	1	55.00
CARSC E4X1-1000	3/4" Resi-Gard, 1000'	1	500.00
CARSC E977EC	3/4" Resi-Gard conduit clamp - 5 pack	20	1.73
CARSC F4X1C-100	1" Resi-Gard with tape, 100'	1	72.00
CARSC F4X1C-1500	1" Resi-Gard with tape, 1500'	1	855.00
CARSC E977FC	1" Resi-Gard conduit clamp - 5 pack	12	3.08
CARSC H4X1C-50	1 1/2" Resi-Gard with tape, 50'	1	52.00
CARSC E977HC	1 1/2" Resi-Gard conduit clamp - 5 pack	6	3.44
CARSC E940H	1 1/2" Resi-Gard standard coupling	25	0.67
CARSC E943H	1 1/2" Resi-Gard male termination adapter	25	0.88
CARSC J4X1C-50	2" Resi-Gard with tape, 50'	1	71.50
CARSC J4X1C-500	2" Resi-Gard with tape, 500'	1	720.00
CARSC E977JC	2" Resi-Gard conduit clamp - 5 pack	6	3.83
CARSC E940J	2" Resi-Gard standard coupling	30	0.93
CARSC E943J	2" Resi-Gard male termination adapter	50	1.17

**Floor Boxes - Priced per Case**

CARE9761BR

		Case	Price
CARE976RFB	Rectangular floor box base assembly	3	202.20
CARE976AK2	Activation Kit 2, rectangular floor box	3	87.99
CARE9761BR	Cover assembly, single, brass	3	696.99
CARE9762BR	Cover assembly, double, brass	3	1,099.02
CARE9762S	Cover assembly, double, slate	9	1,289.61
CARE9763S	Cover assembly, triple, slate	6	1,117.68
CARB121BFBR	Single-gang adjustable residential floor box	8	493.04
CARB234BFBB	Dual-gang adjustable residential floor box	4	1,007.60

**Tools**

CARCC120B

CARCC120B	Small conduit cutter, for fast, smooth field cuts of 1/2" through 1" conduit	44.27
-----------	--	-------

**Enclosures**

CARNC664	6x6x4 NEMA enclosure with external hinged cover-clear. Meets NEMA 1, 2, 3, 3S, 3X, 3SX, 4, 4X, 12 standards.	282.60
CARNC16146	16x14x6 NEMA enclosure with external hinged cover-clear. Meets NEMA 1, 2, 3, 3S, 3X, 3SX, 4, 4X, 12 standards.	339.58



### Are you looking for Fiber?

Leviton will manufacture custom-made fiber bundles with all connectors attached. They even attach the pull-sock. Prices are custom quoted, so please have your detailed needs.



Call

### HDMI over Cat 5e/Cat 6

Cat 5e distribution allows you to use inexpensive UTP wire to distribute HDMI to locations where the proper wire is either not available or not cost-effective. As signal quality increases Cat 6e becomes a better choice due to more bandwidth.



Pages 172-173

### For all your cabling needs.

From 22/2 for security to RG6 for CATV/Satellite as well as direct burial wire for your landscape lighting, Wavenet has cable to fit almost all applications. Please call us if you have questions when specifying wire.



Pages 224-225

### Interconnect Cables

Connect all of your A/V gear with these quality cables. Different levels of quality are available to suit any customers' needs. Please give us a call with questions regarding what interconnect cables to use.



Page 177

### Distributed Audio Systems

Run 16/4 and Cat 5 to the keypad and then 16/2 from there to each speaker you have prewired for C-Series, MRC88, M4, LyriQ, Hi-Fi 2 or A-BUS.



MRC88, M4, LyriQ, Hi-Fi 2 or A-BUS.

### Speaker Cable

Use 16-gauge for runs under 100' and 14-gauge for home theaters or runs over 100.'



### Telephone

Cat 5e has become the standard wire to run for both telephone and home networking.



### Networking

Cat 6 is available for high bandwidth. Fiber is generally not used for networking at this time. Fiber can be used to connect two buildings.



### Security

Most keypads are 22/4, but touchscreens are frequently looking for Cat 5. Use 22/2 for door/window sensors and 22/4 for powered devices, such as motion detectors and glass breaks.



### Fire Alarm

Red fire-wire is required for code. For a home fire system, you must run fire wire to all fire detectors, fire alarm sounders, the transformer, keypads and powered devices.

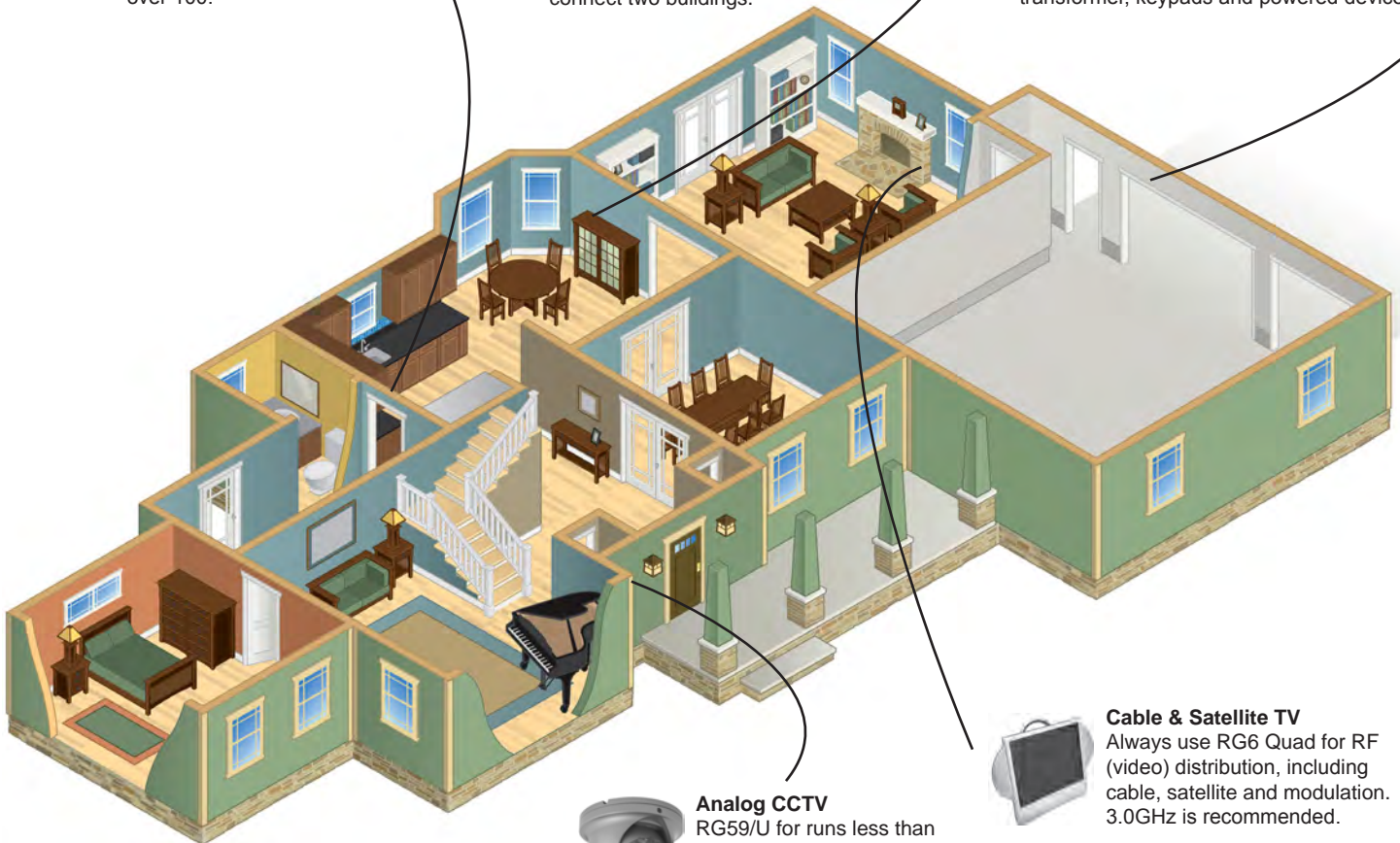

### Analog CCTV

RG59/U for runs less than 750 feet. RG6/U (solid copper center) for runs less than 1,500 feet. 18/2 is common for the power wire. If you are using baluns, you can use Cat 5e, up to 2200 feet.



### Cable & Satellite TV

Always use RG6 Quad for RF (video) distribution, including cable, satellite and modulation. 3.0GHZ is recommended.

Wire and Cable Ordering Options

Put-up and color availability vary by part (prices shown per 1000' unless otherwise noted)

Put-up (packaging)	Last number in code: 1 = pull box, 2 = reel, 3 = reel in box [Please note: reels (2) are charged additional "no-box fee" by UPS/FedEx]
** - Colors	WH-White, YL-Yellow, OR-Orange, GN-Green, BL-Blue, BK-Black, GY-Gray, PR-Purple, PK-Pink, RD-Red
Type	Defines how and where the cable can be used. In most cases the higher type of wire can be substituted for the lower type. CM = communications wire usually in a cable tray, CL3 = in-wall rated for residential use, CMR = verticle riser-rated for commercial use, CMP = Commercial ceiling airspaces, STP, PE, FPLR = Fire Alarm cable, CMX = Outdoor



**Wire pricing is always subject to change due to market fluctuations in copper.**



Cat 5e for Network, Phone, Intercoms, etc. (1000' only)

WAV5E04UR**1	Standard PVC Cat 5e: 24AWG, 4 pair, 350MHZ	CMR	(BK, BL, GN, GY, OR, PK, PR, RD, WH, YL)	1000' Pull Box	63.07
WAV5E04UP3**	Plenum Cat 5e, 24AWG, 4 pair, 350MHZ	CMP	(BL, GN, GY, OR, RD, WH)	1000' RIB	143.64
WAV5E04SR**1	Shielded PVC Cat 5e: 24AWG, 4 pair, shielded, 350MHZ	CMR	(BL, GY, WH)	1000' Pull Box	134.89
WAV5E04FP**3	Shielded Plenum Cat 5e: 24AWG, 4 pair, shielded, 350MHZ	CMP	(BL, WH)	1000' RIB	294.76
WAV5E04UR**1-S	Stranded Conductor PVC Cat 5e: 24AWG, 4 pr, stranded, 350MHZ	CMR	(BK, BL, GN, GY, OR, PK, PR, RD, WH, YL)	1000' Pull Box	93.68
WAV5E0SPBK2	Direct Burial Cat 5e: 24AWG, 4 pair, direct burial, 350MHZ	CMX	(BK)	1000' Reel	112.41
WAV5E0SPGBK2	Direct Burial Cat 5e: Gel PE, 24AWG, 4 pair, direct burial, 350MHZ	CMX	(BK)	1000' Reel	112.41
WAV5E25URGY2	PVC 25 Pair Cat 5e: 24AWG, 25 pair	CMR	(GY)	1000' Reel	612.01

Cat 6 for Network (1000' only)

WAV6E04UR**3	PVC Cat 6: 23AWG, 4 pair, 550MHZ	CMR	(BL, GN, GY, RD, WH, YL)	1000' RIB	98.67
WAV6E04UP**3	Plenum Cat 6: 23AWG, 4 pair, 550MHZ	CMP	(BL, GN, GY, RD, WH, YL)	1000' RIB	228.57
WAV6E04SR**	Shielded PVC Cat 6: 23AWG, 4 pair, shielded, 550MHZ	CMR	(BL, GY, WH)	1000' RIB	166.12
WAV6E0SPBK2	Direct Burial Cat 6: 23AWG, 4 pair, outdoor, 550MHZ	CMX	(BK)	1000' Reel	154.88
WAV6E0SPGBK2	Direct Burial Cat 6: Gel PE, 23AWG, 4 pair, outdoor, 550MHZ	CMX	(BK)	1000' Reel	154.88

Broadband COAX

WAVRG6QRBK1	Quad Shield PVC RG6: 18AWG, CCS, 3.0GHZ	CMR	(BK)	1000' Pull Box	154.88
WAVRG6QOSPBK2	Direct Burial Quad Shield RG6: 18AWG, CCS, 3.0GHZ	CMR	(BK)	1000' Reel	69.94
WAVRG6QPWH1	Plenum Quad Shield RG6: 18AWG, CCS, 3.0GHZ	CMP	(WH)	1000' Pull Box	316.00
WAVRG6UR**1	PVC Dual Shield RG6: 18AWG, 60% shield, CCS, 3.0GHZ	CMR	(BK, WH)	1000' Pull Box	46.21
WAVRG6OSPBK2	Direct Burial RG6: 18AWG, 60% shield, CCS, 3.0GHZ	CMX	(BK)	1000' Reel	59.95
WAVRG11RBK2	PVC RG11: 14AWG, 1.0GHZ	CMR	(BK)	1000' Reel	128.65

**\*\*\*Wire pricing is always subject to change due to market fluctuations in copper\*\*\***

**\*\*\*Price per 1000' unless otherwise noted\*\*\***



Would You Like Free Freight on Wire?

Order your wire in bulk (minimum order is \$3125.00.) and get FREE ground freight shipping (drop shipped). You can mix Cat 5, RG-6, Combination Cable, Speaker/Fire Alarm/Security Wire in the same order.

## CCTV and RG59 COAX

WAVH59182BCR**2	PVC Siamese CCTV Cable: RG59 95% bare copper + 18/2	CMR	(BK, WH)	1000' Reel	153.63
WAVH59182BCR**3	PVC Siamese CCTV Cable: RG59 95% bare copper + 18/2	CMR	(BK, WH)	500' RIB	77.44
WAVH59+182PWH2	Plenum Siamese CCTV Cable: RG59 95% bare copper + 18/2	CMP	(WH)	1000' Reel	299.76
WAVH59+182PWH3	Plenum Siamese CCTV Cable: RG59 95% bare copper + 18/2	CMP	(WH)	500' RIB	157.37
WAVRG59R**1	RG59 95% PVC: 20AWG, 95% bare copper, 3.0GHZ	CMR	(BK, WH)	1000' Pull Box	73.69

## Speaker Cable

WAVAC1202RWH15	12/2 Audio Cable: 16AWG, 2C 65 strand oxygen free copper	CMR	(WH)	500' Pull Box	73.69
WAVAC1402R**15	14/2 Audio Cable: 14AWG, 2C 105 strand oxygen free copper	CMR	(BL, WH)	500' Pull Box	88.68
WAVAC1404R**15	14/4 Audio Cable: 14AWG, 4C 105 strand oxygen free copper	CMR	(BL, WH)	500' Pull Box	176.11
WAVAC1402OSP BK1	14/2 Direct Burial Audio Cable, 2C 65 strand oxygen free copper	CM	(BK)	500' Pull Box	99.92
WAVAC1404OSPWH4	14/4 Direct Burial / UV-Rated Audio Cable, 65 strand oxygen free copper	CMR	(WH)	1000' Pull box	99.92
WAVAC1602R**15	16/2 Audio Cable: 16AWG, 2C 65 strand oxygen free copper	CMR	(BL, WH)	500' Pull Box	58.70
WAVAC1604R**15	16/4 Audio Cable: 16AWG, 4C 65 strand oxygen free copper	CMR	(BK, WH)	500' Pull Box	99.92
WAVAC1602OSP**4	16/2 Direct Burial Audio Cable, 2C 65 strand oxygen free copper	CM	(BL, WH)	1000' Pull box	239.81

## Security Wire

WAVSC2202R**1	22/2 Solid Security wire, 22AWG/2C	CMR	(GY, WH)	1000' Pull Box	31.85
WAVSC2202RWH1-S	22/2 Stranded Security wire, 22AWG/2C	CMR	(WH)	1000' Pull Box	36.85
WAVSC2204R**1	22/4 Solid Security wire, 22AWG/4C	CMR	(GY, WH)	1000' Pull Box	54.33
WAVSC2204R**1-S	22/4 Stranded Security wire, 22AWG/4C	CMR	(GY, WH)	1000' Pull Box	61.83

## Fire-Wire (Always Red)

WAVFC1802URD1	18/2 Unshielded Fire Alarm Riser-rated: 18AWG/2C fire alarm cable	FPLR	(RD)	1000' Pull Box	61.83
WAVFC1602URD1	16/2 Unshielded Fire Alarm Riser-rated: 16AWG/2C fire alarm cable	FPLR	(RD)	1000' Pull Box	106.16
WAVFC1402URD2	14/2 Unshielded Fire Alarm Riser-rated: 14AWG/2C fire alarm cable	FPLR	(RD)	1000' Reel	154.88
WAVFC1804URD1	18/4 Unshielded Fire Alarm Riser-rated: 18AWG/4C fire alarm cable	FPLR	(RD)	1000' Pull Box	154.88
WAVFC1604URD1	16/4 Unshielded Fire Alarm Riser-rated: 16AWG/4C fire alarm cable	FPLR	(RD)	1000' Pull Box	154.88
WAVFC1402SRD2	14/2 Shielded Fire Alarm Riser-rated: 14AWG/2C fire alarm cable	FPLR	(RD)	1000' Reel	192.35
WAVFC1804SRD1	18/4 Shielded Fire Alarm Riser-rated: 18AWG/4C fire alarm cable	FPLR	(RD)	1000' Pull Box	158.62
WAVFC1604SRD2	16/4 Shielded Fire Alarm Riser-rated: 16AWG/4C fire alarm cable	FPLR	(RD)	1000' Reel	209.83

**Wire pricing is always subject to change due to market fluctuations in copper.**

## Power Cables

WAVPW18SM	18/2 7-Strand Shielded PVC: 18AWG/2C	CMR	(GY)	1000' Pull Box	96.17
WAVPW18UM**1	18/2 7-Strand Unshielded PVC: 18AWG/2C	CMR	(GY, WH)	1000' Pull Box	79.94

## Combination Cables

WAVH15E164MYL2	1 Cat 5e + 16/4 Audio Cable PVC: CAT 5e + 16/4 audio cable	CM	(YL)	500' Reel	159.87
WAVH15E16QMBL2	1 Cat 5e + 1 RG6Q PVC: Cat 5e + RG6Q	CM	(BL)	500' Reel	76.19
WAVH25E26Q2FYL2	2 Cat 5e + 2 RG6Q + Fiber PVC: Cat 5e + RG6Q + Fiber	CM	(YL)	500' Reel	307.25
WAVH25E26QMBL2	2 Cat 5e + 2 RG6Q PVC: 2 Cat 5e + 2 RG6Q	CM	(BL)	500' Reel	197.34
WAVH26E26QMGN2	2 Cat 6e + 2 RG6Q PVC: 2 Cat 6e + 2 RG6Q	CM	(GN)	500' Reel	241.06

**Always follow local, state, and national codes and adhere to professional wiring practices.**

Order your wire in bulk (minimum order is \$3125.00.) and get FREE ground freight shipping (drop shipped).  
You can mix Cat 5, RG-6, Combination Cable, Speaker/Fire Alarm/Security Wire in the same order.



**ORDERING:** A toll free call to 1-800-282-8864 connects you to our knowledgeable sales team who seeks to provide you with the information, support and products you need to provide your clients with total solutions. We will gladly provide you with quotations, product information and technical assistance. Our business hours (Eastern Time) are 7:30 am to 6:00 pm Monday through Friday. **Orders can be placed 24 hours via toll free fax at 1-866-542-0470, on our after-hours voice mail order desk at our toll free number, 1-800-282-8864, at our secure dealer web site: [www.worthdist.com](http://www.worthdist.com), or by e-mail to [sales@worthdist.com](mailto:sales@worthdist.com).** We do not have a minimum order.

**SAME DAY SHIPPING:** All orders placed by 4:00 pm Eastern Time (Monday - Friday) will be shipped the same day, F.O.B. Tafton, PA, based on product availability. Our standard methods of shipping are UPS and FedEx Ground. Guaranteed two-day, overnight and Saturday delivery are available for time sensitive orders at an additional fee. US Mail Priority and Parcel Post shipping is also available to some areas.

**PAYMENT TERMS:** We accept VISA, MasterCard, Discover and American Express with no additional charge for credit card payment. We will also ship C.O.D. certified check with prior approval. Please note, FedEx and UPS do not accept cash C.O.D. payments. The carrier's C.O.D. fee will be added to all C.O.D. orders. Our credit application is located on pages 193 and 194. All portions of the credit application **MUST** be completed and signed. Partially completed credit applications cannot be processed. A credit application is not required for credit card orders. A \$25 fee will be charged for any returned check. Prepaid orders from international customers are welcome. Payment options include wire transfer, money order, secured check and PayPal. Additional fees may apply.

**INSURANCE:** Orders under \$100 are automatically insured by FedEx or UPS. Orders greater than \$100 will incur an additional insurance fee.

**REFUSALS/INCORRECT ADDRESS:** Any orders that are refused or are undeliverable will be charged shipping fees to the customer and return shipping fees to Worthington Distribution, plus a restocking fee of 10% of the invoiced amount. FedEx and UPS impose an address correction fee, which Worthington Distribution will bill you for if an incorrect address is given at time of order. This includes, but is not limited to, incorrect street address, missing suite/apartment numbers, or incorrect ZIP code. To avoid both this charge and shipping delays, please confirm accurate shipping information at time of order.

**DROP SHIPMENTS:** We can ship directly to your job site or client as requested. Please make sure that someone will be available to sign for the package(s) or arrange for a signature release on file with the carrier. Manufacturer special orders, large orders and expedited orders may also be drop shipped directly from the manufacturer to your location. Although Worthington Distribution does not charge for drop shipments, please note that several manufacturers do charge a drop ship fee. You will be billed separately for any incurred drop ship fees and shipping costs.

**BILLING/SHIPPING DISCREPANCIES:** Shipping or billing discrepancies (misshipped items, missing items, incorrect charges, etc.) must be brought to our attention within **5 days of receipt of package**.

**DAMAGED IN SHIPPING:** When you receive your merchandise, please open all boxes immediately to check for contents and/or damage. Every effort is made to pack your goods to prevent damage during shipping; however, if damage does occur, you must notify Worthington Distribution within **5 days of receipt of package**. We will file a claim with the carrier, and upon credit from the carrier, we will issue credit to you. FedEx and UPS reserve the right to inspect packaging and damaged products; packaging and product must be made available for inspection at the delivery address. If your package arrives visibly damaged, please ask your courier to make a note of the damage at time of delivery.

**DEFECTIVE RETURNS:** Although Worthington Distribution understands how exasperating it is to receive a defective product, we must adhere to all **manufacturer warranty requirements**. Therefore, in accordance with the manufacturer's terms and conditions, the manufacturer has the right to repair or replace defective product at their discretion. Some manufacturers will handle these returns directly. Upon manufacturer's approval we will replace defective products returned to us within 30 days of the invoice date. Defective products **must** be returned in the manufacturer's original packing, and the carton **must** include **all** components and other items originally packaged with the product, including all manuals, etc. **Do not write on or use the product box as a shipping box**. You pay shipping to us, and we will pay for domestic return shipping to you via UPS Ground. Many manufacturers reserve the right to return your product to you, should the product prove to be operational; in these cases credit will not be issued for the product, and return shipping fees will be billed to you. Please feel free to contact us for free technical assistance and troubleshooting if you feel you have received a defective item. Please note that some manufacturers require factory troubleshooting prior to RMA issuance.

**ALL RETURNS:** **There are no returns on special order merchandise.** All return requests must be made within **30 days** from date of purchase. During this 30-day period, all new and unused products that are currently manufactured, in their original packaging with all hardware and manuals, and in resellable condition, can be returned without a restocking fee; **installed items cannot be returned**. You must pay shipping to us. Product not meeting these criteria, in most cases, cannot be returned or is subject to a restocking fee. Due to copyright laws, software, books, and manuals are not returnable. Wire and conduit are also not returnable. Shipping charges are not refundable and returns must be sent to Worthington Distribution freight prepaid. Worthington Distribution is not responsible for returns lost or damaged during shipping. **Our RMA request form must be completed before an RMA number is issued.** To obtain an RMA request form, contact us at 1-800-282-8864, or you can download the RMA form at [www.worthdist.com>Returns](http://www.worthdist.com>Returns). RMA numbers are issued to ensure proper credit is applied or replacement product is handled correctly. You must write the RMA number on the outside of the shipping package you are returning, not on the manufacturer's package. RMA numbers are valid for **15 days** from date of issue. Returns without an RMA number on the box are subject to refusal. **Note: It is the customer's responsibility to verify compatibility and customer commitment prior to ordering and installing any items. Store credit must be used within one year from date of return.**

**PRICING:** Prices in this catalog supersede all previous pricing. Although catalog price is generally held, prices may change due to market fluctuation. This can result in lower pricing to you, our valued customer. Prices and specifications are subject to change without notice. We are happy to provide written quotes for your upcoming jobs. Quotes are valid for 30 days from date of issuance. Please log in to the dealer store at [www.worthdist.com](http://www.worthdist.com) for the most current pricing.

**DISCLAIMER:** Although every effort has been made to ensure the integrity of this publication, occasional omissions, typographical errors or misprints do occur. Worthington Distribution cannot be held responsible for any misrepresentation associated with any product or price in this publication. All trademarks and registered trademarks are the property of their respective companies. No portion of this publication may be reproduced without express written permission from Worthington Group, Ltd.

**Placing an order with Worthington Distribution indicates acceptance of these terms and conditions.**

# Russound



# 70v Commercial

## Expand Your Marketplace



### XZone70V

70/100V Streaming Mixer Amplifier

The all-in-one solution for all of your light commercial jobs

### AW70V6

70v Surface Mount Indoor/Outdoor Speakers

Easy to install, easy to adjust, perfect for every job, indoors or out

### ALT-70V-50

50-Watt 70V Volume Control

Ultra-reliable and designed for years of use



**Building Sound Solutions™**

[www.russound.com](http://www.russound.com)





# WORTHINGTON

## DISTRIBUTION

566 RT 390 • TAFTON, PA 18464

PRESORTED  
BOUND PRINTED  
MATTER  
U.S. POSTAGE  
PAID  
RIPON, WI  
PERMIT NO 100



CALL 800-282-8864 • VISIT US [WORTHDIST.COM](http://WORTHDIST.COM)

## WORTHINGTON UNIVERSITY

### TRAINING

- ✓ Custom trainings - we fit the training to the products and technologies that you want to learn about
- ✓ Live webinars
- ✓ Online knowledge base featuring articles from our in-house experts
- ✓ Hands-on classroom remodeled with the latest products and systems
- ✓ Class led by industry veterans with years of experience
- ✓ 9 workstations fitted with full automation systems provide hands-on experience
- ✓ Extensive training on lighting systems using the latest communication technologies

### TECHNICAL SALESSTAFF

- ✓ Hands-on and field experienced
- ✓ Unparalleled pre-sales design assistance and technical support after the sale
- ✓ We use the experience we have gained with thousands of dealers nationally to help each dealer individually
- ✓ Our Technical Sales staff has access to a lab with many of the products you use every day

[WWW.WORTHINGTONU.COM](http://WWW.WORTHINGTONU.COM)

NATIONAL DISTRIBUTOR | [WWW.WORTHDIST.COM](http://WWW.WORTHDIST.COM) | 800-282-8864

