

Thank You!



Thank You! We sincerely appreciate your business and will do anything within reason to keep you happy. If you are unhappy with our service, products or whatever, call (931) 553-8651 and ask for the manager or write us a letter giving your name, address, phone number and the nature of your complaint. We really try to give service along with fair prices. We are in our 43rd great year of serving shooters and the Shooting Industry.

Pricing & Typographical Errors

PRICES & TYPOGRAPHICAL ERRORS: Prices in this catalog are EFFECTIVE February 1st, 2012 and are SUBJECT TO CHANGE WITHOUT NOTICE. We are human, and due to the sheer volume of items that we carry, errors do occur. We cannot be held responsible for typographical errors or price misprints contained in this catalog. We apologize in advance. Please ask for or check our website for current prices.

COMPONENT & AMMUNITION UPDATES: While availability does seem to have stabilized somewhat, indications are that pricing could be an issue this year. As the new administration has settled in, demand for shooting related products has more than doubled and the rumors of more legislation are circling. We do not know how this will affect laws and supply. The prices shown in this catalog are current as of February 2012. We apologize for any increases or price discrepancies in advance.

Honest Shipping & Fast Service!



SHIPPING OUT ORDERS: 99% of all in-stock orders are shipped usually within 24 business hours of receipt.

MIDSOUTH'S HONEST SHIPPING: We charge only what it costs to get a package from Clarksville, Tennessee to your door step. We do not use shipping as a profit center. We obviously want to keep your shipping charges as low as possible to keep you happy with our service.

Tennessee Residents

SALES TAX: Tennessee Sales Tax of 9.5% is added to orders from Tennessee only, unless you have a tax certificate on file with us. Sales tax is not added to out of state orders. If you are an FFL holder and want to pick up an order (from any state), we must have a copy of your FFL, and state tax number on file. If you don't have this information on file with us, either send one or bring one with you. Call us for more information.

TWRA TAX: TN residents and Pick-Up Customers pay a .10 TWRA Tax per box of ammunition purchased.



Order Toll Free - 1-800-272-3000

Our telephone hours are 8:00 A.M. to 6:00 P.M. (Central Time), Mon - Fri. If you have trouble reaching us call our local number, 931-553-8651. Or shop On-Line 24 hours a day at www.midsouthshooters.com

Ordering Information

***All phone conversations may be monitored and or recorded to continually improve our service to you!**

TOLL FREE PHONES: Call 1-800-272-3000 to place an order. Our telephone hours are 8:00 A.M. to 6:00 P.M. (Central Time), Monday thru Friday. If you have trouble reaching us please call our local number, 931-553-8651. Our salespeople are prepared to take your orders by order (part) number and description only. For any assistance on orders, technical information or questions about past shipments, please call our business office at 1-931-553-8651. Please have order numbers ready to give to our operators before you call, this will save time and money!

MINIMUM ORDERS: The minimum amount we can process an order for is \$40.00. Any order less than \$40.00 will be assessed a \$5.00 service charge - no exceptions. Due to our low prices, we cannot process an order for less.

FFL DEALER QUALIFICATIONS: Current valid FFL with original signature, copy of sales tax certificate or business lic. and business address and hours. The FFL must be for engaging in the business of dealing firearms. (ie. FFL discount does not include Curio and Collectors) To maintain this discount, total of purchases must be a minimum of \$1,000.00 per year. FFL Can be faxed to 931-503-8037.

NON-FFL DEALERS: Information must be on letterhead, picture of store front with store name, list of store hours, complete address and phone/fax numbers, copy of business license, 3 business references, and a copy of your sales tax certificate. For further information on dealer sales call 931-553-8651 and ask for dealer accounts. (all other criteria for purchase of hazardous materials apply.) To maintain this discount, purchases must be a minimum of \$1,000.00 per year.

SPECIAL ORDERS: All special orders must be for an item that is over \$100.00. Special orders can take 4-6 weeks if available from the manufacturer. Once a special order is ordered it is done. No returns! No cancellations! No exchanges! Any problems with the item after delivery must be directed to the manufacturer.

CANADA & OVERSEAS ORDERS: LOOK AT OUR WEBSITE UNDER INTERNATIONAL ORDERS FOR MORE DETAILS. We will gladly accept orders from any country in the free world. The following items are regulated: bullets, brass and firearm components. Regulated items will be shipped by parcel post only. For all other goods we do offer Fed-Ex, or parcel post. We can not ship any liquids or sprays out of the U.S. **Fed-Ex shipping customers!** In order to expedite your package Fed-Ex may not charge you Tax, Customs and Duty fees at the time of delivery. You will see an additional charge to your credit card when we receive notification that duties and taxes were not paid on your shipment. (Fed-Ex sends customs documentation to us when these are not paid.) **WE MUST HAVE A SIGNED ORDER FORM (FAXED OR MAILED) IF YOU ARE USING A CREDIT CARD!**

Shipping Information

MIDSOUTH'S HONEST SHIPPING: We charge only what it costs to get a package from us to you. We do not use shipping as a profit center. We obviously want to keep your shipping charges as low as possible to keep you happy with our service.

HAZARDOUS MATERIALS CHARGE: Hazardous Material Transportation Charge will be \$25.00 per package (\$35.00 if Air service). If you order 5,000 primers or 20,000 primers, there is a \$25.00 charge. This charge is not per order, but per box leaving our shipping dock with a Hazardous Materials Label. Each case of powder is a \$25.00 charge. Powder and primers may be shipped together in any ground shipment for one hazardous charge provided the total weight of the order (including packaging) remains below 60lbs. We will always try to ship your boxes as economically as possible. **MSDS:** Sheets available for hazardous materials upon request.

COD FEES, SERVICE FEES & FREIGHT CHARGES: The UPS COD fee is now \$11.00 per box. Remember, this is not per order, but per box leaving our dock. If we must use 2 boxes, there will be 2 COD fees applied. If you place an order that requires several boxes for COD shipment, there will be a COD fee on each box. Freight is added to all boxes in addition to the COD fee. Freight Charges are based directly on carrier freight charts for your zone of shipment. See Payment and Refunds for COD Payment Requirements.

OVERSIZED BOXES: We try to ship all orders in as few packages as carriers will allow, but many of the large rifle and shotgun plastic carrying cases we sell are oversized for shipment. They cannot be mailed through the Post Office. Some of the cases weigh only 7 to 8 pounds but the 30 or 70 pound charge appears on your invoice. **HOW TO EFFICIENTLY USE THIS:** If you order other items we can safely put them inside the case and get up to 30 pounds or more, we then simply invoice the weight charge for the box. The extra parts must fit into the case (bullets, ammo, holsters, die sets and other small items work good for this).

Returns

RETURNS: Returns of non-defective, unused products must be in 30 days or authorized by Midsouth. No returns on powder, primers, percussion caps, ammo, software or liquids. There will be a up to a 20% restocking charge on all returned merchandise, except where we have shipped the wrong item. Sorry, no credit on returns until our return department or the factory determines the product is defective or packaging is not damaged for resale. All returns must have a return authorization. This is important! Software problems must deal directly with the factory. No returns on Special Orders. Returns on products manufactured by Savage, Nikon, Leupold, Burris, Streamlight, Barnett, Traditions & RWS must deal directly with the factory as well. Refunds on products over 30 days past purchase date will be issued in Midsouth Gift Certificate Only! Phone calls may be monitored for quality assurance.

Payment & Refunds

Sorry! We do not accept personal or business checks and we do not offer open accounts!

CREDIT CARDS: WE ACCEPT VISA, MASTERCARD, AMERICAN EXPRESS & DISCOVER ON THE PHONE, WEB, FAX & MAIL ORDERS. We must have your home mailing address for credit card verification. Just give us your name, address, phone number (home and/or work), card number and card expiration date. All cards are cleared through a Master Clearing Center.

MONEY ORDERS / CASHIER CHECKS: We do accept Money Orders and Cashiers Checks in US Funds only.

COD ORDERS & FREIGHT: All COD orders are shipped cashier check or money order only - through UPS Ground Service only (Sorry, no 2nd or Next Day service unless to Hawaii or Alaska). If this is not acceptable, please do not order COD.

REFUNDS: Credit / Debit Cards: Depending on your credit card agreement, refunds can take from 24 to 48 hours to show up on your account. **Money Orders and Cashiers Checks:** If any refund is due from prepaid orders it will be mailed to you. Please allow 10 (ten) days after shipping date to receive refund.

RETURNS AFTER 30 DAYS: Refunds on products over 30 days past purchase date will be issued in Midsouth Gift Certificate Only!

Restrictions

By ordering from Midsouth YOU assume all responsibility for your local laws and compliance of them!

RESTRICTIONS AND LOCAL LAWS: Midsouth Shooters Supply cannot possibly know all of the individual state, city and local laws and restrictions for all the products that we sell. Many states and cities prohibit particular products and YOU must be in compliance of the local laws concerning these products. If you place an order with Midsouth for products that may be restricted, you warrant us that you are authorized and in compliance with your local laws. **CHECK YOUR LOCAL LAWS BEFORE YOU PLACE AN ORDER.**

FFL'S & RESTRICTED ORDERS: If you have an FFL send us a copy for our files. We must ship these to the exact address on your FFL - no changes. Only authorized persons may place orders on FFL's. Due to new laws and restrictions in individual states, some restrictions may apply to specific items to states.

PRIMERS, POWDER & AMMUNITION: Proof of age is required in order to purchase Primers, Powder and Ammunition. You must be 18 to purchase these items (21 to purchase Handgun Ammunition)



Order Toll Free! Mon - Fri 8am to 6pm Central Time Zone 1-800-272-3000

Optics

Binoculars	4-6
Rangefinders	6-7
Electric Sights & Lasers	8-10
Spotting Scopes	11-12
Scopes	13-22
Rings & Mounts	23-36
Scope Covers & Acc.	36-38

Muzzleloaders & Firearms

Contender	39-40
Encore	40-42
Muzzleloaders & Accessories	43-54

Reloading & Ammunition

Lead Casting & Moulds	55-63
Shotshell Reloading	64-65
Metallic Reloading	66-105
Ammo Boxes	106-107
Bullets & Brass	108-121
Primers & Powder	122-124
Ammunition	125-134

Gun Cleaning & Care

Cleaning Kits	135-137
Rods, Brushes, Jags...etc	138-141
Chemicals & Solvents	142-146
Cradles & Visers	135
Gun Restoration	146
Bore Guides & Lights	147

Gunsmithing & Parts

Gunsmithing Tools	148-149
Recoil Pads & Stocks	152-155,164
Triggers	150-151
Tactical	156-160
Sights	165
Barrels & Chokes	166-168
Slings & Swivels	168-173
Speedloaders & Mags	173-177
Grips	178-180

Holsters and Gun Storage

Holsters & Belts	181-185
Gun Cases	186-191
Gun Safes Dehumidifiers	188

Range & Shooting Accessories

Rests & Bags	193-196
Shooting Safety	197-198
Bipods	195
Targets & Throwers	199-202
Chronographs	203
Airguns, SoftAir & Crossbows	204-209

Hunting Accessories

Boots & Camo	213
Hunting Accessories	210-218
Decoys, Scents & Calls	212-216
Flashlights	219-221

Cutlery

Knives	222-230
Sharpeners	231-232

Books, Software & Misc	233-239
------------------------	---------

079 - ACCURATE ARMS(WESTERN POWDER)	406-234-0422
POWDER - 123	
019 - ADVANCED TECHNOLOGY	800-925-2522
STOCKS & ACC - 152-156 161, 162 BIPODS - 195	
168 - ALLEN COMPANY	800-876-8600
GUN CASES - 40, 162,190 SHOOTING VESTS -197	
HUNTING ACC. - 210-219 SHOOTING BAGS - 196	
RANGE ACC. - 196 DUCT TAPE- 211	
137 - ALLIANT POWDER	800-276-9337
POWDER - 123 LEAD SHOT - 120	
036 - ALTRACO	415-332-1240
CALIPERS / MICROMETER - 71, 108 CLEANING - 137	
GUNSMITHING - 148-150	
141 - AO SAFETY / PELTOR	800-665-2942
HEARING PROTECTION - 198	
080 - B-SQUARE	800-433-2909
BASES & RINGS - 34-35	
SIGHTING ACC. - 38 GUNSMITH TOOLS - 148	
035 - BARNES BULLETS	800-574-9200
BULLETS - 109 CLEANING SOLVENT - 144 AMMO - 125	
MANUAL - 105 MUZZLELOADER BULLETS & ACC. -52	
058 - BARNETT CROSSBOWS	800-237-4507
CROSSBOWS - 209	
205 - BALLISTOL	800-253-2460
CHEMICALS- 143	
107 - BENJAMIN SHERIDAN/CROSMAN	800-724-7486
PELLETS - 207 MAINTENANCE-206	
143 - BERGARA BARRELS	877-892-7544
BARRELS - 45, 165	
178 - BERGER BULLETS	714-447-5456
BULLETS - 108	
012 - BIRCHWOOD - CASEY	800-328-6156
ACC.-6 GUN REFURBISHING - 146	
CLEANING SUPPLIES - 136, 142, 146	
CHOKE LUBE - 166 TARGETS - 200-201	
080 - BREAK-FREE	800-433-2909
CLEANING SUPPLIES - 144	
048 - BROWNELLS	641-623-5401
GUNSMITH SUPPLIES -149-150 CLEANING - 144	
018 - BUCK KNIVES	800-326-2825
KNIVES - 230	
181 - BUFFERTech	877-628-3337
BUFFERS - 177 CLEANING SUPPLIES - 137 GRIPS - 161	
TACTICAL ACC - 156-163	
208 - BULLDOG GUN CASES	800-843-3483
GUN CASES - 188-189 SLINGS- 173	
RANGE BAGS- 196	
023 - BURRIS	888-228-7747
SCOPES - 14-15 RANGEFINDER- 6 TRIPOD- 11	
BASES & RINGS - 30-31 RED DOT - 9	
LENS PEN - 38 SPOTTING SCOPE - 11	
027 - BUSHNELL	800-423-3537
SCOPES - 13 RED DOTS - 9	
SPOTTING SCOPES - 11 TRIPODS - 38	
BORE SIGHTERS - 38 BINOCULARS - 4	
RANGE FINDERS -6 ACC. - 12	
060 - BUTLER CREEK	800-948-1356
LENS COVERS - 37 BIKINI COVERS - 36	
STOCKS - 155 BINO ACC - 5	
SLINGS - 172 RECOIL PADS - 165	
MAG LOADER & MAGAZINES- 176, 177 GRIPS - 179	
094 - CALDWELL (BATTENFELD)	877-509-9160
SHOOTING ACCESSORIES - 192-193 EAR MUFFS - 198	
148 - CARLSON'S	785-626-3700
CHOKES - 166 HAMMER EXPANDER - 151	
020 - CCI	866-286-7436
AMMUNITION - 126, 134 PRIMERS - 124	
PRIMER STRIPS - 124 PERCUSSION CAPS -54	
072 - CLAYBUSTER	800-922-6287
WADS - 65	
166 - CMC MAGS	800-328-2447
MAGAZINES - 173 GRIPS - 180	
167 - CMC TRIGGERS	830-522-7706
TRIGGERS - 158	
085 - COLD STEEL	800-255-4716
KNIVES - 222	
215 - CVA MUZZLELOADERS	770-449-4687
MUZZLELOADERS - 50-53 POWERBELT BULLETS - 54	
226 - CZ PARTS	800 955-4486
MAGS - 174 GRIPS - 179 CHOKES - 168 RINGS - 36	
185- DNZ PRODUCTS	
SCOPE MOUNTS- 35	
127 - DO EVERYTHING MANUAL	508-965-5100
MANUALS - 148	
126 - DOSKOCIL	877-395-5482
GUN CASES - 187	
229 - DOUBLESTAR	859-745-1757
AR-15 UPPERS & ACC -158	
215 - DURASIGHT	770-449-4687
RINGS AND BASES - 33	
106 - EASTERN MAINE SHOOTING SUPPLY	207-943-8808
CLEANING SUPPLIES - 137, 141 BLACK POWDER- 50	
MUZZLELOADER ACC- 52-53 PATCHES - 141	
214 - EDGE	715-381-2935
GAME CALLERS - 216	
196 - EO TECH	734-741-8868
SIGHTS- 8 ACCESSORIES- 8	
145 - EVA-DRY	877-382-3790
DEHUMIDIFIERS - 188	

081 - EZE-LAP	800-843-4815
KNIFE SHARPENERS - 232 FILES - 149	
129 - FEDERAL CARTRIDGE CO.	800-831-0850
PRIMERS - 124 AMMUNITION - 126, 128, 129, 132, 134	
WADS - 65 209 PRIMERS - 124 BRASS - 120	
160 - FLATLINE OPS	360-733-2924
SHOOTING ACCESSORIES - 196	
194 - FLITZ	800-558-8611
POLISHING PRODUCTS- 144	
070 - FORSTER PRODUCTS	815-493-6360
MUZZLELOADER ACCESSORIES - 56 GOLD KIT - 150	
RELOADING TOOLS - 103-105	
SCREW DRIVER SET - 148	
239 - FOXPRO CALLERS	717-248-2507
GAME CALLER - 215	
164 - GAMO PRECISION	954-581-5822
AIR GUNS - 204 PELLETS - 207 TARGETS - 206	
054 - GERBER	800-950-6161
KNIVES - 226-227	
177 - GLOW AMMO	936-649-2210
TRACER KITS - 116 AMMUNITION - 125	
119 - GOLDEN ROD	800-451-6797
SAFE DEHUMIDIFIER - 188	
186 - GREEN MOUNTAIN	603-4471095
BARRELS - 165	
114 - GROVTEC	503-557-4689
SWIVELS - 168-169 HAMMER EXTENSIONS - 151	
BRUSHES - 136 CLEANING - 138	
060 - GUNMATE PRODUCTS	800-423-3537
HOLSTERS - 181	
097 - GUNSLICK (OUTERS/ATK)	800-635-7656
CLEANING PRODUCTS - 138, 143, 163 GUN VISE - 135	
BORE GUIDE -147 BLACKPOWDER - 51	
053 - HARRIS ENGINEERING	203-266-6906
RIFLE BIPODS - 195	
072 - HARVESTER	800-922-6287
BULLETS - 52 SABOTS - 52, 53	
096 - HEVI-SHOT	541-367-3522
CHOKE TUBES - 166 SHOTSHELLS - 133	
032 - HKS	800-354-9814
SPEED LOADERS & ACCESSORIES - 177	
034 - HODGDON	800-622-4366
POWDER - 122 MANUAL- 105 PYRODEX - 54	
138 - HOGUE GRIPS	800-438-4747
PISTOL GRIPS - 178-179 RIFLE STOCKS - 153	
SWIVELS - 169 AR-FORENSIS - 160 HOLSTER - 181	
060 - HOPPE'S	800-962-5757
CLEANING KITS ETC - 135-139 BORE LIGHT - 147	
BORESNAKE - 139 GUN LOCK - 188 CLEANING- 139	
PATCHES - 141 GUN RACKS - 161 TARGETS - 200	
003 - HORNADY	800-338-3220
SABOTS, ROUND BALLS, - 53	
RELOADERS & ACC - 66-70 BULLETS - 112-113	
AMMO - 126, 127, 129, 131, 132, 134	
MANUAL - 105 SLUGS - 127 CLEANING - 135	
GAS CHECKS - 118 BRASS - 120 GAUGES - 68	
REST - 196 RIFMIRE AMMO - 134 CALIPERS- 68	
CLEANING - 144	
108 - HORTON ARCHERY	800-291-3649
CROSSBOWS - 208	
052 - HUNTERS SPECIALTIES	800-728-0321
CHOKES - 168 HUNTING ACC - 210-214	
034 - IMR POWDER	416-270-3661
POWDER -122	
105 - INDIAN CREEK	573-824-5555
CHOKE TUBES - 166	
200 - IOSSO	847-437-8400
CASE CLEANING - 121 AR-15 CLEANING KIT - 137	
052 - JOHNNY STEWART	800-728-0321
GAME CALLS - 214-215	
100 - KERSHAW	800-325-2891
KNIVES - 224	
056 - K-BAR	800-282-0130
KNIVES- 223	
201 - KANO LAB / KROIL	615-833-4101
CHEMICALS- 143	
206 - KICK EEZ- RECOIL PADS - 152	417-649-2100
043 - KRAUSE PUBLICATIONS	888-467-2873
BOOKS - 233 - 235	
113 - LANSKY	800-825-2675
KNIFE SHARPENERS - 231-232	
109- LAPUA	630-350-1116
AMMUNITION - 129, 134 MANUAL- 105	
BRASS - 120 BULLETS - 117	
116 - LASERLYTE OPRONICS	928-649-3201
SIGHTS - 10 BORESIGHTER - 40, 43	
102 - LEATHERMAN	800-847-8665
MULTI-TOOLS - 225	
006 - LEE PRECISION	262-673-3075
RELOADERS & ACC - 80-85 BULLET MOULDS - 56-57	
MANUAL- 105 LEAD BULLET CASTING - 55-57	
SHOOTER PROGRAM- 237 RELOADING STAND - 229	
068 - LEICA	800-222-0118
RANGEFINDER - 7	
024 - LEUPOLD	503-526-1400
SCOPES - 15, 18 LENS SHADES - 18	
BASES & RINGS - 15, 28-29 RANGEFINDERS - 7	
BORESIGHTER - 40 LENS PEN - 22	
SPOTTING SCOPES - 11 OPTIC ACC. - 18	
BINOCULARS - 5 SCOPE COVERS- 38 TRIPOD- 11	

401 - LIMBSAVER 360-427-6031
BORE RESONATOR - 195

015 - LYMAN 800-225-9626
RELOADERS & ACC - 72-78 SIGHTS - 165
LEAD BULLET CASTING - 58-60 TARGETS - 200
GUNSMITHING - 148-149 TRIGGER GAUGE - 150
RELOADING BOOKS - 105, 236-237 MUZZLELOADERS - 47
BUTCH'S PATCHES - 141 BUTCH'S CLEANER - 141, 143
LOAD DATA BOOKS - 72 GUN VISE - 135

134 - MACE 800-255-2634
DEFENSE SPRAY - 225

065 - MAG INSTRUMENTS 909-947-1006
FLASHLIGHTS - 219

051 - MAGNUS BULLETS 256-420-8610
JACKETED BULLETS - 118 LEAD BULLETS - 118

039 - MAGTECH 800-466-7191
BRASS - 120 AMMO - 125, 127

120 - MAKO GROUP 631-880-3396
TACTICAL ACC - 161-163 SCOPE MOUNT - 10

138 - MARKRON
PRIMER SEALER - 54, 124 CHEMICALS - 143

059 - MEC 800-797-4632
SHOT SHELL RELOADERS - 64-65 REL. ACC - 66

099 - MEC GAR 800-632-4271
MAGAZINES - 174

038 - MIDSOUTH RELOADING 800-272-3000
RELOADING ACCESSORIES - 71

131 - MILLET 800-645-5388
BASES & RINGS - 32, 36 SCOPES - 15

211 - MMP SABOTS 870-741-5019
SABOTS - 53

079 - MONTANA XTREME 406-234-0422
CLEANING SUPPLIES - 145 PATCHES - 141 KIT - 170

049 - MORGAN ADJUSTABLE PADS 330-788-4495
RECOIL PADS - 164

008 - MTM CASEGARD 800-543-0548
GUN CASES - 191 TARGETS - 203
AMMO CASES - 106-107 CLEANING - 135
RELOADING ACC - 106 TARGET THROWER - 199
RELOADERS LOG BOOK - 237 BORE GUIDE - 147
ACC BOXES - 216 SHELL WAD HOPPER - 67
SHOOTING RESTS & TABLE - 193-194 GUN VISE - 135

090 - MUCK BOOTS 877-GET-MUCK
BOOTS - 213

087 - MULTI-SCALE 905-566-1255
ADJUSTABLE SHOT SHELL CHARGE BARS - 64

082 - NALPAK INC 619-258-1200
CASES - 189

125 - NIKON 800-626-4566
SCOPES - 20 LENS PEN - 22, 36 BINOCULARS - 5
SPOTTING SCOPES & ACC - 11, 38 RANGEFINDER - 7

013 - NORMA USA 888-673-5945
BRASS - 121

115 - NOSLER 800-285-3701
BULLETS - 114-117 MANUAL - 105
BRASS - 120 AMMUNITION - 125, 129 BOOKS - 239

280 - OUTDOOR EDGE
CUTLERY - 218

097 - OUTERS/CHAMPION 800-635-7656
CLEANING KITS AND SUPPLIES - 136
TARGETS - 200, 202 TARGET THROWER - 199-200
CHOKE LUBE - 167

010 - PACHMAYR 800-423-9704
RECOIL PADS - 164 SNAP CAPS - 147
PISTOL GRIPS - 179-180 GUNSMITHING - 148
CONTENDER/ENCORE GRIPS - 39 BUMPER KIT - 176
TRIUS TRAP THROWERS - 199 PAC-SKIN - 152
SWIVELS - 171

094 - PAST/TIPTON 877-509-9160
SHOOTING PADS - 197 MOULD RELEASE - 57

174 - PELICAN 800-473-5422
GUN CASES - 186

086 - PLANO 630-552-3111
GUN CASES - 187, 191 ACC. BOXES - 216
AMMO BOXES - 107

221 - PROMAG 800-438-2547
MAGAZINES - 175, 163 GUNSMITH TOOLS - 149
TACTICAL ACC - 159, 162 SIGHTS - 157

002 - POWERBELT BULLETS 800-376-4010
MUZZLELOADER BULLETS - 52

103 - PROTEKTOR MODEL 814-435-2442
SHOOTING REST BAGS - 193 SHELL BAGS - 196

215 - QUAKE INDUSTRIES 406-388-3411
SLINGS - 172 SCOPE COVERS - 36 SWIVELS - 171

077 - RADIANS 877-723-4267
HEARING AND EYE PROTECTION - 197-198
HEARING ENHANCER - 210 REMINGTON SAFETY - 197

097 - RAM-LINE 800-635-7656
STOCKS - 152, 153, 155

079 - RAMSHOT POWDER 800-497-1007
POWDER - 122

044 - RCBS 800-533-5000
RELOADING, DIES & ACC 86-86 AMMO BOXES - 107
SHOT SHELL - 65 SOFTWARE - 237
CHRONOGRAPH - 203 TRIGGER SCALE - 150
LEAD CASTING - 61-63 RASS REST - 194

028 - REDFIELD BASES & RINGS 800-285-0689
BASES & RINGS - 24 SCREW SET - 38

128 - REDFIELD OPTICS 877-798-9686
SCOPES - 22 BINOS - 4 SPOTTER - 11 RANGEFINDER - 7

076 - REDDING 607-753-3331
RELOADING ACCESSORIES - 97-102 SAECO ACC - 102

050 - REMINGTON 888-736-4867
BRASS - 119 BULLETS - 115 PRIMERS - 124
#209 PRIMERS - 124

213 - RIFLE BASIX 704-566-1939
TRIGGERS - 150

062 - RWS / HAMMERLI (UMAREX) 479-646-4210
AIR GUNS - 205 PELLETS - 206-207
PERCUSSION CAPS - 54, 121 HAMMERLI AIR - 205

117 - SABRE RED 800-325-9568
DEFENSE SPRAY - 238-239 STUN GUNS - 239

093 - SACKUPS 800-873-7225
GUN SOCKS - 186

080 - SAFARILAND 800-347-1200
HOLSTERS AND BELTS - 182-183

282 - SEAL 1 207-965-8860
CLEANING ACC - 137

216 - SHARP SHOOT R 785-883-4444
CLEANING SOLVENTS - 143

104 - SHOOTERS CHOICE 800-232-1991
CLEANING SUPPLIES - 144

097 - SHOOTERS RIDGE 800-635-7656
BI-PODS - 195 SHOOTING ACCESSORIES - 194
SHOOTING STICKS - 217 RANGE ACC. - 194
MAGS - 176

084 - SHOOTING CHRONY 800-385-3161
CHRONOGRAPH - 203

007 - SIERRA 888-223-3006
BULLETS - 110-111 MANUAL - 105 SOFTWARE - 237

204 - SIMMONS OPTICS 800-285-0689
SCOPES - 21 BINOCULARS - 4 RINGS - 31 SPOTTERS - 12

047 - SMART RELOADER
RELOADING ACC - 79 AMMO BOXES - 107 RELOADING - 79
HEARING PROTECTION - 198

021 - SPEER 800-627-3640
BULLETS - 116-117 MANUAL - 105 AMMO - 127
ROUND BALLS - 51

066 - STONEY POINT 507-354-3360
SHOOTING STICK - 217
SHOOTING RESTS AND BAGS - 193

210 - STREAMLIGHT 800-523-7488
LIGHTS - 147 220, 221 LASER - 9

146 - SUN OPTICS 817-447-9047
LASER SIGHTS - 10 RINGS & MOUNTS - 33
BIPODS - 195

183 - SUREFIRE 800-828-8809
FLASHLIGHTS - 221

055 - SWARVOSKI 800-426-3089
SCOPES - 22 RANGEFINDER - 8
BINOCULARS - 6

192 - SWIFT BULLETS 785-754-3959
BULLETS - 108 SOFTWARE - 237

101 - TAC-STAR 800-423-9704
GRIPS - 157 MAG EXT - 157 TACTICAL ACC. - 156-157
LIGHTS - 219 AR ACC - 160-161

209 - TASC0 800-221-9035
SCOPES - 21 PRO-POINTS AND SIGHTS - 8
RINGS - 31 BINOCULARS - 4 SPOTTING SCOPES - 12

170 - THERMACELL 866-753-3837
MOSQUITO REPELLANT - 210

011 - THERMOLD 803-604-1550
MAGAZINES - 176

030 & 031 - THOMPSON CENTER 603-332-2394
CONTENDER & ENCORE - 39-46 BASES - 35
BARRELS & ACCESSORIES - 39-46 SCOPES - 13
MUZZLELOADERS - 45-48 HOLSTERS - 40
SABOTS & MAXI-BALLS - 53 LUBES - 46
MUZZLELOADER ACCESSORIES - 44-46

078 - TIMNEY TRIGGERS 602-274-2999
TRIGGERS - 150, 163

094 - TIPTON(BATTENFELD) 877-509-9160
CLEANING VICE - 135 RANGE BOXES - 135
CLEANING SUPPLIES - 140

139 - TRADITIONS INC. 860-388-4656
MUZZLELOADERS - 48-49 ACCESSORIES - 50-53
SNAP CAPS - 147

139 - TRIJICON 800-338-0563
SIGHTS - 8 SIDE MOUNT - 10 SCOPES - 12

147 - ULTRAMAX AMMO 800-345-5852
AMMUNITION - 126, 129

073 - UNCLE BUD'S
BULLS BAGS - 193

060 - UNCLE MIKE'S 800-423-8327
HOLSTERS, BELTS - 181, 184-185 GUNTITE - 148
SWIVELS - 170-171 HUNTING ACC. - 216
HAMMER EXTENSION - 151 SLINGS - 171, 172
BAGS AND GUNCASES - 181, 188 MAGAZINE - 177

004 - VARMINT NIGHTMARE
BULLETS - 111

157 - VIHTAVHORI POWDER 800-683-0464
POWDER - 123 MANUAL - 105

223 - WARNE
RINGS & BASES - 23, 206 TORQUE WRENCH - 38

029 - WEAVER 800-285-0689
BASES & RINGS - 24-27 SCOPES - 19 RED DOT - 9
GUNSMITHING TOOLS - 37, 149 BINOS - 4
TACTICAL ACC - 158, 159, 160, 25

098 - WEATHERBY 800-227-2016
AMMUNITION - 129 BRASS - 120

094 - WHEELER (BATTENFELD) 877-509-9160
FATWRENCH - 148 SCREWDRIVER SET - 148
LEVEL - 38

034 - WINCHESTER POWDER 618-258-3589
POWDER - 123

144 - WOLFE PUBLISHING 800-899-7810
BOOKS - 235 HANDLOADING VIDEO - 236

069 - W.R. CASE 800-821-1924
KNIVES - 228-229

042 - ZEISS 800-338-2984
SCOPES - 22

CONNECT WITH

MIDSOUTH SHOOTERS

 **FACEBOOK**

 **TWITTER**

 **YouTube!**

 **GOOGLE+**

Keep up with us however you prefer! Check out the latest product info, news, videos, polls, give-a-ways, photos and specials!

Check us out!

MIDSOUTH SHOOTERS
SINCE 1969

Bushnell Binoculars

Bushnell H2O - Closeout! Limited Quantities

- 100% waterproof: O-ring sealed and nitrogen purged for reliable, fog-free performance
- Non-slip rubber armor absorbs shock while providing a firm grip
- Twist-up eyecups
- Large center focus knob for easy, precise adjustments
- BaK-4 prisms for bright, clear, crisp viewing
- Multi-coated optics for superior light transmission
- Long eye relief



	Order No.	Closeout
8x42mm Porro Prism	027-132408	\$70.27
10x42mm Porro Prism	027-132410	76.83
8x42mm Roof Prism	027-150842	83.40
10x42 Roof Prism	027-151042	97.82



Bushnell

Bushnell Powerview - Bushnell's Powerview Porro Prism Binoculars have fully coated optics. Rubber covered with easy focus lever. Comes with a soft carrying case, neck strap, lens caps and cleaning cloth.

	Order No.	Price
10 x 50 Powerview Camo	027-131054	\$63.27
16 x 50 Powerview Black	027-131650	68.91
12x50 Wide Angle Black	027-131250	64.91



Bushnell

Bushnell PermaFocus - Don't miss out on action while trying to focus! The perma focus free binoculars offer a preset focus, so all you have to do is aim, and enjoy. Rubber armored.

	Order No.	Price
7x35mm Wide Angle	027-173507	\$56.85
10x50mm Wide Angle	027-175010	66.48



Bushnell

Bushnell PermaFocus - Unique focus-free feature stays in focus at most viewing distances. Non-slip rubber armor absorbs shock while providing a firm grip.

	Order No.	Price
10x42mm Roof Prism	027-171043	\$76.96



Bushnell

Bushnell Compact Powerview 12x25mm Black Binoculars - Folding roof prism compact binoculars. Rubber armored camouflage or black, with contour focus knob. Comes with strap and carrying case. Eyeglass compatible.

Order No. 027-131225 \$22.40



Bushnell

Bushnell Compact 12x25mm Porro Prism - Porro Prism System with center focus. Brown Camo Field of view at 238@7x/73

Order No. 027-131226 \$22.40

Weaver Binoculars

Weaver Grand Slam™ Binoculars -

- Extendable eyecups for comfortable viewing sessions
- Phase coated lenses for great light transmission
- Roof prism design with BK-7/BaK-4 prism glass
- Adaptable to tri-pods
- Waterproof / fogproof performance



	Order No.	Price
8x32mm	029-849660*	\$288.44
10x32mm	029-849661*	293.14



Redfield Binoculars

Redfield Rebel™ Binoculars -

The slim Rebel™ is a perfect all-purpose optic for the American Hunter. Rugged, and gets the job done. Short minimum focus distance and impressive field of view make the Rebel™ a perfect fit for almost any hunting situation.

- BAK4 Prism System
- Fully Multi-Coated Lenses
- Armored Aluminum Body
- Twist-up Eyecups
- Limited Lifetime Warranty



REDFIELD

	Order No.	
8x32mm	128-67610	\$116.11
10x42mm	128-67605	\$133.46

Redfield Renegade™ Binoculars -

Traditional design at a great price, the Renegade™ is great no matter the light. Porro prism design gives you a great 3-D Image.

- Porro Prism
- Fully Multi-Coated Lenses
- Armored Aluminum Body
- Twist-up Eyecups
- Limited Lifetime Warranty



REDFIELD

	Order No.	
7x50mm	128-67615	\$97.43
10x50mm	128-67620	\$116.11

Tasco Binoculars



tasco

Sierra Series - 100% waterproof, fogproof construction and premium multi-coated optics. Their rugged rubber armor protects against rough handling.

	Order No.	Price
8x25mm Compact	209-TS825D	\$23.17
10x25mm Compact	209-TS1025D	26.49
10x42mm Roof Prism	209-TS1042D	49.73
12x50mm Roof Prism	209-TS1250D	62.19

A - Tasco Essentials 7x35mm - Tasco's most versatile, all-purpose binoculars feature an impressive 500 ft. field-of-view. Order No. 209-2001BRZ \$29.74



A

B - Tasco Essentials 8X42mm - It's premium porro power with a little zoom, this binocular features fully coated lenses along with BK7 prisms. Features Rubber fold-down eyecups, black rubber armor, carrying pouch and neck strap. Order No. 209-2023BRZ \$34.82



B

Simmons Binoculars

ProSport® Compact Binoculars - ProSport binoculars are encased in tough and durable rubber armor, for a positive grip and added protection in any weather conditions.

	Order No.	Price
8x21mm Camo	204-899852	\$12.50
8x21mm Matte	204-899853	11.68
10x25mm Camo	204-899854	15.04



SIMMONS

Nikon Binoculars

New! Monarch 5- The new MONARCH 5 All Terrain Binocular couples bright, high-resolution optics with legendary ruggedness in a package that is light enough to carry all day. Incorporating Nikon's exclusive Eco-Glass (made without the use of arsenic or lead) for all lens and prism elements, the MONARCH 5 features phase-corrected, dielectric high-reflective multilayer prism coatings for extreme brightness, superior sharpness and incredible low light performance.



	Order No	Price
8x42mm Black	125-7542	\$379.99
10x42mm Black	125-7543	379.99
8x42mm Camo	125-7545	309.95
10x42mm Camo	125-7546	329.95

The tough, full rubber armored body is O-ring sealed and nitrogen purged for waterproof, fogproof reliability.

Nikon TrailBlazer Binoculars - 100% Waterproof/Fogproof, Rugged ATB design, Turn-and-Slide Eyecups, Rubber Armored Body, Fully Multicoated lenses for bright, clear images.



	Order No.	Price
8x42mm Black	125-8220	\$135.00
10x50mm Black	125-8221	168.75

Nikon Action Extreme Binoculars - Long eye relief for eyeglass wearers. Rugged, 100% Waterproof. 100% Fogproof Construction. Bright Multicoated Optics, Rubber armor for sure grip. BaK4 High Index Prisms. Includes neckstrap and case. 25-Year Limited Warranty!



	Order No	Price
7x35mm EX Ultra Wide View	125-7237	\$125.40
8x40mm EX Ultra Wide View	125-7238	140.30
7x50mm EX	125-7239	151.48
10x50mm EX Wide Angle	125-7245	167.50

Nikon Action Series Binoculars - Aspherical lenses eliminate virtually all distortion. Quick, smooth central focusing. Diopter control to regulate vision imbalance. BaK4 high index prisms. Precision aligned sharp multicoated optics for bright, clear images. Full-size armored body.



	Order No	Price
7x35mm Ultra Wide View	125-7215	\$67.05
8x40mm Ultra Wide View	125-7216	76.98
8x40mm Realtree APG Camo	125-7261	90.64
7x50mm	125-7217	83.19
10x50mm	125-7218	93.12
12x50mm	125-7219	103.05
16x50 (Includes Tripod Adapter)	125-7223	120.44
10-22x50 Zoom (Includes Tripod Adt)	125-7234	142.78

Please read regarding Nikon returns! All Defective Nikon Product Returns Must Go Through Nikon! Please call Nikon 1-800-645-6678 for Assistance.

Binocular Suspenders

Black Bino Buddy- Stretchable tubing that hold binos secure to your body Comes with a Butler Creek padded Medium Bino Strap and a Lens cover that keeps rain or snow off the oculars while you are not using them.



The Bino Caddy- "Takes the Weight of Your Binoculars Off Your Neck". Straps go around your shoulders and cross your back to give you even distribution to the weight. Elastic.

Order No. 060-16123 \$11.10



Swarovski Bino Suspenders
Order No. 055-49200 Price \$37.00



Nikon Prostaff Bino Harness - Attached with a secure quick release connection.
Order No. 125-6121 \$17.02

Leupold Binoculars

Leupold BX-3 Mojave Binoculars - The BX-3 Mojave binoculars weigh in at 28 ounces and provide premium performance in an easy-to-handle format. Long eye relief makes them easy to use, with or without eyeglasses.



- Fully multi-coated lenses with L-Coated BAK4 prisms.
- Silver enhanced, cold-mirror- coatings on prisms
- Includes: case, quick detach neoprene neck strap, eyepiece covers, and tethered objective lens covers.

Armored, waterproof, and covered by the Leupold® Limited Lifetime Warranty for as long as you own them.

	Order No	Price
BX-3 8x42mm Black	024-111766	\$379.99
BX-3 10x42mm Black	024-111768	399.99
BX-3 10x50mm Black	024-111770	429.99
BX-3 12x50mm Black	024-111772	449.99

Leupold BX-2 Acadia Binoculars -

Ergonomic roof-prism design The Multicoat 4® lens system Phase coated roof prisms Generous eye relief Armor coated, rugged, and waterproof. Leupold® Limited Lifetime Warranty.



	Order No	Price
8x42mm Black	024-111746	\$177.87
10x42mm Black	024-111748	194.81

Leupold BX-2 Cascade Binoculars -

An outstanding low-light performer. The multi-coated lens system Slim, in-line design is ergonomic and easy to grip Generous eye relief Close focus distance of 10 feet. Armor coated, rugged, and waterproof. Leupold® Limited Lifetime Warranty.



	Order No	Price
8x42mm Black	024-111738	\$279.99
10x42mm Black	024-111741	299.99

Leupold Rogue Binoculars - A great value, the Porro prism design offers the user excellent depth perception and outstanding 3D image representation. The multi-coated lens system ensures maximum brightness for clarity, contrast, and color fidelity. Rugged, waterproof, and covered by the Leupold® Limited Lifetime Warranty.



	Order No	Price
8x42mm Black	024-65550	\$133.10
8x42mm Mossy Oak	024-65755	148.83
10x42mm Black	024-67630	136.73



Wind River Binocular Tripod Adapter - Enjoy the same steady view with your binoculars that's normally reserved for spotting scopes. Fits Mesa, Pinnacles, and Olympic 8x42mm models.
Order No. 024-48826 \$16.68

Swarovski Binoculars

Swarovski EL 32 Swarovision -

For exploring nature at home or abroad the new EL 32 SWAROVISION is the perfect partner for anyone who wants exceptional technology in a smaller binocular. With this binocular you will see all the beauty there is to see.

- **High Definition** - For maximum contrast
- **Field Flatteners** - Lenses Contrast right up to the image edge
- **Greater Eye Relief** - 100% field of view for eye-glass wearers
- **Optimized Coating** - For maximum color fidelity



	Order No.	M.A.P.
8x32 mm EL	055-32108	\$2099.00
10x32 mm EL	055-32110	2179.00



Swarovski Traveler -

The unique wrap-around grip enables comfortable operation even with one hand. Low weight and excellent balance make light work of long observation periods. The sophisticated top-class optical system delivers high-contrast, lifelike image quality. The EL 32 with its low weight can be carried effortlessly for long periods of time. Its user-friendly compact construction not only sits extremely well in the hand but can be carried in almost any outdoor coat.

	Order No.	M.A.P.
10x32mm EL	055-32120	\$2179.00
8x32mm EL	055-32118	2099.00

Swarovski SLC - With their reliable, high-quality optical system and rugged construction, the SLC binoculars are among the world's most popular high-end binoculars. The thumb rests on the underside and the depressions on the top side of the easy to handle rubber armoring ensure secure and comfortable handling. The diversity of models among the SLC binoculars offers the right solution for every purpose.



	Order No.	M.A.P.
10x42mm B HD	055-58210	\$2179.00
8x56mm B	055-58181	1749.00
15x56mm WB	055-58191	1899.00



Pocket Binos - A complicated 16-lens system ensures a large field of view and bright, high-contrast images. Suitable for eyeglass wearers

	Order No.	M.A.P.
10x25mm Green	055-46110	\$799.00
10x25mm Black	055-46010	799.00

Swarovski Bino Suspenders



Order No.	Price
055-49200	\$37.00

Did You Know We Can... ...order any item from Swarovski? And, if the item is in stock, we can have it within two weeks!

Nikon Binocular Accessories

Prostaff Bino Harness - Attached with a secure quick release connection.
Order No. 125-6121 \$17.02

Optics Maintenance Kit - Contains Static Wisk brush, Precision Cleaning Solution, anti-static microfiber Tiger Cloth and Speck Grabber.
Order No. 125-7073 \$16.71

Nikon Lens Pen - Order No. 125-7072 \$6.62

Micro Fiber Cleaning Cloth - Anti-Static, Clips on.
Order No. 125-8072 \$4.10

Fog Eliminator - 6"x7" Anti Fog Cloth (3pack)
Order No. 125-8073 \$4.10

Lens Cleaner Wet Cloth - Handy, individually wrapped, take-anywhere moist lens cleaner cloths. 21 cloths in a box. Each cloth is 5"x6".
Order No. 125-8175 \$3.47



Laser Rangefinding Scopes



Bushnell

Yardage Pro 4-12x42mm Laser Rangefinder Riflescope - Riflescope Specs: Fully Multi-Coated optics, 100% Waterproof and fogproof, 3.5" eye relief, Windage & Elevation click value .25. Mil-Dot reticle. 25.3oz.

Rangefinder Specs: 32-766 Yards/Meter Range, +/- One Yard Accuracy, Standard and SCAN modes, Wireless trigger pad. Operates on 2AAA Batteries. Bullet drop compensation turrets. Order No. 027-204124 \$808.42

Burris Eliminator Laserscope - No more guessing yardage or fumbling with a shaky handheld rangefinder. No more losing sight of your trophy. No more guessing holdover.



Burris

The Eliminator knows the precise horizontal distance to your trophy and exactly what your cartridge will do. Eliminator lights a 1/3 MOA illuminated aiming dot showing exactly where your shot will go. With The Eliminator, just Range, Aim, and Fire.

Simply enter one of the 40 drop numbers into the Eliminator. In a split second, the Eliminator factors in the distance, the angle of the shot, and the ballistics of your cartridge, and presents a lighted dot for the perfect holdover.
Order No. 023-200112 \$949.00

Miscellaneous Binocular Accessories



	Order No.	Price
Burris Lens Pen	023-626050	\$7.13
Leupold Lens Pen	154-48807	7.00
Viz Wiz - 2oz Pump Spray Bottle	012-32122	3.02



Bushnell Rangefinders



Bushnell

The Bushnell Yardage Pros have changed the way people measure distance. In all hunting sports, the measurement of distance quickly and accurately can improve performance. Using advanced laser technology, the Bushnell Yardage Pro measures distances instantly and accurately within 1 yard. It's as simple as aiming and pressing a button. The Bushnell Yardage Pro is water and shock resistant, lightweight, compact and rubber armored for durability even under the hardest conditions. All Yardage Pro models come with a one-year limited warranty.

	Order No.	Price
A - Yardage Pro Scout 1000 w/ARC Black	027-201932	\$323.38
B - Yardage Pro Scout 1000 w/ARC Realtree AP Camo	027-201942	345.43
C - Sport 450 Rangefinder	027-201916	176.40

Nikon Rangefinders

Nikon Monarch Gold Laser 1200

- Tru-Target Ranging System: First Target/Distant Target priority modes
- Waterproof/fogproof, nitrogen-purged and O-ring sealed
- Nikon's Original Digital Processor
- Belt case and neck lanyard included
- Unmatched 1/2-yard accuracy
- 1200 yard range
- Battery included



	Order No.	Price
Black	125-8358	\$418.75
Team Realtree Camo	125-8359	437.50

Nikon Archer's Choice with APG Camo Case -

- ID (Incline/Decline) Technology
 - Slim, Designed for One-Hand Operation
 - Waterproof/Fogproof Construction (except battery chamber)
 - 6x, Bright Multicoated Optics
 - CR2 Lithium Battery included
 - Provides fast and accurate ranging over flat ground, from treestands or in steep terrain
 - Displays in .2-yard/meter increments in ID Technology Mode, .5-yard/meter increments in standard mode
 - Includes a Silent Technology Neoprene Case in Realtree APG camo with single motion lanyard
- Order No. 125-8366 \$259.95



Nikon RifleHunter 550 Brown -

- ID (Incline/Decline) Technology
- Slim, Designed for One-Hand Operation
- Tru Target Technology
- Waterproof/Fogproof Construction (except battery chamber)
- CR2 Lithium Battery Included
- Bright, Multicoated Optic
- Quickly Ranges to 550/1000 Yards
- In ID Technology mode, the RifleHunter 1000 displays in .1-yard/meter increments out to 999.9 yards. RifleHunter 550 displays in .2-yard increments out to 99.8 yards, 1-yard increments past 100 yards



	Order No.	Price
Brown	125-8367	\$289.95
Max-1 Camo	125-8368	319.95

Please read regarding Nikon returns! All Defective Nikon Product Returns Must Go Through Nikon! Please call Nikon 1-800-645-6678 for Assistance.

Leupold Rangefinders

Leupold Vendetta Bow Mounted Rangefinder - Simply squeeze the pressure pad on the bows grip and range a target with the bow at full draw. Leupolds True Ballistic Range feature automatically calculates the shot angle and provides the incline adjusted distance to the target - rather than straight line distance.



Max range of 70 yards (min 10 yards) Large led for ID at a distance. Weighs just over 9oz.
Order No. 024-68000 \$299.99



Swarovski Rangefinding Binocular

NEW! EL Range Rangefinding Binocular -

The EL Range sets new standards and transforms the experience in to a result: Pinpoint clear observation is combined with precise distance and angle measurement. With sleek design and handling together with its proven optical excellence, the EL Range show exactly where the target is, and exactly how far away.

Sward-Aim Technology
Observation without Compromise
Intuitive Handling- Better Measure
Swaro-Aim
Swaro-Bright
Swaro-Clean



	Order No.	M.A.P.
8x42 Range	055-70008	\$2769.00
10x42 Range	055-70010	2869.00



Swarovski Rangefinder



Swarovski Laser Guide 8x30mm - The Swarovski Laser Guide 8x30 combines the highest quality standards of Swarovski Optik binoculars with the latest Laser range-measuring technologies, packaged together in a comfortable, compact, lightweight instrument. The result is unparalleled performance in terms of image quality and accuracy - even in poor weather and light conditions, as well as at long ranges. The result is that you have absolute certainty that you always aim at the right target.
Order No 055-70002 M.A.P. \$999.00

Redfield Rangefinders

REDFIELD

Redfield Raider™ 550 -

- 6x Magnification
- Compact! Less than 4" Long & under 5oz
- High Speed Digital Processor and Accuracy
- Battery Powered by CR-2 battery (Included)



	Order No.	Price
Black	128-67440	\$160.55
MossyOak Break-Up Infinity	128-67445	170.43

Trijicon RMR Sights (Ruggedized Miniature Reflex)



Developed to improve precision and accuracy with any style or caliber of weapon, the Trijicon RMR™ (Ruggedized Miniature Reflex) is designed to be as durable as the legendary ACOG. Housed in rugged forged aluminum, the RMR is extremely tough yet lightweight. New easy-to-use adjusters with audible clicks allow for quick windage and elevation adjustments. The new Trijicon RMR™ is tougher than any alternative and suitable for military, law enforcement and hunting applications.

RM01: Trijicon RMR Sight (LED) – 4 MOA Red Dot - The RM01 is an LED sight powered by a standard CR2032 battery.

RM04: Trijicon RMR Dual Illuminated Sight – 7.0 MOA Amber Dot - The RM04 is a battery free sight, featuring Trijicon fiber optics and tritium.

	Order No.	M.A.P.	Order No.	M.A.P.	
4 MOA Red Dot Picatinney	202-RM0133	\$575.00	7 MOA Amber Dot Picatinney	202-RM0433	\$514.60
4 MOA Red Dot With Quick Release Picatinney	202-RM0134	602.68	7 MOA Amber Dot With Quick Release Picatinney	202-RM0434	543.54

Tasco Red Dots and Electric Sights

Propoint Red and Green Dot -
-5 M.O.A.
-Red Dot for Bright light
-Green Dot for Low light
-Image Contrast Improvement



Order No. 209-PDPRGD Price \$76.80

Red Dot Sighting Device - Excellent for fast action pistol competition as well as bull's-eye marksmanship and Shotgun. Optically bright with a wider field of view than 1" tubes, Tasco Red Dots feature a reticle with an illuminated 5 M.O.A. dot and an 11-position rheostat. A winner for pistol, rifle, shotgun or bow!



	Order No.	Price
30mm Obj. (38mm Tube) on 5/8" dovetail	209-BKRD30	\$39.14
30mm Obj. (38mm Tube) on 3/8" dovetail	209-BKRD3022	39.14

Tasco Pro Point 3 - Features an 11 rheostat control with a variable intensity illuminated red dot, a 30mm tube for a wider field of view and unlimited eye relief to fit any application. It adapts from a pistol scope to a shotgun scope and comes with rings that fit Weaver style bases. Includes: 30mm ring set, lithium battery, modular polarizer, glare shield and extension tube.



Order No. 209-PDP3 Price \$116.75

Tasco Pro Point TS -
1x32mm with 5moa Red Dot
Rubicon Multi-Layered Fully Coated Optics
Easy-To-Mount Single Ring Design
Flip-up Objective and Ocular Caps
100% Waterproof and Fogproof
Black Matte



Order No. 209-PDTS132 Price \$141.90

EO Tech Sights and Accessories



EOTECH XPS Sight with 65 MOA Circle and 1 MOA Dot - Shortest model sight yet! This sight is smaller than the former N-cell battery sight (511/551) and runs on a single 123 battery. It also has a longer battery life than the N-cell style sights. With the single battery configuration, the XPS allows more rail space than ever, leaving more room for rear iron sights or magnification. Smaller, lighter and always fast; the XPS series is a great addition.
Order No. 196-XPS20 M.A.P. \$462.50

EOTECH MODEL 516 65 MOA Circle and 1 MOA Dot
The EOTech 516 is the ideal all purpose optic for Law Enforcement applications especially when partnered with an EOTech magnifier.

- Buttons on left side of sight (not in back) to work specifically with magnifiers
- CR123 Lithium batteries
- Reticle: 65 MOA ring with a single 1 MOA dot
- Raised 7mm base with knurled cross bolt
- Interfaces to 1" Picatinny (MIL-STD-1913) rail

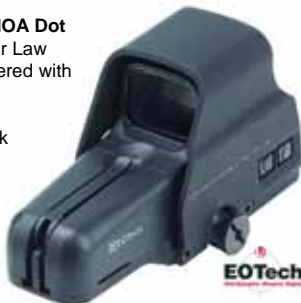

Order No. 196-516A651 M.A.P. \$468.75



L-3 EOTech is the exclusive manufacturer and world leader of holographic sighting systems for small arms, and is dedicated to continually producing high quality, battle tested products for our servicemen and women.

EOTECH GEN II 3X Magnifier - Includes Flip to Side mount -

The 3X magnifier is an affordable magnified solution that will transition a fielded HWS into a lethal medium range optic. Superior light transmission and a large field of view helps this magnifier put the competition to shame. This rugged, streamlined optic offers split-second transitioning from CQB to medium range targeting.



3x magnifier with Flip-To-Side mount and quick detach. Works with all existing HWS units.
Order No. 196-G23FTS 196-516A651 M.A.P. \$518.75

EOTECH MODEL 517 65 MOA Circle and 1 MOA Dot -
- Buttons on left side to work specifically with magnifiers
- AA Battery model (supports Lithium or Alkaline)
- Reticle: 65 MOA ring with a single 1 MOA dot
- Interfaces to 1" Picatinny (MIL-STD-1913) rail
Order No. 196-517A651 M.A.P. \$436.25



Burriss Red Dots and Electric Sights

XTS-135



XTS-135™ Xtreme Tactical SpeedDot - Waterproof, fogproof and severe automatic shockproof. 11 Brightness settings and a high definition 3 MOA red dot. Four Different height 30mm rings to chose from allows either ultra low mounting or high mounting so that iron sights can be used in conjunction with Speed Dot. Rings are sold separately and fit on Picatinny Style Rails. Wide 6 screw rings are built for massive recoil. Only 1 ring needed for XTR-135 mounting.

	Order No.	Price
XTS-135mm Matte Tactical Speed Dot	023-300205	\$249.00
Tactical Ring 1/4" Height Matte Finish	023-420161	29.73
Tactical Ring 1/2" Height Matte Finish	023-420163	29.73
Tactical Ring 3/4" Height Matte Finish	023-420165	29.73
Tactical Ring 1" Height Matte Finish	023-420167	29.73

XTS-235 Reticles

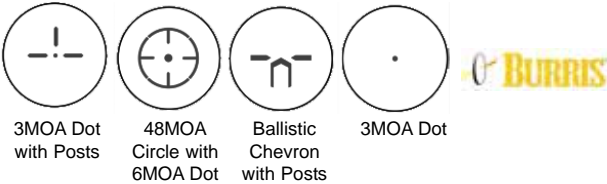

3MOA Dot with Posts 48MOA Circle with 6MOA Dot Ballistic Chevron with Posts 3MOA Dot



Fastfire II™ Red Dot Reflex Sight - The FastFire dramatically increases speed and accuracy. It simplifies the act of aiming, eliminating the need to focus on and align the front sight, rear sight and target. With the FastFire, the aiming red dot and target are always in focus and properly aligned for the ultimate in accuracy.

The FastFire sight is very small, mounts very low, and weighs a mere 1.6 ounces. And it has repeatedly proven it's toughness on the slides of high power semi-autos, on slug guns, on shotguns and on high power rifles.

The FastFire housing is made of metal for strength and durability. It's lenses are precision ground and polished to exacting geometries to virtually eliminate parallax and to provide a very clear crisp sight picture. It is fully windage and elevation adjustable and lockable. It features both an on/off switch and a light sensor that automatically adjusts the dot's brightness to the available light. The included plastic hood covers the light sensor and puts the unit in sleep mode when the on/off switch is set to "on."

Powered by a lithium CR2032 battery, Picatinny Mount allows mounting on just about any rifle. Special bases are available for the most common firearms.

	Order No.	Price
Fastfire II™ with Picatinny Mount	023-300232	\$209.00
Fastfire II™ no mount	023-300233	199.00

Fast Fire Mounting Plates - Installation on most rifles, carbines, and some handguns require the included Picatinni / Weaver Mounting Plate. Most other handguns require a different Mounting Plate.

	Order No.	Price
1911 Standard	023-410321	\$36.86
1911 Bomar / Novak	023-410322	36.86
Kimber Standard & Target	023-410323	36.86
Beretta 92/96 /90-TWO/ Taurus PT99	023-410324	36.86
Beretta PX4 Storm	023-410325	36.86
Glock all	023-410326	36.86
Sig Sauer P226	023-410327	36.86
Springfield XD	023-410328	36.86
Ruger Mark I, II, III	023-410329	36.86

Bushnell Red Dots & Electric Sights



Bushnell Trophy Red Dots - 4 dial in Reticle Model Features all four of the reticles shown below. Both models come with ring mounts.



	Order No.	Price
Trophy Red Dot, 5 M.O.A. 30mm 11 setting brightness	027-730131	\$74.54
Trophy Red Dot, 4 Dial-in Electronic Matte Finish (see reticles above)	027-730134	99.10

Weaver Red / Green Dot Sight



Features & Benefits

- Waterproof/shockproof/fogproof
- Rugged, durable 30mm tube, one-piece construction
- Perfect for deer, big game or turkey hunting as well as shooting sports
- Five red, five green brightness settings for all light conditions
- Adjustments are 1 MOA and parallax is set for 50-yards
- Anti-reflective coating
- Contains four different illumination modes: Micro dot, dot, circle and circle with dot
- Integral adjustable mounting system mounts to a Weaver® Base
- True 1X sight

Order No. 029-849250 \$196.52

Burriss SpeedDot 135 - Features a 35mm main tube that is nitrogen filled and sealed to be waterproof and fog proof. The SpeedDot 135 features fully coated lenses for a bright, sharp, clear, and non-reflective sight picture. Each SpeedDot includes Weaver-style rings, lens covers, and an easy-to-find #2025 camera battery with a 200+ hour life at the highest setting.



	Order No.	Price
1 Power, Black Matte, 3 MOA dot	023-300200	\$199.00

Millett Red Dot Sights



Millett Red Dots - A sophisticated series of electronic red dot sights, engineered on the cutting edge of technology. Red Dot provides the ultimate in fast sighting capabilities. The brightly illuminated red dot contrast sharply against the background under bright and low lighting conditions. All models use battery CR-2032 (included.)

	Order No.	Price
1" SP-1 Compact 3 Min. Dot, Matte	131-RD00004	\$57.20
30mm SP-2 Compact 5 Min. Dot, Matte	131-RD00005	57.20
1" SP-1 Compact 3 Min. Dot, Silver	131-RD00904	57.20
30mm SP-2 Compact 5 Min. Dot, Silver	131-RD00905	57.20
30mm MultiDot SP, Matte (3, 5, 8, 10, min Dot)	131-RD00006	78.66
30mm MultiDot SP, Silver (3, 5, 8, 10, min Dot)	131-RD00906	78.66

Trijicon ACOG



	Order No.	M.A.P.
3.5x35 Scope Dual Illuminated Red Horseshoe/Dot .223 Ballistic Reticle w/TA 51 Mount	202-TA11H	\$1149.98
3.5x35 Scope Dual Illuminated Green Horseshoe/Dot .223 Ballistic Reticle w/TA 51 Mount	202-TA11HG	1149.98
3.5x35 Scope Dual Illuminated Green Horseshoe/Dot .308 M240 Ballistic Reticle w/TA 51 Mount	202-TA11H308G	1149.98
3.5x35 Scope Dual Illuminated Red Crosshair .223 Ballistic Reticle w/TA 51 Mount	202-TA11J	1149.98
3.5x35 Scope Dual Illuminated Green Crosshair .223 Ballistic Reticle w/TA 51 Mount	202-TA11JG	1149.98
3.5x35 Scope Dual Illuminated Green Crosshair .308 M240 Ballistic Reticle w/TA 51 Mount	202-TA11J308G	1149.98
4x32 Scope Dual Illuminated Red Chevron .223 Ballistic Reticle w/TA 51 Mount	202-TA31F	1108.25
4x32 Scope Dual Illuminated Green Chevron .223 Ballistic Reticle w/TA 51 Mount	202-TA31FG	1108.25
4x32 ARMY Rifle Combat Optic for the M150 w/TA 51 Mount	202-TA31RCOM150CP	1313.21
Combo 4x32 Scope Dark Earth Brown Dual Illuminated Green Crosshair .223 Ballistic Reticle & 4.0 MOA RMR Sight, Backup Iron Sights, A.R.M.S. Throw Lever Mount	202-TA31ECOSG	1585.67
4x32 Scope Dual Illuminated Red Chevron .223 Ballistic Reticle & 4.0 MOA RMR Sight,w/TA 51 Mount and Dust Cover	202-TA31FRMR	1709.63
Trijicon ACOG Quick Release Mount	202-TA98	150.00

ACOG Reticles



Horseshoe Reticle Crosshair Reticle Chevron Reticle



Sun Optics Laser Sights

Laser Illuminator Kit - Laser, Light, Integral Mount, and trigger switch all in one. Includes all you need for attachment. Efficient Design and Xenon Quality Lasers.

Order No. 146-CLFMF6X \$66.60

5mw Laser with Weaver Style Mount Includes all you need for Laser attachment. Also includes Batteries

Order No. 146-CL17TD9H2 \$26.24



Laserlyte Side Mount Lasers



Ruger® LCP Side Mount Laser - Easy to mount on the gun by simply pushing out and replacing the stock pins with the screws (included). Then push the ergonomic activation button with the index finger and the laser is on target.

Order No. 116-CKAMF \$88.44

Laserlyte Closeout!



Rear Sight Lasers -

The RSL's ground-breaking laser design incorporated into the rear sight, compact size and revolutionary performance make it the most extraordinary system LaserLyte has produced. Easy-to-install and easy-to-operate, the RSL offers a high-power laser with the benefit of not having to replace existing grips or internal stock parts.



Limited Quantities - While supplies last

	Order No.	Price
1911 (Fits 1911 models with Novak Sights)	116-RL19N	\$98.76
Ruger SR9S (Fits Ruger SR9 and SR9 Compacts)	116-RLSR	98.76
Taurus (Fits Taurus PT709, PT708, PT740 in .380acp, 40s&w and 9mm)	116-RLTS	136.04
Kel-Tec (Fits Kel-Tec model PF9, 9mm.)	116-RLPF	136.04



S&W and Taurus - The side mounted laser fits on all of the Smith & Wesson J-frame revolvers ever made and all Taurus revolvers. And now, the Taurus Judges including the Public Defender finally has a laser system to call its own.

Order No. 116-CKSWAT \$110.84



Smith & Wesson / Sigma VE Rail Adapter - Securely attaches to the pistol's rails or onto Laserlyte's Rail Adapters for S&W Sigma VE, HK USP and USP Compact, Bersa and Hi-Point series

Order no. 116-ADPSIGM140 Price \$8.36



MAKO Glock Tactical Scope Mount -

Designed for any size or caliber Glock pistol with front accessory rail. Lightweight, strong polymer construction. Allows use of iron sights. Easy installation replaces trigger pin and locks to rail. Gives fast sight alignment and improves balance and recoil control.

Order No. 120-GIS \$33.71



Leupold Spotting Scopes

NEW! Leupold KENAI Spotting Scope- When you're hunting wide-open spaces, the all-new SX-2 Kenai™ is a High-Definition spotting scope at an appealing price. With a premium, 80mm objective lens, the SX-2 Kenai delivers generous light transmission and provides a sharp, clear picture with impeccable color reproduction.



KIT-

30x25-60x80 HD Straight Kit Black
Order No. 024-64305 \$999.99

30x25-60x80 HD Angled Kit Black
Order No. 024-64310 \$999.99

SCOPE ONLY-

30x25-60x80 HD Straight Scope Gray/Black
Order No. 024-65365 \$899.99

30x25-60x80 HD Angled Scope Gray/Black
Order No. 024-65375 \$899.99

Bushnell Spotting Scopes



15-45x50mm Black Sportview Zoom
20-60x60mm with Table Top Tripod

Order No.
027-781545
027-782061

Price
\$75.78
86.69



Sentry Spotter Scope 12-36x50mm - Designed specifically for hunting applications where compact optics area necessity. Other features include Mossy Oak, Break-Up, camo rubber armor, tripod, plus versatile car window mount. Premium hard-side and compact soft-side carrying cases included.

Order No.
027-789332 **\$147.73**

Burriss Spotting Scopes



XTS-2575 Spotting Scope - A high performance Cassegrain-style mirror system design allows us to offer this high-magnification, high-resolution 25X-75X-70mm spotting scope in an extremely lightweight, compact configuration. The XTS 2575 weighs in at a mere 33 ounces and measures only 10" long, 5" tall and 3.6" wide.

Features an adjustable angled eyepiece making it ideal for viewing in a sitting or prone position. Every lens surface is broad band multicoated for reflection-free, ultra bright viewing and the XTS 2575 is waterproof, fogproof and highly shock resistant. **Order No. 023-300101 \$239.70**



High Country Spotting Scopes - Burriss has always believed a sportsman shouldn't have to spend a week's pay for reliable spotting optics. High Country Spotting Scopes reflect that vision. In the practical 15X-45X-50mm and the potent 20X-60X-60mm models, both High Countries have handsome and stealthy rubberized, waterproof exteriors and sharp, fully multi-coated lenses. An integrated lens cap on the slide-out sun shade keeps away dust and is near-impossible to lose.

	Order No.	Price
High Country 15-45x50mm with Tripod	023-300111	\$119.85
High Country 20-60x60mm with Tripod	023-300112	159.80

Micro-Adjust Tripod - Just point your spotting scope "in the ball park" and then micro-adjust the windage and elevation knobs to zero in on your image. Window mount detaches from the tripod to quickly mount on a window. Ideal for bench rests and truck hoods. Folded length - 17" Working Height - 8.5" - 18"

Order No. 023-300141 \$45.19



Large Window Mount only



Order No.
023-300158 **Price**
\$29.73

Redfield Spotting Scope



Redfield Rampaige™
20-60x60mm -
• BAK4 Prism System
• Generous Field of View
• Polycarbonate Body
• Retractable Lens Shade
• Limited Lifetime Warranty

Order No.
128-67600 **\$206.76**

Spotting Scope Accessories



	Order No.	Price
Bushnell Field Tripod (Max 36" Tall) (A)	027-783001	\$34.00
Bushnell Car Window Mount (Height: 4 3/4") (B)	027-784405	34.95
Nikon Window Mount (C)	125-7070	34.05



Leupold Compact Tripod- Leupold's Compact Tripod collapses to 15" and the extended length is 31.5" adjustable up to 30". Adjustable ball head with quick release base gives incredible viewing versatility. For use with many spotting scopes and binoculars.

Order No. 024-56446 \$74.96



Tasco Spotting Scopes



World Class Spotting Scope Kits - Fully Multi-Coated Optics. These spotting scope kits come with a car window mount and tripod. All spotters include a soft carrying case. All spotters except the 20x50mm have a hard carrying case.

	Order No.	Price
20-60x60mm Compact Spotting Scope	209-WC206060	\$120.26
20-60x60mm Compact Spotting Scope with 45degree Eye Piece	209-WC20606045	120.26

Simmons Spotting Scopes



ProSport Spotting Scopes -Featuring fully coated optics and rugged waterproof construction, nitrogen purged and fully fogproof Simmons® spotting scopes deliver targeting results in full brilliance almost as fast as you can punch holes. These powerful and lightweight Simmons spotting scopes are equally at home in the field, at the shooting range or even while bird watching. A hard-shell aluminum case, soft case and tripod are included

	Order No.	Price
20-60x60mm Rubber Armor, Matte	204-841101	\$113.44

Leupold Spotting Scopes

Green Ring Sequoia Spotting Scope - Powerful, durable, and waterproof. This combination of features makes it ideal for both the range and the field. Rubber armoring makes it perfect for rugged use. Comes with Neoprene carrying case. Discontinued - Limited Quantities!



Order No.	Price
20-60x80mm 024-61130	\$399.53

Nikon Spotting Scopes



Nikon 16-48x65mm ProStaff™ spotting scope - Nikon's ProStaff Spotting Scope can be close-focused to 13.1 feet, has a field of view at 1,000 yards of 126 feet, and an exit pupil of 4.1mm at 16x. The straight body 65mm scope is 11.5 inches long while the angled body is 12 inches long. It features 15.2mm of eye relief at 16x.

- Waterproof/fogproof, lightweight design
- Built-in sliding sunshade
- Case included
- Multicoated optics for bright, clear image

	Order No.	Price
16-48x65mm Team Realtree® (Straight Body w/eyepiece)	125-8310	\$402.59
16-48x65mm Charcoal Gray Spotting Scope Outfit	125-8314	406.40
16-48x65mm Team Realtree® Outfit	125-8316	495.30



Nikon 20-60x82mm ProStaff™ spotting scope - Nikon's 20-60x82mm ProStaff spotting scope can be close focused to 20 feet, has a field of view at 1,000 yards of 99 feet, and has an exit pupil of 4.1mm at 20x. The straight body 82mm scope is 15 inches long, while the angled body is 15.4 inches long. It features 15.2mm of eye relief at 20x.

- Massive 82mm objective for maximum light gathering
- Multicoated optics for a bright image
- Waterproof/fogproof, lightweight
- Built-in sliding sunshade
- VUE-THRU Case included

	Order No.	Price
20-60x82mm Charcoal Gray Spotting Scope Outfit	125-8317	\$581.66
20-60x82mm Team Realtree Outfit	125-8319	673.10

16-48x60 Spotter XL II Outfit

- 16-48 power zoom range
- Long eye relief for those wearing glasses
- Sliding sunshade and integral peep sight
- Fully waterproof, fogproof and shockproof
- Precision ground and polished, fully multicoated lens system
- Phase correction coated prisms
- Durable rubber armor

Order No.	Price
125-6892	\$649.95



Trijicon AccuPoint Scopes

Trijicon AccuPoint® - The Trijicon AccuPoint features advanced fiber optics and several intelligent features that make this scope the right choice for all light conditions and even the harshest environments. All models in the AccuPoint® Series operate battery free—eliminating the potential for failure during critical moments in the field. They also feature Trijicon's Manual Brightness Adjustment Override, which allows you to control the light output of the fiber-optics during daylight. AccuPoint® riflescopes include other advanced elements like multi-layer coated lenses for superior light transmission with no distortion, quick-focus eyepiece, long-eye relief, and precise windage and elevation adjustments.



- Solid Black Matte Finish
- Multi Layer Coated Lenses
- Aircraft Quality Hard Anodized Aluminum
- Trijicon Fiber Optics
- Longer Eye Relief

	Order No.	M.A.P.
3-9x40mm Matte Finish Green Triangle Reticle	202-TR20G	\$700.25
3-9x40mm Matte Finish Std Crosshair w/ Green Dot	202-TR201G	700.25
3-9x40mm Matte Finish Mil-Dot Crosshair w/ Green Dot	202-TR202G	700.25
2.5-10x56mm Matte Finish Green Triangle Reticle	202-TR22G	797.81
2.5-10x56mm Matte Finish Std Crosshair w/ Green Dot	202-TR221G	797.81
2.5-10x56mm Matte Finish Mil-Dot Crosshair w/ Green Dot	202-TR222G	797.81
5-20x50mm Matte Finish Std Crosshair w/ Green Dot (30mm)	202-TR231G	992.94
5-20x50mm Matte Finish Mil-Dot Crosshair w/ Green Dot (30mm)	202-TR232G	992.94
1-4x24mm Matte Finish Red Triangle Reticle (30mm)	202-TR24R	774.35
1-4x24mm Matte Finish Green Triangle Reticle (30mm)	202-TR24G	774.35

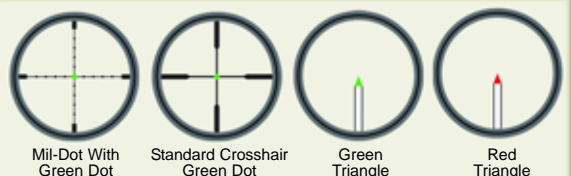

Bushnell Rifle, Pistol and Shotgun Scopes

Elite Riflescopes



	Order No.	Price
3-9x40mm Matte Multi-X	027-E3940	\$293.99
3-9x40mm Matte DOA 600	027-E3940B	368.68
3-9x40mm Silver Multi-X	027-E3940S	293.99
3-9x40mm Matte Multi-X	027-E3940SF	315.99
3-9x50mm Matte Multi-X	027-E3950	368.68
3-9x50mm Matte Multi-X Side Focus	027-E3950SF	421.31
4-16x40mm Matte DOA 600 w/AO Semi Target Turrets	027-E4164B	526.71

Elite Handgun Scopes



	Order No.	Price
2-6X32mm Matte Multi-X 20" Eye Relief	027-EH2632	\$307.66
2-6X32mm Silver Multi-X 20" Eye Relief	027-EH2632S	307.66

Elite Tactical Scopes



	Order No.	Price
Elite Tactical 10x40mm Matte Mil-Dot FMC	027-ET1040	\$263.35
Elite Tactical 2.5-16x42mm Matte Mil-Dot FMC 30mm Tube	027-ET2164	842.69
Elite Tactical 3-12x44mm Matte Illum Mil-Dot FFP Side Focus 30mm Tube	027-ET3124F	948.02
Elite Tactical 4.5-30x50mm Matte Mil-Dot FMC 30mm Tube	027-ET4305	948.02
Elite Tactical 5-15x40mm Matte Mil-Dot FMC w/AO	027-ET5154	474.01
Elite Tactical 6-24x50mm Matte Mil-Dot FMC Side Focus	027-ET6245	827.66
Elite Tactical 6-24x50mm Matte Illum Mil-Dot FFP Side Focus 30mm Tube	027-ET6245F	1053.35

Elite 6500 Scopes



Elite 6500 Riflescopes - Here is a versatile rifle scope, featuring a 6.5x magnification range, the widest in the industry. These scopes are ideal for hunters who want a scope they can use in the brush as well as on the wide-open prairie.

Push/pull turrets with resettable zero make sighting-in easier than ever. The extended 80-MOA of windage and elevation adjustment travel (with .25-MOA clicks) make this scope a "must have" for the hunter who shoots a broad range of game and at distances that vary greatly. All models have a one-piece 30 mm tube. Fully multic coated optics with RainGuard®, for a consistently sharp, clear view even in the worst conditions.

	Order No.	Price
1.25-8x32mm Matte Multi-x Reticle	027-651832M	\$737.36
2.5-16x42mm Matte Fine Multi-X Reticle	027-652164M	814.49
2.5-16x42mm Matte Mil-Dot Reticle	027-652164MD	814.49
2.5-16x50mm Matte Fine Multi-X Reticle	027-652165M	845.55
2.5-16x50mm Matte Mil-Dot Reticle	027-652165MD	845.55
4.5-30x50mm Matte Fine Multi-X Reticle	027-654305M	977.42
4.5-30x50mm Matte Mil-Dot Reticle	027-654305MD	977.42



Bushnell Banner Series - The Banner riflescopes are designed for maximizing Dawn and Dusk brightness so that you can get the most out of your hunting day. Now Available, Banner Riflescopes with Red & Green Illuminated Crosshairs.

	Order No.	Price
1.5x.4.5x32mm Wide Angle, Matte	027-711545	\$82.50
3x9x40mm Black Powder, Matte w/Circle-X Ret.	027-713944	88.54
3x9x40mm Matte	027-713948	85.79
3x9x40mm Matte Multi-X	027-713947	90.30
3x9x40mm Realtree AP Camo Finish Circle-X® Reticle	027-713944AP	102.30
3x9x50mm Matte	027-713950	132.42
6x18x50 Adjustable objective, Matte	027-716185	148.93
4x12x40mm Duplex reticle Matte Finish w/AO	027-714124	109.90
3x9x40mm Matte w/Red & Green Illuminated Crosshairs	027-713949I	108.36
3x9x50mm Matte w/Red & Green Illuminated Crosshairs	027-713959I	141.51
4x16x40mm Matte w/Red & Green Illuminated Crosshairs	027-714164I	141.51
3.5-10x36mm Matte 17 Super Banner (17HMR/.22) Multi-X	027-713510	113.40
6-24x40mm Matte Mil Dot w/AO	027-716244	189.57



Bushnell Trophy XLT Xtended Light Transmission Series -

- Fully Multi-Coated Lenses
- 91% Light Transmission
- One Piece Tube
- New Windage / Elevation Controls
- Integrated Saddle and Power Change Rings
- Butler Creek Flip Open Scope Covers

	Order No.	Price
4-12X40mm Matte DOA 600	027-734120B	\$221.24
2-6x32mm Matte Handgun Scope 9-26" Eye Relief	027-732633	209.25
2-6x32mm Silver Handgun Scope 9-26" Eye Relief	027-732633S	209.25
1x32mm Black Matte Red Dot Green T-Dot Tactical	027-730132P	190.66
3-9x40mm RTAP DOA 250 Reticle	027-733960AB	188.02
3-9x40mm Matte DOA 600	027-733960B	169.12
3-9x40mm Matte DOA 250	027-733960BP	169.12
1.75-4x32mm Realtree Circle-X Shotgun / Slug	027-731432AP	149.63
1.75-4x32mm Realtree Circle-X Shotgun / Slug	027-731432	140.17
3-9x40mm Gloss Multi-X	027-733944	142.22
3-9x40mm Silver Multi-X	027-733944S	142.22
3-9x40mm Matte MilDot	027-733945	142.22
3-9x40mm Matte Circle-X	027-733961	142.22
1x28mm Matte Red Dot 4 Dial-in Red Green Reticles	027-730135	109.21

Thompson Center Muzzleloader Scopes



	Order No.	Price
2.5-7x28mm 1" Black Pistol Scope / Std. Duplex Reticle	030-8315	\$263.18
3-9x40mm 1" WA Hawken Hunter, Matte Finish	030-8652	142.02
1.5-5x32mm 1" Tube, Hawken Hunter, Matte Finish	030-8656	127.31
4x32mm, 1" Hawken Hunter, Matte Pro Diamond Reticle	030-8662	107.60
1.5-5x32mm 1" Tube, Hawken Hunter, Silver Finish	030-8670	127.53

3-9x32mm Rifle Scope with Picatinny Rails -

- Picatinny rails on 3 sides for mounting lights, lasers, etc.
- Dovetail mount included
- Dry nitrogen filled
- Mil-Dot reticle design
- Fully multi-coated precision lenses
- 100% waterproof, fogproof, and shockproof

Order No. 146-CS12RM3932 \$63.91



Burriss Rifle, Pistol and Shotgun Scopes



Fullfield E¹ Riflescope- Burriss upgraded the Fullfield II riflescopes and gave them a sleek profile with upgraded windage/elevation knobs, a integrated power ring and eyepiece that will now accept flip-up lens caps. The precision and accuracy has been enhanced with the Ballistic Plex E¹ reticle, which provides a simple, uncluttered method for determining trajectory and wind compensation. The Fullfield E¹ is waterproof, shock-proof, fog-proof, nitrogen-filled, and backed by Burriss' forever warranty.

	Order No.	M.A.P.
2-7x35mm Ballistic Plex E ¹ Reticle Matte Finish	023-200317	\$199.00
3-9x40mm Ballistic Plex E ¹ Reticle Matte Finish	023-200320	249.00
3-9x50mm Ballistic Plex E ¹ Reticle Matte Finish	023-200330	299.00
4.5x-14x42mm Ballistic Plex E ¹ Reticle Matte Finish	023-200335	349.00



Burriss Fullfield II Scopes - Fullfield II's incorporate more forgiving fore/aft, left/right eye positioning and combine lighter weight with shorter length and added strength. Potential leak paths in the eyepiece/ power ring area are sealed like the rest with special quad seals rather than O-rings. European-style adjustable eyepiece requires no locking mechanism.

	Order No.	M.A.P.
2-7x35mm Ballistic Plex Matte	023-200123	\$149.00
3-9x40mm Plex Matte	023-200161	199.00
3-9x40mm Ballistic Plex Matte	023-200162	199.00
3-9x40mm Reticle Ballistic Plex Nickel	023-200169	199.00
3-9x50mm Ballistic Plex Matte	023-200154	249.00
4.5-14x42mm Ballistic Plex Matte PA	023-200183	299.00
6.5-20x 50mm Ballistic MDot Matte PA	023-200193	399.00



	Order No.	M.A.P.
6X-24X-50mm Matte Target/PA BALL MDOT	023-200934	\$799.00
8X-32X-50mm Matte Target/PA BALL MDOT	023-200943	849.00
4-16X-50mm Matte Finish Plex PA Ballistic Plex	023-200926	699.00

Burriss Tactical XTR Scopes



XTR Xtreme Tactical™ Riflescopes - Extra-large, ultra-premium lenses produce unsurpassed resolution, clarity, and brightness. All XTR scope tubes are 30mm, resulting in 25% thicker main tubes and 42% more strength. Double-force coil spring suspension locks the inner tube in place for unflinching accuracy. The whole package is waterproof, fogproof, shockproof and warranted forever. Tactical scopes just don't come any better.

	Order No.	M.A.P.
1-4x24mm Illuminated XTR Ballistic 5.56 Gen 2 Reticle Matte	023-201904	\$699.00
1-4x24mm Illum w/Fastfire XTR Ballistic 5.56 Gen 2 Ret. Matte	023-201905	899.00
3-12x50mm Illum Ballistic Mil-Dot 12x Matte	023-201916	949.00
4-16x50mm Illum Mil-Dot 14x Matte	023-201940	1049.00
4-16x50mm Illum Mil-Dot Ballistic Mil-Dot 14x Matte	023-201941	929.00



Burriss Handgun Scopes - Burriss offers several models with features which keep in mind scopes with the unique characteristics needed to stand up to the recoil from today's powerful magnums. Possibly the most powerful handgun scopes available anywhere and with parallax adjustment for precision long range and short range shooting. Every Burriss handgun scope includes fully multicoated optics and the unbeatable Burriss Forever Warranty. For heavy recoil, the Posi-Lock models are an ideal choice.

	Order No.	M.A.P.
2.75X-24mm HVY PLX Matte	023-200269	\$249.00
2X-20mm PLX Matte	023-200218	219.00
2X-20mm PLX Nickel	023-200229	229.00
2X-7X PLX Matte	023-200291	349.00
2X-7X PLX Nickel	023-200298	349.00
2X-7X Ballistic Plex Posi-Lock Matte	023-200299	379.00
2X-7X Ballistic Plex Matte	023-200279	349.00
3X-12 Ballistic Plex Matte PA	023-200309	429.00

AR-P.E.P.R.™ Mount - Proper Eye Position Ready for combat riflescopes, this mount provides 2" of forward scope positioning on the M-4 and AR-15 platform. Ring bases are milled as a single, tough unit, and ring tops feature Picatinny tops for mounting additional accessories.



	Order No.	Price
30mm w/ Picatinny Tops	023-410342	\$89.51
1" w/ Picatinny Tops	023-410344	89.51
AR-QD Mount for Prism Scopes	023-410349	68.45

Please read regarding Burriss returns! All Defective Burriss Product Returns Must Go Through Burriss! Please call Burriss 1-888-228-7747 for Assistance.

SPECS/FEATURES:
 PA=Parallax Adjustment
 Target=Target adjustment knobs/Parallax Adjustment
 Target 1=Elevation Target-type adjustment knob only/Parallax Adjustment
 IER=Intermediate eye relief XER=extra eye relief
 HBR=Hunter/Benchrest
 LDPX-Lighted electro-dot reticle

RETICLES:
 PLX=Plex
 FPX=Fine Plex
 HPX=Heavy Plex
 PPX=Peep Plex
 FCH=Fine Crosshair

FINISH:
 BLK=Gloss Black
 MAT=Matte
 CAM=Camo
 NIC=Nickel

Plex

Heavy Plex & Electro-Dot Plex

Ballistic Mil-Dot

MIL-Dot

Fine Plex

Peep Plex

Target Dot

Ballistic Plex

Burriss Value Added Package

3-9x40mm FFL with FREE
3-9x40mm Rimfire Scope!

Order No.
023-200162RF \$219.00



Burriss Eliminator Laserscope - No more guessing yardage or fumbling with a shaky handheld rangefinder. No more losing sight of your trophy. No more guessing holdover.



The Eliminator knows the precise horizontal distance to your trophy and exactly what your cartridge will do. Eliminator lights a 1/3 MOA illuminated aiming dot showing exactly where your shot will go. With The Eliminator, just Range, Aim, and Fire.

Simply enter one of the 40 drop numbers into the Eliminator. In a split second, the Eliminator factors in the distance, the angle of the shot, and the ballistics of your cartridge, and presents a lighted dot for the perfect holdover.

Order No. 023-200112 \$949.00

Burriss Sunshades - These high quality sunshades install in seconds, reduce glare, and aid the shooter in reading mirage.

	Order No.	M.A.P.
Signature 44mm, Matte	023-626013	\$20.21
Fullfield II 6.5x-20x-50mm Matte	023-626032	26.16
2.25" Short Mag 4.5-14, Cmp 4-12	023-626034	16.65



Millett Rifle Scopes

Millett New Generation Target Scopes -

These 30mm target and varmint scopes give the shooter the most value for the money. A distinctive new look, with large, easy-to-use turret and side focus knobs add to the style of these scopes. Millett's proprietary Gimble Pivot increases accuracy and assures intertube alignment. Fully multi-coated optics and unique coil spring ensure sharpness and accuracy.

Millett New Generation Target Scopes -	Order No.	Price
6-25x56mm Matte Side Focus Fine Hair Duplex	131-BK30739	\$419.68

Millett 6-25x56mm Long Range Scope -

- 35mm tube for added strength, brightness and clarity.
- Perfect for large caliber rifles used for extended ranges (50 BMG & 338 Lapua)
- Millett tactical 35mm rings included
- Each Millett LRS-1 is computer tested under recoil to assure the highest quality.

Millett Long Range Scope -	Order No.	Price
6-25x56mm LRS 35mm Main Tube	131-BK81004	\$503.62



NEW! Leupold VX-6 Scopes

Powerful 6:1 zoom ratio!



Leupold® VX®-6™ Riflescopes - Legendary Leupold® durability, ruggedness and stunning optical quality-- times six. With a powerful 6:1 zoom ratio, the Leupold® VX-6™ delivers crystal clear images from edge-to-edge throughout the entire magnification range. Leupold's legendary Xtended Twilight Lens System™ and DiamondCoat 2™ combine with edge-blackened lead free lenses for astonishing clarity and light transmission. The extreme fast-focus eyepiece ensures a generous eyepiece, superior field of view and optimal diopter adjustment in the field. Waterproof, shockproof and backed by the Leupold® Full Lifetime Guarantee / Leupold Golden Ring® Electronics Warranty, the Leupold VX-6™ sets the standard for riflescope performance. ALL scopes come in Matte.

VX-6 Scopes	Reticle		Order No.	M.A.P.
1-6x24mm	Duplex	CDS	024-112316	\$799.99
1-6x24mm	German #4 Dot	CDS	024-112317	799.99
1-6x24mm	Illum. Duplex	CDS	024-112318	899.99
1-6x24mm	Illum. German #4 Dot	CDS	024-112320	899.99
2-12x42mm	Duplex	CDS	024-111977	899.99
2-12x42mm	Boone & Crockett	CDS	024-111978	979.99
2-12x42mm	Illum. Duplex	CDS	024-111979	999.99
2-12x42mm	Illum. LR Duplex	CDS	024-111980	999.99
2-12x42mm	Illum. German #4 Dot	CDS	024-115199	999.99
3-18x44mm	Fine Duplex	Side Focus CDS	024-115001	999.99
3-18x44mm	Illum. Duplex	Side Focus CDS	024-115003	1099.99
3-18x44mm	Illum. Boone & Crockett	Side Focus CDS	024-115004	1099.99
3-18x50mm	Fine Duplex	Side Focus CDS	024-115005	1099.99
3-18x50mm	Illum. Duplex	Side Focus CDS	024-115007	1199.99
3-18x50mm	Illum. Boone & Crockett	Side Focus CDS	024-115008	1199.99
3-18x50mm	Illum. German #4 Dot	Side Focus CDS	024-115198	1199.99
4-24x52mm	Fine Duplex	Side Focus CDS	024-115009	1299.99
4-24x52mm	Illum. Boone & Crockett	Side Focus CDS	024-115011	1399.99
4-24x52mm	Illum. Varmint Hunters	Side Focus CDS	024-115012	1399.99

Leupold Mark AR Riflescopes

Mark AR Riflescopes - The Leupold Mark AR series of riflescopes is ideal for those who hunt with AR15/M-16 style rifles, delivering high performance at a price that's right on target.



	Order No.	M.A.P.
1.5-4x40mm Matte Duplex	024-67170	\$279.99
3-9x40mm Matte Duplex	024-67165	299.99
3-9x40mm Matte Mil-Dot	024-67160	349.99
4-12x40mm AO Fine Plex Matte with T2 1/2 MOA Target Style Windage and Elevation Adjustments	024-67390	449.99
4-12x40mm AO MilDot Matte with T2 1/2 MOA Target Style Windage and Elevation Adjustments	024-67395	499.99
6-18x40mm AO Fine Plex Matte with T1 1/4 MOA Target Style Windage and Elevation Adjustments	024-67400	499.99

Mark4 Law Enforcement Bases & Rings

Mark4 Aluminum Rings

	Order No.	Price
30mm Med 0.84" Matte	154-57398	\$126.52
30mm Super High 1.40" Matte	154-57555	126.52

Mark4 Steel Rings

	Order No.	Price
30mm Med 0.84" Matte	154-61049	\$131.90
30mm Super High 1.40" Matte	154-60750	126.52



Leupold Rifle, Pistol and Shotgun Scopes



The light transmission of a 50mm but mounts like a 36mm!



Leupold VX-3L Low Mount Scope Series - Large riflescopes are great when the light is low, but the high mount and awkward cheek weld always left something to be desired. That something is the Leupold VX-3L Series of riflescopes. This unique shape takes low light performance to a whole level and has the added advantage of an incredibly low mount. By creating a small crescent in the objective of the VX-3L Leupold was able to increase the objective size for greater light transmission. The VX-3L 3.5-10x50mm transmits more light than a typical 40mm rifle scope, yet mounts as low as a 36mm!

	Reticle	Finish	Order No.	M.A.P.
3.5-10x50mm	Duplex	Matte	024-66670	\$699.99
3.5-10x56mm	Duplex	Matte	024-66680	879.99
4.5-14x50mm	Duplex	Matte	024-66695	779.99
4.5-14x50mm	Varmint Hunters	Matte	024-66705	859.99
4.5-14x56mm Long Range	Duplex	Matte	024-66710	999.99
4.5-14x56mm Long Range	Boone & Crockett	Matte	024-66715	1079.99
4.5-14x56mm Long Range	CDS Duplex	Matte	024-115241	1049.99
6.5-20x56mm Long Range	Fine Duplex	Matte	024-66725	1089.99

XT- Xtended Twilight™ Lens Technology - VX-3 Scopes Feature Leupolds XT-Xtended Twilight™ lens technology that targets and raises the light wavelengths most commonly found in near-dark and twilight conditions.



Leupold VX-R Scopes - Sleek design with daylight-capable illumination; the Leupold VX-R patented 1-button design minimizes bulk, while allowing users to select between 8 intensity settings, including a low/high indicator. Waterproof, shockproof, and backed by the Leupold Full Lifetime Guarantee.

	Order No.	M.A.P.
VX-R 1.25-4x20mm Matte Finish FireDot Duplex Reticle	024-111230	\$439.99
VX-R 1.25-4x20mm Matte Finish FireDot 4 Reticle	024-110683	439.99
VX-R 1.25-4x20mm Matte Finish Circle FireDot Reticle	024-111231	449.99
VX-R 1.25-4x20mm Matte Finish FireDot Pig Plex Reticle	024-113165	479.99
VX-R 2-7x33mm Matte Finish FireDot Duplex Reticle	024-110684	459.99
VX-R 2-7x33mm Matte Finish Ballistic FireDot Reticle	024-111233	479.99
VR-R 3-9x40mm Matte Finish FireDot Duplex Reticle	024-110686	479.99
VR-R 3-9x40mm Matte Finish FireDot 4 Reticle	024-110687	479.99
VR-R 3-9x40mm Matte Finish Ballistic FireDot Reticle	024-111236	499.99
VR-R 3-9x40mm Matte Finish FireDot Duplex Reticle	024-112194	529.99
VX-R 3-9x50mm Matte Finish FireDot Duplex Reticle	024-110688	549.99
VX-R 3-9x50mm Matte Finish FireDot 4 Reticle	024-110689	549.99
VX-R 3-9x50mm Matte Finish Ballistic FireDot Reticle	024-111237	569.99
VX-R 3-9x50mm CDS Matte Finish FireDot Dup. Reticle	024-112195	599.99
VX-R 4-12x40mm Matte Finish FireDot 4 Reticle	024-111239	579.99
VX-R 4-12x40mm Matte Finish Ballistic FireDot Reticle	024-111240	599.99
VX-R 4-12x40mm CDS Matte Finish FireDot Dup. Reticle	024-111238	629.99
VX-R 4-12x50mm Matte Finish FireDot Duplex Reticle	024-111241	649.99
VX-R 4-12x50mm Matte Finish FireDot 4 Reticle	024-111242	649.99
VX-R 4-12x50mm Matte Finish Ballistic FireDot Reticle	024-111249	669.99

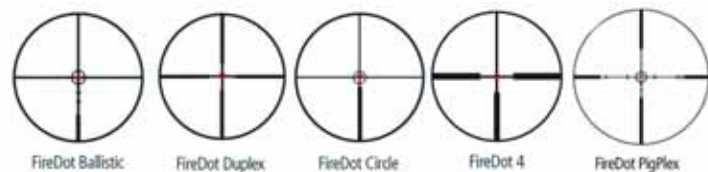

Leupold VX-I Series - For hunters who want quality, accuracy, and affordability, the VX-I has what you are looking for. Rugged, Waterproof, and still features the Leupold's Full Lifetime Guarantee! Made In The U.S.A.!!!



	Order No.	M.A.P.
2-7X33mm Gloss Finish Duplex Reticle	024-113862	\$209.99
2-7X33mm Matte Finish Duplex Reticle	024-113863	209.99
2-7X33mm Matte Finish Wide Duplex Reticle	024-113864	209.99
2-7X33mm Matte Finish LR Duplex Reticle	024-113865	229.99
3-9X40mm Gloss Finish Duplex Reticle	024-113873	229.99
3-9X40mm Matte Finish Duplex Reticle	024-113874	229.99
3-9X40mm Matte Finish Wide Duplex Reticle	024-113875	229.99
3-9X40mm Matte Finish LR Duplex Reticle	024-113876	249.99
3-9X40mm Silver Finish Duplex Reticle	024-113878	229.99
3-9x40mm Mossy Oak Tree Stand Camo Duplex Reticle	024-114785	279.99
3-9x40mm Mossy Oak Break-Up Camo Duplex Reticle	024-114784	279.99
3-9X50mm Gloss Finish Duplex Reticle	024-113881	299.99
3-9X50mm Matte Finish Duplex Reticle	024-113882	299.99
3-9X50mm Matte Finish Wide Duplex Reticle	024-113883	299.99
3-9X50mm Matte Finish LR Duplex Reticle	024-113884	319.99
4-12X40mm Gloss Finish Duplex Reticle	024-113885	299.99
4-12X40mm Matte Finish Duplex Reticle	024-113886	299.99
4-12X40mm Matte Finish Wide Duplex Reticle	024-113887	299.99
4-12X40mm Matte Finish LR Duplex Reticle	024-113888	319.99

Leupold Rifleman Series - Leupold® riflescopes are built to endure the worst the wilds have to offer, and still make the shot of a lifetime. Bright. Clear. Rugged. Waterproof. Accurate. Dependable. Fully coated lenses. Guaranteed for Life and Made in the USA.



	Order No.	Price.
2-7X33mm Matte Finish Wide Duplex Reticle	024-56150	\$185.79
3-9X40mm Matte Finish Wide Duplex Reticle	024-56160	200.80
3-9X50mm Matte Finish Wide Duplex Reticle	024-58160	271.19
4-12X40mm Matte Finish Wide Duplex Reticle	024-56170	240.03



Leupold Ultralight Series - All the features of the full-size models, with 17 percent less weight. Still very Rugged! Absolutely waterproof. Guaranteed for life – each Ultralight rifle scope is covered by the Leupold Full Lifetime Guarantee.

	Order No.	M.A.P.
FX-II 2.5x20mm Matte Finish Wide Duplex Reticle	024-58450	\$269.99
FX-II 2.5x20mm Matte Finish Heavy Duplex Reticle	024-58460	269.99
VX-2 Ultralight 2-7x28mm Gloss Finish Duplex Reticle	024-110818	329.99
VX-2 Ultralight 2-7x28mm Matte Finish Duplex Reticle	024-114400	329.99
VX-2 Ultralight 3-9x33mm Matte Finish Wide Duplex Reticle	024-110819	349.99
VX-2 Ultralight 3-9x33mm Matte Finish LR Duplex Reticle	024-110820	379.99
VX-2 Ultralight 3-9x33mm CDS Matte Finish Wide Duplex	024-114414	399.99
VX-2 Ultralight 3-9x33mm Silver Finish Wide Duplex	024-110821	349.99
VX-2 Ultralight 3-9x33mm EFR Gloss Finish Fine Duplex	024-110822	399.99

More Online!



Leupold Reticles

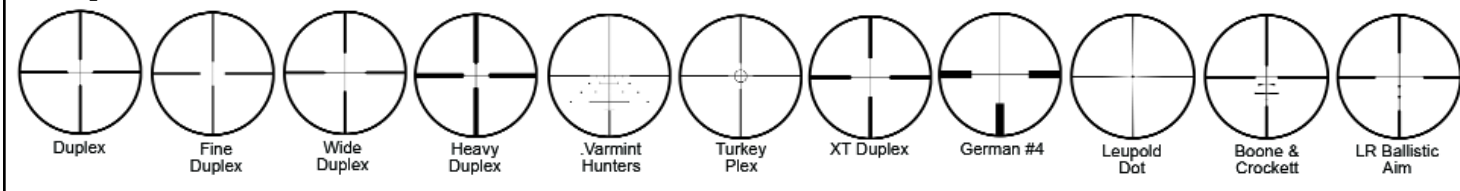



LEUPOLD
HERITAGE OPTICS CORPORATION

Leupold VX-II Series - The Multicoat 4 system is used on all VX-II riflescope lens surfaces, external and internal. It increases the amount of available light that reaches the eye and minimizes reflections on the outer eyepiece. As a result, the system enhances image brightness and clarity, and improves contrast in low-light conditions. 1/4 Min Clicks

VX-II 1-4x20mm

Reticle	Finish	Order No.	M.A.P.
Duplex	Matte	024-110793	\$299.99

VX-II 2-7x33mm

Reticle	Finish	Order No.	M.A.P.
Duplex	Matte	024-110794	\$299.99
LR Duplex	Matte	024-110795	329.99
CDS Duplex	Matte	024-114402	349.99

VX-II 3-9x40mm

Reticle	Finish	Order No.	M.A.P.
Duplex	Gloss	024-110796	\$299.99
Duplex	Matte	024-110797	299.99
Wide Duplex	Matte	024-110798	299.99
LR Duplex	Matte	024-110801	329.99
Leupold Dot	Matte	024-110800	349.99
German #4	Matte	024-110799	349.99
CDS Duplex	Matte	024-114404	349.99
Duplex	Silver	024-110802	299.99

VX-II 3-9x50mm

Reticle	Finish	Order No.	M.A.P.
Duplex	Gloss	024-110804	\$379.99
Duplex	Matte	024-110805	379.99
Heavy Duplex	Matte	024-110806	379.99
LR Duplex	Matte	024-110807	409.99
CDS Duplex	Matte	024-114406	429.99

VX-II 4-12x40mm

Reticle	Finish	Order No.	M.A.P.
Fine Duplex	Matte	024-114396	\$399.99

VX-II 4-12x40mm Adjustable Objective

Reticle	Finish	Order No.	M.A.P.
Fine Duplex	Matte	024-110808	\$449.99
LR Duplex	Matte	024-110809	479.99
CDS Duplex	Matte	024-114408	499.99
Fine Duplex	Matte	024-110810	449.99

VX-II 4-12x50mm

Reticle	Finish	Order No.	M.A.P.
Duplex	Matte	024-110811	\$479.99
Heavy Duplex	Matte	024-110812	509.99
Duplex	Matte	024-114410	529.99
Fine Duplex	Silver	024-110813	479.99

VX-II 6-18x40mm Adjustable Objective

Reticle	Finish	Order No.	M.A.P.
Fine Duplex	Matte	024-110814	\$499.99
LRV Duplex	Matte	024-110815	529.99
CDS Fine Duplex	Matte	024-114412	549.99

VX-II 6-18x40mm Target Adj. Objective

Reticle	Finish	Order No.	M.A.P.
Fine Duplex	Matte	024-110816	\$549.99
Target Dot	Matte	024-110817	599.99

Leupold Illuminated Reticles

Illuminated Duplex Illuminated German #4 Illuminated Circle Dot

VX-3 Scopes Feature Leupolds XT- Xtended Twilight™ lens technology that targets and raises the light wavelengths most commonly found in near-dark and twilight conditions.



LEUPOLD
HERITAGE OPTICS CORPORATION

Leupold VX-3 Series - Leupold's® family of Golden Ring® VX-3 riflescopes replaces and improves on the popular VX® III line with lens coatings and reticle options. VX-3 riflescopes feature a coating system, Leupold's Index Matched Lens System™. In some VX-3 scopes, total light transmission can reach as high as 98%. Each model features finger-adjustable, 1/4-MOA "click" windage and elevation. Lockable, fast-focus eyepiece. All side focus models have a 30mm maintube for increased range of windage and elevation adjustments. Waterproof - each scope is filled with nitrogen and sealed with Leupold's proven process to keep out moisture. Side focus parallax resolution dial on all models of 4.5-14 power and higher (except the EFR model) for easy adjustment from all shooting positions.

VX-3 1.5-5x20mm

Reticle	Finish	Order No.	M.A.P.
Duplex	Gloss	024-66360	\$399.99
Duplex	Matte	024-66370	399.99
Heavy Duplex	Matte	024-66375	399.99
German #4	Matte	024-66380*	449.99

VX-3 1.75-6x32mm

Reticle	Finish	Order No.	M.A.P.
Duplex	Matte	024-66385	\$399.99
Heavy Duplex	Matte	024-66390	399.99

VX-3 2.5-8x36mm

Reticle	Finish	Order No.	M.A.P.
Duplex	Gloss	024-66330	\$399.99
Duplex	Matte	024-66340	399.99
Boone & Crockett	Matte	024-66345	479.99
Duplex	Silver	024-66350	399.99

VX-3 3.5-10x40mm

Reticle	Finish	Order No.	M.A.P.
Boone & Crockett	Gloss	024-66105	\$559.99
Duplex	Matte	024-66090	479.99
Boone & Crockett	Matte	024-66110	559.99
Duplex	Silver	024-66095	479.99
Boone & Crockett	Silver	024-66115	559.99

VX-3 3.5-10x50mm

Reticle	Finish	Order No.	M.A.P.
Duplex	Gloss	024-66255	\$549.99
Duplex	Matte	024-66270	549.99
Heavy Duplex	Matte	024-66275	549.99
Boone & Crockett	Matte	024-66280	629.99
Duplex	Silver	024-66285	549.99
NEW! CDS Duplex	Matte	024-111827	599.99

VX-3 4.5-14x40mm

Reticle	Finish	Order No.	M.A.P.
Duplex	Matte	024-66215	\$529.99
Boone & Crockett	Matte	024-66225	609.99
Varmint Hunters	Matte	024-66220	609.99
Duplex	Silver	024-66230	529.99
Boone & Crockett	Silver	024-66240	609.99
Varmint Hunters	Silver	024-66235	609.99

VX-3 4.5-14x40mm Adjustable Objective

Reticle	Finish	Order No.	M.A.P.
Duplex	Matte	024-66430	\$599.99
Fine Duplex	Matte	024-66435	599.99
Boone & Crockett	Matte	024-66445	679.99
Varmint Hunters	Matte	024-66440	679.99
New! CDS Duplex	Matte	024-115239	649.99

VX-3 4.5-14x40mm Long Range 30mm Tube (Side Focus)

Reticle	Finish	Order No.	M.A.P.
Duplex	Gloss	024-66395	\$679.99
Fine Duplex	Matte	024-66415	679.99
Duplex	Matte	024-66410	679.99
Boone & Crockett	Matte	024-66425	759.99
Varmint Hunters	Matte	024-66420	759.99
New! CDS Duplex	Matte	024-115240	729.99

VX-3 4.5-14x50mm

Reticle	Finish	Order No.	M.A.P.
Duplex	Matte	024-66295	\$659.99
Heavy Duplex	Matte	024-66300	659.99
Boone & Crockett	Matte	024-66310	739.99
Varmint Hunters	Matte	024-66305	739.99
Duplex	Silver	024-66315	659.99
Boone & Crockett	Silver	024-66325*	739.99
New! CDS Duplex	Matte	024-115237	709.99

VX-3 4.5-14x50mm Long Range 30mm Tube (Side Focus)

Reticle	Finish	Order No.	M.A.P.
Duplex	Matte	024-66480	\$759.99
Boone & Crockett	Matte	024-66490	839.99
Varmint Hunters	Matte	024-66485	839.99
New! CDS Duplex	Matte	024-115238	809.99

VX-3 6.5-20x40mm Adj Obj.

Reticle	Finish	Order No.	M.A.P.
Fine Duplex	Matte	024-66550	\$699.99
Target Dot	Matte	024-66555	749.99
Varmint Hunters	Matte	024-66560	779.99

VX-3 6.5-20x40mm Long Range 30mm Tube

Reticle	Finish	Order No.	M.A.P.
Fine Duplex	Gloss	024-66520*	\$759.99
Fine Duplex	Matte	024-66530	759.99
Varmint Hunters	Matte	024-66535	839.99
Fine Duplex	Silver	024-66540	759.99
Varmint Hunters	Silver	024-66545	839.99

VX-3 6.5-20x40mm EFR Target.

Reticle	Finish	Order No.	M.A.P.
Fine Duplex	Matte	024-66565	\$749.99
Target Dot	Matte	024-66570	799.99

VX-3 6.5-20x50mm Long Range Target 30mm Tube

Reticle	Finish	Order No.	M.A.P.
Fine Duplex	Matte	024-66575	\$889.99
Target Dot	Matte	024-66580	939.99
Varmint Hunters	Matte	024-66585	969.99
Fine Duplex	Silver	024-66590	889.99

VX-3 8.5-25x50mm Long Range Target 30mm Tube

Reticle	Finish	Order No.	M.A.P.
Fine Duplex	Matte	024-66600	\$969.99
Target Dot	Matte	024-66605	1019.99
Varmint Hunters	Matte	024-66610	1049.99

Leupold VX-3 CDS™ models allow you to quickly dial your elevation to different sight-in ranges with a custom adjustment matched to your specific ballistics information. The CDS dials change out easily, allowing you flexibility with different loads, conditions and calibers. Included in the box is a coupon and instructions for redeeming your CDS dial through Leupold.



Leupold Rifle, Pistol and Shotgun Scopes



Leupold FX Series Riflescopes - This series of fixed power scopes is for hunters that appreciate the ruggedness, accuracy and purity of a fixed power riflescope. FX-III Models Feature the same index Matched Lens System and other features as the VX-3 Riflescopes. FX-II riflescopes offer the same features and MultiCoat 4 lens system as the VX II.

	Order No.	M.A.P.
FX-II 2.5x28mm Scout Matte Finish Duplex	024-58810	\$299.99
FX-II 2.5x28mm Scout Silver Finish Duplex	024-58820	299.99
FX-II 4x33mm Gloss Finish Duplex	024-58530	299.99
FX-II 4x33mm Matte Finish Duplex	024-58550	299.99
FX-II 6x36mm Gloss Finish Duplex	024-58560	299.99
FX-II 6x36mm Matte Finish Wide Duplex	024-58830	299.99
FX-3 6x42mm Gloss Finish Duplex	024-66805	399.99
FX-3 6x42mm Matte Finish Heavy Duplex	024-66810	399.99
FX-3 6x42mm Matte Finish Wide Duplex	024-66815	399.99
FX-3 12x40mm AO Target Matte Finish Fine Duplex	024-66830	499.99
FX-3 12x40mm AO Target Matte Finish Leupold Dot	024-66840	549.99



Leupold Handgun EER Scopes

	Order No.	M.A.P.
FX-II 2X20mm Gloss Finish Duplex Reticle	024-58720	\$349.99
FX-II 2X20mm Silver Finish Duplex Reticle	024-58730	349.99
FX-II 4X28mm Gloss Finish Duplex Reticle	024-58740	349.99
FX-II 4X28mm Matte Finish Duplex Reticle	024-58750	349.99
FX-II 4X28mm Silver Finish Duplex Reticle	024-58760	349.99
VX-3 2.5-8x32mm Gloss Finish Duplex Reticle	024-66615	549.99
VX-3 2.5-8x32mm Silver Finish Duplex Reticle	024-66620	549.99



Leupold Compact & Rimfire Scopes

	Order No.	M.A.P.
FX-I 4X28mm Gloss Finish Fine Duplex Reticle	024-58670	\$219.99
FX-I 4X28mm Matte Finish Fine Duplex Reticle	024-58680	219.99
VX-1 Rlmfire 2-7x28mm Gloss Finish Fine Duplex	024-113871	219.99
VX-1 Rlmfire 2-7x28mm Matte Finish Fine Duplex	024-113872	219.99
VX-2 Rlmfire 3-9x33mm EFR Matte Finish Fine Duplex	024-110827	399.99

New! KASPA



KASPA™ Extreme Tactical 30mm Tube Riflescopes

- 30mm Main Tube / Matte Finish
- Rugged one piece tube construction
- Nitrogen purged to eliminate internal fogging
- Fully multi-coated lenses for enhanced clarity and light transmission
- Crisp 1/4" MOA adjustments for precise accuracy

Flip-up scope caps (included)

Features Weaver's Limited Lifetime Guarantee

	Order No.	Price
1.5-6x32mm ILL .223 Ballistic-X	029-849813	\$175.57
2.5-10x44mm ILL Mil-Dot	029-849814	195.41
3-12x44mm SF ILL Tac Ballistic-X	029-849820	201.60
2.5-10x50mm SF ILL Mil-Dot	029-849815	200.36



KASPA™ Riflescopes 1" Main Tube

- Rugged one-piece tube construction
- Nitrogen purged to eliminate internal fogging
- Fully multi-coated lenses for enhanced clarity and light transmission
- Crisp 1/4" MOA adjustments for precise accuracy

Features Weaver's Limited Lifetime Guarantee

	Order No.	Price
2-7x32mm Dual-X reticle	029-849801	\$75.01
1x20mm Dual-X reticle	029-849802	78.86
3-9x40mm Dual-X reticle	029-849807	89.42
3-9x40mm Ballistic-X reticle	029-849806	89.42
3-12x50mm Dual-X reticle	029-849808	115.10
3-12x50mm Ballistic-X reticle	029-849809	115.10
4-16x44mm SF Dual-X reticle	029-849810	141.90
4-16x44mm SF Ballistic-X reticle	029-849811	141.90

Leupold Lens Covers, Sunshades and Accessories



Alumina Lens Shades Pre 2004

	Order No.	Price
2.5" 40mm	024-52343	\$19.99
2.5" 40mm Matte	024-52344	21.07
2.5" 40mm Silver	024-52345	21.07
4" 40mm	024-52346	22.21
4" 40mm Matte	024-52347	23.30
4" 40mm Silver	024-52348	23.30
2.5" 50mm Matte	024-52350	26.67
4" 50mm	024-52352	27.75
4" 50mm Matte	024-52353	28.90

Alumina Lens Shades Post 2004

	Order No.	Price
2.5" 40mm	024-56186	\$19.99
2.5" 40mm Matte	024-56187	21.07
2.5" 40mm Silver	024-56188	21.07
4" 40mm	024-56189	22.21
4" 40mm Matte	024-56190	23.30
4" 40mm Silver	024-56191	23.30

Alumina 50Foot Focus Adapter - Excellent for gallery shooting, and fits post-2004 40mm adjustable objective scopes.

Order No. 154-59021 \$48.12



Alumina Flip Back Lens Covers - Protect your lenses from the water, snow, dust and dirt you encounter in the field, yet keep them ready for action at an instant's notice with our machined aluminum Flip Back Lens Cover. Covers cam back to a horizontal position, so they're out of the way & out of your line of sight. **\$39.99**

Order No.	Order No.
50mm 154-59050	28mm 154-58755
42mm 154-58795	20mm 154-59030
40mm 154-59045	Standard Eye 154-59055
32-33mm 154-59035	Ultralight Eye 154-59060



Alumina Flip Back Lens Cover Kit - Includes both the Objective Flip Cover and the Eye Flip Cover.

	Order No.	Price
40mm & Standard Eye Piece	154-62990	\$77.46
50mm & Standard Eye Piece	154-62995	77.46
VX-L 50mm & Standard Eye Piece	154-62730	96.24
VX-L 56mm & Standard Eye Piece	154-62825	96.24

Alumina Threaded Lens Covers - These low-profile, thread-in, knurled disks provide simple and rugged protection of optics during both storage & rough transport.

\$10.16 per

Order No.	Order No.
50mm 154-58950	42mm 154-58785
40mm 154-58940	36mm 154-58935
32-33mm 154-58930	28mm 154-58745
20mm 154-58925*	Standard Eye 154-58955
Ultralight Eye 154-58960	



Alumina Rubber Eyepiece Guard - Add a soft, finishing touch to the eyepiece of your scope to protect you from recoil during extreme uphill shooting angles and from heavy recoiling firearms. **\$15.28**



Order No.	Order No.
Standard Eye 154-58965	Ultralight Eye 154-58970

Retractable Ballistic Chart 1" - Attaches to your scope's main tube (1 or 30mm) for instant access, and the durable metal tape with your ballistics data automatically retracts after use. **Order No. 154-54804 \$33.58**



Weaver Rifle, Pistol & Shotgun Scopes

Target Knob Adjustment
For Windage And Elevation



Weaver V16 Series 4-16x42mm - The magnification range makes this model as versatile as a scope can get. An adjustable objective lens gives you a parallax-free view from 30 feet to infinity. Matte finish, Dot Reticle. **Order No. 029-849410 \$307.10**

4-16x42mm w/AO and Semi Target Turret Matte Finish Dual-X Reticle - **Order No. 029-849408 \$307.10**

Weaver V24 Series - This Target/Varmint scope has a special varmint reticle with very fine crosshairs, for clear shot placement on the smallest or most distant varmints. An adjustable objective lens allows parallax-free shooting.

	Order No.	Price
V24 6x-24x42mm Matte Varminter Reticle	029-849411	\$358.04

Weaver V9 Series - A great combination of eye-relief, low-light ability and variable power. Your choice of a 38mm lens for low-mounting or a 50mm for better light-gathering. Duplex Reticles.



	Order No.	Price
V9 Matte (Dull Finish) 3x9x38mm Variable	029-849402	\$171.79

Weaver Super Slam Scope Series



	Order No.	Price
2-10x42mm Matte Dual-X	029-800310	\$412.02
2-10x42mm Silver Dual-X	029-800311	420.40
2-10x50mm Matte Dual-X	029-800320	462.60
2-10x50mm Matte Glass Etched Ballistic	029-800325	506.66
3-15x42mm Side Focus Matte Dual-X	029-800330	516.94
3-15x50mm Side Focus Matte Dual-X	029-800340	537.92
3-15x50mm Side Focus Matte Glass Etched Ballistic	029-800345	582.00
3-15x50mm Side Focus Matte Illuminated Dual-X	029-800348	621.88
4-20x50mm Side Focus Matte Dual-X	029-800350	600.89
4-20x50mm Side Focus Matte Fine-X	029-800352	644.95

Weaver Super Slam™ Sunshades - Shield your shot from the distracting rays of the sun with the 4" Weaver® Sunshade. Designed for the Super Slam™ series, these sunshades block out glare regardless of sun angle.

	Order No.	Closeout!
4" 42mm - Black	029-846731	Limited
4" 42mm - Silver	029-846732	Quantities
4" 50mm - Black	029-846733	
4" 50mm - Silver	029-846734	



Weaver Classic™ Handgun Scopes - These maintain accuracy, clarity and reliability under the jarring recoil of today's most powerful handguns. Solid, one-piece tubes keep lenses locked in perfect alignment, shot after shot. Fully multi-coated lenses cut glare and increase brightness dramatically for a clear, crisp image all the way to the edges of the scope. Weaver Classic handgun scopes also provide an impressive 4 to 12 inches of eye relief.

	Order No.	Price
2x28mm Stainless Finish	029-849424	172.07
4x28mm Gloss Finish	029-849425	186.54
1.5x4x20mm Gloss Finish	029-849427	229.95
2.5x8x28 Matte Finish	029-849429	243.65



***CALL IN!** A(*) after the part number is an item that we do not keep in stock, but we can usually order this in less than 2-4 weeks!



Weaver Grand Slam Scopes - All Grand Slam scopes are equipped with the Micro-Trac 4 point adjustment system, the best in the industry. Fully multi-coated lenses reduce glare, increase image brightness and give you edge-to-edge clarity — Grand Slam scopes also feature a fast-focus eyepiece adjustment ring to adjust the scope perfectly to your eye. The Weaver "sure grip" power ring helps you find and adjust the scopes' variables, even with heavy hunting gloves on. Waterproof, fogproof, and shockproof

	Order No.	Price
3-10x40mm Matte Finish Dual-X Reticle	029-800473	\$291.02
3.5-10x50mm Matte Finish Dual-X Reticle	029-800474	352.49
4.5-14x40mm w/AO Matte Finish Dual-X Reticle	029-800475	381.71
6-20x40mm AO Matte Varminter	029-800469	390.77
6-20x40mm AO Matte Ballistic-X	029-800478	410.82



T Series Target and Varmint Scopes - Weaver's T-Series™ fixed riflescopes give you the eighth MOA accuracy you need to be dead on, shot after shot. Each T-Series™ scope features the incredibly accurate QuadZero™ adjustment system that gives you more accurate, completely independent windage and elevation control. Every T-Series™ scope comes with traditional eyepiece focus, a sunshade, screw-in metal lens caps and an extra pair of oversized benchrest adjustment knobs.

	Order No.	Price
36x40mm w/AO & SunShade Matte F/C	029-849970	\$428.30
36x40mm w/AO & SunShade Matte 1/8 MOA Dot	029-849974	433.10
24x40mm w/AO & SunShade Gloss 1/8 MOA Dot	029-849976	407.84



Weaver K-Series Fixed Scopes - Fixed scopes have fewer moving parts, so they can take more punishment season after season. Fully multi-coated lenses improve image brightness and reduce glare. A one-piece, aircraft-grade aluminum tube holds the lenses in perfect alignment. Waterproof, fogproof and shockproof.

	Order No.	Price
K4 4x38mm Dual-X Reticle Matte Finish	029-849415	\$134.41

Weaver Tactical Scope Series

- Argon purged tubes to eliminate internal fogging
- Fully multi-coated lenses w/ extra hard coating on exterior lenses
- Waterproof / fogproof / shockproof
- Powerful 5x magnification
- First focal plane reticles
- Side focus parallax adj.
- Reset-to-zero turrets (no caps to lose)
- One-piece construction



	Order No.	Price
3-15x50mm Mil Dot 30mmTube Mil-Dot Reticle	029-800362*	\$693.76
4-20x50mm Mil Dot 30mmTube Mil-Dot Reticle	029-800360	774.48

Weaver Classic™ Rimfire Scopes - Make the most out of .22s and airguns. Weaver Classic™ Rimfire Scopes are designed with the same rugged, sturdy one-piece aluminum housing that keep the larger scopes waterproof and fogproof, they have the same fully multi-coated, nonglare lenses, and with 28mm objective lenses they deliver excellent low-light brightness, just like every Weaver does. Duplex Reticles.

	Order No.	Price
4x28mm Rimfire Matte	029-849430	\$121.63
2.5-7x28mm Rimfire Matte	029-849431	142.14
2.5-7x 28mm Rimfire Silver	029-849432	142.14



Nikon Rifle, Pistol & Shotgun Scopes



Monarch Variable Scopes -

- Monarch Eye Box technology (4" of constant eye relief)
- Wide, four-time zoom magnification range
- Bright, high-resolution optics
- 1/4-MOA hand turn reticle adjustments
- Enhanced ring spacing
- Locking Side Focus Adjustment (On Long Range Models Only)

	Order No.	M.A.P.
2-8x32mm Matte Nikoplex	125-8437	\$289.95
2-8x32mm Matte BDC	125-8438	299.95
2.5-10x42mm Matte Nikoplex	125-8407	389.95
2.5-10x42mm Matte Mildot	125-8408	399.95
2.5-10x42mm Silver BDC Reticle	125-8409	419.95
2.5-10x42mm Matte BDC Reticle	125-8411	399.95
2.5-10x50mm Matte Nikoplex	125-8416	469.95
2.5-10x50mm Matte BDC Reticle	125-8417	479.95
3-12x42mm Side Focus Matte Nikoplex	125-8419	429.95
3-12x42mm Side Focus Matte BDC Reticle	125-8420	449.95
4-16x42mm Side Focus Matte Nikoplex	125-8421	439.95
4-16x42mm Side Focus Matte BDC Reticle	125-8422	449.95
4-16x42mm Side Focus Matte Mildot	125-8423	459.95
4-16x50mm Side Focus Matte Nikoplex	125-8439	489.95
4-16x50mm Side Focus Matte BDC	125-8440	499.95
5-20x44mm Side Focus Matte Nikoplex	125-8424	529.95
5-20x44mm Side Focus Matte BDC Reticle	125-8425	549.95
6-24x50mm Side Focus Matte Nikoplex	125-8426	649.95
6-24x50mm Side Focus Matte Fine Crosshair	125-8427	679.95
6-24x50mm Side Focus Matte Fine Crosshair w/Dot	125-8428	679.95
6-24x50mm Side Focus Matte BDC Reticle	125-8429	679.95
8-32x50mm SF Matte Extra-Low Dispersion Nikoplex	125-8479	689.95
8-32x50mm SF Matte Extra-Low Dispersion BDC	125-8480	699.95



Nikon M223 AR Riflescopes -

- Eye Box Technology - 4-time zoom and 4 inches of constant eye relief
- Rapid Action Turret Technology - paired with Nikoplex reticle
- Return to Zero Turrets - for fast, simple field adjustments
- ARD Technology (2-8x32 & 3-12x42SF only)
- Ultra ClearCoat® Optical System

	Order No.	M.A.P.
2-8x32mm Matte Nikoplex	125-8486	\$329.95
2-8x32mm Matte BDC 600	125-8487	349.95
3-12x42mm Matte Nikoplex	125-8488	449.95
3-12x42mm Matte BDC 600	125-8489	459.95
1-4x20mm Matte Point Blank Reticle	125-8485	289.95

Built-in 20-MOA Incline

M-223 Mount - Maximizes Elevation for Extreme Long Range Shooting. Fits Flattop Picatinny Rails and Weaver-Style Bases. Lightweight Alloy Construction
Order No. 125-743 \$69.49



Monarch Gold 30mm Riflescopes -

- Ultra ClearCoat System for 95% light transmission
- 100% Waterproof/Fogproof/Shockproof
- Four times magnification range
- Quick Focus Eyepiece
- Rugged, one piece 30mm main body tube
- Locking side focus parallax adjustment
- 1/4-minute click reticle handturn adjustments
- Nikon Lifetime Full Warranty
- Fully multicoated lenses

	Order No.	Closeout
2.5-10x50mm Side Focus Nikoplex Matte Finish	125-6619	\$642.67



NEW! P-22 AR Rifle Scope 22LR

- Zero resets turrets with Interchangeability
- Quick Focus Eyepiece
- Bright, Fully Multicoated Optics
- Up to 98% Light Transmission
- Waterproof/Fogproof/Shockproof

2-7x32 Niko Plex Reticle Matte Finish
Order No. 125-8498 M.A.P. \$179.95

2-7x32 BDC 150 Reticle Matte Finish
Order No. 125-8499 M.A.P. \$179.95

Suggested Accessory: P-Series Mount
Order No. 125-826 M.A.P. \$36.64



Coyote Special Riflescopes -

- Nikon's Patent Pending BDC Predator Hunting Reticle
- ARD (Anti Reflective Device) Technology
- Fully Multicoated Lenses
- Precise Hand-turn 1/4-MOA Click Adj
- Long Eye Relief
- Quick Focus Eyepiece
- Waterproof/Fogproof

	Order No.	M.A.P.
3-9x40mm Advantage Max-1 BDC Predator Reticle	125-8449	\$289.95
3-9x40mm Mossy Oak Brush BDC Predator Reticle	125-8450	289.95
3-9x40mm Matte BDC Predator Reticle	125-8453	269.95
4.5-14x40mm Advantage Max-1 BDC Predator Reticle	125-8451	349.95
4.5-14x40mm Mossy Oak Brush BDC Predator Reticle	125-8452	349.95
4.5-14x40mm Matte BDC Predator Reticle	125-8454	329.95



Nikon Prostaff Riflescopes -

- 100% Waterproof/Fogproof
- Nikon anti-reflective multicoating
- Up to 90% light transmission
- Precise, repeatable, 1/4 MOA reticle adj.
- Nitrogen filled and O-ring sealed
- Nikon Lifetime Full Warranty

	Order No.	M.A.P.
2-7x32mm Matte Nikoplex	125-6719	\$149.95
3-9x40mm Matte Nikoplex	125-6721	169.95
3-9x40mm Matte BDC Reticle	125-6722	179.95
3-9x40mm Silver BDC Reticle	125-6723	189.95
3-9x40mm APG Camo BDC Reticle	125-6724	199.95
3-9x50mm Matte Nikoplex	125-6726	219.95
3-9x50mm Matte BDC Reticle	125-6727	229.95
4-12x40mm Matte Nikoplex	125-6728	209.95
4-12x40mm Matte BDC Reticle	125-6729	219.95
4x32mm Rimfire Matte Nikoplex	125-6718	109.95
3-9x40mm Rimfire Matte BDC 150 Reticle	125-6725	149.95



Nikon Buckmaster Riflescopes -

- Superior scopes, superior values
- 100% waterproof, fogproof performance
- Nitrogen filled and O-ring sealed
- Nikon Brightvue™ anti-reflective multicoating for up to 92% light transmission
- 1/4-minute, steel-to-brass, positive click adjustments
- Lifetime full warranty

	Order No.	M.A.P.
3-9x40mm Matte Finish Buckmaster Nikoplex	125-6420	\$219.95
3-9x40mm Matte Finish Buckmaster BDC Reticle	125-6421	229.95
3-9x40mm Team Realtree APG Finish Nikoplex	125-6479	249.95
3-9x50mm Matte Finish Buckmaster Nikoplex	125-6430	319.95
4-12x50mm AO Matte Finish Buckmaster Nikoplex	125-6445	369.95
4.5-14x40mm AO Matte Finish Buckmaster Nikoplex	125-6452	309.95
4.5-14x40mm AO Silver Finish Buckmaster Nikoplex	125-6456	329.95
4.5-14x40mm AO Matte Finish Buckmaster Mil-Dot	125-6469	319.95
4.5-14x40mm AO Matte Finish Buckmaster BDC Reticle	125-6453	319.95
6-18x40mm AO Matte Finish Buckmaster Nikoplex	125-6472	379.95
6-18x40mm AO Matte Finish Buckmaster Target Dot	125-6476	389.95
6-18x40mm AO Matte Finish Buckmaster BDC Reticle	125-6473	389.95
1x20 Matte Finish Blackpowder Buckmaster Nikoplex	125-6460	189.95

Simmons Rifle, Pistol & Shotgun Scopes

Simmons Prohunter Master Series Scopes -

TrueZero™ flex erector system
QTA™ quick target acquisition eyepiece
TrueZero™ Windage & Elevation Dials
True One-Piece Tube Construction
Side Focus Parallax Adjustments
SureGrip™ Rubber Surfaces



3-9x40mm WA Matte
3-9x40mm WA Illum Reticle Matte

Order No.	Price
204-517711	\$93.42
204-517702	125.59

Simmons Prosport Master Series Scopes -

TrueZero™ adjustment system
QTA™ fast focus eyepiece
TrueZero™ Windage & Elevation
True One-Piece Tube Construction
SureGrip™ Rubber Surfaces



3-9x40mm Silver
3-9x40mm Matte
3-9x50mm Matte
4-12x40mm A/O Matte
4-12x50mm A/O Matte
6-18x50mm A/O Matte

Order No.	Price
204-510480	\$68.93
204-510481	68.93
204-510479	84.23
204-510484	87.31
204-510490	104.12
204-510491	122.50

Pro-Diamond Master Series 4x32mm Shotgun Scope - QTA™, TrueZero™ Windage, True One-Piece Tube, SureGrip™ Pro-Diamond Reticle Order No. 204-517793 \$60.45

Simmons 8-Point® -

TrueZero™ Windage & Elevation
SureGrip™ Rubber Surfaces
QTA™ fast focus eyepiece
TruPlex Reticles



Order No.	Price
204-510514	\$33.81
204-510524	43.46
204-510513	46.61
204-510519	57.90



Simmons® .44 MAG®

Multi-coated optics
TrueZero™ flex erector system
QTA™ quick target acquisition eyepiece
TrueZero™ Windage & Elevation Dials
True One-Piece Tube Construction
Waterproof, fogproof and recoilproof



SP = Side Parallax Adj
SS = Sun Shade
TT = Target Turrets

3-10x44mm Truplex Matte
4-12x44mm SP Truplex Matte
6-21x44mm Truplex Matte
6-21x44mm Truplex Matte
6-21x44mm SP/SS/TT Mil/Dot Matte
6-24x44mm SP/SS Mil/Dot Matte

Order No.	Price
204-441044	\$111.80
204-441124	114.89
204-441047	151.59
204-441048	168.46
204-441056	168.46
204-447703	176.14

Simmons 22 Mag Riflescopes -

TrueZero™ flex erector system
QTA™ quick target acquisition eyepiece
TrueZero™ Windage & Elevation
True One-Piece Tube Construction
SureGrip™ Rubber Surfaces
Rimfire Rings Included



4x32mm Silver Finish
4x32mm Matte Finish
3-9x32mm Silver Finish
3-9x32mm Matte Finish
3-9x32mm A/O Matte Finish
3-9x32mm A/O Silver Finish

Order No.	Price
204-511033	\$41.68
204-511022	41.68
204-511037	48.28
204-511039	48.28
204-511072	72.96
204-511073	72.96

Simmons Prohunter® Handgun Scopes -

A perfect match to any hand gunner's favorite pistol. These scopes feature long eye relief, 1/2 and 1/4 MOA adjustments, and are waterproof, fogproof and shock proof.



Order No.	Price
204-807738	\$97.19
204-807739	97.19
204-822009	141.05
204-822010	141.05



Tasco Rifle, Pistol & Shotgun Scopes



Tasco World Class & World Class Plus Optics- World Class riflescopes are world famous for delivering high-performance optics and advanced features at a price any serious hunter can afford. With Tasco's SuperCon™ multi-layered coating on the objective and ocular lenses and fully coated optics, Rugged and dependable, these 100% waterproof, fogproof and shockproof, Limited Lifetime Warranty.



Tasco Varmint Scopes- Long Range, and extremely accurate! The Tasco True Mil-Dot system has made Varmint hunting easier. SuperCon™ multi-layered lens coatings and fully coated optics help you you narrow in on that varmint!

Order No.	Price
209-DWC39X40N	\$59.11
209-WA39X40N	59.11
209-WA39X40STN	59.11
209-DWC39X40M	59.11
209-WC39X40IR	66.63
209-DWC39X50N	69.65
209-DWC416X40	82.37

Tasco's World Class Target Scopes -

High power scope that's ideal for target shooters and varminters. 1/8 M.O.A. Dot reticle and matte finish. Rubberized All Weather Finish, Water, Shock & Fogproof, Multi-coated Optics and Oversized Target Turrets



Order no.	Price
209-TG624X44DS	\$157.47
209-TG104050DS	166.32

Order No.	Price
209-DWC39X40N	\$59.11
209-WA39X40N	59.11
209-WA39X40STN	59.11
209-DWC39X40M	59.11
209-WC39X40IR	66.63
209-DWC39X50N	69.65
209-DWC416X40	82.37



30/30 Reticle.

Bantam 1.54-5x32mm - Compact scope designed for rifle, shotgun and black powder hunting in thick brush or heavy timber. Now with a 1pc tube and a ProShot Reticle. Matte Finish
Order No. 209-BA1545X32 \$48.43



Leupold Neoprene Scope Covers - Black Neoprene covers with Leupold's logo screened right to it.

Order No.	Price
154-53572	\$15.28
154-53574	15.28
154-53576	15.28
154-53578	15.28
154-53580	15.28

Mag IV 6x24x40mm Zoom Black Matte- Built to reach out and touch a prairie dog at the most extreme distance. Features a 30/30 reticle. SuperCon™ and fully coated optics and big objective lens keeps on target even in low light. 1/4 minute positive clickstops. Waterproof, shockproof and fogproof, covered by Tasco's Limited Lifetime Warranty. Order No. 209-MAG624X40 \$90.58



Zeiss Conquest Riflescopes



Zeiss has introduced the Conquest Line to offer hunters top of the line optics, and glass at a mid-price range. Adjust windage and elevation with a fingers touch, and Zeiss's quick focus allows you to make split-second field adjustments. One piece construction and hard anodized surface make it as tough as the rest of the Zeiss line. Compare the price to the rest of the mid-range scopes and you will be shocked! (* Notes Closeout Items - Limited Quantities)

	Order No.	M.A.P.
3-9x40mm Z-Plex Reticle Stainless Steel	042-5214649920	\$452.60
3-9x40mm Z-Plex Reticle Matte Black	042-5214609920	499.99
3-9x40mm Rapid Z-600 Reticle Matte Black	042-5214609971	486.76
3-9x50mm Z-Plex Reticle Tube Matte Black	042-5214809920	538.00
3.5-10x44mm Rapid Z-600 Reticle Matte Black	042-5214209971	799.99
3.5-10x44mm Rapid Z-900 Reticle Matte Black	042-5214209972	799.99
4.5-14x44mm Z-Plex Reticle Matte Black	042-5214309920	829.99
4.5-14x44mm Z-Plex Reticle Stainless Steel	042-5214349920	751.50
4.5-14x50mm Z-Plex Reticle Matte Black	042-5214909920	751.50
4.5-14x50mm #43 Mil-Dot Reticle Matte Black	042-5214909943	794.20
6.5-20x50mm Z-Plex Reticle Matte Black	042-5214509920	879.59
3-12x56mm #8 Reticle 30mm Tube Matte Black	042-5214709908	853.98



Butler Creek Bikini Scope Covers - Designed for the economy-minded shooter who prefers a quick-clearing, one-piece, no hassle scope cover. Two watertight pliable rubber-like cups joined by stretch retainers create a moisture and dust seal to protect optics. One size BIKINI fits most rifle scopes - One size TINI BIKINI fits compact pistol and shotgun scopes!

	Order No.	Price
Bikini Cover	060-19000	\$6.22
Tini-Bikini Cover	060-19001	5.77

Scope Cleaning Accessories



Nikon Micro Fiber Cleaning Cloth - Anti-Static, Clips on.
Order No. 125-8072 \$4.10

Nikon Fog Eliminator - 6"x7" Anti Fog Cloth (3pack)
Order No. 125-8073 \$4.10

Nikon Optics Maintenance Kit - Contains Static Wisk brush, Precision Cleaning Solution, anti-static microfiber Tiger Cloth and Speck Grabber.
Order No. 125-7073 \$16.71

	Order No.	Price
Burris Lens Pen	023-626050	\$7.13
Leupold Lens Pen	154-48807	7.00
Nikon Lens Pen	125-7072	6.62
Viz Wiz - 2oz Pump Spray Bottle	012-32122	3.02

Swarovski Riflescopes

Swarovski Z6 Series



	Order No.	M.A.P.
1-6x24mm CD Reticle 30mm Tube	055-59116	\$1879.00
1.7-10x42mm Plex Reticle 30mm Tube	055-59211	1999.00
1.7-10x42mm #4 Reticle 30mm Tube	055-59212	1999.00
1.7-10x42mm #7A Reticle 30mm Tube	055-59214	1999.00
2-12x50mm Plex Reticle 30mm Tube	055-59311	2149.00
2-12x50mm #4 Reticle 30mm Tube	055-59312	2149.00
2-12x50mm #7A Reticle 30mm Tube	055-59314	2149.00
2.5-15x44mm Plex Reticle 30mm Tube	055-59411	2279.00
2.5-15x44mm #7A Reticle 30mm Tube	055-59414	2279.00
2.5-15x56mm Plex Reticle 30mm Tube	055-59511	2349.00
2.5-15x56mm #4A Reticle 30mm Tube	055-59513	2349.00
2.5-15x56mm #7A Reticle 30mm Tube	055-59514	2349.00
2.5-15x56mm BT Plex Reticle 30mm Tube	055-59510	2499.00
3-18x50mm Plex Reticle 30mm Tube	055-59611	2349.00
3-18x50mm #4A Reticle 30mm Tube	055-59613	2349.00
Z6i 2.5-15x44mm Illuminated #4A Reticle 30mm Tube	055-59438	2949.00
Z6i 2.5-15x56mm Illuminated #4A Reticle 30mm Tube	055-59538	3059.00

Did You Know...

...that we can order any item from Swarovski? And, if the item is in stock, we can have it within two weeks!

Redfield Riflescopes

Back In The USA!



Redfield Revolution -
A No-nonsense scope for no-nonsense hunters -
Everything you need and nothing you don't.

Features: Illuminator Lens System, Rapid Target Acquisition (Generous Eye-Relief), Accu-Trac 1/4MOA Adjustments, 100% Waterproof and fogproof.

	Order No.	M.A.P.
2-7x33mm Matte 4-Plex	128-67080	\$172.27
2-7x33mm Matte Accu-Range	128-67085	181.85
3-9x40mm Matte 4-Plex	128-67090	191.43
3-9x40mm Matte Accu-Range	128-67095	201.02
3-9x50mm Matte 4-Plex	128-67100	229.69
3-9x50mm Matte Accu-Range	128-67105	239.27
4-12x40mm Matte 4-Plex	128-67110	239.27
4-12x40mm Matte Accu-Range	128-67115	248.86



Accu-Range Reticle -
Ideal for fast target acquisition at close range or on running game.

4-Plex - Heavy posts help - guide the eye in to thin crosshairs for precision placement.

The Redfield Rifle Scope Full Lifetime Warranty - Redfield is owned by Leupold & Stevens, Inc. If any Redfield Rifle Scope manufactured by Leupold & Stevens is found to have defects in materials or workmanship, Leupold will at their option repair or replace it.



Warne Tactical Rings & Bases

Matte Finish Only



Warne's Tactical Rings are built to meet real world needs of tactical personnel. Made to 1913 Mil-Spec Picatinny dimensions. These feature Warne's stainless steel recoil lug, Three Torx style fasteners at the top, and a unique clamping nut. This nut works with the standard 65in/lb torque wrench, but also has knurling and cross slot so other tools can be used to remove/attach in emergency situations. Return To Zero when reinstalled!

	Height(in)*	Order No.	Price
1" Medium	.375	223-601M	\$84.55
1" High	.525	223-602M	84.55
1" Extra High	.650	223-603M	84.55
1" Ultra High	.935	223-604M	84.55
30mm Medium	.375	223-614M	90.26
30mm High	.525	223-615M	90.26
30mm Extra High	.650	223-616M	91.61
30mm Ultra High	.850	223-617M	90.26



	Order No.	Price
Remington Short Action	223-M673M	\$77.92
Remington Long Action	223-M674M	77.92
Savage SA (Accu-Trigger Round Top)	223-M666M	77.92
Savage LA (Accu-Trigger Round Top)	223-M667M	77.92

Tactical 1 pc bases with 20 Minute Of Angle Built-In

	Order No.	Price
Rem SA	223-M673M20MOA	\$92.45
Rem LA	223-M674M20MOA	92.45
Sav SA (Accu-Trigger Round Top)	223-M666M20MOA	92.45
Sav LA (Accu-Trigger Round Top)	223-M667M20MOA	92.45

Ruger 77 Quick Detach Rings

As with all Warne QD Systems, They Return to Zero!!



	Height(in)*	Order No.	Price
1" Medium Matte	.460	223-1R7LM	\$69.21
1" High Matte	.585	223-2R7LM	69.21
1" Medium Silver	.460	223-1R7LS	74.26
1" High Silver	.585	223-2R7LS	74.26
30mm High Gloss	.585	223-15R7LG	79.15
30mm Med Matte	.460	223-14R7LM	79.15
30mm High Matte	.585	223-15R7LM	79.15

Rimfire & Airgun Rings

All Steel (Also fits 11mm dovetail grooved receiver) Asymmetrical clamp allows for adjustment on receivers with severe radius.



	Order No.	Price
1" Medium Matte	223-721M	\$21.49
1" Medium Gloss	223-721G	21.49
1" Medium Silver	223-721S	23.23
1" High Matte	223-722M	21.81
1" High Gloss	223-722G	21.49
1" High Silver	223-722S	23.23

Warne Ring Height
Is calculated from the top of the base (or integral dovetail) to the bottom of the scope tube.



Maxima Rings & Bases



Permanent Attach

	Height(in)*	Order No.	Price
1" Low Matte	.250	223-200M	\$25.60
1" Med Matte	.375	223-201M	25.60
1" High Matte	.525	223-202M	25.98
30mm Low Matte	.250	223-213M	34.46
30mm Med Matte	.375	223-214M	34.46
30mm High Matte	.525	223-215M	34.46



Quick Detach

As with all Warne QD Systems, They Return to Zero!!

	Height(in)*	Order No.	Price
1" Low Matte	.250	223-200LM	\$47.96
1" Low Silver	.250	223-200LS	53.00
1" Med Matte	.375	223-201LM	47.96
1" Med Silver	.375	223-201LS	53.00
1" High Matte	.525	223-202LM	47.96
1" Ultra High Matte	.935	223-204LM	71.93
30mm Low Matte	.250	223-213LM	60.55
30mm Med Matte	.375	223-214LM	60.55
30mm Matte High	.525	223-215LM	60.55
30mm Matte Ultra High	.850	223-217LM	84.53



Maxima 2pc Bases
Matte Finish Only \$19.21 Per Pair

	Order No.
Browning A-Bolt	223-M918/918M
Browning A-Bolt WSSM	223-M918/919M
Marlin Lever Action	223-M864/864M
Rem 700	223-M902/876M
Rem Model 7	223-M902/801M
Ruger 10/22	223-M858/918M
Savage Bolt Action	223-M898/936M
Savage Bolt Action Accu-Trigger	223-M902/902M
Weatherby Non-Mag	223-M888/875M
Weatherby Magnum	223-M902/879M
Winchester Model 70	223-M902/924M
Winchester WSSM	223-M902/903M

Kimber 2pc Base Sets

	Order No.	Price
Kimber M8400 Gloss	223-M887/841G	\$19.21
Kimber M8400 Matte	223-M887/841M	19.21
Kimber M84 (8-40 Screws) Gloss	223-M889/843G	19.21
Kimber M84 (8-40 Screws) Matte	223-M889/843M	19.21

1pc S&W Mount

Multi-Sight System For K, L, N, & X Frame Revolvers
Re-install Factory Sights!



Use Warne's Quick Detach Maxima rings, and not only hold zero, but change to iron sights in seconds!!

	Order No.	Price
1 Pc S&W Mount Matte Finish	223-M629M	\$73.10
1 Pc S&W Mount Silver Finish	223-M629S	75.88
1 Pc S&W Mount Gloss Finish	223-M629G	73.10

Maxima Grooved Receiver Quick Detach Rings



As with all Warne QD Systems, They Return to Zero!!

Ruger #1 Blackhawk & Redhawk

	Height(in)*	Order No.	Price
30mm Med Gloss	.460	223-14RLG	\$79.15
30mm High Gloss	.585	223-15RLG	79.15
30mm Med Matte	.460	223-14RLM	79.15
30mm High Matte	.585	223-15RLM	79.15
30mm Med Matte	.460	223-14RLS	84.18
30mm High Matte	.585	223-15RLS	84.18

Ruger M77 & Super Redhawk

	Height(in)*	Order No.	Price
30mm High Gloss	.585	223-15R7LG	\$79.15
30mm Med Matte	.460	223-14R7LM	79.15
30mm High Matte	.585	223-15R7LM	79.15
30mm High Matte	.585	223-15R7LS	84.18

Tikka

	Height(in)*	Order No.	Price
1" Med Matte	.425	223-1TLM	\$69.21

CZ 527 / BRNO

	Height(in)*	Order No.	Price
1" Med Matte (16mm)	.425	223-1B1LM	\$69.21
1" High Matte (16mm)	.535	223-2B1LM	69.21

CZ 550 / BRNO

	Height(in)*	Order No.	Price
1" Med Matte (19mm)	.425	223-1BLM	\$69.21
1" High Matte (19mm)	.535	223-2BLM	69.21

Maxima Grooved Receiver Permanent Attach Rings

CZ 527 / BRNO

	Height(in)*	Order No.	Price
1" Med Matte (16mm)	.425	223-1B1M	\$37.89
1" High Matte (16mm)	.535	223-2B1M	37.89

CZ 550 / BRNO

	Height(in)*	Order No.	Price
1" Med Matte (19mm)	.425	223-1BM	\$37.89
1" High Matte (19mm)	.535	223-2BM	37.89

AR-15 Flat Top Rings

Matte Finish
Tactical Aluminum

	Order No.	Price
1" Ultra High (.935")	223-A604M	\$75.40
30mm Ultra High (.850")	223-A617M	75.40

Warne Torque Wrench -
Built for Warne by California Torque Products, this torque wrench allows you to tighten Torx style screws to Warne's recommended setting of 25in/lb. Break away design tells you when the proper torque has been reached.
Order No. 223-TW1 \$17.42

Redfield Steel Turn-In Style Rings and Mounts



Ring Heights	
1" Low	0.15
1" Med	0.27
1" High	0.4
1" Extra Hi	0.52
30mm Med	0.32
30mm Hi	0.49

One Inch Rings

	Order No.	Price
1" Low Blued	028-47223	\$22.18
1" Low Matte	028-47378	23.80
1" Med Blued	028-47224	22.18
1" Med Matte	028-47230	23.80
1" Med Nickel	028-47233	25.44
1" High Matte	028-47228	23.80
1" High Nickel	028-47214	25.44
1" Extra Hi Blued	028-47231	23.80
1" Extra Hi Matte	028-47232	25.44

Steel 2 Pc (SR) Bases



	Order No.	Price
FN Blued	028-47345	\$17.95
153 Blued	028-47365	20.93
70A Blued	028-47347	17.95
70A Matte	028-47353	19.68
110 Sav LASA Blued	028-47191	17.95
110 Sav LASA Matte	028-47269	19.68
700 LASA Blued	028-47193	17.95
700 LASA Matte	028-47270	19.68
700 LASA Nickel	028-47350	21.36
SDT LASA Blued	028-47349	21.36

Twin Steel Dovetail Bases



	Order No.	Price
Savage 110 Matte	028-47443	22.28
Sav110 Front Extension Matte (.40)	028-47448	22.28

Ruger Ring Mounts



Designed to fit Ruger 77, No. 1 and 77/22 Rifles. Precision machined from solid steel. Features a built in windage adjustment.

	Order No.	Price
1" Med, Model 77 Blued	028-47234	\$32.64
1" High, Model 77 Blued	028-47237	32.64
1" High, Model 77 Matte	028-47236	35.92
30mm High Model 77 Matte	028-47240	42.47

Warne Torque Wrench -

Built for Warne by California Torque Products, this torque wrench allows you to tighten Torx style screws to Warne's recommended setting of 25in/lb. Break away design tells you when the proper torque has been reached.
Order No. 223-TW1 \$17.42



One Inch Extension Rings

	Order No.	Price
1" Med Blued (StdR ExtFr)	028-47218	\$32.66
1" Med Matte (StdR ExtFr)	028-47249	35.86
1" Med Nickel (StdR ExtFr)	028-47223	22.18
1" Med Blued (ExtR ExtFr)	028-47221	42.25
1" High Blued (StdR ExtFr)	028-47220	32.66
1" High Matte (StdR ExtFr)	028-47379	35.86
1" High Nickel (StdR ExtFr)	028-47215	36.89

30mm Steel Turn-In Rings

	Order No.	Price
30mm Medium Blued	028-47383	\$36.69
30mm Medium Matte	028-47250	37.57
30mm High Blue	028-47251	35.92
30mm High Matte	028-47256	36.89
30mm High Matte (StdR ExtFr)	028-47254	51.61

One Inch Twin Dovetail Rings

	Order No.	Price
1" High Matte	028-47426	\$26.81

Steel 1 Pc (JR) Bases



	Order No.	Price
88 Blued	028-47148	\$17.95
110 Savage RH-LA Blued	028-47150	17.95
700LA Blued	028-47152	17.95
700LA Matte	028-47266	19.68
FN Blued	028-47154	17.95
M Blued	028-47156	17.95
MK Blued	028-47157	17.95
788LA Blued	028-47162	17.95
788XLA Blued	028-47163	17.95
336R Blued	028-47343	17.95
700SA/JR 7 LTWT Blued	028-47169	17.95
700SA/JR 7 LTWT Matte	028-47273	19.68
760 Blued	028-47170	17.95
T/C Encore Rifle Blued (Single Dovetail)	028-47173	17.95

Twin Dovetail TC Pistol Bases

	Order No.	Price
JR TCA Encore, Matte	028-47459	\$21.66

.22 Ring Mounts



These rings fit .22 rifles with 3/8 inch dovetails

	Order No.	Price
1" 22 Ring Mount Blued	028-47285	\$27.75
1" 22 Ring Mount Matte	028-47287	29.37
See Thru Dovetail	028-47327	7.71

Super Magnum Proof Bases

Steel Three Ring and Base Set.

	Order No.	Price
JR SMP TC Blued	028-47203	\$50.29
JR TC Encore Blued	028-47376	50.29
JR SMP TC Matte	028-47202	51.96
JR TC Encore Matte	028-47210	51.96

Weaver Aluminum Detachable Top Mount Rings



	Order No.	Price
1" Low Blued	029-49030	\$20.39
1" Low Stainless	029-49034	31.17
1" Low Matte	029-49040	16.80
1" Medium Blued	029-49071	16.80
1" Medium Matte	029-49041	16.80
1" Medium Stainless	029-49032	31.17
1" High Blued	029-49050	20.39
1" High Stainless	029-49033	31.17
1" High Matte	029-49042	20.39
1" Ex-High Blued	029-49080	20.39
1" Ex-High Stainless	029-49036	31.17
1" Ex-High Matte	029-49044	20.39
1" SeeThru Blued	029-49513	20.66
1" SeeThru Stainless	029-49522	24.18
1" SeeThru Matte	029-49523	21.00
1" Tip Off .22 Groved	029-49440	23.18
1" Dual Ext High Blued	029-49061	26.22
1" Dual Ext High Matte	029-49045	26.22
1" Dual Ext High Silver	029-49038	32.00
1" Ext Med Blued	029-49090	24.44
1" Ext Med Matte	029-49091	24.44
1" Ext Med Silver	029-49092	32.10
1" Ext High Blued	029-49060	24.44
1" Ext High Matte	029-49043	24.44
1" Ext High Silver	029-49035	32.10
30mm Low Blued	029-49122	21.00
30mm Low Matte	029-49121	21.00
30mm High Blued	029-49110	21.00
30mm High Matte	029-49120	21.00
30mm High Silver	029-49130	32.10
30mm High Ext Matte	029-49152	29.66

Sure Grip Rings



Two screws on each side

	Order No.	Price
1" Medium Blued	029-49160	\$20.39
1" High Blued	029-49161	20.39
1" Ex-High Blued	029-49162	20.39
1" Medium Matte	029-49163	20.39
1" High Matte	029-49164	20.39
1" Ex-High Matte	029-49165	20.39

Sure Grip Windage Adjustable Rings

Two screws on each side



	Order No.	Price
1" Medium Blued	029-49140	\$22.23
1" Medium Matte	029-49143	22.23
1" High Blued	029-49141	22.23
1" High Matte	029-49144	22.23

Weaver Detachable Top Mount Bases



Gloss Finish

Order No.	Aluminum	Price
029-48011	11 (1/2)	\$3.71
029-48012	12 (1/2)	3.71
029-48014	14 (1/2)	4.55
029-48015	15 (1/2)	3.05
029-48016	16 (1/2)	3.05
029-48017	17 (1/2)	3.71
029-48018	18 (1/2)	3.05
029-48019	19 (1/2)	3.05
029-48020	20A (1/2)	3.05
029-48021	21 (1/2)	3.71
029-48023	23 (1/2)	3.71
029-48024	24 (1/2)	3.71
029-48025	25 (1/2)	3.05
029-48029	29 (1/2)	3.71
029-48035	35 (1/2)	3.05
029-48036	36 (1/2)	3.05
029-48040	40A (1/2)	3.05
029-48042	42 (1/2)	3.71
029-48043	43 (1/2)	3.71
029-48044	44 (1/2)	3.71
029-48045	45 (1/2)	3.05
029-48046	46 (1/2)	3.05
029-48047	47 (1/2)	3.05
029-48048	48 (1/2)	3.05
029-48049	49A (1/2)	6.08
029-48053	53 (1pc)	6.08
029-48054	54 (1/2)	3.05
029-48055	55 (1/2)	3.05
029-48059	59 (1/2)	6.08
029-48064	60A (1pc)	9.06
029-48061	61 (1/2)	3.05
029-48060	61A(8-40 Thread)	3.05
029-48062	62 (1pc)	6.08
029-48069	63B (1pc)	6.08
029-48065	65 (1/2)	12.12
029-48067	67 (1/2)	12.12
029-48068	68 (1/2)	3.05
029-48070	70 (1pc)	7.74
029-48071	71 (1/2)	3.71
029-48010	71A (1/2)	3.71
029-48074	74 (1pc)	6.08
029-48075	75(8-40 Thread)	3.05
029-48076	76 (1/2)	3.05
029-48082	82 (1pc)	7.25
029-48083	83 (1/2)	3.05
029-48085	85 (1/2)	3.05
029-48087	87A (1pc)	6.08
029-48088	88 (1pc)	6.08
029-48090	90 (1pc)	7.25
029-48091	91 (1/2)	3.71
029-48092	92A (1pc)	7.74
029-48093	93 (1pc)	6.08
029-48094	94 (1/2)	6.08
029-48095	95 (1/2)	6.08
029-48096	96 (1pc)	15.65
029-48097	97 (1pc)	15.65
029-48098	98 (1pc)	15.65
029-48109	401 (1pc)	6.08
029-48108	402 (1/2)	3.71
029-48106	404 (1pc)	8.04
029-48105	405 (1pc)	8.04
029-48110	406 (1pc)	5.54
029-48513	410 (1pc)	11.01
029-48450	427 (1/2)	3.05

Matte Finish

Order No.	Aluminum	Price
029-48500	35M (1/2)	\$3.05
029-48501	36M (1/2)	3.05
029-48428	40A-M (1/2)	3.05
029-48502	46M (1/2)	3.05
029-48503	47M (1/2)	3.05
029-48504	61M (1/2)	3.05
029-48429	402M (1/2)	3.71
029-48632	411M (1/2)	5.54
029-48442	413M (1pc)	15.65
029-48426	414M (1pc)	5.66
029-48432	415M (1/2)	2.94
029-48434	416M (1pc)	5.90
029-48440	417M (1pc)	5.90
029-48435	418M (1/2)	5.54
029-48437	419M (1/2)	3.05
029-48444	421M (1/2)	3.05
029-48443	423M (1pc)	5.90

Silver Finish

Order No.	Aluminum	Price
029-48006	35S (1/2)	\$3.05
029-48005	36S (1/2)	3.05
029-48041	40A-S (1/2)	3.71
029-48510	45S (1/2)	3.05
029-48004	46S (1/2)	3.05
029-48003	47S (1/2)	3.05
029-48002	61S (1/2)	3.05
029-48447	63B-S (1pc)	7.28
029-48007	92A-S (1pc)	8.76
029-48001	401S (1pc)	6.08
029-48430	402S (1/2)	3.71
029-48452	410S (1pc)	11.01
029-48633	411S (1/2)	5.54
029-48512	412S (1pc)	38.13
029-48427	414S (1pc)	6.08
029-48453	418S (1/2)	5.54
029-48439	420S (1pc)	15.65



Base Pairs Matte Finish

Order No.	Rifle	Price
029-48460	Rem 700	\$5.63
029-48462	Brn A-Bolt	5.63
029-48464	Mauser 98	5.63
029-48465	Sav 110-116 &(10-16)	5.63
029-48466	Sav 110-116 &(10-16) wAccuTrigger	5.63
029-48468	Win 70	5.63
029-48470	Brng BAR	5.63
029-48471	Marlin 336	5.63
029-48472	Rem 7400	5.63
029-48473	Moss 500	5.63
029-48474	Ruger 10/22	5.63

Silver Finish

Order No.	Rifle	Price
029-48461	Rem 700	\$5.63
029-48467	Sav 110-116 (10-16) wAccuTrigger	5.63

Grand Slam Steel Detachable Top Mount Rings



Order No.	Price
029-49302	\$17.98
029-49303	17.98
029-49321	20.92
029-49304	19.73
029-49305	17.98
029-49322	20.92
029-49306	17.98
029-49307	17.98
029-49308	21.52
029-49309	21.52

How to pick a base...

See the fit chart on the following pages to select the base or bases for your rifle, then find the order number in this section. Be sure you have the correct order number that works with your gun!



1pc- Listed next to the Base number means only one part is required for mounting rings.



1/2- Listed next to the Base number means two parts are required for mounting rings.

Grand Slam Steel Detachable Top Mount Bases

Look For Grand-Slam Ring Mounts listed in far right chart column.

Order No.	Steel	Price
029-48223	S25 (1/2)	\$8.41
029-48224	S35 (1/2)	8.41
029-48225	S36 (1/2)	8.41
029-48243	S40A (1/2)	8.41
029-48226	S45 (1/2)	8.41
029-48227	S46 (1/2)	8.41
029-48228	S47 (1/2)	8.41
029-48244	S49 (1/2)	8.41
029-48230	S54 (1/2)	8.41
029-48231	S55 (1/2)	8.41
029-48234	S61 (1/2)	8.41
029-48241	S91 (1/2)	8.41
029-48247	S402 (1/2)	8.41
029-48249	S430 (1/2)	8.41
029-48282	S466 (1/2)	8.41

Grand Slam Steel Windage Adjustable Rings



Grand Slam Steel Windage Adjustable Rings - Made from all steel for maximum strength. Fits any Weaver Top Mount Base. Front and rear windage adjustable.

Order No.	Price
029-49313	\$22.97
029-49314	22.97
029-49315	22.59
029-49318	22.59
029-49316	22.59
029-49319	22.59
029-49317	22.59
029-49320	22.59

Lever-Lok Rings

Quick Detach of scope, no need for tools or wrenches. Square recoil lug allows for secure, tight fit with Weaver cross lock bases. Solid Steel Construction.

Order No.	Price
029-49325	\$23.42
029-49326	23.42
029-49327	23.42
029-49328	23.42
029-49329	23.42
029-49330	23.42
029-49335	25.26
029-49336	25.26

Grand Slam Turn-In Rings & Bases

All Steel, Rear mount windage adjustment, Torx Screws, positive dovetail locking system.

Order No.	Price
029-49200	\$19.93
029-49201	19.93
029-49202	19.93
029-49203	19.93
029-49204	19.93
029-49205	19.93
029-49238	20.92
029-49206	19.93
029-49207	19.93
029-49226	22.17
029-49227	22.17
029-49208	22.17
029-49209	22.17

Grand Slam Turn-In Bases

Order No.	Price
029-48964	\$19.93
029-48905	16.83
029-48932	16.83
029-48958	16.83
029-48916	16.83
029-48900	16.83
029-48901	16.83
029-48971	17.68
029-48912	16.83
029-48913	16.83
029-48930	16.83
029-48931	16.83
029-48962	16.83
029-48902	16.83
029-48903	16.83
029-48918	16.83
029-48920	16.83
029-48966	16.83
029-48926	16.83
029-48976	16.83
029-48908	16.83
029-48909	16.83
029-48935	17.31
029-48907	17.31

Tactical & AR-15 Mount Systems



Order No.	Price
029-48320	\$18.21
029-48321	18.21
029-48322	30.45
029-48323	30.45
029-48330	14.96
029-48331	26.74
029-48332	32.97
029-48333	6.60
029-48338	14.96
029-48337	5.67
029-48335	5.00
029-48336	5.67

Leupold Standard Turn-In Style Rings and Mounts

LEUPOLD
AMERICA'S OPTICS AUTHORITY

Standard Ring Heights
Super Low - 0.55"
Low - 0.65"
Medium - 0.77"
High - 0.90"
Super High - 1.00"



Now Available in Gun Metal Gray

1 Inch Rings

	Order No.	Price
Super Low Matte	154-49896	\$21.43
Low Blue	154-49897	21.43
Low Matte	154-49898	21.43
Low Silver	154-49899	21.43
Medium Blue	154-49900	21.43
Medium Matte	154-49901	21.43
Medium Silver	154-49902	21.43
High Blue	154-49903	21.43
High Matte	154-49904	21.43
High Silver	154-49905	21.43
Super High Blue	154-49906	21.43
Super High Matte	154-49907	21.43

Standard 1 Piece Bases



	Order No.	Price
BAR Blue	154-49985	\$16.96
BLR Blue	154-49986	16.96
BR A-Bolt SA Blue	154-50009	16.96
BR A-Bolt SA Matte	154-50008	16.96
BR A-Bolt LA Blue	154-50011	16.96
BR A-Bolt LA Matte	154-50010	16.96
336 R Blue	154-49987	16.96
700 RH-LA Blue	154-50003	16.96
700 RH-LA Matte	154-50004	16.96
700 RH-SA Blue	154-50005	16.96
700 RH-SA Matte	154-50006	16.96
700 RH-SA Silver	154-50161	16.96
700 LH-LA Blue	154-50007	16.96
Rem 7400 / 7600	154-49993	16.96
70A	154-50000	16.96
70A Matte	154-50001	16.96
FN Mauser Gloss	154-49988	16.96
Mauser Gloss	154-49990	16.96
760	154-49992	16.96
R1022	154-49994	16.96
R1022 Matte	154-51723	16.96
R1022 Silver	154-51724	16.96
110 RH (Flat Receiver)	154-49996	16.96
110/116 RH (Round Receiver)	154-55701	16.96
110/116 RH Silver(Round Rcvr)	154-55705	16.96
10/16 RH SA Gloss (Round Rcvr)	154-55721	16.96
10/16 RH SA Matte (Round Rcvr)	154-55724	16.96
10/16 RH SA Silver(Round Rcvr)	154-55726	16.96
T/C .22 Classic	154-54427	16.96
1903A3	154-49997	16.96
Husqvarna Gloss	154-49989	16.96
Savage 99	154-49995	16.96
700 Long Range RH-LA Matte	154-51732	20.33
700 Long Range RH-LA Slv.	154-51733	20.33
700 Long Range RH-SA Matte	154-51734	20.33
7400/7600 Matte	154-53056	16.96
70 Long Range RH-LA Matte	154-51736	20.33
70 Long Range RH-LA Silver	154-51737	20.33
70 Long Range RH-SA Matte	154-51738	20.33
10 RH-SA	154-52316	16.96
10 RH-SA Matte	154-52317	16.96
10 RH-SA Silver	154-52318	16.96
10 LH-SA	154-52326	16.96

1 Inch Extension Rings

Low Blue	154-49908	\$28.81
Low Matte	154-49910	28.81
Medium Blue	154-49909	28.81
Medium Matte	154-49911	28.81
High Blue	154-49912	28.81
High Matte	154-49913	28.81

30mm Rings

Low Matte	154-51718	\$32.18
Medium Blue	154-49960	32.18
Medium Matte	154-49956	32.18
Medium Silver	154-52494	32.18
High Blue	154-49961	32.18
High Matte	154-49959	32.18
Super High Matte	154-51033	32.18
Super High Silver	154-52496	32.18

30mm Extension Rings

Medium Matte	154-51034	\$44.61
High Matte	154-51035	44.61

Standard 2 Piece Bases



	Order No.	Price
1888 High Wall Blue	154-50012	\$16.96
700 Blue	154-50015	16.96
700 Matte	154-50016	16.96
700 Silver	154-57510	16.96
700 Rev. Front Blue	154-50017	16.96
700 Rev. Front Matte	154-50018	16.96
700 Rev. Front Silver	154-50019	16.96
STD 7 Blue	154-51256	16.96
STD 7 Matte	154-57277	16.96
STD 7 Silver	154-51257	16.96
Rem. 541	154-50028	16.96
70 Exp. Rev. Front & Rear Matte	154-50378	16.96
70 Exp. Rev. Front & Rear Silver	154-50379	16.96
70 Rev. Rear Blue	154-50020	16.96
70 Rev. Rear Matte	154-50021	16.96
70 Rev. Front & Rear Blue	154-50022	16.96
70 Rev. Front & Rear Matte	154-50023	16.96
70 Rev. Front & Rear Silver	154-50024	16.96
70 WSSM Matte	154-57310	16.96
70 WSSM Blued	154-57300	16.96
70 WSSM Silver	154-57320	16.96
Win 94 Blue	154-50035	16.96
Mauser Blue	154-50025	16.96
Mauser Matte	154-50026	16.96
Mauser Rev. Front Blue	154-50027	16.96
Mauser 98 Matte	154-52370	16.96
STD M 96 Matte	154-51263	16.96
STD Mark V Blue	154-51700	16.96
STD Mark V Matte	154-51701	16.96
Wby Mark V Lightweight Matte	154-52507	16.96
BR A-Bolt Blue	154-50029	16.96
BR A-Bolt Matte	154-50030	16.96
BR A-Bolt Silver	154-50031	16.96
BR A-Bolt WSSM Matte	154-57340	16.96
BR A-Bolt WSSM Blued	154-57330	16.96
BR A-Bolt WSSM Silver	154-57350	16.96
BR X-Bolt Blue	154-65424	16.96
BR X-Bolt Matte	154-65416	16.96
BR X-Bolt Silver	154-65425	16.96
BR European Blue	154-50032	16.96
STD 1885 LW	154-51260	16.96
BR Micro Medallion Blue	154-50036	16.96
STD BLR	154-50237	16.96
STD BLR Matte	154-50238	16.96
STD Cooper Arms 38/21 Matte	154-52980	17.69
STD Mark V LT Matte	154-52507	16.96
Tikka Whitetail Hunter	154-54447	16.96
STD 10/110 Gloss	154-55741	16.96
STD 10/110 Matte	154-55742	16.96
STD 10/110 Silver	154-55743	16.96

Leupold Dual Dovetail Rings & Bases



Now Available in Gun Metal Gray

	Order No.	Price
1"Low Blue	154-49914	\$21.43
1"Low Matte	154-49915	21.43
1"Low Silver	154-52313	21.43
1"Medium Blue	154-49894	21.43
1"Medium Matte	154-49916	21.43
1"Medium Silver	154-52323	21.43
1"High Blue	154-49917	21.43
1"High Matte	154-49918	21.43
1"High Silver	154-51730	21.43
1"High Matte Extension	154-54159	28.81
1"Super High Matte	154-49919	21.43
30mm Low Matte	154-52242	32.18
30mm Medium Matte	154-49957	32.18
30mm High Matte	154-49958	32.18
30mm High Silver	154-57314	32.18
30mm High Matte Extension	154-54186	44.61
30mm Super High	154-52233	32.18
30mm Super High Matte	154-52234	32.18

Dual Dovetail 2 Piece Bases



	Order No.	Price
Rem 700 (2 Pc.) Blue	154-50041	\$16.96
Rem 700 (2 Pc.) Matte	154-50042	16.96
Rem 700 (2 Pc.) Silver	154-51727	16.96
Rem 700 Rev. Front (2 Pc.) Matte	154-50044	16.96
Win 70 (2 Pc.) Blue	154-50045	16.96
Win 70 (2 Pc.) Matte	154-50046	16.96
Win 70 (2 Pc.) Silver	154-57286	16.96
Win 70 Exp Post-64 (2 Pc.) Matte	154-54240	16.96
Win 70 RevFront (2 Pc.) Matte	154-54241	16.96
Bng A-Bolt Rev Front Matte	154-50159	16.96
Mark V (2 Pc.) Blue	154-51705	16.96
Mark V (2 Pc.) Matte	154-51706	16.96
Mark V RVF (2 Pc.) Matte	154-51707	16.96
Kimber 8400 Matte	154-60760	16.96
Kimber 8400 Gloss	154-60810	16.96
Kimber 84 Matte	154-60910	16.96
Kimber 84 Gloss	154-61001	16.96

Dual Dovetail Handgun Base



	Order No.	Price
DD RBH	154-53552	\$16.96
DD RBH Silver	154-53554	16.96
DD T/C- Encore	154-54218	16.96
DD T/C- Encore Silver	154-54798	16.96
DD T/C- Contender	154-53556	16.96
DD T/C- Contender Silver	154-53558	16.96
DD S&W Silver	154-53560	16.96
DD S&W Classic	154-53562	16.96
DD S&W Classic Silver	154-53564	16.96
DD Freedom Arms 83	154-53568	16.96
DD XP-100 Matte	154-53570	16.96



	Order No.	Price
Torx Screw Kit	154-52395	\$35.92
Scope Smith Mounting tool	154-52296	13.45
Ring Wrench	154-48762	10.11

Quick Release Rings & Bases (QR)

Remove and reattach a scope using Leupolds QR™ mount and still return to within half an inch of the original point-of-impact on the target. Machined steel construction.



Lever engages the base of the ring, pulling it down and forward on the base, locking it solidly into its "zero" position

QR Ring Heights	Covers both the 1" and 30mm Rings
Super Low - 0.55"	
Low - 0.65"	High - 0.90"
Medium - 0.77"	Super High - 1.00"

QR Rings

	Order No.	Price
Low Blued	154-49970	\$22.60
Low, Matte	154-49971	22.60
Low, Silver	154-49972	22.60
Medium Blued	154-49973	22.60
Medium Matte	154-49974	22.60
Medium Silver	154-49975	22.60
Medium Matte Extension	154-49976	29.40
High Blued	154-49978	22.60
High, Matte	154-49979	22.60
High, Silver	154-49980	22.60
Super High Matte	154-51715	22.60
High Extension Matte	154-49981	29.40
High Extension Blued	154-49984	29.40
30mm Low Matte	154-51717	35.30
30mm Med Matte	154-49931	33.86
30mm High Matte	154-49933	33.86
30mm High Silver	154-57527	33.86
30mm Super High Matte	154-51716	33.86
30mm Extension High	154-49940	45.20
30mm Extension High Matte	154-49941	45.20

QR Bases

	Order No.	Price
700 RH-SA Matte 1 piece	154-51247	\$46.30
BAR Blue 1 piece	154-51249	46.30
BAR Matte	154-51223	46.30
700 2 piece	154-50049	46.30
700 2 piece, Matte	154-50050	46.30
Win 70, 2 piece	154-50053	46.30
Win 70, 2 piece Matte	154-50054	46.30
Mauser 2 piece	154-50055	46.30
Mauser 2 piece, Matte	154-50056	46.30
Mark V 2 piece, Matte	154-51709	46.30
Mark V LT 2 piece, Matte	154-51712	46.30
Browning A-Bolt, 2 pc Matte	154-50057	46.30
700 Silver 2 piece	154-50059	46.30
Sauer 90, 2 piece	154-50061	46.30
Winchester 70 Exp, 2 piece	154-50063	46.30
Remington 7400/7600 1 piece	154-50067	46.30
TC/C 1 piece	154-50068	46.30
T/C Encore & Omega Matte	154-52325	46.30
T/C Encore & Omega Silver	154-57496	46.30
541 Matte	154-52239	46.30
Savage 110	154-52314	46.30
Savage 10/110 Matte round rcvr	154-55761	46.30
Marlin 1895/336 1pc Matte	154-54229	46.30
Marlin 1895/336 1pc Silver	154-54227	46.30
Steyr/Mannlicher	154-60656	46.30

Quick Release Weaver Rings & Bases (QRW)

The QRW brings Leupold accuracy to the cross-slot format: Steel detachable accuracy mounts that are based on the familiar cross-slot design. Use the QRW mounts to achieve detachable accuracy.



	Order No.	Price
1" Low	154-49852	\$49.73
1" Low Matte	154-49853	49.73
1" Low Silver	154-49854	49.73
1" Medium	154-49855	49.73
1" Medium Matte	154-49856	49.73
1" Medium Silver	154-49867	49.73
1" High	154-49857	49.73
1" High Matte	154-49858	49.73
1" High Silver	154-49859	49.73
30mm Low Matte	154-49861	60.99
30mm Medium	154-49862	60.99
30mm Medium Matte	154-49863	60.99
30mm High	154-49864	60.99
30mm High Matte	154-49865	60.99

Weaver Style QRW Bases

	Order No.	Price
110	154-49833	\$27.13
70 EXP POST-64 MATTE	154-49835	27.13
70 EXP PRE-64 MATTE	154-49836	27.13
70 MATTE	154-49838	27.13
700	154-49840	27.13
700 MATTE	154-49841	27.13
700 SILVER	154-49842	27.13
A-BOLT MATTE	154-49847	27.13
A-BOLT SILVER	154-49848	27.13
R541	154-49866	27.13

QRW & PRW Ring Heights	
1" Low - 0.75"	1" High - 1.00"
1" Medium - 0.88"	30mm Low - 0.84"
	30mm Medium - 0.97"
	30mm High - 1.09"

Leupold Permanent PRW Rings

Leupold PRW Rings Offer Permanent Cross-Slot Stability. Steel rings that are based on the proven cross-slot design. Uses the Leupold QRW bases or any other Picatinny-style mounting rails.



	Order No.	Price
PRW Low Matte	154-54144	\$38.40
PRW Med Gloss	154-54147	38.40
PRW Med Matte	154-54149	38.40
PRW High Matte	154-54150	38.40
PRW Med Matte	154-54167	44.03
PRW High Matte	154-54177	44.03

Leupold Weaver Style Rings

	Order No.	Price
Blued Med	154-49965	\$55.36



Mark4 Law Enforcement Bases & Rings

Mark4 Aluminum Rings	Order No.	Price
30mm Med 0.84" Matte	154-57398	\$126.52
30mm Super High 1.40" Matte	154-57555	126.52

Mark4 Steel Rings	Order No.	Price
30mm Med 0.84" Matte	154-61049	\$131.90
30mm Super High 1.40" Matte	154-60750	126.52

Leupold Ringmounts



CZ Ringmounts	Order No.	Price
527 1" Medium Matte	154-54360	\$50.83
527 1" High Matte	154-62001	50.83
527 30mm Medium Matte	154-61666	62.10
527 30mm High Matte	154-61830	62.10
550 1" Medium Matte	154-54350	50.83
550 1" High Matte	154-61750	50.83
550 30mm Medium Matte	154-61885	62.10
550 30mm High Matte	154-61790	62.10

Sako Ringmounts	Order No.	Price
1" Low Blue	154-49946	\$50.83
1" Medium Blue	154-49945	50.83
1" Medium Matte	154-54409	50.83
1" Medium Silver	154-51719	50.83
30mm Medium Matte	154-51036	62.10
1" High Blue	154-49948	50.83
1" High Matte	154-54410	50.83
1" High Silver	154-51720	50.83
30mm High Matte	154-51037	62.10
1" Super High Blue	154-49942	50.83
1" Super High Matte	154-49943	50.83
30mm Super High Matte	154-51722	62.10

Ruger No.1 & 77/22	Order No.	Price
1" Low Blue	154-49950	\$50.83
1" Low Matte	154-60924	50.83
1" Medium Matte Extension	154-52306	58.73
30mm Medium Matte	154-51038	62.10
1" High Matte	154-50217	50.83
1" High Matte Extension	154-52307	58.73
30mm High Matte	154-51039	62.10
1" Super High Matte Extension	154-52308	58.73

Ruger M77	Order No.	Price
30mm Medium Matte	154-51041	\$62.10
1" High Matte	154-49952	50.83
1" High Silver	154-49953	50.83
1" High Matte Extension	154-52301	58.73
30mm High Matte	154-51042	62.10
30mm High Matte Extension	154-52304	73.43
1" Super High Matte	154-49944	50.83
1" Super High Silver	154-50166	50.83
1" Super High Matte Extension	154-52302	58.73
30mm Super High Matte	154-51043	62.10
30mm Super High Matte Ext.	154-52305	73.43

22 Rimfire 1 Inch No-Tap Ringmounts	Order No.	Price
11mm Med Gloss	154-54231	\$38.40
11mm High Gloss	154-54234	38.40
13mm Low Blue	154-49949	38.40
13mm Medium Blue	154-49947	38.40
3/8 Med Gloss	154-54289	38.40
3/8 High Gloss	154-54286	38.40



Burriss Standard Turn-In Style Rings and Mounts

Trumount Universal (TU) 2 Piece & Supreme Universal (SU) 1 Piece

Solid Steel Rings - Burriss rings are made from a solid piece of steel with the top and bottom half perfectly mated. For information on ring height, see the Burriss Ring Chart on the next page.



1 Inch Rings

	Order No.	Price
Low Matte	023-420012	21.68
Med Gloss	023-420051	21.68
Med Matte	023-420052	21.68
Med Nickel	023-420053	26.16
High Matte	023-420200	21.68

30mm Rings

	Order No.	Price
Medium Matte	023-420321	\$36.86
High Matte	023-420331	36.86



1 Inch Extension Rings

Closeout!!! Limited Quantities

	Order No.	Price
1" Med STD Front EXT Rear Nickel	023-420057	\$42.21

Burriss Signature Rings



Signature rings provide tremendous gripping power, a scratch-free and stress-free mounting method as well as scope value preservation. By putting a synthetic pivoting insert within a steel outer ring, your scope-to-ring surface area contact becomes virtually 100%.

Note! 1" Signature Rings are shipped with one set of concentric inserts. 30mm Signature Rings are shipped with one set of concentric & +/- .010 inserts.

1 Inch Signature Turn-In Rings

	Order No.	Price
1" Medium Gloss	023-420500	\$30.80
1" Medium Matte	023-420501	30.80
1" Medium Nickel	023-420502	32.52
1" High Gloss	023-420510	30.80
1" High Matte	023-420511	30.80
1" High Nickel	023-420512	32.52

30mm Signature Turn-In Rings

	Order No.	Price
30mm Medium Matte	023-420578	\$49.06
30mm High Matte	023-420581	49.06
30mm Ex High Matte	023-420582	49.06

Signature Double Dovetail Rings

	Order No.	Price
1" Medium Gloss	023-420560	\$32.10
1" Medium Matte	023-420561	32.10
1" Medium Nickel	023-420562	33.89
1" High Gloss	023-420570	32.10
1" High Matte	023-420571	32.10
30mm Medium Matte	023-420583	51.13

Signature Ring Insert Kit



Signature Rings also accept Pos-Align Offset Inserts so you can virtually sight-in your gun without moving the scope adjustments.

Signature Pos-Align® Offset Insert Kit - Contains 1 set each of (+/- .005", +/- .010", +/- .020")
Order No. 023-626019 \$11.30

Signature Zee (Weaver Style) Rings



Burriss also offers Weaver Style "Zee Rings" in the Signature mount line. These Zee rings will fit all Weaver Style bases.

	Order No.	Price
1" Medium Gloss	023-420520	\$34.80
1" Medium Matte	023-420521	34.80
1" Medium Nickel	023-420522	36.45
1" High Gloss	023-420530	34.80
1" High Matte	023-420531	34.80
1" High Nickel	023-420532	36.45
30mm Medium Matte	023-420588	51.91
30mm High Matte	023-420587	51.91
30mm Extra High Matte	023-420585	51.91

Signature Rimfire/Airgun 1 Inch Rings

	Order No.	Price
Rimfire/Airgun Gloss High	023-420555	\$47.56
Rimfire/Airgun Matte High	023-420556	47.56



Standard (TU)
2 Piece Bases



Standard (SU)
1 Piece Bases

Closeout!
Limited Quantities!

	Order No.	Price
Savage 110 Short Action Matte	023-410258	\$10.46
Brng A-Bolt Long Matte	023-410262	3.93
Brng A-Bolt Short Matte	023-410263	10.46
Benelli Pump Nova Camo	023-410609	14.09

Handgun (LU) 1 Piece Bases

Long Eye Relief



DD= Dual Dovetail

Closeout!
Limited Quantities!

	Order No.	Price
S&W 629 Classic Nickel	023-410387	\$15.65
TC Encore Handgun Gloss (DD)	023-410595	14.17
TC Encore Handgun Nickel	023-410596	15.28

Double Dovetail

2 Piece & 1 Piece Bases



Closeout!
Limited Quantities!

	Order No.	Price
TC Encore Handgun Gloss (1pc)	023-410595	\$14.17
TC Encore Handgun Nickel (1pc)	023-410596	15.28
TC Encore Carbine Gloss (1pc)	023-410520	15.28
TC Encore Carbine Nickel (1pc)	023-410521	15.28

Gunsmith Bases & Accessories



Customize the height, length, radius, flutes, and hole spacing with Gunsmith Bases. Base Shims Come 10 per pack.

	Order No.	Price
Shims.330-.860, 1.240x .735x .010	023-625050	\$6.24
Shims.330-.860, 1.240x .735x .015	023-625051	6.24

Burriss Ring Heights - This chart shows the dimensions of all Burriss rings from the bottom of the scope tube to the bottom of the ring ("C" dimension).

	SUPER LOW	LOW	MED	HIGH	EXTRA HIGH
Std. 1" & Sig 1"	—	0.15	0.27	0.39	—
Std. 30mm & Sig 30mm	—	—	0.18	0.30	0.42
Zee 1" & Quick Detach 1"	0.044	0.13	0.255	0.45	—
Zee Sig 1"	—	—	0.27	0.42	—
Zee 30mm incl. Sig	—	—	0.205	0.330	0.455
Ruger® 1"	—	0.41	0.535	0.66	—
Ruger® 30mm	—	—	0.545	0.67	—
.22 Signature Deluxe	—	—	0.4	0.793	—
1" .22 rings (all)	—	—	0.4	0.55	—

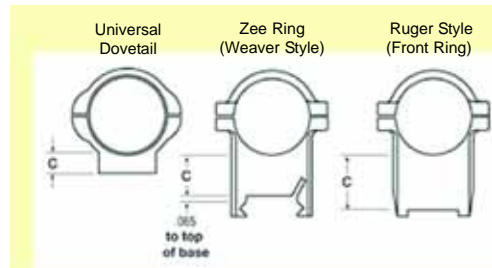

Burriss Weaver Style Zee Rings



Burriss solid steel Weaver Style "Zee Rings" will fit all Weaver Style bases.

	Order No.	Price
1" Low Zee Rings Gloss	023-420080	\$21.96
1" Low Zee Rings Matte	023-420083	21.96
1" Low Zee Rings Nickel	023-420079	26.93
1" Medium Zee Rings Gloss	023-420081	21.96
1" Medium Zee Rings Matte	023-420084	21.96
1" Medium Zee Rings Nickel	023-420085	26.93
1" High Zee Rings Gloss	023-420082	21.96
1" High Zee Rings Matte	023-420087	21.96
1" High Zee Rings Nickel	023-420086	26.93
30mm Med Zee Rings Matte	023-420044	38.64
30mm High Zee Rings Matte	023-420077	38.64



Quick Detach Zee Rings

These solid steel rings fit on any aluminum or steel Weaver style base. With a solid immovable side and a steel recoil stop.

These are truly return-to-zero, quick detach rings!

	Order No.	Price
1" Low Matte	023-420031	\$42.21
1" Med Matte	023-420034	42.21
1" High Matte	023-420037	42.21

Xtreme Tactical Bases & Rings



XTB Solid Steel Weaver Style Base -

XTB Solid Steel Bases are solid steel and designed for maximum mounting flexibility to each rifle mode. All are matte finish and 2 pieces.

	Order No.	Price
Remington 700 & 7	023-410600	\$18.13
Winchester 70 and Express	023-410605	18.13
Savage with Flat Rear	023-410620	18.13
Savage with Round Rear	023-410615	18.13
Browning A-Bolt	023-410625	18.13
Browning A-Bolt Super Short	023-410626	18.13
Tikka	023-410630	18.13



XTR Solid Steel Weaver Style Rings -
Tactical Ring Set (2ea)
Designed to fit Picatinny Style Rails.

	Order No.	Price
30mm - Low 1/4" Height Matte	023-420160	\$53.51
30mm - Med 1/2" Height Matte	023-420162	53.51
30mm - High 3/4" Height Matte	023-420164	53.51
30mm - XHigh 1" Height Matte	023-420166	53.51
1" - Low 1/4" Height Matte	023-420180	48.75
1" - Med 1/2" Height Matte	023-420181	48.75
1" - High 3/4" Height Matte	023-420182	48.75
1" - XHigh 1" Height Matte	023-420183	48.75

Picatinny Style Ring Top - Top off your XTR Rings with these ring tops to mount additional lights etc...

	Order No.	Price
1" Ring Top	023-420189	\$20.21
30mm Ring Top	023-420169	20.21

Burriss Ringmounts

CZ Ringmounts

	Order No.	Price
CZ 550 Long Action 1" Medium Gloss Finish 19mm	023-420130	\$36.86
CZ 527 Short Action 1" Medium Gloss Finish 16mm	023-420140	36.86

Ruger Ringmounts

	Order No.	Price
1" Ruger 1, M77/22, M-14 Low Gloss	023-420103	\$33.41
1" Ruger 1, M77/22, M-14 Medium Gloss	023-420107	33.41
1" Ruger 1, M77/22, M-14 Medium Matte	023-420113	33.41
1" Ruger 1, M77/22, M-14 High Gloss	023-420109	33.41
1" Ruger M77 Medium Gloss	023-420104	33.41
1" Ruger M77 Medium Nickel	023-420100	36.74



Ruger to Weaver Base Adapter



Ruger-to-Weaver Base Adapter - With these adapters you can use Burriss's famed Zee Rings on your Ruger rifle or handgun.

	Order No.	Price
Ruger to Weaver For M77 & Super Redhawk Gloss	023-410990	\$26.16
Ruger to Weaver For 77/22 & Redhawk Gloss	023-410991	26.16

Rimfire & Airgun Rings



	Order No.	Price
1" Med Aluminum Gloss	023-420071	\$22.00
1" Med Deluxe Steel Gloss	023-420072	26.75
1" Med Deluxe Steel Matte	023-420069	26.75
1" Med Signature* Matte	023-420554	47.56
1" High Deluxe Steel Gloss	023-420073	26.75
1" High Deluxe Steel Matte	023-420076	26.75
1" High Signature* Gloss	023-420555	47.56
1" High Signature Matte	023-420556	47.56

*Signature Rimfire Rings are shipped with one set of concentric inserts.

Simmons Rings



Weaver Style Rings

	Order No.	Price
1" Medium Silver Weaver Style	014-49166	\$5.47
1" Medium Gloss Weaver Style	014-49167	5.47
1" Medium Matte Weaver Style	014-49168	5.47
1" High Gloss Weaver Style	014-49171	5.47
1" High Matte Weaver Style	014-49172	5.47
1" High Silver Weaver Style	014-49173	5.47
1" SeeThru Matte Weaver Style	014-49176	7.20
30mm Med Matte Weaver Style	014-49174	10.47
30mm High Matte Weaver Style	014-49175	10.47



Rimfire & Airgun Rings

	Order No.	Price
Matte Weaver Style 22cal rings	014-49169	\$5.47
Silver Weaver Style 22cal rings	014-49170	5.47

Burriss Ring Heights - This chart shows the dimensions of all Burriss rings from the bottom of the scope tube to the bottom of the ring ("C" dimension).

	Universal Dovetail	Zee Ring (Weaver Style)	Ruger Style (Front Ring)
Std. 1" & Sig 1"	—	0.15	0.27
Std. 30mm & Sig 30mm	—	0.18	0.30
Zee 1" & Quick Detach 1"	0.044	0.13	0.255
Zee Sig 1"	—	—	0.27
Zee 30mm incl. Sig	—	—	0.205
Ruger® 1"	—	0.41	0.535
Ruger® 30mm	—	—	0.545
.22 Signature Deluxe	—	—	0.4
1" .22 rings (all)	—	—	0.4

Tasco Aluminum Rings



Weaver Style Rings

	Order No.	Price
1" Matte Black	209-791DSC	\$5.00
1" High Matte Black	209-793DSC	5.00



Rimfire & Airgun Rings

	Order No.	Price
1" High Matte Aluminum	209-797DSC	\$5.00
1" High Gloss Peep	209-799DSC	5.00

Millett Turn-In Style Rings and Bases

One Inch Rings

	Order No.	Price
1" Low Black	131-SR00001	\$18.35
1" Low Matte	131-SR00701	18.35
1" Low Nickel	131-SR00901	24.38
1" Low Engraved	131-ER00001	21.27
1" Medium Black	131-SR00002	18.35
1" Medium Matte	131-SR00702	18.35
1" Medium Nickel	131-SR00902	24.38
1" Medium Engraved	131-ER00002	21.27
1" High Black	131-SR00003	18.35
1" High Matte	131-SR00703	18.35
1" High Nickel	131-SR00903	24.38
1" High Engraved	131-ER00003	21.27
1" Extra-High Black	131-SR00008	18.35
1" Extra-High Matte	131-SR00708	18.35
1" Extra-High Nickel	131-SR00908	24.38

30mm Rings

	Order No.	Price
30mm Medium Black	131-SR00005	\$24.89
30mm Medium Matte	131-SR00705	24.89
30mm High Black	131-SR00006	24.89
30mm High Matte	131-SR00706	24.89



Extension Rings

	Order No.	Price
1" Med (STD R EXT F)	131-EX00001	\$26.16
1" Med (EXT R STD F)	131-EX00002	26.16
1" Med (EXT R EXT F)	131-EX00003	29.97
1" High (STD R EXT F)	131-EX00004	26.16
1" High (EXT R STD F)	131-EX00005	26.16
1" High (EXT R EXT F)	131-EX00006	29.97

Millett Ring Heights -

For Turn-in, Angle Loc and Extensions

	Low	Med	High	Extra High
1"	.145	.265	.365	.500
30mm	.206	.350	.495	-



	Order No.	Price
Browning A-Bolt, Smooth	131-BB00005	\$13.08
Browning A-Bolt, Matte	131-BB00705	13.08
Browning BAR/BLR, Smooth	131-BB00004	13.08
Interarms, Mk X, FN Mauser 98	131-FN00002	13.08
Kimber 82C & 84C, Smooth	131-KM00001	13.08
Marlin 336, 30AS, Smooth	131-MB00007	13.08
Rem 700, Weatherby, Smooth	131-SB70001	13.08
Rem 700, Weatherby, Matte	131-SB70701	13.08
Rem 700, Weatherby, Nickel	131-SB70901	18.35
Rem 7400, 7600, 4, 6, Smooth	131-RB00006	13.08
Sav 110, Smooth	131-SB00009	13.08
Sav 110, Matte	131-SB00709	13.08
Sav 110, Nickel	131-SB00909	18.35
Win 70, Smooth	131-WB70003	13.08
Win 70, Matte	131-WB70703	13.08
Win 70, Nickel	131-WB70903	18.35
Win 94, Angle-Eject, Smooth	131-WB00008	13.08

Millett Angle-Loc Rings and Mounts



The Angle-Loc windage adjustable scope mount system is the most significant improvement to the traditional Weaver-Style mount in many years. All components are made of heat treated nickel steel for rock solid durability.

One Inch Rings

	Order No.	Price
Low Black	131-AL00010	\$23.21
Low Matte	131-AL00710	23.21
Low Nickel	131-AL00910	30.81
Low Engraved	131-AL00007	26.46
Medium Black	131-AL00011	23.21
Medium Matte	131-AL00711	23.21
Medium Nickel	131-AL00911	30.81
Medium Engraved	131-AL00008	26.46
1" Ext. Rings, Med (1ext 1std)	131-EX25001	30.88
High Black	131-AL00012	23.21
High Matte	131-AL00712	23.21
High Nickel	131-AL00912	30.81
High Engraved	131-AL00009	26.46

30mm Rings

	Order No.	Price
Medium Black	131-AL00017	\$29.90
Medium Matte	131-AL00717	29.90
High Black	131-AL00018	29.90
High Matte	131-AL00718	29.90



	Order No.	Price
Brng A-Bolt, WSM Smooth	131-ST00002	\$13.46
Brng A-Bolt, WSM Matte	131-ST00702	13.46
Brng A-Bolt, WSM Nickel	131-ST00902	17.55
Brng A-Bolt, WSSM Smooth	131-ST00016	13.46
Rem 700 Smooth	131-ST00009	13.46
Rem 700 Matte	131-ST00709	13.46
Rem 700 Nickel	131-ST00909	17.55
Rem 7400 Smooth	131-ST00017	13.46
Sav 110 Smooth	131-ST00010	13.46
Sav 110 Matte	131-ST00710	13.46
Sav 110 Nickel	131-ST00910	17.55
Sav 110 Accutrigger Smooth	131-ST00015	13.46
Sav 110 Accutrigger Matte	131-ST00715	13.46
Sav 110 Accutrigger Nickel	131-ST00915	17.55
Win 70, WSM Smooth	131-ST00011	13.46
Win 70, WSM Matte	131-ST00711	13.46
Win 70, WSM Nickel	131-ST00911	17.55



.22cal Angle-Loc Windage Adjustable Ring Mounts -



	Order No.	Price
1" Rings Medium Gloss	131-TP00002	\$19.18
1" Rings High Gloss	131-TP00005	19.18
30mm Rings Medium Gloss	131-TP00008	25.16
1" Rings Medium Matte	131-TP00702	19.18
1" Rings High Matte	131-TP00705	19.18
30mm Rings Medium Matte	131-TP00708	25.16
1" Rings Medium Engraved	131-TP00003	23.73
1" Rings High Engraved	131-TP00006	23.73

Handgun Rings & Mounts



Ruger Super Redhawk 1" Rings Smooth - Handgun hunters and target shooters choose Millett scope mounts because they are rock solid and don't move when shooting the heaviest magnum loads. Each model is custom crafted in heat treated nickel steel yet lightweight because all excess mass is removed.

Order No. 131-RR77004 \$23.28

Angle-Loc Windage Adjustable Ring Mounts -

All components are made of heat treated nickel steel for rock solid durability.



	Order No.	Price
Sako 1" Medium Gloss	131-SA00011	\$36.08
Sako 1" High Gloss	131-SA00012	36.08
Sako 30mm Medium Gloss	131-SA00022	40.63
Sako 30mm High Gloss	131-SA00023	40.63
CZ 527 1" Low Matte	131-BN00001	35.86
CZ 527 1" Medium Matte	131-BN00002	35.86
CZ 527 1" High Matte	131-BN00003	35.86
CZ 527 30mm Low Matte	131-BN00006	42.38
CZ 527 30mm Medium Matte	131-BN00007	42.38
CZ 527 30mm High Matte	131-BN00008	42.38
CZ 452 Euro 1" Med Matte	131-BN00022	35.86
CZ 452 Euro 1" High Matte	131-BN00023	35.86

*For CZ 452 American Classic use 3/8 tip off dovetail rings (Millett .22 Cal Angle-Loc Rings)

BRNO ZK 600, 601, 602	131-BN00016	\$35.86
CZ 550 1" Med Matte		
BRNO ZK 600, 601, 602	131-BN00017	35.86
CZ 550 1" High Matte		
BRNO ZK 600, 601, 602	131-BN00019	42.38
CZ 550 30mm Med Matte		
BRNO ZK 600, 601, 602	131-BN00020	42.38
CZ 550 30mm High Matte		

Millett Ruger Ringmounts

Ruger 10/22 Angle-Loc Windage Adjustable Ring Mounts - These rings fit the factory supplied base.



	Order No.	Price
1" Med. Black	131-RM00026	\$20.22
1" High Black	131-RM00027	20.22

Ruger M77 & 77/22 Angle-Loc Windage Adjustable Ring Mounts - Heat treated nickel steel.

	Order No.	Price
Ruger M77, 1", Medium Gloss	131-RR77004	\$23.28
Ruger M77, 1", High Gloss	131-RR77005	23.28
Ruger 77/22, 1, 3, Ranch Rifle, 1", High Gloss	131-RM00011	23.28



The Grabber™ - The answer for quick, easy, repeatable mounting of scopes and other items on Weaver, Picatinny-type rails. PATENT PENDING

	Order No.	Price
1" Med Matte	131-GB00002	\$53.47
30mm Med Matte	131-GB30002	59.40

DURASIGHT Z2 ALLOY SCOPE RINGS - Weaver® style scope rings provide maximum strength and durability at a very affordable price.



	Order No.	Price
Med (Black)	215-DS300B	\$9.63
Med (Silver)	215-DS300S	9.63
Med (Black)	215-DS301B	10.36
Med (Silver)	215-DS301S	10.36
High (Black)	215-DS302B	9.63
High (Silver)	215-DS302S	9.63

Durasight Z2 Alloy Quick Detach Scope Rings - QD levers allow for quick and easy scope removal and provide "return to zero" capability.



	Order No.	Price
Medium (Black)	215-DS400B	\$13.33
Medium (Silver)	215-DS400S	13.33
High (Black)	215-DS403B	13.33
High (Silver)	215-DS403S	13.33



Grade 8 Torx® screws provide super-secure attachment and a Torx® wrench is included.

Durasight Z2 Alloy Rifle Bases - These Weaver® style scope bases provide maximum strength and durability at a very affordable price. The industrial spec powder coat finish, in matte black or silver, is both beautiful and durable.

	Order No.	Price
Remington Model 700 (Black)	215-DS104B	\$2.97
Remington Model 700 (Silver)	215-DS104S	2.97
Winchester Model 70 (Black)	215-DS105B	2.97
Winchester Model 70 (Silver)	215-DS105S	2.97
Browning A-Bolt (Black)	215-DS106B	2.97
Browning A-Bolt (Silver)	215-DS106S	2.97
Savage 110/112 (Black)	215-DS107B	2.97
Savage 110/112 (Silver)	215-DS107S	2.97
Ruger 10/22 (Black)	215-DS109B	2.97
Ruger 10/22 (Silver)	215-DS109S	2.97



Durasight Bases for Muzzleloaders



Durasight Z2 Alloy Bases for Muzzleloaders - 50% stronger than conventional aluminum bases! These Weaver Style scope bases include Grade 8 Torx® screws and wrench.

	Order No.	Price
CVA, Winchester, Traditions & Frontier Black	215-DS100B	\$5.94
CVA, Winchester, Traditions & Frontier Silver	215-DS100S	5.94
TC Omega/Encore/Triumph Black	215-DS103B	9.63
TC Omega/Encore/Triumph Silver	215-DS103S	9.63

Durasight Z2 Alloy Bases for CVA Optima Elite CF & ML, All Optima, All Kodiak, Wolf, Win. Apex, Frontier Beartooth Black Muzzleloaders - 50% stronger than conventional aluminum bases! These Weaver Style scope bases include Grade 8 Torx® screws and wrench.

	Order No.	Price
Black	215-DS102B	\$9.63
Silver	215-DS102S	9.63

The Improved LaserLyte® Laser Bore Sight - .22 to 50cal - Order No. 116-MBS1 \$47.28

LaserLyte® Mini Laser Bore Sight - .17-.22 caliber firearms. Order No. 116-MBS1722 \$47.28



DURASIGHT™ SCOPE MOUNTING SYSTEMS

Durasight™ Z2 Alloy QD Rings provide 50% more strength than conventional aluminum rings but are priced about the same.

Durasight Z2 Alloy Integral Muzzleloader Ring / Base System - The base and the lower ring are all one unit and are formed in a mold with Z-2 Alloy. This eliminates one of the key weaknesses of traditional two-piece systems.

Fits all CVA In-Lines, Traditions In-Lines, Winchester In-Lines, and T/C Encore, Omega, Triumph

	Order No.	Price
Medium (Black)	215-DS412B	\$19.69
Medium (Silver)	215-DS412S	19.69

Durasight Z2 Alloy Integral Ring / Base System for Centerfire Rifles - The base and the lower ring are all one unit and are formed in a mold with Z-2 Alloy.



	Order No.	Price
Medium (Black): Fits Savage 110/112 with round rear bridge	215-DS417B	\$12.67
Medium (Black): Fits Win Model 70 LA/SA (standard calibers with .860 hole space and super short-magnums with .500 hole spacing)	215-DS415B	12.67
Medium (Black): Fits Browning A-Bolt LA/SA	215-DS416B	12.67



Ruger Mounts



	Order No.	Price
A - Ruger Mini-14 Mount	146-SM4502	\$36.66
B - Ruger MK-II PreDrilled	146-SM4873	10.78

AR-15 Mounts



	Order No.	Price
Flat Top Picatinny	146-SM5100	\$28.26
Carry Handle Picatinny	146-SM8526	21.01

Adapter Mounts -

	Order No.	Price
11mm to Picatinny (4 Screw)	146-SM002	\$17.97
Ruger to Weaver	146-SM4507	22.28
11mm to Weaver Std Elevation	146-SM7021	25.16
3/8" Dovetail to Weaver (2pc)	146-SM7025	9.34



Sun Optics Rings and Mounts

3/8 Dovetail 22 Cal Sport Rings

	Order No.	Price
1" Low Black Matte	146-SM752	\$9.34
1" Med Black Matte	146-SM754	9.34
1" Med Stainless	146-SM755	10.78
1" High Black Matte	146-SM756	10.78
30mm Med Black Matte	146-SM764	12.21
30mm High Black Matte	146-SM766	13.65



	Order No.	Price
FN-FAL	146-SM8500	\$48.16
H&K 91/93/94/MP5	146-SM8513	42.41
SKS	146-SM8569	25.16
AK-47 / MAC90	146-SM8600	30.91



	Order No.	Price
1" Low Black Matte	146-SM052	\$9.34
1" Low Stainless	146-SM053	10.78
1" Med Black Matte	146-SM054	9.34
1" Med Stainless	146-SM055	10.78
1" High Black Matte	146-SM056	10.78
1" High Stainless	146-SM057	12.21
30mm Low Black Matte	146-SM062	12.21
30mm Med Black Matte	146-SM064	12.21
30mm High Black Matte	146-SM066	13.65

Shotgun Mounts -

	Order No.	Price
Baikal 12ga	146-SM4600	\$28.03
Rem 12ga 870/1100/1187	146-SM4805	28.02

B-Square Classic Military Mounts

1903 Springfield. Replaces the gun's magazine cut-off. Quick on and off with no change in zero. Windage and elevation adjustments. See under type allows use of gun's sights. Includes rings.

Order No. 080-18477 \$38.75



SMLE MKI 4, 5 & MKIII 1 - See under type so gun's sights can be used. Easy to install, and comes with 1" rings.

SMLE MKI #4 & #5, Blue Finish

Order No. 080-18564 Price \$30.99

Savage 340 Base and Rings - B-Square makes a professional scope mount for these fine rifles. The gun's sights can be used with the scope installed. Socket screws and wrench are furnished for easy do-it-yourself installation.

Order No. 080-14600 \$54.30



B-Square Sporting Rifle Mounts

Mini-14 Mount - B-Square's no-gunsmithing dovetail mount for the Mini-14 is easily installed by simply replacing the gun's bolt stop cover plate with B-Square's cover plate. No drilling, tapping or sight removal is required. A large clamping knob allows easy on and off without change of zero. The mount has windage and elevation adjustments. Includes rings.



Blued Mini-14 Mount Dovetail w/rings
Stainless Mini-14 Mount Dovetail w/rings

Order No. 080-14502 Price \$69.81
080-14506 69.81

B-Square Modern Military Mounts

NO TAPPING NO DRILLING NO GUNSMITHING

Includes 1" Rings



AK-47 / MAK-90 - Receiver mount for Chinese models. Attaches using steel trigger bolt and hammer bolt. Standard dovetail base accepts Weaver Style Rings (Included).
Order No. 080-18600 \$38.75

M 1 Garand - B-Square's sniper mount for the famous M1 Garand rifle attaches to the rear sight brackets and clamps onto the receiver's side at forward end for a rugged, no movement mount.



The mount is offset to the left to allow loading. It has elevation adjustment so any scope can be used. Comes with 1" rings; wrenches and instructions for easy do-it-yourself installation without destroying the arsenal condition of this fine rifle. Blue Finish w/rings.
Order No. 080-18554 \$54.26



FN-FAL/LAR/L1-A1 Replaces the gun's dust cover and clamps to the receiver for rigid, no movement mounting. Standard dovetail base includes "see-thru" rings.
Order No. 080-18500 \$38.75

M1A/M14 - This military mount for the M1A/M14 rifle is quick on and off with a single knob attachment and returns to zero. It has elevation adjustments to help align hi-power sniper scopes and is see under so the gun's sights can be used with the mount installed. Standard dovetail and NATO Stanag provisions. Comes with 1" dovetail rings. Long enough for mounting all red dot and military devices. Blue Finish
Order No. 080-18514 \$69.77

B-Square Revolver and Automatic Pistol Mounts



B-Square Tactical Tri-Ring Mount & AR-15 Mounts



AR-15 Mounts - B-Square's AR-15/16 military mount has both NATO Stanag and standard dovetail provisions so military optics or standard scopes, rings and devices can be used. It has a military finish to match the gun. Also available: Flat Top AR15 base - both come with rings.

Blued AR-15 Mount (see-thru) w/rings
Blued AR-15 Flat Top Mount w/rings

Order No. 080-18526 Price \$19.35
080-15150 38.75

	Order No.	Price
Browning: Buckmark, Receiver Mount Blue	080-42214	\$23.23
Ruger: Mark 1 //I, Slides on receiver all barrels; Blue	080-42877	23.23
Ruger: Mark 1 //I, Slides on receiver all barrels, Stainless Steel	080-42878	23.23
Smith & Wesson K,L,N Frames Post 1993: Uses existing Pre-drilled tappings 5" or longer barrels Blued Finish	080-42405	38.75
Smith & Wesson K,L,N Frames Post 1993: Uses existing Pre-drilled holes 5" or longer BBL Stainless Steel Finish	080-42406	38.75
Taurus: 44 Magnum Full length rib mount 6.5" nonport barrel, Stainless Steel	080-42306	38.75

More Online! **B-SQUARE**

B-Square Interlock (Weaver Style) Bases & Rings



B-Square Weaver Style Rings - Standard Dovetail Weaver Style Sport Utility Rings. Made of Aluminum!

	Order No.	Price
1" Low Matte	080-20052	\$8.22
1" Low Stainless Steel	080-20053	8.69
1" Med Matte	080-20054	8.22
1" Med Stainless Steel	080-20055	4.81
1" High SeeThru Matte	080-20056	8.22
1" High SeeThru SS	080-20057	8.69
30mm Med Matte	080-20064	8.69
30mm High SeeThru Matte	080-20066	8.69



B-Square Rimfire Rings - .22 Rimfire and Air Rifle Sport Utility Rings. Made of Aluminum!

	Order No.	Price
1" Med .22 & Airgun Matte	080-27054	\$8.22
1" High SeeThru .22 & Airgun	080-27056	8.69



11mm Rings - Rings for European, 11mm dovetail (.22 or airgun) fixed.
Order No. 080-10039 \$19.35



B-Square Shotgun / Slug Scope Mounts



B-Square 12ga Shotgun Saddle Mounts - This view-thru design straddles the shotgun's receiver and fits tight on top of the gun. All mounts are blued finish!

Standard dovetail so any 1" Weaver style rings can be used. Rings are included on most!!!

	Order No.	Price
Rem 1100/11-87, Right Hand (12, 16, 20ga w/sn X/N)	080-16800	\$38.45
Rem 870/870 Express 3.5" Mag	080-16812	38.45
Mossberg 500/Maverick 88	080-16500	38.45
Browning A-5 12 Ga.	080-16205	38.45
Benelli 90 Blue	080-16300	38.45
Benelli Nova 12 ga	080-16305	38.45
Ithaca 37/87 12 Ga.	080-16337	38.45
Mossberg 835 12 Ga.	080-16585	38.45
Winchester Super X 3.5" Mag	080-16212	38.45
Benelli Super Black Eagle 12ga	080-16330	38.45

Ruger To Weaver Adaptors - Unique cam system locks base in place. Adaptors most Ruger rifles with integral receiver mounts. Standard dovetail base only, rings not included.



Ruger 10/22 & 77/22, 96/44

	Order No.	Price
RUGER: 77/22, 96/45, 96/44, 96/40, PC9 - blued	080-14507	\$54.30
RUGER: 77/22, 96/45, 96/44, 96/40, PC9 - stainless steel	080-14508	57.40

Ruger Redhawk & Super Blackhawk with Intergral Barrel Mount Notches

	Order No.	Price
RUGER: 77/22, 96/45, 96/44, 96/40, PC9 - blued	080-14507	\$54.30
RUGER: 77/22, 96/45, 96/44, 96/40, PC9 - stainless steel	080-14508	57.40

Ruger Super Redhawk with Intergral Frame Mount Notches

	Order No.	Price
RUGER: 77/22, 96/45, 96/44, 96/40, PC9 - blued	080-14507	\$54.30
RUGER: 77/22, 96/45, 96/44, 96/40, PC9 - stainless steel	080-14508	57.40

Thompson Center Weaver Style Base for TC/22

THOMPSON/CENTER

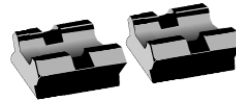

Thompson Center Weaver Style Base 22LR Rifle (Blued) - Weaver-Style Base for T/C 22 Semi-Automatic Rifle. Blue, no drilling & tapping necessary. Order No. 030-9951 \$10.64

DNZ Scope Mounts



Precision machined from the best material on the market, top grade billet aluminum. Each Game Reaper scope mount is created from a solid block of aluminum. Aluminum absorbs shock better than steel.



Freedom Reaper Picatinny Rail



	Order No.	Price
1" Black	185-111PT	\$104.87
30mm Black	185-311PT	125.05

Freedom Reaper Forward Picatinny Rail

	Order No.	Price
1" Black	185-121FPT	\$129.08
30mm Black	185-321FPT	153.30
1" 5.66	185-161FPT	76.62

Freedom Reaper 2pc Picatinny Rail - Weaver Rail

	Order No.	Price
1" Medium Black	185-142PT	\$92.77
1" High Black	185-143PT	92.77
1" X-High Black	185-144PT	92.77
30mm Medium Black	185-342PT	112.94
30mm High Black	185-343PT	112.94



Browning-A Bolt-Long Action- 1" Med. Mount-Black	185-18500	\$49.99
Browning-A Bolt-Long Action- 1" High Mount-Black	185-12500	49.99
Browning-A Bolt-Long Action- 30mm Med. Mount-Black	185-30500	63.71
Browning-A Bolt-Long Action- 30mm High Mount-Black	185-32500	63.71
Browning-A Bolt-Short Action- 1" Low Mount-Black	185-14500	49.99
Browning-A Bolt-Short Action- 1" Med. Mount-Black	185-20500	49.99
Browning-A Bolt-Short Action- 1" High-Mount-Black	185-16500	49.99
Browning-A Bolt-Short Action- 30mm Med. Mount-Black	185-34500	63.71
Browning-A Bolt-Short Action- 30mm High Mount-Black	185-36500	63.71
Browning BLR-Short Action- 1" Medium Mount-Black	185-48500	49.99
Browning X Bolt-Short Action- 1" Medium Mount-Black	185-81500	49.99
Browning X Bolt-Short Action- 1" High Mount-Black	185-82500	49.99
Browning X Bolt-Short Action- 30mm Medium Mount-Black	185-86500	63.71
Browning X Bolt-Long Action- 1" Medium Mount-Black	185-91500	49.99
Marlin 1894,1895 & 336- 1" Med. Mount-Black	185-12042	49.99
Marlin 1894,1895 & 336- 1" Med. Mount-Silver	185-12042S	49.99
Marlin 1894,1895 & 336- 1" High Mount-Black	185-12044	49.99
Marlin 1894,1895 & 336- 1" High Mount-Silver	185-12044S	49.99
Remington 700-Long Action- 1" Low Mount-Black	185-10700	49.99
Remington 700-Long Action- 1" Med. Mount-Black	185-18700	49.99
Remington 700-Long Action- 1" High Mount-Black	185-12700	49.99
Remington 700-Long Action- 30mm Med. Mount-Black	185-30700	63.71
Remington 700-Long Action- 30mm High Mount-Black	185-32700	63.71
Remington 700-Short Action- 1" Med. Mount-Black	185-20700	49.99
Remington 700-Short Action- 1" High Mount-Black	185-16700	49.99
Remington 700-Short Action- 30mm Med. Mount-Black	185-34700	63.71
Remington 700-Short Action- 30mm High Mount-Black	185-36700	63.71
Remington Model 7- 1" Low Mount-Right Hand-Black	185-60700	49.99
Remington Model 7- 1" Med. Mount-Right Hand-Black	185-62700	49.99
Remington Model 7- 1" High Mount-Right Hand-Black	185-64700	49.99
Remington Model 7- 30mm Med. Mount-Black	185-67700	63.71
Ruger 10/22 1" Low Mount-Black	185-11080	49.99
Ruger 10/22 1" Med. Mount-Black	185-11082	49.99
Ruger 10/22 1" High Mount-Black	185-11084	49.99
Winchester Model 70-Long Action- 1" Med. Mount-Black	185-18600	49.99
Winchester Model 70-Long Action- 1" High Mount-Black	185-12600	49.99
Winchester Model 70-Long Action- 30mm Med. Mount-Black	185-30600	63.71
Winchester Model 70-Long Action- 30mm High Mount-Black	185-32600	63.71
Winchester Model 70-WSM Action- 1" Med. Mount-Black	185-20600	49.99

More Millett

On page 34



Millett Tactical Rings and Bases

Tactical Rings - A light-weight, strong solution for the most demanding uses. 6 cap-clamping screws positively hold your scope, no matter the level of recoil and the base clamp holds the scope to the base.

	Order No.	Price
30mm Med	131-DT00715	\$42.38
30mm High	131-DT00714	42.38



Picatinny Rail - This easy, strong mounting system is similar to US military 1913 mounts. Mount a wide range of optics using this rail, from red dots to large target scopes. Heat treated T6 aluminum, black anodized with all required hardware for mounting.

	Order No.	Price
Remington 700 Short Action RH Matte	131-PC00001	\$42.38
Remington 700 Long Action RH Matte	131-PC00005	42.38
Savage Accu-Trigger, Short Action RH Matte	131-PC00002	42.38
Savage Accu-Trigger, Long Action RH Matte	131-PC00006	42.38
Blank Tactical Matte	131-PC00003	42.38

CZ Rings for CZ Guns!

	Order No.	Price
1" Scope rings for CZ 452/ CZ 511 (not for CZ 452 American), 11 mm dovetail	226-19001	\$63.60
1" Scope rings for CZ 527, 16mm dovetail	226-19002	63.60
1" Scope rings for CZ 550/ ZKK 602 (not for CZ 550 Minnesota), 19mm dovetail	226-19003	63.60
30mm Scope rings for CZ 550/ ZKK 602, 19mm dovetail	226-19006	68.03

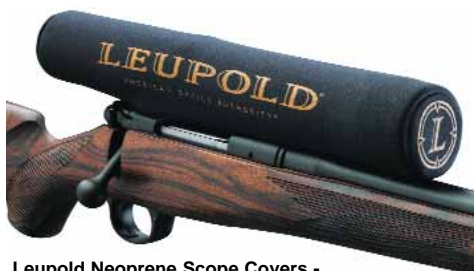

Leupold Neoprene Scope Covers - Black Neoprene covers with Leupold's logo screened right to it.

	Order No.	Price
Sm (8.5"x20mm)	154-53572	\$15.28
Med (10.5"x30mm)	154-53574	15.28
Lg (12.5"x42mm)	154-53576	15.28
X-lg (12.5"x50mm)	154-53578	15.28
XX-Lg (13.1"x40mm)	154-53580	15.28

Butler Creek Bikini Scope Covers - Designed for the economy-minded shooter who prefers a quick-clearing, one-piece, no hassle scope cover. Two watertight pliable rubber-like cups joined by stretch retainers create a moisture and dust seal to protect optics. One size BIKINI fits most rifle scopes - One size TINI BIKINI fits compact pistol and shotgun scopes!



	Order No.	Price
Bikini Cover	060-19000	\$6.22
Tini-Bikini Cover	060-19001	5.77



Scope Boot- One size fits all. Gives airtight protection on 1" to 2" diameter scopes.
Order No. 215-110019 \$4.05

Scope Eye- Avoid eye and facial injuries. Protective, and flexible.
Order No. 215-310013 \$2.45



Optic Accessories from Various Manufacturers



Leupold X-treme Bino Strap -
Order No. 024-55895 \$16.93



Nikon Prostaff Bino Harness - Take the weight of your bino's off of your neck and distribute it evenly across your shoulders. Binoculars attach to the elastic shoulder straps with a secure, quick release connection that moves smoothly and easily up and down the straps for quick access.
Order No. 125-6121 \$17.02

Nikon Micro Fiber Cleaning Cloth - Anti-Static, Clips on. Order No. 125-8072 \$4.10

Nikon Fog Eliminator - 6"x7" Anti Fog Cloth (3pack) Order No. 125-8073 \$4.10

Nikon Optics Maintenance Kit - Contains Static Wisk brush, Precision Cleaning Solution, anti-static microfiber Tiger Cloth and Speck Grabber.
Order No. 125-7073 \$16.71

	Order No.	Price
Burriss Lens Pen	023-626050	\$7.13
Leupold Lens Pen	154-48807	7.00
Nikon Lens Pen	125-7072	6.62
Viz Wiz - 2oz Pump Spray Bottle	012-32122	3.02
Lens Cleaner Cloth	125-8175	3.47



Spotting Scope Accessories



	Order No.	Price
Bushnell Field Tripod (Max 36" Tall) (A)	027-783001	\$34.00
Bushnell Car Window Mount (Height: 4 3/4") (B)	027-784405	34.95
Nikon Window Mount (D)	125-7070	34.05

Butler Creek Flip Open Scope Covers



Flip Open Covers:

- WaterProof Solid Cover System
- Custom sizing to fit all scopes
- Quiet, spring action lid (eye piece)
- Airtight to seal out dust and moisture
- Red button system for right/left hand shooting

Eye Piece Covers

Measure the outside diameter of the eye end of the scope. Fit range is .01 under to .025 over these measurements. **\$7.60**

Cover Number	EYEPIECE DIAMETER Inches	Millimeters	Order Number
2	1.225	31.1	060-MO20020
03A	1.3	33	060-MO20030
1	1.341	34.1	060-MO20010
3	1.388	35.3	060-MO20035
5	1.432	36.4	060-MO20050
7	1.457	37	060-MO20070
9	1.468	37.3	060-MO20090
9A	1.485	37.7	060-MO20095
10	1.516	38.5	060-MO20100
11	1.55	39.4	060-MO20110
13	1.57	39.9	060-MO20130
14	1.605	40.8	060-MO20140
15	1.66x1.45	42.2x36.8	060-MO20150
16	1.66	42.2	060-20160
17	1.675	42.5	060-MO20170
18	1.7	43.2	060-MO20180
19	1.73	43.9	060-MO20190
20	1.775	45.1	060-MO20200

Objective Covers

Measure the outside diameter of the objective end of the scope. Fit range is .01 under to .025 over these measurements. **\$7.60 (*\$7.60) each**

Cover Number	OBJECTIVE DIAMETER		Order Number
	Inches	Millimeters	
1	1	25.4	060-MO30010
4	1.095	27.8	060-30040*
2A	1.181	30	060-MO30025
2	1.221	31	060-MO30020
3A	1.3	33	060-30030*
3	1.34	34	060-30035*
5	1.387	35.2	060-30050*
7	1.429	36.3	060-30070*
9	1.485	37.7	060-30090*
10	1.5	38.1	060-30100*
11	1.54x1.34	39.1x34.0	060-30110*
12	1.76x1.53	44.7x38.9	060-30120*
13	1.53	38.9	060-30130*
15	1.558	39.6	060-30150*
17	1.612	40.9	060-30170*
19	1.646	41.8	060-30190*
20	1.7	43.2	060-30200*
21	1.735	44.1	060-30210*
23	1.76	44.7	060-30230*
25	1.8	45.7	060-30250*
26	1.82	46.2	060-30260*
27	1.84	46.7	060-30270*
28	1.89	48	060-30280*
29	1.919	48.7	060-30290*
30	1.96	49.8	060-30300*
31	1.998	50.7	060-30310
33	2.043	51.9	060-30330
34	2.1	53.3	060-30340
39	2.22	56.4	060-30390
40	2.25	57.2	060-30400
43	2.31	58.7	060-30430
44	2.36	59.9	060-30440
45	2.41	61.2	060-30450
46	2.43	61.7	060-30460
47	2.461	62.5	060-30470
48	2.5	63.5	060-30480
51	2.575	65.4	060-30510

Butler Creek MultiFlex Flip-Open Scope Covers- Spring-activated to give you fast opening action. The tight, flexible collar prevents field of view blockage and eliminates accidental opening. Protects against snow, rain, dirt, dust and brush while hunting or during storage.



Individual Multi-Flex Eye Piece Covers

Measure the outside diameter of the eye end of the scope. Fit range is wider with MultiFlex Covers. **Black Price \$7.94ea**

Cover Number	Eyepiece Dia Inches	Eyepiece Dia MM	Order Number
09-09A	1.468 - 1.485	37.3 - 37.7	060-20909
10-11	1.516 - 1.550	38.5 - 39.4	060-21011
13-14	1.570 - 1.605	39.9 - 40.8	060-21314
16-17-18	1.660 - 1.700	42.3 - 43.2	060-21618
19-20	1.73 - 1.775	43.9 - 45.1	060-21920

Individual Multi-Flex Objective Covers

Measure the outside diameter of the objective end of the scope. Fit range is wider with MultiFlex Covers. **Black Price \$7.94ea**

Cover Number	Eyepiece Dia Inches	Eyepiece Dia MM	Order Number
09-10	1.45 - 1.500	37.7 - 38.1	060-30910
13-15	1.530 - 1.558	38.9 - 39.6	060-31315
17-19	1.612 - 1.646	40.9 - 41.8	060-31719
20-21	1.700 - 1.735	43.2 - 44.1	060-32021
25-26-27	1.800 - 1.840	45.7 - 46.7	060-32527
28-29	1.890 - 1.919	48.0 - 48.7	060-32829
30-31	1.960 - 1.998	49.8 - 50.7	060-33031
33-34	2.043 - 2.100	51.9 - 53.5	060-33334
39-40	2.220 - 2.250	56.4 - 57.2	060-33940
43-44	2.310 - 2.360	58.7 - 59.9	060-34344
46-47	2.43 - 2.461	61.7 - 62.5	060-34647

Closeout! Butler Creek MultiFlex Flip-Open Scope Covers- Spring-activated to give you fast opening action. The tight, flexible collar prevents field of view blockage and eliminates accidental opening. **See the Selection Online!**

More Online!

Weaver Gunsmithing Tools



Scope Mounting Kits - Containing everything needed for precision scope mounting. Kits for the mounting professional or beginner gunsmiths.

Deluxe Scope Mounting Kit (with 1-inch Lapping Tools) Includes: Torque wrench, SureThread™, common bits, level system, lapping bar, 1 inch alignment pins and lapping compound. **Order No. 029-849721 \$90.89**

Standard Scope Mounting Kit (w/o Lapping Tools) Includes: Torque wrench, SureThread™, common bits and level system. **DOES NOT HAVE LAPPING TOOLS** **Order No. 029-849722 \$76.63**

Modular Level System - This system is a simple, yet effective way to guarantee a scope's crosshairs are level to the receiver. High strength magnets for secure grip. **Order No. 029-849724 \$13.20**



Weaver® SureThread™ Adhesive - For use when mounting scopes and bases to assure locked-down optics. Prevents shock and vibration from loosening screws. Loosens easily with basic hand tools **Order No. 029-849722 \$10.78**



Weaver® Tool Kits - Whatever your skill level. Whatever your needs. Weaver has a gunsmith tool kit for you. Choose from among three tool kit models containing professional-grade tools and attachments for gun care and scope mounting work.

Deluxe Kit - Deluxe kit offers a robust 88-piece gunsmith set for the most advanced and accomplished gunsmith **Order No. 029-849719 \$64.88**

Compact Kit - Compact Kit features 36 pieces to address the most common gunsmith needs. **Order No. 029-849717 \$16.41**

Multi-Bit Kit - Multi Bit is a 77-piece kit for just about any at-home maintenance work. **Order No. 029-849718 \$43.49**



Deluxe Kit



Compact Kit

Multi Bit Kit



Weaver® Torque Wrench - Helps mount scopes and bases with consistent screw pressure to manufacturer's specs. The Torque wrench includes a variety of bits for different fasteners. Also helps protect rifle scope tubes from over tightening. Features a magnetized tip that secures bits and comes in a rugged storage case. **Order No. 029-849728 \$52.05**

Bore Sighters and Scope Mounting Tools

Standard Bore Sighters



A- Bushnell Deluxe Bore Sighter with Case- Includes .177, .22, 6mm, .25, 6.5, .27, 7mm, .30, .32, .338, .35, .375, .44, .45, .50 arbors. Carrying case holds 15 arbors. Lifetime limited warranty. **Order No. 027-744001 \$76.89**

B- Bushnell Professional Bore Sighter with Case- Large-diameter objective lens for optimum resolution. Lightweight metal body with mar-resistant, glossy black finish. Deluxe carrying case holds bore sighter and three arbors. The three arbors are expandable arbor for full range of calibers from .22 to .45. (50 cal adjustable arbor is available separately -See C below. **Order No. 027-743333 \$100.78**

C- .50 Caliber to 12-Gauge Expandable Arbor- Just the accessory for the shotgun or muzzleloader. Fits Professional and Deluxe bore sighters. **Order No. 027-740012 \$13.79**

The LaserLyte® Laser Bore Sight - .22 to 50cal - **Order No. 116-MBS1 \$47.28**

LaserLyte® Mini Laser Bore Sight - .17-.22 caliber firearms. **Order No. 116-MBS172 \$47.28**

Scope Mounting and Gunsmith Screw Kits

Redfield Torx Screw Set- If you mount scopes often this is an ideal set to have! 180 Torx screws total which fit Leupold, Burris and Redfield Rings and Bases and 10 Torx wrenches to accompany. **Order no. 028-47362 \$84.02**



WORKS WITH LEUPOLD AND BURRIS ALSO!



Pachmayr Master Gunsmith Firearms Screw Kit - 184 pc screw kit for firearms owners and gunsmiths! Contains 8 each of 23 different "Hard to Find" screws. **Order No. 010-03054 \$28.02**

Contains: 8ea of: #6-40 Plug Screws, #8-40 Plug Screws, #10-32 Plug Screws, #6-48 Fillister head (7 Different Lengths), #6-48 Oval head (7 Different Lengths), #8-40 Fillister head (3 Different Lengths), #8-40 Oval head (3 Different Lengths)

Burris Torx Refill Kit- TORX refill for your gunsmith kits. 35 Screws, 8-40 .205 head. **Order No. 023-625030 \$9.51**

Scope Mounting Tools

	Order no.	Price
Torx Screw Kit	154-52395	\$35.92
Scope Smith Mounting Tool	154-52296	13.45
Ring Wrench	154-48762	10.11

Warne Torque Wrench - Built for Warne by California Torque Products, this torque wrench allows you to tighten Torx style screws to Warne's recommended setting of 25in/lb. Break away design tells you when the proper torque has been reached. **Order No. 223-TW1 \$17.42**

Magnetic Bore Sighters

Bushnell Magnetic BoreSighter- Save time and Ammunition! Works with all sights and scopes, Etched glass reticle. Aligns crosshairs with gun's bore. Magnet eliminates need for arbors.

Order No. 027-740001C \$40.00

Leupold ZeroPoint Illuminated BoreSighter- Get your rounds on the paper faster than ever! Recheck zero, record zero at different ranges, or even bullet weights, and readjust your scope without the need to fire. **Order No. 154-59012 \$62.10**



Laser Bore Sighters

Bushnell Laser BoreSighter- Battery powered laser. Includes arbors for .22-50 caliber rifles and handguns as well as 12 and 20 gauge shotguns. Saves time and ammunition and its easy to use. Includes 3 LR44 batteries. **Order No. 027-740100C \$32.27**

Level Level Level - Gives you the means to level your scope perfectly in only minutes. The scope is leveled to your receiver, not to the top of a scope base. The magnetic base in the rifle level bridges the bolt raceway, allowing you to position your rifle perfectly level. Then level the scope, tighten the rings, and the job is done. **Order No. 094-113088 \$16.93**



Works with practically any bolt-action rifle, and is adaptable to other designs.

Scope Alignment Tools

B-Square Crosshair Square- Square up your scope or front sight in seconds. It accurately sets scope vertical reticle position and determines front sight ramp vertical. Clear plastic, will not mar gun's finish! **Order No. 080-T1001 \$7.72**



B-Square Bubble Level- Here's the only bubble out there that you can check both the rifle bore and reticle alignment at a glance! This is the ultimate economical accurizing device

	Order No.	Price
Bubble Level for 11mm Dovetail (air rifles)	080-T1005	\$11.60
Bubble Level for Weaver Style bases	080-T1006	11.60

A - Redfield Style (100) **Order no. 097-47387 Price \$11.88**

B - Champion Score Keeper 100yd Rifle (12) **Order no. 097-45761 Price 2.92**

C - Birchwood Casey 12\" **Order no. 012-34212 Price 12.63**

D - Birchwood Casey 8\" **Order no. 012-34112 Price 6.32**

E - Birchwood Casey 12\" **Order no. 012-36225 Price 15.85**

F - Birchwood Casey 12\" **Order no. 012-37213 Price 1.74**

Contender G2 Frames w/Grip & Forend



*To buy Frames you must send a valid FFL with original signature, or we must already have your current FFL on file. Your dealer must call us for pricing!



*All old Contender barrels will fit the G2 Contender frame without alteration.

- Easier Opening.
- Automatic Hammer Block Safety with built-in interlock
- Re-cock the hammer without having to "break open" the gun.
- More Clearance between the grip and trigger guard.

	Order No.	Price
G2 Contender Pistol Frame, Blued with Walnut Grip and Forend	031-8700	\$398.25
G2 Contender Rifle Frame, Blued with Walnut Stock and Forend	031-8720	438.75
G2 Contender Pistol Frame, Rubber Stock Stainless Assembly	031-8750	405.00
G2 Contender Rifle Frame, Composite Stock & Forend Stainless Assembly	031-8770	415.80

G2 Contender Grips, Forends & Buttstocks

G2 Contender Compatibility with Old Style Contenders: The G2 Contender Frame will accept all Contender barrels and their corresponding forends (except Herret Forend) The G2 Frame will not accept old style grips because of the change in grip angle. Blued or stainless barrels are readily interchangeable.



*G2 Contender Acc. will not fit the Old Style Contender Frame!

	Order No.	Price
A- G2 Contender Pistol Walnut Grip	030-7707	\$58.04
B- G2 Contender Rifle Walnut Buttstock (14" Length of Pull)	030-7625	114.02
C- G2 Contender Pistol Walnut Forend 12" & 14"	030-7714	40.69
D- G2 Contender Rifle Walnut Forend	030-7689	46.77
G2 Contender Rubber Pistol Grip (Not Shown)	030-7755	37.26
G2 Contender Rubber Pistol Forend for 12" & 14" Barrels (Not Shown)	030-7730	21.86
G2 Contender Composite Rifle Buttstock (Not Shown)	030-7733	51.32
G2 Contender Composite Rifle Forend (Not Shown)	030-7735	23.85

Old Style Contender Grips, Forends & Buttstocks



*Old Style Contender Grips & Buttstocks will not fit the G2 Contender Frames!

	Order No.	Price
A- Standard Walnut Buttstock for Contender Carbine (14" Length of Pull)	030-7626	\$145.11
B- Forend Walnut Fits Super "16" or 21" Contender Pistol or Contender Carbine	030-7616	50.76
C- Forend, Walnut, Fits 12" & 14" Contender Pistol	030-7614	43.09
D- Forend, Walnut, Fits 10" Bull & Vent Rib Barrel Contender Pistol	030-7612	43.89
E- Standard Rynite Buttstock Contender Carbine (14" Length of Pull)	030-7628	\$51.75
F- Forend, Composite, Fits 12" & 14" Contender Pistol	030-7638	17.45
H- Forend, Composite Fits Super 16" Contender Pistol	030-7649	24.92
I- Forend, Composite Fits 16" or 21" Contender Carbine	030-7629	25.04



Contender Accessories from Pachmayr- The Thompson/Center Contender is a fine hunting handgun, it also packs quite a kick. The best way to control that recoil is with a Pachmayr Rubber Grip.

	Order No.	Price
G2 Contender		
G2 Contender Grip/Forend Set	010-02453	\$48.73
G2 Contender Grip	010-02451	30.45
G2 Contender Forend	010-02449	21.93

	Order No.	Price
TC Contender		
TC Contender Gripper	010-05054	
Decelerator		46.63
TC Contender Forend w/ Adapter	010-03373	
TC Adapter For Forend Only	010-03381	16.03

Thompson Center Contender Barrels & Accessories

Contender G2 12" Barrels

	Order No.	Price
22LR Match Grade Blued w/adj Sights	031-4048	\$262.50
357 Magnum Blued	031-4040	262.50
44 Magnum Blued	031-4042	262.50
.45/.410 Ga. Vent Rib Blued Finish w/Bead front sight & internal Choke (no adj sight)	031-4044	300.00

Contender G2 Super 14" Barrels

	Order No.	Price
17 HMR Blued w/adj Sights	031-4462	\$262.50
17 HMR Stainless	031-4251	307.50
.204 Ruger Blued	031-4418	250.00
.22LR Match Grade Blued	031-4531	262.50
.22LR Match Grade Stainless	031-4218	307.50
.22 Hornet Blued	031-4409	250.00
.223 Remington Blued	031-4405	250.00
.223 Remington Stainless	031-4513	300.00
6.8 Remington Blued	031-4203	250.00
7x30 Waters Blued	031-4527	250.00
30/30 Winchester Blued	031-4502	250.00
30/30 Winchester Stainless	031-4205	300.00
.44 Magnum Blued	031-4508	250.00
.44 Magnum Stainless	031-4222	300.00
45/70 Govt w/Muzzle Tamer (no sights) Blued	031-4107	300.00
.45/.410 Ga. Vent Rib w/Bead front sight & internal Choke	031-4547	300.00

Contender G2 23" Rifle Barrels

	Order No.	Price
17 HMR Blued Finish Drilled & Tapped	031-4210	\$260.40
17 HMR Stainless Finish	031-4247	310.00
.204 Ruger Blued	031-4246	248.00
.204 Ruger Stainless	031-4259	303.80
.22LR Match Grade Blued	031-4220	260.40
.22LR Match Grade Stainless	031-4261	303.80
.223 Remington Blued	031-4224	248.00
.223 Remington Stainless	031-4263	303.80
6.8 Remington Blued	031-4202	248.00
30/30 Winchester Blued	031-4228	248.00
30/30 Winchester Stainless	031-4266	303.80
45-70 Stainless	031-4271	303.80
7-30 Waters Blued	031-4275	248.00
7-30 Waters Stainless	031-4273	303.80
45/70 Govt (no sights) Blued	031-4230	248.00
45/70 Govt w/Muzzle Tamer (no sights) Stainless	031-4271	303.80



PLEASE NOTE: NO DISTRIBUTOR CAN SHIP 45/410 BARRELS TO INDIVIDUALS, DEALERS OR OTHER DISTRIBUTORS IN THE STATE OF CALIFORNIA. DOING SO WOULD BE IN VIOLATION OF THE CALIFORNIA STATE STATUTES, IN CALIFORNIA THE 45/410 BARRELS ARE ILLEGAL AND CANNOT BE SHIPPED TO ANYONE!! IT IS ALSO ILLEGAL TO TAKE ONE INTO THE STATE (IF MOVING OR HUNTING THERE, ETC.)

Thompson Center Encore & Contender Accessories

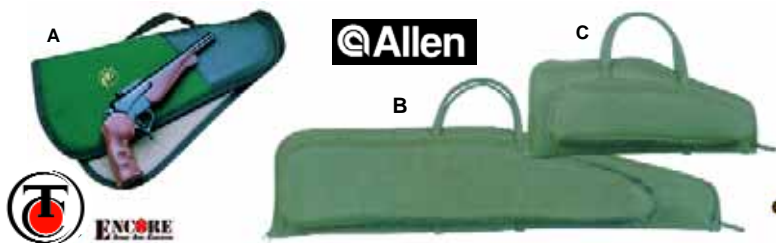

A- Encore & Contender Pistol Case from TC- A conventional styled pistol case for scoped pistols, with a pocket which holds an additional scoped barrel. Interior is long-wearing corduroy. Outside is rugged green/black nylon. For 10" thru 16 1/4" scoped Pistols. **Order No. 030-7472 \$32.54**

B&C- Encore & Contender Padded Gun Cases from Allen- 1200 denier endura, 7/8" thick foam and a #8 Zipper. Rifle Case has a pouch on the side that will hold an extra barrel. Pistol Case has a pouch on the side that will hold two extra barrels.

Encore/Contender Rifle Case 43" Order No. 168-89143 \$29.91
Encore/Contender Pistol Case 22" Order No. 168-89322 \$29.91

D- Cordura® Holsters for Contender & Encore- Specifically designed for large pistols like the Contender and Encore. Construction consists of thick waterproof foam padding, sandwiched between an outer shell of Cordura Nylon and an inner shell of nonabrasive nylon. Cordura Nylon is ten times more scuff resistant than leather. Open top style, offered in lengths and widths to accommodate either a 10" or 12"/15" barrels. May be worn as shoulder holsters or on the belt.

14" Iron Sighter 030-9544 \$58.24 | 14" With Scope 030-9546 \$58.24



Encore Cases with extra Barrel Pouch - Soft case to accommodate the T/C Encore rifle with or without scope. Side pouch holds one extra Encore barrel - scoped or not. Great for taking your Encore system to the range or on your next hunt. Rugged construction and thoroughly padded to provide excellent protection.

Order No.
Rifle Case - 030-7478 \$56.21
Handgun Case - 030-7481 \$43.83



T/C Rifle Sling with Sling Swivels - Encore Pro Hunter™ rifle with QR swivels makes your gun feel 50% lighter by spreading the load over a wider area. Also features built-in shock absorption. **Order No. 030-7501 \$28.80**

Advantage Camo Hunter's Field Pouch- Features one zippered compartment with elastic loops to hold your quick shots. Made of a durable poly/cotton with waterproof liner for protection — this pouch is both soft and quiet. **Order No. 030-7474 \$17.34**



Accessories for the Contender



A- Contender Combination Tool- This handy tool of cast steel and brass can be used for a number of purposes. Remove and replace the gripcap, the grip to forend, to adjust the trigger, to adjust the rear sight elevation and windage. An added feature allows for removal or replacement of the choke tube in .45/.410 gauge barrels. **Order No. 030-7992 Price \$20.65**

B- Weaver Style Bases For Contender (fits Pistol and Carbine)
Stainless- Order No. 030-9895 \$12.27
Blued- Order No. 030-9893 \$10.64

C- Maxima All Steel Matte Base for Contender - Order No. 030-7454 \$40.20
 See a full line of Maxima rings in the TC Muzzleloader section of the catalog



E- Buttstock Cartridge Carrier- Especially suited for single shot rifles like the Encore and Contender, this cartridge carrier is made of Bio-Flex® silicone which tolerates extreme temperatures while still staying flexible. Extremely tear resistant. Maintain its original shape in extreme conditions. Laces quickly onto your stock.

Small- Order No. 030-7069 \$19.92

17 Rem, 204 Ruger, 22 Jet, 22 PPC, 220 Swift, 221 Fireball, 221 Remington, 222 Rem Mag, 222 Rem, 223 Rem, 225 Win, 25/35 Win, 357 Mag, 6.8 Rem, 6mm PPC, 7.62 x 39mm, 7-30 Waters, 7mm TCU, 22-250, 50 Savage, 30/30 Win

Med- Order No. 030-7071 \$19.92 243 Rem, 25-06 Rem, 257 Rbts, 270 Win, 280 Rem, 284 Win, 300 Sav, 30-06 Spr, 7-30 Waters, 308 Win, 35 Rem, 35 Whn, 356 Win, 358 Win, 375 H&H, 375 JDJ, 375 Win, 38-55 Win, 405 Win, 444 Mar, 445 Super Mag, 454 Casull, 6mm Rem, 7mm Mauser, 7mm-08 Rem, 300 H&H

Large- Order No. 030-7165 \$19.53 264 Win Mag, 300 Win Mag, 338 Win Mag, 350 Rem Mag, 416 Rem, 416 Rigby, 45/70 Gov, 450 Marlin, 7mm Rem Mag

F- Encore/Contender Pistol Barrel Case- Case will accommodate pistol barrels up to 15" with forearm attached, as well as mounted scope. Inside dimensions: 19 1/2" long x 4 1/2" wide x 2" high. **Order No. 030-7406 \$26.88**

G- Encore Rifle Barrel Case- Case will accommodate barrels with forearm attached, as well as mounted scope. Inside dimensions: 33 1/2" long x 4 1/2" wide x 2" high. **Order No. 030-7412 \$32.51**

Hammer Expander-
 Ambidextrous- for right or left hand. Fits T.C. Contender, Encore and most exposed hammer weapon's -rifle or handgun. Lightweight, balanced, and you can use it with optics attached. Easy to install! Lifetime Warranty.
Order No. 149-00110 Black \$8.99
Order No. 149-00111 Silver \$8.99

Accessories for the Encore

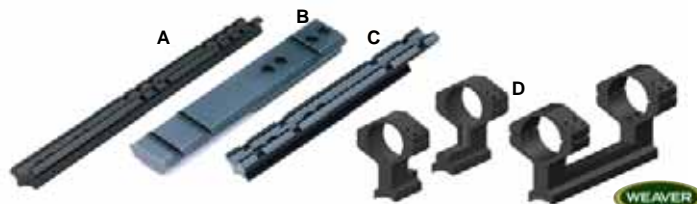

A- Weaver™ Style Base for Encore (12ga only)- Weaver-Style Base for Encore 12 Ga Shotgun Mounts directly on the Encore 12 Ga barrels; Slug barrel or Turkey barrel. Blued finish. **Order No. 030-9949 \$21.31**

B- Maxima All Steel Bases for Encore - See a full line of Maxima rings in the TC Muzzleloader section of the catalog **Matte Finish- Order No. 030-7429 \$40.20**
Hardwoods Camo- Order No. 030-9911 \$50.33

C- Weaver™ Style Mounting System- Weaver Style Mounts For Encore Pistols or Rifles. Mounts directly on the barrel of T/C Encore.
Blued Finish- Order No. 030-9899 \$10.86
Stainless Finish- Order No. 030-9907 \$12.27

D - Weaver Base and Ring Sets For Encore/Omega- Aircraft-grade aluminum

1pc Base/Ring Medium Matte	Order No. 029-48540	\$30.93
1pc Base/Ring High Matte	Order No. 029-48541	\$30.93
2pc Base/Ring Medium Matte	Order No. 029-48545	\$28.05
2pc Base/Ring High Matte	Order No. 029-48546	\$28.05

DNZ Game Reaper Encore Mounts - Precision machined from the best material on the market, top grade billet aluminum. Each Game Reaper scope mount is created from a solid block of aluminum. Aluminum absorbs shock better than steel.

	Black	Silver	
	Order No.	Order No.	Price
Low	185-10002	185-10001	\$49.99
Medium	185-10006	185-10005	\$49.99
High	185-10004	185-10003	\$49.99
X-High	185-10007	185-10007S	\$49.99



Thompson Center Encore Frames, Grips, Forends & Buttstocks

Encore Rifle Buttstocks & Forends

Buttstocks and Forends for Rifles come with Swivel Studs



	Order No.	Price
Composite		
Thumbhole Buttstock, Composite Encore Rifle(14" Pull)	030-7248	\$71.06
Buttstock, Composite Encore Rifle(14 3/4" Pull)	030-7706	51.32
Forend, Composite -STD 24" & 26" Barrels Only	030-7708	23.85
Forend, Composite Fits Encore 209 x 50 Mag. Rifle	030-7710	27.06
Forend, Composite Fits 12ga Encore	030-7682	32.75
Forend, Composite Fits 20ga Encore	030-7687	32.75
Walnut		
Thumbhole Buttstock, Walnut Encore Rifle (14" Pull)	030-7803	\$183.37
Buttstock, Walnut Encore Rifle (14 3/4" Pull)	030-7722	114.02
Bantam Buttstock, Walnut (13 3/4" Pull)	030-7623	103.65
Forend, Walnut Fits Encore Rifle 26" Heavy Barrel	030-7656	57.39
Forend, Walnut Fits Encore Rifle 24" & 26" Barrel	030-7704	43.12
Forend, Walnut Fits Encore 209 x 50 Mag. RIFLE	030-7662	50.68
Forend, Walnut Encore 12 ga. Shotgun	030-7593	54.97
Forend, Walnut Encore 20 ga. Shotgun	030-7664	51.87
Camo		
Thumbhole Buttstock, Hardwoods Camo Rifle(14" Pull)	030-7251	\$109.39
Buttstock, Realtree Hardwoods Encore Rifle(14 3/4" Pull)	030-7146	89.65
Forend, Realtree Hardwoods Fits STD 24" & 26" Barrels	030-7701	43.02
Forend, Realtree Hardwoods Fits 209 x 50 Mag. RIFLE	030-7149	46.21
Forend, Realtree Hardwoods Fits 12ga Encore	030-7683	51.91
Forend, Realtree Hardwoods Fits 12ga Encore Muzzleloading Barrel	030-7699	51.91
Forend, Realtree Hardwoods Fits 20ga Encore	030-7880	51.91

Pistol Grips and Forends



	Order No.	Price
Composite Forend, Fits Encore Pistol 10" or 15"	030-7654	\$17.45
Walnut Forend, Fits Encore Pistol 10" or 15" Barrel	030-7702	36.65
Composite Competitor Grip, Encore Pistol	030-7652	26.61
Walnut Competitor Grip, Encore Pistol	030-7720	45.61

ProHunter Flextech Stocks and Forends



	Order No.	Price
Flex Tech Pro Hunter Composite Stock (14-3/4" Pull)	030-7879	\$78.40
Flex Tech Pro Hunter Hardwoods Camo Stock (14-3/4" Pull)	030-7853	116.73
Flex Tech Pro Hunter Composite Thumbhole Stock	030-7883	78.40
Flex Tech Pro Hunter Hardwoods Camo Thumbhole Stock	030-7881	116.73
FlexTech ProHunter Composite Forend 24", 26", 28" Bbls	030-7569	30.80
FlexTech ProHunter Hardwoods Forend 24", 26", 28" Bbls	030-7571	49.97
FlexTech ProHunter Composite Muzzleloader Forend	030-7514	34.01
FlexTech ProHunter Hardwoods Muzzleloader Forend	030-7567	52.91
FlexTech ProHunter Composite 12ga Forend	030-6011	39.79
FlexTech ProHunter Hardwoods 12ga Forend	030-6711	58.64
FlexTech ProHunter Composite 20ga Forend	030-6013	39.79
FlexTech ProHunter Hardwoods 20ga Forend	030-6713	58.64

Encore Frames With Grip & Forend



*To buy Frames you must send a valid FFL with original signature, or we must already have your current FFL on file. Your dealer must call us for pricing!

	Order No.
Encore Pistol Frame, Blued with Walnut Grip and Forend	031-1806
Encore Pistol Frame, Stainless w/Composite Grip & Forend	031-1842
Encore Rifle Frame, Blued w/Composite Buttstock and Forend	031-1808
Encore Rifle Frame, Stainless w/Composite Buttstock and Forend	031-6288
Encore Rifle Frame, Stainless w/Hardwoods HD Buttstock & Forend	031-1803
Encore Rifle Frame, Blued w/Walnut Buttstock and Forend	031-1804

Encore ProHunter Frames

	Order No.
Prohunter Rifle Blued Frame, w/Black FlexTech Stock and Forend	031-1887
Prohunter Rifle Stainless Frame, w/Black FlexTech Stock & Forend	031-1870
Prohunter Rifle Blued Frame, with Walnut Stock and Forend	031-1918*
Prohunter Rifle Stainless Frame, w/Hardwoods HD FlexTech Stock and Forend	031-1875
Prohunter Rifle Stainless Frame, w/Hardwoods HD FlexTech Thumbhole Stock and Forend	031-1883
Prohunter Rifle Stainless Frame, w/Black FlexTech Thumbhole Stock & Forend	031-1885

Hinge Pin For Encore!

You wouldn't believe how many calls we get for this small, but essential item! Now packaged from TC, great to have even as a back-up. (Blued)
 Order No. 030-7007 \$3.21

Pachmayr Encore Decel Grippers



See the lists below for recommended calibers.

Pachmayr tames even the hardest-kicking T/C Encore using the proven Decelerator material, Pachmayr has crafted a grip and forend that deliver far greater control while softening recoil. Decelerator material offers a more secure, consistent grip that can actually enhance accuracy. The softer forend provides for a secure, steady rest on any handy surface in the field.

T/C Encore Standard Grip and Forend Set - Recommended for use with these calibers: 17HMR, 22LR, 204 Ruger, 223 Rem, 22-250, 243 Win, 25-06, 270 Win, 7mm-08, 308 Win, 44 Mag, 45 Colt **Order No. 010-02441 \$48.73**

	Order No.	Price
Decelerator Grip Only	010-02442	\$30.45
Decelerator Magnum Forend Only	010-02433	21.93

Thompson Center Encore Barrels

12" Barrels	Order No.	Price
44 Rem Mag 12" Blued	031-1528	\$251.25
44 Rem Mag 12" Stainless Steel	031-1566	306.25
45/410 Vent Rib 12" Blued	031-1533	306.25



15" Barrels	Order No.	Price
204 Ruger Stainless Steel Adj. Sights 15"	031-4930	\$291.25
22-250 Blued Adj. Sights 15"	031-1708	255.00
223 Rem Blued Adj. Sights 15"	031-1710	255.00
223 Rem Stainless Steel 15"	031-4970	291.25
243 Win Blued Adj. Sights 15"	031-1716	255.00
243 Winchester Stainless Steel 15"	031-4927	291.25
270 Win Blued 15"	031-1724	255.00
308 Win Blued Adj. Sights 15"	031-1702	255.00
308 Win Stainless Steel 15"	031-4978	291.25
30/06 Springfield Blued Adj. Sights 15"	031-1704	255.00
7mm 08 Blued Adj. Sights 15"	031-1706	255.00
7mm-08 Stainless Steel 15"	031-4976	291.25
45/410 Blued Vent Rib 15"	031-1732	316.25
45/410 Vent Rib Stainless Steel 15"	031-4929	322.50
45/70 Gov't Blued Adj Sights 15"	031-1734	255.00
460 Smith & Wesson Blued 15"	031-1772	255.00
460 Smith & Wesson Stainless 15"	031-4944	291.25
500 Smith & Wesson Blued 15" with Muzzle Tamer	031-1730	302.50
500 Smith & Wesson Stainless 15" w/ Muzzle Tamer	031-4942	310.00



24" Barrels	Order No.	Price
223 Rem Blued Adj. Sights 24"	031-1758	\$261.64
223 Rem Stainless Steel 24"	031-4917	296.36
22-250 Blued Adj. Sights 24"	031-1756	261.64
22-250 Rem Stainless Steel 24"	031-4919	296.36
308 Win Blued Adj. Sights 24"	031-1750	261.64
30/06 Blued Adj. Sights 24"	031-1752	261.64
243 Winchester Blued Adj. Sights 24"	031-1760	261.64
243 Winchester Stainless 24"	031-4999	296.36
25-06 Blued Adj. Sights 24"	031-1765	261.64
25-06 Stainless Steel Adj. Sights 24"	031-4911	296.36
270 Win Blued Adj. Sights 24"	031-1762	261.64
270 Win Stainless Steel Adj. Sights 24"	031-4226	295.12
280 Remington Blued Adj Sights 24"	031-1768	261.64
280 Remington Stainless Adj Sights 24"	031-4213	295.12
7mm 08 Blued Adj. Sights 24"	031-1754	261.64
7mm-08 Stainless Steel 24"	031-4990	296.36
308 Win Stainless Steel 24"	031-4992	296.36
30-06 Stainless Steel 24"	031-4996	296.36
45/70 24" Stainless Steel 24"	031-4995	296.36



26" Barrels do not come with sights

26" Barrels	Order No.	Price
204 Ruger Blued 26"	031-1775	\$261.64
204 Ruger Stainless Steel 26"	031-4907	296.36
223 Rem Blued Heavy Barrel 26"	031-1543	261.64
223 Rem Stainless Steel Heavy Barrel 26"	031-4968	296.36
22-250 Blued Heavy Barrel 26"	031-1557	261.64
22-250 Stainless Steel Heavy Barrel 26"	031-4998	296.36
25-06 Blued Heavy Barrel 26"	031-1547	261.64
25-06 Stainless Steel 26"	031-4914	296.36
7mm Rem Mag Blued Heavy Barrel 26"	031-1551	261.64
7mm Rem Mag Stainless Steel 26"	031-4921	296.36
308 Win Blued 26"	031-1505	261.64
308 Win Stainless Steel 26"	031-4934	296.36
30-06 Blued 26"	031-1507	261.64
30-06 Stainless Steel 26"	031-4936	296.36
300 Win Mag Blued Heavy Barrel 26"	031-1553	261.64
300 Win Mag Stainless Steel 26"	031-4923	296.36

Encore Rimfire Barrels



Encore Rimfire Barrels	Order No.	Price
.17HMR Stainless Barrel 15"	031-1691	\$318.75
.17HMR Blued Barrel 15"	031-1693	300.00
.22LR Stainless Barrel 15"	031-1786	310.00

Encore Prohunter 15" Fluted Barrels



Encore Prohunter 15" Fluted Barrels	Order No.	Price
.17HMR ProHunter Fluted Stainless Barrel 15"	031-1914	\$337.50
.22LR ProHunter Fluted Stainless Barrel 15"	031-1910	337.50
.204 Ruger ProHunter Fluted Stainless Barrel 15"	031-1905	310.00
.223 Remington ProHunter Fluted Stainless Barrel 15"	031-1907	310.00
.22-250 Remington ProHunter Fluted Stainless Barrel 15"	031-1911	310.00
.243 Winchester ProHunter Fluted Stainless Barrel 15"	031-1913	310.00
.25-06 Remington ProHunter Fluted Stainless Barrel 15"	031-1915	310.00
.270 Winchester ProHunter Fluted Stainless Barrel 15"	031-1917	310.00
.30-06 Springfield ProHunter Fluted Stainless Barrel 15"	031-1919	310.00
.308 Winchester ProHunter Fluted Stainless Barrel 15"	031-1927	310.00
7mm-08 Remington ProHunter Fluted Stainless Barrel 15"	031-1929	310.00

Encore Pro Hunter™ 26" Weather Shield Fluted



Pro Hunter™ 26" Weather Shield Fluted - The Weather Shield series of Pro Hunter rifles. For the first time ever, the corrosion protecting Weather Shield finish is part of the interchangeable system and continues to make it the most versatile hunting market on the rifle today. Weather Shield frames and barrels match up with all Thompson Center Stainless Encore and Pro Hunter components and offer a great price point to the Pro Hunter line.

Encore Pro Hunter™ 26" Weather Shield Fluted	Order No.	Price
.22-250 Remington ProHunter Fluted Barrel 26"	031-4756	\$248.00
.223 Winchester ProHunter Fluted Barrel 26"	031-4748	248.00
.25-06 Remington ProHunter Fluted Barrel 26"	031-4746	248.00
.270 Winchester ProHunter Fluted Barrel 26"	031-4754	248.00
.308 Winchester ProHunter Fluted Barrel 26"	031-4755	248.00
.30-06 Springfield ProHunter Fluted Barrel 26"	031-4753	248.00
.300 Win Mag ProHunter Fluted Barrel 26"	031-4749	248.00
7mm Remington Mag ProHunter Fluted Barrel 26"	031-4752	248.00
209x50 M/L ProHunter Fluted Barrel 26"	031-4744	285.20

Encore Prohunter 28" Fluted Barrels



Encore Prohunter 28" Fluted Barrels	Order No.	Price
204 Ruger Fluted Stainless Steel 28"	031-4801	\$314.96
223 Rem Fluted Stainless Steel 28"	031-4813	314.96
22-250 Fluted Stainless Steel 28"	031-4805	314.96
243 Winchester Fluted Stainless Steel 28"	031-4817	314.96
25-06 Fluted Stainless Steel 28"	031-4819	314.96
270 Winchester Fluted Stainless Steel 28"	031-4823	314.96
280 Remington Fluted Stainless Steel 28"	031-4829	314.96
30-06 Springfield Fluted Stainless Steel 28"	031-4831	314.96
300 Winchester Mag Fluted Stainless Steel 28"	031-4833	314.96
308 Winchester Fluted Stainless Steel 28"	031-4839	314.96
7mm Rem Mag Fluted Stainless Steel 28"	031-4857	314.96
7mm-08 Fluted Stainless Steel 28"	031-4859	314.96

Encore Shotgun Barrels



Encore Shotgun Barrels	Order No.	Price
12 Gauge Pro Hunter Fluted Rifled Slug 28" Stainless	031-4824	\$359.60
12 Gauge Pro Hunter Fluted Rifled Slug 28" Blued	031-4787	322.40
20 Gauge Pro Hunter Fluted Rifled Slug 28" Stainless	031-4822	376.96
20 Gauge Pro Hunter Fluted Rifled Slug 28" Blued	031-4788	322.40

20 Gauge Rifled Slug Barrel 26" Blued	031-4234	316.20
12 Gauge 24" Realtree Hardwoods Camo w/Turkey Choke tube, Fiber Optic sights & 3" Chamber	031-6206	359.60
12 Gauge Slug Blued with Fiber Optic Sights 24"	031-4239	322.40

Encore Muzzleloader Barrels



Encore Muzzleloader Barrels	Order No.	Price
209x50 Muzzleloader Barrel, Blued 26"	031-6260	\$299.52
209x50 Muzzleloader Barrel, Stainless Steel 26"	031-4986	323.64
209x50 Muzzleloader Barrel, Hardwoods HD 26"	031-4939	334.08

New! Thompson Center Dimension



Fresh from SHOT Show 2012, introducing the Thompson Center Dimension Bolt Action, fully customizable rifle! The Dimension allows you to change barrels and stocks into four different "Caliber Families" by changing no more than four components. The Dimension is a brand-new product breakthrough, so we're trying to get information as fast as possible! Check out our website to get the latest information on this revolutionary bolt-action platform! ONE and DONE!



Check out our T/C Dimension page online for more info!



www.midsouthshooters.com/tcdimension.asp

Thompson Center Muzzleloaders

209x50 Magnum Encore



The Encore 209 X 50 Magnum Muzzleloader is the most reliable, accurate, long range muzzleloader ever produced. It's a "minute of angle" muzzleloader based on a proven single shot break open action. 26" barrel of 4140 rifle grade steel, button rifled with a 1 in 28" twist. Designed to handle magnum loads of up to 150 grains of FFG Black powder or the Pyrodex equivalent. Also handles 3 of the new 50 grain Pyrodex Pellets with impressive results. Closed breech designed and 209 shotgun primer ignition assures firing in the most adverse conditions. "Universal Breech Plug" allows for quick, reliable ignition with loose powder or Pyrodex Pellets. The easiest cleaning muzzleloader on the market today. There is no striker or breech area to clean. Because of the sealed ignition chamber, all fouling is contained in the barrel. With T/C's patented QLA Muzzle System loading is a snap. When the special season is over, it only takes a few seconds to remove the .50 caliber muzzleloader barrel and install your favorite centerfire rifle barrel. Same frame, same feel, same confidence.

Order No. Price
*209x50 RealtreeHardwoods Camo 26" Bbl, Stock & Forend 031-3929 Call

FFL Required

*To buy complete guns you must have valid FFL with original signature, completed order form with credit card number and expiration date, money order, or certified check. Add freight.

Bergara Encore Barrels

Made in consultation with Ed Shilen, World Renown Custom Barrel Maker! Bergara Barrels are Manufactured in Bergara, Spain, a region known to produce some of the finest guns in the world. Bergara Barrels has combined the most technically-advanced barrel manufacturing equipment with an unwavering commitment to quality and value. This superior technology combined with decades of barrel making experience delivers a production barrel that performs like it was custom made.



24" Centerfire Barrels Drilled and tapped for scope only.

	Order No.	Price
7MM-08 Standard Contour Stainless Steel	143-TC4600S	\$208.90
7MM-08 Standard Contour Blued	143-TC4600	182.78
.308 Standard Contour Stainless Steel	143-TC4500S	208.90
.308 Standard Contour Blued	143-TC4500	182.78
.223 Standard Contour Stainless Steel	143-TC4400S	208.90
.223 Standard Contour Blued	143-TC4400	182.78
.45-70, Full Contour Blued (See Notes)	143-TC4700*	182.78
.30-06 Standard Contour Stainless Steel	143-TC4300S	208.90
.30-06 Standard Contour Blued	143-TC4300	182.78
.270 Standard Contour Stainless Steel	143-TC4200S	208.90
.270 Standard Contour Blued	143-TC4200	182.78
.243 Standard Contour Stainless Steel	143-TC4100S	208.90
.243 Standard Contour Blued	143-TC4100	182.78
.222 Standard Contour Stainless Steel	143-TC4410S	208.90
.222 Standard Contour Blued	143-TC4410	182.78

26" Centerfire Barrels Drilled and tapped for scope only.

	Order No.	Price
.223 Stainless Steel, Full Contour (See Notes)	143-TC4402S *	\$208.90
.300 Win Stainless Steel, Full Contour (See Notes)	143-TC4800S *	208.90
.300 Win Blued, Full Contour	143-TC4800	182.78
.22-250 Stainless Steel, Full Contour (See Notes)	143-TC4422S *	208.90
.222 Stainless Steel, Full Contour (See Notes)	143-TC4412S *	208.90

28" Centerfire Barrels Drilled and tapped for scope only.

	Order No.	Price
.30-06 Stainless Steel Fluted	143-TC4300F	\$224.58
.270 Stainless Steel Fluted	143-TC4200F	224.58
.243 Stainless Steel Fluted	143-TC4100F	224.58

28" Muzzleloader Barrels Muzzleloading barrels include ramrod and are drilled and tapped for scope AND fiber optic sights.

	Order No.	Price
.45cal Muzzleloader Stainless Steel Fluted	143-RB4007S	\$212.16
.45cal Muzzleloader Blued Fluted	143-RB4007	185.64
.50cal Muzzleloader Stainless Steel Fluted	143-RB4006S	212.16
.50cal Muzzleloader Blued Fluted	143-RB4006	185.64

Notes: All Bergara Barrels manufactured to fit the T/C Encore® frame utilize the same hole spacing and thread size as the O.E.M. equipment from Thompson Center Arms.

*These models will require the TC muzzleloading fore stock. Mounting screws included. TC4700 (.45-70) are drilled and tapped for both scope holes and open sights.

Impact



The Impact is a typical modern-day muzzleloader in that it is a 209 primer fired inline, but similarities with other designs stop there. The Impact is simplicity itself. There are only three moving parts: the hammer, the trigger and the sliding breech-latch.

The Impact comes equipped with Williams highly visible fiber optic sights. 41.5" Overall Length, Drilled & Tapped.

	Order No.	Price
Impact 50 Cal 28" Blued Barrel, Black Composite Stock	031-6680	\$227.55
Impact 50 Cal 28" Blued Barrel, Camo Stock	031-6681	252.15

Omega



With it's sleek profile and it's sealed pivoting breech design, the simplicity of the Omega Z5 is unrivaled by any other muzzleloader. The Omega Z5's unique action operates by using the forward motion of the trigger guard lever to pivot the breech block downward, allowing easy access to the 209 primer; bring the lever rearward and the primer is sealed from the elements. Cock the hammer and fire. It's that simple.

1 in 28" Twist for sabots and conical bullets, 42" Overall Length, Drilled & Tapped.

	Order No.	Price
Omega 50 Cal 28" Blued Barrel, Black Composite Stock	031-8898	\$325.95
Omega 50 Cal 28" WeatherShield Barrel, Black Comp Stock	031-8865	356.70

Replacement Stocks for Omega



	Order No.	Price
Composite Thumbhole Replacement Stock	030-7863	\$116.44
Hardwoods HD Camo Thumbhole Replacement Stock	030-7870	173.92
Wood Laminate Thumbhole Replacement Stock	030-7871	208.37

Thompson Center Muzzleloaders

Omega .50



Specs: 1:28 twist, Closed swinging breech plug, 209 Shotgun Primer, Click Adjustable steel sights with Tru-Glo Fiber Optics, Composite stock. Weighs appx 7lbs, 28" barrel, Overall length is 42". Accepts magnum charges of up to 150 grains of FFG, black powder or Pyrodex.

The Omega .50 features "swinging block" lever action design that makes this one of the most simple and no nonsense muzzleloaders on the market! The Omega's unique action operates by using the forward motion of the trigger guard lever to swing the breech block downward allowing easy access to the 209 primer pocket. Once loaded, simply cock the hammer and pull the trigger.

	Order No.	Price
Wood Laminate Thumbhole Stock 50cal 28" SS Barrel	031-8913	\$648.33
Composite Thumbhole Stock 50cal 28" SS Barrel	031-8991	506.27
Hardwoods Camo Thumbhole Stock 50cal 28" SS Barrel	031-8993	565.68
Omega.50 50cal 28" SS barrel composite stock	031-8924	446.86
Omega.50 50cal 28" SS barrel laminated wood stock	031-8926	515.31
Omega.50 50cal 28" SS barrel Realtree Camo stock	031-8928	506.27

Triumph



SPEED BREECH XT™
Speed Breech XT™ (patent pending) can be removed by hand by rotating only 90 degrees!

The Triumph Muzzleloader! Simplicity defines this muzzleloader, only a few parts on this actually move, no need to remove the trigger group, use tools or disassemble the rifle. Alloy receiver reduces the weight and balances the rifle for natural handling. Speed Breech XT™ (patent pending) can be removed by hand by rotating only 90 degrees. 209 Primer Ignition, 28" barrel.

	Order No.	Price
Triumph 50cal Blued Barrel, Black Composite Stock	031-8503	\$394.83
Triumph 50cal Weathershield Barrel, Black Composite Stock	031-8511	446.49
Triumph 50cal Weathershield Barrel, Realtree AP Camo Stock	031-8512	503.07



Hammer Expander- Ambidextrous- for right or left hand. Fits T.C. Contender, Encore and most exposed hammer weapon's -rifle or handgun. Lightweight, balanced, and you can use it with optics attached.

Order No. 149-00110 Black \$8.99
Order No. 149-00111 Silver \$8.99

Hawken



The Hawken is available in cap lock and flintlock models, barrel length is 28" octagonal. The .45 & .50 caliber models are 15/16" across the flats and the .54 caliber models are 1". All barrels are 1 in 48" twist. Features hooked breech, double set triggers, first grade American Walnut, adjustable hunting sights, solid brass trim, beautifully decorated and color case hardened lock.

	Order No.	Price
.50 Cal. Percussion Complete	031-5024	\$762.60
.50 Cal. Flintlock Complete	031-5043	799.50

Tang Sight- This all steel sight is compact and fully adjustable for windage and elevation. Two sizes accommodate a variety of TC muzzleloading rifles. Current rifles require drilling and tapping of one hole. For use with "Bead Style" Front Sights listed below. **Order No. 030-7194 \$53.57**



Fits Hawken, Renegade, Big Boar, White Mtn Carbine, Pennsylvania Hunter.

Sling Swivel Hardware- All the components necessary to use a sling on your favorite traditional T/C Muzzleloader; cap lock or flint lock. Comprised of two Q.D. Sling Swivels, butt-stock stud screw and ramrod thimble stud. Available with brass or blued thimble.

	Order No.	Price
Sling Swivels w/Blued Thimbles	030-9720	\$17.01
Sling Swivels w/Brass Thimbles	030-9700	16.22



TC Muzzleloading Accessories



A- Deluxe Bullet Starter- Four inches in length this starter features a palm saver. The hole in the knob end slips over the ramrod tip to protect the hand when seating bullets. Works with .45-.58 Cal. **Order No. 030-7054 \$10.37**

B- Standard Bullet Starter- Works with .45-.58 Cal. **Order No. 030-7050 \$6.91**

C- Compact Hunters Short Starter- Small and light, this handy little short starter performs big. A solid aluminum shaft with a concave loading tip, attached to a rugged polymer palm saving knob, provides you with a no-nonsense short starter which is all but indestructible. **Order No. 030-7144 \$8.70**

D- T-Handle Short Starter- Hardwood handle with a 2-piece solid brass rod, coupled with standard 10 x 32 threads. Screw the THandle onto a standard ramrod to extend the length of your ramrod for easier seating of projectiles. **Order No. 030-7079 \$8.19**

E- Lightweight Bullet Starter- Composite Short Starter **Order No. 030-7127 \$5.08**

TC Rugged Rod

Aluminum 1pc rods



	Order No.	Price
Rugged Rod-TC Omega .45 & .50 Cal 28" Barrel	030-9144	\$15.45
Rugged Rod-Thunderhawk, Firehawk, Scout w/24" BBL Encore 209x50 w/26" BBL & BIK Dia. w/22.5" BBL	030-9622	15.68
Rugged Rod-Hawken 28"BBL, PA Hunter w/28" BBL	030-9686	15.68
Universal Rugged Rod - 32" long, cut to fit your muzzleloader.	030-9201	14.37

Universal Power Rod™ - Universal Power Rod for all styles of muzzleloaders with barrels up to 31" in length. Simply cut it to fit your gun and install the threaded tip. The tip accepts 10-32 thread loading and cleaning tools. Pivoting handle gives maximum grip and then folds neatly out of the way while stored. **Order No. 030-7980 \$24.10**

Encore Prohunter and Omega Power Rod™ - **Order No. 030-7983 \$30.98**
209-45 with 26" Barrel - Order No. 030-7979 \$30.98



A- Ball, Bullet & Wad Puller- 10x32 Thread -45 Cal **Order No. 030-9013 \$2.79**
-50 Cal **Order No. 030-9014 \$2.79** -54 Cal **Order No. 030-9015 \$3.06**

B- Breech Plug Scraper- .36-.58 Cal. 10x32 Thread **Order No. 030-7092 \$4.05**

C- Cleaning Jag- Solid Brass 10x32 Thread
50 Cal **Order No. 030-9085 \$2.29** 54-56 Cal **Order No. 030-9084 \$2.58**
12ga **Order No. 030-7201 \$3.22**

D- 50cal Cotton Bore Swab- 10x32 Thread. **Order No. 030-9514 \$2.74**

E- Extended Super Jag- Knurled to provide maximum contact between patch and bore. Long stepped shank prevents patches from binding. Concave tip allows use for loading. Adds 3 3/4" to ramrod. Necessary for Encore 209x50 & Omega Muzzleloaders. 10x32 Thread **Order No. 030-9087 \$4.52**

F- 50 Cal Spin Extended Super Jag- Knurled portion spins free for easier loading **Order No. 030-9059 \$7.39**

G- 50 Cal Bronze Bore Brush- 10x32 Thread. **Order No. 030-9502 \$2.75**

H- Worm Patch Puller- All TC Rifles 10x32 Thread. **Order No. 030-9010 \$4.16**

I- Brass Bore Guide- Fits .45 to .58cal **Order No. 030-7158 \$3.53**

Breech Plug Fire Channel Brush - Cleans out the fire channel of most breech plugs. TC recommends using T7 Breech Cleaner in conjunction with the brush for **Order No. 030-9505 \$3.29**



T-17™ Breech Plug Cleaner w/Container - A hard working cleaner specially formulated to clean black powder substitutes including the popular Triple Se7en® powder. No brushing or scrubbing required. Simply drop your breech plug in the handy container and shake for 30 seconds and then wipe clean. This cleaner thoroughly penetrates and cleans the flash hole of your breech plug for improved ignition. **Order No. 030-7433 \$6.01**

Nipples & Accessories



Replacement Nipples (for No.11 Caps)- Made of stainless steel, these nipples are carefully machined and long lasting. No.7070 for most T/C Cap Lock rifles (Except Cherokee, Fire Storm & Seneca). Thread size 1/4 x 28. Also fits all T/C in-lines (except Encore 209x50, T/C Scout and Omega). **Order No. 030-7070 \$3.07**

Flame Thrower Nipples- This nipple design achieves the hottest ignition possible whether you are using the No.11 cap or a musket cap... T/C's Flame Thrower Nipple is a unique design which ignites the powder charge in a muzzleloader through both a direct vent and via side ports that work in conjunction with the inner breech plug surface to throw a "ring of fire."

Flame Thrower Nipple for Musket Caps- Order No. 030-7237 \$8.29

Flame Thrower Nipple for No.11 Caps- Order No. 030-7242 \$8.29

Musket Cap Nipple- This nipple gives the option of using the much larger musket caps. Musket caps produce ignition fire that is 700° hotter than standard No.11 percussion caps. Made of stainless steel, these nipples are carefully machined & long lasting. Fits T/C Traditional cap locks and T/C in-lines (except Encore 209x50, T/C Scout and Omega). (1/4x28). **Order No. 030-7252 \$4.53**

T/C Hot Shot® Nipple- This heat treated stainless steel nipple provides a more even and consistent flow of pressurized gases from the nipple into the ignition chamber. They will virtually eliminate hammer blow back by venting excessive gases through the side ports. (Not recommended for under-hammer rifles or Cap & Ball Revolvers).

Hot Shot® Nipple for #11 Cap-(1/4x28) for most T/C Cap Lock rifles. Uses #11 Cap. (Except Scout, Cherokee, FireStorm & Seneca). **Order No. 030-7075 \$4.41**

Hot Shot® Nipple for Musket Cap (1/4x28) for most T/C Cap Lock rifles. Uses Musket Caps. (Except Scout, Cherokee, Fire Storm & Seneca). **Order No. 030-7204 \$5.95**

Touch Hole Bushings for T/C Flint Locks- Stainless Steel, 1/4"x28. Pkg. of 2.

Order No. 030-7327 \$4.72

Nipples Wrenches & Accessories

A- In-Line Nipple Pick- The perfect tool for ensuring that the ignition channel in your in-line muzzleloader's breech plug is cleared of residue or moisture. Fits all in-lines and is easy to use even when rifle is scoped. **Order No. 030-7244 \$10.09**

B- Nipple Wrench- Universal For #11 & Musket Nipples **Order No. 030-7064 \$5.41**

B- Nipple Wrench- Musket Cap Nipple Only- **Order No. 030-7112 \$5.67**

C- Deluxe "Universal" Nipple Wrench- Extra long nipple wrench for traditional cap lock rifles with either #11 nipples or musket cap nipples. Provides extra leverage for stubborn nipples. Cross bar contains nipple pick for clearing the nipple channel and a threaded hole to hold an extra nipple for emergency replacement in the field. **Order No. 030-7084 \$15.18**

D- Modern Style "Universal" In-Line Nipple Wrench- An extra long nipple wrench for removing the nipple from the ThunderHawk, Fire Hawk, System 1, Blk Dia and Woods Rifle. Allows for use when these rifles are scoped. **Order No. 030-9424 \$8.33**

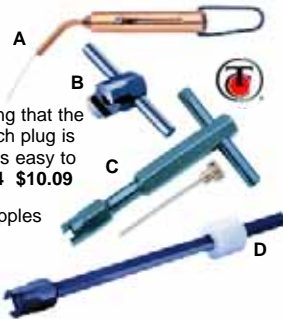

Breech Plugs & Accessories



	Order No.	Price
209 Breech plug for Encore 209x50	030-7763	\$12.16
Breech plug for Black Diamond and Woods rifle	030-7769	12.11
Breech Plug Wrench- Encore 209x50 & Omega	030-7764	9.02
E-Z Thread- anti seize breech plug tape/ sealant (one roll)	030-7148	6.09
Gorilla Grease- anti seize breech plug thread grease	030-7356	3.31
Anti-Seize Super Lube- Teflon all purpose lube 1/2oz	030-7362	5.79
Breech Plug Brush	030-9507	3.94
209 Primer Adapter for Black Diamond and Woods rifle.	030-7805	9.16
E-Z Tip Extractor for Encore 209x50 or 209x45	030-7211	15.65
Encore® Pro Hunter™ Breech Plug Field Wrench	030-7727	13.90
Triumph Breech Plug	030-7729	31.13
Encore® ProHunter™ Breech Plug Wrench 1/2" Hex	030-7521	14.01
Encore® ProHunter™ Speed Breech Plug	030-7523	39.68
Encore® ProHunter™/Triumph O-ring for Speed Breech Plug	030-7531	1.87

TC Muzzleloading Accessories

Cappers



Star 7 Capper- A lightweight capper with seven protruding fingers that hold caps for quick accessibility, and a handy storage compartment in the back for extra caps. Lanyard loop enables it to be worn around neck or attached to a possibles bag. **Order No. 030-7015 \$5.15**

In-Line Capper for #11- Caps Solid brass body with steel jaws. This unique design allows the plunger spring to be locked in compressed position for easy loading. American made, it holds seventeen #11 Percussion Caps. **Order No. 030-7025 \$9.76**

U-View™ In-Line Capper For Musket Caps- This tool is designed specifically for use with any of the muzzleloaders that use a musket cap. It holds eight musket caps ready for instant action. Allows quick visual inspection of your cap reserves. **Order No. 030-7233 \$9.54**

Lightweight Polymer 209 Primer "Priming / Depriming" Tool- Handy 3 Pak of the 209 Priming / Depriming Tool for use with any of the in-line T/C muzzleloaders that accept these primers. (Not for use with Encore 209x50 Magnum). **Order No. 030-7802 \$4.77**

Dog-Bone 209 Primer- A handy and durable polymer 209 priming tool holds two 209 shotshell primers at each end for instant priming. Also holds a "reserve" of six more inserted in the main shaft. Enables you to easily prime most in-lines, even when scoped. **Order No. 030-7808 \$3.65**

U-View™ In-Line Capper For 209 Primers- This tool is designed specifically for use with any of the Fire Storm 209 or modern-style, inline muzzleloaders that use a 209 shotgun primer. It holds eight primers ready for instant action. Allows quick visual inspection of your primer reserves. *Not For Encore 209x50 or Omega* **Order No. 030-7219 \$9.72**

U-View™ Capper for #11 Caps- The ultimate in convenience and durability. Allows you to see exactly what you have in reserve. The traditional shape of this capper makes it easy to use. Hole for attaching a thong. Simple thumb actuated mechanism. For #11 caps (holds 100) **Order No. 030-7226 \$16.53**

Powder Measures

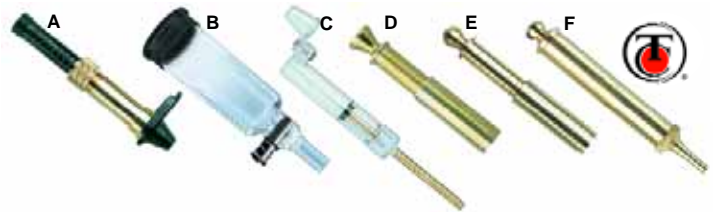

A- Hunter Powder Measure- Compact lightweight powder measure with solid brass cup and durable polymer adjusting sleeve marked in 10 grain increments from 20 to 120 grains. Brass locking setscrew can be locked into infinite positions; at graduated marks or between them. **Order No. 030-7048 \$12.99**

B- U-View™ Powder Flask- See Thru Makes it easy to monitor your powder supply. Small enough to easily fit in your pocket or "possibles" pouch yet it holds enough powder for about a dozen reloads. Spring loaded plunger is easy to control for dispensing powder into a measure. **Order No. 030-7224 \$18.15**

C- U-View™ Powder Measure- See the exact level of the powder in the tube. Eliminate the guesswork of loading consistent charges with this handy, lightweight measure. Includes loading spout that swivels out of the way to fill the measure. Graduated in 5 increments from 15 to 125 grains. **Order No. 030-7222 \$13.49**

D- T/C Magnum Powder Measure- Designed specifically for use with any of the in-line T/C muzzleloaders when using magnum charges of up to 150 grs. of Black Powder or Pyrodex® equivalent. 10 gr. increments **Order No. 030-7102 \$11.47**

E- Adjustable Black Powder Measure- Compact solid brass measures which quickly adjusts to the required increments for rifle or pistol. Positive snap ring "clicks off" each increment of adjustment and holds cavity at desired volume. (50-120 grs. in 10 gr. increments) **Order No. 030-7040 \$8.30**

F- Flint Lock Pan Charger* Solid brass, knurled end screws off for easy filling. Holds appX 80gr FFFFG Black Powder. Dispenses a small amount of priming powder. Each dispensed charge fills the pan of a T/C rifle one-half full. **Order No. 030-7020 \$14.34**

TC Muzzleloading Accessories

Flint Accessories



Premium Agate Flints- Cut from Agate, these premium "flints" will outperform standard flints by producing at least twice the number of strikes. And their ability to produce more consistent sparks, longer, is the reason why they are used by top International Muzzleloading shooters. 3 per package **Order No. 030-7203 \$12.60**

Flint Lock Touch Hole Pick- Rugged stainless steel touch hole pick with lanyard loop. **Order No. 030-7113 \$3.53**

Flint Lock Touch Hole Picks- Durable polymer "spark proof", Package of 2. **Order No. 030-7093 \$3.02**

Flint Lock Field Kit- All the basics you will need for flint lock maintenance while in the field. Contains: pan brush, jaw tightening rod, stainless steel touch hole pick and small screwdriver with 3 different size blades for a multitude of uses including rear sight adjustment. Lightweight and compact. **Order No. 030-7099 \$8.21**

U-View Flex Loader

U-View Flex Loader - Everything you'll need for three shots, all in a compact carrier. Carrier holds three loading tubes, each containing the projectile and charge. When needed, the loading tube is pulled out of the holder and "dumped" down the bore pellets first, followed by the projectile. **Order No. 030-8031 \$5.31**



Replacement U-View Tubes (3pack) - 030-7238 \$2.18

Rip-Cord Speedloader - Attach the carabiner to your belt, suspenders, or pack, pull the tube away from its top and dump your charge. Houses 209 primer as well. **Order No. 030-9613 \$5.91**



Wedge Pin Puller

Pin Puller- A hardened steel, dual purpose tool which taps out the forend wedge just enough so that it can be caught and pulled free with the claw end. It's also a nipple wrench that fits all T/C nipples. **Order No. 030-7062 \$10.14**



Replacement wedge pins for T/C long guns only. High quality blued or brass color.

Fits Hawken (Brass Color) 030-7011 \$7.34
Fits Renegade, PA Hunter, White Mtn., & Big Boar(Blued) 030-7013 5.64

12ga Accessories



A- 12 Gauge Shotcups with Over the Shot Wads - These "multi-metal" 12 gauge shotcups offer muzzleloaders tighter patterns when hunting turkey or waterfowl. Cups provide superior barrel protection and are pre-slit; easy to load. Each shot cup accepts 1-1/4oz. of steel shot or 2oz. of lead shot. Comes with an over the shot wad. 20 per pack. **Order No. 030-7001 \$10.08**

B- 12 Gauge Jag - Solid brass cleaning jag with 10x32 threads. Fits all T/C ramrods. **Order No. 030-7201 \$3.31**

C- 12 Gauge Natural Wads (50 pack) - Woven wool wads, center-lubed with Bore Butter. 1/8" thick, with "memory" which allows them to be used in full choke barrels. **Order No. 030-7024 \$8.26**

Patches and Lubes

Bore Butter- An all natural lubricant with no petroleum based oil additives. Produces much less fouling than conventional lubes. More consistent pressure from shot to shot. The more 1000+ used, the more seasoned the bore will become. Also great protectant for external surfaces of your gun. Now in a 5 ounce tube.

	Order No.	Price
1000+ Bore Butter 5 oz. tube	030-7309	\$6.07
1000+ Bore Butter 2 oz. tube	030-7411	3.84
1000+ Bore Butter 5 oz. tube Pine Scented	030-7409	7.03



Number 13 Bore Cleaner- An all natural bore cleaner which contains no petroleum based additives and is compatible with Natural Lube 1000 Plus. Number 13 will quickly and efficiently remove any trace of residue or fouling without eliminating the "seasoning" which has coated the surface of the bore. Number 13 is non-toxic and FDA food grade rated. 8oz **Order No. 030-9041 \$4.40**

100% Cotton Roundball Patches- Uniform thickness, these economical 100% cotton patches are available pre-lubricated with T/C's Natural Lube 1000 Plus Bore Butter, or unlubricated. Non toxic, biodegradable. 100 per bag.

	Order No.	Price
.45/.50 Cal. Unlubricated Patches	030-7030	\$3.46
.54 Cal. Unlubricated Patches	030-7034	3.46

These patches are fully lubricated with Natural Lube 1000+ and sealed in a plastic bag. 100 to the bag.

	Order No.	Price
.45/.50 Cal. Prelubricated Patches	030-7043	\$5.08
.54/.56 Cal. Prelubricated Patches	030-7044	5.08



Seasoning Patches Treated with Natural Lube 1000 Plus™ Bore Butter - 2-1/2" 100% cotton cleaning patches pre-treated with Natural Lube 1000 Plus™ Bore Butter. Great for use after cleaning your muzzleloader with T/C No. 13™ Bore Cleaner or for easy field cleaning.

	Order No.	Price
Original Natural Lube Scent (25)	030-7147	\$4.08
Original Natural Lube Scent (100)	030-7003	11.21
Pine Scent Natural Lube (100)	030-7326	13.13



Holds Premeasured Powder Charge, Projectile & Primer in a Waterproof Container.

	Order No.	Price
45 Caliber Quick Shot	030-7027	\$5.51
50 Caliber Quick Shot	030-7028	5.51
54 Caliber Quick Shot	030-7029	5.51
45 Caliber Magnum Quick Shot	030-7151	5.51
50 Caliber Magnum Quick Shot	030-7104	5.51
54 Caliber Magnum Quick Shot	030-7109	5.51

Quick Shot Powder Measures

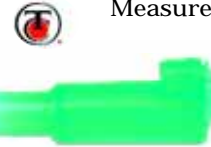

	Order No.	Price
50 Caliber 4-N-1	030-7057	\$6.90
54 Caliber 4-N-1	030-7058	6.90
50 Caliber Mag 4-N-1	030-7106	8.15

4-N-1 Quick Shot

Everything you need for quick loading all in one package. 1 tool does it all; carries your powder, bullet or ball, your cap, and serves as your bullet starter! Waterproof seal to keep your charge dry!! 2 per package!!!

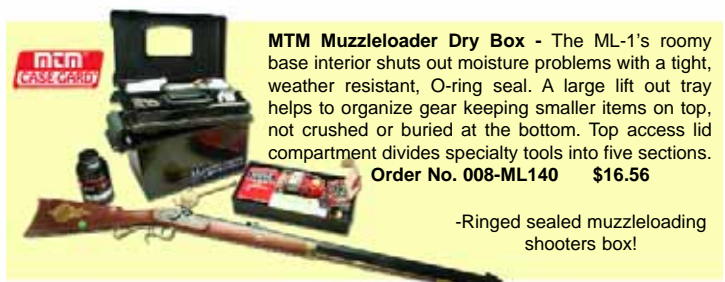

MTM Muzzleloader Dry Box - The ML-1's roomy base interior shuts out moisture problems with a tight, weather resistant, O-ring seal. A large lift out tray helps to organize gear keeping smaller items on top, not crushed or buried at the bottom. Top access lid compartment divides specialty tools into five sections. **Order No. 008-ML140 \$16.56**

-Ringed sealed muzzleloading shooters box!

Great Plains Rifle



Lyman

Lyman's Great Plains is one of the most authentic muzzleloaders found anywhere and has quality rarely found in anything but custom rifles. Features a 32" barrel, double set triggers, 1 in 60" twist and traditional hardware. Oil finished high quality walnut stock. Great Plains rifles use nipples with size of 6x.75mm.

The Great Plains Hunter features a fast, 1 in 32" shallow groove rifle barrel. Ideal for shooting the many types of modern projectiles available to today's black powder hunter. Pre-drilled and tapped for the 57 GPR receiver sight.

	Order No.	Price
Complete .50 Caliber Right Hand	015-6031102	\$479.13
Complete .54 Caliber Right Hand	015-6031103	479.13
Complete .50 Caliber Flintlock Right Hand	015-6031105	512.88
Complete .54 Caliber Flintlock Right Hand	015-6031106	512.88
Kit .50 Caliber Right Hand	015-6031111	381.27
Kit .54 Caliber Right Hand	015-6031112	381.27
Kit .50 Caliber Flintlock Right Hand	015-6031114	411.64
Kit .54 Caliber Flintlock Right Hand	015-6031115	411.64
Complete .50 Caliber Left Hand	015-6031125	489.25
Complete .54 Caliber Left Hand	015-6031126	489.25
Complete .54 Caliber Flintlock Left Hand	015-6031138	519.62

Great Plains Hunter Rifle

Great Plains Hunter 50 Caliber(1:32 TWIST)	015-6031120	\$479.13
Great Plains Hunter 54 Caliber(1:32 TWIST)	015-6031121	479.13
Great Plains Hunter 50 Caliber Flint(1:32 TWIST)	015-6031148	512.88
Great Plains Hunter 50 Caliber Left Hand percussion	015-6031142	479.13

Plains Pistol



Lyman

Authentic recreation of trapper's pistol of the mid 1780's. Walnut stock and blackened furniture. PLAINS PISTOLS USE NIPPLES WITH THREAD SIZE 6x.75mm.

	Order No.	Price
Complete .50 Cal Percussion	015-6010608	\$249.67
Complete .54 Cal Percussion	015-6010609	249.67
Kit .50 Cal Percussion	015-6010610	209.18
Kit .54 Cal Percussion	015-6010611	209.18

Trade Rifle

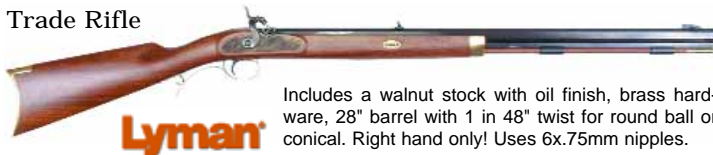

Lyman

Includes a walnut stock with oil finish, brass hardware, 28" barrel with 1 in 48" twist for round ball or conical. Right hand only! Uses 6x.75mm nipples.

	Order No.	Price
Complete .50 Caliber Percussion Trade Rifle	015-6032125	\$348.20
Complete .54 Caliber Percussion Trade Rifle	015-6032126	348.20



Lyman

Lyman Black Powder Barrels

Great Plains 1:60 Twist

	Order No.	Price
50 Cal Flint RH	015-6030198	\$231.00
50 Cal Perc. RH	015-6030221	231.00
54 Cal Perc. RH	015-6030222	231.00
50 Cal Perc. LH	015-6030272	231.00
54 Cal Flint LH	015-6030278	220.00

Great Plains Hunter 1:32

50 Cal Perc. RH	015-6030266	\$220.00
54 Cal Perc. RH	015-6030267	231.00
50 Cal Perc. LH	015-6030268	231.00
54 Cal Perc. LH	015-6030269	231.00
50 Cal Flint RH	015-6031108	231.00
54 Cal Flint RH	015-6031109	231.00

Trade Rifles

	Order No.	Price
50 Cal Perc. RH	015-6030228	\$205.33
54 Cal Perc. RH	015-6030229	205.33
50 Cal Flint RH	015-6030240	205.33
54 Cal Flint RH	015-6030241	205.33

Deerstalker

50 Cal Flint RH	015-6993095	\$205.33
50 Cal Flint RH	015-6993096	205.33
50 Cal Perc. RH	015-6993103	205.33
54 Cal Perc. RH	015-6993104	205.33
54 Cal Perc. LH	015-6993174	205.33
50 Cal Flint LH	015-6993178	205.33

Deerstalker Stainless

50 Cal Perc. RH	015-6993303	\$205.33
54 Cal Perc. RH	015-6993304	205.33

Lyman Muzzleloaders & Accessories

Mustang Breakaway 209 Magnum



Lyman

The "Breakaway" 209 Magnum - Hammerless "Break Action" Rifle!

The Lyman Mustang Breakaway 209 Magnum muzzleloader is a rugged and highly accurate black powder hunting rifle that has the same looks and feel of expensive break-open centerfire rifles and shotguns. The Mustang rifle retains the basic functions of traditional muzzleloaders, while adding the benefits of easy scope installation, sure ignition with 209 shotgun primers, fiber optic sights and a removable breech plug. The Mustang rifle also allows the convenience and power of loading up to three 50-grain Hodgdon pellets (or an equivalent 150 grain powder charge). The fast 1-28" twist allows you to use a wide range of sabots, Power Belts, and conical type hunting bullets. **Order No. 015-6032113 \$354.31**

Deerstalker



Lyman

Lyman's Deerstalker rifle feature oil-finished rich walnut stocks with less drop like modern hunting rifles. All models feature a real Lyman front and rear hunting sight package and are pre-drilled and tapped for the 57 SML receiver sight. Each has a handsome rubber pad to lessen recoil. Deerstalkers all come with top quality sling swivel studs, and unbreakable nylon ramrod. 1 in 48" twist and can use round or maxi-balls.

	Order No.	Price
.50 Cal Percussion, Right Hand	015-6033140	\$347.53
.54 Cal Percussion, Right Hand	015-6033141	347.53
.50 Cal Flint, Left Hand	015-6033171	404.89
.54 Cal Flint, Left Hand	015-6033173	404.89
.50 Cal Flint, Right Hand	015-6033146	377.90
.54 Cal Flint, Right Hand	015-6033147	377.90

Deerstalker Stainless - Feature true stainless steel on all of the major parts such as the barrel, trigger guard, lock assembly, escutcheons and wedge. Available in percussion only and features a special 1-48" twist for shooting modern conical designs.

.50 Caliber Percussion, Right Hand	015-6033185	\$421.77
.54 Caliber Percussion, Right Hand	015-6033186	421.77



Butch's Black Powder Bore Shine! Developed specifically for black powder shooters who asked for a better, faster way to clean their rifles. Butch's Black Powder Bore Shine comes from a special cleaning solvent used by the U.S. Military. This black powder bore cleaner, like the original bore shine, does it all! Odorless, non-toxic, non-flammable, biodegradable and protects against rust and corrosion. **Order no. 015-02949 \$6.89**

LYMAN Stainless Steel Nipple (3 ea) - Fits all Lyman Rifles 6 x.75mm metric thread. **Order No. 015-6030080 \$11.54**



Super Moly- All purpose, high temperature bullet lubricant. With Molybdenum Disulfide added for increased velocity, it coats the barrel with a fine film which improves accuracy and makes leading non-existent. It flows through lube sizers without heat and won't melt at 130 degrees. **Order No. 015-2857272 \$3.69**

Black Powder Gold- Formulated specifically for black powder shooting both muzzleloading and black powder cartridge silhouette. It's high melting temperature makes it ideal for long range match shooting. It keeps fouling soft for continuous shooting and flows through lube sizers for effortless bullet lubing. **Order No. 015-2857266 \$3.82**



Universal Nylon Ramrod - Unbreakable! **Order No. 015-6010030 \$11.19**

Fiber Optic Hunting Sights - Update that black powder rifle with state-of-the-art fiber optic technology. Especially helpful at dawn and dusk. Designed to fit the Lyman Great Plains, Trade and Deerstalker rifles; these bright, light-gathering sights will also fit most other European-made black powder rifles. **Order No. 015-3090145 \$28.78**

Upgrade your muzzleloader to Lyman Hunting Sights. The 16 AML Fold Down Rear Sight and 37 ML Front Sight fits all Lyman rifles and most European imports (CVA, Traditions, etc.).

	Order No.	Price
16 AML Rear Sight	015-3090117	\$12.53
37 ML Front Sight	015-3090118	8.83
16 & 37 SET (Best Buy)	015-3090106	18.44

Traditions Muzzleloaders & Accessories

Tracker 209 In-Line



50cal Synthetic stock, 24" Nickel Barrel (1:28") **Order No. 139-R44103470** **Price \$165.73**

Muzzleloaders Shooters Kits

Side-Lock Muzzleloaders Kit- A perfect choice for newcomers or for old timers who need new equipment! Includes brass flask with easy to use valve style dispenser, wooden ball starter, brass adjustable powder measure with swivel to level loads, nipple wrench and brass straight line capper. The perfect kit! **Order No. 139-A3500 \$34.61**

Flintlock Muzzleloaders Kit- Kit includes a deluxe brass powder flask, wooden ball starter, brass pan primer, universal cleaning pick and brass adjustable powder measure with swivel top. Works with both 50 and 54 caliber. **Order No. 139-A3700 \$34.61**



Traditions Accessories

Loader and Starter- An all-in-one loader and starter. Holds three 50 grain Pyrodex Pellets in one end and a projectile in the other. The covers double as cappers, one #11 and one musket. "T" functions as a convenient ball starter. **Order No. 139-A1315 \$4.83**

Revolvr Nipple Wrench- Fits all 1851, 1860 Colts and 1858 Remington revolvers. Nipple pick attached to brass cap. **Order No. 139-A1260 \$5.69**

Retractable nipple pick- Brass body with push-up slide extends nipple pick at an angle to reach in-line rifle nipples. **Order No. 139-A1420 \$6.45**

209 Depriming Tool- **Order No. 139-A1404 \$3.81**

Advantage Timber Possibles Bag- Attaches to any belt. **Order No. 139-A1318 \$11.82**



Weaver®-style scope bases- Your choice of blued or silvered finish. Designed for round or octagonal barrels, for use with Weaver®-style scope rings. 2 pc. for round barrels Fits Pursuit, Lightning, E-Bolt 209, Tracker 209, Buckhunter, and Buckhunter Pro rifles. **\$5.38 a pair**



Miscellaneous Traditions Accessories

	Order No.	Price
50cal. Ramrod Acc. Pack - 5 Popular Tips (10-32 threads)	139-A1205	\$8.79
Adjustable Powder Measure	139-A1204	9.60
Patch Puller .45 - .50 cal, (10-32 threads)	139-A1256	2.86
Patch Puller Worm .32 - .36 cal, (10-32 threads)	139-A1566	4.01
Colt Style Brass Flask	139-A1259	26.55
Ball Puller .45 - .58 cal, (10-32 threads)	139-A1280	1.94
Capper-Black	139-A1291	6.73
Blackened Powder Measure	139-A1293	9.57
Flask Funnel (to Fit Flask)	139-A1298	6.73
Extra Barrel Wedge for Traditions Rifles	139-A1253	4.15
Wedge Pin Puller	139-A1255	12.47
T-Handle Ball Starter	139-A1206	5.44
Deluxe Flask w/valve	139-A1201	18.37
Spout Set (75 & 100 Grain)	139-A1237	4.95
Straight Line Capper	139-A1203	6.96
Deluxe Nipple Wrench	139-A1211	5.44
Universal In-Line Nipple Wrench	139-A1421	5.12
Powder Horn - Authentic with Leather Sling	139-A1252	17.73
209 Capper, Brass with lanyard loop	139-A1418	12.19
EZ Clean Foaming BoreSolvent 4oz. pump spray	139-A1758	11.47
Fouling Scraper	139-A1258	2.86

Please read regarding Traditions returns! All Defective Traditions Product Returns Must Go Through Traditions! Please call Traditions 1-860-388-4656 for Assistance.



Weaver® Ring & Base Set - These Weaver® ring and base set features lightweight aircraft-grade aluminum for strength and weight reduction and permits windage adjustments as well. For 1" scopes.

	Order No.	Price
1pc CVA / Traditions / Remington Genesis Medium	029-48543	\$30.93
1pc CVA / Traditions / Remington Genesis High	029-48544	30.93
2pc CVA / Traditions / Remington Genesis Medium	029-48548	28.05
2pc CVA / Traditions / Remington Genesis High	029-48549	28.05

Breech Plugs and Nipples

	Order No.	Price
Pursuit 209 Breech Plug (Pursuit Only)	139-A1445	\$12.33
In-Line Breech Plug (Fits all Traditions In-Line Pistols and Rifles)	139-A1344	11.78
Stainless #11 Nipples for M6x1 Threads(2pk)	139-A1250	4.01
Lightning Fire System Musket Nipple M6x1(2pk)	139-A1400	6.16
Lightning Fire System Musket Nipple M6x.75(2pk)	139-A1401	6.16
Lightning Fire System Musket Nipple 1/4x28(2pk)	139-A1402	7.45
Universal Breech Plug / Nipple Wrench	139-A1519	11.95

Deluxe Possibles Bag - 2 Pockets Plus 3 Accessory Holders. Quiet camo cloth that has enough room for all your days needs. The long strap can fit over your shoulder easily. The front pocket has a quick-clip for easy retrieval of accessories or lunch. 10"x10"x6". Advantage Camo. **Order No. 139-A1438 \$28.44**



Pursuit Accessories

	Order No.	Price
Pursuit Replacement Ramrod - Fits 28" Models	139-A1790	\$23.57
Pursuit Replacement Ramrod - Fits 26" Models	139-A1791	20.79
Pursuit Replacement Hammer Spur	139-A1795	2.91

Pellet & Powder Sportsman's Pack - Includes: Magnum quick loaders, breech plug lube, bore solvent, projectiles, sabots, cleaning patches, cleaning brush, 209 capper, #11 capper, ball starter, nipple pick, cleaning jag, ball puller, cleaning swab, re-usable ammo tubes & a free video on muzzle-loading. **\$2.91 Per Pack**

	Order No.	Price
.50cal Pellet	139-A5101	
.50cal Powder	139-A5105	
.45cal Pellet	139-A5110	

	Order No.	Price
Scope Rings Detach See-Thru Blued 1" (Weaver Style)	139-A1367	\$13.46
Scope Rings Detach See-Thru Silver 1" (Weaver Style)	139-A1368	13.80

Please read regarding Traditions returns! All Defective Traditions Product Returns Must Go Through Traditions! Please call Traditions 1-860-388-4656 for Assistance.

Blackpowder Cleaning Supplies



Caliber	Black Powder Wool Mop	Blackpowder Brushes
	10-32 Thread	10-32 Thread
	\$1.58	\$1.58
44/45 Cal	097-41555	097-41561
50 Caliber	097-41556	097-41562
54 Caliber	097-41557	097-41563
58 Caliber	-	097-41564
69 Caliber	-	097-41565
75 Caliber	-	-

Black Powder Handbook 2nd Edition - Written by Sam Fadala, this handbook includes pressure tested loads using Goex and Elephant black powders and Pyrodex Pellets. Complete editorial section includes topics on choosing your muzzleloader, building the best loads, propellants, ignition, maintenance, etc. Also includes a black powder cartridge section by Mike Venturino. **Order No. 015-9827100 \$14.14**



Traditions Blackpowder Revolvers



A & B - 1873 Single Action Revolvers- These formally cartridge firing single-action Colt style revolvers have been retro-fitted as cap and ball black powder firing models. .44 caliber. Brass backstrap and trigger guard.

1873 7 1/2"	Order No. 139-FR187371	\$373.27
1873 4 3/4"	Order No. 139-FR187351	\$373.27

C - 1860 Colt Army Revolver- Single Action Service Revolver, used by the U. S. Army during the war of the North and South! The richly blued .44 cal 8" barrel contrasts handsomely with steel or brass frame. Weighs 2 pounds 11 ounces. Use .454 round ball.

1860 Brass Frame	Order No. 139-FR18601	\$205.99
1860 Steel Frame (Shown)	Order No. 139-FR18602	\$248.43

D - 1860 Colt Army Revolver Gold Tone, - For the enthusiast who needs just that extra bit of flair. Its shiny nickel frame and backstrap glimmer, and its gold tone highlights add a touch of class. The white grips give it the finishing touches. .44 Caliber. Gold Tone: Trigger, Hammer, Cylinder (simulated Pearl grips) **Order No. 139-FR18603 \$285.88**

E & F - 1858 Remington Army Revolver- Wanted because of its one piece frame and internal basics. Used extensively during the Civil War. Complete with authentic 8" barrel, brass trigger guard and adjustable target rear sight. Weighs 2 pounds 11 ounces. Use .454 round ball. Stainless steel or brass frame.

1858 Brass Frame	Order No. 139-FR18581	\$222.22
1858 Stainless Frame	Order No. 139-FR18583	\$448.18

G - Loading Stand- Allows for easy loading of chambers of a cylinder when removed from gun. Fits all 1851, 1860, 1873 Colts and 1858 Remingtons. (Cylinder sold separately) **Order No. 139-A1309 \$17.33**

Traditions Classic Pistols



Crockett Pistol

.32cal Crockett- 1-48" Twist - 10" Octagonal Barrel Fixed Tang Sight **Order No. 139-P12652 \$200.99**



Kentucky Pistol

Ky. Pistol .50 Cal.- Authentic detailing. This .50 caliber pistol was a hot item back in the days of Daniel Boone and Davy Crockett. Deemed as one of the best close up guns ever! **Order No. 139-P1060 \$192.25**

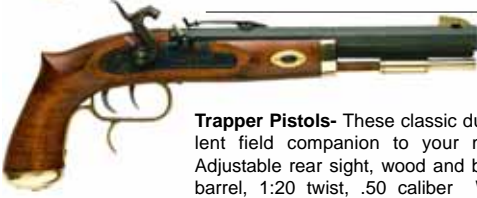

Trapper Pistol

Trapper Pistols- These classic dueling style pistol is an excellent field companion to your muzzleloading hunting rifle. Adjustable rear sight, wood and brass ramrod rests under the barrel, 1:20 twist, .50 caliber Weighs appx. 2 pounds 11 ounces. Uses 6x1 nipple.

Trapper Pistol Percussion Octagonal Barrel	Order No. 139-P1100	\$255.92
Trapper Pistol Flintlock Octagonal Barrel	Order No. 139-P1090	289.63

Traditions Traditional Rifles

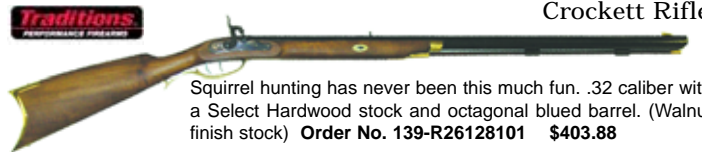

Crockett Rifle

Squirrel hunting has never been this much fun. .32 caliber with a Select Hardwood stock and octagonal blued barrel. (Walnut finish stock) **Order No. 139-R26128101 \$403.88**



Hawken Woodsman

Features a select hardwood stock with a 28" blued oct. barrel. Brass butt plate & nose cap, patch box & trigger guard double set triggers. 1:48" twist

50 Cal Percussion	Order No. 139-R24008	\$367.05
50 Cal Flintlock	Order No. 139-R2390801	\$403.88



DeerHunter Rifles

Designed to be lightweight, easy to shoot and incredibly accurate for a very modest price. The 24" octagonal performance barrel has a 1 in 48" twist and comes with fully adjustable Lite Optic sights, also drilled and tapped for scope mounting. Designed to shoot sabot bullets, conical bullets and patched round balls accurately.

Percussion .50 Cal. Hardwood stock	Order No. 139-R36108101	\$239.38
Percussion .50 Cal. All-Weather Black synthetic stock	Order No. 139-R35108150	201.33
Flintlock .50 Cal. Hardwood stock	Order No. 139-R3590801	288.49



A - Reb Confederate - The brass frame "Navy Type" revolvers are identified with the Confederate manufacturers Griswold & Gunnison, and Leech & Rigdon. Brass was used for the frames because of the scarcity of iron in the United States. They were modeled after the Colt® Navys and feature a blued 7 1/2" octagon barrel. This 6 shot single action revolver was one of the most widely used. Originally offered in .36 caliber, this replica is offered in .44 caliber. **Order No. 139-FR185115 \$202.24**

B - Spiller & Burr - This confederate pistol was born of a need for the South to arm itself. The .36 caliber revolver was adopted as the standard revolver of the Confederate Government. The Spiller & Burr was modeled after the Whitney Revolver with only a few minor adjustments. During the Southern campaign only 1,500 revolvers were actually made, making them very desirable and hard to find. This replica is perfect for re-enactments or display. **Order No. 139-FR18625 \$248.43**

C - Josey Wales - This model (pictured above) is a replica of the revolver found by Josey after his family was killed and his house burned down by Northern Raiders. This is one of the many guns used by Josey, but it is a gun of great significance. 36 Cal. **Order No. 139-FR186126 \$405.73**

D - J.H. Dance - Known for their fine craftsmanship and rarity, the J.H. Dance Company Revolver was one of many southern revolvers that came to be after the South's call to arms. These pistols were based off the Colt Dragoon and were manufactured in Texas for just 3 short years (1862-1865) with less than 400 actually being produced. The single action 6 shooter was originally available in .36 and .44 calibers. This fully functioning replica is available in .44 caliber and is perfect for re-enactments, display, or fun. Own a piece of Southern history. **Order No. 139-FR18622 \$298.37**

CVA Shooting Accessories



The PowerBelt Bullet Starter - Comes with two sets of three loading tips to fit almost all hollow point bullet designs and one set of 3 tips for polymer point bullets. One tip goes on the short rod of the starter, one on the long rod, and one on the ramrod.
Order No. 002-AC1500 \$12.37

T Bullet Starter with Ramrod Extension - Combo bullet starter and ramrod extension that is a must for field loading and cleaning. **Order No. 215-AC1508 \$10.61**

50cal Ramrod Accessory Pack - Cleaning brush, cotton bore swab and cleaning jag/loading tip. **Order No. 215-AC1466B \$4.76**

Universal Fiberglass Ramrod - Flexibility to bend without breaking. Three foot length for you to custom fit. 11/32" diameter. 10-32 threads. **Order No. 215-AC1470 \$6.73**



Replacement Breech Plug - 209 Optima and Kodiak. **Order No. 215-AC1678A \$11.65**

Stainless Steel Perfect Nipple 6x1mm CVA - Concentrates spark, delivering 100% of the spark to the powder charge. 50% more than any other #11.
Order No. 215-AC1422 \$4.51

Replacement Nipples 6x1mm CVA (3 Pack)- Quality heat treated steel with a fire funnel design similar to the perfect nipple. **Order No. 215-AC1481 \$7.21**

Flexible Breech Plug Cleaners (50 Pack)- Pipe cleaners with stiff bristles imbedded in the material for extra heavy duty cleaning in hard to get to places.
Order No. 215-AC1615 \$3.54

CVA Cleaning Products



Barrel Blaster Solvent & Bore Cleaner 4oz - Use as a lube for shooting and cleaning patches. Makes clean-up easier and less messy. Continues the barrel seasoning process. Non-petroleum product. **Order No. 215-AC1437 \$4.30**

Barrel Blaster Solvent Spray 12oz - Use to wet cleaning patches for swabbing the barrel or with a parts cleaning brush to remove fouling from gun parts.
Order No. 215-AC1685 \$7.93

Barrel Blaster Wonder Gel Solvent 4oz - Ammonia-based cleaning gel keeps the cleaner right where you want it for the removal of lead, copper and plastic fouling.
Order No. 215-AC1684 \$9.96

Barrel Blaster Rust Prevent Patches 100ct - The final step in the Barrel Blaster cleaning process protects the bore from corrosion. **Order No. 215-AC1689 \$6.34**

Barrel Blaster Parts Soaker 4oz - Use to soak breech plugs and nipples, or any other small heavily fouled parts. **Order No. 215-AC1686 \$7.17**

Barrel Blaster Quick Clean Patches 100ct - Cleaning patches that are pre-saturated with Barrel Blaster Solvent for quick easy cleaning of your barrel at the range or at home. **Order No. 215-AC1687 \$7.17**

Barrel Blaster Foaming Bore Cleaner 8oz - The easiest way to clean your muzzle-loader! Spray the foam into the barrel and leave in the barrel for a minimum of one hour, swab foam out of the barrel and you are done! **Order No. 215-AC1688 \$9.36**

Breech Plug Anti-Seize Stick - No more mess while taking care of a very important step. Stick applicator allows you to apply the Anti-Seize directly on the threads and without getting it on your hands.. **Order No. 215-AC1682 \$4.30**

Eastern Maine Shooting Supplies Blackpowder Products



Brass Ball Puller- Specifically designed taper and sharp threads allow secure grip.

	Order No.	Price
Ball Puller 8-32	106-1136	\$2.22
Ball Puller 10-32	106-1137	2.22

Brass Fouling Scraper-

	Order No.	Price
10/32 Threads	106-1161	\$2.22
8/32 Threads	106-1162	2.22

Brass Cleaning Jags-

	Order No.	Price
45 Cal 8/32 thread	106-1145	\$1.92
45 Cal 10/32 thread	106-1146	1.92
45 Cal 5/16-27 thread	106-1147	1.92
50 Cal 8/32 thread	106-1150	1.97
50 Cal 10/32 thread	106-1151	1.97
50 Cal 5/16-27 thread	106-1152	1.97
54 Cal 8/32 thread	106-1153	2.00
54 Cal 10/32 thread	106-1154	2.00
54 Cal 5/16-27 thread	106-1155	2.00

Brass Wedge Pin Puller- Solid Brass, Knurled for a secure grip. **Order No. 106-1160 \$3.33**

Aluminum T-Handle Short Starter- is a lightweight and compact short starter with a cupped T-Handle built in for starting multiple styles of projectiles. It also features a removable 10/32 tapped threaded tip, which allows you to screw the T-Handle onto your ramrod and convert to a range rod.
Order No. 106-41 \$7.76



	Premium Lubed 100% Wool Wads 100 Pack	Premium Lubed 100% Wool Wads 1000 Pack	Non- Lubed 100% Wool Wads 100 Pack
31 Cal.	106-3100 \$5.77	-	106-3100D \$5.40
36 Cal Revolver	106-3600 5.92	106-3600BK \$39.98	106-3600D 5.55
44-45 Cal Revolver	106-4400 6.06	106-4400BK 40.98	106-4400D 5.69
50 Cal.	106-5000 6.43	106-5000BK 43.48	106-5000D 6.06
54 Cal.	106-5400 6.80	-	106-5400D 6.43
58 Cal.	106-5800 7.17	-	106-5800D 6.80
12 Gauge	106-7300 9.39	-	106-7300D 9.02



Premium Lubed Patches- Pre-cut and pre-lubricated with Premium Lube™. Allows you to shoot many consecutive shots with NO CLEANING between shots and to do it with top accuracy. These patches will lube both inside and outside metal and wood parts.

Lubed Pillow Ticking - (Shown Above)

	Order No.	Price
.30-.39 Caliber Rifle/Pistol .018	106-3187	\$4.51
.40-.49 Caliber Rifle/Pistol .018	106-4187	4.58
.50-.59 Caliber Rifle/Pistol .018	106-5187	4.66

Lubed Shooting Patches -

	Order No.	Price
.30-.39 Caliber Rifle/Pistol .010	106-3105	\$4.36
.40-.49 Caliber Rifle/Pistol .010	106-4105	4.44
.50-.59 Caliber Rifle/Pistol .010	106-5105	4.51
.30-.39 Caliber Rifle/Pistol .015	106-3155	4.36
.40-.49 Caliber Rifle/Pistol .015	106-4155	4.44
.50-.59 Caliber Rifle/Pistol .015	106-5155	4.51

EMSS Premium Lube™- Has captured the attention of blackpowder shooters all over the world. Premium Lube's™ scent is a natural scent, so that it does not alert nature to man's presence. Available in 4 ounce container.
Order No. 106-5555 \$4.42



Eastern Maine Shooting Supplies Liquid Wonder Competition Patch Lube 8oz -

Order No. 106-425 \$3.33



Oiled Black Powder Patches- Pre-Oiled and ready for use, no further lube is needed.

	Order No.	Price
.30-.39 Caliber .015	106-3152	\$4.36
.40-.49 Caliber .015	106-4152	4.44
.50-.59 Caliber .015	106-5152	4.51
.40-.49 Caliber .010	106-4102	4.44
.50-.59 Caliber .010	106-5102	4.51



Black Powder Cleaning / Loading Kits- Solid Brass 3pc ram/cleaning rod, bronze brush, combo patch/ball puller, brass jag and muzzle guard. (Rods jointing threads are 5/16-27, accessories are threaded 10/32.)

	Order No.	Price
.45 CAL	106-BPK45	\$32.50
.50 CAL	106-BPK50	32.50
.54 CAL	106-BPK54	32.50
.58 CAL	106-BPK58	32.50

Traditions Historical Civil War Pieces

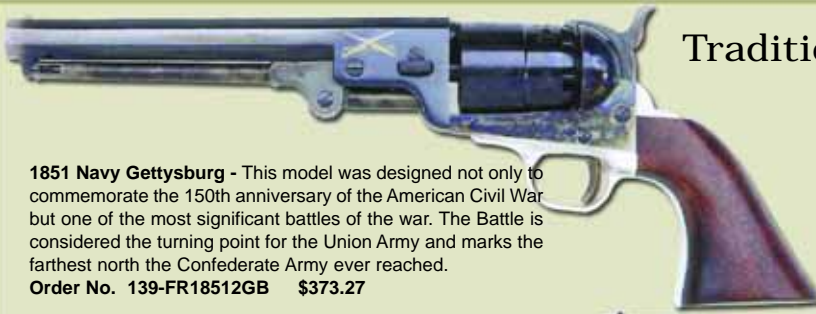

1851 Navy Gettysburg - This model was designed not only to commemorate the 150th anniversary of the American Civil War but one of the most significant battles of the war. The Battle is considered the turning point for the Union Army and marks the farthest north the Confederate Army ever reached.
Order No. 139-FR18512GB \$373.27



1851 Rebel Confederate - This brass frame Navy Type revolver is identified with the Confederate manufacturers Griswold & Gunnison and Leech & Rigdon. This model is being offered to commemorate the men and women of the Confederate Army who fought with great passion throughout the entire conflict. **Order No. 139-FR18515CW \$268.41**



50cal Pellet Shooters Kit - Includes: PowerBelt™ bullets, hollow point bullet starter, breech plug/nipple grease, magnum speed loaders (3), sabot shooter's solvent, cleaning patches, universal nipple pick, cleaning brush, breechbrush set (2), and instructional video. **Order No. 215-AA1716\$45.99**

Powder Horn- Fitted with carved wooden cap and stopper. Leather sling. **Order No. 215-AC1451A \$16.02**



Replacement Optima/Kodiak Forends - Forends For CVA Optima and Kodiak Muzzleloaders and Shotguns



Realtree **Order No. 215-AC28825 Price \$36.06**



Hoppes Muzzleloader BoreSnake

.50-.54 Cal Muzzleloading Rifle BoreSnake-

- Removes loose grit and abrasive contaminants prior to the scrubbing action of the brush.
- Removes hardened deposits with the finest, bench shooter specification, phosphor-bronze brushes.
- Cleans the bore with perfectly-sized floss providing 160 times more cloth than a patch.
- Prevents rust and corrosion with a few drops of gun oil applied to the trailing end of the cord.
- Removes metal fouling.

Order No. 060-24020 Price \$13.87

Blackpowder Adapters

If you're tired of trying to match brushes and tips to rods, Eastern Maine has solved the problem. This wide range of fine brass adapters should match just about any rod to any brush or tip.



ROD TYPE	From(Rod)	Order No.	To(Tip)	TIP, JAG & TYPE
Outers .22 rod	7-32	106-1342 \$2.22	8/32	Ox-Yoke, Kleen Bore, Pachmayr, Hoppes, Marble, Rig, Brite Bore
Ox-Yoke 3/8 dia. rod, Kleen Bore, Hoppes, Marble, Brite Bore	5/16-27	106-1340 \$2.22	8/32	Black powder Tips, Jags & Brushes: Check Mfg. Threads
Ox-Yoke 3/8 dia. rod, Kleen Bore, Hoppes, Marble, Brite Bore	5/16-27	106-1341 \$2.22	10/32	Black powder Tips, Jags & Brushes: Check Mfg. Threads
Ox-Yoke .22 Rifle rod, Kleen Bore, Hoppes, some T/C & CVA, Marble, Durango, Super Rod, Rig, Pachmayr, Brite Bore	8/32	106-1343 \$2.22	5/16-27	Shotgun brushes by: Ox-Yoke, Kleen Bore, Pachmayr, Hoppes, Marble, Rig, Brite Bore; check threads on Dewey. Black powder brushes by: Ox-Yoke, Hoppes, T/C
Ox-Yoke .22 Rifle rod, Kleen Bore, Hoppes, some T/C & CVA, Marble, Durango, Super Rod, Rig, Pachmayr, Brite Bore	8/32	106-1345 \$2.22	10/32	Black powder Tips, Jags & Specific Blackpowder Brushes: Check Mfg. Threads
Some T/C & CVA rods, Super Rod	10-32	106-1346 \$2.22	5/16-27	Shotgun brushes by: Ox-Yoke, Kleen Bore, Pachmayr, Hoppes, Marble, Rig, Brite Bore; check threads on Dewey. Black powder brushes by: Ox-Yoke, Hoppes, T/C
Some T/C & CVA rods, Super Rod	10-32	106-1347 \$2.22	8-32	Tips, Jags & Brushes by: Ox-Yoke, Kleen Bore, Pachmayr, Hoppes, Marble, Rig, Brite Bore, Outers Rifle and Pistol(except Outers .22)



Gunslick Rod Adapter- Blackpowder Adapter 8-32 to 10-32 **097-18002 \$1.82**



Traditions Muzzleloader Bullets

XTP Hunter Muzzleloader Bullets - Hornady's XTP Hollow Point. XTP™ Hunter by Hornady® jacket hollow point bullet. Terminal energy penetration, superb accuracy, balanced expansion. Gives you the best of both worlds by combining the performance of a pistol bullet with the challenge of muzzle-loader hunting. .50 caliber sabot with .44 caliber JHP bullet. 240 grains. 30 per pack.



	Order No.	Price
50cal Sabot, 240gr 45cal Hollow Point (20 pack)	139-A1498	\$14.29
50cal Sabot, 250gr 45cal Hollow Point (20 pack)	139-A1312	9.36
50cal Sabot, 300gr 45cal Hollow Point (20 pack)	139-A1494	10.39

Speer Muzzleloader Round Balls

	Order No.	Price
.350 Round Ball 64gr (100ea)	021-5110	\$8.61
.375 Round Ball 80gr (100ea)	021-5113	8.77
.433 Round Ball 120gr (100ea)	021-5127	10.35
.440 Round Ball 128gr (100ea)	021-5129	10.35
.445 Round Ball 133gr (100ea)	021-5131	11.36
.451 Round Ball 138gr (100ea)	021-5133	11.46
.454 Round Ball 141gr (100ea)	021-5135	11.46
.457 Round Ball 144gr (100ea)	021-5137	11.70
.490 Round Ball 177gr (100ea)	021-5139	12.82
.495 Round Ball 182gr (100ea)	021-5140	12.82
.530 Round Ball 224gr (100ea)	021-5142	14.66
.535 Round Ball 230gr (100ea)	021-5150	15.07
.570 Round Ball 278gr (50ea)	021-5180	8.97



Harvester Muzzleloader Bullets



Hornady XTP Bullets and Sabots

	Order No.	Price
.400 Dia 180gr Hornady XTP w/ 45 Cal Sabot (15)	072-XTP24518	\$9.82
.400 Dia 200gr Hornady XTP w/ 45 Cal Sabot (15)	072-XTP24520	10.08
.430 Dia 240gr Hornady XTP w/ 50 Cal Sabot (12)	072-XTP25024	7.90
.452 Dia 240gr Hornady XTP Mag w/ 50 Cal Sabot (12)	072-XTP25224	9.24
.452 Dia 250gr Hornady XTP w/ 50 Cal Sabot (12)	072-XTP25025	8.57
.452 Dia 300gr Hornady XTP Mag w/ 50 Cal Sabot (12)	072-XTP25030	9.74
.452 Dia 250gr Hornady XTP w/ 54 Cal Sabot (12)	072-XTP25425	8.57
.452 Dia 300gr Hornady XTP w/ 54 Cal Sabot (12)	072-XTP25430	9.74
.430 Dia 240gr Hornady XTP w/ 50 Cal Sabot (20)	072-XTP65024	10.00
.452 Dia 240gr Hornady XTP Mag w/ 50 Cal Sabot (20)	072-XTP65452	11.68

Scorpion Funnel Point Mag Bullets

.50 Cal Sabot .451 dia, 300 gr FP (12) Bullets & Sabots	072-H15030	\$8.90
.54 Cal Sabot .451 dia, 240 gr FP (12) Bullets & Sabots	072-H15424	8.40
.54 Cal Sabot .451 dia, 300 gr FP (12) Bullets & Sabots	072-H15430	9.08
.50 Cal Sabot .451 dia, 300 gr FP (20) Bullets & Sabots	072-H65030	10.50
.50 Cal Sabot .451 dia, 240 gr FP (30) Bullets & Sabots	072-H85024	12.26
.50 Cal Sabot .451 dia, 260 gr FP (30) Bullets & Sabots	072-H85026	12.26

Scorpion Polymer Tip Bullets

.50 Cal Sabot 260gr Poly Tip Bullet (12) Bullets & Sabots	072-H14026	\$11.92
.50 Cal Sabot 300gr Poly Tip Bullet (12) Bullets & Sabots	072-H14030	11.92

Hard Cast Lead Bullets

.50 Cal Sabot .429 dia, 280 gr Solid (20) Bullets & Sabots	072-H35028	\$8.90
.50 Cal Sabot .451 dia, 330 gr Solid (20) Bullets & Sabots	072-H35033	11.68
.50 Cal Sabot .451 dia, 400 gr Solid (20) Bullets & Sabots	072-H35040	11.84
.54 Cal Sabot .451 dia, 330 gr Solid (20) Bullets & Sabots	072-H35433	11.68
.54 Cal Sabot .451 dia, 400 gr Solid (20) Bullets & Sabots	072-H35440	11.84

Sabots Only

.45 Cal Sabot only, holds 40 cal bullet (50 Pack)	072-H4540B	\$5.55
.50 Cal Sabot only, holds 44 cal bullet (50 Pack)	072-H5044G	5.55
.50 Cal Sabot (Large Petal) only, holds 45cal bullet (50)	072-H5045LB	5.55
.50 Cal Sabot (Small Petal) only, holds 45 cal bullet (50)	072-H5045SB	5.55
.54 Cal Sabot only, holds 45 cal bullet (50 Pack)	072-H5445R	5.55

Harvester Crushed Rib High Pressure Sabots - Reduces loading friction up to 50% Excellent accuracy. 50 Per Bag \$6.39 a bag



	Order No.	Price
50cal Crush Rib Green Sabots Holds 44cal Bullets 50pk	072-H15044GR	
50cal Crush Black Sabots Holds 45cal Bullets 50pk	072-H15045BR	
45cal Crush Black Sabots Holds 40cal Bullets 50pk	072-H14540BR	
50cal Crush Red Sabots Holds 45cal Bullets 50pk (Smokeless)	072-H25045SRR	\$8.06

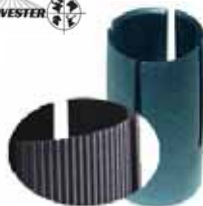

Belted Quality at a Better Price! Belted Muzzleloader Bullets! Affordable! Accurate! Expansion! Takedown Power! 15 per pack.

Sabertooth Belted Muzzleloader Bullets

	Order No.	Price
50cal 250gr	072-ST75025	\$12.77
50cal 270gr	072-ST75027	12.77
50cal 350gr	072-ST75035	12.78



Black Powder Handbook 2nd Edition - Written by Sam Fadala, this handbook includes pressure tested loads using Goex and Elephant black powders and Pyrodex Pellets. Complete editorial section includes topics on choosing your muzzleloader, building the best loads, propellants, ignition, maintenance, etc. Also includes a black powder cartridge section by Mike Venturino.
Order No. 015-9827100 \$14.14



Powerbelt Muzzleloader Bullets

PowerBelt Aerotip Platinum

Platinum finish for a harder exterior, faster velocity, making long distance shots about as accurate as you can get. Innovative gas check loads easy, and seals tight! 15 Bullets Per Package

	Order No.	Price
.45 Cal. 300 grain Aerotip Platinum	002-AC1545AT	\$22.93
.50 Cal. 270 grain Aerotip Platinum	002-AC1553AT	22.10
.50 Cal. 300 grain Aerotip Platinum	002-AC1554AT	22.10
.50 Cal. 338 grain Aerotip Platinum	002-AC1555AT	22.93



Ballistic Point PowerBelt

	Order No.	Price
.45 Cal. 195 grain Ballistic Point (15)	002-AC1584AT	\$17.07
.45 Cal. 225 grain Ballistic Point (15)	002-AC1593AT	18.93
.45 Cal. 275 grain Ballistic Point (15)	002-AC1594AT	19.69
.50 Cal. 223 grain Ballistic Point (15)	002-AC1583AT	16.73
.50 Cal. 245 grain Ballistic Point (15)	002-AC1589AT	17.69
.50 Cal. 295 grain Ballistic Point (15)	002-AC1595AT	19.69
.54 Cal. 295 grain Ballistic Point (15)	002-AC1575AT	18.86
.54 Cal. 348 grain Ballistic Point (15)	002-AC1597AT	19.69
.50 Cal. 245 grain Ballistic Point (50)	002-AC1589ATX	46.20
.50 Cal. 295 grain Ballistic Point (50)	002-AC1595ATX	49.30



PowerBelt Lead Bullets

	Order No.	Price
.50 Cal. 295 grain Hollow Point (20)	002-AC1598	\$16.18
.50 Cal. 348 grain Hollow Point (20)	002-AC1572	16.18
.50 Cal. 444 grain Flat Point (20)	002-AC1574	17.28



Copper Magnum PowerBelt Bullets

	Order No.	Price
.50 Cal. 245 grain Hollow Point (20)	002-AC1589	\$17.69
.50 Cal. 295 grain Hollow Point (20)	002-AC1595	19.69
.54 Cal. 295 grain Hollow Point (20)	002-AC1575	18.86
.45 Cal. 225 grain Hollow Point (20)	002-AC1593	18.93
.50 Cal. 245 grain Hollow Point (50)	002-AC1589X	41.59
.50 Cal. 295 grain Hollow Point (50)	002-AC1595X	44.68



The PowerBelt Bullet Starter - A must for shooters who are interested in maximizing accuracy with any hollow or polymer point bullet - including PowerBelt Bullets. Order No. 002-AC1500 \$12.37

Barnes Muzzleloader Bullets

Expander MZ

	Order No.	Price	Notes
45cal .400 Dia. 195 Gr (24)	035-40052	\$20.35	All come with Sabots
50cal .451 Dia. 245 Gr (24)	035-45142	21.46	
50cal .451 Dia. 250 Gr (24)	035-45152	21.83	
50cal .451 Dia. 285 Gr (24)	035-45154	22.20	
50cal .451 Dia. 300 Gr (24)	035-45162	23.68	
50cal .451 Dia. 250 Gr (24)	035-45180	23.68	
50cal .451 Dia. 290 Gr (24)	035-45190	25.15	
54cal .500 Dia. 275 Gr (24)	035-50052	22.56	
54cal .500 Dia. 325 Gr (24)	035-50054	24.42	



Muzzleloader Aligner Tool

Retains 100% of its original bullet weight while expanding along the engineered six-petal design.

	Order No.	Price
45 Cal Muzz. Aligner	035-04500	\$6.05
50 Cal Muzz. Aligner	035-05000	6.05
50 Cal Spitzer Muzz. Aligner	035-05005	6.05
50 Cal Spitzer TMZ Aligner	035-05007	6.05
54 Cal Muzz. Aligner	035-05400	6.05



Thompson Center Muzzleloader Bullets



Extreme Terminal Performance - Superior Accuracy with charges up to 150 grains of Black Powder or Pyrodex Equivalent (or 3 Pyrodex Pellets). Four flexible fingers which peel back - releasing the bullet quickly. Uses 240 grain XTP bullets for maximum expansion and down range energy at ranges up to 200 yards.

THOMPSON/CENTER	Order No.	Price
.50 Sabots 44Cal 240 grain XTP (30 per box)	030-8246	\$13.62
.50 Sabots 44Cal 300 grain W/sabots XTP(30 per box)	030-8294	13.62
.54 Sabots 45Cal 250 grain W/sabots XTP(30 per box)	030-8287	13.13
Sabots Only 50Cal Mag Express Green (50 per) (uses 44cal bullet)	030-8277	7.41
Sabots Only 50Cal Mag Express Black (50 per) (uses 45cal bullet)	030-8281	7.41



Cast Maxi-Balls and Maxi-Hunters - Precast from pure lead. These original T/C bullets are packaged 20 per box in .45, .50, and .54 caliber (15 per box in .58 caliber). All Maxi-Balls and Maxi-Hunters are pre-lubricated with Natural Lube 1000+.

	Order No.	Price
.50 Cal. (320 gr.) Maxi Balls(20)	030-7895	11.28
.50 Cal. (370 gr.) Maxi Balls(20)	030-7795	11.77
.58 Cal. (555 gr.) Maxi Balls(15)	030-7797	14.23
.50 Cal. (275 gr.) Maxi-Hunter(20)	030-7885	11.22
.50 Cal. (350 gr.) Maxi-Hunter(20)	030-7785	11.97

Cheap Shot Sabots - A more economical alternative to the jacketed bullets that are available. The all-lead 240 grain hollow point bullet provides the shooter with the same basic ballistics and trajectory. 20 all lead hollow point bullets and sabots. **Order No. 030-8296 \$5.51**



50cal Sure Fire Sabots 230gr- Economy Sabot providing shooters with the same ballistics and trajectory offered by the more premium Mag Express but at a fraction of the cost. Comes with a 44cal 230gr copper jacketed hollow point. **Order No. 030-8206 \$8.08**

Super 45 XR Sabots XTP™ Magnum - Superior accuracy at both standard and hyper velocities. Devastating at long ranges, mushrooms to nearly 2 times its original diameter. Driving penetration on the largest of game. Easy to load For use in .45 Cal. muzzleloaders, 180 grain XTP™ Bullet, Pkg of 30. **Order No. 030-7767 \$13.06**



Shock Wave Sabots - The Shock Wave™ is a spire point bullet with polymer tip specifically designed as a muzzleloading sabot bullet, not a conventional pistol bullet converted to a muzzleloading projectile. T/C's Shock Wave incorporates modern technology previously only applied to centerfire rifle bullets. The polymer tip of the Shock Wave™ bullet not only increases the Ballistic Coefficient for sustained high velocity down range, it punches into the pocket to open up the nose cone for fast expansion.

	Order No.	Price
50cal 200gr ShockWave (15)	030-8238	\$10.83
50cal 250gr ShockWave (30)	030-8236	18.06
50cal 300gr ShockWave (15)	030-8230	11.37
50cal 250gr ShockWave SuperGlide Sabot (15)	030-8208	11.56
50cal 300gr ShockWave SuperGlide Sabot (15)	030-8215	11.95



MMP High Pressure Sabots - These are the same High Pressure Sabots Savage packed with accessory kit and the sample pack! Fits .451dia & .452 dia Bullets 50 Caliber Black Sabots - 50 per bag **Order No. 211-50045HPH \$8.21**



MMP Sabots

MMP Standard 50 Cal Sabots - High Quality standard sabots. These are not the high pressure version commonly used in the Savage. Fits .451dia & .452 dia Bullets (180gr - 300gr) 50 Caliber Black Sabots - 50 per bag **Order No. 211-50045 \$6.25**

Hornady Muzzleloader Bullets

Hornady SST Muzzleloader Bullets Only

	Order No.	Price
45Cal .452dia 250gr. SST Bullet (50)	003-45202	\$23.55
45Cal .452dia 300gr. SST Bullet (50)	003-45207	24.66



Hornady SST and XTP Muzzleloader Bullets & Sabots

	Order No.	Price
45 Cal. w/.40 200 gr. SST Bullet (20)	003-67132	\$11.45
50 Cal. w/44 240 gr. JHP XTP Bullet (20)	003-6720	9.50
50 Cal. w/45 300 gr. XTP MAG Bullet (20)	003-6726	11.56
50 Cal. w/45 240 gr. XTP MAG Bullet (20)	003-6727	11.32
50 Cal. Sabot Only (Green), 50 per pack	003-6750	6.40
50 Cal. High Velocity Sabots Only (Black)(50)	003-6751	8.09
50 Cal. w/45 250 gr. SST Bullet (20)	003-67273	12.15
50 Cal. w/45 300 gr. SST Bullet (20)	003-67263	12.15



Hornady Lead Round Balls

	Order No.	Price
.310 Round Ball 100 per box	003-6000	\$7.36
.315 Round Ball 100 per box	003-6003	7.36
.350 Round Ball 100 per box	003-6010	7.36
.375 Round Ball 100 per box	003-6020	7.37
.395 Round Ball 100 per box	003-6025	8.21
.440 Round Ball 100 per box	003-6040	8.70
.445 Round Ball 100 per box	003-6050	9.97
.451 Round Ball 100 per box	003-6060	9.97
.454 Round Ball 100 per box	003-6070	9.97
.457 Round Ball 100 per box	003-6080	13.42
.490 Round Ball 100 per box	003-6090	10.94
.495 Round Ball 100 per box	003-6093	10.94
.530 Round Ball 100 per box	003-6100	12.85
.535 Round Ball 100 per box	003-6110	13.82
.570 Round Ball 50 per box	003-6120	7.63

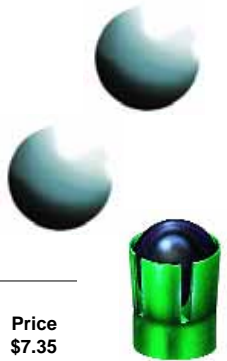

Hornady Hard Ball System

	Order No.	Price
.50 Caliber .485 Hard Ball System(20)	003-6950	\$7.35

Great Plains Maxi-Bullet for Muzzleloaders

	Order No.	Price
50 Cal. 385 grain HBHP(20)	003-6620	\$8.54
54 Cal. 425 grain HBHP(15)	003-6630	8.83



Flex Tip Blackpowder Bullets

Elastomer tip aids in expansion and clean kills. The FPB® requires a mere 25lbs of loading pressure, and no plastic skirt.

	Order No.	Price
50 Cal. 300 grain FPB (15)	003-6605	\$12.60
50 Cal. 350 grain FPB (15)	003-6600	13.69



Sabots Only! Various Brands



Order No.	Cal.	Use Bullet Dia	Color	Description	Brand	Price
003-6750	50 Cal	.430"	Green	Black Powder	Hornady	\$6.40
003-6751	50 Cal	.452"	Black	High Velocity	Hornady	8.09
072-H4540B	45 Cal	.40	Lt Blue	E-Z Load	Harvester	5.55
072-H5044G	50 Cal	.430"	Green	E-Z Load	Harvester	5.55
072-H5045LB	50 Cal	.451"	Black	Large Petal	Harvester	5.55
072-H5045SB	50 Cal	.451"	Black	Small Petal	Harvester	5.55
072-H5445R	54 Cal	.451"	Red	E-Z Load	Harvester	5.55
211-50045HPH	50 Cal	.451"/.452"	Black	High Pressure	MMP	8.21
211-50045	50 Cal	.451"/.452"	Black	Black Powder	MMP	6.25

PLEASE READ VERY IMPORTANT

NO RETURNS ON POWDER! PLEASE NOTE: TO PURCHASE POWDER, PRIMERS, OR AMMUNITION, WE MUST HAVE PROOF OF AGE. YOU MAY MAIL OR CALL THIS IN TO US. YOU MUST BE 21 YEARS OF AGE TO ORDER THESE ITEMS! \$25.00 Haz-Mat Fee applies to Primers, Percussion caps, Powder and Blackpowder substitutes shipments. PRICES SUBJECT TO CHANGE AT ANY TIME!

Hodgdon BlackPowder Substitute

Triple Seven Propellant and Pellets

Hodgdons all sulfurless, muzzleloading propellant

	Order No.	Price
Triple Seven FF	034-T72FF	\$21.52
Triple Seven FFF	034-T73FFF	21.52
Triple Seven Pellets! 45gr (50 per)	034-T74550	14.35
Triple Seven Pellets! 30gr (100 per)	034-T75030	24.73
Triple Seven Pellets! 50gr (100 per)	034-T75050	24.73



Pyrodex Powder

	Order No.	Price
Rifle/Shotgun Powder, 1 lb.	034-60221	\$15.09
Pistol Powder, 1 lb.	034-60224	15.09
Select Rifle Grade Powder, 1 lb.	034-60230	18.87

Pyrodex Pellets

	Order No.	Price
.44 Cal Pistol 30gr Pellets (100)	034-50511	\$15.17
.50 Caliber 50gr Pellets (100ea)	034-50500	22.34

FOR YOUR OWN PERSONAL SAFETY AND OTHER SAFETY ALSO, PLEASE NOTE: THERE ARE MAJOR DIFFERENCES IN BLACKPOWDER AND PYRODEX REPLICA BLACKPOWDER. Pyrodex is bulkier than blackpowder resulting in up to 25% more shots per pound! (Example: If you use 70 grains of blackpowder, the same measure setting would give you 58 grains of Pyrodex! Always consult a loading manual)

Haz-Mat Fee - Pyrodex powder and pellets and Triple 7 powder and pellets receive the \$25.00 haz-mat fee.

Western Powders Blackhorn 209



Blackhorn 209 is a revolutionary propellant that is redefining the term "accuracy" in the muzzleloading industry. When used as directed, this high performance powder consistently shoots with higher velocities and greater accuracy than other muzzleloading propellants. Blackhorn 209's proprietary formulation is engineered to eliminate swabbing and cleaning between shots. Precise accuracy, Higher velocities and ease of use insure Blackhorn 209 will bring out the best performance in your muzzleloading rifle.
Order No. 079-0480 \$24.27

#209 Shotshell Primers, Percussion & Musket Caps

#209 Shotshell Primers - All Primers Priced Per 1,000



	Order No.	Price
CCI - #209M Shotshell Primer	020-0009	\$25.69
Remington - #209Premier STS Shotshell Primers	150-22661	53.03
Federal - #209 Shotshell Primer	129-209A	26.02

RWS Percussion & Musket Caps - All Priced Per 1,000



These are shipped as Hazardous Material and receive the \$25.00 haz-mat fee. We must have Proof of Age in order to ship these.

	Order No.	Price
Dynamil Nobel Percussion Cap 1075 #11	062-2105209	\$71.49
Musket Cap 1081 4 Flange	062-2315820	80.29

RWS Percussion and Musket Caps must be shipped Via Fed-Ex Ground

CCI Percussion & Musket Caps - All Priced Per 1,000

These are shipped as Hazardous Material and receive the \$25.00 haz-mat fee. We must have Proof of Age in order to ship these.

	Order No.	Price
# 11 Percussion Caps	020-0311	\$39.60
#11M Percussion Caps	020-0310	42.04
#10 Percussion Caps	020-0309	39.60



CCI Percussion and Musket Caps must be shipped Via Fed-Ex Ground

Eastern Maine Utility Brushes -

Hundreds of uses. A must for every shooting/cleaning kit or box!

	Order No.	Price
Nylon	106-1230	\$2.94
Stainless Steel	106-1231	2.94

Thompson Center Gorilla Grease- anti seize breech plug thread grease -



Order No.	Price
030-7356	\$3.31

Markron Custom Bullet and Primer Sealer - At last! A product that seals and waterproofs all known metallic cartridges and primers for 100% firing consistency, including up to 30 days water submersion! Waterproofs: Cartridge primers, shot primers, bullet case joints, seals black powder nipples. Fast, Simple & Easy to use. One 1/3 oz. bottle seals approximately 1000 rounds. **Order No. 238-SEALER \$6.67**



Haz-Mat Fee Got You Down?

One of the biggest complaints we hear from reloaders is the dreaded Haz Fee. Midsouth in conjunction with FedEx on all FedEx Ground Hazardous fees has allowed us to have one of the cheapest fees in the country! All FedEx shipments will have a \$25.00 fee not including freight.
 Mix and Match Up-to 50lbs of Powder & Primers! We Ship them together! We ship up to 50lbs of Primers and Powder in the same box, under one Haz-Mat Charge.
 Midsouth's Powder & Primer Prices! We try hard to make sure we have the most competitive prices on all our products, especially Primers and Powder.
 Order Haz-Mat Items with friends and other shooters! If you don't need a full shipment of powder or primers, try ordering with a friend who reloads or fellow shooters at the range...etc. Midsouth will always try and make it work best for you!

Lee Lead Casting

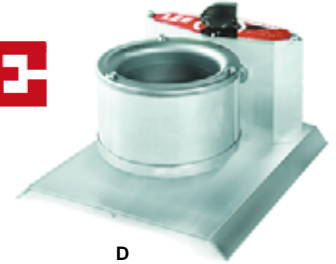
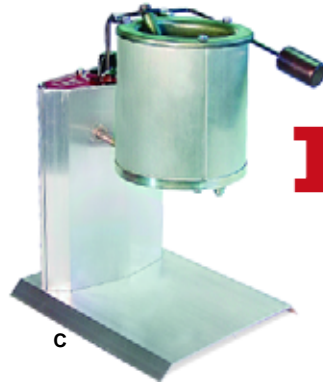
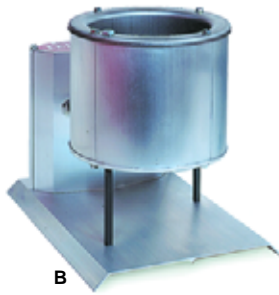

Pro 4-20(A) Large diameter high capacity pot, holds approximately 20 pounds of lead. A generous 4 inches of clearance under the spout accepts all brands of bullet molds and most sinker molds. It also includes an adjustable mold guide to quickly and accurately position any mold for pouring. Incorporates the famous Lee patented high-efficiency design and dependable remote sensing thermostat, now in a dust tight housing. Long life 700-watt tubular heating element assures quick melting and rapid recovery. Micro adjustable, flow control valve adjusts instantly with a twist of the screw driver. Front mounted low maintenance replaceable valve spout allows instant reseating with a turn of a screwdriver.

	Order No.	Price
Pro 4-20 Melter, 110 Volt	006-90947	\$63.04
Pro 4-20 Melter 220 Volt	006-90948	68.52

Prod. Pot IV (C) Four inches of clearance under the spout instead of the standard two inches. This is high enough to accept all brands of bullet moulds and most sinker moulds. The large deep pot holds approximately 10 pounds of lead. Melt time is less than 20 minutes. Pour spout up front where it belongs so you can see what you're doing. With a unique infinite highly reliable heat control that is mounted away from the high heat of the pot. Uses only 500 watts of power during heatup and a lot less to maintain temperature. Thermal feedback to the infinite control permits the heater to put out full power until the metal has melted. 2 year warranty!!

	Order No.	Price
Prod. Pot IV 110 volt	006-90009	\$54.81
Prod. Pot IV 220 volt	006-90008*	58.92

Magnum Melter (B) Large 4" diameter pot allows easy access for the ladle caster. Same high efficiency design that has made Lee pots the most popular. Melt time is less than 20 minutes with just 700 watts. 20-lb capacity for the longest casting session. **Order No. 006-90949 \$48.64**

Precision Melter (D) High speed melter with an infinite heat control for the serious shooter. Easily handles 4 cavity moulds. Takes less than 15 minutes to melt 4 pounds of metal. 500 watts, AC only. 2 year guarantee by Lee Precision. 110v **Order No. 006-90021 \$31.51**



Ingot Mould - The Ingot Mould makes 1 pound and 1/2 pound blocks, and comes with wooden handle. **Order No. 006-90029 \$10.56**

Lead Ladle - The Lead Ladle is a convenient size ladle for bullet casting and comes with wooden handle. **Order No. 006-90026 \$4.22**

Six Cavity Mould Handle - Precision steel mold handles fit not only the Lee Six Cavity blocks, but most other brands of one and two cavity molds. **Order No. 006-90005 \$12.68**



NRA Formula Alox® Beeswax Mix - Excellent for rifle and pistol bullets. The famous NRA formula reduces leading, increases accuracy, and permits higher velocities. Contains 50% alox 2138F lubricant and 50% commercial A-1 beeswax. **Order No. 006-90007 \$5.63**

Liquid Alox® Lubricant - Lee Liquid Alox Lube gives better accuracy and less leading than conventionally lubricated and sized bullets. Comes in a 4 ounce dispenser bottle. Easy and fast. **Order No. 006-90177 \$4.92**



Hardness Testing Kit - No more wasted components shooting too soft or too hard lead. Cast and load with confidence knowing your alloy is up to the job. Quickly and precisely check hardness of your lead alloy. Exclusive conversion chart tells the maximum operating pressure of any lead alloy.

Kit includes calibrated hardened steel ball indenter "v" block cradle snaps into standard press ram 20 power 4 lens optical measuring microscope.

Order No. 006-90924 Price \$56.41



Lee Lube and Sizing Kits - The fastest and easiest way to lubricate and size cast bullets. Standard 7/8x14 threads fit any reloading press. Bullets are pushed through the sizing die cone first so no special nose punches are needed. Sized bullets are captured in the special container. **\$16.91**

*Press sold separately below

Order No.		Order No.	
006-90049	.224 Kit	006-90047	.357 Kit
006-90036	.225 Kit	006-90048	.358 Kit
006-90083	.243 Kit	006-90060	.401 Kit
006-90170	.284 Kit	006-90052	.410 Kit
006-90171	.285 Kit	006-90053	.427 Kit
006-90037	.308 Kit	006-90054	.429 Kit
006-90038	.309 Kit	006-90062	.430 Kit
006-90039	.311 Kit	006-90061	.451 Kit
006-90044	.314 Kit	006-90055	.452 Kit
006-90686	.323 Kit	006-90056	.454 Kit
006-90934	.329 Kit	006-90057	.457 Kit
006-90046	.356 Kit		

Lee Reloader Press - Great addition to your Sizing Station, and an outstanding value! Exclusive balanced lever that can't drop down to pinch your fingers. Unlimited hand clearance that only "C" frame can offer. Works equally well with the right or left hand. Even if you already own a press, an exclusive press set up for only bullet sizing is the way to go!

Order No. 006-90045 \$27.49



Lead: Reducing Exposure

Lead contamination in the air, in dust, and on your skin is invisible. Keep children and pregnant women away during use and until cleanup is complete.

Risk can be reduced—but not eliminated—with strong ventilation; washing hands immediately after use of these products before eating or smoking; and careful cleaning of surfaces and floors with disposable wipes, after lead dust has had a chance to settle. Use a lead-specific cleaner with EDTA, or a high-phosphate detergent (like most detergents sold for electric dishwashers), and bag wipes for disposal.

Use Strong Ventilation!

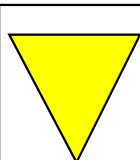

WARNING
THE USE OF CASTING PRODUCTS WILL EXPOSE YOU TO LEAD, A CHEMICAL KNOWN TO THE STATE OF CALIFORNIA TO CAUSE BIRTH DEFECTS AND CANCER. AVOID INHALING THE FUMES FROM MOLTEN LEAD. EXHAUST VENTILATION TO THE OUTSIDE AIR SHOULD BE PROVIDED WHENEVER THIS PRODUCT IS USED. WASH HANDS AFTER EXPOSURE AND BEFORE EATING, DRINKING OR SMOKING.



WARNING
 THE USE OF CASTING PRODUCTS WILL EXPOSE YOU TO LEAD, A CHEMICAL KNOWN TO THE STATE OF CALIFORNIA TO CAUSE BIRTH DEFECTS AND CANCER. AVOID INHALING THE FUMES FROM MOLTEN LEAD. EXHAUST VENTILATION TO THE OUTSIDE AIR SHOULD BE PROVIDED WHENEVER THIS PRODUCT IS USED. WASH HANDS AFTER EXPOSURE AND BEFORE EATING, DRINKING OR SMOKING.

LEE MOULD PRICES

MOULD	PRICE
DOUBLE CAVITY-	\$18.06
6-CAVITY-	\$36.85
HOLLOW POINT	\$18.76

All Lee Moulds come with handles except 6 Cavity Moulds

32/20
32 S&W Long
32 Colt NP

32 Special - 38 S&W - 38 Colt New Police

Works great in 9mm Luger

Ballistic Coefficient	.125	.174	.100	.106	.116	.142	.072	.072	.131	.117	.117	.207	.160
Double Cavity	311-93-1R	311-100-2R	TL314-90-SWC	358-105-SWC	358-125-RF	358-140-SWC	TL358-148WC	358-148-WC	358-150-1R	TL358-158-SWC	C358-158-SWC	TL358-158-2R	358-158-RF
6 Cavity	006-90300	006-90301	006-90301	006-90316	006-90574	006-90318	006-90279	006-90312	006-90328	006-90321	006-90322	006-90388	006-90303
	006-90308			006-90315	-	006-90317	006-90294	006-90380	006-90326	006-90295	006-90327	006-90319	006-90692

9mm Luger - 38 Super Auto - 380 Auto

9mm MAKAROV

40 S&W - 10mm

41 Magnum

44 Spec - 44 Mag - 44/40

Ballistic Coefficient	.105	.123	.164	.127	.166	.093	.117	.141	.110	.119	.111	.124	.124	
Double Cavity	356-102-1R	356-120-TC	TL356-124-2R	TL356-124-TC	356-125-2R	365-95-1R	401-145-SWC	TL401-175-SWC	401-175-TC	410-195-SWC	TL410-210-SWC	429-214-SWC	C429-240-SWC	429-200-RF
6 Cavity	006-90305	006-90239	006-90464	006-90238	006-90309	006-90466	006-90470	006-90431	006-90256	006-90330	006-90335	006-90336	006-90338	006-90285
	-	006-90387	006-90465	006-90402	006-90457	-	-	006-90433	006-90690	-	-	-	006-90483	006-90428

44 Spec - 44 Mag - 44/40

45 ACP - 45 Auto Rim - 45 Colt

Ballistic Coefficient	.196	.169	.218	.090	.127	.140	.127	.145	.189	.146	.146	.210	
Double Cavity	429-240-2R	TL430-240-SWC	C430-310-RF	452-160-RF	452-200-SWC	452-200-RF	TL452-200-SWC	452-228-1R	TL452-230-2R	TL452-230-TC	452-230-TC	452-252-SWC	452-255-RF
6 Cavity	006-90341	006-90299	006-90858	006-90570	006-90348	006-90234	006-90463	006-90351	006-90346	006-90287	006-90290	006-90356	006-90358
	006-90339	006-90357	006-90227	006-90570	006-90310	006-90697	006-90379	006-90352	006-90350	006-90286	006-90289	-	006-90349

45 Colt
454 Casull

480 Ruger
475 Linebaugh

500 S&W

7mm

30 Caliber Rifle

7.62x39

Ballistic Coefficient	.233	.256	.271	.296	.305	.199	.163	.264	.252	.268	.317	.352	.268	.276 CTL
Double Cavity	C452-300-RF	C476-325-RF	C476-400-RF	C501-440-RF	C285-130-R	C309-113-F	C309-120-R	C309-150-F	C309-160-R	C309-170-F	C309-180-R	C309-200-R	C312-155-2R	312-160-2R
6 Cavity	006-90359	006-90237	006-90241	006-90991	006-90360	006-90362	006-90364	006-90366	006-90367	006-90368	006-90369	006-90370	006-90385	006-90361
	006-90228													

Bullet Design by C.E. Harris

303 B

8mm

8x56

338Cal

375 Win
38/55

45-70 Caliber Rifle

Hollow Base

50-70 Cal

Ballistic Coefficient	.247	.216	.361	.250	.250	.211	.225	.250	.278	.443	.220	.283	
Double Cavity	C312-185-1R	C324-175-1R	C329-205-1R	C338-220-1R	379-250-RF	457-340-F	457-405-F	459-405-HB	457-450-F	C457-500-F	459-500-3R	515-450-F	515-500-F
Hollow Point/Base	006-90371	006-90274	006-90775	006-90372	006-90324	006-90373	006-90374	006-90268	006-90375	006-90376	006-90577	006-90255	006-90266

Lee Improved Mould Traditional Design

Cast minie bullets as fast as round balls. These moulds have the automatic core pin. Open the mould upside down to empty. Close it and you are ready to cast the next. The core pin automatically centers in the mould. Easily cast 200 bullets per hour. A quality mould built to last as long as your rifle. OS IS FOR OVERSIZED.

	Order No.	Price
45 Caliber .450-294M	006-90467	\$18.76
45 Caliber OS .454-298M	006-90469	18.76
50 Caliber .500-360M	006-90472	18.76
54 Caliber .533-410M	006-90473	18.76
54 Caliber OS .540-415M	006-90474	18.76
58 Caliber .575-472M	006-90476	18.76
58 Caliber OS .578-478M	006-90478	18.76

Lee Minie Moulds

	Order No.	Price
58 Caliber .575-500M	006-90481	\$18.76

Lee Modern Minie Target Design

The most accurate of all Minies. Makes nice, clean holes in the target. The first choice for highest scores.

	Order No.	Price
50 Caliber .500-354M	006-90471	\$18.76
58 Caliber .575-470M	006-90475	18.76

Real Bullet Moulds for Muzzleloaders

*REAL MEANS RIFLE ENGRAVED AT LOADING. A solid bullet that loads easily even after many firings, because of its unique cleaning action. Will not tumble. A perfect hunting bullet with heavy loads. Easy to cast. Shoots accurately even in greatly oversized barrels. ALSO AVAILABLE is the combo mould with a REAL bullet and one round ball as noted.

Double Cavity REAL Moulds

	Order No.	Price
45 Caliber 200 grain	006-90390	\$18.06
45 Caliber 250 grain	006-90392	18.06
50 Caliber 250 grain	006-90394	18.06
50 Caliber 320 grain	006-90396	18.06
54 Caliber 300 grain	006-90398	18.06
54 Caliber 380 grain	006-90400	18.06
58 Caliber 440 grain	006-90404	18.06

Combo Moulds

	Order No.	Price
.440 dia. RB & 200 gr. Real	006-90405	\$18.06
.490 dia. RB & 320 gr. Real	006-90488	18.06

Lee Shotgun Moulds

	Order No.	Price
1 oz. Shotgun Slug Mould	006-90281	\$19.45
7/8 oz. Shotgun Slug Mould	006-90282	19.45

18 Cavity 00 Buckshot Bullet Mold

Eighteen cavity 00 Buckshot mold. Precision-machined mold produces 18 linked pellets per cast. No need to individually count pellets simply snip three strands into your 12 gauge shell. Each cast produces enough pellets to load two 12 Gauge shotshells. Ball diameter .330.

Order No. 006-90486 \$43.80

Handles not included.



LEE

Lee Conical Bullet Mould for Black Powder Revolvers

A super accurate bullet that is easy to load straight and true. The base of the bullet slips into the chamber while the next two lands guide and seal with a perfect press fit. Two lube grooves prevent flash ignition and lead fouling. More energy and far greater accuracy than round balls.



Lee Double Cavity Conical Bullet Moulds

	Order No.	Price
36 Cal .375-130-1R	006-90378	\$18.06
44 Cal Remington .450-200-1R	006-90382	18.06
44 Ruger Old Army .456-220-1R	006-90384	18.06

We also carry Special Order Moulds!

See Website for listings!

Lee Bullet Moulds for Round Balls

SINGLE CAVITY \$18.06 (*\$18.06)

Order No.		Order No.	
006-90410*	.319	006-90452	.500
006-90415*	.350	006-90454	.530
006-90418	.360	006-90461*	.575
006-90424	.390	006-90975*	.600
006-90425*	.395	006-90978*	.690

DOUBLE CAVITY \$18.06

Order No.	
006-90406	.311
006-90420	.375
006-90436	.440
006-90438	.445
006-90440	.451
006-90442	.454
006-90444	.457
006-90448	.490
006-90450	.495
006-90456	.535
006-90283	.530
006-90460	.562

WARNING

THE USE OF CASTING PRODUCTS WILL EXPOSE YOU TO LEAD, A CHEMICAL KNOWN TO THE STATE OF CALIFORNIA TO CAUSE BIRTH DEFECTS AND CANCER. AVOID INHALING THE FUMES FROM MOLTEN LEAD. EXHAUST VENTILATION TO THE OUTSIDE AIR SHOULD BE PROVIDED WHENEVER THIS PRODUCT IS USED. WASH HANDS AFTER EXPOSURE AND BEFORE EATING, DRINKING OR SMOKING.

Miscellaneous Lead Casting Supplies

Marvelux 1/2 LB Flux - Finest bullet casting flux available. Reduces dross formation. Increases alloy fluidity. Non-Corrosive - Non-Smoking.
Order No. 048-083030050 \$6.54



Universal Case Expanding Die - Gently flares the case mouth to accept cast bullets without shaving. (Also works great on Moly and Jacketed bullets as well) Includes neck plugs for .22 cal through .45 cal) Works on everything from the 22 Hornet to the largest Ultra Mag
Order No. 006-90798 \$11.97



The SAECO Lead Hardness Tester - A precision instrument which accurately determines the hardness of a bullet casting alloy. The SAECO Lead Hardness Tester pays for itself by allowing you to convert scrap lead into casting alloy.
Order No. 076-42000 Price \$143.81

SAECO Mould Handles

Ductile iron castings with hardwood grips. Fit all SAECO moulds 1-8 cavity.



Order No. 076-29000 \$39.40



Frankford Arsenal Drop Out Mold Release When applied sparingly, provides a thin dry film coating of micron-sized graphite. It's Easy to Apply, Fast Drying, and Long Lasting!
Order No. 094-763758 Price \$9.50

Bullet Casting 101 DVD - This DVD video takes you step by step on how to cast your own bullets. From the equipment to sizing, it is all right here in this video.



Order No. 144-54410 \$19.14

Hornady Crimp-On Gas Checks

Priced per 1000



	Order No.	Price
22 Cal	003-7010	\$22.86
25 Cal	003-7030	24.05
6mm	003-7020	23.65
6.5mm Cal	003-7040	23.70
270 Cal	003-7050	24.69
7mm Cal	003-7060	27.97
30 Cal	003-7070	27.31
32 Cal	003-7080	29.00
338 Cal	003-7090	25.99
348 Cal	003-7100	30.56
35 Cal	003-7110	24.38
375 Cal	003-7120	30.46
416 Cal	003-7125	34.26
44 Cal	003-7130	33.38
45 Cal	003-7140	35.08
475/480 Cal	003-7145	37.03
50 Cal	003-7150	51.99

BEFORE SIZING ON BULLETS



AFTER SIZING ON BULLETS





Pistol

	.30		.32		9mm			.38/.357					
Bullet Number	311252	313249	356242	356402	356242	356637	358091	358477	358156	358665			
Weight (#2 Alloy)	75 gr.	85 gr.	90 gr.	120 gr.	120 gr.	147 gr.	150 gr.	150 gr.	155 gr.	158 gr.			
Double Cavity Part #	2660252	2660249	2661242	2660402	2660242	2660637	2660091	2660477	2660156	2660665			
Top Punch Number	465	226	311	402	311	637	495	429	429	495			
Top Punch Part #	2786742	2786703	2786710	2786723	2786710	2786749	2786769	2786731	2786731	2786769			
Four Cavity Part #	-	-	-	2670402	-	2670637	2670091	2670477	2670156	2670665			

Pistol

	.38/.357			40 S&W/10mm		.38/40	.44/40	
Bullet Number	358311	358429	358430	401654	401638	401043	427666	427098
Weight (#2 Alloy)	160 gr.	170 gr.	195 gr.	150 gr.	175 gr.	175 gr.	200 gr.	205 gr.
Double Cavity Part #	2660311	2660429	2660430	2660654	2660638	2660043	2660666	2660098
Top Punch Number	311	429	430	43	43	43	649	43
Top Punch Part #	2786710	2786731	2786732	2786691	2786691	2786691	2786778	2786691
Four Cavity Part #	2670311	2670429	-	-	2670638	-	2670666	-

Pistol

	500 S&W	.44 & .44 mag			.45 Auto	
Bullet Number	501680	429215	429667	429421	429383	429244
Weight (#2 Alloy)	375 gr.	210 gr.	240 gr.	245 gr.	245 gr.	255 gr.
Double Cavity Part #	2640680*	2660215	2660667	2660421	2660638	2660244
Top Punch Number	649	421	649	421	251	421
Top Punch Part #	2786778	2786729	2786778	2786729	2786704	2786729
Four Cavity Part #	-	2670215	2670667	2670421	-	2670244

*Single Cavity

Pistol

	.45 Colt		.45			Devastator Hollow Point Moulds		
Bullet Number	454190	452664	452424	452490	452651	356637	429640	452374
Weight (#2 Alloy)	250 gr.	250 gr.	255 gr.	255 gr.	325 gr.	125 gr.	250 gr.	180 gr.
Double Cavity Part #	2660190	2660664	2660422	2660490	2660651	2650637	2650640	2650374
Top Punch Number	190	649	424	424	649	637	649	374
Top Punch Part #	2786700	2786778	2786730	2786730	2786778	2786749	2786778	2786719
Four Cavity Part #	-	2670664	-	-	-	-	-	-

Mould Key

- ★ Indicates single cavity.
- Uses 30Cal GasChecks
- ★ Indicates Cowboy Action Moulds
- Bullets which should do well on silhouettes and have won many matches.

Round Ball Volume Casting

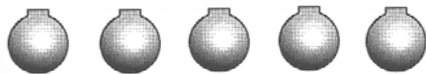

THESE SINGLE & DOUBLE CAVITY MOULDS REQUIRE DOUBLE CAVITY HANDLES!

SINGLE CAVITY		DOUBLE CAVITY	
Order No.	Dia	Order No.	Dia
015-2645530	.530	015-2665375	.375
015-2645535	.535	015-2665440	.440
015-2645570	.570	015-2665445	.445
015-2645600	.600	015-2665451	.451
015-2645662	.662	015-2665454	.454
015-2645690	.690	015-2665457	.457
015-2645715	.715	015-2665490	.490
		015-2665495	.495

Slug and Sabot Slug Moulds

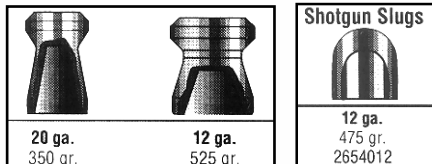

Order No.	Price
015-2654012	\$55.57
015-2654112	55.57
015-2654120	55.57

WARNING
THE USE OF CASTING PRODUCTS WILL EXPOSE YOU TO LEAD, A CHEMICAL KNOWN TO THE STATE OF CALIFORNIA TO CAUSE BIRTH DEFECTS AND CANCER. AVOID INHALING THE FUMES FROM MOLTEN LEAD. EXHAUST VENTILATION TO THE OUTSIDE AIR SHOULD BE PROVIDED WHENEVER THIS PRODUCT IS USED. WASH HANDS AFTER EXPOSURE AND BEFORE EATING, DRINKING OR SMOKING.

Lyman Gas Checks

These gilding metal caps fit the bullet case and protect it from the hot powder gases. Easily seated during bullet sizing, the gas checks also permit higher velocities. Priced per 1000!!



	Order No.	Price
.22 Gas Checks	015-2827261	35.36
.25 Gas Checks	015-2827263	35.36
.264 Gas Checks	015-2827264	35.36
.7mm Gas Checks	015-2827266	37.93
.30 Gas Checks	015-2827267	37.93
.32 Gas Checks	015-2827268	37.93
.35 Gas Checks	015-2827270	37.93
.44 Gas Checks	015-2827272	48.76
.45 Gas Checks	015-2827273	48.76



Rifle

	.22			.25	6.5mm		7mm		.30M1/ 7.62x39mm	.30		
Bullet Number	225438	225415	225646	257420	266469	266673	287346	287641	311359	311672	311291	311041
Weight (#2 Alloy)	44 gr.	55 gr.	55 gr.	65 gr.	140 gr.	150 gr.	135 gr.	160 gr.	115 gr.	160 gr.	170 gr.	173 gr.
Mould #	2660438	2660415	2660646	2660420	2660469	2660673	2660346	2660641	2660359	2660672	2660291	2660041
Top Punch Number	438	415	646	420	463	641	346	641	359	644	465	8
Top Punch Part #	2786733	2786726	2786759	2786728	2786741	2786753	2786715	2786753	2786772	2786758	2786742	2786690

Rifle

	.30				32/20	.314 dia	32/40	8mm	.35	.375/ .38-55	.378/★ .38-55	.40 Cal. .406 dia.	.40Cal. .410dia★	
Bullet Number	311332	311644	311299	311284	311008	314299	319247	323470	358315	375248	375449	378674	403169	410655
Weight (#2 Alloy)	180 gr.	190 gr.	200 gr.	210 gr.	115 gr.	200 gr.	165 gr.	165 gr.	204 gr.	249 gr.	264 gr.	335 gr.	240 gr.	400 gr.
Mould #	2660332	2660644	2661299	2660284	2660008	2660299	2660247	2660470	2660315	2660248	2660449	2640674	2660169	2640655
Top Punch Number	413	644	467	284	8	467	8	470	311	449	449	663	43	449
Top Punch Part #	2786725	2786758	2786743	2786707	2786690	2786743	2786690	2786745	2786710	2786736	2786736	2786779	2786691	2786736

Rifle

	.40 Cal. .410dia★	40 Cal. Snover .410★	43 Span. ★	43 Mauser ★	45	H.P.	★	★	★	★	★	★	★	★	.50
Bullet Number	410660	410663	439186	446110	457191	457122	457124	457643	457193	457671	457658	457125	457132	515141	
Weight (#2 Alloy)	385 gr.	400 gr.	370 gr.	340 gr.	292 gr.	330 gr.	385 gr.	400 gr.	405 gr.	475 gr.	480 gr.	500 gr.	535 gr.	425 gr.	
Mould #	2640660	2640663	2640186	2640110	2640191	2650122	2640124	2640643	2640193	2640671	2640658	2640125	2640132	2640141	
Top Punch Number	658	663	251	251	191	191	374	191	191	374	658	374	132	141	
Top Punch Part #	2786755	2786779	2786704	2786704	2786701	2786701	2786719	2786701	2786701	2786719	2786755	2786719	2786695	2786696	

Plains Bullets

Minie Ball

Maxi Ball

	Volunteer .451	Whitworth .45	.50	.54	.54	.58	Old Style	New Style	Parker Hale	Blue-Grey Target	New 69 Musket	.45	.50	
Bullet #	451114	457121PH	508656	548657	542622	575494	575213-0S	575213	575213PH	577611	578675	68569	454616	504617
Wt.(Lead)	450 gr.	475 gr.	395 gr.	450 gr.	425 gr.	315 gr.	460 gr.	510 gr.	566 gr.	530 gr.	405 gr.	730 gr.	245 gr.	370 gr.
Mould #	2641114	2641121	2654656	2654657	2654622	2654494	2654213	2651213	2650213	2654611	2654675	2654569	2640616	2640617
Handles#	2735793	2735793	2735793	2735793	2735793	2735793	2735793	2735793	2735793	2735793	2735793	2735793	2735793	2735793

Lyman Mould Prices

Lyman moulds are still individually machined from high grade steel. Blocks are hand fit for precision alignment. You Must Order Lyman Moulds & Handles Separately!!

LYMAN MOULD PRICES
WHEN ORDERING A LYMAN MOULD OR TOP PUNCH, PLEASE ADD THE PREFIX "015" TO THE PART NUMBER

All Single Cavity Moulds	Price \$55.57
All Double Cavity Moulds	55.57
All Four Cavity Moulds	75.37



Lyman Mould Handles

Solid metal frame is easily attached to blocks with slotted screws. Hardwood handles provide a cool secure grip. Designed to provide uniform grip with different mould blocks. Lyman mould handles are offered in two sizes. Large, for all current two cavity moulds, current single cavity round ball moulds, and all current Minie and Maxi moulds. Four Cavity, for all Lyman four cavity moulds.

Order No.	Price
Large Mould Handles 015-2735793	\$30.79
4 Cavity Mould Handles 015-2735794	30.79

WARNING
THE USE OF CASTING PRODUCTS WILL EXPOSE YOU TO LEAD, A CHEMICAL KNOWN TO THE STATE OF CALIFORNIA TO CAUSE BIRTH DEFECTS AND CANCER. AVOID INHALING THE FUMES FROM MOLTEN LEAD. EXHAUST VENTILATION TO THE OUTSIDE AIR SHOULD BE PROVIDED WHENEVER THIS PRODUCT IS USED. WASH HANDS AFTER EXPOSURE AND BEFORE EATING, DRINKING OR SMOKING.

Lyman Casting Accessories



Ingot Mould- Lyman's ingot mould is useful when melting down scrap lead or when blending alloys. Each mould forms four easy-to-use ingots.
Order No. 015-2837794 \$17.89

10lbs Cast Iron Lead Pot - Now use any source to melt lead. With convenient pour spout and flat bottom to prevent spilling. **Order No. 015-2867795 \$13.58**

Casting Dipper - Now the dipper can be assembled for right or left handed casters. Dipper with cast iron head is shaped for easy, accurate pouring and prevents air pockets in the finished bullet.
Order No. 015-2867790 \$16.25

Stainless Steel Thermometer- Measure a temperature range from 200°F to 1000°F and has a six inch stem for use with even the deepest furnaces
Order No. 015-2867793 \$34.37

Gas Check Seater (for 450 Bullet Sizer Lubricators)
Order No. 015-2745881 \$7.53

Lyman Master Casting Kit

Comes with the 4500 Lubricator/Sizer!



Complete Casting Kit - This is the perfect kit for the beginner or expert reloader. Save over 20% by purchasing this kit over individual prices. Comes with Mini-Mag 10 pound furnace, the 4500 Lube Sizer, lead dipper, ingot mould and Lyman's famous Cast Bullet Handbook. All this for less than the cost of most furnaces. **Order No. 015-2712000 \$179.18**

WARNING

THE USE OF CASTING PRODUCTS WILL EXPOSE YOU TO LEAD, A CHEMICAL KNOWN TO THE STATE OF CALIFORNIA TO CAUSE BIRTH DEFECTS AND CANCER. AVOID INHALING THE FUMES FROM MOLTEN LEAD. EXHAUST VENTILATION TO THE OUTSIDE AIR SHOULD BE PROVIDED WHENEVER THIS PRODUCT IS USED. WASH HANDS AFTER EXPOSURE AND BEFORE EATING, DRINKING OR SMOKING.

FOR ALL TECHNICAL ADVICE AND QUESTIONS PERTAINING TO DIES, MOULDS, RELOADERS, CASTERS, MUZZLELOADERS, FIT, GUARANTEE, ETC. ON LYMAN PRODUCTS, CALL LYMAN CUSTOMER SERVICE 1-800 22L-YMAN (800-225-9626)

Lyman Furnaces and Heaters

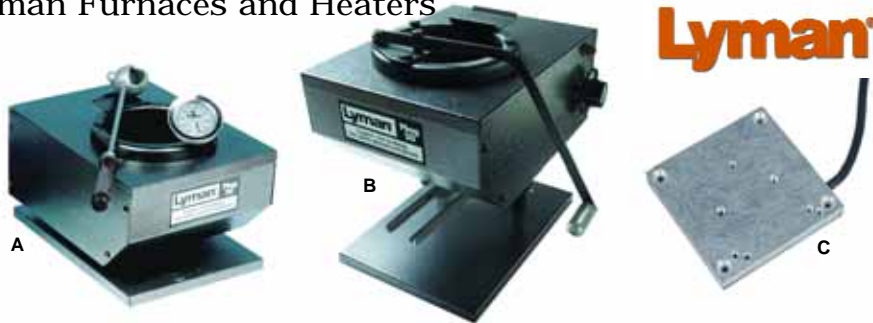

A - The Lyman Mag Dipper - Designed for the ladle-caster only, the Magdipper has the full 20 lb. capacity, the proven heating system, body construction and wide, tip-resistant base of the Mag 20. Larger casting ladles have easy access to the 4 3/8" diameter pot. **Order No. 015-2800061 \$250.87**

B - The Lyman Mag 20 Furnace - Offers important features, advantages and value for bullet casters. The large 20 lb. steel crucible provides the capacity for all casting needs...from single cavity to multiple cavity moulds. It incorporates the proven Lyman bottom-pour valve system and unique mould guide for optimum convenience. Its set screw adjustability accommodates virtually all mould set-ups. Available in 110V.
Order No. 015-2800067 \$304.64

C - LUBE SIZER HEATER - Attaches directly to your Lyman #450, RCBS, SAECO, or STAR lubricator-sizers. Designed for use with hard stick lubes! 110V **Order No. 015-2745885 \$45.84**

Lyman Bullet Lubes



Orange Magic- High performance lube guarantees higher velocity with cast bullets without leading. Low smoke output. Requires use of heater.
Order No. 015-2857286 \$3.69



Alox- Bullet lubricant improves accuracy and prevent barrel leading at higher velocities.
Order No. 015-2857277 \$3.69



Super Moly - An all purpose, high temperature bullet lubricant. With Molydendum Disulfide added for increased velocity, it coats the barrel with a fine flim which improves accuracy and makes leading non-existent. It flows through lube sizers without heat and won't melt at 130 degrees. **Order No. 015-2857272 \$3.69**



Lyman
"Big Dipper"
Electric Casting Furnace -
 Economical electric casting furnace has more than 10 lb. Capacity.

Features fast heat-up time with thermostat control to +/- 10 degrees. Easy "on-off" temperature dial. Compact size with wide mouth for easy lading. Heavy duty aluminum construction with stable non-tip design.

Order No. 015-2800350 \$32.94



"Big Dipper" Casting Starter Kit - Features all the items needed to get started in casting bullets economically and efficiently. Includes "Big Dipper" electric casting furnace with 10+ lbs capacity, Lyman Casting Dipper, Ingot Mold for storing excess lead, Super Moly Bullet Lube and the Lyman Reloading and Cast Bullet Guide.

Order No. 015-2800375 \$68.07

Lyman Cast Bullet Handbook - The pioneer of reloading manuals - will introduce the 4th Edition of their popular Cast Bullet handbook. This will be the first new Cast Bullet Handbook from Lyman in 30 years!

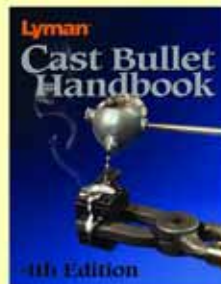

It will include data for all Lyman Moulds, plus additional data for select RCBS, Redding and Lee Moulds. Written by well-known cast bullet authority, Mike Venturino, this will be the most up-to-date and comprehensive cast bullet data available.

Order No. 015-9817004 \$18.00

Casting Dipper -



Now the dipper can be assembled for right or left handed casters. Dipper with cast iron head is shaped for easy, accurate pouring and prevents air pockets in the finished bullet.

Order No. 015-2867790 \$16.25

10lbs Cast Iron Lead Pot - Now use any source to melt lead. With convenient pour spout and flat bottom to prevent spilling.
Order No. 015-2867795 \$13.58



4500 Sizer/Lubricator

Lyman's 4500 Lubricator/Sizer simultaneously sizes and lubricates cast bullets to the desired diameter. Features a solid one piece bottom - ideal for use with hard lubricants. A larger ball knob for more leverage for sizing and lubricating the largest bullets. Easy adjustments for size depth and lube flow. Purchase desired H&I size die and top punches listed below. Available with or without lubricator heater. Note: 4500 Lube heater not adaptable to model 450 Lube/Sizer.



Includes Moly bullet lube & Gas Check Seater.

	Order No.	Price
4500 Lube Sizer	015-2745880	\$150.51
4500 with 110v Heater	015-2745892	157.68
4500 110v Heating Element	015-2745896	31.51

Top Punches

The inside contour of each top punch is precisely machined to fit bullet nose shape exactly. This eliminates most deformation when the top punch forces a bullet down into the sizing die. \$7.91 each



Order No.	Punch/Cal.	Order No.	Punch/Cal.
015-2786690	#8	015-2786729	#421
015-2786691	#43	015-2786730	#424
015-2786754	#93	015-2786731	#429
015-2786695	#132	015-2786732	#430
015-2786696	#141	015-2786733	#438
015-2786700	#190	015-2786736	#449
015-2786701	#191	015-2786740	#460
015-2786748	#203	015-2786741	#463
015-2786703	#226	015-2786742	#465
015-2786704	#251	015-2786743	#467
015-2786707	#284	015-2786745	#470
015-2786709	#303	015-2786769	#495
015-2786710	#311	015-2786749	#637
015-2786715	#346	015-2786753	#641
015-2786772	#359	015-2786758	#644
015-2786719	#374	015-2786759	#646
015-2786723	#402	015-2786778	#649
015-2786725	#413	015-2786755	#658
015-2786726	#415	015-2786779	#663
015-2786728	#420	015-2786781	#677
		015-2786785	#678

H&I Sizer Dies \$21.64 each

Order No.	Size by Diameter	Order No.	Size by Diameter
015-2766462	.224	015-2766494	.359
015-2766463	.225	015-2766495	.360
015-2766542	.243	015-2766559	.363
015-2766465	.244	015-2766497	.375
015-2766460	.251	015-2766527	.377
015-2766466	.257	015-2766524	.378
015-2766467	.258	015-2766498	.379
015-2766543	.264	015-2766501	.400
015-2766470	.266	015-2766502	.401
015-2766551	.277	015-2766504	.406
015-2766471	.278	015-2766548	.408
015-2766552	.284	015-2766550	.409
015-2766473	.285	015-2766505	.410
015-2766476	.308	015-2766508	.427
015-2766477	.309	015-2766537	.428
015-2766478	.310	015-2766509	.429
015-2766479	.311	015-2766510	.430
015-2766528	.312	015-2766511	.431
015-2766480	.313	015-2766541	.439
015-2766553	.314	015-2766513	.446
015-2766485	.321	015-2766514	.450
015-2766486	.323	015-2766515	.451
015-2766487	.325	015-2766516	.452
015-2766488	.338	015-2766517	.454
015-2766534	.354	015-2766519	.457
015-2766490	.355	015-2766535	.458
015-2766491	.356	015-2766530	.459
015-2766492	.357	015-2766520	.509
015-2766493	.358	015-2766521	.512

Pro-Melt Furnace



The heavy duty Pro-Melt furnace features an 800 watt heating element. 110V and a snap action, industrial quality thermostat. For added accuracy and responsiveness, the thermostat is coupled to a remote sensor on the bottom surface of the pot. Can be set up for either left or right hand operation. Capacity is 22 pounds. UL listed.

	Order No.	Price
Pro-Melt Furnace(110v)	044-81100	\$360.59
Pro-Melt Furnace(220v)	044-81200	371.76

RCBS Casting Accessories



Lead Dipper - has a large capacity bowl, tapered pouring spout and a hardwood grip.

Order No. 044-80015 Price \$22.42

Lead Pot - made of heavy duty cast iron, will hold up to 10 pounds of molten metal.

Order No. 044-80010 Price \$18.34

Mould Ingot - mould up to 4 ingots at once and cool them quickly with the handy ingot mould.

Order No. 044-80005 Price \$18.34

Lead Thermometer - With a 1000 F range and plus or minus 1% accuracy. Pour lead at the optimum temperature! Large numbers printed on 1 1/2" glass covered face with a 6" probe. Great for use with any melting pot! Comes with an adjustable 6" handle (prevents burning of fingers). Order No. 044-81175 \$45.61

Mould Mallet - RCBS® has reintroduced the wooden mould mallet to tap out your cast lead bullets without harming your moulds. Order No. 044-80007 \$9.96

WARNING

THE USE OF CASTING PRODUCTS WILL EXPOSE YOU TO LEAD, A CHEMICAL KNOWN TO THE STATE OF CALIFORNIA TO CAUSE BIRTH DEFECTS AND CANCER. AVOID INHALING THE FUMES FROM MOLTEN LEAD. EXHAUST VENTILATION TO THE OUTSIDE AIR SHOULD BE PROVIDED WHENEVER THIS PRODUCT IS USED. WASH HANDS AFTER EXPOSURE AND BEFORE EATING, DRINKING OR SMOKING.

Lube-A-Matic 2 Bullet Sizer-Lubricator



Size and lubricate cast bullets in one step. Just insert a bullet in the sizer die and pull the handle. You must order sizer dies and top punches separately. Also great for seating gas checks!

*See the mould page for sizer dies and top punches.

	Order No.	Price
Lube-A-Matic 2 Sizer	044-80040	\$162.11
Dust Cover	044-86880	8.90

RCBS Bullet Lubes

	Order No.	Price
Pistol Bullet Lube(stick)	044-80008	\$4.52
Rifle Bullet Lube (stick)	044-80009	4.52

Alternate Bullet Cast Bullet Sizers

*All other Sizer Dies are listed on the Bullet mould pages beneath the appropriate mould.

Caliber	Size	Sizer Die	Part No.	Price
22	.224"	.224" dia.	044-82200	\$24.89
6mm	.243"	.243" dia.	044-82201	\$24.89
6mm	.244"	.244" dia.	044-82202	\$24.89
25	.257"	.257" dia.	044-82203	\$24.89
270	.277"	.277" dia.	044-82205	\$24.89
7mm	.284"	.284" dia.	044-82208	\$24.89
30	.308"	.308" dia.	044-82211	\$24.89
30	.310"	.310" dia.	044-82213	\$24.89
30	.311"	.311" dia.	044-82214	\$24.89
32	.312"	.312" dia.	044-82242	\$24.89
32	.313"	.313" dia.	044-82215	\$24.89
32	.314"	.314" dia.	044-82216	\$24.89
38/357	.354"	.354" dia.	044-82219	\$24.89
38/357	.355"	.355" dia.	044-82220	\$24.89
38	.356"	.356" dia.	044-82221	\$24.89
357	.357"	.357" dia.	044-82222	\$24.89
357/38-55	.375"	.375" dia.	044-82224	\$24.89
44-40	.427"	.427" dia.	044-82227	\$24.89
44	.429"	.429" dia.	044-82228	\$24.89
44	.431"	.431" dia.	044-82230	\$24.89
45	.450"	.450" dia.	044-82231	\$24.89
45	.451"	.451" dia.	044-82232	\$24.89
45 Colt	.454"	.452" dia.	044-82233	\$24.89
45	.457"	.457" dia.	044-82235	\$24.89
45	.458"	.458" dia.	044-82236	\$24.89
50	.501"	.501" dia.	044-82250	\$24.89

RCBS Bullet Casting Video - An age-old art explained with modern technology. This comprehensive video is authoritative, informative, and entertaining to watch. Step-by-step instructions on cast bullet preparation and moulding, plus complete information for most RCBS moulds muzzle velocities, powder charges and more. Order No. 044-99907 \$19.23



Hornady Dial-Caliper & Micrometer



Dial Caliper - Make precise measurements to .001. Measure case length, bullet diameter, inside/outside diameters, primer pocket depth. Stainless steel, locks down, comes in case. Order No. 005-050075 \$26.48

Micrometer - Measures bullet and case diameters to .001. Locks down on measurement and has adjustable "0". Comes in a wooden presentation case. Order No. 005-050071 \$21.00

RCBS
Silhouette



CALIBER	.7mm SILHOUETTE	308 CALIBER SILHOUETTE	308 SILHOUETTE	357 SILHOUETTE	.44S&W SILHOUETTE
SIZE:	.285+	.309+	.309+	.358+	.430+
MOULD:	MOULD # 7mm-145-SIL	MOULD # 308-165-SIL	MOULD # 308-200-SIL	MOULD # 357-180-SIL	MOULD # 429-240-SIL
MOULD ORDER #:	ORDER# 044-82150	ORDER# 044-82152	ORDER# 044-82153	ORDER# 044-82154	ORDER# 044-82156
SIZER DIE:	.285 dia. 044-82209	.309 dia. 044-82212	.309 dia. 044-82212	.358 dia. 044-82223	.430 dia. 044-82229
TOP PUNCH:	#531 044-85531	#541 044-85541	#541 044-85541	#430 044-82530	#422 044-82526
SEATER PLUG:	7MM SIL 044-9696 \$5.30	308 SIL 044-9697 \$5.30	308 SIL 044-9697 \$5.30	357 SIL 044-90019 \$4.89	44 SIL 044-90031 \$5.30

Rifle



CALIBER	.225 CALIBER	6mm	25 CAL.	270	7mm	30	30
SIZE:	.225+	.244	.258	.278	.285	.309	.309+
MOULD:	MOULD # 22-055-SP	MOULD # 243-095-SP	MOULD # 257-120-SP	MOULD # 270-150-SP	MOULD # 7mm-168-SP	MOULD # 30-115-SP	MOULD # 30-150-FN
MOULD ORDER #:	ORDER# 044-82007	ORDER# 044-82015	ORDER# 044-82016	ORDER# 044-82017	ORDER# 044-82018	ORDER# 044-82009	ORDER# 044-82019
SIZER DIE:	.225 dia. 044-82240	.244 dia. 044-82202	.258 dia. 044-82204	.278 dia. 044-82206	.285 dia. 044-82209	.309 dia. 044-82212	.309 dia. 044-82212
TOP PUNCH:	#506 044-85506	#509 044-85509	#515 044-85515	#529 044-85529	#531 044-85531	#535 044-85535	#546 044-85546

Rifle



CALIBER	.30 CALIBER	.30 CALIBER	.7.62mm	310 CADET	32	.35 CALIBER	375, 38-55	.38-55	40	40 Single Cav.	40 Single Cav.	40 Single Cav.	416 Single Cav.
SIZE:	.309+	.309+	.309	.310	.321	.358+	.376+	.378	.410	.410	.410	.408	.417
MOULD:	MOULD # 30-180-SP	MOULD # 30-180-FN	MOULD # 7.62-130-SPL	MOULD # 310-120-RN	MOULD # 32-170-FN	MOULD # 35-200-FN	MOULD # 37-250-FN	MOULD # 378-312 BPS	MOULD # 40-300-SP-CSA	MOULD # 40-350-SP-CSA	MOULD # 40-400-SP-CSA	MOULD # 40-400-BPS	MOULD # 416-350-FN
MOULD ORDER #:	ORDER# 044-82020	ORDER# 044-82014	ORDER# 044-82022	ORDER# 044-82023	ORDER# 044-82024	ORDER# 044-82028	ORDER# 044-82029	ORDER# 044-82090	ORDER# 044-82070	ORDER# 044-82072	ORDER# 044-82074	ORDER# 044-82086	ORDER# 044-82075
SIZER DIE:	.309 dia. 044-82212	.309 dia. 044-82212	.309 dia. 044-82212	.310 dia. 044-82213	.321 dia. 044-82217	.358 dia. 044-82223	.376 dia. 044-82225	.378 dia. 044-82252	.410 dia. 044-82226	.410 dia. 044-82226	.410 dia. 044-82226	.410 dia. 044-82226	.417 dia. 044-82246
TOP PUNCH:	#541 044-85541	#546 044-85546	#554 044-85554	#550 044-85550	#565 044-85565	#570 044-85570	#608 044-85608	#378 044-82520	#378 044-82520	#378 044-82520	#609 044-85609	#562 044-85562	

Rifle



CALIBER	44-40	11MM	45 CALIBER	45 CALIBER	45 CALIBER Single Cav.	45 CALIBER Single Cav.	45 CALIBER Single Cav.
SIZE:	.428	.446	.458+	.458+	.458+	.458+	.458+
MOULD:	MOULD # 44-200-FN	MOULD # 44-370-FN	MOULD # 45-300-FN	MOULD # 45-325-FN-U	MOULD # 45-405-FN	MOULD # 45-500-FN	MOULD # 45-500-BPS
MOULD ORDER #:	ORDER# 044-82036	ORDER# 044-82093	ORDER# 044-82051	ORDER# 044-82045	ORDER# 044-82053	ORDER# 044-82054	ORDER# 044-82085
SIZER DIE:	.428 dia. 044-82244	.446 dia. 044-82253	.458 dia. 044-82236	.458 dia. 044-82236	.458 dia. 044-82236	.458 dia. 044-82236	.458 dia. 044-82236
TOP PUNCH:	#595 044-85595	#585 044-85585	#600 044-85600	#383 044-85583	#600 044-85600	#600 044-85600	#607 044-85607

Rifle, Pistol & Silhouette Mould Prices

	Order No.	Price
Rifle Bullet Moulds Double Cavity	Mould Order#	\$71.90
Rifle Bullet Moulds Single Cavity	Mould Order#	71.90
Silhouette Rifle Double Cavity	Mould Order#	71.90
Pistol Moulds Double Cavity	Mould Order#	69.15
Top Punch	Top Punch #	8.23
Sizer Dies	Sizer Die #	24.89

Abbreviation Guide	FN: Flat Nose	R: Round Nose
TG: Target	RN: Round Nose	SIL: Silhouette
SPL: Special	SWC: Semi-Wadcutter	DE: Double End
U: Universal	WC: Wadcutter	
PT: Pointed	SP: Semi-Point	
CAV: Cavalry	BB: Bevel Base	
CN: Conical Nose	M: Minie Ball	

WARNING

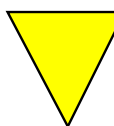

THE USE OF CASTING PRODUCTS WILL EXPOSE YOU TO LEAD, A CHEMICAL KNOWN TO THE STATE OF CALIFORNIA TO CAUSE BIRTH DEFECTS AND CANCER. AVOID INHALING THE FUMES FROM MOLTEN LEAD. EXHAUST VENTILATION TO THE OUTSIDE AIR SHOULD BE PROVIDED WHENEVER THIS PRODUCT IS USED. WASH HANDS AFTER EXPOSURE AND BEFORE EATING, DRINKING OR SMOKING.

Round Ball



DIAMETER	MOULD	MOULD ORDER #
.435	#435-R	044-82134
.440	#440-R	044-82135
.451	#451-R	044-82138
.457	#457-R	044-82140
.490	#490-R	044-82142

Price \$69.15



Mini Ball

Price \$83.66

DIAMETER	MOULD	MOULD ORDER #
.575	Single Cav.	
58-500-M		
MOULD ORDER #:	ORDER#	044-82103



North/South Skirmish Moulds

ADJUSTABLE DIAMETER	MOULD	MOULD ORDER #
.500	.500 Hodgdon	044-82166
.520	.520 Hodgdon	044-82170
.540	.540 Hodgdon	044-82172
DIAMETER	MOULD	MOULD ORDER #
.576	.576 Hodgdon	044-82160
.578	.578 Hodgdon	044-82161
.580	.580 Hodgdon	044-82162
.584	.584 Hodgdon	044-82164

Price \$87.17

Price \$87.17



Pistol

CALIBER	8880432	32	32	38	9MM	9MM	9MM	9MM	9MM	38/357	38/357	38/357	38/357
SIZE:	.311	.311	.314	.356	.356	.356	.356	.356	.356	.358	.358	.358	.358
MOULD:	MOULD # 32-077-RN	MOULD # 32-098-WC	MOULD # 32-098-SWC	MOULD # 38-090-RN	MOULD # 09-115-RN	MOULD # 9mm-124-RN	MOULD # 09-124-RN-TG	MOULD # 09-124-CN	MOULD # 9MM-147-FM	MOULD # 38-148-WC	MOULD # 38-150-SWC	MOULD # 38-158-RN	MOULD # 38-158-SWC
MOULD ORDER #:	ORDER# 044-82021	ORDER# 044-82060	ORDER# 044-82061	ORDER# 044-82057	ORDER# 044-82026	ORDER# 044-82062	ORDER# 044-82063	ORDER# 044-82027	ORDER# 044-82077	ORDER# 044-82031	ORDER# 044-82032	ORDER# 044-82064	ORDER# 044-82065
SIZER DIE:	.314 dia. 044-82214	.314 dia. 044-82216	.314 dia. 044-82216	.356 dia. 044-82221	.356 dia. 044-82221	.356 dia. 044-82221	.356 dia. 044-82221	.356 dia. 044-82221	.356 dia. 044-82221	.358 dia. 044-82223	.358 dia. 044-82223	.358 dia. 044-82223	.358 dia. 044-82223
TOP PUNCH	#465 044-82536	#445 044-82543	#444 044-82542	#311 044-82513	#115 044-82504	#401 044-82521	#115 044-82504	#402 044-82522	#556 044-85556	#429 044-82529	#429 044-82529	#311 044-82513	#429 044-82529

Pistol

CALIBER	40/10MM	10MM	10MM	41	44	44	44	44	44	45 AUTO	45 AUTO	45 AUTO	45 AUTO
SIZE:	.401	.400	.400	.410	.430	.430	.430	.430	.430	.452	.452	.452	.452
MOULD:	MOULD # 40-180-FN	MOULD # 10MM-170-SWC	MOULD # 10MM-200-SWC	MOULD # 41-210-SWC	MOULD # 44-225-SWC	MOULD # 44-240-SWC	MOULD # 44-245-SWC	MOULD # 44-250-K	MOULD # 44-300-SWC	MOULD # 45-185-SWC-BB	MOULD # 45-200-SWC	MOULD # 45-201-SWC	MOULD # 45-201-SWC
MOULD ORDER #:	ORDER# 044-82066	ORDER# 044-82067	ORDER# 044-82068	ORDER# 044-82039	ORDER# 044-82041	ORDER# 044-82042	ORDER# 044-82043	ORDER# 044-82080	ORDER# 044-82079	ORDER# 044-82052	ORDER# 044-82046	ORDER# 044-82047	ORDER# 044-82047
SIZER DIE:	.401 dia. 044-82245	.400 dia. 044-82243	.400 dia. 044-82243	.410 dia. 044-82226	.430 dia. 044-82229	.430 dia. 044-82229	.430 dia. 044-82229	.430 dia. 044-82229	.430 dia. 044-82229	.452 dia. 044-82233	.452 dia. 044-82233	.452 dia. 044-82233	.452 dia. 044-82233
TOP PUNCH	#558 044-85558	#518 044-85518	#518 044-85518	#420 044-82541	#421 044-82527	#421 044-82527	#421 044-82527	#421 044-82527	#421 044-82527	#680 044-82545	#460 044-82534	#680 044-82545	#680 044-82545

Pistol

CALIBER	.45	.45 AUTO	.45 COLT	.45 COLT	.45 COLT	.45	.50 AE
SIZE:	.454	.452	.454	.454	.454	.452	.500
MOULD:	MOULD # 45-225-CAV	MOULD # 45-230-RN	MOULD # 45-250-FN	MOULD # 45-255-SWC	MOULD # 45-270-SAA	MOULD # 45-300-SWC	MOULD # 50-340-SWC
MOULD ORDER #:	ORDER# 044-82081	ORDER# 044-82048	ORDER# 044-82049	ORDER# 044-82050	ORDER# 044-82092	ORDER# 044-82083	ORDER# 044-82087
SIZER DIE:	.454 dia. 044-82234	.452 dia. 044-82233	.454 dia. 044-82234	.454 dia. 044-82234	.454 dia. 044-82234	.454 dia. 044-82233	.500 dia. 044-82254
TOP PUNCH	#552 044-85552	#374 044-82519	#190 044-82506	#424 044-82528	#424 044-82528	#424 044-82528	#611 044-85611

Pistol Mould Prices

Order No.	Price
Pistol Bullet Moulds Double Cavity	Mould Order# \$67.13
Top Punch	Top Punch # 7.99
Sizer Dies	Sizer Die # 24.17

Abbreviation Guide	WC: Wadcutter
TG: Target	SP: Semi-Point
SPL: Special	BB: Bevel Base
U: Universal	M: Minie Ball
PT: Pointed	R: Round Nose
CAV: Cavalry	SIL: Silhouette
CN: Conical Nose	DE: Double End
FN: Flat Nose	
RN: Round Nose	
SWC: Semi-Wadcutter	

INDICATES GAS CHECK BULLET

Cowboy Action

CALIBER	25-20 WIN	30-30 WIN	32H&R MAG 32-20WIN	38 SPEC 357 MAG	38 SPEC 357 MAG	38-40 WCF	44-40 WCF 44 Russian 44 SPEC 44MAG	45 S&W Sch 45 Long Colt
SIZE:	.258	.309	.314	.358	.358	.401	.428-.430	.452-.454
MOULD:	MOULD # 25-85-CM	MOULD # 30-150-CM	MOULD # 32-90-CM	MOULD # 38-140-CM	MOULD # 38-158-CM	MOULD # 40-180-CM	MOULD # 44-200-CM	MOULD # 45-230-CM
MOULD ORDER #:	ORDER# 044-82301	ORDER# 044-82302	ORDER# 044-82303	ORDER# 044-82304	ORDER# 044-82305	ORDER# 044-82306	ORDER# 044-82307	ORDER# 044-82308
PRICE:	\$75.33	\$75.33	\$72.48	\$72.48	\$72.48	\$72.48	\$72.48	\$72.48
SIZER DIE:	.258 dia. 044-82204	.309 dia. 044-82212	.314 dia. 044-82216	.358 dia. 044-82223	.358 dia. 044-82223	.401 dia. 044-82245	.428 dia. 044-82244	.452 dia. 044-82233
TOP PUNCH	#630 044-85630	#631 044-85631	#632 044-85632	#633 044-85633	#633 044-85633	#635 044-85635	#636 044-85636	#637 044-85637

RCBS Bullet Mould Handles - Solid steel frames with extra-long, premium hardwood handles for comfort. Perfect for home bullet casting. One size fits all RCBS bullet moulds. **Order No. 044-80025 \$35.52**



WARNING

THE USE OF CASTING PRODUCTS WILL EXPOSE YOU TO LEAD, A CHEMICAL KNOWN TO THE STATE OF CALIFORNIA TO CAUSE BIRTH DEFECTS AND CANCER. AVOID INHALING THE FUMES FROM MOLTEN LEAD. EXHAUST VENTILATION TO THE OUTSIDE AIR SHOULD BE PROVIDED WHENEVER THIS PRODUCT IS USED. WASH HANDS AFTER EXPOSURE AND BEFORE EATING, DRINKING OR SMOKING.



The MEC 600 Jr. Mark V is the most popular shotshell reloader. Adjustable for 3" shells. Get a perfect shell every time with a Mark V. Die sets available for all gauges!! Order extra bushings and bars separately.

	Order No.	Price
10 Ga. w/2 oz. bar	059-844710	\$162.92
12 Ga. w/ 1 1/8 oz. bar	059-844712	148.76
16 Ga. w/1 oz. bar	059-844716	162.92
20 Ga. w/7/8 oz. bar	059-844720	148.76
28 Ga. w/3.4 oz. bar	059-844728	162.92
410 Ga. w/1/2 oz. bar	059-8447410	162.92

The SIZEMASTER SINGLE STAGE SPECTACULAR, complete with auto primer feed! Also comes with 1 shot bar and dies for the gauge ordered. Order charge bars and powder bushings from accessory page. Adjustable for 3" shells. Handles brass or steel heads, both high or low base. Returns shells to factory specs. The Dust Cover made of heavy canvas duck material protects your investment! Dust and dirt can cause problems!

	Order No.	Price
12 Ga. w/1 1/8 oz. bar	059-812012	\$214.50
20 Ga. w/7/8 oz. bar	059-812020	214.50
Dust Cover	059-8807	23.12

The 650 COMPLETE WITH AUTO PRIMER FEED. 650's are equipped with one bar and no powder bushings. Order extra charge bars and bushing from accessories page. Complete with dies for gauge ordered. No extra dies are available for the 650.

	Order No.	Price
12 Ga. w/1 1/8 oz. bar	059-650N12	\$303.99
20 Ga. w/ 7/8 oz. bar	059-650N20	303.99

PLEASE NOTE: We cannot make substitutions on the powder bushings, they come factory packed as advertised.

8567 Grabber. The 12 gauge is equipped with powder bushings: 29, 30 & 33. Also included is one 1 1/8 ounce shot bar. The 20 gauge is equipped with powder bushings: 20, 22 & 24. Also included is one 7/8 ounce shot bar. Specially designed with you in mind. Now available: MEC Dust Cover made of heavy duty canvas duck material to protect your investment.

	Order No.	Price
12 Ga. w/ 1 1/8 oz. bar	059-8567N12	\$390.44
20 Ga. w/ 7/8 oz. bar	059-8567N20	390.44
Dust Cover	059-8807	23.12



The 9000GN consists of powder and shot measure, large powder container, magnum shot container, and reloading press has automatic indexing and finished shell ejection!! Requires only minimal adjustment from low to high brass domestic shells. The most automatic press in the industry!!! The 12 gauge is equipped with powder bushings: 29, 30 & 33. Also included is one 1 1/8 ounce shot bar. The 20 gauge is equipped with powder bushings: 20, 22 & 24. Also included is one 7/8 ounce shot bar. The Dust Cover made of heavy canvas duck material protects your investment!

	Order No.	Price
12 Ga. w/1 1/8 oz. bar	059-9000GN12	\$476.82
20 Ga. w/ 7/8 oz. bar	059-9000GN20	476.82
Dust Cover	059-8807	23.12

Super Sizer Available in 12 or 20 gauge only. Resizes shotshells perfectly with each pull of the handle! Stop the guess work with a Super Sizer! Helps you work faster so you can shoot sooner!

Order No.	Price
059-811912 12 Ga	\$89.99
059-811920 20 Ga	



LEAD SHOT CHARGE BARS \$13.02EA

	SingleStage	Progressive
1/2 oz.	059-30212	059-50212
5/8 oz.	059-30258	059-50258
11/16 oz.	059-3021116	059-5021116
3/4 oz.	059-30234	059-50234
7/8 oz.	059-30278	059-50278
1 oz.	059-302100	059-502100
1 1/8 oz.	059-302118	059-502118
1 3/16 oz.	059-3021316	059-5021316
1 1/4 oz.	059-302114	059-502114
1 3/8 oz.	059-302138	059-502138
1 1/2 oz.	059-302112	059-502112
1 5/8 oz.	059-302158	059-502158
1 3/4 oz.	059-302134	059-502134
1 7/8 oz.	059-302178	059-502178
2 oz.	059-302200	-
2 1/4oz.	059-302214	-

STEEL SHOT CHARGE BARS \$16.60EA

	Single Stage	Progressive
7/8 oz. #1- #4	059-30207814	059-50207814
7/8 oz. #5- #6	059-30207856	059-50207856
1 oz. #BB- #2	059-302100BB2	059-502100BB2
1 oz. #3- #6	059-30210036	059-50210036
1 1/8oz #BB-#3	059-302118BB3	059-502118BB3
1 1/8oz #4-#6	059-30211846	059-50211846
1 1/4oz #3-#6	059-30211436	059-50211436
1 1/4oz #BB-#2	059-302114BB2	-
1 3/8oz #BB-#2	059-302138BB2	059-50211436
1 3/8oz #3-#6	059-30213836	-
1 1/2oz #BB-#2	059-302112BB2	-
1 1/2oz #3-#6	059-30211236	-

Die Sets Fit 600 JR's After 1983

	Order No.	Price
12 Gauge Die Set	059-845212	\$69.76
16 Gauge Die Set	059-845216	69.76
20 Gauge Die Set	059-845220	69.76
28 Gauge Die Set	059-845228	69.76
410 Gauge Die Set	059-8452410	69.76

Multi-Scale Charge Bars

Model D/DS fits MEC 650 and Grabbers. Model C/CS fits MEC 600 Jr. Mark 5, 600 Jr., 700 Versamec, Sizemaster 77, MEC 600, 400, 250, and 250 Super Reloaders, and the Texan LT.

FREE POWDER BAFFLE WITH EVERY UNIVERSAL CHARGE BAR!

Multi Scale Charge Ltd.



Order No.	Price
Model C/CS 087-CCS	\$43.43
Model D/DS 087-DDS	43.43

Powder Baffle - Use with MEC Shotshell Loaders! Install between powder bottle and charge bar for even powder density and consistent charges. Order No. 087-PBIB \$14.28

Powder Bushings

The Bushing selection chart is much too large for our catalog. Please visit:

www.mecreloaders.com to view the selection chart. All Bushings: \$3.10 ea.



059-5007 07	059-5020 20	059-5034 34
059-5008 08	059-5021 21	059-5035 35
059-5009 09	059-5022 22	059-5036 36
059-5010 10	059-5023 23	059-5037 37
059-5011 11	059-5024 24	059-5038 38
059-5012 12	059-5025 25	059-5039 39
059-5012A 12A	059-5026 26	059-5040 40
059-5013 13	059-5027 27	059-5041 41
059-5014 14	059-5028 28	059-5042 42
059-5015 15	059-5029 29	059-5043 43
059-5016 16	059-5030 30	059-5044 44
059-5017 17	059-5031 31	059-5045 45
059-5018 18	059-5032 32	059-5046 46
059-5019 19	059-5033 33	

Wad Fingers

Pre 1983			Post 1983		
Order No.	Price		Order No.	Price	
10 Ga. 059-453P10	\$1.65		059-830010	\$1.60	
12 Ga. 059-453P12	1.65		059-830012	1.60	
16 Ga. 059-453P16	1.65		059-830016	1.60	
20 Ga. 059-453P20	1.65		059-830020	1.60	
28 Ga. 059-453P28	1.65		-	-	
410 Ga. 059-453P410	1.65		-	-	

Hornady Lock-N-Load™ Presses & Accessories

Case Feeder
Bullet Feeder

Upgrade your Progressive!
Case Feeders and Bullet Feeders sold separately below



Lock-N-Load Classic Kit - Includes: Lock-N-Load Classic loader, L-N-L powder Measure, Powder Scale, Universal Reloading Block, Primer Turning Plate, Chamfering-Deburring Tool, 3 L-N-L Die Bushings, One Shot Case Lube and the New 8th Edition Hornady Handbook. Now the Lock-N-Load Classic Kit includes the Hornady Handheld Priming Tool!

Order No. 005-085003 \$327.65

500 FREE BULLETS with the purchase of The Lock-N-Load Classic Kit!



Lock-N-Load Auto Progressive Press - The Lock-N-Load AP press with its innovative Lock-N-load bushing system combines precision engineering with an innovative design. The result is the easiest, ready to use reloading press you can buy. Now with a simple flick of the wrist, you can change dies and start loading another caliber in mere seconds. DOES NOT INCLUDE a Shell Plate! Includes Deluxe Powder Measure, and Case Activated Powder Drop.
Order No. 005-095100 \$436.87

L-N-L Case Feeder - This features a 110v motor and XL case bowl. Handles 4x the amount of cases that other feeders do. Fits your Auto-Pro Press!
Order No. 005-095300 \$324.39

Lock-N-Load Bullet Feeder -

Turn your progressive press into a bench mounted ammo factory! The Lock-N-Load Bullet Feeder is designed as an accessory for the Hornady Lock-N-Load AP reloading press, but can be used with any other press with 7/8"-14 die threads.

Caliber changeovers are quick and easy and there are no special tools required for adjustments. The easy-feed bullet hopper holds up to 200 pistol bullets and features an adjustable center plate and bullet feed-wipers to ensure smooth feeding.

Lifetime warranty, Bullet feeder dies are sold separately.

NOTE: Bullet Feeder is designed for use with jacketed or plated pistol bullets only.

	Order No.	Price
Case Feeder Plate SM Pistol	005-095310	\$27.62
Case Feeder Plate LG Pistol	005-095312	27.62
Case Feeder Plate SM Rifle	005-095314	27.62
Case Feeder Plate LG Rifle	005-095316	27.62
L-N-L Die Bushing 3 pack	005-044093	13.63
L-N-L Die Bushing 2 pack	005-044094	9.55
L-N-L Press Conversion	005-044095	9.21
L-N-L Die Bushing 10 pack	005-044096	40.29

	Order No.	Price
L-N-L Bullet Feeder	005-095320	\$258.97
380/9mm Bullet Feed Die	005-095330	21.19
38/357 Bullet Feed Die	005-095331	21.19
40/10mm Bullet Feed Die	005-095332	21.19
44 Sp/Mag Bullet Feed Die	005-095333	21.19
45 Auto Bullet Feed Die	005-095334	21.19



500 FREE BULLETS with the purchase of The Lock-N-Load Auto Progressive Press!



Powder Cop - Install on your progressive press after the powder drop station to automatically check dropped charges. Works with all powder types and calibers.
Order No. 005-050063 \$28.77

Automatic Primer Feed - Includes both large and small primer tubes. priming is 100% hands off.

Order No. 005-070905 \$27.42



For L-N-L Classic Presses

Handheld Priming Tool - Now with modified design that makes it easier to change over and the seater punch and spring are captured inside the body; allowing shell holders and primer trays to be changed without removing them. Primers automatically flow from the primer holder to the feeding system while the tool is being used.
Order No. 005-0500021 \$34.80



Lock-N-Load Classic Package- Includes a Lock-N-Load Classic loader and 3 Lock-N-Load Die Bushings.

Order No. 005-085001 \$125.31



Lock-N-Load™ Die and Conversion Bushings - Simply thread a Hornady Lock-N-Load™ Conversion bushing into your RCBS® Rock Chucker or other reloading press using a 1¼-12 thread, and you're ready to start using the Lock-N-Load™ System.

	Order No.	Price
L-N-L Press Conversion Bushing Only	005-044095	\$9.21
L-N-L Press Conversion Kit Conversion Bushing and 3 L-N-L Die Bushings	005-044099	15.91
L-N-L Die Bushing 3 pack	005-044093	13.63
L-N-L Die Bushing 2 pack	005-044094	9.55
L-N-L Die Bushing 10 pack	005-044096	40.29



Get Loaded! Look for the FREE BULLETS logo! Hornady is giving away FREE BULLETS with the purchase of select items! Redemption of Free Bullets is from Hornady and bullets will be shipped from Hornady Manufacturing in Grand Island, Nebraska. (Shipping and Handling Fees apply) Offer is good from January 1st, 2012 through December 31st, 2012. Submission must be received by 2/15/13. Allow 10-12 weeks for delivery. Redemption forms are available at www.hornady.com

Hornady Lock-N-Load® Deluxe Die Wrench

The ultimate 4-in-1 reloading tool for your Lock-N-Load® AP™ or single stage Classic press. This tool holds the shell plate and keeps it from rotating while you change plates and tighten the main press screw. It also adjusts the tightness of the spindle lock and the lock rings, and can tighten or loosen the die flats. No reloading bench should be without one! **Order No. 005-396495 \$17.54**



Stuck Case Remover - Consists of #7 drill and ¼ inch-20 tap. Remover body fits in universal shell holder ram of most any standard reloading press. No wrenches required. No chance of damaging size die. Fits most presses with universal shell holder ram.

Order No. 005-050033 \$12.23

Shell Holder Kit! Best Value! Includes the #1, #2, #5, #16 & #35 shell holders. **Order No. 005-390540 \$14.54**



Shellholders - Fits all Hornady and most other single-stage presses. See die list for size.

50 BMG 005-390585 \$26.36 each
All Other shellholders \$3.64 each

Order No.	Order No.
1 005-390541	26 005-390566
2 005-390542	27 005-390567
3 005-390543	28 005-390568
4 005-390544	29 005-390569
5 005-390545	30 005-390570
6 005-390546	32 005-390572
7 005-390547	35 005-390575
8 005-390548	36 005-390576
10 005-390550	40 005-390580
12 005-390552	42 005-390582
14 005-390554	44(.500) 005-390584
16 005-390556	44(.338) 005-390583
19 005-390559	46 005-390602
22 005-390562	

Shell Plates - Fits Hornady Progressive and Lock-N-Load. Sizes correspond to same size as Hornady shell holders. See die list for size. **\$30.04 each**



Order No.	Order No.
1 005-392601	27 005-392627
2 005-392602	28 005-392628
3 005-392603	29 005-392629
4 005-392604	30 005-392630
5 005-392605	32 005-392632
6 005-392606	35 005-392635
7 005-392607	36 005-392636
8 005-392608	42 005-392642
10 005-392610	44 005-392644
14 005-392614	45 005-392645
16 005-392616	46 005-392646
22 005-392622	

Sure-Lock® Lock Rings - For all standard 7/8"-14 dies & accessories. Clamps around the whole die without damage to the threads.



Order No.
Sure Lock Ring 1ea 005-044000 \$2.99
Sure Lock Ring 6ea 005-044606 15.37

50 BMG 2 Die Set - Guaranteed never to break or wear out from normal use. **Order No. 005-544460 \$237.94**

50 BMG Shell Holder
Order No. 005-390585 \$26.36
50 BMG Lock Ring
Order No. 005-393341 \$14.18



Zip Spindle- Custom Grade Dies spindle design guarantees to never break under normal wear. Light threads strengthen the spindle, stop spindle slippage and make adjustments a breeze.

FREE BULLETS 100 FREE BULLETS with the purchase of any Custom Grade Dies. Series I, II, III, IV or V. **Order No. 005-546_____**

Series II Handgun Dies - Set Includes Full Length Size Die, Expander Die & Seating Die **\$42.63 set**

	Order No.
32S&W Long / Short (SH#36)	005-546509
9mm Luger / 9x21 (SH#8)	005-546515
380 Auto (SH#16)	005-546518
38 Super Auto (SH#8)	005-546524
38/357/357 Max (SH#6)	005-546527
9x18 Makarov (SH#8)	005-546512
10mmAuto / 40S&W (SH#10)	005-546533
41 Mag / 41 AE (SH#29)	005-546539
44 Spl. / 44 Mag (SH#30)	005-546548
45 ACP / Win Mag (SH#1)	005-546554
45 LongColt (SH#32)	005-546582
9x18 Mak (SH#8)	005-546512

Custom Grade Pistol 4 Die Rifle Set - Full-length Sizing Die, Seating Die Roll Crimp, Adj. Case Mouth Expander Die, Crimp Die. **\$65.44 set**

	Order No.
500 S&W (SH#44)	005-546585
475 LB / 480 Ruger (SH#14)	005-546547
460 S&W (SH#46)	005-546583
454 Casull (SH#32)	005-546584

Microjust Seating Stem - Turn your Hornady Dimension dies into the ultimate benchrest precision seaters with the all steel Hornady Microjust seater stem on your Dimension seater die. It features a micrometer-style adjustment which can calibrate seating depths in 1/1000th of an inch increments for ultra fine-tuning your loads. One size fits all Dimension Dies.

Order No. 005-044090 \$20.48



Neck Size Dies - Eliminate problems of excessive head space, and align the bullet perfectly with the bore. **\$22.50 each**

	Order No.
20 Cal (204 Ruger)	005-046038
22 Cal Nk Die	005-046066
22 Cal PPC	005-046053
22 Cal	005-046040
220 Swift	005-046054
6mm PPC	005-046052
6mm	005-046041
6mm Short	005-046047
257 Cal	005-046042
270	005-046051
6.5mm Short	005-046048
6.5mm	005-046043
7mm	005-046044
7mm Short	005-046049
30 Cal	005-046045
308 Short	005-046050
35 Cal	005-046046
270 Cal Mag (.277)	005-046055
7mm Mag (.284)	005-046056
30 Cal Mag (.307)	005-046057
338 Cal Mag (.307)	005-046058

Hornady Dimension Dies

Series I Rifle Dies - Set Includes Full Length Size Die & Seating Die **\$33.50 set**

	Order No.
17 Remington Fireball (SH#16)	005-546117
17 Hornet (SH#3)	005-546118
204 Ruger (SH#16)	005-546201
22 Hornet (SH#3)	005-546212
222 Rem (SH#16)	005-546224
22/250 (SH#1)	005-546220
220 Swift (SH#4)	005-546222
223 Rem (SH#16)	005-546228
223 WSSM (SH#16)	005-546223
243 Win (SH#1)	005-546244
243 WSSM (SH#1)	005-546225
244/6mm (SH#1)	005-546246
25/06 (SH#1)	005-546262
270 Win (SH#1)	005-546300
270 WSM (SH#35)	005-546297
6.5x55 (SH#19)	005-546282
7x57 Mauser (SH#1)	005-546308
7mm Exp/280 (SH#1)	005-546320
7mm08 (SH#1)	005-546316
7mm Rem Mag (SH#5)	005-546326
7mm WSM (SH#35)	005-546327
30/30 Win (SH#2)	005-546342
300 AAC/Whisper (#16)	005-546349
300 Wby (SH#5)	005-546350
308 Win (SH#1)	005-546358
308 Marlin Exp(SH#27)	005-546357
30/06 (SH#1)	005-546340
300 Win Mag (SH#5)	005-546352
8mm Mauser(8x57) (SH#1)	005-546382
338 WinMag (SH#5)	005-546390
338 Ruger Compact Mag (SH#5)	005-546399
300 Rem Ultra Mag (SH#5)	005-546365
300 Rem SA Ultra (SH#5)	005-546347
300 WSM (SH#35)	005-546369
300 Ruger Compact Mag (SH#5)	005-546353
270 Win Short Mag (SH#35)	005-546297
270 Win (SH#1)	005-546300
375 H&H Mag (SH#5)	005-546416
375 Ruger (SH#5)	005-546415

Series II Rifle Dies - Set Includes Full Length Size Die, Expander Die & Seating Die **\$37.73 set**

	Order No.
30M1 Carbine (SH#22)	005-546503
444 Marlin (SH#27)	005-546551
45-70 Govt (SH#14)	005-546566
450 Marlin (SH#5)	005-546553
458 Win Mag (SH#5)	005-546569
458 Lott (SH#5)	005-546465
405 Win (SH #42)	005-546425

Series III Rifle Dies - Set Includes Full Length Size Die & Seating Die **\$40.14 set**

	Order No.
17 Rem (SH#16)	005-546200
25 WSSM (SH#35)	005-546263
257 Roberts (SH#1)	005-546274
260 Rem (SH#1)	005-546269
264 Win Mag (SH#5)	005-546278
6.8mm Rem (SH#12)	005-546299
7mm WBY Mag (SH#5)	005-546330
7mm Rem SA Ultra (SH#5)	005-546309
7mm Rem Ultra Mag (SH#5)	005-546307
338 Rem Ultra Mag (SH#5)	005-546389
6mm PPC (SH#6)	005-546254
221 Rem (SH#16)	005-546210
35 Remington (SH#26)	005-546398
375 Remington Ultra Mag (SH#5)	005-546450

Series IV Specialty Rifle Die Sets - Set Includes Full Length Size Die & Seating Die **\$65.44 set**

	Order No.
218 Bee	005-546206
22/250 Ackley Imp (SH#1)	005-546219
280 Ackley Imp (SH#1)	005-546321
30/30 Ackley Imp (SH# 2)	005-546345
30/06 Ackley Imp (SH#1)	005-546341
5.7x28 FN	005-546203

Hornady Lock-N-Load Precision Gauges



Two Gauge models fit all action types (except Winchester .94).

Lock-N-Load O.A.L. Gauges - Small changes in the clearance between the bullet and the rifling can make a big difference in accuracy. Most often, seating bullets close to the rifling will produce improved accuracy. FINALLY!!! - Here is the solution to proper bullet seating depth for precision handloaders. The O.A.L. (over-all-length) Gauge produces an accurate model of your chamber with the bullet in light contact with the lands of the rifling. The result is then measured with your caliper, allowing easy transfer of this critical dimension to the bullet seating die. This allows you to precisely regulate the bullet's clearance (free-travel) to the lands; typically .020 to .040" for hunting rounds. The O.A.L. Gauge works with any bullet you choose. Eliminates guess work. Monitors throat erosion. No other method "measures up" to the reliability and precision of this easy to use tool. Modified case (required, see below) permits Gauge use with any chamber.

	Order No.	Price
C-1000 Bolt Action, Single Shot, Straight	005-C1000	\$30.46
C-1550 Autoloader, Lever, Pump Action, Curved	005-C1550	34.81

A Series Modified Cases -

	Order No.	Price
17 Rem.	005-A17	\$4.34
17 Hornet	005-A17H	4.34
218 Bee	005-A218	4.34
221 Fireball	005-A221	4.34
222 Rem.	005-A222	4.34
222 Rem Mag	005-A222M	4.34
223 Rem.	005-A223	4.34
22-250 Rem.	005-A22250	4.34
220 Swift	005-A220	4.34
243 Win.	005-A243	4.34
6mm Rem.	005-A6MM	4.34
6mm BR	005-A6MMB	4.34
257 Roberts	005-A257	4.34
250 Sav	005-A250	4.34
25/06 Rem.	005-A2506	4.34
260 Rem	005-A260	4.34
264 Win Mag	005-A264	4.34
270 Win.	005-A270	4.34
7x57 Mauser	005-A7X57	4.34
7mm/08 Rem.	005-A7MM08	4.34
280 Rem.	005-A280	4.34
284 Win	005-A284	4.34
30 TC	005-A30TC	4.34
7mm BR	005-A7MM	4.34
7mm Rem. Mag.	005-A7MMR	4.34
30/30 Win.	005-A3030	4.34
30/40 Krag	005-A3040	4.34
308 Win.	005-A308	4.34
308 Marlin Exp	005-A308ME	4.34
30/06 Spfd	005-A3006	4.34
300 H&H	005-A300H	4.34
300 Win. Mag.	005-A300M	4.34
300 Wby. Mag	005-A300W	4.34
303 British	005-A303	4.34
7.62x39 (308)	005-A762	4.34
8mm Rem. Mag.	005-A8MM	4.34
8x57mm	005-A8X57	4.34
338 Win. Mag.	005-A338	4.34
340 Wby Mag	005-A340	4.34
35 Whelen	005-A35	4.34
35 Rem	005-A35R	4.34
350 Rem Mag	005-A350	4.34
375 H&H	005-A375	4.34
416 Rem. Mag.	005-A416	4.34
450 Bushmaster	005-A450B	4.34
45/70 Gov't.	005-A4570	4.34

Interchangeable Modified Cases-

Threaded case-head allowing them to attach to either O. A. L. Gauge model. Case necks are enlarged to allow bullets to slide in neck area. Use same bullet as intended for reloading. Cases listed are to SAAMI specs.

B Series Modified Cases -

	Order No.	Price
204 Ruger	005-B204	\$5.16
223 WSM	005-B223	5.16
243 WSSM	005-B243	5.16
6.5x55 Mauser	005-B65X55	5.16
6.5x284	005-B65	5.16
270 Wby Mag	005-B270	5.16
270 WSM	005-B270W	5.16
240 Wby Mag	005-B240	5.16
257 Wby Mag	005-B257	5.16
7mm Rem SMag	005-B7MMR	5.16
7mm Wby. Mag.	005-B7MMW	5.16
7mm STW	005-B7MMS	5.16
7mm Ultra Mag	005-B7MM	5.16
7mm WSM	005-B7WS	5.16
300 WSM Rem	005-B300W	5.16
300 Ultra	005-B300	5.16
300 Rem SA	005-B300R	5.16
300 Savage	005-B300S	5.16
338 Ultra Mag	005-B338	5.16
358 Win	005-B358	5.16
378 Wby Mag	005-B378	5.16

C Series Modified Cases -

	Order No.	Price
30/378 Wby	005-C30378	\$5.67
375 Ruger	005-C375R	5.67
458 Win	005-C458W	5.67
416 Rigby	005-C416R	5.67
450 Nitro Exp	005-C450NE	5.67

Universal Trim Length Gauge -

Measures 11 popular calibers from 6.5 Grendel to 375 H&H.

Order No.	005-050149	\$11.21
-----------	------------	---------



Lock-N-Load Bullet Comparator Set w/6 Inserts- Measuring cartridge lengths across the bullet tips can cause variations from one round to the next. A Bullet Comparator allows your caliper to measure off the bullet's ogive to eliminate the variation. Also check bullet uniformity. The Lock-N-Load Comparator attaches to the blade of your caliper with a thumbscrew and uses interchangeable "inserts" available for 17 to 45 caliber. Includes the comparator body and 6 insert bushings (22, 24, 25, 27, 28, 30 cal).

Comparator Set w/6 Inserts	Order No. 005-B234	\$26.11
Comparator Body	Order No. 005-B2000	\$12.17
Additional inserts (below)		\$3.06ea



	Order No.	Price
#1 - 17 Cal. Insert	005-117	
#2 - 22 Cal. Insert	005-222	
#3 - 24 Cal. Insert	005-324	
#4 - 25 Cal. Insert	005-425	
#5 - 26 Cal. Insert	005-526	
#6 - 27 Cal. Insert	005-627	
#7 - 28 Cal. Insert	005-728	
#8 - 30 Cal. Insert	005-830	
#9 - 33 Cal. Insert	005-933	
#10 - 35 Cal. Insert	005-1035	
#11 - 37 Cal. Insert	005-1137	
#12 - 45 Cal. Insert	005-1245	
#13 - 41 Cal. Insert	005-1341	
#14 - 20 Cal. Insert	005-1420	

B-14 Comparator Set - All 14
Comparator Inserts shown above.
Order No. 005-B14 \$44.99

Cartridge Headspace Gauge - Check cartridge headspace with your caliper? You bet! This affordable gauge system eliminates the need for special "mics" for each cartridge you load. It allows you to check variations between fire-formed brass from your chamber and your resized or new brass. Works with or without bullets seated. Precisely measures brass from case-head to datum line on shoulder. Allows you to resize your brass for a proper fit with your chamber. Maximizes brass life and improves accuracy.



	Order No.	Price
5 pc. Bushing Kit Only	005-HK55	\$23.56
Headspace Body & 5pc Bushing Kit	005-HK66	34.81

Headspace Bushings \$6.04ea
(See Size Chart)

Order No.	
005-A330	A - 330" Headspace Bushing
005-B350	B - 350" Headspace Bushing
005-C375	C - 375" Headspace Bushing
005-D400	D - 400" Headspace Bushing
005-E420	E - 420" Headspace Bushing

.330" 17 Rem, 222 Rem, 222 Rem MAG, 223 Rem, 220 SWIFT, 221 Rem FB
.350" 22 PPC, 22/250 Rem, 6PPC, 6 BR Rem, 250 SAV, 7 BR Rem, 7X30 , 22 BR Rem
.375" 6mm Rem, 257 ROB, 25/06 Rem, 270 WIN, 7X57mm Mauser, 280 Rem, 30/30 WIN, 30/06 SPFLD, 7.62 X 39 Russian, 303 BRIT, 300 H&H MAG, 30-40 KRAG, 22 Cheetah
.400" 243 WIN, 7mm/08 Rem, 308 WIN, 7mm STE
.420" 284 WIN, 7mm Rem MAG, 300 WIN MAG, 8mm Rem MAG, 338 WIN MAG, 375 H&H, 7mm STW, 6mm/284 WIN, 358 WIN, 338/06, 30/338 WIN MAG



Dial Caliper- Make precise measurements to .001. Measure case length, bullet diameter, inside/outside diameters, primer pocket depth. Stainless steel, locks down, comes in case. Order No. 005-050075 \$26.48

Micrometer- Measures bullet and case diameters to .001. Locks down on measurement and has adjustable "0". Comes in a wooden presentation case. Order No. 005-050071 \$21.00



Hornady Ammunition Concentricity Tool - Make bullet runout a thing of the past with the Hornady Ammunition Concentricity Tool. Hornady never ceases to find ways to provide unmatched accuracy in every facet of the shooting experience. The Ammunition Concentricity Tool is the first tool on the market to both identify and eliminate bullet runout. Just place ammunition in the tool, roll it, identify runout, and use the dial indicator to adjust runout to zero! It can be used to true-up factory ammunition, too. Order No. 005-050076 \$94.42

NEW! Hornady One Shot Cleaners
5.5 Aerosol Spray

Gun and Tool Conditioner	005-99906	\$8.28
First Firing Bore Conditioner	005-99925	\$8.22
HD Extreme Gun Conditioner	005-99936	\$8.97



Hornady Case Prep and Cleaning



Lock-N-Load™ Power Case Prep Center -

- Micro adjustable to 1/1000"
- Trim cases from 3/4" to 3 1/4" in length
- Vertical design of the power trimmer and horizontal design of the tools keeps shavings from falling into cases, and makes case discharge easy
- Power Chamfer/Deburr Tool cleans inner case diameter
- Power Deburr Tool cleans outer case diameter
- Large and small Primer Pocket Cleaners
- Optional Flash Hole Deburr Tool (purchase separately)
- Optional Primer Pocket Reamer (purchase separately)
- Comes with five popular neck brush sizes

Combining essential case prep tools into one handy unit saves reloaders real estate on their bench and valuable time in the reloading process. The Lock-N-Load Case Prep Center includes a power trimmer, chamfer/deburr tools, primer pocket cleaner and five neck brushes. A primer pocket uniformer, primer pocket reamers, and flash hole deburr tool can be purchased separately. **Order No. 005-050012 \$366.74**



One Shot Cleaner & Dry Lube 5.5oz - One Shot Gun Cleaner & Dry Lube reduces friction, cleans grit, grime, old oil and gunk from firearms, loaders and loading tools. It leaves behind a thin, dry lube that's impervious to heat, cold or buildup. **Order No. 005-9990 \$7.80**

One Shot Case Lube 5.5oz -
Order No. 005-9991 \$6.69

Unique Case Lube 8oz - This all-natural lube is easy to use—a quick swipe as you pick up cases and it's done. **Order No. 005-393299 \$3.06**

One Shot Case Sizing Wax - Simply dab on your index finger and thumb, then apply to your cartridge case before sizing. A little goes a long way. **Order No. 005-9989 \$7.61**



Case Care Kit- Includes Case Size lube, Acc. Handle, Chamfer-deburr tool, Primer pocket heads, Case lube pad & tray, case neck brushes. **Order No. 005-043300 \$24.45**



Primer Pocket Cleaner & Handle- Large- 005-041200 \$5.16 Small- 005-041201 \$5.16

Primer Pocket Reamer - Primer Pocket Reamer Package makes GI Brass reloadable by cutting away the primer pocket crimp. Complete with handle, large head or small head. **\$8.48 each**

Primer Pocket Reamer Large Order No. 005-041202
Primer Pocket Reamer Small Order No. 005-041203

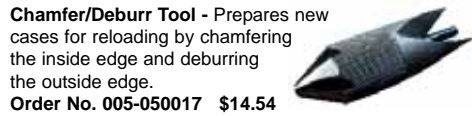

Chamfer/Deburr Tool - Prepares new cases for reloading by chamfering the inside edge and deburring the outside edge. **Order No. 005-050017 \$14.54**



Lock-N-Load® Case Prep Assistant - Compact! Its durable brushed aluminum housing and high torque, low speed motor will provide years of dependable use. Included are chamfer and deburr tools (Optional acc. sold separately below). 8-32 thread allow use with any other 8-32 accessory. Unit is compatible with 110V or 220V power. **Order No. 005-050155 \$83.38**

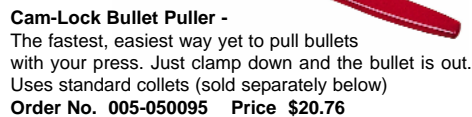

Cam-Lock Bullet Puller - The fastest, easiest way yet to pull bullets with your press. Just clamp down and the bullet is out. Uses standard collets (sold separately below) **Order No. 005-050095 Price \$20.76**

Collets are \$8.07ea

Order No.	Mandrel	Order No.	Mandrel
005-392154	1 .172	005-392161	8 .322
005-392155	2 .224	005-392162	9 .358
005-392156	3 .243	005-392163	10 .375
005-392157	4 .260	005-392164	11 .410
005-392158	5 .277	005-392165	12 .430
005-392159	6 .284	005-392166	13 .454
005-392160	7 .308	005-392167	14 .204



A- Cam Lock Trimmer- Based on the the design of the original Hornady, the Cam-Lock Trimmer lets you change settings from longer to shorter in increments of 1/1000". Large dia. cutting head cuts up to .50 cal in dia. Includes pilots: 22 cal, 6mm, 270cal 7mm, 30cal, 38cal, 45cal. **Order No. 005-050140 \$70.13**



Power Adaptor for Camlock Trimmer-
Order No. 005-050145 \$23.36

Pilots are \$3.18ea (*\$ 4.96)

Order No.	Pilot	Order No.	Pilot
005-390940	22 .204	005-390954	12 .333
005-390943	1 .224	005-390955	13 .338
005-390944	2 .228	005-390956	14 .348
005-390945	3 .243	005-390957	15 .358
005-390946	4 .257	005-390962	20 .361
005-390947	5 .264	005-390958	16 .375
005-390948	6 .277	005-390941	21 .400
005-390949	7 .284	005-390959	17 .410
005-390950	8 .300	005-390960	18 .429
005-390951	9 .308	005-390961	19 .452
005-390952	10 .312	005-390939*	23 .475
005-390953	11 .323	005-390937*	50 .500



Neck turning tool - Hornady's case neck turning tool is a great cutter, at a great price. It is adjustable in 1/1000" increments to trim the outside of the case neck for absolute uniformity. Mandrels sold separate below. **Order No. 005-041222 Price \$50.70**

Mandrels are \$8.03ea

Order No.	Mandrel	Order No.	Mandrel
005-391908	17 .172	005-391924	7mm .2813
005-391909	204 .204	005-391928	308 .3055
005-391910	224 .2210	005-391929	8mm
005-391913	243 .2395	005-391930	338
005-391915	257 .257	005-391931	35
005-391919	264 .2615	005-391932	375
005-391921	270 .275		

Hornady Sonic Cleaning



A - Lock-N-Load® Magnum Sonic Cleaner
Tank dimensions: 9.4" x 5.5" x 3.9"
3L Tank (3.2 qt) 110v
Order No. 005-043340 \$234.01

B - Lock-N-Load® Sonic Cleaner™
Order No. 005-043350 \$99.00

One Shot™ Sonic Clean™ Solutions
Cartridge Case Formula 1 Qt
Order No. 005-043355 \$18.47
Gun Parts Formula 1Qt
Order No. 005-043360 \$18.47



M2 Tumbler- Dirty brass can ruin your dies! Hornady case tumblers clean and polish to a brilliant finish before you reload. M2 model holds up to 500 38Special cases, Brass Bushing Motor. **Order No. 005-050200 \$67.18**

One Shot Tumbler Media (2 lbs) - Media cleans and polishes cases. Use with One Shot® Metal Polish. 1/4 gallon tub. **Order No. 005-050300 Price \$7.52**

One Shot Non-Haz 8oz Metal Polish- For use with Hornady's Tumbling Media, this water-based, biodegradable polish cleans, polishes and protects all metals except aluminum. **Order No. 005-9993 \$7.61**

100 FREE BULLETS - With the purchase of the Magnum Sonic Cleaner

Hornady Lock-N-Load® Sonic Cleaners - Designed with reloaders in mind, the Lock-N-Load Sonic Cleaners excel at cleaning cartridge cases, but simply change over to Gun Cleaning solution, and they also work miracles on gun parts – it does ALL the work. The adjustable heating element of the Lock-N-Load Magnum Sonic Cleaner allows the user to dial in the correct temperature to maximize cleaning efficiency without damaging delicate parts.

Hornady Powder Measuring

Hornady Lock-N-Load® Auto Charge™ - Speed and efficiency save time and money. Hornady's Lock-N-Load™ Auto Charge™ has combined both in one extremely accurate system. Quick to setup, easy to use, and exceptionally precise to within 0.1 grains, and has a scale capacity of 1000 grains.

Easy-to-use keypad, large easy-to-read backlit display, automatic & manual dispense options, trickle function, three speed settings, overcharge protection, and easy clean out.

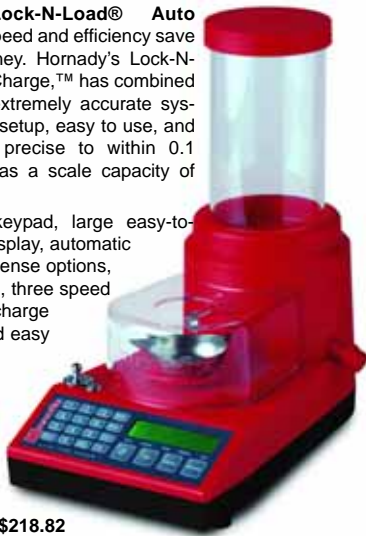

Order No. 005-050068 \$218.82

Hornady Digital Reloading Scale - 1500 grain Electronic Scale. Includes: Aluminum measure pan, 100gr calibration weight. Powered by two AAA batteries (included) and is compact (Only 5" x 3")



Order No. 005-050107 \$27.07

Hornady Lock-N-Load® Bench Scale

1500 grain capacity lets you weigh powder, bullets, cases, cartridges and more. The large LCD display is easy to read and weighs precisely to one tenth (0.1) of a grain. Included are two calibration weights, AC adaptor, 220V adaptor, and metal powder pan. Order No. 005-050108 \$89.20

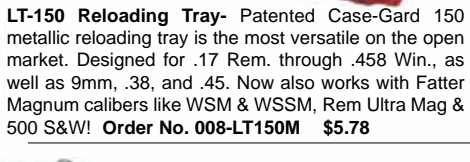

MTM Ammo Can - 750 Cubic inches of durable storage for anything from ammo to reloading equipment. Thick highwall construction. Large handle, heavy-duty latch, double padlock tabs, made of rugged polypropylene. Order No. 008-AC11 \$13.79



The Lock-N-Load™ Powder Measure - Offering probably the most flexible operation and the widest range of any measure on the market today. Not only can you switch powders and settings with a single button push, but add the proper accessories and the Lock-N-Load™ Powder Measure lets you meter charges from .5 to 265 grains of powder! Mount to your bench using standard 7/8"-14 thread, use the Fast Load Powder Measure Stand or mount on the Lock-N-Load AP™ for automatic powder measuring during reloading. Order No. 005-050069 \$65.30



100 FREE BULLETS - With the purchase of the Lock-N-Load Powder Measurer

Powder Measure Mounting Kit - Order No. 005-050121 \$4.64



Go from reloading 30-06 to 45 Auto in no time. Just push the Lock-N-Load™ insert release button and insert another meter.

Fast Load Powder Measure Stand

The incredibly strong Fast-Load Powder Measure Stand has a rigid frame and extra long arm that lets you fill an entire 50-count Universal Loading Block. Accepts any measure with 7/8"-14 thread. Order No. 005-050008 \$28.70



Universal Loading Block - This double side block helps you load quantities of nearly any caliber you choose. Fits magnum, 308 and 223 size case heads. Also works with Fast-Load Powder Measure Stand to reach every case in the block. Order No. 005-480040 \$5.75



A - Case Activated Powder Drop - Improved & smooth! The powder drop only dispenses a powder charge when a case is present. Works with the Lock-N-Load AP™ or other progressive presses that use 7/8" x 14 threads. Order No. 005-050073 \$50.83

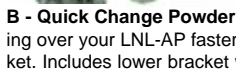

B - Quick Change Powder Die - Designed specifically for use with the Case Activated Powder Drop. Makes changing over your LNL-AP faster and easier than ever! It allows you to preset dies for fast caliber conversion on the market. Includes lower bracket with guide bushing and lock ring. Order No. 005-050074 \$21.00



Powder Trickler (Shown above) - Perfect for those last few tenths! Order No. 005-050100 \$10.32

Powder Funnel - Anti-Static for .22-45 cal Order No. 005-586050 Price \$2.77

.17 Cal Adapter (Shown On Funnel) Order No. 005-586055 Price \$7.18

MTM Reloading Essentials

Now Works with Fat Magnums

LT-150 Reloading Tray - Patented Case-Gard 150 metallic reloading tray is the most versatile on the open market. Designed for .17 Rem. through .458 Win., as well as 9mm, .38, and .45. Now also works with Fatter Magnum calibers like WSM & WSSM, Rem Ultra Mag & 500 S&W! Order No. 008-LT150M \$5.78



MTM Ammo Can - 750 Cubic inches of durable storage for anything from ammo to reloading equipment. Thick highwall construction. Large handle, heavy-duty latch, double padlock tabs, made of rugged polypropylene. Order No. 008-AC11 \$13.79

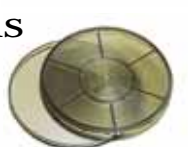

The MTM Primer Flipper - An indispensable time saver for turning primers anvil side up, especially when using an automatic feed priming device. Order No. 008-PF \$1.71

Adapto Funnel - Patented MTM Adapto 5 in 1 Funnel Kit includes funnel adapters for .17 Rem., .222 Rem., and .30 through .45, plus long-drop adapter for maximum capacity loads, .222 Rem. through .45. Comes with storage case! Order No. 008-AF7 \$11.91



Adapter for WSM, WSSM & Ultra Mags



Handloaders Log & Labels - An absolute must for the serious reloader. Now with a total of 150 pages. Space is provided for recording extremely detailed data (ammo performance, 'pet' loads, shotshell data, firearms inventory, etc.). Labels sold separately. Order No. 008-HL95 \$21.55, 008-LL1 3.58

MTM Case-Gard™ DS-750 Mini Digital Reloading Scale

- Powder pan, custom designed to do bullet, powder and arrow weighing
- Extended, 3 minute auto shut-off
- Stainless steel sensory platform
- Plus or minus .2 grain accuracy
- Up to 750 grain capacity
- Measures in grains, grams, carats and ounces
- High-impact, plastic sensory cover that doubles as large powder pan
- Calibration weight included
- Uses 2 AAA batteries (included)



MTM Die Box - Holds 4 full sets of reloading dies, plus 4 shell holders and last round loaded off each set of dies. Tall enough for almost all rifle dies. Comes with built in carrying handle and snap lock lid. Order No. 008-DB4 \$12.75



Midsouth Reloading Accessories



Covered Tray - Holds 50 rounds \$8.62 ea

Order No.
 30-45cal 038-502032
 9mm-223cal 038-502033

Midsouth Bullet Puller -



Rubberized grip, Rubber insert in hammer tip is easy on your bullets. Hammer comes with 4 collets.
Order No. 038-502031 \$14.93



Primer Flipper Tray
 5" circle

Order No.
 038-502030 \$5.97



17cal
 - 50cal

Funnel Kit Order No. 038-502029 \$4.64
Case Lube Plus 8oz 038-502026 5.30



Tumbler Kit - Includes: Tumbler, Rotary Sifter, 8oz Brass Bright Brass Polish, and 6 lbs of Corn Cob Media.



Media & Polish Pack - Includes:
 6 lbs of Corn Cob Media
 & 8oz Brass Bright Brass Polish.

	Order No.	Price
Tumbler Kit	038-502024	\$72.93
Case Tumbler	038-502022	47.72
Rotary Case Sifter	038-502023	19.68
Brass Polish 8oz	038-502025	5.30
Media & Polish Pack -	038-502042	9.61
Corn Media 6lbs	038-502028	4.31
Corn Media 10lbs	038-5020371	7.46
Walnut Media 15lbs	038-5020381	9.20

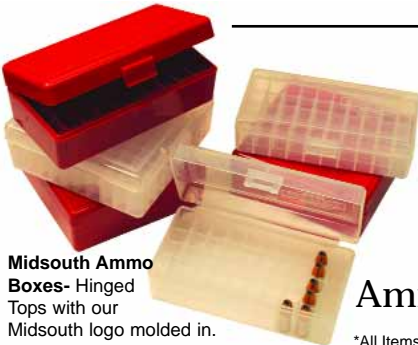

Midsouth Ammo Boxes- Hinged Tops with our Midsouth logo molded in.

Midsouth Ammo Boxes

Caliber	50 Round Clear	50 Round Red	100 Round Clear	100 Round Red
380/9mm	038-502001 \$1.07	038-502000 \$1.07	038-502013 \$2.08	038-502012 \$2.08
38/357	038-502003 1.16	038-502002 1.16	-	-
222/223	038-502005 1.72	038-502004 1.72	038-502017 2.52	038-502016 2.52
270/30-06	038-502011 2.07	038-502010 2.07	-	-
243/308	038-502039 2.01	038-502040 2.01	-	-

*All Items are Made In The U.S.A. with the exception of the motor in the Tumbler, it is Made In China - But assembled in the U.S.A. with all other U.S.A. parts.

Altraco Calipers and Micrometers

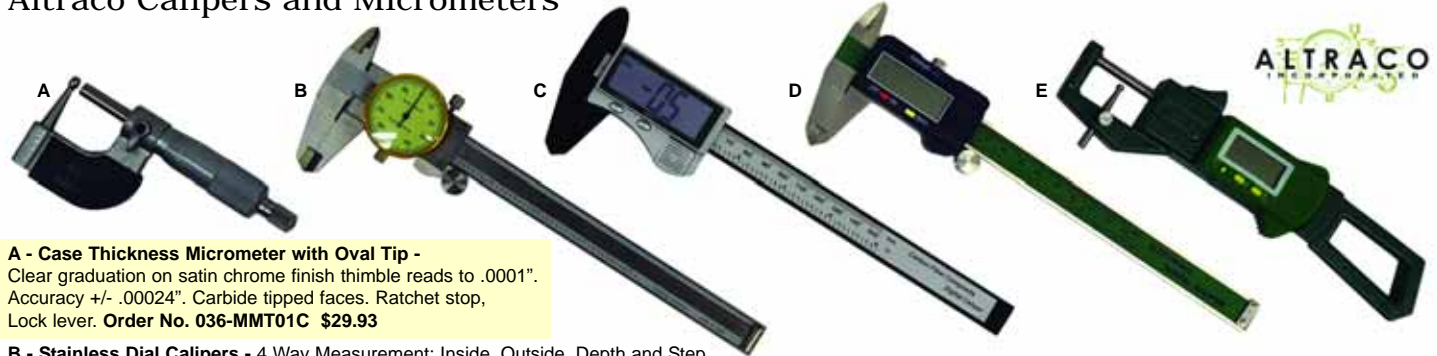

A - Case Thickness Micrometer with Oval Tip - Clear graduation on satin chrome finish thimble reads to .0001". Accuracy +/- .00024". Carbide tipped faces. Ratchet stop, Lock lever. **Order No. 036-MMT01C \$29.93**

B - Stainless Dial Calipers - 4 Way Measurement: Inside, Outside, Depth and Step. Comes in Plastic Box. Range: 0"-6" Accuracy: 0.0001" Graduation: 0.001" **Order No. 036-MCD61 \$20.18**

C - Carbon Fiber Composite Digital Caliper - Measuring Range: 0-150mm / 0" - 6" LCD Display. **Order No. 036-MCC210 \$9.15**

D - Shop Grade Electronic Calipers - 4 way measurement with resolution / repeatability .0005" x 0.01mm. LCD displays 5 digits. **Order No. 036-MCE6A \$22.13**

E - Digital Thickness and Tube Diameter Gauge - Specifically designed to easily measure outside dimensions to 1" and wall thickness up to .08" **Order No. 036-MGR01 \$57.38**

Altraco Deburring Tool - 17 - 45Cal



Order No. 036-NQDT1745 \$8.78

Lyman Reloading Presses and Accessories

How to pick which Press Kit is for you - Choose the press that best suits your reloading needs: If you reload only once in a while the Crusher II is for you, but if you shoot often and reload every week or month, then the T-Mag Turret Press is for you.

Lyman's Expert Reloading Kit - The best way to get started in reloading with all the top equipment. Includes your choice of the T-Mag II Turret Press or the Crusher II Single Station Press. Expert Kits are no caliber, which means that you buy a die set for the caliber(s) you are to reload. Each kit also contains: universal trimmer (with 9 pilots). Powder Scale (Either Pro 500 scale or 1000XP digital scale), 55 powder measure, case lube kit, powder funnel, deburring tool, auto primer feed, primer tray and Lyman's 49th edition reloading handbook! Order dies and shell holders separately and have a complete Expert Reloading Kit!

	Order No.	Price
T-Mag Expert Kit with Pro 500 Scale	015-7810140	\$375.86
Crusher II Expert Kit with Pro 500 Scale	015-7810120	337.38
T-Mag Expert Kit with 1000XP Electronic Scale	015-7810142	403.39
Crusher II Expert Kit with 1000XP Electronic Scale	015-7810149	374.02



Expert Kits are offered with either the Pro 500 beam scale or the 1000XP Digital Scale (Shown Below)



Lyman's Master Reloading Kit - The new Master Reloading Kit includes all the high-end Lyman tools and accessories needed to turn out top quality reloads. All you need to add are the dies and shellholder. Includes: T Mag or Crusher II Reloading Press, 1000XP Electronic Scale, #55 Powder Measure, Universal Priming Arm, Case Prep Multi-Tool, Auto Primer Feed, Loading Block, 49th Edition Reloading Handbook, Primer Catcher, Quick Release Turret System, Powder Funnel, Case Lube Kit, 7/8" x 14 Adapter (mounts #55 powder measure in press).

	Order No.	Price
T-Mag Master Kit	015-7810284	\$336.97
Crusher II Master Kit	015-7810281	298.76



Lyman's Load Data Books - Now Lyman's load data is available by caliber or category in handy books. The Load Data Books are ideal for the reloader who only wants to reload for select calibers. Like all Lyman Handbooks, these cover all popular brands of powder, primers and bullets, even cast bullets. **\$4.99 each**



	Order No.		Order No.
12 Gauge	015-9780000	24, 25, 6.5mm Rifle	015-9780010
16, 20 & 28 Gauge, .410 Bore	015-9780002	270 & 7mm Rifle	015-9780012
Semi-Auto - 380 Auto,	015-9780004	30 Caliber Rifle	015-9780014
9mm Luger, 40 S&W, 45 ACP		Old Military Rifle Calibers	015-9780016
Revolver - 38 Spec, 357 Mag,	015-9780006	8mm, 338 Rifle	015-9780018
44 Mag, 45 Colt		Classic Rifle Calibers	015-9780020
20, 22 Cal Rifle	015-9780008	Big Bore Rifle	015-9780022



Crusher II Pro Kit - Lyman's Crusher II reloading Kit offers big savings on all the basic tools needed to get started in reloading quality rifle and pistol cartridges. Along with the press, this kit includes the Pro 500 scale, case lube kit, primer tray, powder funnel, loading block, and the 48th Ed. Reloading Handbook. Just add dies and shellholder of your choice & you're reloading with the best. **Order No. 015-7810270 \$180.63**



Ideal for Pistol Reloading



T-Mag II and Crusher II Press Accessories are available to the right.

T-Mag II Press- The T-Mag II Press has a hi-tech frame design with silver hammertone powder coat finish. Base is flat machined for solid mounting to wood or metal bench. Six die stations accommodate a 3 die pistol set, a 2 die rifle set and a powder measure. Leave extra dies mounted and ready. Removeable turret features indexing handle, which also removes turret. Handle mounts for right or left hand use. **Order No. 015-7040781 \$173.68**

The Crusher II- is a true magnum press with classic "O" frame design that combines a 4 1/2" press opening with compound leverage for easy loading of even the largest rifle and pistol cartridges. Handle mounts for right or left hand use. Includes universal priming arm and primer catcher. **Order No. 015-7726300 \$121.60**

Extra T-Mag Turret - With an extra detachable T-Mag Turret, reloaders can maintain precise set-up while changing calibers. (Will fit old T-Mag). **Order No. 015-7726153 \$37.31**

Primer Catcher - Made of heavy duty plastic. Unit locks securely to press, but is easily removed when emptying primers. Fits Crusher II, T-Mag Compound Presses **Order No. 015-7726420 \$5.96**

Auto-Primer Feed - Eliminates handling of primers with oily fingers, speeds loading. Supplied with two tubes (large and small). Fits T-Mag II and Crusher II. **Order No. 015-7729050 \$21.97**

Auto-Primer Feed	015-7729050	\$21.97
Feed Tube Lg	015-7412053	5.06
Feed Tube Sm	015-7412052	5.06

Universal Priming Arm - Seats all sizes and types of primers. No extras to buy. Comes with two priming sleeves (lg and sm). **Order No. 015-7728036 \$12.24**

Lyman Rifle Dies

Rifle Caliber	Rifle 2 Die Set \$28.36 *29.01	Classic 3 Die Set \$44.34 \$44.34*	Rifle 3 Die Set \$38.20 \$38.20*	Neck Size Only \$20.93	Rifle M Die Only \$15.53	(Same As)
204 Ruger (SH#26)	015-7452276	-	-	-	-	-
22 Hornet (SH#4)	015-7452277*	-	-	-	015-7349058	22H
22-250 (22Varminter) (SH#2)	015-7452280	-	-	-	015-7342097	22S
222 Remington (SH#26)	-	-	-	-	015-7342097	22S
222 Remington Mag (SH#26)	-	-	-	-	015-7342097	22S
223 Remington (5.56mm) (SH#26)	015-7457111	-	-	015-7135006	015-7342097	22S
223 Win Super Short (SH#34)	015-7452346*	-	-	-	-	-
243 Win Super Short (SH#34)	015-7452351*	-	-	-	-	-
243 Winchester (SH#2)	015-7452283	-	-	015-7135015	015-7349007	24
25-06 Remington (SH#2)	015-7455495*	-	-	-	015-7349057	25L
260 Remington (SH#2)	015-7452285*	-	-	-	015-7349052	26
270 Winchester (SH#2)	015-7452289	-	-	015-7135033	015-7349009	27
270 WSM (SH#2)	015-7452288*	-	-	-	-	-
7mm Remington Magnum (SH#13)	015-7455496*	-	-	-	015-7349011	28
30-30 Winchester (30WCF) (SH#6)	015-7452299*	-	-	-	015-7349003	30S
30-06 (7.62x63mm) (SH#2)	015-7452301	-	-	015-7135049	015-7349002	30L
308 Winchester (307 Win) (SH#2)	015-7452298	-	-	015-7135047	015-7349002	30L
220 Swift (SH#5)	015-7452281*	-	-	-	015-7349024	22L
6mm Remington(244 Rem) (SH#2)	015-7452334*	-	-	-	015-7349007	24
250 Savage (250-3000 Sav) (SH#2)	-	-	-	-	015-7343005	25S
257 Roberts (SH#2)	015-7452287*	-	-	-	015-7349057	25L
25/20 Win (SH#10)	-	-	015-7469042	-	015-7342089	25-20
6.5 x 55 Swedish Mauser (SH#27)	015-7452340*	-	-	015-7135124	015-7349052	26
7mm STW (SH#13)	015-7455498*	-	-	-	015-7349011	28
7mmx64 Brenneke (SH#2)	-	-	-	-	015-7349011	28
7x65R Brenneke (SH#14B)	-	-	-	-	015-7349011	28
30 M-1 Carbine (SH#19)	-	-	015-7460475	-	015-7349004	30M1
7mm Rem Ultra Mag (SH#13)	015-7452292*	-	-	-	-	-
7x57 Mauser (7mm Mauser) (SH#2)	015-7452290*	-	-	-	015-7349011	28
280 Rem (7mm Rem exp) (SH#2)	015-7452343*	-	-	-	015-7349011	28
7.65mm Arg Mauser (SH#2)	015-7458843*	-	-	-	015-7349005	31L
32/20Win (SH#10)	-	-	015-7460484	-	015-7343006	31S
7.62x39mm (SH#3)	015-7459110*	-	-	-	015-7349003	30S
7.62x54 Russian (SH#17)	015-7452291*	-	-	-	015-7349002	30L
7x30 Waters (SH#6)	-	-	-	-	015-7349011	28
7mm-08 Remington (SH#2)	015-7455646	-	-	-	015-7349011	28
300 Rem Ultra-Mag (SH#13)	-	-	-	-	015-7349002	30L
300 Rem Ultra Mag SA (SH#13)	015-7455654*	-	-	-	-	-
300 Savage (SH#2)	015-7452295*	-	-	-	015-7349003	30S
300 Weatherby Mag (SH#13)	015-7455638*	-	-	-	015-7349002	30L
300 Winchester Magnum (SH#13)	015-7455647*	-	-	015-7135051	015-7349002	30L
300 Winchester Short Mag (SH#13)	015-7455652	-	-	-	-	-
303 British (SH#7)	015-7452296*	-	-	-	015-7349005	31L
32 Winchester Special (SH#6)	015-7452304*	-	-	-	015-7342073	32
8x57 Mauser (8mm Mauser) (SH#2)	015-7452305*	-	-	-	015-7349018	8MM
338 Winchester Magnum (SH#13)	015-7452338*	-	-	-	015-7340762	33
338 Ultra-Mag (SH#13)	-	-	-	-	015-7340762	33
35 Remington (SH#2)	015-7458587*	-	-	-	015-7340809	35S
35 Whelen (SH#2)	-	-	-	-	015-7342074	35L
358 Winchester (SH#2)	-	-	-	-	015-7342074	35L
375 H&H Magnum (SH#13)	015-7452316*	-	-	-	015-7349015	37
375 Rem Ultra Mag (SH#13)	-	-	-	-	-	-
38/55Win (SH#6)	-	-	015-7460494*	015-7135126	015-7349015	37
40-65 Win (SH#17)	-	015-7460490	-	015-7135055	015-7343007	40L
40-70 Sharps Straight (SH#33)	-	015-7460492	-	015-7135055	015-7343007	40L
416 Rigby (SH#17)	015-7455449	-	-	-	-	-
44-40 Win (SH#14B)	-	-	015-7460495	-	015-7342102	44-40
444 Marlin (SH#14B)	-	-	015-7467151	-	015-7348739	444
450 Marlin (SH#13)	-	-	015-7460524	-	015-7349053	45-70
45/70 Government (SH#17)	-	-	015-7460496*	015-7135057	015-7349053	45-70
45-90 (SH#17)	-	015-7460499*	-	015-7135057	015-7349053	45-70
45-100 Sharps (SH#17)	-	015-7460520	-	015-7135057	015-7349053	45-70
45-110 Sharps (SH#17)	-	015-7460522	-	015-7135059	015-7349053	45-70
45-120 Sharps (SH#17)	-	015-7460506*	-	015-7135059	015-7349053	45-70
50/70 Government (SH#22)	-	-	015-7660121	-	015-7342107	50-70
50-90 (SH#22)	-	015-7460501	-	-	015-7342109	50-90



Rifle 2-Die Sets - Includes: Full length resizing die (with decapping stem and neck expanding button) and a bullet seating die. Best choice for loading jacketed bullets in bottlenecked rifle cases. For cast bullets, Lyman suggests the addition of a neck expanding M Die, sold separate.

Rifle 3-Die Sets -Straight wall rifle cases require these three die sets consisting of a full length resizing die (with decapping stem) a two step neck expanding (M) die and a bullet seating die. Ideal for loading cast bullets because of the neck exp.die.

Classic Rifle Die Sets -Lyman responds to the requests of Black Powder Cartridge and Cowboy Action Shooters to bring back die sets for the classic cartridges. These standard 7/8" x 14 3-die sets will fit most brands of reloading presses and include Lyman's popular "M" neck expanding die

The Two-Step Neck-Expanding (M) Die Improves accuracy of cast and jacketed bullet reloads. Doesn't stretch cases as does standard expander button. Extends case life.

Ram Prime Die System

Designed for sensitive one-at-a-time seating on top of a press. Includes large and small primer punches.

Order No. 015-7728040 \$15.53



Black Powder Taper Crimp Dies

Allows proper neck tension and minimal taper which is ideal for the compressed black powder charges.

40 Caliber	015-7153120	\$17.30
45 Cal Short	015-7153124	17.30
45 Cal Long	015-7153126	17.30



Die Bench Wrench - A versatile steel combination wrench to fit Lyman and RCBS 7/8x14" Lock Nuts, plus Lyman's decap rod, seating screw and expander plug nuts.

Order No. 015-7990116 \$3.61

Pistol Caliber	Carbide 4 Die Set \$57.40	Carbide 3 Die Set \$42.93	Carbide Size Die only \$30.30	Taper Crimp Die Only \$17.30	Neck Expanding M Die \$15.53
32 ACP (SH#23)	-	015-7680113	-	-	-
32 S&W Long (SH#9)	-	015-7680113	-	-	-
32 H&R Magnum (SH#9)	-	015-7680113	-	-	-
380 Auto (SH#26)	-	015-7680112	-	-	015-7342081
38 S&W (SH#21)	-	015-7680116	-	-	015-7341801
38 Super Auto (SH#12)	-	015-7680116	-	-	015-7342081
9mm Luger (SH#12)	015-7680203	-	-	015-7153097	015-7342081
38 Special/357 Mag (SH#1)	015-7680200	-	015-7590179	015-7153101	015-7341801
357 Rem Max (SH#1)	015-7680200	-	015-7590179	015-7153101	015-7341801
9mm Mak (SH#12)	-	015-7680119	-	-	-
40 S&W (SH#15)	015-7680207	015-7680118	-	015-7153116	015-7340833
10mm Auto (SH#15)	015-7680207	015-7680118	-	015-7153116	015-7340833
44 Mag/44Spl (SH#7)	-	015-7680105	015-7590180	015-7153105	015-7340820
44 Russian (SH#7)	-	-	-	015-7153105	015-7340820
45 Scofield (SH#14B)	-	-	-	015-7153107	015-7340832
445 Super Mag (SH#7)	015-7680213	015-7680105	015-7590180	015-7153105	015-7340820
45 ACP (SH#2)	015-7680208	015-7680107	015-7596323	015-7153107	015-7340832
45 Mag (SH#2)	015-7680208	015-7680107	015-7596323	015-7153107	015-7340832
45 Colt (SH#11)	-	015-7680110	-	015-7153107	015-7340832
454 Casull (SH#11)	-	015-7680122	-	-	015-7340832
480 Ruger	-	015-7680124	-	-	015-7340834

Lyman Pistol Dies

Premium Carbide 4-Die Sets 4-Die Sets feature a separate taper crimp die and powder charge/expanding die. The powder charge/expand die has a special hollow 2-step neck expanding plug which allows powder to flow through the die from a powder measure directly into the case. The powder charge/expanding die has a standard 7/8 x 14 thread and will accept Lyman's 55 Powder Measure, or most other powder measures.

3-Die Carbide Pistol Die Sets Features; a one piece hardened steel decapping rod and extra seating screws for all popular bullet nose shapes, and steel construction.



Deluxe Rifle 3 Die Sets & Deluxe Neck Expanding Die w/ Carbide Button - By adding both a premium Carbide Expander Assembly and a Neck Sizing Die, Lyman has created two die sets in one. Neck sizing eliminates overworking the brass, extending case life.

New!

Set includes: **Deluxe Carbide Expander Assembly**, with a free floating carbide sizing button, which smooths neck expansion by moving the button up the decapping rod to better use the press' leverage. It eliminates the need for inside neck lube.

Neck Sizing Die, which allows the case to retain the precise chamber dimensions of the individual rifle while avoiding excessive working of the brass.

Standard Full Length Sizing Die, for taking brass down to factory dimensions.

Standard Bullet Seating Die

Caliber	Carbide Deluxe Rifle 3 Die Set \$49.09	Carbide Neck Size Die Only \$27.02
204 Ruger	015-7680230	015-7135196
22-250	015-7680232	015-7135198
223 Rem	015-7680234	015-7135200
243 Win	015-7680236	015-7135202
6.5 x 55	015-7680238	015-7135204
270 Win	015-7680240	015-7135206
30-06	015-7680242	015-7135208
308 Win	015-7680244	015-7135210
300 Win	015-7680246	015-7135212
7mm Rem Mag	015-7680248	015-7135214
338 Win Mag	015-7680249	015-7135216
338 Lapua	015-7680250	015-7135218

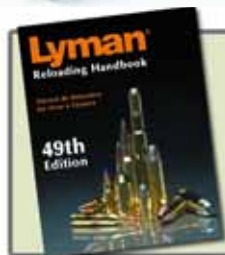

Lyman's 49th Edition Reloading Handbook -

Softcover
Order No. 015-9816049 \$18.00

Hardback
Order No. 015-9816052 \$25.72

Lyman Shell Holder Set - Best Value!

12 Piece Shell Holder Set, in a handy storage box, with one of each number: 1, 2, 6, 7, 11, 12, 13, 14B, 15, 17, 22, and 26.

Order No. 015-7712110 \$27.42



Detachable Shellholders - Precisely machined to insure perfect case fit. Fits all popular presses. For proper fit, see the Lyman die listing and look next to the caliber you are interested in. The shell holder number will follow. Example: 204 Ruger (SH#26) \$5.42 each

S.H.	Order No.	S.H.	Order No.
X-1	015-7738040	X-15	015-7738055
X-2	015-7738041	X-17	015-7738057
X-3	015-7738042	X-19	015-7738060
X-4	015-7738043	X-21	015-7738075
X-5	015-7738044	X-22	015-7738062
X-6	015-7738045	X-23	015-7737486
X-7	015-7738046	X-26	015-7738063
X-9	015-7738048	X-27	015-7738064
X-10	015-7738049	X-30	015-7737492
X-11	015-7738050	X-32	015-7738066
X-12	015-7738051	X-33	015-7738069
X-13	015-7738052	X-34	015-7738148
X-14B	015-7738054	X-35	015-7738149
		X-36	015-7738150

J to X Shellholder Adapter - For use with Lyman's older presses which used the older J-Type shellholders. Converts press to use current X-Type shellholders. Order No. 015-7095762 \$10.47

Lyman Case Prep Multi-Tool

Lyman



Provides you all the essential Case Prep Accessories in one compact double-ended storage tool. Knurled handle unthreads in the middle to store all parts. Both ends are threaded for 2 tools at once use.

Includes:
Inside Deburr tool (VLD) Tool
Outside Deburr Tool
Primer Pocket Reamer (Sm & Lg)
Primer Pocket Cleaner (Sm & Lg)
Order No. 015-7777800 \$18.03



Deluxe Carbide Expander / Decap Die Rod Complete

	Order No.	Price
22 Caliber	015-7680300	\$21.64
6mm	015-7680302	21.64
6.5mm	015-7680304	21.64
270 Caliber	015-7680306	21.64
7mm	015-7680308	21.64
30 Caliber	015-7680310	21.64

- Fits All Lyman Sizing Dies
- Carbide Button can be adjusted for height
- Carbide free floats on the rod for self-centering in case necks
- Replaceable decapping pin

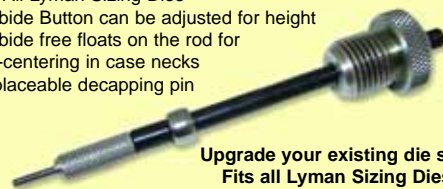

Upgrade your existing die sets. Fits all Lyman Sizing Dies.

Turbo Sonic 700 Ultrasonic Case Cleaner -

The perfect size for small batches.
- 2 color LED display with 5 timed cleaning cycles.
- Uses advanced oscillation circuitry.
- Processes up to 100 9mm cases.

Order No. 015-7631729 \$57.76

Turbo Sonic 6000 Ultrasonic Case Cleaner -

Large capacity for cleaning handgun & pistol frames.
- 6.3 quart tank (12.8" x 8" x 3.9")
- Heated tank for optimum cleaning performance.
- Processes up to 1300 9mm cases in less than 15 minutes.
- 2 color LED display with 5 timed cleaning cycles.
- Sized for cleaning handgun or multiple pistol frames.

Order No. 015-7631725 \$252.80

Turbo Sonic 2500 Ultrasonic Case Cleaner -

Heated tank and plastic basket delivers Superior Ultrasonic Performance.
- Processes up to 900 9mm cases in less than 15 minutes.
- Cleans cases inside & out, including primer pockets.

Order No. 015-7631700 \$101.10



Sonic Cleaners

	Order No.	Price
Case Cleaning Solution 4 oz	015-7631711	7.19
Case Cleaning Solution 16 oz	015-7631705	10.80
Case Cleaning Solution 32 oz	015-7631714	18.02
Steel Cleaning Solution 4 oz	015-7631712	7.19
Steel Cleaning Solution 16 oz	015-7631707	10.80
Steel Cleaning Solution 32 oz	015-7631715	18.02
Turbo Sonic Measuring Cup	015-7631716	2.85

Lyman Micrometers and Calipers



A & B - Reloaders & Shooters 1" Micrometers - Lyman's 1" standard and digital micrometers allow the reloader to accurately measure the diameter of bullets and cartridges. Both feature spindle locks and friction thimbles. Reloaders Micrometer counter reads to .0001". Digital counter reads to .001" and by Vernier scale to .0001". Both include a wooden storage case.

1" Digital Micrometer Order No. 015-7832234 Price \$35.57
1" Reloaders Micrometer Order No. 015-7832230 Price \$20.54

C- Stainless Electronic Micrometer - High tech digital readout switches back and fourth from inches to millimeters with the touch of a button. Accurate to .001"/0.1mm. Comes in a handy plastic storage case. Order No. 015-7832218 Price \$37.52

D- Stainless Dial Caliper - Plastic Case Order No. 015-7832212 Price \$22.24

Lyman Precision Scales and Powder Measurers

1200DPS 3 Digital Powder System - Lyman's Revolutionary 1200DPS Digital Powder System combines a precision electronic Powder Scale and an automatic Powder Dispenser into one easy to use design. The DPS 3 is more than twice as fast as the original DPS. Features a Auto-Repeat Setting enabling you to throw a precise charge automatically each time the pan is put in place. This scale has the capacity to store up to 100 of your favorite loads. Best of all, you can easily recall any of them by Cartridge, Specific Powder and Weight. No Powder Calibration (Flow Rate) is required, just select the load you want and start dispensing powder. It dispenses powder quickly and is accurate to + or - 1/10 grain. It can be used as a complete Dispensing System, just a scale or as a Scale and a Powder Trickler. The 1200DPS 3 is faster, accurate and affordable. Note: not for use with black powder.

110v Order No. 015-7752400 \$248.99
220v Order No. 015-7752411 \$267.52

DPS Speed Upgrade Kit - Upgrade Any DPS I or DPS II to equal the DPS3 High Speed Performance! This inexpensive replacement system installs in seconds and requires no tools. In fact, it's easier than changing powders. Best of all, it speeds up any earlier DPS to the latest, state of the art performance. Order No. 015-7752428 \$27.76

1200DPSII PC Interface- Transfer memory from your computer right to your 1200 DPSII. Includes a separate reloaders log. Stores thousands of loads! Order No. 015-7752455 \$28.86



Lyman



XP1500 Electronic Scale- It's the first scale that comes with a removable powder trickler that works in right or left hand mode. The 1500 is accurate to 1/10 grain over its full weighing capacity. Features a fold back dust cover and handy "pop out" storage tray which stows accessories. Includes calibration weight, AC adapter and cleaning brush. Also works with 9V battery.

110v Order No. 015-7751500 \$146.65

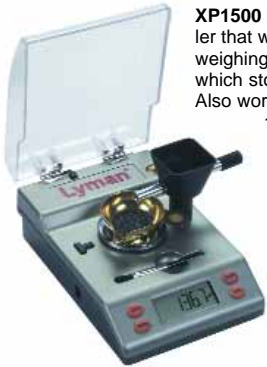

XP1000 Electronic Scale- Ideal for the range or table top. The 1000 XP is accurate to 1/10 grain for the full range of its 1000 grain capacity. Slick, user friendly design has clear "snap lock" platform cover which rotates to full lay down position or may be removed. Scale works on 9V battery or with AC adapter. Calibration weight, powder pan and AC adapter included. 110v Order No. 015-7750750 \$103.90



Deluxe Scale Check Set -Includes: .5gr, 1gr, 2gr(qty 2), 5gr, 10gr, 20gr(qty 2), 50gr, 100gr and tweezer) Order No. 015-7752313 \$31.75

Shooters Scale Check Set -Includes: .5gr, 1gr, 2gr(qty 2), 5gr, 10gr, 20gr(qty 2), and tweezer) Order No. 015-7752314 \$23.80

55 Powder Measure

This powder measure dispenses a charge of smokeless powder with consistent accuracy to a fraction of a grain. The key to this unflinching precision is the 55's unique three-sided micrometer-adjustable cavity. 2400gr clear PVC plastic reservoir resists chemical action. Attached knocker assures a complete charge every time. Mount on your bench or any turret press. No funnel required. Optional powder measure stand available.

	Order No.	Price
#55 Measure	015-7767783	\$71.22
Stand	015-7767784	24.17
Powder Baffle	015-7767758	6.47



E-Zee Flo Universal Powder Trickler -The first trickler that works with any reloading scale. Adjusts in both height and reach distance.

Order No. 015-7752477 \$15.04



55 Classic Powder Measure

Lyman's 55 Classic Powder Measure is ideal for the Cowboy Action Competition or the growing number of black powder cartridge shooters. 11lbs capacity aluminum reservoir, brass powder meter, internal powder baffle, 24" drop tubes work for .38 thru .50cal. Clamp for mounting.

	Order No.	Price
55 Classic -Standard w/o tubes	015-7767760	\$99.02
55 Classic -w/ drop tubes	015-7767775	118.09
Black Powder Drop Tubes Only	015-7767764	25.97



Lyman



Pro Series Scales -Lyman's Pro 1000 and Pro 500 Scales provide top of the line accuracy at about 1/2 the cost of other models - features include high tech base design, x-large leveling wheel, improved platform and pan system. All the hardware and features of standard Lyman 500 and 1000. Accurate to 1/10th grain.

	Order No.	Price
Pro 500 Scale	015-7752222	\$50.38
Pro 1000 Scale	015-7752218	60.80

Powder Pal Funnel Pan - It is no longer necessary to put a separate funnel in the cartridge case to pour the powder in. Just pour directly from the Funnel Pan into the case. (Do not use with beam scales)

Order No. 015-7752433 \$5.10



E-Zee Funnel - Redesigned with all of the latest cartridges in mind, Handles everything from .22 up to .50 cal

Order No. 015-7752431 \$3.67



Powder Dribbler- Use the full measure of accuracy built into a powder scale. Features a large powder reservoir and tip-free base.

Order No. 015-7832201 \$10.11



Lyman Case Prep Xpress

Lyman Case Prep Xpress - The only "All Inclusive" case prep system which offers all of the most popular case prep accessories. It's driven by a high torque gear motor, and allows you the use of 5 different case prep operations at one time. All the accessories are included from the start. Order No. 015-7810220 \$99.77

- Includes:
- Outside Deburr Tool
- Flash Hole Uniformer
- Case Neck Lube (Mica)
- Clean Up Brush
- Inside Deburr tool (VLD) Tool
- Primer Pocket Uniformer (Sm & Lg)
- Primer Pocket Reamer (Sm & Lg)
- Primer Pocket Cleaner (Sm & Lg)
- Case Neck Brush (25, 30, 38, 45 Cal)
- Removeable Brass Shaving Pan



Lyman Universal Trimmer



Each Lyman Trimmer comes with a 9 pilot Multi-Pack. Includes pilot numbers: 22, 24, 27, 28/7mm, 30, 9mm, 35 (.357/.38), 44 and 45A.



Lyman 015-7862000

015-7862003

Lyman's Universal Trimmer with 9 pilot multi-pack has long been the favorite among reloaders. Now, with Lyman's power adapter, you can convert your trimmer to power in seconds. Simply unscrew the cutter head, slide it out of the shaft and replace it with the adapter. Power adapter fits any standard electric drill or power screwdriver (You Must Use Your Own Drill or Power Screwdriver). Power Pack includes both hand trimmer and power adapter at one best buy special price.

	Order No.	Price
Universal Trimmer w/multi pack	015-7862000	\$74.59
Power Pack with Universal Trimmer & Power Adapter	015-7862003	82.17

Power Adapter Only - Converts Standard Lyman Universal Trimmer to Powerin Seconds
Order No. 015-7862001 \$20.17



015-7862001

Lyman Power Trimmer with Chuckhead



Lyman

Lyman's Power trimmer with universal chuckhead will trim cases from .17 caliber on up, quickly and easily. Uses 175 rpm motor in 110 or 220 volt. Includes nine pilots and two cutter heads. Also has separate high speed drive for brushes & primer pocket cleaning. 220v is special order only.

	Order No.	Price
Power Trimmer 110 Volt	015-7862005	\$236.22
Power Trimmer 220 Volt	015-7862006	239.73



Ream and Clean Accessories - This set fits Lyman Universal Trimmer and Accutrimmer. Kit includes reamers and cleaners for primer pockets maintenance. Also includes necessary adapters.
Order No. 015-777795 \$11.52

Lyman Accutrimmer with Pilots



(Shown with optional Outside Neck Turner)



50cal BMG Trimmer with Pilot

Designed to trim the 50 BMG case specifically

ACCUTRIMMER uses standard shell holders to position cartridge case and is an excellent value. Trims cases .17 through .458 Win Mag. The Outside Neck Turner is a simple to operate tool used to uniform neck wall thickness and outside neck diameter. (Works with both Lyman Accutrimmer and Universal Case Trimmer.)

	Order No.	Price
50 cal BMG Trimmer w/Pilot	015-7862130	\$48.61
Accutrimmer with Pilots	015-7862210	47.64
Outside Neck Turner	015-7810185	29.30

	Order No.	Price
Carbide Cutter Head for Case Trimmers(1 pk)	015-7822204	\$31.50
Replacement Cutter Head for Trimmer (2 pk)	015-7822203	12.97



Trimmer Pilot Chart Use this chart to find Trimmer Pilots

Rifle Calibers

17 Remington	17	015-7821985
204 Ruger	20	015-7821981
22 Hornet	22	015-7821987
221 Fireball	22	015-7821987
22-250	22	015-7821987
220 Swift	22	015-7821987
222 Remington	22	015-7821987
222 Remington Mag	22	015-7821987
223 Remington	22	015-7821987
5.6 x 50R Mag	22	015-7821987
243 Winchester	24	015-7821988
244, 6mm Remington	24	015-7821988
25 WSSM	25	015-7821986
25-20	25	015-7821986
25-06 Remington	25	015-7821986
250-3000 Savage	25	015-7821986
257 Roberts	25	015-7821986
6.5 x 55 Swedish	26	015-7822013
260 Remington	26	015-7822013
6.5 x 57 Mauser	26	015-7822013
6.5 x 57R Mauser	26	015-7822013
270 Winchester	27	015-7821989
270 WSM	27	015-7821989
7mm/08 Remington	28	015-7821999
7-30 Waters	28	015-7821999
7mm Rem Mag	28	015-7821999
7mm Rem Ultra Mag	28	015-7821999
7mm Weatherby Mag	28	015-7821999
7mm STW	28	015-7821999
7 x 57 Mauser	28	015-7821999
7 x 64 Brenneke	28	015-7821999
7 x 65R Brenneke	28	015-7821999
280 Rem (7mm Exp)	28	015-7821999
30M1 Carbine	30	015-7821991
30-30	30	015-7821991
300 Savage	30	015-7821991
307 Winchester	30	015-7821991
308 Winchester	30	015-7821991
30-06	30	015-7821991
300 Winchester Mag	30	015-7821991
300 Rem Ultra Mag	30	015-7821991
300 Rem UltraMag SA	30	015-7821991
300 Weatherby Mag	30	015-7821991
300 WSM	30	015-7821991
7.62 x 39	30	015-7821991
32-20	31	015-7821992
7.65 Arg Mauser	31	015-7821992
7.62 x 54 Russian	31	015-7821992
303 British	31	015-7821992
32 Win Special	32	015-7821994
8 x 57 Mauser	8mm	015-7821995
8 x 57 JS	8mm	015-7821995
7.9 x 57	8mm	015-7821995
8 x 57JRS	8mm	015-7821995
8mm Rem Mag	8mm	015-7821995
338 WinMag	33	015-7821996
338 Rem Ultra Mag	33	015-7821996
35 Remington	35	015-7822001
356 Winchester	35	015-7822001
358 Winchester	35	015-7822001
35 Whelen	35	015-7822001
9.3mm x 62	36	015-7822009
375 Winchester	37	015-7822002
38-55	37	015-7822002
375 H&H Magnum	37	015-7822002
375 Rem. Ultra Mag.	37	015-7822002
40-65	41	015-7822004
40-70 Sharps Straight	41	015-7822004
416 Rigby	416	015-7822014
44-40 Winchester	44A	015-7822005
444 Marlin	44	015-7822006
450 Marlin	45	015-7822008
45-70 & .45-90	45	015-7822008
45-100	45	015-7822008

Pistol Calibers

25 A.C.P.	25A	015-7821993
7mm TCU	28	015-7821999
30 Luger	30	015-7821991
30 Mauser	30	015-7821991
32 ACP	31	015-7821992
32 S&W Long	31	015-7821992
32 H&R Mag	31	015-7821992
38 Super Auto	9mm	015-7821997
9mm Luger	9mm	015-7821997
9 x 23mm	9mm	015-7821997
380 Auto	9mm	015-7821997
38 S&W	35	015-7822001
38/.357 Mag	35	015-7822001
357 Rem Maximum	35	015-7822001
9mm Makarov	36	015-7822009
40 &W & 10mm	39	015-7822003
41 Mag	41	015-7822004
41 Action Express	41	015-7822004
44 Mag/ Spl./44 Russ	44	015-7822006
44-40 Winchester	44A	015-7822005
45 ACP/.45 Win Mag	45A	015-7822007
45 Schofield	45A	015-7822007
45 Colt	45A	015-7822007
454 Casull	45A	015-7822007
475 Wildey	47	015-7822010
50 Action Express	50A	015-7821983

Lyman Pilots for Trimmers

Trimmer Pilots - See the Chart on the right for the correct caliber. \$3.43 ea *\$3.79ea

Order No.	Size	Order No.	Size
015-7821985	#17 Pilot	015-7821995	#8mm Pilot
015-7821987	#22 Pilot	015-7821996	#33 Pilot
015-7821988	#24 Pilot	015-7821997	#9mm, 34 Pilot
015-7821993	#25A Pilot	015-7822001	#35 38/357 Pilot
015-7821986	#25 Pilot	015-7822002	#37 Pilot
015-7822013	#26 Pilot	015-7822003	#39 Pilot
015-7821989	#27 Pilot	015-7822004	#41 Pilot
015-7821999	#28 Pilot	015-7822014	#416 Pilot
015-7821990	#29 Pilot	015-7822005	#44A 44-40 Pilot
015-7821991	#30 Pilot	015-7822006	#44 44M Pilot
015-7821992	#31 Pilot	015-7822007	#45A 45P Pilot
015-7822009	#36 Pilot	015-7822008	#45 45R Pilot
015-7822010	#47 Pilot	015-7821983	#45 50AE Pilot
015-7821994	#32 Pilot	015-7821982*	#50 BMG



Nine Pilot Multi-Pack - Includes 9 of the most popular pilots: 22, 24, 27, 28/7mm, 30, 9mm, 35 (38/357), 44 and 45A.
Order No. 015-7822202 \$12.64

Lyman Case Preparation



A- Chamfer/Reamer -Lyman's VLD (very low drag) Chamfer/Reamer eliminates damage to bullets caused by the sharp edges of the cartridge case neck. The long boat-tail on Sierra VLD Match bullets are cut by the case mouth when chamfered with a standard 45 degree reamer. The sharp 22 degrees on the VLD reamer allows all bullets to slip easily into the case ensuring the best accuracy. Ideal For Sierra Match Boattail Bullets! **Order No. 015-7777789 Price \$9.36**

C- The Case Care Kit -Kit includes the pedestal crank, chamfer/deburring tool and a ream clean accessory kit. **Order No. 015-7777793 Price \$33.23**

D- Flash Hole Uniformer -Removes internal flash hole burrs. Consists of a tool steel cutter, shaft, shoulder stop and handle. Improves accuracy on reloads. Works with calibers .22 through .45 **Order No. 015-7777760 Price \$11.70**

B- LYMAN CASE PREPARATION KIT -Kit contains all tools needed for proper case preparation. Includes L&S Primer pocket reamer, L&S primer pocket cleaner, deburring tool, 3 neck brushes and 2 threaded handles. A truly nice kit! **Order No. 015-7777796 Price \$25.74**

E- Case lube Kit -Everything you need to clean and lube cases inside and out in one package. Large cloth lubricating pad dispenses lube evenly. Includes 2 oz. of Lyman case lube, interchangeable neck brushes, and wooden handle. **Order No. 015-7631300 Price \$15.13**



F- Cordless Power Case Prep Tool - High torque rechargeable power driver turns at the perfect speed for performing inside and outside deburring operations in seconds. Set includes all the essential case prep accessories, including large and small primer pocket reamers and cleaners, case neck brushes, and inside/outside deburring tools. With the hex adapters (included), accessories simply pop in and out of the driver, (no threading or chucking required). Set also includes standard and Phillips driver bits. **Order No. 015-7777758 Price \$45.13**

K- Case Spray Lube -5.5 ounce spray can. Lubricates cases in seconds. Won't harm powder or primers! Good for many other uses! **Order No. 015-7631296 Price \$6.33**

L- Lyman Loading Block -Holds 50 Rifle or Pistol cases. .22 through .45 cal. Molded of heavy duty plastic. **Order No. 015-7728054 Price \$5.06**

M-Lyman Magnum Inertia Bullet Puller - Safely strips loaded ammo in seconds without damage to bullet or case. Use on tiny 5.7 X 28FN to the largest Magnums. **Order No. 015-7810216 Price \$16.50**

G- Power Accessories Kit Only -The kit includes all the essential case prep accessories, including large and small primer pocket reamers and cleaners, case neck brushes, inside and outside deburring tools. **Order No. 015-7999050 Price \$28.86**

N-Case Neck Dipper -Help prolong cartridge case life. The three brush set rids of combustion residue in cases from .17 to .45 caliber. Dip in the furnished dry lube. Helps reduce friction! Now available: Mica Replacement Refill (1 oz.) NO MICA PRODUCTS CAN BE SHIPPED TO CALIFORNIA RESIDENTS!

H- In/Out Deburring Tool -Cuts deburring time in half. Simultaneously chamfers and deburrs trimmed cases. Adjustable cutting blade adapts to any rifle or pistol case from .22 thru .45 with hex adjustment wrench. **Order No. 015-7810210 Price \$12.10**

Case Neck Dipper- Mica Refill- **Order No. 015-7631360 Price \$8.13**
Order No. 015-7991415 Price \$3.58

I- Primer Pocket Uniformers -This precision tool features factory pre-set stop collar to uniform primer pocket depth to SAAMI specs. Improves accuracy. Designed for rifle cases only. **LARGE- Order No. 015-7810215 Price \$15.53**
SMALL- Order No. 015-7810218 Price \$15.53

O- Deburring Tools - Standard (.17-45cal)-Order No. 015-7810199 Price \$13.90
Extra Lg(.17-60 Cal)-Order No. 015-7810206 Price \$18.03

J- E-Zee Case Gauge -A quick and accurate gauge to measure case length for both fired and resized cases. Measure most popular rifle and pistol cases. Great for sorting large quantities of mixed brass.

Order No.
Rifle and Pistol 015-7832215 \$15.13
New! Pistol Only 015-7832217 \$10.80

P- Pocket Cleaners - Large -Order No. 015-7777790 Price \$7.59
Small -Order No. 015-7777791 Price \$7.59

Q- Pocket Reamers - Large -Order No. 015-7777785 Price \$7.59
Small -Order No. 015-7777784 Price \$7.59



Outside Chamfer Tool - Removes excess brass from trimmed cases. Deburrs the outside case mouth to leave a smooth even finish. For 17 cal- 45cal. Complements VLDTool. **Order No. 015-7810222 Price \$9.50**

"Universal" Case Prep Accessory Tool Set - All the items necessary for quality case preparation in one deluxe set. Includes both large and small primer pocket reamers, primer pocket cleaners, outside deburring tool, inside (VLD) chamfer and large and small uniform tools. **Order No. 015-7810212 Price \$51.30**

Lyman Precision Cartridge/Case Gauges



	Order No.	Price
Checks both overall case length and case headspace for both loaded rounds and empty cases.	9mm 015-7832330	\$11.92
	45 ACP 015-7832331	11.92
	44 Mag 015-7832336	11.92
	40 S&W 015-7832332	11.92
	.30-06 015-7832320	16.25
	.308 015-7832321	16.25
	.22/250 015-7832324	16.25
	.270 015-7832325	16.25
	.243 015-7832322	16.25
	.223 015-7832323	16.25

Lyman Tumblers



A- Turbo Twin -OUR BEST VALUE! - Features interchangeable 2 bowl system for large or small loads. Comes with 1200 bowl (with a built in sifter) and the 600 bowl and lid. Interchangeable in seconds. Order media separately. Motor-Ball Bearings.

110v Order No. 015-7631327 Price \$64.48
220v Order No. 015-7631328 Price \$67.39

B- 1200 Pro Turbo -Lyman's 1200 Pro Turbo features the same capacity and high endurance as our classic 1200 Turbo. The Pro Turbo has a working capacity of 350 cases per cycle. The base design has a beefed up suspension with upgraded motor, guaranteed to outperform all other tumblers in its class. Order Media Separately. Motor-Ball Bearings. Order No. 015-7631318 Sale Price \$47.67

1200 Pro Turbo Extra Bowl Order No. 015-7631323 Sale Price \$15.13

C- Auto Flo Conversion Kit - Allows conversion of standard tumblers to Auto-Flo tumblers. The 1200 Conversion Kit works for the 1200 and 600 models plus cost competitive models. Conversion systems include bowl, lid, auto flo drain base, media drain pan and appropriate stemware.(1200-600 Model also works with RCBS Vibratory case cleaner, and Vibrashine VS-15) Order No. 015-7631636 Price \$23.62

TUMBLER	Media Charge	#38 Spl cases
600	1lbs	175
1200 Pro&Auto	2lbs	350
2200	5lbs	750
2500 Pro Mag	4.5lbs	900

D, E, F- Auto Flo Tumblers - The patented Lyman Auto Flo system allows for the automatic separation of media from brass cases. When cases are clean, simply pull the Auto Flo drain plug and the media drains into the drain pan, leaving the bowl full of clean, polished cases. Lyman offers a full range of Auto Flo models from 1200 size up to the giant Super Mag. Media drain pan included with all models. Motor Ball Bearings.

1200 Auto Flo 110V 015-7631630 \$80.29
2200 Auto Flo 110V 015-7631601 Sale! 114.66
2200 Auto Flo 220V 015-7631611 119.36

Pro Mag 2500 Auto Flo 110V 015-7631697 105.02

G- 2500 Pro Magnum Turbo Tumbler -To meet the special needs of the high volume reloaders Lyman offers a Large Capacity 2500 Pro Magnum model. The 2500 Pro Magnum has a capacity of 900 .38 special cases per cycle.

Order No. 015-7631692 Price \$71.65

Lyman Super Moly Products



A- Super Moly Tumble Kit -This kit contains everything you need to moly coat thousands of bullets! Moly Coating bullets reduces bore fouling and increases barrel life. This kit contains a Lyman 1200 tumbler, an extra heavy-duty moly coating bowl, 6 ounces of Superfine Grade Moly, 2 pounds of finishing media and coating media. This kit is ideal for casual or high volume shooters who require maximum performance from their firearms. Complete step by step moly coating instructions included. Order No. 015-7631343 Price \$89.61

B- Super Moly Bore Cream -Brushed directly into the barrel, Super Moly bore cream moly coats your barrel in seconds! Designed to minimize barrel wear, and reduce fouling.. Order No. 015-7631419 Price \$13.03

C,D- Super Moly Spray -Designed to spray directly on jacketed and cast bullets. Also works as a spray-on mould release. Ideal for moly coating without a tumbler.
13oz Order No. 015-7631415 Price \$20.81
4oz Order No. 015-7631417 Price \$13.03

Finishing Kit Replacement Medias(Not Shown)
015-7631381 Replacement Ceramic Media \$12.64
015-7631392 6lb Easy Pour Untreated \$12.64

E- Super Moly Extra Fine Powder-For use in moly-coating tumbler. Super Grade Moly is extra fine and gives a superior finish. Coating instructions included. 6oz box. Order No. 015-7631412 Price \$17.34

F- Super Moly Acc Kit-Everything you need to Super Moly Coat bullets! All you add is the tumbler! The two heavy-duty bowls will fit the Lyman 600 and 1200 Tumblers and most other brand tumblers of similar size. The kit contains two heavy-duty, long lasting bowls, 6 ounces of Superfine Moly Grade powder, 2 pounds of media and coating media. This kit will coat thousands of bullets! Only a small amount of Superfine Grade Moly is needed for a durable, high gloss, moly coated finish. Coating instructions included. Order No. 015-7631384 Price \$42.39

BIRCHWOOD CASEY MOLY LUBE DRY FILM LUBE
Dry film lube designed to lubricate and penetrate forming a smooth extremely slippery surface on metal. Easy to use! Uses an almost instant drying solvent degreaser as the carrier in a convenient, 6oz aerosol can. Order No. 012-40131 \$6.52

Turbo Tumbler Media Products



	Order No.	Price
2 lbs. Corncob	015-7631307	\$7.19
10 lb. box Corncob	015-7631320	15.57
6 lb. Easy Pour Corncob	015-7631394	11.87
12 lb. box TufNut(Pecan)	015-7631333	15.57
7 lb. Easy Pour TufNut(Pecan)	015-7631396	11.87



	Order No.	Price
Turbo Media Sifter	015-7631321	\$7.77
Turbo Case Cleaner 16 oz.	015-7631340	7.59
Turbo Charge (reactivator) 4 oz.	015-7631322	5.02
Turbo Brite 5 oz.	015-7631358	5.58
Turbo Brite 20 oz.	015-7631361	14.85
Brass Baggies, 12 per pack	015-7631391	5.02

Flitz Liquid Tumbler Media Additive
Order No 194-TA04885 Price \$12.15

Smart Reloader Reloading Supplies

SmartReloader®



SmartReloader
Omega Reloading Press - Features a strong steel frame, high tech designed and high quality components that will allow the user to reload up to 375H&H. Accepts standard 7/8 x 14 dies.
 Order No. 047-VBSR0083 \$34.28



Case Lube Pad - Lubricate cases before calibration and forming. Lube and place in case load tray/cover. Non skid rubber feet to prevent slippage.
 Order No. 047-VBSR01702 \$13.50

SR747 Jumbo Tumbler - For heavy reloaders! Over 13.5 quarts capacity. Holds up to 2,000 9mm cases and 1,200 223 Rem cases. On and Off switch on the tumbler. 110v.



Order No. 047-VBSR00521 \$153.50



iSD Reloading Powder Scale Dispenser - Make loads faster and more accurate. Stores up to 50 records. the same model will work with both 110v/220v.
 Order No. 047-VBSR0021 \$264.30



Hand Priming Tool - Prime cases fast and safely. Tray holds 100 primers Uses standard shell holders

(Lee reloading standard shellholders work best)

Order No. 047-VBSR00802 \$18.39

Bench Rest Powder Measurer - Extremely Accurate and ready out of the box. Range: From .5 to 100 grains. 7/8" - 14 thread on the body allows installation on any standard press. Powder baffle, micrometer chamber and bench stand included.



Order No. 047-VBSR0042 \$104.71



SR787 Dream Tumbler - 1 Gallon capacity. Holds up to 600 9mm cases and 350 223 rem cases. Purchase a spare bowl separately and switch them out fast!

Order No. 047-VBSR0052001 \$40.09

Spare 787 Bowl - Order No. 047-VBSR0052002 \$10.37

The Smallest Tumbler We Sell!

SR 737 Tumbler Nano - Smaller capacity tumbler. -1.5 quarts -Fits 300 9mm cases or 125 223rem cases -Fast, Silent, Compact -Uses less media & electricity

Order No. 047-VBSR0057 \$25.36



Bullet Puller - Covers .17 up to 50 caliber! Includes 2 sets of collets!

Order No. 047-VBSR0054 \$13.28



S.B.P. - "Smallest Big Press"

- Steel Frame, Ram & Leverage
- Fits all Standard Shell Holders
- Great for decapping, bullet seating and bullet sizing.

Order No. 047-VBSR0084 \$19.13



Smart Reloader 750gr scale with Trickle & Powder Funnel - Get the whole kit for one low price!
 Order No. 047-VBSR0031 \$40.91

Smart Reloader 750gr Scale Only - Includes weight check set and powder dippers.
 Order No. 047-VBSR003 \$32.81



Smartreloader MPT Monster Powder Trickler - Turn the knob and you add powder to the scale pan a granule or two at a time. Brings underweight charges up to accurate readings fast. Solid, stable, low center of gravity.

Order No. 047-VBSR0056 \$13.70

Smart Reloader Ammo Boxes!

See Page 107



SmartReloader

On Target Powder Drop

American Design
 American craftsmanship on German high quality CNC machine



On Target Powder Drop - Throw range 0-85 grains. Culver type powder drum individually fitted into the body hole, complete with 2 drop tubes and 1 bottle. Machined C-Clamp at rear.

Order No. 175-800200 \$245.05

LEE



Lee Breech Lock Challenger Press - Change dies instantly with a twist of the wrist, and you never have to re-adjust your die. Introducing The Breech Lock Quick Change Die System. A larger than average "O" frame opening allows for maximum hand clearance. The spent Primer catcher is positive and allows you to route the spent primers directly to the trash can. Priming is a dream with the Lee Lever Prime System. Best of all, it includes the Breech Lock Quick Change die system. Press includes (3) Breech Lock quick change die inserts.

Order No. 006-90588 \$64.16



Spare Breech Lock Inserts 2pk Order No. 006-90600 \$7.04
4 Die Breech Lock Box Order No. 006-90422 3.46



Lee Breech Lock Challenger Kit - Includes the Breech Lock Challenger Press and three Breech Lock quick-change bushings. Kit also includes Perfect Powder Measure, The Lee Safety Scale, Powder Funnel. Case Preparation Tools include a cutter and lock stud to trim cases, Lee chamfer tool, a tube of premium sizing lube, a small and large primer pocket-cleaning tool. But that's not all! You also get the Auto-Prime and a set of Auto-Prime shell holders. Order No. 006-90030 \$117.39

Lee 50th Anniversary Breech Lock Challenger Kit - All of the items in the Breech kit but the Auto prime has been replaced with the Safety Prime. Order No. 006-90050 \$117.39

Classic Turret Press - The Classic Turret features the solid steel linkage of the Lee Classic Cast. Your first stroke of the hardwood gripped lever will convince you this is one, solid smooth press! The sturdy iron base shows its Classic Cast roots. The long stroke allows rifle cases over three inches long to be loaded using the automatic index. Deactivate the Auto-Index and cases as long as the monster 50BMG can be loaded. The rigid cast iron frame supports the ram with over 12 square inches of area. Order No. 006-90064 \$103.74

Lee Turret Press - A strong and powerful tool. Compound linkage full length sizes the largest magnum cases with ease.

For left or right hand use! Built in primer catcher. Snap out turret. Primer arm lifts out to reverse for large or small size. Why fool around with screwing dies in and out when the convenience of a Lee Turret Press actually costs less? Extra turrets are available in this section. This is a press only. Order Dies separately!!

	Order No.	Price
Turret Press	006-90496	\$73.71
Updating Kit(includes free 4 hole Turret)	006-90933	14.10



Update Kit

4 hole Turret Press w/ Auto Index - Lee now makes the Turret Press with a 4 station turret! This allows you to install your Factory Crimp Die and Taper Crimp Die in the press. Updating kit will convert your 3 station to a 4 in a matter of minutes!

	Order No.	Price
4 hole Turret Press with Auto-Index	006-90932	\$78.49
Updating Kit(includes free 4 hole Turret)	006-90933	14.10
Extra 4 hole Turret	006-90269	9.15

Lee Safety Prime- Never touch the primers from box to shell. Primer flip tray features a CAD designed flipping surface that instantly rights the primers. Change primer size in seconds. Primers are dispensed with a satisfying click of the primer feed trigger.

	Order No.	Price
Large & Small	006-90997	\$21.16

Update Kit for pre-2006 presses - Everything required to add primer feed. Includes both large and small Safety Primer Feed
 Order No. 006-90042 \$28.21

Deluxe Turret Reloading Kit w/Auto Index (4 Hole Turret) - The rugged turret press, along with the Auto Disk Powder Measure, produce high quality pistol ammunition with the utmost in convenience. A finished round with three strokes of the lever. When it is time to change calibers, simply snap in a new turret and begin loading within seconds. In addition the Deluxe Turret Reloading Kit comes complete with: the Lee Safety Scale, a primer pocket cleaner, cutter and lockstud, and a chamfer tool. All you need to start loading is a set of dies.
 Order No. 006-90928 \$116.03



Lee's Classic Cast Single Stage Press - Rigid cast iron frame, cast and machined in the USA. Baked powder finish and all steel linkage make this one of the most attractive and sturdy presses made. Features Large Opening, Classic "O" design for max strength, large flat base with 3 holes for mounting, Adj Handle, Auto Primer with large and small primer arms, Large Hollow Ram catches every primer. Threaded Die Adapter accepts 7/8"-14" dies, remove and press accepts 1 1/4"-12" Large series dies!

LEE

	Order No.	Price
Classic Cast Press	006-90998	\$102.38

Reloader Press - An outstanding value. Exclusive balanced lever that can't drop down to pinch your fingers. Unlimited hand clearance that only "C" frame can offer. Works equally well with the right or left hand. Even if you already own a press, an extra press is always useful for decapping, bullet seating or bullet sizing. Order No. 006-90045 \$27.49



Hand Press- This press is more powerful than some bench mounted tools. Even large magnum cases such as 375 H&H can be full length sized and loaded. Uses standard 7/8"x14 dies.
 Order No. 006-90685 \$31.38



	Order No.
223 Remington	006-90232
22/250	006-90233
243 Winchester	006-90235
270 Winchester	006-90240
7mm Remington Magnum	006-90242
30/30 Win (30 Rem)	006-90244
308 Winchester	006-90245
30/06 Springfield	006-90248
45/70 Government	006-90264
9mm Luger	006-90254
38 Special	006-90257
357 Magnum	006-90258
*44 Magnum	006-90260
*45 ACP	006-90262
*45 Colt	006-90263

**These calibers require considerable force for sizing

The Classic Lee Loader - The perfect tool for those who wish to simply try reloading because it will pay for itself in just an hour or two. Everything you need to begin loading one caliber. *These Calibers require considerable force for sizing \$25.92 per set



Lee Progressive Presses and Accessories



Lee Pro 1000 - The Progressive 1000 Press is shipped complete with carrier and shellplate, four tube case feeder, pro auto disk powder measure, and a set of Lee carbide dies. Cases using the same shell holder require only a new die set to convert the press. Order the optional Case Collator and case feeders separately below. **Each Lee Pro 1000 Press Kit is \$173.36**

	Order No.
38 Special (can use for 357 Mag.)	006-90636
45 ACP	006-90638
9mm Luger	006-90640
40 S&W	006-90682
44 Special (can use for 44 Mag.)	006-90634
44 Magnum (cannot use for 44 Spec.)	006-90635
223 Remington	006-90633
45 Colt	006-90643



Lee Case Collator for Proo 1000 and Loadmaster (Use with case feeders below) - For the ultimate in convenience, an extra Case Feeder can be mounted on each shell plate carrier. This eliminates the need for readjusting when changing calibers. Fills all four tubes with cases in just 10 seconds!
Order No. 006-90667 \$10.56

	Order No.	Price
Small Case Feeder (9mm Luger)	006-90659	\$17.63
Large Case Feeder (45 ACP & longer)	006-90658	17.63
Rifle Case Feeder (222, 223, 30 M1)	006-90663	17.63
Extra Case Feeder Tubes (7 pack)	006-90661	5.63

Lee Loadmaster Kits - A big press with advanced features. The ram is 1 1/4" in diameter. Stroke clearance is enough for the largest magnum calibers. The press has 5 stations and comes with turret, carrier, indexer, primer catcher, case inserter, case ejector and chute.

Grease and oil fittings insure a lifetime of service (even for commercial reloaders). Turrets are easily removed so calibers can be changed in seconds not minutes. Uses any brand of dies. Order the optional Case Collator and case feeders separately above.

Rifle kit includes: Press, dies, perfect powder measure, universal charge die and case inserter.

Pistol kits include: Press, carbide dies, pro-auto disk powder measure and case feeder.

	Order No.	Price
9mm Luger	006-90936	\$245.70
.38 Spec. (will load .357)	006-90938	245.70
.44 Spec. (will load .44 Mag)	006-90943	245.70
.45 ACP	006-90945	245.70
.45 Colt(will load 454 Casull)	006-90946	245.70
.30/06	006-90931	238.88

Loadmaster Shell Plates - Loadmaster shell plate number fit the same cartridges as numbers on shell holders, except number 7A, it is for 30 M1 Carbine only! **\$21.14 each**

	Order No.	Order No.
#1 38 Spec. 357 mag	006-90907	#7S 22 Hornet 006-90884
#2 243,270,308,45A	006-90908	#8 348 Win, 45/70 Gov't 006-90914
#3 22 Sav, 7.5mm, 375 Win	006-90909	#9 41 Magnum 006-90915
#4 222, 232, 380 Auto	006-90910	#10 220 Swift, 6.5 Jap 006-90916
#4A 32 S&W Long/32 H&R Mg	006-90059	#11 44 Spec/Mag, 45 Colt 006-90917
#5 257 Wby. 7mm R, 303B	006-90911	#12 7.62x39, PPC 006-90918
#5A 303 Brit, 30/40 Krag	006-90085	#14 44/40 006-90919
#6 32/20, 218 Bee, 25/20	006-90912	#19 9mm, 41 AE, 38 ACP 006-90920
#7A 30 M1 Carbine	006-90913	#19L 10mm only 006-90068



5 Hole Turret For Loadmaster - Precision 5-Hole Turret with 20 locking lugs takes just seconds to change out.
Order No. 006-90079 \$10.56

Chain Pull Back (Fits Pro 1000 also)
Order No. 006-90479 \$2.81



Pro 1000 Shell Plate Carriers -

To change calibers, the entire shell plate carrier can be replaced, each unit comes complete with shell plate, auto prime, case ejector, auto index, tools and spare parts. Order according to regular shell holder size. Fits Pro 1000 Only!



Lee Pro 1000 Accessories		Shell Plate Carrier \$38.77	Shell Plate Only \$14.10
Caliber	Lee Plate #		
38 Spl, 357 Mag	#1	006-90644	006-90651
45 ACP	#2	006-90645	006-90652
222, 223	#4	006-90646	006-90653
32/30, 25/20	#6	-	006-90976
30 M1 Carbine	#7A	006-90648	006-90655
41 Mag	#9	006-90649	006-90656
44 Spl, 44 Mag, 45 Colt	#11	006-90650	006-90657
7.62x39	#12	-	006-90666
38/40, 44/40, 45 Colt	#14	-	006-90065
32 Auto	#7B	-	006-90668
40 S&W, 10mm, 9mm,	#19	006-90683	006-90669
38 Super, 38 Auto, 41 AE	#19(L) For 10mm Carrier	006-90662	-
45 Win Mag	#2A	-	006-90664
45 Auto Rim	#13	-	006-90665

Lee Progressive 1000 Priming Attachment Kit - The Pro 1000 Priming Attachment Kit is required if you are converting a carrier to another primer size. It is also nice to have on hand for its extra primer tray. The kit contains large and small primer troughs, pins, springs, punches and a tray with cover. **Order No. 006-90660 \$9.87**

3 Hole Turret - For Pro 1000 Turret Press
Order No. 006-90497 \$7.74



Pro1000 and Load-Master Bullet Feed Kits - The bullet feeder designed to directly fit the Pro1000 and Load-Master. Automatically feeds bullets into the mouth of the seating die. Aligns bullets more accurately than possible by hand. Increases the cyclic rate 50 to 100%.



	Order No.	Price
Feed Kit 30 & 32 Cal. up to .60 long	006-90892	\$28.90
Feed Kit 9mm - .365 Dia. up to .46 long	006-90893	28.90
Feed Kit 9mm - .365 Dia., .46 - .60 long	006-90894	28.90
Feed Kit 9mm - .365 Dia., .60 - .75 long	006-90895	28.90
Feed Kit 40 - .44 Cal. up to .65 long	006-90896	28.90
Feed Kit 40 - .44 Cal., .65 - .80 long	006-90897	28.90
Feed Kit 45 Cal. up to .67 long	006-90898	28.90
Feed Die and fingers 9mm/365<.46 long	006-90886	10.56
Feed Die and fingers 9mm/365 .46-.60	006-90887	10.56
Feed Die and fingers 9mm/365 .60-.75	006-90888	10.56
Feed Die and fingers 40/44<.65 long	006-90889	10.56
Feed Die and fingers 40/44 .65-.80	006-90890	10.56
Feed Die and fingers 45<.67 long	006-90891	10.56
Multi-Tube Adapter (Attaches to bullet feed kit, includes lg and sm adapters, four large and small tubes & Cylinder plate assembly.	006-90280	17.63

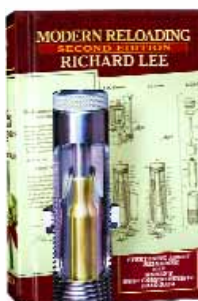

Lee's 2nd Exditiion Modern Reloading Manual- Over 26,000 loads! All in a format, with velocities for starting loads. Load data supplied by the powder companies, the best kind of load data you can have! Latest information on pressure! Exclusive pressure and velocity factors enable you to accurately calculate pressure and velocity for reduced loads. An absolute must for cast bullet shooting. Hundreds of cast bullet loads, with charts and rules about priming. Over 700 pages!

Order No. 006-90277 Price \$14.33

Caliber	RGB Dies \$17.62	Pacesetter Dies & shellholder \$28.19	Limited Production Pacesetter Dies & shellholder \$28.19* \$28.19**	Collet Die Set & shellholder \$27.49	Deluxe Rifle Die Set & shellholder \$31.72	Collet Neck Sizing Die \$18.32 \$27.49*	Factory Crimp Die \$10.56	Case Length Gauge \$4.22
17 Remington	—	—	006-90770	006-90804	—	—	—	—
204 Ruger	—	—	006-90417*	006-90734	—	—	—	—
22 Hornet	—	—	006-90500	006-90705	006-90599	—	006-90829	006-90111
218 Bee	—	—	006-90753	—	—	—	006-90830	—
22 PPC	—	—	—	006-90803	—	—	—	—
221 Fireball	—	—	—	—	—	—	—	006-90112
222 Remington	006-90870	006-90501	—	006-90706	—	—	006-90816	006-90113
223 Remington	006-90871	006-90502	—	006-90707	006-90604	006-90954	006-90817	006-90114
223 WSSM	—	—	006-90446	—	—	—	—	—
22/250	006-90872	006-90503	—	006-90708	006-90606	006-90955	006-90818	006-90116
220 Swift	—	—	006-90542	006-90702	006-90609	—	006-90831	006-90118
243 Winchester	006-90873	006-90504	—	006-90709	006-90610	006-90956	006-90819	006-90119
243 WSSM	—	—	006-90990	—	—	—	006-90187	—
6mm PPC	—	—	006-90796	006-90802	—	—	—	—
6mm Remington	—	—	006-90540	006-90710	—	—	006-90832	006-90120
25/20	—	—	006-90750	—	—	—	006-90833	006-90121
25/35	—	—	006-90778	—	—	—	—	—
250 Savage	—	—	006-90550	—	—	—	006-90834	006-90122
257 Roberts	—	—	006-90551	006-90703	—	—	006-90835	006-90123
260 Remington	—	—	006-90298	006-90974	—	—	006-90977	—
25/06 Remington	—	—	006-90536	006-90711	006-90605	006-90957	006-90836	006-90124
264 Win Mag	—	—	006-90774	—	—	—	—	—
6.5 Carcano	—	—	006-90749	—	—	—	—	—
6.5 Japanese	—	—	006-90730	—	—	—	—	—
6.5 Rem Mag	—	—	006-90773	—	—	—	—	—
6.5x55 Mauser	006-90874	006-90627	—	006-90712	006-90611	—	006-90837	006-90126
270 Win Short Mag	—	—	006-90572	—	—	—	—	—
270 Weatherby	—	—	—	—	—	—	—	—
270 Winchester	006-90875	006-90505	—	006-90713	006-90612	006-90958	006-90820	006-90128
7mm BR	—	—	—	—	—	—	—	—
7mm TCU	—	—	—	—	—	—	—	—
7/30 Waters	—	—	006-90748	—	—	—	006-90838	—
7x57 Mauser	—	—	006-90541	006-90714	—	—	006-90839	006-90130
7x64 Brenneke	—	—	006-90771	—	—	—	—	006-90236
7mm/08	—	—	006-90537	006-90723	—	—	006-90840	006-90167
7mm Exp/280 Rem	—	—	006-90552	006-90724	—	—	006-90841	006-90166
7mm Win Short Mag	—	—	006-90573	—	—	—	—	—
7mm Rem Mag	006-90876	006-90538	—	—	006-90613	—	006-90821	006-90131
7mm STW	—	—	006-90678**	—	—	—	006-90869	—
7mm Ultra Mag	—	—	006-90979	—	—	—	—	—
284 Winchester	—	—	006-90777	—	—	—	—	006-90129
7mm Weatherby	—	—	—	—	—	—	—	—
7.5x55 Swiss	—	—	006-90767	—	—	006-90186*	006-90184*	006-90132
7.62x39 Russian	006-90877	006-90565	—	006-90701	—	—	006-90827	006-90133
7.62x54 Russian	—	—	006-90731	—	—	—	006-90842	006-90147
30 Herret	—	—	—	—	—	—	—	—
30/40 Krag	—	—	006-90555	—	—	—	006-90843	006-90137
30/30 Winchester	006-90878	006-90506	—	006-90716	006-90631	—	006-90822	006-90136
303 Savage	—	—	006-90756	—	—	—	006-90844	006-90138
308 Winchester	006-90879	006-90507	—	006-90718	006-90614	006-90959	006-90823	006-90139
300 Win Short Mag	—	—	006-90942	006-90185	—	—	006-90331	—
300 Savage	—	—	006-90545	—	—	—	006-90844	006-90138
30/06	006-90880	006-90508	—	006-90715	006-90615	006-90960	006-90824	006-90140
300 Win Mag	006-90881	006-90539	—	006-90722	006-90616	006-90961	006-90825	006-90142
300 H&H	—	—	006-90560	006-90726	—	—	—	006-90141
300 Weatherby Mag	—	—	006-90558	006-90727	—	—	006-90845	006-90143
300 Ultra Mag	—	—	006-90698	—	—	—	006-90970	—
7.65 Arg Mauser	—	—	006-90732	—	—	—	006-90846	006-90134
7.7 Jap	—	—	006-90733	—	—	—	006-90847	006-90115
303 British	006-90882	006-90547	—	—	—	—	—	006-90144
32-40	—	—	006-90758	—	—	—	—	—
32 Winchester	—	—	006-90757	—	—	—	—	—
33 Winchester	—	—	006-90759	—	—	—	—	—
8x57 Mauser	006-90883	006-90544	—	006-90719	—	—	006-90848	006-90148
8mm Lebel	—	—	006-90768	—	—	—	—	—
338 Winchester	—	—	006-90546	006-90721	—	—	006-90849	006-90149
338 Ultra Mag	—	—	006-90927	—	—	—	—	—
348 Winchester	—	—	006-90760	—	—	—	—	—
350 Rem Mag	—	—	006-90776	—	—	—	—	—
356 Winchester	—	—	—	—	—	—	006-90904	—
35 Remington	—	—	006-90543	006-90728	—	—	006-90828	006-90150
35 Whelen	—	—	006-90752	—	—	—	—	006-90972
375 H&H	—	—	006-90559	006-90729	—	—	006-90850	006-90164
416 Remington	—	—	006-90805	—	—	—	006-90906	—
32-20	—	—	—	—	—	—	006-90851	006-90146
38-40	—	006-90761	—	—	—	—	006-90852	—
38-55	—	006-90762	—	—	—	—	006-90853	—
375 Winchester	—	006-90563	—	—	—	—	006-90905	006-90165
40/65	—	006-90986*	—	—	—	—	—	—
44/40	—	006-90564	—	—	—	—	006-90854	006-90168
444 Marlin	—	006-90562	—	—	—	—	006-90855	006-90151
45/70 Government	—	006-90561	—	—	—	—	006-90856	006-90152
458 Win Mag	—	006-90800	—	—	—	—	006-90969	006-90971

T
3 Die
Sets With
Powder
Through
Expanding
Die
⌋

Lee Rifle Dies

LEE



More Dies Listed Online!!

RGB Dies

RGB (Really Great Buy) Series dies in the GREEN BOX are exactly the same dies as Lee's standard red box. These sets DO NOT have the factory crimp die, shell holder, powder dipper or load data. You get the 2 die set only!!

Pacesetter Dies

Pacesetter die sets include a conventional bullet seater and roll crimper. You can choose the type of crimp you desire. These dies are your best buy. Also includes a shell holder, powder dipper, load data and are packed in a great storage box.

Limited Production Pacesetter Dies

The same features and quality of the standard dies, The price is slightly higher because production quantities are lower. These include Shellholder, Powder Dipper & Load Data. (*Notes that Lee Factory Crimp Die is NOT included.)

Collet Die Set

These dies size only the case neck to hold the bullet and are only suitable for bolt action guns that the case has already been fired in or for neck sizing new brass. The die set includes its own instructions with load data, powder dipper and shell holder.

Deluxe Rifle 3 Die Set

No case lubrication required on neck sizer die! Reduces or eliminates case trimming, an increased case life up to ten times! Unmatched speed! Truly Deluxe! Includes neck sizing die, dead length bullet seater, full length sizing die

Very Limited Production 2 Die Sets

	Order No.	Price
Includes Free Shell Holder.		
22/250 Ackley Improved	006-90980	\$31.72
223 Ackley Improved	006-90981	31.72
6mm/284 Winchester	006-90984	31.72
325 Win Short Mag	006-90923	28.19



Lee Die Boxes - The perfect storage for dies assembled in a turret. Made of tough, durable plastic. 4 Die Breech Lock Box!

	Order No.	Price
Lee Round Die Box Only	006-90535	\$3.51
Flat 2-Die Box	006-90078	2.81
Flat 4-Die Box	006-90422	3.46



Lock Rings (3 per pack) - No tools needed to lock in place and once locked, they stay put. Yet, they readjust very easily without tools.

Order No. **006-90534** \$2.81

LEE Pistol Dies

Caliber	Deluxe Pistol Die Set & shellholder \$41.59	Carbide 3 Die Set & shellholder \$39.48*	Steel 3 Die Set & shellholder \$28.19	Carbide Sizing Die \$19.73	Powder Through Expanding Die \$9.86	Taper Crimp Die \$9.86	Carbide Factory Crimp Die \$10.56* \$16.21	Bullet Seat & Feed Die \$8.45
25 ACP	—	006-90568	—	—	—	—	—	—
30 M1 Carbine	—	006-90626*	—	—	—	—	006-90421*	—
30 Luger	—	—	006-90754	—	—	—	—	—
30 Mauser	—	—	006-90755	—	—	—	—	—
7.62 Tokarev	—	—	006-90769	—	—	—	—	—
32 ACP	—	006-90622	—	006-90621	—	—	—	—
32 S&W	—	006-90696	—	—	—	—	—	—
32 S&W Long	—	006-90624	—	006-90621	—	006-90779	—	—
32 H&R Mag	—	006-90809	—	006-90621	—	—	—	—
32/20	—	—	006-90751	—	—	—	—	—
9mm Mak	—	006-90176	—	—	—	—	—	—
9mm Luger	006-90963	006-90509	—	006-90548	006-90580	006-90780	006-90860	—
357 Sig	—	—	006-90270	—	—	—	—	—
38 Short/Long Colt	—	006-90276	—	—	—	—	—	—
38 Colt New Police	—	—	—	006-90619	—	—	—	—
38 Super/38 ACP	—	006-90623	—	006-90619	—	—	006-90866	—
380 Auto	—	006-90625	—	006-90618	—	—	—	—
38 S&W	—	—	—	006-90619	—	—	—	—
38 Special	006-90964	006-90510	—	006-90530	006-90581	006-90781	006-90861	—
357 Magnum	—	006-90511	—	006-90530	006-90582	—	006-90861	—
40 S&W	006-90965	006-90799	—	—	006-90620	006-90782	006-90862	—
10mm	—	006-90566	—	—	—	006-90782	006-90862	—
41 Act Express	—	—	—	006-90629	—	—	—	—
41 Mag	—	006-90628	—	—	—	—	006-90416	—
44 Special	006-90966	006-90516	—	006-90531	006-90583	006-90784	006-90863	—
44 Mag	—	006-90512	—	006-90531	006-90584	006-90784	006-90863	—
44 Russian	—	006-90293	—	006-90531	—	—	006-90863	—
45 Colt	006-90967	006-90514	—	—	006-90586	—	006-90865	—
45 ACP	006-90968	006-90513	—	006-90532	006-90585	006-90785	006-90864	—
45 Auto Rim	—	006-90808	—	006-90532	006-90585	006-90785	006-90864	—
45 Schofield	—	006-90323	—	006-90532	—	006-90785	006-90864	—
400 Cor Bon	—	—	006-90430	—	—	—	—	—
455 Web Mark II	—	006-90764	—	—	—	006-90785	006-90865	—
45 Win Mag	—	006-90810	—	006-90532	006-90585	006-90785	006-90864	—
454 Casull	—	006-90795	—	—	—	006-90786	006-90865	—
45 HP Italian	—	—	—	006-90532	—	006-90785	006-90864	—
460 S&W	—	006-90344	—	—	—	—	—	—
480 Ruger	—	006-90499	—	—	—	—	—	—
50 Action Express	—	—	006-90329	—	—	—	—	—
500 S&W	—	006-90288	—	—	—	—	—	—



Lee Pistol Dies



Deluxe Pistol Die Set

The Lee Deluxe Pistol Die set Combines the world's most popular carbide three-die set with the Lee Factory Crimp die at a spectacular price. Includes Shell Holder.

Carbide 3 Die Sets

Includes powder through expanding die, seating die, sizing die, load data, powder dipper and shell holder. With carbide dies, no case lube required.

Steel 3 Die Sets

Lee Steel 3-Die Sets have the same features as the carbide sets, except the case must be lubricated.

Powder Through Expanding Die

While expanding the case with a perfect flare, you can charge the case through the hollow expanding plug. Includes a powder funnel adapter. This die is also used with the Auto Disk Powder Measure for automatic case charging.

Bullet Seat and Feed Dies

Four tube magazines keeps Lee Bullet Feeders fed with a continuous supply of bullets. Listed on the chart.

Sharp Shoot R™ Royal Case & Die Lube™ - Specific for lubrication, resizing and case forming.

This product is an answer to easy and clean application of a case lubricants. This exciting product is easier to use with no messy clean-up.. It has no complicated method of application. Leaves behind a protective coating that prevents corrosion. This coating will not attract grit, grime, or dust.



Order No. 216-RLJ004 \$8.58

Miscellaneous Dies and Accessories



	Order No.	Price
Universal Case Expanding Die	006-90798	\$11.97
Universal Charging Dies	006-90273	18.32
Rifle Charging Die (Charges Thru Top of Die)	006-90194	9.86
Decapping Die	006-90292	9.86
Lock Rings (3 per pack)	006-90534	2.81
Lee Round Die Box Only	006-90535	3.51
Flat 2-Die Box	006-90078	2.81
Flat 4-Die Box (Fits dies with Breech Lock)	006-90422	3.46



LEE Breech Lock Classic Cast Press - Based on the proven design of the Classic Cast, the Breech Lock series adds the quick-change die bushing. Includes [1] Breech Lock Quick Change die insert
Order No. 006-90999 \$102.38

Lee Bench Plate - Includes 3 base blocks; one drilled to fit all current Lee presses. Bolt hardware included. Quickly and securely mounts to any bench or tabletop.
Order No. 006-90251 \$21.14



Lee Bulge Buster Kit - Assure your mixed brass is bulge free! With the Lee Factory Crimp Die, the Bulge Buster will repair all these rimless cases:
 380 ACP, 40 S&W, 45 ACP, 45 Win Mag, 10 mm, 41 AE, 45 GAP
Order No. 006-90487 \$14.09

Lock-Ring Eliminator - (2ea) Breech lock quick change bushings with integral lock collar.
Order No. 006-90063 \$10.58



Lee Reloading Stand

Perfect for the reloader with limited working space, an overwhelmed workbench, or someone looking for solution to portable reloading needs. The sturdy powder coated steel stand places your press at the perfect counter stool or standing height. The 10 inch triangular steel top plate uses the Patented quick change Lee Bench Plate system.

only **\$88.72**

Order No. 006-90688

More information and accessories on page 229

Notes: Comes with one storage bin and bracket, top plate, intermediate shelf, drilled wood bench block, complete fastener set and two steel concrete block hangers.



Lee Standard Shell Holders

Lee Standard Shell Holders - NOTE: THESE SINGLE SHELL HOLDERS LISTED HERE ARE STANDARD PRESS SHELL HOLDERS. Standard press shell holders will not work with Lee Auto-Prime. You must order shell holders for both if you plan to use both!!

These hardened steel shell holders fit Lee, RCBS, Lyman and most other brands of presses. They will not fit Lee Hand Auto-Primers

HOLDER	RIFLE	HOLDER	RIFLE	HOLDER	RIFLE
4	17 Rem.	5	7x61 Sharpe & Hart	3	38/55 Win.
7	22 Hornet	5	7mm Rem. Magnum	8	40/82 Win.
7	22K Hornet	5	7mm Weatherby	3	408 Win.
3	22 Savage	2	284 Win.	18	43 Mauser
2	22 BR	3	7.5mm Schmidt-Rubin	14	44/40
6	218 Bee	7	30 M1 Carbine	11	444 Marlin
3	219 Zipper	3	7.62x53 Arg. Mauser	8	45/70 Gov't
10	220 Swift	12	7.62mmx39	5	458 Win. Mag.
4	221 Fireball	16	7.62mmx54 Russian		
4	222 Rem.	3	30 Herrett	HOLDER	PISTOL
4	222 Rem. Mag.	3	30/30 Win. (30 W.C.F)	1	38 S&W
4	223 (5.56mm)	2	300 Savage	1	38 Colt N.P.
2	224 Clark (22/257)	2	308 Win. (7.62 NATO)	19&6	38 Super Auto
10	225 Win.	5	30/40 Krag (30 U.S.)	19&6	38 ACP
2	22/250	2	30/06 Springfield	1	38 Short Colt
2	240 Weatherby	5	300 H&H	1	38 Long Colt
2	243 Win.	5	300 Weatherby	1	38 Special
2	6mm Rem.	5	300 Win. Mag.	1	357 Magnum
2	224 Rem.	5	308 Norma Mag.	2	357 Auto Mag.
2	6mm Int'l	5	303 British	19	40 S&W
2	6mm/284	2	7.7 Jap.	19	10mm Auto
2	6mm/06	3	32 Win. Spc'l.	1	41 Long Colt
4	6x47 (6mm/222M)	3	32 Win. S.L.	19&6	41 Action Express
2	25/284	6	32/20 (32 W.C.F)	9	41 Magnum
2	25/06	3	32/40 Win.	11	44 S&W Spc'l
6	25/20 Win.	2	8x57 Mauser	11	44 S&W Russian
2	250 Savage	2	8mm 06	11	44 Magnum
3	25/35	2	8mm Man. Schoe.	2	44 Auto Mag.
2	257 Roberts	5	8mm Rem. Mag.	2	45 Auto
5	257 Weatherby	17	8mm Lebel	11	45 Colt
5	303/25	8	33 Win.	5	455 Webley
2	6.5mm06	5	338 Win. Mag.	12	PPC
2	6.5mmx57	5	340 Weatherby	13	45 Auto Rim
3	6.5x55 Mauser	8	348 Win.	1	22 Rem. Jet
10	6.5 Jap	2	35 Rem.	15	25ACP
5	6.5 Rem. Mag.	5	35 Win.	1	256 Win. Mag.
2	6.5 Carcano	2	35 Whelan	19&6	30 Luger
5	264 Win. Mag.	5	350 Rem. Mag.	19&6	30 Mauser
2	270 Win.	2	358 Win.	4	32 Short Colt
5	270 Weatherby	4	358 Norma Mag.	4	32 Long Colt
2	280 Rem.	3	375 Win.	4	32 S&W
2	7mm/08	4	375 H&H	4	32 S&W Long
2	7x57mm Mauser	7B	375 Weatherby	5	32 ACP (Universal)
		7	32 ACP (Auto-Prime)	5	32 Colt N.P.
		4	380 Auto	3	380 Auto
		19&6	9mm Luger	8	9mm Luger

Order No.	Size #	Order No.	Size #
006-90518	R1	006-90526	R9
006-90519	R2	006-90527	R10
006-90520	R3	006-90528	R11
006-90521	R4	006-90529	R12
006-90522	R5	006-90199	R13
006-90523	R6	006-90001	R14
006-90524	R7	006-90002	R15
006-90525	R8	006-90003	R16
		006-90004	R19

Price \$2.81

SHELL HOLDER R13 fits 45 Auto Rim only!!

Standard Shell Holder Set

A set of 11 shell holders, packed in a sturdy plastic box, fits over 120 different cartridges. (Shell holders 1,2,3,4,5,7,8,9,10,11,19)

Shell Holder Set for Std. presses (in green box)

Order No. 006-90197 \$25.37

Red plastic box without shell holders

Order No. 006-90196 \$2.81



WARNING: Users have reported that the primers in the tray of an auto prime can explode for various reasons, some of which include: a cocked primer, or an attempt to prime a case which has a primer already in place, or more than one primer on the punch, or priming a military case with the crimp not completely removed. Should an explosion occur, tests have demonstrated that safety glasses will normally prevent serious injury to the user if CCI or Winchester primers are used, because the explosion is minimal. Other primers, however can explode with sufficient force to seriously injure the user, or persons nearby. Lee Precision does not take any position with respect to the quality or performance of primers available on the market. However, only those primers manufactured by CCI and Winchester are recommended for use in the Lee Auto Prime, and when loading those primers, safety glasses should always be used. No other primers should be used with the Lee Auto Prime.

Includes Lg and Sm Primer Trays



Lee Auto Prime and Shell Holders

LEE

Lee Auto-Prime XR -

- Square primer trays accept all brands of primer boxes.
 - Elevator pin safely separates a single primer and presents it for priming
 - Unbreakable comfort curve lever
- Order No. 006-90230 \$17.05

Lee Auto Prime and Improved Priming Tool Shell Holders - THESE SHELL HOLDERS FIT LEE PRIMING TOOLS # 006-90230, AND 006-90231 ONLY. THEY DO NOT FIT LEE, RCBS, LYMAN, OR ANY OTHER PRESSES!!!!

HOLDER	RIFLE			HOLDER	PISTOL
4	17 Rem.	2	284 Win.	5	458 Win. Mag.
4	224 Ciptok	3	7.5mm Schmidt-Rubin	5	458 Win. Mag.
7	22 Hornet	7	30 M1 Carbine	1	22 Rem. Jet
3	22K Hornet	3	7.62x53 Arg. Mauser	15	25 ACP
3	22 Savage	12	7.62mm x 39	1	256 Win. Mag.
2	22 BR	16	7.62x54 Russian	19&6	30 Luger
6	218 Bee	3	30 Herrett	19&6	30 Mauser
3	219 Zipper	3	30/30 Win. (20 W.C.F)	4	32 Short Colt
10	220 Swift	2	300 Savage	4	32 Long colt
4	221 Fireball	2	308 Win. (7.62 NATO)	4	32 S&W
4	222 Rem.	5	30/40 Krag (30 U.S.)	4	32 S&W Long
4	222 Rem. Magnum	2	30/06 Springfield	7b	32 ACP (Universal)
4	223 (5.56mm)	5	300 H&H	7	32 ACP (Auto-Prime)
2	224 Clark (22/257)	5	300 Weatherby	4	32 Colt N.P.
5	225 Win.	5	300 Win. Mag.	4	380 Auto
10	22/250	5	308 Norma Mag.	19&6	9mm LUGER
2	240 Weatherby	5	303 British	1	38 S&W
2	243 Win.	2	7.7 Jap.	1	38 Colt N.P.
2	6mm Rem.	3	32 Win. Spc'l.	19&6	38 Super Auto
2	244 Rem.	3	32 Win. S.L.	19&6	38 ACP
3	6mm Int'l	6	32/20 (32 W.C.F)	1	38 Short Colt
6	6mm/284	2	32/40 Win.	1	38 Long Colt
2	6mm/06	2	8x57 Mauser	1	38 Special
4	6x47 (6mm/222M)	2	8mm06	1	357 Magnum
2	25/284	2	8mm Man. Schoe	2	357 Auto Mag.
2	25/06	5	8m Rem. Mag.	19	40 S&W
6	25/20 Win.	17	8mm Lebel	19	10mm Auto
4	250 Savage	8	33 Win.	1	41 Long Colt
3	25/35	5	338 Win. Mag.	19&6	41 Action Express
2	257 Roberts	5	340 Weatherby	9	41 Magnum
5	257 Weatherby	8	348 Win.	11	44 S&W Spc'l
5	303/25	2	35 Rem.	11	44 S&W Russian
2	6.5mm 06	5	35 Win.	11	44 Magnum
2	6.5mm x 57	2	35 Whelan	2	44 Auto Mag.
3	6.5 x 55 Mauser	2	350 Rem. Mag.	2	45 Auto
10	6.5 Jap	2	358 Win.	11	45 Colt
5	6.5 Rem. Magnum	5	358 Norma Mag	5	455 Webley
2	6.5 Carcano	3	375 Win.	12	PPC
21	6.8 SPC	5	375 H&H	13	45 Auto Rim
5	264 Win. Magnum	5	375 Weatherby		
2	270 Win.	14	38/40 Win.		
5	270 Weatherby	3	38/55 Win.		
2	380 Rem.	8	40/82 Win.		
2	7mm/08	3	408 Win.		
2	7 x57mm Mauser	18	43 Mauser		
5	7x61 Sharpe & Hart	14	44/40		
5	7mm Re. Magnum	11	444 Marlin		
5	7mm Weatherby	8	45/750 Gov't.		

Order No.	Size #	Order No.	Size #	Order No.	Size #
006-90201	1	006-90208	8	006-90017	15
006-90202	2	006-90209	9	006-90200	16
006-90203	3	006-90210	10	006-90023	19
006-90204	4	006-90211	11	006-90020	20
006-90205	5	006-90212	12	006-90031	21
006-90206	6	006-90213	13	AUTO PRIME SHELL HOLDERS	
006-90207	7	006-90272	14	Price \$2.10	

Auto Prime Shell Holder Set

Auto Prime Shell Holder Set- A set of 11 shell holders, packed in a sturdy plastic box, fits over 120 different cartridges.(Shell holders 1,2,3,4,5,7,8,9,10,11,19)

Shell Holder Set for Lee Auto-Prime (in red box)	Order No.	Price
	006-90198	\$14.80
Red plastic box without shell holders	006-90196	2.81



Lee Ram Prime - Ram Prime primes on the press upstroke for a more sensitive feel. Includes easy to change punches for both large and small primers. Fits all brands of presses. USES STANDARD PRESS SHELL HOLDERS.
Order No. 006-90106 \$9.86

Lee Case Conditioning



Lee ZipTrim - The ZipTrim rotates your case like a lathe. While your case is mounted you can quickly trim, chamfer and polish your case. The ZipTrim power head features a steel spindle that rotates in a housing made of tough nylon.

The spindle is rotated by a recoil mechanism that puts over a 1/4 horsepower and 1,700 rpm at your fingertips!

Use the Zip Trim with your Lee Case length gauge and cutter. Also works great with the chamfer tool (order separately below)

Order Cutter, Holders, Gauges and chamfer separately below.

Lee ZipTrim Power Head Order No. **006-90899** Price **\$17.62**
Spinner Stud (for use with the 3-jaw chuck/ converts electric drill into high speed polisher/lathe) Order No. **006-90607** Price **2.81**

The 3-Jaw Chuck - Also available to use with your Zip Trim. Versatile chuck will hold the tiny 25 ACP case to the giant 460 Wby Mag and everything in between! Order No. **006-90608** \$11.27



The Lee Case Trimmer - The simplest way to check the case and trim to the correct safe length. The Cutter and Lock Stud works for all calibers. You only need one. The Case Length Gauge (Pilot) and Shell Holder must be ordered for each caliber. Use with an electric drill to trim, chamfer and polish cases fast.



Cutter & Lock Stud- Cutter and Lock Stud fits all calibers, you only need to order one of these. The case length gauge (pilot) and shell holder comes as a set. Order these from the list below. Fits only the calibers listed! Order No. **006-90110** \$4.92

Case Length Gauge (Pilot) and Shell Holder - Must be ordered as Case Length Gauge and shell holder for each caliber. See below for product numbers. \$4.22 ea



Order No.	Caliber	Order No.	Caliber	Order No.	Caliber
006-90111	22 Hornet	006-90167	7mm/08	006-90972	35 Whelen
006-90225	218 Bee	006-90166	7mm Exp280 Rem	006-90165	375 Win
006-90112	221 Fireball	006-90131	7mm Rem Mag	006-90164	375 H&H
006-90113	222 Remington	006-90314	7mm WSM	006-90151	444 Marlin
006-90114	223 Remington	006-90132	7.5 Swiss (S-R)	006-90152	45/70 Govt
006-90673	223 WSSM	006-90051	7.5 MAS	006-90169	32 S&W Long
006-90115	7.7 Japanese	006-90133	7.62x39 Russian	006-90153	9mm Luger
006-90116	22/250	006-90147	7.62x54 Russian	006-90684	9mm Mak
006-90118	220 Swift	006-90236	7.62 Brenneke	006-90155	380 Auto
006-90119	243 Winchester	006-90134	7.65 Mauser	006-90156	38 S&W
006-90389	243 WSSM	006-90135	30 M1 Carbine	006-90157	38 Special
006-90120	6mm/224Rem	006-90136	30/30 Winchester	006-90217	38 Super
006-90121	25/20 W.C.F.	006-90137	30/40 Krag	006-90158	357 Mag
006-90122	250 Savage	006-90138	300 Savage	006-90127	10mm Auto
006-90123	257 Roberts	006-90139	308 Win	006-90154	40 S&W
006-90124	25/06 Rem	006-90140	30/06 Spgrd	006-90159	41 Magnum
006-90221	25 WSSM	006-90141	300 H&H	006-90160	44 Special
006-90993	260 Rem	006-90142	300 Win. Mag.	006-90161	44 Magnum
006-90219	5.7x28FN	006-90034	300 WSM	006-90168	44/40
006-90126	6.5x55 Mauser	006-90143	300 Wby Mag.	006-90162	45 ACP
006-90043	6.5 Carcano	006-90144	303 British	006-90163	45 Colt
006-90223	6.5/284	006-90218	338 Federal	006-90224	45 GAP
006-90189	6.8 Rem SPC	006-90146	32/20 W.C.F.	006-90992	454 Casull
006-90128	270 Win	006-90222	325 WSSM	006-90971	458 Win Mag
006-90117	270 WSM	006-90148	8x57 Mauser	006-90220	460 S&W Mag
006-90129	284 Win	006-90149	338 Win Mag	006-90018	480 Ruger
006-90130	7x57 Mauser	006-90150	35 Remington	006-90010	50 BMG \$14.10
				006-90019	500 S&W

Lee Chamfer Tool- Must be used after case trimming. Unique design cuts fast without chatter. One turn does the job. Chamfers and deburrs inside and outside of case neck. Can also be used to remove the crimp from primer pockets of G.I. brass. Order No. **006-90109** \$2.81

Primer Pocket Cleaner - Double Ended design cleans both large and small primer pockets. Primers can be fully seated for better accuracy and safety. Costs so little and works so well, no reloader can afford to be without one! Order No. **006-90101** \$2.10

Decapper and Base - Easily removes crimped in primers from military cases. Guaranteed unbreakable. Should it fail, simply return to the factory for a free replacement. Available for .22 and .30 cal only! \$5.63ea

Order No. **006-90103**
 .22 Cal. Decap/Base
 Order No. **006-90102**
 .30 Cal. Decap/Base



LEE

Lee Powder Handling Tools



Perfect Powder Measure - Almost as good as a scale! The Perfect Powder Measure has a micrometer adjuster that reads directly in cubic centimeters. Works for charges from two grains to over 100 grains. Changing powder is fast and easy. Free sturdy steel stand included with each measure. The valve is also a powder baffle, so accuracy is virtually guaranteed!

Order No. **006-90058** \$21.85

Lee Safety Scale - This is the only scale that can never get out of adjustment. The beam is made from a very tough phenolic. Even if dropped you can feel confident that if it did not break it is still accurate. Sensitive and readable to 1/20 grain.

Order No. **006-90681** \$22.51



Lee Powder Measure Kit - Fifteen uniformly graduated and proportioned powder dippers. Slide card shows the grains of powder each measure will dispense of every type of powder. Powder measures are inherently safe as they cannot get out of adjustment. Perfect for reloaders who load in small quantities.

Order No. **006-90100** \$9.15

Lee Powder Funnel - A large, unbreakable funnel that fits all cases from .22 to .45 caliber. Hole in flange permits mounting to the Lee Turret Press, shelf or bench.

Order No. **006-90190** \$2.47



Lee Auto-Disk Powder Measure - Use the Auto Disc Powder Measure in conjunction with your Lee Powder Through Expanding Die! Each Auto Disk measure comes complete with four charging disks containing six cavities each. A total of 24 cavities! Charges from 2 to 24 grains. Disks are changed in seconds. They slide right through when the measure is raised.

Order No. **006-90578** \$23.19

Double Disk Kit - This kit raises the hopper so you can stack two disks. This not only doubles the capacity of the disks but it makes very fine adjustments possible. Most powders can be adjusted up or down .1 grain with different combinations of disks. Complete listing of combinations, 4 extra disks, screws and risers are included.

Order No. **006-90195** \$10.56

Micro Disk - Accurately measures small charges below the range of the standard Auto-Disk Powder Measure. Six cavities range from 1.1 to 2.5 grains of Bullseye. This is an ideal kit for small caliber cases and light target loads.

Order No. **006-90302** \$6.94



Pro Auto-Disk Powder Measure - Automatically charges your case while expanding the case mouth. Elastomer wiper and the teflon coated metal casing make this the smoothest operating measure ever. The large hopper with shut off valve is attached with brass thumb nuts for the ultimate in disk changing convenience. Includes a swivel adapter which screws into your die without rotating the measure. Also comes with pull back lever. A set of 4 disks with 24 cavities included.

Order No. **006-90429** \$35.49

Pro Auto-Disk Update Kit - Update any Lee Auto-Disk Powder Measure with all the PRO features. Includes over-size hopper and valve assembly with elastomer wiper, swivel adapter assembly for fast and easy transfer between die sets, pullback lever, chain and attachments and adjustable Charge Bar.

Order No. **006-90377** \$19.03

Pull Back Lever & Chain - For progressive reloading. Eliminates the possibility of powder binding and reduces missed or double charges from operator error.

Order No. **006-90479** \$2.81

Swivel Adapter - Fast and easy transfer between die sets. Screws into your die without rotating the measure.

Order No. **006-90477** \$4.22

Adjustable Charge Bar - Infinitely adjustable between .28 and 1.6 cc. Lifetime nylon with solid brass, zero backlash micrometer. Easy to set.

Order No. **006-90792** \$7.04



RCBS Presses and Accessories



Each Master Kit includes a Rock Chucker Press, 505 Reloading Scale, Speer Reloading Manual, Uniflow Powder Measure, Hex Key Set, Case Lube Kit, Powder Funnel, Primer Tray-2, .17-.60 Debur Tool, Universal Case Loading Block and Accessory Handle. You must order dies and shell holders separately!

Rock Chucker™ Supreme Master Kit - Our Top Selling Kit! The Rock Chucker Supreme Master Reloading Kit comes with everything a beginner or expert needs to start reloading except dies, brass, bullets, primers and powder!

	Order No.	Price
RockChucker Supreme Reloading Kit	044-9361	\$320.94
RockChucker Supreme Press Only	044-9356	147.91
Automatic Primer Feed Combo	044-9580	25.60
Primer Catcher Assembly	044-9114	7.65
Primer Plug & Sleeve (large)	044-9552	3.58
Primer Plug & Sleeve (small)	044-9553	3.58
Universal Primer Arm	044-9550	12.79
Rockchucker Supreme Auto Prime	044-9358	39.84



Piggyback IV Conversion Unit - Moves you from single-stage reloading to 5-station, manual indexing, progressive reloading in one step. Increases your output from 50 rounds an hour to well over 400. Reloads all pistol (except 25 Auto) and rifle calibers up to 30-06 (3.340" OAL). Five stations allow use of lube die, lock-out die, powder checker, or separate crimp die. Interchangeable die plate for fast and simple caliber conversion. Utilizes APS(r) Priming System, the most reliable, convenient and safest available. Self-cleaning Shell Plate Holder. Includes bullet tray, loaded cartridge box and empty case box.

Order No. 044-87811 \$403.51

Ammomaster/Piggyback Die Plate - Switch top plates quickly and eliminate the need to remove and readjust dies when making a caliber changeover for your Ammo-Master or PiggyBack. Includes a five-station top plate, clutch bearing with bushing, cam wire clip with lock nut, and set screw.

Order No. 044-88799 \$34.92



Reloader Special-5 - One of the truly remarkable values in reloading. It has everything you need to get started reloading rifle and pistol (except dies and shellholders.) The Reloader Special-5 Kit contains: Reloader Special-5 press, 5-0-5 Scale, Case Lube Kit, Primer Tray-2, Powder Funnel, .17-.60 Debur Tool, Universal Case Loading Block and Accessory Handle, and Speer Reloading Manual.

	Order No.	Price
Reloader Special-5 Kit	044-9046	\$289.03
Reloader Special-5 Press Only	044-9285	127.29

RCBS Precision Handloading DVD - Comprehensive review of RCBS equipment and accessories. Tips and tricks on how to safely and efficiently load a high volume of rounds. Clear, step-by-step directions for shotgun, rifle and pistol reloading. Narration by Jim Scoutten of Shooting USA®

Order No. 044-99910 \$8.68



Partner Press - RCBS's Smallest press, size and price wise. Perfect for beginners or experienced handloaders who want a separate press to handle different functions or calibers. The Partner Press Kit includes: the Partner Press, Case Lube Kit, Primer Tray, Powder Funnel, .17-.60 Debur Tool, Universal Case Loading Block and Accessory Handle, Speer Reloading Manual and the RC-130 Scale.

	Order No.	Price
Partner Press Only	044-87460	\$74.29
Partner Press Reloading Kit	044-87467	187.58
Dust Cover	044-86881	10.02

RCBS® Pro 2000 Progressive Press - Easy-to-use progressive press. It offers simple to use five station manual indexing. It's like having an ammo factory right on your bench! Each pull of the handle produces a perfectly loaded round. All you have to do is insert the bullet and case and rotate the shell plate by hand. Great for short pistol and long rifle cases. Cast iron frame & removable die plate. The Pro 2000 is built to last and carries a Full Lifetime Warranty!

	Order No.	Price
Pro 2000 Progressive Press	044-88875	\$534.50
Pro 2000 Die Plate	044-88877	17.86
Pro 2000 Star Wheel	044-88878	6.66
Tube Priming Conversion Kit	044-88876	108.81
Dust Cover	044-86767	16.57



RCBS® Turret Press - Simple operation - no complex or automated processes. You have complete control over every reloading step. May be operated in progressive or single-stage mode. In the progressive mode, output can be increased from 50 to 200 rounds per hour. Rugged, cast iron frame, toggle block and 6 station turret head.

Order No. 044-88901 \$225.97

Turret Deluxe Reloading Kit -

Turret Press includes: RCBS® Turret Press, Uniflow Powder Measure, Model 5-0-2 Reloading Scale, Speer Manual #14, Case Lube Kit, Fold-up Hex Key Wrench Set, Primer Tray-2, Powder Funnel, .17-.60 Debur Tool, Universal Case Loading Block and Accessory Handle.

Order No. 044-88907 \$443.99

Spare Turret Head - Makes changing calibers quick and simple. Leave the dies set up in the Turret Head and change the Head - one bolt does the trick! Six stations with standard 7/8" - 14 threads.

Order No. 044-88902 \$45.83



AmmoMaster®-2 Single Stage Press - In single stage mode, you have all the clearance and leverage to handle any rifle or pistol round from 25 Auto to 50 BMG. The Ammomaster is designed for use with standard 7-14 thread loading dies and accessories. It easily converts for use of .50 BMG dies with the optional .50 BMG Pack.

	Order No.	Price
AmmoMaster®-2 Press	044-88703	\$279.02
Ammomaster Die Plate	044-88799	34.92
50 BMG Kit for 1 1/2" dies	044-88709	131.31
Dust Cover	044-86767	16.57
50 BMG Shell Holder	044-88746	20.32

AmmoMaster® .50 BMG Pack - The AmmoMaster® .50 BMG Pack makes reloading for the .50 Browning Machine Gun cartridge a simple task. Manufactured to accept RCBS® 1 1/2" .50 BMG dies, along with the massive 1" solid steel ram, provides more than enough strength to handle the .50 and will provide a lifetime of service. This kit includes the press, Full-Length sizer, Seater die, Shell Holder, Ram Priming Unit and Trim die.

Order No. 044-88700 \$606.97





GROUP A

Caliber	Full Length Die Set \$32.22 \$57.09*	Full Length Size Die \$29.17 \$26.79* \$44.05**	Neck Die Set \$35.88 \$38.35* \$35.88+ \$38.35^	Neck Sizer Die \$29.42 \$38.14* \$31.45** \$35.69+	Small Base Die Set \$35.88 \$38.35* \$31.45** \$35.88+ \$38.35+ \$31.45^	Small Base Sizer Die \$29.42 \$35.38* \$38.14** \$31.45^	Seater Die \$24.76	Exp-Decap Die \$6.71 \$7.28*	Trim Die \$34.14 \$31.94*
17 Remington	044-17201	044-17229	044-17202	044-17230	—	—	044-17238	044-9882*	044-17265
204 Ruger	044-10301	—	044-10302	044-10330	—	—	—	044-9801*	—
218 Bee	044-10001	044-10029	044-10002*	044-10030*	—	—	044-10038	044-9802	044-10065
22 Hornet	044-10201	044-10229	044-10202*	044-10230	—	—	044-10238	044-9802	044-10265
22-250 (22 Varminter)	044-10601	044-10629	044-10602	044-10630	044-10603**	044-10631**	044-10638	044-9802	044-10665
220 Swift	044-10701	044-10729	044-10702*	044-10730	—	—	044-10738	044-9802	044-10765
221 Remington Fire Ball	044-10801	044-10829	044-10802*	044-10830**	—	—	044-10838	044-9802	044-10865
222 Remington Magnum	044-11001	044-11029	044-11002*	044-11030**	—	—	044-11038	044-9802	044-11065
222 Remington	044-10901	044-10929	044-10902*	044-10930**	—	—	044-10938	044-9802	044-10965
223 Remington (5.56mm)	044-11101	044-11129	044-11102	044-11130	044-11103	044-11131	044-11138	044-9802	044-11165
223 WSSM	044-10501	—	044-10502*	044-10530*	—	—	—	044-9802	—
5.7mm x 28 (FN)	044-11701*	044-11729*	—	—	044-11703+	044-11731*	044-11738	044-9802	—
240 Weatherby Magnum	044-33201	044-33229	044-33202*	044-33230**	—	—	044-33238	044-9805	044-33265
6mm PPC	044-22601	044-22629	044-22602*	044-22630**	—	—	044-22638	044-9837*	044-22665
243 Winchester	044-11401	044-11429	044-11402	044-11430	044-11403	044-11431	044-11438	044-9805	044-11465
243 WSSM	044-11601	—	044-11602*	044-11630**	—	—	—	044-9805	—
6mm Remington (244 Remington)	044-11501	044-11529	044-11502*	044-11530**	044-11503**	044-11531**	044-11538	044-9805	044-11565
25-06	044-12001	044-12029	044-12002*	044-12030	—	—	044-12038	044-9806	044-12065
25 WSSM	044-12401	044-12429	044-12402	044-12430	—	—	044-12438	044-9806	—
25-20 Winchester	044-11801	044-11829	044-11802*	044-11830**	—	—	044-11838	044-9806	044-11865
25-35 Winchester	044-12101	044-12129	044-12102*	044-12130**	—	—	044-12138	044-9806	044-12165
250 Savage (250-3000 Savage)	044-12201	044-12229	—	—	—	—	044-12238	044-9806	044-12265
257 Roberts	044-12501	044-12529	044-12502**	044-12530*	—	—	044-12538	044-9806	044-12565
257 Weatherby Magnum	044-12601	044-12629	044-12602**	044-12630+	—	—	044-12638	044-9806	044-12665
260 Remington	044-12801	044-12829	044-12802*	044-12830	—	—	044-12838	044-9807*	044-12865
264 Winchester Magnum	044-12701	044-12729	044-12702**	044-12730*	—	—	044-12738	044-9807*	044-12765
6.5 x 55mm Swedish Mauser	044-13201	044-13229	044-13202*	044-13230	—	—	044-13238	044-9807*	044-13265
6.8mm Remington Special	044-13301	044-13329	—	—	—	—	044-13338	044-9808	—
270 Weatherby Magnum	044-13401	044-13429	044-13402**	044-13430*	—	—	044-13438	044-9808	044-13465
270 Winchester	044-13501	044-13529	044-13502*	044-13530	044-13503*	044-13531^	044-13538	044-9808	044-13565
270 Winchester Short Mag	044-31301	044-31329	044-31302**	044-31330*	—	—	044-31338	044-9808	044-31365
280 Remington (7mm Exp. Rem.)	044-14001	044-14029	044-14002**	044-14030+	044-14003**	044-14031**	044-14038	044-9809	044-14065
284 Winchester**	044-14101	044-14129	044-14102*	044-14130	—	—	044-14138	044-9809	044-14165
7mm Remington Magnum	044-13601	044-13629	044-13602**	044-13630	044-13603	044-13631^	044-13638	044-9809	044-13665
7mm Remington Short Ultra Magnum	044-31101	044-31129	044-31102**	044-31130*	—	—	044-31138	044-9809	044-31165
7mm Remington Ultra Magnum	044-17801	044-17829	044-17802*	044-17830**	—	—	044-17838	044-9809	044-17865
7mm Shooting Times Westerner	044-26601	044-26629	044-26602^	044-26630**	—	—	044-26638	044-9809	044-26665
7mm Thompson/Center Ugalde	044-34201	044-34229	044-34202*	044-34230**	—	—	044-34238	044-9811*	044-34265
7mm Weatherby Magnum	044-13701	044-13729	044-13702**	044-13730*	—	—	044-13738	044-9809	044-13765
7mm Winchester Short Mag	044-31401	044-31429	044-31402**	044-31430+	—	044-31403+	044-31438	044-9809	044-31465
7mm-08 Remington	044-13901	044-13929	044-13902	044-13930	—	—	044-13938	044-9809	044-13965
7 x 57mm Mauser (7mm Mauser)	044-13801	044-13829	044-13802*	044-13830	—	—	044-13838	044-9809	044-13865
7 x 64mm Brenneke	044-34001	044-34029	044-34002**	044-34030*	—	—	044-34038	044-9809	044-34065
7-30 Waters	044-34801	044-34829	044-34802**	044-34830+	—	—	044-34838	044-9809	044-34865
7.5 x 55mm Schmidt-Rubin (1911)	044-33501	044-33529	044-33502**	044-33530**	—	—	044-33538	044-9812	044-33565
7.62 x 54Rmm Russian	044-29001	044-29029	044-29002**	044-29030+	—	—	044-29038	044-9812	044-29065
7.62 x 39mm-308/311	044-35001	044-35029	—	—	—	—	044-35038	044-9814	044-35065
7.65 x 53 Mauser (Belgian)	044-14301	044-14329	044-14302*	044-14330**	—	—	044-14338	044-9814	044-14365
7.7 x 58mm Japanese-Arisaka	044-14401	—	044-14402*	044-14430**	—	—	044-14438	044-9814	044-14465
30 Luger (7.65mm Luger)	044-25001	044-25029	044-25002**	044-25030**	—	—	044-25038	044-9813*	044-25065
30-06 Springfield	044-14801	044-14829	044-14802*	044-14830	044-14803	044-14831	044-14838	044-9812	044-14865
30-30 Winchester	044-14601	044-14629	044-14602**	044-14630+	—	—	044-14638	044-9812	044-14665
30-378 Weatherby Magnum	044-29501	044-29529	044-29502*	044-29530**	—	—	044-29538	044-9812	044-29565
30-40 Krag	044-14701	044-14729	—	—	—	—	044-14738	044-9812	044-14765
300 Remington Short Action Ultra Mag	044-31201	044-31229	044-31202**	044-31230*	—	—	044-31238	044-9812	044-31265
300 Remington Ultra Mag	044-17601	044-17629	044-17602	044-17630**	—	—	044-17638	044-9812	044-17665
300 Savage	044-15101	044-15129	—	—	044-15103**	044-15131**	044-15138	044-9812	044-15165
300 Weatherby Magnum	044-15201	044-15229	044-15202	044-15230	—	—	044-15238	044-9812	044-15265
300 Winchester Magnum	044-15301	044-15329	044-15302*	044-15330	044-15303*	044-15331^	044-15338	044-9812	044-15365
300 Winchester Short Magnum	044-30801	044-30829	044-30802**	044-30830+	—	—	044-30838	044-9812	044-30865*
303 British	044-15401	044-15429	044-15402*	044-15430	—	—	044-15438	044-9814	044-15465
308 Winchester/307 Winchester	044-15501	044-15529	044-15502*	044-15530	044-15503	044-15531	044-15538	044-9812	044-15565
32 Winchester Special	044-15701	044-15729	—	—	—	—	044-15738	044-9816*	044-15765
325 Winchester Short Mag	044-31601	044-31629	044-31602*	044-31630**	044-31603**	044-31631**	044-31638	044-9817*	044-16665
8mm Remington Magnum	044-16001	044-16029	044-16002*	044-16030**	—	—	044-16038	044-9817*	044-16065
8 x 57mm Mauser (8mm Mauser)	044-15901	044-15929	044-15902*	044-15930	—	—	044-15938	044-9817*	044-15965
338-378 Weatherby Magnum	044-16801	044-16829	044-16802*	044-16830**	—	—	044-16838	044-9818*	044-16865
338 Winchester Magnum	044-16301	044-16329	044-16302*	044-16330**	044-16303**	044-16331**	044-16338	044-9818*	044-16365
338 Remington Ultra Mag	044-17701	044-17729	044-17702**	044-17730*	—	—	044-17738	044-9818*	044-17765
338 Lapua (.416 Rigby case)	044-16601	044-16629	044-16602*	—	—	—	044-16638	044-9818*	044-16665
340 Weatherby Magnum	044-30601	044-30629	044-30602*	044-30630**	—	—	044-30638	044-9818*	044-30665
35 Remington	044-16501	044-16529	—	—	—	—	044-16538	044-9820*	044-16565
35 Whelen	044-30701	044-30729	—	—	—	—	044-30738	044-9823*	044-30765
357 SIG	044-23101	044-23129	—	—	—	—	044-23138	044-9834*	044-23165
358 Winchester/.356 Winchester	044-32701	044-32729	—	—	—	—	044-32738	044-9823*	044-32765
9.3 x 62mm Mauser	044-34501	044-34529	044-34502*	044-34530**	—	—	044-34538	044-9821*	044-34565
375 Holland & Holland Magnum	044-16901	044-16929	044-16902**	044-16930*	—	—	044-16938	044-9822*	044-16965
375 Remington Ultra Mag	044-30901	044-30929	044-30902**	044-30930*	—	—	044-30938	044-9822*	044-30965

RCBS 2-Die Sets Groups A & D

2-Die Sets are for bottleneck type rifle and pistol cases, and consist of a Full-Length Sizer Die with Expander-Decapping Unit, and a Seater Die with Bullet Seater Plug.

Neck Die Sets Groups A & D

Neck Sizer Dies size only the neck of case (not the shoulder or body) just enough to snugly hold the bullet. Neck Die Sets consist of a Neck Sizer Die with Expander-Decapping Unit and a regular Seater Die with Seater Plug. Neck Sizer Dies are also available individually.

Small Base Die Sets Group A

Small Base Sizer Dies are usually required for reloading ammunition to be used in automatic, semi-automatic, pump, slide and some lever-action rifles. These dies size the body of cases somewhat smaller in diameter and also set the shoulder back slightly more than a Full-Length Sizer Die to ensure proper functioning in the actions of these rifles. Not recommended for ammunition used in bolt-action rifles. Small Base Set contains Small Base Sizer with Expander-Decapping Unit and Regular Seater Die with Seater Plug. Small Base Sizer Dies also available individually.

Tungsten Carbide Die Sets Groups B, C, & E -

The Carbide Sizer Die eliminates the need for case lubrication and cases do not need to be cleaned before sizing. Carbide Die Sets consist of a Carbide Sizer Die with Decapping Unit, Expander Die for expanding and belling the case mouth, plus a Seater Die with Roll or Taper Crimp and Bullet Seater Plug. Carbide Sizer Dies are also available separately.

Trim Dies -

Doubles as a visual case length gauge. Run a case into the Trim Die and if the case sticks out above the top of the die, it's too long. File the case down until it is flush with the top of the die. Then, deburr the case mouth with a Deburring Tool. Precision machined Sizer Die chamber with slightly larger neck to ensure accuracy in gauging case lengths. Headspace is held to minimum tolerances to avoid changing the length of the case. Heat treated to withstand a file bearing against the top surface without damage to die. Cases with an overall length of 1.700" and shorter requires the use of an Extended Shell Holder. Standard 7/8"-14 thread. Packed in a convenient plastic storage box.

COMPETITION DIES

Caliber	Competition Full Length Die Set \$108.02 \$101.07*	Competition Full Length Sizer Die \$41.56 \$38.89*	Competition Seater Die \$70.12 \$65.62*	Competition Extended Shell Holder \$11.63	Decapping Pin \$2.17	Competition Seater Plug Assembly \$10.73	Competition Bullet Guide \$6.80
---------	--	--	---	---	----------------------	--	---------------------------------

204 Ruger	044-39401*	044-39429	044-39438*	044-38260	044-9608	—	—
22 Hornet	044-38301*	044-38329	044-38338	044-38262	044-9608	044-38151	044-38202
222 Remington	044-37001	044-37029	044-37038	044-38260	044-9608	044-38151	044-38202
223 Remington	044-37201*	044-37229*	044-37238*	044-38260	044-9608	044-38151	044-38202
22-250 (22 Varminter)	044-37101*	044-37129*	044-37138*	044-38253	044-9608	044-38151	044-38202
243 Winchester	044-37301*	044-37329*	044-37338	044-38253	044-9608	044-38152	044-38205
6.5 x 55mm Swedish Mauser	044-38401*	044-38429*	044-38438	044-38252	044-9609	044-38154	044-38207
270 Winchester	044-37501*	044-37529*	044-37538	—	044-9609	044-38155	044-38208
7mm-08 Remington							

GROUP B

Caliber	3-Die Carbide Set Roll Crimp \$48.26 \$76.51*	3-Die Carbide Set Taper Crimp \$48.26 \$81.77*	3-Die Set Roll Crimp \$36.07	3-Die Set Taper Crimp \$36.07	Carbide Sizer Die \$37.37 \$53.63* \$34.97+	Sizer Die \$21.22	Expander Die \$15.24 \$24.11* \$14.26+	Roll Crimp Seater Die \$18.79 \$31.76* \$20.09+	Taper Crimp Seater Die \$18.79 \$31.76* \$18.79+ \$20.09*	Decap Unit \$6.71	Trim Die \$34.82 \$32.58+
32 Automatic (RN)1	—	044-20015	—	—	044-20037	—	044-20053	—	044-20062^	044-9622	044-20065
32 S&W Long/32 H&R Mag (RN-SWC)2	044-21412*	044-21415*	—	—	044-21437*	—	044-21453*	044-21442*	044-21462*	044-9622	—
357 Magnum/38 Special/.357 Rem Maxi (RN-WC)	044-18212	044-18215	—	—	044-18237+	—	044-18353	044-18342	044-18262	044-9622	18265/18365
9mm Luger (RN-TMJ)	—	044-20515	—	—	044-20537	—	044-20552	—	044-20562^	044-9622	044-20565
380 Automatic Pistol (RN)	—	044-20415	—	—	044-20437	—	044-20449	—	044-20462^	044-9622	044-20465
40 S&W/10mm Auto (SWC)	—	044-22115	—	—	044-22137	—	044-22153	—	044-22162	044-9622	044-22165+
41 Magnum (RN-SWC)	044-18512	—	—	—	044-18537	—	044-18553	044-18542+	—	044-9622	044-18565
44 Magnum/44 Special (RN-SWC)	044-18612	—	044-18608	—	044-18637+	044-18732	044-18753+	044-18742	044-18662+	044-9622	18665/18765
44-40 Winchester (44 Win) (RN)	—	—	044-18805	—	—	044-18832	044-18853	044-18839+	—	044-9622	044-18865
44-40 Winchester (RN) Jacketed 4	—	—	044-18806	—	—	044-18832	044-18853	044-18840+	—	044-9622	044-18865
45 Automatic (45 ACP) (RN-SWC)	—	044-18915	—	—	044-18937+	—	044-18953	044-18942	044-18962+	044-9622	044-18965
45 Colt (RN-SWC)	044-19112	—	044-19108	—	044-19137	044-19132	044-19153	044-19142	—	044-9622	044-19165
454 Casull (SWC)	044-23212	—	—	—	044-23237	—	044-23253	044-23242+	—	044-9622	044-23265
480 Ruger	044-35212	—	044-35208	—	044-35237	044-35232	044-35238+	—	—	044-9622	044-35265
50 Action Express (SWC)	—	—	—	044-22210	—	044-22232	044-22253	—	044-22262^	044-9622	044-22265
500 Smith & Wesson (Shell Plate/Holder #44)	044-23812	—	044-23808	—	044-23837	044-23832	044-23853	044-23838	—	044-9622	—

GROUP C

Caliber	3-Die Carbide Set Roll Crimp \$65.62	3-Die Carbide Set Taper Crimp \$42.87	3-Die Set Roll Crimp \$42.87	3-Die Set Taper Crimp \$42.87	Carbide Sizer Die \$53.34	Sizer Die \$24.97	Expander Die \$17.60	Roll Crimp Seater Die \$22.72 \$21.26*	Taper Crimp Seater Die \$22.72	Decap Unit \$6.71	Trim Die \$34.14
30 M1 Carbine (RN)	—	044-18015	—	044-18010	044-18037	044-18032	044-18053	—	044-18062	044-9622	044-18065
444 Marlin	—	—	044-20704	—	—	044-20733	044-20758	044-20738	—	044-9619	044-20765
45-70 U.S. Government	—	—	044-20904	—	—	044-20933	044-20955	044-20938*	—	044-9619	044-20965
450 Marlin	—	—	044-35504	—	—	044-35533	044-35558	044-35538	—	044-9619	044-35565
458 Winchester Magnum	—	—	044-20804	—	—	044-20833	044-20858	044-20838	—	044-9619	044-20865
458 Lott	—	—	044-24104	—	—	044-24133	044-20858	044-24138	—	—	044-24165

GROUP D

Caliber	Full Length Die Set \$57.09	Full Length Sizer Die \$44.05	Neck Die Set \$73.91	Neck Sizer Die \$53.38	Seater Die \$34.66	Exp-Decap Unit \$6.71 \$7.28*	Trim Die \$47.40
22 K-Hornet	044-26201	044-26229	044-26202	044-26230	044-26238	044-9802	044-26265
22 Remington Jet	044-10401	044-10429	044-10402	044-10430	044-10438	044-9800*	044-10465
22 Savage High-Power	044-33801	044-33829	044-33802	044-33830	044-33838	044-9803*	044-33865
5.6 x 50mm Rimmed	044-26301	044-26329	044-26302	044-26330	044-26338	044-9802	044-26365
257 Roberts Improved (40°)	044-32201	044-32229	044-32202	044-32230	044-32238	044-9806	044-32265
6.5mm-06	044-27801	044-27829	044-27802	044-27830	044-27838	044-9807*	044-27865
6.5 Remington Magnum	044-33401	044-33429	—	—	044-33438	044-9807*	—
6.5mm 284 Winchester	044-28701	044-28729	—	—	044-28738	—	—
6.5 x 57mm	044-32801	044-32829	044-32802	044-32830	044-32838	044-9807*	044-32865
6.5 x 68Smm	044-27901	044-27929	044-27902	044-27930	044-27938	044-9807*	044-27965
7mm Bench Rest Remington	044-34101	044-34129	044-34102	044-34130	044-34138	044-9809	044-34165
7 x 65mm Rimmed	044-26701	044-26729	044-26702	044-26730	—	044-9809	044-26765
7.5x 54mm French MAS	044-29101	044-29129	044-29102	044-29130	044-29138	044-9832*	044-29165
30 Mauser (7.63mm Mauser)	044-25101	044-25129	044-25102	044-25130	044-25138	044-9813*	044-25165
30 Remington	044-29201	044-29229	044-29202	044-29230	044-29238	044-9812	044-29265
30-338 Winchester Magnum	044-29401	044-29429	044-29402	044-29430	044-29438	044-9812	044-29465
300 H&H Magnum	044-15001	044-15029	044-15002	044-15030	044-15038	044-9812	044-15065
308 Norma Magnum	044-15601	044-15629	044-15602	044-15630	044-15638	044-9812	044-15665
32-40 Winchester	044-32501	044-32529	044-32502	044-32530	044-32538	044-9816*	044-32565
8mm-06	044-32601	044-32629	044-32602	044-32630	044-32638	044-9817*	044-32665
8 x 68Smm Magnum	044-34401	044-34429	044-34402	044-34430	044-34438	044-9817*	044-34465
.338-06	044-16701	044-16729	044-16702	044-16730	044-16738	044-9828*	044-16765
348 Winchester	044-33601	044-33629	—	—	044-33638	044-9819*	044-33665
350 Remington Magnum	044-33701	044-33729	044-33702	044-33730	044-33738	044-9820*	044-33765
9.3 x 74mm Rimmed	044-34601	044-34629	044-34602	044-34630	044-34638	044-9821*	044-34665
378 Weatherby Magnum	044-33001	044-33029	044-33002	044-33030	044-33038	044-9822*	044-33065
400 CorBon	044-17501	044-17529	—	—	044-17538	044-9835*	044-17565
416 Remington Magnum	044-22701	044-22729	044-22702	044-22730	044-22738	044-9827*	044-22765
416 Rigby	044-22801	044-22829	044-22802	044-22830	044-22838	044-9825*	044-22865
460 Weatherby Magnum	044-33101	044-33129	044-33102	044-33130	044-33138	044-9826*	044-33165
376 Steyr	044-17901	044-17929	044-17902	044-17930	044-17938	044-9822*	044-17965

Miscellaneous Die Accessories

Eight heat-treated hex keys fit most hex head screws on RCBS equipment. Key sizes: .050, 1/16", 5/64", 3/32", 7/64", 1/8", 9/64" and 5/32".



The RCBS Die Lock-Ring Wrench simply slips onto the die lock ring for quick and easy adjustment. A pivoting handle allows leverage from any angle and the heat-treated steel stands up to all the brute force you can muster.

Hex Key Fold-Up Wrench	Order No. 044-98975	Price \$8.01
Die Lock Ring Wrench	Order No. 044-9634	Price 5.87

Die Lock Rings

Die Lock Ring 7/8-14 thread(1 per)	Order No. 044-87501	Price \$2.80
Die Lock Ring 7/8-14 thread(5 pack)	Order No. 044-87507	Price 9.82

Shell Holder Rack - Holds 12 to 24 standard shell holders, up to 6 Trim Pro Shell Holders. Can be wall mounted or used on the bench. Clear see through removable cover. Stickers included to number the shell holder posts



Order No. 044-9461 Price \$11.91

GROUP E

Caliber	3-Die Carbide Set Crimp \$76.51 \$81.77*	3-Die Set Crimp \$63.73	Carbide Sizer Die \$53.63	Sizer Die \$40.01*	Expander Die \$24.11 \$15.24*	Seater Die \$31.76	Taper Crimp Seater \$31.76	Decap Unit \$6.71	Trim Die \$47.40
25 Automatic (25 ACP) (RN)	044-21015	—	044-21037	—	044-21049	—	044-21062	044-9621	044-21065
9mm Makarov (RN-SWC)	044-23015*	—	044-23037	—	044-23053	—	044-23062	044-9622	044-23065
32-20 Winchester (RN)	—	044-18105	—	044-18132*	044-18153	044-18139	—	044-9622	044-18165
38 Colt Super Automatic (RN)	044-20215	—	044-20237	—	044-20252	—	044-20262	044-9622	044-20265
38-40 Winchester (RN)1	—	044-35605	—	044-35632*	044-35653	044-35639	—	044-9622	044-35665
475 Linebaugh (1.400")	—	—	—	—	044-23553*	—	—	044-9622	—

GROUP F (Legacy Series Die Sets)

Caliber	3-Die Set \$42.87 \$48.25*	Sizer Die \$24.97 \$36.08*	Expander Die \$19.06* \$17.60	Seater Die \$22.72 \$23.19+	Decap Unit \$6.71	Trim Die \$34.14 \$46.03*
375 Winchester	044-20604	044-20633	044-20658	044-20638	044-9619	044-20665
38-55 Winchester & Ballard	044-36504*	044-36533*	044-36555*	044-36538+	044-9619	044-36565*
40-65 Shiloh-Sharps .408" Bore	044-23304*	044-23333*	044-23358*	044-23338+	044-9619	044-23365*
405 Winchester	044-23608*	044-23633*	044-23658*	044-23638+	044-9619	044-23665*



Die Box (Green) Order No. 044-9889 Price \$4.52

Die Box (Gray) Order No. 044-9890 Price 4.52

COWBOY DIES

Caliber	Full Length 3-DIE Roll Crimp Set \$53.33 \$56.99*	3-Die Roll Crimp Set \$53.33 \$56.99*	3-Die Carbide Roll Crimp \$56.05	Cowboy Steel Sizer Die \$36.29 \$33.96*	Cowboy Carbide Sizer Die \$48.86	Cowboy Expander Die \$24.09	Cowboy Expander Assembly \$6.05	Cowboy Roll Crimp Seater \$24.35 \$22.79*	Cowboy Seater Plug \$6.14	Cowboy Decap Unit \$6.86
.25-20 WIN	044-11850	—	—	044-11856	—	044-11857	044-9901	044-11858	044-90081	044-9628
.30-30 WIN	044-14650*	—	—	044-14656	—	044-14657	044-9902	044-14658	044-90082	044-9628
.32 S&W LONG/32 S&W	—	—	044-21451	—	044-21456	044-21457	9903/9917	044-21458	044-90083	044-9628
.32 WIN SPL	044-15750*	—	—	044-15756	—	044-15757	044-9904	044-15758*	044-90084	044-9628
.32 -20 WIN	—	044-18151	—	044-18156	—	044-18157	044-9905	044-18158	044-90092	044-9628
.32 -40 WIN	044-32550*	—	—	044-32556	—	044-32557	044-9904	044-32558	044-90084	044-9628
.357 MAG/.38 SPL	—	—	044-18251	—	044-18256	044-18257	044-9906	044-18258	044-90085	044-9628
.38 S&W	—	044-20351	—	044-20356	—	044-20357	9906/9916	044-20358	044-90086	044-9628
.38 -40 WIN	—	044-35651	—	044-35656	—	044-35657	044-9907	044-35658	044-90087	044-9628
.38 -55 WIN	—	044-36551	—	044-36556	—	044-36557	9908/9915	044-36558	044-90088	044-9628
.40-65 WIN.410" Bore	—	044-36651*	—	044-36656	—	044-36657	044-9909	044-36658	044-90087	044-9628
.44 S&W RUSSIAN/44 SPL	—	—	044-18651	—	044-18656	044-18657	044-9910	044-18658	044-90089	044-9628
.44-40 WIN	—	044-18851	—	044-18856*	—	044-18857	044-9911	044-18858	044-90089	044-9628
.45 S&W SCHOFIELD/.45 COLT	—	—	044-19151	—	044-19156	044-19157	9912/9913	044-19158*	044-90090	044-9628
.45-70 US COLT	—	044-20951	—	044-20956	—	044-20957	044-9914	044-20958	044-90091	044-9628



X-Sizer Dies

Now X-Sizers are sold Separately or in Full Length Die sets! Limits growth of the overall length of a cartridge case. Eliminates the need to trim rifle cases. Excellent for both progressive and single stage reloaders. Sizes, decaps and expands the same as all full-length sizer dies.



Caliber	X-FL Sizer Die \$42.78 \$40.03*	X-FL Die Set \$46.97 \$50.20*	X-Mandrel Assembly \$9.51 \$8.90*
204 Ruger	044-10309*	044-10312	044-10314*
22 Hornet	044-38309	044-38312*	044-38314
22-250 Varminter	044-37009	044-37112	044-37114
220 Swift	044-38809	044-38812*	044-38814
222 Rem	044-37209*	044-37012*	044-37014
223 Rem	044-37109*	044-37212	044-37214
223 Rem SB	044-38859	044-38862	044-37214
223 WSSM	044-10509	044-10512*	044-10514
243 Winchester	044-37309*	044-37312	044-37314
243 WSSM	044-11609	044-11612	044-11614
25 WSSM	044-12409	044-12412	044-12414
25-06	044-38959	044-38962*	044-38964
260 Rem	044-39009*	044-39012*	044-39014
6.5x55 Sw.Maus	044-38409*	044-38412*	044-38414*
270 Win	044-37509	044-37512*	044-37514
270 WinShortMag	044-31309	044-31312	044-31314
280 Rem	044-39059	044-39062*	044-39064
7mm Rem Mag.	044-37609	044-37612*	044-37614
7mm STW	044-39109	044-39112*	044-39114
7mm-08 Rem	044-37409	044-37412	044-37414
7mmWinShortMag	044-31409	044-31412*	044-31414
7mmR SA UltMag	044-31109	044-31112*	044-31114
7mmRemUltraMag	044-17809	044-17812*	044-17814
30-06 Spfd.	044-37709*	044-37712	044-37714
30-06 Spfd SB	044-39159*	044-39162	044-37714
30-30 Win	044-37909*	044-37912	044-37914
300 WinShortMag	044-30809	044-30812	044-30814
300RemSA UltMag	044-31209	044-31212*	044-31214
300 Wby Mag	044-39209	044-39212*	044-39214
300 Win Mag	044-38909	044-38912*	044-38914
300 RemUltraMag	044-17609	044-17612	044-17614
303 British	044-39359	044-39362*	044-39364
308 Win	044-37809*	044-37812*	044-37814
308 Win SB	044-39259*	044-39262	044-37814
8x57 Mauser	044-38709	044-38712	044-38714
338 Win Mag	044-39309	044-39312*	044-39314
338RemUltraMag	044-17709	044-17712*	044-17714
375RemUltraMag	044-30909	044-30912*	044-30914

See the RCBS Die Reference Table for a detailed listing of what shell holder fits what caliber. NOW AVAILABLE: Adapter for Herters Press.

Herters Adapter	Order No.	Price
Herters Adapter	044-99200	\$18.26
Shell Holder #1	044-9201	6.18
Shell Holder #2	044-9202	6.18
Shell Holder #3	044-9203	6.18
Shell Holder #4	044-9204	6.18
Shell Holder #5	044-9205	6.18
Shell Holder #6	044-9206	6.18
Shell Holder #7	044-9207	6.18
Shell Holder #8	044-9208	6.18
Shell Holder #9	044-9209	6.18
Shell Holder #10	044-9210	6.18
Shell Holder #11	044-9211	6.18

Shell Holder #12	044-9212	\$6.18
Shell Holder #13	044-9213	6.18
Shell Holder #14	044-9214	6.18
Shell Holder #15	044-9215	6.18
Shell Holder #16	044-9216	6.18
Shell Holder #17	044-9217	6.18
Shell Holder #18	044-9218	6.18
Shell Holder #19	044-9219	6.18
Shell Holder #20	044-9220	6.18
Shell Holder #21	044-9221	6.18
Shell Holder #22	044-9222	6.18
Shell Holder #23	044-9223	6.18
Shell Holder #24	044-9224	6.18
Shell Holder #25	044-9225	6.18
Shell Holder #26	044-9226	6.18
Shell Holder #27	044-9227	6.18
Shell Holder #28	044-9228	6.18

50 BMG Dies

These massive dies are designed for use with the AmmoMaster Single Stage Press with the 50 BMG conversion kit installed. All dies are manufactured with 1-1/2" -12 thread. Full Length Die set includes Full length Sizer Die with Expander-Decapping Unit and Seater Die with Bullet Seater Plug. Trim Die is case hardened to prevent damage to the die when filing cases to length. Neck Sizer Die sizes only the neck not the shoulder and body.



Order No.	Price
50 BMG Full Length Die Set	044-30001 \$298.45
50 BMG Neck Sizer Die	044-30030 183.26
50 BMG Trim Die	044-30065 146.60
50 BMG Lock Ring	044-9629 7.82

Auto 4x4 Shell Plates

Order No.	044-87611 #11	044-87623 #23
044-87601 #1	044-87612 #12	044-87624 #24
044-87602 #2	044-87615 #15	044-87625 #25
044-87603 #3	044-87616 #16	044-87626 #26
044-87604 #4	044-87617 #17	044-87627 #27
044-87606 #6	044-87618 #18	044-87628 #28
044-87607 #7	044-87619 #19	044-87630 #30
044-87609 #9	044-87620 #20	044-87632 #32
044-87610 #10	044-87621 #21	\$35.45 ea

Ammomaster/PiggybackII & Pro 2000 Shell Plates

044-88801 #1	044-88816 #16	044-88832 #32
044-88802 #2	044-88817 #17	044-88833 #33
044-88803 #3	044-88818 #18	044-88834 #34
044-88804 #4	044-88819 #19	044-88835 #35
044-88805 #5	044-88820 #20	044-88836 #36
044-88806 #6	044-88821 #21	044-88837 #37
044-88807 #7	044-88822 #22	044-88838 #38
044-88808 #8	044-88823 #23	044-88839 #39
044-88809 #9	044-88824 #24	044-88840 #40
044-88810 #10	044-88825 #25	044-88841 #41
044-88811 #11	044-88826 #26	044-88842 #42
044-88812 #12	044-88827 #27	044-88843 #43
044-88813 #13	044-88828 #28	044-88844 #44
044-88814 #14	044-88830 #30	044-88845* #45
044-88815 #15	044-88831 #31	\$32.38

\$30.30*

Shell Holders

Shell Holder #29	044-9229	\$6.18
Shell Holder #30	044-9230	6.18
Shell Holder #31	044-9231	6.18
Shell Holder #32	044-9232	6.18
Shell Holder #33	044-9233	6.18
Shell Holder #34	044-9234	6.18
Shell Holder #35	044-9235	6.18
Shell Holder #36	044-9236	6.18
Shell Holder #37	044-9237	6.18
Shell Holder #38	044-9238	6.18
Shell Holder #39	044-9239	6.18
Shell Holder #40	044-9240	6.18
Shell Holder #41	044-9241	6.18
Shell Holder #42	044-9242	6.18
Shell Holder #43	044-9243	6.18
Shell Holder #44	044-9244	6.18
50 BMG Shell Hldr	044-88746	20.32

Extended Shell Holders

Order No.	Price
SH #2 Extended	044-8952 \$10.65
SH #3 Extended	044-8953 10.65
SH #6 Extended	044-8956 10.65
SH #10 Extended	044-8960 10.65
SH #18 Extended	044-8968 10.65
SH #45 Extended	044-8995 10.65



Order No.	Price
SH Ram C	044-9109 \$26.08
SH Ram H	044-9180 17.26



Reference Chart

Caliber	Die Group	Shell Holder & Shell Plate Number	Primer Plug & Sleeve Size	Case Trimmer Collet Number	Rotary Case Trimmer Pilot Caliber	Plastic Ammo Box Size	Lube Die
.17 Remington	A	10	Small	1	17	SR	1
.204 Ruger	A	10	Small	1	20	SR	1
.218 Bee	A	1	Small	2	22	MP	-
.22 Bench Rest	GM	3	Small	3	22	MR	1
.22 PPC	GM	32	Small	3	22	MR	1
.22 Hornet	A	12	Small	2	22	MP	-
.22 K-Hornet	D	12	Small	2	22	MP	-
.22 Remington Jet	D	6	Small	3	22	MP	-
.22 Savage High-Power	D	2	Large	2	22	MR	3
.22-250 Remington (22 Varminter)	A	3	Large	1	22	MR	2
.220 Swift	A	11	Large	1	22	MR	3
.221 Remington Fireball	A	10	Small	1	22	SR	1
.222 Remington	A	10	Small	1	22	SR	1
.222 Remington Magnum	A	10	Small	1	22	SR	1
.223 Remington (5.56mm)	A	10	Small	1	22	SR	1
.223 Winchester Super Short Mag	A	43(5)	Large	1	22	(4)	-
5.6mm x 50 Rimmed	D	6	Small	2	22	SR	-
5.7mm x 28 (FN)	A	45	Small	4	22	SR/MP	-
.240 Weatherby Magnum	A	3	Large	1	24	LR	2
.243 Winchester Super Short Mag	A	43(5)	Large	1	24	(4)	2
.243 Winchester	A	3	Large	1	24	MR	2
6mm Bench Rest	GM	3	Small	3	24	MR	1
6mm PPC	A	32	Small	3	24	MR	1
6mm Remington (244 Remington)	A	3	Large	1	24	MR	2
.25 Auto (25 ACP)	E	29(6)	Small	(4)	(4)	(4)	-
.25 Winchester Super Short Mag	A	43(5)	Large	1	25	(4)	-
.25-06	A	3	Large	1	25	LR	2
.25-20 Winchester	A	1	Small	2	25	MP	-
.25-35 Winchester	A	2	Large	2	25	MR	3
.250 Savage (250-3000 Savage)	A	3	Large	1	25	MR	2
.257 Roberts	A	3/11	Large	1	25	MR	2
.257 Roberts Improved 40"	D	3/11	Large	1	25	MR	2
.257 Weatherby Magnum	A	4	Large	1	25	LR	4
.260 Remington	A	3	Large	1	26	MR	2
.264 Winchester Magnum	A	4/26	Large	1	26	LR	4
6.5 Remington Mag	D	4/26	Large	1	26	LR	4
6.5mm-06	D	3	Large	1	26	LR	2
6.5-284 Winchester	D	3	Large	1	26	LR	4
6.5mm x 47 Lapua	D	3	Large	1	26	MR	3
6.5mm x 54 Mannlicher-Schoenauer	D	9	Large	1	26	LR	-
6.5mm x 55 Swedish Mauser	A	2	Large	1	26	LR	2
6.5mm x 57 Mauser	D	3	Large	1	26	LR	2
6.5mm x 68S	D	34(5)	Large (2)	2	26	LR	4
6.8 Remington SPC	A	19	Large	2	27	MR	3
.270 Weatherby Magnum	A	4	Large	1	27	LR	4
.270 Winchester	A	3	Large	1	27	LR	2
.270 Winchester Short Magnum	A	43(5)	Large	1	27	(4)	-
.280 Remington (7mm Exp. Rem.)	A	3	Large	1	28	LR	2
.284 Winchester	A	3	Large	1	28	MR	4
7mm Bench Rest Remington	D	3	Small	1	28	MR	2
7mm Remington Magnum	A	4/26	Large	1	28	LR	4
7mm Remington SA Ultra Magnum	A	38/4(5)	Large	1	28	(4)	-
7mm Remington Ultra Magnum	A	38/4(5)	Large	1	28	(4)	-
7mm Shooting Times Westerner	A	4	Large	1	28	LR	4
7mm Thompson/Center Ugalde	A	10	Small	1	28	SR	1
7mm Weatherby Magnum	A	4	Large	1	28	LR	4
7mm Winchester Short Magnum	A	43(5)	Large	1	28	(4)	-
7mm-08 Remington	A	3	Large	1	28	MR	2
7mm x 57 Mauser (7mm Mauser)	A	3/11	Large	1	28	LR	2
7mm x 64 Brenneke	A	3	Large	1	28	LR	2
7mm x 65 Rimmed	D	26	Large	1	28	LR	2
7-30 Waters	A	2	Large	2	28	MR	3
.30 M-1 Carbine	C	17	Small	3	30	MP	-
.30 Luger (7.65mm Luger)	A	16	Small	2	30	(4)	-
.30 Mauser (7.63mm Mauser)	D	16	Small	2	30	(4)	-
.30 Remington	D	19	Large	2	30	MR	3
.30-06 Springfield	A	3	Large	1	30	LR	2
.30-30 Winchester	A	2	Large	2	30	MR	3
.30-338 Winchester Magnum	D	4	Large	1	30	LR	4
.30-378 Weatherby Magnum	A	14(5)	Large	4	30	(4)	-
.30-40 Krag	A	7	Large	3	30	LR	-
.300 H&H Magnum	D	4	Large	1	30	LR	4
.300 Remington SA Ultra Magnum	A	38/4(5)	Large	1	30	(4)	-
.300 Remington Ultra Magnum	A	38/4(5)	Large	1	30	(4)	-
.300 Savage	A	3	Large	1	30	MR	2
.300 Weatherby Magnum	A	4	Large	1	30	LR	4
.300 Winchester Magnum	A	4/26	Large	1	30	LR	4
.300 Winchester Short Magnum	A	43(5)	Large	1	30	(4)	-
.303 British	A	7	Large	1	31	LR	-
.307 Winchester	A	2	Large	2	30	MR	2
.308 Norma Magnum	D	4	Large	1	30	LR	4
.308 Winchester	A	3	Large	1	30	MR	2
7.5mm x 54 French MAS	D	2	Large	1	30	LR	2
7.5mm x 55 Schmidt-Rubin	A	2	Large	2	30	LR	-
7.62mm x 39-.308/.311	A	32	Large	3	30/31	MR	3
7.62mm x 54R Russian	A	13(5)	Large	4	30	LR	-

Caliber	Die Group	Shell Holder & Shell Plate Number	Primer Plug & Sleeve Size	Case Trimmer Collet Number*	Rotary Case Trimmer Pilot Caliber	Plastic Ammo Box Size	Lube Die
7.65mm x 53 Belgian Mauser	A	3	Large	1	31	LR	2
7.7mm x 58 Japanese Arisaka	A	3/2	Large	1	31	LR	2
.32 Automatic (7.65mm Auto)	B	17	Small	1	31	(4)	-
.32 H&R Magnum	E	23	Small	1	31	(4)	-
.32 Smith & Wesson Long	E	23	Small	1	31	(4)	-
.32 Winchester Special	A	2	Large	2	32	MR	3
.32-20 Winchester	E	1	Small	2	31	MP	-
.32-40 Winchester	D	2	Large	2	32	MR	3
8mm Remington Magnum	A	4	Large	1	32	LR	4
8mm-06	D	3	Large	1	32	LR	2
8mm x 57 Mauser (8mm Mauser)	A	3	Large	1	32	LR	2
8mm x 68S Magnum	D	34(5)	Large (2)	2	32	LR	-
.325 Winchester Short Magnum	A	43(5)	Large	1	32	(4)	-
.338 Federal	A	3	Large	1	33	MR	2
.338 Lapua	A	14/37(6)	Large	4	33	(4)	-
.338 Remington Ultra Magnum	A	38/4(5)	Large	1	33	(4)	-
.338 Winchester Magnum	A	4	Large	1	33	LR	-
.338-06/.338-06 A-Square	D	3	Large	1	33	LR	2
.338-378 Weatherby Magnum	A	14	Large	4	33	(4)	-
.340 Weatherby Magnum	A	4	Large	1	33	LR	4
.348 Winchester	D	5(5)	Large	4	34	MR	-
.35 Remington	A	9	Large	1	35	MR	3
.35 Whelen	A	3	Large	1	35	LR	2
.350 Remington Magnum	D	4	Large	1	35	MR	4
.356 TSW	B	16	Small	2	35	(4)	-
.356 Winchester	A	2	Large	2	35	MR	2
.357 Magnum	B	6	Small	3	35	MP	-
.357 Remington Maximum	B	6	Small	3	35	SR	-
.357 Sig	A	27	Small	3	35	LP	-
.358 Winchester	A	3	Large	1	35	MR	2
9mm FAR	E	16	Small	2	35	MP	-
9mm Luger	B	16	Small	2	35	(4)	-
9mm Makarov	E	16	Small	2	35	(4)	-
9mm x 21	B	16	Small	2	35	(4)	-
9mm x 23 Winchester	B	16	Small	2	35	(4)	-
9.3mm x 62 Mauser	A	3	Large (2)	1	36	LR	2
9.3mm x 74R	D	4	Large	1	36	LR	-
.375 H&H Magnum	A	4	Large	1	37	LR	4
.375 Remington Ultra Mag	A	38/4(5)	Large	1	37	(4)	-
.375 Winchester	C	2	Large	2	37	MR	3
.376 Steyr	D	42	Large	2	37	LR	4
.378 Weatherby Magnum	D	14(5)	Large	4	37	(4)	-
.38 Colt Super Auto (.38 ACP)	E	39	Small	2	35	MP	-
.38 Smith & Wesson	B	6	Small	3	35	MP	-
.38 Special	B	6	Small	3	35	MP	-
.380 Automatic Pistol	B	10	Small	1	35	(4)	-
.38-40 Winchester	E	35(5)	Large	1	40	LP	-
.38-55 Winchester & Ballard	LEGACY	2	Large	2	37	MR	3
.40 S&W	B	27	Small	3	40	LP	-
.400 CorBon	D	3	Large	1	40	LP	2
.40-65 Shiloh Sharps - 408"	LEGACY	14(5)	Large	4	41	(4)	4
.40-70-2 1/2" Sharps Straight	LEGACY	14(5)	Large	4	41	(4)	4
.405 Winchester	LEGACY	24	Large	3	40	(4)	3
10mm Auto	B	27	Large	3	40	LP	-
.41 Magnum	B	30	Large	2	41	LP	4
.416 Remington Magnum	D	4	Large	1	416	LR	-
.416 Rigby	D	37(5)	Large	4	416	(4)	-
.44 Magnum	B	18	Large	2	44	LP	-
.44 S&W Russian	COWBOY	18	Large	2	44	LP	-
.44 Special	B	18	Large	2	44	LP	-
.444 Marlin	C	28	Large	1	44	LR	-
.44-40 Winchester	B	35(5)	Large	1	44	LP	-
.45 Automatic (45 ACP)	B	3	Large	1	45	LP	2
.45 Auto Rim	B	8	Large	1	45	LP	2
.45 Glock Action Pistol	B	3	Large	1	4	LP	2
.45 Colt	B	20	Large	1	45	LP	-
.45 S&W Schofield	COWBOY	34	Large	1	45	LP	-
.45-70 U.S. Government	C	14(5)	Large	4	45-R	(4)	4
.45-90-2.4" Sharps Straight	LEGACY	14(5)	Large	4	45-R	(4)	4
.45-100-2.6" Sharps Straight	LEGACY	14(5)	Large	4	45-R	(4)	4
.45-110-2 7/8" Sharps Straight	LEGACY	14(5)	Large	4	45-R	(4)	4
.45-120-3 1/4" Sharps Straight	LEGACY	14(5)	Large	4	45-R	(4)	4
.45-70 U.S. Government	C	14(5)	Large	4	45-R	(4)	4
.450 Marlin	C	4	Large	1	45-R	LR	4
.454 Casull	B	20	Large	1	45	(4)	-
.458 Winchester Magnum	C	4	Large	1	45-R	LR	4
.458 Lott	C	4	Large	1	45-R	LR	4
.460 Weatherby Magnum	D	14(5)	Large	-	45	(4)	-
.460 Smith & Wesson	B	4	Large	4	45	(4)	-
.475 Linebaugh 1.400"	B	40(5)	Large	1	475	(4)	-
.480 Ruger	B	40(5)	Large	1	475	(4)	-
.50 Action Express	B	33(5)	Large	1	50	(4)	-
.50-70 Gov't	LEGACY	31(5)	Large	4	50	(4)	4
.50-90-2 1/2" Sharps Straight	LEGACY	31(5)	Large	4	50	(4)	4
.500 Smith & Wesson	B	44(5)	Large	-	50	(4)	-

IMPORTANT: Dies listed under Groups A, B, C, D, E and F are Standard Dies. If the caliber of dies you require is not listed, please call for availability. RCBS® Shell Holder numbers do not correspond to those of other manufacturers. When two Shell Holder numbers are listed, the most popular is shown first. It may be necessary to use the alternate, depending on the manufacturer and/or lot of cases being used. The numbers in () in the table indicates the following: (1) Order Shell Holder by caliber. (2) Cases may be Berdan primed. Depriming and priming must be done by hand. If cases were formed from cases having boxer-type primer, use the appropriate Shell Holder for the caliber. (4) Not available. (5) Auto 4x4 Shell Plate not available. (6) Auto 4x4 and Five-Station Shell Plates not available. (7) Use #14 for Lapua brass, #37 for Norma brass. The letter codes in the Plastic Ammo Box Size column indicate the following: SR = Small Rifle, MR = Medium Rifle, LR = Large Rifle, MP = Medium Pistol, LP = Large Pistol. * Used only with Rotary Case Trimmer and Rotary Case Trimmer-2.

Case Neck Turning Accessories - For

fast, easy removal of excessive neck thickness, high spots and case neck out-of-roundness. It guides the cutter over the sized cartridge case neck and is supported by the pilot/neck reamer. The Auto Feed Attachment fits Case Trimmer-2 only and advances the cutting tool over the case neck with each turn of the trimmer handle!



	Order No.	Price
Case Neck Turner w/auto feed	044-98860	\$69.57
Case Neck Turner Only	044-98861	33.70

Pilot/Neck Reamers - \$8.73 each

	Order No.	Order No.
20 cal	044-98876	7mm Cal. 044-98883
17 Cal.	044-98877	30 Cal. 044-98884
223 Cal.	044-98878	8mm Cal. 044-98886
6mm/243 Cal.	044-98879	338 Cal. 044-98887
25 Cal.	044-98880	35 Cal. 044-98889
6.5mm Cal.	044-98881	375 Cal. 044-98891
270 Cal.	044-98882	



Flash Hole Deburring

Tools with Case Pilot Stops -

Burrs left on the inside of the flash hole during manufacturing can cause erratic ignition. This handy tool automatically locates the hole & quickly removes the burr. A self-centering pilot collar with an adjustable stop allows quick alignment & prevents the removal of too much brass. **\$11.82 Each**

	Order No.	Order No.
22 Cal	044-88145	7mm Cal 044-88147
6mm Cal	044-88146	30 Cal 044-88148

	Order No.	Price
Replacement Rod & Cutter Assembly for Flash Hole Deburring Tool	044-88144	\$8.22
RCBS Accessory Handle	044-9332	6.30

Flash Hole Case Pilot Stops only \$4.47

	Order No.	Order No.
.22	044-88122	.34 044-88131
6mm	044-88123	.35 044-88133
.25	044-88124	.36 044-88134
6.5mm	044-88125	.375 044-88135
.270	044-88126	.40/10mm 044-88136
7mm	044-88127	.41 044-88137
.30	044-88128	.44 044-88138
.32	044-88129	.45 044-88139
8mm	044-88130	

Primer Pocket Brush Combo - A build-up of residue in primer pockets can cause misfires. A couple of twists with our Primer Pocket Brush and residue is easily cleaned out.

Brushes have stainless bristles and interchangeable mounts for large and small primer pockets. Comes with a no-roll accessory handle.



	Order No.	Price
Primer Pocket Brush Combo (Handle, Lg Brush, Sm Brush)	044-9575	\$14.83
Replacement Small Brush	044-9578	6.55
Replacement Large Brush	044-9577	6.55

Case Neck Brushes - Clean dirt and powder residue from inside necks.



	Order No.	Price
Small Neck Brush (.22 to .25 cal)	044-9327	\$2.53
Med Neck Brush (.270 to .30 cal)	044-9328	2.53
Large Neck Brush (.35 to .45 cal)	044-9329	2.53



A - Vibratory Case Cleaner - The large 3 1/2 quart bowl cleans up to five hundred-fifty 38 Special cases or one hundred-ninety 30-06 cases at one time. Removable lid lets you inspect cases while motor is running. Thermally protected 1/30 horsepower ball bearing motor works quietly. 110v **Order No. 044-87088 \$75.97**



B - Rotary Case - Separates the cleaned cases from the cleaning media. Simple usage. Heavy-duty plastic construction for years of trouble-free service Capacity: about 180 .30-06 cases or 400 .38 Special cases with media. Snug Fitting lid closes for dust-free operation. **Order No. 044-87076 \$33.69**



C - Sidewinder Case Tumbler - Cleans cases both inside and out. The Sidewinder is a machine designed exclusively and specifically for handloaders. Instead of vibrating, the rum rotates for quicker cleaning. Automatic shutoff. Holds up to three hundred 38 Special cases or one hundred-fifty 30-06 cases. 120V. Comes with one 8 oz. bottle of Liquid Case Cleaner.

	Order No.	Price
Sidewinder Tumbler(110v)	044-87000	\$423.51
Sidewinder Tumbler(220v)	044-87005	423.51
Sidewinder Liquid Case Cleaner	044-87015	6.41
Sidewinder Drum (Drum Only)	044-87050	80.17

Media Sifter

Formula 1 Walnut Shell Dry Media, 3 1/2 lbs.
Formula 2 Corn Cob Dry Media, 3 1/2 lbs.
Polishing Compound

	Order No.	Price
Formula 1 Walnut Shell Dry Media, 3 1/2 lbs.	044-87075	\$11.28
Formula 2 Corn Cob Dry Media, 3 1/2 lbs.	044-87067	14.05
Polishing Compound	044-87068	15.55
	044-87069	5.69



Bullet Puller Without Collets -

7/8"-14 threaded body for use in Single stage and Turret style presses. Uses caliber specific collets (sold below) to clamp onto the bullet to remove from case. **Order No. 044-9440 \$18.95**



Bullet Puller Collets - \$10.60 ea

Calibers	Order No.	Calibers	Order No.
17	044-9419	348	044-9429
20	044-9438	35/38/357	044-9430
22	044-9420	375	044-9431
6mm	044-9421	40	044-9432
25	044-9422	41	044-9433
6.5mm	044-9423	416	044-9434
270	044-9424	44/11mm	044-9435
7mm	044-9425	45	044-9436
30/7.35 Carc.	044-9426	9.3 mm	044-9437
338	044-9427	475	044-9439
32/8mm	044-9428	500	044-9445



Deburring Tool (Cases from .17 to .60) -

Larger Deburring Tool allows the inside and outside deburring of cases 17 cal to 60 cal. If you don't load cases over 45 cal, this may not be the tool for you.

Order No. 044-9348 \$19.85



AR Series Dies -

Designed for AR-style and semi-auto rifles
• Distinctive black RCBS® die box
• Taper Crimp bullet seating
• Small Base sizing
• RCBS Limited Lifetime Warranty



AR Series Dies - It features a Small Base sizing die and a Taper Crimp seating die. The Small Base sizer guarantees that the cartridge will reamber. The Taper Crimp Seater is more forgiving when various case lengths are loaded at the same time. Case neck crimp bulges and buckled shoulders are virtually eliminated when Taper crimping is used with cannellured bullets.

Caliber	Die Set \$40.03	Seater Die \$33.71
204 Ruger SB	044-10307	044-10362
223 Rem SB	044-11107	044-11162
243 Winchester SB	044-11407	044-11462
30-06 Spfd SB	044-14807	044-14862
308 Win SB	044-15507	044-15562
30 Remington AR SB	044-25307	044-25362
6.5 Creedmoor SB	044-32907	044-32962
7.62x39mm SB	044-35007	044-35062

RCBS VLD Deburring Tool -

The increasing popularity of VLD style bullets has lead RCBS to offer a 22 degree VLD Deburring Tool. The 22 degree angle allows the bullet to be seated into the case without damaging the boat-tail and ruining accuracy. The VLD Deburring Tool can be used as is, attached to a RCBS Accessory Handle or mounted on the Trim Mate Case Prep Center.



	Order No.	Price
VLD Deburring Tool with Handle	044-9352	\$13.34
VLD Deburring Tool Only	044-9351	10.62

Stuck Case Remover -

The RCBS Stuck Case Remover extracts stuck cases from standard sizer dies without damaging the die, using a very simple two-step removal process. **Order No. 044-9340 \$16.59**



Stuck Case Remover-2 Kit -

Extract cases from dies with removable guide bushings & RCBS Competition Dies or other sizer dies with a raised expander ball. Kit contains two extractor nuts & two punch rods. **Order No. 044-9355 \$7.00**



RCBS Case Trimming



Trim Pro® Power Case Trimmer Kit - You'll actually look forward to case trimming. A low RPM motor delivers plenty of torque. The spring-fed cutter is easy and accurate. No pushing or feeding pressure is needed, leaving your hands free for deburring or other tasks. A positive locking handle and integral power switch makes it simple and safe.

Kit Includes: Shell holders 2, 3, 4 and 10
Pilot calibers: 22, 24, 25, 27, 28, 30, 35, 44 & 45

	Order No.	Price
Trim Pro Power Kit	044-90350	\$270.03
Trim Pro Power Kit(240v)	044-90351	305.90
Trim Pro Power Unit Only	044-90359	216.42
Trim Pro Power Cover	044-86882	12.25
Power Unit only (240v)	044-90364	261.49

Kits include shell holders and pilots!

Trim Pro® Manual Case Trimmer Kit - Trim cases simply, with a few turns of the handle. The Trim Pro's spring-loaded lever shell holder eliminates the muscle fatigue associated with long hours of tightening a T-bar. The Shell Holder keeps cases securely locked in place and aligned with the cutter. It is relieved for .001" accuracy even with a spent primer in the case. Works with standard pilots & features a micrometer fine-adjustment bushing calibrated for setting exact trim length.

Kit Includes: Shell Holders 2, 3, 4 and 10
Pilot calibers: 22, 24, 25, 27, 28, 30, 35, 44 and 45

	Order No.	Price
Trim Pro Manual Kit	044-90355	\$97.50
Trim Pro Manual Trimmer Only	044-90357	83.93
Trim Pro Manual Cover	044-86883	9.92

Replacement Case Trimmer Cutter -
Order No. 044-9406 \$14.38

Power Drill Converter - This slick little device works with any power drill to convert your hand turned Trim Pro Case Trimmer-2 into a power driven case trimmer. It's an effective and economical alternative to expensive, motorized case trimmers. Convert your trimmer today!

Order No. 044-98930 \$6.51



Trim Pro® Case Trimmer Stand - Provides more working room and hand clearance. Also provides convenient storage space for Trim Pro shell holders and pilots. Mounts easily on accessory base plate or directly on a bench. Manual trimmers only. Shell Holders and Pilots sold separately. **Order No. 044-90360 \$20.45**

Trim Pro® 3-Way Cutter - A unique three-blade head configuration trims cases like a standard cutting tool, chamfers the case and deburrs it. Attaches easily to both Case Trimmers and Trim Pros.



Caliber	TRIM PRO 3-WAY CUTTER	TRIM PRO 3-WAY Pilot/Chamfer
	\$49.76	\$8.19
20 Cal.	044-90277	044-90257
.22 Cal.	044-90278	044-90258
6mm Cal.	044-90279	044-90259
.25 Cal.	044-90280	044-90260
6.5mm Cal.	044-90281	044-90261
270 Cal	044-90282	044-90262
7mm Cal.	044-90283	044-90263
30 Cal.	044-90284	044-90264
.338 Cal.	044-90287	044-90267
.375 Cal.	044-90291	044-90271

Rotary Case Trimmer Collet - Works like a draw collet on a lathe. Secures cases for trimming to length. Refer to the RCBS Reference Chart to determine the correct collet for a specific caliber. For use with RCBS Rotary Case Trimmer and Rotary Case Trimmer-2 only. **\$8.90 ea**

	Order No.
CT Collet #1	044-9371
CT Collet #2	044-9372
CT Collet #3	044-9373
CT Collet #4	044-9374



Trim Pro Shell Holders - These fit only the Trim-Pro Case Trimmers due to configuration. **\$5.38ea**

Order No.	Order No.
SH 1 044-90301	SH 23 044-90323
SH 2 044-90302	SH 24 044-90324
SH 3 044-90303	SH 25 044-90325
SH 4 044-90304	SH 26 044-90326
SH 5 044-90305	SH 27 044-90327
SH 6 044-90306	SH 28 044-90328
SH 7 044-90307	SH 30 044-90330
SH 8 044-90308	SH 32 044-90332
SH 9 044-90309	SH 33 044-90333
SH 10 044-90310	SH 34 044-90334
SH 11 044-90311	SH 35 044-90335
SH 12 044-90312	SH 36 044-90336
SH 13 044-90313	SH 37 044-90337
SH 14 044-90314	SH 38 044-90338
SH 15 044-90315	SH 39 044-90339
SH 16 044-90316	SH 40 044-90340
SH 17 044-90317	SH 41 044-90341
SH 18 044-90318	SH 42 044-90342
SH 19 044-90319	SH 43 044-90343
SH 20 044-90320	SH 44 044-90344
SH 21 044-90321	

Case Trimmer Pilots - Designed with a taper to guide pilot into the case mouth. Prevents case from wobbling when trimming case to length. For use with RCBS® Trim Pro® Case Trimmers, Rotary Case Trimmer-2 and Rotary Case Trimmer. **\$3.92ea**

Order No.	Order No.
17 Cal. Pilot 044-9377	34 Cal. Pilot 044-9388
20 Cal. Pilot 044-9376	35 Cal. Pilot 044-9389
22 Cal. Pilot 044-9378	36 Cal. Pilot 044-9390
24 Cal. Pilot 044-9379	37 Cal. Pilot 044-9391
25 Cal. Pilot 044-9380	40 Cal. Pilot 044-9392
26 Cal. Pilot 044-9381	41 Cal. Pilot 044-9393
27 Cal. Pilot 044-9382	44 Cal. Pilot 044-9394
28 Cal. Pilot 044-9383	45 Cal. Pilot 044-9395
30 Cal. Pilot 044-9384	45 Rifle Pilot 044-9396
31 Cal. Pilot 044-9385	416 Pilot 044-9397
32 Cal. Pilot 044-9386	475 Cal. Pilot 044-9398
33 Cal. Pilot 044-9387	500 Cal Pilot 044-9399

Trim Pro Pistol Pack - Includes: CT Pilot, 40 Caliber, and CT Shell Holders, #6, #16, #18, #27
Order No. 044-90361 \$19.27

Trim Pro Rifle Pack - Includes: CT Shell Holders, #2, #3, #4, #10
Order No. 044-90362 \$18.46

Trim Pro Pilot / Shell Holder Pack - Includes: CT Pilots, 22 Cal, 24 Cal, 25 Cal, 27 Cal, 28 Cal, 30 Cal, 35 Cal, 44 Cal, 45 Cal. and CT Shell Holders: #2, #3, #4, #10
Order No. 044-90363 \$39.37

Trim Pro Handle Only - Upgrade your Rotary Case Trimmer-2 simply by adding this lever-handle shell holder system. Makes case trimming faster and easier than using the old draw collet system. It's also more accurate because the case is perfectly aligned. Uses Trim Pro shell holders.
Order No. 044-90358 \$42.47



Hand Case Neck Turner - Designed to "peel" the brass from the outside of your case necks to a consistent thickness. The cutter portion uses caliber specific pilot/mandrels (sold separately) to guide the case neck.

Features the ability to "zero" the cutter to the pilot/mandrel and then use the micrometer adjustment to dial the desired case neck thickness in .0005" increments. The Cutter can also be set for right or left handed use. The RCBS Quick Change Case Holder features an ergonomic design that allows you to rotate the case and put forward pressure to feed the case neck to the cutter.



	Order No.	Price
Hand Case Neck Turner with Quick Change Case Holder	044-90401	\$60.85
Quick Change Case Holder only	044-90402	30.44
Hand Case Neck Pilots (Below)		9.06ea

	Order No.	Order No.
.17 Cal	044-90405	.34 Cal 044-90417
.20 Cal	044-90406	.35 Cal 044-90418
.22 Cal	044-90407	.36 Cal 044-90419
.24 Cal	044-90408	.37 Cal 044-90420
.25 Cal	044-90409	.40 Cal 044-90421
.26 Cal	044-90410	.41 Cal 044-90422
.27 Cal	044-90411	.416 Cal 044-90423
.28 Cal	044-90412	.44 Cal 044-90424
.30 Cal	044-90413	.45 Cal 044-90425
.31 Cal	044-90414	.475 Cal 044-90426
.32 Cal	044-90415	.500 Cal 044-90427
.33 Cal	044-90416	



Trim Mate™ Case Prep Center - The Trim Mate Case Preparation Center speeds up several case preparation tasks. Five rotating gear driven stations. 110 VAC with a six foot 3 prong power cord. Cupped area provided for securing dry case neck lube. Mounting holes are provided for attaching to a work bench. Includes inside chamfering tool, outside deburring tool, primer pocket brushes (large and small) and a packet of dry case neck lube.

	Order No.	Price
Trim Mate Center & Accessories(110v)	044-90375	\$118.65
Trim Mate Center (240v)	044-90376	145.40
Trim Mate Primer Pocket Uniformer, Lg.	044-90378	22.57
Trim Mate Primer Pocket Uniformer, Sm.	044-90379	22.57
Trim Mate Cover	044-90382	11.10
Trim Mate Primer Pocket Uniformer, Lg. Pistol	044-90383	22.57
Dry Case Neck Lube	044-90377	2.72



RCBS Reloading Scales



A- 10-10 Reloading Scale- The 10-10 features a die cast base (where you can store disassembled components). Guaranteed sensitivity of 0.1 grain. Has its own storage box, no cover is needed! 1,010 grain capacity. **Order No. 044-9073 \$154.88**

B- RC-130 Reloading Scale- Accurate to +/- 0.1 of a grain. Magnetic dampening. Easily moveable three position design. Easy to read grain weight increments. 130 grain capacity. Affordable. **Order No. 044-90400 \$43.55**

C- 5-0-2 Scale - Weigh up to 505 grains with 0.1 grain accuracy. Features a magnetic dampening system for fast readings, maintenance-free movement and a rugged die-cast metal base. Tip-proof aluminum pan. Ounce-to-grain conversion table on the base for handy shotshell reference. **Order No. 044-9069 \$74.63**

D- 5-0-5 Scale - Features magnetic dampening system plus large black-on-white graduations for fast recognition. Its three-poise beam is graduated in ten, one and 0.1 grain increments. Also features a tip-proof aluminum pan, ounce-to-grain conversion on the base for shotshell reloaders. Capacity: 511 grains. A metric version with a capacity of 50.5 grams is also available. **Order No. 044-9071 \$87.31**

E- RCBS Rangemaster 750 Scale - Compact and lightweight design gives it easy portability. Grains or grams, and weighs precisely to + or - 1/10 of a grain up to 750 grains. The RangeMaster Scale comes equipped with two precision calibration weights and an AC adaptor (or can be operated with a 9V battery not included). The RCBS RangeMaster is the perfect choice for the serious shooters that demand the best performance and value. **Order No. 044-98927 110v \$118.12**
Order No. 044-98926 220v \$124.34

F- RCBS Chargemaster 1500 Scale - Grains or grams and weighs precisely to + or - 1/10 of a grain accuracy. With a 1500 grain capacity you can weigh powder, bullets, cases or even loaded cartridges. Includes two calibration weights. AC adaptor is included. The ChargeMaster 1500 Scale can be operated as an independent electronic scale or upgraded into a fully automated powder dispensing system. **Order No. 044-98920 \$186.15**

G- RCBS Chargemaster Combo, Scale & Dispenser - Use the ChargeMaster Dispenser and ChargeMaster 1500 Scale together for an unmatched combination of speed and accuracy. Dispensing time has been cut in half from previous systems. Accurately weighs and dispenses all types of powder to + or - 1/10 of a grain and can dispense from 2.0 to 300 grains. You can store up to 30 favorite loads in memory for fast easy recall. This is a complete powder system that can read and dispense in grains or grams. Includes a powder drain feature that allows for easy emptying of powder from the hopper. The ChargeMaster Scale and Dispenser can be purchased separately or as a Combo set. **Order No. 044-98923 \$354.38**

H- RCBS Chargemaster Dispenser Only - Dispensing time has been cut in half from previous systems. Accurately weighs and dispenses all types of powder to + or - 1/10 of a grain and can dispense from 2.0 to 300 grains. You can store up to 30 favorite loads for fast easy recall. **Order No. 044-98922 \$200.44**

I-Standard Set Scale Check Weights- Includes: .5gr, 1gr, 2gr(qty 2), 5gr, 10gr, 20gr(qty 2) **Order No. 044-98990 \$28.03**

J-Deluxe Set Scale Check Weights-Includes: .5gr, 1gr, 2gr(qty 2), 5gr, 10gr, 20gr(qty 2), 100gr(qty 2), 200gr and forceps) **Order No. 044-98992 \$48.53**

	Order No.	Price
Scale cover Fits 5-0-5 Scale	044-9075	\$8.50
Scale Pan (502, 505, 10-10, 5-10)	044-9078	15.73
Scale Pan Support (502, 505, 10-10, 5-10)	044-9079	17.31

Powder Trickler 2 Upgrade Kit - Many new electronic scales have scale pans that are positioned out of reach of existing powder tricklers. The Powder Trickler-2 solves this problem by adding a height adjustable, non-skid base and powder tube extension!
Order No. 044-9093 \$5.52

Powder Funnel - Specially designed drop tube avoids any messy powder spills around case mouths, a nonstick, anti-static surface plus square lip keeps the funnel from rolling around.

	Order No.	Price
Funnel .22 to .45 cal	044-9087	\$4.69
Funnel .17 cal	044-9086	5.78

Scale Pan w/Integrated Funnel - An integrated powder funnel that allows you to pour the powder directly into the case. Designed for use with electronic scales and powder dispensers.
Order No. 044-9090 \$6.24

Quick Change Powder Funnel - Features adapters that fit large bodied rifle cases. The 4" drop tube helps to get that compressed powder charge into the case. Drop tubes stack to increase drop length if necessary. **Order No. 044-9190 \$10.42**

Powder Trickler System - Attaches to any Uniflow™, Quick Change or Little Dandy™ powder measure. Used in conjunction with the Advanced Powder Measure Stand, the Powder Trickler system allows you to dispense and trickle a powder charge directly onto a scale pan without having to remove the scale pan for the initial filling. With a few turns of the Trickler handle, your weighed charge is complete.

The Advanced Powder Measure Stand - Improved clearance if you are dispensing charges from your powder measure directly into cases in your load block.

Powder Trickler System Combo (Includes Advanced Powder Measure Stand) **Order No. 044-9091 \$44.83**

Advanced Powder Measure Stand Only **Order No. 044-9092 20.28**

RCBS Uniflow™ Powder Measure



Uniflow™ Powder Measure - Throws consistently accurate charges reload after reload. Powder pours uniformly from measuring cylinder into case, thereby eliminating the hazards of "overloads" caused by clogging when charges are "dumped". Changes easily from charge to charge without emptying powder hopper. Numbered measuring screw is used for reference to find a given charge at a later date. Standard 7/8"-14 thread. Includes stand plate, drilled for easy mounting on a bench or under a reloading die lock ring. Two drop tubes for .22 caliber and up are supplied. Accurately measures all three major powder types - ball, cylindrical and flake. *Not for use with black powder.

	Order No.	Price
Uniflow Powder Measure	044-9010	\$79.39
Dust Cover	044-86880	8.90
Drop Tube 17 Cal	044-9028	7.65
Powder Baffle for the Uniflow	044-90225	6.55

Uniflow Powder Measure Micrometer Adjustment Screw - Fits any Uniflow Powder Measure. Installs by removing the standard metering screw, lock ring and bushing. These are replaced with the micrometer unit. Allows you to record the reading for a specific charge of a given powder and reset that reading when reloading at a later time. (Measure the opening to see which size screw you need).

	Order No.	Price
Large UPM Micro Adj. Screw (.0687 Head)	044-98901	\$41.49
Small UPM Micro Adj. Screw (.0500 Head)	044-98902	41.49

RCBS Case Preparation



CaseMaster® Gauging Tool -

A quick, convenient way to determine several important case and cartridge dimensions. The CaseMaster® gauging tool measures case neck concentricity, uniformity and thickness, as well as case length and bullet run-out. All are important to accuracy and safety.

Detects case head separation before symptoms are apparent on the outside of case. Much quicker than a dial caliper and makes a tedious job simple & less tiring. **Order No. 044-87310 \$102.31**



A - Dial Caliper/Case Length Gauge - Fiberglass reinforced super polyimid construction. Range of 0-6"/0-150mm. Direct .001" readings. Graduations .001" increments with 0.100" per single revolution of dial; 1.0mm bar scale. Dial adjustable to zero. Fourway measurements: outside, inside, depth and step. Fitted clear plastic storage case. **Order No. 044-87301 \$47.51**

B - Stainless Steel Dial Caliper - Hardened stainless steel construction. Matte, non-glare finish. Range 0-6". 0.100" direct reading per revolution. 0.001" graduations. Accurate to +/- 0.001". Four-way measurement capability: inside, outside, depth and step. Clear glass lens. Dial easily zeroed. Lock screw holds dial in position for precise measurements. Fitted hard plastic storage case. **Order No. 044-87305 \$42.37**

C - Electronic Digital Caliper - Instant reading. Very easy to use. Hardened stainless steel body for prolonged tool life. Switches from inches to millimeters with the touch of a button. Range of 0-6"/0-150mm. Accuracy +/0.001"/0.02mm. Resolution: 0.0005"/0.01mm. Adjusts to zero at any position. Measures internal, external, depth and step dimensions. Jaw depth measures about 1-1/2" outside, 5/8" inside. Battery included. Low battery indicator. Fitted plastic storage case. **Order No. 044-87323 \$62.52**

D - Electronic Digital Micrometer - Instant reading. Enameled metal body with matte finished, non-glare thimble. Outside micrometer has 0 to 1"/0 to 25mm range. Counter reads to 0.00005". Resolution 0.0005"/0.001mm. Accuracy 0.00005"/0.001mm. Instant inch/millimeter conversion. Zero adjust at any position. Thimble lock for measuring like objects. Battery included. Auto off. Fitted wooden storage cases. **Order No. 044-87320 \$124.22**

E - Vernier Micrometer - Economical version without the bells and whistles. All metal body and thimble with silver matte finish. Crisp black numbers and markings for easy reading. Range: 0-1". Reads to .0001" of an inch. Accuracy within .0001". Ratchet stop on thimble assures uniform application of pressure when measuring. Thimble lock keeps thimble from turning when measuring a constant. Adjustment wrench included. Plastic storage case. **Order No. 044-87321 \$31.02**

F - Mechanical Digital Micrometer - Quick, easy to read. Enameled metal body with satin chrome thimble. Outside micrometer has 0-1" range. Mechanical counter reads to .001". Resolution: .0001". Accuracy: .0001". Ratchet stop on thimble applies even pressure for measuring. Adjustment wrench included with fitted wooden storage case. **Order No. 044-87322 \$52.39**

Precision Mic™ - A few twists of the precision micrometer and you'll know your chamber head-space and bullet seating depth to within 0.001 of an inch!

Measures from the datum point on the case's shoulder to the base! An indispensable tool that gives you SAAMI tolerance readings! **\$50.84 each**



- | | |
|-----------------------|------------------------|
| Order No. | Order No. |
| 044-88299 204 Ruger | 044-88323 7mm x57Mau |
| 044-88302 22-250 | 044-88324 30-06 Spgfld |
| 044-88301 220 Swift | 044-88327 300 Win Mag |
| 044-88303 222 Rem. | 044-88329 308 Win. |
| 044-88304 223 Rem. | 044-88330 325 WSM |
| 044-88300 223 WSSM | 044-88331 338 Win. Mag |
| 044-88305 243 Win. | 044-88337 375 H&H Mag |
| 044-88309 243 WSSM | 044-88315 270 WSM |
| 044-88306 6mm Rem. | 044-88318 7MM WSM |
| 044-88310 25 WSSM | 044-88325 300 WSM |
| 044-88307 25-06 | 044-88340 7mm RUM |
| 044-88308 257 Robts. | 044-88328 300 RUM |
| 044-88314 6.5mm x 55 | 044-88333 338 RUM |
| 044-88316 270 Win. | 044-88339 375 RUM |
| 044-88317 280 Rem. | 044-88321 7MM RSAUM |
| 044-88319 7mm RemMag | 044-88326 300 RSAUM |
| 044-88322 7mm-08 Rem. | |

Universal Case Loading Block-

Designed to fit most any standard rifle or pistol case including the WSM, WSSM and Ultra Mag family of cartridge cases. Holds up to 50 cases. **Order No. 044-9452 \$8.32**

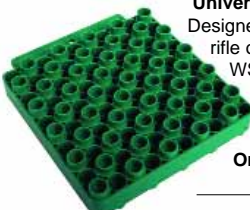

Berdan Decapping Tool -

For efficient removal of Berdan primers, nothing beats the Berdan Decapping tool. Decap 8mm Rimless, 6.5mm Mannlicher-Schoenauer, & more. Includes case holder & hex wrench. **Order No. 044-9525 \$55.46**



Primer Pocket Swager Combo -

The perfect tool for quick removal of primer-pocket crimps from military cases. Unlike reaming, the pocket swager forms a perfectly round pocket correct in dimension for American Boxer-type primers. Comes with swaging heads for large and small pockets; fits nearly all 7/8" x 14 presses with RCBS-type removable shell holders. Not for use on progressive presses. **Order No. 044-9495 \$28.95**



Lube Dies - Decap and lube cases in one step with the RCBS Lube Die. Designed for progressive presses like the Pro 2000®, Auto 4x4, Piggyback™-3, and Piggyback™ II, as well as the AmmoMaster®, but works just fine in single-stage presses. Four sizes cover 45 popular calibers. It's faster and cleaner than a lube pad; easy to refill with lubricant (RCBS® Case Lube-2); standard 7/8"-14 thread. Includes one 2oz bottle of Case Lube 2.



LUBE DIE #1 Order No. 044-87551 \$33.87
222 Rem., 222 Rem. Mag., and 223 Rem.,

LUBE DIE #2 Order No. 044-87552 \$33.87
22-250, 257 Roberts, 7mmx57, 243 Win., 25-06, 300 Sav., 6mm Rem., 270 Win., 308 Win., 240 Wby. Mag., 208Rem., 30-06 Spgfld., 350 Sav., 7mm-08 Rem., and 8mm-06.

LUBE DIE #3 Order No. 044-87553 \$33.87
225 Win., 7-30 Waters, 30 Herrett, 30 Rem., 30-30 Win, 32 WinSpec, 357 Herrett, 375 Win., 38-55 Win.

LUBE DIE #4 Order No. 044-87554 \$33.87
257 Wby. Mag., 264 Win. Mag., 6.5 Rem. Mag., 270 Wby. Mag., 7mm Rem. Mag., 30-338 Win. Mag., 300 H&H Mag., 300 Wby. Mag., 300 Win. Mag., 308 Norma Mag., 8mm Rem. Mag., 388 Win. Mag., 375 H&H Mag., 458 Win. Mag.

Universal Decapping Die - Use the RCBS

Universal Decapping Die to quickly remove primers from case prior to cleaning. A single die handles calibers from 22 through 25. Die body, decapping assembly with lock nut die lock ring and plastic storage box are all included. **Order No. 044-87580 \$16.01**
HD Unit 27- 45 cal 044-87585 \$16.78



Case Lube Kit - Properly clean and lube cases for resizing the simple way with this complete kit. Includes Case Lube Pad, 2-ounce bottle of Case Lube-2, and Accessory Handle with two interchangeable Case Neck Brushes for 22 thru 30 calibers. **Order No. 044-9336 \$19.19**



Case Slick Lube -

Case Slick is an exclusive formulation that provides exceptional lubricity for resizing or forming of metallic rifle and pistol cases. **Order No. 044-9315 \$8.55**



	Case Lube-2 (2oz)	Order No. 044-9311	Price \$3.47
	Case Lube-2 (1 gallon)	044-9313	131.57
	Case Lube Pad	Order No. 044-9307	Price \$8.90

Primer Pocket Swager Bench Tool

New!

Primer Pocket Swager - Bench Tool -

- Simplifies removal of staked primer pockets and requires 35% less force than other tools
- Rugged construction and foam padded handle
- Comes with hardened steel swaging heads and rods for small and large pockets
- Accommodates cases 22-caliber and larger
- RCBS Limited Lifetime Warranty

Order No. 044-9474 \$81.61

RCBS Powder Handling



Little Dandy™ Pistol Powder Measure - Perfect for handloading pistol shooters and select small-caliber rifle shooters. There are 28 interchangeable fixed-charge powder rotors available and you can load any popular powder with the Little Dandy™ in up to 400 different load combinations. There's no readjustment needed after changeover. Can be used handheld or conventional bench-mounted tool with optional Powder Measure Stand. **Order No. 044-86040 \$34.29**

Little Dandy™ Rotor Knob - Attaches to the Little Dandy™ Rotor with a setscrew, making the rotor easier to turn. Crafted of high strength aluminum with knurled outer surfaces for maximum finger-touch control. **Order No. 044-86046 \$5.15**



Little Dandy™ Rotors - Fixed-charge powder rotors that load any popular powder with the Little Dandy™ in up to 400 different load combinations. (See Charge Chart Below) **\$10.01 each**

Rotor No.	Order No.	Rotor No.	Order No.	Rotor No.	Order No.
Rotor 0	044-86035	Rotor 09	044-86009	Rotor 19	044-86019
Rotor 00	044-86036	Rotor 10	044-86010	Rotor 20	044-86020
Rotor 01	044-86001	Rotor 11	044-86011	Rotor 21	044-86021
Rotor 02	044-86002	Rotor 12	044-86012	Rotor 22	044-86022
Rotor 03	044-86003	Rotor 13	044-86013	Rotor 23	044-86023
Rotor 04	044-86004	Rotor 14	044-86014	Rotor 24	044-86024
Rotor 05	044-86005	Rotor 15	044-86015	Rotor 25	044-86025
Rotor 06	044-86006	Rotor 16	044-86016	Rotor 26	044-86026
Rotor 07	044-86007	Rotor 17	044-86017		
Rotor 08	044-86008	Rotor 18	044-86018		



Advanced Powder Measure Stand - This stand will raise any powder measure (with standard 7/8"-14 thread - this stand is not threaded, but is the same diameter as standard threads and will bolt tight with powder measurers locking nut) leaving plenty of space for positioning a powder scale pan or cases in a loading block under the drop tube. Bolts easily to a reloading bench or table. Also serves as a stand for holding a Piggyback™ II, -3 or -4 when not in use. **Order No. 044-9092 \$20.28**



Powder Checker - Visually check powder charges when you use a progressive press. The Powder Checker sits between the powder charging and bullet seating stations. Probe rod lets you visually confirm that the case is properly charged with powder before bullet seating. The Powder Checker also shows low and high charges too. Black oxide finish for contrast & better visibility. For use with rifle and pistol cases. **Order No. 044-87590 \$29.36**



Lock-Out Die - Detects a "no powder" or a "double charge" condition in the progressive reloading process. It locks up, halting the travel of the ram, alerting the reloader to the problem so the cause can be corrected. For use with straight-wall pistol calibers, 9mm & larger, and only on progressive reloading presses. **Order No. 044-87540 \$46.61**

Little Dandy Rotor Charge Chart

Rotor No.	00	0	01	02	03	04	05	06	07	08	09	10	11	12	13	14	15	16	17	18	19	20	21	22	23	24	25	26		
Bullseye	1.7	2.2	2.5	2.7	3.0	3.2	3.5	3.7	4.0	4.5	5.0	5.5	6.0	6.5	7.2	7.8	8.4	9.0	9.7	NR	NR	NR	NR	NR	NR	NR	NR	NR		
231	NR	NR	2.7	3.0	3.3	3.6	3.9	4.2	4.5	5.0	5.6	6.2	6.8	7.2	7.9	8.6	9.3	10.0	10.6	11.3	12.1	NR	NR	NR	NR	NR	NR	NR	NR	
HP38	NR	NR	2.8	3.0	3.4	3.6	4.0	4.2	4.5	5.1	5.5	6.2	6.8	7.5	7.9	8.8	9.4	10.3	10.9	11.7	12.3	NR	NR	NR	NR	NR	NR	NR	NR	
Red Dot	NR	NR	1.7	1.9	2.2	2.3	2.5	2.6	2.9	3.2	3.6	4.0	4.3	4.7	5.1	5.5	6.0	6.5	6.9	7.4	7.8	8.3	8.7	9.1	NR	NR	NR	NR	NR	
700-X	NR	NR	2.0	2.2	2.4	2.6	2.8	3.0	3.2	3.6	4.0	4.4	4.8	5.1	5.7	6.2	6.8	7.3	7.7	8.2	8.7	9.2	NR	NR	NR	NR	NR	NR	NR	
Green Dot	NR	NR	1.9	2.1	2.3	2.5	2.8	3.0	3.1	3.5	3.9	4.4	4.8	5.1	5.5	6.1	6.6	7.0	7.5	8.0	8.8	8.9	9.6	10.0	10.5	10.7	11.4	NR	NR	
SR4756	NR	NR	NR	NR	NR	NR	NR	NR	NR	NR	NR	NR	NR	NR	NR	NR	NR	NR	NR	NR	NR	NR	NR	NR	NR	NR	NR	NR	NR	
HS-5	NR	NR	4.2	4.5	5.0	5.3	5.9	6.2	6.6	7.4	8.2	9.0	NR	NR	NR	NR	NR	NR	NR	NR	NR	NR	NR	NR	NR	NR	NR	NR	NR	
Unique	NR	NR	2.3	2.5	2.8	3.0	3.3	3.5	3.7	4.2	4.7	5.2	5.7	6.0	6.6	7.2	7.8	8.4	9.0	9.5	10.1	10.7	11.3	11.8	12.4	13.1	NR	NR	NR	
SR7625	NR	NR	2.5	2.7	3.0	3.2	3.5	3.8	4.0	4.5	5.0	5.5	6.0	6.5	7.2	7.7	8.3	9.0	9.6	NR	NR	NR	NR	NR	NR	NR	NR	NR	NR	NR
HS-6	NR	NR	NR	NR	NR	NR	NR	NR	NR	NR	NR	NR	NR	NR	NR	NR	NR	NR	NR	NR	NR	NR	NR	NR	NR	NR	NR	NR	NR	
HS-7	NR	NR	NR	NR	NR	NR	NR	NR	NR	NR	NR	NR	NR	NR	NR	NR	NR	NR	NR	NR	NR	NR	NR	NR	NR	NR	NR	NR	NR	NR
Hercro	NR	NR	NR	NR	NR	NR	NR	NR	NR	NR	NR	NR	NR	NR	NR	NR	NR	NR	NR	NR	NR	NR	NR	NR	NR	NR	NR	NR	NR	NR
Blue Dot	NR	NR	NR	NR	NR	NR	NR	NR	NR	NR	NR	NR	NR	NR	NR	NR	NR	NR	NR	NR	NR	NR	NR	NR	NR	NR	NR	NR	NR	NR
630	NR	NR	NR	NR	NR	NR	NR	NR	NR	NR	NR	NR	NR	NR	NR	NR	NR	NR	NR	NR	NR	NR	NR	NR	NR	NR	NR	NR	NR	NR
2400	NR	NR	NR	NR	NR	NR	NR	NR	NR	NR	NR	NR	NR	NR	NR	NR	NR	NR	NR	NR	NR	NR	NR	NR	NR	NR	NR	NR	NR	NR
H110	NR	NR	NR	NR	NR	NR	NR	NR	NR	NR	NR	NR	NR	NR	NR	NR	NR	NR	NR	NR	NR	NR	NR	NR	NR	NR	NR	NR	NR	NR
296	NR	NR	NR	NR	NR	NR	NR	NR	NR	NR	NR	NR	NR	NR	NR	NR	NR	NR	NR	NR	NR	NR	NR	NR	NR	NR	NR	NR	NR	NR
SR4759	NR	NR	NR	NR	NR	NR	NR	NR	NR	NR	NR	NR	NR	NR	NR	NR	NR	NR	NR	NR	NR	NR	NR	NR	NR	NR	NR	NR	NR	NR
IMR 4227	NR	NR	NR	NR	NR	NR	NR	NR	NR	NR	NR	NR	NR	NR	NR	NR	NR	NR	NR	NR	NR	NR	NR	NR	NR	NR	NR	NR	NR	NR
680	NR	NR	NR	NR	NR	NR	NR	NR	NR	NR	NR	NR	NR	NR	NR	NR	NR	NR	NR	NR	NR	NR	NR	NR	NR	NR	NR	NR	NR	NR
IMR 4198	NR	NR	NR	NR	NR	NR	NR	NR	NR	NR	NR	NR	NR	NR	NR	NR	NR	NR	NR	NR	NR	NR	NR	NR	NR	NR	NR	NR	NR	NR
H322	NR	NR	NR	NR	NR	NR	NR	NR	NR	NR	NR	NR	NR	NR	NR	NR	NR	NR	NR	NR	NR	NR	NR	NR	NR	NR	NR	NR	NR	NR
Re-7	NR	NR	NR	NR	NR	NR	NR	NR	NR	NR	NR	NR	NR	NR	NR	NR	NR	NR	NR	NR	NR	NR	NR	NR	NR	NR	NR	NR	NR	NR
AccurateArms#2	NR	NR	NR	NR	NR	NR	NR	NR	NR	NR	NR	NR	NR	NR	NR	NR	NR	NR	NR	NR	NR	NR	NR	NR	NR	NR	NR	NR	NR	NR
AccurateArms#5	NR	NR	NR	NR	NR	NR	NR	NR	NR	NR	NR	NR	NR	NR	NR	NR	NR	NR	NR	NR	NR	NR	NR	NR	NR	NR	NR	NR	NR	NR
AccurateArms#7	NR	NR	NR	NR	NR	NR	NR	NR	NR	NR	NR	NR	NR	NR	NR	NR	NR	NR	NR	NR	NR	NR	NR	NR	NR	NR	NR	NR	NR	NR
AccurateArms#9	NR	NR	NR	NR	NR	NR	NR	NR	NR	NR	NR	NR	NR	NR	NR	NR	NR	NR	NR	NR	NR	NR	NR	NR	NR	NR	NR	NR	NR	NR
Olin 473AA	NR	NR	NR	NR	NR	NR	NR	NR	NR	NR	NR	NR	NR	NR	NR	NR	NR	NR	NR	NR	NR	NR	NR	NR	NR	NR	NR	NR	NR	NR
Olin 452AA	NR	NR	NR	NR	NR	NR	NR	NR	NR	NR	NR	NR	NR	NR	NR	NR	NR	NR	NR	NR	NR	NR	NR	NR	NR	NR	NR	NR	NR	NR
Olin 540	NR	NR	NR	NR	NR	NR	NR	NR	NR	NR	NR	NR	NR	NR	NR	NR	NR	NR	NR	NR	NR	NR	NR	NR	NR	NR	NR	NR	NR	NR
Olin 571	NR	NR	NR	NR	NR	NR	NR	NR	NR	NR	NR	NR	NR	NR	NR	NR	NR	NR	NR	NR	NR	NR	NR	NR	NR	NR	NR	NR	NR	NR
Clays	NR	NR	NR	NR	NR	NR	NR	NR	NR	NR	NR	NR	NR	NR	NR	NR	NR	NR	NR	NR	NR	NR	NR	NR	NR	NR	NR	NR	NR	NR
UniversalClays	1.7	2.2	2.5	2.8	3.0	3.1	3.3	3.8	4.0	4.5	5.0	5.5	6.0	6.6	7.3	7.9	8.5	9.1	9.8	10.5	10.9	11.7	12.2	12.7	13.4	14.2	15.0	15.7	NR	NR
InternationalClays	1.4	1.8	2.2	2.3	2.5	2.7	3.0	3.1	3.3	3.8	4.2	4.7	5.1	5.6	6.1	6.5	7.1	7.7	8.2	8.7	9.2	9.6	10.1	10.6	11.1	11.7	12.4	12.9	NR	NR
453	1.8	2.3	2.7	2.9	3.2	3.4	3.7	3.9	4.2	4.7	5.2	5.7	6.2	6.9	7.5	8.1	8.8	9.5	10.1	10.7	11.3	12.0	12.6	13.2	13.9	14.6	15.3	16.1	NR	NR
Royal "D"	1.4	1.8	2.2	2.4	2.7	2.8	3.1	3.3	3.5	3.9	4.3	4.8	5.2	5.8	6.4	6.9	7.4	8.0	8.5	8.9	9.4	10.0	10.5	11.1	11.8	12.3	12.9	13.5	NR	NR
Solo 1500	1.5	2.0	2.4	2.6	2.9	3.1	3.4	3.8	4.3	4.8	5.3	5.8	6.4	7.0	7.5	8.2	8.8	9.3	9.9	10.6	11.1	11.7	12.4	13.1	13.7	14.3	15.0	NR	NR	NR
N 310	1.5	1.9	2.3	2.4	2.7	2.9	3.2	3.3	3.6	4.0	4.5	4.9	5.3	5.9	6.5	7.0	7.5	8.1	8.6	9.2	9.7	10.2	10.8	11.3	11.9	12.6	13.2	13.8	NR	NR
N 320	1.4	1.9	2.2	2.3	2.6	2.8	3.1	3.2	3.5	3.9	4.3	4.8	5.2	5.8	6.3	6.8	7.4	7.9	8.4	9.0	9.5	10.1	10.7	11.1	11.7	12.3	13.0	13.6	NR	NR
N 330	1.6	2.1	2.5	2.7	3.0	3.2	3.5	3.7	4.0	4.5	5.0	5.5	6.0	6.6	7.2	7.8	8.4	9.0	9.8	10.3										

RCBS Priming Accessories



Universal Hand Priming Tool - Combines the universal shell holder from the APS tool and with the primer tray from the standard tool and offers unmatched performance. The universal shell holder accepts cases from .32ACP to .45-70 Government. The patented safety gate isolates the primer seating operation from the primer supply virtually eliminating the possibility of tray detonation. The removable primer tray orients your primers for use and will fit any manufacturers primer packaging. Includes accessories to seat large and small rifle or pistol primers. **Order No. 044-90201 \$56.23**



Hand Priming Tool - Our hand priming tool not only seats primers quickly, it's also the safest. A patented safety mechanism separates the seating operation from the primer supply, virtually eliminating the possibility of tray detonation. Fits in your hand for portable primer seating. Primer tray installation requires no contact with the primers. Uses the same RCBS® shell holders (post-1980) as RCBS presses. Made of durable cast metal. Includes large and small primer plugs. **Order No. 044-90200 \$37.33**

Primer Catcher - Made to keep spent primers off the floor when ejected from fired cases. Plastic clip holds Primer Catcher snug and secure to press. Easily removed for emptying. For Rock Chucker™, "JR" and Reloader Special Presses only. **Order No. 044-9114 \$7.65**



Primer Tray-2 - The Primer Tray-2 handles today's larger primer package quantities. The square shape makes it easier to handle. Grooved tray surface quickly positions primers anvil-side up. **Order No. 044-9480 \$4.69**



RCBS Pow'r Pull® Kit - This kinetic style bullet puller's rugged one-piece body and user-friendly ergonomic handle resolves mistakes quickly and easily. The three case holding chucks will accommodate case from 5.7x28mm and .22 Hornet up through the WSM and RUM family of cartridges. **Order No. 044-9412 \$17.81**



Die or Press Maintenance Kits - Keep your reloading gear in pristine condition with the RCBS® Die or Press Maintenance Kits. Outfitted with the necessary chemicals and brushes to clean reloading dies and presses, these kits are perfect for removing dirt, oil and other debris from every nook and cranny. They also come equipped with special chemicals and oils designed for safe, long-term storage of your reloading equipment.

	Order No.	Price
Die Maintenance Kit	044-99972	\$24.24
Press Maintenance Kit	044-99971	18.59



Automatic Priming Tool - The Automatic Priming Tool is fast, accurate and highly sensitive due to a unique single-stage lever system. Primers feed through the auto primer feed tube one by one, preventing potential contamination by oily fingers. Two primer rod assemblies and two primer feed tubes are included.

	Order No.	Price
Auto Prime Tool	044-9460	\$85.83
Auto Prime Feed Combo	044-9580	25.60
APF Tube Assbly, Large (Holds 100)	044-9581	11.50
APF Tube Assbly, Small (Holds 100)	044-9582	11.50

RCBS APS Priming System

APS Hand Priming Tool - Uses CCI priming strips to eliminate headaches from spilled primers. The universal shell holder eliminates the need for additional shell holders. Full lifetime RCBS Warranty! **Order No. 044-88507 \$50.61**



APS Bench-Mounted Priming Tool - Created for those reloaders who prefer to have a separate, specialized tool dedicated just to priming. It's a tool with exceptional feel for concise and consistent primer seating.

The handle of the bench-mounted tool is large by design to provide hours of comfortable loading. Handle position can be adjusted for bench height or personal preference.

Order No. 044-88501 \$100.00

APS Press-Mounted Priming Tool - For those of you who have limited space on your bench or prefer priming cases on a press. RCBS has designed an APS press-mounted priming tool for you. It provides the same convenience, speed and precision as the bench-mount tool except it attaches to any single stage press that accepts standard 7/8" x 14 dies. **Order No. 044-88503 \$63.88**

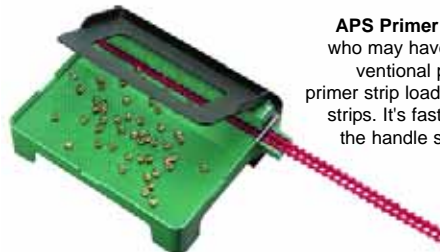

APS Primer Strip Loader - For those of you who may have a supply of CCI primers in conventional packaging, not to worry. The APS primer strip loader allows you to quickly fill empty strips. It's fast and simple to use; each push of the handle seats 25 primers, and its compact size makes easy storage.

Order No. 044-88505 \$30.49

APS® Unprimed Primer Strips - These strips are color-coded for fool-proof identification. Each strip holds 25 primers. Strips can be loaded with the primer of your choice using the striploader. Primers not included. **\$4.74 Each Pack**

	Order No.
APS Large Rifle (8/pk)Yellow	044-88510
APS Large Pistol (8/pk)White	044-88511
APS Small Rifle (8/pk)Yellow	044-88512
APS Small Pistol (8/pk)White	044-88513
APS Mag. Large Rifle (8/pk)Blue	044-88514
APS Mag. Large Pistol (8/pk)Red	044-88515
APS Mag. Small Rifle (8/pk)Blue	044-88516
APS Mag. Small Pistol (8/pk)Red	044-88517
APS BR2 Large Rifle (8/pk)Black	044-88518
APS BR4 Large Rifle (8/pk)Black	044-88519
APS 5.56mm Mil. Rifle (8/pk)Orange	044-88520
APS 7.62mm Mil. Rifle (8/pk)Orange	044-88521

RCBS Neck Expander for Cast Bullets



Strongly recommended when reloading cast rifle bullets in bottleneck cases. In one step, a neck expander die expands the case neck and slightly flares case mouth — critical for accurately seating bullets without shaving lead and bullet weight from their sides.

	Order No.	Price
Neck Expander Body	044-39800	\$20.14
Neck Expander Plug Rod	044-39801	4.38

Bullet Diameter	Complete Die \$25.80	Expander Plug Only \$9.64
.224"	044-39803	044-39851
.228"	044-39805	044-39853
.243"	044-39807	044-39855
.257"	044-39809	044-39857
.264"	044-39811	044-39859
.277"	044-39813	044-39861
.284"	044-39815	044-39863
.308"	044-39817	044-39865
.309"	044-39819	044-39867
.310"	044-39821	044-39869
.311"	044-39823	044-39871
.321"	044-39825	044-39873
.323"	044-39827	044-39875
.338"	044-39829	044-39877
.348"	044-39830	044-39878
.358"	044-39831	044-39879
.375"	044-39833	044-39881
.416"	044-39835	044-39883

Redding Reloading Presses & Powder Measures

The Boss



The Boss - The Boss's cast iron construction insures that it will last a lifetime, yet it is priced with light-duty aluminum presses! The BOSS is powerful, remarkably easy to use, and yet sensitive enough to seat primers without crushing them.

Features:

- Rigid cast iron frame.
- 36" frame offset gives the best visibility and access of all comparable presses.
- "Smart" primer arm automatically moves in and out of position with ram travel. Priming arm is positioned where it should be - at the bottom of ram travel for the lowest leverage and best feel.
- Offset handle is in the most comfortable operating position yet out of the way for best access and visibility.
- Positive ram travel stop.
- Powerful compound linkage.
- 3 holes for rigid mounting.
- Accepts all standard 7/8"-14 threaded dies and universal shell holders.
- Shell holders may be rotated to any comfortable position desired.
- Includes primer catcher.

Order No. 076-72100 \$119.53

The Boss Pro-Pak



The Boss Pro-Pak contains the following:

- The Boss Reloading Press**, includes primer catcher.
- Model 2 Powder and Bullet Scale Powder Trickler**
- Pad Style Case Lube Kit**- Consists of a non-skid lube pad and case lube.
- Deburring Tool**- Accepts cases from .17 to .45 caliber.
- Model 18 Case Preparation Kit**- Plastic accessory handle with all the tools and brushes you need to properly clean your fired cases before resizing.
- Powder Funnel**
- Metallic Cartridge Reloading** - 3rd Edition. A single source for detailed information on advanced handloading issues, while offering a wide variety of loading data.

	Order No.	Price
THE BOSS PRO PAK	076-20000	\$266.98

Versa Pak Reloading Kit - Includes all the items listed in the Pro Pak (less press) plus a Model 3 Master Powder Measure, a 1400 XT Case Trimmer, Imperial Dry Neck Lube in Application Media, a starter size of Imperial Sizing Die Wax and our DVD, "Advanced Handloading, Beyond the Basics".

Order No. 076-35000 \$346.61

The T-7 Turret Press

The REDDING T7 Turret Press combines strength, power and convenience with the speed and versatility of a turret press!

Slide bar priming system sold separately



Features:

- 7 Station Turret Head
- Heavy duty cast iron frame.
- 1" Diameter Ram
- 4-3/4" Press opening
- Interchangeable turret heads
- Powerful Compound linkage with positive Ram stop
- Accepts all standard 7/8"-14 threaded dies and universal shell holders.
- Shell holders may be rotated to any comfortable position desired.
- Includes Smart priming arm for seating both large and small primers.

	Order No.	Price
T7 TURRET PRESS	076-67000	\$261.74
Extra Turret	076-67002	61.42
Slide Bar Priming System	076-99600	39.11
Extra Slide Bar Primer Arm	076-99585	14.22

The Big Boss II & The Big Boss

The Big Boss II and original Big Boss Reloading Presses - Both the original Big Boss and the new Big Boss II reloading presses have all the desirable features of the "Boss" reloading press, but are built on heavier frames with a 1" diameter ram and longer 3.8" usable ram stroke for reloading the largest magnum cartridges.

The Big Boss II now features the unique Redding "Spent Primer Collection System" used on the T-7 and Ultramag presses. This top of the line single station press has the largest window opening and longest usable ram stroke of any press in its class.



Features:

- "Spent primer collection system"
- 1" diameter ram
- Large 4-1/2" frame opening
- 3-3/16" of ram stroke for easy reloading of magnum cartridges
- "Smart" primer arm that moves in & out of position with ram travel
- Heavy duty cast iron frame with 36" offset for easy access and visibility
- Heavy duty compound linkage
- Steel adapter bushing accepts all standard 7/8"-14 threaded dies & is removable for use with oversized dies
- Frame with bushing removed accepts 1-1/4" - 12 dies

	Order No.	Price
Big Boss II	076-97000	\$168.39
Big Boss	076-79000	\$150.94

The Ultramag



The ULTRAMAG features a huge 4-3/4" frame opening and 4-1/8" of usable ram stroke, making it ideal for loading oversized cartridges such as the old Sharps "Buffalo Cartridges" and British "Nitro-Express" rounds.

Order No. 076-70000 \$272.21

The Competition Model 10X-Pistol Powder Measure was designed specifically for handgun and small capacity rifle cartridges. The result is a very specialized small capacity powder measure with a charge weight range of approximately 1 to 25 grains. Measure has a drum assembly that can be easily changed from right to left-handed operation. By simply removing the micrometer unit, the drum orientation can be changed so that the operating handle is on the left side of the powder measure.

Order No. 076-03400 \$167.52



Model 3 Powder Measure -

- Cast mounting bracket included with all Redding Powder Measures.
- Large capacity clear powder reservoir.
- Clear "See thru" drop tube accepts all calibers from .22 thru .50 cal.
- Body has standard 7/8"-14 thread to fit mounting bracket and optional bench stand with locking ring for fast dumping.



	Order No.	Price
Model 3 Powder Measure	076-03000	\$111.68
Model 3 Measure w/ Universal & Handgun Metering Chambers	076-03200	136.11

Model 3BR Powder Measure -

Designed with the accuracy and reliability of the original Model 3 Powder Measure. The Model 3BR Powder Measure utilizes all of the features of the original Model 3 and to that Redding added the conversion features that Benchrest shooters were looking for.



	Order No.	Price
Model 3BR Powder Measure (includes Universal Chamber Charge range appx. 5 to 100gr)	076-03500	\$141.34
Pistol Metering Chamber (Fits only 3BR Measures, Charge appx. 0 to 10gr)	076-03331	42.75
Model 3BR Measure w/both chambers	076-03700	173.62

Model BR-30 Powder Measure - The drum and micrometer limits the overall charging range from a low of 10 grains (dependent upon powder density) to a maximum of approximately 50 grains. The diameter of the metering cavity was redesigned and the metering plunger was given a unique hemispherical or "cup" shape. This shape creates a powder cavity that resembles the bottom of a test tube to alleviate irregular powder settling and to enhance charge to charge uniformity. Shown with optional bench stand and mounting clamp (sold separate) **Order No. 076-03300 \$167.52**



MODEL 2



MODEL 2: 505 grain capacity, 1/10 grain accuracy, pour spout pan, simple two counterpoise system, 1/10 grain over/under graduations. **Order No. 076-02000 \$75.03**

MODEL 5 TRICKLER: Weighs a pound so it won't move all over your bench while you are trying to use it. Perfect height for most powder scales. **Order No. 076-05000 \$20.07**



See the next page for more information on Redding Die set contents and Specialty die information

SERIES A - Die Sets for Bottleneck Cases

Caliber	Full Length Die Set Starting at: \$37.95	Deluxe Die Set \$60.39	Neck Sizing Die \$27.73	Full Length Sizing Die \$27.73	Decap Rod Assembly \$10.67	Decap Rod \$6.75	Size Button \$6.04	Seating Die \$24.89	Seat Plug \$6.75	Form & Trim Die \$24.89	Neck Die Set \$37.95
204 Ruger (SH#10)	076-80287	076-84287	076-81287	076-91287	076-31203	076-01031	076-42203	076-92287	076-01085	076-83287	076-82287
221 Remington Fireball (SH#10)	076-80101	076-84101	076-81101	076-91101	076-32223	076-01032	076-42223	076-92101	076-01083	076-83101	076-82101
22 Hornet (SH#14)	076-80102	076-84102	076-81102	076-91102	076-32923	076-01032	076-39223	076-92102	076-01085	076-83102	076-82102
220 Swift (SH#4)	076-80107	076-84107	076-81107	076-91107	076-34223	076-01034	076-42223	076-92107	076-01083	076-83107	076-82107
222 Remington (SH#10)	076-80109	076-84109	076-81109	076-91109	076-32223	076-01032	076-42223	076-92109	076-01084	N.A.	076-82109
22-250 Remington (SH#10)	076-80106	076-84106	076-81106	076-91106	076-33223	076-01033	076-42223	076-92106	076-01083	076-83106	076-82106
223 Remington (SH#10)	076-80111	076-84111	076-81111	076-91111	076-33223	076-01033	076-42223	076-92111	076-01083	076-83111	076-82111
300 Remington Ultra Mag (SH#6)	076-80288	076-84288	076-81288	076-91288	076-25307	076-01025	076-41307	076-92288	076-01080	076-83288	076-82288
243 WSM (SH#6)	076-80270	076-84270*	076-81270	076-91270	076-32223	076-01032	076-42223	076-92270	076-01067	076-83270	076-82270
243 Winchester (SH#1)	076-80114	076-84114	076-81114	076-91114	076-33242	076-01033	076-42242	076-92114	076-01067	076-83114	076-82114
6MM Remington (SH#1)	076-80115	076-84115	076-81115	076-91115	076-34242	076-01034	076-42242	076-92115	076-01066	076-83115	076-82115
25-06 Remington (SH#1)	076-80120	076-84120	076-81120	076-91120	076-34256	076-01034	076-42256	076-92120	076-01067	076-83120	076-82120
257 Roberts (SH#1)	076-80125	076-84125	076-81125	076-91125	076-34256	076-01034	076-42256	076-92125	076-01066	076-83125	076-82125
260 Remington (SH#1)	076-80531	076-84531	076-81531	076-91531	076-33263	076-01033	076-42263	076-92531	076-01067	076-83531	076-82531
6.5MM x 55 Swedish Mauser (SH#1)	076-80132	076-84132	076-81132	076-91132	076-34263	076-01034	076-42263	076-92132	076-01066	076-83132	076-82132
270 Winchester (SH#1)	076-80135	076-84135	076-81135	N.A.	076-25276	076-01025	076-41276	076-92135	076-01066	076-83135	076-82135
270 WSM (SH#6)	076-80255	076-84255	076-81255	076-91255	076-23276	076-01023	076-41276	076-92255	076-01067	076-83255	076-82255
7MM-08 Remington (SH#1)	076-80139	076-84139	076-81139	076-91139	076-23283	076-01023	076-41283	076-92139	076-01080	076-83139	076-82139
7MM Remington Mag (SH#6)	076-80136	076-84136	076-81136	076-91136	076-24283	076-01024	076-41283	076-92136	076-01067	076-83136	076-82136
7MM x 57 Mauser (SH#1)	076-80138	076-84138	N.A.	076-91138	076-24283	076-01024	076-41283	076-92138	076-01067	076-83138	076-82138
280 Rem (7MM Exp. Rem.) (SH#1)	076-80142	076-84142	076-81142	076-91142	076-25283	076-01025	076-41283	076-92142	076-01067	076-83142	076-82142
30-30 Winchester (SH#2)	076-80146	076-84146	076-81146	076-91146	076-23307	076-01023	076-41307	076-92146	076-01080	076-83146	076-82146
30-06 Springfield (SH#1)	076-80148	076-84148	076-81148	076-91148	076-24307	076-01024	076-41307	076-92148	076-01080	076-83148	076-82148
300 WSM (SH#6)	076-80223	076-84223	076-81223	076-91223	076-23307	076-01023	076-41307	076-92223	076-01080	076-83223	076-82223
300 Winchester Mag (SH#6)	076-80153	076-84153	076-81153	076-91153	076-25307	076-01025	076-41307	076-92153	076-01079	076-83153	076-82153
300 Weatherby Mag (SH#6)	076-80252	076-84252	076-81252	076-91252	076-25307	076-01025	076-41307	076-92252	076-01080	076-83252	076-82252
308 Winchester/307 Win (SH#1)	076-80155*	076-84155	076-81155	076-91155	076-23307	076-01023	076-41307	076-92155	076-01080	076-83155	076-82155
8MM x 57 Mauser (SH#1)	076-80159	076-84159	076-81159	076-91159	076-24222	076-01024	076-41322	076-92159	076-01080	076-83159	076-82159
338 Winchester Mag (SH#6)	076-80163	076-84163	076-81163	076-91163	076-24336	076-01024	076-41336	076-92163	076-01063	076-83163	076-82163
375 H & H Magnum (SH#6)	076-80169	076-84169	076-81169	076-91169	076-25373	076-01025	076-41373	076-92169	076-01081	076-83169	076-82169

SERIES A - Die Sets for Straight Wall Cases

Caliber	Three Die Set Starting at: \$37.95	Sizing Die \$22.22	Decap Rod Assembly \$10.67	Seating Die \$20.97	Seat Plug \$6.75	Expander Die \$15.64	Expander	Profile Crimp \$21.86	Taper Crimp \$21.86	Trim Die \$24.89
30 M1 Carbine (SH#22)	076-80180	076-91180	076-22097	076-92180	076-01069RN	076-93180	-	N.A.	076-85180	076-83180
32 Smith & Wesson Long (SH#10)	076-80158	076-91158	076-22097	076-92158	076-01073WC	076-93158	-	N.A.	076-85158	076-83158
32 H & R Magnum (SH#10)	076-80161	076-91161	076-22097	076-92161	076-01069SWC	076-93161	-	076-86261	N.A.	076-83161
32 S & W Long/32 H & R Mag (SH#10)	076-80162	076-91162	076-22097	076-92162	076-01075SWC	076-93162	-	076-86162	076-85162	N.A.
9MM Luger (SH#13)	076-80172	076-91172	076-22097	076-92172	076-01072RN	076-93172	-	N.A.	076-85172	076-83172
38 Special (SH#12)	076-80183	076-91183	076-22097	076-92183	076-01071SWC	076-93183	-	N.A.	076-85183	076-83183
357 Magnum (SH#12)	076-80182	076-91182	076-22097	076-92182	076-01071SWC	076-93182	-	076-86182	N.A.	076-83182
38 Spec/357 Mag (SH#12)	076-80184	076-91184	076-22097	076-92184	076-01071SWC	076-93184	-	076-86282	076-85282	N.A.
40 Smith & Wesson (SH#5)	076-80272	076-91272	076-22097	076-92272	076-01092SWC	076-93272	-	N.A.	076-85272	076-83272
10MM Auto (SH#5)	076-80520	076-91520	076-22097	076-92520	076-01087SWC	076-93520	-	N.A.	076-85520	076-83520
40 S & W/10MM Auto (SH#5)	076-80253	076-91253	076-22097	076-92253	076-01092SWC	076-93253	-	N.A.	076-85253	N.A.
44 Special (SH#21)	076-80187	076-91187	076-21097	076-92187	076-01074SWC	076-93187	-	N.A.	076-85187	076-83187
44 Magnum (SH#19)	076-80186	076-91186	076-21097	076-92186	076-01074SWC	076-93186	-	076-86186	N.A.	076-83186
44 Spec/44 Mag (SH#19)	076-80194	076-91194	076-21097	076-92194	076-01074SWC	076-93194	-	076-86286	076-85286	N.A.
44-40 Winchester (SH#9)	076-80188	076-91188	076-21097	076-92188	076-01074RN	076-93188	-	076-86188	N.A.	N.A.
45 ACP/45 Auto Rim (SH#1)	076-80189	076-91189	076-21097	076-92189	076-01075RN	076-93189	-	076-86189	076-85189	076-83189
45 Colv/454 Casull (SH#23)	076-80191	076-91191	076-21097	076-92191	076-01076SWC	076-93191	-	076-86191	076-85191	076-83191

SERIES B - Die Sets for Bottleneck Cases

Caliber	Full Length Die Set Starting at: \$52.11	Deluxe Die Set \$83.25	Neck Sizing Die \$37.33	Full Length Sizing Die \$37.33	Decap Rod Assembly \$10.67	Decap Rod \$6.75	Size Button \$6.04	Seating Die \$33.42	Seat Plug \$6.75	Form & Trim Die \$33.42	Neck Die Set \$52.11 \$68.27
17 Remington (SH#10)	076-80217	076-84217	076-81217	076-91217	076-31171	076-01031	076-42171	076-92217	076-01085	076-83217	076-82217
17 Remington Fireball (SH#10)	076-80204	076-84204	076-81204	076-91204	076-26171	076-01026	076-42171	076-92204	076-01085	N.A.	076-82204
218 Bee (SH#3)	076-80200	076-84200	076-81200	076-91200	076-32923	076-01032	076-39223	076-92200	076-01085	076-83200	076-82200
22K Hornet (SH#14)	076-80362	076-84362	076-81362	076-91362	076-32923	076-01032	076-39223	076-92362	076-01085	076-83362	076-82362
22 B.R. Remington (SH#1)	076-80316	076-84316	076-81316	076-91316	076-32223	076-01032	076-42223	076-92316	076-01083	076-83316	076-82316
22 P.P.C. USA (SH#12)	076-80318	076-84318	076-81318	076-91318	076-32223	076-01032	076-42223	076-92318	076-01084	076-83318	076-82318
6MM B.R. Remington (SH#1)	076-80317	076-84317	076-81317	076-91317	076-32242	076-01032	076-42242	076-92317	076-01067	076-83317	076-82317
6MM P.P.C. USA (SH#12)	076-80319	076-84319	076-81319	076-91319		076-01032		076-92319	076-01067	076-83319	076-82319
6.8 Remington SPC (SH#TBD)	076-80259	076-84259	076-81259	076-91259	076-22276	076-01022	076-41276	076-92259	076-01067	076-83259	076-82259
25-20 Winchester (SH#3)	076-80218	076-84218	076-81218	076-91218*	076-32956	076-01032	076-39256	076-92218	076-01066	076-83218	076-82218
250 Savage (SH#1)	076-80122	076-84122	076-81122	076-91122	076-33256	076-01033	076-42256	076-92122	076-01067	076-83122	076-82122
256 Winchester Mag (SH#12)	076-80233	076-84233	076-81233	076-91233	076-32956	076-01032	076-39256	076-92233	076-01066	076-83233	076-82233
257 Weatherby Mag (SH#6)	076-80226	076-84226	076-81226	076-91226	076-35256	076-01035	076-42256	076-92226	076-01066	076-83226	076-82226
264 Winchester Mag (SH#6)	076-80127	076-84127	076-81127	076-91127	076-34263	076-01034	076-42263	076-92127	076-01062	076-83127	076-82127
270 Weatherby Mag (SH#1)	076-80234	076-84234	076-81234	076-91234	076-25276	076-01025	076-41276	076-92234	076-01066	076-83234	076-82234
7MM B.R. Remington (SH#1)	076-80241	076-84241	076-81241	076-91241	076-22283	076-01022	076-41283	076-92241	076-01067	076-83241	076-82241
7MM Rem SA UM (SH#6)	076-80280	076-84280	076-81280	076-91280	076-23283	076-01023	076-41283	076-92280	076-01080	076-83280	076-82280
7MM WSM (SH#6)	076-80265	076-84265	076-81265	076-91265	076-23283	076-01023	076-41283	076-92265	076-01067	076-83265	076-82265
7MM Remington Ultra Mag (SH#6)	076-80923	076-84923	076-81923	076-91923*	076-25283	076-01025	076-41283	076-92923	076-01067	076-83923	076-82923
7MM TCU (SH#10)	076-80242	076-84242	076-81242	076-91242		076-01023		076-92242	076-01067	076-83242	076-82242
284 Winchester (SH#1)	076-80141	076-84141	076-81141	076-91141	076-24283	076-01024	076-41283	076-92141	076-01067	076-83141	076-82141
7MM Weatherby Mag (SH#6)	076-80237	076-84237	076-81237	076-91237	076-25283	076-01025					



The die box is a handy cartridge loading block and storage package. All Redding dies have industry standard 7/8-14 threaded bodies.

Full Length Die Sets for bottleneck cases contain two dies. The full length resizing die contains a decapping rod assembly with a neck expander (size button). The seating die includes bullet guide, built-in crimping ring and the proper seating plug.

Straight Wall Case Die Sets contain three dies. The full length resizing die contains a decapping rod assembly. The expander die contains a neck expanding plug. The seating die includes bullet guide, built-in crimping ring and the proper seating plug.

Deluxe Die Sets for bottleneck cases contain three dies. The full length resizing die contains a decapping rod assembly with a neck expander (size button). The seating die includes bullet guide, built-in crimping ring and the proper seating plug, and neck sizing die.

Pistol Trim Dies

Redding trim dies for pistol calibers allow you to file trim your cases without excessive resizing. Pistol trim dies require extended shellholders. See adjoining chart for available calibers and the extended shellholders required.

Neck Sizing Dies

These dies size only the necks of your bottleneck cases to prolong brass life and improve accuracy. It is important to note that since these dies size only the neck and not the shoulder or body, fired cases should not be interchanged between rifles of the same caliber. Available individually or in a Deluxe Die Set.

Taper Crimp Dies

Designed for handgun cartridges which headspace on the case mouth where conventional roll crimping is undesirable. Also available for some revolver cartridges, for those who prefer the uniformity of a taper crimp.

Form & Trim Dies

Redding trim dies allow you to file trim your cases without unnecessary resizing because they are made to chamber dimensions. Other manufacturers use sizing die dimensions, forcing you to full length resize when trimming. For case forming and necking brass down from another caliber, Redding trim dies can be the perfect intermediate step before full length resizing

Profile Crimp Dies

These handgun cartridge crimp dies were designed for those who want the best possible crimp. Profile crimp dies provide a tighter, more uniform roll type crimp, and requires the bullet to be seated to the correct depth in a previous operation. These dies are not for cartridges that headspace on the case mouth.



SERIES B - Die Sets for Straight Wall Cases

Caliber	Three Die Set Starting at: \$52.11	Sizing Die \$29.86	Decap Rod Assembly \$10.67	Seating Die \$29.33	Seat Plug \$6.75	Expander Die \$26.97	Expander	Profile Crimp \$26.66	Taper Crimp \$26.66	Trim Die \$33.42
32-20 Winchester (SH#3)	076-80281	076-91281	076-22097	076-92281	076-01069RN	076-93281	-	076-86281	N.A.	076-83281
32 ACP (SH#22)	076-80220	076-91220	076-22097	076-92220	076-01070RN	076-93220	-	N.A.	076-85220	N.A.
380 Auto (SH#10)	076-80170	076-91170	076-22097	076-92170	076-01078RN	076-93170	-	N.A.	076-85170	076-83170
38 Super Auto (SH#5)	076-80271	076-91271	076-22097	076-92271	076-01072RN	076-93271	-	N.A.	076-85271	076-83271
375 Winchester (SH#2)	076-80206	076-91206	076-23097	076-92206	076-01081	076-93206	-	N.A.	N.A.	N.A.
41 Magnum (SH#18)	076-80185	076-91185	076-22097	076-92185	076-01077SWC	076-93185	-	076-86185	076-85185	076-83185
45-70 U.S. Govt. (SH#18)	076-80209	076-91209	076-27097	076-92209	076-01065	076-93209	-*	076-86209	N.A.	076-83209
458 Winchester Mag (SH#6)	076-80208	076-91208	076-28097	076-92208	076-01065	076-93208	-*	076-86208	N.A.	076-83208
500 Smith & Wesson Magnum	076-80291	076-91291	076-21097	076-92291				076-86291		

SERIES C - Die Sets for Bottleneck Cases

Caliber	Full Length Die Set Starting at: \$66.44	Deluxe Die Set \$104.52	Neck Sizing Die \$47.28	Full Length Sizing Die \$47.28	Decap Rod Assembly \$10.67	Decap Rod \$6.75	Size Button \$6.04	Seating Die \$41.77 \$41.77+	Seat Plug \$6.75	Form & Trim Die \$41.77	Neck Die Sets \$66.44
219 Zipper (SH#2)	076-80360	N.A.	N.A.	076-91360	076-33223	076-01033	076-42223	076-92360	076-01083	076-83360	N.A.
222 Remington Mag (SH#10)	076-80203	076-84203	076-81203	076-91203	076-33223	076-01033	076-42223	076-92203	076-01083	076-83203	076-82203
225 Winchester (SH#4)	076-80239	076-84239	076-81239	076-91239	076-33223	076-01033	076-42223	076-92239	076-01083	076-83239	076-82239
22-250 Improved 40° (SH#1)	076-80406	076-84406	076-81406	076-91406	076-33223	076-01033	076-42223	076-92406+	076-01083	076-83406	076-82406
22 Savage H.P. (5.6MM x 52R) (SH#2)	076-80338	N.A.	N.A.	076-91338	076-33227	076-01033	076-42227*	076-92338	076-01084	076-83338	N.A.
6MM TCU (SH#10)	076-80245	076-84245	076-81245	076-91245		076-01033	076-42242T	076-92245	076-01066	076-83245	076-82245
6MM/223 Rem (6MM x 45) (SH#10)	076-80312	076-84312	076-81312	076-91312		076-01033	076-42242T	076-92312	076-01066	076-83312	076-82312
6MM/284 Winchester (SH#1)	076-80414	076-84414	076-81414	076-91414	076-34242	076-01034	076-42242	076-92414	076-01066	076-83414	076-82414
240 Weatherby Mag (SH#1)	076-80232	076-84232	076-81232	076-91232	076-34242	076-01034	076-42242	076-92232	076-01067	076-83232	076-82232
243 Winchester Improved 40° (SH#1)	076-80420	076-84420	076-81420	076-91420	076-33242	076-01033	076-42242	076-92420	076-01067	076-83420	076-82420
6.5MM/06 (SH#1)	076-80378	076-84378	076-81378	076-91378	076-34263	076-01034	076-42263*	076-92378	076-01067	076-83378	076-82378
257 Roberts Improved 40° (SH#1)	076-80322	076-84322	076-81322	076-91322	076-34256	076-01034	076-42256	076-92322	076-01066	076-83322	076-82322
280 Remington Improved 40° (SH#1)	076-80428	076-84428	076-81428	076-91428	076-25283	076-01025	076-41283	076-92428	076-01067	076-83428	076-82428
7MM x 64 Brenneke (SH#1)	076-80340	N.A.	N.A.	076-91340	076-24283	076-01024	076-41283	076-92340	076-01062	076-83340	N.A.
7-30 Waters (SH#2)	076-80230	076-81230	076-81230	076-91230	076-23283	076-01023	076-41283	076-92230	076-01067	076-83230	076-82230
7.5MM Schmidt Rubin (Swiss) (SH#2)	076-80235	076-84235	076-81235	076-91235	076-24307	076-01024	076-41307	076-92235	076-01080	076-83235	076-82235
30-20 TC (SH#3)	076-80254	076-84254	076-81254	076-91254	076-22007	076-01022	N.A.	076-92254	076-01066	076-83254	076-82254
30-06 Improved 40° (SH#1)	076-80324	076-84324	076-81324	076-91324	076-24307	076-01024	076-41307	076-92324	076-01080	076-83324	076-82324
30/338 Winchester Mag (SH#6)	076-80394	076-84394	076-81394	076-91394	076-24307	076-01024	076-41307	076-92394	076-01063	076-83394	076-82394
30/378 Weatherby Mag (SH#18)	076-80547	076-84547	076-81547	076-91547	076-25307	076-01025	076-41307	076-92547	076-01080	076-83547	076-82547
303 Savage (SH#21)	076-80296	N.A.	N.A.	076-91296	076-23307	076-01023	076-41307	076-92296	076-01080	N.A.	N.A.
32 Remington (SH#5)	076-80332	N.A.	N.A.	076-91332	N.A.	076-01023	N.A.	076-92332	076-01080	N.A.	N.A.
32 Winchester Spec. (SH#2)	076-80157	076-84157	076-81157	076-91157	076-23320	076-01023	076-41320*	076-92157	076-01080	076-83157	076-82157
338/06 (SH#1)	076-80328	076-84328	076-81328	076-91328	076-91328	076-01024	N.A.	076-92328	076-01063	076-83328	076-82328
348 Winchester (SH#20)	076-80336	N.A.	N.A.	076-91336	076-24347	076-01024	076-41347*	076-92336	076-01081	076-83336	N.A.
35 Winchester (SH#8)	076-80335	N.A.	N.A.	076-91335	076-24356	076-01024	076-41356*	076-92335	076-01081	N.A.	N.A.
358 Norma Mag (SH#6)	076-80210	N.A.	N.A.	076-91210	076-24356	076-01024	076-41356*	076-92210	076-01081	076-83210	N.A.
9MM x 57 Mauser (SH#1)	076-80357	N.A.	N.A.	076-91357	076-24356	076-01024	076-41356*	076-92357	076-01081	076-83357	N.A.
375 Remington Ultra Mag (SH#6)	076-80925	076-84925	076-81925	076-91925	076-25373	076-01025	076-41373	076-92925	076-01081	076-83925	076-82925
416 Remington Magnum (SH#6)	076-80442	076-84442	076-81442	076-91442	076-25414	076-01025	N.A.	076-92442	076-01064	076-83442	076-82442
30-40 Krag (SH#8)	076-80147	076-84147	076-81147	076-91147	076-24307	076-01024	076-41307	076-92147	076-01080	076-83147	076-82147

SERIES C - Die Sets for Straight Wall Cases

Caliber	Three Die Set Starting at: \$66.44	Sizing Die \$36.44 \$36.44+	Decap Rod Assembly \$10.67	Seating Die \$35.55	Seat Plug \$6.75	Expander Die \$25.60	Expander	Profile Crimp \$33.42	Taper Crimp \$33.42	Trim Die \$41.77
30 Mauser (SH#13)	076-80251	076-91251	076-22097	076-92251	076-01069RN	076-93251	-	N.A.	N.A.	076-83251
357 SIG (SH#5)	076-80434	076-91434	076-22097	076-92434	076-01072SWC	076-93434	-	N.A.	076-85434	076-83434
38-55 Winchester & Ballard (SH#2)	076-80365	076-91365	076-23097	076-92365	076-01081	076-93365	-	076-86365	N.A.	076-83365
38-40 Winchester (SH#9)	076-80366	076-91366	076-22097	076-92366	076-01071RN	076-93366	-	076-86366	N.A.	076-83366
40-65 Winchester (SH#18)	076-80465	076-91465+	076-23097	076-92465	076-01081	076-93465	-	076-86465	N.A.	076-83465
41 Long Colt (SH#1)	076-80370	076-91370	076-22097	076-92370	076-01077RN	076-93370	-	N.A.	N.A.	N.A.
44 Russian (SH#19)	076-80372	076-91372	076-21097	076-92372	076-01074RN	076-93372	-	N.A.	N.A.	076-83372
444 Marlin (SH#19)	076-80207	076-91207	076-28097	076-92207	076-01068FP	076-93207	-	N.A.	N.A.	076-83207
450 Marlin (SH#6)	076-80350	076-91350	076-27097	076-92350	076-01065	076-93350	-	N/A	N/A	N.A.

Pistol DieSets In Titanium Carbide

Titanium carbide differs considerably from tungsten carbides, and is one of the most ideal materials for resizing cartridge cases. Titanium carbide has the highest hardness of any readily available carbide, and those smooth rounded micrograins present a slippery, non-galling surface that is simply unattainable with other carbides.

Titanium Carbide Die Sets

Caliber	Titanium Carbide Die Set	Titanium Carbide Cartridge Die Set	Pro-Series Pro-Series Die Set	Pro-Series Pro-Series Die Set (Special Order)	Taper Crimp Sizer Die	Profile Crimp Die	Extended Shellholder	Trim Die
Starting at:	\$69.02 * \$80.38	\$54.21 * \$66.66	\$78.27 * \$89.64	(Special Order)	\$26.66 * \$21.86	\$21.86	\$10.92	\$24.89 \$33.42*
32 ACP (SH#22)	076-88220	076-87220	076-89220	076-94402	076-85220	N/A	22E	N/A
32 Smith & Wesson Long (SH#10)	076-88158	076-87162	N.A.	N.A.	076-85158*	076-86158	10E	076-83158
32 H&R Magnum (SH#10)	076-88261	076-87162	N.A.	N.A.	N.A.	076-86261	10E	076-83161
32 S&W Long/32 H&R Mag (SH#16)	076-88162	076-87162	076-89162	076-94162	076-85162*	076-86162	10E	N.A.
380 Auto (SH#10)	076-88170	076-87170	076-89170	076-94170	076-85170	N.A.	10E	076-83170*
9MM Luger(SH#13)	076-88172*	076-87172*	076-89172*	076-94172	076-85172*	N.A.	13E	076-83172
38 Special (SH#12)	076-88183	076-87282	N.A.	N.A.	N.A.	N.A.	12E	076-83183
357 Magnum (SH#12)	076-88182	076-87282	N.A.	N.A.	N.A.	076-86182	12E	076-83182
38 Spec/357 Mag (SH#12)	076-88282	076-87282	076-89282	076-94282	076-85282*	076-86282	12E	N.A.
38 Super Auto (SH#5)	076-88271	076-87271	076-89271	076-94271	076-85271*	N.A.	5E	076-83271*
40 Smith & Wesson (SH#5)	076-88272	076-87253	076-89272	076-94272	076-85272*	N.A.	5E	076-83272
10MM Auto (SH#5)	076-88520	076-87253	076-89520	076-94520	076-85520*	N.A.	5E	076-83520
40 S&W/10MM Auto (SH#5)	076-88253	076-87253	076-89253	076-94253	076-85253*	N.A.	5E	N.A.
41 Magnum (SH#21)	076-88185	076-87185	076-89185	076-94185	076-85185	076-86158	21E	076-83185*
44 Special (SH#19)	076-88187	076-87286	N.A.	N.A.	N.A.	N.A.	19E	076-83187
44 Magnum (SH#19)	076-88186	076-87286	N.A.	N.A.	N.A.	076-86186	19E	076-83186
44 Spec/44 Mag (SH#19)	076-88286	076-87286	076-89286	076-94286	076-85286*	076-86286	19E	N.A.
45 ACP(SH#1)	076-88189	076-87189	076-89189	076-94189	076-85189*	N.A.	1E	076-83189
45 Auto Rim (SH#17)	076-88189	076-87189	076-89189	076-94189	076-85189*	076-86189	17E	076-83189
45 Colt/454 Casull (SH#23)	076-88191	076-87191	076-89191	076-94191	076-85191*	076-86191	23E	076-83191
460 S&W Magnum (SH#23)	N.A.	076-87191	076-89278	N.A.	N.A.	N.A.	23E	N.A.



Pro Series Die Sets In Titanium Carbide - The "Pro Series" is a specially prepared three (3) die set for use in progressive reloading machines. Since the most popular machines do not make use of an expander die, it has been eliminated in the "Pro Series" sets. The sizing die is the extraordinary Redding Titanium Carbide, complete with a decapping unit.

COMPETITION BUSHING NECK DIE SETS - TYPE-S Category I

	Type S-Full Bushing Die	Type S-Neck Bushing Die	Type S-Neck Bushing Die Set	Type S Match Full Die Set	Type S Match Neck Die Set	Body Die	Competition Bushing Neck Die	Competition Seating Die	Competition Bushing Neck Die Set	Carbide Kit For Comp. Bushing Die
Starting at:	\$48.35	\$48.35	\$91.01	\$135.09	\$158.20	\$24.89	\$93.32	\$98.79	\$200.86	\$29.51
222 Remington(SH#10)	076-77109	076-71109	076-78109	076-36109	076-38109	076-75109	076-56109	076-55109	076-58109	076-98123
223 Remington (SH#10)	076-77111	076-71111	076-78111	076-36111	076-38111	076-75111	076-56111	076-55111	076-58111	076-98123
22-250 Remington (SH#1)	076-77106	076-71106	076-78106	076-36106	076-38106	076-75106	076-56106	076-55106	076-58106	076-98123
220 Swift (SH#4)	076-77107	076-71107	076-78107	076-36107	076-38107	076-75107	076-56107	076-55107	076-58107	076-98223
6MM P.P.C. USA (SH#12)	076-77319	076-71319	076-78319	076-36319	076-38319	076-75319	076-56319	076-55319	076-58319	076-98024
6MM B.R. Rem (SH#1)	076-77317	076-71317	076-78317	076-36317	076-38317	076-75317	076-56317	076-55317	076-58317	076-98024
243 Winchester (SH#1)	076-77114	076-71114	076-78114	076-36114	076-38114	076-75114	076-56114	076-55114	076-58114	076-98224
6MM Remington (SH#1)	076-77115	076-71115	076-78115	076-36115	076-38115	076-75115	076-56115	076-55115	076-58115	076-98224
25-06 Remington (SH#1)	076-77120	076-71120	076-78120	076-36120	076-38120	076-75120	076-56120	076-55120	076-58120	076-98325
260 Rem (6.5MM/308 Win) (SH#1)	076-77531	076-71531	076-78531	076-36531	076-38531	076-75531	076-56531	076-55531	076-58531	076-98226
6.5MM x 55 Swedish Mauser(SH#1)	076-77132	076-71132	076-78132	076-36132	076-38132	076-75132	076-56132	076-55132	076-58132	076-98226
270 Winchester (SH#1)	076-77135	076-71135	076-78135	076-36135	076-38135	076-75135	076-56135	076-55135	076-58135	076-99427
7MM-08 Remington (SH#1)	076-77139	076-71139	076-78139	076-36139	076-38139	076-75139	076-56139	076-55139	076-58139	076-99383
280 Remington(SH#1)	076-77142	076-71142	076-78142	076-36142	076-38142	076-75142	076-56142	076-55142	076-58142	076-99483
7MM Rem Mag (SH#6)	076-77136	076-71136	076-78136	076-36136	076-38136	076-75136	076-56136	076-55136	076-58136	076-99483
308 Winchester (SH#1)	076-77155	076-71155	076-78155	076-36155	076-38155	076-75155	076-56155	076-55155	076-58155	076-99307
30-06 Springfield (SH#1)	076-77148	076-71148	076-78148	076-36148	076-38148	076-75148	076-56148	076-55148	076-58148	076-99407
300 Remington SA Ultra Mag	076-77275	076-71275	076-78275	076-36275	076-38275	N/A	076-56275	076-55275	076-58275	076-99307
300 Winchester Mag (SH#6)	076-77153	076-71153	076-78153	076-36153	076-38153	076-75153	076-56153	076-55153	076-58153	076-99407
300 Weatherby Mag (SH#6)	076-77252	076-71252	076-78252	076-36252	076-38252	076-75252	076-56252	076-55252	076-58252	076-99507
300 Remington Ultra Mag (SH#6)	076-77288	076-71288	076-78288	076-36288	076-38288	076-75288	076-56288	N/A	076-58288	076-99507
300 WSM - (SH#6)	076-77223	076-71223	076-78223	076-36223	076-38223	076-75223	076-56223	N/A	076-58223	076-99307



ALL DIES ARE SUPPLIED WITHOUT BUSHINGS
SEE NECK SIZING BUSHINGS FOR #S

Redding's Bushing Style dies create positive alignment between the bullet and cartridge case prior to bullet seating. The precision fitting seating stem is allowed to move well down into the chamber of the die to accomplish early bullet contact. The spring loading of the seating stem provides the positive alignment bias between its tapered nose and the bullet ogive. This spring loading and bullet alignment are maintained as the bullet and cartridge case move upward until the actual seating of the bullet begins.



Body Dies
Body Dies are designed to full length resize the case body and bump the shoulder position for proper chambering without disturbing the case neck.

COMPETITION BUSHING NECK DIE SETS - TYPE-S Category II

	Type S-Full Bushing Die	Type S-Neck Bushing Die	Type S-Neck Bushing Die Set	Type S Match Full Die Set	Type S Match Neck Die Set	Body Die	Competition Bushing Neck Die	Competition Seating Die	Competition Bushing Neck Die Set	Carbide Kit For Comp. Bushing Die
Starting at:	\$59.01 \$72.88*	\$59.01 \$72.88*	\$114.65 \$140.24*	\$163.53 \$200.86*	\$191.97 \$236.41*	\$30.57 \$37.51*	\$111.98 \$138.65*	\$109.17 \$137.28*	\$241.74 \$298.62*	\$29.51

17 Remington Fireball (SH#10)	076-77204	076-71204	076-78204	076-36204	076-38204	076-75204	N/A	076-55204	N/A	N/A
17 MACH IV (SH#10)	076-77504	076-71504	076-78504	076-36504	076-38504	076-75504	N/A	N/A	N/A	N/A
17 Remington (SH#10)	076-77217	076-71217	076-78217	076-36217	076-38217	076-75217	N/A	076-55217	N/A	N/A
22 Hornet (SH#14)	076-77102	076-71102	076-78102	076-36102	076-38102	076-75102	N/A	076-55102	N/A	N/A
221 Remington (SH#10)	076-77101	076-71101	076-78101	076-36101	076-38101	076-75101	076-56101	076-55101	076-58101	076-98023
223 Rem Imp 40° (SH#10)	076-77907	076-71907	076-78907	076-36907	076-38907	076-75907	076-56907	N/A	076-58907	N/A
22 P.P.C. USA (SH#12)	076-77318	076-71318	076-78318	076-36318	076-38318	076-75318	076-56318	076-55318	076-58318	076-98023
22 B. R. Rem (SH#1)	076-77316	076-71316	076-78316	076-36316	076-38316	076-75316	076-56316	076-55316	076-58316	076-98023
22-250 Rem Imp 40° (SH#1)	076-77406	076-71406	076-78406	076-36406	076-38406	076-75406	076-56406	076-55406	076-58406	076-98123
223 WSSM	076-77295	076-71295	076-78295	076-36295	076-38295	076-75295	076-56295	076-55295	076-58295	076-98123
243 WSSM	076-77270	076-71270	076-78270	076-36270	076-38270	076-75270	076-56270	076-55270	076-58270	076-98124
243 Win Imp 40° (SH#1)	076-77420	076-71420	076-78420	076-36420	076-38420	076-75420	076-56420	076-55420	076-58420	076-98224
6MM Rem Imp 40°(SH#1)	076-77421	076-71421	076-78421	076-36421	076-38421	076-75421	076-56421	076-55421	076-58421	076-98224
6MM/284 Win (SH#1)	076-77414	076-71414	076-78414	076-36414	076-38414	076-75414	076-56414	076-55414	076-58414	076-98224
250 Savage (SH#1)*	076-77122*	076-71122*	076-78122*	076-36122*	076-38122*	076-75122*	076-56122*	076-55122*	076-58122*	076-98125
257 Roberts (SH#1)*	076-77125*	076-71125*	076-78125*	076-36125*	076-38125*	076-75125*	076-56125*	076-55125*	076-58125*	076-98225
257 Roberts Imp 40° (SH#1)	076-77322*	076-71322*	076-78322*	076-36322*	076-38322*	076-75322*	076-56322*	076-55322*	076-58322*	076-98225
25-06 Rem Imp 40° (SH#1)	076-77422*	076-71422*	076-78422*	076-36422*	076-38422*	076-75422*	076-56422*	076-55422*	076-58422*	076-98422
6.5MM/284 Winchester (SH#1)	076-77415	076-71415	076-78415	076-36415	076-38415	076-75415	076-56415	076-55415	076-58415	076-98226
6.5MM/06 (SH#1)	076-77378	076-71378	076-78378	076-36378	N/A	076-75378	N/A	076-55378	N/A	N/A
264 Winchester Mag (SH#6)*	076-77127*	076-71127*	076-78127*	076-36127*	076-38127*	076-75127*	076-56127*	076-55127*	076-58127*	076-98326
270 WSM	076-77255	076-71255	076-78255	076-36255	076-38255	076-75255	076-56255	N/A	076-58255	076-98227
7MM TCU (SH#10)*	076-77242*	076-71242*	076-78242*	076-36242*	076-38242*	076-75242*	076-56242*	076-55242*	076-58242*	076-99283
7MM B. R. Remington (SH#1)	076-77241	076-71241	076-78241	076-36241	076-38241	076-75241	076-56241	076-55241	076-58241	076-99183
7MM X 57 Mauser (SH#1)	076-77138*	076-71138*	076-78138*	076-36138*	076-38138*	076-75138*	N/A	076-55138*	N/A	N/A
280 Rem Imp 40° (SH#1)	076-77428	076-71428	076-78428	076-36428	076-38428	076-75428	076-56428	076-55428	076-58428	076-99483
284 Winchester (SH#1)*	076-77141*	076-71141*	076-78141*	076-36141*	076-38141*	076-75141*	076-56141*	076-55141*	076-58141*	076-99383
7MM Rem SA UM	076-77280	076-71280	076-78280	076-36280	076-38280	076-75280	076-56280	076-55280	076-58280	076-99383
7MM WSM	076-77265	076-71265	076-78265	076-36265	076-38265	076-75265	076-56265	076-55265	076-58265	076-99383
7MM Weatherby Mag (SH#6)*	076-77237*	076-71237*	076-78237*	N/A	N/A	076-75237*	N			

Neck Sizing Bushings



Bushing storage box is available separately.
Order No. 076-76999 \$2.13

TO DETERMINE BUSHING SIZE:

The correct bushing size can be determined by measuring the outside neck diameter of your loaded cartridges with a precision micrometer. With this measurement, subtract .002" to .003". This will allow for approximately .001" brass spring back after sizing and will result in a proper press fit for the bullet of .001" to .002".

Heat treated steel. The sizing diameters are hand-polished with a surface hardness of Rc 60-62 to reduce sizing effort. *Notes that is available but is not part of our inventory.

Steel Neck Sizing Bushings \$12.44

Order No.	Order No.	Order No.
076-73185 .185	076-73247 .247	076-73309 .309
076-73186 .186	076-73248 .248	076-73310 .310
076-73187 .187	076-73249 .249	076-73311 .311
076-73188 .188	076-73250 .250	076-73312 .312
076-73189 .189	076-73251 .251	076-73313 .313
076-73190 .190	076-73252 .252	076-73314 .314
076-73191 .191	076-73253 .253	076-73315 .315
076-73192 .192	076-73254 .254	076-73316 .316
076-73193 .193	076-73255 .255	076-73317 .317
076-73194 .194	076-73256 .256	076-73318 .318
076-73195 .195	076-73257 .257	076-73319 .319
076-73196 .196	076-73258 .258	076-73320 .320
076-73197 .197	076-73259 .259	076-73321 .321
076-73198 .198	076-73260 .260	076-73322 .322
076-73199 .199	076-73261 .261	076-73323 .323
076-73200 .200	076-73262 .262	076-73324 .324
076-73201* .201	076-73263 .263	076-73325 .325
076-73202* .202	076-73264 .264	076-73326 .326
076-73203* .203	076-73265 .265	076-73327 .327
076-73204* .204	076-73266 .266	076-73328 .328
076-73205* .205	076-73267 .267	076-73329 .329
076-73206* .206	076-73268 .268	076-73330 .330
076-73207* .207	076-73269 .269	076-73331 .331
076-73208* .208	076-73270 .270	076-73332 .332
076-73209* .209	076-73271 .271	076-73333 .333
076-73210* .210	076-73272 .272	076-73334 .334
076-73211* .211	076-73273 .273	076-73335 .335
076-73212 .212	076-73274 .274	076-73336 .336
076-73213* .213	076-73275 .275	076-73337 .337
076-73214* .214	076-73276 .276	076-73338 .338
076-73215* .215	076-73277 .277	076-73339 .339
076-73216* .216	076-73278 .278	076-73340 .340
076-73217* .217	076-73279 .279	076-73341 .341
076-73218* .218	076-73280 .280	076-73342 .342
076-73219 .219	076-73281 .281	076-73343 .343
076-73220* .220	076-73282 .282	076-73344 .344
076-73221* .221	076-73283 .283	076-73345 .345
076-73222 .222	076-73284 .284	076-73346* .346
076-73223 .223	076-73285 .285	076-73347* .347
076-73224 .224	076-73286 .286	076-73348* .348
076-73225 .225	076-73287 .287	076-73349* .349
076-73226 .226	076-73288 .288	076-73350* .350
076-73227 .227	076-73289 .289	076-73351* .351
076-73228 .228	076-73290 .290	076-73352* .352
076-73229 .229	076-73291 .291	076-73353* .353
076-73230 .230	076-73292 .292	076-73354* .354
076-73231 .231	076-73293 .293	076-73355* .355
076-73232 .232	076-73294 .294	076-73356* .356
076-73233 .233	076-73295 .295	076-73357 .357
076-73234 .234	076-73296 .296	076-73358 .358
076-73235 .235	076-73297 .297	076-73359 .359
076-73236 .236	076-73298 .298	076-73360 .360
076-73237 .237	076-73299 .299	076-73361 .361
076-73238 .238	076-73300 .300	076-73362 .362
076-73239 .239	076-73301 .301	076-73363 .363
076-73240 .240	076-73302 .302	076-73364 .364
076-73241 .241	076-73303 .303	076-73365 .365
076-73242 .242	076-73304 .304	076-73366 .366
076-73243 .243	076-73305 .305	076-73367 .367
076-73244 .244	076-73306 .306	076-73368 .368
076-73245 .245	076-73307 .307	
076-73246 .246	076-73308 .308	

Carbide Size Button -

Includes: Carbide Size Button, Retainer, and Spare Decapping Pin.



	Order No.	Price
Carbide Size Button Kit 22 cal	076-48223	\$24.89
Carbide Size Button Kit 6mm	076-48242	24.89
Carbide Size Button Kit 25 cal	076-48256	24.89
Carbide Size Button Kit 6.5mm	076-48263	24.89
Carbide Size Button Kit 270 cal	076-49276	24.89
Carbide Size Button Kit 7mm	076-49283	24.89
Carbide Size Button Kit 30 cal	076-49307	24.89
Carbide Size Button Kit 338 cal	076-49337	24.89

Titanium Nitride Heat treated steel as well but with the addition of a Titanium Nitride surface treatment to further increase the effective surface hardness and reduce sizing friction. *Notes that is available but is not part of our inventory.

Titanium Nitride Neck Sizing Bushings \$21.33

Order No.	Order No.	Order No.
076-76185 .185	076-76247 .247	076-76309 .309
076-76186 .186	076-76248 .248	076-76310 .310
076-76187 .187	076-76249 .249	076-76311 .311
076-76188 .188	076-76250 .250	076-76312 .312
076-76189 .189	076-76251 .251	076-76313 .313
076-76190 .190	076-76252 .252	076-76314 .314
076-76191 .191	076-76253 .253	076-76315 .315
076-76192 .192	076-76254 .254	076-76316 .316
076-76193 .193	076-76255 .255	076-76317 .317
076-76194 .194	076-76256 .256	076-76318 .318
076-76195 .195	076-76257 .257	076-76319 .319
076-76196 .196	076-76258 .258	076-76320 .320
076-76197 .197	076-76259 .259	076-76321 .321
076-76198 .198	076-76260 .260	076-76322 .322
076-76199 .199	076-76261 .261	076-76323 .323
076-76200 .200	076-76262 .262	076-76324 .324
076-76201* .201	076-76263 .263	076-76325 .325
076-76202* .202	076-76264 .264	076-76326 .326
076-76203* .203	076-76265 .265	076-76327 .327
076-76204* .204	076-76266 .266	076-76328 .328
076-76205* .205	076-76267 .267	076-76329 .329
076-76206* .206	076-76268 .268	076-76330 .330
076-76207* .207	076-76269 .269	076-76331 .331
076-76208* .208	076-76270 .270	076-76332 .332
076-76209* .209	076-76271 .271	076-76333 .333
076-76210* .210	076-76272 .272	076-76334 .334
076-76211* .211	076-76273 .273	076-76335 .335
076-76212 .212	076-76274 .274	076-76336 .336
076-76213* .213	076-76275 .275	076-76337 .337
076-76214* .214	076-76276 .276	076-76338 .338
076-76215* .215	076-76277 .277	076-76339 .339
076-76216* .216	076-76278 .278	076-76340 .340
076-76217* .217	076-76279 .279	076-76341 .341
076-76218* .218	076-76280 .280	076-76342 .342
076-76219* .219	076-76281 .281	076-76343 .343
076-76220* .220	076-76282 .282	076-76344 .344
076-76221* .221	076-76283 .283	076-76345 .345
076-76222 .222	076-76284 .284	076-76346* .346
076-76223 .223	076-76285 .285	076-76347* .347
076-76224 .224	076-76286 .286	076-76348* .348
076-76225 .225	076-76287 .287	076-76349* .349
076-76226 .226	076-76288 .288	076-76350* .350
076-76227 .227	076-76289 .289	076-76351* .351
076-76228 .228	076-76290 .290	076-76352* .352
076-76229 .229	076-76291 .291	076-76353* .353
076-76230 .230	076-76292 .292	076-76354* .354
076-76231 .231	076-76293 .293	076-76355* .355
076-76232 .232	076-76294 .294	076-76356* .356
076-76233 .233	076-76295 .295	076-76357 .357
076-76234 .234	076-76296 .296	076-76358 .358
076-76235 .235	076-76297 .297	076-76359 .359
076-76236 .236	076-76298 .298	076-76360 .360
076-76237 .237	076-76299 .299	076-76361 .361
076-76238 .238	076-76300 .300	076-76362 .362
076-76239 .239	076-76301 .301	076-76363 .363
076-76240 .240	076-76302 .302	076-76364 .364
076-76241 .241	076-76303 .303	076-76365 .365
076-76242 .242	076-76304 .304	076-76366 .366
076-76243 .243	076-76305 .305	076-76367 .367
076-76244 .244	076-76306 .306	076-76368 .368
076-76245 .245	076-76307 .307	
076-76246 .246	076-76308 .308	

Redding Reloading

Small Base Body Dies - Small Base body dies are now available in the following calibers for firearms with custom chamberings that are tighter than SAMMI Specs.



	Order No.	Price
223 Remington	076-74111	\$30.57
6mm PPC	076-74319	37.51
6mm BR Remington	076-74317	37.51
6mm/284 Winchester	076-74414	37.51
260 Remington	076-74531	30.57
6.5mm/284 Winchester	076-74415	37.51
284 Winchester	076-74141	37.51
308 Winchester	076-74155	30.57
30-06 Springfield	076-74148	30.57

Redding Decapping Pins 5 Pack



Order No. 076-01057P \$2.13

Shell Holders

Redding shellholders are of a Universal "Snap-In" design recommended for use with all Redding dies and can be used with other brands as well. Look at the number in parentheses after die caliber in the die listings for proper fit. If you need one for a caliber not listed, please ask our Tech.



How to find Shell Holder Size: Look at the die caliber in our Redding die listings, and the number of the shell holder is listed next to the caliber in parentheses.

Example: 223 Remington(SH#10)

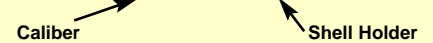

Shell Holders \$7.33

Order No.	Order No.
076-11001 SH #1	076-11016 SH #16
076-11002 SH #2	076-11017 SH #17
076-11003 SH #3	076-11018 SH #18
076-11004 SH #4	076-11019 SH #19
076-11005 SH #5	076-11020 SH #20
076-11006 SH #6	076-11021 SH #21
076-11007 SH #7	076-11022 SH #22
076-11008 SH #8	076-11023 SH #23
076-11009 SH #9	076-11024 SH #24
076-11010 SH #10	076-11026 SH #26
076-11012 SH #12	076-11027 SH #27
076-11013 SH #13	076-11035 SH #35
076-11014 SH #14	
076-11015 SH #15	

Extended Shell Holders

	Order No.	Price
Extended Shell Holder #1E	076-11501	\$11.60
Extended Shell Holder #5E	076-11505	11.60
Extended Shell Holder #10E	076-11510	11.60
Extended Shell Holder #12E	076-11512	11.60
Extended Shell Holder #13E	076-11513	11.60
Extended Shell Holder #17E	076-11517	11.60
Extended Shell Holder #19E	076-11519	11.60
Extended Shell Holder #21E	076-11521	11.60
Extended Shell Holder #22E	076-11522	11.60
Extended Shell Holder #23E	076-11523	11.60

Redding Case Trimmers and Accessories

Model 2400 Match Precision Case Trimming Lathe - The Model 2400 Case Trimming Lathe uses the extended cast iron frame of the Model 1400-XT to maximize case length capacity. The innovative push button chuck lock simplifies loading and unloading while facilitating perfect alignment of the case and pilot. Also increases case length capacity; accommodating not only the latest long action cartridges but old time classics as well. Case lengths up to 3-1/4" can be handled.

The Micrometer adds precision and repeat-ability to the case length adjustment. Changes of as little as .001" can be easily dialed in.

Includes:

- Universal collet (no others to buy)
- Replaceable Titanium Nitride (TiN) coated cutter
- Six pilots - .22 cal., 6mm, .25 cal., .270 cal., 7mm and .30 cal.
- Two neck cleaning brushes (.22 thru .30 cal.)
- Large and small primer pocket cleaners.



Model 2400 features:

- Micrometer...easy adjustments of .001".
- Cast iron frame to maintain precision alignment.
- Push button collet chuck is ideally suited for use with optional power adapter.
- Handles 3-1/4" case length.
- Universal collet fits all popular cases - no others to buy.
- TiN (Titanium Nitride) coated replaceable cutter.

Order No. 076-24000 \$149.31

Model 1400-XT Case Trimming Lathe - Cast iron frame that has been extended to handle all the latest long action cartridges. This case trimmer was designed using precision lathe principles. The TiN coated cutter is held stationary while the case is turned; this produces cases that are perfectly square, resulting in increased accuracy from your handloads.

Includes:

- Universal collet (no others to buy)
- Replaceable Titanium Nitride (TiN) coated cutter
- Six pilots - .22 cal., 6mm, .25 cal., .270 cal., 7mm and .30 cal.
- Two neck cleaning brushes (.22 thru .30 cal.)
- Large and small primer pocket cleaners.

Order No. 076-14000 \$86.21



Case Trimmer Pilots \$3.91ea

Order No.	Caliber	Order No.	Caliber
076-15220	22cal	076-15351	9mm
076-15239	6mm	076-15354	35cal
076-15253	25cal	076-15362	9.3mm
076-15260	6.5mm	076-15371	375cal
076-15273	270cal	076-15400	40cal
076-15280	7mm	076-15406*	41cal
076-15304	30cal	076-15412	416cal
076-15307	31cal	076-15426	44cal
076-15319	8mm	076-15447	45cal
076-15334	338cal	076-15454	458cal
076-15344	348cal		*Special Order

Case Trimmer Accessories

	Order No.	Price
TiN Cutter (17 & 20 caliber)*	076-14040	\$18.66
TiN Cutter & Shaft Complete	076-14045	24.00
TiN Cutter (Standard)	076-14050	18.66
Optional Power Adapter (1/4" Hex for use with Cordless Screwdrivers.)	076-14025	9.95
Model 1400 Cutter Shaft Only	076-14030	8.00

Bench Stand & Clamp

For convenient bench-top mounting of Redding Powder Measures. Will also fit all other Powder Measures with 7/8-14 thread mounting. This bench stand is not threaded; it is secured with a locking ring which enables you to rotate the measure to any desired position and permits quick dump of the reservoir. Clamp allows mount without bolting.



	Order No.	Price
Bench Stand	076-06000	\$30.22
Double "C" Clamo	076-30520	21.97



Redding / Imperial Sizing Die Wax - The original non-liquid sizing die lube. 1 oz. tin.
Order No. 076-21022 \$5.15

SAECO Lead Hardness Tester

A precision instrument which accurately determines the hardness of a bullet casting alloy. The SAECO Lead Hardness Tester pays for itself by allowing you to convert scrap lead into casting alloy.



Order No. 076-42000 \$143.81

Rifle Primer Pocket Uniformers

Designed to cut primer pockets to a uniform depth and square to the case head. The depth of cut is to SAAMI specifications and is controlled by a shoulder ground into the cutter that cannot change.



Each cutter is supplied with an integral holder having a #8-32 threaded shank to fit the Redding accessory handle.

	Order No.	Price
Large Primer Pocket Uniformer	076-09100	\$25.06
Small* Primer Pocket Uniformer	076-09105	25.06
Power Screwdriver Adapter	076-09110	2.31

*Note: Small Rifle Primer Pocket Uniformer is dimensionally correct for small pistol. Do not use the Large Rifle Primer Pocket Uniformer for Large Pistol.

DIE SPACER KIT For use with combination die sets and all 7/8-14 reloading dies to quickly compensate for case length or make a no-crimp adjustment without the need to move the lock rings.

The kit includes three spacers: (.062) No-crimp or partial resizing, (.125) 44 Spl/44 Mag spacer, (.135) 38 Spl/357 Mag spacer.

Order No. 076-80901 \$8.00



Redding Case Neck Gauge

Possibly one of the most important tools you will ever use! A quick and easy way to sort cases by neck wall thickness and uniformity. This tool allows you to accurately measure the neck wall thickness of the cartridge case and determine its uniformity.



Two mandrel sizes are supplied to allow measurement of all cases from .17 cal. to .338 cal.

Mounting base allows direct attachment to your reloading bench, or use the Redding double "C" clamp

Order No. 076-26400 \$78.21

Pilot stops are required for each caliber (see chart below). Two pilot stops are supplied with the tool, .22 cal. and .30 cal.

Stainless Steel Pilot Stops \$6.22ea

Precision CNC machined stainless steel, for use with the Redding Case Neck Gauge and Flash Hole Deburring tools. For 3/16" dia mandrels unless noted with an asterisk (*). *Pilots for small diameter 9/64" mandrels.



Order No.	Caliber	Order No.	Caliber
076-06117	17cal*	076-06126	6.5mm
076-06120	20cal*	076-06127	270cal
076-06121	22cal*	076-06128	7mm
076-06122	22cal	076-06130	30cal
076-06123	6mm*	076-06131	31cal
076-06124	6mm	076-06132	8mm
076-06125	25cal	076-06133	338cal

*Pilots for small diameter 9/64" mandrels

Both tools use Stainless Steel Pilot Stops listed below.



Universal Flash Hole Deburring Tool with Handle

For all calibers from .22 thru .338 cal. using standard (.080") flash holes. This tool controls the cutting depth with a built-in stop that locates on the inside web of the case. A unique feature of this tool is the cross drilled hole for chip relief. Uses standard pilot stops for 3/16" mandrels. Includes .30cal pilot stop

Order No. 076-06100 \$21.33

Small Flash Hole Deburring Tool with Handle

For .17 & .20 cal. and cases with small (.060") flash holes. This tool does not control the cutting depth. The operator must control the cutting depth using the small pilot stops for 9/64" mandrels. Includes .22cal pilot stop

Order No. 076-06110 \$21.33

Redding National Match Die Set

Redding now offers a specialized die set for the military match shooter. The set includes a Full-Length Sizing Die a Competition Bullet Seating Die and a Taper Crimp Die.



	Order No.	Price
223 Rem	076-39111	\$139.63
308 Win	076-39155	140.54
30-06 Spfd	076-39148	140.54

Forster Dies & Die Sets



Ultra (Micrometer) Seater Die Smooth as silk adjustments for precise seating measurements the very first time. The Forster Ultra[®] allows you to adjust seating depth to .001" or even .0005" increments.

Caliber	Full Length & Bench Rest Seater Die Set \$66.07	Full Length & Ultra Micrometer Seater Set \$91.97
17 Remington	070-004011	S/O**
204 Ruger	070-004021	070-U04022
22 Hornet	070-004041	070-U04042
221 Fireball	070-004071	070-U04072
222 Remington	070-004081	070-U04082
222 Rem Mag	070-004091*	S/O*
223 Remington	070-004101	070-U04102
223 WSSM	070-004111	070-U04112
224 Wby Mag	070-006921	S/O*
220 Swift	070-004131	070-U04132
22/250 Rem.	070-004141	070-U04142
240 Wby Mag	070-006931	070-U06932
243 Winchester	070-004171	070-U04172
243 WSSM	070-004175	070-U04178
6mm Rem.	070-004201	070-U04202
25/06 Rem.	070-004221	070-U04222
25 WSSM	070-004211	070-U04212
257 Ackley (40)	070-022431	070-U22432
257 Roberts	070-004241	070-U04242*
257 Wby Mag	070-007071	070-U07072
260 Rem.	070-004251	070-U04252
6.5x55 Swedish	070-004311	S/O*
270 Winchester	070-004331	070-U04332
270 Win Short Mag	070-004321	070-U04321
270 Wby Mag	070-007161	070-U07162
280 Rem	070-004421	S/O*
7mm STW	070-004341	070-U04342
7x64 Brenneke	070-004351	S/O*
7mm-08	070-004361	070-U04362
7x57 Mauser	-	070-U04382
7mm Rem Ultra Mag	070-004415	070-U04415
7mm Rem Short UltMag	070-004418	070-U04418
7mm Win Short Mag	070-004420	070-U04420
7mm Rem Mag	070-004401	070-U04402
30-30 Win.	070-004451	070-U04452
300 Rem Ultra Mag	070-004461	070-U04462
300 Rem Short UltMag	070-004465	070-U04465
300 Win. Mag.	070-004471	070-U04472
300 Win. Short Mag.	070-004481	070-U04482
303 British	-	S/O*
308 Win.	070-004501	070-U04502
308 Win. National	070-018331	S/O*
30/06 Springfield	070-004521	070-U04522
338 Win. Mag.	070-004581	S/O*
375 H&H	070-004651	S/O*
375 Rem Ultra Mag	070-004641	070-U04641
7mm Wby. Mag.	070-007231	070-U07232
300 Wby. Mag.	070-007361	070-U07362
30-378 Wby. Mag.	070-007381	070-U07382
340 Wby Mag	070-007371	070-U07372
6.5mm / 284	070-004281	070-U04282

S/O* - Denotes calibers that can be special ordered

Co-Ax[®] Case And Cartridge Inspector - Forster's exclusive Co-Ax[®] Case & Cartridge Inspector provides you with the ability to ensure uniformity by measuring three critical dimensions: Neck wall thickness, Case neck concentricity, and Bullet runout. Measurements are in increments of one-thousandth of an inch so accuracy is superb. **Order No. 070-010482 \$71.44**

FORSTER PRODUCTS



Extremely accurate and remarkably easy to use because they size the neck and shoulder of the case in just one step. Bushing Bump Dies also prevent over working the case necks, and allow control of the amount of neck tension for your bullet seating operation.

	Part No.	Price
204 Ruger	070-BBK2101	\$73.19
223 Rem	070-BBK2141	73.19
223 WSSM	070-BBK2171	73.19
22-250	070-BBK2191	73.19
243 Win	070-BBK2221	73.19
243 WSSM	070-BBK2241	73.19
6mm BR	070-BBK2301	73.19
6mm PPC	070-BBK2351	73.19
6.5-284	070-BBK2410	73.19
7mm Rem Mag	070-BBK2551	73.19
300 WSM	070-BBK2701	73.19
308 Win	070-BBK2751	73.19
30-06	070-BBK2851	73.19

The "Original" Case Graphiter - Base contains powdered graphite (MICA) and three brushes which accommodates calibers from .22 to .35. Cleans and lubricates case necks. MICA can be replaced with any dry lubricant. **Order No. 070-011341 \$11.92**



PRODUCTS CONTAINING MICA CAN NOT BE SHIPPED TO CALIFORNIA RESIDENTS.

Extra Powdered Graphite MICA - 2oz baggie. **Order No. 070-011341-012 \$73.19**

Forster Co-Ax Press and Accessories

Forster Co-Ax Press - No need to complicate the reloading process. The Co-Ax[®] Press keeps it simple while still delivering famous Forster precision.

The Co-Ax Press makes reloading faster, easier, and more accurate. Snap in and snap out die change. Spent primer catcher. Floating guide rods for perfect alignment.

ACCEPTS ANY 7/8x14 DIE SETS. Co-Ax shell holder is unique (spring loaded jaws) that adjust to any caliber. "S" Jaws fit all calibers except: 22 Hornet, 378 Wby., 45-70, 256 Win. Mag., 44 S&W, 416 Rigby, 416 Rem., 45-90 and 348 Win. These calibers can be used if you purchase the optional "LS" Jaws. No expensive shell holders required!

Order No. 070-028271 \$277.22



Order No.	Price
070-028271-001251	\$23.96
070-AP1000	
Shell Holder Adapter Plate (Use Std Shell holders on Co-ax Press)	14.93

Headspace Gauges

Rimmed Calibers	Go Length \$20.36	No Go Length \$20.36 **\$24.30	Field Length \$20.36 **\$24.30
219 Wasp & Zipper	070-BG3030G	070-BG3030N	070-BG3030F
22 Savage HP, 25-35	070-BG3030G	070-BG3030N	070-BG3030F
30-30, 32 Win Spl	070-BG3030G	070-BG3030N	070-BG3030F
32-40, 38-55	070-BG3030G	070-BG3030N	070-BG3030F
22 Rimfire	070-HG22RIMG	070-HG22RIMN	070-HG22RIMF
300 Mag & all Belted Mags	070-BG300MG	070-BG300MN	070-BG300MF
7.62x54 Russian	N/A	070-BG762RN	070-BG762RF
303 British	070-BG303G	070-BG303N	070-BG303F
30-40 Krag	070-BG3040G	070-BG3040N	070-BG3040F
30 Carbine	070-HG0030N**	070-HG0030F**	070-BGWBYF
Weatherby Magnums (378 Wby, 416 Wby, 30-378 Wby, 460 Wby)	070-BGWBYG	N/A	070-BGWBYF

Rimless Calibers	Go Length \$20.36	No Go Length \$20.36	Field Length \$20.36
22/250 Rem.	070-HG2225G	070-HG2225N	070-HG2225F
22 PPC	070-HG0PPCG	070-HG0PPCN	070-HG0PPCF
220 Swift	070-HG0220G	070-HG0220N	070-HG0220F
222 Remington	070-HG0222G	070-HG0222N	070-HG0222F
222 Remington Magnum	070-HG022MG	070-HG022MN	070-HG022MF
223 Remington	070-HG0223G	070-HG0223N	070-HG0223F
243 Winchester	070-HG0243G	070-HG0243N	070-HG0243F
260 Remington	070-HG0243G	070-HG0243N	070-HG0243F
308 Winchester	070-HG0243G	070-HG0243N	070-HG0243F
358 Winchester	070-HG0243G	070-HG0243N	070-HG0243F
7mm-08 Remington	070-HG0243G	070-HG0243N	070-HG0243F
244 Remington	070-HG0244G	070-HG0244N	070-HG0244F
250 Savage	070-HG0250G	070-HG0250N	070-HG0250F
6mm PPC	070-HG0PPCG	070-HG0PPCN	070-HG0PPCF
6.5 Skan	070-HGSKANG	070-HGSKANN	N/A
6.5x55 Swede	070-HG6555G	070-HG6555N	070-HG6555F
257 Roberts	070-HG0257G	070-HG0257N	070-HG0257F
7mm Mauser	070-HG0257G	070-HG0257N	070-HG0257F
280 Remington	070-HG0280G	070-HG0280N	070-HG0280F
284 Winchester	070-HG0284G	070-HG0284N	070-HG0284F
25-06 Remington	070-HG3006G	070-HG3006N	070-HG3006F
270 Winchester	070-HG3006G	070-HG3006N	070-HG3006F
30-06 Springfield	070-HG3006G	070-HG3006N	070-HG3006F
8mmx57 Mauser	070-HG8X57G	070-HG8X57N	070-HG8X57F



Headspace Gages The best way to check your rifle chamber for safety.

Every gunsmith knows that proper use of a headspace gage is the most reliable way to test the length of a rifle chamber. "Headspace" is the distance between the face of the breech and the base of the cartridge when the action is closed, and excessive headspace can be dangerous as well as impair accuracy. For instance, unsupported brass fired in a rifle action with excessive headspace can rupture, allowing gas to blow rearward like a rocket exhaust.

Important Guidelines For Measuring Headspace:

- If a rifle closes on a GO gage, the rifle chamber will accept any ammunition that is made within S.A.A.M.I. (industry standard) specifications.
- If a rifle closes on a NO GO gage, the rifle chamber might have excessive headspace. Most gunsmiths chamber a rifle's headspace between the GO and NO GO dimensions.
- If a rifle closes on a FIELD gage, rifle chamber is dangerously close to or already over the S.A.A.M.I. specified maximum chamber size.



Forster Case Trimming



The "Original" Forster Case Trimmer - The right choice for most calibers with bullet diameters from .171" to .459". It's actually a fine miniature lathe with a superior shell holder design based on a Brown & Sharpe type collet. Collets #1 through #4 fit the "Original" Case Trimmer and hold the rims of most rifle and pistol calibers within that range. The "Original" Case Trimmer allows you to go as far as you need to go with your reloading because it allows you to expand your system by adding any of the accurizing accessories. **Order No. 070-CT1010 \$54.39**

The "Original" Forster Case Trimmer Kit - Kit comes complete with the "Original" Case Trimmer, collets 1, 2 & 3 and pilots 22, 24, 25, 27, 28 & 30 which satisfy the needs of most rifle handloaders. **Order No. 070-CTK100 \$82.09**

Forster "Classic" Case Trimmer - Larger than the "Original" Case Trimmer, the "Classic" accommodates a large range of classic cartridges. It's suitable for more than three-hundred different big bore calibers from popular big game rifles to classic black powder calibers. The "Classic" trims case lengths from 1 7/8" long through 4 1/8" long; shorter cases can be trimmed by mounting on a standard length base(sold separately). **Order No. 070-CLCT00 \$74.57**

.50 BMG Case Trimmer - Enthusiasts of the .50 Cal BMG cartridge now have access to a reloading tool to help them economize on the high cost of ammunition. The .50 BMG Case Trimmer is designed specifically for the reloading needs of .50 Cal BMG shooters. It does not require a collet but it comes complete with a #510 pilot and rim holder. Optional # 505 pilot may be needed for some 50 BMG Cases. **Order No. 070-50BMGCT \$80.21**

Short And Long Case Trimmer Bases - Two optional bases are available for the "Original" Case Trimmer.

	Order No.	Price
Short Trim Base .374 or shorter (4 5/8" long base)	070-CTB102	\$15.54
Long Trim Base for .375 or longer (6 1/2" long base).	070-CTB103	\$15.54

Power Adapter - This simple to use device screws onto the cutter shaft of your Forster Case Trimmer in place of the hand crank. The adapter functions best with a cordless screwdriver that has an rpm of 140 or higher. It may also be used with a small power drill. **Order No. 070-PA1000-100 \$12.05**

	Order No.	Price
Replacement Cutter Shaft .17 Cal. Only	070-CT1010-CTC417	\$14.90
Replacement Cutter Shaft All Cal. But .17	070-CT1010-CTC400	14.90

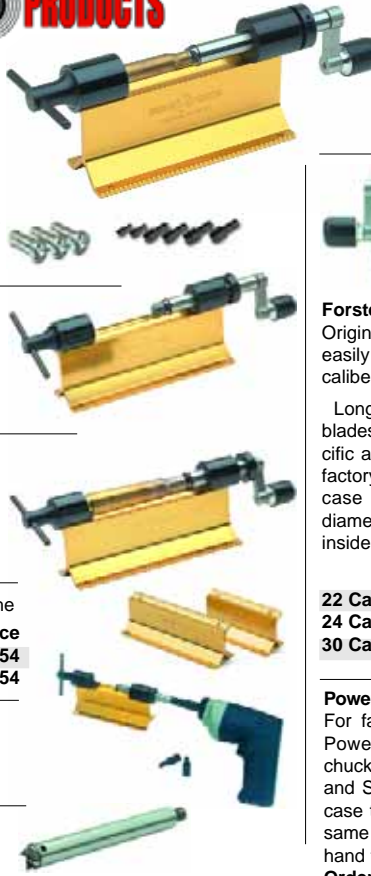

Deburring Tool - Those sharp corners and edges that result from trimming a case can be removed quickly and accurately with an Inside-Outside-Deburring Tool. DBT Base is fast and saves allows you to keep your trimmer ready for trim jobs!
Order No. 070-DB1000 \$15.54



Optional DBT Base - DBT Base is fast and saves allows you to keep your trimmer ready for trim jobs!
Order No. 070-DB2000 \$24.35

Forster 3 in 1 Case Mouth Cutter - Accessory for your Original Case Trimmer. It fits over the cutter shaft and easily secures with one set screw. It is available in three calibers.

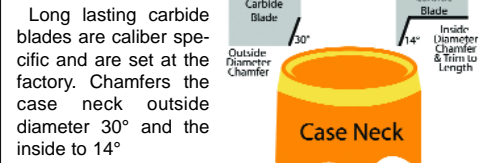

Order No.

22 Cal	070-3CUT224	\$54.41
24 Cal	070-3CUT243	54.41
30 Cal	070-3CUT308	54.41

Power Case Trimmer w/out collet or pilot - For fast and accurate case trimming try the Power Case Trimmer. The cutter shaft chucks into a drill press. The same Brown and Sharpe type collet that makes our hand case trimmer so accurate is used. Uses the same collets and pilots as the hand tool.
Order No. 070-PT1010 \$51.39



Case Trimmer Collets and Pilots



These collets and pilots are designed for use in both the Forster hand and power trimmers. (Please be careful when ordering these. If you give the wrong number, you will receive the wrong item). **If you order the .17 pilot, you must order the .17 caliber cutter shaft in the trimmer section to use the pilot!

	Order No.	Price
Case Trimmer Collet #1 (.379 .473 .532)	070-CT2001	\$9.39
Case Trimmer Collet #2 (.350 .418 .506)	070-CT2002	9.39
Case Trimmer Collet #3 (.356 .440 .545)	070-CT2003	9.39
Case Trimmer Collet #4 one step .605	070-CT2004	9.39
Classic Case Trimmer Collet #5 (A .584 B .675)	070-CT2005	9.39
Classic Case Trimmer Collet #6 (A .545 B .660)	070-CT2006	9.39
Classic Case Trimmer Collet #7 (A----- B .640)	070-CT2007	9.39
Classic Case Trimmer Collet #8 (A----- B .610)	070-CT2008	9.39

Forster Case Trimmer Pilots

	Order No.	Price		Order No.	Price
Pilot 171	070-CT1017	\$3.63	Pilot 355/356	070-CT1351	\$3.63
Pilot 204	070-CT1020	3.63	Pilot 365	070-CT1368	3.63
Pilot 223	070-CT1022	3.63	Pilot 375	070-CT1375	3.63
Pilot 224	070-CT1022	3.63	Pilot 400	070-CT1400	3.63
Pilot 243	070-CT1024	3.63	Pilot 405	070-CT1405	3.63
Pilot 257	070-CT1025	3.63	Pilot 410	070-CT1410	3.63
Pilot 263	070-CT1026	3.63	Pilot 416	070-CT1416	3.63
Pilot 277	070-CT1027	3.63	Pilot 422	070-CT1422	3.63
Pilot 284	070-CT1028	3.63	Pilot 429	070-CT1432	3.63
Pilot 338	070-CT1033	3.63	Pilot 451	070-CT1452	3.63
Pilot 308	070-CT1030	3.63	Pilot 454	070-CT1455	3.63
Pilot 311	070-CT1031	3.63	Pilot 457	070-CT1458	3.63
Pilot 323	070-CT1032	3.63	Pilot 483	070-CT1483	3.63
Pilot 333	070-CT1033	3.63	Pilot 505	070-CT1505	3.63
Pilot 348	070-CT1034	3.63	Pilot 510	070-CT1510	3.63
Pilot 357/358	070-CT1035	3.63	Pilot 513	070-CT1513	3.63

CARTRIDGES	Bullet Diameter	Trim Pilot Order#	Collet Order#	Neck Reamer Order#	Neck Reamer Diameter
17 Rem. (requires 17 cal. cutter shaft)	.171"	CT1017	CT2001	NR1017	.1730"
204 Ruger	.204"	CT1020	CT2001	NR1204	.2065"
22 Hornet, 22 K Hornet-if .224" bullet is reloaded see next line	.223"	CT1022	2 or 3	NR1223	.2255"
222 Rem., 222 Rem. Mag., 22 Varm., 223 Rem., 225 Win., 5.6x50R	.224"	CT1022	CT2001	NR1224	.2265"
22 250, 220 Swift, 221 Fireball, 22 PPC, 22 B.R. Rem.	.224"	CT1022	CT2001	NR1224	.2265"
218 Bee & Mashburn, 219 Zipper and Wasp, 22 Sav., 22-30-30	.224"	CT1022	CT2002	NR1224	.2265"
228 Krag, 22 Jet C.F. Magnum, 224 Varm. Weatherby,	.224"	CT1022	CT2003	NR1224	.2265"
243 Win., 6mm, 6mm mag & Belted Exp., 244 Rem., 6mm B.R. Rem.	.243"	CT1024	CT2001	NR1243	.2455"
6mm PPC	.243"	CT1024	CT2003	NR1243	.2455"
6mm Krag and 6mm Krag Long	.243"	CT1024	CT2003	NR1243	.2455"
257, 250 Sav. & Ackley, 250-3000, 25 Souper, 25-06	.257"	CT1025	CT2001	NR1257	.2595"
25-20 Repeater, 25-35, 25 Rem.	.257"	CT1025	CT2002	NR1257	.2595"
25 Krag Imp., 256 Win.	.257"	CT1025	CT2003	NR1257	.2595"
6.5x57 Mau., 6.5mm Win., 6.5 Jap Mau., 6.5x55 Swede & SKAN	.264"	CT1026	CT2001	NR1263	.2665"
6.5x257 Jap, 256 Newton, 260 A.A.R., 264 Win. Mag, 260 Rem.	.264"	CT1026	CT2001	NR1263	.2665"
270 Win., Sav., Gibbs, Weatherby & Ackley, 257 H & H	.277"	CT1027	CT2001	NR1277	.2795"
7mm, 7x57 Mau., 7mm Weatherby, 7x64, 276, 7mm-08, 7mm TCU	.284"	CT1028	CT2001	NR1284	.2865"
280 Rem., 284 Win., 7mm Rem. Mag., 7mm B.R. Rem.	.284"	CT1028	CT2001	NR1284	.2865"
30-06, 308 Win., 300 Mag., 7.62 NATO, 300 Savage	.308"	CT1030	CT2001	NR1308	.3110"
30-30, 30 Rem., 30 WCF, 303 Savage, 7.5x55 Swiss	.308"	CT1030	CT2002	NR1308	.3110"
30-40 Krag, 30 Carbine, 30-40 Imp., 7.62x39, 300 Rem Ultra Mag	.308"	CT1030	CT2003	NR1308	.3110"
303 British, 32 S&W Long, 7.65 Mau., 7.7mm Jap	.311"	CT1031	CT2001	NR1311	.3135"
32-20	.311"	CT1031	CT2002	NR1311	.3135"
8x57, JS & RS, 8x60, 7.92x57, 8mm-06, 8mm Mauser	.323"	CT1032	CT2001	NR1323	.3255"
32 Win. Spec., 32 Rem., 32-40	.323"	CT1032	CT2002	NR1323	.3255"
333 Win., 333 OKH, 33 Ackley	.333"	CT1033	CT2001		
33 Win.	.338"	CT1033	*CT2004		
338 Win., 338 Win. Mag., 338 Gibbs, 340 Weatherby Mag.	.338"	CT1033	CT2001	NR1338	.3405"
348 Win.	.348"	CT1034	*CT2004		
35 Rem., 358 Win., 358 Norma Mag.	.357", .358"	CT1035	CT2001	NR1358	.3605"
38 Colt Super	.357", .358"	CT1035	CT2002	NR1358	.3605"
38 Spec., 357 Magnum, 35 Win.	.357", .358"	CT1035	CT2003	NR1358	.3605"
9mm Luger (needs extra short base)	.355", .356"	CT1351	CT2002	NR1355	.3575"
380 Auto (needs extra short base)	.356"	CT1351	CT2001		
9.3mmx74R, 9.3mmx62	.365"	CT1368	CT2001		
375 Mag., 375-06, 375 Barnes, Weatherby & Ackley, 375 H&H	.375"	CT1375	CT2001	NR1375	.3780"
38-50, 378 Weatherby	.375"	CT1375	*CT2004	NR1375	.3780"
375 Winchester	.376"	CT1375	CT2002	NR1375	.3780"
41 Coll. 401 Win., 38-40, 395-400, 41 S&W	.400"	CT1400	CT2001	NR1400	.4025"
10mm Auto Pistol, 40 S&W	.400"	CT1400	CT2003	NR1400	.4025"
41 Rem., Mag.	.410"	CT1410	CT2002	NR1410	.4125"
416 Weatherby, 416 Rigby	.416"	CT1416	*CT2004		
44 S&W Spec., 44 Rem. Mag., 44-40, 444 Marlin Mag.	.429"	CT1432	CT2001	NR1432	.4340"
45 ACP, 45 Auto Rim., 45 Win. Magnum	.452"	CT1452	CT2001	NR1452	.4545"
45-90 Sharps Str.	.454"	CT1452	*CT2004		
45 Long Colt	.452" (Pre-WWII), .454"	CT1455	1 or 2		
45-70	.457"	CT1458	*CT2004		
450 Watts, 458 Win., 450 Ackley Mag.	.459"	CT1458	CT2001	NR1458	.4605"

Forster Case Trimming Accessories

Add these high performance accessories to your Forster Case Trimmer System



Forster Case Trimmer Accessories - 1/8" pistol or 1/16" rifle Hollow Pointer works for factory and hand-loaded ammunition. The chamfer tool for removing crimp from military cases. Primer pocket center and cleaner clean out powder residue left in primer pockets after firing.

	Order No.	Price
Rifle Hollow Pointer 1/16"	070-HP1016	\$14.38
Pistol Hollow Pointer 1/8"	070-HP1008	14.38
Primer Pocket Center	070-PPCE02	5.83
Chamfer Tool	070-PPCT01	15.54
Large Primer Pocket Cleaner	070-PPC210	6.41
Small Primer Pocket Cleaner	070-PPC175	6.41

Case Trimmer Accessory Case (products shown in case not included) - CASE ONLY! **Order No. 070-AC5000 \$9.26**

Outside Neck Turner and Accessories - Turn necks concentric with this Forster accessory. All you need to change calibers is an extra OT Pilot. Please note: The OT Pilot and CT pilots are different. You cannot interchange these 2 pilots!!

	Order No.	Price
Outside Neck Turner less pilot	070-OT1010	\$30.57
Spare Carbide Cutter All Calibers	070-OT1010-012	11.85
OT Pilot	See Below	7.51

OT Pilot	Order No.	OT Pilot	Order No.
OT Pilot 171 dia.	070-OT2017	OT Pilot 308 dia.	070-OT2308
OT Pilot 204 dia.	070-OT2204	OT Pilot 311 dia.	070-OT2311
OT Pilot 224 dia.	070-OT2224	OT Pilot 323 dia.	070-OT2323
OT Pilot 243 dia.	070-OT2243	OT Pilot 333 dia.	070-OT2333
OT Pilot 257 dia.	070-OT2257	OT Pilot 338 dia.	070-OT2338
OT Pilot 264 dia.	070-OT2264	OT Pilot 358 dia.	070-OT2358
OT Pilot 277 dia.	070-OT2277	OT Pilot 375 dia.	070-OT2375
OT Pilot 284 dia.	070-OT2284		

	Order No.	Price	Order No.	Price
	070-NR1017	.171	070-NR1323	.323
	070-NR1223	.223	070-NR1338	.338
	070-NR1224	.224	070-NR1358	.358
	070-NR1243	.243	070-NR1375	.375
	070-NR1257	.257	070-NR1400	.400
	070-NR1264	.264	070-NR1410	.410
	070-NR1277	.277	070-NR1432	.432
	070-NR1284	.284	070-NR1452	.452
	070-NR1308	.308	070-NR1458	.458
	070-NR1311	.311		

Inside Neck Reamer - Designed to remove excess brass from the inside of thickened neck walls. **Price \$18.14 each**

Hand Outside Neck Turner (pilots not incl.) - For .17 through .60 caliber, including .50 BMG! Features a Carbide Neck Thickness Cutter and Micrometer Adjustment Knob with fine adjustments in either direction. .001" (thousandth). **Order No. 070-HOT100 \$57.65**



Hand Outside Neck Turner Pilots - Centerless Ground Pilots (mandrels). Standard pilot is precision ground .002" to .0025" smaller than bullet diameter.

Pilot for Dia:	Order No.	Price	Pilot for Dia:	Order No.	Price
HOT Pilot 171 dia.	070-HOT2017	9.46	HOT Pilot 400 dia.	070-HOT2400	9.46
HOT Pilot 204 dia.	070-HOT2204	9.46	HOT Pilot 405 dia.	070-HOT2405	9.46
HOT Pilot 224 dia.	070-HOT2224	9.46	HOT Pilot 410 dia.	070-HOT2410	9.46
HOT Pilot 243 dia.	070-HOT2243	9.46	HOT Pilot 416 dia.	070-HOT2416	9.46
HOT Pilot 257 dia.	070-HOT2257	9.46	HOT Pilot 422 dia.	070-HOT2422	9.46
HOT Pilot 264 dia.	070-HOT2264	9.46	HOT Pilot 432 dia.	070-HOT2432	9.46
HOT Pilot 277 dia.	070-HOT2277	9.46	HOT Pilot 452 dia.	070-HOT2452	9.46
HOT Pilot 284 dia.	070-HOT2284	9.46	HOT Pilot 455 dia.	070-HOT2455	9.46
HOT Pilot 308 dia.	070-HOT2308	9.46	HOT Pilot 458 dia.	070-HOT2458	9.46
HOT Pilot 311 dia.	070-HOT2311	9.46	HOT Pilot 474 dia.	070-HOT2474	9.46
HOT Pilot 323 dia.	070-HOT2323	9.46	HOT Pilot 483 dia.	070-HOT2483	9.46
HOT Pilot 333 dia.	070-HOT2333	9.46	HOT Pilot 505 dia.	070-HOT2505	9.46
HOT Pilot 338 dia.	070-HOT2338	9.46	HOT Pilot 510 dia.	070-HOT2510	9.46
HOT Pilot 358 dia.	070-HOT2358	9.46	HOT Pilot 513 dia.	070-HOT2513	9.46
HOT Pilot 375 dia.	070-HOT2375	9.46			



Forster Bullet Puller (Less Collet) - For fast, economical take down of loaded ammunition. Collet advances upon tightening to grip the bullet at case mouth (especially important for round nosed or tapered bullets). Won't damage bullets. Bullet Puller comes less collet!! The Forster Collet Style Bullet Puller fits any 7/8" X 14 thread reloading press and bullets from .17 caliber to .458. This bullet puller is not intended for use with the Forster Co-Ax® Press.

Order No. 070-BP1010 \$13.28

	Order No.	Price		Order No.	Price
B P Collet 17 dia.	070-BP2017	8.94	B P Collet 323 dia.	070-BP2323	\$8.94
B P Collet 224 dia.	070-BP2224	8.94	B P Collet 338 dia.	070-BP2338	8.94
B P Collet 243 dia.	070-BP2243	8.94	B P Collet 348 dia.	070-BP2348	8.94
B P Collet 257 dia.	070-BP2257	8.94	B P Collet 357 dia.	070-BP2357	8.94
B P Collet 264 dia.	070-BP2264	8.94	B P Collet 358 dia.	070-BP2358	8.94
B P Collet 277 dia.	070-BP2277	8.94	B P Collet 375 dia.	070-BP2375	8.94
B P Collet 284 dia.	070-BP2284	8.94	B P Collet 410 dia.	070-BP2410	8.94
B P Collet 308 dia.	070-BP2308	8.94	B P Collet 432 dia.	070-BP2432	8.94
B P Collet 311 dia.	070-BP2311	8.94	B P Collet 452 dia.	070-BP2452	8.94
B P Collet 333 dia.	070-BP2333	8.94	B P Collet 458 dia.	070-BP2458	8.94

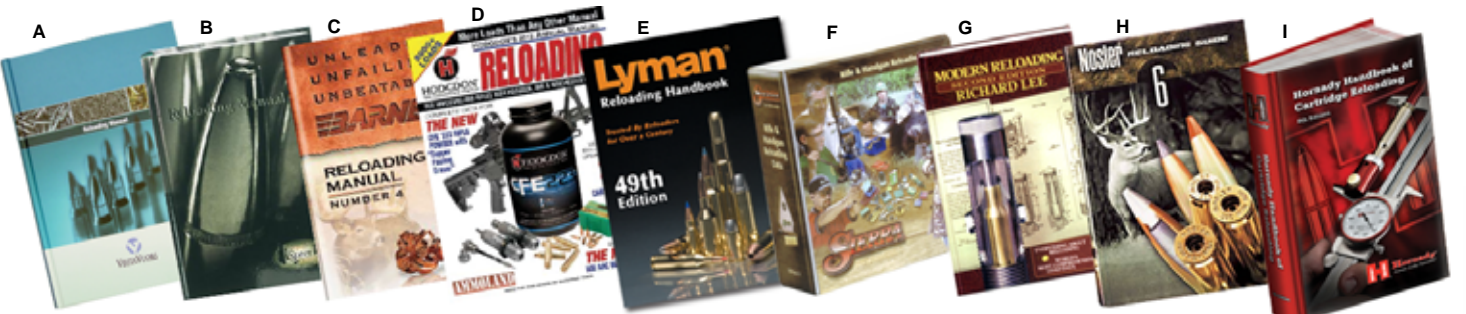

- A - VihtaVuori Reloading Manual #4** Order No. 109-4319707 \$32.96
- B - Speer #14 Reloading Manual** - Sorry, we did not have information or pictures at the time of print, due in June! Order No. 021-9515 Price \$27.78
- C - Barnes Reloading Manual #4** - Includes data for Barnes XLC coated bullets and VLC coated bullets with noted accuracy loads. Order No. 035-BRM4 \$21.93
- D - Hodgdon Annual Manual 2012**- 100-plus pages of rifle and pistol data with well over 5,000 shown loads, information on 30 Hodgdon, 19 IMR and 10 Winchester brand powders, new .300 AAC Blackout data, lead free bullet recipes for 21 rifle cartridges, and seven highly anticipated articles on such topics as economical handloading with lead-free "green" bullets by some of the top outdoor writers. A complete resource for the Hodgdon propellant called CFE223 or "Copper Fouling Eraser" that greatly deters copper fouling, shown in 27 different cartridges and 147 loads. Order No. 034-AM12 Price \$6.63
- E - Lyman's 49th Edition Reloading Handbook** - Covers all popular rifle calibers such as the 204 Ruger, 6.8 Rem SPC, 325 WSM, 338 Federal, 375 Ruger, 405 Winchester and the WSSM series. In addition, pistol calibers such as the 5.7x28mm, and 460 S&W are also included. Most popular bullet brands are also used including Barnes, Hornady, Nosler, Sierra, Speer, and Swift. Full coverage is also given to Lyman cast bullets throughout the handbook. **49th Ed. Reloading Handbook Softcover** Order No. 015-9816049 \$18.00 **49th Ed. Reloading Handbook Hardback** Order No. 015-9816052 \$25.72

- F - Sierra 5th Edition Rifle and Handgun Reloading Manual**- This three ring binder format manual has new cartridge introductions, histories and reloading recommendations. New bullets and powders also covered. An essential accessory for any reloading bench. Order No. 007-0500 Price \$25.50
- G - Lee's 2nd Edition Modern Reloading Manual**- Over 26,000 loads! All in an organized format, with velocities for starting loads. Load data supplied by the powder companies, the best kind of load data you can have! Latest information on pressure! Exclusive pressure and velocity factors enable you to accurately calculate pressure and velocity for reduced loads. An absolute must for cast bullet shooting. Hundreds of cast bullet loads, with charts and rules about priming. Over 700 pages! Order No. 006-90277 Price \$14.33
- H - Nosler 6th Reloading Manual**- Data for the 204 Ruger®, the Winchester short and super short families. All of the Remington Ultra Magnums are included. Even the 7mm RUM can be found among the more than ten new cartridges added to this manual. All of the cartridges have been updated to provide the best data for all of Nosler's bullets, including the AccuBond®. Order No. 115-50006 Price \$21.31
- I - 8th Edition Reloading Manual**- Containing nearly 1100 pages, the handbook features the latest information for all the newest Hornady bullets including: FTX, GMX, DGS, DGX. Also incorporates data for recently released propellant like Hodgdon's groundbreaking Superformance and LEVERevolution powders, as well as RL 17, 4007SSC, 8208XBR, Hybrid 100V and more. Order No. 003-99238 \$27.05

MTM Rifle Ammunition Boxes

Case-Gard R-50 Series



.22 Hornet, .30 Carbine, 6 x 47
:In the bullet down position = .218
Bee, .17/.222/.223 Rem., .222
Rem. **Order No.**
008-22HORN \$4.15

.17/.221/.222/.223 Rem., .222 Rem. Mag., 6 x47
Order No.

Clear Green **008-RS5016T \$2.61**
Clear Blue **008-RS5024 2.61**
Clear Smoke **008-RS5041T 2.61**



22-250, .250 Sav., .35 Rem., 6MM PPC, 7MM BR,
7.62x39

Order No.

Green **008-RSS5010 \$2.84**
Clear Green **008-RSS5016T 2.84**
Clear Blue **008-RSS5024 2.84**



.220 Swift, .243 Win., .300 Sav., .308 Win., .35
Rem., 6MM Rem., 8MM-06

Order No.

Green **008-RM5010 \$2.84**
Blue **008-RM5024 2.84**
Clear Green **008-RM5016T 2.84**
Clear Smoke **008-RM5041T 2.84**



25-06, .270 Win., .280 Rem., 30-06 US, .35 Whelen, 7
x57, 7 x64 Bren, 7MM Mauser

:In the bullet down position = .257/.300/.340/7mm Wby.
Mag., .260 Rem., .264 Win. Mag., .300 H&H Mag., .300
Win. Mag., .338 Win., .375 H&H Mag., 40-70, .405
Win., .416 Rem. Mag., .444 Mar., .458 Win. Mag., 7MM
Rem. Mag., 7mm-08 Rem., 7.5x54.5 Swiss

Order No.

Green **008-RL5010 \$2.84**
Blue **008-RL5024 2.84**

Silhouette Case-Gard 100

Large - Holds 100 rounds of ammo from
.22-250 through .375 H&H plus 40-70,
45-70 & .410 shotshells. Measures
7 1/2"x8"x4 3/8". R100MAG
Fits most wide bodied Magnums!

Order No. Price
008-R100 \$11.10
008-R100MAG 11.10



Small - Rifle Case Gard Silhouette 100
holds 100 rounds of ammunition for .17,
.222, .223, .222 Mag., 6x47. A must for
all silhouette shooters. 4 3/4"x5 3/8"x3".

Order No. Price
Green **008-RS10010 \$4.12**
Blue **008-RS10024 4.12**



Ammunition Wallets

Rifle / Pistol 30 Round Wallet

This wallet style MTM case hold
30 .22 LR, .22 CB or .22 Magnum
cartridges.

Order No. 008-3022M \$4.68

18 Round Pistol Wallet

Triple your fire power with this handy pistol
wallet. Holds 18 rounds of ammo securely.
Great when target practicing or when you
need extra fire power.

Order No. Price
38S-357M **008-1838 \$5.27**
44 Mag. **008-1844 5.27**
45 Auto **008-1845 5.27**
9mm & 380 **008-189 5.27**



Case-Gard H-50 Series

With convenient
handle on top.



17/.221/.222/.223 Rem.,
222 Rem. Mag., 25-20, 6 x 47
Order No. 008-H50RS \$7.46

22-250, .220 Swift, .243 Win., .250 Sav., 30-30 Win.,
.300 Sav., .308 Win., 6MM Rem., 6MM PPC, 6.5 x55
Swed., 7 x57, 7MM BR, 7MM Mau., 7.62x39, (45-70
Bullet Down) **Order No. 008-H50RM \$7.46**

25-06, .270 Win., .280 Rem., 30-06 US., .35 Whelen,
8MM-06, 8MM Mua, 9.3 x57 Mau. .410 Shotshell(rim
up) **Order No. 008-H50RL \$7.46**

.257 Wby. Mag., .264 Win. Mag., 30-30 Win., .300 Wby.
Mag., .300 Win. Mag., .303 Brit., 303 Sav., .32 Win.
Sp., .338 Win. Mag., .375 H&H Mag., 38-55 Ballard,
.416 Rem. Mag., .444 Mar., .458 Win. Mag., 7MM Rem.
Mag., 7MM WbyMag.

Order No. 008-H50RMAG \$7.46

.300/ .338 Rem Ultra Mag.,
45-70, 45-90, .416 Rigby, .416 Rem. Mag.: In the bullet
down position = .378/.416/.460 Wby. Mag.,
.465/.470/.500 Nitro Exp., 28 Gauge Shotshells
Order No. 008-H50XL \$9.53

Ammo Box Foam Liner Pad

Reduces case rattle, protects
bullet tips. Easy to cut for any
size. Comes in a 7 1/4"x 7 1/4"
square. 1/2" thick.

Order No. 008-FL1 \$1.83



Rifle Case-Gard 60

Holds 60 rifle cartridges; available
in RM60 - Medium to fit .22-.250 to
.308 Win. and RL60 - Large to fit
220 Swift to .458 Win.

Order No. Price
Med Rifle **008-RM60 \$5.32**
Lg Rifle **008-RL60 5.32**



Rifle 20 Round Belt Case

Worn on the belt. Puts 20 rounds
at your fingertips. Cartridges fit
bullet head down for easy
removal. Snap-lock latch.

Order No. Price
17 Rem. - 222 Mag. **008-RS20 \$4.29**
.219 Z - .308 W **008-RM20 4.29**
.25/06 - .375 H&H **008-RL20 4.29**



READ THIS! VERY IMPORTANT!

We DO NOT order MTM cases by color
except those noted. We cannot pick colors
of cases unless noted.



Flip Top 50 Round Large Magnum Caliber (Small) -
223/243/25 WSSM, 460/500 S&W Mag, 475/500
Linebaugh, 50-70 DGW

Order No.
Green **008-RSLD5010 \$2.84**
Clear Green **008-RSLD5016T 2.84**
Clear Blue **008-RSLD5024 2.84**



Flip Top 50 Round Large Magnum Caliber (Medium)
- 270/300 WSM, 38-55/348 Win, 45-70 Govt, 45-75
WCF, 45-90, 450 Marlin, 6.5 Rem Mag

Order No.
Green **008-RMLD50 \$2.84**

Flip Top 50 Round Large Magnum Caliber (Large) -
260 Rem., 257 - 7mm Wby. Mag., 264 / 300 / 330 / 338
/ 458 Win. Mag., 300 / 375 H&H Mag., 300 / 338 / 375
/ 7mm / Rem. Ultra Mag., 303 Brit., 405 Win., 444
Marlin, 458 Lott, 7mm STW

Order No.
Green **008-RLLD5010 \$2.84**
Clear Blue **008-RLLD5024 2.84**
Clear Green **008-RLLD5016T 2.84**



Shotshell Cases

Shotshell 25 Round Case

Holds 3 1/2" 10ga or 12ga Magnums
Order No. 008-S2512M \$3.10



Removable Grid- Offers the choice of
either 12ga or 20ga usage

Holds 25 10ga or 12ga shotshells
up to 3"
Order No. 008-S25D \$3.10



Shotshell 25 Round Case

This is the basic shotshell box.
Holds 25 rounds and is ideal for
transporting or storing. Design and
features from MTM. Even holds 3"
Magnum shells. 20ga Case.
Order No. 008-S2520 \$4.17



Shotshell 100 Round Case

The SD100 is a 100 round
capacity, shotshell dry box. 2
trays hold 50 rounds each.
Strong ABS construction!

Order No. Price
008-SD10012 12 Gauge **\$18.55**
008-SD10020 20 Gauge **18.55**



12 Round Pistol Wallet

The 12 Round Pistol Wallet is the
ideal way to carry extra rounds in your
pocket. Dustproof and moistureproof.

Order No. Price
38S-357M **008-W1238 \$6.48**
44 Mag. **008-W1244 6.48**

9 Round Rifle Wallet

This wallet style MTM case holds 9 rifle
cartridges. Provides absolute protection.

Order No. Price
.222-.30-30 **008-W9SM \$5.36**
.22-250-.375 **008-W9LM 5.36**

10 Round Mag Rifle Wallet

378 WBY through 500 Nitro
Order No. 008-BUF10 \$6.67

Extra Trays for 100 Round Boxes - Holds 50 shotshells each.

They are durably built
and stackable, making
them perfect for storing
reloads and saving
space in your reloading
area.



Order No. Price
12 Ga **008-ST12 \$4.71**
20 Ga **008-ST20 4.71**

MTM Rifle / Pistol Ammunition Boxes



Slip Top 20 Round Case

Slip Top cases. Holds 20 of your favorite rifle cartridges. MTM quality.

.17-.223, .222Mag., 6x47	Order No.	Price
Clear Red	008-J20XS29	\$1.63
Clear Smoke	008-J20XS41	1.63

.22-250, .243, 6PPC	Order No.	Price
Clear Red	008-J20M29	\$1.63
Clear Smoke	008-J20M41	1.63

.264, 30-06, .375, 7mm	Order No.	Price
Clear Red	008-J20L29	\$1.63
Clear Smoke	008-J20L41	1.63



50 Round Pistol Case

The P50 Series holds 50 pistol rounds and are stackable. A cheap way to get quality cartridge protection. A load data sticker is included.

9mm-380 ACP	Order No.	Price
Green	008-P509M10	\$1.48
Clear Red	008-P509M29	1.48
Clear Blue	008-P509M24	1.48

38S-357M-38AC	Order No.	Price
Green	008-P503810	\$1.48
Clear Red	008-P503829	1.48
Clear Blue	008-P503824	1.48

41M, 44S, 44M, 45LC	Order No.	Price
Green	008-P504410	\$1.48
Clear Red	008-P504429	1.48
Clear Blue	008-P504424	1.48

45ACP, 10mm, 40SW, 41AE	Order No.	Price
Green	008-P504510	\$1.48
Clear Red	008-P504529	1.48
Clear Blue	008-P504524	1.48

25ACP, 32ACP, 32LC	Order No.	Price
Green	008-P5032	\$1.48

Slip Top 50 Round Pistol

The durable Slip Top 50 pistol case with round compartment is a multi-purpose box for marking or storing handgun ammo.



38S-357M	Order No.	Price
	008-J5038	\$2.87
41AE, 40SW, 10mm, 45ACP	Order No.	Price
	008-J5045	2.87



Slip Top 50 Round Pistol Case with Square Compartments

The Slip Top 50 pistol case. Multi-purpose box. Durability and economy for shooters who prefer a square compartment.

38S-357M, 38AC	Order No.	Price
	008-E5038	\$2.05
44S to 45 LC	Order No.	Price
	008-E5045	2.05



See-Through Pistol Case

The See-Through Pistol cases hold 50 rounds of pistol ammunition. See the amount of rounds you have left without having to open the top.

9mm-380ACP	Order No.	Price
	008-509	\$1.77
38S, 357M, 38AC	Order No.	Price
	008-PS3	1.80
41M to 45LC	Order No.	Price
	008-PL4	1.77



Pistol Flip-Top 64 Round

64 round box holds 50AE, 475 & 500 Linebaugh.

Order No.	Price
008-P645010	\$4.29



100 Round Pistol Case

Dust and moisture resistant design protects ammo while stored or being transported. Label for reloading data. 45cal cases you can choose your color.

38S, 357M, 38AC	Order No.	Price
	008-P1003	\$2.60
.380ACP & 9mm	Order No.	Price
	008-P1009	2.60
45ACP, 10mm, 40SW, 41AE	Order No.	Price
Green	008-P1004510	2.60
Clear Red	008-P1004529	2.60
Clear Blue	008-P1004524	2.60



Short & Ultra Mag Ammo Boxes

22 Round Short Mag
270 WSM, 300 WSM, 300 / 7MM
RSAUM, 45-70, 45-75, 45-90, 450
Marlin, 7mm WSM

Ord No. 008-RF22SM \$2.61

22 Round Ultra Mag
300 RUM, 338 RUM, 378 Wby
Mag, 416 Rem. Mag, 416 Rigby,
333 Jeffrey, 500 Jeffrey, 470
Kynoch.

Ord No. 008-RF22LM \$2.61



Smart Reloader Ammo Boxes

Hinged Ammo Boxes. Box lid lays flat and completely open for easy access loading or unloading.

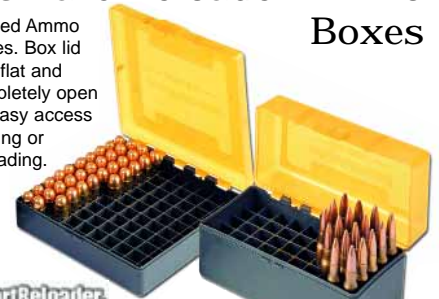

SmartReloader

Handgun 50 Round Boxes	Order No.	Price
#11 9x19, 9x21, 380ACP	047-VBSR620	\$0.90
#12 45 ACP, 10mm, 40 S&W, 41 AE	047-VBSR621	0.99
#13 44 Mag, 44 Spec, 41 Mag, 45 LC	047-VBSR622	1.35
#14 38 Spec, 357 Mag, 38 Auto Colt	047-VBSR623	1.20

Handgun 100 Round Boxes	Order No.	Price
#1A 9x19, 9x21, 380ACP	047-VBSR608	\$2.25
#1 45 ACP, 10mm, 40 S&W, 41 AE	047-VBSR609	2.25
#2 44 Mag, 44 Spec, 41 Mag, 45 LC	047-VBSR610	3.60
#3 38 Spec, 357 Mag, 38 Auto Colt	047-VBSR611	2.55

Rifle 50 Round Ammo Box #4 -
22-250, 22 BR, 22 PPC, 22 Sav. HP, 220 Rus, 224 Wby
Mag, 250 Sav, 30/35 Rem, 32-40 Win, 350 Rem Mag,
351/ 01 WSL, 6mm PPC, 6.8mm Rem SPC, 7mm BR,
450 Bushmaster, 7.62 x 39
Order No. 047-VBSR612 \$2.55

Rifle 50 Round Ammo Box #5 -
220 Swift, 243 Win, 300 Sav, 225/307/308 Win, 338 Fed,
6mm Rem, 6.5x50 Jap Arisaka, 7mm-08 Rem, 7.65x53
Belgian
Order No. 047-VBSR613 \$2.78

Rifle 36 Round Ammo Box #6 -
223/243/25/270 WSSM, 460/500 S&W Mag, 475/500
Linebaugh, 50-70 DGW
Order No. 047-VBSR614 \$2.48

Rifle 50 Round Ammo Box #7 -
17/221/222/223 Rem, 204 Ruger, 222 Rem Mag, 6 x 47
Order No. 047-VBSR615 \$2.18

Rifle 32 Round Ammo Box #8 -
25/270/300/325/338/ 7mm WSM, 300 Pegasus, 300 /
7mm Rem SAUM, 300/338/375/7mm Rem Ultra Mag,
333 Jeffery, 338 Excalibur, 338 Lapua Mag, 338-378
Wby Mag, 348 Win, 358 Shooting Times Alaskan, 404
Jeffery, 404 Nitro, 40-70 Sharps(Straight), 416 Rigby,
458 Lott, 470 Capstick, 500 A-Square.
Order No. 047-VBSR616 \$3.53

Rifle 36 Round Ammo Box #9 -
240 Wby. Mag, 25-06, 257 Roberts, 270 Win, 280 Rem,
30-06, 338-06 A-Square, 35 Whelen, 6.5-06 A-Square,
6.5x54mm Mann-Schone, 6.5x55 Swedish, 7x64
Brenneke, 7x57 / 8x57 / 9.3x57 / 9.5x57 / 9.3x62
Mausier, 7.7x58 Jap, 8mm-06, In the bullet down position
= 260 Rem, 257 / 300 / 340 / 7mm Wby Mag, 264
Order No. 047-VBSR617 \$3.53

Ammo Box 100 Round #10
22LR, 25ACP Order No. 047-VBSR619 \$1.20

Plano Ammunition Boxes



Shotshell Holders

Hard Molded Shell Cases. Dark Green with a convenient flip top

	Order No.	Price
Small Rifle 50rd (22-250, .243 Win., .250 Sav., 30-30 Win., 330 Sav., .32 Win., .35 Rem caliber bullets - Dk. Gray & trans Blue)	086-122850	\$3.01
Med Rifle 50rd (220 Swift, .243 Win., .275 Roberts, 270-300 WSM, .308 Win, 35 Rem, 444 Marlin, & 45-70 gov. - Dk. Gray & trans Blue)	086-122950	3.01
Large Rifle 50rd (378 Wby mag, 375-300 Rem ultra mag, .28 Rem, & 25-06 Rem caliber bullets - Dk. Gray & trans Blue)	086-123050	3.01
Shotgun Shell Cases Holds 25 shells of 12-16ga	086-1216	3.65
Shotgun Shell Cases Holds 25 shells of 12ga 3.5"	086-1217	3.65
Shotgun Shell Cases Holds 25 shells of 20ga	086-1220	3.65

RCBS Ammunition Boxes



These tough, plastic boxes have flush exteriors with recessed latches. They're designed to stack easily, and feature an anti-rattle bullet-tip nest, empty case support, and long-lasting hinge. Available in five sizes.

SEE PAGE 90 FOR FIT CHART

	Order No.	Price
Small Rifle	044-86901	\$5.62
Medium Rifle	044-86902	5.62
Large Rifle	044-86903	7.33
Medium Pistol	044-86905	4.20
Large Pistol	044-86906	5.21





Varmageddon Bullets

All 100 Count	Order No.	Price
17 Cal 20gr Varmageddon FBHP	115-17205	\$13.23
17 Cal 20gr Varmageddon FB Tipped	115-17210	13.51
20 Cal 32gr Varmageddon FBHP	115-17215	13.51
20 Cal 32gr Varmageddon FB Tipped	115-17220	13.80
22 Cal 40gr Varmageddon FBHP	115-17225	13.57
22 Cal 40gr Varmageddon FB Tipped	115-17230	14.09
22 Cal 55gr Varmageddon FBHP	115-17235	14.38
22 Cal 55gr Varmageddon FB Tipped	115-17240	14.67
6mm 55gr Varmageddon FBHP	115-17245	14.95
6mm 55gr Varmageddon FB Tipped	115-17250	15.24

NEW! VARMAGEDDON - Introducing Nosler's new Varmageddon™ line of loaded ammunition and component bullets. Featuring a highly accurate polymer tip or hollow point combined with a flat base design, Varmageddon products were created for the high-volume varmint shooter who requires the utmost precision. Varmageddon™ bullets provide the highest levels of performance for any varmint hunter.



More info on our website!! www.midsouthshooters.com

Berger Bullets



- Extra heavy tapering jacket wall
- Internally bonded lead core
- Reliable expansion and penetration
- 80%+ weight retention.



Swift Scirocco - Scirocco II bonded is the perfect bullet design for today's fast, flat-shooting, long-range cartridges. Its scant ogive, 15-degree boat tail base and Signature Black Tip™ create a sleek, aerodynamic profile that helps maintain down-range velocities and flat trajectories. .

20 Cal (.204 dia)	Order No.	Price
35gr Match Varmint FB (1,000)	178-20703	\$221.90
40gr Match Varmint BT (1,000)	178-20704	222.09
22 Cal (.224 dia)		
52gr Match Target FB (1,000)	178-22708	223.57
52gr Match Varmint FB (1,000)	178-22709	223.92
70gr Match Target VLD (1,000)	178-22718	262.36
73gr Match Target BT (1,000)	178-22720	260.59
80gr Match Target VLD (1,000)	178-22722	260.87
6mm (.243 dia)		
68gr Match Target FB (1,000)	178-24711	238.54
90gr Match Target BT (1,000)	178-24725	302.28
105gr Match Target VLD (500)	178-24729	146.00
108gr Match Target BT (500)	178-24731	152.32
6.5mm (.264 dia)		
140gr Match Target VLD (500)	178-26701	189.63
30 Cal (.308 dia)		
115gr Match Target FB (500)	178-30721	179.90
155.5gr Match BT Fullbore (500)	178-30716	194.02
210gr Match Target VLD (500)	178-30715	220.30

Berry's Bullets



	Order No	Price
44 CAL (.429) 240gr FP (200)	037-97080	\$46.54
45 CAL (.452) 185gr HBRN (250)	037-84477	38.42
45 CAL (.452) 200gr HP (250)	037-41968	39.12
45 CAL (.452) 200gr SWC (250)	037-41391	38.52
45 CAL (.452) 230gr RN (250)	037-98192	39.38
9mm (.356) 115gr RN (250)	037-19355	23.79
9mm (.356) 124gr HBRN-TP (250)	037-15143	28.11
9mm (.356) 124gr RN (250)	037-76848	24.96
9mm (.356) 147gr RN (250)	037-74030	29.15

	Order No.	Price
8mm (.323 dia)		
200gr A-Frame (50)	192-32200	\$53.24
220gr A-Frame (50)	192-32220	53.24
338 Cal (.338 dia)		
210gr Scirocco (100)	192-84210	51.92
225gr A-Frame (50)	192-33225	55.06
250gr A-Frame (50)	192-33250	55.06
275gr A-Frame (50)	192-33275	55.06
35 Cal (.358 dia)		
225gr A-Frame (50)	192-35225	56.87
250gr A-Frame (50)	192-35250	56.87
280gr A-Frame (50)	192-35280	50.22
9.3mm (.366 dia)		
250gr A-Frame (50)	192-36250	59.90
300gr A-Frame (50)	192-36300	59.90
375 Cal (.375 dia)		
250gr A-Frame (50)	192-37250	59.90
270gr A-Frame (50)	192-37270	59.90
300gr A-Frame (50)	192-37300	59.90
416 Cal (.416 dia)		
350gr A-Frame (50)	192-41350	61.71
400gr A-Frame (50)	192-41400	61.71
458 Cal (.458 dia)		
400gr A-Frame (50)	192-45400	65.95
450gr A-Frame (50)	192-45450	65.95
500gr A-Frame (50)	192-45500	65.95



Swift Rifle Bullets

- Cross-member jacket design
- Bonded front core



Swift A-Frame - Famous for its ability to combine three critical performance features – controlled expansion to 2X original diameter, deep penetration and 95% weight retention at all velocities. This has made it the bullet that hunters shoot with confidence, at any game, of any size, close up or far

	Order No.	Price
25 Cal (.257 dia)		
100gr A-Frame (50)	192-25100	\$48.70
120gr A-Frame (50)	192-25120	48.70
6mm (.243 dia)		
90gr Scirocco (100)	192-72090	49.27
6.5mm (.264 dia)		
120gr A-Frame (50)	192-26120	49.91
140gr A-Frame (50)	192-26140	49.91
270 Cal (.277 dia)		
130gr A-Frame (50)	192-27130	49.91
130gr Scirocco (100)	192-78130	53.10
140gr A-Frame (50)	192-27140	49.91
150gr A-Frame (50)	192-27150	49.91
7mm (.284 dia)		
140gr A-Frame (50)	192-28140	50.82
150gr Scirocco (100)	192-80150	53.10
160gr A-Frame (50)	192-28160	50.82
175gr A-Frame (50)	192-28175	50.82
30 Cal (.308 dia)		
150gr Scirocco (100)	192-82150	56.05
165gr A-Frame (50)	192-30165	52.03
165gr Scirocco (100)	192-82165	56.05
180gr A-Frame (50)	192-30180	52.03
180gr Scirocco (100)	192-82180	56.05
200gr A-Frame (50)	192-30200	52.03

Swift Pistol Bullets



	Order No.	Price
.44 cal .430" DIA 240 grain (50)	192-44240	\$48.40
.44 cal .430" DIA 280 grain (50)	192-44280	48.40
.44 cal .430" DIA 300 grain (50)	192-44300	48.40
.45 cal .452" DIA 265 grain (50)	192-45265	48.40
.45 cal .452" DIA 300 grain (50)	192-45300	48.40
.45 cal .452" DIA 325 grain (50)	192-45325	48.40

Barnes Rifle Bullets



Triple Shock-X Bullets - Lead Free 100% Copper Construction, Fast expansion and won't fragment.
Maximum Range X-Bullet - Copper Body with a patented tungsten based Silvēx® Core and Delrin® Tip.
Varmint Grenade™ - Copper-tin composite core, Lead Free and accurate!
Tipped Triple Shock-X Bullets - 100% Lead Free Copper Construction with Polymer tip for instant expansion.
Banded Solids™ - Machined from homogenous copper/zinc alloy. Won't disintegrate or deflect on heavy bone.
MPG™ Frangible- Multi-Purpose Green (MPG™) technology developed for military and law enforcement applications. MPG bullets feature a highly frangible, powdered-metal copper-tin core inside a guiding metal jacket.

20 Cal (.204 dia)		
26gr Varmint Grenade (100)	035-20426	\$15.53
26gr Varmint Grenade (250)	035-20456	36.74
22 Cal (.224 dia)		
36gr Varmint Grenade (100)	035-22436	\$17.09
36gr Varmint Grenade (250)	035-22456	40.54
45gr Banded Solid (50)	035-22425	15.43
50gr Varmint Grenade (100)	035-22486	20.52
50gr Varmint Grenade (250)	035-22496	46.31
50gr TTSX 1:12 Twist or Faster (50)	035-22452	25.77
53gr Triple Shock XFB (50)	035-22443	23.96
55gr MPG Frangible (100)	035-22476	25.77
55gr TAC-X FB (50)	035-22405	24.98
55gr RRLP FB (50)	035-22414	25.77
55gr TTSX 1:9 Twist or Faster (50)	035-22453	26.22
62gr Triple Shock XBT 1:7/1:8 Twist(50)	035-22460	25.59
62gr TAC-X BT (50)	035-22406	25.59
62gr TTSX 1:8 Twist or Faster (50)	035-22454	26.67
70gr Triple Shock XBT 1:7/1:8 Twist(50)	035-22470	26.28
70gr TAC-X BT (50)	035-22407	26.28
6mm (.243 dia)		
62gr Varmint Grenade (100)	035-24372	\$21.75
62gr Varmint Grenade (250)	035-24392	52.56
75gr Banded Solid (50)	035-24375	17.62
80gr Triple Shock Tipped X (50)	035-24338	29.04
85gr Triple Shock XBT (50)	035-24341	26.66
25 Cal (.257 dia)		
80gr Triple Shock Tipped X (50)	035-25731	\$29.12
90gr Banded Solid (50)	035-25793	18.74
100gr Triple Shock Tipped X (50)	035-25734	30.70
100gr Triple Shock XBT (50)	035-25742	27.95
115gr Triple Shock XFB (50)	035-25743	30.24
6.5mm (.264 dia)		
110gr Banded Solid (50)	035-26422	\$20.49
120gr Triple Shock XBT	035-26441	30.68
120gr Triple Shock Tipped X (50)	035-26430	31.61
130gr Triple Shock XFB	035-26442	31.56
140gr BT Match (100)	035-26404	26.01
6.8 Cal (.277 dia)		
85gr TAC-X FB (50)	035-27733	\$27.95
85gr Triple Shock XFB (50)	035-27732	27.95
95gr TTSX (50)	035-27751	29.76
95gr TAC-X BT (50)	035-27721	29.76
110gr TAC-X BT (50)	035-27734	29.03
110gr Triple Shock XBT (50)	035-27738	29.03
270Cal (.277 dia)		
110gr Triple Shock Tipped X (50)	035-27772	\$30.29
120gr Banded Solid (50)	035-27763	21.36
130gr Triple Shock Tipped X (50)	035-27775	31.32
130gr Triple Shock XBT (50)	035-27742	29.75
140gr Triple Shock XBT (50)	035-27744	29.53
150gr Triple Shock XFB (50)	035-27746	31.40
7mm (.284 dia)		
120gr Triple Shock Tipped X (50)	035-28472	\$30.50
120gr Triple Shock XBT (50)	035-28442	27.95
140gr Triple Shock Tipped X (50)	035-28474	32.07
140gr Triple Shock XBT (50)	035-28444	29.53
140gr Banded Solid (50)	035-28464	23.09
150gr Triple Shock XBT (50)	035-28447	31.40
150gr Triple Shock Tipped X (50)	035-28476	32.85
160gr Triple Shock XFB (50)	035-28446	32.25
175gr Triple Shock XFB (50)	035-28448	33.52

Barnes Rifle Bullets (Continued)

30 Cal (.308 dia)		
110gr TAC-X FB (50)	035-30821	\$29.77
110gr Triple Shock XFB (50)	035-30835	29.77
130gr Triple Shock Tipped X (50)	035-30873	31.32
130gr Triple Shock XBT (50)	035-30838	31.42
150gr Triple Shock Tipped X (50)	035-30875	32.89
150gr Triple Shock XBT (50)	035-30841	31.58
150gr Triple Shock XFN (50)	035-30820	31.42
150gr TAC-X BT (50)	035-30824	32.69
150gr MPG Frangible (50)	035-30817	20.58
150gr RRLP FB (50)	035-30802	20.58
155gr BT Palma (100)	035-30892	28.18
165gr Triple Shock XBT (50)	035-30843	31.85
165gr Banded Solid (50)	035-30816	25.00
165gr TSSX (50)	035-30877	33.46
168gr TAC-X BT (50)	035-30826	33.93
168gr Triple Shock XBT (50)	035-30844	32.78
168gr Triple Shock Tipped X (50)	035-30878	33.72
175gr BT Match Palma (100)	035-30896	29.47
180gr Triple Shock Tipped X (50)	035-30879	34.35
180gr Triple Shock XBT (50)	035-30846	33.52
200gr Triple Shock XFB (50)	035-30848	36.61
7.62x39mm (.310 dia)		
123gr Triple Shock XBT (50)	035-31012	\$31.06
123gr TAC-X BT (50)	035-31003	31.06
303 Cal / 7.65mm (.311 dia)		
150gr Triple Shock XFB (50)	035-31115	\$31.42
325 WSM / 8mm Cal (.323 dia)		
180gr Triple Shock XBT (50)	035-32306	\$33.93
200gr Triple Shock XBT (50)	035-32320	35.60
338 Cal (.338 dia)		
160gr Triple Shock Tipped X (50)	035-33873	\$34.81
185gr Triple Shock XBT (50)	035-33843	34.34
210gr Triple Shock XBT (50)	035-33845	37.52
225gr Triple Shock XFB (50)	035-33846	38.43
225gr Triple Shock Tipped X (50)	035-33879	40.24
250gr Triple Shock XFB (50)	035-33848	41.14
35 Cal (.358 dia)		
200gr TripleShock Tipped XBT(50)	035-35832	\$37.98
200gr Triple Shock XFB (50)	035-35820	37.52
225gr Triple Shock XFB (50)	035-35824	38.43
9.3 Cal (.366dia)		
250gr TripleShock Tipped XBT(50)	035-36674	\$41.71
250gr Triple Shock XFB (50)	035-36625	41.14
375 Cal (.375 dia)		
235gr Triple Shock XFB (50)	035-37552	\$39.33
250gr TripleShock Tipped XBT(50)	035-37542	42.15
270gr Triple Shock XFB (50)	035-37556	42.95
300gr Triple Shock XFB (50)	035-37558	43.86
405 Winchester (.411dia)		
300gr Triple Shock XFB (50)	035-41130	\$43.36

Barnes Rifle Bullets (Continued)

416 Cal (.416 dia)		
300gr Triple Shock XFB (50)	035-41683	\$43.36
350gr Triple Shock XFB (50)	035-41686	48.39
400gr Triple Shock XFB (50)	035-41689	54.71
416 Jefferies (.423 dia)		
350gr TripleShock Tipped XBT(50)	035-41623	\$50.60
400gr Triple Shock XFB (50)	035-42340	55.16
4570 (.458 dia)		
250gr Triple Shock XFN (20)	035-45841	\$16.72
300gr Triple Shock XFN (20)	035-45843	18.53
458 Cal (.458 dia)		
300gr Triple Shock XFB(20)	035-45814	\$17.80
450gr Triple Shock XFB (20)	035-45819	23.96
500gr Triple Shock XFB (20)	035-45821	25.77
470 Nitro (.474dia)		
500gr Triple Shock XFB (20)	035-47452	\$25.77
505 Gibbs (.505dia)		
525gr Triple Shock XFB (20)	035-50553	\$26.22
50 BMG (.510 dia)		
647gr TAC-X BT (50)	035-51006	\$29.71
750gr TAC-LR BT	035-51075	33.92
750gr Tangent TAC-LR BT	035-51076	33.92

Barnes Handgun Bullets

355 Dia (.380ACP)		
80gr TAC-XP FB (40)	035-35500	\$22.60
9mm (.355 dia)		
115gr TAC-XP FB (40)	035-35501	\$24.86
357 Sig (.355 dia)		
125gr TAC-XP FB (40)	035-35503	\$25.77
357 Mag (.357 dia)		
140 Gr XPB (20)	035-35714	\$14.01
38 Spl (.357 dia)		
110gr TAC-XP FB (40)	035-35703	\$24.86
44 Cal (.429 dia)		
200 Gr XPB (20)	035-42920	\$15.82
225 Gr XPB (20)	035-42922	16.72
454 Casull (.451 dia)		
250 Gr XPB(20)	035-45123	\$18.08
480 Ruger / 475 Linebaugh		
250 Gr XPB(20)	035-48010	\$18.53
40 S&W (.400 dia)		
125gr TAC-XP (40)	035-40003	\$26.22
140gr TAC-XP FB (40)	035-40005	26.67
155gr TAC-XP FB (40)	035-40006	27.57
429 Dia (.44spl)		
200gr TAC-XP FB (40)	035-42912	\$30.74
45 ACP (.451 dia)		
160gr TAC-XP FB (40)	035-45106	\$28.03
185gr TAC-XP FB (40)	035-45108	29.83
200gr XPB FB (50)	035-45116	16.27
460 S&W (.451 dia)		
200gr XPB (20)	035-45115	\$15.82
275gr XPB (20)	035-45105	18.53
500 S&W (.500 dia)		
275 Gr XPB Pistol (20)	035-50025	\$19.88
325 Gr XPB Pistol (20)	035-50026	21.24
375 Gr XPB Pistol (20)	035-50028	22.60





Sierra Jacketed Rifle Bullets

20 Cal (.204 dia)

32gr BlitzKing(100)	007-1032	\$19.16
32gr BlitzKing(500)	007-1032C	94.69
39gr BlitzKing(100)	007-1039	19.16
39gr BlitzKing(500)	007-1039C	94.69

22 Cal Hornet (.223 Dia)

40gr Hornet Varminter (100)	007-1100	\$14.90
45gr Hornet Varminter (100)	007-1110	14.90

22 Cal Hornet (.224 Dia)

40gr Hornet Varminter (100)	007-1200	\$14.90
45gr Hornet Varminter (100)	007-1210	14.90

22 Cal (.224 Dia)

40grHP Varminter(100)	007-1385	\$14.47
40gr BlitzKing(100)	007-1440	20.30
40gr BlitzKing(500)	007-1440C	100.31
45gr SPT Varminter(100)	007-1310	15.05
45gr SemiPointVarminter(100)	007-1320	15.05
50gr *BlitzKing(100)	007-1450	20.30
50gr SPT Varminter (100)	007-1330	15.05
50gr Blitz Varminter (100)	007-1340	15.05
50gr BlitzKing (500)	007-1450C	97.10
52gr HPBT MatchKing (100)	007-1410	16.95
52gr HPBT MatchKing (500)	007-1410C	83.19
53gr HP MatchKing (100)	007-1400	17.85
53gr HP MatchKing (500)	007-1400C	84.58
55gr HPBT GameKing (100)	007-1390	16.53
55gr Blitz Varminter (100)	007-1345	15.05
55gr FMJBT GameKing (100)	007-1355	14.90
55gr SPT Varminter (100)	007-1360	14.79
55gr SBT GameKing (100)	007-1365	15.60
55Gr *BlitzKing (100)	007-1455	20.30
55Gr *BlitzKing (500)	007-1455C	100.31
60gr HP Varminter (100)	007-1375	14.20
63gr SMP Varminter (100)	007-1370	15.76
65gr SBT GameKing (100)	007-1395	17.93
69gr HPBT MatchKing (100)	007-1380	19.80
69gr HPBT MatchKing (500)	007-1380C	97.26
77gr HPBT MatchKing(500)	007-9377	106.57
77gr HPBT MatchKing (50)	007-1477	13.33
77gr HPBT MatchKing LRSP (50)	007-1478	14.63
80gr HPBT MatchKing (500)	007-9390	110.74
80gr HPBT MatchKing (50)	007-1480	13.75
90gr HPBT MatchKing (500)	007-9290	143.20
90gr HPBT MatchKing (50)	007-1490	17.75

6mm (.243 Dia)

60gr HP Varminter(100)	007-1500	\$18.49
55gr *BlitzKing(100)	007-1502	22.88
55gr BlitzKing (500)	007-1502C	110.70
70gr HPBT MatchKing (100)	007-1505	22.06
70gr HPBT MatchKing (500)	007-1505C	104.84
70gr *BlitzKing (100)	007-1507	23.13
70gr *BlitzKing (500)	007-1507C	111.76
75gr HP Varminter (100)	007-1510	18.75
80gr SBT Blitz Varminter(100)	007-1515	18.91
85gr SPT Varminter (100)	007-1520	19.37
85gr HPBT GameKing (100)	007-1530	20.40
90gr FMJBT GameKing (100)	007-1535	20.16
100gr SPT Prohunter (100)	007-1540	19.50
100gr SBT Gameking (100)	007-1560	21.61
107gr MatchKing HPBT(100)	007-1570	27.04
107gr MatchKing HPBT(500)	007-1570C	128.29

25 Cal (.257 Dia) More 25cal Bullets Online!

75gr HP Varminter (100)	007-1600	\$19.71
87gr SPT Varminter (100)	007-1610	20.16
90gr HPBT GameKing(100)	007-1615	22.35
100gr SPT Prohunter (100)	007-1620	20.42
100gr SBT Gameking (100)	007-1625	20.75
100gr HPBT MatchKing (100)	007-1628	24.83
117gr SBT GameKing(100)	007-1630	24.20
117gr SPT ProHunter (100)	007-1640	22.06
120gr HPBT Gameking (100)	007-1650	24.87

MatchKing® - For serious rifle competition, the hollow point boat tail design provides that extra margin of ballistic performance match shooters need to fire at long ranges under adverse conditions.

GameKing® - Designed for hunting at long range, boat tail design greatly reduces drag. Resulting in higher retained velocity, greater striking energy, a flatter trajectory and less wind drift than comparable flat base bullets.

BlitzKing® - Lightly constructed poly-tipped bullets provide explosive expansion while minimizing ricochets, and lightweight to obtain high velocities with flat trajectories.

Varminter® - Lightly constructed bullets provide explosive expansion while minimizing ricochets.

Pro-Hunter® - The flat base design has been skillfully blended with Sierra's custom-tapered jacket design helps assure maximum expansion, optimum weight retention and deep penetration for game-stopping.

Sports Master® - Handgun bullets engineered to provide consistent, reliable expansion. Serrated "Power Jacket" on hollow cavity and hollow point bullets. Expands uniformly for consistent weight retention.

6.5mm (.264 Dia)

85gr HP Varminter (100)	007-1700	\$22.42
100gr HP Varminter (100)	007-1710	23.49
107gr HPBT MatchKing (100)	007-1715	29.33
107gr HPBT MatchKing (500)	007-1715C	139.15
120gr SPT Prohunter (100)	007-1720	23.77
120gr HPBT MatchKing (100)	007-1725	25.89
120gr HPBT MatchKing (500)	007-1725C	122.99
140gr SBT GameKing (100)	007-1730	27.74
140gr HPBT MatchKing (100)	007-1740	29.66
140gr HPBT MatchKing (500)	007-1740C	140.94
142gr HPBT MatchKing (100)	007-1742	33.42
142gr HPBT MatchKing (500)	007-1742C	158.67

270 Cal (.277 dia)

90gr HP Varminter (100)	007-1800	\$22.28
110gr SPT Prohunter (100)	007-1810	21.84
130gr SBT GameKing (100)	007-1820	24.98
130gr SPT Prohunter (100)	007-1830	22.21
135gr HPBT MatchKing (100)	007-1833	27.15
140gr HPBT GameKing (100)	007-1835	24.58
150gr SBT GameKing (100)	007-1840	27.74
140gr SBT GameKing (100)	007-1845	25.56
115gr HPBT Match (100)	007-1815	23.75

7mm (.284 dia)

100gr HP Varminter (100)	007-1895	\$21.36
120gr SPT Prohunter(100)	007-1900	22.21
130gr HPBT MatchKing (100)	007-1903	29.60
130gr HPBT MatchKing (500)	007-1903C	143.63
140gr SBT Gameking (100)	007-1905	26.17
140gr SPT Prohunter (100)	007-1910	22.86
150gr SBT GameKing (100)	007-1913	27.11
150gr HPBT MatchKing (100)	007-1915	30.23
150gr HPBT MatchKing (500)	007-1915C	143.63
160gr SBT GameKing (100)	007-1920	27.74
160gr HPBT GameKing (100)	007-1925	27.74
168gr HPBT MatchKing (100)	007-1930	30.55
168gr HPBT MatchKing (500)	007-1930C	145.01
175gr SBT GameKing (100)	007-1940	31.04
175gr HPBT MatchKing (100)	007-1975	32.01

30 Cal / 7.62mm (.308 dia)

110gr RN Prohunter (100)	007-2100	\$17.92
110gr HP Varminter (100)	007-2110	21.07
125gr SPT Prohunter (100)	007-2120	21.84

30 Cal / 7.62mm (.308 dia) (cntd)

150gr FMJBT GameKing(100)	007-2115	\$23.99
150gr SPT Prohunter (100)	007-2130	22.28
150gr SBT GameKing (100)	007-2125	25.56
150gr HPBT MatchKing (100)	007-2190	30.55
150gr HPBT MatchKing (500)	007-2190C	144.22
150gr RN Prohunter (100)	007-2135	22.42
155gr HPBT MatchKing (100)	007-2155	30.49
155gr HPBT MatchKing (500)	007-2155C	144.11
165gr SBT GameKing (100)	007-2145	26.74
165gr HPBT GameKing (100)	007-2140	25.24
168gr HPBT MatchKing (100)	007-2200	28.73
168gr HPBT MatchKing (500)	007-2200C	140.83
175gr HPBT MatchKing (100)	007-2275	32.01
175gr HPBT MatchKing (500)	007-2275C	147.65
180gr SPT Prohunter (100)	007-2150	23.99
180gr SBT GameKing (100)	007-2160	27.74
180gr HPBT MatchKing (100)	007-2220	33.38
180gr HPBT MatchKing (500)	007-2220C	159.82
190gr HPBT MatchKing (100)	007-2210	33.84
190gr HPBT MatchKing (500)	007-2210C	160.74
200gr SBT GameKing (100)	007-2165	32.19
200gr HPBT MatchKing (100)	007-2230	34.75
200gr HPBT MatchKing (500)	007-2230C	164.93

303 Cal / 7.7mm (.311 dia)

150gr SPT Prohunter(100)	007-2300	\$25.16
125gr SPT Prohunter (100)	007-2305	22.71
180gr SPT Prohunter (100)	007-2310	26.70
174gr HPBT MatchKing (100)	007-2315	31.00
174gr HPBT MatchKing (500)	007-2315C	147.14

8mm (.323 dia)

150gr SPT Prohunter (100)	007-2400	\$25.29
175gr SPT Prohunter (100)	007-2410	26.70
200gr HPBT MatchKing (100)	007-2415	34.03
220gr SBT GameKing (50)	007-2420	21.00

338 Cal (.338 dia)

250gr SBT GameKing (50)	007-2600	\$20.92
215gr SBT GameKing (50)	007-2610	20.42
250gr HPBT MatchKing (50)	007-2650	29.94
250gr HPBT MatchKing (500)	007-2650C	263.44

35 Cal (.358 dia)

200gr RN Prohunter (50)	007-2800	\$14.71
225gr SBT Gameking (50)	007-2850	19.56



500 Per Box!

22 Cal (.224 Dia)	Order No.	Price
40gr Hi-Vel *BlitzKing	007-1440M	\$123.70
50gr Hi-Vel *BlitzKing	007-1450M	123.70
52gr Hi-Vel HPBT MatchKing	007-1410M	112.13
53gr Hi-Vel HP MatchKing	007-1400M	111.40
55gr Hi-Vel *BlitzKing	007-1455M	123.70
69gr Hi-Vel HPBT MatchKing	007-1380M	119.37
77gr HPBT MatchKing	007-9377M	135.44
80gr HPBT MatchKing	007-9390M	136.93

25 Cal (.257 Dia)	Order No.	Price
70gr Moly BlitzKing (500)	007-1605M	\$141.65
90gr Moly BlitzKing (500)	007-1616M	145.46

Sierra Moly-Coated Rifle Bullets

6mm (.243 Dia)	Order No.	Price
55gr *BlitzKing	007-1502M	\$136.91
70gr HPBT MatchKing	007-1505M	127.63
70gr *BlitzKing	007-1507M	137.92
107gr HPBT MatchKing	007-1570M	157.43

6.5mm (.264 Dia)	Order No.	Price
107gr HPBT MatchKing	007-1715M	\$169.11
140gr HPBT MatchKing	007-1740M	170.92
142gr HPBT MatchKing	007-1742M	189.65

30 Cal / 7.62mm (.308 dia)	Order No.	Price
155gr HPBT MatchKing	007-2155M	\$169.30
168gr HPBT MatchKing	007-2200M	174.60
175gr HPBT MatchKing	007-2275M	182.72
190gr HPBT MatchKing	007-2210M	191.76



Sierra Jacketed Handgun Bullets

Caliber	Weight	Model	Code	Price
32 Cal (.312 dia)				
90gr JHC SportsMaster (100)			007-8030	\$15.63
9mm (.355 Dia)				
90gr JHP SportsMaster (100)			007-8100	\$15.63
115gr JHP SportsMaster (100)			007-8110	16.26
115gr FMJ TournamentM(100)			007-8115	16.26
125gr JHP SportsMaster (100)			007-8125	18.24
38 Cal (.357 dia)				
110gr JHC Blitz SportsM(100)			007-8300	\$16.26
125gr JSP SportsMaster (100)			007-8310	16.53
125gr JHC SportsMaster(100)			007-8320	16.73
140gr JHC SportsMaster (100)			007-8325	17.01
158gr JHC SportsMaster (100)			007-8360	17.47
158gr JSP SportsMaster (100)			007-8340	17.16
180gr FPJ MatchTourmntMstr(100)			007-8370	20.17
10mm (.400 Dia)				
135gr JHP SportsMaster (100)			007-8425	\$21.72
150gr JHP SportsMaster (100)			007-8430	21.95
165gr JHP SportsMaster (100)			007-8445	22.20
180gr JHP SportsMaster (100)			007-8460	22.46
41 Cal (.410 dia)				
170gr JHC SportsMaster (100)			007-8500	\$22.03
210gr JHC SportsMaster (100)			007-8520	22.34
44 Mag (.4295 dia)				
180gr JHC SportsMaster (100)			007-8600	\$22.82
210gr JHC SportsMaster (100)			007-8620	23.08
220gr FPJ Match Tourmnt(100)			007-8605	23.05
240gr JHC SportsMaster (100)			007-8610	23.42
250gr FPJ Match Tourmnt(100)			007-8615	24.27
300gr JSP SportsMaster (50)			007-8630	13.50
45 Cal (.4515 dia)				
185gr JHP SportsMaster (100)			007-8800	\$22.45
230gr JHP SportsMaster(100)			007-8805	23.45
185gr FPJ Tourmnt M(100)			007-8810	23.72
230gr FMJ Match Tourmnt(100)			007-8815	23.99
240gr JHC SportsMaster (100)			007-8820	23.42
200gr FPJ TourmntM(100)			007-8825	23.72
300gr JSP SportsMaster (50)			007-8830	15.69
500 S&W (.50 Cal)				
350gr JHP SportsMaster (50)			007-5350	\$25.45
400gr JSP SportsMaster (50)			007-5400	26.48

JHP...Jacketed Hollow Point FPJ...Flat Point Jacketed
 JHC...Jacketed Hollow Cavity JSP...Jacketed Soft Point



Berger Bullets

Caliber	Weight	Twist	Order No.	Price
17 Cal (.172 dia)				
20gr Match Varmint HP**	1 in 12"		178-17304	\$55.54
25gr Match Bullet**	1 in 10"		178-17407	47.13
25gr Match Varmint HP**	1 in 10"		178-17308	46.00
30gr Match Varmint HP**	1 in 9"		178-17310	52.18
20 Cal (.204 dia)				
30gr Match Varmint HP	1 in 14"		178-20302	\$27.77
35gr Match Varmint HP	1 in 14"		178-20303	23.07
40gr Match Varmint HPBT1	1 in 12"		178-20304	23.10
50gr Match Varmint HPBT1	1 in 9"		178-20305	29.12
55gr Match Varmint HPBT	TBD		178-20306	30.21
22 Cal (.224 dia)				
30gr Match Varmint HP	1 in 15"		178-22301	\$23.81
40gr Match Varmint HP	1 in 15"		178-22303	24.51
50gr Match Varmint HP	1 in 14"		178-22307	24.34
52gr Match	1 in 14"		178-22408	23.21
52gr Match Varmint HP	1 in 14"		178-22309	23.42
55gr Match	1 in 14"		178-22410	23.55
55gr Match Varmint HP	1 in 14"		178-22311	23.78
60gr Match	1 in 12"		178-22312	26.18
64gr Match	1 in 12"		178-22316	29.79
70gr Match VLD*	1 in 9"		178-22418	27.57
73gr Match Boat Tail	1 in 9"		178-22420	27.27
75gr Match VLD*	1 in 9"		178-22421	29.20
80gr Match VLD	1 in 8"		178-22422	27.47
82gr Match			178-22424	27.33
90gr Match	1 in 7"		178-22423	30.84
6mm (.243 dia)				
60gr Match	1 in 14"		178-24301	\$30.66
65gr Match	1 in 13"		178-24405	26.42
65gr Match Boat Tail	1 in 13"		178-24408	25.92
68gr Match	1 in 13"		178-24411	24.75
69gr Match HighBC FB	1 in 12"		178-24313	28.91
80gr Match	1 in 12"		178-24321	26.38
90gr Match Boat Tail	1 in 10"		178-24425	32.21
95gr Match VLD*	1 in 9"		178-24427	32.48
100gr Match TGT BT	TBD		178-24432	34.88
105gr Match Boat Tail	1 in 9"		178-24428	38.35
105gr Match VLD*	1 in 8"		178-24429	31.38
25 Cal (.257 dia)				
87gr Match	1 in 13"		178-25407	\$45.91
115gr Match	1 in 10"		178-25513	39.19

*VLD - Very Low Drag - Ideal choice for the medium to long-range target competition shooter. Provides less drop and drift than any bullet on the market today.

Caliber	Weight	Twist	Order No.	Price
25 Cal (.257 dia)				
87gr Match	1 in 13"		178-25407	\$45.91
115gr Match	1 in 10"		178-25513	39.19
6.5mm (.264 dia)				
100gr Match TGT BT	TBD		178-26408	\$39.69
120gr Match	1 in 10"		178-26402	40.99
130gr Match VLD*	1 in 10"		178-26503	40.33
140gr Match VLD*	1 in 9"		178-26401	41.37
270 Cal (.270 dia)				
130gr Match VLD*	1 in 11"		178-27501	\$40.58
140gr Match VLD*	1 in 11"		178-27502	41.32
150gr Match VLD*	1 in 10"		178-27503	43.53
7mm (.284 dia)				
168gr Match VLD*	1 in 10"		178-28401	\$43.72
180gr Match VLD*	1 in 9"		178-28405	45.03
30 Cal (.308 dia)				
110gr Match	1 in 19"		178-30401	\$39.94
125gr Match	1 in 19"		178-30403	42.77
135gr Match	1 in 16"		178-30405	46.54
150gr Match	1 in 15"		178-30407	48.41
155gr Match VLD*	1 in 14"		178-30508	42.82
168gr Match BT	1 in 13"		178-30411	44.96
168gr Match VLD*	1 in 13"		178-30510	43.23
175gr Match VLD*	1 in 13"		178-30512	46.19
175gr Match TGT BT	1 in 13"		178-30420	46.56
185gr Match TGT BT	1 in 12"		178-30418	45.96
185gr Match VLD*	1 in 12"		178-30513	45.59
190gr Match VLD*	1 in 12"		178-30514	46.32
210gr Match VLD*	1 in 11"		178-30515	47.50
210gr Match TGT BT	1 in 11"		178-30419	48.98

Berger Match Grade Bullets - Match grade bullets, Berger uses the highest quality copper and lead available. Features the J4 Precision Jacket, recognized around the world for the best concentricity available.

100 Per box unless otherwise noted
 **Notes 200 per box

Note about Bullet Twist: Bergers recommended bullet/barrel twist rates are listed next to the bullets. Where Twist is listed, it refers to twist of barrel or faster (example 1 in 19" = 1 in 19" or faster)



See Page 108

Best Bulk Bullet Deal Around!

Varmint Nightmare Bullets

Midsouth's Varmint Nightmare - Our original Varmint Nightmare is a great choice for all varmint hunters. This is a .22 caliber .224 diameter bullet that comes only in 55 grain. Packaged in 500 count or 2000 count. These bullets have a cannellure.

Caliber	Weight	Order No.	Price
22cal .224dia	55gr(500)	004-22455SP500	\$40.68
22cal .224dia	55gr(2000)	004-22455SP2000	157.05

Midsouth's .224 Diameter Varmint Nightmare X-Treme - Our Varmint Nightmare X-Treme is derived from an undisclosed premium bullet manufacturer. Also a .22 caliber .224 diameter bullet but with the choice of 50 or 55 grain. Varmint Nightmare X-Treme packs a powerful punch that will get the job done right.

Caliber	Weight	Order No.	Price
.224dia	50gr Premium SP (500)	004-22450VNE500	\$46.55
.224dia	55gr Premium SP (500)	004-22455VNE500	44.19
.224dia	55gr Premium HP (500)	004-2255HP	46.59
.224dia	34gr Flat Base HP (500)	004-2234	41.67
.172dia	20gr Flat Base HP (500)	004-1720	36.76
.204dia	34gr Flat Base HP (500)	004-2034	41.68

	Order No.	Price
17 Cal (.172 dia)		
20 gr V-Max(100)	003-21710	\$15.27
25 gr Hollow Pt.(100)	003-1710	15.49
25 gr V-Max(100)	003-17105	15.90
20 Cal (.204 dia)		
32 gr V-Max(100)	003-22004	\$15.27
32 gr V-Max (250)	003-22406	36.31
40 gr V-Max(100)	003-22006	15.27
40 gr V-Max(250)	003-22606	36.31
45 gr SP(100)	003-22008	19.65
22 Cal (.222 dia)		
40gr Jet (100)	003-2210	\$18.18
22 Cal (.223 dia)		
45gr Hornet (100)	003-2220	\$18.18
22 Cal (.224 dia)		
35 gr V-Max(100)	003-22252	\$15.27
40 gr V-Max(100)	003-22241	15.27
40gr V-Max(250)	003-22416	36.31
45 gr Bee(100)	003-2229	15.10
45 gr Hornet(100)	003-2230	15.10
50 gr V-Max Moly(100)	003-22613	18.14
50 gr V-Max(100)	003-22261	15.27
50gr V-Max(250)	003-22616	36.31
50 gr SXSP(100)	003-2240	11.43
50 gr SP(100)	003-2245	11.43
52 gr BTHP Match(100)	003-2249	13.98
52 gr BT A-Max(100)	003-22492	16.11
53 gr HP Match(100)	003-2250	13.48
55 gr V-Max Moly(100)	003-22713	17.63
55 gr V-Max(250)	003-22271	15.27
55gr V-Max(100)	003-22716	36.31
55 gr SXSP(100)	003-2260	11.43
55 gr SP(100)	003-2265	11.43
55 gr SPw/Cann.(100)	003-2266	12.27
55 gr FMJ/BT w/ Cann.(100)	003-2267	13.07
60 gr V-Max(100)	003-22281	15.80
60 gr SP(100)	003-2270	11.97
60 gr HP(100)	003-2275	15.61
68 gr BTHP Match(100)	003-2278	15.11
75 gr BTHP Match(100)	003-2279	15.40
75 gr BTHP Match(600)	003-22796	87.76
75 gr A-Max(100)	003-22792	16.63
75 gr A-Max(600)	003-227926	94.69
75 gr A-Max Moly(100)	003-22794	21.11
80 gr A-Max(100)	003-22832	16.63
80 gr A-Max(600)	003-228326	94.69
22 Cal (.227 dia)		
70gr SP w/C (100)	003-2280	\$22.78
6mm (.243 dia)		
58gr V-Max(100)	003-22411	\$17.50
65gr V-Max(100)	003-22415	18.36
75gr V-Max(100)	003-22420	19.25
75gr HP(100)	003-2420	16.65
80gr GMX (50)	003-24370	28.79
85gr Interbond (100)	003-24539	39.73
87gr V-Max(100)	003-22440	19.88
87gr SP(100)	003-2440	20.00
87gr BTHP(100)	003-2442	19.02
95gr SST Interlock w/Cann (100)	003-24532	25.56
100gr SP with Cann (100)	003-2450	19.57
100gr BTSP w/Cannelure(100)	003-2453	19.57
105gr A-Max(100)	003-24562	19.29
105gr A-Max Moly(100)	003-24564	23.33
25 Cal (.257 dia)		
60gr FP(100)	003-2510	\$20.07
75gr HP(100)	003-2520	16.87
75gr V-Max(100)	003-22520	19.25
87gr SP(100)	003-2530	18.07
100gr SP w/Cannelure(100)	003-2540	22.74
110gr Interbond (100)	003-25419	43.30
110gr GMX (50)	003-25410	27.28
117gr RN(100)	003-2550	22.40
117gr BTSP w/Cannelure(100)	003-2552	22.40
117gr SST Interlock w/Cann (100)	003-25522	25.56
120gr HP(100)	003-2560	22.40
6.5mm (.264 dia)		
95gr V-Max (100)	003-22601	\$23.70
120gr GMX (50)	003-26110	26.84
120gr A-Max (100)	003-26172	22.46
123gr A-Max (100)	003-26171	22.46
129gr SP w/ Cannelure(100)	003-2620	23.23
129gr SST Interlock (100)	003-26202	25.56
129gr Interbond (100)	003-26209	44.62
140gr SP w/Cannelure(100)	003-2630	23.23
140gr SST Interlock w/Cann (100)	003-26302	25.56
140gr A-Max(100)	003-26332	26.05



Hornady Jacketed Rifle Bullets
Hornady
Accurate. Deadly. Dependable.

V-Max Bullets - The Poly-Tip is the key to dramatic accuracy and devastating expansion. The Varmint leader!
A-Max Bullets - Ultra-Low Drag™ Tip for optimal in-flight stability and immediate expansion.
SST Bullets - Super Shock Tip.
Interbond Bullets™ - Bonded core, with premium polymer tip!
Interlock™ Bullets - One piece core Copper Construction. Tapered jacket held in place by the Interlock™ ring.
Dangerous Game Bullets - Tough copper clad steel jacket delivers deep penetration and will not deform.
GMX Bullets - Gilding metal construction, Lead-free and California Compatible. Use conventional reloading data

BT...Boattail	RN...Round Nose
HP...Hollow Point	SST...Super Shock Tip
SP...Spire Point	FP...Flat Point
FMJ...Full Metal jacket	Cann...Cannelure

	Order No.	Price
270 Cal (.277 dia)		
100gr SP(100)	003-2710	\$20.78
110gr HP(100)	003-2720	21.22
110gr V-Max w/Cannelure(100)	003-22721	24.21
130gr SP w/Cannelure(100)	003-2730	21.53
130gr SST Interlock w/Cann (100)	003-27302	25.56
130gr Interbond (100)	003-27309	44.62
130gr GMX (50)	003-27370	28.79
140gr BTSP w/Cannelure(100)	003-2735	23.03
140gr SST Interlock w/Cann (100)	003-27352	25.56
150gr SP w/ Cannelure(100)	003-2740	21.61
150gr SST Interlock w/Cann (100)	003-27402	25.56
150gr Interbond (100)	003-27409	46.69
7mm (.284 dia)		
120gr V-Max (100)	003-22810	\$23.70
139gr SP w/Cannelure (100)	003-2820	23.03
139gr SST Interlock w/Cann (100)	003-28202	25.56
139gr BTSP w/Cannelure (100)	003-2825	23.03
139gr Interbond (100)	003-28209	44.66
139gr GMX (50)	003-28270	28.79
154gr SP w/Cannelure (100)	003-2830	22.60
154gr SST Interlock w/Cann (100)	003-28302	27.39
154gr Interbond (100)	003-28309	46.76
162gr A-Max (100)	003-28402	25.62
162gr BTSP w/Cannelure (100)	003-2845	24.25
162gr SST Interlock w/Cann (100)	003-28452	27.39
30 Cal (.308 dia)		
110gr V-Max (100)	003-23010	\$22.57
110gr SP (100)	003-3010	18.30
110gr RN (100)	003-3015	21.22
130gr SP (100)	003-3020	22.82
150gr SP w/Cannelure (100)	003-3031	21.72
150gr BTSP w/Cannelure (100)	003-3033	22.75
150gr RN w/Cannelure (100)	003-3035	22.75
150gr FMJ-BT w/Cann (100)	003-3037	21.75
150gr SST Interlock w/Cann (100)	003-30302	25.56
150gr Interbond (100)	003-30309	46.76
150gr GMX (50)	003-30370	30.63
150gr GMX/FlexTip (30-30) (50)	003-30310	29.15
155gr A-Max Moly (100)	003-30314	29.57
155gr A-Max (100)	003-30312	24.67
165gr SST Interlock w/Cann (100)	003-30452	27.39
165gr SP w/Cannelure (100)	003-3040	23.58
165gr BTSP w/Cannelure (100)	003-3045	23.58
165gr Interbond (100)	003-30459	47.21
165gr GMX (50)	003-30470	30.63
168gr BTHP Match (100)	003-30501	23.50
168gr BTHP Match (250)	003-305016	55.65
168gr A-Max Moly (100)	003-30504	30.56
168gr A-Max (100)	003-30502	25.62
168gr A-Max (250)	003-305026	60.84
168gr BTHP Moly (100)	003-30503	28.02
170gr FP w/Cannelure (100)	003-3060	22.69
178gr A-Max (100)	003-30712	26.33
180gr SP w/Cannelure (100)	003-3070	23.82
180gr BTSP w/Cannelure (100)	003-3072	25.39
180gr RN w/Cannelure (100)	003-3075	25.39
180gr SST Interlock w/Cann (100)	003-30702	27.75
180gr Interbond (100)	003-30709	48.52
190gr BTSP w/Cannelure (100)	003-3085	29.22
208gr A-Max (100)	003-30732	28.41
220gr RN (100)	003-3090	28.49
7.62 Cal (.310 dia)		
123gr SPw/cannelure (100)	003-3140	\$22.10

	Order No.	Price
303 / 7.7 Jap (.312 dia)		
150gr SPw/Cannelure (100)	003-3120	\$21.57
174gr FMJBT w/Cann (100)	003-3131	26.30
174gr RN (100)	003-3130	24.96
32 Cal (.321 dia)		
170gr FP w/cannelure (100)	003-3210	\$23.33
8mm (.323 dia)		
150gr SPw/cannelure (100)	003-3232	\$23.30
170gr RN w/cannelure (100)	003-3235	24.40
195gr SPw/cannelure (100)	003-3236	33.33
338 Cal (.338 dia)		
200gr SP (100)	003-3310	\$31.31
200gr SST (100)	003-33102	33.16
225gr SP w/Cannelure (100)	003-3320	31.31
225gr SST Interlock w/Cann (100)	003-33202	32.07
225gr Interbond (Sale!)	003-33209	54.19
225gr GMX (50)	003-33270	35.27
250gr SPw/Cannelure (100)	003-3335	37.80
348 Cal (.348 dia)		
200gr FP (100)	003-3410	\$33.09
35 Cal (.358 dia)		
180gr. SP Single Shot Pistol with Cannelure (100)	003-3505	\$32.01
200gr SP w/cannelure (100)	003-3510	33.71
200gr RN w/cannelure (100)	003-3515	27.78
9.3 Cal (.366 dia)		
286gr SP-RP (50)	003-3560	\$23.05
375 Cal (.375 dia)		
225gr SP-RP (100)	003-3706	\$36.98
270gr SP-RP (50)	003-3711	22.83
300gr RN (50)	003-3720	22.16
300gr BTSP (50)	003-3725	29.14
405 Win (.411 dia)		
300gr SP (50)	003-41051	\$25.54
300gr FP (50)	003-41050	24.40
416 Cal (.416 dia)		
400gr RN (50)	003-4165	\$35.23
44 Cal (.430 dia)		
265gr FP (100)	003-4300	\$31.01
45 Cal (.458 dia)		
300gr HP w/cannelure (50)	003-4500	\$19.13
350gr RN (50)	003-4502	25.54
350gr FP (50)	003-4503	25.54
500gr RN (50)	003-4504	39.32
50 Cal (.510 dia)		
750gr A-Max (20)	003-5165	439.08

Hornady Dangerous Game Bullets



	Order No.	Price
375cal 375dia 300gr DGX (50)	003-3721	\$34.23
375cal 375dia 300gr DGS (50)	003-3727	34.23
400cal 410dia 400gr DGS (50)	003-4103	42.52
416cal 416dia 400gr DGX (50)	003-4169	41.25
416cal 416dia 400gr DGS (50)	003-4167	41.25
423cal 423dia 400gr DGX (50)	003-4240	47.79
423cal 423dia 400gr DGS (50)	003-4241	47.79
45cal 458dia 500gr DGS (50)	003-4507	44.39
470cal 474dia 500gr DGX (50)	003-4747	56.02
470cal 474dia 500gr DGS (50)	003-4748	56.02
500cal 510dia 570gr DGX (50)	003-5150	58.16
500cal 510dia 570gr DGS (50)	003-5155	58.16
505cal 505dia 525gr DGX (50)	003-5050	63.98
505cal 505dia 525gr DGS (50)	003-5051	63.98

Hornady FlexTip™ Bullets



They're here. FTX™ bullets are the same bullets that are loaded in the most popular levergun ammunition ever devised: LEVERevolution®.

	Order No.	Price
30-30 .308dia 160gr (100)	003-30395	\$27.69
32 cal .321dia 165gr (100)	003-32005	28.85
308 Marlin Ex .308dia 160gr (100)	003-30396	27.69
338 Marlin Ex .338dia 200gr (100)	003-33104	34.96
357cal 357dia 140gr (100)	003-35745	22.33
35cal 358dia 200gr (100)	003-35105	34.20
44cal 430dia 265gr (50)	003-4305	25.82
44 Mag 430dia 225gr (100)	003-44105	27.54
45cal (460 S&W) 452dia 200gr (50)	003-45215	23.25
45 Colt 452dia 225gr (100)	003-45218	27.54
450 Bushmstr 452dia 250gr (50)	003-45201	25.82
45cal 458dia 325gr (50)	003-45015	27.06
50cal (500 S&W) 500dia 300gr (50)	003-50102	26.93



Hornady GMX™ Bullets

The Hornady GMX™ (Gilding Metal eXpanding) bullets. GMX bullets are constructed of the same gilding metal used to make ultra-consistent Hornady bullet jackets. Gilding metal doesn't foul like "sticky" solid copper, and strategically located grooves in the bearing surface of the bullet reduce pressure. These additions make the GMX easy to load using standard published data for comparable Hornady SST® bullets.

	Order No.	Price
6mm GMX .243dia 80gr	003-24370	\$28.79
25 Cal. GMX .257dia 110gr	003-25410	27.28
6.5mm GMX .264dia 120gr	003-26110	26.84
270 Cal. GMX .277dia 130gr.	003-27370	28.79
7mm GMX .284dia 139gr.	003-28270	28.79
30 Cal. GMX .308dia 150gr.	003-30370	30.63
30 Cal. GMX/FT .308dia 150gr.	003-30310	29.15
30 Cal. GMX .308dia 165gr.	003-30470	30.63
338 Cal. GMX .338dia 225gr.	003-33270	35.27

Hornady NTX Bullets

Premium polymer tip and streamlined design for ultra flat trajectories. Match grade jacket design provides maximum accuracy at all ranges. Lead-Free and California Compatible



	Order No.	Price
204 Ruger 204dia 30gr NXT (100)	003-22000	\$16.26
22cal 224dia 45gr NXT (100)	003-22240	16.26



Bulk Bullets packed large quantities ranging from 250 to 10,000 bullets, these rifle bullets meet the same quality control standards as with the standard 100-count boxes.

*Notes that the bullet does not have cannellure



Bulk & Breakdown Rifle Bullets

Breakdown				Bulk			
Qty	Order No.	Price		Qty	Order No.	Price	
22 Cal (.224 dia)							
55gr SP w/Cann (250)	153-2266B250	\$23.26		(6000)	153-2266B	\$457.15	
55gr FMJBT w/Cann (250)	153-2267B250	23.26		(6000)	153-2267B	457.15	
30 Cal (.308 dia)							
110gr FMJ (250)	153-3017B250	\$40.32		(3000)	153-3017B	\$438.82	
150grFMJ-BT (250)	153-3037B250	47.86		(2100)	153-3037B	364.63	
7.62mm (.310dia)							
123grSP (250)	153-3140B250	\$48.30		(2800)	153-3140B	\$490.59	

Hornady Jacketed Handgun Bullets



32 Cal (.312 dia)		
60gr HP-XTP(100)	003-32010	\$15.42
85 gr HP-XTP(100)	003-32050	15.42
100 gr HP-XTP(100)	003-32070	15.42
9mm (.355 dia)		
90gr HP-XTP(100)	003-35500	\$15.68
115gr HP-XTP(100)	003-35540	15.68
115gr ENC FMJ RN (100)	003-35557	15.20
121gr HAP .356 (500)	003-355721	67.18
124gr HP-XTP(100)	003-35571	16.35
124gr FMJ-RN .355 (500)	003-355771	53.48
147gr HP-XTP(100)	003-35580	17.56
38 Cal (.357 dia)		
110gr HP-XTP(100)	003-35700	\$15.82
125gr HP-XTP(100)	003-35710	15.82
125gr FP-XTP(100)	003-35730	15.82
140gr HP-XTP(100)	003-35740	17.86
158gr HP-XTP(100)	003-35750	17.86
158gr FP-XTP(100)	003-35780	17.86
180gr HP-XTP(100)	003-35771	19.53
10mm (.400 dia)		
155gr HP-XTP(100)	003-40000	\$19.53
200gr HP-XTP(100)	003-40060	21.00
180gr HP-XTP(100)	003-40040	20.04
180gr HAP (500)	003-400421	76.89
180gr FMJ-FP (500)	003-400471	79.67
41 Cal (.410 dia)		
210gr HP-XTP(100)	003-41000	\$23.39
44 Cal (.430 dia)		
180gr HP-XTP(100)	003-44050	\$21.00
200gr HP-XTP(100)	003-44100	21.00
240gr HP-XTP(100)	003-44200	23.25
240gr CL/SIL(100)	003-4425	27.71
300gr HP-XTP(50 PER)	003-44280	14.27
45 Cal (.451 dia)		
185gr HP-XTP(100)	003-45100	\$20.76
185gr Tgt. SWC(100)	003-45137	21.61
200gr HP-XTP(100)	003-45140	21.61
230gr JHP/XTP(100)	003-45160	21.61
230gr ENC FMJ RN (100)	003-45177	21.61
230gr FMJ-RN (500)	003-451771	91.05
230gr FMJ-FP (500)	003-451871	91.05
230gr HAP (500)	003-451611	94.74
45 Cal (.452 dia)		
240gr XTP/MAG(100)	003-45220	\$28.61
250gr Long Colt HP-XTP(100)	003-45200	23.58
300gr XTP/MAG(50)	003-45235	16.99
300gr HP/XTP(50)	003-45230	15.21
475 Cal (.475 dia)		
325gr XTP/Mag (50)	003-47500	\$34.54
400gr XTP/Mag (50)	003-47550	36.28
500 S&W (.500 dia)		
350gr XTP/MAG(50)	003-50100	\$34.19
500gr XTP/MAG(50)	003-50105	39.12

Hornady Bulk Pack Lead Pistol Bullets



	Order No.	Price
32 Cal (.314 dia)		
90 gr SWC (500)	003-10008	\$32.59
90 gr HBWC (400)	003-10028	28.66
38 Cal (.358 dia)		
148 gr HBWC (250)	003-10208	\$23.11
158 gr RN (300)	003-10508	27.13
158 gr SWC (300)	003-10408	25.91
158 gr SWC/HP (300)	003-10428	27.13
140 gr Cowboy (350)	003-10078	30.24
44 Cal (.427 dia)		
205 gr FP (250)	003-11208	\$36.52
44 Cal (.430 dia)		
240 grain SWC (200)	003-11108	\$27.33
240 gr SWC/HP (200)	003-11118	26.95
180 gr Cowboy (250)	003-11058	32.89
45 Cal (.452 dia)		
200 gr SWC (200)	003-12108	\$24.04
230 gr LRN (200)	003-12308	25.06
45 Cal (.452 dia)		
255 gr FP (200)	003-12458	\$35.95

Red and Black Hornady Hat - Velcro Back

Only \$9.99

Order No. 003-99261

8th Edition Reloading Manual - Nearly 1100 pages, Incorporates data for Hodgdon's groundbreaking Superformance and LEVERevolution powders. More info in page 105.

Order No. 003-99238 \$27.05

Hornady Buck Shot

	Order No.	Price
Buckshot #00, 5lb.	003-6400	\$22.31
Buckshot #000, 5lb.	003-64000	22.31
Buckshot #4, 5lb.	003-6414	22.31

HP...Hollow Point	ENC...Encapsulated
FMJ...Full Metal jacket	SIL...Silhouette
RN...Round Nose	CL...Crimp Lock
SWC...Semi-Wadcutter	C/T...Combat/Target
XTP...Extreme Terminal Performance	FP...Fiat Point
	SJ...Short Jacket

Hornady Bulk & Breakdown Bullets

Bulk & Breakdown Handgun Bullets

Breakdown				Bulk			
Qty	Order No.	Price		Qty	Order No.	Price	
9mm (.355/356 dia)							
100grFMJ-RN (250)	153-35527B250	\$32.92		(3500)	153-35527B	\$410.41	
115grFMJ-RN .356 (250)	153-35557B250	27.86		(3000)	153-35557B	310.41	
121grHAP .356 (250)	153-35530B250	33.06		(2800)	153-35530B	343.73	
124grFMJ-FP (250)	153-35567B250	30.44		(2900)	153-35567B	327.82	
124grFMJ-RN ENC (250)	153-35577B250	30.44		(2900)	153-35577B	327.82	
125gr HAP .356 (250)	153-35572B250	33.05		(3000)	153-35572B	368.28	
147grFMJ-RN (250)	153-35597B250	33.14		(2500)	153-35597B	307.70	
10mm (.400 dia)							
180grFMJ-FP (250)	153-40047B250	\$39.57		(2000)	153-40047B	\$293.91	
45 Cal (.451 dia)							
185grSWC (250)	153-45137B250	\$42.79		(1900)	153-45137B	\$291.09	
200grFMJ-FP (250)	153-45157B250	42.82		(1700)	153-45157B	270.34	
230grFMJ-RN (250)	153-45177B250	46.37		(1500)	153-45177B	258.32	
230grFMJ-FP (250)	153-45187B250	46.37		(1500)	153-45187B	258.32	

Nosler Rifle Bullets

20 Cal (.204 dia)		
32gr Ballistic Tip Varmint (100)	115-35216	\$21.01
32gr Ballistic Tip Lead Free (50)	115-45145	12.77
32gr Ballistic Tip Lead Free (100)	115-45140	21.16
32gr Ballistic Tip Varmint (250)	115-39573	40.58
40gr Ballistic Tip (100)	115-52111	19.82
22 Cal (.224 dia)		
35gr Ballistic Tip Lead Free (50)	115-45155	\$13.00
35gr Ballistic Tip Lead Free (100)	115-45150	21.62
40gr Ballistic Tip (100)	115-39510	21.80
40gr Ballistic Tip (250)	115-39555	46.35
40gr Ballistic Tip Lead Free (50)	115-45165	13.34
40gr Ballistic Tip Lead Free (100)	115-45160	21.97
50gr Ballistic Tip (100)	115-39522	21.80
50gr Ballistic Tip (250)	115-39557	46.35
52gr HPBT Custom Comp (100)	115-53294	19.75
52gr HPBT Custom Comp (250)	115-53335	48.75
55gr Ballistic Tip (100)	115-39526	21.80
55gr Ballistic Tip (250)	115-39560	42.13
60gr Partition (50)	115-16316	23.81
60gr Ballistic Tip Varmint (100)	115-34992	22.38
60gr Ballistic Tip Varmint (250)	115-39473	43.38
69gr HPBT Custom Comp (100)	115-17101	21.87
69gr HPBT Custom Comp (250)	115-53065	50.76
77gr HPBT Custom Comp (100)	115-22421	24.43
77gr HPBT Custom Comp (250)	115-53064	56.90
6mm (.243 dia)		
55gr Ballistic Tip (100)	115-24055	\$23.97
55gr Ballistic Tip (250)	115-39565	50.69
55gr Ballistic Tip Lead Free (50)	115-45175	14.49
55gr Ballistic Tip Lead Free (100)	115-45170	24.15
70gr Ballistic Tip (100)	115-39532	26.26
70gr Ballistic Tip (250)	115-39570	55.60
80gr Ballistic Tip (100)	115-24080	26.60
85gr Partition (50)	115-16314	29.23
90gr Ballistic Tip (50)	115-24090	15.84
90gr E-Tip (50)	115-59165	26.80
95gr Ballistic Tip (50)	115-24095	14.74
95gr Partition (50)	115-16315	29.56
100gr Partition (50)	115-35642	30.23
105gr HPBT Custom Comp (100)	115-53614	25.88
105gr HPBT Custom Comp (250)	115-16328	61.25
25 Cal (.257 dia)		
85gr Ballistic Tip (100)	115-43004	\$28.31
100gr Ballistic Tip (50)	115-25100	15.36
100gr Partition (50)	115-16317	30.23
100gr E-Tip (50)	115-59456	28.76
110gr Accubond (50)	115-53742	26.51
115gr Ballistic Tip (50)	115-25115	18.30
115gr Partition (50)	115-16318	30.78
120gr Partition (50)	115-35643	31.89
6.5mm (.264 dia)		
100gr Ballistic Tip (50)	115-26100	\$18.07
100gr Partition (50)	115-16319	30.23
120gr Ballistic Tip (50)	115-26120	17.02
125gr Partition (50)	115-16320	32.11
130gr Accubond (50)	115-56902	27.64
140gr Partition (50)	115-16321	33.66
140gr Accubond (50)	115-57873	28.66
140gr HPBT Custom Comp (100)	115-26725	26.44
140gr HPBT Custom Comp (250)	115-49823	62.70
6.8mm (.277 dia)		
100gr Accubond (50)	115-57845	\$26.17
110gr Accubond (50)	115-54382	26.28
270 Cal (.277 dia)		
130gr Ballistic Tip (50)	115-27130	\$17.54
130gr Accubond (50)	115-54987	27.64
130gr Partition (50)	115-16322	32.44
130gr E-Tip (50)	115-59298	31.52
140gr Accubond (50)	115-54765	28.66
140gr Ballistic Tip (50)	115-27140	19.41
140gr Partition (50)	115-35200	33.66
150gr Ballistic Tip (50)	115-27150	19.97
150gr Partition (50)	115-16323	34.10
160gr Partition Semi-Spitzer (50)	115-16324	34.55
7mm (.284 dia)		
120gr Ballistic Tip (50)	115-28120	\$17.02
140gr Ballistic Tip (50)	115-28140	18.06
140gr Accubond (50)	115-59992	26.26
140gr Partition (50)	115-16325	33.66
140gr E-Tip (50)	115-59955	32.55
150gr Ballistic Tip (50)	115-28150	18.58
150gr Partition (50)	115-16326	34.10
150gr E-Tip (50)	115-59426	33.13
160gr Accubond (50)	115-54932	29.80
160gr Partition (50)	115-16327	34.88
175gr Partition (50)	115-35645	35.77



Accubond® - Poly Tipped, Fully tapered, heavy alloy jacket is bonded to the special lead alloy core designed for controlled expansion, deep penetration and a 60-70% weight retention.

Partition® - Special lead alloy dual-core construction provides superior mushrooming at all impact velocities.

Ballistic Tip - Fully tapered jacket and special lead alloy core allows controlled expansion and optimum weight retention. Polycarbonate tip resists deformation in the magazine and initiates expansion upon impact.

Custom Competition™ - Form fitted lead alloy core & quality jacket engineered to exhibit unmatched accuracy.

E-Tip - 100% Lead Free! Exclusive E² Cavity (Energy Expansion Cavity) allows for immediate and uniform expansion with 95%+ Weight Retention, OD green polycarbonate tip

Ballistic Tip Lead Free - Lead Free! Metallic Colored Polymer Tip, Explosive Expansion, Larger Cavity. Certified for use in California's Non-Lead Zone.

30 Cal (.308 dia)		
125gr Ballistic Tip (50)	115-30125	\$17.54
150gr Ballistic Tip (50)	115-30150	18.58
150gr Accubond (50)	115-56719	27.09
150gr Partition (50)	115-16329	33.99
150gr E-Tip (50)	115-59378	33.13
155gr HPBT Custom Comp (100)	115-53155	28.78
155gr HPBT Custom Comp (250)	115-53169	69.06
165gr Ballistic Tip (50)	115-30165	19.10
165gr Accubond (50)	115-55602	27.40
165gr Partition (50)	115-16330	34.88
168gr HPBT Custom Comp (100)	115-53164	28.78
168gr HPBT Custom Comp (250)	115-53168	69.06
168gr E-Tip (50)	115-59415	34.28
168gr Ballistic Tip (50)	115-30168	19.10
170gr Partition Round Nose (50)	115-16333	35.66
175gr HPBT Custom Comp (100)	115-53952	29.79
175gr HPBT Custom Comp (250)	115-53167	71.62
180gr Ballistic Tip (50)	115-30180	19.61
180gr Accubond (50)	115-54825	28.02
180gr Partition (50)	115-16331	36.43
180gr Partiti Protected Point (50)	115-25396	36.43
180gr E-Tip (50)	115-59180	35.43
190gr HPBT Custom Comp (100)	115-53412	31.46
190gr HPBT Custom Comp (250)	115-59156	78.56
200gr Accubond (50)	115-54618	32.74
200gr Partition (50)	115-35626	37.21
220gr Partition Semi-Spitzer (50)	115-16332	37.65
8mm (.323 dia)		
180gr Ballistic Tip (50)	115-32180	\$21.53
200gr Accubond (50)	115-54374	34.21
200gr Partition (50)	115-35277	41.52
200gr HPBT Custom Comp (100)	115-49524	32.33
200gr HPBT Custom Comp (250)	115-56543	78.73
338 Cal (.338 dia)		
180gr Accubond (50)	115-57625	\$35.12
200gr Accubond (50)	115-56382	37.39
200gr E-Tip (50)	115-59186	38.99
210gr Partition (50)	115-16337	46.29
225gr Accubond (50)	115-54357	39.65
225gr Partition (50)	115-16336	48.28
225gr Partiti (25)	115-16436	29.12
250gr Partition (50)	115-35644	49.61
250gr Partition (25)	115-35744	29.79
250gr Accubond (50)	115-57287	41.12
35 Cal (.358 dia)		
225gr Accubond (50)	115-50712	\$40.90
225gr Partition (25)	115-44810	29.12
250gr Partition (25)	115-44811	29.79
9.3mm (.366 dia)		
250gr Accubond (50)	115-59756	\$41.12
286gr Partition (25)	115-44760	29.79
375 Cal (.375 dia)		
260gr Partition (25)	115-44950	\$29.79
260gr Accubond (50)	115-54413	42.26
260gr Solid Dangerous Game (25)	115-29755	60.94
300gr Partition (25)	115-44945	34.55
300gr Accubond (50)	115-53662	48.60
300gr Solid Dangerous Game (25)	115-28451	67.48
416 Cal (.416 dia)		
400gr Partition (25)	115-45210	\$35.88
400gr Solid Dangerous Game (25)	115-23654	73.90
458 Cal (.458 dia)		
500gr Partition (25)	115-44745	\$81.83
500gr Solid Dangerous Game (25)	115-27452	77.64

Nosler Handgun Bullets



38 (.357 dia)		
158gr Jacketed Hollow Point (250)	115-44841	\$40.78
9mm (.355 dia)		
124gr Jacketed Hollow Point (250)	115-43123	\$38.07
10mm (.400 dia)		
200gr Jacketed Hollow Point (250)	115-44952	\$48.94
41 (.410 dia)		
210gr Jacketed Hollow Point (100)	115-43012	\$26.28
44 Cal (.429 dia)		
240gr Jacketed Soft Point (250)	115-44868	\$53.02
300gr Jacketed Hollow Point (100)	115-42069	27.98
45 Cal (.451 dia)		
230gr Full Metal Jacket (250)	115-44964	\$52.21
250gr Jacketed Hollow Point (100)	115-43013	27.42

Nosler Bulk Rifle Bullets

22 Cal (.224 dia)		
40gr Ballistic Tip (1000)	115-62634	\$169.54
50gr Ballistic Tip (1000)	115-15190	168.27
52gr HPBT Custom Comp (1000)	115-59741	155.54
55gr Ballistic Tip (1000)	115-11288	169.54
69gr HPBT Custom Comp (1000)	115-65823	161.30
77gr HPBT Custom Comp (1000)	115-19254	164.52
80gr HPBT Custom Comp (1000)	115-49563	164.52
30 Cal (.308 dia)		
155gr HPBT Custom Comp (1000)	115-45369	\$222.72
168gr HPBT Custom Comp (1000)	115-65934	222.72
190gr HPBT Custom Comp (1000)	115-51268	246.63
6.5 Cal (.264 dia)		
140gr HPBT Custom Comp (1000)	115-50379	219.33

Nosler Bulk Handgun Bullets

9mm (.355 dia)		
115gr Jacketed Hollow Point (250)	115-44848	\$37.95
38 (.357 dia)		
158gr Jacketed Hollow Point (250)	115-44841	\$40.78
10mm (.400 dia)		
135gr Jacketed Hollow Point (250)	115-44852	\$40.10
150gr Jacketed Hollow Point (250)	115-44860	40.78
180gr Jacketed Hollow Point (250)	115-44885	46.45
44 Cal (.429 dia)		
200gr Jacketed Hollow Point (250)	115-44846	\$48.94
240gr Jacketed Hollow Point (250)	115-44842	53.02
45 Cal (.451 dia)		
185gr Jacketed Hollow Point (250)	115-44847	\$48.37
185gr JHP Custom Comp (1000)	115-53264	164.61

Don't Forget!

Nosler Combined Technology Bullets

See Page 117

Remington Bulk & Breakdown Bullets

Remington Bulk Bullets - This is Not Loaded Ammunition. We purchase bulk cases of bullets from Remington, break it down into smaller quantities and pass the savings on to you. You can also purchase the entire Factory Pack Case. Buy in Factory Pack Cases and Get the Same Lot # .



Bulk & Breakdown Rifle Bullets

Breakdown				Bulk		
22 Cal (.224 dia)	Qty	Order No.	Price	Qty	Order No.	Price
45gr SP*	(100)	050-22705100	\$17.48	(2000)	050-22705	\$313.22
45gr HP*	(100)	050-22703100	17.10	(2000)	050-22703	306.47
50gr PLHP*	(100)	050-22951100	19.06	(2000)	050-22951	341.55
50gr PSP*	(100)	050-22957100	14.72	(2000)	050-22957	263.95
55gr PSP	(100)	050-23610100	13.68	(2000)	050-23610	245.26
55gr FMJ	(100)	050-23624100	9.76	(2000)	050-23624	174.90
55gr PLHP	(100)	050-23542100	20.14	(4000)	050-23542	721.41
6mm (.243 dia)						
80gr PSP	(100)	050-22967100	\$19.16	(2000)	050-22967	\$343.47
100gr PSPCL	(100)	050-22965100	20.16	(2000)	050-22965	361.44
25 Cal & 25-20 (.256 & 257 dia)						
.256dia 86gr JSP	(100)	050-22735100	\$20.53	(2000)	050-22735	\$368.08
.257dia 100gr PSPCL	(100)	050-22741100	22.32	(2000)	050-22741	399.90
6.5mm (.264 dia)						
120gr PSPCL	(100)	050-22927100	\$25.86	(2000)	050-22927	\$463.47
140gr PSPCL	(100)	050-22901100	26.24	(2000)	050-22901	470.48
6.8mm (.277 dia)						
115gr MC	(100)	050-22750100	\$18.70	(2000)	050-22750	\$335.03
270 Cal (.277 dia)						
100gr PSP	(100)	050-22745100	\$22.57	(2000)	050-22745	\$404.66
130gr PSPCL	(100)	050-22747100	23.64	(2000)	050-22747	423.59
7mm (.284 dia)						
140gr PSPCL	(100)	050-22754100	\$25.11	(2000)	050-22754	\$450.05
150gr PSPCL	(100)	050-22757100	26.02	(2000)	050-22757	466.38
175gr PSPCL	(100)	050-22919100	28.45	(2000)	050-22919	509.87
30 Cal (.308 dia)						
110gr SP	(100)	050-23628100	\$16.66	(2000)	050-23628	\$298.63
110gr MC	(100)	050-23630100	16.66	(2000)	050-23630	298.63
125gr PSP	(100)	050-22915100	23.89	(2000)	050-22915	428.30
150gr BP	(100)	050-22771100	39.64	(2000)	050-22771	710.62
150gr SPRNCL	(100)	050-22775100	25.64	(2000)	050-22775	459.43
150gr PSPCL	(100)	050-23590100	25.64	(2000)	050-23590	459.43
165gr PSPCL	(100)	050-23595100	26.36	(2000)	050-23595	472.36
170gr SP (30-30)	(100)	050-23656100	27.79	(2000)	050-23656	498.08
180gr PSPCL	(100)	050-22789100	27.95	(2000)	050-22789	500.87
303 Cal (.310 dia)						
125gr PSP	(100)	050-22762100	\$24.42	(2000)	050-22762	\$437.66
180gr SPCL	(100)	050-22813100	28.47	(2000)	050-22813	510.38
8mm (.323 dia)						
185gr PSPCL	(100)	050-22985100	\$29.27	(2000)	050-22985	\$524.70
35 Cal (.358 dia)						
200gr SPCL	(100)	050-22869100	\$31.77	(1000)	050-22869	\$284.69
44/40 Cal (.426 Dia)						
200gr SP	(100)	050-22883100	\$27.93	(1000)	050-22883	\$250.41
45/70 Cal (.457 Dia)						
300gr JHP	(100)	050-23654100	\$35.15	(1000)	050-23654	\$315.16
405gr SP	(100)	050-22899100	36.04	(1000)	050-22899	323.06

*Notes that the bullet does not have cannelure

Bullet Key -	JHP = Jacketed Hollow Point
PSP = Pointed Soft Point	FMJ = Full Metal Jacket
MC = Metal Case	PLHP = Power Lukt® Hollow Point
BP = Bronze Point	BFB = Beveled Flat Base
SP = Soft Point	BJHP = Bronze Jacketed Hollow Point
CL = Core-Lukt®	SJHP = Semi Jacketed Hollow Point

Bulk & Breakdown Handgun Bullets

Breakdown			Bulk			
32 Cal (.312 dia)	Qty	Order No.	Price	Qty	Order No.	Price
71gr FMJ	(250)	050-22817250	\$34.72	(2000)	050-22817	\$265.41
9mm (.355 dia)						
115gr JHP	(250)	050-23554250	\$32.00	(2000)	050-23554	\$244.52
115gr FMJ-BFB	(250)	050-23556250	30.14	(2000)	050-23556	230.31
124gr JHP-BFB	(250)	050-23557250	34.01	(2000)	050-23557	260.06
124gr FMJ-BFB	(250)	050-23558250	31.99	(2000)	050-23558	255.90
124gr BJHP	(250)	050-23934250	38.24	(2000)	050-23934	292.38
147gr JHP	(250)	050-23538250	44.59	(2000)	050-23538	340.73
380 / 38AC / 38 Super (.356 dia)						
88gr JHP-BFB	(250)	050-23637250	\$37.06	(2000)	050-23637	\$283.41
95gr FMJ	(250)	050-23638250	36.71	(2000)	050-23638	280.57
102gr BJHP	(250)	050-23938250	40.81	(2000)	050-23938	311.98
38Spl / 357Mag / 357Max (.357 dia)						
110gr SJHP	(250)	050-23587250	\$33.81	(2000)	050-23587	\$258.36
125gr SJHP	(250)	050-23552250	33.69	(2000)	050-23552	257.58
125gr JSP	(250)	050-23641250	35.53	(2000)	050-23641	271.50
125gr BJHP	(250)	050-23932250	39.24	(2000)	050-23932	300.05
(for 357mag)						
140gr SJHP	(250)	050-23642250	\$39.57	(2000)	050-23642	\$302.38
158gr SP	(250)	050-22847250	41.84	(2000)	050-22847	319.82
158gr SJHP	(250)	050-23560250	41.42	(2000)	050-23560	316.64
180gr SJHP	(250)	050-23646250	51.07	(2000)	050-23646	390.33
10mm / .40Cal (.400 dia)						
155gr JHP	(250)	050-23682250	\$56.97	(1000)	050-23682	\$217.77
165gr BJHP	(250)	050-23942250	60.61	(1000)	050-23942	231.67
180gr JHP	(250)	050-23684250	60.75	(1000)	050-23684	232.18
180gr FMJ	(250)	050-23686250	58.36	(1000)	050-23686	218.97
180gr BJHP	(250)	050-23944250	66.32	(1000)	050-23944	253.47
41 Mag (.410 dia)						
200gr SJHP	(250)	050-23616250	\$58.52	(1000)	050-23616	\$223.65
210gr SP	(250)	050-22889250	60.23	(1000)	050-22889	230.17
44 Mag (.430 dia)						
180gr SJHP	(250)	050-23658250	\$58.12	(2000)	050-23658	\$444.33
210gr SJHP	(250)	050-23664250	58.52	(1000)	050-23664	223.65
240gr SP	(250)	050-22907250	64.27	(1000)	050-22907	245.63
240gr SJHP	(250)	050-23592250	64.27	(1000)	050-23592	245.63
45 Auto (.452 dia)						
185gr Match FMJ	(250)	050-22891250	\$61.92	(2000)	050-22891	\$473.30
185gr JHP	(250)	050-23660250	60.52	(2000)	050-23660	462.56
185gr BJHP	(250)	050-23946250	63.14	(2000)	050-23946	482.72
230gr BJHP	(250)	050-23948250	65.93	(1000)	050-23948	252.02
230gr FMJ-BFB	(250)	050-23604250	54.98	(1000)	050-23604	210.15



On Target Powder Drop

American Design

American craftsmanship on German high quality CNC machine

On Target Powder Drop - Throw range 0-85 grains. Culver type powder drum individually fitted into the body hole, complete with 2 drop tubes and 1 bottle. Machined C-Clamp at rear.

Order No. 175-800200 \$245.05



Maximizes the best features of two great types of hunting bullet construction. It delivers the extreme accuracy and retained energy you would expect from a tipped bullet, in combination with the outstanding penetration and weight retention that only a bonded non-tipped bullet could deliver. Devastating on-game performance from 50 to 500 yards.

Remington Premier® Core-Lokt® Ultra Bonded Bullets



	Order No.	Price
243dia 6mm 100gr PSP	050-24113	\$20.56
257dia 25cal 115gr PSP	050-24114	27.75
264dia 6.5mm 140gr PSP	050-24115	32.30
277dia 6.8mm 115gr PSP	050-24116	29.41
277dia 270cal 140gr PSP	050-24117	24.33
284dia 7mm 140gr PSP	050-24118	26.37
284dia 7mm 160gr PSP	050-24119	27.45
308dia 30cal 150gr PSP	050-24126	24.84
308dia 30cal 168gr PSP	050-24127	25.07
308dia 30cal 180gr PSP	050-24128	25.60
338dia 338cal 225gr PSP	050-24136	59.96

Speer Jacketed Rifle Bullets



20 Cal (.204 dia)
32gr TNT Green No Lead (100) 021-1020 \$21.66

22 Cal (.224 dia)
33gr Hornet TNT HP (100) 021-1014 \$16.57
40gr SP (100) 021-1017 16.15
45gr Spitzer (100) 021-1023 16.15
46gr FN w/Cann (100) 021-1024 15.34
50gr Spitzer (100) 021-1029 15.34
50gr HP-TNT (100) 021-1030 17.10
50gr TNT Green No Lead (100) 021-1028 29.14
52gr HP (100) 021-1035 16.84
52gr HP/BT Match (100) 021-1036 18.95
55gr TNT HP (100) 021-1032 17.72
55gr Spitzer (100) 021-1047 15.44
55gr Spitzer w/Cann (100) 021-1049 16.15
70gr SEMI-Spitzer (100) 021-1053 21.69

6mm (.243 dia)
75gr HP (100) 021-1205 \$19.60
70gr TNT HP (100) 021-1206 21.46
80gr DeepCurl SP (100) 021-1212 20.92
85gr Spitzer/BT (100) 021-1213 22.40
90gr DeepCurl SP (100) 021-1214 21.68
100gr Spitzer/BT (100) 021-1220 22.01
100gr Grand Slam (50) 021-1222 24.97

25 Cal (.257 dia)
75gr SP w/Cann (100) 021-1237 \$21.23
87gr Spitzer (100) 021-1241 22.30
87gr TNT (100) 021-1246 22.78
100gr Spitzer (100) 021-1405 22.83
100gr HP (100) 021-1407 22.74
100gr Spitzer/BT (100) 021-1408 25.15
120gr SP Grand Slam (50) 021-1415 27.11
120gr Spitzer/BT (100) 021-1410 25.76
120gr DeepCurl SP (100) 021-1416 25.25

6.5mm (.264 dia)
90gr TNT HP (100) 021-1445 \$25.25
120gr Spitzer (100) 021-1435 21.20
140gr DeepCurl SP (100) 021-1436 25.95

270 Cal (.277 dia)
90gr HP TNT (100) 021-1446 \$25.95
100gr HP (100) 021-1447 24.76
130gr Spitzer/BT (100) 021-1458 26.45
130gr Spitzer (100) 021-1459 23.49
130gr Grand Slam (50) 021-1465 27.42
150gr Grand Slam (50) 021-1608 27.37
150gr Spitzer/BT (100) 021-1604 27.67
150gr DeepCurl SP (100) 021-1603 26.97

7mm (.284 dia)
110gr HP TNT (100) 021-1616 \$26.15
115gr HP (100) 021-1617 24.97
130gr Spitzer/BT (100) 021-1624 26.12
145gr Grand Slam (50) 021-1632 27.14
145gr Spitzer/BT (100) 021-1628 27.67
145gr Spitzer/SP (100) 021-1629 26.22
145gr Match BT (100) 021-1631 32.09
160gr Grand Slam (50) 021-1638 30.16
160gr Spitzer/BT (100) 021-1634 29.48
160gr DeepCurl SP (100) 021-1639 28.57
175gr Grand Slam (50) 021-1643 32.39

Trophy Bonded Bear Claw - Machined jacket from gilding metal, and a solid rear shank for integrity.

Grand Slam - Thicker fluted jacket for controlled expansion and weight retention.

TNT Bullets - Varmint bullet, small hollow point opening. Thin, straight-taper jacket for complete roll-back.

TNT Green - These excellent varmint options use non-lead technology for great terminal performance.

Trophy Bonded Sledgehammer - Retained weights of over 95%, Fusion Bonded Core, Solid copper shank.

UniCor - True bonded jackets for integrity, Profiled for a variety of shooting sports.

GoldDot - Core and jacket are notched for uniform expansion. Nose profiled for smooth function in semi-autos

30 Cal (.308 dia)

	Order No.	Price
100gr Plinker (100)	021-1805	\$15.84
110gr HP V (100)	021-1835	19.88
110gr Spire SP (100)	021-1855	22.83
110gr FMJ (100)	021-1846	20.08
110gr DeepCurl SP (100)	021-1844	20.08
125gr TNT HP (100)	021-1986	26.47
130gr HP (100)	021-2005	26.15
130gr FN SP (100)	021-2007	24.65
150gr Grand Slam (50)	021-2026	27.14
150gr Spitzer/BT (100)	021-2022	27.67
150gr Spitzer (100)	021-2023	23.51
150gr DeepCurl SP (100)	021-2012	24.76
165gr Grand Slam (50)	021-2038	29.53
165gr Spitzer/BT (100)	021-2034	27.37
165gr Spitzer (100)	021-2035	25.91
168gr Match BT (100)	021-2040	31.18
170gr DeepCurl SP (100)	021-2042	25.49
180gr Grand Slam (50)	021-2063	30.91
180gr Spitzer/BT (100)	021-2052	30.57
180gr DeepCurl SP (100)	021-2043	28.02
200gr SP Grand Slam (50)	021-2212	32.61
200gr Spitzer (100)	021-2211	16.36

303 Cal (.311 dia)

125gr SP/CANN (100)	021-2213	\$24.44
150gr Spitzer (100)	021-2217	26.35
180gr RN (100)	021-2223	27.95

8mm (.323 dia)

150gr Spitzer (100)	021-2277	\$25.91
170gr Semi-Spitzer (100)	021-2283	26.35
200gr Spitzer (50)	021-2285	17.55

338 Cal (.338 dia)

200gr Spitzer/SP (50)	021-2405	\$17.10
225gr Grand Slam (50)	021-2407	39.77
225gr BTSP (50)	021-2406	27.42
250gr Grand Slam (50)	021-2408	40.87

35 Cal (.358 dia)

180gr FN (100)	021-2435	\$32.58
220gr FN (50)	021-2439	17.15
250gr Spitzer (50)	021-2453	20.32

9.3mm (.366 dia)

270gr Semi-Spitzer SP (50)	021-2459	\$21.54
----------------------------	----------	---------

375 Cal (.375 dia)

235gr Semi-Spitzer (50)	021-2471	\$19.38
270gr BT/SP (50)	021-2472	31.18
285gr SP Grand Slam (50)	021-2473	53.49

45 Cal (.458 dia)

350gr FN5P (50)	021-2478	\$28.18
400gr FN (50)	021-2479	27.85



Speer Bulk Rifle Bullets

22 Cal (.224 dia)	Order No.	Price
50gr HP TNT (1000)	021-4705	\$137.13
52gr HP (1000)	021-4708	139.82
55gr Spitzer (1000)	021-4711	129.19
6mm (.243 dia)		
70gr HP TNT (750)	021-4720	\$132.27
25 Cal (.257 dia)		
87gr TNT (750)	021-4722	\$154.00
270 Cal (.277 dia)		
90gr TNT (650)	021-4723	\$147.07
7mm (.284 dia)		
110gr TNT (600)	021-4724	\$137.43
30 Cal (.308 dia)		
125gr HP TNT (500)	021-4725	\$102.36



Glow Ammo is a cold tracer technology that can be applied to any cartridge that you are hand loading. It turns a bullet into a non-incendiary tracer. There is no fire hazard because there is no fire or flame associated with the trace Glow Ammo and it's safe to shoot at any range. The light signature is only visible from the shooter's perspective, so your trace will not give you away. Apply the glow material to the base of the bullet and hand load as usual. The Glow Ammo technology does not adversely affect accuracy and only adds about one grain to the base of the bullet. Glow Ammo is best suited for the low-light situations that criminals prefer! Glow Ammo is easy to use and is addictive fun on the range and invaluable for personal self-defense.

	Order No.	Price
40 Cal Tracer Kit	177-GAT1K81840C	\$49.48
45 Cal Tracer Kit	177-GAT1K81845C	49.48
9mm Tracer Kit	177-GAT1K8189MM	49.48



Now also available in Loaded Ammunition - See Page 125!

Speer Handgun Bullets



32 Cal (.312 dia)		
60 Gr. Gold Dot HP (100)	021-3986	\$19.27
327 Federal Mag (.312 dia)		
100 Gr. Gold Dot HP (100)	021-3990	\$19.84
9mm (.355 dia)		
90 Gr. Gold Dot HP (100)	021-3992	\$19.27
115 Gr. Gold Dot HP (100)	021-3994	19.80
115 Gr. Uni-Cor TMJ (100)	021-3995	17.00
124 Gr. Gold Dot HP (100)	021-3998	21.55
147 Gr. Gold Dot HP (100)	021-4002	21.55
147 Gr. Uni-Cor TMJ (100)	021-4006	18.81
357 Sig / 38 Super (.355 dia)		
125 Gr. Gold Dot HP (100)	021-4360	\$21.55
38 Cal (.357 dia)		
110 Gr. JHP (100)	021-4007	\$18.17
125 Gr. JSP (100)	021-4011	17.75
125 Gr. Gold Dot HP (100)	021-4012	21.64
125 Gr. JHP (100)	021-4013	17.75
135 Gr. GDHP ShortBBI (100)	021-4014	21.64
140 Gr. JHP (100)	021-4203	18.76
158 Gr. Uni-Cor TMJ (100)	021-4207	22.44
158 Gr. JHP (100)	021-4211	18.45
158 Gr. Gold Dot HP (100)	021-4215	22.37
158 Gr. JSP (100)	021-4217	18.45
158 Gr. Lead RN (500)	021-4648	41.32
180 Gr. TMJ/SIL Match (100)	021-4229	23.81
170 Gr. Gold Dot SP (100)	021-4230	22.53
10mm (.400 dia)		
155 Gr. Gold Dot HP (100)	021-4400	\$26.50
165 Gr. Gold Dot HP (100)	021-4397	26.50
180 Gr. Gold Dot HP (100)	021-4406	27.16
180 Gr. TMJ (100)	021-4402	24.67
180 Gr. GDHP ShortBBI (100)	021-4401	27.16
41 Cal (.410 dia)		
210 gr Gold Dot HP (100)	021-4430	\$24.45
44 Cal (.429 dia)		
200 Gr. Gold Dot HP (100)	021-4427	\$28.81
210 Gr. Gold Dot HP (100)	021-4428	26.06
240 Gr. Mag JSP (100)	021-4454	25.24
240 Gr. Gold Dot HP (100)	021-4455	27.54
240 Gr. Gold Dot SP (100)	021-4456	27.54
270 Gr. Gold Dot SP (50)	021-4461	15.33
300 Gr. Uni-Cor SP (50)	021-4463	17.55
45 Cal (.451 dia)		
185 Gr. Gold Dot HP(100)	021-4470	\$28.14
185 Gr. SWMTMJ Match(100)	021-4473	25.95
185 Gr. Auto TMJFN (100)	021-4476	24.67
200 Gr. TMJ Match (100)	021-4475	26.57
200 Gr. Gold Dot HP (100)	021-4478	29.10
230 Gr. Uni-Cor TMJ(100)	021-4480	25.62
230 Gr. Gold Dot HP(100)	021-4483	15.20
230gr GoldDot HP Short BBI (100)	021-4482	29.20
260 Gr. MAG/JHP(100)	021-4481	14.44
300 Gr. Colt SP (50)	021-4485	17.66
45 Cal (.452 dia)		
250gr Colt Gold Dot HP(50)	021-4484	\$16.25
300gr CasullGold Dot HP (50)	021-3974	19.02
475 Linebaugh (.475 dia)		
400gr Gold Dot SP	021-3976	\$22.63
480 Ruger (.475 dia)		
275gr Gold Dot HP	021-3973	\$23.42
325gr Gold Dot SP	021-3978	22.63
50 Cal (.500 dia)		
300 Gr. Gold Dot HP (50 box)	021-4493	\$23.56
300 Gr. TMJ (50 box)	021-4490	21.64
350 Gr. UCSP (50 box)	021-4491	22.44

Speer Value Pack Rifle & Pistol Bullets



	Order No.	Price
357 Sig .357 Dia. 125 Gr. TMJ, 600 per can	021-4731	\$96.75
38 Cal. 357 Dia. 158 Gr. JHP, 450 per can	021-4732	63.90
40cal/10mm .400 Dia. 180 Gr. TMJ, 400 per can	021-4734	78.26
45 Cal. .451 Dia. 230 Gr. TMJ, 300 per can	021-4750	65.33
45 Cal. LEAD BULLET .452 Dia. 230 Gr. RN, 500 per can	021-4691	57.58

Speer Bulk Lead Handgun Bullets

	Order No.	Price
9mm .356 125gr RN (500)	021-4602	\$37.64
38cal .358 158gr SWC (500)	021-4624	41.32
44cal .430 240gr SWC (500)	021-4661	57.58
45cal .452 200gr SWC (500)	021-4678	55.78
45cal .452 250gr SWC (500)	021-4684	62.46

Speer Plastic Cases & Bullets

	Order No.	Price
Target 38 Bullets 50/box	021-8510	\$7.65
Target 38 Cases 50/box	021-8515	7.65
Target 44 Bullets 50/box	021-8520	8.31
Target 44 Cases 50/box	021-8525	8.31
Target 45 Bullets 50/box	021-8530*	8.31

*45 Plastic Bullet for use with Standard brass case. For 45 ACP Only.

Speer Empty Shotgun Capsules

	Order No.	Price
38/357 Empty Capsules with base plugs 50/box	021-8780	\$8.31
44 Cal. Empty Capsules with base plus 50/box	021-8782	7.24
45 Cal. Empty Cap W/base plug	021-8785	5.63

Lapua Rifle Bullets

100 Rounds Per Box



	Order No.	Price
6.5mm 139gr Scenar (100)	109-4PL6018100	\$47.48
6.5mm 108gr Scenar (100)	109-4PL6020100	47.48
6.5mm 123gr Scenar (100)	109-4PL6032100	47.48
6mm 105gr Scnr HPBT (100)	109-4PL6045100	51.55
30 Cal 167gr Scenar (100)	109-4PL7069100	50.19
30 Cal 185gr Scenar (100)	109-4PL7071100	50.19
30 Cal 155gr Scenar (100)	109-4PL7073100	50.19
.338 Cal 250gr Scenar (100)	109-4PL8017100	86.82

Birchwood Casey Dirty Bird Multi-Color Targets

	Order No.	Price
12" Target (10 targets total)	012-35830	\$6.32
Assorted Target 80 - 2", 30 - 2", 100 - 3" (180 targets total)	012-35828	6.32

Nosler Combined Technologies Ballistic Silver Tip Bullets

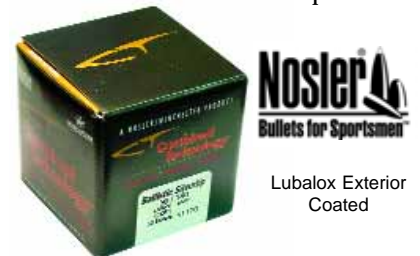

Nosler and Winchester have formed a strategic alliance that combines design and production capabilities to produce a new line of high performance bullets for handloaders. The brand is combined Technology and the line carries the name Supreme Hunting Bullets.

	Order No.	Price
20 cal. 32 gr. (100 pack)	115-51253	\$25.76
22 cal. 50 gr. (100 pack)	115-51010	26.68
22 cal. 55 gr. (100 pack)	115-51031	26.68
6mm cal. 55 gr. (100 pack)	115-51030	29.33
6mm cal. 95 gr. (50 pack)	115-51040	19.00
25 cal. 85 gr. (50 pack)	115-51045	19.23
25 cal. 115 gr. (50 pack)	115-51050	21.70
270 cal. 130 gr. (50 pack)	115-51075	22.82
270 cal. 150 gr. (50 pack)	115-51100	24.06
7mm cal. 140 gr. (50 Pack)	115-51105	23.50
7mm cal. 150 gr. (50 pack)	115-51110	24.06
30 cal. 150 gr. (50 pack)	115-51150	24.06
30 cal. 168 gr. (50 pack)	115-51160	24.62
30 cal. 180 gr. (50 pack)	115-51170	25.63
338 cal. 200 gr. (50 pack)	115-51200	26.42
45-70 Govt 300 gr. (50 pack)	115-51834	32.15

COMPONENT & AMMUNITION UPDATES : While prices do seem to have stabilized somewhat, availability seems to be the issue this year. As our administration settles in, demand for shooting related products has more than doubled. Manufacturers are trying their best to supply what is being ordered, but it seems they are having a hard time catching up. The prices shown in this catalog are current as of February 2012. We apologize for any increases or price discrepancies in advance.

**Magnus Bullet Company
Jacketed Pistol Bullets**



Reliability, accuracy
and affordability...



9mm (.355 dia)		
108 grain JSP (250)	051-J139	\$30.91
115 grain JHP (250)	051-J125	33.07
115 grain FMJ (250)	051-J126	32.15
124 grain FMJ (250)	051-J127	33.35
124 grain FP (250)	051-J158	33.55
125 grain JHP (250)	051-J162	36.58
147 grain FMJ (250)	051-J152	33.52
147 grain JHP (250)	051-J147	35.81
380 Auto (.356 dia)		
95 grain JSPHB (250)	051-J130	\$33.07
38 Super (.356 dia)		
115 grain JSP (250)	051-J132	\$32.15
125 grain JHP (250)	051-J161	36.58
125 grain FMJ (250)	051-J131	35.84
135 grain FMJ (250)	051-J140	33.06
38/357 (.357 dia)		
110 grain JHP (250)	051-J101	\$30.53
125 grain JHP (250)	051-J102	31.65
125 grain JSP (250)	051-J103	31.07
158 grain JHP (250)	051-J104	33.96
158 grain JSP (250)	051-J119	33.64
10mm/40cal (.400 dia)		
165 grain JHP (250)	051-J165	\$50.66
165 grain TCFM (250)	051-J166	48.05
180 grain JHP (250)	051-J134	49.55
180 grain TCFM (250)	051-J143	47.58
200 grain TCFM (250)	051-J144	49.29
45 Auto (.451 dia)		
187 grain JHP (250)	051-J187	\$49.95
230 grain FMJ (250)	051-J123	43.11
230 grain JHP (250)	051-J124	52.46



**Magnus Lead Cowboy Action Rifle
and Handgun Bullets**

30 Cal (.309 dia)		
.309 Dia. 165 gr. RNFP, (500)	051-208	\$43.80
.310 Dia. 150 gr. FPBB, (500)	051-207	40.13
32-30 Cal (.313 dia)		
118gr. FP, (500)	051-202	\$31.57
38-357 Cal (.357 dia)		
125 gr. RNFP(500)	051-513	\$32.38
158 gr. RNFP,(500)	051-510	42.26
158 gr. FPBB, (500)	051-512	42.26
38-55 Cal (.379 dia)		
245 gr. RNFP, (500)	051-908	\$65.55
38-40 Cal (.401 dia)		
180 gr. RNFP, (500)	051-104	\$48.14
44-40 Cal (.428 dia)		
200 gr. RNFP, (500)	051-703	\$53.49
240 gr. RNFP, (400)	051-707	51.35
44 Rifle Cal (.430 dia)		
200 gr. RNFP, (500)	051-705	\$53.49
240 gr. RNFP, (400)	051-708	51.35
45 Long Colt (.452 dia)		
200 gr. RNFP, (500)	051-809	\$53.97
250 gr. RNFP, (400)	051-902	54.56
255 gr. SWCBB (400)	051-901	54.56
45-70 (.458 dia)		
300 gr. FPBB, (500)	051-905	\$77.71
350 gr. RNFP, (500)	051-903	93.64
405 gr. RNFP, (500)	051-904	108.34

Magnus Bullet Company Lead Cast Bullets



Magnus Bullets are hard case match grade, synthetic lubricated bullets that are made in the USA (in Alabama). Contains virgin alloy of 8% anti-mony, 2% tin, and 90% lead, 18 to 20 BHN hardness. These quality rifle and pistol bullets were used to set the National Civilian Team Record in 1991 (a record that to date is unbeaten). For any questions on performance, etc., call Terry at Magnus Bullet Co., 256-420-8359.

Magnus Lead Handgun Bullets

30 Cal (.309 dia)	165 gr. RNFP(500)	051-208	\$43.80
32 Cal (.313 & .309 dia)	.313 Dia. 98 gr. WCBB(500)	051-204	\$26.74
	.313 Dia. 100 gr. SWCBB(500)	051-201C	26.74
	.309 Dia. 100 gr. SWCFB, (excel- lent for Single Shot Pistols)(500)	051-205	26.74
380 Auto (.356 dia)	.356 Dia. 100 gr. TCBB(500)	051-302	\$26.74
9mm (.356 dia)	122 gr. FPBB(500)	051-401	\$32.38
	125 gr. RNBB(500)	051-402	32.38
	135 gr. RNBB(500)	051-505	36.12
	147 gr. FPBB(500)	051-403	40.13
38/357 Cal (.357 & .358 dia)	.357 Dia. 125 gr. FPBB(500)	051-511	\$32.38
	.358 Dia. 130 gr. SWCBB(500)	051-509	36.12
	.357 Dia. 148 gr. HBWC (500) Swaged	051-514	47.97
	.358 Dia. 148 gr. DEWC(500)	051-501	\$39.58
	.357 Dia. 148 gr. WCBB(500)	051-502	39.58
	.357 Dia. 158 gr. SWCBB(500)	051-503	42.26
	.357 Dia. 158 gr. RNBB(500)	051-504	42.26
	.357 Dia. 158 gr. SWCHP(500) Swaged	051-515	49.94
	.357 Dia. 200 gr. RNFB(500)	051-507	\$49.48
40 Cal / 10mm (.451 dia)	140 gr. TCBB(500)	051-106	\$39.58
	155 gr. RNWCBB(500)	051-102	42.26
	175 gr. SWCBB(500)	051-105	48.14
	180 gr. TCBB(500)	051-101	48.14
	200 gr. TCBB(500)	051-103	53.49
41 Cal Lead Bullets (.410 dia)	215 gr. SWCBB(500)	051-601	\$57.52
44 Cal Lead Bullets (.430 dia)	215 gr. SWCBB(500)	051-702	\$57.52
	240 gr. SWCBB(400)	051-701	51.35
	300 gr. TCFP(500)	051-704	84.47
	250 gr. Keith Style (500)	051-709	54.56
45 ACP Lead Bullets (.452 dia)	155 gr. SWCBB(500)	051-805	\$42.26
	170 gr. SWCBB(500)	051-806	45.47
	185 gr. SWCBB(500)	051-808	49.48
	185 gr. SWC Slight BB(500)	051-801	51.17
	185 gr. SWCLN Swaged(500)	051-811	56.07
	200 gr. SWCBB(500)	051-802	53.49
	200 gr. RN (500)	051-810	53.97
	200 gr. SWC Swaged (500)	051-812	59.64
	215 gr. SWCBB(500)	051-807	57.52
	225 gr. FPBB(500)	051-803	61.52
	230 gr. RNBB(500)	051-804	61.52
45/454 Casull (.452 dia)	300 gr. FPBB(500)	051-906	\$77.71

Magnus 30cal Lead Rifle Bullets

	Order No.	Price
.309 Dia. 115 gr. RNBB, (500)	051-203	\$31.57
.311 Dia. (for SKS), 115 gr. RNBB,(7.62x39mm) (500)	051-206	31.57

COMPONENT & AMMUNITION UPDATES : While prices do seem to have stabilized somewhat, availability seems to be the issue this year. As the administration settles in, demand for shooting related products has more than doubled. Manufacturers are trying their best to supply what is being ordered, but it seems they are having a hard time catching up. The prices shown in this catalog are current as of February 2012. We apologize for any increases or price discrepancies in advance.



Bullet
Guide

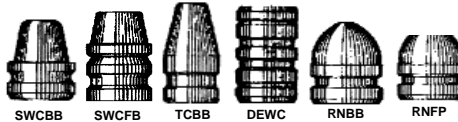

- SWC** - Semi-Wad Cutter
- BB** - Bevel Base
- TC** - Truncated Cone
- FP** - Flat Point
- LN** - Long Nose
- RNFP** - Round Nose Flat Point
- FB** - Flat Base
- DEWC** - Double Ended Wad Cutter
- WC** - Wad Cutter
- JSP** - Jacketed Soft Point
- TCFM** - Truncated Flat Meplat
- JSPHB** - Jacketed Soft Point
Hollow Base



**Advanced Handloading
Beyond the Basics - DVD**
Redding, Sierra and Wolfe Publishing have teamed up to bring you an advanced handloading DVD. This video covers advanced techniques needed to enhance your ammunition accuracy.

John Barsness hosts this DVD and teaches you how to use advanced tools to make your handloads shoot better. **Order No. 144-5449 \$19.09**

RCBS Precision Handloading DVD -
Comprehensive review of RCBS equipment and accessories. Tips and tricks on how to safely and efficiently load a high volume of rounds. Narration by Jim Scoutten of Shooting USA®
Order No. 044-99910 \$8.68



Hornady Gas Checks



Priced per 1000

	Order No.	Price
22 Cal	003-7010	\$22.86
25 Cal	003-7030	24.05
6mm	003-7020	23.65
6.5mm Cal	003-7040	23.70
270 Cal	003-7050	24.69
7mm Cal	003-7060	27.97
30 Cal	003-7070	27.31
32 Cal	003-7080	29.00
338 Cal	003-7090	25.99
348 Cal	003-7100	30.56
35 Cal	003-7110	24.38
375 Cal	003-7120	30.46
416 Cal	003-7125	34.26
44 Cal	003-7130	33.38
45 Cal	003-7140	35.08
475/480 Cal	003-7145	37.03
50 Cal	003-7150	51.99

**BEFORE SIZING
ON BULLETS**

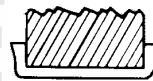

**AFTER SIZING
ON BULLETS**



Unprimed Brass

Remington Centerfire Rifle Unprimed Break-Down & Bulk Brass



Break Down- 100 per bag (unless noted)

	Order No.	Price
17 Rem (100)	050-23065100	\$53.26
17 Rem Fireball (100)	050-23067100	48.54
221 Rem Fireball (100)	050-23007100	46.23
222 Rem (100)	050-23017100	32.59
222 Rem Mag. (100)	050-23003100	44.36
22-250 Rem (100)	050-23273100	44.30
6mm Rem(100)	050-23093100	46.47
243 Win (100)	050-23001100	46.47
6.8mm Rem Spec (100)	050-23290100	44.87
260 Rem (100)	050-22458100	53.42
270 Win (100)	050-23045100	47.48
270 Win Short Mag (100)	050-23048100	71.17
7mm STW (100)	050-22460100	26.61
7mm BR Rem. (100)	050-22485100	75.22
7mm Rem Mag(100)	050-22487100	67.62
7mm Mauser (100)	050-23071100	57.45
7mm Rem Ultra Mag (100)	050-22572100	106.00
30 Carbine (100)	050-23268100	23.98
30-30 Win (100)	050-23021100	34.49
30-40 Krag(100)	050-23037100	53.85
30-06 Springfield (100)	050-23049100	48.32
300 Win. Mag.(100)	050-23261100	70.44
300 Wthrb. Mag. (100)	050-22478100	87.26
8mm Mauser (100)	050-23075100	55.37
8mm Rem. Mag. (100)	050-23099100	78.13
338 Win Mag. (100)	050-23282100	70.68
350 Rem Mag. (100)	050-23284100	73.46
35 Whelen (100)	050-22483100	57.91
375 Rem Ultra Mag. (100)	050-23102100	106.31
444 Marlin (100)	050-23269100	67.91
44-40 Win (100)	050-22490100	32.81
45-70 Government (100)	050-22489100	76.78
300 Rem Ultra Mag(100)	050-22850100	108.65
300 Rem SA Ultra Mag (100)	050-22844100	74.32
338 Rem Ultra Mag(100)	050-22852100	108.96
300 Win Short Mag (100)	050-23250100	72.26

Bulk Case - Buy in the case & receive the same lot #

	Order No.	Price
17 Rem. (2,000) 28 lbs.	050-23065	\$966.10
17 Rem Fireball (2000)	050-23067	880.73
204 Ruger (2,000) 33 lbs.	050-23213	567.00
22 Hornet (2,000) 18 lbs.	050-23005	490.82
220 Swift (1,000) 21 lbs.	050-23006	473.44
221 Rem (2,000) 34 lbs.	050-23007	838.78
222 Rem(2,000) 34 lbs.	050-23017	591.26
222 Rem. Mag. (2,000) 34 lbs.	050-23003	804.69
223 Rem./5.6mm,(2,000) 34 lbs.	050-23089	567.00
22-250 Rem (1,000) 27 lbs.	050-23273	401.79
6mm Rem (1,000) 27 lbs.	050-23093	421.52
243 Win (1,000) 29 lbs.	050-23001	421.52
25-06 Rem (1,000) 33 lbs.	050-22999	521.14
6.5x55SwMauser (1,000)28lbs	050-23056	483.23
6.8mm Rem Spc (1,000) 24lbs	050-23290	448.66
260 Rem (1,000) 34 lbs.	050-22458	484.53
270 Win (1,000) 34 lbs.	050-23045	430.73
270 Win Short Mag (1000)	050-23048	645.59
280 Rem (1,000) 33 lbs.	050-23029	495.77
7mm STW 500 per case, 21 lbs	050-22460	292.56
7mm-08 Rem (1,000) 28 lbs.	050-23097	488.53
7mm BR Rem (2,000) 39 lbs.	050-22485	1364.45
7mm Rem SAMag (1,000) 33	050-22846	664.02
7mm Rem. Mag (500) 21 lbs.	050-22487	306.67
7mm Mauser (1,000) 31 lbs.	050-23071	521.14
7mm Rem UltraMag (500)	050-22572	480.73
30 Carbine (2,000) 22 lbs.	050-23268	434.88
30-30 Win. (1,000) 24 lbs.	050-23021	312.81
30-40 Krag (1,000) 28 lbs.	050-23037	488.51
30-06 Spgfid. (1,000) 35 lbs.	050-23049	438.23
300 Win. Mag. (500) 20 lbs.	050-23261	319.49
300 Wthrb. Mag. (500) 21 lbs.	050-22478	395.75
303 British (1,000) 27 lbs.	050-23043	451.68
308 Win. (1,000) 29 lbs.	050-23057	445.76
8mm Mauser (1,000) 31 lbs.	050-23075	502.20
8mm Rem. Mag (500), 21 lbs.	050-23099	354.36
32-20 Win. (2,000) 24 lbs.	050-23053	562.75
338 Win. Mag. (500) 20 lbs.	050-23282	320.54
350 Rem. Mag. (500) 20 lbs.	050-23284	333.11
35 Whelen (1,000) 35 lbs.	050-22483	525.19
375 H&H Mag. (500) 21 lbs.	050-23100	382.90
375 Rem UltraMag. (500)21lbs.	050-23102	482.18
444 Marlin (500) 17 lbs.	050-23269	308.00
44-40 Win. (2,000) 32 lbs.	050-22490	595.22
45-70 Gov't (500) 15 lbs.	050-22489	348.22
300 Rem Ultra Mag (500)	050-22850	492.77
300 Rem SA Ultra Mag, (1,000)	050-22844	674.16
338 Rem Ultra Mag, (500)	050-22852	494.24
300 Win Short Mag (1000)	050-23250	655.43



Remington Centerfire Unprimed Brass



Pre Bagged by Remington! These are bagged at the factory by Remington. This is not Bulk Breakdown from Midsouth.

	Order No.	Price
.25-06 Rem (50)	050-23020	\$27.50
.25-20 Win (50)	050-23018	15.04
.257 Roberts (50)	050-23024	24.77
.308 Win (50)	050-23044	21.53
6.5 x 55 Swedish Maus.(50)	050-23062	25.14
.280 Rem (50)	050-22858	26.18
7mm-08 Rem (50)	050-22860	24.67
.32-20 Win (50)	050-22884	14.85
.303 British (50)	050-22878	23.66
.375 H&H Mag (50)	050-22910	40.28
.204 Ruger (100)	050-22414	27.67
.22 Hornet (100)	050-22400	25.89
.223 Rem (100)	050-22408	27.67
.220 Swift (100)	050-22402	49.88
300 Win Mag (50)	050-22876	35.18

Remington Unprimed Break-Down & Bulk Nickel Plated Brass



Break Down Bags- 250 per bag (unless noted)

	Order No.	Price
22 Hornet (100)	050-22532100	\$30.88
.222 Rem (100)	050-22534100	35.93
.223 Rem (100)	050-22536100	36.01
.22-250 Rem (100)	050-22538100	49.78
.243 Win (100)	050-22540100	51.58
25-06 Rem (100)	050-22566100	64.20
.270 Win (100)	050-22542100	53.46
7mm Rem Mag(100)	050-22544100	75.57
30/06 Springfield (100)	050-22546100	54.31
.308 Win (100)	050-22548100	55.47
.32-20 Win (100)	050-22550100	36.78
.45-70 Gov't. (100)	050-22552100	87.98
.17 Rem (100)	050-22554100	53.77
.300 Win Mag (100)	050-22584100	78.87
.300 Wby Mag (100)	050-22588100	100.02
.338 Win Mag (100)	050-22594100	79.74
30 Carbine (100)	050-23268100	23.98
30-30 (100)	050-22580100	42.02
444 Marlin (100)	050-22603100	77.92
45 Long Colt (250)	050-22607250	87.63

Bulk Case - Buy in the case & receive the same lot #

	Order No.	Price
22 Hornet,(2,000)	050-22532	\$560.11
.222 Rem (2,000)	050-22534	651.98
.223 Rem (2,000)	050-22536	653.37
.22-250 Rem (1,000)	050-22538	451.61
.243 Win (1,000)	050-22540	467.87
.270 Win (1,000)	050-22542	484.87
7mm Rem Mag, (500)	050-22544	342.72
30/06 Springfield (1,000)	050-22546	492.61
.308 Win (1,000)	050-22548	503.06
.32-20 Win (2,000)	050-22550	667.19
.45-70 Gov't (500)	050-22552	398.99
.17 Rem (2,000)	050-22554	975.48
.25-06 Rem (1,000)	050-22566	582.34
30-30 (1,000)	050-22580	381.23
.300 Win Mag (500)	050-22584	357.66
.300 WBY Mag (500)	050-22588	453.61
.338 Win Mag (500)	050-22594	361.65
444 Marlin (500)	050-22603	353.40
45 Long Colt (2,000)	050-22607	637.90

Remington Centerfire Pistol Unprimed Break-Down & Bulk Brass

Break Down- 250 per bag (unless noted)

	Order No.	Price
221 Rem. Fireball (100)	050-23007100	\$46.23
32 S&W Long (250)	050-23211250	53.54
32 Automatic (250)	050-22484250	53.11
357 Mag. (brass) (250)	050-23263250	55.88
357 Mag. (nickel) (250)	050-22482250	61.96
357 Rem. Max (250)	050-23095250	69.06
9mm Luger (250)	050-23249250	53.78
380 Automatic (250)	050-23233250	54.09
38 Super Auto +P (250)	050-23260250	54.03
38 Special(250)	050-23259250	52.08
40 S&W (250)	050-22512250	75.54
41 Rem. Mag (250)	050-23298250	74.84
44 Rem. Mag (250)	050-23286250	74.84
44 S&W Spec (250)	050-22492250	74.83
45 Long Colt (250)	050-22494250	78.84
45 Automatic (250)	050-23288250	68.83
45 Auto Nickel , (250)	050-22611250	75.10
45 Auto Rim (250)	050-22496250	73.05

Bulk Case - Buy in the case & receive the same lot #

	Order No.	Price
221 Rem Fireball (2,000) 30 lbs	050-23007	\$838.78
32 S&W Long (2,000) 17 lbs.	050-23211	389.78
32 Automatic (2,000) 16 lbs.	050-22484	386.67
357 Mag. (brass) (2,000) 28 lbs.	050-23263	406.82
357 Mag. (nickel) (2,000) 28 lbs.	050-22482	451.12
357 Rem. Max (2,000) 30 lbs.	050-23095	502.72
9mm Luger (2,000) 17 lbs.	050-23249	391.53
380 Automatic (2,000) 17 lbs.	050-23233	393.77
38 Super Auto +P (2,000)	050-23260	393.29
38 Spl (brass) (2,000) 24 lbs.	050-23259	379.21
40 S&W (2,000) 21 lbs.	050-22512	549.92
41 Rem. Mag(2,000) 34 lbs.	050-23298	544.83
44 Rem. Mag. (2,000) 34 lbs.	050-23286	544.83
44 S&W Spec. (2,000) 28 lbs.	050-22492	544.83
45 Long Colt (2,000) 36 lbs.	050-22494	574.02
45 Auto (2,000) 28 lbs.	050-23288	501.01
45 Auto Nickel (2,000) 28 lbs.	050-22611	546.77
45 Auto Rim (2,000) 28 lbs.	050-22496	531.89

*Notes discontinued and limited quantities

Nosler Custom Unprimed Brass



Packaged 50 per box unless Noted.

"Nosler" head-stamped! Made in the USA, NoslerCustom brass is weight-sorted for maximum accuracy and consistency potential.

	Order No	Price
204 Ruger	115-10056	\$41.92
22-250 Remington	115-10065	41.92
223 Remington	115-10070	29.15
243 Winchester	115-10105	41.92
25-06 Rem	115-10132	46.10
257 Roberts	115-10135	63.62
257 Weatherby	115-10138	66.56
260 Remington	115-11354	55.71
264 Win Mag	115-11234	58.87
270 Winchester	115-10155	46.10
270 Weatherby	115-10147	66.56
280 Remington	115-10160	46.10
280 Rem Ackley	115-10175	66.56
6.5-.284 Norma	115-10190	58.87
6.5x55 Swedish	115-10212	46.10
7mm Remington	115-10185	58.87
7mm-08 Remington	115-10187	46.10
7mm STW (25)	115-11472	55.71
7mm SA Ultra Mag (25)	115-10184	55.71
7mm Rem Ultra Mag (25)	115-10188	55.71
308 Winchester	115-10225	46.10
30-06 Springfield	115-10226	46.10
30-378 Weatherby (25)	115-10235	73.79
300 Winchester	115-10227	66.56
300 Weatherby	115-10180	66.56
300 Remington	115-10230	72.83
300 H&H (25)	115-11800	55.71
300 Remington Short	115-11935	66.56
300 WSM (25)	115-11863	55.71
325 WSM (25)	115-11907	55.71
338 Winchester Mag	115-17883	72.83
338-06 A-Square (25)	115-11910	55.71
338 Rem Ultra Mag (25)	115-11912	55.71
338 Lapua (25)	115-11914	58.20
340 Weatherby (25)	115-11924	42.38
35 Whelen	115-11926	72.83
350 Remington Mag (25)	115-11928	42.38
375 H&H (25)	115-11930	55.71
8x57 JS Mauser	115-11888	66.56
8mm Remington Mag (25)	115-11892	55.71
9.3x62 Mauser (25)	115-11952	42.38
9.3x74R (25)	115-11954	53.90

Federal Unprimed Brass



	Order No.	Price
327 Fed Mag (100)	129-P327UPB100	\$20.81
9mm (100)	129-P9UPB100	21.85
40 S&W (100)	129-P40UPB100	30.48
45 Auto (100)	129-P45UPB100	28.04
243 Win (50)	129-P243UPB50	23.85
270 Win (50)	129-P270UPB50	24.24
7mm Mag (50)	129-7UPB50	34.74
30-30 Win (50)	129-P3030UPB50	17.70
308 Win (50)	129-P308UPB50	22.34
30-06 Spgfd (50)	129-P3006UPB50	24.56
300 Win (50)	129-P300UPB50	35.45
270 WSM (50)	129-P270WSMUPB50	37.53
338 Fed (50)	129-P338FUPB50	22.34
300 RUM (50)	129-P300RUMUPB50	55.67

Hornady Unprimed Brass



	Order No.	Price
17 Hornet (50)	003-8611	\$26.85
204 Ruger Brass (50)	003-8604	24.44
222 Remington (50)	003-8600	24.44
22-250 Remington (50)	003-8610	33.61
223 Remington Brass (50)	003-8605	24.44
10mm Pistol Brass (100)	003-8745	38.90
32 Win Spl Brass (50)	003-8728	34.54
44/40 Pistol Brass (100)	003-8748	38.90
44 Special Brass (100)	003-8749	38.90
44 Magnum Brass (100)	003-8750	37.16
45 ACP (100)	003-8760	36.33
45 Long Colt (100)	003-8780	37.16
45/70 (50)	003-8784	45.42
458 Lott (50)	003-8697	54.43
454 Casull Brass (100)	003-8785	50.61
475 Linebaugh Brass (100)	003-8787	57.39
480 Ruger Brass (100)	003-8789	57.39
243 Winchester Brass (50)	003-8620	33.61
6.5/284 Rifle Brass (50)	003-8628	49.88
6.5 Grendel (50)	003-86283	34.54
6.5x55 Swedish (50)	003-86263	34.54
6.5 Creedmoor (50)	003-86281	33.61
6.8 Spc Brass (50)	003-8629	34.54
270 Win Brass (50)	003-8635	34.54
7mm Rem Mag Brass (50)	003-8640	45.42
7x64 Brenneke (50)	003-8647	34.54
30-30 Win Brass (50)	003-8655	34.54
30 TC Brass (50)	003-8663	34.54
308 Marlin Exp Brass (50)	003-8662	34.54
30-06 Sprfd Brass (50)	003-8665	34.54
303 British (50)	003-8675	34.54
308 Win Match Grade Brass (50)	003-8661	33.61
300 H&H Brass (50)	003-86725	52.48
300 Win Mag Rifle Brass (50)	003-8670	45.42
300 Weatherby Mag (50)	003-8672	49.01
300 Blackout (50)	003-86751	34.54
300 Savage (50)	003-86752	34.54
338 Marlin Express (50)	003-8721	34.54
338 Lapua Brass (20)	003-8684	43.47
358 Winchester (50)	003-8741	34.54
375 Ruger Basic Brass (50)	003-8674	43.47
375 Ruger Brass (50)	003-8673	45.42
375 H&H Mag Brass (50)	003-8685	49.01
376 Steyr Brass (50)	003-8690	49.88
404 Jeffery Brass (20)	003-86932	37.29
405 Winchester (50)	003-8691	48.14
416 Rigby Brass (20)	003-8687	37.29
416 Ruger Brass (50)	003-86871	46.70
416 Remington (50)	003-86874	51.58
444 Marlin Brass (50)	003-8692	43.08
450 Marlin Brass (50)	003-8693	45.42
450 Bushmaster Brass (50)	003-86935	41.74
450 Nitro Brass (20)	003-86936	46.93
458 Winchester Mag (50)	003-8694	54.43
460 S&W (50)	003-8786	31.59
500 S&W (50)	003-8790	31.59
8x57 (50)	003-8648	34.54
9.3x62 (50)	003-87263	34.54
9.3x74R (20)	003-8726	26.97
Belted Mag Basic Basic (50)	003-8798	36.91



Brass Case Cleaner, 16 oz Liquid-Super concentrate - this one bottle makes over two gallons of reusable cleaning solution and will clean 8,000 medium sized cases. Easily removes resizing lubricant, oils, grime and stains from brass cartridge cases.

Order No. 012-33845 \$6.60

MagTech Unprimed Brass



	Order No.	Price
.32 Auto (100)	039-BR32A	\$14.41
.32 S&W (100)	039-BR32SW	14.69
.357 Mag (100)	039-BR357	18.80
.38 SPL (100)	039-BR38A	18.53
.380 Auto (100)	039-BR380	18.53
.40 S&W (100)	039-BR40SW	19.21
.44 Mag (100)	039-BR44M	26.61
.44-40 Win (100)	039-BR4440B	30.45
.45 Auto (100)	039-BR45A	22.77
.45 Colt (100)	039-BR45C	27.10
9mm Luger (100)	039-BR9	16.88
454 Casull (100)	039-BR454	33.00
500 S&W (100)	039-BR500	52.00

Weatherby Unprimed Brass



20 Rounds Per Box

	Order No.	Price
.224 WbyMag	098-BRASS224	\$36.12
.240 WbyMag	098-BRASS240	36.12
.257 WbyMag	098-BRASS257	36.12
.270 WbyMag	098-BRASS270	36.12
7mm WbyMag	098-BRASS7MM	36.12
.300 WbyMag	098-BRASS300	36.12
.30-378 WbyMag	098-BRASS303	64.50
.340 WbyMag	098-BRASS340	36.12
.338-378 WbyMag	098-BRASS333	73.53
.378 WbyMag	098-BRASS378	73.53
.416 WbyMag	098-BRASS416	73.53
.460 WbyMag	098-BRASS460	73.53



Lapua Unprimed Brass



100 Rounds Per Box

	Order No.	Price
220 Russian (100)	109-4PH5013100	\$112.60
223 Rem Match (100)	109-4PH5003100	69.19
6.5mm -284 (100)	109-4PH6030100	143.80
6.5X55 Swed Maus (100)	109-4PH6012100	85.47
6MM Benc Rest (100)	109-4PH6046100	103.10
30-06 (100)	109-4PH7068100	134.30
7.62X39 (100)	109-4PH7074100	69.19
308 Win (100)	109-4PH7217100	85.47
338 Lapua Mag (100)	109-4PH8068100	318.80
9.3X62 (100)	109-4PH9050100	142.44
243 Winchester (100)	109-4PH6009100	115.31

Lawrence Lead Shot

25lbs Bags



	Order No.	Price
Chilled Lead Shot #4	137-CHSH4	\$43.66
Chilled Lead Shot #5	137-CHSH5	43.66
Chilled Lead Shot #6	137-CHSH6	43.66
Chilled Lead Shot #7.5	137-CHSH75	43.66
Chilled Lead Shot #8	137-CHSH8	43.66
Magnum Lead Shot #6	137-MAGSH6	47.43
Magnum Lead Shot #7.5	137-MAGSH75	47.43
Magnum Lead Shot #8	137-MAGSH8	47.43

NormaUSA Unprimed Brass



Norma products are known worldwide for high quality. Cartridge cases are an important factor in this reputation. Superior quality ensures a long life and many reloads. Norma cases are made of the best possible raw materials with the narrowest tolerances, and they deliver accuracy round after round.

The case neck is annealed to become softer. This prevents gas leaks and enables the case to hold the bullet firmly for at least 10 years without cracking as a result of aging material. Further down on the case body, the hardness increases to avoid unnecessary stretching. If it is too hard, it would bring the risk of cracks.

Furtherest down, around the primer pocket, the brass should be firm. Here, the hardness is nearly twice that of around the neck. The structure of the material reveals the hardness. During processing the large, soft grains are broken down into smaller ones, which makes for a harder material. At the annealing, small grains become bigger and the hardness decreases.

	Order No.	Price
.204 Ruger	013-20255105	17.01
5,6x52R	013-20256045	32.06
.220 Swift	013-20257015	23.36
.222 Rem.	013-20257115	16.03
.223 Rem	013-20257215	23.36
.22-250 Rem.	013-20257315	24.04
.243 Win.	013-20260015	24.42
6mm PPC	013-10260105	24.04
6mm Norma BR	013-10260155	24.04
6mm XC	013-10260185	26.10
.25-06	013-20264115	27.25
6,5-284	013-20265285	33.65
6,5 Jap.	013-20265315	32.05
6,5 Carcano	013-20265355	32.05
6,5x54MS	013-20265455	32.05
6,5x55	013-20265515	22.05
.260 Rem.	013-20266025	30.06
.264 Win. Mag.	013-20268025	36.09
.270 Win.	013-20269015	26.13
.270 WSM	013-20269075	34.83
7x57	013-20270015	26.13
7x57R	013-20270045	34.67
7x61 Super	013-20270115	42.98
7x64	013-20270125	37.08
7x65R	013-20270185	41.15
7mm Rem. Mag.	013-20270215	34.84
7mm-08 Rem	013-20270225	27.87
.280 Rem.	013-20270505	29.45

	Order No.	Price
7,5x55 Swiss	013-20275115	37.24
.300 Norma Mag.	013-20275615	54.49
.300 SAUM	013-20276115	37.08
.308 Win.	013-20276235	23.97
7,62x53R	013-20276345	28.36
.308 Norma Mag.	013-20276375	41.40
.30-06	013-20276405	26.97
.300 H&H	013-20276535	41.40
.300 Win. Mag.	013-20276665	34.83
.300 WSM	013-20276765	52.26
7,65 Arg.	013-20277015	39.24
7,7 Jap.	013-20277215	39.24
8x57JS	013-20280015	37.37
8x57JRS	013-20280145	39.24
8x68S	013-20280255	43.54
.338 Win. Mag	013-20285045	43.54
.338 Lapua Mag.	013-10285075	65.32
.338 Norma Mag	013-10285205	54.49
.358 Norma Mag.	013-20290015	47.94
.35 Whelen	013-20290025	37.09
9,3x57	013-20293015	39.19
9,3x62	013-20293115	28.36
9,3x74R	013-20293215	50.10
.375 H&H Mag.	013-20295015	435.49
.375 Flanged	013-20295155	72.57
.404 Rimless NE	013-20210435	65.37
.416 Rigby	013-20210605	78.39
.416 Taylor	013-20210675	65.37

	Order No.	Price
.416 Rem Mag	013-20210695	65.37
.500/416 NE	013-20210705	146.49
.45 Cylindrical	013-20211235	146.49
.45-120	013-20211255	58.57
.450 Rigby	013-20211405	123.26
.458 Win.	013-20211555	123.26
.458 Lott	013-20211575	123.26
.470 Nitro Express	013-20211635	121.93
.500 Nitro Express	013-20213005	121.93
.505 Gibbs	013-20213105	152.47
.500 Jeffrey	013-20213155	130.65

NORMA WEATHERBY CASES

	Order No.	Price
.224 Weatherby	013-20257405	152.47
.240 Weatherby	013-20260205	43.12
.257 Weatherby	013-20265025	43.12
.270 Weatherby	013-20269125	45.79
7mm Weatherby	013-20270325	45.79
.300 Weatherby	013-20276605	41.64
.30-378 Weatherby	013-20276775	90.00
.338-06 Weatherby	013-20285115	42.38
.338-378 Weatherby	013-20285165	90.00
.340 Weatherby	013-20286025	0.00
.375 Weatherby	013-20295135	41.89
.378 Weatherby	013-20295125	90.00
.416 Weatherby	013-20210655	92.48
.460 Weatherby	013-20211605	97.72



The Kit contains a quart of Case Cleaner, a bucket and strainer bag.

Case Cleaner Kit & Case Cleaner - Restores brass casings to a bright finish in seconds. Just immerse the casings in the solution for from 20 seconds up to five minutes, rinse, and dry. It cleans the inside of the casings and the primer pocket where tumbling media is not effective.

Solution is reusable, economical and environmentally friendly. 1 quart cleans approximately 1500 casings.

	Order No	Price
Iosso Cleaning Kit	200-10400	\$14.61
Case Cleaner 32oz	200-10401	7.32
Case Cleaner 1 Gal	200-10402	21.82

See our test of the Iosso Cleaning Kit on YouTube -



Go visit our YouTube Channel - Or, go to our website and see it on the Iosso Cleaning kit page!

Iosso Case Polish -

Cleans and polishes brass casings to a high luster. Removes powder fouling, tarnish, residue, oxidation, and discoloration. Reduce tumbling time by adding Iosso Case Polish to your media before tumbling.

	Order No	Price
Case Polish 32oz	200-10601	\$28.65
Case Polish 1 Gal	200-10602	93.36



Order No. 039-BR50

Magtech Brass 25 per box

\$44.04



	Order No.	Price
Turbo Media Sifter	015-7631321	\$7.77
Turbo Case Cleaner 16 oz.	015-7631340	7.59
Turbo Charge (reactivator) 4 oz.	015-7631322	5.02
Turbo Brite 5 oz.	015-7631358	5.58
Turbo Brite 20 oz.	015-7631361	14.85
Brass Baggies, 12 per pack	015-7631391	5.02

Smokeless Powder

NO RETURNS ON POWDER. PLEASE NOTE: TO PURCHASE POWDER, PRIMERS, OR AMMUNITION, WE MUST HAVE A COPY OF YOUR DRIVER'S LICENSE FOR PROOF OF AGE. YOU MAY MAIL OR FAX THIS TO US. YOU MUST BE 21 YEARS OF AGE TO ORDER THESE ITEMS! HAZARDOUS MATERIALS CHARGE: Powder is considered a Hazardous Material! A Haz-Mat Charge of \$25.00 per package(\$35.00 if Air service) will be applied in addition to shipping. SEE PAGE 3 for more details.

Ram-Shot Powder



RamShot Powder	4 or 8 lbs Canister	1 lbs Canister
	Order No. Price	Order No. Price
Competition	079-COMPETITION4 (4lbs) \$58.61	079-COMPETITION \$13.62
Zip	079-ZIP4 (4lbs) 59.93	079-ZIP 16.46
True Blue	079-TRUEBLUE4 (4lbs) 59.93	079-TRUEBLUE 16.46
Enforcer	079-ENFORCER4 (4lbs) 59.93	079-ENFORCER 16.46
Silhouette	079-SILHOUETTE4 (4lbs) 59.93	079-SILHOUETTE 16.46
X-Terminator	079-XTERMINATOR8 (8lbs) 121.49	079-XTERMINATOR 16.87
Tac	079-TAC8 (8lbs) 121.49	079-TAC 16.87
Big Game	079-BIGGAME8 (8 lbs) 121.49	079-BIGGAME 16.87
Hunter	079-HUNTER8 (8 lbs) 121.49	079-HUNTER 16.87
Magnum	079-MAGNUM8 (8 lbs) 121.49	079-MAGNUM 16.87

IMR 8208 XBR



Introducing IMR® 8208 XBR Super Powder - Shawnee Mission Kansas- IMR® Legendary Powders introduces a super powder, IMR 8208 XBR. IMR 8208 XBR is a remarkably advanced technology propellant perfected for the greatest match, varmint and sniper rounds known today---223 Remington/5.56mm, 308 Win./7.62 mm, 6mm PPC, 204 Ruger, 6mm BR, 22-250 Remington and similar calibers.

This short grain extruded rifle powder exhibits a previously unheard of consistency with virtually no change in velocity at temperatures ranging from -40 degrees F to 165+ degrees F. Uniformity from shot to shot translates into tack driving accuracy and this powder has passed the test:

- Currently loaded in premium factory sniper type ammunition
- Leading competitive bench rest shooter Mr. Lou Murdica won numerous matches with it in 2009, starting with Heavy Varmint Grand Aggregate at the Cactus Classic
- August 2009 Mr. Jim Carmichel won the International Benchrest Shooters Association's 40th Group National Championships, Heavy Varmint Grand Aggregate. Because temperature conditions change, bench rest shooters vary charge weights during a day's competition. What is significant here is that Jim shot the exact same load of IMR 8208 XBR both days to win the event

	Order No.	Price
IMR 8208 XBR 8lbs	034-IMR82088	\$141.42
IMR 8208 XBR 1lbs	034-IMR8208XBR1	19.95



VihtaVuori Powder Rifle Powders				
	8lbs Canister		1 lbs Canister	
	Order No.	Price	Order No.	Price
N110	-	-	034-N1101	\$28.00
N120	-	-	-	-
N133	034-N1338	\$182.47	034-N1331	28.00
N135	034-N1358	182.47	034-N1351	28.00
N140	034-N1408	182.47	034-N1401	28.00
N150	034-N1508	182.47	034-N1501	28.00
N160	034-N1608	182.47	034-N1601	28.00
N165	-	-	034-N1651	28.00
N540 High Energy NC	-	-	034-N5401	32.22
N550 High Energy NC	-	-	034-N5501	32.22
N560 High Energy NC	-	-	034-N5601	32.22

VihtaVuori Powder Pistol Revolver Powders				
	4 lbs Canister		1 lbs Canister	
	Order No.	Price	Order No.	Price
N105	-	-	034-N1051	\$28.79
N310	034-N3104	\$97.08	034-N3101	28.79
N320	034-N3204	97.08	034-N3201	28.79
N340	034-N3404	97.08	034-N3401	28.79
N350	034-N3504	97.08	034-N3501	28.79
3N37	034-3N374	97.08	-	-

IMR Powder



IMR Powder				
	8lbs Canister		1 lbs Canister	
	Order No.	Price	Order No.	Price
IMR 4831	034-IMR48318	\$141.42	034-IMR8060091	\$19.95
IMR 4320	034-IMR43208	141.42	034-IMR8060133	19.95
IMR 4350	034-IMR43508	141.42	034-IMR8060154	19.95
IMR 4064	034-IMR40648	141.42	034-IMR8060175	19.95
IMR 4895	034-IMR48958	141.42	034-IMR8060196	19.95
IMR 3031	034-IMR30318	141.42	034-IMR8060217	19.95
IMR 4198	034-IMR41988	141.42	034-IMR8060238	19.95
IMR 4227	034-IMR42278	141.42	034-IMR8060259	19.95
IMR 7828	034-IMR78288	141.42	034-IMR8060275	19.95
IMR 7828SSC	034-IMR7828SSC8	141.42	034-IMR7828SSC1	19.95
IMR 4007SSC	034-IMR4007SSC8	141.42	034-IMR4007SSC1	19.95
Trail Boss	-	-	034-IMR9TB1	11.63
IMR SR4756	034-IMRSR47568	130.87	034-IMRSR47561	19.28
IMR SR4759	034-IMRSR47598	130.87	034-IMRSR47591	19.28
IMR 700X	034-97008	110.26	-	-
IMR 800X	034-98008	111.31	034-98001	15.86
IMR 8208 XBR	034-IMR82088	141.42	034-IMR8208XBR1	19.95



Wolfe Publications Propellant Profiles 5th Edition

Propellant Profiles 5th Edition - The most convenient reference available to American reloaders from the last 45 years. Includes manufacturers and authors' recommended loads and tips. Revised and updated to include the newer powders.
Order No. 144-544 \$29.54

PLEASE READ VERY IMPORTANT

NO RETURNS ON POWDER. PLEASE NOTE: TO PURCHASE POWDER, PRIMERS, OR AMMUNITION, WE MUST HAVE A COPY OF YOUR DRIVER'S LICENSE FOR PROOF OF AGE. YOU MAY MAIL OR FAX THIS TO US. YOU MUST BE 21 YEARS OF AGE TO ORDER THESE ITEMS! HAZARDOUS MATERIALS CHARGE: Powder is considered a Hazardous Material! A Haz-Mat Charge of \$25.00 per package(\$35.00 if Air service) will be applied in addition to shipping. SEE PAGE 3 for more details.

Hodgdon Powder



Hodgdon Powder	8 lbs Canister		1 lbs Canister	
	Order No.	Price	Order No.	Price
Varget	034-VAR8	\$144.01	034-VAR1	\$20.53
H1000	034-10008	144.01	034-10001	20.53
H110	034-1108	128.77	034-1101	17.71
H322	034-3228	144.01	034-3221	20.53
H335	034-3358	131.70	034-3351	18.28
H380	034-3808	131.70	034-3801	18.28
H414	034-4148	131.70	034-4141	18.28
H4198	034-41988	144.01	034-41981	20.53
H4350	034-43508	144.01	034-43501	20.53
H4831 Short Cut	034-4831SC8	144.01	034-4831SC1	20.53
H4831	034-48318	144.01	034-48311	20.53
H4895	034-48958	144.01	034-48951	20.53
BLC2	034-BLC8	131.70	034-BLC1	18.28
CLAYS	034-53123	115.32	-	-
HS-6	034-HS68	131.42	034-HS61	18.11
HP38	034-P388	112.91	034-P381	15.97
H50BMG	034-50BMG8	144.01	034-50BMG1	20.53
Titegroup	034-TG8	108.16	034-TG1	14.68
Hybrid 100V	034-HYBRID100V8	131.70	034-HYBRID100V1	18.28
Lil' Gun Powder	034-LG8	128.77	034-LG1	17.70
Benchmark	034-BM8	144.01	034-BM1	20.53
Longshot	034-LS8	128.77	034-LS1	17.70
Retumbo	034-RET8	144.01	034-RET1	20.53
International	034-53131	115.32	-	-
Universal	034-53127	121.60	034-53124	17.55
US 869	034-8698	134.29	034-8691	18.68

Winchester Powder



Winchester Powder	8 lbs Canister		1 lbs Canister	
	Order No.	Price	Order No.	Price
WST	034-WST8	\$119.76	034-WST1	\$17.10
WSF	034-WSF8	120.92	034-WSF1	17.25
296	034-2968	130.79	034-2961	17.94
231	034-2318	120.92	034-2311	17.25
748	034-7488	136.67	034-7481	18.98
760	034-7608	136.67	034-7601	18.98
780	034-7808	137.98	034-7801	19.13
Super	034-SUPER8	117.41	034-SUPER1	17.10
AA Lite	-	-	034-AALITE1 (14oz)	16.60
AutoComp	034-WINAC8	121.93	034-WINAC1	17.25

Alliant Powder	8 lbs Canister		4 & 5 lbs Canisters		1 lbs Canister	
	Order No.	Price	Order No.	Price	Order No.	Price
Bullseye	137-8120018	\$116.96	137-8120011	\$63.12	137-8120004	\$16.88
2400	137-8120053	125.54	137-8120039	67.80	137-8120032	18.00
Unique	137-8120081	119.24	137-8120074	66.24	137-8120067	17.38
Herco	137-8120109	119.24	137-8120102	66.24	137-8120095	17.38
Red Dot	137-8120137	119.24	137-8120130	66.24	137-8120123	17.38
Green Dot	137-8120165	119.24	137-8120158	66.24	137-8120151	17.38
Power Pistol	-	-	137-PP4	63.12	137-PP1	16.88
Reloader-25	-	-	137-RE255 (5LB)	102.84	137-RE251	21.77
Steel	-	-	-	-	137-STEEL1	17.44
Reloader-15	-	-	137-REL155 (5LB)	102.84	137-8120115	21.77
Reloader-17	-	-	-	-	137-8120117	21.77
Reloader-19	-	-	137-REL195 (5LB)	102.84	137-8120119	21.77
Reloader-22	-	-	137-REL225 (5LB)	102.84	137-8120122	21.77
Blue Dot	-	-	137-BD5 (5LB)	77.17	137-8120179	17.26
Reloader-7	-	-	-	-	137-8120200	21.77
Reloader 10X	-	-	137-RE10X5 (5LB)	102.84	137-RE10X1	21.77
E3 Competition	137-E38	119.24	137-E34	66.24	137-E31	17.38
Clay Dot	137-CLAYDOT8	111.02	-	-	-	-
410 Smokeless Shotshell	-	-	137-4104	67.80	137-4101	18.00



Accurate Powder



Accurate Powder	8 lbs Canister		1 lbs Canister	
	Order No.	Price	Order No.	Price
No. 2	-	-	079-PB000201	\$15.09
No. 5	079-PB000508	\$116.37	079-PB000501	16.16
No 7	079-PB000708	116.37	079-PB000701	16.16
No. 9	079-PB000908	116.37	079-PB000901	16.16
No. 1680	079-PB168008	123.62	079-PB168001	17.17
No. 5744	079-PE574408	165.58	079-PE574401	21.79
No. 2015	079-PE201508	142.82	079-PE201501	19.19
No. 2200	079-22008	123.62	079-2200	17.17
No. 2230	079-PB223008	123.62	079-PB223001	17.17
No. 2460	079-PB246008	123.62	079-PB246001	17.17
No. 2520	079-PB252008	123.62	079-PB252001	17.17
No. 4350	079-PE435008	142.82	079-PE435001	19.19
No. 4064	079-PE406408	142.82	079-PE406401	19.19
No. 2700	079-PB270008	123.62	079-PB270001	17.17
No. 2495	079-PE249508	142.82	079-PE249501	19.19
Mag Pro	079-MAGPRO8	123.62	079-MAGPRO1	17.17

Hodgdon / Hornady Powders!



LEVERevolution & Superformance - Hodgdon® Powder Company and Hornady® Manufacturing have teamed together to answer the frequently asked reloading question; "Can I buy the powder used in Hornady LEVERevolution and Superformance factory ammunition?" Yes, this is the same spherical propellant used in Hornady's innovative and award winning high performance factory ammunition. Because these propellants are tailored for specific applications, the number of cartridges and bullets is limited, but where it works, it really works!

	Order No.	Price
Leverevolution 1lbs	034-HLR1	\$19.03
Leverevolution 8lbs	034-HLR8	136.27
Superformance 1lbs	034-HSP1	19.03
Superformance 8lbs	034-HSP8	136.27



TO ORDER: The Hercules Powder listed below are one pound cans. There are ten (10) one (1) pound cans per case. You may mix or match any of the same weight Hercules Powders in case lots.

PLEASE READ VERY IMPORTANT

NO RETURNS ON POWDER. PLEASE NOTE: TO PURCHASE POWDER, PRIMERS, OR AMMUNITION, WE MUST HAVE A COPY OF YOUR DRIVER'S LICENSE FOR PROOF OF AGE. YOU MAY MAIL OR FAX THIS TO US. YOU MUST BE 21 YEARS OF AGE TO ORDER THESE ITEMS! HAZARDOUS MATERIALS CHARGE: Primers are considered a Hazardous Material! A Haz-Mat Charge of \$25.00 per package(\$35.00 if Air service) will be applied in addition to shipping. SEE PAGE 3 for more details.

Remington Bulk Pack Centerfire Primers
All Primers Priced Per 1,000



	Order No.	Price
1-1/2 Small Pistol Primer	150-22600	\$32.85
2-1/2 Large Pistol Primer	150-22604	\$32.85
9-1/2 Large Rifle Primer	150-22608	\$32.85
9-1/2M Magnum Rifle Primer	150-22622	\$35.41
5-1/2 Small Pistol Primer	150-22626	\$32.85
6-1/2 Small Rifle Primer	150-22606	\$32.85
7-1/2 Small Rifle Primer BR	150-22628	\$32.85
209Premier STS Shotshell Primers	150-22661	\$53.03

Federal Primers

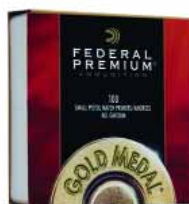

Gold Medal Match Centerfire Primers -

All Primers Priced Per 1,000

	Order No.	Price
Small Pistol Match Primers	129-GM100M	\$29.95
Large Pistol Match Primers	129-GM150M	\$29.95
Large Magnum Pistol Match Primers	129-GM155M	\$32.65
Small Magnum Pistol Match Primers	129-GM200M	\$29.95
Small Rifle Match Primers	129-GM205M	\$29.95
Large Rifle Match Primers	129-GM210M	\$29.95
Large Magnum Rifle Match Primers	129-GM215M	\$32.65

CCI Primers



CCI Standard Primers -

All Primers Priced Per 1,000

	Order No.	Price
200 Large Rifle Standard Primers	020-0011	\$25.69
300 Large Pistol Standard Primers	020-0012	\$25.69
400 Small Rifle Standard Primers	020-0013	\$25.69
500 Small Pistol Standard Primers	020-0014	\$25.69

CCI Bench Rest Primers -

All Primers Priced Per 1,000

	Order No.	Price
BR2 Large Rifle Primers	020-0010	\$45.71
BR4 Small Rifle Primers	020-0019	\$33.49

CCI Magnum Primers -

All Primers Priced Per 1,000

	Order No.	Price
250 Large Rifle Magnum Primers	020-0015	\$28.36
350 Large Pistol Magnum Primers	020-0016	\$28.36
450 Small Rifle Magnum Primers	020-0017	\$28.36
550 Small Pistol Magnum Primers	020-0018	\$25.69

CCI Shotshell Primers -

All Primers Priced Per 1,000

	Order No.	Price
# 209 Trap & Skeet Primers	020-0008	\$25.69
#209M Shotshell Primer	020-0009	\$25.69

CCI Military Primers -

All Primers Priced Per 1,000

	Order No.	Price
No41 Primer for 5.56mm/30Carbine	020-0001	\$34.78
No34 Primer for 7.62mm/30-06	020-0002	\$34.78

CCI 50 BMG Primers -

Primers Priced Per 500

	Order No.	Price
# 35 .50 Cal BMG Primers	020-0320	\$164.59

CCI Primer Strips

All Primers Priced Per 1,000

	Order No.	Price
Standard 200 APS Lg. Rifle	020-0086	\$30.37
Standard 300 APS Lg. Pistol	020-0084	\$30.37
Standard 500 APS Sm. Pistol	020-0078	\$30.37
Magnum 250 APS Mag. Lg.Rifle	020-0087	\$33.49
Magnum 350 APS Mag. Lg. Pistol	020-0085	\$33.49
Magnum 450 APS Mag. Sm. Rifle	020-0081	\$33.49

Haz-Mat Fee Got You Down?

See how to save on your Haz Mat order!

See Page 54

Federal Centerfire Primers -

All Primers Priced Per 1,000

	Order No.	Price
Small Pistol Primers	129-100	\$26.02
Large Pistol Primers	129-150	\$26.02
Large Magnum Pistol Primers	129-155	\$28.72
Small Magnum Pistol Primers	129-200	\$26.02
Small Rifle Primers	129-205	\$26.02
Large Rifle Primers	129-210	\$26.02
Large Magnum Rifle Primers	129-215	\$28.72

Federal Shotshell Primers for 10, 12, 16, 28 & .410 Gauge -

All Primers Priced Per 1,000

Order No.	Price
129-209A	\$26.02



#209 Shotshell Primers, Percussion & Musket Caps

#209 Shotshell Primers -
All Primers Priced Per 1,000

	Order No.	Price
CCI - #209M Shotshell Primer	020-0009	\$25.69
Remington - #209Premier STS Shotshell Primers	150-22661	\$53.03
Federal - #209 Shotshell Primer	129-209A	\$26.02

RWS Percussion & Musket Caps -



RWS Percussion and Musket Caps must be shipped Via Fed-Ex Ground

These are shipped as Hazardous Material and receive the \$25.00 haz-mat fee. We must have Proof of Age in order to ship these.

Order No.	Price
Percussion Cap 1075 #11	062-2105209 \$71.49

CCI Percussion and Musket Caps must be shipped Via Fed-Ex Ground

CCI Percussion & Musket Caps - All Priced Per 1,000

	Order No.	Price
# 11 Percussion Caps	020-0311	\$39.60
#11M Percussion Caps	020-0310	\$42.04
#10 Percussion Caps	020-0309	\$39.60



MARKRON

Say "good-bye" to moisture contaminated misfires!



Markron Custom Bullet and Primer Sealer - At last! A product that seals and waterproofs all known metallic cartridges and primers for 100% firing consistency, including up to 30 days water submersion! Waterproofs: Cartridge primers, shot primers, bullet case joints, seals black powder nipples. Fast, Simple & Easy to use. One 1/3 oz. bottle seals approximately 1000 rounds.
Order No. 238-SEALER \$6.67

PLEASE READ VERY IMPORTANT

PLEASE NOTE: TO PURCHASE, POWDER, PRIMERS, OR AMMUNITION, WE MUST HAVE A COPY OF YOUR DRIVER'S LICENSE FOR PROOF OF AGE. YOU MAY MAIL OR FAX THIS TO US. YOU MUST BE 21 YEARS OF AGE TO ORDER THESE ITEMS! ABSOLUTELY NO RETURN ON POWDER, PRIMERS, OR PERCUSSION CAPS, BE SURE WHAT YOU ARE ORDERING BEFORE YOU GIVE THE ORDER NUMBER!! PRIMER PRICES SUBJECT TO CHANGE AT ANY TIME!! YOU MUST ORDER PRIMERS IN QUANTITIES OF 5,000 FOR US TO SHIP VIA UPS. UPS WILL NOT TRANSPORT LESS THAN A STANDARD PACK, WHICH IS 5,000.

All 20 Count	Order No.	Price
17 Remington 20gr FBHP	115-65100	\$31.20
17 Remington 20gr FB Tipped	115-65105	31.74
204 Ruger 32gr FBHP	115-65110	26.40
204 Ruger 32gr FB Tipped	115-65115	26.88
222 Rem 40gr FBHP	115-65130	25.62
222 Rem 40gr FB Tipped	115-65135	26.10
221 Rem Fireball 40gr FBHP	115-65120	25.62
221 Rem Fireball 40gr FB Tipped	115-65125	26.10
223 Rem 55gr FBHP	115-65140	19.50
223 Rem 55gr FB Tipped	115-65145	19.98
22-250 Rem 55gr FBHP	115-65150	24.00
22-250 Rem 55gr FB Tipped	115-65155	24.54
243 Win 55gr FBHP	115-65160	34.20
243 Win 55gr FB Tipped	115-65165	34.74



ARMAGEDDON
BY NOSLER

New!

NEW! VARMAGEDDON - Introducing Nosler's new Varmageddon™ line of loaded ammunition and component bullets. Featuring a highly accurate polymer tip or hollow point combined with a flat base design, Varmageddon products were created for the high-volume varmint shooter who requires the utmost precision.

Loaded with NoslerCustom® brass, Varmageddon™ ammunition provides the highest levels of performance for any varmint hunter.

More info on our website!!
www.midsouthshooters.com



Bullets Also Available See Page 108

Barnes Vor-Tx Ammo



Barnes TSX®, Tipped TSX™ & TSX FN™ bullets - Precision loaded with the deadliest bullets on the planet. The leader in bullet innovation offers hunters the ultimate in accuracy, terminal performance and hand-loaded precision in a factory loaded round. Now offered in Rifle, Handgun, Metric and Safari cartridges.

	Order No.	Price
223 Rem 55gr TSX	135-21520	\$26.70
243 Win 80gr TTSX BT	135-21522	34.06
270 Win 230gr TTSX BT	135-21524	42.34
7mm Rem Mag 140gr TTSX BT	135-21526	47.92
7mm Rem Mag 160gr TSX BR	135-21529	47.92
30-06 Sprgfld 150gr TTSX BT	135-21531	41.86
30-06 Sprgfld 180gr TTSX BT	135-21533	41.86
30-30 Win 150gr TSX FN	135-21535	34.51
300 WSM 165gr TTSX BT	135-21536	48.79
300 Win Mag 165gr TTSX BT	135-21537	48.79
300 Win Mag 180gr TTSX BT	135-21538	48.79
300 RemUltMag 180gr TTSX BT	135-21539	59.88
308 Win 150gr TTSX BT	135-21540	41.86
308 Win 168gr TTSX BT	135-21541	41.86
338 Win Mag 225gr TTSX BT	135-21542	54.31

Glow Ammo - Visible Ammunition



Only visible from the shooter's perspective!

New from Glow Ammo! Visible Ammunition that uses cold tracer technology to allow you to see exactly where your bullet is going! Glow Ammo performs with zero flame or heat signature, meaning it is safe to shoot at any indoor or outdoor range.



	Order No.	Price
40 S&W 180gr FP (50)	177-GAVA81840CF	\$19.97
40 S&W 180gr FP (20)	177-GAVA81840CH	18.25
45 ACP 230gr RN (50)	177-GAVA81845CF	17.78
45 ACP 230gr RN (20)	177-GAVA81845CH	21.83
9mm 124gr RN (50)	177-GAVA8189MMF	35.05
9mm 124gr RN (20)	177-GAVA8189MMH	19.46

Check out our Glow Ammo Video and our MagTech "Shootin' Size" Video on YouTube!

MagTech Shootin' Size 250 Round Bulk Packs



	Order No.	Price
357 Mag 158gr SJSP Flat (250)	039-MP357A	\$105.00
380 Auto 95gr FMJ (250)	039-MP380A	72.19
38 Auto Spl 158gr LRN (250)	039-MP38A	74.49
40 S&W 180gr FMJ (250)	039-MP40B	80.40
45 Auto 230gr FMJ (250)	039-MP45A	96.80
9mm Luger 115gr FMJ (250)	039-MP9A	57.43

Hornady Critical Defense Handgun Ammunition



Built for Concealed Carry guns

- The patented FTX™ bullet will expand reliably EVERY SINGLE TIME!
- Patented Flex Tip® bullet
- Optimized propellants burn quickly, reduce recoil and limit muzzle flash to protect night vision.
- Shiny nickel cases resist tarnish and greatly enhance low-light chamber checks.
- Cannelured and crimped bullets to avoid setback.

	Order No.	Price
357 Mag 125gr FTX	003-90500	\$20.46
380 Auto 90gr FTX	003-90080	17.42
38 Special 110gr FTX	003-90310	18.77
38 Special+P 110gr FTX	003-90311	18.77
40 S&W 165gr FTX	003-91340	18.02
9mm Luger 115gr FTX	003-90250	17.74
44 Spl 165gr FTX	003-90700	16.88
45ACP 185gr FTX	003-90900	18.86
45 Colt 185gr FTX	003-92790	17.87

Federal American Eagle Handgun Ammunition



	Order No.	Price
9mm Luger 124gr FMJ(50)	129-AE9AP	\$11.43
9mm Luger 115gr FMJ(50)	129-AE9DP	11.43
9mm Luger 147gr FMJ(50)	129-AE9FP	14.28
9mm Makarov 95gr FMJ (50)	129-AE9MK	28.28
40S&W 180gr TMJ(50)	129-AE40N1	21.45
40S&W 155gr FMJ(50)	129-AE40R2	16.52
40S&W 165gr FMJ(50)	129-AE40R3	16.52
45 Auto 230gr FMJ(50)	129-AE45A	19.27
38 Special 130gr FMJ(50)	129-AE38K	18.82
38 Special 158gr RN	129-AE38B	18.82
357 Mag 158gr JSP(50)	129-AE357A	25.96
357 SIG 125gr FMJ (50)	129-AE357S2	34.50
380 Auto 95gr FMJ(50)	129-AE380AP	17.64
44 Rem Mag 240gr JHP(50)	129-AE44A	40.47

Hornady Steel Match



Steel Match ammunition is loaded at the Hornady factory with optimized propellant for each load that provides consistency and the highest levels of accuracy. Utilizing polymer coated steel cartridge cases, and non-corrosive berdan primers, Steel Match ammunition delivers Hornady quality and performance, but with an economical price (saves as much as 40% when compared to brass case match ammo).

	Order No.	Price
9mm Luger 125gr HAP (50)	003-90275	\$18.61
40 S&W 180gr HAP (50)	003-91362	23.93
45 Auto 230gr HAP (50)	003-90985	25.51

Federal Handgun Ammunition



Federal Premium Personal Defense Handgun Ammunition- Hydra-Shok Jacketed Hollow Points are designed to expand on impact yet reduce collateral damage at the same time.

	Order No.	Price
9mm Luger 124 Gr	129-P9HS1	\$20.23
9mm Luger 147 Gr	129-P9HS2	20.23
45 Auto 230 Gr	129-P45HS1	23.42
38 Spl (Hi Vel + P) 129 Gr	129-P38HS1	20.65
357 Mag. 158 Gr	129-P357HS1	23.67

Federal Premium Personal Defense Handgun Hydra-Shok JHP LOW RECOIL - Cut recoil virtually in half!

	Order No.	Price
9mm 135gr HS JHP	129-PD9HS5H	22.11
38 Special 110gr HS JHP	129-PD38HS3H	20.81
357 Mag 130gr HS JHP	129-PD357HS2H	23.28
40 S&W 135gr HS JHP	129-PD40HS4H	24.53
45 Auto 165gr HS JHP	129-PD45HS3H	24.53

Federal Vital Shok Premium Handgun Hunting Cartridges- Perfect for medium game (light, thin-skinned game such as antelope, mule deer, white-tale deer and black bear)

CLFP-Cast Lead Flat Point TBBC-TrophyBondedBearClaw BEB - Barnes Expander Bullet

	Order No.	Price
357 Mag 140gr BEB (20)	129-P357XB1	\$23.34
357 Mag 180gr CLFP (20)	129-P357J	20.73
41 Rem Mag 250gr CLFP(20)	129-P41B	28.51
44 Rem Mag 225gr BEB (20)	129-P44XB1	30.22
44 Rem Mag 300gr CLFP (20)	129-P44E	29.37
454 Casull 250gr BEB (20)	129-P454XB1	35.77
460 S&W 275gr BEB (20)	129-P460XB1	48.05
480 Ruger 275gr BEB (20)	129-P480XB1	49.68
500 S&W 275gr BEB (20)	129-P500XB1	48.09



Federal Classic Centerfire Revolver Ammunition-

	Order No.	Price
357Mag 125gr, JHP Hi-Shok (20)	129-C357B	\$18.73
357Mag 158gr, JHP Hi-Shok (20)	129-C357E	18.73
45Colt 225gr JHP SWC (20)	129-C45LCA	19.45

Personal Defense® Handgun .410 Shotshell - Personal Defense® .410 Shotshell 2-1/2-inch loads designed especially for The Judge. 3-inch loads offer added payloads, more stopping power while special wad design prevents cut-off in barrel.

	Order No.	Price
410ga 2.5" 000 Buck 20 Rounds	129-PD412JGE000	\$12.99

CCI Handgun Ammunition

CCI Blazer (Non-Reloadable) Economy Ammo- These cases are non reloadable after use. 50 per Box



	Order No.	Price
.32 Auto 71 gr. TMJ(50)	020-3503	\$23.07
.380 Auto 95 gr. TMJ(50)	020-3505	16.43
9mm 115 gr. TMJ(50)	020-3509	11.79
9mm 124 gr. TMJ(50)	020-3578	12.24
.38 Sp. 125 gr. JHP+P(50)	020-3514	20.04
.38 Special 158 gr. RNL(50)	020-3522	18.81
.357 Mag., 158 gr. JHP(50)	020-3542	20.89
.40 S&W 165 gr. TMJ.(50)	020-3589	17.79
.40 S&W 180 gr. TMJ(50)	020-3591	17.79
.44 Mag 240 gr. JHP (50)	020-3564	32.22
.45 ACP 230 gr. TMJ (50)	020-3570	18.75
.45 Colt 200 gr. JHP (50)	020-3584	41.25

CCI Blazer (Re-Reloadable) Economy Ammo- These cases can be reloaded after use. 50 per Box

CCI



	Order No.	Price
9mm 115 gr. FMJ (50)	020-5200	\$13.53
9mm 124 gr. FMJ (50)	020-5201	13.53
38 Special 125gr (50)	020-5204	18.35
40 S&W 165 gr. FMJ (50)	020-5210	18.87
45 ACP 230 gr. FMJ (50)	020-5230	22.03
380 Auto 95 gr FMJ	020-5202	17.64
357 Mag 158gr JHP (50)	020-5207	23.21

Hornady TAP Ammunition for Personal Defense



Hornady's family of TAP For Personal Defense ammo is superior tactical ammunition designed specifically for protection from deadly threats. TAP For Personal Defense ammunition is engineered to deliver reliable, consistent performance every single time. Revolutionary black, nickel-coated cases eliminate the potential for corrosion and improve feeding in all firearms. Propellants are engineered to protect your night vision by minimizing muzzle flash.

	Order No.	Price
9mm 124 Grain	003-90248	\$19.86
40 S&W 155 Grain	003-91328	15.62
45ACP 200 Grain	003-91128	16.46
45ACP 230 Grain	003-90958	16.46

COMPONENT & AMMUNITION UPDATES : While prices do seem to have stabilized somewhat, availability seems to be the issue this year. As the administration settles in, demand for shooting related products has more than doubled. Manufacturers are trying their best to supply what is being ordered, but it seems they are having a hard time catching up. The prices shown in this catalog are current as of February 2012. We apologize for any increases or price discrepancies in advance.

Speer Handgun Ammo

Speer Gold Dot Ammunition- Premium law enforcement and defense Ammo. Gold Dot provides extremely higher retained weights



	Order No.	Price
.32 Auto 60 gr. GDHP(20)	020-23604	\$20.95
.380 Auto 90 gr. GDHP(20)	020-23606	16.40
9mm 115 gr. GDHP(20)	020-23614	20.49
9mm 124 gr. GDHP(20)	020-23618	20.49
9mm 147 gr. GDHP(20)	020-23619	20.49
327 Federal 115 gr. GDHP (20)	020-23914	20.39
.38 Spl+P 135 grGDHP Short	020-23921	21.54
.357 Sig 125 gr. GDHP(20)	020-23918	20.48
.357 Mag., 125 gr. GDHP(20)	020-23920	23.78
.357 Mag.,135 gr.GDHP(20) Short	020-23917	23.18
.357 Mag., 158 gr. GDHP(20)	020-23960	23.77
.40 S&W 155 gr. GDHP(20)	020-23961	23.77
.40 S&W 165 gr. GDHP(20)	020-23970	23.33
.40 S&W 180 gr. GDHP(20) Short	020-23974	24.01
.45 Auto 185 gr. GDHP(20)	020-23964	24.98
.45 Auto 230 gr. GDHP(20)	020-23966	23.89
.45 Auto 230 gr GDHP (20) Short	020-23975	24.56
.45 ACP+P 200gr. GDHP(20)	020-23969	23.89
.44 Mag 200 gr GDHP (20) Short	020-23971	26.70
.44 Mag. 240 gr. GDHP(20)	020-23973	24.77
.44 Magnum 210gr GDHP (20)	020-23972	24.48
.45 Colt 250gr GDHP (20)	020-23984	29.32
.454 Casull 300 gr. GDHP(20)	020-23990	46.17
.480 Ruger 275 gr. GDHP(20)	020-23988	37.18

*Notes Closeout - Limited Quantities

Speer Lawman Ammunition- The trusted training and practice companion for millions of shooters around the world. High-strength, low-cost cartridge case passes on the savings to you.



	Order No.	Price
9mm 115 gr. TMJ(50)	020-53615	\$11.19
9mm 124 gr. FMJ(50)	020-53616	11.62
.38 Sp. + P 158 gr. TMJ(50)	020-53750	19.93
.40 S&W 180 gr. TMJ(50)	020-53958	16.79
.40 S&W 165 gr. TMJ(50)	020-53955	16.79
.45 Auto 230 gr. TMJ(50)	020-53967	19.58
.45 Auto 185 gr. TMJ(50)	020-53654	29.59
.45 Auto 200 gr. TMJ(50)	020-53655	29.59

Hornady Leverrevolution for Handguns



Patented Flex Tip® design is safe in all tubular magazines. Flex Tip® technology delivers controlled expansion across a broad range of velocities. Delivers the flat-test trajectories EVER from lever guns.

	Order No.	Price
357 Mag 140gr FTX LVREV (25)	003-92755	\$19.97
44 Mag 225gr FTX LVREV (20)	003-92782	18.25
45 Colt 225gr FTX LVREV (20)	003-92792	17.78
32 Spl 165gr FTX LVREV (20)	003-82732	21.83

Hornady Pistol Ammo

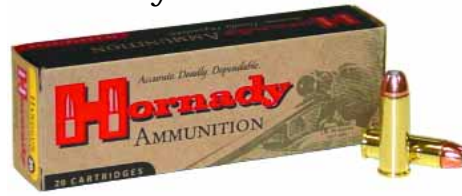

	Order No.	Price
25 Auto 35gr JHP-XTP(25)	003-90012	\$14.34
32 Auto 60gr JHP-XTP(25)	003-90062	14.92
380 Auto 90gr JHP-XTP(25)	003-90102	15.20
9mm Luger 115gr JHP-XTP(25)	003-90252	15.49
9mm Luger 124gr JHP-XTP(25)	003-90242	15.49
9mm Luger 147gr HP-XTP(25)	003-90282	15.49
38 Spl 158gr JHP-XTP(25)	003-90362	17.15
357 Mag 125gr JHP-XTP(25)	003-90502	18.58
357 Mag 140gr JHP-XTP(25)	003-90552	18.97
357 Mag 158gr JHP-XTP(25)	003-90562	18.97
357 Sig 124gr JHP-XTP(20)	003-9130	15.41
44 Mag 180gr JHP-XTP(20)	003-9081	17.12
44 Mag 200gr JHP-XTP(20)	003-9080	17.12
44 Mag 240gr JHP-XTP(20)	003-9085	17.12
44 Mag 300gr JHP-XTP(20)	003-9088	17.12
9mm x18 MAK 95gr JHP-XTP(20)	003-91002	15.49
10mm 180gr JHP-XTP(20)	003-9126	15.56
40 S&W 155gr JHP-XTP(20)	003-9132	15.07
40 S&W 180gr JHP-XTP(20)	003-9136	15.07
44 Special 180gr HP-XTP (20)	003-9070	16.00
45 ACP 185gr JHP-XTP(20)	003-9090	14.76
45 ACP 200gr JHP-XTP(20)	003-9112	14.76
45 ACP+P 200gr JHP-XTP(20)	003-9113	15.75
45 ACP+P 230gr JHP-XTP(20)	003-9096	16.01
454 Casull 300gr JHP/XTP(20)	003-9150	23.93
454 Casull 240gr JHP/XTP MAG(20)	003-9148	23.93
460 S&W 200gr SST (20)	003-9152	25.40
480 Ruger 325gr XTP MAG(20)	003-9138	24.18
480 Ruger 400gr XTP MAG(20)	003-9144	24.18
50 AE 300gr XTP (20)	003-9245	23.88
500 S&W 300gr Evolution(20)	003-9249	52.86
500 S&W 350gr XTP MAG(20)	003-9250	52.86
500 S&W 500gr XTP FP Mag(20)	003-9252	54.36

Ultramax Remanufactured Pistol Ammunition



	Order No.	Price
9mm Luger		
115gr Full Metal Jacket	147-9R2	\$12.18
115gr Jacketed Hollow Point	147-9R3	15.60
125gr Full Metal Jacket	147-9R4	12.18
147gr Full Metal Jacket	147-9R6	13.68
38 Spl		
148gr HB Wadcutter Lead	147-38R3	\$14.94
158gr Semi-Wadcutter Lead	147-38R4	12.12
158gr Round Nose Lead	147-38R5	12.12
45 Auto		
200gr Semi-Wadcutter Lead	147-45R1	\$15.48
230gr Round Nose Lead	147-45R2	15.48
185gr Jacketed Hollow Point	147-45R3	22.68
230gr Jacketed Hollow Point	147-45R4	22.68
230gr Full Metal Jacket	147-45R5	19.68

	Order No.	Price
40 Cal		
40 S&W 165gr JHP	147-40R2	\$20.16
40 S&W 165gr FMJ	147-40R3	15.12
40 S7W 180gr JHP	147-40R4	20.16
40 S7W 180gr FMJ	147-40R5	15.12

Magtech Handgun Ammo



Magtech Pistol / Revolver Ammo- Reliability, top performance and value make Magtech's Pistol and revolver ammo ideal for sport shooting.

	Order No.	Price
.38 SPL 158 LRN (50)	039-38A	\$14.90
.38 SPL 148 LWC (50)	039-38B	19.24
.38 SPL 125 FMJ Flat (50)	039-38Q	15.63
.38 S&W 146 LRN (50)	039-38SWA	21.86
.357 Mag 158 SJSP Flat (50)	039-357A	21.00
.380 Auto 95 FMJ (50)	039-380A	14.44
.380 Auto 95 JHP (50)	039-380B	21.73
9mm Luger 115 FMJ (50)	039-9A	11.49
9mm Luger 124 FMJ (50)	039-9B	12.48
.40 S&W 180 FMJ Flat (50)	039-40B	16.09
.40 S&W 155 JHP (50)	039-40D	24.09
.45 Auto 230 FMJ (50)	039-45A	19.36
.44 Rem Mag 240 SJSP (50)	039-44A	30.06
454 Casull 260 SJSP (20)	039-454A	24.91
.500 S&W 400 SJSP (20)	039-500A	42.00
.500 S&W 325 SJSP (20)	039-500B	42.00



Magtech Guardian Gold Ammunition- Affordable personal protection ammo that really packs a punch.

	Order No.	Price
.380 Auto + P 85 JHP (20)	039-GG380A	\$12.24
9mm Luger + P 124 JHP (20)	039-GG9B	13.24
.45 Auto + P 230 JHP (20)	039-GG45B	16.86



Magtech Cowboy Action Ammunition- Loaded to the specs written by the Single Action Shooting Society.

	Order No.	Price
.44 SPL 240 LFN (50)	039-44B	\$30.26
.45 Colt 250 (50)	039-45D	30.98
.357 Mag 158 LFN (50)	039-357L	25.60
.38 SPL 158 LFN (50)	039-38L	23.24



Magtech First Defense Ammunition - Designed with a 100% solid copper bullet ensuring every round you fire meets its target with maximum impact and effectiveness. Trust the bullet that delivers deep penetration and devastating expansion... the kind that stops a threat in its tracks.

	Order No.	Price
38Spl+P 95gr Solid Copper HP	039-FD38A	\$19.30

COMPONENT & AMMUNITION UPDATES : While prices do seem to have stabilized somewhat, availability seems to be the issue this year. As the administration settles in, demand for shooting related products has more than doubled. Manufacturers are trying their best to supply what is being ordered, but it seems they are having a hard time catching up. The prices shown in this catalog are current as of February 2012. We apologize for any increases or price discrepancies in advance.

Federal Vital-Shok Ammunition

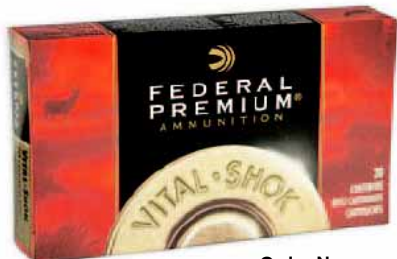

From the world leader in premium ammunition comes Vital-Shok—your best option for medium to large game. Vital-Shok is available in the world's finest big game bullets, from the unrivaled Speer® Trophy Bonded Bear Claw® and Nosler's latest offerings to Sierra® and Barnes®. Match that with world-class brass, select powders and legendary primers and you get unmatched Premium performance.



	Order No.	Price
223 Rem 60gr NP	129-P223Q	\$21.64
22-250 Rem 60gr NP	129-P22250G	28.68
243 Win 95gr NBT	129-P243J	26.39
243 Win 85gr BTSX	129-P243K	27.86
243 Win 100gr SGKBTSP	129-P243C	24.15
243 Win 85gr SGKBTSP	129-P243D	23.67
243 Win 100gr NP	129-P243E	31.26
257 Rbts (HV + P) 120gr NP	129-P257B	32.96
25-06 Rem 117gr SGKBTSP	129-P2506C	26.69
25-06 Rem 100gr BTSX	129-P2506H	36.85
25-06 Rem 100gr NBT	129-P2506D	29.33
260 Rem 120gr NBT	129-P260B	30.55
270 Win 130gr SGKBTSP	129-P270D	27.47
270 Win 150gr NP	129-P270E	34.88
270 Win 130gr NBT	129-P270F	29.05
270 Win 130gr BTSX	129-P270G	36.66
270 Win 140gr NAB	129-P270A1	32.67
270 WSM 130gr NBT	129-P270WSMB	34.53
270 WSM 130gr BTSX	129-P270WSMD	42.10
270 WSM 140gr NAB	129-P270WSMA1	38.17
270 WSM 140gr NP	129-P270WSMC	39.76
280 Rem 140gr BTSX	129-P280E	35.31
280 Rem 140gr NBT	129-P280D	29.21
280 Rem 150gr NP	129-P280A	35.31
7-30Waters 120gr SGKBTSP	129-P730A	24.95
7mm-08 Rem 140gr BTSX	129-P708C	38.11
7mm-08 Rem 140gr NP	129-P708A	35.63
7mm-08 Rem 140gr NBT	129-P708B	29.05
7mmRM 160gr BTSX	129-P7RN	42.10
7mmRM 160gr NAB	129-P7RA1	39.04
7mmRM 160gr NP	129-P7RF	42.10
7mmRM 150gr NBT	129-P7RH	34.57
7mmRM 175gr TBBC	129-P7RT1	42.10
7mm WSM 140gr NBT	129-P7WSMB	33.99

	Order No.	Price
308 Win 165gr SGKBTSP	129-P308C	\$27.47
308 Win 165gr BTSX	129-P308H	34.92
308 Win 150gr NP	129-P308S	34.54
308 Win 150gr BTSX	129-P308V	34.92
30-06 Spfd 165gr NP	129-P3006AD	34.92
30-06 Spfd 180gr NAB	129-P3006A1	33.13
30-06 Spfd 180gr BTSX	129-P3006AE	34.92
30-06 Spfd 165gr SGKBTSP	129-P3006D	27.47
30-06 Spfd 180gr NP	129-P3006F	36.66
30-06 Spfd 150gr SGKBTSP	129-P3006G	27.47
30-06 Spfd 150gr NBT	129-P3006P	29.33
30-06 Spfd 165gr NBT	129-P3006Q	29.33
300 H&H Mag 180gr NP	129-P300HA	51.19
300 H&H Mag 180gr BTSX	129-P300HB	58.28
300 Win Mag 180gr NAB	129-P300WA1	41.59
300 Win Mag 180gr NP	129-P300WD2	44.62
300 WSM 150gr NBT	129-P300WMD	37.19
300 WSM 165gr NP	129-P300WSME	47.09
300 WSM 165gr BTSX	129-P300WSMG	44.84
300 WSM 180gr NAB	129-P300WSMA1	41.59
300 WSM 180gr NP	129-P300WSMB	47.09
300 Wby Mag 180gr NP	129-P300WBA	65.15
300 RUM 200gr NP	129-P300RUMC	48.90
338 Win Mag 180gr NAB	129-P338A3	45.83
338 Win Mag 210gr NP	129-P338A2	47.26
338 Win Mag 225gr TBBC	129-P338T1	51.88
338 Win Mag 225gr BTSX	129-P338K	51.88
375 H&H Mag 260gr NAB	129-P375A1	58.04

BMRX- Barnes MRX Bullet
 BTSX-Barnes Triple Shock X Bullet
 HE-High Energy
 NAB-Nosler Accubond
 NBT-Nosler Ballistic Tip
 NP- Nosler Partition

NSB- Nosler Solid Base
 SGKBTSP- Sierra Game King Boat Tail Hollow Point
 SGKBTSP- Sierra Game King Boat Tail Soft Point
 SMKBTSP- Sierra Match King Boat Tail Hollow Point
 TBBC- Trophy Bonded Bear Claw

Federal Fusion Rifle Ammunition



	Order No.	Price
243 Win 95gr	129-F243FS1	\$19.23
25-06 Rem 120gr	129-F2506FS1	27.09
270 Win 130gr	129-F270FS1	20.91
270 Win 150gr	129-F270FS2	20.91
270 Win Short Mag 150gr	129-F270WSMFS1	31.39
7mm-08 Rem 140gr	129-F708FS1	25.89
280 Rem 140gr	129-F280FS1	29.05
308 Win 150gr	129-F308FS1	\$20.91
308 Win 165gr	129-F308FS2	20.91
308 Win 180gr	129-F308FS3	20.91
30-06 Sprgfd 150gr	129-F3006FS1	20.91
30-06 Sprgfd 165gr	129-F3006FS2	20.91
30-06 Sprgfd 180gr	129-F3006FS3	20.91
300 Win Mag 150gr	129-F300WFS1	28.55
300 Win Mag 165gr	129-F300WFS2	28.55
300 Win Mag 180gr	129-F300WFS3	28.55
300 Win Short Mag 150gr	129-F300WSMFS3	32.29
300 Win Short Mag 165gr	129-F300WSMFS1	32.29
300 Win Short Mag 180gr	129-F300WSMFS2	32.29
338 Federal 200gr	129-F338FFS2	26.16
338 Win Mag 225gr	129-F338FS1	43.36
41 Rem Mag 210gr	129-F41FS1	21.54
44 Rem Mag 240gr	129-F44FS1	23.67
454 Casull 260gr	129-F454FS1	28.82

Federal Gold Medal Match Rifle Cartridges



All Loaded with
 Sierra MatchKing
 BTHP

	Order No.	Price
223 Rem. 69 Grain	129-GM223M	\$29.62
223 Rem. 77 Grain	129-GM223M3	29.62
308 Win. 168 Grain	129-GM308M	36.19
308 Win. 175 Grain	129-GM308M2	36.19
30-06 Spfd. 168 Grain	129-GM3006M	36.19
300 Win. Mag. 190 Grain	129-GM300WM	48.62

Federal Cape-Shok



Those who hunt dangerous game know how important it is to carry the absolute best ammunition for the job—that's why Safari and dangerous game hunters choose Federal Premium Cape-Shok.

	Order No.	Price
375 H&H Mag 300gr NP	129-P375F	\$61.12
375 H&H Mag 300gr TBBC	129-P375T1	68.36
375 H&H Mag 300gr TSH	129-P375T2	87.13
375 H&H Mag 300gr BTSX	129-P375H	59.75
458 Win Mag 500gr TSH	129-P458T3	121.28
458 Win Mag 500gr BTSX	129-P458D	110.68
416 Rigby 400gr BTSX	129-P416D	182.36
416 Rigby 400gr TSH	129-P416T2	170.51
416 Rigby 400gr TBBC	129-P416T1	179.04
416 Rem Mag 400gr TBBC	129-P416RT1	115.72
416 Rem Mag 400gr TSH	129-P416RT2	114.72
470 Nitro Exp 500gr TSH	129-P470T2*	202.51

*Notes a Call-In Item, this item is not in stock, but will be ordered from Federal for you.

BTSX- Barnes Triple Shok X-Bullet
 HE-High Energy
 NP-Nosler Partition
 TBBC-Trophy Bonded Bear Claw
 TSH-Trophy Sledgehammer
 WWSP-Woodleigh Weldcore Soft Point

Federal Power-Shok



All of Federal's "Classic" rifle options are exclusively available under the Power-Shok name and the most popular big game cartridges now feature the Grand Slam™ bullet from Speer.

	Order No.	Price
222 Rem 50gr SP	129-222A	\$17.14
22-250 Rem 55gr SP	129-22250A	17.92
243 Win 80gr Speer Hot-Cor SP	129-243AS	18.02
243 Win 100gr SP	129-243B	18.02
25-06 117gr Speer Hot-Cor SP	129-2506BS	26.71
270 Win 130gr SP	129-270A	18.59
270 Win 150gr SPRN	129-270B	18.59
270 WSM 130gr SP	129-270WSME	30.33
7mm08 Rem 150gr SHCSP	129-708CS	25.53
7mm Rem Mag 150gr SP	129-7RA	24.70
7mm Rem Mag 175gr SP	129-7RB	24.70
7mm WSM 150gr SP	129-7WSME	30.66
7.62x39 R 123gr SP	129-76239B	21.91
30 Carbine 110gr RN	129-30CA	19.57
30-30 Win 125gr JHP	129-3030C	16.66
30-30 Win 170gr SPRN	129-3030B	15.16
30-30 Win 150gr SPFN	129-3030A	15.16
300 Savage 150gr SP	129-300A	29.49
300 Savage 180gr SP	129-300B	29.49
308 Win 150gr SP	129-308A	18.59
308 Win 180gr SP	129-308B	18.59
30-06 Spfd 150gr SP	129-3006A	18.59
30-06 Spfd 180gr SP	129-3006B	18.59
300 WSM 180gr SP	129-300WSMC	31.07
300 Win Mag 150gr SP	129-300WGS	25.25
300 Win Mag 180gr SP	129-300WBS	25.25
35 Rem 200gr SP	129-35A	26.48
8mm Mauser 170gr SP	129-8A	30.32
45-70 Govt 300gr FN	129-4570AS	37.00

FN-Flat Nose
 JSP-Jacketed Soft Point
 LRSP-Low Recoil Soft Point
 SP-Soft Point
 SPRN-Soft Point Round Nose

PLEASE READ VERY IMPORTANT

PLEASE NOTE: YOU MUST BE 21 YEARS OF AGE TO ORDER AMMUNITION! SEE PAGE 3 FOR DETAILS!
 (TN residents pay a .10 TWRA Tax per box of ammunition)

Federal V-Shok

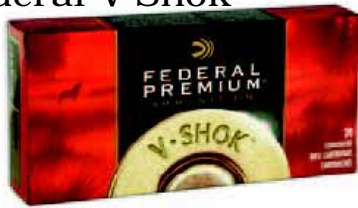

Nothing performs better on varmints than Federal's V-Shok ammunition. Sizzling velocity and explosive disruption make it the ultimate choice for your favorite varmint.

	Order No.	Price
204 Ruger 32gr NBT	129-P204B	\$17.18
22 Hornet 45gr Speer SP	129-P22B	40.87
222 Rem 40gr NBT	129-P222C	18.94
223 Rem 55gr SGKBTHP	129-P223E	18.80
223 Rem 55gr NBT	129-P223F	20.66
22/250 Rem 55gr SGKBTHP	129-P22250B	20.18
243 Win 55gr NBT	129-P243H	26.36
243 Win 70gr NBT	129-P243F	26.36
25/06 85gr NBT	129-P2506G	28.74

SBK-Sierra BlitzKing		
NBT-Nosler Ballistic Tip		
SGKBTHP- Sierra Game King Boat Tail Hollow Point		
SVHP- Sierra Varminter Hollow Point		
SMKBTHP- Sierra Match King Boat Tail Hollow Point		
BTSX- Barnes Triple Shok X-Bullet		

American Eagle Rifle Ammunition



	Order No.	Price
7.62x39 Soviet 124gr FMJ(20)	129-A76239A	\$16.08
308 Win 150gr FMJBT(20)	129-AE308D	18.68
22LR Hi-Vel 38gr *CPHP(40)	129-AE22	1.89
22LR Hi-Vel 40gr Solid(50)	129-AE5022	1.89
30 Carbine 110gr FMJ (50)	129-AE30CB	24.78

* CPHP- Copper Plate Hollow Point

Ultramax Remanufactured Ammunition



	Order No.	Price
223 Rem		
52gr Jacketed Hollow Point	147-223R1	\$21.29
55gr Full Metal Jacket	147-223R2	18.67
55gr Soft Point	147-223R3	19.34
50gr Nosler Ballistic Tip	147-223R4	26.41
40gr Nosler Ballistic Tip	147-223R5	26.41
68gr Match Hollow Point	147-223R6	25.19
55gr Nosler Ballistic Tip	147-223R7	26.41
50gr Speer TNT	147-223R9	22.51
62gr Full Metal Facket	147-223R10	20.62

	Order No.	Price
308 Win		
110gr Sierra Hollow Point	147-308R1	\$16.71
150gr Nosler Ballistic Tip	147-308R2	22.69
165gr Boat Tail Soft Point	147-308R4	16.71
168gr Boat Tail Hollow Point	147-308R5	16.71



Weatherby Ammunition with Hornady Loads

Wby Mag Caliber	Bullet Grain & Type	Order No.	Price
.240	87gr *SP(20)	098-H24087SP	\$57.19
.240	100gr *SP(20)	098-H240100SP	57.19
.257	100gr *SP(20)	098-H257100SP	57.19
.257	117gr RN(20)	098-H257117RN	57.19
.270	130gr *SP(20)	098-H270130SP	57.19
.270	150gr *SP(20)	098-H270150SP	57.19
7mm	154gr *SP(20)	098-H7MM154SP	57.19
7mm	175gr *SP(20)	098-H7MM175SP	57.19
.300	150gr *SP(20)	098-H300150SP	57.19
.300	165gr *SP(20)	098-H300165SP	57.19
.300	180gr *SP(20)	098-H300180SP	57.19
.300	220gr RN(20)	098-H300220RN	57.19
.340	200gr *SP(20)	098-H340200SP	66.50
.378	270gr *SP(20)	098-H378270SP	125.02

*SP ammunition will have PT-EX(Pointed- Expanding) on the box. This is the same as Spire Point.

Weatherby Ammunition with Nosler Loads

Wby Mag Caliber	Bullet Grain & Type	Order No.	Price
.240	100gr PT(20)	098-N240100PT	\$75.81
.257	115gr BST(20)	098-N257115BST	66.50
.257	120gr PT(20)	098-N257120PT	57.19
.257	110gr AB(20)	098-N257110ACB	75.81
.270	140gr AB(20)	098-N270140ACB	75.81
.270	140gr BST(20)	098-N270140BST	66.50
.270	150gr PT(20)	098-N270150PT	75.81
7mm	150gr BST(20)	098-N7MM150BST	66.50
7mm	160gr PT(20)	098-N7MM160PT	75.81
7mm	160gr AB(20)	098-N7MM160ACB	75.81
.300	165gr BST(20)	098-N300165BST	66.50
.300	150gr PT(20)	098-N300150PT	75.81
.300	180gr PT(20)	098-N300180PT	75.81
.300	180gr BST(20)	098-N300180BST	66.50
.300	200gr PT(20)	098-N300200PT	75.81
.300	180gr AB(20)	098-N300180ACB	75.81
.303	180gr AB(20)	098-N303180ACB	125.02
.30-378	180gr BST (20)	098-N303180BST	125.02
.340	210gr PT(20)	098-N340210PT	95.76
.338-378	250gr PT(20)	098-N333250PT	135.66

Weatherby Ammunition with Barnes Loads

Wby Mag Caliber	Bullet Grain & Type	Order No.	Price
.300	165gr TSX(20)	098-B300165TSX	\$75.81
.300	180gr TSX(20)	098-B300180TSX	75.81
.30-378	165gr TSX(20)	098-B303165TSX	135.66
.30-378	180gr TSX(20)	098-B303180TSX	135.66
340	225gr TSX(20)	098-B340225TSX	95.76
416	350gr TSX(20)	098-B416350TSX	163.59
7MM	140gr TSX(20)	098-B7MM140TSX	75.81

Weatherby Ammo Key

SP = Spire Point	XS = Copper Solid
RN = Round Nose	BST = Ballistic Tip
FJ = Full Metal Jacket	AB = AccuBond
SD = Solid	TSX = Triple Shock X
PT = Partition	

NoslerCustom® Trophy Grade™ Ammunition



20 Rounds per box



	Order No.	Price
223 Rem 40gr BT	115-60001	\$21.42
22-250 Rem 55gr BT	115-60003	24.54
243 Win 85gr PT	115-60002*	37.74
257 Roberts+P 110gr Accubond	115-60010*	41.34
257 Wby Mag 110gr Accubond	115-60012	62.94
260 Rem 125gr PT	115-60018*	41.34
264 Win 130gr Accubond	115-60019	49.74
6.5 - 284 Norma 120gr BT	115-60020	49.74
6.5 - 284 Norma 130gr Accubond	115-60021	49.74
6.5x55 SwMsr 140gr Accubond	115-60022	29.34
270 Win 130gr Accubond	115-60025	37.74
270 WSM 140gr Accubond	115-60030*	53.34
7mm-08 Rem 140gr Accubond	115-60042*	37.74
280 Ackley Imp 140gr Accubond	115-60043	49.74
280 Ackley Imp 160gr PT	115-60044	49.74
7mmSA UM 160gr Accubond	115-60045	53.34
7mm STW 140gr PT	115-60046*	62.94
7mm STW 160gr PT Accubond	115-60047*	62.94
7mm Rem Mag 140gr Accubond	115-60033	49.74
7mm RUM 160gr Accubond	115-60048*	62.94
308 Win 150gr Accubond	115-60056*	37.74
308 Win 165gr BT	115-60050*	37.74
308 Win 165gr PT	115-60053*	37.74
308 Win 165gr Accubond	115-60049	37.74
308 Win 168gr Custom Comp	115-60054	27.54
30-06 Spgfd 150gr PT	115-60055*	37.74
30-06 Spgfd 180gr BT	115-60058*	37.74
30-06 Springfield 150gr Partition	115-60055	37.74
300 Win Mag 180gr Accubond	115-60059*	53.34
300 H&H 180gr Accubond	115-60060*	62.94
300 SA UltraMag 165gr PT	115-60061*	53.34
300 SA UltraMag 180gr PT	115-60062*	53.34
300 WSM 180gr Accubond	115-60063	53.34
300 RUM 165gr PT	115-60064	62.94
300 RUM 180gr Accubond	115-60065	62.94
325 WSM 200gr Accubond	115-60077	53.34
338 RUM 225gr Accubond	115-60083	68.34
375 H&H 260gr PT	115-60090	68.34

Nosler Ammo Key
PT = Partition BT = Ballistic Tip

*Notes that these part numbers are call in - We list them and they can be ordered. Delivery times on these part numbers can take from 2-6 weeks.

Lapua Rifle Ammunition



Scenar

	Order No.	Price
338 Lapua Mag 250gr Scenar HPBT (10)	109-4318017	\$67.36



Hornady Superformance™ Ammunition -

The standard by which all ammunition will be judged. Superformance ammunition is 100 to 200 fps FASTER than any conventional ammunition on the market today, and achieves this performance in EVERY gun, WITHOUT increases in felt recoil, muzzle blast, temperature sensitivity, fouling or loss of accuracy.

Superformance uses ultra progressive propellants that take your favorite SST or GMX bullets to levels of performance that are simply unattainable with conventional propellants.

Superformance provides increased performance, and is safe to use in ALL firearms, including semi-autos, lever gun and pump actions.

What Makes Superformance Different? Hornady increases your favorite rifle's performance up to 200 fps WITHOUT extra chamber pressure, recoil, muzzle blast, temperature sensitivity, fouling or loss of accuracy. Superformance™ uses ultra progressive propellants that take your favorite SST® and GMX® bullets to levels of performance that are simply unattainable with conventional propellants.

Sizzling Velocities -

Superformance ammunition is 100 to 200 fps FASTER than any conventional ammunition on the market today. It achieves this performance in EVERY gun without increases in felt recoil, muzzle blast, temperature sensitivity, fouling or loss of accuracy.



Superformance Ammo Loads -

The GMX® bullet is constructed of gilding metal (95% copper 5% zinc) which reduces fouling and increases accuracy. GMX® bullets deliver flat trajectories, DEEP penetration, devastating terminal performance and 95% weight retention from 2000 to 3400 fps. The GMX® bullet is tough enough for any game and is "California Compatible."



The SST® bullet has earned the reputation of being a tough, accurate, flat shooting hunting bullet. Its polymer tip streamlines the profile to deliver high B.C.'s and initiate rapid expansion. The extra heavy jacket and InterLock® feature reduce the chance of core/jacket separation and increase penetration. The SST® is one of the most advanced hunting bullets on the market today.

	Order No.	Price		Order No.	Price
17 Hornet 20gr V-Max (25)	003-83005	\$16.29	308 Win 168gr A-Max	003-80964	\$25.19
222 Rem 50gr V-Max	003-8316	15.92	30-06 Spgfld 150gr SST®	003-81093	25.13
223 Rem 53gr V-Max	003-8025	17.51	30-06 Spgfld 150gr Interbond	003-81098	31.71
223 Rem 55gr GMX	003-83274	19.23	30-06 Spgfld 150gr GMX®	003-8112	34.00
223 Rem 40gr NTX	003-83266	19.94	30-06 Spgfld 165gr SST®	003-81153	25.32
223 Rem 75gr BTHP	003-80264	17.10	30-06 Spgfld 165gr Interbond	003-81158	31.71
5.56 NATO 55gr GMX	003-81254	19.23	30-06 Spgfld 165gr GMX®	003-8116	34.00
5.56 NATO 75gr BTHP	003-81264	17.10	30-06 Spgfld 180gr SST®	003-81183	25.32
22/250 Rem 50gr V-Max	003-83366	19.74	30-06 Spgfld 180gr Interbond	003-81188	31.71
243 Win 58gr V-Max	003-8343	23.17	30 TC 150gr SST®	003-81004	22.65
243 Win 80gr. GMX®	003-80456	28.52	30 TC 165gr SST®	003-81014	24.98
243 Win 95gr SST®	003-80463	24.00	35 Whelen 200gr SP	003-81193	25.39
6mm Rem 95gr SST®	003-81663	24.60	300 Win Mag 150gr GMX®	003-82012	36.06
257 Roberts +P 117gr SST®	003-81353	27.07	300 Win Mag 165gr GMX®	003-82026	36.46
25-06 Rem 110gr GMX®	003-81446	31.50	300 Win Mag 165gr interbond	003-82028	33.76
25-06 Rem 117gr SST®	003-81453	26.95	300 Win Mag 180gr SST®	003-82193	31.89
6.5 Creedmoor 120gr GMX®	003-81490	29.49	300 Win Mag 180gr Interbond	003-82198	33.76
6.5 Creedmoor 129gr SST®	003-81496	24.93	300 RCM 150gr GMX®	003-82230	37.49
6.5x55 140gr SST®	003-85507	26.13	300 RCM 150gr SST®	003-82231	28.35
270 Win 130gr GMX®	003-8052	32.85	300 RCM 165gr GMX®	003-82229	34.00
270 Win 130gr SST®	003-80543	25.27	300 RCM 165gr SST®	003-82232	28.35
270 Win 130gr Interbond	003-80548	30.56	300 RCM 180gr SST®	003-82235	28.35
270 Win 140gr SST®	003-80563	25.27	300 RCM 180gr Interbond	003-82228	31.71
7X57 Mauser 139gr GMX®	003-81556	31.68	338 Win Mag 185gr GMX®	003-82226	38.14
7x57 Mauser 139gr SST®	003-81553	27.11	338 Win Mag 200gr SST®	003-82223	33.58
7mm-08 Rem 139gr GMX®	003-80576	29.56	338 Win Mag 225gr SST®	003-82233	33.58
7mm-08 Rem 139gr SST®	003-80573	24.99	338 Win Mag 225gr Interbond	003-82338	36.24
280 Rem 139gr GMX®	003-81586	30.76	338 RCM 185 gr GMX®	003-82238	38.52
280 Rem 139gr SST®	003-81583	26.20	338 RCM 200gr SST®	003-82237	33.67
7mm Rem Mag 139gr GMX®	003-80592	39.77	338 RCM 225gr SST®	003-82236	33.67
7mm Rem Mag 139gr SST®	003-80593	32.27	338 RCM 225gr Interbond	003-82138	36.24
7mm Rem Mag 154gr SST®	003-8061	32.27	375 H&H 270gr SP-RP	003-8508	52.28
7mm Rem Mag 154gr Interbond	003-80628	33.76	375 H&H 300gr DGS®	003-8509	54.72
7mm Rem Mag 162gr SST®	003-80633	32.27	375 Ruger 270gr SP-RP	003-8231	48.11
308 Win 150gr GMX®	003-8094	37.49	375 Ruger 300gr DGS™	003-8232	53.60
308 Win 150gr SST®	003-80933	24.74	375 Ruger 300gr DGX®	003-82333	48.60
308 Win 150gr Interbond	003-80938	31.71	458 Win 500gr DGS®	003-8585	72.75
308 Win 165gr Interbond	003-80998	31.71	458 Win 500gr DGX®	003-85833	72.75
308 Win 165gr GMX®	003-8099	34.00			
308 Win 165gr SST®	003-80983	24.74			

Hornady Custom Rifle Ammunition



	Order No.	Price
22-250 Rem 60gr SP (20)	003-8039	\$21.48
220 Swift 60gr HP (20)	003-8122	25.47
6.8mm 110gr V-Max (20)	003-8346	20.65
243 Win 75gr HP (20)	003-8040	23.81
243 Win 95gr SST (20)	003-80464	21.63
243 Win 100gr BTSP (20)	003-8046	23.81
257 Roberts 117gr BTSP (20)	003-8135	26.84
25/06 117gr BTSP (20)	003-8145	26.84
25/06 117gr SST (20)	003-81454	24.58
270 Win 130gr SST (20)	003-8054	22.90
270 Win 130gr SP (20)	003-8055	25.13
270 Win 140gr BTSP (20)	003-8056	25.13
270 Win 150gr SP (20)	003-8058	25.13
7mm RemMag 139gr BTSP (20)	003-8059	32.95
7mm RemMag 154gr SP (20)	003-8060	32.95
7mm RemMag 154gr SST (20)	003-8062	29.88
7mm RemMag 162gr BTSP (20)	003-8063	32.95
30/30 Win 150gr RN (20)	003-8080	20.21
308 Win 150gr BTSP (20)	003-8091	24.90
308 Win 150gr SST (20)	003-8093	22.39
308 Win 165gr BTSP (20)	003-8098	24.90
30-06 Spgfd 150gr SP (20)	003-8110	25.06
30-06 Spgfd 150gr SST (20)	003-8109	22.96
30-06 Spgfd 165gr BTSP (20)	003-8115	25.06
30-06 Spgfd 165gr SST (20)	003-81154	22.96
30-06 Spgfd 180gr SP (20)	003-8118	25.73
30-06 Spgfd 180gr SST (20)	003-81184	23.55
300 WinMag 150gr BTSP (20)	003-8201	32.62
300 WinMag 150gr SST (20)	003-82014	29.52
300 WinMag 165gr SST (20)	003-82024	29.86
300 WinMag 165gr BTSP (20)	003-8202	32.62
300 WinMag 180gr SP(20)	003-8200	32.62
300 WinMag 180gr SST (20)	003-82194	30.32
300 WbyMag 150gr InterBond (20)	003-82219	37.44
300 WbyMag 180gr SP MAG (20)	003-8222	41.15
300 H&H 180gr Interbond (20)	003-8210	45.83
375 Ruger 270gr SP (20)	003-8231	48.11
375 Ruger 300gr FMJ/RN (20)	003-8232	53.60
9.3x74R 286gr SP/FP (20)	003-82304	65.93
338 WinMag 225gr SST (20)	003-82234	33.85
405 Win 300gr Spire Point (20)	003-8241	41.78
416 Rigby 400gr FMJ ENC (20)	003-8265	86.47
450 BushMaster 250gr SST (20)	003-82244	25.55

SST-Super Shock Tipped	SP- SpirePoint
BTSP- Boat-tail Soft-point	FMJRN- Full Metal Jacket
LM- Light Magnum	Round Nose
HM- Heavy Magnum	RP- Recoil Proof

Hornady Steel Match



Steel Match ammunition is loaded at the Hornady factory with optimized propellant for each load that provides consistency and the highest levels of accuracy. Utilizing polymer coated steel cartridge cases, and non-corrosive berdan primers, Steel Match ammunition delivers Hornady quality and performance, but with an economical price (saves as much as 40% when compared to brass case match ammo).

	Order No.	Price
223 Rem 55gr HP (50)	003-80274	\$17.40
223 Rem 75gr BTHP (50)	003-80261	20.12
30 Carbine 110gr FMJ (50)	003-8103	28.22
30 Win 155gr BTHP (50)	003-80926	38.98

Match Ammunition



	Order No.	Price
223 Rem 75gr BTHP Match (20)	003-8026	\$17.69
6.5 Creedmoor 120gr A-Max (20)	003-81492	25.10
6.5 Creedmoor 140gr A-Max (20)	003-81494	25.10
6.5 Grendel 123gr A-Max (20)	003-8150	21.15
6.8mm 115gr BTHP (20)	003-8146	18.02
308Win 155gr A-MAX PalmaMatch	003-8095PM	27.42
308 Win 168gr A-MAX Match (20)	003-8096	26.65
308 Win 168gr BTHP Match (20)	003-8097	24.90
308 Win 178gr BTHP Match (20)	003-8077	25.19
338 Lapua 285gr BTHP Match (20)	003-83206	15.61
30-06 Spgfd 168gr A-MAX M1 Garand (20)	003-81170	31.52
50BMG 750gr A-Max (10)	003-8270	52.12

Hornady Leverevolution



Flex Tip™ Technology that is SAFE in your tubular magazine. Its higher ballistic coefficient delivers dramatically flatter trajectories for fantastic downrange energy increases and amazing bullet expansion at all ranges. It truly is an evolution in lever gun ammunition!

	Order No.	Price
30-30 Win FTX GMX 150 gr (20)	003-82731	\$27.01
30-30 Win FTX 160 gr (20)	003-82730	21.73
308 Marlin Exp FTX 160gr (20)	003-82733	24.76
308 Marlin Exp FTX 140gr (20)	003-82734	37.49
35 Rem FTX 200 gr (20)	003-82735	25.19
338 Marlin Exp FTX 200gr (20)	003-82240	27.90
444 Marlin FTX 265gr (20)	003-82744	32.79
45-70 FTX GMX 250gr (20)	003-82741	35.58
45-70 FTX 325gr (20)	003-82747	29.27
450 Marlin FTX 325gr (20)	003-82750	33.02

Varmint Express Ammunition



	Order No.	Price
204 Ruger 30gr NTX (20)	003-83209	\$17.25
204 Ruger 32gr V-Max (20)	003-83204	15.61
204 Ruger 40gr V-Max (20)	003-83206	15.61
204 Ruger 45gr SP (20)	003-83208	16.98
22 Hornet 35gr V-MAX (25)	003-8302	14.89
223 Rem 40gr V-Max (20)	003-8325	15.68
223 Rem 45gr NTX (20)	003-83266	19.94
223 Rem 55gr V-Max Moly (20)	003-83273	16.57
223 Rem 55gr V-Max (20)	003-8327	15.68
22-250 Rem 40gr V-Max (20)	003-8335	18.60
22-250 Rem 50gr V-Max (20)	003-8336	18.60
22-250 Rem 50gr V-Max Moly (20)	003-83363	19.45
22-250 Rem 55gr V-Max (20)	003-8337	17.82
220 Swift 50gr V-Max Moly (20)	003-83213	22.50
220 Swift 55gr V-Max (20)	003-8324	22.50
243 Win 58gr V-Max Moly (20)	003-83423	22.00
5.45x39mm 60gr V-Max Steel (20)	003-8124	20.14
7.62x39mm 123gr V-Max Steel (20)	003-8078	32.11

Dangerous Game Ammunition



	Order No.	Price
9.3x62mm 286gr SP-RP (20)	003-82303	\$48.76
375 H&H 270gr SP-RP (20)	003-82312	52.84
375 H&H 300gr DGX (20)	003-82332	55.32
375 H&H 300gr DGS (20)	003-82322	50.16
404 Jefferies 400gr DGX (20)	003-8238	89.82
404 Jefferies 400gr DGS (20)	003-8239	89.82
416 Rem 400gr DGX (20)	003-82673	61.44
416 Rem 400gr DGS (20)	003-82674	61.44
416 Ruger 400gr DGX (20)	003-82665	61.44
416 Ruger 400gr DGS (20)	003-82666	61.44
450 Nitro EX 480gr DGX (20)	003-8255	96.09
450 Nitro EX 480gr DGS (20)	003-8256	96.09
458 Lott 500gr DGX (20)	003-8262	85.13
470 Nitro EX 500gr DGX (20)	003-8263	116.79
470 Nitro EX 500gr DGS (20)	003-8264	116.79
500 Nitro EX 570gr DGX (20)	003-8268	122.14
500 Nitro EX 570gr DGS (20)	003-8269	122.14

Hornady TAP Personal Defense Ammunition



Hornady's family of TAP For Personal Defense ammo is superior tactical ammunition designed specifically for protection from deadly threats.

	Order No.	Price
223 Rem. 55 Grain	003-83278	\$20.44
223 Rem. 75 Grain	003-80268	20.44
308 Win. 110 Grain	003-80898	29.52
308 Win. 155 Grain	003-80928	29.52
308 Win. 168 Grain	003-80968	29.52

Hornady Shotgun



	Order No.	Price
12ga 2.75" w/300gr SST & Sabot (5 rounds)	003-8623	\$9.80
20ga 2.75" w/250gr SST & Sabot (5 rounds)	003-86232	9.80
12ga #00 Buckshot Superformance (10 rounds)	003-86246	10.95
12ga #00 Buckshot Critical Defense (10 rounds)	003-86240	10.95
12ga #4 Buckshot Varmint Express (10 rounds)	003-86243	10.95

PLEASE READ VERY IMPORTANT

PLEASE NOTE: YOU MUST BE 21 YEARS OF AGE TO ORDER AMMUNITION! SEE PAGE 3 FOR DETAILS!
(TN residents pay a .10 TWRA Tax per box of ammunition)

Federal Classic Shotshells



Federal Classic Duck and Pheasant Steel Speed Shok

12 Gauge	Order No.	Price
3 1/2", 1 3/8oz, BB Shot (25)	129-WF133BB	\$16.76
3", 1 1/4oz, BB Shot (25)	129-WF140BB	12.81
3", 1 1/4oz, 2 Shot (25)	129-WF1402	12.81
2 3/4", 1 1/8oz, BB Shot (25)	129-WF147BB	10.91
2 3/4", 1 1/8oz, 2 Shot (25)	129-WF1472	10.91

Federal Classic Lead Hi-Brass

all 12ga 2 3/4", 3 3/4 dram (25 per box)

12 Gauge	Order No.	Price
1 1/4 oz, #4 shot	129-H1264	\$13.83
1 1/4oz, # 5 shot	129-H1265	13.83
1 1/4 oz, #6 shot	129-H1266	13.83
1 1/4 oz, #7 1/2 shot	129-H12675	13.83

Federal Classic Lead

20 Gauge	Order No.	Price
20ga 2 3/4" 1oz, 2.5Dram #7.5	129-H20275	\$6.74
20ga 2 3/4" 1oz, 2.5Dram #8	129-H2028	6.74

Shotshell Slugs



Federal Classic Rifled Slugs

12 Gauge	Order No.	Price
2 3/4", 1-oz Slug HP(5)	129-F127RS	\$4.17
3", 1 1/4-oz Slug HP(5)	129-F131RS	5.55
2 3/4", 1 1/4-oz Slug HP(5)	129-F130RS	5.55
20 Gauge	Order No.	Price
2 3/4", 3/4 oz. Slug HP(5)	129-F203RS	\$4.17

Vital-Shok Rifled Slugs

12 Gauge	Order No.	Price
2-3/4" 1-OZ Tru-Ball HP Low Recoil (5)	129-PB127LRS	\$4.13
2-3/4" 1-OZ Tru-Ball HP (5)	129-PB127RS	4.13
20 Gauge	Order No.	Price
2-3/4" 3/4-OZ Tru-Ball HP (5)	129-PB203RS	\$4.13

New! Hornady Nickel Plated Turkey Shotshells



12 Gauge	Order No.	Price
3 Inch 4 Shot 10 Rounds	003-86242	\$12.58
3 Inch 5 Shot 10 Rounds	003-86241	12.58
3 Inch 6 Shot 10 Rounds	003-86244	12.58

Federal Premium Blackcloud



Federal Premium Black Cloud™ FS Steel Waterfowl Loads - Move over standard steel, there's a non-tox in town. Black Cloud featuring the FLITECONTROL® wad and FLITESTOPPER™ steel is unlike any other steel shot ever.

12 Gauge	Order No.	Price
3-1/2" 1-1/2 OZ #BBB (25)	129-PWB134BBB	\$24.30
3-1/2" 1-1/2 OZ #BB (25)	129-PWB134BB	24.30
3-1/2" 1-1/2 OZ #2 (25)	129-PWB1342	24.30
3" 1-1/4 OZ #BBB (25)	129-PWB142BBB	20.18
3" 1-1/4 OZ #BB (25)	129-PWB142BB	20.18
3" 1-1/4 OZ #2 (25)	129-PWB1422	20.18

Federal Premium Lead Strut-Shok

12 Gauge	Order No.	Price
3-1/2" 2oz #5 (10)	129-FT1395	\$12.79
3" 1 7/8oz #6 (10)	129-FT1586	8.27

Federal Premium Buck Shot-Copper Coated Lead



12 Gauge	Order No.	Price
2 3/4" #00 Shot, 12 Pellets(5)	129-P15600	\$7.15
3" #00 Shot, 15 Pellets(5)	129-P15800	8.16



Personal Defense® 12ga Shotgun
 - 2-3/4", 9 pellet 00 Buckshot with FC wad 1145 fps
 - Tested extensively for home defense situations
 - Patterns and penetration optimized for close range
 - Excellent terminal performance
 - Features the FLITECONTROL® wad
Order No. 129-PD13200 \$5.93

Personal Defense® Handgun .410 Shotgun
 - Personal Defense® .410 Shotgun 2-1/2-inch loads designed especially for The Judge. 3-inch loads offer added payloads, more stopping power while special wad design prevents cut-off in barrel.

	Order No.	Price
410ga 2.5" 000 Buck 20 Rounds	129-PD412JGE000	\$12.99
410ga 3" 000 Buck 20 Rounds	129-PD413JGE000	14.44
410ga 3" #4 Shot 20 Rounds	129-PD413JGE4B	14.44

COMPONENT & AMMUNITION UPDATES : While prices do seem to have stabilized somewhat, availability seems to be the issue this year. As the administration settles in, demand for shooting related products has more than doubled. Manufacturers are trying their best to supply what is being ordered, but it seems they are having a hard time catching up. The prices shown in this catalog are current as of February 2012. We apologize for any increases or price discrepancies in advance.

Gold Medal Shotshell

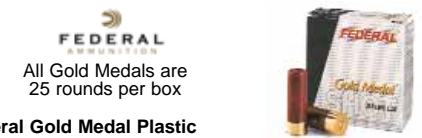

Federal Gold Medal Plastic

410ga 2 1/2", 2 3/4 dram	Order No.	Price
1/2 oz #8.5	129-T41285	\$9.95
1/2 oz #9	129-T4129	9.95

Federal Gold Medal Plastic Trap

12ga 2 3/4", 3 dram	Order No.	Price
1 1/8 oz., #7 1/2 shot	129-T11675	\$8.67
1 1/8 oz., #8 shot	129-T1168	8.67

Federal Gold Medal Plastic Extra Lite Trap

12ga 2 3/4", Extra-Lite	Order No.	Price
1 1/8 oz., #7 1/2 shot (25)	129-T11475	\$8.67
1 1/8 oz., # 8 shot (25)	129-T1148	8.67

Federal Top Gun



12ga 2 3/4" 1 1/8 oz #7.5 (25)	Order No.	Price
12ga 2 3/4" 1 1/8 oz #8 (25)	129-TGL128	5.73
12ga 2 3/4" 1 1/8 oz #9 (25)	129-TGL129	5.73
20ga 2 3/4" 7/8 oz #8 (25)	129-TG208	5.61
20ga 2 3/4" 7/8 oz #9 (25)	129-TG209	5.61

Federal Prairie Storm

-Designed specifically for the pheasant hunter

Check for availability - Not expected until May 2010



-FLITECONTROL® wad system for excellent patterns
 -Mix of copper-plated Premium® lead (70%) and nickel-plated FS lead (30%)

	Order No.	Price
12ga 2.75"Mag 1.25oz 4shot	129-PF154FS4	\$17.84
12ga 2.75"Mag 1.25oz 5shot	129-PF154FS5	17.84
12ga 2.75"Mag 1.25oz 6shot	129-PF154FS6	17.84
12ga 3"Max 1 5/8oz 4shot	129-PF129FS4	20.39
12ga 3"Max 1 5/8oz 5shot	129-PF129FS5	20.39
12ga 3"Max 1 5/8oz 6shot	129-PF129FS6	20.39
20ga 3" 3DE 1.25oz 6shot	129-PF258FS6	19.49



12 Gauge	Order No.	Price
2 3/4", 1 1/8oz., #4 (25)	129-H1234	\$6.74
2 3/4", 1 1/8oz., #6 (25)	129-H1236	6.74
2 3/4", 1 1/8oz., #7.5 (25)	129-H12375	6.74
2 3/4", 1 1/8oz., #8 (25)	129-H1238	6.74

16 Gauge	Order No.	Price
2 3/4", 1oz., #6 (25)	129-H1606	\$9.83
2 3/4", 1oz., #7.5 (25)	129-H16075	9.83
2 3/4", 1oz., #8 (25)	129-H1608	9.83
20 Gauge	Order No.	Price
2 3/4", 7/8oz., #7.5 (25)	129-H20075	\$5.94
2 3/4", 7/8oz., #8 (25)	129-H2008	5.94

Hevi-Shot Shotshells by EnvironMetal



Hevi Metal - 20% More Lethal Pellets On Target.

25 Rounds per box
10 per case

	Order No.	Price
12ga 3.5" 1.5oz BBB shot	096-35888	\$26.98
12ga 3.5" 1.5oz BB shot	096-33588	23.25
12ga 3.5" 1.5oz 2 shot	096-33352	26.98
12ga 3.5" 1.5oz 3 shot	096-33353	26.98
12ga 3.5" 1.5oz 4 shot	096-33354	26.98
12ga 3" 1.25oz BB shot	096-30088	23.25
12ga 3" 1.25oz 2 shot	096-30002	23.25
12ga 3" 1.25oz 3 shot	096-30003	23.25
12ga 3" 1.25oz 4 shot	096-30004	23.25
20ga 3" 1oz 2 shot	096-32002	22.38
20ga 3" 1oz 3 shot	096-32003	22.38
20ga 3" 1oz 4 shot	096-32004	22.38



Dead Coyote - Extreme Lethality, high performance varmint loads. 10 Rounds per box - 10 per case

	Order No.	Price
12ga 3" 1-1/2oz T shot	096-43030	\$41.94
12ga 3.5" 1-5/8oz T shot	096-43035	45.34

Dead Coyote - Extreme Lethality, high performance varmint loads. 5 Rounds per box - 20 per case

	Order No.	Price
12ga 2.75" 1-1/8oz 00B shot	096-42209	\$16.93
12ga 3" 1-3/8oz 00B shot	096-42213	19.39
10ga 3.5" 1.75oz #4B shot (10)	096-41049	56.62
12ga 3.5" 1 5/8oz #4B shot (10)	096-41249	45.34
12ga 3" 1.5oz #4B shot (10)	096-42049	29.66
12ga 3.5" 1.75oz 00B shot (5)	096-41009	28.31
12ga 3.5" 1 3/8oz 00B shot (5)	096-42009	19.39



Hevi Shot Goose - Ultra Density, State of the art waterfowl loads.

10 Rounds per box
10 per case

	Order No.	Price
12ga 3" 1-1/2oz B shot	096-45358	\$40.46
12ga 3" 1-1/2oz 2 shot	096-45352	40.46
12ga 3.5" 1 3/4oz B shot (10)	096-43578	40.46
12ga 3.5" 1 3/4oz 2 shot (10)	096-43572	44.56
12ga 3.5" 1 3/4oz 4 shot (10)	096-43574	44.56
12ga 3" 1-1/2oz 4 shot (10)	096-45354	40.46
12ga 3" 1-1/2oz 6 shot (10)	096-45356	40.46



Hevi-Shot offers Rebate promotions often! Check with your operator to find out current Rebate Promotions! Or check www.hevishot.com



Hevi Shot Duck - High Velocity, High density waterfowl loads.

10 Rounds per box
10 boxes per case

	Order No.	Price
10ga 3.5" 1-3/4oz BB shot	096-10831	\$41.96
10ga 3.5" 1-3/4oz 2 shot	096-10231	53.30
10ga 3.5" 1-3/4oz 4 shot	096-10431	53.30
12ga 2.75" 1-1/4oz 4 shot	096-42324	35.19
12ga 2.75" 1-1/4oz 6 shot	096-42326	35.19
12ga 2.75" 1-1/4oz 7.5 shot	096-42327	35.19
12ga 3" 1-1/4oz 2 shot	096-42312	35.85
12ga 3" 1-1/4oz 4 shot	096-42314	36.61
12ga 3" 1-1/4oz 6 shot	096-42316	36.61
12ga 3.5" 1-3/8oz B shot	096-43508	42.23
12ga 3.5" 1-3/8oz 2 shot	096-43502	42.23
12ga 3.5" 1-3/8oz 4 shot	096-43504	42.23
12ga 3.5" 1-3/8oz 6 shot	096-43506	42.23
20ga 3" 1-1/4oz 2 shot	096-42022	36.17
20ga 3" 1-1/4oz 4 shot	096-42024	36.17
20ga 3" 1-1/4oz 6 shot	096-42026	36.17
12ga 2.75" 1 1/4oz 2 shot (10)	096-42322	33.94
12ga 3" 1 3/8oz 2 shot (10)	096-43002	40.22
12ga 3" 1 3/8oz 6 shot (10)	096-43006	40.22
12ga 3" 1-3/8oz BB shot	096-43008	40.22



Classic Doubles - High Velocity, High density waterfowl loads.

10 Rounds per box
10 boxes per case

	Order No.	Price
12ga 3" 1-1/4oz 2 shot	096-11132	\$45.45
12ga 3" 1-1/4oz 4 shot	096-11134	45.45
12ga 3" 1-1/4oz 5 shot	096-11135	45.45
12ga 3" 1-1/4oz 6 shot	096-11136	45.45
12ga 3" 1-1/4oz 7 shot	096-11137	45.45
12ga 2.75" 1-1/4oz 2 shot	096-12012	42.90
12ga 2.75" 1-1/4oz 4 shot	096-12014	42.90
12ga 2.75" 1-1/4oz 5 shot	096-12015	42.90
12ga 2.75" 1-1/4oz 6 shot	096-12016	42.90
12ga 2.75" 1-1/4oz 7 shot	096-12017	42.90
16ga 2.75" 1oz 4 shot	096-81124	42.16
16ga 2.75" 1oz 5 shot	096-81125	42.16
16ga 2.75" 1oz 6 shot	096-81126	42.16
20ga 3" 1oz 4 shot	096-20334	39.78
20ga 3" 1oz 5 shot	096-20335	39.78
20ga 3" 1oz 6 shot	096-20336	39.78
20ga 2.75" 7/8oz 4 shot	096-20274	37.40
20ga 2.75" 7/8oz 5 shot	096-20275	37.40
20ga 2.75" 7/8oz 6 shot	096-20276	37.40
20ga 2.75" 7/8oz 7 shot	096-20277	37.40
28ga 2.75" 5/8oz 4 shot	096-82124	34.47
28ga 2.75" 5/8oz 5 shot	096-82125	34.47
28ga 2.75" 5/8oz 6 shot	096-82126	34.47
28ga 2.75" 5/8oz 7 shot	096-82127	34.47
410ga 3" 7/16oz 4 shot	096-41094	31.91
410ga 3" 7/16oz 5 shot	096-41095	31.91
410ga 3" 7/16oz 6 shot	096-41096	31.91



Magnum Blend Hevi-13

- New HEVI-13® Pattern-Density™ Technology!
- 40% MORE Lethal Pellets On Target

	Order No.	Price
12ga 3.5" 2.25oz 5, 6, 7 shot	096-41205	\$28.50
12ga 3" 2oz 5, 6, 7 shot	096-41255	24.68
10ga 3.5" 2-3/8 oz 5,6,7 Shot	096-13567	31.23
20ga 3" 1 1/4oz oz 5,6,7 Shot	096-00567	19.88



Hevi 13 - World Record Performance Turkey Loads. 10 Rounds per box - 25 per case

	Order No.	Price
12ga 3" 2oz 7 shot	096-43027	\$25.29
12ga 3" 1.75oz 4 shot	096-43234	23.52
12ga 3" 1.75oz 5 shot	096-43235	23.52
12ga 3" 1.75oz 6 shot	096-43236	23.52
20ga 3" 1.25oz 5 shot	096-00305	18.28
20ga 3" 1.25oz 6 shot	096-00306	18.28
20ga 3" 1.25oz 7 shot	096-00307	18.28
20ga 3" 1-15oz 4 shot	096-00304	18.28

Hevi Shot Hevi 13 - World Record Performance Turkey Loads. 5 Rounds per box - 20 boxes per case

	Order No.	Price
10ga 3.5" 2-3/8oz 5 shot	096-13505	\$31.24
12ga 3.5" 2-1/4oz 4 shot	096-43524	28.05
12ga 3.5" 2-1/4oz 5 shot	096-43525	28.05
12ga 3.5" 2-1/4oz 6 shot	096-43526	28.05
12ga 3" 2oz 4 shot	096-43024	25.29
12ga 3" 2oz 5 shot	096-43025	25.29
12ga 3" 2oz 6 shot	096-43026	25.29
12ga 2.75" 1.5oz 4 shot	096-42734	21.13
12ga 2.75" 1.5oz 5 shot	096-42735	21.13
12ga 2.75" 1.5oz 6 shot	096-42736	21.13



Hevi Shot Pheasant - High Density, Extra range upland loads.

10 Rounds per box
10 per case

	Order No.	Price
12ga 2.75" 1-1/8oz 4 shot	096-42234	\$34.76
12ga 2.75" 1-1/8oz 6 shot	096-42236	34.76
20ga 2.75" 7/8oz 4 shot	096-22234	34.76
20ga 2.75" 7/8oz 6 shot	096-22236	34.76



Hevi-Shot Choke Tubes

How do you make World Class Ammunition perform BETTER? Hevi Shot's High Performance Choke Tube System helps you squeeze every bit of performance from your HEVI-Shot® waterfowl ammunition! **SEE PAGE 166**

Rimfire Ammunition

17 HMR Ammo

Brand	Description	Velocity	Order No.	Price
Hornady	17gr V-Max (50)	2100 fps	003-83170	\$10.53
Hornady	20gr XTP (50)		003-83172	10.64
Hornady	15.5gr NTX (Lead Free) (50)		003-83171	11.61
Federal	17gr HP (50)		129-P770	10.19
Federal	17gr V-Shock (50)		129-P771	10.19
CCI	17gr HP TNT		020-0053	11.49
CCI	17gr HP V-Max		020-0049	11.49
CCI	20gr GamePoint		020-0052	11.49
CCI	20gr TNT FMJ		020-0055	11.49



17 Mach II Ammo

Brand	Description	Velocity	Order No.	Price
Hornady	17gr V-Max (50)	2100 fps	003-83177	\$6.11
Hornady	15.5gr NTX (Lead Free) (50)		003-83176	7.19
CCI	17gr V-Max (50)		020-0048	6.66



22 Long Rifle Ammo



Brand	Description	Velocity	Order No.	Price
CCI	40gr Select Lead Round Nose (100)	1200 fps	020-0045	\$12.77
CCI	40gr Velocitor Copper Plated Lead HP(50)	1435 fps	020-0047	4.94
CCI	32gr Stinger Copper Plated Lead HP (50)	1640 fps	020-0050	4.94
CCI	40gr Sub-Sonic Lead HP (50)	1050 fps	020-0056	6.24
CCI	32gr Segmented HP (50)	1640 fps	020-0064	4.94
CCI	40gr Mini-Mag Copper Plated Lead RN (100)	1235 fps	020-0030	5.74
CCI	36gr Mini-Mag Copper Plated Lead HP (100)	1260 fps	020-0031	5.93
CCI	40gr Small Game Bullet Lead FP (50)	1235 fps	020-0058	5.55
CCI	40gr Green Tag Lead RN (100)	1070 fps	020-0033	14.68
CCI	40gr Pistol Match Lead HP (50)	1070 fps	020-0051	7.56
CCI	40gr Standard Velocity Lead RN(100)	1070 fps	020-0032	6.08
CCI	40gr Blazer Lead Round Nose (50)	-	020-0021	1.87
CCI	29gr CB Sub-Sonic Quiet Pest Control Lead RN (100)	710 fps	020-0038	7.83
Federal	40gr Gold Medal Target Solid (50)	1080 fps	129-711B	3.72
Federal	40gr Copper Plated Solid (50)	1240 fps	129-710	2.73
Federal Am Eagle	38gr American Eagle HV Copper Plated HP (50)	1280 fps	129-AE22	1.89
Federal Am Eagle	40gr American Eagle HV Solid (50)	1260 fps	129-AE5022	1.89

22 Short Ammo

Brand	Description	Velocity	Order No.	Price
CCI	29gr High Velocity Copper Plated Lead RN (100)	1080 fps	020-0027	\$7.44
CCI	27gr High Velocity Copper Plated Lead HP (100)	1105 fps	020-0028	7.64
CCI	29gr Short Target Lead RN (100)	830 fps	020-0037	8.78
CCI	29gr CB Sub-Sonic Quiet Pest Control Lead RN(100)	710 fps	020-0026	7.26

22 Winchester Mag Ammo

Brand	Description	Velocity	Order No.	Price
Hornady	25gr NTX (Lead Free) (50)	-	003-83201	\$10.83
Hornady	30gr V-max (50)	2200 fps	003-83202	9.73
CCI	40gr Maxi-Mag Total Metal Jacket (50)	1875 fps	020-0023	9.89
CCI	40gr Maxi-Mag Jacketed HP (50)	1105 fps	020-0024	9.28
CCI	30gr V-Max (50)	1866 fps	020-0073	10.86
CCI	30gr Maxi-Mag +V Jacketed HP (50)	2200 fps	020-0059	11.58
CCI	30gr TNT Jacketed HP (Speer TNT Bullet) (50)	2200 fps	020-0063	11.58
Federal	50gr Jacketed Hollow Point	1650 fps	129-757	9.67
Federal	40gr Full Metal Jacket	1910 fps	129-737	9.24
Federal	30gr TNT Jacketed HP (Speer TNT Bullet) (50)	2200 fps	129-P765	9.56

(TN residents pay a .10 TWRA Tax per box of ammunition)



Specialty Rimfire 22 WRF Only!

.22 (WRF) Winchester Rimfire Jacketed Hollow Point 45gr - For use in 22 Win Rimfire Only! 50 per Box Order No. 020-0069 \$9.39



22 WMR 45 gr Critical Defense® - Unaffected by thick and heavy clothing, the 45 gr. FTX bullet delivers superior controlled expansion and terminal ballistics comparable to the 380 Auto Critical Defense load. It offers superb accuracy and devastating terminal performance in a rifle. Silver nickel-plated cases prevent corrosion and are easily visible in low-light situations.

Order No. 003-83200 \$11.21

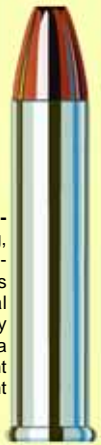

Rimfire Miscellaneous



Rimfire Thickness Gauge- Sort ammo by rim thickness for similar ignition qualities and improved accuracy. Gauge attaches to your caliper and includes bushings for both .17 and .22 cal rimfire.

Order No. 005-RF17 \$23.56

Ruger® 10/22® Magazine Loader - Loads all factory magazines with 22 LR and 17 Mach 2 rimfire ammo. Loads all 10/22 high capacity magazines. Holds more than 50 rounds at a time. Loads high capacity magazines in seconds

Order No. 097-40430 \$23.54



22 Rimfire Ammo Case



This Case-Gard SB-200 for .22 ammunition holds up to 200 rounds (100 in individual compartments and 100 in factory packaging). Has heavy duty snap lock latch. Has EZ grip surface.

Order No. 008-SB200 \$10.20



Champion Bullet Trap - A heavy duty, all steel construction trap designed for use with .22 caliber rimfire ammunition only. Provides a large 10"x11" target area. Comes with bulldog target clip. Please use extreme caution when using this. USE ONLY .22 CALIBER AMMO!! Truly a handy item for when you're target practicing with your favorite .22. Weighs approximately 21 pounds.

Order No. 097-40801 \$64.32

Tipton Gun Vise & Range Box

Tipton® Bench Vise- Molded of high strength plastic. Impervious to oils and solvents. Small storage trays for loose parts. Large tray for bulkier tools. Compartments for solvents, oils, etc. NOT FOR USE AS A BENCH REST!!! **Order No. 094-782731 \$40.80**



Tipton's Best Gun Vise - Designed to accommodate the widest possible range of firearms for cleaning, maintenance, or gunsmithing, and easily converts to handle bolt-action rifles, break-open shotguns, AR-15's, & handguns.

A central aluminum channel lets the user move individual components to the ideal position for their firearm. Each individual component then adjusts to the perfect position for secure support. The rear base features two adjustable offset clamps for a tight grip on a wide range of buttstock configurations. **Order No. 094-181181 \$96.01**



Tipton® Range Boxes- The ideal organizer box for shooters and hunters, the Tipton® Range Box organizes everything you need for the range, from cleaning supplies to targets. Comes with removable storage compartment. **Order No. 094-458509 \$46.39**



The Tipton® Gun Butler™ - A convenient all-in-one solution to all your cleaning/carrying/storage needs. Two removable non-marring forks (which snap into the base for easy storage) hold the gun securely in place, while thoughtfully-planned compartments and slots hold bore solvent, jags, brushes, mops, a cleaning rod, spray lubricant, and tools. **Order No. 094-100333 \$21.99**

Lyman Revolution Gun Vise

Three Lockable Positions,
The Only Vise That
Revolves!



Lyman Revolution Gun Vise - This versatile gun vise is engineered with a full range of adjustment, tilts, clamps and inserts to securely hold any firearm. The padded contact points protect the firearm during cleaning, maintenance or gunsmithing, even bore sighting. Perfect for Pistols! **Order No. 015-7832250 \$71.38**

Gunslick Gun Maintenance Center



Match-Grade Gun Maintenance Center - Clean, repair and mount scopes on your gun all with the Match-Grade Gun Maintenance Center. Now you have a place to securely hold your firearm, making it easier for routine up-keep. With its built-in cam-lock vises and convenient drawers and solvent/parts holders, you can do a little bit of everything quick & easy. For Rifles, Pistols & Shotguns! **Order No 097-51000 \$55.76**

MTM Cleaning Solutions



MTM Gun Vise- Another affordable alternative to a normally high-dollar shooter's item. The MTM Gun Vise! Supports both rifles and shotguns for just about any kind of gunsmithing or maintenance need. Clamps down with a non-marring, rubber padded hold. High and low gun forks allow for level maintenance or a sloped clamp up for drainage. Organize cleaning items into 14 separate compartments. Eleven screw driver bit holders (jag & brush holders), are molded into the unit. Also holds two cleaning rods. Made to last from rugged, chemical and solvent resistant polypropylene plastic. **Order No. 008-GV30 \$32.39**

Portable Maintenance Center-

Finally, a portable rifle/shotgun maintenance center that is excellent for field, range, or home use. Fits on top of A760 or can be used on any level surface. Base is compartmentalized for storage of gun cleaning equipment, tools and gun forks. Also can be used as a shooting rest. **Order No. 008-RMC1 \$29.39**



Accessory Box- Will hold a variety of tools, ammo, ear-muffs, bipods, rifle rests, targets, scopes, reloading dies, binoculars, handguns or numerous other items. Measures 21"x9"x9 1/4". Use your own padlock! Accessory box only. **Order No. 008-A760 \$39.12**

Sight-In Clean Rest-

Great for sighting in rifles and shotguns or to pattern your shotgun. This rest is sturdy for steady holding. Rear adjustment knob allows for precise horizontal positioning. Rubber over-molded, padded forks are adjusted and held in place by using two of four slots located in the base of rest. Guns are gripped for quick and easy shooting or cleaning. Size: 11" x 20" **Order No. 008-SNCR30 \$32.05**



Sight-In Clean & Rest- Same rest as above but comes with a 21"x13"x9" carry case. **Order No. 008-SNCC30 \$52.20**



Jag and Brush Case- Divided into four compartments, this handy case allows you to section brushes and jags by caliber. Digging for brushes will no longer be an issue, you'll see exactly where your cleaning tips are, every time you need them. **Order No. 008-JAG00 \$2.76**

Hoppe's Cleaning Cradle & Pad



Hoppe's Cleaning Cradle - The perfect cleaning system anywhere you need it, this Hoppe's Cleaning Cradle sets up in seconds at the range or on the tailgate of your truck, ready to securely hold any long gun-big & heavy or small and light. Over-molded rubber saddles keep the firearm secure. Adjusts for length, so it works with most guns. Disassembles to fit in your range bag or cleaning. **Order No. 060-HCC \$20.82**

Hoppe's Gun Cleaning Pad - This attractive hunter green pad protects firearms and working surfaces from scratches and spills. Soft acrylic material absorbs eight times its weight in fluids. Non-Slip vinyl backing prevents fluid spills from soaking through onto work surface, allowing you time to wipe up any spills. Simply machine wash and dry. 12"x36" **Order No. 060-MAT2 \$8.32**

Outers / Gunslick Cleaning Kits

32pc Universal Wood Gun Cleaning Box

Get a full compliment of gun care products to perform cleanings quickly and effectively. In addition, this kit offers an attractive full wood grain case for years of enjoyment.

- 3 Solid brass rods for .17 cal
- 3 Solid brass rods for other sizes
- 9 Bronze brushes
- 5 Absorbent mops
- 2 Patch loops
- 6 Cleaning jags
- 2 Adaptors for rifle, pistol and shotgun
- 50 Cleaning patches
- Aged oak wood presentation box

Outers



Order No. 097-70080 \$21.20

62pc Universal Wood Gun Cleaning Box

This special 62-piece universal cleaning wood box is finished in aged oak, and includes solid brass rods. It has everything needed to take care of your guns.

- 3 Solid brass rods for .17 cal
- 3 Solid brass rods for other sizes
- 14 Bronze brushes
- 9 Absorbent mops
- 4 Patch loops
- 3 Adaptors
- 13 Cleaning jags
- 3 Utility brushes
- 3 Muzzle guards
- 50 Cleaning patches for large bore
- 50 Cleaning patches for small bore
- 4 Polishing cloths
- Aged oak wood presentation box

Outers



Order No. 097-70081 \$47.99

32pc Universal Aluminum Gun Care Case

This 32-piece high quality aluminum case is designed to protect your cleaning hardware in the back of your truck or luggage. It includes two sets of brass rods, as well as a full assortment of brushes, mops and cleaning tips.

- 3 Solid brass rods for .17-.270 cal
- 3 Solid brass rods for .30 cal and larger
- 9 Bronze brushes
- 5 Absorbent mops
- 6 Spear pointed brass jags
- 2 Patch loops
- 2 Adaptors
- 50 Cleaning patches
- Durable aluminum case

Order No. 097-70091 \$29.41

19pc Universal Gun Cleaning Kit

This kit covers almost every gun care need. Whether it's a .22 cal rifle or a 28-gauge shotgun, this 19-piece gun cleaning kit has everything required to keep a firearm up and running. It's great for pistol, rifle and shotgun shooters alike with its superb value and dependable products. **Order No. 097-70077 \$10.40**

Brass Pistol Cleaning Kit -

Proven chemicals and brass rods allow you to conveniently clean your firearm without the risk of damaging the barrel. **Order No. 097-46410 \$6.60**



Deluxe Brass Rod Cleaning Kit- Here is an ideal cleaning kit for the shooters who want to consolidate their gun cleaning supplies. The deluxe kit comes with three piece swivel handled brass rod, rod adaptors, phosphorous bronze brushes for the 22, 30 and 38cal and 12 and 20 gauge jag and slot tips. Also includes silicone cloth, patches, solvent and oil all in a wooden case for home or travel. **Order No. 097-96231 \$21.92**



Outers

Cleaning Kits from Hoppe's

HOPPE'S



Rifle Cleaning Kit- contains Hoppe's #9 solvent, lubricating oil, patches, rifle rod, knob and slotted ends, and brush for appropriate caliber. All enclosed in a low, lean box made of miracle, lightweight polypropylene. Measures 5"x14"x2" **ALSO AVAILABLE IN WOOD PRESENTATION KIT** See Order No. 060-BUOX.

.22 Caliber Rifle Kit **Order No. 060-U22** **Price \$9.57**

Rifle and Shotgun Cleaning Kit (All Caliber)- Contains Hoppe's #9 solvent, lubricating oil, patches, rifle rod with shotgun adapter, and slotted ends for rifle and shotguns (Buy brushes and swabs separately for this kit). **Order No. 060-UO \$9.96**

Handgun Cleaning Kit- Contains Hoppe's #9 Plus, cleaning rod with accessories, two sizes of round cotton patches, cloths presoaked Moisture Displacing Lubricant, and Hoppe's Lubricating Oil. The contents are packaged in a black polypropylene box and encased in a protective sleeve. Fits .30 caliber and larger with barrels, up to 44 inches long.

All Calibers Handgun Kit **Order No. 060-PCO** **\$9.57**

Airgun Cleaning Kit- Includes all products necessary to clean and maintain all air pistols, air rifles, BB & pellet guns. Contains three piece steel rod with looped handle, lubricating oil, brass knob end, .17 caliber brush, cleaning patches and Hoppe's Guide To Gun Care. (8/32 thread) **Order No. 060-AC1 \$9.37**



HOPPE'S

Premium Universal Soft Sided Case Gun Cleaning Kit-

Take the whole thing to the range! Includes: #9 solvent, lube oil, 3pc brass rod, 3 slotted ends, 2 adaptors, 5 popular phosphorous bronze brushes, silicone cleaning cloth, phosphorous bronze utility brush, bore light, 12"x36" gun cleaning mat, Hoppe's "Guide to Gun Care"

Order No. 060-DFC \$50.81



HOPPE'S

Deluxe Wooden Presentation Kit.

Comes with rich dark stained wooden presentation case that has finger joints for maximum strength and durability. Contains Hoppe's #9 solvent, lubricating oil, patches, three piece brass rod, four slotted ends and five brushes to fit .22 & .30 caliber rifles, .38 caliber pistols and 12 & 20 gauge shotguns. Also comes with a rifle/shotgun adapter, pistol adapter, silicone cleaning cloth and Hoppe's Guide To Gun Care booklet fitted into a heavy duty flocked tray. **Order No. 060-BUOX \$33.49**



HOPPE'S

Birchwood Cleaning Kit

Stainless Steel Universal Gun Cleaning System - Cleaning rifles, shotguns and pistols with this Universal Gun Cleaning System is a snap. The V-groove designed handle ensures a solid grip while cleaning. The Cleaning System is compatible with most brushes, swabs and tips on the market. When needed, the Cleaning System easily converts into a screwdriver for further cleaning purposes. The specially designed swivel end of the rod easily moves with any rifling, removing lead, plastic and powder residue. Made of 304-stainless steel, this Cleaning System is durable, convenient and compact for storage and travel. For use with all rifles, pistols or shotguns. **Order No. 012-41130 \$21.11**



Barrel Cots Gun Barrel Protectors -

Keep debris, rain, snow, mud, bugs and more out of your barrel with Barrel Cot. Simply roll the Barrel Cot onto the barrel of your firearm - when you're ready to shoot, go right ahead. One size fits all barrels - pistol, rifle, shotgun and muzzleloader. 20 Cots per bag. **Order No. 012-33712 \$2.92**



AR-15 Cleaning

AR-15 Cleaning Kit - Gunslick® now offers AR-15 owners a top of the line, specialized cleaning kit. Headlining this offering is Ultra-Klenz® and Ultra-Lube™. The kit also includes a full line of cleaning accessories, a steel rod and the special AR-15 bronze and steel brush that cleans the chamber and rifled barrel. **Order No. 097-41455 \$20.20**



Iosso AR-15 Cleaning Kit



AR-15 or AR-10 Cleaning Kit - This cleaning kit contains 6 precision fit brushes. The brushes clean the Upper Receiver, Chamber, Bolt Carrier, .223 bore (AR-15), or .30 bore (AR-10), Bolt Carrier Key Tube, and the Gas Tube. The Gas tube brush cleans the entire length of the gas tube without disassembly of the upper receiver. The kit also includes the Eliminator Cleaning Tool & Rod. **Order No. 200-19515 \$46.67**

Seal 1 CLP Plus



Seal 1 CLP Plus Liquid - SEAL 1™ CLP PLUS™ is a "Green Engineered" biodegradable CLP lubricant made from "bio-based" ingredients. This Non-Toxic cleaner dissolves carbon on contact. After several applications your cleaning time is reduced even further as the SEAL 1™ CLP PLUS™ creates a protective barrier that prevents fouling from sticking.

Liquid 4oz Bottle -	Order No. 282-SL4	\$8.49
Liquid 8oz Bottle -	Order No. 282-SL8	\$16.83

Seal 1 CLP Plus Paste - SEAL 1™ CLP Plus™ Paste dissolves carbon on contact and creates a barrier that resists copper, lead, and carbon build up.

Plus Paste 4oz Jar -	Order No. 282-SL4	\$8.49
Plus Paste 8oz Jar -	Order No. 282-SL8	\$16.83

Seal Skinz Presaturated Cleaning Patches -		
22 - 270 Cal (40 per bag)	Order No. 282-SS09	\$3.72
270 - 35 Cal (25 per bag)	Order No. 282-SS10	\$3.72
38 - 45 Cal (25 per bag)	Order No. 282-SS12	\$3.72
12ga - 16ga (25 per bag)	Order No. 282-SS14	\$3.72

SEAL 1™ Complete Gun Care Kit -

- This kit includes;
- 1 - 4oz. container of our multi-purpose CLP Plus™ Gun Care Paste,
 - 1 - 4oz. container of our multi-purpose CLP Plus™ Gun Care Liquid
 - 1 - Package of our SEAL 1™ CLP PLUS™ Pre-Saturated EZ-Cloth™ 4 - 6 inch square cleaning cloth Pre-saturated with SEAL 1™ CLP PLUS™ paste.
 - 1 - 12"x12" square micro fiber cloth
 - 1 - Nylon bristle brush
- Order No. 282-SKIT4 \$20.13**



M16/AR15 Buttstock Cleaning Kit -

Fits into the stock. Includes rod set, T-brush, bore brush, chamber brush, oil bottle, & pouch.

Order No. 181-CJARBC \$17.85.

A - Cleaning & Oil Brush - Shaving brush for quick clean or oil application. **Order No. 036-OSB01 \$1.72**

	Order No.	Price
B - Double End Cleaning Brush	036-OSH12	\$1.38
C - Double End Flat & Bottle Brush	036-OSH16	1.12
D - Nylon Utility Brushes	036-OSH02	0.69
E - Steel Utility Brushes	036-OSH04	0.69
F - Brass Utility Brushes	036-OSH06	0.69

Olive Drab GI Nylon Cleaning Pouch - Same cleaning pouch style that the US Military uses.

Order No. 036-NMOCPO0 \$1.80



Utility Brush - Two bristled ends, one for large areas, the other for tight spots. Intense scrubbing without scratching.

	Order No.	
Nylon	060-1380	\$1.92
Phosphor Bronze	060-1380P	1.92

HOPPE'S

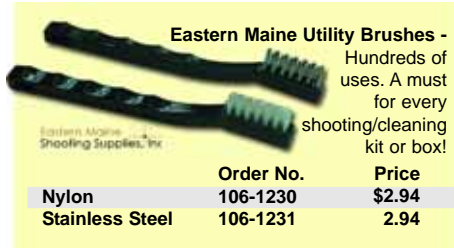

Eastern Maine Utility Brushes -

Hundreds of uses. A must for every shooting/cleaning kit or box!

	Order No.	Price
Nylon	106-1230	\$2.94
Stainless Steel	106-1231	2.94



Eastern Maine Shooting Supplies Liquid Wonder Competition Patch Lube 8oz -

Order No. 106-425 \$3.33

Eastern Maine Shooting Supplies

AR-15 / M-16 Cleaning Kit -

Kit includes rod(s) with a rotating handle, gun oil, gun solvent, premium lube, dry cotton cleaning patches, cotton tip swabs, gas tube brushes, bore brush, bore mop, brass slotted tip, utility brush and chamber brush.

	Order No.	
1 Piece Rod Kit -	106-EMSSAR15B	\$31.83
3 Piece Rod Kit -	106-EMSSAR15	34.14



Eastern Maine Shooting Supplies, Inc.

Gunslick (by Outers) Cleaning Rods, Brushes, Mops & Tips



Size	Thread Size	Brush Stainless Steel	Nylon Slotted Tip \$0.84	Nylon Jag-Tip \$0.91
RIFLE		Order No	Price	Order No
17 Caliber	5-40	-	-	-
20/204 Caliber	5-40	-	-	-
22 Caliber	8-32	097-40301	\$1.35	097-92402
243, 25 Cal, 6mm, 6.5mm	8-32	097-40302	1.35	097-92402
270 Caliber 7mm	8-32	097-40303	1.35	097-92402
30 Cal, 8mm	8-32	097-40306	1.35	097-92435
338, .35, 375 Caliber	8-32	-	-	097-92435
40, 41, 44, 45 Caliber	8-32	097-40307	1.35	097-92435
PISTOL		Order No	Price	Order No
22 Caliber	8-32	097-40308	1.35	097-92402
25 Caliber	8-32	097-40308	1.35	097-92402
30, 32 Caliber	8-32	-	-	097-92435
38, 357 Cal, 9mm	8-32	097-40309	1.35	097-92435
40, 41, 44, 45 Cal, 10mm	8-32	097-40310	1.35	097-92435
SHOTGUN		Order No	Price	Order No
10 Gauge	5/16-27	097-40315	1.88	097-92409
12 Gauge	5/16-27	097-40315	1.88	097-92409
16 Gauge	5/16-27	-	-	097-92409
20 Gauge	5/16-27	097-40317	1.88	097-92409
28 Gauge	5/16-27	097-40317	1.88	097-92409
.410 Gauge	5/16-27	-	-	097-92411

Tico Tools - Clean the dirtiest shotguns with one quick sweep. Layer-wrapped so powder and carbon fouling are removed in one pass. The rigid internal rod gives you plenty of strength. Oil mop included.

	Order No.	Price
12/16 ga 1 pc	097-41706	\$12.10
20 ga 1 pc	097-41707	12.10
12/16 ga 2 pc	097-41708	14.06



Picks and Swabs - Keep those hard-to-reach areas clean with picks and swabs from Gunslick. These high-quality accessories get to even the smallest areas - just what you need to keep your gun in top condition. Includes 4 Picks, 4 Swabs and 1 Double Ended Brush. Order No. 097-91924 \$7.72

Muzzleguards for Gunslick Rods



	Order No.	Price
.22 Cal Brass	097-18016	\$2.33
.30 Cal Brass	097-18018	2.33

Black Powder Mops and Brushes



Cal	Wool Mop \$1.58	Brush \$1.58
	Order No.	Order No.
44/45 Cal	097-41555	-
50 Cal	097-41556	097-41562
54 Cal	097-41557	097-41563

1-pc Carbon Fiber Cleaning Rods - The one-piece Carbon Fiber Cleaning Rods from Gunslick® are extremely strong and straight. Carbon fiber offers the serious rifle shooter a rod that eliminates particle pickup and possible damage to your barrel. The soft grip handle is ergonomically designed for comfort, as well as efficient cleaning. It contains ball bearings to ensure years of smooth rotation and function.

	Order No.	Price
1-pc Carbon Fiber .17-.204 cal	097-32010	\$27.66
1-pc Carbon Fiber .22-.260 cal	097-32011	27.66
1-pc Carbon Fiber .270-.45 cal 20ga	097-32012	27.66

Nylon Coated Rods- Nylon coated to protect the inside of your barrel against accidental scratches or marring. These rods provide the ultimate in durability, performance and protection. They will not damage the barrel, attract debris or leave fouling behind. Includes a brass muzzleguard and storage hanger.



1 pc Universal 36" (Rifle & Shotgun) Order No. 097-35004 \$25.10

Blackend Steel Rods- Soft Grip Handles (8-32 Threads)

Cal	Order No.	Price
Universal 3pc Rfl/Pist/Shgn 30"	097-36002	\$7.14
.17 cal 3pc Rifle Rod (5-40 thread)	097-36004	\$9.46
.22 cal 3pc Rifle Rod 30"	097-36006	\$6.62
.30 cal 3pc Rifle Rod 30"	097-36008	\$6.62
.38 cal 1pc Pistol Rod 7"	097-36010	\$5.07
.40-.45/10mm 1pc Pistol Rod 7"	097-36012	\$5.07
All Gauge 3pc Shotgun Rod 30"	097-36014	\$6.62



1 pc Stainless Steel Rods- Specially designed to withstand tough scrubbing, these rods provide the ultimate in durability and performance. The handle is ergonomically designed with double ball bearings to assure complete bore coverage. Rods include a brass muzzle guard and storage hanger.

	Order No.	Price
.22 cal 1pc 36" Rifle Rod	097-32002	\$21.63
.30 cal 1pc 36" Rifle Rod	097-32004	\$21.63
.17-.204 cal 1pc 36" Rifle Rod	097-32006	\$21.63

Rod Adapters-	Order No.	Price
Blackpowder Adapter 8-32 to 10-32	097-18002	\$1.82
Shotgun 8-32 to 5/16-27	097-18006	\$1.82

GT EZ-Clean

GT EZ Clean - Premium brush and mop combination, equal in quality to the finest rod-mounted cleaners attached to a nylon coated aircraft cable and non-corrosive brass connectors secure the system, providing maximum strength. Operated with an ergonomic, quick disconnect handle, the EZ Clean offers simplicity, strength and quality for the long term. Packaged complete in it's own instantly accessible case,

	Order No.	Price
.17 cal	114-GTEZ17	\$15.82
.204 Cal	114-GTEZ204	15.82
.22 Rifle/Pistol Cal	114-GTEZ22	15.82
6mm, .243 Cal	114-GTEZ243	15.82
.25, 6.5mm, .264 Cal	114-GTEZ25	15.82
.270, 7mm, .284, .280 Cal	114-GTEZ27	15.82
.308, 30-30, .30-06, .300, .303 Cal	114-GTEZ30	15.82
.338, .340 Cal	114-GTEZ34	15.82
.35, .350, .357, .358, .375 Cal	114-GTEZ36	15.82
.416, .44, .45-70, .458, .460	114-GTEZ44	15.82

Stainless Steel Bore Brush

	Order No.	Price	Eastern Maine Stainless Steel Bore Brush. More Eastern Maine Shooting Supplies (Formerly Ox-Yoke Originals) on the next page.
22 Pistol 8/32" Threads	106-1090	\$2.22	
.357 - .38 Pistol 8/32" Threads	106-1091	2.22	
.44 - .45 Pistol 8/32" Threads	106-1092	2.22	
.22 8/32" Threads	106-1094	2.22	
.243 - 6mm 8/32" Threads	106-1095	2.22	
.270 - 7mm 8/32" Threads	106-1096	2.22	
.30 - 7.62mm 8/32" Threads	106-1097	2.22	
.35 - 9mm 8/32" Threads	106-1098	2.22	
.44 - .45 8/32" Threads	106-1099	2.22	
12 Gauge 5/16-27" Threads	106-1100	2.59	
20 Gauge 5/16-27" Threads	106-1101	2.59	

Hoppe's Cleaning Rods, Brushes, Jags, Mops & Boresnakes

Hoppe's Cleaning Rods- All Hoppe's Gun Cleaning Rods have a ball bearing swivel handle, designed to follow the rifling of the bore and make turning easier when cleaning.



Three Piece Aluminum	Order No	Price
.22 Cal. Rifle	060-3PA22	\$5.77
.30 Cal. Rifle	060-3PA30	\$5.78
All Caliber (.22-.30 Cal. Rod Ends)	060-3PU	\$6.17

Three Piece Steel	Order No	Price
All Caliber Rifle/Shotgun	060-3PSS	\$12.05

One Piece Steel	Order No	Price
All Caliber Rifle/Shotgun	060-1PSS	\$8.54
All Caliber Pistol	060-PSS	\$5.43

Conversion Adapters-

	Order No.	Price
Shotgun (8-32 to 5/16-27)	060-1401	\$0.88



Wax Treated Gun Cloths - Pretreated cloths clean, polish and protect. Great for gun barrels, stocks and most metals.
Order No. 060-1217 \$2.71



HOPPE'S

*Female threads 5-40

Size	Thread Size	Tynex Brush	Stainless Steel Tornado Brush	Cotton Swabs	Phosphorous Bronze Brush
RIFLE					
.17 Caliber	5-40F*	-	-	060-1325 \$1.38	060-1302P \$1.27
.204 Ruger	5-40F*	-	-	060-1325 1.38	060-1302P 1.27
.22 Caliber	8-32	060-1303 \$1.27	060-1250 \$3.24	060-1321 1.27	060-1303P 1.27
.243/.25 Cal	8-32	060-1310 1.27	060-1253 3.24	060-1321 1.27	060-1310P 1.27
6mm	8-32	060-1301 1.27	-	060-1321 1.27	060-1301P 1.27
.270 Cal/7mm	8-32	060-1304 1.27	060-1254 3.24	060-1321 1.27	060-1304P 1.27
.30 Caliber	8-32	060-1305 1.27	060-1251 3.24	060-1322 1.27	060-1305P 1.27
338/8mm Cal	8-32	-	-	-	060-1305AP 1.27
.35 Cal/9mm	8-32	060-1309 1.27	060-1252 3.24	060-1323 1.27	060-1309P 1.27
.38 Caliber	8-32	-	060-1256 3.24	060-1323 1.27	060-1316P 1.27
.416 Caliber	8-32	-	-	-	-
.44/.45 Cal	8-32	060-1315 1.27	060-1257 3.24	060-1324 1.27	060-1315P 1.27
PISTOL					
.22 Caliber	8-32	060-1306 1.27	060-1250 3.24	060-1321 1.27	060-1306P 1.27
.32 Caliber	8-32	-	-	060-1322 1.27	060-1306AP 1.27
.38 Caliber	8-32	060-1307 1.27	060-1256 3.24	060-1323 1.27	060-1307P 1.27
9mm Caliber	8-32	-	060-1252 3.24	060-1323 1.27	060-1307AP 1.27
.45 Caliber	8-32	060-1308 1.27	060-1257 3.24	060-1324 1.27	060-1308P 1.27
10mm/40 Cal	8-32	060-1308A 1.27	060-1258 3.24	060-1324 1.27	060-1308AP 1.27
SHOTGUN					
.410 Gauge	5/16-27	-	-	060-1317 1.63	060-1311P 1.63
28 Gauge	5/16-27	-	-	060-1317A 1.63	060-1311AP 1.63
20 Gauge	5/16-27	060-1312 1.63	060-1262 3.24	060-1318 1.63	060-1312P 1.63
16 Gauge	5/16-27	-	-	060-1319 1.63	060-1313P 1.63
12 Gauge	5/16-27	060-1314 1.63	060-1260 3.24	060-1320 1.63	060-1314P 1.63
10 Gauge	5/16-27	-	-	-	060-1314AP 1.63



Full Length Barrel Scrubber- 100% cotton scrubbers run the full length of the shotgun bore. Solvents and oils can be applied. Also includes a Tynex tip to loosen dirt, 38".

HOPPE'S

Order No.	Closeout
12 GA 060-FLS1	\$10.65

Order No	Price	Brush Combo Kits -
22cal Rifle 8-32 Threads 060-1454BK	\$7.15	Includes cleaning swab, tornado brush & phosphorus bronze brush.
270cal/7mm Rifle 8-32 Threads 060-1455BK	7.15	
30cal Rifle 8-32 Threads 060-1456BK	7.15	
9mm Pistol 8-32 Threads 060-1451BK	7.15	
45cal Pistol 8-32 Threads 060-1452BK	7.15	
12ga Shotgun 5/16-27 Threads 060-1459BK	7.98	

HOPPE'S

- Removes loose grit and abrasive contaminants prior to the scrubbing action of the brush.
- Removes hardened deposits with the finest, bench shooter specification, phosphor-bronze brushes.
- Cleans the bore with perfectly-sized floss providing 160 times more cloth than a patch.
- Prevents rust and corrosion with a few drops of gun oil applied to the trailing end of the cord.
- Removes metal fouling.
- No exposed metal to damage sensitive crowns or riflings.

Pistol Boresnakes-

Order No.	Price
.22 Cal. 060-24000	\$13.17
.30-.32 Cal. 060-24001	13.17
.357-.38 & 9mm 060-24002	13.17
.40 Cal. 060-24003	13.17
.44-.45 Cal. 060-24004	13.17

Rifle Boresnakes-

Order No.	Price
.177 Airgun** 060-24009	\$13.87
.17 Cal & 17 HMR 060-24010	13.87
.204 Ruger 060-24025	13.87
.22 Cal. 060-24011	13.87
.243 Cal. 060-24012	13.87
.257-.263 Cal. 060-24013	13.87
.270-7MM Cal. 060-24014	13.87
.30 Cal. 060-24015	13.87
.32-8MM Cal. 060-24016	13.87
.338 Cal. 060-24017	13.87
.357-.375 Cal. 060-24018	13.87
.458 Cal. 060-24019	13.87
.50-.54 Cal 060-24020	13.87

** 17 HMR does not have a Brush

Hoppe's Viper



Everything you love about the BoreSnake plus 50% more brush cleaning power and superior strength.

Order No.	Price
.357, 9mm, .380, .38 Cal 060-24002V	\$17.15
.44, .45 Cal 060-24004V	17.15
M-16, .22-.225 Cal 060-24011V	17.15
7mm, .270, .284, .280 Cal 060-24014V	17.15
.308-.30 Cal 060-24015V	17.15
12 Gauge Shotgun 060-24035V	19.20

Boresnake by Hoppe's



BORESNAKE



BoreSnake Field Kits- Includes: BoreSnake for specific caliber, antirust gunwipe cloth, bore cleaner .5oz and gun oil .5oz.

BORESNAKE

Order No.	Price
17 HMR Field Kit 060-34010	\$21.50
.357 Cal, .38 Cal, .380 Cal, & 9mm Field Kit 060-34002	20.82
.44 cal, 45 Cal, Pistol Field Kit 060-34004	20.82
M-16, .22, .222, .223, .22 Hornet, .22-250, 220 Swift Field Kit 060-34011	21.50
.270, 7mm, 7mm-08, .284 Cal Field Kit 060-34014	21.50
.308, 7.62x39mm, 30-30, 30-06, .300, .303, .300 Mag Field Kit 060-34015	21.50
20 Gauge Shotgun Kit 060-34033	22.27
12 Gauge Shotgun Kit 060-34035	22.27

Tipton Cleaning Rods, Brushes, Jags & Mops



Tipton® 26-piece Ultra Jag & Best Bore Brush Set -
Combine the Ultra Jags and Best Bore Brushes into one convenient 26-piece set 17 to 45 caliber (does not include 20 caliber). All jags and brushes have 8-32 threads (17cal has 5-40 threads and is a standard borebrush).

Size	Thread Size	Bronze Brush (10ea)		Nylon Brush(3ea)		Wool Bore Mop(3ea)		Solid Brass Cleaning Jag		Ultra Jag Cleaning Jags	
		Order No	Price	Order No	Price	Order No	Price	Order No	Price	Order No	Price
RIFLE											
17 Caliber	5-40	094-179052	\$14.05	094-698306	\$4.64	094-312659	\$3.07	094-154070	\$2.10	094-175543	\$3.77
20 Caliber	5-40	-	-	-	-	094-312659	3.07	-	-	-	-
22 Caliber	8-32	094-466875	11.56	094-749051	3.26	094-653568	3.07	094-356987	2.10	094-225659	3.77
243 Cal/ 6mm	8-32	094-543889	11.56	094-176663	3.26	094-653568	3.07	094-696435	2.10	094-243865	3.77
25 Caliber	8-32	094-100225	11.56	094-559632	3.26	094-653568	3.07	094-584696	2.10	-	-
6.5mm	8-32	094-291327	11.56	094-413806	3.26	094-386626	3.07	094-584696	2.10	-	-
270 Caliber	8-32	094-848786	11.56	094-887541	3.26	094-386626	3.07	094-768059	2.10	094-277555	3.77
7mm	8-32	094-188414	11.56	094-355747	3.26	094-386626	3.07	094-768059	2.10	094-277555	3.77
30 Caliber	8-32	094-113901	11.56	094-125012	3.26	094-386626	3.07	094-193225	2.10	094-303033	3.77
8mm	8-32	094-103729	11.56	094-437445	3.26	094-181031	3.07	094-485467	2.10	094-338338	3.77
338 Caliber	8-32	094-103563	11.56	094-565703	3.26	094-386626	3.07	094-434832	2.10	094-338338	3.77
35 Caliber	8-32	094-587953	11.56	094-105458	3.26	094-181031	3.07	094-434832	2.10	094-348359	3.77
375 Caliber	8-32	094-646413	11.56	094-468709	3.26	094-181031	3.07	094-272744	2.10	094-375375	3.77
40/416 Cal	8-32	094-588385	11.56	094-592325	3.26	094-676648	3.07	094-412599	2.10	094-404169	3.77
44/45 Cal	8-32	094-709648	11.56	094-303351	3.26	094-676648	3.07	094-301110	2.10	-	-
50 Cal	8-32	-	-	-	-	-	-	094-505050	2.58	-	-
PISTOL											
22 Caliber	8-32	094-356062	11.56	-	-	-	-	094-356987	2.10	094-225659	3.77
25 Caliber	8-32	-	-	-	-	-	-	094-584696	2.10	094-255684	3.77
32 Caliber	8-32	-	-	-	-	-	-	094-193225	2.10	094-303033	3.77
38 Cal, 9mm	8-32	094-627021	11.56	-	-	-	-	094-434832	2.10	094-348359	3.77
41/10mm Auto	8-32	094-548257	11.56	-	-	-	-	094-412599	2.10	094-404169	3.77
44 Caliber	8-32	094-335060	11.56	-	-	-	-	094-301110	2.10	094-444444	3.77
45 Caliber	8-32	094-392203	11.56	-	-	-	-	094-239013	2.10	094-454545	3.77
475/480 Cal	8-32	-	-	-	-	-	-	-	-	-	-
SHOTGUN											
10 Gauge	5/16-27	094-662575	4.36	-	-	094-657972	3.74	-	-	-	-
12 Gauge	5/16-27	094-612735	4.36	-	-	094-657972	3.74	-	-	-	-
16 Gauge	5/16-27	094-383231	4.36	-	-	094-681324	3.74	-	-	-	-
20 Gauge	5/16-27	094-215223	4.36	-	-	094-681324	3.74	-	-	-	-
.410 Gauge	5/16-27	094-286637	4.36	-	-	094-682539	3.74	-	-	-	-

Order No. 094-444777 \$29.51

Tipton® Ultra Jags 12-pc Set -
Nickel-plated, will not react with solvents. 17 to 45 cal (does not include 20 caliber). All jags have 8-32 threads (17caliber has 5-40 threads).
Order No. 094-500012 \$18.14

12 pc Solid Brass Rifle Cleaning Jags -
Made with 8-32 threads (17 caliber has 5-40 threads). Kit includes 17, 22, 243/6mm, 25/6.5mm, 270/7mm, 30, 338/8mm, 35/9mm, 375, 40, 44 and 45 jags.
Order No. 094-749245 \$11.85

14pc Rifle Brush Sets - Contains 1 each .17, .22, 6mm, .25, 6.5mm, .270, 7mm, .30, 8mm, .338, .35, .375, .40-416, & .45 cal Brushes. (All have 8-32 threads except .17 cal has 5-40 threads.) Available in Phosphor Bronze & Nylon.

Order No. Price
Bronze Set 094-168577 \$17.17
Nylon Set 094-615333 17.08

Tipton® 8-piece Bronze Handgun Bore Brush Set -
Contains: 1 each .22, .25, .32, 9mm-38/357, 10mm-41, .44, .45, & .476-.480 Cal Brushes. (8-32 threads)
Order No. 094-845102 \$9.73

Tipton® 6-piece Bronze Shotgun Bore Brush Set -
Contains: 1 each .410, .28, .20, .16, .12, & .10 Ga Brushes. All brushes have 5-16/27 threads.
Order No. 094-671861 \$11.54

Tipton® Jag & Brush Box - Store brushes and jags of all types in this handy box.
Order No. 094-856117 \$3.74

Deluxe Carbon Fiber Cleaning Rods- Combine the best features of stainless steel rods with coated rods, and won't scratch like stainless steel or embed like coated rods. Handle spins on two sets of ball bearings for a smooth flow through the barrel.

	Order No.	Price
26" 22 - 26 Cal Cleaning Rod	094-216411	\$26.77
26" 27 - 45 Cal Cleaning Rod	094-376252	26.77
36" 17 - 20 Cal Cleaning Rod	094-107486	30.26
36" 22 - 26 Cal Cleaning Rod	094-430886	30.26
36" 27 - 45 Cal Cleaning Rod	094-720747	30.26
44" 22 - 26 Cal Cleaning Rod	094-783485	31.86
44" 27 - 45 Cal Cleaning Rod	094-509320	31.86
36" Shotgun Cleaning Rod	094-713415	34.23
62" 50 BMG Cleaning Rod	094-157379	51.00



Tipton Patch Catcher- Cleaning the barrel on your rifle, shotgun or muzzleloader can be a messy choir. Solvent splatter, drips and dirty patches always seem to end up where you don't want them. Strong solvents and powder residue can stain clothes and work surfaces. The Tipton Patch Trap puts an end to the mess.
Order No. 094-777890 \$8.28

Tipton® Action Cleaning Swabs 100-pack
Replacement swabs for the action cleaning kit. **Order No. 094-115373 \$4.61**



Tipton Large Pipettes, Pack of 12 - All-plastic, disposable "eye droppers" are just the ticket for measuring and transferring liquid products. Great for cold bluing solutions, cutting oils, solvents, preservatives, etc. Two lengths, 3-1/2" and 6" lengths match the job at hand. Put the product just where you want it.
Order No. 094-146527 \$3.73



The Tipton® Gun Butler™ - A convenient all-in-one solution to all your cleaning/carrying/storage needs. Two removable non-marring forks (which snap into the base for easy storage) hold the gun securely in place, while thoughtfully-planned compartments and slots hold bore solvent, jags, brushes, mops, a cleaning rod, spray lubricant, and tools.
Order No. 094-100333 \$21.99

Gun Vises!

See More on Page 133

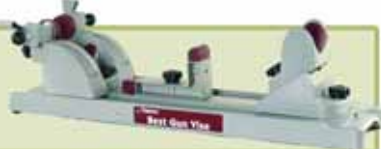

Eastern Maine Shooting Supply Cleaning Rods, Brushes, Jags & Mops



Muzzle Guards- Protects bore from damage while loading and cleaning.

	Order No.	Price
.22 Caliber	106-1260	\$2.66
.270 - .45 Rifle/Pistol	106-1261	2.88
Shotgun All Gauges	106-1262	3.11

Brass Button Tips- Rifle/ Handgun

\$2.22ea



	Order No.
.22-.270/7mm	106-1130
.31-.32/8mm	106-1133
.338-.38/9mm	106-1134
.41-.45	106-1135

Eastern Maine Shooting Supplies, Inc.



Size	Thread Size	Phos. Bronze Brush (1ea)	100% Cotton Bore Mop (1ea)	Slotted Brass Tip/Patch Holder
RIFLE				
.22 Caliber	8-32	106-1070 \$2.22	106-1111 \$2.22	106-1120 \$2.59
.243/.25 Cal.	8-32	106-1070 2.22	106-1111 2.22	106-1120 2.59
.270/7mm Cal.	8-32	106-1072 2.22	106-1111 2.22	106-1121 2.59
.30/7.62 Cal.	8-32	106-1073 2.22	106-1112 2.22	106-1121 2.59
.35/9mm Cal.	8-32	106-1074 2.22	106-1112 2.22	106-1121 2.59
.375/.380 Cal.	8-32	106-1075 2.22	106-1112 2.22	106-1121 2.59
.44/.45 Caliber	8-32	106-1076 2.22	106-1113 2.22	106-1121 2.59
PISTOL				
.22 Caliber	8-32	106-1078 2.22	106-1111 2.22	106-1120 2.59
.25/.257 Cal.	8-32	106-1079 2.22	106-1111 2.22	106-1120 2.59
.32 Caliber	8-32	106-1080 2.22	106-1112 2.22	106-1121 2.59
.38/.357 Cal.	8-32	106-1081 2.22	106-1112 2.22	106-1121 2.59
.41/10mm Cal.	8-32	106-1082 2.22	106-1113 2.22	106-1121 2.59
.44/.45 Cal.	8-32	106-1083 2.22	106-1113 2.22	106-1121 2.59
SHOTGUN				
28 Gauge	5/16-27	106-1084 2.59	106-1115 2.59	-
.410 Gauge	5/16-27	106-1085 2.59	106-1114 2.59	106-1121 2.59
20 Gauge	5/16-27	106-1086 2.59	106-1115 2.59	106-1126 2.59
16 Gauge	5/16-27	106-1087 2.59	106-1116 2.59	106-1126 2.59
12 Gauge	5/16-27	106-1088 2.59	106-1116 2.59	106-1126 2.59
10 Gauge	5/16-27	106-1089 2.59	106-1116 2.59	106-1126 2.59
BLACKPOWDER				
44/45 Cal.	5/16-27	106-1360 2.59	106-1114 2.59	-
50 Cal.	5/16-27	106-1365 2.59	106-1114 2.59	-
54/55 Cal.	5/16-27	106-1370 2.59	106-1115 2.59	-
44/45 Cal.	10-32	106-1361 2.59	106-1110 2.59	-
50 Cal.	10-32	106-1366 2.59	106-1117 2.59	-
54/55 Cal.	10-32	106-1371 2.59	106-1118 2.59	-

Rod Adapters- If you're tired of trying to match brushes and tips to rods, Ox-Yoke has solved the problem. This wide range of fine brass adapters should match just about any rod to any brush or tip.



ROD TYPE	From (Rod)	Order No.	To (Tip)	TIP, JAG & TYPE
Outers .22 rod	7-32	106-1342 \$2.22	8/32	Ox-Yoke, Kleen Bore, Pachmayr, Hoppes, Marble, Rig, Brite Bore
Ox-Yoke 3/8 dia. rod, Kleen Bore, Hoppes, Marble, Brite Bore	5/16-27	106-1340 \$2.22	8/32	Black powder Tips, Jags & Brushes: Check Mfg. Threads
Ox-Yoke 3/8 dia. rod, Kleen Bore, Hoppes, Marble, Brite Bore	5/16-27	106-1341 \$2.22	10/32	Black powder Tips, Jags & Brushes: Check Mfg. Threads
Ox-Yoke .22 Rifle rod, Kleen Bore, Hoppes, some T/C & CVA, Marble, Durango, Super Rod, Rig, Pachmayr, Brite Bore	8/32	106-1343 \$2.22	5/16-27	Shotgun brushes by: Ox-Yoke, Kleen Bore, Pachmayr, Hoppes, Marble, Rig, Brite Bore; check threads on Dewey. Black powder brushes by: Ox-Yoke, Hoppes, T/C
Ox-Yoke .22 Rifle rod, Kleen Bore, Hoppes, some T/C & CVA, Marble, Durango, Super Rod, Rig, Pachmayr, Brite Bore	8/32	106-1345 \$2.22	10/32	Black powder Tips, Jags & Specific Blackpowder Brushes: Check Mfg. Threads
Some T/C & CVA rods, Super Rod	10-32	106-1346 \$2.22	5/16-27	Shotgun brushes by: Ox-Yoke, Kleen Bore, Pachmayr, Hoppes, Marble, Rig, Brite Bore; check threads on Dewey. Black powder brushes by: Ox-Yoke, Hoppes, T/C
Some T/C & CVA rods, Super Rod	10-32	106-1347 \$2.22	8-32	Tips, Jags & Brushes by: Ox-Yoke, Kleen Bore, Pachmayr, Hoppes, Marble, Rig, Brite Bore, Outers Rifle and Pistol (except Outers .22)

Gun Cleaning Patches



Montana X-treme™ Cleaning Patches - Super tough and all natural. Made from 100% cotton flannel and finished on both sides for "X-Treme" absorbency.

1000 Patches	Order No	Price
3/4" square	165-07200	\$10.48
1 1/8" square	165-07205	11.99
1 3/8" square	165-07215	12.82
1 3/4" square	165-07225	14.45

500 Patches	Order No	Price
2 1/4" square	165-07240	\$12.33
2 1/2" round	165-07245	14.81
3" square	165-07250	20.44

G.I. SQUARE COTTON



G.I. PATCHES The United States Government has used this type of gun cleaning patch for our armed forces for years. Many shooters feel these are the best.

CALIBERS	SIZE	100 PER		1000 PER	
		PART NO.	PRICE	PART NO.	PRICE
12-16GA	3"x3"	106-1019.....	\$4.69	106-1019T.....	\$31.69
.45 and up	2.5" x 2.5"	106-1021.....	\$2.88	106-1021T.....	\$19.49
.270-.38	2" x 2"	106-1023.....	\$2.56	106-1023T.....	\$17.29

ROUND WHITE COTTON



ROUND GUN CLEANING PATCHES are die cut from 100% white cotton flannel.

CALIBERS	DIA.	100 PER		1000 PER	
		PART NO.	PRICE	PART NO.	PRICE
.177 Air Guns	7/8"	106-1017.....	\$1.46		N/A
.22 Rimfire	7/8"	106-1008.....	\$1.469	106-1008T.....	\$9.90
.22-.270, 6mm	1 1/4"	106-1009.....	\$1.70	106-1009T.....	\$11.50
.270-.35, 7mm	1 3/4"	106-1010.....	\$2.22	106-1010T.....	\$14.99
.40 S&W	2"	106-1011.....	\$2.50	106-1011T.....	\$16.89
.38-.45, 9mm, 28&410	2 1/4"	106-1012.....	\$2.90	106-1012T.....	\$19.59
.45-.58 Cal	2 1/2"	106-1013.....	\$3.37	106-1013T.....	\$22.79
12ga - 16ga	3"	106-1014.....	\$4.29	106-1014T.....	\$28.99



HOPPE'S

Hoppe's Cleaning Patches - Uniformly woven patches. Pre-cut caliber and gauge sizes for optimum gun cleaning performance.

	Order No.	Price
Small Bore, (60 per pack)	060-1201	\$1.08
.22 to .270, (60 per pack)	060-1202	1.08
.22 to .270, (500 per pack)	060-1202S	2.74
.270 to .35, (50 per pack)	060-1203	1.08
.270 to .35, (650 per pack)	060-1203S	4.45
.38 to .45, .410ga, .20ga, (40 per)	060-1204	1.08
.38 to .45, .410ga .20ga, (500 per)	060-1204S	5.02
16 ga., 12 ga., (25 per pack)	060-1205	1.08
16 ga., 12 ga., (300 per pack)	060-1205S	5.32

Butch's Triple Twill Patches



"Drop Zones"



Butch's Patches are woven from a special fabric, called *Triple Twill*, which has tiny "drop zones" and ridges which scrub and capture fouling better than cotton flannel patches. They will not shed lint or fray at the edges like other patches. Available in the following sizes:

	Order No.	Price
1 1/8" Square - 22-270 Cal (Bag of 1000)	015-02901	\$9.46
1 1/2" Square - 6mm Bench Rest (Bag of 1000)	015-02913	9.46
1 3/4" Square - 7mm - 35 Cal Rifle (Bag of 750)	015-02904	9.46
2 1/4" Square - 38 Cal - 45 Cal Rifle (Bag of 500)	015-02906	9.46
2 1/2" Square - 45-48 Cal Rifle (Bag of 375)	015-02908	8.78
3" Square - 10, 12, & 16ga Shotgun (Bag of 300)	015-02911	8.11

Hoppe's Cleaning Chemicals, Oils and Lubricants



Hoppe's Elite Cleaning Chemicals- The most universally used solvent for removing primer, powder, lead and metal fouling - for preventing rust. Quick, super-efficient, safe and easy to use. Flows freely and penetrates rapidly. A favorite with sportsmen throughout the world.

	Order No.	Price
Elite 4oz Bore Gel	060-BG4	\$9.46
Elite 4oz Gun Oil	060-GO4	9.46
Elite Foaming Bore Cleaner 4oz	060-EFGC4	8.27

#9 Solvent- The most universally used solvent for removing primer, powder, lead and metal fouling - for preventing rust. Quick, super-efficient, safe and easy to use. Flows freely and penetrates rapidly.

	Order No.	Price
#9 Solvent 4 oz.	060-904	\$4.23
#9 Solvent Aerosol	060-905	3.97
#9 Solvent 1 Quart	060-932	14.79
#9 Plus BlackPowder Solvent 8 oz.	060-999	4.99
#9 Solvent for Semi-Auto guns	060-SA904	7.07



Bench Rest 9 Copper Solvent 4 oz. - Formulated especially for bench rest shooters to clean their bores of copper fouling overnight (instead of 3 or 4 days). Bench Rest-9 is powerful, safe and fast, and contains no abrasives. Also great for removing powder, lead and plastic foulings from all firearms. **Order No. 060-BR904 \$7.07**

Cleaner Degreaser- High performance cleaner/degreaser spray was created to get rid of oils, and grease deposits from gunmetal parts. Allows for cleaning without complete disassembly. **Order No. 11oz Aerosol 060-CD1 \$5.31**

Rust & Lead Cloth- Remove rust and lead deposits without hard scrubbing. Non-abrasive and will not harm wood finishes. After shooting, wipe around the action, chamber, and muzzle for quick lead and carbon removal. CAUTION: Continued hard scrubbing may remove some blued finishes. **Order No. 060-1215 \$3.62**

Silicone Cloth- Ideal for cleaning all metal, wood and plastic equipment. Treated cloth is excellent for fishing or hunting. Flannel, silicone treated. **Order No. 060-1218 \$2.77**



Benchrest Weatherguard Lube Oil- Use before and after hunting or fishing trips for moisture and rust protection. Contains a moisture fighting agent that drives out moisture while lubricating your firearm. **Order No. 060-BR1003 \$3.06**

Lubricating Oil 2.5oz- Use before and after hunting or fishing trips for moisture and rust protection. Contains a moisture fighting agent that drives out moisture while lubricating your firearm. **Order No. 060-1003 \$2.18**

Precision Lubricator- Convenient to use and carry. Needle-thin extra long stem spouts designed to reach hard to get at spots. **Order No. 060-3060 \$4.10**

Gun Grease- Specifically compounded for protecting idle firearms. When applied to bore or exterior metal parts it displaces metal "sweat" from gun surfaces. Provides long term protection when cleaning is delayed. Also lubricates moving parts while protecting them from corrosion. **Order No. 060-1102 \$2.42**

Moisture Displacing Lubricant- MDL drives out moisture and at the same time cleans, lubricates, protects and prevents corrosion on metal surfaces. Ideal for immediate after-use protection of guns, fishing gear, and most outdoor equipment. Prevents damage from moisture, salt, and friction. **Order No. 060-MDL \$4.64**

Dri-Lube with Teflon- Reduces friction on metal and bearing surfaces. It contains no sticky oils or silicones and will not attract dust or dirt. Easy aerosol spray-on application. Evaporates in seconds, leaving a dry lubricating film. **Order No. 060-DL1 \$4.73**

Lubricating Field Wipes- Wipe out moisture and keep out rust! These handy wipes, lube and protect! Soaked in lube oil with weatherguard **Order No. 060-1631 \$7.52**



Hoppe's Moly Spray- Great for competition shooters who demand the highest level of performance. Prevents wear and reduces friction. Available as an aerosol can for bores and bullets.

HOPPE'S

	Order No.	Price
MOLY 4oz Aerosol	060-3068	\$9.33

Birchwood Casey Cleaning Chemicals, Oils and Lubricants



Gun Scrubber- Jet-action, high pressure solvent/degreaser that blasts away dirt and fouling - and air dries immediately. Removes all kinds of oil, grease, grit and softens powder residue. Excellent for removing preservative coating from bullet molds, and cleaning all reloading tools. **Order No. Price**

Synthetic Safe 13oz Aerosol	012-33344	\$8.28
-----------------------------	-----------	--------

Super Strength Bore Scrubber- No need for two different solvents, one for copper and one for fouling. Each ingredient was specifically chosen for its ability to attack, dissolve and remove all types of barrel fouling. Rust preventive additives as well for long term protection. Great for all firearms. **Order No. Price**

10 oz. Aerosol	012-33640	\$6.21
3 oz. Liquid	012-33625	2.65
6 oz. Aerosol	012-33635	5.59
16 oz. Liquid	012-33645	9.41



Synthetic Gun Oil - A superior lubricant for all climates. Contains Teflon lubricant to greatly reduce the friction between mating surfaces. Will not gum-up or lose its viscosity under extreme temperature variations from -55 F to +300 F. The natural solvency of Synthetic Gun Oil cleans as it oils while its low evaporation rate assures protection against rust. **Order No. Price**

Synthetic Gun Oil Aer. 10oz	012-44140	\$6.21
Synthetic Gun Oil 4.5oz.	012-44128	3.97
Synthetic Gun Oil Aer. 6oz	012-44135	5.59

Barricade Rust Preventative- Provides long-lasting protection from rust for your firearms. It rapidly drives out moisture from metal pores and deposits a transparent coating which seals the surface with a protective film that clings tightly to all metal. Withstands 500 hours in ASTM humidity test & 96 hours in ASTM salt spray test. **Order No. Price**

Rust Prev. 4.5 oz Liquid	012-33128	\$3.97
Rust Prev. 6 oz Aerosol	012-33135	5.59
Rust Prev. 10 oz Aerosol	012-33140	6.21



Barricade Take Alongs - Individually wrapped 5" x 8" cloths soaked in Barricade. **Order No. 25 Barricade Take Alongs 012-33025 \$5.29**

Lead Remover Cloth - Brings back original luster. Quickly removes leading, burn rings and carbon. 1 ea - 9x12" **Order No. 012-31001 \$5.17**

Gun & Reel Silicone Cloth - Leaves a lusterous lasting protective film. 100% Cotton flannel cloth covered in pure silicone. 14.4x15" **Order No. 012-30001 \$3.46**

#77 Black Powder Solvent 16oz.- Water-soluble cleaner. Safe to use with natural lubricants. Effectively dissolves powder residue and loosens any metal traces for easy removal. **Order No. 012-33745 \$4.71**



Gunslick Chemicals



Foaming Bore Cleaner, 12 oz.- Order No. 097-92098 \$9.90

Nu-Gun, 5 oz.- Ready your gun for shooting. Simple spray-on formula removes factory applied coatings to improve accuracy and function. **Order No. 097-84114 \$5.03**

Ultra-Klenz, 11 oz.- Remove 99% of the powder fouling, remove copper and loosen lead deposits. Also leaves a light coat of lubricant. **Order No. 097-84110 \$7.74**

Gun Flush, 16 oz.- Gun Flush give your firearm a swift thorough cleaning. This high pressure cleaning solution removes grease, oil and dirt. Also lubricates and leaves a layer of rust inhibitor to protect against moisture. **Order No. 097-84112 \$7.78**

Copper Klenz, 4 oz.- Copper Klenz removes more copper residue than leading comparable brands. Also removes 99% of powder fouling. **Order No. 097-84116 \$5.58**

Gun Dri, 4 oz.- Keeps rain, snow, condensation and humidity at bay. Water will not adhere to the steel for up to 48 hours after application. **Order No. 097-83008 \$5.27**

Ultra Lube, 5 oz.- Ultra Lube bonds to metal surfaces for superior lubricity and offers layers of powerful protection from corrosion. **Order No. 097-85006 \$7.33**

Gun seal, 5 oz.- An instant long lasting waterproof barrier that penetrates deep into metal pores to protect against corrosion, in the field or the safe. **Order No. 097-83004 \$5.05**

Gun Grease, 2 oz, Advanced, graphite based lubricant specially formulated to keep your firearm working smoothly. Perfect for both storage & use. **Order No. 097-83012 \$1.48**

Butch's Gun Care Products



Revolutionary gun solvents designed by well known bench rest competitor Butch Fisher. Butch has received nothing but the highest praise from competitive shooting circles.

Butch's Bore Shine- Quickly removes all forms of bore fouling including copper with an absolute minimum of effort. **Order No.**

Butch's Bore Shine 4oz 015-02937 \$7.51

Butch's Bore Shine 16oz 015-02941 19.22

Butch's Gun Oil 4oz- An excellent bore conditioner to be used with Butch's Bore Shine. Designed to withstand extreme heat & pressure. **Order No. 015-02948 \$5.35**

Butch's Black Powder Bore Shine 8oz- For black powder shooters who want a fast, and better way to clean & protect muzzleloaders. **Order No.015-02949 \$6.89**

Ballistol Sportsman's Oil



Ballistol dissolves traces of lead, copper, zinc, brass and tombac, which are used to make projectiles and jackets for them. Due to its alkaline character it is ideal for cleaning and maintaining black powder firearms.

	Order No	Price
6oz Aerosal	205-120006	\$6.63
16oz Non Aerosol	205-120076	10.78

KROIL

Kano Labs Kroil



Use to loosen the toughest stuck together metal parts, nuts, bolts, pins, studs etc...Cleans off rust and corroded metal as well as lubricating during use. Harmless to metals and prevents rust.

	Order No.	Price
13oz Aerosol	201-KROIL13	\$15.46
8oz Can	201-KROIL8	9.42

Sharp Shoot R

Sharp Shoot R
Precision Products



Flush-Out Cleaner Degreaser 18oz- Cleaner and degreaser which uses no harmful Tri-chlor-ethylene. Use on firearms, lawnmowers etc...**Order No. 216-WFA180 \$10.53**

Wipe-Out Painless Black Powder 14oz- The fast acting foam cleaner is now faster! Just spray, Wait for 15 to 20 minutes. Put a clean cotton patch on a good jag and push through the bore. The use of a bore brush is not necessary, ever. 14oz Aerosol **Order No. 216-WBP140 \$14.04**

Wipe-Out Accelerator 8oz- Designed to double the speed of Wipe-Out™ within a given time period. Doubles the residue too! **Order No. 216-WAC800 \$7.02**

Wipe-Out Brushless Bore Cleaner 5oz- The Original Foaming Bore Cleaner! If you're going to wear a barrel out, do it with thousands of rounds, Not with thousands of brush strokes! With Wipe-Out, spray, wait, run patches! **Order No. 216-WOA510 \$10.07**

Carb-Out™ by Wipe-Out - A non-aerosol for the specific removal of carbon. The answer to a problem where shooters have to use specific chemical solvents for the removal of stubborn carbon deposits. Dissolves and removes carbon on contact. **Order No. 216-WCO440 \$9.13**

Patch-Out™ Brushless LIQUID Bore Cleaner - Non-aerosol improved version of the "original" Wipe-Out™ Brushless Bore Cleaner which is to be used as a conventional cleaner, applied to patches or mops. **Order No. 216-WPO810 \$9.83**

Markron Chemicals

MARKRON



High Pro Bore Oil - Friction Free, low friction protection for firearm barrel bores. Perfect for new barrel break-in. Zero residue and maintains film strength to +400°. 4oz. **Order No. 238-HPBO \$8.33**

Friction Free Action Lube - Friction Free Protection for firearm action components. Reduces wear of high stress internal action parts. Maintains film strength from -60° to +400°. 4oz. **Order No. 238-FFAL \$8.33**

RIG Cleaning



RIG-RAG® Universal™ Grease Applicator - Long-lasting sheepskin treated with RIG® Universal Gun Grease to safely coat metal items, protecting them against rust and corrosion. Use it again and again – just add more RIG Universal Grease as needed. **Order No. 012-30002 \$6.90**

Rig #2 Lubricant and Protectant - Formulated for lubrication and rust prevention. Excellent for moisture displacement on metal. Will not harm painted surfaces.

	Order No.	Price
4.5oz Can	012-40028	\$4.18
10oz Aerosol	012-40040	6.52

RIG® Universal™ Gun Grease - A thin film of RIG® Universal™ Gun Grease will help keep your firearms rust-free. Inside and out it protects your rifle, handgun, shotgun or muzzleloader against rust and corrosion. Lubricant and preservative.

	Order No.	Price
3 oz net wt Plastic Jar	012-40027	\$4.89
12 oz net wt Plastic Jar	012-40045	9.76

Shooters Choice Cleaners and Lubes



Quick Scrub III- Aerosol Fights Grime and Fouling. For Trouble-Free Actions and Precision Trigger Pulls! (Without Disassembling). **Order No. 104-DG315 \$8.30**

Polymer Safe Quick Scrub 12.5oz Aerosol- Completely safe to use on polymers, plastics, synthetic stocks, bluing, Teflon, paint, camouflage and wood finishes. Will not harm delicate optics or sights. **Order No. 104-PSQ12 \$8.30**

Rust Preventative 6oz Aerosol- A superior anti-oxidant moisture displacing agent engineered to preserve all gun metals. Protects against: Rust, corrosion, fingerprints and body acids, pitting, & salt air. **Order No. 104-RP006 Closeout! \$5.43**

Xtreme Clean Bore Cleaner 12oz Aerosol- Quickly removes copper, carbon lead and powder fouling. Ammonia free, fast acting, non-abrasive – harmless to the bore surface. Convenient to use aerosol. **Order No. 104-XT012 \$11.34**

Shotgun and Choke Tube Cleaner 12oz Aerosol- Designed specially to remove fouling from barrels, choke tubes and ports. Cleans receiver and trigger assembly. Removes plastic wad, lead shot and powder fouling. **Order No. 104-SG012 \$9.89**

Copper Remover 8oz- Special extra strength formula for tough jobs. Increase accuracy by totally removing copper or gilded metal fouling in firearm bores, put there by jacketed ammunition. **Order No. 104-CRS08 \$8.52**

FP-10 Lubricant Elite- Temperature Operating Range: -76°F to +500°F. Advantages: Used by U.S. Special Forces. Out performs Teflon® based products, reduces friction & wear, protects against metal damage, eliminates most malfunctions.

	Order No.	Closeout Price
4 oz bottle	104-FPL04	\$6.43 (limited quantities)

Lead Remover 4oz- Lead remover quickly removes fouling without the need for harsh abrasives. Removes lead, powder and carbon fouling. Restores accuracy, safe, quick and easy, non-abrasive, helps prevent rusting. **Order No. 104-LR004 \$8.30**

Synthetic High Tech All Weather Grease 10cc- Engineered to meet the most demanding needs for firearm lubrication and protection! Great for nickel, stainless, and chrome moly. Quick and easy to apply, doesn't gum-up, odorless (for the hunter). Doesn't wash off with water **Order No. 104-G10CC \$5.78**



Shooters Choice MC#7 Bore Cleaner & Conditioner- Safe, quick and easy. Conditions bore for impact accuracy on first shot. Seasons bore to resist fouling build-up. Non-abrasive – harmless to the bore surface. Removes All Types of Fouling: Powder, Lead, Plastic shotgun wad fouling, Carbon, Copper.

	Order No	Price
16 oz Replenisher Bottle	104-MC716	\$21.69
2 oz Resin Bottle	104-MC702	5.20
4 oz Wide Mouth Jar	104-MC704	7.79

Miscellaneous Cleaners and Lubes



J-B® Non-Embedding Bore Cleaning Compound- BoreCuts Through Toughest Bullet Jacket & Powder Fouling, Paste Formulation, Cushioned Abrasive Action Leaves Bores Sparkling. **Order No. 048-083065002 \$7.63**

Sweet's 7.62 Solvent- Popular with Varmint Hunters & Benchrest Shooters! Quickly removes fouling & copper **Order No. 048-100000001 \$13.90**

One Shot Gun Cleaner & Dry Lube- One Shot reduces friction, cleans grit, grime and gunk from firearms, loaders and more. 5.5oz aerosol **Order No. 005-9990 \$7.80**

CR-10 Bore Cleaning Solvent 8oz- Barnes CR-10 bore cleaning solvent is great for removing copper, brass, and lead fouling! **Order No. 035-CR10 \$8.24**

Break Free Cleaners and Lubes



Break Free CLP- Break-Free's flagship product, CLP is a unique formulation of synthetic oils and individual proprietary ingredients which synergize in combination to do three important tasks simultaneously: Effectively Clean, Lubricate and Protect metal.

	Order No.	
12oz Aerosol	080-CLP12	\$9.67
4oz Aerosol	080-CLP2	5.79
4oz Plastic Bottle	080-CLP4	5.80
1 Gallon	080-CLP7	77.56

Break Free Collector 4oz Liquid Bottle- Collector Liquid provides a protective coating against rust and corrosion on metal to metal finishes; no need to remove before use. Developed for military use to protect weapons for up to 5 years in storage. Ideal to protect gun collections, knives & swords. **Order No. 080-CO4 \$5.42**

Break Free Bore Cleaner Foam 3oz- Non-toxic and odorless, Bore Cleaning Foam chemically removes copper and brass compounds from the barrel in 15 minutes, and leaves a protective film behind to impede the accumulation of residue. Fast, easy, effective, safe and efficient. **Order No. 080-BCF3 \$9.28**

Break Free Powder Blast 16oz Aerosol- Powder Blast is a powerful, high pressure solvent gun cleaner that blasts away powder residue, grease and oil build-up, leaving the firearm clean and ready for lubrication. **Order No. 080-GC16 \$8.91**

Break Free Lubricant - Preservative 16oz- Designed for firearms under sustained fire (aka: "Lots of shooting"). Specially formulated polymerized synthetic oils preserve and lubricate. **Order No. 080-LP4 \$6.19**

Flitz Polishing



Flitz Polish - Paste - One product, Many uses. Metal, Plastic, Fiberglass, Glass, Corian®... A concentrated cream, Flitz Polish is unsurpassed in its ability to Clean, Polish, Deoxidize and Protect. Tough, durable protection Easily Removes: Tarnish, Rust, Water Stains, Chalking, Lime Deposits, Heat Discoloration, Lead & Powder Residue, Oxidation, Bugs, Tar, Oil, Fingerprints, Tree Sap, Bird Droppings, Graffiti, Dyes, Black Streaks/Scuff Marks.

Order No. 194-BP03511 \$8.34

Flitz Premium Microfiber Cloth - Super-Premium Microfiber Polishing Cloth. Clean faster, easier, cheaper! Use it everywhere, ON ANY SURFACE! Made from StarFiber® Microfiber technology, this cloth works better than any other cloth on the market today -- with or without chemicals.

Removes: Dust, Dirt, Fingerprints, Grease and Oil, Polish, Waxes, Bugs and Tar, Nicotine

Order No. 194-MC200 \$5.57



Lyman Revolution Gun Vise - This versatile gun vise is engineered with a full range of adjustment, tilts, clamps and inserts to securely hold any firearm. The padded contact points protect the firearm during cleaning, maintenance or gunsmithing, even bore sighting. Perfect for Pistols! **Order No. 015-7832250 \$71.38**

Montana X-Treme Cleaners and Lubes



The Montana X-treme™ line of gun cleaning products is specially formulated to handle the toughest cleaning problems in each shooting discipline. These advanced cleaners and conditioners will reduce the time necessary to clean firearms and extend barrel life. Montana X-treme™ is endorsed by many of today's top shooters.

Montana X-treme™ Bore Solvent - Designed specifically for removing all forms of fouling in today's high velocity firearms. Copper and powder fouling are removed completely and very quickly. Contains ammonia, but is formulated to have no adverse effects on barrel metal. It is completely barrel safe. Endorsed by numerous competition shooters and law enforcement agencies.

16oz Order No. 165-07000 \$17.72
4oz Order No. 165-07005 \$6.17

Montana X-treme™ Copper Killer 50 BMG Solvent - The industrial strength copper remover that all shooters have been looking for. It is completely barrel safe and contains no acids, amines or chlorides.

4 oz Order No. 165-07035 \$7.33
16 oz Order No. 165-07040 \$20.53

Montana X-treme™ Bore Cleaning Compound - A superior non-embedding cleaning & polishing compound that quickly removes all forms of fouling. Used on a regular basis, it leaves a mirror like finish that helps prevent future copper and powder fouling build-up. Reducing copper and powder build-up helps retain its accuracy longer. 10ml syringe. (Closeout Limited Quantities) **Order No. 165-07045 Closeout! \$5.50**

Montana X-treme™ Bore Conditioner - A bore lubricant specially formulated for x-treme accuracy in today's precision match grade barrels. It is a super refined, low residue oil that has been processed to eliminate the factors that cause oil to gum and congeal. Contains no P.T.F.E., silicones or synthetics of any kind which leave residue behind that can affect accuracy. 4oz bottle.

Order No. 165-07030 \$6.69

Montana X-treme™ Copper Cream - A creamy liquid (bore cleaner) that quickly removes all forms of fouling, including copper, lead, plastic wad residue, powder fouling and moly. This formula makes quick work of those problem barrels that are hard to clean and is completely barrel safe. It is non-embedding and non-abrasive to barrel metals and is highly recommended for new barrel break in. 4oz.

Order No. 165-07025 \$6.87

Montana X-treme™ Cowboy Blend - Specially formulated for our friends in the cowboy action shooting sport but can be used in any firearm that has lead and powder fouling. This product has been tested and recommended by many of the top handgun shooters in the sport. 16oz Bottle.

16oz Order No. 165-07010 \$17.72
4oz Order No. 165-07014 \$6.17

Montana X-treme™ Gun Grease - An extremely effective lubricant that works well at temperature ranging from (-50o to 600o F.). This anti-friction grease was developed specifically for the firearms industry. It deposits a fine protective and lubricating film on metal that will continue to function after the top layer of grease has extruded away. It is virtually unaffected by corrosive moisture and will not mitigate from hot surfaces. Works great for weatherproofing metal. 10 ml Syringe

Order No. 165-07020 \$4.92

Montana X-treme™ Gun Oil - A non-teflon lubricant and rust preventative designed for high and low temperature conditions. It is designed as a finishing or storage oil to follow routine bore cleaning. Works great for weatherproofing metal surfaces. Helps prevent copper and lead fouling.

4oz Applicator Bottle Order No. 165-07015 \$5.75



New! Montana Xtreme Cleaning Kit

See Page 170

Montana X-treme™ Nylon Bore Brushes - Extremely stiff, heavy bristles that provide an excellent aid to removing stubborn powder and copper fouling. Ammonia and oil based cleaners will not easily dissolve these bristles as they will with bronze brushes. All brushes are the standard 8-32 thread except for the 17 & 20 cal brushes which are the 5-40 thread.

Rifle Brushes

Size	Order No	Price
17 cal. (5-40)	165-07120	\$2.56
20 cal. (5-40)	165-07122	2.56
22 cal. (8-32)	165-07125	1.54
6mm (8-32)	165-07135	1.54
25 cal. (8-32)	165-07130	1.54
6.5mm (8-32)	165-07132	1.54
270 cal. (8-32)	165-07131	1.54
7mm (8-32)	165-07133	1.54
30 cal. (8-32)	165-07140	1.54
338 cal. (8-32)	165-07145	1.54

Handgun Brushes (8-32)

Size	Order No.	Price
22 cal.	165-07100	\$1.54
38/357/9mm	165-07105	1.54
40/41 cal.	165-07110	1.54
44/45 cal.	165-07115	1.54



Montana X-treme™ Cleaning Patches - Super tough and all natural. Made from 100% cotton flannel and finished on both sides for "X-Treme" absorbency.

500 Patches	Order No	Price	1000 Patches	Order No	Price
2 1/4" square	165-07240	\$12.33	3/4" square	165-07200	\$10.48
2 1/2" round	165-07245	14.81	1 1/8" square	165-07205	11.99
3" square	165-07250	20.44	1 3/8" square	165-07215	12.82
			1 3/4" square	165-07225	14.45

Montana X-treme Cleaning Rods

- Thrust Bearing Technology
- Machined Aluminum Handle
- High Grade Spring Steel
- Proprietary Non-Embedding Coating

MONTANA X-TREME

	Order No.	Price
.17 to 20 Cal Cleaning rod 42"	165-9145	\$43.43
.22 to 264 Cal Cleaning rod 42"	165-9165	43.43
.270 to 50 Cal Cleaning rod 42"	165-9190	43.43
.270 to 50 Cal Cleaning rod 54"	165-9210	43.43

Montana X-Treme Brass Jags



	Order No.	Price
17 Cal (5-40)	165-07400	\$2.78
20 Cal (5-40)	165-07405	2.82
22 Cal (8-32)	165-07410	2.82
243cal - 6mm (8-32)	165-07415	2.82
257cal / 264 / 6.5mm (8-32)	165-07420	2.82
270cal - 7mm (8-32)	165-07430	3.68
308cal - 325cal (8-32)	165-07440	3.68
338cal / 357 / 35cal (8-32)	165-07445	4.27
375cal - 40cal (8-32)	165-07450	4.27
44cal - 45cal (8-32)	165-07455	4.94
50cal (12-28)	165-07460	6.24



Birchwood Metal Finishing

Complete Perma Blue Paste Gun Blue Kit- Make your gun like new with the Perma Blue Paste Gun Blue Kit. Complete, easy to follow instructions are included with each kit. A generous supply of everything you need to do a "first class" job is included.

Kit includes:

- 2 oz PERMA BLUE Paste Gun Blue
 - 3 oz Cleaner-Degreaser
 - 3 oz Blue & Rust Remover
 - 00 Steel Wool Pads
 - Blueing Applicators, Sponge, Service Cloth Sheath® Rust Preventive Gun Wipes Complete Instruction Guide
- Order No. 012-13701 \$11.01**



PERMA BLUE LIQUID GUN BLUE. The #1 best seller, Perma Blue Liquid Gun Blue, is the proven way to touch-up scratches and worn sports or to completely re-blue most guns. It will give a non-streaky, even blue-black finish to steel (except stainless). All parts to be blueed must be thoroughly cleaned with a metal cleaner and any rust must be removed before applying the blue. Apply without heating with swab or "Q-tip". Two applications are normally required followed by a sealant to enhance the finish and protect it from rust. **Order No. 012-13125 \$4.68**

PERMA BLUE PASTE GUN BLUE. The longest lasting finish but slower to darken than the liquid blues. Easy to use, Perma Blue Paste Blue reacts slowly with the metal but builds up a denser finish that will outlast the liquid blues. A dark blue color may require three or more applications of Perma Blue Paste but each coat takes only 30 to 60 seconds to work. **Order No. 012-13322 \$4.68**

SUPER BLUE LIQUID GUN BLUE. A double-strength blueing solution designed for blueing the highly polished steel parts and hardened steels containing nickel and chrome alloys. SuperBlue is the blackest blue but is not as easy to use as Perma Blue to get an even, non-streaky finish. Use caution to confine the solution to the area to be reblued as it will have an effect on the existing blue. **Order No. 012-13425 \$6.24**

PLUM BROWN BARREL FINISH. Produces a rich, authentic, old style brown finish for original or replica firearms. Plum Brown is ideal for restoring antique guns, muzzleloaders and other metal antiques. A durable, protective and attractive finish that's simple to apply. 5oz. **Order No. 012-14130 \$6.61**



BLUE & RUST REMOVER. Blue & Rust Remover is a safe, reliable solution that removes rust and old blue easily and quickly without damaging base metal. Safe for removing old finish from firearms, muzzleloaders and antiques. Also excellent for removing rust from tools, gauges and precision instruments. **Order No. 012-16125 \$3.17**

ALUMINUM BLACK METAL FINISH. The room temperature chemical used by gunsmiths and industry to blacken aluminum parts. Fast acting liquid is easy to apply with no dimensional change. Aluminum black is also excellent for blackening name plates, plaques, trophies and other engraved items. **Order No. 012-15125 \$6.24**

BRASS BLACK METAL TOUCH-UP. Fast acting liquid used by gunsmiths and industry to blacken or antique brass, copper and bronze parts. **Order No. 012-15225 \$6.24**

Markron Stock Scratch Eraser

Gun Stock Scratch Eraser - Removes scratches from clear-coat gun stocks and buffs to a high-gloss shine. 4oz. **Order No. 238-GSSE \$8.95**

Super Black™ Touch-Up Pens- An easy and effective way to touch-up nicks, scratches and worn areas of black anodized aluminum or black painted surfaces. Use like a marking pen with no mess - simply rub on with "chisel point" felt tip. **Order No.**

- Gloss Black** 012-15101 \$4.90
- Flat Black** 012-15102 \$4.90



Gun Blue & Stock Finish Kit

Deluxe Perma Blue® Liquid Gun Blue & Tru-Oil® Gun Stock Finish Kit- Here's the kit for making that old favorite look like new. Easy to use PERMA BLUE Liquid Gun Blue and TRU-OIL Gun Stock Finish, A complete combination kit.

Kit includes:

- 3 oz Perma Blue Liquid Gun Blue
- 3 oz Tru-Oil Gun Stock Finish
- 3 oz Cleaner-Degreaser
- 3 oz Walnut Stain
- 3 oz Blue & Rust Remover
- 3 oz Stock Sheen & Conditioner
- Blueing Applicators, Sponge, Service Cloth Sheath® Rust Preventive Gun Wipes Complete Instruction Guide



Order No. 012-20001 \$18.91

Stock Finishes & Specialties



GUN STOCK WAX. A high quality formula combining protective and beautifying qualities of the finest, carnauba, beeswax and silicone. Produces a lustrous water repellent film that will not rub off like oils. Offers maximum protection against finish cracking from weather and handling. **Order No. 012-23723 \$4.21**

STOCK SHEEN & CONDITIONER. The easy way to give your newly finished Tru-Oil gun stock a traditional satin finish or to clean, beautify and polish your old stocks. Removes surface imperfections and gives your stock a smooth, hand-rubbed finish. Will not fingermark. **Order No. 012-23623 \$4.21**

Walnut Stain- Water soluble stains are sun-fast, true to color and non-bleeding. Produces a clear, rich color without grain clouding or smearing. Highlights the grain and enhances with natural beauty of wood. Color intensity is easily controlled by adding water to concentrate or using full strength for light colored woods such as birch. **Order No. 012-24123 \$3.75**

GUN STOCK SEALER & FILLER. Sealer & Filler seals out moisture and fills the pores in one easy step. A clear sealer and filler lets you choose your favorite stain or leave the wood in a natural tone. **Order No. 012-23323 \$4.21**

GUN STOCK REJUVENATOR. If your shooting equipment look worn out, bring it back to life with Stock Restorer and Protectant! Enriches the color of synthetic stocks, and enhances the luster of wood stocks. Harmless to metals. 2oz pump spray bottle. **Order No. 012-23422 \$4.21**



Tru-Oil Finish- Easy for the amateur to use and dries quickly so that you can apply several coats in a day. Its unique blend of linseed & natural oils dries fast and will not cloud, yellow or crack with age and resists water damage.

- | | | |
|-------------------------------|----------------------------|---------------------|
| Tru-Oil Finish 3 oz. | Order No. 012-23123 | Price \$4.68 |
| Tru Oil S/Finish 8 oz. | 012-23035 | 8.33 |

Birchwood Casey Sight Black

Sight Black 3.5 oz. Aerosol- Convenient take-along "jet" black spray that stops glare! Great for hunting, skeet, trap and target shooting. Sight Black gives a velvety, flat black coating to barrels, sights and other metal surfaces. Dries instantly. Harmless to precision sights and all finishes. Exclusive hand snorkel tube to control spray. **Order No. 012-33925 \$6.52**



Muzzle Magic™ Foam - Bore Scrubber® Foaming Gel Bore Cleaner - Foaming Gel 2-in-1 Bore Cleaner quickly, easily and safely removes all types of fouling...carbon, powder, copper, lead and plastic wad residue. Contains no highly toxic ingredients and is safe for use on steel. Solvent clings to and penetrates neglected or fouled bores. Great for rifles, shotguns and handguns. 5oz **Order No. 012-33633 \$6.52**

Bore Guides

MTM's Bore Guide assures perfect alignment of a cleaning rod to the bore, prevents solvent contamination of magazine and trigger mechanism, and protects a rifle's finish. Four sizes to choose from.



For .17 to .243(6MM) Calibers- Fits Remington 700, 788, 40X short actions; Mauser 300, Ruger 77 short actions; and similar bolt sizes. **Order No. 008-BGRS \$7.82**

For .17 to .243(6MM) Calibers- Fits Remington 700, 788 long actions; Winchester 70 short actions; Savage 110; Weatherby Mark V long actions & Vanguard actions; Ruger 77 long actions. **Order No. 008-BGWS Closeout! \$7.17**

For .25 to .378 WBY. Mag. Calibers- Fits Remington 700, 788 long actions; Winchester 70 & 54 long actions; Ruger 77 long actions; Mauser 300; Weatherby Mark V long actions & Vanguard actions; Browning A-bolt long action standard & magnum calibers; Savage 110; Mossberg 3500; Sako long actions(AV); and other long actions. **Order No. 008-BGWL \$7.82**



Gunslick Bore Guide- Lightweight aluminum • Chemical resistant finish • Universal adapters included to fit .17 to .415 caliber centerfire bolt action
Order No. 097-18008 \$20.82

Universal Bore Guide - The Universal Bore Guide is just what's needed to properly clean almost any caliber of centerfire bolt-action firearm. Three interchangeable chamber tips fit bore sizes from .17 to .416 caliber. Aluminum Action Collar fits .695"/.700" (17.65mm/17.78mm) diameter bolt actions of any action length. Threaded Brass Pin locks the guide into the action in place of the bolt to allow proper cleaning from the breech.
Order No. 060-UBG \$24.41

HOPPE'S



AR-15 Bore Guide - Designed specifically for the AR-15 style firearm, the Bore Guide is durable and made from aluminum. The knurled end makes for easy removal from the firearm. A large solvent port allows access to full length of brushes and mops. And the chemical resistant o-rings hold this bore guide in place.
Order No. 097-18202 \$25.05



Streamlight Stylus® Reach™ The same great features as the Stylus® but has a flexible cable extension, allowing you to get deep into the tightest spots. With a waterproof, aircraft aluminum casing and a tough PVC shielded cable, the Stylus Reach is built to illuminate those unforgiving, hard-to-reach areas. It's unbreakable, 100,000-hour LED - which never needs replacing.



Order No. Price

White Light 210-65618 \$17.11



HOPPE'S



Hoppe's Bore Light- A great tool for clear inspection under any conditions. Illuminates the bore fully, so nicks, scratches, pits and fouling can be seen easily. Locking feature can lock light on for longer inspections. USES TWO AAA BATTERIES (NOT INCLUDED) **Order No. 060-BRL1 \$4.62**

Snap Caps & Action Proving Rounds

Hard Anodized solid Aluminum, Exact Size, CNC Machined(Handles just like real ammo) Very durable primer(Absorbs repeated impact of the firing pin over 3,000 times)



	Order No.	Price
10 Gauge	010-12210	\$7.66
12 Gauge	010-12211	7.00
16 Gauge	010-12212	7.00
20 Gauge	010-12213	7.00
28 Gauge	010-12214	7.00
410	010-12215	7.00
25 Auto	010-15152	12.65
357 Magnum	010-16119	13.31
38 Special	010-16118	13.31
44 Magnum	010-16120	13.31
44 Special	010-16121	13.31
45 Colt	010-16124	13.31
204 Ruger	010-12218	6.65
32 Auto	010-15153	11.31
357 Sig	010-15159	11.31
380 Auto	010-15113	11.31
40 S & W	010-15114	11.31
45 Auto	010-15115	11.31
9mm Luger	010-15116	11.31
454 Casull	010-16126	14.65
22 Hornet	010-12236	6.65
220 Swift	010-12255	10.65
222 Rem	010-12238	6.65
22-250 Rem	010-12254	6.65

	Order No.	Price
223 Rem	010-12222	\$6.65
243 Win	010-12223	6.65
25-06 Rem	010-12256	6.65
260 Rem	010-12287	10.65
270 Win	010-12224	6.65
280 Rem	010-12246	10.65
7mm-08	010-12247	9.31
30 Carbine	010-12225	6.65
300 Rem Ultra Mag	010-12263	10.65
300 Wby Mag	010-12284	10.65
300 Win Mag	010-12237	6.65
300 Win Short Mag	010-12296	6.65
30-06	010-12227	6.65
30-30	010-12229	6.65
308 Win	010-12228	6.65
338 Win Mag	010-12230	6.65
338 Lapua	010-12250	10.65
444 Marlin	010-12270	10.65
45-70	010-12231	6.65
6mm Rem	010-12276	10.65
6.5x55 Swed	010-12251	6.65
7mm Rem Mag	010-12252	6.65
7mm STW	010-12277	12.65
7.62x39	010-12234	6.65
7 x57 Mauser	010-12232	9.31
8x57 Mauser	010-12235	6.65
50 BMG	010-11451	6.33
243 WSSM (2pk)	010-12298	10.65
480 Ruger (6 pk)	010-16146	14.65
500 S&W (6pk)	010-16144	14.65

Rimfire Action Proving Dummies. These Are Not Snap Caps! These are cnc machined from solid aluminum and act as a functional dummy.

	Order No	Price
17 HMR 6 pack	010-12202	\$6.65
17 Mach2 6 pack	010-12203	6.65
22 Win Mag 6 pack	010-12204	6.65
22 Rimfire 12 pack	010-12206	8.33



Snap Caps from Pachmayr- Dummy Rounds and Snap Caps allow you to dry fire your pistol, revolver or shotgun without causing expensive damage to your firing pin.



	Order No.	Price
.40 S&W, 5/pack	010-03228	\$13.31
.45 ACP, 5/pack	010-03230	13.31
9MM, 5/pack	010-03231	13.31
.38 Special, 5/pack	010-03229	14.33
12 Gauge, 2/pack	010-04499	6.65
20 Gauge, 2/pack	010-04484	6.65

Presentation Chrome Shotgun Snap-Caps - High quality snap-caps for high quality shotguns. Built for years of use!

	Order No	Price
12ga	010-12200	\$25.31
20ga	010-12190	25.31



	Order No.	Price
.45 Cal ACP 5PK	139-ASA45	\$14.06
.22 Cal Handgun 12PK	139-ASC22	4.01
.223 Cal Rifle 2PK	139-ASC223	6.33
.243 Cal Rifle 2PK	139-ASC243	6.33
.270 Cal Rifle 2PK	139-ASC270	6.33
30-06 Cal Rifle 2PK	139-ASC3006	6.33
.308 Cal Rifle 2PK	139-ASC308	6.33
.357 Mag Handgun 6PK	139-ASC357	14.06
.38 Cal Handgun 6PK	139-ASC38	11.25
.380 ACP Handgun 5PK	139-ASC380	14.06
40 S&W Handgun 5PK	139-ASC40	14.06
44 Mag Handgun 6PK	139-ASC44	14.06
44/40 Cal Handgun 6PK	139-ASC4440	14.06
45 LC Handgun 6PK	139-ASC45	12.65
45/70 Cal Rifle 2PK	139-ASC4570	18.28
9mm Handgun 5PK	139-ASM9	14.06

Dummy Rounds and Snap Caps allow you to dry fire your pistol, revolver or shotgun without causing expensive damage to your firing pin. Shotgun caps have a nickel plated, solid brass, adjustable tension spring.

Do Everything Manual

Do Everything Manuals cover: Disassembly and assembly, Lubrication, Ammunition, Maintenance, Safety Check and Storage.

Published by JEM Enterprises, these manuals were written so that anyone can understand the instructions, not just an engineer or gunsmith. 5-1/2" X 8-1/2". Black and white. This book is proudly published in the USA \$6.65ea

	Order No.
AK-47 & MAC 90	127-5038
AR-15 & M-16	127-5053
Benelli M1 Super 90	127-5111
Browning BAR All Models M1918 cal .30/06	127-5034
Colt 1911	127-5042
Colt Revolver M1917 .45ACP/.38/357	127-5083
Hi-Standard .22 LR	127-5106
Ithaca Models 37 & 87	127-5109
Luger 9mm	127-5066
M1 Carbine	127-5086
M1 Garand	127-5096
Marlin	127-5055
Mauser	127-5057
Mossberg Pump Action Shotgun	127-5115
Ruger 10/22	127-5070
Ruger MKII .22 Models 1949 to present	127-5059
SIG Sauer	127-5082
SKS	127-5039
Thompson	127-5050
Personal Firearms Record Book	127-RB

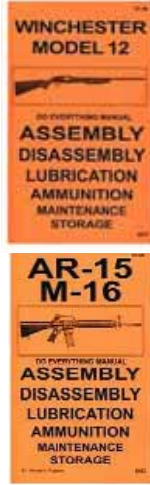

B-Square Gunsmithing Tools



Pro Gunsmith Screwdriver Set - This set comes complete with 26 Hardened Steel Bits: Phillips, Slotted, Hex, Torx, & Posi-Dive plus 3 long bits for recoil pad and see-thru mount installation, a full featured screwdriver, and a 1/4" socket drive adapter all housed in a sturdy molded case with individual compartments for each item. Lifetime Warranty on Bits!

Order No. 080-T0045 \$23.23



Pachmayr Gunsmithing Tools

Pachmayr Master Gunsmith Screwdriver Set - This classic set of 10 screwdrivers is designed specifically for gunsmiths and firearms enthusiasts. Each driver has an ultra smooth, rubber coated handle for a comfortable, sure grip. Tips are magnetized, parallel ground and are the exact size to fit all Colt, Smith & Wesson, Ruger pistols and revolver screws as well as torx for all scope rings and bases. The handy driver caddy is included and stands on the bench top or mounts to wall. Reg \$34.36

Order No. 010-03050 Sale!!! \$38.21



Altraco Torque Wrench

Altraco Torque Wrench Kit - Altraco 19 Tips Included. Comes in durable plastic case.

Order No. 036-NA888445 \$35.63



Forster-Bonanza Gunsmith Screwdriver Set



Eight of the most popular sizes of Forster - Bonanza Screwdrivers, complete with compartmented roll. Each set of screwdrivers contains numbers 1, 2, 3, 4, 5, 14, 15 and 16. Great for mounting and working on scopes, butt stocks, guard screws, and even for just general purpose use.

Order No. 070-001201 \$41.48

Wheeler Gunsmithing Tools

The FATwrench - This amazing handheld torque wrench lets you apply repeatable, accurate torque settings to scope rings, guard screws and other screws, which aids in accuracy and decreases the opportunity for problems in the field. Order No 094-553556 \$48.22



Wheeler's Deluxe 89 pc Gunsmithing Screwdriver Set - The bits are made from specially selected steel and hardened to 56-58 Rockwell "C." Wheeler's engineers measured the screws on over one hundred modern and antique firearms to make sure that bits are offered for every situation. The 54 Hollowground flat bits range in size from .120"x.020" to .360"x.070", and includes doubles in the thinnest sizes, so you won't be stuck in the middle of a job without the proper bit.

The set also includes a complete selection of Phillips, Allen, and Torx bits to cover scope rings, bases, recoil pads, etc. Comes with two handles made from comfortable overmolded plastic.

Order No. 094-562194 \$79.30



Magdriver - The portable gunsmithing screwdriver for when you need a precision set of screwdrivers. Order No. 015-7031249 Price \$12.40

Mini Mag Driver - A little brother to the Magdriver. Perfect for close-up, delicate jobs. Comes with 5 bits - three slotted and two phillips heads in a handy storage pouch. Order No. 015-7631285 Price \$5.98



Pachmayr Gunsmith Tool Kit - Pachmayr's 30 piece gunsmith screwdriver set contains the best selection of bits for working on all firearms. Gunsmith slotted bits for action screws, hex bits to fit the new scope mounting screws and Phillips bits including special long Phillips bits for buttplate and recoil pad removal. A must for the serious shooter. Order No. 010-03047 \$13.36



Pachmayr Master Gunsmith Firearms Screw Kit - 184 pc screw kit for firearms owners and gunsmiths! Contains 8 each of 23 different "Hard to Find" screws. Order No. 010-03054 \$28.02

Contains: 8ea of: #6-40 Plug Screws, #8-40 Plug Screws, #10-32 Plug Screws, #6-48 Filler head (7 Different Lengths), #6-48 Oval head (7 Different Lengths), #8-40 Filler head (3 Different Lengths), #8-40 Oval head (3 Different Lengths)

Gun-Tite



Gun-Tite from Uncle Mike's - Specially formulated compound for gun applications. Gun-Tite "welds" on scope mounts, tightens loose or worn screws, anchors swivel bases, etc., but can be easily removed with ordinary hand tools, if necessary. A product of Loctite technology. 6ml resealable tube. Order No. 060-16310 \$5.45

Altraco 6 Piece Mini Screwdriver Set - 6 Pc set: 3 Phillips, 3 Slotted - Finger tip turning speed handle caps - Black oxide hardened and tempered magnetic tip - High impact molded handles - Carded and shrink wrapped with peg hole Order No. 036-ASS206 \$2.63



Weaver Gunsmithing Tools

Weaver® Tool Kits - Whatever your skill level. Whatever your needs. Weaver has a gunsmith tool kit for you. Choose from among three tool kit models containing professional-grade tools and attachments for gun care and scope mounting work.

Deluxe Kit - Deluxe kit offers a robust 88-piece gunsmith set for the most advanced and accomplished gunsmith
Order No. 029-849719 \$64.88

Compact Kit - Compact Kit features 36 pieces to address the most common gunsmith needs.
Order No. 029-849717 \$16.41

Multi-Bit Kit - Multi Bit is a 77-piece kit for just about any at-home maintenance work.
Order No. 029-849718 \$43.49



Weaver® Torque Wrench - Helps mount scopes and bases with consistent screw pressure to manufacturer's specs. The Torque wrench includes a variety of bits for different fasteners. Also helps protect riflescope tubes from over tightening. Features a magnetized tip that secures bits and comes in a rugged storage case. **Order No. 029-849728 \$52.05**

Weaver® SureThread™ Adhesive - For use when mounting scopes and bases to assure locked-down optics. Prevents shock and vibration from loosening screws. Loosens easily with basic hand tools
Order No. 029-849272 \$10.78

Scope Mounting Kits - Containing everything needed for precision scope mounting. Kits for the mounting professional or beginner gunsmiths.

Deluxe Scope Mounting Kit (with 1-inch Lapping Tools) Includes: Torque wrench, SureThread™, common bits, level system, lapping bar, 1 inch alignment pins and lapping compound.
Order No. 029-849721 \$90.89

Standard Scope Mounting Kit (w/o Lapping Tools) Includes: Torque wrench, SureThread™, common bits and level system. DOES NOT HAVE LAPPING TOOLS
Order No. 029-849722 \$76.63

EZE-Lap Gunsmithing Tools

Diamond Needle Files - Gunsmiths, tool and die makers, jewelers, stockmakers, rely on EZE-LAP needle files to get the job done. 5.5 inches (14 cm) overall length O.A.L.) and shank diameter of 0.118 inches (3 mm).



- | | | | |
|---------------|----------------|------------|--------------|
| ○ Round | ○ Half-round | Hand | ⊓ Round Edge |
| □ Square | □ Flat/Warding | ◇ Crossing | ◇ Slitting |
| △ Threesquare | △ Knife | ◁ Barrette | ▽ Pippin |

Diamond Needle Files Fine (600 grit) - Six files in wallet: Round, square, three-square, half-round, flat/warding and knife. **Order No. 081-600F \$25.10**

Diamond Needle Files Coarse (250 grit) - Six files in wallet (select fine or coarse). Hand, crossing, barrette, round edge joint, slitting and pippin.
Order No. 081-607F \$25.10



Altraco 12 Piece Needle File Set - Rockwell Hardness C38-54 - With knurled handle - Set in wallet type plastic pouch. **Order No. 036-SNF12 \$5.16**

Hammers and Punches

Lyman



Roll Pin

Brass Tapper- For delicate or precise tapping, use the knurled brass drift punch conveniently stored inside the handle. Comes with three interchangeable heads (nylon, brass and steel). **Order No. 015-7031290 Price \$14.25**

Gunsmith Punch Sets- All Lyman Punches feature 4140 Molychrome Steel with machine knurled grips and hardened tips. Gunsmith set features a complete set (1/16", 3/32", 1/8", 5/32", and 3/16") with 1/8" center punch and brass drift in a redwood case. Pistol set includes 1/16", 1/8", 5/32", and brass punch. Deluxe Set in hardwood case also includes a brass tapper hammer.

Pistol Punch Set	Order No. 015-7031271	Price \$12.74
Gunsmith's Punch Set	Order No. 015-7031273	Price \$19.92
Deluxe Hammer/Punch Set	Order No. 015-7031298	Price \$35.71

Roll Pin Punch Set- Ideal tools for removing hollow split roll pins. Special round nose design allows proper alignment of punch in roll pin to prevent damage to fine mechanisms such as trigger group parts. Set of 4 punches 1/16", 3/32", 1/8" and 5/32".
Order No. 015-7031277 Price \$12.74

Hammer and 14 Punches Set -

This hammer and punch set includes the most common size punches used for rifles, pistol and shotguns. The steel handled brass hammer, brass and polymer punches are housed in a sturdy polymer pistol styled case.

Order No. 221-PM058 \$30.00



ALTRACO

Altraco 13 Piece Punch Set - Includes No-mar brass head hammer, all in a sturdy case.
Order No. 036-OPH10 \$19.88

Weaver® Hammer & Punch Set -

Includes (8) steel punches to fit just about any pin and a hammer with brass and plastic faces. For fast, easy, gentle disassembly and reassembly of firearms.

Order No. 029-849723 \$21.53



BROWNELLS

AR-15 Front Sight Bench Block - Big, tough, polyethylene block gives fitted support for installing/removing the front sight assembly on mil-spec, AR-15 rifles and carbines. Precision-machined and clearly marked on both sides for driving the mounting pins "IN" or "OUT" of the sight. Accommodates the sling swivel, plus, includes provisions for removing the gas tube roll pin. **Order No. 048-080000252AC \$42.74**

Pachmayr 1911 Widget - This patented tool makes assembly/disassembly of the 1911 type semiautomatic pistols faster and easier. The small end is used as an aid in getting the slide stop back in place without scratching the frame.
Order No. 010-03471 \$2.54



A Must if you have a 1911!

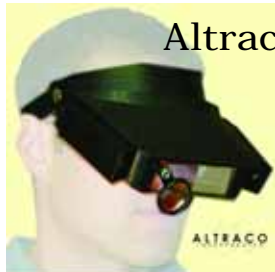

Altraco Headband Magnifier and Headlamp

Altraco Headband Magnifier and Headlamp - Hands free magnification. Features two binocular flip up lenses & one monocular lens. Magnification level of x 1.8, 2.3, 3.7 and 4.8. One light one each side with independent switches. Batteries not included.
Order No. 036-OYJ7127C \$5.78

Forster-Bonanza Gold Filling Kit



Gold Filling Kit for engraved guns increases the value of new and used guns. Adds distinction to any firearm with engraving. May also be used to fill the lettering on barrels and receivers of handguns and rifles.
Order No. 070-001001 \$11.40



Altraco 36 Pc Steel Stamp Set: Letters & Numbers - Strong steel stamp - Letters A-Z size 1/16" - Numbers 0-9 size 1/16" - 36 piece set packed in plastic box.
Order No. 036-OS361 \$7.95



Lyman Trigger Pull Gauges

Trigger Pull Gauge - The Lyman Trigger Pull Gauge is designed to be the fastest and most accurate Trigger Pull Gauge available on the market.

Unlike other gauges, there are no weights or sliding pointers to contend with. Simply place the gauge on the trigger and pull! This instrument will accurately record the results, as you can take multiple readings and then take the average weight for the string at the touch of a button!

- 0-12 Pound Range
- 1/10 Ounce Accuracy
- 10 Pull Averaging
- Reads in Kilograms
- Strain Gauge Technology

Order No. 015-7832248 \$52.59

Timney Replacement Triggers



Model	Weight of Pull	Order No.	Price
Win 70 (Pre and post 64)	1.5 to 3.5lbs.	078-401	\$109.16
Win 70 (Pre and Post 64) Nickel Plated	2 to 4lbs.	078-416	118.26
Mauser 98FN Sportsman	2 to 3.5lbs.	078-101	50.01
Mauser 98FN Featherweight	2 to 4lbs.	078-201	72.76
Mauser KAR98 Sportsman	2 to 4lbs.	078-102	50.01
Mauser Swed 94, Span. 93, 95 & 96 Sportsman	2 to 4lbs.	078-103	50.01
Springfield All except .22 Cal.	2 to 4lbs.	078-109	50.01
Enfield P14, P17 5 Shot Mags	2 to 4lbs.	078-110	50.01
Enfield P14, P17 6 Shot Mags	1.5 to 3.5lbs.	078-111	50.01
Ruger 77	-	078-601	100.06
Ruger 77 MK II	1.5 to 2lbs.	078-1100	105.52
Ruger 77/22 Sear & Spring set	1.5 to 3.5lbs.	078-7722	41.81
Sako "A" Actions - L461, L579, L61	1.5 to 4lbs.	078-621	113.71
Remington 700	1.5 to 4lbs.	078-501	118.26
Remington 700 Nickel Plated	1.5 to 3.5lbs.	078-505	136.46
Remington 788	1.5 to 4lbs.	078-788	118.26
Savage 110 (Post 1977) not for accutrigger models-		078-631	95.51
Weatherby Vanguard, S&W 1500 & HOWA1500		078-611	105.52



Altraco Tin Coated Drill Bit Sets -

	Order No.	Price
29pc Drill Bit Set Metal Box	036-SHT29	\$20.25
115pc Drill Bit Set Metal Box	036-SHT115	59.40

Brownells Acraglas

Brownell's ACRAGLAS and ACRAGLAS GEL are professional quality accurizing and bedding kits for gunsmiths and hobbyist. Shrinks less than 1/10th of 1%. Acid and water-proof - resists alkalis, oils, cleaners and solvents. Will not warp, dent, rot or deteriorate. Exceptional bonding strength!!



	Order No.	Price
Acraglas Gel Accurizing Kit	048-081014004	\$18.85
Acraglas Accurizing Kit	048-081003002	16.71



AR Triggers! See Page 158

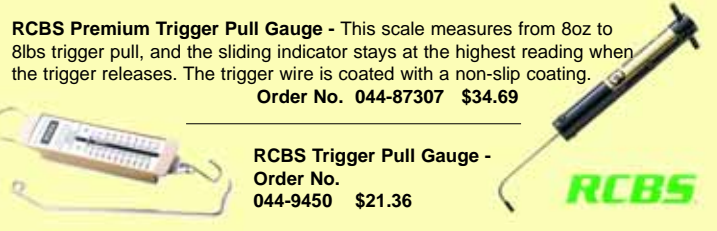

RCBS Premium Trigger Pull Gauge - This scale measures from 8oz to 8lbs trigger pull, and the sliding indicator stays at the highest reading when the trigger releases. The trigger wire is coated with a non-slip coating.
Order No. 044-87307 \$34.69

RCBS Trigger Pull Gauge -
Order No. 044-9450 \$21.36

Mauser Featherweight Deluxe - Features a trigger blocking side safety which makes it suitable for most bolt action rifles with Mauser actions as well as Husquvama and Mark X. Pull weight adjusts from 2 to 3 1/2 pounds.

	Order No.	Price
Fits Mauser 98, Husquvama, and Mark X	078-301	\$90.96
Fits Mauser KAR98	078-302	90.96
Fits Mauser Swedish 94, Span. 93, 95 & 96	078-303	90.96

A-Bolt Spring Kit - Browning A-Bolt trigger pull spring set includes two springs. The first will give a pull of 2 - 2 1/2 pounds, the second delivers a range of 3- 3 1/2 pounds. **Order No. 078-602 \$23.21**

Timney AR-15 Triggers

Replace creepy two-stage triggers with one that is smooth and breaks crisp. The trigger is factory preset with a pull weight of either 3 or 4 pounds. Installation is quick and no adjustments are necessary, 100% true drop-in trigger. The trigger module installs using your rifle's original hammer/trigger pins and the proprietary design eliminates pin rotation and walkout.

Note: Large Pin or Small Pin - Does your receiver have large or small pin holes? Measure your existing pins with a caliper. Pins that measure approximately 0.169" in Outside Diameter are large pin. Pins that measure approximately 0.154" in Outside Diameter are small pin.

Pound	Skeleton		Standard	
	Small Pin	Large Pin	Small Pin	Large Pin
	\$245.66	\$245.66	\$191.41	\$191.06
3lbs	078-6610S	078-6610L	078-6670S	078-6670L
4lbs	078-6640S	078-6640L	078-6680S	078-6680L
4.5lbs	078-6650S	078-6650L	078-6690S	078-6690L

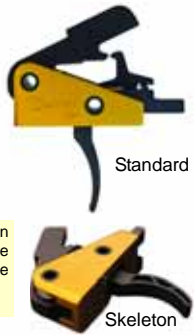

Rifle Basix Replacement Triggers



-All models use factory safties & bolt release
-Wide factory width finger levers!
-100% Drop-in

Remington Replacement Triggers

Direct Replacement Triggers for 700, 40X, Model 7, and XP-100. Fully adjustable for sear engagement, weight of pull & overtravel.

Model	Weight of Pull Range	Order No	Price
Standard	1.5 lb to 3 lbs	213-L1	\$104.73
Varmint	8oz to 1.5 lbs	213-LV1	\$114.78
Extended Range			
Varmint	4 oz to 20oz	213-ERV3	\$134.06
Target	2 oz to 6oz	213-L3	\$135.25

Rem Mechanical Safety- Factory duplicate Rem700 safety! ALL parts interchangeable with factory safety
Order No. 213-REMSAF \$31.81



Remington - Remington Trigger with safety and bolt stop release. Replaces all Remington 700 triggers including X-Mark Pro.

Weight of Pull Range	Order No.	Price
1.5 lb to 4 lbs	213-L1K	\$127.08
8oz to 1.5 lbs	213-LV1K	137.13
4 oz to 20oz	213-ERV3K	156.41
2 oz to 6oz	213-L3K	156.41

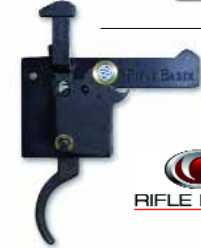

Weatherby Vanguard - Replaces Weatherby Vanguard, Howa ("Legacy") with both 2 and 3 position factory safties, Smith & Wesson 1500 Safety included and installed.

Weight of Pull Range	Order No.	Price
12 oz to 1.5 lbs	213-WTHBYV	\$117.30
1.5 lbs to 4 lbs	213-WTHBY1	108.92

Marlin Replacement Triggers

Marlin Models: 15, 25, 782, 783, 880, 882, 883, 17V, 17VS, & 2000.

Weight of Pull Range	Order No	Price
10oz to 2 lbs	213-MAR1	\$82.10

Marlin Rimfire: T-900 Trigger Systems 915, 917, 925, 980, 982, & 983

Weight of Pull Range	Order No	Price
14 oz. to 2 lbs.	213-MAR917	\$82.10



Savage Replacement Trigger

Works with Savage Models: 10, 11, 12, 110, 111, 112, 114 & 116

Weight of Pull Range	Order No	Price
4oz to 3 1/2 lbs	213-SAV2	\$142.44



Savage Replacement Trigger

Savage Models 10, 11, 12, 110, 111, 112, 114 & 116

Weight of Pull Range	Order No	Price
1 lbs to 3 1/2 lbs	213-SAV1	\$82.10



Savage Replacement Trigger

Sav. Models: 93, 501 & 502 Striker Repl. Trigger Adj.

Weight of Pull Range	Order No	Price
10oz to 2 lbs	213-SAVR	\$82.10

Savage Rimfire Replaces AccuTrigger	Weight of Pull	Order No	Price
Savage Mark 1 & 2, 93, 40 w/AccuTrigger	1.25 to 3.5 lbs	213-SAVRAT	\$82.10

Ruger MKII Replacement Triggers

Ruger MKII Centerfire Right Hand	14oz 2.5lbs Pull	213-RUMK2	\$83.77
Ruger MKII Rimfire Right Hand	14oz 2.5lbs Pull	213-RUR	\$82.10

Ruger Replacement Sear - Replacement Sear for early bolt action centerfire Rugers with 'Tang' Safety.

Produces clean, crisp, light pull operation in conjunction with fully adjustable factory trigger. Uses factory safety. Comes complete with instruction sheet for easy installation.
Order No. 213-RUT \$33.48



CZ 452 - This unit replaces the factory trigger on the bolt action rimfire Ceska Zbrojovka 452. This trigger is adjustable for sear engagement, produces VERY light weights of pull and uses the factory safety. Functions with clean, crisp, single stage operation. Comes with adjustment wrench. Operational Range: 10oz-2.5lbs
Order No. 213-CZ52 \$82.10

CZ 527, 550, and 550 Magnums- This unit replaces and converts 'set triggers' to single stage function on CZ 527, 550, and 550 Magnums, encompassing all models with factory 'set' triggers. Uses factory safety and produces clean, crisp, light weights of pull. Comes with adjustment wrench. Operational Range: 12oz.-3lbs. Order No. 213-CZ527 \$82.10



Winchester Replacement Trigger

Model 70 centerfires - pre or post 1964.

Weight of Pull Range	Order No	Price
10oz to 4 lbs	213-WIN1	\$83.77

GrovTec Hammer Extensions

Hammer Extensions - Adding a horizontal extension to hammers provides a larger contact surface and outstanding grip and control. Especially useful on scoped firearms where clearance can become an issue, GrovTec hammer extensions are made with the finest materials and finish in the industry. Can be mounted on the right or left side. Each hammer extension is specific to the firearms it fits. Do not use any hammer extension on a firearm not directly specified in the hammer extension's fit list.



	Order No.	Price
Winchester 94s and Big Bore 94s including Angle-Eject (except 94/22) · Ithaca X-Caliber · Henry Lever Action .22 & Pump Action .22	114-GTHM68	\$5.61
Winchester 94/22	114-GTHM69	5.61
Marlin Lever Actions 1957-1982	114-GTHM70	5.61
Browning BL-22 · Astra 357	114-GTHM71	5.61
Ruger Blackhawk · H&R Topper · New England Firearms Handi Rifle	114-GTHM72	5.61
Browning BLR 1981-1991. Does not fit 1992 and later models.	114-GTHM73	5.61
All Marlin Lever Actions made in 1983 and later including: 39A, 39M, 1894, 1894C, 1895S, 336C, 336T, 375, 444S, Glenfield 30A.	114-GTHM74	5.61

Carlson's Hammer Expander



Lifetime Warranty

Ambidextrous- Fits T.C. Contender, Encore and most exposed hammer weapon's -rifle or handgun. You can use it with optics attached. Easy to install!

	Order No.	Price
Black	149-00110	\$8.99
Silver	149-00111	8.99



Hammer Expanders

Uncle Mike's Hammer Extensions- with allen wrench included makes hard to reach hammers easier to get to. A must for second guns with external hammers. Right or left hand use.

	Order No.	Price
Fits All Win. 94, Big Bore 94, Angle Eject; Ithaca X-caliber	060-24500	\$6.84
Fits Winchester 94/22	060-24510	6.84
Fits Marlin Lever Actions 1957-1982	060-24520	6.84
Fits Ruger Blackhawk, H&R Topper, NEF Handi Rifle	060-24560	6.84
Fits All Marlin Lever Actions made in 1983 or Later (39A, 39M, 1894, 1894C, 1895S, 336C, 336T, 375, 444S, Glenfield 30A)	060-24580	6.84

Pachmayr Pac-Skin



Pac-Skin is a new generation of non-slip, sure gripping rubber technology. This "peel-n-stick" rubber material provides the "ultimate gripping surface" on those items where improving the grip was difficult, if not impossible, in the past. A finely textured neoprene .050" thick rubber surface coupled with a "peel-n-stick" adhesive backing makes a perfect accessory for your favorite gun or bow.



	Order No.	Price
Pac-Skin Rifle Grip	010-00710	\$9.98
Pac-Skin Shotgun Grip	010-00711	9.98
Pac-Skin Cheek Cushion	010-00712	9.00
Pac-Skin Multi-use 5x20" Sheet	010-00716	9.00

Kick-Eez Shooting Accessories



Size	Cheek Protector	Price	Size	Shoulder Eez	Price
5 x 6 x 1/16	206-703116	\$8.02	6 x 12 x 1/4	206-702140	\$23.56
5 x 6 x 1/4	206-703140	13.09		Palm Swell	
5 x 6 x 1/8	206-703180	8.02	Right Hand	206-102RPS	6.34
5 x 6 x 3/16	206-703316	12.24	Left Hand	206-102LPS	6.34

ProMag ArchAngel Conversion Kit



AA556R Archangel Rifle (10-22*) (ARS) Package -

Convert your Ruger 10-22* Carbine into the Archangel rifle (Advanced Rimfire System) The Archangel allows you to use modern accessories and optics on your Ruger 10-22* carbine. Manufactured entirely from Mil-Spec battle proven polymers the Archangel is no toy. The standard model includes: Upper receiver housing with integral Picatinny rail and lower receiver housing with pistol grip (built in storage compartment), Six position Archangel combat stock (built in storage in stock extension tube), Free float handguard with Picatinny rails located at the twelve o'clock (top) and six o'clock (bottom) positions (additional rails may be added. PM003D is recommended) and the Archangel muzzle device with Picatinny rail and Bayonet Lug (Lug accepts Archangel Display bayonet). Special bonus: Aluminum extended magazine release, a \$25.00 Value!

Order No. 221-AA556R \$106.94

Ruger Mini-14 Strikeforce Parts

Ruger Mini-14® Strikeforce Package -

Six-Position Collapsible/Side Folding Buttstock with Adjustable Cheekrest, Buttpad, Pistol Grip and Ventilated Forend (FITS: Ruger Mini-14® and Ruger Mini-30 with serial number 181 and above. Minor Modification required for Mini-30) (Scope and Rings are not included)



No Gunsmithing
Virtually Indestructible
Matte Black
Glass-Filled Nylon
Made in USA
Lifetime Warranty

Order No.
019-RUG2200 \$87.98

Kit also Includes:

- One 7" Picatinny Rail (Removable)
- Three 2" Picatinny Rails (Removable)
- Six Sling Swivel Stud Mounting Locations (Two Sling Swivel Studs)
- Minor Modification required for Mini-30

Lock Arm And Folding Stocks for 10/22, Mini-14/30 & SKS



Get the look of a folding stock, OR get a folding stock. These tough stocks are rock solid, and feature pistol grips with storage. No gunsmithing required! Accessories are listed below also.

	Order No.	Price
Folding Stock for Ruger 10/22 (Black)	097-91423	\$64.44
Folding Stock for Mini14/Mini30 (Black)	097-91424	64.44

Ruger M-14/30® Folding Stocks - From compact to full-length in an instant. Fits Mini-14 or MiniThirty® 181 series to present, does not fit Model 180.



	Order No	Price
10/22 Blued Folding Stock	060-FS10B	\$86.41
10/22 Stainless Folding Stock	060-FS10S	89.99
M-14/30 Blued Folding Stock	060-MCB	86.41
M-14/30 Stainless Folding Stock	060-MCS	89.99

Ruger 10/22 Fiberforce Stock

For left or right handed shooters



Ruger 10/22 Fiberforce Stock- The most innovative stock available today for the Ruger 10/22. Light, strong and weatherproof, the vertical grip and ventilated handguard add complete control and comfort to an already legendary product. Comes complete with ventilated upper handguard and sling swivel studs both front and rear. Can be used with either open sights or scoped guns. Order No. 019-RUG3000 \$35.87

Carbine Rifle Stocks



Tried and proven Syn-Tech Stocks are now available for carbine rifles. Each is equipped with pistol grip cap, rubber buttplate, molded in texturing and stud swivels.

	Order No.	Price
M1 Carbine Stock	097-18025	\$50.22
Ruger 10/22 Stock	097-11125	51.22
Ruger Mini-14/Mini-30 Stock	097-14125	51.22

Customize the Ruger 10/22 Features budget savvy tips for customizing this popular firearm with readily available after-market add-ons including barrels, stocks and magazine releases. 336 pages. Order No. 043-NGRTT \$17.13

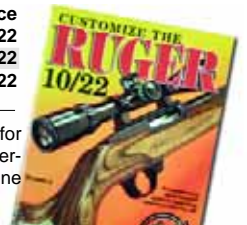

Do Everything Manuals - Cover's Disassembly and assembly, Lubrication, Ammunition, Maintenance, Safety Check and Storage. \$6.65ea

	Order No.
AK-47 & MAC 90	127-5038
AR-15 & M-16	127-5053
Benelli M1 Super 90	127-5111
Browning BAR All Models M1918 cal .30/06	127-5034
Colt 1911	127-5042
Colt Revolver M1917 .45ACP/.38/357	127-5083
Hi-Standard .22 LR	127-5106
Ithaca Models 37 & 87	127-5109
Luger 9mm	127-5066
M1 Carbine	127-5086
M1 Garand	127-5096
Marlin	127-5055
Mauser	127-5057
Mossberg Pump Action Shotgun	127-5115
Ruger 10/22	127-5070
Ruger MKII .22 Models 1949 to present	127-5059
SIG Sauer	127-5082
SKS	127-5039
Thompson	127-5050
Personal Firearms Record Book	127-RB



Hogue Overmolded Rifle Stocks



	Order No.	Price
Ruger 10-22 Standard Barrel	138-22000	\$57.58
Ruger 10-22 Bull Barrel(.920)	138-22010	57.58
Ruger 10-22 with Magnum Action and Standard Barrel	138-22020	70.38
Ruger 10-22 Bull Barrel(.920)Magnum(mod. for Mag Action)	138-22030	70.38
Rem. 700 BDL, SA, Standard Barrel with pillar bed.	138-70000	95.98
Rem. 700 BDL, LA, Standard Barrel with pillar bed.	138-70001	95.98
Rem. 700 BDL, SA, Standard Barrel Full length bed block.	138-70002	179.20
Rem. 700 BDL, LA, Standard Barrel Full length bed block.	138-70003	179.20
Rem. 700 BDL, SA, Heavy Barrel Pillar Bed Stock	138-70010	95.98
Rem 700 BDL LA Hv/Varmint Barrel Pillar Bed Stock	138-70011	95.98
Rem 700 BDL SA Hv/Varmint Barrel Full Length Bed Stock	138-70012	179.20
Rem 700 BDL LA Hv/Varmint Barrel Full Length Bed Stock	138-70013	179.20
Rem 700 BDL SA D.M. Std Barrel Full Length Bed Stock	138-70020	95.98
Rem 700 BDL LA D.M. Std Barrel Full Length Bed Stock	138-70021	95.98
Rem 700 BDL SA D.M. Std Barrel Full Length Bed Block	138-70022	179.20
Rem 700 BDL LA D.M. Std Barrel Full Length Bed Block	138-70023	179.20
Rem 700 BDL SA D.M. Heavy Barrel Pillar Bed Stock	138-70030	95.98
Rem 700 BDL LA D.M. Heavy Barrel Pillar Bed Stock	138-70031	95.98
Rem 700 BDL SA D.M. Heavy Barrel Full Length Bed Block	138-70032	179.20
Rem 700 BDL LA D.M. Heavy Barrel Full Length Bed Block	138-70033	179.20
Win. 70 LA, Heavy/Varmint Barrel pillar bed stock	138-07011	95.98
Win. 70 LA Heavy/Varmint Barrel full length bed stock	138-07013	179.20
Win. 70 SA, Heavy/Varmint Barrel full length bed stock	138-07012	179.20
Win. 70 SA, Heavy/Varmint Barrel pillar bed stock	138-07010	95.98
Win. 70, SA, Featherweight Barrel with pillar bed	138-07000	95.98
Win. 70, LA, Sporter Barrel with pillar bed.	138-07001	95.98
Win. 70, LA, Sporter Barrel with Full length bed block	138-07003	179.20
Win. 70, WSM, Sporter Barrel with pillar bed block	138-07050	95.98
Win. 70, WSM, Sporter Barrel with Full length bed block	138-07052	179.20
Win. 70, WSSM, pillar bed stock	138-07041	95.98
Win. 70, WSSM, Full length bed stock	138-07042	179.20
Ruger 77, SA, "A" Barrel with pillar bed	138-77000	95.98
Ruger 77, LA, "A" Barrel with pillar block	138-77001	95.98
Ruger 77, SA, "A" Barrel with Full length bed block	138-77002	179.20
Ruger 77, LA, "A" Barrel with Full length block	138-77003	179.20
Ruger 77, SA, Heavy/Varmint Barrel Pillar Bed Stock	138-77010	95.98
Ruger 77, LA, Heavy/Varmint Barrel Pillar Bed Stock	138-77011	95.98
Ruger 77, SA, Heavy/Varmint Barrel Full Length Bed Stock	138-77012	179.20
Ruger 77, LA, Heavy/Varmint Barrel Full Length Bed Stock	138-77013	179.20
Mauser 98 Military and Sports Actions Pillar Bed Stock	138-98000	95.98
AR-15/M-16 Rubber Grip Only (Black)	138-15000	14.74
AR-15/M-16 Free Float Aluminum Forend tube Rubber OverMolded Gripping Area (Black)	138-15004	60.78
AR-15/M-16 (Carbine)Free Float Forend w/ OM Grip (Black)	138-15014	63.98
AR-15/M-16 O.M. kit, Grip and forend together (Black)	138-15008	63.98
AR-15/M-16 Rubber Grip Only (OD Green)	138-15001	17.69
AR-15/M-16 Free Float Aluminum Forend tube Rubber OverMolded Gripping Area (OD Green)	138-15204	67.17
AR-15/M-16 O.M. kit, Grip and Forend together (OD Green)	138-15208	70.38
Rem 870 Overmold Stock and Forend combo	138-08712	44.77
Winchester 1300 Overmolded Stock & Forend Combo	138-03012	44.77
Mossberg 500 Overmolded Stock and Forend Combo	138-05012	44.77
Wby Vanguard SA, Std Barrel Pillar Bed Stock	138-15100	95.98
Wby Vanguard LA, Std Barrel Pillar Bed Stock	138-15101	95.98
Wby Vanguard SA, Std Barrel Full Length Bed Block	138-15102	179.20
Wby Vanguard LA, Std Barrel Full Length Bed Block	138-15103	179.20
Wby Vanguard SA, Heavy Barrel PillarBed Stock	138-15110	95.98
Wby Vanguard LA, Heavy/Varmint Barrel PillarBed Stock	138-15111	95.98
Wby Vanguard SA, Hvy/Varmint Barrel Full Length Bed Block	138-15112	179.20
Wby Vanguard LA, Hvy/Varmint Barrel Full Length Bed Block	138-15113	179.20

2pc Rifle Stocks



Butt stock and forend



	Order No.	Price
Remington 7400, 2 Piece(w/RECOIL PAD)	097-74001	\$56.01
Winchester 94, 2 Piece(w/ Plastic Butt Plate)	097-94001	56.01
Remington 760 / 7600, 2 Piece(w/RECOIL PAD)	097-76001	56.01
Marlin 336 2 Piece	097-78025	56.01

Classic Syn-Tech Stocks



No cutting or fitting of inletting required! Made of tough, scratch resistant aerospace glass filled fiber polymer, with a set of Uncle Mike's swivel studs, crisp checkering and a hunter recoil pad. Black only!

	Order No.	Price
Springfield 1903, '03-A3 all calibers	097-20031	\$86.45
Interarms Mark X Long & Magnum Action Excluding 458 & 375, & Whitworth	097-20981	86.45
Military Mauser Large Ring 98	097-21981	86.45
Military Mauser Swedish 96, will fit 93, 94, 95 & small ring 98 (with minimal fitting -cutting or bedding)	097-20961	86.45
Mossberg, S&W, Vanguard, Interarms 1500 (Will Not Fit Mark X), Howa 1500: .25/06, .270, 7mm Mag., .30/06, .300 Win.	097-78005	86.45
Remington 600 Mohawk (Short Action)	097-78019	86.45
Remington 700 ADL Long Action .25/06, .270 Win., .30/06	097-27051	86.45
Remington 700 ADL Short Action .22/250, .243, .308 Win.	097-27151	86.45
Remington 700 BDL Long Action .25/06, .270 Win., .30/06	097-27001	86.45
Remington 700 BDL Short Action .222, .223, .243, .22/250, 6mm, .308	097-27101	86.45
Remington 788 Short Action .308	097-27881	86.45
Remington 788 Short Action .22-250	097-78023	86.45
Ruger M77 R, RS, ST Long Action .270, 7x57, .30/06	097-20771	86.45
Ruger M77, R, RS, ST Short Action .243,.308 .22/250, .223, .220 Swift	097-21771	86.45
Ruger M77, R, RS, ST Magnum Action 7mm Rem. Mag., 300 Win Mag., .338 Mag., 375 H&H, .458 Mag. (requires minimal fitting). Varmint barrels need to have barrel channel opened up to use	097-22771	86.45
Savage 110 E & G Long Action (All Calibers)	097-11021	86.45
Winchester 670 Ranger (All Calibers) Blind Box Magazine	097-78017	86.45
Winchester Pre '64 (All Calibers), Barrel Channel w/Sight Lug Will Require Slight Modification	097-24701	86.45
Winchester M70 Sporter (64-84 Models) All Calibers: .270, .308, .254, .300 Win., .300 Weatherby, .338 Win. Mag. (pre-64 models require fitting)	097-20701	86.45

Advanced Tech Hi-Point Accessories



Hi-Point 9mm Carbine Replacement Stock-

The only replacement stock available for the Hi-Point 9mm Carbine. Made of virtually indestructible matte black, glass filled nylon. This tactical thumbhole stock is rugged, compact, and perfect for every tactical situation. Made in U.S.A. Lifetime Warranty. No Gunsmithing.

	Order No.	Price
Black Matte Finish	019-HIP9000	\$55.19



Laserlyte Laser and Mount for Hi-Point 9mm - Barrel laser mount fits inside stock. Includes pressure switch.

Order No. 019-HIP9100 \$78.32



Universal Tactical Rails for Hi-Point 9mm - Fits most stocks. Includes two 1.75" Picatinny rails and hardware.

Order No. 019-HIP9200 \$9.32

SKS Replacement Stocks & Acc.



SKS 6-Position Collapsible Side Folding Buttstock with Adjustable Cheekrest -

- 6 Position Collapsible/Side Folding
- Can Be Fired From Folded Position
- DuPont® Extreme Temperature Glass Reinforced Polymer
- Removable/Adjustable Cheekrest
- Three 2" and One 4" Picatinny Rail
- 6 Sling Swivel Studs
- Non-Slip Removable Rubber Buttpad

Order No. 019-SKS8000 \$68.99



Monte Carlo Stock SKS- One of the most popular stocks ever made! Has an expensive look and feel, with extended length and a cheek piece, checkered grip, matching handguard, rubber butt pad and butt plate. Black, 33% glass filled Zytel. Manufacturer's lifetime warranty. **Order No. 019-SKS0300 \$53.82**



Fiberforce Stock SKS- The SKS Fiberforce Stock is the comfortable, durable 33% glass filled Zytel alternative to the factory wooden stock. Molded after the world famous Dragunov rifle. The stock kit includes a sporty thumbhole grip, a ventilated forearm and an adjustable cheek rest. Installation takes only minutes. Manufacturer's lifetime warranty. Left or right hand can shoot with no modifications. **Order No. 019-SKS3000 \$54.17**

Butt Pad SKS/MAK90- Specially designed for the Fiberforce Stocks, this slip-on rubber butt pad adds 1" to the length of your stock and provides a cushion that absorbs recoil. Fits the SKS and MAK/90 Fiberforce Stocks! **Order No. 019-SKS0550 \$5.74**

Advanced Tech AK Scorpion Parts

NEW!! AK Scorpion Package - Six Position Collapsible Side Folding Strikeforce Stock with Scorpion Recoil System, Ventilating Handguards, Pistol Grip and Adjustable Cheekrest



- 6 Position Collapsible/Side Folding
- Can Be Fired from Folded Position
- New and Improved Pivot Housing Assembly
- Scorpion Recoil System
- Absorbs Recoil Energy

Kit also includes:

- One 4" Picatinny Rail (Removable)
- Three 2" Picatinny Rails (Removable)
- Sling Swivel Stud
- Counts Towards US Compliance Parts

Scorpion Package Order No. 019-A2101250 \$96.59

Or buy the components separately:

Buttstock Only* Order No. 019-AK3600 40.02

Handguards Only Order No. 019-AKA3500 33.81

*Buttstock does not have Scorpion Recoil Pad.

Read Before Buying!

Conversion kit may only be utilized on AK's using folding stocks prior to 11/90 or you must have enough compliance parts to be legal as a folder; assembly otherwise may be in violation of Sec. 922(R). NOTE: Stock, Pistol Grip and handguard are Made in USA and count towards compliance parts.

Mak-90/Maadi Fiberforce Stock



MAK-90/MAADI Fiberforce Stock-

The surprisingly comfortable alternative to those clumsy factory thumbhole stocks. The distinctive design of the Fiberforce Stock will turn your MAK-90/MADDI into a better handling, better looking gun. Molded from 33% glass filled Zytel for ultimate strength and durability. Installation is simple (fits all variations of MAK-90). The stock kit includes the butt stock and the upper and lower handguard assembly. Left or right hand with no modifications. Manufacturer's lifetime warranty! Made in USA!! **Order No. 019-MAK0100 \$54.17**

Enfield Monte Carlo Stock

Update your Enfield!



Enfield Monte Carlo Stock-

Classic Monte Carlo design. Virtually indestructible, this stock is great for hunting. Made of Matte Black, Glass-Filled Nylon. Easy "Drop-In" installation and no gunsmithing required. Length of pull 14 inches. Features sling swivel studs, raised cheek rest, includes butt plate, checkered pistol grip and forearm. Scratchproof & weatherproof. Made in USA and comes with a Lifetime Warranty. Scope Mount sold separately below.

Fits Model No1, MK3, .303 & .308 Order No. 019-ENF0013 \$54.17

Fits Model No4, MK1, MK2, MK5, .303 Order No. 019-ENF0041 \$54.17

.303 Enfield No1 Mk3 Scope Mounts- (Does not fit .308) This .303 Enfield scope mount is extremely stable and will hold zero. Black, T-6 aluminum. Great hunting rifle. Install using weaver-type rings. Installation requires only the included set screws and cap screws. (No gunsmithing.) For .303 Enfields only. Cannot be modified to fit .308.



No1, MK3, .303
Order No. 019-ENF0113 \$31.24

No4, MK1, MK2, MK5, .303
Order No. 019-ENF0141 \$31.24

Moisin Nagant



Moisin Nagant 7.62 x 54R Fiberforce Stock-

This distinctive stock with its montecarlo style cheek rest fits all models of the 7.62x54R rifles and carbines. Instantly transform your Moisin Nagant into an appealing hunting rifle! **Black** Order No. 019-MOI0300 \$60.72

Moisin Nagant Stainless Steel Bolt Handle - Order No. 019-MOI0700 \$19.39



Moisin Nagant Scope Mounting System

This newly designed mounting system for your rifle is comprised of a scope mount and replacement bolt handle. The scope mount is made from T-6 aluminum with a black anodized finish. The bolt handle is polished stainless steel. System includes assembly hardware and detailed instructions. Unconditional Lifetime Warranty.

Order No. 019-MOI0600 \$41.29

Fiberforce Marlin Semi-Auto Stock



MARLIN SEMI-AUTO FIBERFORCE STOCK-

Marlin Semi-Auto rifles, Both tube and clip fed, old and new styles, Models 60,990,995 etc.. can now be fitted with the popular Fiber force stock. comes complete with ventilated upper handguard and sling swivel studs. For both right and left hand **Order No. 019-MAR3000 \$36.92**



Gunsmithing Tips and Projects 2nd Edition - REVISED & UPDATED! NOW AVAILABLE! A collection of How-to's including such subjects on the shop, stocking, actions, tuning, triggers, barrels and chambering problem solving customizing, muzzleloaders, odd jobs and restoration. Over 500 pages of information. **Order No. 144-5663 \$29.54**

Gunsmithing Pistols & Revolvers, 3rd Edition - By Patrick Sweeney Whether you're a professional gunsmith or just an interested do-it-yourselfer, you'll find what you need in this revised 3rd Edition. From basic disassembly and maintenance to more complex repair and customization techniques, clear text and detailed photos explain how to get the very most out of your pistol or revolver. Special sections on the 1911, the Makarov, the vZ-52 and the Springfield XD. Pages: 384 **Order No. 043-Z5056 \$15.99**

The Gun Digest® Book of Firearms Assembly/Disassembly Part IV: Centerfire Rifles 2nd Ed Easily disassemble and reassemble 66 centerfire rifles. Cross reference more than 400 models that also follow these directions. 576 pages and 1,750 b&w photos. **Order No. 043-AS4R2 \$14.27**

The Gun Digest® Book of Firearms Assembly/Disassembly Part V: Shotguns 2nd Edition Instructions for more than 59 popular shotgun models and 285 variants, including field stripping basics and a thorough explanation of all key take down and reassembly steps. 592 pages and 1,600 b&w photos. **Order No. 043-AS5R2 \$14.27**

The Gun Digest Book of Tactical Weapons Assembly/Disassembly - By J.B. Wood This book will help you save money with steps for maintaining, cleaning and handling minor repairs of your own tactical firearms, and strengthen your shooting performance with a deeper understanding of how your weapon works. Pages: 304 **Order No. 043-Z2297 \$14.27**

Automatic Pistols Assembly/Disassembly - By J.B. Wood Clean and maintain your autoloading pistols yourself. Step-by-step instructions and crisp photographs make it simple. Easy-to-understand text describes each step of disassembly and reassembly for 86 different pistol models & 260 closely-related models 752 Pages. **Order No. 043-Z0737 \$21.13**

ATI Adjustable Shotgun Stock



Adjustable 4 position Hunting Stock - Revolutionary adjustable hunting stock, with a competition grade adjustable stock. Perfect for all shooters: big, small, old and young.

Fits all 12/20ga (with Adapters) Mossberg 500/590, Remington 870, Winchester 1200/1300 & Maverick 88 *Synthetic forends on new Mossberg 500A cannot be replaced because the action bars are attached to the forend.

Black Stock and Forend Combo **Order No. 019-AHS0100 Price \$93.33**

Advanced Tech Shotforce Accessories

Shotforce Tactical Stock For Mossberg 500/590/835, Rem 870, Win 1200 **Nov 88 & Norinco 98** Collapsible, six position SHOTFORCE Buttstock with Pistol Grip and Buttpad combo is patterned after the Colt CAR-15 style assault rifle. The buttstock is California compliant. Matte Black, Glass-Filled Nylon. **Order No. 019-MRW4100 \$54.17 Deluxe Buttpad Included**



Shotforce Acc for H&R Shotguns- Collapsible, six position SHOTFORCE Buttstock with Pistol Grip and Forend combo is patterned after the Colt CAR-15 style assault rifle. The matching "mil-spec" Colt CAR-15 forend is included in this combo package. The Buttstock is California compliant. Matte Black, Glass-Filled Nylon.



Shotforce Tactical Stock & Forend For H&R **Order No. 019-HRN4100 \$41.39**
Shotforce 5 round 12ga Buttstock Shellholder **Order No. 019-SBS4300 12.57**
Shotforce Deluxe Heatshield with Ghosting Sights **Order No. 019-SBS4600 22.19**

Shotforce Tactical Stock For Rossi - The Tactical Buttstock fits all Rossi Shotgun & Rifle Models, including .223, .410, 12GA and 20GA. Rossi Products are manufactured in several different receiver/forend lengths and widths. This retro-fits all Rossi rifle & shotgun styles. **Order No. 019-ROS4100 \$40.02**



Butler Creek Folding Shotgun Stock

Shotgun Folding Stock - Solid Steel Folding Stock For Remington, Mossberg and Winchester 12-gauge pump shotguns. Certain shotguns may require replacement of forearm to allow shell ejection while stock is folded.



Remington 870 **Order No. 060-FSRB Price \$86.41**

2pc Shotgun Stocks



12 ga Stocks	Black	Camo Hardwoods	Youth Black	Camo MossyOak
Brng A-5	097-55551	-	-	-
Moss500(pre '96)	097-50001	-	-	097-50002
Rem 870	097-87001	-	097-87008	097-87002
Rem 1100	097-11011*	097-11074	097-11018	097-50075
Win 1400	097-14111	-	-	-
	\$54.86	\$73.49	\$53.00	\$72.64
	53.16*			

Ram-Line Cadet Stocks



Designed to provide a comfortable fit for smaller statures.

	Order No.	Price
Savage Model 110E&G, Long Action only 1pc	097-11028	\$60.30
Remington Model 7600/760 rifle, .30-06 2pc	097-76008	53.00
Remington Model 870, 12 ga only shotgun 2pc	097-87008	53.00
Remington 700 BDL/721 Long Action 1pc	097-27008	60.30
Remington 7400/740/742 30/06 2pc	097-74000	53.00
Remington 1100 12ga 2pc	097-11018	53.00
Winchester Model 94, 30-30, 2 pc	097-94008	53.00
Marlin 336, 30-30 2pc	097-33608	51.37
Mossberg 500 12ga 2pc	097-55008	53.00

Mix and match Tactical components to create the ideal Tactical shotgun! Components fit most popular 12 gauges (Will adapt to any 12ga. Mossberg, Remington, Winchester shotguns)
No Gunsmithing Required!

Advanced Tech Tactical Shotgun System

No Gunsmithing Required!

Tactical Stocks

A - Rear Pistol Grip - Designed with an ergonomic, textured grip for maximum control and comfort. Features include an integral top-mounted sling loop and slimmer style. Mounting Hardware and Adapters Included.
Fits: 12/20GA Mossberg 500/535/590/835, Remington 870, Winchester 1200/1300 & Maverick 88. **Order No. 019-SRG0200 \$16.52**

B - Top Folding Stock with Pistol Grip - Shotgun functions in open or closed position. Includes rear pistol grip. Quick release button allows stock to lock in folded or unfolded positions. Sling swivel stud included. Ambidexterous. Stock is pre-drilled to accept shell holder. Shotshell Holder sold separately (019-SHO0500). Mounting Hardware and Adapters Included. Stock Fits: 12/20GA Mossberg 500/590, Remington 870, Winchester 1200/ 1300 & Maverick 88 **Order No. 019-TFS0600 \$54.17**

C - Pistol Grip Buttstock - This full length stock features a slim, ergonomically designed pistol grip for maximum control, a recoil pad and sling swivel stud. Uses factory stock bolt. Non-slip pebble grain grip area for better control. Made of Matte Black, Glass-Filled Nylon. Mounting Hardware and Adapters included. Made in USA. Lifetime Warranty. No Gunsmithing. Fits: 12/20GA Mossberg 500/535/590/835, Remington 870, Winchester 1200/1300 and Maverick 88 **Order No. 019-SPG0100 \$35.18**
Also Available for Rem 1100 /11-87 (12/20ga) Order No. 019-SPG0200 \$33.81

D - Tactical Stock with Pistol Grip and Free Buttpad - Collapsible, six position Shotgun Buttstock with Pistol Grip and Buttpad combo is patterned after the Colt CAR-15 style assault rifle. Stock changes length of pull from 9-1/4" to 13-1/4". The buttstock is California compliant. Matte Black, Glass-Filled Nylon. Fits: 12 & 20 Gauge Mossberg 500/590, Remington 870, Winchester 1200/1300, Maverick 88.
Order No. 019-MRW4100 \$54.17

Forends

E - Pistol Grip Forend - Ergonomically designed with a double-finger, non-slip pebble-grain grip for maximum control and comfort. Forend wrench and instructions included for easy removal and installation. Adapters included. (Will Not Fit Maverick 88) Fits: 12/20GA Mossberg 500*/535/590/835, Remington 870, Winchester 1200/1300 *Synthetic forends on new Mossberg 500A cannot be replaced because action bars are attached to forend. **Order No. 019-SFP0300 \$19.39**

F - Shotgun Standard Forend - No jamming! Designed NOT to overlap the shotgun's receiver when cycling the pump action, thereby reducing the chance of a momentary jam by sling of clothing. Adapters included. (Will not fit Maverick 88) Fits: 12/20GA Mossberg 500*/535/590/835, Remington 870, Winchester 1200/1300 Note* Synthetic Forends on new Mossberg Model 500A cannot be replaced because action bars are attached to forend. **Order No. 019-SFS0400 \$16.52**

Heat Shields

G - 12ga Shotgun Heatshield - Made from formed steel. Elongated cooling slots allow maximum, quick dissipation of heat for ultimate protection against burns. Simply slide over barrel and secure with supplied hardware. Matte Finish, 13-1/2" long. Fits: Most 12GA Pumps, Mossberg 500/535/590/835, Remington 870, Winchester 1200/1300, Maverick 88, etc... **Order No. 019-SHS1300 \$19.03**

H - Deluxe Heatshield with Ghost-Ring Sights - AR-15 style fixed nylon ghost ring sights further enhance the high quality steel heatshield which has elongated cooling slots. NOTE: Heatshield must be "slotted" and ghost ring sights removed when used on scoped rifles. Matte Finish, 13-1/2" long. Hardware included. Fits: All 12, 16, 20 and .410 gauge shotgun barrels. **Order No. 019-SBS4600 \$22.19**



Tactical Shotgun Accessories

I - Tactical Shotshell Holder - Five additional 12GA shotshells are easily accessed from the elastomeric polymer Shotshell Holder. Designed for right or left-handed shooters, it is specially engineered for the Advanced Technology, Inc. Tactical AR-15/M-4 Style Buttstock. (019-MRW4100) Mounting hardware and adapters included. Fits: ATI's AR-15/M-4 Style Buttstock **Order No. 019-SBS4300 \$12.57**

J - Shotshell Holder - Durable elastomeric polymer 5-shell carrier mounts securely with screws. Quick and easy access to extra 12 GA rounds. Hardware included. Fits: Top Folding Stock or on either side of any full length wood or synthetic stock.
Order No. 019-SHO0500 \$11.42

K - Mag Clamp/Accessory Clamp - Strengthen the connection of the mag extension to barrel. Includes sling swivel stud which is reversible for right or left-handed shooters. May also be used to mount 1" diameter light or laser to barrel. Fits all 12GA Shotguns
Order No. 019-SMC1100 \$6.82

Gun Digest Book of the Tactical Shotgun - Gun Digest Book of the Tactical Shotgun is the essential buyer's guide to the modern home defense and combat shotgun. Author Scott Wagner reviews many makes and models of currently available tactical shotguns, ammunition and accessories. 224 pages. 250 b&w photos. **Order No. 043-Y1448 \$14.27**

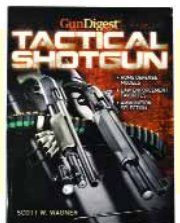

Tac-Star Shotgun Conversion Kits

From Practical to Tactical

Everything needed to convert your shotgun to tactical.

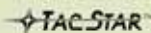

Includes:
Front and Rear Tactical Grips, 6 Shot Sidesaddle, Tactical Shotgun Sling, Barrel Magazine Clamp, and Quick Detach Swivel Kit

	Order No.	Price
Remington 870/1100	101-1081147	\$89.63
Mossberg 500/590	101-1081148	89.63



Also Available in Mossy Oak Camo

B - Rem 870 Collapsible Stock & Forend Package - Fits Rem 870, Moss 500/590/835, Win 1200/1300 12 & 20ga. Collapsible, six-position Buttstock with Pistol Grip.
Order No. 019-MRF6200 \$68.66

C - Pistol Grip Buttstock and Forend Package - Fits Rem 870, Mossberg 500/590/835 & Winchester 1200/1300.
Order No. 019-PGB6100 \$49.34

Shown with optional heatshield (Sold Above)

D - 12GA Pistol Grip Package - Fits: Mossberg 500/590 and Rem 870 and Winchester 1200/1300 - 12ga. Package includes: Pistol Grip Forend, Rear Pistol Grip, Heatshield, and Tactical Flashlight Mount. Easy Installation, No Gunsmithing.
Order No. 019-FRG6300 \$50.72

Tac-Star Tactical Shotgun Grips

Tac-Star Tactical Shotgun Grips are designed with the proper width, rearward angle and back swell to distribute recoil energy evenly into both hands. The shape, the angle and the fingered notches all add up to painless positive control of the shotgun. Injection molded from high impact resistant ABS polymer. Forend grip and rear grip sold separately. You need to order one of each to use on your shotgun! Add improved control and recoil absorbtion to the Tactical grips with SLIP-ON GRIPS!



	Order No.	Price
Forend Grip Fits Winchester 1200/1300	101-1081155	\$21.29
Rear Grip Fits Winchester 1200/1300	101-1081156	21.29
Forend Grip Fits Remington 870	101-1081153	21.29
Rear Grip Fits Remington 870	101-1081154	21.29
Forend Grip Fits Mossberg 500/600	101-1081151	21.29
Rear Grip Fits Mossberg 500/600	101-1081152	21.29

Tac-Star Shotgun Magazine Extensions

TacStars Magazine extensions increase capacity and are made from a super strong chrome moly steel tubing. Each extension comes with a specially designed magazine spring. Easy installation!! 10 shot extensions include a barrel/ magazine clamp. 12 gauge only.

	Order No.	Price
10 Shot Extension Fits Remington 870 w/26" or Longer Barrel (11-87 & 870 Express Require Slight Modification)	101-1081179	\$47.84
10 Shot Extension Fits Remington 1100 & 11-87	101-1081180	47.84
7 Shot Extension Fits Remington 870/1100/1187 w/18" or Longer Barrel (11-87 & 870 Express Require Slight Modification)	101-1081169	40.08
Parkerized Remington 7 shotExt(fits same as above)	101-1081184	45.26
8 Shot Extension Fits Remington 870/1100/1187 w/20" or Longer Barrel (11-87 & 870 Express Require Slight Modification)	101-1081170	42.03
Parkerized Remington 8 Shot EXT(fits same as above)	101-1081186	45.26
7 Shot Extension Fits Winchester 1200 Defender/1300 w/18" or Longer Barrel	101-1081177	40.08
10 Shot Extension for Winchester Barrel/ Magazine Clamp for 12ga Moss, Rem and Win.	101-1081172	9.04
Barrel/ Magazine Clamp for 12ga Rem 1100/1187	101-1081173	9.04
7 Shot Extension for Benelli Nova & Super Nova	101-1081188	42.03
8 Shot Extension for Benelli M, M2, Super Black Eagle	101-1081189	43.65
7 Shot Extension Benelli M-4	101-1081185	42.23

Remington 870 and Mossberg 500/590 Handguards with 3-Rails - Forearm rail system for the Remington 870 or Mossberg 500/590 shotguns. Compliant with MIL-STD 1913. Specifically designed and manufactured to provide a rigid, super-strong, ultra-light platform on which to mount virtually any mission-specific accessory. Lower rail and two removable side rails for mounting foregrips, tactical lights and lasers. No gunsmithing required. Manufactured from reinforced polymer composite.

	Order No.	Price
Remington 870	120-PR870	\$46.76
Mossberg 500/590	120-PRMO	46.76

Uncle Mike's Neoprene Open Buttstock Shell Holder (5 Loop) - Heavy Duty Neoprene sleeve stretches over rifle or shotgun stock. Non-slip surface for improved gun handling. Sewn on elastic loops.
Order No. 060-88493 \$10.38



Streamlight PolyTac

Streamlight Black PolyTac LED - 120 lumens
Made of rugged, virtually indestructible, super-bright, nylon polymer tactical light!
Powered by two 3V CR123A lithium batteries (included) -

Order No.	Price
210-88850	\$35.69



Tac-Star Tactical Accessories

Sidesaddle Shotgun Carriers



6 Round Side Saddle - The sidesaddle easily mounts to the receiver of your shotgun and conveniently places extra shells at your fingertips. The injection molded polymer carrier resists moisture and temperature extremes. Available in a 6 shell model for tactical or defense shotguns.

	Order No.	Price
Fits Remington 870/1100/1187 (Express & Wingmaster Require Slight Modification)	101-1081157	\$24.68
Fits Winchester 1200/1300	101-1081161	24.68
Fits Mossberg 500/600	101-1081159	24.68
Fits HK Super 90, Beretta 1201, Benelli M1	101-1081163	24.68

Benelli M-4 6-Round Side Saddle - For the M-4 Benelli, a handy six extra rounds when needed. When combined with the TacStar M-4 magazine extension, these extra 6-rounds deliver an awesome 13 round capacity that travels with the shotgun.
Order No. 101-1081164 \$24.68

4 Round Side Saddle - A shorter version of the popular SideSaddle that is designed for shotguns where the forend comes back over the receiver. Great for hunters. This will keep your goose loads or specialty ammunition handy for quick reloading. Requires no modification.

	Order No.	Price
Rem 870/1100/1187 12ga	101-1081168	\$23.07
Fits Rem 870/1100/1187 20ga	101-1081130	23.07
Mossberg 500/590 12ga	101-1081167	23.07
Fits Mossberg 500 20ga	101-1081134	23.07
Rem 870/1100/1187(Realtree Camo) 12ga	101-1081139	23.07
Benelli Nova 12ga	101-1081140	23.07

Pachmayr Vindicator Grips



Pachmayr Vindicator Grips - Convert popular model shotguns into compact defense weapons. Features patented air pocket recoil chamber to reduce shock.

	Order No.	Price
Remington 870 Forend Only	010-02808	\$31.65
Mossberg 500 Forend Only	010-02807	31.65
Mossberg 500 Vindicator Presentation Kit Grip & Forend	010-03437	54.68

Weapons Light Systems

Weapons Light System 2000 - A compact, super bright flashlight that mounts on most rifles and shotguns. Features an on/off pressure sensitive finger controlled switch, a nose cone that adjusts for beam width and mounting hardware. The WLS 2000 is shock and water resistant.

Order No. 101-1081025 \$77.55



Universal Barrel Mounts

Precision machined mounts attach flashlights to barrels. Sturdy steel construction.

	Order No.	Price
1/2" to 3/4" barrel to 3/4" light	101-1081111	\$14.55
1/2" to 3/4" barrel to 1" light	101-1081112	14.55
3/4" to 1" barrel to 3/4" light	101-1081113	14.55
3/4" to 1" barrel to 1" light	101-1081114	14.55



More On Pages 219 - 221



12ga Mag Tube Rail Mount - Mounts right onto magazine tube.
Order No. 210-69901 \$15.77

AR-15/M16 Brass Catcher - No More Scrounging On The Ground For Scattered Brass - Fits All Models Of AR-15 Rifles.
Order No. 048-084000262 \$44.57



Tactical AR-15/10 Trigger Group -
- Totally Self-Contained 1pc Assembly
- Revolutionary design yields a superior Match Grade Trigger
- Installs in minutes

Patented Tactical Flat Drop-in Tactical AR-15/10 Trigger Group -

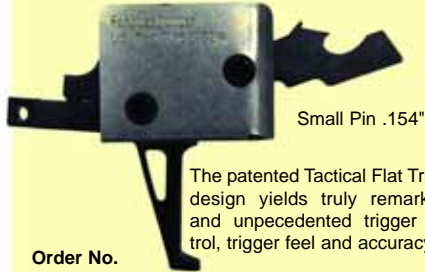

Small Pin .154"

The patented Tactical Flat Trigger design yields truly remarkable and unpecedented trigger control, trigger feel and accuracy

Order No. 167-91503 \$161.70

Traditional Curved Drop-in Tactical AR-15/10 Trigger Group -



Small Pin .154"

Order No. 167-91501 \$161.70

Field Repair Kits



Field Repair Kit - Kit contains all the parts most likely to break, wear out or be lost. Includes: firing pin, 2 firing pin retainers, bolt cam pin, 3 bolt gas rings, buffer detent, buffer detent spring, extractor springs & pads, disconnecter spring, disconnecter, hammer spring and trigger spring
Order No. 229-AR785 \$27.51



Oops Replacement Kit - Kit includes replacements of the most commonly lost or damaged accidentally parts. Includes 4 takedown pin detents, 4 takedown oin detent springs, 2 buffer detents, 2 buffer detent springs, 2 firing pin retainers, 2 selector detents, 2 selector detent springs and 2 extractor springs and pads.
Order No. 229-AR791 \$13.40

Bolt Carrier & Accessories



Bolt Carrier Assembly - Complete with bolt assembly, firing pin, cam pin, firing pin retainer, and bolt carrier key. Made to military contractor specs. Chrome Lined. Carrier Keys are torqued and staked to spec.
Order No. 229-AR100 \$134.02



Firing Pin - This is one of the best spare parts to have. Order No. 229-AR106 \$6.03

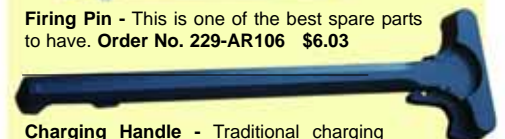

Charging Handle - Traditional charging handle with standard latch assembly.
Order No. 229-AR460 \$15.42

Badger Ordnance Tac Latch Extended Charging Handle Latch

For use with the M16/AR-15, AR-10 and SR-25 series rifles. Replaces the Charging handle latch, allows easy function of rifle with either hand. A must for Tactical or scoped flat top rifles. Charging handle not included. Latch only.



Tac Latch

Gen II



BADGER ORDNANCE

TacLatch
TacLatch Gen II

Order No. 181-TL1 \$18.58
181-TL2 19.36

Uppers!

Check Online for our selection!





AR-15 Brass Catcher -
 - Quickly attaches to any AR-15
 - Holds approx 30 rounds of spent brass
 - Zipper for easy emptying
 - Won't interfere with gun's cycling
094-122231 \$9.53



What does your AR-15 need?

- A - Advanced Technologies Six Position Collapsible Stock** - All of our buttstock accessories, buffer tubes and this Six Position Collapsible Buttstock are on **Page 161**
- B - ProMag Rear Single Plane Dual Aperture Sight** - Perfect for Flat Tops. See all of our Replacement Sights on this page. **Shown Below**
- C - Hogue OverMold Replacement Grip** - This one shown is in Ghillie Tan. It comes in a set on **Page 160**. You can see our entire selection of replacement grips on **Page 161**
- D - CMC Replacement Triggers** - New to Midsouth! **Page 158**
- E - Forends, Handguards and Accessories** - Even more online! **Page 160**
- F - Foregrips and Vertical Grips** - Lots of them. Our choice is the Mako Foregrip with integrated On/Off Trigger. See the bottom of **Pages 160 and 161**
- G - Tactical Flashlights** - We carry TacStar, Streamlight and Mag-lite **Pages 219 through 221**
- H - Magazines and Accessories** - The Mag is a ProMag with a Magpul Ranger Plate. See all of it on **Page 163**



Detachable Carry Handle -
Order No.
121-GMCH \$23.20



Dual Aperture

	Order No.	Price
Detachable A2 Rear Sight	121-GMRS1	\$21.75
Detachable Front Sight	121-GMFS1	18.27
Detachable A2 Style Rear Sight and Detachable Front Sight Combo	121-GMFRS1	38.06

ProMag Industries AR-15 / M16 Flip Up Sights - All Machined or Molded to fit AR-15 flat top A3 uppers. All Lock upright and fold down.



A - Rear Single Plane Dual Aperture Sight - Four apertures by rotating the dial. Folds Flat **221-PM136 \$64.53**
B - Rear Dual Aperture Sight A2 Style - Full windage adjustment. **221-PM137 \$64.53**
C - Gas Block Front Sight - Straight protective ears. T6 aircraft grade aluminum. **221-PM138 \$64.53**
D - Polymer Rail Mount Front Sight - **221-PM210 \$40.04**
E - Polymer A2 Dual Aperture Rear Sight - **221-PM202 \$40.04**

Iosso AR-15 Cleaning Kit



AR-15 or AR-10 Cleaning Kit - This cleaning kit contains 6 precision fit brushes. The brushes clean the Upper Receiver, Chamber, Bolt Carrier, .223 bore (AR-15), or .30 bore (AR-10), Bolt Carrier Key Tube, and the Gas Tube. The Gas tube brush cleans the entire length of the gas tube without disassembly of the upper receiver. The kit also includes the Eliminator Cleaning Tool & Rod. **Order No. 200-19515 \$46.67**

MTM AR Accessories

MTM K-Zone Shooting Rest -
 - Quick and easy to adjust
 - handwheel elevation
 - Ideal for hunting rifles, AR-15's,
 - lever action rifles, slug guns, handguns.
 - Use as a front rifle rest or
 - handgun rest
 - Overall length adjusts up to 7.5"

Order No.
008-KSR30 \$33.42



Made in USA

Tactical Range Box from MTM - Works on both bolt action and AR-15 style rifles. Box includes 2 adjustable gun forks, action block insert (Fits in the mag well for AR-15/M16 style rifles)

Removable top storage box, and small item storage trays.



Order No.
008-TRB40 \$38.69

AR-15 Forends and Handguards



2 Piece Forend with Adjustable Rail Mounts - Move the Forend Rails wherever you want on the forend - or don't have them on at all! Includes various sized rails so that you can customize your forend!



	Order No.	Price
AR-15 Carbine 2pc Forend Package Includes 2" (2ea), 4" (2ea) and 6" (2ea) rails	019-A5101210	\$111.30
AR-15 Carbine 2pc Forend (Free Float) Package Includes 2" (2ea), 4" (2ea) and 6" (2ea) rails	019-A5101270	125.66
AR-15 Rifle Length 2pc Forend Package Includes 12" (2ea), and 4" (6ea) rails	019-A5101390	231.74
2" AR-15 Forend Rail	019-A5101320	8.62
4" AR-15 Forend Rail	019-A5101340	12.92
6" AR-15 Forend Rail	019-A5101350	14.36

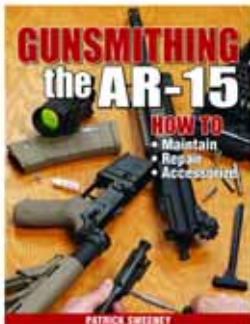

Gunsmithing the AR-15 - How to Maintain, Repair & Accessorize - By Patrick Sweeney Whether you're interested in simple tasks such as disassembling and maintaining your AR, or if you're ready to tackle more complex projects such as rebarreling or converting your AR to a piston design.

- Hundreds of detailed photos
- Maintenance
- Repair
- Accessories and Modifications
- Tips, Tools and Techniques

256 pages
Order No. 043-Z6613 \$15.99

AR-15 Sling Adapter - Fits round Mil-Spec handguards. Swivel included.
Order No. 019-ARA1700 \$5.67



ProMag Industries Delta Ring Wrench - Aids in the removal and installation of AR-15 / M16 rifle and carbine handguards. This must have tool turns a difficult task into a simple function.



Order No. 221-PM009 \$12.16

Free Float Forend Only	Order No.	Price
Black (Standard)	138-15004	\$60.78
OD Green (Standard)	138-15204	67.17
Black (Carbine)	138-15014	63.98

Grip & Forend Kit	Order No.	Price
Black (Standard)	138-15008	63.98
OD Green (Standard)	138-15208	70.38
Ghillie Green (Standard)	138-15808	70.38
Ghillie Tan (Standard)	138-15908	70.38
Ghillie Tan (Carbine)	138-15918	73.58



Hogue OverMold Free Float Forend -

A unique two-piece, free floating rubber OverMolded aluminum forend tube. The rubber OverMolding gives a super comfortable, non slip grasping area that insulates your hand from the heat produced during rapid fire. May require some gunsmithing, or knowledge of the AR/M16 Barrel etc...



Double Star DS-4 Handguards - Great replacement handguards. Minimal Gap.

	Order No.	
Double Heat Shield	229-AR420	\$13.40
Single Heat Shield	229-AR420S	12.40

11 Rib Picatinny AR-15 Polymer panel cover 4 pack - Protects the rail when not in use. Mil-Spec glass filled black polymer. Panels may be custom fit to cover specific lengths of exposed rails.

Order No. 221-PM015A \$16.13



Transform to Picatinny

Transform factory hand guards into picatinny rail systems by attaching these low cost alternatives!

MAKO M16/AR15/M4 Handguard Polymer Dual Picatinny Mount - Features two 45° rails for accessories.

Provides excellent positioning for flashlights, lasers, and canted grips. Tough reinforced polymer composite.

Order No. 120-DPR164 \$11.96



MAKO AR15 / M4 (Standard Length) Polymer Parallel Picatinny Rail for - Easy to fit. Tough reinforced polymer composite. Built in angle keeps devices parallel to the barrel.

Order No. 120-UPR164 \$11.96



ProMag AR-15 / M16 Aluminum Universal Rifle & Carbine Handguard Rail - Constructed of aircraft grade, hard anodized aluminum.

No permanent modification to the firearm is required. All mounting hardware included.

Order No. 221-PM003D \$12.87



AR-15 ForeGrips and Vertical Grips



TangoDown Vertical BattleGrip - Designed to use Sure-Fire pressure switches This rugged grip features a Dual locking bar system, Integrated pressure switch pocket and a waterproof internal storage compartment. Length: 4 7/8"

Order No. 181-VBG \$70.00

TangoDown



Streamlight Vertical Grip with Rail - Machined aluminum, hard anodized rail grabber vertical foregrip with integral Picatinny rail and storage compartment. (Light sold separately) Order No. 210-69114 \$70.30

Weaver® Rail Mount Vertical Grips - Molded of high performance fiberglass-reinforced polymer. Secure, reliable mounting and an adjustable fit. O-ring sealed storage compartment is ideal for tools, batteries or spare parts while the two different caps (included) allow for custom length. Made in the USA. Closeout! \$27.66



WEAVER
Order No.
Black 029-99676
Olive 029-99561
Dark Earth 029-99562

Tac-Star AR-15 Tactical Front Folding Vertical Grip - Front grip folds up to provide greater versatility. Developed with premium Decelerator recoil absorbing material. This grip delivers a new level of comfort and control. No gunsmithing
Order No. 101-1081127 \$19.41



Also sold as a Combo Package in our Replacement Grips Section to the right.

TAC-STAR

MAKO Tactical Foregrip with 1" Weapon Light Adapter and Integrated On/Off Trigger -

No need for fragile, expensive pressure switches or wires. Reinforced polymer composite is strong and lightweight. Storage compartment for batteries, etc. A 1" light trigger is incorporated along with an on/off trigger located in the grip itself.

Order No. 120-TGRIP \$66.34



TGrip with Rear Activation Switch - For those who prefer to use the rear activation switch. Order No. 120-TGRIPR \$66.34



"Swiss Pattern" Black Polymer Vertical Fore Grip - The "Swiss Pattern" vertical fore grip attaches to forend rails, quad forends or any Picatinny rail. The fore grip provides a natural grip and operation of flashlights, lasers and other weapon mounted accessories. Manufactured from injection molded black Mil-Spec polymer. No tools or hardware required. No permanent modification required.
Order No. 221-PM007 \$9.65

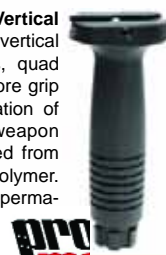

AR-15 Buttstocks, Buffers & Accessories

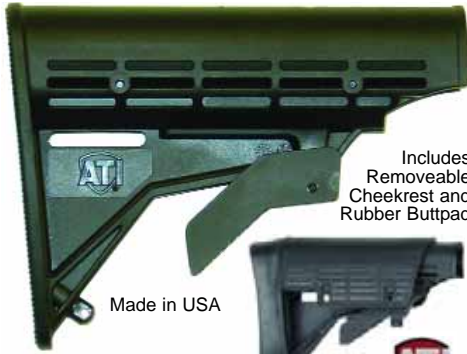

Includes Removable Cheekrest and Rubber Buttpad

Made in USA

Advanced Technologies Six Position Collapsible Stock -

Features: Six-Position Collapsible Buttstock, Removable/Adjustable (3/8") Cheekrest, Checkered, Non-Slip Removable Buttpad, Uses Original Buffer Tube and requires No Gunsmithing. Also includes Sling Swivel Stud and Slot for Tactical Sling Attachment. It's virtually indestructible, made of Glass-Filled Matte Black Nylon and is backed by a Lifetime Warranty.

Order No. 019-ARA3300 \$27.60

AR-15 / M16 (6) Position Stock Carbine

"US" Marked 1/2" Recoil Pad - Adds 1/2" length of pull to AR-15 / M16 carbines equipped with six position collapsible stocks. Black rubber

Order No. 221-PM088 \$5.72



AR-15 Buffer Parts

	Order No.	Price
A - Commercial Buffer Tube	019-A510100	\$28.72
B - Recoil Plug (Buffer Assy)	019-A5101040	18.67
C - Castle Nut	019-A5101020	5.03
D - Locking Ring	019-A5101010	3.59
E - Buffer Spring	019-A5101030	11.49

AR-15 Recoil Buffer™ - An advanced polymer that will decelerate the bolt more gradually, reducing the felt recoil and allowing for quicker set-up for the next shot. Installation is required.

You'll feel the difference immediately.

Order No. 181-AR15 \$9.76



Commercial Buffer Tube Package - (Includes Buffer Tube, Recoil Plug, Castle Nut, Locking Ring and Buffer Spring)

Order No. 019-A5101050 \$43.08



Strikeforce AR-15 Commercial Package - (Includes 6 Position Collapsible Stock, Pistol Grip, Buffer Tube, Recoil Plug, Castle Nut, Locking Ring and Buffer Spring) Order No. 019-A2101050 \$64.62

The ACCU - Wedge™ - Eliminates the play and "rattle" which is often associated with uppers and lowers loosening. Fits in the Lower Receiver to the rear of the trigger housing. Just slip in, and you have an instant, snug fit.

Order No. 181-AW1 \$4.86



Mil-Spec Vs Commercial - Which do you Have?

Mil-spec buffer tubes are slightly smaller in diameter, where the Commercial tube is bigger. Typically the commercial tube will have an angle at the rear.



MAKO Tactical Folding Grip with 1 1/8" Flashlight Adapter

Made for the Streamlight Stinger, Inova T4 or any 1 1/8" diameter flashlight. When horizontal, just push the grip open and it locks in the vertical position. Press a button to fold back.

Order No. 120-FFAT4 \$65.25



Tactical Folding Grip Only - Just like the one above without the flashlight adapter.

Order No. 120-FGGS \$33.71

MAKO AR15/ M16/M4 Quick Release Front Grip and Magazine Holder

Carry a spare magazine, ready to use, on your weapon. It also serves as a unique ergonomic foregrip. Can be used as an ergonomic foregrip with or without the magazine inside.

Order No. 120-MG20 \$33.64



Tactical Horizontal Foregrip with 1 1/8" Weapon Light Adapter

Fits perfectly in your hand. Holds any 1 1/8" diameter flashlight like the Streamlight Stinger and Inova T4. Includes a sleeve insert enabling use of 1" lights. Features a quick release locking system that allows quick mounting or removal of the light, an advantage for rechargeable lights. Molded from reinforced polymer composite. Super lightweight.

Order No. 120-MIKI \$41.33



MAKO Tactical Foregrip with Integrated Adjustable Bipod

Fully functional bipod built into a vertical foregrip. A touch of a button transforms the grip into a sturdy bipod. Aircraft aluminum legs are height adjustable. Super strong and lightweight.

Order No. 120-TPOD \$103.31



Replacement Grips

Hogue OverMold Replacement Grip

Specially designed to retain the important lines and aesthetics of the AR, while at the same time providing a comfortable lightweight rubber grip with finger grooves and palm swells. No Gunsmithing Needed.



	Order No.	Price
Black	138-15000	\$14.74
OD Green	138-15001	17.69

MAKO M16/AR15 Ergonomic Pistol Grip

Made from reinforced plastic composite, it incorporates finger swells and a backstrap that is designed with surfacing to enhance your grip and minimize the chance of slippage should the grip become wet. Accessible storage area beneath. Lifetime Replacement Guarantee from MAKO!

Order No. 120-AG43 \$19.58



TacStar AR-15 Tactical Rear Grip

All the advantages of Pachmayr's premium Decelerator recoil absorbing material. Finger groove design of the rear grip provides secure handling. No Gunsmithing.

Order No. 101-1081126 \$19.41



AR-15 Tactical Front & Rear Grip Combo - Decel Front and Rear grip

Order No. 101-1081125 \$36.03

TangoDown Battlegrip

Fits all M4 / M16 / AR-15 series rifles and clones (AR-10). Grip includes foam anti-rattle battery spacers, stainless steel Dry-Lok fastener, installation tool and complete instructions for easy installation. Internal Battery Storage Compartment, Aggressive Texture, Weather Resistant Cover & Aggressive Texture.

Order No. 181-BG2 \$36.40



AR-15 Strikeforce Pistol Grip

Ergonomic, textured pistol grip. Uses original mounting hardware for installation

Order No. 019-ARA3200 \$15.87



AR-15 / M16 Storage



Allen 42" Universal Camo Assault Case - Camo endura with carry handle and built in sling. Ammo pouch is removable and attaches with velcro. 7/8" foam, and features a #5 zipper.
Order No. 168-1068 \$33.64



Allen Black Assault Cases - Black endura with carry handle and built in sling. 6 Pockets. 7/8" foam, and features a #5 zipper.

	Order No.	Price
42"	168-106542	\$21.96
46"	168-106646	21.96



Bulldog Magnum Tactical Cases - Heavy duty 1200 denier nylon water resistant outer shell. 4 velcro external magazine pouches. Deluxe 2 1/4" total soft padding. Heavy duty double stitching. Adjustable shoulder strap. 10" accessory pocket. Full length zipper.

	Order No.	Price
Black with black trim- 45"	208-BD420	\$27.77
Black with black trim- 40"	208-BD421	27.77
Black with black trim- 35"	208-BD422	27.77
Black with black trim- 48"	208-BD430	27.77
OD green - 45"	208-BD440	27.77
OD green - 40"	208-BD441	27.77
OD green - 35"	208-BD442	27.77
OD green - 48"	208-BD450	27.77



Bulldog Hybrid Tactical Cases - Deluxe Soft Tricot Lining. 2.5" Total Soft Padding. Large Outer Pocket. Deluxe Padded Shoulder Strap

	Order No.	Price
Black with Black trim- 45"	208-BD460	\$37.21
Black with Black trim- 40"	208-BD461	37.21
Black with Black trim- 35"	208-BD462	37.21



Sack-Ups - Sturdy lightweight, knitted storage sacks. Silicone treated cotton blend-Safe Sack, 100% natural cotton. Wicks moisture off the weapon.

	Order No.	Price
AR-15 52" Camo Grey	093-104	\$7.00
AR-15 40" Camo Grey	093-110	6.14

Tactical & AR-15 Mount Systems

AR-15 / M16 Gooseneck Co-Witness Carry Handle Aluminum Scope Mount - This mount allows attachment of the Eotech Hologight to the rifle carry handle. The mount places the Hologight forward of the carry handle allowing co-witness of the iron sights and optic. (Both sights visible at the same time). Hard anodized aircraft grade aluminum construction. **Order No. 221-PM103A \$44.69**



AR-15 / M16 Colt Delta Style Extended Length Aluminum Scope Mount - This extended mount allows use of iron sight while the scope, red dot or holographic sight is mounted to the rifle carry handle. Accepts standard Weaver STANAG rings. Hard anodized aircraft grade aluminum construction, includes hardware. Measurement: 6 9/16th inches long. **Order No. 221-PM100 \$13.59**



AR-15 / M16 Colt Delta Style Scope Mount - The Delta style mount allows the use of AR-16 / M16 rifle sights while a scope, red dot or holographic sight is mounted to the rifle carry handle. The mount accepts standard Weaver STANAG scope rings. Manufactured from hard anodized aircraft grade aluminum. All hardware included. No permanent modification required. **Order No. 221-PM002 \$13.59**



AR-15 / M16 Flat Top Picatinny Rail Aluminum Scope Riser - The scope riser allows optics to be raised 3/4" of an inch. The riser ensures proper scope height without the need for extra high rings. The riser is quick detachable, held in place by a full length spring loaded locking bar with two thumb screws. Accepts Weaver and STANAG rings on its Picatinny rail. Constructed of hard anodized aircraft grade aluminum. **Order No. 221-PM066 \$23.95**



AR-15 / M16 Flat Top Dual Ring Aluminum Scope Mount - The mount ensures proper scope height without the need for extra high rings. The mount is quick detachable, held in place by a full length spring loaded locking bar with two thumb screws. Constructed of hard anodized aircraft grade aluminum. **\$44.69**



Weaver® AR-15 Mounts - These sturdy, versatile mounts easily attach to various AR-15 style weapons. Picatinny style rails accept Weaver® Top Mount Rings to secure your optics. Utilize the Tri Rail design to mount a variety of accessories including tactical lasers or flashlights.



	Order No.	Price
Single Rail Mount System—Carry Handle Mount	029-48320	\$18.21
Single Rail Mount System— Flat Top Mount	029-48321	18.21
Tri Rail Mount System— Carry Handle Mount	029-48322	30.45
Tri Rail Mount System— Flat Top Mount	029-48323	30.45

Weaver® AR-15 Flat Top Mount Riser Rail - Turn your flat-top into the perfect optics platform. This riser rail is made out of aircraft grade 6061-T1 Aluminum.

	Order No.	Price
Flat Top Riser Rail Quick Detatch	029-99659	\$45.31
Flat Top Riser Rail	029-99673	41.33



SunOptics AR-15 Mounts -

	Order No.	Price
Flat Top Picatinny	146-SM5100	\$28.26
Carry Handle Picatinny	146-SM8526	21.01

B-Square AR-15 Mounts - B-Square's AR-15/16 military mount has both NATO Stanag and standard dovetail provisions so military optics or standard scopes, rings and devices can be used.

	Order No.	Price
Blued AR-15 Mount (see-thru) w/rings	080-18526	\$19.35
Blued AR-15 Flat Top Mount w/rings	080-15150	38.75

Offset Rail Adaptor - Quickly go from a primary, magnified optic to red dot action—without head shift—with the new Weaver Offset Rail Adaptor. Use for miniature red dots, lights or other accessories. Picatinny spec rail
Order No. 029-99671 \$22.66



AR-15 Snap on Recoil Pad for 6-Position Tactical Stocks - Universal fit for most 6-position tactical stocks including the TAPCO model. Controls muzzle jump and reduces felt recoil, improving your accuracy. 5 3/16" x 1 7/8" Max. Must have a 1/4" step-down to properly snap on.
Order No. 401-10019 \$30.99



Picatinny Rail Gas Block - Machined from 6061 T6 aluminum and incorporating the 1913 picatinny rail, Has an additional set screw on the top surface to insure a perfect gas seal. The blocks are hard coat anodized and are shipped with 3 set screws.



The blocks are hard coat anodized and are shipped with 3 set screws.

	Order No.	Price
Lightweight (.625")	229-AR452	\$21.44
HBAR (.75")	229-AR453	21.44
Bull AR (.9375)	229-AR454	21.44

AR-15 / M16 Magazines & Accessories

Pro Mag Replacement AR Magazines - Replacement Mags For AR Rifles and variants (Black Polymer or Blued Metal)

	Order No.	Price
A - .223 Flush 5 round Blued	221-COL21	\$21.74
A - .223 Flush 10 round Blued	221-COL22	21.74
B - .223 20 round Blued	221-COLA4	14.80
C - .223 20 round Black Polymer	221-COLA9	12.49
D - .223 30 round Blued	221-COLA1	14.80



E - Thermold AR 30rd Black Polymer Magazine - Black Polymer Mags for AR Rifles and variants. **Order No. 011-M16AR1530BULK \$9.99**

Timney AR-15 Triggers

Replace creepy two-stage triggers with one that is smooth and breaks crisp. The trigger is factory preset with a pull weight of either 3 or 4 pounds. Installation is quick and no adjustments are necessary, 100% true drop-in trigger. The trigger module installs using your rifle's original hammer/trigger pins and the proprietary design eliminates pin rotation and walkout.

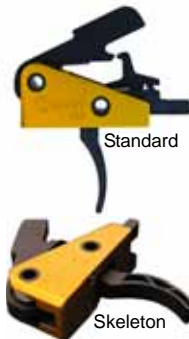

Note: Large Pin or Small Pin - Does your receiver have large or small pin holes? Measure your existing pins with a caliper. Pins that measure approximately 0.169" in Outside Diameter are large pin. Pins that measure approximately 0.154" in Outside Diameter are small pin.

Pound	Skeleton Small Pin	Skeleton Large Pin	Standard Small Pin	Standard Large Pin
	\$245.66	\$245.66	\$191.41	\$191.06
3lbs	078-6610S	078-6610L	078-6670S	078-6670L
4lbs	078-6640S	078-6640L	078-6680S	078-6680L
4.5lbs	078-6650S	078-6650L	078-6690S	078-6690L

Magpul Ranger Floor Plate 5.56 NATO, 3 Pack - A floorplate replacement for current issue USGI 30 round magazines that incorporates an integral loop, floorplate lock, and mag identifier. When installed on the base of a magazine, the Magpul Ranger provides unsurpassed speed and controllability during high stress, tactical magazine changes.

Order No. 181-PULRP \$21.50



F - AR-15 30 Round Zytel Magazine 5.56mm Expanding 45 round Capacity - Expands from 30 round to 45 round capacity. **Order No. 011-M16AR153045 \$16.38**



Magazine Dust Covers for AR-15 - Perfect for keeping dust, dirt and sand out of the top of magazines. Made of clear rubber, Advanced Technology offers a lifetime warranty on these! 4 Per Pack! **Order No. 019-AR15223 \$4.67**



ProMag AR-15 / M16 (5) Round .223 / 5.56 USGI Magazine Loader - The loader is slipped over any AR-15 / M16 .223 / 5.56 type magazine. Five cartridges are dropped in and loaded by depressing the plunger. The process is repeated until the magazine is loaded. Mil-Spec polymer. **Order No. 221-PM017 \$11.56**

LULA M-16/AR-15 Speed Loader / Unloader - Quick magazine loading without thumb pain! Protect your fingers and your mags. Simply attach the Butler Creek Lula loader on top of your magazine to easily load and unload rounds. **Order No. 060-24215 \$21.62**



MAKO Universal Polymer Magazine Couplers - Set of two quick-attach couplers firmly holds two magazines. Durable and lightweight polymer construction is resistant to extreme operating conditions. Easy to install. Improves operational efficiency. **Order No. 120-TZ2 \$8.70**



Mag Charger for AR-15 / M-16 Mags With 3 10rd Stripper Clips/Emergency Fuel Sticks -

10 round black Zytel mag charger will fit and function with any weapon that uses the AR-15 / M-16 Mags. Works with metal mags and GI Metal Strippers. Loads 30 round mags in 10 seconds or less. **Order No. 011-MCSCM16AR15 \$7.92**

AR-15 / Mini-14 Black Polymer Magazine Clamp (4 pack) - Hold two AR-15 / Mini-14 polymer or metal magazines side-by-side for quick reloading. Two mag clamps are required to clamp two AR-15 mags. Glass filled Mil-Spec polymer. **Order No. 221-PM016B \$11.56**



AR-15 Cleaning Kit - Ultra-Klenz® & Ultra-Lube™. Steel rod and the special AR-15 bronze and steel brush that cleans the chamber & rifled barrel. **Order No. 097-41455 \$20.20**

AR-15 Bore Guide - Large solvent port allows access to full length of brushes and mops. Made from aluminum. **Order No. 097-18202 \$25.05**



M16/AR15 Buttstock Cleaning Kit - Fits into the stock. Includes rod set, T-brush, bore brush, chamber brush, oil bottle, and pouch. **Order No. 181-CJARBC \$17.85.**



Chamber Brush

Order No. 036-22BRUSH \$1.72



Chamber Mop

Order No. 036-22MOP \$2.00

A - Cleaning & Oil Brush - Shaving brush for quick clean or oil application. **Order No. 036-OSB01 \$1.72**

B - Double End Cleaning Brush **Order No. 036-OSH12 \$1.38**

C - Double End Flat & Bottle Brush **Order No. 036-OSH16 1.12**

D - Nylon Utility Brushes **Order No. 036-OSH02 0.69**

E - Steel Utility Brushes **Order No. 036-OSH04 0.69**

F - Brass Utility Brushes **Order No. 036-OSH06 0.69**

OD GI Nylon Pouch - Same cleaning pouch that the US Military uses. **Order No. 036-NMOCPO0 \$1.80**

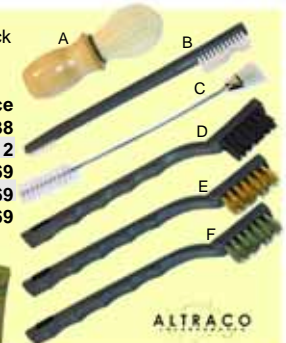
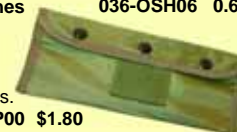

Morgan Adjustable Recoil Pads



Morgan

Morgan Adjustable Recoil Pads are available either curved or straight. Choose the feel you like best. Top quality recoil pads. Both Morgan pads are 4 7/8" long, 1 5/8" wide, 5 1/4" base, with a 1" thick pad.

	Order No.	Price
Curved Pad	049-4	\$31.17
Straight Pad	049-5	31.17

Premium Adjustable Recoil Pads - Adjustable recoil pads with machined aluminum plates.

	Order No.	Price
Premium Curved Pad	049-14	\$58.10
Premium Curved Long Pad	049-14L	58.10
Premium Straight Pad	049-15	58.10
Premium Straight Long Pad	049-15L	58.10

Dimensions: Standard: 1.9" x 5.1"
Long: 1.9" x 5.3"

Replacement Shoulder Pads - These fit any version of Morgan Recoil Pad.

	Order No.	Price
Curved Shoulder Pad	049-4SP	\$21.96
Straight Shoulder Pad	049-5SP	21.96

Morgan

Kick-Eez Recoil Pads



Model and Dimensions	Black Order No.	Brown Order No.	Price
Rocker (2x5 5/8 x 1 1/8 tapered)	206-6018LBBL	N/A	\$30.52
Rocker (2x5 5/8 x 3/4 tapered)	206-6016LBBL	N/A	30.52
Special (2 1/4 x 6 x 15/16)	206-8018XLBL	N/A	31.32
Special (2 1/4 x 6 x 3/4)	206-8016XLBL	N/A	31.32
Magnum (2 x 5 5/8 x 13/8)	206-501LBL	206-501LBR	31.32
Magnum (1 7/8 x 5 1/4 x 1 3/8)	206-502MBL	206-502MBR	31.32
Trap (2 x 5 5/8 x 11/8)	206-40110LBL	206-40110LBR	31.32
Trap (2 x 5 5/8 x 15/16)	206-4018LBL	206-4018LBR	31.32
Trap (2 x 5 5/8 x 3/4)	206-4016LBL	206-4016LBR	31.32
Trap (1 7/8 x 5 1/4 x 11/8)	206-40210MBL	206-40210MBR	31.32
Trap (1 7/8 x 5 1/4 x 15/16)	206-4028MBL	206-4028MBR	31.32
Trap (1 7/8 x 5 1/4 x 3/4)	206-4026MBL	206-4026MBR	31.32
All-Purpose (2 x 5 5/8 x 11/8)	206-30110LBL	206-30110LBR	30.52
All-Purpose (2 x 5 5/8 x 15/16)	206-3018LBL		30.52
All-Purpose (2 x 5 5/8 x 3/4)	206-3016LBL		30.52
All-Purpose (1 7/8 x 5 1/4 x 11/8)	206-30210MBL	206-30210MBR	30.52
All-Purpose (1 7/8 x 5 1/4 x 15/16)	206-3028MBL	206-3028MBR	30.52
All-Purpose (1 7/8 x 5 1/4 x 3/4)	206-3026MBL	206-3026MBR	30.52
Junior (1 11/16 x 4 5/8 x 15/16)	206-3048JRBL	206-3048JRBR	30.52
Sporting Clay (2 x 5 5/8 x 11/8)	206-20110LBL	206-20110LBR	30.52
Sporting Clay (2 x 5 5/8 x 15/16)	206-2018LBL	206-2018LBR	30.52
Sporting Clay (2 x 5 5/8 x 3/4)	206-2016LBL	206-2016LBR	30.52
Sporting Clay (1 7/8 x 5 1/4 x 11/8)	206-20210MBL	206-20210MBR	30.52
Sporting Clay (1 7/8 x 5 1/4 x 15/16)	206-2028MBL	206-2028MBR	30.52
Sporting Clay (1 7/8 x 5 1/4 x 3/4)	206-2026MBL	206-2026MBR	30.52

Universal Pitch Spacers	Thick	Price	Spacers
Positive & Negative			206-701120 1/2" Thick \$7.60
206-105120	1/2	\$9.54	206-701140 1/4" Thick 4.56
206-105140	1/4	6.34	206-701180 1/8" Thick 4.56

Slack Eez Recoil Pad Lubricant.....Order No. 206-101SE \$20.26

More Online!
See our Selection
LIMBSAVER
BY SVL
SWISS VIBRATION LABORATORY

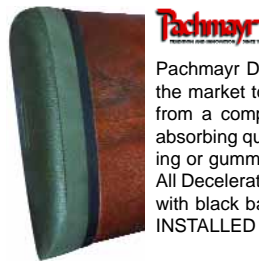

Pachmayr Recoil Pads

Pachmayr Decelerator Pads are the finest recoil absorbing pads on the market today. They are based on proven designs that are made from a completely new material and elastomer with greater shock absorbing qualities than rubber, but can be easily ground without oozing or gumming. Maintains shape even when stored butt down. All Decelerator pads are 1" thick, available in black or brown as noted, with black base. All pads have a fast mount skeet face. **MUST BE INSTALLED BY A QUALIFIED GUNSMITH!**

	Order No.	Price
D752B Small Black, 5.30"x1.68"x1"	010-01413	\$25.97
D752B Small Brown, 5.30"x1.68"x1"	010-01414	25.97
D752B Medium Black, 5.50"x1.80"x1"	010-01407	25.97
D752B Medium Brown, 5.50"x1.80"x1"	010-01408	25.97
D752B Large Black, 5.75"x1.92"x1"	010-01401	25.97
D752B Large Brown, 5.75"x1.92"x1"	010-01402	25.97
D752B Youth 1" Black Base 5.30"x1.68"x1"	010-01380	25.97
Skeet Small Black 5.30"x1.68"x1	010-04856	31.97
Skeet Medium Black 5.50"x1.80"x1	010-03235	31.97
Skeet Large Black 5.75"x1.92"x1	010-03233	31.97

The Decelerator Slip-On Pad! Decelerator quality, with slip-on ease!

	Order No.	Price
Decelerator Slip-on Black Small	010-04414	\$17.66
Decelerator Slip-on Black Med	010-04413	17.66
Decelerator Slip-on Black Large	010-04412	17.66
Decelerator Slip-on Brown Small	010-04418	17.66
Decelerator Slip-on Brown Med	010-04417	17.66
Decelerator Slip-on Brown Large	010-04416	17.66



Pachmayr's Pre-Fit Decelerator recoil pads provide the ultimate in recoil control and appearance and now you can install them on all your long guns. Designed to fit within .050 inch tolerance on factory stocks, these pads will enhance the look and feel of the gun, improve your shooting experience and maybe help you bag more game.

	Order No.	Price
Marlin 1894P/ 1895M/ 1895G/ 444P	010-01740	\$27.97
Rem. 1100 Wood Stock(late model flat butt plate)	010-01700	27.97
Win. 70 Classic Wood Stock	010-01701	27.97
Savage 110 Wood Stock(pre '96)	010-01702	27.97
Ruger M-77 MKII Wood Stock	010-01704	27.97
Rem. 870 Express Wood Stock(12 & 20 ga)	010-01705	27.97
Mossberg 500 Wood Finish Stock	010-01708	27.97
Rem. 700 BDL Wood Stock	010-01710	27.97
Rem. 700 ADL/BDL Synthetic Stock	010-01711	27.97
Rem. 700 ADL Wood Stock	010-01712	27.97
Rem. 700 Wingmaster & 1187 Wood Stock	010-01713	27.97
Winchester 70 Featherlight Wood Stock/Sav. M-111	010-01717	27.97
Winchester 70 Synthetic Stock(post 1999)	010-01743	27.97
Winchester 94 Wood Stock	010-01719	27.97
Savage 110 Synthetic Stock	010-01724	27.97
Ruger 77 MKII Synthetic Stock (pre 2001)	010-01736	27.97
Ruger 77 MKII Synthetic Stock (post 2001)	010-01741	27.97
Mossberg 835/500 Maverick 88 Syn Stock (post '99)	010-01738	27.97
Browning Citori Wood Stock (Post 99)	010-01727	27.97
Marlin 336	010-01739	27.97

	Order No.
Sm Black, 5.15"x1.80"x1"	010-00010
Sm Brown, 5.25"x1.80"x1"	010-00011
Med Black, 5.40"x1.90"x1.10"	010-00006
Med Brown, 5.40"x1.90"x1.10"	010-00007
Lg Black, 5.70"x2.05"x1.15"	010-00001
Lg Brown, 5.70"x2.05"x1.15"	010-00002



The most popular and versatile Pachmayr recoil pad. Has excellent recoil absorption and attractive white line base. **MUST BE INSTALLED BY A COMPETENT GUNSMITH!** \$18.99ea

Slip-on recoil pads install easily without modification to the stock. They offer excellent recoil absorbing qualities and are available in three sizes.

	Order No.	Price
Small Slip On Pad, Brown	010-02306	\$9.98
Small Slip On Pad, Black	010-04455	9.98
Large Slip On Pad, Brown	010-02302	9.98
Medium Slip On Pad, Black	010-04433	9.98
Medium Slip On Pad, Brown	010-20223	9.98
Large Slip On Pad, Black	010-04482	9.98



SIZE CHART(fits stock)
Small:4.85"L X1.50"W
Med: 5.05"L X1.58"W
Large:5.30"L X1.72"W

Lyman Sights

Lyman Target Sights - Lyman has recreated the sight that Lyman Gun Sight Company was founded on in 1878. It has been designed for the Winchester Model 94 and is featured on the new Winchester 1894 Centennial. The No. 2 features height index marks on the aperture and is elevation adjustable only. It comes with both .093 hunting aperture and a .040 target aperture. The Winchester 94 Tang sight fits Win models 1894, 1885, 1887, 1890, 62 and 62A. The Marlin Tang sight fits models 336, 1894, 1895 and 30 series lever actions. The new 1886 model fits Winchester 1886 and Browning replicas. Note: these will not fit rifles with a tang safety.

Lyman
America's Favorite For
Over 100 Years



	Order No.	Price
No. 2 Tang -Winchester 94	015-3902094	\$66.47
No. 2 Tang -Marlin	015-3902100	66.47
No. 2 Tang -Win 1886	015-3902105	66.47



Lyman's #57 SML Rifle Sight offers immediate accuracy improvement for the serious target shooter or hunter. It's made expressly for the Lyman Trade Rifle. Will not fit T/C Hawks!! It will fit other imported Hawken type models with minimum gunsmithing required. Must be shimmed to use on Great Plains. Features include audible-click 1/4 minute adjustments. Use a blade or a bead front sight for hunting or Lyman's 17 AML. Use model 17 AEU for Lyman Rifles. **Order No. 015-3090114 \$72.05**

Lyman Series 17A Target Front Sight - The 17A Target Front Sight is designed to fit a standard 3/8" dovetail. Machined from solid steel. Includes 8 individual. The model 17 AEU is designed for European models, (Lyman, CVA) with a .360" dovetail.

Lyman



	Order No.	Price
17 AHB .404 Height	015-3171076	\$27.71
17 AML .494 Height	015-3090115	27.71
17 AUG .584 Height	015-3171080	27.71
17 AEU .494 Height	015-3171074	27.71
17 ATC .852 Height	015-3090116	27.71



Lyman Front Globe Sights - 20 MJT large 7/8" Globe Front Sight is machined from one solid piece of steel. Mounts in standard 3/8" rifle dovetail or base, such as Lyman 25A. 200 MJT height is .700". 20LJT is .825" in height and has 7 Anschutz inserts included.

	Order No.	Price
20MJT Globe Front Sight	015-3201150	\$35.10
93 Match Globe Front Sight	015-3902035	46.19

Lyman 57 and 66 Universal Receiver Sights - Lyman 57 and 66 Peep Sights have long been favored by shooters and hunters. 57 is for rounded receivers and 66 is for flat receivers. Features include audible click micrometer adjustments for elevation and windage, quick release slide, coin slotted stayset knobs and two interchangeable aperture discs (large hunting aperture and small target aperture) for any shooting condition. Some models require drilling and tapping to be installed! Check with Lyman at 1-800-22L-YMAN about your model gun!



	Order No.	Price
#57 GPR (Lyman's Great Plains Rifle)	015-3090112	\$72.05
#57 SME (Mauser, Sako, Springfield)	015-3572087	72.05
#57 SMET (White Systems in Line Rifle)	015-3572091	72.05
#57 WJS (Rem. 700, Win. 70, Savage 110)	015-3572088	72.05
#66 A (Winchester 94)	015-3662214	72.05
#66 LA (Marlin 336, 1894)	015-3662215	72.05
#66MC (Marlin 39A)	015-3662218	72.05
#66WB (Win/Browning 1886)	015-3662265	72.05
90MJT Right Hand RCVR Sight	015-3902050	72.05
Mounting Base 540 for 90MJT on 1" RCVR	015-3902085	11.79

Lyman Hunting Sights - Upgrade your muzzle-loader to Lyman Hunting Sights. The 16 AML Fold Down Rear Sight and 37 ML Front Sight fits all Lyman rifles and most European imports (CVA, Traditions, etc.).

Lyman



	Order No.	Price
16 AML Rear Sight	015-3090117	\$12.53
37 ML Front Sight	015-3090118	8.83
16 & 37 SET (Best Buy)	015-3090106	18.44

Butler Creek Slip-On Recoil Pad



Brown Slip-On Recoil Pad - Convenient slip-on cushioning reduces felt recoil. Ideal for firearms with plastic or metal buttplates. Improves accuracy by minimizing fatigue and flinching. Elastomer material has a leather-like texture and appearance.

	Order No.	Price
Small Slip-on 4.85" x 1.50" .75" Thickness	060-50325	\$12.03
Med Slip-on 5.10" x 1.60" .75" Thickness	060-50326	12.03
Large Slip-on 5.30" x 1.72" .75" Thickness	060-50327	12.03



RP-250 Black Recoil Pad - has been designed to prevent a rifle's buttstock from sliding down your shoulder during recoil. The horizontal ribbed grooves and traditional Pachmayr rubber material do this job very effectively. **MUST BE INSTALLED BY A QUALIFIED GUNSMITH!** One size only! 5.55"x1.925"x.50" **Order No. 010-00404 \$15.31**

Pachmayr

Green Mountain Replacement Barrels

10/22 Replacement Barrels



GREEN MOUNTAIN
Rifle Barrel Co. Inc.

	Order No.	Price
.22 Cal 10/22 Bull Blued 18" Barrel	186-901501	\$101.08
.22 Cal 10/22 Bull Blued 20" Barrel	186-901520	89.24
.22 Cal 10/22 Bull Stainless Steel 20" Barrel	186-901521	105.13
.22 Cal 10/22 Fluted Blued 20" Barrel	186-901522	121.31
.22 Cal 10/22 Fluted Stainless Steel 20" Barrel	186-901523	136.55
.22 Cal 10/22 Fluted Stainless Steel 20" Barrel Stinger Chambered	186-901610	121.31
.22 Cal 10/22 Fluted Blued 16.5" Sporter Barrel	186-901675	115.53



Benelli Super Black Eagle II Replacement Barrels

	Order No.	Price
24" Matte Finish Slug Barrel	232-80109	\$599.01
24" Timber HD Finish Slug Barrel	232-81065	670.63
26" Matte Finish Barrel	232-81205	566.46
26" Realtree APG Finish Barrel	232-81206	638.08
26" Realtree Max4 Finish Barrel	232-81235	638.08
24" Realtree Max4 Slug Barrel	232-81241	670.63

CVA Optima Elite Replacement Barrels

CVA
1971



Optima Elite 24" Centerfire Barrels

	Order No.	Price
7MM-08 Optima Elite Stainless Steel	143-BC4600S	\$208.87
7MM-08 Optima Elite Blued	143-BC4600	182.78
.30-06 Optima Elite Stainless Steel	143-BC4300S	208.90
.270 Optima Elite Stainless Steel	143-BC4200S	208.90
.243 Optima Elite Blued	143-BC4100	182.78

Optima Elite 26" Centerfire Barrels

	Order No.	Price
.22-250 Optima Elite Stainless Steel, Std. Contour	143-BC4422SA	\$208.90



CVA
1971

Hevi-Shot Choke Tube Systems



ENVIRON-Metal, makers of World Performance HEVI-13® turkey loads and waterfowl ammunition, announces the introduction of a performance line of HEVI-SHOT® Choke Tubes!

Constructed to ENVIRON-Metal's exacting specifications, the tubes are made from premium 17-4 stainless steel and are built to handle all lead, high density, and steel pellets.

The HEVI-SHOT® Choke Tube Systems are optimized for three types of hunting:

- Turkey Hunting, where hunters are looking for extremely tight patterns for ultimate performance at extreme range;
- Waterfowl hunting over decoys, where more patterns improve performance;
- Waterfowl hunting for jump shooting and pass shooting, where hunters require tight patterns that give them long range control.

The HEVI-SHOT® Choke Tube Systems will answer the most common question HEVI-SHOT® hunters ask, which is "What choke tube should I use with HEVI-SHOT®?"

	Waterfowl Combo Mid & Extreme Range Choke Tubes \$88.95	Waterfowl Extreme Range Choke Tubes \$47.44	Waterfowl Mid-Range Choke Tubes \$47.44	H13 Turkey Extreme Range Choke Tubes \$47.44
12ga Rem, Chas Daly Pump/Auto	096-570121	096-560121	096-550121	096-450121
12ga Beretta/Benelli style threads, Nova, Super Nova	096-570122	096-560122	096-550122	096-450122
12ga SBE2, M-2, Current Sport 11, Super Sport, Cordoba, Montefeltro	096-570123	096-560123	096-550123	096-450123
12ga Optima Plus Threads (Model 391 Extrema, Tekny's) Silver Pigeon II, III	096-570124	096-560124	096-550124	096-450124
12ga Win 12/13/14/1500, Mossberg 500, 9200, Wby, Mav 88, S&W, Savage Style Threads	096-570125	096-560125	096-550125	096-450125
12ga Inv Plus, Win SX2, SX3, Win Supreme Threads	096-570126	096-560126	096-550126	096-450126
12ga Mossberg 835/935 style threads	096-570127	096-560127	096-550127	096-450127

Indian Creek Shooting Systems Choke Tubes



Indian Creek Shooting Systems Black Diamond Strike Choke Tubes - Designed to knock turkeys right off their feet. Precision engineered to the industries tightest tolerances. Accommodates all lead, steel and hybrid heavy loads with shot sizes from #2 through #8. The Strike has been proven to increase pattern density by 40% or better. That means tighter groups, more pellets down range, and more birds in the freezer! Don't settle for anything less, be ready to Strike that trophy gobbler this spring!

12 Gauge	Order No.	Price
Browning, Winchester, Mossberg 500/9200, H&R, Weatherby, SKB, .660 Constriction	105-0001	\$64.98
Remington (All) .665 Constriction*	105-0002	64.98
Berretta/Benelli .665 Constriction*	105-0003	64.98
Mossberg 835/935 .675 Constriction	105-0004	71.97
Benelli Super Black Eagle II/ Beretta A391 Extrema .665 Constriction*	105-0005	71.97
Browning Invector Plus .665 Constriction*	105-0006	64.98

20 Gauge	Order No.	Price
Browning, Winchester, Mossberg 500/9200, H&R, Weatherby, SKB, .555 Constriction	105-0011	64.98
Remington (All) .555 Constriction	105-0012	64.98
Berretta/Benelli .555 Constriction	105-0013	64.98
Benelli M2 with Crio Choke System .555 Constriction	105-0015	64.98
Browning Invector Plus .555 Constriction	105-0016	64.98

*Indian Creek recommends 3" 2oz #6s Hevi-13 for .665 constriction. The .655 will shoot all lead shells very well.



5 time winner in the NWTf Still Target Shoot!

Black Diamond Triumph Waterfowl - Anyone that's hunted waterfowl knows what a challenge it presents. Indian Creek invented the Black Diamond Triumph to put the odds in your favor. The Triumph will accommodate shot size #2 through #8 including steel and hybrid heavy loads. With their dashing moves and amazing agility waterfowl are the ultimate target but this year it's time to Triumph with a Black Diamond Choke Tube in your favorite gun.

Standard Constrictions - .710 (Pass choke) - .720 (decoying ducks)

12 Gauge	Order No.	Price
Browning, Winchester, Mossberg 500/9200, H&R, Weatherby, SKB, .710 Constriction	105-2001	\$64.98
Remington (All) .710 Constriction	105-2002	64.98
Berretta/Benelli .710 Constriction	105-2003	64.98
Mossberg 835/935 .710 Constriction	105-2004	64.98
Benelli Super Black Eagle II/ Beretta A391 Extrema .710 Constriction	105-2005	71.97
Browning Invector Plus .710 Constriction	105-2006	64.98

Carlson's Flush Mount Choke Tubes

	Remington 12ga \$11.70	Remington 20ga \$11.70	Beretta/Benneli 12ga \$14.27	Beretta/Benneli 20ga \$14.27	Moss 835/935 12 Ga \$18.09	Browning Invector Win / Moss / Wby 12 Ga \$11.70
Cyl	.730 148-12268	.620 148-10207	.725 148-16611	.620 148-10611	.774 148-19951	.730 148-12217
Skeet	.725 148-12264	.615 148-10201	.720 148-16612	.615 148-10612	.767 148-19952	.725 148-12211
I.C.	.720 148-12261	.610 148-10202	.715 148-16613	.610 148-10613	.760 148-19953	.720 148-12212
Modified	.710 148-12262	.600 148-10203	.705 148-16614	.600 148-10614	.743 148-19954	.710 148-12213
Imp.Mod.	.705 148-12266	.595 148-10206	.700 148-16615	.595 148-10615	.735 148-19955	.705 148-12214
Full	.700 148-12263	.590 148-10204	.695 148-16616	.590 148-10616	.727 148-19956	.700 148-12215
X-Full	.690 148-12267	.585 148-10205	.685 148-16617	.585 148-10617	.710 148-19957	.690 148-12216
Turkey	.680 148-19582	.575 148-10208	.675 148-16618	.575 148-10651	.680 148-19958	.680 148-19891



Carlson's Choke Tube Fit Guide

Benelli: (Current production-square threads) Interchanges with Beretta style threads
Benelli Sport Crio System: Interchanges with Beretta Optima style threads
Browning Invector: Interchanges with Winchester, Mossberg 500, Weatherby, Maverick 88, Smith and Wesson and Savage Guns style threads
Browning Invector Plus: Interchanges with Browning Invector Plus, Winchester Super X2 and Winchester Supreme style threads
Mossberg 500: Interchanges with Winchester, Weatherby, Browning Invector, and Maverick 88 style threads
Mossberg 835 and 935: Interchanges with 835 Mossberg style threads
Mossberg 9200: Interchanges with Mossberg 500 style threads
Remington: Interchanges with Remington and Charles Daly
Stoeger 2000 Semi-Auto: Interchanges with Beretta and Benelli style threads
Stoeger Condor (O/U): Interchanges with Winchester style threads
Weatherby: Interchanges with Winchester, Mossberg 500 and Weatherby style threads
Winchester: Interchanges with Winchester, Mossberg 500 Weatherby and Browning Invector style threads
Win Super X2 & Supreme: Interchanges w/Browning Invector Plus style threads

Beretta/Benelli 12ga Extended Super Steel Chokes- These choke tubes feature a longer parallel section allowing for less flyers and denser patterns. These choke tubes extend 3/4 " outside the barrel eliminating damage to your barrel caused by prolonged steel shot use. **\$29.24ea**

	Order No.
Close Range .715 Constriction	148-07113
Mid Range .705 Constriction	148-07115
Extended Range .695 Constriction	148-07117



Carlson's Choke Tube Wrenches

Sporting Clays Speed Wrench - The Quickest wrench you will ever use! Simply insert wrench into choke, tighten and spin choke out!

	Order No.	Price
SPEED WRENCH 12ga	148-06601	\$13.10
SPEED WRENCH 20ga	148-06602	13.10



T-HANDLE - These wrenches are designed to work with all chokes with slotted ends.

	Order No.	Price
T-HANDLE 12ga	148-06608	\$10.68
T-HANDLE 20ga	148-06609	10.68



Choke Tube Holders



	Order No.	Price
MTM Choke Tube Box (Holds items in place with foam pad. Holds 6 std/3 ext)	008-CT341	\$2.76
MTM Choke Tube Box(Large) holds 9 Reg chokes	008-CT941	4.11
MTM Choke Tube Box(Large) holds extended chokes	008-CT641	3.53
MTM Shotshell Box holds 100 rounds of shotshell with a removable choke tube case.	008-SW100	12.51



Plastic Choke Tube Case- These solid plastic cases will hold up to 3 extended choke tubes or 6 flush mounted choke tubes depending on the styles. Colors may vary. **Order No. 148-00204 \$3.20**



Protective Choke Carry Case- The EVA molded foam exterior on this carry case provides superior protection to your choke tubes while hunting or shooting. Ideal case for storing and keeping your choke tubes organized. 3 or 5 choke storage capacity. **Order No. 148-00400 \$10.81**



Sack-ups Cloth Choke Tube Protector - Sack-Ups are Silicone treated to prevent rust and to wick moisture away from your firearm. They provide protection in the field or in storage and prevent dings and scratches. Keeps your tubes looking as new as they did the day that you bought them. Grey (Holds 3ea 2"-3" choke tubes) **Order No. 093-601 \$7.03**

Carlson's Replacement Choke Tubes



Extended Turkey Choke Tubes. Extended choke made from 1704 stainless steel and heat treated.

	Order No.	Price
Rem. 12ga .640 Extended Turkey Choke	148-19585	\$20.06
Rem. 12ga .660 Extended Turkey Choke	148-19583	20.06
Rem. 12ga .670 Extended Turkey Choke	148-19584	20.06
Beretta/Benelli 12ga .640 Ext Turkey Choke	148-19590	21.42
Beretta/Benelli 12ga .650 Ext Turkey Choke	148-19591	21.42
Beretta/Benelli 12ga .665 Ext Turkey Choke	148-19592	21.42
Mossberg 835 12ga .675 Ext Turkey Choke	148-19870	21.42
Mossberg 835 12ga .690 Ext Turkey Choke	148-19871	21.42
Mossberg 835 12ga .705 Ext Turkey Choke	148-19872	21.42
Browning Inv Plus 12ga .655 Ext Turkey Choke	148-19880	21.42
Browning Inv Plus 12ga .665 Ext Turkey Choke	148-19881	21.42
Browning Inv Plus 12ga .680 Ext Turkey Choke	148-19882	21.42



Extended Turkey Choke Tubes for Win, Browning, Moss, Weatherby, and Savage.

	Order No.	Price
.640 Extended Turkey Choke Tube	148-19894	\$20.06
.660 Extended Turkey Choke Tube	148-19892	20.06
.670 Extended Turkey Choke Tube	148-19893	20.06

Carlson's Sporting Clays Choke Tubes



	Beretta/Benelli 12GA	Remington 12GA	Win, Moss500, Brng Inv, Wby, and Savage 12 ga
	\$29.24	\$29.24	\$29.24
Cylinder	148-15511	148-13368	148-19770
Skeet	148-15512	148-13364	148-19771
Improved Cylinder	148-15513	148-13361	148-19772
Light Modified	148-15514	148-13362	148-19773
Modified	148-15515	148-13363	148-19774
Improved Modified	148-15516	148-13367	148-19775
Full	148-15517	148-13365	148-19776
Extra Full	148-15518	148-13366	148-19777

Carlson's Ported Turkey Choke Tubes

Designed for the Serious Turkey Hunter each Super Full Choke has been specifically bored to throw the optimum pattern at short and long distances. Each choke is ported, allowing gases to escape quickly, reducing recoil and muzzle jump in the process. Chokes are manufactured from aircraft stainless steel and a blue non-reflective finish has been added. Additionally each choke is knurled, allowing for fast, easy removal and insertion. Lifetime warranty.....**\$31.21ea (*\$34.34)**

	Order No.
Browning Invector/Win 12ga (.660)	148-70000
Mossberg 835 12ga(.675)	148-70010
Remington 12ga (.665)	148-70020
Beretta/Benelli 12ga (.665)	148-70030
Browning Inv. Plus 12ga (.665)	148-70040
Benelli Crio Plus 12ga (.665)	148-67099*



Choke Tube Lubes

Birchwood Casey Choke Tube Lube 3/4oz - Prevents stuck choke tubes caused by corrosion, high stress of steel shot loads, extreme temperatures and pressure from repeated trap and skeet shooting. Withstands heat and prevents seizure even at extreme temperatures up to 2000°F. **Order No. 012-40015 \$4.41**

Outers Choke Tube Lube And Gun Grease - Provides a heavy-duty positive barrier against wear and corrosion. Recommended for heavy trap and skeet shooting to prevent stuck choke tubes. **Order No. 097-42057 \$2.92**



Plano Small Choke Tube box - Holds 3-6 Chokes, Smoke Gray in color. **Order No. 086-120501 \$2.70**

CZ Brand Extended Choke Tubes

CZ-USA Extended Choke Tube Set - Contains one of each of the 5 sizes: Full, Improved Modified, Modified, Improved Cylinder, Cylinder. **\$71.00 per set**

	Order No.
12 Gauge Black Set	226-19026
12 Gauge Silver Set	226-19027
20 Gauge Black Set	226-19036
20 Gauge Silver Set	226-19037
28 Gauge Black Set	226-19046
28 Gauge Silver Set	226-19047



CZ-USA Extended Choke Tubes - Buy the CZ Chokes Separately Below

\$25.56 Per Choke	12 Gauge Black	28 Gauge Silver	20 Gauge Black	28 Gauge Black
Full	226-19051	226-19076	226-19061	226-19071
Improved Modified	226-19052	226-19077	226-19062	226-19072
Modified	226-19053	226-19078	226-19063	226-19073
Improved Cylinder	226-19054	226-19079	226-19064	226-19074
Cylinder	226-19055	226-19080	226-19065	226-19075

More Available Online! - Check online for our complete listing of CZ Choke Tubes

Hunters Specialties Replacement Choke Tubes



HS Strut Undertaker Turkey Choke Tubes

	Order No.	Price
Rem.M1187, 1100, 870 12ga 3", .665 Knurled end	052-00660	\$15.93
Moss, 835, 12ga .695 3" Knurled end	052-00661	15.93
Moss, Win, & Browning Invictor 12ga .665 Knurled end	052-00662	15.93
Beretta/Benelli 12ga .665 Knurled end	052-00663	15.93
Beretta Optima, Extrema, Benelli SBE2, M2 Super 2	052-00669	15.93
Browning Inv. Plus 12ga Blued 2 3/4" & 3" Guns -3" Long	052-00664	15.93
Remington & Charles Daly 20ga .572 ID Blued 3"	052-00665	15.93
Moss, Win, & Browning Invictor 20ga .572 ID 2 3/4" & 3"	052-00666	15.93
Beretta, Benelli, Franchi, Gazelle ONLY 20ga .572 ID Blued 3"	052-00667	15.93

Undertaker Hevi-Shot Turkey Choke Tubes

	Order No.	Price
Remington and Charles Daly 20ga	052-00652	\$15.93
Win, Moss, Brng Inv, Ithaca, Charles Daly O/U, H&R 20ga	052-00653	15.93
Beretta, Benelli, Franchi, Traditions ALS 2100 20ga	052-00654	15.93
Rem.M1187, 1100, 870 12ga Knurled end	052-00655	15.93
Moss, 835, 12ga Knurled end	052-00656	15.93
Moss, Win, & Brng Inv 12ga 2 3/4 & 3" Knurled end	052-00657	15.93
Beretta/Benelli 12ga Knurled end	052-00658	15.93
Winchester Super X2, Supreme and Browning Inv Plus 12ga	052-00659	15.93
Beretta Optima, Extrema, Benelli SBE2, M2 Super 2	052-00649	15.93

Grovtec Push Button Swivels



Push Button Swivel Magazine Cap - Standard Shotgun Cap replaces factory cap, allows the use of our PB swivels, Twist Lock series or even the multi-Adaptor. Fits standard factory threads, unscrew the old cap and install the replacement. Black Oxide finish. Made in the USA.

	Order No.	Price
Rem 870 Exp. 12ga	114-GTSW296	\$19.19
Rem 870 12ga	114-GTSW297	\$19.19
Moss 590-835 12ga	114-GTSW298	\$19.19



Heavy Duty Push Button Swivel - All Stainless Steel material, including base, swivel and spring. 1 1/4" loop fits all standard 1 1/4" swivels. Black Oxide finish. Made in the USA.
Order No. 114-GTSW295 \$15.39



Grovtec Sling Swivels



GT™ Locking Swivels - Superior machining tolerances, all-steel construction, and premium finish define this swivel. Locking point and ergonomic steel sleeve enhance security and function. Fits any standard swivel stud.

	Order No.	Price
1" Loops - Black-Oxide Finish	114-GTSW01	\$6.67
1-1/4" Loops - Black-Oxide Finish	114-GTSW02	6.67
1" Loops - Satin Nickel Plated	114-GTSW03	8.02
1-1/4" Loops - Satin Nickel Plated	114-GTSW04	8.02



GT™ Mil-Force™ Swivels - Patent-pending design constructed from investment cast steel. Refined lines reduce overall weight while increasing strength. Meets or exceeds all military specifications. Industry-leading strength is suitable for the hardest working firearms. Fits any standard swivel stud. 1-1/4" Loops - Phosphate Finish. **Order No. 114-GTSW05 \$13.31**



GT™ Push Button Swivel Set - GT Push Button Swivels provide a flush mounting system without protruding swivel studs. Fore end and buttstock swivel bases are countersunk into stock, and glued into place. Easily installed and fast operating for users who remove slings often. 1" Loops - Black-Oxide Finish. **Order No. 114-GTSW06 \$12.68**



GT™ Swivel Sets For Bolt Action Rifles

Machine Screw Fore End - Set includes 7/8" machine screw fore end swivel stud with nut, 3/4" rear wood screw stud, spacers and pair of GT Locking Swivels.

	Order No.	Price
1" Loops - Black-Oxide Finish	114-GTSW07	\$7.30
1-1/4" Loops - Black-Oxide Finish	114-GTSW08	7.30
1" Loops - Satin Nickel Plated	114-GTSW09	8.66



Wood Screw Fore End - Set includes 1/2" wood screw fore end swivel stud, 3/4" rear wood screw stud, spacers and pair of GT Locking Swivels.

	Order No.	Price
1" Loops - Black-Oxide Finish	114-GTSW23	\$7.30
1" Loops - Satin Nickel Plated	114-GTSW14	8.66



Ruger All-Weather Stock - Set replaces non-detachable factory loop and includes Chicago screws to fill holes from factory-installed swivels. Contains 3/8" machine screw stud with nut and washer, 1/4" rear machine screw stud, Chicago screws and one pair GT Locking Swivels. Fits Models 77 and 77/22 All-Weather Stocks. 1" Loops - Satin Nickel Finish.
Order No. 114-GTSW10 \$9.32



GT™ Swivel Sets For Remingtons

760 and 7600 (1968 and later) - Custom adaptor bolt swivel base and spacers replace factory bolt to provide an exact fit. Set includes adaptor bolt, 3/4" rear wood screw stud, spacers and one pair GT Locking Swivels. 1" Loops - Black-Oxide Finish.
Order No. 114-GTSW18 \$11.32

7400 & Four Autoloaders - Set includes custom adaptor bolt swivel base with spacers for exact fit, 3/4" rear wood screw stud with spacer and one pair GT Locking Swivels. 1" Loops - Black-Oxide Finish. **Order No. 114-GTSW16 \$10.68**

742 ADL - Adaptor bolt swivel base and spacers provide exact fit on 742 ADL and Standard models. Does not fit BDL. Includes adapter bolt, 3/4" rear wood screw stud, spacers, and one pair GT Locking Swivels. 1" Loops - Black-Oxide Finish.
Order No. 114-GTSW17 \$11.32

760 and 7600 (1969 to present) - Barrel band set fits Remington 760's, 7600 and Six Pump Actions, 740, 742, and other .22 caliber and centerfire rifles with .645"-.660" diameter barrels. Set includes barrel band, 3/4" rear wood screw stud, spacer and one pair GT Locking Swivels. 1" Loops - Black-Oxide Finish. **Order No. 114-GTSW45 \$10.68**



GT™ Non Detachable Swivels

Centerfire Lever Actions - Classically styled for Winchester 94, Marlin 36, Marlin 336 and others, this set features a one-piece band for tube magazines .640-.660" diameter. Includes 3/4" non-detachable rear wood screw stud. 1" Loops - Black-Oxide Finish. **Order No. 114-GTSW24 \$8.66**



GT™ Swivels Sets For Lever Action, Tube Magazine Rifles and Carbines.



.630"-.675" Diameter Tubes - Two-piece band fits magazine tubes .630"-.675" diameter, band barrels of certain Browning and Ruger models and .410 shotguns. Set also includes 3/4" rear wood screw stud, Allen wrench and one pair GT Locking Swivels.

	Order No.	Price
1" Loops - Black-Oxide Finish	114-GTSW43	\$10.00
1-1/4" Loops - Black-Oxide Finish	114-GTSW44	10.00

.645"-.660" Full Band - One-piece band fits tube diameters of .645"-.660" for Winchester and Marlin centerfire lever actions. Set also includes 3/4" rear wood screw stud and one pair GT Locking Swivels. 1" Loops - Black-Oxide Finish. **Order No. 114-GTSW41 \$10.68**

Fore End Band Mount - Custom machine screw fore end base allows for mounting on Mossberg 500 shotguns and tube magazine lever action rifles, carbines with fore end band. Some gunsmithing required. Set also includes 3/4" rear wood screw stud, spacer and one pair GT Locking Swivels. 1" Loops - Black-Oxide Finish. **Order No. 114-GTSW31 \$8.02**

GT™ Custom Designs For Hard to Fit Firearms



T/C Contenders - Selection of machine screw swivel studs and spacers easily replace fore end and grip bolts on all factory and non-factory fore ends and grips. Set includes one pair GT Locking Swivels. 1" Loops - Black-Oxide Finish. **Order No. 114-GTSW22 \$18.71**

Winchester 70A - Fore end swivel stud and metal spacer replace factory-installed non-detachable swivel. Includes 3/4" rear wood screw stud, spacers and one pair GT Locking Swivels. 1" Loops - Black-Oxide Finish. **Order No. 114-GTSW25 \$8.02**

Ithaca M37, M87 and DeerSlayer - Custom fore end swivel base screws into barrel lug on Ithaca 37's, Ithacagun 87's, Deerslayer, DSPS and M&P models with regular and extended magazines. Other 37's require drill and tap. Also includes 3/4" rear wood screw stud and one pair GT Locking Swivels. 1" Loops - Black-Oxide Finish. **Order No. 114-GTSW26 \$9.32**

Ruger Carbines, Auto & Single Shot - Packaged with both fore end adaptor to fit 10/22, .44 Mag. and No. 3 carbines and 1/2" wood screw suitable for fore end stock mounting. Also includes 3/4" rear wood screw stud and one pair GT Locking Swivels.

	Order No.	Price
1" Loops - Black-Oxide Finish	114-GTSW27	\$10.00
1" Loops - Satin Nickel Finish	114-GTSW28	11.32

Browning BLR - Included fore end replacement spacer provides simplified mounting. Set also contains 3/4" rear wood screw stud and one pair GT Locking Swivels. Does not fit BLR Lightning. 1" Loops - Black-Oxide Finish. **Order No. 114-GTSW29 \$9.32**

Savage 99 - Fore end stud and spacer replaces stock screw exactly. No modifications required. Also includes 3/4" rear wood screw stud, spacer and one pair GT Locking Swivels. 1" Loops - Black Oxide Finish. **Order No. 114-GTSW32 \$8.02**

Ruger Mini-14 - Fits pre- and post-1978 Mini 14's with provisions to accommodate factory and non-factory stocks. Requires modifications to gas block on current models. Set includes one pair GT Locking Swivels. 1" Loops - Black-Oxide Finish. **Order No. 114-GTSW13 \$8.66**



GrovTec Sling Swivels



GT™ Swivel Sets For Bolt Action Rifles

.420"-.470" Diameter Tubes - Two-piece band attaches to tube magazines of .420"-.470" diameter without dismantling gun. Set also includes 3/4" rear wood screw stud with spacer, Allen wrench and one pair GT Locking Swivels. 1" Loops - Black-Oxide Finish. **Order No. 114-GTSW40 \$9.32**

.430"-.445" Full Band - Once piece band fits most .22's with tube diameters of .430"-.445". Does not fit Winchester 94/22M. U.S. Set also includes 3/4" rear wood screw stud with spacer, Allen wrench and one pair GT Locking Swivels. 1" Loops - Black-Oxide Finish. **Order No. 114-GTSW42 \$10.68**

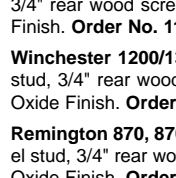
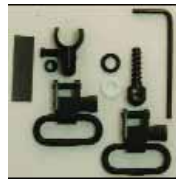

Swivels For Shotguns (Mag Cap Swivels)



Remington 870 Express, 12 Gauge - Set includes mag cap replacement with swivel stud, 3/4" rear wood screw stud and one pair GT Locking Swivels. Does not fit 3-1/2" mags. 1" Loops - Black-Oxide Finish. **Order No. 114-GTSW34 \$22.04**

Mossberg 590/835, 12 Gauge - Set includes mace cap replacement with swivel stud, 3/4" rear wood screw stud and one pair GT Locking Swivels. 1" Loops - Black-Oxide Finish. **Order No. 114-GTSW38 \$22.04**



Remington 11-87, 12 Gauge - Set includes mag cap replacement with swivel stud, 3/4" rear wood screw stud and one pair GT Locking Swivels. 1" Loops - Black-Oxide Finish. **Order No. 114-GTSW36 \$22.04**

Winchester 1200/1300, 12 Gauge - Set includes mace cap replacement with swivel stud, 3/4" rear wood screw stud and one pair GT Locking Swivels. 1" Loops - Black-Oxide Finish. **Order No. 114-GTSW39 \$22.04**

Remington 870, 870 Youth, 12 Gauge - Set includes mag cap replacement with swivel stud, 3/4" rear wood screw stud and one pair GT Locking Swivels. 1" Loops - Black-Oxide Finish. **Order No. 114-GTSW35 \$22.04**

Swivels For Shotguns (Standard)

Side-By-Side Double Barrels - Drill and tap for mounting of custom swivel stud base between barrels. Also includes 3/4" rear wood screw stud and one pair GT Locking Swivels. 1" Loops - Black Oxide Finish. **Order No. 114-GTSW30 \$15.39**

Most Pump and Autos - Custom adapter fits most magazine caps and Beretta 390 specifically. Does not fit Browning 2000, Ithaca 37, Savage 30, Sears 21, Stevens pumps or Winchester 1400. Includes 3/4" rear wood screw stud and one pair GT Locking Swivels. 1" Loops - Black-Oxide Finish. **Order No. 114-GTSW19 \$10.68**

Most Pumps and Autos - Simple modification to magazine cap allows mounting on most pump and autos. Not for use on Ithaca 37, Savage 30, Sears 21 or 30, Stevens pumps, Winchester 1400 or any firearm with gas operated recoil. Set includes 3/4" rear wood screw stud and one pair GT Locking Swivels. 1" Loops - Black-Oxide Finish. **Order No. 114-GTSW33 \$9.32**



Mossberg 500, 12 Gauge - Set replaces factory magazine bolt with a bolt with swivel stud. Includes 3/4" rear wood screw stud and one pair GT Locking swivels. Spanner wrench included for assembly. 1" Loops - Black-Oxide Finish. **Order No. 114-GTSW37 \$22.04**

Uncle Mike's Sling Swivels



QD Swivels For Rimfire Rifles

Rimfire Rifle 1" QD Swivels - Full Band - Standard Full Band mounts on most .22 tube diameters .430-.445" rifles except Winchester 94/22M. U.S.
Order No. 060-13412 \$12.15

QD Swivels For Bolt Action Rifles



Bolt Action - Wood Screw Type Swivel - Wood Screw Type-installs without dismantling gun. 1/2" deepthreaded wood screw forend base.

	Order No.	Price
Blued 1"	060-13112	\$8.24
Blued 1 1/4"	060-13113	8.24

QD Swivels For Lever Action, Tube Magazine Rifles and Carbines



Magnum Band- Mounts on magazine tubes
 .630 to .675" dia& some Rugers
 .420 to .470" fits .22 Magazine tube

	Order No.	Price
.630 to .675" dia& some Rugers	060-13912	\$11.29
.420 to .470" fits .22 Magazine tube	060-10712	10.55

Marlin .357 Magnum 1894C Carbine- Special Magnum split band swivels to install on magazine tube without dismantling gun. Fits tube diameters .540 to .590".
Order No. 060-10512 \$12.87



Lever Action Full Band - Full magazine tube band for Winchester and Marlin centerfire lever actions.
Order No. 060-13312 \$11.29

Lever Action Fore End Band Style- Special machine screw base for mounting in tube magazine lever action rifles, carbines, with forend band; also Mossberg 500 shot-guns. Gun alterations required!
Order No. 060-15312 \$9.03



New!

MONTANA X-TREME

Kit Includes: Four-Piece Rod - Constructed of heat-treated 17-4 stainless steel with centerless ground shaft that will not pick up grit and dirt. Hardened steel pre-loaded bearing system eliminates galling and wear. Solid aluminum, comfort-fit anodized handle.

Cleaning tools - stainless steel pick and scraper for tough carbon deposits, two double-ended brushes (brass and stiff nylon), and pipets

Montana X-Treme Bore Solvent (2 oz)
 Montana X-Treme Gun Oil (2 oz)
 Jag and brush

Highest quality 100% cotton flannel patches

Also includes hard sided molded case.

	Order No.	Price
22 - 264 Caliber	165-9107	\$62.64
30 - 50 Caliber	165-9109	62.64

QD Swivels For Special Rifles

Auto, Single Shot Ruger Carbines- Forend adapter fits barrel band of 10/22, .44 Mag. and No. 3 carbines, 1/2" wood screw allows forend stock mounting.



	Order No.	Price
Blued	060-14612	\$11.29
Nickel	060-14622	12.81



Browning BLR- Replaces factory forend spacer without altering or dismantling gun. **Order No. 060-14812 \$10.55**

Military Spec Swivels

Super heavy duty, Made to military specifications. Dependable under the most demanding conditions. Set of two 1 1/4" swivels.
Order No. 060-14023 \$15.07



QD Super Swivel with Tri-Lock- Set of 2 with Swivel-lock feature. For rifles with factory-installed studs or to interchange with other QD swivels. No studs provided. 1" and 1 1/4" sizes as noted below.

	Order No.	Price
1" Blued	060-14032	\$7.57
1 1/4" Blued	060-14033	7.57
1" Nickel	060-10932	9.03
1 1/4" Nickel	060-10933	9.03



QD Swivels For Shotguns

Flush-Mount QD Swivels for Most Pumps and Autos-

Flush-mount swivel system. Read QD base screws into inletted receptacle in the stock. Standard wood screw rear base also provided. Front base has special adapter to fit magazine cap. DOES NOT FIT: Browning 2000, Winchester 1400, Ithaca 37, Savage 30, Sears 21 or Stevens pumps. **Order No. 060-12312 \$12.15**



QD Swivels for Singles and Over/Unders- Magnum Band Swivels: QD115SG2 Fits most 12 Gauge (.800-.850" diameter). QD115SG3 Fits all 16 Gauge, some others (.750-.800" diameter). QD115SG4 Fits most 20 Gauge (.700-.750" diameter). Magnum split barrel band base mounts easily without tools or dismantling your gun.

	Order No.	Price
QD115SG2	060-15932	\$15.07
QD115SG3	060-15952	15.07

QD Swivels for Most Pumps and Autos- Mounts on most pumps and autos except Browning 2000, Winchester 1400, Ithaca 37, Savage 30, Sears 21, 30, or Stevens Pumps.
Order No. 060-15612 \$10.55



QD Swivels For Remington Shotguns



For 760s and 7600s - 760BB Fits Remington 7600 and Six Pump Actions, 760's, 740, 742, other .22 and centerfires with .645 to .660" diameter barrels.
Order No. 060-14412 \$11.29

For Remington 760 (1968 and later) - 760ES Adapter bolt swivel base replaces factory forend bolt without dismantling.
Order No. 060-12212 \$12.81



For 742 ADLs - 742ES Adapter bolt swivel base replaces factory forend bolt on standard or ADL models only. Will not fit 742 BDL.
Order No. 060-11812 \$12.81

For 7400 and Four Autoloaders - 7400 Four Special forend adapter bolt swivel base. Wood screw base for stock. **Order No. 060-11712 \$12.15**



Shotgun Magazine Cap Swivels



Remington 870 Express- Replacement magazine cap with swivel base, 3/4" wood screw butt-stock swivel base and two Super Swivels. Not for 3 1/2" mags.

	Order No.	Price
12 gauge	060-18002	\$14.16



Remington 870- Replacement magazine cap with swivel base, 3/4" wood screw butt-stock swivel base and two Super Swivels.

	Order No.	Price
12 gauge	060-18012	\$14.16
20 gauge	060-18015	14.16



Remington 11-87- Includes replacement magazine cap with swivel base, 3/4" wood screw butt-stock swivel base and two Super Swivels

	Order No.	Price
12 gauge	060-18032	\$14.16



Mossberg 500/590- Includes replacement magazine cap with swivel base, 3/4" wood screw butt-stock swivel base and two Super Swivels.

	Order No.	Price
12 gauge	060-18102	\$14.16



Mossberg 835- Includes replacement magazine cap with swivel base, 3/4" wood screw butt-stock swivel base and two Super Swivels. For 12 gauge.

Order No. 060-18112 \$14.16



Winchester 1200/1300- Includes replacement magazine cap with swivel base, 3/4" wood screw butt-stock swivel base and two Super Swivels. For 12 gauge.

Order No. 060-18202 \$14.16



Browning BPS/A5- Includes replacement magazine cap swivel base, 3/4" wood screw buttstock swivel base and two Super Swivels.

	Order No.	Price
12 gauge	060-18302	\$14.16

Miscellaneous Swivels



Hogue Poly Swivel Sling Swivels - Hogue Poly Swivel (tm) sling swivels are manufactured from a high strength polymer for maximum strength and durability. Will not rust and are super quiet. Quick release stud easily attaches to standard swivel studs. Poly swivels are sold in sets of 2.

	Order No.	Price
1"	138-00050	\$5.51
1 1/4"	138-00051	5.51



Hush Stalker II™ Sling Swivels - The same no squeak, no rattle features of the original Hush Stalker™ with the added convenience of a Quick Release stud. Simply unscrew with your fingers and remove the swivel/sling unit. No tools required.



Quake Hushstalker 1" Swivels (2ea) Order No. 215-234012 Price \$5.47
Hushstalker 1.25" Swivels (2ea) Order No. 215-234111 Price 5.47



Pachmayr Flush Mount Sling Swivels - Offers a unique, clean design that has been copied, but never equaled. Mounts are threaded into the stock for the greatest strength and security. Must be installed by a qualified gunsmith. Order No. 010-03291 \$17.52

Sling Swivel Accessories



Pachmayr Flush Mount Installation Kit - In order to properly install Pachmayr's Flush Mount Sling Swivel Set, an installation kit should be used. The installation kit provides the necessary drilling fixture to accurately and cleanly drill stocks for the flush mount sling swivels. The installation kit includes a universal mounting base that is equipped with a hardened steel drill guide, a specially ground two-step drill with pre-set stop collar, padded stock clamps, and swivel installation tools. With this installation kit, swivels are installed with a professional appearance. The perfect finishing touch for the serious rifleman. Works on both wooden & synthetic stocks. Order No. 010-03285 \$95.55

Gunsmithing Swivel / Sling Screws



Wood screw base- Set of 1 each of 1/2" wood screw fore-end base and 3/4" rear wood screw base with white spacers.

Order No. 060-25200 \$2.32



Chicago Screws- Pack of 24 solid brass Chicago screws for use on slings and carry straps.

	Order No.	Price
Brass Finish	060-25090	\$16.60

Step Drills for Swivel Mounting



StepSpecial blade cuts cleanly without drawing down or splintering wood. Step shoulder counter-sinks to correct depth in one operation. One drill for forend, one for rear.

Order No. 060-25520 \$25.95

GrovTec Gunsmithing Swivel / Sling Screws

Small parts Pack - One 1/2" wood screw swivel stud. One 3/4" wood screw swivel stud. Spacers. Order No. 114-GTHM50 \$1.89

Bulk Packs of Screws and Spacers

	Order No.	Price
24 - Brass Chicago Screws	114-GTHM61	\$16.24
24 - Black Chicago Screws	114-GTHM62	16.91
12 - White Spacers	114-GTHM63	2.49
48 - White Spacers	114-GTHM64	3.76
12 - Black Spacers	114-GTHM65	2.49
48 - Black Spacers	114-GTHM66	3.76

Uncle Mike's Slings



Nylon Shotgun Sling - Slips over the barrel and tightens above the forend. The other end, with a larger loop, slips over the stock and tightens at the pistol grip. When you are ready to shoot, just remove and stuff in your pocket. Fits all shotguns.

	Order No.	Price
Black	060-26781	\$15.94



Padded Rifle Cartridge Sling - Padded cordura nylon sling provides comfort and durability. A new feature lets you carry extra ammunition/shotshells (6 rifle, 9 shotshell) in the cartridge loops. 1" wide strap measures 48" long. Order No. 060-26972 \$17.58



Tactical Sling - 1 1/4" nylon web tactical sling with sewn-on 1 1/4" swivels. Open snap converts sling from carrying mode to shooting mode. Length adjustable with snap open or closed. Ideal for tactical team rifles or shotguns. Converts to a hasty sling for shooting. Order No. 060-26993 \$21.10



Quake Industries

The Claw® Original Rifle Sling - This utilizes the latest in "soft touch" materials. The durable, non-slip polymer pad is molded directly onto the sling webbing and will allow approximately 1/2" of stretch. As an added value, The Claw® Rifle Sling comes with Hush Stalker II™ Sling Swivels which will not squeak, rust or rattle, and are 2 1/2 times stronger and lighter than conventional metal swivels. These swivels fit all standard studs and will not dent or mar the finish on your stock.

	Order No.	Price
A. Black	215-500001	\$17.83
B. Camo	215-500018	17.83
C. O.D. Green	215-500025	17.83
D. Brown	215-500063	17.83
E. Sand Camo	215-500100	17.83
F. Break-Up	215-500124	29.70
G. Hardwoods HD	215-500155	29.70

The Claw® Shotgun Sling - Designed to slip over the barrel and butt of any single or double-barrelled shotgun, cinching tight for a safe and comfortable fit. It is fully adjustable for length and the barrel strap is lined with a soft suede pad for barrel protection.

	Order No.	Price
H. Black	215-500032	\$15.89
I. Camo	215-500049	15.89
J. Brown	215-500087	15.89

The Claw® Sling Stix - Why carry a heavy set of shooting sticks around the whole hunt just for that few seconds of glory? SlingStix™ are so light you'll never know they're there until you need them. All packed inside the padded pouch on your sling.

	Order No.	Price
K. Camo	215-550013	\$36.67
L. Black	215-550006	36.67

Ultra Sling - Premium padded nylon slings for hunters and shooters who want comfort and quality. All models have a durable Cordura nylon shoulder pad with cross-stitching for extra strength.



	Order No.	Price
Ultra Black with out swivels	060-26762	\$14.36
Ultra Mossy Oak with Sewn-in swivels	060-26724	19.16
Ultra Black with Sewn-in swivels	060-26764	19.16

Utility Nylon Slings - Nylon web slings 1" and 1 1/4" can take whatever punishment your hunting trip can dish out. Unaffected by mildew or rot.

	Order No.	Price
1" x 48" Black	060-26702	\$7.97
1 1/4" x 48" Black	060-26703	8.73
1" x 72" Black	060-26712	8.73

Mountain Sling - Mountain style 1-1/4" sling with sewn-on swivels to fit guns with QD studs. Wide enough for comfort. Black. Order No. 060-26923 \$18.33



The Claw Contour Rifle Sling - The same durable non-slip, weather resistant sling as the standard Claw, but with a tapered design to fit the shoulder closely.

	Order No.	Price
M. Black	215-530008	\$17.83
N. Camo	215-530015	17.83
O. Brown	215-530060	17.83

The Claw® 3-Point Sling System - Offers hunters the extra stability of a third point. The sling is fully adjustable for a secure fit. With multiple hands-free carrying positions, hunters can rest assured this comfortable sling can be quickly drawn into a 3-Point shooting position. Includes 2 Hush Stalker Sling Swivels!

	Order No.	Price
P. Black	215-520009	\$23.59
Q. O.D. Green	215-520023	23.59

The Claw® Jungle Sling - Lets you maneuver quickly into the shooting position from several hands free carrying-positions. Fights the fatigue of long carry, while keeping your rifle at the ready. Includes 2 Hush Stalker Sling Swivels!

	Order No.	Price
R. O.D. Green	215-510024	\$25.24
S. Black	215-510000	25.24

The Claw® Crossbow Sling - The ONLY sling specifically designed for crossbows. This sling holds the top-heavy crossbow close to your side has a quick-disconnect gator clip that attaches to your clothing for hands-free transporting. Release the gator clip and your ready! Includes 2 Hush Stalker Sling Swivels!

	Order No.	Price
T. O.D. Green	215-601029	\$27.97

Uncle Mikes Slings



Cobra Slings - Suede and Leather Cobra Slings are made of the highest quality leather. Beautiful precise stitching. Wide shoulder pad for carrying comfort, and it clings to your shoulder like glue.

	Order No.	Price
Padded Suede	060-26522	\$26.30
Basketweave Cobra	060-26412	20.75



Leather Military Slings - For shooting accuracy in either prone or kneeling position, the military leather sling locks your rifle tightly against your arm and body. 2 pc traditional construction with brass plated "D" ring & hooks.

	Order No.	Price
1" Plain	060-26112	\$19.16
1 1/4" Plain	060-26113	19.92

Bulldog Slings

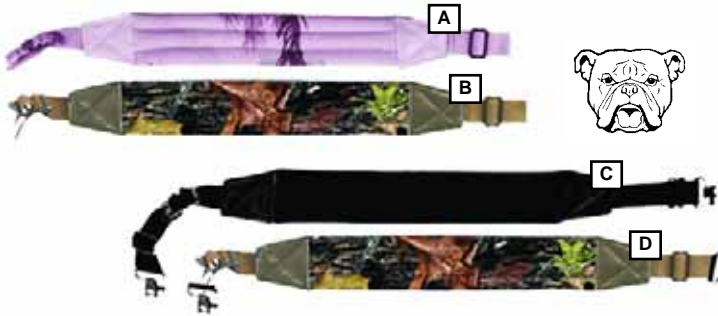

A - Pink 1" deluxe padded rifle sling with 48" long.
Order No. 208-BD815PC \$6.48

B - Camo 1" deluxe padded rifle sling with 48" long.
Order No. 208-BD815 \$6.48

C - Black 1" Deluxe padded rifle sling with swivels 48" long.
Order No. 208-BD810S \$14.41

D - APHD Camo 1" Deluxe padded rifle sling with swivels 48" long.
Order No. 208-BD815S \$14.41

Butler Creek Slings

Butler Creek Comfort Stretch - A patented shock absorption action for greater comfort as well as snug, solid hold when shooting off-hand. The Non Slip Grippers holds the gun comfortably in place on shoulder carry.

	Order No.	Price
Black Rifle	060-80013	\$16.32
Black Shotgun	060-80023	17.84

Butler Creek Slings with Sewn-in Swivels - Now available with the new Uncle Mike's Swivels with Tri-Lock already installed. These new patent pending swivels are a perfect compliment to Butler Creek Slings and your favorite firearm.



	Order No.	Price
Black Rifle Sling with Swivels	060-81013	\$20.88
Mossy Oak Rifle Sling with Swivels	060-81017	20.88

Padded "Easy Rider" Sling - Offers quality, thick neoprene to absorb the weight of your rifle. The SharkSkin rubberized backing grips your shoulder and keeps the sling in place. The polypro webbing works with Uncle Mike's QD 1" swivels and is adjustable to 48" length.



	Order No.	Price
Black Easy Rider Rifle Sling	060-80073	\$9.83
Advantage Camo Easy Rider Rifle Sling	060-80078	9.83

Quick Carry™ Slings - React like lightning to unexpected shot opportunities with the Quick Carry Sling. It quickly converts from a carry position to a shooting sling, and even permits one-handed adjustment. Black.



Order No. 060-80091 \$18.55

Chip McCormick Mags

CMC 45 ACP POWER MAG™

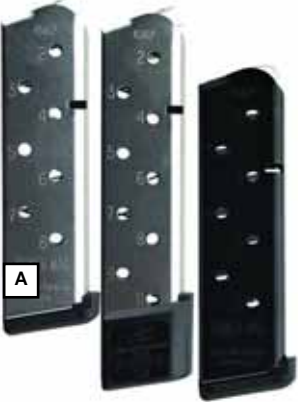

CMC POWER MAG+™

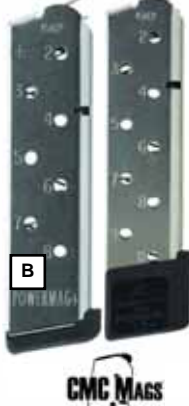

MATCH GRADE™



Shooting Star™ "Classic" Mil-Spec Mags -



M1911 10mm & .38 Super Mags -



A - CMC 45 ACP POWER MAG™ - CMC'S Extra Heavy Duty Stainless Steel 10 round Magazine - the POWER MAG™ 10 magazine is consistent with the POWER MAG™ Series concept, the POWER MAG™ 10 magazines are designed to significantly increase reliability and service life, even when kept fully loaded and seated in a pistol for extended periods.

	Order No.	Price
8rd SS	166-14131	\$24.75
10rd SS	166-15150	27.32
8rd Black	166-16131	20.48
Compact 8rd SS	166-14132	25.61
Compact 8rd Black	166-16132	21.33

B - CMC POWER MAG+™ - Lean and sleek! CMC's unique follower design doesn't require an extra long magazine with protruding dimensions like other brands. POWER+ stainless steel follower allows space for larger spring coils and more coils in any given length. Stainless Steel

	Order No.	Price
8rd .45acp	166-12131	\$28.17
10rd .45acp	166-12150	30.74

C - MATCH GRADE™ - Stainless steel magazines are flush fitting for best concealability and least hindrance with clothing. 100% designed by CMC and built in the USA, to the same exacting tolerances, with the same heavy duty construction and materials as Power Mags™.

	Order No.	Price
8rd .45acp SS	166-14110	\$22.19
8rd .45acp SS/Pad	166-14111	23.90
7rd .45acp SS	166-14120	22.19
7rd .45acp SS/Pad	166-14121	23.90

D - CMC 1911 Shooting Star™ "Classic" Mil-Spec 8 round 45ACP Mags - 50% tighter tolerances than other military specification magazines. Same length as stock magazines with extra capacity and improved performance. This is the same design CMC supplies to America's top 1911 manufacturers for use as factory standard in their pistols. Since 1992, this line of .45 ACP magazines has never suffered from the common problem of cracked feed lips.

	Order No.	Price
Carbon Blue Mag	166-14310	\$16.76
Carbon Blue Mag with Pad	166-14311	18.44
Stainless Steel Mag	166-14142	19.28
Stainless Steel Mag with Pad	166-14141	20.96

E - M1911 10mm & .38 Super Mags - These flush fitting mags offer the advantage of one extra round of capacity. Stainless Steel.

	Order No.	Price
10mm 9rd	166-11110	\$33.18
10mm 9rd w/pad	166-11111	34.47
.38 Super 10rd	166-13110	31.46
.38 Super 10rd w/pad	166-13111	32.36

Power+ Follower & Spring Conversions Kits for 1911 Mags - Convert full size standard capacity mags from 7rds to 8rd capacity - or - Convert compact sized capacity 1911 mags from 6rds to 7rd capacity.
\$12.75 per kit

	Order No.
7rd & 8rd Fixed	166-15055A
10rd Power Mags	166-15055B
8rd Power Mag	166-15055C



Mec-Gar Magazine



	Order No.	Price
Browning HP Blue 9mm 10RD	099-MGBRHP10B	\$20.66
Browning HP Nickel 9mm 10RD	099-MGBRHP10N	22.48
Browning HP Blued 9mm 15RD	099-MGBRHP15B	22.48
Browning HP Nickel 9mm 15RD	099-MGBRHP15N	24.29
Browning 40SW Blue 10RD	099-MGBR4010B	20.66
Browning 40SW Nickel 10RD	099-MGBR4010N	22.48
CZ 75 Compact Blued 9mm 14RD	099-MGCZ7514B	\$20.66
CZ 75 Blued 9mm 16RD	099-MGCZ7516B	20.66
CZ 75 Anti Friction Coating 9mm 17RD	099-MGCZ7517AFC	25.45
CZ 75 Anti Friction Coating 9mm 19RD	099-MGCZ7519AFC	30.89
CZ 75B Anti Friction Coating 40S&W 12RD	099-MGCZ4012AFC	25.45
CZ 75B Anti Friction Coating 40S&W 14RD	099-MGCZ4014AFC	30.89

Colt 1911 Blue 45 acp 10RD	099-MGCG4510B	\$20.53
Colt 1911 Nickel 45 acp 10RD	099-MGCG4510N	22.29
Colt 1911 Blue 45 acp 11RD	099-MGCG4511B	21.27
Colt 1911 Nickel 45 acp 11RD	099-MGCG4511N	23.14
Colt Off Blue 45 acp 6RD	099-MGCO4506B	15.81
Colt Off Nickel 45 acp 6RD	099-MGCO4506N	17.60
Colt Gov. Blue 45 acp 7RD	099-MGCG4507B	15.81
Colt Gov. Nickel 45 acp 7RD	099-MGCG4507N	17.60
Colt Gov. Blue 45 acp 8RD Plastic Floor Plate	099-MGCG4508PFB	17.60

Ruger MK11 Blue 22 LR 10RD	099-MGMK22LRB	\$15.52
Ruger 85/89 Blue 9mm 10RD	099-MGRP8510B	20.66
Ruger 85/89 Nickel 9mm 10RD	099-MGRP8510N	22.48
Ruger 85/89 Blue 9mm 17RD	099-MGRP8517B	22.48
Ruger 85/89 Nickel 9mm 17RD	099-MGRP8517N	24.29

Beretta 92FS Blue 9mm 10RD	099-MGPB9210B	\$20.66
Beretta 92FS Nickel 9mm 10RD	099-MGPB9210N	22.48
Beretta 92FS Anti Friction Coating 9mm 18RD	099-MGPB9218AFC	25.45
Beretta 92FS Anti Friction Coating 9mm 20RD	099-MGPB9220AFC	30.89
Beretta 96FS Blue 40 S&W 10RD	099-MGPB9610B	20.66
Beretta 96FS Nickel 40 S&W 10RD	099-MGPB9610N	22.48
Beretta 96FS Anti Friction Coating 40 S&W 13RD	099-MGPB9613AFC	25.45

Taurus 92/99 Blue 9mm 10RD	099-MGPT9210B	\$20.66
SW59/915 Nickel 9mm 10RD	099-MGSW5910N	\$22.48
SW59/915 Blue 9mm 10RD	099-MGSW5910B	20.66
SW59/915 Nickel 9mm 17RD	099-MGSW5917N	24.29
SW59/915 Blue 9mm 17RD	099-MGSW5917B	22.48

Sig P226 9mm Blued 10RD	099-MGP22610B	\$20.66
Sig P226 9mm Nickel 10RD	099-MGP22610N	22.48
Sig P226 9mm Anti Friction Coating 18RD	099-MGP22618AFC	25.45

Star Firestar40 SW 10 Round	099-MGFS4010B	\$20.66
Kimber Ten II Anti Friction Coating 45ACP 10RD	099-MGK4510AFC	\$23.64
Kimber Ten II Anti Friction Coating 45ACP 14RD	099-MGK4514AFC	23.64

You May Not Know This! Mec-Gar makes a majority of the magazines that come with your handgun from the manufacturer! Mec-Gar has been an Original Equipment Manufacturer of magazines to most of the prominent firearm manufacturers for the last 40 years. The following are a few of the firearm manufacturers to whom Mec-Gar has supplied magazines to throughout their history:

AMT Armscor Astra Beretta Bernadelli FN Browning BUL Charles Daly
 Colt CZ IMI Kel-Tec Kimber Llama North American Arms Remington
 Sigarms Smith & Wesson Springfield Armory STI Standard Arms Star
 Steyr Tanfoglio Taurus Walther

CZ Magazines



CZ Handgun Magazines



	Order No.	Price
CZ 75/ 85 cal. 9 mm Luger, 16-round	226-11101	\$43.41
CZ 75/ 85 cal. 9 mm Luger, 10-round	226-11102	37.98
CZ 75 cal. 40 S&W, 10-round	226-11103	39.34
CZ 75 Compact cal. 9 mm Luger, 10-round	226-11104	37.98
CZ 75 Compact cal. 9mm Luger - 14- round	226-11107	43.41
CZ 75 Compact cal. 40 S&W - 10 -round	226-11108	39.34
CZ 75/85 cal. 9mm Luger, 25-round	226-11109	66.47
CZ 75/85 cal. 40S&W, 16-round	226-11110	66.47
CZ 75/85 cal. 40S&W, 12-round	226-11111	44.77
CZ 75 SP-01 cal. 9mm Luger, 18-round	226-11152	50.19
CZ 75 TS cal. 40 S&W, 17-round	226-11171	50.19
CZ 75 TS cal. 9mm Luger, 20-round	226-11172	50.19
CZ 83 cal. 9 mm Browning, 10-round (cal.380 AUTO)	226-11301	37.98
CZ 83 cal. 9 mm Browning, 12-round (cal.380 AUTO)	226-11302	43.41
CZ 83 cal. 7.65 mm, 12-round (cal. 32 ACP)	226-11303	43.41
CZ 100 cal. 9 mm Luger, 10-round	226-11501	37.98
CZ 97 B cal. 45 ACP, 10-round	226-11401	39.34
CZ 75 KADET cal. 22 LR, 10-round	226-11601	40.70
CZ 2075 RAMI cal. 9mm Luger, 10-round	226-11750	37.98
CZ 2075 RAMI cal. 40S&W, 8-round	226-11751	37.98
CZ 2075 RAMI cal. 9mm Luger, 14-round - grip extension	226-11752	43.41



CZ Rimfire Magazines

	Order No.	Price
CZ 452 cal. 22 LR, 5-round	226-12001	\$32.56
CZ 452 cal. 22 LR, 5-round, polymer	226-12003	27.13
CZ 452 cal. 22 LR, 10-round, polymer	226-12004	28.49
CZ 452 cal. 22 LR, single shot adapter	226-12005	17.64
CZ 452 cal. 22 WMR, 5-round	226-12006	35.27
CZ 452 cal. 17 HMR 5-round	226-12008	\$35.27
CZ 452 cal. 17 HM2 5-round, polymer	226-12009	27.13



CZ Rifle Magazines

	Order No.	Price
CZ 527 cal. 22 Hornet, 5-round	226-13001	\$39.34
CZ 527 cal. 222 Remington, 5-round	226-13002	39.34
CZ 527 cal. 223 Remington, 5-round	226-13003	39.34
CZ 527 cal. 7.62 x 39 Russian, 5-round	226-13004	39.34
CZ 527 cal. 221 Fireball, 5-round	226-13005	39.34
CZ 527 cal.17 Rem, 5 - round	226-13006	39.34
CZ 527 cal.204 Ruger, 5 - round	226-13007	39.34
CZ 550 cal. 243 Win., 4-round	226-14001	58.33
CZ 550 cal. 308 Win., 4-round	226-14002	58.33
CZ 550 cal. 22-250, 4-round	226-14003	58.33
CZ 550 cal. 300 WMag, 3-round	226-14005	80.04
CZ 750 Sniper cal. 308 Win, 10-round	226-15001	120.74

Pro Mag Industries Replacement Magazines

Pro Mag Replacement Handgun Magazines - Replacement Mags For Handguns.

Brand	Model	Caliber	Capacity	Finish / Material	Order No.	Price
Beretta	92F	9mm	15 Rd	Blued	221-BERA1	\$19.89
Beretta	92F	9mm	32 Rd	Blued	221-BERA4	25.90
Beretta	950BS Jetfire	25 ACP	8 Rd	Blued	221-BER03	19.89
Beretta	21A Bobcat	22 LR	7 Rd	Blued	221-BER04	19.89
Beretta	21A Bobcat	25 ACP	8 Rd	Blued	221-BER05	19.89
Beretta	3032 Tomcat	32 ACP	7 Rd	Blued	221-BER10	19.89
Beretta	84	380 Cal	13 Rd	Blued	221-BERA2	21.74
Bersa	Thunder 380	380 ACP	7 Rd	Blued	221-BRA01	19.89
Browning	Hi-Power	9mm	32 Rd	Blued	221-BROA6	25.90
CZ	75/Z-75/Baby Eagle	9mm	15 Rd	Blued	221-CZA1	19.89
Colt	1911 & Govt	45 ACP	8 Rd	Blued	221-COL03	19.89
Colt	1911 & Govt	45 ACP	10 Rd	Blued	221-COL04	21.74
H&K	USP Full Size	45 ACP	12 Rd	Blued	221-HECA1	30.99
H&K	USP Full Size	45 ACP	20 Rd	Blued	221-HECA2	39.31
Mag Research	Desert Eagle	44 Mag	8 Rd	Blued	221-MAG04	26.83
Kel-Tec	P-32	32 ACP	7 Rd	Blued	221-KEL03	16.65
Para-Ordinance	P-14	45 ACP	14 Rd	Blued	221-PARA1	21.74
Para-Ordinance	Warthog/P12, 13, 14	45 ACP	20 Rd	Blued	221-PARA3	39.31
Sig Sauer	P226	9mm	15 Rd	Blued	221-SIGA1	21.74
Sig Sauer	P226	9mm	32 Rd	Blued	221-SIGA6	25.90
Sig Sauer	P228	9mm	13 Rd	Blued	221-SIGA3	21.74
Sig Sauer	P229	40S&W 357Sig	12 Rd	Blued	221-SIGA2	25.90
Sig Sauer	P230	380 ACP	7 Rd	Blued	221-SIG06	21.74
Sig Sauer	P220	45 ACP	8 Rd	Blued	221-SIG08	21.74
Sig Sauer	P220	45 ACP	10 Rd	Blued	221-SIG09	21.74
Springfield	XD-9	9mm	32 Rd	Blued	221-SPRA3	25.90
Springfield	XD-40	40 S&W	20 Rd	Blued	221-SPRA4	25.90
Ruger	P90 / P97	45 ACP	15 Rd	Blued	221-RUGA2	25.90
Ruger	P Series	9mm	15 Rd	Blued	221-RUGA5	21.74
Ruger	P Series	9mm	20 Rd	Blued	221-RUGA10	24.05
Taurus	PT-92 Compact	9mm	32 RD	Blued	221-TAU3	25.90
Walther / S&W	Walther P-38	9mm	8 Rd	Blued	221-WAL01	21.74
Walther / S&W	P-99 / SW99	40 S&W	20 Rd	Blued	221-WALA5	25.90



Beretta 92F 32rd Mag

M1A1 20rd Mag

Pro Mag Replacement Rifle Magazines - Replacement Mags For Rifles.

Brand	Model	Caliber	Capacity	Finish / Material	Order No.	Price
M1 Carbine	M1 Carbine	30 Carbine	15 Rd	Blued	221-CARA1	\$15.73
M1 Carbine	M1 Carbine	30 Carbine	30 Rd	Blued	221-CARA2	19.89
Saiga	Saiga	7.62x39mm	30 Rd	Black Polymer	221-SAIA2	21.74
Saiga	Saiga	.223 Rem	30 Rd	Black Polymer	221-SAIA4	21.74
Springfield	M1A	.308	20 Rd	Blued	221-MIAA1	21.74
Ruger	Mini 14	.223 Rem	30 Rd	Black Polymer	221-RUGA4	13.88
Ruger	10-22, Charger	22 LR	25 Rd	Clear Polymer	221-RUGA6	16.19
Ruger	10-22, Charger	22 LR	32 Rd	Clear Polymer	221-RUGA9	16.65
Ruger	10-22	17 HMR	23 Rd	Smoke Polymer	221-RUGA15	19.89



SKS 30rd Mag

Ruger Mini-14 30rd Mag

Pro Mag Replacement AK Magazines - Black Polymer Replacement Mags For AK Rifles and variants (Not For Saiga Rifles).

	Order No.	Price
AK-47 7.62x39mm 30 Round	221-AKA1	\$12.49
AK-223 (WASR-3) .223 30 Round	221-AKA5	13.41
AK-5.45 (WASR-2) 5.45x30mm 30 Round	221-AKA6	12.49



SMG 32rd Mag



AR-15 Flush 5rd Mag

Pro Mag Replacement AR Magazines - Replacement Mags For AR Rifles and variants (Black Polymer or Blued Metal)

	Order No.	Price
AR-15 .223 Flush 5 Round Blued	221-COL21	\$21.74
AR-15 .223 Flush 10 Round Blued	221-COL22	21.74
AR-15 .223 20 Round Blued	221-COLA4	14.80
AR-15 .223 30 Round Blued	221-COLA1	14.80
AR-15 .223 20 Round Black Polymer	221-COLA9	12.49



AR-15 20rd Mag



AK-47 30rd Mag



ProMag AR-15 / M16 (5) Round .223 / 5.56 USGI Magazine Loader - The loader is slipped over any AR-15 / M16 .223 / 5.56 type magazine. Five cartridges are dropped in and loaded by depressing the plunger. The process is repeated until the magazine is loaded. Mil-Spec polymer.

Order No. 221-PM017 \$11.56

Thermold Magazines



Thermold Magazines are made of tough Zytel Nylon. They are non-corrosive, self-lubricating and will not jam under normal conditions.

	Order No.	Price
AR-15 / 5.56mm 20 Round Zytel Mag	011-M16AR152BULK	\$10.70
AK-47 / 7.62X39mm 30 Round Zytel Mag	011-AK4730	7.40
AR-15 / 5.56mm 30 Round Zytel Mag	011-M16AR1530BULK	9.99
AR-15 / 5.56mm 30rd(optional 45rd Cap) Zytel Mag	011-M16AR153045	16.38
Ruger Mini-14 30rd 5.56mm / .223 Zytel Mag	011-RM1430BULK	19.47



Mag Charger for AR-15 / M-16 Mags With 3 10rd Stripper Clips/Emergency Fuel Sticks - 10 round black Zytel mag charger will fit and function with any weapon that uses the AR-15 / M-16 Mags. Works with metal mags and GI Metal Strippers. Loads 30 round mags in 10 seconds or less.
Order No.
 011-MCSCM16AR15 \$7.92

Midsouth Ammo Can



Midsouth 30 Cal Plastic Ammo Can - Modeled after the military can, this tough unit has a gasket in the lid to protect contents from moisture.

Order No.
 038-502036 \$6.38

Magazine Accessories

Rubber Magazine Bumper Pads - Pachmayr rubber bumper pads protect ejected pistol magazines and make loading easier and faster. The bumper pads are supplied in sets of five. Double sided tape included. Colt Style attaches with supplied screws

	Order No.	Price
45 Colt Bumper Kit	010-02988	\$16.88
Browning HP Bumper Kit	010-02989	12.42



Magazine Dust Covers - Perfect for keeping dust, dirt and sand out of the top of magazines. Made of clear rubber, Advanced Technology offers a lifetime warranty on these! 4 Per Pack!



	Order No.	Price
DUST COVERS FOR AR-15	019-AR15223	\$4.67
DUST COVERS FOR AK 7.62X39	019-MAK0762	5.73



Hot Lips Banana Magazines



HOT LIPS provides 10-shot capacity for Ruger 10/22. They can be clipped together for a 20 or 30 round capacity. The separately molded feed lip yields superior dependability and longer life. Butler Creek's constant force spring design makes loading easy. LIFETIME WARRANTY.



	Order No.	Price
MAG R/1022 Clear - single magazine	060-HL10CL	\$10.84
Steel Lips 10/22 10rd Mag Clear - single mag	060-SL10CL	13.78

Hot Lips High Capacity 25 Round Mags - Stainless steel feeder lips feed all 22 LR ammo.



	Order No.	Price
Clear 25 round Steel Hot Lips	060-MO112562	\$18.63
Smoke 25 round Steel Hot Lips	060-MO112563	18.63

IMPORTANT!!!! PLEASE READ!!!
 NOT INTENDED FOR SALE, USE OR POSSESSION IN THE STATES OF CALIFORNIA, MASSACHUSETTS, DELAWARE AND NEW YORK, OR ANY STATE WHERE STATE LAW PROHIBITS USE OF HIGH CAPACITY MAGS.



Hot Lips Loader- Now you can load a HOT LIPS banana mag in a half-minute or less-at home or in the field! The HOT LIPS LOADER is compact, lightweight and easy to use. The hopper has a 50 round capacity and automatically positions each round for loading. Simply turn the knob and load!
Order No. 060-24211 \$26.35

Shooters Ridge Magazines

Ruger® 10/22® Magazine - The 25 Round Ruger® 10/22® Single Stack Magazine from Shooters Ridge™ will keep your firearm blazing all day long. The constant force 1lb spring and improved "Jungle Clip" ensure flawless feeding. Also features a "trap door" for easy cleaning of the magazine.
Order No. 097-40420 \$15.82



	Order No.	Price
10/22 25 Round Metal Head Steel Lip Mag	097-40422	\$15.97
10/22 30 Round Single Stack Black Mag	097-40423	19.17
10/22 30 Round Clear Smoke Mag	097-40425	19.17
10/22 25 Round Steel Lip Mag	097-40625	19.17



17HMR / 22 MAG - This compact 25 round high capacity mag feeds both 17 HMR and .22 WMR calibers, and fits Magnum receiver guns from Ruger® and other firearm manufacturers that utilize rotary style mags. Side by side design reduces overall length.
Order No. 097-40421 \$16.12

Ruger® 10/22® Magazine Loader -

- Loads all factory magazines with 22 LR and 17 Mach 2 rimfire ammo
 - Loads all 10/22 high capacity magazines
 - Portable and dependable in the field
 - Holds more than 50 rounds at a time
 - Loads high capacity magazines in seconds
 - Cascading loading track feeds cartridges flawlessly
- Order No. 097-40430 \$23.54**



HKS Speedloaders

Model A Speedloaders



Why load one cartridge at a time when you can zip a full load in a couple of seconds. Super fast, super dependable. Strong metal points hold cartridges securely in the loader until you release them into the revolver with a twist of your wrist. Used for years by police, competition shooters, and your next door neighbors when out back plinking!!

	Order No.	Price
.38 & .357, fits S&W 10, 12, 13, 14, 15, 19, 64, 65, 66, 67/Dan Wesson/Charter Arms/Taurus 80-82, 65-66/Rossi 971, 951,851	032-10A*	
.38 & .357, fits S&W 27, 28/Ruger Redhawk	032-27A*	7.76
.38 & .357, fits S&W 36, 37, 38, 40, 42, 49, 60 (5 Shot)/Charter Arms/Taurus 85/Ruger SP101/Rossi 68	032-36A*	7.76
.38 fits Colt Det. Spec., Cobra, Agent, Diamondback	032-DSA*	7.76
.38 & .357 fits Colt Mk 3 & Mk 5, King Cobra, Peacekeeper/Ruger Security 6	032-MK3A*	7.76
.38 & .357 fits Colt Python	032-PYA*	7.76
.38 & .357 fits S&W 586, 686, 581, 681/Ruger GP100	032-586A*	7.76
.38 & .357 Fits S&W 686 (7 Shot)	032-587A	7.76

Model M Speedloaders

*Fits medium size carrying case, ** Fits large size carrying case, No * on number uses small carrying case

	Order No.	Price
.22 LR fits H&R 9 Shot/Taurus 94	032-22HR*	\$7.76
.22 LR fits S&W 34, 35, 43, 63 (Also K Frame)	032-22J*	7.76
.22 LR fits S&W 17, 18, K22/Colt Diamondback Dan Wesson 22	032-22K*	7.76
.22 MRF fits S&W 51 ('J' Frame)	032-51J	7.76
.22 MRF fits S&W 48 ('K' Frame)/Cole Mk3 (22 Mag)	032-48K*	7.76
.45 Auto Rim fits S&W 25-2	032-25M**	7.76
.45 Long Colt fits S&W 25-5	032-255**	7.76
.44 Spec./44 Mag. fits S&W 29, 629/Dan Wesson/Ruger Redhawk, Super Redhawk/Colt Anaconda	032-29M**	7.76
.41 Mag. fits S&W 57, 58/Ruger	032-57M**	7.76
.44 Spec. fits Carter Arms/Rossi/Taurus 431	032-CA44*	7.76

.32 H&R fits S&W 16, Taurus 76, 761, K Frame Size 6 Shot	032-32K	7.76
.32 H&R fits Ruger SP101, Taurus 73, 74, 751 J Frame Size 6 Shot	032-32J	7.76



203 Speedloader Case - HKS double-side-by-side speedloader case molded or Dupont Hytrel. Black only, available in medium and large, plain or basketweave.

	Order No.	Price
Med. Basketweave	032-203MB	\$12.12
Lg. Basketweave	032-203LB	12.12
Medium Plain	032-203MPB	12.12
Large Plain	032-203LPB	12.12

Cordura Carry Case - Double-side-by-side carrying cases made of durable cordura nylon. Lightweight, compact, one size fits all speed loaders. Case fits 2 1/4" belts

	Order No.	Price
Black Cordura Case	032-100B	\$9.41
Camo. Cordura Case	032-100C	9.41



BufferTech Recoil Buffers™ - Recoil buffers eliminate the metal to metal impact of the slide on the receiver each time the weapon is fired. You will extend the service life of your firearm as well as have reduced felt recoil by installing one in your weapon. Installation is easy and requires no special tools or modification to your gun

	Order No.	Price
1911 Recoil Buffer (8 in pack)	181-45A	\$9.76
CZ75/85 Recoil Buffer	181-CZ1	9.76
Glock Recoil Buffer	181-GK1	9.76
M1A/M14 Recoil Buffer	181-M1A	14.66
Ruger Mini 14/30 Recoil Buffer	181-RM14	14.66
SKS Recoil Buffer	181-SKS1	9.76



Double Stack Magazine Speedloaders



Magazine slips into side of loader. Hold the magazine and loader together in a pistol grip fashion, push down on the thumb lever to load each cartridge. No sore fingers, no fatigue, load 15 rounds in as little as 18 seconds. Works for right or left hand use! For single or double stack magazines!



	Order No.	Price
Fits 380 Cal. Taurus/Browning/Beretta/Bersa	032-380	\$9.41
Fits Browning Hi-Power/Ruger P85, P89,P93/S&W411, 4003, 4006, 4026, 4043, 4046/SIG P226, P228, P229, Taurus PT100, PT101/CZ-75, 85, 99, TZ	032-940	
Fits Beretta 92F, 96F/Ruger P91/MRI Baby Eagle/S&W 915, 946, 5903, 5904, 5906, 5926, 6904, 6906, 6946/Taurus PT92, PT99	032-941	9.41
Llama13/SpfgdArmory P9/Walther P88/Witness 13, 16, 9, 12		9.41
Fits Glock 17, 17L, 19, 22, 23	032-GL940	9.41
Fits H&K USP/Para Ord. P12, P14/Star Mega Star/ Glock Plus 2 (not 45 ACP/McCormick	032-452	9.41
Glock 20, 21, 10mm/.45 ACP (Adjustable)	032-GL453	9.41
Glock Plus 2 17, 22 only	032-GL942	9.41



Single Stack Magazine Speedloaders

	Order No.	Price
Fits Colt (All 7 Rd.-Most 8 Rd)/Llama 45 ACP/ Auto Ordnance 1911 A1, Pitbull/Springfield 1911 A1/ Safari Arms G1, Matchmaker	032-450	
Fits Colt (Lg. Frame)/Star Fire Star 40 Cal/ Ruger P90/SIG 220/Safari Arms/Llama/S&W	032-451	\$9.41
Fits 380's Walther PPK, PPKS/AMT/Colt Beretta/Bersa/SIG/Astra; Fits 9mm S&W/Taurus/ Walther P5, P38/Sig 225/Astra/Llama/Star Fire Star 9mm	032-943	9.41
Fits 9mm Mitchell American Eagle, Luger P08	032-P08	2.66



.22 Long Rifle Magazine Speedloaders

	Order No.	Price
Fits .22 LR Browning Buck Mark, Challenger II, Colt,Ruger 2245, High Standard	032-22B	\$2.66
Fits .22 LR Ruger MK 1 & MK II	032-22R	2.66
Fits .22 LR S&W 41. 622, 2213, & 2214	032-22S	2.66

Universal Speedloader Cases



Carry speedloaders of any size safely and conveniently in these Cordura nylon pouches. Velcro closures permit taking one out at a time. Black only available: single or double.

	Order No.	Price
Double Pouch	060-88281	\$15.54
Single Pouch	060-88271	12.48

Fitted Double Pistol Magazine Cases With Insert

	Order No.	Price
Black Double Row	060-88361	\$17.45
Black Single Row	060-88371	17.45

Molded inserts for a tight fit, yet easy to remove. Can be worn in vertical or horizontal position. Cordura nylon. For all .45 and 9mm clips.



LULA Speed Loader / Unloader

Quick magazine loading without thumb pain! Protect your fingers and your mags. Simply attach the Butler Creek Lula loader on top of your magazine to easily load and unload rounds.

	Order No.	Price
Fits M-16/AR-15	060-24215	\$21.62
Fits AK-47/GALIL	060-24216	21.62
Fits M1A/M14	060-24220	22.37



UPLULA Universal Pistol Loader / Unloader - One size fits virtually all 9mm, 10mm, 357, 40, 45cal - both single and double stack from all manufacturers.

Order No. 060-24222 \$26.42



Hogue Automatic Grips

Hogue Replacement Grips for Autos - Molded from a durable synthetic rubber that is not spongy or tacky, but gives that soft recoil absorbing feel. Provides years of durable, dependable service.



	Order No.	Price
Colt Officer Auto - Fits Colt Officer Model.	138-43000	\$15.41
Colt ACP - Fits 1911, Gold Cup, Commander & duplicate frames. Imp. panels w/ palm swells.	138-45090	10.47
CZ-EAA-Tangfolio Springfield - Fits EAA Witness, CZ-75, CZ-85, Tanfoglio, TZ-75, Springfield P9 and most clones. w/finger grooves	138-75000	15.41
Beretta Monogrip - Fits Beretta 92S and 92SBFS	138-92010	10.47
Beretta with finger grooves - Fits Beretta 92S and 92SBFS	138-92000	15.41
Browning Hi-Power with finger grooves - Wraparound with finger grooves	138-09000	15.41
Para Ordnance P-14 - With finger grooves	138-14000	15.41
Ruger Auto's with finger grooves - Fits P85, P89, P90, & P91 Wraparound w/ finger grooves	138-85000	15.41
Ruger MKII Right Hand with finger grooves - Fits MK II Wraparound w/Thumb Rest.	138-82060	15.41
Ruger MKII Left Hand with finger grooves - Fits MK II Wraparound w/Thumb Rest.	138-82070	15.41
Ruger P93/94 with finger grooves - Fits P93/94 w/finger grooves	138-94000	15.41
Sig Sauer P220 Monogrip - Fits P220 American (Side Magazine Release)	138-20010	15.41
Sig Sauer P226 Monogrip - Fits Sig Sauer P226 American	138-26010	15.41
Sig Sauer P226 with finger grooves - Fits Sig Sauer P226 American	138-26000	15.41
Sig Sauer P228 & 229 Monogrip - Fits Sig Sauer P228 & P229 American	138-28010	15.41
Sig Sauer P228 & 229 with finger grooves - Fits Sig Sauer P228 & P229 American	138-28000	15.41
Sig Sauer P239 - Fits Sig Sauer P239 Wrap around with finger grooves	138-31000	15.41
Sig Sauer P220 - Fits Sig Sauer P220 Wrap around with finger grooves	138-20000	15.41
S&W 5900/4000 - Fits Full Size 9mm Models; 5903, 5904, 5906, 5944, 5946, 5943, 4006, 4096, 411 & 915	138-40010	15.41
S&W 3rd. gen. 9mm - Fits Compact 9mm, Single Stack Mag., Models 3913, 908 etc.	138-13010	15.41
S&W Compacts - Fits Compact 45 & 40 Cal. Model 4516, 4053, 457, etc. Shorty .45	138-16010	15.41
S&W Compacts - Fits Compact 45 & 40 Cal. Model 4053,6906, Shorty .40 TSW, 4013 TSW	138-69000	15.41
Taurus Autos - Fits PT99, PT92, PT100 & PT101 Models. Shipped with 3 panels to fit models with frame or slide mounted decocker.	138-99010	10.47

Hogue Revolver Grips



Rubber Revolver Grips come standard with finger grooves and palm swells.

Hogue Cowboy Single Action Revolver Grips - Traditional style grips in White Pearlized Polymer. Models are available for Colt and Ruger single action revolvers. \$38.55 per set

Order No.

Ruger Blackhawk, Vaquero & Single Six 138-83070

	Order No.	Price
Colt Python - Fits Python (I Frame) and Officers Model Match	138-46000	\$15.41
Colt King Cobra & Anaconda - Fits King Cobra & Anaconda V Frame	138-47000	15.41
Dan Wesson Small Frame - Fits Small Frame .357 Square Tang	138-57000	15.41
Dan Wesson Large Frame - Fits Large Frame .357 Max. & .44 Round Tang w/finger grooves	138-58000	15.41
Ruger GP100 - Fits Ruger GP100 & Super Redhawk w/finger grooves	138-80000	15.41
Ruger SP101 - Fits Ruger SP101	138-81000	15.41
Ruger Redhawk - Fits Ruger Redhawk	138-86000	15.41
Ruger Blackhawk/Single Six - Fits Ruger Blackhawk & Single Six Fits: XR3-Red, XRN-3 and XRN-3RED (excludes old XR3 Frames) w/finger grooves	138-83000	15.41
Ruger Super Blackhawk - Fits Super Blackhawk (Square Trigger Guard) w/finger grooves	138-84000	15.41
Ruger Security Six - Fits Ruger Security Six and Police Service Six Models with serial number prefix 151 and above. (Post 1976 production)	138-87000	15.41
S&W K & L Frame Square Butt - Fits Square Butt Models: 10, 12, 14, 15, 17, 18, 19, 48, 53, 64, 65, 66, 67, 547, 581, 586, 681, 686, and .357 Classic Hunter w/finger grooves	138-10000	15.41
S&W N Frame Square Butt - N Frame Square Butt Models: 25, 27, 28, 29, 57, 58, 624, 629, 657, and .44 Classic Hunter. w/finger grooves	138-29000	15.41
S&W K & L Frame Round Butt - K & L Frame Round Butt Models: 10, 12, 13, 19, 64, 65, 66, 547, 581, 586, 681, and 686.	138-19000	15.41
S&W N Frame Round Butt - N Frame Round Butt Models: 625, 610 and Classic Hunter. w/finger grooves	138-25000	15.41
S&W J Frame Round Butt - J Frame Round Butt Models: 30, 32, 35, 36, 37, 38, 39, 51, 60, 649 and 650.	138-60000	15.41
S&W K to A Frame Conversion - Convert K Round Butt Frames To A Square Butt Grip	138-19002	15.41
S&W N to A Frame Conversion - Convert N Round Butt Frames To A Square Butt Grip w/finger grooves	138-25002	15.41
S&W Bantam J Frame - Bantam Round Butt Models: 30, 32, 34, 36, 37, 38, 39, 51, 60, 442, 640, 649 and 650, 651, 940.	138-61000	15.41
S&W Bantam K & L Frame - Bantam Round Butt Models: 30, 32, 34, 36, 37, 38, 39, 51, 60, 442, 640, 649 and 650, 651, 940.	138-62000	15.41
Taurus Medium - Fits Medium Frame Models 65, 66, 80, 82, 83, 669 & 689	138-66000	15.41
Taurus Small - Fits Small Frame Model 85. w/finger grooves	138-67000	15.41

Handall Universal Sleeve

Handall Universal Rubber Sleeve - Fits semi-auto pistols: Glock, S&W, Sig Sauer, Ruger, Colt Double Eagle, Beretta 84, 85, 92, 92C; Browning Buckmark, Challenger II, BDA, High Power & clones; Taurus; EAA Witness 83 & 85; Springfield P9; CZ75; Tanfoglio & clones; Astra A100, Constable; Interarms Firestar; Walther P-38, P88; Llama Omni; Steyr GB; KBI BK & Compact GKK-92C; Bernadelli P018S; Daewoo DP51; H&K USP & 70-Z; Intratec TECDC9; TEC22; Auto Mag III; Zastava 99; High Standard Victor; and most other larger 9mm, 10mm, 45 ACP, etc.!

NOW FITS GLOCKS WITH FINGER GROOVES!



Molded from a durable synthetic rubber that is not spongy or tacky, but gives that soft recoil absorbing feel. Provides years of durable, dependable service.



Handall JR. Universal Rubber Sleeve

Handall JR. Universal Rubber Sleeve - Fits most 22, 25, & 380 pocket semi-auto pistols; Walther PPK, PPK/S & PP; Colt 380 Gov. & Mustang; Beretta & Taurus Tip Ups; American Arms; Davis; Seecamp; Raven; Jennings; Accutec; Intratec; AMT; and many other clones, etc. **Order No. 138-18000 \$5.53**

FOR ALL TECHNICAL ADVICE OR QUESTIONS ABOUT FIT OR GUARANTEE, ETC., PLEASE CALL HOGUE AT 1-800-GET-GRIP (1-800-438-4747).

	Order No.	Price
Handall Univ. Sleeve	138-17000	\$6.15
Handall Univ. Sleeve OD Green	138-17001	6.76

Hogue Extreme Series Grips

Hogue Extreme series grips are machined from Aerospace grade 6061 T6 Aluminum. The strength of these materials allow for the thinnest possible grips on large double stack autos such as SIG pistols. Extreme grips are precision machined from solid billet stock to exacting specifications and are designed for a lifetime of use. These grips are hard Type III anodized and more colors are available online!

Handgun Model	Black Matte	Olive Green	Black Gloss Brushed	Black Matte Checkered	Black Gloss Checkered
	\$52.64	\$52.64	\$52.64	\$70.21	\$70.21
Browning Hi-Power 9mm	138-09160	-	-	-	-
CZ-75, CZ-85, & EAA P-9 Models	138-75160	138-75161	138-75166	138-75170	-
Ruger P-85 - P-91	138-85160	138-85161	138-85166	138-85170	138-85176
Beretta 92	138-92160	138-92161	138-92166	138-92170	138-92176
Beretta 92 Compact	138-93160	138-93161	138-93166	138-93170	138-93176
Ruger P94	138-94160	138-94161	138-94166	138-94170	138-94176
Taurus PT99	138-99160	138-99161	138-99166	138-99170	138-99176



More Colors and Models Online

Also Available! The Hogue Extreme Series Aluminum Flame Grips! Anodized colors available in red, blue, black and olive green. These are special order due to the vast amount of possibilities, and can be ordered online! Visit our website to see if we have these available for your handgun. Look under **Gun Care & Acc.** and click on **Grips**. A list of manufactures will appear. Find your model, and look through the listing for "Extreme Aluminum Flame" and the colors!



Pachmayr Tactical Grip Gloves

These "Stretch-to-fit" Grip Gloves are custom molded for each top-selling pistol and are ideal for the popular polymer frame models which have no replacement grips available. In addition, Pachmayr's Decelerator material delivers recoil reduction and enhanced control that no other slip-on can match.



	Order No	Price
Beretta 92 FS, M9	010-05160	\$8.97
CZ 75/85	010-05162	8.97
Glock 17, 20, 21, 22, 31, 34, 35, 37	010-05164	8.97
S&W Sigma	010-05166	8.97
Sig 220, 226, 228, 229	010-05168	8.97
Springfield XD, XD(M)	010-05170	8.97
S&W M&P Series	010-05172	8.97
Glock Compacts 19, 23, 25, 32, 38	010-05174	8.97
Ruger LCP, Taurus 738TCP, KelTec P-3AT & P-32	010-05176	8.97



Pachmayr Gripper Grips for TC Encore & Contender

Contender



Contender Accessories from Pachmayr- Three grip design offer the best control for this heavy recoiling handgun. Each features a patented air pocket recoil chamber and deep checkered finish. (Does not work with G2). The Pachmayr TC Contender forend fits all round barrel models including 12" and Super 14. Will not fit Super 16. The forend adapter adapts one forend for use with either 10" round, 12" or Super 14 barrels. Forend has adapter built in. Can be changed to fit either 10", 12" or 14" T/C Contender barrels.

	Order No.	Price
A- Gripper Decel with finger grooves	010-05054	\$46.63
B- Forend One Size Fits 10", 12", 14"	010-03373	44.88
C- Adapter One Size Fits 10", 12", 14"	010-03381	16.03

Butler Creek Slip-On Grips



Butler Creek Slip-On Grips - Slip onto pistol stock to improve control. Fit virtually any pistol. Medium and Large have finger grooves.



	Order No.	Price
Medium Fits compact large frame autos	060-50542	\$8.47
Large Fits full size large frame autos	060-50543	8.47

Encore



See the lists below for recommended calibers.



CZ Handgun Replacement Grips



	Order No.	Price
Standard plastic grips CZ 75/ 85	226-19102	\$16.42
Rubber grips CZ 75/ 85	226-19105	27.13
Rubber grips CZ 75 COMPACT	226-19106	27.13

Pachmayr tames even the hardest-kicking T/C Encore using the proven Decelerator material, Pachmayr has crafted a grip and forend that deliver far greater control while softening recoil. Decelerator material offers a more secure, consistent grip that can actually enhance accuracy. The softer forend provides for a secure, steady rest on any handy surface in the field.

T/C Encore Standard Grip and Forend Set - Recommended for use with these calibers: 17HMR, 22LR, 204 Ruger, 223 Rem, 22-250, 243 Win, 25-06, 270 Win, 7mm-08, 308 Win, 44 Mag, 45 Colt **Order No. 010-02441 \$48.73**

	Order No.	Price
Decelerator Grip Only	010-02442	\$30.45
Decelerator Magnum Forend Only	010-02433	21.93

Presentation - This classic, original rubber grip design by Pachmayr is deeply checkedered and has a classic style. Presentation grips are also designed to be the best pointing grips available.

Gripper - Made from a specially formulated rubber compound optimized for control and recoil absorption. Features finger grooves, a slight palm swell and a covered backstrap.

Gripper Decelerator - The same as the Gripper, featuring the finest recoil absorbing material available.

Gripper Professional - A smaller version of the gripper Grip. This features an open backstrap. Perfect for smaller hands and or concealed carry.

Compac & Compac Pro - These special rubber compound grips are designed for control and concealability. Secure non-slip finish is the first choice for concealed carry. Compac Pro's are smaller versions of the Compac.



Presentation \$21.16	Gripper \$22.77	Gripper Decelerator \$25.64	Gripper Professional \$22.45	Compac & Compac Pro \$22.43
--------------------------------	---------------------------	---------------------------------------	--	---

Model	Presentation	Gripper	Gripper Decelerator	Gripper Professional	Compac & Compac Pro
Colt					
Colt Agent, Cobra, Det Special, Police Pos Special (Older Large Frame 1940 - 1971)	010-02514	-	-	-	-
Colt Agent, Cobra, Det Special, Police Pos Special, Diamond Back (Newer Small Frame)	-	-	-	-	010-02515
MkIII Models, Lawman, Metropolitan, Off. Police, Trooper	010-02538	-	-	-	-
Official Model Match, Python, Official Police, Trooper, (Pre-1970)	-	010-02528	-	-	-
Rossi					
Rossi Small Revolvers 22, 32 & 38 Special	-	-	-	-	010-03147
Ruger					
Ruger Vaquero - New Models Blackhawk (Not with Bisley Frame), Old Army	010-03137	-	-	-	-
Ruger GP-100	-	010-02929	-	-	-
Ruger Redhawk	010-03140	010-03142	010-05058	-	-
Ruger Super Redhawk	-	-	010-05150	-	-
Ruger SP-101	-	-	-	-	010-03183
Ruger New Model Super Blackhawk, (Square trigger guard only)	010-03163	010-05067	010-05134	-	-
Ruger New Model Super Blackhawk Stainless, (Square trigger guard only)	-	010-05067	010-05134	-	-
Ruger New Model Super Single Six	010-03137	-	-	-	-
S&W					
S&W Fits all J-Frame Models with Round butt	-	010-03249	010-05136	-	010-03252
S&W Fits all J-Frame Models with Square butt	-	010-03250	-	-	010-03255
S&W Fits all K&L -Frame Models with Round butt	-	010-03266	010-05138	-	010-03270
S&W Fits all K&L -Frame Models with Square butt	010-03267	010-03264	010-05140	010-03265	-
S&W Fits all N-Frame Models with Round butt	010-02938	-	010-05148	-	-
S&W Fits all N-Frame Models with Square butt	010-03294	010-03292	010-05056	010-03293	-
Taurus					
Taurus Alpha Pref Ser#, 357 & 44Spl, Square Butt (Except 2 1/2" Barrel)	-	010-04506	-	-	-



Pachmayr Slip-On Grips - Introducing the easy to install slip on neoprene grip. Only 4 models to fit all automatics. Comfortable, sure gripping with no added bulk. No lubricants, hot water soaks or hair dryers are required (as with other manufacturers). Ask the champions. Pachmayr is the choice, no comparison!!

Size	Order No.	Price
Size 1 Fits Large Auto w/o finger grooves	010-05069	\$7.05
Size 2 F its Large Auto w/finger grooves	010-05106	7.05
Size 3 Fits Med. Auto w/finger grooves	010-05108	7.05
Size 4 Fits Small auto with finger grooves	010-05110	7.05
Size 5 Fits Glock Auto with finger grooves	010-05117	7.05

Pachmayr Automatic Grips



Pachmayr Signature Grips - Features Pachmayr's Patented full wrap-around design. This rubber compound is specially formulated for semi-automatic pistols. NOT ALL MODELS HAVE FINGER GROOVES!!!!!!

Model	Order No.	Price
Colt (all semi-auto) 45ACP, 9mm, 38 Super	010-02919	\$20.20
Colt Gov't Model .45 Combat	010-02921	20.20
Colt 1911 Thumb Reduction-Combat Special	010-02922	20.20
Colt 1911 w/finger grooves	010-05008	20.99
Browning 9mm, Hi-Power w/backstrap	010-02420	25.64
Taurus PT99 Decocker w/finger grooves	010-05043	25.64
Taurus PT99AF & 92AF w/backstrap Will Not Fit PT92D	010-03102	25.64
Walther PP & PPK/S, all calibers w/backstrap	010-03086	25.64
Colt New Officers Model	010-02545	20.20
Ruger P85/89/90	010-03953	25.64
Browning BDA .380	010-02437	25.64
Bruno CZ75	010-02697	25.64

Double-Diamond Checked Gov't -

Only the finest exhibition grade rosewood with spectacular contrasting grain & color. Shaped to strengthen your grip and enhance the pistol's handling characteristics. Extremely simple installation only requires a common flat head screw driver.



	Order No	Price
Full Size	166-82000	\$38.96
Slim Carry	166-83000	51.93

Pachmayr American Legend Grips - Pachmayr's American Legend offers you the best of both worlds, by combining the feel and appearance of wood with the performance, gripability, and control of rubber.



Model	Order No.	Price
Colt 1911 and Copies Legend In "Pacwood" Special Price!	010-00423	\$30.77

Uncle Mike's Holster Belt's



Sidekick Black Holster Belt - These are perfect companions to Uncle Mike's SIDEKICK holsters and will work equally well with others. Practically indestructible, they're made of tough, heavy-gauge nylon web a full two inches wide. They're 54 inches long, so they will fit every shooter, even over heavy hunting jackets.
Order No. 060-88001 \$9.19



Deluxe Duty Belt - Made of two layers of 2-inch nylon web with Velcro size adjustment; quick release buckle; rounded ends on flaps to avoid chafing of clothes. Available in black. Order sizes as stated below.

	Order No.	Price
Medium Black Fits 32-38"	060-88011	\$15.87
Large Black Fits 38-44"	060-88021	15.87

Holster Belt Accessories

Nylon Web Keepers for Belts - Constructed of improved material that resist stretching or fraying. Anchors duty belt to inner belt. No wear, no glare-snaps.



	Order No.	Price
Flashlight Holder D Cell	060-88621	\$5.60
Flashlight Holder C Cell	060-88631	5.60

Hogue Universal Speed Holster



Universal Speed Holster - The most versatile and unique holster ever made! The PowerSpeed is designed for competition, duty and concealed carry. Use only the parts that you need for your gun, and within seconds the PowerSpeed is ready for right or left hand use! Fits virtually any semi-automatic handgun! Locking mechanism has 3 settings; Fully locked, Semi-race and Full race mode! Even fully locked the PowerSpeed can beat other holsters on the draw!
Order No. 138-00500 \$87.78

GunMate Gunmate Holsters

Handgun Frame Size	Barrel Length	Size
Small Frame Pistol	up to 2 1/4" barrel	00
Medium Frame Pistol	up to 4" barrel	06
Large Frame Pistol	up to 4" barrel	10
Large Frame Pistol	4" to 5" barrel	12
Small Frame Revolver	up to 2 1/2" barrel	20
Medium Frame Revolver	up to 4" barrel	28
Medium - Large Frame Revolver	4" to 6 1/2" barrel	34
.22 Auto/Airgun	up to 6" barrel	52



Ambidextrous Hip Holsters - Versatile pistol holster with pouch for extra magazine. Velcro adjustable retention strap with thumb break, reversible for ambidextrous use. Web belt loop fits up to 2", reversible belt clip included for inside the pant wear. **\$12.99 ea**

	Order No.
#10	060-21110C
#52	060-21152C

Inside Pants Holsters - Extra thin laminate for comfort and concealment. Outer fabric clings to clothing to keep holster in place. Ambidextrous just switch reversible belt clip for right or left hand, strong side or cross draw. **\$6.40 ea**

	Order No.
#00	060-21300C
#6	060-21306C
#10	060-21310C
#12	060-21312C
#20	060-21320C



UNCLE MIKE'S MAGAZINE POUCHES



Double pistol clip pouch (.45 and 9mm clips.) **Order No. 060-88291 Price \$15.54**

FITTED DOUBLE PISTOL MAGAZINE CASES WITH INSERT



A double pistol clip pouch with molded inserts for a tight fit, yet easy to remove. Has individual snap on front for ease of use. Can be worn on your belt in vertical or horizontal position. Made of Cordura nylon. This is a DOUBLE CLIP CASE for all .45 and 9mm clips (double row or single row magazines as noted below). Black only!

	Order No.	Price
Black Double Row	060-88361	\$17.45
Black Single Row	060-88371	17.45

UNIVERSAL SPEEDLOADER CASES



Carry speedloaders of any size safely and conveniently in these Cordura nylon pouches. Velcro closures permit taking one out at a time. Black only available: single or double.

	Order No.	Price
Double Pouch	060-88281	\$15.54
Single Pouch	060-88271	12.48

Uncle Mike's Utility Bags & Pouches

Original Gun Pak - 8" W x 5 1/2" H x 1 5/8" D. Carries most small and medium frame pocket autos, compact 9mms, and small frame, 2" - to 3"-barrel revolvers.
Order No. 060-88891 \$26.63



Briefcase with Hidden Holster - Uncle Mike's prepares you for a risky commute or workplace. It looks and functions like a high-quality, expandable briefcase, but gives you easy access to a hidden interior holster. Internal holster adjusts to fit most handguns. Quick firearm access - even when closed.
Order No. 060-52551 Closeout! \$20.34

Wheeled Duffel Bag - A big, rugged duffel with smooth-rolling urethane wheels and a telescoping pull handle for easy transport of your heaviest loads - perfect for extend stays anywhere. Huge center compartment and padded top-end compartment. Two full-length zippered side compartments - one is divided in half, the other offers general storage and two lockable, zippered storage compartments.
Order No. 060-52451 Closeout! \$57.70



Dimensions: Center compartment: 13.5" high x 27.5" long and 14" wide (343 x 699 x 356mm). Top end compartment is 13.5" high x 2" deep x 13.5" wide (343 x 51 x 343mm).

Tactical Bag with Shoulder Straps - Use as a duffel bag or pack - built for the rigors of tactical conditions. Wrap-around web carry handle and two padded, adjustable shoulder straps for multiple carrying options. Reinforced bottom panel increases abrasion resistance and water repellency. **Order No. 060-52492 Closeout \$46.36**



Dimensions: Main compartment is 31" long x 12" high x 18" wide (787 x 305 x 457mm). One end compartment is two-tiered with a 10" x 10.5" (254 x 267mm) zippered pocket behind a 5.75" x 7" (146 x 178mm) Velcro-sealed front pouch. Opposite end has a zippered pocket measuring 10.5" x 16.5" (267 x 419mm).



Bulldog Fannypack - Heavy duty 1200 denier nylon water resistant outer shell, Quick access design uses no snaps or velcro, simply pull the top lanyard, to quickly expose your weapon. Universal internal holster design fits most pistols

	Order No.	Price
Black with black trim- small	208-BD850	\$12.29



New To Midsouth!

SAFARILAND

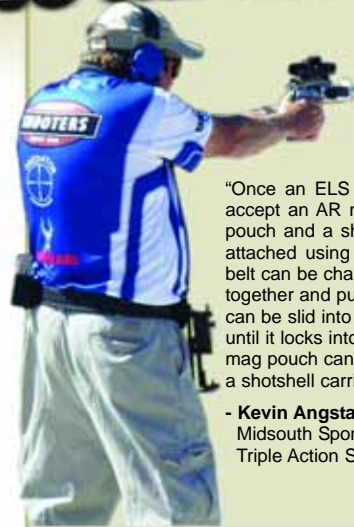

"I feel that the new Safariland ELS (equipment locking system) is the most versatile competition rig on the market today. Gone are the days of having to have a belt set up for each sport or having to completely disassemble an existing belt."

"Once an ELS receiver is mounted to the belt, it can accept an AR mag pouch, single or double stack mag pouch and a shotshell carrier. The holster can also be attached using an ELS receiver. An accessory on the belt can be changed by merely pushing two tabs together and pulling up. A new accessory can be slid into the receiver and pushed until it locks into place therefore a mag pouch can be replaced with a shotshell carrier in seconds."

- Kevin Angstadt
Midsouth Sponsored
Triple Action Shooter

Kevin Angstadt, is quite an accomplished Action Pistol shooter! Kevin has placed in the Top 5 at the NRA Bianchi Cup three times and within the Top 25 nine times. In May 2010, he became the first Action Pistol shooter to become 'Distinguished' in Production, making him the first Action Pistol shooter to be Triple Distinguished! With over 52 Regional and State Championship wins under his belt, we are proud to have Kevin wear the Midsouth logo!

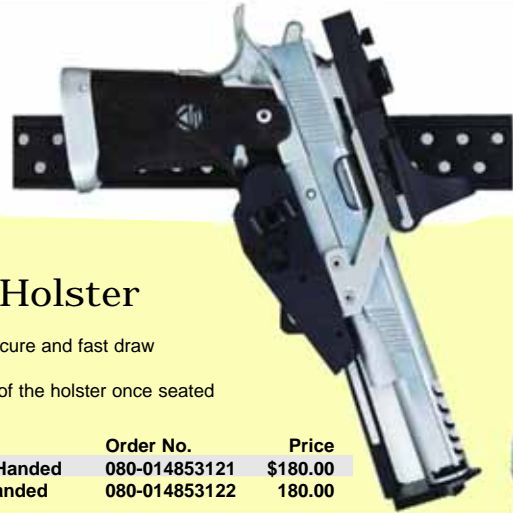

Model 014 Open Class Competition Holster

- Body Machined out of aluminum to stabilize the handgun, yet offers little resistance for a secure and fast draw
- Ball joint on holster allows complete freedom of movement to customize the handgun draw
- Front nosepiece designed to retain handgun and help prevent gun from being knocked out of the holster once seated
- Fully adjustable nosepiece accommodates barrels from 5" to 7.5" (13 cm - 19 cm)
- Fit a variety of competition handguns, with or without red dot or magnified optics
- Injection-molded adjustable trigger guard lock
- Incorporates a simple push lock which secures handgun into the trigger block
- Available in Black.

	Order No.	Price
Right Handed	080-014853121	\$180.00
Left Handed	080-014853122	180.00

"The model 013 holster is an updated version of the model 012 which I have used for years. The 013 features a lock that keeps the gun in the holster and can be deactivated by a flick of the trigger finger during the draw. I have other locking holsters but the model 013 by far holds my guns more securely than any other. My holster is mounted to the belt with an ELS receiver. I can remove the holster from the belt with the gun in the holster with the confidence that the gun will not fall out. I can't wait to get my hands on the New Model 014 to try it out." - Kevin Angstadt



ELS Competition Belt (Model 032) -

- Reinforced to hold heavy competition handguns and ammunition
- Hook lined to loop to 030 underbelt
- Pre-cut holes to mount ELS 35 Receiver Plates in multiple locations and angles
- 1.75" (45mm) Belt Width
- Black

Price
\$50.40

	Order No.
26 inch	080-0322626
28 inch	080-0322826
30 inch	080-0323026
32 inch	080-0323226
34 inch	080-0323426
36 inch	080-0323626
38 inch	080-0323826
40 inch	080-0324026

Underbelt for ELS Competition Belt (Model 032)

- Belt is worn in regular pant belt loops with the exterior exposed to mate with outer belt
- Available in Black with web finish

Price
\$17.10

	Order No.
26 inch	080-030262
28 inch	080-030282
30 inch	080-030302
32 inch	080-030322
34 inch	080-030342
36 inch	080-030362
38 inch	080-030382
40 inch	080-030402





Model ELS 35

Model ELS 34

ELS Equipment Locking System

Model ELS 34 - Mounts directly to the back of Tactical Accessory models and locks into the ELS 35 Receiver Plate. Allows for the quick detachment and attachment of various accessories to wherever an ELS 35 Receiver Plate is located, whether it be a Belt Clip, Tactical Rig, or elsewhere. Each ELS 34 includes (2) Locking Forks and hardware for both.

Model ELS 35 - The mounting platform for the ELS 34 Locking Fork. It can be placed in various locations, including Belt Clips, Tactical Rigs, or directly on MOLLE loops with the use of an MLS 16 Locking Fork. Allows for the quick detachment and attachment of various tactical accessories to wherever they are needed. Each ELS 35 includes (2) Receiver Plates and hardware for both.

ELS Kit - Features the ELS 34 Locking Fork and the ELS 35 Receiver Plate. Each ELS Kit includes (2) ELS 34 Locking Forks and (2) ELS 35 Receiver Plates.

	Order No.	Price
Model ELS 34 (2pc)	080-6004342	\$18.00
Model ELS 35 (2pc)	080-6004352	18.00
ELS Kit	080-ELSKIT12	31.50

Magazine Pouches



Open Front Magazine Pouch (Model 771) -

Open Top Magazine Pouch (Model 773) -

For Pouch Fit

There are too many magazine models to list here - please ask our tech or visit:

www.midsouthshooterssupply.com/safariland.asp

Open Front Magazine Pouch (Model 771) -

Two magazine tensioning screws on the back side to adjust tension on both the middle & the end of the magazine. The magazine sits against plastic rollers that reduce drag during draw. Open front design keeps index finger from touching the holder during reload. This pouch includes an ELS 34 locking fork and ELS 35 receiver plate.

Size	Right Hand	Left Hand	Price
53	080-77153121MS36	080-77153122MS36	\$57.60
76	080-77176121MS36	080-77176122MS36	57.60
83	080-77183121MS36	080-77183122MS36	57.60
85	080-771850121MS36	080-771850122MS36	57.60

Open Top Magazine Pouch (Model 773) -

Uses the 90 degree adjustable belt loop. Two sets of magazine tension screws threaded through rollers for greater adjustment and fast reloads. Closed low cut front to help secure magazine and prevent it from being knocked out of the front pouch. Built up channel for clearance of the bullet during the draw. This pouch includes an ELS 34 locking fork and ELS 35 receiver plate.

Size	Right Hand	Left Hand	Price
53	080-77353121MS36	080-77353122MS36	\$57.60
76	080-77376121MS36	080-77376122MS36	57.60
83	080-77383121MS36	080-77383122MS36	57.60
85	080-773850121MS36	080-773850122MS36	57.60

Shotgun Shell Holders



- For use with 2 3/4 shells
- All shells can be grasped and employed at once
- Tensioners provide solid retaining system to hold shells, even when some are removed

	Order No.	Price
(6) 12 Ga shell holder	080-0841223MS36	\$67.50
(4) 12 Ga shell holder	080-0851223MS36	31.50



IDPA approved.

Fits belt widths up to 1.75" (45 mm)

SAFARI LAMINATE™ construction with suede lining to help protect the gun's finish.

The 568 features an all-new ergonomic injection molded paddle designed for concealability and comfort. This design offers varied cant angle and it can even be worn crossdraw.

Autos

Size	Right Hand	Left Hand	Price
53	080-56853411	080-56853412	\$47.70
744	080-568744411	080-568744412	47.70
54	080-56854411	080-56854412	47.70
51	080-56851411	080-56851412	47.70
49	080-56849411	080-56849412	47.70
83	080-56883411	080-56883412	47.70

Revolvers

Size	Right Hand	Left Hand	Price
01	080-56801411	080-56801412	\$47.70
09	080-56809411	080-56809412	47.70
12	080-56812411	080-56812412	47.70
13	080-56813411	080-56813412	47.70

Custom Fit Paddle & Belt Loop Combo Holster

SafariLam Model 568 Custom Fit Holster - One of the lightest, thinnest, best fitting concealment holsters available. True to its name, it adjusts to a wide variety of popular handguns, giving each a "custom fit" in this holster. In just four fits, this design can accommodate over 100 handguns. See fit chart below for most popular autos and revolvers.

Autos (Red number notes holster size)

- AMT - 53 Hardballer - 5" BBL
- Beretta - 744 PX4 Storm - 4" BBL
- Beretta - 54 8000, 8040 G, F, D - 3.6" BBL
- Beretta - 53 92D, 92DM, 92DS, 92F, 92FS, 92G, 92 Brigadier FS, 92 Brigadier D, 96, 96D, 96DS Brigadier D, 96G, 96 Brigadier G, 96 Brigadier D - 4.9" BBL
- Beretta - 51 92FC, 92FCM, 92FCDA - 4.25" BBL 92FS Centurion, 96DC, 96 Centurion - 4.3" BBL
- Beretta - 49 92 Vertec, 96 Vertec, 90-Two, 92 Brigadier - 4.3" BBL
- Browning - 53 Hi-Power 9mm - 4.625" BBL BDM 9mm - 4.73" BBL
- Colt - 53 Combat Elite, Delta Elite, Delta Gold Cup, Gold Cup Nat'l Match, Government 1911 - 5" BBL
- Colt - 51 Commander - 4.25" BBL
- Colt - 54 Officers' ACP 45 - 3.5" BBL
- CZ - 51 75, 85 - 4.5" BBL
- EAA - 51 Witness - 4.5" BBL
- FN - 744 FNP-9, FNP-45, FNX 9mm, 40 - 4.5" BBL
- Glock - 83 17, 22 - 4.5" BBL 20, 21 - 4.6" BBL 38 - 4" BBL
- Glock - 54 19, 23 - 4" BBL 26, 27 - 3.5" BBL 36 - 3.75" BBL
- Glock - 49 34, 35 5.32" BBL - 37 4.5" BBL
- 21SF w/ Picatinny Rails 4.6" BBL
- Glock - 744 39 3.46" BBL
- Heckler & Koch - 54 USP 9C, 40C 3.58" BBL
- Heckler & Koch - 744 USP 9mm, 40 4.1" BBL USP 45 4.41" BBL
- Heckler & Koch - 49 USP Expert 45
- Kahr - 54 K9 4" BBL
- Kimber - 53 KIP45CUS 5" BBL
- Para-Ordnance - 53 P-14 5" BBL
- Ruger - 83 KP-89, KP-89 DC, KP-89 DW, P-89 W, P-89 DW, 4.5" BBL
- Ruger - 49 KP-90, KP-91 DC, P90 45, P91 4.5" BBL
- Ruger - 54 SR9 4" BBL
- Sig Sauer - 54 P225, P228 3.9" BBL P239 3.625" BBL P229 3.9" BBL

- Sig Sauer - 83 P220, P226, Old Style P220, P226, New Style P226 DA 4.41" BBL
- Sig Sauer - 49 P226R DA/SA, DAK Bobbed or Spurred Hammer 4.41" BBL
- Sig Sauer - 744 P229R DA/SA, DAK 3.9" BBL P220R Compact 3.75" BBL
- Smith & Wesson - 53 645, 1006, 1026, 1046, 4506, 4506-1, 4526, 4546 5" BBL
- Smith & Wesson - 54 469, 669, 908, 3913, 3913TSW, 3914, 3953, 3954, 4013, 4013TSW, 4053, 4053TSW, 4056TSW, 4513TSW, 6904, 6906, 6924, 6926, 6944, 6946, Short Trigger Guard, 6906, 6946 Lg Trigger Guard 3.5" BBL 4516-1 Ver. II, 4516-2, 4536, 4556 3.75" BBL CS9 3" BBL
- Smith & Wesson - 83 39, 59, 410, 411, 439, 457, 459, 639, 659, 909, 910, 915, 3904, 3906, 4006, 4026, 4046, 5903, 5904, 5923, 5924, 5926, Sigma 40C, 5906, 5943, 5944, 5946, Short Trigger Guard 9C, 40V, 9V, 5906, 5946 Lg Trigger Guard 4" BBL 1066, 1076, 1086, 4566, 4576, 4586 4.25" BBL Sigma 9mm, 40, 4.5" BBL
- Smith & Wesson - 83 M&P 9mm, 40, 45 w/ & w/o Manual Thumb Safety 4.25" BBL
- Sphinx - 49 3000 4.5" BBL
- Springfield Armory - 744 XD 9mm, 40, 45, 357 4" BBL
- Springfield Armory - 49 XD(M) 40 4.5" BBL
- Springfield Armory XD 9mm, 40, 45, 357 5" BBL
- Springfield Armory - 53 1911-A1 5" BBL
- STI - 83 GP6 4.25" BBL
- Taurus - 53 PT92, PT99 5" BBL
- Taurus - 51 PT92C, PT99C 4" BBL
- Walther - 54 P99, P-5 4" BBL
- Wilson Combat - 53 1911 4.9" BBL

Revolvers (Red number notes holster size)

- Colt - 01 Agent, Detective Special, DS-II, SF-VI 2" BBL
- Colt - 09 King Cobra, Python, Trooper 4" BBL
- Ruger - 01 LCR .38 Special 1.875" BBL
- Ruger - 01 SP101 2.25" BBL
- Ruger - 09 GP100, Security Six Service Six, Speed Six 4" BBL
- Smith & Wesson - 12 25, 27, 28, 29, 57, 325, 327, 329, 357, 625, 627, 629, 657 N Large Frame 4" BBL

- Smith & Wesson - 13 25, 27, 28, 29, 57, 325, 327, 329, 357, 625, 627, 629, 657 N Large Frame 5" BBL
- Smith & Wesson - 09 10, 12, 13, 15, 19, 64, 65, 66, 67, 617, 648 K Medium Frame, 581, 586, 681, 686, L Medium Frame 4" BBL
- Smith & Wesson - 01 31, 34, 36, 36LS, 37, 60, 60LS, 38HL, 49HL, 649HL, J Small Frame 2" BBL
- Taurus - 01 M-85 2" BBL

Uncle Mike's Holsters

Sidekick® Vertical Shoulder Holsters - Keeps your gun secure regardless of where your hunting and shooting takes you. A wide, comfortable shoulder harness, combined with an inside belt loop and an offside belt loop, distributes the weight of your gun and keeps it in place. The design of the holster itself protects the handgun, yet makes it easy to draw and re-holster. Can be worn under street clothes or over hunting clothes. Available as noted for non-scoped or scoped guns.



	Order No.	Price
Size 2 Right Hand Black, Not for Scoped Gun 3"-4" Barrel Medium/Large, 6"-7.5" Barrel Single Action Revolver	060-83021	\$29.42
Size 3 Right Hand Black, Not for Scoped Gun 5"-6.5" Medium/Large Double Action Revolvers, 4 5/8"-5.5" Barrel Single Action Revolvers	060-83031	29.42
Size 4 Right Hand Black, Not for Scoped Gun	060-83041	29.42
Size 4 Left Hand Black, Not for Scoped Gun 7 - 8 1/2" barrel medium and large double action revolvers and 6 - 7 1/2" barrel single action revolvers	060-83042	29.42
Size 5 Right Hand Black, Not for Scoped Gun 4 1/2" - 5" barrel large autos, open end, safety strap rotates to secure auto either on grip or hammer	060-83051	29.42
Size 15 Right Hand Black, Not for Scoped Gun 3 3/4" - 4 1/2" barrel large autos	060-83151	29.42
Size 3 Right Hand Black, For Scoped Gun Only Scoped 5 - 6 1/2" barrel medium and large double action and 4 5/8" - 5 1/2" barrel single action revolvers	060-85031	34.76
Size 4 Right Hand Black, For Scoped Gun Only Scoped 7 - 8 1/2" barrel med. & lg. double action and 6 - 7 1/2" barrel single action revolvers, & 10" barrel T/C Contenders	060-85041	34.76
Size 13 Right Hand Black, For Scoped Gun Only Scoped 14" & 16" barrel T/C Super Contenders, Encore & 10" barrel Remington XP-100, & 9 1/2" - 10 3/4" barrel single & double action revolvers	060-85131	34.76

Sidekick® Cross-Harness Shoulder Holsters - An extremely flat shoulder harness is anchored by outside and offside tie-downs for comfort, stability and concealment. Retention strap snaps to thumb break and is adjustable by Velcro on front of the holster.



Strap is covered to prevent loss of strap when unsnapped and to prevent chafing. Converts for use with right or left hand. Black only.

	Order No.	Price
Size 1 Black Horizontal 3 - 4" barrel medium autos	060-87010	\$30.51
Size 15 Black Horizontal 3 3/4" - 4 1/2" barrel large autos	060-87150	30.51



Pro-Pak Horizontal Shoulder Holsters - Holster has a tough grade of smooth nylon outer shell, thumb break, ambidextrous (just reverse thumb break and retention strap). New harness design (all 4 adjust). Tool included for strap adjustment. Black only in holsters and accessories!

	Order No.	Price
Size 5 Black Right Hand 4 1/2" - 5" barrel large autos	060-77050	\$39.76
Size 15 Black Right Hand 3 3/4" - 4 1/2" barrel large autos	060-77150	39.76
Size 16 Black Right Hand 3 1/4" - 3 3/4" barrel medium/ large autos	060-77160	39.76
Size 36 Black Right Hand 2" barrel small frame 5-shot revolvers with hammer spur	060-77360	39.76

Sidekick® Hip Holsters - Incredibly tough, tightly woven material has proven itself up to the test. Waterproof - Keeps moisture off your sidearm and bolsters durability. Form fit - They mold to the shape of your gun for tight, sure carry, and return to original shape when empty. Comfortable - Lightweight with a medium-high ride design. Fits holster belts up to 2 1/4" wide and standard trouser belts.

Price \$12.01



	Size	Left Hand	Right Hand
2 -3" barrel sm./med. dbl. action revolver expect 2" 5-shot	0	-	060-81001
3-4" barrel medium autos	1	-	060-81011
3-4" barrel medium and large double action revolvers	2	060-81022	060-81021
5 - 6 1/2" barrel medium and large double action revolvers	3	060-81032	060-81031
7 - 8 1/2" barrel med./large dbl. action revolvers, tie-down loop included	4	-	060-81041
4 1/2" - 5" barrel large autos, open end	5	060-81052	060-81051
5 1/2" - 6" barrel .22 autos and airguns	6	-	060-81061
3 1/2" - 5" barrel single action revolvers	7	-	060-81071
5 1/2" - 6 1/2" barrel single action revolvers	8	-	060-81081
6 1/2" - 7 1/2" barrel single action revolvers	9	-	060-81091
Small autos (.22 - .25 cal.)	10	-	060-81101
6 7/8" barrel .22 autos	14	-	060-81141
3 1/2" - 4 1/2" barrel large autos, open ends	15	060-81152	060-81151
3 1/4" - 3 3/4" barrel medium and large autos	16	060-81162	060-81161
2" small frame 5-shot revolvers with hammer spur	36	-	060-81361



Sidekick® Ambidextrous Hip Holsters - Fully ambidextrous holster with belt loops on both sides, plus a removeable belt clip for use as an inside-pant holster. Intergal magazine pouch on forward edge of holster next to the belt accommodates most single or double row magazines. Velcro retaining strap secures magazine but provides easy access. Simple to convert from right to left. Holster constructed of tough, patented SIDE-KICK laminate of Cordura nylon, weatherproof closed-cell foam padding and smooth nylon lining. Non-stretch retention strap and molded thumb break. String steel belt clip powder coated for rust and corrosion resistance.

	Order No.	Price
Size 15 Ambidextrous Hip Holster 3 3/4" - 4 1/2" barrel large autos	060-70150	\$20.06
Size 16 Ambidextrous Hip Holster 3 1/4" - 3 3/4" barrel medium and large autos	060-70160	20.06

Sidekick® Bandolier Holsters - Large, scoped handguns have never been so easy to carry. Removable and adjustable padded flap shields your firearm from inclement weather. Even when flap is removed, a retention strap with adjustment buckle and snap keeps your gun retained.



	Realtree Hardwoods HD	
Black	060-94036 \$42.81	Size 3 - Scoped 5 - 6 1/2" barrel medium and large double action revolvers and 4 5/8" - 5 1/2" barrel single action revolvers
060-95041 \$42.81	060-94046 \$42.81	Size 4 - Scoped 7 - 8 1/2" barrel medium and large double action revolvers, 6 - 7 1/2" barrel single action revolvers, and 10" barrel Thompson/Center Contenders
060-95131 \$42.81	060-94136 \$42.81	Size 13 - Scoped 14" - 16" barrel Thompson/Center Super Contenders, Encore; 10" barrel Remington XP-100; 9 1/2" - 10 3/4" barrel single/double action revolvers; Savage Striker

Uncle Mike's Holsters

Inside-the-Pant Holsters - Ultra-thin four-layer laminate no thicker than conventional suede leather holsters. Internal moisture barrier won't transmit perspiration to gun. Smooth nylon lining for easy draw. Offered in 2 styles; Open Style as shown or with Fold-Over Velcro Retention Strap. Suede-like exterior helps anchor holster inside pants or skirt. Fold-Over Hook & Loop retention strap releases quickly with thumb and meets requirements of many jurisdictions.



	Left Hand	Right Hand	Price
Size 0 Inside-the-Pant Right Hand 2 - 3" barrel small/medium dbl. act. revolver except 2" 5-shot	-	060-89001	\$8.62
Size 1 Inside-the-Pant Right Hand 3 - 4" barrel medium autos	-	060-89011	8.62
Size 5 Inside-the-Pant Right Hand 4 1/2" - 5" barrel large autos	060-89052	060-89051	8.62
Size 10 Inside-the-Pant Right Hand Small autos (.22 - .25 cal.)	-	060-89101	8.62
Size 12 Inside-the-Pant Right Hand Glock 26, 27, 33 & other sub-compact 9 mm/.40 cal	-	060-89121	8.62
Size 15 Inside-the-Pant Right Hand 3 3/4" - 4 1/2" barrel large autos	060-89152	060-89151	8.62
Size 16 Inside-the-Pant Right Hand 3 1/4 - 3 3/4" barrel medium and large autos	060-89162	060-89161	8.62
Size 36 Inside-the-Pant Right Hand 2" barrel small frame 5-shot revolvers with hammer spur	060-89362	060-89361	8.62



Super Belt Slide Holsters - Flattened profile for optimum concealment. Extra-thin laminate conforms to body contours. Medium-high-ride design positions your firearm for a smooth draw. Three-slot design on all models for crossdraw, dual-position or strong-side carry. Thumb break and retention strap protected by Strap Traps™. Adjustment tool included. Kodra nylon is highly abrasion-resistant as well as water-resistant



	Order No.	Price
Size 0 Super Belt Slide Holster 2 - 3" barrel sm/med double action revolvers except 2" 5-shot	060-86000	\$18.67
Size 1 Super Belt Slide Holster 3-4" barrel medium autos	060-86010	18.67
Size 2 Super Belt Slide Holster 4" barrel medium and intermediate double action revolvers	060-86020	18.67
Size 16 Super Belt Slide Holster 3 1/4 - 3 3/4" barrel medium & large autos	060-86160	18.67
Size 30 Super Belt Slide Holster HK USP 9mm, .40, .45, USP Compact	060-86300	18.67
Size 36 Super Belt Slide Holster 2" barrel small frame 5-shot revolvers with hammer spur	060-86360	18.67

Paddle Holsters - This unique holster can be worn straight, or butt forward; paddle reverses for muzzle forward or cross draw. Paddle is made of semi-rigid material that contours itself to hip for comfort and concealability. Spring steel reinforced thumb break. High ride design. Convenient when you're not wearing a belt.

	Order No.	Price
Size 0 Black, Right Hand 2 - 3" barrel small/medium double action revolvers except 2" 5-shot	060-78001	\$28.04
Size 5 Black, Right Hand 4 1/2 - 5" barrel large autos	060-78051	28.04
Size 15 Black, Right Hand 3 3/4" - 4 1/2" barrel large autos	060-78151	28.04
Size 16 Black, Right Hand 3 1/4" - 3 3/4" barrel medium and large autos	060-78161	28.04
Size 36 Black, Right Hand 2" barrel small frame 5-shot revolvers with hammer spur	060-78361	28.04



Uncle Mike's Kydex Holsters

Kydex Paddle Holsters - Featuring an ultra-adjustable design, this paddle holster is soft, pliable and features air vents for the utmost in wearing ease. Drawing is easier because the body's lead edge is cut down. Adjusts for rake and height to match your torso height and body type. An excellent choice for both men and women.



PADDLE	SIZE	
060-54121	12	Glock 26, 27
060-54151	15	Ruger P85, P89, P90, P91
060-54161	16	Ruger P93, P94, P95, P97
060-54191	19	Up to 5" barrel 1911
060-54201	20	Beretta 92, 96
060-54211	21	Glock 17, 22
060-54251	25	Glock 20,21
060-54261	26	Springfield XD Full Size
060-54271	27	Springfield XD Compact
060-54361	36	S&W J Frame 38/357 up to 2 1/8" barrel



Price
\$16.72



Side Bet & Baby Bet Belt Slide Holsters - The choice for carrying very small revolvers and autos. They hold the gun at a butt-forward angle ideal for strong-side concealment. Ambidextrous design - reverse thumb break & retention strap. Fits belts up to 1 1/2" wide.

	Order No.	Price
Side Bet (fits most autos and revolvers)	060-86900	\$14.89
Baby Bet (fits .22 and .25 Autos and Sm. frame .380's)	060-86901	14.89

Kydex Mag Cases - Give your magazines the same protection as your firearm. Internal tensioning device for security. Fits belt loops up to 1 3/4" or can be clipped over waistband.

	Order No.	Price
Kydex Double Row Double Mag Belt Case	060-51361	\$15.37
Kydex Single Row Double Mag Belt Case	060-51371	15.37
Kydex Double Row Double Mag Paddle	060-51362	17.60
Kydex Single Row Paddle Double Mag Case	060-51372	17.60
Kydex Large Double Row Single Mag Case	060-50361	12.08
Kydex Double Row Single Mag case Belt	060-50362	12.08



Uncle Mike's Ankle Holster

Ankle Holster for 2' Barrel Small Frame 5-Shot Revolvers with Hammer Spur - Hides small and medium guns, even compact large-frame autos inside pant leg. Kordura nylon with soft-knit fabric for durable comfort. Cinch-down design with Hook & Loop adjustment. Nylon web retention strap with reinforced thumb break. Wrap-around design sunglasses holster strap around ankle. Hook and loop adjustable, removable calf strap.
Order No. 060-88201 \$26.77



Inside-the-Pocket Holster - holster provides better concealment and protection for your gun and clothing. Lessens print-through and recognition of guns carried inside pants or jacket pocket! Size 1 fits: small autos (.22-.25 cal.), Size 2 fits: most .380 autos. Size 3 fits: 2" 5 shot revolvers. All are black only!

	Order No.	Price
Size 1	060-87441	\$8.62
Size 2	060-87442	8.62
Size 3	060-87443	8.62



Pelican Small Cases



Pelican Small Cases Feature:

- Watertight, crushproof, and dust proof
- Open cell core with solid wall design - strong, light weight
- O-ring seal
- Automatic Pressure Equalization Valve
- Stainless steel hardware
- Pick N Pluck™ with convoluted lid foam
- Lifetime Guarantee of Excellence

1400 Case - Black

All the features above plus:

- Easy open Double Throw latches
- Stainless steel padlock protectors
- Comfortable rubber over-molded handle

Order No.
Black 174-1400BLK \$82.22

Interior Dimensions:
 11.81" x 8.87" x 5.18"

1120 OD Green Case -

Interior Dim: 7.25" x 4.75" x 3.06" (18.4 x 12.1 x 7.8 cm)

Order No.
OD Green 174-1120 \$39.72



i1010 iPhone / iPod Case -

- Designed for any 1st or 2nd generation iPod®, Nano, & Shuffle™
- Great for rugged sports
- NOT FOR SWIMMING OR SUBMERGING
- Protect your player while using it via the external headphone jack
- Lid organizer stores earphones
- Active sport double end tie down strap with reflective safety stripes
- Custom rubber liner doubles as o-ring seal
- Stainless steel hardware
- Lifetime Guarantee of Excellence
- Water resistant, crushproof, and dust proof

Order No.
Black 174-I1015 \$20.46



Interior Dimensions:
 4.37" x 2.87" x 1.68"

1020 Micro Case -

- Perfect for cell phones, PDA's etc.
- Great for rugged sports
- NOT FOR SWIMMING OR SUBMERGING
- Rubber liner for extra protection doubles as o-ring seal
- Automatic Pressure Equalization Valve - balances interior pressure, keeps water out
- Stainless steel hardware
- Water resistant, crushproof, and dust proof

Order No.
Black 174-1020 \$21.40

- Includes Carabiner



Interior Dimensions:
 5.31" x 3.56" x 1.68"

Pelican Long Cases

Pelican Long Cases Feature:

- Watertight, crushproof, and dust proof
- Open Double Throw latches
- Open cell core with solid wall design - strong, lightweight
- O-ring seal
- Automatic Pressure Equalization Valve
- Fold down handles
- Strong polyurethane wheels with stainless steel bearings
- Stainless steel hardware and padlock protectors
- 3-piece foam set
- Lifetime Guarantee of Excellence

1770 Long Case - All the features above plus:

- Four extra-deep base-to-lid locking cleats that ensure maximum stacking stability
- 6 Easy open Double Throw latches
- Two Integrated Automatic Pressure Equalization Valves
- 2 rugged double-wide handles
- 4-piece foam set

Interior Dimensions:
 54.58" x 15.58" x 8.63"

Order No.
Black 174-1770BK \$439.42
Tan 174-1770TAN 439.42

1750 Long Case - Interior Dim: 50.50" x 13.50" x 5.25"

Order No.
Black 174-1750BK \$235.01
Tan 174-1750TAN 235.01

1720 Long Case - Interior Dim: 42.00" x 13.50" x 5.25"

Order No.
Black 174-1720BK \$222.51
Tan 174-1720TAN 222.51



Sack-Ups Gun Storage Socks



Sack-Ups - Sturdy lightweight, knitted storage sacks. Silicone treated cotton blend-Safe Sack, 100% natural cotton. The cottons natural wicking ability continually draws moisture off the weapon, making Sack-ups ideal for year round storage at home and in the field. All Sack-ups come equipped with a draw string.

	Order No.	Price
Rifle/Shotgun Camo Grey 52" Bulk 6 pack (6each)	093-109	\$31.97
Rifle/Shotgun Camo Grey 52" 6 pack with Midsouth Logo!	093-109MSS	37.01
Rifle/Shotgun Swat Black 52"	093-101	7.72
Pistol Camo Grey 13.5"	093-200	4.58
Trap/Skeet Barrel Camo Grey 36"	093-511	5.67
Trap/Skeet Receiver Camo Grey 24"	093-512	5.56
Choke Tube Protector Grey(Holds 3ea 2"-3" choke tubes)	093-601	7.03
Knitted Storage Sock 66" Black Powder Camo Grey	093-507	6.71
Knitted Storage Sock 76" Black Powder Camo Grey	093-508	7.35
AR-15 Magnum 52" Camo Grey	093-104	7.00
AR-15 Magnum 40" Camo Grey	093-110	6.14
Rimfire Rifle 42" Camo Grey	093-106	6.51

Made In the USA

Doskocil Gun Cases

XLT Edition Series Cases



Lockable locks and latches. Textured to resist scatching and scuffing. Interlocking foam offers maximum protection. Contoured design for extra strength. Five-year limited warranty.

	Order No.	Price
XLT-12 Two Pistol Case (11 3/4"x7 7/8"x5")	126-10088	\$32.63
XLT-18 Four Pistol Case (17 3/4"x12"x6")	126-10089	45.38

Deluxe Edition Series Cases



Airline transportation approved. Luggage grade materials. Continuous piano hinge. Safe, tamper-proof storage. Dual positive locks and draw bolt. 4" convoluted foam padding.



126-10402

	Order No.	Price
Deluxe Double Rifle (52" x 13" x 4" inner)	126-10252	\$107.84
Deluxe Two Pistol (13 3/4" x 8 5/8" x3 7/8" inner)	126-10402	43.45
Deluxe Four Pistol (18" x 14" x 4" inner)	126-10404	53.89



All-Weather Pistol Cases

The ultimate shield against the elements. This case is designed to carry up to two scoped pistols. The "O" ring System makes the case water, moisture and dust tight. Low profile, pressure relief valve. Airline transport approved. Layered protective foam. Lifetime limited warranty. Unique four-latch system.

	Order No.	Price
All-Weather Large Pistol Case (17 1/4"x 12" x 7 1/4" inner)	126-10802	\$91.47
All-Weather Ex-Large Pistol Case (18 7/8" x14 1/4" x 8 1/4" inner)	126-10803	109.44

Gunguard SE Series Pistol Case

Scoped Pistol/Accessory- Holds longer barreled pistols with scopes and accessories. (inner:13"x9.5"x2.5")
Order No. 126-10137 \$8.15

4 Pistol/Accessory- Holds multiple longer barreled pistol with scopes and accessories. (inner:16.5"x14.25"x5.85")
Order No. 126-10164 \$18.61



Sack-Ups 6 Pack - With Midsouth Logo! - Sturdy lightweight, knitted storage sacks. Silicone treated cotton blend-Safe Sack, 100% natural cotton.

Order No. 093-109MSS \$37.01



All Weather Case With Wheels



All-Weather Double Scoped Rifle/Shotgun Case- With Wheels- Carries up to two scoped rifles or shotguns. Dri-Loc® Seal ensures case is water-tight & dust proof. Lockable and airline approved.
Order No. 126-10819 \$147.07

Special Edition Series

(Exterior:52.5"x11.32"x3.25")
(Interior:52"x10.38"x3")



CONTOUR GUN CASE

- Fits a shotgun or a rifle with standard or high-mount scope
- Protective foam liner
- Recessed handle
- Contoured recessed latches
- Padlock tabs for safe storage

Order No. 126-1010485 \$19.59



DOUBLE GUN CASE

- Can carry up to 2 rifles w/50mm high-mount scopes
- Can also carry up to 2 shotguns with space for accessories
- Recessed handle
- Padlock lockable
- 52.2" x 15.97" x 4" (Exterior)
- 51.7" x 14.88" x 3.77" (Interior)

Order No. 126-1010587 \$33.91

Aggressor Case With Bail Latches

Oversize interior holds rifle with scope up to 56mm! Even really long shotguns 52 3/4" x 9" x 4 1/2" inner dim.



Order No. 126-10527 \$48.19

Plano Aluminum Gun Case

Eggcrate Foam Interiors



	Order No.	Price
ALUMINUM PISTOL CASE 18"x13"x5"	086-1418	\$54.18
ALUMINUM GUN CASE 48"x13"x4.5"	086-1448	117.42
ALUMINUM GUN CASE 53"x13"x4.5"	086-1453	120.43

Uncle Mike's Gun Cases



Over/Under Shotgun Case - Durable, weather-resistant canvas, with a snag-free zipper and leatherette accents. Snag-free poly-padded lining keeps your gun protected and looking newer longer. 33.5" x 10.5" (851 x 267 mm).

Order No. 060-52082 \$29.45

Medium Tactical Case -
 •33"x10" (838 x 254 mm) inside
 •Three magazine pouches with hook-and-loop closures



Order No. 060-52121 \$21.65

Hoppe's Gun Storage Products



This is a simple, affordable way for gun owners to prevent unauthorized use of their firearms. The casing is bright orange, and the key is LED-lighted for easy opening in the dark! Comes with an additional standard key. Universal fit for Pistols, Rifles and Shotguns.

HOPPE'S

Order No. 060-L1 \$7.61

GoldenRod Dehumidifiers

GoldenRod
DEHUMIDIFIER



Keep mildew & rust out of your gun safe!

Gun cabinets, being made of metal, naturally stay cool and tend to condense moist air quickly. GoldenRod will maintain a constant level of warmth in the steel and virtually eliminate all moisture condensation. Comes in different sizes to fit your cabinet! Cord detaches to make installation easy! Gold in color.

Tube Length	Watts	Cord Length	Order No.	Price
12"	12	6'	119-1D12	\$26.70
18"	18	6'	119-3D18	28.24
24"	25	6'	119-5D24	29.84
36"	38	6'	119-7D36	31.38

GoldenRod® has the solution for the price conscious shopper. The GunSaver by GoldenRod® incorporates the same advanced design as the GoldenRod® at a reduced price. Both have a 10 foot cord.

Length	Watts	Order No.	Price
12"	8	119-1GS12	\$18.82
18"	12	119-3GS18	20.42



Bulldog Gun Cases



Bulldog Pink 44" Scoped Rifle Case with Pink Trim!!

- 1 1/2" Total soft padding
- Full-length zipper with pull
- Durable Nylon water-resistant outer Shell
- Brushed Tricot, soft scratch-resistant inner lining

Order No. 208-BD20444 \$16.64

Pinnacle Scoped Rifle Cases



Deluxe 2 1/4" total soft padding, Soft fur inner lining for extra protection, Full length zipper, Extra large zippered accessory pocket, Improved shape accommodates scoped and non-scoped rifles, Removable adjustable shoulder strap, Raised ribbed center padding, Heavy duty double stitching.

	Order No.	Price
Pinnacle- Mossy Oak with Brown trim- 44"	208-BD205	\$28.44
Pinnacle- Mossy Oak with Brown trim- 46"	208-BD206	28.44
Pinnacle- Black with Black trim- 46"	208-BD207	25.41

Black Nylon Hard Side Cases



Durable, hard reinforced composite construction, Soft fur lining on the top lid, Thick egg-crate style foam padding on bottom, Large velcro accessory pocket, Full length double locking zipper, Heavy-duty nylon, Water resistant padded outer shell.

	Order No.	Price
4 Pistol HardSide - 18" x 14" x 3"	208-BD518	\$25.88

Pistol Rugs

Thick 1 3/4" total soft padding, Full length zipper, Heavy duty 1200 denier nylon water resistant outer shell, Nylon wrap around carry straps



	Order No.	Price
Black pistol rug- 12"x6" (outer)	208-BD600	\$6.05
Black pistol rug- 15"x6" (outer)	208-BD601	6.66
Black pistol rug- 18"x8" (outer)	208-BD602	7.26

Eva-Dry Dehumidifiers

Eva-Dry EDV-500 High Capacity Dehumidifier - 100% renewable and needs no power to operate! Absorbs 8-10oz of moisture. A specialized non-toxic crystallized silica gel absorbs moisture and it will not leak or spill. Crystals remain active for 10 years if used correctly and Eva-Dry offers a 5 year limited manufactures warranty. Size: 8"L x 2.5"W x 5.5"H
 Order No. 145-EDV500 \$24.40



Eva-Dry EDV-300 Mini Dehumidifier - 100% renewable and needs no power to operate! Absorbs 4-6oz of moisture. A specialized non-toxic crystallized silica gel absorbs moisture and it will not leak or spill. Plug in to outdoor socket to empty, moisture turns to water vapor. Crystals remain active for 10 years if used correctly and Eva-Dry offers a 5 year limited manufactures warranty. Size: 6 1/4"L x 1 1/4"W x 4 3/4"H
 Order No. 145-EDV300 \$17.01

Extreme Scoped Rifle Cases

Deluxe 2 1/4" total soft padding, Full length zipper, Large zippered accessory pocket, Improved shape accommodates scoped and non-scoped rifles, Adjustable shoulder strap, Heavy duty double stitching.

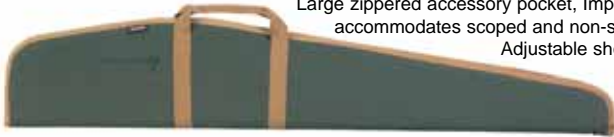

	Order No.	Price
Extreme-black with black trim- 44"	208-BD240-44	\$21.48
Extreme-black with black trim- 48"	208-BD240	21.48
Extreme-black with black trim- 52"	208-BD240-52	21.48
Extreme- green with camel trim- 44"	208-BD241-44	21.48
Extreme- green with camel trim- 48"	208-BD241	21.48
Extreme- green with camel trim- 52"	208-BD241-52	21.48
Extreme- tan with brown trim- 44"	208-BD242-44	21.48
Extreme- tan with brown trim- 48"	208-BD242	21.48

Economy Rifle Cases

1 1/2" total soft padding, Full length zipper, Durable 600 denier nylon water resistant outer shell, Shaped to accommodate scoped and non-scoped rifles.



	Order No.	Price
Economy- black with black trim-48"	208-BD100	\$10.89
Economy- green with tan trim-48"	208-BD101	10.89



Deluxe Rifle Cases

1 3/4" total soft padding, Full length zipper, Durable 1200 denier nylon water resistant outer shell, Shaped to accommodate scoped and non-scoped rifles. 10" accessory pocket



	Order No.	Price
Deluxe- Black with black trim- 48"	208-BD200	\$16.64
Deluxe- Green with camel trim- 48"	208-BD201	19.06



Tactical Cases

Heavy duty 1200 denier nylon water resistant outer shell 4 velcro external magazine pouches Deluxe 2 1/4" total soft padding Heavy duty double stitching Adjustable shoulder strap 10" accessory pocket Full length zipper



	Order No.	Price
Magnum- black with black trim- 45"	208-BD420	\$27.77
Magnum- black with black trim- 40"	208-BD421	27.77
Magnum- black with black trim- 35"	208-BD422	27.77
Magnum- black with black trim- 48"	208-BD430	27.77
Magnum- OD green - 45"	208-BD440	27.77
Magnum- OD green - 40"	208-BD441	27.77
Magnum- OD green - 35"	208-BD442	27.77
Magnum- OD green - 48"	208-BD450	27.77

Hybrid Assault Rifle Cases

-Deluxe Soft Tricot Lining
-2.5" Total Soft Padding
-Large Outer Pocket
-Deluxe Padded Shoulder Strap



	Order No.	Price
Hybrid - Black with Black trim- 45"	208-BD460	\$37.21
Hybrid - Black with Black trim- 40"	208-BD461	37.21
Hybrid - Black with Black trim- 35"	208-BD462	37.21



Bulldog Gun Cases

Long Rifle/Scoped Shotgun Cases

Improved Shape Fits Guns Better!
Zippered Accessory Pocket
It Floats!



	Order No.	Price
Camo Panel- black with camo panel- 55"	208-BD215	\$19.06

Extreme 55" Shotgun Cases

Improved Shape Fits Guns Better!
10" accessory pocket
It Floats!



	Order No.	Price
Extreme- Black with Black trim- 55"	208-BD280	\$21.21
Extreme- Green with Camel trim- 55"	208-BD281	21.21

Hybrid Magnum Rifle Cases

-Heat Resistant Tricot Lining
-2.75" Total Soft Padding
-Hidden Carry Strap



	Order No.	Price
Hybrid "Magnum" - Brown with Tan trim- 48"	208-BD264	\$49.31
Hybrid "Magnum" - Green with Tan trim- 48"	208-BD266	49.31
Hybrid "Magnum" - Green with Tan trim- 44"	208-BD266-44	49.31

Hybrid Magnum Shotgun Cases

-Heat Resistant Tricot Lining
-2.75" Total Soft Padding



	Order No.	Price
Hybrid "Magnum" - Brown with Tan trim- 53"	208-BD274	\$48.69
Hybrid "Magnum" - Green with Tan trim- 53"	208-BD276	48.69

Tuffpak by Nalpak

THIS WILL CARRY 5 GUNS!



The best part is that Tuffpak doesn't even look like a gun case!
(Tuffpak may be carrying golf clubs or a tripod for a camera.)

The Tuffpak has plenty of room for all your gear. Up to five long guns in their soft cases or any combination of guns-n-gear. With this much room, you'll be taking fewer bags on your trip. Inside, there's 50" in length and 10" in diameter. At only 17 lb., you can fill it up and not worry about exceeding any weight restrictions. Even if it does get close, you can easily move the case on its built in wheels.

Tamper-Proof Key Lock and Molded Ribs, Removable Lid, Tuff Webbed Strap, Twin Carry Handles, "Side Release" Buckle, High-Tech/Lightweight Materials, Wheels! TSA Lock models are TSA Airline approved.

	Order No.	Price
Tuffpak Guncase w/TSA Lock, Black case	082-1050TSA	\$384.56
Black Tuff-Sack	082-TPTS B	53.55

Allen Gun Cases



Allen Green Canvas Quilted Case - Quilted interior as well, with 7/8" padding and a tough #8 zipper.

	Order No.	Price
46" Scoped Rifle	168-96146	\$35.56
52" Shotgun	168-96052	37.02



Allen Euro Oversized 50" Case - Fits guns with scopes and bipods. Tough green Endura with tan accents. Thick padding and a tough #10 zipper. Three accessory pockets for storage. **Order No. 168-91550 \$38.79**



Allen Sante Fe Cases - Endura with Leather Trim, with 7/8" padding and a tough #8 zipper.

	Order No.	Price
48" Rifle	168-77548	\$30.55



Allen Brown Endura Double Pistol Case - 2 separate compartments for 2 pistols. large outside pocket with velcro flap. Approximate inside dimensions. 12"w x 7"h
Order No. 168-5015 \$17.95



Allen 42" Universal Camo Assault Case - Camo endura with carry handle and built in sling. Ammo pouch is removable and attaches with velcro. 7/8" foam, and features a #5 zipper.
Order No. 168-1068 \$33.64



Allen Black Assault Cases - Black endura with carry handle and built in sling. 6 Pockets. 7/8" foam, and features a #5 zipper.

	Order No.	Price
42"	168-106542	\$21.96
46"	168-106646	21.96

Ducks Unlimited Gun Sock

Green Camo with Ducks Unlimited Logo imprinted on it. **Order No. 168-138 \$5.67**



ENCORE
Single Shot Excellence

CONTENDER

Finally!!! A case made specifically for our Contender's and Encore's! These are well built too! 1200 denier endura, 7/8" thick foam and a #8 Zipper. Pouch on the side will hold extra barrels.

	Order No.	Price
Encore/Contender Rifle Case 43"	168-89143	\$29.91
Encore/Contender Pistol Case 22"	168-89322	29.91



Scoped Rifle Indian Grey Montana Case

	Order No.	Price
SCOPED RIFLE INDIAN GREY MONTANA 46"	168-26546	\$20.13
SCOPED RIFLE INDIAN GREY MONTANA 48"	168-26548	20.13
SHOTGUN INDIAN GREY MONTANA 52"	168-26452	19.44



Standard Camo Gun Cases

	Order No.	Price
Shotgun Break-up 52"	168-39652	\$13.29
Scoped Rifle Break-up 46"	168-39746	14.15



Legend Break-Up Camo Gun Cases

	Order No.	Price
Legend 52" Shotgun Case	168-50452	\$16.75
Legend 46" Scoped Rifle Case	168-50546	18.42
Legend 48" Scoped Rifle & Bipod Case	168-50748	23.04



32" Gun Cases

Allen Shadow Youth/Shotgun 32" Case - Perfect for Mini 22 rifles and for pistol grip shotguns as well. **Order No. 168-28132 \$10.34**



Handgun Cases

Order No.	Price
168-7511 Suede Leather Handgun Case 11" Rust	\$14.52
168-7513 Suede Leather Handgun Case 13" Rust	16.89
168-746 Black Vinyl Handgun Case 6" Locking	8.46
168-748 Black Vinyl Handgun Case 8" Locking	8.46
168-7411 Black Vinyl Handgun Case 11" Locking	8.46
168-7413 Black Vinyl Handgun Case 13" Locking	8.46

Plano Scoped Rifle Case



Dimensions:
- 53.25"L
- 4.125"W
- 12"H



PRO-Max™ Single Scoped Rifle Case - Patented PillarLock™ System protects firearm. Holds rifle with large objective lens. Thick wall construction, Comfortable molded-in handle, Lockable /airline approved, Black.
Order No. 086-1531 \$28.85

Plano Gunslinger ATV Cases

Gunslinger with grab and go case



Order No. 086-150596

Price \$45.64

Plano Protector Bow Case



Two crush resistant structural pillars inside protect sights from damage, while velcro straps hold the bow in place. High density foam. Hold 12 arrows. 49"x 19.5"x 6.5"
Order No. 086-111100 \$42.27



51.5"x4"x15" dimensions

Double Gun Scoped Rifle Case - Fits two shotguns or rifles up to 50" long. Lockable / airline approved
Order No. 086-150201 \$33.42

Plano Airglide



Single Scoped Rifle/Shotgun Case 50" BLACK - Foam inserts and straps protect/secure gun. 1" air space surrounds gun to help avoid impact damage. Heavy-duty latches and hinges with solid brass hardware. Oversized easy carry handle. Single Scoped Rifle/Shotgun case is for rifles or shotguns up to 50" long.
Order No. 086-130102 \$40.72

Plano Pistol Cases



Lockable high-impact shell
Foam padding
Over-sized easy carry handle
Storage Beneath



	Order No.	Price
Four Pistol Case (black) 16 3/4"L x6"W x 14 1/2"H	086-1404	\$15.67
Single Pistol Case (black) 11 1/2"L x 7 1/2"W x2 3/4"H	086-1403	7.05

MTM Pistol / Handgun Cases



Pistol cases for handguns with barrel lengths up to 8". Firearms are held securely in place by 2 layers of high quality foam in the two pistol case & 3 Layers of foam in the 4 pistol case. Each have double padlock tabs.

	Order No.	Price
2 Pistol Case	008-809	\$11.70
4 Pistol Case	008-811	14.66

802C- Fits up to 2" revolvers and most compact semi-autos.

803- Fits up to 3" revolver and most full size compact semi-autos



Compact Pistol Case	Order No.	Price
	008-802C	\$4.32
	008-803	5.51



Single HandGun Cases- The ultimate answer to your single handgun protection needs. Holds up to a 6" barrel. Sleek, trim design that offers more protection than a pistol rug. Convoluted foam interior, EZ stacking. Measures 12 1/4"x8 3/8"x2 5/16".

	Order No.	Price
Autos & Revolvers w/ 4" barrel	008-805	\$5.51
Autos & Revolvers w/ 6" barrel	008-806	7.72
Autos & Revolvers w/ 8.8" barrel	008-808	10.81

Single HandGun Case- A more stylish design offers more strength and durability. Has more depth for higher capacity semi-auto. Includes tab for padlock as well as strong snapping latches.

Autos & Revolvers w/ 6" barrel	Order No.	Price
	008-807	\$6.55



Sportsman's Utility Case- MTM's latest dual purpose item! The top tray holds up-to 4 handguns(size dependent) and the bottom compartment is designed for necessary items such as : Ear protection, targets spray lubes, etc.... can be hauled as well. 18.5"x10.5 liftout tray/20.7"x12.75x8.75 overall.

Order No. 008-SU411 \$27.61

Single Gun Long Term Case- Designed as a compact storage case. Fits most revolvers with up to 4" barrels and most semi-autos. Comes with convertible ammo trays that hold 25 rounds of 9mm, 38-357, 44 Mag., or 45 ACP ammo. Measures 10 1/4"x7 1/8"x2 1/8". Plus a compartment for an extra clip or cleaning supplies.
Order No. 008-804 \$10.93

MTM Archery Accessories

Ultra Compact Arrow Case- Excellent accessory for soft bow case pockets. Notched foam padding keeps arrows secure and separated. Made of rugged polypropylene and it's padlockable for security! For arrows up to 32.2" total length. Measures 33"Lx5.9"Wx3"H.

Order No. 008-BHUC6 \$12.87



18-24 Arrow Case- Designed to hold 18 to 24 full length arrows with broadheads. Arrows are held in place by two piece of foam. Snap lock latches and stainless steel hinge pins. Luggage grade high density polypropylene.

Order No. 008-BH18S \$17.64

Caldwell Shooting Supplies



Order No. 094-101777 \$77.15

- Ultra stable design
- Great recoil reducing performance
- AR-15/lever action compatible
- Heavy Duty steel frame construction
- Durable non-marring feet in front & rear
- Fast, precise pivoting elevation system
- Gun retention strap included
- 25 pound capacity weight tray

The Lead Sled™ Solo - The newest addition to Caldwell's line of recoil reducing rests. Heavy duty steel construction provides a stable and solid shooting platform. Its unique offset frame is designed to accommodate all rifles including detachable magazine rifles like the popular AR-15 platform as well as lever actions guns.

The Lead Sled DFT Shooting Rest - Dual Frame Technology absorbs more recoil and adjusts 22" to fit rifles and shotguns of all sizes. Fine windage and elevation adjustments with fingertip control. 2.5" of elevation adjustment on smooth ball bearings. Baffled tray keeps lead shot bags in place and holds up to 100 lbs of shot. Rubber feet prevent slippage.



Includes a filled front bag specially designed for the DFT

Order No. 094-336647 \$199.75

- The Lead Sled™ Plus** -
- Up to 95% recoil reduction
 - Ideal for magnum rifles & slug guns
 - Innovative, adjustable weight tray slides to accommodate bar bell weights as well as weight bags
 - Holds two 25 lb. bar bell weights
 - Holds up to 100lbs. of lead shot
 - Fingertip elevation adjustment
 - Filled front bag included
 - Padded rear rest
 - Non-marring rubber feet
 - Adjustable height rear foot
 - Improved "no wobble" elevation ram



\$120.87

Order No. 094-820300

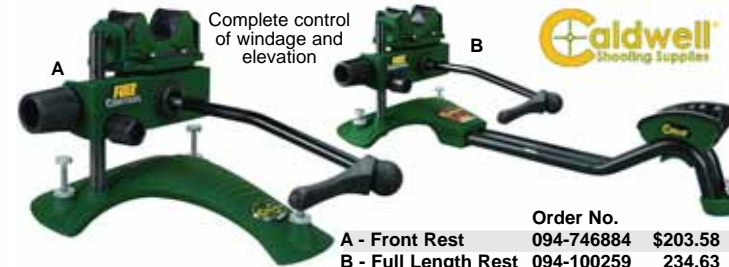

Complete control of windage and elevation

Order No. A - Front Rest 094-746884 \$203.58 B - Full Length Rest 094-100259 234.63

Fire Control Rest™ - Perfect fingertip control over the location of your crosshairs when your trigger breaks. This control means unmatched accuracy, precision, and repeatability in sighting-in, handload development or competition. The glass-smooth mechanisms inside allow you to move the front bag up and down and left and right to accommodate small shifts in wind or firearm position between shots.

- Caldwell 7 Rest™** -
- Overmolded supports
 - Folds compact for transport and storage
 - Works great with AR-15s and lever-action rifles
 - Ambidextrous - folds to accommodate right or left-handed shooters
- Order No. 094-101557 \$30.29

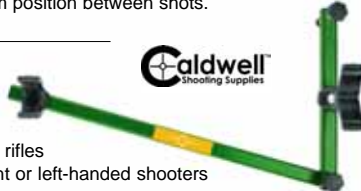

A - The Rock BR - This high-quality rest is designed for the most accuracy-minded shooters around - Bench Rest Competitors - but everyone who wants the best from their rifle will benefit from the advanced design of the Rock BR. The rest weighs a satisfying 15-1/2 lbs, thanks to its cast-iron base. Fine elevation adjustments are made from a large-diameter rotating wheel that glides on a set of ball bearings. Coarse elevation adjustments are made with a locking collar. A full 5" wide synthetic 3-lobe bag is included. Order No. 094-440907 \$165.52

B - The Rock Shooting Rest - Wide cast iron base makes this one stable! 1" Diameter steel center post with large elevation wheel for quick height adjustments from 4.5" to 7.25". Three leveling feet, with bubble level mounted on the cradle. Cradle accepts a wide variety of bags (Not Included) Order No. 094-383774 \$74.01

C - The Rock JR - Uses same Universal Front Bags as The Rock enabling you to choose a configuration to match your rifle. Elevation wheel provides height adjustment from 4-1/2" to 7-1/4" at your fingertips. Includes an unfilled medium front bag. Order No. 094-323225 \$35.59



Caldwell Rest Bags- Perfect compliments for "The Rock" sold above! Made of Cordura & Leather. Available filled with ground walnut shells or unfilled. The approximate shipping weight of filled bags is shown.

	Filled (Crushed Walnut Shells)		Unfilled		
	Appx weight	Order No.	Price	Order No.	Price
A- Rear Bag	2.5lbs	094-598458	\$25.39	094-226645	\$22.40
B- Narrow Bag	0.5lbs	094-108325	14.74	094-391981	11.96
C- Wide Bench Rest	0.5lbs	094-576578	14.80	094-489585	11.96
D- Medium Varmint	0.4lbs	094-263234	14.80	094-174122	11.96
E- Universal 4 Bag Set				094-421196	51.68
Includes All 4 bags shown above (unfilled)					

Deadshot Shooting Bags- Great for sighting in! Made of Cordura & Leather. Front Bag dimension: 10"w x 8"h x 6"deep. Rear Bag dimension: 5"w x 5"h x 4"deep. Available separate or now in Combo's



	Order No.	Price
Filled Rear Bag (appx 1.5lbs)	094-640721	\$12.19
Filled Front Bag (appx 8lbs)	094-516620	16.44
Filled Combo (Front & Rear Bags)	094-939333	26.95
Unfilled Combo (Front & Rear Bags)	094-248885	14.63

The Tack Driver- One bag to take the place of two! The Tack Driver supports practically any forearm size and shape; shotguns and rifles. Non-slip, non-marring material on the top and bottom combine to offer you the most stable, secure, and rock solid shooting rest available.



The Tack Driver (Filled) - Order No. 094-569230 \$40.55
The Tack Driver (Unfilled) - Order No. 094-191743 \$27.82



Handy Rest NXT™ - Extremely versatile front rest. Constructed of durable, lightweight materials. The intuitive design includes a removable handgun support attachment that easily converts this rifle rest into a handgun rest. Order No. 094-574662 \$20.75



Includes removable handgun support.

Steady Rest NXT™ - The 3pc design allows the shooter to use the rest in one or two-piece configurations, allowing it to adjust to any length long gun as well as handguns. Order No. 094-548664 \$25.54

Stoney Point Shooting Bags



Stoney Point Shooting Bags - Super-tough 600-denier nylon construction. Nonskid bottom keeps them in place. Filled with polypropylene pellets.

	Order No.	Price
A - Standard Rear Bag 7" (L) x 5.5" (H) x 5" (W)	060-FSRB10	\$15.24
B - Standard Front Bag 7" (L) x 4.25" (H) x 5" (W)	060-FSPB25	11.10
C - Compact Rear Bag 5.5" (L) x 4.5" (H) x 5.375" (W)	060-FCRB15	11.10
D - Bench Rest/Universal Front Bag 4.75"(L)x2.5"(H)x2"(W)	060-FUFB20	8.31
E - Marksman's BenchRest Bag 11.25"(L)x10.75"(H)x7.5"(W)	060-FMFB30	38.80

Uncle Buds Bulls Bags

Uncle Bud's



BULLS BAGS holds your firearms like a vice. It's unique patented design increases stability while reducing felt recoil. Unlike other clamping systems, the Bulls Bag will not affect your point of impact.

Self-tightening, four-chamber butterfly design protects the finish of your gun. This one bag system eliminates the need for a toe and heel bag. Two bag systems creates 2 points of upward pressure, and one point of downward pressure on the gun, creating a flex in the shooting pattern.

	Order No.	Price
A - 10/10 Field (9 1/2")	073-1001	\$42.44
B -10/10 Bench (15")	073-1005	49.55

Uncle Bud's

Ballistic Tactical-Black/Gold w/Blk Tuff-Tec rubberized top -

- 600 Polyester w/UV coating (Moisture resistant)
- Comes with military spec "D" rings and carrying strap
- Cradle Height approx: 3.5"
- External fill spout w/military grade "Velcro" No-leak filling spout/seams
- Lifetime Guarantee against wear and tear

	Order No.	Price
10" Tactical Blk/Gold	073-16012	\$26.74
15" Tactical Blk/Gold	073-16022	33.01

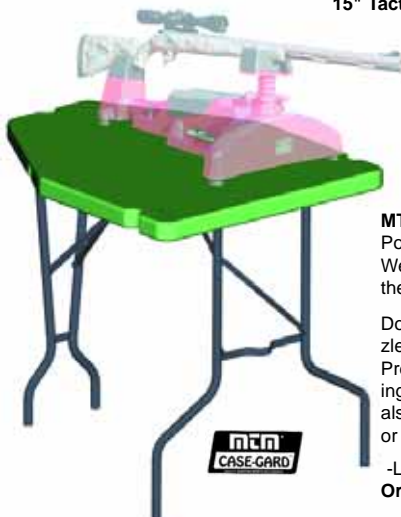

Shooting Tables

MTM Predator Shooting Table- Molded Polymer tabletop. Collapses in seconds. Weighs less than 18lbs. Ideal for use with the MTM Predator Shooting Rest!

Doubling as a maintenance bench or muzzle loader table at the range, the MTM Predator Shooting Table is ideal for sight-in and testing firearm performance. It is also ideally suited to the back-forty shooter or the prairie dog hunter on the go.

-L-35" x W-28" x H-30"
Order no. 008-PST01 \$66.36

Protektor Shooting Bags & Rests



The original source of sandbag rifle rests and pistol rests. All leather and leather covered items are made with the best top grain cowhide leather that is available. All bags are unfilled unless noted.



A - Sissy Bag- The "Sissy Bag" may be that to some, but it absorbs plenty of recoil when placed in back of any rear sandbag. This bag is 4" in diameter by 8 1/2" high. Carrying strap stitched to the top. **Order No. 103-15 \$19.60**

B - Bunny Ear- A replica of the Rabbit Ear, but is only half as high and not as long. **Order No. 103-14 \$25.48**

C - No. 13 Rabbit Ear Rear Bag- Complete two-compartment bag sewn to the top. This compartment which forms the ears is 4 3/8" by 4 3/8" on its base. Each ear is 2 5/8" high and each is filled separately.

	Order No.	Price
Unfilled	103-13	\$25.48
Filled	103-13F	27.93

D - Standard Front Bag- The No. 7 Standard Front Bag is great for every shooter. Bag size (height from bottom to top of saddle) is 4". a base or black (wood) 6" wide by 6" long by 2" to 2 1/4" high (thick) is used under this bag. **Order No. 103-7 \$21.36**



E - The No. 1 Small Owl Ear Front Bag- Narrow hollow center to accommodate most hunting rifles. Bag size is 2 1/4" wide by 5 3/4" long by 1" high (in the center) and about 1 1/2" to 1 3/4" from ear to ear in the center. **Order No 103-1 \$15.97**

F - The No. 2 Regular Owl Ear Front Bag- Hollow center to accommodate the forend of most sporter or varmintier rifles. Bag size is 2 1/4" wide x 5 3/4" long and 1" high (in the center), and about 2" to 2 1/2" for ear to ear in the center. **Order No 103-2 \$15.97**

Owl Window Bags - These bags have two extra bags sewn on so that the bag can rest on a car door with the window down. The bags can be used by disabled hunters or disabled veterans to shoot from a vehicle. (Legal with permit in some states). Also these may be placed on rounded areas such as a wooden fence railing.

	Order No.	Price
G - Sml Owl (No. 1) Ear Window Bag	103-4	\$21.56
H - Reg Owl (No. 2) Ear Window Bag	103-5	21.56

Metal Rifle and Pistol Rest - Welded steel adjustable tripod rifle and pistol rest. Strong enough to stand on and it won't break if dropped like cast aluminum will. Black enamel finish and made to accommodate all Protektor Model front bags. (Adjusts from 4 3/4" to 8 1/4" high.)
Order No. 103-52 \$48.02



Caldwell's Stable Table™ Deluxe Shooting Bench - This tri-pod design has fewer joints and tighter connections than other fold-up style shooting tables. This means minimal wobble, which produces an extremely stable shooting bench. Also, the tabletop features recesses designed to hold ammo boxes, binoculars, etc. In addition, the tabletop incorporates a raised ridge around the outside to keep ammunition, cartridge cases or cleaning supplies from rolling off the table onto the ground. Padded seat Weighs less than 50 lbs.

Order No. 094-252552 \$194.47

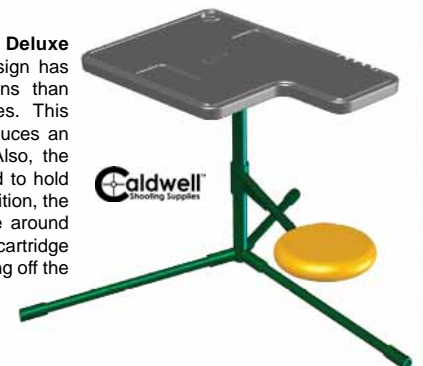

MTM Shooting Rests



The MTM Predator Shooting Rest - Provides a stable, teeter free platform, at half the cost of a metal rest. Adjusts in Length to fit various rifles and handguns. Adjusts in Height for Pinpoint Accuracy while shooting. Provides firm footing on uneven surfaces. **Order No. 008-PSR30 \$35.09**



Easily converts from a rifle rest to a stand alone handgun rest.



MTM Front Rifle Rest- Excellent, rock-solid stability at a price any shooter can afford. Wide, wobble free stance with gripping rubber feet. Handgun support & extra wide, rear leg designed for comfortable handgun support. Two-Point rear footing for added stability. Precision Dialed Adjustment offer 3.5" of vertical deviation for pin-point accuracy. **Order No. 008-FRR \$18.81**

MTM Shoulder-Gard Rifle Rest- Magnum Rifle Recoil Reduction! This new weightable, 4 point flex base shooting rest is designed to ease the punishment of sighting in powerful magnum rifles. Integrated recoil reduction sling helps absorb most of the energy, while up to 50lbs of storage weight (Not included) in the central storage compartment stabilizes your shot. Forearm support adjusts 3.5" vertically for pin point accuracy. **Order No. 008-SGR \$32.05**

Plastic Pistol Rest- So versatile, it will accommodate any size handgun from derringer to a 14" TC Contender. Adjusts for 20 different heights. Measures 6"x11"x2 1/2". Rubber padding is molded to the front to protect your firearm. Can also be used as a front rifle rest. **Order No. 008-PR30 \$16.05**

Spot and Shoot Tripod Adaptor- Convert any tripod with standard screw threads into a shooting tripod in seconds! The MTM Adaptor features a quick release scope or camera mount plus a non-marring shooting pad. Made of rugged polypropylene. **Order No. 008-SST \$16.29**



Shooters Ridge Shooting Rests



Zero Kick Rifle Rest- Reduces up to 90% of felt recoil. Make use of the old weights in your basement, or add shot bags to further reduce recoil. Front and rear sand bags for traditional shooting feel. Has front and rear elevation adjustment as well as Micro windage adjustment. Sturdy, light-weight aluminum construction **Order No. 097-40805 \$131.40**

Deluxe Rifle Rest- Constructed of rigid tubular steel with a durable, high-tech powder coated finish is designed to eliminate felt recoil. Comes with leatherfront sand bag. Attaches by Velcro. Right or left handed shooters, precise windage adjustments **Order No. 097-40804 \$101.28**



Steady Point Tri-Stance Rest with Sandbag
 -Leveling Screws on each leg for uneven surfaces
 -Adjustable Stay-Put foot pins keep rest stationary
 -Vertical Adjustment feature with locking device
 -Suitable for competitive shooting
 -Comes complete with leather sandbag **Order No. 097-40874 \$56.37**

Two Tone Pre-Filled Shooting Bags - Tough Forest Green Polyester & Suede

	Order No.	Price
Shot Bag Sand Bag	097-40474	\$17.84
Front Bag Large	097-40472	15.73
Rear Bag	097-40473	17.90



Gun Grip Shooting Vise
 -Great for sighting in or Cleaning
 -Adjusts to most rifles & shotguns
 -Clamps are padded to protect
 -Lightweight & Portable
 -Adjustable rear foot for elevation **Order No. 097-40871 \$36.52**

Steady Point Shooting Rest with Gun Vise

-High-tech steel construction for durability
 -Rest Rotates 360 degrees
 -Major elevation Adjustment is Easy
 -Minor elevation Adjustment can be done on the front cradle
 -Leather Covered rear gun vise is included for cleaning and maintenance **Order No. 097-40873 \$53.65**



Steady Point Handgun Rest

-Great for sighting in, target practice, long range hunting
 -Easy vertical & horizontal adjustments
 -3-point stance for great stability
 -Soft rubber feet won't mar bench
 -High-tech steel construction for durability
 -Durable leather platform protects finishes **Order No. 097-40875 \$56.65**



The R.A.S.S. Shooting Bench
 Full 360° movement, Portable, adjustable and more! Visit our website for more info and a video!

Order No. 044-9320 \$372.40

Shooters Ridge Bipods

Shooters Ridge Bipods- Telescoping legs with spring return, attaches easily to sling swivel stud.

	Order No.	Price
Prone or Benchrest 13.5" - 23"	097-40852	\$34.93
Prone or Benchrest 9" - 13"	097-40853	32.92
Prone or Benchrest 6" - 9"	097-40854	30.90
Pivoting Bi-Pods		
Adjustable Pivot Bi-pod 6" - 9"	097-40855	\$36.95
Adjustable Pivot Bi-pod 9" - 13"	097-40856	38.96
Adjustable Pivot Bi-pod 13.5" - 23"	097-40857	40.98



Shooters Ridge AR-15 Bipod Adapter - Mounts Shooters Ridge Bi-Pod to Colt AR-15. Detachable swivel included. Fits round hand guard only, not triangular.
Order No. 097-40450 \$10.52

ATI Featherweight Bipods

Mounts to Bayonet Lug



SKS- Bipod

	Order No.	Price
Featherweight Non-Swivel	019-BIP0700	\$20.82

Universal Featherweight Bipod - Fits any firearm with a sling swivel stud and AR-15 types. Will mount to any rifle sling swivel stud. Can be adapted to swivel or remain fixed. Easily adjusts from 9" to 13". Weighs Only 6 oz. Allows Use of a sling, extra sling swivel stud included. Order No. 019-BIP0300 \$28.36



Now also available, AR-15 Sling Adapter! Fits round mil-spec handguard. Swivel Included.
Order No. 019-ARA1700 \$5.67



Bipods -		Order No.	Price
•Stud or Stud/Barrel	6"	146-CBP6	\$36.95
•Picatinny compatible	9"	146-CBP9	38.40
•Lightweight design			

Order No.		Price
13"	146-CBS1323TILT	\$54.34
6"	146-CBS69TILT	48.54
9"	146-CBS913TILT	49.99

New! MTM K-Zone Shooting Rest

MTM K-Zone Shooting Rest - Quick and easy to adjust bench rest style handwheel elevation system - Ideal for hunting rifles, AR-15's, lever action rifles, slug guns, handguns, etc. - Use as a front rifle rest or handgun rest - Overall length adjusts up to 7.5"



Made in USA

Order No. 008-KSR30 \$33.42



Harris Bipods

Series 1A Solid Base Bipods - Attaches quickly and securely to QD sling stud. Can be removed in seconds. Pull out self-retracting leg extensions. Adjustment for off-centered stud. Legs held in shooting position or folded parallel to barrel by strong spring tension.



	Order No.	Price
13 1/2" - 23" High Rest Bipod	053-1AH	\$67.64
9" - 13" Low Rest Bipod	053-1AL	67.64
9" - 13" Low Rest Bipod (Notched)	053-1ALM	67.64
6" - 9" Bench Rest Bipod	053-1BR	67.64
6" - 9" Bench Rest Bipod (Notched)	053-1BRM	67.64

Series S Hinged Base Bipods - Rotates 45 degrees for instant leveling on uneven ground. Hinged base has tension adjustment and buffer springs to eliminate tremor or looseness in crotch area of the bipod. Attaches quickly and works well.



	Order No.	Price
12" - 25" High Rest Swivel Bipod	053-S25	\$113.67
9" - 13" Low Rest Swivel Bipod	053-SL	97.95
9" - 13" Low Rest Swivel Bipod (Notched)	053-SLM	97.95
6" - 9" Bench Rest Swivel Bipod	053-SBR	97.95
6" - 9" Bench Rest Swivel Bipod (Notched)	053-SBRM	97.95

Adapters for Harris Bipods



	Order No.	Price
A - Adapter Fits: Mini-30 & Mini 14 (excluding folding stock)	053-14	\$20.44
B - Universal Adapter Requires 2" of Free Space, Fits Barrels from .550 - .812"	053-4	20.44
C - Stud Adapter Fits: AR15 Round Handguard with alterations	053-5	10.33
D - Stud for European size rails (about 3/8" across rail slot)	053-6	8.10
D - Stud for rails (about 5/16" across rail slot)	053-6A	8.10

Harris Bipod adapter (Picatinny / Weaver) - Fits Picatinny or Weaver rail. A Bipod previously attached to this accessory will allow the operator quick installation of bipod as a rail-mounted accessory.
Order No. 120-HBA \$19.72



New! MTM K-Zone Shooting Rest

Limbsaver Barrel De-Resonator

Sharpshooter X-Ring De-Resonators -

- Improves Accuracy
- Tightens Groups
- Easy to Install
- Dampens Barrel Whip
- Fits Multiple Barrel Sizes
- Designed for scoped rifles



Standard

Bull Barrel

Tightens groups by taming barrel vibration waves.

Standard Sporter Barrel - Fits 1/2" to 7/8" Diameter
Order No. 401-12051 \$8.22

Competition/Bull Barrel - Fits 3/4" to 1 1/8" Diameter
Order No. 401-12052 \$8.22



Flatline Ops Long Range Shooting Products



Flatline Ops designs and produces highly technical hunting, long range shooting and firearm products to improve accuracy. Made in the USA.

Scope Levels - Flatline Scope Levels aid in the correction of "can't error" for a dead-on, true vertical hold. Quick and easy to install and do not require that you remove your scope. They have a highly visible fluorescent fluid level and are built for right and left-handed shooters.



	Order No	Price
1 Inch	160-HUNTER	\$127.40
30mm	160-SNIPER	137.20
34mm	160-COVERT	166.60

Angle Degree Indicator (ADI) - The Angle Degree Indicator takes the guesswork out of uphill and downhill shots. It mounts quick and easy to a strong-arm mount. This simple rugged design requires no batteries and is calibrated in degrees. The ADI gives an instant angle readout that can be entered into your pocket PC or used with preprinted angle drop charts. **Order No. 160-ADI \$133.00**



Slotlock ADI Mount - The Slotlock Mount allows mounting under low-mounted scope tubes without removing the scope. Mounts to most common ADI indicators on Picatinny Rail Systems. It has three position height adjustments, plus left and right hand mounting options. 6061-T6 aluminum. **Order No. 160-SLOTLOCK \$83.30**

Strong Arm Mounting System for ADI - The Strong Arm Mount mounts quickly and easily to position the ADI for an unobstructed view of uphill/downhill trajectory angles. The Strong Arm Mounts are constructed with 6061-T6 aluminum, stainless steel hardware and a hard anodized finish. **Order No. 160-STRONGARM \$58.80**



Range Bags & Boxes



A- BULLDOG Economy Range Bag- 13"x7"x7", 1200 Denier Comes with strap **Order No. 208-BD900Price \$15.15**

B- BULLDOG Deluxe Range Bag- 13"x7"x7", 1200 Denier Comes with strap, Large main compartment with moveable divider, outer pockets for extra storage. Deluxe Padding! **Order No. 208-BD910Black..... \$30.71**
208-BD911Navy..... \$30.71

C-UNCLE MIKE'S Equipment Bag- Tough, water resistant Cordura nylon bag designed specifically to carry and protect gear normally carried by serious shooters. Hard Shell Case 18.5"x9"x7" **Order No. 060-52471 Closeout! \$33.97**

D- UNCLE MIKE'S Range Bag- The ideal case for carrying two handguns and a full compliment of ammo and supplies to the range. Main compartment has removable Velcro dividers. Comes with pistol rug that can be used as a rest. Made of 1000 denier Cordura. Water Repellant. Case 16"x7"x8" **Order No. 060-52411 Closeout! \$40.72**

E- MTM Utility Box- MTM's latest dual purpose item! The top tray holds up-to 4 handguns(size dependant) and the bottom compartment is designed for necessary items such as : Ear protection, targets spray lubes, etc.... can be hauled as well. 18.5"x10.5" liftout tray/20.7"x12.75x8.75 overall. **Order No. 008-SU411Price \$27.61**

Shotshell & Trap-Skeet Bags



PROTECTOR Shell Bag- Two compartments for 25 shotgun shells and 25 empties. The bag is 7 1/2" wide by 8" height and it fits any type of belt you decide.

	Order No.	
A- Suede	103-23B	\$20.58
B- TopGrain Leather	103-23A	25.48

C - Allen Shooters Bag - Green Canvas, 2 compartments. **Order No. 168-2102 \$11.69**

D - Allen Eliminator DoubleComp Bag - **Order No. 168-8203 \$12.17**

E - Allen Eliminator Single Box Carrier - **Order No. 168-8210 \$7.69**

Caldwell 7 Rest™ - The 7-Rest is a truly innovative shooting accessory that utilizes a unique design to deliver exceptional versatility and true value. The asymmetric frame provides great stability while maximizing length adjustability. By simply loosening the lock knob, the angle between the two halves of the frame can be adjusted to change the distance between the front and rear supports.



- Works great with AR-15s and lever-action rifles
 - Ambidextrous - folds to accommodate right or left-handed shooters
 - Overmolded supports
 - Folds compact for transport and storage
- Order No. 094-101557 \$30.29**



Allen Filled Bench Bag - 8"x7"x5", Shoulder Strap Included. Inert Poly Filled bags, Sticky textured, reinforced synthetic gun rest surfaces. **Order No. 168-185 \$24.34**

The Hornady Delta Rest- NINE DIFFERENT SHOOTING HEIGHTS! This lightweight gun rest is perfect for varmint shooting or sighting in rifles. Eliminates bulky tripods or heavy rests. It has a removable end cap and hollow cavity for easy filling. **Order No. 005-010062 \$16.98**



Shooting Shields



A- PAST® Magnum Plus Shield- Delivers essential additional protection for big bore cartridges from 7mm calibers and up. Tuned and tested for maximum effectiveness during the critical 2-millisecond peak impact "pain window". Body shaped over the shoulder, onto the arm design architecture protects against buttstock slip. Stays in place, yet lightweight, 1/2" patented foam protection system covers a larger shoulder area than the Magnum Shield. Excellent for all shotgun sports (hunting, trap, skeet, sporting clays, etc.) and large caliber rifles! **Order No. 094-310010 \$26.12**

B- PAST® Field Shield- Right & Left Hand. Contoured for close fit and fastest gun mounting. Protection with the greatest flexibility using lightweight patented 1/4" foam protection system. This makes a great shield for trap and skeet shooters and is also a good starter shield for the young shooters just getting into the sport! Don't get bruised and rattle your body, use a shield! **Order No. 094-350010 \$21.50**

C- PAST® The Heraean Shield for Women- allows today's women shooters to get a customized competitive edge to shoot with under tunic Olympic freedom plus the recoil protection formerly available only from outerwear. Slides easily under the bra strap. Stays firmly in place with perfectly placed velcro closures. Lightweight patented foam system: silky smooth cotton blend cover. Excellent for lady shotgunners and rifle shooters. One Size Fits All **Order No. 094-360000 \$13.83**

D- PAST® The Magnum Shield - The Original Recoil Shield. Superior protection for use with medium to high caliber rifles during sight-in, practice and field action. Original 1/2" patented foam protection system. Excellent for all shotgun sports (hunting, trap, skeet, sporting clays, etc.) and large caliber rifles! Right & Left Hand Shooters. **Order No. 094-300010 \$21.50**

E- The PAST® Super Mag Plus Ambidextrous Shield - Has the same quality construction as all PAST® shields, but it is designed to ease the blow of heavy duty calibers like the .416 Rigby and the .500 Nitro. **Order No. 094-330110 \$30.74**



A- Black 3 Pocket Eyeglass Soft Case - Order No. 077-EX5001 \$4.12

B- Black Eyeglass Soft Case - Order No. 077-EX5002HC \$2.89

C- Tech Cord Neck Cord - Order No. 077-TC100BL \$1.46



Allen Shooting Vests



- Accommodates right or left hand shooter
- Choke tube pocket with individual compartments
- Pockets inside the vest to hold recoil reducing pads
- Two large pockets for spent hulls and loaded ammo

	Order No	Price
Ace Shooting Vest Med/Large	168-2261	\$39.38
Ace Shooting Vest XL/XXL	168-2262	39.38

Allen Sound Sensors

Allen Sound Sensor Hearing Protection

- Revolutionary Non-Electric hearing protection, that still allows easy conversation. No batteries needed! Lightweight, only 1.7oz and compact folding design makes them easy to wear and carry. Noise Reduction Rating of 26. Extra foam ear cushions included.

	Order No.	Price
Black	168-2320	\$16.80
Pink	168-2321	\$16.80



Radians Polarized Cobalt™ - Polarized lenses provide superior glare control for bright outdoor conditions.

- Polarized lenses ease glare for bright conditions
- Blocks 99.9% of the suns harmful UV rays
- Lightweight design and extremely comfortable fit
- ANSI Z87.1-2003 compliant

Order No. 077-CB01POCS \$7.49



	Order No.	Price
Clear	077-RL110CS	\$7.38
Smoke	077-RL120CS	7.38
Amber	077-RL140CS	7.38

Radians Ridgeline™ -

- Sleek, lightweight full frame glass
- Bayonet style temples with rubber tips for superior comfort
- Polycarbonate lens for impact resistance
- Integrated rubber nose piece for comfort
- Meets ANSI Z87.1+ standards and provides 99.9% UVA/UVB protection



A - R2000™ Electronic Thin Muff - Compresses harmful impulse sounds above 85dB. Features Padded CoolMax® headband which moves moisture away while providing cool comfort. Independent volume controls, adjustable, folding headband and Two easy access external battery compartments hold 3 AAA batteries each for long lasting use (approx. 280 hours). Batteries are included. **Order No. 077-R2000C \$91.89**

B - M-31™ Ear Muffs - These super-compact folding ear muffs store easily when not in use. The soft foam ear cups and lightweight construction make them ideal for extended wear. Furnished with convenient belt clip for easy toting. Noise Reduction Rating (NRR) of 30 **Order No. 077-M31C \$27.01**

T-10™ True Jr.™ Shooting Glasses -

True smaller-frame design, Black synthetic frames, Partially mirrored lenses, ANSI Z-87+ certified.

	Order No.	Price
Clear	077-T1010C	\$6.36
Amber	077-T1040C	\$6.36

Perfect for Young Shooters!



T-10™/ True Jr.™ Combo Pack

True Jr.™ Ear Muffs - NRR of 21, True smaller-frame headband, Full-size ear cups for proper coverage, Remington "R" logo on ear muffs.

T-10™ True Jr.™ Shooting Glasses - True smaller-frame design, Black synthetic frames, Partially mirrored lenses, ANSI Z-87+ certified.

Order No. 077-T10YM21C \$20.87

T-71™ - Dual injected rubber frame and temples provide a durable frame and soft, cushioned brow protection. Vented frame allows free air flow to prevent fogging. Adjustable, soft nose piece, Polycarbonate lenses provide 99% protection against harmful UV rays.

	Order No.	Price
Clear A/F	077-T7111C	\$10.81
Smoke A/F	077-T7121C	10.81
Amber	077-T7140C	10.81
Indoor/Out	077-T7190C	10.81



T-70™ - Polycarbonate lenses provide maximum impact resistance. Full wraparound frame provides ultimate protection. Soft, rubber temple pads provide a comfortable, secure fit. Neck cord included.

	Order No.	Price
Clear	077-T7010C	\$8.66
Yellow Mirror	077-T7065C	8.66
Indoor/Out	077-T7090C	8.66



T-70™ Polarized - Polarized polycarbonate lens eliminates reflected glare and reduces eye fatigue. Neck cord and carry bag included.

Order No. 077-T70PC \$23.12

AO Safety/Peltor Shooting Protection



A - The Shotgunner- Tapered Cup for the Trap and Skeet Shooter. Eliminates Gun Stock Interference. Liquid/Foam Cushions. Folds for Portability. Adjustable Headband
Order No. 141-97011Black.....Price \$15.64 (NRR 21dB)
141-97013Red.....Price \$15.64

B - The Shotgunner Behind The Head- Designed for Cap & Hat Wearers. Very Lightweight (5.3 oz.). Low Profile Liquid/Foam Cushions. Adjustable Stainless Steel Back Band. Black Domes (NRR 19dB) **Order No. 141-97008 Price \$16.97**

C - Push to Listen- (NRR 25) Push button to hear **Order No. 141-97088 \$33.48**

D - Disposable Plug Dispenser - 50 Pair (NRR 29dB) **Order No. 141-90579 \$7.17**

E - Indoor/Outdoor -In(NRR 22dB) Out(NRR 0-22db) Order No. 141-97079 \$9.22

F - Disposable Ear Plugs -Corded Pods (NRR 33dB) Order No. 141-97081 \$1.74

G - Reusable EarPlugs -Flanged/Washable(NRR 26dB) Order No. 141-97317 \$4.47

H - Disposable Ear Plugs - 3 Pair (NRR 33dB) Order No. 141-97080 \$2.02

Peltor Tactical 6S- Distortion-Free Amplification of Low Level Sounds Up to 19dB. Electronics Limits Amplified Sounds to 82dB. Folding Design for Easy Storage. Stereo Microphones Enhance Sound Localization. Independent Volume Controls. Lightweight (8.8 oz.)

Gray Domes. 141-97044 \$52.43



Peltor Tactical 6S Behind The Head- Designed for Cap & Hat Wearers. Electronics Limits Amplified Sounds to 82dB. Distortion-Free Amp of Low Level Sounds Up to 19dB. Stereo Microphones Enhance Sound Localization. Independent Volume Controls on Each Cup. Adjustable Stainless Steel Back Band. Gray Domes.
Order No. 141-97043Price \$52.43

Smartreloader SR112 Slim Electronic Stereo Earmuffs - The speakers shut down in milliseconds when the noise goes over 85dB. They also amplify the sounds below 20dB. The NRR is 20dB

Order No.

Gray 047-VBSR0061 \$32.90
Olive Drab 047-VBSR00611 32.90

SmartReloader



Caldwell Sound Right ES-85

ES-85 Low Profile - Muff out the noise of gunshots while listening to normal conversation and range commands. The Caldwell ES-85 earmuffs block out noises above 85 dB while amplifying normal sounds and voices. Perfect for all your shooting needs, and inexpensive enough that you can afford more than one set. Requires 2 AA batteries (not included). **Order No. 094-487557 \$26.77**



Radians Shooting Protection



A - Cease Fire Noise Activated internal baffle eliminates "plugged up feeling". NRR 7 **Order No. 077-CF700BPPrice \$5.22**

B- Foam Plugs Disposable with a NRR of 29
 Uncorded **Order No. 077-FP8000BPPrice \$1.87**
 Corded **Order No. 077-FP8100BPPrice \$2.74**

C - Low Set feature Cool Max technology in a lightweight, low profile design. Folding design for easy storage and keeps dust & dirt out. NRR 29db
Order No. 077-LS0100CS ...Above the head NRR 21db...Price \$11.03
077-LS0101CS ...Behind the head NRR 19db...Price \$11.03

D - Maximus with 4 independent high frequency microphones. Compresses harmful noises to 85db without clipping or cutting. Has "Coolmax head band"
 NRR 29db **Order No. 077-MA0600CSPrice..... \$93.68**

E - Omni Electronic same as above but in Mossy Oak Obsession
Order No. 077-OM0600CS ...\$112.42

F - Pro-Amp Low Profile Ear Cups. Compress harmful impulse and continuous noises to safe levels while enhances low level sounds. Headbands feature "coolmax". NRR 23db **Order No. 077-PA0600CS\$67.53**

Pro-Amp Behind The Head Low Profile Ear Cups - NRR 31db
Order No. 077-PA0601CS \$67.54

G - Hunter's Ear- Provide warmth on cold days. Compresses all noises to 85db Amplifies low level sounds to enhance your hunting experience.
Mossy Oak Break-Up Order No. 077-HE4B00CS \$87.30
Realtree Hardwoods HD Green Order No. 077-HE4G00CS \$87.30

H-Revelation Shooting Glasses- 5 position lens angle adjustment and 4 position temple length adjustment. Slim temples and a semi frame provide a lightweight wear. Features a soft nose piece with self adjusting fingers provides a comfortable, secure fit. Meets or exceeds all ANSI Z87.1+ standard.

	Order No	Price	Order No	Price
Clear	077-RV0110CS	\$7.22	Silver Mirror	077-RV0160CS \$7.22
Dark Smoke	077-RV0120CS	7.22	Blue Mirror	077-RV0170CS 7.22
Amber Yellow	077-RV0140CS	7.22	Copper	077-RV01C0CS 7.22

Micro Glasses- Made specifically for children. Meets all ANSI Z87.1+ standards.

	Order No	Price
Clear	077-MC0110CS	\$4.37
Dark Smoke	077-MC0120CS	4.37
Amber	077-MC0140CS	4.37



Coveralls - Wear over prescription glasses.

	Order No	Price
Clear	077-CV0010	\$ 2.65
Amber Lens	077-CV0040	2.65



Meet or exceeds all ANSI Z87.1+ standards.

More Radians!
See More Radians Online!



Champion Traps & Throwers

MatchBird 3/4 Cock Trap w/seat - This MatchBird seated trap provides multiple mounting positions for the easy-to-use 3/4-cock trap. Throws targets up to 70 yards and quickly attach to a 2-inch receiver hitch for sturdy and comfortable clay tossing. Throws all clay target sizes, standard, mini, midi, and rabbits.

Order no. 097-40904 \$157.47



SkyBird™ 3/4 Cock Foot Release Trap - Designed for use as a balanced foot release ground trap. The foot release trap is excellent for shooting alone, just step and release. This balanced trap throws all types of targets up to 70 yards. Shoot standard, mini, midi, & doubles.

Order no. 097-40903 \$97.27



THE BENEFITS OF A 3/4 COCK TRAP - A 3/4 Cock Trap has a one-way clutch that allows throwing arm travel in only one direction. When the throwing arm is tripped and a clay target thrown, the inertia of the arm carries it to about an 8 o'clock position. The one-way clutch does not allow the spring to pull the arm back to the twelve o'clock position, but instead stops it at the furthest distance traveled, which is closer to the setter. This feature requires less force and a much shorter distance to fully cock the trap for the next throw.

High Fly™ String Release Manual Trap -

Target is thrown with a simple pull of the string. Features a target clip for secure placement and a consistent flight path. Stake in the ground or mount to a tire.

Order no. 097-40901 \$22.98



Super Sport™ Hand Thrower -

Easy, Fun to use handthrower that can be used by any age. Throw standard, mini, midi, and even challenging rabbits. Order no. 097-40900 \$11.97

Trius Traps & Throwers



4 Height Adjustments



The Trap Thrower - The Trap Thrower is "The Original Foot Trap" and the only one with these exclusive features: High angle retainer, Can thrower, and Tire mounting bolt all in one. Regulation singles fly up to 65 yards. Fully adjustable without tools. The most complete and versatile trap you can own! Order No. 010-10205 \$56.61



The Trius TrapMaster2 - Designed to give the operator sit down comfort on a padded seat and the variety of pivoting action. No anchors are needed, as the operator's weight anchors the TrapMaster. Comes complete with the easy cocking Trius Trap to give the ultimate performance in clay target shooting.

Order No. 010-10225 \$94.14



4 Height Adjustments

One easy step cocks & releases target!

One Step Target Thrower - Almost effortless to use! Arm is set and target (s) placed on arm without tension. Operator steps on the pedal to put tension on the arm and release target in one continuous motion. One person can throw and shoot! Order No. 010-10201 \$82.49



The Birdshooter - The Birdshooter comes with a "T" base to hold with foot, as well as a tire mounting bolt! Aluminum arm plus oil impregnated bushings make it easy to cock and will give you years of trouble free use. High angle retainer.

Order No. 010-10220 \$35.37



EZ Throw II & EZ Double Throw - The patented power curve throws a clay target an average of 20 yards further than before. Available in single throw or heavy duty double throw for versatility. Double throw allows for adjustable horizontal and vertical separation.

	Order No.	Price
EZ Single	008-EZ11	\$3.98
EZ Double	008-EZDT	12.09



Flightmaster Jr. Thrower - Delivers high performance at a 'casual' price. Heavy duty steel construction. Finger pull trigger allows for point and shoot target throws. High Strength aluminum arm partially resets after each cycle. Adjustable tension spring (up to 50 yard throws). Comes with an assembly/adjustment wrench. Balanced design eliminates the need for mounting. Order No. 097-40240 \$46.39

The Gun Digest Book of Trap & Skeet Shooting, 5th Edition - By Rick Sapp The Gun Digest Book of Trap & Skeet Shooting, 5th Ed., covers every facet of trap and skeet shooting and provides valuable insight on how to improve and win at clay-busting sports. Choose the right shotgun, and fit the gun to your needs. Understand the hows and whys of chokes - in plain language! Get the most current data on shells, loads, and reloading. From the latest rules and regulations to the hottest new guns and gear. Pages: 256 Order No. 043-Z5055 \$14.27

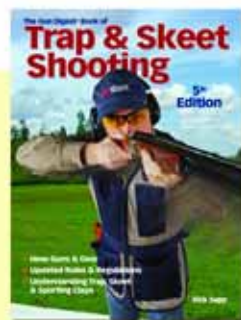

Starting At \$5.61

Federal Top Gun

	Order No.	Price
12ga 2 3/4" 1 1/8 oz #7.5 (25)	129-TGL1275	\$5.73
12ga 2 3/4" 1 1/8 oz #8 (25)	129-TGL128	5.73
12ga 2 3/4" 1 1/8 oz #9 (25)	129-TGL129	5.73
20ga 2 3/4" 7/8 oz #8 (25)	129-TG208	5.61
20ga 2 3/4" 7/8 oz #9 (25)	129-TG209	5.61

Rimfire Target Spinners

WARNING! For .22 Caliber rimfire rifles and handguns! **WARNING:** A fired cartridge could possibly ricochet.

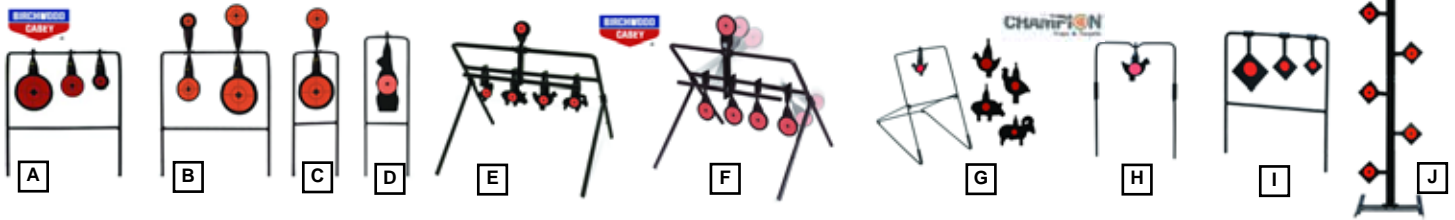

A - Birchwood Casey Qualifier Rimfire Spinner - Three disc spinning target for members of the .22 rimfire club. The three different sizes: 3 5/8", 2 1/4" and 1 5/8" circles. **Order No. 012-46322 \$16.83**

B - Birchwood Casey Double Rimfire Spinner - With two independent spinners featuring 3 5/8", 2 1/4" and 1 5/8" circles. **Order No. 012-46422 \$25.25**

C - Birchwood Casey Sharpshooter™ Spinner Target - Your choice between the challenging 2 1/4" and easier 3 5/8" circle. **Order No. 012-46221 \$15.15**

D - Birchwood Casey Prairie Chuck™ Silhouette Target - Sharpen your skills with your favorite .22 rimfire. A popular practice target among squirrel hunters as well. 3/16" thick. **Order No. 012-46676 \$15.15**

E - Birchwood Casey Animal Gallery® Resetting Target NRA .22 Animal Gallery - The Gallery Resetting Target includes animal silhouettes. Perfect for .22 rimfire rifles and handguns, each animal silhouette is proportionally sized to meet the standards of NRA shooting distances at 40 meters. **Order No. 012-47024 \$29.46**

F - Birchwood Casey Gallery® Resetting Target - Knock down all the hanging paddles, and then shoot the upper paddle to reset the others for another round! 1 3/4" paddles. **Order No. 012-47022 \$29.46**

G - Champion 22 Spinner Targets – NRA Silhouettes - Set the chicken up at 40-meters, the Ram at 100-meters, and you've got yourself targets at official NRA rimfire distances. Includes 4 targets & 1 stand **Order No. 097-40984 \$40.48**

H - Champion .22/17 HMR Compact Single Spinner - For use at any distance greater than 25 yards (for .22 LR) and greater than 100 yards (for .17 HMR or .22 WMR). **Order No. 097-40990 \$7.49**

I - Champion Triple Diamond Plated Spinner Target - 3 interactive targets of varying sizes for different skill levels. **Order No. 097-40864 \$13.02**

J - Champion .22 LR Metal Target Tree - Targets move easily from side to side for fast action and hours of fun. Solid steel construction. **Order No. 097-40881 \$56.99**

Centerfire Target Spinners

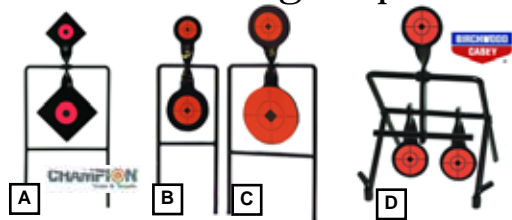

WARNING: A fired cartridge could possibly ricochet.

A - Champion Sight and Sound™ Handgun Spinner Target - Diamond shapes spin back to place after hitting. **Order No. 097-40865 \$41.02**

B - Birchwood Casey Double Mag Spinner Target - 44 Mag. & Lower. Top paddle is 3" in diameter, bottom paddle is 4.5" in diameter. 3/8" thick. **Order No. 012-46244 \$25.25**

C - Birchwood Casey Super Double Mag Spinner Target - 44 Mag. & Lower. Top paddle is 4.5" in diameter, bottom paddle is 6" in diameter. 3/8" thick. **Order No. 012-46344 \$31.57**

D - Birchwood Casey .44 Gallery® Resetting Target - Centerfire Handguns up to .44 Magnum (no Rimfires) 3 3/4" paddles. **Order No. 012-47044 \$49.11**

Dura-Seal Spinners



- .22 cal through most large caliber rifles and handguns
- Target wobbles/spins upon impact to show positive hits & Self-resets

	Order No.	Price
Black Single 7"	097-40953	\$14.65
Orange Single 7"	097-40954	14.65
Black Triple 5"	097-40952	28.15

Lyman Targets

	Order No.	Price
1" Standard Dot 110 per pack	015-4026100	\$2.44
2" Standard Dot 45 per pack	015-4026200	2.44
3" Standard Dot 25 per pack	015-4026300	2.44
6" Standard Dot 15 per pack	015-4026600	2.44
1" Square 50 per pack	015-4026914	2.44
2" Square 40 per pack	015-4026924	2.44
3" Square 20 per pack	015-4026934	2.44
Varmint Pack 10 per pack	015-4026970	4.12

A

B

C

Sight-In Targets

	Order no.	Price
A - Redfield Style (100)	097-47387	\$11.88
B - Champion Score Keeper 100yd Rifle (12)	097-45761	2.92
C - Birchwood Casey 12" Shoot-N-C (12)	012-34212	12.63
D - Birchwood Casey 8" Shoot-N-C (15)	012-34112	6.32
E - Birchwood Casey 12" Big Burst (25)	012-36225	15.85
F - Birchwood Casey 12" EZ-Score Paper (13)	012-37213	1.74

E

F

Outers / Champion Targets

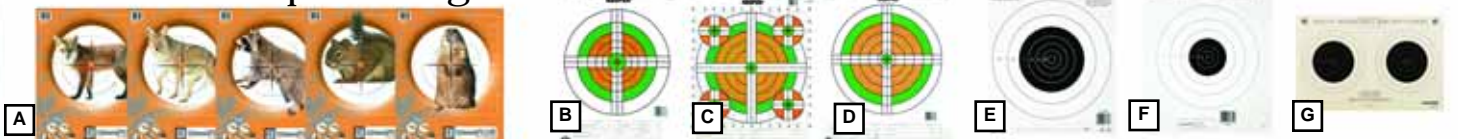

A - Critter Series Target- Two of each Critter Photo with integrated bullseye target (10 per pack) **Order No. 097-45781 \$2.95**

B - Champion Scorekeeper 25 yd Pistol Slow Fire - 12 per pack **Order No. 097-45760 \$2.92**

C - Champion Scorekeeper 100 yd Rifle Sight-in - 12 per pack **Order No. 097-45761 \$2.92**

D - Champion Scorekeeper 100 yd Small Bore Rifle - 12 per pack **Order No. 097-45762 \$2.92**

E - Champion 25 yd Slow Fire NRA Target - 12 Pack **Order No. 097-40749 \$1.68**

F - Champion 50 foot timed and Rapid Fire NRA Target - (12) **Order No. 097-40751 \$1.96**

G - Champion 50 Yard 2- Bullseye NRA - 12 per pack **Order No. 097-40760 \$1.88**

H - Champion X-Ray Turkey Target - (18.75"x16.75") 16 pack **Order No. 097-45903 \$5.17**

Birchwood Casey Dirty Bird Targets

Black and White Value Priced Splattering Targets



Non-Adhesive Targets

	Order No.	Price
A - 8" Round Bulls Eye (200 total)	012-35871	\$42.07
B - 12" Round Bulls Eye (100 total)	012-35070	42.07
C - 5.5" Round Bulls Eye (400 total)	012-35570	42.07
D - 3" Round Bulls Eye (192 total)	012-35309	6.32
E - 12" Sight-In Target (100 total)	012-35270	42.07
F - 12" x 18" Silhouette (8 total)	012-35608	6.32

Big Burst Splatter Targets

Big Burst™ Revealing Targets - If you can't see where your bullet hits, what's the point? Shoot from any distance and BIG BURST Revealing Targets instantly reveal your bullet holes in a high-visibility white burst! See your bullet holes appear immediately and enjoy a more fun shooting experience and more productive practice. BIG BURST reveals results on the entire target, from border-to-border - every shot that hits bursts into white! Self-adhesive for quick and easy set up.



	Order No.	Price
3" Round Targets (48)	012-36348	\$2.85
6" Round Targets (12)	012-36612	2.85
8" Target (3) Combo with 4" (15)	012-36818	2.85
12" Targets (3)	012-36123	2.85
12" Sight-In Targets (3)	012-36213	2.85
3" Round Targets (400)	012-36325	15.85
6" Round Targets (100)	012-36625	15.85
8" Target (25) Combo with 4" (125)	012-36825	15.85
12" Round Targets (25)	012-36025	15.85
12" Sight-In Targets (25)	012-36225	15.85

Birchwood Casey Paper Targets



Paper Targets - Simple and effective target shooting to sight in your firearms. Targets include space to enter key data including temperature, yardage, make/model, caliber, bullet and much more.

	Order No.	Price
A - 8" Round Bulls Eye (26 targets total)	012-37826	\$1.74
B - 12" Round Bulls Eye (13 targets total)	012-37013	1.74
C - 12" Sight-In (13 targets total)	012-37213	1.74

Hoppe's Targets



Hoppe's Paper Targets are an affordable option for zoning in on critters or bigger game like deer. The Deer Target Zone highlights vulnerable areas.

	Order No.	Price
Ground Hog 10 1/2" x 12" (20)	060-CT2	\$3.50
Crow 10 1/2" x 12" (20)	060-CT5	3.50
Sight In Target (100)	060-S5B	9.94
Deer Target Zone 28"x28" (5)	060-CT6	3.50

Life Size Deer Target Zone
Unfolds to 28"x28"
(5 Come in a pack)

Birchwood Casey Targets

Birchwood Casey Shoot-N-C Targets



Shoot-N-C® Self-Adhesive 3", 6" and 8" Bull's-Eye Packs -

Upon bullet impact, a bright yellow ring appears around each hole. Use the self-adhesive 3", 6" or 8" bull's-eye targets to design your own custom target sheet.

	Order No.	Price
3" Target (180 targets, 540 pasters)	012-34375	\$12.63
6" Target (60 targets, 240 pasters)	012-34550	12.63
8" Target (30 targets, 120 pasters)	012-34825	12.63



Shoot-N-C® Targets 1", 2" and Assorted Bull's-Eye Packs - Great for close-range shooting with airguns and sharp shooting with .22 rimfire or centerfire guns. Use the self-adhesive 1", 2" or 3" bull's-eye targets to design your own custom target sheet.

	Order No.	Price
1" Target (324 targets total)	012-34115	\$3.28
2" Target (108 targets total)	012-34210	3.28
Assorted Target 60 - 1", 30 - 2", 20 - 3" (121 targets total)	012-34608	3.80



Shoot-N-C® 7" Silhouette Packs - Silhouette targets for handguns and shooting ranges. Each sheet comes with corner pasters for target repair. 12 targets, 48 pasters. Order No. 012-34710 \$3.80

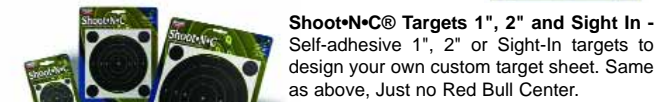

Shoot-N-C® Targets 1", 2" and Sight In - Self-adhesive 1", 2" or Sight-In targets to design your own custom target sheet. Same as above, Just no Red Bull Center.

	Order No.	Price
8" Sight-In	012-34112	\$6.32
1" Round Targets (270)	012-34115	3.28
2" Round Targets (90)	012-34210	3.28



Shoot-N-C Silhouette - Replaceable self adhesive Shoot-N-C "chest" targets. 12"x18" replacement Shoot-N-C oval covers center to extend the life of expensive silhouettes. Shoot-N-C explodes in color, compared to that paper target!

	Order No.	Price
Silhouette 12"x18" 5 pack	012-34605	\$7.58

Birchwood Casey Target Spots

Target Spots- Convenient, self-adhesive fluorescent red Target Spots available in 1", 2" and 3". For all types of target practice. Only \$2.69 Per Package

	Order No.
216 One Inch Target Spots	012-33901
36 - 2" & 72 - 1" Spots	012-33902
24 Three Inch Spots	012-33903
1"(72ea), 2" (36ea), & 3" (24ea) Target Spots	012-33928



Birchwood Casey Darkotic Targets



Darkotic Targets - Change up the range and eliminate some Zombies instead of circles and squares! Fun for all ages! Each shot will "Halo" for easy visibility. Eight (8ea) 12"x18" targets in each pack. These 12" x 18" Splattering targets are a blast! Body shots are fun, but head shots take down...ZOMBIES!

Zombies -	Order No	Price
A - Primal Cut 12"x 18" Splattering Target (8pk)	012-35655	\$6.32
B - Shopping Spree 12"x 18" Splattering Tgt (8pk)	012-35665	6.32
C - Fine Print 12"x 18" Splattering Target (8pk)	012-35645	6.32
D - Special Delivery 12"x 18" Splattering Tgt (8pk)	012-35650	6.32
Zombified Animals -	Order No	Price
E - Go Fetch 12"x 18" Splattering Target (8pk)	012-35660	\$6.32
F - Drain Pipe 12"x 18" Splattering Target (8pk)	012-35630	6.32
G - Blood Trail 12"x 18" Splattering Target (8pk)	012-35635	6.32
H - Smoke House 12"x 18" Splattering Target (8pk)	012-35640	6.32
Zombified Bugs -	Order No	Price
I - Buzz Kill 12"x 18" Splattering Target (8pk)	012-35620	6.32
J - Blood Drive 12"x 18" Splattering Target (8pk)	012-35615	6.32
K - House Guest 12"x 18" Splattering Target (8pk)	012-35625	6.32
L - Crawl Space 12"x 18" Splattering Target (8pk)	012-35610	6.32

Birchwood Casey Dirty Bird Game Targets



Birchwood Casey Dirty Bird Game Targets - Fun for all ages! Each shot will "Halo" for easy visibility. Eight (8ea) 12"x18" targets in each pack.
\$6.32 per pack

	Order No.
Shotboard	012-35562
Saloon Shootout	012-35564
Battle At Sea	012-35560
Chip Shot	012-35566

Champion VisiColor™ Targets

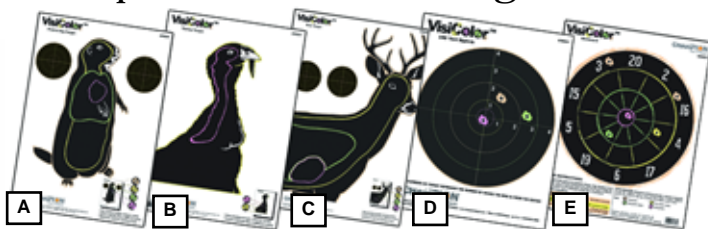

VisiColor™ High-Visibility Paper Targets - VisiColor provides multi-colored impact halos for easy identification of specific hit locations. The 5" Double-Bullseye and a Sight-In option give shooters even more down-range variety. 10 per pack.

	Order No	Price
A - VisiColor Prairie dog 11" x 16"	097-45820	\$7.56
B - VisiColor Turkey 11" x 16"	097-45822	7.56
C - VisiColor Deer 13" x 18"	097-45823	8.22
D - VisiColor 8" Bull	097-45824	5.28
E - VisiColor Dartboard 11" x 14" (10" Diameter)	097-45825	7.61



Champion Bullet Trap - A heavy duty, all steel construction trap designed for use with .22 caliber rimfire ammunition only. Provides a large 10"x11" target area. Comes with bulldog target clip. Please use extreme caution when using this. USE ONLY .22 CALIBER AMMO!! Truly a handy item for when you're target practicing with your favorite .22. Weighs approximately 21 pounds.
Order No. 097-40801 \$64.32



Champion VisiColor™ Zombie Targets

Equipped with VisiColor technology, the heads of each Zombie react to reveal a radiation green color and Zombie bodies react in fluorescent yellow upon positive hits. Misses and accidental hits to hostages react in white.



Zombie Targets: 50-Count Bulk Packs

- Classic, photo-realistic Zombie images
- Large, 18-inch x 12-inch target size
- Full-color, high-quality, durable paper
- Multiple VisiColor areas for easy tracking of positive hits.

	Order No.	Price
Door Breach	097-46080	\$36.83
Street Attack	097-46082	36.83



Zombie Variety 6-Pack-Hostage - This multi-pack consists of 3 different designs with 2 targets each of: "Heavy Metal Defense," "Hatchet Help" and "Charlie The Chomper." 18" x 12"
Order No. 097-46050 \$6.52

Zombie Variety 6-Pack-Attack

This multi-pack consists of 3 different designs with 2 targets each of: "Boneyard Bill," "The Gruesome Two-Some" and "Eddie The Executive." 18" x 12"

Order No. 097-46052 \$6.52



Shooting Chrony Chronographs

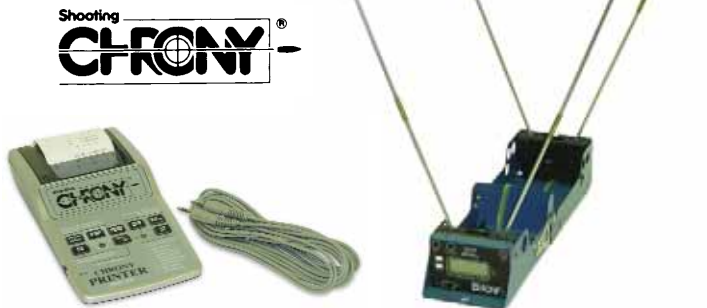

Every CHRONY measures the speed of bullets, arrows, shotguns and air-pellets, paintballs, etc. from 30/fps, to 7000/fps. and within 0.5% accuracy. A CHRONY chronograph completes your reloading needs at an affordable price. It can go with you anywhere. Just unfold (like a book), mount onto a tripod or place on a table, insert diffusers (sky-screens) and shoot in less than 2 minutes. Every CHRONY is made of 20 gauge steel but weighs less than 2 1/2 lbs.: It is powered by one 9 volt alkaline battery (not included) and equipped with an extra large LCD-readout: 0.5" high- when folded, it is 7 1/2" long, 4 1/2" wide and 2.75" high.

ALPHA CHRONY All the features of the Delta plus:

- 1) 1-string, from 2 to 32 shot memory (numbered)
- 2) Measures high, low and average velocities, extreme spread and standard deviations
- 3) Stereo jack for optional remote control.
- 4) Retrieval of individual shot velocity measurements.

BETA CHRONY All the features of the Alpha plus:

- 1) 60-shot memory (divided into 6 numbered strings from up to 10 shots each)
- 2) Can be switched off, taken home and switched on for reviewing information retrieval or downloading onto your computer.
- 3) Moves instantly from string to string, interrupts shooting on any string, returns to any string without memory loss, each string delivers its own statistics, etc.

MASTER GAMMA CHRONY All of the features of the Beta plus:

- 1) 1000-shot memory (divided into 100 numbered strings of up to 10 shots each.)
- 2) Change string size capability
- 3) Rapid-fire mode measures velocity of 1800 rounds per minute.
- 4) Ballistic Chrony Printer(14 foot interface cable)and LCD Remote.
- 5) In the timer mode, the velocity is measured as well as the time elapsed between shots; the timer is shot activated, not sound activated.

*Download Ballistic Programs for IBM computers in DOS, Windows '95, and IBM ballistic Interface (All sold separately)

THE MASTER CHRONY comes with the following models:

the **Master Delta**, the **Master Alpha**, the **Master Beta** and the **Master Gamma** chrony. The Master Chronys have the same capabilities as their counter parts. However, the Master Chronys have a remote which brings the LCD readout and most electronic components as well as other controls right up to your bench and away from the bullets path.

	Order No.	Price
Alpha Chrony	084-ALPHA	\$93.73
Beta Chrony	084-BETA	101.66
Archery Chrony	084-ARCHERY	104.24
Master Alpha Chrony	084-MASTER ALPHA	109.39
Master Beta Chrony	084-MASTER BETA	120.98
Master Gamma Chrony (Includes Printer)	084-MASTER GAMMA	178.93
Indoor Shooting Light Fixture	084-ISLF	39.24
Carrying Case Fits All Chrony's	084-CASE	16.73
Ballistic Printer for Alpha, Beta	084-PRINTER BALLIST	62.41
Ballistic II Software	084-BALLISTICSII	62.41



The Gun Digest Book of Long Range Shooting - LP Brezney gives hunters and shooters instruction and advice on how to shoot well at 500+ yards. Learn how to make the most of your shooting gear, as well as additional equipment that will increase success at distance. Covers Optics, rifles cartridges, barrels, triggers and more. 224pages **Order No. 043-Z0735 \$14.27**

RCBS Ammomaster Chronographs

AmmoMaster® Chronograph - Whether you are checking the velocity of your arrows, paintball gun, favorite hunting rifle or seeing if your pistol load makes major Power Factor, this is the unit for you. Forgetting to bring your diffusers and supports is a thing of the past as all the parts store neatly into the AmmoMaster housing. The detachable keypad display has a 20' cord that allows you to edit the string and not have to use binoculars to see the velocity. The display shows you the last velocities recorded. The AmmoMaster Chronograph has a velocity range of 50-7000 feet per second and will also measure in meters per second. The memory is capable of storing 100 velocities in 10 strings of 10 shots each. The edit function allows you to delete a shot(s) and display the following functions: average velocity, high, low, extreme spread and standard deviation.



Features

- 100 shot memory
- Self contained carry case
- Velocity range 50-7000 feet/meters per second
- Operates on one 9 VDC battery (not included)
- Detachable keypad display
- Standard camera tripod mounting
- RCBS one year warranty

Order No.

Chronograph - 044-81190 \$117.91

Target Holders



Champion- For paper targets and cans. Includes case **Order No. 097-40882 \$16.10**



Lyman Targetman Target Stand- Comes with a variety of paper targets, fluorescent targets, and balloons. **Order No. 015-4320000 \$14.96**

The Jammit Target Stand is a perfect accessory for a good days shooting. Takes only seconds to set up. Just push the stakes into the ground and slide target holder into place. Made of strong flexible polypropylene. Weather resistant and weighs 2 lbs. One 17 3/4" x 23 9/16" cardboard backer included.

Plastic backer (sold separately) is a perfect holder to tape, tack or staple targets to. Good for thousands of rounds (sold only by the case amount of 12!)

Compact Stand packs down 3" x 4" x 17.5"



	Order No.	Price
Jammit Target Stand	008-JMST	\$14.20
Plastic Backer all weather(12 pack)	008-TB20	39.43
Jammit Compact Target Stand	008-JMCTS	11.29

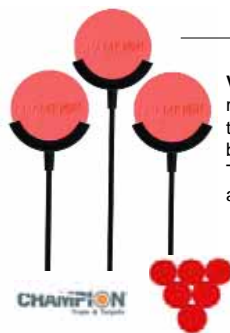

VisiChalk™ Targets - You'll know instantly when you hit your mark. The bright chalk discs provide shooters high visibility targets at various distances. The Single Holder Systems are bendable to accommodate hanging from nails or fence lines. They also feature push pins in the back, allowing shooters to attach them to cardboard and other similar materials.

	Order No.	Price
Single Holder System	097-40931	\$6.74
Refill Pack (48 count)	097-40940	7.70

New! Gamo Bull Whisper Air Rifles



One of the latest innovations from Gamo® is the new Bull Whisper™ barrel, this technology allows Gamo® airguns to reduce the sound dramatically due to the incorporated sound dampener into the bull barrel.

The compressed air propels the pellet and passes through the Bull Whisper that keeps part of the air reducing the noise but keeping the same velocity.

Gamo Bull Whisper Extreme™

- Single cocking system
- One-piece solid mount
- GAMO 3-9X50 RGBD Illuminated, Glass Etched



Velocity (FPS) -
With PBA® ammo
1000 (.22),
1400 (.177)

	Order No.	
.177 Cal	164-611009154	\$228.20
.22 Cal	164-61100915554	228.20

Gamo Bone Collector Bull Whisper (IGT)-

- Fiber optic sights
- Single cocking system
- Non-removable noise dampener
- One-piece solid mount



Velocity (FPS) -
With PBA® ammo
950 (.22),
1250 (.177)

	Order No.	
.177 Cal	164-61100671W54	\$193.37
.22 Cal	164-6110067155W54	193.37

Gamo Hunter Supersport 177 cal-

- Single cocking system
- One-piece solid mount
- Non-slip checkering finish on grip and forearm
- GAMO 3-9X50 RGBD Illuminated, Glass Etched
- One tube of Red Fire and PBA® Platinum ammo included



Order No.
164-611008654 \$180.47

Gamo Recon -

Includes 4x20mm Scope and 1-piece mount
Velocity: 525 fps with standard lead pellets
.177 Cal

Velocity: 525 fps, Rifled steel - fluted Bullbarrel, 4x20 air rifle scope included. Spring piston break barrel air rifle, Tough all-weather molded thumbhole synthetic stock, Twin cheek pads (comfortable for ambidextrous shooting), Thick, ventilated rubber recoil pad, Automatic cocking safety, Manual trigger safety, Grooved receiver to accommodate scope, Two stage adjustable trigger **Order No. 164-611002554 \$86.32**



Whisper is the first Air Rifle with noise dampener in the Gamo family!

Gamo Whisper -

Velocity: 1200 fps with Gamo Ballistic Alloy Pellets
1000 fps with standard lead pellets

Non-removable noise dampener (with up to 52% reduction) - This model will change the way you think about hunting with airguns! Offering 1200fps with PBA or 1000fps with standard lead, your sure to be ready for the elements. The non-removable noise dampener reduce the noise up to 52%! Includes 3-9x40mm standard reticle air rifle scope with one piece solid mount.



	Order No.	
.177 Caliber Whisper	164-611004954	\$186.92
.22 Caliber Whisper	164-61100495554	\$186.92

Gamo Varmint Hunter HP



Varmint Hunter HP 177 - .177 Caliber, 1400 fps with PBA Ammo, 4X32 Air Rifle Scope with Laser Sight and Flash Light. Tough All Weather Green molded Synthetic Stock, with cheekpiece molded on each side. Non-Slip texture design on grip and forearm.
Order No. 164-6110087154 \$206.27

The Gamo V3 Pistol-

- .177 Cal- Velocity : 410fps
- CO2 Air Pistol
- 15 Shot BB Semi-Auto
- 110 Shots CO2 Capacity
- Single and Double Action
- Adj Rear Sight
- 4.25" Rifled Steel Barrel
- 3 Dot Position Aiming
- Weight: 1.06 lbs
- Manual Safety Catch



Limited
Lifetime Warranty

\$55.34

The Gamo P-23 Pistol -

- Single shot with pellets
- Barrel: 4.25" rifled steel
- Muzzle Velocity: 400 fps
- Accuracy: 10 yards - 5 shots group 1.25"
- CO2 capacity: 80 shots
- 10 shots for BB's
- Rear sight adjustment for windage
- Semiautomatic with BB's(not Included)
- Double Action
- Weight: .99 lbs
- Length 7.5"
- Manual safety

10 Shots in 2 Seconds!



Limited
Lifetime Warranty

Order No.
164-611134054 \$51.47

PT-80 - One of the sharpest CO2 pistols out on the market. The fine detail is unbelievable! Fires 8 pellets (not BB's) as fast as you can pull the trigger. 410fps, CO2, 8 shot rotary clip, .177 cal.
Order No.
164-611135054 \$59.21



Gamo Blowback Air Pistols

Gamo Air pistols featuring the innovative Blowback feature. This technique provides a realistic action and an authentic look and feel when shooting. This is achieved utilizing a small portion of air to move the slide backward when firing.



Illustrated with PT-85 Model

P-25 Blowback CO2 Powered Air Pistol -

- Slide: Blowback
- Action: Single / Double
- Power Source: 12g CO2
- Barrel: Rifled Steel
- Safety Mechanism: Manual
- Fixed Sights with Reflective White Dots
- Textured Plastic Grip
- Capacity: 16 Pellets Double Magazine
- Velocity: up to 450 FPS (138 M/S) With PBA Platinum Pellets
- Length: 7.75"
- Weight: 1.5 lb (0.7 Kg)
- Ammunition: .177 Cal. (4.5mm) Pellets
- Caliber: .177 Cal.



Order No. 164-611138054 \$68.24

PT-85 Blowback CO2 Powered Air Pistol -

- Slide: Blowback
- Capacity: 16 Pellets Double Magazine
- Action: Single / Double
- Power Source: 12g CO2
- Barrel: Rifled Steel
- Safety Mechanism: Manual
- Textured Grip
- Fixed Sights with Reflective White Dots
- Velocity: up to 450 FPS (138 M/S)
- Weight: 1.5 lb (0.7 Kg)
- Length: 7.8"
- Ammunition: .177 Cal. (4.5mm) Pellets
- Caliber: .177 Cal.



Order No. 164-611138254 \$74.69

RWS Airguns



Length	Barrel	Weight	Trigger	Cocking
45"	18-7/16"	8.3 lbs.	3.3 lbs.	36 lbs.

460 Magnum - The 460 Magnum utilizes an under-lever cocking mechanism that provides superior leverage when cocking the airgun, resulting in less cocking effort than other spring airguns. The 460 offers magnum velocities of 1350 fps in .177 and 1150 fps in .22. With an easy to use top-side loading port, micro adjustable sights, fixed rifled barrel, scope capability, and a classic American Sporter stock with rubber butt pad, the 460 magnum delivers the performance, power, and grace expected from an RWS rifle.

	Order No.	Price
.177cal Velocity up to 1350 fps	062-2166445	\$450.33
.22cal Velocity up to 1150 fps	062-2166447	450.33



Model 48 - A new generation of side lever cocking magnum air rifles. Has record breaking power. Fixed barrel with velocity of 1100 feet per second in .177 caliber. Both front and rear sights are adjustable. Two stage trigger with adjustable pull.

	Order No.	Price
Diana Model 48 .177 Cal	062-2166200	\$356.56
Diana Model 48 .22 Cal	062-2166205	356.56



RWS 350 Feuerkraft Pro - With a velocity in the range of rimfires the RWS 350 Feuerkraft Pro Compact provides the power of Diana's 350 Magnum with the German craftsmanship of an ambidextrous elegant straight wood stock that's ambidextrous and topped with 3-9x40 air gun scope. This 350 Pro Compact comes with an RWS Lock Down mount that makes scope mounting a breeze. Velocity - FPS 1250.

	Order No.	Price
RWS 350 Feuerkraft Pro .177 Cal	062-2166157	\$351.90

Beretta Airguns by Hammerli



Length	Barrel	Weight	Capacity
30.75"	17.5"	5.25 lbs.	30

Beretta CX4 Storm - Powered by an 88g CO2 cylinder housed within the airgun, this exciting 30-shot semi-automatic .177 caliber carbine will provide years of shooting enjoyment. With over 200 shots from one 88g CO2 cylinder, this Beretta replica airgun is fun, fast, and accurate.

	Order No.	Price
.177cal Beretta CX4 Storm Velocity up to 600 fps	062-2253005	\$258.75

Multi-Reticle Sight MRS - Red dot with variable reticles, 4 different reticles by turning switch, integrated mount for Weaver rail. **Order No. 062-2300569 \$52.80**

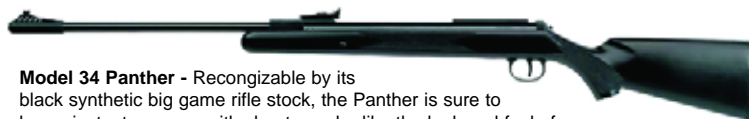

Model 34 Panther - Recognizable by its black synthetic big game rifle stock, the Panther is sure to be an instant success with shooters who like the look and feel of a big game rifle stock to complement their airgun action. Built from rugged injected molded plastic, the Model 34 is lighter than traditional wood airguns, which makes carrying it all day a breeze. Add in the standard TruGlo open sights and you have a model that shoots with the best of them while performing with cat-like precision.

	Order No.	Price
Diana Model 34 Panther, .177 cal 1000 fps	062-2166022	\$175.79
Diana Model 34 Panther, .22cal 800 fps	062-2166023	175.79

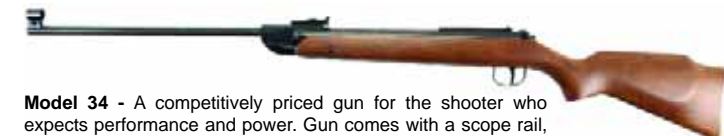

Model 34 - A competitively priced gun for the shooter who expects performance and power. Gun comes with a scope rail, two stage adjustable trigger, and synthetic piston seals.

	Order No.	Price
Diana Model 34, .177 cal 1000 fps	062-2166160	\$187.18
Diana Model 34, .22cal 800 fps	062-2166165	187.18



RWS Model 350 - The 350 represents a level in airgun shooting. With its sleek design and break barrel action, the 350 is easy to cock and handle. With velocities in the range of Rimfire shells, this model offers the shooter many options for use. Velocity is 1250 feet per second.

	Order No.	Price
RWS Model 350 .177 Cal	062-2166155	\$338.03
RWS Model 350 .22 Cal 1050 fps	062-2166150	338.03

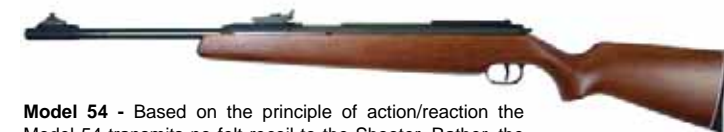

Model 54 - Based on the principle of action/reaction the Model 54 transmits no felt recoil to the Shooter. Rather, the floating action shifts in the stock and absorbs all recoil. Velocity of 1100 feet per second in .177 cal. (900 fps .22) Adjustable sights

	Order No.	Price
Diana Model 54 .177 Cal	062-2166220	\$543.22
Diana Model 54 .22 Cal	062-2166225	543.22

Beretta PX4 Storm - Beretta created a market frenzy when the first PX4 Storm was introduced to the industry. Now Umarex USA is offering an outstanding .177 caliber CO2 pistol replica. Utilizing a 14-shot magazine and CO2 housed within the grip, the PX4 is designed and manufactured for years of fast action and fun shooting. Velocity up to 380 fps.

Order No. 062-2253004 \$76.12

Capacity	Action	Length	Barrel	Weight
14-shot	Double	-	4"	1.6 lbs.



Beretta Elite II - The famous Beretta legacy continues in CO2 pistols with this exciting 18 shot .177 caliber BB repeater. Powered by a 12g CO2 cartridge housed within the pistol's grip, this pistol is a great sporting replica of the real firearm. Velocity is a smoking 480 fps.

Order No. 062-2253003 \$37.78

Capacity	Action	Length	Barrel	Weight
18-shot	Double	8.5"	4.8"	1.5 lbs.



Airgun Target, Traps & Swingers



Backyard Cone Pellet Trap
Includes 100 Free Paper Targets

Rocker Pellet Trap

GAMO
Precision Airguns

	Order No.	Price
Backyard Cone Pellet Trap w/100 tgts	164-6212204354	\$11.84
Rocker Pellet Trap	164-621220354	22.48
Paper Targets Bulls Eye (100 pack)	164-621210654	3.19



Gamo Resetable Squirrel Field Target- Pull the string and he bounces right back up for your next best shot!!! Includes four metal stakes, and 150ft string. Made of heavy steel. Portable and durable. Gamo suggests that you use lead pellets rather than BB's when shooting.

Order No. 164-621220854 \$19.82



Animal Silhouette Targets - 6 animal silhouette targets interchangeable with Gamo Squirrel Field Target. 4 bullseye ring reducers to increase the level of difficulty as your skills improve. Order No. 164-621221154 \$15.83

Target Holders



Champion- For paper targets and cans. Includes case
Order No. 097-40882 \$16.10

Lyman Targetman Target Stand- Comes with a variety of paper targets, fluorescent targets, and balloons.
Order No. 015-4320000 \$14.96

Airgun Cleaning & Maintenance



	Order No.	Price
Gamo Co2 Cartridges (5pk)	164-621247054	\$3.33
Crosman Co2 Cartridges (15pk)	107-C2315	10.61



Hoppe's Air Pistol/Rifle Maintenance Kit - Contains 3pc steel rod with looped handle, lubricating oil, brass knob end, .17 cal brush, cleaning patches & Hoppe's Guide To Gun Care. (8/32 thread)
Order No. 060-AC1 \$9.37



RWS Shooter's Kit- The RWS Shooter's Kit contains everything needed to shoot and maintain your RWS airgun in one complete package.



BORESNAKE

	Order No.	Price
.177 Cal. Rifle	060-24010	\$13.87
.22 Cal. Rifle	060-24011	13.87

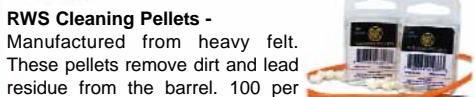

RWS Cleaning Pellets - Manufactured from heavy felt. These pellets remove dirt and lead residue from the barrel. 100 per box. Helps improve accuracy.

	Order No.	Price
Cleaning Pellets .177cal	062-2201933	\$6.78
Cleaning Pellets .22cal (80count)	062-2193817	6.78



	Order No.	Price
Chamber Lube Silicone lube 1oz	062-2167510	\$7.49
Gamo Air Gun Oil	164-621241054	2.13

Airgun Mounts & Rings



SUPPTICS USA

3/8 Dovetail
22 Cal Sport Rings

	Order No.	Price
1" Low Matte	146-SM752	\$9.34
1" Med Matte	146-SM754	9.34
1" Med Stainless	146-SM755	10.78
1" High Matte	146-SM756	10.78
30mm Med Matte	146-SM764	12.21
30mm High Matte	146-SM766	13.65

Gamo 1 Piece Mount - Medium 1 piece mount fits 1" tube scopes and works with scopes up to 44mm Obj.

Order No. 164-6213199854 \$17.16

Warne All Steel - (Also fits 11mm dovetail grooved receiver) Asymmetrical clamp allows for adjustment on receivers with severe radius.

REDFIELD

Redfield 1" Ring Mounts- For rifles with 3/8" dovetail

Order No.		Price
028-47285	Gloss	\$27.75
028-47287	Matte	29.37

	Order No.	Price
1" Medium Matte	223-721M	\$21.49
1" Medium Gloss	223-721G	21.49
1" Medium Silver	223-721S	23.23
1" High Matte	223-722M	21.81
1" High Gloss	223-722G	21.49
1" High Silver	223-722S	23.23



Adapter Mounts



	Order No.	Price
11mm to Picatinny (4 Screw)	146-SM002	\$17.97
Ruger to Weaver	146-SM4507	22.28
11mm to Weaver Std Elevation	146-SM7021	25.16
3/8" Dovetail to Weaver (2pc)	146-SM7025	9.34

SUPPTICS USA



RWS

Multi-Reticle Sight MRS - Red dot with variable reticles, 4 different reticles by turning switch, integrated mount for Weaver rail.
Order No. 062-2300569 \$52.80

RWS Meisterkugeln Pellets



Meisterkugeln - RWS Meisterkugeln Pellets are world leaders in accuracy. Since 1973 nearly 80% of all the medals won in World Class Competition have been won by RWS Meisterkugeln. Caliber .177, and .22 500 per tin.

	Order No.	Price
Meisterkugeln .177 8.3gr (500)	062-2317374	\$9.38
Meisterkugeln .22 13.9gr (250)	062-2317375	7.06



SuperPoint - RWS Super Point Pellets were designed primarily for field use. Sharply pointed head. Caliber .177,8.3gr 500 per tin.

	Order No.	Price
SuperPoint .177 (500)	062-2317385	\$9.38
SuperPoint .22 (250)	062-2317384	7.06



Super H Point - This Hollow-Point expansion type pellet was developed for field use. Able to deliver a shock like effect to small game. Caliber .177, 7.4gr 500 per tin.

	Order No.	Price
Super H Point .177 (500)	062-2317381	\$9.38
Super H Point For .22 caliber. (250)	062-2317382	7.06



Superdome - A bulldog roundhead pellet ideal for both target practice and general use. Highly accurate. Caliber .177, 8.3gr 500 per tin.

	Order No.	Price
Superdome .177 (500)	062-2317378	\$9.38
Superdome .22 (250)	062-2317379	7.06



Hobby Pellets - Offers the uncompromising guarantee of quality at rock bottom prices. Designed for practice and plinking. High velocity. Caliber .177, 6.9gr 500 per tin.

	Order No.	Price
Hobby Pellets For .177 caliber. (500)	062-2317376	\$6.50
Hobby Pellets For .22 caliber. (250)	062-2317377	5.94



The RWS Pellet Sampler - The practical, economical way to determine the most effective target shooting and hunting pellet for your airgun. Includes 100 each of the five most popular precision .177 caliber lead airgun pellets: Meisterkugeln, Superdome, Hobby, Superpoint, and Super-H-Point.

Order No. 062-2135900 \$10.75



Cleaning Pellets - Manufactured from heavy felt. These pellets remove dirt and lead residue from the barrel. 100 per box. Helps improve accuracy.

	Order No.	Price
Cleaning Pellets .177cal	062-2201933	\$6.78
Cleaning Pellets .22cal (80count)	062-2193817	6.78

Champion Airgun Pellet Trap

- Designed to handle up to 1200 FPS pellet guns
- All steel construction trap pellets for safe shooting
- Accepts paper targets for additional versatility and fun

Order No. 097-40810 \$24.09



Includes interchangeable silhouette spinner targets

Gamo Pellets & BB's

Combo Pack 1000 Assorted Pellets .177 Cal - Contains 4 Types of Pellets Cal .177: Master Point, Match, Magnum, Hunter. 250 per tin, 1000 pellets total, a great way to sample them all! .177cal
Order No. 164-632092754 \$9.18



Viper Express Shot Shell Qty. 25 - .22 cal Airgun shotshell. #9 lead shot with enough power and velocity to penetrate over 1/8" of 200 lbs compressed paper board at over 10 yards.
Order No. 164-632300054 \$5.19

Raptor Precision Ballistic Alloy - 25% Increased Velocity! If your Airgun shoots 1200fps, the PBA Non-Lead Alloy enables you to shoot 1200fps! 90% weight retention. Has tremendous penetration power! 100pk .177cal
Order No. 164-632264454 \$7.65



Rocket Ballistic Tip - Combines performance lead with a hardened steel tip to yield enhanced penetration and shock with precision accuracy. .177 Caliber (250)
Order No. 164-632127454 \$4.79



Tomahawk Pointed Hollow Point! Unique lead pellet forms a perfect "mushroom" shape on impact. .177 Caliber (750 Pack!)
Order No. 164-6322544CP54 \$6.32



Master Point



Magnum Spire



Hunter Round Nose



Match Flat Nose



Steel Round Ball

	Order No.	Price
Master Point Pellets .177 Caliber (250)	164-632063454	\$2.59
Master Point Pellets .177 Caliber (250)	164-632022454	2.59
Magnum Spire Point Pellets .177 Cal(250)	164-632082454	2.59
Hunter Round Nose Pellets .177 Cal(250)	164-632052554	3.86
Hunter Round Nose Pellets .22 Cal (250)	164-632002454	1.86
Match Flat Nose .177 Caliber (250)	164-632002554	2.99
Steel Round Ball .177 Caliber (250)	164-632032454	2.59

Crosman Pellets & BB's



	Order No.	Price
Premier.177 Hollow Point Hunter (500)	107-LHP77	\$7.91
Premier.22 Hollow Point Hunter (500)	107-LHP22	7.91
Premier.177 Super Match (500)	107-LM77	7.91
Premier.177 Super Point Hunter (500)	107-LSP77	7.91
Premier.177 Ultra Magnum (500)	107-LUM77	7.91
Premier.177 Destroyer (250)	107-DS177	3.65
Wadcutter .177 (500)	107-7577	4.41
BB's Milk Carton .177 1,500ea	107-0737	2.80



Benjamin Sheridan BB's & Pellets

Specially designed airgun pellets which provide top-flight performance in Benjamin Sheridan and other quality airguns. Diablo pellets are individually molded and feature a dome shaped nose for greater down-range energy and accuracy.

	Order No.	Price
.20 Cal Diablo Pellets 500 ea	107-P50	\$12.38
BB's Milk Carton .177 1,500ea	107-0737	2.80



Horton Crossbows



Order No. 108-CB300 \$378.66

(Broadheads not included)

Draw Weight - 160
Length - 37"
Powerstroke - 13 1/2"
Speed - 300 FPS

Brotherhood Specs:
Width (Axle to Axle) - 24 7/16"
Loaded Width (Axle to Axle) - 21"
Weight - 8.6 pounds
Kinetic Energy - 85 ft pounds
Arrow Length - 20"

- Features:**
- 55% High Let Off Cams - Easy to Cock
 - Advanced Wheel Design Compatible w/Portable Bow Press
 - Precision Die Cast Riser Inserts
 - Composite Ergonomic Thumbhole Stock Design
 - Customized Length of Pull from 13" to 14" (13.5" std.)
 - Extended Length Die Cast Sight Bridge (7/8" Weaver)
 - Steel Foot Stirrup w/Vibration Damping Coating
 - Anti-Dry Fire Mechanism w/Ambidextrous Safety
 - MIM Talon Trigger
 - High Performance Synthetic String and Cables



Order No. 108-CB315 \$472.08

(Broadheads not included)

Draw Weight - 175
Length - 36 1/8"
Powerstroke - 14 3/4"
Speed - 320 FPS

Bone Collector Specs:
Width (Axle to Axle) - 24 7/16"
Loaded Width (Axle to Axle) - 21"
Weight - 8.6 pounds
Kinetic Energy - 97 ft pounds
Arrow Length - 20"

- Features:**
- 55% High Let Off Cams - Easy to Cock
 - Recoil Damping Riser Inserts
 - Composite Ergonomic Thumbhole Stock Design
 - Interchangeable Overmolded Recoil pad (+/-1/2")
 - Customized Length of Pull from 13" to 14" (13.5" std.)
 - Overmolded Cheek Rest w/Repositionable Fore-End
 - Extended Length Aluminum Sight Bridge (7/8" Weaver)
 - Bullpup Design with MIM Talon Trigger
 - Anti-Dry Fire Mechanism w/Ambidextrous Safety
 - High Performance Synthetic String and Cables



Order No. 108-CB517 \$558.03

(Broadheads not included)

Draw Weight - 175
Length - 37 1/8"
Powerstroke - 12 3/4"
Speed - 330 FPS

TRT Specs:
Width (Axle to Axle) - 21 3/8"
Loaded Width (Axle to Axle) - 17 3/4"
Weight - 6.5 pounds
Kinetic Energy - 103 ft pounds
Arrow Length - 20"

- FEATURES:**
- Forged 7075-T6 Aerospace Aluminum Riser
 - Gordon Composite Asymmetric Laminated Limbs
 - Stumper Arms with SIMS Navcom® material
 - Customized Length of Pull from 13" to 14" (13.5" std.)
 - Forged Aluminum Stirrup w/Vibration Damping Coating
 - CNC Aluminum Sight Bridge w/Picatinny Scope Rail
 - Anti-Dry Fire Mechanism w/Ambidextrous Safety
 - MIM Talon Ultra Light Trigger
 - High Performance Synthetic String and Cables



Order No. 108-CB861 \$720.64

(Broadheads not included)

Draw Weight - 175
Length - 35 3/8"
Powerstroke - 13"
Speed - 300 FPS

Vision Specs:
Width (Axle to Axle) - 16 1/4"
Loaded Width (Axle to Axle) - 9 7/8"
Weight - 8.3 pounds
Kinetic Energy - 85 ft pounds
Arrow Length - 20"

- Features:**
- Patented Frontal String Technology for Compact Design
 - Reverse Draw Limb Optimizes Speed, Stealth and Balance
 - CNC Machined Wheels with Dual Ball Bearings
 - CH Arm Equipped for In-field String Replacement
 - CNC Machined Riser with Integrated Cocking Rope Groove
 - Dual Sided Safety Design
 - MIM Talon Ultra Light Trigger
 - High Performance Synthetic String and Cables



Lightning Strike Aluminum 20" Arrow (6pk) - 3" Performance vanes (Orange 2ea / White 1ea) Moon Nock (Orange) 353 grains **Order No. 108-AP050 \$27.94**

Bone Collector Carbon 20" (6pk) - 3" Quick Spin vanes (Flo Green 2ea / White 1ea) Moon Nock (Flo Green) 319 grains **Order No. 108-AP102 \$41.91**

De-Cocking Arrow - Featuring a durable fiberglass shaft and blunt tip for easy recovery from both targets and the ground, it provides a safe, convenient way to de-cock your bow after your hunt. **Order No. 108-DC100 \$7.87**

Vision Soft Crossbow Case -

Order No. 108-AC361 \$47.71



- Custom designed to fit the Vision 175 crossbow
- Heavy gauge zippers ensure added durability
- Internal pocket design to hold accessories

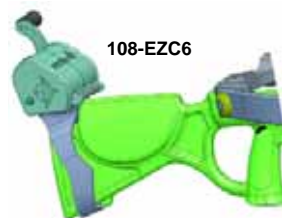

108-EZC6



108-EZC5

Cocking Devices - Amazingly simple, user-friendly design to ensure that shooters of all ages and skill levels can load and shoot their bows efficiently, safely and effectively. They offer a safer, easier alternative to hand cocking your bow.

	Order No	
Fits TRT, Bone Collector and Brotherhood	108-EZC5	\$130.91
Universal crank fits Vision 175 and other Horton Crossbows	108-EZC6	130.91



- Cocking Rope** -
- T-Handle design provides solid surface for secure grip
 - Lightweight and portable for in-field use
 - Fits most Horton crossbow models (excluding Vision)

	Order No	
EZ Loader™ Cocking Rope w/ Bridge	108-EZCR	\$18.59
Universal Cocking Rope (No Bridge)	108-AC250	14.30

Rail Lube for Crossbow Barrels -

Order No. 108-ST091 \$7.87

Rail Lube and String Wax Combo -

Order No. 108-STWAX 14.30



Plano Bow-Max™ Crossbow Case -

Patented PillarLock™ system protects crossbow. Fits most of today's largest crossbows with scopes attached. High-density foam and poly tie down straps secure, cushion and protect bow. Bolt storage in lid. Quiver can stay attached to most bows. Black. 41.5"L x 33.5"W x 11"H



Order No. 086-113100 \$72.24

Barnett Crossbows



A - Predator - The first patented bow of its kind, the Predator's pioneering design offers a shoot through foot stirrup increasing the power stroke to an amazing 17.25" and produces speeds to 375 Feet Per Second. The Predator features Barnett's "AVI" limb system combined with re-designed, high-velocity cam and cable system. WT: 7.5lbs Power Stroke: 17.25" Draw Weight: 175 Pounds

Package with Quiver, 3-22" Arrows & 4x32mm Scope 058-78015 \$487.44
Package with Quiver, 3-22" Arrows & Red Dot 058-78035 \$487.44

B - Barnett Jackal - Produces arrow speeds of 315 feet per second. The combination of the lightweight stock and the power this bow delivers makes it a devastating weapon for any hunter. Includes a Premium Red and Green Dot Scope. Features Barnett's ADF MIM trigger providing for a smooth 3.5 lb. trigger pull and the added benefits of a picatinny rail.

Package w/ Quiver, 4-20" Arrows & Dot Scope Order No. 058-78404 \$271.37

C - Barnett Buck Commander - Shoots 365 FPS with a 14 inch power stroke and packs 126 ft. pounds of energy. Barnsdale laminated limbs encapsulated with Barnett's AVi technology to reduce the noise 20-30 percent. Aluminum flight rail, Barnett's Whiplash Cams combined with "Crosswire" Strings and Cables for fast, precise shot. Comes with the ADF trigger system, Illuminated 3x32 multi-reticle red/green dot sight .

Package with 3-22" Arrows & 3x32mm Scope 058-78039 \$586.06

D - Ghost 350 CarbonLite - One of the lightest ones out there at just over 7.5 lbs. It includes an illuminated 3x32mm scope. It shoulders with great comfort and is much easier to carry around to your hunting spot. The package will be complete with quiver and 4 arrows, and Rope Cocking device and an illuminated 3x32mm scope. Made in the USA. WT: 7.7lbs Power Stroke:12" Draw Weight: 175lbs 350FPS

Package with Quiver, 4-20" Arrows & 3x32mm Scope 058-78021 \$487.44



QUAD 400 Package - Get it All! The Bow, Quiver with 3-22" Arrows and either a 4x32mm scope or Red Dot. The Quad 400 features a new composite stock, vented quad limb assembly & "Veloci-Speed" high energy cam system, a thumbhole grip, and a built in crank cocking device attachment (Specs: 150-lb Draw Weight, 15.5" Power Stroke, Foot Pounds Energy - 122 Speed - 345 fps, Max Hunting range - 60 yds. Limb Type - Compound)

Order No. Price
 w/ 4x32mm Scope 058-78032 \$334.65
 w/ Red Dot 058-78071 334.65

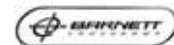

Order No. Price
 Black 058-78073 \$302.44
 Camo 058-78076 325.81

Wildcat C5 Package- With speed, performance and comfort in mind this bow features a lightweight composite stock, a thumbhole grip, vented quad limbs, and the "Veloci-Speed" high energy wheel assembly. This bow also allows for easy installation of the optional crank cocking device while maintaining a sleek low profile look and feel. Package includes QDQ Quiver, 3-20" Arrows, and Premium Red Dot Scope



Nikon Bolt XR 3x32mm Crossbow Scope (BDC 60 Reticle) Designed to do what other crossbow scopes do not, the Bolt XR features bright, fully multicoated 3x Nikon optics, a large ocular that makes full use of its wide field of view, 3.4-inches of eye relief and quick focus eyepiece with ±4 diopter adjustment.

The advanced BDC 60 reticle offers precise aiming points out to a very achievable 60 yards based upon velocity of approximately 305 fps. You can match virtually any crossbow velocity and bolt weight using Spot On Ballistic Match Technology. Order No. 125-8461 \$159.95

Barnett Crossbow Accessories

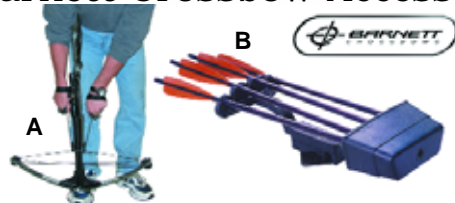

A- Rope Cocking Device- A must for every crossbow owner. The Rope Cocking Device is the easiest and most affordable way to cock a crossbow. Compatible with all Barnett full-size crossbows and most other manufacturer's bows. Order No. 058-17014 Price \$14.04

B- Quiver, Quick Detach- With 4 bolts for all Barnett Standard Crossbows and the RC-150. Order No. 058-17042 Price \$33.43

Not Shown- Revolution Crank Cocking Device - Order No. 058-17057 \$93.75

String & Lubewax

	Order No.	Price
Synth String, RC150	058-16055	\$13.55
Synth String, RevXS	058-16037	13.55
String, Rhino Sport	058-16052	13.29
String, RhinoSportMag	058-16030	13.29
String, Wildcat C5	058-16201	13.55
Wax, Lube	058-16061	5.36



Check our website for more information on the New 2012 Barnett Crossbow models

Bolts

	Order No.	Price
Bolts, 20" 5 Pk Fl. w/Field Pit & Moon Nocks	058-16075	\$35.03
Bolts, 22" Aluminum 48 Pk w/ Threaded Insert	058-19000	301.67
Bolts, 22" Aluminum 6 Pk w/ Threaded Insert	058-19000PK6	37.71
Bolts, 20" XX75 48 Pk w/ Threaded Insert	058-19002	301.67
Bolts, 20" XX75 6 Pk w/ Threaded Insert	058-19002PK6	37.71

Rhino Accessories

	Order No.	Price
Quiver, Rhino (4 20" Arrows)	058-17044	\$42.86
Revolution/Quad 400 Quiver (With 4 22" Arrows)	058-17041	42.86
Crank Cocking device (For Quad400 Models)	058-17031	80.36



Game Processing Tools

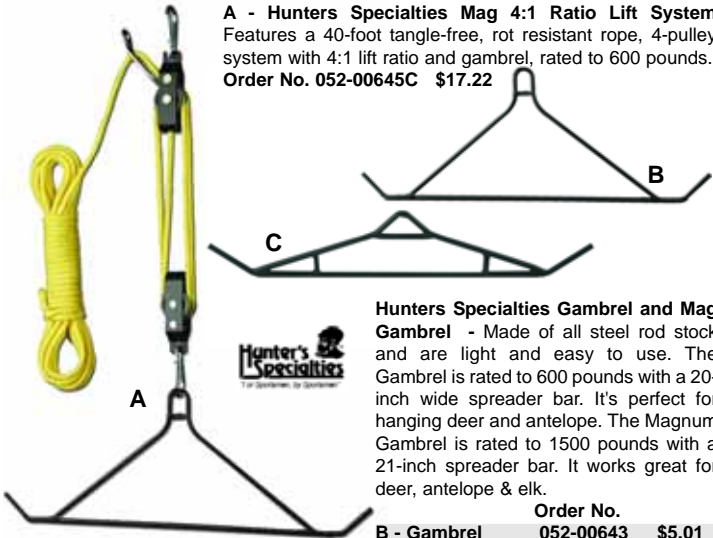

A - Hunters Specialties Mag 4:1 Ratio Lift System
Features a 40-foot tangle-free, rot resistant rope, 4-pulley system with 4:1 lift ratio and gambrel, rated to 600 pounds.
Order No. 052-00645C \$17.22

Hunters Specialties Gambrel and Mag Gambrel - Made of all steel rod stock and are light and easy to use. The Gambrel is rated to 600 pounds with a 20-inch wide spreader bar. It's perfect for hanging deer and antelope. The Magnum Gambrel is rated to 1500 pounds with a 21-inch spreader bar. It works great for deer, antelope & elk.

Order No.
B - Gambrel 052-00643 \$5.01
C - Mag Gambrel 052-00644 8.47



Allen Sportsman Scale - Weighs up to 440 pounds. Adjustable tare weight for allowing for gambrels. Readout in pounds and kilograms.

Order No. 168-4400 \$20.45



Deluxe Deer Drag - Durable safety orange body harness frees arms and hands and makes bringing game from the field easy. Includes shoulder straps and waist belt for more comfort. Includes rope.

Order No. 052-02019 \$5.68



Butt-Out II Tool - Quickly and easily remove the anal alimentary canal on deer and deer-sized game by just a turn and a pull.
Order No. 052-00631 \$8.75



Allen Field Dressing Gloves
Includes 6 pairs of wrist length latex gloves and 6 pairs of shoulder length gloves
Order No. 168-516 \$4.24



H.S. Field Dressing Gloves - These heavy-duty gloves protect against mess, stains and infectious disease. The shoulder-length gloves are made of poly to protect jacket sleeves. The wrist length gloves are made of latex to provide the best dexterity and sense of touch when dressing game.

Order No. Price
2 Pack (1 pair wrist length, 1 pair shoulder length) 052-01071 \$1.15
1 Pair shoulder length 052-01073 0.81

Allen Game Bags

Big Game Dressing Bags - 4 bags hold a quartered elk, moose or caribou. Allows excellent air circulation. Washable / reusable. 4 Bags per package. Order No. 168-60 \$6.28

Deer Carcass Bag - This "Beef Cloth" carcass bag holds one deer carcass or one elk quarter. Order No. 168-59 \$1.76

Deluxe Elk Bag - Rugged Stretch knit fabric. Washable and reusable. 4 Bags per package. Order No. 168-6020 \$10.08



ThermaCELL



ThermaCELL Woodlands Appliance - Stay mosquito free with ThermaCELL Appliance. Lightweight, cordless and portable, ThermaCELL mosquito repellent is perfect for outdoor activities like camping, fishing, and hunting, which may be disrupted by the buzz of mosquitoes. Provides 15ft diameter of protection. Includes 1 Butane cartridge and 3 repellent mats (Enough to repel Mosquitoes and Black Flies for up to 12 hours)

Order No.
Woodlands Camo 170-MRF \$22.33

ThermaCELL

ThermaCELL 48 Hour Refill pack - Enough to charge you up for up to 48 hours again. Includes 4 Butane cartridges and 12 mats. Order No. 170-R4 \$15.96

ThermaCELL 12 Hour Refill pack - Enough to charge you up for up to 12 hours again. Includes 1 Butane cartridges and 3 mats. Order No. 170-R1 \$5.18

ThermaCELL 2-Butane Cartridge Refill - Contains two 0.42oz Butane cartridges. Order No. 170-C2 \$5.18

ThermaCELL Mosquito Repellent with Earth Scent 12 Hour Refill - The Earth Scent mosquito repellent mats offer the same 15 x 15 ft zone of protection against pesky biting insects as the original ThermaCELL unscented mats - but with the added benefit and convenience of a cover scent. Order No. 170-E1 \$5.18



Gut It Cut It Cook It - The Deer Hunter's Guide to Processing & Preparing Venison

Gut It • Cut It • Cook It guides you every step of the way from the field to the table. No detail is left out— from proper field dressing and butchering to storing and preparing your venison. •BONUS CD includes 50 venison recipes, field dressing chart and meat cuts chart. So stop paying someone else to butcher your deer, with Gut It • Cut It • Cook It you can do it yourself. Save money and eat your own meat! 256 pages (Hardcover, spiral bound)
Order No. 043-Z5014 \$14.27



Radians Hearing Enhancers



Radians Tac Ear - Contains a compression circuit that protects hearing from impulse sounds. Fits snugly behind the ear. Prevents muzzle blast from damaging the ear. Increases the ability to hear low level sounds. Reduces high level noises by 29db. No special fitting required. Contains 2 units
Order No. 077-TAC2601CS \$65.12

Enhance Ear 2 unit set - Amplifies sound, contains a compression circuit that protects hearing from impulse sounds. Contains two units, 1 for each ear.
Order No. 077-TA2701CS \$72.22



Remington R-1700™ In The Ear Hearing Enhancer and Protector - Amplifies Sound, Suppresses Noise Above 85db, Small Lightweight Design, Fits Snugly Inside the Ear Canal, Five Level Volume Adjustment, Batteries and Hard Case Included
Order No. 077-R1700C \$22.25

Trail Marking

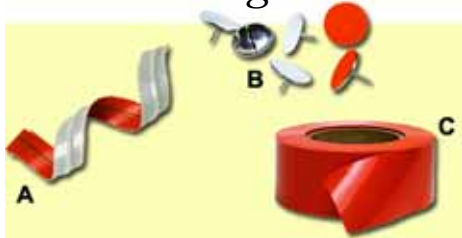

A - Limb Lights - 36 reflective twist tie strips wrap around small limbs. Can be seen up to 100 yards with a flashlight. **Order No. 052-00795 \$3.26**

B - Reflective Trail Marking Tacks (50pk) -
 White 168-47 \$2.61
 Orange 052-00718 1.41

C - HS Trail Marker Tape - 150 ft roll of Orange (photodegradable) Tape. **Order No. 052-00790 \$1.65**

Hunters Specialties Windicator - Simply spray the odorless powdered contents into the air and be 100% sure which direction the wind is blowing. Small enough to fit any pocket when not in use.
Order No. 052-00792 \$2.30



Hunter's Specialties
 "For Sportsmen, by Sportsmen"

H.S. Archery Hunter's Utility Rope - Designed to fit bows and other items into your treestand. Quiet, convenient snap hooks on both ends.
Order No. 052-00772 \$3.23

Magnum Cough Muffler - Cough Muffler. Muffles your cough while hunting. Also works great for theatre.
Order No. 052-00712 \$8.81



Pack-Saw - From stowed to a sturdy 12" bow-saw in seconds.
 Includes 3 blades.
Order No. 280-PS100 \$21.07

Replacement Blades
Bone 280-PSRB \$2.42
Wood 280-PSRW 3.11

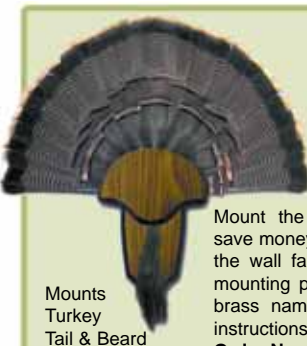

Turkey Mount Kit

Mount the trophy yourself, save money and get it up on the wall faster. Kit includes mounting plaque, hardware, brass nameplate and easy instructions.
Order No. 052-00849 \$11.58

Mounts Turkey Tail & Beard

Camouflage Clothing, Tape & Face Paint



Camo Creme Make-up - 1 oz. tubes that can pack anywhere. Available in a kit of flat black, mud brown and leaf green or buy individual tubes.

Order No
Camo Kit 052-00268 \$5.32
Flat Black 052-00271 1.62
Leaf Green 052-00272 1.62

Woodland Camo - Pocket-size case has a handy built-in mirror and three camo make-up colors. Includes mud brown, leaf green and flat black colors.
Order No. 052-00260 \$3.23



Camo-Off® Wipes - Disposable 7" x 4" wipes are formulated to remove H.S. Camo-Compac® and Camo Creme makeup. Each flex pack holds 30 wipes to let hunters clean up fast when soap and water may not be handy.
Order No. 052-00299 \$3.19



	Order No.	Price
- Flex Form II Face Mask, 3/4 Realtree APG	052-05305	\$2.53
- Flex Form II Nylon Head Net, Realtree APG	052-05300	2.53
- Flex Form II Nylon Head Net, Advantage Max 4 HD Camo	052-04546	2.53

Hunters Specialties Net Gloves - These camo gloves feature the "Dot Grip" ultra light jersey material on the palms and net backs. Extra-long cotton jersey cuffs cover your wrists for excellent camouflage. One size fits most.



	Order No.	Price
Realtree APG	052-05310	\$2.56
Advantage Max 4HD	052-04535	2.56



Hunters Specialties Camo Gun Sock - The Camo Gun Sock camouflages and protects gun finishes. Form fitting, stretchable design fits most shotguns and rifles. Now Available in Realtree APG Camouflage. **Order No. 052-05320 \$3.65**

Allen 2"x20yds Break-Up Camo - 20yard roll, approx 2" width. High rugged tape with hundreds of uses.
Order No. 168-43 \$4.86



Turkey Seats & Etc...



Sportman's Rump Rester - This ground hunting seat holds four 12ga shotshells, Seat no longer comes with Camo Accessory Pouch (shown in photo).
Order No. 008-SRR \$14.80

Allen Thermo Seat - 18" nylon seat. Shown in Blaze Orange



Mossy Oak Camo
Order No. 168-107 \$6.71

Allen Low Profile Portable Stool - Lightweight steel frame, heavy web seat, web carry strap, folds flat 16" x 12".
Order No. 168-58 \$10.80



Gunrest Realtree Hardwoods® Camo - This unique foam pad straps around your knee and holds your gun in place until you're ready for a shot. Adjustable elastic strap releases quickly.
Order No. 052-05325 \$9.02



Bunsaver - Self-inflating, water-resistant seat cushion allows you to sit on a cushion of air instead of roots, rocks and cold ground. Inflate, adjust, or deflate by simply turning the valve. 8 oz. Realtree APG. **Order No. 052-05323 \$10.00**



CVA Bull Seat ATS - Lightweight and portable, the All-Terrain Seat is easy to assemble and setup, then breaks down quickly for the hunter on the move.
Order No. 215-83009 \$58.50



Allen Self Inflating Seatcushion - Rugged endura shell fabric. Adjustable belt with side release buckle and elastic comfort. 16" x 10".
Order No. 168-136 \$11.27



Carbon Clean - Formulated to clean all types of carbon clothing.

Garment Wash - For laundering high performance hunting and sports fabrics.

Dryer sheets - Prevent static cling while adding a fresh earth cover scent.

	Order No.	Price
Carbon Clean 24oz	052-01146	\$7.66
Garment Wash 24oz	052-01156	5.81
Dryer Sheets 10 Sheets	052-01068	3.53



Scent-A-Way Scent Elimination

The powerful, fast-acting Scent-A-Way Advanced Formula works by neutralizing, oxidizing, bonding, and molecularly changing a wide range of odors on clothing and equipment. Safe, and environmentally friendly. It won't stain or fade clothing or materials and is not harmful to your skin. *Refill Combo includes one 32oz bottle and one 12oz spray bottle both filled with Scent-A-Way!*

Odorless	Order No.	Price
12oz Odorless	052-01174	\$4.06
Fresh Earth		
12oz Fresh Earth	052-01176	4.87
Acorn		
12oz Acorn	052-01175	4.87



Basic Scent Elimination System - Remain odor-free with Scent-A-Way™ Advanced Formula Spray, Scent-A-Way Laundry Detergent, Fresh Earth Dryer Sheets, Scent-A-Way Bar Soap, Scent-A-Way Anti-Perspirant and Scent-Safe™ Storage Bag.

Order No. 052-01113 \$17.50

Scent-Safe™ Clothing Bag - Resealable and reusable. Made of specially formulated plastic that stops all odor and scent transfer. Locks out foreign odors. Bag is large enough to hold the bulkiest clothing.

Order No. 052-01110 \$4.12



Scent-Safe Deluxe Travel Bag -

The specially formulated foil on the inside locks out foreign odors. The bag includes inside mesh pockets, two Fresh Earth Scent Wafers and a zip-lock barrier bag for storage of small items.

Order No. 052-01179 \$28.73



Scent-A-Way Deodorant & Body Powder - Specially formulated, odorless anti-perspirant will keep hunters dry and scent free. Eliminates bacterial odors, absorbs and reduces moisture. Extended 24-hour plus protection.

	Order No.	Price
Powder 4oz shaker	052-01087	\$5.84
Deodorant 2.25 oz	052-01141	3.64



Scent-A-Way™ Soap - The original "Green soap" contains natural vegetable proteins that attack body odors. Can be used as a body soap or shampoo and is also a great all-around hand soap.

	Order No.	Price
Bar Soap	052-01154	\$3.25
Liquid Soap 12oz	052-01150	4.68



HS Scents Cover-ups & Lures

Primetime Scents come in 2oz. amber bottles with an atomizer.

Premium Doe Estrus - Made from 100% natural doe-in-heat urine, collected during the estrous cycle, plus secretions taken during the 24-36 hour breeding period. Order No. 052-03003 \$4.28

Natural Doe Urine - Natural whitetail doe urine is taken during the pre- and post-rut periods. It provides an excellent territorial, non-threatening curiosity appeal. Order No. 052-03013 \$4.14

Dominant Buck Urine - Made from buck-in-rut urine, this scent will cause a buck's territorial urge to minimize his caution. Works dominant bucks into a frenzy. Order No. 052-03016 \$4.23

Premium Doe Estrus Plus - Collected during the 24-36 hour estrus cycle, is now spiked with the most potent sexual and territorial deer musk. This special blend stimulates and challenges a buck's natural hormonal urges during the rut. Order No. 052-03005 \$4.80

PRIMETIME® Cover Scents - Cover scent both when walking and while in the stand. 2 oz. amber bottles with atomizer.

	Order No.	Price
Raccoon Urine	052-03026	\$2.83
Red Fox Urine	052-03025	2.83



Scent Wafers™ - Solid Scent Wafers have a pure concentrated scent that masks odors. Scent can't spill, freeze or wash away. The wafers can be pinned to clothing or hung from hunting site. Available in a variety of cover scents. 3 wafers per resealable container which revitalizes wafers after use.

	Order No.	Price
BucRut	052-01000	\$8.23
Doe Estrus	052-01001	8.23
White Oak Acorn	052-01010	5.81
Fresh Earth	052-01022	5.81
Natural Cedar	052-01023	5.81
Natural Pine	052-01024	5.81
Cow/Elk Urine	052-70450	8.23



Scent Station - Just remove the cap from the bottle and pull up the hanging wick to release scent, and hang. Scent not included. Order No. 052-03047 \$2.59

Primetime Boot Pads - 2" x 2" tough absorbent felt pads, perfect for concealing tracks. Just apply any PRIMETIME® liquid. 052-03036 \$1.44



Double Scent Drag - Clips to your waist. Just add your favorite scent to create an effective scent trail. Use a doe estrus scent on one drag and buck urine on the other to simulate a buck trailing a hot doe. Order No. 052-03044 \$5.42

Spike Wick - Felt scent pads with a spiked end that can be used with Primetime® scents and lures. Open end is for hanging. Includes 4ea. Order No. 052-03040 \$0.71



Kershaw ZIPIT Gut-hook Knife - Shaving sharp blade. Injection molded rubber boot for finger comfort during those tough field dressing jobs. Order No. 100-2520 \$6.59



Primetime Bucks XIII - Primetime Bucks XIII contains 26 hunts with over three hours of video. From early season bucks in velvet through the wild and crazy whitetail rut into the frozen fields of winter.

Order No. 052-20057 Closeout \$7.00

The Silent Retriever - The Silent Retriever was designed to pick up dropped or forgotten items from a tree or tree stand without climbing down. It could save your hunt! Watch a demo video on our website!

Order No. 169-100 \$12.95



Muck Boots

The Woody Max Boot 16" Height / Advantage Timber Upper

Made to endure prolonged cold conditions, these boots are great for hunting in unpredictable climates. Stretch-fit topline binding snugs calf to keep warmth in and cold out. Breathable Airmesh™ lining. Additional achilles overlay for added protection. 10mm kick rim for hands-free removal. EVA molded midsole with contoured footbed (internal). 2mm thermal foam underlay added to the instep area for additional warmth. Molded, durable, rubber outsole provides maximum protection and stability. Added toe protection with a wrap-up bumper. Reinforced toe CR flex-foam bootie (5mm) with four-way stretch nylon, snag-resistant cover is 100% waterproof, lightweight, flexible, buoyant, and will form to virtually any calf girth. Comfort range 60° F to -40° F.



Special Order Muck Boots - Other Muck Boot sizes are available by special order only!!!!

	Order No.	Price
SIZE 8	090-MBCWDM8	\$137.10
SIZE 9	090-MBCWDM9	137.10
SIZE 10	090-MBCWDM10	137.10
SIZE 11	090-MBCWDM11	137.10
SIZE 12	090-MBCWDM12	137.10



Woody Max Elite™ Stealth Premium 16" Hunting Boot - The sent-masking Incentible™ improves concealment and earned this boot the title Stealth Premium Hunting Boot. This boot is designed for the most serious of sportsmen. Stretch-fit topline binding snugs calf to keep warmth in and cold out. Comfort range -40° F to 60° F



	Order No.	Price
Size 8	090-MBCWDE8	\$154.09
Size 9	090-MBCWDE9	154.09
Size 10	090-MBCWDE10	154.09
Size 11	090-MBCWDE11	154.09
Size 12	090-MBCWDE12	154.09
Size 13	090-MBCWDE13	154.09

Muck Boots Replacement Insoles - These insoles fit all shoe and boot styles from The Original Muck Boot Company™. The lightweight and comfortable insoles are 6mm Nitracele EVA and have vent holes for added breathability. They are covered in 220 gram moisture resistant brushed nylon for added comfort.



	Order No.	Price
EVA INSOLE SIZE 8	090-MBCINS8	\$3.86
EVA INSOLE SIZE 9	090-MBCINS9	3.86
EVA INSOLE SIZE 10	090-MBCINS10	3.86
EVA INSOLE SIZE 11	090-MBCINS11	3.86
EVA INSOLE SIZE 12	090-MBCINS12	3.86
EVA INSOLE SIZE 13	090-MBCINS13	3.86

Muck Excursion Hiker Shoes - Carbon

- Cinch Lace with Cord Lock for Snug Fit Around Ankle
- Cushion EVA Midsole
- Flexible 2-Color Lightweight Rubber "Radial" Outsole
- 5MM CR Flex-Foam Bootie with Four-Way Stretch Nylon
- 100% Waterproof, Lightweight, and Flexible
- Full Perimeter Outsole Provides Maximum Protection to Toe, Arch, and Heel Areas



	Order No.	Price
Size 10	090-EXL10010	\$81.85
Size 11	090-EXL10011	81.85
Size 12	090-EXL10012	81.85

Muck Wetland Bark Upper Premium Field Boot

- Stretch-fit topline binding snugs calf to keep warmth in and cold out
- 100% waterproof, lightweight and flexible
- MS-1 molded outsole is rugged, aggressive and durable
- Additional achilles reinforcement for added protection
- Added toe protection with a wrap-up toe bumper
- Comfort range of -20°F to 70°F

	Order No.	Price
Size 9	090-WET998K9	\$99.95
Size 10	090-WET998K10	99.95
Size 11	090-WET998K11	99.95
Size 12	090-WET998K12	99.95



Uplander Mossy Oak Break-Up Boot

- 100% Waterproof, lightweight and flexible
- Comfort range of sub-freezing conditions to 85°F
- Classid bird hunting profile
- Full lace gusset
- Snug, ankle fit last
- 5mm CR flex-foam bootie with four-way stretch nylon,

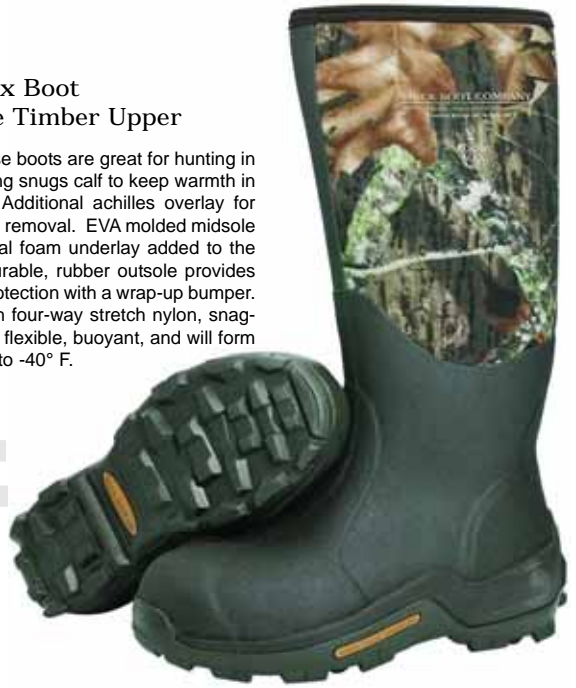

	Order No.	Price
Size 10	090-UPBMOBU10	\$140.05
Size 11	090-UPBMOBU11	140.05
Size 12	090-UPBMOBU12	140.05

Fieldblazer All-Terrain Sport Boot

- Stretch-fit topline binding snugs calf to keep warmth in and cold out
- 5mm CR flex-foam bootie with four-way stretch nylon,
- 100% waterproof, lightweight and flexible
- Self-cleaning outsole wraps the entire perimeter to provide maximum protection & stability on steep terrain
- Additional achilles overlay for added protection
- Shank reinforcement for added support
- Added toe protection with a wrap-up toe bumper
- Mossy Oak Break-Up® Camo
- Comfort range of sub-freezing conditions to 85°



	Order No.	Price
15" HEIGHT MOSSY OAK BREAK UP SIZE 8	090-MBCFLD8	\$97.30
15" HEIGHT MOSSY OAK BREAK UP SIZE 9	090-MBCFLD9	97.30
15" HEIGHT MOSSY OAK BREAK UP SIZE 10	090-MBCFLD10	97.30
15" HEIGHT MOSSY OAK BREAK UP SIZE 11	090-MBCFLD11	97.30
15" HEIGHT MOSSY OAK BREAK UP SIZE 12	090-MBCFLD12	97.30

The Muckster Shoe

Breathable Airmesh™ lining. Diamond tread, self-cleaning outsole. Full-perimeter wrapped outsole provides maximum protection to the toe, arch, and heel area. CR flex-foam bootie (5mm) with four-way stretch, snag-resistant cover—100% waterproof, lightweight, flexible, and buoyant Stretch-fit topline binding snugs ankles—keeps dirt, leaves, grit, and pebbles out



	Order No.	Price
TAN/BLACK COLOR SIZE 10	090-MBCMST10	\$61.92
TAN/BLACK COLOR SIZE 11	090-MBCMST11	61.92
TAN/BLACK COLOR SIZE 12	090-MBCMST12	61.92



Predator and Small Game Calls



	Order No.	Price
Slammer Mouth Crow Call - Distress, fighting, gathering and "come here" sounds of a crow	052-CC2	\$6.88
Coon Squaller - Produces effective growls and squalls that drive coons wild	052-CS1	8.99
Crit'r Distress Mouth Call - Distress sound of rabbit, raccoon, and deer. Great for coyote, fox, bobcat and bear	052-CGM3	6.26
Song Dog Coyote Call - Mimics yelps, whines barks and howls of coyotes	052-SD1	13.15

FOXPRO Skyote - Their first hand call, the Skyote! You will find the same high quality craftsmanship, versatility, and reliability in FOXPRO's hand calls as you have come to appreciate in FOXPRO's digital calls. **Order No. 297-SKYOTE \$15.40**

Coyote Hooker® Predator Call - The Coyote Hooker® will bring in even the most wary predators. Lightweight, internal reed design imitates all known coyote vocalizations. Pushing down on the molded membrane allows you to easily increase pitch for different calling effects. **Order No. 052-CHP1 \$13.23**

Handmade Lanyard - Handmade! Mags Custom Mags 4 Loop Lanyard. Attach your Calls! **Order No. 419-LANYARD \$8.00**

Deer, Elk & Big Game Calls



	Order No.	Price
A- Deer Quad Grunter Plus, Super Slamwith tube	052-00175	\$7.01
B- Buc Grunter Deer Grunt Call with tube	052-00176	5.20
C- Super Slam Rattle Bag	052-00177	9.87
D- Elk Estrus Squeeze Me Call	052-70146	16.00



Estrus Bleat Calls - These easy-to-use can calls make the sound of a doe in estrus and work throughout the rut. Our Estrus Bleat calls come in three sizes--Young Doe, Adult Doe and for extra long range, Mega Estrus. Also available is our Estrus Bleat 3-Pack, which includes all three sizes.

	Order No.	Price
A- Adult Doe Estrus Bleat	052-00167	\$7.30
B- Mega Estrus Bleat	052-00168	8.93
C- Young Doe Estrus Bleat	052-00166	5.93

Turkey Calls



Li'l Deuce 2 Double Slate over Glass - The Li'l Deuce™ 2 is the second in the H.S. series of compact and lightweight calls. Its double slate over glass design produces high pitched yelping and cutting. Includes a carbon striker, rougher pad and complete instructions.

Order No. 052-00873 \$10.40



CLOSER- Waterproof. Features poplar wood bottom and cherry lid. Makes realistic turkey sounds. Includes an elastic strap to keep it quiet.

Order No. 052-06998 \$13.99

PUSH BUTTON YELPER- Made from select walnut, this call is eas to use and offers fingertip control. It creates soft clucks, purrs and yelps.

Order No. 052-07056 \$11.23



SAWED OFF- Made of select cherry and poplar woods, this compact call works great for spot-and-stalk hunting. Includes chalk.

Order No. 052-07055 \$10.85

Handmade!
Mags Custom Mags
4 Loop Lanyard
Attach your Calls!

Order No. 419-LANYARD \$8.00

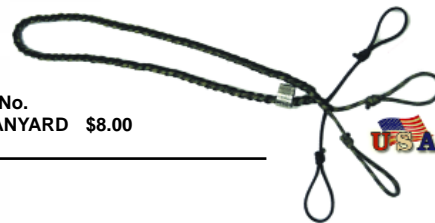

	Order No.	Price
Turkey Pattern Target (12 Per Pack)	052-06850	\$1.96
Single D Premium Flex 2 Mouth Call	052-06900	4.10
Double D Premium Flex 2 Mouth Call	052-06904	4.10
E-Z Rasp Premium Flex 3 Mouth Call	052-06907	4.10
Split V II Premium Flex 2 Mouth Call	052-06940	4.10
Box Call Chalk 4 pieces	052-06864	0.92

New! Johnny Stewart Digital Game Callers

JURY

- Includes omni-directional speaker, external audio jack and ergonomic remote with 12 quiet soft keys with touch registers
- Wireless remote has a range of 75 yards.
- Features 25 preloaded sounds with 128 MB of internal memory.
- Can play two sounds at once.
- 9 watt audio output.

Order No. 052-JS1 \$129.66



Johnny Stewart
DIGITAL GAME CALLERS

BLOODHOUND

- Remote has LCD display with real-time clock, stand timer and power save.
- Wireless remote has a range of 200 yards.
- Features 50 preloaded sounds with 2 GB of internal memory.
- Can play two sounds at once.
- Volume selection of 0-50, which can be adjusted while in mute.
- Includes speaker.

Order No. 052-JS2 \$242.05



Johnny Stewart
DIGITAL GAME CALLERS

New! Johnny Stewart Digital Game Callers

GALLOWS

- Features 75 preloaded sounds with 4 GB of internal memory.
- Wireless remote has a range of 300 yards.
- Can play two sounds at once.
- Three-mode calling. Includes LCD display with real-time clock, stand timer & power save.
- Includes speaker.

Order No.
052-JS3 \$432.24



EXECUTIONER

- Wireless remote has a range of 300 yards.
- Features 100 preloaded sounds with 4 GB of internal memory.
- Can play two sounds at once.
- Three-mode calling. Includes LCD display with real-time clock, stand timer & power save.
- Includes speaker.

Order No.
052-JS4 \$518.69



The Attractor Digital Caller



Includes a holster for the remote and a belt clip for the base unit.

Hunter's Specialties® Attractor from Johnny Stewart Wildlife Calls has plenty of features built into a light-weight, compact digital caller. Each handheld caller comes with five pre-programmed 16-bit sounds. The base unit has an 8-ohm, .5-watt speaker that pivots 180° for directional calling. The 30-second sounds can be played in a loop for continuous action.

The handheld remote has a range of 50 yards. The remote operates on a 12-volt, 23-amp battery and the base unit on 4AA batteries, which are all included.

	Order No.	Price
Deer	052-DT1	\$31.55
Predator 1	052-PT1	31.55
Predator 2	052-PT2	31.55
Turkey	052-TT1	31.55

Jack Attack!

FOX PRO JACK ATTACK!

The Jack Attack comes standard with two toppers; a bird topper which resembles a woodpecker, and a jack topper which imitates a rabbit or rodent. It simulates two distressed animals to entice those weary predators in close enough for you to make the shot!



Only \$99.02

FoxPro Digital Callers & Decoys

SPITFIRE FEATURES

- Internal Storage
- User Accessible Micro SD Card.
- External Speaker Jack
- Connect an additional speaker to the SpitFire for more volume.
- Internal Speaker "On/Off" Switch
- Turn your internal speaker on or off with the convenient slid switch located on the front of the unit.
- Pilot Lamp/Low Battery Indicator
- Tripod Mount

- Operates on 4 'AA' Batteries

Order No.
297-SF1 \$199.95



The SpitFire features a rugged ABS injection molded housing for superior strength and durability. A single high quality horn speaker is built in for great volume and a crisp sound. An auxiliary jack is present to plug in an approved auxiliary device, such as the FOXPRO Jack-in-the-Box Decoy. The external speaker jack allows you to plug in an additional speaker to increase your volume if desired. You can disable your internal speaker via the speaker "on/off" slide switch. The low battery/pilot light allows you to see when your SpitFire is turned on and also blinks when your batteries are getting low. The tripod mount located on the bottom of the SpitFire allows you to elevate your caller off of the ground when hooking it up to a tripod.

The SpitFire runs off of 4AA batteries. Alkaline batteries are recommended for use with this unit. You will see run times of 20-24 hours off of a fresh set of alkaline batteries. It comes with 24 high quality FOXPRO sounds. The SpitFire is user reprogrammable from home. The sounds are stored on a micro-SD card. A compatible reader/writer (not included) is necessary for reprogramming. It is capable of playing FOXPRO's own FXP audio files as well as MP3 and WAV files

Camo Carry Case (Padded)	297-CASEBRUSH	\$29.75
NIMH/Charger for FX, Scorpion, Fury	297-FXNIMH	\$29.40

- Two toppers
 - Remote control operation and variable speed control
 - LED for nighttime use
 - Decoy jack for you to use with your FOXPRO remote caller
 - Removeable stake and toppers for extreme portability
 - 4 'C' Batteries Required
 - One Year Warranty
 - Made in the USA
- Order No. 297-JACKATTACK1



SCORPION FEATURES

- TX-9 Remote that features backlit LCD panel
- Comes with 50 High-quality sounds
- Store and play up to 200 sounds!
- LED for nighttime use
- 2 'AA' Batteries Required
- One Year Warranty
- Made in the USA

Order No.
297-X1BINF \$369.95



FOX PRO FURY GX7 FEATURES

- Comes with 100 Sounds!
- TX-500 remote control system.
- 24-bit Audio

Order No. 297-GX7 \$605.95



All Call - The All Call allows you to connect almost any electronic caller, CD player, MP3 player or anything with an external speaker jack and creates motion when the sound is produced. Features 2 speakers and built in amplifier. Includes 25' of cord, furry decoy, and adjustable height stake. All Call requires the use of a separate electronic caller, not included. Requires 4-AA batteries, not included.

Order No.
214-483077 \$48.99

Quiver Critter - The simple quivering and shaking motion produced by this decoy makes it irresistible to even the wildest critter. Easy on and off operation. Furry rabbit design for that realistic look. Requires 2 AA batteries, not included.

Order No.
214-460078 \$24.76



Runs on 4 AAA batteries, not included.

Pre-loaded sounds include: several coyote calls, jackrabbit, cotton-tail, woodpecker, fawn distress and a number of rodent/rabbit sounds

Mighty Predator MP3 Digital Caller with Speaker - Comes complete with 2 speaker options, 16 pre-programmed animal and distress sounds on its 64 MB internal memory—or add your own SD card to download your own calls. Creates sounds up to 120 dB. Comes with USB cable and downloadable instructions. **Order No. 214-645093 \$99.07**

Cartridge Holders and Cases

Uncle Mike's Folding Cartridge Carrier - These ingenious fold-down pouches give you a compact, easily accessible means for keeping cartridges. Fits over 2-inch belt. Holds 10 rifle, 12 handgun, or 8 magnum rifle cartridges. Order as stated below.

	Order No.	Price
Black Folding Rifle Carrier	060-88451	\$12.60
Black Folding Magnum Rifle Carrier	060-88331	11.10
Black Folding Handgun Carrier	060-88441	12.60

Uncle Mike's Cartridge Slides - Have quick refills available on your belt with Uncle Mike's handgun or rifle cartridge slides. Handgun and shotgun slides have 6 loops; rifle slides have 10 loops. All are extra sturdy with loops sewn into the web backing; with full length loop supports. Black or camo.

	Order No.	Price
Black Rifle Slide	060-88411	\$11.10
Black Handgun Slide	060-88401	8.88



Bulldog Butt Stock Rifle (Holds 8 Cartridges) - **Order No. 208-WBSR \$6.05**

Allen Smart Rig Accessory Pouches - Cordura belt ammo carrier pouch. All pouches fit on 2" web belts.

	Order No.	Price
Shotgun Pouch	168-17245	\$5.09
Rifle Pouch	168-17255	5.09



Field & Sportsman's Boxes

MTM Field Boxes



	Order No.	Price
A - 18.25x 8.5x 13" Forest Green	008-SPUD2	\$22.12
B - ATV BOX 15.5x 8.5x 9.5" Camo(bungee Included)	008-SDB1ATV	24.26
C - ATV BOX 18.25x 13x 10" Camo(bungee Included)	008-SPUD7	27.87
D - ATV BOX 18.25x 13x 10" Camo(Shoulder Strap Incl.)	008-SPUD6	24.71

Plano Field Box

Plano Model 1412 Shallow Shell Case - Great for centerfire, pistol, muzzleloader, shotgun, air rifles, hunting gear, archery supplies and shooting accessories.

Dimensions:
15" Long x 8" Wide x 6 1/4" High.
Order No. 086-1412 \$11.98



Allen Neoprene Open Buttstock ShotShell Holders - Heavy Duty Neoprene sleeve stretches over rifle or shotgun stock. Fastens with velcro.

	Order No.	Price
4 Shell Neoprene Stock cover Break-up	168-20143	\$5.90
6 Shell Neoprene Stock cover Break-up	168-20123	5.90



Allen Buttstock Shell Holders -

	Order No.	Price
Shotgun (Holds 5 Shells)	168-205	\$3.11
Rifle (Holds 9 Shells)	168-206	3.11



Cartridge Belt - Quick access to extra rounds. Cartridges secured in elastic loops. Tough 2" black nylon web with flip-open buckle fits up to 50" waists.

	Order No.	Price
Shotgun Belt (25 loops)	060-88051	\$14.82

MTM Sportsmans Electronic Case - Ideal for GPS, Two-way Radios, Compact Camera, Weather Radios. Three Layers of Foam, One layer is "Pick-Out Foam for custom configurations. Clear Battery Organizer included. Holds up to 20AA or 28 AAA Batteries. **Order No. 008-SEC \$10.68**



Stoney Point Shooting Products

Monopods / Staffs

PoleCat Monopods

	Order No.	Price
Explorer 3 Section Staff, with V-Yoke Extends 25"- 62"	060-T3M62VXX	\$27.68
Compact 3 Section Staff, with V-Yoke Extends 16"-38"	060-T3M38VXX	20.76

Bipods

	Order No.	Price
Compact 3 Section Bi-pod, Extends 16"-38" (10oz)	060-T3B38BXX	\$34.61
Explorer 3 Section Bi-pod, Extends 25"-62" (16oz)	060-T3B62BXX	41.52
Tag-A-Long Pivoting V-Yoke Attachment	060-CP112	20.76

Rapid Pivot Bipods

	Order No.	Price
Prone/Bench Bi-Pod, Extends 10"-13" (8oz)	060-T2B13PXX	\$27.68
Sitting/Kneeling Bi-Pod, Extends 25"-43" (12oz)	060-T2B43PXX	34.61
Standing Bi-Pod, Extends 36"-64" (16oz)	060-T2B64PXX	41.52
Stock Attachment Hardware	060-RPB101	11.10

Tripods

	Order No.	Price
Compact 3 Section Tripod, Extends 16"-38" (20oz)	060-T3T38BXX	\$51.16
Explorer 3 Section Tripod, Extends 25"-62" (29oz)	060-T3T62BXX	62.28

Steady Stix II

	Order No.	Price
Steady Stix II, Folded 14", Extended 39" (6oz) .354in. tubing diameter	060-F3B39R1X	\$22.16
Steady Stix II Magnum, Folded 14" Extended 39" (8oz) .520in. tubing diameter	060-F3B40R1X	27.68

Safari Stix II

	Order No.	Price
Safari Stix II, Extends 72" .520in. tubing Belt sheath (incl)	060-F4B70R1X	\$33.21

HS Turkey Pod



V-Pod Shooting Stick - The V-Pod Shooting Stick clamps onto a shotgun to quickly position for a shot. Two telescoping sections allow for adjusting to any height. Keep the bottom section retracted to use like a mono-pod or extend to use the split legs for side-to-side stability. Unique design allows for full range of motion without picking up the gun. The V-Pod comes with the Gun Stock Buddy, which holds the stock of the gun against the body.

Order No. 052-00614 \$22.43 Includes 12ga & 20ga Mounting Clamps.

Lightweight!
Sturdy!
Compact!
Versatile!
Essential!



Best Choice? The Explorer Tripod!

Why The Explorer? So many limitless configurations of the PoleCat Products, however, the Explorer provides you with The best of all three! It can be used as Monopod, Bipod and Tripod! 3 section legs extend from 25" up to 62".



Explorer



Outback II



Bipod



Detach the third leg of your Explorer Tripod, Add any of the monopod accessories to it and you now have a monopod, and bipod to use in any terrain!



Use as tripod or fold and clamp leg in for a bipod



Explorer Tripod Shown



STEADY STIX II



SAFARI STIX

Hunters Specialties Realtree® APG HD® Portable Hunting Blind - Measures 12' x 27". With attached stakes, it unrolls quickly for setup and folds up to approximately 14 inches long for easy carrying. Made of diecut leaf patterns in lightweight, durable spun-bonded polyester.

Order No. 052-05316 \$16.95



Stalk Stick Walking Stick/Monopod

- Adjustable 29"-64"
 - Sturdy Leg Construction
 - High Resistance to weather and chemicals
 - Use as a walking stick or a gun rest
 - Camera or spotting scope can be attached
- Order No. 097-40858 \$21.01**

Shooters Ridge Shooting Products

Collapsible Shooting Sticks -Fast, lightweight and easy to use. Two sizes to fit a variety of shooting situations. Sturdy construction for heavy barreled guns. Convenient belt pouch.

Order No. Price

Kneeling/Sitting Sticks 38" 097-40860 \$27.34



Fixed Length Shooting Sticks - Quickly steady yourself for that precise shot.

38" Black 097-40862 \$16.09

Tri-Leg™ Shooting Sticks - These shooting sticks form a tripod rest for the ultimate in stability. Rest any size firearm in this versatile rest. It all comes in a convenient belt carrying pouch for the ultimate in portability. Extend and collapse in seconds with shock cord design.

097-40451 \$44.04



Deluxe Stalk Stick - This innovative 2 in 1 Hiking Staff supports in rough terrain with the super strong hiking staff, and when the shot of a lifetime presents itself just slide the retractable shooting yoke into position to steady your aim. Lightweight and sturdy, Comfortable ergonomic "Soft Grip" handle steadies rifle for quick, clean shot. Adjustable height up to 66-1/2" Patent pending.

Order No. 097-40458 \$49.51

Outdoor Edge Cutlery

SwingBlade / SwingBlaze (Orange) -

Simply push the lock button and the blade changes from a drop-point skinner to the most functional gutting knife for big game.



This innovative design cuts beneath the skin to open game like a zipper. Eliminates the chance of cutting hair or internal organs. The SwingBlade is hand finished shaving sharp from AUS-8 stainless steel and subzero quenched for superior edge retention and performance. Rubberized Kraton® handles ensure a positive, non-slip grip, even when wet. The SwingBlade comes complete with a quality nylon belt sheath and is lifetime guaranteed.

	Order No.	
SwingBlade (Black)	280-SB10N	\$49.67
SwingBlaze (Orange)	280-SZ20N	49.67

Combo includes the Flip-N-Zip Saw.

Flip-N-Zip / Flip-N-Blaze (Orange) -

Features a lockback skinning blade and a flip out gutting blade. Cuts underneath that skin to open game like a zipper.



	Order No.	
Flip-N-Zip (Black)	280-FZ20	\$49.67
Flip-N-Zip Combo (Black)	280-FC30	\$59.61
Flip-N-Blaze (Orange)	280-FZB20	\$49.67
Flip-N-Blaze Combo (Orange)	280-FCB30	\$59.61



SwingBlade-Pak -

Combines the SwingBlade with the 6" Kodi-Saw on a full-grain leather belt sheath.

Order No. 280-SP1 \$74.53

Allen Back Packs

Canyon Realtree AP®

Hydration Pack with Zip Off Fanny Pack-

- 1750 Cubic Inch Capacity * Break-Up Camo Pack Cloth
- Main Compartment 13" X 14" X 6"
- Fanny Pack 7" X 6" X 13"
- Bungee Cord System for outer storage.
- Both The Padded Back And Shoulder Straps Have Cool Mesh For Comfort
- Inside Main Hydration Bladder Compartment

Order No. 168-19270 \$39.99



Pagosa Mossy

Oak Break-Up® Deluxe Day Pack -

- 1600 Cubic Inch Capacity
- No Rattle Zippers
- Contoured Shoulder Straps
- Mesh Flat Front Pocket
- 19" X 13" X 6" Main Compartment
- 11 1/2" X 9 1/2" X 2" Front Compartment
- Made From Waterproof Timbercloth Fabric

Order No. 168-19090 \$29.09

Game-Processor Kit -

The most complete portable butchering set for preparing big game, waterfowl, wild turkey, small game and fish.

Knives - Each knife incorporates high carbon 420 stainless steel blades, and ergonomic Kraton handles.

Knives Include:

- 3" Caping knife
- 4" Skinner
- 5-1/2" Boning-Fillet knife
- 8" Butcher knife for carving turkeys, steaks and roasts.

Also Includes:

- Cutting board
- Carving Fork
- Wood-bone saw
- Heavy duty game shears
- Tungsten-Carbide V-sharpener
- Ribcage spreader and a set of latex game cleaning gloves.



	Order No.	Price
Game-Processor Kit	280-PR1	\$62.10
Steel Stick Spreader Only	280-SS10	8.64
Tungsten-Carbide V-sharpener Only	280-TC100	6.98



The Butcher-Lite -

The ideal light-weight, portable field butcher kit. The Butcher-lite includes every tool to skin quarter and debone big game in a nylon roll pack that converts to a belt scabbard to easily access each tool.

Includes 3" caping knife, 4-1/4" gut hook skinner, 6" boning/fillet, 7-1/4" wood-bone saw, Tungsten-Carbide sharpener, ribcage spreader and a set of game cleaning gloves. The nylon roll-pack features snap-in plastic knife scabbards for easy removal and cleaning. Order No. 280-BL1 \$49.67



Deer & Big Game Processing: Volume 1 - The most in-depth step by step processing video produced. Covers field dressing, caping, aging, quartering de-boning, identifying primary muscles, grinding, and packaging. Bonus feature on CWD. Run time 3 hours. Order No. 280-DP101 \$12.37

Quarter and De-bone Big Game In the Field: Volume 2 - For any hunter harvesting deer, elk, caribou and moose in remote locations. Learn step-by-step techniques to completely de-bone big game in the field and minimize carry weight. Run time 2 hours. Order No. 280-QD101 \$12.37

Advanced Sausage Processing: Volume 3 - Learn to make a variety of fresh and smoked sausage. Covers grinding, seasonings, preservatives, fat to lean ratios, natural and liquid smoke application, humidity and surface moisture. 2 hours. Order No. 280-SP101 \$12.37

Advanced Jerky Processing: Volume 4 - Learn step-by-step to produce jerky nuggets, smoked, formed, re-structured and whole muscle jerky. How to de-bone the best game meat for whole muscle jerky. Run time 2 hours. Order No. 280-JP101 \$12.37

Advanced Game Processing Library, (5 DVD Set, 9 hours of knowledge) - Features volumes 1-4 of the Advanced Wild Game Processing series with 9 hours of knowledge. Order No. 280-AP101 \$43.45

Mag-Lite C & D Cell Flashlights



Mag-lite flashlights. Tough, Durable, Performance and reliability you can trust. Every Mag-lite flashlight embodies a true balance of superior optics, efficient power, strength and quality. EXCLUSIVE: Because of its unique design, Mag-Lite is the only flashlight that converts to an "Auxiliary" Lantern. Just a twist will do it!

D-Cell Mag-Lite

	Order No.	Price
Small Head Model ML		
2 D Cell Mag Lite Flashlight	065-S2D016	\$17.13
3 D Cell Mag Lite Flashlight	065-S3D016	14.31
4 D Cell Mag Lite Flashlight	065-S4D016	14.78
5 D Cell Mag Lite Flashlight	065-S5D016	18.07
6 D Cell Mag Lite Flashlight	065-S6D016	20.11

C-Cell Mag-Lite

	Order No.	Price
Large Head Model LCL		
2 C Cell Mag Lite Flashlight	065-S2C016	\$12.63
3 C Cell Mag Lite Flashlight	065-S3C016	13.12

Mag-Lite Lite Pack



This combo pack from Mag includes: one 3-D cell Mag-Lite flashlight and one Mini-Maglite AA flashlight. Available in black finish only. Does not include batteries! This is an excellent value!

Order No. 065-X01016 \$19.57

Mini Mag-Lite



	Order No.	Price	
AA Mini Black	065-M2A016	\$7.80	Mini-Mag Lite AA & AAA Cell Flashlights. Comes with 2 AA or AAA Eveready alkaline Energizer Batteries
AA Mini Camo	065-M2A026	8.48	
AAA Mini Black	065-M3A016	7.04	

Mag-Lite Replacement Lamps

	Order No.	Price	
2 Cell C or D Replacement Lamp	065-LWSA201	\$1.36ea	
3 Cell C or D Replacement Lamp	065-LWSA301		
4 Cell C or D Replacement Lamp	065-LWSA401		
5 Cell C or D Replacement Lamp	065-LWSA501		
6 Cell C or D Replacement Lamp	065-LWSA601		
Mini Mag-Lite AA Krypton 2/pkg.	065-LM2A001		

Mag-Lite LED Flashlights



Maglite® 3 Watt LED Flashlights™ - The Maglite® flashlight, renowned for its quality, durability, and reliability, is now available with the new MAG-LED™ Technology.

Available in 2, 3, & 4 Cell D size, the benefits include: A Powerful Projecting Beam that focuses simply by rotating the head. Balances high brightness with extended battery life.

	Order No.	Price
2AA Cell LED	065-SP2201H	\$15.55
2 D Cell LED	065-ST2D016	21.22
3 D Cell LED	065-ST3D016	21.84

Mag-Lite Rechargeable System

5-Cell (1/2-D) Nickel-Cadmium battery pack. Rechargeable up to 1000 times. Comes with a 12 volt cigarette lighter charger and a 110 volt (AC/DC) charger, Permanently stamped serial number for registration and identification, O-ring sealed throughout, High intensity halogen lamp (50-hour rating), 40,000 peak beam candlepower, Adjustable light beam (Spot to Flood), Recessed, pushbutton, self-cleaning, 3-position switch, Rugged, machined aluminum construction with knurled design, Anodized inside and out for improved corrosion resistance, Water and shock resistant



	Order No.	Price
Mag-Charger w/12v & 110v AC/DC Charger	065-RE1019	\$73.38
Mag-Charger Replacement Bulb	065-LR00001	3.49
Battery Pack (6v Nicad)	065-ARXX235	16.98



CR123A Replacement Lithium Batteries - Replacement batteries for T6, T3 and other similar lights.

	Order No.	Price
Dura cell 3 Volt Lithium (2 pk)	101-1081372	\$6.55
Energizer 3 Volt Lithium (2 pk)	210-85175	4.35
Energizer 3 Volt Lithium (12 pk)	210-85177	21.73

Tac-Star Tactical Lights



TacStar T6 Tactical Lights - Ideal for tactical use or home security. The rugged design features a precision knurled exterior of aircraft grade aluminum and double o-ring for a perfect grip. The patented tail switch allows intermittent or "full on" mode. No other 6 volt light exceeds brightness of the T6 with factory preset spot: so powerful it can blind intruders on sight. Illuminates up to 150 yards in the dark. Features also include water resistant, matte black anodized finish with rubber tail switch. Batteries included on all models.

	Order No.	Price
T6 Tactical 6v Xenon (70 Lumens)	101-1081030	\$31.58
T6 Replacement Bulb Assy (T6 Xenon)	101-1081377	13.64
T6 Pressure Switch end cap	101-1081206	21.64

Universal Barrel Mounts

Precision machined mounts attach flashlights to barrels. Sturdy steel construction.

	Order No.	Price
1/2" to 3/4" barrel to 3/4" light	101-1081111	\$14.55
1/2" to 3/4" barrel to 1" light	101-1081112	14.55
3/4" to 1" barrel to 3/4" light	101-1081113	14.55
3/4" to 1" barrel to 1" light	101-1081114	14.55



Weapons Light Systems

Weapons Light System 2000 - A compact, super bright flashlight that mounts on most rifles and shotguns. Features an on/off pressure sensitive finger controlled switch, a nose cone that adjusts for beam width and mounting hardware. The WLS 2000 is shock and water resistant.

Order No. 101-1081025 \$77.55



Compact Weapons Light System - Inexpensive and lightweight! For Rifles and shotguns. Spot flood beam adjustment, comes with mounts that fit 22Cal up to 12 Ga!

Order No. 101-1081034 \$33.33



	Order No.	Price
PRESSURE SWITCH END CAP(Mini-Mag, Streamlite Jr.)	101-1081196	\$13.11
PRESSURE SWITCH END CAP(Surefire 6P)	101-1081206	21.64

Streamlight Stingers

- Stinger-10oz, 7.4", 15,000 Candlepower
- StingerHP-12.2oz, 8.25", 40,000 Candlepower
- StingerXT-11.1oz, 7.7", 15,000 Candlepower
- StingerXTHP-14.6oz, 8.75", 40,000 Candlepower
- UltraStinger-17oz, 11.75", 75,000 Candlepower

All Stingers will run approximately 1 hour of continuous use.
All Stingers come with a AC/DC charger
Piggyback chargers will charge light and spare battery simultaneously
*Piggybacks include a spare battery stick

"Smart" Fast Chargers are also available for a 2.5 hour recharge.



All Stingers come with a 10-hour Steady charger.

	Order No.	Price
Stinger w/ 10 hour Steady Charger(2 holders)	210-75014	\$94.45
StingerLED w/ 10 hour Steady Charger(2 holders)	210-75713	109.83
UltraStinger w/ 10 hour Steady Charger(2 holders)	210-78014	110.38
Battery Stick for Stinger, HP, XT, XTHP, Poly	210-75175	15.57
Battery Stick for UltraStinger	210-77175	27.77
Bulb for Stinger, XT, Poly	210-75914	6.77
Bulb for StingerHP, XTHP	210-78915	6.77
Bulb for UltraStinger	210-78914	6.77

Streamlight Tacticals



TLR-1 - Intensely bright, virtually indestructible tactical light, attaches/detaches to almost any gun in seconds. Powered by two 3-volt CR123 lithium batteries with 10-year storage life. Shockproof super high-flux LED with blinding beam (up to 80 lumens) with bright side-light - will not break or burn out. Up to 2.5 hrs runtime. **Order No. 210-69110 \$110.63**

TLR-1S Strobe - C4® LED with blinding beam (TLR-1: 135 lumens, TLR-1s 160 lumens) with optimum peripheral illumination - will not break or burn out!. Strobe model with user programmable strobe enable/disablewith bright side-light - will not break or burn out. Up to 2.5 hrs runtime. **Order No. 210-69210 \$109.28**

TLR Remote Switches - Easily replaces standard battery door/switch



- Retains momentary/lock on function of original paddle switch
- Tethered rubber weather cap keeps connector dry when remote is not in use
- All remotes feature rotating quick disconnect plug with O-ring seal

	Order No.	Price
A - TLR Battery Door Switch	210-69130	\$33.58
B - Pump Shotgun Coil Switch	210-69134	27.24
C - Long Gun Remote Switch	210-69135	27.24
D - Remote Tape Switch	210-69132	27.24
E - Remote Retaining Clips	210-88178	3.13



Streamlight Black PolyTac LED - 120 lumens Made of rugged, virtually indestructible, super-bright, nylon polymer tactical light! Powered by two 3V CR123A lithium batteries (included) - **Order No. 210-88850 \$35.69**

	Order No.	Price
Scorpion - Compact, Xenon 4.9" long, uses two 3v Lithium batteries (included)	210-85001	\$35.35
Scorpion Replacement Bulb	210-85914	5.98



Streamlight Stylus

The Stylus® Reach™ has the same great features as the Stylus® but has a flexible cable extension, allowing you to get deep into the tightest spots. With a waterproof, aircraft aluminum casing and a tough PVC shielded cable, the Stylus Reach is built to illuminate those unforgiving, hard-to-reach areas. It's unbreakable, 100,000-hour LED - which never needs replacing



	Order No.	Price
White Light	210-65618	\$17.11



	Order No.	Price
RED LED	210-65006	\$12.55
BLUE LED	210-65022	12.55
GREEN LED	210-65020	12.55
WHITE LED	210-65018	12.55



PolyStylus® - Ultra Tough Fiberglass Penlight. The PolyStylus® is an ultra-slim, ultra-tough fiberglass penlight that fits in your pocket so you can take it with you wherever you go. High intensity 5mm LED, impervious to shock with a 100,000 hour lifetime. Interchangeable colored LED modules included - Green (527nm), Blue (470nm), Red (624nm), and White. Powered by 3 "AAAA" alkaline batteries.

Streamlight Stylus Pro LED - Bright and Compact! 24 Lumens, that's two times brighter than the Standard Stylus! 5.3" in Length **Order No. 210-66118 \$18.67**



Streamlight Nano LED - Bright and Very Compact! 10 Lumens **Order No. 210-73001 \$5.70**

Replacement Batteries (4pk) - **Order No. 210-61205 \$4.47**

Streamlight Super Tac Light



Vertical Grip with Rail - Machined aluminum, hard anodized rail grabber vertical foregrip with integral Picatinny rail and storage compartment. **Order No. 210-69114 \$70.30**

-Up to 3.5 hours at regulated intensity
-135 Lumens
-7.1oz



Streamlight Super Tac High Performance Tactical Light - Streamlights C4 LED Technology generates 3x the brightness of a standard LED. 135 Lumens. Runs on two 3v CR123A Lithium Batteries. **Order No. 210-88700 \$73.33**



Long Gun Rail Mount -

Flashlight clamp tightens without tools. Positive engagement teeth match and grip groove on the flashlight body for recoil-proof installation. **Order No. 210-69100 \$44.02**

12ga Mag Tube Rail Mount -

Mounts right onto magazine tube. **Order No. 210-69901 \$15.77**



Super Tac Remote Switch with Coil Cord - Includes 2 screws, tiedown wrap, doublestick tape & retaining clips. **Order No. 210-88186 \$29.57**

Streamlight Super Tac Remote Switch with 8" Straight Cord - Includes 2 screws, tiedown wrap, doublestick tape and retaining clips. **Order No. 210-88185 \$29.57**



Lithium Batteries - CR123A Lithium Batteries. 2 Per Pack. **Order No. 210-85175 \$4.35**

Sidewinder® - Sidewinder, the most versatile military light in the world. Twenty flashlights in one! Each LED features 4 levels of output intensities: Low (5%), Medium (20%), Medium-High (50%), High (100%) plus a Strobe function (100%)

- White/Green/Blue/Red Lights
- Articulating 185° rotating head
- Spring steel clip attaches to MOLLE or belt
- Clip can be mounted on either side of the light
- Dimensions: 4.63" High; 2.31" Wide
- Weight: 4.96 ounces
- One year limited warranty



	Order No.	Price
Coyote Brown	210-14002	\$55.31

Streamlight Headlamps

Uses 3AAA Alkaline batteries



Trident
Hands free Trident™ headlamp. The Trident is truly unique because it combines a super bright Krypton bulb with 3 LEDs, giving you high power and longevity. This lightweight headlamp features 3 way lighting for short, medium and long distances. Plus, with a durable design and a battery life of up to 120 hours.

	Order No.	Price
Green Light BuckmasterCamo	210-61070	\$24.52
Xenon bulb	210-61004	\$3.26

Septor- Piercing light comes from seven super bright white LEDs each with a life of 100,000 hours so you'll never replace a bulb again. The LEDs provide 3 way, hands free lighting for short, medium, and long distances. Plus, a 90 degree tilting head lets you zero in on the source you're illuminating. Constructed of virtually indestructible polymer, the Septor has fully adjustable straps for the ultimate in hands free LED lighting.

Order No. 210-61052 \$29.08

Uses 2AAA Alkaline batteries



Enduro™- One of the brightest, lightest, most compact headlamps for the price. Ultra-bright 0.5 watt LED uses (2) "AAA" batteries. 2 modes: Low (runtime of 24 hours), High (runtime of 7 hours) 18 Lumens of light, power regulator maintains max light output throughout battery life. Impact resistant polycarb lens & body. Water resistant. Non-slip comfort headstrap. Only 2.75 ounces (with batteries). "No Excuses" warranty Order No. 210-61400 \$13.12

Enduro™ Camo Headband - Order No. 210-61405 \$15.97



Gerber Triode™ Headlamps - The versatile Triode headlamp features two configuration modes: bright steady white and dimmed steady white for longer burn time. Attach the Triode to your cap or vest or use the adjustable head strap. AAA battery included.

	Order No.	
Black	054-22-80005	Closeout



The Ultimate Alternative to Night Vision. Patented technology creates true night vision and turns your scoped rifle into a night hunter. Combining a powerful, eye safe green laser diode and a precision optical collimator to cast a bright beam of green laser light to fully illuminate targets up to 250 yards. Animal eyes are intensely illuminated by green laser light and clearly visible at extended distances.

ND3 Long Distance Laser Locator - Illuminates up to 250 yards, Laser is visible up to 3 miles (Extreme cold weather use) 1" tube to mount to weapon systems. Operates on 1 CR123A Battery (Included) Order No. 164-ND3874678 \$252.57

ND5 Long Distance Laser Locator - Illuminates up to 400 yards, Laser is visible up to 5 miles (Extreme cold weather use) 8 Hours of continuous use. Operates on 2 CR123A Batteries (Included) Order No. 164-ND5118470 \$279.17

SureFire Tactical Lights

Surefire G2® -

- Nitrolon® polymer and rugged aerospace-grade aluminum
- Lightweight, weatherproof & rugged
- Tailcap switch: press for momentary-on, twist for constant-on



	Order No.	Price
Surefire G2® LED	183-G2LBK	\$80.10

Surefire 6P® -

- Aerospace-grade aluminum body
- Lightweight, weatherproof & rugged
- Tailcap switch: press for momentary-on, twist for constant-on



	Order No.	Price
Surefire 6P®	183-6PBK	\$55.80

E1E Executive Elite® -

- Ultra compact (finger length)
- Aerospace-grade aluminum body
- Lightweight, weatherproof & rugged
- Tailcap switch: press for momentary-on, twist for constant-on



Order No. 183-E1EBK \$71.10

Streamlight Pro Tac Lights

Streamlight ProTac 1L-

- HIGH - 110 lumens/1.75 Hours
- LOW - 12 lumens/14 Hours
- STROBE - 3 Hours

Includes 1 CR123A lithium battery

Order No. 210-88030 \$39.54



Streamlight ProTac 2L-

- HIGH - 180 lumens/2.5 Hours
- LOW - 18 lumens/33 Hours
- STROBE - 6 Hours

Includes 2 CR123A lithium batteries

Order No. 210-88031 \$43.93



CR123A Replacement Lithium Batteries - Replacement batteries for T6, T3 and other similar lights.

	Order No.	
Dura cell 3 Volt Lithium (2 pk)	101-1081372	\$6.55
Energizer 3 Volt Lithium (2 pk)	210-85175	4.35
Energizer 3 Volt Lithium (12 pk)	210-85177	21.73



Flashlight Accessories

Uncle Mikes Black Flap Style Mini-Lite Pouch- Carry MINI-MAG or other AA flashlights in these handy Cordura nylon belt cases

Order No. 060-88671 \$10.76



Cold Steel Axes

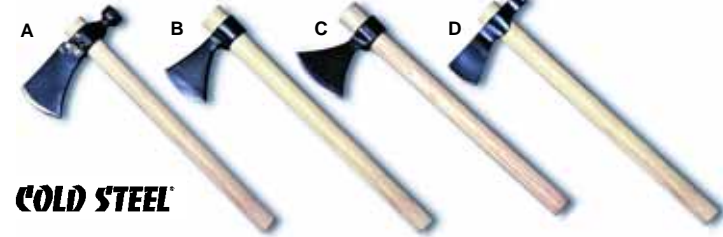

COLD STEEL

A- Rifleman's Axe- Overall length 18 1/2", Hawk length 8 1/8", Weight 32 oz., Primary edge 3 1/2", Handle is American Hickory. **Order No. 085-90RH \$24.10**

B- Frontier Hawk Axe- Suitable for re-enactors from any period stretching from the French and Indian War clear up to the final settling of the West in the late 1800's Its drop forged head is lighter than the Plainsman's. Comes with an American hickory handle. **Order No. 085-90FH \$21.42**

C- Norse Hawk Axe- This tomahawk shows a strong Viking influence with its upswept blade for maximum slashing effect. The head is drop forged out of 5150 steel and comes with an American hickory handle. **Order No. 085-90N \$21.42**

D- Trail Hawk Axe- Modeled after an early frontier pattern, our Trail Hawk can do it all. It's an excellent chopper and has a functional hammer poll with a hardened face so you can drives nails, hammer in stakes, and smash or crush just about anything. 19.1 oz **Order No. 085-90TH \$21.42**

Cold Steel Machetes

COLD STEEL



These machete's have an anti rust matte finish baked black on 1055 Carbon steel. The sheath is condura and is made to give your machete a protective cover.

	Order No.	Price
Bolo Machete 16 3/8" Blade (A)	085-97BM	\$10.18
Sheath for Bolo Machete Cordura	085-SC97BM	4.30
Heavy Machete 14 5/8" Blade (B)	085-97HM	10.18
Sheath for Heavy Machete Cordura	085-SC97HM	4.30
Latin Machete 18" Blade (C)	085-97AM18	10.18
Sheath for Light Machete Cordura	085-SC97AM18	4.30
Latin Machete 24" Blade (C)	085-97AM24	11.78
Sheath for Light Machete Cordura	085-SC97AM24	4.30
Panga Machete 16" Blade (D)	085-97PM	10.18
Sheath for Panga Machete Cordura	085-SC97PM	4.30



COLD STEEL

	Order No.	Price
Kukri Machete 13" Blade 16oz (E)	085-97KMS	\$15.53
Magnum Kukri Machete 17" (G)	085-97MKM	18.21
Two Handed Machete 32" (H)	085-97THM	16.07



Gurkha Kukri- This unique blade curvature allows the LTC Kukri to out-cut machetes and swords twice its size. 12" blade, Overall 17", Weight 22 oz., SK-5 High Carbon, Handle Kraton. Comes with Secure-Ex Sheath. **Order No. 085-39LGK \$169.89**

Cold Steel Knives

COLD STEEL

Double Edged



Black Bear Classic: Blade length 8 1/4", Thickness 3/16", Overall length 13 1/2", Weight 12.7 oz., AUS 8A Stainless Steel Blade, 300 series stainless guard, Black linen Micarta handle, Blackleather Sheath & stone pouch. **Order No. 085-14BBCJ \$296.63**

Master Hunter - Blade length 4 1/2", Blade thickness 3/16", Handle Kraton, Weight 6.4 oz., Available in Carbon V or 8A Stainless Steel.



	Order No.	Price
Master Hunter Carbon V Steel	085-36JSK	\$86.29
Master Hunter PLUS(With Guthook)	085-36G	91.68



A- Survival Rescue Knife: Blade length 6", Blade tickness 3/16", Steel Carbon V, Weight 8.2 oz., Handle Kraton, Finish Epoxy Powder Coat. **Order No. 085-38CK \$72.81**

B- Recon Tanto: Blade length 7", thickness, 3/16", Weighs 9oz, 4 3/4" long Kraton Handle. Carbon V steel, overall length, 11 3/4" **Order No. 085-13RTK \$72.81**



Super Edge - The very smallest package available. This rugged little workhorse can cut through the tough materials that would make a bigger knife "choke". It's diminutive overall length and feather light Secure-Ex sheath make it a natural for attachment to a key ring, zipper pull, "D" ring or belt loop. .8oz, 2" Blade, Overall length 4 5/16" **Order No. 085-42SS \$16.18**

Cold Steel Kitchen Classics



	Order No.	Price
Paring Knife 3" Long Blade (A)	085-59KPZ	\$5.93
Boning Knife 6" Long Blade (B)	085-59KBNZ	10.25
Bread Knife 9" Long Blade (C)	085-59KBRZ	11.87
Chef's Knife 8" Long Blade (D)	085-59KCZ	17.26
Slicer 9" Blade (E)	085-59KSLZ	11.87
Utility Knife 6" Blade (F)	085-59KUZ	10.25
Steak 4 5/8" Blade (G)	085-59K SZ	7.01
Set of 6 Steak Knives (G)	085-59KS6Z	37.75



The Kitchen Classics are made of 420 Sub Zer Quench Steel. The Kitchen Classics Set includes 1 each Boning, Bread, Chef's, Slicer, Paring and 6 Steak knives.

Order No. 085-59KSET \$134.83

Nathan's Oil - Specially formulated for use with all Lansky Sharpeners and Natural Arkansas Benchstones. Just a few drops will protect your stone and give you the professional edge you desire. **Order No. 113-L0L01 \$2.61**



Ka-Bar Knives

U.S.M.C. Fighting / Utility Knives



KA-BAR



K1 Fighting Knife - An American Legend - the knife Marines depended on during World War II. Oval handle constructed of compact leather disks, smoothed and polished. High carbon steel (1095) blade, black epoxy powder coated, buff polished, razor sharp edge. Powdered metal butt cap, carbon steel guard, both powder coated. Cowhide sheath. Blade length 7", overall 11 7/8". **Order No. 056-1217 \$55.01**

Black Hard Plastic Sheath! Fits 7" blade fighters **Order No. 056-1216 \$11.58**



Black Ka-Bar - An American Legend, now with oval shaped Kraton G thermoplastic elastomer handles. High carbon steel (1095) blade, black epoxy powder coated, buff polished, razor sharp edge. Powdered metal butt cap, carbon steel guard, both powder coated. Durable, all weather Kydex sheath is impact, abrasion and corrosion resistant. Blade length 7", overall 11 3/4".

	Order No.	Price
Black Ka-Bar Straight Edge, Kydex Sheath	056-1213	\$60.01
Black Ka-Bar Triple peaked, Serrated Edge Kydex Sheath	056-1214	60.01
Black Ka-Bar Straight Edge, Leather Sheath	056-1211	55.01
Black Short Ka-Bar Tanto Edge, Kydex Sheath (9 3/8" Overall, 5 1/4" Blade)	056-5054	48.33



Black Tanto - An American Legend, now with oval shaped Kraton G thermoplastic elastomer handles. High carbon steel (1095) blade, black epoxy powder coated, buff polished, razor sharp edge. Powdered metal butt cap, carbon steel guard, both powder coated. Durable, all weather Kydex sheath is impact, abrasion and corrosion resistant. Blade: 8", hollow ground with 2" triple peaked serration. Overall length 12 7/8" **Order No. 056-1245 \$60.01**

KA-BAR

TDI Law Enforcement Knives

Optimal for low profile or concealed carry and effective for close quarters defense. Grips are angled for easy access, firm hold and to prevent hand slippage and overriding the blade. Blades maximize instinctive moves during a confrontation.



KA-BAR

	Order No.	Price
Original TDI Sheath & Belt application Straight edge blade (5 5/8" Overall Length, 2 5/16" Blade)	056-1480	\$35.13
Large TDI Sheath & Vest application Straight edge blade (7 9/16" Overall Length, 3 11/16" Blade)	056-1482	41.50

Cutlass Machete - 11" Blade, 16.5" overall length. Width 2 3/8". Comes with Black Leather Sheath. **Order No. 056-1248 \$46.81**



Ka-Bar Machetes



Kukri Machete - 11.5" Blade, 17" overall length. Width 2 7/8". Comes with Black Leather Sheath. **Order No. 056-1249 \$46.81**

Ka-Bar Commemorative Fighting Knives



KA-BAR

Celebrate a milestone, honor retired or active duty military personnel, showcase your pride in the U.S.A., or simply add to your collection! Ka-Bar celebrates its world renowned relationship with the branches of the military and those who serve or served under them with these carefully designed commemorative fighting knives. Each knife comes with a brown leather sheath decorated with the corresponding military insignia.

	Order No.	Price
Operation Iraqi Freedom US Army	056-9127	\$60.13
Operation Iraqi Freedom USMC	056-9128	60.13
Vietnam War US Army	056-9139	60.13
Vietnam War USMC	056-9140	60.13

Leather Handled Hunters

AUS6 stainless steel blade, Leather handle, Blade length 4", overall length Brown leather KA-BAR sheath included, Made in Japan



	Order No.	Price
A- Hunter 8 1/8" overall (4" Blade)	056-1232	\$28.51
B- Skinner 8 1/4" overall (4 3/8" Blade)	056-1233	31.83
C- Little Finn 7" overall (3 5/8" Blade)	056-1226	24.84
Marine Hunter - Bowie - Bowie Style Blade	056-1235	36.72
	056-1236	40.10

KA-BAR

KA-BAR



KA-BAR/Dozier Folding Thumb Notch - A thumb notched blade makes this nicely priced folder even easier to open and use. Designed by Bob Dozier. Closed length 4 1/4", Open length 7 1/4" **Order No. 056-4065 \$17.80**

Ka-Bar Hobo Knife

The Hobo - The perfect fork, knife and spoon combo. Great for camping, traveling and just to keep at work!

Order No.	056-1300	\$16.14
------------------	----------	---------



KA-BAR

Cutlass Machete - 11" Blade, 16.5" overall length. Width 2 3/8". Comes with Black Leather Sheath. **Order No. 056-1248 \$46.81**



Ka-Bar Machetes



Kukri Machete - 11.5" Blade, 17" overall length. Width 2 7/8". Comes with Black Leather Sheath. **Order No. 056-1249 \$46.81**

A- ZK "Famine" Tanto : Blade length 7 5/8", Overall Length - 13-1/8". Includes Sheath. **Order No. 056-5700 \$46.81**

B- ZK "Kharon" Tanto Folder : Blade length 3 3/8", Overall Length - 7-7/8". Includes Sheath. **Order No. 056-5698 \$25.36**



Kershaw Knives





	Order No.	Price
Black Out -3 3/8" Blade, 4 3/8" Closed w/pocket clip	100-1550	\$50.85
Black Out -3 3/8" 1/2 serrated Blade, 4 3/8" Closed w/clip	100-1550ST	50.85
Whirlwind -3 3/8" Blade, 4 3/8" Closed w/pocket clip	100-1560	45.76
Whirlwind -3 3/8" 1/2 serrated Blade, 4 3/8" Closed w/clip	100-1560ST	45.76



	Order No.	Price	The Chive- Speed Safe
Stainless Handle	100-1600	\$31.21	Opening Blade, 420 High
Pink Handle	100-1600PINK	34.57	Carbon Steel, Handle-410
Rainbow Handle & Blade	100-1600VIB	52.83	Stainless steel, Blade-1
Black Polished Handle & Blade	100-1600BLK	55.93	15/16", Closed 27/8",
SS Polished Handle & Blade	100-1600SS	43.22	Weight-1.9oz



	Order No.	Price	The Scallion- Speed-Safe
Bik Poly Handle Plain Blade	100-1620	\$31.21	Opening Blade, 420 High
Bik Poly Handle Serrated Blade	100-1620ST	33.05	Carbon Steel, Handle-
Camo Handle Plain Blade	100-1620C	40.67	Polyamide, Blade-2 1/4",
Blue Handle Plain Blade	100-1620BL	38.13	Closed 3 1/4", Weight-2.3oz
Green Handle Plain Blade	100-1620GRN	38.13	Designed by Ken Onion.
Red Handle Plain Blade	100-1620RD	38.13	

	Order No.	Price	The Leek- Locking blade
Stainless Handle	100-1660	\$36.02	3", 4" closed, Speed Assist
Smoke Black & Blue Handle	100-1660BB	38.13	Opening Stainless Handle.
Rainbow Handle & Blade	100-1660VIB	62.44	Designed by Ken Onion.
Tungsten Coated DLC Handle	100-1660CKT	50.85	
Pink Handle	100-1660PINK	40.67	
Stainless Handle 2 Tone Blade	100-1660CB	61.02	

Kershaw ZIPIT Gut-hook Knife - Shaving sharp blade. Injection molded rubber boot for finger comfort during those tough field dressing jobs.
Order No. 100-2520 \$6.59



	Order No.	Price	The Blur - 3 3/8" Blade
Black Handle	100-1670BLK	\$55.93	4.5" Closed, SpeedSafe,
Red Handle	100-1670RD	53.40	Locking Liner, Thumb Stud,
Black Handle Tactical Blur	100-1670TBLKST	55.93	Pocket Clip

Bear Hunter II - Tough 4.5" AUS8A stainless steel blade. The co-polymer handles are designed for a sure grip, even in wet, outdoor conditions.
Order No. 100-1029 \$17.79 Includes genuine leather belt sheath.

Kershaw Needs Work - Sandvik 13C26 stainless steel 3" blade (4 1/8" Closed). Polyimide Handle.
 • SpeedSafe
 • Locking Liner
 • Pocket Clip
Order No. 100-1820 \$38.13

Kershaw Oso Sweet - AUS6A stainless steel blade. 3.5" (4 3/8" Closed) Black injection-molded glass-filled nylon handle.
 • SpeedSafe
 • Locking Liner
 • Pocket Clip
Order No. 100-1830 \$20.32



Alaskan Trader
 Gut Hook Blade: 4 3/8"
 Hunting Blade: 3 1/2"
 Saw Blade: 6"
 Weight: 12.1oz
 Included Leather sheath!
Order No. 100-1098AK \$38.13

Roughneck-6 1/4" Blade, 11 1/4" Overall w/Leather sheath
Order No. 100-1010 \$40.67

Fillet Knife - High-carbon 420J2 stainless-steel blades that provide the ideal degree of flex for fast and easy filleting. Sure-grip co-polymer handles.
 7" **Order No. 100-1257 \$9.65**
 9" **Order No. 100-1259 \$10.15**

TaskMaster Shears - Actually a multipurpose tool. In addition to handling a wide variety of cutting tasks, they include a nut-cracker, jar opener, bone notch, lid lifter and screwdriver tips. For easy cleaning, the blades fully separate.
Order No. 100-1120 \$26.17

Coral Creek II - 2.5" Clip Blade
GRANT COUNTY-Lockback Folder 1 7/8" blade, 2 5/8" Closed
Order No. 100-3115 \$17.79
Order No. 100-3100 \$15.23

Fire Starter- Magnesium shaft striker with lanyard
Order No. 100-1019 \$9.40



Camp Axe - This sturdy axe is drop forged in a single piece for reliable durability. Drop forging aligns and stretches the metal's grain structure for improved strength. For secure grip, we added a non-slip Krayton® handle and a handy sheath to protect the blade.
Order No. 100-1018 \$26.17

D.W.O. Classic - The ideal companions for pocket, glove compartment, toolbox, or truck box. Co-polymer handle that ensures a secure grip in most any outdoor condition. Blade Length: 2 3/8 in. (6.1 cm) Closed Length: 3 1/4 in. (8.4 cm)
Order No. 100-3000 \$10.53

Mace Pepper Spray & Security Items



We Do Not Sell Mace Products in Massachusetts, Hawaii and New York



10 % PepperFoam Large Model 67 gram - 10% PepperFoam is a revolutionary new defense spray that combines a unique blend of 10% pepper solution and foam to produce a powerful deterrent against personal attack. PepperFoam's thick, pepper-impregnated foam spray coats an attacker's face, making it difficult to see. When the attacker attempts to wipe the foam away, the pepper is ground into the face and eyes, causing a severe burning sensation. PepperFoam's highly visible, amber-colored lather makes it easier to aim at a small target. Features MSI's "Flip-Top" safety cap. **Order No. 134-80245 \$9.76**



10 % Pepper Gard Defense Spray - Superior formula of high-grade OC pepper used by police. Offers powerful protection against attackers. OC pepper causes eyes to slam shut, uncontrollable coughing and choking and a painful burning sensation. Features MSI's "Flip-Top" safety cap and "Finger-Grip" dispenser, plus keychain. Flip-Top & Finger-Grip not available on 134-80184.

	Order No.	Price
Leather Plus w/keychain 15 grams	134-80184	\$5.82
Pocket Model w/keyring 15 grams	134-80171	7.94
Personal Model w/keyring 17 grams	134-80153	8.29



Triple Action Pepper Tear Gas - "TRIPLE-ACTION" Pepper Formula is a superior grade personal protection product that "does it all!" Leading defense spray formula, used by police departments, combines premium quality OC Pepper with CN Tear gas along with a UV marking dye. "TRIPLE-ACTION" makes ordinary pepper sprays obsolete. OC Pepper causes eyes to slam shut and uncontrollable coughing and choking plus an intense painful burning sensation. CN Tear gas causes profuse tearing and disorientation. UV dye marks the assailant and can aid in identification once apprehended. Features MSI's unique "Flip-Top" safety cap and "Finger-Grip" dispenser. (Flip-Top & Finger-Grip not available on 80185).

	Order No.	Price
Leather Plus w/keychain 11 grams	134-80185	\$5.95
Pocket Model w/keyring 11 grams	134-80141	8.27
Personal Model w/keyring 17 grams	134-80136	8.55
Home Model 120 grams(sprays up to 8 ft)	134-80196	10.50



Mace Animal Spray

BEAR PEPPER -Great for true outdoor enthusiasts! Now you can protect yourself against possible bear attacks, with safe, humane Pepper Mace Bear Spray. 260 gram unit empties in 5.4 seconds. Magnum Fogger sprays up to 30 ft! **Order No. 134-80346 \$27.83**

Muzzle® Canine Repellent - EPA approved Muzzle® provides safe, effective and humane protection against canine attack. Ideal protection for walkers, joggers, cyclists or delivery people. Velcro like attachment included. Features flip-top safety cap, finger grip dispenser, belt clip and keychain. This 14 gram stream unit sprays up to 10 feet. Contains 10, one second bursts. **Order No. 134-80146 \$7.01**



Mace Safety Flasher

Safety Flasher - Safety Flasher is a personal protection flashing light. Red lens design allows user to be more visible at dusk or in the dark. Built in belt clip or fluorescent arm strap allows user to wear easily. Great for walking, running, and other outdoor activities. Compact unit measures 1.75" x 1.5". Two "AAA" batteries (not included). **Order No. 134-80242 \$5.09**



Leatherman Tools

The Kick™

- Needlenose Pliers
- Regular Pliers
- Wire Cutters
- Hard-Wire Cutters
- Clip-Point Knife
- Large Screwdriver
- Small Screwdriver
- Phillips Screwdriver
- Bottle/Can Opener
- Wire Stripper
- Lanyard Attachment
- Zytel® Contoured Handle Grips
- w/Black Nylon Sheath 102-830017

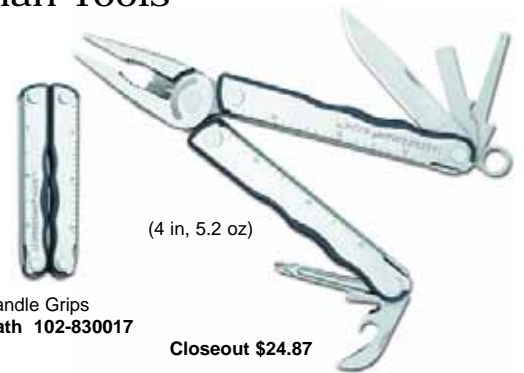

(4 in, 5.2 oz)

Closeout \$24.87

The Micra®

- Key chain sized (2.5 in)
- Spring-action scissors
- Weighs just 1.8 oz.
- 100% stainless steel



Order No. 102-64010101K \$19.58

Features: Scissors, Clip-Point Knife, Nail File/Cleaner, Tweezers, Extra-Small Screwdriver, Medium Screwdriver, Flat Phillips Screwdriver, Ruler, Bottle Opener, Key Ring Attachment

Leatherman Skeletool - At a mere five ounces, the Leatherman Skeletool has a stainless steel combo blade, pliers, bit driver, removable pocket clip and carabiner/bottle opener. The Skeletool is just what you need in one good lookin' package.



Tools:

- 420HC Stainless Steel
- Clip Point Combo Straight/Serrated Knife
- Needlenose Pliers
- Regular Pliers
- Wire Cutters
- Hard-wire Cutters
- Large Bit Driver
- Bottle Opener
- Carabiner Clip
- INCLUDED BITS: Phillips #1 and #2 Bit, Screwdriver 3/16" and 1/4" Bit

Order No. 102-830948 \$55.83

Leatherman M.U.T.

- Needlenose & Regular Pliers
- 154CM Replaceable Hard-wire Cutters
- 154CM Replaceable Wire Cutters
- Stranded Wire Cutters
- 420HC Combo Knife
- Saw & Hammer
- Replaceable Cutting Hook
- Bolt Override Tool
- Replaceable Firearm Disassembly Punch
- Replaceable Bronze Carbon Scraper
- Cleaning Rod/Brush Adapter
- Carabiner/Bottle Opener
- Bit Driver
- Removable Pocket Clip
- 1/2" and 3/8" Wrench Accessory
- MOLLE Sheath

Order No. 102-850022 \$149.95

Weight: 11.2 oz | 317.5 g
Closed Length: 5 in | 12.7 cm
Blade Length: 3 in | 7.62 cm



Included Bits:
Phillips #1-2 and 3/16" Screwdriver
Phillips #2 and 1/4" Screwdriver
Torx #15 and Hex 7/64"

Gerber Knives & Tools



Overall Length: 10.59"
Length of Blade: 4.84"
Weight: 11.4 oz.
Blade Material: 12C27 Stainless
Order No 054-01400 \$71.29

LMF - Rugged, versatile survival tool, Safety knife included, Low-profile sheath with built-in sharpener



Freeman Hunter- Surgical Steel combined with Pear Wood Handles! No wonder it made the Field and Stream Best of the Best for 2003! Overall Length: 8.35", Weight: 6.8oz

	Order No.	Closeout
Freeman Hunter Gut Hook Fine Edge 3.25" Blade	054-2208465	\$35.16



MAGNUM LST- Lockback has DuPont Zytel handles that are checkered and notched. 2.65" folding stainless steel drop point blade. Comes with a black cordura sheath. Made in USA. Weighs only 2.6 ounces. Overall length is 6.04", closed 3.5".

	Order No.	Closeout
Mossy Oak Break-Up Finish Handle	054-46944	\$23.06



FAST Draw - Gerber introduces its Forward Action Spring Technology (F.A.S.T.) Which allows one handed opening with either the thumb stud or the index finger flip. Developed by Butch Vallotton exclusively for Gerber. Overall Length: 7.13" Closed Length : 4.17" Weight:: 3.6oz

	Order No.	Price
Fast Draw Fine Edge 3" Blade	054-2207162	\$25.25
Fast Draw Serrated Edge 3" Blade	054-2207161	25.29



Incredible Detail!
Filigree etched bolsters!



Gerber Stag Stockman Knives - Introducing the first Stockman knife with a locking blade. Genuine stag handle with filigree etched bolster. Features a bronze liner and comes with a velveteen gift bag. Lifetime warranty.

	Order No.	Price
3 Blade - Longest Blade 2.75"; overall: 6.13" long	054-22-01035	\$27.76
2 Blade - Longest Blade 2.75"; overall: 5.50" long	054-22-01034	25.45

Big Rock Camp Knife Fine Edge -

- Textured SoftGrip overmold ensures secure grip
- Ergonomic contoured handle
- Full tang, fixed blade
- Lanyard attachment
- Nylon sheath



Order No.
054-22-01589 \$24.57



Gerber Gators



Gator Fixed Blades - Santoprene rubber handle surrounds the glass filled inner core polypropylene. This makes a handle that is lightweight and easy to grip! Each come with a ballistic cloth sheath with hard plastic insert.

	Order No.	Price
Gator XDP Fixed Blade Drop Point 4" Blade overall 9"	054-06904	\$33.24
Gator XGH Fixed Blade Gut Hook 4" Blade Overall 9"	054-06906	33.24

Gator & Gator Serrator - These lockback are simulated alligator hide rubber encapsulated handle for superior grip. 3 3/4" folding stainless steel blade. Comes with black cordura sheath. Made in USA. Weighs 5 ounces. Open length is 8 3/4", closed 5".

	Order No.	Price
Gator Lockback	054-06069	\$28.61
Gator Serrator Knife	054-06079	28.61
Gator Guthook	054-06932	33.54

Gator Mate 2 3/4" - Kraton rubber handles, featuring simulated black alligator hide texturing for a sure grip. Each comes with a 2 3/4" stainless steel clip point lockback blade. Has a rugged black ballistic cloth belt pouch. Weighs 3.2 ounces; Blade thickness .100"; length 7 1/4" open, 4 1/8" closed.

Order No. 054-06149 \$23.06



Applegate Combat Folder- Designed by noted author and hand-to-hand combat expert Colonel Rex Applegate to be the first and finest folding combat knife ever developed. The blade features a thumb stud for easy one hand deployment and the knife carries the shape of the legendary Applegate-Fairbairn knives.

Order No. 054-05780 \$84.62



Applegate-Fairbairn Covert Double Edge- It's a 3/4 scale version of the classic, with a major modification! By incorporating the "Interlock" manual safety lock designed and patented by the team of Michael and Ron Lake, we've increased reliability by ensuring the liner lock hold tight with the push of a button. The Covert comes standard with a detachable steel pocket clip and is available in two models, single edged or double-beveled with a second side unsharpened.

Order No. 054-05785 \$87.92

AR 3.00 - Die cast aluminum handle, Black Teflon Coated Blade, 440A, Stainless Steel Clip, Rubber Soft Grip inserts on die cast aluminum handle.



	Order No.	Price
AR 3.00 7.13" Open, 3.13" Blade Fine Edge	054-05842	\$26.86
AR 3.00 7.13" Open, 3.13" Blade Fine Edge Teflon Coated	054-05848	29.98

Gerber Knife Sharpener



	Order No.	Price
Diamond Knife Sharpener	054-09841	\$5.78



Freehand™ - Gerbers largest industrial multi-tool, the Freehand combines the functionality of our one-handed opening pliers with the convenience of outboard tools, including a thick, industrial driver.

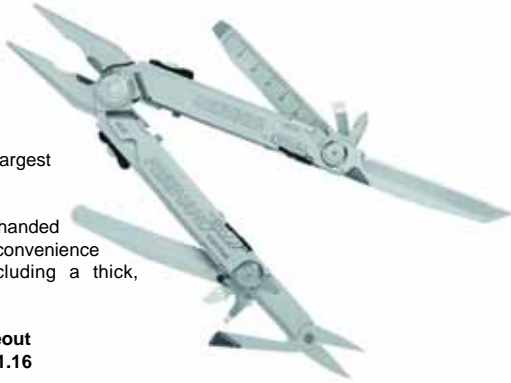

Order No. 054-22-01517
Closeout \$71.16

Deluxe Model 600 -

One-handed opening pliers, making deployment quick and easy. All locking components-all tools lock in place for safety and convenience Independent tool rotation-select and open only the component desired The most user-friendly lock-simply slide the lock release button back to unlock The safest lock on the market.



Order No. 054-07564
\$53.37

Multi-Plier Pocket Tools



13 component multi-plier features slide out plier head for one handed operation. Features include: pliers, three straight head screwdrivers, phillips screwdriver, lanyard ring, can/bottle openers, drop point blade, serrated sheepfoot blade, scale, wire cutter, and a file. Now available a tool kit to add to your multi-plier, made your 13 piece screwdriver on the multi-plier and six bits (3 straight head and 3 phillips in varying sizes). You can use the screwdriver heads on any standard 1/4" bits, including allen head and torque bits. The tool kit comes with a ballistic sheath that also houses your multi-plier. Upgrade your tool today!!

	Order No.	Price
Needlenose Multi-Lock Tool	054-07530	\$43.79
Compact Tool (3/4 size) With scissors and cordura sheath	054-05500	34.20
Multi-Plier Legend 800 w/ Replaceable Saw	054-08239	74.44

E-Z OUT - Heat-treated high carbon stainless steel blade, lightweight-tough textured handle and opens easily with one hand. Comes with a clip for pocket or belt use! Blade length as noted below!



E-Z Out

E-Z Out Jr.



	Order No.	Price
E-Z Out 3 1/2"	054-06701	\$24.11
E-Z Out Serrated 3 1/2"	054-06751	24.11
E-Z Out Jr. 2 3/8"	054-06501	20.34



Gerber Knives & Tools



ParaFrame™ - The Paraframe family of knives offers two different sizes to choose from, both of which have a pocket clip, a sturdy frame lock design, and open stainless steel handles that make them exceptionally lightweight and easy to clean.

	Order No.	Price
Mini-Paraframe Stainless Steel 6" Overall	054-22-08485	\$8.71
Paraframe Stainless Steel 7" Overall	054-22-08444	17.35
Paraframe Black 7" Overall	054-22-08446	17.35



Gator Machete - The Gator Machete wields a 15 inch fine edge blade on one side, a 15 inch high performance saw blade on the other. Features the Gator rubber grip for ergonomic control while using either. Includes a riveted, nylon sheath provides safe, durable transport. **Order No. 054-31-000758 \$15.11**

Gator Combo Axe II - Hatchet includes a 6" saw that stores in the handle
Order No. 054-2241420 **\$32.97**



Sport Axe II - Durable Lexan handle and is lightweight without sacrificing strength. Sufficient head weight for campsite chores, but compact enough for your backpack. Head length is 4 3/4" with a 12 1/8" handle. Weighs only 1.5 pounds and comes with a durable plastic case (style may vary slightly).

	Order No.	Price
Sport Axe II	054-31-000913	\$29.67
Back Paxe II	054-31-000912	27.47

BACK PAXE II - Miniture Axe with ballistic cloth sheath, same as sport but smaller.

Exchange-A-Blade Sport Saw - Whether you're using the coarse blade on wood or the fine blade on hardwoods or big game bones, Gerber Exchange-A-Blade Saws are built to maximize every effort. The blades are stainless steel and it's compact, for one on every trip. Includes Course & Fine Blades.

	Order No.	Price
Exchange-A-Blade Saw	054-46036	\$12.66
Course Replacement Blade 6.25"	054-70151	3.24
Fine Replacement Blade 6.25"	054-70176	3.24



	Order No.	Price
Gator Exchange-A-Blade Saw (Includes 1 Wood/Course Blade & 1 Fine/Bone Blade)	054-22-41457	\$17.91
Course Replacement Blade 6.25"	054-22-41462	5.49
Fine Replacement Blade 6.25"	054-22-41461	5.49



Nathan's Oil - Specially formulated for use with all Lansky Sharpeners and Natural Arkansas Benchstones. Just a few drops will protect your stone and give you the professional edge you desire.
Order No. 113-LOL01 \$2.61

Outdoor Edge V Sharpener - Tungsten-Carbide V-sharpener.
Order No. 280-TC100 \$6.98

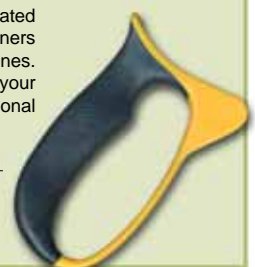

Case Collector Series Knives

Pocket Worn Old Red Bone



Old Red Bone Jigged handles combined with gleaming Tru-Sharp surgical steel blades make this series one of the most stunning of all the different series. A little extra finishing on the handles ensures that they feel like you've carried it in your pocket for years.

	Order No.	Price
A-Trapper - 4 1/8" Closed (Clip & Spey)	069-783	\$45.61
B-Medium Stockman - 3 5/8" Closed (Clip, Spey, Sheepfoot)	069-786	44.55
C-Baby Butterbean - 2 3/4" closed (Spear & Pen)	069-724	45.60
D-Peanut - 2 7/8" closed (Clip, & Pen)	069-781	39.06
E-Mini Trapper - 3 1/2" closed (Clip & Spey)	069-784	42.48
F-Small Texas Toothpick - 3" Closed (Long Clip Blade)	069-792	39.06
G-Small Stockman - 2 5/8" Closed (Clip, Pen, & Sheepfoot)	069-2741	42.19



Bright in color, so it's difficult to lose. Whether your in the woods, the yard or the house, the Yellow Handle Case's standout. Blades are Chrome Vanadium. A long time favorite of Case carriers.

	Order No.	Price
A-Medium Stockman - 3 5/8" Closed (Clip, Spey, Sheepfoot)	069-035	\$35.16
B-Sod Buster Jr. - 3 5/8" closed (Skinner Blade)	069-032	22.66
C-Peanut - 2 7/8" closed (Clip & Pen)	069-030	29.09
D-Barehead Slimline Trapper - 4 1/8" closed (Clip Blade)	069-031	28.50
E-Mini Trapper - 3 1/2" closed (Clip & Spey)	069-029	32.45
F-Trapper - 4 1/8" Closed (Clip & Spey)	069-161	35.16
G-Fishing Knife - 4 1/4" closed (Clip & Scaler)	069-120	41.54

Amber Bone with Stainless Steel Blades

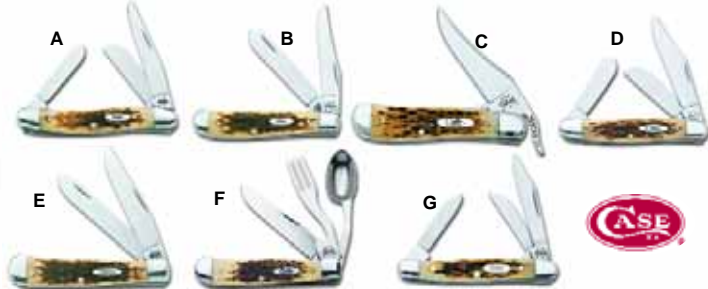

Case has brought the classic look of Amber Bone back again. The Golden Amber hue combined with the Deep Dark PeachSeed jig reaches back to that same classic natural bone style like your grandpa had!

	Order No.	Price
A-Medium Stockman - 3 5/8" closed (Clip, Spey, Sheepfoot)	069-042	\$40.89
B-Mini Trapper - 3 1/2" closed (Clip & Spey)	069-013	38.70
C-Russlock - 4 1/4" closed (Clip)	069-260	49.56
D-Stockman - 3 7/8" closed (Clip, Spey, Sheepfoot)	069-128	44.07
E-Trapper - 4 1/8" closed (Clip, Spey,)	069-164	42.48
F-Hobo - 4 1/8" closed (Clip, Fork & Spoon)	069-052	69.03
G-Small Stockman - 2 5/8" closed (Clip, Sheepfoot & Pen)	069-262	39.53



W.R. CASE & SONS CUTLERY CO.
HAND-CRAFTED KNIVES SINCE 1889

Black Bone Series



The Rogers Jigged Black Bone family of knives feature the red oval Case logo - an eye-catching combination that's sure to please. Folding Hunter Shown.

	Order No.	Price
Stockman - 3 5/8" Closed (Clip, Pen, & Sheepfoot)	069-6958	\$42.31
Baby Butter Bean - 2 3/4" Closed (Spear & Pen Blades)	069-6961	44.55

Blue Bone Series



Carry a Blue Bone handled Case knife and show your true colors. The genuine bone handles also include our Case "USA" logo shield. Trapper Shown.

	Order No.	Price
Trapper - 4 1/8" Closed (Clip & Spey)	069-2800	\$43.01
Medium Stockman - 3 5/8" Closed (Clip, Sheepfoot, & Spey)	069-2801	41.42
Small Texas Toothpick - 3" Closed (Long Clip Blade)	069-2804	37.64
Medium Stockman - 3 5/8" Closed (Clip, Sheepfoot, & Pen)	069-2806	41.42

Harvest Orange Series



These Pocket Worn Harvest Orange knives from Case are sure to become favorites in any season. Medium Stockman Shown.

	Order No.	Price
Trapper - 4 1/8" Closed (Clip & Spey)	069-7401	\$45.66
Canoe - 3 5/8" Closed (Spear & Pen Blades)	069-7402	52.84
Medium Stockman - 3 5/8" Closed (Clip, Sheepfoot, & Spey)	069-7403	44.55
Peanut - 2 7/8" Closed (Clip & Pen)	069-7404	39.06
Muskrat - 3 7/8" Closed (Two Clip Blades)	069-7406	45.61

Amber Bone with Chrome Vanadium Blades

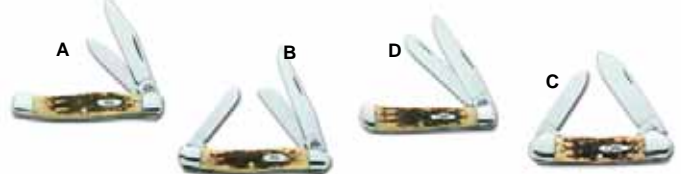

	Order No.	Price
A-Small Texas Jack - 3 1/2" closed (Clip & Pen)	069-077	\$39.35
B-Medium Stockman - 3 5/8" closed (Clip, Spey & Sheepfoot)	069-039	40.89
C-Canoe - 3 5/8" closed (Pen & Etched Spear Blade)	069-263	48.03
D-Trapper - 4 1/8" closed (Clip & Spey)	069-163	42.48
Not Shown-Medium Stockman - 3 5/8" closed (Clip, Spey, Sheepfoot)	069-079	40.89

W.R. Case Ridgeback Wood Knives



	Order No.	Price
Hunter - Swept Skinner Blade 8 1/2" Overall	069-398	\$44.84
Drop Point - Drop Point Blade 8 1/2" Overall	069-1402	44.84

Case Utility / Working Knives



SOD BUSTER - Skinner blade with etching. 4 5/8" closed: 4.3 oz. Smooth black synthetic handle. **Order No. 069-092 \$25.67**



SOD BUSTER, JR. Skinner blade with etching. 3 5/8" closed: 2.3 oz.



	Order No.	Price
Smooth Black Synthetic Handle	069-095	\$21.83
Yellow Synthetic Handle.	069-032	22.66

FOLDING HUNTER. Skinner and 4" clip blades. 5 1/4" closed: 7.5 oz. Jigged Brown Laminated Handle

Order No. 069-189 \$55.52



Case Lockbacks



MAKO- Skillfully etched blade. 4 1/4" closed: 7.5 oz. Contoured black laminated Staminawood handle. Genuine leather sheath. **Order No. 069-169 \$53.40**



HAMMERHEAD- 5" closed: 9.5 oz. Smooth black high-impact synthetic handle. Genuine leather sheath. **Order No. 069-177 \$53.51**



CALIBER LOCKBACK. 3 3/4" closed: 1.2 oz. Lightweight black Zytel handle. **Order No. 069-147 \$12.51**



Case Fillet Knives

W.R. Case Fillet Knives
6" Fillet
Fixed Blade
11" Overall; 6.3 oz.



9" Fillet
Fixed Blade
14" Overall; 8.1 oz.



Order No.	Price
6" 069-342	\$16.28
9" 069-363	\$19.59



Perfect for the reloader with limited working space, an overwhelmed workbench, or someone looking for solution to portable reloading needs. The sturdy powder coated steel stand places your press at the perfect counter stool or standing height. The 10 inch triangular steel top plate uses the Patented quick change Lee Bench Plate system.

Lee Reloading Stand

Fits: All Lee metallic presses (Fasteners for mounting one press are included).

only \$88.72

Order No. 006-90688

Includes a sturdy steel shelf with two bench plate receivers that will neatly and securely store your extra presses or mountable accessories. Included with the stand is one storage bin for component or tool storage, which clips onto the steel bin bracket provided with the stand. Each leg has eight mounting holes that allow you to accessorize your stand with a multitude of bins, shelves or accessory die racks. Includes drawing to customize and make your own extended work surface. This reloading stand is perfect for the apartment-dweller or anyone who is limited on space.

Notes: Comes with one storage bin and bracket, top plate, intermediate shelf, drilled wood bench block, complete fastener set and two steel concrete block hangers.

Additional Accessories

Die Rack - Holds your dies at the ready, designed for the Lee Reloading stand. Can also be wall or bench mounted. **Order No. 006-90680 \$6.81**

Hardwood Base Blocks - Precut hardwood blanks for Lee Bench plate or Reloading stand. Includes 6 bolts, nuts & washers. **Order No. 006-90571 \$9.54**

Bin and Bracket - Sturdy steel bracket and parts bin. Includes fasteners to allow direct mounting to the Lee Reloading stand. Perfect for holding bullets, cases and loaded rounds. **Order No. 006-90687 \$9.54**

Buck Knives

Alpha Hunter



Leather Sheath with Rosewood Handles, Cordura with Walnut & Rubber.

	Order No.	Price
Rosewood Handle, ATS34 Guthook 8 1/2" overall, 7.2oz	018-5239	\$88.55
Mini Alpha Rosewood Handle, 2 1/2" Drop Point Blade ATS34 1/4" overall, 3.6oz and Brown Leather Sheath	6018-5419	67.85

Alpha Hunter Folders

Leather Sheath with Rosewood Handles, Cordura with Walnut & Rubber.



	Order No.	Price
Rosewood Handle, ATS34 Guthook 3 1/2", 5" closed, 8oz	018-5247	\$71.30
Rosewood Handle ATS34 Honed Blade 3 1/2", 5" closed, 8oz	018-5245	65.55
Black Rubber Handle, 420HC Guthook 3 1/2", 5" closed, 8oz	018-5243	54.05
Black Rubber Handle 420HC Honed Blade 3 1/2", 5" closed, 8oz	018-5241	48.30

Alpha Dorado

4" When Closed



	Order No.	Price
Charcoal Birchwood Handle, 2.5" Spear Point 420HC Blade, 4.3oz Comes with a Black Nylon Sheath	018-5666	\$43.70
Rosewood Handle, 2.5" Spear Point ATS-34 Blade, 4.3oz Comes with a Burgandy Leather Sheath	018-5668	54.05

Buck Fixed Blade Knives



	Order No.	Price
A - BUCK ZIPPER -Rubber Handle, 4 1/4" blade 8 1/2" overall. 7oz, Cordura Sheath	018-2607	\$60.38
B - VANGUARD -Rubber Handle 4 1/8" Drop Point. 8 3/8" overall. 7oz. Cordura Sheath	018-2615	54.34
B - VANGUARD -Woodgrain Handle (Not Shown) 4 1/8" Drop Point. 8 3/8" overall 7oz. Brown leather sheath	018-2584	64.11
C - BUCK ZIPPER -Woodgrain Handle, 4 1/4" blade 8 1/2" overall. 7oz Brown leather sheath	018-2550	70.15
D - SPECIAL - Black & Aluminum Handle, 6" blade with blood groove. 10 1/2" overall 7.5oz closed Black Leather Sheath	018-9207	48.88
D - SPECIAL Cocabola Wood & Brass Handle (Not Shown) (Same specs as above) Burgandy Leather Sheath	018-2638	71.88
E - SKINNER - Black Handle 4" Turned down point. 8 1/4" overall 5.5oz. Black Leather Sheath	018-2659	49.45

PakLite Guthook - Lightweight, compact and convenient. For field dressing small or large game. A great companion to your favorite skinning knife.

Blade Material: 420HC
Black, heavy duty nylon sheath
Handle Material: Stainless steel
Quantity: Yes
Weight: 1.5 oz. (42.7 g)

Order No. 018-3295 \$15.24



Includes Nylon Sheath



Buck Pocket Knives

Stockman - 3 Bladed Black handle. Clip, spey and sheepfoot. 3 7/8" closed

	Order No.	Price
Stockman	018-2587	\$30.19

Buck Cadet - 3 Bladed Black handle. Clip, spey and sheepfoot. 3 1/4" closed

	Order No.	Price
Buck Cadet	018-9203	\$27.89

Companion - 2 Bladed Black handle. Clip, and pen. 3" closed

	Order No.	Price
Companion	018-9202	\$25.30

Lancer - 2 Bladed Black handle. Clip, and coping. 2 5/8" closed

	Order No.	Price
Lancer	018-2588	\$21.85

Squire - 2 3/4" Drop Point . 3 3/4" closed. Nickel silver, and woodgrain. Black leather sheath

	Order No.	Price
Squire	018-2598	\$36.23

Prince - 2 1/2" Drop Point . 3 3/8" closed. Nickel silver, and woodgrain.

	Order No.	Price
Prince	018-9201	\$34.50

Knight - 1 7/8" Drop Point . 2 3/4" closed. Nickel silver, and woodgrain.

	Order No.	Price
Knight	018-2599	\$32.20

Folding Hunter Lockblade - Buck's #1 Lockblade Knives!
Specs: 3 3/4" blade 4 7/8" closed. Weighs: 8oz
Natural woodgrain w/ brass bolsters
Black leather sheath

	Order No.	Price
Folding Hunter Lockblade	018-9210	\$39.96

	Order No.	Price
w/finger grooves	018-2538	\$46.00

	Order No.	Price
55, 2 3/8" Blade, 3 3/8" Closed (No sheath)	018-5684	\$33.93

Silver Creek™ Fishing Knives from Buck - Safe, reliable and durable. All three have a full-tang blade made of 420J2 stainless steel coated with titanium for extra flexibility and corrosion resistance. Ergonomically shaped, rubberized anti-slip grips and stainless steel safety guard.

Bait Knife Serrated Backbone
Blade 4-3/8"; overall length: 9-1/8" long
Order No. 018-3114 \$19.55

Fillet Knife 6-3/8" Blade,
overall length: 11-1/8" long
Order No. 018-3116 \$22.14

Large Fillet 9-5/8" Blade,
overall length: 14-3/8" long
Order No. 018-3118 \$25.88



Bait



Fillet



Large Fillet

Silver Creek™ knives come with injection-molded sheaths.



Lansky Knife Sharpening Systems & Accessories

Diamond



Deluxe



Lansky Diamond Sharpening System- Coarse purple hone for a fast but not a finished edge; medium orange hone for keeping fine, sharp, polished edge on all knives; fine gold hone used for final polishing of a sharpened blade or for touching up-finishing a sharp edge. **NOT FOR USE WITH SOFT METALS OR ALUMINUM!!!! USE ONLY WITH HARD METALS!!!!** Order No. 113-LK3DM \$57.14

Lansky Deluxe Sharpening System- Everything the standard (Listed Below) has plus extra coarse and ultra fine high ceramic stones; and two additional guide rods. Order No. 113-LKCLX \$36.23

Lansky Standard Sharpening System- Custom carrying case, knife clamp with angle selector, fine, medium and coarse honing stones each on color-coded, finger groove holders, 3 guide rods, oil, extra screws and instruction guide. Order No. 113-LKC03 \$25.24

Standard



Universal



Lansky Universal Sharpening Kit- Course, medium and fine and fine serrated hones, along with clamp, guide rods and honing oil. Order No. 113-LKUNV \$32.86

Universal Mount- This mount consists of a knurled clamp holder post and an aluminum base drilled to facilitate screwing to workbench. Use in the field, fishing, hunting, or camping trips. Sharpen knives without touching the blade. Really handy for the home! Order No. 113-LM009 \$7.39

"C" Clamp- Allows you to mount the Lansky Sharpening System on any vertical or horizontal surface. Drilled to accept the post when clamped vertically or horizontally. Order No. 113-LM010 \$13.44

Pedestal Mount- Designed to give you maximum stability. Light weight single piece unit. Screw holes to facilitate optional mounting. Made of space age plastic. Order No. 113-LM007 \$4.02

Accessory Sharpening Hones- These specially designed hones are for use with all Lansky Multi-Angle Knife Sharpening Systems. All hones are interchangeable and are mounted on their own color-coded finger grooved handles. Great for use where conventional sharpeners can't get to. Gives you perfect edges.

	Order No.	Price
Super Sapphire Polishing Hone- Ultimate factory finish on a pre-sharpened edge	113-S2000	\$10.08
Fine Serrated Hone- Perfect for producing a fast sharp edge and final polishing	113-LSERT	6.72
Medium Diamond Hone- Excellent for keeping a fine sharp edge on all knives	113-LDHMD	13.45
Medium Serrated Hone- Rehabs and reshapes serrated edges (Not Final Finish)	113-LSMRT	6.72
Extra Course Hone- Bevels and reshapes extremely dull & deteriorated edges	113-S0070	4.69
Ultra Fine Hone- A good finishing stone for sharpening high quality cutlery	113-S1000	7.39
Course Diamond Hone- Used to produce a fast but finished edge	113-LDHCR	13.45
Fine Diamond Hone- Perfect for touching up a sharpened edge	113-LDHFH	13.45
Medium Hone- For fine sharp edges on hunting, fishing, kitchen & pocket knives	113-S0280	6.05
Coarse Hone- For fastest cutting edges on home, woodcarving, butcher knives	113-S0120	5.39
Fine Sharpening Hone- Produces a razor-sharp edge	113-S0600	6.72
Multi-Groove Fish Hook Sharpener- For your fish hooks!	113-LFISH	3.27



Universal

Pedestal

"C" Clamp

Mount your Multi-Angle Knife Clamp on one of these mounts for solid, constant sharpening.



Nathan's Oil - Specially formulated for use with all Lansky Sharpeners and Natural Arkansas Benchstones. Just a few drops will protect your stone and give you the professional edge you desire. Order No. 113-L0L01 \$2.61



Diamond Sharpeners! These handy sharpeners are 100% Diamond grit and will sharpen the toughest of steel.
Folding Diamond Paddles- .75" x 3.5"
Extra Course- 113-LDFPX \$13.05
Course- 113-LDFPC \$13.05
Medium- 113-LDFPM \$13.05
Fine- 113-LDFPF \$13.05
Extra Fine- 113-LDFPE \$13.05

Diamond Rods- 3.5" Rods, 100% Diamond Grit. The Diamond Rods are Ideal for scalloped blades, and guthooks, The Tapered Rat tail is great for serrated blades and gut hooks as well..

	Order No.	Price
Retractable Diamond Rod	113-LRRDF	\$12.53
Folding Diamond Rod	113-LFRDF	\$9.73
Folding Diamond Rat Tail	113-LFRTF	\$9.73



Quick Fix Crock Stick and Tungsten Carbide Sharpener all in one! 3-4 strokes on the Tungsten Carbide Sharpening Heads and your knife is sharpened, 3-4 strokes on the Crock Stocks and your knife is polished. Order No. 113-LCSTC \$4.32

Quick Sharp Easy Grip with Overmold Handle - 3 or 4 strokes and it's Sharp! No Slip Thumb Guard, Lightweight and Compact! Order No. 113-LSTCN \$5.86

Diamond Bench Stones 6" x 2"

	Order No.	Price
Extra Course-	113-LDB6X	\$19.57
Course-	113-LDB6C	\$19.57
Medium-	113-LDB6M	\$19.57
Fine-	113-LDB6F	\$19.57
Extra Fine-	113-LDB6E	\$19.57



Lansky Tool Sharpeners



The Garden/Lawnmower sharpener is specially shaped for easiest sharpening of garden tools, lawnmower blades, etc. The Abrasive Hone is a space age ceramic sharpening device that is designed for heavy duty sharpening of damaged and abused power and hand tools around the shop, house, farm, barn, etc.

	Order No.	Price
Garden/Lawnmower Sharpener	113-LGRDN	\$5.23
Abrasive Sharpening Hone	113-LHONE	5.88



The Puck is a dual grit purpose sharpener that is excellent for use with knives, axes, lawnmower blades, almost all sharpening needs. Small enough to put in tool box, tackle box, etc. for easy use. Order No. 113-LPUCK \$5.23

Arkansas Benchstones



Lansky's natural Arkansas Benchstones are cut from carefully selected novaculite and permanently mounted to a solid Walnut block (with non-slip feet) elevating the stone for greater sharpening ease and hand protection.

	Order No.	Price
6" x 2" Hard Arkansas Benchstone	113-LBS6H	\$15.67
6" x 2" Soft Arkansas Benchstone	113-LBS6S	14.36
3 1/4" x 1" x 1/4" Super Arkansas pocket stone, with lanyard hole, 2 sharpening grooves and leather pouch.	113-LSAPS	5.21

Nathan's Oil - Specially formulated for use with all Lansky Sharpeners and Natural Arkansas Benchstones. Just a few drops will protect your stone and give you the professional edge you desire. Order No. 113-L0L01 \$2.61



Lansky Crock Sticks



A- Mini Dog Bone Crock Stick- This alumina ceramic rod is a super compact pocket sharpener and perfect for quick sharpening of knives. Features a convenient key chain. **Order No. 113-LCDOG \$2.61**

B- Eraser Block - Special Pliable abrasive type eraser used to clean metal filings from your Crock sharpeners. **Order No. 113-LERAS \$3.27**

C- The Crock Stick Multi Sharpener- A revolutionary super compact alternative to the old sharpening stones. This will sharpen all knives, arrow heads, fish hooks, darts, needles etc..The triangular shape help you obtain a keen edge. Handy key chain attached. **Order No. 113-LTRIM \$5.21**

D- Cold Steel Sharpener- A handy pocket-sized sharpener specially designed for the proprietary serrations used on Cold Steel brand knives. **Order No. 113-LTRCS \$5.21**

Spyder Sharpener(Not Shown) Ideal for the distinctive serrations on Spyderco knives. **Order No. 113-LTRSP \$5.21**

E- "The Mini" Knife Sharpener - Key chain compact! A versatile knife and fish hook sharpener. It features two removable alumina ceramic sharpening rods that are easily positioned for fish hook sharpening, or easy cleaning. **Order No. 113-LCKEY \$3.24**

F-Deluxe Turn-Box Sharpener- This 2 Stage Sharpening system features a deluxe hardwood turn-box with internal rod storage. Comes with 2 medium grit and 2 fine grit rods **Order No. 113-LCD5D \$15.67**

Standard Turn-Box Sharpener- (Similar to F) This 2 Stage Sharpening system features a deluxe hardwood turn-box with internal rod storage. Comes with 2 medium grit. **Order No. 113-LCS5D \$9.79**

G-Sharp Stick- A classic butcher's sharpener updated with a space age 8" alumina ceramic sharpening rod. **Order No. 113-LSS8CM \$8.48**

H- FOLD-A-VEE- Folding space age plastic frame with two 5" alumina ceramic rods and two adjustable sharpening angles. Ideal for hunts, fisherman, backpackers, and home use. **Order No. 113-LCSFV \$11.75**

EZE-Lap Gunsmithing Tools

Diamond Needle Files - Gunsmiths, tool and die makers, jewelers, stockmakers, rely on EZE-LAP needle files to get the job done. 5.5 inches (14 cm) overall length O.A.L.) and shank diameter of 0.118 inches (3 mm).



- Round
- Half-round
- Square
- Flat/Warding
- △ Threesquare
- △ Knife

- ▭ Hand
- ◇ Crossing
- ◁ Barrette
- ◇ Slitting
- ▽ Pippin

Diamond Needle Files Fine (600 grit) - Six files in wallet: Round, square, three-square, half-round, flat/warding and knife. **Order No. 081-600F \$25.10**

Diamond Needle Files Coarse (250 grit) - Six files in wallet (select fine or coarse). Hand, crossing, barrette, round edge joint, slitting and pippin. **Order No. 081-607F \$25.10**



Outdoor Edge V Sharpener

Outdoor Edge V Sharpener - Tungsten-Carbide V-sharpener. **Order No. 280-TC100 \$6.98**

EZE-Lap Sharpeners



Professional Size Round Sharpener - 10" x 7/16" Round diamond coated shaft with plastic handle. Fine 600 grit. **Order No. 081-P \$25.10**

Leather Scabbard for Sharpener - **Order No. 081-PL \$6.25**



Diamond Oval with Plastic Handle - 5" x 3/4" x 1/4" diamond oval with plastic handle.

	Order No.	Price
Fine (600 Grit)	081-D5F	\$10.65
Super Fine (1200 Grit)	081-D5SF	10.65



Model S Sharpener - 2 1/4" Diamond coated shaft D-shaped with groove for fishhooks, opens to 5.5", stores onto pen type cap. **Order No. 081-S \$4.36**

Model ST Sharpeners- Pocket sized sharpener with tapered shaft for serrated blades. **Order No. 081-ST \$5.63**

Eze-Lap Diamond Stones -

These diamond stones are perfect for hunting and fishing knives, woodworking tools, exacto blades, axes and industrial use. No oil or water is necessary, the surface will remain true and flat.



	Order No.	Price
1" X 3" Fine Stone w/hook groove	081-26F	\$6.25
2" X 4" Fine Stone	081-56F	15.68
2" X 6" Fine Stone	081-66F	21.34
2" x 6" Medium Stone	081-66M	25.10
1" X 3" Fine Paddle Sharpener	081-24F	7.50

Eze-Lap Diamond Hone & Stone - All diamond hone & stone are 3/4" x 2" on a 6" color coded plastic handle.



	Order No.	Price
Super Fine Stone (1200 Grit)	081-LSF	\$3.74
Fine Stone (600 Grit)	081-LF	3.74
Medium Stone (400 Grit)	081-LM	4.68
Course Stone (250 Grit)	081-LC	5.63
Extra Course Stone (150 Grit)	081-LXC	6.88



EZE-Fold Diamond Oval with Plastic Handle - EZE-FOLD models have a carrying case that unfolds into a handle. When closed the case protects the diamond surface. When open the case becomes a functional handle

	Order No.	Price
Model 590 Superfine	081-590	\$12.54
Model 591 Fine	081-591	12.54

Model M Sharpener- 3 3/4" Diamond coated shaft that stores in a brass handle. Comes with leather pouch and belt loop. **Order No. 081-M \$14.41**



Hook Hone - Clip it to your vest or belt loop. 100% diamond surface for fast precise sharpening. Compact size, fits in your pocket and double as a keyring. Will sharpen: all types of metal, glass, carbide knives, hooks and .. Made to withstand the elements. **Order No. 081-H \$4.36**

Books From Krause Publications



Gun Digest 2012 - Features in-depth articles about the world's most fascinating guns, test-fire reports on the latest models, insights about fine collectibles, and roundups of what's new from leading manufacturers... you simply won't find a more comprehensive collection of firearms information. 568 pages. **Order No. 043-Y0626 \$18.84**

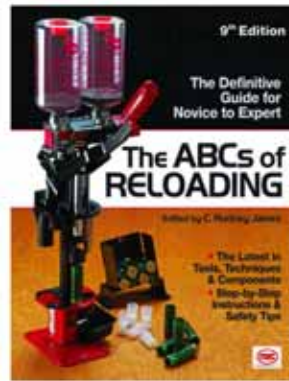

ABCs of Reloading 9th Edition- A step-by-step guide to reloading rifle and handgun cartridges and shotshells! Hundreds of detailed photos. Everything you need to know about primers, bullets, powders and cases. **BONUS:** The best reloading articles from the Gun Digest archives and more! 288 pages **Order No. 043-Z9165 \$15.42**

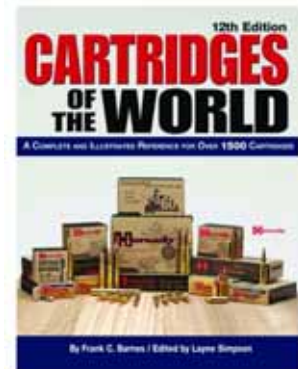

Cartridges of the World 12th edition - This premiere ammunition guide outlines the different facets of a wide variety of cartridges, and helps you choose the best caliber for the type of shooting you are doing. Large photographs, load data & ballistics for commercially made, obsolete, military & wildcat cartridges, from the 1870s to present. 568 pages **Order No. 043-Z3651 \$18.84**

Standard Catalog of Smith and Wesson Clearly details 775 Smith and Wesson models, knives, holsters, ammunition and police items with complete pricing information, illustrated glossary and index. 272 pages	Order No. 043-FSW03 \$22.84
Gunsmithing Rifles Patrick Sweeney helps show you how to repair rifles and improve performance. From wood refinishing to smoothing your trigger pull, this book is great for the gun hobbyist. 700 B&W photos. 352 page	043-GRIF 15.42

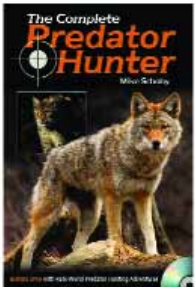

The Complete Predator Hunter - By Michael Schoby - Are you ready to take your predator hunting skills and knowledge to the next level? In this must read book, Mike Schoby will cover everything you need to know about predator hunting. You will learn about choosing the right firearms for predator hunting, the innovations in ammunition and the latest developments in technology for decoys, calls, and gear. This book also includes a DVD featuring a predator hunt up close. 256 Pages. **Order No. 043-Z3652 \$13.13**

Build the Perfect Survival Kit - Each kit is described with a list of components, a picture of the finished product, and a discussion of each component and its value. Gives instructions on how to use each component. Not just for hardcore outdoorsmen - this is valuable information for anyone who drives a car, walks in the woods, etc. 160 pages. **Order No. 043-SVKTS \$8.56**



Mauser Military Rifles of the World, Fifth Edition - Robert Ball, the world's foremost authority on Mauser military rifles, continues to scour the continents in search of more details and models of this ubiquitous rifle. His years of research and expertise culminate in this definitive, full-color Mauser reference. 448 Pages **Order No. 043-Y1287 \$28.55**

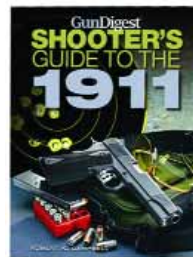
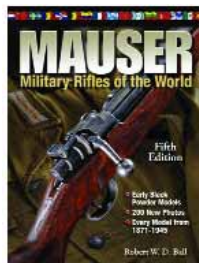

Gun Digest Shooter's Guide to the 1911 - Written by renowned 1911 authority Robert K. Campbell, this is the definitive shooter's guide to John M. Browning's most famous creation. From tips, tricks and techniques for getting the most out of your 1911 to real-world evaluations of more than 50 different models of the 1911, you'll find it in The Shooter's Guide to the 1911. **Order No. 043-Y0048 \$11.42**

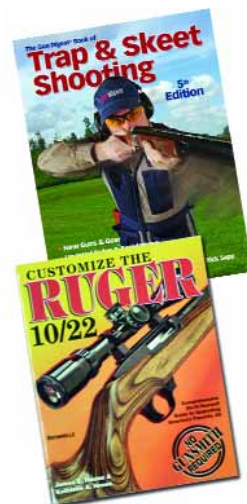

The Gun Digest Book of Trap & Skeet Shooting, 5th Edition - By Rick Sapp The Gun Digest Book of Trap & Skeet Shooting, 5th Ed., covers every facet of trap and skeet shooting and provides valuable insight on how to improve and win at clay-busting sports. Choose the right shotgun, and fit the gun to your needs. Understand the hows and whys of chokes - in plain language! Get the most current data on shells, loads, and reloading. From the latest rules and regulations to the hottest new guns and gear. Pages: 256 **Order No. 043-Z5055 \$14.27**

Customize the Ruger 10/22 Features budget savvy tips for customizing this popular firearm with readily available aftermarket add-ons including barrels, stocks and magazine releases. 336 pages. **Order No. 043-NGRIT \$17.13**

Gun Digest Big Fat Book of the .45 ACP - By Patrick Sweeney Everything You've Ever Wanted to Know About America's Favorite Handgun Cartridge! Designed nearly a century ago, the .45 ACP cartridge has earned a well-deserved reputation as a superbly accurate, slap-'em-down handgun cartridge. An honored veteran of two World Wars, Korea, Vietnam and lesser conflicts across the globe, the .45 ACP is now more popular than ever for competition shooting, law enforcement and self-defense. Pages: 400 **Order No. 043-Z4204 \$14.27**



Automatic Pistols Assembly/Disassembly - By J.B. Wood Pistol disassembly/reassembly has never been easier! Clean and maintain your autoloading pistols yourself. Step-by-step instructions and crisp photographs make it simple. Easy-to-understand text describes each step of disassembly and reassembly for 86 different pistol models - plus 260 closely-related models 752 Pages. **Order No. 043-Z0737 \$21.13**

The Gun Digest Book of Long Range Shooting - LP Brezney gives hunters and shooters instruction and advice on how to shoot well at 500+ yards. Learn how to make the most of your shooting gear, as well as additional equipment that will increase success at distance. Covers Optics, rifles cartridges, barrels, triggers and more. 224pages **Order No. 043-Z0735 \$14.27**



The Gun Digest Book of the Glock, How to Accessorize and Turn Your Glock, 2nd Edition By Patrick Sweeney Delves into the fascinating world of the Glock. It's all here: the models, the variations, the ammo and the accessories. If it has anything to do with Glock, you'll find it here! 336 Pages. **Order No. 043-Z1926 \$15.99**

More Books From Krause Publications

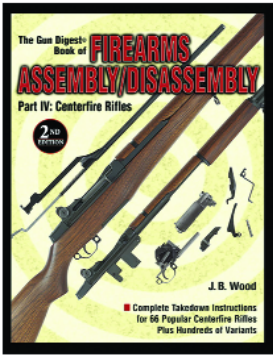

The Gun Digest® Book of Firearms Assembly/Disassembly Part IV: Centerfire Rifles 2nd Edition *By J.B. Wood* - Covers the Argentine Mauser to Marlin Model 9 to Russian AK-47 to U.S. M-1 Garand to Winchester Model 1894. Easily disassemble and reassemble 66 centerfire rifles. Cross reference more than 400 models. Only centerfire rifle reference of its kind 576 Pages

Order No. 043-AS4R2 \$14.27

The Gun Digest® Book of Firearms Assembly/Disassembly Part V: Shotguns 2nd Edition *By J.B. Wood* - Covers assembly/disassembly of 59 popular shotgun models, plus more than 285 mechanically similar variants. Lists field stripping basics and key take down and reassembly steps. More than 1,600 large, clear photos and illustrations accompany the detailed instructions 592 Pages

Order No. 043-AS5R2 \$14.27

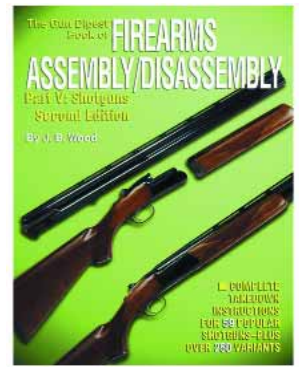

Gunsmithing Pistols & Revolvers, 3rd Edition - *By Patrick Sweeney* Whether you're a professional gunsmith or just an interested do-it-yourselfer, you'll find what you need in this revised 3rd Edition. From basic disassembly and maintenance to more complex repair and customization techniques, clear text and detailed photos explain how to get the very most out of your pistol or revolver. Special sections on the 1911, the Makarov, the vZ-52 and the Springfield XD. Pages: 384
Order No. 043-Z5056 \$15.99

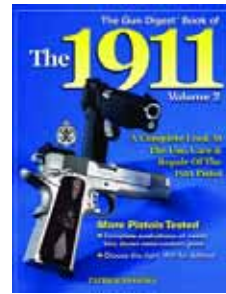
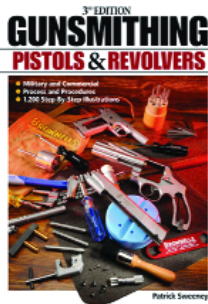

The Gun Digest Book of the 1911, Volume 2 Second of a two volume set, this book presents performance reviews for various 1911 pistols providing technical specifications, model reviews, test fire evaluations and more. Whether your interest is handgun, self-defense or target-shooting, you'll gain access to valuable technical information and more than 350 detailed photos in this superior resource devoted to using, caring for and repairing 1911 pistols.
327 pages Order No. 043-VIPT \$15.99

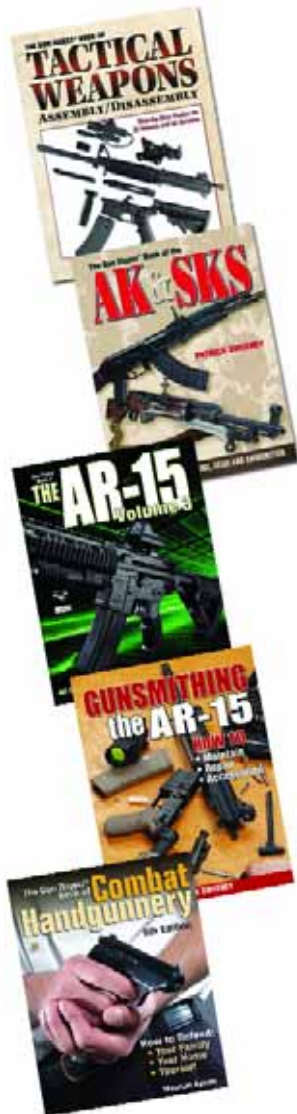

The Gun Digest Book of Tactical Weapons Assembly/Disassembly - *By J.B. Wood*
This book will help you save money with steps for maintaining, cleaning and handling minor repairs of your own tactical firearms, and strengthen your shooting performance with a deeper understanding of how your weapon works. Pages: 304
Order No. 043-Z2297 \$14.27

The Gun Digest® Book of the AK & SKS, A Complete Guide to Guns, Gear and Ammunition *By Patrick Sweeney* The complete lowdown on the AK-47 and its variants. It's all here: tips on building an AK, choosing ammunition and accessories, keeping your AK perking for years to come, and much more. There's also a section dealing with the "other" great Soviet rifle, the Simonov SKS! Order No. 043-Z2207 \$14.27

The Gun Digest® Book of the AR-15 Volume 3 - *By Patrick Sweeney* The latest volume from ace gunsmith Patrick Sweeney for all the most recent tips, tricks and techniques for using and customizing your AR-15. You'll enjoy extensive coverage on the hot piston ARs and can learn how to convert a gas AR to a piston operation - information you won't find in any other book! 288 Pages.
Order No. 043-Z8816 \$17.13

Gunsmithing the AR-15 - How to Maintain, Repair & Accessorize *By Patrick Sweeney* Whether you're interested in simple tasks such as disassembling and maintaining your AR, or if you're ready to tackle more complex projects such as rebarreling or converting your AR to a piston design, Gunsmithing: The AR-15 tells you everything you need to know. Protect your investment and avoid costly mistakes - with Gunsmithing: The AR-15! 288pages.
Order No. 043-Z6613 \$15.99

The Gun Digest Book of Combat Handgunnery 6th edition *by Massad Ayoob*. This book prepares people for potential life-threatening situations with its practical instruction and expert guidance. Includes: Selecting the right pistol, ammunition and holster, handgun accessories and U.S. Military CQB techniques. 256 pages, 500 b&w photos. Order No. 043-Z0880 \$14.27

2012 Standard Catalog of Firearms - *By Jerry Lee* A uniquely valuable guide to the world of collectible firearms. In it, the reader will be not only be able to accurately identify collectible firearms but assign up-to-the-minute values to them as well. Be able to buy, sell, collect and trade firearms with confidence and without fear that he or she is paying too much or selling for too little. 1472 pages.
Order No. 043-X4714 \$22.84

Standard Catalog of® Winchester Firearms - *By Joseph Cornell* Guides you through the production history of America's top firearms manufacturer Winchester. With five grades of pricing for Winchester rifles and shotguns manufactured between 1866 and the present, technical details, trend reports for popular models, with this guide you can immerse yourself in years of Winchester history and performance details. 288 Pages.
Order No. 043-Z0932 \$15.42

Standard Catalog of® Remington Firearms - *By Dan Shidele* In Standard Catalog of® Remington Firearms you gain access to identifying details, historical background, production and value data and more than 300 distinguished color photos taken by expert firearm photographer Paul Goodwin. Plus, you'll discover bonus production and serial number data. 288 Pages.
Order No. 043-Z1828 \$17.13

Standard Catalog of® Colt Firearms - *By Rick Sapp* More than 400 brilliant, full-color photos Up-to-the-minute, real-world values Accurate, detailed descriptions From the first Paterson revolvers of the 1830s to the latest Colt-built M16s, you'll find it here - in Standard Catalog of® Colt Firearms! 288 Pages.
Order No. 043-Z0931 \$17.13

Standard Catalog of Military Firearms, The Collector's Price and Reference Guide, 6th Edition - *By Phillip Peterson* From handguns to rifles to shotguns and fully-automatic machineguns and submachineguns, Standard Catalog of Military Firearms provides a remarkable complete guide to the world's military firearms and their accessories. 528 Pages.
Order No. 043-Y0772 \$18.84



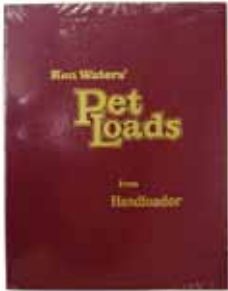

Pet Loads - A Monumental work by the leading authority in the handloading field. More than just a reloading manual, this large, comprehensive book contains loading procedures, tables, tips, precautions, and commentary; over 100 cartridges are detailed. (incorporates all supplements from #1 to #22.) **Order No. 144-549 \$44.37**

Propellant Profiles 5th Edition - The most convenient reference available to American reloaders from the last 45 years. Includes manufacturers and authors' recommended loads and tips. Newly revised and updated to include the newer powders.
Order No. 144-544 \$29.54

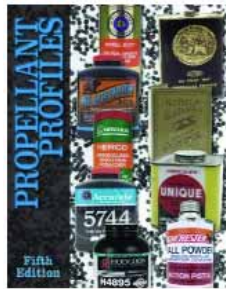

Guns Illustrated 2011 43rd Ed. - By Dan Shideler
Included are an illustrated catalog section and more than a dozen field reports from some of the industry's premier gun writers. Guns Illustrated 2011 is specifically for the consumer who wants to know what is currently available on the guns and gear market. It's a lean and mean guide for the true gun geek!
320 pages
Order No. 043-Z7969 \$13.13

Gunsmithing Tips and Projects 2nd Edition - REVISED & UPDATED! NOW AVAILABLE! A collection of How-to's including such subjects on the shop, stocking, actions, tuning, triggers, barrels and chambering, problem solving customizing, muzzleloaders, odd jobs and restoration. Over 500 pages of information.
Order No. 144-5663 \$29.54

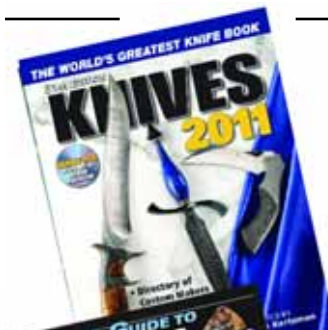
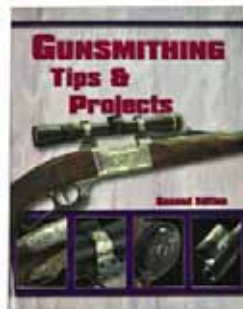

Knives 2011 - World's Greatest Knife Book
By Joe Kertzman Get all the latest knife trends and techniques in Knives 2011! You will find everything from traditional pocket knives to modern custom bowies, autos, dirks, daggers and fast-opening, one-hand folders. Also, included is an UPDATED directory of custom knifemakers! Plus, you will receive a BONUS DVD that includes 10 years of Blade Magazine! Whether you are a knife collector, enthusiast, knifemaker or dealer, this is the perfect book for you! 312 pages. **Order No. 043-Z7017 \$17.13**



Blade's Guide to Knives & Their Values - If you call yourself a serious knife collector you will want to have this edition of Blade's Guide to Knives & Their Values. This book includes cutting-edge research and features revised and updated pricing information, 500 new knife entries, and thousands of detailed illustrations and descriptions to help you identify and date virtually any knife.
Order No. 043-Z5054 \$17.13



How to Make Knives By Richard W. Barney & Robert W. Loveless
Learn how with "the bible of knife-making." Gives complete instructions on making high quality handmade knives. Forging and stock removal, mirror polishing, sheath making, safety techniques, required tools and supplies and more. 182 pages.
Order No. 043-KHM01 \$10.28

Family Protection Guide -

Craig Fox Huber - Learn how to outsmart anyone threatening your family's safety with these practical tips from a former Marine with 25 years' experience in high-risk personal security. Guides to making your home as safe as possible and avoiding potential hazards of day-to-day living wherever you go may save the life of a loved one. Customize your family's self-defense plan with recommended products, training and conditioning. This book will teach you how to "think security" in everything you do.
Order No. 144-5551 \$18.45

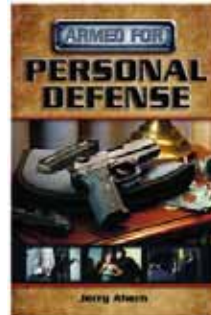

Armed for Personal Defense - Violent criminals are everywhere - and that's why you need Armed for Personal Defense by Jerry Ahern. You'll learn the basics of concealed carry, from what kind of gun to choose, to what kind of holster. In addition, you'll learn about knives, clubs and improvised weapons that can save your life when a gun isn't available. 240 pages.
Order No. 043-Z9404 \$11.42

Gun Digest Buyer's Guide to Concealed Carry Handguns By Jerry Ahern In Gun Digest Guide to Concealed Carry Handguns, renowned authority Jerry Ahern describes the types of concealed carry handguns available to today's shooter and explains the advantages and disadvantages of each type. In addition, he discusses suitable ammunition, holsters and other accessories. For the experienced shooter the first-time holder of a concealed-carry permit, it's an indispensable buyer's guide. 224 Pages. **Order No. 043-Z8905 \$14.27**

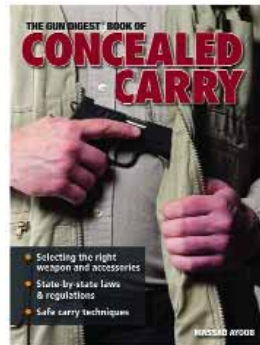
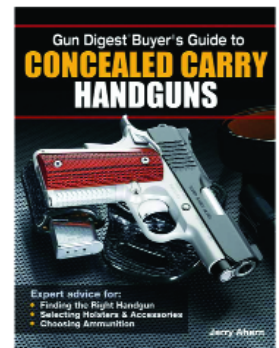

The Gun Digest Book of Concealed Carry
By Massad Ayoob - This book is a must-read for anyone interested in concealed carry of a handgun. Detailed chapters focus on selecting the best handgun, whether new or used, choosing the most effective ammunition for your purpose and options for carrying your pistol. Also covers the expansive accessories market, and provides real-life practicalities for each accessory. He also educates you about concealed carry laws, and how they pertain to you. This is essential information for anyone considering concealed carry. 256 Pages.
Order No. 043-Z1782 \$14.27

Gun Digest Book of the Tactical Shotgun - Gun Digest Book of the Tactical Shotgun is the essential buyer's guide to the modern home defense and combat shotgun. Author Scott Wagner reviews many makes and models of currently available tactical shotguns, ammunition and accessories. 224 pages. 250 b&w photos
Order No. 043-Y1448 \$14.27

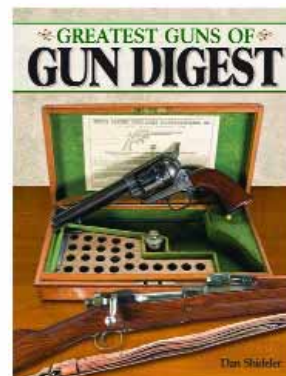
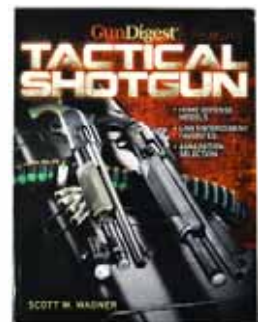

Greatest Guns of Gun Digest - Shooters, collectors and hunters will find the greatest firearms ever, presented by the greatest gun writers of all time, as they originally appeared in Gun Digest, the world's most popular firearms book. Greatest Guns of Gun Digest represents the strongest, most enduring gun annual of all time. From historical firearms such as Winchester lever-actions and Colt revolvers to modern classics like the Smith & Wesson .44 Magnum, the Glock and the ruger Super Blackhawk, Greatest Guns of Gun Digest provides a unique perspective on the firearms that are recognized around the world as classics. 224 pages.
Order No. 043-Z9830 \$14.27



Reloading Videos

Advanced Handloading Beyond the Basics-DVD - Redding, Sierra and Wolfe Publishing have teamed up to bring you an advanced handloading DVD. John Barsness hosts this DVD and teaches you how to use advanced tools to make your handloads shoot better. This video covers advanced techniques needed to enhance your ammunition accuracy.
Order No. 144-5449 \$19.09

RCBS Precision Handloading DVD - Comprehensive review of RCBS equipment and accessories. Tips and tricks on how to safely and efficiently load a high volume of rounds. Clear, step-by-step directions for shotgun, rifle and pistol reloading. Narration by Jim Scoutten of Shooting USA®
Order No. 044-99910 \$8.68



Bullet Casting 101 DVD - This DVD video takes you step by step on how to cast your own bullets. From the equipment to sizing, it is all right here in this video.
Order No. 144-54410 \$19.14

Casting Premium Handgun Bullets DVD - explains all the necessary techniques in detail. You'll learn: to cast the highest quality bullets for accuracy; to cast bullets from a single cavity mold to the six cavity gang mold while balancing mold and alloy temperatures; to maintain good production without sacrificing quality; you'll get an introduction to the bottom pour casting furnace and thermometer; learn to detect flaws and understand the how's and why's of the most common flaws. Then we'll take the same bullets cast in this DVD to the range to test for accuracy.
Order No. 144-54411 \$19.14



Varmint Hunting Videos Made by Varmint Hunters



Eastern Coyotes.Com Vol. 1 - 12 hunts and bonus footage! Watch a scouting trip, how to set up for the hunt, and see what makes them successful hunting the Eastern Coyote. DVD **Order No. 228-ECC1 \$14.96**



All Hogs Go To Heaven Volume 2 - After 3 years of filming and applying everything they learned from the first video, this north east varmint hunting video will set the standard for a long time to come. Packed with tons of tips and techniques and filmed with the best gear on the planet including Filmed in pure HD at 36X. Join them as they learn the art of long range and stretch things out to beyond half a mile. **Order No. 240-HOGS2 Only \$19.99**

Coyote Rage DVD - Tips, Tactics, Exciting Action, Gear Segments, Demos and More! 30 Exciting Hunts completely on PUBLIC land! A must have for beginner hunters and veterans alike.
Order No. 239-CR8G \$13.99



Lyman Publications

Lyman Reloading Data Log - The new Lyman Reloading Data Log is a must for shooters who reload. The large, easy-to-use format has plenty of room to enter all important data such as bullet, powder, primer, case, firearm used, plus size, velocity, conditions and several lines for comments on your reloads. 8-1/2" x 11" size. 50 pages per log.
Order No. 015-9847261 \$4.18

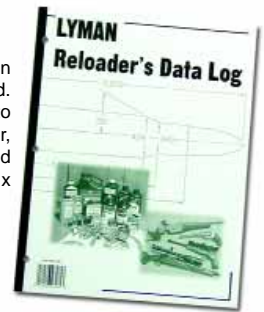

Lyman's 5th Edition Shotshell Handbook - Covers cases, wads and primers currently offered by all leading manufacturers in all gauges from .410 to 10 gauge. In addition, the latest and also the most popular powders from Alliant, Hodgdon, Accurate, IMR, VihtaVuori, Ramshot, Winchester are included.
Order No. 015-9827111 \$16.71

Lyman Cast Bullet Handbook - The pioneer of reloading manuals - will introduce the 4th Edition of their popular Cast Bullet handbook. This will be the first new Cast Bullet Handbook from Lyman in 30 years!

It will include data for all Lyman Moulds, plus additional data for select RCBS, Redding and Lee Moulds. Written by well-known cast bullet authority, Mike Venturino, this will be the most up-to-date and comprehensive cast bullet data available.
Order No. 015-9817004 \$18.00



Black Powder Handbook 2nd Edition - Written by Sam Fadala, this handbook includes pressure tested loads using Goex and Elephant black powders and Pyrodex Pellets. Complete editorial section includes topics on choosing your muzzle-loader, building the best loads, propellants, ignition, maintenance, etc. Also includes a black powder cartridge section by Mike Venturino.
Order No. 015-9827100 \$14.14

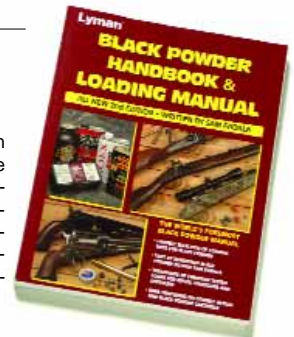

Reloading For Shotgunners 5th edition - By Rick Sapp This is the one reloading guide every shotgunner should own! This 5th edition of Reloading for Shotgunners teaches the shotshell, slug and buckshot reloader all the basics of the art, plus advanced techniques for loading everything from field to high-performance target loads.

Teaches the basics of reloading and advanced techniques. All-new feature articles on the latest trends in reloading. Comprehensive data section offers current load data
 Over 11,000 loads 288 pages
Order No. 043-RFS5 \$14.27

Hunters Specialties Hunting Videos



Primetime Bucks 13 - The Hunter's Specialties Pro Staff and friends have put together some great deer hunting footage for the Primetime Bucks® XIII DVD. From early season bucks in velvet through the wild and crazy whitetail rut into the frozen fields of winter, the hunters have put hour after hour in stands, covering hundreds of miles to bring viewers the kind of exciting hunting action they have come to expect in the Primetime® videos. Contains 26 hunts with over three hours of video. A Primetime® deer track window sticker is included.
Order No. 052-20057 Closeout! \$7.00

Reloading Manuals, Software and Etc...



A - VihtaVuori Reloading Manual #4 Order No. 109-4319707 \$32.96

B - Speer #14 Reloading Manual - Sorry, we did not have information or pictures at the time of print, due in June! Order No. 021-9515 Price \$27.78

C - Barnes Reloading Manual #4 - Includes data for Barnes XLC coated bullets and VLC coated bullets with noted accuracy loads. Order No. 035-BRM4 \$21.93

D - Hodgdon Annual Manual 2012- 100-plus pages of rifle and pistol data with well over 5,000 shown loads, information on 30 Hodgdon, 19 IMR and 10 Winchester brand powders, .300 AAC Blackout data, lead free bullet recipes for 21 rifle cartridges, and seven highly anticipated articles on such topics as economical handloading with lead-free "green" bullets by some of the top outdoor writers.

A complete resource for the Hodgdon propellant called CFE223 or "Copper Fouling Eraser" that greatly deters copper fouling, shown in 27 different cartridges and 147 loads. Order No. 034-AM12 Price \$6.63

E - Lyman's 49th Edition Reloading Handbook - Covers all popular rifle calibers such as the 204 Ruger, 6.8 Rem SPC, 325 WSM, 338 Federal, 375 Ruger, 405 Winchester and the WSSM series. In addition, pistol calibers such as the 5.7x28mm, and 460 S&W are also included. Most popular bullet brands are also used including Barnes, Hornady, Nosler, Sierra, Speer, and Swift. Full coverage is also given to Lyman cast bullets throughout the handbook.

49th Ed. Reloading Handbook Softcover - Order No. 015-9816049 \$18.00
49th Ed. Reloading Handbook Hardback - Order No. 015-9816052 \$25.72

F - Sierra 5th Edition Rifle and Handgun Reloading Manual- This three ring binder format manual has cartridge introductions, histories and reloading recommendations. New bullets and powders also covered. An essential accessory for any reloading bench. Order No. 007-0500 Price \$25.50

G - Lee's 2nd Exdition Modern Reloading Manual- Over 26,000 loads! All in a new format, with velocities for starting loads. Load data supplied by the powder companies, the best kind of load data you can have! Latest information on pressure! Exclusive pressure and velocity factors enable you to accurately calculate pressure and velocity for reduced loads. An absolute must for cast bullet shooting. Hundreds of cast bullet loads, with charts and rules about priming. Over 700 pages!

Order No. 006-90277 Price \$14.33

H - Nosler 6th Reloading Manual- Data for the 204 Ruger®, the Winchester short and super short families. All of the Remington Ultra Magnums are included. Even the 7mm RUM can be found among the more than ten new cartridges added to this manual. All of the cartridges have been updated to provide the best data for all of Nosler's bullets, including the AccuBond®. Order No. 115-50006 Price \$21.31

I - 8th Edition Reloading Manual- Containing nearly 1100 pages, the handbook features the latest information for all the newest Hornady bullets including: FTX, GMX, DGS, DGX. Also incorporates data for recently released propellant like Hodgdon's groundbreaking Superformance and LEVERevolution powders, as well as RL 17, 4007SSC, 8208XBR, Hybrid 100V and more. Order No. 003-99238 \$27.05

MTM Reloading Accessories



MTM Reloaders Log Book - An absolute must for the serious reloader. Now with a total of 150 pages. Space is provided for recording extremely detailed data (ammo performance, 'pet' loads, shotshell data, firearms inventory, etc.).

Order No. 008-HL95 \$21.55

MTM Rifle and Handgun Reload Labels - 50 load labels per pack along with 48 small color coded labels for the outside of your boxes. These color labels can help you organize your reloading room. Each load label has a space for caliber, powder, bullet, weights, primers, times loaded, date, and notes etc. Dimensions: 4" x 2 1/8" Order No. 008-LL1 \$3.58



John Nosler Going Ballistic

"Going Ballistic" The Life and Adventures of John Nosler - By John Nosler as told to Gary Lewis. This is the tale of a hunter, innovator and self-taught ballistics engineer. He first hunted moose in Canada in the 1940s and recognized the need for a projectile that would stand up to the velocity generated by the new magnum rifle cartridges. He developed a bullet that married the qualities of penetration and expansion - the Nosler Partition. Order No. 115-50160 \$19.83

Born in California, raced his home-built cars on the dirt tracks of Huntington Beach and Pomona. Moved to Oregon and embarked on his legendary big game hunting career.



Sierra Infinity Version 6.0 Reloading Software - Improved Atmospherics - revised to improve atmosphere model and add improved altitude estimates with atmospheric conditions. Revised print formats - MOA (clicks) column and field print added for more "field friendly" print outs. Tabular formats added for tactical shooters in MOA and MIL including uphill and downhill calculations. Profiled Winds - allows for 5 separate wind zone conditions downrange for deflection/drop/rise calculations. Twist rate - calculates recommended twist rate for each bullet/muzzle velocity/stability factor. Recoil - calculates recoil momentum and energy for each gun weight/bullet weight/powder charge weight/muzzle velocity combination.

Order No. 007-0601 \$32.49

System requirements: Windows Vista, XP or Win2K, 800x600 resolution (1024x768 recommended), IE 6 or higher, Dot Net Framework 2.0 or higher (included in install), 60MB hard drive space

Sierra Infinity Version 6.0 Reloading Software With 5th edition Sierra Reloading Manual - Order No. 007-0602 \$52.24

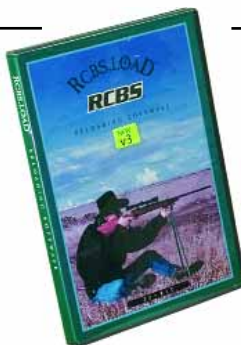

Reloading Software

RCBS Reloading Software - Index of nearly 400 cartridges. Drawings with dimensions for 269 cartridges. Includes Load Data from the Speer #12 Accurate Arms #1 and RCBS Case Bullet manuals. Highly precise external ballistics calculator. Additional data from over 40 historic and current load data manuals is available. User generated load data can be added to the data base. Graphing of all data with options for sorting, filtering and displaying in different panes. Kinetic energy calculator. Database of more than 1,100 standard bullets and over 625 factory loads. Order No. 044-99915 \$98.28

Reloading Software

Swift Bullet Company
NEW! Reloading Manual on DVD

Order No. 192-MANUAL \$18.98



ABSOLUTELY NO RETURNS ON SOFTWARE! ALL SOFTWARE PROBLEMS MUST DEAL DIRECTLY WITH THE MANUFACTURER!

Golden Stag Gloves



Deerskin All Purpose Glove -

- Seamless palm
- Velcro Wrist Strap
- Neoprene Knuckle
- Stretch Knit Back

\$12.69 a pair

Order No
Small 040-2150S
Medium 040-2150M
Large 040-2150L
XL 040-2150XL



Deerskin Work Glove -

- Thinner Leather for better feel
- Keystone Thumb
- Shirred Elastic Back

\$12.15 a pair

Order No
Small 040-810IRS
Medium 040-810IRM
Large 040-810IRL
XL 040-810IRXL

Mesh Back Wrist Strap Glove -

- Velcro Wrist Strap

\$13.37 a pair

Order No
Small 040-M7017S
Medium 040-M7017M
Large 040-M7017L
XL 040-M7017XL



The Gun Digest Book of Modern Gun Values The Shooter's Guide to Guns 1900-Present Up-to-date pricing to buy, sell and trade with confidence. Contains accurate pricing and identification for new guns introduced since the 14th edition. 712 Pages.

Order No. 043-W1804 \$18.84

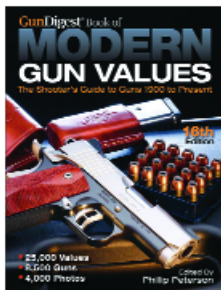

Sure Shot Sid's & Mojo Mama Seasoning



"That Great Grill Flavor With Or Without The Grill"

Mojo Mama Blackened Seasoning - Mama says "Shake generously over chicken, meat or fish, until it tastes right for you." Mojo Mama is great on all meats, whether you grill it or cook it in the oven. Also, try it out on salads, french fries, and even popcorn. All Natural ingredients include: Salt, Dehydrated Garlic, Citric Acid, Paprika, Spices, Dehydrated Onion, Black Pepper, Red Pepper, White Pepper, Natural Lime and Orange Flavors & Extractives of Paprika (Soybean Oil, Paprika Extractives)

Order No. 233-77712 \$3.98

Sure Shot Sids Seasoning - A perfect compliment to Pork, Hamburgers, Chicken, Steak, Ribs, Shrimp, Popcorn and Wild Game! Contains MSG. Also in available in Chipotle Pepper!

	Order No.	Price
Original Gunpowder 5.5oz	233-77701	\$3.62
Chipotle Pepper 5.5oz	233-77702	3.62
Lime Pepper 5.5oz	233-77703	3.62



Blue Face Pepper Spray Keychain by SABRE Red - SABRE's new BLUE MARKING DYE adds another powerful ingredient to keep you safe. Coupling the unbelievable, intense burning of the eyes, coughing, sneezing, and runny nose with a NEW, thick, blue marking dye. The Blue Dye provides immediate evidence allowing law enforcement to facilitate the arrest!



Features:
 Maximum strength pepper spray
 Effective Range = 10 Feet
 Blue marking dye last 24 hours
 Hard case
 Quick release key ring attachment
Order No.
 117-HC22TCUSBD \$6.91



SABRE Red 1.8 oz DUATHLETE Pepper Spray - Running, cycling or maybe both today? Doesn't matter, you need protection. SABRE RED's DUATHLETE Pepper Spray straps onto your bicep to protect you whether on foot or two wheels!



The adjustable arm band fits securely around your bicep. The tear away design puts SABRE RED's police strength pepper spray immediately at your finger tips. A strong stream delivery with a 15 foot range gives you safety at a distance. The reflective covering enhances your safety, alerting drivers and others.

Order No.
 117-MK3AMUS \$11.69

SABRE Red 1.8 oz Pepper GEL - Protection at a safe distance is a huge advantage of pepper spray. Pepper Gel increases safety with its 15 foot range! Less affected by weather conditions, Pepper Gel's velocity and consistency covers your threat and reduces cross contamination.

SABRE RED's Pepper Gel is the same size canister used by professionals such as the NYPD & LA County Sheriff's. Protect yourself and your family at a safe distance with Pepper Gel. Free Holster Included!

Order No.
 117-MK3GELHUS \$10.59



Pocket Self Defense Spray Unit 0.75 oz with Clip - The Pocket Unit with Clip is a very compact canister with Clip to increase accessibility. This is the preferred option for the non-key chain user. It also provides an option for not wishing to draw attention to their self-defense spray. The powerful 0.75 oz Pocket Unit with Clip delivers a ballistic stream which reduces wind blow-back. This compact canister delivers approximately 35 shots with a range of 8-10 feet.

Order No.
 117-P220C \$4.08



SABRE RED Lipstick Pepper Spray - Why? Because it's compact, attractive, pink and more modern looking than traditional pepper spray. Perfect for your purse!

Effective Range = 10 Feet

Order No.
 117-LS22US \$5.97

SABRE Red

Sabre Security Sprays And Personal Defense

Gate Keeper Door Alarm by SABRE Red -

Home invasions occur every 14.5 seconds in the USA. A new trend is developing internationally as intruders rob you while you sleep and leave with your former possessions by means of your automobile. GATEKEEPER takes you out of R.E.M. and into action. The piercing 120 decibel siren will likely startle and deter the intruder while waking you. Its door wedge design blocks inward opening doors giving you precious time to reach for your SABRE pepper spray. Small, practical and easy to use GATEKEEPER lets you rest easy until it's time to take action!

Features:

- 120 decibel door alarm
- Door wedge helps to block inward opening doors
- Non skid bottom

Order No.

117-GK01 \$6.96



NBCF PINK Key Ring Quick Release - SABRE Red Self-Defense Maximum Strength Red Pepper Spray & Invisible UV Dye - The Quick Release with detachable key chain allows immediate access to your defense spray when unlocking a door or driving an automobile. The most popular SABRE style, the Quick Release, is a powerful 0.54 oz container delivering a ballistic stream which reduces wind blow-back about 8-10 feet. Approximately 25 shots are contained in the compact canister.

Order No.

117-HCNBCF01 \$5.74



Pocket Key Case - SABRE Advanced 3-in-1 Self Defense Spray with Red Pepper Spray, Tear Gas, & Invisible UV Dye -

The Pocket Key Case is a traditional favorite providing a handsome colored key case and key ring attachment. The small, yet powerful 0.54 oz Key Case delivers a ballistic stream which reduces wind blow-back. This compact canister delivers approximately 25 shots with a range of 8-10 feet.

Order No.

117-SPKC14PCOC \$5.84

SABRE Red 3/4 oz Runner / Jogger Pepper Spray

- Running early in the morning or evening, often times when it's dark outside, creates the demand for The Runner Pepper Spray. The adjustable hand strap puts police strength protection at your finger tips and is by far the easiest pepper spray to carry and use while running.

Effective Range = 10 Feet



	Order No.	
Pink	117-P22JPKUS	\$6.49
Black	117-P22JOC	6.49



SABRE 800,000 Stun Gun - SABRE 800,000 volt Black stun gun with LED. Holster included. On/Off safety switch, LED and Stun Button. Serial number and 2 Year Warranty.

Dimensions: 4.75 inches tall X 2 inches wide X 1 inch deep - 22% smaller than traditional stun guns

Order No.

117-S1002BK \$25.58



Home 80 - SABRE Advanced 3-in-1 Self Defense Spray with Red Pepper Spray, Tear Gas, & Invisible UV Dye - Locate this 2.5 oz home defense spray with glow-in-dark (gid) safety and wall mount clip immediately in dark. Home defense contains 25 shots with a range of 8 to 10 feet.

Order No.

117-HM80 \$7.49



Home Defense Pepper 13oz Fogger for Family, Home & Property Protection -

The SABRE RED Home Defense Fogger provides trusted family, home, and property protection from the experts. Home Defense delivers a powerful fog delivery with a range of up to 25 feet which will cover an entire doorway. As with all SABRE products, Home Defense should be kept out of the reach of children.

Order No. 117-FHP01 \$32.71



120,000 Volts Stun Gun with belt clip & wrist strap - The SABRE 120,000 volt, 4" tall with wrist strap and belt clip. On-Off safety switch, separate firing trigger. Serial number & 2 year warranty date inside the battery cover. Uses one 9 volt alkaline battery.

Features:

- 120,000 volt
- 4" tall with wrist strap and belt clip
- On-Off safety switch, separate firing trigger
- Serial number & 2 year warranty date inside the battery cover
- Uses one 9 volt alkaline battery

Order No.

117-S120S \$14.54



Key Ring Quick Release - SABRE Red Self-Defense Maximum Strength Red Pepper Spray & Invisible UV Dye - The Quick Release with detachable key chain allows immediate access to your defense spray when unlocking a door or driving an automobile. The most popular SABRE style, the Quick Release, is a powerful 0.54 oz container delivering a ballistic stream which reduces wind blow-back about 8-10 feet. Approximately 25 shots are contained in the compact canister.

Order No.

117-HC14BKOC \$5.52



Warning - You must check YOUR local laws for restrictions before ordering Stun Guns.

500,000 Volts Stun Baton with belt clip & wrist strap -

The SABRE 500,000v Stun Baton is 13 1/4" tall with a wrist strap and nylon belt holster. On-Off safety switch, separate firing trigger. Serial number & 2 year warranty date inside the battery cover. Uses two 9 volt alkaline batteries.

Features:

- 500,000 volt
- 6" tall with wrist strap and belt clip
- On-Off safety switch, separate firing trigger
- Serial number & 2 year warranty date inside the battery cover
- Uses two 9 volt alkaline batteries

Order No.

117-S500SB \$48.25



Key Ring - SABRE Red Self-Defense Maximum Strength Red Pepper Spray & Invisible UV Dye -

The small, yet powerful 0.54 oz KEY RING delivers a ballistic stream which reduces wind blow-back about 8-10 feet. Approximately 25 shots are contained in the compact canister.

Order No. 117-KR14OC \$4.08



FRONTIERSMAN Bear Attack Deterrent with Belt Holster - The FRONTIERSMAN is the best animal attack deterrent on the market. Designed for bear attacks, the FRONTIERSMAN provides a 30 foot range, glow-in-the-dark safety, heavy fog delivery and 2.0% CRC for maximum strength. 9.2oz

Order No.

117-FBAD07 \$33.11

Just look at it...it's all you can do really.





Mail Orders To: Midsouth Shooters Supply, 770 Economy Dr, Clarksville, TN 37043
 Order Toll Free 1-800-272-3000 Fax 1-931-503-8037 Info. & Office 1-931-553-8651

Customer Number: _____
 Name: _____
 Ship to Address: _____

 City: _____ State: _____
 Zip: _____ Fax #: _____
 Is this a Home OR Business
 Special Instructions: _____
 E-Mail: _____

PREPAID - AMOUNT PREPAID \$ _____ COD (FEE IS \$11.00)

CARD NO. _____ EXPIRATION DATE _____

 CVV CODE _____ VISA MASTER CARD DISCOVER AMEX

CREDIT CARD BILLING: Please fill out if different than your shipping address
 Address Where Your CC is Billed: _____
 City _____ State _____ Zip _____
 Home Phone _____ Work Phone _____

SORRY - NO BUSINESS OR PERSONAL CHECKS!!!

FOR DELIVERY IN THE UPPER 48 U.S. STATES, PLEASE CHECK WHICH MEANS OF DELIVERY YOU WANT US TO USE FOR SHIPPING

UPS GROUND UPS 3 DAY UPS 2 DAY UPS NEXT DAY PRIORITY MAIL FEDEX 2DAY FEDEX NEXT DAY FEDEX GROUND

ALASKA and HAWAII: PRIORITY MAIL UPS 2 DAY FEDEX 2DAY **INTERNATIONAL:** INTL PRIORITY UPS FEDEX
See usps.com for rates

ORDER NO.	ITEM DESCRIPTION	QTY.	PRICE	TOTAL

Would you like a Midsouth Catalog for yourself or a friend? () QTY Extra Order Forms? () QTY

ORDER INFORMATION: SORRY NO BUSINESS OR PERSONAL CHECKS ACCEPTED! All COD orders shipped UPS CASHIER CHECK or MONEY ORDER only! The COD fee is \$11.00 per box. **PLEASE NOTE THE HAZARDOUS FEE FOR PRIMERS, POWDER AND PERCUSSION CAPS. This is \$25.00 per package leaving our dock! (not per box of primers, etc.) Each box of powder is a separate \$25.00(\$35.00 by Air) hazard fee, due to shipping regulations. We must have a copy of your drivers license or FFL to ship any bullets, brass, primers, powder, ammo or percussion caps. MINIMUM ORDERS \$40.00 (*If less than \$40.00 add a \$5.00 service charge). Please estimate freight cost, if in doubt, add extra to the order and we will refund any excess promptly! Tennessee residents add 9.75% sales tax . (TN residents also pay a .10 TWRA Tax per box of ammunition)

Sales Tax - 9.5% (TN Residents Only)
COD Fee \$11.00 (If Not Pre-Paid)
Freight (Estimate heavy, we'll refund the balance)
Service Charge* / HazMat Fee**
Insurance (\$2.25 UPS/FedEx up to \$300)
 (\$4.40 USPS up to \$300)

Total Amount \$

INTERNATIONAL CUSTOMER EXPORT RELEASE: (FOR INTERNATIONAL CUSTOMERS ONLY) By signing I accept and will follow all laws local, state and federal, pertaining to but not limited to exporting goods outside the United States. I accept responsibility for all said laws and their penalties if and when goods are exported outside the U.S. **SIGNATURE REQUIRED (Please sign at lower right)**

STATEMENT OF BUYER: By placing this order I understand that Midsouth Shooters Supply does not warrant that I may legally purchase, transfer or possess airguns, ammunition, black powder supplies, knives, reloading components, firearm parts, slingshots or other items. I have checked my federal, state and local laws, I am an adult (21 years of age or older), and I am not under any legal disability which would prohibit me from purchasing these items. **SIGNATURE REQUIRED**

 Signature of Buyer / Cardholder (If Pre-Paid)