

URYU

URYU

AIR TOOLS
MADE IN JAPAN

CE

URYU

AIR TOOLS GENERAL CATALOG

BOLT & NUT SETTERS / SCREWDRIVERS / ABRASIVE TOOLS /
DRILLS & TAPPERS / PERCUSSION TOOLS / TESTERS & OTHERS

PIONEER of PNEUMATIC TOOLS in JAPAN established in 1915

Since established in 1915 as the pioneer manufacturer of pneumatic tools in Japan, we have been maintaining the top leading position in all respects. Now, the name of "URYU" has become remarkably popular worldwide with the customers who love quality. It is our honor to introduce our latest products to you with this catalog for your additional productivity and greater profit.

CERTIFICATION

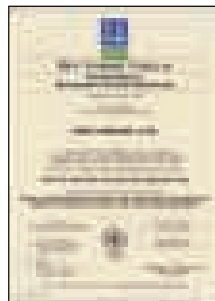

ISO14001
in 1999

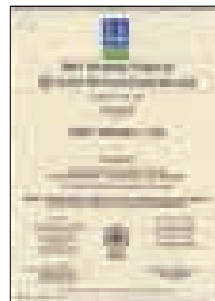

ISO9001
in 1996

URYU

AIR TOOLS GENERAL CATALOG

**BOLT & NUT SETTERS / SCREWDRIVERS / ABRASIVE TOOLS /
DRILLS & TAPPERS / PERCUSSION TOOLS / TESTERS & OTHERS**
(Individual catalog sheets and parts lists are available for further information.)

CONTENTS

CLASSIFICATION OF URYU PRODUCTS	2
OPERATOR'S SAFETY MANUAL	4

BOLT & NUT SETTERS	5
OIL-PULSE WRENCHES	6
ULT SERIES	8
UL SERIES	11
ALPHA (T) SERIES	13
UX-T SERIES	16
U • UX SERIES	17
UX-ST SERIES	19
SUPER "INTELEC" SYSTEM	20
ELECTRIC SERIES	25
BATTERY SERIES	26
IMPACT WRENCHES	28
UW SERIES	30
MULTIPLE NUTRUNNERS	36
UST • UMT • F SERIES	36
RATCHET / OPEN-END / GEARED WRENCHES	
URW SERIES	38
UOW SERIES	39
UGW SERIES	39
ANGLE NUTRUNNERS	40
UAN SERIES	41
FASTENING COUNTER	42
UTM-1100	42
SCREWDRIVERS	43
TORQUE CONTROL	46
US-LT SERIES	46
OTHER TYPES	49
CUSHION CLUTCH SERIES	49
DIRECT DRIVE SERIES	50
IMPACT SERIES	51
OIL-PULSE SERIES	52
ABRASIVE TOOLS	55
VARIOUS TYPES OF GRINDERS	56
SANDERS / POLISHERS	63
DRILLS & TAPPERS	65
DRILLS (UD & URD SERIES)	66
TAPPERS (UT SERIES)	68
PERCUSSION TOOLS	69
RIVETING HAMMERS	70
FLUX CHIPPERS	71
CHIPPING & CAULKING HAMMERS	71
TESTERS & OTHERS	73
VARIOUS TYPES OF TESTERS	74
URYU NETWORK	77

BOLT & NUT SETTERS

SCREWDRIVERS

ABRASIVE TOOLS

DRILLS & TAPPERS

PERCUSSION TOOLS

TESTERS & OTHERS

CLASSIFICATION OF URYU PRODUCTS

BOLT & NUT SETTERS		5
OIL-PULSE WRENCHES		6
	ULT SERIES	PISTOL TYPE 8 STRAIGHT TYPE 10
	UL SERIES	PISTOL TYPE 11
	ALPHA & ALPHA-T SERIES	PISTOL TYPE 13
	ALPHA-T SERIES	STRAIGHT/ANGLE TYPE 14
	ALPHA SERIES	STRAIGHT/ANGLE TYPE 14
	UX-T SERIES	PISTOL TYPE 16
	U • UX SERIES	PISTOL TYPE 17
	SUPER "INTELEC" SYSTEM	UL-MC SERIES 22 ALPHA-MC SERIES 23 UXR-MC SERIES 23 U-EC SERIES 23 UX-EC SERIES 23
	ELECTRIC SERIES	UEP SERIES 25
		UBP SERIES 26
	BATTERY SERIES	
	IMPACT WRENCHES	
	UW SERIES	PISTOL TYPE 30
		STRAIGHT/ANGLE TYPE 31
		EK SERIES 32
		JUMBO TYPE 34
		STUD BOLT TYPE 34
MULTIPLE NUTRUNNERS		36
	MULTIPLE NUTRUNNERS	UST • UMT SYSTEM 36
		F SERIES 37
RATCHET/OPEN-END/GEARED WRENCHES		38
	URW SERIES	RATCHET WRENCHES 38
	UOW SERIES	OPEN-END WRENCHES 39
	UGW SERIES	GEARED WRENCHES 39
ANGLE NUTRUNNERS		40
	UAN SERIES	TORQUE CONTROL SERIES 41
		TORQUE CONTROL SERIES (TRANSDUCER) 41
FASTENING COUNTER		42
	UTM-1100	FASTENING COUNTER WITH POKA-YOKE 42

SCREWDRIVERS 43

TORQUE CONTROL TYPES 46

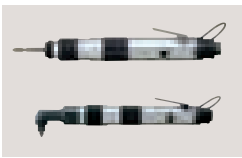

US-LT SERIES	STRAIGHT TYPE	46
	PISTOL TYPE	47
	ANGLE TYPE	48

OTHER TYPES 49

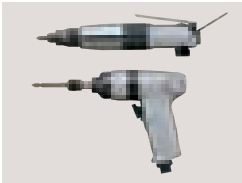

CUSHION CLUTCH SERIES	STRAIGHT TYPE	49
	PISTOL/ANGLE TYPE	50
DIRECT DRIVE SERIES	PISTOL TYPE	50
IMPACT SERIES	STRAIGHT TYPE	51
OIL-PULSE SERIES	STRAIGHT TYPE	52

ABRASIVE TOOLS 55

GRINDERS 56

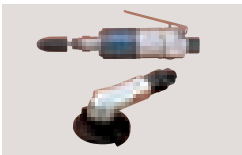

UG SERIES	DIE GRINDERS	56
	HORIZONTAL GRINDERS	58
AG SERIES	ANGLE GRINDERS	59
USG SERIES	ANGLE GRINDERS	59
VG/USG SERIES	VERTICAL GRINDERS	60
UAG SERIES	ANGLE GRINDERS	61

SANDERS & POLISHERS 63

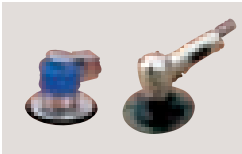

UP SERIES	SANDERS	63
	POLISHERS	63

DRILLS & TAPPERS 65

DRILLS & TAPPERS 66



UD SERIES	PISTOL TYPE	66
	STRAIGHT TYPE	67
	ANGLE TYPE	67
URD SERIES	HEAVY DUTY TYPE	68
UT SERIES	PISTOL/STRAIGHT TYPE	68

PERCUSSION TOOLS 69

PERCUSSION TOOLS 70

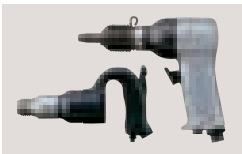

SBH & BRH SERIES	RIVETING HAMMERS	70
BRH & UFC SERIES	FLUX CHIPPERS	71
AA & PB SERIES	CHIPPING & CAULKING HAMMERS	71

TESTERS & OTHERS 73

TESTERS 74

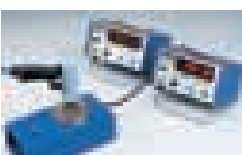

UDT SERIES	DIGITAL TORQUE TESTERS	74
UFT & UHT SERIES	OTHER TESTERS	75

BOLT & NUT SETTERS

SCREWDRIVERS

ABRASIVE TOOLS

DRILLS & TAPPERS

PERCUSSION TOOLS

TESTERS & OTHERS

OPERATOR'S SAFETY MANUAL FOR URYU PNEUMATIC TOOLS

1. The air pressure at the tool air inlet of Pneumatic Tools shall not exceed the maximum operating pressure 0.63MPa - 90 psi.
2. Air hoses and line shall be relieved of compressed air before being disconnected or disjointed, unless there is an automatic closing valve at the joint being separated.
3. An accessible means for shutting off air supply should be provided at each tool station.
4. Air hoses shall be blown out before connection to the tool and when not in use the air inlet shall be plugged.
5. Hose coupling shall be securely fitted to the tool and take off point. If an air hose and fitting are not correctly used or improperly installed, the air hose may come off and whip. Air Hose and fittings must be inspected regularly for damage and wear. Replace them when necessary.
6. Before the tool is connected to the air supply, check the throttle for proper operation(i.e., throttle moves freely and return to closed position.)
7. Operator of Pneumatic Tools shall be instructed in their proper use.
 - A) Handle with care, paying careful attention to the weight of the tool.
 - B) Keep hands and clothing away from the rotating parts of tools. Never wear loose-fitting clothes and be careful that long hair is not drawn in the tool during the operation
 - C) Hold the tool correctly. Anticipate and be alert for sudden changes in motion during start up and operation of any Pneumatic Tools. Keep body stance balanced and firm. Do not overreach when operating the tool.
 - D) Protective safety glasses and ear protectors shall be used. Other personal protective equipment such as gloves, apron and helmet shall be used when necessary.
 - E) The machine should be disconnected from the air supply before servicing or changing the accessories. This will prevent the tool from operating if the throttle is accidentally engaged.
 - F) Remember the tools are still running on for a while even after stopping operation. Do not lay down the tool until the tool completely stops moving.
 - G) Never use the air hose for supporting, lifting or lowering the tool. Use a line or cable on the tool when working in elevated areas.
 - H) Air Powered tools can vibrate in use. Vibration, repetitive motion or uncomfortable position may prove harmful to your hands and arms. Stop using any tool if discomfort, tingling feeling or pain occurs. Seek medical advice before resuming use.
 - I) Uryu Seisaku, Ltd. is not responsible for any troubles and accidents, caused by customer's own modifications of tools and accessories without having consulted with Uryu Seisaku, Ltd.
8. Where the working process in certain materials creates emission of dust and fumes, personnel shall be protected with dust collectors and personal protective device.
9. Check the spindle speed frequently with a tachometer to make sure that actual free speed at 0.6MPa does not exceed rated free speed marked on the tool.
10. If the tool is fixed to a balancer or a similar device, make sure that the fixation is secured.
11. When air supply is interrupted, retrain the throttle trigger to the stop position.
12. The Pneumatic Tools must not be used in explosive atmospheres.
13. The Pneumatic Tools are not insulated against coming into contact with electric power.

BOLT & NUT SETTERS

ULT SERIES OIL-PULSE TOOLS
UL SERIES OIL-PULSE TOOLS
ALPHA-T SERIES OIL-PULSE TOOLS
ALPHA SERIES OIL-PULSE TOOLS
UX-T SERIES OIL-PULSE TOOLS
U · UX SERIES OIL-PULSE TOOLS
SUPER INTELEC SYSTEM MC · EC TOOLS
ELECTRIC OIL-PULSE TOOLS
BATTERY PULSE TOOLS
IMPACT WRENCHES
MULTIPLE NUTRUNNERS
RATCHET WRENCHES
OPEN-END WRENCHES · GEARED WRENCHES
ANGLE NUTRUNNERS
FASTENING COUNTER

PHOTO ; MODEL NO. UXR-TL1820 1993
STILL USED AT USERS



* Sound Level measured to ISO 15744
* Vibration Level measured to ISO 8662

SELECTION CHART & TORQUE CHART FOR OIL-PULSE WRENCHES

LESS VIBRATION *1

LESS NOISE *2

SHUT-OFF

LIGHT WEIGHT & HIGHPOWER

TORQUE ACCURACY ~±15%

TORQUE ACCURACY ~±20%

TORQUE ACCURACY ~±15%

TORQUE ACCURACY ~±20%

TORQUE ACCURACY ~±30%

TORQUE ACCURACY ~±30%

PISTOL TYPE

STRAIGHT TYPE

PISTOL TYPE

STRAIGHT TYPE

ANGLE TYPE

PISTOL TYPE

STRAIGHT TYPE

PISTOL TYPE

STRAIGHT TYPE

PISTOL TYPE

STRAIGHT TYPE

ANGLE TYPE

PISTOL TYPE

STRAIGHT TYPE

ANGLE TYPE

● ELECTRONIC CONTROL TYPE
UL○○MC P.22

● UL○○ P.9 · ALPHA-○○ P.13

● UL○○S P.10 · ALPHA-○○S P.14

● ALPHA-○○C P.14

● ELECTRONIC CONTROL TYPE
UEP-○○MC P.25

● ELECTRONIC CONTROL TYPE
UX-○○EC·U-○○EC·ALPHA-○○MC P.23

● U-○○SEC·ALPHA-○○SMC P.23

● MECHANICAL CONTROL TYPE
UBP-○○ P.25

● UX-T(L)○○·UXR-T(L)○○ P.16

● UXR-○○S P.16

● MECHANICAL CONTROL TYPE
UEP-○○ P.25

● UL○○ P.12 · ALPHA-○○ P.13

● ALPHA-○○S P.14

● ALPHA-○○C P.14

● MECHANICAL CONTROL TYPE
UBP-○○ P.26

● UX-○○·U-○○ P.17

● UX-○○S·U-○○S·UXR-○○S P.18

● UX-○○C P.19

● IMPACT WRENCHES P.30

● RATCHET WRENCHES P.38

(Attention) The torque accuracy in this chart is the guide line based on Uryu's standard. The selection of right models according to the actual work standard is recommended.

*1 Vibration Level
Less than 2.5m/sec (108dB(VL))
...measured to ISO 8662-7

*2 Noise Level Less than 85dB(A)
...measured to ISO 15744

The torque chart is made based on the measurement of our standard, and the actual fastening power can be different. Please use this chart as a reference when selecting the model.



STANDARD TYPE

● UL SERIES (P.12)

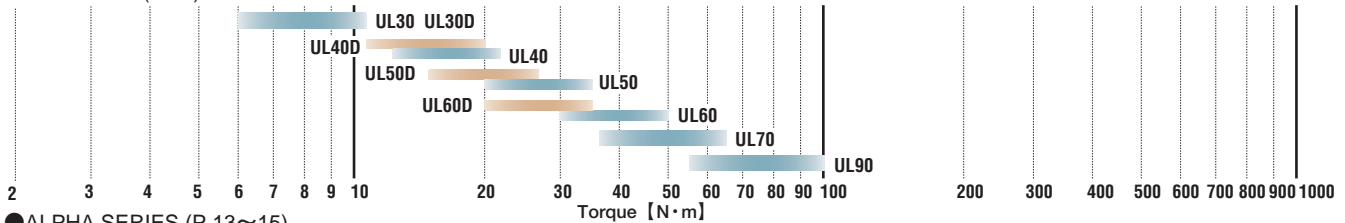

● ALPHA SERIES (P.13~15)

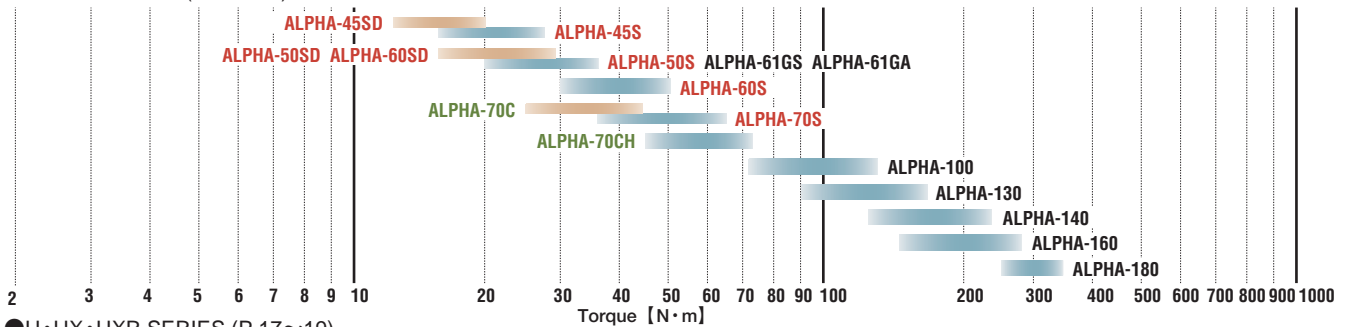

● U·UX·UXR SERIES (P.17~19)

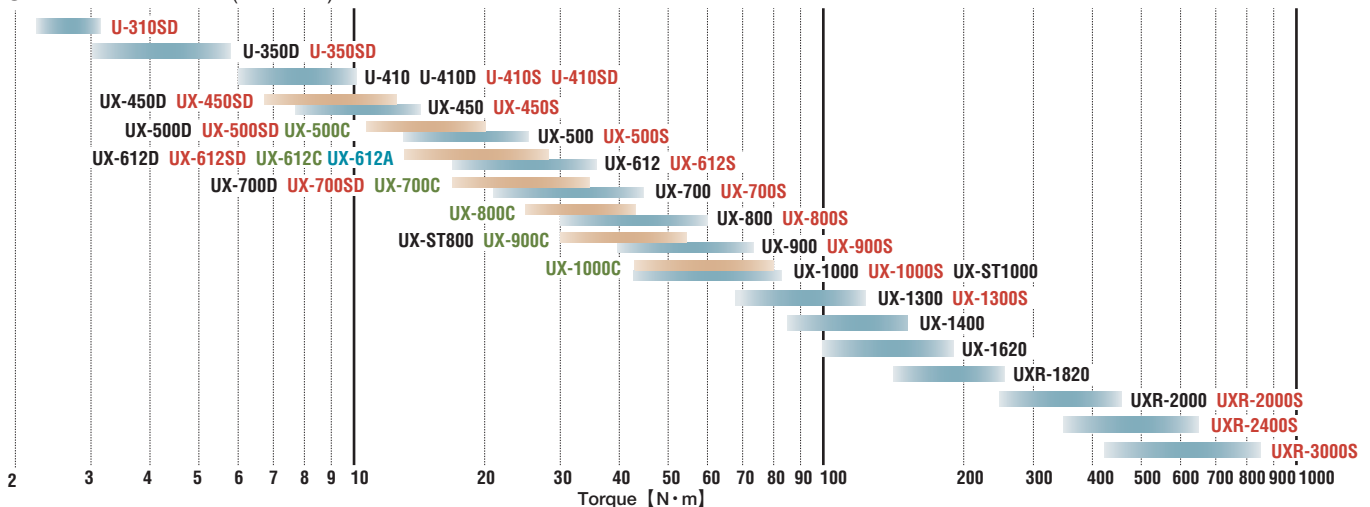

TORQUE CHART FOR OIL-PULSE WRENCHES

TORQUE-CONTROL TYPE

●ULT SERIES (P.9~10)

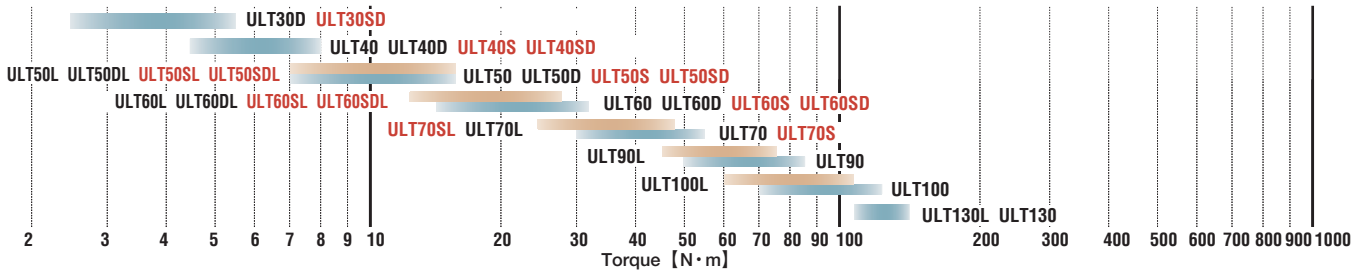

●UX(R)-T SERIES (P.16)

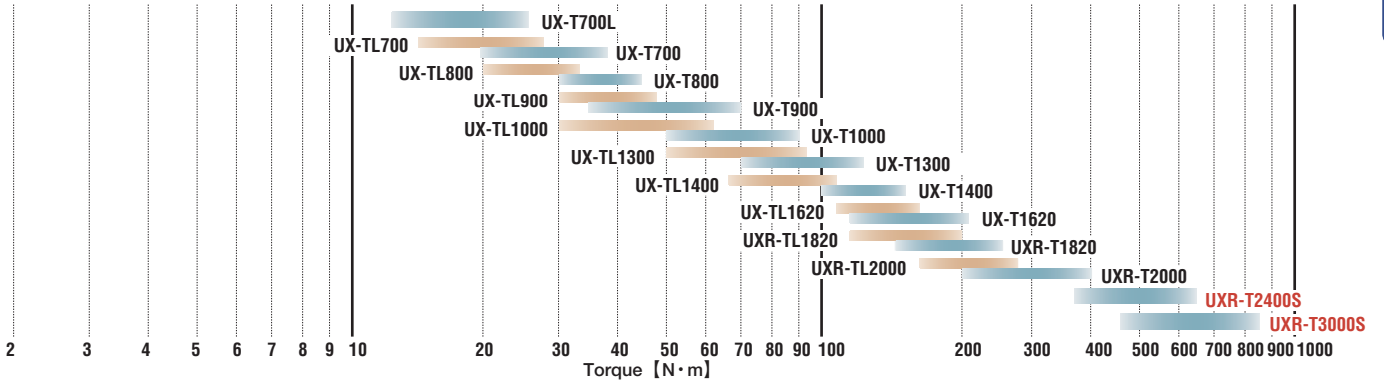

●MC·EC SERIES (P.22~23)

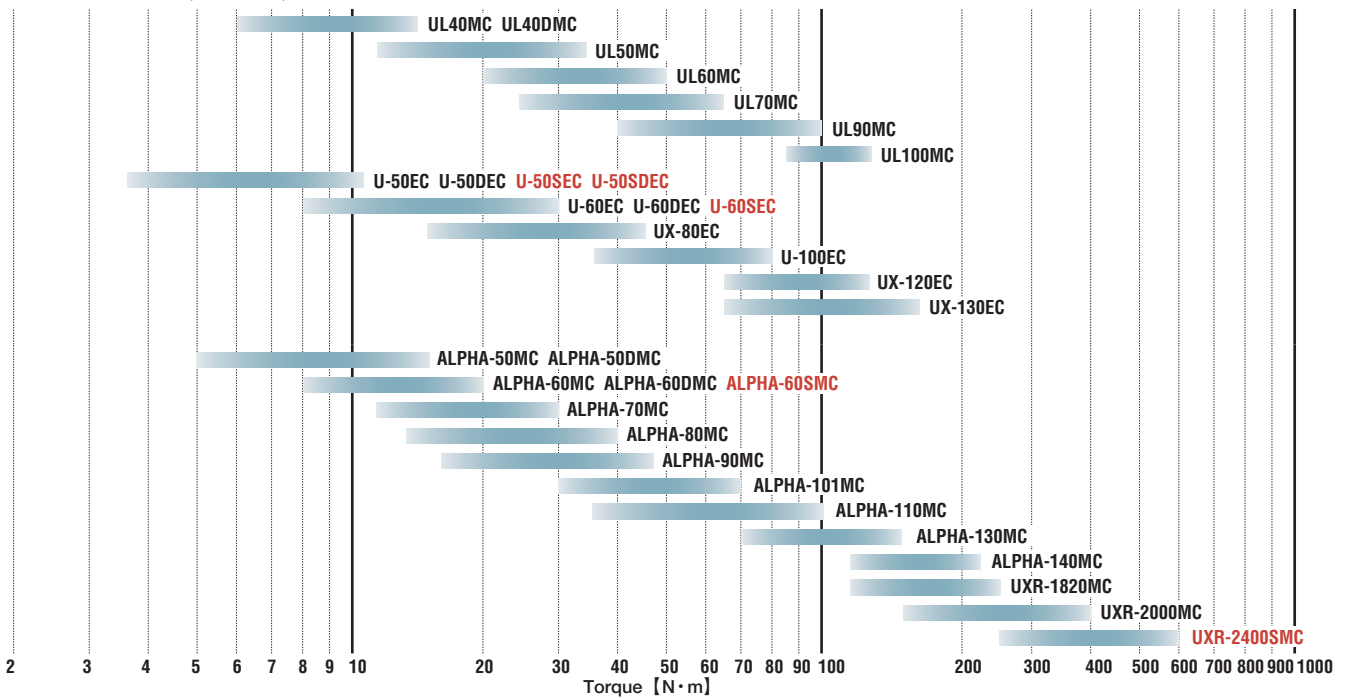

ELECTRIC TYPE

●ELECTRIC·BATTERY SERIES (P.25~26)

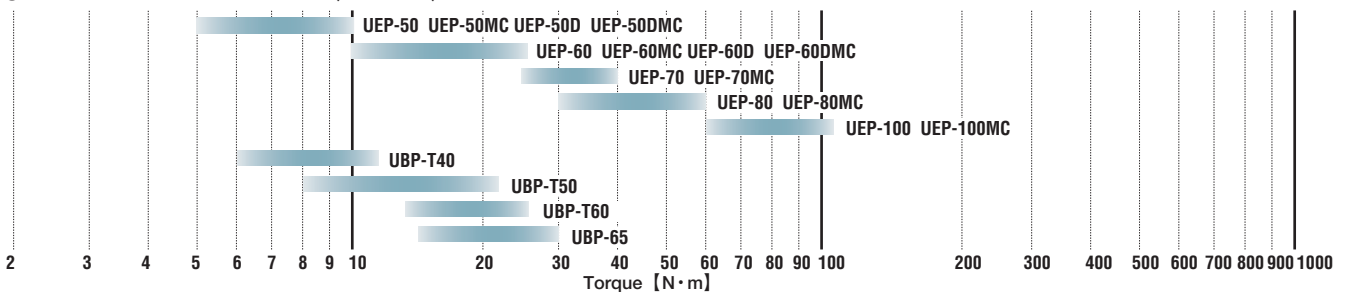

ULT ULTIMATE SERIES OIL-PULSE TOOLS (SHUT-OFF TYPE)

Since started the production of Oil-Pulse Tools about 30 years ago, we have been continuously developing advanced mechanisms. Featured with unique Air/Hydraulic mechanism, **URYU Oil-Pulse Tools** have now come to the fourth generation "**ULT Ultimate Series**" passing through the first generation "**U Single-Blade Series**", the second "**UX Two-Blade Series**" and the third "**ALPHA Double-Chamber Series**". ULT Ultimate Fastening Tools achieve tremendous light weight & short size in addition to numerous features and benefits to raise your productivity.

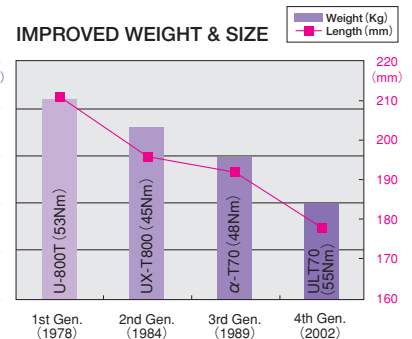
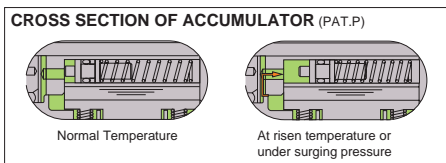
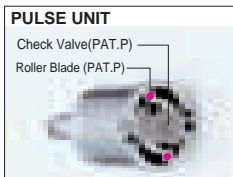
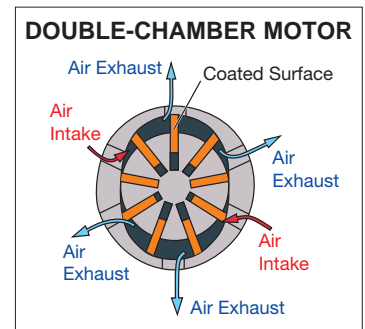
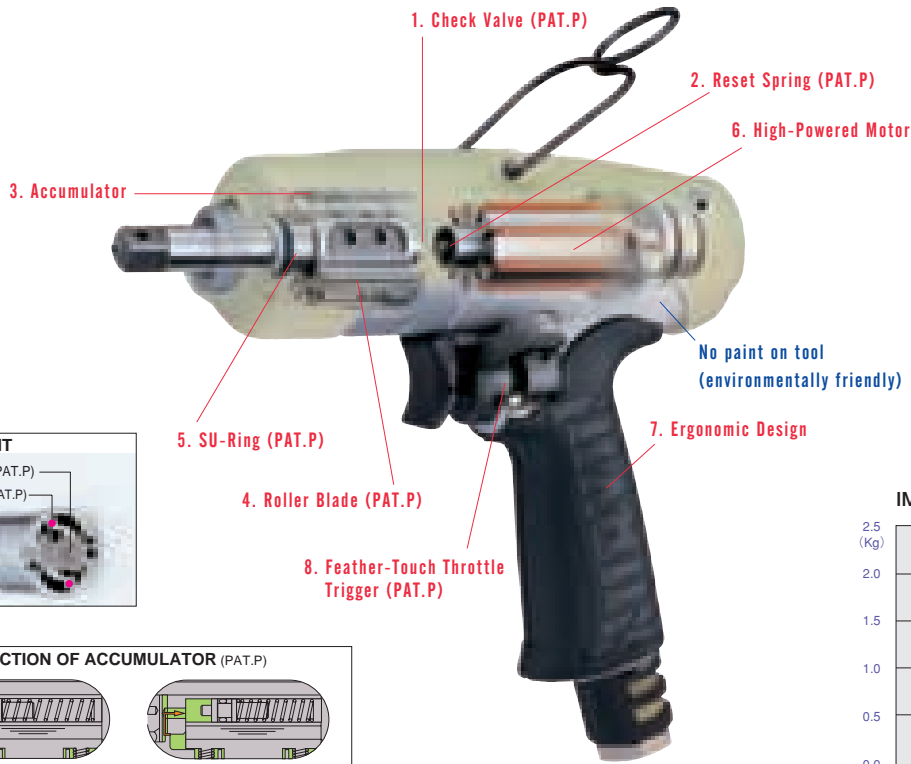

1. Improvement in Torque Accuracy

Newly adopted Check Valve (PAT.P) stabilizes the current of oil. By stabilizing the oil current, the shut-off valve can sense with accuracy the small volume of high-pressure oil from the relief valve section during operation and shuts the tool off as soon as it has reached the target torque.

2. Workable at Low Air Pressure

We have added a Reset Spring (PAT.P) to help the operation rod return back to the original position without fail every time. Therefore, the operation rod can always sense more accurately the load on the shut-off valve and shuts the tool off even when operated at lower air pressure.

3. Room to expand

The new Accumulator works as a surge drum against the sudden rise of oil pressure. And when the oil temperature rises during consecutive fastening, the accumulator will take in the expanded oil volume and keep the same pulse condition.

4. High Speed Fastening

Newly adopted Roller Blades (Driving Blade with Roller Pin)(PAT.P) reduce the friction inside the pulse unit and improve the energy efficiency. They also create less frictional wear of driving blades, which will reduce maintenance costs. Furthermore, they smooth the pulse blows and shorten the fastening time.

5. Increased Durability

Our original unique sealing, SU-Ring (PAT.P) extends the maintenance interval than the conventional O-Ring. Compared with our conventional pulse wrenches, the life cycle becomes increased by 60% or more with no leakage.

6. Improvement in Energy Efficiency

For the high-powered dual chamber motor that minimized torque ripples, we employed 9 pcs. of specially-coated blades. The special coating on the blades creates a better seal in the cylinder, helping to reduce the weight of the motor and increasing the energy efficiency.

7. Standard Handgrip & Body Protector

In addition to the oil pulse mechanism offering low noise, low vibration and small reaction, the comfortable handgrip lightens the burden for operators. Taking the environmental issue into consideration, the protective full-cover jacket is equipped as standard instead of painting.

8. Feather-Touch Throttle Trigger

Feather-touch trigger mechanism (PAT.P) with interchangeable direction lever lightens the load imposed on the operator's finger by at least 50%. Non-step valve is adopted for smooth speed adjustment. Stationary to full speed is proportional to the throttle stroke. Therefore, ULT series tools make it easier on run down and final tightening.

ULT ULTIMATE SERIES OIL-PULSE TOOLS (SHUT-OFF TYPE)

PISTOL TYPE



SHUT-OFF MECHANISM

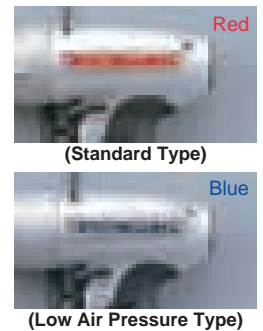
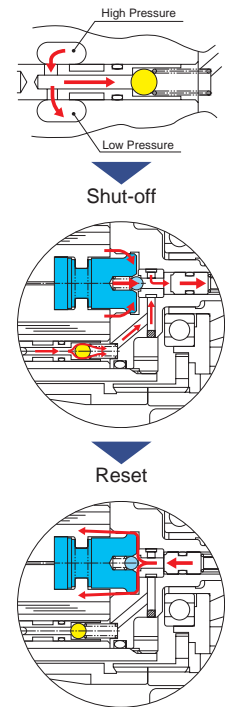

BOLT & NUT SETTERS

SPECIFICATIONS

Recommended Air Pressure: 0.4MPa(57psi)~0.6MPa(85psi)

Model	Capacity (Nominal Bolt Size)		Torque Range				Free Speed (Approx.) r.p.m.		Overall Length less Socket or Bit (about)		Weight less Socket or Bit (about)		From Center to Outside (about)		Sq. Drive or Hex. Size		Average Air Consumption		Noise Level	Vibra- tion Level
			0.4-0.5MPa		0.5-0.6MPa															
	mm	in	Nm	ft-lbs	Nm	ft-lbs	0.4MPa	0.6MPa	mm	in	kg	lb	mm	in	mm	in	m ³ /min	ft ³ /min	dB(A)	m/sec ²
ULT30D	4-5	5/32-13/34	2.5-5.5	1.9-4.1	2.5-5.5	1.9-4.1	3300	3700	163	6 27/64	0.88	1.9	21.5	27/32	6.35	1/4	0.20	7.0	74	1.0
ULT40	5	13/64	4.5-8.0	3.3-5.9	4.5-8.0	3.3-5.9	3200	3600	160	6 19/64	0.92	2.0	22.5	57/64	9.5	3/8	0.20	7.0	75	1.0
ULT40D	5	13/64	4.5-8.0	3.3-5.9	4.5-8.0	3.3-5.9	3200	3600	163	6 27/64	0.92	2.0	22.5	57/64	6.35	1/4	0.20	7.0	75	1.0
ULT50	6-8	1/4-5/16	-	-	7.0-15.5	5.2-11.5	-	4400	160	6 19/64	0.92	2.0	22.5	57/64	9.5	3/8	0.25	8.8	78	1.2
ULT50D	6-8	1/4-5/16	-	-	7.0-15.5	5.2-11.5	-	4400	163	6 27/64	0.92	2.0	22.5	57/64	6.35	1/4	0.25	8.8	78	1.2
ULT60	8	5/16	-	-	15-32	11.1-23.7	-	6700	172	6 49/64	0.95	2.1	22.5	57/64	9.5	3/8	0.35	12.3	80	1.5
ULT60D	8	5/16	-	-	15-32	11.1-23.7	-	6700	175	6 57/64	0.95	2.1	22.5	57/64	6.35	1/4	0.35	12.3	80	1.5
ULT70	8-10	5/16-3/8	-	-	30-55	22.2-40.7	-	6000	178	7 1/64	1.05	2.3	23.5	59/64	9.5	3/8	0.40	14.0	80	1.5
ULT90	10-12	3/8-1/2	-	-	50-85	37.0-62.9	-	5700	190	7 31/64	1.45	3.2	27.0	1 1/16	12.7	1/2	0.53	18.6	82	2.0
ULT100	12	1/2	-	-	70-130	51.8-96.2	-	5200	197	7 3/4	1.70	3.7	29.5	1 5/32	12.7	1/2	0.55	19.3	82	2.0
ULT130	14	9/16	-	-	110-150	81.4-111.0	-	4000	215	8 15/32	2.30	5.1	32.0	1 17/64	12.7	1/2	0.73	25.6	82	2.0
ULT150	16	5/8	-	-	140-210	103.6-155.4	-	3700	238	9 3/8	2.80	6.2	36.0	1 27/64	19.0	3/4	UNDER DEVELOPMENT			
ULT200	18	45/64	-	-	222-300	164.3-222.0	-	3800	238	9 3/8	2.80	6.2	36.0	1 27/64	19.0	3/4	UNDER DEVELOPMENT			
ULT50L	6-8	1/4-5/16	7.0-15.5	5.2-11.5	-	-	4000	-	160	6 19/64	0.92	2.0	22.5	57/64	9.5	3/8	0.20	7.0	75	1.0
ULT50DL	6-8	1/4-5/16	7.0-15.5	5.2-11.5	-	-	4000	-	163	6 27/64	0.92	2.0	22.5	57/64	6.35	1/4	0.20	7.0	75	1.0
ULT60L	8	5/16	13-28	9.6-20.7	-	-	6000	-	172	6 49/64	0.95	2.1	22.5	57/64	9.5	3/8	0.25	8.8	77	1.2
ULT60DL	8	5/16	13-28	9.6-20.7	-	-	6000	-	175	6 57/64	0.95	2.1	22.5	57/64	6.35	1/4	0.25	8.8	77	1.2
ULT70L	8-10	5/16-3/8	25-48	18.5-35.5	-	-	5500	-	178	7 1/64	1.05	2.3	23.5	59/64	9.5	3/8	0.30	10.5	78	1.3
ULT90L	10-12	3/8-1/2	45-75	33.3-55.5	-	-	5100	-	190	7 31/64	1.45	3.2	27.0	1 1/16	12.7	1/2	0.45	12.8	79	1.5
ULT100L	12	1/2	60-110	44.4-81.4	-	-	4800	-	197	7 3/4	1.70	3.7	29.5	1 5/32	12.7	1/2	0.48	16.8	79	1.5
ULT130L	12-14	1/2-9/16	80-125	59.2-92.5	-	-	3600	-	215	8 15/32	2.30	5.1	32.0	1 17/64	12.7	1/2	0.60	21.1	79	1.5

Air Inlet Size : N.P.T. 1/4"

Air Hose Size : 10mm×6.5mm×5m for ULT30-50 12mm×8.0mm×5m for ULT60-100 16mm×11.0mm×5m for ULT100L-130L

ULT ULTIMATE SERIES OIL-PULSE TOOLS (SHUT-OFF TYPE)

STRAIGHT SQ. DRIVE TYPE

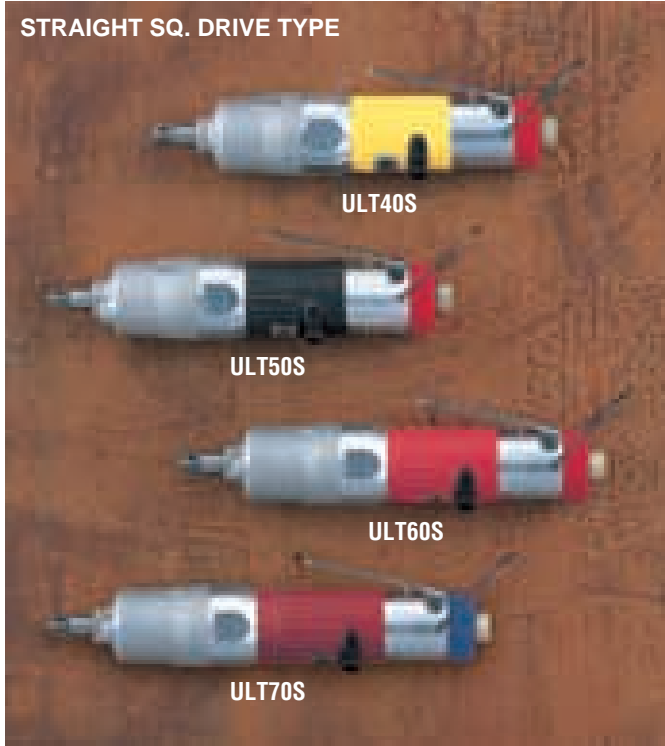

STRAIGHT HEX. SIZE TYPE

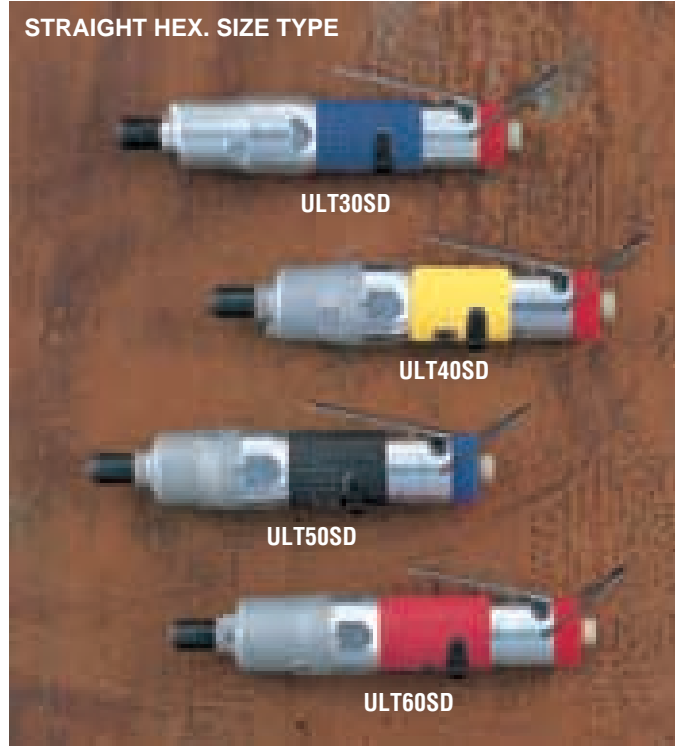

(Standard Type)

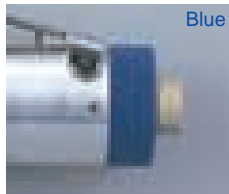

(Low Air Pressure Type)



SPECIFICATIONS

Recommend Air Pressure:0.4MPa(57psi)-0.6MPa(85psi)

Model	Capacity (Nominal Bolt Size)		Torque Range				Free Speed (Approx.) r.p.m.		Overall Length less Socket or Bit (about)		Weight less Socket or Bit (about)		From Center to Outside (about)		Sq. Drive or Hex. Size		Average Air Consumption		Noise Level	Vibra- tion Level
			0.4~0.5MPa		0.5~0.6MPa															
	mm	in	Nm	ft-lbs	Nm	ft-lbs	0.4MPa	0.6MPa	mm	in	kg	lb	mm	in	mm	in	m ³ /min	ft ³ /min	dB(A)	m/sec ²
ULT30SD	4-5	5/32-13/34	2.5-5.5	1.9-4.1	2.5-5.5	1.9-4.1	3300	3700	221	8 45/64	0.75	1.6	21.5	27/32	6.35	1/4	0.20	7.0	66	1.1
ULT40S	5	13/64	4.5-8.0	3.3-5.9	4.5-8.0	3.3-5.9	3200	3600	218	8 19/52	0.83	1.8	22.5	57/64	9.5	3/8	0.20	7.0	70	5.0
ULT40SD	5	13/64	4.5-8.0	3.3-5.9	4.5-8.0	3.3-5.9	3200	3600	221	8 11/16	0.83	1.8	22.5	57/64	6.35	1/4	0.20	7.0	70	5.0
ULT50S	6-8	1/4-5/16	-	-	7.0-15.5	5.2-11.5	-	4700	218	8 19/52	0.83	1.8	22.5	57/64	9.5	3/8	0.25	8.8	78	5.0
ULT50SD	6-8	1/4-5/16	-	-	7.0-15.5	5.2-11.5	-	4700	221	8 11/16	0.83	1.8	22.5	57/64	6.35	1/4	0.25	8.8	78	5.0
ULT60S	8	5/16	-	-	15-32	11.1-23.7	-	5400	229	9 1/64	0.87	1.9	22.5	57/64	9.5	3/8	0.30	10.5	80	6.0
ULT60SD	8	5/16	-	-	15-32	11.1-23.7	-	5400	232	9 9/64	0.87	1.9	22.5	57/64	6.35	1/4	0.30	10.5	80	6.0
ULT70S	8-10	5/16-3/8	-	-	30-50	22.2-37.0	-	4700	239	9 13/32	0.95	2.1	23.5	59/64	9.5	3/8	0.35	12.3	80	7.0
ULT50SL	6-8	1/4-5/16	7.0-15.5	5.2-11.5	-	-	4500	-	218	8 19/52	0.83	1.8	22.5	57/64	9.5	3/8	0.20	7.0	75	3.5
ULT50SDL	6-8	1/4-5/16	7.0-15.5	5.2-11.5	-	-	4500	-	221	8 11/16	0.83	1.8	22.5	57/64	6.35	1/4	0.20	7.0	75	3.5
ULT60SL	8	5/16	13-28	9.6-20.7	-	-	5000	-	229	9 1/64	0.87	1.9	22.5	57/64	9.5	3/8	0.25	8.8	77	4.0
ULT60SDL	8	5/16	13-28	9.6-20.7	-	-	5000	-	232	9 9/64	0.87	1.9	22.5	57/64	6.35	1/4	0.25	8.8	77	4.0
ULT70SL	8-10	5/16-3/8	25-45	18.5-33.3	-	-	4400	-	239	9 13/32	0.95	2.1	23.5	59/64	9.5	3/8	0.27	9.5	78	4.0
ULT30SPD	4-5	5/32-13/34	2.5-4.8	1.9-3.6	2.5-4.8	1.9-3.6	3000	3200	222	8 3/4	0.75	1.6	UNDER DEVELOPMENT		6.35	1/4	0.20	7.0	70	1.0
ULT40SP	5	13/64	4.5-8.0	3.3-5.9	4.5-8.0	3.3-5.9	3200	3600	219	8 5/8	0.80	1.8	UNDER DEVELOPMENT		9.5	3/8	0.20	7.0	70	1.0
ULT40SPD	5	13/64	4.5-8.0	3.3-5.9	4.5-8.0	3.3-5.9	3200	3600	222	8 3/4	0.80	1.8	UNDER DEVELOPMENT		6.35	1/4	0.20	7.0	70	1.0
ULT50SP	6-8	1/4-5/16	-	-	7.0-15.5	5.2-11.5	5000	219	8 5/8	0.80	1.8	UNDER DEVELOPMENT		9.5	3/8	0.25	8.8	78	5.0	
ULT50SPD	6-8	1/4-5/16	-	-	7.0-15.5	5.2-11.5	5000	222	8 3/4	0.80	1.8	UNDER DEVELOPMENT		6.35	1/4	0.25	8.8	78	5.0	
ULT60SP	8	5/16	-	-	15-32	11.1-23.7	5700	230	9 1/16	0.83	1.9	UNDER DEVELOPMENT		9.5	3/8	0.30	10.5	80	6.0	
ULT60SPD	8	5/16	-	-	15-32	11.1-23.7	5700	233	9 11/64	0.83	1.9	UNDER DEVELOPMENT		6.35	1/4	0.30	10.5	80	6.0	
ULT50C	6-8	1/4-5/16	-	-	7.0-15.5	5.2-11.5	4900	250	9 27/32	1.35	3.0	UNDER DEVELOPMENT		9.5	3/8	0.25	8.8	78	5.0	
ULT60C	8	5/16	-	-	15-32	11.1-23.7	5400	261	10 9/32	1.45	3.2	UNDER DEVELOPMENT		9.5	3/8	0.30	10.5	80	6.0	
ULT70C	8	5/16	-	-	20-35	14.8-25.9	4400	275	10 53/64	1.65	3.6	UNDER DEVELOPMENT		9.5	3/8	0.35	12.3	80	6.0	
ULT70CH	8-10	5/16-3/8	-	-	30-50	22.2-37.0	2500	290	11 27/64	1.85	4.1	UNDER DEVELOPMENT		12.7	1/2	0.35	12.3	80	6.0	

Air Inlet Size : N P.T. 1/4"

Air Hose Size : 10mm×6.5mm×5m for ULT30S~50S 12mm×8.0mm×5m for ULT60S~70S

UL SERIES OIL-PULSE TOOLS

UL series has the same features as ULT series, such as intensified sealing and roller blade. Furthermore, the oil pulse unit is the "one-piece construction", in which liner casing, liner and front liner plate are all in one piece, to reduce the weight.

Pulse Unit

CONVENTIONAL

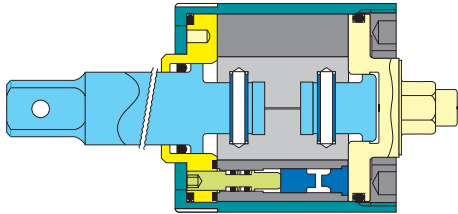

NEW

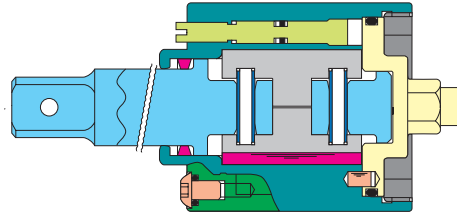

One-Piece-Component Pulse Unit

New Sealing
PAT.P

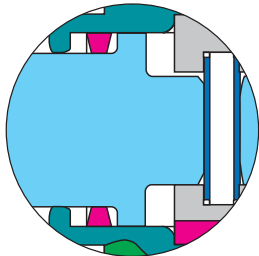

As a measure of the new sealing, a partition on the anvil and SU-Ring (PAT.P) are adopted. The partition walls off the direct high pressure from the liner front plate. And SU-Ring intensifies the gripping area of the liner front plate to avoid its rotation together with the anvil. It brings you a long durability.

Roller Blade
PAT.P

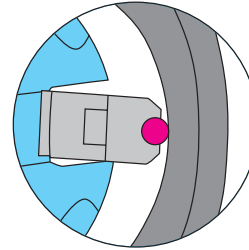

Newly adopted Roller Blades (Driving Blade with Roller Pin) (PAT.P) reduce the friction inside the pulse unit and improve the energy efficiency. Roller Blades also reduce the frictional wear of driving blades, which helps you to save the maintenance cost of driving blades.

MOTOR COMPARISON CROSS SECTION

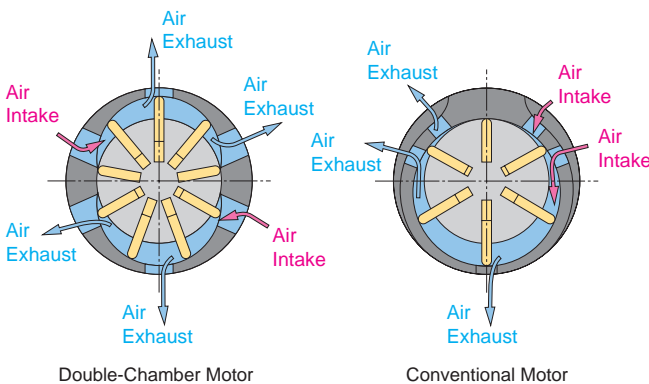

EFFICIENCY OF MOTOR UNDER LOAD

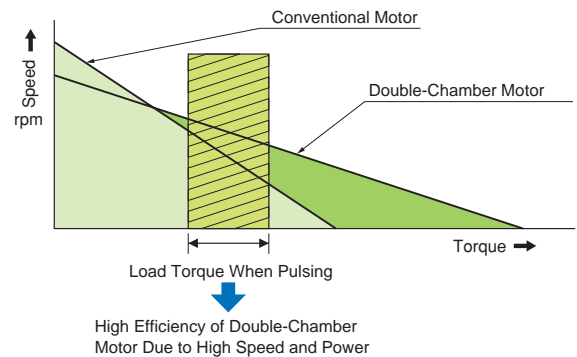

9-blade "Double-Chamber" motor creates super productivity on any joint rate. It provides efficiently slow free speed, compared with the same sized "Single-Chamber" motor. Bolt seating is performed very smoothly, and the torque spike caused by the spinning of the anvil is eliminated to the minimum level on the hard joint. Prevailing torque type joint is also overcome with the optimum cycle time by the effective motor power.

UL SERIES OIL-PULSE TOOLS

PISTOL TYPE



COMPARISON GRAPH

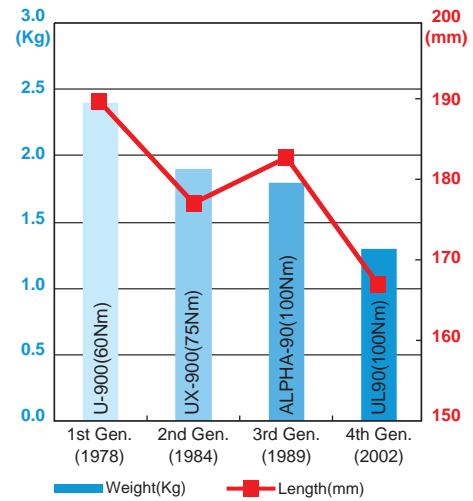

EASY TORQUE ADJUSTMENT

The torque output can be easily adjusted by turning Torque Adjuster through the plug hole or the anvil hole without dismantling the tool.

- ① Turn clockwise
Increase torque, decrease number of blows
- ② Turn anti-clockwise
Decrease torque, increase number of blows

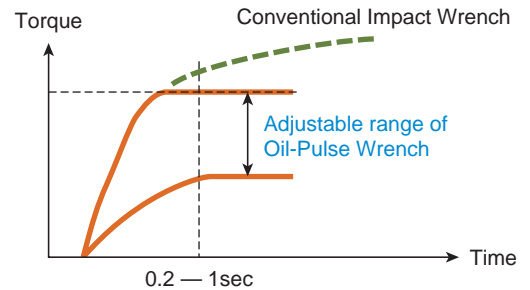

SPECIFICATIONS

Recommended Air Pressure: 0.5MPa(72psi)-0.6MPa(85psi)

Model	Capacity (Nominal Bolt Size)		Torque Range				Free Speed (Approx.) r.p.m.		Overall Length Less Socket or Bit (Approx.)		Weight less Socket or Bit (Approx.)		From Center to Outside (Approx.)		Sq. Drive or Hex. Size		Average Air Consumption		Noise Level	Vibration Level
			0.5MPa		0.6MPa															
	mm	in	Nm	ft-lbs	Nm	ft-lbs	0.5MPa	0.6MPa	mm	in	kg	lb	mm	in	mm	in	m ³ /min	ft ³ /min	dB(A)	m/sec ²
UL30	5	13/64	5.5-10.5	4.1-7.8	6-12	4.4-8.9	5400	5700	131	5 5/32	0.70	1.5	20.5	13/16	9.5	3/8	0.20	7.0	75	1.2
UL30D	5	13/64	5.5-10.5	4.1-7.8	6-12	4.4-8.9	5400	5700	135	5 5/16	0.70	1.5	20.5	13/16	6.35	1/4	0.20	7.0	75	1.2
UL40	5-6	13/64-1/4	11-20	8.1-14.8	13-22	9.6-16.3	5800	6100	131	5 5/32	0.70	1.5	20.5	13/16	9.5	3/8	0.20	7.0	75	1.2
UL40D	5-6	13/64-1/4	9-17	6.7-12.6	11-20	8.1-14.8	5800	6100	135	5 5/16	0.70	1.5	20.5	13/16	6.35	1/4	0.20	7.0	75	1.2
UL50	6-8	1/4-5/16	20-32	14.8-23.7	22-35	16.3-25.9	6100	6400	137	5 25/64	0.77	1.7	22.0	55/64	9.5	3/8	0.30	10.5	78	1.5
UL50D	6-8	1/4-5/16	16-25	11.8-18.5	18-28	13.3-20.7	6100	6400	144	5 43/64	0.77	1.7	22.0	55/64	6.35	1/4	0.30	10.5	78	2.3
UL50(TM)	6-8	1/4-5/16	-	-	22-35	16.3-25.9	6100	6400	137	5 25/64	0.77	1.7	22.0	55/64	9.5	3/8	0.30	10.5	78	1.5
UL50D(TM)	6-8	1/4-5/16	-	-	18-28	13.3-20.7	6100	6400	144	5 43/64	0.77	1.7	22.0	55/64	6.35	1/4	0.30	10.5	78	2.3
UL60	8	5/16	30-45	22.2-33.3	32-50	23.7-37.0	6700	7000	137	5 25/64	0.82	1.8	22.0	55/64	9.5	3/8	0.40	14.0	80	1.5
UL60D	8	5/16	20-32	14.8-23.7	22-35	16.3-25.9	6700	7000	142	5 19/32	0.82	1.8	22.0	55/64	6.35	1/4	0.40	14.0	80	2.3
UL60(TM)	8	5/16	-	-	32-50	23.7-37.0	6700	7000	143	5 5/8	0.82	1.8	22.0	55/64	9.5	3/8	0.40	14.0	80	1.5
UL60D(TM)	8	5/16	-	-	22-35	16.3-25.9	6700	7000	142	5 19/32	0.82	1.8	22.0	55/64	6.35	1/4	0.40	14.0	80	2.3
UL70	8-10	5/16-3/8	36-60	26.6-44.4	40-65	29.6-48.1	5400	5700	149	5 55/64	0.95	2.1	23.0	29/32	9.5	3/8	0.45	15.8	80	1.5
UL70(TM)	8-10	5/16-3/8	-	-	40-65	29.6-48.1	5400	5700	149	5 55/64	0.95	2.1	23.0	29/32	9.5	3/8	0.45	15.8	80	1.5
UL90	10-12	3/8-1/2	55-90	40.7-66.6	60-100	44.4-74.0	5700	6000	168	6 39/64	1.30	2.9	27.0	1 1/16	12.7	1/2	0.53	18.6	82	2.0
UL90(TM)	10-12	3/8-1/2	-	-	60-100	44.4-74.0	5700	6000	168	6 39/64	1.30	2.9	27.0	1 1/16	12.7	1/2	0.53	18.6	82	2.0

Air Inlet Size : N P.T.1/4"

Air Hose Size : 10mm×6.5mm×5m for UL30-50 12mm×8.0mm×5m for UL60-90

ALPHA SERIES OIL-PULSE TOOLS

ALPHA SERIES (STANDARD TYPE)



ALPHA's 9-blade "Double-Chamber" motor creates super productivity on any joint rate. It provides efficiently slow free speed, compared with the same sized "Single-Chamber" motor. Bolt seating is performed very smoothly, and the torque spike caused by the spinning of the anvil is eliminated to the minimum level on the hard joint. Prevailing torque type joint is also overcome with the optimum cycle time by the effective motor power.

ALPHA-T SERIES (SHUT-OFF TYPE)



This series combines the benefits of the ALPHA series with the quality benefit of improved tightening accuracy, regardless of joint rate and operator training level. This is accomplished by incorporating a pressure sensing shut-off mechanism with ALPHA series components.

PISTOL TYPE



ALPHA-T62MI/T62DMI



ERGONOMIC ADVANCEMENT

The ALPHA-T62MI/T62DMI is designed with MULTIPLE AIR INLET PORTS. Top, bottom and back inlets insure that the tool is always in the optimum position for operator comfort. Inefficient tool/hose combinations (FIG.1 & 2) are eliminated.

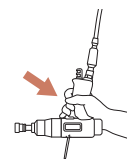

FIG.1

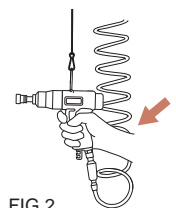

FIG.2

SPECIFICATIONS

Recommended Air Pressure: 0.6 MPa (85 psi)

Model	Capacity (Nominal Bolt Size)		Torque Range				Free Speed (Approx.) r.p.m.		Overall Length Less Socket or Bit (Approx.)		Weight less Socket or Bit (Approx.)		From Center to Outside (Approx.)		Sq. Drive or Hex. Size		Average Air Consumption		Noise Level	Vibration Level
			0.5MPa		0.6MPa															
	mm	in	Nm	ft-lbs	Nm	ft-lbs	0.5MPa	0.6MPa	mm	in	kg	lb	mm	in	mm	in	m ³ /min	ft ³ /min	dB(A)	m/sec ²
ALPHA-100	12	1/2	72-120	52.8-88.2	80-130	58.5-95.4	4500	4700	189	7 7/16	2.16	4.8	33.5	1 5/16	12.7	1/2	0.60	21.1	82	2.0
ALPHA-130	14	9/16	90-145	65.8-106.3	100-160	73.0-117.8	3250	3400	209	8 15/64	2.65	5.8	36.0	1 13/32	12.7	1/2	0.65	22.9	82	2.3
ALPHA-140	16	5/8	135-210	99.0-154.7	150-230	109.9-169.2	2900	3100	226	8 57/64	3.35	7.4	40.0	1 37/64	19.0	3/4	0.70	24.7	84	5.0
ALPHA-160	18	45/64	140-220	103.4-162.3	160-270	117.9-198.5	3500	3700	245	9 41/64	3.80	8.4	40.0	1 37/64	19.0	3/4	0.90	31.8	84	5.0
ALPHA-180	18-20	45/64-25/32	250-320	183.8-235.3	270-350	198.5-257.4	3300	3500	250	9 27/64	4.70	10.3	42.0	1 21/32	19.0	3/4	0.95	33.6	84	5.0
ALPHA-T62MI*	6-8	1/4-5/16	20-30	14.4-21.6	20-30	14.4-21.6	6600	7000	217	8 35/64	1.25	2.8	22.5	57/64	9.5	3/8	0.40	14.1	78	1.5
ALPHA-T62DMI*	6-8	1/4-5/16	15-25	11.1-18.4	15-25	11.1-18.4	6600	7000	222	8 1/32	1.25	2.8	22.5	57/64	6.35	1/4	0.40	14.1	78	1.5
ALPHA-T130	14	9/16	110-160	81.0-117.8	110-160	81.0-117.8	3400	3500	230	9 1/16	2.8	6.2	36.0	1 27/64	12.7	1/2	0.90	31.7	82	2.3
ALPHA-T140	16	5/8	140-210	102.7-154.7	140-210	102.7-154.7	2900	3100	246	9 11/16	3.5	7.7	40.0	1 37/64	19.0	3/4	1.00	35.3	84	3.2

*ALPHA-T62MI/T62DMI are multi inlet type.

Air Inlet Thread : N.P.T.1/4" for ALPHA-100 ~ ALPHA-140 & ALPHA-T62MI ~ ALPHA-T140 N.P.T.3/8 for ALPHA-160 & ALPHA-180

Air Hose Size : 12.7mm (1/2") for ALPHA-180 9.5mm (3/8") for other models

ALPHA SERIES OIL-PULSE TOOLS (SHUT-OFF TYPE)

STRAIGHT / ANGLE TYPE



ALPHA-T70CH

Head Sizes

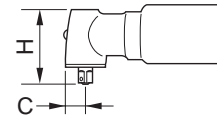

MODEL	C		H	
	mm	in	mm	in
ALPHA-T70C	18.0	45/64	70.0	2 3/4
ALPHA-T70CH	22.0	55/64	76.5	3 1/64

SPECIFICATIONS

Recommended Air Pressure:0.5MPa(72psi)-0.6MPa(85psi)

Model	Capacity (Nominal Bolt Size)		Torque Range		Free Speed (about) r.p.m.		Overall Length less Socket or Bit (about)		Weight less Socket or Bit (about)		From Center to Outside (about)		Sq. Drive or Hex. Size		Average Air Consumption		Noise Level dB(A)	Vibration Level m/sec ²
	mm	in	Nm	ft-lbs	0.5MPa	0.6MPa	mm	in	kg	lb	mm	in	mm	in	m ³ /min	ft ³ /min		
ALPHA-T42SPD *	4-5	No.8-10	4.8-7	3.6-5.2	3600	3900	246	9 11/16	0.93	2.0	22.5	57/64	6.35	1/4	0.20	7.0	70	1.5
ALPHA-T47SP *	5	No.10	6-11	4.4-8.1	5200	5500	243	9 11/16	0.93	2.0	22.5	57/64	9.5	3/8	0.25	8.8	75	1.5
ALPHA-T47SPD *	5	No.10	6-11	4.4-8.1	5200	5500	246	9 11/16	0.93	2.0	22.5	57/64	6.35	1/4	0.25	8.8	75	1.5
ALPHA-T70C	8	5/16	20-35	14.4-25.3	5800	6100	266	10 15/32	1.80	4.0	70.0**	2 1/32	9.5	3/8	0.45	15.8	82	22.4
ALPHA-T70CH	8-10	5/16-3/8	30-50	21.6-36.1	2900	3100	282	11 7/64	2.00	4.4	76.5**	3	12.7	1/2	0.45	15.8	82	22.4

*ALPHA-T42SPD/T47SP/T47SPD are push-to-start type.
**Angle Height

Air Inlet Thread : N P.T.1/4"
Air Hose Size : 6.35mm (1/4") for ALPHA-T42SD-ALPHA-T47SPD
9.5mm (3/8") for ALPHA-T70C-ALPHA-T70CH

ALPHA SERIES OIL-PULSE TOOLS

STRAIGHT / ANGLE TYPE

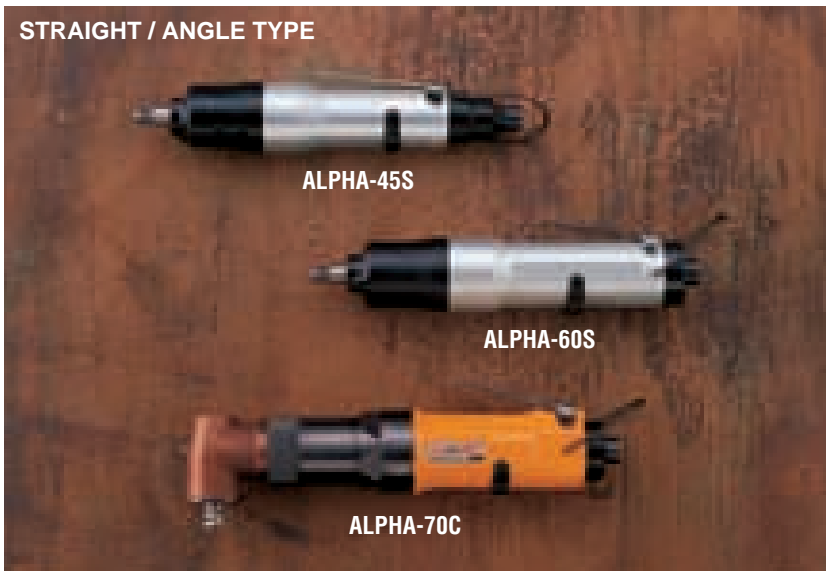

ALPHA-45S

ALPHA-60S

ALPHA-70C

Head Sizes

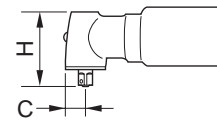

MODEL	C		H	
	mm	in	mm	in
ALPHA-70C	18.0	45/64	69.0	2 23/32
ALPHA-70CH	22.0	55/64	76.5	3 1/64

SPECIFICATIONS

Recommended Air Pressure:0.5MPa(72psi)-0.6MPa(85psi)

Model	Capacity (Nominal Bolt Size)		Torque Range				Free Speed (Approx.) r.p.m.		Overall Length (about)		Weight less Socket or Bit (about)		From Center to Outside (about)		Sq. Drive or Hex. Size		Average Air Consumption		Noise Level dB(A)	Vibration Level m/sec ²
	mm	in	0.5MPa		0.6MPa		0.5MPa	0.6MPa	mm	in	kg	lb	mm	in	mm	in	m ³ /min	ft ³ /min		
			Nm	ft-lbs	Nm	ft-lbs														
ALPHA-45S	5	No.10	16-25	11.5-18.0	18-27	13.0-19.5	5300	5500	238	9 3/8	0.86	1.8	22.0	55/64	9.5	3/8	0.25	8.8	75	1.5
ALPHA-45SD	5	No.10	12-19	8.6-13.7	13-20	9.4-14.4	5300	5500	243	9 9/16	0.86	1.8	22.0	55/64	6.35	1/4	0.25	8.8	75	1.5
ALPHA-50S	6-8	1/4-5/16	20-32	14.4-23.1	22-35	15.9-25.3	7000	7500	229	9 1/64	0.87	1.9	22.0	55/64	9.5	3/8	0.30	10.5	77	7.9
ALPHA-50SD	6-8	1/4-5/16	16-25	11.5-18.0	18-28	13.0-20.2	7000	7500	232	9 8/64	0.87	1.9	22.0	55/64	6.35	1/4	0.30	10.5	77	7.9
ALPHA-60S	8	5/16	30-45	21.6-32.5	32-50	23.1-36.1	6600	7000	241	9 31/64	0.93	2.0	22.5	57/64	9.5	3/8	0.45	15.8	78	7.9
ALPHA-60SD	8	5/16	20-32	14.4-23.1	22-35	15.9-25.3	6600	7000	244	9 39/64	0.93	2.0	22.5	57/64	6.35	1/4	0.45	15.8	78	7.9
ALPHA-70S	8-10	5/16-3/8	36-60	26.0-44.1	40-65	28.9-47.7	6000	6300	234	9 7/32	1.19	2.6	26.5	1 3/64	9.5	3/8	0.45	15.8	78	7.9
ALPHA-70C	8-10	5/16-3/8	25-40	18.0-28.9	28-45	20.2-32.5	6000	6300	266	10 15/32	1.77	3.9	69.0*	2 23/32	9.5	3/8	0.45	15.8	82	22.4
ALPHA-70CH	10-12	3/8-1/2	45-68	32.5-49.9	50-76	36.1-56.0	3400	3600	282	11 7/64	2.00	4.4	76.5*	3 1/64	12.7	1/2	0.45	15.8	82	22.4

Air Inlet Thread : N.P.T.1/4" * Angle Height
Air Hose Size : 6.35mm (1/4") for ALPHA-45S-ALPHA-50SD 9.5mm (3/8") for ALPHA-60S-ALPHA-70CH

GEARED HEAD SERIES OIL-PULSE TOOLS

These models are specially designed for user's request giving priority to productivity or workability rather than durability.

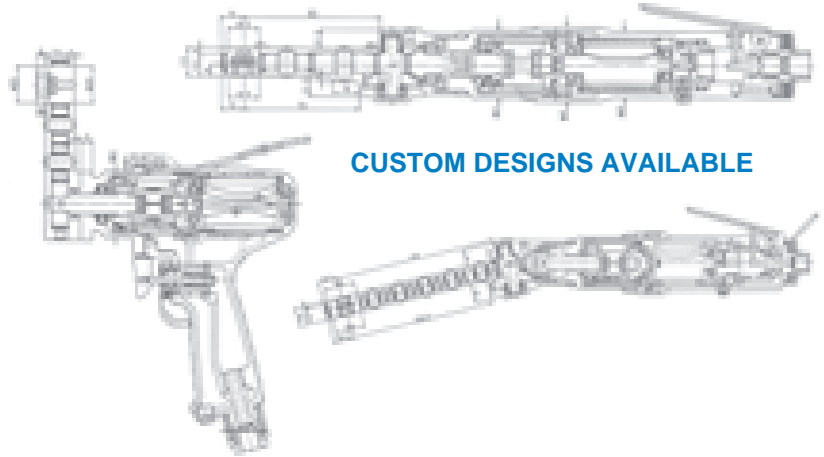

SPECIFICATIONS

Recommended Air Pressure 0.5MPa(72psi)-0.6MPa(85psi)

Model	Capacity (Nominal Bolt Size)		Torque Range				Free Speed (Approx.) r.p.m.		Overall Length (about)		Weight less Socket or Bit (about)		From Center to Outside (about)		Hex. Size of Gear Socket	Average Air Consumption		Noise Level	Vibration Level
			0.5MPa		0.6MPa														
	mm	in	Nm	ft-lbs	Nm	ft-lbs	0.5MPa	0.6MPa	mm	in	kg	lb	mm	in	mm	m³/min	ft³/min	dB(A)	m/sec²
ALPHA-61GS	8	5/16	20-32	14.4-23.1	22-35	15.9-25.3	3000	3200	316	12.7/16	1.50	3.3	16.0	5/8	12.0	1.50	52.5	80	-
ALPHA-61GA	8	5/16	20-32	14.4-23.1	22-35	15.9-25.3	3000	3200	313	12.5/16	1.50	3.3	16.0	5/8	12.0	1.50	52.5	80	-

Air Inlet Thread : N.P.T.1/4" Air Hose Size : 9.5mm (3/8")

OIL FILLER

The new UOF-2 eliminates troublesome process of oil-filling procedure repeated at previous model UOF-1 due to employment of the powerful vacuuming system.

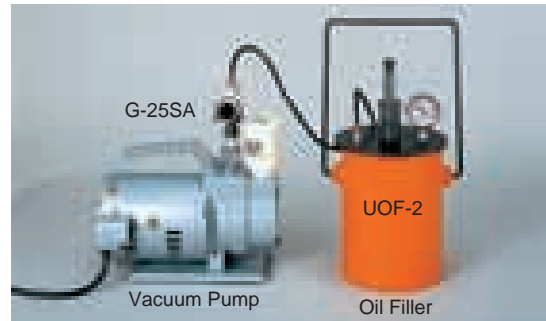

TORQUE, TENSION & CLAMP FORCE

Most joints are assembled to specifications that are determined by torque or tension (clamp load) requirements. Torque is torque regardless of the tool type used. Torque as a standard is force times distance. However, tension has completely different characteristics and behavior.

A tool applies torque to a fastener to achieve clamp force. On average, 10% of applied torque generates clamp force. The remaining 90% of applied torque distributes as thread and bearing surface friction.

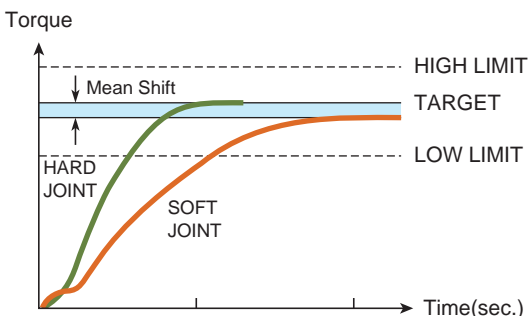
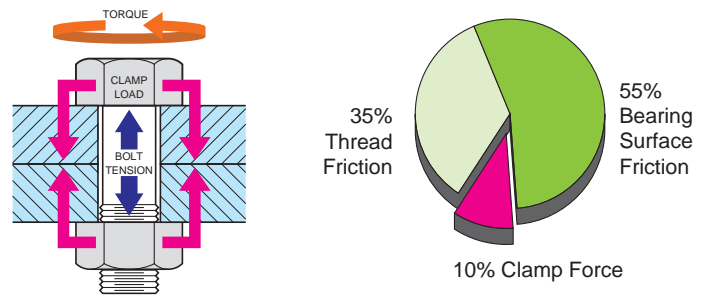

TORQUE TENSION OF OIL-PULSE TOOL

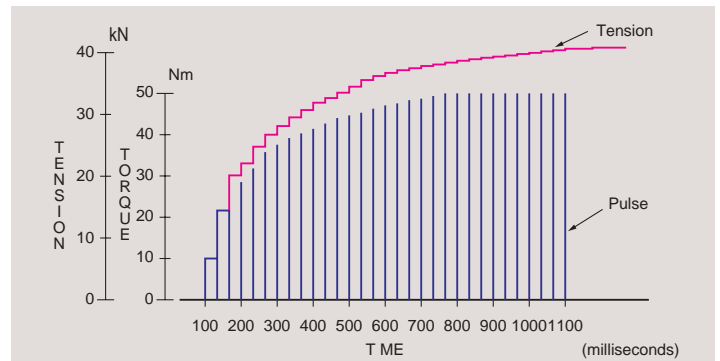

UX-T SERIES OIL-PULSE TOOLS (SHUT-OFF TYPE)

PISTOL / STRAIGHT TYPE



SHUT-OFF MECHANISM

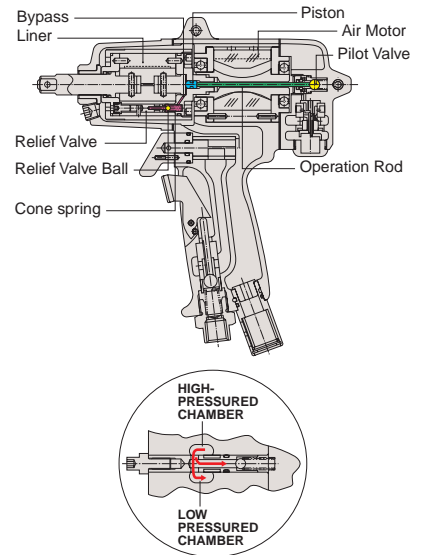

When the increase in oil pressure in the pulse unit overcomes the tension of Relief Valve Spring, the oil in the high-pressure chamber displaces the Relief Valve Ball and travels to the Piston via bypass.

The Piston displaced by oil moves the Operating Rod, which causes the Shut-off Valve Ball to be displaced via Pilot Valve. Immediately after the Pilot Valve opens, the Shut-off Valve gets closed and the tool shuts off.

SPECIFICATIONS

Recommended Air Pressure:0.6MPa(85psi)

Model	Capacity (Nominal Bolt Size)		Torque Range		Free Speed (about) r.p.m.		Overall Length less Socket or Bit (about)		Weight less Socket or Bit (about)		From Center to Outside (about)		Sq. Drive or Hex. Size		Average Air Consumption		Noise Level	Vibration Level
	mm	in	Nm	ft-lbs	0.5MPa	0.6MPa	mm	in	kg	lb	mm	in	mm	in	m ³ /min	ft ³ /min	dB(A)	m/sec ²
UX-T700L	6-8	1/4-5/16	13-26	10-19	7250	7500	187	7 23/64	1.46	3.21	25.5	1	9.5	3/8	0.30	10.5	72	0.7
UX-T700	8	5/16	20-38	15-28	7250	7500	187	7 23/64	1.46	3.21	25.5	1	9.5	3/8	0.30	10.5	72	0.7
UX-T800	8-10	5/16-3/8	30-45	22-33	8000	8300	196	7 23/32	1.80	3.96	28.0	1 7/64	9.5	3/8	0.35	12.3	75	1.0
UX-T900	8-10	5/16-3/8	35-70	25-50	6800	7000	202	7 15/16	2.00	4.40	30.0	1 3/16	12.7	1/2	0.45	16.0	75	1.7
UX-T1000	10-12	3/8-1/2	50-90	36-65	6550	6800	207	8 5/32	2.35	5.17	33.0	1 19/64	12.7	1/2	0.50	17.6	75	1.4
UX-T1300	12-14	1/2-35/64	70-130	50-94	6000	6200	225	8 57/64	2.80	6.16	36.0	1 27/64	12.7	1/2	0.55	19.4	77	1.3
UX-T1400	14	35/64	100-160	75-115	4900	5300	245	9 41/64	3.40	7.48	40.0	1 37/64	12.7	1/2	0.60	21.1	79	1.8
UX-T1620	14-16	35/64-5/8	120-210	87-150	4800	5000	260	10 15/64	3.70	8.14	40.0	1 37/64	19.0	3/4	0.65	22.9	82	2.3
UXR-T1820	16-18	5/8-45/64	150-250	110-180	4200	4400	270	10 5/8	4.50	9.90	42.0	1 21/32	19.0	3/4	0.70	24.7	84	3.2
UXR-T2000	18-20	45/64-25/32	200-400	150-290	3800	4000	303	11 15/16	6.80	14.96	47.0	1 27/32	19.0	3/4	0.95	34.0	85	3.2
UXR-T2400S	24	61/64	360-650	260-470	3400	3600	444	17 31/64	12.00	26.46	61.5	2 27/64	25.4	1	1.00	35.3	85	3.2
UXR-T3000S	30	1-3/16	450-850	330-620	4200	4400	477	18 25/32	14.50	31.97	62.0	2 7/16	25.4	1	1.05	37.1	85	3.2

Air Inlet Thread : N.P.T.1/4" for UX-T700L-UX-T1620 N.P.T.3/8" for UXR-T1820-UXR-T2000 N.P.T.1/2" for UXR-T2400S & UXR-T3000S

Air Hose Size : 9.5mm (3/8") for UX-T700L-UX-T1620 12.7mm (1/2") for UXR-T1820-UXR-T3000S

Inside Trigger is available for UXR-T2400S & UXR-T3000S

SPECIFICATIONS

Recommended Air Pressure:0.4MPa(57psi)

Model	Capacity (Nominal Bolt Size)		Torque Range		Free Speed (about) r.p.m.		Overall Length less Socket or Bit (about)		Weight less Socket or Bit (about)		From Center to Outside (about)		Sq. Drive or Hex. Size		Average Air Consumption		Noise Level	Vibration Level
	mm	in	Nm	ft-lbs	0.5MPa	0.6MPa	mm	in	kg	lb	mm	in	mm	in	m ³ /min	ft ³ /min	dB(A)	m/sec ²
UX-TL700	6-8	1/4-5/16	15-28	11.1-20.2	7500	7750	187	7 23/64	1.46	3.21	25.5	1	9.5	3/8	0.20	7.0	72	0.7
UX-TL800	8	5/16	20-32	14.4-23.1	7600	8000	196	7 23/32	1.80	3.96	28.0	1 7/64	9.5	3/8	0.25	8.8	75	1.0
UX-TL900	8-10	5/16-3/8	30-48	22-34.7	7000	7200	202	7 15/16	2.00	4.40	30.0	1 3/16	12.7	1/2	0.30	10.5	75	1.7
UX-TL1000	8-10	5/16-3/8	30-63	22-46.2	6300	6550	207	8 5/32	2.35	5.17	33.0	1 19/64	12.7	1/2	0.35	12.3	75	1.4
UX-TL1300	10-12	3/8-1/2	50-95	36-70	5700	6000	225	8 57/64	2.80	6.16	36.0	1 27/64	12.7	1/2	0.40	14.1	77	1.3
UX-TL1400	12-14	1/2-35/64	65-105	47.7-77.5	4500	4900	245	9 41/64	3.40	7.48	40.0	1 37/64	12.7	1/2	0.45	16.0	79	1.8
UX-TL1620	14	35/64	110-170	81-123	4500	4800	260	10 15/64	3.70	8.14	40.0	1 37/64	19.0	3/4	0.50	17.6	82	2.3
UXR-TL1820	14-16	35/64-5/8	120-200	87-150	4400	4600	270	10 5/8	4.50	9.90	42.0	1 21/32	19.0	3/4	0.50	17.6	84	3.2
UXR-TL2000	16-18	5/8-45/64	170-280	123-206	3900	4100	303	11 15/16	6.80	14.96	47.0	1 27/32	19.0	3/4	0.70	24.7	85	3.2

Air Inlet Thread : N.P.T.1/4" for UX-TL700-UX-TL1620 N.P.T.3/8" for UXR-TL1820-UXR-TL2000

Air Hose Size : 9.5mm (1/4") for UX-TL700-UX-TL1620 12.7mm (1/2") for UXR-TL1820 & UXR-TL2000

U·UX·UXR SERIES OIL-PULSE TOOLS

PISTOL TYPE



U-WRENCH

The "U-WRENCH" is a combination tool of a standard air motor and a hydraulic pulse unit utilizing one-blade impulsing mechanism.

The high speed rotation of the air motor increases the oil pressure quickly in the front pulse unit to deliver repeated hydraulic pulse powers to the anvil for bolt and nut fastening and loosening job.

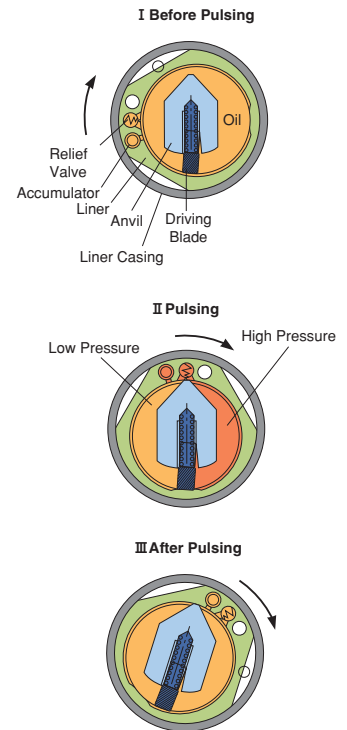

SPECIFICATIONS

Recommended Air Pressure: 0.6MPa(85psi)

Model	Capacity (Nominal Bolt Size)		Torque Range				Free Speed (Approx.) r.p.m.		Overall Length (about)		Weight less Socket or Bit (about)		From Center to Outside (about)		Sq. Drive or Hex. Size		Average Air Consumption		Noise Level		Vibration Level	
			0.5MPa		0.6MPa																	
	mm	in	Nm	ft-lbs	Nm	ft-lbs	0.5MPa	0.6MPa	mm	in	kg	lb	mm	in	mm	in	m ³ /min	ft ³ /min	dB(A)	m/sec ²		
U-350D	3-4	No.8	3.0-5.0	2.2-3.7	3.5-5.8	2.5-4.2	10000	10500	154	6 1/16	0.77	1.7	22.0	7/8	6.35	1/4	0.15	5.3	74	1.0		
U-410	4-5	No.8-No.10	6.0-8.5	4.4-6.3	7-10	5.0-7.2	10000	10500	177	7	1.00	2.2	22.0	7/8	9.5	3/8	0.15	5.3	70	1.4		
U-410D	4-5	No.8-No.10	6.0-8.5	4.4-6.3	7-10	5.0-7.2	10000	10500	188	7 13/32	1.00	2.2	22.0	7/8	6.35	1/4	0.15	5.3	70	1.4		
UX-450	5-6	No.10-1/4	7.7-13	5.7-9.6	9-15	6.5-11	9000	9500	147	5 25/32	0.85	1.9	22.0	7/8	9.5	3/8	0.20	7.0	65	1.0		
UX-450D	5	No.10	6.8-12	5.0-8.9	8-14	5.8-10	9000	9500	152	5 63/64	0.85	1.9	22.0	7/8	6.35	1/4	0.20	7.0	65	1.0		
UX-500	5-6	No.10-1/4	13-21	9.6-15.5	15-25	11-19	9000	9300	147	5 25/32	0.87	1.9	22.0	7/8	9.5	3/8	0.25	8.8	70	1.0		
UX-500D	5-6	No.10-1/4	11-17	8.1-12.5	13-20	10-15	9000	9300	152	5 63/64	0.87	1.9	22.0	7/8	6.35	1/4	0.25	8.8	70	1.0		
UX-612	6-8	1/4-5/16	17-30	12.5-22.1	20-35	15-25	9000	9300	160	6 5/16	0.95	2.1	22.5	7/8	9.5	3/8	0.32	11.2	75	1.0		
UX-612D	6-8	1/4-5/16	13.5-24	10.0-17.7	16-28	12-20	9000	9300	165	6 1/2	0.95	2.1	22.5	7/8	6.35	1/4	0.32	11.2	75	1.0		
UX-700	8	5/16	21-38	15.5-28.0	25-45	20-35	8700	9000	169	6 21/32	1.38	3.0	25.5	1	9.5	3/8	0.35	12.3	72	0.7		
UX-700D	8	5/16	17-31	12.5-22.9	20-36	16-28	8700	9000	174	6 27/32	1.38	3.0	25.5	1	6.35	1/4	0.35	12.3	72	0.7		
UX-800	8-10	5/16-3/8	30-51	22.1-37.6	35-60	25-45	8500	9000	175	6 7/8	1.70	3.7	28.0	1 7/64	9.5	3/8	0.40	14.1	75	1.0		
UX-900	10	3/8	38-64	28.0-47.2	45-75	35-55	7300	7600	181	7 1/8	1.88	4.1	30.0	1 3/16	12.7	1/2	0.42	14.7	75	1.7		
UX-1000	10-12	3/8-1/2	43-81	31.7-59.8	50-95	40-70	6500	6800	187	7 23/64	2.20	4.8	33.0	1 19/64	12.7	1/2	0.51	17.9	75	1.4		
UX-1300	12-14	1/2-9/16	68-110	50.2-81.2	80-130	60-95	5800	6200	205	8 5/64	2.70	5.9	36.0	1 27/64	12.7	1/2	0.55	19.4	77	1.3		
UX-1400	14	9/16	85-135	62.7-99.6	100-160	75-120	5000	5300	224	8 13/16	3.20	7.0	40.0	1 37/64	12.7	1/2	0.60	21.1	79	1.8		
UX-1620	14-16	9/16-5/8	100-160	73.8-118.1	120-190	90-140	4700	5000	241	9 1/2	3.60	7.9	40.0	1 37/64	19.0	3/4	0.65	22.9	82	2.3		
UXR-1820	16-18	5/8-45/64	135-215	99.6-158.7	160-250	120-185	4400	4600	242	9 17/32	4.10	9.0	42.0	1 21/32	19.0	3/4	0.75	26.3	84	3.2		
UXR-2000	18-20	45/64-25/32	255-385	188.2-284.1	300-450	220-330	4000	4200	282	11 3/32	6.50	14.3	47.0	1 27/32	19.0	3/4	0.90	31.5	85	3.2		

Air Inlet Thread : N P.T.1/4" for U-350D~UX-1620

N P.T 3/8" for UXR-1820 & UXR-2000

Air Hose Size : 6.35mm (1/4") for U-350D~UX-500D

9.5mm (3/8") for UX-612~UX-1620

12.7mm (1/2") for UXR-1820 & UXR-2000

U·UX·UXR SERIES OIL-PULSE TOOLS

STRAIGHT TYPE



UX Series

Torque Range : 9~190 Nm
6.5~140 ft-lbs

The UX series tools have twin Driving Blades in oil pulse unit and generate higher torque output with lighter weight (Better Power-to-Weight Ratio), which is furnished to UX-450 ~UX-1620 series.

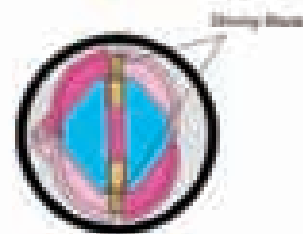

UXR Series

Torque Range : 160~800 Nm
120~580 ft-lbs

Rollers on Anvil in Liner are provided to have perfect contact between Anvil and Liner in UXR series. The patented technology is applied specially to larger tools such as UXR-1820~UXR-3000S.



SPECIFICATIONS

Recommended Air Pressure:0.6MPa(85psi)

Model	Capacity (Nominal Bolt Size)		Torque Range				Free Speed (Approx.) r.p.m.		Overall Length (about)		Weight less Socket or Bit (about)		From Center to Outside (about)		Sq. Drive or Hex. Size		Average Air Consumption		Noise Level	Vibration Level
			0.5MPa		0.6MPa															
	mm	in	Nm	ft-lbs	Nm	ft-lbs	0.5MPa	0.6MPa	mm	in	kg	lb	mm	in	mm	in	m³/min	ft³/min	dB(A)	m/sec²
U-310SD	3-4	No.8	2.1-2.6	1.6-1.9	2.5-3.1	1.8-2.2	10000	11000	222	8 45/64	0.62	1.5	18.0	47/64	6.35	1/4	0.15	5.3	74	1.8
U-350SD	3-4	No.8	3.0-5.0	2.2-3.7	3.5-5.8	2.5-4.2	10000	10500	238	9 3/8	0.71	1.5	22.0	47/64	6.36	1/4	0.15	5.3	74	1.8
U-410S	4-5	No.8-No.10	6.0-8.5	4.4-6.2	7-10	5.0-7.2	10000	10500	239	9 27/32	0.80	1.8	22.0	7/8	9.5	3/8	0.15	5.3	70	1.4
U-410SD	4-5	No.8-No.10	6.0-8.5	4.4-6.3	7-10	5.0-7.2	10000	10500	240	9 11/64	0.80	1.8	22.0	7/8	6.35	1/4	0.15	5.3	70	2.2
UX-450S	5-6	No.10	7.7-13	5.7-9.6	9-15	6.5-11	9000	9500	234	9 3/16	0.80	1.8	22.0	7/8	9.5	3/8	0.20	7.0	67	2.2
UX-450SD	5	No.10	6.8-12	5.0-8.8	8-14	5.8-10	9000	9500	239	9 11/64	0.80	1.8	22.0	7/8	6.35	1/4	0.20	7.0	67	2.2
UX-500S	5-6	No.10-1/4	13-21	9.6-15.5	15-25	11-19	9000	9300	239	9 13/32	0.92	2.0	22.0	7/8	9.35	3/8	0.25	8.8	70	2.2
UX-500SD	5-6	No.10-1/4	11-17	8.1-12.5	13-20	10-15	9000	9300	244	9 39/64	0.92	2.0	22.0	7/8	6.35	1/4	0.25	8.8	70	2.2
UX-612S	6-8	1/4-5/16	17-30	12.5-22	20-35	15-25	9000	9300	248	9 49/64	1.00	2.2	23.3	29/32	9.5	3/8	0.32	11.1	75	2.2
UX-612SD	6-8	1/4-5/16	13.5-24	10-17.7	16-28	12-20	9000	9300	253	9 61/64	1.00	2.2	23.3	29/32	6.35	1/4	0.32	11.1	75	2.2
UX-700S	8	5/16	21-38	15.5-28	25-45	20-35	8700	9000	244	9 39/64	1.27	2.8	26.5	13/64	9.5	3/8	0.35	12.3	78	2.2
UX-700SD	8	5/16	17-31	12.5-22.9	20-36	16-28	8700	9000	249	9 51/64	1.27	2.8	26.5	13/64	6.35	1/4	0.35	12.3	78	2.2
UX-800S	8-10	5/16-3/8	30-51	22-37.6	35-60	25-45	8500	9000	250	9 27/32	1.48	3.2	35.5	1	9.5	3/8	0.40	14.2	75	2.3
UX-900S	10	3/8	38-64	28-47.2	45-75	35-55	7300	7600	310	12 13/64	1.80	3.9	37.5	19/64	12.7	1/2	0.42	14.9	75	2.3
UX-1000S	10-12	3/8-1/2	43-81	31.7-59.8	50-95	40-70	6500	6800	320	12 19/32	2.10	4.6	39.0	1 17/64	12.7	1/2	0.51	17.9	75	2.7
UX-1300S	13-14	1/2-9/16	68-110	50.2-81.2	80-130	60-95	5800	6200	336	13 15/64	2.55	6.6	42.0	1 11/32	12.7	1/2	0.55	19.4	77	2.7
UXR-2000S	18-20	45/64-25/32	255-385	188-284	300-450	220-330	4000	4200	340	13 25/64	7.00	15.4	47.0	1 27/32	19.0	3/4	0.90	31.6	85	3.2
UXR-2400S	24	15/16	340-550	251-406	400-650	290-470	3700	4000	385	15 5/32	11.00	23.7	55.0	2 1/8	25.4	1	1.00	35.2	85	3.2
UXR-3000S	30	1-3/16	425-725	313-535	500-850	360-630	4200	4400	455	16 37/64	13.30	29.3	62.0	2 1/8	25.4	1	1.05	37.1	85	3.2

Air Inlet Size : N.P.T.1/4" for U-310SD~UX-1300S N.P.T.3/8" for UXR-2000S
N.P.T.1/2" for UXR-2400S~UXR-3000S

Air Hose Size : 6.35mm (1/4") for U-310SD~UX-500SD 9.5mm (3/8") for UX-612C~UX-1300S
12.7mm (1/2") for UXR-2000S~UXR-3000S

Inside Trigger is available for UXR-2000S~UXR-3000S

UX SERIES OIL-PULSE TOOLS

ANGLE TYPE



Head Sizes

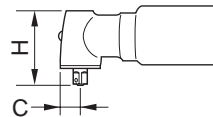

MODEL	C		H	
	mm	in	mm	in
UX-500C	15.0	19/32	59.5	2 11/32
UX-612C	16.0	5/8	59.5	2 11/32
UX-700C	16.0	5/8	62.0	2 7/16
UX-800C	18.0	45/64	70.0	2 3/4
UX-900C	18.0	45/64	70.0	2 3/4
UX-1000C	21.5	27/32	80.0	3 5/32

SPECIFICATIONS

Recommended Air Pressure: 0.6MPa(85psi)

Model	Capacity (Nominal Bolt Size)		Torque Range				Free Speed (Approx.) r.p.m.		Overall Length (about)		Weight less Socket or Bit (about)		Angle Height (about)		Sq. Drive or Hex. Size		Average Air Consumption		Noise Level	Vibration Level
			0.4MPa		0.6MPa		0.5MPa	0.6MPa	mm	in	kg	lb	mm	in	mm	in	m³/min	ft³/min	dB(A)	m/sec²
	mm	in	Nm	ft-lbs	Nm	ft-lbs														
UX-500C	5-6	No. 10-1/4	11-17	8.0-12.5	13-20	10.0-15.0	8800	9300	270	10 5/8	1.28	2.8	59.5	2 11/32	9.5	3/8	0.25	8.8	82	18.0
UX-612C	6	1/4	13.5-24	9.9-17.7	16-28	12.0-20.0	9300	9800	283	11 5/32	1.38	3.0	59.5	2 11/32	9.5	3/8	0.32	11.2	85	30.0
UX-700C	8	5/16	17-31	12.5-22.8	20-36	16.0-28.0	9000	9500	273	10 13/18	1.67	3.7	62.0	2 7/16	9.5	3/8	0.35	12.3	85	5.6
UX-800C	8-10	5/16-3/8	25-36	18.4-26.5	29-43	20.0-31.0	8500	9000	285	11 7/32	1.93	4.3	70.0	2 3/4	9.5	3/8	0.40	14.1	86	7.6
UX-900C	10	3/8	30-47	22.1-34.6	35-55	25.0-40.0	7300	7600	338	13 5/16	2.25	5.0	70.0	2 3/4	9.5	3/8	0.42	14.9	90	30.0
UX-1000C	10-12	3/8-1/2	43-68	31.7-50.1	50-80	40.0-58.0	6600	6800	365	14 23/64	3.05	6.8	80.0	2 5/32	12.7	1/2	0.51	17.9	90	10.0
UX-612A	6	1/4	13.5-24	9.9-17.7	16-28	12.0-20.0	9300	9800	297	11 11/16	1.38	3.0	-	-	9.5	3/8	0.30	10.5	85	30.0

Air Inlet size : N.P.T.1/4"

Air Hose Size : 6.35mm (1/4") for UX-500C 9.5mm (3/8") for UX-612C~UX-1000C

UX-ST SERIES OIL-PULSE TOOLS

PISTOL TYPE

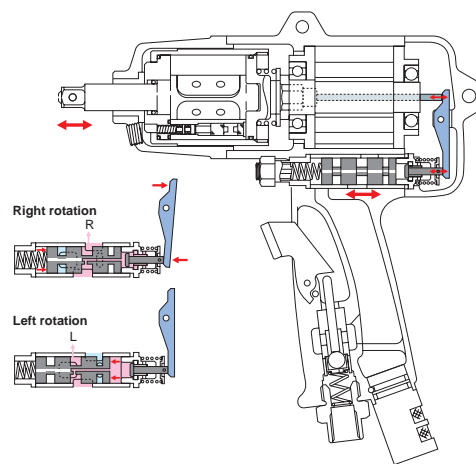

Auto-reversing mechanism

These unique Push-Pull type Oil-Pulse tools simplify stud-bolt driving job considerably without any special operation for frequent reversing. Push the tool forward to the work for driving and simply pull back for automatic reversing.

SPECIFICATIONS

Recommended Air Pressure: 0.6MPa(85psi)

Model	Capacity (Nominal Bolt Size)		Torque Range				Free Speed (Approx.) r.p.m.		Overall Length (about)		Weight less Socket or Bit (about)		From Center to Outside (about)		Sq. Drive or Hex. Size		Average Air Consumption		Noise Level	Vibration Level
			0.5MPa		0.6MPa		0.5MPa	0.6MPa	mm	in	kg	lb	mm	in	mm	in	m³/min	ft³/min	dB(A)	m/sec²
	mm	in	Nm	ft-lbs	Nm	ft-lbs														
UX-ST800	8-10	5/16-3/8	30-47	22-35	35-55	25-40	7000	7300	195	7 43/64	1.75	3.8	28.0	1 3/32	9.5	3/8	0.30	10.5	75	1.0
UX-ST1000	10-12	3/8-1/2	43-77	32-57	50-90	40-65	6000	6300	210	8 17/64	2.50	5.5	33.0	1 19/64	12.7	1/2	0.48	16.8	75	1.4

Air Inlet Size: N.P.T.1/4"

Air Hose Size: 9.5mm (3/8")

SUPER "INTELEC" UEC-4500 SYSTEM CONTROLLER

It is not easy to select the most suitable tool to meet with International Standards or customer's demand in the fastening process. **UEC-4500** is a light weight and compact designed multi-function Controller which conforms to various different fastening operations.

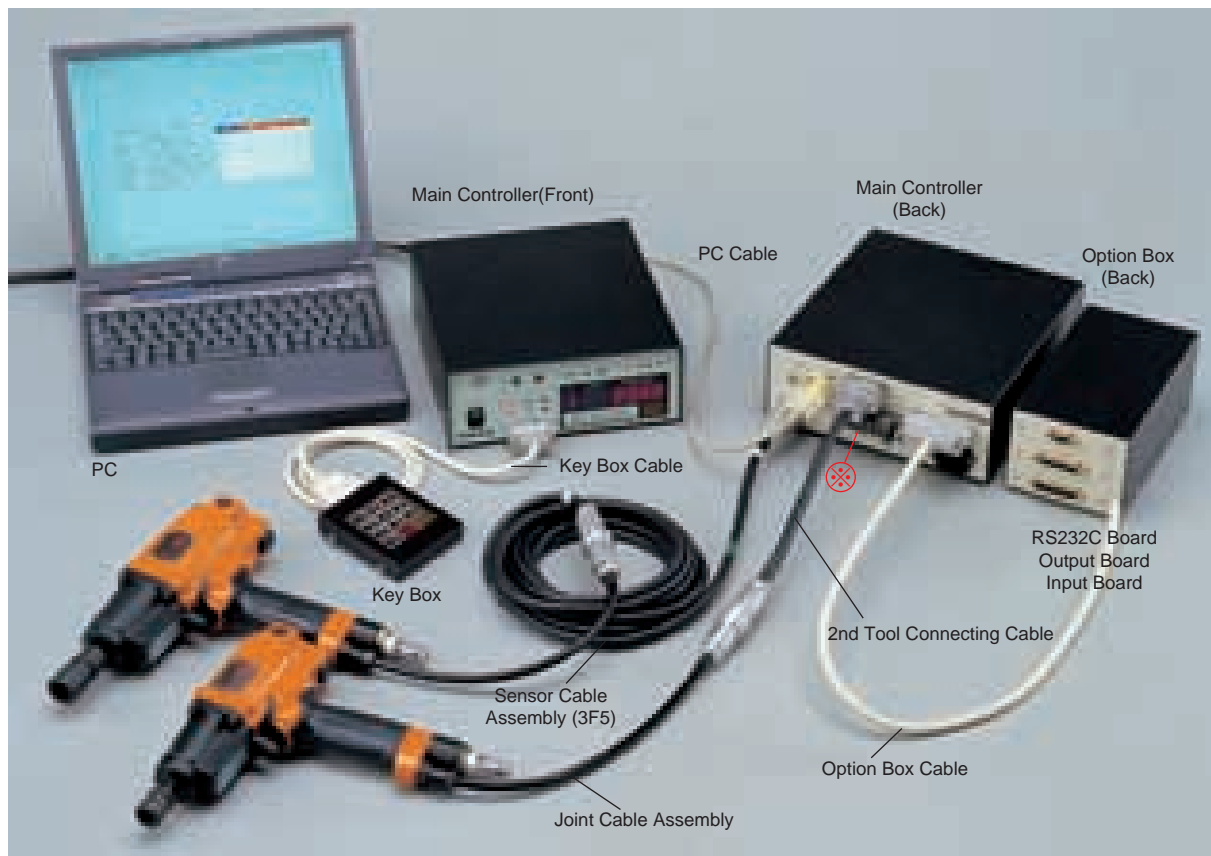

1. Easy Set-up Function !

The Controller set-up for the upper and lower limits and all the other settable parameters can be completed through the remote Key Box. Set-up of the Controller can also be done through a P.C. by using the optional Uryu standard control software, Windows 95 / 98 and XP operating systems. The Down loading of fastening data can also be achieved by using the optional RS-232C interface from the controller, a maximum of 10,000 readings per tool giving the Controller, a maximum capacity of 20,000 readings.

2. Controlling Two Tools simultaneously !

By adding a 2nd tool connecting board, the UEC-4500 has the capability of controlling two tools simultaneously regardless of the type of transducer fitted.

3. Torque Control !

As standard the Controller is capable of Ultra high-speed sampling. After reaching the required cut torque level the controller can be set to command the tool to carry out additional pulses then shut-off automatically. This enables the tool to have more accurate control with hard-joint conditions.

4. Statistical Data Analysis Function !

CP value, CPK value and standard deviations can be analyzed instantly from the stored data within the Controller, which contributes the Quality Control Process.

5. Interlock Software - Standardization !

Various interlock software, which is an optional function for conventional controllers until today, is employed as standard in the UEC-4500.

UEC-4500 SPECIFICATIONS

Power Supply	AC100 - 240V
Power Frequency	50/60 Hz
Noise Protection	1200V 1 μ S (depending on the noise simulator)
Insulation Protection	DC 500V over 10M Ω
Ambient Temperature	0 - 50 °C
Ambient Humidity	30 - 95%(noncondensing)
Power Consumption	Approx. 70VA
Dimensions	240(D)x222(W)x90(H)
Weight	Approx. 2.5Kg
Main Functions	Torque Monitor/Control Angle Monitor/Control Fastening Count Control
Parameter setup	Key box Personal Computer(with setup software)
Display	Torque resolution ±2048(12 Bit A/D) 1-Digit digital display (DPM) Display: Tool Number 2-Digit digital display (DPM) Display: Fastening Count Number 4-Digit digital display (DPM) Display: Torque/Angle Value
LED	Total Judgement: TOTAL OK(green) /NOK(red) Each tool fastening counter judgement: COUNTOK (green) /NOK(red) Each tool fastening judgement: OK(green) /LOW(yellow) /HIGH(red) Work NO.: 1,2,3,4(orange)
Input Terminal Signal	Operation voltage / Current: DC24V / Approx. 10mA LS1-1, START 1, RESET , 1K
Output Terminal Signal	Contact capacity: AC: 125V, 0.3A DC: 30V, 1A COUNT OK VALVE(DC24V) COUNT NOK OPTION OUTPUT (1 Spindle TORQUE OK)
Key Switch	[RESET] Key (front panel)

SUPER "INTELEC" UEC-4500 SYSTEM CONTROLLER

FRONT PANEL

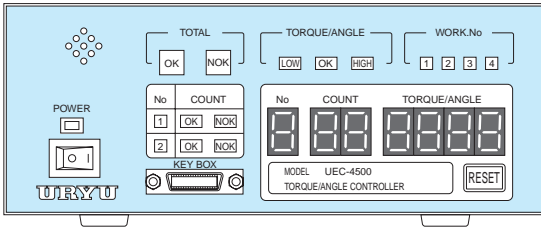

BACK PANEL

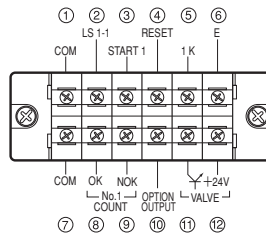

INPUT		OUTPUT	
①	COM:INPUT COMMON	⑦	COM:OUTPUT COMMON
②	LS 1-1	⑧	1 SP NDLE COUNT OK
③	START 1	⑨	1 SPINDLE COUNT NOK3
④	RESET	⑩	OPTION OUT
⑤	1K	⑪	VALVE 1
⑥	E: EARTH	⑫	VALVE COM(+)

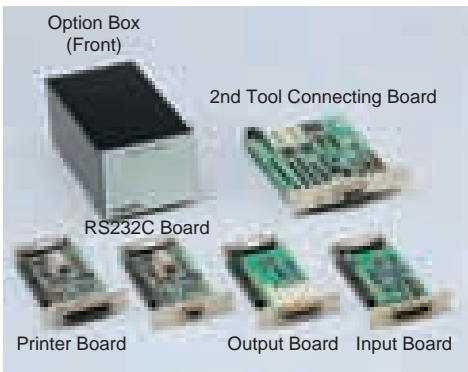

TIMING CHART

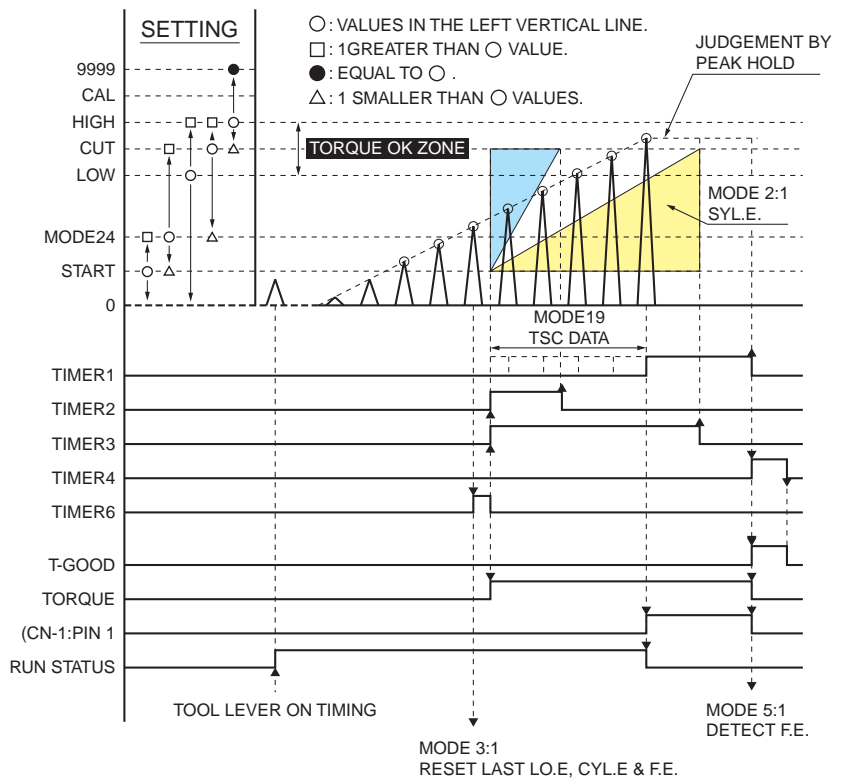

Model Name	Components	Q'ty
UEC-4500	Main Controller with AC Power Cable	1
UEC-4500-1STD	Main Controller with AC Power Cable	1
	Key Box (#910-208-0)	1
	Key Box Cable (#910-206-0)	1
	Sensor Cable Assy 3F5 (#909-921-0)	1
UEC-4500-2STD	Main Controller with AC Power Cable	1
	Key Box (#910-208-0)	1
	Key Box Cable (#910-206-0)	1
	Sensor Cable Assy 3F5 (#909-921-0)	2
	2nd Tool Connecting Board Cable (#910-215-0)	1
	2nd Tool Connecting Board (#910-201-0)	1

SYSTEM LAYOUT (Versatility for all types of Transducerized Tool Control)

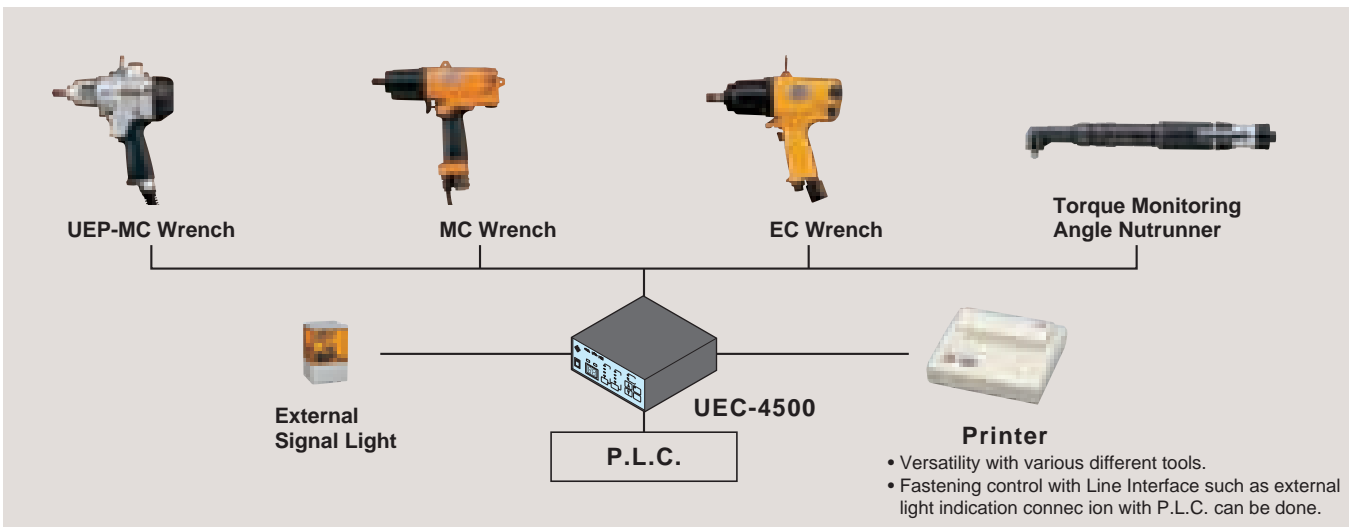

SUPER "INTELEC" SYSTEM UL-MC TOOLS

We have added the new range of Super Intelec System in combination with **UL-series** Air Motor and non-contact magnetostrictive type transducer. The main object to develop UL-MC series is to reduce the weight and length of the tool for operator's comfort by removing the built-in shut-off valve mechanism. As a result, we could succeed in reducing both the weight and the length by approx. 20% in comparison with conventional ALPHA-MC series tools.

PISTOL TYPE

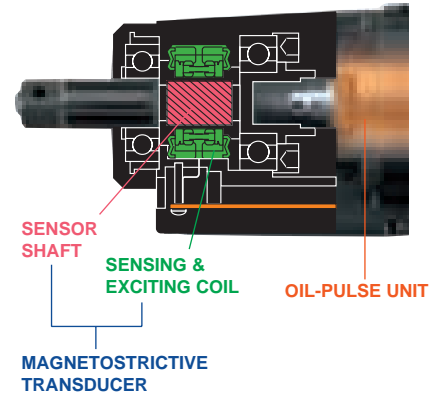

MAGNETOSTRICTIVE TRANSDUCER

Uryu's brushless Magnetostrictive Torque Transducer consists of Anvil and a pair of sensor coils. Without contacting to the Anvil, the sensor coil detects load given to the Anvil. (non-contact)
 The grooves in the Anvil are provided at ± 45 degree angle in two regions. When torque is applied to the Anvil, tensile stress appears on the region and magnet permeability increase.
 These permeability changes are detected, respectively transformed to the voltage change (proportional to applied torque) and converted to torque signals to control the tool.

SYSTEM LAYOUT

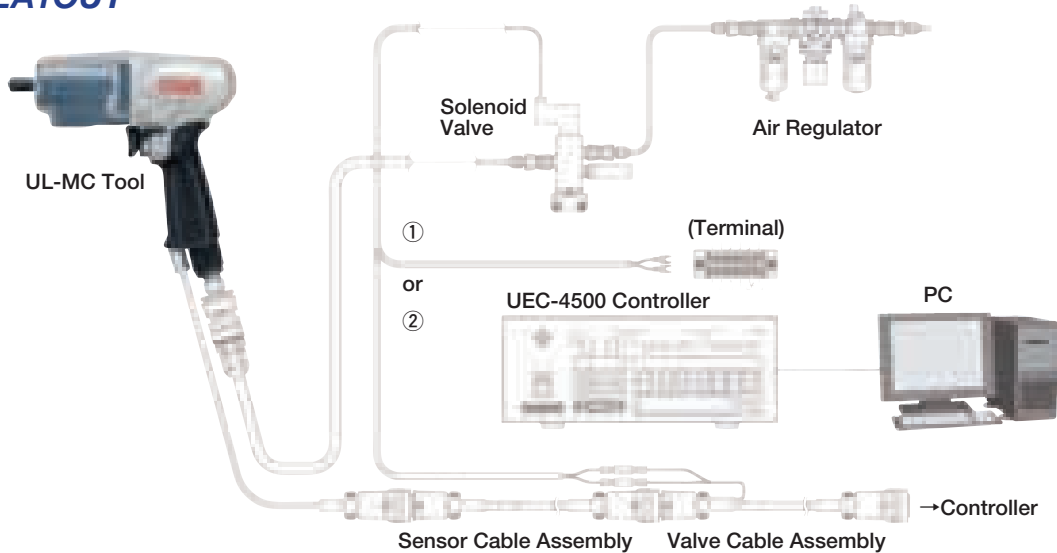

SPECIFICATIONS

Recommended Air Pressure: 0.5MPa(72psi)-0.6MPa(85psi)

Model	Capacity (Nominal Bolt Size)		Torque Range				Free Speed (Approx.) r.p.m.		Overall Length (about)		Weight less Socket or Bit (about)		From Center to Outside (about)		Sq. Drive or Hex. Size		Average Air Consumption		Noise Level	Vibration Level
			0.5MPa		0.6MPa															
	mm	in	Nm	ft-lbs	Nm	ft-lbs	0.5MPa	0.6MPa	mm	in	kg	lb	mm	in	mm	in	m ³ /min	ft ³ /min	dB(A)	m/sec ²
UL40MC	6	No.10	6-11	4.3-7.9	7.5-15	5.6-11.1	6200	6500	170.0	6 11/16	1.10	2.42	26.0	1 1/32	9.5	3/8	0.20	7.0	78	1.2
UL40DMC	6	No.10	6-11	4.3-7.9	7.5-15	5.6-11.1	6200	6500	169.5	6 43/64	1.10	2.42	26.0	1 1/32	6.35	1/4	0.20	7.0	78	1.2
UL50MC	6	No.10	12-25	8.9-18.5	20-35	14.8-25.9	6300	6700	175.0	6 57/64	1.10	2.42	26.0	1 1/32	9.5	3/8	0.25	8.8	78	1.5
UL60MC	8	5/16	20-40	14.8-29.6	30-50	22.2-37.0	6100	6600	175.0	6 57/64	1.14	2.51	26.0	1 1/32	9.5	3/8	0.40	14.0	80	1.5
UL70MC	8-10	5/16-3/8	25-50	18.5-37.0	36-65	26.6-48.1	5300	5700	187.0	7 23/64	1.24	2.73	26.0	1 1/32	9.5	3/8	0.45	15.8	80	1.5
UL90MC	10-12	3/8-1/2	40-80	29.6-59.2	55-100	40.7-74.0	5200	5500	203.0	7 63/64	1.70	3.74	28.0	1 3/16	12.7	1/2	0.58	20.3	82	2.0
UL100MC	12	1/2	70-110	51.8-81.4	85-130	62.9-96.2	4900	5200	215.0	8 15/32	2.05	4.51	30.0	1 27/64	12.7	1/2	0.55	19.3	82	2.0

Air Inlet size : N.P.T.1/4" Air Hose size : 6.35mm (1/4")

SUPER "INTELEC" SYSTEM EC & MC TOOLS

The **EC-Series** of URYU popular Oil-Pulse Tools are equipped with strain-gauged torque transducer on the geared Oil-Pulse Unit and are matched with the Electronic Control Unit, model UEC-4500. This system performs easily with strict control and monitoring of fastening torque and eliminates time consuming manual torque check for super quality control and higher productivity. Cautionary lamp and buzzer warn when fasteners are missed or insufficiently fastened.

SPECIFICATIONS

Recommended Air Pressure: 0.5MPa(72psi)-0.6MPa(85psi)

Model	Capacity (Nominal Bolt Size)		Torque Range				Free Speed (Approx.) r.p.m.		Overall Length (about)		Weight less Socket or Bit (about)		From Center to Outside (about)		Sq. Drive or Hex. Size		Average Air Consumption		Noise Level	Vibration Level
			0.5MPa		0.6MPa		0.5MPa	0.6MPa												
	mm	in	Nm	ft-lbs	Nm	ft-lbs	mm	in	kg	lb	mm	in	mm	in	m ³ /min	ft ³ /min	dB(A)	m/sec ²		
U-50EC	6	No.10	4-10	2.9-7.4	5-11	3.7-8.1	2000	2100	195	7 64/64	1.50	3.31	24.0	1 1/32	9.5	3/8	0.25	8.8	72	3.0
U-50DEC	6	No.10	4-10	2.9-7.4	5-11	3.7-8.1	2000	2100	201	7 15/16	1.50	3.31	24.0	1 1/32	6.35	1/4	0.25	8.8	72	3.0
U-60EC	6	No.10	10-25	7.4-18.4	15-30	11.1-22.1	1800	1900	193	7 19/32	1.57	3.46	27.0	1 1/16	9.5	3/8	0.35	12.3	75	6.0
U-60DEC	6	No.10	10-25	7.4-18.4	15-30	11.1-22.1	1800	1900	198	7 51/64	1.57	3.46	27.0	1 1/16	9.5	3/8	0.35	12.3	75	6.0
UX-80EC	8	5/16-3/8	15-40	18.4-29.5	20-45	14.7-33.2	1700	1800	196	7 3/4	1.80	3.97	30.0	1 3/16	9.5	3/8	0.45	15.8	77	5.0
U-100EC	10	25/64	40-70	29.5-51.6	50-80	36.9-59.0	1500	1600	233	8 11/64	2.80	6.17	33.0	1 19/64	12.7	1/2	0.65	22.9	78	10.0
UX-120EC	12	1/2	-	-	-	-	-	-	255	9 61/64	3.90	8.60	36.0	1 27/64	12.7	1/2	0.80	28.2	80	15.0
UX-130EC	12	1/2	80-150	59.0-110.2	90-170	66.1-125.4	1050	1250	273	10 3/4	4.70	10.37	40.0	1 9/16	12.7	1/2	1.00	35.0	80	20.0
U-50SEC*	6	No.10	4-10	2.9-7.4	5-11	3.7-8.1	2000	2100	280	11 11/64	1.55	3.42	21.0	53/64	9.5	3/8	0.22	7.7	72	43.0
U-50SDEC*	6	No.10	4-10	2.9-7.4	5-11	3.7-8.1	2000	2100	288	11 11/32	1.55	3.42	21.0	53/64	6.35	1/4	0.22	7.7	72	43.0
U-60SEC	6	No.10	10-20	7.4-19.1	15-25	11.1-18.4	1800	1900	305	12	2.00	4.41	27.0	1 1/16	9.5	3/8	0.35	12.3	75	55.0

*External Solenoid Valve is required. Air Inlet Size : N.P.T.1/4" Air Hose Size : 9.5mm (3/8")

UX-120EC has to be used at about 0.35MPa (50psi) - 0.40MPa (57psi) The Torque Range : 65 - 120Nm The Free Speed : 900 r.p.m.

PISTOL / STRAIGHT TYPE



PISTOL / STRAIGHT TYPE



The **MC-series** combines the benefits of the ALPHA Series with the quality and reliability benefits of a Good or No Good judgement, based on torque, after each tightening. This is accomplished by incorporating brushless Magnetostrictive transducer, solenoid valve, electronic control unit, and indicator lights with ALPHA Series components.

SPECIFICATIONS

Recommended Air Pressure: 0.5MPa(72psi)-0.6MPa(85psi)

Model	Capacity (Nominal Bolt Size)		Torque Range				Free Speed (Approx.) r.p.m.		Overall Length (about)		Weight less Socket or Bit (about)		From Center to Outside (about)		Sq. Drive or Hex. Size		Average Air Consumption		Noise Level	Vibration Level
			0.5MPa		0.6MPa		0.5MPa	0.6MPa												
	mm	in	Nm	ft-lbs	Nm	ft-lbs	mm	in	kg	lb	mm	in	mm	in	m ³ /min	ft ³ /min	dB(A)	m/sec ²		
ALPHA-60MC	6	1/4	9-15	6.5-10.8	10-20	7.2-14.4	6800	7000	215	8 5/54	1.40	3.1	25.5	1	9.5	3/8	0.25	8.8	75	1.0
ALPHA-60DMC	6	1/4	9-15	6.5-10.8	10-20	7.2-14.4	6800	7000	215	11 1/32	1.40	3.1	25.5	1	6.35	1/4	0.25	8.8	75	1.0
ALPHA-60SMC*	6	1/4	9-15	6.5-10.8	10-17	7.2-14.4	6000	6300	280	8 5/54	1.40	2.6	25.5	1	9.5	3/8	0.25	8.8	75	1.0
ALPHA-70MC	8	1/4-5/16	12.5-25	8.6-18.0	15-30	10.8-21.6	6800	7300	215	8 5/54	1.35	3.1	25.5	1	9.5	3/8	0.25	8.8	75	1.0
ALPHA-80MC	8	5/16	16-30	11.5-21.6	20-40	14.4-28.9	6800	7000	231	8 21/32	1.50	3.3	25.5	1	9.5	3/8	0.45	15.8	78	1.5
ALPHA-90MC	8-10	5/16-3/8	20-40	14.4-28.9	30-47	21.6-33.9	6000	6500	231	8 21/32	1.50	3.3	25.5	1 7/64	9.5	3/8	0.45	15.8	78	1.5
ALPHA-101MC	10	3/8	34-58	24.5-42.6	38-70	27.4-51.3	6000	6200	243	9 11/64	2.10	4.6	28.0	1 3/16	12.7	1/2	0.50	17.6	80	1.5
ALPHA-110MC	12	3/8-1/2	45-75	32.5-54.9	55-100	40.5-72.3	4500	5000	250	9 51/64	2.50	5.6	30.0	1 27/64	12.7	1/2	0.65	22.9	80	1.5
ALPHA-130MC	14	9/16	80-130	58.5-95.4	90-150	65.8-109.9	3200	3400	276	10 15/32	3.50	7.7	36.0	1 21/32	12.7	1/2	0.65	22.9	82	2.3
ALPHA-140MC	16	5/8	140-200	103.4-147.6	150-220	110.7-162.0	3300	3500	295	11 5/8	4.63	10.2	40.0	1 37/64	19.0	3/4	0.80	28.3	84.5	4.5
UXR-1820MC	18	45/64	140-220	102.7-162.0	160-250	117.8-183.7	4400	4600	322	12 43/64	5.50	12.3	42.0	1 21/32	19.0	3/4	0.70	24.7	84	3.2
UXR-2000MC	20	25/32	200-350	147.6-258.2	250-400	184.4-295.1	4600	4800	355	13 31/64	8.00	17.6	47.0	1 21/32	19.0	3/4	0.95	33.6	85	3.2
UXR-2400SMC	24	15/16	300-550	221.3-405.8	350-600	258.2-442.7	3100	3300	457	16 3/8	12.5	27.6	55.0	1 11/64	25.4	1	1.00	35.3	85	3.2

*External Solenoid Valve is required. Inside Trigger is available for UXR-2400SMC

Air Inlet size : N.P.T.1/4" for ALPHA-50MC-ALPHA-140MC N.P.T.3/8" for UXR-1820MC & UXR-2000MC N.P.T.1/2" for UXR-2400MC

Air Hose size : 6.35mm (1/4") for ALPHA-50MC & ALPHA-50DMC 9.5mm (3/8") for ALPHA-60MC-ALPHA-140MC 12.7mm (1/2") for UXR-1820MC-UXR-2400MC

BOLT & NUT SETTERS

ELECTRIC OIL-PULSE TOOLS

The newly developed "UEP WRENCH" is a combination tool of the unique hydraulic pulse unit and the brushless electric motor utilized as a driving source taking environmental problem into consideration and displays "GOOD" or "NG" on LED by connecting with UEPD Driver. UEP-MC WRENCH is additionally incorporated the Magnetostrictive transducer designed to precisely measure dynamic torque of Oil-Pulse Tool and displays "Torque Value" and "Fastening Count-Down" by connecting with UEC-4500 Controller through UEPD Driver. With the more amazing features than typical Oil-Pulse Tool, UEP Electric Oil-Pulse Wrenches are ideal for continuous heavy production as the Ultimate fastening tools employing ergonomic design (low noise, low vibration, low torque reaction) for minimum operator fatigue.

BOLT & NUT SETTERS

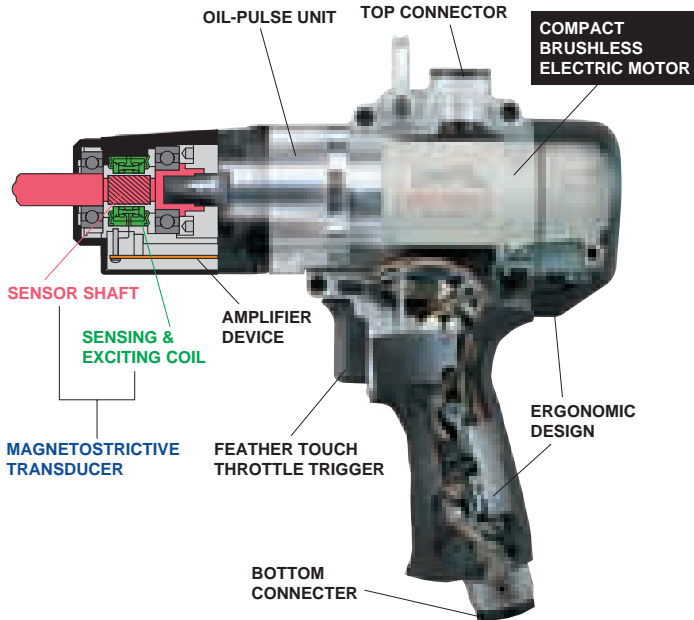

The main features :

1. Since using the normal common power supply (AC100V - 230V), the line-layout of production site can be easily designed with flexible usage.
2. Single cable connection between the tool and driver is used to improve the working condition for the operator. Power cable can be connected either on the top or bottom (handle grip) of the tool.
3. Using the brushless electric motor, the electric noise from the brush is eliminated and both noise and vibration level has been reduced. The global cost reduction can be expected thanks to "maintenance free" Electric Motor.
4. Based on our long experience of Oil Pulse technology, newly developed "one-piece construction" Oil Pulse Unit is employed for consistent torque operation.
5. Compact handle grip is used for the maximum comfort for the operator with a feather touch throttle trigger.
6. The function of driver is minimized, but it still has capability to connect with some peripheral devices such as bolt fastening device (UTM-1100) and torque controller (UEC-4500).
7. Automatic power cut down device is employed against the abnormalities such as over loaded operation, electric leakage, cable damage and etc.

DRIVER Front Panel

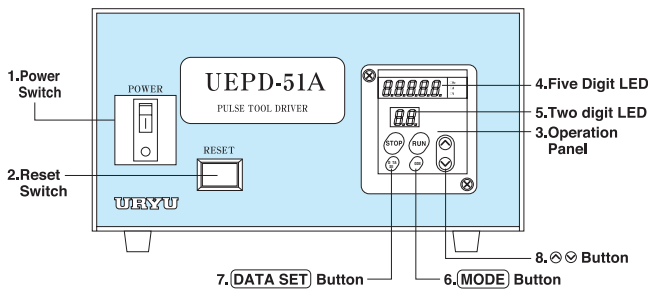

DRIVER Rear Panel

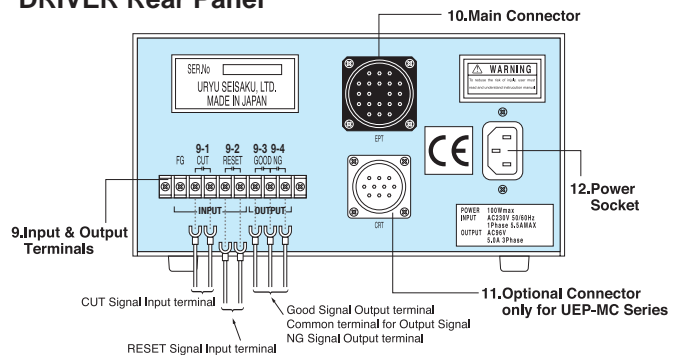

SPECIFICATIONS

Model	UEP Model	Dimensions (WxDxH)	Weight	Frequency	Voltage	Rated Power
UEPD-51A/E	UEP-50 Series	222(8 45/64)×265(10 7/16)×143(5 5/8)	3.2Kg (7.1lb)	50Hz/60Hz	115V/230V	3.7A
UEPD-61A/E	UEP-60 Series	222(8 45/64)×265(10 7/16)×143(5 5/8)	3.2Kg (7.1lb)	50Hz/60Hz	115V/230V	8.0A
UEPD-71A/E	UEP-70/80 Series	222(8 45/64)×265(10 7/16)×143(5 5/8)	3.2Kg (7.1lb)	50Hz/60Hz	115V/230V	8.8A
UEPD-101A/E	UEP-100 Series	222(8 45/64)×265(10 7/10)×158(6 7/32)	7.0Kg (15.4lb)	50Hz/60Hz	115V/230V	8.4A

Operation Temperature : 10°C ~ 50°C (No Freeze)

Operation Humidity : Less than 85%RH (No Dew)

ELECTRIC OIL-PULSE TOOLS

PISTOL TYPE

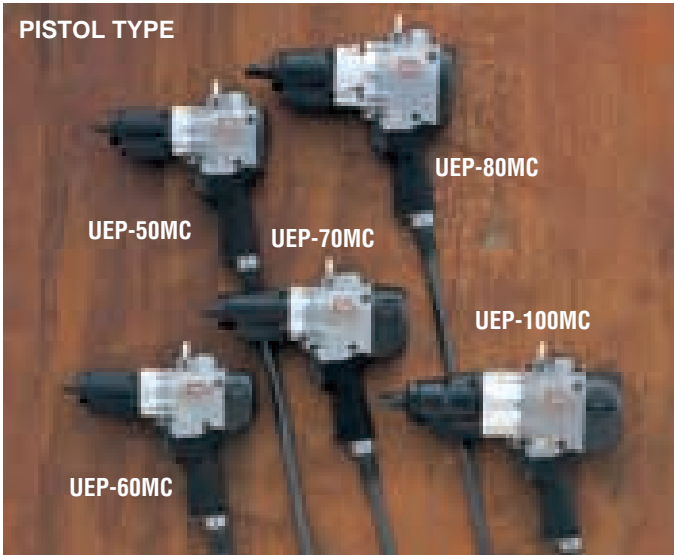

After connecting with UEPD Driver as below ;

1. Select "0" (Time Control) on MODE 04 setting
2. Set fastening time from 0 to 5.0 second
3. Tool shuts off at preset time after bolt-seating
4. Digital display of "GOOD" or "NG" on LED
5. Measure static torque by torque wrench

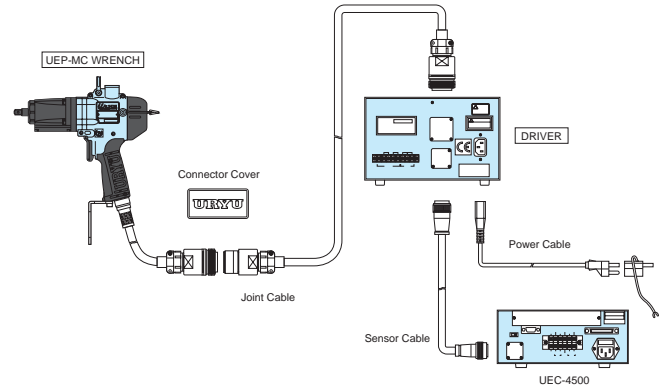

SPECIFICATIONS (UEP-MC TORQUE CONTROL)

Model	Capacity (Nominal Bolt Size)		Torque range		Free Speed (Approx.)	Overall Length (about)		Weight less Socket or Bit (about)		From Center to Outside (about)		Sq. Drive or Hex. Size		Noise Level	Vibration Level
	mm	in	Nm	ft-lbs	r.p.m.	mm	in	kg	lb	mm	in	mm	in	dB(A)	m/sec ²
UEP-50MC	5	No. 10	5-10	3.7-7.4	2000	200.0	7 7/8	1.83	4.03	25	63/64	9.5	3/8	70.0	0.70
UEP-50DMC	5	No. 10	5-10	3.7-7.4	2000	199.5	7 55/64	1.83	4.03	25	63/64	6.35	1/4	70.0	0.70
UEP-60MC	6	1/4	10-25	7.4-18.5	2000	222.5	8 49/64	2.13	4.69	25	63/64	9.5	3/8	70.0	1.00
UEP-60DMC	6	1/4	10-25	7.4-18.5	2000	222.0	8 47/64	2.13	4.69	25	63/64	6.35	1/4	70.0	1.00
UEP-70MC	8	5/16	25-40	18.5-29.6	2000	238.0	8 3/8	2.38	5.24	31	1 7/32	9.5	3/8	72.0	1.41
UEP-80MC	8-10	5/16-3/8	30-60	22.2-44.4	2000	237.5	8 23/64	3.01	6.62	36.5	1 7/16	12.7	1/2	75.0	1.58
UEP-100MC	10-12	3/8-1/2	60-120	44.4-88.8	2000	276.0	9 55/64	4.16	9.15	36.5	1 7/16	12.7	1/2	75.0	2.24

PISTOL TYPE

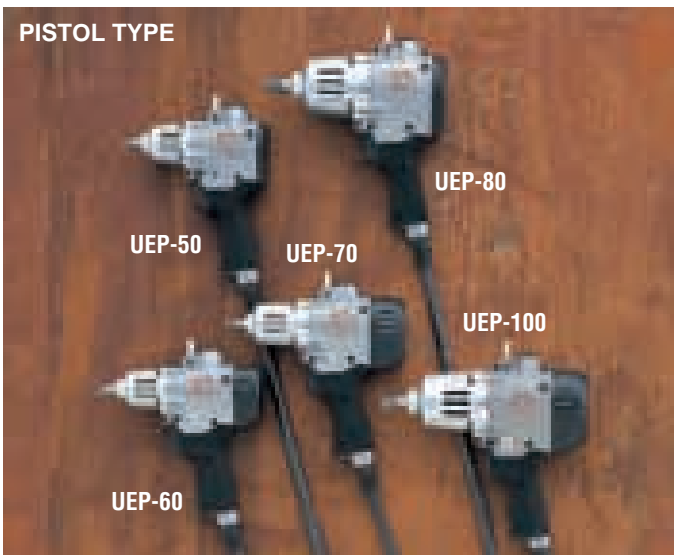

After connecting with below devices;

1. Select "2" (External Control) on MODE 04 setting
2. Set each MODE following UEC-4500 Inst/Manual
3. Tool stops immediately at preset "Cut Torque"
4. Display of dynamic torque or fastening count-down
5. Data collection of tightening torque through PC

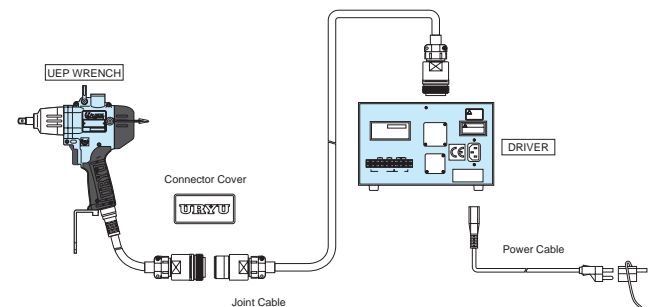

SPECIFICATIONS (UEP TIME CONTROL)

Model	Capacity (Nominal Bolt Size)		Torque range		Free Speed (Approx.)	Overall Length (about)		Weight less Socket or Bit (about)		From Center to Outside (about)		Sq. Drive or Hex. Size		Noise Level	Vibration Level
	mm	in	Nm	ft-lbs	r.p.m.	mm	in	kg	lb	mm	in	mm	in	dB(A)	m/sec ²
UEP-50	5	No. 10	5-10	3.7-7.4	2000	166.0	6 35/64	1.43	3.15	25	63/64	9.5	3/8	70.0	0.70
UEP-50D	5	No. 10	5-10	3.7-7.4	2000	171.0	6 49/64	1.43	3.15	25	63/64	6.35	1/4	70.0	0.70
UEP-60	6	1/4	10-25	7.4-18.5	2000	188.0	7 13/32	1.76	3.87	25	63/64	9.5	3/8	70.0	1.00
UEP-60D	6	1/4	10-25	7.4-18.5	2000	193.0	7 39/64	1.76	3.87	25	63/64	6.35	1/4	70.0	1.00
UEP-70	8	5/16	25-40	18.5-29.6	2000	203.5	8 1/64	2.2	4.84	31	1 7/32	9.5	3/8	72.0	1.41
UEP-80	8-10	5/16-3/8	30-60	22.2-44.4	2000	202.0	7 61/64	2.73	6.01	36.5	1 7/16	12.7	1/2	75.0	1.58
UEP-100	10-12	3/8-1/2	60-120	44.4-88.8	2000	233.5	8 13/64	3.66	8.05	36.5	1 7/16	12.7	1/2	75.0	2.24

BATTERY OIL-PULSE TOOLS

UBP-T series 12V Battery Powered Oil-Pulse Tool offer the most convenient cordless operation without dragging tool hoses. The characteristics of the shut-off torque mechanism eliminates the operator influence and increases the torque accuracy for continuous heavy production.

PISTOL TYPE (12V)

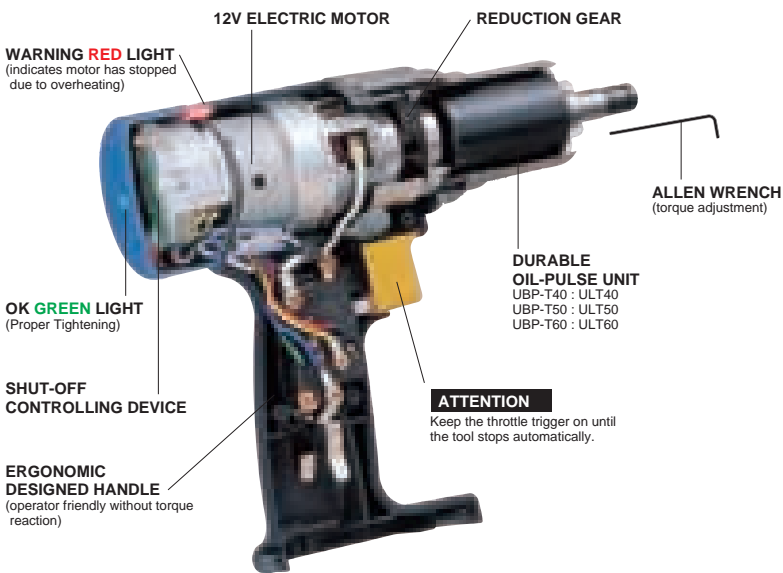

UBP SERIES

Offer a healthy work environment featuring operator comfort while reducing fatigue. The Hydraulic Pulse Action of Battery Oil-Pulse tools minimizes noise & vibration generated by the structural metal-to-metal contact of Battery Impact Types, eliminating most wearing parts thus producing cost savings in addition to easy torque adjustment.

DIFFERENCE OF FASTENING MECHANISM

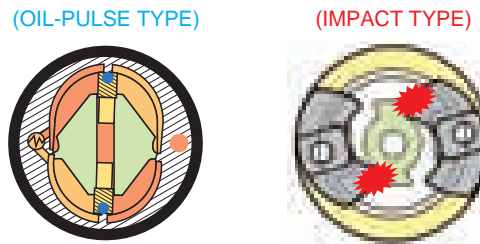

TORQUE CHART

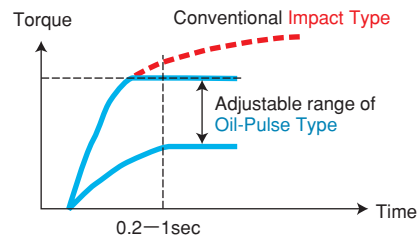

NOISE LEVEL

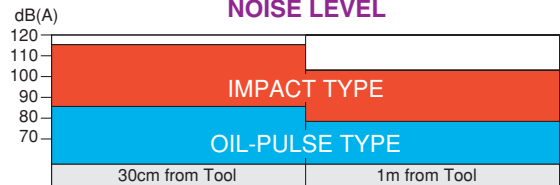

VIBRATION LEVEL

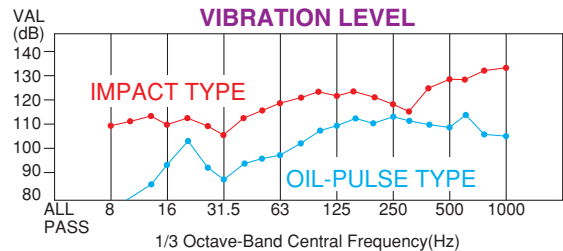

SPECIFICATIONS

Model	Capacity (Nominal Bolt Size)		Torque range		Free Speed (Approx.) r.p.m.	Overall Length (about)		Weight less Battery (about)		From Center to Outside (about)		Sq. Drive or Hex. Size		Number of Fastenings per charge (about)	Noise Level dB(A)	Vibration Level m/sec ²
	mm	in	Nm	ft-lbs		mm	in	kg	lb	mm	in	mm	in			
UBP-T40	6	1/4	6-12	4.4-8.9	2,200	211	8 5/16	1.2	2.64	28.0	1 7/64	6.35	1/4	420	85	8.0
UBP-T50	6-8	1/4-5/16	8-22	5.9-16.3	2,200	211	8 5/16	1.2	2.64	28.0	1 7/64	6.35	1/4	490	85	8.0
UBP-T50(P)	6-8	1/4-5/16	8-22	5.9-16.3	2,200	211	8 5/16	1.2	2.64	28.0	1 7/64	9.5	3/8	490	85	8.0
UBP-T60	8	5/16	14-26	10.4-19.2	2,200	216	8 1/2	1.3	2.85	28.0	1 7/64	6.35	1/4	470	85	8.0
UBP-T60(P)	8	5/16	14-26	10.4-19.2	2,200	212	8 11/32	1.3	2.85	28.0	1 7/64	9.5	3/8	470	85	8.0
UBP-65*	8	5/16	15-30	11.1-22.2	2,200	189	7 7/16	1.2	2.64	28.0	1 7/64	6.35	1/4	530	83	7.0
UBP-65(P)*	8	5/16	20-37	14.8-27.4	2,200	189	7 7/16	1.2	2.64	28.0	1 7/64	9.5	3/8	530	83	7.0

Numbers of tightenings per charge varies depending on torque level, fastener length and application. *Non Shut-off Type
Recommended Battery Charger : Panasonic Model EY0230B(AC110V~230V). Recommended Battery Pack : Panasonic Model EY9200B(DC12V)
(Please procure above parts from the local supplier of Panasonic products in your country.)

OIL-PULSE TOOLS

It is the greatest feature of **UX, ALPHA & UL series** that one pulse per rotation is actualized in the two-blade impulsing mechanism to be capable of producing higher torque with less vibration. In the mechanism 2 blades and 4 seal points are provided for maximum energy utilization, while 1 blade and 2 seal points in the single blade mechanism. 2 seal points are aligned concentrically and 2 other seal points are made eccentric by some degree from the center line in order not to make the sealing status in 180 degree rotation (in case of 180 degree rotation sealing, 2 pulses/rotation...low power impulsing). This innovation enables two blades to more efficiently absorb impulsing power to deliver about 30 - 40% higher torque than the single blade mechanism.

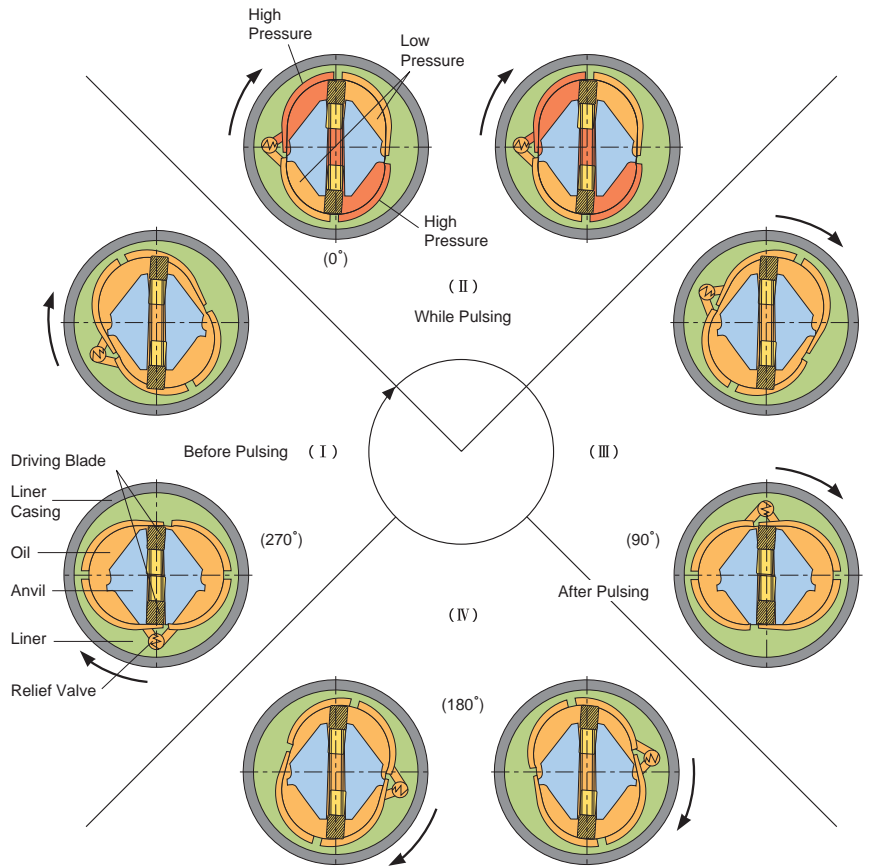

When selecting the tool for fastening operation, it is necessary to consider bolt size, fastening torque, working conditions and so on. Generally, working conditions can be defined as hard joint (H-joint) and soft joint (S-joint) from the aspect of relation between fastening torque and angle. (Please refer to ISO-5393.) It is also necessary to consider characteristics of work pieces.

Fig. 1 Joint

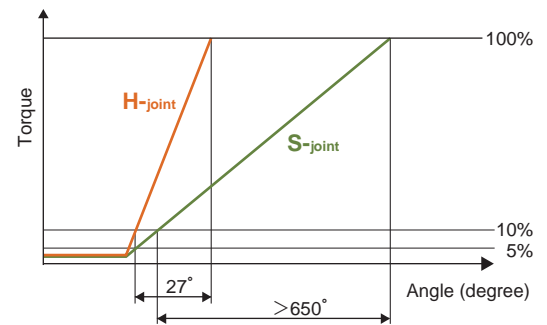
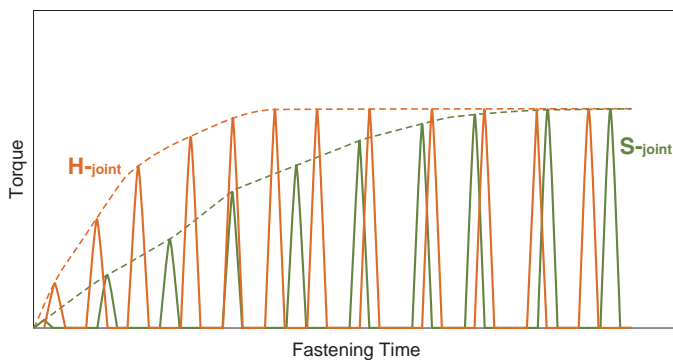
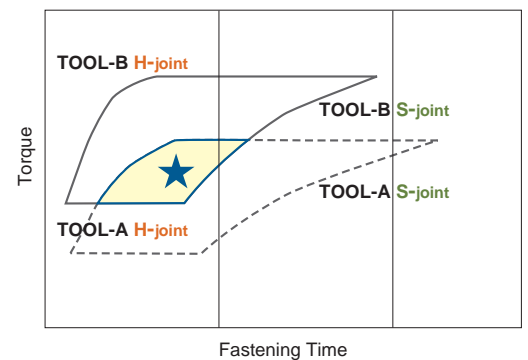

Fig. 2 Fastening with Oil-Pulse Tool(H-S Joint)



As shown above Fig. 2, torque output curve of the hard joint and soft joint is different when the same torque setting against same tool is applied. (Difference of torque raise up speed and time to reach the target torque.)

Fig. 3 Tool selection by work feature



When selecting the tool against the target torque of ★ as shown Fig. 3, pay attention to the operating conditions (tool weight, fastening time), required torque accuracy, torque adjusting position of tools and select the most suitable model.

RECOMMENDED TORQUE CHART OF THE IMPACT WRENCHES

Fastening force of the impact wrenches changes in accordance to the fastening time and the bolt size. This table shows various common fastening torque. Please use this table as just guide line when selecting the model.

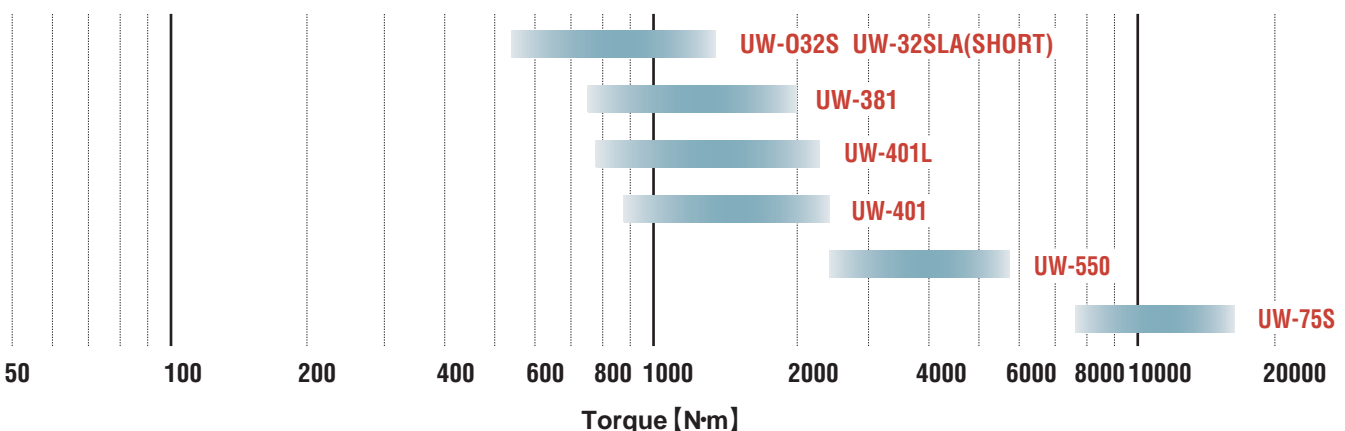
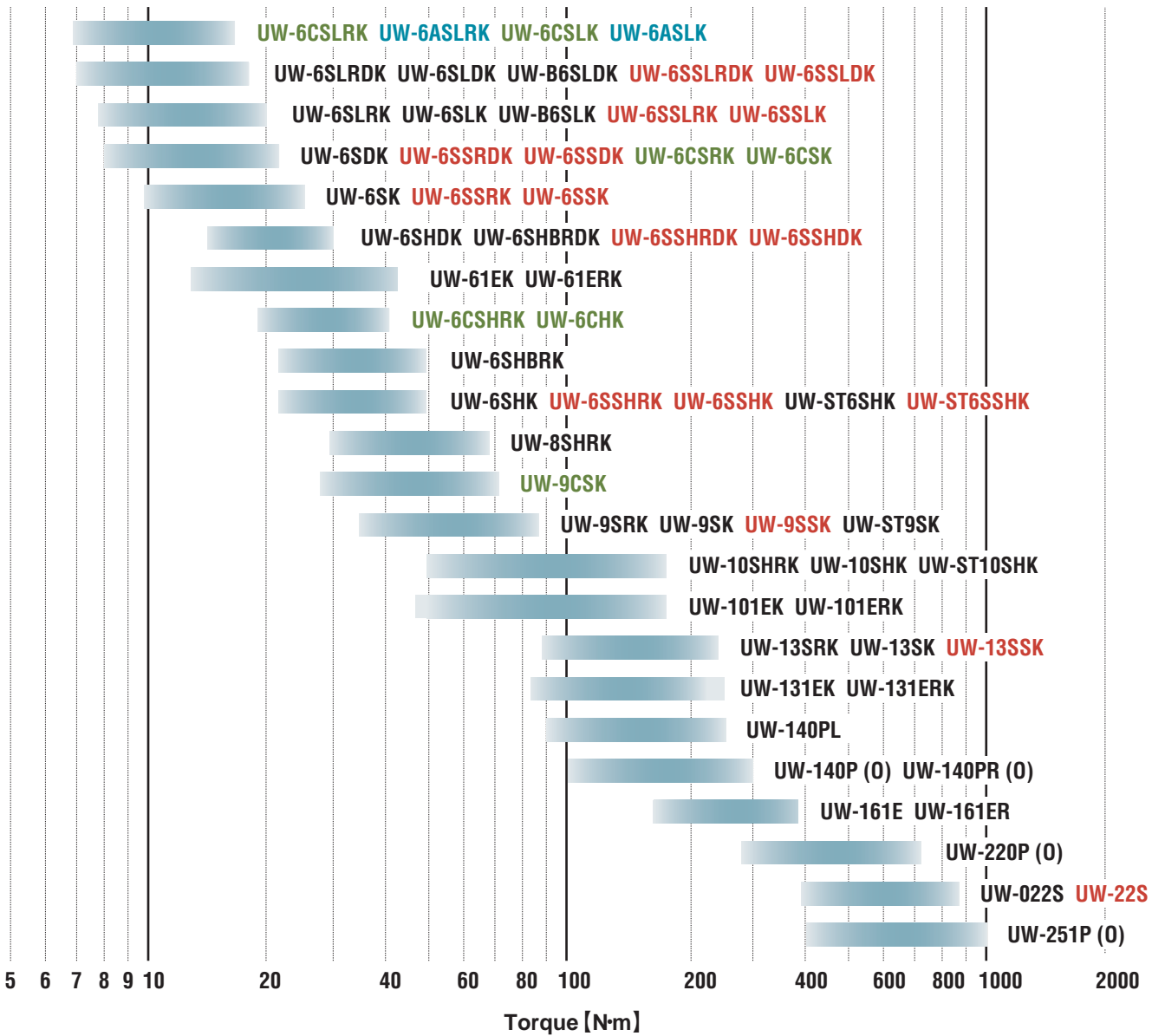

IMPACT WRENCHES

Torque in the chart is the reference value which is calculated from the proof load of the bolt, the metric coarse thread and the torque coefficient 0.2. Please select the tool in accordance to your true joint conditions. In general, if the fastening time is longer than 5 seconds, a larger model should be used.

Recommended torque of the bolt (calculated value)

Hardness class of the bolt	4.8		5.8		6.8		8.8		10.9		12.9	
	Torque (N·m)	Proof Load (kN)	Torque (N·m)	Proof Load (kN)	Torque (N·m)	Proof Load (kN)	Torque (N·m)	Proof Load (kN)	Torque (N·m)	Proof Load (kN)	Torque (N·m)	Proof Load (kN)
M6	6.9	5.7	8.6	7.2	10.4	8.6	13.7	11.5	18.7	15.6	22.4	18.7
M8	16.7	10.4	20.9	13.0	25.1	15.7	33.4	20.9	45.5	28.4	54.6	34.1
M10	33.1	16.6	41.4	20.7	49.6	24.8	66.2	33.1	90.0	45.0	107.8	54.0
M12	57.6	24.0	72.2	30.1	86.5	36.1	115.6	48.0	156.8	65.5	188.2	78.5
M14	91.9	32.8	114.7	41.1	138.2	49.3	183.3	65.6	249.9	89.2	298.9	106.8
M16	143.1	44.8	179.3	56.0	215.6	67.2	286.2	89.6	389.1	121.5	467.5	146.0
M18	197.0	54.8	247.0	68.5	296.0	82.2	394.9	109.8	536.1	149.0	641.9	178.4
M20	279.3	69.9	349.9	87.4	419.4	104.9	560.6	140.1	760.5	190.1	913.4	288.3
M22	380.2	86.4	474.3	107.8	569.4	129.4	758.5	172.5	1038.8	235.2	1244.6	282.2
M24	484.1	100.9	601.7	125.4	724.2	150.9	964.3	200.9	1313.2	274.4	1577.8	328.3
M27	709.5	131.3	884.0	163.7	1068.2	197.0	1411.2	261.7	1930.6	356.7	2303.0	427.3
M30	958.4	159.7	1195.6	199.9	1440.6	240.1	1920.8	319.5	2606.8	435.1	3136.0	522.3
M33	1303.4	198.0	1636.6	247.9	1960.0	296.9	2616.6	395.9	3557.4	539.0	4263.0	645.8

BOLT & NUT SETTERS

Model name of Impact Wrenches

Example	UW	-	6SH	L	K
			<ul style="list-style-type: none"> - 6SH (pistol grip for 6mm bolt*) - 6SSH (straight handle) - 6CSH (angle head) - 6AS (45 degree angle head) - ST (for stud bolt) - P (pistol grip only for UW-140•220•381 series) 	<ul style="list-style-type: none"> - L (long anvil) - R (rear exhaust) 	<ul style="list-style-type: none"> - K (light weight) - DK (driver type anvil • light weight)

*Exception: UW-140 series =14mm bolt, UW-220 series =22mm, UW-381 series=38mm, UW-401 series=40mm and UW-550 = 55 mm

Socket Retaining Methods

Please specify the type of Anvil when ordering.

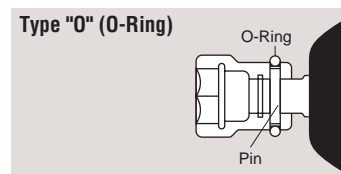
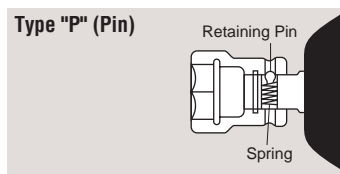
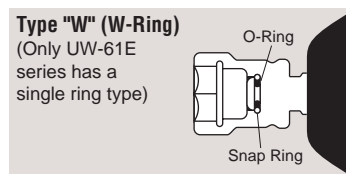

Double-Hammer mechanism

Powerful & fast assembly for highest productivity with well-balanced hammer mechanism and less torque reaction to operator. Recommended for general high-volume assembly such as motor vehicles, appliances, machinery and so forth.

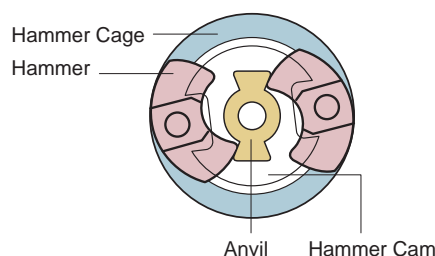

Swing-Hammer mechanism

Powerful & durable impacting mechanism with one piece Hammer-Hammer pin. Recommended to steel erection, refineries, mines, heavy motor vehicle industries and etc. (UW-140, 220P, 251P, and 381 series)

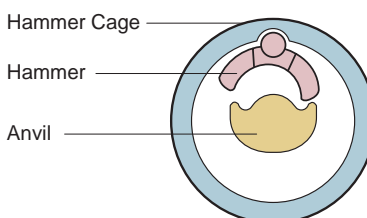

TORQUE CHART

To avoid excess wear of the parts, the tightening time is recommended not to exceed 5 seconds.

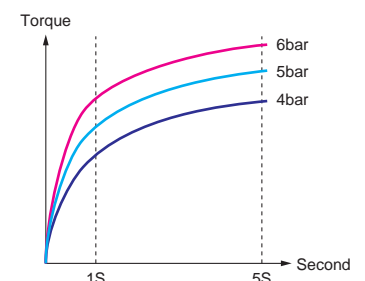

IMPACT WRENCHES

The widest range of URYU Impact Wrenches offer fast, powerful and economical operation in high-volume heavy assembly applications such as Cars, Trucks, Tractors, Appliances, Construction, Machinery and so forth.

PISTOL TYPE

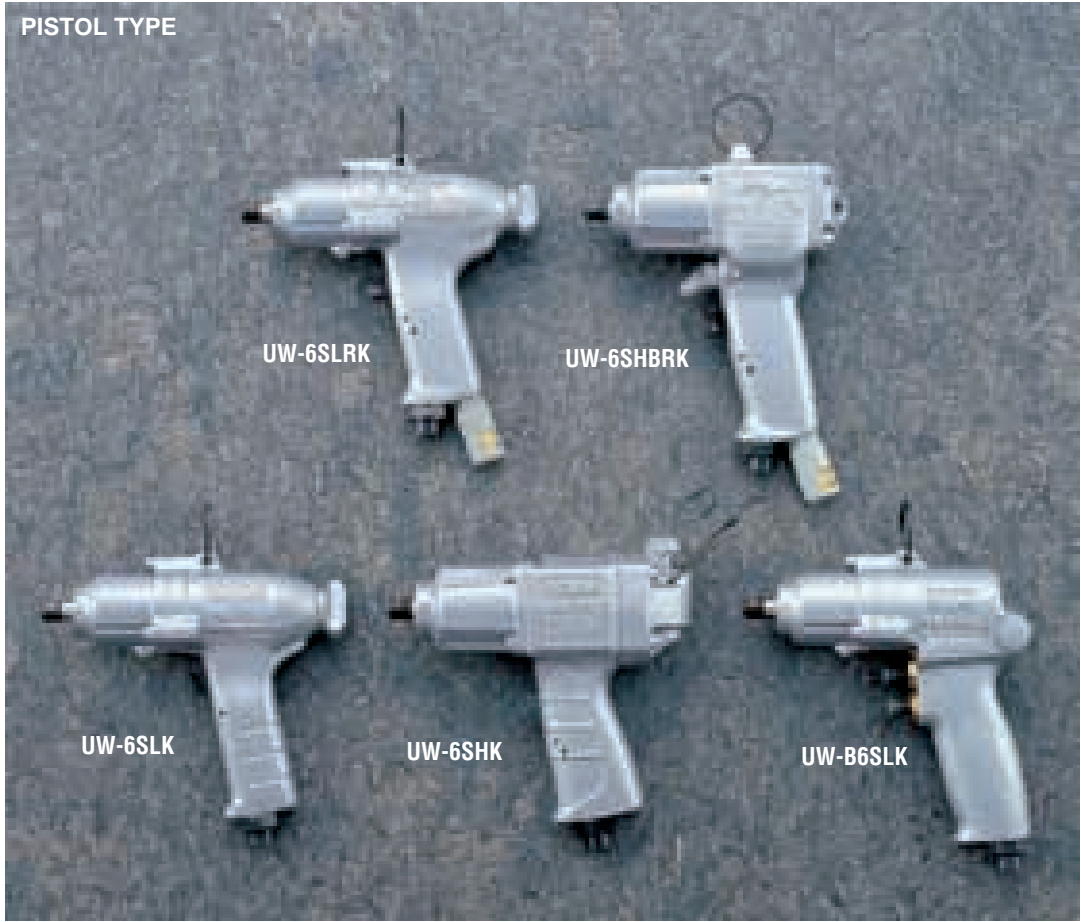

WARNING

Repetitive work motions or vibration can cause injury to hands and arms such as Carpal Tunnel Syndrome.

(BAD POSTURE)

Avoid repeated bending of wrists and hands.

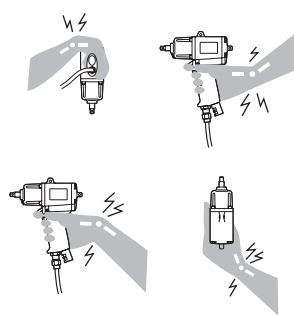

(GOOD POSTURE)

Keep wrists straight.

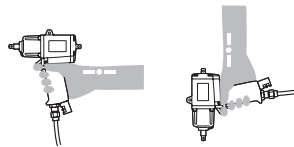

BOLT & NUT SETTERS



Front exhaust type (model which does not have "R" in model name.)

Quick-change driver anvil

Pull the sleeve and insert or take off the bit. Please add "D" to each model name like UW-6SDK when ordering.

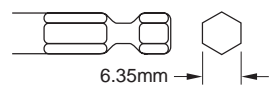

SPECIFICATIONS

Recommended Air Pressure: 0.6MPa(85psi)

Model	Capacity (Nominal Bolt Size)		Free Speed (about)	Overall Length less Socket or Bit (about)		Weight less Socket or Bit (about)		From Center to Outside (about)		Sq. Drive or Hex. Size		Average Air Consumption		Noise Level	Vibration Level
	mm	in		r.p.m.	mm	in	kg	lb	mm	in	mm	in	m ³ /min		
UW-6SLRK	6	1/4	8500	169	6 21/32	0.97	2.13	22	27/32	9.5	3/8	0.35	12.4	91	5.6
UW-6SHBRK	8	5/16	7300	153	6 1/32	1.36	2.99	24	15/16	9.5	3/8	0.35	12.4	92	5.6
UW-6SLK	6	1/4	8500	165	6 1/2	0.97	2.13	22	27/32	9.5	3/8	0.30	10.5	92	5.6
UW-B6SLK	6	1/4	8500	160	6 5/16	0.97	2.13	24	15/16	9.5	3/8	0.30	10.5	92	5.6
UW-6SK	6	1/4	7500	160	6 5/16	1.22	2.68	22	27/32	9.5	3/8	0.30	10.5	93	5.6
UW-6SAK	6	1/4	7500	134	5 9/32	1.10	2.47	22	27/32	9.5	3/8	0.30	10.5	93	5.6
UW-6SHK	8	5/16	7500	171	6 47/64	1.41	3.10	24	15/16	9.5	3/8	0.35	12.4	92	5.6
UW-6SLRDK	6	1/4	8500	169	6 21/32	0.97	2.13	22	27/32	6.35	1/4	0.30	10.5	91	5.6
UW-6SHBRDK	8	5/16	7300	153	6 1/32	1.36	2.99	24	15/16	6.35	1/4	0.35	12.4	91	5.6
UW-6SLDK	6	1/4	8500	165	6 1/2	0.97	2.13	22	27/32	6.35	1/4	0.30	10.5	92	5.6
UW-B6SLDK	6	1/4	8500	170	6 45/64	1.00	2.20	24	15/16	6.35	1/4	0.30	10.5	92	5.6
UW-6SDK	8	5/16	7500	160	6 5/16	1.22	2.68	22	27/32	6.35	1/4	0.30	10.5	93	5.6
UW-6SADK	6	1/4	7500	160	6 5/16	1.10	2.47	22	27/32	6.35	1/4	0.30	10.5	93	5.6
UW-6SHDK	8	5/16	7500	190	6 47/64	1.45	3.19	24	15/16	6.35	1/4	0.35	12.4	92	5.6

Air Hose Size (Inside Diameter) : 9.5mm (3/8")
Air Inlet Thread (Pipe Tap) : N.P.T.1/4"

IMPACT WRENCHES

STRAIGHT / ANGLE TYPE

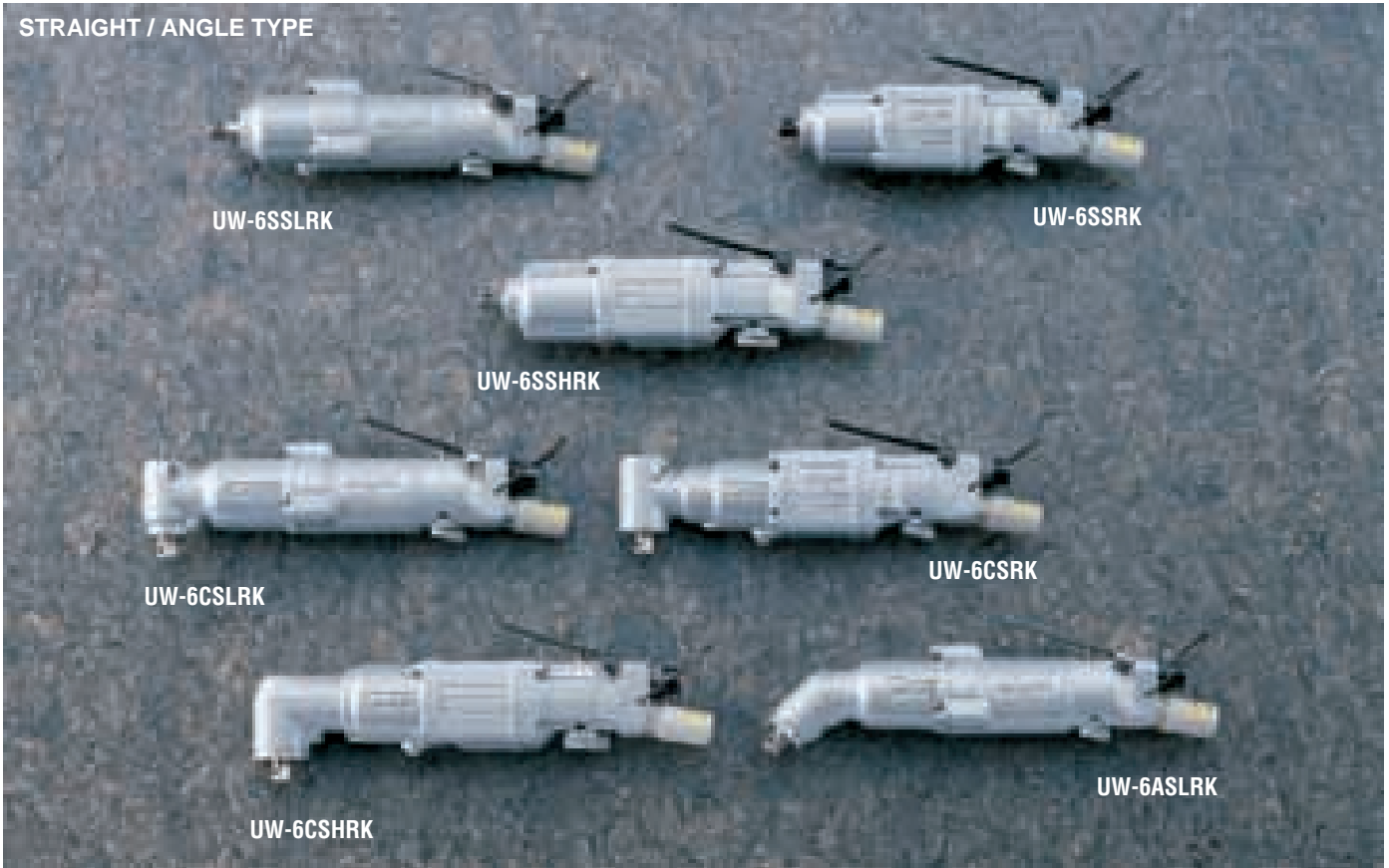

Head Sizes

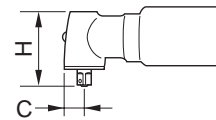

MODEL	C		H	
	mm	in	mm	in
UW-6CSLRK	13.5	17/32	59.5	2 11/32
UW-6CSRK	15.0	19/32	60.0	2 23/64
UW-6CSHRK	17.5	11/16	65.0	2 9/16
UW-6CSLK	13.5	17/32	59.5	2 11/32
UW-6CSK	15.0	19/32	60.0	2 23/64
UW-6CSHK	17.5	11/16	65.0	2 9/16

SPECIFICATIONS

Recommended Air Pressure: 0.6MPa(85psi)

Model	Capacity (Nominal Bolt Size)		Free Speed (about)	Overall Length less Socket or Bit (about)		Weight less Socket or Bit (about)		From Center to Outside (about)		Sq. Drive or Hex. Size		Average Air Consumption		Noise Level	Vibration Level
	mm	in		r.p.m.	mm	in	kg	lb	mm	in	mm	in	m ³ /min		
UW-6SSLRK	6	1/4	8500	212	8 11/32	0.87	1.91	21	53/64	9.5	3/8	0.30	10.5	90	10.0
UW-6SSRK	6	1/4	7500	201	7 29/32	0.97	2.13	22	27/32	9.5	3/8	0.30	10.5	90	10.0
UW-6SSHRK	8	5/16	7300	228	8 63/64	1.26	2.77	24	15/16	9.5	3/8	0.35	12.4	91	17.8
UW-6SSLK	6	1/4	8500	190	7 31/64	0.87	1.91	22	27/32	9.5	3/8	0.30	10.5	91	10.0
UW-6SSK	6	1/4	7500	184	7 1/4	0.97	2.13	22	27/32	9.5	3/8	0.30	10.5	91	10.0
UW-6SSHK	8	5/16	7500	201	7 27/32	1.21	2.66	24	15/16	9.5	3/8	0.35	12.4	92	17.8
UW-6SSLRDK	6	1/4	8500	227	8 15/16	0.90	1.98	22	27/32	6.35	1/4	0.30	10.5	90	10.0
UW-6SSRDK	6	1/4	7500	213	8 3/8	1.00	2.20	22	27/32	6.35	1/4	0.30	10.5	90	10.0
UW-6SSHRDK	8	5/16	7300	238	9 3/8	1.30	2.86	24	15/16	6.35	1/4	0.35	12.4	91	17.8
UW-6SSLDK	6	1/4	8500	202	7 61/64	0.90	1.98	22	27/32	6.35	1/4	0.30	10.5	91	10.0
UW-6SSDK	6	1/4	7500	194	7 41/64	1.00	2.20	22	27/32	6.35	1/4	0.30	10.5	91	10.0
UW-6SSHDK	8	5/16	7500	211	8 5/16	1.25	2.75	24	15/16	6.35	1/4	0.35	12.4	92	17.8
UW-6CSLRK	6	1/4	8000	238	8 11/32	1.17	2.57	14	9/16	9.5	3/8	0.30	10.5	93	31.6
UW-6CSRK	6	1/4	7300	234	9 7/32	1.42	3.12	22	27/32	9.5	3/8	0.30	10.5	94	31.6
UW-6CSHRK	8	5/16	7300	256	10 5/64	1.71	3.76	19	47/64	9.5	3/8	0.30	10.5	94	56.2
UW-6ASLRK	6	1/4	6500	260	10 15/64	1.14	2.50	15	19/32	9.5	3/8	0.30	10.5	92	31.6
UW-6CSLK	6	1/4	8000	218	8 19/32	1.17	2.57	14	9/16	9.5	3/8	0.30	10.5	93	31.6
UW-6CSK	6	1/4	7500	271	10 43/64	1.42	3.12	22	27/32	9.5	3/8	0.30	10.5	94	31.6
UW-6CSHK	8	5/16	7500	238	9 3/8	1.71	3.76	19	47/64	9.5	3/8	0.35	12.4	94	56.2
UW-6ASLK	6	1/4	6500	240	9 5/32	1.14	2.50	15	19/32	9.5	3/8	0.30	10.5	92	31.6

Air Hose Size (Inside Diameter) : 9.5mm (3/8")
Air Inlet Thread (Pipe Tap) : N.P.T.1/4"

IMPACT WRENCHES

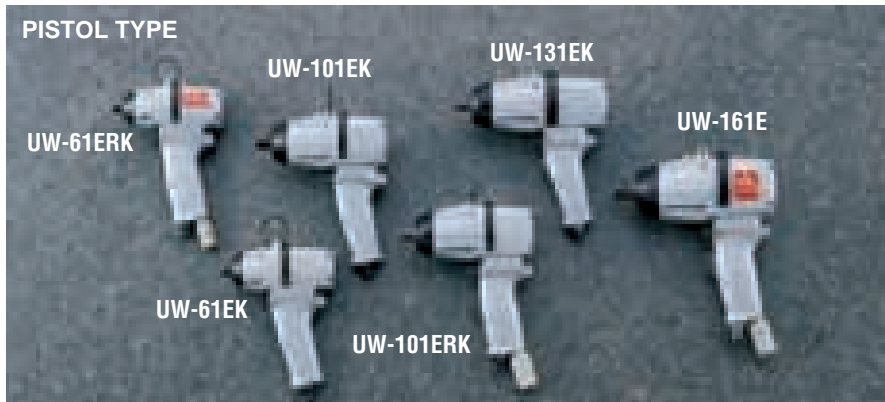

Built-in AIR REGULATOR

Set "4" at the arrow mark for strongest and "1" for weakest.



SPECIFICATIONS

Recommended Air Pressure : 0.6MPa (85psi)

Model	Capacity (Nominal Bolt Size)		Free Speed (about)	Overall Length less Socket (about)		Weight less Socket (about)		From Center to Outside (about)		Sq. Drive Shank		Average Air Consumption		Noise Level	Vibration Level
	mm	in		r.p.m.	mm	in	kg	lb	mm	in	mm	in	m ³ /min		
UW-61EK	8	5/16	7500	150	5 15/64	1.62	3.56	30	1 3/16	9.5	3/8	0.35	12.4	92	5.6
UW-101EK	10	3/8	6500	183	7 13/64	2.32	5.87	36	1 27/64	12.7	1/2	0.45	16.0	97	5.6
UW-131EK	13	1/2	6000	212	8 11/32	2.87	6.31	38	1 1/2	12.7	1/2	0.55	19.4	98	7.6
UW-161E	16	5/8	4200	210	8 17/64	4.00	8.80	42	1 25/32	19.0	3/4	0.65	23.0	97	5.6
UW-61ERK	8	5/16	7300	154	6	1.51	3.32	30	1 3/16	9.5	3/8	0.35	12.4	91	5.6
UW-101ERK	10	3/8	5500	185	7 9/32	2.27	4.99	36	1 27/64	12.7	1/2	0.45	16.0	96	5.6
UW-131ERK	13	1/2	5500	210	8 17/64	2.97	6.53	38	1 1/2	12.7	1/2	0.55	19.4	97	7.6
UW-161ER	16	5/8	3800	215	8 15/32	4.10	9.00	42	1 21/32	19.0	3/4	0.65	23.0	96	5.6

Air Hose Size (Inside Diameter) : 12.7mm (1/2") for UW-161E & UW-161ER 9.5mm (3/8") for UW-61E, 101E & 131E series

Air Inlet Thread (Pipe Tap) : N.P.T. 3/8" for UW-161E & 161ER N.P.T. 1/4" for UW-61E, 101E & 131E series

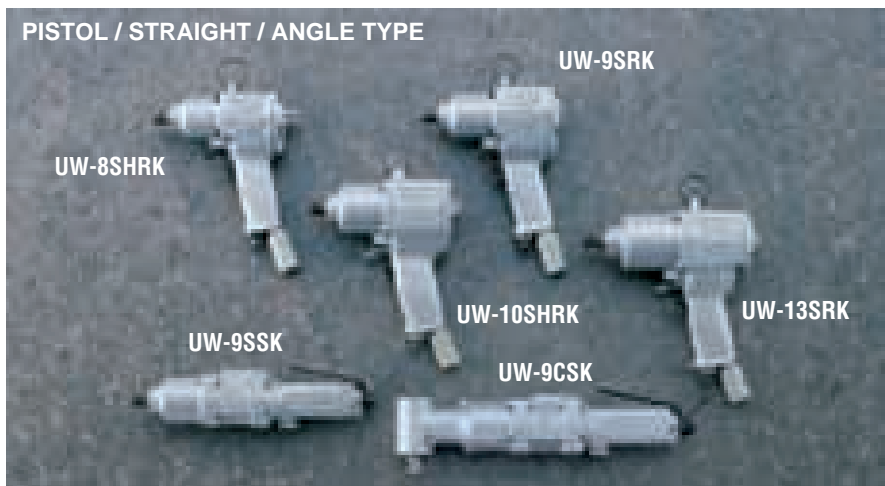

Head Sizes

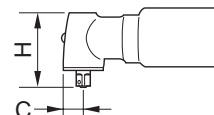

MODEL	C		H	
	mm	in	mm	in
UW-9CSK	22.0	7/8	85.0	3 11/32
UW-13CSK	26.0	1 1/32	102.0	4 7/32

SPECIFICATIONS

Recommended Air Pressure : 0.6MPa (85psi)

Model	Capacity (Nominal Bolt Size)		Free Speed (about)	Overall Length less Socket (about)		Weight less Socket (about)		From Center to Outside (about)		Sq. Drive Shank		Average Air Consumption		Noise Level	Vibration Level
	mm	in		r.p.m.	mm	in	kg	lb	mm	in	mm	in	m ³ /min		
UW-8SHRK	8	5/16	7300	172	6 25/32	1.55	3.41	26.0	1 1/32	12.7	1/2	0.40	14.0	93	7.6
UW-9SRK	10	3/8	7000	173	6 13/16	1.79	3.93	27.5	1 3/32	12.7	1/2	0.45	16.0	93	5.6
UW-10SHRK	10 - 12	3/8 - 1/2	6000	197	7 3/4	2.13	4.68	30.5	1 3/16	12.7	1/2	0.45	16.0	95	5.6
UW-13SRK	13	1/2	6000	205	8 5/64	2.61	5.74	34.0	1 11/32	12.7	1/2	0.45	16.0	95	5.6
UW-8SHK	8	5/16	7500	172	6 25/32	1.55	3.41	26.0	1 1/32	12.7	1/2	0.40	14.0	95	7.6
UW-9SK	10	3/8	7000	185	7 3/16	1.84	4.04	27.5	1 3/32	12.7	1/2	0.50	17.6	95	5.6
UW-10SHK	10 - 12	3/8 - 1/2	6500	197	7 3/4	2.13	4.68	28.5	1 7/64	12.7	1/2	0.45	16.0	97	5.6
UW-13SK	13	1/2	6500	221	8 23/32	2.61	5.74	34.0	1 11/32	12.7	1/2	0.55	19.4	97	5.6
UW-9SSK	10	3/8	7000	290	11 7/16	2.10	4.62	33.0	1 9/32	12.7	1/2	0.45	16.0	95	18.0
UW-13SSK	13	1/2	6300	303	11 15/16	3.17	6.97	34.0	1 11/32	12.7	1/2	0.55	19.4	97	18.0
UW-9CSK	10	3/8	7000	338	13 5/16	2.78	6.11	22.0	7/8	12.7	1/2	0.35	12.4	95	58.5
UW-13CSK	13	1/2	6500	375	14 3/4	5.17	11.37	26.0	1 1/32	12.7	1/2	0.75	26.5	97	60.0

Air Hose Size (Inside Diameter) : 9.5mm (3/8") Air Inlet Thread : N.P.T. 1/4"

IMPACT WRENCHES

PISTOL / STRAIGHT TYPE

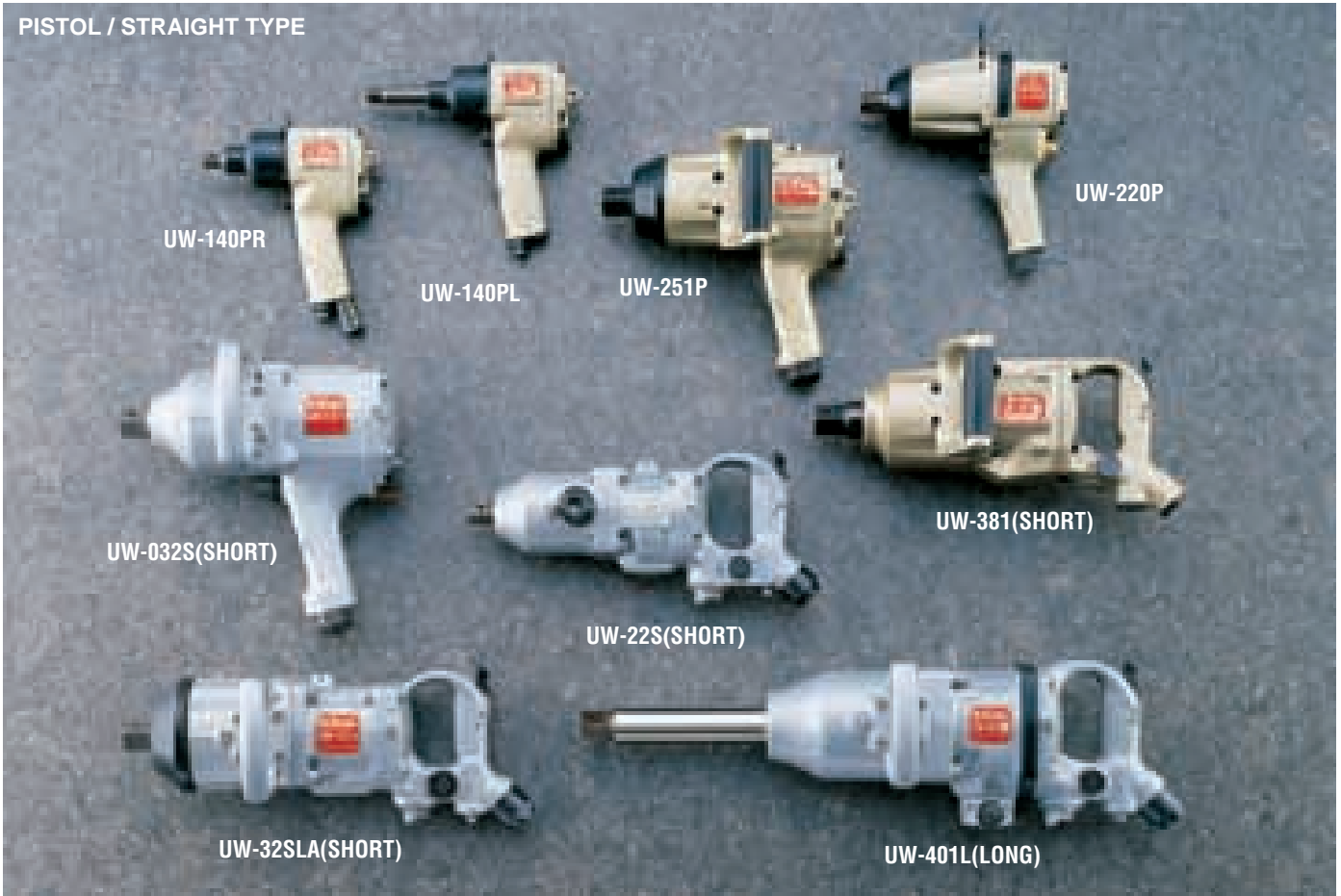

BOLT & NUT SETTERS

*Inside Trigger is also available for UW-381, UW-22S, UW-32SLA and UW-401.



Suffix "L" to Model Name.

MODEL	L		MODEL	L	
	mm	in		mm	in
UW-140PL	74.0	2 29/32	UW-381L	200.0	7 7/8
UW-220PL	156.0	6 9/64	UW-381PL	200.0	7 7/8
UW-251PL	151.0	5 15/16	UW-401L	195.5	7 45/64

SPECIFICATIONS

Recommended Air Pressure:0.6MPa(85psi)

Model	Capacity (Nominal Bolt Size)		Free Speed (about)	Overall Length less Socket (about)		Weight less Socket (about)		From Center to Outside (about)		Sq. Drive Shank		Average Air Consumption		Noise Level dB(A)	Vibration Level m/sec ²
	mm	in		r.p.m.	mm	in	kg	lb	mm	in	mm	in	m ³ /min		
UW-140P, -140PR	12	1/2	6500	190	7 1/2	2.70	5.90	30.0	1 3/16	12.7	1/2	0.70	25.0	93	7.9
UW-140PL, -140PRL	12	1/2	6500	233	9 3/16	2.80	6.10	30.0	1 3/16	12.7	1/2	0.70	25.0	93	7.9
UW-220P	19	3/4	5500	225	8 7/8	4.40	9.60	42.0	1 21/32	19.0	3/4	0.70	25.0	95	5.6
UW-220PL	19	3/4	5500	338	13 1/4	4.70	10.30	42.0	1 21/32	19.0	3/4	0.70	25.0	95	5.6
UW-251P	25	1	5500	275	10 53/64	8.00	17.60	48.0	1 7/8	25.4	1	0.80	28.0	95	5.6
UW-251PL	25	1	5500	394	15 33/64	8.80	19.40	48.0	1 7/8	25.4	1	0.80	28.0	95	5.6
UW-22S	22	7/8	4000	395	14 1/16	7.90	17.41	46.0	1 13/16	19.0	3/4	0.75	26.5	103	25.0
UW-22S(L)	22	7/8	4000	480	18 29/32	8.30	18.30	46.0	1 13/16	19.0	3/4	0.75	26.5	103	25.0
UW-022S	22	7/8	3800	277	10 29/32	7.65	16.80	46.0	1 13/16	19.0	3/4	0.75	26.5	103	25.0
UW-032S	32	1 1/4	3500	304	11 31/32	11.60	25.50	59.0	2 9/32	25.4	1	1.15	40.6	109	30.0
UW-32SLA	32	1 1/4	3500	390	15 1/32	11.70	25.74	62.5	2 29/64	25.4	1	0.90	32.0	109	30.0
UW-32SLA(L)	32	1 1/4	3500	535	21 1/16	12.50	27.50	62.5	2 29/64	25.4	1	0.90	32.0	109	30.0
UW-381	38	1 1/2	4700	355	13	9.50	20.90	55.0	2 11/64	25.4	1	0.90	31.5	100	11.1
UW-381L	38	1 1/2	4700	504	19 27/32	10.00	22.00	55.0	2 11/64	25.4	1	0.90	31.5	100	11.1
UW-381P	38	1 1/2	4700	276	10 7/8	9.50	20.90	55.0	2 11/64	25.4	1	0.90	31.5	99	7.3
UW-381PL	38	1 1/2	4700	425	16 3/4	10.00	22.00	55.0	2 11/64	25.4	1	0.90	31.5	99	7.3
UW-401	38	1 1/2	3200	421	16 37/64	15.10	33.22	60.0	2 3/8	25.4	1	1.20	42.4	110	35.0
UW-401L	38	1 1/2	3200	591	23 17/64	16.50	36.30	60.0	2 3/8	25.4	1	1.20	42.4	110	35.0

Air Hose Size (Inside Diameter) : 9.5mm (3/8") for UW-140P Series, 12.7mm (1/2") for other models above

Air Inlet Thread : N.P.T.1/4" for UW-140P Series N.P.T.3/8" for UW-220P, UW-251P Series, UW-22S, UW-022S & UW-032S N.P.T.1/2" for UW-381 series & UW-401 Series

UW-140P Series combine compact size and light weight with high torque, 70 - 200Nm to meet a wide range of applications. Recommendable for overall automotive service, body shops etc.

UW-220P Series are recommendable for various popular fastening joints in general industry. (300 - 700Nm)

UW-251P Series are recommendable for heavy industrial production work such as engine work, truck springs, tractor pads, off-road equipment and heavy duty farm equipment. (600 - 1000Nm)

UW-381Series are powerful, light-weight impact wrenches that are ideal for wide applications (1400 - 2000Nm) in steel erection refineries, petrochemical plants, mines, steel mills and heavy motor vehicle plants.

IMPACT WRENCHES

JUMBO TYPE

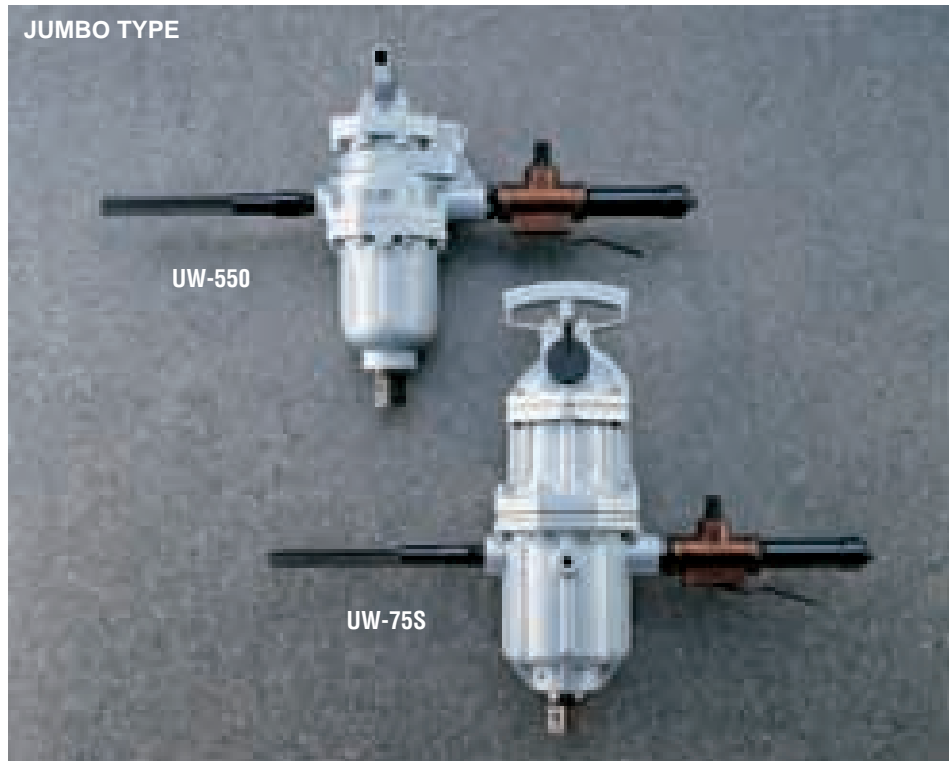

Double-Hammer Jumbo Type

URYU heavy-duty double-hammer impact wrenches offer the ultimate power for handling big, tough nut running and removal jobs in shipyards, steel mills, chemical plants, powerhouses as well as in plant manufacturing heavy machinery, large diesel engines, turbogenerators etc.



Built-In Air Regulator

Pull up the spring loaded knob and turn clockwise to lower the power and an iclockwise to increase it, then reset.

SPECIFICATIONS

Recommended Air Pressure : 0.6MPa (85psi)

Model	Capacity (Nominal Bolt Size)		Free Speed (about)	Overall Length less Socket (about)		Weight less Socket (about)		From Center to Outside (about)		Sq. Drive Shank		Average Air Consumption		Noise Level dB(A)	Vibration Level m/sec ²
	mm	in		mm	in	kg	lb	mm	in	mm	in	m ³ /min	ft ³ /min		
UW-550	56	2 1/4	3500	525	20 43/64	36.0	79.2	75.0	2 61/64	38.1	1 1/2	2.20	79	112	40.0
UW-75S	76	3	1400	668	26 17/64	56.0	123.0	91.0	3 19/32	44.4	1 3/4	3.20	114	112	45.0
UW-75S(1 1/2)	76	3	1400	668	26 17/64	56.0	123.0	91.0	3 19/32	38.1	1 1/2	3.20	114	112	45.0

Air Hose Size (Inside Diameter) : 19.0mm (3/4")

Air Inlet Thread : N.P.T.1"

STUD BOLT WRENCHES

PISTOL / STRAIGHT TYPE



Double-Hammer Auto-Reversing for Stud Bolt Driving

These unique Auto-Reversing tools simplify stud-bolt driving (frequent reversing) job considerably for less operator's fatigue & high productivity. Push the tool forward to the work for driving and simply pull it back.

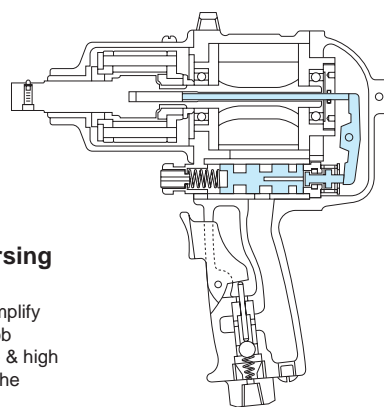

SPECIFICATIONS

Recommended Air Pressure : 0.6MPa (85psi)

Model	Capacity (Nominal Bolt Size)		Free Speed (about)	Overall Length less Socket (about)		Weight less Socket (about)		From Center to Outside (about)		Sq. Drive Shank		Average Air Consumption		Noise Level dB(A)	Vibration Level m/sec ²
	mm	in		mm	in	kg	lb	mm	in	mm	in	m ³ /min	ft ³ /min		
UW-ST6SHK	8	5/16	6500	170	6 11/16	1.70	3.74	24.0	31/32	9.5	3/8	0.40	14.0	92	5.6
UW-ST9SK	10	3/8	6300	192	7 19/32	2.35	5.06	28.0	1 3/32	12.7	1/2	0.50	17.6	97	5.6
UW-ST10SHK	10 - 12	3/8 - 1/2	6300	195	7 11/16	2.60	5.72	28.0	1 3/32	12.7	1/2	0.50	17.6	97	5.6
UW-ST6SSHK	8	3/8 - 1/2	6500	230	9 1/16	1.35	2.97	24.0	31/32	9.5	3/8	0.40	14.0	92	17.8

Air Hose Size (Inside Diameter) : 9.5mm (3/8")

Air Inlet Thread : N.P.T.1/4"

BOLT & NUT SETTERS ACCESSORIES

HEXAGONAL SOCKETS

Code Nos.	Dimensions of Sockets (mm)					Sq. Drive F
	A	B	C	D	E	
900-028-0	16	19	5.3	9.4	10	9.5
900-044-0	20	21	5.5	11.4	11	
900-056-0	22	25	6.5	12.0	13	
900-064-0	22	25	6.5	15.4	14	
900-132-0	23	30	6.5	14.0	13	
900-140-0	24	30	6.5	14.0	14	
900-153-0	28	31	7.5	15.0	17	
900-170-0	30	35	8.5	15.0	19	
900-176-0	35	38	9.5	18.0	21	
900-187-0	36	40	9.5	19.0	22	15.9
900-193-0	37	41	10.0	20.0	23	
900-243-0	33	37	8.5	15.0	19	
900-248-0	35	38	9.5	18.0	21	
900-255-0	36	40	10.0	17.0	22	
900-260-0	37	41	10.0	18.0	23	19.0
900-266-0	38	42	11.0	19.0	24	
900-269-0	40.5	44	12.0	24.0	26	
900-342-0	40	48	11.0	21.0	24	
900-347-0	43	49	12.0	22.0	26	
900-360-0	45	50	14.0	23.0	27	25.4
900-377-0	48	52	15.0	27.0	30	
900-380-0	50	54	15.0	29.0	32	
900-390-0	54	57	17.0	32.0	35	
900-400-0	55	58	17.0	33.0	36	
900-464-0	54	57	15.0	29.0	32	25.4
900-475-0	54	60	17.0	32.0	35	
900-483-0	56	60	17.0	32.0	36	
900-499-0	62	66	19.0	38.0	41	
900-512-0	68	70	21.0	42.0	46	
900-519-0	78	76	24.0	48.0	50	

Code Nos.	Dimensions of Sockets (mm)					Sq. Drive F
	A	B	C	D	E	
900-580-0	64	66	19.0	31.0	41	31.8
900-587-0	70	70	21.0	35.0	46	
900-601-0	78	75	24.0	40.0	50	
900-605-0	82	80	27.0	45.0	54	
900-609-0	82	80	27.0	45.0	55	
900-610-0	88	83	29.0	48.0	58	38.1
900-613-0	90	86	30.0	51.0	60	
900-653-0	100	98	33.0	53.0	67	
900-655-0	109	100	36.0	55.0	70	
900-660-0	115	103	38.0	58.0	77	
900-664-0	120	107	40.0	62.0	80	44.4
900-666-0	125	111	43.0	66.0	85	
900-694-0	120	114	38.0	68.0	77	
900-697-0	125	117	41.0	71.0	80	
900-700-0	145	130	48.0	84.0	95	
900-706-0	165	140	60.0	94.0	110	50.8
900-744-0	164	140	60.0	89.0	110	
900-750-0	194	157	70.0	106.0	130	
900-752-0	196	162	64.0	111.0	135	
900-754-0	210	171	79.0	120.0	145	
900-780-0	95	120	30.0	47.0	58	63.5
900-786-0	155	142	41.0	69.0	95	
900-794-0	252	206	83.0	143.0	175	

HEXAGONAL SOCKETS

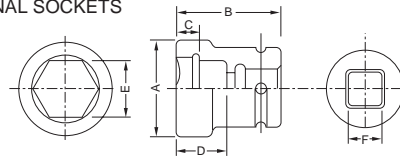

Sockets for Stud-Bolt Driving

Code Nos.	Nominal Bolt Sizes Dimensions of Sockets (mm)							Models	
	mm	in	A	B	C	D	E		
903-002-0	6	-	16	29	9.0	M6	5/32	9.5	UW-ST6SHK
903-035-0	-	-	16	19	9.0	W1/4-20	5/32	9.5	UW-ST6SSHK
903-003-0	8	-	17	35	16.0	M8	7/32	9.5	UX-ST800
903-103-0	8	-	17	39	16.0	M8	7/32	12.5	UW-ST9SK
903-105-0	10	-	19	41	18.5	M10	9/32	12.5	UW-ST10SHK
903-137-0	-	-	19	41	18.5	W3/8-16	9/32	12.5	UX-ST1000

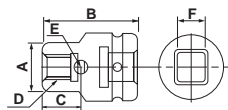

Bit Chuck Assembly

Code Nos.	A	B	C	D
907-000-0	22	41	6.35Hex	9.5Sq
907-050-0	24	46	8.0Sq	12.7Sq

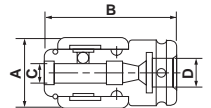

Please do not use UX-1000/UW-10SHK or bigger models as the torque is too strong to use with the above.

Joint Assembly

Code Nos.	A	B	C
906-000-0	45	20	9.5
906-020-0	69	30	12.7
906-040-0	84	46	12.7

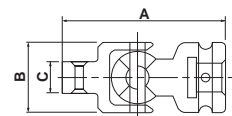

SPECIAL EXTENSION BARS FOR OIL-PULSE TOOLS

For tool optimum performance these extension bars are especially designed for deeper engagement with tool anvils to minimize torque-down and wobbling.

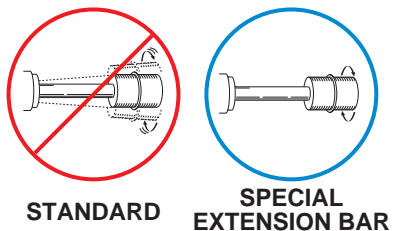

Code Nos.	B (mm)	A&C Sq. Drive	Socket Retainer Type	Models
904-049-0	75	9.5mm (3/8")	OP-P TYPE	UX-450
904-050-0	100			UX-500
904-051-0	150			UX-612
904-075-0	190			UX-(T)700(L)
904-052-0	254			UX-(T)800
904-054-0	300	UL30	UL(T)40(S)	
904-053-0	320	UL(T)50(S)	UL(T)60(S)	
904-155-0	76	12.7mm (1/2")	OP-P TYPE	UX-(T)900
904-156-0	125			
904-157-0	204			
904-158-0	254			
904-159-0	355			

Code Nos.	B (mm)	A&C Sq. Drive	Socket Retainer Type	Models
904-168-0	76	12.7mm (1/2")	OP-P TYPE	UX-(T)1000
904-169-0	125			UX-(T)1300
904-172-0	204			UX-(T)1400
904-173-0	355			UL(T)90
904-350-0	76	19.05mm (3/4")	O-RING TYPE	UL(T)100
904-352-0	100			UX-(T)1620
904-351-0	150			UXR-(T)1820
904-353-0	200			UXR-2000(S)
904-455-0	200			25.4mm (1")
904-455-0	200	25.4mm (1")	O-RING TYPE	UXR-2400S
904-455-0	200	25.4mm (1")	O-RING TYPE	UXR-3000S

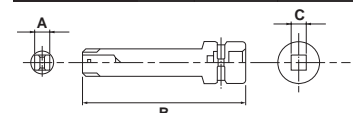

MULTIPLE NUTRUNNERS (ORDER-MADE PRODUCTS EXEMPTED FROM ISO 9001 CERTIFICATION.)

URYU Air Multiple Nutrunners are now very popular in various modern industries, especially in automobile assembly lines, where two or more bolts or nuts must be tightened simultaneously at uniform torque.



UMT (URYU Minimum Torque Sensing) SYSTEM

URYU UMT comprises the normal stall torque air motor unit and the torque sensing device. The motor unit is held by bearings between the upper and lower plates and is joined to the Reaction Shaft of the Torque Sensing Device.

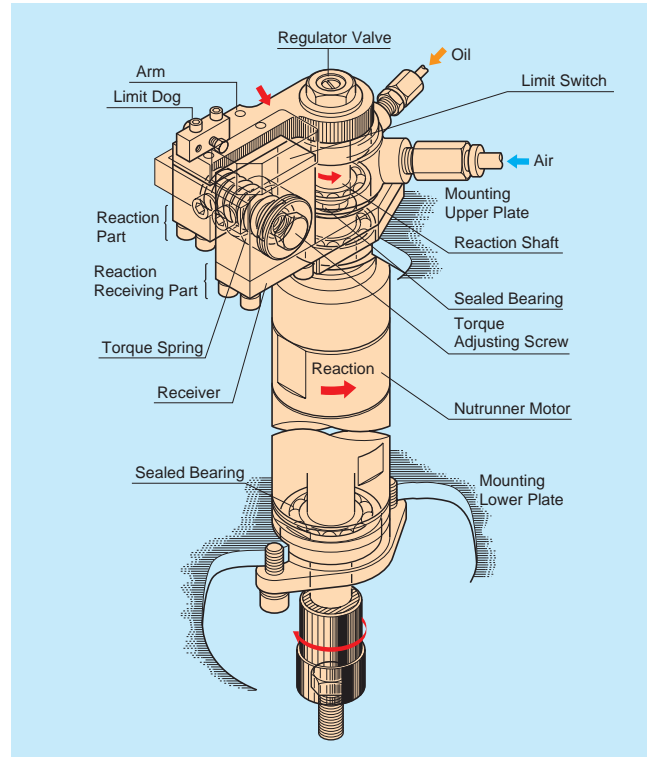

UST (URYU Stall Torque) SYSTEM

URYU precisely made stall type torque control air motor spindles of either single speed or two-speed are assembled into various multiple units to suit the customers' specific requirements. The satisfactory operation of each air motor incorporated in the conventional multiple units depends on correct adjustment of air pressure by stalling within the tolerance figure for each application.

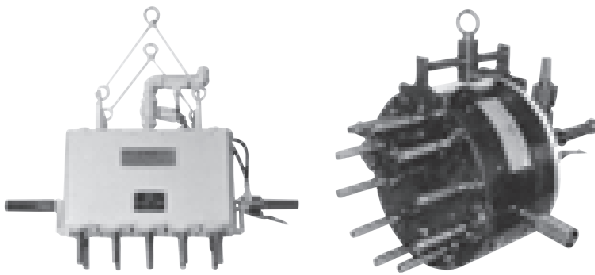

Vertical Suspension

Horizontal Suspension

TIMING CHART

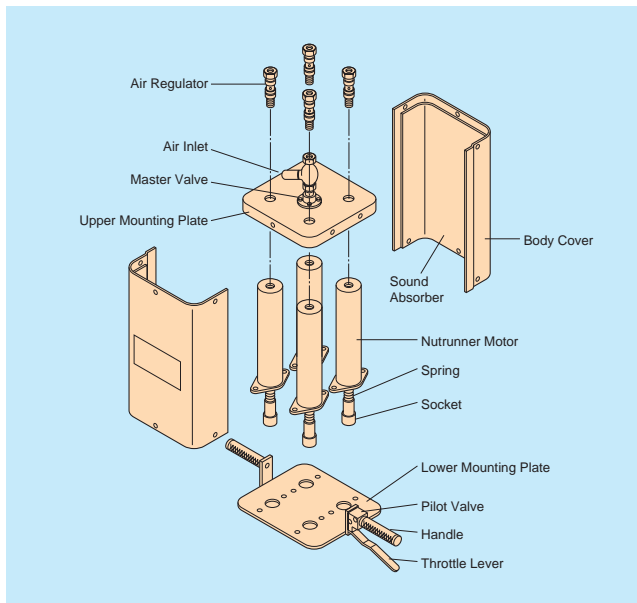
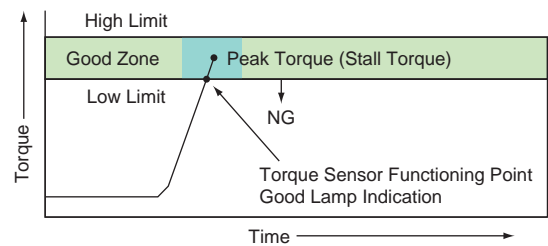

AUTOMATIC BOLT FEEDING SYSTEM

In combination with F Series Nutrunner System, URYU Automatic Bolt Feeding System is recommended to be applied for more effective production. As illustrated below, a bolt is automatically chuted to the Chuck of each nutrunner through Hopper - Bucket - Feeder - escapement - Chute Hose. The autofeeding is controlled with photo sensors and pressure switches. This full automation system surprisingly boosts productivity and yet greatly reduces operator's fatigue.

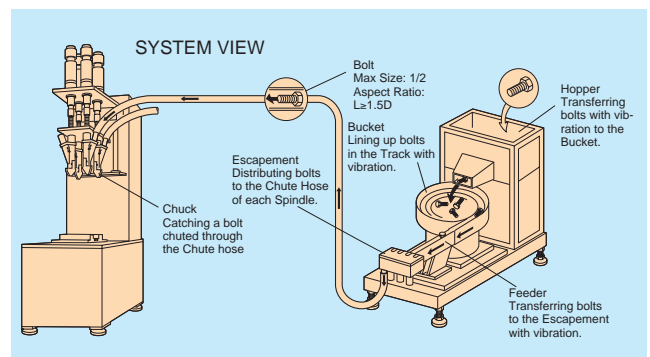

MULTIPLE NUTRUNNERS (ORDER-MADE PRODUCTS EXEMPTED FROM ISO 9001 CERTIFICATION.)



AUTOMATIC UNLOADING SYSTEM

This is the system, called "NAGARA" in Japan, which enables manually-handled multiple nutrunners to make the auto-cycling fastening operation. This system is mainly made up of Air Cylinder, two Spring Balancers and Control Device. After placed on the work flowing on the conveyor line, the multiple nutrunner travels with the work while fastening is going on. Upon completion of fastening operation, the multiple nutrunner is automatically lifted from the work by means of the automatic unloading system. If required, it is possible to have the multiple nutrunner returned to the original position with an air motor.

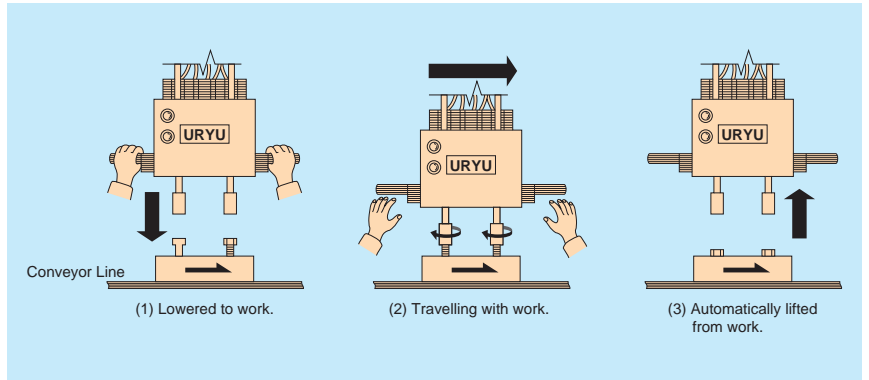

F SERIES ELECTRIC NUTRUNNER SYSTEM

- 1) Torque Control 2) Angle Control 3) Plastic Area Angle Control 4) Spline Fit-in Control 5) Pin Hole Control 6) Pre-load Control
- 7) Idle Running Control 8) Spline Angle Control 9) Yield Control

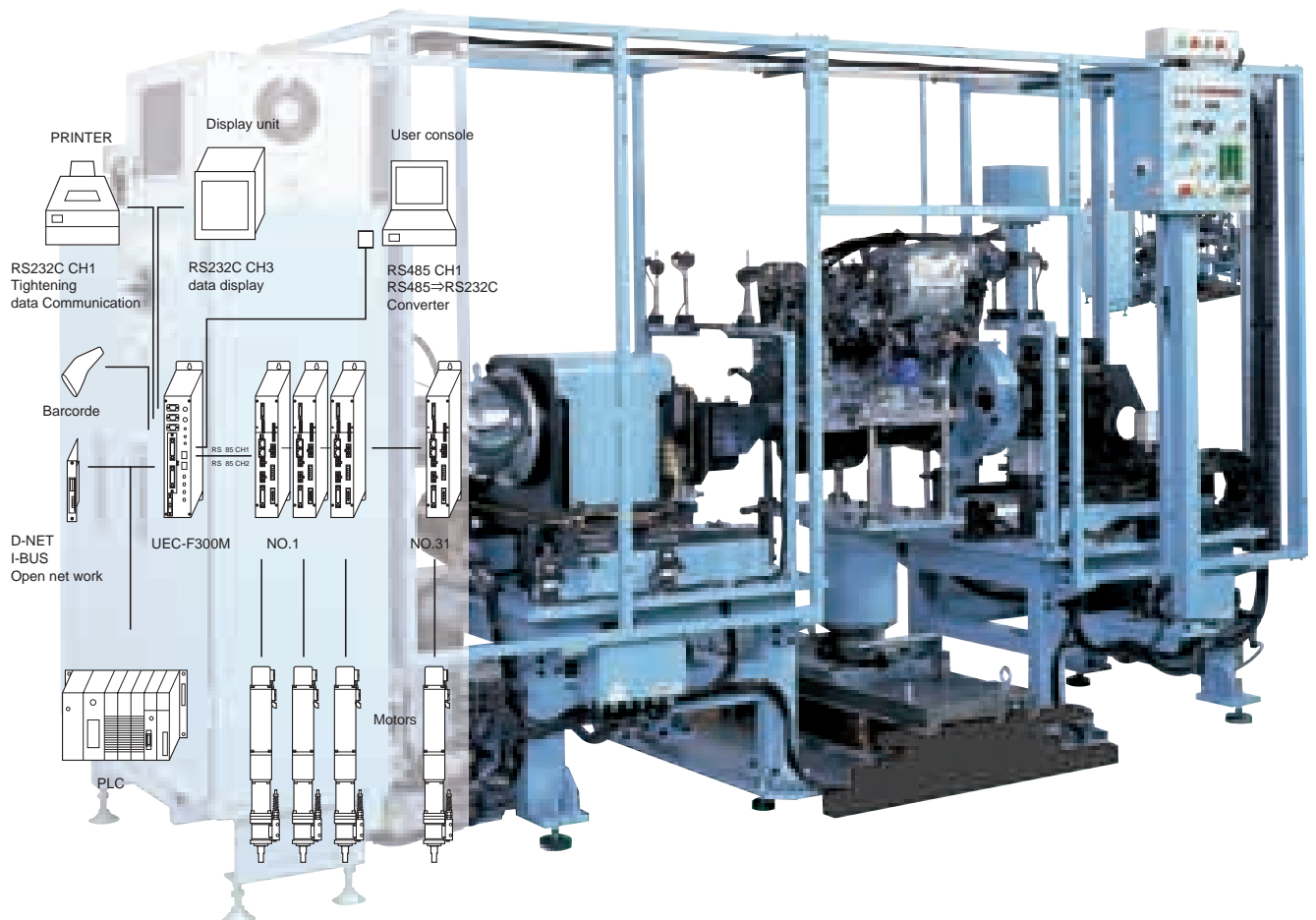

URYU can design and manufacture the complete machine to meet customer's demands besides components individual supply. Please feel free to contact nearest URYU distributors. Individual sheet catalogue is available for further information.

RATCHET WRENCHES

URYU wide range of **URW series** Ratchet Wrenches offer versatile service for driving and removing bolts or nuts in narrow application. Bent head type, Thinner head type and Extended Head type are also available for many kinds of hard-to-reach access fastening jobs, where even the standard head of Ratchet Wrenches can not get in. Reverse rotation is obtained by simply turning a tool over.

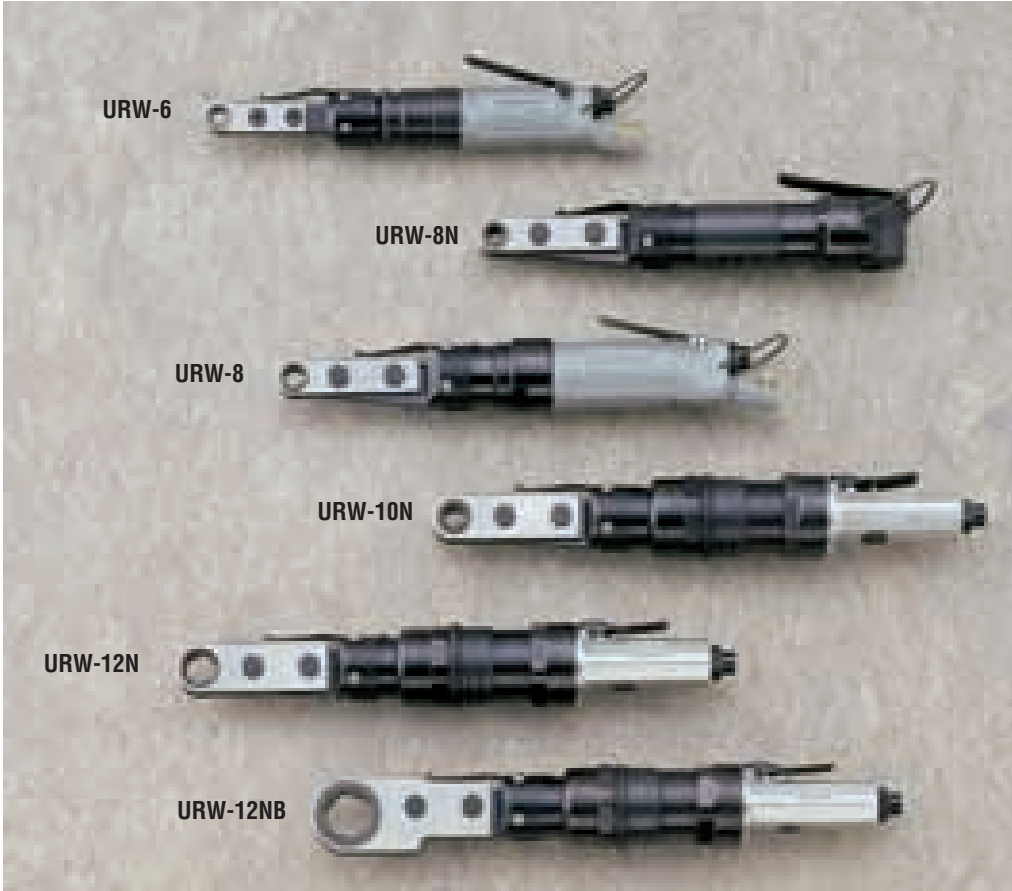

RATCHET VARIATION

Specify type of ratchet, size of across flat and extension length.

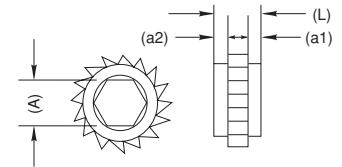

(A): Across Flat
(L): Thickness
(a1): Size in fastening side
(a2): Size in loosening side



Standard Hex Ratchet (Hex)

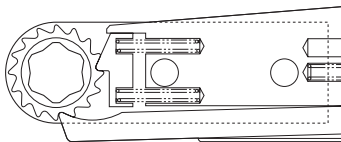
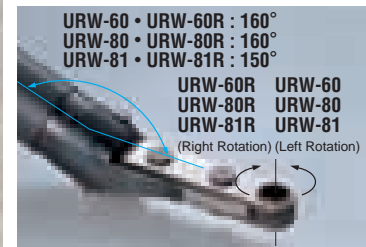

Head Sizes

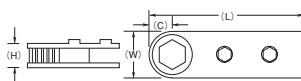

MODEL	H		W		L		C	
	mm	in	mm	in	mm	in	mm	in
URW-6,60,60R	13.0	33/64	20.0	25/32	88.0	3 5/32	10.0	25/64
URW-8,8N,80,80R,81,81R	18.0	45/64	25.0	63/64	102.5	4 1/32	12.5	31/64
URW-10N	18.0	45/64	33.0	19/64	106.5	4 3/16	16.5	21/32
URW-12N	18.0	45/64	36.0	27/64	109.5	4 5/16	18.0	45/64
URW-12NA	18.0	45/64	46.0	1 13/16	120.5	4 3/4	23.0	29/32
URW-12NB	18.0	45/64	54.0	2 1/8	128.5	5 1/16	27.0	1 1/16

SPECIFICATIONS

Recommended Air Pressure:0.6MPa(85psi)

Model	Capacity (Nominal Bolt Size)		Max. Torque		Free Speed (about)	Overall Length (about)		Weight (about)		* Hex Size of Ratchet Wrench () Standard		Average Air Consumption		Noise Level	Vibration Level
	mm	in	Nm	ft-lbs		mm	in	kg	lb	mm	in	m ³ /min	ft ³ /min		
URW-6	6	15/64	10.78	7.95	200	292	11 1/2	1.15	2.54	7, 8, (10), 12	3/8	0.28	9.9	81	3.2
URW-60, 60R	6	15/64	10.78	7.95	200	292	11 1/2	1.15	2.54	7, 8, (10), 12	3/8	0.28	9.9	85	10.0
URW-8N	8	5/16	15.68	11.56	220	300	11 13/16	1.80	3.96	9, 10, 12, (14)	7/16, 1/2, 9/16	0.55	19.5	90	17.8
URW-80, 80R	8	5/16	15.68	11.56	220	300	11 13/16	1.80	3.96	9, 10, 12, (14)	7/16, 1/2, 9/16	0.55	19.5	93	25.4
URW-81, 81R	8	5/16	15.68	11.56	220	300	11 13/16	1.80	3.96	9, 10, 12, (14)	7/16, 1/2, 9/16	0.55	19.5	93	25.4
URW-8	8	5/16	13.72	10.12	240	360	14 3/16	1.80	3.96	9, 10, 12, (14)	7/16, 1/2, 9/16	0.56	19.8	86	10.0
URW-9N	10	3/8	31.36	23.13	200	380	15	2.30	5.06	9, 10, 12, (14)	7/16, 1/2, 9/16	0.67	23.7	90	17.8
URW-10N	10	3/8	56.84	41.92	150	394	15 33/64	2.65	5.83	12, 14, (17)	9/16, 5/8, 11/16	0.70	25.0	90	17.8
URW-12N	13	1/2	58.80	43.38	150	397	15 5/8	2.70	5.94	19, (21)	3/4, 13/16	0.70	25.0	91	17.8
URW-12NA	14	9/16	78.40	57.84	100	408	16 1/16	3.00	6.60	22, (24), 27	3/4, 7/8, 15/16, 1	0.70	25.0	91	17.8
URW-12NB	16	5/8	93.10	68.69	85	416	16 19/64	3.20	7.04	29, (30), 32	3/4, 7/8, 15/16, 1	0.70	25.0	91	17.8

Air Inlet Thread (Pipe Tap) : N.P.T.1/4"

Air Hose Size (Inside Diameter) : 9.5mm (3/8")

In addition to listed size, many other sizes are available for each models. Specify Hex. size when ordering, otherwise the standard ratchet is supplied.

Max Torque is a guideline.

OPEN-END WRENCHES

URYU offers two series of Open-End Wrenches for fast, accurate tube nut tightening. **UOW-11 series** is stall torque type and **UOW-T60 series** is mechanical shut-off type with external torque adjustment. All gear drive mechanism without ratcheting provides precise torque, silent operation and longer tool life. The unique one-hand two-step throttle lever simplifies releasing the socket back to the open position and ensures smooth & easy operation. **UOW-T60 series** ensures more precise fastening and less operator fatigue due to fast shut-off clutch mechanism. **UGW** Geared Wrench offers quit and smooth nut fastening operation in hard-to-reach spaces.

OPEN-END WRENCH

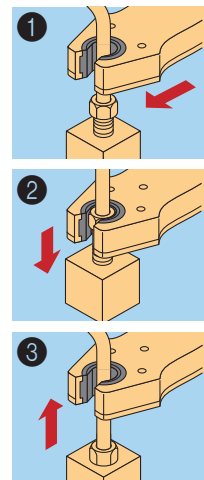

TWO-STEP THROTTLE LEVER

① HALF-WAY for Releasing the Gear Socket back to the open position.

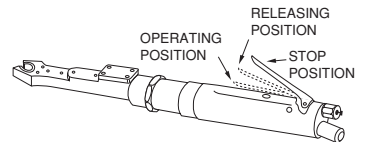

② Full-down for Operation.

EXTERNAL DIAL

Torque adjustment (No special tool is needed)



UOW-T60 series only.

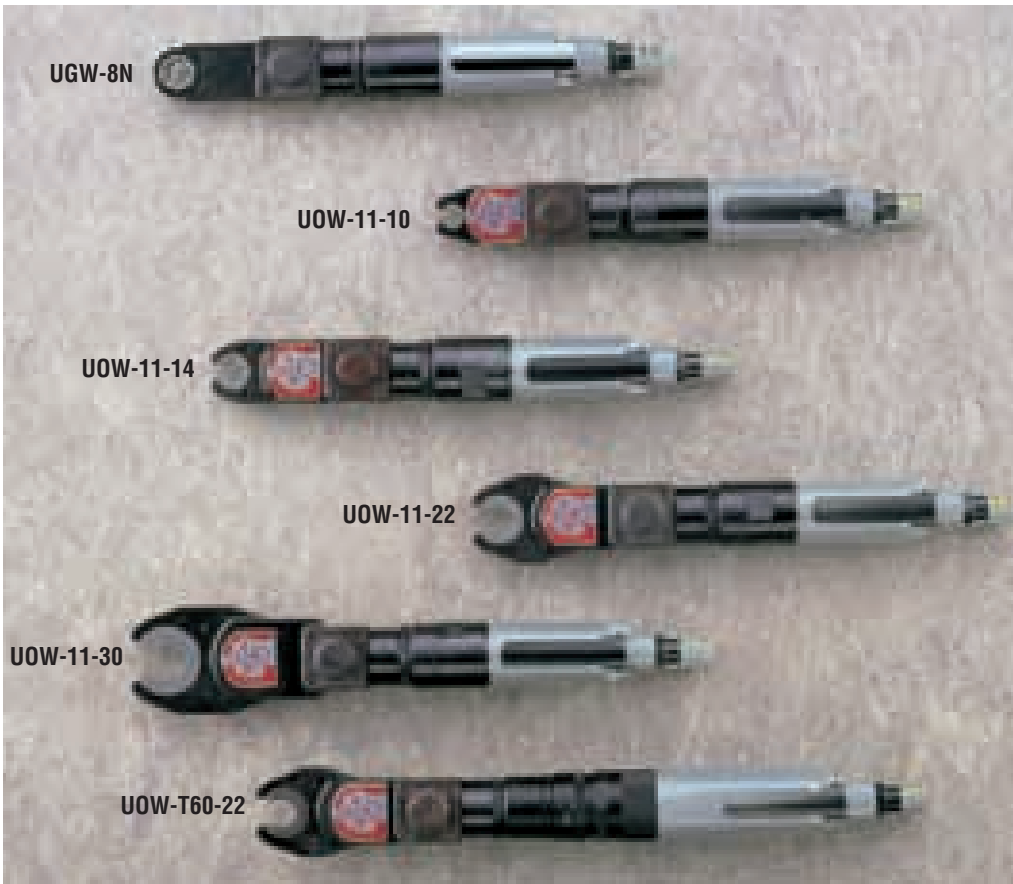

BOLT & NUT SETTERS

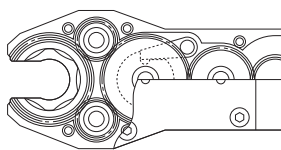

Head Sizes

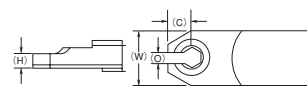

MODEL	H		W		O		C	
	mm	in	mm	in	mm	in	mm	in
UOW-11-10,UOW-T60-10	14.0	35/36	37.0	1 29/64	5.0-6.0	13/64-15/64	10.0	25/64
UOW-11-14,UOW-T60-14	14.0	35/36	40.0	1 37/64	6.0-9.0	15/64-23/64	13.0	25/64
UOW-11-22,UOW-T60-22	16.0	5/8	56.0	2 13/64	13.0-15.0	33/64-19/32	17.0	43/64
UOW-11-30,UOW-T60-30	16.0	5/8	68.0	2 43/64	15.0-23.0	19/32-29/32	21.0	53/64

SPECIFICATIONS

Recommended Air Pressure 0.6MPa(85psi)

Model	Max. Torque / Range		Free Speed (about)	Overall Length (about)		Weight (about)		* Hex Size of Gear Socket () Standard		Average Air Consumption		Noise Level	Vibration Level
	Nm	ft-lbs		r.p.m.	mm	in	kg	lb	mm	in	m ³ /min		
UOW-11-10	12.74	9.40	400	295	11 47/64	1.4	3.08	8, 9, (10)	1/8	0.35	12.5	76	2.0
UOW-11-14	15.68	11.57	260	311	12 1/4	1.8	3.96	10, 11, 12, 13, (14)	3/8, 1/2	0.35	12.5	76	2.0
UOW-11-22	23.52	17.35	180	326	12 53/64	1.8	3.96	17, 19, 21, (22)	5/8, 3/4, 7/8	0.35	12.5	76	1.6
UOW-11-30	31.36	23.14	135	347	13 21/32	2.5	5.50	23, 24, 26, 28, (30)	5/8, 3/4, 7/8	0.35	12.5	76	1.6
UOW-T60-10	3.9-12.7	2.9-9.4	300	370	14 5/8	1.8	3.96	8, 9, (10)	1/8	0.50	18.0	76	1.6
UOW-T60-14	4.9-16.7	3.6-12.3	230	385	15 1/8	2.2	4.85	10, 11, 12, 13, (14)	3/8, 1/2	0.50	18.0	76	1.6
UOW-T60-22	6.9-23.5	5.1-17.4	170	400	15 3/4	2.2	4.85	17, 19, 21, (22)	5/8, 3/4, 7/8	0.50	18.0	76	1.25
UOW-T60-30	9.8-31.4	7.2-23.1	130	420	16 5/8	2.9	3.30	23, 24, 26, 28, (30)	5/8, 3/4, 7/8	0.50	18.0	76	1.25
UGW-8N	22.56	16.64	410	322	12 11/16	1.5	3.31	12, 13, (14)	7/16, 9/16, 5/8	0.63	22.0	76	1.25

Air Inlet Thread (Pipe Tap) : N.P.T.1/4"

Air Hose Size (Inside Diameter) : 9.5mm (3/8")

In addition to listed size, many other sizes are available for each models. Specify Hex. size when ordering, otherwise the standard ratchet is supplied.

Max Torque is a guideline.

TORQUE CONTROL ANGLE NUTRUNNER (MECHANICAL-CUT)

The New **UAN-611R & UAN-701R series** Torque Control Angle Nutrunners offer exceptional fastening performance in the areas of productivity, ergonomics, reliability and quality.

Six Performance Advantages

1. Instant shut-off providing increased accuracy and reduced reaction.
2. Low inertia design providing increased accuracy.
3. Simple and accurate method to adjust torque output permitting quick setup.
4. Smooth rolling selector allowing easy adjustment to forward rotation or reverse rotation.
5. Rear exhaust providing low noise operation.
6. Multiple angle head positions allowing comfortable operation on limited access application.

Right Angle Head

Designed with a spline type interface allowing multiple head positions for the most comfortable throttle location on those hard to reach applications.

Torque Adjustment

Use a Phillips driver to adjust the torque from the outside of the tool. A gauge displaying 1, 2 and 3 allows you to "roughly adjust" the tool to the desired torque. When adjusting the torque, always disconnect the tool from the air hose.

Pneumatic Motor

Designed to offer high power performance in a low weight package. The high power feature produces torque efficiently on soft joint and prevailing torque applications. The low weight feature reduces motor inertia and assists in producing accurate torque on hard joints. In addition, the motor is designed for easy maintenance.

Rear Exhaust

Allows the tool to operate at less than 80 dBA. The piped away exhaust option for further reduces noise.



Ergo-Touch Protector

Ergonomically designed Protector offers firm gripping for ergonomic fastening.

Forward/Reverse Selector

Allows easy operator adjustment to forward rotation or reverse rotation.

Grease Cock

Allows periodic lubrication of the angle head bevel gears without having to disassemble the tool

Mechanical Clutch

The Uryu "Ergo Clutch" mechanism offers precise control of torque regardless of joint rate. The benefit is virtually no change in torque even on a joint that varies from 30 degrees of rotation (hard joint) to 720 degrees of rotation (soft joint). ISO 5393 testing reveals a 6-sigma combined capability of less than 20% on all models.

Poka-Yoke (Option)

A "TM" option is available for bolt counting or "error proofing". This option is used in conjunction with the UTM-1100 Fastening Counter.

Torque Adjustment

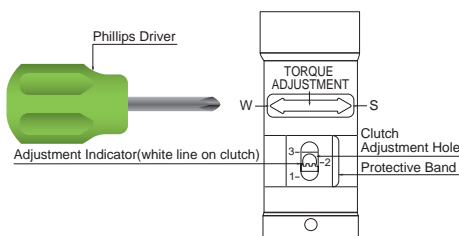

When adjusting the torque, always disconnect the tool from the air hose.

1. Rotate the protective band until the slot of clutch adjustment gauge becomes visible.
2. Turn 3/8" square drive of the angle head so the clutch adjustment hole is visible within the clutch adjustment slot.
3. Put the Phillips Driver into the clutch hole and adjust the torque output as follows:-
 - * Turning the Phillips Driver in the clockwise direction moves the adjustment indicator on the clutch towards the "3" and increases the torque output.
 - * Turning the Phillips Driver in the counterclockwise direction moves the adjustment indicator on the clutch towards the "1" and decrease the torque output.
4. After achieving the desired torque output level, rotate the protective band until the slot of the clutch adjustment gauge is completely covered.

TORQUE CONTROL ANGLE NUTRUNNER



Noise Level Comparison

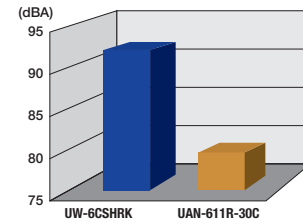

BOLT & NUT SETTERS

SPECIFICATIONS

Recommended Air Pressure: 0.6MPa(85psi)

Model	Bolt Capacity		Max. Torque		Free Speed (about) r.p.m.	Overall Length (about)		Weight less Socket (about)		From Center to Outside (about)		Angle Height (about)		Square Drive Shank		Average Air Consumption		Noise Level dB(A)	Vibration Level m/sec ²
	mm	in	Nm	ft-lbs		mm	in	kg	lb	mm	in	mm	in	mm	in	m ³ /min	ft ³ /min		
UAN-611R-60C	6	1/4	6.5-12.0	4.3-8.6	620	383	15 5/64	1.6	3.52	14.0	35/64	47	1 55/64	9.5	3/8	0.6	21.2	80	1.78
UAN-611R-50C	6-8	1/4-5/16	8.5-15.0	5.7-10.8	470	373	14 11/16	1.6	3.52	14.0	35/64	47	1 55/64	9.5	3/8	0.6	21.2	80	1.78
UAN-611R-40C	6-8	1/4-5/16	10.0-18.0	7.2-12.9	400	373	14 11/17	1.6	3.52	14.0	35/64	47	1 55/64	9.5	3/8	0.6	21.2	80	1.78
UAN-611R-30C	8	5/16	13.0-25.0	9.3-18.0	270	373	14 11/18	1.6	3.52	14.0	35/64	47	1 55/64	9.5	3/8	0.6	21.2	80	1.78
UAN-701R-60C	8	5/16	20.0-31.0	14.5-23.1	600	445	17 33/64	2.4	5.29	14.0	35/64	47	1 55/64	9.5	3/8	0.9	31.8	85	1.78
UAN-701R-40C	8-10	5/16-3/8	28.0-45.0	21.0-33.3	400	455	17 29/32	2.4	5.29	18.0	45/64	51	2	9.5	3/8	0.9	31.8	85	1.78
UAN-701R-30C	10-12	3/8-1/2	37.0-60.0	27.5-44.1	300	455	17 29/32	2.4	5.29	18.0	45/64	58	2 9/32	12.7	1/2	0.9	31.8	85	1.78

Air Inlet Thread (Pipe Tap) : N.P.T.1/4"
Air Hose Size (Inside Diameter) : 9.5mm (3/8")

BUILT-IN TRANSDUCER TYPE



Torque Distribution Chart

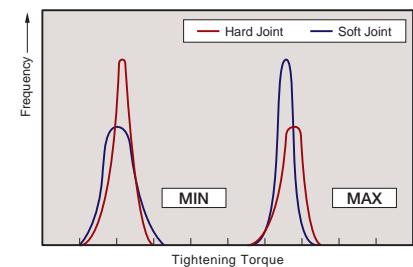

SPECIFICATIONS

Recommended Air Pressure 0.6MPa(85psi)

Model	Bolt Capacity		Max. Torque		Free Speed (about) r.p.m.	Overall Length less Socket (about)		Weight less Socket (about)		From Center to Outside (about)		Angle Height (about)		Square Drive Shank		Average Air Consumption		Noise Level dB(A)	Vibration Level m/sec ²
	mm	in	Nm	ft-lbs		mm	in	kg	lb	mm	in	mm	in	mm	in	m ³ /min	ft ³ /min		
UAN-611RM-60C	6	1/4	6.5-12.0	4.3-8.6	620	419	16 1/2	2.0	4.4	14.0	35/64	47	1 55/64	9.5	3/8	0.6	21.2	80	1.78
UAN-611RM-50C	6-8	1/4-5/16	8.5-15.0	5.7-10.8	470	409	16 7/64	2.0	4.4	14.0	35/64	47	1 55/64	9.5	3/8	0.6	21.2	80	1.78
UAN-611RM-40C	6-8	1/4-5/16	10.0-18.0	7.2-12.9	400	409	16 7/64	2.0	4.4	14.0	35/64	47	1 55/64	9.5	3/8	0.6	21.2	80	1.78
UAN-611RM-30C	8	5/16	13.0-25.0	9.3-18.0	270	409	16 7/64	2.0	4.4	14.0	35/64	47	1 55/64	9.5	3/8	0.6	21.2	80	1.78
UAN-701RM-60C	8	5/16	20.0-31.0	14.5-23.1	600	480	18 57/64	2.7	5.94	14.0	35/64	47	1 55/64	9.5	3/8	0.9	31.8	85	1.78
UAN-701RM-40C	8-10	5/16-3/8	28.0-45.0	21.0-33.3	400	492	19 3/8	2.9	6.38	18.0	45/64	51	2	9.5	3/8	0.9	31.8	85	1.78
UAN-701RM-30C	10-12	3/8-1/2	37.0-60.0	27.5-44.1	300	492	19 3/8	2.9	6.38	18.0	45/64	58	2 9/32	12.7	1/2	0.9	31.8	85	1.78

Air Inlet Thread (Pipe Tap) : N.P.T.1/4"
Air Hose Size (Inside Diameter) : 9.5mm (3/8")

FASTENING COUNTER WITH POKA-YOKE

URYU Fastening Counter Model, **UTM-1100**, counts down the number of bolts or nuts after fastening by the TM-type of Oil-Pulse Tool or Impact Wrench modified to sense the back pressure from the tool. This remarkable function automatically ensures the perfect fastening of all the required number of bolts and nuts. Human errors and fastening troubles can be avoided by clear LED display followed by cautionary lamp and buzzer.

FRONT PANEL

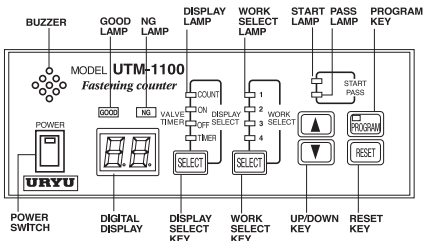

SPECIFICATIONS

- Power Source : AC100V - 240V 50 / 60Hz
- Count-down Number : Max. 99 by key
- Judgement Indication : GOOD LED (Green)
NG. LED (Red) with buzzer sounding
- Dimensions (mm) : 210 (W) x 85 (H) x 200 (D)
- Working Temperature: 0 - 40°C (Humidity : Max. 85%)

FEATURES

- Four Different workpieces can be covered.
- Four kinds of control mode are available to various assembly lines.
- Easy key programming
- Torque (QL) Wrench with limit switch can also be used.

MODE 1 : Judgement after limit switch signal

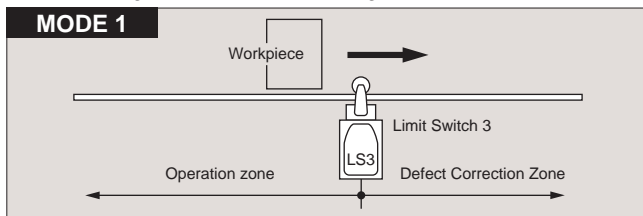

MODE 3 : Timer Control

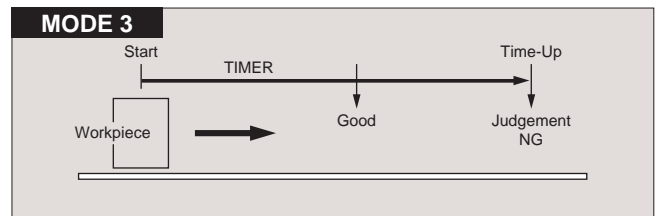

MODE 2 : Operation zone with 3 pieces of Limit Switches

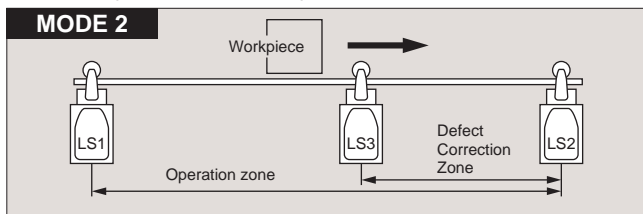

MODE 4 : Automatic WORK SELECT through external signal

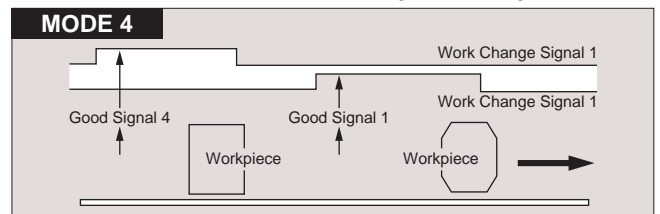

COMBINATIONS

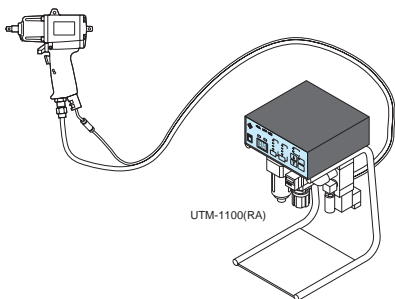

(A) With TM-Type Tool

Controlled by making use of air pressure difference at the chamber just before the motor.
*Shut-off Type Tools Controlled by shut-off signal

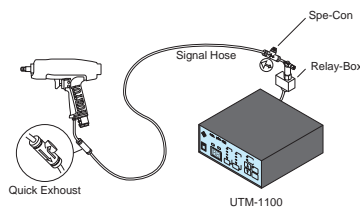

(B) With Shut-off Tool (T-Type)*

Relay box converts the air signal (release air at the shut-off moment) to electric signal. The electric signal is counted down as OK signal of fasteners up to 99 pieces.
*Except US-LT, UOW-T60, ALPHA-T70C(H), ALPHA-T70S & UAN Series
These models cannot be used with this relay from air to electric.

Combinations	Count Down	Initial Trouble Detection	Cycle Error Detection
(A)	Yes	Yes	Yes
(B)	Yes	No	No



PHOTO ; MODEL NO.US-350PW 1985
STILL USED AT USERS



SCREW DRIVERS

TORQUE CONTROL SCREWDRIVERS
CUSHION CLUTCH TYPE SCREWDRIVERS
OIL-PULSE TYPE SCREWDRIVERS
IMPACT SCREWDRIVERS
DIRECT DRIVE SCREWDRIVERS

* Sound Level measured to ISO 15744
* Vibration Level measured to ISO 8662

SELECTION CHART

Pistol Type



Push-Start Type



Lever-Start Type



Angle-Head Type



TORQUE-CONTROL TYPE

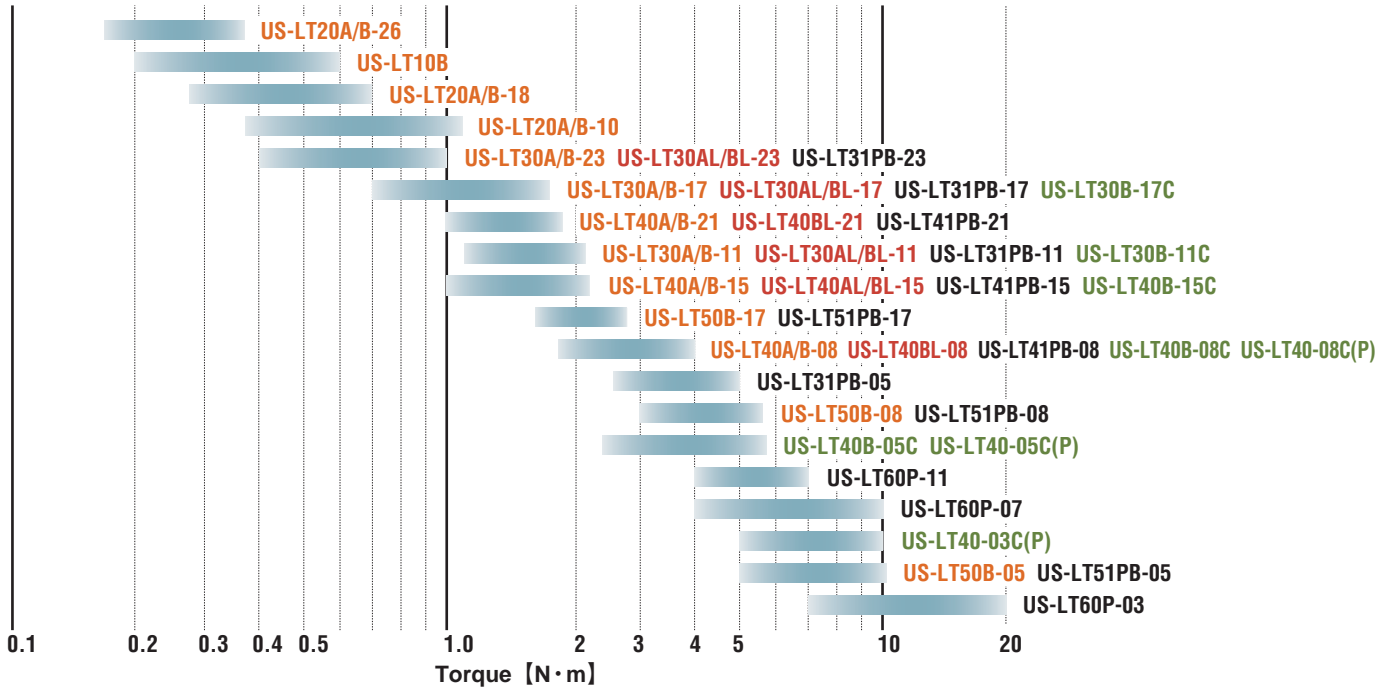

CUSHION CLUTCH TYPE

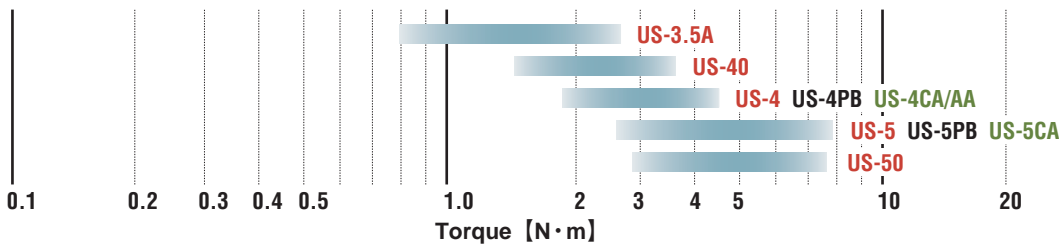

IMPACT TYPE

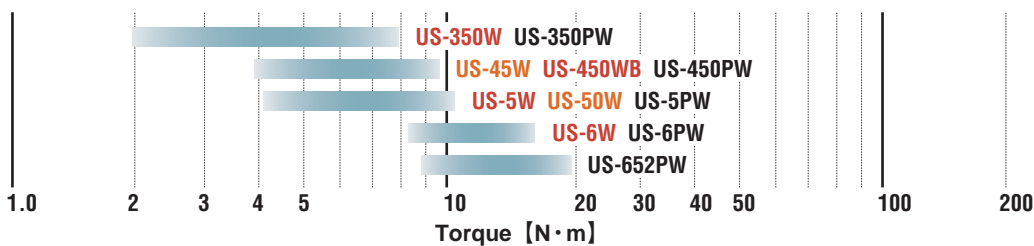

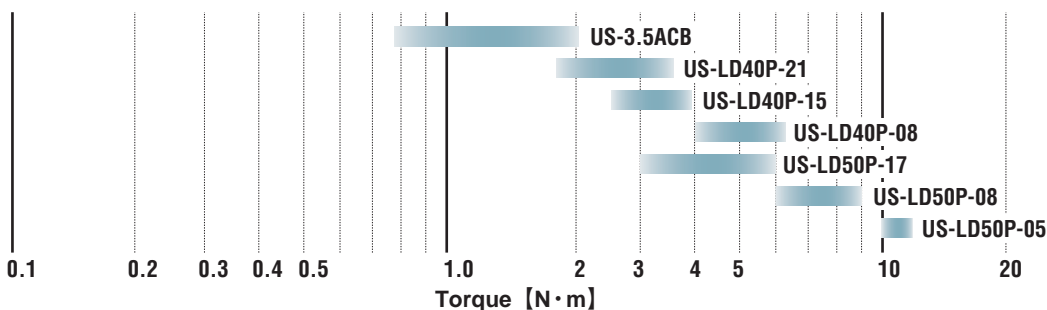

DIRECT DRIVE TYPE

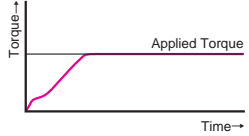
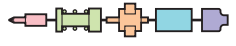
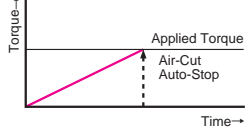

STRUCTURE & PECULIARITY FOR EACH TYPE

URYU offers a wide range of Screwdrivers to meet every application of screw-fastening in all assembly industries. Following are each feature and torque curve.

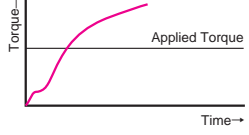
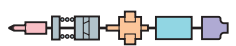
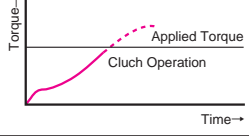
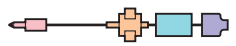
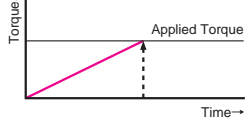
<p>OIL-PULSE TYPE</p> <p>Combined with air motor and the unique hydraulic system equipped with single or double blade impulse unit, Oil-Pulse types offer high productivity, precise fastening & ergonomic working environment.</p>		
<p>TORQUE-CONTROL TYPE</p> <p>Featured with unique clutch mechanism patented, US-LT series types are automatically shut off at the pre-set torque assuring precise fastening for high quality control.</p>		
<p>IMPACT TYPE</p> <p>Impact type screwdrivers of well-balanced Double-Hammer mechanism deliver tremendously high torque per weight and perform fast operation in driving and removing screws.</p>		
<p>CUSHION CLUTCH TYPE</p> <p>Only air motor starts running when throttle lever is operated. The screw bit rotates when operator's push or axial pressure is applied. The output torque can be adjusted by turning regulator to control spring compression or by changing the springs.</p>		
<p>DIRECT DRIVE TYPE</p> <p>US-LD series types are direct drive screwdriver which stalls when final torque is reached. Applied torque is controlled by operator and output of the motor. Torque level is adjusted by regulating air pressure.</p>		

 : Bit
  : Clutch
  : Hammer
  : Control
  : Reduction Gear
  : Oil-Pulse
  : Air Motor
  : Air Inlet

SELECTION GUIDE

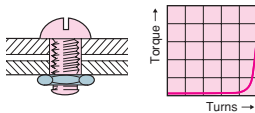
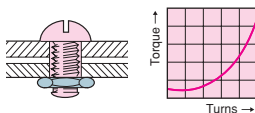
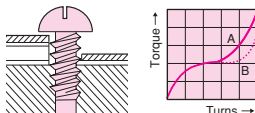
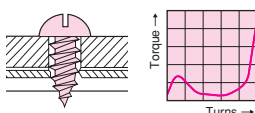
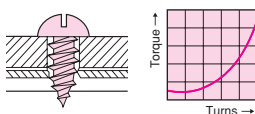
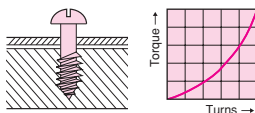
Joint & Torque Curve	Feature	Clutch Type	Model	A	B	C
Free Running Hard Stop 	Turns easily until head seats, then instant resistance to torque build-up.	Oil-Pulse	U,UX & ALPHA	⊙	⊙	○
		Impact	UW & US-○○W	×	○	×
		Torque Control	US-LT series	○	⊙	⊙
		Direct Drive	US-LD series	○	○	○
		Cushion	Other US series	○	○	○
Soft Stop 	Turns easily until head seats, Gradual resistance as material compresses.	Oil-Pulse	U,UX & ALPHA	⊙	⊙	○
		Impact	UW & US-○○W	×	○	×
		Torque Control	US-LT series	○	⊙	⊙
		Direct Drive	US-LD series	○	○	○
		Cushion	Other US series	○	○	○
Self-Tapping Thick Material 	Constant heavy resistance until head seats. Then gradual or sudden build-up.	Oil-Pulse	U,UX & ALPHA	⊙	⊙	⊙
		Impact	UW & US-○○W	×	○	×
		Torque Control	US-LT series	×	×	×
		Direct Drive	US-LD series	○	○	○
		Cushion	Other US series	○	○	○
Self-Tapping Sheet Metal 	Increasing resistance followed by easing then sudden build-up as head seats.	Oil-Pulse	U,UX & ALPHA	⊙	⊙	⊙
		Impact	UW & US-○○W	×	○	×
		Torque Control	US-LT series	×	×	×
		Direct Drive	US-LD series	○	○	○
		Cushion	Other US series	○	○	○
Self-Tapping Plastic 	Constant heavy resistance until head seats. Then gradual or sudden build-up.	Oil-Pulse	U,UX & ALPHA	⊙	⊙	⊙
		Impact	UW & US-○○W	×	×	×
		Torque Control	US-LT series	○	⊙	⊙
		Direct Drive	US-LD series	○	○	○
		Cushion	Other US series	○	○	○
Wood Screws 	Small starting resistance which increases as screw is driven in. Heavier resistance when head seats.	Oil-Pulse	U,UX & ALPHA	○	○	○
		Impact	UW & US-○○W	×	×	×
		Torque Control	US-LT series	×	×	×
		Direct Drive	US-LD series	○	⊙	⊙
		Cushion	Other US series	○	○	○

Remarks : A=Ergonomics B=Job Efficiency C=Torque Accuracy
 Recommendation : ⊙=Excellent ○=Good ×=Not Recommended

SCREWDRIVERS

TORQUE CONTROL SCREWDRIVERS

The **US-LT series** Screwdrivers offer the most advanced design and engineering concepts ever brought together. Accuracy, durability, comfort, simplicity and flexibility will be some of the benefits you will experience with their use.

STRAIGHT TYPE

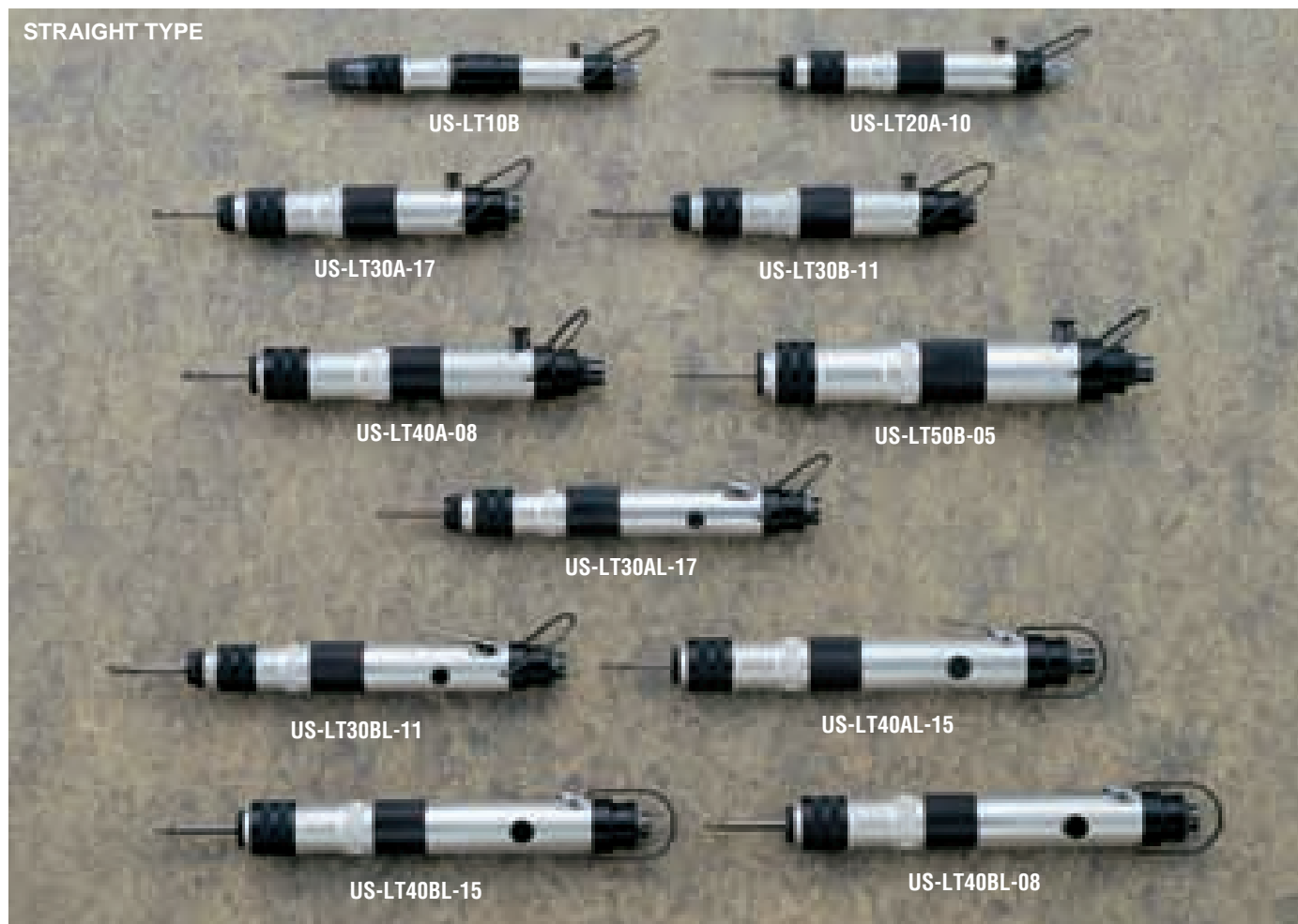

SPECIFICATIONS

Recommended Air Pressure:0.6MPa(85psi)

Model	Capacity (Screw Size)		Torque Range		Free Speed (Approx.) r.p.m.	Overall Length (about)		Weight less Bit (about)		From Center to Outside (about)		Air Hose Size (inside Dia.)		Average Air Consumption		Noise Level dB(A)	Vibration Level m/sec ²
	mm	in	Nm	in-lbs		mm	in	kg	lb	mm	in	mm	in	m ³ /min	ft ³ /min		
US-LT10B	2.6	7/64	0.20~0.60	1.8~5.3	1000	190	7 31/64	0.29	0.63	12.0	31/64	6.35	1/4	0.15	5.2	75	0.5
US-LT20A(B)-26	2.2	3/32	0.15~0.35	1.3~3.1	2600	180	7 3/32	0.34	0.68	13.0	33/64	6.35	1/4	0.16	5.6	71	1.0
US-LT20A(B)-18	2.6	7/64	0.25~0.70	2.2~6.2	1800	180	7 3/32	0.34	0.68	13.0	33/64	6.35	1/4	0.16	5.6	70	1.0
US-LT20A(B)-10	3	1/8	0.35~1.10	3.1~9.68	1000	180	7 3/32	0.34	0.68	13.0	33/64	6.35	1/4	0.16	5.6	70	1.0
US-LT30A(B)-23	3	1/8	0.40~1.00	3.5~8.8	2300	187	7 23/64	0.43	0.94	15.5	39/64	6.35	1/4	0.20	7.0	71	1.8
US-LT30A(B)-17	3.5	9/64	0.70~1.50	6.2~13.2	1700	187	7 23/64	0.43	0.94	15.5	39/64	6.35	1/4	0.20	7.0	70	1.8
US-LT30A(B)-11	4	5/32	1.10~2.10	9.7~18.5	1100	187	7 23/64	0.43	0.94	15.5	39/64	6.35	1/4	0.20	7.0	70	1.8
US-LT40A(B)-21	4	5/32	1.00~1.70	6.2~15.0	2100	209	8 15/64	0.65	1.43	16.5	41/64	6.35	1/4	0.30	10.5	74	1.8
US-LT40A(B)-15	4	5/32	1.00~2.20	6.2~19.4	1500	209	8 15/64	0.65	1.43	16.5	41/64	6.35	1/4	0.30	10.5	70	1.8
US-LT40A(B)-08	5	13/64	1.60~4.00	14.1~35.2	800	209	8 15/64	0.65	1.43	16.5	41/64	6.35	1/4	0.30	10.5	70	1.8
US-LT50B-17	4~5	5/32~13/64	1.50~2.60	9.7~23.0	1700	240	9 29/64	1.00	2.20	19.5	49/64	9.50	3/8	0.50	17.5	75	1.8
US-LT50B-08	5~6	13/64~15/64	3.00~5.50	26.4~48.4	800	240	9 29/64	1.00	2.20	19.5	49/64	9.50	3/8	0.50	17.5	75	1.8
US-LT50B-05	5~6	13/64~15/64	5.00~10.5	44.0~92.4	480	240	9 29/64	1.00	2.20	19.5	49/64	9.50	3/8	0.50	17.5	74	1.8
US-LT30A(B)L-23	3	1/8	0.40~1.00	3.52~8.8	2300	229	8 15/64	0.53	1.16	15.0	19/32	6.35	1/4	0.20	5.2	71	1.8
US-LT30A(B)L-17	3.5	9/64	0.70~1.50	6.2~13.2	1700	229	8 15/64	0.53	1.16	15.0	19/32	6.35	1/4	0.20	5.2	70	1.8
US-LT30A(B)L-11	3.5	9/64	1.10~2.10	9.7~18.5	1100	229	8 15/64	0.53	1.16	15.0	19/32	6.35	1/4	0.20	5.2	70	1.8
US-LT40BL-21	4	5/32	1.00~1.70	8.8~15.0	2100	249	9 25/32	0.70	1.54	17.0	21/32	6.35	1/4	0.30	5.6	74	1.8
US-LT40A(B)L-15	4	5/32	1.00~2.20	8.8~19.4	1500	249	9 25/32	0.70	1.54	17.0	21/32	6.35	1/4	0.30	5.6	70	1.8
US-LT40BL-08	5	3/16	1.60~4.00	14.1~35.2	800	249	9 25/32	0.70	1.54	17.0	21/32	6.35	1/4	0.30	5.6	70	1.8

Air Inlet Size : N.P.T.1/4"

Hex. Size of Bit : 5mm (13/64") for A-Type
6.35mm (1/4") for B-Type

TORQUE CONTROL SCREWDRIVERS

PISTOL TYPE



US-LT60P(P) Series

Optional 9.5mm (3/8") Sq. Drive Anvil is alternatively available. Suffix each model name with (P) as US-LT60P-11(P) when ordering.



Torque reaction bar should be attached for solid support to absorb the reaction when the tool comes to stall.

SCREWDRIVERS

SPECIFICATIONS

Recommended Air Pressure: 0.6MPa(85psi)

Model	Capacity (Screw Size)		Torque Range		Free Speed (Approx.) r.p.m.	Overall Length (about)		Weight less Bit (about)		From Center to Outside (about)		Air Hose Size (inside Dia.)		Average Air Consumption		Noise Level dB(A)	Vibration Level m/sec ²
	mm	in	Nm	in-lbs		mm	in	kg	lb	mm	in	mm	in	m ³ /min	ft ³ /min		
US-LT31PB-23	2.6	7/64	0.40~1.00	3.5~8.8	2300	170	7 1/64	0.71	1.56	16.0	39/64	6.35	1/4	0.20	7.0	70	1.0
US-LT31PB-17	2.2	3/32	0.70~1.50	6.2~13.2	1700	170	7 1/64	0.71	1.56	16.0	39/64	6.35	1/4	0.20	7.0	70	1.0
US-LT31PB-11	2.6	7/64	1.10~2.10	9.7~18.5	1100	170	7 1/64	0.71	1.56	16.0	39/64	6.35	1/4	0.20	7.0	70	1.0
US-LT31PB-05	3	1/8	2.40~5.00	21.1~44.0	500	189	8 3/16	0.85	1.87	16.0	39/64	6.35	1/4	0.20	7.0	70	1.0
US-LT41PB-21	3	1/8	1.00~1.70	8.8~15.0	2500	175	7 23/32	0.87	1.91	17.0	41/64	6.35	1/4	0.30	10.5	74	1.0
US-LT41PB-15	3.5	9/64	1.00~2.20	8.8~19.4	1500	175	7 23/32	0.87	1.91	17.0	41/64	6.35	1/4	0.30	10.5	70	1.0
US-LT41PB-08	4	5/32	1.60~4.00	14.1~35.2	800	175	7 23/32	0.87	1.91	17.0	41/64	6.35	1/4	0.30	10.5	70	1.0
US-LT51PB-17	4	5/32	1.50~2.60	13.2~22.9	1700	198	8 35/64	1.20	2.64	20.0	49/64	9.50	3/8	0.50	17.5	75	1.8
US-LT51PB-08	4	5/32	3.00~5.50	26.4~48.4	800	198	8 35/64	1.20	2.64	20.0	49/64	9.50	3/8	0.50	17.5	75	1.8
US-LT51PB-05	5	13/64	5.00~10.5	44.0~92.4	480	198	8 35/64	1.20	2.64	20.0	49/64	9.50	3/8	0.50	17.5	74	1.8
US-LT60P-11	4~5	5/32~13/64	4.00~7.00	35.2~61.6	1100	230	9 1/16	1.70	3.74	22.0	57/64	9.50	3/8	0.60	21.0	77	2.0
US-LT60P-07	5~6	13/64~15/64	4.00~10.0	35.2~88.0	650	230	9 1/16	1.70	3.74	22.0	57/64	9.50	3/8	0.60	21.0	76	2.5
US-LT60P-03	5~6	13/64~15/64	7.00~20.0	61.6~176	320	230	9 29/64	1.70	3.74	22.0	57/64	9.50	3/8	0.60	21.0	75	2.5

Air Inlet Size : N.P.T.1/4"

Hex. Size of Bit : 6.35mm (1/4")

TORQUE-CONTROL MECHANISM

1. Neutral

2. Operation

3. Shut-off

External Torque Adjustment (Air Shut-Off)

Set the hand driver through the slot into the key hole on the Adjusting Gear and turn clockwise to increase torque, and anti-clockwise to decrease.

Locking Reverse Button

The Reverse Button can be locked during reversing operation. Push the Button and turn clockwise or anti-clockwise for locking.

TORQUE CONTROL SCREWDRIVERS

ANGLE TYPE



Head Sizes

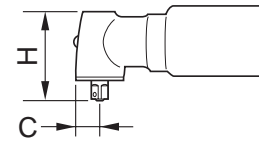

MODEL	C		H	
	mm	in	mm	in
US-LT30B-17C	10	25/64	36.0	1 27/64
US-LT30B-11C	10	25/64	36.0	1 27/64
US-LT40B-15C	10	25/64	36.0	1 27/64
US-LT40B-08C	10	25/64	36.0	1 27/64
US-LT40B-05C	10	25/64	38.5	1 33/64
US-LT40-08C(P)	10	25/64	32.0	1 17/64
US-LT40-05C(P)	13	33/64	35.5	1 25/64
US-LT40-03C(P)	13	33/64	35.5	1 25/64

SPECIFICATIONS

Recommended Air Pressure:0.6MPa(85psi)

Model	Capacity (Screw Size)		Torque Range		Free Speed (Approx.) r.p.m.	Overall Length (about)		Weight less Bit (about)		From Center to Outside (about)		Air Hose Size (inside Dia.)		Average Air Consumption		Noise Level dB(A)	Vibration Level m/sec ²
	mm	in	Nm	in-lbs		mm	in	kg	lb	mm	in	mm	in	m ³ /min	ft ³ /min		
US-LT30B-17C	2.6	7/64	0.70~1.50	6.2~13.2	1700	295	10 3/4	0.70	1.54	36.0	1 27/64	6.35	1/4	0.20	7.0	73	2.5
US-LT30B-11C	2.2	3/32	1.10~2.10	9.7~18.5	1100	295	10 3/4	0.70	1.54	36.0	1 27/64	6.35	1/4	0.20	7.0	73	2.5
US-LT40B-15C	2.6	7/64	1.00~2.20	8.8~19.4	1500	314	12 25/32	0.90	1.98	36.0	1 27/64	6.35	1/4	0.30	10.5	75	3.2
US-LT40B-08C	3	1/8	1.60~4.00	14.1~35.2	800	314	12 25/32	0.90	1.98	36.0	1 27/64	6.35	1/4	0.30	10.5	75	3.2
US-LT40B-05C	3	1/8	2.30~5.70	20.2~50.2	500	325	13 7/32	0.95	2.09	38.5	1 33/64	6.35	1/4	0.30	10.5	75	3.2
US-LT40-08C(P)	3.5	9/64	1.60~4.00	14.1~35.2	800	314	12 25/32	0.90	1.98	32.0	1 17/64	6.35	1/4	0.30	10.5	75	3.2
US-LT40-05C(P)	4	5/32	2.30~5.70	20.2~50.2	500	325	13 7/32	0.95	2.09	35.5	1 25/64	6.35	1/4	0.30	10.5	75	3.2
US-LT40-03C(P)	4	5/32	5.00~10.0	44~88	300	359	14 11/64	1.10	2.42	35.5	1 25/64	6.35	1/4	0.30	10.5	72	3.2

Air Inlet Size : N.P.T.1/4"

Hex. Size of Bit : 6.35mm (1/4") for B-Type

Sq Size of Anvil : 6.35mm (1/4") for US-LT40 Series

OPTIONAL CLUTCH SPRINGS FOR US-LT SERIES

Model Name	Color of Clutch Spring		Torque Range(soft joint)		Torque Range(hard joint)		Code No.
	Standard	Option	Nm	in.lbs	Nm	in.lbs	
US-LT10B	● Black		0.20~0.60	1.76~5.28	0.20~0.60	1.76~5.28	976-379-0
US-LT20B-10	● Black		0.35~1.10	3.08~9.68	0.34~1.17	3.0~10.3	976-432-0
		● Red ● Yellow	0.20~0.70 0.15~0.35	1.76~6.16 1.32~3.08	0.20~0.70 0.20~0.34	1.76~6.16 1.76~2.99	976-431-0 976-430-0
US-LT20B-18	● Red		0.25~0.70	2.2~6.16	0.34~0.67	3.0~5.9	976-431-0
		● Yellow	0.15~0.35	1.32~3.08	0.29~0.34	2.55~2.99	976-430-0
US-LT20B-26	● Yellow		0.15~0.35	1.32~3.08	0.39~0.44	3.4~3.9	976-430-0
US-LT31PB-05	● Red		2.40~5.00	21.12~44.0	2.40~5.00	21.12~44.0	976-493-0
		● Pink	1.00~2.80	8.8~24.64	1.00~2.80	8.8~24.64	976-471-0
US-LT30B/31PB-11	● Blue		1.10~2.10	9.68~18.48	1.10~2.10	9.68~18.48	976-472-0
		● Red	0.70~1.80	6.16~15.84	0.70~1.80	6.16~15.84	976-493-0
		● Pink	0.40~1.00	3.52~8.8	0.40~1.00	3.52~8.8	976-471-0
US-LT30B/31PB-17	● Red		0.70~1.50	6.16~13.2	0.83~1.76	7.3~15.5	976-493-0
		● Pink	0.40~1.00	3.52~8.8	0.59~0.98	5.19~8.62	976-471-0
US-LT30B/31PB-23	● Pink		0.40~1.00	3.52~8.8	0.78~1.08	6.86~9.5	976-471-0
US-LT40-03C	● Red		5.00~10.0	44.0~88.0	5.00~10.0	44~88	976-516-0
US-LT40B/41PB-08	● Black		1.60~4.00	14.08~35.2	1.60~4.00	14.08~35.2	976-515-0
		● Red	1.00~2.20	8.8~19.36	1.00~2.20	8.8~19.36	976-516-0
		● Yellow	1.00~1.70	8.8~14.96	1.00~1.70	8.8~14.96	976-517-0
US-LT40B/41PB-15	● Red		1.00~2.20	8.8~19.36	1.00~2.20	8.8~19.36	976-516-0
		● Yellow	1.00~1.70	8.8~14.96	1.00~1.70	8.8~14.96	976-517-0
US-LT40B/41PB-21	● Yellow		1.00~1.70	8.8~14.96	1.00~1.70	8.8~14.96	976-517-0
US-LT50B/51PB-05	● Black		5.0~10.5	44.0~92.4	5.0~10.5	44~92.4	976-620-0
		● Red	3.0~5.5	26.4~48.4	3.0~5.5	26.4~48.4	976-614-0
		● Yellow	1.5~2.6	13.2~22.88	1.5~2.6	13.2~22.88	976-588-0
US-LT50B/51PB-08	● Red		3.0~5.5	26.4~48.4	3.0~5.5	26.4~48.4	976-614-0
		● Yellow	1.5~2.6	13.2~22.88	1.5~2.6	13.2~22.88	976-588-0
US-LT50B/51PB-17	● Yellow		1.5~2.6	13.2~22.88	1.5~2.6	13.2~22.88	976-588-0

CUSHION CLUTCH SCREWDRIVERS

STRAIGHT TYPE

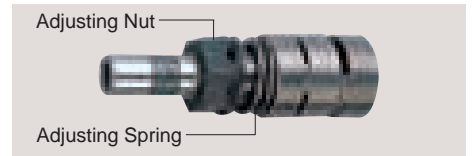

The output torque can be adjusted by turning the adjusting nut to control spring compression or by changing the suitable spring.

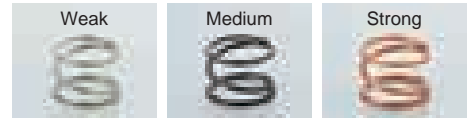

Adjusting Springs of three different tensions are available for wider adjustment of torque.

SPECIFICATIONS

Recommended Air Pressure: 0.4MPa(57psi)

Model	Capacity (Screw Size)		Free Speed (Approx.)	Overall Length (about)		Weight Less Socket or Bit (about)		From Center to Outside (about)		Hex. Size of Bit		Air Hose Size		Average Air Consumption		Noise Level	Vibration Level
	mm	in		r.p.m.	mm	in	kg	lb	mm	in	mm	in	mm	in	m³/min		
US-3.5A	M4	5/32	2000	196	7 31/64	0.60	1.39	17.0	43/64	5.00	13/64	6.35	1/4	0.20	7.0	75	5.6
US-3.5B	M4	5/32	2000	214	8 27/54	0.63	1.39	17.0	43/64	6.35	1/4	6.35	1/4	0.20	7.0	75	5.6
US-4	M4	5/32	1400	236	7 3/32	0.95	2.09	20.0	25/32	5.00	13/64	6.35	1/4	0.20	7.0	75	10.0
US-5	M5	3/16	1400	236	7 3/32	1.10	2.42	21.0	53/64	6.35	1/4	6.35	1/4	0.20	7.0	75	10.0

Air Inlet Size : N.P.T.1/4"

MAGNET TYPE



Cutaway view of Magnet type head

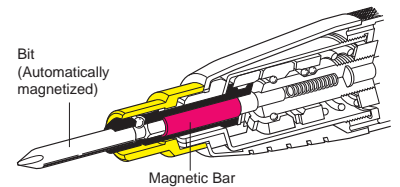

The standard bit contacts the built-in Magnetic Bar to be magnetized and holds the screw.

SPECIFICATIONS

Recommended Air Pressure: 0.4MPa(57psi)

Model	Capacity (Screw Size)		Free Speed (Approx.)	Overall Length (about)		Weight Less Socket or Bit (about)		From Center to Outside (about)		Hex. Size of Bit		Air Hose Size		Average Air Consumption		Noise Level	Vibration Level
	mm	in		r.p.m.	mm	in	kg	lb	mm	in	mm	in	mm	in	m³/min		
US-3.5MA	M4	5/32	2000	198	7 3/32	0.65	0.68	17.0	33/64	6.35	1/4	6.35	1/4	0.20	7.0	75	2.3

Air Inlet Size : N.P.T.1/4"

PUSH-TO-START THROTTLE TYPE

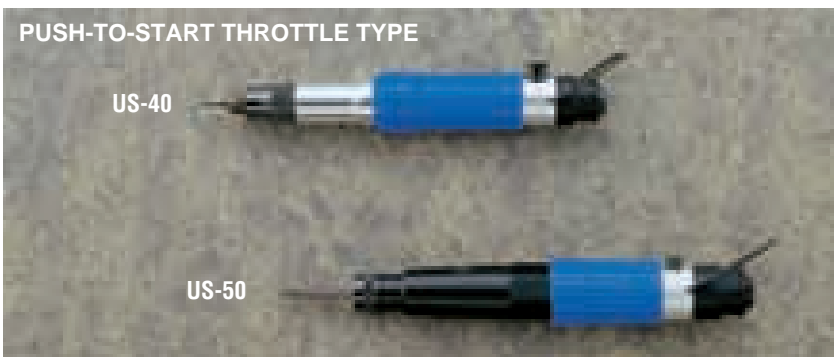

Non-Lever type Throttle

Operator's axial pressure pushes up the operating rod to open the throttle valve automatically.

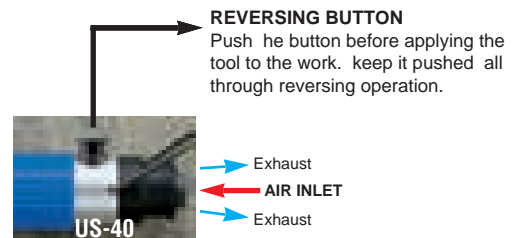

SPECIFICATIONS

Recommended Air Pressure: 0.4MPa(57psi)

Model	Capacity (Screw Size)		Free Speed (Approx.)	Overall Length (about)		Weight Less Socket or Bit (about)		From Center to Outside (about)		Hex. Size of Bit		Air Hose Size		Average Air Consumption		Noise Level	Vibration Level
	mm	in		r.p.m.	mm	in	kg	lb	mm	in	mm	in	mm	in	m³/min		
US-40	M4	5/32	2200	225	8 55/64	0.56	1.23	17.0	43/64	5.00	13/64	6.35	1/4	0.20	7.0	70	5.6
US-50	M5	3/16	1200	245	9 41/64	0.90	1.98	18.0	45/64	6.35	1/4	6.35	1/4	0.30	10.7	76	10.0

Air Inlet Size : N.P.T.1/4"

CUSHION CLUTCH SCREWDRIVERS

PISTOL / ANGLE TYPE



Head Sizes

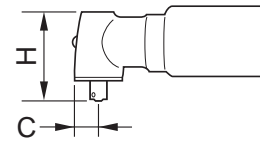

MODEL	C		H	
	mm	in	mm	in
US-3.5ACB	10.0	25/64	36.5	1 33/64
US-4CA	12.0	15/32	45.0	1 25/32
US-5CA	12.0	15/32	45.0	1 25/32

SPECIFICATIONS

Recommended Air Pressure: 0.4MPa(57psi)

Model	Capacity (Screw Size)		Free Speed (Approx.) r.p.m.	Overall Length (about)		Weight Less Bit (about)		From Center to Outside (about)		Air Inlet Size	Hex. Size of Bit		Average Air Consumption		Noise Level dB(A)	Vibration Level m/sec ²
	mm	in		mm	in	kg	lb	mm	in		mm	in	m ³ /min	ft ³ /min		
US-3.5PB	M4	5/32	2000	200	7 7/8	0.75	1.65	17.0	43/64	N.P.T.1/4	6.35	1/4	0.20	7.0	75	2.3
US-4PB	M4	5/32	1400	223	8 25/32	1.15	2.53	20.0	49/64	N.P.T.1/4	5.00	13/64	0.20	7.0	75	2.3
US-5PB	M5	3/16	1400	236	9 19/64	1.30	2.86	21.0	33/64	N.P.T.1/4	6.35	1/4	0.20	7.0	75	2.3
*US-3.5ACB	M4	5/32	2000	236	9 19/64	0.65	1.43	10.0	25/64	N.P.T.1/4	6.35	1/4	0.20	7.0	85	5.6
US-4CA	M4	5/32	1400	225	8 7/8	1.10	2.24	12.0	29/64	N.P.T.1/4	6.35	1/4	0.30	10.7	85	3.2
US-5CA	M5	3/16	500	198	7 3/32	1.40	3.08	12.0	29/64	N.P.T.1/4	6.35	1/4	0.30	10.7	85	3.2

*US-3.5ACB is not the cushion clutch type but the direct drive type. Air Hose Size (Inside Diameter) : 6.35mm (1/4")

DIRECT DRIVE SCREWDRIVERS

PISTOL TYPE

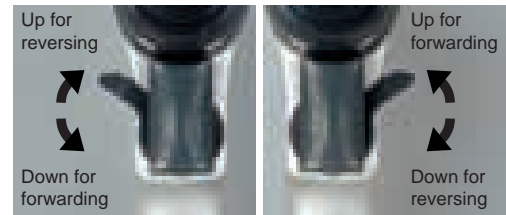

By replacing Reverse Lever, Operator can use either left or right hand.

SPECIFICATIONS

Recommended Air Pressure : 0.5MPa(71psi)

Model	Capacity (Screw Size)		Torque Range				Free Speed (about) r.p.m.	Overall Length (about)		Weight Less Bit (about) kg lb	From Center to Outside (about)		Average Air Consumption		Noise Level dB(A)	Vibration Level m/sec ²	
	mm	in	Soft Joint		Hard Joint			mm	in		mm	in	m ³ /min	ft ³ /min			
			Nm	ft-lbs	Nm	ft-lbs											
US-LD40P-21	M4	5/32	2.0	1.5	2.8	2.1	2500	130	5 1/14	0.7	1.54	17.0	43/64	0.40	14.0	74	1.0
US-LD40P-15	M4	5/32	3.0	2.2	3.2	2.4	1700	130	5 1/14	0.7	1.54	17.0	43/64	0.40	14.0	70	1.0
US-LD40P-08	M5	3/16	4.8	3.6	5.7	4.2	940	130	5 1/14	0.7	1.54	17.0	43/64	0.40	14.0	70	1.0
US-LD50P-17	M4	5/32	3.5	2.6	5.9	4.4	1900	150	5 29/32	0.9	2.01	20.0	49/64	0.50	17.5	75	2.0
US-LD50P-08	M5	3/16	6.5	4.8	7.8	5.8	900	153	6 1/32	0.9	2.01	20.0	49/64	0.50	17.5	75	2.0
US-LD50P-05	M5	3/16	10.0	7.4	11.2	8.3	500	153	6 1/32	0.9	2.01	20.0	49/64	0.50	17.5	74	2.0

Air Inlet Size : N.P.T.1/4" Air Hose Size : 6.35mm (1/4") Hex. Size of Bit : 6.35mm (1/4")

IMPACT TYPE SCREWDRIVERS

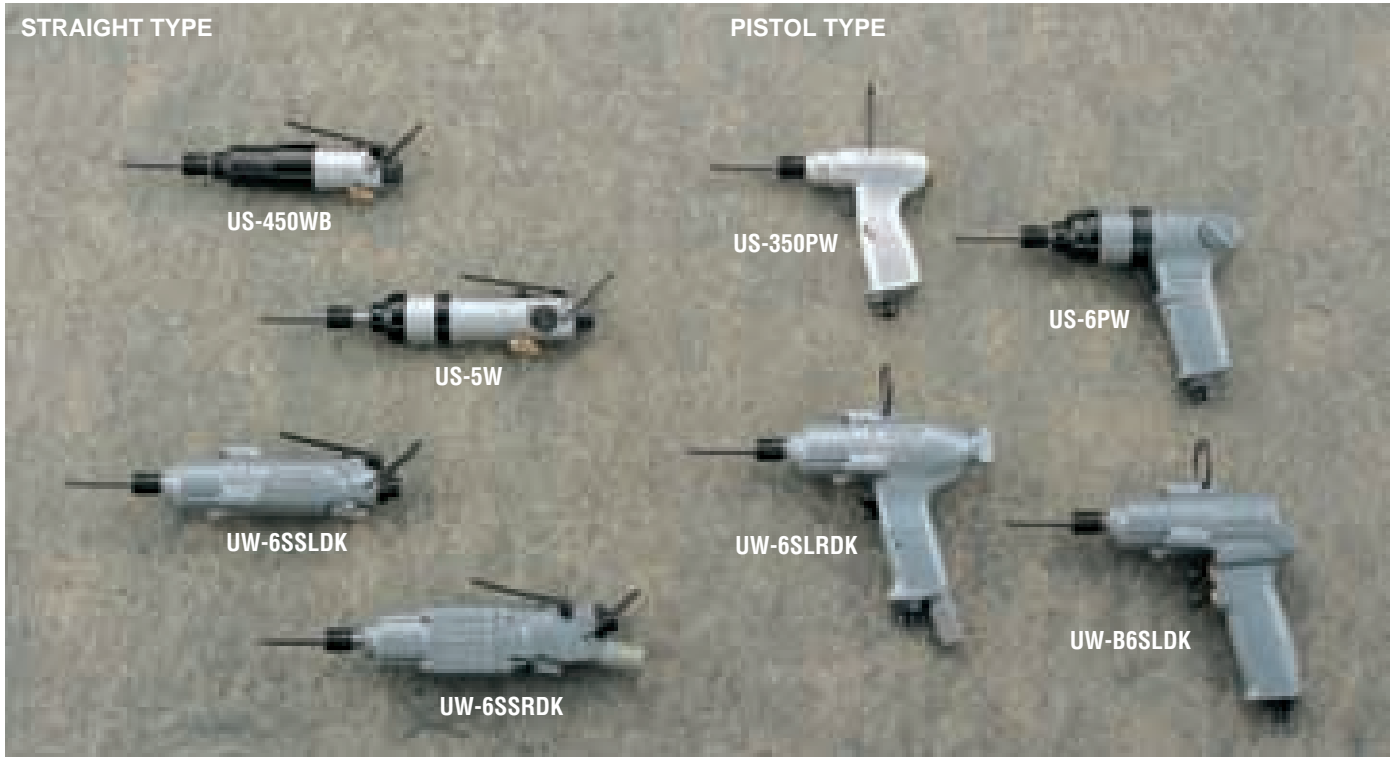

SPECIFICATIONS (STRAIGHT TYPE)

Model	Capacity (Screw Size)		Free Speed (Approx.)	Overall Length (about)		Weight Less Bit (about)		From Center to Outside (about)		Hex. Size of Bit		Air Hose Size (inside Dia)		Average Air Consumption		Noise Level	Vibration Level	Recommended Air Pressure	
	mm	in		r.p.m.	mm	in	kg	lb	mm	in	mm	in	mm	in	m³/min			ft³/min	dB(A)
US-350W	M4	5/32	14000	168	6 5/8	0.40	0.88	17.0	43/64	6.35	1/4	6.35	1/4	0.20	7.0	80	2.3	0.4	57
US-450WB	M5	3/16	11000	161	6 5/16	0.55	1.21	18.5	47/64	6.35	1/4	6.35	1/4	0.20	7.0	80	2.3	0.4	57
US-45W	M5	3/16	12000	193	7 19/32	0.50	1.10	17.0	43/64	6.35	1/4	6.35	1/4	0.20	7.0	80	2.3	0.4	57
US-5W	M5	3/16	9500	198	7 51/64	0.80	1.60	20.0	27/32	6.35	1/4	6.35	1/4	0.20	7.0	85	5.6	0.4	57
US-6W	M6	1/4	9500	187	7 23/64	0.80	1.76	22.5	57/64	6.35	1/4	6.35	1/4	0.30	10.5	85	3.2	0.4	57
UW-6SSLRDK	M6	1/4	8500	245	9 21/32	0.87	1.98	21.5	27/32	6.35	1/4	9.5	3/8	0.30	10.5	90	10.0	0.6	85
UW-6SSRDK	M6	1/4	7500	241	9 31/64	0.97	2.20	22.0	27/32	6.35	1/4	9.5	3/8	0.30	10.5	90	10.0	0.6	85
UW-6SSHRDK	M8	5/16	7300	265	10 7/16	1.26	2.75	24.0	15/16	6.35	1/4	9.5	3/8	0.35	12.4	91	17.8	0.6	85
UW-6SSLDK	M6	1/4	8500	203	7 63/64	0.90	1.98	21.5	27/32	6.35	1/4	9.5	3/8	0.30	10.5	91	10.0	0.6	85
UW-6SSDK	M6	1/4	7500	202	7 61/64	1.00	2.20	22.0	27/32	6.35	1/4	9.5	3/8	0.30	10.5	91	10.0	0.6	85
UW-6SSHDK	M8	5/16	7500	220	8 21/32	1.25	2.86	24.0	15/16	6.35	1/4	9.5	3/8	0.35	12.4	92	17.8	0.6	85

Air Inlet Size : N.P.T.1/4"

SPECIFICATIONS (PISTOL TYPE)

Model	Capacity (Screw Size)		Free Speed (Approx.)	Overall Length (about)		Weight Less Bit (about)		From Center to Outside (about)		Hex. Size of Bit		Air Hose Size (inside Dia)		Average Air Consumption		Noise Level	Vibration Level	Recommended Air Pressure	
	mm	in		r.p.m.	mm	in	kg	lb	mm	in	mm	in	mm	in	m³/min			ft³/min	dB(A)
US-350PW	M4	5/32	16000	121	4 49/64	0.53	1.16	17.0	43/64	6.35	1/4	6.35	1/4	0.20	7.0	81	2.5	0.4	57
US-450PW	M5	3/16	11000	149	5 55/64	0.75	1.65	17.0	43/64	6.35	1/4	6.35	1/4	0.20	7.0	79	2.5	0.4	57
US-5PW	M5	3/16	9500	173	6 13/16	0.95	2.10	20.0	25/32	6.35	1/4	6.35	1/4	0.30	10.5	85	1.0	0.4	57
US-6PW	M6	15/64	10000	170	6 45/64	1.00	2.20	23.0	57/64	6.35	1/4	6.35	1/4	0.30	10.5	85	1.0	0.4	57
US-652PW	M6	15/64	9300	155	6 7/64	0.85	1.87	23.0	15/16	6.35	1/4	6.35	1/4	0.25	8.8	79	1.8	0.4	57
UW-6SLRDK	M6	1/4	8500	169	6 21/32	0.97	2.13	22.0	27/32	6.35	1/4	9.5	3/8	0.30	10.5	91	5.6	0.6	85
UW-6SHBRDK	M8	5/16	7300	153	6 1/32	1.36	2.99	24.0	15/16	6.35	1/4	9.5	3/8	0.35	12.4	91	5.6	0.6	85
UW-6SLDK	M6	1/4	8500	165	6 1/2	0.97	2.13	22.0	27/32	6.35	1/4	9.5	3/8	0.30	10.5	92	5.6	0.6	85
UW-B6SLDK	M6	1/4	8500	170	6 45/64	1.00	2.20	24.0	61/64	6.35	1/4	9.5	3/8	0.30	10.5	92	5.6	0.6	85
UW-6SDK	M6	1/4	7500	160	6 5/16	1.22	2.68	22.0	27/32	6.35	1/4	9.5	3/8	0.30	10.5	93	5.6	0.6	85
UW-6SADK	M6	1/4	7500	160	6 5/16	1.10	2.47	22.0	27/32	6.35	1/4	9.5	3/8	0.30	10.5	93	5.6	0.6	85
UW-6SHDK	M8	5/16	7500	190	7 31/64	1.45	3.10	24.0	15/16	6.35	1/4	9.5	3/8	0.35	12.4	92	5.6	0.6	85

Air Inlet Size : N.P.T.1/4"

OIL-PULSE TYPE SCREWDRIVERS

STRAIGHT TYPE

PISTOL TYPE



SPECIFICATIONS (STRAIGHT TYPE)

Recommended Air Pressure:0.6MPa(85psi)

Model	Capacity (Screw Size)		Torque Range		Free Speed (Approx.) r.p.m.	Overall Length (about)		Weight Less Bit (about)		From Center to Outside (about)		Air Hose Size (inside Die)		Average Air Consumption		Noise Level dB(A)	Vibration Level m/sec ²
	mm	in	Nm	ft-lbs		mm	in	kg	lb	mm	in	m ³ /min	ft ³ /min	dB(A)	m/sec ²		
U-310SD	M3-4	No.8	2.50-3.10	1.8-2.2	11000	222	8 45/64	0.62	1.50	18.0	47/64	9.5	3/8	0.15	5.3	68	1.8
U-350SD	M3-4	No.8	3.50-5.80	2.6-3.1	10500	238	9 3/8	0.71	1.50	22.0	47/64	9.5	3/8	0.15	5.3	74	1.8
U-410SD	M4-5	No.8-10	7.00-10.0	5.2-7.4	10500	240	9 27/32	0.80	1.80	22.0	7/8	9.5	3/8	0.15	5.3	91	2.2
UX-450SD	M5	No.10	8.00-14.0	5.9-10.4	9500	239	9 11/64	0.80	1.80	22.0	7/8	6.35	1/4	0.20	7.0	67	2.2
UX-500SD	M5-6	No.10-1/4	13.0-20.0	9.6-14.8	9300	244	9 39/64	0.92	2.00	22.0	7/8	6.35	1/4	0.25	8.8	70	2.2
UX-612SD	M6-8	1/4-5/16	16.0-28.0	11.9-20.8	9300	253	9 61/64	1.00	2.20	23.0	29/32	6.35	1/4	0.30	10.7	77	2.2
UX-700SD	M8	5/16	20.0-36.0	14.6-26.6	9000	249	9 51/64	1.27	2.80	26.5	1 3/64	6.35	1/4	0.35	12.3	79	2.2
ALPHA-45SD	M4	5/32	13.0-20.0	9.6-14.8	5500	243	9 9/16	0.86	2.53	22.0	7/8	6.35	1/4	0.20	7.0	80	2.3
ALPHA-50SD	M5	3/16	18.0-28.0	13.3-20.7	7500	232	9 9/64	0.87	2.86	22.0	7/8	6.35	1/4	0.20	7.0	80	2.3
ALPHA-60SD	M4	5/32	22.0-35.0	16.3-25.9	7000	244	9 39/64	0.93	1.43	23.0	29/32	6.35	1/4	0.30	10.7	85	5.6
ALPHA-T42D	M4-5	No.8-10	3.8-7.0	2.8-5.2	3900	194	7 41/64	1.08	2.40	22.5	57/64	6.35	1/4	0.20	7.0	70	1.0
ALPHA-T47SPD	M5	3/16	6.00-11.0	4.4-8.1	5700	246	9 11/16	1.40	3.08	23.7	33/64	9.5	3/8	0.30	10.7	90	1.5

Air Inlet Size : N.P.T.1/4"

Hex. Size of Bit : 6 35mm (1/4")

SPECIFICATIONS (PISTOL TYPE)

Recommended Air Pressure:0.6MPa(85psi)

Model	Capacity (Screw Size)		Torque Range		Free Speed (Approx.) r.p.m.	Overall Length (about)		Weight Less Bit (about)		From Center to Outside (about)		Air Hose Size (inside Die)		Average Air Consumption		Noise Level dB(A)	Vibration Level m/sec ²
	mm	in	Nm	ft-lbs		mm	in	kg	lb	mm	in	m ³ /min	ft ³ /min	dB(A)	m/sec ²		
U-350D	M3-4	No.8	3.5-5.8	2.6-4.3	11500	155	6 3/32	0.76	1.60	22.0	7/8	6.35	1/4	0.15	5.3	74	1.0
U-410D	M4-5	No.8-10	7.0-10.0	5.2-7.4	10000	188	7 13/32	1.00	2.20	22.0	7/8	6.35	1/4	0.15	5.3	70	1.4
UX-450D	M5	No.10	8.0-14.0	5.9-10.4	9500	151	5 15/16	0.85	1.90	22.0	7/8	6.35	1/4	0.20	7.0	75	1.0
UX-500D	M5-6	No.10-1/4	13.0-20.0	9.6-14.8	9300	152	5 63/64	0.85	1.90	22.0	7/8	6.35	1/4	0.25	8.8	70	1.0
UX-612D	M6-8	1/4-5/16	16.0-28.0	11.8-20.7	9300	164	6 29/64	0.95	2.10	23.0	29/32	6.35	1/4	0.30	10.5	75	1.0
UX-700D	M8	5/16	20.0-36.0	14.8-26.6	9000	171	6 47/64	1.38	3.00	26.0	1.00	6.35	1/4	0.35	12.3	75	0.7

Air Inlet Size : N.P.T.1/4"

Hex. Size of Bit : 6 35mm (1/4")

AIR HOSE BALANCER

The "Line Reel" air hose balancer, without any hampering chain or rope to balance the tool, contributes to keep the work bench and work area uncluttered for safer operation, higher productivity, less operator's fatigue and longer tool life.

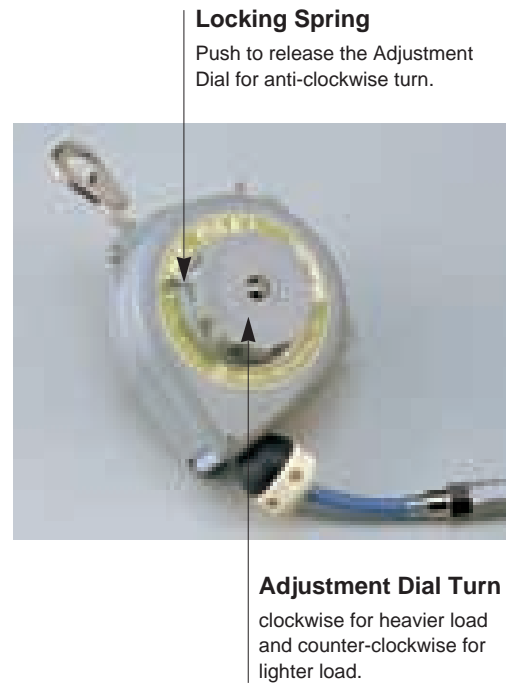
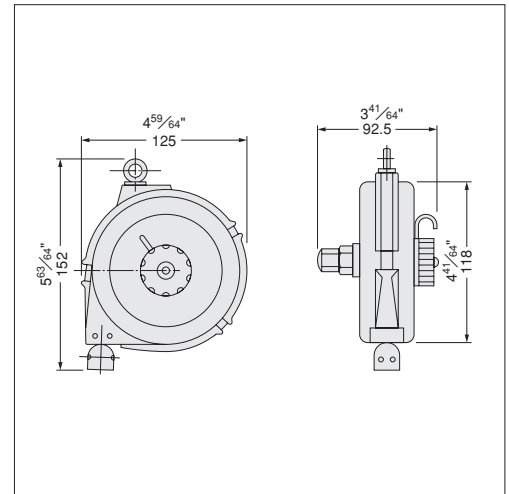
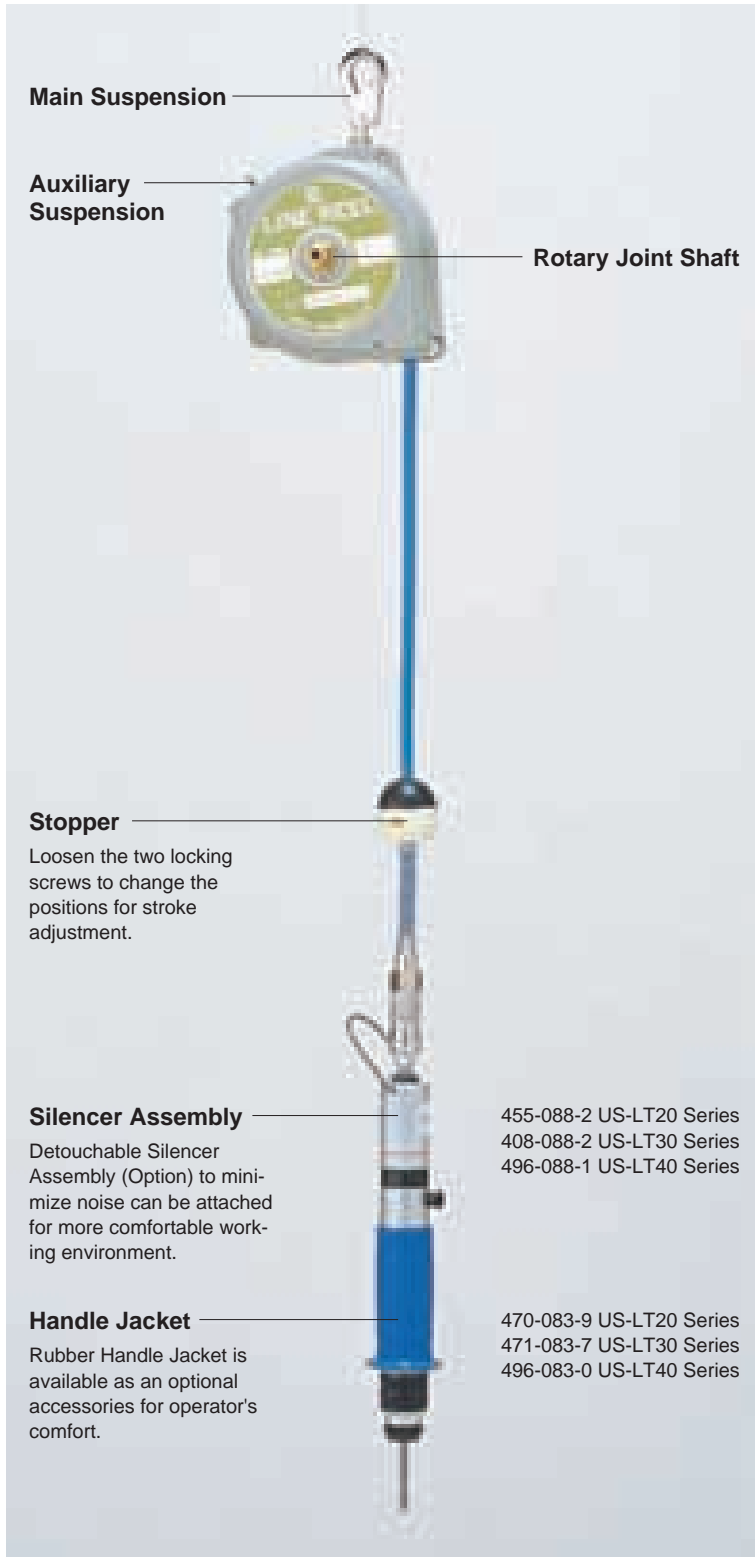

SPECIFICATIONS

Model	Max Suspending Capacity		Air Hose Size I.D.xO.D.xLength		Weight (about)		Max Stroke		Max Air Pressure	
	Kg	lb	mm	in	kg	lb	mm	in	Mpa	psi
LR-09B(200)	1.4	3.08	5 x 8.5 x 2000	13/64 x 21/64 x 78 47/64	1.89	0.86	700	27 9/16	1	142

ACCESSORIES

GROUP OF TOOLS	A	US-LT20A, LT30A & 40A, US-3.5A, US-40, US-4, US-3.5PA, US-4PB
	B	US-○○, UW-○○D, ALPHA/UX/U-○○D, US-LT10B, LT30B, LT40B, LT50B & LT60, US-5, US-50, US-3, US-3.5PB, US-5PB
	C	US-LT10B
	D	US-3.5MA
	E	US-LT30B-11C & 17C, US-LT40B-08C & 15C, US-3.5ACB, US-4CA, US-4AA, US-5AA, US-5CA

PHILLIPS BITS

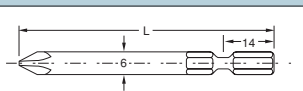
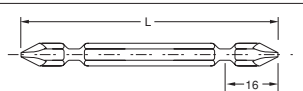
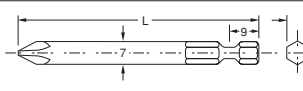
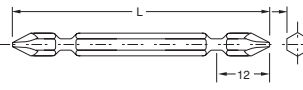
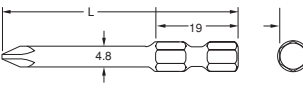
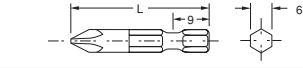
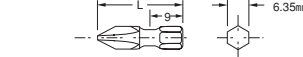

Group	Bit	Phillips No.1			Phillips No.2			Phillips No.3		
		mm (L) in	Code No.	mm (L) in	Code No.	mm (L) in	Code No.			
A		70	2 3/4	916-300-0	70	2 3/4	916-310-0	75	2 61/64	916-320-0
		100	3 15/16	916-301-0	100	3 15/16	916-311-0	120	4 23/32	916-321-0
		120	4 23/32	916-306-0	120	4 23/32	916-316-0	150	5 29/32	916-323-0
		150	5 29/32	916-302-0	150	5 29/32	916-312-0	200	7 7/8	916-322-0
A		70	2 3/4	916-700-0	70	2 3/4	916-710-0	70	2 3/4	916-710-0
		100	3 15/16	916-701-0	100	3 15/16	916-711-0	100	3 15/16	916-793-0
		120	4 23/32	916-704-0	120	4 23/32	916-714-0	125	4 59/64	916-794-0
		150	5 29/32	916-702-0	150	5 29/32	916-712-0			
B		75	2 61/64	916-400-0	75	2 61/64	916-410-0	75	2 61/64	916-420-0
		100	3 15/16	916-401-0	100	3 15/16	916-411-0	100	3 15/16	916-421-0
		120	4 23/32	916-405-0	120	4 23/32	916-416-0	120	4 23/32	916-426-0
		150	5 29/32	916-402-0	150	5 29/32	916-412-0	150	5 29/32	916-422-0
B		75	2 61/64	916-800-0	75	2 61/64	916-810-0	75	2 61/64	916-820-0
		100	3 15/16	916-801-0	100	3 15/16	916-811-0	100	3 15/16	916-821-0
		120	4 23/32	916-804-0	120	4 23/32	916-814-0	120	4 23/32	916-824-0
		150	5 29/32	916-802-0	150	5 29/32	916-812-0	150	4 29/32	916-822-0
C		Phillips No.0 50	1 31/32	916-135-0	-	-	-	-	-	-
		Phillips No.0 70	2 3/4	916-136-0						
		50	1 31/32	916-137-0						
		70	2 3/4	916-138-0						
D		Phillips No.0 40	1 37/64	916-530-0	40	1 37/64	916-550-0	40	1 37/64	916-560-0
		40	1 37/64	916-540-0						
E		23	1 37/64	916-500-0	23	29/32	916-510-0	23	29/32	916-520-0
		30	1 37/64	916-501-0	30	1 3/16	916-511-0	30	13/16	916-521-0

* Bits are available in five different hardness to meet every application.

Suffix the code number of required bit with following identification letter : C (54-58HRC) is standard, A (46-50 HRC), B (50-54 HRC), D (58-62 HRC) and E (over 62 HRC)

* Double ended Phillips No.3 Bits listed in B-2 can be used only with US-6series and UW-6series with special Driver Anvil for these models.

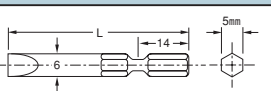
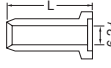
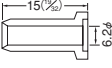
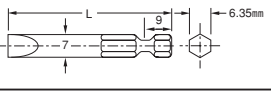
SLOTTED HEAD BITS & FINDERS

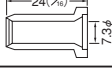
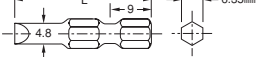
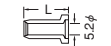
Group	Bit	Overall Length(L)		Code No.	FINDER	Overall Length(L)		Code No.	FINDER	Code No.
		mm	in			mm	in			
A		51	2 1/4	916-020-0		19	3/4	917-300-0		917-299-0
		75	2 61/64	916-021-0		43	1 11/16	917-301-0		
		100	3 15/16	916-022-0		68	2 43/64	917-302-0		
		150	5 29/32	916-023-0		118	4 41/64	917-304-0		
B		56	2 13/64	916-030-0		23	29/32	917-400-0		917-350-0
		75	2 61/64	916-031-0		42	1 21/32	917-401-0		
		100	3 15/16	916-032-0		67	2 41/64	917-402-0		
		150	5 29/32	916-033-0		117	4 39/64	917-403-0		
C		49.2	1 15/16	916-084-0		16	5/8	917-031-0	-	-

HEXAGONAL SOCKET BITS

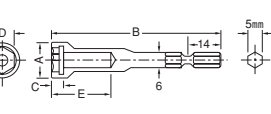
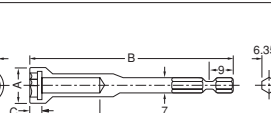
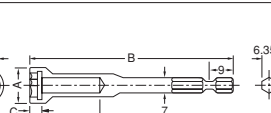
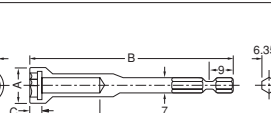
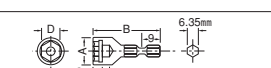
Group	Hex. Socket Bit	Nominal Screw Size	Dimensions										Code No.	
			A		B		C		D		E			
			mm	in	mm	in	mm	in	mm	in	mm	in		
A		M3.5	10.0	25/64	100	3 15/16	3.0	1/8	6.0	16/64	30	1 13/16	918-104-0	
			11.0	7/16	100	3 15/16	3.0	1/8	7.0	9/32	30	1 13/16	918-107-0	
			11.0	7/16	100	3 15/16	3.5	9/64	7.5	19/64	30	1 13/16	918-108-0	
			12.0	15/32	100	3 15/16	4.0	5/32	8.0	5/16	30	1 13/16	918-109-0	
			12.0	15/32	100	3 15/16	4.0	5/32	9.0	23/64	30	1 13/16	918-111-0	
B		M5	13.0	33/64	100	3 15/16	4.5	11/64	9.5	3/8	30	1 13/16	918-112-0	
B		M3	9.5	3/8	100	3 15/16	3.0	1/8	5.5	7/32	30	1 13/16	918-202-0	
			10.0	25/64	100	3 15/16	3.0	1/8	6.0	15/64	30	1 13/16	918-205-0	
			11.0	7/16	100	3 15/16	3.2	1/8	7.0	9/32	30	1 13/16	918-206-0	
			12.0	15/32	100	3 15/16	4.5	11/64	8.0	5/16	30	1 13/16	918-208-0	
			12.0	15/32	100	3 15/16	4.5	11/64	9.0	23/64	27	1 1/16	918-212-0	
B		M4	13.0	33/64	100	3 15/16	4.5	11/64	10.0	25/64	27	1 1/16	918-216-0	
			15.0	19/32	100	3 15/16	5.5	7/32	11.0	7/16	27	1 1/16	918-220-0	
C		M4	11.0	7/16	28	17/64	3.2	1/8	7.0	9/32	7	9/32	918-304-0	
			M5	12.0	15/32	28	17/64	4.5	11/64	8.0	5/16	7	5/16	918-305-0
			M6	15.0	19/32	31	17/32	5.5	7/32	10.0	25/64	10	25/64	918-307-0

ABRASIVE TOOLS

GRINDERS

SANDERS

PHOTO ; MODEL NO.USG-4SU 1981
STILL USED AT USERS



* Sound Level measured to ISO 15744
* Vibration Level measured to ISO 8662

DIE GRINDERS

URYU Die Grinders, ruggedly designed for mounted wheels and carbide burrs, are ideal for rapid metal removal or precise finishing such as weld cleaning, deburring, die contouring and repair, blending and smoothing.



Self-Locking Lever attachment

To prevent accidental start of motor.



COLLET CHUCKS

G-38EB & UG-50S-200

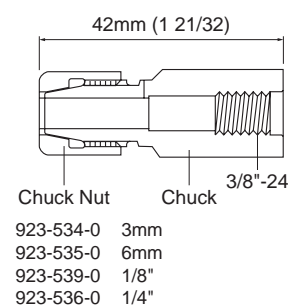

SPECIFICATIONS

Recommended Air Pressure : 0.6MPa (85psi)

Model	Collet Chuck Size		Max.Free Speed (about)	Rated Horse Power	Overall Length (about)		Weight less wheel (about)		Air Inlet Thread (Pipe Tap)	Air Hose Size		Average Air Consumption		Noise Level	Vibration Level
	mm	in	r.p.m.	w	mm	in	kg	lb	in	mm	in	m ³ /min	ft ³ /min	dB(A)	m/sec ²
UG-25NA	6	1/4	25000	210	153	6 1/32	0.53	1.17	N.P.T.1/4	9.5	3/8	0.3	10.7	82	1.3
G-38EB	6	1/4	20000	315	165	6 1/2	0.65	1.43	N.P.T.1/4	9.5	3/8	0.4	14.0	85	2.3
UG-38N	6	1/4	25000	315	164	6 15/32	0.57	1.25	N.P.T.1/4	9.5	3/8	0.3	10.7	85	2.3
UG-38NA	6	1/4	20000	315	165	6 1/2	0.65	1.43	N.P.T.1/4	9.5	3/8	0.4	14.0	75	1.0
UG-38NL	6	1/4	25000	315	330	13	0.92	2.02	N.P.T.1/4	9.5	3/8	0.3	10.7	85	2.0
UG-50S-200	6	1/4	20000	195	198	7 51/64	0.60	1.32	N.P.T.1/4	9.5	3/8	0.4	14.0	73	2.3

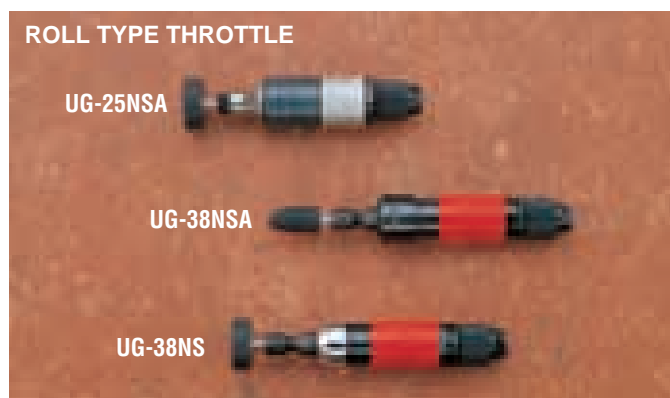

COLLET CHUCKS

UG-25N & UG-50S-200A

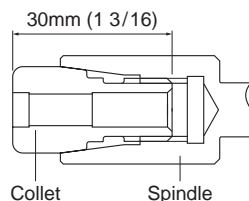

- 923-001-0 3mm
- 923-003-0 6mm
- 923-005-0 1/8"
- 923-006-0 1/4"

UG-38N Series

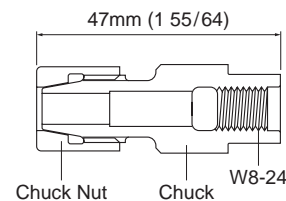

- 923-510-0 3mm
- 923-512-0 6mm
- 923-515-0 1/8"
- 923-516-0 1/4"

SPECIFICATIONS

Recommended Air Pressure : 0.6MPa (85psi)

Model	Collet Chuck Size		Max.Free Speed (about)	Rated Horse Power	Overall Length (about)		Weight less wheel (about)		Air Inlet Thread (Pipe Tap)	Air Hose Size		Average Air Consumption		Noise Level	Vibration Level
	mm	in	r.p.m.	w	mm	in	kg	lb	in	mm	in	m ³ /min	ft ³ /min	dB(A)	m/sec ²
UG-25NSA	6	1/4	25000	210	145	5 23/32	0.56	1.23	N.P.T.1/4	9.5	3/8	0.3	10.7	82	1.3
UG-38NS	6	1/4	25000	315	168	6 5/8	0.60	1.32	N.P.T.1/4	9.5	3/8	0.3	10.7	85	2.3
UG-38NSA	6	1/4	22000	315	174	6 54/64	0.65	1.43	N.P.T.1/4	9.5	3/8	0.3	10.7	75	1.0
UG-38NSL	6	1/4	25000	315	340	13 25/64	0.95	2.09	N.P.T.1/4	9.5	3/8	0.3	10.7	85	2.3

DIE GRINDERS & MIDGET GRINDER

UMG-450, muffled by a rubber silencer to minimize sound level for operator's comfort, is a super speed model for precise grinding and polishing for die making.



Fasten the collet chuck firmly to avoid loosening of the cutting tool.

COLLET CHUCKS

UG-45H

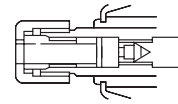

- 923-170-0 6mm
- 923-171-0 1/4"
- 923-172-0 8mm

SPECIFICATIONS

Recommended Air Pressure: 0.6MPa (85psi)

Model	Collet Chuck Size		Max.Free Speed (about)	Rated Horse Power	Overall Length (about)		Weight less wheel (about)		Air Inlet Thread (Pipe Tap)	Air Hose Size		Average Air Consumption		Noise Level	Vibration Level
	mm	in	r.p.m.	w	mm	in	kg	lb	in	mm	in	m ³ /min	ft ³ /min	dB(A)	m/sec ²
UMG-450	3	1/8	45000	37	145	5 45/64	0.19	0.42	N.P.T.1/4	4.8	3/16	0.2	7.0	75	1.0
UG-45H	6	1/4	18000	375	196	7 23/62	0.80	1.76	N.P.T.1/4	9.5	3/8	0.6	22.0	76	2.3

ABRASIVE TOOLS

MINI ANGLE GRINDERS

UG-20A series are specially designed for applications of hard-to-reach areas.

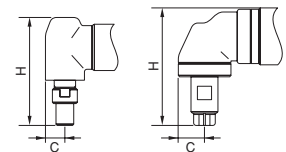

Model	C(about)	H(about)
UG-20A-200	14.5mm	80.0mm
UG-20A-120	14.5mm	80.0mm
UG-50S-200A	19.5mm	87.0mm

ERICKSON Type COLLET CHUCKS

- UG-20A Series 923-207-0 6mm
- 923-201-0 1/4"

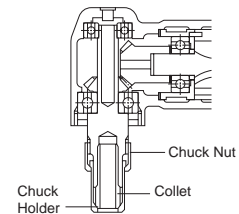

SPECIFICATIONS

Recommended Air Pressure: 0.6MPa (85psi)

Model	Collet Chuck Size		Max.Free Speed (about)	Rated Horse Power	Overall Length (about)		Weight less wheel (about)		Air Inlet Thread (Pipe Tap)	Air Hose Size		Average Air Consumption		Noise Level	Vibration Level
	mm	in	r.p.m.	w	mm	in	kg	lb	in	mm	in	m ³ /min	ft ³ /min	dB(A)	m/sec ²
UG-20A-200	6	1/4	20000	113	131	5 3/16	0.50	1.10	N.P.T.1/4	9.5	3/8	0.3	10.7	75	1.0
UG-20A-120	6	1/4	12000	113	131	5 3/16	0.50	1.10	N.P.T.1/4	9.5	3/8	0.3	10.7	76	2.3
UG-50S-200A	6	1/4	20000	195	195	7 45/64	0.90	1.98	N.P.T.1/4	9.5	3/8	0.4	14.0	75	2.3

HORIZONTAL GRINDERS

LIGHT TYPE UG-65 SERIES (NON-GOVERNED)

Available in 9 models with three different throttle handles, these lightweight and compact grinders are generally used in all metal working industries for every grinding and polishing job.

UG-65 SERIES HORIZONTAL GRINDERS

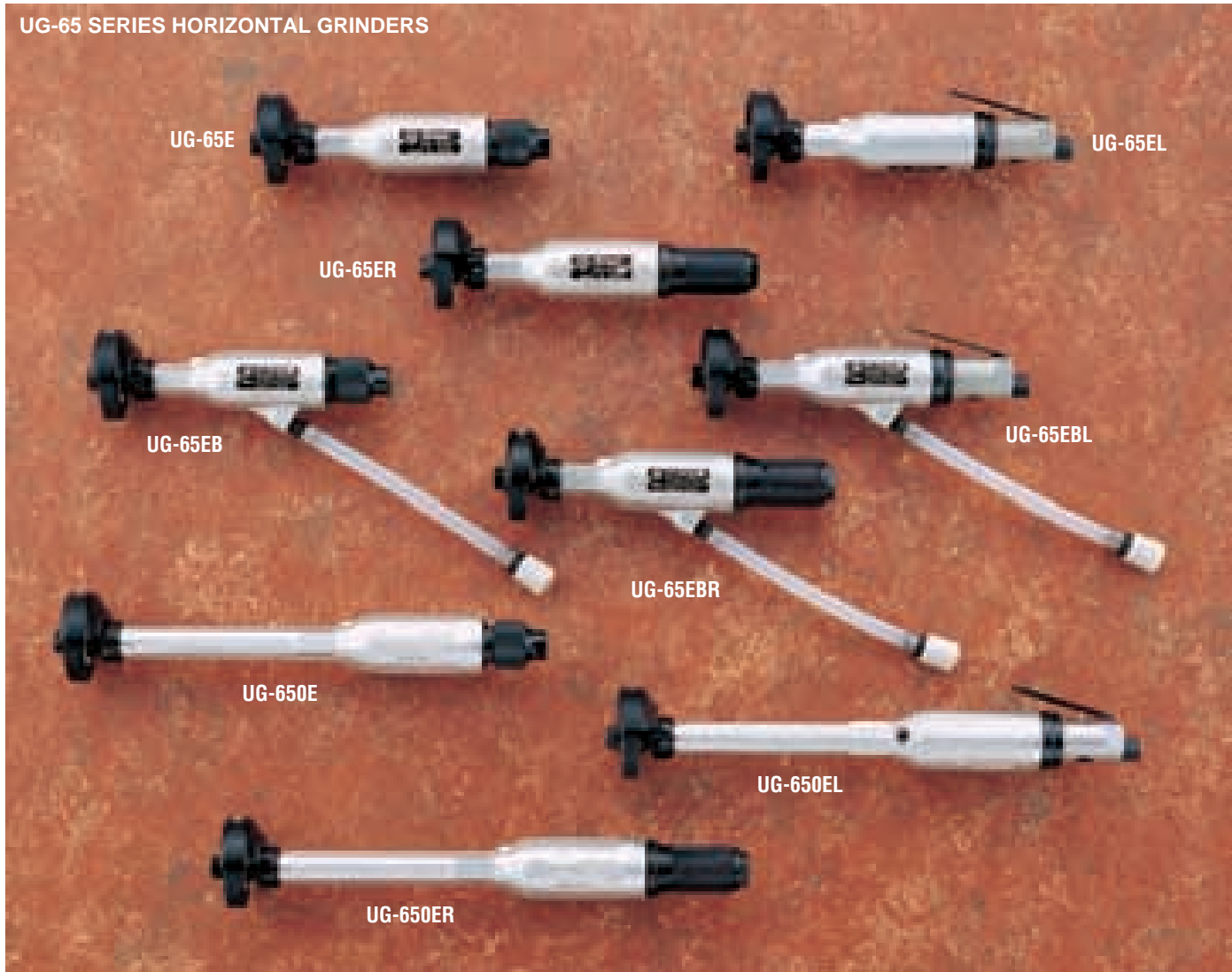

Collet chucks of 6mm and 1/4" capacity are available as optional accessories for mandrel mounted abrasives, cutters and files.

	6mm	1/4"
UNF3/8-24	923-530-0	923-532-0
W3/8-16	923-523-0	923-526-0

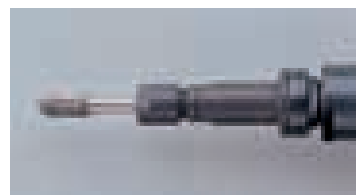
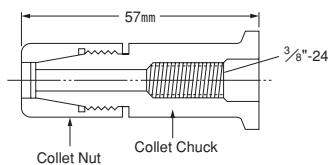

SPECIFICATIONS

Recommended Air Pressure: 0.6MPa (85psi)

Type	Model	Throttle Handle	Capacity (Wheel Size)		Max.Free Speed (about)	Rated Horse Power	Overall Length (about)		Weight less wheel (about)		Air Inlet Thread (Pipe Tap)	Air Hose Size		Average Air Consumption		Noise Level	Vibration Level
			mm	in			r.p.m.	w	mm	in		kg	lb	in	mm		
Standard	UG-65E	Sleeve	63.5	2 1/2	14600	412	242	9 27/32	1.25	2.75	N.P.T.1/4	9.5	3/8	0.6	22	88	1.8
	UG-65ER	Self-closing	63.5	2 1/2	14600	412	271	10 43/64	1.50	3.30	N.P.T.1/4	9.5	3/8	0.6	22	85	1.8
	UG-65EL	Lever	63.5	2 1/2	14600	412	272	10 23/32	1.40	3.08	N.P.T.1/4	9.5	3/8	0.6	22	85	1.8
Rear Exhaust	UG-65EB	Sleeve	63.5	2 1/2	*14600	412	242	9 27/32	1.25	2.75	N.P.T.1/4	9.5	3/8	0.6	22	95	1.8
	UG-65EBR	Self-closing	63.5	2 1/2	*14600	412	271	10 43/64	1.50	3.30	N.P.T.1/4	9.5	3/8	0.6	22	95	1.8
	UG-65EBL	Lever	63.5	2 1/2	*14600	412	272	10 23/32	1.40	3.08	N.P.T.1/4	9.5	3/8	0.6	22	95	1.8
Extended	UG-650E	Sleeve	63.5	2 1/2	14600	412	390	15 23/64	1.72	3.78	N.P.T.1/4	9.5	3/8	0.6	22	85	1.8
	UG-650ER	Self-closing	63.5	2 1/2	14600	412	419	16 1/2	1.97	4.33	N.P.T.1/4	9.5	3/8	0.6	22	85	1.8
	UG-650EL	Lever	63.5	2 1/2	14600	412	420	16 17/32	1.55	3.41	N.P.T.1/4	9.5	3/8	0.6	22	85	1.8

* Speed without silencer

ANGLE GRINDERS

These handy angle grinders are ideally suited for close-quarter work with less operator fatigue.

The governed models are recommended for heavy-duty production grinding. Two (2) different types of wheel retainers are available for customers' choice or practice.

"OUT" type :
3/8"-24 Spindle with large FLANGE

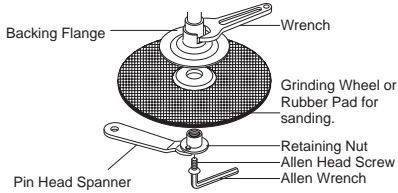

"IN" type :
URYU special Spindle with small FLANGE

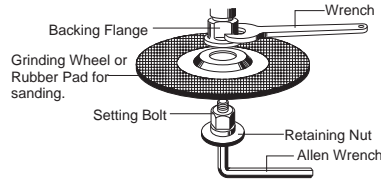

WHEEL SIZE

Model Name	Thickness	Height
AG-50 Series	3-5mm	9mm
AG-100 Series	4-6mm	10mm
USG-4S	4-6mm	10mm
USG-7S	6-8mm	13mm
USG-L180D	6-8mm	13mm

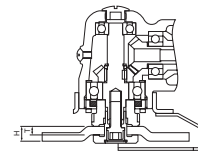

ANGLE GRINDERS



SPECIFICATIONS

Recommended Air Pressure: 0.6MPa (85psi)

Model	Capacity (Wheel size)		Max.Free Speed (about)	Rated Horse Power	Overall Length (about)		Overall Height (about)		Weight less wheel (about)		Type of Spindle	Air Inlet Thread (Pipe Tap)	Air Hose Size		Average Air Consumption		Noise Level	Vibration Level
	mm	in			r.p.m.	w	mm	in	mm	in			kg	lb	in	mm		
AG-50(OUT)	50	2	15000	337	147	5 25/32	54	2 1/2	0.63	1.40	OUT	N.P.T.1/4	9.5	3/8	0.45	16.0	80	2.0
AG-50L(OUT)	50	2	15000	337	140	5 34/64	54	2 1/2	0.63	1.40	OUT	N.P.T.1/4	9.5	3/8	0.45	16.0	80	2.0
AG-100(IN)	100	4	13500	315	175	6 57/64	68	2 43/64	0.95	2.10	IN	N.P.T.1/4	9.5	3/8	0.50	18.0	80	2.3
AG-100L(IN)	100	4	13500	315	179	7 3/64	68	2 43/64	1.05	2.30	IN	N.P.T.1/4	9.5	3/8	0.50	18.0	80	2.3
AG-100(OUT)	100	4	13500	315	175	6 57/64	68	2 43/64	0.95	2.10	OUT	N.P.T.1/4	9.5	3/8	0.50	18.0	80	2.3
AG-100L(OUT)	100	4	13500	315	179	7 3/64	68	2 43/64	1.05	2.30	OUT	N.P.T.1/4	9.5	3/8	0.50	18.0	80	2.3
AG-100S(IN)	100	4	13500	315	175	6 57/64	68	2 43/64	1.00	2.20	IN	N.P.T.1/4	9.5	3/8	0.50	18.0	80	2.3
AG-100SL(IN)	100	4	13500	315	179	7 3/64	68	2 43/64	1.10	2.40	IN	N.P.T.1/4	9.5	3/8	0.50	18.0	80	2.3
AG-100S(OUT)	100	4	13500	315	179	6 57/64	68	2 43/64	1.00	2.20	OUT	N.P.T.1/4	9.5	3/8	0.50	18.0	80	2.3
AG-100SL(OUT)	100	4	13500	315	179	7 3/64	68	2 43/64	1.10	2.40	OUT	N.P.T.1/4	9.5	3/8	0.50	18.0	80	2.3
USG-4S	100	4	13500	450	232	9 9/64	94	3 45/64	1.65	3.60	IN	N.P.T.1/4	9.5	3/8	0.60	22.0	80	2.3
USG-7S	180	7	7600	962	296	11 21/32	120	4 47/54	3.00	6.60	IN	N.P.T.3/8	12.7	1/2	1.30	46.0	85	2.5
USG-L180D	180	7	7600	888	267	9 1/2	92	3 5/8	2.70	5.90	IN	N.P.T.3/8	12.7	1/2	1.00	36.0	85	2.5

VERTICAL GRINDERS

100mm(4") & 125mm(5") Type

USG series * These gear-less vertical grinders of simple non-governed design offer powerful and trouble free operation.

150mm(6") ~ 230mm(9") Type

VG series * VG grinder can be converted into another type of VG by changing wheel guard and spring tension of speed governor.

* Simple design with one-piece housing.

UVG series

* Non-friction speed control governor incorporated with over-speed sensing device. This special governor contributes to power compensation also especially when grinding resistance gets strong causing slow speed.

* Three different speeds are available for UVG-1800.

* UVG-2300 series is equipped with Dual and Consecutive action Speed Piston Valve for smooth valve opening.

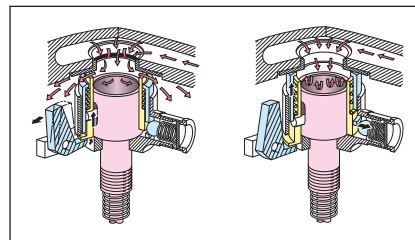

UVG SERIES

NON-FRICTION SPEED CONTROL GOVERNOR incorporated in OVERSPEED SENSING DEVICE (Patente P.)

VERTICAL GRINDERS

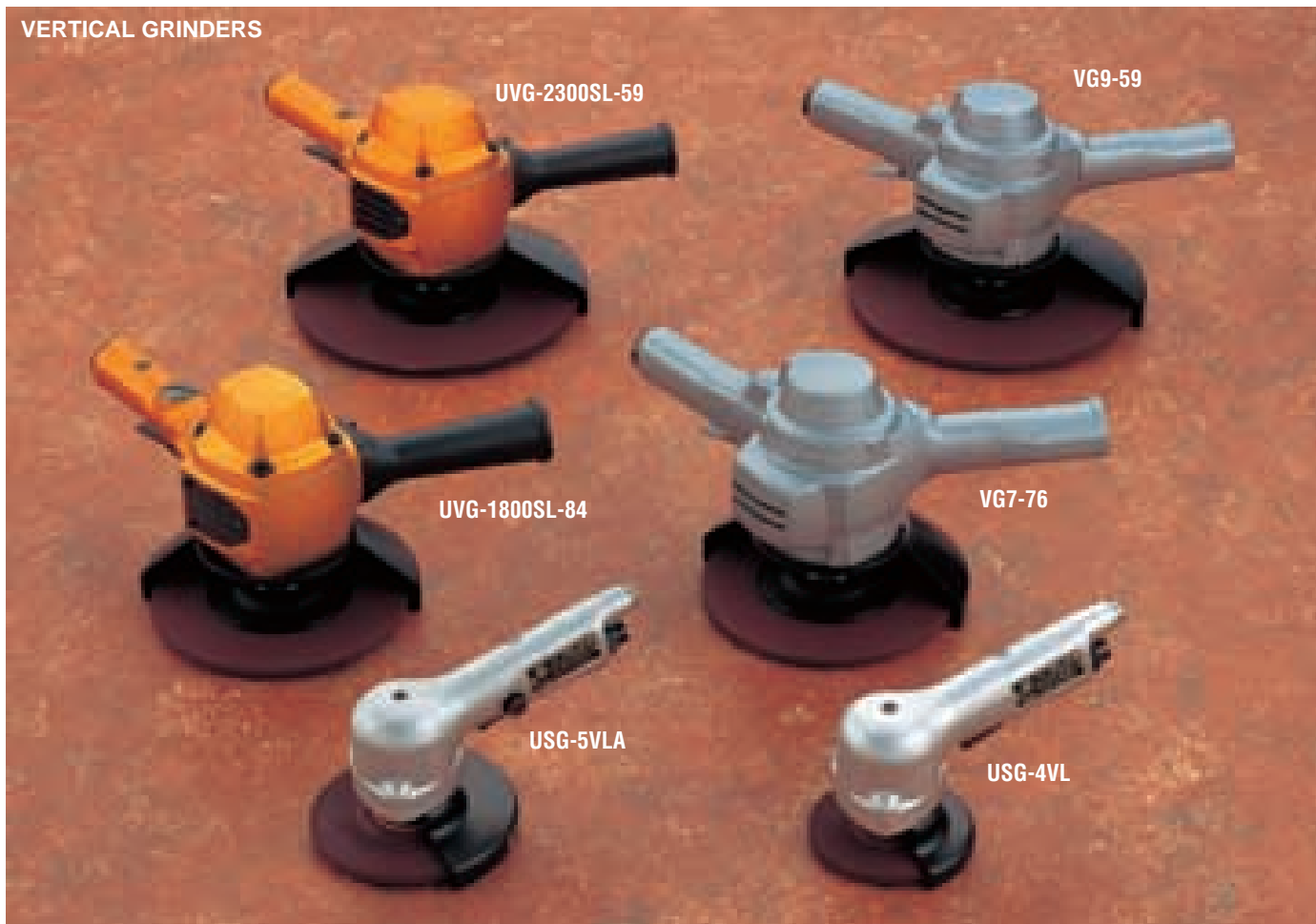

SPECIFICATIONS

Recommended Air Pressure: 0.6MPa (85psi)

Model	Capacity (Wheel size)		Max.Free Speed (about)	Rated Horse Power	Overall Length (about)		Overall Height (about)		Weight less wheel (about)		Type of Spindle	Air Inlet Thread (Pipe Tap)	Air Hose Size		Average Air Consumption		Noise Level	Vibration Level
	mm	in			r.p.m.	w	mm	in	mm	in			kg	lb	mm	in		
USG-4VL	100	4	12000	435	220	8 21/32	97	3 13/16	1.40	3.09	IN	N.P.T.1/4	9.5	3/8	0.85	30.0	88	2.0
USG-5VLA	125	5	10500	375	220	8 21/32	97	3 13/16	1.48	3.26	IN	N.P.T.1/4	9.5	3/8	0.85	30.0	88	2.0
VG6-45	150	6	4500	2250	-	-	196	7 23/32	4.60	10.10	OUT	N.P.T.1/2	19.0	3/4	2.20	77.7	89	1.6
VG6-59	150	6	5900	2250	-	-	196	7 23/32	4.60	10.10	OUT	N.P.T.1/2	19.0	3/4	2.20	77.7	89	1.6
VG7-59	180	7	5900	2250	-	-	179	7 3/64	4.30	9.50	OUT	N.P.T.1/2	19.0	3/4	2.30	81.0	89	1.6
VG7-76	180	7	7600	2250	-	-	179	7 3/64	4.30	9.50	OUT	N.P.T.1/2	19.0	3/4	2.30	81.0	89	1.6
VG9-59	230	9	5900	2250	-	-	179	7 3/64	4.60	10.10	OUT	N.P.T.1/2	19.0	3/4	2.30	81.0	87	1.8
UVG-1500SL-76	180	7	7600	1200	-	-	162	6 3/8	3.30	7.26	OUT	N.P.T.3/8	12.7	1/2	1.40	49.0	78	2.5
UVG-1500SL-84	180	7	8400	1200	-	-	162	6 3/8	3.30	7.26	OUT	N.P.T.3/8	12.7	1/2	1.40	49.0	78	2.5
UVG-1800SL-59	230	9	5900	1575	-	-	175	6 7/8	4.00	8.80	OUT	N.P.T.3/8	12.7	1/2	1.90	67.0	78	2.5
UVG-1800SL-76	180	7	7600	1650	-	-	175	6 7/8	4.00	8.80	OUT	N.P.T.3/8	12.7	1/2	2.00	70.0	78	2.5
UVG-1800SL-84	180	7	8400	1650	-	-	175	6 7/8	4.00	8.80	OUT	N.P.T.3/8	12.7	1/2	2.00	70.0	78	2.5
UVG-2300SL-59	230	9	5900	2550	-	-	182	7 5/32	4.80	10.56	OUT	N.P.T.1/2	19.0	3/4	2.50	80.0	82	2.5

ANGLE GRINDERS

100mm-230mm(4"-9") Wheel Dia.

URYU offers UAG-series Angle Grinders of 100mm(4"), 125mm(5"), 180mm(7") and 230mm(9") capacity. These governed lightweight and compact grinders deliver high power to weight ratio and feature :-

- Non-friction Speed Governor for most efficient grinding performance.
- Unique spring-loaded Exhaust Valve for noise-less trouble free operation.
- Vibration absorbent Dead Handle for less Operator fatigue.

UAG SERIES ANGLE GRINDERS



Spring-loaded EXHAUST VALVE

This exhaust hole is kept closed off-operation but is opened upon triggering.

This unique exhaust valve features:

- Cutting exhaust noise especially when air is shut off.
- Preventing foreign matters inhalation into the tool.



LOCK BUTTON

Push the spring-loaded Lock Button to release the Throttle Lever for operation. When released the Lever is locked automatically.

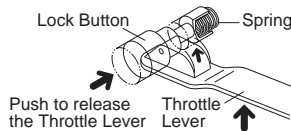

ROLL TYPE THROTTLE HANDLE

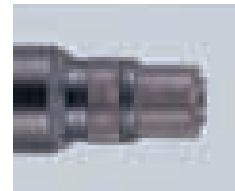

UAG-○○SB series
UAG-○○SC series

SPECIFICATIONS

Recommended Air Pressure: 0.6MPa (85psi)

Model	Capacity (Wheel size)		Max.Free Speed (about)	Rated Horse Power	Overall Length (about)		Overall Height (about)		Weight less wheel (about)		Type of Spindle	Air Inlet Thread (Pipe Tap)	Air Hose Size		Average Air Consumption		Noise Level	Vibration Level
	mm	in			r.p.m.	w	mm	in	mm	in			kg	lb	mm	in		
UAG-40SB-136	100	4	13600	712	208	8 3/16	76	3	1.5	3.3	OUT	N.P.T.1/4	9.5	3/8	0.95	34.0	84	3.2
UAG-40SBL-136	100	4	13600	712	246	9 11/16	76	3	1.3	2.9	OUT	N.P.T.1/4	9.5	3/8	0.95	34.0	84	3.2
UAG-40SC-136	100	4	13600	712	208	8 3/16	76	3	1.5	3.3	IN	N.P.T.1/4	9.5	3/8	0.95	34.0	84	3.2
UAG-40SCL-136	100	4	13600	712	246	9 11/16	76	3	1.3	2.9	IN	N.P.T.1/4	9.5	3/8	0.95	34.0	84	3.2
UAG-50SBL-120	125	5	12000	712	246	9 11/16	76	3	1.4	3.1	OUT	N.P.T.1/4	9.5	3/8	0.95	34.0	82	3.2
UAG-50SCL-120	125	5	12000	712	246	9 11/16	76	3	1.4	3.1	IN	N.P.T.1/4	9.5	3/8	0.95	34.0	82	3.2
UAG-50SB-120	125	5	12000	712	246	9 11/16	76	3	1.6	3.5	OUT	N.P.T.1/4	9.5	3/8	0.95	34.0	82	3.2
UAG-50SC-120	125	5	12000	712	246	9 11/16	76	3	1.6	3.5	IN	N.P.T.1/4	9.5	3/8	0.95	34.0	82	3.2
UAG-50SB-109	125	5	10900	712	246	9 11/16	76	3	1.6	3.5	OUT	N.P.T.1/4	9.5	3/8	0.95	34.0	82	3.2
UAG-50SBL-109	125	5	10900	712	246	9 11/16	76	3	1.4	3.1	OUT	N.P.T.1/4	9.5	3/8	0.95	34.0	82	3.2
UAG-70SBL-76	180	7	7600	1500	300	11 13/16	98	3 55/64	2.9	6.4	OUT	N.P.T.1/4	9.5	3/8	1.60	57.0	83	5.6
UAG-70SB-76	180	7	7600	1500	253	10	87	3 27/64	3.0	6.6	OUT	N.P.T.1/4	9.5	3/8	1.60	57.0	83	5.6
UAG-70SC-76	180	7	7600	1500	253	10	87	3 27/64	3.0	6.6	IN	N.P.T.1/4	9.5	3/8	1.60	57.0	83	5.6
UAG-70SCL-76	180	7	7600	1500	300	11 13/16	87	3 27/64	2.8	6.2	IN	N.P.T.3/8	12.7	1/2	1.60	57.0	83	5.6
UAG-90SBL-59	230	9	5900	1875	308	12 1/8	98	3 55/64	3.3	7.3	OUT	N.P.T.3/8	12.7	1/2	1.90	67.0	88	7.4

HORIZONTAL GRINDERS

Heavy-Duty Type (Governed)

- Two speeds are available for UG-1500 and UG-2000 series.
(Higher speed for resinoid wheels and lower speed for vitrified wheels)
- Two different Throttle Handles are available for every model.
- Lever and Roll type Throttle Handles are recommended for safer operation.

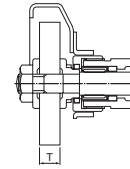

WHEEL SIZE

Model Name	Thickness
UG-1200 Series	13-19mm
UG-1500 Series	13-25mm
UG-2000 Series	19-25mm

HEAVY-DUTY HORIZONTAL GRINDERS (GOVERNED)

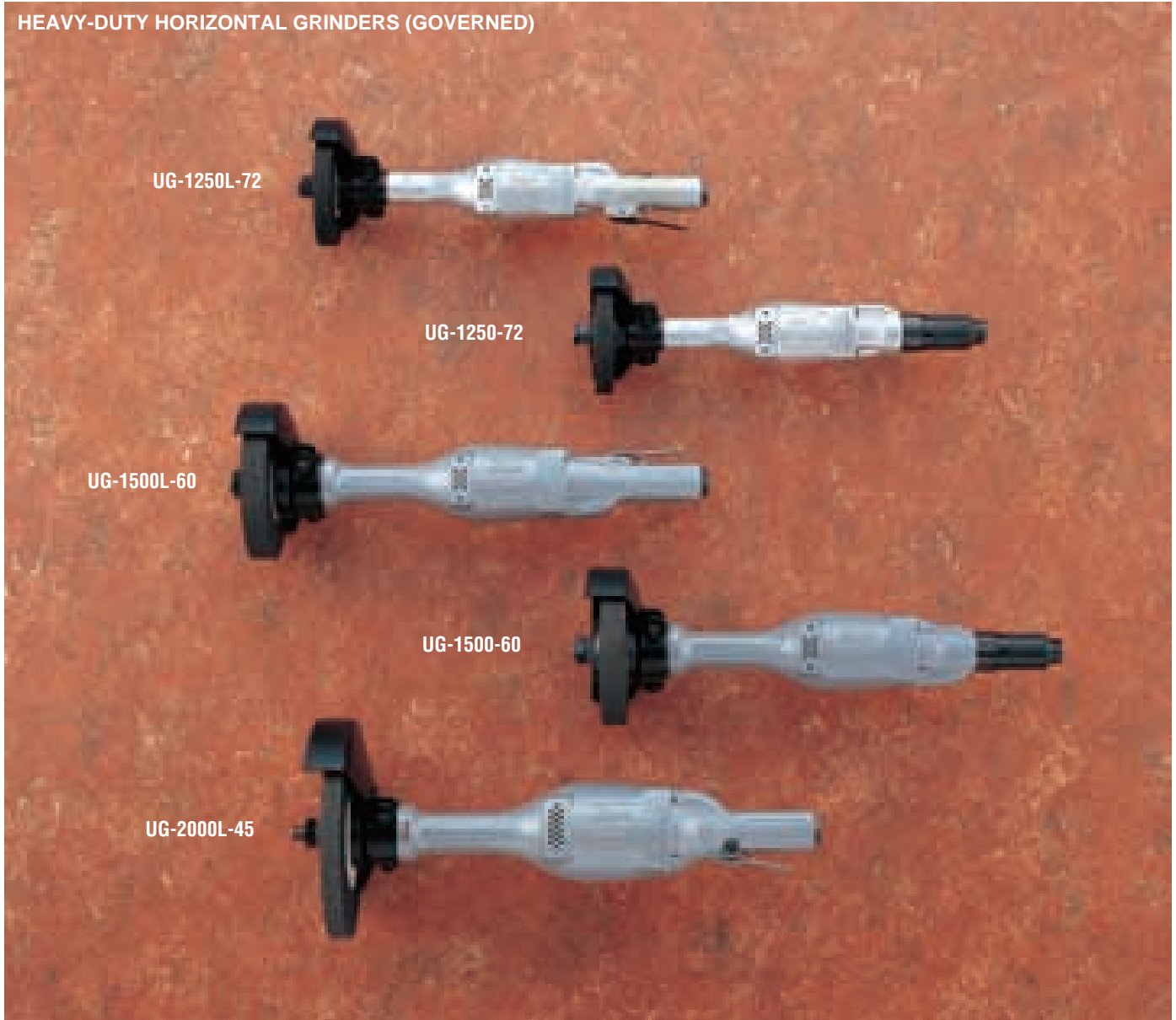

SPECIFICATIONS

Recommended Air Pressure: 0.6MPa (85psi)

Model	Capacity (Wheel Size)		Max.Free Speed (about) r.p.m.	Rated Horse Power w	Overall Length (about)		Weight less wheel (about)		Spindle Size in-thr'd	Air Inlet Thread (Pipe Tap) in	Air Hose Size		Average Air Consumption		Noise Level dB(A)	Vibration Level m/sec ²
	mm	in			mm	in	kg	lb			mm	in	m ³ /min	ft ³ /min		
UG-1250-72	125	5	7200	750	436	17 11/64	3.20	7.04	1/2-13	N.P.T.3/8	12.7	1/2	0.90	32.7	88	1.8
UG-1250L-72	125	5	7200	750	436	17 11/64	2.80	6.16	1/2-13	N.P.T.3/8	12.7	1/2	0.90	32.7	88	1.8
UG-1500-60	150	6	6000	1320	497	19 9/16	4.88	10.74	5/8-11	N.P.T.3/8	12.7	1/2	1.30	45.9	88	2.5
UG-1500-41	150	6	4100	975	497	19 9/16	4.88	10.74	5/8-11	N.P.T.3/8	12.7	1/2	1.30	45.9	88	2.5
UG-1500L-60	150	6	6000	1320	495	19 31/64	4.62	10.16	5/8-11	N.P.T.3/8	12.7	1/2	1.30	45.9	88	2.5
UG-1500L-41	150	6	4100	975	495	19 31/64	4.62	10.16	5/8-11	N.P.T.3/8	12.7	1/2	1.30	45.9	88	2.5
UG-2000L-45	200	8	4500	1500	520	20 15/32	5.30	11.62	5/8-11	N.P.T.3/8	12.7	1/2	1.55	54.7	90	2.5
UG-2000L-31	200	8	3100	1260	520	20 15/32	5.30	11.62	5/8-11	N.P.T.3/8	12.7	1/2	1.55	54.7	90	2.5

* Do not use vitrified wheels with higher speed type of each model.

ABRASIVE TOOLS

SANDERS, POLISHERS & ORBITAL SANDERS

AG-180W

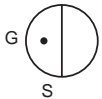

Standard type
Self-suction type

* Two different speeds available: 4,500rpm for sanding and polishing and 7,000rpm for grinding. AG-180W comes with sanding/polishing speed setting 4,500rpm with relevant accessories as standard. AG-180W can be converted into grinder model by changing speed regulator to G position and mounting wheel guard.

* Well-balanced orbital action achieves smooth scratch-free finish on any type of material.

* As well as being the same well-balanced orbital action, following UP-15N, UP-25NB and UP-26NB have built-in type direct sanded-residue suction device. Sanded residue is sucked directly through the holes of the pads and corresponding holed sanding papers, keeping working environment clean.

* No additional dust cover system enables operators to watch the edge of paper directly, giving comfort and efficient operation.

UP-15N/25NB PAD

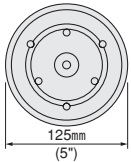

UP-26NB PAD

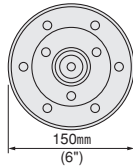

HOLED PAD



Dust collection bag
For UP-15N, 25NB&26NB

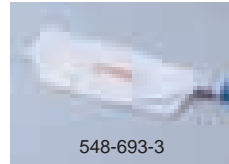

Cut view of UP-25NB

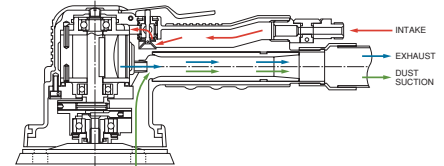

SANDERS / POLISHERS



ABRASIVE TOOLS

SPECIFICATIONS

Recommended Air Pressure: 0.6MPa (85psi)

Model	Capacity (Wheel size)		Max.Free Speed (about)	Rated Horse Power	Overall Length (about)		Overall Height (about)		Weight less wheel (about)		Spindle Size	Air Inlet Thread (Pipe Tap)		Air Hose Size		Average Air Consumption		Noise Level	Vibration Level
	mm	in			r.p.m.	mm	in	mm	in	kg		lb	in	in	mm	in	m ³ /min		
USG-45P	125	5	12000	225	187	7 23/64	104	4 3/32	0.87	1.91	3/8-24	N.P.T.1/4	9.5	3/8	0.55	20.0	81	2.1	
AG-180W	180	7	7000	690	315	12 13/32	111	4 3/8	2.80	6.16	5/8-11	N.P.T.1/4	9.5	3/8	0.90	32.0	86	2.5	
UP-80-15	180	7	1500	337	-	-	170	6 11/16	1.80	3.96	5/8-11	N.P.T.1/4	9.5	3/8	0.80	28.0	82	1.0	
UP-80-40	180	7	4000	337	-	-	164	6 15/32	1.80	3.96	5/8-11	N.P.T.1/4	9.5	3/8	0.80	28.0	84	1.0	
UP-80-60	160	6 3/8	6000	337	-	-	170	6 7/8	1.80	3.96	5/8-11	N.P.T.1/4	9.5	3/8	0.80	28.0	85	1.0	
UP-15	125	5	8000	210	112	4 13/32	93	3 21/32	1.20	2.64	-	N.P.T.1/4	6.35	1/4	0.45	16.0	87	7.0	
UP-25DB	125	5	9000	262	212	8 11/32	120	4 3/4	1.70	3.74	-	N.P.T.1/4	6.35	1/4	0.20	7.0	73	5.6	
UP-26DB	150	6	8000	225	212	8 11/32	120	4 3/4	1.78	3.92	-	N.P.T.1/4	6.35	1/4	0.20	7.0	74	5.6	
UP-15N	125	5	9000	225	175	6 57/64	103	4 1/16	1.50	3.30	-	N.P.T.1/4	6.35	1/4	0.45	16.0	94	7.0	
UP-25NB	125	5	9000	300	250	9 23/64	119	4 23/32	1.77	3.90	-	N.P.T.1/4	9.5	3/8	0.60	21.0	97	5.6	
UP-26NB	150	6	9000	300	263	10 23/64	119	4 23/32	1.95	4.30	-	N.P.T.1/4	9.5	3/8	0.60	21.0	98	5.6	

[WARNING FOR SAFETY USE]

Firstly, follow your local safety regulations strictly on grinders and abrasives. Following are basically required.



1) Before mounting to the Grinder, make sure that the Grinding Wheels or other Abrasives are of suitable size, shape, quality and strength to the rated speed (RPM) stamped on the name plate or tool housing.



2) The Wheel Spindle speed should be regularly checked with a tachometer to make sure whether normal speed is maintained. The governed grinders must be checked to be sure governor mechanism is functioning properly.



3) Make sure before operation that the abrasive Wheel should be mounted carefully and sufficiently with flanges and nuts of proper size and shape by use of the Spanners.



4) All Grinding Wheels should be closely inspected before installation and use. If cracks, nicks, or chips are found, do not use the Wheel in question.

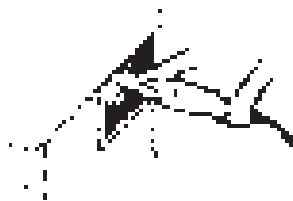

5) Before installing a grinding Wheel, after all Grinders repair and whenever the Grinder is issued for use, test run the Grinder by a competent person for a while under a protected area.



6) Never exceed maximum speed of the abrasive Wheel to avoid dangerous breakage. Fragments from the Wheel can cause serious injury or death. Do not operate without wearing eye protector and gloves.

RUBBER PAD, FIBER PAD & POLISHING PAD

PAD	MODEL	SIZE	CODE NOS.
RUBBER PAD	AG-100 series USG-4V series USG-5V series	80mm	554-406-1
	UP-80 series UAG-70 series UVG-1500 series UVG-1800 series AG-180W	125mm	892-006-1
		170mm	566-406-1
FIBER PAD	USG-45P	73 φ	553-415-1
		115 φ	553-416-1
	AG-180W	120 φ	585-415-1
		174 φ	585-416-1
POLISHING PAD	UP-80-15 & 60	6"	998-510-0
	UP-80-40	7"	998-513-0

RECOMMENDED AIR PIPING SYSTEM

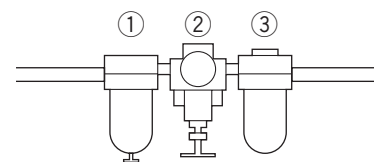
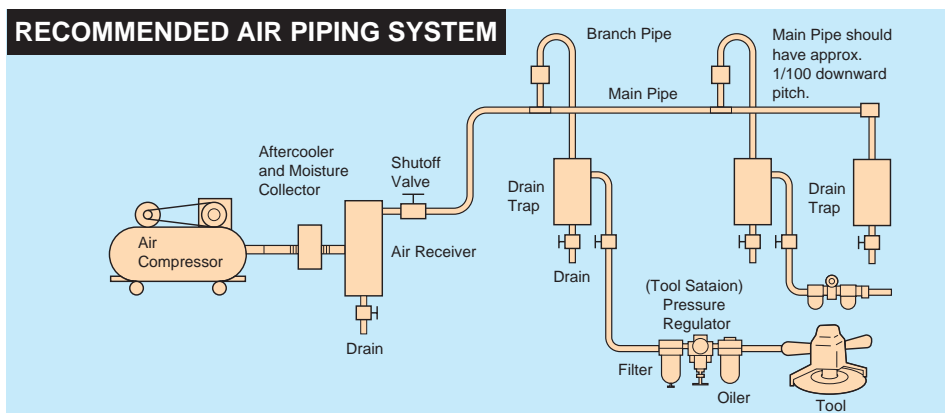

- ① **Air Filter :**
removes water and dirt particles out of compressed air.
- ② **Pressure Regulator :**
gives steady and dependable regulation at 0.6MPa (85psi).
- ③ **Air Oiler (Lubricator) :**
assures longer and more dependable tool life.



PHOTO : MODEL NO.UD-50-45 1993
STILL USED AT USERS

DRILLS & TAPPERS

COMBINATION DRILLS
TAPPERS

* Sound Level measured to ISO 15744
* Vibration Level measured to ISO 8662

UD-50/60/80 SERIES DRILLS

With interchangeable Gear Boxes these **UD-series** Drills offer a wide range of speeds for various applications. Rear exhaust through silencer results in extremely low noise.

PISTOL TYPE



Power is controlled by the built-in Air Regulator located on the handle. (Pistol handle type only)

Dead Handle Assembly (Option)



For UD-60 series 612-896-0
For UD-80 series 613-896-0

SPECIFICATIONS

Recommended Air Pressure : 0.6MPa(85psi)

Model	Drilling Capacity		Free Speed (about)	Overall Length (about)		Weight with Chuck (about)		From Center to Outside (about)		Nominal Chuck Size		Type of Spindle	Average Air Consumption		Noise Level	Vibration Level
	mm	in	r.p.m.	mm	in	kg	lb	mm	in	mm	in	in-thr'd	m ³ /min	ft ³ /min	dB(A)	m/sec ²
UD-50-200	3	1/8	23000	135	5 5/16	0.70	1.50	21.0	53/64	8	5/16	3/8-24UNF	0.40	14	73	0.5
UD-50-45	6	1/4	5000	145	5 23/32	0.86	1.89	21.0	53/64	8	5/16	3/8-24UNF	0.40	14	72	0.5
UD-50-22	8	5/16	2200	140	5 1/2	0.90	1.98	21.0	53/64	8	5/16	3/8-24UNF	0.40	14	72	1.0
UD-60-29	8	5/16	2900	167	6 9/16	1.10	2.43	22.5	57/64	8	5/16	3/8-24UNF	0.50	18	77	1.0
UD-60-20	8	5/16	2000	180	7 1/8	1.20	2.64	22.5	57/64	8	5/16	3/8-24UNF	0.50	18	77	1.0
UD-60-15	8	5/16	1600	180	7 1/8	1.20	2.64	22.5	57/64	8	5/16	3/8-24UNF	0.50	18	76	1.0
UD-60-07	13	1/2	700	214	8 27/64	1.40	3.08	22.5	57/64	13	1/2	1/2-20UNF	0.50	18	75	2.0
UD-60-04	13	1/2	500	220	8 5/8	1.40	3.08	22.5	57/64	13	1/2	1/2-20UNF	0.50	18	75	2.0
UD-80-12	13	1/2	1200	212	8 7/16	1.80	3.96	26.0	1 1/64	13	1/2	1/2-20UNF	0.65	23	79	2.0
UD-80-07	13	1/2	700	242	9 1/2	2.30	5.06	26.0	1 1/64	13	1/2	1/2-20UNF	0.65	23	79	2.0
UD-80-04	16	5/8	400	265	10 7/16	2.90	6.39	26.0	1 1/64	16	5/8	5/8-16UNF	0.65	23	79	2.0

*Air Hose Size (Inside Diameter) : 9.5mm (3/8")

*Air Inlet Thread : N.P.T.1/4"

UD-50/60/80 SERIES DRILLS

STRAIGHT TYPE



SPINDLE	3/8"-24 UNF	1/2"-20 UNF	5/8"-16 UNF
Key Chuck	○ 8mm (923-070-0) * 10mm (923-072-0)	○ 13mm (923-071-0) * 10mm (923-073-0)	○ 16mm (927-080-0)
Chuck Handle	(927-051-0)	(927-053-0)	(927-055-0)

○ : Standard * : Option

SPECIFICATIONS

Recommended Air Pressure : 0.6MPa(85psi)

Model	Drilling Capacity		Free Speed (about)	Overall Length (about)		Weight with Chuck (about)		From Center to Outside (about)		Nominal Chuck Size		Type of Spindle	Average Air Consumption		Noise Level	Vibration Level
	mm	in	r.p.m.	mm	in	kg	lb	mm	in	mm	in	in-thr'd	m ³ /min	ft ³ /min	dB(A)	m/sec ²
UD-50S-200	3	1/8	23000	200	7 7/8	0.70	1.50	21.0	53/64	8	5/16	3/8-24UNF	0.40	14	78	1.0
UD-50S-45	6	1/4	5000	210	8 9/32	0.85	1.87	21.0	53/64	8	5/16	3/8-24UNF	0.40	14	77	1.0
UD-50S-22	8	5/16	2200	205	8 1/16	0.83	1.83	21.0	53/64	8	5/16	3/8-24UNF	0.40	14	77	1.5
UD-60S-29	8	5/16	2900	227	8 15/16	1.05	2.32	22.5	57/64	8	5/16	3/8-24UNF	0.50	18	77	1.5
UD-60S-20	8	5/16	2000	238	9 3/8	1.15	2.54	22.5	57/64	8	5/16	3/8-24UNF	0.50	18	77	2.0
UD-60S-15	8	5/16	1600	238	9 3/8	1.15	2.54	22.5	57/64	8	5/16	3/8-24UNF	0.50	18	77	2.5
UD-60S-07	13	1/2	700	272	10 23/32	1.35	2.98	22.5	57/64	8	5/16	1/2-20UNF	0.50	18	75	2.5
UD-60S-04	13	1/2	500	279	10 63/64	1.35	2.98	22.5	57/64	8	5/16	1/2-20UNF	0.50	18	75	2.5
UD-80S-12	13	1/2	1200	280	11 13/64	1.60	3.53	26.0	1 1/64	13	1/2	1/2-20UNF	0.65	23	79	2.5
UD-80S-07	13	1/2	700	300	11 13/16	2.10	4.73	26.0	1 1/64	13	1/2	1/2-20UNF	0.65	23	79	2.5
UD-80S-04	16	5/8	400	323	12 23/32	2.70	5.95	26.0	1 1/64	16	5/8	5/8-16UNF	0.65	23	79	2.5
UD-80-12G	13	1/2	1200	290	11 27/64	2.30	5.06	26.0	1 1/64	13	1/2	1/2-20UNF	0.65	23	79	1.0
UD-80-07G	13	1/2	700	310	12 13/64	2.80	6.16	26.0	1 1/64	13	1/2	1/2-20UNF	0.65	23	79	1.5
UD-80-04G	16	5/8	400	333	13 7/64	3.40	7.50	26.0	1 1/64	16	5/8	5/8-16UNF	0.65	23	79	1.5

*Air Hose Size (Inside Diameter) : 9.5mm (3/8")

*Air Inlet Thread : N.P.T.1/4"

ANGLE TYPE



DRILL ADAPTER (for UD-50S Series)

Available sizes : 2mm, 3mm, 4mm, 5mm, 6mm
1/8", 5/32", 1/4"

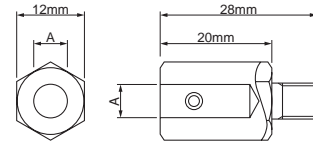

CONE JAW CHUCK (for UD-50S Series)

Capacity : up to 1/4" or 6.35mm
Code No. : 923-100-0

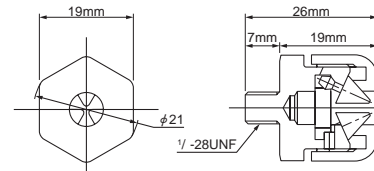

SPECIFICATIONS

Recommended Air Pressure : 0.6MPa(85psi)

Model	Drilling Capacity		Free Speed (about)	Overall Length (about)		Weight with Chuck (about)		Height with Chuck (about)		From Center to Outside (about)		Nominal Chuck Size	Type of Spindle	Average Air Consumption		Noise Level	Vibration Level	
	mm	in	r.p.m.	mm	in	kg	lb	mm	in	mm	in	mm	in	in-thr'd	m ³ /min	ft ³ /min	dB(A)	m/sec ²
UD-50S-45A	4	5/32	5000	253	9 31/32	0.90	1.98	40	1 57/64	21.0	53/64	-	-	1/4-28UNF	0.40	14	79	2.5
UD-50S-22A	4	5/32	2200	248	9 49/64	0.88	1.94	40	1 57/64	21.0	53/64	-	-	1/4-28UNF	0.40	14	79	2.5
UD-60S-29C	8	5/16	2900	276	10 55/64	1.52	3.34	90	3 35/64	22.5	57/64	8	5/16	3/8-24UNF	0.50	18	79	3.2
UD-60S-15C	8	5/16	1600	283	11 9/64	1.60	3.52	90	3 35/64	22.5	57/64	8	5/16	3/8-24UNF	0.50	18	79	3.2

URD-22 SERIES HEAVY DUTY DRILLS

Smooth and accurate operations for many kinds of applications, such as drilling, tapping, reaming and tube rolling, etc.



SELF-RETURNING ROLL TYPE THROTTLE HANDLE (STANDARD)

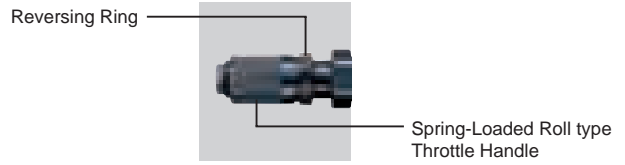

ROLL TYPE THROTTLE HANDLE (OPTION)

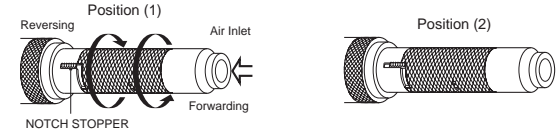

Pull out and set the stopper to position (2) to avoid accidental reversing operation.

Push back and release the stopper to position (1) for reversing operation.

SPECIFICATIONS

Recommended Air Pressure : 0.6MPa(85psi)

Model	Type	Drilling Capacity		Free Speed (about)	Overall Length (about)		Weight (about)		From Center to Outside (about)		Feed Length (about)		Air Hose Size		Average Air Consumption		Noise Level	Vibration Level
		mm	in		r.p.m.	mm	in	kg	lb	mm	in	mm	in	mm	in	m³/min		
URD-22RR	Self-Returning	22.0	7/8	600	442	17 13/32	5.8	12.8	39	1 17/32	70	2 3/4	12.7	1/2	1.3	46	95	3.0

Air Inlet Thread : N.P.T. 3/8" for URD-22RR

UT-60 & 66 SERIES TAPPERS

UT-60 series equipped with the "PUSH-PULL" auto-reversing clutch mechanism need no special operation for reversing. Push the tool forward against the work for tapping in, and just pull it backward for reversing out.

UT-66 series reversible drills have the double trigger handle for quick and frequent switchover of rotation.

PISTOL / STRAIGHT TYPE

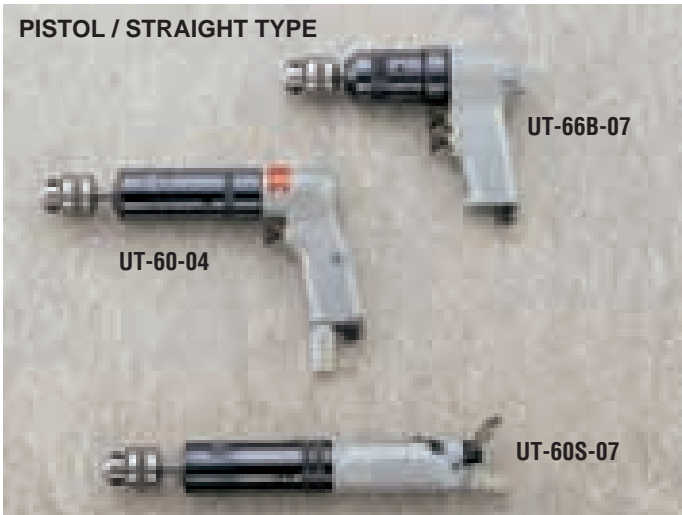

Double-Trigger Handle

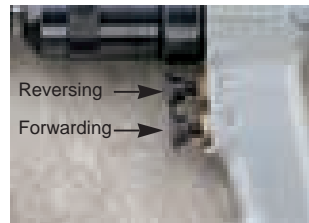

"Push-Pull" Auto reversing Clutches

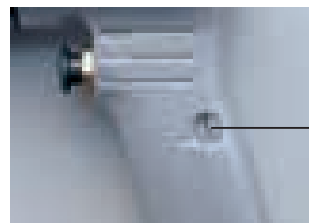
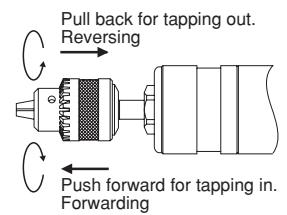

Built-in Air Regulator

SPECIFICATIONS

Recommended Air Pressure : 0.6MPa(85psi)

Model	Tapping Capacity		Free Speed (about)	Overall Length (about)		Weight with Chuck (about)		From Center to Outside (about)		Average Air Consumption		Noise Level	Vibration Level
	mm	in		r.p.m.	mm	in	kg	lb	mm	in	m³/min		
UT-66B-15	6	1/4	1500	183	7 7/32	1.32	2.90	25.0	31/32	0.4	14.4	85	1.8
UT-66B-07	8	5/16	800	196	7 23/32	1.42	3.12	25.0	31/32	0.4	14.4	85	1.8
UT-60-07	8	5/16	680	244	9 39/64	1.80	3.96	22.5	57/64	0.5	18.0	75	2.0
UT-60-04	8	5/16	400	244	9 39/64	1.80	3.96	22.5	57/64	0.5	18.0	75	2.0
UT-60S-07	8	5/16	680	300	11 13/16	1.65	3.63	22.5	57/64	0.5	18.0	75	2.5
UT-60S-04	8	5/16	400	316	12 7/16	1.65	3.63	22.5	57/64	0.5	18.0	75	2.5

Air Inlet Thread : N.P.T. 1/4" for UT-66B-15-UT-60S-04 Air Hose Size : 9.5mm (3/8") for UT-66B-15-UT-60S-04
Nominal Chuck Size : 8mm (5/16") for UT-66B-07-UT-60S-04



PHOTO ; MODEL NO.BRH-1U 1996.5
STILL USED AT USERS



PERCUSSION TOOLS

RIVETING HAMMERS
FLUX CHIPPERS
CHIPPING & CAULKING HAMMERS

* Sound Level measured to ISO 15744
* Vibration Level measured to ISO 8662

RIVETING HAMMERS

Easily controlled, slow hitting heavy blow gives just the right impact to form a rivet without excessive work or damage to the surrounding metal. These tools are convertible to chipping, caulking and ripping hammers with suitable chisels.



SHANK SIZE

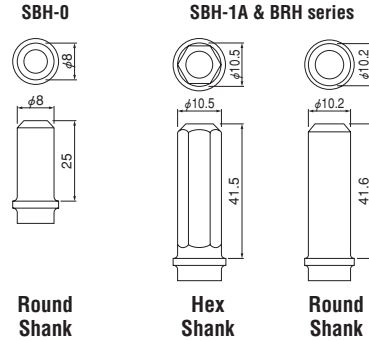

SPECIFICATIONS

Recommended Air Pressure : 0.6MPa(85psi)

Model	Riveting Capacity				Blow Per Min. (about)	Overall Length (about)		Weight Less Rivet Set (about)		Piston Diameter (about)		Piston Stroke (about)		Air Inlet Thread (Pipe Tap)	Air Hose Size		Average Air Consumption		Noise Level	Vibration Level
	Duralumin		Steel			mm	in	kg	lb	mm	in	mm	in		mm	in	m ³ /min	ft ³ /min		
	mm	in	mm	in																
SBH-0	2.3	3/32	-	-	6500	123	4 27/32	0.32	0.7	10.00	25/64	23	29/32	N.P.T.1/4	6.35	1/4	0.10	3.5	90	2.5
SBH-1A(R,H)	2.6	7/64	-	-	4000	209	8 15/64	0.86	1.9	11.11	7/16	56	2 3/16	N.P.T.1/4	6.35	1/4	0.15	5.0	92	5.0
BRH-1U(R,H)	3.2	1/8	2.4	3/32	2800	122	4 15/16	1.05	2.4	14.30	9/16	38	1 1/2	N.P.T.1/4	9.5	3/8	0.34	12.0	95	10.0
BRH-1US(R,H)	3.2	1/8	2.4	3/32	2800	180	7 1/8	1.00	2.2	14.30	9/16	38	1 1/2	N.P.T.1/4	9.5	3/8	0.34	12.0	95	10.0
BRH-1UG(R,H)	3.2	1/8	2.4	3/32	2800	187	7 3/8	1.78	3.9	14.30	9/16	38	1 1/2	N.P.T.1/4	9.5	3/8	0.34	12.0	95	10.0
BRH-5U(R,H)	6.4	1/4	4.8	3/16	1800	190	7 1/2	1.40	3.1	12.70	1/2	100	4	N.P.T.1/4	9.5	3/8	0.37	13.0	95	10.0
BRH-5US(R,H)	6.4	1/4	4.8	3/16	1800	248	9 25/32	1.45	3.2	12.70	1/2	100	4	N.P.T.1/4	9.5	3/8	0.37	13.0	95	10.0
BRH-5UG(R,H)	6.4	1/4	4.8	3/16	1800	255	10 3/16	2.13	4.7	12.70	1/2	100	4	N.P.T.1/4	9.5	3/8	0.37	13.0	95	10.0

VIBRATION-LESS TYPE

To meet the growing demand for low noise and less vibration percussive tools, URYU offers four different models.

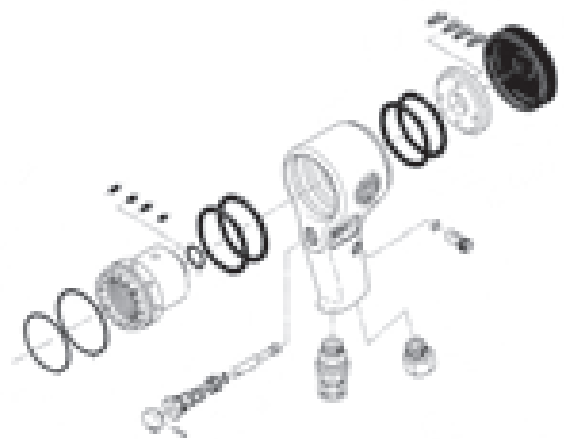
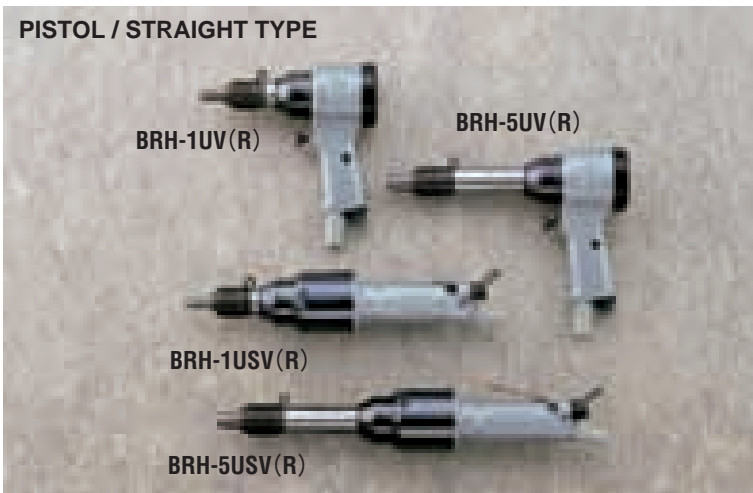

SPECIFICATIONS

Recommended Air Pressure : 0.6MPa(85psi)

Model	Riveting Capacity				Blow Per Min. (about)	Overall Length (about)		Weight Less Rivet Set (about)		Piston Diameter (about)		Piston Stroke (about)		Air Inlet Thread (Pipe Tap)	Air Hose Size		Average Air Consumption		Noise Level	Vibration Level
	Duralumin		Steel			mm	in	kg	lb	mm	in	mm	in		mm	in	m ³ /min	ft ³ /min		
	mm	in	mm	in																
BRH-1UV(R,H)	3.2	1/8	2.4	3/32	2800	162	6 3/8	1.37	3.0	14.30	9/16	38	1 1/2	N.P.T.1/4	9.5	3/8	0.34	12.0	91	6.3
BRH-5UV(R,H)	6.4	1/4	4.8	3/16	1800	227	8 15/16	1.68	3.7	12.70	1/2	100	4	N.P.T.1/4	9.5	3/8	0.37	13.0	91	7.9
BRH-1USV(R,H)	3.2	1/8	2.4	3/32	2800	271	10 21/32	1.60	3.5	14.30	9/16	38	1 1/2	N.P.T.1/4	9.5	3/8	0.34	12.0	91	6.3
BRH-5USV(R,H)	6.4	1/4	4.8	3/16	1800	338	13 5/16	1.90	4.1	12.70	1/2	100	4	N.P.T.1/4	9.5	3/8	0.34	12.0	91	7.9

IMPACT CUTTERS/FLUX CHIPPERS

BRH-7 series fast hitting and powerful hammers are versatile for various hammering jobs in cutting, ripping, shearing, punching, etc., Needle scaling attachments are available.

UFC series are needed for general scaling applications such as removal of splatter and excess metal after welding, removal of rust, scale paint and soot from metal surface, light fins, flash and sand from castings. Two models are available : UFC-0N for light work and UFC-1N with Valve for heavy duty work.

PISTOL / STRAIGHT TYPE

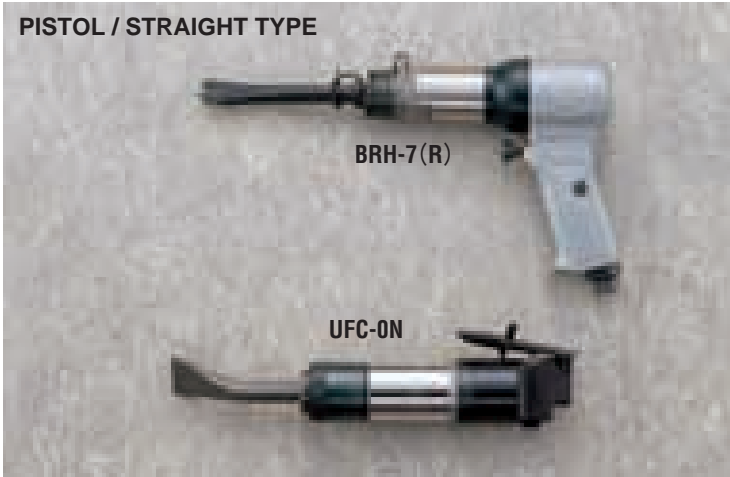

SHANK SIZE

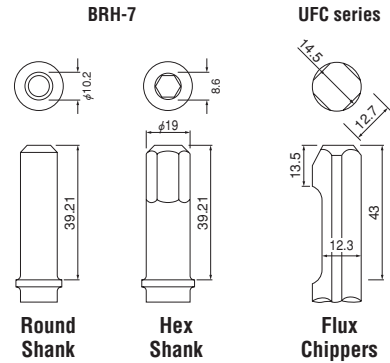

SPECIFICATIONS

Recommended Air Pressure : 0.6MPa(85psi)

Model	Blow Per Min. (about)	Overall Length (about)		Weight Less Chisel (about)		Piston Diameter (about)		Piston Stroke (about)		Air Inlet Thread (Pipe Tap)	Air Hose Size		Average Air Consumption		Noise Level	Vibration Level
	b.p.m	mm	in	kg	lb	mm	in	mm	in	in	mm	in	m ³ /min	ft ³ /min	dB(A)	m/sec ²
BRH-7(R,H)	3400	190	7 1/2	1.64	3.60	19.05	3/4	50	1 31/32	N.P.T.1/4	9.5	3/8	0.48	17.0	100	10.0
UFC-0N	5300	180	7 1/8	1.38	3.04	25.00	63/64	28	1 1/4	N.P.T.1/4	9.5	3/8	0.3	10.7	90	4.0
UFC-1N	4200	190	7 1/2	1.50	3.30	25.00	63/64	34	1 11/32	N.P.T.1/4	9.5	3/8	0.3	10.7	90	4.0

CHIPPING & CAULKING HAMMERS

Rugged-designed powerful Hammers with high speed blows are ideal for billet chipping/general chipping and caulking/weld flux, paint, and rust removal/removing gates and fins from castings.

STRAIGHT TYPE

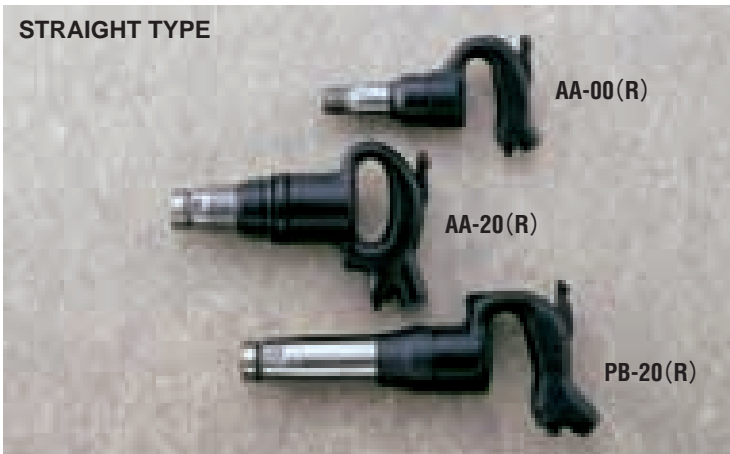

CHISEL RETAINER (Option)

Applicable to both PB and AA series excepting AA-00.

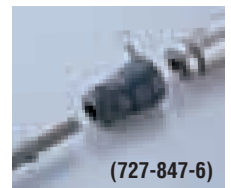
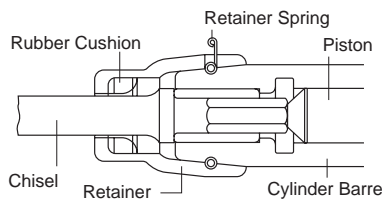

SPRING CHISEL RETAINER

(for AA-00)



(705-813-1)

SPECIFICATIONS

Recommended Air Pressure : 0.6MPa(85psi)

Model	Chisel Shank Size				Blow Per Min. (about)	Overall Length (about)	Weight Less Chisel (about)		Piston Diameter (about)		Piston Stroke (about)		Air Inlet Thread (Pipe Tap)	Air Hose Size		Average Air Consumption		Noise Level	Vibration Level		
	Round		Hexagonal				mm	lb	mm	in	mm	in		mm	in	mm	in			m ³ /min	ft ³ /min
	mm	in	mm	in																	
AA-00(R,H)	12.7	1/2	10.5	13/32	2700	228	8 31/32	2.3	5.00	20.0	25/32	50	1 31/32	N.P.T.1/4	9.5	3/8	0.35	12.3	95	4.0	
AA-20(R,H)	17.5	11/16	14.7	19/32	2300	270	10 5/8	5.3	11.60	28.0	1 7/64	55	2 5/32	N.P.T.3/8	12.7	1/2	0.60	21.1	100	2.2	
AA-30(R,H)	17.5	11/16	14.7	19/32	2000	298	11 23/32	5.7	12.50	28.0	1 7/64	79	3 1/8	N.P.T.3/8	12.7	1/2	0.60	21.1	100	1.6	
AA-40(R,H)	17.5	11/16	14.7	19/32	1450	340	13 3/8	6.1	13.40	28.0	1 7/64	111	4 3/8	N.P.T.3/8	12.7	1/2	0.60	21.1	100	3.2	
PB-20(R,H)	17.5	11/16	14.7	19/32	1900	350	13 25/32	6.6	14.50	28.5	1 1/8	76	3	N.P.T.3/8	12.7	1/2	0.80	28.0	100	5.6	
PB-30(R,H)	17.5	11/16	14.7	19/32	1500	397	15 5/8	7.1	15.60	28.5	1 1/8	102	4 1/62	N.P.T.3/8	12.7	1/2	0.80	28.0	100	5.6	

PERCUSSION TOOLS

PERCUSSION TOOLS ACCESSORIES

SHANK SIZE OF RIVET SETS

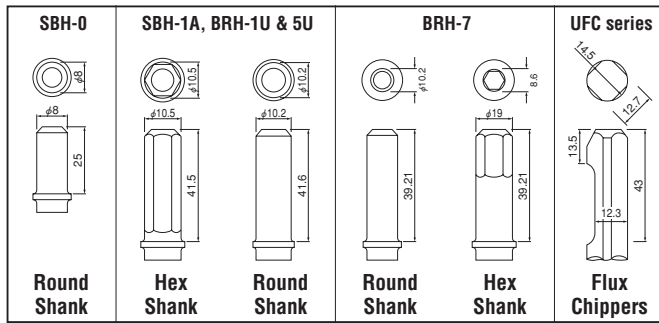

RIVET SETS

	RETAINER SPRING	RIVET SETS	MODEL
Round Shank			SBH-0
			SBH-1A(R) BRH-1U(R) BRH-5U(R) series
			BRH-5U(R) series
			SBH-1A(R) BRH-1U(R) BRH-5U(R) series

CHISELS for AA-00 SERIES (Collared type)

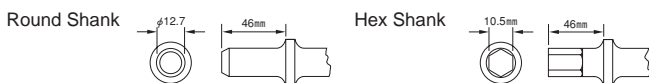

POINT shape	Overall Length		Code No.	
	mm	in	Round Shank	Hex Shank
	200	7 7/8"	921-224-0	921-049-0
	176	6 15/16"	877-035-1	921-221-0
	220	8 21/32"	921-225-0	921-220-0

CHISELS for AA & PB SERIES

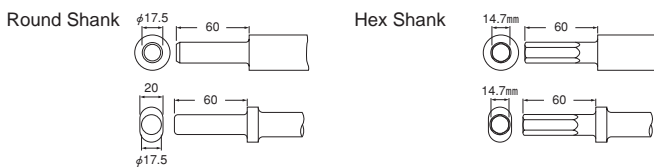

POINT shape	Overall Length		Code No.		
	mm	in	Plain Type	Collared Type	
	200	7 7/8"	R	921-021-0	921-072-0
			H	921-025-0	921-075-0
	220	8 21/32"	R	921-003-0	921-070-0
			H	921-010-0	921-073-0
	200	7 7/8"	R	921-056-0	921-071-0
			H	921-055-0	921-074-0

CHISELS FOR BRH-7

CHISEL	Code No.	
	Round Shank	Hex. Shank
Blank	921-095-0	★ 921-120-0
Flat	○ (7")921-087-0 (9")921-086-0	○ 921-127-0 921-126-0
Sheet Metal(A)	○ 921-096-0	○ 921-115-0
Sheet Metal(B)	921-092-0	★ 921-117-0
Spot Weld Breaker	○ 921-085-0	○ 921-125-0
Taper Punch	921-091-0	★ 921-121-0
Bushing Remover	921-094-0	★ 921-119-0
Fork	921-097-0	★ 921-122-0
Hammer	921-098-0	★ 921-123-0
Scraper	○ 921-088-0	○ 921-128-0
Tail Pipe Cutter	921-093-0	★ 921-118-0
Double Blade Panel Cutter	921-089-0	★ 921-129-0
Panel Crimper	921-099-0	★ 921-116-0

Min. quantity for ordering Hex. Shank Chisels marked with "★" is 30-100 pcs. each. Standard Chisels are marked with "○"

Needle Scaler Attachments



Complete Set

Tool	Needle	Model	Code No.
BRH-7(R)	φ 2mm × 27pcs	NA-21	881-046-1
	φ 3mm × 16pcs	NA-31	881-051-1
BRH-7(H)	φ 2mm × 27pcs	NA-23	881-056-1
	φ 3mm × 16pcs	NA-33	881-061-1
UFC-series	φ 2mm × 27pcs	NA-22	881-031-1
	φ 3mm × 16pcs	NA-32	881-041-1

TESTERS & OTHERS

DIGITAL TORQUE TESTERS
TESTERS
URYU NETWORK



DIGITAL TORQUE TESTER

The down-sized **UDT-200 & UDT-500 series** are designed to fill a definite need for accurate check and adjustment of torque output of oil-pulse tools and hand torque testers. With built-in rechargeable battery in addition to the AC power source, it offers a mobility at different application in your factory. Newly integrated function of the data storage for down-loading contributes to the periodic diagnosis of the tools for quality products. By the conventional functions the existing customers have been familiar with same usage in previous models UET-200BP & UET-500BP.

Features

- * Ni-Cad battery operation gives hand-carry mobile use in your assembly site especially for pulse-tools' commencement of one day operation. AC power source from your plug can be used together.
- * 10-hour continuous operation by battery is possible. Full recharging time is approx. 8-hours.
- * Designed compact, amplifier of UDT-200A(E) has only 1.7Kg in weight 43% lighter and W198xD171xH115mm in dimensions 34% smaller than previous model UET-200BP.
- * Memory function can store maximum 250 torque data.
- * Supreme accuracy of within $\pm 0.5\%$ at the rated output.
- * Red color LED display gives clear visual confirmation.
- * PC output terminal RS-232C (9,600 bps) allows RS printer connection.
- * Torque transducer mounted in pickup has optimum function for measure of Oil-Pulse tools. The traceability remains the same as previous models.

Application

- * Torque check and adjustment for standard type of Oil-Pulse tools. (Shut-off type of Oil-Pulse tools needs optional Soft-Joint Attachment.)
- * Torque check and adjustment for Angle Nutrunners using optional Soft-Joint Attachment.
- * Torque check for manual torque wrenches.



WARNING !

- * Never apply torque higher than the specific rated output.
- * Never disassemble. Never give strong shock or vibration.
- * Never use under situation giving direct rays of the sun, high humidity or dust.
- * Never apply the tools of such impacting mechanism as impact clutches, cushion clutches, etc.

SPECIFICATIONS

Model	Recommended Torque Capacity Range	Blow Capacity Range	Accuracy	Dimensions mm(about) (WxDxH)	Weight Kg(about)	Accessories Socket Adapter
UDT-200A -200E	15-200N.m 10-150ft-lb 150-2000kgf.cm	0-99 blows (*)	$\pm 0.5\%$ at rated output	Amplifier (198×171×115) PicK-up (240×125×76)	Amplifier (1.7) PicK-up (8.5)	(3/8) 836-520-0 (1/2) 836-520-1
UDT-500A -500E	150-500N.m 110-370ft-lb 15-50kgf.m	0-99 blows (*)	$\pm 0.5\%$ at rated output	Amplifier (198×171×115) PicK-up (280×150×90)	Amplifier (1.7) PicK-up (15.0)	(1/2) 836-520-7 (5/8) 836-520-8 (3/4) 836-520-9

(※) on condition that input torque is over 10% of rated output.

(○) Operating Environment : (10-40°C), Humidity(20-80%), No Dew

URYU **UET-10C torque tester** is designed to check output torque of US-LT series Torque Control Screwdrivers & hand torque testers and shows LED digital reading on display.

Furnish your tool control room and laboratory with tester for reception, regular check and torque adjustment of tools.

Features & Specifications

- * LED DIGITAL DISPLAY-Easy reading in the darkness as well.
- * PORTABLE(with a built-in-battery)-Easy use on production lines.
- * APPLICABLE TO REVERSING TORQUE AS WELL.
- * APPLICABLE TO MANUAL TORQUE WRENCHES.
- * EAST OPERATION and HIGH PRECISION.
- * CAPACITY RANGE 0-10.0Nm
- * SIZE (Approx) 190 x 160 x 65mm (7 31/32" x 6 19/64" x 2 9/16")
- * WEIGHT (Approx) 2.3kg (5.1lbs)



UFT SERIES TESTER

UFT-Fastening Tester is designed to detect and indicate precise fastening torque or tension to simulate joints to various actual fastening applications.

Before the fastening operation, tools can be justified by checking with tester to prevent incorrect fastening due to power drop and etc.

SPECIFICATIONS

Model	Bolt Size	Tension Range(kN)	Torque Range(Nm)
UFT-6	M5	3.6-6.1	3.2-5.4
	M6	5.1-13.9	5.4-14.7
UFT-10	M6	5.1-13.9	5.4-14.7
	M8	10.4-22.2	14.7-31.4
	M10	17.8-30.6	31.4-53.9
UFT-16	M12	25.5-41.7	53.9-88.2
	M14	35.7-60.3	88.2-149
	M16	52.8-67.4	149-190
UFT-24	M18	59.9-92.6	190-294
	M20	83.3-125	294-441
	M24	104-162	441-686

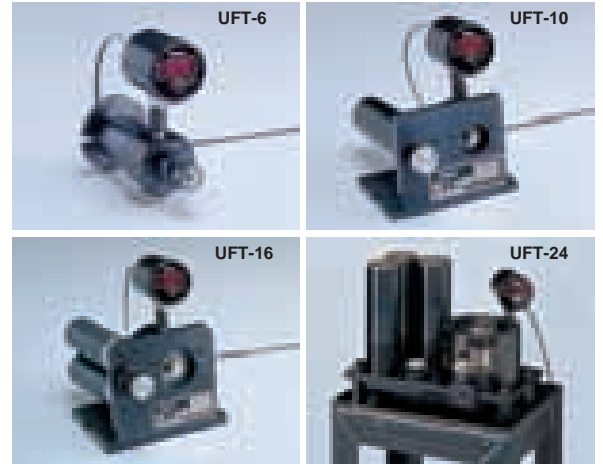

UHT SERIES TESTER

The **UHT-series** simply designed hydraulic torque testers are suitable to be applied to Screwdrivers (Cushion, Positive, Impact Clutch types), Impact Wrenches and similar Impact action fastening tools in monitoring torque output of new and repaired tools in comparison with their master tools.

The readout in the dial indicator does not show absolute torque value, but just comparative degree of power of the tool being tested.

SPECIFICATIONS

Model	Applicable Tool Type or Square Drive Size	Applicable Torque Range		
		Nm	kgf-m	ft-lbs
UHT-12	Cushion/Positive Clutch	1-8	0.1-0.8	0.7-5.9
UHT-16	Impact Clutch	3-20	0.3-2.0	2.2-14.8
UHT-25	3/8"(9.5mm)	20-50	2-5	14-36
UHT-35	1/2"(12.7mm)	50-300	5-30	36-215
UHT-50	3/4"-1"(19.0-25.4mm)	300-2000	30-200	215-1450



OTHERS

URYU NETWORK

URYU Pneumatic Tools have gained markets with the highest satisfaction of our customers not only island but also far abroad in more than 40 countries through a world-wide network of independent distributors who offer tool inspection, repair, testing, maintenance and quick delivery.

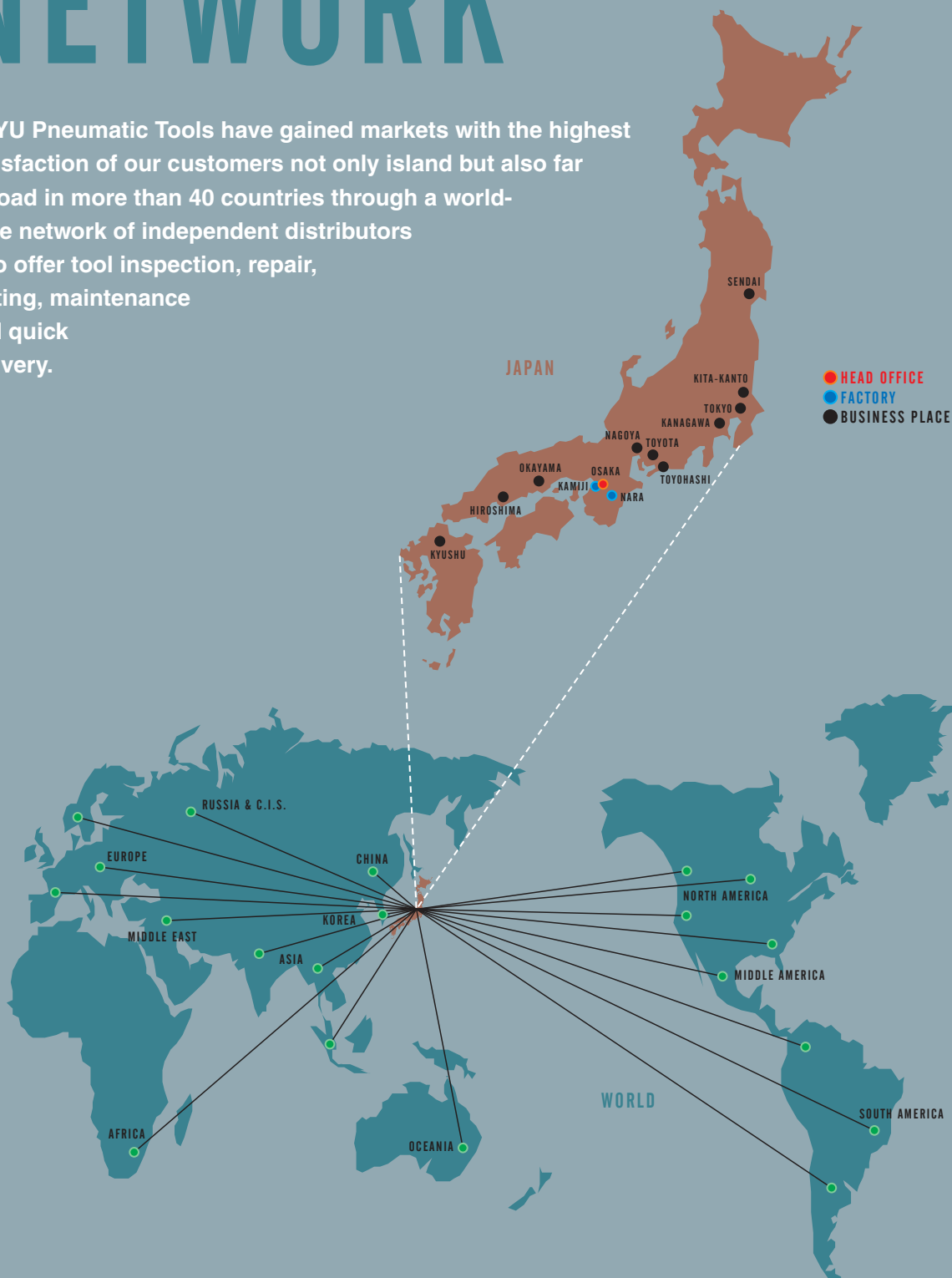



Specifications & contents are subject to change without notice.

 **URYU SEISAKU, LTD.**

P.O Box 7 Higashinari, Osaka, Japan.

Telephone No : 816-6973-9414~9415

Fax : 816-6972-0346

E-Mail : uryuair@uryu.co.jp

[http : //www.uryu.co.jp](http://www.uryu.co.jp)

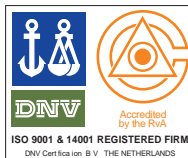

DISTRIBUTED BY :

