



Digital & Analog Mixers  
Active & Passive Speakers  
Professional Line Array Systems  
Digital Processors & Amplifiers  
Advanced Wireless Systems



PRODUCT CATALOG

# Index

Mixers	DM48.20 <b>NEW!</b>	4	Array System	APX Array	20
	DIO24	6		KS Array	22
	DM24.8	8		SWIFT25 Array	24
	T2208	10		TD500.4DSP V2	26
	DR16.4	12		FLX3 Array	28
	DLM408 PLUS/DLM808 14			X3 Mini Array	30
	MXi Series	16			
Portable System	READY 5 - 6 <b>NEW!</b>	18	PA Audio System	EVENT2K	32
				EVENT4K	34
				VA42.12	36
				SOHO V8 PLUS / S15	38

World Class Marketing!

[www.topppro.com](http://www.topppro.com)



CREATIVE, INSIGHTFUL, VALUABLE... **ALWAYS RELIABLE!**



Speakers	KS HD Series	40
	KS HD Subwoofers	42
	KS CS Series	44
	KS Active Subwoofers	46
	FORZA Series	48
	AVANTI Series	50
	X Series	52
	CMA / MA Series	54
	MAXX Series	56
TPS / i Series	58	

Install PA	TMA-54ZBT / TAP Series	60
	PAX Series	62
	WRS Series	64
Wireless	Wireless Devices	66
	TMW Series	68
Power Amplifiers	TRX / TDX Series	70
	HVA / LVA Series	72
Processor	Digital / Analog Processors	74
Powered Mixers	TPM Series	76

## World Class Representation!



**prolight+sound**

**Integrated Systems Europe**

**infocomm**



# DM48.20 Technical Specifications

Microphone input	Electronically balanced
Frequency Response to Main Output	22Hz ~ 20KHz at 0dBu ±1.5dBu
Distortion (THD&N) to Main Output	<0.03% at 0dBu 1KHz
Gain	0dBu ~ 50dBu
SNR (Signal to Noise Ratio)	109dB
Maximum Input Level	+20dBu ±0.5dBu
Phantom Power (+/-3V)	+48VDC
<b>USB stereo inputs</b>	
Frequency Response to Main Output	22Hz ~ 22KHz at 0dBu ±1.5dBu
Distortion (THD&N) to Main Output	<0.03% at 0dBu 1KHz
Maximum Input Level	10dBu ±0.5dBu
<b>Out 1-16</b>	
Maximum Outputs Level	+20dBu ±0.5dBu
<b>Main Outputs</b>	
Maximum Outputs Level	+20dBu ±0.5dBu
<b>Control Room Outputs</b>	
Maximum Output Level	+20dBu ±0.5dBu
<b>Noise Gate</b>	
Threshold Range	-80dBu ~ -30dB
Attack time	0.5mS ~ 200mS
Release time	10mS~1S
<b>Compressor</b>	
Threshold Range	-30dBu - +20dB
Attack time	10mS ~ 150mS
Release time	10mS ~ 1S
Ratio	1:1 to Limit
Gain	0dBu - +20dB
<b>EQ</b>	
Low (LowPass or LowShelf)	21Hz ~ 19.2KHz ±(24dBu±2dBu)
Low Mid	21Hz ~ 19.2KHz ±(24dBu±2dBu)
High Mid	21Hz ~ 19.2KHz ±(24dBu±2dBu)
High (HighPass or HighShelf)	21Hz ~ 19.2KHz ±(24dBu±2dBu)
<b>Digital Audio</b>	
ADC Dynamic Range	114dB
DAC Dynamic Range	114dB
Internal Processor	32-bit , floating point
ADC, DAC bit depth	24bit
Main LCD	10.1inch (1024x600)
Channel OLED	0.96 inch (128x64)
<b>Impedances</b>	
Microphone input	6.8K Ohm
All output	120 Ohm
Operating free-air temperature range	0°C ~ 40°C
Storage temperature range	-20°C ~ 45°C

Territory restrictions may apply.

Control up to  
**48 x 20 I/O\***



\*Using 2 DIO24s

**DiO24**  
Dante Digital Snake



CERTIFIED **USB**

**Record / Playback  
to USB Key**

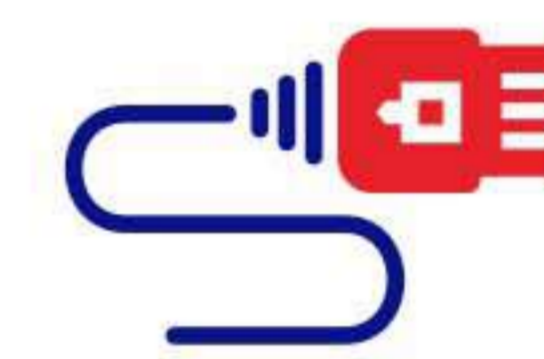

Now with **AES67**  
**Dante**  
SPOKEN HERE



**Dante**  
Optional Digital Card

Download the free  
App from App Store  
to control

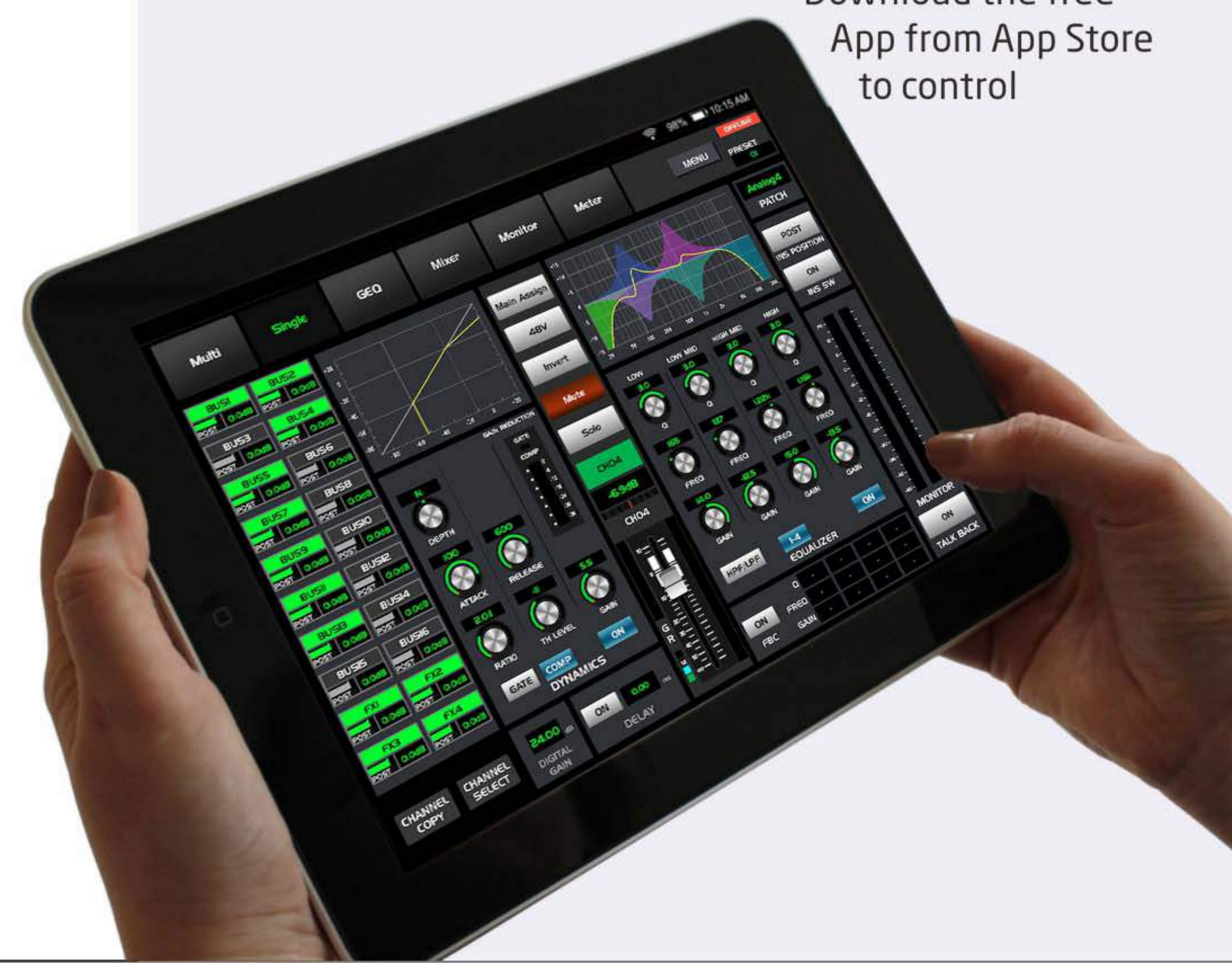

# DM48.20



- | Up to 48 Inputs
- | 32 XLR Mic Inputs
- | 20 XLR Outputs
- | 10" Touchscreen
- | OLED Name Strips
- | 4 Multi-Effects Engines
- | 17 Motorized Faders
- | Sends On Faders
- | GEQ On Faders
- | 16 DCA Groups
- | Automix
- | Programmable User Keys
- | Programmable User Layer
- | Digital Inserts\*  
(External Plug-in Processing)
- | USB 2-Track Record / Playback
- | Dante Compatible\*  
(Using optional Dante card)

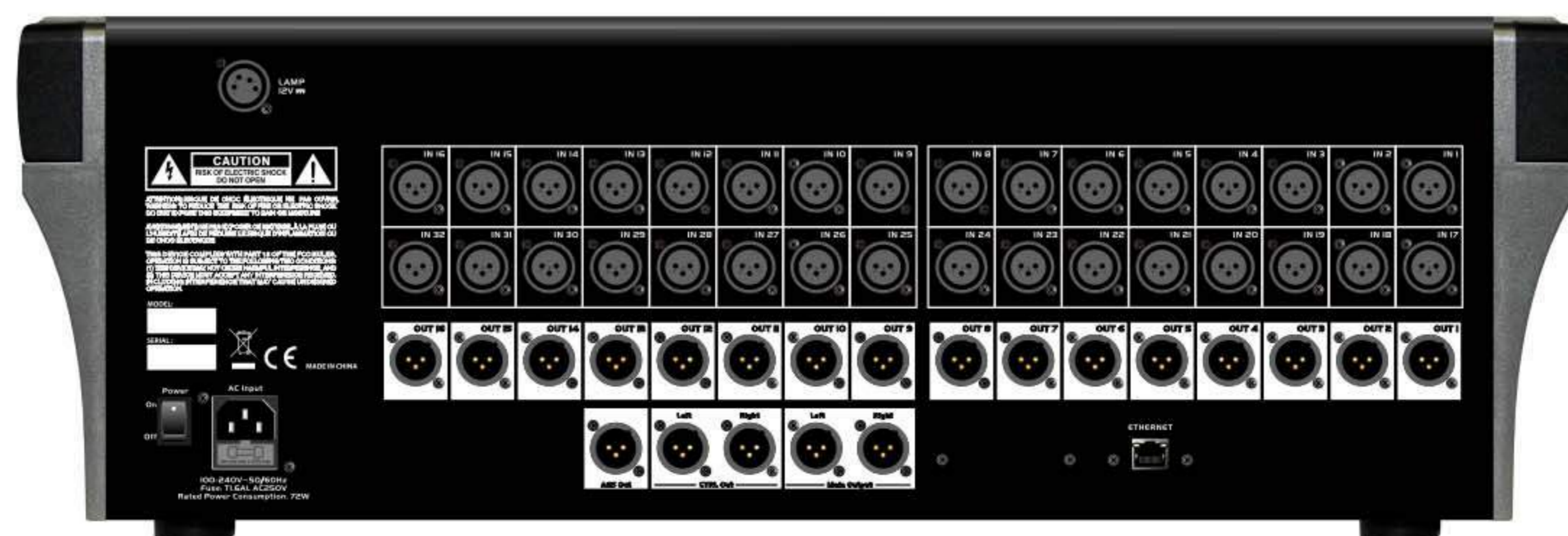

# DIO24 Technical Specifications

Microphone input	Electronically balanced
Frequency Response to Main Output	20Hz~20KHz at 0dBu ±1dB
Distortion (THD&N) to Main Output	<0.03% at 0dBu 1KHz
SNR (Signal to Noise Ratio)	5108dB
Maximum Input Level	+20dBu
Phantom Power (+/-3V)	+48VDC
EIN (Input noise)	125dB
<b>XLR outputs</b>	
Maximum Output Level	+20dBu
<b>System Crosstalk Adjacent Channels</b>	
Input to Output (at +20dBu 1KHz)	-70dBu
Noise (Bus noise)	-91dBu
<b>Digital Audio</b>	
ADC Dynamic Range	114dB
DAC Dynamic Range	114dB
Internal Processor 32-bit	32-bit, floating point
ADC, DAC bit depth 32-bit	32-bit
<b>Impedances</b>	
Microphone input	6.8KΩ
Output	240Ω
Operating free-air temperature range	0°C~40°C
Storage temperature range	-20°C ~60°C



**Allows Remote Access  
and Digital Gain for  
DM Series Digital Mixers**



Shown with  
DM48.20 Mixer



PC Control

Compatible with:



DM48.20

# DIO24



24 x 12-XLR I/O  
Includes Dante I/O



Ethernet Switch



iPad or  
Android  
Tablet  
Control

# DM24.8 Technical Specifications

Microphone input	Electronically balanced
Frequency Response to Main Output	22Hz ~ 20KHz at 0dBu ±1.5dBu
Distortion (THD&N) to Main Output	<0.01% at 0dBu 1KHz
Gain	0dBu ~ 50dBu
SNR (Signal to Noise Ratio)	111dB
Maximum Input Level	+20dBu ±0.5dBu
Phantom Power (+/-3V)	+48VDC
Line input	Electronically balanced
Frequency Response to Main Output	22Hz ~ 22KHz at 0dBu ±1.5dBu
Distortion (THD&N) to Main Output	<0.01% at 0dBu 1KHz
Gain	-20dBu ~ +30dBu
Maximum Input Level (Gain at 0dBu)	+20dBu ±0.5dBu
<b>USB stereo inputs</b>	
Frequency Response to Main Output	22Hz ~ 22KHz at 0dBu ±1.5dBu
Distortion (THD&N) to Main Output	<0.01% at 0dBu 1KHz
Maximum Input Level	10dBu ±0.5dBu
<b>Main Outputs</b>	
Maximum Outputs Level	+20dBu ±0.5dBu
<b>AUX SEND (XLR)</b>	
Maximum Output Level	+20dBu ±0.5dBu
<b>AUX SEND (1/4" TRS)</b>	
Maximum Output Level	+20dBu ±0.5dBu
<b>Control Room Outputs</b>	
Maximum Output Level	+20dBu ±0.5dBu
<b>Headphones Level</b>	
Maximum Output Level	+15dBu ±0.5dBu
<b>System Crosstalk</b>	
Input to Output (at + 0dBu 1KHz)	-88dBu
Adjacent Channels (at + 0dBu 1KHz)	-87dBu
<b>Noise (Bus noise)</b>	
Noise Gate	-91dBu
<b>Threshold Range</b>	
Attack time	-84dBu ~ +20dB
Release time	0.5mS ~ 200mS
Compressor	10mS~1S
Threshold Range	-30dBu - +20dB
Attack time	10mS ~ 150mS
Release time	10mS ~ 1S
Ratio	1:1 to Limit
Gain	0dBu - +24dB
<b>EQ</b>	
Low (LowPass or LowShelf)	21Hz ~ 19.2KHz +/- 24dB
Low Mid	21Hz ~ 19.2KHz +/- 24dB
High Mid	21Hz ~ 19.2KHz +/- 24dB
High (HighPass or HighShelf)	21Hz ~ 19.2KHz +/- 24dB
<b>Digital Audio</b>	
ADC Dynamic Range	114dB
DAC Dynamic Range	114dB
Internal Processor	32-bit , floating point
ADC, DAC bit depth	24bit
<b>Impedances</b>	
Microphone input	6.8K Ohm
Line input	75K
Stereo input	27K
All other output	240 Ohm
Operating free-air temperature range	0°C ~ 40°C

Territory restrictions may apply.



**Dante**  
Optional Digital Card

Download the free App from App Store to control





# DM24.8

**BEST  
SELLER**

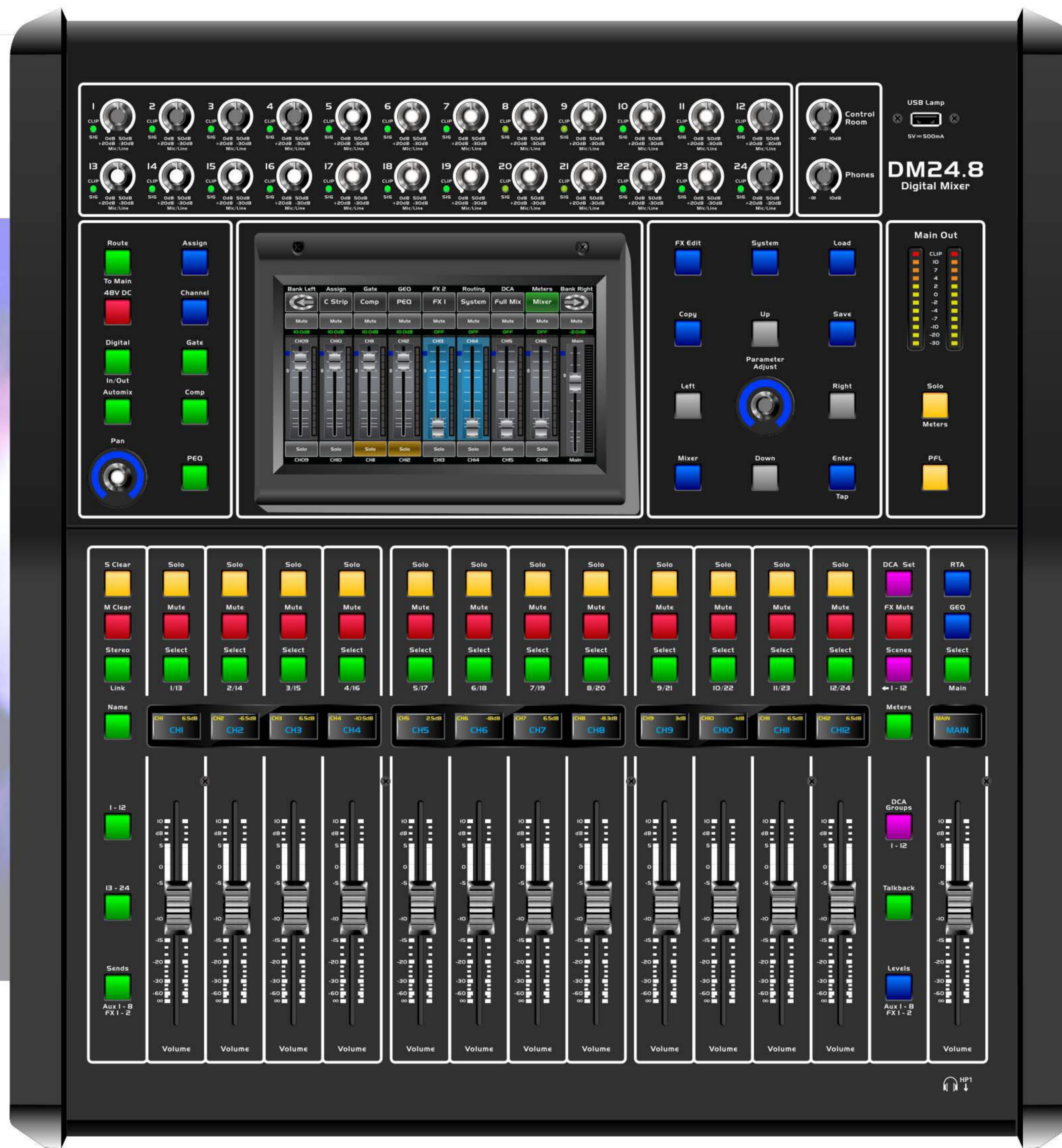

- | 24-XLR Mic Inputs
- | 8-XLR Auxiliary Outputs
- | XLR- Main Out
- | Headphones Out
- | Digital Inserts
- | 13 Motorized Multi-Use Faders
- | OLED Name Strips
- | External Plug-In Processing
- | 2 Multi-Effects Engines
- | 7" Touchscreen
- | Sends on Faders
- | 12 DCA Groups
- | Automix



# T2208 Technical Specifications

Microphone input	Electronically balanced
Frequency Response to direct Output	20Hz-20KHz at 0dBu ±1.5dB
Distortion (THD&N) to Main Output	<0.01% at 0dBu 1KHz
SNR (Signal to Noise Ratio)	104dB
Maximum Input Level	+22dBu
Phantom Power (+/-3V)	+48VDC
Line inputs	Unbalanced
Frequency Response to direct Output	20Hz-20KHz at 0dBu ±1.5dB
Distortion (THD&N) to Main Output	<0.01 % at 0dBu 1KHz
Gain	-15dBu ~ +35dBu
Maximum Input Level (Gain at 0dBu)	+20dBu
17-18/19-20 stereo inputs	Balanced (2 stereo pair)
Frequency Response to Main Output	20Hz~20KHz at +4dBu ±1.5dB
Distortion (THD&N) to Main Output	<0.01 % at 0dBu 1KHz
Gain	-8 to +10dBu
Maximum Input Level	+22dBu
Tape L/R input/USB	20Hz-20KHz at +4dBu
Frequency Response to Main Output	20Hz-20KHz at +4dBu ±1.5dB
Distortion (THD&N) to Main Output	<0.01 % at 0dBu 1KHz
Gain	-8 to + 10dBu
Maximum Input Level	+22dBu
<b>Main Outputs</b>	
Maximum Output Level	+20dBu
<b>AUX1-8 Outputs</b>	
Maximum Output Level	+20dBu
<b>Control Room Outputs</b>	
Maximum Output Level	+20dBu
<b>System Crosstalk</b>	
Input to Output (at +4dBu 1 KHz)	-87dBu
Adjacent Channels (at +4dBu 1 KHz)	-86dBu
Noise (Bus noise)	-90dBu
<b>Noise Gate</b>	
Threshold Range	-84dBu - 0dB
Attack time	0.5mS ~ 200mS
Release time	5mS ~ 2S
<b>Compressor</b>	
Threshold Range	-30dBu -+20dB
Attack time	10mS ~ 150mS
Release time	10mS-1S
Ratio	1 :1 to 24:1
Gain	0dBu - +24dB
<b>EQ</b>	
Low (LowPass or LowShelf)	21Hz~19.2KHz ±24dB
Low Mid	21Hz~19.2KHz ±24dB
High Mid	21Hz~19.2KHz ±24dB
High (HighPass or HighShelf)	21Hz~19.2KHz ±24dB
<b>Digital Audio</b>	
ADC Dynamic Range	114dB
DAC Dynamic Range	114dB
Internal Processor	32-bit, floating point
ADC, DAC bit depth	24bit
<b>Impedances</b>	
Microphone input	1.4K Ohm
Channel Isert return	2.5K Ohm
All other inputs	10K Ohm or greater
Tape out	1K Ohm
All other output	120 Ohm
Operating free-air temperature range	0°C~40°C

Territory restrictions may apply.

## Easy Install Matrix



**Save, Lock, Restore!**

6 Programmable Groups  
10 Programmable Zones



**Dante**  
Optional Digital Card

Download the free App from App Store to control



# T2208

**BEST  
SELLER**



- | 16-XLR Mic Inputs
- | 8-XLR Auxiliary Outputs
- | XLR- Main Out
- | Control Room Out
- | Headphone Out
- | Digital Inserts
- | External Plug-In Processing
- | 2 Multi-Effects Engines
- | 7" Touchscreen
- | 1 Motorized Multi-Use Fader
- | 6 DCA Groups
- | AutoMix
- | Talkback
- | Photo Capture



# DR16.4 Technical Specifications

Main Out L/R	0dB (Balanced)
Frequency Response to Main Output	22Hz ~ 20KHz at 0dBu ±1.5dBu
Distortion (THD&N) to Main Output	<0.01% at 0dBu 1KHz
Gain	0dBu ~ 50dBu
SNR (Signal to Noise Ratio)	108dB
Maximum Input Level	+20dBu ±0.5dBu
Phantom Power (+/-3V)	+48VDC ±3V
Line input	Main Out L/R = 0dB (Balanced)
Frequency Response to Main Output	20Hz ~ 20KHz at 0dBu ±1.5dBu
Distortion (THD&N) to Main Output	<0.01% at 0dBu 1KHz
Gain	-20dBu ~ +30dBu
Maximum Input Level	+20dBu
AUX 1~ 2 input	Balanced (2 stereo pair)
Frequency Response to Main Output	20Hz ~ 20KHz at 0dBu ±1.5dBu
Distortion (THD&N) to Main Output	<0.01% at 0dBu 1KHz
LEVEL Gains	- ~ +10dBu
Maximum Input Level	+20dBu
<b>Main Outputs</b>	
Maximum Outputs Level	+20dBu
<b>AUX 1~ 8 Outputs</b>	
Maximum Output Level	+20dBu
<b>Tape Outputs</b>	
Maximum Output Level	+20dBu
<b>Control Room Outputs</b>	
Maximum Output Level	+20dBu
<b>HP1 Level</b>	
Maximum Output Level	+15dB
Input to Output (at + 0dBu 1KHz)	-88dBu
Adjacent Channels (at + 0dBu 1KHz)	-85dBu
Noise (Bus noise)	-91dBu
<b>Noise Gate</b>	
Threshold Range	-84dBu ~ +20dB
Attack time	0.5mS ~ 200mS
Release time	10mS~1S
<b>Compressor</b>	
Threshold Range	-30dBu - +20dB
Attack time	10mS ~ 150mS
Release time	10mS ~ 1S
Ratio	1:1 to Limit
Gain	0dBu - +24dB
<b>EQ</b>	
Low (LowPass or LowShelf)	21Hz ~ 19.2KHz +/- 24dB
Low Mid	21Hz ~ 19.2KHz +/- 24dB
High Mid	21Hz ~ 19.2KHz +/- 24dB
High (HighPass or HighShelf)	21Hz ~ 19.2KHz +/- 24dB
<b>Digital Audio</b>	
ADC Dynamic Range	114dB
DAC Dynamic Range	114dB
Internal Processor	32-bit , floating point
ADC, DAC bit depth	24bit
<b>Impedances</b>	
Microphone input	6.8K Ohm
Line input	75K
Stereo input	27K
All other output	240 Ohm
Operating free-air temperature range	0°C ~ 40°C

Territory restrictions may apply.



... iPad support available  
Not Required!



**Dante**  
Optional Digital Card

Download the free App from App Store to control





# DR16.4



## A professional DANTE digital rack that... **does not** require wifi to mix!

Great for Education Halls, Houses of Worship, Entertainment, Corporate Events

### Affordable & Easy to Integrate!

- | 16 Total Inputs plus digital I/O
- | 10 XLR High-Gain Mic Pres
- | XLR- Main Out
- | 6 Line Inputs (linked) 3 Stereo Channels
- | 2 Auxiliary Outs / Pre / Post Main
- | Solo Bus with separate Output
- | Multi-Effects Engine
- | All Inputs: Gate / Comp / PEQ
- | All Outputs: Comp / PEQ / GEQ
- | Ducker
- | Feedback Control
- | Automix
- | iPad Remote Control



# DLM408 PLUS & DLM808 Technical Specifications

## DLM408 PLUS

Microphone input	Electronically balanced
Frequency Response to Main Output	20Hz~20KHz at 0dBu +/-3dB
Distortion (THD&N) to Main Output	<0.01% at 0dBu 1KHz
SNR (Signal to Noise Ratio)	108dB
Maximum Input Level	+20dBu
Maximum Output Level	+20dBu
Crosstalk, Input to Output	-90dBu
Crosstalk, Adjacent Channels	-90dBu
Noise Gate, Threshold Range	-80dBu - +20dB
Noise Gate, Attack time	10mS~150mS
Noise Gate, Release time	10mS~1S
Noise Gate, Ratio	1.0:1 to 10:1
Compressor, Threshold Range	-30dBu~+20dB
Compressor, Attack time	10mS ~ 150mS
Compressor, Release time	10mS~1S
Compressor, Ratio	1:1 to 10:1
Gain	0dB~ +24dB
EQ Low (Low Pass or Low Shelf)	19.7Hz~20.1KHz +/-18dB
EQ Low Mid	19.7Hz~20.1KHz +/-18dB
EQ High Mid	19.7Hz~20.1KHz +/-18dB
EQHigh (High Pass or High Shelf)	19.7Hz~20.1KHz +/-18dB
Impedances	10K Ohm
Power Supply	100-240V~50/60Hz

## DLM808

Microphone input	Electronically balanced
Frequency Response to Main Output	20Hz~20KHz at 0dBu +/-1dB
Distortion (THD&N) to Main Output	<0.01% at 0dBu 1KHz
SNR (Signal to Noise Ratio)	110dB
Maximum Input Level	+20dBu
Maximum Output Level	+20dBu
Input to Output & Adjacent Channels	-87dBu
Noise Gate, Threshold Range	-87dBu
Noise Gate, Attack time	-84dBu -0dB
Noise Gate, Release time	0.5mS~200mS
Compressor	5mS~2S
Threshold Range	-30dBu - +20dB
Attack time	10mS~150mS
Release time	10mS~1 S
Ratio	1:1 to 24:1
Gain	0dBu - +24dB
EQ-Low (Low Pass or Low Shelf)	20Hz~19.2KHz +/-24dB
Low Mid / High Mid	20Hz~19.2KHz +/-24dB
High (High Pass or High Shelf)	20Hz~19.2KHz +/-24dB
ADC/DAC Dynamic Range	114dB
DSP Processor	32-bit, floating point
Sample Rate	48K/24bit

## Control More... Better!



## Professional Dante-AES67

Compatible with Digital Processor





# DLM408 PLUS & DLM808

## DLM408 PLUS



8 XLR Outputs 4 XLR Inputs



## DLM808



8 XLR Outputs 8 XLR Inputs



# MXi Series Technical Specifications

## MXi Series

MXi.3	MXi.3BT	MXi.5
1 Precision mono input Mic/Line with combo jack	1 Precision mono input Mic/Line with combo jack	5 Input Mixer
Stereo Input	Stereo Input	1 Mic/Line input
Monitor Output	Monitor Output	2 Stereo Line inputs
RCA Tape inputs/ outputs	RCA Tape inputs/ outputs	RCA Tape inputs/ outputs
2 band EQ	2 band EQ	2 band EQ
Monitor Output	Monitor Output	Headphone output
-	Bluetooth	-

MXi.6	MXi.6USB	MXi.6FX
6 Input Mixer	6 Input Mixer	6 Input Mixer
2 MIC/Line inputs	2 MIC/Line inputs	2 MIC/Line inputs
2 Stereo Line Inputs	2 Stereo Line Inputs	2 Stereo Line Inputs
-	USB i/o	24-bit Digital FX Processor
-	-	100 Presets

### Common Spec.

RCA Tape inputs/ outputs, 3-band EQ, AUX send per channel, Phantom Power, Headphone output, Control Room Out

MXi.10	MXi.10USB
10 Input Mixer	10 Input Mixer
2 MIC/Line inputs	2 MIC/Line inputs
4 Stereo Line Inputs	4 Stereo Line Inputs
-	USB i/o

### Common Spec.

RCA Tape inputs/ outputs, 3-band EQ, AUX send per channel, Phantom Power, Headphone output, Control Room Out, Main Master Fader

MXi.12	MXi.12USB	MXi.12FX
12 Input Mixer	12 Input Mixer	12 Input Mixer
4 MIC/Line inputs	4 MIC/Line inputs	4 MIC/Line inputs
4 Stereo Line Inputs	4 Stereo Line Inputs	4 Stereo Line Inputs
-	USB i/o	24-bit Digital FX Processor
-	-	100 Presets

### Common Spec.

RCA Tape inputs/ outputs, 3-band EQ, AUX send per channel, Phantom Power, Headphone output, Control Room Out, Main Master Fader

## MXi CFX Series

MXi.1222CFX	MXi.1422CFX	MXi.1622CFX	MXi.2422CFX
12 Input Mixer	14 Input Mixer	16 Input Mixer	24 Input Mixer
6 MIC/Line inputs	8 MIC/Line inputs	10 MIC/Line inputs	12 MIC/Line inputs

### Common Spec.

2 Stereo Line inputs, 2 Subgroups, RCA Tape inputs / outputs, 3-band EQ, Parametric Mid Freq., AUX send per channel, FX Send Per Channel, 60mm Faders, Phantom Power, Headphone output, Control Room Out, 24-bit Digital Effect, 100 Presets, Built-in MP3 player

# MXi Series



MXi.3BT



MXi.5



MXi.6USB



MXi.6FX



MXi.10USB



MXi.12USB



MXi.12FX





# MXi CFX Series

**BEST  
SELLER**



- | XLR MIC/Line inputs
- | 2 Stereo Line inputs
- | 2 Subgroups
- | RCA Tape inputs / outputs
- | 3-band EQ

- | Parametric Mid Freq.
- | AUX send per channel
- | FX Send Per Channel
- | 60mm Faders
- | Phantom Power

- | Headphone output
- | Control Room Out
- | 24-bit Digital Effect
- | 100 Presets
- | Built-in MP3 player



MXi.1222CFX



MXi.1422CFX



MXi.1622CFX



MXi.2422CFX

# Ready 6B & 5B Technical Specifications

	READY 6B	READY 5B
Frequency Bands	UHF (470~494), (542~566), (863~865) MHz Dependent on applicable country regulations	
Power Supply	AC: 100V/110-240V / Battery: 25.9V (lithium)	
System Type	2-Way Active All-in-one PA system	Power adaptor 24V 2.5A / Battery: 16.8V (lithium)
Transducer Low	6.5" Woofer	5.25" Woofer
Transducer High	1" Neodymium driver	-
Frequency Response (-6dB)	70Hz - 16KHz	80Hz - 16KHz
Crossover Frequency	1.9KHz	-
Max SPL	116dB Max	110dB Max
AMP Power	Bi-amp, Class-D 100W RMS	Class-D MONO 40W RMS
Output	(LF 90W / HF 10W)	
Input	CH1 MIC: -35dBu (±1dBu) CH2 LINE: 0dBu (±1dBu)	
Sensitivity	CH1 LINE: 0dBu (±1dBu) CH2 Hi-Z: -35dBu (±1dBu) / AUX: -10dBu (±1dBu)	
Equalizer Controls	BASS: ±10dB (at 100Hz) / HIGH: ±10dBu (at 10KHz)	
External	Master Volume; MIC & LINE Switch; Hi-Z & LINE AUX each Volume	
Controls	Controls; Voice priority Switch; Power Indicators; Recharged Indicators; Battery Level Indicators	
Connectors	1 x XLR / 6.3 mm jack combo line / Mic input with 2 bands EQ 1 x 6.3 mm jack line / Hi-Z input with 2 bands EQ 1 x 3.5mm stereo jack input 1 x 6.3 mm jack line mix output	
Voice Priority	MIC 1 and Wireless	-
Battery charge time	At least 4 hours	
Battery use time	More than 6 hours (Regular Play)	More than 5 hours (Regular Play)
Wireless Frequency band	UHF (470-960) MHz	
Built-in player	MP3 & Bluetooth	
Enclosure Construction	Plastic cabinet, Trapezoidal, Metal grille, plastic handle.	
Mounting	35mm standard pole-mount	20mm standard pole mount
Dimensions (LxWxH)	265 x 240 x 323 mm / 10.43" x 9.45" x 12.72"	258 x 192 x 211 mm / 10.16" x 7.56" x 8.31"
Net weight	5.8 Kg / 12.79 lbs	3.4 Kg / 7.50 lbs
Volume	1.85CFT	1.09CFT

BT/MP3 Module



Floor Monitor



Tripod  
(not included)  
(optional)



Ready 6 UHF Receiver Module

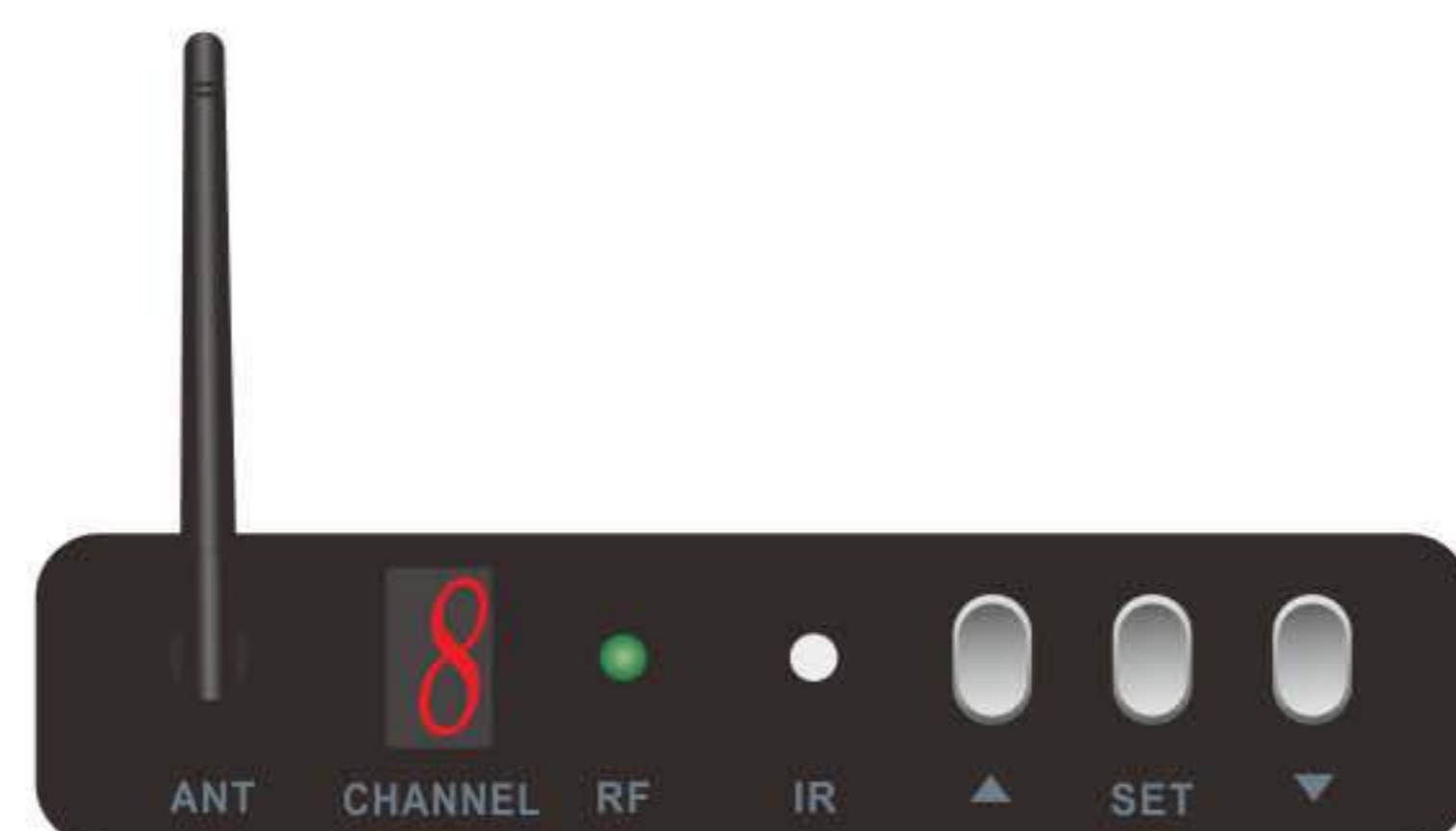

Ready 5 UHF Receiver Module



Tilt Back

Floor Stand

# Ready 6B & 5B

**NEW**  
MODEL



**6H**  
BATTERY  
OPERATION

**5H**  
BATTERY  
OPERATION



**Ready 6B**  
3Ch Mixer w/ Reverb Effect  
2 EQ Bands  
Wireless Option

**Ready 5B**  
3Ch Mixer  
Wireless Option

**MAXHEB**  
POWER MODULE *Optimum Headroom & SPL*

**NEODYMIUM**  
**ND**  
DRIVER

**Hi-Def**  
COMPONENTS



Wireless  
Microphones:



TMW U1.100P



R6 HMT

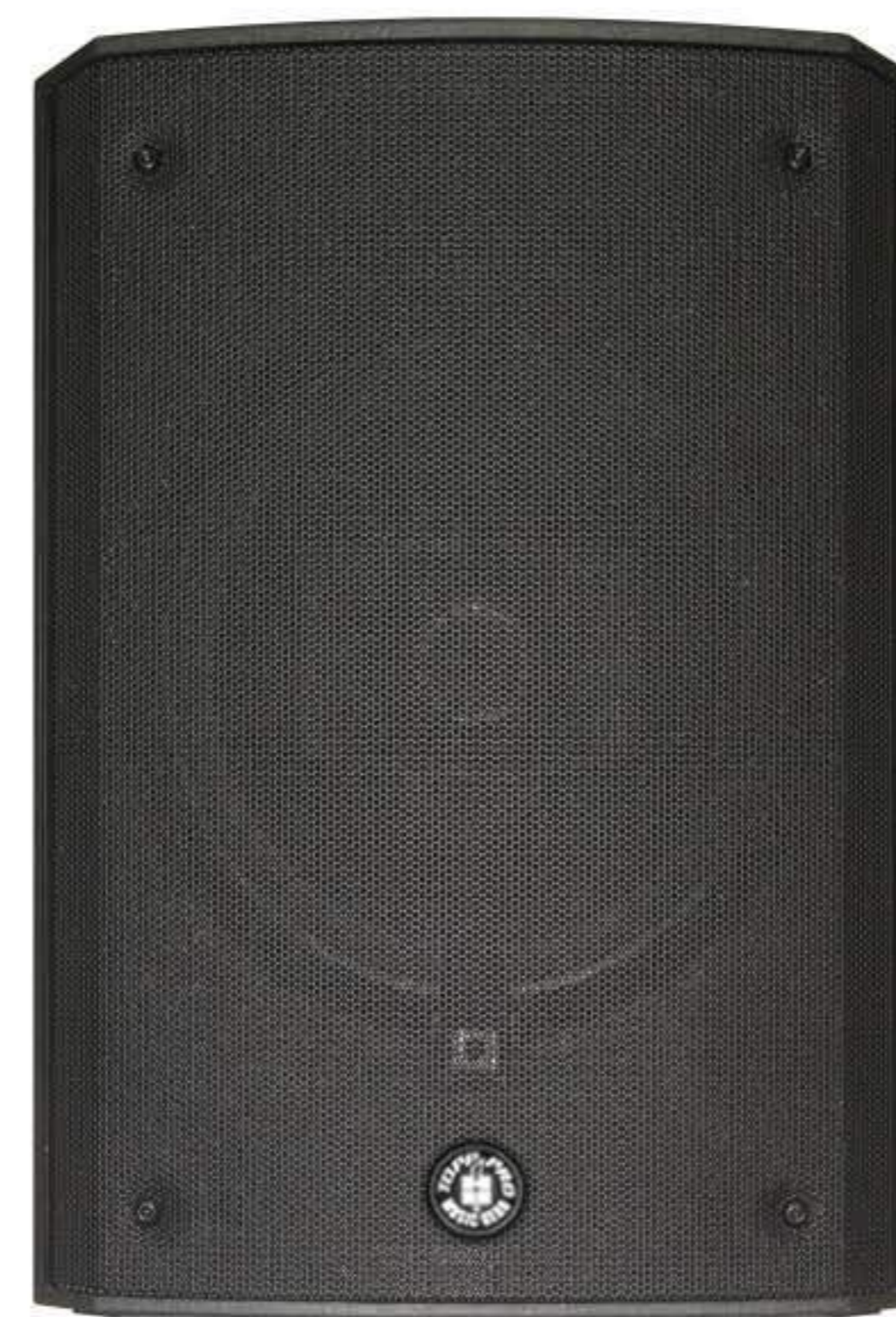

**6.5"**  
WOOFER

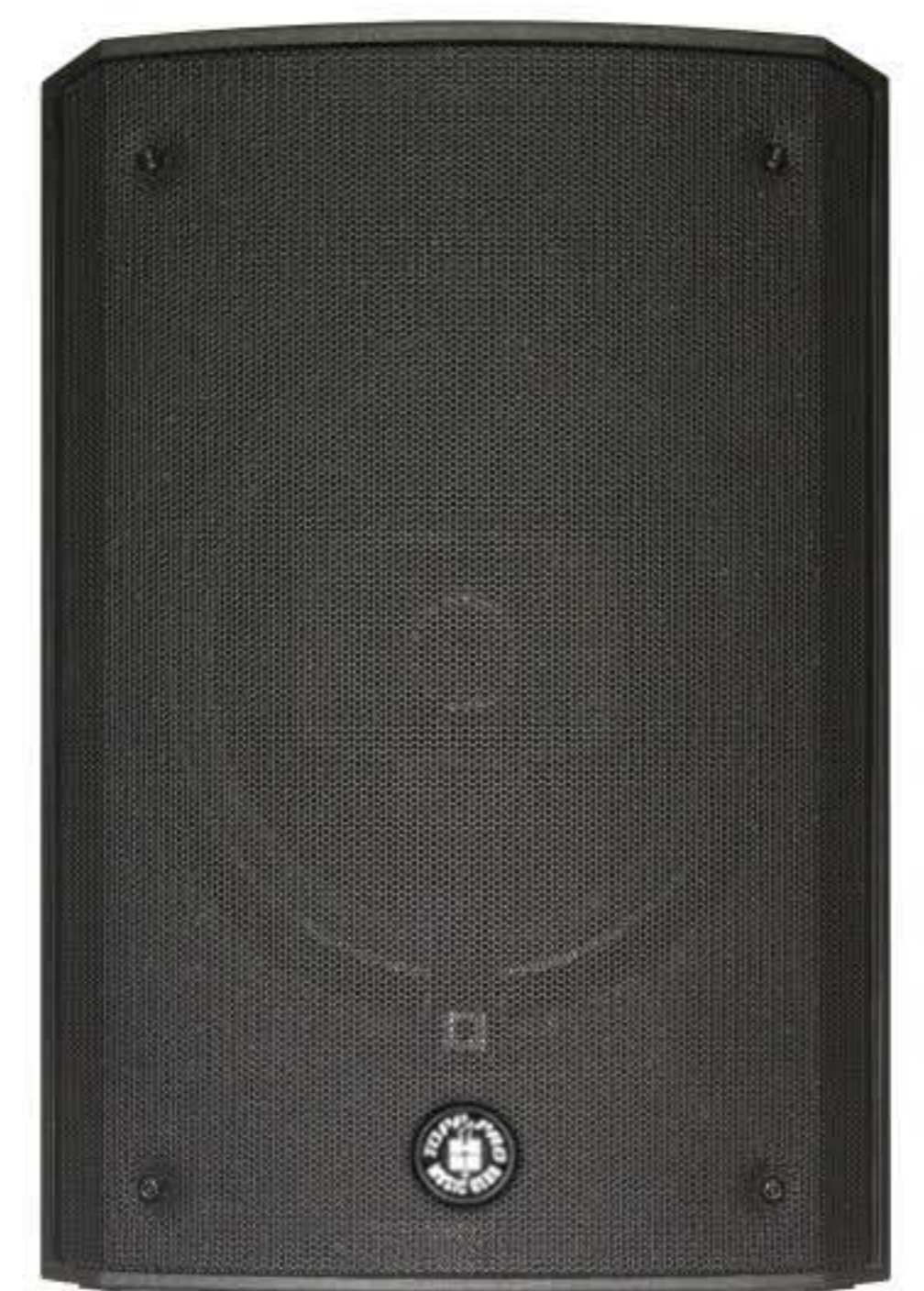

**5.25"**  
WOOFER

# APX Array Technical Specifications

## APX 28HA Satellite

System Type	2-way full range, Active Array Element
AMP Power	800W Continuous / Bi-AMP (Class D-650W LF, Class AB-150W HF) / 3200W Peak
Speaker	2 x 1" Neo Driver, 1.75" V.C., 2 x 8" Woofer
Frequency Response ( $\pm 3$ dB)	70Hz - 19kHz
MAX SPL @ 1m	121dB (continuous) / 127dB (peak)
Crossover (MID-High)	1.8 kHz
Dispersion (-6dB)	110° Horizontal / 10° Vertical
Cooling	Passive Cooling + Inside Fan
Input Connector	XLR In / Link / DSP Module with RJ45 Date In & Link
Controls	9 User Presets
DSP Processor	32 bit, 24bit/48kHz AD/DA, Digital Volume Control
Electronic Protections	Thermal / Convection-Fan / Overload / Digital Limiter / Compressor
Mains Connector	Neutrik PowerCON Connector In & Out
Power Supply	Auto-Range 100V-120V/220V-240V 50Hz/60Hz Switch mode
Enclosure Construction	18mm Birch Plywood, Resistant Black Paint, 1.5T Metal Grille with Foam, Two Handles on Each Side, Water Resistant Coating
Mounting	3-point Suspension, Horizontal Trapezoid 2 x 7.5°, 3 configuration styles (Small, Stack & Array)
Accessories	Flybar / Adaptor / Ground stacking bar / Flying pin / DSP control center
Dimensions (HxWxD)	556 x 388 x 753 mm / 21.89" x 15.26" x 29.65"
Net Weight	22.5 kg / 49.6 lbs

## APX 28SA Subwoofer

System Type	Active Subwoofer
AMP POWER	Class D 1500W RMS, 3000W Program
Speaker	1 x 18" woofer, 4" Voice Coil
Frequency Response ( $\pm 3$ dB)	30 z - 120Hz
SPL @ 1m	136dB (peak)
Cooling	Passive Cooling + Inside Fan
Input Connector	XLR In / Link / DSP Module with RJ45 Date In & Link
External Controls	9 Preset
DSP Processor	32 bit, 24bit/48KHz Audio conversion AD/DA, Digital Volume Control
Electronic Protections	Thermal / Convection-Fan / Overload / Digital Limiter / Compressor
Mains Connector	Neutrik PowerCON Connector In & Link
Power Supply	Auto-Range 100V-120V/220V-240V 50Hz/60Hz Switch mode
Enclosure Construction	18mm Birch Plywood, Resistant Black Paint, 1.5T Metal Grille with Foam, Rubber Feet, Two Handles on Each Side, Water Resistant Coating
Mounting	One Metal M20 Pole-mount, Four-point Suspension, Three configuration styles (Small, Stack & Array)
Accessories	Flybar / Adaptor / Ground stacking bar / Flying pin / DSP control center
Dimensions (H x W x D)	812 x 750 x 778mm / 31.97" x 29.53" x 30.63"
Net Weight	58.5 Kg / 128.97 lbs

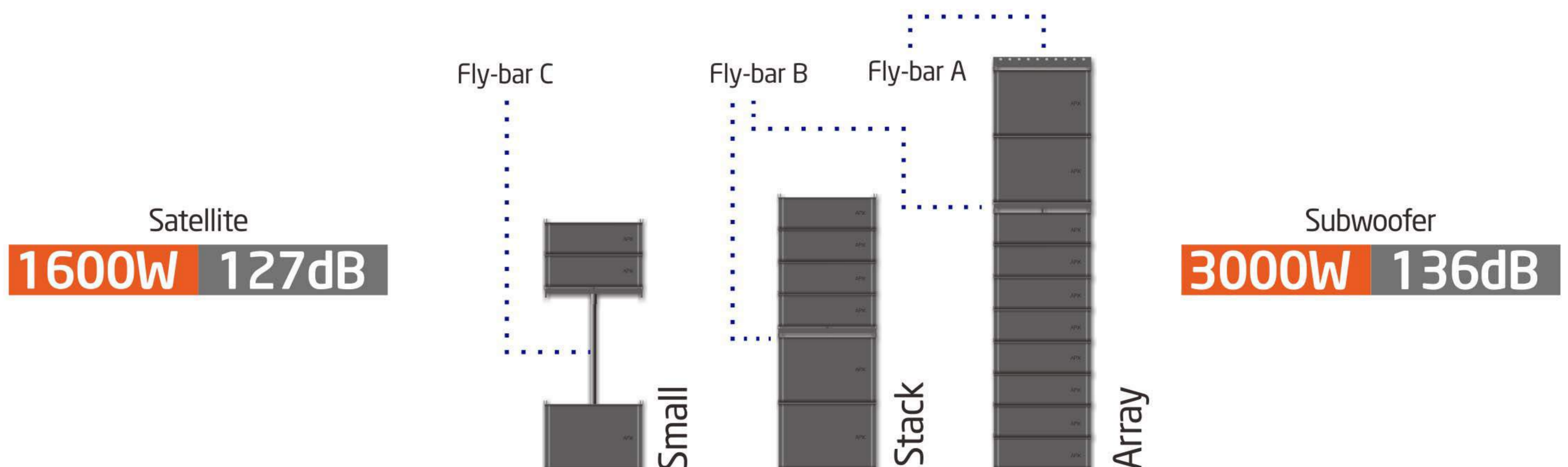

# APX Array System

**BEST  
SELLER**

## Professional Concert Level Line Array System



**CL-4**



4 RC-Net Ports  
RS485 = 57600 BPS  
Control Via PC software

# KS Array Technical Specifications

## KS T28A

System Type	2-Way Active Vented Speaker with DSP
Transducer Low	2 x 8" Woofer, 2" Voice Coil
Transducer High	2 x 1" Titanium diaphragm, Neodymium magnet, 1.4" Voice Coil
Coverage Horizontal	100° nominal, single unit
Coverage Vertical	7.5° variable with array configuration
Frequency Response (-6dB)	65Hz - 20KHz
Crossover Frequency	At 2.0KHz with 24dB filter slope, DSP process
Max SPL	129dB Max.
AMP Power Output	1600W Program, Bi-AMP (Class D-650W LF, Class AB-150W HF), 3200W Peak
Input Connector	Line in -Combo / Link-XLR
DSP Presets	Flat / HF +3dB / User (Custom Sound)
Line Input	Combo Connector -6dBu
External Controls	Volume Control / Neutrik POWER CON® connector (Grey) offers linking the mains power supply power display with green LED / Clip Limiter with Red LED / IP Control Module (Opt.)
Electronic Protections	Thermal / Convection-Fan / Overload / Digital Lim. / Compressor
Power Supply	Neutrik POWER CON® connector, 110-120V / 220-240V~50/60Hz Switch mode
Suspension/Mounting:	Integrated hardware for suspension in Line Array, dual pole socket, two handles
Enclosure Construction	18mm calibrated plywood, black painted finish, 1.2T metal grille, power coating with internal foam
Dimensions (HxWxD)	272 x 692 x 424 mm / 10.71" x 27.24" x 16.69"
Net Weight	29.1 Kg / 64.15 lbs

## KS LT118A SUB

System Type	Active Subwoofer
Power Rating	1500W Continuous Class D, 3000W PROGRAM, 6000W PEAK
Transducer Low	18" Woofer, 4" Voice Coil
Max SPL	132 dB
Frequency Response (-6dB)	40Hz to 120Hz
Crossover Frequency	LOW pass band type 24dB/oct
Connectors	Input: A and B XLR-F / High Pass and Full Range: A and B XLR-M
External Controls	Volume / DSP Processing / Signal Limit LED / Power ON with Green LED / LAN / Phase / Stereo or Mono
Electronic Protections	Thermal / Convection-Fan / Overload / Limit / Compressor
Power Supply	Neutrik POWER CON® connector, 110-240V~50/60Hz Switch mode
Suspension / Mounting	Integrated hardware for suspension in Line Array, One metal standard pole-mount, four handles
Enclosure Construction	Plywood cabinet, resistant black paint, metal grille with black foam, rubber feet
Dimensions (HxWxD)	620 x 692 x 713 mm / 24.41" x 27.24" x 28.07"
Net weight	74 Kg / 163.14 lbs

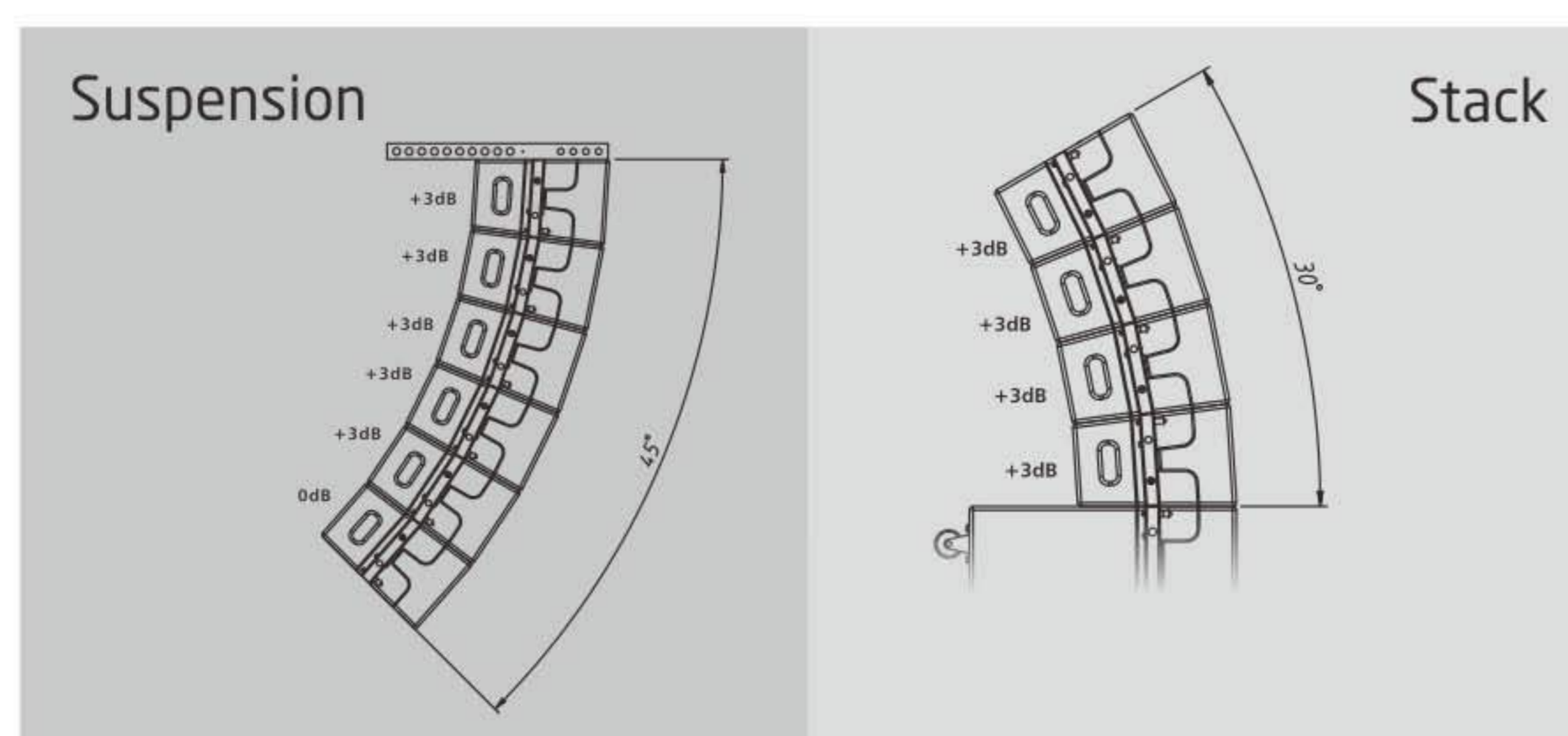

Also available in PASSIVE

# KS Array System

**BEST  
SELLER**

KS T28A  
Dual 8" Active  
Vented Speaker



KS T28A  
Dual 8" Active  
Vented Speaker



**1600W** CE  
PROGRAM POWER - EACH APPROVED

**1600W** CE  
PROGRAM POWER - EACH APPROVED

**3000W** CE  
PROGRAM POWER - EACH APPROVED

**3000W** CE  
PROGRAM POWER - EACH APPROVED

KS LT118A  
18" Active Sub

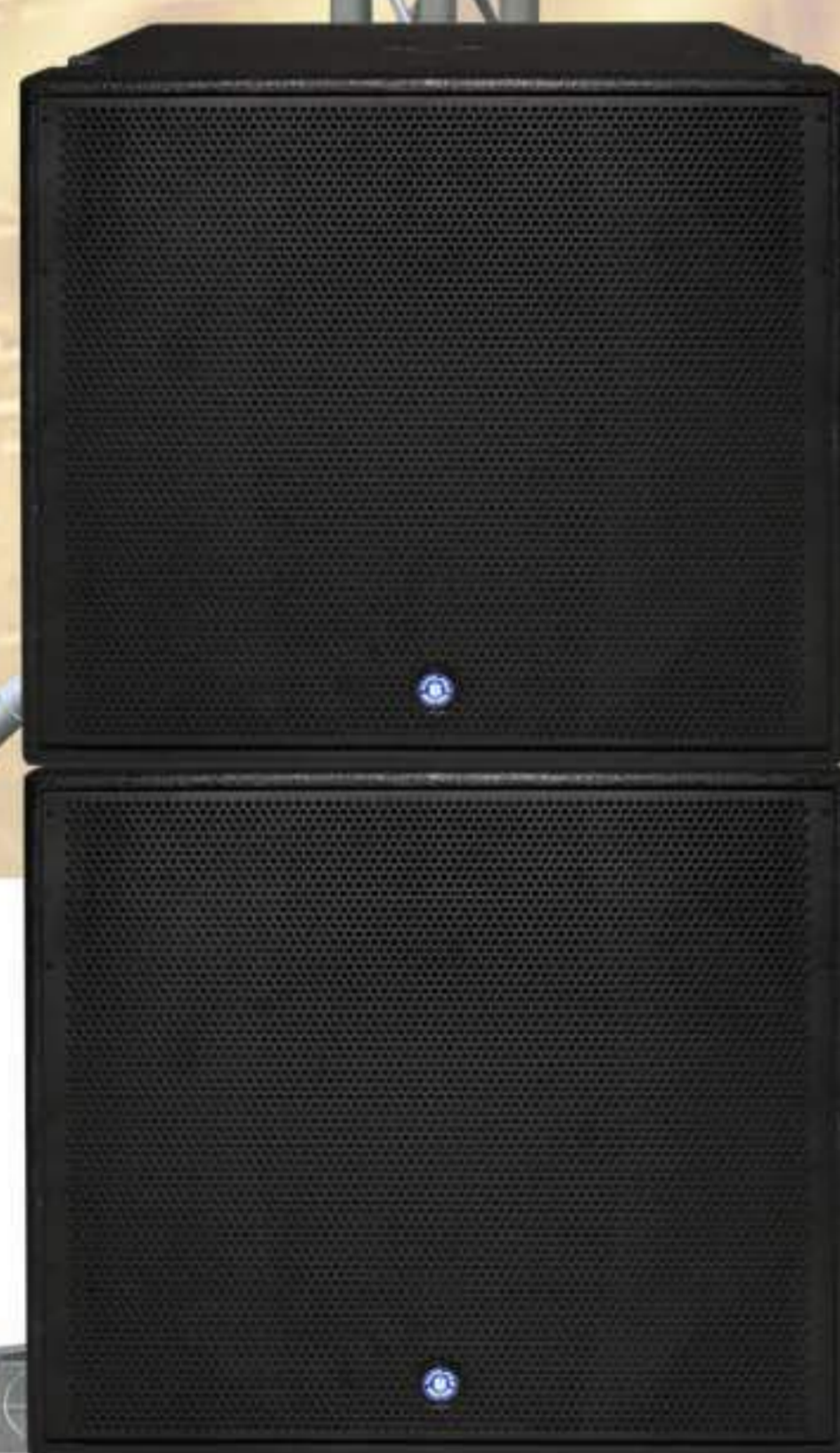

KS LT118A  
18" Active Sub



**MAX HED**  
POWER MODULE *Optimum Headroom & SPL*



**Rigging  
READY!**

Download the free  
App from App Store  
to control



Professional Line Array with DSP

# SWIFT 25 Array System



8 x SWIFT 25  
Passive Satellites  
Dual 5" Woofers,  
1" Tweeter

**8000W** CE  
PEAK POWER - TOTAL SYSTEM APPROVED



TD500.4DSP V2  
Amplifier with DSP



2 x KS18S  
18" Passive  
Subwoofer

**MAXHEB**  
POWER MODULE Optimum Headroom & SPL





**NEW  
MODEL**



8 x SWIFT 25  
Passive Satellites  
Dual 5" Woofers,  
1" Tweeter



TD500.4DSP V2  
Amplifier with DSP



2 x KS18S  
18" Passive  
Subwoofer



# SWIFT 25 & TD 500.4DSP V2 Technical Specifications

## SWIFT 25

System Type	5" 2-way Passive System
Output Power	120W (CONTINUOUS), 240W (PROGRAM)
Sensitivity (1W/1M)	95dB
Maximum SPL @ 1m	115, 5dB Max. (calculated)
Frequency Response	90Hz-20KHz (-10dB)
Impedance	16 ohms
Transducer Low	2 x 5" Woofer, 1,18" Voice Coil
Transducer High	1 x 1" Tweeter, 1" Voice Coil
Crossover Frequency	2kHz Passive
Dispersion (-6dB)	100° Horizontal, 12° Vertical (one module)
Attachment Points	Adjustable Rigging System, Vertical Splay Adjustable in 1.5° Increments from 0°- 12°
Connectors	2 x SPK4 Style
Enclosure Construction	Polypropylene Enclosure with side handles, steel Metal Grille with foam
Fittings information	Steel Stirrup Material, 3 Flying Points
Dimensions (HxWxD)	430 x 161x 304 mm / 16.93 x 6.34" x 11.97"
Net Weight	8.0 Kg / 17.64 lbs

## KS18 SUB

System Type	Bass Reflex Subwoofer
Transducer Low	18" Woofer, 3" voice coil
Frequency Response	40Hz - 200Hz (-6dB)
Crossover Frequency	500Hz
Nominal Impedance	8 Ohms
Max SPL	128dB Max.
Power Rating	500W RMS / 1000W PROGRAM
Input Connector	2 x NL4 (Pin1+, Pin1-)
Enclosure Construction	Plywood cabinet, resistant black paint, metal grille, rubber feet, two handles
Mounting	Metal pole-mount
Dimensions (HxWxD)	535 x 661x 516 mm / 21.06" x 26.02 x 20.3"
Volume	10.44 CFT
Net Weight	30.58 Kg / 67.42 lbs



Swift 25  
Rear View



Swift 25  
Fly Bar

## TD500.4 DSP V2

Stereo Mode	4 Ohm (RMS)	500W x 4
(Both Channels Drive)	8 Ohm (RMS)	250W x 4
Bridge Mono Mode	8 Ohm (RMS)	1000W x 2
Input Sensitivity	0.9-1.1V (0+/-1dBv) (Limit Off)	
Input Impedance	20K Ohm balanced or 10K Ohm unbalanced	
Frequency Response	20Hz ~ 20KHz (+0/-1dB) (at 10dB Rated Output Power 8 Ohm)	
Voltage Gain	34+/- 0.5dB	
THD+N	<0.15% (Ref.1K 1/8 Rated Power, A-Weighted)	
S/N rate	>95dB (Ref. Rated Power, A-Weighted)	
Crosstalk	>50dB (Below Rated Power)	
Damping Factor	>180 (1K 8 Ohm)	
Power/Output Circuitry	Switching Power Class D	
Protections	Full short circuit, open circuit, thermal, ultrasonic, and RF protection, stable into reactive or mismatched loads, turn ON/OFF, muting, tripped crowbar.	
Controls	Encoder	
Indicators	OLED Display	
Connectors	INPUT: Active bala. XLR / OUTPUT: Speak-on jacks	
Power Supply	110V-120V or 220V-240V AC 50/60 Hz	
Dimensions (HxWxD)	44 x 483 x 290mm / 1.73" x 19.02" x 11.42"	
Net Weight	6.0 Kg / 13.23 lbs	

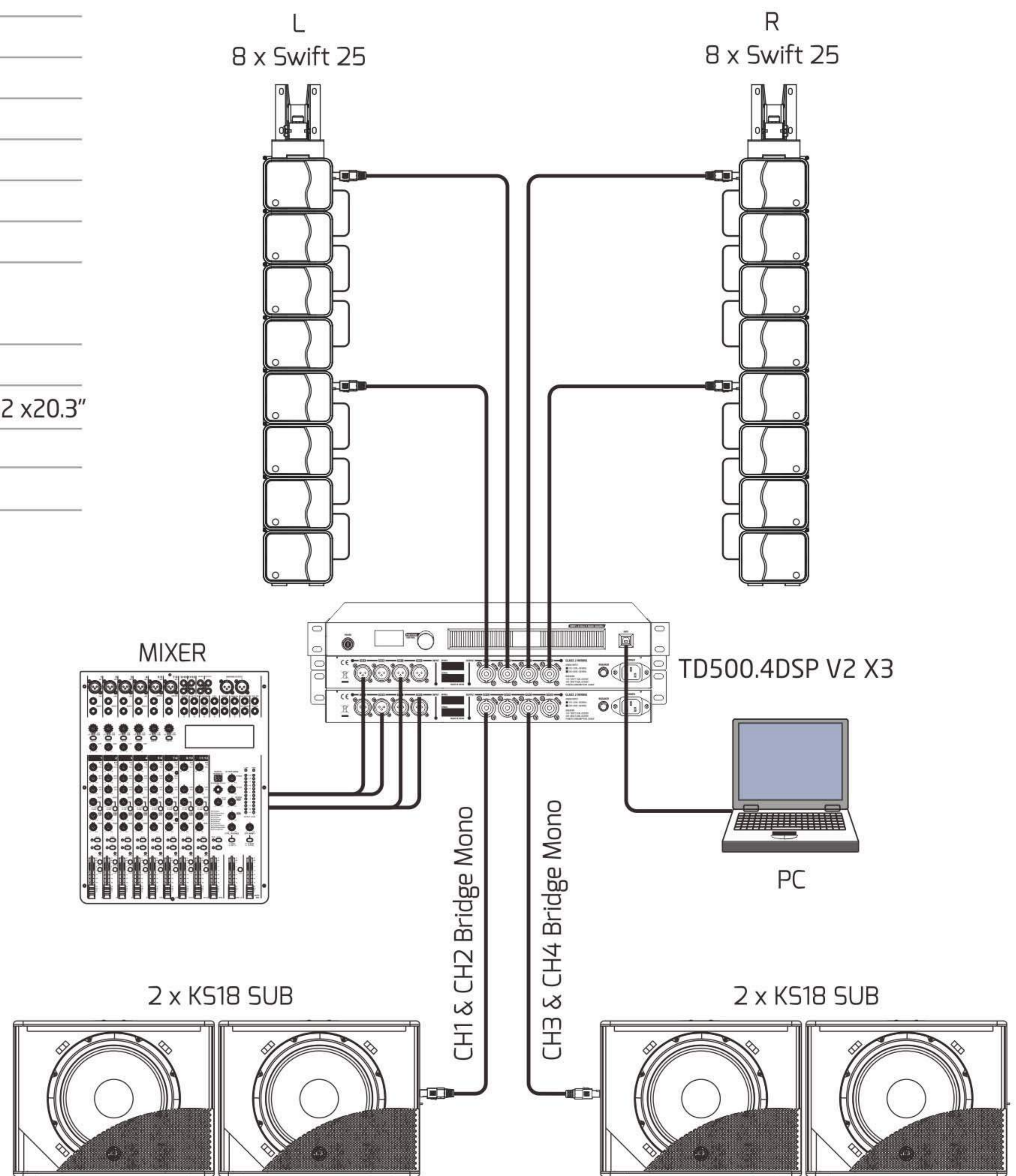

Versatile Active Processor

# TD500.4DSP V2

**NEW**  
MODEL

**4000W**  
PEAK POWER

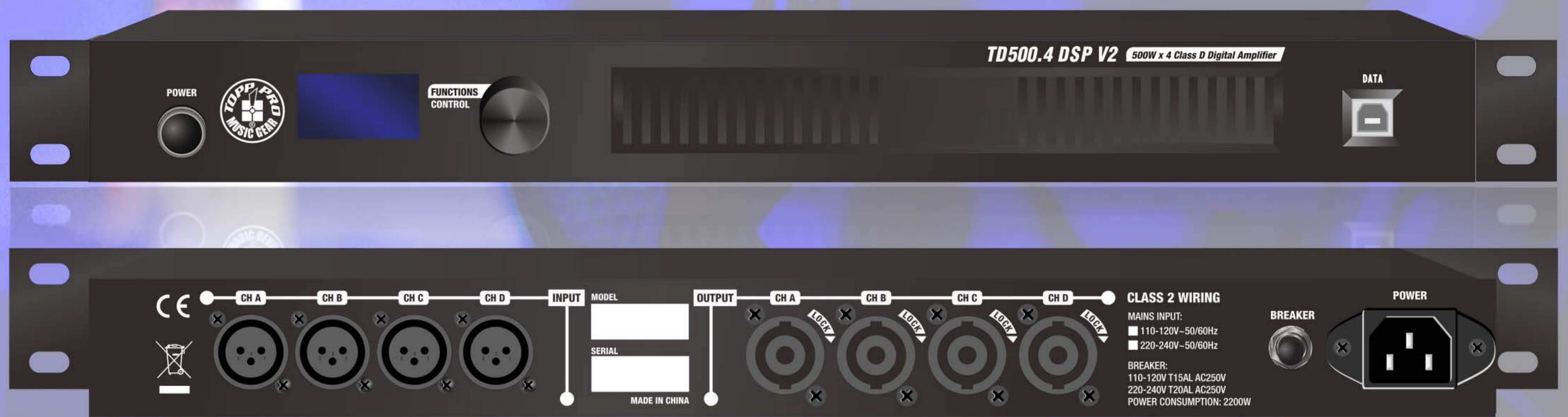

Ideal for using with **SWIFT 25 / FLX3 / X3** systems



4 x 500W  
2 x 500W

2 x 1000W



Control  
**Everything**  
Better!



# FLX3 Technical Specifications

## FLX3

System Type	3" 2-way Passive System
Output Power	40W CONTINUOUS / 80W PROGRAM
Sensitivity (1W/1M)	90dB
Maximum SPL @ 1m	106dB Max. (calculated)
Frequency Response	100Hz-20KHz (-10dB)
Impedance	8 Ohm
Transducer Low	2 x 3" Woofer, 0.75" Voice Coil
Transducer High	3 x Ø13mm V.C. Neodymium Tweeter
Crossover Frequency	2.5KHz
Dispersion (-6dB)	100° Horizontal, 30° Vertical (one module)
Attachment	Adjustable Rigging System, Vertical Splay
Points	Adjustable in 1.5° Increments from 0°- 12°
Connectors	Parallel or Series Ø6.3mm Socket / Selection Switch
Enclosure	Polypropylene Enclosure, steel Metal Grille
Construction	with foam, Steel Stirrup Material, 3 Flying Points
Dimensions (HxWxD)	124 x 265 x 195 mm / 4.88" x 10.43" x 7.68"
Net Weight	3.2 Kg / 7.06 lbs

## SOHO S12P

System Type	12" Passive Subwoofer Speaker
Output Power	300W PROGRAM / 125W PEAK
Sensitivity	122dB Continuous / 125dB Peak
Frequency Response	45Hz-2.8KHz (-10dB)
Impedance	4 Ohm
Transducer	12" Ferrite Woofer, 2.55" Voice Coil
Connectors	4 Pin Terminal Block and 2 x NL-4 Speakon Parallel Socket
Enclosure	Plywood Cabinet, Resistant Black
Construction	Paint, Metal Grille
Mounting	One metal standard Pole-mount
Dimensions (HxWxD)	500 x 350 x 542 mm / 19.69" x 13.78" x 21.34"
Net Weight	20.10 Kg / 44.31 lbs

FLX3  
Front View



FLX3  
Rear View

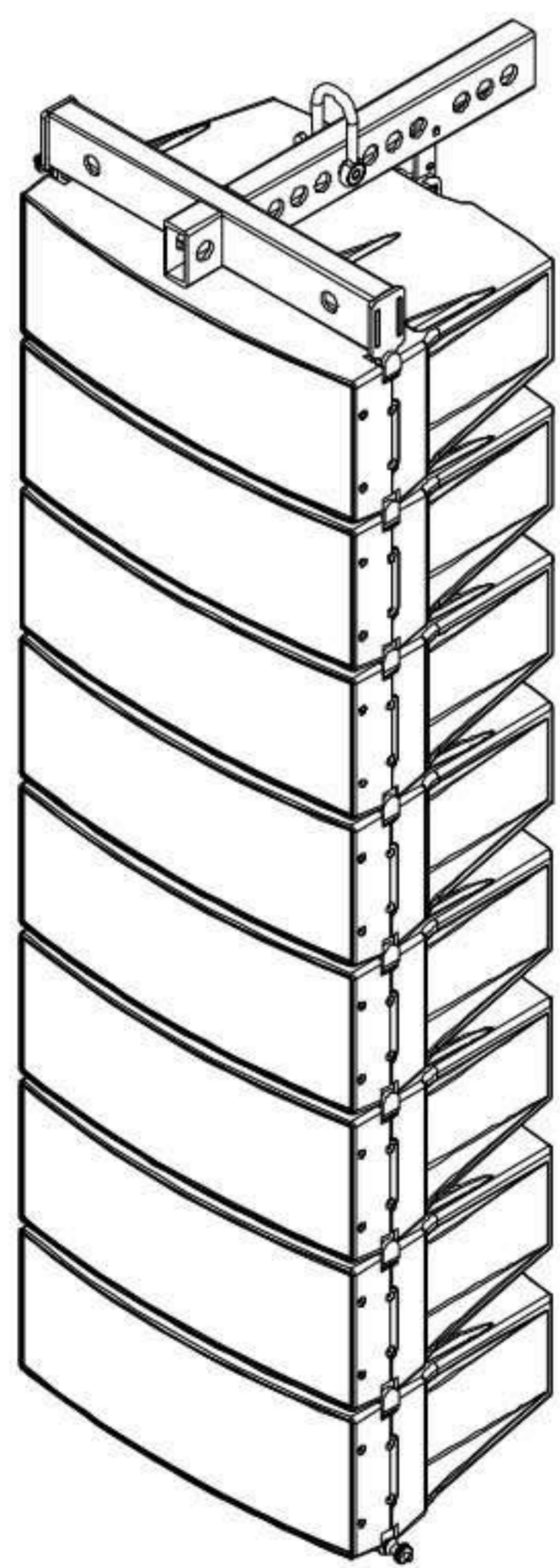

Array bracket

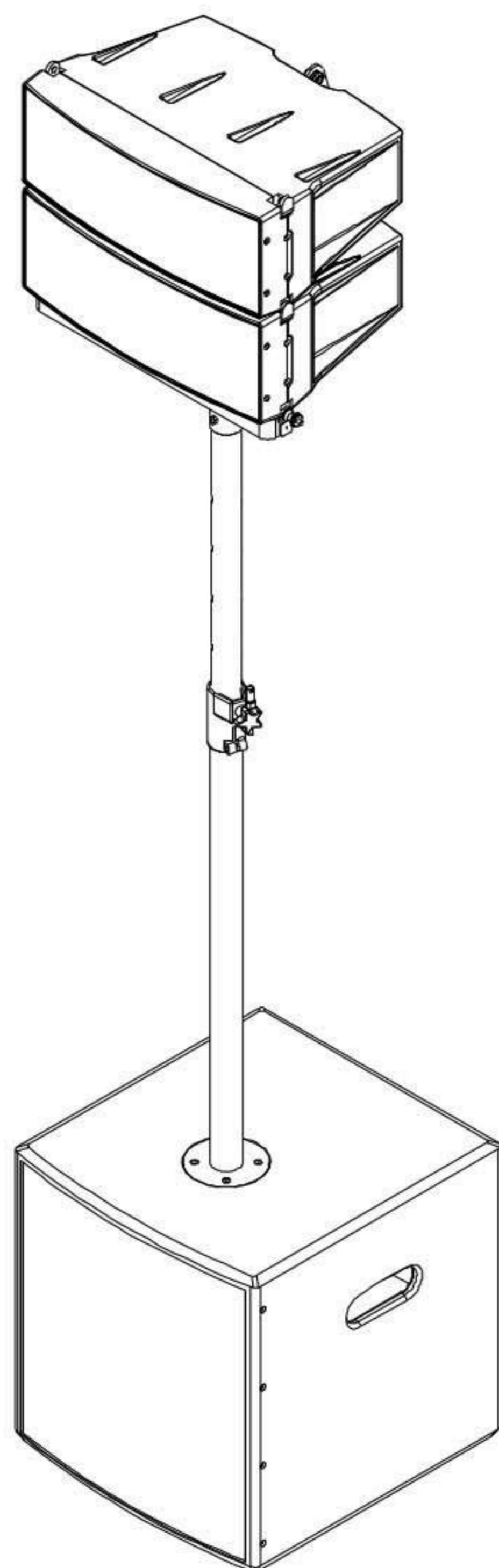

Stack pole

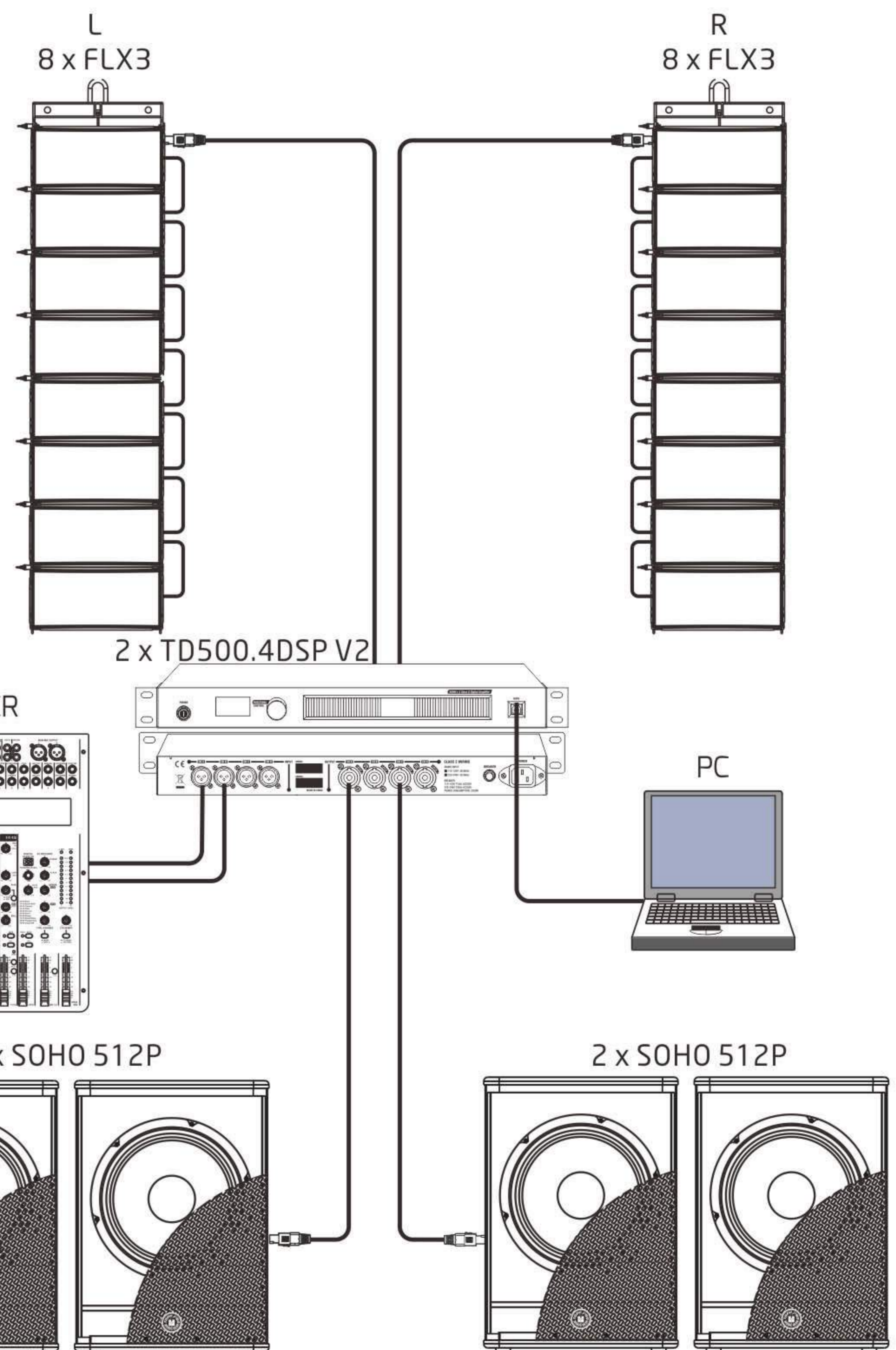

# FLX3 Array System

**BEST  
SELLER**



8 x **FLX3**  
Passive Satellites  
Dual 3" Woofers,  
3 x 0.5" Tweeter



8 x **FLX3**  
Passive Satellites  
Dual 3" Woofers,  
3 x 0.5" Tweeter

**4000W**  
PEAK POWER **CE**  
APPROVED



**TD500.4DSP V2**  
Amplifier with DSP



2 x **SOHO S12P**  
Subwoofer 12" Passive



**MAXHEB**  
POWER MODULE *Optimum Headroom & SPL*



2 x **SOHO S12P**  
Subwoofer 12" Passive

# X3 Technical Specifications

## X3 Mid / High Unit

System Type	4" Two-way passive system
Output Power	30W Continuous / 60W Program
Sensitivity (1W/1m)	88dB
Maximum SPL @ 1m	103dB Max. (calculated)
Frequency Response	100Hz-20KHz (-10dB)
Impedance	8 Ohm
Transducer Low	4" Neodymium Woofer, 1" Voice Coil
Transducer High	3 x Ø13mm V.C. Neodymium Tweeter
Crossover Frequency	3.0KHz
Dispersion (-6dB)	110° Horizontal, 20° Vertical (one module)
Attachment Points	Adjustable Rigging System & Vertical Splay in 0° - 4° - 8° - 12° Increments from 0° - 12°
Connectors	Parallel or Series Ø6.3mm Socket / Selection Switch
Enclosure Construction	Aluminum die casting enclosure, Resistant Black Paint, Steel Grille with foam, Steel Stirrup Material, 3 Flying Points
Dimensions (HxWxD)	141 x 170 x 162 mm / 5.55" x 6.69" x 6.38"
Net Weight	1.46 Kg / 3.22 lbs

## SOHO S12P

System Type	12" Passive Subwoofer Speaker
Output Power	300W PROGRAM / 125W PEAK
Sensitivity	122dB Continuous / 125dB Peak
Frequency Response	45Hz-2.8KHz (-10dB)
Impedance	4 Ohm
Transducer Low	12" Ferrite Woofer, 2.55" Voice Coil
Connectors	4 Pin Terminal Block and 2 x NL-4 Speakon Parallel Socket
Enclosure	Plywood Cabinet, Resistant Black
Construction	Paint, Metal Grille
Mounting	One metal standard Pole-mount
Dimensions (HxWxD)	500 x 350 x 542 mm / 19.69" x 13.78" x 21.34"
Net Weight	20.10 Kg / 44.31 lbs

X3  
Front View



X3  
Rear View

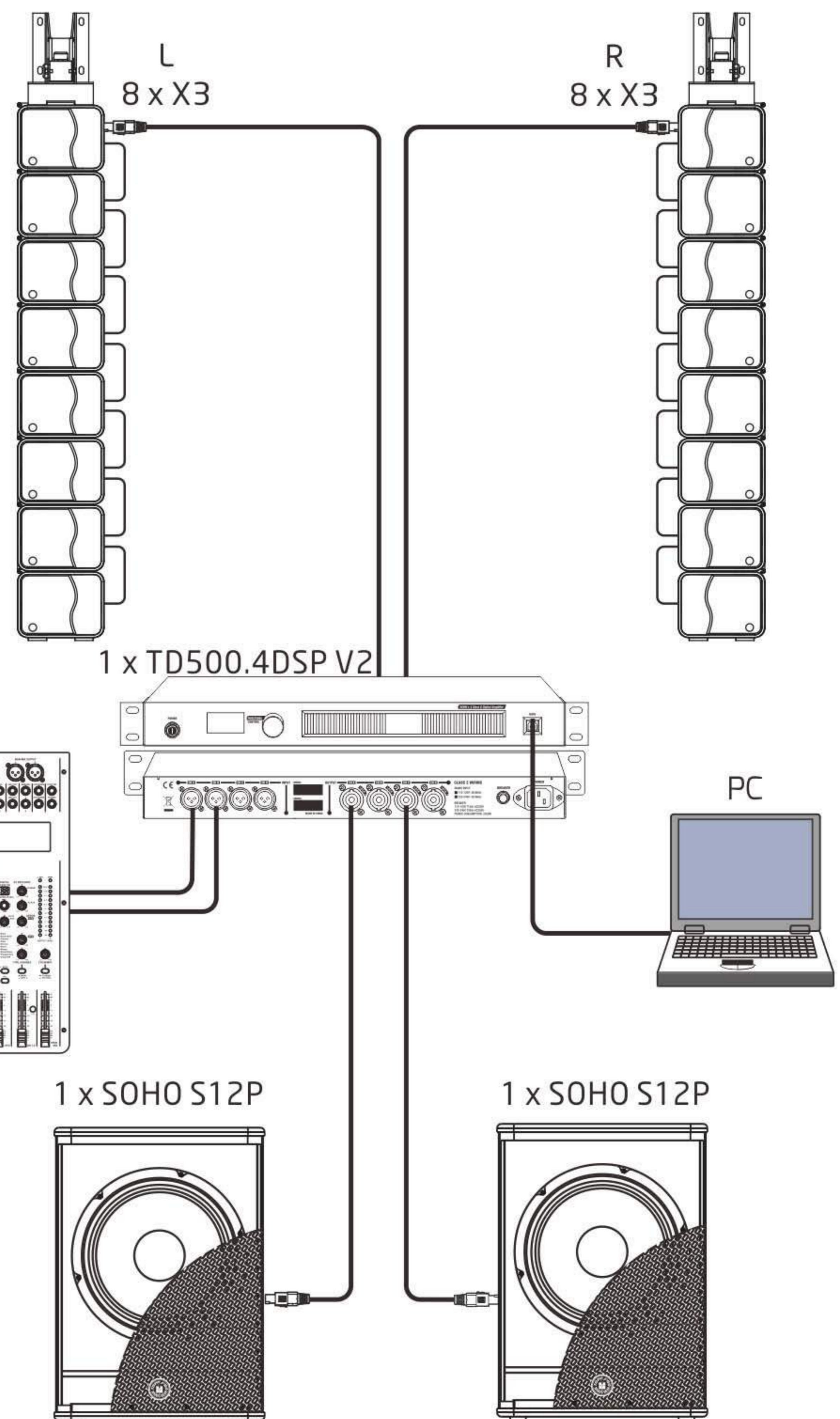
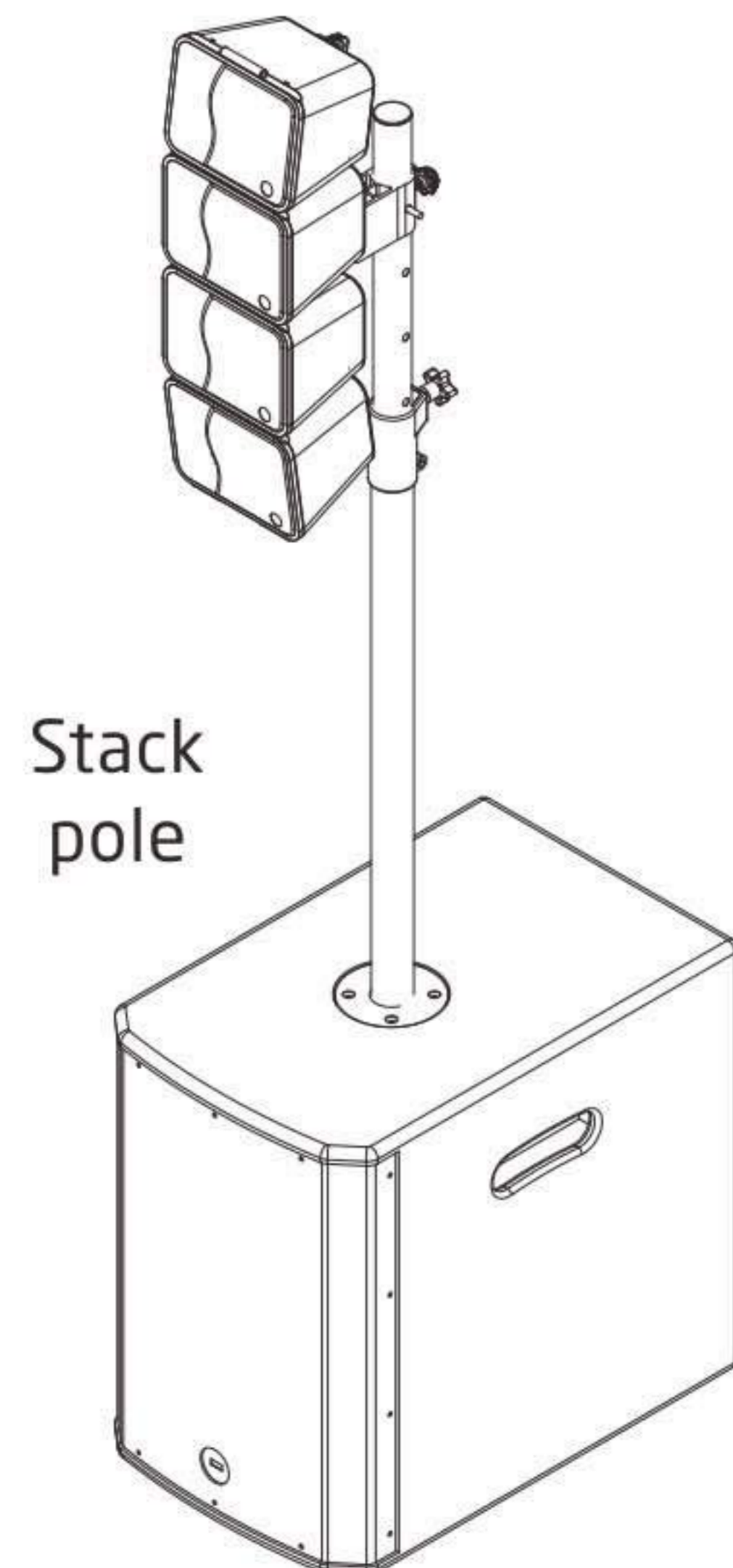
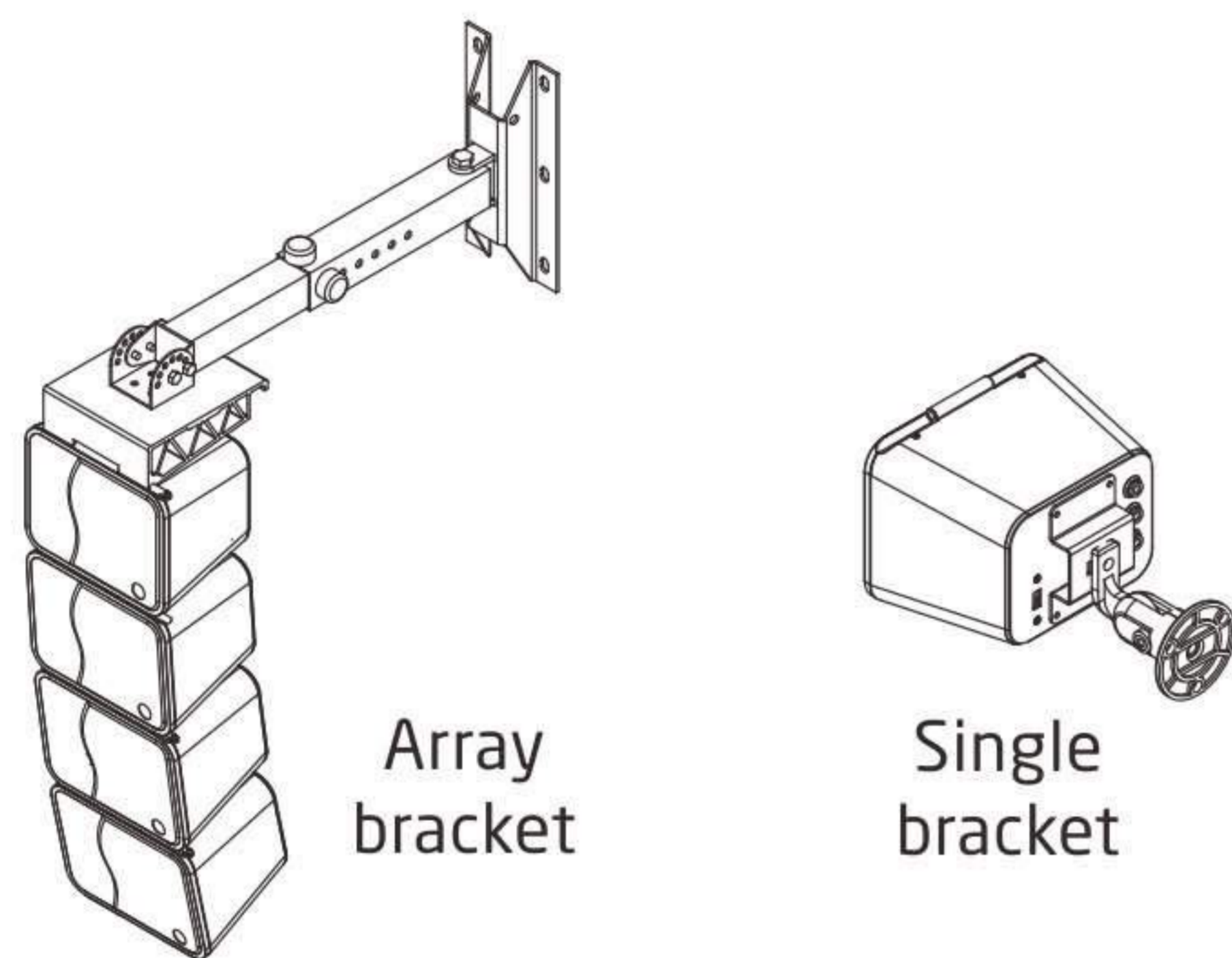

Modular Ultra-Compact Line Array

# X3 Mini Array System

**BEST  
SELLER**



8 x X3  
Passive Satellites  
4" Woofer,  
3 x 0.5" Tweeter

**4000W**  
PEAK POWER



8 x X3  
Passive Satellites  
4" Woofers,  
3 x 0.5" Tweeter

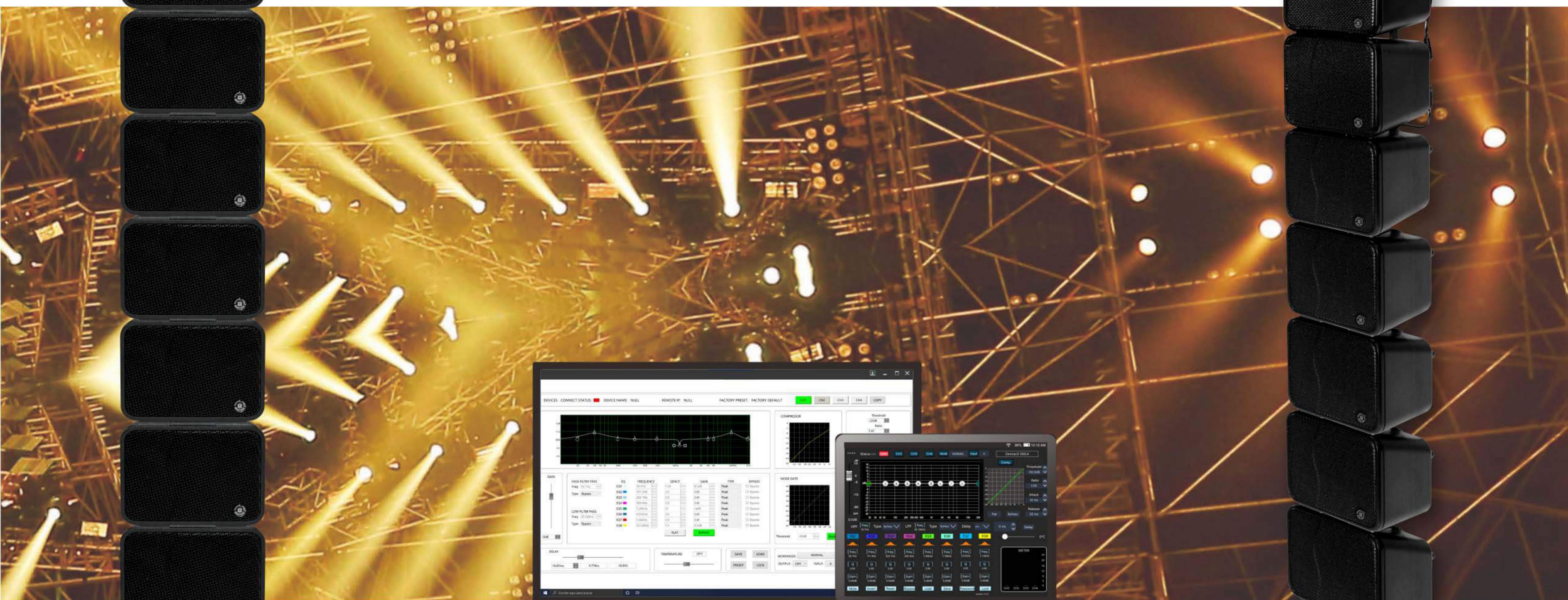

TD500.4DSP V2  
Amplifier with DSP



**MAXHEB**  
POWER MODULE *Optimum Headroom & SPL*



1 x SOHO S12P  
Subwoofer 12" Passive



1 x SOHO S12P  
Subwoofer 12" Passive

# EVENT2K Technical Specifications

## EVENT 2K SYSTEM

Frequency Response	40Hz - 20KHz (-10dB)
Total Amplifier Power	1000W Continuous / 2000W Program / 4000W Peak Class-D @ 4 Ohm
Maximum SPL@1M	128dB
Crossover Frequency	220Hz
Dispersion (-6dB)	120° Horizontal
Dimensions (WxHxD)	440 x 2015 x 640 mm / 17.32" x 79.33" x 25.20"
Net Weight	37.81 Kg / 83.35 lbs

## Subwoofer

System Type	15" Active Subwoofer Speaker Cabinet
Frequency Response (-6dB)	40Hz - 210Hz
Total Amplifier Power	1000W Continuous / 2000W Program / 4000W Peak Class-D @ 4 Ohm
Amplifier, Subwoofer	500W Continuous / 1000W Program / 2000W Peak Class-D @ 4 Ohm
Amplifier, Satellite	500W Continuous / 1000W Program / 2000W Peak Class-D @ 4 Ohm
DSP Presets Modes	LIVE / Music / FLAT / SPEECH / DJ
Electronic Protections	Overheat Protection / Short Circuit Protection / Digital Compressor
Cooling	Temperature-controlled fan
Connections	Input: 4 x Combo-XLR & 1/4", 1 x RCA In L&R, 1 x 3.5 Stereo Jack, Output: 1 x XLR Thru & Mixout
External Controls	Volume Control / Switch for Input sens / Switch for mode selector / Power ON with Green LED / Limiter with Red LED / Ground Lift / OLED DSP Display and Control / IP Control / MP3 and BT (optional)
Power Supply	115V/230V ~50/60Hz Switch mode
Enclosure Construction	Plywood Cabinet, Resistant Black Paint, Metal Grille with Foam, Rubber Feet, Integrated side handles
Mounting	Smart Mounting and Connection
Dimensions (WxHxD)	440 x 521 x 640 mm / 17.32" x 20.49" x 25.20"
Net Weight	26.1 Kg / 57.54 lbs

## Pole

Enclosure Construction	15" Active Aluminium Cabinet, Metal Grille, Resistant Paint
Connector	2 x Electronic Adapter - 1 x Input Connector for Sub & Another with Input Connector for Satellite
Dimensions (WxHxD)	1135 x 354 mm / 13.94" x 4.43"
Net Weight	1.36 Kg / 3.0 lbs

## Satellite

System Type	6 x 3.5" Passive Speaker System
Output Power	180W Continuous, 360W Program, 720W Peak
Sensitivity (1W/1M)	96dB
Frequency Response (-6dB)	150Hz-20KHz
Impedance	16 Ohm
Transducer Low	3.5" Woofer, 1" Voice Coil
Rotation	180 Degree Mechanical Adjustment
Enclosure Construction	Aluminium Cabinet, Metal Grille, Resistant Paint
Connector	2 x Electronic Adapter - 1 x Input Connector for AX Pole & Another with Input Connector for AXV62TP
Dimensions (WxHxD)	113 x 610 mm / 4.43" x 24.0"
Net Weight	5.2 Kg / 11.46 lbs

## SAT-TP

System Type	6 x 3.5" Passive 6 x 3.5" Passive Speaker System
Output Power	180W Continuous, 360W Program, 720W Peak
Sensitivity (1W/1M)	96dB
Frequency Response (-6dB)	150Hz-20KHz
Impedance	16 Ohm
Transducer Low	3.5" Woofer, 1" Voice Coil
Rotation	180 Degree Mechanical Adjustment
Enclosure Construction	Aluminium Cabinet, Metal Grille, Resistant Paint
Connector	2 Pin smart connection
Dimensions (WxHxD)	113 x 583 mm / 4.43" x 22.96"
Net Weight	5.15 Kg / 11.35 lbs

## Subwoofer rear view



4 Ch Mixer  
DSP  
OLED Display



# EVENT2K SYSTEM

**BEST  
SELLER**

**4000W** **CE**  
4 OHM PEAK POWER - TOTAL SYSTEM APPROVED

12 x 3.5" HD Speakers

12 x 3.5" HD Speakers

15" Active Subwoofer

15" Active Subwoofer

Easy to Set Up and Transport!

180°  
Dispersion

**MAXHEB**  
POWER MODULE Optimum Headroom & SPL

**Hi-Def**  
COMPONENTS



Download the FREE  
App from App Store  
to Control!



# EVENT4K Technical Specifications

## EVENT 4K SYSTEM

Frequency Response	35Hz - 20KHz (-10dB)
Total Amplifier Power	2000W Continuous / 4000W Program / 8000W Peak / Class-D @ 4 Ohm
Maximum SPL@1M	134dB
Crossover Frequency	200Hz
Dispersion (-6dB)	130° Horizontal
Dimensions (WxHxD)	460 x 2010 x 676 mm / 18.11" x 79.13" x 26.6"
Net Weight	50.15 Kg / 110.56 lbs

## Subwoofer

System Type	2 x 15" Active Subwoofer Speaker Cabinet
Frequency Response	35Hz - 180Hz (-6dB)
Total Amplifier Power	2000W Continuous / 4000W Program / 8000W Peak / Class-D @ 4 Ohm
Amplifier, Subwoofer	1000W Continuous / 2000W Program / 4000W Peak / Class-D @ 4 Ohm
Amplifier, Satellite	1000W Continuous / 2000W Program / 4000W Peak / Class-D @ 4 Ohm
DSP Presets Modes	LIVE / Music / SPEECH / DJ
Electronic Protections	Overheat Protection / Short Circuit Protection / Digital Compressor
Cooling	Temperature-controlled fan
Connections	Input: 4 x Combo-XLR & 1/4", 1 x RCA In L & R, 1 x 3.5 Stereo Jack, Output: 1 x XLR Thru & Mixout
External Controls	Volume Control / Switch for Input sens. / Switch for mode selector / Power ON with Green LED / Limiter with Red LED / Ground Lift / OLED DSP Display and Control / IP Control / MP3 and BT module (optional)
Power Supply	115V/230V ~50/60Hz Switch mode
Enclosure Construction	Plywood Cabinet, Resistant Black Paint, Metal Grille with Foam, Wheels, Integrated side handles
Mounting	Smart Mounting and Connection
Dimensions (WxHxD)	460 x 830 x 676 mm / 18.11" x 32.67" x 26.6"
Net Weight	40.47 Kg / 89.22 lbs

## Satellite

System Type	24 x 3" Passive Speaker System
Output Power	480W Continuous, 960W Program, 1920W Peak
Sensitivity (1W/1M)	99dB
Frequency Response	150Hz-20KHz (-6dB)
Impedance	4 ohms
Transducer Low	3" Neodymium Fullrange Speaker, 0.8" Voice Coil
Enclosure Construction	Aluminium Cabinet, Metal Grille, Resistant Paint
Connector	2 Pin smart connection
Dimensions (WxHxD)	167 x 1170 mm / 6.57" x 46.06"
Net Weight	9.7 Kg / 21.38 lbs

EVENT4K rear & side view



Subwoofer rear view



4 Ch Mixer  
DSP  
OLED Display

# EVENT4K SYSTEM

**BEST  
SELLER**

**8000W** **CE**  
4 OHM PEAK POWER - TOTAL SYSTEM APPROVED

24 x 3.5" HD Speakers

24 x 3.5" HD Speakers

2 x 15" Active  
Subwoofers

2 x 15" Active  
Subwoofers

Easy to Set Up and Transport!

130°  
Dispersion

**MAXHEB**  
POWER MODULE Optimum Headroom & SPL



Download the FREE  
App from App Store  
to Control!



# VA42.12 Technical Specifications

## VA12SA

System Type	12" Active Subwoofer Speaker Cabinet
Frequency Response	40Hz - 500 Hz (-6dB)
Total Amplifier Power	1000W Continuous / 2000W Program / 4000W Peak / Class-D @ 4 Ohm
Amplifier, Subwoofer	500W Continuous / 1000W Program / 2000W Peak / Class-D @ 4 Ohm
Amplifier, Satellite	500W Continuous / 1000W Program / 2000W Peak / Class-D @ 4 Ohm
SUB WOOFER	12" Woofer, 2.5" Voice Coil
DSP Presets	Center / Open / User
Sensitivity (1W/1M)	96dB
Maximum SPL@1M	130dB Max (Calculated)
Electronic Protections	Thermal DC / Overload / Digital Compressor / Limiter
Cooling	Temperature controlled fan
Connections	Input: 2 Combo - XLR & 1/4", RCA In L & R, 1 XLR Thru & Mix out
External	Volume Control / Switch for Input sens / Switch for mode selector / Power ON with Green LED / Limiter with Red LED / Ground Lift /
Controls	IP Control / MP3 including
Power Supply	115V/230V ~50/60Hz
Enclosure Construction	Plywood Cabinet, Resistant Black Paint, Metal Grille with Foam, Rubber Feet, handles
Mounting	Holder with Input Jacks for VA-WP
Dimensions (HxWxD)	450 x 430 x 480 mm / 17.72" x 16.93" x 18.9"
Net Weight	20.51 Kg / 45.22 lbs

## VA42TP

System Type	3.5" Passive Speaker System
Output Power	240W Program, 480W Peak
Sensitivity (1W/1M)	95dB
Maximum SPL @ 1m	122dB Max. (calculated)
Frequency Response	160Hz-20KHz (-6dB)
Impedance	8 ohms
Transducer Low	4 x 3.5" Woofer, 1" Voice Coil
Crossover Frequency	500Hz
Dispersion(-6dB)	100° Horizontal
Attachment Points	Adjustable Rigging System, Horizontal Splay Rotation in -90°- 0° - 90° Increments from 180°
Connectors	Parallel or Series 6.3mm Socket / Selection Switch
Enclosure Construction	Plywood Cabinet, Resistant Paint, Metal Grille with Foam
Mounting	1 x Holder, 1 x Input Connector for VA42BM or VA-WP
Dimensions (HxWxD)	422 x 107 x 98 mm / 16.61" x 4.21" x 3.86"
Net Weight	3.41 Kg / 7.52 lbs

## VA42BM

System Type	3.5" Passive Speaker System
Output Power	240W Program, 480W Peak
Sensitivity (1W/1M)	95dB
Maximum SPL @ 1m	122dB Max. (calculated)
Frequency Response	160Hz-20KHz (-6dB)
Impedance	8 ohms
Transducer Low	4 x 3.5" Woofer, 1" Voice Coil
Crossover Frequency	500Hz
Dispersion(-6dB)	100° Horizontal
Connectors	Parallel or Series 6.3mm Socket / Selection Switch
Enclosure Construction	Plywood Cabinet, Resistant Paint, Metal Grille with Foam
Mounting	2 x Holder, 1 x Input Connector for VA-WP, Another with input connector for VA42TP
Dimensions (HxWxD)	448 x 107 x 98 mm / 17.64" x 4.21" x 3.86"
Net Weight	3.48 Kg / 7.67 lbs

## VA-WP

System Type	POLE
Enclosure	Plywood Cabinet, Resistant Paint
Construction	Metal Grille with Foam
Mounting	2 x Holder, 1 x Input connector for Sub, another with Input Connector for Satellite BM/TP
Dimensions (HxWxD)	700 x 107 x 98 mm / 27.56" x 4.21" x 3.86"
Net Weight	2.7 Kg / 5.95 lbs



VA12SA rear view

# VA42.12 SYSTEM

**BEST  
SELLER**



8 x 3.5" HD Speakers

12" Active Subwoofer

**4000W** **CE**  
4 OHM PEAK POWER - TOTAL SYSTEM APPROVED

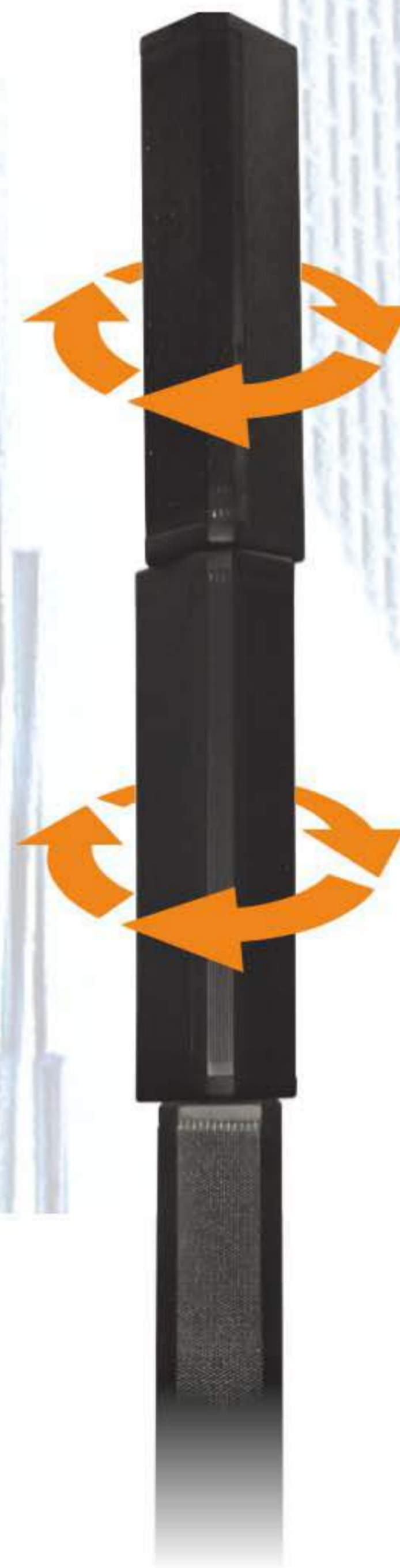

100°  
Dispersion



8 x 3.5" HD Speakers

12" Active Subwoofer

**MAXHEB**  
POWER MODULE *Optimum Headroom & SPL*

**Hi-Def**  
COMPONENTS



Download the FREE  
App from App Store  
to Control!



# SOHO V8 PLUS & S15 Technical Specifications

## SOHO V8 PLUS

System Type	3.5" Passive Speaker System
Output Power	240W Continuous, 480W Program, 960W Peak
Sensitivity (1W/1M)	97dB
Maximum SPL @ 1m	127dB Max. (calculated)
Frequency Response (-6dB)	140Hz - 20KHz
Impedance	4 Ohm
Transducer Low	7 x 3.5" Woofer, 1" Voice Coil, 1 x 3.5" wideband speaker with 1 x 1.35" coaxial tweeter
Crossover Frequency	350Hz, 24dB/Oct. ACTIVE
Dispersion(-6dB)	100° Horizontal
Enclosure Construction	Body In extruded wood, black paint
Mounting	One metal pole-mount, two M8 hanging-points
Dimensions (HxWxD)	130 x 760 x 103 mm / 5.12" x 29.92" x 4.06"
Net Weight	6.98 Kg / 15.39 lbs

## SOHO S15 SUB

Subwoofer	15" Woofer - 2.5" Voice Coil
Frequency response -6dB	40Hz-500Hz
Total amplifier power	1400W PROGRAM / 2800W PEAK Class-D @ 4 Ohm
Amplifier, subwoofer	700W PROGRAM / 1400W PEAK Class-D @ 4 Ohm
Amplifier, satellite/ mid-high unit	700W PROGRAM / 1400W PEAK Class-D @ 4 Ohm
Axial sensitivity 1W@1m	96dB / 130dB Max.
Electronic Protections	Thermal DC / Overload / Digital Compressor / Limit
Cooling	Temperature-controlled fan
Connections	Input: 2 Combo - XLR 1/4", 1 RCA in L&R / Output: SPK Satellite / XLR Link
External Controls	Volume Control / Switch for Input sens / Switch for mode selector / Power ON with Green LED / Limiter with Red LED / Ground Lift / IP Control
Power Supply	115V / 230V Switch mode
Enclosure Construction	Plywood cabinet, resistant black paint, metal grille with foam, rubber feet, handles
Mounting	One metal standard 35mm pole-mount
Dimensions (HxWxD)	520 x 480 x 562 mm / 20.47" x 18.9" x 22.13"
Net Weight	28.3 Kg / 62.39 lbs

Also available with in 12" subwoofer, SOHO S12



SOHO S15 rear view



# SOHO V8 PLUS & S15 SYSTEM

**BEST  
SELLER**

1 x 3.5" Coaxial Speaker

1 x 3.5" Coaxial Speaker

**2800W**

**CE**

4 OHM PEAK POWER - TOTAL SYSTEM

APPROVED

7 x 3.5" HD Speakers

7 x 3.5" HD Speakers

S15 Active Subwoofer

S15 Active Subwoofer

100° Dispersion

Easy to Set Up and Transport!

**MAXHEB**  
POWER MODULE Optimum Headroom & SPL

**Hi-Def**  
COMPONENTS

**coaxial  
design**



Download from  
App Store the FREE  
iPad app to control  
your Speakers!



# KS HD Series Technical Specifications

	KS HD8A	KS HD10A
System Configuration	Multi-purpose, 2-way Active Loudspeaker with DSP/OLED	
LF Transducer	8" Woofer, 2" Voice coil	10" Woofer, 2.5" Voice coil
HF Transducer	1" exit, ferrite magnet compression driver with 1.75" edgewound copper clad aluminium voice coil	
Power Rating	2000W PROGRAM / 4000W PEAK	
Frequency Response(-6 dB)	60Hz-20KHz	50Hz-20KHz
Frequency Range (-10 dB)	55Hz-20KHz	45Hz-20KHz
Maximum Rated SPL	127dB Peak	129dB Peak
Crossover Frequency	At 1.8KHz with 24dB filter slope,Linkwitz-Riley Type	
Controls	Power / 3 x Level / Rotary encoder	
Indicators	Monochrome OLED Display 1.65" x 1.1" (42.04mm x 27.22mm), 2 x Power LED (front and rear), 3 x Input Signal LED, Input 1 MIC selected LED, Input 2 HI-Z selected LED, Limiter active LED	
Connectors	2 x locking XLR/F 1/4" combo (Mic/Line Input and Hi-Z/Line Input), 1 x 3.5mm TRS (Stereo Input), 1 x XLR/M (Mix Output), 1 x locking IEC power connector	
AC Power Input	110-120V~50/60Hz or 220-240V~50/60Hz Switch mode	
Enclosure	Plywood cabinet, resistant black paint, rubber feet, metal handle, metal grille with black foam	
Attachment Points	One metal standard pole-mount, 10 x M10 threaded inserts plus integrated Pull-Back	
Dimensions (HxWxD)	460 x 272.2 x 302 mm / 18.11" x 10.74" x 11.88"	510 x 299 x 310 mm / 20.5" x 11.77" x 12.2"
Net Weight	13.2 Kg / 29.1 lbs	15.1 Kg / 33.3 lbs

	KS HD12A	KS HD15A
System Configuration	Multi-purpose, 2-way Active Loudspeaker with DSP/OLED	
LF Transducer	12" Woofer, 3" Voice coil	15" Woofer, 3" Voice coil
HF Transducer	1" exit, ferrite magnet compression driver with 1.75" edgewound copper clad aluminium voice coil	
Power Rating	2000W PROGRAM / 4000W PEAK	
Frequency Response(-6 dB)	48Hz-20KHz	45Hz-20KHz
Frequency Range (-10 dB)	42Hz-20KHz	40Hz-20KHz
Maximum Rated SPL	131dB Peak	133dB Peak
Crossover Frequency	At 1.6KHz with 24dB filter slope,Linkwitz-Riley Type	At 1.5KHz with 24dB filter slope,Linkwitz-Riley Type
Controls	Power / 3 x Level / Rotary encoder	
Indicators	Monochrome OLED Display 1.65" x 1.1" (42.04mm x 27.22mm), 2 x Power LED (front and rear), 3 x Input Signal LED, Input 1 MIC selected LED, Input 2 HI-Z selected LED, Limiter active LED	
Connectors	2 x locking XLR/F 1/4" combo (Mic/Line Input and Hi-Z/Line Input), 1 x 3.5mm TRS (Stereo Input), 1 x XLR/M (Mix Output), 1 x locking IEC power connector	
AC Power Input	110-120V~50/60Hz or 220-240V~50/60Hz Switch mode	
Enclosure	Plywood cabinet, resistant black paint, rubber feet, metal handle, metal grille with black foam	
Attachment Points	One metal standard pole-mount, 10 x M10 threaded inserts plus integrated Pull-Back	
Dimensions (HxWxD)	637 x 363 x 350 mm / 25.07" x 14.28" x 13.78"	726 x 421 x 410 mm / 28.58" x 16.57" x 16.14"
Net Weight	19.2 Kg / 42.3 lbs	25.1 Kg / 55.3 lbs



FOH or  
Monitor!

Scratch-Resistant Paint





HD Speaker with DSP/OLED

# KS HD Series

**NEW**  
MODEL

**2000W** **130dB** **CE**  
TOTAL SYSTEM - PROGRAM POWER APPROVED

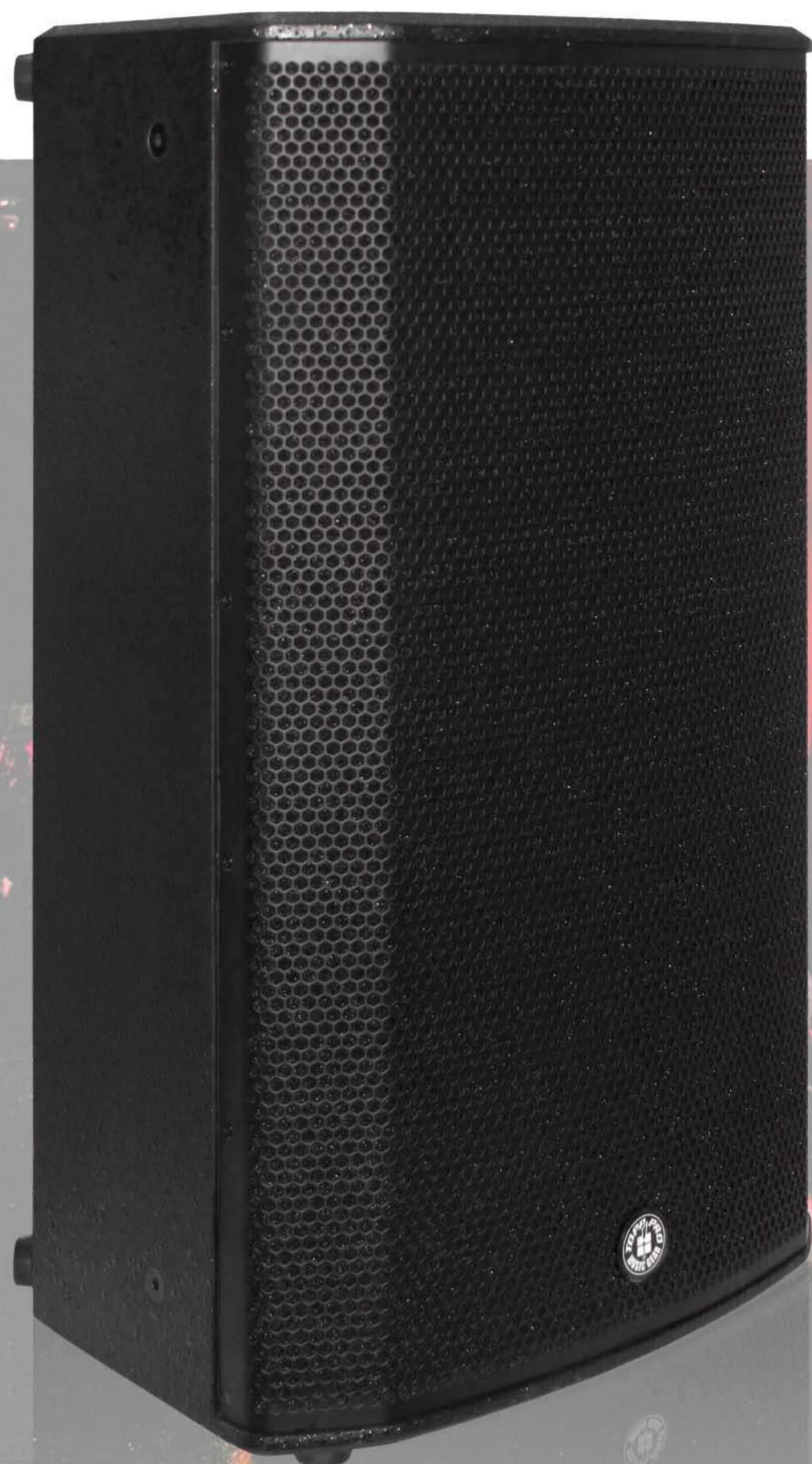

1.75" Driver

3-Input Mixer with DSP

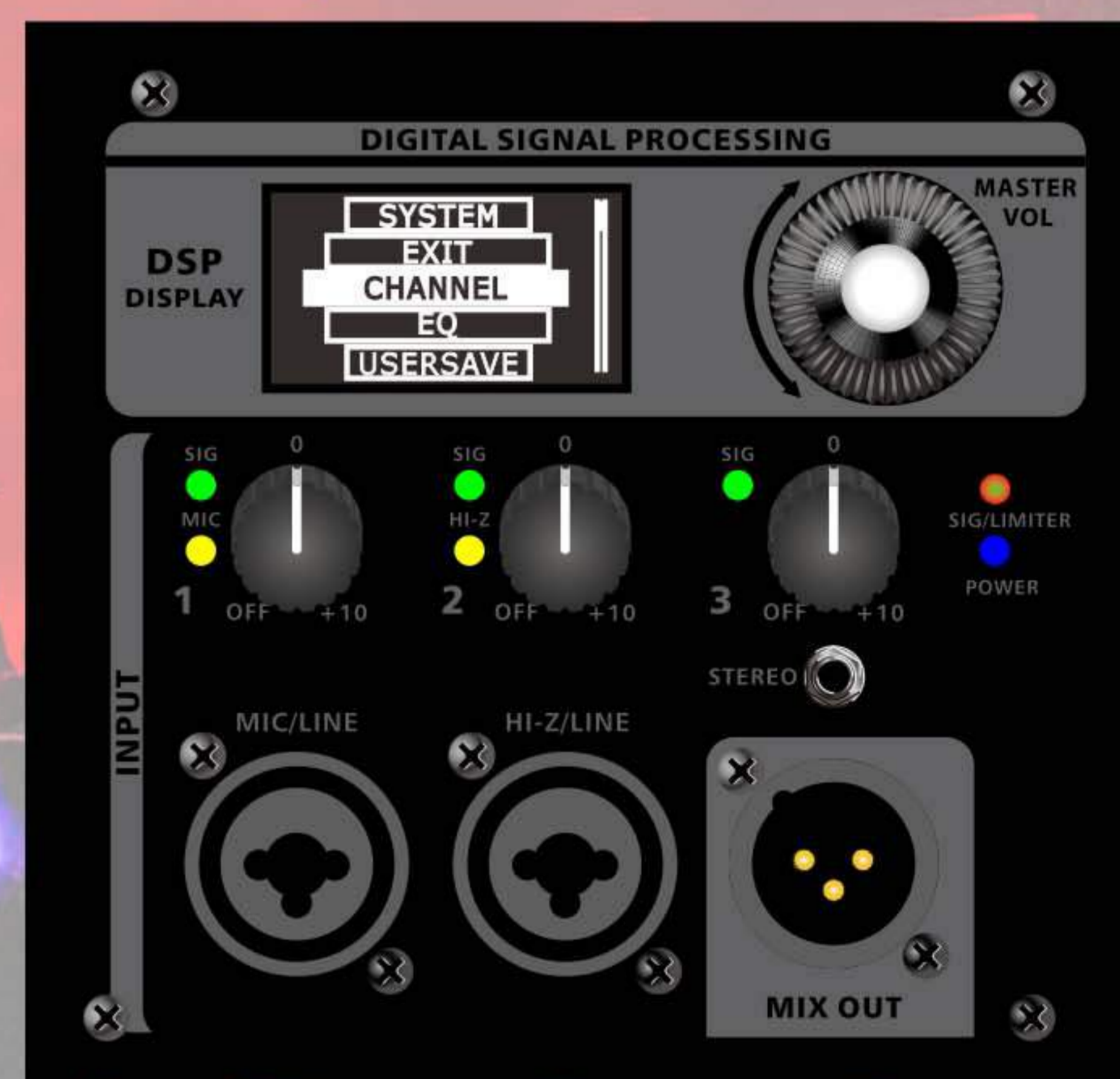

Bi-Amp

Mix Out



KS HD8A

KS HD10A

KS HD12A

KS HD15A

2"

VOICE COIL

2.5"

VOICE COIL

3"

VOICE COIL

3"

VOICE COIL



**MAXHEB**  
POWER MODULE Optimum Headroom & SPL



# KS HD Subwoofers Technical Specifications

## KS HD15A SUB

System Type	15" Active Vented Subwoofer
Power Rating	2000W Program / 4000W Peak
Transducer Low	15" Ferrite Woofer, 3" Voice Coil with Long Excursion
Frequency Response (-6dB)	45Hz - 120Hz
Max.SPL	129dB
DSP Presets Modes	BOOST / EXTENDED LF / NORMAL
Crossover Frequency	80Hz / 100Hz / 120Hz selectable
Electronic Protections	Overheat Protection / Short Circuit Protection / Digital Compressor
Cooling	Temperature-controlled fan
Connectors	Input: Left Mono (Combo) / Right (XLR-F), Output: Left Mono / Right (XLR-M)
External Controls	Volume Control / Phase Switch / Switch for EQ Mode Selector / Switch for LPF / Power ON with Green LED / Limiter with Red LED
Power Supply	100-240V ~50/60Hz
Enclosure Construction	Plywood Cabinet, Resistant Black Paint, Metal Grille with Foam, Rubber Feet, Double handles
Mounting	One Metal Standard Pole-Mount
Dimensions (WxHxD)	580 x 450 x 503 mm / 22.83" x 17.72" x 19.80"
Net Weight	25.2 Kg / 55.55 lbs

## KS HD18A SUB

System Type	18" Active Vented Subwoofer
Power Rating	2000W Program / 4000W Peak
Transducer Low	18" Ferrite Woofer, 3" Voice Coil with Long Excursion
Frequency Response (-6dB)	40Hz - 120Hz
Max.SPL	130dB
DSP Presets Modes	BOOST / EXTENDED LF / NORMAL
Crossover Frequency	80Hz / 100Hz / 120Hz selectable
Electronic Protections	Overheat Protection / Short Circuit Protection / Digital Compressor
Cooling	Temperature-controlled fan
Connectors	Input: Left Mono (Combo) / Right (XLR-F), Output: Left Mono / Right (XLR-M)
External Controls	Volume Control / Phase Switch / Switch for EQ Mode Selector / Switch for LPF / Power ON with Green LED / Limiter with Red LED
Power Supply	100-240V ~50/60Hz
Enclosure Construction	Plywood Cabinet, Resistant Black Paint, Metal Grille with Foam, Rubber Feet, Double handles
Mounting	One Metal Standard Pole-Mount
Dimensions (WxHxD)	661 x 535 x 537 mm / 26.02" x 21.06" x 21.12"
Net Weight	31.0 Kg / 68.33 lbs

# KS HD Subwoofers

**NEW**  
MODEL

**4000W** **130dB** **CE**  
TOTAL SYSTEM - PROGRAM POWER APPROVED



Combo I/O

3 DSP Modes



XLR-F I/O

Crossover Frequency  
3 Low Pass Filter Modes  
& Phase Switch

Scratch-Resistant Paint Process



KS HD15A SUB

3"  
VOICE COIL



KS HD18A SUB

3"  
VOICE COIL

# KS CS Series Technical Specifications

	KS CS8A	KS CS10A	KS CS12A
System Type	2- Way Active Vented Speaker with DSP		
Transducer Low	8" Woofer, 2" voice coil	10" Woofer, 2.5" voice coil	12" Woofer, 3" voice coil
Transducer Driver	1" Celestion compression driver, 1.75" voice coil		
Frequency Response (-6dB)	60Hz - 20KHz	55Hz - 20KHz	50Hz - 20KHz
Crossover Frequency (Linkwitz-Riley Type)	At 1.8KHz with 24dB filter slope	At 1.8KHz with 24dB filter slope	At 1.6KHz with 24dB filter slope
Max SPL	127dB Max	129dB Max	131dB Max
Power Rating	1600W PROGRAM / 3200W PEAK		2000W PROGRAM / 4000W PEAK
Input Connector	Line / Mic (COMBO) / Link - XLR		
DSP Presets	Flat / Loudness / User (Custom Sound)		
Line Input	Combo connector -6dBu		
External Controls	Volume Control / Power ON with Green LED / Clip Limiter with Red LED / Ground Lift / Switch for input sens. / Switch On for front LED / USB		
Electronic Protections	Thermal / Convection-Fan / Overload / Digital Limiter / Compressor		
Power Supply	115V / 230V Switchable		
Enclosure Construction	Plywood cabinet, resistant black paint, metal grille with black foam, rubber foot, plastic handles		
Mounting	One metal standard pole-mount 10 x M10 Flying points	One metal standard pole-mount 12 x M10 Flying points	One metal standard pole-mount 12 x M10 Flying points
Dimensions (HxWxD)	460 x 277 x 300 mm 18.11" x 10.91" x 11.81"	583 x 332 x 325 mm 22.95" x 13.07" x 12.8"	625 x 430 x 350 mm 24.61" x 16.93" x 13.78"
Net Weight	15.93 Kg / 35.12 lbs	19.72 Kg / 43.78 lbs	23.18 Kg / 51.1 lbs
Volume	2.55 CFT	3.89 CFT	4.9 CFT

	KS CS15A	KS CS215A
System Type	2- Way Active Vented Speaker with DSP	
Transducer Low	15" Woofer, 3" voice coil	2 x 15" Woofer, 3" voice coil
Transducer Driver	1" Celestion compression driver, 1.75" voice coil	
Frequency Response (-6dB)	48Hz - 20KHz	45Hz - 20KHz
Crossover Frequency (Linkwitz-Riley Type)	At 1.5KHz with 24dB filter slope	At 1.5KHz with 24dB filter slope
Max SPL	133dB Max	134dB Max
Power Rating	2000W PROGRAM / 4000W PEAK	
Input Connector	Line / Mic (COMBO) / Link - XLR	
DSP Presets	Flat / Loudness / User (Custom Sound)	
Line Input	Combo connector -6dBu	
External Controls	Volume Control / Power ON with Green LED / Clip Limiter with Red LED / Ground Lift / Switch for input sens. / Switch On for front LED / USB	
Electronic Protections	Thermal / Convection-Fan / Overload / Digital Limiter / Compressor	
Power Supply	115V / 230V Switchable	
Enclosure Construction	Plywood cabinet, resistant black paint, metal grille with black foam, rubber foot, plastic handles	
Mounting	One metal standard pole-mount 12 x M10 Flying points	12 x M10 Flying points
Dimensions (HxWxD)	700 x 430 x 386 mm 27.56" x 16.93" x 15.2"	1100 x 430 x 386 mm 43.314" x 16.93" x 15.2"
Net Weight	23.16 Kg / 51.06 lbs	39.12 Kg / 86.25 lbs
Volume	6.82 CFT	10.22 CFT

Also available in PASSIVE version

Active Speaker with DSP

# KS CS Series



**2000W** **134dB** **CE**  
TOTAL SYSTEM - PROGRAM POWER APPROVED



1.75" HD Driver

DSP  
Enhanced  
Bass Response



Download the FREE App from App Store to Control!

Your Own Sound Calibration!



KS CS8A

2"  
VOICE COIL

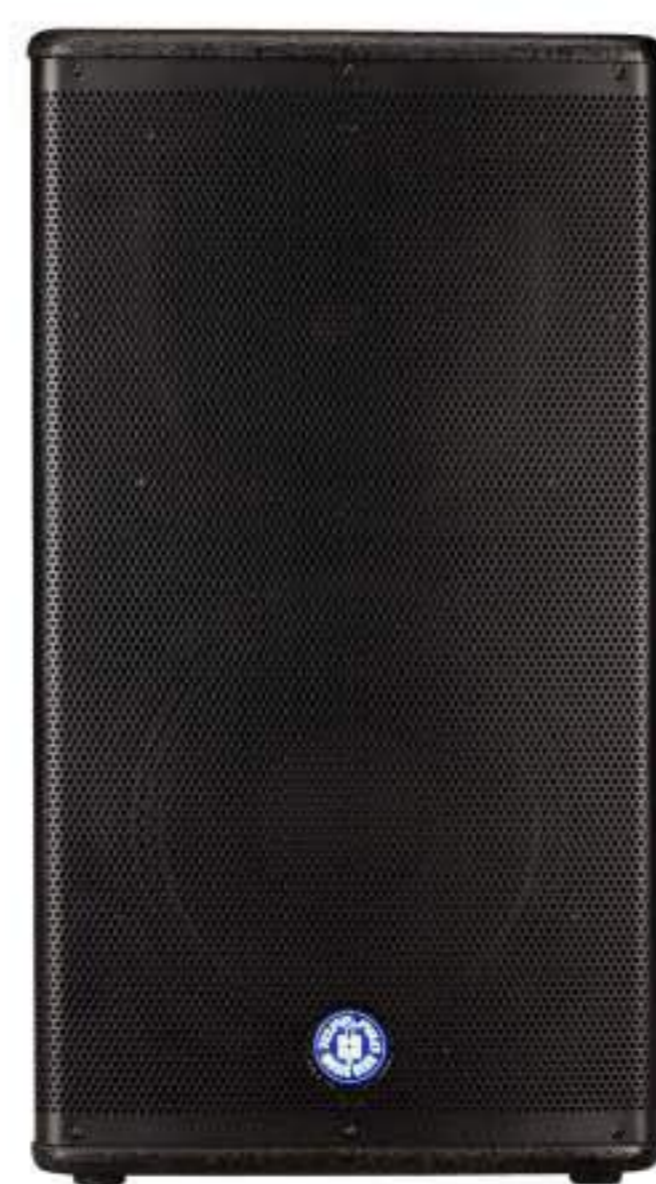

KS CS10A

2.5"  
VOICE COIL

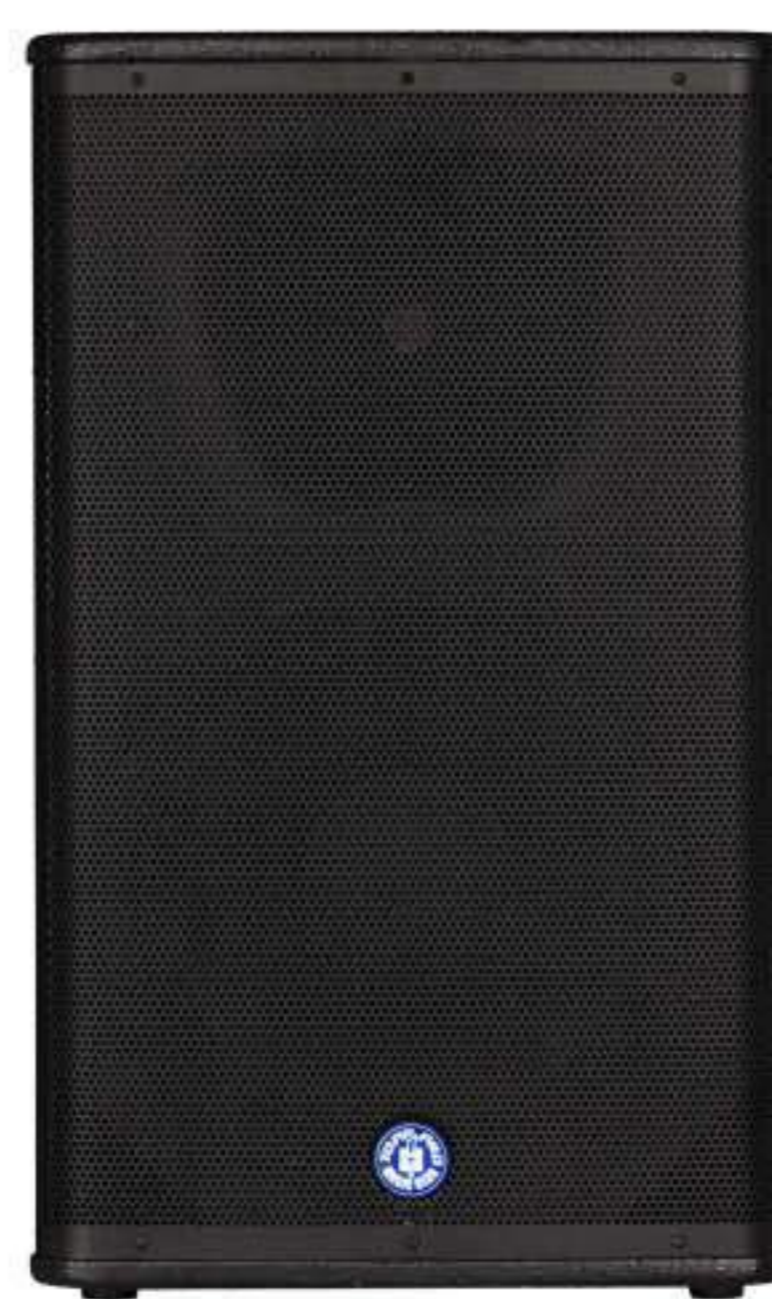

KS CS12A

3"  
VOICE COIL

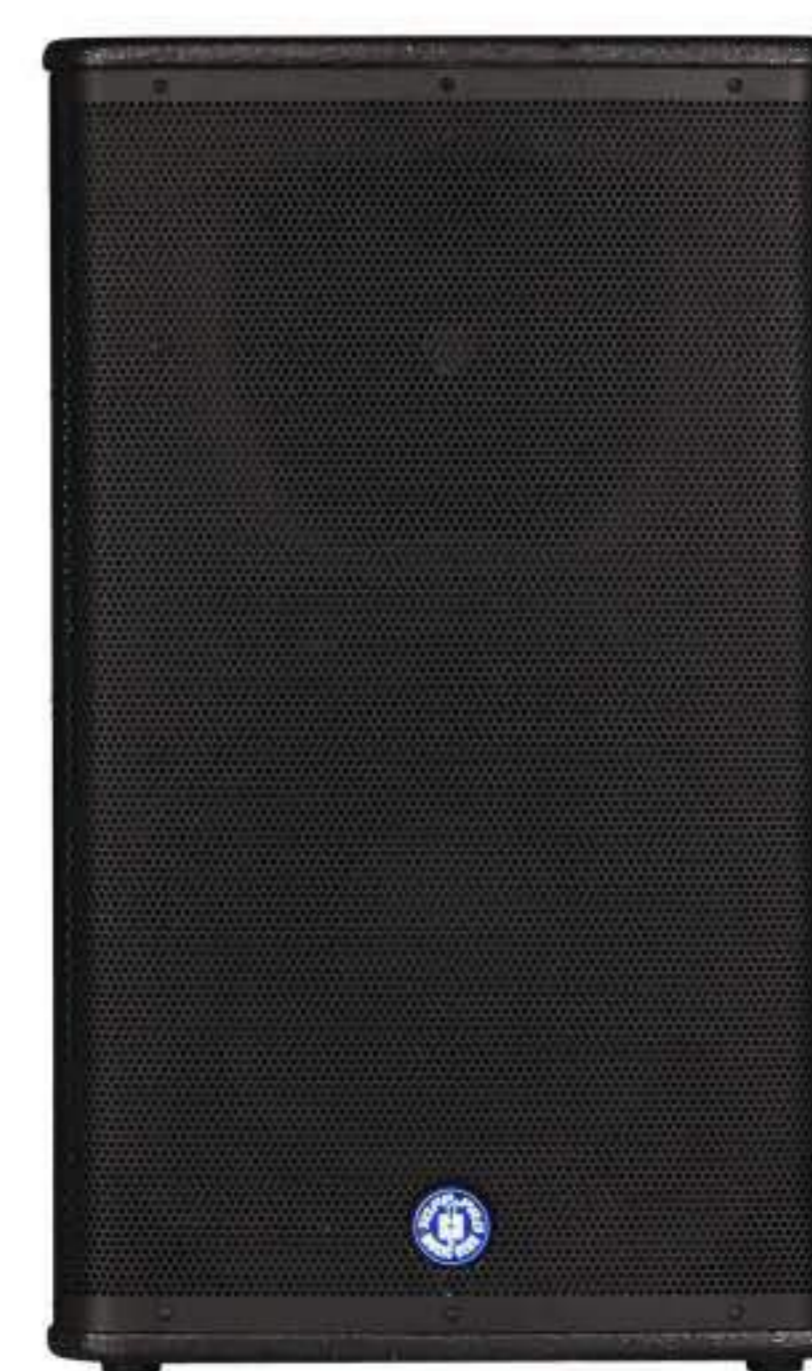

KS CS12A

3"  
VOICE COIL

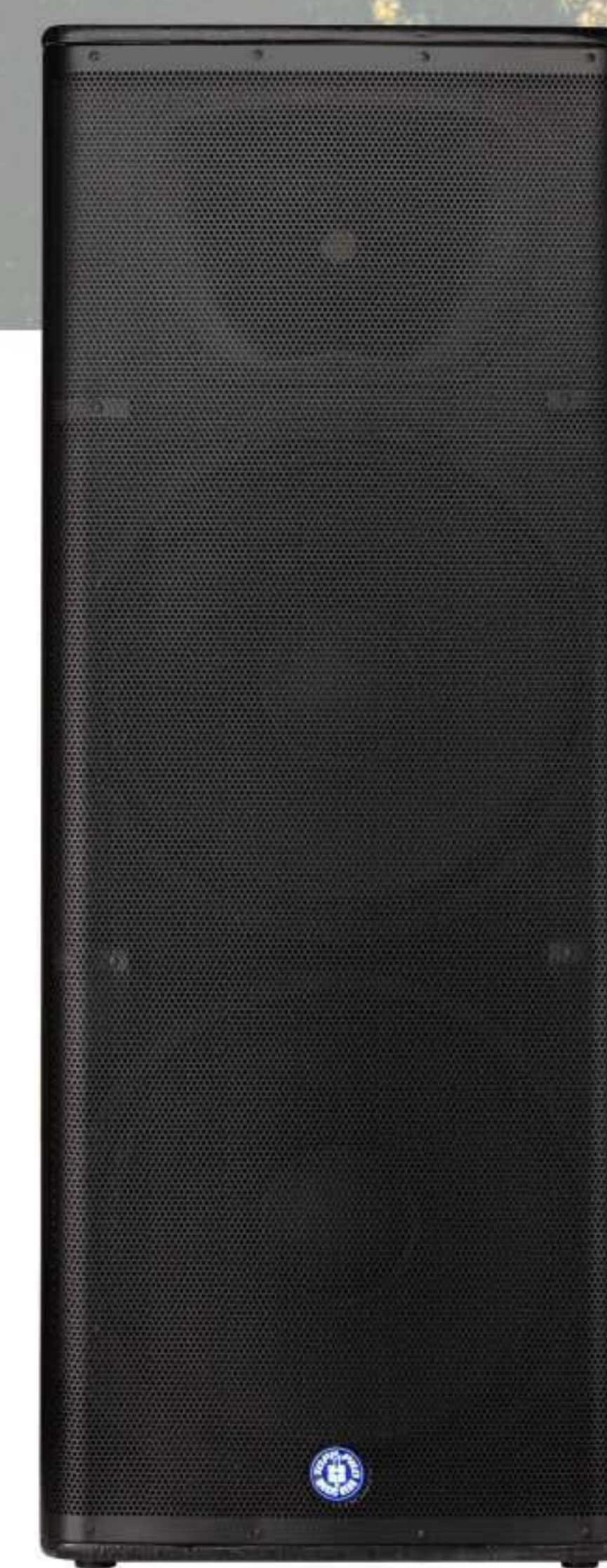

KS CS15A

3"  
VOICE COIL

# KS Active Subwoofers Technical Specifications

	KS 15A SUB	KS 18A SUB
System Type	Active subwoofer	Active subwoofer
Power Rating	2000W PROGRAM / 4000W PEAK	2000W PROGRAM / 4000W PEAK
Transducer Low	15" Woofer, 3" Sandwich Voice Coil with long excursion	18" Woofer, 3" Sandwich Voice Coil with long excursion
Max SPL	131dB Max.	134dB Max.
Active Crossover	BandPass type 12dB/oct.	BandPass type 12dB/oct.
Frequency Response (-6dB) Under analog processor	45Hz - 120Hz	40Hz - 120Hz
Input Connector	In-Left / Mono (COMBO) Right (XLR-F) / Out-Left / Mono Right (XLR-M) / Link-Left / Mono-Right (XLR-M) Balanced (15K Ohm)	
External Controls	Volume Control / Phase Switch / HPF-80Hz for L-R Satellite or By Pass / Power ON with Green LED / Clip Limiter with Red LED / Ground Lift	
Electronic Protections	Thermal / Convection-Fan / Overload / Lim. / Compressor	
Power Supply	110-120V~50/60Hz or 220-240V~50/60Hz Switch mode	
Enclosure Construction	Plywood cabinet, metal grille, rubber feet	
Mounting	One metal standard pole-mount	
Dimensions (HxWxD)	450 x 580 x 485 mm (17.72" x 22.84" x 19.1")	535 x 661 x 516 mm (21.06" x 26.02" x 20.32")
Net Weight	24.95 Kg / 55.01 lbs	31.94 Kg / 70.42 lbs
Volume	7.58 CFT	10.45 CFT

	KS218A SUB
System Type	Active subwoofer
Power Rating	4000W PROGRAM / 8000W PEAK
Transducer Low	2 x 18" Woofer, 3" Sandwich Voice Coil with long excursion
Max SPL	138dB Max.
Active Crossover	BandPass type 12dB/oct.
Frequency Response (-6dB) Under analog processor	35Hz - 120Hz
Input Connector	In-Left / Mono (COMBO) Right (XLR-F) / Out-Left / Mono Right (XLR-M) / Link-Left / Mono-Right (XLR-M) Balanced (15K Ohm)
External Controls	Volume Control / Phase Switch / HPF-80Hz for L-R Satellite or By Pass / Power ON with Green LED / Clip Limiter with Red LED / Ground Lift
Electronic Protections	Thermal / Convection-Fan / Overload / Lim. / Compressor
Power Supply	110-120V~50/60Hz or 220-240V~50/60Hz Switch mode
Enclosure Construction	Plywood cabinet, metal grille, rubber feet
Mounting	One metal standard pole-mount
Dimensions (HxWxD)	353 x 519 x 1000 mm / 13.9" x 20.43" x 39.37"
Net Weight	46.64 Kg / 102.82 lbs
Volume	15.89 CFT

# KS Active Subwoofer

**BEST  
SELLER**

**4000W** **138dB** **CE**  
TOTAL SYSTEM - PROGRAM POWER APPROVED



Combo I/O



XLR-F Link

Ground  
& Phase Switch

**MAXHEB**  
POWER MODULE *Optimum Headroom & SPL*



KS 15A SUB

3"  
VOICE  
COIL



KS 18A SUB

3"  
VOICE  
COIL



KS 218A SUB

3"  
VOICE  
COIL

# FORZA Series Technical Specifications

## FORZA 12A

System Type	2-Way Active Vented Speaker
Transducer Low	12" Woofer, 3" Voice coil
Transducer Driver	1.4" Titanium Driver
Horn Coverage H° x V°	90°H x 45°V
Frequency Response (-6dB)	57Hz - 20KHz
Crossover Frequency	2.6KHz
Max SPL	126dB Max.
Power Rating	830W PROGRAM / 1660W PEAK
USB Player	USB & Micro SD CARD / BT
Connector	INPUT 1 - Mic with XLR & 6.3 Jack / INPUT 2 - Line with XLR & 6.3 jack & 3.5 jack
External Controls	Input 1 & 2 and Master Volume Control / 2 Band EQ - High & Low / Power ON with Green LED / Clip Limiter with Red LED
Electronic Protections	Thermal / Overload / Analog limiter / Compressor
Power Supply	110V / 240V Switchable
Enclosure Construction	Plastic cabinet, Trapezoidal & Monitor shape, Metal grille, Rubber feet, 3 x Handles (sides and Top)
Mounting	36mm standard pole-mount / M10 x 4pcs Flying Points (Optional)
Dimensions (HxWxD)	607 x 308 x 337 mm / 23.9" x 12.13" x 13.27"
Net Weight	18.2 Kg / 40.12 lbs
Volume	4.54CFT

## FORZA 15A

System Type	2-Way Active Vented Speaker
Transducer Low	15" Woofer, 3" voice coil
Transducer Driver	1.4" Titanium Driver
Horn Coverage H° x V°	90°H x 45°V
Frequency Response (-6dB)	55Hz - 20KHz
Crossover Frequency	2.5KHz
Max SPL	128dB Max.
Power Rating	830W PROGRAM / 1660W PEAK
USB Player	USB & Micro SD CARD / BT
Connector	INPUT 1 - Mic with XLR & 6.3 Jack / INPUT 2 - Line with XLR & 6.3 jack & 3.5 jack
External Controls	Input 1 & 2 and Master Volume Control / 2 Band EQ - High & Low / Power ON with Green LED / Clip Limiter with Red LED
Electronic Protections	Thermal / Overload / Analog limiter / Compressor
Power Supply	110V / 240V Switch mode
Enclosure Construction	Plastic cabinet, Trapezoidal & Monitor shape, Metal grille, Rubber feet, 3 x Handles (sides and Top)
Mounting	36mm standard pole-mount / M10 x 4pcs Flying Points (Optional)
Dimensions (HxWxD)	632 x 386 x 366 mm / 24.88" x 15.2" x 14.41"
Net Weight	19.5 Kg / 43 lbs
Volume	5.47CFT

Also available in PASSIVE - FORZA 15P



Active Speaker



# FORZA Series



**1660W** **128dB** **CE**  
TOTAL SYSTEM - PEAK POWER APPROVED

3 Channel\* Mixer  
(Mic / XLR / Line / Music Player)



2-band EQ / Master Volume / Mix Out

**Ti** TITANIUM DRIVER

**MAXHEB**  
POWER MODULE Optimum Headroom & SPL

**Hi-Def**  
COMPONENTS



Built-in Media Player



FORZA 15A

3"

VOICE COIL



FORZA 12A

3"

VOICE COIL

# AVANTI 15A Technical Specifications

System Type	2-Way Active Vented Speaker
Transducer Low	15" Woofer, 2" voice coil
Transducer Driver	1" NEO Driver, 1" Voice Coil
Horn Coverage H° x V°	90°H x 45°V
Frequency Response (-6dB)	55Hz - 20KHz
Crossover Frequency	2.5KHz
Max SPL	117dB Max.
Power Rating	240W PROGRAM / 500W PEAK
USB Player	With USB & Micro SD CARD / BT
Connector	INPUT 1 - Mic with XLR x 1 & 6.3 Jack x 1 / INPUT 2 - Line with XLR x 1 & 6.3 jack x 1 & 3.5 jack x 1
External Controls	Input 1 & 2 and Master Volume Control / 2 Band EQ - High & Low / Power ON with Green LED / Clip Limiter with Red LED
Electronic Protections	Thermal / Overload / Analog limiter / Compressor
Power Supply	110V / 240V Switch mode
Enclosure Construction	Plastic cabinet, Trapezoidal & Monitor shape, Metal grille, Rubber feet, 3 x Handles (both side and Top)
Mounting	36mm standard pole-mount / M10 x 4pcs Flying Points (Optional)
Dimensions (HxWxD)	632 x 386 x 366 mm / 24.88" x 15.2" x 14.41"
Net Weight	14.09 Kg / 31.06 lbs
Volume	5.47CFT



AVANTI 15A  
Rear View

HD Active Speaker

# AVANTI 15A

**BEST  
SELLER**



**500W**

**118dB**



TOTAL SYSTEM - PEAK POWER

**3 Channel\* Mixer**  
(Mic / XLR / Line / Music Player)



**2-band EQ / Master Volume / Mix Out**

**MAXHEB**  
POWER MODULE *Optimum Headroom & SPL*

**Hi-Def**  
COMPONENTS

**NEODYMIUM**  
**ND**  
DRIVER



Built-in Media Player



**AVANTI 15A**

**2"**

VOICE  
COIL



# X Series Active Technical Specifications

	X8A	X10A	X12A	X15A
System Type	2-Way Active Vented Speaker			
Transducer Low	8" Woofer, 1.5" voice coil	10" Woofer, 1.5" voice coil	12" Woofer, 2" voice coil	15" Woofer, 2" voice coil
Transducer Driver	1" Ferrite Twitter, 1" Voice Coil		1" NEO Driver, 1" Voice Coil	
Horn Coverage H° x V°	90°H x 60°V			
Frequency Response (-6dB)	68Hz-20KHz	65Hz-20KHz	60Hz-20KHz	55Hz-20KHz
Crossover Frequency	2000 Hz	1900 Hz	2100 Hz	2100 Hz
Max SPL	113dB at 1m	116dB at 1M	118dB Max.	119dB Max.
Power Rating	240W PROGRAM 480W PEAK	240W PROGRAM 480W PEAK	400W PROGRAM 800W PEAK	400W PROGRAM 800W PEAK
Connector	Line In & Link With XLR			
External Controls	Volume Control / Power ON with Green LED / Contour / MIC & Line Switch / Clip Limiter with Red LED / Ground Lift			
Electronic Protections	Thermal / Overload / Analog limiter / Compressor			
Power Supply	110V-120V / 50-60Hz or 220V-240V / 50-60Hz			
Enclosure Construction	Plastic cabinet, Trapezoidal & Monitor shape, Metal grille, Rubber foot, 1 x Handle-On Top			
Mounting	36mm standard pole-mount / M10 x 4pcs Flying Points (Optional)			
Dimensions (HxWxD)	346 x 321 x 478 mm 13.62" x 12.64" x 18.82"	361 x 341 x 578 mm 14.21" x 13.43" x 22.76"	458 x 411 x 683 mm 18.03" x 16.18" x 26.89"	468 x 488 x 708 mm 18.43" x 19.21" x 27.87"
Net Weight	5.4 Kg / 11.91 lbs	6.92 Kg / 15.26 lbs	13.2 Kg / 29.1 lbs	14.5 Kg / 32 lbs
Volume	1.87 CFT	2.25 CFT	4.54CFT	5.47CFT

## X Series Also available in PASSIVE version

	X CS12A	X CS15A
System Type	2-Way Active Vented Speaker / Bi-Amp. With DSP processor	
Transducer Low	12" Woofer, 2" voice coil	15" Woofer, 2" voice coil
Transducer Driver	1" Neodymium Driver, 1" Voice Coil	
Horn Coverage H° x V°	90°H x 60°V	
Frequency Response	50Hz-20KHz (-6dB)	45Hz-20KHz (-6dB)
Crossover Frequency	1.6KHz - DSP Processor	
Max SPL	125dB Max.	126dB Max.
AMP Power Output	400W Continuous (LF-Class D 350W,HF-Class AB 65W), 1600W Peak	
Connector	Line/Mic With Combo & Link With XLR	
External Controls	Volume Control / Lin & Mic Switch / Preset Switch / Power on with Green LED / Clip Limiter with Red LED / Ground Lift	
Digital Presets	FLAT - MUSIC - USER	
Electronic Protections	Thermal / Overload / Digital Limiter / Compressor	
Power Supply	110V-120V~50/60Hz or 220V-240V~50/60Hz Switch mode	
Enclosure Construction	Plastic cabinet, Trapezoidal & Monitor Shape, Metal Grille, Rubber Feet, 3 x Handles (Top and sides)	
Mounting	36mm standard pole-mount	
Dimensions (HxWxD)	458 x 411 x 683 mm / 18.03" x 16.18" x 26.89"	468 x 488 x 708 mm / 18.43" x 19.21" x 27.87"
Net Weight	14.6 Kg / 32.19 lbs	14.7 Kg / 32.41lbs
Volume	4.54 CFT	5.47 CFT

HD Active Speaker with DSP



# X Series



**1600W** **126dB** **CE**  
TOTAL SYSTEM - PEAK POWER APPROVED

1" Neodymium Driver



Download the free App from App Store to control!

DSP Enhanced Bass Response

Your Own Sound Calibration!



**MAX HED**  
POWER MODULE Optimum Headroom & SPL

**Hi-Def**  
COMPONENTS

**Rigging**  
READY!



# KS CMA & TPS MA Series Active Technical Specifications

	KS 12CMA	KS 15CMA
System Type	2-Way Active Monitor with DSP	
Transducer Low	12" Woofer, 3" Voice Coil	15" Woofer, 3" Voice Coil
Transducer Driver	1" Compression Driver, 1.75" Voice Coil	
Nominal Coverage (HV)	60° x 40° (-6dB)	
Frequency Response	60Hz - 20KHz (-6dB)	55Hz - 20KHz (-6dB)
Crossover Frequency	At 1.5KHz with 24dB filter slope, Linkwitz-Riley Type	
Max SPL	128dB Max.	129dB Max.
Power Rating	1600W PROGRAM - 3200W PEAK	
Input Connector	Line/Mic - Combo/Link - XLR	
Line Input	Combo Connector 0dBu	
DSP Presets	VOCAL1 / FLAT / VOCAL2	
External Controls	Volume Control / Power ON with Green LED / Clip Limiter with Red LED / Ground Lift / Switch for Input Sens	
Electronic Protections	Thermal / Convection-Fan / Overload / Digital Limiter / Compressor	
Power Supply	115V 60Hz / 230V 50Hz Switch mode	
Enclosure Construction	Trapezoidal, Plywood cabinet, resistant black paint, metal grille with black foam, rubber feet	
Monitor angle	Adjustable (20°, 25°, 30°, 35°, 40°)	
Dimensions (HxWxD)	292 x 470 x 570 mm / 11.5" x 18.5" x 22.44"	307 x 510 x 570 mm / 12.09" x 20.08" x 22.44"

	TPS10MA	TPS12MA
System Type	2-Way Bi-Amp Active Monitor Speaker, with DSP	
Power Rating	830W PROGRAM / 1660W PEAK	
Frequency Response	68Hz - 20KHz (-6dB)	60Hz - 20KHz (-6dB)
Speaker Sensitivity (1m)	94dB / 120dB Max.	95dB / 121dB Max.
Low Frequency	10" Woofer / 2" Voice Coil, with ventilation	12" Woofer / 2" Voice Coil, with ventilation
High Frequency	1" Driver / 1" Voice Coil	
Horn Coverage (H x V)	70° x 70°	
Enclosure	Trapezoidal Shape, MDF WOOD Black Paint, Handle, metal grille, rubber feet	
Input connectors	Input with Combo / Link with XLR	
External Controls	Volume Control / Power ON Volume Control / Power ON with Green LED / Clip Limiter with Red LED / Ground Lift	
Input Impedance	30 K Ohm Balanced / 15K Ohm Unbalanced	
Preset	FOH / Monitor	
Input Sensitivity	Line - 6dBu	
Protection Low-High	Analog Limiter	
Indicator	Power / Clip	
Power Supply	115V-60Hz / 230V-50Hz Switch mode	
Dimension (HxWxD)	448 x 390 x 437 mm / 17.64" x 15.35" x 17.21"	488 x 442 x 469 mm / 19.21" x 17.4" x 18.47"
Weight	12.74 Kg / 28.09 lbs	15.54 Kg / 34.26 lbs



# KS CMA & TPS MA Series



**1600W** **129dB** **CE**  
TOTAL SYSTEM - PROGRAM POWER APPROVED

1.75" HD Driver

3 User-Selectable Settings:  
Vocal Focus 1 / 2 & Satellite FOH

Both monitors are fully adjustable! 45° Angle



KS 12CMA



KS 15CMA

coaxial design

MAX HEB  
POWER MODULE: Maximum Headroom & SPL



**830W** **121dB** **CE**  
TOTAL SYSTEM - PROGRAM POWER APPROVED

1" HD Driver

2 User-Selectable Settings:  
Monitor & Satellite FOH



TPS 12MA



TPS 15MA

MAX HEB  
POWER MODULE: Maximum Headroom & SPL

# MAXX Series Active Subwoofers Technical Specifications

## MAXX 10A SUB

System Type	10" Active Subwoofer Speaker Cabinet
Transducer Low	10" woofer - 2.5" voice coil with ventilation
Frequency Response	50Hz-120Hz (-6dB)
Active Crossover:	HPF 80Hz under analog processor
Max SPL	94dB / 121.8dB Max
Power Rating	600W PROGRAM / 1200W PEAK
Input Connector	L-R (COMBO / XLR-F) / L-R Link (2 - XLR - M) / L-R Output (2 - XLR - M) Balanced (15K Ohm)
Input Level	L-R Line Input 0dBu
External Controls	Volume Control / Power on with Green LED / Clip Limiter with RED LED / Ground Lift / Phase Switch / HPF 100Hz Bypass
Power Supply	110-120V / 220-240V 50/60Hz
Enclosure Construction	Painted Plywood cabinet / Black Metal Grille Protection / Rubber feet
Dimensions (HxWxD)	536 x 501 x 391 mm / 21.1" x 19.72" x 15.39"
Weight	17.16 Kg / 37.83 lbs

## MAXX 12A SUB

System Type	12" Active Subwoofer Speaker Cabinet
Transducer Low	12" woofer - 2.5" voice coil with ventilation
Frequency Response	47Hz-125Hz (-6dB)
Active Crossover:	HPF 80Hz under analog processor
Max SPL	96dB / 123.8dB Max
Power Rating	600W PROGRAM / 1200W PEAK
Input Connector	L-R (COMBO / XLR-F) / L-R Link (2 - XLR - M) / L-R Output (2 - XLR - M) Balanced (15K Ohm)
Input Level	L-R Line Input 0dBu
External Controls	Volume Control / Power on with Green LED / Clip Limiter with RED LED / Ground Lift / Phase Switch / HPF 100Hz Bypass
Power Supply	110-120V / 220-240V 50/60Hz
Enclosure Construction	Painted Plywood cabinet / Black Metal Grille Protection / Rubber feet
Dimensions (HxWxD)	629 x 579 x 474 mm / 24.76" x 22.8" x 18.66"
Weight	24 Kg / 52.91 lbs

## MAXX 15A SUB

System Type	15" Active Subwoofer Speaker Cabinet
Transducer Low	15" woofer - 2.5" voice coil with ventilation
Frequency Response	45Hz-125Hz (-6dB)
Active Crossover:	HPF 80Hz under analog processor
Max SPL	97dB / 124.8dB Max
Power Rating	600W PROGRAM / 1200W PEAK
Input Connector	L-R (COMBO / XLR-F) / L-R Link (2 - XLR - M) / L-R Output (2 - XLR - M) Balanced (15K Ohm)
Input Level	L-R Line Input 0dBu
External Controls	Volume Control / Power on with Green LED / Clip Limiter with RED LED / Ground Lift / Phase Switch / HPF 100Hz Bypass
Power Supply	110-120V / 220-240V 50/60Hz
Enclosure Construction	Painted Plywood cabinet / Black Metal Grille Protection / Rubber feet
Dimensions (HxWxD)	676 x 581 x 544 mm / 26.61" x 22.87" x 21.42"
Weight	26.57 Kg / 58.58 lbs





# MAXX Series

**1200W** **125dB** **CE**  
TOTAL SYSTEM - PEAK POWER APPROVED



**MAXHEB**  
POWER MODULE Optimum Headroom & SPL

**Hi-Def**  
COMPONENTS

**Rigging**  
READY!



MAXX 10A

2.5"  
VOICE COIL



MAXX 12A

2.5"  
VOICE COIL



MAXX 15A

2.5"  
VOICE COIL

# TPS 16 & i Series Active - Technical Specifications

## TPS 16P

System Type	2-Way 6.5" Vented PASSIVE Speaker Cabinet
Power Handling	RMS: 70 Watts / Program: 140 Watts
Frequency Response	75Hz-20KHz (-6dB)
Sensitivity	110dB Max
X-over Frequency	6KHz@12dB/oct
Low Frequency	6.5" Woofer / 1" Voice Coil
High Frequency	1" Neodymium Tweeter
Enclosure	Trapezoidal painted wood cabinet.metal grille
Fixing Point	2 x M4 Standard (2 x Vertical side)
Dimensions (HxWxD)	318 x 200 x 202 mm / 12.52" x 7.87" x 7.95"
Net Weight	4.2 Kg / 9.26 lbs

## TPS 16AP

System Type	2-Way 6.5" Vented Active Speaker Cabinet
Power Handling	RMS: 70Watts / Program: 140Watts
Frequency Response	75Hz-20KHz (-6dB)
Sensitivity	110dB Max
X-over Frequency	6KHz@12dB/oct
X-over Frequency	6KHz@12dB/oct
Low Frequency	6.5" woofer / 1" Voice Coil
High Frequency	1" Neodymium Tweeter
Connectors	MIC/LINE balanced input -40/0dB (Combo Connector), AUX input -10dB with RCA Connector, LINK Output -40/0dB with XLR
Amplifier	Class-D 70Wx2 (BTL)
Electronic Protections	Thermal / overload / analog limiter
Volume Control	Continuous, work only on MIC/LINE input
Power Supply	110-120V / 220-240V~50/60Hz
Enclosure	Trapezoidal painted wood cabinet.metal grille
Fixing Point	2 x M4 Standard (2 x Vertical side)
Dimensions (HxWxD)	318 x 200 x 202 mm / 12.52" x 7.87" x 7.95"
Net Weight	4.6 Kg / 10.14 lbs

## TPS 16AM.UB

System Type	2-Way 6.5" Vented Active Speaker Cabinet
Power Handling	RMS: 140Watts / Program: 280Watts
Frequency Response	75Hz-20KHz (-6dB)
Sensitivity	113dB Max
Low Frequency	6.5" woofer / 1" Voice Coil
High Frequency	1" Neodymium Tweeter
X-over Frequency	5KHz@12dB/oct
Mixer	2-band equalizer on input channels, 5 Input channels with individual Volume control, 3 bands Master EQ, 3 COMBO microphone Inputs with phantom power, 2 RCA Line Inputs/3.5mm jack, 2 RCA Line Outputs, Monitor output with level control, Powered output 70W (@4 Ohm, min) for optional external speakers, 16-preset digital effect processor
USB Player	USB & Micro SD CARD, Bluetooth
Power Supply	230V - 115V @50 - 60Hz
Amplifier	Class-D 70W x 2, one for inside speaker / one for optional external speaker
Electronic Protections	Thermal / overload / analog limiter
Enclosure	Trapezoidal painted wood cabinet. metal grille
Fixing Point	4 x M4 Standard (2 x Vertical and Horizontal side)
Dimensions (HxWxD)	318 x 200 x 220 mm / 12.52" x 7.87" x 8.66"
Net Weight	6.2 Kg / 13.67 lbs



	TPS i8HA	TPS i10HA	TPS i12HA	TPS i15HA
System Type	2-Way Vented Cabinet			
Transducer Low	8" Woofer - 1.5" Voice Coil	10" Woofer - 2" Voice Coil	12" Woofer - 2" Voice Coil	15" Woofer - 2" Voice Coil
Transducer Driver	1" Driver - 1" Voice Coil	1" Driver - 1" Voice Coil	1" Driver - 1" Voice Coil	1" Driver - 1" Voice Coil
Frequency Response (-6dB)	68Hz~20KHz (-6dB)	58Hz~20KHz (-6dB)	55Hz~20KHz (-6dB)	50Hz~20KHz (-6dB)
Horn Coverage	50° x 50°			
Max SPL	94dB / 119.5dB (Max)	95dB / 120dB (Max)	95.6dB / 122.2dB (Max)	96.5dB / 123.5dB (Max)
Power / Rating	350W PROGRAM 700W PEAK	390W PROGRAM 780W PEAK	460W PROGRAM / 920W PEAK	500W PROGRAM / 1000W PEAK
Input Connector	2 x SPK4	2 x SPK4 / 2 x NL4	2 x SPK4	2 x SPK4
Line Input	5dBu ±1dBu			
Input Impedance	Line 15K Ohm input			
External Controls	Volume, Master switch / AC Select / Power LED / CLIP LED			
Power Supply	110-120V~60Hz / 220-240V~50/60Hz			
Enclosure Construction	Plywood cabinet, resistant black paint, metal grille, rubber feet, two handles			
Dimensions (HxWxD)	366 x 358 x 548 mm 14.41" x 14.10" x 21.58"	418 x 408 x 631 mm 16.46" x 16.06" x 24.84"	449 x 438 x 653 mm 17.68" x 17.24" x 25.71"	522 x 486 x 736 mm 20.55" x 19.13" x 28.98"
Net Weight	15.3 Kg / 33.73 lbs	18.5 Kg / 40.79 lbs	22.1 Kg / 48.72 lbs	25.1 Kg / 55.34 lbs

Also available in PASSIVE



# TPS 16 & i Series

**280W 122dB** CE APPROVED  
TOTAL SYSTEM - PEAK POWER



ACTIVE MONITOR WITH MIXER **TPS16AM.UB**

**140W 113dB** CE APPROVED  
TOTAL SYSTEM - PEAK POWER



INSTALL SYSTEM **TPS16P / TPS16AP**



Active Monitor with Mixer

1" Neodymium Driver  
MP3 / USB / BLUETOOTH



AP Active Output  
Powers TPS 16P Passive

**1000W 124dB** CE APPROVED  
TOTAL SYSTEM - PEAK POWER



1" HD Driver

Up to 8  
Rigging Points!



TPS i8HA



TPS i10HA



TPS i12HA



TPS i15HA

# TMA-54ZBT / TAP Airport Series Technical Specifications

## TMA-54ZBT

Inputs Sensitivity	Ch1- 4: Mic/Phantom: -50dBV; Line: -10dBV balance / CH5: -10dBV unbal. / Telephone paging: -10dBV
Frequency response	60-17000Hz (-3dB)
Tone control	Treble: 10dB at 10KHz / Bass: 10dB at 100Hz
T.H.D.	<1%
S/N ratio	Mic. >65dB / Line >75dB / Tel. >65dB
Priority for Mic-1	mute CH2-CH5
Outputs impedance	4 Ohm, 8 Ohm
Output constant voltage	25V, 70V, 100V
Power Rating	960W PROGRAM / 1920W PEAK
Monitor output	1W RMS
Phone output	1V ( 47 Ohm)
Line out	2.0V (BAL)
Monitor Line out	1V (600 Ohm)
Controls	5 Gain controls for Ch1-5 / 8 Volume controls for Ch1-5, tel. paging, monitor, phone / 4 Master volume control / 5 Treble controls / 5 Bass controls / 4 Zone select switch for each channel / 4 Zone monitor select switch / 5 mute controls / 1 AC select switch / 1 Bluetooth PAIR Switch
Indicate LED	5VU meters (LED type) / 1 Power indicator / 5 Mute indicators / 1 Bluetooth PAIR indicators
Dimensions (HxWxD)	133 x 483 x 395 mm / 5.24" x 19.02" x 15.55"
Power Supply	110-120V~ 60Hz or 220-240V~50/60Hz Switch mode

	TAP20BT	TAP40BT	TAP20	TAP40	TAP20A	TAP40A
System Type	Active speaker cabinet with Bluetooth		Speaker cabinet with transformer		Active speaker cabinet	
Continuous Power	20W	40W	70V: 20W / 10W / 5W / 2.5W 100V: 20W / 10W / 5W	70V: 40W / 200W / 10W / 5W 100V: 40W / 20W / 10W	20W	40W
SPL (1w/1m)	85dB (±3dB)	90dB (±3dB)	85dB (±3dB)	90dB (±3dB)	85dB (±3dB)	90dB (±3dB)
Impedance	4 Ohm		70V: 245Ω / 500Ω / 1KΩ / 2KΩ 100V: 500Ω / 1KΩ / 2KΩ	70V: 122Ω / 250Ω / 500Ω / 1KΩ 100V: 250Ω / 500Ω / 1KΩ	4 Ohm	
Speaker	3" Full range speaker 0.8" Voice Coil	4" Full range speaker 1" Voice Coil	3" Full range speaker 0.8" Voice Coil	4" Full range speaker 1" Voice Coil	3" Full range speaker 0.8" Voice Coil	4" Full range speaker 1" Voice Coil
External Controls	Volume control / Power switch / Pair button for Bluetooth		Power selective switch		Volume control / Power switch	
Frequency	150Hz	88Hz	132Hz	76Hz	132Hz	76Hz
Response	20KHz	18KHz	20KHz	18KHz	20KHz	18KHz
Connectors	Input - RCA and Ø6.3mm Balanced / Output - link Ø6.3mm Jack		Wiring terminal		Input - RCA and Ø6.3mm Balanced / Output - link Ø6.3mm Jack	
Power Supply	100 - 120V~60Hz / 210 - 240V~50Hz		-	-	100 - 120V~60Hz / 210 - 240V~50Hz	
Dimension (HxWxD)	285 x 155 x 240 mm 11.22" x 6.1" x 9.45"	360 x 190 x 278 mm 14.17" x 7.48" x 10.95"	285 x 155 x 240 mm 11.22" x 6.1" x 9.45"	360 x 190 x 270 mm 14.17" x 7.48" x 10.63"	285 x 155 x 240 mm 11.22" x 6.1" x 9.45"	360 x 190 x 270 mm 14.17" x 7.48" x 10.63"
Weight	1.7 Kg / 3.75 lbs	2.8 Kg / 6.17 lbs	1.28 Kg / 2.82 lbs	2.44 Kg / 5.38 lbs	1.43 Kg / 3.15 lbs	2.54 Kg / 5.6 lbs

Installation Ready!



# TMA-54ZBT / TAP Airport Series

**1920W** CE APPROVED  
TOTAL SYSTEM - PEAK POWER



5 Channel Mixer / 4 Zones

Frequency Response: 60-17KHz (-3dB)  
Treble: 10dB at 10KHz / Bass: 10dB at 100Hz

Priority for Mic-1

Output Constant Voltage: 25V, 70V & 100V

8 Volume Controls for: Ch1-5, Tel. Paging, Monitor & Phone



TAP20T TAP20A TAP20BT

TAP40T TAP40A TAP40BT



3" Full range speaker / 0.8" Voice Coil

4" Full range speaker / 1" Voice Coil



TAP-20BT / TAP-40BT Real Wireless - Stereo Bluetooth

# PAX Series Technical Specifications

## PAX-60

Power output (1K / 70V / 100V)	60W (RMS)
Frequency response	80Hz- 16KHz ( ±3dB)
T.H.D.	1≤1%
S/N Ratio	Mic: ≥65dB / Phantom: ≥65dB / Line: ≥75dB / AUX: ≥75dB
Input / Sensitivity	Mic: -52dBV balanced / Phantom: -52dBV / 18V balanced / Line: -10dBV balanced / AUX: -10dBV balanced / Test/alarm: -10dBV balanced
Equalizer Controls	BASS: ±10dB (at 100Hz), TREBLE: ±10dB (at 10KHz)
Indicators	Power: Green led / Signal: Green led / Pro: Red led / Clip : Red led
Output	COM, 4 Ohm, 70V / 100V Class-D amplifier
Controls	4 input volume controls, 1 Aux volume control / 2 Treble / Bass controls, 1 Master volume control / 4 Mic / Phantom / Line selector switch / 1 Mic / Priority controls / MP3 player with SD/USB interface / ECHO function
Power supply	AC 100-240V 50/60HZ / DC24V
Dimensions (WxDx H)	483 x 281 x 44 mm / 19.02" x 11.06" x 1.73"
Net weight	4.1 Kg / 9.04 lbs

## PAX-120

Power output (1K / 70V / 100V)	120W (RMS)
Frequency response	80Hz- 16KHz ( ±3dB)
T.H.D.	1≤1%
S/N Ratio	Mic: ≥65dB / Phantom: ≥65dB / Line: ≥75dB / AUX: ≥75dB
Input / Sensitivity	Mic: -52dBV balanced / Phantom: -52dBV / 18V balanced / Line: -1 0dBV balanced / AUX: -1 0dBV balanced / Test/alarm: -10dBV balanced
Equalizer Controls	BASS: ±10dB (at 100Hz), TREBLE: ±10dB (at 10KHz)
Indicators	Power: Green led / Signal: Green led / Pro: Red led / Clip : Red led
Output	COM, 4 Ohms, 70V, 100V Class-D amplifier
Controls	4 input volume controls, 1 Aux volume control / 2 Treble / Bass controls, 1 Master volume control / 4 Mic / Phantom / Line selector switch / 1 Mic / Priority controls / MP3 player with SD/USB interface / ECHO function
Power supply	AC 100-240V 50/60HZ / DC24V
Dimensions (WxDx H)	483 x 281 x 44mm / 19.02" x 11.06" x 1.73"
Net weight	4.9 Kg / 10.8 lbs

## PAX-240

Power output (1K / 70V / 100V)	240W (RMS)
Frequency response	80Hz- 16KHz ( ±3dB)
T.H.D.	1≤1%
S/N Ratio	Mic: ≥65dB / Phantom: ≥65dB / Line: ≥75dB / AUX: ≥75dB
Input / Sensitivity	Mic: -52dBV balanced / Phantom: -52dBV / 18V balanced / Line: -1 0dBV balanced / AUX: -1 0dBV balanced / Test/alarm: -10dBV balanced
Equalizer Controls	BASS: ±10dB (at 100Hz), TREBLE: ±10dB (at 10KHz)
Indicators	Power: Green led / Signal: Green led / Pro: Red led / Clip : Red led
Output	COM, 4 Ohm, 70V, 100V Class-D amplifier
Controls	4 input volume controls, 1 Aux volume control / 2 Treble / Bass controls, 1 Master volume control / 4 Mic / Phantom / Line selector switch / 1 Mic / Priority controls / MP3 player with SD/USB interface / ECHO function
Power supply	AC 100-240V 50/60HZ / DC24V
Dimensions (WxDx H)	483 x 281 x 44mm / 19.02" x 11.06" x 1.73"
Net weight	5.6 Kg / 12.35 lbs



# PAX Series



PAX-60

**60W**  
TOTAL SYSTEM - RMS POWER  
CE APPROVED



PAX-120

**120W**  
TOTAL SYSTEM - RMS POWER  
CE APPROVED



PAX-240

**240W**  
TOTAL SYSTEM - RMS POWER  
CE APPROVED

2 Tones (BASS/TREBLE)

Output level display

5 Input volume controls / 1 Master

4 MIC (XLR) inputs

MP3 player with SD/USB interface

MIC / LINE / PHANTOM exchange SW

Constant voltage output is 70V / 100V

1 AUX (RCA) Input ECHO Function



PAX-240  
Rear View

# WRS Series Technical Specifications

## WRS-5 & WRS-5W

System	2-Way Passive Speaker Cabinet
Type Standard	Loudspeaker for voice alarm systems for fire detection and fire alarm system
Environment Type	Type B (Outdoor applications)
Transducer Low	5" ferrite woofer, 1" voice coil
Transducer Driver	1" Neodymium Tweeter
Rated Noise Power	40W (100V and 70V line)
Rated	100V line: 250 Ohm (40W) / 500 Ohm (20W) / 1K Ohm (10W) / 2K Ohm (5W)
Impedance	70V Line: 122 Ohm (40W) / 250 Ohm (20W) / 500 Ohm (10W) / 1K Ohm (5W) Bypass: 8 Ohm
Sensitivity	500Hz-5KHz pink noise: 85dB (1W, 1m)
Max SPL	97dB (40W, 1m)
Coverage Angle (H x V)	500Hz: 360° x 360° / 1kHz: 188° x 140° / 2kHz: 92° x 58° / 4kHz: 128° x 165°
Protection Rate	IP55
Cable Connection	Steatite terminal x 2 speaker cable (Ø 6.6mm)
Finish	Enclosure: ABS + PC / Mesh speaker grill: surface-treated steel plate Speaker Wall bracket: surface-treated steel plate, painted joint bracket, screw and stainless steel cable
Dimensions (HxWxD)	278 x 170 x 172 mm / 10.9" x 6.7" x 6.8"
Net Weight	3.1 Kg / 6.83 lbs

## WRS-8 & WRS-8W

System	2-Way Passive Speaker Cabinet
Type Standard	Loudspeaker for voice alarm systems for fire detection and fire alarm system
Environment Type	Type B (Outdoor applications)
Transducer Low	8" ferrite Woofer, 1,2" voice coil
Transducer Driver	1" Neodymium Tweeter
Rated Noise Power	80W (100V and 70V line)
Rated	100V line: 125 Ohm (80W) / 250 Ohm (40W) / 500 Ohm (20W) / 1K Ohm (10W)
Impedance	70V Line: 62 Ohm (80W) / 125 Ohm (40W) / 250 Ohm (20W) / 500 Ohm (10W) Bypass: 8 Ohm
Sensitivity	500Hz-5KHz pink noise: 87dB (1W, 1m)
Max SPL	105dB (80W, 1m)
Coverage Angle (H x V)	500Hz: 162° x 140° / 1KHz: 114° x 123° / 2KHz: 171° x 52° / 4KHz: 131° x 97°
Protection Rate	IP55
Cable Connection	Steatite terminal x 2 speaker cable (Ø 6.6mm)
Finish	Enclosure : ABS + PC / Mesh speaker grill : surface-treated steel plate Speaker Wall bracket: surface-treated steel plate, painted joint bracket, screw and stainless steel cable
Dimensions (HxWxD)	406 x 250 x 251 mm / 16" x 9.8" x 10"
Net Weight	6.4 Kg / 14.1 lbs







# WRS Series

**40W** **87dB** **CE**  
TOTAL SYSTEM - RATED NOISE POWER APPROVED

**80W** **92dB** **CE**  
TOTAL SYSTEM - RATED NOISE POWER APPROVED



**WRS-5W**  
5" Ferrite Woofer /  
1" Voice Coil  
1" Neodymium Tweeter



8" Ferrite Woofer /  
1.2" Voice Coil  
1" Neodymium Tweeter  
**WRS-8**



**WRS-5**

5"  
WOOFER



**WRS-5W**

5"  
WOOFER



**WRS-8**

8"  
WOOFER



**WRS-8W**

8"  
WOOFER

# Wireless Systems Technical Specifications

	KTX	KRX
Channel	16 presets frequency channel. (0~9 , A~F)	16 presets frequency channel. (0~9 , A~F)
Frequency band	UHF 470-960MHz Dependent on applicable country regulations	UHF 470-960MHz Dependent on applicable country regulations
Oscillation mode	PLL UHF Synthesized	PLL UHF Synthesized
Frequency response	50Hz-15KHz (±3dB)	50Hz-15KHz (±3dB)
Frequency stability	±0,005% (-10 - 50)	±0,005% (-10 - 50)
T.H.D	1KHz<0,8%	1KHz<0,8%
Modulation mode	FM (F3E)	FM (F3E)
S/N Ratio	>90dB	>90dB
R/F output power	10mW	-
R/F sensitivity	-	-100dBm/12dB SINAD
Balance output	-	1V, 40KHz deviation
Max. Deviation	36KHz	-
Power supply	DC 1.5V Battery	DC 1.5V Battery

## R1 / T2

Power Supply	DC 5V ADAPTOR
Frequency	2404 - 2471MHz
Channel	25
Modulation	GFSK
Receive Sensitivity (R1)	-84dBm (Min)
Transmit Power (T2)	14dBm
Output Level (R1)	+5dBu
Input Level (T2)	+18dBu (BAL Max.)
Bandwidth	>=1.8MHz
Frequency Response	20 - 20KHz, +3dB / -3dB
S/N	>80dB
Dynamic Range @ 1kHz	>90dB
Crosstalk @ 1kHz	>90dB
Distortion THD	<0.1%
Latency	20ms

## BT-STR

Bluetooth Version	Bluetooth V4.0+EDR
Bluetooth protocol	AVCTP 1.0, AVRCP 1.0, GAVDP 1.2, AVDTP 1.0, A2DP 1.2, Hands-Free Profile 1.5, Headset Profile V1.1
Max Transmit Power	Class 2 4dBm
Receive Sensitivity	-80dBm@0.1%BER
Frequency	2.4GHz - 2.480GHz
Audio performance	High acoustic fidelity sound
SNR	=75dB
THD	=0.01%
Power Supply	AC 9V ADAPTOR



# Wireless Systems

## KRX / KTX Modules

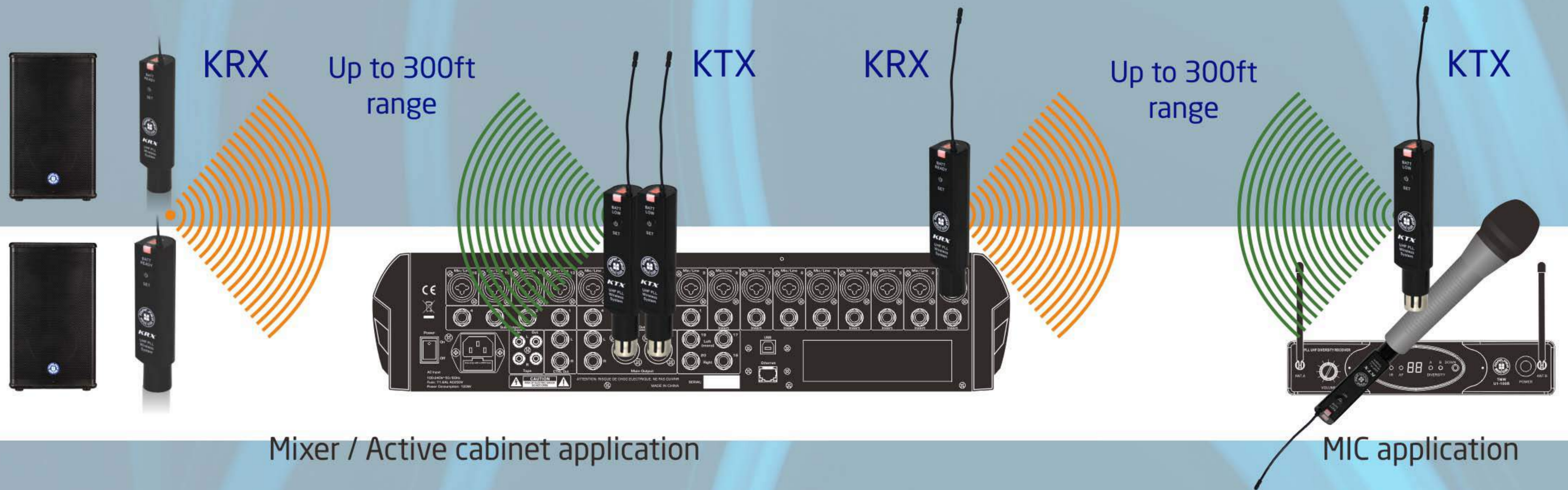

## R1 / T2

I/O Stereo Receiver to Active speakers

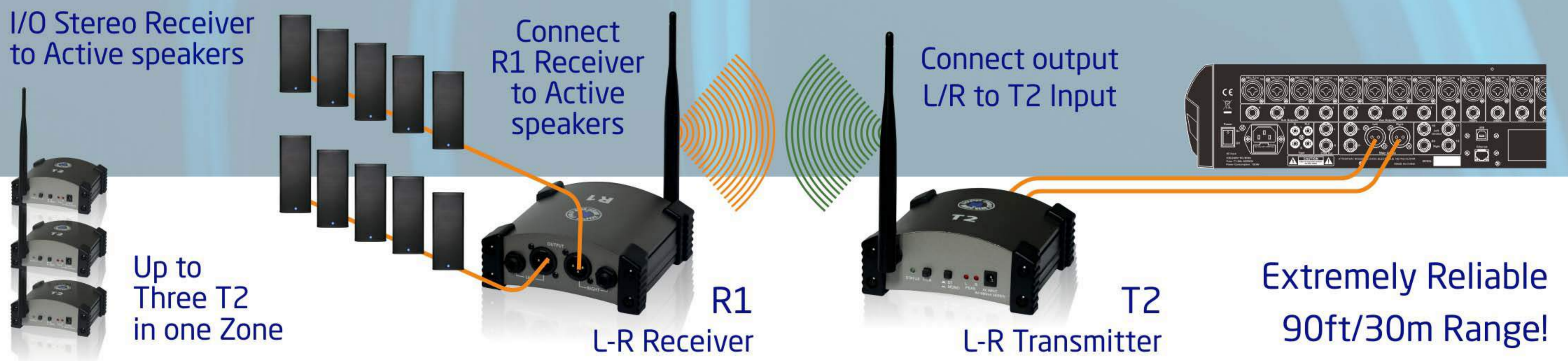

## BT-STR 4.0 Bluetooth Stereo Receiver



# Wireless Systems Technical Specifications

## TMW8000R

Reception Mode: Diversity  
 Carrier Frequency Range: UHF 780 - 865 MHz  
 Frequency Response: 50Hz - 15KHz  $\pm$ 3dB  
 Oscillation Mode: Quartz Controlled fixed Frequency  
 Squelch: Tone Key (32.768 KHz). External Control

## TMW U1.100R

Channel : Single, 100 Frequencies  
 Receiver Type: True Diversity PLL Synthesized  
 Frequency Band: UHF 470-900MHz  
 Modulation: FM (F3E)  
 Frequency Response: 50Hz - 15KHz ( $\pm$ 3dB)

## TMW U2.100R -Half rack-

Channel: Dual, 100 Frequencies per channel. 200 Total  
 Receiver Type: Dual Receiver PLL Synthesized  
 Frequency Band: UHF 470-900 MHz  
 Modulation: FM (F3E)  
 Frequency Response: 50Hz - 15KHz ( $\pm$ 3dB)

## TMW8000T

Carrier Frequency: UHF 780-865MHz  
 Microphone Element: Dynamic  
 RF Carrier Power: 10mW  
 Battery: More than 8 hours  
 Antenna: Built in

## TMW U1.100P

Channel: Dual, 100 Frequencies per channel. 200 Total  
 Receiver Type: Dual Receiver PLL Synthesized  
 Frequency Band: UHF 470-900 MHz  
 Modulation: FM (F3E)  
 Frequency Response: 50Hz - 15KHz ( $\pm$ 3dB)

## TMW U1.100T

Frequency band: UHF 470-900MHz  
 Oscillation Mode: PLL UHF Synthesized  
 RF Radiation FCC: 10mW  
 Battery: "AA" type x 2pcs (used for more than 6 hours)  
 Microphone Capsule: Dynamic Capsule  
 Frequency Response: 50Hz-15KHz ( $\pm$ 3dB)

Up to 300ft Range!

Up to 8h operating time with 2 x "AA" type batteries

TMW 8000



TMW U1.100  
 TMW U2.100  
 TMW U2.200



M Pack Wireless System includes:  
 Receiver and Hand held Microphone

LTHSGT Pack Wireless System includes:  
 Receiver, Beltpack, Headset, Mic Lavalier  
 and Guitar cable



# Wireless Systems



**UHF**  
DIVERSITY



TMW 8000M / LTHSGT



TMW U1.100M / LTHSGT



**PLL**  
**UHF**  
SYNTHESIZED



INTELLIGENT RECOGNITION



INTELLIGENT ID LOCK

TMW U2.100M / LTHSGT

**100**  
FREQUENCIES  
**PLL**  
**UHF**  
SYNTHESIZED

**PLL**  
**UHF**  
SYNTHESIZED



**100**  
FREQUENCIES  
PER CHANNEL  
**PLL**  
**UHF**  
SYNTHESIZED

TMW U2.200M / LTHSGT

# TRX / TDX Series Technical Specifications

## TRX1500

Bridge Mode 8 Ohms	Continuous	80W
	Program/Peak	1000W / 1600W
Stereo Mode 4 Ohms	Continuous	400W x 2
	Program/Peak	540W x 2 / 800W x 2
Stereo Mode 8 Ohms	Continuous	250W x 2
	Program/Peak	320W x 2 / 500W x 2
Dimensions (HxWxD)		591 x 539 x 179 mm / 23.27" x 21.22" x 6.69"
Weight		17.85 Kg / 39.35 lbs

Common Specifications: Distortion (SMPTE-IM): <0.005%, Frequency Response: 20Hz-20KHz  $\pm$  0.1/ 3dB, Damping Factor, 1KHz:>300 at 8 Ohms, Signal to Noise, 20Hz-20KHz: 102dB, Voltage Gain: 40 x (32dB), Input Sensitivity 24 Ohm: 1 Vrms, Input Clipping: 10 Vrms (+22dB, Input Impedance: 10K Ohms unbalanced, 20K Ohms balanced 56 (3dB), Controls: Front: AC Switch, CH1 & CH2 Gain Knobs, Rear: Limiter, Bridge Selector, Indicators (1 per channel): Power-On: Blue LED, Operation / Protection: Dual Color (Yellow LED), Limit: Yellow LED, Clip: Red LED, Connectors, each channel: Input: Active balanced XLR, Parallel Output: XLR, Output: Neutrik Speakon and Binding posts, Cooling: Continuously Variable-speed fan, rear-to-front air flow, Load Protection: On/off muting, DC-fault load grounding relay, internal fault fuses, Power Requiriments: 200-240V (100-120V) AC 50~60Hz.

		TRX2500	TRX4000	TRX5000	TRX6000
Stereo Mode	8 Ohms Continuous	350W x 2	700W x 2	1160W x 2	1225W x 2
	4 Ohms Continuous	540W x 2	1200W x 2	190W x 2	2150W x 2
	2 Ohms Program / Peak	1500W x 2	2800W x 2	5100W x 2	5200W x 2
Bridge Mode	8 Ohms Continuous	1090W	2080W	3860W	4140W
	4 Ohms Continuous	3000W	5000W	9000W	9600W
Max. Power Consumption Output Power		1600W	2500W	6000W	7000W
Dimensions (HxWxD)		611 x 594 x 186 mm 24.06" x 23.39" x 7.32"	611 x 594 x 186 mm 24.06" x 23.39" x 7.32"	591 x 566 x 219 mm 23.27" x 22.28" x 8.62"	591 x 566 x 219 mm 23.27" x 22.28" x 8.62"
Weight		20.5 Kg / 45.2 lbs	25.1 Kg / 55.34 lbs	42.25Kg / 93.15 lbs	39.6 Kg / 87.3 lbs

Common Specifications: Single to Noise Ratio A-weighted: > 105dB, Residual Noise, A-weighted: < -65dBu, Input Sensitivity: 1.1V, Total Harmonic Distortion: < 0.05%, Crosstalk ref. 1KHz at rated output power: > 60dB, Frequency Response: 20Hz~20KHz  $\pm$ 1dB at 10dB below rated output power, all models, Input Impedance: 10KOhms Unbalanced, 20KOhms balance, all models, Damping Factor, 1KHz: > 500 at 8 Ohms, all models, Slew Rate: 40V/ $\mu$ S, Power Requirements: 100V, 120V, 220V, 230V, 240V, 50/60Hz (factory configured), Protections: Turn-on delay, Over-heat, Short-circuit, DC, overcurrent, mismatched loads.

## TDX8000 Digital Amplifier

Power (Both channels Driven)	2000W x 2/4 Ohms (RMS)
Input Sensitivity (Limiter Off)	0.9 - 1.1V (+0/-1dBv)
Input Impedance	20K Ohms balanced or 10K Ohm unbalanced
Frequency Response (At 10dB below Rated Output Power)	20Hz~20KHz (+0/-1dB)
Voltage Gain	40dB (+/-0.5dB)
THD + N	<0.1% (Ref. 1kHz 1/8 Rated Power, A-Weighted)
S/N Ratio	>100dB (Ref. 1kHz, A-Weighted)
Power / Output Circuitry	Switching Power Class-D
Protections	Full short circuit, open circuit, thermal, ultrasonic, and RF protection stable into reactive or mismatched loads, turn ON/OFF, muting, tried crowbar
Controls	Front: AC switch (soft-start), Input level control / Rear: stereo, parallel selector
Indicators	POWER & SIGNAL: 2 green LED / CLIP & PROTECTION: 2 red LED
Connectors	Inputs: NEUTRIK COMBO XLR/TRX / Outputs: SPEAKON
Power Supply	AC: 110-120V or 220~240V 50/60Hz
Dimension (HxWxD)	44 x 483 x 360 mm / 1.73" x 19.02" x 14.17"
Weight	5.0 Kg / 11.02 lbs

# TRX / TDX Series

**BEST  
SELLER**



TRX1500



TRX2500

**D+V+S**  
Dual Ventilation System



TRX4000

**D+V+S**  
Dual Ventilation System



TRX5000

**D+V+S**  
Dual Ventilation System



TRX6000

**D+V+S**  
Dual Ventilation System



TDX8000

**D+V+S**  
Dual Ventilation System

TRX1500



TRX5000  
TRX6000

TRX2500  
TRX4000



TDX8000

# LVA / HVA Series Technical Specifications

## LVA4.150

Power (Both channels driven)	2 Ohms (EIAJ)	360W x 4
	4 Ohms (RMS)	150W x 4
	8 Ohms (RMS)	90W x 4
Bridge Mono Mode	4 Ohms (EIAJ)	400W x 2
	8 Ohms (RMS)	310W x 2
Input Sensitivity (Limiter Off)	0.9 - 1.1V (+0/-1dBv)	
Input Impedance	20K Ohm balanced or 10K Ohm unbalanced	
Frequency Response	20Hz~20KHz (+0/-1dB) (At 10dB below Rated Output Power)	
Voltage Gain	28 (+/-0.5dB)	
THD + N	<0.1% (1KHz 1/8 Rated Power, A-Weighted)	
S/N Ratio (Ref. 1KHz, A-Weighted)	> 96dB	
Crosstalk (Below Rated Power)	> 70dB	
Damping Factor (1KHz, 8W)	> 200	
Power/Output Circuitry	Switching Power Class-D	
Protections	Full short circuit, open circuit, thermal, ultrasonic, and RF protection stable into reactive or mismatched loads, turn ON/OFF, muting, tried crowbar	
Controls	Front: On/Off Power Switch, Volume Channel A, B, C, D - Rear : 8 preset modes	
Indicators	POWER: 1 blue - PROTECTION & CLIP: 4 red - SIGNAL: 4 green LED	
Connectors	Inputs: Euro block - Outputs: Euro block	
Power Supply	AC: 110-120V or 220~240V 50/60Hz	
Dimension (HxWxD)	44 x 483 x 360 mm / 1.73" x 19.02" x 14.17"	
Weight	4.6 Kg / 10.14 lbs	

	LVA8.150	LVA16.150
Power (Both channels driven)	130W x 8 / 4 Ohm	130W x 16 / 4 Ohm
	70W x 8 / 8 Ohm	70W x 16 / 4 Ohm
Input Sensitivity (Limiter Off)	0.9 - 1.1V (+0/-1dBv)	
Input Impedance	20K Ohm balanced or 10K Ohm unbalanced	
Frequency Response	100Hz~15KHz (+0/-1dB) (At 10dB below Rated Output Power)	
Voltage Gain	28 (+/-0.5dB)	
THD + N	<0.1% (1KHz 1/8 Rated Power, A-Weighted)	
S/N Ratio (Ref. 1KHz, A-Weighted)	> 95dB	
Crosstalk (Below Rated Power)	> 70dB	
Damping Factor (1KHz, 8W)	> 200	
Power/Output Circuitry	Switching Power Class-D	
Protections	Full short circuit, open circuit, thermal, ultrasonic, and RF protection stable into reactive or mismatched loads, turn ON/OFF, muting, tried crowbar	
Controls	Front: On/Off Power Switch - Rear: Volume Channel 1 to 8	
Indicators	SIGNAL: 8 green LED - CLIP 8 red LED SIGNAL: 16 green LED - CLIP 16 red LED	
Connectors	POWER: 1 green LED - PROTECTION: 8 red LED POWER: 1 green LED - PROTECTION: 16 red LED	
Inputs	Inputs: Euro Block - Outputs: Euro Block	
Power Supply	AC: 110-120V or 220~240V 50/60Hz	
Dimension (HxWxD)	44 x 483 x 360 mm / 1.73" x 19.02" x 14.17"	
Weight	6.3 Kg / 13.89 lbs	6.8 Kg / 14.99 lbs

	HVA4.150	HVA8.150	
Power 70V (RMS)	One Channel Driven	150W x 4	150W x 8 / 135W x 8
	All Channel Driven	135W x 4	150W x 8 / 135W x 8
Power 100V (RMS)	One Channel Driven	150W x 4	150W x 8 / 135W x 8
	All Channel Driven	135W x 4	150W x 8 / 135W x 8
Input Sensitivity (Limiter Off)	0.9 - 1.1V (+0/-1dBv)		
Input Impedance	20K Ohm balanced or 10K Ohm unbalanced		
Frequency Response	100Hz~15KHz (+0/-3dB) (At 10dB Below Output Power)	20Hz~20KHz (+0/-1dB)	
Voltage Gain (100V)	40 (+0/-1dB)	-	
THD + N	<0.1% (Ref. 1KHz 1/8 Rated Power, A-Weighted)		
S/N Ratio	>95dB (Ref. Rated Power, A-Weighted)		
Crosstalk (Below Rated Power)	>70dB		
Damping Factor (1KHz, 8W)	>200		
Power/Output Circuitry	Switching Power Class-D		
Protections	Full short circuit, open circuit, thermal, ultrasonic, and RF protection stable into reactive or mismatched loads, turn ON/OFF, muting, tried crowbar.		
Controls	Front: On/Off Power Switch, Volume Channel A, B / Rear 70/100V selector	Rear: On/Off Power Switch, Volume Channel 1 to 8, 70V/ 100V selector	
Indicators	SIGNAL: 4 green LED - CLIP & PROTECTION 4 red LED / POWER: 1 green LED	POWER: 1 green LED - PROTECTION: 2 red LED - SIGNAL: 8 green LED CLIP & PROTECTION: 8 red LED - POWER: 1 green LED	
Connectors	Inputs: Euro Block - Outputs: Euro Block		
Power Supply	AC: 110-120V or 220~240V 50/60Hz		
Dimension (HxWxD)	44 x 483 x 360 mm / 1.73" x 19.02" x 14.17"		
Weight	5.4 Kg / 11.91 lbs	7.0 Kg / 15.43 lbs	





# LVA / HVA Series



**LVA4.150**



**LVA8.150**



**LVA16.150**



**HVA4.150**  
(70V / 100V)



**HVA8.150**  
(70V / 100V)

**LVA4.150**



**LVA8.150**



**LVA16.150**



**HVA4.150**



**HVA8.150**

# Digital & Analog Processors Technical Specifications

---

## TXO-234MKII

---

Crossover 2 and 3 way stereo, 4 way mono crossover, Delay effect, Available in 110V or 220V, 1 rack unit.

## TCL-2

---

Compressor / limiter / gate, smart ratio control expander, smart knee control compressor, smart gain control. Peak limiter, In / Out XLR & TRS, 1 rack unit.

## TLINK-8

---

SPLIT / MIX switch for each mono channel, 2 inputs, 6+2 outputs splitter, 8 balance / Pan control for each channel, main input and output level control, MAIN LINK function allows to route the MAIN IN signal to MAIN OUT, viceversa, level meters for each stage, XLR balanced connectors for 4 mono channels, and TRS type for another 2 mono channels, 1 rack unit.

## THA-6

---

6 channel headphones amplifier, In: XLR and 1/4" jack, RF filtered, servo balanced input, Out: XLR and 1/4" Jack, balanced / unbalanced, 10Hz to 50KHz, +/-3 dB, available in 110V or 220V, 1 rack unit.

## TEQ-231SW

---

2 x 15 band graphic equalizer, subwoofer out, In/Out XLR & TRS, LEDs lights up on faders, 2 rack units.

## CL-4

---

Control hub, 4 RC-Net ports, RS-485 57600BPS, control via PC software for APX series Line Array.

## T-MIC TUBE

---

Input & output type: 2 XLR and 1/4" TRS, output impedance: balanced / unbalanced: 40 Ohm, 4 meter LEDs: -30 dBu to +10 dBu.

## TDI-A2

---

Active direct box, 1/4" TRS or XLR, electronically unbalanced, input +12dBu, PAD switch: two 20dB PAD SW, output: 47K Ohm electronically balanced, XLR 120 Ohm output, Freq. response: +/-2dB @1KHz, THD <0.03%, power source: 9V battery or 48V Phantom Power.

## TDI-P1

---

Passive direct injection box, In: 1/4" TRS electronically unbalanced, discrete input configuration, out: electronically balanced XLR, max. input +22dBu, frequency response: +/-1dB @ 1KHz.

# Digital & Analog Processors

TXO-234 MKII



TCL-2



T-LINK 8



THA-6



TEQ-231SW

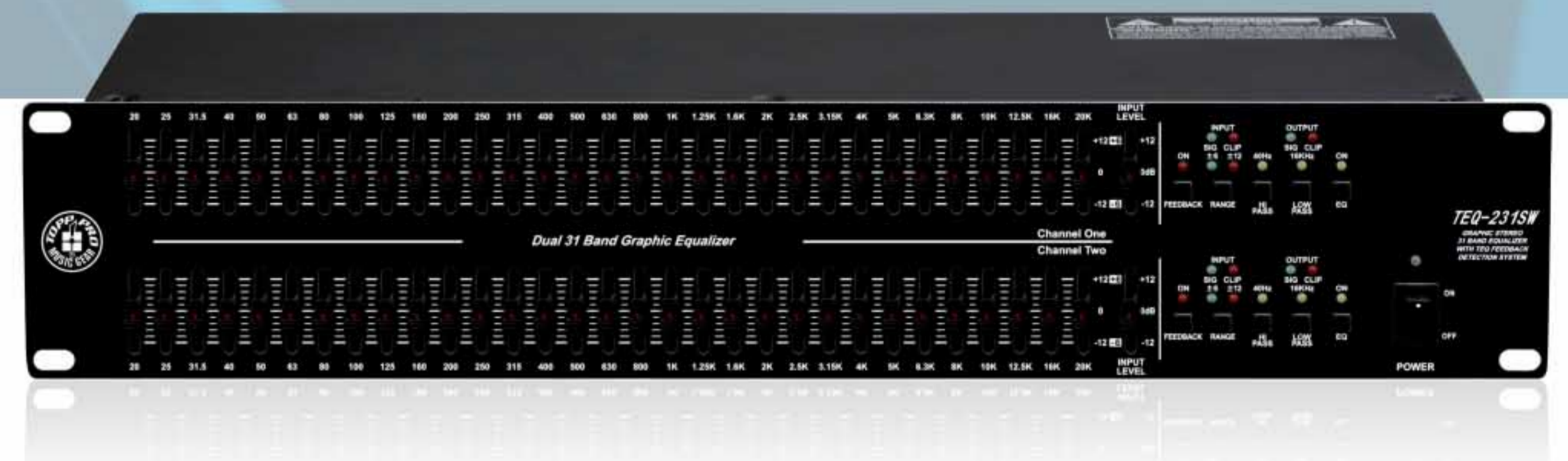

CL-4



T-MIC TUBE



TDI-A2



TDI-P1



# TPM Series Technical Specifications

## TPM9.1000

2000W PROGRAM / 1000W RMS @ 4 Ohm  
 Total 14Ch Input: 6Ch / STEREO: 3Ch x 2TK: 2 Ch  
 3 band EQ on each channel / 2x7 band EQ  
 24 bit DSP -100 programs  
 Intelligent auto compressor  
 Built-in Side Handles  
 Dimension(LxWxH): 667 x 367 x 370 mm / 26.26" x 14.45" x 14.57"  
 Weight: 19.6 Kg / 43.21 lbs

## TPM8.2000

2000W PROGRAM / 1000W RMS @ 4 Ohm  
 Total 12 Input: 6Ch / STEREO: 2Ch x 2TK: 2 Ch  
 3 band EQ on each channel / 2x9 band EQ  
 24 bit DSP -100 programs  
 Intelligent auto compressor  
 Built-in Side Handles  
 Dimension(LxWxH): 557 x 296 x 280 mm / 21.93" x 11.65" x 11.02"  
 Weight: 15.95 Kg / 35.16 lbs

## TPM7.800

1600W PROGRAM / 800W RMS @ 4 Ohm  
 Total 10Ch Input: 6Ch / STEREO: 1Ch x 2TK: 2 Ch  
 3 band EQ on each channel / 2x7 band EQ  
 24 bit DSP -100 programs  
 Intelligent Auto Compressor  
 Built-in Side Handles  
 Dimension(LxWxH): 604 x 367 x 370 mm / 23.78" x 14.45" x 14.57"  
 Weight: 16.2 Kg / 35.72 lbs

## TPM8250MKII

600W PROGRAM / 300W RMS @ 4 Ohm  
 Total 10 inputs  
 2 band EQ on each channel / 7 band EQ  
 24 bit DSP - 100 programs  
 Send and Return for External Processor,  
 Intelligent Auto Compressor  
 Dimension(LxWxH): 576 x 311 x 348 mm / 22.68" x 12.24" x 13.7"  
 Weight: 12.58 Kg / 27.73 lbs

## TPM6250MKII

600W PROGRAM / 300W RMS @ 4 Ohm  
 Total 8 inputs  
 2 band EQ on each channel / 7 band EQ  
 24 bit DSP - 100 programs  
 Send and Return for External Processor,  
 Intelligent Auto Compressor  
 Dimension(LxWxH): 511 x 311 x 348 mm / 20.12" x 12.24" x 13.7"  
 Weight: 11.4 Kg / 25.13 lbs

### Common features:

1 Expandable module bay, digital FX, Phantom Power switch, 12V lamp socket, 115V/230V switchable, all wood cabinet, retail ready packaging.

### TOPP Modular Expandability Optional user installable modules:



MP3 USB T



MP3 USB R



MX DSP

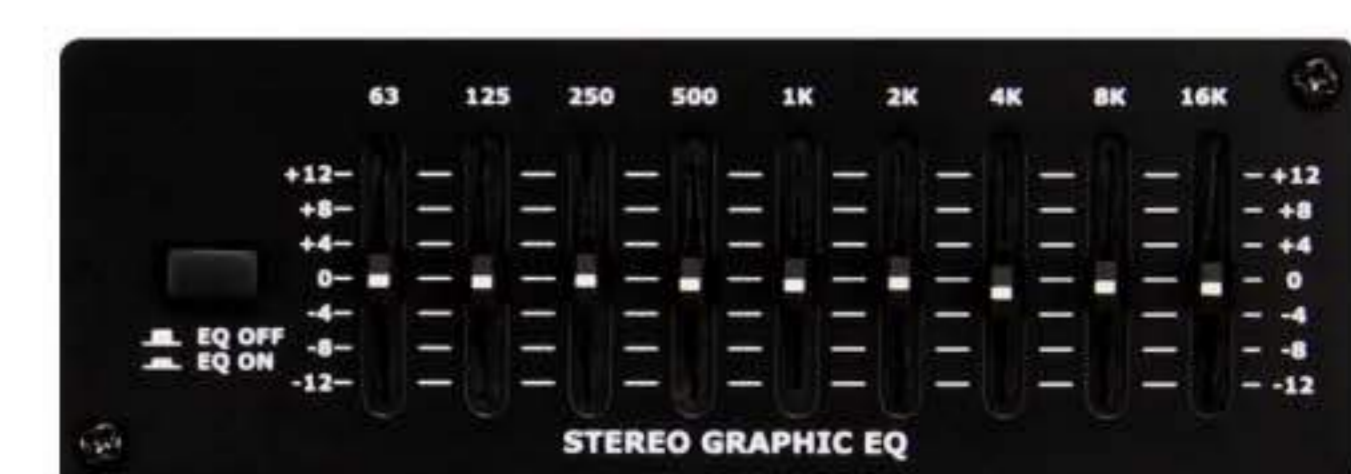

MX EQ

**Maximizes the Value & Prolongs** the life of your Investment

# TPM Series

**BEST  
SELLER**



**digital fx**

**MAXHEB**  
POWER MODULE *Optimum Headroom & SPL*

**600W** PROGRAM STEREO **300W** RMS **CE** APPROVED  
TOTAL SYSTEM POWER



**8** CH INPUTS **TPM6250MKII**

**600W** PROGRAM STEREO **300W** RMS **CE** APPROVED  
TOTAL SYSTEM POWER



**10** CH INPUTS **TPM8250MKII**

**1600W** PROGRAM STEREO **800W** RMS **CE** APPROVED  
TOTAL SYSTEM POWER



**10** CH INPUTS **TPM7.800**

**2000W** PROGRAM STEREO **1000W** RMS **CE** APPROVED  
TOTAL SYSTEM POWER



**12** CH INPUTS **TPM8.2000**

**2000W** PROGRAM STEREO **1000W** RMS **CE** APPROVED  
TOTAL SYSTEM POWER



**14** CH INPUTS **TPM9.1000**

CREATIVE, INSIGHTFUL, VALUABLE... **ALWAYS RELIABLE!**



[www.topppro.com](http://www.topppro.com)



2022-AF00196