

XS708T, XS712Tv2, XS716T, XS728T, XS748T



### Leading the industry with the 2nd generation of 10-Gigabit Smart Managed Pro Switches, Purposely Designed for SMB with Cost-Effective 10GBASE-T Connectivity and Advanced L2+/Layer 3 Lite Features

As a leading provider of network equipment for SMBs, NETGEAR® understands the importance of reliable and high performance networks. With the growth of virtualization, cloud-based services and applications like VoIP, video streaming and IP surveillance, SMB networks need to extend beyond simple reliability to higher speed and performance. The 10-Gigabit Smart Managed Pro Switch series from NETGEAR presents the right solution for this requirement; delivering unprecedented non-blocking 10-Gigabit bandwidth at an affordable cost.

The NETGEAR XS708T, XS712Tv2, XS716T, XS728T, and XS748T are powerful Smart Managed Switches that come with 8, 12, 16, 24, or 44 10-Gigabit Copper ports and either 2 Shared (Combo) Copper/SFP+ ports (XS708T/XS712Tv2/XS716T) or 4 additional Dedicated SFP+ ports (XS728T/XS748T) for 10G Fiber links. The NETGEAR 10-Gigabit Smart Managed Switches are purposely designed as a cost-effective way to provide 10G connections to 10G-capable servers and NAS (Network Attached Storage) systems. They can be used at the “center of a small business network” or as an aggregation / access switch in a larger organization including workgroup access, connecting to a 10-Gigabit NETGEAR Fully Managed Switch on one end and extending the 10G connections to the edge. The XS708T, XS712Tv2 and XS716T are also ideal for smaller workgroups that need high bandwidth for sharing, collaborating, editing, and publishing high-density content like video or animation.

### Highlights

The ProSAFE 10G Smart Managed Pro Switches provide comprehensive L2+/Layer 3 Lite features in order to meet current and future needs on virtualization, converged networking and mobility. Some of the main features include:

- Advanced VLAN features such as Protocol-based VLAN, MAC-based (Media Access Control) VLAN and 802.1x Guest VLAN
- Advanced QoS (Quality of Service) with L2/L3/L4 awareness and 8 priority queues
- IPv4 and IPv6 static routing
- Private VLAN
- Dynamic VLAN assignment
- IGMP and MLD snooping
- Advanced Security
- IPv6 for management, QoS and ACL

#### 10-Gigabit Transition with BASE-T

- 10GBASE-T, like other BASE-T technologies, uses the standard RJ45 Ethernet jack
- It is backward compatible, auto-negotiating between higher and lower speeds – thereby not forcing an all-at-once network equipment upgrade
- Cat5/Cat5e are supported for Gigabit speeds up to 100 meters

- Cat6 twisted pair copper cabling supports 10-Gigabit speeds up to 45 meters
- Cat6a or newer Cat7 cabling will allow for up to 100 meter 10GBASE-T connections

#### Designed as Core Switch for SMB Network

- 10G connection to 10G-capable servers and network storage
- Powerful L2+/Layer 3 Lite features make them the most cost-effective core switches for SMB and virtualization environment
- Future-proof your network with 10G bandwidth, advanced traffic management and comprehensive IPv6 support
- Static routing helps to route internal traffic for more efficient use of network resources
- IGMP and MLD snooping provide advanced multicast filtering

#### Act as Aggregation Switch for Medium Sized Networks

- 10-Gigabit switches help to resolve the congestion issue between network edge and core, which is caused by the broader adoption of Gigabit-to-the-desktop
- 10-Gigabit Ethernet provides greater scalability than multiple Gigabit Ethernet links, resulting in a simplified and highly efficient network infrastructure

- Up to eight 10-Gigabit Ethernet links can be aggregated into a virtual 80-Gbps connection
- 10-Gigabit Ethernet reduces cabling complexity and uses existing cabling efficiently

#### Smart IT, not Big IT

- Easy-to-use Web browser-based management GUI makes setup and management simple
- Standards-based technology ensures interoperability with any standards-based devices in the existing network
- Dual firmware images improve reliability and uptime to your network
- Worry-free with NETGEAR ProSAFE Limited LIFETIME Hardware Warranty\*
- Minimal down-time with NETGEAR ProSAFE Limited LIFETIME Next-Business-Day Replacement Warranty
- Get deployment assistance with 90-days Free 24x7 Advanced Technical Phone Support\*\*
- Limited LIFETIME Online Chat Technical Support



### Hardware at a Glance

Model Name	Form-Factor	FRONT				REAR	
		100M/1G/10G Copper Ports	1G/10G Copper Ports	1G/10G SFP+ Ports	Firmware/Config Access	Power Supply	Fans
XS708T	Rackmount	8		2 shared (combo)	1 x USB	1 internal PSU, fixed	1 internal, fixed fan
XS712Tv2	Rackmount	12		2 shared (combo)	1 x USB	1 internal PSU, fixed	2 internal, fixed fans
XS716T	Rackmount	16		2 shared (combo)	1 x USB	1 internal PSU, fixed	2 internal, fixed fans
XS728T	Rackmount		24	4 dedicated	1 x USB	1 internal PSU, fixed	4 internal, fixed fans
XS748T	Rackmount		44	4 dedicated	1 x USB	1 internal PSU, fixed	4 internal, fixed fans



#### XS708T: 8-port 10-Gigabit Smart Managed Pro Switch

- 8 x 10GBASE-T copper ports supporting 10G/1G/100M speeds
- 2 x Shared (combo) 10GBASE-T copper/10GBASE-X SFP+ ports supporting 10G/1G speeds



#### XS728T: 28-port 10-Gigabit Smart Managed Pro Switch

- 24 x Dedicated 10GBASE-T copper ports supporting 10G/1G speeds
- 4 x Dedicated 10GBASE-X SFP+ 10G ports supporting 10G/1G speeds



#### XS712Tv2: 12-port 10-Gigabit Smart Managed Pro Switch

- 12 x 10GBASE-T copper ports supporting 10G/1G/100M speeds
- 2 x Shared (combo) 10GBASE-T copper/10GBASE-X SFP+ ports supporting 10G/1G speeds



#### XS716T: 16-port 10-Gigabit Smart Managed Pro Switch

- 16 x 10GBASE-T copper ports supporting 10G/1G/100M speeds
- 2 x Shared (combo) 10GBASE-T copper/10GBASE-X SFP+ ports supporting 10G/1G speeds



#### XS748T: 48-port 10-Gigabit Smart Managed Pro Switch

- 44 x Dedicated 10GBASE-T copper ports supporting 10G/1G speeds
- 4 x Dedicated 10GBASE-X SFP+ 10G ports supporting 10G/1G speeds

### Software at a Glance

LAYER 2+ / LAYER 3 LITE FEATURES							
Management	IPv4/IPv6 ACL and QoS	IPv4/IPv6 Multicast filtering	Auto-VoIP, Auto-Video	IEEE (802.3az) Energy Efficient Ethernet	VLANs	Convergence	IPv4 & IPv6 Static Routing
Web Browser-based GUI (HTTP/HTTPS), PC-Based Smart Control Center Utility (SCC) RMON, SNMP	L2, L3, L4 Ingress	IGMP and MLD Snooping	Yes	Yes	Static, Dynamic, Voice, MAC, Protocol-based, and Private	LLDP-MED, RADIUS, 802.1X	Yes

### Performance at a Glance

Model Name	Packet buffer	CPU	ACLs	MAC Address Table RP/NDP Table VLANs	Fabric	Latency (Max Connection Speed)	Static Routes (IPv4 & IPv6)	Multicast IGMP Group
XS708T	2 MB	600 MHz Cortex-A9 Single Core, 512MB RAM 8MB SPI + 256MB NAND FLASH	100 shared	16K MAC 738 ARP/NDP 256 VLANs	160Gbps line-rate	10GBASE-T: <3.012 µs 10GBASE-X SFP+: <2.466 µs	IPv4: 32 IPv6: 32	512
XS712Tv2	2 MB	600 MHz Cortex-A9 Single Core, 512MB RAM 8MB SPI + 256MB NAND FLASH	100 shared	16K MAC 738 ARP/NDP 256 VLANs	240Gbps line-rate	10GBASE-T: <2.624 µs 10GBASE-X SFP+: <2.128 µs	IPv4: 32 IPv6: 32	512
XS716T	2 MB	600 MHz Cortex-A9 Single Core, 512MB RAM 8MB SPI + 256MB NAND FLASH	100 shared	16K MAC 738 ARP/NDP 256 VLANs	320Gbps line-rate	10GBASE-T: <2.624 µs 10GBASE-X SFP+: <2.128 µs	IPv4: 32 IPv6: 32	512
XS728T	3 MB	800 MHz Dual Core, 512MB RAM 8MB SPI + 256MB NAND Flash	164 shared	16K MAC 1K ARP/NDP 512 VLANs	560Gbps line-rate	10GBASE-T: <11.649 µs 10GBASE-X SFP+: <2.619 µs	IPv4: 64 IPv6: 64	512
XS748T	3 MB	800 MHz Dual Core, 512MB RAM 8MB SPI + 256MB NAND Flash	164 shared	16K MAC 1K ARP/NDP 512 VLANs	960Gbps line-rate	10GBASE-T: <3.674 µs 10GBASE-X SFP+: < 3.693 µs	IPv4: 64 IPv6: 64	512

### Features at a glance

HARDWARE FEATURES	BENEFITS
10GBASE-T Copper Ethernet connections	Support low-latency, line-rate 10G Copper "BASE-T" technology with backward compatibility to Fast Ethernet and Gigabit Ethernet. Cost-effectively migrate current network to 10G capacity by utilizing the existing Cat6 RJ45 short connections (up to 30m) and Cat6a/Cat7 connections up to 100m.
10GBASE-X SFP+ ports	Providing flexibility to uplink to 10G-capable core or aggregation switches that support fiber links. Backward compatible to Gigabit fiber. Support copper or fiber modules.
USB Configuration Port	Quickly and conveniently upgrade or restore firmware, load or backup configuration files, or download system log files for troubleshooting.
Energy Efficient Ethernet (IEEE 802.3az)	Maximum power reduction for ongoing operation cost savings.
SOFTWARE FEATURES	BENEFITS
Comprehensive IPv6 Support for Management, ACL and QoS	Build current network with future in mind. Ensure investment protection and a smooth migration to an IPv6-based network without switch replacement.
IPv4 & IPv6 Static Routing	A simple way to provide segmentation of the network with internal routing through the switch – reserving the router for external traffic routing only, making the entire network more efficient.
Robust security features: <ul style="list-style-type: none"> <li>• 802.1x authentication (EAP)</li> <li>• Port-based security by locked MAC</li> <li>• ACL filtering to permit or deny traffic based on MAC and IP addresses</li> </ul>	Build a secured, converged network with all types of traffic by preventing external attacks and blocking malware while allowing secure access for authorized users.
Comprehensive QoS features: <ul style="list-style-type: none"> <li>• Port-based or 802.1p-based prioritization</li> <li>• Layer 3-based (DSCP) prioritization</li> <li>• Port-based ingress and egress rate limiting</li> </ul>	Advanced controls for optimized network performance and better delivery of mission-critical traffic such as voice and video.
Auto-VoIP, Auto-Voice VLAN, and Auto-Video VLAN	Automatic Voice over IP prioritization (Auto-VoIP) simplifies most complex multi-vendor IP telephone deployments either based on protocols (SIP, H.323 and SCCP) or on OUI bytes (default database and user-based OUIs) in the phone source MAC address, providing the best class of service to VoIP streams (both data and signaling) over other ordinary traffic by classifying traffic, and enabling correct egress queue configuration. Similarly, Auto-Video VLAN enables IGMP snooping to minimize broadcast streams.
IGMP Snooping and MLD Snooping	Facilitate fast receiver joins and leaves for multicast streams. Save cost and improve network efficiency by ensuring multicast traffic only reaches designated receivers without the need of an extra multicast router.
Protected Ports	Ensure no exchange of unicast, broadcast, or multicast traffic between the protected ports on the switch, thereby improving the security of your converged network. This allows your sensitive phone conversations to stay private and your surveillance video clips can be forwarded to their designated storage device without leakage or alteration.
DHCP Snooping	Ensure IP address allocation integrity by only allowing DHCP messages from trusted DHCP servers and dropping malformed DHCP messages with a port or MAC address mismatch.
Dynamic VLAN Assignment (RADIUS)	IP phones and PCs can authenticate on the same port but under different VLAN assignment policies. Users are free to move around and enjoy the same level of network access regardless of their physical location on the network.
Private VLAN	Private VLANs help reduce broadcast with added security.
Dual Firmware Images and Configuration Files	Dual firmware images and dual configuration files for transparent firmware updates/configuration changes with minimum service interruption.
Multiple Language Local GUI (XS708T, XS712Tv2, XS716T only)	Product documentation and local-only web user interfaces are translated, giving you the ability to select your preferred language. English, German and Japanese are currently supported in local-only Web GUI.

### Target Application

XS708T in SMB Network

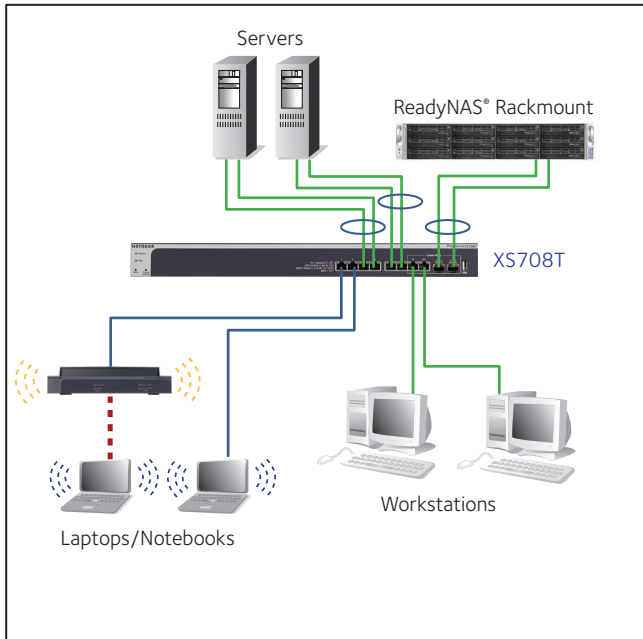

XS728T in Medium-sized Network

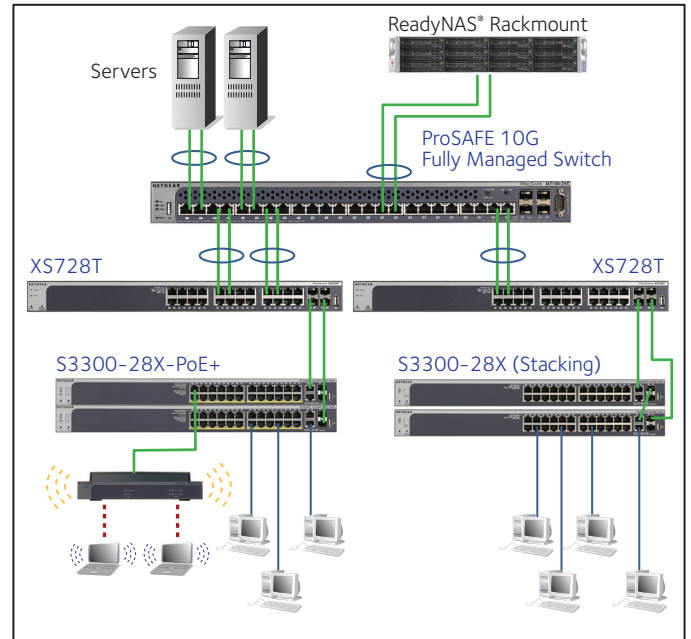





— 10GE link    — GE link    - - - Wireless link

### Why 10-Gigabit Switches and Why from NETGEAR?

NETGEAR introduced the industry's first cost-effective 10-Gigabit Switches for SMBs in 2013 and is the leading provider for 10G solutions at affordable price points:

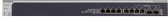
- Ideal for SMBs to use as the core switch, connecting to 10G-capable Servers and network storage.
- Expand network capacity, remove performance bottlenecks and/or support premise expansion needs.
- Cost-effectively expand 10G bandwidth from core switch in medium-sized networks to access switches which are equipped with 10G uplinks.
- Powerful feature sets with advanced L2+/Layer 3 Lite functions, enhanced security measures, static routing, dynamic VLAN assignment and IPv6 management and support.
- Improved usability for easier and smoother deployment of voice, video, and WLAN on the same converged platform.
- Limited LIFETIME warranty on hardware, Limited LIFETIME Next-Business-Day (NBD) replacement, Limited LIFETIME tech support online chat, and 90-days Free Advanced Tech Phone Support\*\* for peace-of-mind.

### Technical Specifications

PRODUCT	XS708T	XS712Tv2	XS716T	XS728T	XS748T
					
100M/1G/10G RJ-45 copper ports	8	12	16	n/a	n/a
1G/10G copper ports	n/a	n/a	n/a	24	44
1G/10G SFP+ (fiber) ports	2 shared (combo)	2 shared (combo)	2 shared (combo)	4 (dedicated)	4 (dedicated)
USB port (for config file upload/backup & firmware updates)	Yes				
PERFORMANCE SPECIFICATION					
Packet buffer memory (Dynamically shared across only used ports)	2MB			3MB	
Forwarding modes	Store-and-forward				
Bandwidth	160Gbps	240Gbps	320Gbps	560Gbps	960Gbps
Priority queues	8				
Priority queuing	Weighted Round Robin (WRR) and Strict Priority				
MAC Address database size (48-bit MAC addresses)	16K				
Multicast groups	512				
Number of IPv4 static routes	32			64	
Number of IPv6 static routes	32			64	
Number of VLANs	256			512	
Number of ARP cache entries	738			1024	
Number of DHCP snooping bindings	8K			1K	
Access Control Lists (ACLs)	100 shared for MAC, IP and IPv6 ACLs			164 shared for MAC, IP and IPv6 ACLs	
Packet forwarding rate (64 byte packet size) (Mfps or Mpps)	119.0	178.5	238.0	416.6	714.2
Jumbo frame support	Up to 9K packet size			Up to 10K packet size	
Acoustic noise level @ 25°C (dBA) (ANSI-S10.12)	27.4 dBA	29.1 dBA	29.1 dBA	41.6 dBA	47.8 dBA
Mean Time Between Failures (MTBF) @ 25°C	276,197 hours	938,178 hours	276,832 hours	514,977 hours	483,808 hours
L2 SERVICES - VLANS					
IEEE 802.1Q VLAN tagging	Yes				
IP-based VLANs	Yes				
MAC-based VLANs	Yes				
Auto-VoIP VLAN / Auto-Voice VLAN	Yes, based on OUI bytes (default database and user-based OUIs) in the phone source MAC address			Yes, based on OUI bytes (default database and user-based OUIs) in the phone source MAC address, voice packets must have 802.1Q VLAN tag	
Auto-VoIP	Yes, based on protocols (SIP, H.323 and SCCP). Prioritizes traffic to a higher queue				
Voice VLAN	Yes, based on either VLAN ID or 802.1p priority, packets are passed onto the connecting VoIP phone using LLDP-MED.			No	
Auto-Video VLAN	Yes				
Private VLAN	Yes				

PRODUCT	XS708T	XS712Tv2	XS716T	XS728T	XS748T
<b>L2 SERVICES - AVAILABILITY</b>					
Broadcast, multicast, unknown unicast storm control			Yes		
IEEE 802.3ad - LAGs (LACP)			Yes		
IEEE 802.3x (full duplex and flow control)			Yes		
IEEE 802.1D Spanning Tree Protocol			Yes		
IEEE 802.1w Rapid Spanning Tree Protocol			Yes		
IEEE 802.1s Multiple Spanning Tree Protocol			Yes		
<b>L2 SERVICES - MULTICAST FILTERING</b>					
IGMP snooping (v1, v2 and v3)			Yes		
MLD snooping support (v1 and v2)			Yes		
IGMP snooping queries			Yes		
Block unknown multicast			Yes		
Multicast VLAN Registration (MVR)		Yes		No	
<b>L3 SERVICES - DHCP</b>					
DHCP client			Yes		
DHCP snooping			Yes		
<b>L3 SERVICES - ROUTING</b>					
IPv4 static routing		32		64	
IPv6 static routing		32		64	
VLAN routing			Yes		
Host ARP table (number of entries)		738		1024	
ICMP Router Discovery Protocol (IRDP)		Yes		No	
Number of IP VLAN interfaces (routed VLANs)		15		32	
<b>LINK AGGREGATION</b>					
IEEE 802.3ad - LAGs (LACP)			Yes		
Manual Static LAG			Yes		
# of Static or LACP LAGs # of members in each LAG		8 LAGs with max 8 members in each LAG		12 LAGs with max 8 members in each LAG	24 LAGs with max 8 members in each LAG
<b>NETWORK MONITORING AND DISCOVERY SERVICES</b>					
802.1ab LLDP			Yes		
SNMP			v1, v2c, v3		
RMON group 1,2,3,9			Yes		
<b>NETWORK SECURITY</b>					
IEEE 802.1x			Yes		
Guest VLAN			Yes		
RADIUS-based VLAN assignment via .1x			Yes		
MAC-based .1x			Yes		
RADIUS accounting			Yes		
Access Control Lists (ACLs)			L2 / L3 / L4		
IP-based ACLs (IPv4 and IPv6)			Yes		

PRODUCT	XS708T	XS712Tv2	XS716T	XS728T	XS748T
MAC-based ACLs			Yes		
TCP/UDP-based ACLs			Yes		
MAC lockdown			Yes		
MAC lockdown by the number of MACs			Yes		
Control MAC # Dynamic learned entries			600		
Control MAC # static entries	20			600	
IEEE 802.1x RADIUS port access authentication			Yes		
Port-based security by locked MAC addresses			Yes		
Dynamic ARP inspection	Yes			No	
Broadcast, multicast, unknown unicast storm control			Yes		
DoS attacks prevention	Yes			No	
<b>QUALITY OF SERVICE (QoS)</b>					
Port-based rate limiting	Egress only			Ingress and egress	
Port-based QoS			Yes		
Support for IPv6 fields			Yes		
DiffServ QoS			Yes		
IEEE 802.1p COS			Yes		
Destination MAC and IP			Yes		
IPv4 and v6 DSCP			Yes		
IPv4 and IPv6 ToS			Yes		
TCP/UDP-based			Yes		
Weighted Round Robin (WRR)			Yes		
Strict priority queue technology			Yes		
Auto-VoIP VLAN / Auto-Voice VLAN	Yes, based on OUI bytes (default database and user-based OUIs) in the phone source MAC address			Yes, based on OUI bytes (default database and user-based OUIs) in the phone source MAC address, voice packets must have 802.1Q VLAN tag	
Auto-VoIP	Yes, based on protocols (SIP, H.323 and SCCP). Prioritizes traffic to a higher queue				
Voice VLAN	Yes, based on either VLAN ID or 802.1p priority, packets are passed onto the connecting VoIP phone using LLDP-MED			No	
Auto-Video VLAN			Yes		
<b>IEEE NETWORK PROTOCOLS</b>					
<ul style="list-style-type: none"> <li>• IEEE 802.3 Ethernet</li> <li>• IEEE 802.3u 100BASE-T (XS708T/XS716T only)</li> <li>• IEEE 802.3ab 1000BASE-T</li> <li>• IEEE 802.3an 10GBASE-T 10Gbps Ethernet Over Copper Twisted Pair Cable</li> <li>• IEEE 802.3ae 10-Gigabit Ethernet Over Fiber (10GBASE-LRM) – XS708T, XS712Tv2, XS716T only</li> <li>• IEEE 802.3ae 10-Gigabit Ethernet Over Fiber (10GBASE-SR, 10GBASE-LR, 10GBASE-ER, 10GBASE-LX4) – All models</li> <li>• IEEE 802.3z Gigabit Ethernet 1000BASE-SX/LX</li> <li>• IEEE 802.3x Full-Duplex Flow Control</li> </ul>					



PRODUCT	XS708T	XS712Tv2	XS716T	XS728T	XS748T
<b>MANAGEMENT</b>					
Password management	Yes				
Configurable management VLAN	Yes				
Admin access control via RADIUS and TACACS+	Yes				
IPv6 management	Yes				
SNTP client over UDP port 123	Yes				
SNMP v1/v2c	Yes				
SNMP v3 with multiple IP addresses	Yes				
RMON group 1,2,3,9	Yes				
Port mirroring	Yes				
Many-to-one port mirroring	8	12	16	8	8
Web browser-based graphical user interface (GUI)	Yes				
Smart Control Center (SCC) for multi-switch management	Yes				
Dual software (firmware) image	Yes				
Dual configuration file	Yes				
Cable test utility	Yes				
SSL/HTTPS Web-based access (version)	Yes (v3)			Yes (v2)	
TLS Web-based access (version)	Yes (v1.0)			Yes (v1.0 ~ v1.2)	
File transfers (uploads, downloads)	TFTP / HTTP				
HTTP upload/download (firmware)	Yes				
Syslog (RFC 3164)	Yes				
USB port for firmware and config upload / download	Yes				
<b>LEDS</b>					
Per port	Speed, Link, Activity				
Per device	Power and Fan				
<b>PHYSICAL SPECIFICATIONS</b>					
Dimensions (W x D x H)	440 x 204 x 43 mm (17.3 x 8 x 1.7 in)	440 x 204 x 43 mm (17.3 x 8 x 1.7 in)	440 x 204 x 43 mm (17.3 x 8 x 1.7 in)	440 x 310 x 43 mm (17.3 x 12.2 x 1.7 in)	440 x 310 x 43 mm (17.3 x 12.2 x 1.7 in)
Weight	2.61 kg (5.76 lb)	2.87 kg (6.33 lb)	2.98 kg (6.57 lb)	5.04 kg (11.11 lb)	6.25 kg (13.78 lb)
<b>POWER CONSUMPTION</b>					
Max power (worst case, all ports used, line-rate traffic) (Watts)	49.5 W	75.3 W	96.0 W	134.9 W	262.8 W
Min power (link-down standby) (Watts)	26.3 W	38.3 W	45.3 W	67.8 W	97.6 W
Heat Dissipation (max and min) (BTU/hr)	Max: 169.00 BTU Min: 89.79 BTU	Max: 285.29 BTU Min: 145.21 BTU	Max: 327.74 BTU Min: 154.65 BTU	Max: 460.55 BTU Min: 231.57 BTU	Max: 897.17 BTU Min: 333.14 BTU
Energy Efficient Ethernet (EEE) IEEE 802.3az	Yes (deactivated by default)				
Power back-off	No			Drops power consumption by 15% to 20% when short copper cables are detected	
Fan	1	2	2	4	4

PRODUCT	XS708T	XS712Tv2	XS716T	XS728T	XS748T
<b>ENVIRONMENTAL SPECIFICATIONS</b>					
Operating					
Operating temperature	0° to 50°C (32° to 122°F)				
Humidity (relative)	90% maximum relative humidity (RH), non-condensing				
Altitude	10,000ft (3,000m) maximum				
Storage					
Storage temperature	-10° to 70°C (-14° to 158°F)		-20° to 70°C (-4° to 158°F)		
Humidity (relative)	95% maximum relative humidity, non-condensing				
Altitude	10,000ft (3,000m) maximum				
<b>ELECTROMAGNETIC EMISSIONS AND IMMUNITY</b>					
Certifications	CE mark, commercial				
	FCC Part 15 Class A, VCCI Class A				
	Class A EN 55022 (CISPR 22) Class A				
	Class A C-Tick				
	EN 55024				
	CCC				
	47 CFR FCC Part 15, SubpartB, Class A				
	ICES-003: 2016 Issue 6, Class A				
	ANSI C63.4:2014				
	IEC 60950-1:2005 (ed.2)+A1:2009+A2:2013				
	AN/NZS CISPR 22:2009+A1:2010 CLASS A				
<b>SAFETY</b>					
Certifications	CB mark, commercial				
	CSA certified (CSA 22.2 #950)				
	UL listed (UL 1950)/cUL IEC 950/EN 60950				
	EN 60950-1: 2006 + A11:2009 + A1:2010 + A12:2011 + A2:2013				
	IEC 60950-1:2005 (ed.2)+A1:2009+A2:2013				
	AN/NZS 60950.1:2015				
	CCC (China Compulsory Certificate)				
<b>WARRANTY AND SUPPORT</b>					
ProSAFE Limited LIFETIME Warranty	Limited LIFETIME*				
24x7 Online Technical Support*	Limited LIFETIME*				
Next-Business-Day (NBD) Replacement	Limited LIFETIME*				
ProSUPPORT OnCall 24x7, Category 2** Service Packs	Category 1: PMB0311 (1 yr.) PMB0331 (3 yrs.) PMB0351 (5 yrs.)	Category 2: PMB0312 (1 yr.) PMB0332 (3 yrs.) PMB0352 (5 yrs.)	Category 2: PMB0312 (1 yr.) PMB0332 (3 yrs.) PMB0352 (5 yrs.)	Category 2: PMB0312 (1 yr.) PMB0332 (3 yrs.) PMB0352 (5 yrs.)	Category 3: PMB0313 (1 yr.) PMB0333 (3 yrs.) PMB0353 (5 yrs.)

### Ordering Information

XS708T, XS712Tv2, XS716T, XS728T, XS748T

PACKAGE CONTENT	
All Models	10-Gigabit Ethernet Smart Managed Pro Switch
	Power cord (localized to country of sale)
	Rack-mounting kit
	Rubber footpads for tabletop installation
	Quick install guide
ORDERING INFORMATION	
XS708T-100NES	North America, Latin America and Europe
XS708T-100AJS	Asia Pacific and Australia
XS708T-100PRS	China
XS708T-100INS	India
XS712T-200NES	North America, Latin America and Europe
XS712T-200AJS	Asia Pacific and Australia
XS712T-200PRS	China
XS716T-100NES	North America, Latin America and Europe
XS716T-100AJS	Asia Pacific and Australia
XS716T-100PRS	China
XS716T-100INS	India
XS728T-100NES	North America, Latin America and Europe
XS728T-100AJS	Asia Pacific and Australia
XS728T-100PRS	China
XS728T-100INS	India
XS748T-100NES	North America, Latin America and Europe
XS748T-100AJS	Asia Pacific and Australia
OPTIONAL MODULES AND ACCESSORIES	
AXM761-10000S	SFP+ Transceiver 10GBASE-SR (Short range, multimode)
AXM762-10000S	SFP+ Transceiver 10GBASE-LR (Long range, single mode)
AXM763-10000S	SFP+ Transceiver 10GBASE-LRM (Long range, multimode) - XS708T/XS716T only
AXM764-10000S	SFP+ Transceiver 10GBASE-LR Lite (Long range lite, single mode)
AXM765-10000S	SFP+ Transceiver 10GBASE-T Copper RJ45 GBIC - up to 30 meters only
AXM763-10000S	SFP+ Transceiver 10GBASE-LRM (Long range, multimode) - XS708T/XS712Tv2/XS716T only
AGM731F-10000S	SFP Transceiver 1000BASE-SX (Short range, multimode)
AGM732F-10000S	SFP Transceiver 1000BASE-LX (Long range, single mode)
AGM734-10000S	SFP Transceiver 1000BASE-T Copper RJ45 GBIC
AXC761-10000S	SFP+ DAC CABLE (1m)
AXC763-10000S	SFP+ DAC CABLE (3m)

\* This product comes with a limited warranty that is valid only if purchased from a NETGEAR authorized reseller, and modifications to product may void the warranty; covers hardware, fans, and internal power supplies - not software or external power supplies; see <http://www.netgear.com/about/warranty/> for details. Lifetime technical support includes basic phone support for 90 days from purchase date and lifetime online chat support when purchased from a NETGEAR authorized reseller. Hardware warranty is limited to 5 years in China and India.

\*\* The NETGEAR OnCall 24x7 contract provides unlimited phone and email technical support for your networking product. For ProSAFE products purchased prior to 06/2014, also includes next business-day hardware replacement.

† NETGEAR #1 in US Market Share according to NPD data for Unmanaged and Smart Switches, January 2019. NETGEAR #1 in Europe Market Share according to Context data for Unmanaged and Smart Switches, January 2019.

NETGEAR, the NETGEAR Logo, ProSUPPORT and ProSAFE are trademarks of NETGEAR, Inc. in the United States and/or other countries. Other brand names mentioned herein are for identification purposes only and may be trademarks of their respective holder(s). Information is subject to change without notice. © 2019 NETGEAR, Inc. All rights reserved.